

Int. Cls.: 1, 29, 31, 35, 36 and 42

Prior U.S. Cls.: 1, 5, 6, 10, 26, 46, 100, 101 and 102

United States Patent and Trademark Office

Reg. No. 3,574,339

Registered Feb. 17, 2009

**TRADEMARK
SERVICE MARK
PRINCIPAL REGISTER**

NUTRECO

TROUW INTERNATIONAL B.V. (NETHERLANDS CORPORATION)
VEERSTRAAT 38
5831 JN BOXMEER, NETHERLANDS

FOR: CHEMICAL PREPARATIONS USED IN THE MANUFACTURE OF LIVESTOCK FEED FOR USE IN THE AGRICULTURAL AND FEED INDUSTRIES; MANURES; FERMENTATION PREPARATIONS AND ENZYMES USED IN THE MANUFACTURE OF LIVESTOCK FEED ALL FOR INDUSTRIAL USE, IN CLASS 1 (U.S. CLS. 1, 5, 6, 10, 26 AND 46).

FOR: MEAT, FISH FOR FOOD PURPOSES, POULTRY AND EGGS, IN CLASS 29 (U.S. CL. 46).

FOR: LIVING ANIMALS IN THE NATURE OF LIVE STOCK FOR SALE TO INTEGRATED PRODUCERS AND/OR MULTIPLIER FARMS, IN CLASS 31 (U.S. CLS. 1 AND 46).

FOR: BUSINESS MANAGEMENT, IN CLASS 35 (U.S. CLS. 100, 101 AND 102).

FOR: INSURANCE UNDERWRITING IN THE FIELDS OF LIVESTOCK, FARM, FIRE AND PRODUCT LIABILITY; FINANCIAL AND MONETARY AFFAIRS, NAMELY, LOAN FINANCING AND CREDIT UNION SERVICES; REAL ESTATE AFFAIRS, NAMELY, REAL ESTATE BROKERAGE SERVICES AND LEASING OF REAL ESTATE; ACTIVITIES OF A HOLDING COMPANY IN THE FORM OF CAPITAL INVESTMENT AND FINANCING SERVICES, IN CLASS 36 (U.S. CLS. 100, 101 AND 102).

FOR: MEDIATION SERVICES IN THE FIELD OF AGRICULTURAL AND AQUACULTURAL PRODUCTS, IN CLASS 42 (U.S. CLS. 100 AND 101).

OWNER OF BENELUX REG. NO. 0800353, DATED 11-1-2007, EXPIRES 5-16-2016.

SER. NO. 74-682,205, FILED 5-9-1995.

FRED MANDIR, EXAMINING ATTORNEY

Int. Cl.: 5

Prior U.S. Cls.: 6, 18, 44, 46, 51 and 52

United States Patent and Trademark Office

Reg. No. 3,574,340

Registered Feb. 17, 2009

**TRADEMARK
PRINCIPAL REGISTER**

FOR THE REST OF YOUR LIFE!

TROPICAL BEACHES, INC. (ARIZONA CORPORATION), DBA NEW STRATEGIES, INC.
3550 N. CENTRAL AVENUE, SUITE 350
PHOENIX, AZ 85012

FOR: VITAMINS, MINERAL SUPPLEMENTS,
NUTRITIONAL SUPPLEMENTS AND DIETARY
SUPPLEMENTS, IN CLASS 5 (U.S. CLS. 6, 18, 44, 46,
51 AND 52).

FIRST USE 6-0-1992; IN COMMERCE 6-0-1992.

OWNER OF U.S. REG. NO. 2,183,461.

SER. NO. 75-434,721, FILED 2-17-1998.

ALICIA COLLINS, EXAMINING ATTORNEY

Int. Cls.: 3, 9, 14, 16, 20 and 25

Prior U.S. Cls.: 1, 2, 4, 5, 6, 13, 21, 22, 23, 25, 26, 27, 28, 29, 32, 36, 37, 38, 39, 50, 51 and 52

Reg. No. 3,574,341

United States Patent and Trademark Office

Registered Feb. 17, 2009

TRADEMARK
PRINCIPAL REGISTER

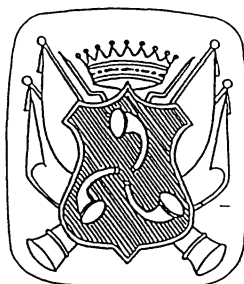

Abbonchi & Vinca

CONTESSA DA VINCI S.R.L. (ITALY LIMITED LIABILITY COMPANY)
VIA CASAGRANDE 50
00153 ROME, ITALY

FOR: AFTER SHAVE LOTIONS, ANTIPERSPIRANTS, BATH SALTS, NOT FOR MEDICAL USE, BEAUTY MASKS, CAKES OF TOILET SOAPS, CLEANSING MILK FOR TOILET PURPOSES, COSMETIC CREAMS, DEODORANT SOAP, DEODORANTS FOR PERSONAL USE, ESSENTIAL OILS FOR PERSONAL USE, EYEBROW PENCILS, HAIR SPRAY, HAIR LOTIONS, HAIR COLORANTS, SACHETS FOR PERFUMING LINEN, LIPSTICKS, LOTIONS FOR COSMETIC PURPOSES, MAKE-UP, MAKE-UP POWDER, MASCARA, PERFUMES, OILS FOR COSMETIC PURPOSES, OILS FOR TOILET PURPOSES, ROUGE, SCENTED WATER, SHAMPOOS, SHAVING SOAPS, TOILET SOAP, SUN TANNING PREPARATIONS, TALCUM POWDER, TISSUES IMPREGNATED WITH COSMETIC LOTIONS, NAIL VARNISH, NAIL POLISH, VARNISH REMOVING PREPARATIONS, IN CLASS 3 (U.S. CLS. 1, 4, 6, 50, 51 AND 52).

FOR: EYEGLASS CASES, EYEGLASS CHAINS, EYEGLASS CORDS, EYEGLASS FRAMES, EYEGLASSES, SUNGLASSES, IN CLASS 9 (U.S. CLS. 21, 23, 26, 36 AND 38).

FOR: AMULETS, BADGES OF PRECIOUS METALS, BOXES OF PRECIOUS METALS, BRACELETS, BROOCHES, BUCKLES OF PRECIOUS

METAL, CANDLESTICKS OF PRECIOUS METAL, CIGAR AND CIGARETTE CASES OF PRECIOUS METAL, JEWELRY CHAINS, CHARMS, TIE CLIPS, CUFF LINKS, EARRINGS, JUGS OF PRECIOUS METAL, KEY RINGS OF PRECIOUS METAL, MEDALLIONS, NAPKIN HOLDERS OF PRECIOUS METAL, NECKLACES, ORNAMENTAL PINS, POWDER COMPACTS OF PRECIOUS METAL, SILVER ORNAMENTS, TRINKETS, NAMELY, JEWELRY, IN CLASS 14 (U.S. CLS. 2, 27, 28 AND 50).

FOR: STAMP ALBUMS, PHOTOGRAPH ALBUMS, COIN ALBUMS, ADDRESS BOOK, TELEPHONE BOOKS, ANNOUNCEMENT CARDS, BAGS OF PAPER OR PLASTICS, FOR PACKAGING, BOOKENDS, BOOKBINDING CLOTH, BOOKLETS, BOOKS, BOXES FOR PENS, CARDBOARD BOXES, CALENDARS, DIARY, POCKET DIARY, FOUNTAIN PENS, GARBAGE BAGS OF PAPER OR PLASTICS, GREETING CARDS, NOTE BOOKS, PACKING PAPER, WRITING PADS, PAPERWEIGHTS, PASSPORT HOLDERS, PEN CASES, PENS, PENCILS, PHOTOGRAPH STANDS, PLACE MATS OF PAPER, POSTCARDS, POSTERS, PRINTED PUBLICATIONS, NAMELY, BOOKLETS, BOOKS, MAGAZINES, ALL IN THE FIELD OF FASHION; TABLE CLOTH OF PAPER, WRITING PAPER, IN CLASS 16 (U.S. CLS. 2, 5, 22, 23, 29, 37, 38 AND 50).

FOR: WORKS OF ART OF WOOD, WAX, PLASTER OR PLASTICS, BASKETS, NOT OF METAL, BOTTLE CAPS, NOT OF METAL, BOXES OF WOOD OR PLASTICS, CLOTHES HOOKS, NOT OF METAL,

COAT HANGERS, PICTURE FRAMES, MIRRORS, JEWELRY CASES, NOT OF PRECIOUS METALS, MAGAZINE RACKS, PILLOWS, TEA TROLLEYS, NON-METAL SERVING TRAYS, UMBRELLAS STANDS, IN CLASS 20 (U.S. CLS. 2, 13, 22, 25, 32 AND 50).

FOR: BATH SLIPPERS, BATH ROBES, BATHING SUITS, BELTS, COATS, DRESSING GOWNS, DRESSES, GLOVES, HATS, BOOTS, HALF-BOOTS, JACKETS, JERSEYS, NECKTIES, OVERALLS, PARKAS, PULLOVERS, PAJAMAS, SANDALS, SCARVES, SHIRTS, SHOES, SKIRTS, SLIPPERS, SOCKS, STOCKINGS, SUITS, SWEATERS, T-SHIRTS, TROUSERS, UNDERWEAR, VESTS, WAISTCOATS, IN CLASS 25 (U.S. CLS. 22 AND 39).

PRIORITY CLAIMED UNDER SEC. 44(D) ON ITALY APPLICATION NO. RM99C003721, FILED 7-26-1999, REG. NO. 00891820, DATED 5-19-2003, EXPIRES 7-26-2009.

PRIORITY CLAIMED UNDER SEC. 44(D) ON ITALY APPLICATION NO. RM99C003187, FILED 6-25-1999, REG. NO. 00871258, DATED 7-2-2002, EXPIRES 6-25-2009.

THE LINING SHOWN IN THE DRAWING IS A FEATURE OF THE MARK, AND IS NOT INTENDED TO INDICATE COLOR.

ALEXANDRA DA VINCI IDENTITIES A LIVING PERSON WHOSE CONSENT IS OF RECORD.

THE MARK CONSISTS OF THE WORDS "ALEXANDRA DA VINCI" AND A COAT OF ARMS CONSISTING OF A SHIELD, POWDER HORNS, BANNERS AND A CROWN.

SER. NO. 75-796,383, FILED 9-10-1999.

ESTHER BELENKER, EXAMINING ATTORNEY

Int. Cl.: 41

Prior U.S. Cls.: 100, 101 and 107

United States Patent and Trademark Office

Reg. No. 3,574,342

Registered Feb. 17, 2009

SERVICE MARK
PRINCIPAL REGISTER



Q-dees

BUSIFIELD SDN. BHD. (MALAYSIA CORPORATION)

NO. 85M & 85A, JALAN SS21/37
DAMANSARA UTAMA, 47400 PETALING JAYA
SELANGOR DARUL EHSAN, MALAYSIA

FOR: EDUCATIONAL SERVICES, NAMELY, ARRANGING AND CONDUCTING ACADEMIES, COLLOQUIUMS, CONFERENCES, CONGRESSES, SEMINARS, TRAINING WORKSHOPS, SYMPOSIA IN THE FIELD OF CHILDREN'S EDUCATION, BOARDING SCHOOLS, BOOKMOBILE SERVICES, HOLIDAY CAMP SERVICES, PROVIDING CINEMA FACILITIES, EDUCATIONAL AND ENTERTAINMENT CLUB SERVICES, NAMELY, THE PRODUCTION OF CHILDREN'S EDUCATION PROGRAMS, ORGANIZING SPORTS COMPETITIONS, PROVIDING CORRESPONDENCE COURSES IN THE FIELD OF CHILDREN'S EDUCATION, DUBBING SERVICES, FILM, VIDEO, VIDEO TAPE AND CD-ROM EDITING, RELIGIOUS EDUCATION, NAMELY, CONDUCTING CLASSES, COURSE AND SEMINARS IN THE FIELD OF RELIGION, ENTERTAINMENT SERVICES, NAMELY, PRODUCTION OF CHILDREN'S EDUCATION PROGRAMS, ENTERTAINMENT SERVICES, NAMELY, PRESENTATION OF LIVE PERFORMANCES BY A MUSICAL BAND, ACTORS OR PERFORMERS, DRAMATICAL PERFORMANCES AND PLAYS, PROVIDING ENTERTAINMENT INFORMATION IN THE NATURE OF UPCOMING AND RECENTLY RELEASED MOVIES, MOTION PICTURE FILM PRODUCTION SERVICES, GYMNASIAC INSTRUCTION, INSTRUCTION SERVICES, NAMELY, GYMNASIACS AND EXERCISE CLASSES, LENDING LIBRARIES, LIBRARIES,

LIVE PERFORMANCES BY CHILDREN AND EDUCATIONAL BODIES, MOBILE LIBRARY SERVICES, MOVIE STUDIOS, PROVIDING MOVIE THEATRE FACILITIES, MUSIC HALLS, NURSERY SCHOOLS, ARRANGING AND CONDUCTING SPELLING AND MATHEMATICS COMPETITIONS, ORGANIZING EXHIBITIONS FOR CULTURAL OR EDUCATIONAL PURPOSES, NAMELY, DANCES, SONGS, CONCERTS AND LIVE CULTURAL PERFORMANCES, AMUSEMENT PARKS, PHYSICAL EDUCATION SERVICES, PRODUCTION OF RADIO AND TELEVISION PROGRAMS, PRODUCTION OF RECORDED AND LIVE SHOWS FOR TELEVISION, PUBLICATION OF BOOKS, PUBLICATION OF TEXT BOOKS, DISTRIBUTION OF RADIO AND TELEVISION PROGRAMS FOR OTHERS, RENTAL OF CINEMA FILMS, RENTAL OF MOTION PICTURES, RENTAL OF VIDEO TAPES, SCRIPT WRITING SERVICES, SPORT CAMP SERVICES, TEACHING CLASSES IN THE FIELD OF CHILDREN'S EDUCATION, TELEVISION ENTERTAINMENT, NAMELY, PRODUCTION OF CHILDREN'S EDUCATIONAL PROGRAMS, PRODUCTION OF PERFORMANCES ON TAPES, CASSETTES, VIDEO TAPE AND CD-ROM, VIDEO TAPE EDITING, AUDIO AND VIDEO TAPE FILM PRODUCTION, IN CLASS 41 (U.S. CLS. 100, 101 AND 107).

OWNER OF MALAYSIA REG. NO. 99009260,
DATED 9-21-1999, EXPIRES 9-21-2013.

SER. NO. 76-007,809, FILED 3-17-2000.

CHRIS WELLS, EXAMINING ATTORNEY

Int. Cl.: 9

Prior U.S. Cls.: 21, 23, 26, 36 and 38

Reg. No. 3,574,343

United States Patent and Trademark Office

Registered Feb. 17, 2009

**TRADEMARK
PRINCIPAL REGISTER**

AMPCON Applied Magnetics & Power Converters

FRANCE/SCOTT FETZER COMPANY (DELA-
WARE CORPORATION)
726 FAIRVIEW BOULEVARD
FAIRVIEW, TN 37062

FOR: BATTERY CHARGERS, CHARGING SYS-
TEMS COMPONENTS, NAMELY, BATTERY
CABLES; ELECTRICAL TRANSFORMERS, HIGH
VOLTAGE ELECTRICAL POWER SUPPLIES, AND
ELECTRICAL TRANSFORMERS ALL FOR OZONE
PRODUCTION, STATIC CONTROL AND LIGHT-
ING; ELECTRICAL POWER CABLES, VOLTAGE
REGULATORS, ELECTRICAL POWER REGULA-
TORS, ELECTRICAL POWER RECTIFIERS, ELEC-
TRONIC CONTROLLERS; INVERTERS;

UNINTERRUPTIBLE ELECTRICAL POWER SUP-
PLIES, IN CLASS 9 (U.S. CLS. 21, 23, 26, 36 AND 38).

FIRST USE 7-19-2000; IN COMMERCE 7-19-2000.

NO CLAIM IS MADE TO THE EXCLUSIVE
RIGHT TO USE "APPLIED MAGNETICS & POWER
CONVERTERS", APART FROM THE MARK AS
SHOWN.

SER. NO. 76-102,372, FILED 8-3-2000.

BRENDAN REGAN, EXAMINING ATTORNEY

Int. Cls.: 1, 2, 3, 4, 5, 6, 7, 8, 10, 12, 13, 14, 15, 17, 18, 19, 20, 21, 22, 23, 24, 26, 27, 28, 29, 30, 31, 32, 33, 34, 36, 37, 39, 40 and 41

Prior U.S. Cls.: 1, 2, 3, 4, 5, 6, 7, 8, 9, 10, 11, 12, 13, 14, 15, 16, 17, 18, 19, 20, 21, 22, 23, 25, 26, 27, 28, 29, 30, 31, 32, 33, 34, 35, 36, 37, 38, 39, 40, 41, 42, 43, 44, 45, 46, 47, 48, 49, 50, 51, 52, 100, 101, 102, 103, 105, 106 and 107

Reg. No. 3,574,344

Registered Feb. 17, 2009

United States Patent and Trademark Office

**TRADEMARK
SERVICE MARK
PRINCIPAL REGISTER**

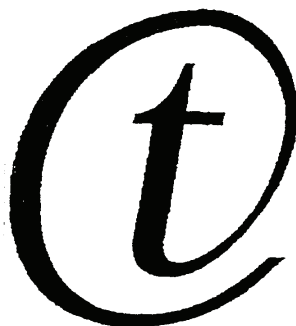

DEUTSCHE TELEKOM AG (FED REP GERMA-
NY CORPORATION)
FRIEDRICH-EBERT-ALLEE 140
53113 BONN, FED REP GERMANY

FOR: PHOTOGRAPHIC CHEMICALS; TEMPER-
ING AND SOLDERING PREPARATIONS; CHEMI-
CAL SUBSTANCES FOR PRESERVING
FOODSTUFFS, TANNING SUBSTANCES; ADHE-
SIVES USED IN INDUSTRY, IN CLASS 1 (U.S. CLS.
1, 5, 6, 10, 26 AND 46).

FOR: PAINTS FOR INDUSTRIAL EQUIPMENT
AND MACHINERY, VARNISHES, LACQUERS IN
THE NATURE OF A COATING; PRESERVATIVES
AGAINST RUST AND AGAINST DETERIORATION
OF WOOD; COLORANTS FOR USE IN THE MAN-
UFACTURE OF PAINT, PAPER, AND PRINTING
INK; METALS IN FOIL AND POWDER FORM FOR
PAINTERS, DECORATORS, PRINTERS AND AR-
TISTS, IN CLASS 2 (U.S. CLS. 6, 11 AND 16).

FOR: BLEACHING PREPARATIONS AND
OTHER SUBSTANCES FOR LAUNDRY USE; ALL
PURPOSE HOUSEHOLD CLEANING, POLISHING,
SCOURING AND ABRASIVE PREPARATIONS;
FACE AND SKIN SOAPS; PERFUMES, ESSENTIAL
OILS FOR USE IN THE MANUFACTURE OF SCEN-

TED PRODUCTS, HAIR LOTIONS; DENTIFRICES,
IN CLASS 3 (U.S. CLS. 1, 4, 6, 50, 51 AND 52).

FOR: INDUSTRIAL OILS AND GREASES; AUTO-
MOTIVE AND INDUSTRIAL LUBRICANTS; FUEL
FOR AIRCRAFT AND FUEL FOR MOTOR VEHI-
CLES, NAMELY GASOLINE AND DIESEL; CAN-
DLES; WICKS FOR CANDLES, IN CLASS 4 (U.S.
CLS. 1, 6 AND 15).

FOR: DIETARY SUPPLEMENTS FOR MEDICAL
USE, BABY FOOD; MEDICAL PLASTERS FOR
DRESSING, MATERIAL FOR STOPPING TEETH,
DENTAL WAX; ALL-PURPOSE DISINFECTANTS;
DOMESTIC AND AGRICULTURAL PREPARA-
TIONS FOR DESTROYING VERMIN; FUNGICIDES
AND HERBICIDES FOR DOMESTIC USE, IN CLASS
5 (U.S. CLS. 6, 18, 44, 46, 51 AND 52).

FOR: COMMON METALS AND THEIR ALLOYS;
TRANSPORTABLE BUILDING OF METAL; MATE-
RIALS OF METAL FOR RAILWAY TRACKS,
NAMELY, RAILS, GUARDRAILS AND RAILWAY
MATERIAL MADE OF METAL, NAMELY, SPRING
STEEL FASTENINGS, CLIPS, CROSS TIES, TURN-
OUTS, SHOULDERS AND CROSS TIE BASE
PLATES; NON-ELECTRIC CABLES AND WIRES
OF COMMON METAL; PIPES AND TUBES OF

METAL; METAL SAFES, IN CLASS 6 (U.S. CLS. 2, 12, 13, 14, 23, 25 AND 50).

FOR: AIRCRAFT MOTORS AND ENGINES; MACHINE TRANSMISSION COMPONENTS, NAMELY, BEARINGS FOR TRANSMISSION SHAFTS, POWER TRANSMISSION BELTS AND TRANSMISSION GEARS; AGRICULTURAL IMPLEMENTS, NAMELY, CULTIVATORS, HARVESTORS, DISK HARROWS, SEEDERS, AND SEED DRILLS; INCUBATORS FOR EGGS, IN CLASS 7 (U.S. CLS. 13, 19, 21, 23, 31, 34 AND 35).

FOR: HAND-OPERATED HAND TOOLS AND IMPLEMENTS FOR THE CONSTRUCTION OF MACHINES, APPARATUS AND VEHICLES FOR THE BUILDING INDUSTRY, NAMELY, DRILLS, HAMMERS, HAND JACKS, WRENCHES, SAWS, NUT DRIVERS, BOLT CUTTERS AND SCREWDRIVERS; CUTLERY, NAMELY, BREAD KNIVES AND STEAK KNIVES; SIDE ARMS, NAMELY, SWORDS AND HUNTING KNIVES, RAZORS, IN CLASS 8 (U.S. CLS. 23, 28 AND 44).

FOR: SURGICAL, MEDICAL, DENTAL AND VETERINARY APPARATUS AND INSTRUMENTS, NAMELY, ARTIFICIAL LIMBS, ARTIFICIAL EYES AND TEETH; ORTHOPEDIC ARTICLES, NAMELY, BELTS, BRACES, FOOTWEAR, JOINT IMPLANTS, SOLES, SUPPORT BANDAGES, ORTHOPEDIC SUPPORTS; SUTURES , IN CLASS 10 (U.S. CLS. 26, 39 AND 44).

FOR: VEHICLES, NAMELY CARS, BICYCLES, MOTOR BIKES, BOATS, AIRPLANES, HELICOPTERS, IN CLASS 12 (U.S. CLS. 19, 21, 23, 31, 35 AND 44).

FOR: FIREARMS; AMMUNITION AND WEAPONS, NAMELY, PROJECTILES; EXPLOSIVE TORPEDOES; FIREWORKS NAMELY, SKY ROCKETS, ROMAN CANDLES, SPARKLERS, IN CLASS 13 (U.S. CLS. 2 AND 9).

FOR: JEWELRY, NAMELY CHAINS, LAPEL PINS AND PINS BEING JEWELRY, PENDANTS, EARRINGS, BRACELETS, RINGS, ALL MADE EITHER OF PRECIOUS METALS, COATED THEREWITH OR FOR COSTUME JEWELRY; HOROLOGICAL INSTRUMENTS, NAMELY, CLOCKS AND WATCHES; CHRONOMETERS AND CHRONOGRAPHS FOR USE AS WATCHES, IN CLASS 14 (U.S. CLS. 2, 27, 28 AND 50).

FOR: MUSICAL INSTRUMENTS IN GENERAL, IN CLASS 15 (U.S. CLS. 2, 21 AND 36).

FOR: RUBBER, GUTTA-PERCHA, GUM, ASBESTOS AND MICA FOR USE AS FILLER IN PLASTICS, IN THE MANUFACTURE OF ELECTRONIC INSTRUMENTS; PLASTICS IN EXTRUDED FORM FOR USE IN MANUFACTURE; PACKING AND INSULATING MATERIALS, NAMELY, INSULATING PLASTERS, INSULATING SLEEVES FOR POWER LINES, ELECTRICAL INSULATING TAPE, ASBESTOS FABRICS FOR USE AS CABLE INSULA-

TION AND BUILDING INSULATION, IN CLASS 17 (U.S. CLS. 1, 5, 12, 13, 35 AND 50).

FOR: UMBRELLAS, PARASOLS; GOODS MADE OF LEATHER AND IMITATION LEATHERS, NAMELY, WALLETS, VALISES, CARRYING CASES FOR CREDIT CARDS AND TICKETS IN PARTICULAR, AIR TRAVEL TICKETS, PURSES, WRITING CASES, NAMELY, BRIEFCASE-TYPE PORTFOLIOS, SUITCASES, TRAVELING BAGS, AND BRIEFCASES; TRUNKS FOR TRAVEL AND TRAVEL BAGS, IN CLASS 18 (U.S. CLS. 1, 2, 3, 22 AND 41).

FOR: NON-METALLIC RIGID PIPES FOR BUILDING; ASPHALT, PITCH AND BITUMEN ASPHALT, BITUMEN-BASED ASPHALT SEALANTS; NON-METALLIC TRANSPORTABLE BUILDINGS; MONUMENTS, NOT OF METAL, IN CLASS 19 (U.S. CLS. 1, 12, 33 AND 50).

FOR: MUSICAL FURNITURE, FURNITURE, NAMELY, MIRRORS, PICTURE FRAMES, IN CLASS 20 (U.S. CLS. 2, 13, 22, 25, 32 AND 50).

FOR: HOUSEHOLD OR KITCHEN UTENSILS AND CONTAINERS NOT OF METAL OR COATED THEREWITH, NAMELY, SPATULA, SIEVES, TURNERS, GRATERS; HAIR COMB AND SPONGES FOR APPLYING BODY POWDER; HAIR BRUSHES; BRUSH-MAKING MATERIALS; ARTICLES FOR CLEANING PURPOSES, NAMELY, STEELWOOL; UNWORKED OR SEMI-WORKED GLASS, EXCEPT GLASS USED IN BUILDING; BEVERAGE GLASSWARE; INSULATING SLEEVE HOLDERS FOR BEVERAGE CANS, IN CLASS 21 (U.S. CLS. 2, 13, 23, 29, 30, 33, 40 AND 50).

FOR: ROPES, STRING, COMMERCIAL NETS, TENTS, AWNING, TARPAULINS, SAILS, SACKS AND BAGS USED FOR THE TRANSPORTATION AND STORAGE OF MATERIALS IN BULK; PADDING AND STUFFING MATERIALS NOT MADE OF RUBBER OR PLASTICS; RAW FIBROUS TEXTILE MATERIALS, IN CLASS 22 (U.S. CLS. 1, 2, 7, 19, 22, 42 AND 50).

FOR: YARNS AND THREADS, FOR TEXTILE USE, IN CLASS 23 (U.S. CL. 43).

FOR: TEXTILES AND TEXTILE GOODS, NAMELY, BED AND TABLE COVERS, IN CLASS 24 (U.S. CLS. 42 AND 50).

FOR: LACE TRIMMING AND EMBROIDERY, RIBBONS AND BRAID, BUTTONS FOR CLOTHING, IN CLASS 26 (U.S. CLS. 37, 39, 40, 42 AND 50).

FOR: CARPETS, RUGS, TEXTILE DOOR MATS AND FLOOR MATS FOR CARS; FLOOR MATTING, LINOLEUM; NON-TEXTILE WALL HANGINGS, IN CLASS 27 (U.S. CLS. 19, 20, 37, 42 AND 50).

FOR: TOYS, NAMELY, BOARD GAMES, PARLOR GAMES, CARD GAMES, TOY ACTION FIGURES, WIND-UP TOYS, STUFFED TOYS, ELECTRICAL AND MECHANICAL ACTION TOYS, GYMNASIAC APPARATUS AND SPORTING ARTICLES, NAME-

LY, CYCLING EQUIPMENT AND ACCESSORIES, NAMELY STATIONARY CYCLES, FOOTBALL EQUIPMENT AND ACCESSORIES, NAMELY, FOOTBALLS, FOOTBALL SHOULDER PADS, FOOTBALL GIRDLES, FOOTBALL PROTECTORS, FOOTBALL KNEE, ELBOW, CHEST AND LEG PADS, SOCCER EQUIPMENT AND ACCESSORIES, NAMELY, SOCCER BALLS, SOCCER BALL GOAL NETS, SOCCER BALL KNEE PADS, BASEBALL EQUIPMENT AND ACCESSORIES, NAMELY BASEBALLS, BASEBALL BATS, BASEBALL BASES, BASEBALL MITTS, BASEBALL GLOVES, BASKETBALL EQUIPMENT AND ACCESSORIES, NAMELY, BASKETBALLS, BASKETBALL GOALS, BASKETBALL NETS, AND ALL PARTS RELATED THERETO, IN CLASS 28 (U.S. CLS. 22, 23, 38 AND 50).

FOR: MEAT, FISH IN GENERAL FOR FOOD PURPOSES, POULTRY IN GENERAL AND GAME; MEAT EXTRACTS; PRESERVED DRIED AND COOKED FRUITS AND VEGETABLES; JELLIES; JAMS; EGGS, MILK; EDIBLE OILS AND FATS; FRUIT CONSERVES, IN CLASS 29 (U.S. CL. 46).

FOR: COFFEE, TEA, COCOA, SUGAR, RICE, TAPIOCA, SAGO, ARTIFICIAL COFFEE; FLOUR AND BREAKFAST CEREALS; BREAD, PASTRY AND CONFECTIONERY CHIPS FOR BAKING AND FROZEN CONFECTIONS, FLAVORED ICES; HONEY, TREACLE; YEAST, BAKING-POWDER; SALT; MUSTARD; VINEGAR, SAUCES AND CONDIMENTS, NAMELY, ARTICHOKE SAUCE, BARBECUE SAUCE, CHEESE SAUCE, CHILI SAUCE, PIZZA SAUCE, SOY SAUCE, TARTAR SAUCE; SPICES; ICE; SALAD DRESSINGS, IN CLASS 30 (U.S. CL. 46).

FOR: AGRICULTURAL GRAINS FOR PLANTING; LIVE ANIMALS IN GENERAL; FRESH FRUITS AND VEGETABLES; AGRICULTURAL SEEDS, BIRD SEEDS, FLOWER SEEDS, GRASS SEEDS, PLANT SEEDS, LIVING PLANTS, LIVE FLOWERING PLANTS AND LIVE FLOWER ARRANGEMENTS; FOODSTUFFS FOR ANIMALS, MALT FOR BREWING AND DISTILLING, IN CLASS 31 (U.S. CLS. 1 AND 46).

FOR: BEERS; NON-ALCOHOLIC DRINKS, NAMELY, MINERAL AND AERATED WATERS; FRUIT DRINKS AND FRUIT JUICES; SYRUPS AND PREPARATIONS FOR MAKING FRUIT DRINKS, IN CLASS 32 (U.S. CLS. 45, 46 AND 48).

FOR: ALCOHOLIC BEVERAGES, NAMELY, WINE IN GENERAL, IN CLASS 33 (U.S. CLS. 47 AND 49).

FOR: TOBACCO; SMOKER'S ARTICLES, NAMELY, CIGARETTE LIGHTERS NOT OF PRECIOUS METAL, ASHTRAYS NOT OF PRECIOUS METAL; MATCHES, IN CLASS 34 (U.S. CLS. 2, 8, 9 AND 17).

FOR: INSURANCE SERVICES, NAMELY, INSURANCE BROKERAGE, INSURANCE CLAIMS PROCESSING; FINANCIAL SERVICES, NAMELY, CLEARING OF SECURE FINANCIAL TRANSACTIONS THROUGH ONLINE SERVICES; FINAN-

CIAL ANALYSIS AND CONSULTATION, PROVIDING FINANCIAL INFORMATION, ISSUANCE OF SECURITIES, COMMERCIAL LENDING SERVICES, FINANCIAL PORTFOLIO MANAGEMENT, DISCOUNT BROKERAGE SERVICES, STOCK BROKERAGE, SECURITY BROKERAGE, BUSINESS BROKERAGE, BUSINESS VENTURE SERVICES IN THE NATURE OF VENTURE CAPITAL FUNDING SERVICES TO EMERGING AND START-UP COMPANIES, SECURITIES CONSULTING AND SAFE KEEPING, BROKERAGE OF PRODUCTIVE INVESTMENTS AND FUNDS; FINANCIAL SPONSORSHIP OF SPORTS, EDUCATIONAL AND ENTERTAINMENT PROGRAMS AND EVENTS; REAL ESTATE SERVICES, NAMELY BROKERAGE, MANAGEMENT, LEASING, APPRAISAL OF REAL PROPERTY; CUSTOMS BROKERAGE FOR THIRD PARTIES; MONETARY EXCHANGE; CREDIT CARD SERVICES; TELEPHONE CALLING CARD SERVICES; ELECTRONIC COMMERCE SERVICES, NAMELY, ELECTRONIC DEBIT AND CREDIT CARD PROCESSING SERVICES, FUNDS TRANSFER AND PAYMENT PROCESSING SERVICES; PROVIDING INFORMATION VIA THE TELEPHONE AND THE GLOBAL COMMUNICATIONS INFORMATION NETWORK IN THE FIELD OF FINANCE, IN CLASS 36 (U.S. CLS. 100, 101 AND 102).

FOR: CUSTOM CONSTRUCTION AND BUILDING RENOVATION; CONSTRUCTION PLANNING, CONSTRUCTION SUPERVISION; MAINTENANCE AND REPAIR OF TELECOMMUNICATIONS NETWORKS APPARATUS AND INSTRUMENTS; INSTALLATION OF TELECOMMUNICATIONS NETWORK, APPARATUS AND INSTRUMENTS; INSTALLATION, MAINTENANCE AND REPAIR OF COMPUTER NETWORKS AND COMPUTER HARDWARE FOR TELECOMMUNICATION PURPOSES, IN CLASS 37 (U.S. CLS. 100, 103 AND 106).

FOR: WAREHOUSE STORAGE OF GOODS, IN CLASS 39 (U.S. CLS. 100 AND 105).

FOR: MOLD PREVENTION TREATMENT OF FABRIC OR PREPARATION, TREATMENT OF FABRIC, WOOL TREATMENT AND FINISHING, METAL TREATMENT, PAPER TREATMENT, IN CLASS 40 (U.S. CLS. 100, 103 AND 106).

FOR: EDUCATION AND INSTRUCTION, NAMELY, EDUCATIONAL SERVICES IN THE NATURE OF CLASSES AND SEMINARS IN THE FIELDS OF BUSINESS, TELECOMMUNICATIONS AND COMPUTERS, AND THE DISTRIBUTION OF COURSE MATERIALS THERewith; ENTERTAINMENT IN THE NATURE OF LIVE VISUAL AND AUDIO PERFORMANCES, NAMELY, MUSICAL BANDS, GYMNASIc, DANCE, AND BALLET PERFORMANCES; ENTERTAINMENT SERVICES, NAMELY, PROVIDING MUSICAL, VARIETY, NEWS AND COMEDY SHOWS VIA A GLOBAL COMPUTER INFORMATION NETWORK; ENTERTAINMENT SERVICES, NAMELY, PROVIDING ON-LINE COMPUTER GAMES FOR CHILDREN AND ADULTS; PROVIDING ENTERTAINMENT INFORMATION AND GENERAL INFORMATION AT THE SPECIFIC

REQUEST OF END-USERS BY MEANS OF TELEPHONE OR GLOBAL COMMUNICATIONS NETWORKS; ORGANIZING COMMUNITY SPORTING AND CULTURAL EVENTS; PUBLICATION OF BOOKS, MAGAZINES, JOURNALS, MANUALS, BROCHURES AND LEAFLETS ON THE SUBJECT OF TELECOMMUNICATIONS; ELECTRONIC PUBLISHING SERVICES, NAMELY, PUBLICATION OF TEXT AND GRAPHIC WORKS OF OTHERS ON TELECOMMUNICATIONS RECORDED ON CD-

RIN AND CD-1 IN THE FIELD OF TELECOMMUNICATIONS, IN CLASS 41 (U.S. CLS. 100, 101 AND 107).

OWNER OF FED REP GERMANY REG. NO. 30020659, DATED 7-11-2000, EXPIRES 3-31-2010.

SER. NO. 76-130,251, FILED 9-18-2000.

SUE LAWRENCE, EXAMINING ATTORNEY

Int. Cl.: 35

Prior U.S. Cls.: 100, 101 and 102

United States Patent and Trademark Office

Reg. No. 3,574,345

Registered Feb. 17, 2009

**SERVICE MARK
PRINCIPAL REGISTER**

CALYPSO

CALYPSO COMMUNICATIONS LLC (NEW HAMPSHIRE LIMITED LIABILITY COMPANY)
33 DEER STREET, SUITE 2A
PORTSMOUTH, NH 03801

FOR: PROVIDING INTEGRATED MARKETING AND CORPORATE COMMUNICATIONS FOR OTHERS; NAMELY PUBLIC RELATIONS, DIRECT MARKETING SERVICES, AND CONSULTANCY

SERVICES REGARDING BUSINESS STRATEGIES, IN CLASS 35 (U.S. CLS. 100, 101 AND 102).

FIRST USE 6-1-2000; IN COMMERCE 6-1-2000.

SER. NO. 76-280,836, FILED 7-6-2001.

ALEXANDER L. POWERS, EXAMINING ATTORNEY

Int. Cls.: 9, 35, 38, 39, 41 and 42

Prior U.S. Cls.: 21, 23, 26, 36, 38, 100, 101, 102, 104, 105 and 107

Reg. No. 3,574,346

United States Patent and Trademark Office

Registered Feb. 17, 2009

**TRADEMARK
SERVICE MARK
PRINCIPAL REGISTER**



VODAFONE GROUP PLC (UNITED KINGDOM CORPORATION)
THE CONNECTION, NEWBURY
VODAFONE HOUSE
BERKSHIRE RG14 2FN, UNITED KINGDOM

FOR: ELECTRICAL, ELECTRONIC, TELECOMMUNICATIONS AND TELEPHONIC APPARATUS AND INSTRUMENTS, NAMELY, RADIO TELEPHONES, MOBILE AND FIXED TELEPHONES, RADIO AND RADIO-TELEPHONE TRANSMITTERS AND RECEIVERS AND RADIO PAGERS, VIDEO TELEPHONES, PORTABLE COMPUTERS, TRANSCEIVERS EMBODIED IN DOMESTIC APPLIANCES AND TELEVISION EQUIPMENT; MULTIMEDIA EQUIPMENT, NAMELY TELEVISION AND COMPUTERS ADAPTED FOR RECEIVING AND TRANSMITTING VOICE, DATA, VIDEO AND INFORMATION, RADIO FACSIMILE APPARATUS AND INSTRUMENTS, NAMELY, RADIO FACSIMILE MACHINES, TELEPHONE EXCHANGE APPARATUS, NAMELY, TELEPHONES, TRANSMITTERS, RECEIVERS, TELECOMMUNICATION SWITCHES, POWER CABLES AND INTEGRATED CIRCUITS, MODEMS, DATA COMMUNICATION APPARATUS AND INSTRUMENTS, NAMELY, TRANSMITTERS, RECEIVERS, PROCESSORS, MODEMS, FACSIMILE MACHINES, TELEPHONES AND PAGERS FOR COMMUNICATING ALL TYPES OF DATA, COMPUTER SOFTWARE FOR USE IN TELECOMMUNICATIONS, NAMELY, COMPUTER SOFTWARE FOR FACILITATING REMOTE ACCESS TO INFORMATION, BILLING AND CHARGING IN COMMERCE AND NETWORK PLANNING AND MAINTENANCE,

AND MAGNETIC CODED CARDS CONTAINING PROGRAMMING WHICH ENABLES THE FUNCTIONING OF MOBILE PHONES AND PERMITS ACCESS TO THE SERVICES PROVIDED VIA THE MOBILE PHONES; ENCODED SMART CARDS CONTAINING PROGRAMMING WHICH ENABLES THE FUNCTIONING OF MOBILE PHONES AND PERMITS ACCESS TO THE SERVICES PROVIDED VIA THE MOBILE PHONES; DOWNLOADABLE RINGTONE RECORDINGS AND DOWNLOADABLE GRAPHICS FOR MOBILE PHONES, IN CLASS 9 (U.S. CLS. 21, 23, 26, 36 AND 38).

FOR: TELEPHONE DIRECTORY INFORMATION SERVICES; ON-LINE BUSINESS DIRECTORIES FEATURING INFORMATION ON TELEPHONE NUMBERS AND ADDRESSES, THE OWNERSHIP OF TELECOMMUNICATIONS EQUIPMENT, THE AVAILABILITY OF COMMUNICATIONS SERVICES, THE SECURITY OF DWELLINGS AND BUSINESSES AND MULTIMEDIA SERVICES; DIRECTORY LISTING SERVICES, NAMELY, A SERVICE WHICH PROVIDES CUSTOMERS WITH LISTINGS OF ACCESSIBLE INFORMATION IN A MENU-BASED SYSTEM ON THEIR COMMUNICATIONS APPARATUSES AND DIRECTS THEM TO THE RELEVANT CONTENT HOSTED BY SERVICE PROVIDERS OR TO THIRD PARTY WEB SITES ON THE GLOBAL COMPUTER INFORMATION NETWORK, IN CLASS 35 (U.S. CLS. 100, 101 AND 102).

FOR: TELECOMMUNICATION SERVICES, NAMELY, PERSONAL COMMUNICATION SERVICES, LOCAL AND LONG DISTANCE TRANSMISSION OF VOICE, DATA, GRAPHICS BY MEANS OF

TELEPHONE, TELEGRAPHIC, CABLE AND SATELLITE TRANSMISSION, MOBILE RADIO COMMUNICATION SERVICES; MOBILE AND FIXED TELEPHONE COMMUNICATION SERVICES; SATELLITE COMMUNICATION SERVICES; CELLULAR TELEPHONE SERVICES; RADIO TELEPHONE COMMUNICATION SERVICES; RADIO FACSIMILE TRANSMISSION SERVICES; RADIO PAGING SERVICES; RADIO COMMUNICATION SERVICES, NAMELY, THE ELECTRONIC TRANSMISSION OF VOICE, DATA, FACSIMILE, VIDEO AND INFORMATION; ELECTRONIC TRANSMISSION OF MESSAGES AND DATA; CABLE RADIO TRANSMISSION; RENTAL OF TELECOMMUNICATION EQUIPMENT, NAMELY, TELEPHONES, RADIO TELEPHONES AND RADIO FACSIMILE MACHINES AND EQUIPMENT AND PROVIDING SUCH EQUIPMENT ON A TEMPORARY BASIS IN THE CASE OF BREAKDOWN, LOSS OR THEFT OF THE EQUIPMENT; TELECOMMUNICATION SERVICES, NAMELY, ASSIGNING A PARTICULAR TELEPHONE NUMBER TO A PARTICULAR CUSTOMER; PROVIDING COLLOCATION SERVICES FOR VOICE, VIDEO AND DATA COMMUNICATIONS APPLICATIONS; PROVIDING TELECOMMUNICATIONS CONNECTIONS TO A GLOBAL COMPUTER NETWORK; TELEPHONE VOICE MESSAGING SERVICES; PROVIDING INFORMATION RELATING TO TELECOMMUNICATION EQUIPMENT AND OTHER TELECOMMUNICATION RELATED MATTER; ELECTRONIC MAIL SERVICES; PROVIDING ON-LINE ELECTRONIC BULLETIN BOARDS AND ON-LINE CHAT ROOMS FOR TRANSMISSION OF MESSAGES AMONG COMPUTER USERS CONCERNING TELECOMMUNICATIONS, NEWS EVENTS, ACCOMMODATION, WEATHER, HOROSCOPES, COMPUTING, MULTIMEDIA SERVICES, THE GLOBAL COMPUTER INFORMATION NETWORK, THE SECURITY OF DWELLINGS AND BUSINESSES, A CALENDAR/DIARY SYSTEM FOR APPOINTMENTS, TECHNOLOGY DEVELOPMENTS, PERSONAL ADDRESS SERVICES, BUSINESS, FINANCE, BANKING, TRAVEL AND SPORTS EVENTS; PROVIDING SINGLE AND MULTIPLE-USER ACCESS TO CORPORATE NETWORKS AND PERSONAL INFORMATION MANAGEMENT SYSTEM NETWORKS, INCLUDING ACCESS VIA MOBILE TELEPHONES; CONSULTATION SERVICES IN THE FIELD OF TELECOMMUNICATIONS AND THE GLOBAL COMPUTER INFORMATION NETWORK, IN CLASS 38 (U.S. CLS. 100, 101 AND 104).

FOR: ELECTRONIC STORAGE OF INFORMATION RELATING TO TELEPHONE NUMBERS AND ADDRESSES, THE OWNERSHIP OF TELECOMMU-

NICATIONS EQUIPMENT, THE AVAILABILITY OF COMMUNICATIONS SERVICES, THE SECURITY OF DWELLINGS AND BUSINESSES, TRAVEL, ENTERTAINMENT, WEATHER, SPORTS EVENTS, NEWS EVENTS, THE GLOBAL COMPUTER INFORMATION NETWORK, FINANCE, COMPUTING AND MULTIMEDIA SERVICES; PROVIDING TRAVEL INFORMATION; PROVISION OF LOCATION BASED SERVICES FOR TELECOMMUNICATIONS APPARATUS, NAMELY, A SERVICE WHICH PROVIDES MOBILE PHONE USERS WITH DIRECTIONS TO A PARTICULAR LOCATIONS VIA THEIR MOBILE PHONES, IN CLASS 39 (U.S. CLS. 100 AND 105).

FOR: PROVIDING INFORMATION ON SPORTS EVENTS AND NEWS EVENTS; RENTAL OF RADIOS, IN CLASS 41 (U.S. CLS. 100, 101 AND 107).

FOR: PROVIDING INFORMATION ON THE WEATHER; PROVIDING SPECIFIC INFORMATION AS REQUESTED BY CUSTOMERS VIA THE GLOBAL COMPUTER NETWORK, TELEPHONE OR ELECTRONIC MAIL; PROVIDING INFORMATION AT THE REQUEST OF END-USERS BY MEANS OF TELEPHONE, GLOBAL COMPUTER NETWORKS OR ELECTRONIC MAIL; NEWS AGENCIES, NAMELY, GATHERING AND DISSEMINATION OF NEWS; RENTAL OF COMPUTER HARDWARE; COMPUTER CONSULTATION SERVICES; COMPUTER SERVICES, NAMELY, DESIGNING AND IMPLEMENTING NETWORK WEB PAGES FOR OTHERS; COMPUTER PROGRAMMING AND SOFTWARE DESIGN FOR OTHERS; COMPUTER SERVICES, NAMELY, PROVIDING SEARCH ENGINES FOR OBTAINING DATA ON A GLOBAL COMPUTER INFORMATION NETWORK; PROVIDING CUSTOM DESIGN AND ADAPTATION SERVICES FOR OTHERS OF DISPLAY SCREENS ON TELECOMMUNICATIONS EQUIPMENT, IN CLASS 42 (U.S. CLS. 100 AND 101).

PRIORITY CLAIMED UNDER SEC. 44(D) ON ERPN CMNTY TM OFC APPLICATION NO. 002364297, FILED 9-4-2001, REG. NO. 002364297, DATED 10-24-2002, EXPIRES 9-4-2011.

OWNER OF U.S. REG. NO. 2,145,714.

THE MARK CONSISTS OF THE TERM "VODAFONE" AND THE DESIGN OF A SINGLE QUOTATION MARK.

SER. NO. 76-375,495, FILED 2-26-2002.

KATHERINE STOIDES, EXAMINING ATTORNEY

Int. Cls.: 9, 16, 35, 36, 38, 41 and 42

**Prior U.S. Cls.: 2, 5, 21, 22, 23, 26, 29, 36, 37, 38, 50,
100, 101, 102, 104 and 107**

Reg. No. 3,574,347

United States Patent and Trademark Office

Registered Feb. 17, 2009

**TRADEMARK
SERVICE MARK
PRINCIPAL REGISTER**



DEUTSCHE TELEKOM AG (FED REP GERMA-
NY CORPORATION)
FRIEDRICH-EBERT-ALLEE 140
53113 BONN, FED REP GERMANY

FOR: ELECTRIC, ELECTRONIC, OPTICAL, MEASURING, SIGNALING, CONTROLLING AND TEACHING APPARATUS AND INSTRUMENTS, ALL FOR USE WITH TELECOMMUNICATIONS, NAMELY, APPARATUS FOR PRODUCING SOUND, IMAGES OR DATA, NAMELY, MAGNETIC AND OPTICAL DATA CARRIERS, DATA PROCESSORS AND COMPUTERS, NAMELY, MICROCOMPUTERS, MINICOMPUTERS, COMPUTER CENTRAL PROCESSORS, COMPUTER MONITORS, COMPUTER KEYBOARDS, COMPUTER TERMINALS, COMPUTER INTERFACE BOARDS, COMPUTER MEMORIES, COMPUTER LASER PRINTERS, COMPUTER IMPACT PRINTERS, COMPUTER DOT MATRIX PRINTERS, COMPUTER OPERATING SYSTEMS, COMPUTERS AND INSTRUCTIONAL MANUALS SOLD AS A UNIT, COMPUTER INTERFACE APPARATUS, NAMELY, COMPUTER MODEMS, COMPUTER MOUSE AND MOUSE PAD, COMPUTER PERIPHERALS AND PARTS THEREOF; COMPUTER PROGRAMS AND DATABASES FOR USE IN OPERATING TELECOMMUNICATIONS AND BUSINESS MANAGEMENT SYSTEMS AND RELATED INSTRUCTION MANUALS SOLD AS A UNIT; COMPUTER PROGRAMS, NAMELY, FINANCIAL ACCOUNTING SYSTEM SOFTWARE, SOFTWARE USED FOR THE PROVISION OF ONLINE INFORMATION SERVICES, NETWORK MANAGEMENT SOFTWARE, COMPUTER PROXY SOFTWARE FOR USE WITH OTHER SOFTWARE PROGRAMS, ALARM MONITORING SOFTWARE, BILLING ANALYSIS SOFTWARE, AND SOFTWARE FOR NETWORK ACCESS CONTROL, CREATING AND MAINTAINING FIREWALLS;

COMPUTER PROGRAMS FOR ACCESSING A GLOBAL COMPUTER NETWORK AND INTERACTIVE COMPUTER COMMUNICATIONS NETWORK; OPTICAL CABLES, OPTIC FILTERS, OPTICAL SCANNERS, OPTICAL CHARACTER READERS, OPTICAL DISCS, OPTICAL FIBERS, OPTICAL GLASS FOR SIGNAL TRANSMISSION, OPTIC TRANSMITTERS, OPTIC RECEIVERS, OPTICAL SIGNAL PROCESSING APPARATUS, OPTIC SWITCHES, OPTICAL ATTENUATORS, OPTICAL AMPLIFIERS, OPTICAL CHARACTER RECOGNITION APPARATUS, AND PARTS THEREOF; AUDIO, VIDEO AND DATA COMMUNICATIONS SYSTEMS, NAMELY, DIGITAL AND ANALOGUE SIGNAL TRANSMITTERS, RECEIVERS AND CONVERTERS, RADIO AND TELEPHONE TRANSMITTERS, RECEIVERS AND SERVERS, ANSWERING MACHINES, TELECOMMUNICATION TRANSMISSION, RECEIVING AND STORAGE APPARATUS, NAMELY, TELECOMMUNICATIONS TRANSMITTING SETS, DATA TRANSMITTERS, FACSIMILE MACHINES, ELECTRONIC MAIL APPARATUS FOR ELECTRONIC EXCHANGE OF DATA IMAGES AND MESSAGES, REMOTE CONTROLS AND SET-TOP UNITS FOR TELEVISION, CINEMATOGRAPHIC TELEVISION AND AMUSEMENT EQUIPMENT, NAMELY, SIGNAL DECODERS, ELECTRICAL WIRE, ELECTRICAL WIRE CONNECTORS, INTEGRATED CIRCUITS, PRINTED CIRCUITS, ELECTRIC CIRCUITS, CIRCUIT BREAKERS, PRINTED CIRCUIT BOARDS, ELECTRIC CIRCUIT BOARDS, CIRCUIT CONNECTORS, ELECTRICAL CONTROLLERS, ELECTRICAL CONVERTERS, ELECTRICAL FUSES, ELECTRIC LUMINESCENT DISPLAY PANELS, ELECTRICAL SWITCH PLATES, ELECTRIC PLUGS, ANTENNAS, ELECTRICAL CABLES, COMPUTER CABLES, COMPUTER CHIPS, SILICON CHIPS, CHRONOGRAPHS FOR USE AS SPECIA-

LIZED TIME RECORDING APPARATUS, ELECTRIC COILS, COMPUTER BUFFERS, BLANK COMPUTER DISCS, BLANK COMPUTER FLOPPY DISKS, COMPUTER HARD DISCS, ELECTRICAL CONDUCTORS, ACOUSTIC CONDUITS, ELECTRICAL CONDUITS, FIBER OPTIC CONDUITS AND PARTS THEREOF; COMPACT DISC PLAYERS, AUDIO AND VIDEO TAPE RECORDERS, AUDIO AND VIDEO TAPE PLAYERS, AUDIO AND VIDEO CASSETTE RECORDERS, AUDIO AND VIDEO CASSETTE PLAYERS, BLANK AUDIO AND VIDEO TAPES, CASSETTES, DISCS AND MICROFICHE; AUDIO AND VIDEO TAPES, CASSETTES, DISCS AND MICROFICHE FEATURING INFORMATION CONCERNING TELECOMMUNICATIONS, AND CONCERNING PERSONAL AND BUSINESS MANAGEMENT SYSTEMS; AUDIO AND VIDEO RECORDINGS IN THE FIELD OF TELECOMMUNICATIONS, INFORMATION TECHNOLOGY, SAFETY; TELEVISION AND TELEVISION PERIPHERAL EQUIPMENT, NAMELY CAMERAS, SET BOXES, REMOTE CONTROL UNITS FOR INTERACTIVE AND NON-INTERACTIVE USE; COMPUTER MEMORY, COMPUTER PERIPHERALS AND MODEMS; VIDEO MONITORS, AUTOMATIC VENDING MACHINES AND TIMING MECHANISMS THEREFOR, AND PARTS THEREOF; MACHINE READABLE, MAGNETICALLY ENCODED CARDS, NAMELY, TELEPHONE CALLING CARDS AND CREDIT CARDS; SMART CARDS; DATA PROCESSORS AND READERS, WORD PROCESSORS, MAGNETIC CODED CARD READERS, MAGNETIC CODED CARDS, ELECTRONIC ENCRYPTION UNITS, LASERS NOT FOR MEDICAL USE, LIGHT EMITTING DIODES, LIGHT EMITTING DIODE DISPLAYS, MICROPROCESSORS, BLANK DATA CARRIERS, DEMAGNETIZERS FOR MAGNETIC TAPES, AND PARTS THEREOF; COMPUTER, DATA AND VIDEO NETWORKING AND CONFERENCING EQUIPMENT, NAMELY, TELECONFERENCING EQUIPMENT AND AUDIOVISUAL TEACHING EQUIPMENT IN THE NATURE OF OVERHEAD FILM, PHOTOGRAPHIC AND SLIDE PROJECTORS, PROJECTION SCREENS, COMPUTER BASED INFORMATION DISPLAY EQUIPMENT, NAMELY, COMPUTERS WHICH DISPLAY INFORMATION ON AN OVERHEAD SCREEN, INTERCOMS; TELEPHONES, TELEPHONE ANSWERING MACHINES, TELEPHONE TRANSMITTERS, TELEPHONE NETWORKS, TELEPHONE WIRES, TELEPRINTERS, TELETYPEWRITERS, AND PARTS THEREOF, NAMELY, CALLER IDENTIFICATION BOXES, DIALING ASSEMBLIES, TELEPHONE UNITS, AUDIO OPERATED RELAYS, AUDIO OPERATED RELAYS, AUDIO/VIDEO SIGNAL AND OPTICAL FILTERS, PROTECTORS AND AUTOMATIC SIGNALING AND CONTROL EQUIPMENT, TELEMETERS, WIRELESS AND CELLULAR TELEPHONES, RADIO PAGERS, PORTABLE COMPUTER DEVICES, NAMELY LAPTOPS, HANDHELD AND POCKET COMPUTERS, FACSIMILE TRANSMITTERS AND RECEIVERS, WIRELESS FAX MACHINES, PERSONAL COMMUNICATIONS EQUIPMENT, NAMELY, PERSONAL DIGITAL ASSISTANTS (PDA), CALCULATORS AND RELATED PERIPHERALS; SATELLITE PROCESSORS, SATELLITES AND SATELLITE COMMUNICATION

EARTH STATIONS BOTH STATIONARY AND MOVEABLE; AUDIO AND VIDEO RECORDINGS IN THE FIELD OF NEWS, SPORTS, ENTERTAINMENT, CULTURE, BUSINESS AND FINANCE, WEATHER AND TRAVEL; PRERECORDED COMPACT DISCS, AUDIO CASSETTE TAPES, VIDEO CASSETTE TAPES, DIGITAL AUDIO TAPES AND DIGITAL VIDEO DISCS FEATURING MUSICAL, VARIETY, NEWS AND COMEDY SHOWS; COMPUTER GAME PROGRAMS FOR CHILDREN AND ADULTS; VIDEO AND COMPUTER GAME CARTRIDGES, IN CLASS 9 (U.S. CLS. 21, 23, 26, 36 AND 38).

FOR: PRINTED MATTER, NAMELY, TELEPHONE DIRECTORIES, BOOKS, NEWSLETTERS, PAMPHLETS, BROCHURES, MAGAZINES AND PAPERBACKS ALL IN THE FIELD OF TELECOMMUNICATIONS, STAMPED AND/OR PRINTED CARDS OF CARDBOARD OR PLASTIC, NAMELY, BASEBALL CARDS, GREETING CARDS, TRADING CARDS, TRIVIA CARDS; NOTE PAPER AND ENVELOPES, RUBBER STAMPS, NAME TAGS AND LABELS MADE FROM PAPER OR CARDBOARD, NOTEBOOKS, DIARIES, NOTE PAPERS, NOTE PADS, ADDRESS BOOKS, FOLDERS FOR LETTERS, FILES OR LOOSE PAPER, CLEAR HOLE REINFORCEMENTS, STUDENT CALENDARS, STAMP ALBUMS AND PHOTO-ALBUMS; PAPER WEIGHTS, LETTER OPENERS, BLOTTING PADS; DESK TRAYS, DESK STANDS AND HOLDERS FOR HOLDING STATIONERY AND OFFICE IMPLEMENTS; PRINTED INSTRUCTIONAL AND TEACHING MATERIALS ALL IN THE FIELDS OF TELECOMMUNICATIONS, INFORMATION TECHNOLOGY, SAFETY, NEWS, SPORTS, ENTERTAINMENT, CULTURE, BUSINESS AND FINANCE, WEATHER AND TRAVEL; STATIONERY, DRAWING AND UNGRADUATED RULERS, ERASERS, STAPLERS, STAPLES, PAPER CLIPS, BOOK MARKERS, CUTOUT SAMPLES AND STENCILS; SCRATCH PICTURES, PAPER, NAMELY, BOND PAPER AND ART PAPER, PVC STICKERS, GIFT WRAP PAPER; BLACKBOARDS, CHALK STICKS, ADHESIVES FOR STATIONERY OR HOUSEHOLD PURPOSES; DRAWING AND PAINTING MATERIALS, NAMELY, PENCILS, DRAWING PENCILS, PENS, DRAWING PENS, PAINT TRAYS, PAINTING SETS FOR ARTISTS, PAINTING SETS FOR CHILDREN, PAINT KITS, AND PENCIL CASES; NON-MAGNETICALLY ENCODED, PREPAID TELEPHONE CALLING CARDS, IN CLASS 16 (U.S. CLS. 2, 5, 22, 23, 29, 37, 38 AND 50).

FOR: TELEPHONE DIRECTORY SERVICES; ADVERTISING SERVICES, NAMELY, PREPARING AND PLACING ADVERTISEMENTS FOR OTHERS PROMOTING THE GOODS AND SERVICES OF OTHERS THROUGH PRINTED ADVERTISING, PRINTED DIRECTORIES, THROUGH ENCODED MEDIA, THROUGH THE DISSEMINATION OF PROMOTIONAL MATERIALS, THROUGH DIRECT MAIL ADVERTISING, THROUGH ELECTRONIC BILLBOARD ADVERTISING, PREPARING AUDIOVISUAL PRESENTATIONS FOR USE IN ADVERTISING; BUSINESS SERVICES, NAMELY, BUSINESS APPRAISALS, BUSINESS AUDITING, PROVIDING

BUSINESS INFORMATION, NAMELY, PREPARING BUSINESS REPORTS AND CONDUCTING BUSINESS RESEARCH, ANALYSIS AND SURVEYS, BUSINESS MANAGEMENT PLANNING, BUSINESS MANAGEMENT CONSULTATION, BUSINESS MANAGEMENT SUPERVISION, CONDUCTING BUSINESS NETWORKING FOR OTHERS; BUSINESS MANAGEMENT AND CONSULTING SERVICES EXCLUDING AGRICULTURAL BUSINESS MANAGEMENT AND CONSULTING SERVICES; BUSINESS INFORMATION SERVICES IN THE FIELD OF TELECOMMUNICATIONS, ADVERTISING, INFORMATION TECHNOLOGY AND MARKETING; RENTAL OF AUTOMATIC VENDING MACHINES; ORGANIZING JOB FAIRS; RENTAL OF DATA PROCESSING EQUIPMENT; PROVIDING INFORMATION VIA THE TELEPHONE AND THE GLOBAL COMMUNICATION NETWORKS IN THE FIELD OF ADVERTISING AND BUSINESS MARKETING; PROFESSIONAL CONSULTANCY IN THE FIELD OF DATA PROCESSING, IN CLASS 35 (U.S. CLS. 100, 101 AND 102).

FOR: CLEARING OF SECURE FINANCIAL TRANSACTIONS THROUGH ONLINE SERVICES; FINANCIAL AND MONETARY SERVICES, NAMELY FINANCIAL ANALYSIS AND CONSULTATION, PROVIDING FINANCIAL INFORMATION, ISSUANCE OF SECURITIES, COMMERCIAL LENDING SERVICES, FINANCIAL PORTFOLIO MANAGEMENT, DISCOUNT BROKERAGE SERVICES, BROKERAGE OF SHARES, OF SETS AND BUSINESS VENTURES, BROKERAGE OF FUND SHARES, SECURITIES CONSULTING AND SAFE KEEPING, BROKERAGE OF PRODUCTIVE INVESTMENTS AND FUNDS; FINANCIAL SPONSORSHIP OF SPORTS, EDUCATIONAL AND ENTERTAINMENT PROGRAMS AND EVENTS; REAL ESTATE SERVICES, NAMELY BROKERAGE, MANAGEMENT, LEASING, APPRAISAL OF REAL PROPERTY; CUSTOMS BROKERAGE FOR THIRD PARTIES; MONETARY EXCHANGE; CREDIT CARD SERVICES; TELEPHONE CALLING CARD SERVICES; ELECTRONIC COMMERCE SERVICES, NAMELY, ELECTRONIC DEBIT AND CREDIT CARD PROCESSING SERVICES, FUNDS TRANSFER AND PAYMENT PROCESSING SERVICES; PROVIDING INFORMATION VIA THE TELEPHONE AND THE GLOBAL COMMUNICATION NETWORKS IN THE FIELD OF FINANCE, IN CLASS 36 (U.S. CLS. 100, 101 AND 102).

FOR: TELECOMMUNICATIONS AND INFORMATION TECHNOLOGY SERVICES, NAMELY ELECTRIC, DIGITAL, CELLULAR AND WIRELESS TRANSMISSION OF VOICE, DATA, INFORMATION, IMAGES, SIGNALS AND MESSAGES AND TRANSMISSION OF VOICE, DATA, IMAGES, AUDIO, VIDEO AND INFORMATION VIA TELEPHONE, TELEVISION AND GLOBAL COMMUNICATION NETWORKS; PROVIDING TELECOMMUNICATIONS CONNECTIONS OVER A GLOBAL COMMUNICATIONS NETWORK, ELECTRONIC MAIL, VOICE MAIL AND MESSAGING SERVICES, NAMELY, THE RECORDING AND STORAGE AND SUBSEQUENT TRANSMISSION OF VOICE MESSAGES BY TELEPHONE;

RENTAL OF TELECOMMUNICATIONS EQUIPMENT, NAMELY, EQUIPMENT FOR ELECTRONIC ACCESS TO GLOBAL TELECOMMUNICATIONS NETWORK, EQUIPMENT FOR TRANSMITTING, RECEIVING, RECORDING AND MONITORING VOICE, DATA, INFORMATION, IMAGES, SIGNALS, MESSAGES, COMPRISED OF DATA AND WORD PROCESSORS, AND TELECOMMUNICATIONS HARDWARE AND SOFTWARE INCLUDING COMPONENTS AND PERIPHERALS THEREOF FOR USE IN THE TELECOMMUNICATIONS INDUSTRY, AND RENTAL OF EQUIPMENT FOR TRANSMITTING, RECEIVING, RECORDING AND MONITORING COMPUTER PROGRAMS FOR USE IN OPERATING AND ACCESSING TELECOMMUNICATIONS SYSTEMS; AUDIO AND VIDEO BROADCASTING FEATURING ENTERTAINMENT IN THE NATURE OF LIVE VISUAL AND AUDIO PERFORMANCES, AND MUSICAL, VARIETY, NEWS AND COMEDY SHOWS; PROVIDING ACCESS TO COMPUTER INFORMATION NETWORKS; PERSONAL COMMUNICATIONS SERVICES; PAGER SERVICES; ELECTRONIC MAIL SERVICES; TRANSMISSION AND BROADCAST OF AUDIO AND VIDEO PROGRAMMING; PROVIDING MULTIPLE-USER ACCESS TO A GLOBAL COMMUNICATION NETWORK; LEASING TELECOMMUNICATIONS EQUIPMENT, COMPONENTS, SYSTEMS AND SUPPLIES; CONSULTING IN THE FIELD OF TELECOMMUNICATIONS; CONSULTING IN THE FIELDS OF TELECOMMUNICATIONS AND GLOBAL COMMUNICATION NETWORKS, IN CLASS 38 (U.S. CLS. 100, 101 AND 104).

FOR: EDUCATION AND INSTRUCTION, NAMELY, EDUCATIONAL SERVICES IN THE NATURE OF CLASSES AND SEMINARS IN THE FIELDS OF BUSINESS, TELECOMMUNICATIONS AND COMPUTERS, AND THE DISTRIBUTION OF COURSE MATERIALS THEREWITH; ENTERTAINMENT IN THE NATURE OF VISUAL AND AUDIO PERFORMANCES, NAMELY, MUSICAL BAND, ROCK GROUP, GYMNASTIC, DANCE, AND BALLET PERFORMANCES; ENTERTAINMENT SERVICES, NAMELY, PROVIDING MUSICAL, VARIETY, NEWS AND COMEDY SHOWS VIA A GLOBAL COMPUTER INFORMATION NETWORK; ENTERTAINMENT SERVICES, NAMELY, PROVIDING ONLINE COMPUTER GAMES FOR CHILDREN AND ADULTS; PROVIDING ENTERTAINMENT INFORMATION AT THE SPECIFIC REQUEST OF END-USERS BY MEANS OF TELEPHONE OR GLOBAL COMMUNICATIONS NETWORKS; ORGANIZING COMMUNITY SPORTING AND CULTURAL EVENTS; PUBLICATION OF BOOKS, MAGAZINES, JOURNALS, MANUALS, BROCHURES AND LEAFLETS ON THE SUBJECT OF TELECOMMUNICATIONS; ELECTRONIC PUBLISHING SERVICES, NAMELY, PUBLICATION OF TEXT AND GRAPHIC WORKS OF OTHERS ON TELECOMMUNICATIONS RECORDED ON ELECTRONIC MEDIA; ORGANIZING FAIRS AND EXHIBITIONS IN THE FIELD OF VISUAL AND AUDIO PERFORMANCES, NAMELY, ROCK GROUP, GYMNASTIC, DANCE, AND BALLET PERFORMANCES, IN CLASS 41 (U.S. CLS. 100, 101 AND 107).

FOR: COMPUTER PROGRAMMING SERVICES FOR OTHERS; RENTAL OF SOFTWARE AND HARDWARE FOR ONLINE ACCESS; SERVICES OF AN INTERNET TRUST CENTER, NAMELY, ASSURANCE AND ADMINISTRATION OF DIGITAL KEYS AND/OR DIGITAL CERTIFICATES; GENERATION OF DATA PROCESSING PROGRAMS; WEB PAGE HOSTING SERVICES; COMPUTER SERVICES NAMELY CREATING INDEXES OF INFORMATION AVAILABLE ON COMPUTER NETWORKS; CONSULTING AND DESIGN SERVICES IN THE FIELD OF INFORMATION TECHNOLOGY, AND COMPUTER PROGRAMMING; DESIGN SERVICES IN THE FIELDS OF TELECOMMUNICATIONS AND GLOBAL COMMUNICATION NETWORKS; INSTALLATION, MAINTENANCE AND REPAIR OF COMPUTER SOFTWARE; PROVIDING GENERAL INFORMATION AT THE SPECIFIC REQUEST OF END-USERS BY MEANS OF TELEPHONE OR GLOBAL COMMUNICATIONS NETWORKS, IN CLASS 42 (U.S. CLS. 100 AND 101).

PRIORITY CLAIMED UNDER SEC. 44(D) ON FED REP GERMANY APPLICATION NO. 30217932.1/3, FILED 4-12-2002, REG. NO. 30217932, DATED 6-18-2002, EXPIRES 4-30-2012.

NO CLAIM IS MADE TO THE EXCLUSIVE RIGHT TO USE KIDS, APART FROM THE MARK AS SHOWN.

THE APPLICANT IS CLAIMING THE COLORS MAGENTA, WHITE, AND GREY AS FEATURES OF THE MARK.

THE MARK CONSISTS OF THE CIRCLE AROUND THE LETTER "T" IS MAGENTA; THE LETTER "T" IN A CIRCLE AND THE LINE FOLLOWING FROM THE LETTER "T" ARE WHITE; AND THE WORD "KIDS" IS GREY.

SER. NO. 76-459,065, FILED 10-15-2002.

JOHN KELLY, EXAMINING ATTORNEY

Int. Cls.: 9, 16, 35, 36, 38, 41 and 42

Prior U.S. Cls.: 2, 5, 21, 22, 23, 26, 29, 36, 37, 38, 50,
100, 101, 102, 104 and 107

Reg. No. 3,574,348

United States Patent and Trademark Office

Registered Feb. 17, 2009

TRADEMARK
SERVICE MARK
PRINCIPAL REGISTER

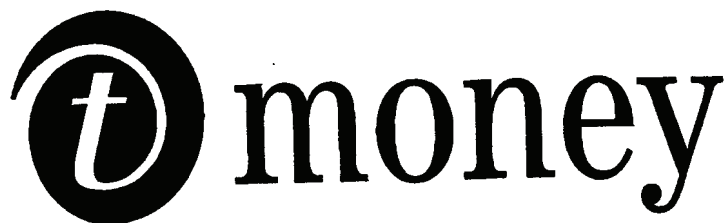

DEUTSCHE TELEKOM AG (FED REP GERMA-
NY CORPORATION)
FRIEDRICH-EBERT-ALLEE 140
53113 BONN, FED REP GERMANY

FOR: ELECTRIC, ELECTRONIC, OPTICAL, MEASURING, SIGNALING, CONTROLLING AND TEACHING APPARATUS AND INSTRUMENTS, ALL FOR USE WITH TELECOMMUNICATIONS, NAMELY, APPARATUS FOR PRODUCING SOUND, IMAGES OR DATA, NAMELY, MAGNETIC AND OPTICAL DATA CARRIERS, DATA PROCESSORS AND COMPUTERS, NAMELY, MICROCOMPUTERS, MINICOMPUTERS, COMPUTER CENTRAL PROCESSORS, COMPUTER MONITORS, COMPUTER KEYBOARDS, COMPUTER TERMINALS, COMPUTER INTERFACE BOARDS, COMPUTER MEMORIES, COMPUTER LASER PRINTERS, COMPUTER IMPACT PRINTERS, COMPUTER DOT MATRIX PRINTERS, COMPUTER OPERATING SYSTEMS, COMPUTERS AND INSTRUCTIONAL MANUALS SOLD AS A UNIT, COMPUTER INTERFACE APPARATUS, NAMELY, COMPUTER MODEMS, COMPUTER MOUSE AND MOUSE PAD, COMPUTER PERIPHERALS AND PARTS THEREOF; COMPUTER PROGRAMS AND DATABASES FOR USE IN OPERATING TELECOMMUNICATIONS AND BUSINESS MANAGEMENT SYSTEMS AND RELATED INSTRUCTION MANUALS SOLD AS A UNIT; COMPUTER PROGRAMS, NAMELY, FINANCIAL ACCOUNTING SYSTEM SOFTWARE, SOFTWARE USED FOR THE PROVISION OF ONLINE INFORMATION SERVICES, NETWORK MANAGEMENT SOFTWARE, COMPUTER PROXY SOFTWARE FOR USE WITH OTHER SOFTWARE PROGRAMS, ALARM MONITORING SOFTWARE, BILLING ANALYSIS SOFTWARE, AND SOFTWARE FOR NETWORK ACCESS CONTROL,

CREATING AND MAINTAINING FIREWALLS; COMPUTER PROGRAMS FOR ACCESSING A GLOBAL COMPUTER NETWORK AND INTERACTIVE COMPUTER COMMUNICATIONS NETWORK; OPTICAL CABLES, OPTIC FILTERS, OPTICAL SCANNERS, OPTICAL CHARACTER READERS, OPTICAL DISCS, OPTICAL FIBERS, OPTICAL GLASS FOR SIGNAL TRANSMISSION, OPTIC TRANSMITTERS, OPTIC RECEIVERS, OPTICAL SIGNAL PROCESSING APPARATUS, OPTIC SWITCHES, OPTICAL ATTENUATORS, OPTICAL AMPLIFIERS, OPTICAL CHARACTER RECOGNITION APPARATUS, AND PARTS THEREOF; AUDIO, VIDEO AND DATA COMMUNICATIONS SYSTEMS, NAMELY, DIGITAL AND ANALOGUE SIGNAL TRANSMITTERS, RECEIVERS AND CONVERTERS, RADIO AND TELEPHONE TRANSMITTERS, RECEIVERS AND SERVERS, ANSWERING MACHINES, TELECOMMUNICATION TRANSMISSION, RECEIVING AND STORAGE APPARATUS, NAMELY, TELECOMMUNICATIONS TRANSMITTING SETS, DATA TRANSMITTERS, FACSIMILE MACHINES, ELECTRONIC MAIL APPARATUS FOR ELECTRONIC EXCHANGE OF DATA IMAGES AND MESSAGES, REMOTE CONTROLS AND SET-TOP UNITS FOR TELEVISION, CINEMATOGRAPHIC TELEVISION AND AMUSEMENT EQUIPMENT, NAMELY, SIGNAL DECODERS, ELECTRICAL WIRE, ELECTRICAL WIRE CONNECTORS, INTEGRATED CIRCUITS, PRINTED CIRCUITS, ELECTRIC CIRCUITS, CIRCUIT BREAKERS, PRINTED CIRCUIT BOARDS, ELECTRIC CIRCUIT BOARDS, CIRCUIT CONNECTORS, ELECTRICAL CONTROLLERS, ELECTRICAL CONVERTERS, ELECTRICAL FUSES, ELECTRIC LUMINESCENT DISPLAY PANELS, ELECTRICAL SWITCH PLATES, ELECTRIC PLUGS, ANTENNAS, ELECTRICAL CABLES, COM-

PUTER CABLES, COMPUTER CHIPS, SILICON CHIPS, CHRONOGRAPHS FOR USE AS SPECIALIZED TIME RECORDING APPARATUS, ELECTRIC COILS, COMPUTER BUFFERS, BLANK COMPUTER DISCS, BLANK COMPUTER FLOPPY DISKS, COMPUTER HARD DISCS, ELECTRICAL CONDUCTORS, ACOUSTIC CONDUITS, ELECTRICAL CONDUITS, FIBER OPTIC CONDUITS AND PARTS THEREOF; COMPACT DISC PLAYERS, AUDIO AND VIDEO TAPE RECORDERS, AUDIO AND VIDEO TAPE PLAYERS, AUDIO AND VIDEO CASSETTE RECORDERS, AUDIO AND VIDEO CASSETTE PLAYERS, BLANK AUDIO AND VIDEO TAPES, CASSETTES, DISCS AND MICROFICHE; AUDIO AND VIDEO TAPES, CASSETTES, DISCS AND MICROFICHE FEATURING INFORMATION CONCERNING TELECOMMUNICATIONS, AND CONCERNING PERSONAL AND BUSINESS MANAGEMENT SYSTEMS; AUDIO AND VIDEO RECORDINGS IN THE FIELD OF TELECOMMUNICATIONS, INFORMATION TECHNOLOGY, SAFETY; TELEVISION AND TELEVISION PERIPHERAL EQUIPMENT, NAMELY CAMERAS, SET BOXES, REMOTE CONTROL UNITS FOR INTERACTIVE AND NON-INTERACTIVE USE; COMPUTER MEMORY, COMPUTER PERIPHERALS AND MODEMS; VIDEO MONITORS, AUTOMATIC VENDING MACHINES AND TIMING MECHANISMS THEREFOR, AND PARTS THEREOF; MACHINE READABLE, MAGNETICALLY ENCODED CARDS, NAMELY, TELEPHONE CALLING CARDS AND CREDIT CARDS; SMART CARDS; DATA PROCESSORS AND READERS, WORD PROCESSORS, MAGNETIC CODED CARD READERS, MAGNETIC CODED CARDS, ELECTRONIC ENCRYPTION UNITS, LASERS NOT FOR MEDICAL USE, LIGHT EMITTING DIODES, LIGHT EMITTING DIODE DISPLAYS, MICROPROCESSORS, BLANK DATA CARRIERS, DEMAGNETIZERS FOR MAGNETIC TAPES, AND PARTS THEREOF; COMPUTER, DATA AND VIDEO NETWORKING AND CONFERENCING EQUIPMENT, NAMELY, TELECONFERENCING EQUIPMENT AND AUDIOVISUAL TEACHING EQUIPMENT IN THE NATURE OF OVERHEAD FILM, PHOTOGRAPHIC AND SLIDE PROJECTORS, PROJECTION SCREENS, COMPUTER BASED INFORMATION DISPLAY EQUIPMENT, NAMELY, COMPUTERS WHICH DISPLAY INFORMATION ON AN OVERHEAD SCREEN, INTERCOMS; TELEPHONES, TELEPHONE ANSWERING MACHINES, TELEPHONE TRANSMITTERS, TELEPHONE NETWORKS, TELEPHONE WIRES, TELEPRINTERS, TELETYPEWRITERS, AND PARTS THEREOF, NAMELY, CALLER IDENTIFICATION BOXES, DIALING ASSEMBLIES, TELEPHONE UNITS, AUDIO OPERATED RELAYS, AUDIO OPERATED RELAYS, AUDIO/VIDEO SIGNAL AND OPTICAL FILTERS, PROTECTORS AND AUTOMATIC SIGNALING AND CONTROL EQUIPMENT, TELEMETERS, WIRELESS AND CELLULAR TELEPHONES, RADIO PAGERS, PORTABLE COMPUTER DEVICES, NAMELY LAPTOPS, HANDHELD AND POCKET COMPUTERS, FACSIMILE TRANSMITTERS AND RECEIVERS, WIRELESS FAX MACHINES, PERSONAL COMMUNICATIONS EQUIPMENT, NAMELY, PERSONAL DIGITAL ASSISTANTS (PDA), CALCULATORS AND RELATED

PERIPHERALS; SATELLITE PROCESSORS, SATELLITES AND SATELLITE COMMUNICATION EARTH STATIONS BOTH STATIONARY AND MOVEABLE; AUDIO AND VIDEO RECORDINGS IN THE FIELD OF NEWS, SPORTS, ENTERTAINMENT, CULTURE, BUSINESS AND FINANCE, WEATHER AND TRAVEL; PRERECORDED COMPACT DISCS, AUDIO CASSETTE TAPES, VIDEO CASSETTE TAPES, DIGITAL AUDIO TAPES AND DIGITAL VIDEO DISCS FEATURING MUSICAL, VARIETY, NEWS AND COMEDY SHOWS; COMPUTER GAME PROGRAMS FOR CHILDREN AND ADULTS; VIDEO AND COMPUTER GAME CARTRIDGES, IN CLASS 9 (U.S. CLS. 21, 23, 26, 36 AND 38).

FOR: PRINTED MATTER, NAMELY, TELEPHONE DIRECTORIES, BOOKS, NEWSLETTERS, PAMPHLETS, BROCHURES, MAGAZINES AND PAPERBACKS ALL IN THE FIELD OF TELECOMMUNICATIONS, STAMPED AND/OR PRINTED CARDS OF CARDBOARD OR PLASTIC, NAMELY, BASEBALL CARDS, GREETING CARDS, TRADING CARDS, TRIVIA CARDS; NOTE PAPER AND ENVELOPES, RUBBER STAMPS, NAME TAGS AND LABELS MADE FROM PAPER OR CARDBOARD, NOTEBOOKS, DIARIES, NOTE PAPERS, NOTE PADS, ADDRESS BOOKS, FOLDERS FOR LETTERS, FILES OR LOOSE PAPER, CLEAR HOLE REINFORCEMENTS, STUDENT CALENDARS, STAMP ALBUMS AND PHOTO-ALBUMS; PAPER WEIGHTS, LETTER OPENERS, BLOTTING PADS; DESK TRAYS, DESK STANDS AND HOLDERS FOR HOLDING STATIONERY AND OFFICE IMPLEMENTS; PRINTED INSTRUCTIONAL AND TEACHING MATERIALS ALL IN THE FIELDS OF TELECOMMUNICATIONS, INFORMATION TECHNOLOGY, SAFETY, NEWS, SPORTS, ENTERTAINMENT, CULTURE, BUSINESS AND FINANCE, WEATHER AND TRAVEL; STATIONERY, DRAWING AND UNGRADUATED RULERS, ERASERS, STAPLERS, STAPLES, PAPER CLIPS, BOOK MARKERS, CUTOUT SAMPLES AND STENCILS; SCRATCH PICTURES, PAPER, NAMELY, BOND PAPER AND ART PAPER, PVC STICKERS, GIFT WRAP PAPER; BLACKBOARDS, CHALK STICKS, ADHESIVES FOR STATIONERY OR HOUSEHOLD PURPOSES; DRAWING AND PAINTING MATERIALS, NAMELY, PENCILS, DRAWING PENCILS, PENS, DRAWING PENS, PAINT TRAYS, PAINTING SETS FOR ARTISTS, PAINTING SETS FOR CHILDREN, PAINT KITS, AND PENCIL CASES; NON-MAGNETICALLY ENCODED, PREPAID TELEPHONE CALLING CARDS, IN CLASS 16 (U.S. CLS. 2, 5, 22, 23, 29, 37, 38 AND 50).

FOR: TELEPHONE DIRECTORY SERVICES; ADVERTISING SERVICES, NAMELY, PREPARING AND PLACING ADVERTISEMENTS FOR OTHERS PROMOTING THE GOODS AND SERVICES OF OTHERS THROUGH PRINTED ADVERTISING, PRINTED DIRECTORIES, THROUGH ENCODED MEDIA, THROUGH THE DISSEMINATION OF PROMOTIONAL MATERIALS, THROUGH DIRECT MAIL ADVERTISING, THROUGH ELECTRONIC BILLBOARD ADVERTISING, PREPARING AUDIOVISUAL PRESENTATIONS FOR USE IN ADVERTIS-

ING; BUSINESS SERVICES, NAMELY, BUSINESS APPRAISALS, BUSINESS AUDITING, PROVIDING BUSINESS INFORMATION, NAMELY, PREPARING BUSINESS REPORTS AND CONDUCTING BUSINESS RESEARCH, ANALYSIS AND SURVEYS, BUSINESS MANAGEMENT PLANNING, BUSINESS MANAGEMENT CONSULTATION, BUSINESS MANAGEMENT SUPERVISION, CONDUCTING BUSINESS NETWORKING FOR OTHERS; BUSINESS MANAGEMENT AND CONSULTING SERVICES EXCLUDING AGRICULTURAL BUSINESS MANAGEMENT AND CONSULTING SERVICES; BUSINESS INFORMATION SERVICES IN THE FIELD OF TELECOMMUNICATIONS, ADVERTISING, INFORMATION TECHNOLOGY AND MARKETING; RENTAL OF AUTOMATIC VENDING MACHINES; ORGANIZING JOB FAIRS; RENTAL OF DATA PROCESSING EQUIPMENT; PROVIDING INFORMATION VIA THE TELEPHONE AND THE GLOBAL COMMUNICATION NETWORKS IN THE FIELD OF ADVERTISING AND BUSINESS MARKETING; PROFESSIONAL CONSULTANCY IN THE FIELD OF DATA PROCESSING, IN CLASS 35 (U.S. CLS. 100, 101 AND 102).

FOR: CLEARING OF SECURE FINANCIAL TRANSACTIONS THROUGH ONLINE SERVICES; FINANCIAL AND MONETARY SERVICES, NAMELY FINANCIAL ANALYSIS AND CONSULTATION, PROVIDING FINANCIAL INFORMATION, ISSUANCE OF SECURITIES, COMMERCIAL LENDING SERVICES, FINANCIAL PORTFOLIO MANAGEMENT, DISCOUNT BROKERAGE SERVICES, BROKERAGE OF SHARES, OF SETS AND BUSINESS VENTURES, BROKERAGE OF FUND SHARES, SECURITIES CONSULTING AND SAFE KEEPING, BROKERAGE OF PRODUCTIVE INVESTMENTS AND FUNDS; FINANCIAL SPONSORSHIP OF SPORTS, EDUCATIONAL AND ENTERTAINMENT PROGRAMS AND EVENTS; REAL ESTATE SERVICES, NAMELY BROKERAGE, MANAGEMENT, LEASING, APPRAISAL OF REAL PROPERTY; CUSTOMS BROKERAGE FOR THIRD PARTIES; MONETARY EXCHANGE; CREDIT CARD SERVICES; TELEPHONE CALLING CARD SERVICES; ELECTRONIC COMMERCE SERVICES, NAMELY, ELECTRONIC DEBIT AND CREDIT CARD PROCESSING SERVICES, FUNDS TRANSFER AND PAYMENT PROCESSING SERVICES; PROVIDING INFORMATION VIA THE TELEPHONE AND THE GLOBAL COMMUNICATION NETWORKS IN THE FIELD OF FINANCE, IN CLASS 36 (U.S. CLS. 100, 101 AND 102).

FOR: TELECOMMUNICATIONS AND INFORMATION TECHNOLOGY SERVICES, NAMELY ELECTRIC, DIGITAL, CELLULAR AND WIRELESS TRANSMISSION OF VOICE, DATA, INFORMATION, IMAGES, SIGNALS AND MESSAGES AND TRANSMISSION OF VOICE, DATA, IMAGES, AUDIO, VIDEO AND INFORMATION VIA TELEPHONE, TELEVISION AND GLOBAL COMMUNICATION NETWORKS; PROVIDING TELECOMMUNICATIONS CONNECTIONS OVER A GLOBAL COMMUNICATIONS NETWORK, ELECTRONIC MAIL, VOICE MAIL AND MESSAGING SERVICES, NAMELY, THE RECORDING

AND STORAGE AND SUBSEQUENT TRANSMISSION OF VOICE MESSAGES BY TELEPHONE; RENTAL OF TELECOMMUNICATIONS EQUIPMENT, NAMELY, EQUIPMENT FOR ELECTRONIC ACCESS TO GLOBAL TELECOMMUNICATIONS NETWORK, EQUIPMENT FOR TRANSMITTING, RECEIVING, RECORDING AND MONITORING VOICE, DATA, INFORMATION, IMAGES, SIGNALS, MESSAGES, COMPRISED OF DATA AND WORD PROCESSORS, AND TELECOMMUNICATIONS HARDWARE AND SOFTWARE INCLUDING COMPONENTS AND PERIPHERALS THEREOF FOR USE IN THE TELECOMMUNICATIONS INDUSTRY, AND RENTAL OF EQUIPMENT FOR TRANSMITTING, RECEIVING, RECORDING AND MONITORING COMPUTER PROGRAMS FOR USE IN OPERATING AND ACCESSING TELECOMMUNICATIONS SYSTEMS; AUDIO AND VIDEO BROADCASTING FEATURING ENTERTAINMENT IN THE NATURE OF LIVE VISUAL AND AUDIO PERFORMANCES, AND MUSICAL, VARIETY, NEWS AND COMEDY SHOWS; PROVIDING ACCESS TO COMPUTER INFORMATION NETWORKS; PERSONAL COMMUNICATIONS SERVICES; PAGER SERVICES; ELECTRONIC MAIL SERVICES; TRANSMISSION AND BROADCAST OF AUDIO AND VIDEO PROGRAMMING; PROVIDING MULTIPLE-USER ACCESS TO A GLOBAL COMMUNICATION NETWORK; LEASING TELECOMMUNICATIONS EQUIPMENT, COMPONENTS, SYSTEMS AND SUPPLIES; CONSULTING IN THE FIELD OF TELECOMMUNICATIONS; CONSULTING IN THE FIELDS OF TELECOMMUNICATIONS AND GLOBAL COMMUNICATION NETWORKS, IN CLASS 38 (U.S. CLS. 100, 101 AND 104).

FOR: EDUCATION AND INSTRUCTION, NAMELY, EDUCATIONAL SERVICES IN THE NATURE OF CLASSES AND SEMINARS IN THE FIELDS OF BUSINESS, TELECOMMUNICATIONS AND COMPUTERS, AND THE DISTRIBUTION OF COURSE MATERIALS THEREWITH; ENTERTAINMENT IN THE NATURE OF VISUAL AND AUDIO PERFORMANCES, NAMELY, MUSICAL BAND, ROCK GROUP, GYMNASTIC, DANCE, AND BALLET PERFORMANCES; ENTERTAINMENT SERVICES, NAMELY, PROVIDING MUSICAL, VARIETY, NEWS AND COMEDY SHOWS VIA A GLOBAL COMPUTER INFORMATION NETWORK; ENTERTAINMENT SERVICES, NAMELY, PROVIDING ONLINE COMPUTER GAMES FOR CHILDREN AND ADULTS; PROVIDING ENTERTAINMENT INFORMATION AT THE SPECIFIC REQUEST OF END-USERS BY MEANS OF TELEPHONE OR GLOBAL COMMUNICATIONS NETWORKS; ORGANIZING COMMUNITY SPORTING AND CULTURAL EVENTS; PUBLICATION OF BOOKS, MAGAZINES, JOURNALS, MANUALS, BROCHURES AND LEAFLETS ON THE SUBJECT OF TELECOMMUNICATIONS; ELECTRONIC PUBLISHING SERVICES, NAMELY, PUBLICATION OF TEXT AND GRAPHIC WORKS OF OTHERS ON TELECOMMUNICATIONS RECORDED ON ELECTRONIC MEDIA; ORGANIZING FAIRS AND EXHIBITIONS IN THE FIELD OF VISUAL AND AUDIO PERFORMANCES, NAMELY, ROCK GROUP, GYMNASTIC, DANCE, AND BAL-

LET PERFORMANCES, IN CLASS 41 (U.S. CLS. 100, 101 AND 107).

FOR: COMPUTER PROGRAMMING SERVICES FOR OTHERS; RENTAL OF SOFTWARE AND HARDWARE FOR ONLINE ACCESS; SERVICES OF AN INTERNET TRUST CENTER, NAMELY, ASSURANCE AND ADMINISTRATION OF DIGITAL KEYS AND/OR DIGITAL CERTIFICATES; GENERATION OF DATA PROCESSING PROGRAMS; WEB PAGE HOSTING SERVICES; COMPUTER SERVICES NAMELY CREATING INDEXES OF INFORMATION AVAILABLE ON COMPUTER NETWORKS; CONSULTING AND DESIGN SERVICES IN THE FIELD OF INFORMATION TECHNOLOGY, AND COMPUTER PROGRAMMING; DESIGN SERVICES IN THE FIELDS OF TELECOMMUNICATIONS AND GLOBAL COMMUNICATION NETWORKS; INSTALLATION, MAINTENANCE AND REPAIR OF COMPUTER SOFTWARE; PROVIDING GENERAL INFORMATION AT THE SPECIFIC REQUEST OF END-USERS BY MEANS OF TELEPHONE OR GLOBAL COMMUNICATIONS NETWORKS, IN CLASS 42 (U.S. CLS. 100 AND 101).

PRIORITY CLAIMED UNDER SEC. 44(D) ON FED REP GERMANY APPLICATION NO. 30217935.6, FILED 4-12-2002, REG. NO. 30217935, DATED 6-18-2002, EXPIRES 4-30-2012.

NO CLAIM IS MADE TO THE EXCLUSIVE RIGHT TO USE MONEY, APART FROM THE MARK AS SHOWN.

THE APPLICANT IS CLAIMING THE COLORS MAGENTA, WHITE, AND GREY AS FEATURES OF THE MARK.

THE MARK CONSISTS OF THE CIRCLE AROUND THE LETTER "T" IS MAGENTA; THE LETTER "T" IN A CIRCLE AND THE LINE FOLLOWING FROM THE LETTER "T" ARE WHITE; AND THE WORD "KIDS" IS GREY.

SER. NO. 76-459,066, FILED 10-15-2002.

JOHN KELLY, EXAMINING ATTORNEY

Int. Cls.: 9, 16, 35, 36, 38, 39, 41 and 42

**Prior U.S. Cls.: 2, 5, 21, 22, 23, 26, 29, 36, 37, 38, 50,
100, 101, 102, 104, 105 and 107**

Reg. No. 3,574,349

United States Patent and Trademark Office

Registered Feb. 17, 2009

**TRADEMARK
SERVICE MARK
PRINCIPAL REGISTER**



DEUTSCHE TELEKOM AG (FED REP GERMA-
NY CORPORATION)
FRIEDRICH-EBERT-ALLEE 140
53113 BONN, FED REP GERMANY

FOR: ELECTRIC, ELECTRONIC, OPTICAL, MEASURING, SIGNALING, CONTROLLING AND TEACHING APPARATUS AND INSTRUMENTS, ALL FOR USE WITH TELECOMMUNICATIONS, NAMELY APPARATUS FOR PRODUCING SOUND, IMAGES OR DATA, NAMELY, MAGNETIC AND OPTICAL DATA CARRIERS, DATA PROCESSORS AND COMPUTERS, NAMELY, MICROCOMPUTERS, MINICOMPUTERS, COMPUTER CENTRAL PROCESSORS, COMPUTER MONITORS, COMPUTER KEYBOARDS, COMPUTER TERMINALS, COMPUTER INTERFACE BOARDS, COMPUTER MEMORIES, COMPUTER LASER PRINTERS, COMPUTER IMPACT PRINTERS, COMPUTER DOT MATRIX PRINTERS, COMPUTER OPERATING SYSTEMS, COMPUTERS AND INSTRUCTIONAL MANUALS SOLD AS A UNIT, COMPUTER INTERFACE APPARATUS, NAMELY, COMPUTER MODEMS, COMPUTER MOUSE AND MOUSE PACT, COMPUTER PERIPHERALS AND PARTS THEREOF; COMPUTER PROGRAMS AND DATABASES FOR USE IN OPERATING TELECOMMUNICATIONS AND BUSINESS MANAGEMENT SYSTEMS AND RELATED INSTRUCTION MANUALS SOLD AS A UNIT; COMPUTER PROGRAMS, NAMELY, FINANCIAL ACCOUNTING SYSTEM SOFTWARE, SOFTWARE USED FOR THE PROVISION OF ON-LINE INFORMATION SERVICES, NETWORK MANAGEMENT SOFTWARE, COMPUTER PROXY SOFTWARE FOR USE WITH OTHER SOFTWARE PROGRAMS, ALARM MONITORING SOFTWARE, BILLING ANALYSIS SOFTWARE, AND SOFTWARE FOR NETWORK ACCESS CONTROL,

CREATING AND MAINTAINING FIREWALLS; COMPUTER PROGRAMS FOR ACCESSING A GLOBAL COMPUTER NETWORK AND INTERACTIVE COMPUTER COMMUNICATIONS NETWORK; OPTICAL CABLES, OPTIC FILTERS, OPTICAL SCANNERS, OPTICAL CHARACTER READERS, OPTICAL DISCS, OPTICAL FIBERS, OPTICAL GLASS FOR SIGNAL TRANSMISSION, OPTIC TRANSMITTERS, OPTIC RECEIVERS, OPTICAL SIGNAL PROCESSING APPARATUS, OPTIC SWITCHES, OPTICAL ATTENUATORS, OPTICAL AMPLIFIERS, OPTICAL CHARACTER RECOGNITION APPARATUS, AND PARTS THEREOF; AUDIO, VIDEO AND DATA COMMUNICATIONS SYSTEMS, NAMELY, DIGITAL AND ANALOGUE SIGNAL TRANSMITTERS, RECEIVERS AND CONVERTERS, RADIO AND TELEPHONE TRANSMITTERS, RECEIVERS AND SERVERS, ANSWERING MACHINES, TELECOMMUNICATION TRANSMISSION, RECEIVING AND STORAGE APPARATUS, NAMELY, TELECOMMUNICATIONS TRANSMITTING SETS, DATA TRANSMITTERS, FACSIMILE MACHINES, ELECTRONIC MAIL APPARATUS FOR ELECTRONIC EXCHANGE OF DATA IMAGES AND MESSAGES, REMOTE CONTROLS AND SET-TOP UNITS FOR TELEVISION, CINEMATOGRAPHIC TELEVISION AND AMUSEMENT EQUIPMENT, NAMELY, SIGNAL DECODERS, ELECTRICAL WIRE, ELECTRICAL WIRE CONNECTORS, INTEGRATED CIRCUITS, PRINTED CIRCUITS, ELECTRIC CIRCUITS, CIRCUIT BREAKERS, PRINTED CIRCUIT BOARDS, ELECTRIC CIRCUIT BOARDS, CIRCUIT CONNECTORS, ELECTRICAL CONTROLLERS, ELECTRICAL CONVERTERS, ELECTRICAL FUSES, ELECTRIC LUMINESCENT DISPLAY PANELS, ELECTRICAL SWITCH PLATES, ELECTRIC PLUGS, ANTENNAS, ELECTRICAL CABLES, COMPUTER CABLES, COMPUTER CHIPS, SILICON

CHIPS, CHRONOGRAPHS FOR USE AS SPECIALIZED TIME RECORDING APPARATUS, ELECTRIC COILS, COMPUTER BUFFERS, BLANK COMPUTER DISCS, BLANK COMPUTER FLOPPY DISKS, COMPUTER HARD DISCS, ELECTRICAL CONDUCTORS, ACOUSTIC CONDUITS, ELECTRICAL CONDUITS, FIBER OPTIC CONDUITS AND PARTS THEREOF; COMPACT DISC PLAYERS, AUDIO AND VIDEO TAPE RECORDERS, AUDIO AND VIDEO TAPE PLAYERS, AUDIO AND VIDEO CASSETTE RECORDERS, AUDIO AND VIDEO CASSETTE PLAYERS, BLANK AUDIO AND VIDEO TAPES, CASSETTES, DISCS AND MICROFICHE; AUDIO AND VIDEO TAPES, CASSETTES, DISCS AND MICROFICHE FEATURING INFORMATION CONCERNING TELECOMMUNICATIONS, AND CONCERNING PERSONAL AND BUSINESS MANAGEMENT SYSTEMS; AUDIO AND VIDEO RECORDINGS IN THE FIELD OF TELECOMMUNICATIONS, INFORMATION TECHNOLOGY, SAFETY - TELEVISION AND TELEVISION PERIPHERAL EQUIPMENT, NAMELY CAMERAS, SET BOXES, REMOTE CONTROL UNITS FOR INTERACTIVE AND NON-INTERACTIVE USE; COMPUTER MEMORY COMPUTER PERIPHERALS AND MODEMS; VIDEO MONITORS, AUTOMATIC VENDING MACHINES AND TIMING MECHANISMS THEREFOR, AND PARTS THEREON MACHINE READABLE, MAGNETICALLY ENCODED CARDS, NAMELY TELEPHONE CALLING CARDS AND CREDIT CARDS; SMART CARDS; DATA PROCESSORS AND READERS, WORD PROCESSORS, MAGNETIC CODED CARD READERS, MAGNETIC CODED CARDS, ELECTRONIC ENCRYPTION UNITS, LASERS NOT FOR MEDICAL USE, LIGHT EMITTING DIODES, LIGHT EMITTING DIODE DISPLAYS, MICROPROCESSORS, BLANK DATA CARRIERS, DEMAGNETIZERS FOR MAGNETIC TAPES, AND PARTS THEREOF; COMPUTER, DATA AND VIDEO NETWORKING AND CONFERENCING EQUIPMENT, NAMELY, TELECONFERENCING EQUIPMENT AND AUDIOVISUAL TEACHING EQUIPMENT IN THE NATURE OF OVERHEAD FILM, PHOTOGRAPHIC AND SLIDE PROJECTORS, PROJECTION SCREENS, COMPUTER BASED INFORMATION DISPLAY EQUIPMENT, NAMELY, COMPUTERS WHICH DISPLAY INFORMATION ON AN OVERHEAD SCREEN, INTERCOMS; TELEPHONES, TELEPHONE ANSWERING MACHINES, TELEPHONE TRANSMITTERS, TELEPHONE NETWORKS, TELEPHONE WIRES, TELEPRINTERS, TELETYPEWRITERS, ARID PARTS THEREOF, NAMELY, CALLER IDENTIFICATION BOXES, DIALING ASSEMBLIES, TELEPHONE UNITS, AUDIO OPERATED RELAYS, AUDIO OPERATED RELAYS, AUDIO/VIDEO SIGNAL AND OPTICAL FILTERS, PROTECTORS AND AUTOMATIC SIGNALING AND CONTROL EQUIPMENT, TELEMETERS, WIRELESS AND CELLULAR TELEPHONES, RADIO PAGERS, PORTABLE COMPUTER DEVICES, NAMELY LAPTOPS, HANDHELD AND POCKET COMPUTERS, FACSIMILE TRANSMITTERS AND RECEIVERS, WIRELESS FAX MACHINES, PERSONAL COMMUNICATIONS EQUIPMENT, NAMELY, PERSONAL DIGITAL ASSISTANTS (PDA), CALCULATORS AND RELATED PERIPHERALS; SATELLITE PROCESSORS, SATEL-

LITES AND SATELLITE COMMUNICATION EARTH STATIONS BOTH STATIONARY AND MOVEABLE; PRERECORDED COMPACT DISCS, AUDIO CASSETTE TAPES, VIDEO CASSETTE TAPES DIGITAL AUDIO TAPES AND DIGITAL VIDEO DISCS FEATURING VARIETY SHOWS; COMPUTER GAME PROGRAMS FOR CHILDREN AND ADULTS; VIDEO AND COMPUTER GAME CARTRIDGES, IN CLASS 9 (U.S. CLS. 21, 23, 26, 36 AND 38).

FOR: PRINTED MATTER, NAMELY, TELEPHONE DIRECTORIES, BOOKS, NEWSLETTERS, PAMPHLETS, BROCHURES, MAGAZINES AND PAPERBACKS ALL IN THE FIELD OF TELECOMMUNICATIONS, PRINTED AND STAMPED PLASTIC AND CARDBOARD GREETING, BLANK, NOTE, AND INDEX CARDS; NOTE PAPER AND ENVELOPES, RUBBER STAMPS, NAME TAGS AND LABELS MADE FROM PAPER OR CARDBOARD, NOTEBOOKS, DIARIES, NOTE PAPERS, NOTE PADS, ADDRESS BOOKS, FOLDERS FOR LETTERS, FILES OR LOOSE PAPER, CLEAR HOLE REINFORCEMENTS, STUDENT CALENDARS, STAMP ALBUMS AND PHOTO-ALBUMS; PAPER WEIGHTS, LETTER OPENERS, BLOTTING PADS; DESK TRAYS, DESK STANDS AND HOLDERS FOR HOLDING STATIONERY AND OFFICE IMPLEMENTS; PRINTED INSTRUCTIONAL AND TEACHING MATERIALS ALL IN THE FIELDS OF TELECOMMUNICATIONS, INFORMATION TECHNOLOGY, BUSINESS AND FINANCE; STATIONERY, DRAWING AND UNGRADUATED RULERS, ERASERS, STAPLERS, STAPLES, PAPER CLIPS, BOOK MARKERS, CUTOUT SAMPLES AND STENCILS; SCRATCH PICTURES, PAPER, NAMELY, BOND PAPER AND AN PAPER, PVC STICKERS, GIFT WRAP PAPER; BLACKBOARDS, CHALK STICKS, ADHESIVES FOR STATIONERY OR HOUSEHOLD PURPOSES; DRAWING AND PAINTING MATERIALS, NAMELY, PENCILS, DRAWING PENCILS, PENS, DRAWING PENS, PAINT WAYS, PAINTING SETS FOR ARTISTS, PAINTING SETS FOR CHILDREN, PAINT KITS AND PENCIL CASES; NON-MAGNETICALLY ENCODED, PREPAID TELEPHONE CALLING CARDS, IN CLASS 16 (U.S. CLS. 2, 5, 22, 23, 29, 37, 38 AND 50).

FOR: ADVERTISING SERVICES, NAMELY, PREPARING AND PLACING ADVERTISEMENTS FOR OTHERS PROMOTING THE GOODS AND SERVICES OF OTHERS THROUGH PRINTED ADVERTISING, PRINTED DIRECTORIES, THROUGH ENCODED MEDIA, THROUGH THE DISSEMINATION OF PROMOTIONAL MATERIALS, THROUGH DIRECT MAIL ADVERTISING, THROUGH ELECTRONIC BILLBOARD ADVERTISING, PREPARING AUDIO-VISUAL PRESENTATIONS FOR USE IN ADVERTISING; BUSINESS SERVICES, NAMELY, BUSINESS APPRAISALS BUSINESS AUDITING, PROVIDING BUSINESS INFORMATION, NAMELY, PREPARING BUSINESS REPORTS AND CONDUCTING BUSINESS RESEARCH, ANALYSIS AND SURVEYS, BUSINESS MANAGEMENT PLANNING, BUSINESS MANAGEMENT CONSULTATION, BUSINESS MANAGEMENT SUPERVISION, CONDUCTING BUSINESS

NETWORKING FOR OTHERS; BUSINESS MANAGEMENT AND CONSULTING SERVICES EXCLUDING AGRICULTURAL BUSINESS MANAGEMENT AND CONSULTING SERVICES; BUSINESS INFORMATION SERVICES IN THE FIELD OF TELECOMMUNICATIONS, ADVERTISING, INFORMATION TECHNOLOGY, MARKETING AND RELATED FIELDS; RENTAL OF DATA PROCESSING EQUIPMENT; PROFESSIONAL CONSULTANCY IN THE FIELD OF DATA PROCESSING; PROVIDING INFORMATION VIA THE TELEPHONE AND THE GLOBAL COMMUNICATION NETWORKS IN THE FIELD OF ADVERTISING AND BUSINESS MARKETING, IN CLASS 35 (U.S. CLS. 100, 101 AND 102).

FOR: INSURANCE SERVICES, NAMELY, INSURANCE BROKERAGE, INSURANCE CLAIMS PROCESSING; CLEARING OF SECURE FINANCIAL TRANSACTIONS THROUGH ONLINE SERVICES; FINANCIAL AND MONETARY SERVICES, NAMELY FINANCIAL ANALYSIS AND CONSULTATION, PROVIDING FINANCIAL INFORMATION, ISSUANCE OF SECURITIES, COMMERCIAL LENDING SERVICES, FINANCIAL PORTFOLIO MANAGEMENT, DISCOUNT BROKERAGE SERVICES, BROKERAGE OF SHARES, OF SETS AND BUSINESS VENTURES, BROKERAGE OF FUND SHARES, SECURITIES CONSULTING AND SAFE KEEPING, BROKERAGE OF PRODUCTIVE INVESTMENTS AND FUNDS; FINANCIAL SPONSORSHIP OF SPORTS, EDUCATIONAL AND ENTERTAINMENT PROGRAMS AND EVENTS; REAL ESTATE SERVICES, NAMELY BROKERAGE, MANAGEMENT, LEASING, APPRAISAL OF REAL PROPERTY; CUSTOMS BROKERAGE FOR THIRD PARTIES; MONETARY EXCHANGE; CREDIT CARD SERVICES; TELEPHONE CALLING CARD SERVICES; ELECTRONIC COMMERCE SERVICES, NAMELY, ELECTRONIC DEBIT AND CREDIT CARD PROCESSING SERVICES, FUNDS TRANSFER AND PAYMENT PROCESSING SERVICES; PROVIDING INFORMATION VIA THE TELEPHONE AND THE GLOBAL COMMUNICATION NETWORKS IN THE FIELD OF FINANCE, IN CLASS 36 (U.S. CLS. 100, 101 AND 102).

FOR: TELECOMMUNICATIONS AND INFORMATION TECHNOLOGY SERVICES, NAMELY ELECTRIC, DIGITAL, CELLULAR AND WIRELESS TRANSMISSION OF VOICE, DATA, INFORMATION, IMAGES, SIGNALS AND MESSAGES AND TRANSMISSION OF VOICE, DATA, IMAGES, AUDIO, VIDEO AND INFORMATION VIA TELEPHONE, TELEVISION AND GLOBAL COMMUNICATION NETWORKS; PROVIDING TELECOMMUNICATIONS CONNECTIONS OVER A GLOBAL COMMUNICATIONS NETWORK, ELECTRONIC MAIL, VOICE MAIL AND MESSAGING SERVICES, NAMELY, THE RECORDING AND STORAGE AND SUBSEQUENT TRANSMISSION OF VOICE MESSAGES BY TELEPHONE; RENTAL OF TELECOMMUNICATIONS EQUIPMENT, NAMELY, EQUIPMENT FOR ELECTRONIC ACCESS TO GLOBAL TELECOMMUNICATIONS NETWORK, EQUIPMENT FOR TRANSMITTING, RECEIVING, RECORDING AND MONITORING

VOICE, DATA, INFORMATION, IMAGES, SIGNALS, MESSAGES, COMPRISED OF DATA AND WORD PROCESSORS, AND TELECOMMUNICATIONS HARDWARE AND SOFTWARE INCLUDING COMPONENTS AND PERIPHERALS THEREOF FOR USE IN THE TELECOMMUNICATIONS INDUSTRY, AND RENTAL OF EQUIPMENT FOR TRANSMITTING, RECEIVING, RECORDING AND MONITORING COMPUTER PROGRAMS FOR USE IN OPERATING AND ACCESSING TELECOMMUNICATIONS SYSTEMS; AUDIO AND VIDEO BROADCASTING FEATURING ENTERTAINMENT IN THE NATURE OF LIVE VISUAL AND AUDIO PERFORMANCES AND VARIETY SHOWS; PROVIDING ACCESS TO COMPUTER INFORMATION NETWORKS; PERSONAL COMMUNICATIONS SERVICES; PAGER SERVICES; ELECTRONIC MAIL SERVICES; TRANSMISSION AND BROADCAST OF AUDIO AND VIDEO PROGRAMMING; PROVIDING MULTIPLE-USER COMPONENTS, SYSTEMS AND SUPPLIES; CONSULTING IN THE FIELD OF TELECOMMUNICATIONS; CONSULTING IN THE FIELDS OF TELECOMMUNICATIONS AND GLOBAL COMMUNICATION NETWORKS, IN CLASS 38 (U.S. CLS. 100, 101 AND 104).

FOR: WAREHOUSE STORAGE OF GOODS; STORAGE OF GOODS RELATING TO TELECOMMUNICATIONS, COMPUTERS AND OTHER INFORMATION TECHNOLOGY DEVICES; TRANSPORTATION OF GOODS BY TRUCK, SHIP, RAILWAY AND PLANE; ELECTRONIC STORAGE OF INFORMATION IN THE NATURE OF FILES AND DOCUMENTS, IN CLASS 39 (U.S. CLS. 100 AND 105).

FOR: EDUCATION AND INSTRUCTION, NAMELY, EDUCATIONAL SERVICES IN THE NATURE OF CLASSES AND SEMINARS IN THE FIELDS OF BUSINESS, TELECOMMUNICATIONS AND COMPUTERS, AND THE DISTRIBUTION OF COURSE MATERIALS THEREWITH; ENTERTAINMENT IN THE NATURE OF VISUAL AND AUDIO PERFORMANCES, NAMELY, ROCK GROUP, GYMNASTIC, DANCE, AND BALLET PERFORMANCES; ENTERTAINMENT SERVICES, NAMELY, PROVIDING VARIETY SHOWS VIA A GLOBAL COMPUTER INFORMATION NETWORK; ENTERTAINMENT SERVICES, NAMELY, PROVIDING ONLINE COMPUTER GAMES FOR CHILDREN AND ADULTS; PROVIDING ENTERTAINMENT INFORMATION AT THE SPECIFIC REQUEST OF END-USERS BY MEANS OF TELEPHONE OR GLOBAL COMMUNICATIONS NETWORKS; PUBLICATION OF BOOKS, MAGAZINES, JOURNALS, MANUALS, BROCHURES AND LEAFLETS ON THE SUBJECT OF TELECOMMUNICATIONS; ELECTRONIC PUBLISHING SERVICES, NAMELY, PUBLICATION OF TEXT AND GRAPHIC WORKS OF OTHERS ON TELECOMMUNICATIONS RECORDED ON ELECTRONIC MEDIA; ORGANIZATION OF SPORTING AND CULTURAL EVENTS, IN CLASS 41 (U.S. CLS. 100, 101 AND 107).

FOR: COMPUTER PROGRAMMING SERVICES FOR OTHERS; RENTAL OF SOFTWARE AND HARDWARE FOR ONLINE ACCESS; SERVICES OF AN INTERNET TRUST CENTER, NAMELY,

ASSURANCE ARID ADMINISTRATION OF DIGITAL KEYS AND/OR DIGITAL CERTIFICATES; GENERATION OF DATA PROCESSING PROGRAMS; WEB PAGE HOSTING SERVICES; COMPUTER SERVICES NAMELY CREATING INDEXES OF INFORMATION AVAILABLE ON COMPUTER NETWORKS; CONSULTING AND DESIGN SERVICES IN THE FIELD OF INFORMATION TECHNOLOGY, AND COMPUTER PROGRAMMING; DESIGN SERVICES IN THE FIELDS OF TELECOMMUNICATIONS AND GLOBAL COMMUNICATION NETWORKS; INSTALLATION, MAINTENANCE AND REPAIR OF COMPUTER SOFTWARE; PROVIDING GENERAL INFORMATION AT THE SPECIFIC REQUEST OF END-USERS BY MEANS OF TELE-

PHONE OR GLOBAL COMMUNICATIONS NETWORKS, IN CLASS 42 (U.S. CLS. 100 AND 101).

OWNER OF FED REP GERMANY REG. NO. 30054563, DATED 7-21-2000, EXPIRES 7-31-2010.

OWNER OF U.S. REG. NO. 2,367,890.

NO CLAIM IS MADE TO THE EXCLUSIVE RIGHT TO USE "MUSIC", APART FROM THE MARK AS SHOWN.

SER. NO. 76-460,027, FILED 10-17-2002.

JOHN KELLY, EXAMINING ATTORNEY

Int. Cl.: 14

Prior U.S. Cls.: 2, 27, 28 and 50

United States Patent and Trademark Office

Reg. No. 3,574,350

Registered Feb. 17, 2009

**TRADEMARK
PRINCIPAL REGISTER**



HON CORPORATION (REPUBLIC OF KOREA CORPORATION)
10-630, SHILIM-DONG
KWANACK-GU, 151-010
SEOUL, REPUBLIC OF KOREA

FOR: GOLD PLATED JEWELRY; PRECIOUS METAL, NAMELY, GOLD IN FOIL FORM; PRECIOUS METALS, NAMELY, GOLD, PLATINUM, SILVER AND ALUMINUM GOLD IN BULLION FORM; DIAMONDS; PASTE JEWELRY, NAMELY, EARRINGS, PENDANTS, NECKLACES, RINGS, AND BRACELETS; BUCKLES MADE OF PRECIOUS ME-

TALS; TIE PINS; BADGES OF PRECIOUS METALS, NAMELY, MEDALS; ORNAMENTAL PINS, NAMELY, BROOCHES WITH PRECIOUS GEMSTONES; AMULETS, NAMELY, CHARMS, IN CLASS 14 (U.S. CLS. 2, 27, 28 AND 50).

OWNER OF REPUBLIC OF KOREA REG. NO. 40-0673911, DATED 8-11-2006, EXPIRES 8-11-2016.

SER. NO. 76-461,409, FILED 10-22-2002.

BILL DAWE, EXAMINING ATTORNEY

Int. Cls.: 9, 36, 38 and 42

Prior U.S. Cls.: 21, 23, 26, 36, 38, 100, 101, 102 and 104

United States Patent and Trademark Office

Reg. No. 3,574,351

Registered Feb. 17, 2009

TRADEMARK
SERVICE MARK
PRINCIPAL REGISTER



VODAFONE GROUP PLC (UNITED KINGDOM
PUBLIC LIMITED COMPANY)
THE CONNECTION, NEWBURY
VODAFONE HOUSE
BERKSHIRE RG14 2FN, UNITED KINGDOM

FOR: ELECTRICAL, ELECTRONIC, TELECOMMUNICATIONS AND TELEPHONIC APPARATUS AND INSTRUMENTS, NAMELY, RADIOTELEPHONES, MOBILE AND FIXED TELEPHONES, RADIO AND RADIOTELEPHONE TRANSMITTERS AND RECEIVERS AND RADIO PAGERS; VIDEO TELEPHONES, PORTABLE COMPUTERS; TRANSCIVERS EMBODIED IN DOMESTIC APPLIANCES AND TV EQUIPMENT; MULTIMEDIA EQUIPMENT, NAMELY, TELEVISION AND COMPUTERS AND COMPUTERS ADAPTED FOR RECEIVING AND TRANSMITTING VOICE, DATA, VIDEO AND INFORMATION; RADIO FACSIMILE APPARATUS AND INSTRUMENTS, NAMELY, RADIO FACSIMILE MACHINES; TELEPHONE EXCHANGE APPARATUS, NAMELY, TELEPHONES, TRANSMITTERS, RECEIVERS, TELECOMMUNICATION SWITCHES, POWER CABLES AND INTEGRATED CIRCUITS; MODEMS; DATA COMMUNICATION APPARATUS AND INSTRUMENTS, NAMELY, TRANSMITTERS, RECEIVERS, PROCESSORS, MODEMS, FACSIMILE MACHINES, TELEPHONES AND PAGERS FOR COMMUNICATING ALL TYPES OF DATA; COMPUTER SOFTWARE FOR USE IN TELECOMMUNICATIONS, NAMELY, COMPUTER SOFTWARE FOR FACILITATING REMOTE ACCESS TO INFORMATION, BILLING AND CHARGING IN COMMERCE AND NETWORK PLANNING AND MAINTENANCE; MAGNETIC CODED CARDS CONTAINING PROGRAMMING WHICH ENABLES THE FUNCTIONING OF MOBILE PHONES AND PERMITS ACCESS

TO THE SERVICES PROVIDED VIA THE MOBILE PHONES; ENCODED SMART CARDS CONTAINING PROGRAMMING WHICH ENABLES THE FUNCTIONING OF MOBILE PHONES AND PERMITS ACCESS TO THE SERVICES PROVIDED VIA THE MOBILE PHONES; COMPUTER STORAGE MEDIA, NAMELY, COMPUTER MEMORY, COMPUTER PERIPHERALS, AND BLANK COMPUTER DISCS; DOWNLOADABLE DIGITAL MUSICAL SOUND RECORDINGS PROVIDED FROM A COMPUTER DATABASE OR THE INTERNET, INCLUDING MP3 INTERNET WEB SITES; BATTERY CHARGERS FOR USE WITH TELECOMMUNICATIONS APPARATUS; BATTERIES; DOWNLOADABLE VIDEO RECORDINGS, DOWNLOADABLE FILMS, DOWNLOADABLE GRAPHIC IMAGES ALL RELATING TO TELECOMMUNICATIONS, ACTION, ADVENTURE, ANIMATION, COMEDY, DRAMA, MUSIC, FICTION, NON-FICTION, SPORTS, ENTERTAINMENT, CULTURE, THE ARTS, LITERATURE, LIFESTYLES, FITNESS AND BUSINESS AND DOWNLOADABLE MUSIC SOUND RECORDINGS; ELECTRICAL AND ELECTRONIC GAME APPARATUS OTHER THAN THOSE ADAPTED FOR USE WITH TELEVISION, NAMELY, HAND HELD ELECTRONIC GAME UNITS; ELECTRONIC PERSONAL ORGANIZERS; DOWNLOADABLE RINGTONE RECORDINGS AND DOWNLOADABLE SOFTWARE FOR USE IN GRAPHICS FOR MOBILE PHONES, IN CLASS 9 (U.S. CLS. 21, 23, 26, 36 AND 38).

FOR: FINANCIAL SERVICES, NAMELY PROVIDING TEMPORARY LOANS AND TEMPORARY CREDIT IN PURCHASE AGREEMENTS FOR THE PURCHASE OF TELECOMMUNICATIONS EQUIPMENT; CREDIT CARD SERVICES; CHARGE CARD SERVICES; PROVIDING INSURANCE CONSULTA-

TION SERVICES, INSURANCE BROKERAGE SERVICES AND PROVIDING INSURANCE INFORMATION FOR THE DAMAGE, LOSS OR MALFUNCTION OF COMMUNICATIONS EQUIPMENT; PROVIDING FINANCE-RELATED INFORMATION; BANKING SERVICES, INCLUDING HOME BANKING AND INTERNET BANKING; FINANCIAL SPONSORSHIP OF SPORTS, EDUCATIONAL, ENTERTAINMENT AND CHARITABLE PROGRAMS AND EVENTS; PROMOTING THE SALE OF GOODS AND SERVICES OF OTHERS BY THE ISSUE AND REDEMPTION OF TOKENS, VOUCHERS AND POINTS, INCLUDING THOSE ACCUMULATED ON LOYALTY CARDS AND DISCOUNT CARDS; FINANCIAL GUARANTEE AND SURETY SERVICES RELATING TO COMMUNICATIONS EQUIPMENT; ELECTRONIC COMMERCE SERVICES, NAMELY, ELECTRONIC DEBIT AND CREDIT CARD PROCESSING SERVICES, FUNDS TRANSFER AND PAYMENT PROCESSING SERVICES, IN CLASS 36 (U.S. CLS. 100, 101 AND 102).

FOR: TELECOMMUNICATION SERVICES, NAMELY, PERSONAL COMMUNICATIONS SERVICES; TELECOMMUNICATION SERVICES, NAMELY, LOCAL AND LONG DISTANCE TRANSMISSION OF VOICE, DATA, AND GRAPHICS BY MEANS OF TELEPHONE, TELEGRAPHIC, CABLE AND SATELLITE TRANSMISSION; MOBILE RADIO COMMUNICATION SERVICES; MOBILE AND FIXED TELEPHONE COMMUNICATION SERVICES; SATELLITE COMMUNICATION SERVICES; CELLULAR TELEPHONE SERVICES; RADIO TELEPHONE COMMUNICATION SERVICES; RADIO FACSIMILE TRANSMISSION SERVICES; RADIO PAGING SERVICES; RADIO COMMUNICATION SERVICES, NAMELY, THE ELECTRONIC TRANSMISSION OF VOICE, DATA, FACSIMILE, VIDEO AND INFORMATION; ELECTRONIC TRANSMISSION OF MESSAGES AND DATA; CABLE RADIO TRANSMISSION; RENTAL OF TELECOMMUNICATION EQUIPMENT, NAMELY, TELEPHONES, RADIOS, RADIO TELEPHONES, AND RADIO FACSIMILE MACHINES AND EQUIPMENT AND PROVIDING SUCH EQUIPMENT ON A TEMPORARY BASIS UNDER AGREEMENTS WITH CUSTOMERS IN THE CASE OF BREAKDOWN, LOSS OR THEFT OF THE EQUIPMENT; PROVIDING COLLOCATION SERVICES FOR VOICE, VIDEO AND DATA COMMUNICATIONS APPLICATIONS; PROVIDING TELECOMMUNICATIONS CONNECTIONS TO A GLOBAL COMPUTER NETWORK; CABLE RADIO TRANSMISSION; TELEPHONE VOICE MESSAGING SERVICES; PROVIDING INFORMATION RELATING TO TELECOMMUNICATIONS; PROVIDING MULTIPLE USER ACCESS TO A GLOBAL COMPUTER INFORMATION NETWORK; ELECTRONIC MAIL SERVICES; PROVIDING ON-LINE ELECTRONIC BULLETIN BOARDS FOR TRANSMISSION OF MESSAGES AMONG COMPUTER USERS CONCERNING TELECOMMUNICATIONS, NEWS EVENTS, ACCOMMODATIONS, WEATHER, HOROSCOPES, COMPUTING, MULTIMEDIA SERVICES, THE GLOBAL COMPUTER INFORMATION NETWORK, THE SECURITY OF DWELLINGS AND BUSINESSES, A CALENDAR AND/OR DIARY SYSTEM FOR APPOINTMENTS,

TECHNOLOGY DEVELOPMENTS, PERSONAL ADDRESS SERVICES, BUSINESS, FINANCE, BANKING, TRAVEL AND SPORTS EVENTS; PROVIDING ON-LINE CHAT ROOMS FOR TRANSMISSION OF MESSAGES AMONG COMPUTER USERS CONCERNING TELECOMMUNICATIONS, NEWS EVENTS, ACCOMMODATIONS, WEATHER, HOROSCOPES, COMPUTING, MULTIMEDIA SERVICES, THE GLOBAL COMPUTER INFORMATION NETWORK, THE SECURITY OF DWELLINGS AND BUSINESSES, A CALENDAR AND/OR DIARY SYSTEM FOR APPOINTMENTS, TECHNOLOGY DEVELOPMENTS, PERSONAL ADDRESS SERVICES, BUSINESS, FINANCE, BANKING, TRAVEL AND SPORTS EVENTS; BROADCASTING AND TRANSMISSION OF RADIO OR TELEVISION PROGRAMS; VIDEO TEXT AND TELETEXT SERVICES, NAMELY, PROVIDING A TWO WAY INTERACTIVE SYSTEM FOR PROVIDING INFORMATION; MESSAGING SERVICES, NAMELY, SENDING, RECEIVING AND FORWARDING MESSAGES IN THE FORM OF TEXT, AUDIO, GRAPHIC IMAGES OR VIDEO OR A COMBINATION OF THESE FORMATS; UNIFIED MESSAGING SERVICES, NAMELY, A SERVICE WHICH PERMITS THE USER TO RETRIEVE ALL MESSAGES FROM A SINGLE SOURCE IRRESPECTIVE OF WHETHER THE MESSAGE IS IN THE FORM OF A VOICEMAIL, ELECTRONIC MAIL OR A FACSIMILE; VOICEMAIL SERVICES; PROVIDING FACILITIES AND EQUIPMENT FOR VIDEO CONFERENCING; VIDEO TELEPHONE SERVICES; PROVIDING TELECOMMUNICATIONS CONNECTIONS TO ON-LINE INFORMATION SERVICES; PROVIDING INFORMATION RELATING TO TELECOMMUNICATIONS EQUIPMENT AND OTHER TELECOMMUNICATION RELATED MATTERS; CONSULTATION IN THE FIELDS OF TELECOMMUNICATIONS AND THE GLOBAL COMPUTER INFORMATION NETWORK, IN CLASS 38 (U.S. CLS. 100, 101 AND 104).

FOR: RENTAL OF COMPUTER HARDWARE; COMPUTER CONSULTATION SERVICES; COMPUTER SERVICES, NAMELY, DESIGNING AND IMPLEMENTING NETWORK WEB PAGES FOR OTHERS; COMPUTER PROGRAMMING AND SOFTWARE DESIGN FOR OTHERS; COMPUTER SERVICES, NAMELY, PROVIDING SEARCH ENGINES FOR OBTAINING DATA ON A GLOBAL COMPUTER INFORMATION NETWORK; MAINTENANCE AND UPDATING OF COMPUTER SOFTWARE AND PROGRAMS FOR OTHERS; HOSTING THE WEBSITES OF OTHERS ON A COMPUTER SERVER FOR A GLOBAL COMPUTER NETWORK; INSTALLATION AND MAINTENANCE OF COMPUTER SOFTWARE, IN CLASS 42 (U.S. CLS. 100 AND 101).

PRIORITY CLAIMED UNDER SEC. 44(D) ON UNITED KINGDOM APPLICATION NO. 2307529, FILED 8-8-2002, REG. NO. 2307529, DATED 8-8-2002, EXPIRES 8-8-2012.

NO CLAIM IS MADE TO THE EXCLUSIVE RIGHT TO USE "LIVE!", APART FROM THE MARK AS SHOWN.

SER. NO. 76-462,142, FILED 10-23-2002.

KATHERINE STOIDES, EXAMINING ATTORNEY

Int. Cl.: 9

Prior U.S. Cls.: 21, 23, 26, 36 and 38

United States Patent and Trademark Office

Reg. No. 3,574,352

Registered Feb. 17, 2009

**TRADEMARK
PRINCIPAL REGISTER**



SANCHEZ, LUIS MANUEL RODRIGUEZ (MEX-
ICO INDIVIDUAL)
REPUBLICA DE EL SALVADOR
NO. 9, PASILLO D
COLONIA CENTRO C.P. 06000, MEXICO

FOR: BURGLAR ALARMS, AUDIO SYSTEMS
AND COMPONENTS NAMELY, RADIOS, EQUAL-
IZERS, AMPLIFIERS, SPEAKERS, COMPACT DISC
PLAYERS, VIDEO DISC PLAYERS, CASSETTE

PLAYERS AND HEADPHONE SPEAKERS, IN
CLASS 9 (U.S. CLS. 21, 23, 26, 36 AND 38).

OWNER OF MEXICO REG. NO. 722350, DATED
10-31-2001, EXPIRES 8-3-2011.

SER. NO. 76-512,569, FILED 5-8-2003.

TINA L. SNAPP, EXAMINING ATTORNEY

Int. Cls.: 15, 16, 28 and 35

**Prior U.S. Cls.: 2, 5, 21, 22, 23, 29, 36, 37, 38, 50, 100,
101 and 102**

Reg. No. 3,574,353

United States Patent and Trademark Office

Registered Feb. 17, 2009

**TRADEMARK
SERVICE MARK
PRINCIPAL REGISTER**



ORIENTAL TRADING COMPANY, INC. (NEBRASKA CORPORATION)
4206 SOUTH 108TH STREET
OMAHA, NE 68137

FOR: MUSICAL INSTRUMENTS, ALL OF WHICH ARE NOT MARKETED TO GENERAL MERCHANDISE MASS RETAILERS FOR RESALE, IN CLASS 15 (U.S. CLS. 2, 21 AND 36).

FIRST USE 5-8-2003; IN COMMERCE 5-8-2003.

FOR: SCHOOL SUPPLIES AND EDUCATIONAL CRAFT ITEMS, NAMELY, ARTS AND CRAFTS PAINT KITS, PARTY ORNAMENTS OF PAPER, PARTY ORNAMENTS OF PLASTIC, PHOTO HOLDER CARDS, STICKERS, CARDBOARD, STENCILS, PAPER BAGS, PAPER BOXES, CALENDARS, BOOKMARKS, CORKBOARDS, PAPER BANNERS, NOTEBOOKS, CORKBOARD PINS, POMPOMS, PAINT BRUSHES, PAPER DROP CLOTHS, MARKER CADDIES, ADHESIVE TAPES FOR STATIONERY OR HOUSEHOLD USE, GLUE FOR STATIONERY OR HOUSEHOLD USE, PAPER HOLE PUNCH, PENCIL SHARPENERS, PERSONAL STORAGE ORGANIZERS, PAINT APPLICATOR ROLLERS, STAMP PADS, PAPER FILTERS, CRAYONS, CHALK, DRY ERASE WRITING BOARDS, LAP BOARDS FOR READING AND WRITING, CHALKBOARDS; ART SUPPLIES AND ARTISTS' MATERIALS, NAMELY, STENCILS, CARDBOARD, NOTEBOOKS, PENS, GLUE FOR STATIONERY OR HOUSEHOLD USE, CORKBOARDS, PAPER HOLE PUNCH, PAINT BRUSHES, PAPER FILTERS, CRAYONS, PENCIL SHARPENERS, CHALK, DRY ERASE WRITING BOARDS, LAP BOARDS FOR READING AND WRITING, CHALKBOARDS, PAPER EMBOSSERS, MODELING CLAY, MOLDS FOR MODELING CLAY, COLLAGES, MAGNETIC PAPER, CELLOPHANE PAPER, PAPER DROP CLOTHS, SPONGE

STAMPS, PERSONAL STORAGE ORGANIZERS, PAINT APPLICATOR ROLLERS, AND STAMP PADS, ALL OF WHICH ARE NOT MARKETED TO GENERAL MERCHANDISE MASS RETAILERS FOR RESALE, IN CLASS 16 (U.S. CLS. 2, 5, 22, 23, 29, 37, 38 AND 50).

FIRST USE 5-8-2003; IN COMMERCE 5-8-2003.

FOR: TOYS, GAMES, AND NOVELTY ITEMS, NAMELY, PUZZLES, PLASTIC TOY JEWELS AND JEWELRY, RIBBON STICKS, FLYING DISKS, JUMP ROPES, PLASTIC ANIMALS, PLAYGROUND CONES, HOOPS, RUBBER BALLS, BEAN BAGS, TOY BUILDING BLOCKS, KALEIDOSCOPIES, PUPPETS, PLAY FOOD, TOY MASKS, FOAM WIGS; TOY MODELING DOUGH, PLAY TUNNELS, CHILDREN'S WIRE CONSTRUCTION AND ART ACTIVITY TOYS, ALL OF WHICH ARE NOT MARKETED TO GENERAL MERCHANDISE MASS RETAILERS FOR RESALE, IN CLASS 28 (U.S. CLS. 22, 23, 38 AND 50).

FIRST USE 5-8-2003; IN COMMERCE 5-8-2003.

FOR: MAIL ORDER CATALOG SERVICES IN THE FIELD OF SCHOOL SUPPLIES AND EDUCATIONAL, CRAFT, GIFT AND NOVELTY ITEMS, ART SUPPLIES, ART MATERIALS, TOYS AND MUSICAL INSTRUMENTS, ALL OF WHICH ARE NOT MARKETED TO GENERAL MERCHANDISE MASS RETAILERS FOR RESALE, IN CLASS 35 (U.S. CLS. 100, 101 AND 102).

FIRST USE 5-8-2003; IN COMMERCE 5-8-2003.

SER. NO. 76-586,885, FILED 4-15-2004.

SHARON MEIER, EXAMINING ATTORNEY

Int. Cls.: 15, 16, 28 and 35

Prior U.S. Cls.: 2, 5, 21, 22, 23, 29, 36, 37, 38, 50, 100,
101 and 102

Reg. No. 3,574,354

United States Patent and Trademark Office

Registered Feb. 17, 2009

TRADEMARK
SERVICE MARK
PRINCIPAL REGISTER



ORIENTAL TRADING COMPANY, INC. (NE-
BRASKA CORPORATION)
4206 SOUTH 108TH STREET
OMAHA, NE 68137

FOR: MUSICAL INSTRUMENTS, ALL OF WHICH
ARE NOT MARKETED TO GENERAL MERCHAN-
DISE MASS RETAILERS FOR RESALE, IN CLASS 15
(U.S. CLS. 2, 21 AND 36).

FIRST USE 5-8-2003; IN COMMERCE 5-8-2003.

FOR: SCHOOL SUPPLIES AND EDUCATIONAL
CRAFT ITEMS, NAMELY, ARTS AND CRAFTS
PAINT KITS, PARTY ORNAMENTS OF PAPER,
PARTY ORNAMENTS OF PLASTIC, PHOTO HOLD-
ER CARDS, STICKERS, CARDBOARD, STENCILS,
PAPER BAGS, PAPER BOXES, CALENDARS, BOOK-
MARKS, CORKBOARDS, PAPER BANNERS, NOTE-
BOOKS, CORKBOARD PINS, POMPOMS, PAINT
BRUSHES, PAPER DROP CLOTHS, MARKER CAD-
DIES, ADHESIVE TAPES FOR STATIONERY OR
HOUSEHOLD USE, GLUE FOR STATIONERY OR
HOUSEHOLD USE, PAPER HOLE PUNCH, PENCIL
SHARPENERS, PERSONAL STORAGE ORGANI-
ZERS, PAINT APPLICATOR ROLLERS, STAMP
PADS, PAPER FILTERS, CRAYONS, CHALK, DRY
ERASE WRITING BOARDS, LAP BOARDS FOR
READING AND WRITING, CHALKBOARDS; ART
SUPPLIES AND ARTISTS' MATERIALS, NAMELY,
STENCILS, CARDBOARD, NOTEBOOKS, PENS,
GLUE FOR STATIONERY OR HOUSEHOLD USE,
CORKBOARDS, PAPER HOLE PUNCH, PAINT
BRUSHES, PAPER FILTERS, CRAYONS, PENCIL
SHARPENERS, CHALK, DRY ERASE WRITING
BOARDS, LAP BOARDS FOR READING AND

WRITING, CHALKBOARDS, PAPER EMBOSSERS,
MODELING CLAY, MOLDS FOR MODELING
CLAY, COLLAGES, MAGNETIC PAPER, CELLO-
PHANE PAPER, PAPER DROP CLOTHS, SPONGE
STAMPS, PERSONAL STORAGE ORGANIZERS,
PAINT APPLICATOR ROLLERS, AND STAMP
PADS, ALL OF WHICH ARE NOT MARKETED TO
GENERAL MERCHANDISE MASS RETAILERS
FOR RESALE, IN CLASS 16 (U.S. CLS. 2, 5, 22, 23,
29, 37, 38 AND 50).

FIRST USE 5-8-2003; IN COMMERCE 5-8-2003.

FOR: TOYS, GAMES, AND NOVELTY ITEMS,
NAMELY, PUZZLES, PLASTIC TOY JEWELS AND
JEWELRY, RIBBON STICKS, FLYING DISKS, JUMP
ROPES, PLASTIC ANIMALS, PLAYGROUND
CONES, HOOPS, RUBBER BALLS, BEAN BAGS,
TOY BUILDING BLOCKS, KALEIDOSCOPES, PUP-
PETS, PLAY FOOD, TOY MASKS, FOAM WIGS; TOY
MODELING DOUGH, PLAY TUNNELS, CHIL-
DREN'S WIRE CONSTRUCTION AND ART ACTIV-
ITY TOYS, ALL OF WHICH ARE NOT MARKETED
TO GENERAL MERCHANDISE MASS RETAILERS
FOR RESALE, IN CLASS 28 (U.S. CLS. 22, 23, 38 AND
50).

FIRST USE 5-8-2003; IN COMMERCE 5-8-2003.

FOR: MAIL ORDER CATALOG SERVICES IN
THE FIELD OF SCHOOL SUPPLIES AND EDUCA-
TIONAL, CRAFT, GIFT AND NOVELTY ITEMS,
ART SUPPLIES, ART MATERIALS, TOYS AND
MUSICAL INSTRUMENTS, ALL OF WHICH ARE
NOT MARKETED TO GENERAL MERCHANDISE

MASS RETAILERS FOR RESALE, IN CLASS 35 (U.S.
CLS. 100, 101 AND 102).

SER. NO. 76-586,891, FILED 4-15-2004.

FIRST USE 5-8-2003; IN COMMERCE 5-8-2003.

SHARON MEIER, EXAMINING ATTORNEY

Int. Cls.: 25 and 35

Prior U.S. Cls.: 22, 39, 100, 101 and 102

United States Patent and Trademark Office

Reg. No. 3,574,355

Registered Feb. 17, 2009

**TRADEMARK
SERVICE MARK
PRINCIPAL REGISTER**



AMERICAN APPAREL, INC. (CALIFORNIA CORPORATION)
747 WAREHOUSE STREET
LOS ANGELES, CA 90021

FOR: CLOTHING, NAMELY, T-SHIRTS, TANK TOPS, TOPS, SHIRTS, JACKETS, PANTS, SKIRTS, SHORTS, SKORTS, SLEEPWEAR, UNDERWEAR, HEADWEAR, SCARVES, SWIM WEAR, BELTS, AND NECKWEAR; FOOTWEAR, IN CLASS 25 (U.S. CLS. 22 AND 39).

FIRST USE 0-0-1988; IN COMMERCE 0-0-1988.

FOR: RETAIL STORE SERVICES, ONLINE RETAIL STORE SERVICES, AND MAIL ORDER CATALOG SERVICES IN THE FIELD OF CLOTHING AND CLOTHING ACCESSORIES FOR MEN, WOMEN, CHILDREN AND PETS; WHOLESALE DISTRIBUTORSHIP FEATURING CLOTHING AND

CLOTHING ACCESSORIES FOR MEN, WOMEN, CHILDREN AND PETS; ON-LINE WHOLESALE ORDERING SERVICES IN THE FIELD OF CLOTHING AND CLOTHING ACCESSORIES FOR MEN, WOMEN, CHILDREN AND PETS; AND PROVIDING GIFT, PRODUCT AND SERVICE INFORMATION TO CUSTOMERS IN THE FIELD OF CLOTHING AND CLOTHING ACCESSORIES FOR MEN, WOMEN, CHILDREN & PETS., IN CLASS 35 (U.S. CLS. 100, 101 AND 102).

FIRST USE 0-0-1988; IN COMMERCE 0-0-1988.

OWNER OF U.S. REG. NOS. 2,063,013 AND 2,359,401.

SER. NO. 76-624,847, FILED 12-16-2004.

HOWARD SMIGA, EXAMINING ATTORNEY

Int. Cl.: 16

Prior U.S. Cls.: 2, 5, 22, 23, 29, 37, 38 and 50

United States Patent and Trademark Office

Reg. No. 3,574,356

Registered Feb. 17, 2009

**TRADEMARK
PRINCIPAL REGISTER**

PLAN - IT

AVALANCHE PUBLISHING ACQUISITION, INC.
(DELAWARE CORPORATION)
514 WELLS STREET
DELAFIELD, WI 53018

THE MARK CONSISTS OF STANDARD CHARACTERS WITHOUT CLAIM TO ANY PARTICULAR FONT, STYLE, SIZE, OR COLOR.

FOR: CALENDARS WITH STORAGE POCKETS, STICKERS, AND EASY WRITE-ON GRIDS TO HELP PEOPLE STAY ORGANIZED, IN CLASS 16 (U.S. CLS. 2, 5, 22, 23, 29, 37, 38 AND 50).

SER. NO. 76-625,219, FILED 12-21-2004.

FIRST USE 5-1-1998; IN COMMERCE 7-21-1998.

ANDREW RHIM, EXAMINING ATTORNEY

Int. Cl.: 9

Prior U.S. Cls.: 21, 23, 26, 36 and 38

United States Patent and Trademark Office

Reg. No. 3,574,357

Registered Feb. 17, 2009

**TRADEMARK
PRINCIPAL REGISTER**

TRAVEL MATE

VECTOR PRODUCTS, INC. (FLORIDA CORPORATION)
4140 S.W. 28TH WAY
FT. LAUDERDALE, FL 33312

THE MARK CONSISTS OF STANDARD CHARACTERS WITHOUT CLAIM TO ANY PARTICULAR FONT, STYLE, SIZE, OR COLOR.

FOR: AC/DC CONVERTERS, IN CLASS 9 (U.S. CLS. 21, 23, 26, 36 AND 38).

SER. NO. 76-626,978, FILED 1-5-2005.

FIRST USE 3-0-2002; IN COMMERCE 3-0-2002.

TEJBIR SINGH, EXAMINING ATTORNEY

Int. Cl.: 25

Prior U.S. Cls.: 22 and 39

United States Patent and Trademark Office

Reg. No. 3,574,358

Registered Feb. 17, 2009

**TRADEMARK
PRINCIPAL REGISTER**

TURBO PHANTOM

ASICS CORPORATION (JAPAN CORPORATION)
1-1, MINATOJIMA-NAKAMACHI 7-CHOME
CHUO-KU, KOBE 650-8555, JAPAN

THE MARK CONSISTS OF STANDARD CHAR-
ACTERS WITHOUT CLAIM TO ANY PARTICULAR
FONT, STYLE, SIZE, OR COLOR.

FOR: FOOTWEAR, IN CLASS 25 (U.S. CLS. 22 AND
39).

SER. NO. 76-653,000, FILED 1-6-2006.

FIRST USE 12-2-2005; IN COMMERCE 12-2-2005.

NAAKWAMA ANKRAH, EXAMINING ATTORNEY

Int. Cls.: 6, 9 and 20

**Prior U.S. Cls.: 2, 12, 13, 14, 21, 22, 23, 25, 26, 32, 36,
38 and 50**

Reg. No. 3,574,359

United States Patent and Trademark Office

Registered Feb. 17, 2009

**TRADEMARK
PRINCIPAL REGISTER**

SANUS
S Y S T E M S

MILESTONE AV TECHNOLOGIES LLC (DELA-
WARE LIMITED LIABILITY COMPANY)
8401 EAGLE CREEK PARKWAY SUITE 700
SAVAGE, MN 55378

FOR: METAL AUDIO, VIDEO AND COMPUTER
WALL, CEILING, DESK, IN-WALL, UNDER-CABI-
NET, AND IN-CABINET MOUNTS, IN CLASS 6 (U.S.
CLS. 2, 12, 13, 14, 23, 25 AND 50).

FIRST USE 12-31-2007; IN COMMERCE 12-31-2007.

FOR: STANDS SPECIALLY ADAPTED FOR
AUDIO SPEAKERS AND AUDIO AND VIDEO
EQUIPMENT, NAMELY, FOR STEREO SYSTEMS
AND COMPUTERS, IN CLASS 9 (U.S. CLS. 21, 23, 26,
36 AND 38).

FIRST USE 12-31-1997; IN COMMERCE 12-31-1997.

FOR: FURNITURE, NAMELY, CABINETS AND
TABLES FOR HOLDING AND DISPLAYING

AUDIO AND VIDEO EQUIPMENT, NOT INCLUD-
ING CABINETS FOR LOUDSPEAKERS; DISPLAY
STANDS THAT CAN BE USED WITH NON-METAL
AUDIO, VIDEO, AND COMPUTER WALL, CEIL-
ING, DESK, IN-WALL, UNDER-CABINET, AND IN-
CABINET MOUNTS; TELEVISION STANDS, IN
CLASS 20 (U.S. CLS. 2, 13, 22, 25, 32 AND 50).

FIRST USE 12-31-1997; IN COMMERCE 12-31-1997.

OWNER OF U.S. REG. NOS. 2,662,879 AND
2,674,634.

NO CLAIM IS MADE TO THE EXCLUSIVE
RIGHT TO USE "SYSTEMS", APART FROM THE
MARK AS SHOWN.

SER. NO. 76-661,097, FILED 6-5-2006.

LYDIA BELZER, EXAMINING ATTORNEY

Int. Cl.: 7

Prior U.S. Cls.: 13, 19, 21, 23, 31, 34 and 35

United States Patent and Trademark Office

Reg. No. 3,574,360

Registered Feb. 17, 2009

**TRADEMARK
PRINCIPAL REGISTER**

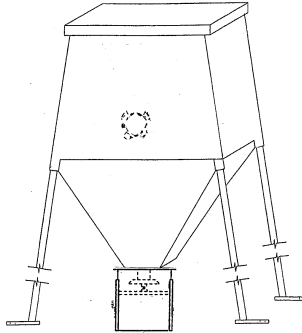

ALL SEASONS FEEDERS, LTD (TEXAS LIMITED PARTNERSHIP)
8424 US HIGHWAY 87
SAN ANTONIO, TX 78263

FOR: MECHANIZED DEER, TURKEY, QUAIL, WILD GEESE AND EXOTIC ANIMAL FEEDER, IN CLASS 7 (U.S. CLS. 13, 19, 21, 23, 31, 34 AND 35).

FIRST USE 6-30-2006; IN COMMERCE 6-30-2006.

OWNER OF U.S. REG. NO. 3,486,761.

THE MARK CONSISTS OF A FOOD STORAGE COMPARTMENT. THE FOOD STORAGE COMPARTMENT HAS AN UPPER SECTION, WHICH IS MULTIPLE FLAT SIDED WALLS WITH THE WALLS SLANTING INWARD. THE UPPER SECTION WALLS TERMINATE AT A FLAT LID. THE

LOWER SECTION DESCENDS DOWNWARD FROM THE BOTTOM OF THE UPPER SECTION AND IS COMPRISED OF FLAT SIDED WALLS TAPERING INWARD. THESE WALLS TERMINATE AT A HEAD. MULTIPLE LEGS DESCEND FROM THE FOOD COMPARTMENT AND MAINTAIN THE FOOD COMPARTMENT AND HEAD ABOVE THE GROUND OR THE SUPPORT SURFACE. THE BROADCAST FEEDER ELEMENT IS DRAWN WITH DOTTED LINES TO INDICATE THAT IT IS NOT PART OF THE MARK.

SEC. 2(F).

SER. NO. 76-662,925, FILED 7-12-2006.

NICHOLAS ALTREE, EXAMINING ATTORNEY

Int. Cl.: 14

Prior U.S. Cls.: 2, 27, 28 and 50

United States Patent and Trademark Office

Reg. No. 3,574,361

Registered Feb. 17, 2009

**TRADEMARK
PRINCIPAL REGISTER**



KIRSTEN ANNE PAGACZ (UNITED STATES
INDIVIDUAL)
9946 SCHOLAR DRIVE
PINCKNEY, MI 48169

FIRST USE 6-25-2004; IN COMMERCE 6-25-2004.

SER. NO. 76-665,014, FILED 8-23-2006.

FOR: JEWELRY AND ACCESSORIES, NAMELY,
NECKLACES, IN CLASS 14 (U.S. CLS. 2, 27, 28 AND
50).

RAMONA ORTIGA, EXAMINING ATTORNEY

Int. Cls.: 6, 7, 40 and 42

**Prior U.S. Cls.: 2, 12, 13, 14, 19, 21, 23, 25, 31, 34, 35,
50, 100, 101, 103 and 106**

Reg. No. 3,574,362

United States Patent and Trademark Office

Registered Feb. 17, 2009

**TRADEMARK
SERVICE MARK
PRINCIPAL REGISTER**



ITI SCOTLAND LIMITED (UNITED KINGDOM CORPORATION)
191 WEST GEORGE STREET
GLASGOW G2 2LB, UNITED KINGDOM

FOR: PIPES AND TUBES OF METAL, NAMELY, PIPELINES, SEAM WELDED PIPES AND TUBES, SPIRAL WOUND PIPES AND TUBES, INTERLOCKING PIPES AND TUBES, SPIRAL WOUND INTERLOCKING PIPES AND TUBES, REINFORCED PIPES AND TUBES, MULTI-LAYER PIPES AND TUBES, COMPOSITE PIPES AND TUBES, ADHESIVELY BONDED PIPES AND TUBES, PIPES AND TUBES HAVING NON-METALLIC PORTIONS THEREOF, FLEXIBLE AND RIGID PIPES AND TUBES, PIPES AND TUBES HAVING END FITTINGS FOR CONNECTION TO FURTHER PIPES AND TUBES OR OTHER CONNECTION DEVICES OR FIXTURES AND FITTINGS, PIPES AND TUBES LINED WITH NON-METALLIC MATERIALS; BARRELS AND BALLISTIC DEVICES COMPRISING METALLIC PIPES OR TUBES; PLATFORMS OF METAL; POSTS OF METAL; MASTS OF METAL; TUBULAR METAL SUPPORT STRUCTURES FOR USE IN A WIDE VARIETY OF FIELDS OR APPLICATIONS; METAL SUPPORT STRUCTURES FOR USE IN A WIDE VARIETY OF FIELDS OR APPLICATIONS; METAL TOWERS FOR USE IN A VARIETY OF FIELDS AND APPLICATIONS; PYLONS; METAL PIPE FITTINGS; METAL PARTS AND FITTINGS FOR ALL THE AFORESAID GOODS, NAMELY, END CONNECTORS, COLLARS, ELBOWS, MANIFOLDS, FLANGES, VALVES, VALVE BODIES OR CONNECTORS, IN CLASS 6 (U.S. CLS. 2, 12, 13, 14, 23, 25 AND 50).

FOR: MACHINES AND MACHINE TOOLS ALL FOR THE MANUFACTURE OF PIPES AND TUBES, NAMELY, PIPELINES, SEAM WELDED PIPES AND TUBES, SPIRAL WOUND PIPES AND TUBES, INTERLOCKING PIPES AND TUBES, SPIRAL

WOUND INTERLOCKING PIPES AND TUBES, REINFORCED PIPES AND TUBES, MULTI-LAYER PIPES AND TUBES, COMPOSITE PIPES AND TUBES, ADHESIVELY BONDED PIPES AND TUBES, PIPES AND TUBES HAVING NON-METALLIC PORTIONS THEREOF, FLEXIBLE AND RIGID PIPES AND TUBES, PIPES AND TUBES HAVING END FITTINGS FOR CONNECTION TO FURTHER PIPES AND TUBES OR OTHER CONNECTION DEVICES OR FIXTURES AND/OR FITTINGS, PIPES AND TUBES LINED WITH NON-METALLIC MATERIALS, BARRELS AND BALLISTIC DEVICES COMPRISING PIPES OR TUBES, PLATFORMS, POSTS, MASTS, TUBULAR SUPPORT STRUCTURES, SUPPORT STRUCTURES, TOWERS, PYLONS, METAL PIPE FITTINGS, PARTS AND FITTINGS FOR ALL THE AFORESAID GOODS, IN CLASS 7 (U.S. CLS. 13, 19, 21, 23, 31, 34 AND 35).

FOR: TECHNICAL ADVISORY AND TECHNOLOGICAL CONSULTATION SERVICES RELATING TO THE MANUFACTURE OF METAL AND NON-METALLIC PIPES AND TUBES, BARRELS AND BALLISTIC DEVICES COMPRISING PIPES OR TUBES, PLATFORMS, POSTS, MASTS, TUBULAR SUPPORT STRUCTURES, SUPPORT STRUCTURES, TOWERS, PYLONS AND/OR PARTS AND FITTINGS FOR THE AFORESAID GOODS, IN CLASS 40 (U.S. CLS. 100, 103 AND 106).

FOR: SCIENTIFIC CONSULTATION AND RESEARCH AND DESIGN SERVICES RELATING TO THE MANUFACTURE OF METAL AND NON-METALLIC PIPES AND TUBES, BARRELS AND BALLISTIC DEVICES COMPRISING PIPES OR TUBES, PLATFORMS, POSTS, MASTS, TUBULAR SUPPORT STRUCTURES, SUPPORT STRUCTURES, TOWERS, PYLONS AND/OR PARTS AND FITTINGS FOR THE AFORESAID GOODS, IN CLASS 42 (U.S. CLS. 100 AND 101).

PRIORITY CLAIMED UNDER SEC. 44(D) ON
UNITED KINGDOM APPLICATION NO. 2417576,
FILED 3-23-2006, REG. NO. 2417576, DATED 3-23-
2006, EXPIRES 3-23-2016.

SER. NO. 76-666,323, FILED 9-19-2006.

PRISCILLA MILTON, EXAMINING ATTORNEY

Int. Cls.: 9 and 16

Prior U.S. Cls.: 2, 5, 21, 22, 23, 26, 29, 36, 37, 38 and 50

United States Patent and Trademark Office

Reg. No. 3,574,363

Registered Feb. 17, 2009

**TRADEMARK
PRINCIPAL REGISTER**

TEAM INTELLIGENCE

FORMULA4MEDIA, LLC. (NEW YORK LIMITED
LIABILITY COMPANY)
P.O. BOX 231318
GREAT NECK, NY 11023

FOR: DOWNLOADABLE ELECTRONIC PERIOD-
ICAL MAGAZINES IN THE FIELD OF NEWS AND
ANALYSIS OF THE SPORTS TEAM MARKET, IN
CLASS 9 (U.S. CLS. 21, 23, 26, 36 AND 38).

FIRST USE 1-0-2006; IN COMMERCE 1-0-2006.

FOR: PRINTED PERIODICAL MAGAZINES IN
THE FIELD OF NEWS AND ANALYSIS OF THE
SPORTS TEAM MARKET, IN CLASS 16 (U.S. CLS. 2,
5, 22, 23, 29, 37, 38 AND 50).

FIRST USE 1-0-2006; IN COMMERCE 1-0-2006.

THE MARK CONSISTS OF STANDARD CHAR-
ACTERS WITHOUT CLAIM TO ANY PARTICULAR
FONT, STYLE, SIZE, OR COLOR.

NO CLAIM IS MADE TO THE EXCLUSIVE
RIGHT TO USE "TEAM", APART FROM THE
MARK AS SHOWN.

SER. NO. 76-666,673, FILED 9-27-2006.

FLORENTINA BLANDU, EXAMINING ATTORNEY

Int. Cl.: 35

Prior U.S. Cls.: 100, 101 and 102

United States Patent and Trademark Office

Reg. No. 3,574,364

Registered Feb. 17, 2009

**SERVICE MARK
PRINCIPAL REGISTER**



AEC PARTNERS SAS (FRANCE COMPANY)
33 BOULEVARD MALESHERBES
75008 PARIS, FRANCE

FOR: PROVIDING ADVICE FOR THE ORGANIZATION AND THE MANAGEMENT OF BUSINESS, CONSULTATION FOR THE MANAGEMENT OF BUSINESS, CONSULTATION IN THE FIELD OF HUMAN RESOURCES AND PROFESSIONAL BUSINESS CONSULTATIONS, IN CLASS 35 (U.S. CLS. 100, 101 AND 102).

PRIORITY CLAIMED UNDER SEC. 44(D) ON ERPN CMNTY TM OFC APPLICATION NO. 005329677, FILED 9-21-2006, REG. NO. 005329677, DATED 8-6-2007, EXPIRES 9-21-2016.

NO CLAIM IS MADE TO THE EXCLUSIVE RIGHT TO USE "PARTNERS", "EXPERTS", "ADVISORS" OR "CONSULTANTS", APART FROM THE MARK AS SHOWN.

THE COLOR(S) BLACK AND RED IS/ARE CLAIMED AS A FEATURE OF THE MARK.

THE MARK CONSISTS OF A PARTIAL SQUARE IN RED WITH THE LETTERS "AEC" ALSO IN RED. THE REMAINING WORD ARE IN BLACK.

SER. NO. 76-669,634, FILED 11-28-2006.

DOMINICK J. SALEMI, EXAMINING ATTORNEY

Int. Cl.: 33

Prior U.S. Cls.: 47 and 49

United States Patent and Trademark Office

Reg. No. 3,574,365

Registered Feb. 17, 2009

TRADEMARK
PRINCIPAL REGISTER



KE CELLARS, INC. (TEXAS CORPORATION)

3933 FM 344 E.

TYLER, TX 75703

FOR: ALCOHOLIC BEVERAGES, NAMELY,
WINE, IN CLASS 33 (U.S. CLS. 47 AND 49).

FIRST USE 11-22-2006; IN COMMERCE 11-22-2006.

NO CLAIM IS MADE TO THE EXCLUSIVE
RIGHT TO USE "CELLARS" , APART FROM THE
MARK AS SHOWN.

THE MARK CONSISTS OF THE STYLIZED LET-
TERS "KE CELLARS" ON A DRAWING OF A
BARREL.

SER. NO. 76-672,102, FILED 1-31-2007.

BRENDAN REGAN, EXAMINING ATTORNEY

Int. Cl.: 3

Prior U.S. Cls.: 1, 4, 6, 50, 51 and 52

United States Patent and Trademark Office

Reg. No. 3,574,366

Registered Feb. 17, 2009

**TRADEMARK
PRINCIPAL REGISTER**

GREAT FACES

EVE PEARL, LLC (NEW YORK LIMITED LIABILITY COMPANY)
162 EAST 55TH STREET, SUITE 5E
NEW YORK, NY 10022

FOR: COSMETIC AND SKIN CARE PRODUCTS, NAMELY, COSMETIC CREAMS FOR SKIN, EYE-SHADOW, BLUSH, EYELINER, CONCEALER, MASCARA, LIPSTICK, LIPGLOSS, FOUNDATION , IN CLASS 3 (U.S. CLS. 1, 4, 6, 50, 51 AND 52).

FIRST USE 1-0-2000; IN COMMERCE 1-0-2000.

THE MARK CONSISTS OF STANDARD CHARACTERS WITHOUT CLAIM TO ANY PARTICULAR FONT, STYLE, SIZE, OR COLOR.

SER. NO. 76-672,775, FILED 2-16-2007.

ALLISON SCHRODY, EXAMINING ATTORNEY

Int. Cl.: 29

Prior U.S. Cl.: 46

United States Patent and Trademark Office

Reg. No. 3,574,367

Registered Feb. 17, 2009

**TRADEMARK
PRINCIPAL REGISTER**



THE ART OF EATING HEALTHY

VEGE USA, LLC (CALIFORNIA LIMITED LIABILITY COMPANY)
4257 E. LIVE OAK AVENUE
ARCADIA, CA 91006

FIRST USE 6-2-2000; IN COMMERCE 6-2-2000.

SER. NO. 76-673,947, FILED 3-12-2007.

FOR: VEGETABLE-BASED SNACK FOODS AND UNFORMED VEGETABLE PROTEIN FOR USE AS A MEAT ALTERNATIVE, IN CLASS 29 (U.S. CL. 46).

MICHAEL WEBSTER, EXAMINING ATTORNEY

Int. Cls.: 20 and 24

Prior U.S. Cls.: 2, 13, 22, 25, 32, 42 and 50

United States Patent and Trademark Office

Reg. No. 3,574,368

Registered Feb. 17, 2009

**TRADEMARK
PRINCIPAL REGISTER**

BELLE MAISON

BELLE MAISON USA LTD. (NEW YORK CORPORATION)
89-50 127TH STREET
RICHMOND HILL, NY 11418

FOR: FURNITURE, IN CLASS 20 (U.S. CLS. 2, 13, 22, 25, 32 AND 50).

FIRST USE 1-24-2000; IN COMMERCE 1-24-2000.

FOR: HOME FURNISHINGS, TEXTILE CONVERTERS AND TEXTILES, NAMELY, BEDSPREADS, COMFORTERS, PILLOW SHAMS, PILLOWS, DUST RUFFLES, DRAPERIES, VALANCES, FOAM BACK DRAPERIES, BLACK OUT DRAPERIES, THROWS, UNFITTED FABRIC COVER CHAIR COVERS, TABLE COVERS, TABLE CLOTHS NOT OF PAPER, TEXTILE TABLE NAPKINS, CURTAIN PANELS

AND KITCHEN CURTAINS, IN CLASS 24 (U.S. CLS. 42 AND 50).

FIRST USE 1-24-2000; IN COMMERCE 1-24-2000.

THE MARK CONSISTS OF STANDARD CHARACTERS WITHOUT CLAIM TO ANY PARTICULAR FONT, STYLE, SIZE, OR COLOR.

THE ENGLISH TRANSLATION OF THE FRENCH WORDING "BELLE MAISON" IS "BEAUTIFUL HOUSE".

SER. NO. 76-674,888, FILED 4-2-2007.

GIANCARLO CASTRO, EXAMINING ATTORNEY

Int. Cl.: 1

Prior U.S. Cls.: 1, 5, 6, 10, 26 and 46

Reg. No. 3,574,369

United States Patent and Trademark Office

Registered Feb. 17, 2009

**TRADEMARK
PRINCIPAL REGISTER**

XHALE

OLIVER PRODUCTS COMPANY (MICHIGAN CORPORATION)
445 SIXTH STREET, N.W.
GRAND RAPIDS, MI 49504

THE MARK CONSISTS OF STANDARD CHARACTERS WITHOUT CLAIM TO ANY PARTICULAR FONT, STYLE, SIZE, OR COLOR.

FOR: ADHESIVES FOR GENERAL INDUSTRIAL USE, NAMELY, ADHESIVES FOR PACKAGING, IN CLASS 1 (U.S. CLS. 1, 5, 6, 10, 26 AND 46).

SER. NO. 76-677,027, FILED 5-18-2007.

FIRST USE 1-31-2006; IN COMMERCE 1-31-2006.

KATHERINE E. HALMEN, EXAMINING ATTORNEY

Int. Cl.: 36

Prior U.S. Cls.: 100, 101 and 102

United States Patent and Trademark Office

Reg. No. 3,574,370

Registered Feb. 17, 2009

**SERVICE MARK
PRINCIPAL REGISTER**

TOMPKINS 

TOMPKINS TRUSTCO, INC. (NEW YORK COR-
PORATION)
110 N. TIOGA STREET
ITHACA, NY 14850

FIRST USE 10-31-2006; IN COMMERCE 10-31-2006.

SER. NO. 76-677,129, FILED 5-18-2007.

FOR: BANKING SERVICES AND CREDIT AND
DEBIT CARD SERVICES, IN CLASS 36 (U.S. CLS. 100,
101 AND 102).

JESSICA A. POWERS, EXAMINING ATTORNEY

Int. Cl.: 36

Prior U.S. Cls.: 100, 101 and 102

United States Patent and Trademark Office

Reg. No. 3,574,371

Registered Feb. 17, 2009

**SERVICE MARK
PRINCIPAL REGISTER**

GUARANTYLINE

GUARANTY BANK (UNITED STATES FEDERALLY CHARTERED SAVINGS BANK)

8333 DOUGLAS AVENUE

DALLAS, TX 75225

FOR: ELECTRONIC BANKING VIA A GLOBAL COMPUTER NETWORK, IN CLASS 36 (U.S. CLS. 100, 101 AND 102).

FIRST USE 4-0-2005; IN COMMERCE 4-0-2005.

THE MARK CONSISTS OF STANDARD CHARACTERS WITHOUT CLAIM TO ANY PARTICULAR FONT, STYLE, SIZE, OR COLOR.

OWNER OF U.S. REG. NOS. 1,654,486, 1,731,586 AND OTHERS.

SEC. 2(F).

SER. NO. 76-678,255, FILED 6-11-2007.

CAROLINE WOOD, EXAMINING ATTORNEY

Int. Cl.: 12

Prior U.S. Cls.: 19, 21, 23, 31, 35 and 44

Reg. No. 3,574,372

United States Patent and Trademark Office

Registered Feb. 17, 2009

**TRADEMARK
PRINCIPAL REGISTER**

SKY DEK

PREMIER MARINE, INC. (MINNESOTA CORPORATION)
26612 FALLBROOK AVENUE
P.O. BOX 509
WYOMING, MN 55092

THE MARK CONSISTS OF STANDARD CHARACTERS WITHOUT CLAIM TO ANY PARTICULAR FONT, STYLE, SIZE, OR COLOR.

FOR: BOATS, NAMELY, PONTOON BOATS, IN CLASS 12 (U.S. CLS. 19, 21, 23, 31, 35 AND 44).

SER. NO. 76-682,210, FILED 9-24-2007.

FIRST USE 8-1-2007; IN COMMERCE 8-1-2007.

MONIQUE MILLER, EXAMINING ATTORNEY

Int. Cl.: 42

Prior U.S. Cls.: 100 and 101

United States Patent and Trademark Office

Reg. No. 3,574,373

Registered Feb. 17, 2009

**SERVICE MARK
PRINCIPAL REGISTER**



THETA BIOMEDICAL CONSULTING AND DEVELOPMENT CO., INC. (MASSACHUSETTS CORPORATION)

14 PARKMAN ST.
BROOKLINE, MA 02446

FOR: PROVIDING CONSULTATION AND ADVICE IN THE FIELD OF BIOMEDICAL SCIENTIFIC RESEARCH TO THE BIOMEDICAL INDUSTRY; PROVIDING CONSULTATION IN THE FIELD OF PRODUCT DEVELOPMENT TO THE BIOMEDICAL INDUSTRY, IN CLASS 42 (U.S. CLS. 100 AND 101).

FIRST USE 1-1-1997; IN COMMERCE 1-1-1997.

NO CLAIM IS MADE TO THE EXCLUSIVE RIGHT TO USE "BIOMEDICAL CONSULTING AND DEVELOPMENT CO., INC.", APART FROM THE MARK AS SHOWN.

THE MARK CONSISTS OF THE DESIGN OF A SNAKE AND A DOUBLE HELIX WRAPPED AROUND A WINE GLASS WITH THE WORDING "THETA BIOMEDICAL CONSULTING AND DEVELOPMENT CO., INC." CIRCLING AROUND THE DESIGN PORTION.

SER. NO. 76-682,272, FILED 9-24-2007.

JANET LEE, EXAMINING ATTORNEY

Int. Cl.: 20

Prior U.S. Cls.: 2, 13, 22, 25, 32 and 50

United States Patent and Trademark Office

Reg. No. 3,574,374

Registered Feb. 17, 2009

**TRADEMARK
PRINCIPAL REGISTER**

HIDDEN GLIDES

AMERICAN WOODMARK CORPORATION (VIR-
GINIA CORPORATION)
3102 SHAWNEE DRIVE
WINCHESTER, VA 22601

FOR: DRAWER SLIDES, IN CLASS 20 (U.S. CLS. 2,
13, 22, 25, 32 AND 50).

FIRST USE 4-27-1995; IN COMMERCE 4-27-1995.

THE MARK CONSISTS OF STANDARD CHAR-
ACTERS WITHOUT CLAIM TO ANY PARTICULAR
FONT, STYLE, SIZE, OR COLOR.

OWNER OF U.S. REG. NO. 2,011,225.

NO CLAIM IS MADE TO THE EXCLUSIVE
RIGHT TO USE "GLIDES", APART FROM THE
MARK AS SHOWN.

SEC. 2(F).

SER. NO. 76-683,059, FILED 10-18-2007.

MARLENE BELL, EXAMINING ATTORNEY

Int. Cl.: 41

Prior U.S. Cls.: 100, 101 and 107

United States Patent and Trademark Office

Reg. No. 3,574,375

Registered Feb. 17, 2009

**SERVICE MARK
PRINCIPAL REGISTER**



JONES, JERREN DEWAYNE (UNITED STATES INDIVIDUAL)

2405 SILVER MAPLE DR
LITTLE ROCK, AR 72210

FOR: RECORD PRODUCTION; MUSIC PRODUCTION; AUDIO RECORDING AND PRODUCTION; VIDEOTAPE PRODUCTION; MOTION PICTURE SONG PRODUCTION; PRODUCTION OF VIDEO DISCS FOR OTHERS; RECORDING STUDIOS; ENTERTAINMENT SERVICES, NAMELY, PRODUCING MUSICAL AUDIO AND VIDEO RECORDINGS; MUSIC COMPOSITION AND TRANSCRIPTION FOR OTHERS; SONG WRITING SERVICES; MUSIC PUBLISHING SERVICES; ENTERTAINMENT IN THE NATURE OF A LIVE MUSICAL PERFORMER, MUSICAL BAND OR MUSICAL GROUP; ENTERTAINMENT IN THE NATURE OF VISUAL AND AUDIO PERFORMANCES BY A MUSICAL ARTIST, MUSICAL GROUP AND MUSICAL BAND; ENTERTAINMENT, NAMELY, LIVE MUSIC CONCERTS; ENTERTAINMENT, NAMELY, PERSONAL APPEARANCES BY A MUSICIAN, MUSICAL GROUP OR MUSICAL BAND; ENTERTAINMENT, NAMELY, PERSONAL APPEARANCES BY A TELEVISION STAR, MOVIE STAR, COMEDIAN, RADIO PERSONALITY; ENTERTAINMENT SERVICES, NAMELY, PROVIDING A WEB SITE FEATURING MUSICAL PERFORMANCES, MUSICAL VIDEOS, RELATED FILM CLIPS, PHOTOGRAPHS, AND OTHER MULTIMEDIA MATERIALS; ENTERTAINMENT SERVICES, NAMELY, PROVIDING PRERECORDED MUSIC, INFORMATION IN THE FIELD OF MUSIC, COMMENTARY AND ARTICLES ABOUT MUSIC, ALL ONLINE VIA A GLOBAL COMPUTER NETWORK; ENTERTAINMENT SERVICES, NAMELY, PROVIDING A WEB SITE FEATURING ANIMATIONS, CARTOON CHARACTERS, DRAWINGS, PHOTO-

GRAPHS, AND RELATED ENTERTAINMENT PERTAINING THERETO, AND OTHER MULTIMEDIA MATERIALS; PROVIDING A COMPUTER GAME THAT MAY BE ACCESSED NETWORK-WIDE BY NETWORK USERS; TELEVISION AND RADIO PRODUCTION; TELEVISION SHOW PRODUCTION; CABLE TELEVISION SHOW PRODUCTION; RADIO ENTERTAINMENT PRODUCTION; MOTION PICTURE FILM PRODUCTION; FILM EDITING; SPECIAL EFFECTS ANIMATION SERVICES FOR FILM AND VIDEO; ENTERTAINMENT IN THE NATURE OF ON-GOING TELEVISION, CABLE TELEVISION AND RADIO PROGRAMS FEATURING MUSICAL, COMEDIC AND DRAMATIC ACTS AS WELL AS PROGRAMS THAT FEATURE ACTION AND ADVENTURE STORIES, ANIMATION AND CARTOONS; TELEVISION AND CABLE TELEVISION PROGRAMS FEATURING MUSIC, DRAMA, COMEDY, ACTION AND ADVENTURE STORIES, ANIMATION AND CARTOONS VIA THE INTERNET; PROVIDING A VARIETY SHOW DISTRIBUTED OVER TELEVISION, CABLE TELEVISION, RADIO, SATELLITE, AUDIO AND VIDEO MEDIA; THEATRE PRODUCTIONS; ENTERTAINMENT IN THE NATURE OF LIVE MUSIC, DRAMATIC OR COMEDY PERFORMANCES, IN CLASS 41 (U.S. CLS. 100, 101 AND 107).

FIRST USE 9-15-2007; IN COMMERCE 9-15-2007.

NO CLAIM IS MADE TO THE EXCLUSIVE RIGHT TO USE "ENTERTAINMENT", APART FROM THE MARK AS SHOWN.

A CIRCLE WITH THE LETTER "W" IN THE CENTER OF THE CIRCLE WITH THE SHADOW OF ANOTHER "W" IN THE BACKGROUND EXTENDING OUT FURTHER. THE RIGHT SIDE WINGS OF BOTH "W"'S ARE EXTENDING OUT

OF THE CIRCLE. STARTING AT THE BOTTOM
RIGHT COMER OF THE SHADOWED "W" ARE
THE WORDS "WOODWORK ENTERTAINMENT".

SER. NO. 76-683,347, FILED 10-26-2007.

ELIZABETH HUGHITT, EXAMINING ATTORNEY

Int. Cl.: 41

Prior U.S. Cls.: 100, 101 and 107

United States Patent and Trademark Office

Reg. No. 3,574,376

Registered Feb. 17, 2009

**SERVICE MARK
PRINCIPAL REGISTER**

FOR THE GOOD OF ILLINOIS

N. ANDRZEJEWSKI, ADAM (UNITED STATES
INDIVIDUAL)
6300 ROBERT KINGERY HIGHWAY, SUITE 416
P.O. BOX 331
WILLOWBROOK, IL 60527

FOR: PROVIDING BLOGS TO THE CITIZENS OF
ILLINOIS AND THE NATION OF THE UNITED
STATES FEATURING INFORMATION ON ISSUES
OF PUBLIC IMPORTANCE, STATE DEBT, JUVE-
NILE VIOLENT CRIME, ILLINOIS POPULATION
DECLINE COMPARED TO THE USA, ILLINOIS
STUDENT TEST AVERAGES, LAWMAKER'S PAY
RAISE, ILLINOIS OFFICIALS CONVICTED OF PUB-
LIC CORRUPTION, IMMIGRATION, TRANSPOR-
TATION, GUNS, JOB GROWTH, FREEDOM OF
SPEECH, FEDERALISM AND STATES RIGHTS,
SMOKING, DRUGS, EMPLOYMENT LAW, TORT

REFORM, SEPARATION OF CHURCH AND STATE,
INDIVIDUAL LIBERTIES, AND FAMILY VALUES,
IN CLASS 41 (U.S. CLS. 100, 101 AND 107).

FIRST USE 9-21-2007; IN COMMERCE 9-21-2007.

THE MARK CONSISTS OF STANDARD CHAR-
ACTERS WITHOUT CLAIM TO ANY PARTICULAR
FONT, STYLE, SIZE, OR COLOR.

NO CLAIM IS MADE TO THE EXCLUSIVE
RIGHT TO USE "ILLINOIS", APART FROM THE
MARK AS SHOWN.

SER. NO. 76-683,386, FILED 10-29-2007.

TEJBIR SINGH, EXAMINING ATTORNEY

Int. Cl.: 35

Prior U.S. Cls.: 100, 101 and 102

United States Patent and Trademark Office

Reg. No. 3,574,377

Registered Feb. 17, 2009

**SERVICE MARK
PRINCIPAL REGISTER**

REGULAR PEOPLE. COMMON SENSE.

ANDRZEJEWSKI, ADAM N. (UNITED STATES
INDIVIDUAL)
6300 ROBERT KINGERY HIGHWAY, SUITE 416
P.O. BOX 331
WILLOWBROOK, IL 60527

FOR: PROVIDING INFORMATION TO THE CI-
TIZENS OF ILLINOIS AND THE NATION ON
ISSUES OF PUBLIC IMPORTANCE, NAMELY, JOB
GROWTH, AND THE LOSS OF POPULATION IN
ILLINOIS AS COMPARED TO OTHER STATES AND
ITS EFFECT ON TAXES AND POLITICAL REPRE-

SENTATION, IN CLASS 35 (U.S. CLS. 100, 101 AND
102).

FIRST USE 9-21-2007; IN COMMERCE 9-21-2007.

THE MARK CONSISTS OF STANDARD CHAR-
ACTERS WITHOUT CLAIM TO ANY PARTICULAR
FONT, STYLE, SIZE, OR COLOR.

SER. NO. 76-683,387, FILED 10-29-2007.

MARY CRAWFORD, EXAMINING ATTORNEY

Int. Cl.: 25

Prior U.S. Cls.: 22 and 39

United States Patent and Trademark Office

Reg. No. 3,574,378

Registered Feb. 17, 2009

**TRADEMARK
PRINCIPAL REGISTER**

RED HOT MAMAS

GIBLIN, KAREN L. (UNITED STATES INDIVIDUAL)
7712 GEORGETOWN CHASE
ROSWELL, GA 30075

THE MARK CONSISTS OF STANDARD CHARACTERS WITHOUT CLAIM TO ANY PARTICULAR FONT, STYLE, SIZE, OR COLOR.

FOR: SWEATERS, JACKETS, VESTS, SHIRTS, SWEAT SHIRTS, SWEAT PANTS, JERSEYS, T-SHIRTS, SKIRTS, SCARVES, UNDERWEAR, NIGHTCLOTHES, NAMELY, PAJAMAS, NIGHTGOWNS, BED JACKETS AND ROBES, FOOTWEAR, HATS AND CAPS, IN CLASS 25 (U.S. CLS. 22 AND 39).

OWNER OF U.S. REG. NOS. 1,812,212, 3,214,562 AND OTHERS.

SER. NO. 76-683,819, FILED 11-8-2007.

FIRST USE 6-1-1992; IN COMMERCE 6-1-1992.

CAROLYN GRAY, EXAMINING ATTORNEY

Int. Cl.: 12

Prior U.S. Cls.: 19, 21, 23, 31, 35 and 44

Reg. No. 3,574,379

United States Patent and Trademark Office

Registered Feb. 17, 2009

**TRADEMARK
PRINCIPAL REGISTER**

A TRADITION OF PERFORMANCE

EMPI, INC. (CALIFORNIA CORPORATION)
301 E. ORANGETHORPE AVE.
ANAHEIM, CA 92801

FOR: AUTOMOBILE PARTS AND ACCESSORIES, NAMELY, AXLES, BODY PANELS, BRAKE AND CLUTCH PEDAL ASSEMBLIES, BUMPERS, GAS PEDALS, SEMI-FITTED CAR COVERS, TRANSAXLE GEARS, CLUTCH DISCS, DASH KNOBS, DASH PANELS, DOOR PANELS, HEADLINERS, LICENSE PLATE FRAMES, AND TRANSAXLE MOUNTS, TRANSAXLE SHIFTERS, NERF BARS, ROLL BAR PADDING, PEDAL PADS, PRESSURE PLATES, ROCKER ARMS, ROCKER SHAFTS, ROLL BARS, ROLL CAGES, RUNNING BOARDS, SAND RAIL FRAMES, SEAT BELTS, SEAT COVERS, SHOCK ABSORBERS, STEERING BRAKES, SKID PLATES, STEERING WHEELS, STEERING WHEEL ADAPTERS, TOW BARS, VALVE COVERS, VALVE LIFTERS, VALVES, WHEEL ADAPTERS, WHEEL

HUBS, WINDOWS, WIRE COVER PANELS, DRIVE AXLE ASSEMBLIES, PARTS FOR REMANUFACTURING DRIVE AXLES, NAMELY, AXLES; SHIFTERS; BRAKE REPAIR KITS FOR LAND VEHICLES COMPRISING BRAKE PADS, BRAKE ROTORS, BRAKE CABLES, BRAKE CALIPERS AND BRAKE HARDWARE FOR VEHICLES, SOLD AS A UNIT; CONSTANT VELOCITY JOINTS, AND CONSTANT VELOCITY BOOTS, IN CLASS 12 (U.S. CLS. 19, 21, 23, 31, 35 AND 44).

FIRST USE 9-1-2007; IN COMMERCE 9-1-2007.

THE MARK CONSISTS OF STANDARD CHARACTERS WITHOUT CLAIM TO ANY PARTICULAR FONT, STYLE, SIZE, OR COLOR.

SER. NO. 76-683,990, FILED 11-13-2007.

ELLEN B. AWRICH, EXAMINING ATTORNEY

Int. Cls.: 9 and 38

Prior U.S. Cls.: 21, 23, 26, 36, 38, 100, 101 and 104

United States Patent and Trademark Office

Reg. No. 3,574,380

Registered Feb. 17, 2009

**TRADEMARK
SERVICE MARK
PRINCIPAL REGISTER**

ZIXCORP

ZIX CORPORATION (TEXAS CORPORATION)
2711 N. HASKELL AVENUE
SUITE 2200, LB 36
DALLAS, TX 75204

FOR: COMPUTER SOFTWARE FOR ELECTRONIC TRANSMISSION OF PRESCRIPTIONS FROM DOCTORS, IN CLASS 9 (U.S. CLS. 21, 23, 26, 36 AND 38).

FIRST USE 7-22-2003; IN COMMERCE 7-22-2003.

FOR: INFORMATION TRANSMISSION VIA ELECTRONIC COMMUNICATIONS NETWORKS IN THE NATURE OF ELECTRONIC TRANSMISSION OF PRESCRIPTIONS BY PHYSICIANS TO PHARMACIES; INFORMATION TRANSMISSION VIA ELECTRONIC COMMUNICATIONS NETWORKS IN THE NATURE OF ELECTRONIC TRANSMISSION OF INFORMATION REGARDING

ALTERNATIVE COURSES OF THERAPIES FOR MEDICAL PATIENTS; PROVIDING ACCESS TO DATABASES OF MEDICAL PATIENT RECORDS, CLINICAL DECISION SUPPORT INFORMATION AT POINT OF CARE AND INSURANCE COVERAGE INFORMATION, IN CLASS 38 (U.S. CLS. 100, 101 AND 104).

FIRST USE 7-22-2003; IN COMMERCE 7-22-2003.

THE MARK CONSISTS OF STANDARD CHARACTERS WITHOUT CLAIM TO ANY PARTICULAR FONT, STYLE, SIZE, OR COLOR.

OWNER OF U.S. REG. NOS. 2,656,933, 2,870,421 AND OTHERS.

SER. NO. 76-684,858, FILED 12-12-2007.

LYDIA BELZER, EXAMINING ATTORNEY

Int. Cl.: 21

Prior U.S. Cls.: 2, 13, 23, 29, 30, 33, 40 and 50

United States Patent and Trademark Office

Reg. No. 3,574,381

Registered Feb. 17, 2009

**TRADEMARK
PRINCIPAL REGISTER**

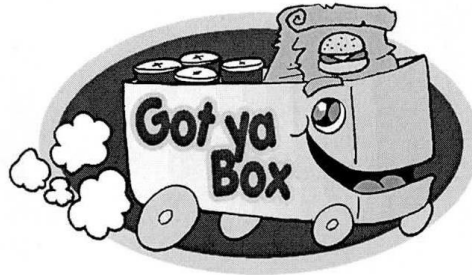

GOT YA BOX ENTERPRISES, INC. (NEW YORK CORPORATION)
7 WHITE SPRUCE LANE
HAUPPAUGE, NY 11788

FOR: CONTAINERS FOR DOMESTIC USE, NAMELY, PLASTIC ALL-PURPOSE CONTAINERS REMOVABLY ATTACHED TO A SEAT INSIDE A VEHICLE, IN CLASS 21 (U.S. CLS. 2, 13, 23, 29, 30, 33, 40 AND 50).

FIRST USE 1-31-2008; IN COMMERCE 1-31-2008.

NO CLAIM IS MADE TO THE EXCLUSIVE RIGHT TO USE "BOX", APART FROM THE MARK AS SHOWN.

SER. NO. 76-684,893, FILED 12-13-2007.

EUGENIA MARTIN, EXAMINING ATTORNEY

Int. Cl.: 37

Prior U.S. Cls.: 100, 103 and 106

United States Patent and Trademark Office

Reg. No. 3,574,382

Registered Feb. 17, 2009

**SERVICE MARK
PRINCIPAL REGISTER**

PREMIER POOLS CONSTRUCTION, INC.

PREMIER POOLS CONSTRUCTION, INC. (FLOR-
IDA CORPORATION)
15924 ADOBE DRIVE
HUDSON, FL 34667

NO CLAIM IS MADE TO THE EXCLUSIVE
RIGHT TO USE "POOLS CONSTRUCTION, INC.",
APART FROM THE MARK AS SHOWN.

FOR: NEW SWIMMING POOL AND SPA CON-
STRUCTION, POOL AND SPA RENOVATION, IN
CLASS 37 (U.S. CLS. 100, 103 AND 106).

SEC. 2(F).

FIRST USE 5-1-1993; IN COMMERCE 5-1-1993.

SER. NO. 76-685,032, FILED 12-17-2007.

THE MARK CONSISTS OF STANDARD CHAR-
ACTERS WITHOUT CLAIM TO ANY PARTICULAR
FONT, STYLE, SIZE, OR COLOR.

CARYN GLASSER, EXAMINING ATTORNEY

Int. Cl.: 12

Prior U.S. Cls.: 19, 21, 23, 31, 35 and 44

United States Patent and Trademark Office

Reg. No. 3,574,383

Registered Feb. 17, 2009

**TRADEMARK
PRINCIPAL REGISTER**

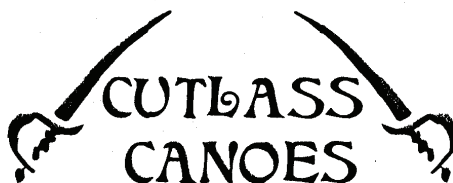

BOND, PRESCOTT DELBERT (UNITED STATES
INDIVIDUAL)
689 GROOVER ROAD
SPRING CITY, TN 37381

NO CLAIM IS MADE TO THE EXCLUSIVE
RIGHT TO USE "CANOES", APART FROM THE
MARK AS SHOWN.

FOR: CANOES, IN CLASS 12 (U.S. CLS. 19, 21, 23,
31, 35 AND 44).

SER. NO. 76-685,281, FILED 12-26-2007.

FIRST USE 3-4-2006; IN COMMERCE 7-4-2007.

RUDY R. SINGLETON, EXAMINING ATTORNEY

Int. Cl.: 9

Prior U.S. Cls.: 21, 23, 26, 36 and 38

Reg. No. 3,574,384

United States Patent and Trademark Office

Registered Feb. 17, 2009

**TRADEMARK
PRINCIPAL REGISTER**

Green Benjamin

KARASEK, ZDENEK (CZECH REPUBLIC INDIVIDUAL)
22028 NE 75TH STREET
REDMOND, WA 98053

FOR: COMPUTER SEARCH ENGINE SOFTWARE; INTERNET PORTAL SOFTWARE, NAMELY, SOFTWARE THAT IS USED TO COLLECT, AGGREGATE, DISPLAY AND DELIVER OPERATIONAL, FINANCIAL AND ORGANIZATIONAL INFORMATION VIA THE INTERNET TO A COMPUTER, TELEPHONE OR PDA; SHOPPING NETWORKS SYSTEMS SOFTWARE, NAMELY, COMPUTER E-COMMERCE SOFTWARE THAT ALLOWS USERS TO PERFORM ELECTRO-

NIC SHOPPING TRANSACTIONS VIA THE INTERNET, IN CLASS 9 (U.S. CLS. 21, 23, 26, 36 AND 38).

FIRST USE 9-7-2007; IN COMMERCE 10-1-2007.

THE MARK CONSISTS OF STANDARD CHARACTERS WITHOUT CLAIM TO ANY PARTICULAR FONT, STYLE, SIZE, OR COLOR.

THE NAME "GREEN BENJAMIN" DOES NOT IDENTIFY A LIVING INDIVIDUAL.

SER. NO. 76-685,531, FILED 1-7-2008.

ELISSA GARBER KON, EXAMINING ATTORNEY

Int. Cl.: 6

Prior U.S. Cls.: 2, 12, 13, 14, 23, 25 and 50

Reg. No. 3,574,385

United States Patent and Trademark Office

Registered Feb. 17, 2009

**TRADEMARK
PRINCIPAL REGISTER**

BAYTOP

STRUCTURAL GROUP, INC. (MARYLAND CORPORATION)
7455 NEW RIDGE ROAD, SUITE T
HANOVER, MD 21076

THE MARK CONSISTS OF STANDARD CHARACTERS WITHOUT CLAIM TO ANY PARTICULAR FONT, STYLE, SIZE, OR COLOR.

FOR: MINERAL AND METALLIC AGGREGATE FLOORING FOR INDUSTRIAL APPLICATIONS, IN CLASS 6 (U.S. CLS. 2, 12, 13, 14, 23, 25 AND 50).

SER. NO. 76-685,579, FILED 1-7-2008.

FIRST USE 0-0-2000; IN COMMERCE 0-0-2000.

LINDA POWELL, EXAMINING ATTORNEY

Int. Cl.: 28

Prior U.S. Cls.: 22, 23, 38 and 50

United States Patent and Trademark Office

Reg. No. 3,574,386

Registered Feb. 17, 2009

**TRADEMARK
PRINCIPAL REGISTER**

MACHO460

STEINBARTH, RALPH H. (UNITED STATES IN-
DIVIDUAL)
3400 W. 35TH STREET
CHICAGO, IL 60632

FOR: GOLF CLUBS, IN CLASS 28 (U.S. CLS. 22, 23,
38 AND 50).

FIRST USE 7-29-2005; IN COMMERCE 7-29-2005.

THE MARK CONSISTS OF STANDARD CHAR-
ACTERS WITHOUT CLAIM TO ANY PARTICULAR
FONT, STYLE, SIZE, OR COLOR.

OWNER OF U.S. REG. NO. 2,470,403.

SER. NO. 76-685,688, FILED 1-11-2008.

KOURTNEE HODGES, EXAMINING ATTORNEY

Int. Cls.: 3, 5 and 35

**Prior U.S. Cls.: 1, 4, 6, 18, 44, 46, 50, 51, 52, 100, 101
and 102**

Reg. No. 3,574,387

United States Patent and Trademark Office

Registered Feb. 17, 2009

**TRADEMARK
SERVICE MARK
PRINCIPAL REGISTER**

IRIS

IRIS, LE GROUPE VISUEL (1990) INC. (CANADA CORPORATION)
3030, BOUL. LE CARREFOUR, SUITE 1200
LAVAL (QUÉBEC), CANADA H7T 2P5

FOR: CLEANING PRODUCTS FOR SPECTACLES LENSES, NAMELY, CLEANING SOLUTIONS , IN CLASS 3 (U.S. CLS. 1, 4, 6, 50, 51 AND 52).

FOR: CLEANING PRODUCTS FOR CORNEAL LENSES, NAMELY, CLEANING, SOAKING AND RINSING SOLUTIONS, IN CLASS 5 (U.S. CLS. 6, 18, 44, 46, 51 AND 52).

FOR: RETAIL STORE SERVICES IN THE FIELD OF GOODS FOR THE CORRECTION OF VISION AND EYE CARE; FRANCHISING SERVICES, NAMELY, OFFERING TECHNICAL ASSISTANCE

IN THE ESTABLISHMENT AND OPERATION OF RETAIL STORES IN THE FIELD OF OPTICAL PRODUCTS FOR THE CORRECTION OF VISION AND EYE CARE, IN CLASS 35 (U.S. CLS. 100, 101 AND 102).

THE MARK CONSISTS OF STANDARD CHARACTERS WITHOUT CLAIM TO ANY PARTICULAR FONT, STYLE, SIZE, OR COLOR.

OWNER OF CANADA REG. NO. TMA436032, DATED 11-25-1994, EXPIRES 11-25-2009.

SER. NO. 76-686,003, FILED 1-22-2008.

RAUL CORDOVA, EXAMINING ATTORNEY

Int. Cl.: 40

Prior U.S. Cls.: 100, 103 and 106

United States Patent and Trademark Office

Reg. No. 3,574,388

Registered Feb. 17, 2009

SERVICE MARK
PRINCIPAL REGISTER



MILLS, GARRY (UNITED STATES INDIVIDUAL)
6752 LIMEKILN PIKE
PHILADELPHIA, PA 19138

FOR: IMPRINTING MESSAGES ON WEARING APPAREL, ACCESSORIES, AND MUGS, IN CLASS 40 (U.S. CLS. 100, 103 AND 106).

FIRST USE 8-25-2007; IN COMMERCE 8-27-2007.

THE COLOR(S) ORANGE, BLACK AND WHITE IS/ARE CLAIMED AS A FEATURE OF THE MARK.

THE MARK CONSISTS OF THE WORDING "BALLERS" IN ORANGE STYLIZED FONT ON A WHITE BACKGROUND OUTLINED IN BLACK. BELOW IS THE WORDING "CONVENTION" IN BLACK. TO THE RIGHT IS THE DESIGN OF THE SILHOUETTE OF A MAN DUNKING A BASKETBALL. THE MAN APPEARS IN WHITE, THE BASKETBALL IS ORANGE, THE BACKBOARD, BASKET AND NET ARE WHITE AND ALL APPEAR ON A BLACK BACKGROUND.

SER. NO. 76-686,389, FILED 2-1-2008.

KATHERINE CONNOLLY, EXAMINING ATTORNEY

Int. Cls.: 41 and 45

Prior U.S. Cls.: 100, 101 and 107

United States Patent and Trademark Office

Reg. No. 3,574,389

Registered Feb. 17, 2009

**SERVICE MARK
PRINCIPAL REGISTER**



CLEAR MIND SOLUTIONS, LLC (NEVADA LIMITED LIABILITY COMPANY)

2940 LEE ROAD
SHAKER HEIGHTS, OH 44120

FOR: PUBLICATION OF BOOKS AND COMPACT DISCS RELATING TO SPIRITUALITY, IN CLASS 41 (U.S. CLS. 100, 101 AND 107).

FIRST USE 10-0-2005; IN COMMERCE 8-26-2006.

FOR: METAPHYSICAL COUNSELING RELATING TO PERSONAL IMPROVEMENT, PERSONAL GROWTH, SELF ESTEEM, MANAGING STRESS

AND ANXIETY, AND MEDITATION, IN CLASS 45 (U.S. CLS. 100 AND 101).

FIRST USE 10-0-2005; IN COMMERCE 8-26-2006.

THE MARK CONSISTS OF THE WORDS "CLEAR MIND SOLUTIONS", ONE WORD ABOVE THE OTHER, THE PHRASE "WITH A CLEAR MIND, YOU CAN ACHIEVE ANYTHING" BELOW IT ON TWO LINES, AND A DEPICTION OF A BUTTERFLY WITH THREE STARS ON THE LEFT HAND SIDE.

SER. NO. 76-686,649, FILED 2-8-2008.

MAYUR VAGHANI, EXAMINING ATTORNEY

Int. Cls.: 9 and 20

Prior U.S. Cls.: 2, 13, 21, 22, 23, 25, 26, 32, 36, 38 and 50

Reg. No. 3,574,390

United States Patent and Trademark Office

Registered Feb. 17, 2009

**TRADEMARK
PRINCIPAL REGISTER**

VERTIFLEX PRODUCTS

ADVANTUS CORP. (FLORIDA CORPORATION)
BUILDING 618
12276 SAN JOSE BOULEVARD
JACKSONVILLE, FL 32223

FOR: OFFICE MACHINE STANDS, NAMELY, COMPUTER STANDS, SPECIFICALLY DESIGNED FOR HOLDING A COMPUTER, PRINTER AND ACCESSORIES, IN CLASS 9 (U.S. CLS. 21, 23, 26, 36 AND 38).

FIRST USE 1-3-2005; IN COMMERCE 1-3-2005.

FOR: OFFICE FURNITURE, NAMELY, OFFICE MACHINE STANDS, MOVABLE FILING CABINETS AND MOVABLE OFFICE TABLES TO BE USED

WITH OFFICE MACHINES, IN CLASS 20 (U.S. CLS. 2, 13, 22, 25, 32 AND 50).

FIRST USE 1-3-2005; IN COMMERCE 1-3-2005.

THE MARK CONSISTS OF STANDARD CHARACTERS WITHOUT CLAIM TO ANY PARTICULAR FONT, STYLE, SIZE, OR COLOR.

NO CLAIM IS MADE TO THE EXCLUSIVE RIGHT TO USE "PRODUCTS" , APART FROM THE MARK AS SHOWN.

SER. NO. 76-686,699, FILED 2-11-2008.

PAULA MAHONEY, EXAMINING ATTORNEY

Int. Cl.: 22

Prior U.S. Cls.: 1, 2, 7, 19, 22, 42 and 50

United States Patent and Trademark Office

Reg. No. 3,574,391

Registered Feb. 17, 2009

**TRADEMARK
PRINCIPAL REGISTER**

SPARKEATER

SLINGMAX, INC. (PENNSYLVANIA CORPORATION)
2626 MARKET STREET
ASTON, PA 19014

FOR: NON-METAL SLINGS USED IN RIGGING;
NON-METAL INDUSTRIAL SLINGS FOR LIFTING,
LOADING, MOVING AND TOWING; SLINGS
MADE OF SYNTHETIC MATERIALS FOR LIFT-
ING, LOADING, MOVING AND TOWING, IN
CLASS 22 (U.S. CLS. 1, 2, 7, 19, 22, 42 AND 50).

FIRST USE 0-0-1992; IN COMMERCE 0-0-1992.

THE MARK CONSISTS OF STANDARD CHAR-
ACTERS WITHOUT CLAIM TO ANY PARTICULAR
FONT, STYLE, SIZE, OR COLOR.

SER. NO. 76-687,547, FILED 3-10-2008.

KIMBERLY FRYE, EXAMINING ATTORNEY

Int. Cl.: 11

Prior U.S. Cls.: 13, 21, 23, 31 and 34

United States Patent and Trademark Office

Reg. No. 3,574,392

Registered Feb. 17, 2009

**TRADEMARK
PRINCIPAL REGISTER**

CHIM-E-GRILL

GOBER, TED (UNITED STATES INDIVIDUAL)
408 CEDAR CREEK COURT
FORT WORTH, TX 76103

THE MARK CONSISTS OF STANDARD CHAR-
ACTERS WITHOUT CLAIM TO ANY PARTICULAR
FONT, STYLE, SIZE, OR COLOR.

FOR: FIREPLACES, BARBEQUE GRILLS AND
SMOKERS, IN CLASS 11 (U.S. CLS. 13, 21, 23, 31 AND
34).

SER. NO. 76-687,621, FILED 3-10-2008.

FIRST USE 2-16-2007; IN COMMERCE 2-16-2007.

DAVID TOOLEY, EXAMINING ATTORNEY

Int. Cl.: 5

Prior U.S. Cls.: 6, 18, 44, 46, 51 and 52

United States Patent and Trademark Office

Reg. No. 3,574,393

Registered Feb. 17, 2009

TRADEMARK
PRINCIPAL REGISTER

Think *Caffe*

RUDELIC, ROBERT A (UNITED STATES INDIVIDUAL)

944 MARKET STREET, SUITE 400
SAN FRANCISCO, CA 94102 AND

RUDELIC, SHERYL GRACE (UNITED STATES INDIVIDUAL)

944 MARKET STREET, SUITE 400
SAN FRANCISCO, CA 94102

FOR: VITAMINS AND DIETARY SUPPLEMENTS
, IN CLASS 5 (U.S. CLS. 6, 18, 44, 46, 51 AND 52).

FIRST USE 1-9-2007; IN COMMERCE 8-21-2007.

NO CLAIM IS MADE TO THE EXCLUSIVE
RIGHT TO USE "CAFFE", APART FROM THE
MARK AS SHOWN.

SER. NO. 76-688,260, FILED 4-1-2008.

HOWARD SMIGA, EXAMINING ATTORNEY

Int. Cl.: 35

Prior U.S. Cls.: 100, 101 and 102

United States Patent and Trademark Office

Reg. No. 3,574,394

Registered Feb. 17, 2009

**SERVICE MARK
PRINCIPAL REGISTER**



JTH TAX, INC. (DELAWARE CORPORATION)
1716 CORPORATE LANDING PARKWAY
VIRGINIA BEACH, VA 23454

FOR: TAX PREPARATION SERVICES, IN CLASS
35 (U.S. CLS. 100, 101 AND 102).

FIRST USE 1-8-2006; IN COMMERCE 1-8-2006.

OWNER OF U.S. REG. NOS. 2,479,692 AND
3,167,134.

THE DRAWING IS A TWO-DIMENSIONAL REPRESENTATION OF THE MARK, WHICH CONSISTS OF THE NONFUNCTIONAL ELEMENTS OF A THREE-DIMENSIONAL STATUE OF LIBERTY COSTUME TO BE WORN BY A HUMAN IN THE ADVERTISING OF THE SERVICES; THE DOTTED LINES SURROUNDING THE HANDS AND FEET INDICATE THAT THOSE PORTIONS OF THE DRAWING ARE NOT PART OF THE MARK.

SER. NO. 76-688,329, FILED 4-1-2008.

PAUL CROWLEY, EXAMINING ATTORNEY

Int. Cl.: 42

Prior U.S. Cls.: 100 and 101

United States Patent and Trademark Office

Reg. No. 3,574,395

Registered Feb. 17, 2009

**SERVICE MARK
PRINCIPAL REGISTER**

FIND A WAY

AXIS GROUP, LLC (NEW JERSEY LIMITED
LIABILITY COMPANY)
400 CONNELL ROAD, STE. 7200
BERKELEY HEIGHTS, NJ 07922

THE MARK CONSISTS OF STANDARD CHAR-
ACTERS WITHOUT CLAIM TO ANY PARTICULAR
FONT, STYLE, SIZE, OR COLOR.

FOR: COMPUTER CONSULTING AND INTE-
GRATION SERVICES RELATED TO THE INTE-
GRATION OF COMPUTER HARDWARE AND
SOFTWARE, IN CLASS 42 (U.S. CLS. 100 AND 101).

SER. NO. 76-688,476, FILED 4-9-2008.

FIRST USE 7-0-2007; IN COMMERCE 7-0-2007.

SUZANNE BLANE, EXAMINING ATTORNEY

Int. Cls.: 24 and 28

Prior U.S. Cls.: 22, 23, 38, 42 and 50

United States Patent and Trademark Office

Reg. No. 3,574,396

Registered Feb. 17, 2009

**TRADEMARK
PRINCIPAL REGISTER**

CRAWLY BABIES

LUJAN, EMILIA (UNITED STATES INDIVIDUAL)
11240 TOMAS GRANILLO
EL PASO, TX 79927

FOR: CHILDREN'S BLANKETS; BEDDING, NAMELY, BED SHEETS, COMFORTERS AND PILLOW CASES; CRIB COMFORTERS, CRIB BUMPERS, CRIB BUMPER PADS, AND DIAPER CHANGING PADS NOT OF PAPER, IN CLASS 24 (U.S. CLS. 42 AND 50).

FIRST USE 5-11-2007; IN COMMERCE 5-11-2007.

FOR: KNEE PADS FOR RECREATIONAL USE, FOR CHILDREN LEARNING TO CRAWL, IN CLASS 28 (U.S. CLS. 22, 23, 38 AND 50).

FIRST USE 5-11-2007; IN COMMERCE 5-11-2007.

THE MARK CONSISTS OF STANDARD CHARACTERS WITHOUT CLAIM TO ANY PARTICULAR FONT, STYLE, SIZE, OR COLOR.

NO CLAIM IS MADE TO THE EXCLUSIVE RIGHT TO USE "BABIES", APART FROM THE MARK AS SHOWN.

SER. NO. 76-688,643, FILED 4-15-2008.

JAMES MACFARLANE, EXAMINING ATTORNEY

Int. Cl.: 9

Prior U.S. Cls.: 21, 23, 26, 36 and 38

Reg. No. 3,574,397

United States Patent and Trademark Office

Registered Feb. 17, 2009

**TRADEMARK
PRINCIPAL REGISTER**

TRAILER EYES

MARK POINT CORPORATION (ILLINOIS CORPORATION)
6N742 PALOMINO DR.
ST. CHARLES, IL 601758439

THE MARK CONSISTS OF STANDARD CHARACTERS WITHOUT CLAIM TO ANY PARTICULAR FONT, STYLE, SIZE, OR COLOR.

FOR: TRAILER INTERIOR MONITORING SYSTEM COMPOSED OF WIRELESS CAMERAS, COLOR SCREEN MONITORS, ANTENNAS, POWER SUPPLY CONNECTORS AND ADAPTORS FOR USE WITH PORTABLE ELECTRONIC DEVICES, AND MOUNTING DEVICES FOR CAMERAS AND MONITORS, IN CLASS 9 (U.S. CLS. 21, 23, 26, 36 AND 38).

NO CLAIM IS MADE TO THE EXCLUSIVE RIGHT TO USE "TRAILER", APART FROM THE MARK AS SHOWN.

SER. NO. 76-688,898, FILED 4-23-2008.

FIRST USE 4-11-2008; IN COMMERCE 4-11-2008.

AISHA SALEM, EXAMINING ATTORNEY

Int. Cl.: 44

Prior U.S. Cls.: 100 and 101

United States Patent and Trademark Office

Reg. No. 3,574,398

Registered Feb. 17, 2009

**SERVICE MARK
PRINCIPAL REGISTER**

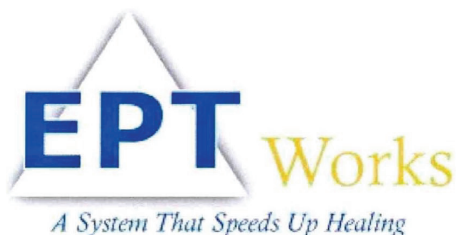

EPT SEMINARS (INDIANA SOLE PROPRIETORSHIP)
18812 LONG WALK LANE
NOBLESVILLE, IN 46060

FOR: MEDICAL SERVICES, NAMELY, ANALYSIS AND TREATMENT FOR USE IN SPEEDING UP HEALING; PSYCHOLOGICAL CONSULTATION, NAMELY, ANALYSIS AND TREATMENT FOR USE IN SPEEDING UP HEALING, IN CLASS 44 (U.S. CLS. 100 AND 101).

FIRST USE 3-17-2008; IN COMMERCE 4-1-2008.

NO CLAIM IS MADE TO THE EXCLUSIVE RIGHT TO USE "A SYSTEM THAT SPEEDS UP HEALING", APART FROM THE MARK AS SHOWN.

THE COLOR(S) BLUE, YELLOW-GOLD, WHITE AND GRAY IS/ARE CLAIMED AS A FEATURE OF THE MARK.

THE LITERAL ELEMENT OF THE MARK CONSISTS OF "EPT WORKS A SYSTEM THAT SPEEDS UP HEALING". THE MARK CONSISTS OF A RAISED TRIANGLE WITH A SHADOW OUTLINE. THE LETTERS "EPT" IS SUPERIMPOSED OVER THE TRIANGLE IN LARGE UPPERCASE LETTERING. TO THE RIGHT OF THE TRIANGLE APPEARS THE WORD "WORKS" IN LARGE STYLIZED LETTERING. UNDERNEATH THE TRIANGLE IS THE WORDING "A SYSTEM THAT SPEEDS UP HEALING" IN SMALL STYLIZED LETTERING. THE COLOR BLUE APPEARS IN THE WORD "EPT" AND "A SYSTEM THAT SPEEDS UP HEALING"; THE COLOR YELLOW-GOLD APPEARS IN THE WORD "WORKS"; THE COLOR WHITE APPEARS IN THE TRIANGLE; THE COLOR GRAY APPEARS IN THE OUTLINE SHADOW OF THE TRIANGLE.

SER. NO. 76-688,988, FILED 4-24-2008.

LAURA HAMMEL, EXAMINING ATTORNEY

Int. Cl.: 14

Prior U.S. Cls.: 2, 27, 28 and 50

United States Patent and Trademark Office

Reg. No. 3,574,399

Registered Feb. 17, 2009

**TRADEMARK
PRINCIPAL REGISTER**

PATINA

MARC-WAYNE, INC. (CALIFORNIA CORPORATION)

1342 MAIN STREET

ST. HELENA, CA 94574

FOR: JEWELRY, IN CLASS 14 (U.S. CLS. 2, 27, 28 AND 50).

FIRST USE 7-8-1995; IN COMMERCE 7-10-1995.

THE MARK CONSISTS OF STANDARD CHARACTERS WITHOUT CLAIM TO ANY PARTICULAR FONT, STYLE, SIZE, OR COLOR.

OWNER OF U.S. REG. NO. 2,721,291.

SEC. 2(F).

SER. NO. 76-689,076, FILED 4-28-2008.

SHAUNIA CARLYLE, EXAMINING ATTORNEY

Int. Cl.: 14

Prior U.S. Cls.: 2, 27, 28 and 50

United States Patent and Trademark Office

Reg. No. 3,574,400

Registered Feb. 17, 2009

**TRADEMARK
PRINCIPAL REGISTER**

PATINA ESTATE AND FINE JEWELRY

MARC-WAYNE, INC. (CALIFORNIA CORPORATION)
1342 MAIN STREET
ST. HELENA, CA 94574

FOR: JEWELRY, IN CLASS 14 (U.S. CLS. 2, 27, 28 AND 50).

FIRST USE 7-8-1995; IN COMMERCE 7-10-1995.

THE MARK CONSISTS OF STANDARD CHARACTERS WITHOUT CLAIM TO ANY PARTICULAR FONT, STYLE, SIZE, OR COLOR.

OWNER OF U.S. REG. NO. 2,721,291.

NO CLAIM IS MADE TO THE EXCLUSIVE RIGHT TO USE "ESTATE AND FINE JEWELRY", APART FROM THE MARK AS SHOWN.

SEC. 2(F).

SER. NO. 76-689,077, FILED 4-28-2008.

SHAUNIA CARLYLE, EXAMINING ATTORNEY

Int. Cl.: 11

Prior U.S. Cls.: 13, 21, 23, 31 and 34

Reg. No. 3,574,401

United States Patent and Trademark Office

Registered Feb. 17, 2009

**TRADEMARK
PRINCIPAL REGISTER**

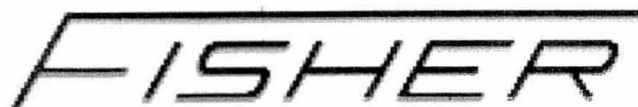
The logo for the trademark 'FISHER' is displayed in a stylized, italicized, sans-serif font. The letters are slanted to the right. A thin horizontal line is positioned above the letters, extending from the left edge of the 'F' to the right edge of the 'R'. The 'F' and 'R' have a distinctive shape with a slight curve at the top.

FISHER MANUFACTURING COMPANY (CALIFORNIA CORPORATION)
1900 S. "O" STREET
TULANE, CA 93275

FOR: PLUMBING FITTINGS AND FIXTURES FOR THE FOODSERVICE INDUSTRY, NAMELY, FAUCETS, FAUCET SPOUTS, PRE-RINSE SPRAY VALVES, SHUT-OFF VALVES, WASTE VALVES, FOOT/KNEE VALVES, PRE-RINSE UNITS, REEL RINSE UNITS, PRE-RINSE HOSES, WASTE SOCKETS, KETTLE FILLERS, GLASS FILLERS, POT

FILLERS, ANGLE STOPS, UTILITY SPRAYS, DIPPERWELL FAUCETS/SINKS, IN CLASS 11 (U.S. CLS. 13, 21, 23, 31 AND 34).

FIRST USE 0-0-1936; IN COMMERCE 0-0-1936.

SEC. 2(F).

SER. NO. 76-689,078, FILED 4-28-2008.

ANDREW RHIM, EXAMINING ATTORNEY

Int. Cl.: 9

Prior U.S. Cls.: 21, 23, 26, 36 and 38

United States Patent and Trademark Office

Reg. No. 3,574,402

Registered Feb. 17, 2009

**TRADEMARK
PRINCIPAL REGISTER**

SOFTBILLPLUS

SOFT COMPUTER CONSULTANTS, INC. (NEW
YORK CORPORATION)
5400 TECH DATA DRIVE
CLEARWATER, FL 33760

FOR: COMPUTER SOFTWARE WHICH PRO-
VIDES CONCISE BILLING CLAIMS TO HOSPITAL
AND LABORATORY INFORMATION SYSTEMS
ALONG WITH CLIENT OUTREACH BILLING
FUNCTIONALITY TO INCLUDE GENERATING
CLIENT STATEMENTS, AGING REPORTS, AND
PAYMENT POSTING, IN CLASS 9 (U.S. CLS. 21, 23,
26, 36 AND 38).

FIRST USE 2-1-2001; IN COMMERCE 2-1-2001.

THE MARK CONSISTS OF STANDARD CHAR-
ACTERS WITHOUT CLAIM TO ANY PARTICULAR
FONT, STYLE, SIZE, OR COLOR.

OWNER OF U.S. REG. NO. 3,182,364.

SER. NO. 76-689,231, FILED 5-2-2008.

TRICIA SONNEBORN, EXAMINING ATTORNEY

Int. Cl.: 33

Prior U.S. Cls.: 47 and 49

United States Patent and Trademark Office

Reg. No. 3,574,403

Registered Feb. 17, 2009

**TRADEMARK
PRINCIPAL REGISTER**

CANADIAN SELECT

EAST-WEST DISTRIBUTING CO. (ILLINOIS
CORPORATION)
200 WILMOT ROAD
DEERFIELD, IL 60015

FOR: WHISKEY, IN CLASS 33 (U.S. CLS. 47 AND
49).

FIRST USE 1-1-1971; IN COMMERCE 1-1-1971.

THE MARK CONSISTS OF STANDARD CHAR-
ACTERS WITHOUT CLAIM TO ANY PARTICULAR
FONT, STYLE, SIZE, OR COLOR.

SEC. 2(F).

SER. NO. 76-689,256, FILED 5-5-2008.

JORDAN BAKER, EXAMINING ATTORNEY

Int. Cl.: 42

Prior U.S. Cls.: 100 and 101

United States Patent and Trademark Office

Reg. No. 3,574,404

Registered Feb. 17, 2009

**SERVICE MARK
PRINCIPAL REGISTER**

F.A.S.T.

BRADFORD COMPANY (MICHIGAN CORPORATION)
13500 QUINCY STREET, P.O. BOX 1199
HOLLAND, MI 494221199

THE MARK CONSISTS OF STANDARD CHARACTERS WITHOUT CLAIM TO ANY PARTICULAR FONT, STYLE, SIZE, OR COLOR.

FOR: PACKAGING DESIGN SERVICES, IN CLASS 42 (U.S. CLS. 100 AND 101).

SER. NO. 76-689,260, FILED 5-5-2008.

FIRST USE 12-31-2004; IN COMMERCE 12-31-2004.

BONNIE LUKEN, EXAMINING ATTORNEY

Int. Cl.: 35

Prior U.S. Cls.: 100, 101 and 102

United States Patent and Trademark Office

Reg. No. 3,574,405

Registered Feb. 17, 2009

**SERVICE MARK
PRINCIPAL REGISTER**

FLOWER GIRL DRESS 4U.COM

LEE, BUM JAI (REPUBLIC OF KOREA INDIVIDUAL)
3581 FARQUHAR AVENUE, #1
LOS ALAMITOS, CA 90720

FOR: ONLINE RETAIL STORE SERVICES FEATURING WOMEN'S AND GIRLS' FORMAL DRESSES, IN CLASS 35 (U.S. CLS. 100, 101 AND 102).

FIRST USE 3-7-2008; IN COMMERCE 3-7-2008.

THE MARK CONSISTS OF STANDARD CHARACTERS WITHOUT CLAIM TO ANY PARTICULAR FONT, STYLE, SIZE, OR COLOR.

NO CLAIM IS MADE TO THE EXCLUSIVE RIGHT TO USE "FLOWER GIRL DRESS", APART FROM THE MARK AS SHOWN.

SER. NO. 76-689,299, FILED 5-6-2008.

MARK PILARO, EXAMINING ATTORNEY

Int. Cl.: 42

Prior U.S. Cls.: 100 and 101

United States Patent and Trademark Office

Reg. No. 3,574,406

Registered Feb. 17, 2009

**SERVICE MARK
PRINCIPAL REGISTER**

IT'S SO SECURE EVEN YOUR IT TEAM CAN'T GET TO IT

DIRECTORFORCE, INC. (DELAWARE CORPORATION)
435 DEVON PARK DRIVE BUILDING 500
WAYNE, PA 190871939

FOR: PROVIDING ON-LINE, NON-DOWNLOADABLE SOFTWARE THAT FACILITATES HOSTED BOARD OF DIRECTOR COMMUNICATION, COLLABORATION, AND FILE MANAGEMENT, IN CLASS 42 (U.S. CLS. 100 AND 101).

FIRST USE 10-0-2006; IN COMMERCE 10-0-2006.

THE MARK CONSISTS OF STANDARD CHARACTERS WITHOUT CLAIM TO ANY PARTICULAR FONT, STYLE, SIZE, OR COLOR.

SER. NO. 76-689,449, FILED 5-8-2008.

DORITT L. CARROLL, EXAMINING ATTORNEY

Int. Cl.: 28

Prior U.S. Cls.: 22, 23, 38 and 50

United States Patent and Trademark Office

Reg. No. 3,574,407

Registered Feb. 17, 2009

**TRADEMARK
PRINCIPAL REGISTER**



MINIMALS

DREAMING LION, LLC (D.C. LIMITED LIABILITY COMPANY)
3324 HIGHLAND PLACE
WASHINGTON, DC 20008

FIRST USE 2-17-2008; IN COMMERCE 2-17-2008.

FOR: PLUSH TOYS AND DOLLS RESEMBLING A SMALL CHILD'S DRAWINGS OF FAMILY MEMBERS, HOUSEHOLD PETS AND OTHER CREATURES, IN CLASS 28 (U.S. CLS. 22, 23, 38 AND 50).

SER. NO. 76-689,633, FILED 5-14-2008.

APRIL ROACH, EXAMINING ATTORNEY

Int. Cl.: 31

Prior U.S. Cls.: 1 and 46

United States Patent and Trademark Office

Reg. No. 3,574,408

Registered Feb. 17, 2009

**TRADEMARK
PRINCIPAL REGISTER**

Puriden

QUALITY TECHNOLOGY INTERNATIONAL,
INC. (DELAWARE CORPORATION)
2250 POINT BOULEVARD, SUITE 322
ELGIN, IL 60123

THE MARK CONSISTS OF STANDARD CHAR-
ACTERS WITHOUT CLAIM TO ANY PARTICULAR
FONT, STYLE, SIZE, OR COLOR.

FOR: PET FOOD INGREDIENTS PRODUCED
FROM CORN, NAMELY, NON-MEDICATED AD-
DITIVES FOR ANIMAL FEED, IN CLASS 31 (U.S.
CLS. 1 AND 46).

SER. NO. 76-689,759, FILED 5-19-2008.

FIRST USE 4-14-2008; IN COMMERCE 4-14-2008.

MARY BOAGNI, EXAMINING ATTORNEY

Int. Cl.: 12

Prior U.S. Cls.: 19, 21, 23, 31, 35 and 44

Reg. No. 3,574,409

United States Patent and Trademark Office

Registered Feb. 17, 2009

**TRADEMARK
PRINCIPAL REGISTER**

LITEFOOT

MATTRACKS, INC. (MINNESOTA CORPORATION)
202 CLEVELAND AVENUE EAST, PO BOX 214
KARLSTAD, MN 567320214

FOR: LAND VEHICLE PARTS, NAMELY, ALL-TERRAIN, ENDLESS TRACK ASSEMBLIES, COMPRISED OF SUPPORT FRAME, DRIVE SPROCKET, IDLER WHEELS, AND TRACKS FOR MODIFYING VEHICLES FOR OFF-ROAD TRAVEL; AND REPLACEMENT PARTS THEREFOR, IN CLASS 12 (U.S. CLS. 19, 21, 23, 31, 35 AND 44).

FIRST USE 9-1-2001; IN COMMERCE 9-1-2001.

THE MARK CONSISTS OF STANDARD CHARACTERS WITHOUT CLAIM TO ANY PARTICULAR FONT, STYLE, SIZE, OR COLOR.

SER. NO. 76-689,773, FILED 5-19-2008.

MELVIN AXILBUND, EXAMINING ATTORNEY

Int. Cl.: 33

Prior U.S. Cls.: 47 and 49

United States Patent and Trademark Office

Reg. No. 3,574,410

Registered Feb. 17, 2009

**TRADEMARK
PRINCIPAL REGISTER**

ERNA SCHEIN

BEHRENS, LES (UNITED STATES INDIVIDUAL)
1547 MAIN STREET
ST. HELENA, CA 94574 AND
DRINKWARD, LISA (UNITED STATES INDIVI-
DUAL)
1547 MAIN STREET
ST. HELENA, CA 94574

THE MARK CONSISTS OF STANDARD CHAR-
ACTERS WITHOUT CLAIM TO ANY PARTICULAR
FONT, STYLE, SIZE, OR COLOR.

"ERNA SCHEIN" DOES NOT IDENTIFY A LIV-
ING INDIVIDUAL.

FOR: WINE, IN CLASS 33 (U.S. CLS. 47 AND 49).

SER. NO. 76-689,951, FILED 5-23-2008.

FIRST USE 3-31-2007; IN COMMERCE 3-31-2007.

SAIMA MAKHDOOM, EXAMINING ATTORNEY

Int. Cl.: 16

Prior U.S. Cls.: 2, 5, 22, 23, 29, 37, 38 and 50

United States Patent and Trademark Office

Reg. No. 3,574,411

Registered Feb. 17, 2009

TRADEMARK
PRINCIPAL REGISTER

REACHABLES

BIRTH TO THREE (OREGON CORPORATION)
86 CENTENNIAL LOOP
EUGENE, OR 97401

FOR: FLASH CARDS AND MOTIVATIONAL
CARDS USED TO TEACH AND LEARN GOAL
SETTING, IN CLASS 16 (U.S. CLS. 2, 5, 22, 23, 29, 37,
38 AND 50).

FIRST USE 4-28-2008; IN COMMERCE 4-28-2008.

THE MARK CONSISTS OF STANDARD CHAR-
ACTERS WITHOUT CLAIM TO ANY PARTICULAR
FONT, STYLE, SIZE, OR COLOR.

SER. NO. 76-690,029, FILED 5-27-2008.

JOHN SCHUYLER YARD, EXAMINING ATTOR-
NEY

Int. Cl.: 5

Prior U.S. Cls.: 6, 18, 44, 46, 51 and 52

United States Patent and Trademark Office

Reg. No. 3,574,412

Registered Feb. 17, 2009

**TRADEMARK
PRINCIPAL REGISTER**



AMERICAN BIO MEDICA (NEW YORK COR-
PORATION)
122 SMITH ROAD
KINDERHOOK, NY 12106

FOR: IMMUNOASSAY DIAGNOSTIC TEST DE-
VICES CONTAINING REAGENT TEST STRIPS FOR
DETECTING THE PRESENCE OF DRUGS OF
ABUSE IN SALIVA AND URINE SPECIMENS, IN
CLASS 5 (U.S. CLS. 6, 18, 44, 46, 51 AND 52).

FIRST USE 4-4-2008; IN COMMERCE 4-4-2008.

OWNER OF U.S. REG. NOS. 2,535,111 AND
2,609,650.

NO CLAIM IS MADE TO THE EXCLUSIVE
RIGHT TO USE "RAPID", APART FROM THE
MARK AS SHOWN.

SER. NO. 76-690,239, FILED 6-2-2008.

KELLY MCCOY, EXAMINING ATTORNEY

Int. Cl.: 30

Prior U.S. Cl.: 46

United States Patent and Trademark Office

Reg. No. 3,574,413

Registered Feb. 17, 2009

TRADEMARK
PRINCIPAL REGISTER



MARIE SHARP, LLC (WYOMING LIMITED LIABILITY COMPANY)
3094 CENTRAL AVENUE, SUITE A-117
CHEYENNE, WY 82001

FOR: PEPPER SAUCE IN WHOLE OR SUBSTANTIAL PART FROM BELIZE, IN CLASS 30 (U.S. CL. 46).

FIRST USE 9-18-2003; IN COMMERCE 9-18-2003.

NO CLAIM IS MADE TO THE EXCLUSIVE RIGHT TO USE "PRODUCTS OF BELIZE", APART FROM THE MARK AS SHOWN.

"MARIE SHARP" DOES NOT IDENTIFY A LIVING INDIVIDUAL.

THE MARK CONSISTS OF A HEART DESIGN CONTAINING A DESIGN OF TWO ONIONS, TWO CARROTS, GARLIC, THREE HOT PEPPERS, A LIME, AND A HALF CUT LIME. THE WORDING "MARIE SHARP'S" APPEARS IN STYLIZED FONT WITHIN A BANNER DESIGN AND ABOVE THE HEART DESIGN. THE WORDING "PROUD PRODUCTS OF BELIZE" APPEARS IN STYLIZED FONT UNDERNEATH THE BANNER DESIGN. THE MARK IS NOT IN COLOR.

SER. NO. 76-690,539, FILED 6-13-2008.

CIMMERIAN COLEMAN, EXAMINING ATTORNEY

Int. Cl.: 9

Prior U.S. Cls.: 21, 23, 26, 36 and 38

Reg. No. 3,574,414

United States Patent and Trademark Office

Registered Feb. 17, 2009

**TRADEMARK
PRINCIPAL REGISTER**



NDSI HEALTHCARE, INC. (DELAWARE CORPORATION)
804 OMNI BOULEVARD - SUITE 101
NEWPORT NEWS, VA 23606

FOR: COMPUTER SOFTWARE PROGRAMS FOR THE COLLECTION, TRANSMISSION, STORAGE AND SHARING OF DATA AND INFORMATION IN THE FIELD OF BILLING, SCHEDULING, PAYROLL, ACCOUNTS RECEIVABLE, ACCOUNTS PAYABLE, PATIENT AND EMPLOYEE PROFILES, NURSES' PROGRESS NOTES AND CARE PLANS, CLINICAL DOCUMENTATION, HUMAN RESOURCES AND MANAGEMENT AND STATISTICAL REPORTING DATA FOR HEALTH CARE PROFES-

SIONALS, IN CLASS 9 (U.S. CLS. 21, 23, 26, 36 AND 38).

FIRST USE 10-13-2006; IN COMMERCE 10-13-2006.

THE MARK CONSISTS OF THE DESIGN OF A ROOF OF A HOME ON TOP OF THE TERM "NHOME" WHICH IS ON TOP OF THE TERM "COMPLETE".

SER. NO. 76-690,544, FILED 6-13-2008.

COLLEEN KEARNEY, EXAMINING ATTORNEY

Int. Cl.: 9

Prior U.S. Cls.: 21, 23, 26, 36 and 38

Reg. No. 3,574,415

United States Patent and Trademark Office

Registered Feb. 17, 2009

**TRADEMARK
PRINCIPAL REGISTER**



NDSI HEALTHCARE, INC. (DELAWARE CORPORATION)
804 OMNI BOULEVARD - SUITE 101
NEWPORT NEWS, VA 23606

FOR: COMPUTER SOFTWARE PROGRAMS FOR THE COLLECTION, TRANSMISSION, STORAGE AND SHARING OF DATA AND INFORMATION IN THE FIELD OF BILLING, SCHEDULING, PAYROLL, ACCOUNTS RECEIVABLE, ACCOUNTS PAYABLE, PATIENT AND EMPLOYEE PROFILES, NURSES' PROGRESS NOTES AND CARE PLANS, CLINICAL DOCUMENTATION, HUMAN RESOURCES AND MANAGEMENT AND STATISTICAL REPORTING DATA FOR HEALTH CARE PROFES-

SIONALS, IN CLASS 9 (U.S. CLS. 21, 23, 26, 36 AND 38).

FIRST USE 10-13-2006; IN COMMERCE 10-13-2006.

THE MARK CONSISTS OF THE DESIGN OF A ROOF OF A HOME ON TOP OF THE TERM "HOME" WHICH COMPRISES THE LITERAL ELEMENT OF THE MARK, "HOMEPRO".

SER. NO. 76-690,545, FILED 6-13-2008.

COLLEEN KEARNEY, EXAMINING ATTORNEY

Int. Cls.: 35 and 42

Prior U.S. Cls.: 100, 101 and 102

United States Patent and Trademark Office

Reg. No. 3,574,416

Registered Feb. 17, 2009

**SERVICE MARK
PRINCIPAL REGISTER**

INTEGRAPHIX

INTEGRAPHIX, INC. (ILLINOIS CORPORATION)
375 PLUM CREEK DRIVE
WHEELING, IL 60090

FOR: CREATIVE MARKETING DESIGN SERVICES FOR COMMERCIAL CUSTOMERS AND INDIVIDUALS IN THE AREAS OF MARKETING, PUBLISHING, ADVERTISING AND PROMOTIONAL INFORMATION, IN CLASS 35 (U.S. CLS. 100, 101 AND 102).

FIRST USE 7-20-1995; IN COMMERCE 7-20-1995.

FOR: GRAPHIC DESIGN SERVICES FOR COMMERCIAL CUSTOMERS AND INDIVIDUALS IN THE AREAS OF MARKETING, PUBLISHING, AD-

VERTISING AND PROMOTIONAL INFORMATION; PROVIDING GRAPHIC AND MULTIMEDIA DESIGN SERVICES FOR THE PURPOSE OF PROMOTING THE GOODS AND SERVICES OF OTHERS, IN CLASS 42 (U.S. CLS. 100 AND 101).

FIRST USE 7-20-1995; IN COMMERCE 7-20-1995.

THE MARK CONSISTS OF STANDARD CHARACTERS WITHOUT CLAIM TO ANY PARTICULAR FONT, STYLE, SIZE, OR COLOR.

SER. NO. 76-690,553, FILED 6-16-2008.

KATHLEEN M. VANSTON, EXAMINING ATTORNEY

Int. Cl.: 30

Prior U.S. Cl.: 46

United States Patent and Trademark Office

Reg. No. 3,574,417

Registered Feb. 17, 2009

TRADEMARK
PRINCIPAL REGISTER



JD INDUSTRIES LLC (CALIFORNIA LIMITED
LIABILITY COMPANY)
2033 SAN ELIJO AVE #470
CARDIFF, CA 92007

FOR: SHELF-STABLE TOMATO SAUCE, IN
CLASS 30 (U.S. CL. 46).

FIRST USE 3-3-2008; IN COMMERCE 3-3-2008.

NO CLAIM IS MADE TO THE EXCLUSIVE
RIGHT TO USE "SPICY GRAVY .COM" , APART
FROM THE MARK AS SHOWN.

THE COLOR(S) RED, GREEN AND BLACK IS/
ARE CLAIMED AS A FEATURE OF THE MARK.

THE MARK CONSISTS OF "SPICY GRAVY.COM"
IN STYLIZED LETTERING SUPERIMPOSED OVER
A STAR BURST WITH CHILI PEPPERS. THE COLOR
RED APPEARS IN THE WORDING "SPICY GRA-
VY.COM"; THE COLOR GREEN APPEARS IN THE
CHILI PEPPERS; THE COLOR BLACK APPEARS IN
THE BORDER OUTLINE IN THE WORDING "SPICY
GRAVY.COM".

SER. NO. 76-690,561, FILED 6-16-2008.

ELISSA GARBER KON, EXAMINING ATTORNEY

Int. Cl.: 35

Prior U.S. Cls.: 100, 101 and 102

United States Patent and Trademark Office

Reg. No. 3,574,418

Registered Feb. 17, 2009

**SERVICE MARK
PRINCIPAL REGISTER**

GO GREEN, SAVE GREEN

WESTERN EXTRALITE COMPANY (MISSOURI
CORPORATION)
1470 LIBERTY
KANSAS CITY, MO 64102

FOR: WHOLESALE AND RETAIL DISTRIBUTORSHIP SERVICES FEATURING ECO-FRIENDLY, COST-EFFECTIVE AND LABOR-SAVING PRODUCTS, NAMELY, FLUORESCENT LAMPS, FLUORESCENT HIGH BAY FIXTURES, FLUORESCENT DOWN-LITES, ELECTRONIC BALLASTS, OCCUPANCY SENSORS, LED EXIT SIGNS, LED LINEAR LIGHTING, INCANDESCENT/HALOGEN DIMMERS, POWER FAILURE LIGHTS AND

FLUORESCENT LAMP RECYCLING PACKAGING, IN CLASS 35 (U.S. CLS. 100, 101 AND 102).

FIRST USE 12-0-2007; IN COMMERCE 12-0-2007.

THE MARK CONSISTS OF STANDARD CHARACTERS WITHOUT CLAIM TO ANY PARTICULAR FONT, STYLE, SIZE, OR COLOR.

SER. NO. 76-690,568, FILED 6-16-2008.

CARRIE GENOVESE, EXAMINING ATTORNEY

Int. Cl.: 45

Prior U.S. Cls.: 100 and 101

United States Patent and Trademark Office

Reg. No. 3,574,419

Registered Feb. 17, 2009

SERVICE MARK
PRINCIPAL REGISTER



ABIDE IN JESUS LIBERTY CHURCH (MINNESOTA NON-PROFIT CORPORATION)
1845 HYACINTH AVENUE EAST
SAINT PAUL, MN 55119

FOR: EVANGELISTIC MINISTERIAL SERVICES,
IN CLASS 45 (U.S. CLS. 100 AND 101).

FIRST USE 9-5-2004; IN COMMERCE 10-1-2007.

NO CLAIM IS MADE TO THE EXCLUSIVE RIGHT TO USE "JESUS" AND "CHURCH", APART FROM THE MARK AS SHOWN.

THE MARK CONSISTS OF A SPHERE WITH THE STYLIZED WORDS "ABIDE IN JESUS LIBERTY

CHURCH" ARCHED ALONG THE TOP OF THE SPHERE. IN THE MIDDLE OF THE SPHERE IS A STAR WITH 14 POINTS SHOWING AND AN OPEN BIBLE IN THE MIDDLE OF IT. AT THE TOP OF THE OPEN BIBLE IS A CROSS WITH A DOVE FLYING DOWN TOWARD THE CROSS AND ITS BEAK LOCATED CLOSE TO THE TOP OF THE CROSS. THE BOTTOM PORTION OF THE STAR AND LOWER PART OF THE SPHERE IS COVERED BY A DEPICTION OF THE OUTLINE OF THE CONTINENTS WITH LATITUDE AND LONGITUDE LINES.

SER. NO. 76-690,611, FILED 6-17-2008.

KOURTNEE HODGES, EXAMINING ATTORNEY

Int. Cls.: 35 and 42

Prior U.S. Cls.: 100, 101 and 102

United States Patent and Trademark Office

Reg. No. 3,574,420

Registered Feb. 17, 2009

**SERVICE MARK
PRINCIPAL REGISTER**



INTEGRAPHIX, INC. (ILLINOIS CORPORATION)
375 PLUM CREEK DRIVE
WHEELING, IL 60090

FOR: CREATIVE MARKETING DESIGN SERVICES FOR COMMERCIAL CUSTOMERS AND INDIVIDUALS IN THE AREAS OF MARKETING, PUBLISHING, ADVERTISING AND PROMOTIONAL INFORMATION, IN CLASS 35 (U.S. CLS. 100, 101 AND 102).

FIRST USE 7-8-2005; IN COMMERCE 7-8-2005.

FOR: GRAPHIC DESIGN SERVICES FOR COMMERCIAL CUSTOMERS AND INDIVIDUALS IN THE AREAS OF MARKETING, PUBLISHING, ADVERTISING AND PROMOTIONAL INFORMATION;

PROVIDING GRAPHIC AND MULTIMEDIA DESIGN SERVICES FOR THE PURPOSE OF PROMOTING THE GOODS AND SERVICES OF OTHERS, IN CLASS 42 (U.S. CLS. 100 AND 101).

FIRST USE 7-8-2005; IN COMMERCE 7-8-2005.

THE MARK CONSISTS OF A CIRCLE THAT IS COMPLETELY OR PARTIALLY SHADED CONTAINING A CONTRASTING CIRCLE WITHIN A CIRCLE WITH CURVED LINES SURROUNDING THE CIRCLE.

SER. NO. 76-690,615, FILED 6-17-2008.

KATHLEEN M. VANSTON, EXAMINING ATTORNEY

Int. Cl.: 25

Prior U.S. Cls.: 22 and 39

United States Patent and Trademark Office

Reg. No. 3,574,421

Registered Feb. 17, 2009

**TRADEMARK
PRINCIPAL REGISTER**



SASCO TRADING, INC. (NEW YORK CORPORATION)
1410 BROADWAY, SUITE 1908
NEW YORK, NY 10018

FOR: JEANS, PANTS, SHORTS, TOPS, SHIRTS, T-SHIRTS, JACKETS, AND HATS, IN CLASS 25 (U.S. CLS. 22 AND 39).

FIRST USE 1-0-2008; IN COMMERCE 1-0-2008.

THE MARK CONSISTS OF "7S" AND A FIVE POINTED STAR IN A STYLIZED INTERCONNECTED FORM.

SER. NO. 76-690,806, FILED 6-23-2008.

RONALD MCMORROW, EXAMINING ATTORNEY

Int. Cl.: 1

Prior U.S. Cls.: 1, 5, 6, 10, 26 and 46

United States Patent and Trademark Office

Reg. No. 3,574,422

Registered Feb. 17, 2009

**TRADEMARK
PRINCIPAL REGISTER**

ESPRIJET

ESPRIX TECHNOLOGIES, L.P. (DELAWARE
LIMITED PARTNERSHIP), DBA ESPRIX
TECHNOLOGIES
7680 MATOAKA ROAD
SARASOTA, FL 34243

FOR: POLYMER COATING AGENTS FOR PA-
PER, CANVAS AND FILMS, IN CLASS 1 (U.S. CLS. 1,
5, 6, 10, 26 AND 46).

FIRST USE 10-0-2002; IN COMMERCE 10-0-2002.

THE MARK CONSISTS OF STANDARD CHAR-
ACTERS WITHOUT CLAIM TO ANY PARTICULAR
FONT, STYLE, SIZE, OR COLOR.

OWNER OF U.S. REG. NO. 3,379,947.

SER. NO. 76-690,892, FILED 6-27-2008.

ANDREA K. NADELMAN, EXAMINING ATTOR-
NEY

Int. Cl.: 4

Prior U.S. Cls.: 1, 6 and 15

United States Patent and Trademark Office

Reg. No. 3,574,423

Registered Feb. 17, 2009

**TRADEMARK
PRINCIPAL REGISTER**

CARBONITE

WOLFE, RICHARD A. (UNITED STATES INDIVIDUAL)
P. O. BOX 1274
BANNER ELK, NC 28604

FOR: CARBON BASED ENERGY FUEL, IN CLASS 4 (U.S. CLS. 1, 6 AND 15).

FIRST USE 6-8-2008; IN COMMERCE 6-8-2008.

THE MARK CONSISTS OF STANDARD CHARACTERS WITHOUT CLAIM TO ANY PARTICULAR FONT, STYLE, SIZE, OR COLOR.

SER. NO. 76-690,893, FILED 6-27-2008.

COURTNEY MCCORMICK, EXAMINING ATTORNEY

Int. Cl.: 35

Prior U.S. Cls.: 100, 101 and 102

United States Patent and Trademark Office

Reg. No. 3,574,424

Registered Feb. 17, 2009

**SERVICE MARK
PRINCIPAL REGISTER**

MASCARAPAQ

FLEXPAC CORPORATION (NEW JERSEY CORPORATION)
550 HADLEY ROAD
SOUTH PLAINFIELD, NJ 07080

FOR: PACKAGING SAMPLES OF COSMETICS AND PERSONAL BEAUTY AND HEALTH-CARE PRODUCTS TO THE ORDER AND SPECIFICATIONS OF OTHERS, IN CLASS 35 (U.S. CLS. 100, 101 AND 102).

FIRST USE 0-0-1996; IN COMMERCE 0-0-1996.

THE MARK CONSISTS OF STANDARD CHARACTERS WITHOUT CLAIM TO ANY PARTICULAR FONT, STYLE, SIZE, OR COLOR.

OWNER OF U.S. REG. NO. 2,258,202.

SEC. 2(F).

SER. NO. 76-690,937, FILED 6-30-2008.

ELLEN PERKINS, EXAMINING ATTORNEY

Int. Cl.: 37

Prior U.S. Cls.: 100, 103 and 106

United States Patent and Trademark Office

Reg. No. 3,574,425

Registered Feb. 17, 2009

**SERVICE MARK
PRINCIPAL REGISTER**



AUTOMATED FINANCIAL, L.L.C. (ARIZONA
LIMITED LIABILITY COMPANY)
2105 N. NEVADA STREET
CHANDLER, AZ 85225

FOR: INSTALLATION AND SERVICE OF AUTO-
MATED TELLER MACHINES, IN CLASS 37 (U.S.
CLS. 100, 103 AND 106).

FIRST USE 1-1-1999; IN COMMERCE 1-1-1999.

NO CLAIM IS MADE TO THE EXCLUSIVE
RIGHT TO USE "AUTOMATED" AND "LLC",
APART FROM THE MARK AS SHOWN.

THE MARK IS PRESENTED IN AN OVAL WITH
THE WORD "AUTOMATED" FOLLOWED BY THE
WORDS "FINANCIAL, L.L.C." PRESENTED IN UP-
PER AND LOWER CASE FONT WITH A STYLIZED
DOLLAR SIGN SLANTING THROUGH THE OVAL.

SER. NO. 76-690,949, FILED 6-30-2008.

SANJEEV VOHRA, EXAMINING ATTORNEY

Int. Cl.: 9

Prior U.S. Cls.: 21, 23, 26, 36 and 38

United States Patent and Trademark Office

Reg. No. 3,574,426

Registered Feb. 17, 2009

**TRADEMARK
PRINCIPAL REGISTER**

PHYSIOVIEW

TRANSONIC SYSTEMS, INC. (NEW YORK CORPORATION)
34 DUTCH MILL ROAD
ITHACA, NY 14850

FOR: SOFTWARE TO COLLECT, ANALYZE AND DISPLAY BIOLOGICAL AND PHYSIOLOGICAL DATA OF ANIMALS WEARING TELEMETRIC MONITORS, IN CLASS 9 (U.S. CLS. 21, 23, 26, 36 AND 38).

FIRST USE 8-15-2005; IN COMMERCE 1-3-2006.

THE MARK CONSISTS OF STANDARD CHARACTERS WITHOUT CLAIM TO ANY PARTICULAR FONT, STYLE, SIZE, OR COLOR.

SER. NO. 76-691,034, FILED 7-7-2008.

KIM MONINGHOFF, EXAMINING ATTORNEY

Int. Cls.: 35 and 40

Prior U.S. Cls.: 100, 101, 102, 103 and 106

United States Patent and Trademark Office

Reg. No. 3,574,427

Registered Feb. 17, 2009

**SERVICE MARK
PRINCIPAL REGISTER**

CLAYTON KENDALL

CLAYTON KENDALL, INC. (PENNSYLVANIA CORPORATION)
150 WEST STREET
EAST PITTSBURGH, PA 15112

FOR: MAIL ORDER AND COMPUTERIZED ON-LINE ORDERING SERVICES FEATURING CUSTOMIZED IMPRINTED APPAREL, PROMOTIONAL PRODUCTS, PERSONAL AND OFFICE ACCESSORIES, GIFTS AND AWARDS, IN CLASS 35 (U.S. CLS. 100, 101 AND 102).

FIRST USE 6-17-2002; IN COMMERCE 6-17-2002.

FOR: CUSTOMIZED IMPRINTING OF APPAREL, PROMOTIONAL PRODUCTS, PERSONAL AND OF-

FICE ACCESSORIES, GIFTS AND AWARDS, IN CLASS 40 (U.S. CLS. 100, 103 AND 106).

FIRST USE 6-17-2002; IN COMMERCE 6-17-2002.

THE MARK CONSISTS OF STANDARD CHARACTERS WITHOUT CLAIM TO ANY PARTICULAR FONT, STYLE, SIZE, OR COLOR.

THE NAME "CLAYTON KENDALL" DOES NOT IDENTIFY A LIVING INDIVIDUAL.

SER. NO. 76-691,049, FILED 7-7-2008.

KATHERINE E. HALMEN, EXAMINING ATTORNEY

Int. Cl.: 41

Prior U.S. Cls.: 100, 101 and 107

United States Patent and Trademark Office

Reg. No. 3,574,428

Registered Feb. 17, 2009

**SERVICE MARK
PRINCIPAL REGISTER**

FIRESTOP INSTALLER TRAINING

SPECIFIED TECHNOLOGIES INC. (DELAWARE CORPORATION)
200 EVANS WAY
SUITE 2
SOMERVILLE, NJ 08876

FOR: CLASSES, SEMINARS AND INDIVIDUAL INSTRUCTION IN THE FIELD OF BUILDING CONSTRUCTION AND MAINTENANCE WITH A DIRECTED CONCERN FOR PREVENTION AND CONTAINMENT OF FIRE AS WELL AS SMOKE AND HEAT ASSOCIATED THEREWITH, IN CLASS 41 (U.S. CLS. 100, 101 AND 107).

FIRST USE 6-21-1999; IN COMMERCE 6-21-1999.

THE MARK CONSISTS OF STANDARD CHARACTERS WITHOUT CLAIM TO ANY PARTICULAR FONT, STYLE, SIZE, OR COLOR.

OWNER OF U.S. REG. NO. 2,358,865.

NO CLAIM IS MADE TO THE EXCLUSIVE RIGHT TO USE "INSTALLER TRAINING", APART FROM THE MARK AS SHOWN.

SEC. 2(F).

SER. NO. 76-691,079, FILED 7-7-2008.

ALYSSA STEEL, EXAMINING ATTORNEY

Int. Cl.: 28

Prior U.S. Cls.: 22, 23, 38 and 50

United States Patent and Trademark Office

Reg. No. 3,574,429

Registered Feb. 17, 2009

**TRADEMARK
PRINCIPAL REGISTER**

SEA STINGER

SEA SEARCH, INC. (FLORIDA CORPORATION)
1736 ST. JOHNS BLUFF ROAD
JACKSONVILLE, FL 32246

THE MARK CONSISTS OF STANDARD CHAR-
ACTERS WITHOUT CLAIM TO ANY PARTICULAR
FONT, STYLE, SIZE, OR COLOR.

FOR: SPEARS FOR USE IN FISHING, NAMELY,
SPEAR FISHING TIPS AND ATTACHED CABLES,
IN CLASS 28 (U.S. CLS. 22, 23, 38 AND 50).

SER. NO. 76-691,088, FILED 7-7-2008.

FIRST USE 7-13-1987; IN COMMERCE 7-13-1987.

LINDA E. BLOHM, EXAMINING ATTORNEY

Int. Cl.: 3

Prior U.S. Cls.: 1, 4, 6, 50, 51 and 52

Reg. No. 3,574,430

United States Patent and Trademark Office

Registered Feb. 17, 2009

**TRADEMARK
PRINCIPAL REGISTER**

HAIR JUICE

INTERFASHION U.S.A., INC. (NEW YORK CORPORATION)
31-40 DOWNING STREET
FLUSHING, NY 11354

FOR: HAIR LOTIONS, NAMELY, SHAMPOOS, CONDITIONERS, HAIR BLEACHES, HAIR DYES, HAIR TINTS, HAIR COLORS, HAIR SETTING AND HAIR WAVING PREPARATIONS, IN CLASS 3 (U.S. CLS. 1, 4, 6, 50, 51 AND 52).

FIRST USE 6-1-2008; IN COMMERCE 6-1-2008.

THE MARK CONSISTS OF STANDARD CHARACTERS WITHOUT CLAIM TO ANY PARTICULAR FONT, STYLE, SIZE, OR COLOR.

NO CLAIM IS MADE TO THE EXCLUSIVE RIGHT TO USE "HAIR", APART FROM THE MARK AS SHOWN.

SER. NO. 76-691,098, FILED 7-7-2008.

NICHOLAS COLEMAN, EXAMINING ATTORNEY

Int. Cl.: 33

Prior U.S. Cls.: 47 and 49

United States Patent and Trademark Office

Reg. No. 3,574,431

Registered Feb. 17, 2009

**TRADEMARK
PRINCIPAL REGISTER**

SIERRA SOL

PALOMAR, JUAN M. (UNITED STATES INDIVIDUAL)
7391 CADES COVE
DAYTON, OH 45459

OWNER OF U.S. REG. NO. 3,039,530.

FOR: WINE, IN CLASS 33 (U.S. CLS. 47 AND 49).

THE ENGLISH TRANSLATION OF THE WORD "SOL" IN THE MARK IS "SUN".

FIRST USE 7-1-2008; IN COMMERCE 7-1-2008.

SER. NO. 76-691,103, FILED 7-7-2008.

THE MARK CONSISTS OF STANDARD CHARACTERS WITHOUT CLAIM TO ANY PARTICULAR FONT, STYLE, SIZE, OR COLOR.

NICHOLAS COLEMAN, EXAMINING ATTORNEY

Int. Cl.: 35

Prior U.S. Cls.: 100, 101 and 102

United States Patent and Trademark Office

Reg. No. 3,574,432

Registered Feb. 17, 2009

**SERVICE MARK
PRINCIPAL REGISTER**

YOURS' AND OTHERS' GENETIC CODE

SAHLGREN, MYLES R. (UNITED STATES INDIVIDUAL)
P.O. BOX 37176
TALLAHASSEE, FL 32315

FOR: FRANCHISING, NAMELY, OFFERING TECHNICAL ASSISTANCE IN THE ESTABLISHMENT AND/OR OPERATION OF HUMAN GENOME ANALYSIS LABORATORIES, IN CLASS 35 (U.S. CLS. 100, 101 AND 102).

FIRST USE 1-24-2008; IN COMMERCE 7-3-2008.

THE MARK CONSISTS OF STANDARD CHARACTERS WITHOUT CLAIM TO ANY PARTICULAR FONT, STYLE, SIZE, OR COLOR.

NO CLAIM IS MADE TO THE EXCLUSIVE RIGHT TO USE "GENETIC", APART FROM THE MARK AS SHOWN.

SER. NO. 76-691,118, FILED 7-8-2008.

JOHN DALIER, EXAMINING ATTORNEY

Int. Cl.: 3

Prior U.S. Cls.: 1, 4, 6, 50, 51 and 52

United States Patent and Trademark Office

Reg. No. 3,574,433

Registered Feb. 17, 2009

**TRADEMARK
PRINCIPAL REGISTER**

CLEARLY NOTICEABLE NAIL THICKENER

J.E.B. VENTURES, INC. (FLORIDA CORPORATION)
5479 ASCOT BEND
BOCA RATON, FL 33496

OWNER OF U.S. REG. NO. 1,593,751.

FOR: NAIL CARE PREPARATIONS, NAMELY, NAIL THICKENERS, IN CLASS 3 (U.S. CLS. 1, 4, 6, 50, 51 AND 52).

NO CLAIM IS MADE TO THE EXCLUSIVE RIGHT TO USE "NAIL THICKENER", APART FROM THE MARK AS SHOWN.

FIRST USE 12-1-1985; IN COMMERCE 3-3-1986.

SER. NO. 76-691,128, FILED 7-9-2008.

THE MARK CONSISTS OF STANDARD CHARACTERS WITHOUT CLAIM TO ANY PARTICULAR FONT, STYLE, SIZE, OR COLOR.

MAYUR VAGHANI, EXAMINING ATTORNEY

Int. Cl.: 7

Prior U.S. Cls.: 13, 19, 21, 23, 31, 34 and 35

United States Patent and Trademark Office

Reg. No. 3,574,434

Registered Feb. 17, 2009

**TRADEMARK
PRINCIPAL REGISTER**

TRUMARK

TRUMPF GMBH + CO. KG (FED REP GERMA-
NY COMPANY)
JOHANN-MAUS-STRASSE 2
D-71254 DITZINGEN, FED REP GERMANY

FOR: LASER MARKING MACHINES FOR LA-
BELING, MARKING, DECORATING AND PROCES-
SING SURFACES BY USE OF LASER BEAMS, IN
CLASS 7 (U.S. CLS. 13, 19, 21, 23, 31, 34 AND 35).

FIRST USE 8-1-2007; IN COMMERCE 8-1-2007.

THE MARK CONSISTS OF STANDARD CHAR-
ACTERS WITHOUT CLAIM TO ANY PARTICULAR
FONT, STYLE, SIZE, OR COLOR.

OWNER OF U.S. REG. NO. 3,275,339.

SER. NO. 76-691,138, FILED 7-9-2008.

CARYN GLASSER, EXAMINING ATTORNEY

Int. Cl.: 9

Prior U.S. Cls.: 21, 23, 26, 36 and 38

United States Patent and Trademark Office

Reg. No. 3,574,435

Registered Feb. 17, 2009

**TRADEMARK
PRINCIPAL REGISTER**

TRUMARK

TRUMPF GMBH + CO. KG (FED REP GERMA-
NY COMPANY)
JOHANN-MAUS-STRASSE 2
D-71254 DITZINGEN, FED REP GERMANY

FOR: LASERS NOT FOR MEDICAL PURPOSES,
IN CLASS 9 (U.S. CLS. 21, 23, 26, 36 AND 38).

FIRST USE 8-1-2007; IN COMMERCE 8-1-2007.

THE MARK CONSISTS OF STANDARD CHAR-
ACTERS WITHOUT CLAIM TO ANY PARTICULAR
FONT, STYLE, SIZE, OR COLOR.

OWNER OF U.S. REG. NO. 3,275,339.

SER. NO. 76-691,139, FILED 7-9-2008.

CARYN GLASSER, EXAMINING ATTORNEY

Int. Cl.: 9

Prior U.S. Cls.: 21, 23, 26, 36 and 38

United States Patent and Trademark Office

Reg. No. 3,574,436

Registered Feb. 17, 2009

**TRADEMARK
PRINCIPAL REGISTER**

FASTMATICS

KNOX, LEE (UNITED STATES INDIVIDUAL)
8633 S. KENWOOD LANE
P.O. BOX 11925
TEMPE, AZ 85284

FOR: COMPUTER SOFTWARE DESIGNED FOR
CONTROL OF PROCESS MODULES IN VACUUM
SYSTEMS AND GENERAL PROCESS CONTROL IN
OTHER INDUSTRIAL CONTROL APPLICATIONS,
IN CLASS 9 (U.S. CLS. 21, 23, 26, 36 AND 38).

FIRST USE 5-20-2008; IN COMMERCE 5-20-2008.

THE MARK CONSISTS OF STANDARD CHAR-
ACTERS WITHOUT CLAIM TO ANY PARTICULAR
FONT, STYLE, SIZE, OR COLOR.

SER. NO. 76-691,165, FILED 7-10-2008.

FLORENTINA BLANDU, EXAMINING ATTORNEY

Int. Cl.: 25

Prior U.S. Cls.: 22 and 39

United States Patent and Trademark Office

Reg. No. 3,574,437

Registered Feb. 17, 2009

**TRADEMARK
PRINCIPAL REGISTER**

BIKELAHOMA

PRYOR CREEK MUSIC FESTIVALS, INC. (OK-
LAHOMA CORPORATION)
114 SOUTH MILL STREET
PRYOR, OK 74361

THE MARK CONSISTS OF STANDARD CHAR-
ACTERS WITHOUT CLAIM TO ANY PARTICULAR
FONT, STYLE, SIZE, OR COLOR.

FOR: CLOTHING, NAMELY, T-SHIRTS, TANK
TOPS AND BANDANAS, IN CLASS 25 (U.S. CLS. 22
AND 39).

SER. NO. 76-691,188, FILED 7-11-2008.

FIRST USE 4-18-2008; IN COMMERCE 4-18-2008.

ALICE BENMAMAN, EXAMINING ATTORNEY

Int. Cl.: 41

Prior U.S. Cls.: 100, 101 and 107

United States Patent and Trademark Office

Reg. No. 3,574,438

Registered Feb. 17, 2009

**SERVICE MARK
PRINCIPAL REGISTER**

BIKELAHOMA

PRYOR CREEK MUSIC FESTIVALS, INC. (OK-
LAHOMA CORPORATION)
114 SOUTH MILL STREET
PRYOR, OK 74361

FOR: ENTERTAINMENT SERVICES, NAMELY,
LIVE MUSIC CONCERTS AND CONDUCTING EN-
TERTAINMENT EXHIBITIONS IN THE NATURE
OF LIVE MUSIC FESTIVALS, IN CLASS 41 (U.S. CLS.
100, 101 AND 107).

FIRST USE 4-18-2008; IN COMMERCE 4-18-2008.

THE MARK CONSISTS OF STANDARD CHAR-
ACTERS WITHOUT CLAIM TO ANY PARTICULAR
FONT, STYLE, SIZE, OR COLOR.

SER. NO. 76-691,193, FILED 7-11-2008.

ALICE BENMAMAN, EXAMINING ATTORNEY

Int. Cl.: 3

Prior U.S. Cls.: 1, 4, 6, 50, 51 and 52

United States Patent and Trademark Office

Reg. No. 3,574,439

Registered Feb. 17, 2009

TRADEMARK
PRINCIPAL REGISTER

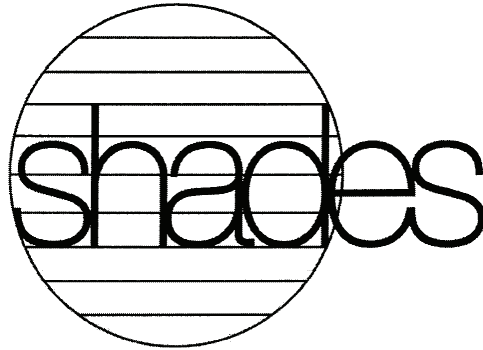

J.E.B. VENTURES, INC. (FLORIDA CORPORATION)
5479 ASCOT BEND
BOCA RATON, FL 33496

THE MARK CONSISTS OF THE WORD "SHADES" IN FRONT OF A DESIGN OF A CIRCLE WITH HORIZONTAL LINES.

FOR: COSMETICS, NAMELY, NAIL POLISH AND NAIL CARE PREPARATIONS, IN CLASS 3 (U.S. CLS. 1, 4, 6, 50, 51 AND 52).

SER. NO. 76-691,195, FILED 7-11-2008.

FIRST USE 4-26-2005; IN COMMERCE 4-26-2005.

MAYUR VAGHANI, EXAMINING ATTORNEY

Int. Cl.: 25

Prior U.S. Cls.: 22 and 39

United States Patent and Trademark Office

Reg. No. 3,574,440

Registered Feb. 17, 2009

**TRADEMARK
PRINCIPAL REGISTER**

ROCKLAHOMA

PRYOR CREEK MUSIC FESTIVALS, INC. (OK-
LAHOMA CORPORATION)
114 SOUTH MILL STREET
PRYOR, OK 74361

FOR: CLOTHING, NAMELY, T-SHIRTS, TANK
TOPS, SWEATSHIRTS AND PANTS, SHORTS, CA-
PRIS, NIGHTSHIRTS, POLO SHIRTS, JACKETS,
UNDERWEAR, CAPS, HATS AND BANDANAS, IN
CLASS 25 (U.S. CLS. 22 AND 39).

FIRST USE 7-12-2007; IN COMMERCE 7-12-2007.

THE MARK CONSISTS OF STANDARD CHAR-
ACTERS WITHOUT CLAIM TO ANY PARTICULAR
FONT, STYLE, SIZE, OR COLOR.

SER. NO. 76-691,207, FILED 7-11-2008.

ALICE BENMAMAN, EXAMINING ATTORNEY

Int. Cl.: 16

Prior U.S. Cls.: 2, 5, 22, 23, 29, 37, 38 and 50

United States Patent and Trademark Office

Reg. No. 3,574,441

Registered Feb. 17, 2009

**TRADEMARK
PRINCIPAL REGISTER**

ROCKLAHOMA

PRYOR CREEK MUSIC FESTIVALS, INC. (OK-
LAHOMA CORPORATION)
114 SOUTH MILL STREET
PRYOR, OK 74361

THE MARK CONSISTS OF STANDARD CHAR-
ACTERS WITHOUT CLAIM TO ANY PARTICULAR
FONT, STYLE, SIZE, OR COLOR.

FOR: PRINTED MATERIALS, NAMELY, BUM-
PER STICKERS AND EVENT PROGRAMS, IN
CLASS 16 (U.S. CLS. 2, 5, 22, 23, 29, 37, 38 AND 50).

SER. NO. 76-691,208, FILED 7-11-2008.

FIRST USE 7-12-2007; IN COMMERCE 7-12-2007.

REBECCA SMITH, EXAMINING ATTORNEY

Int. Cl.: 41

Prior U.S. Cls.: 100, 101 and 107

United States Patent and Trademark Office

Reg. No. 3,574,442

Registered Feb. 17, 2009

**SERVICE MARK
PRINCIPAL REGISTER**

IT'S ALL ABOUT THE PARTY!

PRYOR CREEK MUSIC FESTIVALS, INC. (OK-
LAHOMA CORPORATION)
114 SOUTH MILL STREET
PRYOR, OK 74361

FOR: ENTERTAINMENT SERVICES, NAMELY,
LIVE MUSIC CONCERTS AND CONDUCTING EN-
TERTAINMENT EXHIBITIONS IN THE NATURE
OF LIVE MUSIC FESTIVALS, IN CLASS 41 (U.S. CLS.
100, 101 AND 107).

FIRST USE 6-12-2003; IN COMMERCE 6-12-2003.

THE MARK CONSISTS OF STANDARD CHAR-
ACTERS WITHOUT CLAIM TO ANY PARTICULAR
FONT, STYLE, SIZE, OR COLOR.

SER. NO. 76-691,209, FILED 7-11-2008.

REBECCA SMITH, EXAMINING ATTORNEY

Int. Cl.: 25

Prior U.S. Cls.: 22 and 39

United States Patent and Trademark Office

Reg. No. 3,574,443

Registered Feb. 17, 2009

**TRADEMARK
PRINCIPAL REGISTER**

IT'S ALL ABOUT THE PARTY!

PRYOR CREEK MUSIC FESTIVALS, INC. (OK-
LAHOMA CORPORATION)
114 SOUTH MILL STREET
PRYOR, OK 74361

THE MARK CONSISTS OF STANDARD CHAR-
ACTERS WITHOUT CLAIM TO ANY PARTICULAR
FONT, STYLE, SIZE, OR COLOR.

FOR: CLOTHING, NAMELY, T-SHIRTS, IN
CLASS 25 (U.S. CLS. 22 AND 39).

SER. NO. 76-691,210, FILED 7-11-2008.

FIRST USE 12-31-2007; IN COMMERCE 12-31-2007.

REBECCA SMITH, EXAMINING ATTORNEY

Int. Cl.: 41

Prior U.S. Cls.: 100, 101 and 107

United States Patent and Trademark Office

Reg. No. 3,574,444

Registered Feb. 17, 2009

**SERVICE MARK
PRINCIPAL REGISTER**

ROCKLAHOMA

PRYOR CREEK MUSIC FESTIVALS, INC. (OK-
LAHOMA CORPORATION)
114 SOUTH MILL STREET
PRYOR, OK 74361

FOR: ENTERTAINMENT SERVICES, NAMELY,
LIVE MUSIC CONCERTS AND CONDUCTING EN-
TERTAINMENT EXHIBITIONS IN THE NATURE
OF LIVE MUSIC FESTIVALS, IN CLASS 41 (U.S. CLS.
100, 101 AND 107).

FIRST USE 7-12-2007; IN COMMERCE 7-12-2007.

THE MARK CONSISTS OF STANDARD CHAR-
ACTERS WITHOUT CLAIM TO ANY PARTICULAR
FONT, STYLE, SIZE, OR COLOR.

SER. NO. 76-691,211, FILED 7-11-2008.

ALICE BENMAMAN, EXAMINING ATTORNEY

Int. Cl.: 35

Prior U.S. Cls.: 100, 101 and 102

United States Patent and Trademark Office

Reg. No. 3,574,445

Registered Feb. 17, 2009

**SERVICE MARK
PRINCIPAL REGISTER**

**Talent is your most valuable asset.
The talent for finding it is ours.**

THE PACHERA GROUP (CALIFORNIA LIMITED
LIABILITY COMPANY)
23335 DEERFIELD ROAD
LOS GATOS, CA 95033

THE MARK CONSISTS OF STANDARD CHAR-
ACTERS WITHOUT CLAIM TO ANY PARTICULAR
FONT, STYLE, SIZE, OR COLOR.

FOR: PERSONNEL RECRUITING SERVICES, IN
CLASS 35 (U.S. CLS. 100, 101 AND 102).

SER. NO. 76-691,223, FILED 7-11-2008.

FIRST USE 1-5-2007; IN COMMERCE 1-5-2007.

DOMINICK J. SALEMI, EXAMINING ATTORNEY

Int. Cl.: 35

Prior U.S. Cls.: 100, 101 and 102

United States Patent and Trademark Office

Reg. No. 3,574,446

Registered Feb. 17, 2009

**SERVICE MARK
PRINCIPAL REGISTER**

PERFECT PLACES

INFLORESCENCE, LLC (CALIFORNIA LIMITED
LIABILITY COMPANY)
16 TECHNOLOGY DRIVE, SUITE 173
IRVINE, CA 92618

THE MARK CONSISTS OF STANDARD CHAR-
ACTERS WITHOUT CLAIM TO ANY PARTICULAR
FONT, STYLE, SIZE, OR COLOR.

FOR: ONLINE RETAIL FLORIST SHOP FEATUR-
ING GIFT BASKETS, IN CLASS 35 (U.S. CLS. 100, 101
AND 102).

SER. NO. 76-691,226, FILED 7-11-2008.

FIRST USE 6-16-2008; IN COMMERCE 6-16-2008.

DOMINICK J. SALEMI, EXAMINING ATTORNEY

Int. Cl.: 18

Prior U.S. Cls.: 1, 2, 3, 22 and 41

United States Patent and Trademark Office

Reg. No. 3,574,447

Registered Feb. 17, 2009

**TRADEMARK
PRINCIPAL REGISTER**

ON-BRELLA

SIEGEL, FREDERIC S. (UNITED STATES INDIVIDUAL)
133 LAGOON DRIVE EAST
LIDO BEACH, NY 11561

THE MARK CONSISTS OF STANDARD CHARACTERS WITHOUT CLAIM TO ANY PARTICULAR FONT, STYLE, SIZE, OR COLOR.

FOR: UMBRELLA FOR DEPARTING AUTO PASSENGER, IN CLASS 18 (U.S. CLS. 1, 2, 3, 22 AND 41).

SER. NO. 76-691,257, FILED 7-14-2008.

FIRST USE 1-1-2008; IN COMMERCE 1-1-2008.

DEIRDRE ROBERTSON, EXAMINING ATTORNEY

Int. Cl.: 43

Prior U.S. Cls.: 100 and 101

United States Patent and Trademark Office

Reg. No. 3,574,448

Registered Feb. 17, 2009

SERVICE MARK
PRINCIPAL REGISTER

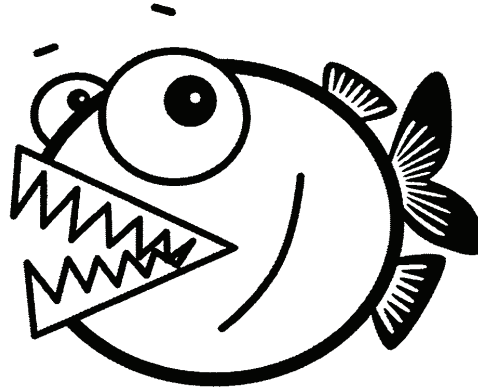

LUCKY GOLD, LLC (TEXAS LIMITED LIABILITY COMPANY)
2201 N. COLLINS, SUITE 148
ARLINGTON, TX 76011

FOR: RESTAURANT SERVICES, IN CLASS 43
(U.S. CLS. 100 AND 101).

FIRST USE 7-1-2002; IN COMMERCE 7-1-2002.

THE MARK COMPRISES A ROUNDED CARTOON FISH WITH WIDE EYES, EYEBROWS, THREE FINS, AND A WIDE MOUTH WITH MULTIPLE TRIANGULAR SHAPED TEETH.

SER. NO. 76-691,270, FILED 7-14-2008.

EMILY CHUO, EXAMINING ATTORNEY

Int. Cl.: 30

Prior U.S. Cl.: 46

United States Patent and Trademark Office

Reg. No. 3,574,449

Registered Feb. 17, 2009

**TRADEMARK
PRINCIPAL REGISTER**

BUF-MEX AT ITS BEST.

MIGHTY TACO, INC. (NEW YORK CORPORATION)
9362 TRANSIT ROAD
EAST AMHERST, NY 14051

THE MARK CONSISTS OF STANDARD CHARACTERS WITHOUT CLAIM TO ANY PARTICULAR FONT, STYLE, SIZE, OR COLOR.

FOR: BUFFALO STYLE CHICKEN BURRITO, IN CLASS 30 (U.S. CL. 46).

SER. NO. 76-691,615, FILED 7-28-2008.

FIRST USE 6-30-2008; IN COMMERCE 6-30-2008.

ALICE BENMAMAN, EXAMINING ATTORNEY

Int. Cl.: 41

Prior U.S. Cls.: 100, 101 and 107

United States Patent and Trademark Office

Reg. No. 3,574,450

Registered Feb. 17, 2009

**SERVICE MARK
PRINCIPAL REGISTER**

NATIVE AMERICAN EDUCATIONAL & CULTURAL CENTER

THE CRAZY HORSE MEMORIAL FOUNDATION
(SOUTH DAKOTA NON-PROFIT CORPORATION)

AVENUE OF THE CHIEFS
CRAZY HORSE, SD 577309506

FOR: MUSEUM SERVICES; AND EDUCATIONAL SERVICES, NAMELY, CONDUCTING CLASSES AND LECTURES IN THE FIELD OF NATIVE AMERICAN HISTORY, ART AND CULTURE, IN CLASS 41 (U.S. CLS. 100, 101 AND 107).

FIRST USE 0-0-1996; IN COMMERCE 0-0-1996.

THE MARK CONSISTS OF STANDARD CHARACTERS WITHOUT CLAIM TO ANY PARTICULAR FONT, STYLE, SIZE, OR COLOR.

NO CLAIM IS MADE TO THE EXCLUSIVE RIGHT TO USE "EDUCATIONAL & CULTURAL CENTER", APART FROM THE MARK AS SHOWN.

SEC. 2(F).

SER. NO. 76-692,343, FILED 8-25-2008.

KATHY DE JONGE, EXAMINING ATTORNEY

Int. Cl.: 30

Prior U.S. Cl.: 46

United States Patent and Trademark Office

Reg. No. 3,574,451

Registered Feb. 17, 2009

TRADEMARK
PRINCIPAL REGISTER

H-E-B CLASSIC SELECTIONS

HEB GROCERY COMPANY, LP (TEXAS LIMITED PARTNERSHIP)
646 SOUTH MAIN
SAN ANTONIO, TX 78204

FOR: FROZEN FOODS, NAMELY, EGG ROLLS, POTSTICKERS, SPRING ROLLS, BREAKFAST BURRITOS, FROZEN EMPANADAS, TACOS, WAFFLES, PIES, CAKES, CHEESECAKE, PIZZA, ENTREES CONSISTING PRIMARILY OF PASTA, DOUGH-BASED POCKETS WITH FILLING CONSISTING PRIMARILY OF VEGETABLES, IN CLASS 30 (U.S. CL. 46).

FIRST USE 12-0-2000; IN COMMERCE 12-0-2000.

THE MARK CONSISTS OF STANDARD CHARACTERS WITHOUT CLAIM TO ANY PARTICULAR FONT, STYLE, SIZE, OR COLOR.

OWNER OF U.S. REG. NOS. 2,534,650 AND 3,392,227.

NO CLAIM IS MADE TO THE EXCLUSIVE RIGHT TO USE "SELECTIONS", APART FROM THE MARK AS SHOWN.

SER. NO. 76-692,550, FILED 9-2-2008.

JUDITH HELFMAN, EXAMINING ATTORNEY

Int. Cls.: 16, 41 and 44

Prior U.S. Cls.: 2, 5, 22, 23, 29, 37, 38, 50, 100, 101 and 107

Reg. No. 3,574,452

United States Patent and Trademark Office

Registered Feb. 17, 2009

**TRADEMARK
SERVICE MARK
PRINCIPAL REGISTER**

SYN

MILES-BRAMWELL EXECUTIVE SERVICES
LIMITED (UNITED KINGDOM CORPORATION)
CLOVER NOOK ROAD
SOMERCOTES, ALFRETON
DERBYSHIRE DE55 4RF, ENGLAND

FOR: (BASED ON UK REGISTRATION 2336403)
PRINTED MATTER, NAMELY PRINTED GUIDES,
DIARIES, LEAFLETS, PAMPHLETS, BOOKS, BOOK-
LETS, PRINTED TABLES, PRINTED SCHEDULES,
PRINTED CARDS ALL FOR THE USE IN THE
AREAS OF, OR RELATING TO, SLIMMING,
WEIGHT CONTROL, DIET, DIETING, EXERCISE
AND HEALTH; DIRECTORIES, PAMPHLETS AND
CHARTS, ALL FOR USE IN THE AREAS OF, OR
RELATING TO, SLIMMING, WEIGHT CONTROL,
DIET, DIETING, EXERCISE AND HEALTH; RECIPE
BOOKS, RECIPE CARDS, RECIPE LEAFLETS, RE-
CIPE BOOKLETS; PUBLICATIONS IN THE NAT-
URE OF BOOKS, MAGAZINES, DIARIES,
BROCHURES, LEAFLETS, PAMPHLETS, DIREC-
TORIES, GUIDES AND BOOKLETS IN THE AREAS
OF, OR RELATING TO, SLIMMING, WEIGHT CON-
TROL, DIET, DIETING, EXERCISE AND HEALTH,
IN CLASS 16 (U.S. CLS. 2, 5, 22, 23, 29, 37, 38 AND 50).

FOR: (BASED ON UK REGISTRATION 2331402A)
PROVIDING TRAINING IN THE FIELDS OF SLIM-
MING, WEIGHT CONTROL, DIET, DIETING, EX-
ERCISE AND HEALTH; ARRANGING
EDUCATIONAL SEMINARS RELATING TO SLIM-
MING, DIET, DIETING, WEIGHT CONTROL, EX-

ERCISE AND HEALTH; PROVIDING EDUCATION
AND TRAINING SERVICES, NAMELY CONDUCT-
ING EDUCATIONAL SEMINARS AND CLASSES
RELATING TO SLIMMING, WEIGHT CONTROL,
DIET, DIETING, EXERCISE AND HEALTH AND
THE DISSEMINATION OF EDUCATIONAL PUBLI-
CATIONS, VIDEOS, DVDS, AND TUTORIALS FOR
USE IN CONNECTION THEREWITH; PHYSICAL
FITNESS CONSULTATION, IN CLASS 41 (U.S. CLS.
100, 101 AND 107).

FOR: (BASED ON UK REGISTRATION 2331402A)
HEALTHCARE ADVISORY AND COUNSELING
SERVICES RELATING TO SLIMMING, DIET, DIET-
ING, WEIGHT CONTROL AND HEALTHCARE;
ADVISORY AND COUNSELING SERVICES RELAT-
ING TO DIET, DIETING, WEIGHT CONTROL, IN
CLASS 44 (U.S. CLS. 100 AND 101).

THE MARK CONSISTS OF STANDARD CHAR-
ACTERS WITHOUT CLAIM TO ANY PARTICULAR
FONT, STYLE, SIZE, OR COLOR.

OWNER OF UNITED KINGDOM REG. NO.
2336403, DATED 3-14-2008, EXPIRES 7-2-2013.

OWNER OF UNITED KINGDOM REG. NO.
2331402A, DATED 3-14-2008, EXPIRES 5-8-2013.

SER. NO. 76-978,860, FILED 11-19-2004.

MARLENE BELL, EXAMINING ATTORNEY

Int. Cl.: 25

Prior U.S. Cls.: 22 and 39

United States Patent and Trademark Office

Reg. No. 3,574,453

Registered Feb. 17, 2009

**TRADEMARK
PRINCIPAL REGISTER**



VBR CARIBBEAN, INC. (PUERTO RICO CORPORATION)
URB CIUDAD JARDIN
170 ANAMU ST.
GURABO, PUERTO RICO 00778

FIRST USE 11-1-2004; IN COMMERCE 11-1-2004.

SER. NO. 77-002,010, FILED 9-19-2006.

FOR: BEACHWEAR; CAPS; HEADGEAR, NAME-
LY, HATS, CAPS; TOPS, IN CLASS 25 (U.S. CLS. 22
AND 39).

GRETTA YAO, EXAMINING ATTORNEY

Int. Cls.: 10 and 37

Prior U.S. Cls.: 26, 39, 44, 100, 103 and 106

United States Patent and Trademark Office

Reg. No. 3,574,454

Registered Feb. 17, 2009

**TRADEMARK
SERVICE MARK
PRINCIPAL REGISTER**

WAVERLEY GLEN

WAVERLEY GLEN SYSTEMS LTD. (CANADA CORPORATION)
87 SHARER ROAD
VAUGHAN, ONTARIO L4L 8Z3

FOR: INVALID LIFTS, NAMELY, APPARATUS AND DEVICES FOR LIFTING AND MOVING MOBILITY IMPAIRED INDIVIDUALS, NAMELY, PORTABLE AND CEILING LIFTS, TRACKS FOR CEILING LIFTS, MOBILE FLOOR LIFTS AND SLINGS; TRANSFER AND REPOSITIONING PRODUCTS FOR USE WITH MEDICAL PATIENTS OR USE BY HANDICAPPED PERSONS, NAMELY, HANDLING BELTS, TRANSFER BOARDS, LOW FRICTION TURNING DISKS AND GLIDE SHEETS; BATH SAFETY EQUIPMENT SPECIALLY ADAPTED FOR USE BY MEDICAL PATIENTS OR HANDICAPPED PERSONS, NAMELY, BATH SEATS AND SHOWER SEATS; TOILET AIDS, INCLUDING TOILETS ADAPTED FOR MEDICAL PATIENTS OR USE BY HANDICAPPED PERSONS, IN CLASS 10 (U.S. CLS. 26, 39 AND 44).

FIRST USE 10-0-1998; IN COMMERCE 10-0-1998.

FOR: INSTALLATION AND SERVICING OF INVALID LIFTS, APPARATUS AND DEVICES FOR LIFTING AND MOVING MOBILITY IMPAIRED INDIVIDUALS, NAMELY, PORTABLE AND CEIL-

ING LIFTS, TRACKS FOR CEILING LIFTS, MOBILE FLOOR LIFTS AND SLINGS; TRANSFER AND REPOSITIONING PRODUCTS, NAMELY, HANDLING BELTS, TRANSFER BOARDS, LOW FRICTION TURNING DISKS AND GLIDE SHEETS; BATH SAFETY EQUIPMENT, NAMELY, BATH AND SHOWER SEATS; TOILET AIDS, INCLUDING TOILETS ADAPTED FOR MEDICAL PATIENTS OR USE BY HANDICAPPED PERSONS, IN CLASS 37 (U.S. CLS. 100, 103 AND 106).

FIRST USE 10-0-1998; IN COMMERCE 10-0-1998.

THE MARK CONSISTS OF STANDARD CHARACTERS WITHOUT CLAIM TO ANY PARTICULAR FONT, STYLE, SIZE, OR COLOR.

PRIORITY CLAIMED UNDER SEC. 44(D) ON CANADA APPLICATION NO. 1316820, FILED 9-19-2006.

OWNER OF CANADA REG. NO. TMA703076, DATED 12-13-2007, EXPIRES 12-13-2022.

SER. NO. 77-002,665, FILED 9-19-2006.

MATTHEW EINSTEIN, EXAMINING ATTORNEY

Int. Cls.: 9, 38 and 42

Prior U.S. Cls.: 21, 23, 26, 36, 38, 100, 101 and 104

United States Patent and Trademark Office

Reg. No. 3,574,455

Registered Feb. 17, 2009

**TRADEMARK
SERVICE MARK
PRINCIPAL REGISTER**

SIPGUARD

ART OF DEFENCE GMBH (FED REP GERMANY CORPORATION)
BRUDERWOHRDSTRASSE 15B
D - 93055 REGENSBURG, FED REP GERMANY

FOR: SOFTWARE AND DOWNLOADABLE SOFTWARE FOR PROTECTING COMPUTERS AND NETWORKS FROM UNAUTHORIZED USERS AND SOFTWARE, IN CLASS 9 (U.S. CLS. 21, 23, 26, 36 AND 38).

FOR: TRANSMISSION OF INFORMATION BY COMPUTER COMMUNICATIONS NETWORKS, IN CLASS 38 (U.S. CLS. 100, 101 AND 104).

FOR: COMPUTER PROGRAMMING, UPDATING COMPUTER SOFTWARE FOR OTHERS, PROVIDING ON-LINE NON-DOWNLOADABLE SOFTWARE FOR PROTECTING COMPUTERS AND NETWORKS FROM UNAUTHORIZED USERS AND SOFTWARE, COMPUTER VIRUS PROTECTION SERVICES, SOFTWARE CONFIGURATION

OF COMPUTER NETWORKS, PERFORMANCE MONITORING AND ANALYZING OF COMPUTER NETWORKS, AND COMPUTER NETWORK SECURITY SERVICES, NAMELY, RESTRICTING ACCESS TO COMPUTER NETWORKS BY UNAUTHORIZED INDIVIDUALS, IN CLASS 42 (U.S. CLS. 100 AND 101).

THE MARK CONSISTS OF STANDARD CHARACTERS WITHOUT CLAIM TO ANY PARTICULAR FONT, STYLE, SIZE, OR COLOR.

PRIORITY CLAIMED UNDER SEC. 44(D) ON FED REP GERMANY APPLICATION NO. 30622697.9, FILED 4-6-2006, REG. NO. 30622697, DATED 9-15-2006, EXPIRES 4-30-2016.

SER. NO. 77-003,347, FILED 9-20-2006.

DAVID TOOLEY, EXAMINING ATTORNEY

Int. Cls.: 35 and 42

Prior U.S. Cls.: 100, 101 and 102

United States Patent and Trademark Office

Reg. No. 3,574,456

Registered Feb. 17, 2009

**SERVICE MARK
PRINCIPAL REGISTER**

**Helping Companies Connect
Smarter**

GRIFFITH HOLDINGS, INC. (OHIO CORPORATION)
3035 WEYMOUTH ROAD
MEDINA, OH 44256

FOR: ADVERTISING, PROMOTION AND MARKETING SERVICES IN THE NATURE OF E-MAIL BLAST CAMPAIGNS FOR OTHERS FOR SENDING E-MAILS TO PROSPECTIVE AND EXISTING CUSTOMERS; PROVIDING COMMERCIAL INFORMATION AND ADVICE FOR CONSUMERS TO PROSPECTIVE AND EXISTING CUSTOMERS BY PROVIDING LINKS TO WEB SITES OF OTHERS FEATURING COMMERCIAL INFORMATION AND ADVICE FOR CONSUMERS, IN CLASS 35 (U.S. CLS. 100, 101 AND 102).

FIRST USE 12-0-1999; IN COMMERCE 12-0-1999.

FOR: DESIGNING WEBSITES FOR INTERNET MARKETING PURPOSES, SUCH SITES DESIGNED TO ATTRACT PROSPECTIVE AND EXISTING CUSTOMERS, IN CLASS 42 (U.S. CLS. 100 AND 101).

FIRST USE 12-0-1999; IN COMMERCE 12-0-1999.

THE MARK CONSISTS OF STANDARD CHARACTERS WITHOUT CLAIM TO ANY PARTICULAR FONT, STYLE, SIZE, OR COLOR.

SER. NO. 77-004,363, FILED 9-21-2006.

LYDIA BELZER, EXAMINING ATTORNEY

Int. Cl.: 11

Prior U.S. Cls.: 13, 21, 23, 31 and 34

United States Patent and Trademark Office

Reg. No. 3,574,457

Registered Feb. 17, 2009

**TRADEMARK
PRINCIPAL REGISTER**

optAER

NELSON ENVIRONMENTAL INC. (CANADA CORPORATION)
94 DURAND ROAD
WINNIPEG, MANITOBA, CANADA R2J 3T2

FOR: LAGOON BASED WASTEWATER TREATMENT APPARATUS, NAMELY, AERATION HEADERS AND DIFFUSERS, FLOW OPTIMIZATION BAFFLES, FLOATING COVERS, FLOATING ATTACHED GROWTH MEDIA, SUBMERGED ATTACHED GROWTH REACTORS AND GRAVITY SAND FILTERS, IN CLASS 11 (U.S. CLS. 13, 21, 23, 31 AND 34).

PRIORITY CLAIMED UNDER SEC. 44(D) ON CANADA APPLICATION NO. 1318013, FILED 9-26-2006, REG. NO. TMA718,585, DATED 7-15-2008, EXPIRES 7-15-2023.

THE MARK CONSISTS OF THE TERM "OPT" IN LOWER CASE LETTERS AND THE TERM "AER" IN UPPER CASE LETTERS.

SER. NO. 77-008,474, FILED 9-27-2006.

SUE LAWRENCE, EXAMINING ATTORNEY

Int. Cl.: 35

Prior U.S. Cls.: 100, 101 and 102

United States Patent and Trademark Office

Reg. No. 3,574,458

Registered Feb. 17, 2009

SERVICE MARK
PRINCIPAL REGISTER



PIANO BENCH.COM, INC. (OHIO CORPORATION)
3914 MIAMI ROAD
SUITE 211
MARIEMONT, OH 45277

FOR: (BASED ON USE IN COMMERCE) ELECTRONIC RETAIL STORE SERVICES OVER THE INTERNET IN THE FIELD OF PIANO BENCHES; PIANO LAMPS AND REPLACEMENT LAMP BULBS; PIANO MOVING DOLLIES AND MOVERS; PIANO COVERS; PIANO BENCH CUSHIONS; MUSIC STANDS; STORAGE CABINETS FOR STORING MUSIC BOOKS, SHEET MUSIC AND ELECTRONIC MEDIA MUSIC; CLEANING, MAINTENANCE AND CARE PRODUCTS FOR PIANOS, PIANO BENCHES, MUSIC STANDS, AND MUSIC STORAGE CABINETS, INCLUDING CLEANING CLOTHS, DUSTING CLOTHS, POLISHING CLOTHS, COMBINATION DUSTING AND POLISHING CLOTHS, SHEEPSKIN MITTS FOR DUSTING AND/OR POLISHING, FURNITURE POLISH, KEYBOARD POLISH, AND KITS CONTAINING TWO OR MORE OF THE FOREGOING PIANO CLEANING, MAINTENANCE AND CARE PRODUCTS;

KEYBOARD LOCKS; CASTER CUPS; TOUCH-UP MARKERS FOR SEALING, STAINING AND FINISHING SCRATCHES ON WOOD PIANOS, BENCHES, AND CABINETS; PIANO AND FURNITURE MOVING PROTECTIVE PADS; AND GIFT CERTIFICATES FOR THE PURCHASE OF THE FOREGOING GOODS, IN CLASS 35 (U.S. CLS. 100, 101 AND 102).

FIRST USE 7-28-2006; IN COMMERCE 7-28-2006.

NO CLAIM IS MADE TO THE EXCLUSIVE RIGHT TO USE "PIANO BENCH.COM", APART FROM THE MARK AS SHOWN.

THE MARK CONSISTS OF THE WORDS "PIANO BENCH.COM" STYLIZED WITH THE LETTER "B" IN BENCH BEING A MUSICAL NOTE, PLUS A PIANO BENCH DESIGN.

SER. NO. 77-010,279, FILED 9-29-2006.

ELISSA GARBER KON, EXAMINING ATTORNEY

Int. Cl.: 14

Prior U.S. Cls.: 2, 27, 28 and 50

United States Patent and Trademark Office

Reg. No. 3,574,459

Registered Feb. 17, 2009

**TRADEMARK
PRINCIPAL REGISTER**

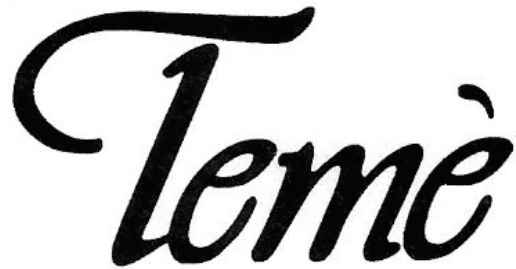

TEME, INC. (NEW MEXICO CORPORATION)
306 COUNTY RD. #1
GALLUP, NM 87301

FOR: JEWELRY, IN CLASS 14 (U.S. CLS. 2, 27, 28
AND 50).

FIRST USE 3-1-1984; IN COMMERCE 3-1-1984.

THE MARK CONSISTS OF "TEME".

THE ENGLISH TRANSLATION OF THE WORD-
ING "TEME" IN THE MARK IS SILVERSMITH.

SER. NO. 77-024,416, FILED 10-18-2006.

LINDA ESTRADA, EXAMINING ATTORNEY

Int. Cls.: 16, 17 and 20

**Prior U.S. Cls.: 1, 2, 5, 12, 13, 22, 23, 25, 29, 32, 35, 37,
38 and 50**

Reg. No. 3,574,460

United States Patent and Trademark Office

Registered Feb. 17, 2009

**TRADEMARK
PRINCIPAL REGISTER**

PETPEEL

TSCHEULIN ROTHAL GMBH (FED REP GER-
MANY GMBH)
FRIEDRICH-MEYER-STR. 23
TENINGEN, FED REP GERMANY 79331

FOR: PLASTIC SHEETS FOR PACKAGING,
NAMELY, PLASTIC FILM NOT FOR COMMERCIAL
OR INDUSTRIAL PURPOSES FOR WRAP-
PING, WITH OR WITHOUT LINING; PLASTIC
MATERIALS NAMELY, FILMS AND BAGS FOR
PACKAGING COMPRISED OF PLASTIC COMPO-
SITES COMBINED WITH ALUMINUM, ALUMI-
NUM ALLOYS, PAPER OR LAYERS OF
LACQUER; PLASTIC BAGS FOR MERCHANDISE
PACKAGING; BAGS OF PLASTIC COMBINED
WITH ALUMINUM, ALUMINUM ALLOYS, PAPER
OR LAYERS OF LACQUER FOR MERCHANDISE
PACKAGING, STATIONERY SHEETS; GRAPHIC
ART REPRODUCTIONS; PAPER LABELS, LABELS
OF PAPER COMBINED WITH PLASTIC; PLASTIC
FILM FOR PACKAGING, PLASTIC SHEETS COM-
BINED WITH ALUMINUM, ALUMINUM ALLOYS,
PAPER OR LAYERS OF LACQUER FOR PACKA-
GING, NOT FOR COMMERCIAL PURPOSES, IN
CLASS 16 (U.S. CLS. 2, 5, 22, 23, 29, 37, 38 AND 50).

FOR: PLASTIC TAPES, NAMELY, STRIPS OR
BANDS OF PLASTIC FROM A ROLL FOR SEALING
CONTAINERS, BUT NOT ADHESIVE TAPE, AND

SHEETS OF PLASTIC FOR PACKAGING; PLASTIC
TAPES, NAMELY, STRIPS OR BANDS OF PLASTIC
COMBINED WITH ALUMINUM ALLOYS, PAPER
OR LAYERS OF LACQUER, FROM A ROLL FOR
SEALING CONTAINERS, BUT NOT ADHESIVE
TAPE, AND SHEETS OF PLASTIC COMBINED
ALUMINUM, ALUMINUM ALLOYS, PAPER OR
LAYERS OF LACQUER, ALL FOR PACKAGING
PURPOSES, IN CLASS 17 (U.S. CLS. 1, 5, 12, 13, 35
AND 50).

FOR: LIDS OF PLASTIC; LIDS OF PLASTIC
COMBINED WITH ALUMINUM, ALUMINUM AL-
LOYS, PAPER OR LAYERS OF LACQUER; PLASTIC
LABELS, LABELS OF PLASTIC COMBINED WITH
PAPER, IN CLASS 20 (U.S. CLS. 2, 13, 22, 25, 32 AND
50).

THE MARK CONSISTS OF STANDARD CHAR-
ACTERS WITHOUT CLAIM TO ANY PARTICULAR
FONT, STYLE, SIZE, OR COLOR.

OWNER OF ERPN CMNTY TM OFC REG. NO.
005024658, DATED 8-3-2007, EXPIRES 4-3-2016.

SER. NO. 77-024,921, FILED 10-19-2006.

ASMAT KHAN, EXAMINING ATTORNEY

Int. Cl.: 10

Prior U.S. Cls.: 26, 39 and 44

United States Patent and Trademark Office

Reg. No. 3,574,461

Registered Feb. 17, 2009

**TRADEMARK
PRINCIPAL REGISTER**

ADAPT-SV

RESMED LIMITED (AUSTRALIA CORPORATION)
1 ELIZABETH MACARTHUR DRIVE
BELLA VISTA, NSW, AUSTRALIA 2153

FOR: MEDICAL APPARATUS AND INSTRUMENTS, NAMELY RESPIRATORY APPARATUS BEING FOR THE SCREENING, DIAGNOSIS AND TREATMENT OF SLEEP DISORDERED BREATHING, PUMPS FOR MEDICAL RESPIRATORS, DIAGNOSTIC SENSORS FOR NASAL MASKS, FEEDBACK CONTROLLERS FOR MEDICAL RESPIRATORS, MECHANICAL VENTILATORS, NON-INVASIVE POSITIVE PRESSURE VENTILATORS,

AND PARTS THEREOF, IN CLASS 10 (U.S. CLS. 26, 39 AND 44).

THE MARK CONSISTS OF STANDARD CHARACTERS WITHOUT CLAIM TO ANY PARTICULAR FONT, STYLE, SIZE, OR COLOR.

OWNER OF AUSTRALIA REG. NO. 1069911, DATED 8-12-2005, EXPIRES 8-12-2015.

SER. NO. 77-026,290, FILED 10-20-2006.

CHERYL CLAYTON, EXAMINING ATTORNEY

Int. Cl.: 3

Prior U.S. Cls.: 1, 4, 6, 50, 51 and 52

United States Patent and Trademark Office

Reg. No. 3,574,462

Registered Feb. 17, 2009

**TRADEMARK
PRINCIPAL REGISTER**



PAGLIERI PROFUMI S.P.A. (ITALY JOINT
STOCK COMPANY)
STRADA STATALE PER GENOVA KM 98
ALESSANDRIA, ITALY 15100

FOR: SOAPS; TOILET SOAPS AND DETERGENTS
FOR PERSONAL USE; CLEANSING MILK; BATH
AND SHOWER FOAMS; BATH AND SHOWER
GELS; SKIN CARE PREPARATIONS IN THE FORM
OF CREAMS, GELS AND LOTIONS; INTIMATE
SOAPS, IN CLASS 3 (U.S. CLS. 1, 4, 6, 50, 51 AND 52).

FIRST USE 2-0-2004; IN COMMERCE 9-0-2006.

THE MARK CONSISTS OF THE WORD CLEO IN
STYLIZED SCRIPT WITH AN ACCENT OVER THE
E AND AN UNDERLINE UNDER THE WORD
CLEO.

SER. NO. 77-027,341, FILED 10-23-2006.

ALYSSA STEEL, EXAMINING ATTORNEY

Int. Cl.: 42

Prior U.S. Cls.: 100 and 101

United States Patent and Trademark Office

Reg. No. 3,574,463

Registered Feb. 17, 2009

**SERVICE MARK
PRINCIPAL REGISTER**

**Micro-Bac International,
Inc.**

MICRO-BAC INTERNATIONAL, INC. (TEXAS
CORPORATION)
3200 N IH35
ROUND ROCK, TX 786812410

OWNER OF U.S. REG. NO. 1,787,812.

FOR: RESEARCH AND DEVELOPMENT OF BIO-
LOGICAL PRODUCTS FOR ENVIRONMENTAL
REMEDATION AND WASTE MANAGEMENT AP-
PLICATIONS, IN CLASS 42 (U.S. CLS. 100 AND 101).

NO CLAIM IS MADE TO THE EXCLUSIVE
RIGHT TO USE "INTERNATIONAL, INC.", APART
FROM THE MARK AS SHOWN.

FIRST USE 4-0-1982; IN COMMERCE 4-0-1982.

SER. NO. 77-029,066, FILED 10-25-2006.

THE MARK CONSISTS OF STANDARD CHAR-
ACTERS WITHOUT CLAIM TO ANY PARTICULAR
FONT, STYLE, SIZE, OR COLOR.

LEIGH CAROLINE CASE, EXAMINING ATTOR-
NEY

Int. Cl.: 3

Prior U.S. Cls.: 1, 4, 6, 50, 51 and 52

United States Patent and Trademark Office

Reg. No. 3,574,464

Registered Feb. 17, 2009

**TRADEMARK
PRINCIPAL REGISTER**

TUNU ELASTIK

OJON CORPORATION (DELAWARE CORPORATION)
767 FIFTH AVENUE
NEW YORK, NY 10153

FOR: HAIR STYLING PRODUCTS AND TREATMENTS, NAMELY, HAIR SPRAY, HAIR GEL, STYLING PASTE, STYLING POMADES, HAIR STYLING FOAMS, IN CLASS 3 (U.S. CLS. 1, 4, 6, 50, 51 AND 52).

THE MARK CONSISTS OF STANDARD CHARACTERS WITHOUT CLAIM TO ANY PARTICULAR FONT, STYLE, SIZE, OR COLOR.

PRIORITY CLAIMED UNDER SEC. 44(D) ON CANADA APPLICATION NO. 1320603, FILED 10-18-2006, REG. NO. TMA721306, DATED 8-19-2008, EXPIRES 8-19-2023.

SER. NO. 77-029,741, FILED 10-26-2006.

INGA ERVIN, EXAMINING ATTORNEY

Prior U.S. Cl.: B

United States Patent and Trademark Office

Reg. No. 3,574,465

Registered Feb. 17, 2009

CERTIFICATION MARK
PRINCIPAL REGISTER



CHARITY NAVIGATOR (DELAWARE CORPORATION)
SECOND FLOOR
1200 MACARTHUR BLVD
MAHWAH, NJ 07430

FOR: CHARITABLE FUNDRAISING SERVICES,
IN CLASS B (U.S. CL. B).

FIRST USE 12-18-2002; IN COMMERCE 12-18-2002.

NO CLAIM IS MADE TO THE EXCLUSIVE
RIGHT TO USE "CHARITY" AND "FOUR STAR
CHARITY", APART FROM THE MARK AS SHOWN.

THE CERTIFICATION MARK, AS USED BY
PERSONS AUTHORIZED BY THE CERTIFIER,
CERTIFIES THAT EVALUATION OF CHARITABLE
FUNDRAISING SERVICES PROVIDED HAVE EX-

CEEDS INDUSTRY STANDARDS AND OUTPERFORMS MOST CHARITIES IN ITS CAUSE USING A CHARITIES FINANCIAL HEALTH IN TERMS OF ORGANIZATIONAL EFFICIENCY AND ORGANIZATIONAL CAPACITY. WE USE A SET OF PERFORMANCE CATEGORIES TO RATE EACH OF THESE TWO CATEGORIES AND ISSUE AN OVERALL RATING THAT COMBINES THE CHARITY'S PERFORMANCE IN THESE TWO AREAS. THE RATINGS SHOW HOW EFFICIENTLY A CHARITY WILL USE SUPPORT THAT IT IS GIVEN, AND TO WHAT EXTENT THE CHARITIES ARE GROWING PROGRAMS AND SERVICES OVER TIME.

SER. NO. 77-038,313, FILED 11-7-2006.

ZACHARY BELLO, EXAMINING ATTORNEY

Int. Cl.: 5

Prior U.S. Cls.: 6, 18, 44, 46, 51 and 52

United States Patent and Trademark Office

Reg. No. 3,574,466

Registered Feb. 17, 2009

TRADEMARK
PRINCIPAL REGISTER



HISAMITSU PHARMACEUTICAL CO., INC. (JAPAN CORPORATION)
408 TASHIRO DAIKAN-MACHI
TOSU, JAPAN

FOR: MEDICATED PLASTERS, MEDICATED CATAPLASMS, AND MEDICATED POULTICES, ADHESIVE PATCHES FOR THE RELIEF OF ACHES, PAINS AND INFLAMMATIONS ASSOCIATED WITH MUSCLE FATIGUE, MUSCLE PAIN, STIFF SHOULDER, SIMPLE BACK ACHE, BRUISES, SPRAINS, STRAINS, ARTHRITIS, BONE FRACTURE, AND MINOR FROST BITE; GAUZE, ADHESIVE MEDICAL PLASTERS, AND ADHESIVES BANDAGES, IN CLASS 5 (U.S. CLS. 6, 18, 44, 46, 51 AND 52).

OWNER OF JAPAN REG. NO. 4944984, DATED 4-14-2006, EXPIRES 4-14-2016.

OWNER OF U.S. REG. NOS. 2,992,606, 3,144,134 AND OTHERS.

THE NAME "HISAMITSU" DOES NOT IDENTIFY A LIVING INDIVIDUAL.

THE COLOR(S) BLUE, GREEN, AND WHITE IS/ARE CLAIMED AS A FEATURE OF THE MARK.

THE MARK APPLIED-FOR CONSISTS OF THE WORDING "SALONPAS" IN WHITE LETTERS ON A BLUE RECTANGULAR BACKGROUND OVER THE WORD "HISAMITSU" IN WHITE LETTERS ON A GREEN RECTANGULAR BACKGROUND.

SER. NO. 77-038,691, FILED 11-7-2006.

JASON TURNER, EXAMINING ATTORNEY

Int. Cls.: 25 and 41

Prior U.S. Cls.: 22, 39, 100, 101 and 107

Reg. No. 3,574,467

United States Patent and Trademark Office

Registered Feb. 17, 2009

**TRADEMARK
SERVICE MARK
PRINCIPAL REGISTER**

GUY

HALL, AARON (UNITED STATES INDIVIDUAL)
C/O UNIVERSAL ATTRACTIONS, 15TH FLOOR
145 W 57TH STREET
NEW YORK, NY 10019

FOR: CLOTHING, NAMELY, T-SHIRTS, BANDANAS, SWEAT BANDS, BASEBALL CAPS, VISORS AND SWEATSHIRTS , IN CLASS 25 (U.S. CLS. 22 AND 39).

FIRST USE 1-1-1987; IN COMMERCE 1-1-1987.

FOR: ENTERTAINMENT, NAMELY, LIVE PERFORMANCES BY A MUSICAL BAND; ENTERTAINMENT SERVICES, NAMELY, LIVE, TELEVISED AND MOVIE APPEARANCES BY A PROFESSIONAL ENTERTAINER; ENTERTAINMENT SERVICES, NAMELY, PERSONAL APPEARANCES BY A MUSICAL GROUP; ENTERTAINMENT SERVICES, NAMELY, PROVIDING A WEB SITE FEATURING MUSICAL PERFORMANCES, MUSICAL VIDEOS,

RELATED FILM CLIPS, PHOTOGRAPHS, AND OTHER MULTIMEDIA MATERIALS; ENTERTAINMENT SERVICES, NAMELY, PROVIDING PRERECORDED MUSIC, INFORMATION IN THE FIELD OF MUSIC, AND COMMENTARY AND ARTICLES ABOUT MUSIC, ALL ON-LINE VIA A GLOBAL COMPUTER NETWORK; ENTERTAINMENT, NAMELY, LIVE MUSIC CONCERTS; FAN CLUBS, IN CLASS 41 (U.S. CLS. 100, 101 AND 107).

FIRST USE 1-1-1987; IN COMMERCE 1-1-1987.

THE MARK CONSISTS OF STANDARD CHARACTERS WITHOUT CLAIM TO ANY PARTICULAR FONT, STYLE, SIZE, OR COLOR.

SER. NO. 77-039,255, FILED 11-8-2006.

ALEXANDER L. POWERS, EXAMINING ATTORNEY

Int. Cl.: 41

Prior U.S. Cls.: 100, 101 and 107

United States Patent and Trademark Office

Reg. No. 3,574,468

Registered Feb. 17, 2009

**SERVICE MARK
PRINCIPAL REGISTER**

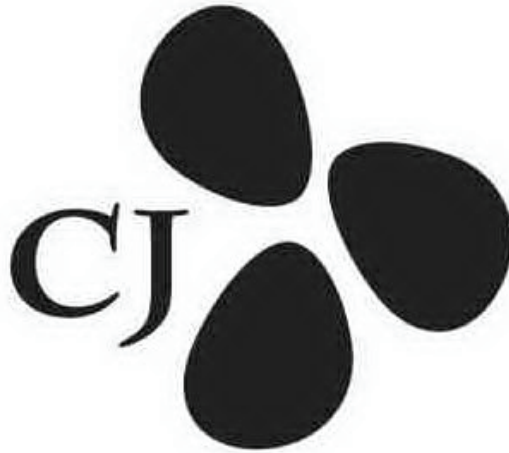

CJ CORP. (REPUBLIC OF KOREA CORPORATION)
500, 5GA, NAMDAEMOON-NO, CHUNG-KU
SEOUL, REPUBLIC OF KOREA

FOR: CINEMA THEATERS; INSTRUCTION ON SKILLS FOR LIVESTOCK FARMING; NEWS REPORTING SERVICES; INSTRUCTION ON CONFECTIONERY AND BAKERY SKILL; PROVIDING GOLF FACILITIES; ORGANIZATION OF FASHION SHOWS; PHOTOGRAPHY SERVICES; ORGANIZATION OF SPORTING EVENTS IN THE FIELD OF GOLF; ORGANIZATION OF COMMUNITY SPORT-

ING EVENTS AND CULTURAL EVENTS, IN CLASS 41 (U.S. CLS. 100, 101 AND 107).

OWNER OF REPUBLIC OF KOREA REG. NO. 0094366, DATED 12-10-2003, EXPIRES 12-10-2013.

OWNER OF U.S. REG. NOS. 3,033,390, 3,033,392 AND OTHERS.

SER. NO. 77-041,374, FILED 11-10-2006.

MAUREEN DALL, EXAMINING ATTORNEY

Int. Cl.: 29

Prior U.S. Cl.: 46

United States Patent and Trademark Office

Reg. No. 3,574,469

Registered Feb. 17, 2009

**TRADEMARK
PRINCIPAL REGISTER**

IRON GRILL

F&S GOURMET FOODS, LLC (CALIFORNIA
LIMITED LIABILITY COMPANY)
SUITE 150
72 FAIRBANKS
IRVINE, CA 92618

FOR: FOOD PACKAGE COMBINATIONS CON-
SISTING PRIMARILY OF CHEESE, MEAT AND/OR
PROCESSED FRUIT; PRE-PACKAGED DINNERS
CONSISTING OF MEAT, SEAFOOD, OR POULTRY;
PROCESSED MEAT; FROZEN, PREPARED, AND
PACKAGED ENTREES CONSISTING PRIMARILY
OF MEAT, FISH, POULTRY OR VEGETABLES;
FROZEN, PREPARED, AND PACKAGED MEALS

CONSISTING PRIMARILY OF MEAT, FISH, POUL-
TRY OR VEGETABLES, IN CLASS 29 (U.S. CL. 46).

FIRST USE 11-15-2006; IN COMMERCE 11-15-2006.

THE MARK CONSISTS OF STANDARD CHAR-
ACTERS WITHOUT CLAIM TO ANY PARTICULAR
FONT, STYLE, SIZE, OR COLOR.

SER. NO. 77-046,045, FILED 11-16-2006.

CURTIS FRENCH, EXAMINING ATTORNEY

Int. Cl.: 6

Prior U.S. Cls.: 2, 12, 13, 14, 23, 25 and 50

Reg. No. 3,574,470

United States Patent and Trademark Office

Registered Feb. 17, 2009

**TRADEMARK
PRINCIPAL REGISTER**

ULT-EMAX

SAINT-GOBAIN PIPELINES PLC (UNITED
KINGDOM CORPORATION)
STANTON-BY-DALE, ILKESTON
LOWS LANE
DERBYSHIRE, UNITED KINGDOM DE74QU

FOR: DUCTILE IRON ACCESS COVERS FOR
MANHOLES; ACCESS COVERS OF METAL FOR
MANHOLES, IN CLASS 6 (U.S. CLS. 2, 12, 13, 14, 23, 25
AND 50).

THE MARK CONSISTS OF STANDARD CHAR-
ACTERS WITHOUT CLAIM TO ANY PARTICULAR
FONT, STYLE, SIZE, OR COLOR.

PRIORITY CLAIMED UNDER SEC. 44(D) ON
UNITED KINGDOM APPLICATION NO. 2433127,
FILED 9-19-2006.

OWNER OF UNITED KINGDOM REG. NO.
2433127, DATED 3-23-2007, EXPIRES 9-19-2016.

SER. NO. 77-046,437, FILED 11-17-2006.

MARK SPARACINO, EXAMINING ATTORNEY

Int. Cl.: 5

Prior U.S. Cls.: 6, 18, 44, 46, 51 and 52

United States Patent and Trademark Office

Reg. No. 3,574,471

Registered Feb. 17, 2009

**TRADEMARK
PRINCIPAL REGISTER**

MICRO-SLIP

FEMPRO I, INC. (CANADA CORPORATION)

1330, RUE MICHAUD

DRUMMONDVILLE J2C 2Z5

QUEBEC, CANADA

FOR: FEMININE HYGIENIC PRODUCTS, NAME-
LY, PANTY LINERS, SANITARY NAPKINS AND
TAMPONS, IN CLASS 5 (U.S. CLS. 6, 18, 44, 46, 51
AND 52).

THE MARK CONSISTS OF STANDARD CHAR-
ACTERS WITHOUT CLAIM TO ANY PARTICULAR
FONT, STYLE, SIZE, OR COLOR.

PRIORITY CLAIMED UNDER SEC. 44(D) ON
CANADA APPLICATION NO. 1323910, FILED 11-14-
2006, REG. NO. TMA697901, DATED 10-4-2007, EX-
PIRES 10-4-2022.

SER. NO. 77-046,832, FILED 11-17-2006.

JOHN KELLY, EXAMINING ATTORNEY

Int. Cls.: 9, 28 and 41

Prior U.S. Cls.: 21, 22, 23, 26, 36, 38, 50, 100, 101 and 107

Reg. No. 3,574,472

United States Patent and Trademark Office

Registered Feb. 17, 2009

**TRADEMARK
SERVICE MARK
PRINCIPAL REGISTER**

Cloudtopia

GWINNER, HENRIK (DENMARK INDIVIDUAL)
RØDEGÅRDSVEJ 3
VÆRLØSE, DENMARK 3500

FOR: RECORDED COMPUTER SOFTWARE FOR USE WITH VIDEO AND COMPUTER GAMES; COMPUTER GAME PROGRAMS; COMPUTER GAME CASSETTES, COMPUTER GAME CDS, COMPUTER GAME DVDS, COMPUTER GAME PORTABLE DISCS, UNIVERSAL SERIAL BUS DRIVES; COMPUTER GAME TAPES; VIDEO GAME CARTRIDGES, DISCS AND CASSETTES; DVDS FEATURING TV GAMES, NAMELY, ADVENTURE AND COMEDY SHOWS; GAMES ADAPTED TO USE WITH TELEVISION RECEIVERS, NAMELY, VIDEO GAME DISCS AND COMPUTER GAME CARTRIDGES; OPERATORS FOR GAMES ADAPTED TO VCR, NAMELY, VIDEO GAME INTERACTIVE REMOTE CONTROL UNITS, JOYSTICKS FOR VIDEO GAMES, AND CONTROL BOXES FOR VIDEO GAMES; EXPOSED CAMERA FILM AND EXPOSED CINEMATOGRAPHIC FILMS, IN CLASS 9 (U.S. CLS. 21, 23, 26, 36 AND 38).

FOR: GAMES, NAMELY, BOARD GAMES, CARD GAMES, ELECTRONIC DART GAMES, ROLE-PLAYING GAMES AND ACTION SKILL GAMES; TOYS, NAMELY, BATHTUB TOYS, MECHANICAL ACTION TOYS, MUSICAL TOYS, FANTASY CHAR-

ACTER TOYS, AND PLUSH TOYS, IN CLASS 28 (U.S. CLS. 22, 23, 38 AND 50).

FOR: EDUCATIONAL SERVICES, NAMELY, PROVIDING AN ONLINE GAME TO TEACH ABOUT THE CLIMATE, EARTH, AIR, SKY, WIND, RAIN AND THE ENVIRONMENT; TRAINING SERVICES IN THE FIELD OF CLIMATE, EARTH, AIR, SKY, WIND, RAIN AND THE ENVIRONMENT; ENTERTAINMENT SERVICES, NAMELY, PROVIDING AN ON-LINE COMPUTER GAME; ENTERTAINMENT IN THE NATURE OF ADVENTURE AND COMEDY SHOWS; ORGANIZING COMMUNITY SPORTING AND CULTURAL ACTIVITIES; PRODUCTION OF RADIO AND TELEVISION PROGRAMS, IN CLASS 41 (U.S. CLS. 100, 101 AND 107).

THE MARK CONSISTS OF STANDARD CHARACTERS WITHOUT CLAIM TO ANY PARTICULAR FONT, STYLE, SIZE, OR COLOR.

PRIORITY CLAIMED UNDER SEC. 44(D) ON DENMARK APPLICATION NO. VA20060219, FILED 5-22-2006, REG. NO. VR20060315, DATED 9-18-2006, EXPIRES 9-18-2016.

SER. NO. 77-049,680, FILED 11-22-2006.

JENNIFER DIXON, EXAMINING ATTORNEY

Int. Cl.: 9

Prior U.S. Cls.: 21, 23, 26, 36 and 38

Reg. No. 3,574,473

United States Patent and Trademark Office

Registered Feb. 17, 2009

**TRADEMARK
PRINCIPAL REGISTER**

REFLECTIONS
REFLECTIONS

THE FELDMAN CORPORATION (MICHIGAN CORPORATION), DBA I-DEAL OPTICS, INC.
840 E. LEWISTON
FERNDALE, MI 48220

FOR: EYEGLASSES; SUNGLASSES, IN CLASS 9
(U.S. CLS. 21, 23, 26, 36 AND 38).

FIRST USE 12-31-2003; IN COMMERCE 12-31-2003.

OWNER OF U.S. REG. NOS. 1,442,880, 2,788,591,
AND 2,852,328.

THE MARK CONSISTS OF THE WORD "REFLECTIONS" WITH THE SECOND LETTER "E" IN STYLIZED FORM AND THE LETTER "C" FACING IN THE OPPOSITE DIRECTION AND EACH LETTER OF THE WORD REFLECTING ITSELF.

SER. NO. 77-052,880, FILED 11-29-2006.

ARETHA SOMERVILLE, EXAMINING ATTORNEY

Int. Cl.: 36

Prior U.S. Cls.: 100, 101 and 102

United States Patent and Trademark Office

Reg. No. 3,574,474

Registered Feb. 17, 2009

**SERVICE MARK
PRINCIPAL REGISTER**

1ST PACIFIC BANK

1ST PACIFIC BANK OF CALIFORNIA (CALIFORNIA CORPORATION)
4275 EXECUTIVE SQUARE, SUITE 650
LA JOLLA, CA 92037

FOR: BANKING SERVICES; CHECKING ACCOUNT SERVICES; SAVINGS ACCOUNT SERVICES; CERTIFICATE OF DEPOSIT ACCOUNT SERVICES; INDIVIDUAL AND BUSINESS RETIREMENT ACCOUNT SERVICES; PROVIDING BANK ACCOUNT INFORMATION BY TELEPHONE; ON-LINE BANKING SERVICES; COMMERCIAL LENDING SERVICES; BUSINESS LENDING SERVICES; CONSUMER LENDING SERVICES; MORTGAGE BANKING; SMALL BUSINESS ADMINISTRATION LOAN SERVICES; CREDIT CARD SERVICES; DEBIT CARD SERVICES; AUTOMATED TELLER MACHINE SERVICES; DIRECT DEPOSIT SERVICES;

CONSTRUCTION LOAN SERVICES; CASH MANAGEMENT SERVICES, IN CLASS 36 (U.S. CLS. 100, 101 AND 102).

FIRST USE 11-17-2000; IN COMMERCE 11-17-2000.

THE MARK CONSISTS OF STANDARD CHARACTERS WITHOUT CLAIM TO ANY PARTICULAR FONT, STYLE, SIZE, OR COLOR.

NO CLAIM IS MADE TO THE EXCLUSIVE RIGHT TO USE "1ST" AND "BANK", APART FROM THE MARK AS SHOWN.

SER. NO. 77-057,676, FILED 12-5-2006.

CHRISTINA SOBRAL, EXAMINING ATTORNEY

Int. Cl.: 9

Prior U.S. Cls.: 21, 23, 26, 36 and 38

United States Patent and Trademark Office

Reg. No. 3,574,475

Registered Feb. 17, 2009

**TRADEMARK
PRINCIPAL REGISTER**

DDFA

ZETEX SEMICONDUCTORS PLC (UNITED
KINGDOM CORPORATION)
ZETEX TECHNOLOGY PARK, CHADDERTON
OLDHAM, UNITED KINGDOM OL99LL

FOR: ELECTRICAL, ELECTRONIC AND DIGI-
TAL COMPONENTS, NAMELY, SIGNAL PROCES-
SORS; FIELD EFFECT MICRO-PROCESSORS, IN
CLASS 9 (U.S. CLS. 21, 23, 26, 36 AND 38).

THE MARK CONSISTS OF STANDARD CHAR-
ACTERS WITHOUT CLAIM TO ANY PARTICULAR
FONT, STYLE, SIZE, OR COLOR.

PRIORITY CLAIMED UNDER SEC. 44(D) ON
ERPNTY TM OFC APPLICATION NO.
5543988, FILED 12-11-2006, REG. NO. 5543988, DATED
10-30-2007, EXPIRES 12-11-2016.

SER. NO. 77-062,482, FILED 12-12-2006.

TRACY WHITTAKER-BROWN, EXAMINING AT-
TORNEY

Int. Cl.: 41

Prior U.S. Cls.: 100, 101 and 107

United States Patent and Trademark Office

Reg. No. 3,574,476

Registered Feb. 17, 2009

**SERVICE MARK
PRINCIPAL REGISTER**



THE UNIVERSITY OF BRITISH COLUMBIA (CANADA CORPORATION)
6328 MEMORIAL ROAD
VANCOUVER, CANADA V6T1Z2

FOR: EDUCATION SERVICES, NAMELY, CONDUCTING DISTANCE LEARNING INSTRUCTION AT THE UNIVERSITY AND GRADUATE LEVELS, IN CLASS 41 (U.S. CLS. 100, 101 AND 107).

FIRST USE 0-0-1995; IN COMMERCE 0-0-1995.

PRIORITY CLAIMED UNDER SEC. 44(D) ON CANADA APPLICATION NO. 1305571, FILED 6-15-

2006, REG. NO. TMA715,903, DATED 6-4-2008, EXPIRES 6-4-2023.

OWNER OF U.S. REG. NO. 3,098,134.

THE MARK CONSISTS OF THE LETTERS "UBC" ABOVE THREE WAVY LINES AND A SUNBURST WITHIN A SHIELD.

SER. NO. 77-062,874, FILED 12-12-2006.

JOHN GARTNER, EXAMINING ATTORNEY

Int. Cls.: 16, 39 and 43

Prior U.S. Cls.: 2, 5, 22, 23, 29, 37, 38, 50, 100, 101 and 105

Reg. No. 3,574,477

United States Patent and Trademark Office

Registered Feb. 17, 2009

**TRADEMARK
SERVICE MARK
PRINCIPAL REGISTER**

GRAND X

FIRST CHOICE HOLIDAYS PLC (ENGLAND PUBLIC LIMITED COMPANY (PLC))
FIRST CHOICE HOUSE, LONDON ROAD
CRAWLEY, WEST SUSSEX, ENGLAND RH109GX

FOR: PRINTED PUBLICATIONS AND PRINTED MATTER, NAMELY, BOOKS AND BOOKLETS IN THE FIELD OF TRAVEL AND TOURISM, TRAVEL GUIDES, LOG BOOKS, MAPS AND CHARTS; PICTURES, PHOTOGRAPHS, POSTERS AND PRINTS; POSTCARDS AND GREETINGS CARDS; STATIONERY; PAPER LABELS, PAPER BADGES, STICKERS, PAPER SIGNS AND PAPER BANNERS; DIARIES, CALENDARS, TELEPHONE NUMBER BOOKS AND ADDRESS BOOKS; BOOKMARKS; DESKTOP ORGANIZERS; PAPER BAGS; GIFT WRAP PAPER; PAPER PLACE MATS AND PAPER COASTERS, IN CLASS 16 (U.S. CLS. 2, 5, 22, 23, 29, 37, 38 AND 50).

FOR: TRAVEL AGENCY SERVICES, NAMELY, MAKING RESERVATIONS AND BOOKINGS FOR TRANSPORTATION; TOURIST AGENCY; PASSENGER TRANSPORTATION SERVICES BY LAND, AIR AND/OR SEA; AIR TRANSPORTATION SERVICES; MARINA SERVICES; PROVIDING VESSEL MOORING FACILITIES; PLEASURE BOAT CRUISES, BOAT CRUISES, AND TOUR CONDUCTING SERVICES; ORGANIZATION OF BOATING HOLIDAYS; ARRANGING AND CONDUCTING TRAVEL TOURS AND EXCURSIONS; RENTAL AND CHAR-

TER OF WATERCRAFT AND OF CARS; PROVIDING ADVICE AND INFORMATION RELATING TO THE AFORESAID SERVICES, IN CLASS 39 (U.S. CLS. 100 AND 105).

FOR: HOTEL, BOARDING HOUSE, TOURIST HOME, TOURIST HOSTEL, MOTEL, CAFE, CAFETERIA AND RESTAURANT SERVICES; BAR AND RESORT HOTEL SERVICES; PROVISION OF CAMPGROUND FACILITIES; PROVISION OF FACILITIES FOR EXHIBITIONS AND CONFERENCES; ARRANGING TEMPORARY HOUSING ACCOMMODATIONS FOR HOLIDAYS; PROVIDING ADVICE AND INFORMATION RELATING TO THE AFORESAID SERVICES, IN CLASS 43 (U.S. CLS. 100 AND 101).

THE MARK CONSISTS OF STANDARD CHARACTERS WITHOUT CLAIM TO ANY PARTICULAR FONT, STYLE, SIZE, OR COLOR.

PRIORITY CLAIMED UNDER SEC. 44(D) ON ERPN CMNTY TM OFC APPLICATION NO. 005516745, FILED 12-1-2006, REG. NO. 005516745, DATED 12-1-2006, EXPIRES 12-1-2016.

SER. NO. 77-063,471, FILED 12-13-2006.

STEVEN R. FINE, EXAMINING ATTORNEY

Int. Cl.: 36

Prior U.S. Cls.: 100, 101 and 102

United States Patent and Trademark Office

Reg. No. 3,574,478

Registered Feb. 17, 2009

SERVICE MARK
PRINCIPAL REGISTER



CATAPULT CONSULTING ASSOCIATES LLC
(CALIFORNIA LIMITED LIABILITY COMPAN-
NY)
SUITE 145
6140 STONERIDGE MALL ROAD
PLEASANTON, CA 94588

FOR: ASSESSMENT AND MANAGEMENT OF
REAL ESTATE; CAPITAL INVESTMENT CONSUL-
TATION; EQUITY CAPITAL INVESTMENT; FINAN-
CIAL ANALYSIS AND CONSULTATION;
FINANCIAL CONSULTATION; FINANCIAL DUE
DILIGENCE; FINANCIAL PLANNING CONSULTA-
TION; FINANCIAL SERVICES, NAMELY, ASSIST-
ING OTHERS WITH THE COMPLETION OF
FINANCIAL TRANSACTIONS FOR STOCKS,
BONDS, SECURITIES AND EQUITIES; INVEST-
MENT ADVISORY SERVICES; INVESTMENT CON-
SULTATION; INVESTMENT SERVICES, NAMELY,
ASSET ACQUISITION, CONSULTATION, DEVEL-
OPMENT AND MANAGEMENT SERVICES; LEVER-
AGED BUY OUTS AND INVESTMENTS IN

FINANCIALLY DISTRESSED OR UNDERPER-
FORMING COMPANIES; REAL ESTATE ACQUI-
SITION SERVICES; REAL ESTATE INVESTMENT, IN
CLASS 36 (U.S. CLS. 100, 101 AND 102).

FIRST USE 5-1-2001; IN COMMERCE 6-1-2001.

THE COLOR(S) NAMELY, BLUE AND RED IS/
ARE CLAIMED AS A FEATURE OF THE MARK.

THE MARK CONSISTS OF THE WORD "CATA-
PULT" IS ITALICIZED IN BLUE FONT AND TO THE
RIGHT IS A ROUND ABSTRACT LOGO IMAGE
WITH BLUE LINES AT THE BASE AND ARCING
SHAPES IN SHADES OF RED ABOVE THAT FILL
OUT THE CIRCLE.

SER. NO. 77-064,662, FILED 12-14-2006.

DOMINICK J. SALEMI, EXAMINING ATTORNEY

Int. Cls.: 35 and 41

Prior U.S. Cls.: 100, 101, 102 and 107

United States Patent and Trademark Office

Reg. No. 3,574,479

Registered Feb. 17, 2009

**SERVICE MARK
PRINCIPAL REGISTER**

GYMFLESH

GYMFLESH CORPORATION (NEW YORK CORPORATION)
P.O. BOX 475
TAPPAN, NY 10983

FOR: MAIL ORDER CATALOG SERVICES, ON-LINE CATALOG SERVICES, AND ON-LINE RETAIL STORE SERVICES, ALL FEATURING- SPORTS EQUIPMENT, BOOKS AND PUBLICATIONS, VIDEOS, PRODUCTS AND ACCESSORIES FOR PHYSICAL FITNESS, ATHLETIC TRAINING, NUTRITIONAL SUPPLEMENTS, HEALTH AND STRENGTH TRAINING, IN CLASS 35 (U.S. CLS. 100, 101 AND 102).

FIRST USE 3-19-2004; IN COMMERCE 3-19-2004.

FOR: EDUCATION SERVICES, NAMELY, CONDUCTING CLASSES, CONFERENCES AND SEMINARS AND ON-SITE INSTRUCTION FOR HEALTH AND FITNESS, AND IN THE FIELDS OF PERSONAL IMPROVEMENT, PHYSICAL TRAINING, HEALING, HEALTH, WELL-BEING, THE MIND-BODY CONNECTION AND MEDITATION, HOLISTIC HEALTH, PHILOSOPHY AND WISDOM TRADITIONS, MEDICAL PRACTICES AND PHYSICS, EXERCISE AND FITNESS PROTOCOLS, SPORTS AND ATHLETICS, MILITARY PROCEDURES AND MARTIAL ARTS, KINESIOLOGY AND PHYSIATRY, PSYCHOLOGICAL AND BEHAVIORAL SCIENCES, PHYSICAL AND OCCUPATIONAL

THERAPIES, WELLNESS AND NUTRITIONAL GUIDELINES, AND IN THE FIELDS OF LEADERSHIP, PERSONAL AND PROFESSIONAL SUCCESS, SELF-AWARENESS, SELF-IMPROVEMENT, SELF-HELP, SELF-FULFILLMENT, ENLIGHTENMENT, SELF-EMPOWERMENT, MEDITATION, METAPHYSICAL AND SPIRITUAL DISCOVERY, RELAXATION, HEALING TECHNIQUES, AND PHYSICAL NURTURING, AND DISTRIBUTION OF COURSE MATERIALS IN CONNECTION THEREWITH; YOGA INSTRUCTION; CONDUCTING SEMINARS, LECTURES AND WORKSHOPS IN THE FIELDS OF WEIGHT LOSS, WEIGHT CONTROL, NUTRITION AND FITNESS; ON-SITE INSTRUCTION FOR HEALTH AND FITNESS GYMNASIUM, HEALTH CLUB SERVICES, NAMELY, PROVIDING INSTRUCTION AND EQUIPMENT IN THE FIELD OF PHYSICAL EXERCISE AND FITNESS INSTRUCTION SERVICES, IN CLASS 41 (U.S. CLS. 100, 101 AND 107).

FIRST USE 3-19-2004; IN COMMERCE 3-19-2004.

THE MARK CONSISTS OF STANDARD CHARACTERS WITHOUT CLAIM TO ANY PARTICULAR FONT, STYLE, SIZE, OR COLOR.

SER. NO. 77-065,558, FILED 12-15-2006.

MARY BOAGNI, EXAMINING ATTORNEY

Int. Cl.: 41

Prior U.S. Cls.: 100, 101 and 107

United States Patent and Trademark Office

Reg. No. 3,574,480

Registered Feb. 17, 2009

**SERVICE MARK
PRINCIPAL REGISTER**

BLUE CODA

BARKER, ROBERT A. AND BARKER, DERRICK
A. (NEW YORK JOINT VENTURE)
816 EAST CARL AVENUE
BALDWIN, NY 11510

THE MARK CONSISTS OF STANDARD CHAR-
ACTERS WITHOUT CLAIM TO ANY PARTICULAR
FONT, STYLE, SIZE, OR COLOR.

FOR: ENTERTAINMENT, NAMELY, LIVE PER-
FORMANCES BY A MUSICAL BAND, IN CLASS 41
(U.S. CLS. 100, 101 AND 107).

SER. NO. 77-071,748, FILED 12-27-2006.

FIRST USE 5-9-2003; IN COMMERCE 5-9-2003.

JOHN GARTNER, EXAMINING ATTORNEY

Int. Cl.: 36

Prior U.S. Cls.: 100, 101 and 102

United States Patent and Trademark Office

Reg. No. 3,574,481

Registered Feb. 17, 2009

SERVICE MARK
PRINCIPAL REGISTER

The logo for 1st Pacific Bank features the text "1ST PACIFIC BANK" in a stylized, serif font. The "1" is significantly larger and more prominent than the other characters. Below the text is a decorative, wavy line that resembles a stylized ocean wave, with two distinct crests.

1ST PACIFIC BANK OF CALIFORNIA (CALIFORNIA CORPORATION)
4275 EXECUTIVE SQUARE, SUITE 650
LA JOLLA, CA 92037

FOR: BANKING SERVICES; CHECKING ACCOUNT SERVICES; SAVINGS ACCOUNT SERVICES; CERTIFICATE OF DEPOSIT ACCOUNT SERVICES; INDIVIDUAL AND BUSINESS RETIREMENT ACCOUNT SERVICES; PROVIDING BANK ACCOUNT INFORMATION BY TELEPHONE; ON-LINE BANKING SERVICES; COMMERCIAL LENDING SERVICES; BUSINESS LENDING SERVICES; CONSUMER LENDING SERVICES; MORTGAGE BANKING; SMALL BUSINESS LOAN SERVICES; CREDIT CARD SERVICES; DEBIT CARD SERVICES; AUTOMATED TELLER MACHINE SERVICES; DIRECT DEPOSIT SERVICES; CONSTRUCTION

LOAN SERVICES; CASH MANAGEMENT SERVICES, IN CLASS 36 (U.S. CLS. 100, 101 AND 102).

FIRST USE 11-17-2000; IN COMMERCE 11-17-2000.

NO CLAIM IS MADE TO THE EXCLUSIVE RIGHT TO USE "1ST" AND "BANK", APART FROM THE MARK AS SHOWN.

THE MARK CONSISTS OF "1ST PACIFIC BANK" WITH A DESIGN OF A STYLISTIC OCEAN WAVE WITH TWO CRESTS, PLACED BETWEEN AND BENEATH THE WORDS "1ST PACIFIC" AND "BANK".

SER. NO. 77-072,076, FILED 12-27-2006.

CHRISTINA SOBRAL, EXAMINING ATTORNEY

Int. Cl.: 36

Prior U.S. Cls.: 100, 101 and 102

United States Patent and Trademark Office

Reg. No. 3,574,482

Registered Feb. 17, 2009

SERVICE MARK
PRINCIPAL REGISTER



1ST PACIFIC BANK OF CALIFORNIA (CALIFORNIA CORPORATION)
4275 EXECUTIVE SQUARE, SUITE 650
LA JOLLA, CA 92037

FOR: BANKING SERVICES; CHECKING ACCOUNT SERVICES; SAVINGS ACCOUNT SERVICES; CERTIFICATE OF DEPOSIT ACCOUNT SERVICES; INDIVIDUAL AND BUSINESS RETIREMENT ACCOUNT SERVICES; PROVIDING BANK ACCOUNT INFORMATION BY TELEPHONE; ONLINE BANKING SERVICES; COMMERCIAL LENDING SERVICES; BUSINESS LENDING SERVICES; CONSUMER LENDING SERVICES; MORTGAGE BANKING; SMALL BUSINESS LOAN SERVICES; CREDIT CARD SERVICES; DEBIT CARD SERVICES; AUTOMATED TELLER MACHINE SERVICES; DIRECT DEPOSIT SERVICES; CONSTRUCTION

LOAN SERVICES; CASH MANAGEMENT SERVICES, IN CLASS 36 (U.S. CLS. 100, 101 AND 102).

FIRST USE 11-17-2000; IN COMMERCE 11-17-2000.

NO CLAIM IS MADE TO THE EXCLUSIVE RIGHT TO USE "1ST" AND "BANK OF CALIFORNIA", APART FROM THE MARK AS SHOWN.

THE MARK CONSISTS OF "1ST PACIFIC BANK OF CALIFORNIA" WITH A DESIGN OF A STYLISTIC OCEAN WAVE WITH TWO CRESTS, PLACED BETWEEN AND BENEATH THE WORDS "1ST PACIFIC" AND "BANK OF CALIFORNIA".

SER. NO. 77-072,084, FILED 12-27-2006.

CHRISTINA SOBRAL, EXAMINING ATTORNEY

Int. Cl.: 16

Prior U.S. Cls.: 2, 5, 22, 23, 29, 37, 38 and 50

United States Patent and Trademark Office

Reg. No. 3,574,483

Registered Feb. 17, 2009

TRADEMARK
PRINCIPAL REGISTER



SHINN JEE ENTERPRISE CO., LTD. (TAIWAN CORPORATION)
YUNG-AN RD., (HO-SHUN INDUSTRIAL DIST.)
TAINAN, TAIWAN

FOR: PHOTOGRAPH ALBUMS; NOTE BOOKS; DIARIES; FOLDERS; NOTE PADS; SCHOOL SUPPLY KITS CONTAINING VARIOUS COMBINATIONS OF SELECTED SCHOOL SUPPLIES, NAMELY, WRITING INSTRUMENTS, PENS, PENCILS, MECHANICAL PENCILS, ERASERS, MARKERS, CRAYONS, HIGHLIGHTERS, FOLDERS, NOTEBOOKS, PAPER, GRADUATED RULERS, PROTRACTORS, PAPER CLIPS, PENCIL SHARPENERS, WRITING GRIPS, GLUE AND BOOK MARKS; CARDS NOT MAGNETICALLY CODED FOR USE IN BUSINESS TRANSACTIONS; STATIONERY BOXES; LETTER PAPER; BOOKLETS FOR USE RECORDING TELEPHONE NUMBERS AND ADDRESS; PEN CASES; PEN AND PENCIL BOXES;

ADDRESS BOOKS; COLORING BOOKS; DOCUMENT PORTFOLIOS; STICKERS; ALBUMS FOR STICKERS; SOUVENIR BOOKLETS, IN CLASS 16 (U.S. CLS. 2, 5, 22, 23, 29, 37, 38 AND 50).

FIRST USE 2-1-1981; IN COMMERCE 2-1-1995.

THE NAME(S), PORTRAIT(S), AND/OR SIGNATURE(S) SHOWN IN THE MARK DOES NOT IDENTIFY A PARTICULAR LIVING INDIVIDUAL.

THE MARK CONSISTS OF THE STYLIZED LETTERS "SJ" WITHIN A RECTANGULAR BOX WITH A BORDER, FOLLOWED WITH THE WORDS "SHINN JEE".

SER. NO. 77-072,322, FILED 12-28-2006.

CARYN GLASSER, EXAMINING ATTORNEY

Int. Cls.: 9 and 10

Prior U.S. Cls.: 21, 23, 26, 36, 38, 39 and 44

Reg. No. 3,574,484

United States Patent and Trademark Office

Registered Feb. 17, 2009

**TRADEMARK
PRINCIPAL REGISTER**

FACT

ELBIT SYSTEMS LTD. (ISRAEL COMPANY)
ADVANCED TECHNOLOGY CENTRE, P.O. BOX 539
HAIFA 31053, ISRAEL

FOR: ELECTROMAGNETIC FIELD DETECTION AND CHARACTERIZATION SYSTEM COMPOSED OF A COMPUTER, A DETECTION WAND AND COMPUTER SOFTWARE FOR STORING, ANALYZING AND REPORTING ELECTROMAGNETIC FIELD DATA, FOR USE IN POSITION AND ORIENTATION SYSTEMS, TRACKING SYSTEMS, AIRBORNE PLATFORMS AND SIMULATORS; ELECTROMAGNETIC DATA COLLECTING AND ANALYZING SYSTEM COMPOSED OF A COMPUTER, A DETECTION WAND AND COMPUTER SOFTWARE FOR STORING, ANALYZING AND REPORTING ELECTROMAGNETIC FIELD DATA, FOR GENERATION OF MAGNETIC COMPENSATION DATA FOR USE IN POSITION AND ORIENTATION SYSTEMS, TRACKING SYSTEMS, AIRBORNE PLATFORMS AND SIMULATORS, IN CLASS 9 (U.S. CLS. 21, 23, 26, 36 AND 38).

FOR: ELECTROMAGNETIC FIELD DETECTION AND CHARACTERIZATION SYSTEM FOR MEDICAL DIAGNOSTIC USE AND FOR MEDICAL TREATMENT COMPOSED OF A COMPUTER, DETECTION WAND FOR USE ON INDIVIDUALS AND COMPUTER SOFTWARE FOR STORING, ANALYZING AND REPORTING ELECTROMAGNETIC FIELD DATA, IN CLASS 10 (U.S. CLS. 26, 39 AND 44).

THE MARK CONSISTS OF STANDARD CHARACTERS WITHOUT CLAIM TO ANY PARTICULAR FONT, STYLE, SIZE, OR COLOR.

PRIORITY CLAIMED UNDER SEC. 44(D) ON ISRAEL APPLICATION NO. 195529, FILED 11-16-2006, REG. NO. 195529, DATED 8-6-2008, EXPIRES 11-16-2016.

SER. NO. 77-074,305, FILED 1-2-2007.

DEIRDRE ROBERTSON, EXAMINING ATTORNEY

Int. Cl.: 9

Prior U.S. Cls.: 21, 23, 26, 36 and 38

United States Patent and Trademark Office

Reg. No. 3,574,485

Registered Feb. 17, 2009

**TRADEMARK
PRINCIPAL REGISTER**

MAILPRIMER

CALCIUM SOFTWARE LIMITED (NEW ZEAL-
AND COMPANY)
LEVEL 4, CATHEDRAL HOUSE
48-52 WYNDHAM STREET
AUCKLAND, NEW ZEALAND

FOR: MULTIMEDIA MESSAGING SOFTWARE;
COMPUTER SOFTWARE FOR THE WRITING,
SENDING, STORAGE, PROCESSING, CONTROL,
ORGANIZATION AND/OR MANAGEMENT OF
EMAIL AND OTHER FORMS OF COMMUNICA-
TION, IN CLASS 9 (U.S. CLS. 21, 23, 26, 36 AND 38).

FIRST USE 12-31-2003; IN COMMERCE 3-31-2006.

THE MARK CONSISTS OF STANDARD CHAR-
ACTERS WITHOUT CLAIM TO ANY PARTICULAR
FONT, STYLE, SIZE, OR COLOR.

OWNER OF NEW ZEALAND REG. NO. 700543,
DATED 8-29-2003, EXPIRES 8-29-2013.

SER. NO. 77-076,322, FILED 1-4-2007.

MICHAEL WEBSTER, EXAMINING ATTORNEY

Int. Cl.: 9

Prior U.S. Cls.: 21, 23, 26, 36 and 38

Reg. No. 3,574,486

United States Patent and Trademark Office

Registered Feb. 17, 2009

**TRADEMARK
PRINCIPAL REGISTER**

MedPro

DATABRIDGE SOFTWARE, INC. (PENNSYLVANIA CORPORATION)
137 BUCKWALTER ROAD
ROYERSFORD, PA 19468

FOR: MEDICAL SOFTWARE FOR MEDICAL PRACTICE MANAGEMENT AND BILLING PURPOSES, NAMELY, SOFTWARE FOR CREATING BILLING DOCUMENTS AND CREATING SPREADSHEETS FOR APPOINTMENTS , IN CLASS 9 (U.S. CLS. 21, 23, 26, 36 AND 38).

FIRST USE 1-1-2006; IN COMMERCE 1-1-2006.

THE MARK CONSISTS OF STANDARD CHARACTERS WITHOUT CLAIM TO ANY PARTICULAR FONT, STYLE, SIZE, OR COLOR.

SER. NO. 77-079,139, FILED 1-9-2007.

MARY BOAGNI, EXAMINING ATTORNEY

Int. Cl.: 40

Prior U.S. Cls.: 100, 103 and 106

United States Patent and Trademark Office

Reg. No. 3,574,487

Registered Feb. 17, 2009

**SERVICE MARK
PRINCIPAL REGISTER**



REKLAIM TECHNOLOGIES, INC. (WASHING-
TON CORPORATION)
127 BELLEVUE WAY SE, SUITE 100
BELLEVUE, WA 98004

FOR: RECYCLING AND RECLAMATION OF
WASTE PRODUCTS, EXCEPT FOR RECYCLING
AND RECLAMATION OF INDUSTRIAL REFRIG-
ERANTS, IN CLASS 40 (U.S. CLS. 100, 103 AND 106).

FIRST USE 9-5-2006; IN COMMERCE 1-4-2007.

NO CLAIM IS MADE TO THE EXCLUSIVE
RIGHT TO USE "TECHNOLOGIES, INC.", APART
FROM THE MARK AS SHOWN.

THE COLOR(S) BLACK AND GREEN IS/ARE
CLAIMED AS A FEATURE OF THE MARK.

THE COLOR BLACK APPEARS IN LETTERS RE,
LAIM, AND THE WORDING TECHNOLOGIES, INC
AND THE COLOR GREEN APPEARS IN THE
RECYCLING SYMBOL AND THE LETTER K IT
FORMS.

SER. NO. 77-082,747, FILED 1-14-2007.

ELLEN BURNS, EXAMINING ATTORNEY

Int. Cls.: 16, 25, 33, 35, 36, 37, 39, 41, 43 and 45

Prior U.S. Cls.: 2, 5, 22, 23, 29, 37, 38, 39, 47, 49, 50,
100, 101, 102, 103, 105, 106 and 107

Reg. No. 3,574,488

United States Patent and Trademark Office

Registered Feb. 17, 2009

**TRADEMARK
SERVICE MARK
PRINCIPAL REGISTER**



LEGATUM LIMITED (UNITED ARAB EMIR.
LIMITED LIABILITY COMPANY)

LEVEL 9, CONVENTION TOWER 71082

DUBAI, UNITED ARAB EMIR.

FOR: PRINTED MATTER AND PUBLICATIONS, NAMELY, MAGAZINES, LEAFLETS, BROCHURES, BOOKS, PAMPHLETS, NEWSLETTERS, JOURNALS, PRINTED INSTRUCTIONAL AND TEACHING MATERIAL IN THE FIELD OF FINANCIAL, INVESTMENT, ECONOMIC, CONSTRUCTION, TRAVEL, ENTERTAINMENT AND CHARITY; NEWSPAPERS; STATIONERY; OFFICE REQUISITES, NAMELY, STAPLERS, ENVELOPES FOR STATIONERY USE, FILE POCKETS; ARTISTS' MATERIALS, NAMELY, INK, FELT PENS, BALLPOINT, ROLLER BALL AND ARTIST'S PENS, PENCILS, PEN AND PENCIL CASES, BOXES, TRAYS AND HOLDERS; PEN INK REFILLS, PEN REFILLS, TIPS FOR BALLPOINT PENS; PAPER; ARTISTS BRUSHES AND ARTISTS PASTELS, IN CLASS 16 (U.S. CLS. 2, 5, 22, 23, 29, 37, 38 AND 50).

FOR: CLOTHING, NAMELY, SHIRTS, BLOUSES, PANTS, TROUSERS, DRESSES, JACKETS, WIND JACKETS, COATS, SHORTS, SWEAT SHIRTS, SWEAT PANTS, RUNNING SUITS, T-SHIRTS, SOCKS, HEAD BANDS, SWEAT BANDS, TIES, CAPS, HATS, VISORS; BELTS; FOOTWEAR, IN CLASS 25 (U.S. CLS. 22 AND 39).

FOR: ALCOHOLIC BEVERAGES, NAMELY, WINE AND DISTILLED LIQUOR, IN CLASS 33 (U.S. CLS. 47 AND 49).

FOR: ACCOUNTANCY SERVICES; BUSINESS MANAGEMENT; BUSINESS ADMINISTRATION; BUSINESS MANAGEMENT AND ADMINISTRATION CONSULTANCY SERVICES; BUSINESS RESEARCH AND THE PROVISION OF PRICE AND STATISTICAL INFORMATION AND PRICE AND STATISTICAL REPORTS ON BUSINESSES; COMPUTERIZED OFFICE MANAGEMENT; PROVIDING OFFICE FUNCTIONS; BUSINESS FINANCE PROCUREMENT SERVICES; PROCUREMENT SERVICES, NAMELY, PURCHASING OF GOODS AND SERVICES, NAMELY, COMPUTERS, AUDIO AND VISUAL EQUIPMENT, NAMELY, STEREOS, MP3 PLAYERS, CAMERAS, MOBILE TELEPHONES, JEWELRY, CLOCKS, WATCHES, BAGS, LUGGAGE, PURSES, WALLETS, FURNITURE, BED LINENS, CLOTHING, FOOTWEAR, TOYS, GAMES, SPORTING GOODS FOR A BUSINESS; RETAIL STORE SERVICES FEATURING CLOTHING, FURNITURE, STATIONERY AND WINES; RELOCATION SERVICES FOR BUSINESSES; PROVIDING INFORMATION WITH RESPECT TO AFOREMENTIONED SERVICES; ADVISORY AND CONSULTANCY SERVICES RELATED TO THE AFORESAID SERVICES, IN CLASS 35 (U.S. CLS. 100, 101 AND 102).

FOR: FINANCIAL MANAGEMENT AND FINANCIAL CONSULTANCY; FINANCIAL SERVICES, NAMELY, PROVIDING INFORMATION IN THE

FIELDS OF FOREIGN CURRENCY, COMMODITIES, FINANCIAL DERIVATIVES, INTEREST RATE PRODUCTS, AND EQUITIES VIA THE INTERNET AND INTRANET SYSTEMS; PROVIDING ONLINE INFORMATION IN THE FIELD OF CHARITABLE MONETARY GIVING THROUGH FINANCIAL AND ESTATE PLANNING; FINANCIAL INFORMATION PROVIDED BY ELECTRONIC MEANS; FINANCIAL INFORMATION PROCESSING; FINANCIAL EVALUATION FOR INSURANCE PURPOSES; REPAIR COST EVALUATION; INVESTMENT CONSULTATION; INVESTMENT MANAGEMENT; TRANSFER AGENCY SERVICES RENDERED TO ISSUERS OF INVESTMENT SECURITIES; INVESTMENT ADVISORY SERVICES; FINANCIAL SERVICES, NAMELY, A TOTAL PORTFOLIO OFFERING FOR HIGH NET WORTH CLIENTS CONSISTING OF BOTH SEPARATE ACCOUNTS AND MUTUAL FUNDS FOR EQUITY AND FIXED INCOME INVESTMENTS; FINANCIAL SERVICES, NAMELY, ASSISTING OTHERS WITH THE COMPLETION OF FINANCIAL TRANSACTIONS FOR STOCKS, BONDS, SECURITIES AND EQUITIES; FINANCIAL SERVICES, NAMELY, THE PURCHASE OF RESIDENTIAL MORTGAGES ON BEHALF OF OTHERS AND THE ISSUANCE OF MORTGAGE-BACKED SECURITIES; PROVIDING A WEB SITE WHERE USERS CAN POST RATINGS, REVIEWS AND RECOMMENDATIONS ON STOCKS, BONDS, MUTUAL FUNDS AND OTHER FINANCIAL INSTRUMENTS; MORTGAGE BANKING SERVICES, NAMELY, ORIGINATION, ACQUISITION, SERVICING, SECURITIZATION AND BROKERAGE OF MORTGAGE LOANS; BROKERAGE IN THE FIELD OF ART, INSURANCE, STOCKS, COMMODITIES; INSURANCE AGENCY AND BROKERAGE; INSURANCE SERVICES, NAMELY, WRITING PROPERTY AND CASUALTY INSURANCE; INSURANCE SERVICES, NAMELY, UNDERWRITING, ISSUING AND ADMINISTRATION OF LIFE INSURANCE; ESTATE TRUST MANAGEMENT; FINANCIAL TRUST OPERATIONS; REAL ESTATE MANAGEMENT AND BROKERAGE; REAL ESTATE AGENCY; RENTAL AND LEASING OF OFFICES AND DOMESTIC APARTMENTS; ACCEPTING AND ADMINISTERING MONETARY CHARITABLE CONTRIBUTIONS; CHARITABLE FUND RAISING; PROVIDING INFORMATION IN THE FIELD OF REAL ESTATE VIA THE INTERNET, IN CLASS 36 (U.S. CLS. 100, 101 AND 102).

FOR: CHARITABLE SERVICES, NAMELY, RENOVATING AND CONSTRUCTING HOMES FOR LOW INCOME FAMILIES; BUILDING CONSTRUCTION AND REPAIR OF COMMERCIAL, INDUSTRIAL, PUBLIC AND DOMESTIC BUILDINGS; MECHANICAL CONTRACTOR SERVICES IN THE CONSTRUCTION OF INDUSTRIAL, COMMERCIAL, PUBLIC AND DOMESTIC BUILDINGS, INSTALLATION, MAINTENANCE AND REPAIR OF HEATING, VENTILATION AND AIR CONDITIONING SYSTEMS; MAINTENANCE AND REPAIR OF COMMERCIAL, INDUSTRIAL, DOMESTIC AND PUBLIC BUILDINGS; RESTORATION AND RENOVATION OF BUILDINGS; REPAIR OR MAINTENANCE OF AIR-CONDITIONING APPARATUS;

PLASTERING, PLUMBING, AND PAINTING; GLAZING SERVICES, ELECTRICAL CONTRACTOR SERVICES IN CONSTRUCTION, ELECTRICAL INSTALLATION AND REPAIR SERVICES; ROOFING SERVICES; INSTALLATION, MAINTENANCE AND REPAIR OF BURGLAR ALARMS AND SECURITY SYSTEMS; INSTALLING CARPET, NAMELY, CARPET FITTING AND CARPET LAYING; MAID SERVICES; AIR DUCT CLEANING SERVICES; PEST-CONTROL SERVICES; PROVIDING INFORMATION IN THE FIELD OF BUILDING CONSTRUCTION, MAINTENANCE AND REPAIR; CLEANING OF RESIDENTIAL HOUSES, IN CLASS 37 (U.S. CLS. 100, 103 AND 106).

FOR: TRANSPORT SERVICES, NAMELY, TRANSPORT AND DELIVERY OF GOODS AND TRUCK TRANSPORT; COORDINATING TRAVEL ARRANGEMENTS FOR INDIVIDUALS AND GROUPS; TRAVEL AGENCY SERVICES, NAMELY, MAKING RESERVATIONS AND BOOKINGS FOR TRANSPORTATION AND TEMPORARY LODGING; SERVICES IN THE NATURE OF PACKING AND WAREHOUSING GOODS FOR OTHERS; PROVIDING INFORMATION IN THE FIELDS OF TRAVEL AND WAREHOUSING, PACKING, AND TRANSPORTING GOODS FOR OTHERS; CONSULTANCY SERVICES IN THE FIELD OF TRAVEL AND WAREHOUSING, PACKING, AND TRANSPORTING GOODS FOR OTHERS, IN CLASS 39 (U.S. CLS. 100 AND 105).

FOR: ENTERTAINMENT SERVICES, NAMELY, PROVIDING A WEB SITE FEATURING MUSICAL PERFORMANCES, MUSICAL VIDEOS, RELATED FILM CLIPS, PHOTOGRAPHS, AND OTHER MULTIMEDIA MATERIALS; ENTERTAINMENT SERVICES, NAMELY, WINE TASTINGS; MULTIMEDIA ENTERTAINMENT SERVICES IN THE NATURE OF RECORDING, PRODUCTION AND POST-PRODUCTION SERVICES IN THE FIELDS OF MUSIC, VIDEO AND FILMS; ORGANIZING COMMUNITY SPORTING AND CULTURAL EVENTS; ENTERTAINMENT, NAMELY, LIVE MUSIC CONCERTS; ENTERTAINMENT IN THE NATURE OF LIVE PERFORMANCES BY MUSICIANS, ACTORS, ACTRESSES, COMEDICS AND MAGICIANS; BOOKING AGENCY SERVICES, NAMELY, BOOKING OF SEATS FOR SHOWS AND BOOKING OF THEATER TICKETS; PUBLISHING OF BOOKS, MAGAZINES; PUBLISHING OF ELECTRONIC-PUBLICATIONS; PROVIDING INFORMATION IN THE FIELD OF EXERCISE TRAINING; LIBRARY SERVICES; ENTERTAINMENT, NAMELY, LIVE PERFORMANCES BY MUSICAL BANDS; MENTORING IN THE FIELD OF MATH, SCIENCE, HISTORY, SOCIAL STUDIES AND LANGUAGES, IN CLASS 41 (U.S. CLS. 100, 101 AND 107).

FOR: ARRANGING TEMPORARY HOUSING ACCOMMODATIONS; PROVISION OF TEMPORARY ACCOMMODATION; PROVIDING OF FOOD AND DRINK FOR PATIENTS AND GUESTS; BOOKING AND RESERVATION SERVICES FOR BARS, RESTAURANTS AND TEMPORARY ACCOMMODATION; PROVIDING INFORMATION IN THE FIELD OF TEMPORARY ACCOMMODATIONS

AND RESTAURANT RESERVATIONS, IN CLASS 43 (U.S. CLS. 100 AND 101).

FOR: LOCKSMITHING, NAMELY, OPENING OF LOCKS; PERSONAL CONCIERGE SERVICES FOR OTHERS COMPRISING MAKING REQUESTED PERSONAL ARRANGEMENTS AND RESERVATIONS, RUNNING ERRANDS AND PROVIDING CUSTOMER SPECIFIC INFORMATION TO MEET INDIVIDUAL NEEDS, ALL RENDERED IN BUSINESS ESTABLISHMENTS, OFFICE BUILDINGS, HOTELS, RESIDENTIAL COMPLEXES AND HOMES; CHARITABLE SERVICES, NAMELY, PROVIDING CLOTHING TO NEEDY PERSONS; CONSULTING SERVICES IN THE FIELD OF THE SAFETY NEEDS OF COMMERCIAL AND INDUSTRIAL COMPANIES; PERSONAL SECURITY CONSULTATION; BODYGUARD SERVICES; PRIVATE INVESTIGATION SERVICES; HOUSE-SITTING SERVICES; FASHION TREND CONSULTING FOR THE

FASHION INDUSTRY; PROVIDING A WEBSITE FEATURING INFORMATION AND CONTENT IN THE FIELDS OF PERSONAL RELATIONSHIPS, DATING AND FASHION; PROVIDING FASHION INFORMATION; PERSONAL LETTER WRITING; PERSONAL REMINDER SERVICES IN THE AREA OF UPCOMING DATES AND EVENTS, IN CLASS 45 (U.S. CLS. 100 AND 101).

PRIORITY CLAIMED UNDER SEC. 44(D) ON ERPN CMNTY TM OFC APPLICATION NO. 5608799, FILED 1-11-2007, REG. NO. 5608799, DATED 1-11-2007, EXPIRES 1-11-2017.

THE MARK CONSISTS OF MAN IN CARRIAGE WITH BOW AND ARROW BEHIND TWO HORSES.

SER. NO. 77-086,334, FILED 1-19-2007.

SETH A. RAPPAPORT, EXAMINING ATTORNEY

Int. Cl.: 42

Prior U.S. Cls.: 100 and 101

United States Patent and Trademark Office

Reg. No. 3,574,489

Registered Feb. 17, 2009

**SERVICE MARK
PRINCIPAL REGISTER**

SIMPLIFY IT

APPARATUS, INC. (INDIANA CORPORATION)
912 N. DELAWARE STREET
INDIANAPOLIS, IN 46202

FOR: COMPUTER CONSULTATION RELATING TO COMPUTER USE IN BUSINESS; COMPUTER PROJECT MANAGEMENT SERVICES; COMPUTER CONSULTATION IN THE FIELD OF COMPUTER SECURITY; COMPUTER SECURITY SERVICE, NAMELY, RESTRICTING ACCESS TO AND BY COMPUTER NETWORKS TO AND OF UNDESIRE WEB SITES, MEDIA AND INDIVIDUALS AND FACILITIES; DESIGN, IMPLEMENTATION, AND

MAINTENANCE OF COMPUTER SOFTWARE PROGRAMS AND WEBSITES FOR OTHERS, IN CLASS 42 (U.S. CLS. 100 AND 101).

FIRST USE 6-1-2004; IN COMMERCE 6-1-2004.

THE MARK CONSISTS OF STANDARD CHARACTERS WITHOUT CLAIM TO ANY PARTICULAR FONT, STYLE, SIZE, OR COLOR.

SER. NO. 77-092,122, FILED 1-26-2007.

RAUL CORDOVA, EXAMINING ATTORNEY

Int. Cls.: 9 and 41

Prior U.S. Cls.: 21, 23, 26, 36, 38, 100, 101 and 107

Reg. No. 3,574,490

United States Patent and Trademark Office

Registered Feb. 17, 2009

**TRADEMARK
SERVICE MARK
PRINCIPAL REGISTER**

PHAT PANDA

PHAT PANDA, LLC (CALIFORNIA LIMITED LIABILITY COMPANY)
3702 SOUTH VIRGINIA STREET, STE. G12-401
RENO, CA 89502

FOR: MUSICAL SOUND RECORDINGS; PRE-RECORDED COMPACT DISCS, AUDIO CASSETTES, VIDEOTAPES, AUDIO-VISUAL RECORDINGS FEATURING MUSIC; DOWNLOADABLE MUSICAL SOUND RECORDINGS, DOWNLOADABLE AUDIO-VISUAL RECORDINGS FEATURING MUSIC; AND DOWNLOADABLE RING TONES, IN CLASS 9 (U.S. CLS. 21, 23, 26, 36 AND 38).

FIRST USE 1-9-2007; IN COMMERCE 1-9-2007.

FOR: ENTERTAINMENT SERVICES, NAMELY, LIVE MUSICAL PERFORMANCES BY A MUSICAL ROCK BAND; PROVIDING NEWS AND COMMEN-

TARY IN THE FIELD OF ENTERTAINMENT RELATING TO MUSICAL PERFORMANCES BY A MUSICAL ROCK BAND; PROVIDING A FAN CLUB AND BIOGRAPHICAL INFORMATION ABOUT A MUSIC ROCK BAND VIA WEBSITES ON A GLOBAL COMPUTER NETWORK, IN CLASS 41 (U.S. CLS. 100, 101 AND 107).

FIRST USE 1-9-2007; IN COMMERCE 1-9-2007.

THE MARK CONSISTS OF STANDARD CHARACTERS WITHOUT CLAIM TO ANY PARTICULAR FONT, STYLE, SIZE, OR COLOR.

SER. NO. 77-092,406, FILED S.R. 1-26-2007 AM. P.R. 1-16-2008.

AMY C. KEAN, EXAMINING ATTORNEY

Int. Cls.: 9, 35, 38 and 42

Prior U.S. Cls.: 21, 23, 26, 36, 38, 100, 101, 102 and 104

United States Patent and Trademark Office

Reg. No. 3,574,491

Registered Feb. 17, 2009

**TRADEMARK
SERVICE MARK
PRINCIPAL REGISTER**

CYBLE CODER

ACTARIS S.A.S. (FRANCE CORPORATION)
92100
62 BIS AVENUE ANDRE MORIZET
BOULOGNE-BILLANCOURT, FRANCE

FOR: FLOW METERS AND METERS, PARTICULARLY GAS, WATER, ELECTRICITY AND THERMAL ENERGY METERS, STATIC FLOW METERS, INCLUDING ELECTROMAGNETIC FLOW METERS; SPARE PARTS FOR SUCH FLOW METERS AND METERS; DATA RECORDING APPARATUS FOR SUCH FLOW METERS AND COUNTERS, APPARATUS FOR THE REMOTE TRANSMISSION OF DATA, REMOTE DATA READING AND/OR TRANSMISSION AND/OR SURVEILLANCE SYSTEMS FOR SUCH FLOW METERS AND METERS; SOFTWARE RELATING TO THE PROGRAMMING OF THE DEVICE FOR REMOTE READING OF METERS, COMPUTER TERMINALS; ELECTRONIC PAYMENT TERMINALS, AUTOMATIC METER READING DEVICES; MODEM, IN CLASS 9 (U.S. CLS. 21, 23, 26, 36 AND 38).

FIRST USE 3-15-2005; IN COMMERCE 3-15-2005.

FOR: AUTOMATIC METER BILLING SERVICES; TECHNICAL INFORMATION AND ADVICE RELATING TO AUTOMATIC METER BILLING, IN CLASS 35 (U.S. CLS. 100, 101 AND 102).

FIRST USE 3-15-2005; IN COMMERCE 3-15-2005.

FOR: REMOTE TRANSMISSION OF DATA RELATING TO WATER, GAS, THERMAL ENERGY AND/OR ELECTRICITY METERS AND FLOW METERS; RADIO, TELEGRAPH OR TELEPHONE COMMUNICATION SERVICES; ELECTRONIC TRANSMISSION OF MESSAGES AND INFORMATION, INCLUDING BY MEANS OF A NETWORK; COMMUNICATIONS BETWEEN COMPUTER TERMINALS AND/OR BETWEEN A METER, A DETECTOR, A SENSOR, A DATA READER AND A COMPUTER TERMINAL, IN CLASS 38 (U.S. CLS. 100, 101 AND 104).

FIRST USE 3-15-2005; IN COMMERCE 3-15-2005.

FOR: COMPUTER PROGRAMMING; UTILITY METER SERVICES, NAMELY, READING AND RECORDING IN A COMPUTER FILE OF DATA RELATING TO WATER, GAS, THERMAL ENERGY AND/OR ELECTRICITY FLOW METERS AND METERS; REMOTE METER READING; AUTOMATIC METER READING SERVICES, IN CLASS 42 (U.S. CLS. 100 AND 101).

FIRST USE 3-15-2005; IN COMMERCE 3-15-2005.

THE MARK CONSISTS OF STANDARD CHARACTERS WITHOUT CLAIM TO ANY PARTICULAR FONT, STYLE, SIZE, OR COLOR.

SER. NO. 77-093,560, FILED 1-29-2007.

PAUL E. FAHRENKOPF, EXAMINING ATTORNEY

Int. Cl.: 43

Prior U.S. Cls.: 100 and 101

United States Patent and Trademark Office

Reg. No. 3,574,492

Registered Feb. 17, 2009

**SERVICE MARK
PRINCIPAL REGISTER**

MARLIN GRILL

WT RESTAURANTS CONCEPTS, LLC (FLORIDA
CORPORATION)
9100 BAYTOWNE WHARF BLVD
#B2
SANDESTIN, FL 32550

FOR: RESTAURANT AND BAR SERVICES, NOT
RELATING TO SPORTS OR A SPORTS TEAM, IN
CLASS 43 (U.S. CLS. 100 AND 101).

FIRST USE 3-15-2002; IN COMMERCE 7-1-2002.

THE MARK CONSISTS OF STANDARD CHAR-
ACTERS WITHOUT CLAIM TO ANY PARTICULAR
FONT, STYLE, SIZE, OR COLOR.

NO CLAIM IS MADE TO THE EXCLUSIVE
RIGHT TO USE "GRILL", APART FROM THE
MARK AS SHOWN.

SER. NO. 77-094,372, FILED 1-30-2007.

CAROLYN CATALDO, EXAMINING ATTORNEY

Int. Cl.: 37

Prior U.S. Cls.: 100, 103 and 106

United States Patent and Trademark Office

Reg. No. 3,574,493

Registered Feb. 17, 2009

**SERVICE MARK
PRINCIPAL REGISTER**

BECON

BECHTEL GROUP, INC. (DELAWARE CORPORATION)
50 BEALE STREET
SAN FRANCISCO, CA 94105

FOR: CONSTRUCTION, REPAIR AND MODERNIZATION SERVICES RELATED TO INFRASTRUCTURE, AND TO MANUFACTURING, ENVIRONMENTAL REMEDIATION, MINING AND METAL, OIL, GAS AND CHEMICAL, POWER AND POWER PLANT, COMMUNICATIONS, TRANSPORTATION, WATER AND WASTEWATER, PULP AND PAPER, AND ADMINISTRATIVE AND HOUSING INSTALLATIONS, ALL FOR UTILITY, INDUSTRIAL AND COMMERCIAL COMPANIES,

GOVERNMENTS, AND OTHERS; AND CONSULTING AND SUPERVISORY SERVICES IN CONNECTION WITH THE FOREGOING, IN CLASS 37 (U.S. CLS. 100, 103 AND 106).

FIRST USE 9-1-1978; IN COMMERCE 9-1-1978.

THE MARK CONSISTS OF STANDARD CHARACTERS WITHOUT CLAIM TO ANY PARTICULAR FONT, STYLE, SIZE, OR COLOR.

SER. NO. 77-104,176, FILED 2-9-2007.

KHANH LE, EXAMINING ATTORNEY

Int. Cl.: 37

Prior U.S. Cls.: 100, 103 and 106

United States Patent and Trademark Office

Reg. No. 3,574,494

Registered Feb. 17, 2009

**SERVICE MARK
PRINCIPAL REGISTER**



BECHTEL GROUP, INC. (DELAWARE CORPORATION)
50 BEALE STREET
SAN FRANCISCO, CA 94105

FOR: CONSTRUCTION, REPAIR AND MODERNIZATION SERVICES RELATED TO INFRASTRUCTURE, AND TO MANUFACTURING, ENVIRONMENTAL REMEDIATION, MINING AND METAL, OIL, GAS AND CHEMICAL, POWER AND POWER PLANT, COMMUNICATIONS, TRANSPORTATION, WATER AND WASTEWATER, PULP AND PAPER, AND ADMINISTRATIVE AND HOUSING INSTALLATIONS, ALL FOR UTILITY, INDUSTRIAL AND COMMERCIAL COMPANIES, GOVERNMENTS, AND OTHERS; AND CONSULTING AND SUPERVISORY SERVICES IN CONNEC-

TION WITH THE FOREGOING, IN CLASS 37 (U.S. CLS. 100, 103 AND 106).

FIRST USE 9-1-1978; IN COMMERCE 9-1-1978.

THE COLOR(S) BLUE AND ORANGE IS/ARE CLAIMED AS A FEATURE OF THE MARK.

THE MARK CONSISTS OF THE WORD "BECON" IN LOWERCASE LETTERS, WITH THE LETTERS "BE" IN BLUE AND THE LETTERS "CON" IN ORANGE.

SER. NO. 77-104,182, FILED 2-9-2007.

KHANH LE, EXAMINING ATTORNEY

Int. Cl.: 43

Prior U.S. Cls.: 100 and 101

United States Patent and Trademark Office

Reg. No. 3,574,495

Registered Feb. 17, 2009

**SERVICE MARK
PRINCIPAL REGISTER**

LA VERA CUCINA

RAJA, ALEXANDER (UNITED STATES INDIVIDUAL)
1 PRINCETON DRIVE
HIGHLAND MILLS, NY 10930

FOR: RESTAURANT SERVICES, IN CLASS 43
(U.S. CLS. 100 AND 101).

FIRST USE 4-15-2001; IN COMMERCE 4-15-2001.

THE MARK CONSISTS OF STANDARD CHARACTERS WITHOUT CLAIM TO ANY PARTICULAR FONT, STYLE, SIZE, OR COLOR.

NO CLAIM IS MADE TO THE EXCLUSIVE RIGHT TO USE "CUCINA", APART FROM THE MARK AS SHOWN.

THE FOREIGN WORDING IN THE MARK TRANSLATES INTO ENGLISH AS TRUE CRUISINE.

SER. NO. 77-107,261, FILED 2-14-2007.

MICHAEL SOUDERS, EXAMINING ATTORNEY

Int. Cls.: 9, 16, 41 and 45

**Prior U.S. Cls.: 2, 5, 21, 22, 23, 26, 29, 36, 37, 38, 50,
100, 101 and 107**

Reg. No. 3,574,496

United States Patent and Trademark Office

Registered Feb. 17, 2009

**TRADEMARK
SERVICE MARK
PRINCIPAL REGISTER**

BILLION SOUL

BILLION SOULS INC. (FLORIDA CORPORATION)
P.O. BOX 592880
ORLANDO, FL 328592880

FOR: PRE-RECORDED CDS, VIDEO TAPES, LASER DISKS AND DVDS FEATURING LEADERSHIP TRAINING, CHURCH PLANTING RESOURCES AND RELIGIOUS TEACHINGS, IN CLASS 9 (U.S. CLS. 21, 23, 26, 36 AND 38).

FIRST USE 1-1-2005; IN COMMERCE 1-1-2005.

FOR: NEWSLETTERS IN THE FIELD OF RELIGION, CHURCH PLANTING AND LEADERSHIP TRAINING; PUBLICATIONS, NAMELY, BROCHURES, BOOKLETS, AND TEACHING MATERIALS IN THE FIELD OF RELIGION, CHURCH PLANTING AND LEADERSHIP TRAINING; RELIGIOUS BOOKS, IN CLASS 16 (U.S. CLS. 2, 5, 22, 23, 29, 37, 38 AND 50).

FIRST USE 1-1-2005; IN COMMERCE 1-1-2005.

FOR: EDUCATIONAL SERVICES, NAMELY, CONDUCTING CONFERENCES, SEMINARS, WORKSHOPS AND PROGRAMS IN THE FIELD OF RELIGION, CHURCH PLANTING AND LEADERSHIP TRAINING AND DISTRIBUTION OF COURSE MATERIAL IN CONNECTION THEREWITH, IN CLASS 41 (U.S. CLS. 100, 101 AND 107).

FIRST USE 1-1-2005; IN COMMERCE 1-1-2005.

FOR: EVANGELISTIC AND MINISTERIAL SERVICES, IN CLASS 45 (U.S. CLS. 100 AND 101).

FIRST USE 1-1-2005; IN COMMERCE 1-1-2005.

THE MARK CONSISTS OF STANDARD CHARACTERS WITHOUT CLAIM TO ANY PARTICULAR FONT, STYLE, SIZE, OR COLOR.

SER. NO. 77-110,012, FILED 2-16-2007.

CHRIS WELLS, EXAMINING ATTORNEY

Int. Cls.: 16, 41 and 45

Prior U.S. Cls.: 2, 5, 22, 23, 29, 37, 38, 50, 100, 101 and 107

United States Patent and Trademark Office

Reg. No. 3,574,497

Registered Feb. 17, 2009

**TRADEMARK
SERVICE MARK
PRINCIPAL REGISTER**



**BILLION SOULS INC. (FLORIDA CORPORATION)
P.O. BOX 592880
ORLANDO, FL 328592880**

FOR: NEWSLETTERS IN THE FIELD OF RELIGION, CHURCH PLANTING AND LEADERSHIP TRAINING; PUBLICATIONS, NAMELY, BROCHURES, BOOKLETS, AND TEACHING MATERIALS IN THE FIELD OF RELIGION, CHURCH PLANTING AND LEADERSHIP TRAINING, IN CLASS 16 (U.S. CLS. 2, 5, 22, 23, 29, 37, 38 AND 50).

FIRST USE 1-1-2005; IN COMMERCE 1-1-2005.

FOR: EDUCATIONAL SERVICES, NAMELY, CONDUCTING CONFERENCES, SEMINARS, WORKSHOPS AND PROGRAMS IN THE FIELD OF RELIGION, CHURCH PLANTING AND LEA-

DERSHIP TRAINING AND DISTRIBUTION OF COURSE MATERIAL IN CONNECTION THEREWITH, IN CLASS 41 (U.S. CLS. 100, 101 AND 107).

FIRST USE 1-1-2005; IN COMMERCE 1-1-2005.

FOR: EVANGELISTIC AND MINISTERIAL SERVICES, IN CLASS 45 (U.S. CLS. 100 AND 101).

FIRST USE 1-1-2005; IN COMMERCE 1-1-2005.

THE MARK CONSISTS OF THE NUMBER 1,000,000,000 WITH VARIOUS HUMAN FACES IN THE BACKGROUND.

SER. NO. 77-110,209, FILED 2-17-2007.

CHRIS WELLS, EXAMINING ATTORNEY

Int. Cls.: 41 and 42

Prior U.S. Cls.: 100, 101 and 107

United States Patent and Trademark Office

Reg. No. 3,574,498

Registered Feb. 17, 2009

**SERVICE MARK
PRINCIPAL REGISTER**



SOMMET GROUP, LLC (TENNESSEE LIMITED LIABILITY COMPANY)
725 COOLSPRINGS BLVD., SUITE 320
FRANKLIN, TN 37067

FOR: COMPUTER EDUCATION TRAINING SERVICES, IN CLASS 41 (U.S. CLS. 100, 101 AND 107).

FIRST USE 5-6-2006; IN COMMERCE 5-6-2006.

FOR: ADVISORY SERVICES IN THE FIELD OF PRODUCT DEVELOPMENT AND QUALITY IMPROVEMENT OF SOFTWARE; APPLICATION SERVICE PROVIDER (ASP), NAMELY, HOSTING COMPUTER SOFTWARE APPLICATIONS OF OTHERS; APPLICATION SERVICE PROVIDER FEATURING SOFTWARE FOR PROVIDING AN ON-LINE DATABASE IN THE FIELD OF TRANSACTION PROCESSING TO UPLOAD TRANSACTIONAL DATA, PROVIDE STATISTICAL ANALYSIS, AND PRODUCE NOTIFICATIONS AND REPORTS; COMPUTER CONSULTATION; COMPUTER DIAGNOSTIC SERVICES; COMPUTER HARDWARE DEVELOPMENT; COMPUTER MONITORING SERVICE WHICH TRACKS HARDWARE PERFORMANCE AND PROCESSES AND SENDS OUT HISTORICAL REPORTS AND ALERTS; COMPUTER NETWORK DESIGN FOR OTHERS; COMPUTER PROGRAMMING; COMPUTER PROGRAMMING FOR OTHERS; COMPUTER PROJECT MANAGEMENT SERVICES; COMPUTER SERVICE, NAMELY, ACTING AS AN APPLICATION SERVICE PROVIDER IN THE FIELD OF KNOWLEDGE MANAGEMENT TO HOST COMPUTER APPLICATION SOFTWARE FOR CREATING SEARCHABLE DATABASES OF INFORMATION

AND DATA; COMPUTER SERVICE, NAMELY, ACTING AS AN APPLICATION SERVICE PROVIDER IN THE FIELD OF KNOWLEDGE MANAGEMENT TO HOST COMPUTER APPLICATION SOFTWARE FOR SEARCHING AND RETRIEVING INFORMATION FROM DATABASES AND COMPUTER NETWORKS; COMPUTER SERVICE, NAMELY, ACTING AS AN APPLICATION SERVICE PROVIDER IN THE FIELD OF KNOWLEDGE MANAGEMENT TO HOST COMPUTER APPLICATION SOFTWARE FOR THE COLLECTION, EDITING, ORGANIZING, MODIFYING, BOOK MARKING, TRANSMISSION, STORAGE AND SHARING OF DATA AND INFORMATION; COMPUTER SERVICES IN THE NATURE OF CUSTOMIZED WEB PAGES FEATURING USER-DEFINED INFORMATION, PERSONAL PROFILES AND INFORMATION; COMPUTER SERVICES, NAMELY, CREATING AN ONLINE COMMUNITY FOR REGISTERED USERS TO PARTICIPATE IN COMPETITIONS, SHOWCASE THEIR SKILLS, GET FEEDBACK FROM THEIR PEERS, FORM VIRTUAL COMMUNITIES, ENGAGE IN SOCIAL NETWORKING AND IMPROVE THEIR TALENT; COMPUTER SERVICES, NAMELY, CREATING AND MAINTAINING WEB SITES FOR OTHERS; COMPUTER SERVICES, NAMELY, DATA RECOVERY SERVICES; COMPUTER SERVICES, NAMELY, DESIGNING AND IMPLEMENTING WEB SITES FOR OTHERS; COMPUTER SERVICES, NAMELY, MANAGING WEB SITES FOR OTHERS; COMPUTER SERVICES, NAMELY, PROVIDING SEARCH ENGINES FOR OBTAINING DATA ON A GLOBAL COMPUTER NETWORK; COMPUTER SERVICES, NAMELY, REMOTE AND ON-SITE MANAGEMENT OF ELECTRONIC MESSAGING SYSTEMS

AND APPLICATIONS FOR OTHERS; COMPUTER SITE DESIGN; COMPUTER SOFTWARE CONSULTATION; COMPUTER SOFTWARE DESIGN FOR OTHERS; COMPUTER SOFTWARE DESIGN, COMPUTER PROGRAMMING, OR MAINTENANCE OF COMPUTER SOFTWARE; COMPUTER SOFTWARE DEVELOPMENT; COMPUTER SYSTEMS ANALYSIS; CONSULTANCY IN THE FIELD OF SOFTWARE DESIGN; CONSULTATION SERVICES IN THE FIELDS OF SELECTION, IMPLEMENTATION AND USE OF COMPUTER HARDWARE AND SOFTWARE SYSTEMS FOR OTHERS; CUSTOMIZATION OF COMPUTER HARDWARE AND SOFTWARE; DESIGN AND DEVELOPMENT OF ON-LINE COMPUTER SOFTWARE SYSTEMS; DESIGN OF COMPUTER HARDWARE, INTEGRATED CIRCUITS, COMMUNICATIONS HARDWARE AND SOFTWARE AND COMPUTER NETWORKS FOR OTHERS; DESIGN OF COMPUTERS FOR OTHERS; DESIGN OF HOME PAGES, COMPUTER SOFTWARE AND WEB SITES; DEVELOPMENT OF SOFTWARE FOR SECURE NETWORK OPERATIONS; DEVELOPMENT, UPDATING AND MAINTENANCE OF SOFTWARE AND DATA BASES; DOCUMENT DATA TRANSFER FROM ONE COMPUTER FORMAT TO ANOTHER; INSTALLATION OF COMPUTER SOFTWARE; INTEGRATION OF COMPUTER SYSTEMS AND NETWORKS; MAINTENANCE OF COMPUTER SOFTWARE; RECOVERY OF COMPUTER DATA; REPAIR OF COMPUTER SOFTWARE; REPAIR OF DAMAGED COMPUTER PROGRAMS; SOFTWARE AUTHORIZING; TECHNICAL SUPPORT SERVICES, NAMELY, TROUBLESHOOTING OF COMPUTER HARDWARE AND

SOFTWARE PROBLEMS; TECHNICAL SUPPORT SERVICES, NAMELY, TROUBLESHOOTING OF COMPUTER SOFTWARE PROBLEMS; TECHNICAL SUPPORT, NAMELY, PROVIDING BACK-UP COMPUTER PROGRAMS AND FACILITIES; UPDATING OF COMPUTER PROGRAMS FOR THIRD PARTIES, IN CLASS 42 (U.S. CLS. 100 AND 101).

FIRST USE 5-6-2006; IN COMMERCE 5-6-2006.

NO CLAIM IS MADE TO THE EXCLUSIVE RIGHT TO USE "IT" AND "SOLUTIONS", APART FROM THE MARK AS SHOWN.

THE COLOR(S) BLACK, GRAY, RED, BLUE AND WHITE IS/ARE CLAIMED AS A FEATURE OF THE MARK.

THE MARK CONSISTS OF A GRAY COMPUTER MONITOR WITH STAND, ON THE SCREEN ARE THE LETTERS "IT" IN WHITE AND LOWER CASE WITH A RED DOT OVER THE "I", A WHITE BORDER SURROUNDS THE BLUE BACKGROUND ON THE SCREEN AND THE RED DOT, BELOW THE MONITOR STAND IS THE WORD "XPRESS" IN ALL CAPS AND BLACK, BELOW "XPRESS" IS THE WORD "SOLUTIONS" IN ALL CAPS AND GRAY.

SER. NO. 77-111,108, FILED 2-20-2007.

ZACHARY BELLO, EXAMINING ATTORNEY

Int. Cl.: 5

Prior U.S. Cls.: 6, 18, 44, 46, 51 and 52

United States Patent and Trademark Office

Reg. No. 3,574,499

Registered Feb. 17, 2009

**TRADEMARK
PRINCIPAL REGISTER**

RevGenetics
RevGenetics

LOERA, ANTHONY (UNITED STATES INDIVIDUAL)
650 NW 133 CT
MIAMI, FL 33182

FOR: DIETARY AND NUTRITIONAL SUPPLEMENTS; DIETARY SUPPLEMENTAL DRINKS; DIETARY SUPPLEMENTS; DIETARY SUPPLEMENTS FOR HUMAN CONSUMPTION; HERBAL SUPPLEMENTS; NUTRACEUTICALS FOR USE AS A DIETARY SUPPLEMENT; NUTRITIONAL SUPPLEMENTS; NUTRITIONAL SUPPLEMENTS IN LOTION FORM SOLD AS A COMPONENT OF NUTRITIONAL SKIN CARE PRODUCTS; POWDERED NUTRITIONAL SUPPLEMENT DRINK MIX, IN CLASS 5 (U.S. CLS. 6, 18, 44, 46, 51 AND 52).

FIRST USE 1-1-2007; IN COMMERCE 1-15-2007.

THE COLOR(S) LIGHT GREEN, DARK GREEN, BLACK AND WHITE IS/ARE CLAIMED AS A FEATURE OF THE MARK.

THE COLOR LIGHT GREEN APPEARS IN THE WORDING "REV GENETICS" WHICH IS ON TOP OF THE SECOND WORD "REV GENETICS" AND THAT WORDING APPEARS IN THE COLOR DARK GREEN WITH BLACK SPOTS. THE ENTIRE BACKGROUND OF THE MARK IS WHITE.

SER. NO. 77-111,236, FILED 2-20-2007.

JAY FLOWERS, EXAMINING ATTORNEY

Int. Cls.: 9, 18 and 25

Prior U.S. Cls.: 1, 2, 3, 21, 22, 23, 26, 36, 38, 39 and 41

United States Patent and Trademark Office

Reg. No. 3,574,500

Registered Feb. 17, 2009

**TRADEMARK
PRINCIPAL REGISTER**

THAKOON

THAKOON, LLC (DELAWARE LIMITED LIABILITY COMPANY)
270 LAFAYETTE STREET, SUITE 810
NEW YORK, NY 10012

FOR: EYEWEAR, IN CLASS 9 (U.S. CLS. 21, 23, 26, 36 AND 38).

FIRST USE 9-1-2006; IN COMMERCE 2-1-2007.

FOR: HANDBAGS AND UMBRELLAS, IN CLASS 18 (U.S. CLS. 1, 2, 3, 22 AND 41).

FIRST USE 3-1-2004; IN COMMERCE 9-1-2004.

FOR: APPAREL, NAMELY, WOMEN'S HIGH FASHION JACKETS, TROUSERS, SHORTS, SHIRTS, SWEATSHIRTS, T-SHIRTS, GLOVES, AND SHOES; WOMEN'S COATS, BLAZERS, CARDIGANS, SUITS, DRESSES, EVENING GOWNS, SKIRTS, PANTS, SLACKS, JEANS, DUNGAREES, JUMPSUITS, GYM SUITS, JOGGING SUITS, SWEAT PANTS, CU-

LOTES, SWEATERS, BLOUSES, HALTER TOPS, TANK TOPS, BODYSUITS, CAMISOLES, CHEMISES, UNDERSHIRTS, SLIPS, FOUNDATION GARMENTS, AND BELTS, IN CLASS 25 (U.S. CLS. 22 AND 39).

FIRST USE 3-1-2004; IN COMMERCE 9-1-2004.

THE MARK CONSISTS OF STANDARD CHARACTERS WITHOUT CLAIM TO ANY PARTICULAR FONT, STYLE, SIZE, OR COLOR.

THE NAME "THAKOON" IDENTIFIES A LIVING INDIVIDUAL WHOSE CONSENT IS OF RECORD.

THE MARK "THAKOON" DOES NOT HAVE ANY MEANING IN A FOREIGN LANGUAGE.

SER. NO. 77-114,163, FILED 2-22-2007.

MARLENE BELL, EXAMINING ATTORNEY

Int. Cls.: 1, 5, 9, 10, 40, 42 and 44

Prior U.S. Cls.: 1, 5, 6, 10, 18, 21, 23, 26, 36, 38, 39, 44, 46, 51, 52, 100, 101, 103 and 106

Reg. No. 3,574,501

United States Patent and Trademark Office

Registered Feb. 17, 2009

**TRADEMARK
SERVICE MARK
PRINCIPAL REGISTER**



CELLCURA AS (NORWAY CORPORATION)
KJOLNES RING, 3914
PORSGRUNN, NORWAY

FOR: PROTEIN FREE FLUIDS FOR USE IN HUMAN AND ANIMAL REPRODUCTIVE TECHNOLOGIES RESEARCH AND THERAPEUTIC STEM CELL RESEARCH; STEM CELLS TO BE USED IN RESEARCH APPLICATIONS, IN CLASS 1 (U.S. CLS. 1, 5, 6, 10, 26 AND 46).

FOR: CULTURE MEDIA FOR MEDICAL OR VETERINARY USE; PROTEIN FREE FLUIDS USED TO CULTIVATE EGGS, SPERM, EMBRYOS AND CELLS FOR USE IN HUMAN AND ANIMAL REPRODUCTIVE TECHNOLOGIES FOR MEDICAL OR VETERINARY USE AND IN THERAPEUTIC STEM APPARATUS, AND CELL THERAPIES; STEM CELLS TO BE USED IN THERAPEUTIC APPLICATIONS, IN CLASS 5 (U.S. CLS. 6, 18, 44, 46, 51 AND 52).

FOR: LABORATORY EQUIPMENT, INSTRUMENTS AND ACCESSORIES, NAMELY, CLASS II HEPA FILTERS, INFRARED ENVIRONMENTAL TEMPERATURE MONITORS, INCUBATOR MONITORS, DIGITAL WIDE VIEW MICROSCOPES, COMPUTER MONITORS, BAR CODE AND RADIO-FREQUENCY IDENTIFICATION MONITORS, ELECTRICAL SOCKETS, GAS PORTS, PROCESS DOCUMENTATION AND ENVIRONMENTAL MONITORING SOFTWARE, MORPHOLOGICAL EXAMINATION SOFTWARE, INVERTED MICROSCOPES, ANTI-VIBRATION TABLES, AND MICRO-MANIPULATION SYSTEMS WITH PADDLES FOR OPERATING SYSTEMS; FURNITURE FOR LABORATORIES; WORKSTATIONS FOR LABORATORIES, IN CLASS 9 (U.S. CLS. 21, 23, 26, 36 AND 38).

FOR: FURNITURE, NAMELY, OPERATING THEATRES, LAMINAR FLOW HOODS, TEMPERATURE CONTROLLED WORK BENCHES, MICRO-DISSECTION OBSERVATION BENCHES, AND CHAIRS FOR MEDICAL OR VETERINARY USE, IN CLASS 10 (U.S. CLS. 26, 39 AND 44).

FOR: CONTRACT MANUFACTURING OF PROTEIN FREE MEDIA AND CULTURE MEDIA FOR OTHERS FOR USE IN THE FIELD OF BIOTECHNOLOGY, IN CLASS 40 (U.S. CLS. 100, 103 AND 106).

FOR: SCIENTIFIC DEVELOPMENT, ADVISORY AND CONSULTANCY SERVICES IN RELATION TO HUMAN AND ANIMAL REPRODUCTIVE TECHNOLOGIES, STEM CELL PREPARATION AND CULTIVATION, CELL CULTURE DEVICES, STEM CELLS AND CELL CULTURE METHODS, LABORATORY EQUIPMENT AND WORK STATIONS FOR LABORATORIES; CONTRACT SCIENTIFIC RESEARCH SERVICES; TESTING, ANALYSIS AND EVALUATION OF LABORATORY EQUIPMENT AND WORKSTATIONS FOR THE PURPOSE OF CERTIFICATION; PROVIDING CLINICAL DATABASES IN THE FIELD OF SCIENTIFIC RESEARCH, IN CLASS 42 (U.S. CLS. 100 AND 101).

FOR: MEDICAL ANALYSIS IN THE FIELD OF REPRODUCTIVE TECHNOLOGIES, STEM CELLS AND CULTURE MEDIA, IN CLASS 44 (U.S. CLS. 100 AND 101).

PRIORITY CLAIMED UNDER SEC. 44(D) ON NORWAY APPLICATION NO. 200613932, FILED 11-29-2006, REG. NO. 244195, DATED 2-8-2008, EXPIRES 2-8-2018.

NO CLAIM IS MADE TO THE EXCLUSIVE RIGHT TO USE "LIFE SCIENCE", APART FROM THE MARK AS SHOWN.

THE COLOR(S) BLUE, PURPLE, AND BLACK IS/ ARE CLAIMED AS A FEATURE OF THE MARK.

THE MARK CONSISTS OF THE COLOR BLACK APPEARS AS THE COLOR OF THE WORDING

"CELLCURA", THE COLOR BLUE APPEARS AS THE COLOR OF THE WORDING "PURE LIFE SCIENCE" AND THE TOP HALF OF THE DESIGN ELEMENT AND THE COLOR PURPLE APPEARS AS THE COLOR OF THE BOTTOM HALF OF THE DESIGN ELEMENT.

SER. NO. 77-114,340, FILED 2-23-2007.

JEFF DEFORD, EXAMINING ATTORNEY

Int. Cl.: 41

Prior U.S. Cls.: 100, 101 and 107

United States Patent and Trademark Office

Reg. No. 3,574,502

Registered Feb. 17, 2009

**SERVICE MARK
PRINCIPAL REGISTER**

**Movement Improvement T'ai
Chi**

SHOULDERS DOWN, INC. (GEORGIA CORPORATION)
460 STERLING ST. NE
ATLANTA, GA 30307

FOR: ARRANGING PROFESSIONAL WORKSHOP AND TRAINING COURSES FOR T'AI CHI INSTRUCTORS, IN CLASS 41 (U.S. CLS. 100, 101 AND 107).

FIRST USE 1-1-1996; IN COMMERCE 1-1-1996.

THE MARK CONSISTS OF STANDARD CHARACTERS WITHOUT CLAIM TO ANY PARTICULAR FONT, STYLE, SIZE, OR COLOR.

NO CLAIM IS MADE TO THE EXCLUSIVE RIGHT TO USE "T'AI CHI", APART FROM THE MARK AS SHOWN.

SER. NO. 77-116,539, FILED 2-26-2007.

ANDREA K. NADELMAN, EXAMINING ATTORNEY

Int. Cl.: 16

Prior U.S. Cls.: 2, 5, 22, 23, 29, 37, 38 and 50

Reg. No. 3,574,503

United States Patent and Trademark Office

Registered Feb. 17, 2009

**TRADEMARK
PRINCIPAL REGISTER**

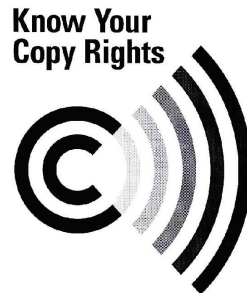

ASSOCIATION OF RESEARCH LIBRARIES (D.C.
NON-PROFIT CORPORATION)
SUITE 800
21 DUPONT CIRCLE, N.W
WASHINGTON, DC 20036

THE MARK CONSISTS OF TWO CONCENTRIC
CIRCLES NEXT TO A DESIGN DEPICTING A
SOUND WAVE-LIKE AFFECT FOLLOWED BY
THE WORD MARK.

FOR: PRINTED MAGAZINES, PERIODICALS
AND EDUCATIONAL MATERIALS IN THE FIELD
OF LIBRARY SERVICES, IN CLASS 16 (U.S. CLS. 2, 5,
22, 23, 29, 37, 38 AND 50).

SER. NO. 77-116,823, FILED 2-27-2007.

FIRST USE 1-16-2007; IN COMMERCE 1-16-2007.

SOPHIA S. KIM, EXAMINING ATTORNEY

Int. Cl.: 37

Prior U.S. Cls.: 100, 103 and 106

United States Patent and Trademark Office

Reg. No. 3,574,504

Registered Feb. 17, 2009

**SERVICE MARK
PRINCIPAL REGISTER**

THE BUG PRO

ALL PRO PEST SERVICES, INC. (GEORGIA
CORPORATION)
1259 COBB INDUSTRIAL DRIVE
MARIETTA, GA 30066

FOR: PEST CONTROL AND TERMITE EXTER-
MINATION SERVICES, IN CLASS 37 (U.S. CLS. 100,
103 AND 106).

FIRST USE 11-1-1971; IN COMMERCE 11-1-1971.

THE MARK CONSISTS OF STANDARD CHAR-
ACTERS WITHOUT CLAIM TO ANY PARTICULAR
FONT, STYLE, SIZE, OR COLOR.

SEC. 2(F).

SER. NO. 77-116,853, FILED 2-27-2007.

SOPHIA S. KIM, EXAMINING ATTORNEY

Int. Cl.: 42

Prior U.S. Cls.: 100 and 101

United States Patent and Trademark Office

Reg. No. 3,574,505

Registered Feb. 17, 2009

**SERVICE MARK
PRINCIPAL REGISTER**

FORMFREE

TAXEDGE.COM, LLC (GEORGIA LIMITED LIABILITY COMPANY)
1690 STONE VILLAGE LANE, SUITE 501
KENNESAW, GA 30152

FOR: PROVIDING ONLINE NON-DOWNLOADABLE SOFTWARE FOR PREPARING TAX RETURNS, IN CLASS 42 (U.S. CLS. 100 AND 101).

FIRST USE 3-1-2001; IN COMMERCE 3-1-2001.

THE MARK CONSISTS OF STANDARD CHARACTERS WITHOUT CLAIM TO ANY PARTICULAR FONT, STYLE, SIZE, OR COLOR.

SEC. 2(F).

SER. NO. 77-121,793, FILED 3-4-2007.

ALICE BENMAMAN, EXAMINING ATTORNEY

Int. Cl.: 1

Prior U.S. Cls.: 1, 5, 6, 10, 26 and 46

United States Patent and Trademark Office

Reg. No. 3,574,506

Registered Feb. 17, 2009

**TRADEMARK
PRINCIPAL REGISTER**

SPA GENIE

TECHNOLOGY ADVANCEMENT GROUP, INC.
(VIRGINIA CORPORATION)
22355 TAG WAY
DULLES, VA 20166

FOR: WATER TREATMENT CHEMICALS FOR
USE IN SPAS, IN CLASS 1 (U.S. CLS. 1, 5, 6, 10, 26
AND 46).

FIRST USE 3-0-2003; IN COMMERCE 3-0-2003.

THE MARK CONSISTS OF STANDARD CHAR-
ACTERS WITHOUT CLAIM TO ANY PARTICULAR
FONT, STYLE, SIZE, OR COLOR.

OWNER OF U.S. REG. NO. 1,542,269.

SER. NO. 77-125,408, FILED 3-8-2007.

HOWARD SMIGA, EXAMINING ATTORNEY

Int. Cl.: 42

Prior U.S. Cls.: 100 and 101

United States Patent and Trademark Office

Reg. No. 3,574,507

Registered Feb. 17, 2009

**SERVICE MARK
PRINCIPAL REGISTER**



CONTENT MANAGEMENT CORPORATION (CA-
NADA CORPORATION)
UNIT 18
100 WEST BEAVER CREEK
RICHMOND HILL, CANADA L4B1H4

FOR: APPLICATION SERVICE PROVIDER (ASP)
FEATURING SOFTWARE IN THE FIELD OF E-
LEARNING, NAMELY, THE CAPTURE, MANAGE-
MENT, PUBLISHING, AND DISTRIBUTION OF
EVENT-BASED CONTENT FOR EDUCATIONAL
PURPOSES, IN CLASS 42 (U.S. CLS. 100 AND 101).

FIRST USE 1-1-2003; IN COMMERCE 1-1-2003.

NO CLAIM IS MADE TO THE EXCLUSIVE
RIGHT TO USE "LIVE LEARNING CENTER",
APART FROM THE MARK AS SHOWN.

THE MARK CONSISTS OF "LIVE LEARNING
CENTER".

SER. NO. 77-132,741, FILED 3-16-2007.

MARTHA SANTOMARTINO, EXAMINING ATTOR-
NEY

Int. Cl.: 16

Prior U.S. Cls.: 2, 5, 22, 23, 29, 37, 38 and 50

Reg. No. 3,574,508

United States Patent and Trademark Office

Registered Feb. 17, 2009

**TRADEMARK
PRINCIPAL REGISTER**

HOMESPA

WELLNESS / DESIGN / LIFESTYLE

BAINS ULTRA INC. (CANADA CORPORATION)
956 CHEMIN OLIVIER, SAINT-NICOLAS
QUEBEC, CANADA G7A2N1

2007, REG. NO. TMA717,676, DATED 6-30-2008, EX-
PIRES 6-30-2023.

FOR: MAGAZINES FEATURING THE SUBJECT
OF HOME DESIGN, HEALTH, FITNESS, AND LIFE-
STYLE, IN CLASS 16 (U.S. CLS. 2, 5, 22, 23, 29, 37, 38
AND 50).

NO CLAIM IS MADE TO THE EXCLUSIVE
RIGHT TO USE "WELLNESS DESIGN LIFESTYLE",
APART FROM THE MARK AS SHOWN.

SER. NO. 77-132,748, FILED 3-16-2007.

PRIORITY CLAIMED UNDER SEC. 44(D) ON
CANADA APPLICATION NO. 1337800, FILED 3-2-

LESLIE RICHARDS, EXAMINING ATTORNEY

Int. Cl.: 41

Prior U.S. Cls.: 100, 101 and 107

United States Patent and Trademark Office

Reg. No. 3,574,509

Registered Feb. 17, 2009

**SERVICE MARK
PRINCIPAL REGISTER**

BURN 60

BURN 60, LLC (DELAWARE LIMITED LIABILITY COMPANY)
159 SOUTH BARRINGTON PLACE
LOS ANGELES, CA 90049

FOR: HEALTH AND FITNESS CENTERS, NAME-
LY PROVIDING FITNESS AND EXERCISE FACIL-
ITIES; PHYSICAL FITNESS INSTRUCTION AND
PHYSICAL FITNESS CONSULTATION , IN CLASS
41 (U.S. CLS. 100, 101 AND 107).

FIRST USE 6-20-2005; IN COMMERCE 6-20-2005.

THE MARK CONSISTS OF STANDARD CHAR-
ACTERS WITHOUT CLAIM TO ANY PARTICULAR
FONT, STYLE, SIZE, OR COLOR.

NO CLAIM IS MADE TO THE EXCLUSIVE
RIGHT TO USE "60", APART FROM THE MARK
AS SHOWN.

SER. NO. 77-132,975, FILED 3-16-2007.

JAMES MACFARLANE, EXAMINING ATTORNEY

Int. Cl.: 16

Prior U.S. Cls.: 2, 5, 22, 23, 29, 37, 38 and 50

United States Patent and Trademark Office

Reg. No. 3,574,510

Registered Feb. 17, 2009

**TRADEMARK
PRINCIPAL REGISTER**

Super Value Checks

PRINCIPAL MARKETING GROUP (ILLINOIS
CORPORATION)

823 N. RIDGELAND AVENUE

OAK PARK, IL 60302

FOR: BANK CHECKS, IN CLASS 16 (U.S. CLS. 2, 5,
22, 23, 29, 37, 38 AND 50).

FIRST USE 0-0-1998; IN COMMERCE 0-0-1998.

THE MARK CONSISTS OF STANDARD CHAR-
ACTERS WITHOUT CLAIM TO ANY PARTICULAR
FONT, STYLE, SIZE, OR COLOR.

NO CLAIM IS MADE TO THE EXCLUSIVE
RIGHT TO USE "SUPER" AND "CHECKS", APART
FROM THE MARK AS SHOWN.

SER. NO. 77-133,477, FILED 3-16-2007.

TOBY BULLOFF, EXAMINING ATTORNEY

Int. Cls.: 1, 6, 7, 9, 19, 37, 40 and 42

Prior U.S. Cls.: 1, 2, 5, 6, 10, 12, 13, 14, 19, 21, 23, 25, 26, 31, 33, 34, 35, 36, 38, 46, 50, 100, 101, 103 and 106

Reg. No. 3,574,511

United States Patent and Trademark Office

Registered Feb. 17, 2009

**TRADEMARK
SERVICE MARK
PRINCIPAL REGISTER**

MINTEQ

SPECIALTY MINERALS (MICHIGAN) INC. (MICHIGAN CORPORATION)
30600 TELEGRAPH ROAD
BINGHAM FARMS, MI 48025

FOR: CHEMICALS FOR USE IN THE IRON, STEEL AND NON-FERROUS METALS INDUSTRIES; PYROLYTIC GRAPHITE, IN CLASS 1 (U.S. CLS. 1, 5, 6, 10, 26 AND 46).

FIRST USE 12-0-1998; IN COMMERCE 12-0-1998.

FOR: NON-ELECTRIC CABLES AND WIRES OF COMMON METAL, NAMELY, CALCIUM WIRE AND ALUMINUM CALCIUM WIRE FOR USE IN THE MANUFACTURE OF STEEL, IN CLASS 6 (U.S. CLS. 2, 12, 13, 14, 23, 25 AND 50).

FIRST USE 3-1-1993; IN COMMERCE 3-1-1993.

FOR: REFRACTORY APPLICATION MACHINERY COMPRISING REFRACTORY GUNS, MECHANICAL BOOM AND PLC (PROGRAMMABLE LOGIC CONTROLLER) SOFTWARE FOR THE PLACEMENT OF REFRACTORY MATERIALS TO METALLURGICAL VESSELS, SOLD TOGETHER AS A UNIT, IN CLASS 7 (U.S. CLS. 13, 19, 21, 23, 31, 34 AND 35).

FIRST USE 3-1-1993; IN COMMERCE 3-1-1993.

FOR: ELECTRONIC MEASURING DEVICES AND CONTROLS, NAMELY, OXYGEN ACTIVITY MEASURING PROBES AND LASER PROFILE METERS FOR MEASURING DEFORMATIONS AND LININGS OF HIGH-TEMPERATURE VESSELS; AND COMPUTER SOFTWARE FOR EVALUATING MEASUREMENTS OF REFRACTORY LININGS IN HIGH-TEMPERATURE VESSELS AND FOR CONTROLLING REFRACTORY APPLICATION MA-

CHINERY DURING REPAIR OF REFRACTORY LININGS ALL FOR USE IN THE IRON, STEEL AND NON-FERROUS METALS INDUSTRIES, IN CLASS 9 (U.S. CLS. 21, 23, 26, 36 AND 38).

FIRST USE 9-30-2004; IN COMMERCE 9-30-2004.

FOR: REFRACTORY MATERIALS, NAMELY, MONOLITHIC CASTABLE AND GUNNING MIXES, REFRACTORY COATINGS, SHAPES AND BLOCKS, NOT OF METAL, IN CLASS 19 (U.S. CLS. 1, 12, 33 AND 50).

FIRST USE 3-1-1993; IN COMMERCE 3-1-1993.

FOR: INSTALLATION, REPAIR AND MAINTENANCE OF REFRACTORY LININGS IN HIGH-TEMPERATURE VESSELS, IN CLASS 37 (U.S. CLS. 100, 103 AND 106).

FIRST USE 3-1-1993; IN COMMERCE 3-1-1993.

FOR: MANUFACTURE OF REFRACTORY LININGS AND LASER MEASURING EQUIPMENT TO THE ORDER AND SPECIFICATION OF OTHERS, IN CLASS 40 (U.S. CLS. 100, 103 AND 106).

FIRST USE 4-25-2000; IN COMMERCE 4-25-2000.

FOR: TECHNOLOGY DEVELOPMENT AND CONSULTING SERVICES FOR THE IRON, STEEL AND NON-FERROUS METALS INDUSTRIES, IN CLASS 42 (U.S. CLS. 100 AND 101).

FIRST USE 3-1-1993; IN COMMERCE 3-1-1993.

THE MARK CONSISTS OF STANDARD CHARACTERS WITHOUT CLAIM TO ANY PARTICULAR FONT, STYLE, SIZE, OR COLOR.

OWNER OF U.S. REG. NOS. 1,830,376 AND
1,831,353.

SER. NO. 77-137,545, FILED 3-22-2007.

LAURA KOVALSKY, EXAMINING ATTORNEY

Int. Cl.: 42

Prior U.S. Cls.: 100 and 101

United States Patent and Trademark Office

Reg. No. 3,574,512

Registered Feb. 17, 2009

**SERVICE MARK
PRINCIPAL REGISTER**

SPECIAL OPS SECURITY

SPECIAL OPS SECURITY, INC. (NEVADA CORPORATION)
SUITE 210
2727 NEWPORT BLVD
NEWPORT BEACH, CA 92663

FOR: COMPUTER CONSULTATION IN THE FIELD OF COMPUTER SECURITY; COMPUTER DIAGNOSTIC SERVICES; COMPUTER NETWORK DESIGN FOR OTHERS; COMPUTER SECURITY SERVICE, NAMELY, RESTRICTING ACCESS TO AND BY COMPUTER NETWORKS TO AND OF UNDESIRE WEB SITES, MEDIA AND INDIVIDUALS AND FACILITIES; ON-LINE SECURITY SERVICES, NAMELY, PROVIDING SECURITY AND ANONYMITY FOR ELECTRONICALLY

TRANSMITTED CREDIT CARD TRANSACTIONS, IN CLASS 42 (U.S. CLS. 100 AND 101).

FIRST USE 11-1-2004; IN COMMERCE 11-1-2004.

THE MARK CONSISTS OF STANDARD CHARACTERS WITHOUT CLAIM TO ANY PARTICULAR FONT, STYLE, SIZE, OR COLOR.

NO CLAIM IS MADE TO THE EXCLUSIVE RIGHT TO USE "SECURITY" , APART FROM THE MARK AS SHOWN.

SER. NO. 77-138,166, FILED 3-22-2007.

MAUREEN DALL, EXAMINING ATTORNEY

Int. Cls.: 9, 28 and 41

Prior U.S. Cls.: 21, 22, 23, 26, 36, 38, 50, 100, 101 and 107

Reg. No. 3,574,513

United States Patent and Trademark Office

Registered Feb. 17, 2009

TRADEMARK
SERVICE MARK
PRINCIPAL REGISTER



SPYRES, MICHAEL (UNITED KINGDOM INDIVIDUAL)

22A GEORGE STREET

ST. ALBANS, HETFORDSHIRE, UNITED KINGDOM AL3 4ES AND

WILDSMITH, ADRIAN (UNITED KINGDOM INDIVIDUAL)

17 HIGHFIELD HOUSE

QUEENSWAY, HEMEL HEMPSTEAD, UNITED KINGDOM HP2 SG2 AND

STAVRINIDES, PHYTOS (UNITED KINGDOM INDIVIDUAL)

64 GAMES ROAD

BARNET, UNITED KINGDOM EN4 9HT

FOR: DOWNLOADABLE ELECTRONIC PUBLICATIONS IN THE NATURE OF BOOKS, MAGAZINES, NEWSLETTERS AND MANUALS IN THE FIELD OF ELECTRONIC GAMES, QUIZ GAMES, TRIVIA GAMES, AND MEMORY GAMES; ELECTRONIC TRIVIA GAME IN THE NATURE OF QUIZ COMPUTER SOFTWARE PROGRAMS AND QUIZ SOFTWARE; COMPUTER PROGRAMS AND SOFTWARE FOR LOADING AND RUNNING ELECTRONIC TRIVIA AND QUIZ GAMES; GAMING SYSTEMS COMPRISING COMPUTER SOFTWARE AND FIRMWARE FOR ELECTRONIC GAMES, TRIVIA GAMES, MEMORY GAMES, QUIZ GAMES ON ANY COMPUTERIZED PLATFORM, INCLUDING THE INTERNET, THAT ENABLE INTERACTION WITH OTHER PLAYERS ONLINE; APPARATUS FOR ELECTRONIC GAMES AND GAMING, NAMELY, COMPUTERS, COMPUTER HARDWARE, AND COMPUTER PERIPHERALS, IN CLASS 9 (U.S. CLS. 21, 23, 26, 36 AND 38).

FOR: BOARD GAMES, BOARD QUIZ GAMES, AND OTHER GAMES NOT ADAPTED FOR USE WITH ELECTRONIC APPARATUS, NAMELY, TRIVIA CARD GAMES, TRIVIA PARLOR GAMES, AND QUIZ PARLOR GAMES, IN CLASS 28 (U.S. CLS. 22, 23, 38 AND 50).

FOR: ENTERTAINMENT, AMUSEMENT, AND RECREATION SERVICES, NAMELY, PROVIDING ON-LINE COMPUTER GAMES AND ON-LINE COMPUTER QUIZ GAMES; PROVIDING ON-LINE NON-DOWNLOADABLE PUBLICATIONS IN THE NATURE OF BOOKS, MAGAZINES, NEWSLETTERS AND MANUALS IN THE FIELD OF ELECTRONIC GAMES, QUIZ GAMES, TRIVIA GAMES, AND MEMORY GAMES; ORGANIZING COMPETITIVE TRIVIA AND QUIZ EVENTS FOR THE ENTERTAINMENT OF OTHERS VIA THE INTERNET, IN CLASS 41 (U.S. CLS. 100, 101 AND 107).

PRIORITY CLAIMED UNDER SEC. 44(D) ON UNITED KINGDOM APPLICATION NO. 2433876, FILED 9-28-2006, REG. NO. 2433876, DATED 5-11-2007, EXPIRES 9-28-2016.

NO CLAIM IS MADE TO THE EXCLUSIVE RIGHT TO USE "TRIVIA", APART FROM THE MARK AS SHOWN.

THE MARK CONSISTS OF A MALE AND FEMALE FIGURE WITH THE WORDS "SERIOUS TRIVIA".

SER. NO. 77-141,051, FILED 3-27-2007.

ADA HAN, EXAMINING ATTORNEY

Int. Cl.: 35

Prior U.S. Cls.: 100, 101 and 102

United States Patent and Trademark Office

Reg. No. 3,574,514

Registered Feb. 17, 2009

SERVICE MARK
PRINCIPAL REGISTER

Paris Gallery  باريس غاليري

PARIS GALLERY LLC (UNITED ARAB EMIR.
LIMITED LIABILITY COMPANY)
P.O. BOX 44537
DUBAI, UNITED ARAB EMIR.

OWNER OF UNITED ARAB EMIR. REG. NO.
60725, DATED 4-9-2005, EXPIRES 5-12-2014.

FOR: RETAIL STORE SERVICES IN THE NATURE OF BRINGING TOGETHER, FOR THE BENEFIT OF OTHERS, OF A VARIETY OF GOODS, EXCLUDING THE TRANSPORT THEREOF, ENABLING CUSTOMERS TO CONVENIENTLY VIEW AND PURCHASE THOSE GOODS, NAMELY, RETAIL STORE SERVICES FEATURING PERFUMES, COSMETICS, SKIN CARE PRODUCTS, BODY CARE PRODUCTS AND MAKE UP, WATCHES, SUNGLASSES, CLOTHES, FINE JEWELRY, LEATHER BRIEFCASES, BELTS, AND FOOTWEAR, PRESCRIPTION GLASSES AND FRAMES; BUSINESS ADVICE AND CONSULTANCY, IN CLASS 35 (U.S. CLS. 100, 101 AND 102).

NO CLAIM IS MADE TO THE EXCLUSIVE RIGHT TO USE "PARIS GALLERY" OR THE NON-LATIN CHARACTERS THAT MEAN "PARIS GALLERY", APART FROM THE MARK AS SHOWN.

THE NON-LATIN CHARACTERS IN THE MARK TRANSLITERATE TO "PAR ES GAL A REE" AND THIS MEANS "PARIS GALLERY."

SER. NO. 77-141,702, FILED 3-27-2007.

JAMES STEIN, EXAMINING ATTORNEY

Int. Cls.: 6, 9 and 20

**Prior U.S. Cls.: 2, 12, 13, 14, 21, 22, 23, 25, 26, 32, 36,
38 and 50**

Reg. No. 3,574,515

United States Patent and Trademark Office

Registered Feb. 17, 2009

**TRADEMARK
PRINCIPAL REGISTER**

SPECTHERM

SPECTITE LIMITED (UNITED KINGDOM CORPORATION)
THE STUDIO, ST. NICOLAS CLOSE, ELSTREE
HERTS, UNITED KINGDOM WD63EW

FOR: COMPRESSED AIR PIPE FITTINGS OF METAL; CONNECTORS OF METAL, NAMELY, PLUGS, SOCKETS, PANELS AND CABLE CLAMPS, FOR USE WITH TEMPERATURE SENSORS, TEMPERATURE CONTROLLERS, TEMPERATURE VALUE TRANSMITTERS, AND THERMOCOUPLES, IN CLASS 6 (U.S. CLS. 2, 12, 13, 14, 23, 25 AND 50).

FOR: TEMPERATURE SENSORS; THERMOCOUPLES; TEMPERATURE CONTROLLERS; ELECTRONIC TRANSMITTERS FOR TRANSMITTING TEMPERATURE VALUES; ELECTRICAL RECEPTACLES AND CONNECTORS FOR TEMPERATURE SENSORS, TEMPERATURE CONTROLLERS AND TEMPERATURE VALUE TRANSMITTERS; ELECTRICAL CONNECTION BOXES AND CONNECTION HEADS; AND THERMOCOUPLE

CONNECTORS, IN CLASS 9 (U.S. CLS. 21, 23, 26, 36 AND 38).

FOR: NON-METAL CONNECTORS, NAMELY, PLUGS, SOCKETS, PANELS AND CABLE CLAMPS, FOR USE WITH TEMPERATURE SENSORS, TEMPERATURE CONTROLLERS, TEMPERATURE VALUE TRANSMITTERS, AND THERMOCOUPLES, IN CLASS 20 (U.S. CLS. 2, 13, 22, 25, 32 AND 50).

THE MARK CONSISTS OF STANDARD CHARACTERS WITHOUT CLAIM TO ANY PARTICULAR FONT, STYLE, SIZE, OR COLOR.

PRIORITY CLAIMED UNDER SEC. 44(D) ON ERPN CMNTY TM OFC APPLICATION NO. 005411178, FILED 10-24-2006, REG. NO. 005411178, DATED 12-20-2007, EXPIRES 10-24-2016.

SER. NO. 77-147,138, FILED 4-3-2007.

STEVEN R. FINE, EXAMINING ATTORNEY

Int. Cl.: 7

Prior U.S. Cls.: 13, 19, 21, 23, 31, 34 and 35

United States Patent and Trademark Office

Reg. No. 3,574,516

Registered Feb. 17, 2009

**TRADEMARK
PRINCIPAL REGISTER**

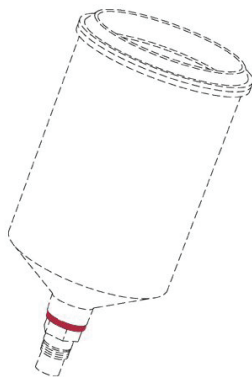

SATA GMBH & CO. KG (FED REP GERMANY
GMBH & CO. KG)
DOMERTALSTRASSE 20
KORNWESTHEIM, FED REP GERMANY 70806

FOR: PAINT SPRAY GUNS AND PARTS THERE-
OF, NAMELY, PAINT RESERVOIRS, IN CLASS 7
(U.S. CLS. 13, 19, 21, 23, 31, 34 AND 35).

FIRST USE 2-13-2003; IN COMMERCE 2-13-2003.

OWNER OF U.S. REG. NO. 3,072,417.

THE COLOR(S) RED IS/ARE CLAIMED AS A
FEATURE OF THE MARK.

THE MARK CONSISTS OF THE COLOR RED
ENCIRCLING THE NECK OF THE CUP FITTING
OF THE PAINT RESERVOIR. THE CONFIGURA-
TION OF THE DRAWING OF THE GOODS SHOWN
IN DOTTED LINES IS INTENDED TO SHOW THE
POSITION OF THE MARK ON THE GOODS AND IS
NOT A PART OF THE MARK.

SEC. 2(F).

SER. NO. 77-149,125, FILED 4-5-2007.

MARY BOAGNI, EXAMINING ATTORNEY

Int. Cl.: 16

Prior U.S. Cls.: 2, 5, 22, 23, 29, 37, 38 and 50

United States Patent and Trademark Office

Reg. No. 3,574,517

Registered Feb. 17, 2009

**TRADEMARK
PRINCIPAL REGISTER**

POLYMER

ELSEVIER LIMITED (UNITED KINGDOM COR-
PORATION)
THE BOULEVARD, LANGFORD LANE
KIDLINGTON, OXFORD, UNITED KINGDOM
OX51GB

FOR: PRINTED PUBLICATIONS, NAMELY,
JOURNALS IN THE FIELDS OF SCIENCE AND
TECHNOLOGY, IN CLASS 16 (U.S. CLS. 2, 5, 22, 23,
29, 37, 38 AND 50).

FIRST USE 12-31-1960; IN COMMERCE 12-31-1960.

THE MARK CONSISTS OF STANDARD CHAR-
ACTERS WITHOUT CLAIM TO ANY PARTICULAR
FONT, STYLE, SIZE, OR COLOR.

SEC. 2(F).

SER. NO. 77-150,069, FILED 4-5-2007.

MICHELE SWAIN, EXAMINING ATTORNEY

Int. Cls.: 14, 16, 21 and 28

Prior U.S. Cls.: 2, 5, 13, 22, 23, 27, 28, 29, 30, 33, 37, 38, 40 and 50

Reg. No. 3,574,518

United States Patent and Trademark Office

Registered Feb. 17, 2009

**TRADEMARK
PRINCIPAL REGISTER**



BRIGHAM YOUNG UNIVERSITY (UTAH CORPORATION)
OFFICE OF THE GENERAL COUNSEL
A-357 ASB
PROVO, UT 84602

FOR: JEWELRY, ESPECIALLY RINGS, EARRINGS, NECKLACES, BRACELETS AND KEY CHAINS OF PRECIOUS METAL , IN CLASS 14 (U.S. CLS. 2, 27, 28 AND 50).

FIRST USE 8-1-2005; IN COMMERCE 8-1-2005.

FOR: PAPER PRODUCTS, NAMELY, NOTEBOOKS, STATIONERY, LETTERHEAD, ENVELOPES, BROCHURES IN THE FIELD OF ATHLETICS AND ACADEMICS, PRINTED MATERIALS IN THE NATURE OF UNIVERSITY PROGRAMS AND MEDIA GUIDES, IN CLASS 16 (U.S. CLS. 2, 5, 22, 23, 29, 37, 38 AND 50).

FIRST USE 8-1-2005; IN COMMERCE 8-1-2005.

FOR: BEVERAGE GLASSWARE; MUGS; CUPS, IN CLASS 21 (U.S. CLS. 2, 13, 23, 29, 30, 33, 40 AND 50).

FIRST USE 8-1-2005; IN COMMERCE 8-1-2005.

FOR: GAMES, NAMELY, BOARD GAMES; TOYS, NAMELY, MINIATURE FOOTBALLS, BASKETBALLS, AND BASEBALLS, IN CLASS 28 (U.S. CLS. 22, 23, 38 AND 50).

FIRST USE 8-1-2005; IN COMMERCE 8-1-2005.

OWNER OF U.S. REG. NO. 3,126,920.

THE MARK CONSISTS OF THE LETTER "Y".

SER. NO. 77-151,840, FILED 4-9-2007.

JOHN GARTNER, EXAMINING ATTORNEY

Int. Cl.: 5

Prior U.S. Cls.: 6, 18, 44, 46, 51 and 52

United States Patent and Trademark Office

Reg. No. 3,574,519

Registered Feb. 17, 2009

**TRADEMARK
PRINCIPAL REGISTER**

EFFEZEL

GALDERMA S.A. (SWITZERLAND SOCIETE
ANONYME)
ZUGERSTRASSE 8
CHAM, SWITZERLAND 6330

PRIORITY CLAIMED UNDER SEC. 44(D) ON
SWITZERLAND APPLICATION NO. 002241/2006,
FILED 11-8-2006, REG. NO. 554219, DATED 1-16-
2007, EXPIRES 11-8-2016.

FOR: PHARMAMCEUTICAL DERMATOLOGI-
CAL PREPARATIONS, NAMELY, ANTI-ACNE PRE-
PARATIONS, IN CLASS 5 (U.S. CLS. 6, 18, 44, 46, 51
AND 52).

SER. NO. 77-152,508, FILED 4-10-2007.

THE MARK CONSISTS OF STANDARD CHAR-
ACTERS WITHOUT CLAIM TO ANY PARTICULAR
FONT, STYLE, SIZE, OR COLOR.

MARILYN IZZI, EXAMINING ATTORNEY

Int. Cls.: 14, 16 and 20

**Prior U.S. Cls.: 2, 5, 13, 22, 23, 25, 27, 28, 29, 32, 37, 38
and 50**

Reg. No. 3,574,520

United States Patent and Trademark Office

Registered Feb. 17, 2009

**TRADEMARK
PRINCIPAL REGISTER**



BIDEAWEE, INC. (NEW YORK CORPORATION)
410 EAST 38TH STREET
NEW YORK, NY 10016

FOR: JEWELRY, NAMELY, LAPEL PINS,
CHAINS; PET JEWELRY, IN CLASS 14 (U.S. CLS. 2,
27, 28 AND 50).

FIRST USE 8-15-2006; IN COMMERCE 3-15-2007.

FOR: INFORMATIONAL FLYERS AND BRO-
CHURES RELATING TO ANIMAL CARE, WEL-
FARE AND PROTECTION; PRINTED
INSTRUCTIONAL AND EDUCATIONAL MATERI-
ALS RELATING TO ANIMAL CARE, WELFARE
AND PROTECTION; STICKERS, WRITING PAPERS
AND CARDS, NAMELY, GREETING CARDS AND
POSTCARDS, IN CLASS 16 (U.S. CLS. 2, 5, 22, 23, 29,
37, 38 AND 50).

FIRST USE 8-15-2006; IN COMMERCE 8-15-2006.

FOR: ACCESSORIES, NAMELY, PLASTIC KEY
RINGS, IN CLASS 20 (U.S. CLS. 2, 13, 22, 25, 32 AND
50).

FIRST USE 8-15-2006; IN COMMERCE 8-15-2006.

OWNER OF U.S. REG. NO. 3,267,565.

THE MARK CONSISTS OF A CIRCLE WITH AN
ENCLOSED SCHEMATIC DESIGN RESEMBLING A
CAT'S FACE.

SER. NO. 77-155,014, FILED 4-12-2007.

MARLENE BELL, EXAMINING ATTORNEY

Int. Cl.: 29

Prior U.S. Cl.: 46

United States Patent and Trademark Office

Reg. No. 3,574,521

Registered Feb. 17, 2009

TRADEMARK
PRINCIPAL REGISTER



SIGMA ALIMENTOS, S.A. DE C.V. (MEXICO CORPORATION)
COLONIA CARRIZALEJO
AVE. GOMEZ MORIN NO. 1111
SAN PEDRO, GARZA GARCIA, MEXICO

FOR: CHEESE, IN CLASS 29 (U.S. CL. 46).

FIRST USE 7-0-2006; IN COMMERCE 7-0-2006.

OWNER OF U.S. REG. NO. 2,855,973.

NO CLAIM IS MADE TO THE EXCLUSIVE RIGHT TO USE "MEXICO," "SEMISOFT PART SKIM MILK CHEESE" AND "QUESO FRESCO", APART FROM THE MARK AS SHOWN.

THE COLOR(S) GREEN, WHITE, BLUE, RED AND YELLOW IS/ARE CLAIMED AS A FEATURE OF THE MARK.

THE MARK CONSISTS OF A LABEL, ESSENTIALLY COMPRISING A GREEN AND WHITE CHECKERBOARD FIELD, HAVING A SUPERIMPOSED CIRCULAR LABEL WITH THE OUTER

CIRCULAR AREA BEING BLUE AND INNER PART OF THE CIRCULAR ARE BEING WHITE. THE MARK "LA VILLITA" IS IN A BANNER, IN THE TOP CENTRAL PORTION OF THE DESIGN IS IN THE COLOR BLUE; THE BANNER ACROSS THE CENTER OF THE DESIGN AND THE HALF OF THE BANNER AT THE LOWER RIGHT OF THE DESIGN ARE IN THE COLOR RED; THE HALF OF THE BANNER AT THE LOWER LEFT OF THE DESIGN IS IN THE COLOR GREEN WITH SEVERAL RED AND WHITE HOUSES. A DINNER DISH IS LOCATED IN THE BOTTOM RIGHT CORNER OF THE CIRCULAR IMAGE.

THE ENGLISH TRANSLATION OF "LA VILLITA" IN THE MARK IS LITTLE TOWN. THE ENGLISH TRANSLATION OF THE SLOGAN "EL VERDADERO SABOR DE MEXICO" IN THE MARK IS THE TRUE TASTE OR FLAVOR OF MEXICO. THE ENGLISH TRANSLATION OF "QUESO FRESCO" IN THE MARK IS FRESH CHEESE.

SER. NO. 77-156,563, FILED 4-13-2007.

DOMINICK J. SALEMI, EXAMINING ATTORNEY

Int. Cl.: 35

Prior U.S. Cls.: 100, 101 and 102

United States Patent and Trademark Office

Reg. No. 3,574,522

Registered Feb. 17, 2009

**SERVICE MARK
PRINCIPAL REGISTER**

SELEKTPOINTS

THE INTERNATIONAL INVESTOR KSCC (KU-
WAIT CORPORATION)
PO BOX 29233
SAFAT, KUWAIT 13153

FOR: ORGANIZATION, OPERATION AND SU-
PERVISION OF LOYALTY AND PROMOTIONAL
INCENTIVE SCHEMES; PROMOTIONAL SERVI-
CES; BUSINESS CONSULTANCY; MANAGEMENT
OF COMPUTER DATABASES; COMPILATION OF
DATA, IN CLASS 35 (U.S. CLS. 100, 101 AND 102).

THE MARK CONSISTS OF STANDARD CHAR-
ACTERS WITHOUT CLAIM TO ANY PARTICULAR
FONT, STYLE, SIZE, OR COLOR.

PRIORITY CLAIMED UNDER SEC. 44(D) ON
KUWAIT APPLICATION NO. 82987, FILED 2-10-
2007, REG. NO. 69490, DATED 2-17-2008, EXPIRES 2-
9-2017.

SER. NO. 77-160,027, FILED 4-18-2007.

SEAN CROWLEY, EXAMINING ATTORNEY

Int. Cl.: 9

Prior U.S. Cls.: 21, 23, 26, 36 and 38

United States Patent and Trademark Office

Reg. No. 3,574,523

Registered Feb. 17, 2009

**TRADEMARK
PRINCIPAL REGISTER**

BAYZ

BAYZ SUNWEAR, INC. (MARYLAND CORPORATION)
920 REVOLUTION STREET
HAVRE DE GRACE, MD 21078

FOR: SUNGLASSES; FRAMES FOR SPECTACLES AND SUNGLASSES; LENSES FOR SUNGLASSES; SUNGLASS LENSES; EYEGLOSS FRAMES; EYEGLOSS LENSES; EYEGLOSSSES; OPHTHALMIC LENSES, IN CLASS 9 (U.S. CLS. 21, 23, 26, 36 AND 38).

FIRST USE 11-17-1998; IN COMMERCE 11-17-1998.

THE MARK CONSISTS OF STANDARD CHARACTERS WITHOUT CLAIM TO ANY PARTICULAR FONT, STYLE, SIZE, OR COLOR.

OWNER OF U.S. REG. NO. 2,336,639.

SEC. 2(F).

SER. NO. 77-162,464, FILED 4-21-2007.

PAULA MAHONEY, EXAMINING ATTORNEY

Int. Cls.: 35, 38, 42 and 45

Prior U.S. Cls.: 100, 101, 102 and 104

United States Patent and Trademark Office

Reg. No. 3,574,524

Registered Feb. 17, 2009

**SERVICE MARK
PRINCIPAL REGISTER**



ACCESS WEB, LLC (CALIFORNIA LIMITED LIABILITY COMPANY)
317 ROBIN HOOD LANE
COSTA MESA, CA 92627

FOR: MANAGING THE ONLINE STORES OF OTHERS; INFORMATION, ADVISORY AND CONSULTANCY SERVICES RELATING TO BUSINESS AND MANAGEMENT OR BUSINESS ADMINISTRATION, INCLUDING SUCH SERVICES PROVIDED ON LINE OR VIA THE INTERNET; PROVIDING A SECURED DATABASE VIA THE INTERNET THROUGH WHICH DOCUMENTS AND IMAGES CAN BE VIEWED, COPIED, AND PRINTED FOR PURPOSES OF CONDUCTING BUSINESS TRANSACTIONS; COMPUTERIZED DATABASE MANAGEMENT; ELECTRONIC COMMERCE SERVICES, NAMELY, PROVIDING INFORMATION ABOUT PRODUCTS VIA TELECOMMUNICATION NETWORKS; PROMOTING THE GOODS AND SERVICES OF OTHERS BY PROVIDING AUTOMATED HYPERTEXT LINKS TO THE WEBSITES OF OTHERS USING OPTIMAL SEARCH TERMS AND SEARCH ENGINES VIA THE GLOBAL COMPUTER NETWORK; AND FACILITATING THE EXCHANGE OF NEEDED INFORMATION FOR FINANCIAL COMPENSATION VIA THE INTERNET, IN CLASS 35 (U.S. CLS. 100, 101 AND 102).

FIRST USE 11-1-2006; IN COMMERCE 11-1-2006.

FOR: PROVIDING ELECTRONIC MAIL, ELECTRONIC MAIL FORWARDING AND MESSAGING SERVICES; CONSULTATION IN THE FIELD OF ELECTRONIC TRANSMISSION OF VOICE, DATA,

VIDEO, OTHER IMAGES AND DOCUMENTS VIA COMMUNICATION NETWORKS, AND GLOBAL COMPUTER NETWORKS; ELECTRONIC FILE TRANSFER SERVICES FOR THE SECURE TRANSFER AND DISSEMINATION OF A WIDE RANGE OF INFORMATION; PROVIDING FOR ON-LINE COMMUNICATIONS LINKS WHICH TRANSFER THE WEB SITE USER TO OTHER LOCAL AND GLOBAL WEB PAGES; PROVIDING FOR THE TRANSMISSION AND DISTRIBUTION OF DATA OR AUDIO VISUAL IMAGES VIA A GLOBAL COMPUTER NETWORK OR THE INTERNET; PROVIDING ACCESS TO DATABASES; PROVIDING FOR ELECTRONIC EXCHANGE OF DATA STORED IN DATABASES ACCESSIBLE VIA GLOBAL TELECOMMUNICATION NETWORKS; AND PROVIDING FOR THE DELIVERY OF IMAGES, PHOTOGRAPHS AND ON-LINE DOCUMENTS VIA A GLOBAL COMPUTER NETWORK, IN CLASS 38 (U.S. CLS. 100, 101 AND 104).

FIRST USE 11-1-2006; IN COMMERCE 11-1-2006.

FOR: COMPUTER AND INTERNET SERVICES, NAMELY, DESIGNING AND IMPLEMENTING NETWORK WEB PAGES FOR OTHERS; CONSULTING SERVICES IN THE FIELD OF DESIGN, SELECTION, IMPLEMENTATION AND USE OF COMPUTER HARDWARE AND SOFTWARE SYSTEMS FOR OTHERS; HOSTING THE WEB SITES OF OTHERS ON A COMPUTER SERVER FOR A GLOBAL COMPUTER NETWORK, DISPLAYING THE WEB SITES AND IMAGES OF OTHERS ON A COMPUTER SERVER; SOFTWARE SERVICES, NAMELY, DATABASE DESIGN, DEVELOPMENT

AND DEPLOYMENT, CUSTOM SOFTWARE PROGRAMMING OF CODE IN VARIOUS COMPUTER LANGUAGES; DESIGN SERVICES, NAMELY, DESIGN OF ORIGINAL GRAPHICAL IMAGES AND ARTWORK; AND E-MAIL SYSTEM DESIGN AND IMPLEMENTATION FOR OTHERS, IN CLASS 42 (U.S. CLS. 100 AND 101).

FIRST USE 11-1-2006; IN COMMERCE 11-1-2006.

FOR: REGISTRATION OF DOMAIN NAMES FOR IDENTIFICATION OF USERS ON A GLOBAL COMPUTER NETWORK; PROVIDING USER AUTHENTICATION SERVICES IN E-COMMERCE TRANSACTIONS; AND CONSULTING SERVICES IN THE FIELD OF MAINTAINING THE SECURITY AND INTEGRITY OF DATABASES, IN CLASS 45 (U.S. CLS. 100 AND 101).

FIRST USE 11-1-2006; IN COMMERCE 11-1-2006.

THE MARK CONSISTS OF TWO RECTANGLES. THERE IS A SWIRL BEHIND THE SQUARES. THEY ARE TURNED 90 DEGREES SO ONE CORNER IS ON THE BOTTOM. THERE IS A WAVEY LINE OF VARYING THICKNESS, FROM THICKEST ON THE LEFT TO THINNEST ON THE RIGHT. AT THE END OF THE LINE ON THE RIGHT IS A DOT AND AT THE LEFT END OF THE LINE IS A DOT. THE RECTANGLE OVERLAYS THIS LINE WITH THE APPEARANCE IT IS ON TOP OF THE LINE. THE NAME "ACCESSWEB" IS WRITTEN BELOW WITH ACCESS (FONT = NEWS GOTHIC BOLD) AND WEB (FONT = NEWS GOTHIC ROMAN).

SER. NO. 77-163,645, FILED 4-23-2007.

KIMBERLY PERRY, EXAMINING ATTORNEY

Int. Cl.: 44

Prior U.S. Cls.: 100 and 101

United States Patent and Trademark Office

Reg. No. 3,574,525

Registered Feb. 17, 2009

SERVICE MARK
PRINCIPAL REGISTER



Inner Health. Outer Beauty.

PULNIK, HELENE (UNITED STATES INDIVIDUAL)
158 APPLETREE LANE
PORTLAND, CT 06480

FOR: HEALTH SPA SERVICES, NAMELY, COSMETIC BODY CARE SERVICES, IN CLASS 44 (U.S. CLS. 100 AND 101).

FIRST USE 8-1-2005; IN COMMERCE 8-1-2005.

NO CLAIM IS MADE TO THE EXCLUSIVE RIGHT TO USE "HOLISTIC SPA", APART FROM THE MARK AS SHOWN.

THE MARK CONSISTS OF STYLIZED LETTERING WITH A LEAF DESIGN DISPLAYED ABOVE THE TEXT.

SER. NO. 77-164,273, FILED 4-24-2007.

MICHAEL KEATING, EXAMINING ATTORNEY

Int. Cl.: 37

Prior U.S. Cls.: 100, 103 and 106

United States Patent and Trademark Office

Reg. No. 3,574,526

Registered Feb. 17, 2009

**SERVICE MARK
PRINCIPAL REGISTER**

IT'S DIFFERENT IN HERE

ROSEHAVEN HOMES LIMITED (CANADA CORPORATION)
145 REYNOLDS STREET
SUITE 300
OAKVILLE, ONTARIO, CANADA L6J 3K8

FOR: LAND DEVELOPMENT SERVICES, NAME-
LY, PLANNING AND LAYING OUT OF RESIDEN-
TIAL AND COMMERCIAL COMMUNITIES;
CONSTRUCTION SERVICES, NAMELY, PLAN-
NING, LAYING OUT AND CUSTOM CONSTRUC-
TION OF RESIDENTIAL AND COMMERCIAL
COMMUNITIES; MAINTENANCE OF RESIDEN-
TIAL AND COMMERCIAL BUILDINGS AND DE-
VELOPMENTS; REAL ESTATE DEVELOPMENT
SERVICES, NAMELY, THE IMPROVEMENT AND
SUBDIVIDING OF LAND, AND THE DEVELOP-
MENT AND CONSTRUCTION OF RESIDENTIAL

AND/OR COMMERCIAL PROPERTIES THEREON
FOR SUBSEQUENT SALE AND/OR LEASE, IN
CLASS 37 (U.S. CLS. 100, 103 AND 106).

THE MARK CONSISTS OF STANDARD CHAR-
ACTERS WITHOUT CLAIM TO ANY PARTICULAR
FONT, STYLE, SIZE, OR COLOR.

PRIORITY CLAIMED UNDER SEC. 44(D) ON
CANADA APPLICATION NO. 1335625, FILED 2-15-
2007, REG. NO. TMA717191, DATED 6-23-2008, EX-
PIRES 6-23-2023.

SER. NO. 77-165,253, FILED 4-25-2007.

MARIAM MAHMOUDI, EXAMINING ATTORNEY

Int. Cl.: 29

Prior U.S. Cl.: 46

United States Patent and Trademark Office

Reg. No. 3,574,527

Registered Feb. 17, 2009

TRADEMARK
PRINCIPAL REGISTER



YANG, YI-LIEN (TAIWAN CORPORATION)
EAST DISTRICT
NO. 3, LANE 64, DONGGUANGYUAN RD.
TAICHUNG CITY, TAIWAN

FOR: BROTH; MEAT EXTRACT; CHICKEN EXTRACT; BOUILLON; SOUP STOCK, NAMELY, CHICKEN STOCK; SOUP BASES; VEGETABLE SOUP EXTRACT; SOUP CONCENTRATE, NAMELY, PREPARATIONS FOR MAKING SOUP; STEWS, NAMELY, STEWED CHICKEN WINGS; STEWED DRIED TOFU; EDIBLE OIL; JELLIES; DRIED MEAT; FISH CAKES; INSTANT AND PRE-COOKED, NAMELY, PREPARED MEATS; PRESERVED, DRIED, COOKED AND GRILLED VEGETABLES; FRUIT PRESERVES; INSTANT PEANUT SOUP; JAMS; FREEZE-DRIED TOFU PIECES; VEGETARIAN SOUP STOCK, IN CLASS 29 (U.S. CL. 46).

FIRST USE 10-19-2000; IN COMMERCE 4-22-2005.

NO CLAIM IS MADE TO THE EXCLUSIVE RIGHT TO USE THE NON-LATIN CHARACTERS

THAT MEAN "BRAND" , APART FROM THE MARK AS SHOWN.

THE MARK CONSISTS OF THE WORDING "GOLDEN HOWARD" WITH AN UPPER CASE "G" AND ALL REMAINING LETTERING IN LOWER CASE STYLE SUPERIMPOSED UPON A ROUNDED RECTANGULAR BACKGROUND WITH A HORIZONTAL LINE UNDERNEATH THE WORD "HOWARD", ALL OF WHICH APPEARS ABOVE THREE NON-LATIN CHARACTERS THAT TRANSLITERATE INTO "FU HWA PAI".

THE NON-LATIN CHARACTER(S) IN THE MARK TRANSLITERATE INTO "FU HWA PAI", AND THIS MEANS HAPPINESS, SPLENDOR, BRAND IN ENGLISH.

SER. NO. 77-165,675, FILED 4-25-2007.

ERIN FALK, EXAMINING ATTORNEY

Int. Cls.: 3 and 5

Prior U.S. Cls.: 1, 4, 6, 18, 44, 46, 50, 51 and 52

United States Patent and Trademark Office

Reg. No. 3,574,528

Registered Feb. 17, 2009

**TRADEMARK
PRINCIPAL REGISTER**

PIERRE FABRE

PIERRE FABRE MEDICAMENT (FRANCE SOCI-
ETE ANONYME)
45, PLACE ABEL GANCE
BOULOGNE, FRANCE 92100

FOR: HOUSE MARK FOR FULL LINE OF COS-
METICS, NON-MEDICATED ORAL CARE PRE-
PARATIONS AND HAIR CARE PREPARATIONS,
IN CLASS 3 (U.S. CLS. 1, 4, 6, 50, 51 AND 52).

FIRST USE 4-26-1983; IN COMMERCE 4-26-1983.

FOR: HOUSE MARK FOR FULL LINE OF DER-
MATOLOGICAL AND SKIN CARE PHARMACEU-
TICAL PREPARATIONS, DIETARY AND
NUTRITIONAL SUPPLEMENTS, IN CLASS 5 (U.S.
CLS. 6, 18, 44, 46, 51 AND 52).

FIRST USE 4-26-1983; IN COMMERCE 4-26-1983.

THE MARK CONSISTS OF STANDARD CHAR-
ACTERS WITHOUT CLAIM TO ANY PARTICULAR
FONT, STYLE, SIZE, OR COLOR.

OWNER OF U.S. REG. NOS. 1,310,696 AND
2,373,105.

THE NAME SHOWN IN THE MARK IDENTIFIES
WHOSE CONSENT IS OF RECORD.

SER. NO. 77-169,509, FILED 4-30-2007.

GISELLE AGOSTO, EXAMINING ATTORNEY

Int. Cl.: 41

Prior U.S. Cls.: 100, 101 and 107

United States Patent and Trademark Office

Reg. No. 3,574,529

Registered Feb. 17, 2009

**SERVICE MARK
PRINCIPAL REGISTER**

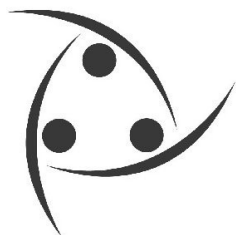

**National Survey
of Student Engagement**

INDIANA UNIVERSITY RESEARCH AND TECHNOLOGY CORPORATION (INDIANA CORPORATION)

501 N. MORTON ST. SUITE 204
BLOOMINGTON, IN 47404

FOR: EDUCATIONAL RESEARCH, NAMELY, CONDUCTING AN ANNUAL EDUCATIONAL SURVEY FOR COLLEGE STUDENTS AT THE UNDERGRADUATE LEVEL; PROVIDING EDUCATIONAL INFORMATION, NAMELY, AN ANNUAL EDUCATIONAL SURVEY FOR COLLEGE STUDENTS AT THE UNDERGRADUATE LEVEL; AND CONSULTING IN THE FIELD OF EDUCATION, IN CLASS 41 (U.S. CLS. 100, 101 AND 107).

FIRST USE 1-1-1999; IN COMMERCE 1-1-1999.

NO CLAIM IS MADE TO THE EXCLUSIVE RIGHT TO USE "NATIONAL SURVEY OF STUDENT ENGAGEMENT", APART FROM THE MARK AS SHOWN.

THE MARK CONSISTS OF THREE CIRCLES BORDERED BY THREE CURVED LINES.

SER. NO. 77-169,673, FILED 5-1-2007.

JOHN SCHUYLER YARD, EXAMINING ATTORNEY

Int. Cl.: 41

Prior U.S. Cls.: 100, 101 and 107

United States Patent and Trademark Office

Reg. No. 3,574,530

Registered Feb. 17, 2009

**SERVICE MARK
PRINCIPAL REGISTER**

GCV

CORE GLOBAL CORPORATION (CALIFORNIA CORPORATION)
SUITE A
3542 HAYDEN AVENUE
CULVER CITY, CA 90232

FOR: EDUCATIONAL SERVICES, NAMELY, PROVIDING INTENSIVE SHORT-TERM COURSES OF INSTRUCTION, CLASSES, SEMINARS, TRAINING, WORKSHOPS AND COURSES IN THE FIELDS OF EDUCATION, SPORTS, CULTURE, BUSINESS, AND ENTERTAINMENT, THROUGH A NETWORK OF GLOBALLY FOCUSED AND MANAGED EDUCATIONAL, CULTURAL AND CORPORATE INSTITUTIONS; ENTERTAINMENT SERVICES, NAMELY, PROVIDING ART EXHIBITIONS, EDUCATIONAL EXHIBITIONS IN THE FIELDS OF SPORTS, CULTURE, BUSINESS AND ENTERTAINMENT, ANIMAL EXHIBITIONS, MAGIC SHOWS, FOOD FESTIVALS, WINE FESTIVALS, LIVE MUSIC CONCERTS, SYMPHONY ORCHESTRA CONCERTS, DANCE PERFORMANCES, BALLET PERFORMANCES, LIVE PERFORMANCES BY

MUSICAL BANDS, THEATRICAL PRODUCTIONS, LIVE OPERA PERFORMANCES, AMUSEMENT PARKS, PARTICIPATION IN LIVE INTERACTIVE TEAM AND INDIVIDUAL COMPETITIVE GAMES; PROVIDING LIVE INTERACTIVE VIDEO GAMES, CARNIVAL GAMES AND QUIZ GAME SHOWS, FASHION SHOWS, AIR SHOWS, LASER SHOWS, FIREWORK SHOWS, LIGHT SHOWS AND LIVE ANIMAL SHOWS THROUGH A NETWORK OF GLOBALLY FOCUSED AND MANAGED EDUCATIONAL, CULTURAL AND CORPORATE INSTITUTIONS, IN CLASS 41 (U.S. CLS. 100, 101 AND 107).

FIRST USE 6-15-2006; IN COMMERCE 6-15-2006.

THE MARK CONSISTS OF STANDARD CHARACTERS WITHOUT CLAIM TO ANY PARTICULAR FONT, STYLE, SIZE, OR COLOR.

SER. NO. 77-170,369, FILED 5-1-2007.

AMY C. KEAN, EXAMINING ATTORNEY

Int. Cl.: 35

Prior U.S. Cls.: 100, 101 and 102

United States Patent and Trademark Office

Reg. No. 3,574,531

Registered Feb. 17, 2009

**SERVICE MARK
PRINCIPAL REGISTER**

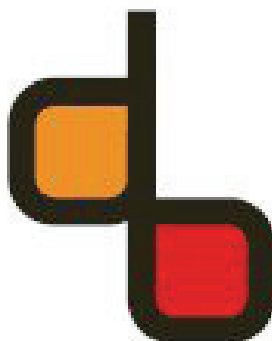

DEALER BASICS, LLC (TEXAS LIMITED LIABILITY COMPANY)
SUITE 900
3625 N. HALL STREET
DALLAS, TX 75219

FOR: BUSINESS CONSULTING SERVICES, NAMELY, PROVIDING BUSINESS AND MARKETING DATA IN THE FIELD OF VEHICLES AND AUTOMOTIVE EQUIPMENT; COMPUTERIZED REAL-TIME AND DELAYED TRANSACTIONAL DATA MANAGEMENT SERVICES IN THE FIELD OF VEHICLES AND AUTOMOTIVE EQUIPMENT; COST AND PRICE ANALYSIS SERVICES IN THE FIELD OF VEHICLES AND AUTOMOTIVE EQUIPMENT; PROVIDING BUSINESS CONSULTING SERVICES FOR AUTO DEALERSHIPS RELATING TO DATA ANALYSIS; COMPILATION AND PROVI-

SION OF AUTOMOTIVE PRICING INFORMATION, IN CLASS 35 (U.S. CLS. 100, 101 AND 102).

FIRST USE 2-1-2007; IN COMMERCE 2-1-2007.

THE COLOR(S) RED, ORANGE, AND BLACK IS/ ARE CLAIMED AS A FEATURE OF THE MARK.

THE MARK CONSISTS OF THE LOWERCASE LETTERS "D" AND "B" IN BLACK, WITH THE LETTERS SHARING A SINGLE VERTICAL LINE. THE INTERIOR OF THE LETTER "D" IS ORANGE. THE INTERIOR OF THE LETTER "B" IS RED".

SER. NO. 77-173,333, FILED 5-4-2007.

KAREN SEVERSON, EXAMINING ATTORNEY

Int. Cl.: 35

Prior U.S. Cls.: 100, 101 and 102

United States Patent and Trademark Office

Reg. No. 3,574,532

Registered Feb. 17, 2009

**SERVICE MARK
PRINCIPAL REGISTER**

DEALERBASICS

DEALER BASICS, LLC (TEXAS LIMITED LIABILITY COMPANY)
SUITE 900
3625 N. HALL STREET
DALLAS, TX 75219

FOR: BUSINESS CONSULTING SERVICES, NAMELY, PROVIDING BUSINESS AND MARKETING DATA IN THE FIELD OF VEHICLES AND AUTOMOTIVE EQUIPMENT; COMPUTERIZED REAL-TIME AND DELAYED TRANSACTIONAL DATA MANAGEMENT SERVICES IN THE FIELD OF VEHICLES AND AUTOMOTIVE EQUIPMENT; COST AND PRICE ANALYSIS SERVICES IN THE FIELD OF VEHICLES AND AUTOMOTIVE EQUIPMENT; PROVIDING BUSINESS CONSULTING SER-

VICES FOR AUTO DEALERSHIPS RELATING TO DATA ANALYSIS; COMPILATION AND PROVISION OF AUTOMOTIVE PRICING INFORMATION, IN CLASS 35 (U.S. CLS. 100, 101 AND 102).

FIRST USE 2-1-2004; IN COMMERCE 2-1-2004.

THE MARK CONSISTS OF STANDARD CHARACTERS WITHOUT CLAIM TO ANY PARTICULAR FONT, STYLE, SIZE, OR COLOR.

SER. NO. 77-173,358, FILED 5-4-2007.

KAREN SEVERSON, EXAMINING ATTORNEY

Int. Cl.: 35

Prior U.S. Cls.: 100, 101 and 102

United States Patent and Trademark Office

Reg. No. 3,574,533

Registered Feb. 17, 2009

SERVICE MARK
PRINCIPAL REGISTER



DEALER BASICS, LLC (TEXAS LIMITED LIABILITY COMPANY)
SUITE 900
3625 N. HALL STREET
DALLAS, TX 75219

FIRST USE 3-7-2007; IN COMMERCE 3-7-2007.

THE COLOR(S) ORANGE, RED AND BLACK IS/ARE CLAIMED AS A FEATURE OF THE MARK.

FOR: BUSINESS CONSULTING SERVICES, NAMELY, PROVIDING BUSINESS AND MARKETING DATA IN THE FIELD OF VEHICLES AND AUTOMOTIVE EQUIPMENT; COMPUTERIZED REAL-TIME AND DELAYED TRANSACTIONAL DATA MANAGEMENT SERVICES IN THE FIELD OF VEHICLES AND AUTOMOTIVE EQUIPMENT; COST AND PRICE ANALYSIS SERVICES IN THE FIELD OF VEHICLES AND AUTOMOTIVE EQUIPMENT; PROVIDING BUSINESS CONSULTING SERVICES FOR AUTO DEALERSHIPS RELATING TO DATA ANALYSIS; COMPILATION AND PROVISION OF AUTOMOTIVE PRICING INFORMATION, IN CLASS 35 (U.S. CLS. 100, 101 AND 102).

THE MARK CONSISTS THE LOWERCASE LETTERS "D" AND "B" IN BLACK, WITH THE LETTERS SHARING A SINGLE VERTICAL LINE. THE INTERIOR OF THE LETTER "D" IS ORANGE. THE INTERIOR OF THE LETTER "B" IS RED. THE WORDING "DEALERBASICS" APPEARS IN BLACK.

SER. NO. 77-173,380, FILED 5-4-2007.

KAREN SEVERSON, EXAMINING ATTORNEY

Int. Cl.: 35

Prior U.S. Cls.: 100, 101 and 102

United States Patent and Trademark Office

Reg. No. 3,574,534

Registered Feb. 17, 2009

**SERVICE MARK
PRINCIPAL REGISTER**



DEALER BASICS, LLC (TEXAS LIMITED LIABILITY COMPANY)
SUITE 900
3625 N. HALL STREET
DALLAS, TX 75219

FOR: PROVIDING BUSINESS CONSULTING SERVICES FOR AUTO DEALERSHIPS RELATING TO DATA ANALYSIS; COMPILATION AND PROVISION OF AUTOMOTIVE PRICING INFORMATION, IN CLASS 35 (U.S. CLS. 100, 101 AND 102).

FIRST USE 2-1-2007; IN COMMERCE 2-1-2007.

THE COLOR(S) RED AND ORANGE IS/ARE CLAIMED AS A FEATURE OF THE MARK.

THE MARK CONSISTS OF AN UPWARD-POINTING ARROW IN RED AND A DOWNWARD-POINTING ARROW IN ORANGE.

SER. NO. 77-173,409, FILED 5-4-2007.

KAREN SEVERSON, EXAMINING ATTORNEY

Int. Cl.: 35

Prior U.S. Cls.: 100, 101 and 102

United States Patent and Trademark Office

Reg. No. 3,574,535

Registered Feb. 17, 2009

**SERVICE MARK
PRINCIPAL REGISTER**

 **Price Analysis Report**

DEALER BASICS, LLC (TEXAS LIMITED LIABILITY COMPANY)
SUITE 900
3625 N. HALL STREET
DALLAS, TX 75219

FOR: PROVIDING BUSINESS CONSULTING SERVICES FOR AUTO DEALERSHIPS RELATING TO DATA ANALYSIS; COMPILATION AND PROVISION OF AUTOMOTIVE PRICING INFORMATION, IN CLASS 35 (U.S. CLS. 100, 101 AND 102).

FIRST USE 2-1-2007; IN COMMERCE 2-1-2007.

NO CLAIM IS MADE TO THE EXCLUSIVE RIGHT TO USE "PRICE ANALYSIS REPORT", APART FROM THE MARK AS SHOWN.

THE COLOR(S) RED, ORANGE AND BLACK IS/ARE CLAIMED AS A FEATURE OF THE MARK.

THE MARK CONSISTS OF AN UPWARD-POINTING ARROW IN RED, A DOWNWARD-POINTING ARROW IN ORANGE, AND THE WORDING "PRICE ANALYSIS REPORT" IN BLACK.

SER. NO. 77-173,438, FILED 5-4-2007.

KAREN SEVERSON, EXAMINING ATTORNEY

Int. Cls.: 12, 16, 25 and 41

Prior U.S. Cls.: 2, 5, 19, 21, 22, 23, 29, 31, 35, 37, 38, 39, 44, 50, 100, 101 and 107

Reg. No. 3,574,536

United States Patent and Trademark Office

Registered Feb. 17, 2009

**TRADEMARK
SERVICE MARK
PRINCIPAL REGISTER**



LAC AUTOMOTIVE, S.L. (SPAIN LIMITED LIABILITY COMPANY)
BARRIO SAN JUAN 50
VERGARA, GUIPUZCOA, SPAIN 20570

FOR: VEHICLE PARTS, NAMELY, CONSTANT VELOCITY JOINTS; VEHICLE PARTS, NAMELY, IDLER ARMS; VEHICLE PARTS, NAMELY, REAR-VIEW MIRRORS; VEHICLE PARTS, NAMELY, SHOCK ABSORBERS; VEHICLE PARTS, NAMELY, STEERING WHEELS; VEHICLE PARTS, NAMELY, SUN VISORS; VEHICLE PARTS, NAMELY, SUSPENSION STRUTS; VEHICLE PARTS, NAMELY, WINDSHIELD VISORS; VEHICLE PARTS, NAMELY, WINDSHIELD WIPERS; VEHICLE SEAT COVERS; VEHICLE SEATS; LAND VEHICLES; SCOOTERS; SEAT BELTS FOR USE IN VEHICLES; THREE-WHEELED MOTOR VEHICLES; TIRES FOR LAND VEHICLES; TWO-WHEELED MOTOR VEHICLES; VEHICLE WINDOWS; AUTOMOBILE SPARE WHEEL HOLDERS; SPARE TIRE CARRIERS FOR VEHICLES, IN CLASS 12 (U.S. CLS. 19, 21, 23, 31, 35 AND 44).

FOR: ADHESIVE NOTE PAPER; ADVERTISING SIGNS OF PAPER OR CARDBOARD; ART PAPER; BOXES OF PAPER OR CARDBOARD; CALENDAR-FINISHED PAPER; CARRYING CASES MADE OF PAPER; CELLOPHANE PAPER; COMPUTER PAPER; COPIER PAPER; CRAFT PAPER; CUSHIONING OR PADDING MADE OF PAPER FOR PACKING PURPOSES; ENVELOPE PAPER; ILLUSTRATION PAPER; LABEL PAPER; LETTER PAPER; MAGAZINE PAPER; NOTEBOOK PAPER; PAPER; PAPER AND CARDBOARD; PAPER BAGS; PAPER FLAGS; PAPER LABELS; POSTCARD PAPER; POSTERS MADE OF PAPER; PRINTED PAPER LABELS;

STATIONERY WRITING PAPER AND ENVELOPES; A SERIES OF BOOKS, WRITTEN ARTICLES, HAND-OUTS AND WORKSHEETS IN THE FIELD OF SPORTS AND VEHICLES; NEWSPAPERS IN THE FIELD OF SPORTS AND VEHICLES, IN CLASS 16 (U.S. CLS. 2, 5, 22, 23, 29, 37, 38 AND 50).

FOR: CAPS; SCARVES; POLO SHIRTS; SHIRTS; SPORT SHIRTS; SPORTS SHIRTS; T-SHIRTS; FOOTWEAR; HEADGEAR, NAMELY, CAPS, IN CLASS 25 (U.S. CLS. 22 AND 39).

FOR: AMATEUR YOUTH SPORTS SERVICES, NAMELY, ORGANIZING, PROVIDING AND MANAGING YOUTH SPORTS ACTIVITIES; ENCOURAGING AMATEUR SPORTS AND PHYSICAL EDUCATION BY ORGANIZING, PROMOTING, SPONSORING, SANCTIONING, CONDUCTING, ADMINISTERING, REGULATING AND GOVERNING AMATEUR ATHLETIC PROGRAMS AND ACTIVITIES; ENTERTAINMENT SERVICES, NAMELY, PERFORMING AND COMPETING IN MOTOR SPORTS EVENTS; ORGANISATION AND PROVISION OF SPORTS INSTALLATIONS FOR FIGURE AND SPEED SKATING CHAMPIONSHIPS; ENTERTAINMENT IN THE NATURE OF AUTOMOBILE RACES; PROVIDING INFORMATION IN THE FIELD OF ENTERTAINMENT, FEATURING ANIMATION RENDERED BY MEANS OF A GLOBAL COMPUTER NETWORK; PROVIDING SPORTS INFORMATION BY MEANS OF TELEPHONE PRE-RECORDED MESSAGES; ORGANIZING COMMUNITY SPORTING AND CULTURAL EVENTS; EDITING OR RECORDING OF SOUNDS AND IMAGES; FILM EDITING; PHOTO EDITING; PUBLICATION AND EDITING OF PRINTED MATTER; VIDEO EDITING; VIDEO TAPE EDITING; WRIT-

TEN TEXT EDITING; ARRANGING OF EXHIBITIONS, SEMINARS AND CONFERENCES; ARRANGING OF SEMINARS AND CONFERENCES; ARRANGING OF CONTESTS; ENTERTAINMENT SERVICES, NAMELY, CONDUCTING CONTESTS; OFFICIATING AT SPORTS CONTESTS; PROVIDING VARIOUS FACILITIES FOR AN ARRAY OF SPORTING EVENTS, SPORTS AND ATHLETIC COMPETITIONS AND AWARDS PROGRAMMES, IN CLASS 41 (U.S. CLS. 100, 101 AND 107).

PRIORITY CLAIMED UNDER SEC. 44(D) ON ERPN CMNTY TM OFC APPLICATION NO. 5668744, FILED 2-6-2007, REG. NO. 5668744, DATED 1-14-2008, EXPIRES 2-6-2017.

THE APPLICANT CLAIMS COLOR AS A FEATURE OF THE MARK, NAMELY, BLACK, YELLOW, GREY, WHITE AND GREEN.

THE MARK CONSISTS OF A LARGER RECTANGLE ADJACENT TO A SMALLER RECTANGLE, BOTH WITH BLUNT VERTICES AND DISPOSED VERTICALLY AND INCLINED TOWARDS THE RIGHT. THE RECTANGLES ARE SURROUNDED BY A YELLOW LINE THAT IS FRAMED BETWEEN BLACK FINE LINES. THE INTERIOR OF THE RECTANGLES IS COLORED BY A GRADIENT OF GRAY TONES, FROM BLACK AT THE OUTER EDGES OF THE RECTANGLES TO WHITE IN THE MIDDLE OF THE RECTANGLES. FROM THE BASE OF THE MIDDLE OF THE LARGER RECTANGLE ASCENDS A GREEN LINE THAT TURNS TO THE RIGHT. THE GREEN LINE CONTINUES ACROSS THE CENTER OF THE SMALLER RECTANGLE.

SER. NO. 77-176,075, FILED 5-9-2007.

PAUL CROWLEY, EXAMINING ATTORNEY

Int. Cl.: 9

Prior U.S. Cls.: 21, 23, 26, 36 and 38

United States Patent and Trademark Office

Reg. No. 3,574,537

Registered Feb. 17, 2009

**TRADEMARK
PRINCIPAL REGISTER**

EASYBAR

BTICINO S.P.A. (ITALY CORPORATION)
VIA MESSINA, 38
MILANO, ITALY 20154

FOR: ELECTRIC APPARATUS AND SYSTEMS FOR TRANSPORT AND DISTRIBUTION OF ELECTRICITY, NAMELY, ELECTRICAL POWER DISTRIBUTION UNITS; ELECTRICAL CONDUCTORS, NAMELY, BUSBAR TRUNKING SYSTEMS, BUSBAR LINKS, BUSBAR BENDS, BUSBAR T-JUNCTIONS, BUSBAR TERMINALS, BUSBAR SOCKET OUTLETS, JUNCTION BOXES, BOXES FOR ELECTRICAL ACCESSORIES, NAMELY, BOXES FOR ELECTRICAL SWITCHES, BOXES FOR ELECTRICAL SOCKET OUTLETS, BOXES FOR ELECTRICAL

JUNCTIONS, IN CLASS 9 (U.S. CLS. 21, 23, 26, 36 AND 38).

THE MARK CONSISTS OF STANDARD CHARACTERS WITHOUT CLAIM TO ANY PARTICULAR FONT, STYLE, SIZE, OR COLOR.

PRIORITY CLAIMED UNDER SEC. 44(D) ON ITALY APPLICATION NO. MI2007C0033, FILED 3-28-2007, REG. NO. 0001139927, DATED 9-17-2008, EXPIRES 3-28-2017.

SER. NO. 77-176,209, FILED 5-9-2007.

DOMINIC FATHY, EXAMINING ATTORNEY

Int. Cls.: 16 and 35

Prior U.S. Cls.: 2, 5, 22, 23, 29, 37, 38, 50, 100, 101 and 102

United States Patent and Trademark Office

Reg. No. 3,574,538

Registered Feb. 17, 2009

**TRADEMARK
SERVICE MARK
PRINCIPAL REGISTER**

INDUSTRY 360°

ERNST & YOUNG U.S. LLP (DELAWARE LIMITED LIABILITY PARTNERSHIP)
5 TIMES SQUARE, 36TH FLOOR
NEW YORK, NY 100366530

FOR: PRINTED REPORTS FEATURING BUSINESS INFORMATION ON BUSINESSES IN VARIOUS INDUSTRY SECTORS, IN CLASS 16 (U.S. CLS. 2, 5, 22, 23, 29, 37, 38 AND 50).

FIRST USE 11-12-2007; IN COMMERCE 11-12-2007.

FOR: PROVIDING BUSINESS INFORMATION FEATURING INFORMATION ON BUSINESSES IN VARIOUS INDUSTRY SECTORS BY MEANS OF ONLINE REPORTS, PODCASTS AND WEBCASTS, IN CLASS 35 (U.S. CLS. 100, 101 AND 102).

FIRST USE 11-12-2007; IN COMMERCE 11-12-2007.

THE MARK CONSISTS OF STANDARD CHARACTERS WITHOUT CLAIM TO ANY PARTICULAR FONT, STYLE, SIZE, OR COLOR.

NO CLAIM IS MADE TO THE EXCLUSIVE RIGHT TO USE "INDUSTRY", APART FROM THE MARK AS SHOWN.

SER. NO. 77-176,378, FILED 5-9-2007.

DAYNA BROWNE, EXAMINING ATTORNEY

Int. Cl.: 42

Prior U.S. Cls.: 100 and 101

United States Patent and Trademark Office

Reg. No. 3,574,539

Registered Feb. 17, 2009

**SERVICE MARK
PRINCIPAL REGISTER**



U.S. DEPARTMENT OF HEALTH AND HUMAN
SERVICES (UNITED STATES AGENCY OF
THE UNITED STATES GOVERNMENT)
6120 EXECUTIVE BLVD., SUITE 450
TECHNOLOGY TRANSFER CENTER, NCI
BETHESDA, MD 208927181

FOR: SCIENTIFIC RESEARCH OF THE EFFECTS
OF PHARMACOLOGIC DOSES OF DIETARY SUP-
PLEMENTS ON AGE-RELATED MACULAR DE-
GENERATION AND CATARACT; SCIENTIFIC
RESEARCH OF THE CLINICAL COURSE, PROG-
NOSIS AND RISK FACTORS OF AGE-RELATED
MACULAR DEGENERATION AND CATARACT;
PROVIDING INFORMATION RELATED TO SCIENTIFIC
RESEARCH OF THE EFFECTS OF PHARMA-
COLOGIC DOSES OF DIETARY SUPPLEMENTS ON
AGE-RELATED MACULAR DEGENERATION AND
CATARACT AND SCIENTIFIC RESEARCH OF THE

CLINICAL COURSE, PROGNOSIS AND RISK FAC-
TORS OF AGE-RELATED MACULAR DEGENERA-
TION AND CATARACT, IN CLASS 42 (U.S. CLS. 100
AND 101).

FIRST USE 1-1-2007; IN COMMERCE 1-1-2007.

NO CLAIM IS MADE TO THE EXCLUSIVE
RIGHT TO USE "AGE-RELATED EYE DISEASE
STUDY 2", APART FROM THE MARK AS SHOWN.

THE MARK CONSISTS OF A FANCIFUL REPRESENTATION OF AN EYE SHOWN AS TWO OVERLAPPING IMAGES.

SER. NO. 77-176,528, FILED 5-9-2007.

JESSICA FATHY, EXAMINING ATTORNEY

Int. Cl.: 35

Prior U.S. Cls.: 100, 101 and 102

United States Patent and Trademark Office

Reg. No. 3,574,540

Registered Feb. 17, 2009

**SERVICE MARK
PRINCIPAL REGISTER**

HEXAWARE

HEXAWARE TECHNOLOGIES LIMITED (INDIA COMPANY)
'A' BLOCK, TTC INDUSTRIAL AREA, MAHAPE
152, MILLENIUM BUSINESS PARK, SECTOR III
NAVI MUMBAI, INDIA 400710

FOR: BUSINESS PROCESS OUTSOURCING SERVICES IN THE FIELDS OF HEALTHCARE, HUMAN RESOURCES, FINANCE AND ACCOUNTING, TRAVEL, TRANSPORTATION, HOSPITALITY AND LOGISTICS; HUMAN RESOURCES CONSULTATION AND MANAGEMENT; MANAGEMENT AND COMPILATION OF COMPUTERIZED AND OTHER DATABASES; COMPUTERIZED FILE MANAGEMENT; BUSINESS CONSULTING SERVICES IN THE FIELD OF ENTERPRISE SOLUTIONS, NAMELY, BUSINESS INFORMATION SOLUTIONS WHICH ASSIST WITH AN ORGANIZATION'S STRATEGY, PROCES-

SES, OPERATIONS, AND INFORMATION TECHNOLOGY SYSTEMS; BUSINESS ANALYSIS; PROFESSIONAL BUSINESS CONSULTANCY; BUSINESS INFORMATION; BUSINESS INQUIRIES AND INVESTIGATIONS; BUSINESS RELOCATION SERVICES, IN CLASS 35 (U.S. CLS. 100, 101 AND 102).

FIRST USE 0-0-1994; IN COMMERCE 0-0-1994.

THE MARK CONSISTS OF STANDARD CHARACTERS WITHOUT CLAIM TO ANY PARTICULAR FONT, STYLE, SIZE, OR COLOR.

SER. NO. 77-178,816, FILED 5-11-2007.

MICHAEL ENGEL, EXAMINING ATTORNEY

Int. Cl.: 25

Prior U.S. Cls.: 22 and 39

United States Patent and Trademark Office

Reg. No. 3,574,541

Registered Feb. 17, 2009

**TRADEMARK
PRINCIPAL REGISTER**

MOTHERHOOD MATERNITY

CAVE SPRINGS, INC. (DELAWARE CORPORATION)
2751 CENTERVILLE ROAD
WILMINGTON, DE 19808

FOR: MATERNITY CLOTHING, NAMELY, JEANS, PANTS, SHIRTS, TOPS, BLOUSES, T-SHIRTS, TANK TOPS, CAMISOLES, SWEATERS, DRESSES, BLAZERS, SHORTS, SKIRTS, JACKETS, COATS, VESTS, LOUNGEWEAR, SWEAT PANTS, YOGA PANTS, SWEAT JACKETS, SLEEPWEAR, ROBES, BRAS, UNDERWEAR, SHAPEWEAR, NAMELY, PANTIES, SHORTS, CAMISOLES, AND TANK TOPS, SWIMWEAR, SWIM AND BEACH COVER-UPS, LEGGINGS, HOSIERY, TIGHTS, MATERNITY GARMENTS, NAMELY, ELASTIC FABRIC BAND TO BE WORN DURING AND AFTER PREGNANCY TO RETAIN UNFASTENED PREGNANCY PANTS AND SKIRTS OR OVER-SIZED MATERNITY CLOTHING; NURSING APPAREL, NAMELY, TOPS, SHIRTS, T-SHIRTS, TANK TOPS, BLOUSES, CAMISOLES, DRESSES, BRAS,

SHAPEWEAR, NAMELY, CAMISOLES AND TANK TOPS, AND SLEEPWEAR, IN CLASS 25 (U.S. CLS. 22 AND 39).

FIRST USE 3-0-1993; IN COMMERCE 3-0-1993.

THE MARK CONSISTS OF STANDARD CHARACTERS WITHOUT CLAIM TO ANY PARTICULAR FONT, STYLE, SIZE, OR COLOR.

OWNER OF U.S. REG. NOS. 1,055,611 AND 1,898,334.

NO CLAIM IS MADE TO THE EXCLUSIVE RIGHT TO USE "MATERNITY", APART FROM THE MARK AS SHOWN.

SER. NO. 77-179,096, FILED 5-11-2007.

JIM RINGLE, EXAMINING ATTORNEY

Int. Cl.: 38

Prior U.S. Cls.: 100, 101 and 104

United States Patent and Trademark Office

Reg. No. 3,574,542

Registered Feb. 17, 2009

**SERVICE MARK
PRINCIPAL REGISTER**

CPDMA

AEROASTRO, INC. (DELAWARE CORPORATION)
20145 ASHBROOK PLACE
ASHBURN, VA 20147

FOR: TELECOMMUNICATIONS SERVICES USING SPREAD SPECTRUM ALGORITHMS FOR WIRELESS DATA EXFILTRATION, NAMELY, DATA TRANSMISSION AND SIGNAL PROCESSING, IN CLASS 38 (U.S. CLS. 100, 101 AND 104).

FIRST USE 5-0-2003; IN COMMERCE 5-0-2003.

THE MARK CONSISTS OF STANDARD CHARACTERS WITHOUT CLAIM TO ANY PARTICULAR FONT, STYLE, SIZE, OR COLOR.

SER. NO. 77-181,112, FILED 5-15-2007.

ANNE MADDEN, EXAMINING ATTORNEY

Int. Cl.: 38

Prior U.S. Cls.: 100, 101 and 104

United States Patent and Trademark Office

Reg. No. 3,574,543

Registered Feb. 17, 2009

**SERVICE MARK
PRINCIPAL REGISTER**

STUNONYMOUS.COM

THE ADLER GROUP, LLC (TEXAS LIMITED
LIABILITY COMPANY)
5226 WEATHERSTONE CIRCLE
SUGAR LAND, TX 77479

FOR: PROVIDING ON-LINE COMMUNICA-
TIONS LINKS WHICH TRANSFER THE WEBSITE
USER TO OTHER LOCAL AND GLOBAL WEB
PAGES, IN CLASS 38 (U.S. CLS. 100, 101 AND 104).

FIRST USE 10-1-2006; IN COMMERCE 10-1-2006.

THE COLOR(S) ORANGE AND GRAY IS/ARE
CLAIMED AS A FEATURE OF THE MARK.

THE MARK CONSISTS OF THE WORDING
"STUNONYMOUS.COM", WITH "STUNONYMOUS"
APPEARING IN ORANGE, AND ".COM" APPEAR-
ING IN GRAY.

SER. NO. 77-184,098, FILED 5-17-2007.

LYDIA BELZER, EXAMINING ATTORNEY

Int. Cl.: 28

Prior U.S. Cls.: 22, 23, 38 and 50

United States Patent and Trademark Office

Reg. No. 3,574,544

Registered Feb. 17, 2009

**TRADEMARK
PRINCIPAL REGISTER**

FASHION NETWORK

MATTEL, INC. (DELAWARE CORPORATION)
M1-1518
333 CONTINENTAL BLVD.
EL SEGUNDO, CA 90245

FOR: TOYS, GAMES AND PLAYTHINGS, NAME-
LY, HAND HELD UNITS FOR PLAYING ELECTRO-
NIC GAMES, IN CLASS 28 (U.S. CLS. 22, 23, 38 AND
50).

FIRST USE 2-20-2008; IN COMMERCE 2-20-2008.

THE MARK CONSISTS OF STANDARD CHAR-
ACTERS WITHOUT CLAIM TO ANY PARTICULAR
FONT, STYLE, SIZE, OR COLOR.

NO CLAIM IS MADE TO THE EXCLUSIVE
RIGHT TO USE "FASHION", APART FROM THE
MARK AS SHOWN.

SER. NO. 77-184,114, FILED 5-17-2007.

MONIQUE MILLER, EXAMINING ATTORNEY

Int. Cl.: 30

Prior U.S. Cl.: 46

United States Patent and Trademark Office

Reg. No. 3,574,545

Registered Feb. 17, 2009

TRADEMARK
PRINCIPAL REGISTER

"EL REY DEL TAMAL"



JACOME CABRERA, PEDRO (MEXICO INDIVIDUAL)
NIÑOS HEROES 1028 COL. CENTRO
TIJUANA, MEXICO

FOR: FLOUR; PREPARATIONS MADE FROM CEREALS, NAMELY, CEREAL BASED SNACK FOOD AND BREAKFAST CEREALS; BREAD; PASTRIES, IN CLASS 30 (U.S. CL. 46).

OWNER OF MEXICO REG. NO. 694686, DATED 4-20-2001, EXPIRES 11-3-2010.

NO CLAIM IS MADE TO THE EXCLUSIVE RIGHT TO USE "TAMAL", APART FROM THE MARK AS SHOWN.

THE MARK CONSISTS OF THE STYLIZED WORDING "EL REY DEL TAMAL" ABOVE THE DESIGN OF A PLATE WITH FOUR STEAMING TAMALES, WHICH IS NEXT TO THE DESIGN OF TWO EARS OF CORN.

THE ENGLISH TRANSLATION OF "EL REY DEL TAMAL" IS "THE KING OF TAMALE."

SER. NO. 77-184,237, FILED 5-17-2007.

MAUREEN DALL, EXAMINING ATTORNEY

Int. Cl.: 38

Prior U.S. Cls.: 100, 101 and 104

United States Patent and Trademark Office

Reg. No. 3,574,546

Registered Feb. 17, 2009

**SERVICE MARK
PRINCIPAL REGISTER**



T-MOBILE USA, INC. (DELAWARE CORPORATION)
12920 S.E. 38TH STREET
BELLEVUE, WA 98006

FOR: TELECOMMUNICATIONS SERVICES, NAMELY, WIRELESS VOICE AND DATA TRANSMISSION, TWO WAY WIRELESS TRANSMISSION OF EMAIL AND TEXT BETWEEN WIRELESS TELECOMMUNICATIONS TERMINALS AND COMPUTERS, AND PROVIDING MULTIPLE-USER ACCESS TO A GLOBAL COMPUTER NETWORK, IN CLASS 38 (U.S. CLS. 100, 101 AND 104).

FIRST USE 4-13-2007; IN COMMERCE 4-13-2007.

THE COLOR(S) MAGENTA AND WHITE IS/ARE CLAIMED AS A FEATURE OF THE MARK.

THE MARK CONSISTS OF THE WHITE LETTERS "iD" INSIDE A MAGENTA SQUARE.

SER. NO. 77-185,300, FILED 5-18-2007.

DAVID TOOLEY, EXAMINING ATTORNEY

Int. Cls.: 1, 2, 3 and 5

Prior U.S. Cls.: 1, 4, 5, 6, 10, 11, 16, 18, 26, 44, 46, 50, 51 and 52

Reg. No. 3,574,547

United States Patent and Trademark Office

Registered Feb. 17, 2009

**TRADEMARK
PRINCIPAL REGISTER**

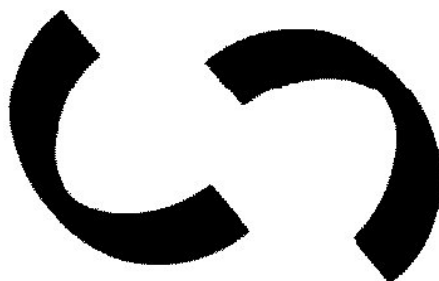

FLAMEL TECHNOLOGIES (FRANCE SOCIETE ANONYME)

33 AVENUE DU DOCTEUR GEORGES LEVY
PARC DU MOULIN A VENT
69693 VENISSIEUX CEDEX, FRANCE

FOR: CHEMICALS FOR USE IN THE MANUFACTURE OF DRUGS; FERTILIZERS FOR DOMESTIC AND AGRICULTURAL USE; CERAMIC MATRIX COMPOSITE MATERIALS (CMC) FOR MANUFACTURING USE IN THE AERONAUTICS INDUSTRY; PHOTOGRAPHIC CHEMICALS; UNPROCESSED ARTIFICIAL RESINS; DESCALING AGENTS, NAMELY, DETERGENTS IN THE INDUSTRIAL AND CONSUMER CLEANING PRODUCTS INDUSTRY; BIOPOLYMERS, PROTEINS, GLYCOPROTEINS, POLYAMINOACIDS, COLLAGENS, COPOLYMERS FROM LACTIC/GLYCOLIC CARBOXYLIC ACIDS FOR USE IN THE MANUFACTURE OF DRUGS AND BIOLOGICAL MATERIALS; CHEMICALS, NAMELY, POLYMERS, PLASTIC POLYMERS, SPIROPYRANS, NAPHTHOPYRANS, AND CHROMENS FOR USE IN THE MANUFACTURE OF OPTICAL DEVICES AND NON-LINEAR OPTICAL DEVICES, IN CLASS 1 (U.S. CLS. 1, 5, 6, 10, 26 AND 46).

FOR: COLORANTS FOR USE IN THE MANUFACTURE OF PAINT, PIGMENTS, DYES FOR USE IN THE MANUFACTURE OF OPTICAL GLASSES AND LENSES; COLORANTS, NAMELY, PHOTOCHROMIC COMPOUNDS FOR USE IN THE MANUFACTURE OF PAINT, PIGMENTS, DYES FOR USE IN THE MANUFACTURE OF OPTICAL GLASSES AND LENSES; COLORANTS FOR USE IN THE MANUFACTURE OF WASHING AND COSMETIC PRODUCTS, IN CLASS 2 (U.S. CLS. 6, 11 AND 16).

FOR: COSMETICS, DISHWASHING DETERGENTS, PERSONAL DEODORANTS, STAIN REMOVERS, WASHING PRODUCTS, NAMELY, WINDSHIELD WASHING FLUID; SOAPS, NAMELY, DEODORANT SOAP, ESSENTIAL OILS FOR PERSONAL USE, ESSENTIAL OILS FOR PERSONAL USE AND PERFUMES, IN CLASS 3 (U.S. CLS. 1, 4, 6, 50, 51 AND 52).

FOR: ALL PURPOSE DISINFECTANTS; PHARMACEUTICAL PREPARATIONS FOR THE TREATMENT OF HEART DISEASES, PAIN, DIABETES, AND CARDIOVASCULAR DISEASES; VACCINES; VETERINARY VACCINES FOR BOVINES, SHEEP, AND HORSES; SANITARY NAPKINS; DIETARY SUPPLEMENTS; DRESSING FOR WOUNDS, BURNS, AND SURGICAL PURPOSES; FUNGICIDES FOR AGRICULTURAL USE AND DOMESTIC USE; HERBICIDES FOR AGRICULTURAL USE AND DOMESTIC USE; WEED KILLERS FOR AGRICULTURAL USE AND DOMESTIC USE; INSECTICIDES FOR AGRICULTURAL USE AND DOMESTIC USE; MEDICINES FOR THE TREATMENT OF HEART DISEASES, PAIN, DIABETES, AND CARDIOVASCULAR DISEASES; MEDICINES WITH DELAYED RELEASE OF THE ACTIVE PRINCIPLES FOR THE TREATMENT OF HEART DISEASES, PAIN, DIABETES, AND CARDIOVASCULAR DISEASES; MEDICINES WITH ENCAPSULATED ACTIVE PRINCIPLE BIOCIDES FOR THE TREATMENT OF HEART DISEASES, PAIN, DIABETES, AND CARDIOVASCULAR DISEASES; MEDICINES BASED ON ASPIRIN, INSULIN, METFORMINE, ACICLOVIR, GLIBENCLAMIDE FOR THE TREATMENT OF HEART DISEASES, PAIN, DIABETES, AND CARDIOVASCULAR DISEASES; MEDICINES BASED ON ENCAPSULATED

ASPIRIN, INSULIN, METFORMINE, ACICLOVIR, GLIBENCLAMIDE FOR THE DELAYED RELEASE OF THE ACTIVE PRINCIPLE FOR THE TREATMENT OF HEART DISEASE, PAIN, DIABETES, AND CARDIOVASCULAR DISEASES; LIQUID PHARMACEUTICAL PREPARATIONS FOR ORAL ADMINISTRATION AND INJECTION AND ALLOWING FOR THE DELAYED RELEASE OF THE PHARMACEUTICAL ACTIVE PRINCIPLES FOR THE TREATMENT OF HEART DISEASES, PAIN,

DIABETES, AND CARDIOVASCULAR DISEASES, IN CLASS 5 (U.S. CLS. 6, 18, 44, 46, 51 AND 52).

OWNER OF FRANCE REG. NO. 013137171, DATED 5-17-2002, EXPIRES 12-14-2011.

THE MARK CONSISTS OF TWO CURVED LINES.

SER. NO. 77-186,044, FILED 5-21-2007.

TINA L. SNAPP, EXAMINING ATTORNEY

Int. Cl.: 43

Prior U.S. Cls.: 100 and 101

United States Patent and Trademark Office

Reg. No. 3,574,548

Registered Feb. 17, 2009

SERVICE MARK
PRINCIPAL REGISTER



FANTAUZZO FAMILY BRANDS INC. (NEW YORK CORPORATION)
1900 EMPIRE BLVD., SUITE 255
WEBSTER, NY 14580

FOR: CARRY-OUT RESTAURANTS; RESTAURANT SERVICES; RESTAURANTS; RESTAURANTS FEATURING HOME DELIVERY; TAKE-OUT RESTAURANT SERVICES, ALL FEATURING PIZZA AND INCLUDING OTHER TYPES OF FOOD, IN CLASS 43 (U.S. CLS. 100 AND 101).

FIRST USE 0-0-2000, THE MARK WAS FIRST USED ANYWHERE IN A DIFFERENT FORM OTHER THAN THAT SOUGHT TO BE REGISTERED ON 00/00/1978.; IN COMMERCE 0-0-2000, THE MARK WAS FIRST USED IN COMMERCE IN A DIFFERENT FORM OTHER THAN THAT SOUGHT TO BE REGISTERED ON 00/00/1978..

NO CLAIM IS MADE TO THE EXCLUSIVE RIGHT TO USE "PIZZERIA", APART FROM THE MARK AS SHOWN.

THE COLOR(S) BLACK, YELLOW, RED, AND WHITE IS/ARE CLAIMED AS A FEATURE OF THE MARK.

THE WORDING "SALVATORE'S" AND "PIZZERIA" APPEARS IN THE COLOR RED, THE WORDING "OLD FASHIONED" APPEARS IN BLACK, THE BORDER APPEARS IN BLACK WITH YELLOW CIRCLES, AND THE INTERIOR BACKGROUND IS WHITE.

SEC. 2(F) AS TO "OLD FASHIONED".

SER. NO. 77-187,252, FILED 5-22-2007.

JEAN IM, EXAMINING ATTORNEY

Int. Cl.: 3

Prior U.S. Cls.: 1, 4, 6, 50, 51 and 52

United States Patent and Trademark Office

Reg. No. 3,574,549

Registered Feb. 17, 2009

TRADEMARK
PRINCIPAL REGISTER

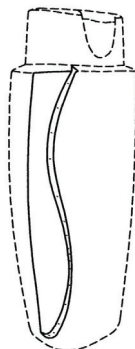

C.B. FLEET INVESTMENT CORPORATION (DELAWARE CORPORATION)
SUITE 202
103 FOULK ROAD
WILMINGTON, DE 19803

FOR: BATH AND SHOWER GEL; FOAMING CLEANSING SOLUTION FOR EXTERNAL FEMININE HYGIENE; BATH SOLUTION FOR EXTERNAL FEMININE HYGIENE AND CLEANSING , IN CLASS 3 (U.S. CLS. 1, 4, 6, 50, 51 AND 52).

FIRST USE 4-30-2007; IN COMMERCE 4-30-2007.

THE MARK CONSISTS OF A THREE-DIMENSIONAL PORTION OF THE CONTAINER FOR THE GOODS CONSISTING OF AN INDENTED PORTION OF THE LEFT FRONT SURFACE OF THE CONTAINER AND A VERTICAL WAVY LINE ON THE LEFT FRONT SIDE OF THE CONTAINER RUNNING FROM THE TOP TO THE BOTTOM OF THE FRONT OF THE CONTAINER HAVING BEEN FORMED BY THE INDENTATION ON THE SUR-

FACE OF THE CONTAINER. THE MATTER SHOWN IN BROKEN LINES SHOWING THE OUTLINE OF THE CONTAINER AND THE LID IS NOT PART OF THE MARK AND SERVES TO SHOW THE PLACEMENT OF THE MARK. THE SOLID LINE APPEARING TO THE LEFT OF THE VERTICAL WAVY LINE SERVES TO SHOW THE LIMIT OF THE INDENTED PORTION OF THE CONTAINER'S SURFACE AND THE DELINEATION BETWEEN THE FRONT AND BACK SIDES OF THE CONTAINER WITH THE MATTER APPEARING TO THE LEFT NOT BEING PART OF THE MARK. THE PORTION OF THE SURFACE OF THE CONTAINER TO THE RIGHT OF THE VERTICAL WAVY LINE IS NOT PART OF THE MARK. THE DASHED LINES APPEARING WITHIN THE OUTLINE OF THE VERTICAL WAVY LINE DO NOT FORM PART OF THE MARK BUT ARE INTENDED TO SHOW DEPTH.

SER. NO. 77-188,080, FILED 5-23-2007.

MARK SPARACINO, EXAMINING ATTORNEY

Int. Cl.: 41

Prior U.S. Cls.: 100, 101 and 107

United States Patent and Trademark Office

Reg. No. 3,574,550

Registered Feb. 17, 2009

**SERVICE MARK
PRINCIPAL REGISTER**



NEW YORK STATE DIVISION OF THE LOT-
TERY (NEW YORK STATE AGENCY)
ONE BROADWAY CENTER
SCHENECTADY, NY 12301

FOR: LOTTERY SERVICES AND LOTTO GAME
SERVICES, IN CLASS 41 (U.S. CLS. 100, 101 AND 107).

FIRST USE 3-31-2006; IN COMMERCE 3-31-2006.

NO CLAIM IS MADE TO THE EXCLUSIVE
RIGHT TO USE "LOTTERY", APART FROM THE
MARK AS SHOWN.

THE COLOR(S) BLUE, YELLOW, GREEN, OR-
ANGE, RED, BLACK AND WHITE IS/ARE
CLAIMED AS A FEATURE OF THE MARK.

THE MARK CONSISTS OF THE COLOR WHITE
IN THE WORDING "NEW YORK". THE COLOR
BLUE APPEARS IN THE BACKGROUND OF THE
GLOBE, THE COLOR YELLOW APPEARS IN THE
WORD "LOTTERY", THE COLORS YELLOW, RED
AND ORANGE APPEAR IN THE RAINBOW, THE
COLORS BLACK AND GREEN APPEAR IN THE
MOUNTAIN SCENERY CONTAINED WITHIN THE
GLOBE.

SEC. 2(F) AS TO "NEW YORK LOTTERY".

SER. NO. 77-191,796, FILED 5-29-2007.

TRICIA SONNEBORN, EXAMINING ATTORNEY

Int. Cls.: 9, 36 and 42

Prior U.S. Cls.: 21, 23, 26, 36, 38, 100, 101 and 102

United States Patent and Trademark Office

Reg. No. 3,574,551

Registered Feb. 17, 2009

**TRADEMARK
SERVICE MARK
PRINCIPAL REGISTER**



BUS SYSTEMS INC. (CANADA CORPORATION)
465 ST-JEAN STREET, SUITE 800
MONTREAL, CANADA H2Y2R6

FOR: COMPUTER SOFTWARE FOR ACCOUNTING TO BE USED BY BODYSHOPS AND MANUALS DISTRIBUTED IN CONNECTION THEREWITH; COMPUTER SOFTWARE FOR OPERATIONS MANAGEMENT TO BE USED BY BODYSHOPS AND MANUALS DISTRIBUTED IN CONNECTION THEREWITH, IN CLASS 9 (U.S. CLS. 21, 23, 26, 36 AND 38).

FOR: PROVIDING INFORMATION IN THE FIELD OF INSURANCE CLAIMS, NAMELY, INSURANCE CLAIMS ADJUSTMENT, INSURANCE CLAIMS ADMINISTRATION AND INSURANCE CLAIMS PROCESSING VIA A WEBSITE, IN CLASS 36 (U.S. CLS. 100, 101 AND 102).

FOR: PROVIDING ON-LINE NON-DOWNLOADABLE COMPUTER SOFTWARE ACCOUNTING TO BE USED BY BODYSHOPS AND MANUALS DIS-

TRIBUTED IN CONNECTION THEREWITH; PROVIDING ON-LINE NON-DOWNLOADABLE COMPUTER SOFTWARE FOR OPERATIONS MANAGEMENT TO BE USED BY BODYSHOPS AND MANUALS DISTRIBUTED IN CONNECTION THEREWITH; PROVIDING NON-DOWNLOADABLE COMPUTER SOFTWARE FOR USE IN MANAGING INSURANCE CLAIMS, IN CLASS 42 (U.S. CLS. 100 AND 101).

PRIORITY CLAIMED UNDER SEC. 44(D) ON CANADA APPLICATION NO. 1340952, FILED 3-27-2007, REG. NO. TMA719671, DATED 7-29-2008, EXPIRES 7-29-2023.

THE MARK CONSISTS OF A PUZZLED CAR AND THE WORDING "BUS" AND "BUSCONNECT.COM".

SER. NO. 77-192,220, FILED 5-29-2007.

JANET LEE, EXAMINING ATTORNEY

Int. Cl.: 43

Prior U.S. Cls.: 100 and 101

United States Patent and Trademark Office

Reg. No. 3,574,552

Registered Feb. 17, 2009

**SERVICE MARK
PRINCIPAL REGISTER**

COSMOS BEAUTY BAR

COSMOS BEAUTY BAR, INC. (ILLINOIS CORPORATION)

526 DUANE STREET

GLEN ELLYN, IL 60137

FOR: BAR SERVICES, IN CLASS 43 (U.S. CLS. 100 AND 101).

FIRST USE 11-4-2006; IN COMMERCE 11-4-2006.

THE MARK CONSISTS OF STANDARD CHARACTERS WITHOUT CLAIM TO ANY PARTICULAR FONT, STYLE, SIZE, OR COLOR.

NO CLAIM IS MADE TO THE EXCLUSIVE RIGHT TO USE "BAR", APART FROM THE MARK AS SHOWN.

SER. NO. 77-193,268, FILED 5-30-2007.

ROBIN CHOSID, EXAMINING ATTORNEY

Int. Cl.: 42

Prior U.S. Cls.: 100 and 101

United States Patent and Trademark Office

Reg. No. 3,574,553

Registered Feb. 17, 2009

**SERVICE MARK
PRINCIPAL REGISTER**

QIID

AMC REGISTRY, INC. (OHIO CORPORATION)
SUITE 224
3040 RIVERSIDE DRIVE
UPPER ARLINGTON, OH 43221

FOR: PROVIDING WEB-BASED SERVICES, NAMELY, PROVIDING ON-LINE NON-DOWNLOADABLE ANALYTICAL PROCESSING SOFTWARE FOR EVALUATING THE PERFORMANCE OF MEDICAL FACILITIES CONCERNING PATIENT CARE AND WORK FLOW PROCESS AND FOR GENERATING EVALUATION RESULTS, CUSTOMIZED REPORTS, SORTING INFORMATION, AND STATISTICAL ANALYSIS REGARDING

SAME FOR THE PURPOSES OF IMPROVING QUALITY OF CARE, EFFICIENCY AND PROFITABILITY, IN CLASS 42 (U.S. CLS. 100 AND 101).

FIRST USE 4-1-2007; IN COMMERCE 4-1-2007.

THE MARK CONSISTS OF STANDARD CHARACTERS WITHOUT CLAIM TO ANY PARTICULAR FONT, STYLE, SIZE, OR COLOR.

SER. NO. 77-195,455, FILED 6-1-2007.

MICHELE SWAIN, EXAMINING ATTORNEY

Int. Cl.: 7

Prior U.S. Cls.: 13, 19, 21, 23, 31, 34 and 35

Reg. No. 3,574,554

United States Patent and Trademark Office

Registered Feb. 17, 2009

**TRADEMARK
PRINCIPAL REGISTER**



EVONIC INDUSTRIES AG (FED REP GERMANY CORPORATION)
RELLINGHAUSER STRABE 1-11
ESSEN, FED REP GERMANY 45128

FOR: MACHINES FOR ENVIRONMENTAL TECHNOLOGY, NAMELY, GARBAGE AND WASTE SHREDDING MACHINES, GARBAGE AND WASTE COMPACTING MACHINES, WEIGHING MACHINES FOR GARBAGE AND WASTE, BRIQUETTING MACHINES; MACHINES FOR WASTE DISPOSAL; MACHINES FOR CHEMICAL PROCESSING ENGINEERING, NAMELY, DISINTEGRATORS, DISSOLVING MACHINES, EXTRACTING MACHINES, GRANULATING MACHINES, GRINDING MILLS, KNEADING MACHINES, SEPARATING MACHINES, SINTERING MACHINES, SORTING MACHINES FOR CHEMICAL PROCESSING, AND SEMICONDUCTOR WAFER PROCESSING ENGINEERING EQUIPMENT AND MACHINES; CONTINUOUS-FLOW MACHINES, NAMELY, CONTINUOUS CASTING MACHINES, CONTINUOUS METAL CASTING MACHINES, CONTINUOUS SCOURING AND BLEACHING MACHINES; MINING MACHINES, NAMELY, CENTRIFUGES AND SHAKING TABLES IN THE NATURE OF MACHINES FOR SEPARATING TARGET MATERIALS FROM MIXTURES OF MATERIALS, DRILLING MACHINES, POWER DRILLS AND TRUCK MILLS; HOISTS, MECHANICAL AND PNEUMATIC HOISTING APPARATUS AND CONVEYERS; CONSTRUCTION EQUIPMENT, NAMELY, POWER ROAD AND STREET SWEEPERS,

DRILLING MACHINES, CONCRETE CONSTRUCTION MACHINES, TIRE CHAINS AND OVER THE TIRE TRACK SYSTEMS FOR SKID STEER LOADERS; TRANSPORT MACHINES EQUIPMENT, NAMELY, POWER-OPERATED LIFT USED TO TRANSPORT AND PLACE PORTABLE STORAGE CONTAINERS; CASTING MACHINES; MACHINE TOOLS, NAMELY, BROACHES, CHASERS, MILLING CUTTERS, ELECTRO-CHEMICAL DISCHARGE MACHINE TOOLS FOR METALWORKING, GEAR CUTTERS, GRINDING TOOLS FOR GRINDING MACHINES, MACHINE TOOLS FOR REMOVING WASTE MATERIAL, MACHINE TOOLS, NAMELY, ROTARY DIES FOR CUTTING BOXES FOR THE PACKAGING INDUSTRY, MACHINE TOOLS FOR THE CUTTING AND FORMING OF MATERIALS, METAL CLAMPS USED FOR HOLDING PIECE PARTS ON MACHINE TOOL TABLES, METALWORKING MACHINE TOOLS, THREAD MILLING CUTTERS, TOOL BITS FOR MACHINES AND TOOL GRINDING MACHINES; MOTORS AND ENGINES NOT FOR LAND VEHICLES; MACHINE COUPLING AND TRANSMISSION COMPONENTS NOT FOR LAND VEHICLES, NAMELY, DRIVING BELTS FOR MACHINES, MACHINE PARTS IN THE NATURE OF FLEXIBLE SHAFT COUPLINGS, SHAFT COUPLINGS FOR MACHINES, BEARINGS FOR TRANSMISSION SHAFTS BEING PARTS OF MACHINES, BELTS FOR TRANSMISSION SHAFTS, BELTS FOR TRANSMISSIONS, POWER TRANSMISSIONS BELTS AND TRANSMISSION GEARS FOR MA-

CHINES; AGRICULTURAL MACHINES OTHER THAN HAND-OPERATED, NAMELY, ROTARY CUTTING MACHINES, ROTARY MOWERS, ROTARY GRINDING MACHINES, POWER OPERATED HAY LIFTERS, SEED DRILLS, POWER OPERATED CULTIVATORS, HARVESTERS, MACHINES IN THE NATURE OF DISK HARROWS, SEEDERS, COMBINES, THRESHERS, POWER TILLERS, WINDROWER, AGRICULTURE SEED PLANTING MACHINES, BALERS FOR AGRICULTURE OR INDUSTRIAL USE, REAPERS, PLOWS, TRACTOR TOWED HARROWS, TRACTOR TOWED AGRICULTURAL MOWERS, TRACTOR TOWED HAY RAKES, TRACTOR TOWED HAY BALERS, TRACTOR TOWED BROADCAST SEEDERS, TRACTOR TOWED MANURE SPREADERS, TRACTOR TOWED FERTILIZER DISTRIBUTORS, TRACTOR TOWED CORN HUSKERS, AND TRACTOR TOWED ROLLERS; CATALYTIC CONVERTERS FOR MOTORS AND ENGINES; MACHINES AND MACHINE PARTS FOR GENERATING GAS, NAMELY, GAS COMPRESSORS, GAS SPLITTERS IN THE NATURE OF VALVES AND ELECTRIC VALVES AND PUMPS; MACHINES AND PARTS THEREFOR FOR USING ALTERNATIVE ENERGY SOURCES TO GENERATE AND DISTRIBUTE ENERGY, IN THE NATURE OF HEAT, STEAM AND ELECTRICITY, NAMELY, STEAM ENGINES, STEAM MARINE ENGINES, STEAM PRESSURE VARIATION ENGINES, STEAM TURBINES, SOLAR POWERED ELECTRICITY

GENERATORS, WIND POWERED ELECTRICITY GENERATORS, FUEL CELL ELECTRICAL POWER GENERATORS; CENTRIFUGAL, DUST, OIL, CYCLONE AND VIBRATOR SCREEN SEPARATORS; STEAM CONDENSERS AS PARTS OF MACHINES; AND COMPONENT AND REPLACEMENT PARTS FOR THE AFOREMENTIONED GOODS, IN CLASS 7 (U.S. CLS. 13, 19, 21, 23, 31, 34 AND 35).

PRIORITY CLAIMED UNDER SEC. 44(D) ON FED REP GERMANY APPLICATION NO. 30674165.2/3, FILED 12-2-2006, REG. NO. 30674165, DATED 12-12-2006, EXPIRES 12-31-2016.

THE COLOR(S) DARK PURPLE, LIGHT PURPLE, DARK GREY, LIGHT GREY, AND WHITE IS/ARE CLAIMED AS A FEATURE OF THE MARK.

THE MARK CONSISTS OF THE COLOR DARK PURPLE OUTLINED WITH LIGHT PURPLE AND DARK GREY APPEARS IN THE INTERIOR "E" SHAPED DESIGN; THE COLOR LIGHT GRAY OUTLINED WITH DARK GREY AND WHITE APPEARS IN THE EXTERIOR CIRCULAR DESIGN.

SER. NO. 77-195,853, FILED 6-1-2007.

Laura Hammel, Examining Attorney

Int. Cl.: 39

Prior U.S. Cls.: 100 and 105

United States Patent and Trademark Office

Reg. No. 3,574,555

Registered Feb. 17, 2009

**SERVICE MARK
PRINCIPAL REGISTER**

WEBVIEW

ANCOR INFORMATION MANAGEMENT, LLC
(MICHIGAN LIMITED LIABILITY COMPANY)
1911 WOODSLEE
TROY, MI 48083

FOR: STORAGE SERVICES FOR ARCHIVING
DATABASES OF ELECTRONIC WRITTEN DATA
COMMUNICATIONS THAT CAN BE ACCESSED
VIA THE INTERNET, IN CLASS 39 (U.S. CLS. 100
AND 105).

FIRST USE 8-0-1999; IN COMMERCE 8-0-1999.

THE MARK CONSISTS OF STANDARD CHAR-
ACTERS WITHOUT CLAIM TO ANY PARTICULAR
FONT, STYLE, SIZE, OR COLOR.

SER. NO. 77-196,943, FILED 6-4-2007.

NELSON SNYDER, EXAMINING ATTORNEY

Int. Cl.: 28

Prior U.S. Cls.: 22, 23, 38 and 50

United States Patent and Trademark Office

Reg. No. 3,574,556

Registered Feb. 17, 2009

**TRADEMARK
PRINCIPAL REGISTER**



SHENZHEN ART-TECH R/C HOBBY CO. LTD.
(CHINA CORPORATION)
3 FLOOR, D 41, LIYUAN INDUSTRIAL ZONE
LANGXIN DIST., SHIYAN ST.
BAOAN DIST., SHENZHEN, CHINA

FOR: TOY MODEL VEHICLES AND RELATED
ACCESSORIES SOLD AS UNITS; ELECTRONIC AC-
TION TOYS; TOY TRAINS AND PARTS AND AC-
CESSORIES THEREFOR; REMOTE CONTROL
TOYS, NAMELY, CARS, RACE CARS, AIRPLANES,
BOATS; ELECTRONIC LEARNING TOYS; GYM-
NASTIC APPARATUS, IN CLASS 28 (U.S. CLS. 22,
23, 38 AND 50).

FIRST USE 2-18-2005; IN COMMERCE 2-18-2005.

THE MARK CONSISTS OF THE WORDING
"ART-TECH WWW.ART-TECH.CN", WITH BOTH
LETTER "T'S" IN THE LARGER "ART-TECH" IN
THE SHAPE OF AIRPLANES, AND WITH A BAND
CURVING FROM THE BOTTOM OF THE FIRST
LETTER "T" BACK TO THE FIRST LETTER "A"
AND WITH ANOTHER BAND CURVING FROM
THE BOTTOM OF THE SECOND LETTER "T" BACK
TO THE LETTER "R" IN "ART".

SER. NO. 77-198,624, FILED 6-6-2007.

MICHAEL ENGEL, EXAMINING ATTORNEY

Int. Cls.: 12 and 20

**Prior U.S. Cls.: 2, 13, 19, 21, 22, 23, 25, 31, 32, 35, 44
and 50**

Reg. No. 3,574,557

United States Patent and Trademark Office

Registered Feb. 17, 2009

**TRADEMARK
PRINCIPAL REGISTER**

TAYLOR-READY SYSTEM

JDM VENTURES LLC (DELAWARE LIMITED
LIABILITY COMPANY)
1801 WEST EDGAR ROAD
LINDEN, NJ 07036

FOR: STRUCTURE PARTS AND ACCESSORIES
FOR MOTOR VEHICLES AND MOTOR VEHICLE
TRAILERS, RAIL VEHICLES, AIRCRAFT AND
SHIPS, NAMELY, SHELVES, BRACKETS, WALL
RAILS, UPRIGHT POSTS, CROSS BEAMS AND
BRACES, SUPPORTS, COLUMNS AND METAL
CONNECTING AND FASTENING HARDWARE
THEREFOR, IN CLASS 12 (U.S. CLS. 19, 21, 23, 31,
35 AND 44).

FIRST USE 1-0-2005; IN COMMERCE 1-0-2005.

FOR: SHELVES; SHELVING UNITS AND COM-
PONENT PARTS THEREOF, NAMELY, SHELVES,
BRACKETS, WALL RAILS, UPRIGHT POSTS,

CROSS BEAMS AND BRACES, SUPPORTS, COL-
UMNS AND METAL CONNECTING AND FASTEN-
ING HARDWARE THEREFOR, IN CLASS 20 (U.S.
CLS. 2, 13, 22, 25, 32 AND 50).

FIRST USE 1-0-2005; IN COMMERCE 1-0-2005.

THE MARK CONSISTS OF STANDARD CHAR-
ACTERS WITHOUT CLAIM TO ANY PARTICULAR
FONT, STYLE, SIZE, OR COLOR.

NO CLAIM IS MADE TO THE EXCLUSIVE
RIGHT TO USE "SYSTEM", APART FROM THE
MARK AS SHOWN.

SER. NO. 77-199,940, FILED 6-7-2007.

NANCY CLARKE, EXAMINING ATTORNEY

Int. Cls.: 30 and 32

Prior U.S. Cls.: 45, 46 and 48

United States Patent and Trademark Office

Reg. No. 3,574,558

Registered Feb. 17, 2009

TRADEMARK
PRINCIPAL REGISTER

! VIVAZ!

BIG TRAIN, INC. (CALIFORNIA CORPORATION)
19732 DESCARTES
FOOTHILL RANCH, CA 92610

FOR: POWDERED MIXES FOR MAKING BLENDED TEA DRINK AND A CINNAMON RICE DRINK, IN CLASS 30 (U.S. CL. 46).

FIRST USE 5-11-2007; IN COMMERCE 5-11-2007.

FOR: POWDERED MIXES FOR MAKING A FRUIT-FLAVORED DRINK, IN CLASS 32 (U.S. CLS. 45, 46 AND 48).

FIRST USE 5-11-2007; IN COMMERCE 5-11-2007.

THE MARK CONSISTS OF STANDARD CHARACTERS WITHOUT CLAIM TO ANY PARTICULAR FONT, STYLE, SIZE, OR COLOR.

THE ENGLISH TRANSLATION OF THE WORD "VIVAZ!" IN THE MARK IS "VIVACIOUS, ATTRACTIVELY LIVELY AND ANIMATED".

SER. NO. 77-202,689, FILED 6-11-2007.

JESSICA FATHY, EXAMINING ATTORNEY

Int. Cl.: 5

Prior U.S. Cls.: 6, 18, 44, 46, 51 and 52

United States Patent and Trademark Office

Reg. No. 3,574,559

Registered Feb. 17, 2009

**TRADEMARK
PRINCIPAL REGISTER**

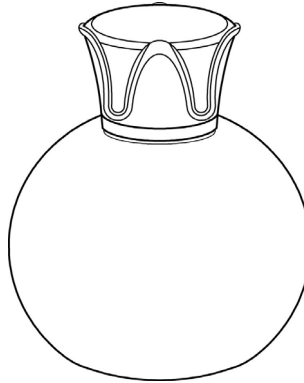

POMWONDEFUL LLC (DELAWARE LIMITED
LIABILITY COMPANY)
10TH FLOOR
11444 W. OLYMPIC BLVD.
LOS ANGELES, CA 90064

FOR: DIETARY AND NUTRITIONAL SUPPLEMENTS, NAMELY, ANTIOXIDANT SUPPLEMENTS DERIVED FROM AND CONTAINING POMEGRANATE EXTRACTS, IN VARIOUS CONSUMABLE FORMS INCLUDING CAPSULES AND PILLS, AND NUTRACEUTICALS FOR USE AS A DIETARY SUPPLEMENT, IN VARIOUS CONSUMABLE FORMS INCLUDING CAPSULES AND PILLS, IN CLASS 5 (U.S. CLS. 6, 18, 44, 46, 51 AND 52).

FIRST USE 5-7-2007; IN COMMERCE 5-7-2007.

THE MARK CONSISTS OF A THREE-DIMENSIONAL PACKAGE DESIGN OF A BOTTLE FEATURING A GLOBULAR SECTION AND A CAP FEATURING A WAVE-LIKE DESIGN.

SER. NO. 77-203,139, FILED 6-11-2007.

ANDREA K. NADELMAN, EXAMINING ATTORNEY

Int. Cl.: 41

Prior U.S. Cls.: 100, 101 and 107

United States Patent and Trademark Office

Reg. No. 3,574,560

Registered Feb. 17, 2009

**SERVICE MARK
PRINCIPAL REGISTER**

BRAZILIAN VOICES

BRAZILIAN VOICES, INC. (FLORIDA NON-
PROFIT CORPORATION)
1840 NW 19 ST
PEMBROKE PINES, FL 33029

FOR: ENTERTAINMENT IN THE NATURE OF
LIVE PERFORMANCES BY A MUSICAL GROUP;
EDUCATION SERVICES, NAMELY, PROVIDING
MULTIMEDIA EXHIBITIONS, SEMINARS, AND
WORKSHOPS IN THE FIELD OF BRAZILIAN CUL-
TURE, IN CLASS 41 (U.S. CLS. 100, 101 AND 107).

FIRST USE 8-15-2001; IN COMMERCE 8-15-2001.

THE MARK CONSISTS OF STANDARD CHAR-
ACTERS WITHOUT CLAIM TO ANY PARTICULAR
FONT, STYLE, SIZE, OR COLOR.

SEC. 2(F).

SER. NO. 77-204,950, FILED 6-13-2007.

RONALD MCMORROW, EXAMINING ATTORNEY

Int. Cl.: 42

Prior U.S. Cls.: 100 and 101

United States Patent and Trademark Office

Reg. No. 3,574,561

Registered Feb. 17, 2009

SERVICE MARK
PRINCIPAL REGISTER



NANOCOATINGS, S.L. (SPAIN CORPORATION)
MARINETA, 2-5,POL.IND. LLEVANT
PARETS DEL VALLES
BARCELONA, SPAIN

FOR: SCIENTIFIC RESEARCH, TECHNOLOGICAL CONSULTATION IN THE TECHNOLOGY FIELD OF THE PRODUCTION OF TECHNICAL PLASTIC PARTS WITH HIGH DEFINITION METAL DECORATIONS, DESIGN SERVICES REGARDING THE USES OF METAL ALLOYS ON PLASTIC BY PVP, AND TECHNOLOGY AND INDUSTRIAL RESEARCH SERVICES IN THE FIELD OF THE PRODUCTION OF TECHNICAL PLASTIC PARTS WITH HIGH DEFINITION METAL DECORATIONS, IN CLASS 42 (U.S. CLS. 100 AND 101).

PRIORITY CLAIMED UNDER SEC. 44(D) ON SPAIN APPLICATION NO. 2771299, FILED 5-10-

2007, REG. NO. 2771299, DATED 9-17-2007, EXPIRES 5-10-2017.

NO CLAIM IS MADE TO THE EXCLUSIVE RIGHT TO USE "NANOCOATINGS", APART FROM THE MARK AS SHOWN.

THE COLOR(S) ORANGE, GREY AND BLACK IS/ ARE CLAIMED AS A FEATURE OF THE MARK.

THE MARK CONSISTS OF THE WORD "NANOCOATINGS" IN STYLIZED LETTERING AND A GREY CURVY LINE OVER THE LETTER "I"; THE WORD "NANO" IS IN ORANGE AND THE WORD "COATINGS" IS IN BLACK.

SER. NO. 77-205,342, FILED 6-13-2007.

CAROLINE WOOD, EXAMINING ATTORNEY

Int. Cl.: 9

Prior U.S. Cls.: 21, 23, 26, 36 and 38

United States Patent and Trademark Office

Reg. No. 3,574,562

Registered Feb. 17, 2009

**TRADEMARK
PRINCIPAL REGISTER**

EMERGENCY ESSENTIALS

EMERGENCY ESSENTIALS, INC. (UTAH CORPORATION)
653 NORTH 1500 WEST
OREM, UT 84057

FOR: COMPUTER PROGRAMS, NAMELY, COMPUTER PROGRAMS THAT ASSIST THE INDIVIDUAL IN PLANNING AND PREPARING FOR NATURAL AND MAN MADE EMERGENCIES SUCH AS FLOODS, FIRE, EARTHQUAKES, HURRICANES, TORNADOES AND THE LIKE, BY PROVIDING USEFUL INFORMATION AND TIPS; PRE-RECORDED VIDEO RECORDINGS ON THE TOPICS OF PREPAREDNESS AND SURVIVAL; AUTOMOTIVE PREPAREDNESS ROAD KIT CONSISTING OF JUMPER CABLES, FLASHLIGHT, BATTERIES, CANDLES, FIRST AID KIT, FIRST AID GUIDE

BOOK, MULTIFUNCTION UTILITY KNIFE, WATER RATIONS, AND SLEEPING BAGS SOLD AS A UNIT; HELMET SAFETY LIGHTS, IN CLASS 9 (U.S. CLS. 21, 23, 26, 36 AND 38).

FIRST USE 1-0-1990; IN COMMERCE 1-0-1990.

THE MARK CONSISTS OF STANDARD CHARACTERS WITHOUT CLAIM TO ANY PARTICULAR FONT, STYLE, SIZE, OR COLOR.

SEC. 2(F).

SER. NO. 77-207,613, FILED 6-15-2007.

LESLEY LAMOTHE, EXAMINING ATTORNEY

Int. Cl.: 26

Prior U.S. Cls.: 37, 39, 40, 42 and 50

United States Patent and Trademark Office

Reg. No. 3,574,563

Registered Feb. 17, 2009

TRADEMARK
PRINCIPAL REGISTER



HUMANISTS DEVELOPMENT FOUNDATION
(CALIFORNIA CORPORATION)
P.O. BOX 8248
STOCKTON, CA 95208 AND
BUSHONG, G.M. (UNITED STATES INDIVIDUAL)
P.O. BOX 8248
STOCKTON, CA 95208 AND
ONOVAKPURI, I. (UNITED STATES INDIVIDUAL)
P. O. BOX 8248
STOCKTON, CA 95208

FOR: EMBROIDERY FOR GARMENTS, IN
CLASS 26 (U.S. CLS. 37, 39, 40, 42 AND 50).

FIRST USE 9-4-2006; IN COMMERCE 9-4-2006.

THE COLOR(S) RED, GOLD, BLACK AND
WHITE IS/ARE CLAIMED AS A FEATURE OF
THE MARK.

THE MARK CONSISTS OF THE WORDING "YOU
ARE THE KEY TO MY HEART" IN THE COLOR
BLACK SURROUNDING A RED HEART WITH
TWO WHITE SPOTS AND WITH A GOLD KEY.
THE GOLD KEY HAS BLACK DETAILING AND IS
LYING ON TOP OF THE RED HEART POISED TO
ENTER A BLACK KEY HOLE IN THE HEART. THE
TOP OF THE GOLD KEY IS ALSO POSITIONED
OUTSIDE THE HEART SEPARATING THE WORDS
"KEY" AND "TO" IN THE PHRASE "YOU ARE THE
KEY TO MY HEART".

SER. NO. 77-208,003, FILED 6-17-2007.

LINDA ESTRADA, EXAMINING ATTORNEY

Int. Cl.: 20

Prior U.S. Cls.: 2, 13, 22, 25, 32 and 50

United States Patent and Trademark Office

Reg. No. 3,574,564

Registered Feb. 17, 2009

**TRADEMARK
PRINCIPAL REGISTER**

Innovative Water Solutions

INNOVATIVE WATER SOLUTIONS, LLC (TEXAS
LIMITED LIABILITY COMPANY)
1203 ROMERIA DR.
AUSTIN, TX 78757

FOR: WATER CONSERVATION SYSTEMS AND PRODUCTS USED AS AND WITHIN THE RAIN-WATER HARVESTING AND GRAYWATER REUSE SYSTEMS INSTALLED FOR HOUSEHOLD, INDUSTRIAL, AND AGRICULTURAL USE, NAMELY, WATER TANKS OF PLASTIC FOR HOUSEHOLD, INDUSTRIAL, AND AGRICULTURAL PURPOSES SOLD AND INSTALLED AS A UNIT WITH WATER FILTERING COMPONENTS AND PUMPS FOR THE DISTRIBUTION OF WATER, IN INT. CLASS 20, IN CLASS 20 (U.S. CLS. 2, 13, 22, 25, 32 AND 50).

FIRST USE 4-30-2004; IN COMMERCE 4-30-2004.

THE MARK CONSISTS OF STANDARD CHARACTERS WITHOUT CLAIM TO ANY PARTICULAR FONT, STYLE, SIZE, OR COLOR.

NO CLAIM IS MADE TO THE EXCLUSIVE RIGHT TO USE "WATER" , APART FROM THE MARK AS SHOWN.

SER. NO. 77-211,275, FILED 6-20-2007.

ALICIA COLLINS, EXAMINING ATTORNEY

Int. Cl.: 41

Prior U.S. Cls.: 100, 101 and 107

United States Patent and Trademark Office

Reg. No. 3,574,565

Registered Feb. 17, 2009

**SERVICE MARK
PRINCIPAL REGISTER**

**HIGH SCHOOL MATHEMATICAL
CONTEST IN MODELING
(HIMCM)**

COMAP, INC. (MASSACHUSETTS CORPORATION)
175 MIDDLESEX TURNPIKE, SUITE 3B
BEDFORD, MA 01730

FOR: CONTESTS AND INCENTIVE AWARD PROGRAMS TO ENCOURAGE STUDENTS AND ORGANIZATION MEMBERS TO SET UP AND ACHIEVE GOALS IN ACADEMICS, ATTENDANCE, CITIZENSHIP AND CONDUCT , IN CLASS 41 (U.S. CLS. 100, 101 AND 107).

FIRST USE 2-2-1996; IN COMMERCE 4-1-1996.

THE MARK CONSISTS OF STANDARD CHARACTERS WITHOUT CLAIM TO ANY PARTICULAR FONT, STYLE, SIZE, OR COLOR.

NO CLAIM IS MADE TO THE EXCLUSIVE RIGHT TO USE "HIGH SCHOOL MATHEMATICAL CONTEST IN MODELING", APART FROM THE MARK AS SHOWN.

SER. NO. 77-211,535, FILED 6-21-2007.

BENJAMIN ALLEN, EXAMINING ATTORNEY

Int. Cl.: 37

Prior U.S. Cls.: 100, 103 and 106

United States Patent and Trademark Office

Reg. No. 3,574,566

Registered Feb. 17, 2009

**SERVICE MARK
PRINCIPAL REGISTER**



MILLER-DAVIS COMPANY (MICHIGAN CORPORATION)
1029 PORTAGE ST.
KALAMAZOO, MI 49001

THE MARK CONSISTS OF "MILLER DAVIS" WITH A STYLIZED BUILDING SEPARATING THE WORDS AND BENEATH THE PHRASE "EXPERIENCE MATTERS".

FOR: CONSTRUCTION MANAGEMENT; CONSTRUCTION CONSULTATION; CONSTRUCTION PLANNING; BUILDING CONSTRUCTION SERVICES, IN CLASS 37 (U.S. CLS. 100, 103 AND 106).

SER. NO. 77-212,827, FILED 6-22-2007.

FIRST USE 4-1-2007; IN COMMERCE 4-1-2007.

HEATHER SAPP, EXAMINING ATTORNEY

Int. Cl.: 3

Prior U.S. Cls.: 1, 4, 6, 50, 51 and 52

United States Patent and Trademark Office

Reg. No. 3,574,567

Registered Feb. 17, 2009

**TRADEMARK
PRINCIPAL REGISTER**

SUPER FLIGHT CREAM

ESTEE LAUDER INC. (DELAWARE CORPORATION)
767 FIFTH AVENUE
NEW YORK, NY 10153

FOR: NON-MEDICATED SKIN CARE PREPARATIONS, IN CLASS 3 (U.S. CLS. 1, 4, 6, 50, 51 AND 52).

FIRST USE 2-0-2002; IN COMMERCE 2-0-2002.

THE MARK CONSISTS OF STANDARD CHARACTERS WITHOUT CLAIM TO ANY PARTICULAR FONT, STYLE, SIZE, OR COLOR.

NO CLAIM IS MADE TO THE EXCLUSIVE RIGHT TO USE "CREME", APART FROM THE MARK AS SHOWN.

SEC. 2(F).

SER. NO. 77-214,210, FILED 6-25-2007.

CHARISMA HAMPTON, EXAMINING ATTORNEY

Int. Cls.: 10 and 44

Prior U.S. Cls.: 26, 39, 44, 100 and 101

United States Patent and Trademark Office

Reg. No. 3,574,568

Registered Feb. 17, 2009

**TRADEMARK
SERVICE MARK
PRINCIPAL REGISTER**

Z-TECH

Z-TECH (CANADA) INC. (CANADA CORPORATION)
SUITE 310
2 BERKELEY STREET
TORONTO, ONTARIO, CANADA M5A4J5

FOR: MEDICAL DEVICES, NAMELY, BIOELECTRIC IMPEDANCE ANALYSIS INSTRUMENTS FOR MEASURING THE ELECTRICAL IMPEDANCE OF BIOLOGICAL TISSUES; ELECTRONIC INSTRUMENTS COMPRISING OF A CONTROLLER SWITCHING UNIT AND/OR MULTIPLEXING UNIT AND/OR ELECTRODE ARRAYS FOR APPLYING VERY LOW VOLTAGES TO SKIN CONTACTING ELECTRODES AND FOR MEASURING AND ANALYZING THE RESULTANT CURRENTS BETWEEN THE ELECTRODES AND ELECTRODE ARRAYS, ALL FOR THE SCREENING AND DETECTION OF BREAST DISEASES; INSTRUMENTS IN THE NATURE OF ELECTRODE ARRAYS FOR THE SCREENING AND DETECTION OF BREAST DISEASES, IN CLASS 10 (U.S. CLS. 26, 39 AND 44).

FOR: CONSULTING SERVICES RELATING TO THE OPERATION OF INSTRUMENTS FOR THE SCREENING AND DETECTION OF BREAST DISEASES AND TO THE ASSESSMENT OF RESULTS THEREFROM, IN CLASS 44 (U.S. CLS. 100 AND 101).

THE MARK CONSISTS OF STANDARD CHARACTERS WITHOUT CLAIM TO ANY PARTICULAR FONT, STYLE, SIZE, OR COLOR.

PRIORITY CLAIMED UNDER SEC. 44(D) ON CANADA APPLICATION NO. 1,344,414, FILED 4-20-2007, REG. NO. TMA722,176, DATED 8-26-2008, EXPIRES 8-26-2023.

OWNER OF U.S. REG. NO. 2,076,012.

SER. NO. 77-214,230, FILED 6-25-2007.

KATHLEEN LORENZO, EXAMINING ATTORNEY

Int. Cl.: 41

Prior U.S. Cls.: 100, 101 and 107

United States Patent and Trademark Office

Reg. No. 3,574,569

Registered Feb. 17, 2009

**SERVICE MARK
PRINCIPAL REGISTER**

BIO-GEOMETRIC INTEGRATION

BROWN, SUSAN M. (UNITED STATES INDIVIDUAL)
25W330 GENEVA ROAD
CAROL STREAM, IL 60188

THE MARK CONSISTS OF STANDARD CHARACTERS WITHOUT CLAIM TO ANY PARTICULAR FONT, STYLE, SIZE, OR COLOR.

FOR: EDUCATIONAL SERVICES, NAMELY, CONDUCTING CLASSES, SEMINARS, CONFERENCES AND WORKSHOPS IN THE FIELD OF CHIROPRACTIC MEDICINE AND DISTRIBUTION OF COURSE MATERIALS IN CONNECTION THEREWITH, IN CLASS 41 (U.S. CLS. 100, 101 AND 107).

SEC. 2(F).

SER. NO. 77-214,688, FILED 6-25-2007.

FIRST USE 1-30-2000; IN COMMERCE 1-30-2000.

ROBERT LAVACHE, EXAMINING ATTORNEY

Int. Cl.: 16

Prior U.S. Cls.: 2, 5, 22, 23, 29, 37, 38 and 50

Reg. No. 3,574,570

United States Patent and Trademark Office

Registered Feb. 17, 2009

**TRADEMARK
PRINCIPAL REGISTER**

CANYON ROAD ARTS

MARK SUBLETTE MEDICINE MAN GALLERY
INC. (ARIZONA CORPORATION)
7000 E. TANQUE VERDE
TUCSON, AZ 85715

FOR: PRINTED TOURISM GUIDE, RELATING
TO A NEW MEXICO HISTORIC AND CULTURAL
LOCATION, AND ITS SURROUNDING ENVIRON-
MENT, IN CLASS 16 (U.S. CLS. 2, 5, 22, 23, 29, 37, 38
AND 50).

FIRST USE 5-13-2003; IN COMMERCE 5-13-2003.

THE MARK CONSISTS OF STANDARD CHAR-
ACTERS WITHOUT CLAIM TO ANY PARTICULAR
FONT, STYLE, SIZE, OR COLOR.

NO CLAIM IS MADE TO THE EXCLUSIVE
RIGHT TO USE "ARTS", APART FROM THE MARK
AS SHOWN.

SEC. 2(F).

SER. NO. 77-214,903, FILED 6-25-2007.

MELISSA VALLILLO, EXAMINING ATTORNEY

Int. Cl.: 42

Prior U.S. Cls.: 100 and 101

United States Patent and Trademark Office

Reg. No. 3,574,571

Registered Feb. 17, 2009

**SERVICE MARK
PRINCIPAL REGISTER**

INSIGHT, NOT HINDSIGHT

MULTIVIEW GEOSERVICES INC. (CANADA CORPORATION)
1091 BREVIK PLACE
MISSISSAUGA, CANADA L4W3R7

FOR: INSPECTION SERVICES USING ANY NUMBER OF TECHNIQUES, NAMELY, ELECTRICAL, ELECTROMAGNETIC, RADAR, SONIC, ULTRASONIC, RADIOACTIVE, RADIOGRAPHIC, MAGNETIC TO LOCATE AND/OR DELINEATE FEATURES, NAMELY, MAN-MADE BURIED OBJECTS, SUCH AS WIRES, CABLES, BARS, TREASURES, CAVITIES, NATURAL DISTURBANCES BURIED BENEATH THE GROUND OR IN MAN-MADE STRUCTURES SUCH AS CONCRETE BUILDINGS, CONCRETE STRUCTURES, ASPHALT PAVEMENTS, CONCRETE PAVEMENTS, BRIDGE DECKS, TUNNELS, TUNNEL WALLS; SUBSURFACE MAPPING SERVI-

CES; UTILITY MAPPING, LOCATING AND DETECTING PLACEMENT OF UNDERGROUND UTILITY PIPES, CABLES OR WIRES, IN CLASS 42 (U.S. CLS. 100 AND 101).

THE MARK CONSISTS OF STANDARD CHARACTERS WITHOUT CLAIM TO ANY PARTICULAR FONT, STYLE, SIZE, OR COLOR.

PRIORITY CLAIMED UNDER SEC. 44(D) ON CANADA APPLICATION NO. 1330097, FILED 1-3-2007, REG. NO. TMA701530, DATED 11-23-2007, EXPIRES 11-23-2022.

SER. NO. 77-215,476, FILED 6-26-2007.

HOWARD SMIGA, EXAMINING ATTORNEY

Int. Cl.: 42

Prior U.S. Cls.: 100 and 101

United States Patent and Trademark Office

Reg. No. 3,574,572

Registered Feb. 17, 2009

**SERVICE MARK
PRINCIPAL REGISTER**

multiLOCATE

MULTIVIEW GEOSERVICES INC. (CANADA CORPORATION)
1091 BREVIK PLACE
MISSISSAUGA, CANADA L4W3R7

FOR: INSPECTION SERVICES USING ANY NUMBER OF TECHNIQUES, NAMELY, ELECTRICAL, ELECTROMAGNETIC, RADAR, SONIC, ULTRASONIC, RADIOACTIVE, RADIOGRAPHIC, MAGNETIC TO LOCATE AND/OR DELINEATE FEATURES, NAMELY, MAN-MADE BURIED OBJECTS, SUCH AS WIRES, CABLES, BARS, TREASURES, CAVITIES, NATURAL DISTURBANCES BURIED BENEATH THE GROUND OR IN MAN-MADE STRUCTURES SUCH AS CONCRETE BUILDINGS, CONCRETE STRUCTURES, ASPHALT PAVEMENTS, CONCRETE PAVEMENTS, BRIDGE DECKS, TUNNELS, TUNNEL WALLS; SUBSURFACE MAPPING SERVI-

CES; UTILITY MAPPING, LOCATING AND DETECTING PLACEMENT OF UNDERGROUND UTILITY PIPES, CABLES OR WIRES, IN CLASS 42 (U.S. CLS. 100 AND 101).

THE MARK CONSISTS OF STANDARD CHARACTERS WITHOUT CLAIM TO ANY PARTICULAR FONT, STYLE, SIZE, OR COLOR.

PRIORITY CLAIMED UNDER SEC. 44(D) ON CANADA APPLICATION NO. 1330137, FILED 1-4-2007, REG. NO. TMA702604, DATED 12-7-2007, EXPIRES 12-7-2022.

SER. NO. 77-215,490, FILED 6-26-2007.

HOWARD SMIGA, EXAMINING ATTORNEY

Int. Cls.: 19 and 37

Prior U.S. Cls.: 1, 12, 33, 50, 100, 103 and 106

United States Patent and Trademark Office

Reg. No. 3,574,573

Registered Feb. 17, 2009

**TRADEMARK
SERVICE MARK
PRINCIPAL REGISTER**

PRO-RIDE

PRO-RIDE RACING AUSTRALIA PTY LTD
(AUSTRALIA CORPORATION)
33B BELL STREET
YARRA GLEN, VICTORIA, AUSTRALIA 3775

FOR: GROUND COATING MATERIALS FOR SURFACES AND SURFACING OF TRACKS, NAMELY, EQUESTRIAN TRACKS, RACING TRACKS, ARENAS, AND COURSES COMPRISING SAND, GRAVEL, ASPHALT, POLYMERIC MATERIALS AND/OR COMBINATIONS OF THE AFORESAID; ARTIFICIAL SURFACES, NAMELY, POLYURETHANE SURFACES FOR HORSE RIDING, TRAINING, RACING, EXERCISING AND OTHER EQUESTRIAN ACTIVITIES, IN CLASS 19 (U.S. CLS. 1, 12, 33 AND 50).

FOR: INSTALLATION, REPAIR AND MAINTENANCE OF ARTIFICIAL SURFACES, NAMELY, GROUND COATING MATERIALS FOR SURFACES AND SURFACING OF EQUESTRIAN TRACKS,

RACING TRACKS, ARENAS, AND COURSES; INFORMATION, ADVISORY AND CONSULTANCY SERVICES IN RELATION TO THE INSTALLATION, REPAIR AND MAINTENANCE OF SURFACES IN THE NATURE OF GROUND COATING MATERIALS FOR SURFACES AND SURFACING TRACKS, IN CLASS 37 (U.S. CLS. 100, 103 AND 106).

THE MARK CONSISTS OF STANDARD CHARACTERS WITHOUT CLAIM TO ANY PARTICULAR FONT, STYLE, SIZE, OR COLOR.

PRIORITY CLAIMED UNDER SEC. 44(D) ON AUSTRALIA APPLICATION NO. 1168654, FILED 3-29-2007, REG. NO. 1168654, DATED 3-29-2007, EXPIRES 3-29-2017.

SER. NO. 77-217,864, FILED 6-28-2007.

CHARLOTTE CORWIN, EXAMINING ATTORNEY

Int. Cl.: 25

Prior U.S. Cls.: 22 and 39

United States Patent and Trademark Office

Reg. No. 3,574,574

Registered Feb. 17, 2009

**TRADEMARK
PRINCIPAL REGISTER**

KLIP-FLOPS

JASPEN COMPANY, INC. (TEXAS CORPORATION)
1727 LAKEVILLE DRIVE
KINGWOOD, TX 77339

THE MARK CONSISTS OF STANDARD CHARACTERS WITHOUT CLAIM TO ANY PARTICULAR FONT, STYLE, SIZE, OR COLOR.

FOR: SANDALS, IN CLASS 25 (U.S. CLS. 22 AND 39).

SER. NO. 77-218,377, FILED 6-28-2007.

FIRST USE 1-1-2006; IN COMMERCE 1-1-2006.

DAVID ELTON, EXAMINING ATTORNEY

Int. Cls.: 38 and 41

Prior U.S. Cls.: 100, 101, 104 and 107

United States Patent and Trademark Office

Reg. No. 3,574,575

Registered Feb. 17, 2009

**SERVICE MARK
PRINCIPAL REGISTER**

The Future of Television

THE DEVINE COMPANY, LLC (CALIFORNIA
LIMITED LIABILITY COMPANY)
8981 SUNSET BLVD, SUITE 305
LOS ANGELES, CA 90069

FOR: AUDIO AND VIDEO BROADCASTING SERVICES OVER THE INTERNET OR OTHER COMMUNICATIONS NETWORK; STREAMING OF AUDIO AND VIDEO; TRANSMITTING AND/OR MANIPULATING OF VIDEO, PICTURES, IMAGES, TEXT, AUDIO AND/OR OTHER ELECTRONIC MEDIA OR INFORMATION; PROVIDING ACCESS TO DATABASES FEATURING INFORMATION ABOUT AUDIO, AND VIDEO VIA WEBSITES, ON-LINE FORUMS, LISTSERVS AND BLOGS OVER THE INTERNET; PROVIDING ON-LINE ELECTRONIC BULLETIN BOARDS FOR TRANSMISSION OF MESSAGES AMONG USERS IN THE FIELD OF GENERAL INTEREST, IN CLASS 38 (U.S. CLS. 100, 101 AND 104).

FIRST USE 4-3-2007; IN COMMERCE 6-15-2007.

FOR: FILM DISTRIBUTION; VIDEO EDITING; ON-LINE JOURNALS, NAMELY, BLOGS FEATURING POLITICS, ENTERTAINMENT, AND CURRENT EVENTS; ENTERTAINMENT SERVICES, NAMELY, PROVIDING A WEBSITE FEATURING VIDEOS ABOUT ENTERTAINMENT, SPORTS AND NEWS, IN CLASS 41 (U.S. CLS. 100, 101 AND 107).

FIRST USE 4-3-2007; IN COMMERCE 6-15-2007.

THE MARK CONSISTS OF STANDARD CHARACTERS WITHOUT CLAIM TO ANY PARTICULAR FONT, STYLE, SIZE, OR COLOR.

NO CLAIM IS MADE TO THE EXCLUSIVE RIGHT TO USE "TELEVISION", APART FROM THE MARK AS SHOWN.

SER. NO. 77-218,528, FILED 6-28-2007.

ARETHA SOMERVILLE, EXAMINING ATTORNEY

Int. Cl.: 35

Prior U.S. Cls.: 100, 101 and 102

United States Patent and Trademark Office

Reg. No. 3,574,576

Registered Feb. 17, 2009

**SERVICE MARK
PRINCIPAL REGISTER**

SmarterHomeSearch.com

SMARTERHOMESearch, LLC (PENNSYLVANIA LIMITED LIABILITY COMPANY)
ROSE TREE CORPORATE CENTER II
1400 NORTH PROVIDENCE ROAD, SUITE 6035
MEDIA, PA 19063

FOR: PROVIDING ONLINE MARKETING AND CONSUMER INFORMATION SERVICES CONSISTING OF DATABASES OF REAL ESTATE CHARACTERISTICS, NAMELY, STATISTICS AND DATA REGARDING PROPERTIES, PHOTOGRAPHS OF PROPERTIES, AND CHARTS AND REPORTS REGARDING CHARACTERISTICS OF PROPERTIES, SEARCHABLE THROUGH USER-SELECTABLE

CRITERIA; PROVIDING ONLINE LEAD GENERATING SERVICES FOR REAL ESTATE BROKERS, IN CLASS 35 (U.S. CLS. 100, 101 AND 102).

FIRST USE 6-29-2006; IN COMMERCE 6-29-2006.

THE MARK CONSISTS OF STANDARD CHARACTERS WITHOUT CLAIM TO ANY PARTICULAR FONT, STYLE, SIZE, OR COLOR.

SER. NO. 77-218,917, FILED 6-29-2007.

SHAUNIA CARLYLE, EXAMINING ATTORNEY

Int. Cl.: 40

Prior U.S. Cls.: 100, 103 and 106

United States Patent and Trademark Office

Reg. No. 3,574,577

Registered Feb. 17, 2009

**SERVICE MARK
PRINCIPAL REGISTER**

STUD STYL

HARRISON, TWYLA R. (UNITED STATES INDIVIDUAL)

#372

4450 N. CALIFORNIA PL.
LONG BEACH, CA 90807

FOR: CUSTOM IMPRINTING OF WEARING APPAREL, SHOES, ACCESSORIES, MUGS, LABELS, SOUVENIRS, AND ANY PRINTABLE ITEM WITH DECORATIVE DESIGNS; IMPRINTING MESSAGES ON T-SHIRTS; IMPRINTING MESSAGES ON WEARING APPAREL, ACCESSORIES AND MUGS; SCREEN PRINTING; SILK SCREEN PRINTING,

EMBROIDERY, IN CLASS 40 (U.S. CLS. 100, 103 AND 106).

FIRST USE 8-31-2006; IN COMMERCE 2-4-2007.

THE MARK CONSISTS OF STANDARD CHARACTERS WITHOUT CLAIM TO ANY PARTICULAR FONT, STYLE, SIZE, OR COLOR.

SER. NO. 77-220,003, FILED 7-1-2007.

SUSAN LESLIE DUBOIS, EXAMINING ATTORNEY

Int. Cl.: 29

Prior U.S. Cl.: 46

United States Patent and Trademark Office

Reg. No. 3,574,578

Registered Feb. 17, 2009

**TRADEMARK
PRINCIPAL REGISTER**

Farm Valley Foods

FARM VALLEY FOODS, LLC (ILLINOIS LIMITED LIABILITY COMPANY)
7147 W. ARCHER AVE.
CHICAGO, IL 60638

FOR: MEAT PRODUCTS, NAMELY, BEEF, PORK, POULTRY AND PROCESSED MEAT, IN CLASS 29 (U.S. CL. 46).

FIRST USE 12-31-2006; IN COMMERCE 12-31-2006.

THE MARK CONSISTS OF STANDARD CHARACTERS WITHOUT CLAIM TO ANY PARTICULAR FONT, STYLE, SIZE, OR COLOR.

NO CLAIM IS MADE TO THE EXCLUSIVE RIGHT TO USE "FOODS", APART FROM THE MARK AS SHOWN.

SER. NO. 77-220,283, FILED 7-2-2007.

BONNIE LUKEN, EXAMINING ATTORNEY

Int. Cl.: 1

Prior U.S. Cls.: 1, 5, 6, 10, 26 and 46

United States Patent and Trademark Office

Reg. No. 3,574,579

Registered Feb. 17, 2009

**TRADEMARK
PRINCIPAL REGISTER**

ECO-CURE

PRIME ECO GROUP, INC. (TEXAS CORPORATION)
2933 HWY 60 S.
WHARTON, TX 77488

THE MARK CONSISTS OF STANDARD CHARACTERS WITHOUT CLAIM TO ANY PARTICULAR FONT, STYLE, SIZE, OR COLOR.

FOR: CHEMICAL COMPOUNDS FOR CURING CONCRETE, IN CLASS 1 (U.S. CLS. 1, 5, 6, 10, 26 AND 46).

SER. NO. 77-220,457, FILED 7-2-2007.

FIRST USE 12-1-2004; IN COMMERCE 11-17-2005.

KRISTINA MORRIS, EXAMINING ATTORNEY

Int. Cl.: 39

Prior U.S. Cls.: 100 and 105

United States Patent and Trademark Office

Reg. No. 3,574,580

Registered Feb. 17, 2009

**SERVICE MARK
PRINCIPAL REGISTER**



NETWORK GLOBAL LOGISTICS, LLC (OREGON
LIMITED LIABILITY COMPANY)
9010 BELANCA AVENUE
LOS ANGELES, CA 90045

FOR: SHIPPING AND DELIVERY SERVICES,
NAMELY, PICKUP, TRANSPORTATION AND DE-
LIVERY OF PACKAGES AND LETTERS BY VAR-
IOUS MODES OF TRANSPORTATION; COURIER
SERVICES; TRANSPORTATION AND SHIPPING OF
PACKAGES BY MESSENGER, LAND VEHICLES,
NAMELY, TRUCKS, CARS AND AIRCRAFT; CEN-
TRALIZED WAREHOUSE SERVICES, NAMELY,
WAREHOUSE STORAGE; SUPPLY CHAIN AND
LOGISTICS SERVICES, NAMELY, STORAGE,
TRANSPORTATION AND DELIVERY OF DOCU-
MENTS, PACKAGES, RAW MATERIALS, AND
OTHER FREIGHT FOR OTHERS BY AIR, RAIL,

SHIP OR TRUCK; STORAGE OF MEDICAL, SUR-
GICAL AND ELECTRONICS PRODUCTS FOR OTH-
ERS, IN CLASS 39 (U.S. CLS. 100 AND 105).

FIRST USE 3-31-2007; IN COMMERCE 3-31-2007.

NO CLAIM IS MADE TO THE EXCLUSIVE
RIGHT TO USE "NETWORK GLOBAL LOGISTICS",
APART FROM THE MARK AS SHOWN.

THE MARK CONSISTS OF A BOX WITH THE
LETTER "NGL" FOLLOWED BY THE WORDS
"NETWORK GLOBAL LOGISTICS."

SER. NO. 77-221,880, FILED 7-3-2007.

CHRISTINA SOBRAL, EXAMINING ATTORNEY

Int. Cl.: 35

Prior U.S. Cls.: 100, 101 and 102

United States Patent and Trademark Office

Reg. No. 3,574,581

Registered Feb. 17, 2009

**SERVICE MARK
PRINCIPAL REGISTER**



NETWORK GLOBAL LOGISTICS, LLC (OREGON
LIMITED LIABILITY COMPANY)
9010 BELANCA AVENUE
LOS ANGELES, CA 90045

FOR: TRANSPORTATION LOGISTICS SERVICES,
NAMELY, ARRANGING THE TRANSPORTATION
OF GOODS FOR OTHERS; INFORMATION MAN-
AGEMENT SERVICES, NAMELY, SHIPMENT PRO-
CESSING, PREPARING SHIPPING DOCUMENTS
AND INVOICES, TRACKING DOCUMENTS,
PACKAGES AND FREIGHT OVER COMPUTER
NETWORKS, INTRANETS AND INTERNETS; IN-
VENTORY MANAGEMENT IN THE FIELD OF
MEDICAL, SURGICAL AND ELECTRONIC PRO-
DUCTS; LOGISTICS MANAGEMENT IN THE
FIELD OF MEDICAL, SURGICAL AND ELECTRO-

NIC PRODUCTS, IN CLASS 35 (U.S. CLS. 100, 101
AND 102).

FIRST USE 3-31-2007; IN COMMERCE 3-31-2007.

NO CLAIM IS MADE TO THE EXCLUSIVE
RIGHT TO USE "NETWORK GLOBAL LOGISTICS",
APART FROM THE MARK AS SHOWN.

THE MARK CONSISTS OF A BOX WITH THE
LETTERS "NGL" FOLLOWED BY THE WORDS
"NETWORK GLOBAL LOGISTICS."

SER. NO. 77-221,901, FILED 7-3-2007.

CHRISTINA SOBRAL, EXAMINING ATTORNEY

Int. Cls.: 36 and 44

Prior U.S. Cls.: 100, 101 and 102

United States Patent and Trademark Office

Reg. No. 3,574,582

Registered Feb. 17, 2009

**SERVICE MARK
PRINCIPAL REGISTER**

FIRSTPLAN

FIRST PLAN OF MINNESOTA, INC. (MINNESOTA NON-PROFIT CORPORATION)
525 SOUTH LAKE AVENUE
DULUTH, MN 55802

FOR: INSURANCE CLAIMS PROCESSING, IN CLASS 36 (U.S. CLS. 100, 101 AND 102).

FIRST USE 6-29-2007; IN COMMERCE 6-29-2007.

FOR: MEDICAL CLINICS; HEALTH CARE IN THE NATURE OF HEALTH MAINTENANCE ORGANIZATIONS, IN CLASS 44 (U.S. CLS. 100 AND 101).

FIRST USE 6-29-2007; IN COMMERCE 6-29-2007.

THE MARK CONSISTS OF STANDARD CHARACTERS WITHOUT CLAIM TO ANY PARTICULAR FONT, STYLE, SIZE, OR COLOR.

OWNER OF U.S. REG. NO. 2,045,403.

SER. NO. 77-222,365, FILED 7-5-2007.

APRIL HESIK, EXAMINING ATTORNEY

Int. Cl.: 12

Prior U.S. Cls.: 19, 21, 23, 31, 35 and 44

United States Patent and Trademark Office

Reg. No. 3,574,583

Registered Feb. 17, 2009

**TRADEMARK
PRINCIPAL REGISTER**

PIVOT CYCLES

CLV, INC. (ARIZONA CORPORATION)
3852 EAST SEQUOIA TRAIL
PHOENIX, AZ 85044

FOR: BICYCLE FRAMES AND COMPLETE BICYCLES, EXCLUDING CYCLE PEDALS AND PEGS, IN CLASS 12 (U.S. CLS. 19, 21, 23, 31, 35 AND 44).

FIRST USE 8-1-2006; IN COMMERCE 6-20-2007.

THE MARK CONSISTS OF STANDARD CHARACTERS WITHOUT CLAIM TO ANY PARTICULAR FONT, STYLE, SIZE, OR COLOR.

NO CLAIM IS MADE TO THE EXCLUSIVE RIGHT TO USE "CYCLES", APART FROM THE MARK AS SHOWN.

SER. NO. 77-222,948, FILED 7-5-2007.

B. PARADEWELAI, EXAMINING ATTORNEY

Int. Cl.: 45

Prior U.S. Cls.: 100 and 101

United States Patent and Trademark Office

Reg. No. 3,574,584

Registered Feb. 17, 2009

**SERVICE MARK
PRINCIPAL REGISTER**

UNFORGETTABLE PASSWORD

VOICEVERIFIED, INC. (DELAWARE CORPORATION)
110 UNION SQUARE DRIVE
NEW HOPE, PA 18938

FOR: IDENTIFICATION VERIFICATION SERVICES, NAMELY, PROVIDING AUTHENTICATION OF PERSONAL IDENTIFICATION INFORMATION, IN CLASS 45 (U.S. CLS. 100 AND 101).

FIRST USE 7-6-2007; IN COMMERCE 7-6-2007.

THE MARK CONSISTS OF STANDARD CHARACTERS WITHOUT CLAIM TO ANY PARTICULAR FONT, STYLE, SIZE, OR COLOR.

NO CLAIM IS MADE TO THE EXCLUSIVE RIGHT TO USE "PASSWORD", APART FROM THE MARK AS SHOWN.

SER. NO. 77-223,745, FILED 7-6-2007.

ZACHARY BELLO, EXAMINING ATTORNEY

Int. Cls.: 1, 2, 3 and 5

**Prior U.S. Cls.: 1, 4, 5, 6, 10, 11, 16, 18, 26, 44, 46, 50,
51 and 52**

Reg. No. 3,574,585

United States Patent and Trademark Office

Registered Feb. 17, 2009

**TRADEMARK
PRINCIPAL REGISTER**

FLAMEL TECHNOLOGIES

FLAMEL TECHNOLOGIES (FRANCE SOCIETE ANONYME)
33 AVENUE DU DOCTEUR GEORGES LEVY
PARC DU MOULIN A VENT
69693 VENISSIEUX CEDEX, FRANCE

WINDSHIELD WASHING FLUID; SOAPS, NAME-
LY, DEODORANT SOAP, ESSENTIAL OILS FOR
PERSONAL USE, ESSENTIAL OILS FOR PERSONAL
USE AND PERFUMES, IN CLASS 3 (U.S. CLS. 1, 4, 6,
50, 51 AND 52).

FOR: CHEMICALS FOR USE IN THE MANUFAC-
TURE OF DRUGS; FERTILIZERS FOR DOMESTIC
AND AGRICULTURAL USE; CERAMIC MATRIX
COMPOSITE MATERIALS (CMC) FOR MANUFAC-
TURING USE IN THE AERONAUTICS INDUSTRY;
PHOTOGRAPHIC CHEMICALS; UNPROCESSED
ARTIFICIAL RESINS; DESCALING AGENTS,
NAMELY, DETERGENTS IN THE INDUSTRIAL
AND CONSUMER CLEANING PRODUCTS INDUS-
TRY; BIOPOLYMERS, PROTEINS, GLYCOPRO-
TEINS, POLYAMINOACIDS, COLLAGENS, CO-
POLYMERS FROM LACTIC/GLYCOLIC CARBOYL-
IC ACIDS FOR USE IN THE MANUFACTURE OF
DRUGS AND BIOLOGICAL MATERIALS; CHEMI-
CALS, NAMELY, POLYMERS, PLASTIC POLY-
MERS, SPIROPYRANS, NAPHTHOPYRANS, AND
CHROMENS FOR USE IN THE MANUFACTURE
OF OPTICAL DEVICES AND NON-LINEAR OPTI-
CAL DEVICES, IN CLASS 1 (U.S. CLS. 1, 5, 6, 10, 26
AND 46).

FOR: ALL PURPOSE DISINFECTANTS; PHAR-
MACEUTICAL PREPARATIONS FOR THE TREAT-
MENT OF HEART DISEASES, PAIN, DIABETES,
AND CARDIOVASCULAR DISEASES; VACCINES,
AND VETERINARY VACCINES FOR BOVINES, SHEEP,
AND HORSES; SANITARY NAPKINS; DIETARY
SUPPLEMENTS; DRESSING FOR WOUNDS,
BURNS, AND SURGICAL PURPOSES; FUNGI-
CIDES FOR AGRICULTURAL USE AND DOME-
STIC USE; HERBICIDES FOR AGRICULTURAL USE
AND DOMESTIC USE; WEED KILLERS FOR AGRI-
CULTURAL USE AND DOMESTIC USE; INSECTI-
CIDES FOR AGRICULTURAL USE AND
DOMESTIC USE; MEDICINES FOR THE TREAT-
MENT OF HEART DISEASES, PAIN, DIABETES,
AND CARDIOVASCULAR DISEASES; MEDICINES
WITH DELAYED RELEASE OF THE ACTIVE PRIN-
CIPLES FOR THE TREATMENT OF HEART DIS-
EASES, PAIN, DIABETES, AND
CARDIOVASCULAR DISEASES; MEDICINES WITH
ENCAPSULATED ACTIVE PRINCIPLE BIOCIDES
FOR THE TREATMENT OF HEART DISEASES,
PAIN, DIABETES, AND CARDIOVASCULAR DIS-
EASES; MEDICINES BASED ON ASPIRIN, INSULIN,
METFORMINE, ACICLOVIR, GLIBENCLAMIDE
FOR THE TREATMENT OF HEART DISEASES,
PAIN, DIABETES, AND CARDIOVASCULAR DIS-
EASES; MEDICINES BASED ON ENCAPSULATED
ASPIRIN, INSULIN, METFORMINE, ACICLOVIR,
GLIBENCLAMIDE FOR THE DELAYED RELEASE
OF THE ACTIVE PRINCIPLE FOR THE TREAT-
MENT OF HEART DISEASE, PAIN, DIABETES,
AND CARDIOVASCULAR DISEASES; LIQUID
PHARMACEUTICAL PREPARATIONS FOR ORAL
ADMINISTRATION AND INJECTION AND AL-

FOR: COLORANTS FOR USE IN THE MANU-
FACTURE OF PAINT, PIGMENTS, DYES FOR USE
IN THE MANUFACTURE OF OPTICAL GLASSES
AND LENSES; COLORANTS, NAMELY, PHOTO-
CHROMIC COMPOUNDS FOR USE IN THE MANU-
FACTURE OF PAINT, PIGMENTS, DYES FOR
USE IN THE MANUFACTURE OF OPTICAL GLAS-
SES AND LENSES; COLORANTS FOR USE IN THE
MANUFACTURE OF WASHING AND COSMETIC
PRODUCTS, IN CLASS 2 (U.S. CLS. 6, 11 AND 16).

FOR: COSMETICS, DISHWASHING DETER-
GENTS, PERSONAL DEODORANTS, STAIN RE-
MOVERS, WASHING PRODUCTS, NAMELY,

LOWING FOR THE DELAYED RELEASE OF THE PHARMACEUTICAL ACTIVE PRINCIPLES FOR THE TREATMENT OF HEART DISEASES, PAIN, DIABETES, AND CARDIOVASCULAR DISEASES, IN CLASS 5 (U.S. CLS. 6, 18, 44, 46, 51 AND 52).

THE MARK CONSISTS OF STANDARD CHARACTERS WITHOUT CLAIM TO ANY PARTICULAR FONT, STYLE, SIZE, OR COLOR.

OWNER OF FRANCE REG. NO. 013137173, DATED 5-17-2002, EXPIRES 12-14-2011.

NO CLAIM IS MADE TO THE EXCLUSIVE RIGHT TO USE "TECHNOLOGIES", APART FROM THE MARK AS SHOWN.

SER. NO. 77-224,518, FILED 7-9-2007.

TINA L. SNAPP, EXAMINING ATTORNEY

Int. Cls.: 9, 36, 38, 41 and 42

**Prior U.S. Cls.: 21, 23, 26, 36, 38, 100, 101, 102, 104
and 107**

Reg. No. 3,574,586

United States Patent and Trademark Office

Registered Feb. 17, 2009

**TRADEMARK
SERVICE MARK
PRINCIPAL REGISTER**



ADVANCED FINANCIAL SOLUTIONS, INC.
(OKLAHOMA CORPORATION)
INTERNATIONAL CORPORATECENTER
1200 SOVERIGN ROW
OKLAHOMA CITY, OK 73108

FOR: COMPUTER SOFTWARE TO CONDUCT ELECTRONIC FUNDS TRANSFERS, CHECK IMAGING AND PROCESSING; NETWORK ACCESS SERVER HARDWARE; NETWORK ACCESS SERVER OPERATING SOFTWARE; COMPUTER SOFTWARE FOR CHECK PROCESSING, IN CLASS 9 (U.S. CLS. 21, 23, 26, 36 AND 38).

FIRST USE 4-1-2001; IN COMMERCE 4-1-2001.

FOR: FINANCIAL SERVICES, NAMELY, ELECTRONIC FUNDS TRANSFER AND TRANSACTION SERVICES; FINANCIAL INFORMATION PROVIDED BY ELECTRONIC MEANS; ELECTRONIC FUNDS TRANSFER SERVICES, IN CLASS 36 (U.S. CLS. 100, 101 AND 102).

FIRST USE 4-1-2001; IN COMMERCE 4-1-2001.

FOR: ELECTRONIC DELIVERY OF IMAGES VIA A GLOBAL COMPUTER NETWORK; ONLINE DOCUMENT DELIVERY VIA A GLOBAL COMPUTER NETWORK; PROVIDING ELECTRONIC TRANSMISSION OF CREDIT CARD TRANSACTION DATA AND ELECTRONIC PAYMENT VIA A GLOBAL COMPUTER NETWORK, IN CLASS 38 (U.S. CLS. 100, 101 AND 104).

FIRST USE 4-1-2001; IN COMMERCE 4-1-2001.

FOR: DIGITAL IMAGING SERVICES; DIGITAL CHECK IMAGING SERVICES, IN CLASS 41 (U.S. CLS. 100, 101 AND 107).

FIRST USE 4-1-2001; IN COMMERCE 4-1-2001.

FOR: DOCUMENT DATA TRANSFER FROM ONE COMPUTER FORMAT TO ANOTHER; PHYSICAL CONVERSION OF PRINTED TEXT AND IMAGES INTO DIGITAL FORM; PHYSICAL DOCUMENT CONVERSION FROM ELECTRONIC TO PRINTED FORMAT FOR OTHERS; ELECTRONIC CHECK CONVERSION PROCESSING THROUGH DOCUMENT DATA TRANSFER AND PHYSICAL CONVERSION SERVICES FROM ONE MEDIA TO ANOTHER; CONVERSION OF DOCUMENT FROM A PHYSICAL MEDIUM TO AN ELECTRONIC MEDIUM, IN CLASS 42 (U.S. CLS. 100 AND 101).

FIRST USE 4-1-2001; IN COMMERCE 4-1-2001.

OWNER OF U.S. REG. NO. 2,867,462.

THE COLOR(S) BLUE AND GREY IS/ARE CLAIMED AS A FEATURE OF THE MARK.

THE MARK CONSISTS OF THE WORDS ENDPOINT EXCHANGE WHERE THE "E" IN ENDPOINT AND THE SECOND "E" IN EXCHANGE ARE STYLIZED AND BLUE, AND WHERE THE DOT IN THE "I" IS ALSO BLUE, THE REST OF THE MARK IS GREY.

SER. NO. 77-226,118, FILED 7-10-2007.

GINA FINK, EXAMINING ATTORNEY

Int. Cl.: 25

Prior U.S. Cls.: 22 and 39

United States Patent and Trademark Office

Reg. No. 3,574,587

Registered Feb. 17, 2009

**TRADEMARK
PRINCIPAL REGISTER**

ROSE IS A ROSE

KYOKO HIGA CREATION INC. (JAPAN CORPORATION)
5-4-44 MINAMIAOYAMA, MINATO-KU
TOKYO, JAPAN 107-0062

FOR: CLOTHING, NAMELY, OVERALLS, UNDERWEAR, SWEATERS, SHIRTS, AND JUMPERS; FUR CLOTHING, NAMELY, FUR CLOAKS, FUR COATS AND JACKETS, FUR HATS, FUR MUFFS, AND FUR STOLES; SUITS; KNITWEAR, NAMELY, KNIT SHIRTS, KNITTED CAPS, AND KNITTED UNDERWEAR; VESTS; COATS; SKIRTS; APRONS; OVERCOATS; JACKETS; CLOTHING OF LEATHER, NAMELY, LEATHER BELTS, LEATHER COATS, LEATHER HEADWEAR, LEATHER JACKETS, LEATHER PANTS, AND LEATHER TROUSERS; T-SHIRTS; CAMISOLES; PANTS; TROUSERS; BODY SHIRTS; DRESSING GOWNS; TIGHTS; STOCKINGS; SWIMWEAR; PAJAMAS; BRASSIERES; BATH ROBES; SLIPS; WATER PROOF CLOTHING, NAME-

LY, WATERPROOF JACKETS AND PANTS; HEADGEAR FOR CLOTHING, NAMELY, HATS AND CAPS; SOCKS; GLOVES, MITTENS; SHAWLS; SCARVES; BELTS; WEDDING DRESSES, IN CLASS 25 (U.S. CLS. 22 AND 39).

THE MARK CONSISTS OF STANDARD CHARACTERS WITHOUT CLAIM TO ANY PARTICULAR FONT, STYLE, SIZE, OR COLOR.

PRIORITY CLAIMED UNDER SEC. 44(D) ON JAPAN APPLICATION NO. 2007-001355, FILED 1-12-2007, REG. NO. 5083249, DATED 10-12-2007, EXPIRES 10-12-2017.

SER. NO. 77-226,887, FILED 7-11-2007.

JAY FLOWERS, EXAMINING ATTORNEY

Int. Cls.: 9, 16 and 41

**Prior U.S. Cls.: 2, 5, 21, 22, 23, 26, 29, 36, 37, 38, 50,
100, 101 and 107**

Reg. No. 3,574,588

United States Patent and Trademark Office

Registered Feb. 17, 2009

**TRADEMARK
SERVICE MARK
PRINCIPAL REGISTER**

ANDREW REYNOLDS

REYNOLDS, ANDREW (UNITED KINGDOM INDIVIDUAL)
STANHOPE GATE, STANHOPE ROAD, CAMBERLEY
ENTERPRISE HOUSE, 10-12 STANHOPE GATE
SURREY, UNITED KINGDOM

FOR: EDUCATION AND TRAINING COMPUTER SOFTWARE FEATURING INSTRUCTION IN ESTABLISHING, SETTING UP, ORGANIZING, AND OPERATING OF BUSINESSES, IN CLASS 9 (U.S. CLS. 21, 23, 26, 36 AND 38).

FOR: PRINTED TEACHING MATERIALS IN THE FIELD OF ESTABLISHING, SETTING UP, ORGANIZING, AND OPERATING OF BUSINESSES, IN CLASS 16 (U.S. CLS. 2, 5, 22, 23, 29, 37, 38 AND 50).

FOR: EDUCATIONAL SERVICES, NAMELY, PROVIDING SEMINARS, CLASSES AND WORK-

SHOPS RELATED TO ESTABLISHING, SETTING UP, ORGANIZING, AND OPERATING OF BUSINESS; AND PERSONAL COACHING SERVICES RELATED TO ESTABLISHING, SETTING UP, ORGANIZING AND OPERATING OF BUSINESSES, IN CLASS 41 (U.S. CLS. 100, 101 AND 107).

THE MARK CONSISTS OF STANDARD CHARACTERS WITHOUT CLAIM TO ANY PARTICULAR FONT, STYLE, SIZE, OR COLOR.

PRIORITY CLAIMED UNDER SEC. 44(D) ON ERPNTY TM OFC APPLICATION NO. 6082432, FILED 7-9-2007, REG. NO. 006082432, DATED 4-25-2008, EXPIRES 7-9-2017.

SER. NO. 77-229,063, FILED 7-13-2007.

KAPIL BHANOT, EXAMINING ATTORNEY

Int. Cl.: 9

Prior U.S. Cls.: 21, 23, 26, 36 and 38

Reg. No. 3,574,589

United States Patent and Trademark Office

Registered Feb. 17, 2009

**TRADEMARK
PRINCIPAL REGISTER**

EPIRATE

ZELBY, LLC (RHODE ISLAND LIMITED LIABILITY COMPANY)
100 MAIN STREET
PAWTUCKET, RI 02860

FOR: VIDEO GAME DISCS, IN CLASS 9 (U.S. CLS. 21, 23, 26, 36 AND 38).

FIRST USE 7-6-2007; IN COMMERCE 7-6-2007.

THE MARK CONSISTS OF STANDARD CHARACTERS WITHOUT CLAIM TO ANY PARTICULAR FONT, STYLE, SIZE, OR COLOR.

SER. NO. 77-229,484, FILED 7-13-2007.

MATTHEW MCDOWELL, EXAMINING ATTORNEY

Int. Cl.: 43

Prior U.S. Cls.: 100 and 101

United States Patent and Trademark Office

Reg. No. 3,574,590

Registered Feb. 17, 2009

**SERVICE MARK
PRINCIPAL REGISTER**

PUREBREAD

PUREBREAD MANAGEMENT, INC. (DELA-
WARE CORPORATION)
SUITE 31
5201A WEST WOODMILL DRIVE
WILMINGTON, DE 19808

THE MARK CONSISTS OF STANDARD CHAR-
ACTERS WITHOUT CLAIM TO ANY PARTICULAR
FONT, STYLE, SIZE, OR COLOR.

FOR: CAFE-RESTAURANTS; DELICATESSENS,
IN CLASS 43 (U.S. CLS. 100 AND 101).

SER. NO. 77-229,581, FILED 7-13-2007.

FIRST USE 9-19-2001; IN COMMERCE 9-19-2001.

DOMINICK J. SALEMI, EXAMINING ATTORNEY

Int. Cl.: 36

Prior U.S. Cls.: 100, 101 and 102

United States Patent and Trademark Office

Reg. No. 3,574,591

Registered Feb. 17, 2009

**SERVICE MARK
PRINCIPAL REGISTER**

**WORLD MASTERCARD FOR
BUSINESS**

MASTERCARD INTERNATIONAL INCORPORATED (DELAWARE CORPORATION)
2000 PURCHASE STREET
PURCHASE, NY 105772509

FOR: FINANCIAL SERVICES, NAMELY, BANKING AND CREDIT CARD SERVICES; PROVIDING CREDIT CARD, DEBIT CARD, CHARGE CARD AND STORED VALUE PREPAID PURCHASE CARD SERVICES, NAMELY, PROCESSING ELECTRONIC PAYMENTS MADE THROUGH PREPAID CARDS; REMOTE CREDIT CARD PAYMENT PROCESSING SERVICES; STORED VALUE ELECTRONIC PURSE FINANCIAL SERVICES, NAMELY, PROVIDING ON-LINE STORED VALUE ACCOUNTS IN AN ELECTRONIC ENVIRONMENT; PROVIDING ELECTRONIC FUNDS AND CURRENCY TRANSFER SERVICES; ELECTRONIC COMMERCE PAYMENT SERVICES, NAMELY, ESTABLISHING FUNDED ACCOUNTS USED TO PURCHASE GOODS AND SERVICES ON THE INTERNET; PREPAID TELEPHONE CALLING CARD SERVICES; CASH DISBURSEMENT SERVICES IN THE NATURE OF AUTOMATED TELLER MACHINE SERVICES; CREDIT CARD TRANSACTION PROCESSING SERVICES, NAMELY, AUTHORIZATION AND SETTLEMENT OF CREDIT CARD TRANSACTIONS; PROVISION OF ELECTRONIC DEBIT AND CREDIT CARD TRANSACTIONS BY MEANS OF RADIO

FREQUENCY IDENTIFICATION DEVICES KNOWN AS TRANSPONDERS; TRAVEL INSURANCE UNDERWRITING SERVICES; CHEQUE VERIFICATION SERVICES; ISSUING AND REDEMPTION SERVICES ALL RELATING TO TRAVELERS CHEQUES AND TRAVEL VOUCHERS; BILL PAYMENT SERVICES PROVIDED THROUGH A WEBSITE; ON-LINE BANKING; FINANCIAL SERVICES, NAMELY, BANKING AND PAYMENT CARD SERVICES IN THE NATURE OF CREDIT, CASH, AND DEBIT CARD SERVICE, PROVIDED BY MEANS OF A GLOBAL COMPUTER NETWORK OR THE INTERNET, IN CLASS 36 (U.S. CLS. 100, 101 AND 102).

FIRST USE 10-17-2007; IN COMMERCE 10-17-2007.

THE MARK CONSISTS OF STANDARD CHARACTERS WITHOUT CLAIM TO ANY PARTICULAR FONT, STYLE, SIZE, OR COLOR.

NO CLAIM IS MADE TO THE EXCLUSIVE RIGHT TO USE "FOR BUSINESS", APART FROM THE MARK AS SHOWN.

SER. NO. 77-230,097, FILED 7-16-2007.

NELSON SNYDER, EXAMINING ATTORNEY

Int. Cls.: 35, 36 and 37

Prior U.S. Cls.: 100, 101, 102, 103 and 106

United States Patent and Trademark Office

Reg. No. 3,574,592

Registered Feb. 17, 2009

**SERVICE MARK
PRINCIPAL REGISTER**



MALCOLM PIRNIE, INC. (NEW YORK CORPORATION)
104 CORPORATE PARK DRIVE
WHITE PLAINS, NY 10602

FOR: BUSINESS MANAGEMENT CONSULTING, PERFORMANCE MEASUREMENT CONSULTING, AND ORGANIZATIONAL AND LEADERSHIP DEVELOPMENT CONSULTING , IN CLASS 35 (U.S. CLS. 100, 101 AND 102).

FIRST USE 1-1-2003; IN COMMERCE 1-1-2003.

FOR: FINANCIAL MANAGEMENT SERVICES AND ONGOING FINANCIAL CONSULTING SERVICES IN THE NATURE OF ECONOMIC ANALYSIS AND ESTABLISHMENT OF RATES AND CHARGES FOR UTILITIES, MUNICIPALITIES, STATE GOVERNMENTS, AND PUBLICLY-OWNED TREATMENT WORKS, IN CLASS 36 (U.S. CLS. 100, 101 AND 102).

FIRST USE 1-1-2003; IN COMMERCE 1-1-2003.

FOR: CONSULTING SERVICES FOR THE CONSTRUCTION OF WATER TREATMENT AND PURIFICATION PLANTS, SOLID WASTE TREATMENT PLANTS AND OTHER MUNICIPAL INFRASTRUCTURE FACILITIES, IN CLASS 37 (U.S. CLS. 100, 103 AND 106).

FIRST USE 1-1-2003; IN COMMERCE 1-1-2003.

NO CLAIM IS MADE TO THE EXCLUSIVE RIGHT TO USE "CONSULTING" AND "A DIVISION OF", APART FROM THE MARK AS SHOWN.

SER. NO. 77-230,637, FILED 7-16-2007.

SHARON MEIER, EXAMINING ATTORNEY

Int. Cl.: 44

Prior U.S. Cls.: 100 and 101

United States Patent and Trademark Office

Reg. No. 3,574,593

Registered Feb. 17, 2009

**SERVICE MARK
PRINCIPAL REGISTER**

HEALTHEASE

WELLCARE MANAGEMENT GROUP, INC., THE
(NEW YORK CORPORATION)
RENAISSANCE ONE
8725 HENDERSON ROAD
TAMPA, FL 33634

FOR: HEALTH CARE SERVICES IN THE NAT-
URE OF A HEALTH MAINTENANCE ORGANIZA-
TION FOR BENEFICIARIES OF GOVERNMENT-
SPONSORED HEALTH CARE PROGRAMS , IN
CLASS 44 (U.S. CLS. 100 AND 101).

FIRST USE 6-23-1994; IN COMMERCE 6-23-1994.

THE MARK CONSISTS OF STANDARD CHAR-
ACTERS WITHOUT CLAIM TO ANY PARTICULAR
FONT, STYLE, SIZE, OR COLOR.

SER. NO. 77-231,332, FILED 7-17-2007.

SUE LAWRENCE, EXAMINING ATTORNEY

Int. Cl.: 44

Prior U.S. Cls.: 100 and 101

United States Patent and Trademark Office

Reg. No. 3,574,594

Registered Feb. 17, 2009

**SERVICE MARK
PRINCIPAL REGISTER**



WELLCARE MANAGEMENT GROUP, INC., THE
(NEW YORK CORPORATION)
RENAISSANCE ONE
8725 HENDERSON ROAD
TAMPA, FL 33634

FOR: HEALTH CARE SERVICES IN THE NATURE OF A HEALTH MAINTENANCE ORGANIZATION FOR BENEFICIARIES OF GOVERNMENT-SPONSORED HEALTH CARE PROGRAMS , IN CLASS 44 (U.S. CLS. 100 AND 101).

FIRST USE 6-23-1994; IN COMMERCE 6-23-1994.

THE COLOR(S) BLUE AND WHITE IS/ARE CLAIMED AS A FEATURE OF THE MARK.

THE MARK CONSISTS OF A BLUE BOX WITH THE LETTERS "HE" WRITTEN DIAGONALLY FROM BOTTOM LEFT TO UPPER RIGHT THE COLOR BLUE APPEARS IN THE WORDING "HEALTH EASE" AS WELL AS IN THE BOX TO THE RIGHT OF THIS WORD, AND THE LETTERS "HE" WRITTEN DIAGONALLY FROM BOTTOM LEFT TO UPPER RIGHT WITHIN THE BLUE BOX ARE IN WHITE.

SER. NO. 77-231,453, FILED 7-17-2007.

SUE LAWRENCE, EXAMINING ATTORNEY

Int. Cls.: 9 and 11

Prior U.S. Cls.: 13, 21, 23, 26, 31, 34, 36 and 38

United States Patent and Trademark Office

Reg. No. 3,574,595

Registered Feb. 17, 2009

TRADEMARK
PRINCIPAL REGISTER

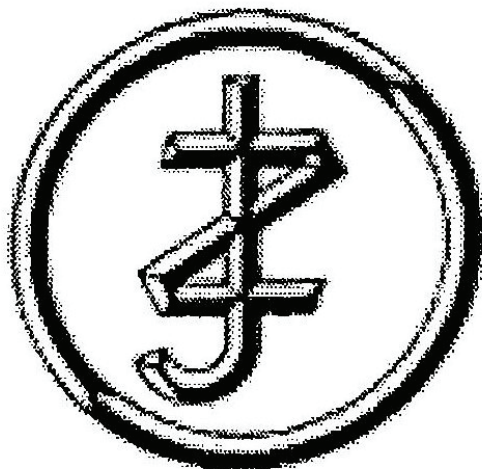

Z & J TECHNOLOGIES GMBH (FED REP GER-
MANY LIMITED LIABILITY COMPANY)
BAHNSTRABE 52
DUREN, FED REP GERMANY D-52355

FOR: CONTROL VALVES FOR ISOLATING THE
FLOW OF GASES AND LIQUIDS, IN CLASS 9 (U.S.
CLS. 21, 23, 26, 36 AND 38).

FIRST USE 11-0-1956; IN COMMERCE 11-0-1956.

FOR: SPARK IGNITERS FOR GAS APPLIANCES,
GAS BURNERS, IN CLASS 11 (U.S. CLS. 13, 21, 23, 31
AND 34).

FIRST USE 11-0-1956; IN COMMERCE 11-0-1956.

OWNER OF U.S. REG. NOS. 821,028 AND 1,885,824.

THE STIPPLING IS FOR SHADING PURPOSES
ONLY.

THE MARK CONSISTS OF LETTERS "Z" AND "J"
COMBINED WITHIN A CIRCLE.

SER. NO. 77-231,705, FILED 7-17-2007.

JANET LEE, EXAMINING ATTORNEY

Int. Cl.: 16

Prior U.S. Cls.: 2, 5, 22, 23, 29, 37, 38 and 50

United States Patent and Trademark Office

Reg. No. 3,574,596

Registered Feb. 17, 2009

**TRADEMARK
PRINCIPAL REGISTER**

Listen, Write, and Read

WICKHAM, PAUL (UNITED STATES INDIVIDUAL)
3929 E. 3RD ST.
LONG BEACH, CA 90814

THE MARK CONSISTS OF STANDARD CHARACTERS WITHOUT CLAIM TO ANY PARTICULAR FONT, STYLE, SIZE, OR COLOR.

FOR: PRINTED INSTRUCTIONAL, EDUCATIONAL AND TEACHING MATERIALS IN THE FIELD OF DICTATION, IN CLASS 16 (U.S. CLS. 2, 5, 22, 23, 29, 37, 38 AND 50).

SER. NO. 77-232,068, FILED 7-17-2007.

FIRST USE 4-28-2007; IN COMMERCE 4-28-2007.

HOWARD SMIGA, EXAMINING ATTORNEY

Int. Cls.: 35 and 42

Prior U.S. Cls.: 100, 101 and 102

United States Patent and Trademark Office

Reg. No. 3,574,597

Registered Feb. 17, 2009

**SERVICE MARK
PRINCIPAL REGISTER**

HEALTHY SCHOOLS BUILDER

AMERICAN HEART ASSOCIATION, INC. (NEW YORK CORPORATION)
7272 GREENVILLE AVENUE
DALLAS, TX 752314596 AND
WILLIAM J. CLINTON FOUNDATION, THE (ARKANSAS NON-PROFIT CORPORATION)
1200 PRESIDENT CLINTON AVENUE
LITTLE ROCK, AR 72201

FOR: PROMOTING PUBLIC AWARENESS OF THE NEED FOR HEALTHY LIFESTYLE CHOICES ONLINE VIA GLOBAL COMPUTER NETWORK TO ENABLE SCHOOLS AND SCHOOL DISTRICTS TO PROMOTE A HEALTHIER SCHOOL ENVIRONMENT THROUGH HEALTHY EATING, PHYSICAL ACTIVITY AND STAFF WELLNESS, IN CLASS 35 (U.S. CLS. 100, 101 AND 102).

FIRST USE 8-11-2006; IN COMMERCE 8-11-2006.

FOR: PROVIDING A WEBSITE FEATURING TEMPORARY USE OF NON-DOWNLOADABLE

SOFTWARE THAT ALLOWS USERS TO CREATE CUSTOMIZED ACTION PLANS FOR THE PROMOTION OF A HEALTHIER SCHOOL ENVIRONMENT THROUGH HEALTHY EATING, PHYSICAL ACTIVITY, AND STAFF WELLNESS, IN CLASS 42 (U.S. CLS. 100 AND 101).

FIRST USE 8-11-2006; IN COMMERCE 8-11-2006.

THE MARK CONSISTS OF STANDARD CHARACTERS WITHOUT CLAIM TO ANY PARTICULAR FONT, STYLE, SIZE, OR COLOR.

NO CLAIM IS MADE TO THE EXCLUSIVE RIGHT TO USE "HEALTHY SCHOOLS", APART FROM THE MARK AS SHOWN.

SER. NO. 77-232,556, FILED 7-18-2007.

AMY C. KEAN, EXAMINING ATTORNEY

Int. Cl.: 32

Prior U.S. Cls.: 45, 46 and 48

United States Patent and Trademark Office

Reg. No. 3,574,598

Registered Feb. 17, 2009

**TRADEMARK
PRINCIPAL REGISTER**

NIGHTSTAR

THE COCA-COLA COMPANY (DELAWARE
CORPORATION)
ONE COCA-COLA PLAZA
ATLANTA, GA 30313

FOR: CARBONATED BEVERAGES AND OTHER
NON-ALCOHOLIC BEVERAGES, NAMELY, SOFT
DRINKS, FRUIT DRINKS AND FRUIT JUICES;
SYRUPS, CONCENTRATES AND POWDERS FOR
MAKING BEVERAGES, NAMELY, SOFT DRINKS,
FRUIT DRINKS AND FRUIT JUICES, IN CLASS 32
(U.S. CLS. 45, 46 AND 48).

THE MARK CONSISTS OF STANDARD CHAR-
ACTERS WITHOUT CLAIM TO ANY PARTICULAR
FONT, STYLE, SIZE, OR COLOR.

PRIORITY CLAIMED UNDER SEC. 44(D) ON
UNITED KINGDOM APPLICATION NO. 2443962,
FILED 1-18-2007, REG. NO. 2443962, DATED 1-18-
2007, EXPIRES 1-18-2017.

SER. NO. 77-232,657, FILED 7-18-2007.

DANNEAN HETZEL, EXAMINING ATTORNEY

Int. Cl.: 45

Prior U.S. Cls.: 100 and 101

United States Patent and Trademark Office

Reg. No. 3,574,599

Registered Feb. 17, 2009

**SERVICE MARK
PRINCIPAL REGISTER**

HARD-SHELL NEST EGG

BAILEY, OLEN M. JR. (UNITED STATES INDIVIDUAL)
5100 WHEELIS DR., STE. 215
MEMPHIS, TN 38117

THE MARK CONSISTS OF STANDARD CHARACTERS WITHOUT CLAIM TO ANY PARTICULAR FONT, STYLE, SIZE, OR COLOR.

FOR: LEGAL DOCUMENT PREPARATION AND RESEARCH SERVICES FOR ATTORNEYS; LEGAL SERVICES, IN CLASS 45 (U.S. CLS. 100 AND 101).

SER. NO. 77-233,715, FILED 7-19-2007.

FIRST USE 7-1-2007; IN COMMERCE 10-11-2008.

CHRISTINE COOPER, EXAMINING ATTORNEY

Int. Cls.: 1, 5, 9, 10 and 16

Prior U.S. Cls.: 1, 2, 5, 6, 10, 18, 21, 22, 23, 26, 29, 36, 37, 38, 39, 44, 46, 50, 51 and 52

Reg. No. 3,574,600

United States Patent and Trademark Office

Registered Feb. 17, 2009

**TRADEMARK
PRINCIPAL REGISTER**



COVIDIEN

COVIDIEN AG (SWITZERLAND CORPORATION)
VICTOR VON BRUNS-STRASSE 19
NEUHAUSEN AM RHEINFALL, SWITZERLAND
8212

FOR: CHEMICALS FOR LABORATORY USE; CHEMICALS AND CHEMICAL ADDITIVES FOR THE MANUFACTURE OF PHARMACEUTICALS, MEDICAL PRODUCTS, FOOD AND MICROELECTRONIC DEVICES; CHEMICALS USED IN THE FIELD OF PROCESS CHROMATOGRAPHY; REAGENTS FOR CHEMICAL OR BIOLOGICAL ANALYSIS; CHEMICAL COMPOSITIONS FOR SOLIDIFICATION AND ABSORPTION OF FLUIDS AND LIQUIDS; CHEMICAL SPILL CLEAN UP KITS COMPRISED PRIMARILY OF CHEMICAL COMPOSITIONS FOR SOLIDIFICATION AND ABSORPTION OF FLUIDS AND LIQUIDS; CHEMICAL ANTI FOG PREPARATIONS, IN CLASS 1 (U.S. CLS. 1, 5, 6, 10, 26 AND 46).

FOR: PHARMACEUTICALS AND PHARMACEUTICAL INGREDIENTS SOLD AS INTEGRAL COMPONENTS OF FINISHED PHARMACEUTICALS, NAMELY, PREPARATIONS FOR THE TREATMENT OF NEUROLOGICAL, LEARNING, BEHAVIORAL, SLEEPING, ATTENTION DEFICIT AND ATTENTION DEFICIT HYPERACTIVITY DISORDERS, SUBSTANCE ABUSE, COLD AND FLU SYMPTOMS, ALLERGIES, DEPRESSION AND PAIN; MEDICATED SKIN CARE PREPARATIONS; CLEANSING SOLUTIONS FOR MEDICAL AND SURGICAL USE; DISINFECTING HAND AND BODY WASH FOR USE BEFORE SURGERY; SURGICAL PAINTS TO MARK THE HUMAN BODY BEFORE SURGERY; MEDICAL GELS FOR CONDUCTIVITY AND IMAGING PURPOSES; BIOMATERIAL SURGICAL SEALANTS AND ADHESION BARRIERS; TOPICAL HUMAN TISSUE ADHESIVES; MEDICAL AND SURGICAL ANTI-ADHESIVES AND RESORBABLE HYDROPHILIC ADHESION-PREVENTION FILMS; CONTRAST MEDIA, DYES AND RADIOISOTOPES FOR MEDICAL IMAGING AND DIAGNOSTIC PURPOSES; CHEMICAL SOLUTIONS TO FILL AND FLUSH CATHETERS; PREFILLED SYRINGES CONTAINING CONTRAST MEDIA FOR IMAGING PURPOSES; SURGICAL AND WOUND DRESSINGS, SPONGES, PADS, AND TAPES; INCONTINENCE PADS, DIAPERS AND GARMENTS; DIETETIC FOOD AND PREPARATIONS FOR MEDICAL USE; ENTERAL FEEDING PREPARATIONS; NUTRITIONAL AND FOOD SUPPLEMENTS FOR MEDICAL PURPOSES; MEDICAL WAX; MEDICAL BANDAGES, NAMELY, ADHESIVE BANDAGES, BANDAGES FOR SKIN WOUNDS, BANDAGES FOR DRESSINGS AND/OR SURGICAL BANDAGES, IN CLASS 5 (U.S. CLS. 6, 18, 44, 46, 51 AND 52).

FOR: COMPUTER SOFTWARE AND FIRMWARE FOR USE IN OPERATING ELECTROSURGICAL GENERATORS, MRI DIAGNOSTIC APPARATUS, SLEEP DIAGNOSTIC APPARATUS AND SLEEP THERAPY APPARATUS; COMPUTER SOFTWARE USED FOR PATIENT RECORD MANAGEMENT; ELECTRONIC THERMOMETERS FOR LABORATORY USE; TEMPERATURE SENSORS AND MONITORS; PROTECTIVE CLOTHING, PROTECTIVE MASKS; NEEDLE AND BLADE COUNTING APPARATUS; ALKALINE BATTERIES, IN CLASS 9 (U.S. CLS. 21, 23, 26, 36 AND 38).

FOR: MEDICAL AND SURGICAL APPARATUS AND INSTRUMENTS, NAMELY, MEDICAL, SURGICAL AND PATIENT HEALTH SENSORS, SCANNERS, DETECTORS, METERS AND MONITORS ALL FOR USE IN MEASURING AND MONITORING THE VITAL FUNCTIONS IN HUMANS AND ANIMALS AND ELECTRODES, CABLES AND LEAD WIRES AS ACCESSORIES THEREFOR; MEDICAL AND THERAPEUTIC PUMPS FOR ENTERAL

FEEDING; AIR PUMPS TO BE USED AS PART OF MEDICAL VENTILATION SYSTEMS; DRUG DELIVERY SYSTEMS, AND INFUSION SETS; PAIN MANAGEMENT SYSTEMS PRIMARILY COMPOSED OF ELECTRICAL GENERATORS AND ELECTRODES; MEDICAL IMAGING APPARATUS FOR UROLOGICAL EXAMINATIONS; MEDICAL APPARATUS FOR THE TREATMENT OF PULMONARY DISORDERS AND CONDITIONS, NAMELY, PORTABLE AND STATIONERY OXYGEN THERAPY UNITS PRIMARILY COMPOSED OF AN OXYGEN RESERVOIR, A CONTROL UNIT AND TUBING; MEDICAL VENTILATION AND RESPIRATION SYSTEMS PRIMARILY COMPOSED OF MEDICAL VENTILATORS, MEDICAL RESPIRATORS, INHALERS AND NEBULIZERS; SURGICAL SCRUB SUITS, SURGICAL MASKS; MEDICAL AND SURGICAL GLOVES; APPARATUS FOR DRAWING BLOOD; CONTAINERS AND BAGS FOR MEDICAL WASTE AND BRACKETS THEREFOR; MEDICAL, SURGICAL AND DENTAL NEEDLES AND SYRINGES; MEDICAL NEEDLE HOLDERS AND NEEDLE TRAYS; CANNULAS, SCALPELS AND LANCETS FOR MEDICAL AND SURGICAL USE; BLOOD AND SPECIMEN COLLECTION TUBES, BAGS, CONTAINERS AND TRAYS; GUIDE WIRES FOR MEDICAL AND SURGICAL USE; MEDICAL AND SURGICAL TUBES AND CATHETERS; MEDICAL AND SURGICAL CHEST DRAINAGE APPARATUS; VASCULAR ACCESS SYSTEMS COMPOSED OF DILATORS, RADIALLY EXPANDABLE SLEEVES, REDUCERS AND SEALS; VASCULAR COMPRESSION SYSTEMS PRIMARILY COMPOSED OF ELECTRONIC CONTROLLER, TUBING AND MEDICAL LEG GARMENTS; ELASTIC STOCKINGS FOR MEDICAL USE; SEALS FOR MEDICAL BOTTLES, VIALS AND BAGS; SEALS FOR SYRINGES AND MEDICATION CONTAINERS. PATIENT SAFETY RESTRAINTS, NAMELY, HEAD AND BODY RESTRAINTS, HARNESES AND SURGICAL POSITIONERS; ELECTRIC BLANKETS FOR MEDICAL AND SURGICAL PURPOSES; HOT AND COLD PACKS FOR MEDICAL USE; ENTERAL FEEDING PUMPS, TUBES AND BAGS; INCONTINENCE BED PADS AND BED PROTECTORS; BRONCHIAL, TRACHEAL AND TRACHEOSTOMY TUBES; MEDICAL EQUIPMENT USED IN THE DIAGNOSIS AND TREATMENT OF SLEEP DISORDERS, NAMELY, RECORDING SYSTEMS, MASKS, HEADGEAR AND OXYGEN UNITS; RESUSCITATION APPARATUS AND BAGS; SURGICAL ASPIRATORS AND TUBING THEREFOR; MEDICAL SMOKE EVACUATOR SYSTEMS FOR CAPTURING AND FILTERING SMOKE DURING ELECTROSURGICAL PROCEDURES AND EVACUATOR TOOLS, TUBES AND TIPS TO BE USED THEREWITH; ARGON GAS DELIVERY UNITS FOR MEDICAL USE; BREATHING MASKS FOR SURGICAL PROCEDURES; WOUND DRAINAGE APPARATUS; SURGICAL IMPLANTS, NAMELY, ABSORBABLE AND NON-ABSORBABLE MESH; SURGICAL IMPLANTS COMPRISING ARTIFICIAL MATERIAL; SURGICAL INSTRUMENTS FOR USE WITH IMPLANTS; MEDICAL THERMOMETERS AND TEMPERA-

TURE PROBE; POWER INJECTORS FOR CONTRAST MEDIA IMAGING INJECTION PROCEDURES; PULSE OXIMETRY SENSORS AND CABLES USED AND SOLD THEREWITH; SUTURES, SUTURE ANCHORS, SUTURE LIGATURES, SUTURING NEEDLES AND DEVICES; ELECTROSURGICAL GENERATORS AND DEVICES AND ELECTRODES TO BE USED THEREWITH; MEDICAL AND SURGICAL VESSEL AND TISSUE SEALING DEVICES; ENDOSCOPIC AND LAPAROSCOPIC INSTRUMENTS AND DEVICES; SURGICAL TROCARS, BALLOON TROCARS, SURGICAL BALLOONS AND BALLOON DISSECTORS; STENTS; BIPOLAR SCISSORS FOR SURGICAL USE; SURGICAL DEVICES IN THE NATURE OF AORTIC PUNCHES; MEDICAL AND SURGICAL INSUFFLATION NEEDLES, LIGATING LOOPS, KNOT PUSHERS, DISSECTORS, CLAMPS, GRASPERS AND RETRACTORS; SURGICAL ANCHORING DEVICES, NAMELY DRILL GUIDES AND BITS; SURGICAL DRILL GUIDE OBTURATORS; SURGICAL CLIP APPLIERS; SURGICAL TISSUE FIXATION DEVICES; MEDICAL AND SURGICAL STAPLERS AND FASTENERS. IRRIGATION SYSTEMS FOR CLEANSING BODY CAVITIES PRIMARILY COMPRISED OF SYRINGE, DISINFECTANT PREPARATION PAD AND PROTECTOR CAP; MEDICAL AND SURGICAL STERILIZATION TRAYS; VEIN HARVEST SYSTEMS AND DEVICES COMPRISED OF BALLOON DISSECTOR AND RETRACTOR; MEDICAL BANDAGES, NAMELY, BANDAGES FOR ANATOMICAL JOINTS, COMPRESSION BANDAGES, ELASTIC BANDAGES, SUPPORT BANDAGES AND/OR SUPPORTIVE BANDAGES; PADS FOR ABSORPTION OF MEDICAL WASTE NOT WORN ON THE BODY, IN CLASS 10 (U.S. CLS. 26, 39 AND 44).

FOR: PRINTED EDUCATIONAL AND INSTRUCTIONAL MATERIALS, NAMELY, PAMPHLETS, BOOKS AND BOOKLETS CONCERNING HUMAN HEALTH AND DISPENSING OF PHARMACEUTICALS; MEDICAL CHARTING PAPER AND PRINTED MEDICAL LABELS, NAMELY, PRINTED MEDICAL LABELS MADE OF PAPER OR CARDBOARD AND ADHESIVE LABELS; DISPOSABLE DIAPERS AND TRAINING PANTS, IN CLASS 16 (U.S. CLS. 2, 5, 22, 23, 29, 37, 38 AND 50).

PRIORITY CLAIMED UNDER SEC. 44(D) ON SWITZERLAND APPLICATION NO. 50831/2007, FILED 1-23-2007, REG. NO. 555920, DATED 1-23-2007, EXPIRES 1-23-2017.

THE MARK CONSISTS OF TWO BLOCK LETTER "C'S", WITH ONE REVERSED SO THEY ARE FACING EACH OTHER AND WITH SQUARES FILLING IN THE SPACE BETWEEN THE "C'S", COMBINED WITH THE DESIGNATION "COVDIEN".

SER. NO. 77-233,852, FILED 7-19-2007.

DANIEL CAPSHAW, EXAMINING ATTORNEY

Int. Cls.: 35 and 43

Prior U.S. Cls.: 100, 101 and 102

United States Patent and Trademark Office

Reg. No. 3,574,601

Registered Feb. 17, 2009

**SERVICE MARK
PRINCIPAL REGISTER**



B2 BURRITO BISTRO, INC (MASSACHUSETTS CORPORATION), DBA BURRITO BISTRO
790 IYANNOUGH RD
HYANNIS, MA 02601

FOR: ASSOCIATION SERVICES, NAMELY, PROMOTING DIVERSITY IN THE RESTAURANT AND HOTEL INDUSTRIES ON BEHALF OF EMPLOYEES, VENDORS, MANAGEMENT, AND OWNERS; FRANCHISING, NAMELY, OFFERING TECHNICAL ASSISTANCE IN THE ESTABLISHMENT AND/OR OPERATION OF RESTAURANTS FEATURING FOOD AND BEVERAGES; OFFERING TECHNICAL ASSISTANCE IN THE ESTABLISHMENT AND/OR OPERATION OF RESTAURANTS; ON-LINE ORDERING SERVICES IN THE FIELD OF RESTAURANT TAKE-OUT AND DELIVERY; RESTAURANT FRANCHISING; RESTAURANT MANAGEMENT FOR OTHERS; CHARITABLE SERVICES, NAMELY, COORDINATION OF THE PROCUREMENT AND DISTRIBUTION OF FOOD DONATIONS FROM MANUFACTURERS, WHOLESALE, RETAILERS, AND GOVERNMENT AGENCIES TO ORGANIZATIONS PROVIDING FREE FOOD TO NEEDY PEOPLE; WHOLESALE DISTRIBUTORSHIPS FEATURING FOOD AND BEVERAGES; WHOLESALE ORDERING SERVICES IN THE FIELD OF FOOD AND BEVERAGES; WHOLESALE STORES FEATURING FOOD AND BEVERAGES; RETAIL BAKERY SHOPS; RETAIL DELICATESSEN SERVICES; RETAIL GROCERY STORES; RETAIL SHOPS FEATURING FOOD AND BEVERAGES; RETAIL STORE SERVICES FEATURING FOOD AND

BEVERAGES; RETAIL STORES FEATURING FOOD AND BEVERAGES; TEMPORARY RETAIL STORES SET UP ON-SITE AT SCHOOLS TO PROVIDE SHOPPING FACILITIES FOR STUDENTS, IN CLASS 35 (U.S. CLS. 100, 101 AND 102).

FIRST USE 5-0-2005; IN COMMERCE 5-0-2005.

FOR: CAFE-RESTAURANTS; CARRY-OUT RESTAURANTS; DELICATESSENS; FAST FOOD AND NON-STOP RESTAURANT SERVICES; FAST-FOOD RESTAURANTS; FAST-FOOD RESTAURANTS AND SNACKBARS; HOTEL, BAR AND RESTAURANT SERVICES; PROVIDING ADVICE TO TOURISTS AND BUSINESS TRAVELERS ON HOTEL AND RESTAURANT DESTINATIONS; PROVIDING ON-LINE REVIEWS OF RESTAURANTS AND HOTELS; PROVIDING PROGRESSIVE DINNER EVENTS WHERE PARTICIPANTS SAMPLE MEALS AND DRINKS AT A SERIES OF RESTAURANTS; PROVIDING REVIEWS OF RESTAURANTS; RESERVATION OF RESTAURANTS; RESTAURANT AND BAR SERVICES; RESTAURANT SERVICES; RESTAURANTS; RESTAURANTS FEATURING HOME DELIVERY; SELF SERVICE RESTAURANTS; SELF-SERVICE RESTAURANTS; TAKE-OUT RESTAURANT SERVICES; TRAVEL AGENCY SERVICES, NAMELY, MAKING RESERVATIONS AND BOOKINGS FOR RESTAURANTS AND MEALS, IN CLASS 43 (U.S. CLS. 100 AND 101).

FIRST USE 5-0-2005; IN COMMERCE 5-0-2005.

NO CLAIM IS MADE TO THE EXCLUSIVE RIGHT TO USE "BURRITO BISTRO", APART FROM THE MARK AS SHOWN.

THE MARK CONSISTS OF A DESIGN COMPRISED OF THREE CONCENTRIC CIRCLES WITH A DESIGN COMPRISED OF SEVERAL BRUSH STROKES IN A CIRCULAR SWIRLING PATTERN IN THE INNERMOST CIRCLE, THE LITERAL ELE-

MENT, "BURRITO BISTRO", AND TWO DESIGNS REPRESENTING FLAMES SEPARATING THE WORDING IN THE LITERAL ELEMENT, IN THE MIDDLE CIRCLE, AND A PLAIN LINE OUTER CIRCLE.

SER. NO. 77-234,834, FILED 7-20-2007.

PAUL CROWLEY, EXAMINING ATTORNEY

Int. Cls.: 35, 38 and 41

Prior U.S. Cls.: 100, 101, 102, 104 and 107

United States Patent and Trademark Office

Reg. No. 3,574,602

Registered Feb. 17, 2009

**SERVICE MARK
PRINCIPAL REGISTER**

HOPE HOUSE

HOPE HOUSE (D.C. NON-PROFIT CORPORATION)
600 13TH STREET, NW
WASHINGTON, DC 20005

FOR: PROMOTING THE INTERESTS OF INCARCERATED PERSONS AND THEIR FAMILIES, IN CLASS 35 (U.S. CLS. 100, 101 AND 102).

FIRST USE 6-0-2002; IN COMMERCE 6-0-2002.

FOR: CHARITABLE SERVICES, NAMELY, PROVIDING VIDEO CONFERENCE SERVICES TO INCARCERATED PERSONS AND THEIR FAMILIES, IN CLASS 38 (U.S. CLS. 100, 101 AND 104).

FIRST USE 11-0-1999; IN COMMERCE 11-0-1999.

FOR: CHARITABLE SERVICES, NAMELY, OPERATING SUMMER CAMPS FOR INCARCERATED PERSONS AND THEIR FAMILIES; CHARITABLE SERVICES, NAMELY, ORGANIZING AND CONDUCTING MOTIVATIONAL AND EDUCATIONAL

SPEAKER SERVICES FOR INCARCERATED PERSONS AND THEIR FAMILIES; CHARITABLE SERVICES, NAMELY, ORGANIZING YOUTH GROUPS CONSISTING OF CHILDREN OF INCARCERATED PERSONS TO ENGAGE IN RECREATIONAL AND COMMUNITY SERVICE ACTIVITIES; CHARITABLE SERVICES, NAMELY, AUDIO TAPE RECORDING READING SESSIONS FOR THE FAMILIES OF INCARCERATED PERSONS, IN CLASS 41 (U.S. CLS. 100, 101 AND 107).

FIRST USE 11-0-1999; IN COMMERCE 11-0-1999.

THE MARK CONSISTS OF STANDARD CHARACTERS WITHOUT CLAIM TO ANY PARTICULAR FONT, STYLE, SIZE, OR COLOR.

SER. NO. 77-236,226, FILED 7-23-2007.

JACQUELINE A. LAVINE, EXAMINING ATTORNEY

Int. Cls.: 35, 38 and 41

Prior U.S. Cls.: 100, 101, 102, 104 and 107

United States Patent and Trademark Office

Reg. No. 3,574,603

Registered Feb. 17, 2009

**SERVICE MARK
PRINCIPAL REGISTER**

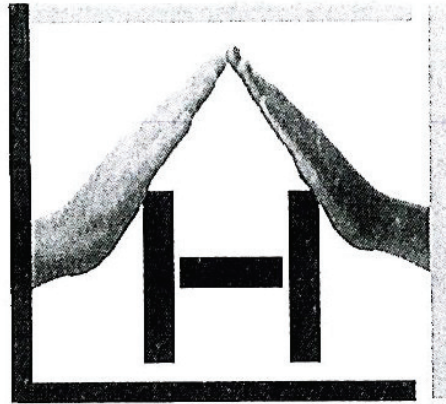

HOPE HOUSE (D.C. NON-PROFIT CORPORATION)
600 13TH STREET, NW
WASHINGTON, DC 20005

FOR: PROMOTING THE INTERESTS OF INCARCERATED PERSONS AND THEIR FAMILIES, IN CLASS 35 (U.S. CLS. 100, 101 AND 102).

FIRST USE 6-0-2002; IN COMMERCE 6-0-2002.

FOR: CHARITABLE SERVICES, NAMELY, PROVIDING VIDEO CONFERENCE SERVICES TO INCARCERATED PERSONS AND THEIR FAMILIES, IN CLASS 38 (U.S. CLS. 100, 101 AND 104).

FIRST USE 11-0-1999; IN COMMERCE 11-0-1999.

FOR: CHARITABLE SERVICES, NAMELY, OPERATING SUMMER CAMPS FOR INCARCERATED PERSONS AND THEIR FAMILIES; CHARITABLE SERVICES, NAMELY, ORGANIZING AND CONDUCTING MOTIVATIONAL AND EDUCATIONAL

SPEAKER SERVICES FOR INCARCERATED PERSONS AND THEIR FAMILIES; CHARITABLE SERVICES, NAMELY, ORGANIZING YOUTH GROUPS CONSISTING OF CHILDREN OF INCARCERATED PERSONS TO ENGAGE IN RECREATIONAL AND COMMUNITY SERVICE ACTIVITIES; CHARITABLE SERVICES, NAMELY, AUDIO TAPE RECORDING READING SESSIONS FOR THE FAMILIES OF INCARCERATED PERSONS, IN CLASS 41 (U.S. CLS. 100, 101 AND 107).

FIRST USE 11-0-1999; IN COMMERCE 11-0-1999.

THE MARK CONSISTS OF A BOX ENCOMPASSING A HOUSE COMPOSED OF TWO HANDS FORMING THE ROOF AND THE LETTER "H" FORMING THE FOUNDATION.

SER. NO. 77-236,284, FILED 7-23-2007.

JACQUELINE A. LAVINE, EXAMINING ATTORNEY

Int. Cl.: 35

Prior U.S. Cls.: 100, 101 and 102

United States Patent and Trademark Office

Reg. No. 3,574,604

Registered Feb. 17, 2009

**SERVICE MARK
PRINCIPAL REGISTER**



I LOVE BAGELS, INC. (CALIFORNIA CORPORATION)
2 COMPADRE CIRCLE
LAGUNA NIGUEL, CA 92677

FOR: RETAIL DELICATESSEN SERVICES; RETAIL BAKERY SHOPS, IN CLASS 35 (U.S. CLS. 100, 101 AND 102).

FIRST USE 9-0-1989; IN COMMERCE 9-0-1989.

NO CLAIM IS MADE TO THE EXCLUSIVE RIGHT TO USE "BAGELS", APART FROM THE MARK AS SHOWN.

THE COLOR(S) RED AND BLACK IS/ARE CLAIMED AS A FEATURE OF THE MARK.

THE MARK CONSISTS OF THE SLOGAN "THE HEALTHY WAY TO START YOUR DAY" PRINTED IN QUOTES AND IN THE COLOR BLACK ABOVE THE PHRASE "I LOVE BAGELS" PRINTED IN BLACK; HOWEVER THE WORD "LOVE" IS REPLACED WITH A RED HEART LOGO.

SER. NO. 77-238,135, FILED 7-25-2007.

SETH A. RAPPAPORT, EXAMINING ATTORNEY

Int. Cls.: 9, 16 and 42

Prior U.S. Cls.: 2, 5, 21, 22, 23, 26, 29, 36, 37, 38, 50,
100 and 101

Reg. No. 3,574,605

United States Patent and Trademark Office

Registered Feb. 17, 2009

TRADEMARK
SERVICE MARK
PRINCIPAL REGISTER



SILICON SENSING SYSTEMS LIMITED (UNITED KINGDOM CORPORATION)
CLITTAFORD ROAD
SOUTHWAY, PLYMOUTH, UNITED KINGDOM
PL66DE

FOR: VIBRATING ELEMENT RATE OF TURN GYROSCOPES, VIBRATING ELEMENT ANGULAR RATE SENSORS, AND MICRO-MACHINED MULTI-AXIS ACCELEROMETERS; AND PARTS AND FITTINGS FOR THE AFOREMENTIONED GOODS; VIDEOS AND FILMS, NAMELY, PRE-RECORDED STORAGE MEDIA FEATURING GYROSCOPES, ANGULAR RATE SENSORS AND ACCELEROMETERS AND CINEMATOGRAPHIC FILMS FEATURING GYROSCOPES, ANGULAR RATE SENSORS AND ACCELEROMETERS, IN CLASS 9 (U.S. CLS. 21, 23, 26, 36 AND 38).

FOR: NOTEPAPER; PHOTOGRAPHS; PRINTED EDUCATIONAL AND INSTRUCTIONAL MATERIAL RELATING TO GYROSCOPES, ANGULAR RATE SENSORS AND ACCELEROMETERS; BROCHURES RELATING TO GYROSCOPES, ANGULAR RATE SENSORS AND ACCELEROMETERS; PRINTED REPORTS IN THE FIELD OF GYROSCOPES, ANGULAR RATE SENSORS AND ACCELEROMETERS; PRINTED ADVERTISING PAMPHLETS AND BROCHURES RELATING TO GYROSCOPES, ANGULAR RATE SENSORS AND

ACCELEROMETERS, IN CLASS 16 (U.S. CLS. 2, 5, 22, 23, 29, 37, 38 AND 50).

FOR: RESEARCH, DESIGN, ANALYSIS AND DEVELOPMENT SERVICES RELATING TO VIBRATING ELEMENT RATE OF TURN GYROSCOPES, VIBRATING ELEMENT ANGULAR RATE SENSORS AND MICRO-MACHINED MULTI-AXIS ACCELEROMETERS, IN CLASS 42 (U.S. CLS. 100 AND 101).

OWNER OF ERPN CMNTY TM OFC REG. NO. 003587664, DATED 1-4-2007, EXPIRES 12-17-2013.

OWNER OF U.S. REG. NO. 2,735,880.

NO CLAIM IS MADE TO THE EXCLUSIVE RIGHT TO USE "SILICON SENSING", APART FROM THE MARK AS SHOWN.

THE MARK CONSISTS OF THE WORD "SILICON" CENTERED OVER THE WORD "SENSING" WITH A SUN DESIGN AFTER THE WORD "SILICON".

THE WORDING "SILICON SENSING" HAS NO MEANING IN A FOREIGN LANGUAGE.

SER. NO. 77-239,831, FILED 7-26-2007.

KELLEY WELLS, EXAMINING ATTORNEY

Int. Cl.: 38

Prior U.S. Cls.: 100, 101 and 104

United States Patent and Trademark Office

Reg. No. 3,574,606

Registered Feb. 17, 2009

**SERVICE MARK
PRINCIPAL REGISTER**

**CHARTER BRINGS YOUR HOME
TO LIFE**

CHARTER COMMUNICATIONS HOLDING
COMPANY, LLC (DELAWARE LIMITED LIABILITY COMPANY)
12405 POWERSCOURT DRIVE
ST. LOUIS, MO 63131

FOR: PROVIDING COMMUNICATIONS CONNECTIONS TO GLOBAL COMPUTER NETWORKS AND LOCAL AND WIDE AREA COMPUTER AND TELEPHONE NETWORK SYSTEMS BY MEANS OF FIBER OPTIC AND COAXIAL CABLES; VOICE OVER INTERNET PROTOCOL TELEPHONY SERVICES; TELECOMMUNICATIONS SERVICES PROVIDED VIA PREPAID TELEPHONE CALLING CARDS, NAMELY, LOCAL AND LONG DISTANCE TRANSMISSION OF VOICE, DATA, AND GRAPHICS BY MEANS OF PREPAID TELEPHONE CALLING CARDS; ELECTRONIC, ELECTRIC AND DIGITAL TRANSMISSION OF VIDEO AND VOICE, NAMELY, VIDEO AND VOICE CONFERENCE TRANSMISSION SERVICES; PROVIDING FACILITIES AND EQUIPMENT FOR VIDEO AND VOICE CONFERENCING; VIRTUAL PRIVATE NETWORK SERVICES, NAMELY, PROVIDING ACCESS TO A VIRTUAL PRIVATE NETWORK FOR REMOTE SITES; ELECTRONIC TRANSMISSION OF DATA, SOUND, IMAGES AND VIDEO TO SUPPORT DISTANCE EDUCATION NETWORKS, AND PROVIDING MULTIPLE-USER ACCESS TO A GLOBAL

COMPUTER NETWORK; BROADBAND COMMUNICATIONS SERVICES, NAMELY, ANALOG AND DIGITAL CABLE TELEVISION TRANSMISSION SERVICES, NAMELY, PROVIDING MULTIPLE-USER ACCESS TO THE INTERNET, VIDEO ON DEMAND TRANSMISSION SERVICES, TRANSMISSION OF INTERACTIVE TELEVISION PROGRAMS AND TRANSMISSION OF HIGH-DEFINITION TELEVISION PROGRAMS; PROVIDING HOME AND OFFICE TELEPHONE SERVICES, NAMELY, LOCAL AND LONG DISTANCE TRANSMISSION OF VOICE, DATA, GRAPHICS AND VIDEO BY MEANS OF BROADBAND, COPPER AND OPTICAL OR WIRELESS NETWORKS, IN CLASS 38 (U.S. CLS. 100, 101 AND 104).

FIRST USE 6-15-2007; IN COMMERCE 6-15-2007.

THE MARK CONSISTS OF STANDARD CHARACTERS WITHOUT CLAIM TO ANY PARTICULAR FONT, STYLE, SIZE, OR COLOR.

OWNER OF U.S. REG. NOS. 3,196,133, 3,219,707, AND 3,221,579.

SER. NO. 77-239,891, FILED 7-26-2007.

EDWARD FENNESSY, EXAMINING ATTORNEY

Int. Cl.: 33

Prior U.S. Cls.: 47 and 49

United States Patent and Trademark Office

Reg. No. 3,574,607

Registered Feb. 17, 2009

**TRADEMARK
PRINCIPAL REGISTER**

Tramonto

CASA LARGA VINEYARDS, INC. (NEW YORK CORPORATION)

2287 TURK HILL ROAD

FAIRPORT, NY 14450

FOR: WINE, IN CLASS 33 (U.S. CLS. 47 AND 49).

FIRST USE 0-0-1983; IN COMMERCE 0-0-1983.

THE MARK CONSISTS OF STANDARD CHARACTERS WITHOUT CLAIM TO ANY PARTICULAR FONT, STYLE, SIZE, OR COLOR.

THE FOREIGN WORDING IN THE MARK TRANSLATES INTO ENGLISH AS SUNSET.

SER. NO. 77-241,152, FILED 7-27-2007.

ALYSSA STEEL, EXAMINING ATTORNEY

Int. Cl.: 3

Prior U.S. Cls.: 1, 4, 6, 50, 51 and 52

United States Patent and Trademark Office

Reg. No. 3,574,608

Registered Feb. 17, 2009

**TRADEMARK
PRINCIPAL REGISTER**

DYNAMATIC HAIR MIST

L'OREAL (FRANCE SOCIETE ANONYME)
14 RUE ROYALE
PARIS, FRANCE 75008

FOR: PERFUME, TOILET WATER; BATH AND SHOWER GELS AND SALTS NOT FOR MEDICAL PURPOSES; TOILET SOAPS, BODY DEODORANTS; COSMETICS, NAMELY, CREAMS, MILKS, LOTIONS, GELS AND POWDERS FOR THE FACE, THE BODY AND THE HANDS; NON-MEDICATED SUN CARE PREPARATIONS; MAKEUP PREPARATIONS; SHAMPOOS; GELS, SPRAYS, MOUSSES AND BALMS FOR THE HAIR STYLING AND HAIR CARE; HAIR LACQUERS; HAIR COLOURING AND HAIR DECOLORANT PREPARATIONS; PERMANENT WAVING AND CURLING PREPARATIONS; ESSENTIAL OILS FOR PERSONAL USE, IN CLASS 3 (U.S. CLS. 1, 4, 6, 50, 51 AND 52).

THE MARK CONSISTS OF STANDARD CHARACTERS WITHOUT CLAIM TO ANY PARTICULAR FONT, STYLE, SIZE, OR COLOR.

PRIORITY CLAIMED UNDER SEC. 44(D) ON ERPN CMNTY TM OFC APPLICATION NO. 006141899, FILED 7-26-2007, REG. NO. 006141899, DATED 7-26-2007, EXPIRES 7-26-2017.

NO CLAIM IS MADE TO THE EXCLUSIVE RIGHT TO USE "HAIR MIST", APART FROM THE MARK AS SHOWN.

SER. NO. 77-242,704, FILED 7-31-2007.

KATHY DE JONGE, EXAMINING ATTORNEY

Int. Cl.: 43

Prior U.S. Cls.: 100 and 101

United States Patent and Trademark Office

Reg. No. 3,574,609

Registered Feb. 17, 2009

**SERVICE MARK
PRINCIPAL REGISTER**

**Dirty Don's Oyster Bar &
Grill**

CAUTHEN, DONALD E. (UNITED STATES IN-
DIVIDUAL)

309 67TH AVENUE NORTH

MYRTLE BEACH, SC 29572

FOR: CAFE-RESTAURANTS, IN CLASS 43 (U.S.
CLS. 100 AND 101).

FIRST USE 9-26-1991; IN COMMERCE 9-26-1991.

THE MARK CONSISTS OF STANDARD CHAR-
ACTERS WITHOUT CLAIM TO ANY PARTICULAR
FONT, STYLE, SIZE, OR COLOR.

NO CLAIM IS MADE TO THE EXCLUSIVE
RIGHT TO USE "OYSTER BAR & GRILL", APART
FROM THE MARK AS SHOWN.

SER. NO. 77-243,142, FILED 7-31-2007.

BRENDAN REGAN, EXAMINING ATTORNEY

Int. Cls.: 1, 7 and 8

Prior U.S. Cls.: 1, 5, 6, 10, 13, 19, 21, 23, 26, 28, 31, 34, 35, 44 and 46

Reg. No. 3,574,610

United States Patent and Trademark Office

Registered Feb. 17, 2009

**TRADEMARK
PRINCIPAL REGISTER**

NACOL

NIPPON ACCUMULATOR CO., LTD. (JAPAN CORPORATION)
415, NISHIKUBO, SHIMIZU-KU, SHIZUOKA-SHI
SHIZUOKA-KEN, JAPAN

FOR: NITROGEN GAS FILLED BOTTLES FOR USE IN POWERING HYDRAULIC ACCUMULATORS, IN CLASS 1 (U.S. CLS. 1, 5, 6, 10, 26 AND 46).

FIRST USE 3-31-1981; IN COMMERCE 12-31-1988.

FOR: MACHINES, NAMELY, HYDRAULIC ACCUMULATORS; HYDRAULIC ACCUMULATOR MACHINE PARTS, NAMELY, GAS RELIEF AND CHANGE VALVES, SPRING LOADED SAFETY VALVES, AND STOP VALVES; HYDRAULIC ACCUMULATOR MACHINE PARTS, NAMELY, HYDRAULIC FLUID BLADDERS, FLANGES FOR ACCUMULATORS, BUSHINGS, SPRING LOADED SAFETY VALVES, STOP VALVES, GAS VALVES, GAS CHARGING VALVES, FUSE PLUGS IN THE NATURE OF GLOW PLUGS, VALVE STEMS WITH VALVE PACKING, VALVE SPRINGS, VALVE SPRING NUTS, TURNBUCKLES FOR GAS VALVES, PRESSURE GAUGES, ADAPTERS FOR GAS CHARGING HOSES, GAS CHARGING HOSES, CLAMPS FOR FIXING ACCUMULATORS, STANDS, BASE MOUNTING PLATES, EYE NUTS FOR HANGING ACCUMULATORS, RUBBER BOOTS FOR PROTECTING ACCUMULATORS FROM DUST AND

WATER, MANIFOLD BLOCKS, ACCUMULATOR CAPS, OIL PORT HOUSINGS, CORES FOR ACCUMULATOR GAS VALVES, NAMEPLATES FOR ACCUMULATORS, PRESSURE STABILIZING DEVICES IN THE NATURE OF ANTI-DUST AIR RESERVOIR FOR CLOSED OIL TANKS, ALL OF THE FOREGOING BEING HYDRAULIC ACCUMULATOR MACHINE PARTS AND SOLD AS INTEGRAL COMPONENTS OF HYDRAULIC ACCUMULATOR MACHINES, IN CLASS 7 (U.S. CLS. 13, 19, 21, 23, 31, 34 AND 35).

FIRST USE 3-31-1981; IN COMMERCE 12-31-1988.

FOR: NUT WRENCHES; SPRING NUT KEYS IN THE NATURE OF WRENCHES; CORE ROTATORS IN THE NATURE OF HAND TOOLS, IN CLASS 8 (U.S. CLS. 23, 28 AND 44).

FIRST USE 3-31-1981; IN COMMERCE 5-31-1989.

THE MARK CONSISTS OF STANDARD CHARACTERS WITHOUT CLAIM TO ANY PARTICULAR FONT, STYLE, SIZE, OR COLOR.

SER. NO. 77-243,907, FILED 8-1-2007.

PAUL CROWLEY, EXAMINING ATTORNEY

Int. Cl.: 3

Prior U.S. Cls.: 1, 4, 6, 50, 51 and 52

United States Patent and Trademark Office

Reg. No. 3,574,611

Registered Feb. 17, 2009

TRADEMARK
PRINCIPAL REGISTER



GAIL GREENWOOD (UNITED STATES INDIVIDUAL)
13020 NORTH SHORE RD.
OCEAN CITY, MD 21842 AND
JOY S. BENENSON (UNITED STATES INDIVIDUAL)
5235 EAST 1ST AVENUE
DENVER, CO 80220

FOR: COSMETICS AND NON-MEDICATED SKIN CARE PREPARATIONS FOR THE PURPOSE OF REMOVING SAND, IN CLASS 3 (U.S. CLS. 1, 4, 6, 50, 51 AND 52).

FIRST USE 10-29-2007; IN COMMERCE 10-29-2007.

NO CLAIM IS MADE TO THE EXCLUSIVE RIGHT TO USE "SAND ELIMINATOR", APART FROM THE MARK AS SHOWN.

SER. NO. 77-245,813, FILED 8-2-2007.

HEATHER THOMPSON, EXAMINING ATTORNEY

Int. Cl.: 41

Prior U.S. Cls.: 100, 101 and 107

United States Patent and Trademark Office

Reg. No. 3,574,612

Registered Feb. 17, 2009

**SERVICE MARK
PRINCIPAL REGISTER**

**INTERACTIVE LEARNING
XPERIENCE**

XACTWARE SOLUTIONS, INC. (DELAWARE
CORPORATION)
545 WASHINGTON BOULEVARD
JERSEY CITY, NJ 07310

FOR: EDUCATION SERVICES, NAMELY, MUL-
TI-MEDIA TRAINING SERVICES OFFERED TO
OTHERS IN THE FIELD OF INSURANCE COST
VALUATION AND RESIDENTIAL CONSTRU-
TION AND REMODELING, IN CLASS 41 (U.S. CLS.
100, 101 AND 107).

FIRST USE 2-21-1997; IN COMMERCE 8-29-2005.

THE MARK CONSISTS OF STANDARD CHAR-
ACTERS WITHOUT CLAIM TO ANY PARTICULAR
FONT, STYLE, SIZE, OR COLOR.

OWNER OF U.S. REG. NO. 2,147,712.

NO CLAIM IS MADE TO THE EXCLUSIVE
RIGHT TO USE "INTERACTIVE LEARNING",
APART FROM THE MARK AS SHOWN.

SER. NO. 77-246,364, FILED 8-3-2007.

ELI HELLMAN, EXAMINING ATTORNEY

Int. Cls.: 25, 41 and 45

Prior U.S. Cls.: 22, 39, 100, 101 and 107

United States Patent and Trademark Office

Reg. No. 3,574,613

Registered Feb. 17, 2009

TRADEMARK
SERVICE MARK
PRINCIPAL REGISTER



THE BELIEVERS WORSHIP CENTER (MARY-
LAND CORPORATION)
3300 WALTERS LANE
FORESTVILLE, MD 21108

FOR: TOPS; HEADWEAR; JACKETS; SHIRTS;
COATS, IN CLASS 25 (U.S. CLS. 22 AND 39).

FIRST USE 1-1-2000; IN COMMERCE 1-1-2000.

FOR: EDUCATIONAL SERVICES, NAMELY,
CONDUCTING CLASSES, CONFERENCES, SEMI-
NARS, AND WORKSHOPS IN THE FIELD OF
RELIGION AND DISTRIBUTION OF COURSE MA-
TERIAL IN CONNECTION THEREWITH; PROVID-
ING ONLINE RELIGIOUS INSTRUCTION
PROMOTING CHRISTIAN AND FAMILY VALUES;
RELIGIOUS INSTRUCTION SERVICES; PUBLICA-
TION OF BOOKS; PUBLICATION OF BOOKS, OF
MAGAZINES, OF JOURNALS, OF NEWSPAPERS,
OF PERIODICALS, OF CATALOGS, OF BRO-
CHURES, IN CLASS 41 (U.S. CLS. 100, 101 AND 107).

FIRST USE 1-22-2005; IN COMMERCE 1-22-2005.

FOR: MINISTERIAL SERVICES, NAMELY HOLD-
ING SPIRITUAL RETREATS TO ASSIST RELI-
GIOUS LEADERS, BOTH CLERGY AND LAY, TO
DEVELOP AND ENHANCE THEIR SPIRITUAL
LIVES; RELIGIOUS AND SPIRITUAL SERVICES,
NAMELY, PROVIDING GATHERINGS AND RE-
TREATS TO DEVELOP AND ENHANCE THE SPIRI-
TUAL LIVES OF INDIVIDUALS; EVANGELISTIC
AND MINISTERIAL SERVICES; COUNSELING
SERVICES IN THE FIELD OF CHRISTIAN CON-
DUCT IN PERSONAL RELATIONSHIPS; GRIEF
COUNSELING; MARRIAGE COUNSELING, IN
CLASS 45 (U.S. CLS. 100 AND 101).

FIRST USE 1-1-2000; IN COMMERCE 1-1-2000.

THE MARK CONSISTS OF THREE OVERLAP-
PING DIAMONDS WITH GEOMETRIC SPACES IN-
SIDE THEM DESIGNED TO REPLICATE THREE
HUMAN BEINGS.

SER. NO. 77-246,474, FILED 8-3-2007.

FRED CARL, EXAMINING ATTORNEY

Int. Cl.: 37

Prior U.S. Cls.: 100, 103 and 106

United States Patent and Trademark Office

Reg. No. 3,574,614

Registered Feb. 17, 2009

**SERVICE MARK
PRINCIPAL REGISTER**

LaMettry's Collision

LAMETTRY'S COLLISION, INC. (MINNESOTA CORPORATION)

501 WEST 77TH STREET

RICHFIELD, MN 55423

FOR: VEHICLE REPAIR AND MAINTENANCE, NAMELY, COLLISION REPAIR, BODY WORK, AND GLASS REPLACEMENT AND REPAIR, IN CLASS 37 (U.S. CLS. 100, 103 AND 106).

FIRST USE 12-31-1987; IN COMMERCE 12-31-1987.

THE MARK CONSISTS OF STANDARD CHARACTERS WITHOUT CLAIM TO ANY PARTICULAR FONT, STYLE, SIZE, OR COLOR.

NO CLAIM IS MADE TO THE EXCLUSIVE RIGHT TO USE "COLLISION", APART FROM THE MARK AS SHOWN.

SEC. 2(F).

SER. NO. 77-248,444, FILED 8-6-2007.

SCOTT BIBB, EXAMINING ATTORNEY

Int. Cl.: 38

Prior U.S. Cls.: 100, 101 and 104

United States Patent and Trademark Office

Reg. No. 3,574,615

Registered Feb. 17, 2009

**SERVICE MARK
PRINCIPAL REGISTER**

Crochetville

CROCHETVILLE LLC (ALABAMA LIMITED LIABILITY COMPANY)
103 SCARLET OAK CIRCLE
HARVEST, AL 35749

CROCHET AND FIBER ARTS, IN CLASS 38 (U.S. CLS. 100, 101 AND 104).

FIRST USE 2-28-2004; IN COMMERCE 2-28-2004.

FOR: PROVIDING ON-LINE ELECTRONIC BULLETIN BOARDS FOR TRANSMISSION OF MESSAGES AMONG COMPUTER USERS CONCERNING

SER. NO. 77-248,677, FILED 8-7-2007.

LINDSEY RUBIN, EXAMINING ATTORNEY

Int. Cls.: 35 and 37

Prior U.S. Cls.: 100, 101, 102, 103 and 106

United States Patent and Trademark Office

Reg. No. 3,574,616

Registered Feb. 17, 2009

**SERVICE MARK
PRINCIPAL REGISTER**



GAS NATURAL COMPRIMIDO S.A. GNC S.A.
(COLOMBIA CORPORATION)
CALLE 66 NO. 67-123
BARRANQUILLA, COLOMBIA

FOR: RETAIL GAS STATION SERVICES FEATURING NATURAL GAS PUMPS FOR VEHICLES, IN CLASS 35 (U.S. CLS. 100, 101 AND 102).

FOR: VEHICLE REPAIR AND MAINTENANCE SERVICES; CAR REPAIR AND MAINTENANCE SERVICES; AUTOMOBILE SERVICE STATION SERVICES; VEHICLE SERVICE STATIONS, IN CLASS 37 (U.S. CLS. 100, 103 AND 106).

PRIORITY CLAIMED UNDER SEC. 44(D) ON COLOMBIA APPLICATION NO. 07-51458, FILED 5-

23-2007, REG. NO. 342804, DATED 12-6-2007, EXPIRES 12-6-2017.

THE COLOR(S) GREEN AND BLUE IS/ARE CLAIMED AS A FEATURE OF THE MARK.

THE MARK CONSISTS OF A GREEN ABSTRACT FIGURE REMINISCENT OF A GAZELLE ABOVE THE WORD "GAZEL" IN STYLIZED BLUE LOWER CASE LETTERS.

SER. NO. 77-253,101, FILED 8-11-2007.

MELISSA VALLILLO, EXAMINING ATTORNEY

Int. Cls.: 9, 35, 36, 37, 38, 39 and 42

Prior U.S. Cls.: 21, 23, 26, 36, 38, 100, 101, 102, 103, 104, 105 and 106

Reg. No. 3,574,617

United States Patent and Trademark Office

Registered Feb. 17, 2009

**TRADEMARK
SERVICE MARK
PRINCIPAL REGISTER**

KIZOO

KIZOO AG (FED REP GERMANY AG)
AMALIENBADSTRABE 41
D - 76227 KARLSRUHE, FED REP GERMANY

FOR: COMPUTER SOFTWARE FOR PROVIDING ACCESS AND TELECOMMUNICATION CONNECTIONS TO A WORLD WIDE COMPUTER NETWORK; COMPUTER SOFTWARE FOR GENERATING AVATARS AND AVATAR ICONS; COMPUTER SOFTWARE FOR GENERATING LOGOS AND RINGTONES FOR ELECTRONIC END USER DEVICES; COMPUTER SOFTWARE FOR OPERATING A VIRTUAL ONLINE WORLD WITH TRANSMISSION OF ELECTRONIC MESSAGES BETWEEN NETWORK USERS; COMPUTER GAME SOFTWARE; COMPUTER MEMORIES AND DATA CARRIERS CONTAINING DOWNLOADED DATABASES CONTAINING, DATA FILES AND DATA IN THE NATURE OF TEXT, SOUND FILES AND RINGTONES; BLANK MACHINE READABLE DATA CARRIERS AND BLANK CD-ROMS; COMPUTER PERIPHERAL DEVICES; MOUSE PADS FOR COMPUTERS; TELECOMMUNICATION DEVICES, NAMELY, TELECOMMUNICATION CABLES, TELECOMMUNICATION EXCHANGERS, TELECOMMUNICATION SWITCHES, AND TELECOMMUNICATION TRANSMITTERS, IN CLASS 9 (U.S. CLS. 21, 23, 26, 36 AND 38).

FOR: ADVERTISING AND MARKETING IN THE FIELDS OF COMPUTER NETWORKS AND THE INTERNET; ADVERTISING SERVICES FOR PROMOTING THE BROKERAGE OF CONTRACTS FOR THIRD PERSONS CONCERNING THE PURCHASE OR SALE OF GOODS OR THE DELIVERY OF SERVICES VIA THE INTERNET; COMPILATION AND SYSTEMIZATION OF INFORMATION INTO COMPUTER DATABASES, NAMELY, CHECKING AND STRUCTURING DATES WITHIN THE DATA-

BASE; ORGANIZATION OF DATA IN COMPUTER DATABASES; COLLECTION OF DATA IN COMPUTER DATABASES; PRESENTATION OF GOODS AND SERVICES ON WEBSITES ACCESSIBLE THROUGH COMPUTER NETWORKS, FOR RETAIL PURPOSES; SALES PROMOTION OF GOODS AND SERVICES OF THIRD PERSONS THROUGH THE PLACEMENT OF ADVERTISING AND ADVERTISING DISPLAYS ON AN ELECTRONIC WEBSITE WHICH IS ACCESSIBLE VIA NETWORKS; ONLINE RETAIL STORE SERVICES FEATURING DOWNLOADABLE PRE-RECORDED MUSIC, DOWNLOADABLE COMPUTER GAMES, DOWNLOADABLE ADD-ON CONTENT FOR USE IN DOWNLOADABLE COMPUTER GAMES AND IN CUSTOMIZED WEB PAGES FEATURING SOCIAL NETWORK PROFILES, DOWNLOADABLE RINGTONES, DOWNLOADABLE IMAGES, DOWNLOADABLE VIDEOS, DOWNLOADABLE TELEVISION SHOWS, DOWNLOADABLE NEWS REPORTS, DOWNLOADABLE STOCK INFORMATION, DOWNLOADABLE WEATHER REPORTS, DOWNLOADABLE PROFILES, DOWNLOADABLE PRODUCT REFERENCE TEXTS, DOWNLOADABLE PRODUCT EVALUATIONS, DOWNLOADABLE PRODUCT COMPARISON TEST RESULTS, DOWNLOADABLE AUDIOBOOKS, DOWNLOADABLE PODCASTS, DOWNLOADABLE MOBILE GAMES, DOWNLOADABLE PRODUCT MANUALS, DOWNLOADABLE CITY GUIDES, DOWNLOADABLE MAPS, DOWNLOADABLE GPS-DATA-SETS, DOWNLOADABLE RESTAURANT GUIDES, DOWNLOADABLE TRAVEL GUIDES, DOWNLOADABLE REFERENCE BOOKS, DOWNLOADABLE DICTIONARIES, DOWNLOADABLE BIBLIOGRAPHIES, DOWNLOADABLE CLIP ART, IN CLASS 35 (U.S. CLS. 100, 101 AND 102).

FOR: TELECOMMUNICATIONS AIR TIME BROKERAGE IN THE NATURE OF BROKERING OF ACCESS TO ELECTRONIC DATABASES, IN CLASS 36 (U.S. CLS. 100, 101 AND 102).

FOR: SET-UP, INSTALLATION, MAINTENANCE AND REPAIR OF COMPUTER HARDWARE AND TELECOMMUNICATION DEVICES, IN CLASS 37 (U.S. CLS. 100, 103 AND 106).

FOR: TELECOMMUNICATION ACCESS SERVICES; TELECOMMUNICATION ACCESS SERVICES FEATURING A PLATFORM IN THE INTERNET WHICH ENABLES USERS TO CHOOSE FROM A VARIETY OF FUNCTIONS FOR TELECOMMUNICATION SERVICES, ESPECIALLY FOR EMAIL, INSTANT MESSAGING, CHATTING, INTERNET TELEPHONY AND DATA FILE EXCHANGE; PROVIDING ACCESS TO A WORLD-WIDE COMPUTER NETWORK; PROVIDING ACCESS TO DATA IN TELECOMMUNICATION NETWORKS; PROVIDING ELECTRONIC MAILBOX SERVICES; PROVIDING ELECTRONIC ACCESS TO MOBILE TELEPHONE LOGOS, RINGTONES, ANIMATED ICONS OR AVATARS; PROVIDING ACCESS TO A VIRTUAL ONLINE WORLD WITH TRANSMISSION OF ELECTRONIC MESSAGES BETWEEN NETWORK USERS; PROVIDING ACCESS TO ONLINE SHOP PLATFORMS VIA NETWORKS, IN CLASS 38 (U.S. CLS. 100, 101 AND 104).

FOR: STORAGE SERVICES FOR ARCHIVING ELECTRONIC DATA FOR THIRD PERSONS; ELECTRONIC STORAGE OF DATA, NAMELY, SAVING DATA IN COMPUTER DATABASES, IN CLASS 39 (U.S. CLS. 100 AND 105).

FOR: DESIGN AND DEVELOPMENT OF COMPUTER HARDWARE AND COMPUTER SOFTWARE;

INSTALLATION, MAINTENANCE AND UPDATING OF COMPUTER SOFTWARE; RECORDING DATA FOR THIRD PERSONS ON OPTICAL, DIGITAL AND MAGNETIC MEDIA FOR ELECTRONIC STORAGE; HOSTING OF WEBSITES FOR THIRD PERSONS; RENTAL OF COMPUTER SOFTWARE, COMPUTER HARDWARE AND COMPUTER PERIPHERAL DEVICES; DESIGN OF NETWORK WEBSITES INCLUDING INTERNET HOMEPAGES FOR THIRD PERSONS; TECHNOLOGY CONSULTATION FOR THIRD PERSONS IN THE FIELD OF DATA PROCESSING AND COMPUTER NETWORKS; CONSULTANCY FOR TELECOMMUNICATION TECHNOLOGY; HARDWARE AND SOFTWARE CONSULTING; INSTALLATION AND MAINTENANCE OF SOFTWARE FOR INTERNET ACCESS; COMPUTER SECURITY SERVICES, NAMELY, CODING, ENCODING, DECODING, AUTHENTICATION OF DATA FOR SECURITY PURPOSES; CONVERTING DIGITAL DATA IN OTHER DIGITAL OUTPUT FORMATS; DATA CONVERSION OF COMPUTER SOFTWARE AND PROGRAM DATA AND INFORMATION, IN CLASS 42 (U.S. CLS. 100 AND 101).

THE MARK CONSISTS OF STANDARD CHARACTERS WITHOUT CLAIM TO ANY PARTICULAR FONT, STYLE, SIZE, OR COLOR.

OWNER OF FED REP GERMANY REG. NO. 30753110, DATED 11-6-2007, EXPIRES 8-31-2017.

THE WORDING "KIZOO" HAS NO MEANING IN A FOREIGN LANGUAGE.

SER. NO. 77-256,292, FILED 8-15-2007.

COLLEEN KEARNEY, EXAMINING ATTORNEY

Int. Cl.: 9

Prior U.S. Cls.: 21, 23, 26, 36 and 38

United States Patent and Trademark Office

Reg. No. 3,574,618

Registered Feb. 17, 2009

TRADEMARK
PRINCIPAL REGISTER



GMV, S.A. (SPAIN CORPORATION)
C/ ISAAC NEWTON, NO. 11 P.T.M.
TRES CANTOS (MADRID), SPAIN 28760

FOR: HAPTIC SENSORS FOR USE IN CONTROL-
LING ROBOTS AND ROBOT SIMULATORS; COM-
PUTER SOFTWARE FOR CONTROLLING ROBOTS
AND ROBOT SIMULATORS, IN CLASS 9 (U.S. CLS.
21, 23, 26, 36 AND 38).

OWNER OF ERPN CMNTY TM OFC REG. NO.
005057963, DATED 4-5-2007, EXPIRES 5-4-2016.

OWNER OF U.S. REG. NO. 3,074,510.

NO CLAIM IS MADE TO THE EXCLUSIVE
RIGHT TO USE "ROBOT", APART FROM THE
MARK AS SHOWN.

THE COLOR(S) BLUE, WHITE AND GREEN IS/
ARE CLAIMED AS A FEATURE OF THE MARK.

THE MARK CONSISTS OF THE WORDS "IN-
SIGHT" IN BLUE LOWER CASE LETTERS AND
"ROBOT" IN LIGHT GREEN UPPER CASE LET-
TERS OUTLINED IN DARKER GREEN, TO THE
RIGHT SIDE OF A LOGO CONSISTING OF A
WHITE CIRCLE WITHIN A BLUE SQUARE. THE
CONVERGING ARROWS FROM BOTH SIDES
CROSS THE SQUARE'S AREA IN WHITE COLOR
AND THE CIRCLE'S AREA IN BLUE.

SER. NO. 77-257,622, FILED 8-17-2007.

DAWN FELDMAN, EXAMINING ATTORNEY

Int. Cls.: 16, 21, 25, 28, 41 and 42

**Prior U.S. Cls.: 2, 5, 13, 22, 23, 29, 30, 33, 37, 38, 39,
40, 50, 100, 101 and 107**

Reg. No. 3,574,619

United States Patent and Trademark Office

Registered Feb. 17, 2009

**TRADEMARK
SERVICE MARK
PRINCIPAL REGISTER**

THE UNIVERSITY OF ARIZONA

THE ARIZONA BOARD OF REGENTS ON BEHALF OF THE UNIVERSITY OF ARIZONA (ARIZONA CORPORATION)
MCKALE MEMORIAL CENTER
1 NATIONAL CHAMPIONSHIP DRIVE
TUCSON, AZ 85721

FOR: PAPER AND PRINTED MATERIALS, NAMELY, STATIONERY, ENVELOPES, ANNOUNCEMENT CARDS, BUSINESS CARDS, STICKERS, DECALS, PENS AND PENCILS, IN CLASS 16 (U.S. CLS. 2, 5, 22, 23, 29, 37, 38 AND 50).

FIRST USE 0-0-1885; IN COMMERCE 0-0-1885.

FOR: COFFEE MUGS, PILSNER DRINKING GLASSES, AND SERVING PLATTERS, IN CLASS 21 (U.S. CLS. 2, 13, 23, 29, 30, 33, 40 AND 50).

FIRST USE 0-0-1904; IN COMMERCE 0-0-1904.

FOR: T-SHIRTS, POLO SHIRTS, BASEBALL CAPS, SWEATSHIRTS, AND JACKETS, IN CLASS 25 (U.S. CLS. 22 AND 39).

FIRST USE 0-0-1909; IN COMMERCE 0-0-1909.

FOR: DIVOT REPAIR TOOLS FOR GOLFERS, GOLF BALL MARKERS, BASKETBALLS, AND CHRISTMAS TREE ORNAMENTS, IN CLASS 28 (U.S. CLS. 22, 23, 38 AND 50).

FIRST USE 0-0-1909; IN COMMERCE 0-0-1909.

FOR: EDUCATION AND ENTERTAINMENT SERVICES, NAMELY, PROVIDING COURSES OF INSTRUCTION AT THE UNIVERSITY LEVEL; EDU-

CATIONAL RESEARCH; ARRANGING AND CONDUCTING ATHLETIC EVENTS AND TOURNAMENTS IN NUMEROUS INTERCOLLEGIATE SPORTS; ARRANGING AND CONDUCTING EDUCATIONAL CONFERENCES; ARRANGING AND CONDUCTING ENTERTAINMENT EXHIBITIONS AND FESTIVALS IN THE NATURE OF CRAFTS FAIRS, AND ART SHOWS; ENTERTAINMENT IN THE NATURE OF LIVE PERFORMANCES BY THEATER GROUPS, MUSIC GROUPS, AND MARCHING BANDS, IN CLASS 41 (U.S. CLS. 100, 101 AND 107).

FIRST USE 0-0-1885; IN COMMERCE 0-0-1885.

FOR: SCIENTIFIC RESEARCH, IN CLASS 42 (U.S. CLS. 100 AND 101).

FIRST USE 0-0-1901; IN COMMERCE 0-0-1901.

THE MARK CONSISTS OF STANDARD CHARACTERS WITHOUT CLAIM TO ANY PARTICULAR FONT, STYLE, SIZE, OR COLOR.

OWNER OF U.S. REG. NOS. 1,678,170 AND 1,709,695.

NO CLAIM IS MADE TO THE EXCLUSIVE RIGHT TO USE "UNIVERSITY" IN CLASS 41, APART FROM THE MARK AS SHOWN.

SEC. 2(F).

SER. NO. 77-257,826, FILED 8-17-2007.

BRENDAN REGAN, EXAMINING ATTORNEY

Int. Cl.: 41

Prior U.S. Cls.: 100, 101 and 107

United States Patent and Trademark Office

Reg. No. 3,574,620

Registered Feb. 17, 2009

**SERVICE MARK
PRINCIPAL REGISTER**



OSDENE FAMILY, L.L.C (VIRGINIA LIMITED LIABILITY COMPANY)

823 W. BROAD STREET
RICHMOND, VA 23220

FOR: RUNNING A MUSEUM EXHIBITING ELECTRONIC APPLIANCES, ELECTRONIC GADGETS, AND EARLY VINTAGE ANTIQUE ELECTRIC DEVICES AND APPLIANCES , IN CLASS 41 (U.S. CLS. 100, 101 AND 107).

FIRST USE 1-4-2001; IN COMMERCE 4-1-2001.

THE COLOR(S) BLACK, WHITE, RED, ORANGE, LIGHT RED AND LIGHT BLUE IS/ARE CLAIMED AS A FEATURE OF THE MARK.

THE MARK CONSISTS OF A WHITE RECTANGULAR FRAME WITH LIGHT BLUE ACCENTS ON THE TOP LEFT, TOP RIGHT, AND BOTTOM RIGHT AND RED ACCENT IN THE BOTTOM MIDDLE. THE TOP OF THE FRAME HAS A CIRCLE IN WHITE WITH LIGHT BLUE SHADING ON THE OUTER EDGES AND LIGHT RED SHADING IN THE MIDDLE. ALSO IN THE MIDDLE IS A LIGHTNING BOLT OUTLINED IN RED. IN THE MIDDLE OF THE FRAME IS THE WORDING "ECLECTIC ELECTRIC" IN ORANGE AND SHADED IN LIGHT RED. THE ENTIRE MARK APPEARS ON A BLACK BACKGROUND.

SER. NO. 77-260,133, FILED 8-21-2007.

JESSICA A. POWERS, EXAMINING ATTORNEY

Int. Cls.: 25 and 41

Prior U.S. Cls.: 22, 39, 100, 101 and 107

Reg. No. 3,574,621

United States Patent and Trademark Office

Registered Feb. 17, 2009

**TRADEMARK
SERVICE MARK
PRINCIPAL REGISTER**

Outdoor Envy

OUTDOOR ENVY, LLC (ALABAMA LIMITED
LIABILITY COMPANY)
677 LEE RD. 229
SMITHS STATION, AL 36877

FOR: CLOTHING, NAMELY, SHIRTS, HATS,
JACKETS, SOCKS, VESTS, PANTS, SHORTS, BELTS,
DRESSES, SKIRTS, DRESSES, GLOVES, IN CLASS 25
(U.S. CLS. 22 AND 39).

FIRST USE 1-12-2001; IN COMMERCE 10-2-2001.

FOR: EDUCATIONAL AND ENTERTAINMENT
SERVICES, NAMELY, PROVIDING TRAINING
AND INSTRUCTION IN THE FIELDS OF OUT-

DOOR RECREATIONAL ACTIVITIES SUCH AS
HUNTING AND FISHING, IN CLASS 41 (U.S. CLS.
100, 101 AND 107).

FIRST USE 1-12-2001; IN COMMERCE 6-29-2006.

THE MARK CONSISTS OF STANDARD CHAR-
ACTERS WITHOUT CLAIM TO ANY PARTICULAR
FONT, STYLE, SIZE, OR COLOR.

SER. NO. 77-261,184, FILED 8-21-2007.

KATHERINE CHANG, EXAMINING ATTORNEY

Int. Cls.: 40 and 41

Prior U.S. Cls.: 100, 101, 103, 106 and 107

United States Patent and Trademark Office

Reg. No. 3,574,622

Registered Feb. 17, 2009

**SERVICE MARK
PRINCIPAL REGISTER**

QOOP

QOOP, INC. (CALIFORNIA CORPORATION)
20 SUNNYSIDE AVENUE SUITE A345
MILL VALLEY, CA 94941

FOR: ON DEMAND PRINTING AND PHOTO
PROCESSING ALL PROVIDED TO OTHERS OVER
AN ON-LINE WEBSITE ACCESSED THROUGH THE
INTERNET, IN CLASS 40 (U.S. CLS. 100, 103 AND
106).

FIRST USE 2-10-2005; IN COMMERCE 2-10-2005.

FOR: ON DEMAND MULTIMEDIA PUBLISHING
SERVICES OF BOOKS, MAGAZINES, STORIES,
POETRY, ARTICLES, MANUALS, JOURNALS, RE-
CIPES, PHOTOGRAPHS, PAINTINGS, GRAPHIC
DESIGNS, TEMPLATES, ILLUSTRATIONS, DESIGN
TOOLS, SOFTWARE, GAMES, AVATARS, MUSIC

AND ELECTRONIC PUBLICATIONS, ALL PROVI-
DED TO OTHERS OVER AN ON-LINE WEBSITE
ACCESSED THROUGH THE INTERNET, IN CLASS
41 (U.S. CLS. 100, 101 AND 107).

FIRST USE 2-10-2005; IN COMMERCE 2-10-2005.

THE MARK CONSISTS OF STANDARD CHAR-
ACTERS WITHOUT CLAIM TO ANY PARTICULAR
FONT, STYLE, SIZE, OR COLOR.

OWNER OF U.S. REG. NOS. 3,317,160 AND
3,323,875.

SER. NO. 77-261,738, FILED 8-22-2007.

WARREN L. OLANDRIA, EXAMINING ATTOR-
NEY

Int. Cls.: 40 and 41

Prior U.S. Cls.: 100, 101, 103, 106 and 107

United States Patent and Trademark Office

Reg. No. 3,574,623

Registered Feb. 17, 2009

**SERVICE MARK
PRINCIPAL REGISTER**



QOOP, INC. (CALIFORNIA CORPORATION)
4 EMBARCADERO CENTER, 39TH FLOOR
SAN FRANCISCO, CA 94111

FOR: ON DEMAND PRINT AND PHOTO PROCESSING ALL PROVIDED TO OTHERS OVER AN ON-LINE WEBSITE ACCESSED THROUGH THE INTERNET, IN CLASS 40 (U.S. CLS. 100, 103 AND 106).

FIRST USE 2-10-2005; IN COMMERCE 2-10-2005.

FOR: ON DEMAND MULTIMEDIA PUBLISHING SERVICES OF BOOKS, MAGAZINES, STORIES, POETRY, ARTICLES, MANUALS, JOURNALS, RECIPES, PHOTOGRAPHS, PAINTINGS, GRAPHIC DESIGNS, TEMPLATES, ILLUSTRATIONS, DESIGN TOOLS, SOFTWARE, GAMES, AVATARS, MUSIC AND ELECTRONIC PUBLICATIONS, ALL PROVIDED TO OTHERS OVER AN ON-LINE WEBSITE ACCESSED THROUGH THE INTERNET, IN CLASS 41 (U.S. CLS. 100, 101 AND 107).

FIRST USE 2-10-2005; IN COMMERCE 2-10-2005.

OWNER OF U.S. REG. NOS. 3,317,160 AND 3,323,875.

THE COLOR(S) GREEN AND RED IS/ARE CLAIMED AS A FEATURE OF THE MARK.

THE MARK CONSISTS OF GREEN CHARACTERS FORMING "QOOP" WITH A RED ARC BETWEEN THE "O'S" WITH THE "O'S" AND ARC THERE BETWEEN FORMING AN IMPRESSION OF EYEWEAR.

SER. NO. 77-261,746, FILED 8-22-2007.

WARREN L. OLANDRIA, EXAMINING ATTORNEY

Int. Cls.: 40 and 41

Prior U.S. Cls.: 100, 101, 103, 106 and 107

United States Patent and Trademark Office

Reg. No. 3,574,624

Registered Feb. 17, 2009

**SERVICE MARK
PRINCIPAL REGISTER**



QOOP, INC. (CALIFORNIA CORPORATION)
20 SUNNYSIDE AVENUE SUITE A345
MILL VALLEY, CA 94941

FOR: ON DEMAND PRINTING AND PHOTO PROCESSING ALL PROVIDED TO OTHERS OVER AN ON-LINE WEBSITE ACCESSED THROUGH THE INTERNET, IN CLASS 40 (U.S. CLS. 100, 103 AND 106).

FIRST USE 2-10-2005; IN COMMERCE 2-10-2005.

FOR: ON DEMAND MULTIMEDIA PUBLISHING SERVICES OF BOOKS, MAGAZINES, STORIES, POETRY, ARTICLES, MANUALS, JOURNALS, RECIPES, PHOTOGRAPHS, PAINTINGS, GRAPHIC DESIGNS, TEMPLATES, ILLUSTRATIONS, DESIGN TOOLS, SOFTWARE, GAMES, AVATARS, MUSIC AND ELECTRONIC PUBLICATIONS, ALL PROVIDED TO OTHERS OVER AN ON-LINE WEBSITE ACCESSED THROUGH THE INTERNET, IN CLASS 41 (U.S. CLS. 100, 101 AND 107).

FIRST USE 2-10-2005; IN COMMERCE 2-10-2005.

OWNER OF U.S. REG. NO. 3,126,099.

THE COLOR(S) GREEN IS/ARE CLAIMED AS A FEATURE OF THE MARK.

THE MARK CONSISTS OF A GREEN CAPITAL "Q" HAVING A PERIMETER BORDER EXTENDING FROM A TAIL OF THE "Q" PROVIDING AN IMPRESSION OF AN "@" SYMBOL USED IN ELECTRONIC MAIL ADDRESSES/COMMUNICATIONS.

SER. NO. 77-261,749, FILED 8-22-2007.

WARREN L. OLANDRIA, EXAMINING ATTORNEY

Int. Cl.: 35

Prior U.S. Cls.: 100, 101 and 102

United States Patent and Trademark Office

Reg. No. 3,574,625

Registered Feb. 17, 2009

SERVICE MARK
PRINCIPAL REGISTER



BLUE MOOSE LITIGATION SUPPORT, INC.
(COLORADO CORPORATION)
633 17TH STREET, SUITE 120
DENVER, CO 80202

FOR: ARRANGING FOR PICKUP, DELIVERY, STORAGE AND TRANSPORTATION OF DOCUMENTS, PACKAGES, FREIGHT AND PARCELS VIA GROUND AND AIR CARRIERS; COPYING OF DOCUMENTS; COPYING OF DOCUMENTS FOR OTHERS; DOCUMENT COPYING TASKS; DOCUMENT REPRODUCTION; DUPLICATION OF DOCUMENTS; PROVIDING TRANSPORTATION DOCUMENTATION FOR OTHERS, IN CLASS 35 (U.S. CLS. 100, 101 AND 102).

FIRST USE 6-16-2003; IN COMMERCE 6-16-2003.

THE COLOR(S) YELLOW, PURPLE, PEACH, BLUE, CYAN, GREEN, BROWN, GRAY, WHITE,

RED, ORANGE. IS/ARE CLAIMED AS A FEATURE OF THE MARK.

THE MARK CONSISTS OF A MOOSE THAT IS BLUE WITH GRAY HOOVES. THE MOOSE IS WEARING A COLLARED CYAN SHIRT WITH GREEN AND BROWN PALM TREES. THE MOOSE IS HOLDING A WHITE SURF BOARD WITH RED, ORANGE AND YELLOW FLAMES ON THE RIGHT END OF THE SURF BOARD. THE MOOSE AND SURFBOARD ARE BEFORE A BLUE BODY OF WATER WITH A YELLOW SUN SETTING INTO A PURPLE AND PEACH SKY. THERE ARE GRAY CLOUDS IN THE SKY.

SER. NO. 77-262,174, FILED 8-22-2007.

BARBARA BROWN, EXAMINING ATTORNEY

Int. Cl.: 41

Prior U.S. Cls.: 100, 101 and 107

United States Patent and Trademark Office

Reg. No. 3,574,626

Registered Feb. 17, 2009

**SERVICE MARK
PRINCIPAL REGISTER**

**THE NUTS AND BOLTS
SYMPOSIUMS**

NUTS & BOLTS SYMPOSIUM OF MIDDLE LEVEL EDUCATION, INC. (COLORADO CORPORATION)
1437 DUNSFORD WAY
BROOMFIELD, CO 80020

FOR: ARRANGING AND CONDUCTING EDUCATIONAL CONFERENCES FOR MIDDLE SCHOOL TEACHERS, PRINCIPALS AND ADMINISTRATORS, IN CLASS 41 (U.S. CLS. 100, 101 AND 107).

FIRST USE 7-0-1990; IN COMMERCE 7-0-1990.

THE MARK CONSISTS OF STANDARD CHARACTERS WITHOUT CLAIM TO ANY PARTICULAR FONT, STYLE, SIZE, OR COLOR.

NO CLAIM IS MADE TO THE EXCLUSIVE RIGHT TO USE SYMPOSIUMS, APART FROM THE MARK AS SHOWN.

SEC. 2(F).

SER. NO. 77-263,725, FILED 8-24-2007.

LINDA ESTRADA, EXAMINING ATTORNEY

Int. Cl.: 25

Prior U.S. Cls.: 22 and 39

United States Patent and Trademark Office

Reg. No. 3,574,627

Registered Feb. 17, 2009

**TRADEMARK
PRINCIPAL REGISTER**

REFUSE

ARTANI, AMMAR (UNITED STATES INDIVIDUAL)
200 GATES RD., SUITE J
LITTLE FERRY, NJ 07643

THE MARK CONSISTS OF STANDARD CHARACTERS WITHOUT CLAIM TO ANY PARTICULAR FONT, STYLE, SIZE, OR COLOR.

FOR: CLOTHING, NAMELY, JEANS, T-SHIRTS AND TOPS, IN CLASS 25 (U.S. CLS. 22 AND 39).

SER. NO. 77-264,395, FILED 8-25-2007.

FIRST USE 12-31-1999; IN COMMERCE 12-31-1999.

KELLEY WELLS, EXAMINING ATTORNEY

Int. Cls.: 29, 30 and 39

Prior U.S. Cls.: 46, 100 and 105

United States Patent and Trademark Office

Reg. No. 3,574,628

Registered Feb. 17, 2009

**TRADEMARK
SERVICE MARK
PRINCIPAL REGISTER**

Copper County

APETITO HOLDINGS (CANADA) LIMITED (CANADA CORPORATION)
C/O LACROWICZ SHIER & HOFFMAN
300 - 204 BLACK STREET
WHITEHORSE, YUKON, CANADA Y1A2M9

FOR: FROZEN MEALS CONSISTING PRIMARILY OF MEAT, FISH, POULTRY OR VEGETABLES; SOUPS; YOGURT; SOYBEAN MILK, IN CLASS 29 (U.S. CL. 46).

FOR: FROZEN MEALS CONSISTING PRIMARILY OF PASTA OR RICE; DESSERT MOUSSE; ICE CREAM; FROZEN YOGURT; BAKERY DESSERTS; BREAD; CAKES; PASTRIES; TARTS; PIES; MUFFINS; COFFEE; TEA; HERBAL TEA; COCOA; HOT CHOCOLATE; DESSERT PUDDINGS, IN CLASS 30 (U.S. CL. 46).

FOR: FOOD DELIVERY, IN CLASS 39 (U.S. CLS. 100 AND 105).

THE MARK CONSISTS OF STANDARD CHARACTERS WITHOUT CLAIM TO ANY PARTICULAR FONT, STYLE, SIZE, OR COLOR.

PRIORITY CLAIMED UNDER SEC. 44(D) ON CANADA APPLICATION NO. 1361070, FILED 8-24-2007.

OWNER OF CANADA REG. NO. 724447, DATED 9-25-2008, EXPIRES 9-25-2023.

SER. NO. 77-265,483, FILED 8-27-2007.

MATTHEW EINSTEIN, EXAMINING ATTORNEY

Int. Cl.: 25

Prior U.S. Cls.: 22 and 39

United States Patent and Trademark Office

Reg. No. 3,574,629

Registered Feb. 17, 2009

**TRADEMARK
PRINCIPAL REGISTER**

Good Job

MOM WORKS, INC. (MASSACHUSETTS CORPORATION)
10 PINE HILL CIRCLE
WAKEFIELD, MA 01880

FOR: SHORT-SLEEVED OR LONG-SLEEVED T-SHIRTS; BASEBALL CAPS; SWEAT SHIRTS; CHILDREN'S CLOTH EATING BIBS; INFANT AND TODDLER ONE PIECE CLOTHING, IN CLASS 25 (U.S. CLS. 22 AND 39).

FIRST USE 4-29-2006; IN COMMERCE 4-29-2006.

THE MARK CONSISTS OF STANDARD CHARACTERS WITHOUT CLAIM TO ANY PARTICULAR FONT, STYLE, SIZE, OR COLOR.

SER. NO. 77-265,849, FILED 8-28-2007.

MICHAEL GAAFAR, EXAMINING ATTORNEY

Int. Cl.: 35

Prior U.S. Cls.: 100, 101 and 102

United States Patent and Trademark Office

Reg. No. 3,574,630

Registered Feb. 17, 2009

**SERVICE MARK
PRINCIPAL REGISTER**

CUT THE SCRAP

ASKO, INC. (PENNSYLVANIA CORPORATION)
P.O. BOX 355
HOMESTEAD, PA 15120

FOR: PROMOTING THE SALE OF INDUSTRIAL
KNIVES AND BLADES TO OTHERS BY MEANS OF
PRODUCT DEMONSTRATIONS AND DISTRIBUTION
OF PRINTED LITERATURE, IN CLASS 35
(U.S. CLS. 100, 101 AND 102).

FIRST USE 2-16-2007; IN COMMERCE 3-31-2007.

THE MARK CONSISTS OF STANDARD CHAR-
ACTERS WITHOUT CLAIM TO ANY PARTICULAR
FONT, STYLE, SIZE, OR COLOR.

SER. NO. 77-266,187, FILED 8-28-2007.

CHRIS WELLS, EXAMINING ATTORNEY

Int. Cl.: 35

Prior U.S. Cls.: 100, 101 and 102

United States Patent and Trademark Office

Reg. No. 3,574,631

Registered Feb. 17, 2009

**SERVICE MARK
PRINCIPAL REGISTER**

BLADES DIRECT

ASKO, INC. (PENNSYLVANIA CORPORATION)
P.O. BOX 355
HOMESTEAD, PA 15120

FOR: PROMOTING THE SALE OF INDUSTRIAL
KNIVES AND BLADES TO OTHERS BY MEANS OF
PRODUCT DEMONSTRATIONS, AND DISTRIBUTION
OF PRINTED MATERIALS, IN CLASS 35 (U.S.
CLS. 100, 101 AND 102).

FIRST USE 3-19-2007; IN COMMERCE 3-31-2007.

THE MARK CONSISTS OF STANDARD CHAR-
ACTERS WITHOUT CLAIM TO ANY PARTICULAR
FONT, STYLE, SIZE, OR COLOR.

NO CLAIM IS MADE TO THE EXCLUSIVE
RIGHT TO USE "BLADES", APART FROM THE
MARK AS SHOWN.

SER. NO. 77-266,205, FILED 8-28-2007.

CHRIS WELLS, EXAMINING ATTORNEY

Int. Cls.: 37 and 42

Prior U.S. Cls.: 100, 101, 103 and 106

United States Patent and Trademark Office

Reg. No. 3,574,632

Registered Feb. 17, 2009

**SERVICE MARK
PRINCIPAL REGISTER**



UTILITY SYSTEMS SOLUTIONS, INC.

A Service Disabled Veteran Owned Small Business (SDVOSB)

UTILITY SYSTEMS SOLUTIONS, INC. (TEXAS CORPORATION)
SUITE 1000
5956 SHERRY LANE
DALLAS, TX 752258021

INC. A SERVICE DISABLED VETERAN OWNED SMALL BUSINESS (SDVOSB)", APART FROM THE MARK AS SHOWN.

FOR: INSTALLATION, MAINTENANCE, REPAIR, AND SERVICING OF STEAM, AIR AND HOT WATER SYSTEMS; TURNKEY INSTALLATION AND MAINTENANCE, NAMELY, INSTALLING AND MAINTAINING STEAM, AIR AND HOT WATER SYSTEMS, IN CLASS 37 (U.S. CLS. 100, 103 AND 106).

THE MARK CONSISTS OF AN UPRIGHT OVAL TILTED TO THE RIGHT WHICH CONTAINS THE LETTERS "US" AND THE NUMBER "2" IN SUPERSCRIPT AFTER THE "S". THE LETTERS AND NUMBER RUN FLUSH WITH THE OVAL IN THREE AREAS OF THE OVAL - TOP LEFT CORNER OF THE "U", BOTTOM RIGHT CORNER OF THE "S", AND BOTTOM RIGHT CORNER OF THE "2". UNDER THE OVAL ARE THE WORDS "UTILITY SYSTEMS SOLUTIONS, INC." IN CAPITAL LETTERS, AND UNDER THOSE WORDS ARE THE WORDS "A SERVICE DISABLED VETERAN OWNED SMALL BUSINESS (SDVOSB)" IN SENTENCE FONT.

FIRST USE 5-10-2005; IN COMMERCE 5-10-2005.

FOR: REMOTE MONITORING SERVICES OF STEAM, AIR AND HOT WATER SYSTEMS; ENGINEERING DESIGN SERVICES, IN CLASS 42 (U.S. CLS. 100 AND 101).

FIRST USE 5-10-2005; IN COMMERCE 5-10-2005.

SER. NO. 77-266,231, FILED 8-28-2007.

NO CLAIM IS MADE TO THE EXCLUSIVE RIGHT TO USE "UTILITY SYSTEMS SOLUTIONS,

KEVON CHISOLM, EXAMINING ATTORNEY

Int. Cl.: 42

Prior U.S. Cls.: 100 and 101

United States Patent and Trademark Office

Reg. No. 3,574,633

Registered Feb. 17, 2009

**SERVICE MARK
PRINCIPAL REGISTER**

**ENGINEERING DESIGN
TECHNOLOGIES, INC.**

ENGINEERING DESIGN TECHNOLOGIES, INC.
(GEORGIA CORPORATION)
SUITE 200
1705 ENTERPRISE WAY
MARIETTA, GA 30067

NO CLAIM IS MADE TO THE EXCLUSIVE
RIGHT TO USE "ENGINEERING "OR "INC.",
APART FROM THE MARK AS SHOWN.

FOR: CIVIL ENGINEERING, IN CLASS 42 (U.S.
CLS. 100 AND 101).

SEC. 2(F).

FIRST USE 2-26-1993; IN COMMERCE 2-26-1993.

SER. NO. 77-266,319, FILED 8-28-2007.

THE MARK CONSISTS OF STANDARD CHAR-
ACTERS WITHOUT CLAIM TO ANY PARTICULAR
FONT, STYLE, SIZE, OR COLOR.

SEAN CROWLEY, EXAMINING ATTORNEY

Int. Cl.: 37

Prior U.S. Cls.: 100, 103 and 106

United States Patent and Trademark Office

Reg. No. 3,574,634

Registered Feb. 17, 2009

**SERVICE MARK
PRINCIPAL REGISTER**

**ENGINEERING DESIGN
TECHNOLOGIES, INC.**

ENGINEERING DESIGN TECHNOLOGIES, INC.
(GEORGIA CORPORATION)
SUITE 5200
1705 ENTERPRISE WAY
MARIETTA, GA 30067

FOR: CONSTRUCTION OF OFFICE BUILDINGS
AND EDUCATIONAL, GOVERNMENT, HOUSING,
INDUSTRIAL, MEDICAL AND RETAIL FACIL-
ITIES, RESTAURANTS, ROADS, BRIDGES, AND
AIRPORTS; CONSTRUCTION MANAGEMENT;
BUILDING INSPECTION IN THE COURSE OF
CONSTRUCTION; CONSTRUCTION PLANNING;
CONSTRUCTION CONSULTATION, IN CLASS 37
(U.S. CLS. 100, 103 AND 106).

FIRST USE 2-26-1993; IN COMMERCE 2-26-1993.

THE MARK CONSISTS OF STANDARD CHAR-
ACTERS WITHOUT CLAIM TO ANY PARTICULAR
FONT, STYLE, SIZE, OR COLOR.

NO CLAIM IS MADE TO THE EXCLUSIVE
RIGHT TO USE "ENGINEERING" OR "INC.",
APART FROM THE MARK AS SHOWN.

SEC. 2(F).

SER. NO. 77-266,366, FILED 8-28-2007.

SEAN CROWLEY, EXAMINING ATTORNEY

Int. Cls.: 36 and 37

Prior U.S. Cls.: 100, 101, 102, 103 and 106

United States Patent and Trademark Office

Reg. No. 3,574,635

Registered Feb. 17, 2009

**SERVICE MARK
PRINCIPAL REGISTER**

VICEROY

VICEROY HOTELS, L.L.C. (DELAWARE LIMITED LIABILITY COMPANY)
SUITE 500
1212 SOUTH FLOWER STREET
LOS ANGELES, CA 90015

FOR: REAL ESTATE AGENCY AND BROKERAGE SERVICES; REAL ESTATE SERVICES NAMELY PROVIDING REAL ESTATE LISTINGS FOR FACILITATING CONDOMINIUM AND OTHER REAL ESTATE TRANSACTIONS, IN CLASS 36 (U.S. CLS. 100, 101 AND 102).

FIRST USE 10-1-2005; IN COMMERCE 10-1-2005.

FOR: REAL ESTATE SITE SELECTION AND REAL ESTATE DEVELOPMENT; BUILDING CON-

STRUCTION; SUPERVISING AND MANAGING BUILDING CONSTRUCTION AND SITE DEVELOPMENT, IN CLASS 37 (U.S. CLS. 100, 103 AND 106).

FIRST USE 10-1-2005; IN COMMERCE 10-1-2005.

THE MARK CONSISTS OF STANDARD CHARACTERS WITHOUT CLAIM TO ANY PARTICULAR FONT, STYLE, SIZE, OR COLOR.

OWNER OF U.S. REG. NOS. 2,670,019 AND 2,741,530.

SER. NO. 77-266,810, FILED 8-29-2007.

ELLEN PERKINS, EXAMINING ATTORNEY

Int. Cls.: 3, 9, 11, 14, 16, 24, 25, 28 and 41

Prior U.S. Cls.: 1, 2, 4, 5, 6, 13, 21, 22, 23, 26, 27, 28, 29, 31, 34, 36, 37, 38, 39, 42, 50, 51, 52, 100, 101 and 107

Reg. No. 3,574,636

United States Patent and Trademark Office

Registered Feb. 17, 2009

**TRADEMARK
SERVICE MARK
PRINCIPAL REGISTER**

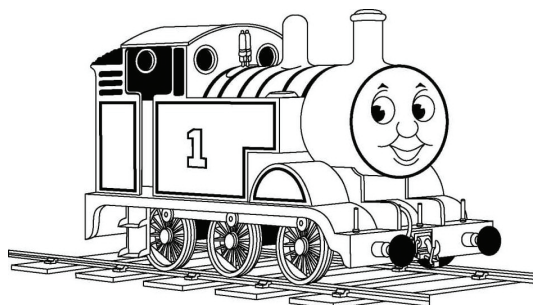

GULLANE (THOMAS) LIMITED (UNITED KINGDOM CORPORATION)
149 TOTTENHAM COURT ROAD
MAPLE HOUSE, 5TH FLOOR
LONDON, UNITED KINGDOM W1T7NF

FOR: BABY WIPES, TOOTHPASTE, SHAMPOO, HAIR CONDITIONER, TALCUM POWDER, SKIN MOISTURIZER, SKIN SOAP, FRAGRANCES FOR COSMETIC USE; LIP BALM, BUBBLE BATH, ALL PURPOSE COTTON SWABS FOR PERSONAL USE, COTTON BALLS FOR PERSONAL USE, IN CLASS 3 (U.S. CLS. 1, 4, 6, 50, 51 AND 52).

FOR: PRERECORDED VIDEO CASSETTES, AUDIO CASSETTES FEATURING CHILD THEMES; CD'S, DVDS AND OPTICAL AND MAGNETO-OPTICAL DISCS FEATURING MUSIC, STORIES, STILL IMAGES AND MOTION PICTURES FOR CHILDREN'S ENTERTAINMENT; ELECTRONIC BOOKS FOR CHILDREN RECORDED ON COMPUTER MEDIA, DVD PLAYERS, VIDEOCASSETTE PLAYERS, AUDIO CASSETTE PLAYERS, TELEVISIONS, PERSONAL STEREOS, MP3 PLAYERS, WALKIE-TALKIES, DECORATIVE MAGNETS, SPORT WHISTLES, CD CASES, CELL PHONES, CELL PHONE COVERS, VIDEO GAME CARTRIDGES AND COMPUTER SOFTWARE FEATURING EDUCATIONAL AND ENTERTAINMENT PROGRAMS FOR CHILDREN; SUNGLASSES, SPECTACLE FRAMES, BICYCLE HELMETS, DISPOSABLE CAMERAS, IN CLASS 9 (U.S. CLS. 21, 23, 26, 36 AND 38).

FOR: ELECTRIC HOLIDAY LIGHTS; NIGHT LIGHTS, LAMPS, LAMP SHADES, LIGHT WANDS,

FLASHLIGHTS, BICYCLE REFLECTORS, IN CLASS 11 (U.S. CLS. 13, 21, 23, 31 AND 34).

FOR: CLOCKS AND WATCHES, HOLIDAY ORNAMENTS MADE OF PRECIOUS METALS, IN CLASS 14 (U.S. CLS. 2, 27, 28 AND 50).

FOR: CHILDREN'S BOOKS, COLORING BOOKS, CHILDREN'S ACTIVITY BOOKS, STICKERS, STICKER BOOKS, STICKER ALBUMS, BOOKENDS, PHOTO ALBUMS, PHOTO STORAGE BOXES, SCRAP BOOKS, CHILDREN'S MAGAZINES IN THE FIELD OF GENERAL FEATURES, FLASH CARDS, BOXED NOTE CARDS, STATIONERY, PAPER GIFT WRAP, PAPER GIFT BAGS, PAPER GIFT BOXES, PAPER GIFT TAGS, PAPER RIBBONS FOR GIFT WRAPPING, GREETING CARDS, INVITATION CARDS, PAPER TABLE CLOTHS, PAPER NAPKINS, PAPER GARLANDS, PAPER DIARIES, PAPER ORGANIZERS, ADDRESS BOOKS, NOTEBOOKS, DISPOSABLE DIAPERS, PAPER BOOKMARKS, CALENDARS, GREETING CARDS, PENCILS, PENCIL CASES, PENCIL SHARPENERS, RUBBER ERASERS, PENS, CRAYONS, MARKERS, PAINTING SETS FOR CHILDREN AND ARTISTS, DRAWING PAPER, SKETCH PADS, CONSTRUCTION PAPER, EASELS, CHALK, RUBBER STAMP SETS CONSISTING OF RUBBER STAMPS AND INK PADS; DRAWING RULERS, MODELING CLAY, TEMPORARY TATTOOS, DRY ERASE WRITING BOARDS; PLASTIC BAGS FOR PARTY FAVORS, BULLETIN BOARDS, KITS COMPRISED OF REUSABLE DESIGN STICKERS FOR ATTACHMENT TO PLAY SURFACES, IN CLASS 16 (U.S. CLS. 2, 5, 22, 23, 29, 37, 38 AND 50).

FOR: TEXTILE TABLE CLOTHS AND TABLE MATS; TOWELS, WASH CLOTHS, SHOWER CURTAINS, BLANKETS, THROWS, BED SHEETS, DUVET COVERS, BED SKIRTS, BED SPREADS, PILLOW COVERS, CURTAINS, HANDKERCHIEFS, TEXTILE WALL HANGINGS, FABRIC FLAGS, IN CLASS 24 (U.S. CLS. 42 AND 50).

FOR: CLOTH BIBS, HATS, SOCKS, SCARVES, MITTENS, GLOVES, HOSIERY, EARMUFFS, SLIPPER SOCKS, PONCHOS, RAINCOATS, PAJAMAS, ROBES, NIGHTGOWNS, INFANT SLEEPERS, BODYSUITS, LEGGINGS, BOOTS, SHOES, SANDALS, SLIPPERS, T-SHIRTS, JACKETS, COATS, JUMPERS, NECKTIES, VESTS, WAISTCOATS, DRESSES, PANTS, BELTS, DUNGAREES, SKIRTS, SHORTS, SWEATERS, SWIMWEAR, SWEATSHIRTS, SWEAT PANTS, FLEECE PULLOVERS, WIND RESISTANT JACKETS; WIND RESISTANT PANTS; SNOWSUITS, SNOW PANTS, UNDERWEAR, APRONS, MASQUERADE COSTUMES, IN CLASS 25 (U.S. CLS. 22 AND 39).

FOR: PLUSH TOYS, TOY BUILDING BLOCKS, TOY FIRE TRUCKS, TOY VEHICLES, TOY CONSTRUCTION SETS; ELECTRONIC NOVELTY TOYS, NAMELY, TOYS FEATURING MUSIC, SOUND, LIGHT AND/OR MOVEMENT; ELECTRONIC LEARNING TOYS; WOODEN TOYS, NAMELY, TRAINS AND TRAIN ACCESSORIES; HANDHELD ELECTRONIC GAMES, PLAY SETS COMPRISED OF FIGURES AND ACCESSORIES WITH TOY BUILDINGS, LANDSCAPES, ENVIRONMENTS AND/OR SETTINGS; TOY DIECAST FIGURES, TOY PLASTIC FIGURES, TOY TRAINS; LEARNING TOYS, NAMELY, TOYS FOR TEACHING LANGUAGE, ALPHABET, NUMBERS, COLORS, SPATIAL RELATIONSHIPS, MANNERS, VOCABULARY, AND/OR MATH; BOARD GAMES, PLAYING CARDS, CARD GAMES, JIGSAW PUZZLES, MANIPULATIVE PUZZLES, CARDS FOR PLAYING A MATCHING CARD GAME; MULTIPLE ACTIVITY BABY TOYS, CRIB TOYS, CRIB MOBILES, BATH TOYS, BUBBLE MAKING TOYS, SAND TOYS, INFLATABLE TOYS, SPORTS EQUIPMENT, NAMELY, BASEBALL GLOVES, BASEBALL BATS, SPORTS BALLS, JUMP ROPES, ROLLER SKATES AND ATHLETIC PROTECTIVE PADS FOR ROLLER SKATING; PLAYGROUND BALLS,

TOY SCOOTERS, PLAYHOUSES FOR CHILDREN, KITCHEN PLAY SETS COMPRISED OF PLASTIC TOY APPLIANCES, PLASTIC TOY UTENSILS, PLASTIC TOY PLATES, AND PLASTIC TOY FOOD; HOUSE CLEANING PLAY SETS COMPRISED OF PLASTIC TOY CLEANING EQUIPMENT AND TOY ACCESSORIES; COIN-OPERATED AMUSEMENT RIDES, RIDE-ON TOYS, PULL TOYS, BALLOONS, PIÑATAS, BABY RATTLES, POGO STICKS, CHRISTMAS STOCKINGS; CHRISTMAS TREE ORNAMENTS; DOLLS, BEAN BAG DOLLS, PUPPETS, SNOW GLOBES, TOY CHRISTMAS TREES, TOY MUSIC BOXES, WATER PISTOLS; PARTY FAVORS IN THE NATURE OF CRACKERS AND NOISEMAKERS; KITES, IN CLASS 28 (U.S. CLS. 22, 23, 38 AND 50).

FOR: ENTERTAINMENT SERVICES, NAMELY, AN ON-GOING SERIES OF PROGRAMS FOR CHILDREN PROVIDED THROUGH BROADCAST TELEVISION, CABLE TELEVISION, AND SATELLITE TELEVISION; PERSONAL APPEARANCES BY COSTUMED CHARACTERS; PROVISION OF EDUCATION AND ENTERTAINMENT FOR CHILDREN BY MEANS OF THE INTERNET, NAMELY, PROVIDING A WEBSITE FEATURING EDUCATIONAL GAMES IN THE FIELDS OF LANGUAGE, ALPHABET, NUMBERS, COLORS, SPATIAL RELATIONSHIPS, MANNERS, VOCABULARY, AND/OR MATH, AND INFORMATION ABOUT CHILDREN'S TELEVISION PROGRAMS; FAN CLUBS; EDUCATIONAL SERVICES IN THE NATURE OF LANGUAGE INSTRUCTION, THEME PARK SERVICES, IN CLASS 41 (U.S. CLS. 100, 101 AND 107).

PRIORITY CLAIMED UNDER SEC. 44(D) ON UNITED KINGDOM APPLICATION NO. 2448329, FILED 3-3-2007, REG. NO. 2448329, DATED 9-7-2007, EXPIRES 3-3-2017.

THE MARK CONSISTS OF THE DESIGN OF A TRAIN WITH A FACE ON TRACKS WITH THE NUMBER "1" ON THE SIDE.

SER. NO. 77-267,930, FILED 8-30-2007.

DOMINIC J. FERRAIUOLO, EXAMINING ATTORNEY

Int. Cl.: 41

Prior U.S. Cls.: 100, 101 and 107

United States Patent and Trademark Office

Reg. No. 3,574,637

Registered Feb. 17, 2009

**SERVICE MARK
PRINCIPAL REGISTER**

The Cowboy Heroes

MARTIN, TED E (OREGON LIMITED LIABILITY COMPANY), DBA THE COWBOY HEROES
9485 SW SATTLER ST
TIGARD, OR 97224

FOR: AUDIO RECORDING AND PRODUCTION; COMPOSITION OF MUSIC FOR OTHERS; EDITING OR RECORDING OF SOUNDS AND IMAGES; ENTERTAINMENT SERVICES, NAMELY, PROVIDING A WEBSITE FEATURING, PHOTOGRAPHIC, AUDIO, VIDEO AND PROSE PRESENTATIONS FEATURING MUSIC, BAND INFORMATION, UPCOMING EVENTS; ENTERTAINMENT IN THE NATURE OF LIVE PERFORMANCES BY MUSICAL GROUP; ENTERTAINMENT IN THE NATURE OF VISUAL AND AUDIO PERFORMANCES, AND MUSICAL, VARIETY, NEWS AND COMEDY SHOWS; ENTERTAINMENT IN THE NATURE OF VISUAL AND AUDIO PERFORMANCES, NAMELY, MUSICAL BAND, ROCK GROUP, GYMNASTIC, DANCE, AND BALLET PERFORMANCES; ENTERTAINMENT IN THE NATURE OF PERFORMANCES BY A MUSICAL GROUP; ENTERTAINMENT NAMELY, LIVE PERFORMANCES BY A MUSICAL BAND;

ENTERTAINMENT SERVICES, NAMELY, AN ON-LINE ACTIVITY WHERE YOU CREATE YOUR OWN MUSIC VIDEOS; ENTERTAINMENT, NAMELY, LIVE MUSIC CONCERTS; ENTERTAINMENT, NAMELY, LIVE PERFORMANCES BY MUSICAL BANDS; ENTERTAINMENT, NAMELY, LIVE PERFORMANCES BY ROCK GROUPS; MUSIC COMPOSITION FOR OTHERS; POEM AND LYRIC WRITING; PRESENTATION OF MUSICAL PERFORMANCE; PRODUCTION OF SOUND AND MUSIC VIDEO RECORDINGS, IN CLASS 41 (U.S. CLS. 100, 101 AND 107).

FIRST USE 3-27-2007; IN COMMERCE 3-27-2007.

THE MARK CONSISTS OF STANDARD CHARACTERS WITHOUT CLAIM TO ANY PARTICULAR FONT, STYLE, SIZE, OR COLOR.

SER. NO. 77-272,197, FILED 9-5-2007.

RONALD AIKENS, EXAMINING ATTORNEY

Int. Cls.: 9 and 41

Prior U.S. Cls.: 21, 23, 26, 36, 38, 100, 101 and 107

United States Patent and Trademark Office

Reg. No. 3,574,638

Registered Feb. 17, 2009

**TRADEMARK
SERVICE MARK
PRINCIPAL REGISTER**

SPIRIT CHIEF

ATRONIC INTERNATIONAL GMBH (FED REP
GERMANY GMBH)
BORSIGSTR. 26
LÜBBECKE, FED REP GERMANY 32312

FOR: ELECTRIC AND ELECTRONIC, COIN AND
TOKEN-OPERATED GAMING MACHINES, NAME-
LY, SLOT MACHINES WITH OR WITHOUT VIDEO
OUTPUT AND VIDEO LOTTERY TERMINALS;
MULTI-USER AND NETWORKED GAMING MA-
CHINES WITH OR WITHOUT VIDEO OUTPUT OR
VIDEO LOTTERY TERMINALS, COMPUTER PRO-
GRAMS FOR OPERATING ELECTRIC AND ELEC-
TRONIC MACHINES FOR GAMING AND/OR
AMUSEMENT PURPOSES; ACCOUNTING APPA-
RATUS FOR COIN AND TOKEN OPERATED MA-
CHINES FOR GAMING AND AMUSEMENT
PURPOSES, AND STRUCTURAL AND REPLACE-
MENT PARTS FOR AFORESAID GOODS, IN CLASS
9 (U.S. CLS. 21, 23, 26, 36 AND 38).

FOR: ENTERTAINMENT IN THE NATURE OF
CASINO SERVICES FEATURING A PROGRESSIVE
GAMING MACHINE JACKPOT INVOLVING ONE
OR MORE GAMING MACHINES, NAMELY A
JACKPOT OR PRIZE WITH A FIXED MINIMUM
VALUE WHICH INCREASES UNTIL THE JACKPOT
IS WON, IN CLASS 41 (U.S. CLS. 100, 101 AND 107).

THE MARK CONSISTS OF STANDARD CHAR-
ACTERS WITHOUT CLAIM TO ANY PARTICULAR
FONT, STYLE, SIZE, OR COLOR.

PRIORITY CLAIMED UNDER SEC. 44(D) ON
ERPNTM CMNTY TM OFC APPLICATION NO.
006231096, FILED 8-27-2007, REG. NO. 006231096,
DATED 8-7-2008, EXPIRES 8-27-2017.

SER. NO. 77-272,992, FILED 9-6-2007.

TRACY FLETCHER, EXAMINING ATTORNEY

Int. Cl.: 36

Prior U.S. Cls.: 100, 101 and 102

United States Patent and Trademark Office

Reg. No. 3,574,639

Registered Feb. 17, 2009

**SERVICE MARK
PRINCIPAL REGISTER**

80/20 LENDING

LODESTONE BANKING CONSULTANCY, INC.
(NEW YORK CORPORATION)
6901 HENDERSON ROAD
JAMESVILLE, NY 13078

FOR: BANKING CONSULTATION SERVICES,
NAMELY, ANALYSIS AND REORGANIZATION
OF WORKFLOW AND FUNCTIONS OF RELATION-
SHIP MANAGERS AND COMMERCIAL BANKING
OPERATIONS, IN CLASS 36 (U.S. CLS. 100, 101 AND
102).

FIRST USE 7-0-2007; IN COMMERCE 7-0-2007.

THE MARK CONSISTS OF STANDARD CHAR-
ACTERS WITHOUT CLAIM TO ANY PARTICULAR
FONT, STYLE, SIZE, OR COLOR.

NO CLAIM IS MADE TO THE EXCLUSIVE
RIGHT TO USE "LENDING", APART FROM THE
MARK AS SHOWN.

SER. NO. 77-273,943, FILED 9-7-2007.

TRACY CROSS, EXAMINING ATTORNEY

Int. Cl.: 3

Prior U.S. Cls.: 1, 4, 6, 50, 51 and 52

United States Patent and Trademark Office

Reg. No. 3,574,640

Registered Feb. 17, 2009

**TRADEMARK
PRINCIPAL REGISTER**

PHLORETIN CF

L'OREAL USA CREATIVE, INC. (DELAWARE
CORPORATION)

575 FIFTH AVENUE

NEW YORK, NY 10017

FOR: NON-MEDICATED SKINCARE PREPARA-
TIONS, IN CLASS 3 (U.S. CLS. 1, 4, 6, 50, 51 AND 52).

FIRST USE 6-1-2008; IN COMMERCE 6-1-2008.

THE MARK CONSISTS OF STANDARD CHAR-
ACTERS WITHOUT CLAIM TO ANY PARTICULAR
FONT, STYLE, SIZE, OR COLOR.

NO CLAIM IS MADE TO THE EXCLUSIVE
RIGHT TO USE "PHLORETIN", APART FROM
THE MARK AS SHOWN.

SER. NO. 77-274,070, FILED 9-7-2007.

SANI KHOURI, EXAMINING ATTORNEY

Int. Cls.: 35 and 41

Prior U.S. Cls.: 100, 101, 102 and 107

United States Patent and Trademark Office

Reg. No. 3,574,641

Registered Feb. 17, 2009

**SERVICE MARK
PRINCIPAL REGISTER**

HELI-EXPO

HELICOPTER ASSOCIATION INTERNATIONAL,
INC. (DELAWARE CORPORATION)
1635 PRINCE STREET
ALEXANDRIA, VA 22314

FOR: ARRANGE AND CONDUCT TRADE
SHOWS, TRADE CONVENTIONS, TRADE EXPO-
SITIONS, TRADE EXHIBITIONS, AND TRADE MEET-
INGS IN THE FIELD OF HELICOPTERS, IN CLASS
35 (U.S. CLS. 100, 101 AND 102).

FIRST USE 2-4-1990; IN COMMERCE 2-4-1990.

FOR: ARRANGE AND CONDUCT EDUCATION-
AL CONVENTIONS, EDUCATIONAL EXPOSI-
TIONS, EDUCATIONAL EXHIBITIONS, AND
EDUCATIONAL MEETINGS IN THE FIELD OF

HELICOPTERS, IN CLASS 41 (U.S. CLS. 100, 101
AND 107).

FIRST USE 2-4-1990; IN COMMERCE 2-4-1990.

THE MARK CONSISTS OF STANDARD CHAR-
ACTERS WITHOUT CLAIM TO ANY PARTICULAR
FONT, STYLE, SIZE, OR COLOR.

OWNER OF U.S. REG. NO. 2,675,137.

SEC. 2(F).

SER. NO. 77-275,178, FILED 9-10-2007.

TRACY FLETCHER, EXAMINING ATTORNEY

Int. Cls.: 36 and 37

Prior U.S. Cls.: 100, 101, 102, 103 and 106

United States Patent and Trademark Office

Reg. No. 3,574,642

Registered Feb. 17, 2009

**SERVICE MARK
PRINCIPAL REGISTER**



EDGEWORTH

EDGEWORTH VENTURES INC. (CANADA CORPORATION)
5500 NORTH SERVICE ROAD, 1ST FLOOR
BURLINGTON, ONTARIO, CANADA L7L6W6

FOR: REAL ESTATE INVESTMENT SERVICES IN THE NATURE OF PURCHASING AND SELLING OF REAL ESTATE FOR OTHERS; REAL ESTATE MANAGEMENT; MORTGAGE INVESTMENT SERVICES, IN CLASS 36 (U.S. CLS. 100, 101 AND 102).

FOR: REAL ESTATE DEVELOPMENT, IN CLASS 37 (U.S. CLS. 100, 103 AND 106).

PRIORITY CLAIMED UNDER SEC. 44(D) ON CANADA APPLICATION NO. 1339078, FILED 3-13-2007, REG. NO. TMA722482, DATED 8-27-2008, EXPIRES 8-27-2023.

THE MARK CONSISTS OF A HERALDIC LION ABOVE THE UNDERLINED WORD "EDGEWORTH".

SER. NO. 77-275,822, FILED 9-10-2007.

LINDA LAVACHE, EXAMINING ATTORNEY

Int. Cl.: 25

Prior U.S. Cls.: 22 and 39

United States Patent and Trademark Office

Reg. No. 3,574,643

Registered Feb. 17, 2009

**TRADEMARK
PRINCIPAL REGISTER**

DECRASTINATION

KALEM, ASHER A (UNITED STATES INDIVIDUAL)
11111-70 SAN JOSE BLVD
SUITE 290
JACKSONVILLE, FL 32223

FOR: ATHLETIC AND CASUAL CLOTHING AND FOOTWEAR FOR MEN, WOMEN, AND CHILDREN, NAMELY, SHIRTS, PANTS, SHORTS, COATS, JACKETS, ATHLETIC UNIFORMS, WARM UP SUITS, SWIMWEAR, TENNIS WEAR, SKIRTS, SWEATERS, UNDERWEAR, HEADWEAR, SOCKS, SNEAKERS, BOOTS, SHOES, AND WRISTBANDS, IN CLASS 25 (U.S. CLS. 22 AND 39).

FIRST USE 9-1-2006; IN COMMERCE 9-10-2006.

THE MARK CONSISTS OF STANDARD CHARACTERS WITHOUT CLAIM TO ANY PARTICULAR FONT, STYLE, SIZE, OR COLOR.

SER. NO. 77-278,181, FILED 9-12-2007.

MARIA-VICTORIA SUAREZ, EXAMINING ATTORNEY

Int. Cl.: 44

Prior U.S. Cls.: 100 and 101

United States Patent and Trademark Office

Reg. No. 3,574,644

Registered Feb. 17, 2009

**SERVICE MARK
PRINCIPAL REGISTER**

HeartSmart IMTplus

IMT TECHNOLOGY, INC. (DELAWARE CORPORATION), DBA HEARTSMART TECHNOLOGIES

19700 FAIRCHILD RD. SUITE 300
IRVINE, CA 92660

FOR: MEDICAL IMAGING SERVICES, NAMELY, CONSULTING SERVICES IN THE FIELD OF USING AND OPERATING MEDICAL IMAGING APPARATUS INCLUDING X-RAY, COMPUTED TOMOGRAPHY, MAGNETIC RESONANCE IMAGING, ULTRASOUND, AND POSITRON EMISSION TO-

MOGRAPHY APPARATUS, IN CLASS 44 (U.S. CLS. 100 AND 101).

FIRST USE 8-25-2007; IN COMMERCE 9-5-2007.

THE MARK CONSISTS OF STANDARD CHARACTERS WITHOUT CLAIM TO ANY PARTICULAR FONT, STYLE, SIZE, OR COLOR.

SER. NO. 77-279,599, FILED 9-14-2007.

ZACHARY BELLO, EXAMINING ATTORNEY

Int. Cl.: 9

Prior U.S. Cls.: 21, 23, 26, 36 and 38

United States Patent and Trademark Office

Reg. No. 3,574,645

Registered Feb. 17, 2009

**TRADEMARK
PRINCIPAL REGISTER**

MSG

SEIKOH GIKEN CO., LTD. (JAPAN CORPORATION)
296-1, MATSUHIDAI, MATSUDO-SHI
CHIBA, JAPAN 270-2214

FOR: PHOTOGRAPHIC INSTRUMENTS AND APPARATUS, NAMELY, LENSES FOR ASTROPHOTOGRAPHY, LENSES FOR DIGITAL CAMERAS, LENSES FOR FACSIMILE MACHINES, LENSES FOR MOBILE PHONES CAMERAS, LENSES FOR IN-CAR CAMERAS, LENSES FOR MONITORING CAMERAS, LENSES FOR CAMERAS; CINEMATOGRAPHIC INSTRUMENTS AND APPARATUS, NAMELY, LENSES FOR TELEVISION CAMERAS, LENSES FOR VIDEO CAMERAS, LENSES FOR LIQUID-CRYSTAL PROJECTORS; OPTICAL APPARATUS AND INSTRUMENTS, NAMELY, OPTICAL CORRECTING LENSES, EYEPIECES, OPTICAL

LENSES, OPTICAL OBJECTIVE LENSES, IN CLASS 9 (U.S. CLS. 21, 23, 26, 36 AND 38).

THE MARK CONSISTS OF STANDARD CHARACTERS WITHOUT CLAIM TO ANY PARTICULAR FONT, STYLE, SIZE, OR COLOR.

PRIORITY CLAIMED UNDER SEC. 44(D) ON JAPAN APPLICATION NO. 2007-084429, FILED 7-31-2007, REG. NO. 5119050, DATED 3-14-2008, EXPIRES 3-14-2018.

THE WORDING "MSG" HAS NO MEANING IN A FOREIGN LANGUAGE.

SER. NO. 77-279,796, FILED 9-14-2007.

ANDREA HACK, EXAMINING ATTORNEY

Int. Cl.: 9

Prior U.S. Cls.: 21, 23, 26, 36 and 38

Reg. No. 3,574,646

United States Patent and Trademark Office

Registered Feb. 17, 2009

**TRADEMARK
PRINCIPAL REGISTER**

SMARTPUBLISHER

PRE1.COM, LLC (OREGON LIMITED LIABILITY
COMPANY)
SUITE 650
1200 NW NAITO PARKWAY
PORTLAND, OR 97209

FOR: COMPUTER SOFTWARE FOR PRODUCTION,
ACCOUNTING, MANAGEMENT, SALES,
AND SCHEDULING FUNCTIONS IN THE PUBLISHING
INDUSTRY, IN CLASS 9 (U.S. CLS. 21, 23,
26, 36 AND 38).

FIRST USE 11-1-1999; IN COMMERCE 11-1-1999.

THE MARK CONSISTS OF STANDARD CHARACTERS
WITHOUT CLAIM TO ANY PARTICULAR FONT,
STYLE, SIZE, OR COLOR.

SEC. 2(F).

SER. NO. 77-281,027, FILED 9-17-2007.

HEATHER SAPP, EXAMINING ATTORNEY

Int. Cls.: 9, 35, 38, 41, 42 and 45

**Prior U.S. Cls.: 21, 23, 26, 36, 38, 100, 101, 102, 104
and 107**

Reg. No. 3,574,647

United States Patent and Trademark Office

Registered Feb. 17, 2009

**TRADEMARK
SERVICE MARK
PRINCIPAL REGISTER**



APEX INNOVATIONS, INC. (DELAWARE CORPORATION)
19951 WEST 162ND STREET
OLATHE, KS 660622787

FOR: COMPUTER PROGRAMS FOR ALLOWING MULTIPLE PERSONS OR ORGANIZATIONS TO ENTER, MAINTAIN AND SHARE STRUCTURED OR UNSTRUCTURED INFORMATION OF ANY KIND WITH OTHER INDIVIDUAL(S), ORGANIZATION(S) OR PRE-DEFINED GROUPS OF ORGANIZATIONS IN A SECURE WEB-BASED ENVIRONMENT, AND FOR ALLOWING MULTIPLE PERSONS OR ENTITIES WITHIN A COMMUNITY TO ENTER AND UPDATE THEIR ORGANIZATIONAL AND PERSONAL FILES TO MAINTAIN AND SHARE RESOURCE INFORMATION, REGARDING PERSONS AND ASSETS, WITH SELECTED EMERGENCY PERSONNEL, COMPUTER PROGRAMS WHICH PROVIDE A MEANS OF COLLECTING AND TRACKING DONATED GOODS AND SERVICES, EITHER PREEMPTIVELY OR IN RESPONSE TO DISASTERS, FROM PRIVATE SECTOR ORGANIZATIONS OR INDIVIDUALS FOR USE BY EMERGENCY ORGANIZATIONS, CHARITABLE GROUPS OR PERSONS IN NEED, COMPUTER PROGRAMS WHICH ALLOWS MULTIPLE PERSONS OR ORGANIZATIONS TO ENTER AND UPDATE PROJECTS AND ACTIVITIES TO MAINTAIN, SECURELY SHARE AND/OR PUBLISH INFORMATION TO THE PUBLIC REGARDING THE STATUS OF PLANS AND ACTIONS WITHIN A COMMUNITY OR AREA, COMPUTER PROGRAMS WHICH PROVIDES A MEANS OF COLLECTING AND VERIFYING THE SKILLS AND CREDENTIALS FOR ANY NUMBER OF INDIVIDUALS FROM ONE OR MULTIPLE ORGANIZATIONS, ENSURING ADHERENCE TO ONE OR MULTIPLE

ORGANIZATIONAL AND REGIONAL CREDENTIALING STANDARDS AND, COMPUTER PROGRAMS WHICH ALLOWS ANY NUMBER OF GOVERNMENT AGENCIES TO ENTER, MAINTAIN AND SHARE INDIVIDUAL RESPONDER INFORMATION WITH SCHOOLS OR OTHER ORGANIZATIONS TO ALLOW QUICKER ACCESS TO FACILITIES IN RESPONSE TO ANY EMERGENCY OR DISASTER; DOWNLOADABLE SCIENTIFIC AND MEDICAL DATA VIA THE INTERNET; DOWNLOADABLE COMPUTER PROGRAMS FOR THE PURPOSE OF DOWNLOADING INFORMATION TO COMPUTERS, WIRELESS, AND MOBILE DEVICES; COMPUTER PROGRAMMES FOR DOCUMENT MANAGEMENT, IN CLASS 9 (U.S. CLS. 21, 23, 26, 36 AND 38).

FIRST USE 1-1-2007; IN COMMERCE 1-1-2007.

FOR: PROVIDING BUSINESS INFORMATION, ALSO VIA INTERNET, THE CABLE NETWORK OR OTHER FORMS OF DATA TRANSFER; COMPUTER SERVICES, NAMELY, ADDRESS CHANGE NOTIFICATION SERVICES IN THE NATURE OF POSTING NOTIFICATIONS OF CHANGES OF ADDRESSES FOR BUSINESSES VIA THE INTERNET; MAINTAINING REGISTRY OF CERTIFIED MEDICAL TECHNICAL PROFESSIONALS; BUSINESS SERVICES, NAMELY, REGISTERING, SCREENING, CREDENTIALING, AND ORGANIZING THIRD-PARTY VENDORS, SUPPLIERS, AND CONTRACTORS, AND DOCUMENTATION AND INFORMATION ON BEHALF OF OTHERS; ON-LINE BUSINESS DIRECTORIES FEATURING INDIVIDUALS, ORGANIZATIONS, AND RESOURCES USEFUL BEFORE, DURING AND AFTER ANY DISASTER, ACT OF TERRORISM, OR OTHER EMERGENCY SITUATION; PROVIDING AN ON-

LINE COMMERCIAL INFORMATION DIRECTORY ON THE INTERNET; PROVIDING AN ONLINE DIRECTORY INFORMATION SERVICE FEATURING INFORMATION REGARDING INDIVIDUALS, ORGANIZATIONS, AND RESOURCES USEFUL BEFORE, DURING AND AFTER ANY DISASTER, ACT OF TERRORISM, OR OTHER EMERGENCY SITUATION; TELEPHONE DIRECTORY INFORMATION; PROVIDING ON-LINE REGISTRATION SERVICES FOR ANY TYPE OF TRAINING, MEETING, CONFERENCE, OR EXERCISE EVENTS; CONNECTING BUYERS AND SELLERS OF FINANCIAL ASSETS; PROVIDING TRACKING SERVICES AND INFORMATION CONCERNING TRACKING OF ASSETS IN TRANSIT, NAMELY, VEHICLES, TRAILERS, DRIVERS, CARGO AND DELIVERY CONTAINERS; ON-LINE TRADING SERVICES IN WHICH SELLER POSTS PRODUCTS TO BE AUCTIONED AND BIDDING IS DONE VIA THE INTERNET; ONLINE AUCTION BIDDING FOR OTHERS; DISSEMINATION OF ADVERTISING, SCHEDULING AND MANAGING OF TRAINING COURSES AND PROGRAMS FOR OTHERS VIA A GLOBAL COMPUTER NETWORK, IN CLASS 35 (U.S. CLS. 100, 101 AND 102).

FIRST USE 1-1-2007; IN COMMERCE 1-1-2007.

FOR: COMPUTER-AIDED TRANSMISSION OF MESSAGES; ELECTRONIC MESSAGE SENDING; ELECTRONIC MESSAGE TRANSMISSION; DELIVERY OF MESSAGES BY ELECTRONIC TRANSMISSION; ELECTRONIC TRANSMISSION OF MESSAGES AND DATA; ELECTRONIC VOICE MESSAGING, NAMELY, THE RECORDING AND SUBSEQUENT TRANSMISSION OF VOICE MESSAGES BY TELEPHONE; ELECTRONIC, ELECTRIC, AND DIGITAL TRANSMISSION OF VOICE, DATA, IMAGES, SIGNALS, AND MESSAGES; PROVIDING ON-LINE CHAT ROOMS AND ELECTRONIC BULLETIN BOARDS FOR TRANSMISSION OF MESSAGES AMONG USERS IN THE FIELD OF GENERAL INTEREST; INSTANT MESSAGING SERVICES; ELECTRONIC STORE-AND-FORWARD MESSAGING; TRANSMISSION OF INFORMATION BY DATA COMMUNICATIONS FOR ASSISTING DECISION MAKING; TRANSMISSION OF INFORMATION BY ELECTRONIC COMMUNICATIONS NETWORKS; INFORMATION TRANSMISSION VIA ELECTRONIC COMMUNICATIONS NETWORKS, IN CLASS 38 (U.S. CLS. 100, 101 AND 104).

FIRST USE 1-1-2007; IN COMMERCE 1-1-2007.

FOR: PROVIDING ON-LINE TRAINING CLASSES, PROGRAMS, WORKSHOPS AND COACHING IN THE FIELD OF INFORMATION MANAGEMENT AND INFORMATION SHARING; EDUCATIONAL SERVICES, NAMELY, CONDUCTING INFORMAL ON-LINE PROGRAMS IN THE FIELDS OF INFORMATION MANAGEMENT AND INFORMATION SHARING, AND PRINTABLE MATERIALS DISTRIBUTED THEREWITH; EDUCATIONAL SERVICES, NAMELY, CONDUCTING ON-LINE EXHIBITIONS AND DISPLAYS AND INTERACTIVE EXHIBITS IN THE FIELD OF INFORMATION MANAGEMENT AND INFORMATION SHARING;

EDUCATIONAL SERVICES, NAMELY, DEVELOPING, ARRANGING, AND CONDUCTING EDUCATIONAL CONFERENCES AND PROGRAMS AND PROVIDING COURSES OF INSTRUCTION IN THE FIELD OF INFORMATION MANAGEMENT AND INFORMATION SHARING; EDUCATIONAL AND ENTERTAINMENT SERVICES, NAMELY, A CONTINUING PROGRAM ABOUT INFORMATION MANAGEMENT AND INFORMATION SHARING ACCESSIBLE BY RADIO, TELEVISION, SATELLITE, AUDIO, VIDEO AND COMPUTER NETWORKS; EDUCATION SERVICES, NAMELY, PROVIDING CLASSES, PROGRAMS, WORKSHOPS AND COACHING IN THE FIELD OF INFORMATION MANAGEMENT AND INFORMATION SHARING; EDUCATION SERVICES, NAMELY, PROVIDING CLASSES, PROGRAMS, WORKSHOPS AND COACHING IN THE FIELDS OF INFORMATION MANAGEMENT AND INFORMATION SHARING; DEVELOPING EDUCATIONAL MANUALS FOR OTHERS IN THE FIELD OF INFORMATION MANAGEMENT AND INFORMATION SHARING; DEVELOPMENT AND DISSEMINATION OF EDUCATIONAL MATERIALS OF OTHERS IN THE FIELD OF INFORMATION MANAGEMENT AND INFORMATION SHARING, IN CLASS 41 (U.S. CLS. 100, 101 AND 107).

FIRST USE 1-1-2007; IN COMMERCE 1-1-2007.

FOR: APPLICATION SERVICE PROVIDER (ASP) FEATURING SOFTWARE FOR USE ON ALLOWING MULTIPLE PERSONS OR ORGANIZATIONS TO ENTER, MAINTAIN AND SHARE STRUCTURED OR UNSTRUCTURED INFORMATION OF ANY KIND WITH OTHER INDIVIDUAL(S), ORGANIZATION(S) OR PRE-DEFINED GROUPS OF ORGANIZATIONS IN A SECURE WEB-BASED ENVIRONMENT AND FOR ALLOWING MULTIPLE PERSONS OR ENTITIES WITHIN A COMMUNITY TO ENTER AND UPDATE THEIR ORGANIZATIONAL AND PERSONAL FILES TO MAINTAIN AND SHARE RESOURCE INFORMATION, REGARDING PERSONS AND ASSETS, WITH SELECTED EMERGENCY PERSONNEL, AND THAT PROVIDES A MEANS OF COLLECTING AND TRACKING DONATED GOODS AND SERVICES, EITHER PREEMPTIVELY OR IN RESPONSE TO DISASTERS, FROM PRIVATE SECTOR ORGANIZATIONS OR INDIVIDUALS FOR USE BY EMERGENCY ORGANIZATIONS, CHARITABLE GROUPS OR PERSONS IN NEED AND THAT ALLOWS MULTIPLE PERSONS OR ORGANIZATIONS TO ENTER AND UPDATE PROJECTS AND ACTIVITIES TO MAINTAIN, SECURELY SHARE AND/OR PUBLISH INFORMATION TO THE PUBLIC REGARDING THE STATUS OF PLANS AND ACTIONS WITHIN A COMMUNITY OR AREA AND THAT PROVIDES A MEANS OF COLLECTING AND VERIFYING THE SKILLS AND CREDENTIALS FOR ANY NUMBER OF INDIVIDUALS FROM ONE OR MULTIPLE ORGANIZATIONS, ENSURING ADHERENCE TO ONE OR MULTIPLE ORGANIZATIONAL AND REGIONAL CREDENTIALING STANDARDS AND THAT ALLOWS ANY NUMBER OF GOVERNMENT AGENCIES TO ENTER, MAINTAIN AND SHARE INDIVIDUAL RESPONDER IN-

FORMATION WITH SCHOOLS OR OTHER ORGANIZATIONS TO ALLOW QUICKER ACCESS TO FACILITIES IN RESPONSE TO ANY EMERGENCY OR DISASTER; APPLICATION SERVICE PROVIDER (ASP), NAMELY, HOSTING COMPUTER SOFTWARE APPLICATIONS AND DATA OF OTHERS; APPLICATION SERVICE PROVIDER, NAMELY, PROVIDING, HOSTING, MANAGING, DEVELOPING, AND MAINTAINING APPLICATIONS, SOFTWARE, WEBSITES, AND DATABASES IN THE FIELDS OF PERSONAL PRODUCTIVITY, WIRELESS COMMUNICATION, MOBILE INFORMATION ACCESS, AND REMOTE DATA MANAGEMENT FOR WIRELESS DELIVERY OF CONTENT TO HANDHELD COMPUTERS, LAPTOPS AND MOBILE ELECTRONIC DEVICES; COMPUTER SERVICE, NAMELY, ACTING AS AN APPLICATION SERVICE PROVIDER IN THE FIELD OF KNOWLEDGE MANAGEMENT TO HOST COMPUTER APPLICATION SOFTWARE FOR CREATING SEARCHABLE DATABASES OF INFORMATION AND DATA; COMPUTER SERVICE, NAMELY, ACTING AS AN APPLICATION SERVICE PROVIDER IN THE FIELD OF KNOWLEDGE MANAGEMENT TO HOST COMPUTER APPLICATION SOFTWARE FOR SEARCHING AND RETRIEVING INFORMATION FROM DATABASES AND COMPUTER NETWORKS; COMPUTER SERVICE, NAMELY, ACTING AS AN APPLICATION SERVICE PROVIDER IN THE FIELD OF KNOWLEDGE MANAGEMENT TO HOST COMPUTER APPLICATION SOFTWARE FOR THE COLLECTION, EDITING, ORGANIZING, MODIFYING, BOOK MARKING, TRANSMISSION, STORAGE AND SHARING OF DATA AND INFORMATION; COMPUTER SERVICES IN THE NATURE OF CUSTOMIZED WEB PAGES FEATURING USER-DEFINED INFORMATION, PERSONAL PROFILES AND INFORMATION; HOSTING OF DIGITAL CONTENT ON THE INTERNET; COMPUTER SERVICES, NAMELY, HOSTING ON-LINE INTERACTIVE PUBLIC CALENDARS THAT ALLOW MULTIPLE PARTICIPANTS TO SHARE EVENT SCHEDULES, FACILITY RESERVATIONS, AND TRANSPORTA-

TION REQUESTS; COMPUTER DISASTER RECOVERY PLANNING; DESIGN, CREATION, HOSTING AND MAINTENANCE OF INTERNET SITES FOR THIRD PARTIES; COMPUTER PROJECT MANAGEMENT SERVICES, IN CLASS 42 (U.S. CLS. 100 AND 101).

FIRST USE 1-1-2007; IN COMMERCE 1-1-2007.

FOR: VERIFYING AND MONITORING THE CREDENTIALS OF DOCTORS AND OTHER MEDICAL PROFESSIONALS; REMINDER SERVICES IN THE AREA OF UPCOMING IMPORTANT DATES AND EVENTS; PROVIDING INFORMATION REGARDING UNDERSTANDING AND PREVENTING TERRORISM; CONSULTATION SERVICES CONCERNING HOMELAND SAFETY AND SECURITY ISSUES; PROVIDING INFORMATION CONCERNING HOMELAND SAFETY AND SECURITY ISSUES; PROVIDING NEWS CONCERNING HOMELAND SAFETY AND SECURITY ISSUES, IN CLASS 45 (U.S. CLS. 100 AND 101).

FIRST USE 1-1-2007; IN COMMERCE 1-1-2007.

NO CLAIM IS MADE TO THE EXCLUSIVE RIGHT TO USE "INFO", APART FROM THE MARK AS SHOWN.

THE COLOR(S) BLACK AND RED IS/ARE CLAIMED AS A FEATURE OF THE MARK.

THE MARK CONSISTS OF A STYLIZED "I" FOLLOWED BY A HYPHEN AND THE WORD "INFO" IN ALL UPPER CASE LETTERS OF A STYLIZED FONT. ALL CHARACTERS ARE BLACK EXCEPT THE FIRST "I" WHICH IS RED.

SER. NO. 77-281,592, FILED 9-17-2007.

JACQUELINE A. LAVINE, EXAMINING ATTORNEY

Int. Cl.: 9

Prior U.S. Cls.: 21, 23, 26, 36 and 38

United States Patent and Trademark Office

Reg. No. 3,574,648

Registered Feb. 17, 2009

**TRADEMARK
PRINCIPAL REGISTER**

PORTFOLIO

SRC, LLC (CALIFORNIA LIMITED LIABILITY
COMPANY)
190 SOUTH GLASSELL STREET, SUITE 201
ORANGE, CA 92866

FOR: COMPUTER SOFTWARE FOR MARKET
ANALYSIS, MANAGEMENT OF MARKET AND
DEMOGRAPHIC DATA AND CREATING DEMO-
GRAPHIC REPORTS TO ENABLE BUSINESSES TO
ANALYZE MARKETS FOR BUSINESS DEVELOP-
MENT PURPOSES, IN CLASS 9 (U.S. CLS. 21, 23, 26,
36 AND 38).

FIRST USE 1-0-2000; IN COMMERCE 1-0-2000.

THE MARK CONSISTS OF STANDARD CHAR-
ACTERS WITHOUT CLAIM TO ANY PARTICULAR
FONT, STYLE, SIZE, OR COLOR.

SER. NO. 77-282,929, FILED 9-18-2007.

MARY MUNSON, EXAMINING ATTORNEY

Int. Cl.: 9

Prior U.S. Cls.: 21, 23, 26, 36 and 38

United States Patent and Trademark Office

Reg. No. 3,574,649

Registered Feb. 17, 2009

**TRADEMARK
PRINCIPAL REGISTER**



THE F.J. WESTCOTT COMPANY (OHIO CORPORATION)
1447 SUMMIT STREET
TOLEDO, OH 43603

FOR: LIGHT SOURCE PRODUCT, NAMELY, LIGHTING DEVICES FOR TAKING STILL PICTURES, OR FOR DIGITAL, VIDEO OR HIGH DEFINITION IMAGE CAPTURE, IN CLASS 9 (U.S. CLS. 21, 23, 26, 36 AND 38).

FIRST USE 1-31-2008; IN COMMERCE 2-6-2008.

OWNER OF U.S. REG. NOS. 1,421,789 AND 3,062,843.

NO CLAIM IS MADE TO THE EXCLUSIVE RIGHT TO USE "STROBE LIGHT", APART FROM THE MARK AS SHOWN.

SER. NO. 77-283,557, FILED 9-19-2007.

DEZMONA MIZELLE, EXAMINING ATTORNEY

Int. Cl.: 9

Prior U.S. Cls.: 21, 23, 26, 36 and 38

Reg. No. 3,574,650

United States Patent and Trademark Office

Registered Feb. 17, 2009

**TRADEMARK
PRINCIPAL REGISTER**

PRE1

PRE1.COM, LLC (OREGON LIMITED LIABILITY
COMPANY)
SUITE 650
1200 NW NAITO PARKWAY
PORTLAND, OR 97209

THE MARK CONSISTS OF STANDARD CHAR-
ACTERS WITHOUT CLAIM TO ANY PARTICULAR
FONT, STYLE, SIZE, OR COLOR.

FOR: COMPUTER SOFTWARE FOR PRODUC-
TION, ACCOUNTING, MANAGEMENT, SALES,
AND SCHEDULING FUNCTIONS IN THE PUB-
LISHING INDUSTRY, IN CLASS 9 (U.S. CLS. 21, 23,
26, 36 AND 38).

SEC. 2(F).

SER. NO. 77-283,902, FILED 9-19-2007.

FIRST USE 12-1-1999; IN COMMERCE 12-1-1999.

HEATHER SAPP, EXAMINING ATTORNEY

Int. Cl.: 35

Prior U.S. Cls.: 100, 101 and 102

United States Patent and Trademark Office

Reg. No. 3,574,651

Registered Feb. 17, 2009

**SERVICE MARK
PRINCIPAL REGISTER**



AMERICAN HERBALISTS GUILD (CALIFORNIA CORPORATION)
141 NOB HILL ROAD
CHESHIRE, CT 06410

FOR: ASSOCIATION SERVICES, NAMELY, PROMOTING THE INTERESTS OF HERBALISTS SPECIALIZING IN THE MEDICINAL USE OF PLANTS, IN CLASS 35 (U.S. CLS. 100, 101 AND 102).

FIRST USE 5-7-1990; IN COMMERCE 5-7-1990.

NO CLAIM IS MADE TO THE EXCLUSIVE RIGHT TO USE "GUILD", APART FROM THE MARK AS SHOWN.

THE STIPPLING AND LINING ARE A FEATURE OF THE MARK.

SEC. 2(F) AS TO "AMERICAN HERBALISTS".

SER. NO. 77-284,863, FILED 9-20-2007.

MARY CRAWFORD, EXAMINING ATTORNEY

Int. Cls.: 21, 25 and 30

Prior U.S. Cls.: 2, 13, 22, 23, 29, 30, 33, 39, 40, 46 and 50

United States Patent and Trademark Office

Reg. No. 3,574,652

Registered Feb. 17, 2009

**TRADEMARK
PRINCIPAL REGISTER**

PETE & SHORTY'S

PETE & SHORTY'S, INC. (FLORIDA CORPORATION)
SUITE 120
107 HAMPTON ROAD
CLEARWATER, FL 33759

FOR: MUGS; DRINKING GLASSES; SHOT GLASSES; PITCHERS, IN CLASS 21 (U.S. CLS. 2, 13, 23, 29, 30, 33, 40 AND 50).

FIRST USE 3-31-1998; IN COMMERCE 3-31-1998.

FOR: SHIRTS; CAPS, IN CLASS 25 (U.S. CLS. 22 AND 39).

FIRST USE 3-31-1998; IN COMMERCE 3-31-1998.

FOR: HAMBURGER SANDWICHES, IN CLASS 30 (U.S. CL. 46).

FIRST USE 3-31-1998; IN COMMERCE 3-31-1998.

THE MARK CONSISTS OF STANDARD CHARACTERS WITHOUT CLAIM TO ANY PARTICULAR FONT, STYLE, SIZE, OR COLOR.

OWNER OF U.S. REG. NO. 2,177,169.

SER. NO. 77-284,987, FILED 9-20-2007.

SONYA STEPHENS, EXAMINING ATTORNEY

Int. Cl.: 30

Prior U.S. Cl.: 46

United States Patent and Trademark Office

Reg. No. 3,574,653

Registered Feb. 17, 2009

**TRADEMARK
PRINCIPAL REGISTER**

SHORTY BURGERS

PETE & SHORTY'S, INC. (FLORIDA CORPORATION)
SUITE 120
107 HAMPTON ROAD
CLEARWATER, FL 33759

FOR: HAMBURGER SANDWICHES, IN CLASS 30
(U.S. CL. 46).

FIRST USE 3-31-1998; IN COMMERCE 3-31-1998.

THE MARK CONSISTS OF STANDARD CHARACTERS WITHOUT CLAIM TO ANY PARTICULAR FONT, STYLE, SIZE, OR COLOR.

OWNER OF U.S. REG. NO. 3,279,774.

NO CLAIM IS MADE TO THE EXCLUSIVE RIGHT TO USE "BURGERS" FOR CLASSES 29 AND 30, APART FROM THE MARK AS SHOWN.

SER. NO. 77-285,039, FILED 9-20-2007.

SONYA STEPHENS, EXAMINING ATTORNEY

Int. Cl.: 9

Prior U.S. Cls.: 21, 23, 26, 36 and 38

United States Patent and Trademark Office

Reg. No. 3,574,654

Registered Feb. 17, 2009

**TRADEMARK
PRINCIPAL REGISTER**

VR6 SYSTEMS

A.J. HUNT CONSULTING, INC. (MICHIGAN CORPORATION)
49527 DUNHILL DR.
MACOMB, MI 48044

FOR: COMPUTERS, DESKTOP COMPUTERS, NOT FOR USE FOR VIRTUAL REALITY APPLICATIONS, IN CLASS 9 (U.S. CLS. 21, 23, 26, 36 AND 38).

FIRST USE 9-6-2007; IN COMMERCE 9-6-2007.

THE MARK CONSISTS OF STANDARD CHARACTERS WITHOUT CLAIM TO ANY PARTICULAR FONT, STYLE, SIZE, OR COLOR.

NO CLAIM IS MADE TO THE EXCLUSIVE RIGHT TO USE "SYSTEMS", APART FROM THE MARK AS SHOWN.

SER. NO. 77-285,994, FILED 9-21-2007.

MARGERY A. TIERNEY, EXAMINING ATTORNEY

Int. Cl.: 25

Prior U.S. Cls.: 22 and 39

United States Patent and Trademark Office

Reg. No. 3,574,655

Registered Feb. 17, 2009

**TRADEMARK
PRINCIPAL REGISTER**

NIMANY

NIMA BEHNOUD (UNITED STATES INDIVIDUAL)
C/O TUCKER & LATIFI, LLP
160 EAST 84TH STREET - SUITE 5E
NEW YORK, NY 10028

FOR: SHORT-SLEEVED OR LONG-SLEEVED T-SHIRTS; T-SHIRTS; DRESS SHIRTS; DRESSES;

SKIRTS AND DRESSES; PANTS; BELTS; CAPS, IN CLASS 25 (U.S. CLS. 22 AND 39).

FIRST USE 7-14-2004; IN COMMERCE 7-14-2004.

SER. NO. 77-286,939, FILED 9-24-2007.

MATTHEW PAPPAS, EXAMINING ATTORNEY

Int. Cls.: 9 and 41

Prior U.S. Cls.: 21, 23, 26, 36, 38, 100, 101 and 107

United States Patent and Trademark Office

Reg. No. 3,574,656

Registered Feb. 17, 2009

**TRADEMARK
SERVICE MARK
PRINCIPAL REGISTER**

WILD VALLEY

ATRONIC INTERNATIONAL GMBH (FED REP
GERMANY GESELLSCHAFT MIT BES-
CHRÄNKTER HAFTUNG (GMBH))
BORSIGSTR. 26
LÜBBECKE, FED REP GERMANY 32312

FOR: ELECTRIC AND ELECTRONIC, COIN AND
TOKEN-OPERATED GAMING MACHINES, NAME-
LY, SLOT MACHINES WITH OR WITHOUT VIDEO
OUTPUT AND VIDEO LOTTERY TERMINALS;
MULTI-USER AND NETWORKED GAMING MA-
CHINES WITH OR WITHOUT VIDEO OUTPUT OR
VIDEO LOTTERY TERMINALS, COMPUTER PRO-
GRAMS FOR OPERATING ELECTRIC AND ELEC-
TRONIC MACHINES FOR GAMING AND/OR
AMUSEMENT PURPOSES; ACCOUNTING APPA-
RATUS FOR COIN AND TOKEN OPERATED MA-
CHINES FOR GAMING AND AMUSEMENT
PURPOSES, AND STRUCTURAL AND REPLACE-
MENT PARTS FOR AFORESAID GOODS, IN CLASS
9 (U.S. CLS. 21, 23, 26, 36 AND 38).

FOR: ENTERTAINMENT IN THE NATURE OF
CASINO SERVICES FEATURING A PROGRESSIVE

GAMING MACHINE JACKPOT INVOLVING ONE
OR MORE GAMING MACHINES, NAMELY A
JACKPOT OR PRIZE WITH A FIXED MINIMUM
VALUE WHICH INCREASES UNTIL THE JACKPOT
IS WON, IN CLASS 41 (U.S. CLS. 100, 101 AND 107).

THE MARK CONSISTS OF STANDARD CHAR-
ACTERS WITHOUT CLAIM TO ANY PARTICULAR
FONT, STYLE, SIZE, OR COLOR.

PRIORITY CLAIMED UNDER SEC. 44(D) ON
ERPNTY TM OFC APPLICATION NO.
006242168, FILED 8-31-2007.

OWNER OF ERPNTY TM OFC REG. NO.
006242168, DATED 8-7-2008, EXPIRES 8-31-2017.

SER. NO. 77-287,141, FILED 9-24-2007.

JANICE L. MCMORROW, EXAMINING ATTOR-
NEY

Int. Cl.: 9

Prior U.S. Cls.: 21, 23, 26, 36 and 38

United States Patent and Trademark Office

Reg. No. 3,574,657

Registered Feb. 17, 2009

**TRADEMARK
PRINCIPAL REGISTER**

SYMMETRIX

SYMMETRIX, INC. (WASHINGTON CORPORATION)
6408 216TH ST SW
MOUNTLAKE TERRACE, WA 98043

FOR: AUDIO SIGNAL PROCESSING EQUIPMENT, NAMELY, PREAMPLIFIERS, AMPLIFIERS, ANALOG AND DIGITAL SIGNAL PROCESSORS AND MIXERS, ANALOG TO DIGITAL AND DIGITAL TO ANALOG CONVERTERS, REMOTE CONTROL PANELS, ASSOCIATED POWER SUPPLIES, RACK MOUNTS, AND CABLES AND EMBEDDED FIRMWARE FOR USE WITH DEDICATED HARDWARE AND/OR SOFTWARE RUNNING ON PERSONAL COMPUTERS, IN CLASS 9 (U.S. CLS. 21, 23, 26, 36 AND 38).

FIRST USE 1-1-1995; IN COMMERCE 1-1-1995.

THE MARK CONSISTS OF STANDARD CHARACTERS WITHOUT CLAIM TO ANY PARTICULAR FONT, STYLE, SIZE, OR COLOR.

"SYMMETRIX" APPEARING IN THE MARK HAS NO MEANING IN A FOREIGN LANGUAGE.

SER. NO. 77-288,504, FILED 9-25-2007.

TINA L. SNAPP, EXAMINING ATTORNEY

Int. Cl.: 7

Prior U.S. Cls.: 13, 19, 21, 23, 31, 34 and 35

United States Patent and Trademark Office

Reg. No. 3,574,658

Registered Feb. 17, 2009

**TRADEMARK
PRINCIPAL REGISTER**

Mushbox

GEOFF BAKER (CANADA SOLE PROPRIETOR-
SHIP)
205 SOUTHWEST BLVD., #102, P.O. BOX 961
LAKE COWICHAN, BRITISH COLUMBIA, CANA-
DA V0R 2G0

FOR: POWER OPERATED CULTIVATORS FOR
CULTIVATION OF EDIBLE MUSHROOMS, IN
CLASS 7 (U.S. CLS. 13, 19, 21, 23, 31, 34 AND 35).

FIRST USE 6-0-2001; IN COMMERCE 6-0-2001.

THE MARK CONSISTS OF STANDARD CHAR-
ACTERS WITHOUT CLAIM TO ANY PARTICULAR
FONT, STYLE, SIZE, OR COLOR.

SER. NO. 77-289,923, FILED 9-26-2007.

MELISSA VALLILLO, EXAMINING ATTORNEY

Int. Cls.: 35, 36, 41 and 44

Prior U.S. Cls.: 100, 101, 102 and 107

United States Patent and Trademark Office

Reg. No. 3,574,659

Registered Feb. 17, 2009

**SERVICE MARK
PRINCIPAL REGISTER**

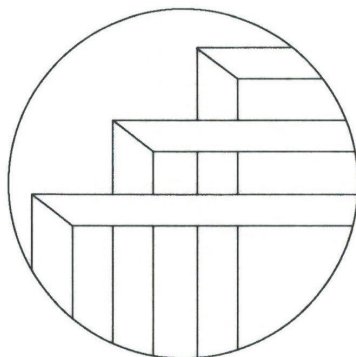

FACTOR HEALTH MANAGEMENT, LLC (DELAWARE LIMITED LIABILITY COMPANY)
7700 CONGRESS AVENUE
BOCA RATON, FL 33487

FOR: DRUG UTILIZATION REVIEW SERVICES; DISTRIBUTORSHIP IN THE FIELD OF PHARMACEUTICAL PRODUCTS AND MEDICAL SUPPLIES DIRECTLY TO PATIENTS, IN CLASS 35 (U.S. CLS. 100, 101 AND 102).

FIRST USE 2-0-2003; IN COMMERCE 2-0-2003.

FOR: PHARMACEUTICAL AND MEDICAL INSURANCE BENEFIT MANAGEMENT SERVICES, IN CLASS 36 (U.S. CLS. 100, 101 AND 102).

FIRST USE 2-0-2003; IN COMMERCE 2-0-2003.

FOR: EDUCATIONAL SERVICES, NAMELY, SEMINARS AND WORKSHOPS ON SUBJECTS RELEVANT TO THE BLEEDING DISORDERS COMMUNITY, NAMELY, IN THE FIELD OF BLEEDING

DISORDERS, IN CLASS 41 (U.S. CLS. 100, 101 AND 107).

FIRST USE 2-0-2003; IN COMMERCE 2-0-2003.

FOR: HOME HEALTH CARE SERVICES; PROVIDING INFORMATION IN THE FIELD OF HEALTH CARE AND PROVIDING MEDICAL INFORMATION RELATING TO PHARMACEUTICAL PRODUCTS FOR BLEEDING DISORDERS; PHARMACY SERVICES, NAMELY, PHARMACEUTICAL ADVICE AND COUNSELING, IN CLASS 44 (U.S. CLS. 100 AND 101).

FIRST USE 2-0-2003; IN COMMERCE 2-0-2003.

THE MARK CONSISTS OF THREE SETS OF GEOMETRIC LINES AT DIFFERENT LEVELS.

SER. NO. 77-292,033, FILED 9-28-2007.

ANGELA M. MICHELI, EXAMINING ATTORNEY

Int. Cl.: 42

Prior U.S. Cls.: 100 and 101

United States Patent and Trademark Office

Reg. No. 3,574,660

Registered Feb. 17, 2009

**SERVICE MARK
PRINCIPAL REGISTER**

**PINNACLE PERFORMANCE
SOLUTIONS**

THARPERROBBINS COMPANY, INC. (DELA-
WARE CORPORATION)
149 CRAWFORD ROAD
STATESVILLE, NC 28625

FOR: PROVIDING A WEB-BASED TECHNOLO-
GY FOR EMPLOYERS THAT ENABLES EMPLOY-
ERS TO IN-HOUSE ADMINISTER AND MANAGE
EMPLOYEE INCENTIVE AWARD PROGRAMS TO
PROMOTE EMPLOYEE PRODUCTIVITY, RECOG-
NITION AND MORALE, EXCLUDING THE ROOF-
ING INDUSTRY, IN CLASS 42 (U.S. CLS. 100 AND
101).

FIRST USE 8-0-2001; IN COMMERCE 8-0-2001.

THE MARK CONSISTS OF STANDARD CHAR-
ACTERS WITHOUT CLAIM TO ANY PARTICULAR
FONT, STYLE, SIZE, OR COLOR.

NO CLAIM IS MADE TO THE EXCLUSIVE
RIGHT TO USE "PERFORMANCE SOLUTIONS",
APART FROM THE MARK AS SHOWN.

SER. NO. 77-292,255, FILED 9-29-2007.

SHAILA SETTLES, EXAMINING ATTORNEY

Int. Cl.: 12

Prior U.S. Cls.: 19, 21, 23, 31, 35 and 44

United States Patent and Trademark Office

Reg. No. 3,574,661

Registered Feb. 17, 2009

**TRADEMARK
PRINCIPAL REGISTER**

 *CO-MOTIVE*

RAILPOWER TECHNOLOGIES CORP. (CANADA
CORPORATION)
9955 AVENUE CATANIA
BROSSARD J4Z 3V5, CANADA

FOR: MULTI-GENERATOR ROAD SWITCHER
LOCOMOTIVES, IN CLASS 12 (U.S. CLS. 19, 21, 23, 31,
35 AND 44).

PRIORITY CLAIMED UNDER SEC. 44(D) ON
CANADA APPLICATION NO. 1361018, FILED 8-23-
2007, REG. NO. TMA722730, DATED 8-29-2008, EX-
PIRES 8-29-2023.

SER. NO. 77-294,614, FILED 10-2-2007.

MARY MUNSON, EXAMINING ATTORNEY

Int. Cl.: 35

Prior U.S. Cls.: 100, 101 and 102

United States Patent and Trademark Office

Reg. No. 3,574,662

Registered Feb. 17, 2009

**SERVICE MARK
PRINCIPAL REGISTER**

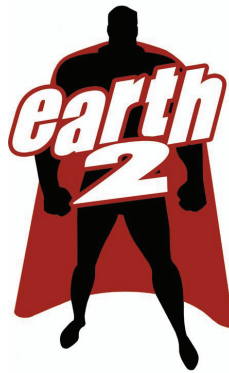

EARTH-2 COMICS, INC. (CALIFORNIA CORPORATION)
15017 VENTURA BLVD.
SHERMAN OAKS, CA 91403

FOR: RETAIL STORE SERVICES FEATURING COMIC BOOKS, GRAPHIC NOVELS, PERIODICALS AND REFERENCE BOOKS ABOUT COMIC BOOKS AND COMIC BOOK ART, REFERENCE BOOKS ABOUT THE CREATION AND PRODUCTION AND HISTORY OF COMIC BOOKS, COMIC BOOK COLLECTING SUPPLIES, TOYS AND ACTION FIGURES BASED ON COMIC BOOK CHARACTERS, T-SHIRTS FEATURING COMIC BOOK SYMBOLS AND CHARACTERS, STATUES BASED ON COMIC BOOK CHARACTERS, DVDS ADAPTED FROM COMIC BOOK STORIES FEATURING COMIC BOOK CHARACTERS, IN CLASS 35 (U.S. CLS. 100, 101 AND 102).

FIRST USE 1-31-2003; IN COMMERCE 3-1-2003.

THE COLOR(S) RED, BLACK AND WHITE IS/ARE CLAIMED AS A FEATURE OF THE MARK.

THE MARK CONSISTS OF A BLACK SILHOUETTE OF A CAPED SUPERHERO STANDING WITH THE WORDS "EARTH-2" EMBLAZONED ACROSS HIS CHEST. THE OUTLINE OF THE HERO, CAPE AND LETTERS ARE DEEP RED. THE LETTERS ARE WHITE.

SER. NO. 77-298,587, FILED 10-8-2007.

TEJBIR SINGH, EXAMINING ATTORNEY

Int. Cl.: 25

Prior U.S. Cls.: 22 and 39

United States Patent and Trademark Office

Reg. No. 3,574,663

Registered Feb. 17, 2009

**TRADEMARK
PRINCIPAL REGISTER**

ITS MORE FUN TO BE A GIRL

KATHY WITH A "K" DESIGNS, LLC (TENNESSEE LIMITED LIABILITY COMPANY)
1010 #A CALDWELL LANE
NASHVILLE, TN 372043910

THE MARK CONSISTS OF STANDARD CHARACTERS WITHOUT CLAIM TO ANY PARTICULAR FONT, STYLE, SIZE, OR COLOR.

FOR: CHILDREN'S AND INFANTS' CLOTH BIBS; T-SHIRTS, IN CLASS 25 (U.S. CLS. 22 AND 39).

SER. NO. 77-298,875, FILED 10-8-2007.

FIRST USE 9-14-2005; IN COMMERCE 10-1-2006.

BILL DAWE, EXAMINING ATTORNEY

Int. Cl.: 16

Prior U.S. Cls.: 2, 5, 22, 23, 29, 37, 38 and 50

Reg. No. 3,574,664

United States Patent and Trademark Office

Registered Feb. 17, 2009

**TRADEMARK
PRINCIPAL REGISTER**

VENTURE

PETER LI, INC. (OHIO CORPORATION)
2621 DRYDEN ROAD, SUITE 300
DAYTON, OH 45439

FIRST USE 9-0-1980; IN COMMERCE 9-0-1980.

FOR: PRINTED PERIODICALS FEATURING
LECTIONARY-BASED RELIGIOUS CONTENT
AND PRINTED TEACHERS' RESOURCE MAN-
UALS THEREFOR, IN CLASS 16 (U.S. CLS. 2, 5, 22,
23, 29, 37, 38 AND 50).

THE MARK CONSISTS OF STANDARD CHAR-
ACTERS WITHOUT CLAIM TO ANY PARTICULAR
FONT, STYLE, SIZE, OR COLOR.

SER. NO. 77-299,020, FILED 10-9-2007.

JENNIFER MARTIN, EXAMINING ATTORNEY

Int. Cl.: 16

Prior U.S. Cls.: 2, 5, 22, 23, 29, 37, 38 and 50

Reg. No. 3,574,665

United States Patent and Trademark Office

Registered Feb. 17, 2009

**TRADEMARK
PRINCIPAL REGISTER**

GOOD NEWS FOR CHILDREN

PETER LI, INC. (OHIO CORPORATION)
2621 DRYDEN ROAD, SUITE 300
DAYTON, OH 45439

FOR: PRINTED PERIODICALS FEATURING
LECTIONARY-BASED RELIGIOUS CONTENT
AND PRINTED TEACHERS' RESOURCE MAN-
UALS THEREFOR, IN CLASS 16 (U.S. CLS. 2, 5, 22,
23, 29, 37, 38 AND 50).

FIRST USE 9-0-1982; IN COMMERCE 9-0-1982.

THE MARK CONSISTS OF STANDARD CHAR-
ACTERS WITHOUT CLAIM TO ANY PARTICULAR
FONT, STYLE, SIZE, OR COLOR.

NO CLAIM IS MADE TO THE EXCLUSIVE
RIGHT TO USE "FOR CHILDREN", APART FROM
THE MARK AS SHOWN.

SER. NO. 77-299,194, FILED 10-9-2007.

JENNIFER MARTIN, EXAMINING ATTORNEY

Int. Cl.: 16

Prior U.S. Cls.: 2, 5, 22, 23, 29, 37, 38 and 50

United States Patent and Trademark Office

Reg. No. 3,574,666

Registered Feb. 17, 2009

**TRADEMARK
PRINCIPAL REGISTER**

PROMISE

PETER LI, INC. (OHIO CORPORATION)
2621 DRYDEN ROAD, SUITE 300
DAYTON, OH 45439

FOR: PRINTED PERIODICALS FEATURING
LECTIONARY-BASED RELIGIOUS CONTENT
AND PRINTED TEACHERS' RESOURCE MAN-
UALS THEREFOR, IN CLASS 16 (U.S. CLS. 2, 5, 22,
23, 29, 37, 38 AND 50).

FIRST USE 9-0-1986; IN COMMERCE 9-0-1986.

THE MARK CONSISTS OF STANDARD CHAR-
ACTERS WITHOUT CLAIM TO ANY PARTICULAR
FONT, STYLE, SIZE, OR COLOR.

SER. NO. 77-299,261, FILED 10-9-2007.

JENNIFER MARTIN, EXAMINING ATTORNEY

Int. Cl.: 16

Prior U.S. Cls.: 2, 5, 22, 23, 29, 37, 38 and 50

Reg. No. 3,574,667

United States Patent and Trademark Office

Registered Feb. 17, 2009

**TRADEMARK
PRINCIPAL REGISTER**

SEEDS

PETER LI, INC. (OHIO CORPORATION)
2621 DRYDEN ROAD, SUITE 300
DAYTON, OH 45439

FIRST USE 9-0-1995; IN COMMERCE 9-0-1995.

FOR: PRINTED PERIODICALS FEATURING
LECTIONARY-BASED RELIGIOUS CONTENT
AND PRINTED TEACHERS' RESOURCE MAN-
UALS THEREFOR, IN CLASS 16 (U.S. CLS. 2, 5, 22,
23, 29, 37, 38 AND 50).

THE MARK CONSISTS OF STANDARD CHAR-
ACTERS WITHOUT CLAIM TO ANY PARTICULAR
FONT, STYLE, SIZE, OR COLOR.

SER. NO. 77-299,378, FILED 10-9-2007.

JENNIFER MARTIN, EXAMINING ATTORNEY

Int. Cl.: 35

Prior U.S. Cls.: 100, 101 and 102

United States Patent and Trademark Office

Reg. No. 3,574,668

Registered Feb. 17, 2009

**SERVICE MARK
PRINCIPAL REGISTER**

THINK RC

LEE, PETER (UNITED STATES INDIVIDUAL)
17939 CHATSWORTH STREET 351
GRANADA HILLS, CA 91344 AND
CHI, JAE SUK (UNITED STATES INDIVIDUAL)
17939 CHATSWORTH STREET, SUITE 351
GRANADA HILLS, CA 91344

FOR: ON-LINE RETAIL STORE SERVICES FEATURING REMOTE CONTROL TOYS; RETAIL OUTLETS FEATURING REMOTE CONTROL TOYS, IN CLASS 35 (U.S. CLS. 100, 101 AND 102).

FIRST USE 2-3-2007; IN COMMERCE 2-3-2007.

THE MARK CONSISTS OF STANDARD CHARACTERS WITHOUT CLAIM TO ANY PARTICULAR FONT, STYLE, SIZE, OR COLOR.

NO CLAIM IS MADE TO THE EXCLUSIVE RIGHT TO USE "RC", APART FROM THE MARK AS SHOWN.

SER. NO. 77-299,934, FILED 10-9-2007.

DAVID YONTEF, EXAMINING ATTORNEY

Int. Cl.: 35

Prior U.S. Cls.: 100, 101 and 102

United States Patent and Trademark Office

Reg. No. 3,574,669

Registered Feb. 17, 2009

**SERVICE MARK
PRINCIPAL REGISTER**

Machinery

CILLS, KEN (UNITED STATES INDIVIDUAL)
109 SOUTH 13TH STREET, 3RD FLOOR
PHILADELPHIA, PA 19107

THE MARK CONSISTS OF STANDARD CHAR-
ACTERS WITHOUT CLAIM TO ANY PARTICULAR
FONT, STYLE, SIZE, OR COLOR.

FOR: ADVERTISING AND MARKETING, IN
CLASS 35 (U.S. CLS. 100, 101 AND 102).

SER. NO. 77-300,753, FILED 10-10-2007.

FIRST USE 9-15-2007; IN COMMERCE 9-15-2007.

EMILY CARLSEN, EXAMINING ATTORNEY

Int. Cls.: 1, 29 and 30

Prior U.S. Cls.: 1, 5, 6, 10, 26 and 46

United States Patent and Trademark Office

Reg. No. 3,574,670

Registered Feb. 17, 2009

**TRADEMARK
PRINCIPAL REGISTER**

MAXARITE

DSM IP ASSETS B.V. (NETHERLANDS LIMITED
LIABILITY COMPANY)
HET OVERLOON 1
HEERLEN, NETHERLANDS 6411TE

FOR: CHEMICAL AND BIOCHEMICAL PRODUCTS USED IN THE MANUFACTURE OF FOOD; CHEMICAL AND BIOCHEMICAL PRODUCTS FOR USE AS FLAVORINGS IN THE FOOD INDUSTRY; CHEMICAL AND BIOCHEMICAL PRODUCTS FOR PRESERVING FOODSTUFFS, IN CLASS 1 (U.S. CLS. 1, 5, 6, 10, 26 AND 46).

FOR: FOOD SUPPLEMENTS AND FOOD INGREDIENTS, NOT FOR MEDICAL USE, NAMELY, FOR USE IN DAIRY-BASED FOODS AND BEVERAGES, IN CLASS 29 (U.S. CL. 46).

FOR: YEAST, YEAST EXTRACTS, YEAST PRODUCTS, NAMELY, YEAST POWDER; FOOD SUP-

PLEMENTS AND FOOD INGREDIENTS, NOT FOR MEDICAL USE, NAMELY, FOOD ADDITIVES FOR USE AS A FLAVORINGS, INGREDIENTS OR FIL- LERS; FOOD FLAVORINGS, FLAVORINGS FOR BEVERAGES, IN CLASS 30 (U.S. CL. 46).

THE MARK CONSISTS OF STANDARD CHAR- ACTERS WITHOUT CLAIM TO ANY PARTICULAR FONT, STYLE, SIZE, OR COLOR.

PRIORITY CLAIMED UNDER SEC. 44(D) ON BENELUX APPLICATION NO. 1143534, FILED 9-21-2007, REG. NO. 830260, DATED 9-24-2007, EXPIRES 9-24-2017.

SER. NO. 77-301,197, FILED 10-10-2007.

CAROLYN GRAY, EXAMINING ATTORNEY

Int. Cl.: 30

Prior U.S. Cl.: 46

United States Patent and Trademark Office

Reg. No. 3,574,671

Registered Feb. 17, 2009

TRADEMARK
PRINCIPAL REGISTER



KUNSHAN P&A IMP.&EXP.TRADE CO., LTD
(CHINA CORPORATION)
8#ZHAOFENG RD. INT'L COMMERCIAL CENTER
HUAQIAO TOWN
KUNSHAN, JIANGSU, CHINA 215300

FOR: COFFEE FLAVORINGS IN THE NATURE
OF SYRUP USED IN MAKING FOOD BEVERAGES;
NATURAL SWEETENER; AROMATIC PREPARA-
TIONS FOR FOOD NOT FROM ESSENTIAL OILS,
NAMELY, FOOD FLAVORINGS; ESSENCES FOR
FOODSTUFFS NOT FROM ESSENTIAL OILS,
NAMELY, EXTRACTS USED AS FLAVORING; FLA-
VORINGS FOR CAKES OTHER THAN ESSENTIAL
OILS; PROCESSED HERBS, NAMELY, MINT FOR

CONFECTIONERY; VANILLA FLAVORING; VA-
NILLIN VANILLA SUBSTITUTE; FLAVORINGS
FOR BEVERAGES OTHER THAN ESSENTIAL OILS,
IN CLASS 30 (U.S. CL. 46).

FIRST USE 1-1-2004; IN COMMERCE 1-1-2005.

THE MARK CONSISTS OF A CHINESE DRAGON
DESIGN APPEARING ABOVE THE LETTERS
"P&A".

SER. NO. 77-301,254, FILED 10-11-2007.

SHAILA SETTLES, EXAMINING ATTORNEY

Int. Cls.: 1, 3 and 9

**Prior U.S. Cls.: 1, 4, 5, 6, 10, 21, 23, 26, 36, 38, 46, 50,
51 and 52**

Reg. No. 3,574,672

United States Patent and Trademark Office

Registered Feb. 17, 2009

**TRADEMARK
PRINCIPAL REGISTER**

DYNALLOY

DYNALLOY, LLC (INDIANA LIMITED LIABILITY
COMPANY)
6445 OLIVIA LANE
INDIANAPOLIS, IN 46226

FOR: SOLVENTS, NAMELY, SOLVENT TYPE
PROCESSING COMPOSITIONS FOR USE IN THE
ELECTRONICS INDUSTRY, POTTING AND EN-
CAPSULATION REMOVERS, RESIST REMOVERS
AND STRIPPERS, POLYIMIDE REMOVERS, IN
CLASS 1 (U.S. CLS. 1, 5, 6, 10, 26 AND 46).

FIRST USE 12-31-1968; IN COMMERCE 12-31-1968.

FOR: ADHESIVE REMOVERS, NAMELY, EPOXY
REMOVERS AND CLEANERS, NAMELY, ELEC-
TRONICS PARTS CLEANERS, FLUX CLEANERS,
CLEANERS FOR MOLDING MOLDS, INK CLEA-
NERS, STENCIL CLEANERS, AND POLYIMIDE,
URETHANE, SILICONE AND ACRYLIC REMOV-
ERS, IN CLASS 3 (U.S. CLS. 1, 4, 6, 50, 51 AND 52).

FIRST USE 12-31-1968; IN COMMERCE 12-31-1968.

FOR: ELECTRICALLY CONDUCTIVE ADHE-
SIVES FOR USE IN THE SHIELDING, MANUFAC-
TURE AND REPAIR OF ELECTRONIC
COMPONENTS; ELECTRICALLY CONDUCTIVE
COATINGS FOR USE IN THE SHIELDING AND
MANUFACTURE OF ELECTRONIC COMPO-
NENTS, IN CLASS 9 (U.S. CLS. 21, 23, 26, 36 AND 38).

FIRST USE 10-11-2007; IN COMMERCE 10-11-2007.

THE MARK CONSISTS OF STANDARD CHAR-
ACTERS WITHOUT CLAIM TO ANY PARTICULAR
FONT, STYLE, SIZE, OR COLOR.

SER. NO. 77-301,476, FILED 10-11-2007.

JIM RINGLE, EXAMINING ATTORNEY

Int. Cl.: 37

Prior U.S. Cls.: 100, 103 and 106

United States Patent and Trademark Office

Reg. No. 3,574,673

Registered Feb. 17, 2009

**SERVICE MARK
PRINCIPAL REGISTER**

SUNSTATE AUTOGLASS

SUNSTATE AUTOGLASS, INC. (FLORIDA CORPORATION)
1062 SEMORAN BLVD.
CASSELBERRY, FL 32707

FOR: AUTOMOBILE GLASS REPAIR AND INSTALLATION, IN CLASS 37 (U.S. CLS. 100, 103 AND 106).

FIRST USE 9-10-2007; IN COMMERCE 9-10-2007.

THE MARK CONSISTS OF STANDARD CHARACTERS WITHOUT CLAIM TO ANY PARTICULAR FONT, STYLE, SIZE, OR COLOR.

NO CLAIM IS MADE TO THE EXCLUSIVE RIGHT TO USE "AUTO GLASS", APART FROM THE MARK AS SHOWN.

SER. NO. 77-301,804, FILED 10-11-2007.

VERNA BETH RIRIE, EXAMINING ATTORNEY

Int. Cl.: 37

Prior U.S. Cls.: 100, 103 and 106

United States Patent and Trademark Office

Reg. No. 3,574,674

Registered Feb. 17, 2009

**SERVICE MARK
PRINCIPAL REGISTER**

ENDLESS POSSIBILITIES

STENNER PUMP COMPANY, INC. (FLORIDA CORPORATION)
3174 DESALVO ROAD
JACKSONVILLE, FL 32246

FOR: TECHNICAL SUPPORT SERVICES, NAME-
LY, PROVIDING TECHNICAL ADVICE IN THE
FIELD OF METERING PUMP INSTALLATION
AND REPAIR, IN CLASS 37 (U.S. CLS. 100, 103
AND 106).

FIRST USE 4-1-2007; IN COMMERCE 4-1-2007.

THE MARK CONSISTS OF STANDARD CHAR-
ACTERS WITHOUT CLAIM TO ANY PARTICULAR
FONT, STYLE, SIZE, OR COLOR.

SER. NO. 77-301,929, FILED 10-11-2007.

ROBIN CHOSID, EXAMINING ATTORNEY

Int. Cl.: 5

Prior U.S. Cls.: 6, 18, 44, 46, 51 and 52

United States Patent and Trademark Office

Reg. No. 3,574,675

Registered Feb. 17, 2009

**TRADEMARK
PRINCIPAL REGISTER**



NEXT LEVEL NUTRITION, INC. (CALIFORNIA CORPORATION)

#297
2034 E. LINCOLN AVE.,
ANAHEIM, CA 92806

FOR: DIETARY SUPPLEMENTS, IN CLASS 5 (U.S. CLS. 6, 18, 44, 46, 51 AND 52).

FIRST USE 6-1-2007; IN COMMERCE 6-1-2007.

THE COLOR(S) WHITE, RED, BLACK AND SILVER IS/ARE CLAIMED AS A FEATURE OF THE MARK.

THE MARK CONSISTS OF A RED RECTANGLE WITH THE OUTLINE OF A MAN'S BODY IN BLACK AS THE BACKGROUND; APPEARING IN THE FOREGROUND IS A RED, SILVER AND WHITE SPEEDOMETER ABOVE THE WORD "TORQUE" IN WHITE AND OUTLINED IN BLACK, WHICH IS UNDERLINED BY A WHITE LINE OUTLINED IN BLACK.

SER. NO. 77-302,412, FILED 10-12-2007.

KATHERINE CHANG, EXAMINING ATTORNEY

Int. Cls.: 29 and 30

Prior U.S. Cl.: 46

United States Patent and Trademark Office

Reg. No. 3,574,676

Registered Feb. 17, 2009

TRADEMARK
PRINCIPAL REGISTER

BANANA MOON

IN-ROOM PLUS, INC. (NEW YORK CORPORATION)
SUITE 217
2495 MAIN STREET
BUFFALO, NY 14214

FOR: PREPACKAGED SNACKS FOR SALE IN HOTEL IN-ROOM HONOR BARS, NAMELY, HONEY-ROASTED NUTS, ROASTED NUTS, SMOKED NUTS, BLANCHED NUTS, CANDIED NUTS, MIXED PROCESSED NUTS, DEHYDRATED FRUIT SNACKS, CANDIED FRUIT SNACKS, SOY-BASED SNACK FOODS, POTATO-BASED SNACK FOODS, AND SNACK MIXES CONSISTING PRIMARILY OF PROCESSED FRUITS, PROCESSED NUTS AND/OR RAISINS, IN CLASS 29 (U.S. CL. 46).

FIRST USE 9-21-1995; IN COMMERCE 9-21-1995.

FOR: PREPACKAGED SNACKS FOR SALE IN HOTEL IN-ROOM HONOR BARS, NAMELY, COOKIES, PRETZELS, CORN-BASED SNACK FOODS,

CANDY, CHEESE FLAVORED PUFFED CORN SNACKS, SNACK MIXES CONSISTING PRIMARILY OF PRETZELS, CORN-BASED SNACKS, WHEAT-BASED SNACKS, SOY-BASED SNACKS, PEANUTS, AND/OR PROCESSED NUTS, AND SNACK MIXES CONSISTING PRIMARILY OF CARAMEL POPCORN AND PROCESSED NUTS, IN CLASS 30 (U.S. CL. 46).

FIRST USE 9-21-1995; IN COMMERCE 9-21-1995.

THE MARK CONSISTS OF STANDARD CHARACTERS WITHOUT CLAIM TO ANY PARTICULAR FONT, STYLE, SIZE, OR COLOR.

OWNER OF U.S. REG. NO. 2,050,461.

SER. NO. 77-302,841, FILED 10-12-2007.

LORETTA C. BECK, EXAMINING ATTORNEY

Int. Cls.: 38 and 42

Prior U.S. Cls.: 100, 101 and 104

United States Patent and Trademark Office

Reg. No. 3,574,677

Registered Feb. 17, 2009

**SERVICE MARK
PRINCIPAL REGISTER**

INTAND

SCHOOL CALENDAR ASSOCIATES, INC. (WASHINGTON CORPORATION)
227 BELLEVUE WAY NE #283
BELLEVUE, WA 98004

FOR: COMMUNICATION SERVICES, NAMELY, TRANSMISSION OF INFORMATION BY MEANS OF ONLINE CALENDARS AND ELECTRONIC MAIL, IN CLASS 38 (U.S. CLS. 100, 101 AND 104).

FIRST USE 7-1-2006; IN COMMERCE 7-1-2006.

FOR: COMPUTER SERVICES, NAMELY, HOSTING ON-LINE INTERACTIVE PUBLIC CALENDARS THAT ALLOW MULTIPLE PARTICIPANTS

TO SHARE EVENT SCHEDULES FOR EDUCATIONAL ACTIVITIES, SPORTING EVENTS, AND CULTURAL EVENTS, IN CLASS 42 (U.S. CLS. 100 AND 101).

FIRST USE 7-1-2006; IN COMMERCE 7-1-2006.

THE MARK CONSISTS OF STANDARD CHARACTERS WITHOUT CLAIM TO ANY PARTICULAR FONT, STYLE, SIZE, OR COLOR.

SER. NO. 77-303,541, FILED 10-13-2007.

MARK SPARACINO, EXAMINING ATTORNEY

Int. Cl.: 36

Prior U.S. Cls.: 100, 101 and 102

United States Patent and Trademark Office

Reg. No. 3,574,678

Registered Feb. 17, 2009

**SERVICE MARK
PRINCIPAL REGISTER**

The Pet Fund

THE PET FUND (CALIFORNIA NON-PROFIT
ASSOCIATION)
2747 14TH STREET
SACRAMENTO, CA 95818

FOR: CHARITABLE FUNDRAISING FOR ANI-
MAL WELFARE, IN CLASS 36 (U.S. CLS. 100, 101
AND 102).

FIRST USE 9-2-2002; IN COMMERCE 9-2-2002.

THE MARK CONSISTS OF STANDARD CHAR-
ACTERS WITHOUT CLAIM TO ANY PARTICULAR
FONT, STYLE, SIZE, OR COLOR.

OWNER OF U.S. REG. NOS. 3,077,949 AND
3,294,151.

NO CLAIM IS MADE TO THE EXCLUSIVE
RIGHT TO USE FUND, APART FROM THE MARK
AS SHOWN.

SEC. 2(F).

SER. NO. 77-304,702, FILED 10-15-2007.

BILL DAWE, EXAMINING ATTORNEY

Int. Cl.: 32

Prior U.S. Cls.: 45, 46 and 48

United States Patent and Trademark Office

Reg. No. 3,574,679

Registered Feb. 17, 2009

TRADEMARK
PRINCIPAL REGISTER



THOMAS, ALEX R. (UNITED STATES INDIVIDUAL)

14133 ROSSINI

DETROIT, MI 48205

FOR: ENERGY DRINKS, IN CLASS 32 (U.S. CLS. 45, 46 AND 48).

FIRST USE 9-1-2007; IN COMMERCE 10-14-2007.

THE MARK CONSISTS OF STANDARD CHARACTERS WITHOUT CLAIM TO ANY PARTICULAR FONT, STYLE, SIZE, OR COLOR.

NO CLAIM IS MADE TO THE EXCLUSIVE RIGHT TO USE "ENERGY", APART FROM THE MARK AS SHOWN.

SER. NO. 77-304,785, FILED S.R. 10-16-2007 AM. P.R. 10-16-2008.

TINA BROWN, EXAMINING ATTORNEY

Int. Cls.: 9, 16, 41 and 45

**Prior U.S. Cls.: 2, 5, 21, 22, 23, 26, 29, 36, 37, 38, 50,
100, 101 and 107**

Reg. No. 3,574,680

United States Patent and Trademark Office

Registered Feb. 17, 2009

**TRADEMARK
SERVICE MARK
PRINCIPAL REGISTER**

**SECRETS OF POWER
NEGOTIATING**

SELLING SOLUTIONS INC. (CANADA CORPORATION)
9 DOOLEY PLACE
GUELPH, CANADA N1G4M7

FOR: COMPUTER PROGRAMS FOR USE IN WORD PROCESSING DESIGNED TO ASSIST IN COACHING, TRAINING, PROJECT PLANNING AND PERSONAL PLANNING IN THE FIELDS OF NEGOTIATION, MEDIATION, DISPUTE RESOLUTION CONSULTING AND COACHING SERVICES, PHOTOGRAPHIC SLIDES, PRERECORDED VIDEO TAPES FEATURING NEGOTIATION, MEDIATION AND DISPUTE RESOLUTION TECHNIQUES, DOWNLOADABLE PODCASTS IN THE FIELDS OF NEGOTIATION, MEDIATION AND DISPUTE RESOLUTION TECHNIQUES, IN CLASS 9 (U.S. CLS. 21, 23, 26, 36 AND 38).

FIRST USE 2-1-1995; IN COMMERCE 2-1-1995.

FOR: PRINTED INSTRUCTIONAL, EDUCATIONAL, AND TEACHING MATERIALS TO ASSIST IN COACHING, TRAINING, PROJECT PLANNING AND PERSONAL PLANNING IN THE FIELDS OF NEGOTIATION, MEDIATION AND DISPUTE RESOLUTION; PRINTED MATERIALS, NAMELY, PROGRAM HANDOUTS, WORKBOOKS, REFERENCE MATERIALS AND NEWSLETTERS IN THE FIELDS OF NEGOTIATION, MEDIATION AND DISPUTE RESOLUTION, IN CLASS 16 (U.S. CLS. 2, 5, 22, 23, 29, 37, 38 AND 50).

FIRST USE 2-1-1995; IN COMMERCE 2-1-1995.

FOR: PROVISION OF COACHING IN THE FIELDS OF NEGOTIATION, MEDIATION AND

DISPUTE RESOLUTION; PROFESSIONAL COACHING SERVICES IN THE FIELDS OF NEGOTIATION, MEDIATION AND DISPUTE RESOLUTION; EDUCATION SERVICES, NAMELY, CONDUCTING PRESENTATIONS, SEMINARS, COURSES, LEARNING WORKSHOPS, SPEAKING ENGAGEMENT SERVICES, LECTURES, COACHING SERVICES AND TUTORING IN THE FIELDS OF NEGOTIATION, MEDIATION, DISPUTE RESOLUTION, IN CLASS 41 (U.S. CLS. 100, 101 AND 107).

FIRST USE 2-1-1995; IN COMMERCE 2-1-1995.

FOR: CONSULTING SERVICES IN THE FIELDS OF NEGOTIATION, MEDIATION AND DISPUTE RESOLUTION; INFORMATION SERVICES IN THE FIELDS OF NEGOTIATION, MEDIATION AND DISPUTE RESOLUTION PROVIDED BY ELECTRONIC MEANS AND BY PAPER, IN CLASS 45 (U.S. CLS. 100 AND 101).

FIRST USE 2-1-1995; IN COMMERCE 2-1-1995.

THE MARK CONSISTS OF STANDARD CHARACTERS WITHOUT CLAIM TO ANY PARTICULAR FONT, STYLE, SIZE, OR COLOR.

NO CLAIM IS MADE TO THE EXCLUSIVE RIGHT TO USE "POWER NEGOTIATING", APART FROM THE MARK AS SHOWN.

SER. NO. 77-305,121, FILED 10-16-2007.

ANNE E. GUSTASON, EXAMINING ATTORNEY

Int. Cl.: 42

Prior U.S. Cls.: 100 and 101

United States Patent and Trademark Office

Reg. No. 3,574,681

Registered Feb. 17, 2009

**SERVICE MARK
PRINCIPAL REGISTER**

SMARTPACKS

ELOQUA CORPORATION (CANADA CORPORATION)
553 RICHMOND STREET WEST, SUITE 214
TORONTO, ONTARIO, CANADA M5M1Y6

FOR: PROVIDING TEMPORARY USE OF ON-LINE NON-DOWNLOADABLE ADAPTIVE COMPUTER SOFTWARE DESIGNED TO FACILITATE FOR OTHERS THE AUTOMATION, CUSTOMIZATION AND TRANSFER OF BEST PRACTICE TEMPLATES, PROCESSES, CONTENT, CAMPAIGNS, AND PROGRAMS, ALL FOR MARKETING AND SALES PURPOSES, IN CLASS 42 (U.S. CLS. 100 AND 101).

FIRST USE 9-1-2006; IN COMMERCE 9-1-2006.

THE MARK CONSISTS OF STANDARD CHARACTERS WITHOUT CLAIM TO ANY PARTICULAR FONT, STYLE, SIZE, OR COLOR.

SER. NO. 77-306,472, FILED 10-17-2007.

KATHERINE E. HALMEN, EXAMINING ATTORNEY

Int. Cl.: 36

Prior U.S. Cls.: 100, 101 and 102

United States Patent and Trademark Office

Reg. No. 3,574,682

Registered Feb. 17, 2009

**SERVICE MARK
PRINCIPAL REGISTER**



COMMONWEALTH HEALTH INSURANCE CON-
NECTOR AUTHORITY (MASSACHUSETTS
PUBLIC AUTHORITY)
100 CITY HALL PLAZA
BOSTON, MA 02108

FIRST USE 11-30-2006; IN COMMERCE 1-9-2007.

SER. NO. 77-307,914, FILED 10-18-2007.

FOR: ADMINISTRATION OF SUBSIDIZED AND
UNSUBSIDIZED HEALTH INSURANCE PLANS, IN
CLASS 36 (U.S. CLS. 100, 101 AND 102).

MARK RADEMACHER, EXAMINING ATTORNEY

Int. Cl.: 19

Prior U.S. Cls.: 1, 12, 33 and 50

United States Patent and Trademark Office

Reg. No. 3,574,683

Registered Feb. 17, 2009

**TRADEMARK
PRINCIPAL REGISTER**

ALFA GLASS

ALFAGRES S.A. (COLOMBIA CORPORATION)
AVENIDA CARACAS NO. 35-55
BOGOTÁ, COLOMBIA

FIRST USE 4-4-2005; IN COMMERCE 9-1-2007.

FOR: BUILDING MATERIALS, NAMELY, WALL,
HARDWOOD, DECKING AND WOOD BOARDS;
CERAMIC TILES; CERAMIC ENAMEL TILES; CON-
CRETE; CONCRETE BLOCKS; FLOOR PANELS
NOT OF METAL; GLASS TILES; GRANITE; HARD-
BOARD; MARBLE; NON-METAL ROOF COVER-
INGS; NON-METAL CEILING PANELS; NON-
METAL CURTAIN WALLS; NON-METAL DOOR
PANELS; NON-METAL FLOOR TILES; NON-ME-
TAL FLOORS; NON-METAL TILES, IN CLASS 19
(U.S. CLS. 1, 12, 33 AND 50).

THE MARK CONSISTS OF STANDARD CHAR-
ACTERS WITHOUT CLAIM TO ANY PARTICULAR
FONT, STYLE, SIZE, OR COLOR.

NO CLAIM IS MADE TO THE EXCLUSIVE
RIGHT TO USE "GLASS", APART FROM THE
MARK AS SHOWN.

SER. NO. 77-308,076, FILED 10-19-2007.

HENRY S. ZAK, EXAMINING ATTORNEY

Int. Cl.: 25

Prior U.S. Cls.: 22 and 39

United States Patent and Trademark Office

Reg. No. 3,574,684

Registered Feb. 17, 2009

**TRADEMARK
PRINCIPAL REGISTER**



ACOPA INTERNATIONAL, LLC (CALIFORNIA
LIMITED LIABILITY COMPANY)
2328 JEANNE DR.
LAS VEGAS, NV 89108

FOR: LEATHER SHOES, IN CLASS 25 (U.S. CLS. 22
AND 39).

FIRST USE 10-17-2003; IN COMMERCE 10-17-2003.

THE MARK CONSISTS OF AN OPEN UP-ARROW
WITHIN AN ELLIPTICAL CIRCLE THAT IS OPEN
ON THE BOTTOM AND POSTIONED ABOVE THE
WORDING "ACOPA" IN STYLIZED LETTERS.

SEC. 2(F).

SER. NO. 77-308,339, FILED 10-19-2007.

JILL C. ALT, EXAMINING ATTORNEY

Int. Cl.: 33

Prior U.S. Cls.: 47 and 49

United States Patent and Trademark Office

Reg. No. 3,574,685

Registered Feb. 17, 2009

TRADEMARK
PRINCIPAL REGISTER

KEULE

INMOBILIARIA E INVERSIONES LOS MAITOS
LIMITADA (CHILE LIMITED LIABILITY
COMPANY)
ALCANTARA 200, 6 PISO, LOS CONDES
SANTIAGO, CHILE

FOR: WINE, IN CLASS 33 (U.S. CLS. 47 AND 49).

THE MARK CONSISTS OF STANDARD CHAR-
ACTERS WITHOUT CLAIM TO ANY PARTICULAR
FONT, STYLE, SIZE, OR COLOR.

OWNER OF CHILE REG. NO. 792498, DATED 7-18-
2007, EXPIRES 7-18-2017.

'KEULE' HAS NO MEANING IN A FOREIGN
LANGUAGE.

SER. NO. 77-309,843, FILED 10-22-2007.

BENJAMIN OKEKE, EXAMINING ATTORNEY

Int. Cl.: 42

Prior U.S. Cls.: 100 and 101

United States Patent and Trademark Office

Reg. No. 3,574,686

Registered Feb. 17, 2009

**SERVICE MARK
PRINCIPAL REGISTER**

TERRALOGOS

TERRA LOGOS (MARYLAND CORPORATION)
SUITE B301
3225 ELLERSLIE AVENUE
BALTIMORE, MD 21218

FOR: ARCHITECTURAL DESIGN AND DRAFT-
ING SERVICES; INSPECTIONS OF RESIDENTIAL
AND COMMERCIAL BUILDINGS FOR THEIR
STRUCTURAL AND ENERGY EFFICIENCY, IN
CLASS 42 (U.S. CLS. 100 AND 101).

FIRST USE 1-1-2002; IN COMMERCE 1-1-2002.

THE MARK CONSISTS OF STANDARD CHAR-
ACTERS WITHOUT CLAIM TO ANY PARTICULAR
FONT, STYLE, SIZE, OR COLOR.

SER. NO. 77-310,565, FILED 10-23-2007.

DAWN HAN, EXAMINING ATTORNEY

Int. Cl.: 35

Prior U.S. Cls.: 100, 101 and 102

United States Patent and Trademark Office

Reg. No. 3,574,687

Registered Feb. 17, 2009

**SERVICE MARK
PRINCIPAL REGISTER**

EMOTIONAL CONNECTIONS

MYERS, JACK (UNITED STATES INDIVIDUAL)
125 WEST 80TH STREET
NEW YORK, NY 10024

FOR: CONSUMER RESEARCH, NAMELY, RESEARCH IN THE AREA OF THE ATTITUDES AND PERCEPTIONS OF PEOPLE TOWARD THE MEDIA THEY CONSUME, THE PRODUCTS THEY PURCHASE, THE ADVERTISING MESSAGES THEY SEE, THE PERSONALITIES THEY ARE IN CONTACT WITH, AND OTHER PERSONAL PERCEPTIONS RESULTING FROM EXPOSURE EITHER IN-PERSON OR THROUGH MEDIA AND OTHER

FORMS OF CONNECTION, IN CLASS 35 (U.S. CLS. 100, 101 AND 102).

FIRST USE 10-0-2005; IN COMMERCE 10-0-2005.

THE MARK CONSISTS OF STANDARD CHARACTERS WITHOUT CLAIM TO ANY PARTICULAR FONT, STYLE, SIZE, OR COLOR.

SER. NO. 77-311,161, FILED 10-23-2007.

RENEE MCCRAY, EXAMINING ATTORNEY

Int. Cl.: 41

Prior U.S. Cls.: 100, 101 and 107

United States Patent and Trademark Office

Reg. No. 3,574,688

Registered Feb. 17, 2009

**SERVICE MARK
PRINCIPAL REGISTER**

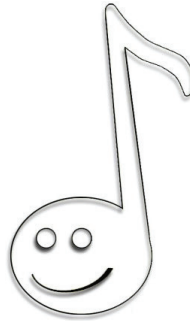

DANIEL WORK (UNITED STATES INDIVIDUAL)
2855 BROOKSIDE ROAD
LAKE OSWEGO, OR 97035

FOR: MULTIMEDIA ENTERTAINMENT SERVICES IN THE NATURE OF RECORDING, PRODUCTION AND POST-PRODUCTION SERVICES IN THE FIELDS OF MUSIC, VIDEO, AND FILMS; PRODUCTION OF VIDEO AND CREATION OF VISUAL EFFECTS FOR OTHERS FOR USE IN DVDS, TELEVISION PROGRAMS AND ON WEBSITES; VIDEO

EDITING; VIDEO MASTERING SERVICES, IN CLASS 41 (U.S. CLS. 100, 101 AND 107).

FIRST USE 6-6-1996; IN COMMERCE 6-6-1996.

THE MARK CONSISTS OF CIRCULAR SMILEY FACE FORMING THE BASE OF A MUSIC STAFF NOTE.

SER. NO. 77-311,342, FILED 10-23-2007.

ANGELA GAW, EXAMINING ATTORNEY

Int. Cl.: 9

Prior U.S. Cls.: 21, 23, 26, 36 and 38

Reg. No. 3,574,689

United States Patent and Trademark Office

Registered Feb. 17, 2009

**TRADEMARK
PRINCIPAL REGISTER**

SPECTRUM SERIES

E.D. BULLARD COMPANY (DELAWARE CORPORATION)
1898 SAFETY WAY
CYNTHIANA, KY 41031

FOR: RESPIRATORY PROTECTION DEVICES, NAMELY, PERSONAL RESPIRATORS SUPPLYING GRADE 'D' OR BETTER BREATHING AIR, WHEREBY SUCH PROTECTIVE DEVICE IS WORN DURING PHARMACEUTICAL MANUFACTURING, SPRAY PAINTING, PLANT MAINTENANCE, TANK CLEANING, CHEMICAL AND PESTICIDE HANDLING, AND OTHER INDUSTRIAL AND AGRICULTURAL APPLICATIONS, IN CLASS 9 (U.S. CLS. 21, 23, 26, 36 AND 38).

FIRST USE 3-0-1998; IN COMMERCE 3-0-1998.

THE MARK CONSISTS OF STANDARD CHARACTERS WITHOUT CLAIM TO ANY PARTICULAR FONT, STYLE, SIZE, OR COLOR.

NO CLAIM IS MADE TO THE EXCLUSIVE RIGHT TO USE "SERIES", APART FROM THE MARK AS SHOWN.

SER. NO. 77-311,780, FILED 10-24-2007.

RAUL CORDOVA, EXAMINING ATTORNEY

Int. Cl.: 9

Prior U.S. Cls.: 21, 23, 26, 36 and 38

Reg. No. 3,574,690

United States Patent and Trademark Office

Registered Feb. 17, 2009

**TRADEMARK
PRINCIPAL REGISTER**



UNIVERSAL ABUNDANCE, INC. (GEORGIA CORPORATION)
1017 CROOKED CREEK CT.
MABLETON, GA 30126

FOR: AUDIO AND VIDEO RECORDINGS IN THE FIELD OF PERSONAL IMPROVEMENT AND PROFESSIONAL DEVELOPMENT, IN CLASS 9 (U.S. CLS. 21, 23, 26, 36 AND 38).

FIRST USE 8-1-2006; IN COMMERCE 8-1-2006.

THE COLOR(S) GREEN AND TEAL IS/ARE CLAIMED AS A FEATURE OF THE MARK.

THE MARK CONSISTS OF A DANCING FIGURE IN GREEN AND THE WORDING "UNIVERSAL ABUNDANCE" IN TEAL; THE DOT OF THE LETTER "I" IN THE WORDING "UNIVERSAL" ALSO APPEARS IN GREEN.

SER. NO. 77-311,857, FILED 10-24-2007.

JORDAN BAKER, EXAMINING ATTORNEY

Int. Cls.: 16 and 25

Prior U.S. Cls.: 2, 5, 22, 23, 29, 37, 38, 39 and 50

United States Patent and Trademark Office

Reg. No. 3,574,691

Registered Feb. 17, 2009

**TRADEMARK
PRINCIPAL REGISTER**



BURRUS BROS. & ASSOCIATED GROWERS (IL-
LINOIS COOPERATIVE ASSOCIATION)
826 ARENZVILLE RD.
ARENZVILLE, IL 62611

FOR: MARKERS, IN CLASS 16 (U.S. CLS. 2, 5, 22,
23, 29, 37, 38 AND 50).

FIRST USE 7-20-1978; IN COMMERCE 7-20-1978.

FOR: CAPS; JACKETS; KNIT SHIRTS, IN CLASS
25 (U.S. CLS. 22 AND 39).

FIRST USE 7-20-1978; IN COMMERCE 7-20-1978.

NO CLAIM IS MADE TO THE EXCLUSIVE
RIGHT TO USE THE IMAGE OF A CORN SEED,
APART FROM THE MARK AS SHOWN.

THE MARK CONSISTS OF CORN SEED IN
STYLIZED HOUSE WITH THE WORD "BURRUS".

SER. NO. 77-313,078, FILED 10-25-2007.

DAWN FELDMAN, EXAMINING ATTORNEY

Int. Cl.: 41

Prior U.S. Cls.: 100, 101 and 107

United States Patent and Trademark Office

Reg. No. 3,574,692

Registered Feb. 17, 2009

**SERVICE MARK
PRINCIPAL REGISTER**

Pure Aesthetics

PURE AESTHETICS, L.L.C. (ARIZONA LIMITED
LIABILITY COMPANY)
5110 E. 5TH ST.
TUSON, AZ 85711

FOR: EDUCATIONAL SERVICES, NAMELY,
CONDUCTING CLASSES IN THE FIELD OF NAT-
URAL SKIN CARE AND DISTRIBUTION OF
COURSE MATERIAL IN CONNECTION THERE-
WITH, IN CLASS 41 (U.S. CLS. 100, 101 AND 107).

FIRST USE 11-30-2006; IN COMMERCE 11-30-2006.

THE MARK CONSISTS OF STANDARD CHAR-
ACTERS WITHOUT CLAIM TO ANY PARTICULAR
FONT, STYLE, SIZE, OR COLOR.

SER. NO. 77-313,829, FILED 10-25-2007.

RAUL CORDOVA, EXAMINING ATTORNEY

Int. Cl.: 33

Prior U.S. Cls.: 47 and 49

United States Patent and Trademark Office

Reg. No. 3,574,693

Registered Feb. 17, 2009

**TRADEMARK
PRINCIPAL REGISTER**

A TRAILBLAZER WINE

SHOPPERS VILLAGE LIQUORS, LLC (KEN-
TUCKY LIMITED LIABILITY COMPANY)

343 WALLER AVENUE, SUITE 100

LEXINGTON, KY 40504

FOR: GRAPE WINE, IN CLASS 33 (U.S. CLS. 47
AND 49).

FIRST USE 12-8-2005; IN COMMERCE 12-8-2005.

THE MARK CONSISTS OF STANDARD CHAR-
ACTERS WITHOUT CLAIM TO ANY PARTICULAR
FONT, STYLE, SIZE, OR COLOR.

NO CLAIM IS MADE TO THE EXCLUSIVE
RIGHT TO USE "WINE", APART FROM THE MARK
AS SHOWN.

SER. NO. 77-314,239, FILED 10-26-2007.

JAMES LOVELACE, EXAMINING ATTORNEY

Int. Cl.: 35

Prior U.S. Cls.: 100, 101 and 102

United States Patent and Trademark Office

Reg. No. 3,574,694

Registered Feb. 17, 2009

**SERVICE MARK
PRINCIPAL REGISTER**



CHARTING NEW COURSES, INC. (MARYLAND CORPORATION)
5570 LA PAZ STREET
LONG BEACH, CA 90803

FOR: ASSISTANCE, ADVISORY SERVICES AND CONSULTANCY WITH REGARD TO BUSINESS PLANNING, BUSINESS ANALYSIS, BUSINESS MANAGEMENT, AND BUSINESS ORGANIZATION, IN CLASS 35 (U.S. CLS. 100, 101 AND 102).

FIRST USE 10-1-2007; IN COMMERCE 10-1-2007.

THE COLOR(S) GRAY, YELLOW, TAN, BLUE, GREEN, AND WHITE IS/ARE CLAIMED AS A FEATURE OF THE MARK.

THE MARK CONSISTS OF AN IMAGE OF A GRAY ROAD WITH A YELLOW DIVIDER ON A BOTTOM PORTION OF THE MARK, WITH A TAN MOUNTAINOUS LANDSCAPE FEATURING SOME GREEN TREES AND SHRUBS POSITIONED ABOVE THE ROAD AND BLUE SKY AND WHITE CLOUDS ABOVE THE MOUNTAINOUS LANDSCAPE, AND THE TERM "ENTREMANEUR" IN WHITE TEXT INTERPOSED ON THE SKY PORTION.

SER. NO. 77-315,095, FILED 10-26-2007.

FRANK LATTUCA, EXAMINING ATTORNEY

Int. Cl.: 35

Prior U.S. Cls.: 100, 101 and 102

United States Patent and Trademark Office

Reg. No. 3,574,695

Registered Feb. 17, 2009

**SERVICE MARK
PRINCIPAL REGISTER**

QUEENSBOUND

ELEND, CIARA (UNITED STATES INDIVIDUAL), DBA QUEENSBOUND
APT 1E
4142 42ND STREET
SUNNYSIDE, NY 11104

FIRST USE 5-1-2007; IN COMMERCE 10-1-2007.

SER. NO. 77-315,288, FILED 10-27-2007.

FOR: ONLINE RETAIL STORE SERVICES FEATURING CLOTHING, IN CLASS 35 (U.S. CLS. 100, 101 AND 102).

DAWN HAN, EXAMINING ATTORNEY

Int. Cls.: 38 and 42

Prior U.S. Cls.: 100, 101 and 104

United States Patent and Trademark Office

Reg. No. 3,574,696

Registered Feb. 17, 2009

**SERVICE MARK
PRINCIPAL REGISTER**

AVFINITY

AVFINITY, LLC (TEXAS LIMITED LIABILITY
COMPANY)
SUITE 204 B
11782 JOLLYVILLE ROAD
AUSTIN, TX 78759

FOR: ELECTRONIC DATA COMMUNICATIONS AND TRANSMISSIONS SERVICES FOR THE AVIATION INDUSTRY, NAMELY, THE TRANSMISSION OF MISSION CRITICAL MESSAGES FOR OTHERS; PROVIDING OPERATIONAL ELECTRONIC STORE AND FORWARD MESSAGING SERVICES FOR OTHERS, NAMELY, TRANSMISSION OF FLIGHT DATA COMMUNICATIONS BETWEEN AIR TRANSPORTATION COMPANIES AND SERVICES AND DESTINATIONS INCLUDING GOVERNMENT AGENCIES; ELECTRONIC TRANSMISSION OF DATA FEATURING ENCRYPTION AND DECRYPTION, IN CLASS 38 (U.S. CLS. 100, 101 AND 104).

FIRST USE 10-18-2007; IN COMMERCE 10-18-2007.

FOR: ELECTRONIC CONVERSION OF DATA, NAMELY, DATA CONVERSION OF COMPUTER PROGRAM DATA TO GENERATE COMMUNICATIONS BETWEEN DIFFERENT FILE FORMATS REGARDING ADVANCED PASSENGER INFORMATION AND OTHER MISSION-CRITICAL MESSAGES, IN CLASS 42 (U.S. CLS. 100 AND 101).

FIRST USE 10-18-2007; IN COMMERCE 10-18-2007.

THE MARK CONSISTS OF STANDARD CHARACTERS WITHOUT CLAIM TO ANY PARTICULAR FONT, STYLE, SIZE, OR COLOR.

SER. NO. 77-315,393, FILED 10-28-2007.

SAIMA MAKHDOOM, EXAMINING ATTORNEY

Int. Cl.: 35

Prior U.S. Cls.: 100, 101 and 102

United States Patent and Trademark Office

Reg. No. 3,574,697

Registered Feb. 17, 2009

**SERVICE MARK
PRINCIPAL REGISTER**



MICHELLE LETENDRE HEDLUND (UNITED STATES INDIVIDUAL)
4337 WILSHIRE BOULEVARD
MOUND, MN 55364

FOR: PROVIDING ADVERTISING, MARKETING AND PROMOTIONAL SERVICES, NAMELY, DEVELOPMENT OF ADVERTISING CAMPAIGNS FOR PRINT AND THE INTERNET FOR COMPANIES THAT OFFER PRODUCTS OR SERVICES THAT ARE SAFER FOR THE ENVIRONMENT; ADVERTISING AGENCIES, NAMELY, PROMOTING THE SERVICES OF COMPANIES THAT OFFER PRODUCTS OR SERVICES THAT ARE SAFER FOR THE ENVIRONMENT, THROUGH THE DISTRIBUTION OF PRINTED AND AUDIO PROMOTIONAL MATE-

RIALS AND BY RENDERING SALES PROMOTION ADVICE, IN CLASS 35 (U.S. CLS. 100, 101 AND 102).

FIRST USE 4-7-2007; IN COMMERCE 7-7-2007.

THE COLOR(S) GREEN AND WHITE IS/ARE CLAIMED AS A FEATURE OF THE MARK.

THE MARK CONSISTS OF THE WHITE WORDING "UP" IN A GREEN ORB DESIGN.

SER. NO. 77-315,419, FILED 10-28-2007.

DAWN HAN, EXAMINING ATTORNEY

Int. Cl.: 35

Prior U.S. Cls.: 100, 101 and 102

United States Patent and Trademark Office

Reg. No. 3,574,698

Registered Feb. 17, 2009

**SERVICE MARK
PRINCIPAL REGISTER**

Lewis Paper

LEWIS PAPER INTERNATIONAL, INC (DELA-
WARE CORPORATION)
SUITE 100
1400 S. WOLF RD
WHEELING, IL 60090

FOR: RETAIL STORE AND ONLINE RETAIL
STORE SERVICES FEATURING COPY PAPER,
BOND PAPER, WRITING PAPER, OFFSET PAPER,
PLASTIC-COATED COPYING PAPER, INDEX PA-
PER, BRISTOL BOARD, CARBONLESS PAPER,
IMAGING PAPER, LASER PRINT PAPER, LASER
PRINTING PAPER, INK JET PAPER, FAX PAPER,
COMPUTER PAPER, OFFICE PAPER, STATION-
ERY, PAPER STATIONERY, COVER PAPER, PAPER
BOARD, DOUBLE THICK PAPER, ENVELOPES,
PAPER LABELS, DIE CUT LABELS, ANNOUNCE-
MENT CARDS, GRAPHIC ARTS REPRODUCTION,
PAPER FOR USE IN THE GRAPHIC ARTS INDUS-
TRY, GRAPHIC ART SUPPLIES, DIGITAL IMAGIN-

ING SUPPLIES, LASER TONER CARTRIDGES, IN
CLASS 35 (U.S. CLS. 100, 101 AND 102).

FIRST USE 1-1-1985; IN COMMERCE 1-1-1985.

THE MARK CONSISTS OF STANDARD CHAR-
ACTERS WITHOUT CLAIM TO ANY PARTICULAR
FONT, STYLE, SIZE, OR COLOR.

OWNER OF U.S. REG. NO. 1,938,666.

NO CLAIM IS MADE TO THE EXCLUSIVE
RIGHT TO USE "PAPER", APART FROM THE
MARK AS SHOWN.

SER. NO. 77-315,927, FILED 10-29-2007.

KATINA MISTER, EXAMINING ATTORNEY

Int. Cl.: 36

Prior U.S. Cls.: 100, 101 and 102

United States Patent and Trademark Office

Reg. No. 3,574,699

Registered Feb. 17, 2009

**SERVICE MARK
PRINCIPAL REGISTER**



ENVISAGE INTERNATIONAL CORPORATION
(DELAWARE CORPORATION)
SUITE 3
241 ATLANTIC BOULEVARD
NEPTUNE BEACH, FL 32266

FOR: ARRANGING OF TEMPORARY LOANS
FOR INTERNATIONAL STUDENTS, IN CLASS 36
(U.S. CLS. 100, 101 AND 102).

FIRST USE 3-11-2000; IN COMMERCE 3-11-2000.

NO CLAIM IS MADE TO THE EXCLUSIVE
RIGHT TO USE "INTERNATIONAL" AND "STU-
DENTLOAN.COM", APART FROM THE MARK AS
SHOWN.

"THE COLOR(S) GREEN, WHITE AND BLACK IS/
ARE CLAIMED AS A FEATURE OF THE MARK."

"THE MARK CONSISTS OF THE WORDING
"INTERNATI" AND "NAL" IN GREEN, AND "STU-
DENTLOAN.COM" IN BLACK. THE DESIGN OF
THE STUDENT READING ON THE GLOBE IS IN
BLACK AND WHITE."

SER. NO. 77-316,910, FILED 10-30-2007.

DAWN HAN, EXAMINING ATTORNEY

Int. Cl.: 28

Prior U.S. Cls.: 22, 23, 38 and 50

United States Patent and Trademark Office

Reg. No. 3,574,700

Registered Feb. 17, 2009

TRADEMARK
PRINCIPAL REGISTER

TRANS ELEMENT

GLOBE INTERNATIONAL NOMINEES PTY LTD
(AUSTRALIA CORPORATION)
42 BARKLY STREET
ST KILDA, VICTORIA, AUSTRALIA 3182

FOR: SKATEBOARDS, SKATEBOARD WHEELS SOLD BOTH SEPARATELY AND AS A UNIT; SKATEBOARD HARDWARE AND PARTS THEREFOR, NAMELY, BEARINGS, MOUNTING HARDWARE, TRUCKS, DECKS, GRIP TAPE, AND RISER PADS; WATERSKIS; SURF SKIS; SKIS; EDGES OF SKIS; SCRAPERS FOR SKIS; SEAL SKIN COVERINGS FOR SKIS; SKI BINDINGS; SOLE COVERINGS FOR SKIS; WAX FOR SKIS; SURFBOARDS; SURFBOARD LEASHES; BAGS ESPECIALLY DESIGNED FOR SKIS AND SURFBOARDS; BODY BOARDS, WAKE BOARDS; SNOWBOARDS; SAILBOARDS; HARNESS FOR SAILBOARDS; MASTS FOR SAILBOARDS; PARAGLIDERS; ICE SKATES; ROLLER SKATES; HOCKEY STICKS; PROTECTIVE PADDING FOR PARTS OF SUITS USED IN SKATEBOARDING, SNOWBOARDING, SKIING, WATERSKIING, SURFING, BODY BOARDING, WAKE BOARDING, AND WINDSURFING; ELBOW, KNEE AND SHIN GUARDS FOR ATHLETIC USE;

PUNCHING BAGS; RACKETS; STRINGS FOR RACKETS; STATIONARY EXERCISE BICYCLES; MACHINES FOR PHYSICAL EXERCISE; BALLS FOR GAMES; BATS FOR GAMES; KITES; KITE REELS; BOARD GAMES; HAND HELD UNITS FOR PLAYING ELECTRONIC GAMES; PARLOUR GAMES; BOBSLEIGHS, IN CLASS 28 (U.S. CLS. 22, 23, 38 AND 50).

THE MARK CONSISTS OF STANDARD CHARACTERS WITHOUT CLAIM TO ANY PARTICULAR FONT, STYLE, SIZE, OR COLOR.

PRIORITY CLAIMED UNDER SEC. 44(D) ON AUSTRALIA APPLICATION NO. 1202199, FILED 10-3-2007, REG. NO. 1202199, DATED 10-3-2007, EXPIRES 10-3-2017.

OWNER OF U.S. REG. NO. 2,737,412.

SER. NO. 77-317,779, FILED 10-31-2007.

MARTHA FROMM, EXAMINING ATTORNEY

Int. Cl.: 42

Prior U.S. Cls.: 100 and 101

United States Patent and Trademark Office

Reg. No. 3,574,701

Registered Feb. 17, 2009

**SERVICE MARK
PRINCIPAL REGISTER**



POWER PROGRAMMING LLC (ARKANSAS
LIMITED LIABILITY COMPANY)
32 BALL HILL DRIVE
GREENBRIER, AR 72058

FOR: COMPUTER PROGRAMMING WHICH ENHANCES MOTOR POWER AND FUEL ECONOMY IN VEHICLES THAT USE COMPUTERIZED ENGINE MANAGEMENT, IN CLASS 42 (U.S. CLS. 100 AND 101).

FIRST USE 7-3-2005; IN COMMERCE 7-3-2005.

NO CLAIM IS MADE TO THE EXCLUSIVE RIGHT TO USE "POWER PROGRAMMING", APART FROM THE MARK AS SHOWN.

THE MARK CONSISTS OF THE WORD "POWER" ON TOP OF A RECTANGLE. THE RECTANGLE HAS THE WORD "PROGRAMMING" CUT OUT OF IT. THE WORDS "POWER" AND "PROGRAMMING" ARE IN CAPS AND IN THE FONT OF "IMPACT". A COMPUTER CABLE IS COMING OUT OF THE RECTANGLE WITH A SERIAL END VISIBLE.

SER. NO. 77-318,673, FILED 11-1-2007.

EMILY CARLSEN, EXAMINING ATTORNEY

Int. Cl.: 41

Prior U.S. Cls.: 100, 101 and 107

United States Patent and Trademark Office

Reg. No. 3,574,702

Registered Feb. 17, 2009

**SERVICE MARK
PRINCIPAL REGISTER**

Digital Sight

SEDLAK, MICHAEL G (CALIFORNIA SOLE
PROPRIETORSHIP)

443 LOS RIOS COURT

PLEASANTON, CA 945667669

FOR: PHOTOGRAPHY SERVICES, IN CLASS 41
(U.S. CLS. 100, 101 AND 107).

FIRST USE 5-1-1998; IN COMMERCE 5-1-1998.

THE MARK CONSISTS OF STANDARD CHAR-
ACTERS WITHOUT CLAIM TO ANY PARTICULAR
FONT, STYLE, SIZE, OR COLOR.

NO CLAIM IS MADE TO THE EXCLUSIVE
RIGHT TO USE "DIGITAL", APART FROM THE
MARK AS SHOWN.

SER. NO. 77-319,347, FILED 11-1-2007.

KAREN K. BUSH, EXAMINING ATTORNEY

Int. Cl.: 41

Prior U.S. Cls.: 100, 101 and 107

United States Patent and Trademark Office

Reg. No. 3,574,703

Registered Feb. 17, 2009

**SERVICE MARK
PRINCIPAL REGISTER**

Transitioning Adults plus

ALLISON, BROWN & COLLEAGUE, INC. (NEVADA CORPORATION), DBA TRANSITIONING ADULTS PLUS
711 S. CARSON ST. #4
CARSON CITY, NV 89701

FOR: PERSONAL COACHING SERVICES IN THE FIELD OF LIFE TRANSITIONS, IN CLASS 41 (U.S. CLS. 100, 101 AND 107).

FIRST USE 6-1-2007; IN COMMERCE 6-2-2007.

THE MARK CONSISTS OF STANDARD CHARACTERS WITHOUT CLAIM TO ANY PARTICULAR FONT, STYLE, SIZE, OR COLOR.

NO CLAIM IS MADE TO THE EXCLUSIVE RIGHT TO USE "TRANSITIONING ADULTS", APART FROM THE MARK AS SHOWN.

SER. NO. 77-319,411, FILED 11-1-2007.

KELLEY WELLS, EXAMINING ATTORNEY

Int. Cls.: 12 and 35

Prior U.S. Cls.: 19, 21, 23, 31, 35, 44, 100, 101 and 102

United States Patent and Trademark Office

Reg. No. 3,574,704

Registered Feb. 17, 2009

**TRADEMARK
SERVICE MARK
PRINCIPAL REGISTER**

COLGAN CUSTOM

COLGAN CUSTOM MANUFACTURING, INC.
(CALIFORNIA CORPORATION)
2851-B ALTON PARKWAY
IRVINE, CA 92606

FOR: ACCESSORIES FOR CARS, TRUCKS, VANS AND SUVS IN THE NATURE OF FITTED BRA COVERS, FITTED MIRROR BRA COVERS, TIRE COVERS, SERVICE AND MECHANICS COVERS IN THE NATURE OF PROTECTIVE PADDING TO PROTECT VEHICLE SURFACES FROM DAMAGE OR SCRATCHING DURING VEHICULAR MAINTENANCE OR REPAIR, CARGO STORAGE BAGS ESPECIALLY ADAPTED TO FIT IN THE TRUNK OR STORAGE SPACE OF CARS, TRUCKS, VANS AND SUVS, AND TRUNK MATS, IN CLASS 12 (U.S. CLS. 19, 21, 23, 31, 35 AND 44).

FIRST USE 0-0-1961; IN COMMERCE 0-0-1961.

FOR: RETAIL STORE SERVICES FEATURING CAR, TRUCK, VAN AND SUV BRA COVERS, MIRROR BRA COVERS, TIRE COVERS, SERVICE AND MECHANICS COVERS, STORAGE BAGS AND TRUNK MATS, IN CLASS 35 (U.S. CLS. 100, 101 AND 102).

FIRST USE 0-0-1961; IN COMMERCE 0-0-1961.

THE MARK CONSISTS OF STANDARD CHARACTERS WITHOUT CLAIM TO ANY PARTICULAR FONT, STYLE, SIZE, OR COLOR.

SEC. 2(F).

SER. NO. 77-320,879, FILED 11-4-2007.

ANN E. SAPPENFIELD, EXAMINING ATTORNEY

Int. Cl.: 41

Prior U.S. Cls.: 100, 101 and 107

United States Patent and Trademark Office

Reg. No. 3,574,705

Registered Feb. 17, 2009

**SERVICE MARK
PRINCIPAL REGISTER**

THE CHAMPAGNE CONNECTION

WILSON-COLEMAN, STEPHANIE E. (UNITED STATES INDIVIDUAL)
7858 S. HALSTED
CHICAGO, IL 60621

FOR: PERSONAL APPEARANCES BY AN INSPIRATIONAL AND MOTIVATIONAL SPEAKER; EDUCATIONAL SERVICES, NAMELY, PROVIDING WORKSHOPS, SEMINARS AND TRAINING IN THE FIELD OF SELF IMPROVEMENT, SELF-EMPOWERMENT AND SELF-RELIANCE; MEETING FACILITATOR, NAMELY, ARRANGING WORKSHOPS, SEMINARS AND TRAINING COURSES IN THE FIELD OF SELF IMPROVEMENT,

SELF-EMPOWERMENT, AND SELF-RELIANCE FOR BUSINESSES AND INDIVIDUALS, IN CLASS 41 (U.S. CLS. 100, 101 AND 107).

FIRST USE 1-15-1995; IN COMMERCE 1-15-1995.

THE MARK CONSISTS OF STANDARD CHARACTERS WITHOUT CLAIM TO ANY PARTICULAR FONT, STYLE, SIZE, OR COLOR.

SER. NO. 77-322,066, FILED 11-6-2007.

KAREN K. BUSH, EXAMINING ATTORNEY

Int. Cl.: 27

Prior U.S. Cls.: 19, 20, 37, 42 and 50

United States Patent and Trademark Office

Reg. No. 3,574,706

Registered Feb. 17, 2009

TRADEMARK
PRINCIPAL REGISTER

fee-fee DOG

NADERI, NADIA (UNITED STATES INDIVIDUAL)
4992 RANCH RD.
TIBURON, CA 94920

FOR: SYNTHETIC GRASS PLAY AREA FOR DOGS, IN CLASS 27 (U.S. CLS. 19, 20, 37, 42 AND 50).

FIRST USE 12-13-2005; IN COMMERCE 12-13-2005.

THE MARK CONSISTS OF STANDARD CHARACTERS WITHOUT CLAIM TO ANY PARTICULAR FONT, STYLE, SIZE, OR COLOR.

NO CLAIM IS MADE TO THE EXCLUSIVE RIGHT TO USE "DOG", APART FROM THE MARK AS SHOWN.

SER. NO. 77-322,539, FILED 11-6-2007.

MARIA-VICTORIA SUAREZ, EXAMINING ATTORNEY

Int. Cl.: 2

Prior U.S. Cls.: 6, 11 and 16

United States Patent and Trademark Office

Reg. No. 3,574,707

Registered Feb. 17, 2009

**TRADEMARK
PRINCIPAL REGISTER**

CURB COAT

THE CONCRETE EDGE CO. (FLORIDA CORPORATION)
11516 SATELLITE BLVD
ORLANDO, FL 32837

FOR: COLOR COATINGS IN THE NATURE OF POWDERS FOR USE IN CONNECTION WITH THE COLORING, HARDENING AND DUSTPROOFING OF CONCRETE SURFACES, IN CLASS 2 (U.S. CLS. 6, 11 AND 16).

FIRST USE 0-0-2000; IN COMMERCE 0-0-2000.

THE MARK CONSISTS OF STANDARD CHARACTERS WITHOUT CLAIM TO ANY PARTICULAR FONT, STYLE, SIZE, OR COLOR.

OWNER OF U.S. REG. NO. 2,637,695.

NO CLAIM IS MADE TO THE EXCLUSIVE RIGHT TO USE "CURB", APART FROM THE MARK AS SHOWN.

SEC. 2(F).

SER. NO. 77-322,635, FILED 11-6-2007.

YAT SYE, LEE, EXAMINING ATTORNEY

Int. Cl.: 5

Prior U.S. Cls.: 6, 18, 44, 46, 51 and 52

United States Patent and Trademark Office

Reg. No. 3,574,708

Registered Feb. 17, 2009

**TRADEMARK
PRINCIPAL REGISTER**

MINI

BODY DYNAMICS, INC. (INDIANA CORPORATION)
9700 NORTH MICHIGAN ROAD
CARMEL, IN 46032

FOR: OVER-THE-COUNTER PHARMACEUTICAL PREPARATIONS, NAMELY, DECONGESTANTS; ANALGESICS; SLEEP AIDS; CENTRAL NERVOUS SYSTEM STIMULANTS; APPETITE SUPPRESSANTS; DIET AIDS, NAMELY, DIET PILLS, CAPSULES, LIQUIDS AND GELS; BRONCHODILATORS; EXPECTORANTS AND PAIN KILLERS; AND DIETARY SUPPLEMENTS, IN CLASS 5 (U.S. CLS. 6, 18, 44, 46, 51 AND 52).

FIRST USE 6-30-1980; IN COMMERCE 6-30-1980.

THE MARK CONSISTS OF STANDARD CHARACTERS WITHOUT CLAIM TO ANY PARTICULAR FONT, STYLE, SIZE, OR COLOR.

OWNER OF U.S. REG. NOS. 2,380,485 AND 2,444,168.

SER. NO. 77-323,943, FILED 11-7-2007.

CAROLYN GRAY, EXAMINING ATTORNEY

Int. Cl.: 42

Prior U.S. Cls.: 100 and 101

United States Patent and Trademark Office

Reg. No. 3,574,709

Registered Feb. 17, 2009

**SERVICE MARK
PRINCIPAL REGISTER**

Shoutsay

SHOUTSAY, L.L.C. (GEORGIA LIMITED LIABILITY COMPANY)
7112 LAKEVIEW ROAD
STATESBORO, GA 30461

FOR: COMPUTER SERVICES, NAMELY, HOSTING AND MAINTAINING AN ONLINE WEBSITE FOR OTHERS TO NETWORK SOCIALLY; HOSTING AN ONLINE COMMUNITY WEBSITE FEATURING SOCIAL NETWORKING; PROVIDING A WEBSITE FEATURING TEMPORARY USE OF NONDOWNLOADABLE SOFTWARE ALLOWING WEBSITE USERS TO UPLOAD ONLINE VIDEOS FOR SHARING WITH OTHERS FOR ENTERTAINMENT PURPOSES, IN CLASS 42 (U.S. CLS. 100 AND 101).

FIRST USE 10-29-2007; IN COMMERCE 10-29-2007.

THE MARK CONSISTS OF STANDARD CHARACTERS WITHOUT CLAIM TO ANY PARTICULAR FONT, STYLE, SIZE, OR COLOR.

SEC. 2(F).

SER. NO. 77-324,557, FILED 11-8-2007.

APRIL ROACH, EXAMINING ATTORNEY

Int. Cl.: 24

Prior U.S. Cls.: 42 and 50

United States Patent and Trademark Office

Reg. No. 3,574,710

Registered Feb. 17, 2009

**TRADEMARK
PRINCIPAL REGISTER**

Feather Dancer

QUALITY BANNER COMPANY (FLORIDA CORPORATION)
1302 SW 42ND AVE
OCALA, FL 34474

FOR: FABRIC FLAGS, IN CLASS 24 (U.S. CLS. 42 AND 50).

FIRST USE 11-15-2006; IN COMMERCE 1-2-2007.

THE MARK CONSISTS OF STANDARD CHARACTERS WITHOUT CLAIM TO ANY PARTICULAR FONT, STYLE, SIZE, OR COLOR.

SER. NO. 77-324,567, FILED 11-8-2007.

VIVIAN MICZNIK FIRST, EXAMINING ATTORNEY

Int. Cls.: 7 and 16

**Prior U.S. Cls.: 2, 5, 13, 19, 21, 22, 23, 29, 31, 34, 35,
37, 38 and 50**

Reg. No. 3,574,711

United States Patent and Trademark Office

Registered Feb. 17, 2009

**TRADEMARK
PRINCIPAL REGISTER**

LAMICAN

LAMICAN OY (FINLAND CORPORATION)
LEMPAALANTIE 18 B
FIN-37600 VALKEAKOSKI, FINLAND

FOR: MACHINES, NAMELY, MACHINES FOR
ASEPTIC LIQUID PACKAGING, IN CLASS 7 (U.S.
CLS. 13, 19, 21, 23, 31, 34 AND 35).

FOR: GOODS MADE FROM PAPER AND CARD-
BOARD, NAMELY, LAMINATED PAPER AND
CARDBOARD PACKAGING CONTAINERS FOR
ASEPTIC LIQUID, IN CLASS 16 (U.S. CLS. 2, 5, 22,
23, 29, 37, 38 AND 50).

THE MARK CONSISTS OF STANDARD CHAR-
ACTERS WITHOUT CLAIM TO ANY PARTICULAR
FONT, STYLE, SIZE, OR COLOR.

OWNER OF FINLAND REG. NO. 229229, DATED
12-31-2003, EXPIRES 12-31-2013.

THE WORDING "LAMICAN" HAS NO MEANING
IN A FOREIGN LANGUAGE.

SER. NO. 77-324,633, FILED 11-8-2007.

BILL DAWE, EXAMINING ATTORNEY

Int. Cl.: 35

Prior U.S. Cls.: 100, 101 and 102

United States Patent and Trademark Office

Reg. No. 3,574,712

Registered Feb. 17, 2009

**SERVICE MARK
PRINCIPAL REGISTER**

FRONTLINE SOURCE GROUP

FRONTLINE SOURCE GROUP, INC. (TEXAS CORPORATION)
SUITE 200
311 N. MARKET STREET
DALLAS, TX 75202

FOR: TEMPORARY AND PERMANENT EMPLOYMENT STAFFING, SEARCH, HIRING, RECRUITING, PLACEMENT AND CONSULTATION, IN CLASS 35 (U.S. CLS. 100, 101 AND 102).

FIRST USE 11-15-2004; IN COMMERCE 11-23-2004.

THE MARK CONSISTS OF STANDARD CHARACTERS WITHOUT CLAIM TO ANY PARTICULAR FONT, STYLE, SIZE, OR COLOR.

NO CLAIM IS MADE TO THE EXCLUSIVE RIGHT TO USE "GROUP", APART FROM THE MARK AS SHOWN.

SER. NO. 77-324,939, FILED 11-8-2007.

DEIRDRE ROBERTSON, EXAMINING ATTORNEY

Int. Cl.: 35

Prior U.S. Cls.: 100, 101 and 102

United States Patent and Trademark Office

Reg. No. 3,574,713

Registered Feb. 17, 2009

**SERVICE MARK
PRINCIPAL REGISTER**

Flower Pedal

RHARHA & COMPANY, LLC (MARYLAND LIMITED LIABILITY COMPANY), DBA FLOWER PEDAL
1100 KENTMORR RD
STEVENSVILLE, MD 21666

FOR: ON-LINE RETAIL STORE SERVICES IN THE FIELD OF SCULPTURES, JEWELRY AND HOME ACCESSORIES FEATURING BICYCLE SHAPES, IMAGES AND THEMES , IN CLASS 35 (U.S. CLS. 100, 101 AND 102).

FIRST USE 4-0-2005; IN COMMERCE 9-0-2005.

THE MARK CONSISTS OF STANDARD CHARACTERS WITHOUT CLAIM TO ANY PARTICULAR FONT, STYLE, SIZE, OR COLOR.

SER. NO. 77-326,151, FILED 11-9-2007.

BARBARA A. GOLD, EXAMINING ATTORNEY

Int. Cls.: 41, 43, 44 and 45

Prior U.S. Cls.: 100, 101 and 107

United States Patent and Trademark Office

Reg. No. 3,574,714

Registered Feb. 17, 2009

**SERVICE MARK
PRINCIPAL REGISTER**

**VISTA DEL MAR CHILD &
FAMILY SERVICES**

VISTA DEL MAR CHILD & FAMILY SERVICES
(CALIFORNIA NON-PROFIT ORGANIZATION)

3200 MOTOR AVENUE
LOS ANGELES, CA 90034

FOR: EDUCATIONAL SERVICES, NAMELY, PROVIDING INSTRUCTION TO PRIMARY AND SECONDARY AGE AND SPECIAL NEEDS STUDENTS AT THE PRIMARY AND SECONDARY LEVEL, AND VOCATIONAL GUIDANCE AND ASSESSMENT; PROVIDING CHILDREN'S LIBRARY SERVICES; PROVIDING CHILDREN'S RECREATIONAL ACTIVITIES, NAMELY, SPORTS, GAMES, ARTS AND CRAFTS, CREATIVE WRITING, AND COMMUNITY OUTINGS; PROVIDING PARENTING SKILLS INSTRUCTION; CAREER COUNSELING, NAMELY, PROVIDING VOCATIONAL INSTRUCTION FOR CAREER GOALS; PROVIDING RELIGIOUS AND CULTURAL DIVERSITY EDUCATIONAL PROGRAMS; PROVIDING COMMUNITY BASED INSTRUCTION IN THE FIELDS OF PARENT EDUCATION, PREVENTION OF CHILD ABUSE AND NEGLECT, CHILD CARE, AND HEALTH AND DEVELOPMENT OF CHILDREN, IN CLASS 41 (U.S. CLS. 100, 101 AND 107).

FIRST USE 4-28-1999; IN COMMERCE 4-28-1999.

FOR: PROVIDING TEMPORARY HOUSING, NAMELY, GROUP HOMES, FOR CHILDREN, IN CLASS 43 (U.S. CLS. 100 AND 101).

FIRST USE 4-28-1999; IN COMMERCE 4-28-1999.

FOR: MENTAL HEALTH SERVICES FOR CHILDREN, NAMELY, MENTAL HEALTH COUNSELING, THERAPY AND PSYCHO-BIOSOCIAL ASSESSMENT; PROVIDING INFORMATION FOR HOW TO SECURE MEDICAL SERVICES FROM OTHERS; PROVIDING MEDICAL AND DENTAL SERVICES; PSYCHOLOGICAL SERVICES, NAME-

LY, PROVIDING OUTPATIENT COUNSELING AND PSYCHO-EDUCATIONAL CLINIC SERVICES TO CHILDREN WITH EMOTIONAL, BEHAVIORAL AND/OR LEARNING DIFFICULTIES; SUBSTANCE ABUSE PROGRAMS IN THE NATURE OF REHABILITATION OF DRUG ADDICTED PATIENTS; PROVIDING MEDICAL ASSESSMENT FOR CHILDREN WHO ARE VICTIMS OF CHILD ABUSE, NEGLECT, ABANDONMENT, DOMESTIC VIOLENCE AND FAMILY DYSFUNCTION, IN CLASS 44 (U.S. CLS. 100 AND 101).

FIRST USE 4-28-1999; IN COMMERCE 4-28-1999.

FOR: ADOPTION AGENCY SERVICES; ADOPTION COUNSELING, NAMELY, COUNSELING TO ADOPTIVE PARENTS, ADOPTEEES AND BIRTH MOTHERS; FOSTER CARE AGENCY SERVICES, NAMELY, EVALUATING, SELECTING AND MONITORING FOSTER CARE PARENTS; COUNSELING IN THE FIELD OF SUPPORTING AND STRENGTHENING THE FAMILY UNIT; PROVIDING SUPPORT SERVICES TO CHILDREN WHO ARE VICTIMS OF CHILD ABUSE, NEGLECT, ABANDONMENT, DOMESTIC VIOLENCE AND FAMILY DYSFUNCTION, NAMELY, EMOTIONAL SUPPORT AND COUNSELING; MINISTERIAL SERVICES, NAMELY, PROVIDING RELIGIOUS WORSHIP SERVICES; PROVIDING INFORMATION FOR HOW TO SECURE LEGAL AND ADOPTION SERVICES FROM OTHERS, IN CLASS 45 (U.S. CLS. 100 AND 101).

FIRST USE 4-28-1999; IN COMMERCE 4-28-1999.

THE MARK CONSISTS OF STANDARD CHARACTERS WITHOUT CLAIM TO ANY PARTICULAR FONT, STYLE, SIZE, OR COLOR.

NO CLAIM IS MADE TO THE EXCLUSIVE RIGHT TO USE "CHILD & FAMILY SERVICES", APART FROM THE MARK AS SHOWN.

SEC. 2(F).

SER. NO. 77-326,188, FILED 11-9-2007.

JEAN IM, EXAMINING ATTORNEY

Int. Cl.: 41

Prior U.S. Cls.: 100, 101 and 107

United States Patent and Trademark Office

Reg. No. 3,574,715

Registered Feb. 17, 2009

**SERVICE MARK
PRINCIPAL REGISTER**

HOMEGROWN REVOLUTION

DERVAES INSTITUTE (CALIFORNIA CORPORATION)
631 CYPRESS AVENUE
PASADENA, CA 91103

FOR: EDUCATIONAL SERVICES, NAMELY, CONDUCTING INFORMAL PROGRAMS IN THE FIELDS OF SUSTAINABLE LIVING, ORGANIC FOODS AND GARDENING, HOMESTEADING, THE ENVIRONMENT, AND CONSERVATION, USING ON-LINE ACTIVITIES AND INTERACTIVE EXHIBITS; ENTERTAINMENT SERVICES, NAMELY, PROVIDING A WEB SITE FEATURING PHOTOGRAPHIC, AUDIO AND VIDEO FEATURING SUSTAINABLE LIVING, ORGANIC FOODS AND GARDENING, HOMESTEADING, THE ENVIRONMENT, AND CONSERVATION; ON-LINE JOUR-

NALS, NAMELY, BLOGS FEATURING SUSTAINABLE LIVING, ORGANIC FOODS AND GARDENING, HOMESTEADING, THE ENVIRONMENT, AND CONSERVATION, IN CLASS 41 (U.S. CLS. 100, 101 AND 107).

FIRST USE 7-0-2005; IN COMMERCE 8-0-2005.

THE MARK CONSISTS OF STANDARD CHARACTERS WITHOUT CLAIM TO ANY PARTICULAR FONT, STYLE, SIZE, OR COLOR.

SER. NO. 77-326,578, FILED 11-10-2007.

JESSICA A. POWERS, EXAMINING ATTORNEY

Int. Cl.: 20

Prior U.S. Cls.: 2, 13, 22, 25, 32 and 50

United States Patent and Trademark Office

Reg. No. 3,574,716

Registered Feb. 17, 2009

**TRADEMARK
PRINCIPAL REGISTER**

DANCING DNA

DAKOTA STEEL ART, INC. (NORTH DAKOTA
CORPORATION)
405 COUNTY RD 25
MANTADOR, ND 58058

THE MARK CONSISTS OF STANDARD CHAR-
ACTERS WITHOUT CLAIM TO ANY PARTICULAR
FONT, STYLE, SIZE, OR COLOR.

FOR: DECORATIVE MOBILES, IN CLASS 20 (U.S.
CLS. 2, 13, 22, 25, 32 AND 50).

SER. NO. 77-326,595, FILED 11-10-2007.

FIRST USE 7-1-2007; IN COMMERCE 10-1-2007.

AISHA CLARKE, EXAMINING ATTORNEY

Int. Cl.: 25

Prior U.S. Cls.: 22 and 39

United States Patent and Trademark Office

Reg. No. 3,574,717

Registered Feb. 17, 2009

**TRADEMARK
PRINCIPAL REGISTER**

**IF THIS IS ALL YOU SEE THEN
YOU CAN'T SEE ME**

KALEM, ASHER A (UNITED STATES INDIVIDUAL)
115 GREENBRIAR ESTATES DR
JACKSONVILLE, FL 32259

FOR: ATHLETIC AND CASUAL CLOTHING AND FOOTWEAR FOR MEN, WOMEN, AND CHILDREN COMPRISED OF SHIRTS, PANTS, SHORTS, COATS, JACKETS, ATHLETIC UNIFORMS, WARM UP SUITS, SWIMWEAR, TENNIS WEAR, SKIRTS, SWEATERS, UNDERWEAR, HEADWEAR, SOCKS, SNEAKERS, BOOTS, SHOES, AND WRISTBANDS, IN CLASS 25 (U.S. CLS. 22 AND 39).

FIRST USE 12-10-2005; IN COMMERCE 12-11-2005.

THE MARK CONSISTS OF STANDARD CHARACTERS WITHOUT CLAIM TO ANY PARTICULAR FONT, STYLE, SIZE, OR COLOR.

SER. NO. 77-326,887, FILED 11-12-2007.

MARIA-VICTORIA SUAREZ, EXAMINING ATTORNEY

Int. Cls.: 9, 16 and 28

Prior U.S. Cls.: 2, 5, 21, 22, 23, 26, 29, 36, 37, 38 and 50

Reg. No. 3,574,718

United States Patent and Trademark Office

Registered Feb. 17, 2009

**TRADEMARK
PRINCIPAL REGISTER**

Once Upon a Potty

FRANKEL, ALONA (ISRAEL INDIVIDUAL)
155 BEECH STREET
BOSTON, MA 02131

FOR: DIGITAL MEDIA, NAMELY, PRE-RECORDED VIDEO CASSETTES, DIGITAL VIDEO DISCS, DIGITAL VERSATILE DISCS, DOWNLOADABLE AUDIO AND VIDEO RECORDINGS, DVDS, AND HIGH DEFINITION DIGITAL DISKS ALL FEATURING ANIMATION, SONGS, STORIES AND EDUCATIONAL INFORMATION IN THE FIELD OF POTTY AND TOILET LEARNING AND OTHER HYGIENE MATTERS, ALL FOR CHILDREN AND FAMILIES; DOWNLOADABLE MP3 FILES, MP3 RECORDINGS, ONLINE DISCUSSION BOARDS, WEBCASTS AND PODCASTS ALL FEATURING MUSIC, AUDIO BOOKS AND NEWS BROADCASTS IN THE FIELD OF POTTY AND TOILET LEARNING AND OTHER HYGIENE MATTERS, ALL FOR CHILDREN AND FAMILIES; DOWNLOADABLE MOTION PICTURES AND TV SHOWS IN THE FIELD OF POTTY AND TOILET LEARNING AND OTHER HYGIENE MATTERS, ALL FOR CHILDREN AND FAMILIES, IN CLASS 9 (U.S. CLS. 21, 23, 26, 36 AND 38).

FIRST USE 9-1-1990; IN COMMERCE 9-1-1990.

FOR: A SERIES OF BOOKS, WRITTEN ARTICLES, HANDOUTS AND WORKSHEETS IN THE FIELD

OF POTTY AND TOILET LEARNING AND OTHER HYGIENE MATTERS; EDUCATIONAL PUBLICATIONS, NAMELY, EDUCATIONAL LEARNING CARDS, FLASH CARDS, ACTIVITY CARDS, WORKBOOKS, TEXTBOOKS, ACTIVITY BOOKS, STORY BOOKS, PUZZLE BOOKS, PUZZLES, TEACHER GUIDES, MANUALS, POSTERS, EDUCATIONAL CARD GAMES AND EDUCATIONAL BOOKLETS IN THE FIELD OF POTTY AND TOILET LEARNING AND OTHER HYGIENE MATTERS, IN CLASS 16 (U.S. CLS. 2, 5, 22, 23, 29, 37, 38 AND 50).

FIRST USE 4-1-1980; IN COMMERCE 4-1-1980.

FOR: DOLLS AND ACCESSORIES THEREFOR; DOLLS AND PLAYSETS THEREFOR, IN CLASS 28 (U.S. CLS. 22, 23, 38 AND 50).

FIRST USE 12-1-1987; IN COMMERCE 12-1-1987.

OWNER OF U.S. REG. NO. 2,409,895.

THE MARK CONSISTS OF (4) WORDS IN STYLIZED FORM.

SER. NO. 77-328,012, FILED 11-13-2007.

TRACY WHITTAKER-BROWN, EXAMINING ATTORNEY

Int. Cl.: 20

Prior U.S. Cls.: 2, 13, 22, 25, 32 and 50

United States Patent and Trademark Office

Reg. No. 3,574,719

Registered Feb. 17, 2009

**TRADEMARK
PRINCIPAL REGISTER**

IntimateRider

HEALTHPOSTURES, LLC (MISSISSIPPI LIMITED
LIABILITY COMPANY)
125 MAIN STREET
BELLE PLAINE, MN 56011

THE MARK CONSISTS OF STANDARD CHAR-
ACTERS WITHOUT CLAIM TO ANY PARTICULAR
FONT, STYLE, SIZE, OR COLOR.

FOR: SEATING FURNITURE; BEDROOM FUR-
NITURE, IN CLASS 20 (U.S. CLS. 2, 13, 22, 25, 32 AND
50).

SER. NO. 77-328,153, FILED 11-13-2007.

FIRST USE 6-1-2007; IN COMMERCE 6-1-2007.

LINDA ESTRADA, EXAMINING ATTORNEY

Int. Cl.: 35

Prior U.S. Cls.: 100, 101 and 102

United States Patent and Trademark Office

Reg. No. 3,574,720

Registered Feb. 17, 2009

**SERVICE MARK
PRINCIPAL REGISTER**

JINGLE NETWORKS

JINGLE NETWORKS, INC. (DELAWARE CORPORATION)
36 CROSBY DRIVE
149 COMMONWEALTH AVENUE
BEDFORD, MA 01730

FOR: ADVERTISING AND PUBLICITY SERVICES, NAMELY, PROMOTING THE GOODS, SERVICES, AND COMMERCIAL INFORMATION OF THIRD PARTIES THROUGH ON-LINE AND TELEPHONE DIRECTORIES; PROVIDING ON-LINE DIRECTORY INFORMATION SERVICES; TELEPHONE DIRECTORY ASSISTANCE SERVICES; ADVERTISING SERVICES FOR OTHERS; PROVIDING AND RENTAL OF ADVERTISING SPACE ON THE INTERNET, IN CLASS 35 (U.S. CLS. 100, 101 AND 102).

FIRST USE 7-24-2006; IN COMMERCE 7-24-2006.

THE MARK CONSISTS OF STANDARD CHARACTERS WITHOUT CLAIM TO ANY PARTICULAR FONT, STYLE, SIZE, OR COLOR.

NO CLAIM IS MADE TO THE EXCLUSIVE RIGHT TO USE "NETWORKS", APART FROM THE MARK AS SHOWN.

SER. NO. 77-328,221, FILED 11-13-2007.

TINA BROWN, EXAMINING ATTORNEY

Int. Cl.: 25

Prior U.S. Cls.: 22 and 39

United States Patent and Trademark Office

Reg. No. 3,574,721

Registered Feb. 17, 2009

**TRADEMARK
PRINCIPAL REGISTER**

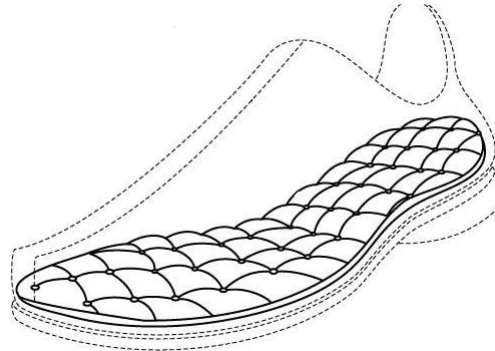

DETTY FOOTWEAR, INC. (NEW YORK CORPORATION)
SUITE 714
1650 BROADWAY
NEW YORK, NY 10019

PATTERN LOCATED ON THE INSIDE SOLES OF SHOES. THE DOTTED LINES ARE NOT A FEATURE OF THE MARK, BUT ARE USED TO SHOW PLACEMENT OF THE MARK ON THE PRODUCT.

FOR: FOOTWEAR; INSOLES, IN CLASS 25 (U.S. CLS. 22 AND 39).

SEC. 2(F).

FIRST USE 2-0-2003; IN COMMERCE 2-0-2003.

SER. NO. 77-329,702, FILED 11-14-2007.

THE MARK CONSISTS OF DIMPLED CUSHIONED DESIGN LAID OUT IN A DIAMOND LIKE

TRACY CROSS, EXAMINING ATTORNEY

Int. Cl.: 36

Prior U.S. Cls.: 100, 101 and 102

United States Patent and Trademark Office

Reg. No. 3,574,722

Registered Feb. 17, 2009

**SERVICE MARK
PRINCIPAL REGISTER**

cashBridge

EAST WEST BANK (CALIFORNIA CORPORATION)
7TH FLOOR
135 N. LOS ROBLES AVENUE
PASADENA, CA 91101

FOR: FINANCIAL SERVICES, NAMELY, REMOTE DEPOSIT AND CASH MANAGEMENT SERVICES FEATURING THE USE OF ARMORED TRANSPORT, ELECTRONIC SAFE WITH CURRENCY NOTE ACCEPTOR/READER, SOFTWARE FOR DATA ENTRY, REPORTING, AND COMMUNICA-

TION WITH BANK, AND PRINTER, IN CLASS 36 (U.S. CLS. 100, 101 AND 102).

FIRST USE 10-24-2007; IN COMMERCE 10-24-2007.

THE MARK CONSISTS OF STANDARD CHARACTERS WITHOUT CLAIM TO ANY PARTICULAR FONT, STYLE, SIZE, OR COLOR.

SER. NO. 77-329,829, FILED 11-14-2007.

ALLISON SCHRODY, EXAMINING ATTORNEY

Int. Cl.: 25

Prior U.S. Cls.: 22 and 39

United States Patent and Trademark Office

Reg. No. 3,574,723

Registered Feb. 17, 2009

**TRADEMARK
PRINCIPAL REGISTER**



LEMOYNE ANDERSON (UNITED STATES INDIVIDUAL)
1243 FTELEY AVE.
BRONX, N.Y., NY 10472

FIRST USE 10-23-1997; IN COMMERCE 10-23-1997.

OWNER OF U.S. REG. NO. 2,510,829.

FOR: CLOTHING, NAMELY, SHIRTS, PANTS, UNDERWEAR, SOCKS, GLOVES, JACKET, COATS, FOOTWEAR, SNEAKERS, SHOES, SANDALS, BOOTS, HEADWEAR, HATS AND SCARVES, IN CLASS 25 (U.S. CLS. 22 AND 39).

SER. NO. 77-331,082, FILED 11-15-2007.

MICHAEL KEATING, EXAMINING ATTORNEY

Int. Cls.: 41 and 44

Prior U.S. Cls.: 100, 101 and 107

United States Patent and Trademark Office

Reg. No. 3,574,724

Registered Feb. 17, 2009

**SERVICE MARK
PRINCIPAL REGISTER**

Mana Lomi

YATES, MAKALA (OREGON INDIVIDUAL),
DBA HAWAIIAN HEALING ACADEMY
1430 GREENMEADOWS WAY
ASHLAND, OR 97520

FOR: ARRANGING PROFESSIONAL WORK-
SHOPS AND TRAINING COURSES IN THE FIELD
OF MASSAGE, IN CLASS 41 (U.S. CLS. 100, 101 AND
107).

FIRST USE 11-9-2007; IN COMMERCE 11-9-2007.

FOR: TRADITIONAL HAWAIIAN BODYWORK
THERAPY, IN CLASS 44 (U.S. CLS. 100 AND 101).

FIRST USE 11-9-2007; IN COMMERCE 11-9-2007.

THE MARK CONSISTS OF STANDARD CHAR-
ACTERS WITHOUT CLAIM TO ANY PARTICULAR
FONT, STYLE, SIZE, OR COLOR.

NO CLAIM IS MADE TO THE EXCLUSIVE
RIGHT TO USE "LOMI", APART FROM THE MARK
AS SHOWN.

THE FOREIGN WORDING IN THE MARK
TRANSLATES INTO ENGLISH AS SPIRITUAL MAS-
SAGE.

SER. NO. 77-331,106, FILED 11-16-2007.

ROBIN CHOSID, EXAMINING ATTORNEY

Int. Cl.: 29

Prior U.S. Cl.: 46

United States Patent and Trademark Office

Reg. No. 3,574,725

Registered Feb. 17, 2009

**TRADEMARK
PRINCIPAL REGISTER**

BUILD-A-BEAR WORKSHOP

BUILD-A-BEAR RETAIL MANAGEMENT, INC.
(DELAWARE CORPORATION)
1954 INNERBELT BUSINESS CENTER DRIVE
ST. LOUIS, MO 631145760

FOR: FRUIT BASED SNACK FOOD, IN CLASS 29
(U.S. CL. 46).

FIRST USE 11-1-2006; IN COMMERCE 11-1-2006.

THE MARK CONSISTS OF STANDARD CHAR-
ACTERS WITHOUT CLAIM TO ANY PARTICULAR
FONT, STYLE, SIZE, OR COLOR.

OWNER OF U.S. REG. NOS. 2,553,748, 2,756,424
AND OTHERS.

SER. NO. 77-331,188, FILED 11-16-2007.

HEATHER BIDDULPH, EXAMINING ATTORNEY

Int. Cls.: 6 and 28

Prior U.S. Cls.: 2, 12, 13, 14, 22, 23, 25, 38 and 50

Reg. No. 3,574,726

United States Patent and Trademark Office

Registered Feb. 17, 2009

**TRADEMARK
PRINCIPAL REGISTER**

AAI

RUSSELL CORPORATION (DELAWARE CORPORATION)
SUITE 800
3330 CUMBERLAND BOULEVARD
ATLANTA, GA 30339

FOR: NON-ELECTRIC, ALUMINUM SPORTS SCORING DEVICE USING MANUAL FLIP NUMERALS THAT ALLOW SPECTATORS TO KEEP TRACK OF SCORES AND OTHER DATA AT SPORTS EVENTS, IN CLASS 6 (U.S. CLS. 2, 12, 13, 14, 23, 25 AND 50).

FIRST USE 10-6-1986; IN COMMERCE 10-6-1986.

FOR: GYMNASTIC, ATHLETIC AND CONDITIONING EQUIPMENT, NAMELY, PARALLEL BARS, BALLET BARS, POMMEL HORSES, VAULTING HORSES, GYMNASTIC RINGS, UNEVEN BARS, HORIZONTAL BARS, BALANCE BEAMS, VAULTING BOARDS, AND ACCESSORIES FOR ALL OF THE FOREGOING, NAMELY, CHALK HOLDERS, METAL BAR WITH SUPPORT BASE FOR USE IN ADAPTING HORIZONTAL BARS, RING TOWERS AND UNEVEN BARS WHERE FLOOR PLATES CANNOT BE UTILIZED, TWISTING BELTS, SOMERSAULT BELTS, SPOTTING BELTS, CLIMBING ROPES, CHINNING BARS, AND OVERHEAD TRAVELING SUSPENSIONS, COMPRISED OF PULLEY, CABLE, ROPE AND TUMBLING BELT, PERSONAL EXERCISE FLOORS

AND MATS, NAMELY, TUMBLING MATS, LANDING MATS, AND FOLDING MATS FOR GYMNASTICS, CHEERLEADING AND AEROBICS, AND ACCESSORIES THEREFOR, NAMELY, SPRING TABLES AND FOAM BORDERS, PROTECTIVE PADDING FOR GYMNASTICS, CHEERLEADING, AND AEROBICS, MOTOR-DEVELOPMENT FOAM SHAPES AND MATS, VOLLEYBALL GAME PLAYING EQUIPMENT, NAMELY, VOLLEYBALL POSTS, VOLLEYBALL PADS, VOLLEYBALL NETS, REFEREE STANDS AND FLOOR PLATES, BASEBALL AND SOFTBALL EQUIPMENT, NAMELY, SAFETY SCREENS AND NETS, PITCHING MOUNDS AND BATTING CAGES, BASKETBALL RIMS, BACKBOARDS, BASKETBALL BACKSTOPS, AND POLE SYSTEMS FOR BASKETBALL HOOPS COMPRISED OF SUPPORT POLES, DIVIDER CURTAINS, AND NETTING, IN CLASS 28 (U.S. CLS. 22, 23, 38 AND 50).

FIRST USE 10-6-1986; IN COMMERCE 10-6-1986.

THE MARK CONSISTS OF STANDARD CHARACTERS WITHOUT CLAIM TO ANY PARTICULAR FONT, STYLE, SIZE, OR COLOR.

SEC. 2(F).

SER. NO. 77-331,754, FILED 11-16-2007.

LINDA MICKLEBURGH, EXAMINING ATTORNEY

Int. Cl.: 9

Prior U.S. Cls.: 21, 23, 26, 36 and 38

Reg. No. 3,574,727

United States Patent and Trademark Office

Registered Feb. 17, 2009

TRADEMARK
PRINCIPAL REGISTER

EXHÍBÍO

EXHIBIO, LLC (NEW YORK LIMITED LIABILITY COMPANY)
325 HAMPTON HILL DRIVE
WILLIAMSVILLE, NY 14221

FOR: ELECTRONIC LCD ADVERTISEMENT DISPLAY UNIT WITH MULTI-NETWORKING (TCP/IP) CAPABILITIES; ELECTRONIC ADVERTISEMENT AND MESSAGING DISPLAY UNIT WITH MULTI-NETWORKING (TCP/IP) CAPABILITIES AND REMOTE CONNECTIVITY; COMPUTER HARDWARE AND COMPUTER SOFTWARE PROGRAMS FOR THE INTEGRATION OF TEXT, AUDIO, GRAPHICS, STILL IMAGES AND MOVING PICTURES INTO AN

INTERACTIVE DELIVERY FOR MULTIMEDIA APPLICATIONS, IN CLASS 9 (U.S. CLS. 21, 23, 26, 36 AND 38).

FIRST USE 8-31-2003; IN COMMERCE 12-13-2003.

THE MARK CONSISTS OF THE WORD "EXHIBIO" IN CAPITAL LETTERS, WITH A STYLIZED "X" AND TWO "I"'S WITH ACUTE ACCENTS.

SER. NO. 77-331,780, FILED 11-16-2007.

ALLISON SCHRODY, EXAMINING ATTORNEY

Int. Cl.: 33

Prior U.S. Cls.: 47 and 49

United States Patent and Trademark Office

Reg. No. 3,574,728

Registered Feb. 17, 2009

**TRADEMARK
PRINCIPAL REGISTER**

VOGELZANG

MB VOGELZANG VINEYARDS, LLC (CALIFORNIA LIMITED LIABILITY COMPANY)
C/O KOENIG & ASSOCIATES
226 EAST CANON PERDIDO, SUITE M
SANTA BARBARA, CA 93101

FOR: TABLE WINES; WINE; WINES, IN CLASS 33 (U.S. CLS. 47 AND 49).

FIRST USE 5-26-2006; IN COMMERCE 5-26-2006.

THE MARK CONSISTS OF STANDARD CHARACTERS WITHOUT CLAIM TO ANY PARTICULAR FONT, STYLE, SIZE, OR COLOR.

THE ENGLISH TRANSLATION OF THE WORD "VOGELZANG" IN THE MARK IS BIRD SONG.

SER. NO. 77-332,365, FILED 11-17-2007.

SEAN CROWLEY, EXAMINING ATTORNEY

Int. Cl.: 44

Prior U.S. Cls.: 100 and 101

United States Patent and Trademark Office

Reg. No. 3,574,729

Registered Feb. 17, 2009

**SERVICE MARK
PRINCIPAL REGISTER**

PEDIATRIC HOME SERVICE

PEDIATRIC HOME RESPIRATORY SERVICES,
INC. (MINNESOTA CORPORATION)
2800 CLEVELAND AVE N
ROSEVILLE, MN 55113

NO CLAIM IS MADE TO THE EXCLUSIVE
RIGHT TO USE "HOME SERVICE", APART FROM
THE MARK AS SHOWN.

FOR: CHILDREN'S HEALTH CARE SERVICES,
IN CLASS 44 (U.S. CLS. 100 AND 101).

SEC. 2(F).

FIRST USE 6-30-1997; IN COMMERCE 6-30-1997.

SER. NO. 77-332,685, FILED 11-19-2007.

THE MARK CONSISTS OF STANDARD CHAR-
ACTERS WITHOUT CLAIM TO ANY PARTICULAR
FONT, STYLE, SIZE, OR COLOR.

ALICE SUE CARRUTHERS, EXAMINING ATTOR-
NEY

Int. Cl.: 36

Prior U.S. Cls.: 100, 101 and 102

United States Patent and Trademark Office

Reg. No. 3,574,730

Registered Feb. 17, 2009

**SERVICE MARK
PRINCIPAL REGISTER**

UFG ALTERAM

UFG ALTERAM-UFG ALTERNATIVE ASSET
MANAGEMENT (FRANCE LIMITED LIABILITY
COMPANY)
173 BOULEVARD HAUSMANN
PARIS, FRANCE 75008

FOR: INSURANCE AND FINANCE SERVICES,
NAMELY, PROVIDING INFORMATION ON IN-
SURANCE MATTERS; INSURANCE CONSULTA-
TION; FINANCIAL CONSULTATION; INSURANCE
BROKERAGE; REAL ESTATE BROKERAGE;
BROKERAGE OF SHARES OR STOCKS OR OTHER
COMMODITIES; LEASING OF REAL ESTATE; AD-
MINISTRATION OF EMPLOYEE PENSION PLANS;
SAVINGS BANK SERVICES; INSURANCE UNDER-
WRITING IN THE FIELD OF ACCIDENT, AUTO-
MOBILE, MOTORCYCLE, HOUSEHOLD, FIRE,
HEALTH AND LIFE INSURANCE; UNDERWRIT-
ING INSURANCE FOR PRE-PAID LEGAL SERVI-
CES; ACTUARIAL SERVICES; BANKING;
FINANCIAL AFFAIRS, NAMELY, BROKERAGE,
DISTRIBUTION AND INVESTMENT OF MUTUAL
FUNDS, EQUITY CAPITAL INVESTMENT, FUNDS
INVESTMENT, HEDGE FUND INVESTMENT,
MANAGEMENT OF CAPITAL INVESTMENT
FUNDS, FINANCIAL CONSULTATION, FINAN-
CIAL EVALUATION FOR INSURANCE PURPOSES;
FINANCIAL TRANSACTIONS, NAMELY, INVEST-
MENT FUND TRANSFER AND TRANSACTION
SERVICES; ASSISTING OTHERS WITH THE COM-

PLETION OF FINANCIAL TRANSACTIONS FOR
STOCKS, BOND, SECURITIES AND EQUITIES;
PROVIDING ADVICE IN THE FIELD OF SECURI-
TIES INVESTMENT; MONETARY EXCHANGE
SERVICES; FINANCIAL PORTFOLIO MANAGE-
MENT; MORTGAGE LENDING; REAL ESTATE
AGENCY SERVICES; REAL ESTATE APPRAISAL;
APARTMENT HOUSE MANAGEMENT; REAL ES-
TATE MANAGEMENT; RENTAL OF APART-
MENTS AND RETAIL SHOPS; RENT
COLLECTION; PROVIDING INVESTMENT ADVICE
IN THE FIELD OF REAL ESTATE, IN CLASS 36 (U.S.
CLS. 100, 101 AND 102).

THE MARK CONSISTS OF STANDARD CHAR-
ACTERS WITHOUT CLAIM TO ANY PARTICULAR
FONT, STYLE, SIZE, OR COLOR.

PRIORITY CLAIMED UNDER SEC. 44(D) ON
ERPNTY TM OFC APPLICATION NO.
006177372, FILED 8-7-2007.

OWNER OF ERPNTY TM OFC REG. NO.
006177372, DATED 7-3-2008, EXPIRES 8-7-2017.

SER. NO. 77-333,205, FILED 11-19-2007.

KAREN BRACEY, EXAMINING ATTORNEY

Int. Cl.: 36

Prior U.S. Cls.: 100, 101 and 102

United States Patent and Trademark Office

Reg. No. 3,574,731

Registered Feb. 17, 2009

**SERVICE MARK
PRINCIPAL REGISTER**

ALTERAM

UFG ALTERAM-UFG ALTERNATIVE ASSET
MANAGEMENT (FRANCE LIMITED LIABILITY
COMPANY)
173 BOULEVARD HAUSSMANN
PARIS, FRANCE 75008

FOR: INSURANCE AND FINANCE SERVICES,
NAMELY, PROVIDING INFORMATION ON IN-
SURANCE MATTERS; INSURANCE CONSULTA-
TION; FINANCIAL CONSULTATION; INSURANCE
BROKERAGE; REAL ESTATE BROKERAGE;
BROKERAGE OF SHARES OR STOCKS OR OTHER
COMMODITIES; LEASING OF REAL ESTATE; AD-
MINISTRATION OF EMPLOYEE PENSION PLANS;
SAVINGS BANK SERVICES; INSURANCE UNDER-
WRITING IN THE FIELD OF ACCIDENT, AUTO-
MOBILE, MOTORCYCLE, HOUSEHOLD, FIRE,
HEALTH AND LIFE INSURANCE; UNDERWRIT-
ING INSURANCE FOR PRE-PAID LEGAL SERVI-
CES; ACTUARIAL SERVICES; BANKING;
FINANCIAL AFFAIRS, NAMELY, BROKERAGE,
DISTRIBUTION AND INVESTMENT OF MUTUAL
FUNDS, EQUITY CAPITAL INVESTMENT, FUNDS
INVESTMENT, HEDGE FUND INVESTMENT,
MANAGEMENT OF CAPITAL INVESTMENT
FUNDS, FINANCIAL CONSULTATION, FINAN-
CIAL EVALUATION FOR INSURANCE PURPOSES;
FINANCIAL TRANSACTIONS, NAMELY, INVEST-

MENT FUND TRANSFER AND TRANSACTION
SERVICES; ASSISTING OTHERS WITH THE COM-
PLETION OF FINANCIAL TRANSACTIONS FOR
STOCKS, BOND, SECURITIES AND EQUITIES;
PROVIDING ADVICE IN THE FIELD OF SECURI-
TIES INVESTMENT; MONETARY EXCHANGE
SERVICES; FINANCIAL PORTFOLIO MANAGE-
MENT; MORTGAGE LENDING; REAL ESTATE
AGENCY SERVICES; REAL ESTATE APPRAISAL;
APARTMENT HOUSE MANAGEMENT; REAL ES-
TATE MANAGEMENT; RENTAL OF APART-
MENTS AND RETAIL SHOPS; RENT
COLLECTION; PROVIDING INVESTMENT ADVICE
IN THE FIELD OF REAL ESTATE, IN CLASS 36 (U.S.
CLS. 100, 101 AND 102).

THE MARK CONSISTS OF STANDARD CHAR-
ACTERS WITHOUT CLAIM TO ANY PARTICULAR
FONT, STYLE, SIZE, OR COLOR.

OWNER OF ERPN CMNTY TM OFC REG. NO.
006180442, DATED 7-17-2008, EXPIRES 8-8-2017.

SER. NO. 77-333,230, FILED 11-19-2007.

KAREN BRACEY, EXAMINING ATTORNEY

Int. Cl.: 5

Prior U.S. Cls.: 6, 18, 44, 46, 51 and 52

United States Patent and Trademark Office

Reg. No. 3,574,732

Registered Feb. 17, 2009

**TRADEMARK
PRINCIPAL REGISTER**

BALANCED NATURALS

WINDHAWK INC. (DELAWARE CORPORATION)
STE. 3
49 S. SYCAMORE ST.
MESA, AZ 85202

FOR: EDIBLE DIETARY SUPPLEMENTS, TOPICAL DIETARY SUPPLEMENTS, AND FOOD SUPPLEMENTS, IN CLASS 5 (U.S. CLS. 6, 18, 44, 46, 51 AND 52).

FIRST USE 9-6-2007; IN COMMERCE 11-14-2007.

THE MARK CONSISTS OF STANDARD CHARACTERS WITHOUT CLAIM TO ANY PARTICULAR FONT, STYLE, SIZE, OR COLOR.

NO CLAIM IS MADE TO THE EXCLUSIVE RIGHT TO USE "NATURALS", APART FROM THE MARK AS SHOWN.

SER. NO. 77-333,376, FILED 11-19-2007.

KEVIN CORWIN, EXAMINING ATTORNEY

Int. Cls.: 9 and 37

Prior U.S. Cls.: 21, 23, 26, 36, 38, 100, 103 and 106

United States Patent and Trademark Office

Reg. No. 3,574,733

Registered Feb. 17, 2009

TRADEMARK
SERVICE MARK
PRINCIPAL REGISTER

SAFELINE

METTLER-TOLEDO AG (SWITZERLAND CORPORATION)
IM LANGACHER
GREIFENSEE, SWITZERLAND 8606

FOR: METAL AND MINERAL DETECTORS AS WELL AS PARTS THEREOF; DEVICES FOR CREATING AND CONTROLLING X-RADIATION (EXCEPT FOR MEDICAL USE), NAMELY, INDUSTRIAL X-RAY APPARATUS IN THE NATURE OF TESTING EQUIPMENT FOR DETERMINING INDUSTRIAL FLAWS, APPARATUS FOR THE MEASUREMENT OF ABSORBED, REFLECTED, TRANSMITTED, ATTENUATED AND SCATTERED RADIATION, NAMELY, RADIATION-MEASURING INSTRUMENTS, APPARATUS FOR THE IDENTIFICATION OF FOREIGN MATERIALS WITHIN FOOD, MEDICAL, PHARMACEUTICAL, CHEMICAL, BIOCHEMICAL AND BIOLOGICAL PRODUCTS, APPARATUS FOR CHECKING PRODUCT INTEGRITY AND CONTROL OF PACKAGED GOODS; INDUSTRIAL PROCESS CONTROL SOFTWARE; SOFTWARE INTERFACE INTEGRATED IN METAL AND MINERAL DETECTORS FOR THE PURPOSE OF USING SOURCE CODES FOR DATA COMMUNICATION, INCLUDING AUTOMATIC SOFTWARE INSTALLATION, DATA EXCHANGE, REMOTE DIAGNOSIS AND OPERATIONS ASSISTANCE WITH PROGRAMMABLE CLIENT/SERVER FUNCTIONS FOR THE CONNECTION OF SENSORS, MEASURING DEVICES, LABORATORY DEVICES AND OPERATING TERMINALS TO A NETWORK, IN CLASS 9 (U.S. CLS. 21, 23, 26, 36 AND 38).

FIRST USE 6-0-1989; IN COMMERCE 6-0-1989.

FOR: INSTALLATION, SERVICING AND REPAIR OF METAL AND MINERAL DETECTORS, DEVICES FOR CREATING AND CONTROLLING X-RADIATION (EXCEPT FOR MEDICAL USE), NAMELY, INDUSTRIAL X-RAY APPARATUS IN THE NAT-

URE OF TESTING EQUIPMENT FOR DETERMINING INDUSTRIAL FLAWS, APPARATUS FOR THE MEASUREMENT OF ABSORBED, REFLECTED, TRANSMITTED, ATTENUATED AND SCATTERED RADIATION, APPARATUS FOR THE IDENTIFICATION OF FOREIGN MATERIALS WITHIN FOOD PRODUCTS, APPARATUS FOR CHECKING PRODUCT INTEGRITY AND CONTROL OF PACKAGED GOODS; PROVISION OF INFORMATION REGARDING MAINTENANCE OF METAL AND MINERAL DETECTORS, DEVICES FOR CREATING AND CONTROLLING X-RADIATION (EXCEPT FOR MEDICAL USE), NAMELY, INDUSTRIAL X-RAY APPARATUS IN THE NATURE OF TESTING EQUIPMENT FOR DETERMINING INDUSTRIAL FLAWS, APPARATUS FOR THE MEASUREMENT OF ABSORBED, REFLECTED, TRANSMITTED, ATTENUATED AND SCATTERED RADIATION, APPARATUS FOR THE IDENTIFICATION OF FOREIGN MATERIALS WITHIN FOOD PRODUCTS, APPARATUS FOR CHECKING PRODUCT INTEGRITY AND CONTROL OF PACKAGED GOODS, IN CLASS 37 (U.S. CLS. 100, 103 AND 106).

FIRST USE 6-0-1989; IN COMMERCE 6-0-1989.

THE MARK CONSISTS OF STANDARD CHARACTERS WITHOUT CLAIM TO ANY PARTICULAR FONT, STYLE, SIZE, OR COLOR.

PRIORITY CLAIMED UNDER SEC. 44(D) ON SWITZERLAND APPLICATION NO. 55497/2007, FILED 5-23-2007, REG. NO. 564491, DATED 11-9-2007, EXPIRES 5-23-2017.

OWNER OF U.S. REG. NO. 2,052,493.

SER. NO. 77-333,705, FILED 11-20-2007.

BONNIE LUKEN, EXAMINING ATTORNEY

Int. Cl.: 43

Prior U.S. Cls.: 100 and 101

United States Patent and Trademark Office

Reg. No. 3,574,734

Registered Feb. 17, 2009

**SERVICE MARK
PRINCIPAL REGISTER**



DINE DESIGN GROUP, INC. (FLORIDA CORPORATION)
315 NE 14TH STREET
OCALA, FL 34470

FOR: RESTAURANT SERVICES, IN CLASS 43
(U.S. CLS. 100 AND 101).

FIRST USE 8-31-2007; IN COMMERCE 8-31-2007.

NO CLAIM IS MADE TO THE EXCLUSIVE
RIGHT TO USE "ASIAN FUSION" , APART FROM
THE MARK AS SHOWN.

THE MARK CONSISTS OF THE WORD "SKY" IN
A STYLIZED FORM ABOVE THE WORDS "ASIAN
FUSION" IN A STYLIZED FORM OVERLAYING A
RECTANGULAR BOX WITH ASIAN CHARACTERS
INSIDE OF IT.

THE NON-LATIN CHARACTER(S) IN THE
MARK TRANSLITERATES INTO TIAN KONG,
AND THIS MEANS SKY IN ENGLISH.

SER. NO. 77-333,930, FILED 11-20-2007.

INGA ERVIN, EXAMINING ATTORNEY

Int. Cl.: 8

Prior U.S. Cls.: 23, 28 and 44

United States Patent and Trademark Office

Reg. No. 3,574,735

Registered Feb. 17, 2009

TRADEMARK
PRINCIPAL REGISTER



BECKERICH ELECTRICAL MAINTENANCE
AND TOOLS, INC. (INDIANA CORPORATION), DBA HANDY TOOL
2750 EAST 55TH STREET, SUITE B
INDIANAPOLIS, IN 46220

FOR: HAND TOOLS, NAMELY, A GUIDE HAND-
MOUNTED ON A GIRDER FOR THREADING
ELECTRICAL CABLE THROUGH THE GIRDER,
IN CLASS 8 (U.S. CLS. 23, 28 AND 44).

FIRST USE 3-1-1998; IN COMMERCE 3-1-1998.

THE MARK CONSISTS OF THE WORDING HAN-
DY TOOL WITH THE Y BEING FORMED BY THE
SHAPE OF A HUMAN HAND. THE WORDS HAVE A
SOLID LINE OVER AND UNDER THEM. UNDER-
NEATH THIS WORDING IS THE PHRASE BETTER
IDEAS FOR BETTER RESULTS.

SER. NO. 77-334,297, FILED 11-20-2007.

EVELYN BRADLEY, EXAMINING ATTORNEY

Int. Cls.: 35, 37, 39 and 43

Prior U.S. Cls.: 100, 101, 102, 103, 105 and 106

United States Patent and Trademark Office

Reg. No. 3,574,736

Registered Feb. 17, 2009

**SERVICE MARK
PRINCIPAL REGISTER**



WESTERN FLIGHT, INC. (GEORGIA CORPORATION)
2210 PALOMAR AIRPORT ROAD
CARLSBAD, CA 92011

FOR: PROCUREMENT SERVICES, NAMELY, PURCHASING AIRCRAFT AND FRACTIONAL INTERESTS IN AIRCRAFT FOR OTHERS; PURCHASING AGENTS FOR AIRCRAFT AND FRACTIONAL INTERESTS IN AIRCRAFT, BUSINESS MANAGEMENT SERVICES, NAMELY, PRIVATE AIRCRAFT MANAGEMENT FOR OTHERS, IN CLASS 35 (U.S. CLS. 100, 101 AND 102).

FIRST USE 4-0-1990; IN COMMERCE 4-0-1990.

FOR: AIRCRAFT REPAIR, MAINTENANCE, FUELING AND CLEANING, IN CLASS 37 (U.S. CLS. 100, 103 AND 106).

FIRST USE 4-0-1990; IN COMMERCE 4-0-1990.

FOR: AIRPORT SERVICES, AIRCRAFT LEASING SERVICES, AIRCRAFT CHARTER SERVICES, AIRCRAFT STORAGE, PROVIDING RESERVATION AND BOOKINGS FOR GROUND TRANSPORTA-

TION, PROVIDING AIRPORT SERVICES FEATURING TRANSIT LOUNGE FACILITIES FOR PASSENGER RELAXATION, IN CLASS 39 (U.S. CLS. 100 AND 105).

FIRST USE 4-0-1990; IN COMMERCE 4-0-1990.

FOR: PROVIDING CONFERENCE ROOMS, PROVIDING RESERVATIONS AND BOOKINGS FOR TEMPORARY LODGINGS, IN CLASS 43 (U.S. CLS. 100 AND 101).

FIRST USE 4-0-1990; IN COMMERCE 4-0-1990.

THE MARK CONSISTS OF A THREE DIMENSIONAL DESIGN OF THE LETTERS "W" AND "F" WITH LINES EXTENDING ON EITHER SIDE OF THE LETTER "W" AND A SECOND SET OF LINES UNDERNEATH THE LETTER "W" AND ALONG SIDE THE LETTER "F".

SER. NO. 77-334,642, FILED 11-20-2007.

AMY ALFIERI, EXAMINING ATTORNEY

Int. Cl.: 25

Prior U.S. Cls.: 22 and 39

United States Patent and Trademark Office

Reg. No. 3,574,737

Registered Feb. 17, 2009

**TRADEMARK
PRINCIPAL REGISTER**

its a wonderful world

THIERRY GUETTA (UNITED STATES INDIVIDUAL)
417 N. MAINSFEILD
LOS ANGELES, CA 90036

FOR: SHORT-SLEEVED OR LONG-SLEEVED T-SHIRTS; SWEAT PANTS; SWEAT SHIRTS; T-SHIRTS; JEANS; JACKETS; ATHLETIC SHOES; LEATHER SHOES; SHOES, IN CLASS 25 (U.S. CLS. 22 AND 39).

FIRST USE 10-1-2007; IN COMMERCE 10-1-2007.

THE MARK CONSISTS OF STANDARD CHARACTERS WITHOUT CLAIM TO ANY PARTICULAR FONT, STYLE, SIZE, OR COLOR.

SER. NO. 77-334,820, FILED 11-20-2007.

RAUL CORDOVA, EXAMINING ATTORNEY

Int. Cl.: 35

Prior U.S. Cls.: 100, 101 and 102

United States Patent and Trademark Office

Reg. No. 3,574,738

Registered Feb. 17, 2009

**SERVICE MARK
PRINCIPAL REGISTER**

TIGERCHEF

SUBURBAN BOWERY OF SUFFERN, INC. (NEW YORK CORPORATION)
27 CHESTNUT STREET
SUFFERN, NY 10901

FOR: ON-LINE RETAIL STORE SERVICES, RETAIL STORE SERVICES, WHOLESALE STORE SERVICES, AND DISTRIBUTORSHIP SERVICES, ALL FEATURING RESTAURANT, PROFESSIONAL, COMMERCIAL, INDUSTRIAL, INSTITUTIONAL, LUXURY HOME, AND LUXURY RESIDENTIAL EQUIPMENT, APPLIANCES, TOOLS, UTENSILS, SUPPLIES AND FURNITURE FOR USE IN KITCHENS, FOR COOKING, FOR FOOD SERVICE, FOR USE IN BAKERIES, FOR REFRIGERATION PURPOSES, FOR FOOD STORAGE PURPOSES, FOR CATERING USE AND FOR BAR SUPPLY; ON-LINE RETAIL STORE SERVICES, RETAIL STORE SERVICES, WHOLESALE STORE SERVICES, AND DISTRIBUTORSHIP SERVICES, ALL FEATURING RESTAURANT, PROFESSIONAL, COMMERCIAL, INDUSTRIAL, INSTITUTIONAL, LUXURY HOME, AND LUXURY RESIDENTIAL EQUIPMENT, APPLIANCES, TOOLS, UTENSILS, SUPPLIES AND FURNITURE FOR CLEANING AND JANITORIAL PURPOSES; FRANCHISING, NAMELY, OFFERING TECHNICAL ASSISTANCE IN THE ESTABLISH-

MENT AND/OR OPERATION OF ON-LINE RETAIL STORE SERVICES, RETAIL STORE SERVICES, WHOLESALE STORE SERVICES, AND DISTRIBUTORSHIP SERVICES, ALL FEATURING RESTAURANT, PROFESSIONAL, COMMERCIAL, INDUSTRIAL, INSTITUTIONAL, LUXURY HOME, AND LUXURY RESIDENTIAL EQUIPMENT, APPLIANCES, TOOLS, UTENSILS, SUPPLIES AND FURNITURE FOR USE IN KITCHENS, FOR COOKING, FOR FOOD SERVICE, FOR USE IN BAKERIES, FOR REFRIGERATION PURPOSES, FOR FOOD STORAGE PURPOSES, FOR CATERING USE, FOR BAR SUPPLY AND FOR CLEANING AND JANITORIAL PURPOSES, IN CLASS 35 (U.S. CLS. 100, 101 AND 102).

FIRST USE 11-15-2007; IN COMMERCE 11-15-2007.

THE MARK CONSISTS OF STANDARD CHARACTERS WITHOUT CLAIM TO ANY PARTICULAR FONT, STYLE, SIZE, OR COLOR.

SER. NO. 77-335,815, FILED S.R. 11-22-2007 AM.
P.R. 8-25-2008.

SONYA STEPHENS, EXAMINING ATTORNEY

Int. Cl.: 9

Prior U.S. Cls.: 21, 23, 26, 36 and 38

Reg. No. 3,574,739

United States Patent and Trademark Office

Registered Feb. 17, 2009

**TRADEMARK
PRINCIPAL REGISTER**

FLATEEZ

DANIEL, KINGSLEY (UNITED STATES INDIVIDUAL)
9218 227TH AVE NE
REDMOND, WA 98053

FOR: COMPUTER HARDWARE AND COMPUTER SOFTWARE PROGRAMS FOR THE INTEGRATION OF TEXT, AUDIO, GRAPHICS, STILL IMAGES AND MOVING PICTURES INTO AN INTERACTIVE DELIVERY OF HEALTHCARE INFORMATION; INTERACTIVE MULTIMEDIA COMPUTER PROGRAM FOR COMMUNICATING HEALTHCARE INFORMATION TO PATIENTS; MULTIMEDIA SOFTWARE RECORDED ON CD-ROM FEATURING HEALTHCARE INFORMATION; DOWNLOADABLE MULTIMEDIA FILE

CONTAINING ARTWORK, TEXT, AUDIO, VIDEO, GAMES, AND INTERNET WEB LINKS RELATING TO COMMUNICATING HEALTHCARE INFORMATION TO PATIENTS, IN CLASS 9 (U.S. CLS. 21, 23, 26, 36 AND 38).

FIRST USE 12-1-2004; IN COMMERCE 12-1-2004.

THE MARK CONSISTS OF STANDARD CHARACTERS WITHOUT CLAIM TO ANY PARTICULAR FONT, STYLE, SIZE, OR COLOR.

SER. NO. 77-335,884, FILED 11-23-2007.

KELLY BOULTON, EXAMINING ATTORNEY

Int. Cl.: 40

Prior U.S. Cls.: 100, 103 and 106

United States Patent and Trademark Office

Reg. No. 3,574,740

Registered Feb. 17, 2009

**SERVICE MARK
PRINCIPAL REGISTER**

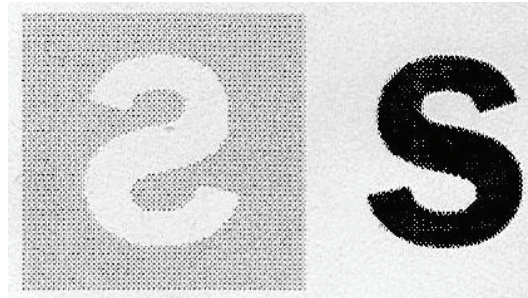

SIDER, GABRIEL (UNITED STATES INDIVIDUAL)
SIERRA PACIFIC CASTING INC. 292 4TH ST
OAKLAND, CA 946074332

THE MARK CONSISTS OF A DOUBLE "S" IN THE FORM "SS" IN WHICH THE FIRST "S" IS REVERSED AND DISPOSED IN A BOX. COLOR IS NOT CLAIMED AS A FEATURE OF THE MARK.

FOR: JEWELRY CASTING SERVICES, IN CLASS 40 (U.S. CLS. 100, 103 AND 106).

SER. NO. 77-336,080, FILED 11-23-2007.

FIRST USE 5-12-1997; IN COMMERCE 5-12-1997.

HOWARD SMIGA, EXAMINING ATTORNEY

Int. Cl.: 42

Prior U.S. Cls.: 100 and 101

United States Patent and Trademark Office

Reg. No. 3,574,741

Registered Feb. 17, 2009

SERVICE MARK
PRINCIPAL REGISTER



DIGITAL NETWORK SYSTEMS & SECURITY
(FLORIDA CORPORATION)
9022 NW 28TH DR. APT: 312
CORAL SPRINGS, FL 33065

FOR: COMPUTER CONSULTATION; COMPUTER CONSULTATION IN THE FIELD OF COMPUTER SECURITY; COMPUTER DIAGNOSTIC SERVICES; COMPUTER DISASTER RECOVERY PLANNING; COMPUTER GRAPHICS SERVICES; COMPUTER MONITORING SERVICE WHICH TRACKS HARDWARE PERFORMANCE AND PROCESSES AND SENDS OUT HISTORICAL REPORTS AND ALERTS; COMPUTER NETWORK DESIGN FOR OTHERS; COMPUTER SECURITY SERVICE, NAMELY, HARD DRIVE ERASURE; COMPUTER SECURITY SERVICE, NAMELY, RESTRICTING ACCESS TO AND BY COMPUTER NETWORKS TO AND OF UNDESIRED WEB SITES, MEDIA AND INDIVIDUALS AND FACILITIES; COMPUTER SERVICES, NAMELY, COMPUTER SYSTEM ADMINISTRATION FOR OTHERS; COMPUTER SERVICES, NAMELY, CREATING AND MAINTAINING WEB SITES FOR OTHERS; COMPUTER SERVICES, NAMELY, DATA RECOVERY SERVICES; COMPUTER SERVICES, NAMELY, DESIGNING AND IMPLEMENTING NETWORK WEB PAGES FOR OTHERS; COMPUTER SERVICES, NAMELY, DESIGNING AND IMPLEMENTING WEB SITES FOR OTHERS; COMPUTER SERVICES, NAMELY, FILTERING OF UNWANTED E-MAILS; COMPUTER SERVICES, NAMELY, MANAGING WEB SITES FOR OTHERS; COMPUTER SERVICES, NAMELY, ONLINE SCANNING, DETECTING, QUARANTINING AND ELIMINATING VIRUSES, WORMS, TROJANS, SPYWARE, ADWARE, MALWARE AND UNAUTHORIZED DATA AND PROGRAMS ON COMPUTERS AND ELECTRONIC DEVICES; COMPUTER SITE DESIGN; COMPUTER SOFTWARE CONSULTANCY; COMPUTER SOFTWARE CONSULTATION; COMPUTER SOFTWARE DESIGN FOR OTHERS; COMPUTER SOFTWARE DESIGN, COM-

PUTER PROGRAMMING, OR MAINTENANCE OF COMPUTER SOFTWARE; COMPUTER VIRUS PROTECTION SERVICES; CONSULTING SERVICES IN THE FIELD OF OFFICE AND WORKPLACE AUTOMATION; CUSTOMIZATION OF COMPUTER HARDWARE AND SOFTWARE; DESIGN OF HOME PAGES, COMPUTER SOFTWARE AND WEB SITES; GRAPHIC DESIGN SERVICES; GRAPHIC ILLUSTRATION SERVICES FOR OTHERS; INSTALLATION OF COMPUTER SOFTWARE; INTEGRATION OF COMPUTER SYSTEMS AND NETWORKS; MAINTENANCE OF COMPUTER SOFTWARE; RECOVERY OF COMPUTER DATA; REPAIR OF DAMAGED COMPUTER PROGRAMS; TECHNICAL SUPPORT SERVICES, NAMELY, TROUBLESHOOTING OF COMPUTER HARDWARE AND SOFTWARE PROBLEMS; TECHNICAL SUPPORT SERVICES, NAMELY, TROUBLESHOOTING OF COMPUTER SOFTWARE PROBLEMS; VISUAL DESIGN SERVICES IN THE NATURE OF DESIGNING VISUAL ELEMENTS FOR ONLINE, BROADCAST, PRINT, OUTDOOR AND OTHER COMMUNICATION MEDIA, IN CLASS 42 (U.S. CLS. 100 AND 101).

FIRST USE 6-1-2007; IN COMMERCE 9-1-2007.

NO CLAIM IS MADE TO THE EXCLUSIVE RIGHT TO USE "DIGITAL NETWORK SYSTEMS & SECURITY", APART FROM THE MARK AS SHOWN.

THE COLOR(S) BLUE AND GRAY IS/ARE CLAIMED AS A FEATURE OF THE MARK.

THE MARK CONSISTS OF A STYLIZED ABBREVIATION OF "DIGITAL NETWORK SYSTEM & SECURITY". THE CHARACTER "D" IS BLUE, "N" IS GRAY, "S" IS GRAY AND LAST "S" IS BLUE. ALL CHARACTERS ARE SEPARATED BY A BLUE DOT. BELOW THE ABBREVIATION IS THE NAME OF

THE COMPANY IN BLUE "DIGITAL NETWORK
SYSTEMS & SECURITY".

SER. NO. 77-336,314, FILED 11-25-2007.

SHAUNIA CARLYLE, EXAMINING ATTORNEY

Int. Cl.: 33

Prior U.S. Cls.: 47 and 49

United States Patent and Trademark Office

Reg. No. 3,574,742

Registered Feb. 17, 2009

**TRADEMARK
PRINCIPAL REGISTER**

PENDLETON

PENDLETON WOOLEN MILLS, INC. (OREGON
CORPORATION)

220 NW BROADWAY

PORTLAND, OR 97209

FOR: DISTILLED SPIRITS, IN CLASS 33 (U.S. CLS.
47 AND 49).

FIRST USE 4-3-2003; IN COMMERCE 5-7-2003.

THE MARK CONSISTS OF STANDARD CHAR-
ACTERS WITHOUT CLAIM TO ANY PARTICULAR
FONT, STYLE, SIZE, OR COLOR.

OWNER OF U.S. REG. NO. 2,953,861.

SEC. 2(F).

SER. NO. 77-336,487, FILED 11-26-2007.

KAREN BRACEY, EXAMINING ATTORNEY

Int. Cl.: 21

Prior U.S. Cls.: 2, 13, 23, 29, 30, 33, 40 and 50

United States Patent and Trademark Office

Reg. No. 3,574,743

Registered Feb. 17, 2009

**TRADEMARK
PRINCIPAL REGISTER**

PENDLETON

PENDLETON WOOLEN MILLS, INC. (OREGON
CORPORATION)
220 NW BROADWAY
PORTLAND, OR 97209

FOR: DINNERWARE, NAMELY, PLATTERS,
PITCHERS, PLATES, BOWLS, BEVERAGE GLAS-
SES, MUGS; WASTE BASKETS; TOWEL HOLDERS
IN THE NATURE OF BARS, RAILS AND RINGS;
SOAP DISPENSERS; TOOTHBRUSH HOLDERS;
SOAP DISHES; CUPS; BASKETS OF WICKER,
STRAW, WOOD OR CLOTH; VASES; COASTERS
NOT OF PAPER AND NOT BEING TABLE LINEN,
IN CLASS 21 (U.S. CLS. 2, 13, 23, 29, 30, 33, 40 AND 50).

FIRST USE 4-1-2002; IN COMMERCE 4-1-2002.

THE MARK CONSISTS OF STANDARD CHAR-
ACTERS WITHOUT CLAIM TO ANY PARTICULAR
FONT, STYLE, SIZE, OR COLOR.

OWNER OF U.S. REG. NOS. 2,713,136, 3,049,323
AND OTHERS.

SEC. 2(F).

SER. NO. 77-336,531, FILED 11-26-2007.

KAREN BRACEY, EXAMINING ATTORNEY

Int. Cls.: 35, 40 and 42

Prior U.S. Cls.: 100, 101, 102, 103 and 106

United States Patent and Trademark Office

Reg. No. 3,574,744

Registered Feb. 17, 2009

**SERVICE MARK
PRINCIPAL REGISTER**

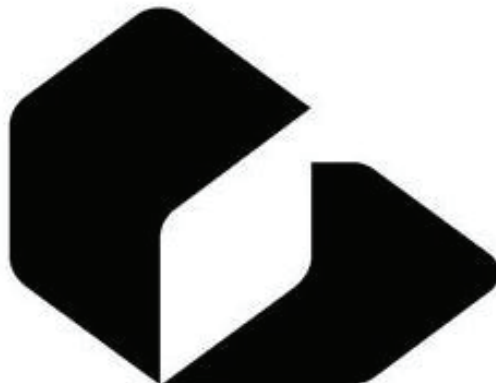

PONOKO LIMITED (NEW ZEALAND LIMITED COMPANY (LTD.))
C/- JONES YOUNG
LEVEL 14, ASB CENTRE, 135 ALBERT STREET
AUCKLAND, NEW ZEALAND

FOR: BUSINESS MANAGEMENT AND ADVICE; BUSINESS FACILITATION, NAMELY, BUSINESS INTERMEDIARY AND ADVISORY SERVICES IN THE FIELD OF SELLING PRODUCTS AND RENDERING SERVICES; BUSINESS FACILITATION, NAMELY, PROMOTION AND MARKETING SERVICES AND RELATED CONSULTING; BUSINESS FACILITATION, NAMELY, BUSINESS CONSULTING SERVICES RELATING TO PRODUCT DISTRIBUTION; BUSINESS FACILITATION, NAMELY, PROVIDING ON-LINE ADVERTISING AND MARKETING SERVICES; BUSINESS FACILITATION, NAMELY, OPERATING ON-LINE MARKETPLACES FOR SELLERS OF GOODS; BUSINESS FACILITATION, NAMELY, PROVIDING A WEB SITE AT WHICH USERS CAN OFFER GOODS FOR SALE AND BUY GOODS OFFERED BY OTHERS; BUSINESS FACILITATION, NAMELY, PROCURING MANUFACTURING SERVICES FOR OTHERS; FACILITATING OF COMMUNICATION BETWEEN PRODUCT DESIGNERS AND PRODUCT MANUFACTURERS, NAMELY, FACILITATION AND PROCUREMENT OF CONTRACTS FOR OTHERS FOR THE MANUFACTURE OF PRODUCTS, IN CLASS 35 (U.S. CLS. 100, 101 AND 102).

FOR: PRODUCTION OF ARTICLES, MACHINES AND APPARATUS TO SPECIFIED DESIGNS, NAMELY, CUSTOM MANUFACTURE OF GOODS

MADE FROM WOOD, PLASTICS, METAL, GLASS, PAPER, LEATHER, TEXTILES, ORGANIC, AND COMPOSITE MATERIALS, IN THE NATURE OF JEWELRY, FURNITURE, ORNAMENTS, HOUSEHOLD GOODS, TOYS, GAMES, HOBBY MODELS, VEHICLE ACCESSORIES, OFFICE PRODUCTS, AND VARIOUS OTHER CONSUMER PRODUCTS, IN CLASS 40 (U.S. CLS. 100, 103 AND 106).

FOR: NEW PRODUCT DESIGN AND DEVELOPMENT SERVICES; SCIENTIFIC AND TECHNOLOGICAL CONSULTATION SERVICES, AND RESEARCH AND PRODUCT DESIGN ANALYSIS SERVICES RELATING THERETO IN THE FIELD OF CUSTOM MANUFACTURING OF GOODS MADE FROM WOOD, PLASTICS, METAL, GLASS, PAPER, LEATHER, TEXTILES, ORGANIC, AND COMPOSITE MATERIALS, IN THE NATURE OF JEWELRY, FURNITURE, ORNAMENTS, HOUSEHOLD GOODS, TOYS, GAMES, HOBBY MODELS, VEHICLE ACCESSORIES, OFFICE PRODUCTS, AND VARIOUS OTHER CONSUMER PRODUCTS; AND DESIGN AND DEVELOPMENT OF COMPUTER HARDWARE AND SOFTWARE, IN CLASS 42 (U.S. CLS. 100 AND 101).

OWNER OF NEW ZEALAND REG. NO. 764699, DATED 3-8-2007, EXPIRES 3-8-2017.

THE MARK CONSISTS OF AN ABSTRACT DESIGN OF A BOX.

SER. NO. 77-337,002, FILED 11-26-2007.

DAYNA BROWNE, EXAMINING ATTORNEY

Int. Cl.: 25

Prior U.S. Cls.: 22 and 39

United States Patent and Trademark Office

Reg. No. 3,574,745

Registered Feb. 17, 2009

TRADEMARK
PRINCIPAL REGISTER



HIGHAM, ANDREA M (CALIFORNIA SOLE PROPRIETORSHIP), DBA RAGAZZI CLOTHING COMPANY

A109-119

1835 NEWPORT BOULEVARD
COSTA MESA, CA 92627

FOR: (BASED ON USE IN COMMERCE) SHIRTS; SHORT-SLEEVED OR LONG-SLEEVED T-SHIRTS; SHORT-SLEEVED SHIRTS; T-SHIRTS(BASED ON INTENT TO USE) BABY BODYSUITS; BABY BOTTOMS; BABY BUNTING; BABY TOPS; BANDANAS; BASEBALL CAPS; BLOUSES; BOARD SHORTS; BOARDSHORTS; BOTTOMS; BOXER BRIEFS; BOXER SHORTS; CAMISOLES; CAPRI PANTS; CAPRIS;

CAPS; CHILDREN'S AND INFANTS' CLOTH BIBS; CHILDREN'S HEADWEAR; DRESSES; INFANT AND TODDLER ONE PIECE CLOTHING; INFANTWEAR; SHORTS; SWEAT SHIRTS; TANK TOPS; TANK-TOPS, IN CLASS 25 (U.S. CLS. 22 AND 39).

FIRST USE 10-0-2007; IN COMMERCE 10-0-2007.

THE MARK CONSISTS OF A POOKA GREMLIN'S HEAD WITH THE WORD "POOKA" BELOW.

SER. NO. 77-337,033, FILED 11-26-2007.

MICHAEL ENGEL, EXAMINING ATTORNEY

Int. Cl.: 9

Prior U.S. Cls.: 21, 23, 26, 36 and 38

United States Patent and Trademark Office

Reg. No. 3,574,746

Registered Feb. 17, 2009

**TRADEMARK
PRINCIPAL REGISTER**

ASTERISK APPLIANCE

DIGIUM, INC. (DELAWARE CORPORATION)
445 JAN DAVIS DRIVE
HUNTSVILLE, AL 35806

OWNER OF U.S. REG. NO. 3,013,408.

FOR: COMPUTER TELEPHONY HARDWARE;
COMPUTER TELEPHONY SOFTWARE, IN CLASS
9 (U.S. CLS. 21, 23, 26, 36 AND 38).

NO CLAIM IS MADE TO THE EXCLUSIVE
RIGHT TO USE "APPLIANCE", APART FROM
THE MARK AS SHOWN.

FIRST USE 8-0-2006; IN COMMERCE 8-0-2006.

SER. NO. 77-337,962, FILED 11-27-2007.

THE MARK CONSISTS OF STANDARD CHAR-
ACTERS WITHOUT CLAIM TO ANY PARTICULAR
FONT, STYLE, SIZE, OR COLOR.

JOHN KELLY, EXAMINING ATTORNEY

Int. Cl.: 25

Prior U.S. Cls.: 22 and 39

United States Patent and Trademark Office

Reg. No. 3,574,747

Registered Feb. 17, 2009

**TRADEMARK
PRINCIPAL REGISTER**

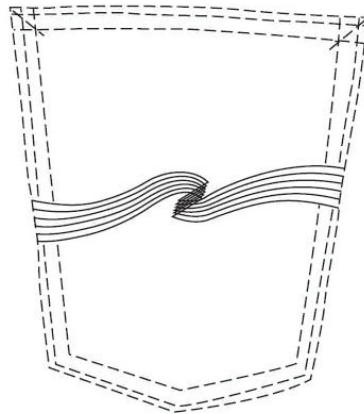

NUDIE JEANS CO AB (SWEDEN CORPORATION)
SODRA LARMGATAN 14
GOTEBORG, SWEDEN 41116

FOR: TROUSERS, INCLUDING JEANS, IN CLASS
25 (U.S. CLS. 22 AND 39).

FIRST USE 0-0-2001; IN COMMERCE 0-0-2001.

THE MARK CONSISTS OF A SERIES OF STITCHED LINES THAT CROSS TO FORM A Z SHAPED

DESIGN EXTENDING CONTINUOUSLY ACROSS THE POCKET OF THE GOODS. THE BROKEN LINES OUTLINING THE POCKET ARE USED TO INDICATE THE POSITIONING OF THE MARK ON THE GOODS AND ARE NOT A FEATURE OF THE MARK.

SEC. 2(F).

SER. NO. 77-338,199, FILED 11-27-2007.

GENE MACIOL, EXAMINING ATTORNEY

Int. Cl.: 28

Prior U.S. Cls.: 22, 23, 38 and 50

United States Patent and Trademark Office

Reg. No. 3,574,748

Registered Feb. 17, 2009

**TRADEMARK
PRINCIPAL REGISTER**

LINDI LAUREN

LINDI LAUREN LLC (HAWAII LIMITED LIABILITY COMPANY)

4824 OHU RD.

KAPAA, HI 96746

FOR: SURFBOARDS, IN CLASS 28 (U.S. CLS. 22, 23, 38 AND 50).

FIRST USE 7-0-2007; IN COMMERCE 10-20-2007.

THE MARK CONSISTS OF STANDARD CHARACTERS WITHOUT CLAIM TO ANY PARTICULAR FONT, STYLE, SIZE, OR COLOR.

THE NAME "LINDI LAUREN" IDENTIFIES A LIVING INDIVIDUAL WHOSE CONSENT IS OF RECORD.

SER. NO. 77-338,320, FILED 11-27-2007.

CHRISTINE COOPER, EXAMINING ATTORNEY

Int. Cl.: 43

Prior U.S. Cls.: 100 and 101

United States Patent and Trademark Office

Reg. No. 3,574,749

Registered Feb. 17, 2009

**SERVICE MARK
PRINCIPAL REGISTER**

The logo for Casalingo features the word "Casalingo" in a sans-serif font. The letter "i" has a gray dot above it. The letter "o" is filled with orange and has a gray triangular shape cut out of its top-right corner, resembling a slice of pizza.

CASALINGO, L.L.C. (FLORIDA LIMITED LIABILITY COMPANY)
33054 SUNNY PARKE CIRCLE
FERNANDINA BEACH, FL 32034

FOR: RESTAURANT SERVICES, IN CLASS 43
(U.S. CLS. 100 AND 101).

FIRST USE 1-8-2007; IN COMMERCE 1-8-2007.

NO CLAIM IS MADE TO THE EXCLUSIVE RIGHT TO USE CASALINGO, APART FROM THE MARK AS SHOWN.

THE COLOR(S) ORANGE AND GRAY IS/ARE CLAIMED AS A FEATURE OF THE MARK.

THE MARK CONSISTS OF THE WORD "CASALINGO" IN ORANGE LETTERING WITH A GRAY TRIANGULAR DOT ABOVE THE LETTER "I" AND THE LETTER "O" IS COMPLETELY FILLED IN ORANGE EXCEPT FOR A GRAY TRIANGULAR PIECE MADE TO RESEMBLE A PIZZA SLICE.

THE FOREIGN WORDING IN THE MARK TRANSLATES INTO ENGLISH AS HOMEMADE.

SER. NO. 77-339,135, FILED 11-28-2007.

JASON LOTT, EXAMINING ATTORNEY

Int. Cl.: 12

Prior U.S. Cls.: 19, 21, 23, 31, 35 and 44

Reg. No. 3,574,750

United States Patent and Trademark Office

Registered Feb. 17, 2009

**TRADEMARK
PRINCIPAL REGISTER**

Liberator

KURYAKYN HOLDINGS, INC. (WISCONSIN CORPORATION)
454 COUNTY ROAD VV
SOMERSET, WI 54025

THE MARK CONSISTS OF STANDARD CHARACTERS WITHOUT CLAIM TO ANY PARTICULAR FONT, STYLE, SIZE, OR COLOR.

FOR: MOTORCYCLE PARTS AND ACCESSORIES, NAMELY, FOOT PEGS, SHIFT PEGS, BRAKE PEDAL PADS AND STIRRUPS, IN CLASS 12 (U.S. CLS. 19, 21, 23, 31, 35 AND 44).

SER. NO. 77-339,142, FILED 11-28-2007.

FIRST USE 10-23-2007; IN COMMERCE 10-23-2007.

CHRISTOPHER BUONGIORNO, EXAMINING ATTORNEY

Int. Cls.: 6, 7, 9, 11, 35 and 42

**Prior U.S. Cls.: 2, 12, 13, 14, 19, 21, 23, 25, 26, 31, 34,
35, 36, 38, 50, 100, 101 and 102**

Reg. No. 3,574,751

United States Patent and Trademark Office

Registered Feb. 17, 2009

**TRADEMARK
SERVICE MARK
PRINCIPAL REGISTER**

NORGREN

NORGREN, INC. (DELAWARE CORPORATION)
5400 S. DELAWARE ST.
LITTLETON, CO 80120

FOR: METAL CONNECTORS AND PUSH IN FITTINGS FOR HYDRAULIC AND PNEUMATIC DEVICES; METAL TUBING, IN CLASS 6 (U.S. CLS. 2, 12, 13, 14, 23, 25 AND 50).

FIRST USE 8-1-1966; IN COMMERCE 8-1-1966.

FOR: PARTS OF MACHINES, NAMELY, LUBRICATORS FOR AIR-OPERATED EQUIPMENT, AUTOMATIC DRAINS FOR LIQUIDS, LIQUID FILL DEVICES; POWERED-OPERATED SPRAY AND BLOW GUNS; MUFFLERS FOR PNEUMATIC AND HYDRAULIC DEVICES; SILENCERS FOR PNEUMATIC AND HYDRAULIC DEVICES; PNEUMATIC AND HYDRAULIC ACTUATORS; MACHINE PARTS, NAMELY, PNEUMATIC AND HYDRAULIC CYLINDERS; PNEUMATIC DIRECTIONAL CONTROL VALVES; PNEUMATIC AIR PREPARATION UNITS AND PARTS THEREOF FOR USE IN PNEUMATIC MACHINERY; PARTS OF MACHINES, NAMELY, NYLON, POLYURETHANE AND POLYESTER REINFORCED PVC TUBING AND TUBING ACCESSORIES, NAMELY, CHANNELS IN THE NATURE OF TUBE MOUNTS NOT MADE OF METAL, AND PVC MARKERS FOR IDENTIFYING TUBES, BOTH PARTS OF MACHINES; SLIDE TABLES FOR PNEUMATIC AND HYDRAULIC DEVICES; POWERED GRIPPERS FOR PNEUMATIC AND HYDRAULIC DEVICES; GUIDE BLOCKS WITH ROLLER BEARINGS FOR MACHINES; ELECTRIC SPINDLES; PARTS OF MACHINES, NAMELY, MANIFOLD ASSEMBLIES FOR VALVES COMPRISED PRIMARILY OF PRESSURE SWITCHES, CHECK VALVES, REGULATORS AND GAUGES; GAS AND OIL REMOVAL FILTERS FOR USE WITH

PNEUMATIC AND HYDRAULIC MACHINERY; FILTERS FOR PNEUMATICALLY CONTROLLED MOTORS, NAMELY, EXHAUST FILTERS; MACHINE VALVES FOR COMPRESSIBLE AND INCOMPRESSIBLE FLUIDS, NAMELY, CHECK VALVES, RELIEF VALVES AND SELECTOR VALVES, IN CLASS 7 (U.S. CLS. 13, 19, 21, 23, 31, 34 AND 35).

FIRST USE 3-1-1926; IN COMMERCE 3-1-1926.

FOR: VALVES FOR CONTROLLING COMPRESSIBLE AND INCOMPRESSIBLE FLUIDS, NAMELY, AUTOMATIC SAFETY VALVES, ELECTRONIC TIME DELAY VALVES, AUTOMATIC CONTROL VALVES, ELECTRONIC PILOT VALVES, AND ELECTRONIC MIXING VALVES; ACCESSORIES FOR ELECTRONIC VALVES THAT CONTROL COMPRESSIBLE AND INCOMPRESSIBLE FLUIDS, NAMELY, VALVE ISLANDS, FIELDBUS, LINEAR, VALVE AND DAMPING MODULES AND ELECTRONIC CONNECTORS; FLUID PRESSURE REGULATORS, NAMELY, PRESSURE REGULATORS FOR GASES AND LIQUIDS AND PARTS THEREOF; FLUID CONTROL ELEMENTS AND FLUIDIC DEVICES, NAMELY, PRESSURE SIGNAL GENERATORS, FLUID PRESSURE SENSORS, PRESSURE AMPLIFIER BOOSTERS, PRESSURE INDICATORS AND FLUIDIC MODULES, GAUGES; SOLENOID VALVES; SOLENOID COMPONENTS INTERCHANGEABLE WITHOUT TOOLS, NAMELY, VALVES; FILTERS FOR PNEUMATIC AND HYDRAULIC SYSTEMS, NAMELY, FILTERS FOR PNEUMATIC AND HYDRAULIC PRESSURE REGULATORS FOR REMOVING WATER AND PARTICLES FROM COMPRESSED AIR, IN CLASS 9 (U.S. CLS. 21, 23, 26, 36 AND 38).

FIRST USE 3-1-1926; IN COMMERCE 3-1-1926.

FOR: DRIERS FOR PNEUMATIC SYSTEMS, NAMELY, AIR AND GAS DRIERS AND PARTS THEREFOR, AND AIR VENTS, IN CLASS 11 (U.S. CLS. 13, 21, 23, 31 AND 34).

FIRST USE 11-1-1967; IN COMMERCE 11-1-1967.

FOR: COMPUTERIZED ON-LINE ORDERING SERVICES IN THE FIELD OF MOTION AND FLUID CONTROL PRODUCTS; CATALOG ORDERING SERVICES FEATURING MOTION AND FLUID CONTROL PRODUCTS; PROVIDING CUSTOMER INFORMATION, NAMELY, PROVIDING SHOPPERS GUIDE INFORMATION IN THE FIELD OF MOTION AND FLUID CONTROL PRODUCTS , IN CLASS 35 (U.S. CLS. 100, 101 AND 102).

FIRST USE 6-30-2000; IN COMMERCE 6-30-2000.

FOR: TECHNOLOGY CONSULTATION IN THE FIELD OF MOTION AND FLUID CONTROL PRODUCTS, IN CLASS 42 (U.S. CLS. 100 AND 101).

FIRST USE 12-31-1967; IN COMMERCE 12-31-1967.

THE MARK CONSISTS OF STANDARD CHARACTERS WITHOUT CLAIM TO ANY PARTICULAR FONT, STYLE, SIZE, OR COLOR.

OWNER OF U.S. REG. NO. 950,639.

SEC. 2(F).

SER. NO. 77-339,153, FILED 11-28-2007.

MAUREEN DALL, EXAMINING ATTORNEY

Int. Cl.: 33

Prior U.S. Cls.: 47 and 49

United States Patent and Trademark Office

Reg. No. 3,574,752

Registered Feb. 17, 2009

**TRADEMARK
PRINCIPAL REGISTER**

ESCORT

NAKED WINES, LLC (OREGON LIMITED LIABILITY COMPANY)
1767 12TH ST.
HOOD RIVER, OR 97031

FOR: WINE; NATURAL WINES; TABLE WINES;
AND WHITE WINE, IN CLASS 33 (U.S. CLS. 47 AND
49).

FIRST USE 12-13-2006; IN COMMERCE 1-15-2007.

THE MARK CONSISTS OF STANDARD CHARACTERS WITHOUT CLAIM TO ANY PARTICULAR FONT, STYLE, SIZE, OR COLOR.

SER. NO. 77-339,425, FILED 11-28-2007.

ANDREA K. NADELMAN, EXAMINING ATTORNEY

Int. Cl.: 33

Prior U.S. Cls.: 47 and 49

United States Patent and Trademark Office

Reg. No. 3,574,753

Registered Feb. 17, 2009

**TRADEMARK
PRINCIPAL REGISTER**

PENETRATION

NAKED WINES, LLC (OREGON LIMITED LIABILITY COMPANY)
1767 12TH ST.
HOOD RIVER, OR 97031

FOR: WINE; NATURAL WINES; TABLE WINES;
AND RED WINE, IN CLASS 33 (U.S. CLS. 47 AND 49).

FIRST USE 2-10-2006; IN COMMERCE 2-10-2006.

THE MARK CONSISTS OF STANDARD CHARACTERS WITHOUT CLAIM TO ANY PARTICULAR FONT, STYLE, SIZE, OR COLOR.

SER. NO. 77-339,434, FILED 11-28-2007.

ANDREA K. NADELMAN, EXAMINING ATTORNEY

Int. Cl.: 33

Prior U.S. Cls.: 47 and 49

United States Patent and Trademark Office

Reg. No. 3,574,754

Registered Feb. 17, 2009

**TRADEMARK
PRINCIPAL REGISTER**

MISSIONARY

NAKED WINES, LLC (OREGON LIMITED LIABILITY COMPANY)
1767 12TH ST.
HOOD RIVER, OR 97031

FOR: WINE; NATURAL WINES; TABLE WINES;
AND RED WINE, IN CLASS 33 (U.S. CLS. 47 AND 49).

FIRST USE 2-10-2006; IN COMMERCE 2-10-2006.

THE MARK CONSISTS OF STANDARD CHARACTERS WITHOUT CLAIM TO ANY PARTICULAR FONT, STYLE, SIZE, OR COLOR.

SER. NO. 77-339,441, FILED 11-28-2007.

ANDREA K. NADELMAN, EXAMINING ATTORNEY

Int. Cl.: 25

Prior U.S. Cls.: 22 and 39

United States Patent and Trademark Office

Reg. No. 3,574,755

Registered Feb. 17, 2009

**TRADEMARK
PRINCIPAL REGISTER**

FEU FOLLET

ABU TALIR JAILI (UNITED KINGDOM INDIVIDUAL)
9, THE GATEWAYS ST JAMES PARISH
GOFFS OAK EN7 6US, UNITED KINGDOM

FOR: CLOTHING, NAMELY, TROUSERS, SKIRTS, TOPS, JEANS, COATS, JACKETS, BLOUSES, SHORTS, NIGHTWEAR, BABY BODY SUITS, BABY BOTTOMS, BABY TOPS, BABY BUNTING, SHIRTS, SCARVES, DRESSES, UNDERWEAR, SWEATERS, SWEAT TOPS, SWEAT PANTS, SWEAT SUITS, JOGGING PANTS, JOGGING SUITS, CARDIGANS, SOCKS AND TIGHTS; HEADGEAR, NAMELY, HEADWEAR, HATS AND CAPS; AND FOOTWEAR, IN CLASS 25 (U.S. CLS. 22 AND 39).

THE MARK CONSISTS OF STANDARD CHARACTERS WITHOUT CLAIM TO ANY PARTICULAR FONT, STYLE, SIZE, OR COLOR.

OWNER OF ERPN CMNTY TM OFC REG. NO. 002335628, DATED 2-18-2003, EXPIRES 3-9-2012.

"FEU FOLLET" CAN BE TRANSLATED FROM FRENCH AS WIL-O-WISP.

SER. NO. 77-339,714, FILED 11-29-2007.

DOMINICK J. SALEMI, EXAMINING ATTORNEY

Int. Cls.: 35 and 40

Prior U.S. Cls.: 100, 101, 102, 103 and 106

United States Patent and Trademark Office

Reg. No. 3,574,756

Registered Feb. 17, 2009

**SERVICE MARK
PRINCIPAL REGISTER**



DOXTEK, INC. (UTAH CORPORATION)
264 WEST CENTER STREET
OREM, UT 84057

FOR: CONSULTING SERVICES AND PROJECT MANAGEMENT FOR DOCUMENT MANAGEMENT, RETAIL STORE SERVICES, AND ON-LINE ORDERING SERVICES FEATURING DOCUMENT IMAGING PRODUCTS, NAMELY, DOCUMENT SCANNERS, SCANNER ACCESSORIES, SCANNER MAINTENANCE PLANS, CAPTURE SOFTWARE AND SOFTWARE MAINTENANCE PLANS AND LEASING OF DOCUMENT SCANNERS, IN CLASS 35 (U.S. CLS. 100, 101 AND 102).

FIRST USE 2-1-2000; IN COMMERCE 2-1-2000.

FOR: DOCUMENT SCANNING SERVICES, IN CLASS 40 (U.S. CLS. 100, 103 AND 106).

FIRST USE 2-1-2000; IN COMMERCE 2-1-2000.

THE COLOR(S) BLACK AND RED IS/ARE CLAIMED AS A FEATURE OF THE MARK.

THE MARK CONSISTS OF THE STYLIZED WORD "DOXTEK", PRINTED IN BLACK AND RED INK WITH A GRAY DROP SHADOW. THE LETTERS "D", "O" AND ONE HALF OF THE "X" ARE BLACK, WHILE THE SECOND HALF OF THE "X" AND THE REMAINDER OF THE LETTERS "T", "E" AND "K" ARE RED.

SER. NO. 77-339,725, FILED 11-29-2007.

DOMINICK J. SALEMI, EXAMINING ATTORNEY

Int. Cl.: 30

Prior U.S. Cl.: 46

United States Patent and Trademark Office

Reg. No. 3,574,757

Registered Feb. 17, 2009

TRADEMARK
PRINCIPAL REGISTER



CHOCOLAFABRIKEN LINDT & SPRÜNGLI
AG (SWITZERLAND CORPORATION)
SEESTRAßE 204
CH-8802 KILCHBERG, SWITZERLAND

FOR: CHOCOLATE, IN CLASS 30 (U.S. CL. 46).

FIRST USE 3-0-2006; IN COMMERCE 3-0-2006.

OWNER OF U.S. REG. NOS. 2,495,655, 2,594,888,
AND 2,632,256.

NO CLAIM IS MADE TO THE EXCLUSIVE
RIGHT TO USE "SAN FRANCISCO," "FOUNDED
IN 1852," "CHOCOLATE" AND "CLASSIC CHOCO-

LATE COLLECTION", APART FROM THE MARK
AS SHOWN.

THE MARK CONSISTS OF THE WORDS "SAN
FRANCISCO FOUNDED IN 1852 GHIRARDELLI
CHOCOLATE SQUARES CLASSIC CHOCOLATE
COLLECTION" CENTERED ON A HEART DESIGN
WITH SMALLER HEART SHAPES COVERING THE
SURFACE OF THE LARGER HEART.

SER. NO. 77-339,748, FILED 11-29-2007.

DOMINICK J. SALEMI, EXAMINING ATTORNEY

Int. Cl.: 44

Prior U.S. Cls.: 100 and 101

United States Patent and Trademark Office

Reg. No. 3,574,758

Registered Feb. 17, 2009

**SERVICE MARK
PRINCIPAL REGISTER**

Balanced Organic Rejuvenation

SCOTT B. WELLS, MD, PC (NEW YORK LIMITED LIABILITY COMPANY)

655 PARK AVENUE

NEW YORK, NY 10065

FOR: COSMETIC AND PLASTIC SURGERY, IN CLASS 44 (U.S. CLS. 100 AND 101).

FIRST USE 11-16-2007; IN COMMERCE 11-16-2007.

THE MARK CONSISTS OF STANDARD CHARACTERS WITHOUT CLAIM TO ANY PARTICULAR FONT, STYLE, SIZE, OR COLOR.

NO CLAIM IS MADE TO THE EXCLUSIVE RIGHT TO USE "ORGANIC REJUVENATION", APART FROM THE MARK AS SHOWN.

SER. NO. 77-339,908, FILED 11-29-2007.

JEFF DEFORD, EXAMINING ATTORNEY

Int. Cls.: 35, 36 and 37

Prior U.S. Cls.: 100, 101, 102, 103 and 106

United States Patent and Trademark Office

Reg. No. 3,574,759

Registered Feb. 17, 2009

**SERVICE MARK
PRINCIPAL REGISTER**

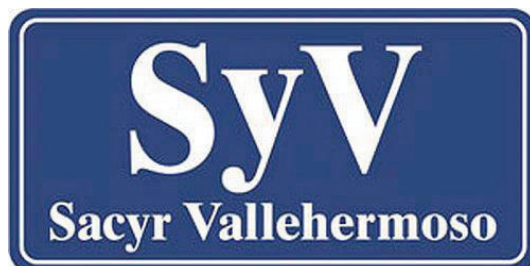

SACYR VALLEHERMOSO, S.A. (SPAIN CORPORATION)
PASEO DE LA CASTELLANA, 83-85
MADRID, SPAIN 28046

FOR: ADVERTISING; BUSINESS MANAGEMENT; BUSINESS ADMINISTRATION; OFFICE FUNCTIONS, IN CLASS 35 (U.S. CLS. 100, 101 AND 102).

FOR: INSURANCE BROKERAGE; INSURANCE CONSULTANCY; INSURANCE ADMINISTRATION; FINANCIAL MANAGEMENT AND CONSULTING; FINANCIAL CONSULTING IN THE FIELDS OF FINANCIAL AFFAIRS, MONETARY AFFAIRS AND REAL ESTATE AFFAIRS; REAL ESTATE INVESTMENT; REAL ESTATE APPRAISAL AND VALUATION; REAL ESTATE MANAGEMENT, IN CLASS 36 (U.S. CLS. 100, 101 AND 102).

FOR: BUILDING CONSTRUCTION; BUILDING MAINTENANCE AND REPAIR, IN CLASS 37 (U.S. CLS. 100, 103 AND 106).

PRIORITY CLAIMED UNDER SEC. 44(D) ON ERPN CMNTY TM OFC APPLICATION NO. 006151071, FILED 7-30-2007, REG. NO. 006151071, DATED 8-18-2008, EXPIRES 7-30-2017.

THE COLOR(S) BLUE AND WHITE IS/ARE CLAIMED AS A FEATURE OF THE MARK.

THE MARK CONSISTS OF THE LETTERS "SYV" AND "SACYR VALLEHERMOSO" IN WHITE ON A BLUE RECTANGLE. A THIN, WHITE LINE APPEARS JUST INSIDE THE EDGES OF THE BLUE RECTANGLE. THE MARK APPEARS ON A TRANSPARENT BACKGROUND, AND NO OTHER COLOR IS CLAIMED AS A FEATURE OF THE MARK.

THE ENGLISH TRANSLATION OF "VALLEHERMOSO" IN THE MARK IS "BEAUTIFUL VALLEY".

SER. NO. 77-340,358, FILED 11-29-2007.

DAVID MILLER, EXAMINING ATTORNEY

Int. Cls.: 35, 36 and 37

Prior U.S. Cls.: 100, 101, 102, 103 and 106

United States Patent and Trademark Office

Reg. No. 3,574,760

Registered Feb. 17, 2009

**SERVICE MARK
PRINCIPAL REGISTER**

GRUPO SYV

SACYR VALLEHERMOSO, S.A. (SPAIN CORPORATION)
PASEO DE LA CASTELLANA, 83-85
MADRID, SPAIN 28046

FOR: ADVERTISING; BUSINESS MANAGEMENT; BUSINESS ADMINISTRATION; OFFICE FUNCTIONS, IN CLASS 35 (U.S. CLS. 100, 101 AND 102).

FOR: INSURANCE BROKERAGE; INSURANCE CONSULTANCY; INSURANCE ADMINISTRATION; FINANCIAL MANAGEMENT AND CONSULTING; FINANCIAL CONSULTING IN THE FIELDS OF FINANCIAL AFFAIRS, MONETARY AFFAIRS AND REAL ESTATE AFFAIRS; REAL ESTATE INVESTMENT; REAL ESTATE APPRAISAL AND VALUATION; REAL ESTATE MANAGEMENT, IN CLASS 36 (U.S. CLS. 100, 101 AND 102).

FOR: BUILDING CONSTRUCTION; BUILDING MAINTENANCE AND REPAIR, IN CLASS 37 (U.S. CLS. 100, 103 AND 106).

THE MARK CONSISTS OF STANDARD CHARACTERS WITHOUT CLAIM TO ANY PARTICULAR FONT, STYLE, SIZE, OR COLOR.

PRIORITY CLAIMED UNDER SEC. 44(D) ON ERPN CMNTY TM OFC APPLICATION NO. 006136303, FILED 7-25-2007, REG. NO. 006136303, DATED 8-18-2008, EXPIRES 7-25-2017.

NO CLAIM IS MADE TO THE EXCLUSIVE RIGHT TO USE "GRUPO", APART FROM THE MARK AS SHOWN.

THE ENGLISH TRANSLATION OF THE WORD "GRUPO" IN THE MARK IS GROUP.

SER. NO. 77-340,441, FILED 11-29-2007.

DAVID MILLER, EXAMINING ATTORNEY

Int. Cl.: 10

Prior U.S. Cls.: 26, 39 and 44

United States Patent and Trademark Office

Reg. No. 3,574,761

Registered Feb. 17, 2009

**TRADEMARK
PRINCIPAL REGISTER**

GRID  VIEW

COMPUTERIZED IMAGING REFERENCE SYSTEMS, INC. (VIRGINIA CORPORATION)

2428 ALMEDA AVENUE, SUITE 212

NORFOLK, VA 23513

FOR: SURGICAL BIOPSY SPECIMEN CONTAINER, IN CLASS 10 (U.S. CLS. 26, 39 AND 44).

FIRST USE 6-15-1993; IN COMMERCE 6-15-1993.

NO CLAIM IS MADE TO THE EXCLUSIVE RIGHT TO USE "GRID", APART FROM THE MARK AS SHOWN.

THE MARK CONSISTS OF A FOUR-SQUARE GRID POSITIONED BETWEEN THE TWO WORDS OF THE LITERAL ELEMENT.

SER. NO. 77-340,863, FILED 11-30-2007.

CHRISTINA SOBRAL, EXAMINING ATTORNEY

Int. Cl.: 18

Prior U.S. Cls.: 1, 2, 3, 22 and 41

United States Patent and Trademark Office

Reg. No. 3,574,762

Registered Feb. 17, 2009

**TRADEMARK
PRINCIPAL REGISTER**



VITALIO VERA

MERCHANDISE SERVICES ONLINE, INC.
(FLORIDA CORPORATION)
5482 WILSHIRE BLVD., SUITE 131
LOS ANGELES, CA 90036

FOR: HANDBAGS; WALLETS; BACKPACKS;
TRAVEL BAGS; BRIEFCASE-TYPE PORTFOLIOS;
BRIEFCASES, IN CLASS 18 (U.S. CLS. 1, 2, 3, 22 AND
41).

FIRST USE 8-19-2004; IN COMMERCE 8-19-2004.

OWNER OF U.S. REG. NOS. 3,015,362 AND
3,040,838.

THE NAME "V VITALIO VERA" DOES NOT
IDENTIFY A LIVING INDIVIDUAL.

THE MARK CONSISTS OF ONE "V", WITH AN-
OTHER INVERTED "V" TRANSPOSED ON IT.

SER. NO. 77-341,764, FILED 11-30-2007.

MICHAEL WEBSTER, EXAMINING ATTORNEY

Int. Cl.: 35

Prior U.S. Cls.: 100, 101 and 102

United States Patent and Trademark Office

Reg. No. 3,574,763

Registered Feb. 17, 2009

**SERVICE MARK
PRINCIPAL REGISTER**

STUFFINGTON BEAR FACTORY

KYLE BARRETT (UNITED STATES INDIVIDUAL)
2302 E. THOMAS RD
PHOENIX, AZ 85018

FOR: WHOLESALE DISTRIBUTORSHIP AND RETAIL STORE SERVICES FEATURING TOYS AND PLAYTHINGS, NAMELY, STUFFED ANIMALS, TEDDY BEARS, CLOTHING FOR STUFFED TOYS, BIRTH CERTIFICATES AND ACCESSORIES THEREFOR, IN CLASS 35 (U.S. CLS. 100, 101 AND 102).

FIRST USE 11-30-1998; IN COMMERCE 11-30-1998.

THE MARK CONSISTS OF STANDARD CHARACTERS WITHOUT CLAIM TO ANY PARTICULAR FONT, STYLE, SIZE, OR COLOR.

NO CLAIM IS MADE TO THE EXCLUSIVE RIGHT TO USE "BEAR FACTORY", APART FROM THE MARK AS SHOWN.

SER. NO. 77-342,907, FILED 12-3-2007.

KATHERINE CONNOLLY, EXAMINING ATTORNEY

Int. Cl.: 41

Prior U.S. Cls.: 100, 101 and 107

Reg. No. 3,574,764

United States Patent and Trademark Office

Registered Feb. 17, 2009

SERVICE MARK
PRINCIPAL REGISTER

sinphonics

ANDREW RIVAS (UNITED STATES INDIVIDUAL)

2222 SILVERBELL TREE DR.

TUCSON, AZ 85745 AND

JOHNNY PEREZ (UNITED STATES INDIVIDUAL)

3813 E. CALLE ALTAR

TUCSON, AZ 85716 AND

DAVIAN JAVIER PEDROZA (UNITED STATES INDIVIDUAL)

1932 N. MADELYN

TUCSON, AZ 85712 AND

ROBERT RAMON CUNES MENDIBLES (UNITED STATES INDIVIDUAL)

P.O. BOX 86273

TUCSON, AZ 85754

FOR: ENTERTAINMENT IN THE NATURE OF LIVE PERFORMANCES BY A MUSICAL BAND; ENTERTAINMENT IN THE NATURE OF VISUAL AND AUDIO PERFORMANCES, NAMELY, MUSICAL BAND, ROCK GROUP, GYMNASTIC, DANCE, AND BALLET PERFORMANCES; ENTERTAINMENT, NAMELY, LIVE PERFORMANCES BY A MUSICAL BAND; ENTERTAINMENT SERVICES, NAMELY, PROVIDING A WEB SITE FEATURING MUSICAL PERFORMANCES, MUSICAL VIDEOS, RELATED FILM CLIPS, PHOTOGRAPHS, AND OTHER MULTIMEDIA MATERIALS; MULTIMEDIA ENTERTAINMENT SERVICES IN THE NATURE OF RECORDING, PRODUCTION AND POST-PRODUCTION SERVICES IN THE FIELDS OF MUSIC, VIDEO, AND FILMS; MULTIMEDIA PUBLISHING OF BOOKS, MAGAZINES, JOURNALS, SOFTWARE, GAMES, MUSIC, AND ELECTRONIC PUBLICATIONS; MUSIC PRODUCTION SERVICES; MUSIC PUBLISHING SERVICES; AUDIO AND VIDEO RECORDING SERVICES; AUDIO RECORDING AND PRODUCTION; COMPOSITION OF MUSIC FOR OTHERS; CONCERT BOOKING; DIGITAL VIDEO, AUDIO, AND MULTIMEDIA PUBLISHING SERVICES; EDITING OR RECORDING OF SOUNDS AND IMAGES; ENTERTAINMENT

SERVICES, NAMELY, PROVIDING A WEBSITE FEATURING PHOTOGRAPHIC, AUDIO, VIDEO AND PROSE PRESENTATIONS FEATURING A MUSICAL BAND; ENTERTAINMENT IN THE NATURE OF VISUAL AND AUDIO PERFORMANCES, AND MUSICAL, VARIETY, NEWS AND COMEDY SHOWS; ENTERTAINMENT, NAMELY, PRODUCTION OF SOUND AND MUSIC VIDEO RECORDINGS; ENTERTAINMENT SERVICES, NAMELY, AN ONLINE ACTIVITY WHERE YOU CREATE YOUR OWN MUSIC VIDEOS; ENTERTAINMENT SERVICES, NAMELY, NON-DOWNLOADABLE RINGTONES, PRE-RECORDED MUSIC, VIDEO AND GRAPHICS PRESENTED TO MOBILE COMMUNICATIONS DEVICES VIA A GLOBAL COMPUTER NETWORK AND WIRELESS NETWORKS; ENTERTAINMENT SERVICES, NAMELY, PERSONAL APPEARANCES BY A MUSICAL BAND; ENTERTAINMENT SERVICES, NAMELY, PROVIDING PODCASTS IN THE FIELD OF MUSIC AND VIDEO ENTERTAINMENT. ENTERTAINMENT SERVICES, NAMELY, PROVIDING WEBCASTS IN THE FIELD OF MUSIC AND VIDEO ENTERTAINMENT; ENTERTAINMENT, NAMELY, A CONTINUING VARIETY SHOW BROADCAST OVER TELEVISION, SATELLITE, AUDIO, AND VIDEO MEDIA; ENTERTAINMENT, NAMELY, LIVE MUSIC CONCERTS; ENTERTAINMENT, NAMELY, LIVE PERFORMANCES BY MUSICAL BANDS; ENTERTAINMENT, NAMELY, LIVE PERFORMANCES BY ROCK GROUPS; FAN CLUBS; FILM AND VIDEO FILM PRODUCTION; FILM AND VIDEO PRODUCTION; FILM AND VIDEO TAPE FILM PRODUCTION; FILM DISTRIBUTION; FILM EDITING; FILM MASTERING SERVICES; FILM PRODUCTION; LIVE PERFORMANCES FEATURING PRERECORDED VOCAL AND INSTRUMENTAL PERFORMANCES VIEWED ON A BIG SCREEN; MEDIA PRODUCTION SERVICES, NAMELY, VIDEO AND FILM PRODUCTION; MOTION PICTURE FILM PRODUCTION; MOTION PICTURE SONG PRODUCTION; MUSIC COMPOSITION AND TRANSCRIPTION

FOR OTHERS; MUSIC COMPOSITION FOR OTHERS; MUSIC SELECTION SERVICES FOR USE IN TV, FILM, RADIO AND VIDEO GAMES; MUSIC TRANSCRIPTION FOR OTHERS; MUSIC-HALLS; POST-PRODUCTION EDITING SERVICES IN THE FIELD OF MUSIC, VIDEOS AND FILMS; PRESENTATION OF LIVE SHOW PERFORMANCES; PRESENTATION OF MUSICAL PERFORMANCE; PRODUCTION OF SOUND AND IMAGE RECORDINGS ON SOUND AND IMAGE CARRIERS; PRODUCTION OF SOUND AND MUSIC VIDEO RECORDINGS; PRODUCTION OF SOUND RECORDINGS; PRODUCTION OF VIDEO AND CREATION OF VISUAL EFFECTS FOR OTHERS FOR USE IN DVDS, TELEVISION PROGRAMS AND ON WEBSITES; PRODUCTION OF VIDEO CASSETTES; PRODUCTION OF VIDEO DISCS AND TAPES;

PRODUCTION OF VIDEO DISCS FOR OTHERS; RECORD MASTER PRODUCTION; RECORD PRODUCTION; RECORDING STUDIO SERVICES; RECORDING STUDIOS; SONG WRITING SERVICES; SOUND RECORDING STUDIOS, IN CLASS 41 (U.S. CLS. 100, 101 AND 107).

FIRST USE 6-15-2007; IN COMMERCE 6-15-2007.

THE MARK CONSISTS OF STANDARD CHARACTERS WITHOUT CLAIM TO ANY PARTICULAR FONT, STYLE, SIZE, OR COLOR.

SER. NO. 77-343,088, FILED 12-3-2007.

DAWN HAN, EXAMINING ATTORNEY

Int. Cls.: 16 and 25

Prior U.S. Cls.: 2, 5, 22, 23, 29, 37, 38, 39 and 50

United States Patent and Trademark Office

Reg. No. 3,574,765

Registered Feb. 17, 2009

**TRADEMARK
PRINCIPAL REGISTER**



AGAGAS, REX P (UNITED STATES INDIVIDUAL)
154 N. DILLON ST. #2
LOS ANGELES, CA 90026

FOR: ADVERTISING MATERIALS, NAMELY, SUNDAY CLOTHING IRON-ON TRANSFERS, ADVERTISING BOARDS OF PAPER OR CARDBOARD, INFORMATIONAL FLYERS FEATURING SUNDAY CLOTHING EVENTS AND NEWS, BUMPER STICKERS, DECORATIVE STICKERS FOR HELMETS, STICKERS AND IRON-ON TRANSFERS, POSTERS, POSTCARDS, BUSINESS CARDS, PAPER BANNERS, FOLDERS, PRESENTATION FOLDERS, IN CLASS 16 (U.S. CLS. 2, 5, 22, 23, 29, 37, 38 AND 50).

FIRST USE 11-1-2007; IN COMMERCE 11-1-2007.

FOR: CLOTHING, NAMELY, T-SHIRTS, PANTS, SHOES, JACKETS, SWEATERS, HATS, BANDANAS, HEADBANDS, PANTIES, BRAS, SHORTS, SOCKS, WRISTBANDS, BELTS, SKIRTS, JERSEYS, SWEATERS, SWEAT SHIRTS, PANTS, POLO SHIRTS, BEANIES, RUBBER SHOES, IN CLASS 25 (U.S. CLS. 22 AND 39).

FIRST USE 11-1-2007; IN COMMERCE 11-1-2007.

NO CLAIM IS MADE TO THE EXCLUSIVE RIGHT TO USE "SUNDAY CLOTHING", APART FROM THE MARK AS SHOWN.

THE MARK CONSISTS OF AN "S" WHICH IS ON THE LEFT SIDE COVERED IN DISTRESS LETTERING AND A PROFILE OF A PAINTBALL MASK NEXT TO THE "S" ON THE RIGHT SIDE WITH A OUTER BORDER OF BOTH THE "S" AND THE MASK. BELOW THAT ARE THE WORDS "SUNDAY CLOTHING" IN ALL CAPS USING EUROSTILE FONT. "SUNDAY" IS BOLD EXTENDED WITH SPACING IN BETWEEN EACH LETTER AND "CLOTHING" IS REGULAR EXTENDED WITH SPACING IN BETWEEN EACH LETTER.

SER. NO. 77-343,089, FILED 12-3-2007.

DAWN HAN, EXAMINING ATTORNEY

Int. Cl.: 3

Prior U.S. Cls.: 1, 4, 6, 50, 51 and 52

United States Patent and Trademark Office

Reg. No. 3,574,766

Registered Feb. 17, 2009

TRADEMARK
PRINCIPAL REGISTER



RIVERSTONE MARKETING LIMITED (BR.VIRGIN ISLANDS CORPORATION)
WICKHAMS CAY 1
AKARA BUILDING, 24 DE CASTRO STREET
ROAD TOWN, TORTOLA, BR.VIRGIN ISLANDS

FOR: HAIR CARE PREPARATIONS, IN CLASS 3
(U.S. CLS. 1, 4, 6, 50, 51 AND 52).

FIRST USE 8-31-2000; IN COMMERCE 8-31-2000.

OWNER OF U.S. REG. NOS. 1,273,265, 2,315,404
AND OTHERS.

THE COLOR(S) PURPLE, BLUE, WHITE, ORANGE AND PINK IS/ARE CLAIMED AS A FEATURE OF THE MARK.

THE COLOR PURPLE APPEARS IN THE WORDING "SOFN'FREE N'PRETTY" AND THE COLOR WHITE SURROUNDS THE WORDING. THE COLOR PINK APPEARS IN THE TWO HEARTS THAT APPEAR ABOVE AND BELOW THE WORDING "SOFN'FREE". THE COLOR BLUE APPEARS ON THE LEFT TRIANGLE IN THE BACKGROUND OF THE LITERAL ELEMENT AND THE COLOR ORANGE APPEARS ON THE RIGHT TRIANGLE IN THE BACKGROUND OF THE LITERAL ELEMENT.

SER. NO. 77-343,448, FILED 12-4-2007.

ELIZABETH KAJUBI, EXAMINING ATTORNEY

Int. Cl.: 3

Prior U.S. Cls.: 1, 4, 6, 50, 51 and 52

United States Patent and Trademark Office

Reg. No. 3,574,767

Registered Feb. 17, 2009

**TRADEMARK
PRINCIPAL REGISTER**

GROHEALTHY

RIVERSTONE MARKETING LIMITED (BR.VIR-
GIN ISLANDS CORPORATION)
WICKHAMS CAY 1
AKARA BUILDING, 24 DE CASTRO STREET
ROAD TOWN, TORTOLA, BR.VIRGIN ISLANDS

FOR: HAIR CARE PREPARATIONS, IN CLASS 3
(U.S. CLS. 1, 4, 6, 50, 51 AND 52).

FIRST USE 8-31-2007; IN COMMERCE 8-31-2007.

THE MARK CONSISTS OF STANDARD CHAR-
ACTERS WITHOUT CLAIM TO ANY PARTICULAR
FONT, STYLE, SIZE, OR COLOR.

SER. NO. 77-343,554, FILED 12-4-2007.

ELIZABETH KAJUBI, EXAMINING ATTORNEY

Int. Cl.: 11

Prior U.S. Cls.: 13, 21, 23, 31 and 34

United States Patent and Trademark Office

Reg. No. 3,574,768

Registered Feb. 17, 2009

**TRADEMARK
PRINCIPAL REGISTER**

QUICK ADJUST

WCM INDUSTRIES, INC. (COLORADO CORPORATION)
2121 WAYNOKA ROAD
COLORADO SPRINGS, CO 80915

THE MARK CONSISTS OF STANDARD CHARACTERS WITHOUT CLAIM TO ANY PARTICULAR FONT, STYLE, SIZE, OR COLOR.

FOR: PLUMBING FITTINGS, NAMELY, DRAINS,
IN CLASS 11 (U.S. CLS. 13, 21, 23, 31 AND 34).

SER. NO. 77-343,692, FILED 12-4-2007.

FIRST USE 9-30-1980; IN COMMERCE 9-30-1980.

KHANH LE, EXAMINING ATTORNEY

Int. Cl.: 36

Prior U.S. Cls.: 100, 101 and 102

United States Patent and Trademark Office

Reg. No. 3,574,769

Registered Feb. 17, 2009

**SERVICE MARK
PRINCIPAL REGISTER**

PARKMOBILE

PARKMOBILE GROUP B.V. (NETHERLANDS
CORPORATION)
WISSELWERKING 40
DIEMEN, NETHERLANDS 1112XR

FOR: PAYMENT SERVICES, NAMELY, BILL
PAYMENT SERVICES USING ON-LINE SYSTEMS,
THE INTERNET OR MOBILE PHONES, IN CLASS 36
(U.S. CLS. 100, 101 AND 102).

THE MARK CONSISTS OF STANDARD CHAR-
ACTERS WITHOUT CLAIM TO ANY PARTICULAR
FONT, STYLE, SIZE, OR COLOR.

OWNER OF ERPN CMNTY TM OFC REG. NO.
003397106, DATED 1-20-2005, EXPIRES 10-9-2013.

SER. NO. 77-344,082, FILED 12-4-2007.

ALICIA COLLINS, EXAMINING ATTORNEY

Int. Cls.: 9 and 10

Prior U.S. Cls.: 21, 23, 26, 36, 38, 39 and 44

United States Patent and Trademark Office

Reg. No. 3,574,770

Registered Feb. 17, 2009

**TRADEMARK
PRINCIPAL REGISTER**

THE POWER OF A SMALL WORLD

MEMSCAP (FRANCE JOINT STOCK COMPANY)
PARC TECHNOLOGIQUE DES FONTAINES
BERNIN
38920 CROLLES, FRANCE

FOR: COMPUTER SOFTWARE FOR THE ANALYSIS OF DATA COLLECTED BY PROBES ANALYZING THE CHARACTERISTICS OF THE SKIN; ELECTRONIC AND MICROELECTRONIC COMPONENTS, NAMELY, MICROCHIPS; OPTICAL, MEASURING, CHECKING INSTRUMENTS, NAMELY, PHYSIOLOGICAL SENSORS FOR HYDRATION, TRANS-EPIDERMAL WATER LOSS, TEMPERATURE, PIGMENTATION DEPTH AND ROUGHNESS, PRESSURE MODULUS, PRESSURE REGULATORS, ALL THESE GOODS FOR SCIENTIFIC AND INDUSTRIAL USE; ELECTRIC SWITCHERS, ELECTRIC TRANSFORMERS, ELECTRIC ACCUMULATORS, ELECTRIC REGULATORS, ELECTRIC FLOW CONTROLLERS; ANALYSIS APPARATUS FOR NON MEDICAL USE COMPOSED OF PRESSURE SENSORS AND/OR PICTURE SENSORS; ELECTRONIC DATA PROCESSORS; COMPUTERS; COMPUTER SCREENS, IN CLASS 9 (U.S. CLS. 21, 23, 26, 36 AND 38).

FOR: OPTICAL, MEASURING, CHECKING INSTRUMENTS, NAMELY, PHYSIOLOGICAL SENSORS FOR HYDRATION, TRANS-EPIDERMAL WATER LOSS, TEMPERATURE, PIGMENTATION DEPTH AND ROUGHNESS, PRESSURE MODULUS, PRESSURE REGULATORS, ALL THESE GOODS FOR MEDICAL USE; ANALYSIS APPARATUS FOR MEDICAL AND DERMATOLOGICAL USE, NAMELY, DERMATOLOGICAL PROBE, APPARATUS ANALYZING THE CHARACTERISTICS OF THE SKIN , IN CLASS 10 (U.S. CLS. 26, 39 AND 44).

THE MARK CONSISTS OF STANDARD CHARACTERS WITHOUT CLAIM TO ANY PARTICULAR FONT, STYLE, SIZE, OR COLOR.

PRIORITY CLAIMED UNDER SEC. 44(D) ON FRANCE APPLICATION NO. 07/3539036, FILED 11-22-2007, REG. NO. 07/3539036, DATED 5-16-2008, EXPIRES 11-22-2017.

SER. NO. 77-344,238, FILED 12-5-2007.

MAUREEN DALL, EXAMINING ATTORNEY

Int. Cl.: 16

Prior U.S. Cls.: 2, 5, 22, 23, 29, 37, 38 and 50

United States Patent and Trademark Office

Reg. No. 3,574,771

Registered Feb. 17, 2009

**TRADEMARK
PRINCIPAL REGISTER**

PATBAR

INSTITUTE FOR PATENT STUDIES, INC. (NEW
YORK CORPORATION)
195 SOUTH STREET
MIDDLETOWN, NY 10940

FOR: STUDY GUIDES FOR THE PATENT BAR
EXAMINATION IN THE FORM OF KITS COMPRIS-
ING BOOKS, CD LECTURES, AND SOFTWARE, IN
CLASS 16 (U.S. CLS. 2, 5, 22, 23, 29, 37, 38 AND 50).

FIRST USE 12-5-1998; IN COMMERCE 1-1-2000.

THE MARK CONSISTS OF STANDARD CHAR-
ACTERS WITHOUT CLAIM TO ANY PARTICULAR
FONT, STYLE, SIZE, OR COLOR.

SEC. 2(F).

SER. NO. 77-344,535, FILED 12-5-2007.

BARBARA GAYNOR, EXAMINING ATTORNEY

Int. Cls.: 3 and 5

Prior U.S. Cls.: 1, 4, 6, 18, 44, 46, 50, 51 and 52

United States Patent and Trademark Office

Reg. No. 3,574,772

Registered Feb. 17, 2009

**TRADEMARK
PRINCIPAL REGISTER**



RECKITT BENCKISER INC. (DELAWARE CORPORATION)
399 INTERPACE PARKWAY
PARSIPPANY, NJ 07054

FOR: ALL PURPOSE CLEANER FOR HOUSEHOLD, COMMERCIAL, INDUSTRIAL AND INSTITUTIONAL USE; ALL PURPOSE HOUSEHOLD CLEANING PREPARATION; CLEANING PREPARATIONS FOR TOILETS, BATHTUBS, SINKS, AND FLOORS; DISPOSABLE WIPES IMPREGNATED WITH CLEANSING COMPOUNDS FOR USE IN BATHROOMS AND KITCHENS, IN CLASS 3 (U.S. CLS. 1, 4, 6, 50, 51 AND 52).

FIRST USE 7-5-2007; IN COMMERCE 7-5-2007.

FOR: ALL PURPOSE CLEANER WITH DISINFECTING PROPERTIES; ALL PURPOSE DISINFECTING PREPARATIONS, NAMELY, ALL PURPOSE TOILET AND BATHROOM CLEANING PREPARATIONS, SANITIZING PREPARATIONS FOR HOUSEHOLD, COMMERCIAL, INDUSTRIAL AND INSTITUTIONAL USE; HARD SURFACE SANITIZING PREPARATION; HOUSEHOLD DEO-

DORIZERS, IN CLASS 5 (U.S. CLS. 6, 18, 44, 46, 51 AND 52).

FIRST USE 7-5-2007; IN COMMERCE 7-5-2007.

NO CLAIM IS MADE TO THE EXCLUSIVE RIGHT TO USE "4 IN 1", APART FROM THE MARK AS SHOWN.

THE COLOR(S) WHITE, RED AND YELLOW IS/ARE CLAIMED AS A FEATURE OF THE MARK.

THE MARK CONSISTS OF THE NUMERALS "4" AND "1" WITH THE WORD "IN" BETWEEN THEM, ALL IN RED WITH WHITE AND YELLOW HIGHLIGHTS ABOVE A CURVED LINE WITH A BAND OF YELLOW AND A BAND OF RED, ON WHICH ARE WHITE SPARKLE STARS. THE MARK APPEARS ON A TRANSPARENT BACKGROUND.

SER. NO. 77-344,635, FILED 12-5-2007.

DAVID MILLER, EXAMINING ATTORNEY

Int. Cl.: 20

Prior U.S. Cls.: 2, 13, 22, 25, 32 and 50

United States Patent and Trademark Office

Reg. No. 3,574,773

Registered Feb. 17, 2009

**TRADEMARK
PRINCIPAL REGISTER**

JOHN LOUIS

JOHN LOUIS INC. (MISSOURI CORPORATION)
9380 WATSON INDUSTRIAL DRIVE
ST. LOUIS, MO 63126

FOR: PREFABRICATED CLOSET ORGANIZATION SYSTEMS MADE OF WOOD; CLOSET ACCESSORIES, NAMELY, SHOE RACKS, CLOTHES BARS, AND BELT RACKS; SHELVING, IN CLASS 20 (U.S. CLS. 2, 13, 22, 25, 32 AND 50).

FIRST USE 10-1-2005; IN COMMERCE 10-1-2005.

THE MARK CONSISTS OF STANDARD CHARACTERS WITHOUT CLAIM TO ANY PARTICULAR FONT, STYLE, SIZE, OR COLOR.

THE NAME "JOHN LOUIS" DOES NOT IDENTIFY A LIVING INDIVIDUAL.

SER. NO. 77-344,655, FILED 12-5-2007.

DAWN HAN, EXAMINING ATTORNEY

Int. Cl.: 36

Prior U.S. Cls.: 100, 101 and 102

United States Patent and Trademark Office

Reg. No. 3,574,774

Registered Feb. 17, 2009

**SERVICE MARK
PRINCIPAL REGISTER**

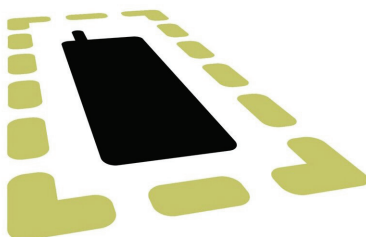

PARKMOBILE GROUP B.V. (NETHERLANDS CORPORATION)

WISSELWERKING 40

DIEMEN, NETHERLANDS 1112XR

FOR: FINANCIAL TRANSACTIONS SERVICES, NAMELY, PROVIDING SECURE COMMERCIAL TRANSACTIONS AND PAYMENT OPTIONS USING A MOBILE DEVICE AT A POINT OF SALE; FINANCIAL AFFAIRS SERVICES, NAMELY, FINANCIAL CONSULTATION; PAYMENT SERVICES, NAMELY, BILL PAYMENT SERVICES USING ON-LINE SYSTEMS, THE INTERNET OR MOBILE PHONES; ELECTRONIC FUNDS TRANSFERS, IN CLASS 36 (U.S. CLS. 100, 101 AND 102).

PRIORITY CLAIMED UNDER SEC. 44(D) ON ERPN CMNTY TM OFC APPLICATION NO. 6029615, FILED 6-26-2007.

OWNER OF ERPN CMNTY TM OFC REG. NO. 006029615, DATED 5-26-2008, EXPIRES 6-22-2017.

THE COLOR(S) GREEN, BLACK IS/ARE CLAIMED AS A FEATURE OF THE MARK.

THE MARK CONSISTS OF GREEN LINES SURROUNDING A BLACK RECTANGLE.

SER. NO. 77-345,107, FILED 12-5-2007.

ALICIA COLLINS, EXAMINING ATTORNEY

Int. Cls.: 35 and 36

Prior U.S. Cls.: 100, 101 and 102

United States Patent and Trademark Office

Reg. No. 3,574,775

Registered Feb. 17, 2009

**SERVICE MARK
PRINCIPAL REGISTER**

OFFICEFINDER

OFFICEFINDER LLC (WASHINGTON LIMITED
LIABILITY COMPANY)
19661 SE 24TH WAY
SAMMAMISH, WA 98075

FOR: MATCHING CONSUMERS WITH REAL
ESTATE PROFESSIONALS IN THE FIELD OF REAL
ESTATE SERVICES VIA COMPUTER NETWORK,
IN CLASS 35 (U.S. CLS. 100, 101 AND 102).

FIRST USE 4-8-1996; IN COMMERCE 4-8-1996.

FOR: PROVIDING INFORMATION IN THE
FIELD OF REAL ESTATE VIA THE INTERNET;
PROVIDING REAL ESTATE LISTINGS AND REAL
ESTATE INFORMATION VIA THE INTERNET;
REAL ESTATE BROKERAGE; REAL ESTATE CON-

SULTATION; REAL ESTATE LISTING, IN CLASS 36
(U.S. CLS. 100, 101 AND 102).

FIRST USE 3-21-1996; IN COMMERCE 4-8-1996.

THE MARK CONSISTS OF STANDARD CHAR-
ACTERS WITHOUT CLAIM TO ANY PARTICULAR
FONT, STYLE, SIZE, OR COLOR.

OWNER OF U.S. REG. NO. 2,099,108.

SEC. 2(F).

SER. NO. 77-345,512, FILED 12-6-2007.

BERYL GARDNER, EXAMINING ATTORNEY

Int. Cl.: 14

Prior U.S. Cls.: 2, 27, 28 and 50

United States Patent and Trademark Office

Reg. No. 3,574,776

Registered Feb. 17, 2009

**TRADEMARK
PRINCIPAL REGISTER**

BIRKS RIBBONS

BIRKS & MAYORS INC. (CANADA CORPORATION)
1240 PHILLIPS SQUARE
MONTREAL, CANADA H3B3H4

OWNER OF U.S. REG. NOS. 1,156,142, 2,925,048,
AND 3,312,301.

FOR: JEWELRY, IN CLASS 14 (U.S. CLS. 2, 27, 28
AND 50).

NO CLAIM IS MADE TO THE EXCLUSIVE
RIGHT TO USE "RIBBONS", APART FROM THE
MARK AS SHOWN.

FIRST USE 11-30-2006; IN COMMERCE 11-30-2006.

SER. NO. 77-345,704, FILED 12-6-2007.

THE MARK CONSISTS OF STANDARD CHAR-
ACTERS WITHOUT CLAIM TO ANY PARTICULAR
FONT, STYLE, SIZE, OR COLOR.

CAROLINE WOOD, EXAMINING ATTORNEY

Int. Cl.: 39

Prior U.S. Cls.: 100 and 105

United States Patent and Trademark Office

Reg. No. 3,574,777

Registered Feb. 17, 2009

**SERVICE MARK
PRINCIPAL REGISTER**



DAVOODIAN, DAVID (UNITED STATES INDIVIDUAL)
SUITE 200
10537 SANTA MONICA BLVD.
LOS ANGELES, CA 90025

FOR: DOCUMENT DELIVERY; EXPRESS DELIVERY OF GOODS BY HAND-CARRIED PERSONAL DELIVERY, AIR, ROAD, RAIL AND SEA; FOOD DELIVERY; PARCEL DELIVERY; PICK UP, DELIVERY AND STORAGE OF PERSONAL PROPERTY; PIZZA DELIVERY; SHIPPING AND DELIVERY SERVICES, NAMELY, PICKUP, TRANSPORTATION, AND DELIVERY OF PACKAGES AND LET-

TERS BY VARIOUS MODES OF TRANSPORTATION; TRANSPORTATION AND DELIVERY SERVICES BY AIR, ROAD, RAIL AND SEA; TRANSPORTATION AND DELIVERY SERVICES, NAMELY, SAME DAY SHIPMENT SERVICES, IN CLASS 39 (U.S. CLS. 100 AND 105).

FIRST USE 9-1-2007; IN COMMERCE 9-1-2007.

SER. NO. 77-346,217, FILED 12-6-2007.

NANCY CLARKE, EXAMINING ATTORNEY

Int. Cl.: 36

Prior U.S. Cls.: 100, 101 and 102

United States Patent and Trademark Office

Reg. No. 3,574,778

Registered Feb. 17, 2009

**SERVICE MARK
PRINCIPAL REGISTER**

**ASSISTED REPRODUCTION
INSURANCE**

NEW LIFE AGENCY, INC. (CALIFORNIA CORPORATION)
6900 ARAGON CIRCLE
8383 WILSHIRE BLVD.
BUENA PARK, CA 90620

FOR: INSURANCE BROKERAGE IN THE FIELD OF ASSISTED REPRODUCTION MEDICAL TECHNIQUES, ASSISTED REPRODUCTION DRUG THERAPY, ARTIFICIAL INSEMINATION, IN VITRO FERTILIZATION, FERTILITY ENHANCEMENT THERAPY; FERTILITY ENHANCEMENT DRUG THERAPY, THIRD PARTY EGG DONATION, THIRD PARTY SPERM DONATION, AND THIRD PARTY SURROGACY; INSURANCE ACTUARIAL SERVICES; INSURANCE ADMINISTRATION IN THE FIELD OF ASSISTED REPRODUCTION MEDICAL TECHNIQUES, ASSISTED REPRODUCTION DRUG THERAPY, ARTIFICIAL INSEMINATION, IN VITRO FERTILIZATION, FERTILITY ENHANCEMENT THERAPY; FERTILITY ENHANCEMENT DRUG THERAPY, THIRD PARTY EGG DONATION, THIRD PARTY SPERM DONATION, AND THIRD PARTY SURROGACY; INSURANCE AGENCIES IN THE FIELD OF ASSISTED REPRODUCTION MEDICAL TECHNIQUES, ASSISTED REPRODUCTION DRUG THERAPY, ARTIFICIAL INSEMINATION, IN VITRO FERTILIZATION, FERTILITY ENHANCEMENT THERAPY; FERTILITY ENHANCEMENT DRUG THERAPY, THIRD PARTY EGG DONATION, THIRD PARTY SPERM DONATION, AND THIRD PARTY SURROGACY; INSURANCE AGENCY AND BROKERAGE; INSURANCE CLAIMS ADMINISTRATION; INSURANCE

CLAIMS PROCESSING; INSURANCE UNDERWRITING IN THE FIELD OF ASSISTED REPRODUCTION MEDICAL TECHNIQUES, ASSISTED REPRODUCTION DRUG THERAPY, ARTIFICIAL INSEMINATION, IN VITRO FERTILIZATION, FERTILITY ENHANCEMENT THERAPY; FERTILITY ENHANCEMENT DRUG THERAPY, THIRD PARTY EGG DONATION, THIRD PARTY SPERM DONATION, AND THIRD PARTY SURROGACY; A SURROGATE IS ONE WHO TAKES THE PLACE OF ANOTHER; IN THE INSTANT CASE, APPLICANT PROVIDES INSURANCE COVERAGE AND OTHER COVERAGE FOR THE ASSISTED REPRODUCTION PROCESS, OR FOR INSURANCE COVERAGE FOR THE SURROGATE WHO DIES OF A SUDDEN AND PERHAPS UNFORESEEN DEATH, IN CLASS 36 (U.S. CLS. 100, 101 AND 102).

FIRST USE 1-1-2002; IN COMMERCE 1-1-2002.

THE MARK CONSISTS OF STANDARD CHARACTERS WITHOUT CLAIM TO ANY PARTICULAR FONT, STYLE, SIZE, OR COLOR.

NO CLAIM IS MADE TO THE EXCLUSIVE RIGHT TO USE "INSURANCE", APART FROM THE MARK AS SHOWN.

SEC. 2(F).

SER. NO. 77-346,255, FILED 12-6-2007.

CAROLYN GRAY, EXAMINING ATTORNEY

Int. Cl.: 36

Prior U.S. Cls.: 100, 101 and 102

United States Patent and Trademark Office

Reg. No. 3,574,779

Registered Feb. 17, 2009

**SERVICE MARK
PRINCIPAL REGISTER**

SURROGATE MATERNITY CARE

NEW LIFE AGENCY, INC. (CALIFORNIA CORPORATION)
6900 ARAGON CIRCLE
8383 WILSHIRE BLVD.
BUENA PARK, CA 90620

FOR: INSURANCE BROKERAGE IN THE FIELD OF ASSISTED REPRODUCTION MEDICAL TECHNIQUES, ASSISTED REPRODUCTION DRUG THERAPY, ARTIFICIAL INSEMINATION, IN VITRO FERTILIZATION, FERTILITY ENHANCEMENT THERAPY; FERTILITY ENHANCEMENT DRUG THERAPY, THIRD PARTY EGG DONATION, THIRD PARTY SPERM DONATION, AND THIRD PARTY SURROGACY; INSURANCE ACTUARIAL SERVICES; INSURANCE ADMINISTRATION IN THE FIELD OF ASSISTED REPRODUCTION MEDICAL TECHNIQUES, ASSISTED REPRODUCTION DRUG THERAPY, ARTIFICIAL INSEMINATION, IN VITRO FERTILIZATION, FERTILITY ENHANCEMENT THERAPY; FERTILITY ENHANCEMENT DRUG THERAPY, THIRD PARTY EGG DONATION, THIRD PARTY SPERM DONATION, AND THIRD PARTY SURROGACY; INSURANCE AGENCIES IN THE FIELD OF ASSISTED REPRODUCTION MEDICAL TECHNIQUES, ASSISTED REPRODUCTION DRUG THERAPY, ARTIFICIAL INSEMINATION, IN VITRO FERTILIZATION, FERTILITY ENHANCEMENT THERAPY; FERTILITY ENHANCEMENT DRUG THERAPY, THIRD PARTY EGG DONATION, THIRD PARTY SPERM DONATION, AND THIRD PARTY SURRO-

GACY; INSURANCE AGENCY AND BROKERAGE; INSURANCE CLAIMS ADMINISTRATION; INSURANCE CLAIMS PROCESSING; INSURANCE UNDERWRITING IN THE FIELD OF ASSISTED REPRODUCTION MEDICAL TECHNIQUES, ASSISTED REPRODUCTION DRUG THERAPY, ARTIFICIAL INSEMINATION, IN VITRO FERTILIZATION, FERTILITY ENHANCEMENT THERAPY; FERTILITY ENHANCEMENT DRUG THERAPY, THIRD PARTY EGG DONATION, THIRD PARTY SPERM DONATION, AND THIRD PARTY SURROGACY; A SURROGATE IS ONE WHO TAKES THE PLACE OF ANOTHER; IN THE INSTANT CASE, CARE FOR PREGNANCY IN THE FORM OF INSURANCE COVERAGE AND OTHER SERVICES FOR THE SURROGATE WHO DIES OF A SUDDEN AND PERHAPS UNFORESEEN DEATH IS THE USE FOR APPLICANT'S SERVICES, IN CLASS 36 (U.S. CLS. 100, 101 AND 102).

FIRST USE 1-1-2002; IN COMMERCE 1-1-2002.

THE MARK CONSISTS OF STANDARD CHARACTERS WITHOUT CLAIM TO ANY PARTICULAR FONT, STYLE, SIZE, OR COLOR.

SEC. 2(F).

SER. NO. 77-346,268, FILED 12-6-2007.

CAROLYN GRAY, EXAMINING ATTORNEY

Int. Cl.: 9

Prior U.S. Cls.: 21, 23, 26, 36 and 38

United States Patent and Trademark Office

Reg. No. 3,574,780

Registered Feb. 17, 2009

**TRADEMARK
PRINCIPAL REGISTER**

JetStream

CENTRALITE SYSTEMS, INC. (ALABAMA CORPORATION)
6420 WALL STREET
MOBILE, AL 36695

FOR: RADIO FREQUENCY LIGHTING CONTROL SYSTEM, NAMELY, A WIRELESS SENSOR NETWORK OF INTELLIGENT RADIO FREQUENCY TRANSCEIVER NODES FOR CONNECTION TO CONTROLLED LIGHTING APPLIANCES WITH NODE TO NODE COMMUNICATION AND CONTROL PROTOCOLS RESIDENT ON SUCH NODES, IN CLASS 9 (U.S. CLS. 21, 23, 26, 36 AND 38).

FIRST USE 9-0-2007; IN COMMERCE 9-0-2007.

THE MARK CONSISTS OF STANDARD CHARACTERS WITHOUT CLAIM TO ANY PARTICULAR FONT, STYLE, SIZE, OR COLOR.

SER. NO. 77-346,393, FILED 12-7-2007.

MATTHEW PAPPAS, EXAMINING ATTORNEY

Int. Cl.: 16

Prior U.S. Cls.: 2, 5, 22, 23, 29, 37, 38 and 50

Reg. No. 3,574,781

United States Patent and Trademark Office

Registered Feb. 17, 2009

**TRADEMARK
PRINCIPAL REGISTER**

Classified Flea Market

TARGET MEDIA PARTNERS OPERATING COMPANY, LLC (DELAWARE LIMITED LIABILITY COMPANY)

5900 WILSHIRE BLVD, SUITE 550
LOS ANGELES, CA 90036

FOR: NEWSPAPERS IN THE FIELD OF CLASSIFIED AD SALES, IN CLASS 16 (U.S. CLS. 2, 5, 22, 23, 29, 37, 38 AND 50).

FIRST USE 5-15-1969; IN COMMERCE 5-14-1970.

THE MARK CONSISTS OF STANDARD CHARACTERS WITHOUT CLAIM TO ANY PARTICULAR FONT, STYLE, SIZE, OR COLOR.

NO CLAIM IS MADE TO THE EXCLUSIVE RIGHT TO USE "CLASSIFIED", APART FROM THE MARK AS SHOWN.

SER. NO. 77-346,559, FILED 12-7-2007.

DANIEL CAPSHAW, EXAMINING ATTORNEY

Int. Cls.: 35, 41 and 43

Prior U.S. Cls.: 100, 101, 102 and 107

United States Patent and Trademark Office

Reg. No. 3,574,782

Registered Feb. 17, 2009

**SERVICE MARK
PRINCIPAL REGISTER**

**NEW YORK WINE & CULINARY
CENTER**

THE NEW YORK STATE WINE AND CULINARY
CENTER, INC. (NEW YORK CORPORATION)
800 SOUTH MAIN STREET
CANANDAIGUA, NY 14424

FOR: RETAIL SHOPS FEATURING CULINARY
TOOLS, GLASSWARE, WINE ACCESSORIES,
GIFTS, APPAREL, JEWELRY, FOODS, BEVERA-
GES, BOOKS, CARDS, NOVELTIES, STATIONARY
AND SOUVENIRS, IN CLASS 35 (U.S. CLS. 100, 101
AND 102).

FIRST USE 6-17-2006; IN COMMERCE 6-17-2006.

FOR: EDUCATION SERVICES, NAMELY, PRO-
VIDING CLASSES, SEMINARS, WORKSHOPS,
TASTINGS, AND DEMONSTRATIONS IN THE
FIELD OF FOOD, WINE, BEER, COOKING, BAK-
ING, GROWING, AND KITCHEN TECHNIQUES;
DEMONSTRATIONS AND TOURS OF WINERIES,
FARMS AND FOOD PREPARATION FACILITIES;
EDUCATIONAL VIDEO AND PHOTO INTERAC-
TIVE DISPLAYS ABOUT THE HISTORY AND
CHARACTERISTICS OF NEW YORK'S AGRICUL-
TURE, WINE, FOOD AND CULINARY TRADES;
EDUCATIONAL SERVICES, NAMELY, CONDUCT-
ING EXHIBITIONS AND DISPLAYS, NAMELY,
FOOD SAMPLING OF NEW YORK FOOD PRO-
DUCTS, IN CLASS 41 (U.S. CLS. 100, 101 AND 107).

FIRST USE 6-17-2006; IN COMMERCE 6-17-2006.

FOR: BAR SERVICES; CATERING; RESTAU-
RANT; SNACK BARS; WINE BARS; CAFE; PRE-
PARATION OF FOOD AND BEVERAGES;
RESTAURANT SERVICES; PROVIDING A DATA-
BASE IN THE FIELD OF RECIPES AND COOKING
INFORMATION; PROVIDING BANQUET AND SO-
CIAL FUNCTION FACILITIES FOR SPECIAL OC-
CASIONS; PROVIDING CONFERENCE ROOMS;
PROVISION OF CONFERENCE FACILITIES; PRO-
VISION OF CONFERENCE, EXHIBITION AND
MEETING FACILITIES; SOMMELIER SERVICES,
NAMELY, PROVIDING ADVICE ON WINE AND
WINE AND FOOD PAIRING, IN CLASS 43 (U.S. CLS.
100 AND 101).

FIRST USE 6-17-2006; IN COMMERCE 6-17-2006.

THE MARK CONSISTS OF STANDARD CHAR-
ACTERS WITHOUT CLAIM TO ANY PARTICULAR
FONT, STYLE, SIZE, OR COLOR.

NO CLAIM IS MADE TO THE EXCLUSIVE
RIGHT TO USE "WINE & CULINARY CENTER" ,
APART FROM THE MARK AS SHOWN.

SEC. 2(F).

SER. NO. 77-347,190, FILED 12-7-2007.

CAROLYN CATALDO, EXAMINING ATTORNEY

Int. Cl.: 7

Prior U.S. Cls.: 13, 19, 21, 23, 31, 34 and 35

United States Patent and Trademark Office

Reg. No. 3,574,783

Registered Feb. 17, 2009

**TRADEMARK
PRINCIPAL REGISTER**

TINTMASTER

FLUID MANAGEMENT, INC. (DELAWARE
CORPORATION)
1023 WHEELING ROAD
WHEELING, IL 60090

FOR: POWER-OPERATED DISPENSERS FOR
COLORANTS FOR INDUSTRIAL USE; POWER-OP-
ERATED LIQUID LUBRICANT DISPENSERS FOR
MACHINES, IN CLASS 7 (U.S. CLS. 13, 19, 21, 23, 31, 34
AND 35).

FIRST USE 1-1-1959; IN COMMERCE 1-1-1959.

THE MARK CONSISTS OF STANDARD CHAR-
ACTERS WITHOUT CLAIM TO ANY PARTICULAR
FONT, STYLE, SIZE, OR COLOR.

OWNER OF U.S. REG. NO. 1,472,861.

SER. NO. 77-348,181, FILED 12-10-2007.

MARY BOAGNI, EXAMINING ATTORNEY

Int. Cls.: 35, 36, 38, 39 and 40

Prior U.S. Cls.: 100, 101, 102, 103, 104, 105 and 106

United States Patent and Trademark Office

Reg. No. 3,574,784

Registered Feb. 17, 2009

**SERVICE MARK
PRINCIPAL REGISTER**

SPEEDWAY

SPEEDWAY SUPERAMERICA LLC (DELAWARE
LIMITED LIABILITY COMPANY)
500 SPEEDWAY DRIVE
ENON, OH 45323

FOR: PROVIDING AN INCENTIVE AWARD PROGRAM FOR CUSTOMER LOYALTY/FREQUENT PURCHASES VIA ELECTRONIC KIOSKS, IN CLASS 35 (U.S. CLS. 100, 101 AND 102).

FIRST USE 3-31-2002; IN COMMERCE 3-31-2002.

FOR: PROVIDING FINANCIAL SERVICES VIA A SELF-SERVE ATM, NAMELY, PROVIDING ON-LINE CASH TRANSACTIONS, MONEY ORDERS, MONEY TRANSFERS AND BILL PAYING, IN CLASS 36 (U.S. CLS. 100, 101 AND 102).

FIRST USE 3-31-2002; IN COMMERCE 3-31-2002.

FOR: PROVIDING USER ACCESS TO A GLOBAL COMPUTER NETWORK AND TO DATABASES VIA ELECTRONIC KIOSKS, IN CLASS 38 (U.S. CLS. 100, 101 AND 104).

FIRST USE 3-31-2002; IN COMMERCE 3-31-2002.

FOR: PROVIDING A WEBSITE AND WEBSITE LINKS TO MAP IMAGES AND TRIP ROUTING VIA ELECTRONIC KIOSKS, IN CLASS 39 (U.S. CLS. 100 AND 105).

FIRST USE 3-31-2002; IN COMMERCE 3-31-2002.

FOR: PRINTING OF PHOTOGRAPHIC IMAGES FROM DIGITAL MEDIA VIA ELECTRONIC KIOSKS, IN CLASS 40 (U.S. CLS. 100, 103 AND 106).

FIRST USE 3-31-2002; IN COMMERCE 3-31-2002.

THE MARK CONSISTS OF STANDARD CHARACTERS WITHOUT CLAIM TO ANY PARTICULAR FONT, STYLE, SIZE, OR COLOR.

OWNER OF U.S. REG. NOS. 1,592,374, 2,980,063 AND OTHERS.

SER. NO. 77-349,220, FILED 12-11-2007.

ANNE MADDEN, EXAMINING ATTORNEY

Int. Cl.: 40

Prior U.S. Cls.: 100, 103 and 106

United States Patent and Trademark Office

Reg. No. 3,574,785

Registered Feb. 17, 2009

**SERVICE MARK
PRINCIPAL REGISTER**

Nature Mandalas

TRENTELMAN, ALLISON P (UNITED STATES
INDIVIDUAL), DBA ROCKY TOP STUDIO
22 WHITE ORCHARD RD.
FRANKFORT, ME 04438

FOR: PHOTOGRAPHIC COMPUTER IMAGING,
IN CLASS 40 (U.S. CLS. 100, 103 AND 106).

FIRST USE 11-8-2004; IN COMMERCE 1-1-2005.

THE MARK CONSISTS OF STANDARD CHAR-
ACTERS WITHOUT CLAIM TO ANY PARTICULAR
FONT, STYLE, SIZE, OR COLOR.

NO CLAIM IS MADE TO THE EXCLUSIVE
RIGHT TO USE "MANDALAS", APART FROM
THE MARK AS SHOWN.

SER. NO. 77-349,485, FILED 12-11-2007.

MICHAEL LITZAU, EXAMINING ATTORNEY

Prior U.S. Cl.: B

United States Patent and Trademark Office

Reg. No. 3,574,786

Registered Feb. 17, 2009

**CERTIFICATION MARK
PRINCIPAL REGISTER**

**REGISTERED ENVIRONMENTAL
MANAGER**

NATIONAL REGISTRY OF ENVIRONMENTAL
PROFESSIONALS (ILLINOIS NON-PROFIT
CORPORATION)
P.O. BOX 2099
GLENVIEW, IL 60025

FOR: PROVIDING AUDITS, ASSESSMENTS,
TECHNICAL AND SCIENTIFIC SUPPORT, IMPLI-
MENTATION, COORDINATION, AND MANAGE-
MENT, OF ENVIRONMENTAL PROGRAMS AND
PROJECTS, IN CLASS B (U.S. CL. B).

FIRST USE 1-31-1988; IN COMMERCE 1-31-1988.

THE MARK CONSISTS OF STANDARD CHAR-
ACTERS WITHOUT CLAIM TO ANY PARTICULAR
FONT, STYLE, SIZE, OR COLOR.

NO CLAIM IS MADE TO THE EXCLUSIVE
RIGHT TO USE "ENVIRONMENTAL MANAGER",
APART FROM THE MARK AS SHOWN.

THE CERTIFICATION MARK, AS USED BY
AUTHORIZED PERSONS, CERTIFIES THAT SUCH
PERSON HAS MET THE ENVIRONMENTAL
KNOWLEDGE AND EXPERIENCE STANDARDS
ESTABLISHED BY THE CERTIFIER.

SEC. 2(F).

SER. NO. 77-349,750, FILED 12-12-2007.

LINDA LAVACHE, EXAMINING ATTORNEY

Prior U.S. Cl.: B

United States Patent and Trademark Office

Reg. No. 3,574,787

Registered Feb. 17, 2009

**CERTIFICATION MARK
PRINCIPAL REGISTER**

REM

NATIONAL REGISTRY OF ENVIRONMENTAL
PROFESSIONALS (ILLINOIS NON-PROFIT
CORPORATION)
P.O. BOX 2099
GLENVIEW, IL 60025

FOR: PROVIDING AUDITS, ASSESSMENTS,
TECHNICAL AND SCIENTIFIC SUPPORT, IMPLI-
MENTATION, COORDINATION, AND MANAGE-
MENT, OF ENVIRONMENTAL PROGRAMS AND
PROJECTS, IN CLASS B (U.S. CL. B).

FIRST USE 5-1-1989; IN COMMERCE 5-1-1989.

THE MARK CONSISTS OF STANDARD CHAR-
ACTERS WITHOUT CLAIM TO ANY PARTICULAR
FONT, STYLE, SIZE, OR COLOR.

THE CERTIFICATION MARK, AS USED BY
AUTHORIZED PERSONS, CERTIFIES THAT SUCH
PERSON HAS MET THE ENVIRONMENTAL
KNOWLEDGE AND EXPERIENCE STANDARDS
ESTABLISHED BY THE CERTIFIER.

SER. NO. 77-349,756, FILED 12-12-2007.

LINDA LAVACHE, EXAMINING ATTORNEY

Int. Cl.: 24

Prior U.S. Cls.: 42 and 50

United States Patent and Trademark Office

Reg. No. 3,574,788

Registered Feb. 17, 2009

**TRADEMARK
PRINCIPAL REGISTER**

CUBICLE CURTAIN FACTORY

CUBICLE CURTAIN FACTORY, INC. (FLORIDA CORPORATION)
425 KANUGA DRIVE
WEST PALM BEACH, FL 33401

FOR: CURTAINS, BEDPREADS, DRAPERY TREATMENTS, NAMELY, DRAPERY, VALANCE TREATMENTS, NAMELY, FABRIC VALANCES, CURTAIN CLOTH TIEBACKS OF TEXTILE, SHOWER CURTAINS, CLOTH BLACKOUT CURTAINS, IN CLASS 24 (U.S. CLS. 42 AND 50).

FIRST USE 2-27-1997; IN COMMERCE 1-3-2000.

THE MARK CONSISTS OF STANDARD CHARACTERS WITHOUT CLAIM TO ANY PARTICULAR FONT, STYLE, SIZE, OR COLOR.

NO CLAIM IS MADE TO THE EXCLUSIVE RIGHT TO USE "CUBICLE CURTAIN", APART FROM THE MARK AS SHOWN.

SEC. 2(F).

SER. NO. 77-349,957, FILED 12-12-2007.

BONNIE LUKEN, EXAMINING ATTORNEY

Int. Cl.: 9

Prior U.S. Cls.: 21, 23, 26, 36 and 38

United States Patent and Trademark Office

Reg. No. 3,574,789

Registered Feb. 17, 2009

**TRADEMARK
PRINCIPAL REGISTER**

TOKUTEK

TOKUTEK, INC. (DELAWARE CORPORATION)
1 MILITIA DRIVE, #11
LEXINGTON, MA 02421

THE MARK CONSISTS OF STANDARD CHAR-
ACTERS WITHOUT CLAIM TO ANY PARTICULAR
FONT, STYLE, SIZE, OR COLOR.

FOR: COMPUTER SOFTWARE FOR STORAGE
AND RETRIEVAL OF DATA AND DOCUMENTS,
IN CLASS 9 (U.S. CLS. 21, 23, 26, 36 AND 38).

SER. NO. 77-350,090, FILED 12-12-2007.

FIRST USE 7-0-2007; IN COMMERCE 7-0-2007.

REBECCA SMITH, EXAMINING ATTORNEY

Int. Cl.: 35

Prior U.S. Cls.: 100, 101 and 102

United States Patent and Trademark Office

Reg. No. 3,574,790

Registered Feb. 17, 2009

**SERVICE MARK
PRINCIPAL REGISTER**



CCS MEDICAL, INC. (DELAWARE CORPORATION)

14255 49TH STREET NORTH, SUITE 301
CLEARWATER, FL 33762

FOR: TELEPHONE AND MAIL ORDER SERVICES FEATURING PHARMACEUTICAL PREPARATIONS AND MEDICAL SUPPLIES FOR CHRONIC ILLNESSES, NAMELY, DIABETES, RESPIRATORY CONDITIONS, WOUND CARE, UROLOGICAL CONDITIONS, INCONTINENCE, AND OSTOMY PATIENTS, IN CLASS 35 (U.S. CLS. 100, 101 AND 102).

FIRST USE 1-2-2004; IN COMMERCE 1-2-2004.

NO CLAIM IS MADE TO THE EXCLUSIVE RIGHT TO USE "MEDICAL", APART FROM THE MARK AS SHOWN.

THE MARK CONSISTS OF THE LETTERS "CCS" ABOVE A LINE, WITH THE WORD "MEDICAL" BELOW THE LINE, AND WITH FOUR RECTANGLES OF DIFFERENT SIZES ABOVE AND TO THE LEFT OF THE LETTERS "CCS".

SER. NO. 77-350,109, FILED 12-12-2007.

ERIN FALK, EXAMINING ATTORNEY

Int. Cl.: 41

Prior U.S. Cls.: 100, 101 and 107

United States Patent and Trademark Office

Reg. No. 3,574,791

Registered Feb. 17, 2009

**SERVICE MARK
PRINCIPAL REGISTER**



LONE STAR YOGA, LLC (TEXAS LIMITED LIABILITY COMPANY)
SUITE 112B
112 W. WASHINGTON STREET
WHITNEY, TX 76692

FOR: YOGA INSTRUCTION, IN CLASS 41 (U.S. CLS. 100, 101 AND 107).

FIRST USE 11-1-2007; IN COMMERCE 11-1-2007.

NO CLAIM IS MADE TO THE EXCLUSIVE RIGHT TO USE "LONE STAR YOGA", APART FROM THE MARK AS SHOWN.

THE COLOR(S) RED, BLUE, WHITE, GOLD IS/ ARE CLAIMED AS A FEATURE OF THE MARK.

THE MARK CONSISTS OF A WHITE STAR OUTLINED IN GOLD SUPERIMPOSED ON A RED QUOTE MARK THAT IS PART OF A RED CIRCLE WITH A BLUE BACKGROUND. THE WORDS "LONE STAR YOGA" APPEAR ABOVE THE CIRCLE IN THE COLOR RED AND THE WORDS "EAST GOES WEST" APPEAR BELOW THE CIRCLE IN THE COLOR RED. ALL WORDING FOLLOWS THE SHAPE OF THE CIRCLE. FURTHERMORE, THERE ARE THREE SMALL, BLUE DECORATIVE LINES ON EACH SIDE OF THE CIRCULAR DESIGN.

SER. NO. 77-350,188, FILED 12-12-2007.

TINA L. SNAPP, EXAMINING ATTORNEY

Int. Cls.: 29 and 30

Prior U.S. Cl.: 46

United States Patent and Trademark Office

Reg. No. 3,574,792

Registered Feb. 17, 2009

**TRADEMARK
PRINCIPAL REGISTER**



EMBOTELLADORA DE AGUAS GASEOSAS
HUANCAYO S.R.L. (PERU SOCIEDAD DE
RESPONSABILIDAD LIMITADA (SRL))
SANTA MARIA DE HUACHIPA
AV. LA PAZ, LOTE 25
LIMA, PERU

FOR: MILK; DAIRY PRODUCTS EXCLUDING
ICE CREAM, ICE MILK AND FROZEN YOGURT;
EDIBLE OILS AND FATS; SOY-BASED FOOD BEV-
ERAGE USED AS A MILK SUBSTITUTE, IN CLASS
29 (U.S. CL. 46).

FOR: BREAD; DOUGH; FLOUR; FOOD LEAVEN-
ING AGENTS; FROZEN CONFECTIONERY; FRO-
ZEN YOGHURT; ICE CREAM; MOLASSES SYRUP;
PASTRIES; PROCESSED CEREALS; BAKING-POW-
DER, IN CLASS 30 (U.S. CL. 46).

PRIORITY CLAIMED UNDER SEC. 44(D) ON
PERU APPLICATION NO. 338248-07, FILED 12-12-
2007, REG. NO. 00138962, DATED 6-2-2008, EXPIRES
6-2-2018.

PRIORITY CLAIMED UNDER SEC. 44(D) ON
PERU APPLICATION NO. 338247-07, FILED 12-12-
2007, REG. NO. 00138961, DATED 6-2-2008, EXPIRES
6-2-2018.

THE MARK CONSISTS OF A DESIGN IN THE
FORM OF A HEART WITH THE STYLIZED WORD-
ING "BIANCA" IN IT.

SER. NO. 77-350,973, FILED 12-13-2007.

DORITT L. CARROLL, EXAMINING ATTORNEY

Int. Cl.: 42

Prior U.S. Cls.: 100 and 101

United States Patent and Trademark Office

Reg. No. 3,574,793

Registered Feb. 17, 2009

**SERVICE MARK
PRINCIPAL REGISTER**

CHANGING THE WAY CANCER IS
TREATED

ONYX PHARMACEUTICALS, INC. (DELAWARE
CORPORATION)
2100 POWELL STREET
EMERYVILLE, CA 94608

FOR: PHARMACEUTICAL RESEARCH AND DE-
VELOPMENT; MEDICAL AND SCIENTIFIC RE-
SEARCH, NAMELY, CONDUCTING CLINICAL
TRIALS; MEDICAL AND SCIENTIFIC RESEARCH
IN THE FIELD OF TREATMENT FOR CANCER
AND ONCOLOGY, IN CLASS 42 (U.S. CLS. 100 AND
101).

FIRST USE 7-0-2002; IN COMMERCE 7-0-2002.

THE MARK CONSISTS OF STANDARD CHAR-
ACTERS WITHOUT CLAIM TO ANY PARTICULAR
FONT, STYLE, SIZE, OR COLOR.

OWNER OF U.S. REG. NOS. 3,063,994 AND
3,063,997.

SER. NO. 77-351,251, FILED 12-13-2007.

LESLEY LAMOTHE, EXAMINING ATTORNEY

Int. Cls.: 35 and 36

Prior U.S. Cls.: 100, 101 and 102

United States Patent and Trademark Office

Reg. No. 3,574,794

Registered Feb. 17, 2009

**SERVICE MARK
PRINCIPAL REGISTER**



CORPORATE INVESTMENT INTERNATIONAL,
INC. (FLORIDA CORPORATION)
1999 W. COLONIAL DRIVE
ORLANDO, FL 32804

FOR: BUSINESS CONSULTING SERVICES, CONSULTING IN THE FIELDS OF BUSINESS ACQUISITIONS AND MERGERS, BUSINESS MARKETING, CONSULTING IN THE FIELD OF REAL ESTATE SALES, NAMELY, REAL ESTATE ADVERTISING, IN CLASS 35 (U.S. CLS. 100, 101 AND 102).

FIRST USE 9-1-2007; IN COMMERCE 9-1-2007.

FOR: BUSINESS BROKERAGE SERVICES, BUSINESS VALUATION, BUSINESS MERGER AND ACQUISITION SERVICES, NAMELY, ACQUISITION OR TRANSFER OF MONETARY CLAIMS, INVESTMENT SERVICES IN THE NATURE OF ASSET ACQUISITION, REAL ESTATE BROKERAGE, IN CLASS 36 (U.S. CLS. 100, 101 AND 102).

FIRST USE 9-1-2007; IN COMMERCE 9-1-2007.

OWNER OF U.S. REG. NO. 3,112,082.

NO CLAIM IS MADE TO THE EXCLUSIVE RIGHT TO USE "CORPORATE INVESTMENT INTERNATIONAL", APART FROM THE MARK AS SHOWN.

THE COLOR(S) BLUE AND GOLD IS/ARE CLAIMED AS A FEATURE OF THE MARK.

THE MARK CONSISTS OF THE WORDING "CII CORPORATE INVESTMENT INTERNATIONAL" IN BLUE, SUPERIMPOSED ON A GLOBE OF THE WORLD SHOWING THE OUTLINE OF THE WESTERN HEMISPHERE DRAWN IN GOLD.

SER. NO. 77-351,332, FILED 12-13-2007.

ALLISON SCHRODY, EXAMINING ATTORNEY

Int. Cl.: 3

Prior U.S. Cls.: 1, 4, 6, 50, 51 and 52

United States Patent and Trademark Office

Reg. No. 3,574,795

Registered Feb. 17, 2009

TRADEMARK
PRINCIPAL REGISTER



CYCLO TOOLMAKERS, INC. (COLORADO CORPORATION)
1740 SKYWAY DRIVE
LONGMONT, CO 80504

FOR: POLISHING PREPARATIONS FOR USE WITH ELECTRIC POLISHERS, IN CLASS 3 (U.S. CLS. 1, 4, 6, 50, 51 AND 52).

FIRST USE 2-15-2005; IN COMMERCE 2-15-2005.

OWNER OF U.S. REG. NO. 3,208,025.

NO CLAIM IS MADE TO THE EXCLUSIVE RIGHT TO USE "INCORPORATED", APART FROM THE MARK AS SHOWN.

THE MARK CONSISTS OF THE WORD "CYCLO" INSIDE AN OVAL WITHIN AN OVAL AND THE WORDS "TOOLMAKERS INCORPORATED" BORDERING THE PERIMETER OF AN OVAL.

SER. NO. 77-351,671, FILED 12-13-2007.

NELSON SNYDER, EXAMINING ATTORNEY

Int. Cl.: 6

Prior U.S. Cls.: 2, 12, 13, 14, 23, 25 and 50

Reg. No. 3,574,796

United States Patent and Trademark Office

Registered Feb. 17, 2009

**TRADEMARK
PRINCIPAL REGISTER**



ARCUS AUSTRALIA PTY LTD (AUSTRALIA CORPORATION)
UNIT 2
6-8 GREENFIELD STREET
BANKSMEADOW, AUSTRALIA 2019

FOR: METAL GOODS, NAMELY, NON-ELECTRIC METAL WIRES AND METAL ROPES, NON-ELECTRIC STAINLESS STEEL WIRES AND STAINLESS STEEL ROPES, AWNINGS OF METAL, AWNINGS OF STAINLESS STEEL, CLAMPS OF METAL FOR FIXING AWNINGS, STAINLESS STEEL IN STRIP FORM, LOOPS OF METAL FOR WIRE ROPES, CONNECTORS OF METAL FOR USE WITH RIGGING, METAL CLAMPS, NON-ELECTRIC MULTI-STRAND METAL WIRE, METAL WIRE THREAD FOR USE IN MARINE AND ARCHITECTURAL RIGGING APPLICATIONS, MASTS OF METAL, MAST FITTINGS OF METAL FOR YACHTS AND OTHER WATERCRAFT, SUPPORTS OF METAL FOR RIGS, BOAT ANCHORS OF METAL, METAL RODS FOR USE WITH MARINE AND ARCHITECTURAL RIGGING APPLICATIONS, METAL REINFORCEMENT MATERIALS FOR CONSTRUCTION AND BUILDING, NAMELY, CHAINS, HOOKS, BARS, RODS, WIRES, ROPES; REINFORCEMENT BARS AND RODS OF METAL FOR MARINE AND ARCHITECTURAL RIGGING APPLICATIONS, STAINLESS STEEL REINFORCING RODS FOR CONCRETE CONSTRUCTION AND BUILDING WORKS, METAL HARDWARE FOR ROOFS, NAMELY, SHEET STEEL AND HIGH TEN-

SILE STEEL, METAL GOODS FOR USE IN CONSTRUCTION AND BUILDING, NAMELY, STAINLESS STEEL, STEEL WIRE, WIRE ROPE AND GALVANIZED METAL FITTINGS, METAL HARDWARE FOR BUILDINGS, NAMELY, STAINLESS STEEL, STEEL WIRE, WIRE ROPE AND GALVANIZED METAL FITTINGS, CLADDING OF METAL FOR CONSTRUCTION AND BUILDING, DEVICES OF METAL FOR USE IN REINFORCING CONCRETE, NAMELY, STRENGTHENED BEAMS AND RODS OF STEEL, METAL REINFORCEMENT MATERIALS FOR CIVIL ENGINEERING, NAMELY, METAL WIRE, WIRE ROPES, MASTS OF METAL, METAL RODS AND AWNINGS OF STAINLESS STEEL, REINFORCING METAL WIRE MESH, METAL HARDWARE FOR ARCHITECTURAL PURPOSES, NAMELY, STAINLESS STEEL, STEEL WIRE, WIRE ROPE AND GALVANIZED METAL FITTINGS, IN CLASS 6 (U.S. CLS. 2, 12, 13, 14, 23, 25 AND 50).

PRIORITY CLAIMED UNDER SEC. 44(D) ON AUSTRALIA APPLICATION NO. 1195084, FILED 8-23-2007, REG. NO. 1195084, DATED 9-23-2007, EXPIRES 8-23-2017.

SER. NO. 77-351,928, FILED 12-14-2007.

WILLIAM P. SHANAHAN, EXAMINING ATTORNEY

Int. Cl.: 42

Prior U.S. Cls.: 100 and 101

United States Patent and Trademark Office

Reg. No. 3,574,797

Registered Feb. 17, 2009

**SERVICE MARK
PRINCIPAL REGISTER**



FIREGIANTS, INC. (WASHINGTON CORPORATION)
8826 122ND AVE. NE
KIRKLAND, WA 98033

FOR: CREATING, DESIGNING, HOSTING AND MAINTAINING WEB SITES; SOFTWARE DESIGN AND DEVELOPMENT; DATABASE DESIGN AND DEVELOPMENT, IN CLASS 42 (U.S. CLS. 100 AND 101).

FIRST USE 11-1-2007; IN COMMERCE 11-1-2007.

THE MARK CONSISTS OF TEAR DROP FLAME IN MOTION.

SER. NO. 77-352,367, FILED 12-14-2007.

DEIRDRE ROBERTSON, EXAMINING ATTORNEY

Int. Cl.: 42

Prior U.S. Cls.: 100 and 101

United States Patent and Trademark Office

Reg. No. 3,574,798

Registered Feb. 17, 2009

**SERVICE MARK
PRINCIPAL REGISTER**

FIREGIANTS

FIREGIANTS, INC. (WASHINGTON CORPORATION)
8826 122ND AVE. NE
KIRKLAND, WA 98033

FOR: CREATING, DESIGNING, HOSTING AND MAINTAINING WEB SITES; SOFTWARE DESIGN AND DEVELOPMENT; DATABASE DESIGN AND DEVELOPMENT, IN CLASS 42 (U.S. CLS. 100 AND 101).

FIRST USE 11-1-2007; IN COMMERCE 11-1-2007.

THE MARK CONSISTS OF STANDARD CHARACTERS WITHOUT CLAIM TO ANY PARTICULAR FONT, STYLE, SIZE, OR COLOR.

SER. NO. 77-352,380, FILED 12-14-2007.

DEIRDRE ROBERTSON, EXAMINING ATTORNEY

Int. Cl.: 25

Prior U.S. Cls.: 22 and 39

United States Patent and Trademark Office

Reg. No. 3,574,799

Registered Feb. 17, 2009

**TRADEMARK
PRINCIPAL REGISTER**

Achieve o2

ACHIEVE O2 LLC (NORTH CAROLINA LIMITED
LIABILITY COMPANY)
27 CONGRESS STREET LOWER LEVEL
SALEM, MA 01970

FOR: SOCKS; HOSIERY, IN CLASS 25 (U.S. CLS. 22
AND 39).

FIRST USE 11-1-2003; IN COMMERCE 11-1-2003.

THE MARK CONSISTS OF STANDARD CHAR-
ACTERS WITHOUT CLAIM TO ANY PARTICULAR
FONT, STYLE, SIZE, OR COLOR.

SER. NO. 77-352,845, FILED 12-14-2007.

DOMINIC J. FERRAIUOLO, EXAMINING ATTOR-
NEY

Int. Cl.: 35

Prior U.S. Cls.: 100, 101 and 102

United States Patent and Trademark Office

Reg. No. 3,574,800

Registered Feb. 17, 2009

**SERVICE MARK
PRINCIPAL REGISTER**

**PUSHING FOR BETTER
SOLUTIONS**

CONTROLLED ENTRY DISTRIBUTORS, INC.
(UTAH CORPORATION)
2500 SOUTH 3850 WEST, SUITE A
SALT LAKE CITY, UT 84120

FOR: DISTRIBUTORSHIP SERVICES IN THE
FIELD OF TRANSMITTERS, GATE OPERATORS,
AND ACCESS CONTROL SYSTEMS, IN CLASS 35
(U.S. CLS. 100, 101 AND 102).

FIRST USE 11-30-2007; IN COMMERCE 11-30-2007.

THE MARK CONSISTS OF STANDARD CHAR-
ACTERS WITHOUT CLAIM TO ANY PARTICULAR
FONT, STYLE, SIZE, OR COLOR.

SER. NO. 77-352,854, FILED 12-14-2007.

DOMINIC J. FERRAIUOLO, EXAMINING ATTOR-
NEY

Int. Cl.: 35

Prior U.S. Cls.: 100, 101 and 102

United States Patent and Trademark Office

Reg. No. 3,574,801

Registered Feb. 17, 2009

SERVICE MARK
PRINCIPAL REGISTER



KORETKO, INC. (COLORADO CORPORATION),
DBA DAN-INJECT NORTH AMERICA
5813 CARROLL CREEK LANE
KNOXVILLE, TN 37912

FOR: ON-LINE RETAIL STORE SERVICES FEATURING CHEMICAL IMMOBILIZATION EQUIPMENT FOR VETERINARY USE, IN CLASS 35 (U.S. CLS. 100, 101 AND 102).

FIRST USE 6-2-2003; IN COMMERCE 6-3-2003.

NO CLAIM IS MADE TO THE EXCLUSIVE RIGHT TO USE "NORTH AMERICA", APART FROM THE MARK AS SHOWN.

"THE COLOR(S) BLUE, BLACK, RED, YELLOW, GREEN, GRAY AND WHITE IS/ARE CLAIMED AS A FEATURE OF THE MARK."

"THE MARK CONSISTS OF A DESIGN OF A STYLIZED BEAR WITH A PLUMED TRANQUILIZER DART IN THE BEAR'S REAR FLANK; BELOW THE BEAR DESIGN IS A DESIGN OF A GUN; OVERLAYING THE BEAR AND GUN DESIGNS IS A CIRCULAR TARGET DESIGN WITH CROSSHAIRS;

CURVED ABOVE THE DESIGN ELEMENTS IS THE WORDING DAN-INJECT; CURVED BELOW THE DESIGN ELEMENTS IS THE WORDING NORTH AMERICA; PORTIONS OF THE BEAR, TRANQUILIZER DART AND GUN DESIGNS OVERLAP THE CIRCULAR EDGE OF THE TARGET DESIGN AND THE LETTER "C" IN THE WORD "INJECT" AND THE LETTERS "ER" IN THE WORD "AMERICA". THE COLOR BLUE APPEARS ON THE WORDING "DAN-INJECT" AND "NORTH AMERICA"; THE COLOR BLACK APPEARS THE DESIGNS OF THE BEAR AND GUN; THE COLOR RED APPEARS ON THE DESIGNS OF THE TARGET AND CROSSHAIRS, THE TRANQUILIZER DART AND PLUME OF THE DART; THE COLOR YELLOW APPEARS ON THE DESIGN OF THE TRANQUILIZER DART; THE COLOR GREEN APPEARS ON THE DESIGN OF THE GUN; THE COLOR GRAY APPEARS ON THE DESIGNS OF THE TRANQUILIZER DART AND THE GUN; AND THE COLOR WHITE APPEARS ON THE DESIGN OF THE BEAR AND AS THE MARK BACKGROUND."

SER. NO. 77-353,046, FILED 12-15-2007.

KAELIE KUNG, EXAMINING ATTORNEY

Int. Cl.: 20

Prior U.S. Cls.: 2, 13, 22, 25, 32 and 50

United States Patent and Trademark Office

Reg. No. 3,574,802

Registered Feb. 17, 2009

**TRADEMARK
PRINCIPAL REGISTER**

PLANT BUTLER

RIDGEFIELD PRODUCTS, INC. (ILLINOIS CORPORATION)

2955 N. MAIN STREET

PRINCETON, IL 61356

FOR: PLANT STANDS, IN CLASS 20 (U.S. CLS. 2, 13, 22, 25, 32 AND 50).

FIRST USE 6-5-2003; IN COMMERCE 6-5-2003.

THE MARK CONSISTS OF STANDARD CHARACTERS WITHOUT CLAIM TO ANY PARTICULAR FONT, STYLE, SIZE, OR COLOR.

NO CLAIM IS MADE TO THE EXCLUSIVE RIGHT TO USE "PLANT", APART FROM THE MARK AS SHOWN.

SER. NO. 77-353,547, FILED 12-17-2007.

JULIE WATSON, EXAMINING ATTORNEY

Int. Cls.: 16 and 41

Prior U.S. Cls.: 2, 5, 22, 23, 29, 37, 38, 50, 100, 101 and 107

Reg. No. 3,574,803

United States Patent and Trademark Office

Registered Feb. 17, 2009

**TRADEMARK
SERVICE MARK
PRINCIPAL REGISTER**

Lesson on Golf

LESSON, JEFFREY S. (UNITED STATES INDIVIDUAL)
SUITE 1800
3000 TOWN CENTER
SOUTHFIELD, MI 48075

FOR: SYNDICATED NEWSPAPER COLUMNS IN THE FIELD OF GOLF, IN CLASS 16 (U.S. CLS. 2, 5, 22, 23, 29, 37, 38 AND 50).

FIRST USE 12-31-1997; IN COMMERCE 12-31-1997.

FOR: ENTERTAINMENT SERVICES, NAMELY, AN ON-GOING SERIES FEATURING GOLF PROVIDED THROUGH RADIO BROADCASTS AND WEBCASTS, IN CLASS 41 (U.S. CLS. 100, 101 AND 107).

FIRST USE 12-31-1997; IN COMMERCE 12-31-1997.

THE MARK CONSISTS OF STANDARD CHARACTERS WITHOUT CLAIM TO ANY PARTICULAR FONT, STYLE, SIZE, OR COLOR.

NO CLAIM IS MADE TO THE EXCLUSIVE RIGHT TO USE "GOLF", APART FROM THE MARK AS SHOWN.

SER. NO. 77-353,654, FILED 12-17-2007.

SHANNON TWOHIG, EXAMINING ATTORNEY

Int. Cl.: 35

Prior U.S. Cls.: 100, 101 and 102

United States Patent and Trademark Office

Reg. No. 3,574,804

Registered Feb. 17, 2009

**SERVICE MARK
PRINCIPAL REGISTER**

BILLINGTON WINES

BILLINGTON IMPORTS, INC. (VIRGINIA CORPORATION)
7536E FULLERTON CT
SPRINGFIELD, VA 22153

FOR: DISTRIBUTORSHIP SERVICES IN THE FIELD OF WINE, BEVERAGES AND FOOD; IMPORT SERVICES IN THE FIELD OF WINE, BEVERAGES AND FOOD; ADVERTISING SERVICES, NAMELY, PROMOTING THE FOOD AND WINE OF OTHERS; BUSINESS MANAGEMENT AND BUSINESS ADMINISTRATION SERVICES FOR OTHERS, IN CLASS 35 (U.S. CLS. 100, 101 AND 102).

FIRST USE 3-22-1985; IN COMMERCE 3-22-1985.

THE MARK CONSISTS OF STANDARD CHARACTERS WITHOUT CLAIM TO ANY PARTICULAR FONT, STYLE, SIZE, OR COLOR.

NO CLAIM IS MADE TO THE EXCLUSIVE RIGHT TO USE "WINES", APART FROM THE MARK AS SHOWN.

SEC. 2(F).

SER. NO. 77-353,974, FILED 12-17-2007.

TINA L. SNAPP, EXAMINING ATTORNEY

Int. Cl.: 33

Prior U.S. Cls.: 47 and 49

United States Patent and Trademark Office

Reg. No. 3,574,805

Registered Feb. 17, 2009

**TRADEMARK
PRINCIPAL REGISTER**

BILLINGTON WINES

BILLINGTON IMPORTS, INC. (VIRGINIA CORPORATION)
7536E FULLERTON CT
SPRINGFIELD, VA 22153

NO CLAIM IS MADE TO THE EXCLUSIVE RIGHT TO USE "WINES", APART FROM THE MARK AS SHOWN.

FOR: ALCOHOLIC BEVERAGES, NAMELY, WINES, IN CLASS 33 (U.S. CLS. 47 AND 49).

SEC. 2(F).

FIRST USE 3-22-1985; IN COMMERCE 3-22-1985.

SER. NO. 77-353,990, FILED 12-17-2007.

THE MARK CONSISTS OF STANDARD CHARACTERS WITHOUT CLAIM TO ANY PARTICULAR FONT, STYLE, SIZE, OR COLOR.

TINA L. SNAPP, EXAMINING ATTORNEY

Int. Cl.: 25

Prior U.S. Cls.: 22 and 39

United States Patent and Trademark Office

Reg. No. 3,574,806

Registered Feb. 17, 2009

**TRADEMARK
PRINCIPAL REGISTER**

SCOOTER PIE BABY

GARNER, CONNIE J (UNITED STATES INDIVIDUAL)
3542C S. KITTREDGE ST.
AURORA, CO 80013

FOR: CHILDREN'S HATS, SHIRTS, AND PANTS;
CLOTH BIBS FOR CHILDREN, IN CLASS 25 (U.S.
CLS. 22 AND 39).

FIRST USE 11-14-2007; IN COMMERCE 11-14-2007.

THE MARK CONSISTS OF STANDARD CHARACTERS WITHOUT CLAIM TO ANY PARTICULAR FONT, STYLE, SIZE, OR COLOR.

NO CLAIM IS MADE TO THE EXCLUSIVE RIGHT TO USE "BABY", APART FROM THE MARK AS SHOWN.

SER. NO. 77-354,109, FILED 12-17-2007.

ALYSSA STEEL, EXAMINING ATTORNEY

Int. Cls.: 1 and 19

Prior U.S. Cls.: 1, 5, 6, 10, 12, 26, 33, 46 and 50

United States Patent and Trademark Office

Reg. No. 3,574,807

Registered Feb. 17, 2009

**TRADEMARK
PRINCIPAL REGISTER**



JAHOVIAH EARTH, LLC (OREGON LIMITED LIABILITY COMPANY)
4543 SOUTH PACIFIC HWY.
PHOENIX, OR 97535

FOR: PURE NATURAL CERTIFIED ORGANIC GARDENING PRODUCTS NAMELY FERTILIZERS, COMPOST, SOIL ADDITIVES NAMELY SOIL BUILDERS AND SOIL INOCULANTS, HUMUS, SOIL AMENDMENTS, AND SOIL IMPROVING AGENTS, ALL FOR USE IN ORGANIC HOME GARDENS, GREENHOUSES, ORGANIC FARMING, AND COMPOSTING, IN CLASS 1 (U.S. CLS. 1, 5, 6, 10, 26 AND 46).

FIRST USE 3-1-2002; IN COMMERCE 3-1-2002.

FOR: ECO-FRIENDLY NONMETALLIC BUILDING MATERIALS FOR USE IN HOME AND COMMERCIAL CONSTRUCTION NAMELY HARDWOOD, DECKING, AND WOOD BOARDS; COMPOSITE PANELS FOR USE IN HOME AND COMMERCIAL CONSTRUCTION COMPOSED PRIMARILY OF NON-METAL MATERIALS; FLOOR BOARDS, FLOOR PANELS NOT OF METAL, FLOOR TILES OF WOOD, NON-METAL FLOORS, ALL FOR USE IN HOME AND COMMERCIAL CONSTRUCTION; NON-METAL COUNTERTOPS FOR FURTHER INSTALLATION FOR USE IN

HOME AND COMMERCIAL CONSTRUCTION; NON-METAL FENCE PANELS, NON-METAL FENCE POSTS, ALL FOR USE IN HOME AND COMMERCIAL CONSTRUCTION; WOOD PANELING, NON-METAL ROOFING PANELS, ALL FOR USE IN HOME AND COMMERCIAL CONSTRUCTION; WALL BOARDS, WALL PANELS NOT OF METAL, WALL TILES, ALL FOR USE IN HOME AND COMMERCIAL CONSTRUCTION; AND NON-METAL ROOFING FOR USE IN HOME AND COMMERCIAL CONSTRUCTION, IN CLASS 19 (U.S. CLS. 1, 12, 33 AND 50).

FIRST USE 3-1-2002; IN COMMERCE 3-1-2002.

NO CLAIM IS MADE TO THE EXCLUSIVE RIGHT TO USE "ORGANICS", APART FROM THE MARK AS SHOWN.

THE MARK CONSISTS OF "PHOENIX ORGANICS" IN BLOCK LETTERING. A HOUSE WITH A SWIRL IN THE MIDDLE AND A LEAF GROWING OUT OF THE SWIRL IS SITUATED BETWEEN THE WORDS "PHOENIX" AND "ORGANICS".

SER. NO. 77-354,208, FILED 12-17-2007.

TINA KUAN, EXAMINING ATTORNEY

Int. Cl.: 16

Prior U.S. Cls.: 2, 5, 22, 23, 29, 37, 38 and 50

Reg. No. 3,574,808

United States Patent and Trademark Office

Registered Feb. 17, 2009

**TRADEMARK
PRINCIPAL REGISTER**

PURE ADVICE

LUCID ADVISORS, INC. (WASHINGTON CORPORATION)
500 UNION STREET, SUITE 600
SEATTLE, WA 98101

FOR: PRINTED MATERIALS, NAMELY, NEWSLETTERS, WHITE PAPERS, PRESENTATIONS, AND REPORTS (EXCLUDING PORTFOLIO REPORTS) IN THE FIELDS OF RETIREMENT PLAN MANAGEMENT, INVESTMENT MANAGEMENT, MANAGEMENT OF RETIREMENT PLAN AND INVESTMENT EXPENSES, FINANCIAL PLANNING, AND EMPLOYEE EDUCATION AND TRAINING REGARDING RETIREMENT AND FINANCIAL MATTERS, IN CLASS 16 (U.S. CLS. 2, 5, 22, 23, 29, 37, 38 AND 50).

FIRST USE 12-31-2003; IN COMMERCE 12-31-2003.

THE MARK CONSISTS OF STANDARD CHARACTERS WITHOUT CLAIM TO ANY PARTICULAR FONT, STYLE, SIZE, OR COLOR.

OWNER OF U.S. REG. NOS. 3,185,782, 3,330,597, AND 3,352,144.

NO CLAIM IS MADE TO THE EXCLUSIVE RIGHT TO USE "ADVICE", APART FROM THE MARK AS SHOWN.

SER. NO. 77-354,488, FILED 12-18-2007.

ALYSSA STEEL, EXAMINING ATTORNEY

Int. Cl.: 14

Prior U.S. Cls.: 2, 27, 28 and 50

United States Patent and Trademark Office

Reg. No. 3,574,809

Registered Feb. 17, 2009

**TRADEMARK
PRINCIPAL REGISTER**

WEAR ART

JEWELRY BY S.A. GAUTHIER, INC. (ARIZONA
CORPORATION)
4211 NORTH MARSHALL WAY
SCOTTSDALE, AZ 85251

THE MARK CONSISTS OF STANDARD CHAR-
ACTERS WITHOUT CLAIM TO ANY PARTICULAR
FONT, STYLE, SIZE, OR COLOR.

FOR: JEWELRY, IN CLASS 14 (U.S. CLS. 2, 27, 28
AND 50).

SER. NO. 77-354,491, FILED 12-18-2007.

FIRST USE 3-17-1994; IN COMMERCE 3-17-1994.

MARY MUNSON, EXAMINING ATTORNEY

Int. Cl.: 9

Prior U.S. Cls.: 21, 23, 26, 36 and 38

Reg. No. 3,574,810

United States Patent and Trademark Office

Registered Feb. 17, 2009

**TRADEMARK
PRINCIPAL REGISTER**

TOPSPRO

CASAS - COMPREHENSIVE ADULT STUDENT
ASSESSMENT SYSTEMS (CALIFORNIA NON-
PROFIT ORGANIZATION)
5151 MURPHY CANYON ROAD, SUITE 220
SAN DIEGO, CA 921234339

FOR: COMPUTER PROGRAMS FOR USE IN
MONITORING AND TRACKING STUDENTS BA-
SIC SKILLS IN EDUCATIONAL DEVELOPMENT,
INSTRUCTIONAL COMPLIANCE, STUDENT TEST-
ING, FOR STUDENT ASSESSMENT FOR ADULT
AND SECONDARY EDUCATION, AND FOR AU-
TOMATED TEST SCORING, DATA COLLECTION,
AND DATA REPORTING ALL IN THE FIELD OF

EDUCATIONAL TESTING, IN CLASS 9 (U.S. CLS. 21,
23, 26, 36 AND 38).

FIRST USE 10-1-1995; IN COMMERCE 8-1-1996.

THE MARK CONSISTS OF STANDARD CHAR-
ACTERS WITHOUT CLAIM TO ANY PARTICULAR
FONT, STYLE, SIZE, OR COLOR.

SER. NO. 77-354,614, FILED 12-18-2007.

RENEE SERVANCE, EXAMINING ATTORNEY

Int. Cl.: 41

Prior U.S. Cls.: 100, 101 and 107

United States Patent and Trademark Office

Reg. No. 3,574,811

Registered Feb. 17, 2009

**SERVICE MARK
PRINCIPAL REGISTER**

SPORTNET

WMG PRODUCTIONS LLC (DELAWARE LIMITED LIABILITY COMPANY)
12100 W. OLYMPIC BLVD., SUITE 400
LOS ANGELES, CA 90064

FOR: ELECTRONIC PUBLISHING SERVICES, NAMELY, PUBLICATION OF TEXT AND GRAPHIC WORKS OF OTHERS ON THE WORLD WIDE WEB FEATURING SPORTS; ENTERTAINMENT SERVICES, NAMELY, PROVIDING A WEBSITE FEATURING, PHOTOGRAPHIC, AUDIO, VIDEO AND PROSE PRESENTATIONS FEATURING SPORTS; ON-LINE JOURNALS, NAMELY, BLOGS FEATURING SPORTS; PUBLICATIONS OF THE EDITORIAL CONTENT RELATING TO SPORTS OF SITES AC-

CESSIBLE VIA A GLOBAL COMPUTER NETWORK, IN CLASS 41 (U.S. CLS. 100, 101 AND 107).

FIRST USE 1-1-2007; IN COMMERCE 1-1-2007.

THE MARK CONSISTS OF STANDARD CHARACTERS WITHOUT CLAIM TO ANY PARTICULAR FONT, STYLE, SIZE, OR COLOR.

SEC. 2(F).

SER. NO. 77-354,816, FILED 12-18-2007.

HOWARD SMIGA, EXAMINING ATTORNEY

Int. Cl.: 37

Prior U.S. Cls.: 100, 103 and 106

United States Patent and Trademark Office

Reg. No. 3,574,812

Registered Feb. 17, 2009

SERVICE MARK
PRINCIPAL REGISTER



E-LOC CORP. (MINNESOTA CORPORATION),
DBA TWIN CITIES CLOSET COMPANY
2634 MINNEHAHA AVENUE SOUTH
MINNEAPOLIS, MN 55406

FOR: CONSTRUCTION AND INSTALLATION OF CLOSETS AND SHELVING UNITS FOR UTILITY ROOMS, PANTRIES, GARAGE INTERIORS, CABINETS, MEDIA UNITS, WALL UNITS, HOBBY CENTERS, AND CUSTOM CONSTRUCTION OF HOME OFFICES AND STORAGE SPACE STRUCTURES; CONSTRUCTION AND INSTALLATION OF WALL BEDS; INSTALLATION OF HEATING EQUIPMENT, IN CLASS 37 (U.S. CLS. 100, 103 AND 106).

FIRST USE 5-1-2001; IN COMMERCE 5-1-2001.

NO CLAIM IS MADE TO THE EXCLUSIVE RIGHT TO USE "CLOSET CO.", APART FROM THE MARK AS SHOWN.

THE MARK CONSISTS OF A STYLIZED OVAL CONTAINING THE WORDS "TWIN-CITIES CLOSET CO." WITH A LINE UNDERNEATH THE WORDS.

SEC. 2(F).

SER. NO. 77-354,965, FILED 12-18-2007.

JASON TURNER, EXAMINING ATTORNEY

Int. Cls.: 9 and 42

Prior U.S. Cls.: 21, 23, 26, 36, 38, 100 and 101

Reg. No. 3,574,813

United States Patent and Trademark Office

Registered Feb. 17, 2009

**TRADEMARK
SERVICE MARK
PRINCIPAL REGISTER**

MAPS

MAPS TECHNOLOGY LTD (UNITED KINGDOM CORPORATION)
127 MILTON PARK
16 NORTH CENTRAL
ABINGDON, OXFORDSHIRE, UNITED KINGDOM
OX144SA

FOR: ELECTRONIC INSTRUMENTATION FOR MEASURING MECHANICAL AND ELECTROMAGNETIC PROPERTIES OF MATERIALS, NAMELY, MECHANICAL STRESS, ELECTRICAL CONDUCTIVITY, ELECTRICAL RESISTIVITY, MAGNETIC PERMEABILITY AND MAGNETIC COERCIVITY, FOR USE IN THE FIELD OF NONDESTRUCTIVE EXAMINATION OF STRUCTURES; ELECTROMAGNETIC PROBES FOR MEASURING MECHANICAL AND ELECTROMAGNETIC PROPERTIES OF MATERIALS, NAMELY, MECHANICAL STRESS, ELECTRICAL CONDUCTIVITY, ELECTRICAL RESISTIVITY, MAGNETIC PERMEABILITY AND MAGNETIC COERCIVITY FOR USE IN THE FIELD OF NONDESTRUCTIVE EXAMINATION OF STRUCTURES; SOFTWARE FOR DETERMINING MECHANICAL AND ELECTROMAGNETIC PROPERTIES OF MATERIALS, NAMELY, MECHANICAL STRESS, ELECTRICAL CONDUCTIVITY, ELECTRICAL RESISTIVITY, MAGNETIC PERMEABILITY

AND MAGNETIC COERCIVITY, FROM ELECTROMAGNETIC MEASUREMENTS USING AN ELECTROMAGNETIC PROBE, IN CLASS 9 (U.S. CLS. 21, 23, 26, 36 AND 38).

FOR: CONSULTANCY SERVICES AND ADVISORY SERVICES RELATING TO MATERIALS TESTING; MATERIAL TESTING SERVICES; MATERIALS TESTING, NAMELY, MEASUREMENTS OF MECHANICAL AND ELECTROMAGNETIC PROPERTIES OF MATERIALS, NAMELY, MECHANICAL STRESS, ELECTRICAL CONDUCTIVITY, ELECTRICAL RESISTIVITY, MAGNETIC PERMEABILITY AND MAGNETIC COERCIVITY USING MAGNETIC FIELDS, IN CLASS 42 (U.S. CLS. 100 AND 101).

THE MARK CONSISTS OF STANDARD CHARACTERS WITHOUT CLAIM TO ANY PARTICULAR FONT, STYLE, SIZE, OR COLOR.

OWNER OF ERPN CMNTY TM OFC REG. NO. 006109714, DATED 6-19-2008, EXPIRES 6-19-2018.

SER. NO. 77-355,250, FILED 12-18-2007.

ANTHONY RINKER, EXAMINING ATTORNEY

Int. Cls.: 6 and 19

Prior U.S. Cls.: 1, 2, 12, 13, 14, 23, 25, 33 and 50

United States Patent and Trademark Office

Reg. No. 3,574,814

Registered Feb. 17, 2009

**TRADEMARK
PRINCIPAL REGISTER**

PANEL CRAFT

CRAFT-BILT MANUFACTURING COMPANY
(PENNSYLVANIA CORPORATION)
53 SOUDERTON-HATFIELD PIKE
SOUDERTON, PA 18964

FOR: BUILDING MATERIALS, NAMELY, COMPOSITE PANELS COMPOSED PRIMARILY OF METAL USED IN THE MANUFACTURE OF SUNROOMS, PATIO ROOMS, PORCH ENCLOSURES, CARPORTS, PATIO COVERS, SCREEN ROOMS, IN-PLANT OFFICES, SWIMMING POOL ENCLOSURES; AND PARTS THEREFOR, IN CLASS 6 (U.S. CLS. 2, 12, 13, 14, 23, 25 AND 50).

FIRST USE 5-1-1964; IN COMMERCE 5-1-1964.

FOR: BUILDING MATERIALS, NAMELY, COMPOSITE PANELS COMPOSED PRIMARILY OF NONMETAL USED IN THE MANUFACTURE OF SUNROOMS, PATIO ROOMS, PORCH ENCLOSURES, CARPORTS, PATIO COVERS, SCREEN

ROOMS, IN-PLANT OFFICES, SWIMMING POOL ENCLOSURES; AND PARTS THEREFOR, IN CLASS 19 (U.S. CLS. 1, 12, 33 AND 50).

FIRST USE 5-1-1964; IN COMMERCE 5-1-1964.

THE MARK CONSISTS OF STANDARD CHARACTERS WITHOUT CLAIM TO ANY PARTICULAR FONT, STYLE, SIZE, OR COLOR.

OWNER OF U.S. REG. NO. 1,421,710.

NO CLAIM IS MADE TO THE EXCLUSIVE RIGHT TO USE "PANEL", APART FROM THE MARK AS SHOWN.

SER. NO. 77-355,350, FILED 12-19-2007.

DOMINIC J. FERRAIUOLO, EXAMINING ATTORNEY

Int. Cls.: 9 and 10

Prior U.S. Cls.: 21, 23, 26, 36, 38, 39 and 44

United States Patent and Trademark Office

Reg. No. 3,574,815

Registered Feb. 17, 2009

**TRADEMARK
PRINCIPAL REGISTER**

HTG

HERBAL TRACER.COM, LLC (MICHIGAN LIMITED LIABILITY COMPANY)
PO BOX 4660
TROY, MI 48009

FOR: PRE-RECORDED VIDEO CASSETTE TAPES FEATURING INFORMATION IN THE FIELD OF PERSONAL NUTRITIONAL ANALYSIS, IN CLASS 9 (U.S. CLS. 21, 23, 26, 36 AND 38).

FIRST USE 1-1-1998; IN COMMERCE 1-1-1998.

FOR: SALIVA TESTING KITS COMPRISING A RECEPTACLE FOR RECEIVING AND RETAINING SALIVA AND INSTRUCTIONS FOR OBTAINING

TEST RESULTS FOR MEDICAL PURPOSES FOR PERSONAL NUTRITIONAL ANALYSIS, IN CLASS 10 (U.S. CLS. 26, 39 AND 44).

FIRST USE 1-1-1998; IN COMMERCE 1-1-1998.

THE MARK CONSISTS OF STANDARD CHARACTERS WITHOUT CLAIM TO ANY PARTICULAR FONT, STYLE, SIZE, OR COLOR.

SER. NO. 77-355,366, FILED 12-19-2007.

DOMINIC J. FERRAIUOLO, EXAMINING ATTORNEY

Int. Cl.: 9

Prior U.S. Cls.: 21, 23, 26, 36 and 38

Reg. No. 3,574,816

United States Patent and Trademark Office

Registered Feb. 17, 2009

**TRADEMARK
PRINCIPAL REGISTER**

NEW AGE COMPUTER SYSTEMS

KUEHNEL, CHRISTOPHER M. (UNITED STATES
INDIVIDUAL)
1030 BEECH STREET
CLEVELAND, WI 53015

FOR: COMPUTER SOFTWARE FOR USE IN
DATABASE MANAGEMENT, IN CLASS 9 (U.S.
CLS. 21, 23, 26, 36 AND 38).

FIRST USE 8-0-1982; IN COMMERCE 8-0-1982.

THE MARK CONSISTS OF STANDARD CHAR-
ACTERS WITHOUT CLAIM TO ANY PARTICULAR
FONT, STYLE, SIZE, OR COLOR.

NO CLAIM IS MADE TO THE EXCLUSIVE
RIGHT TO USE "COMPUTER SYSTEMS", APART
FROM THE MARK AS SHOWN.

SER. NO. 77-355,530, FILED 12-19-2007.

LESLEY LAMOTHE, EXAMINING ATTORNEY

Int. Cl.: 41

Prior U.S. Cls.: 100, 101 and 107

United States Patent and Trademark Office

Reg. No. 3,574,817

Registered Feb. 17, 2009

**SERVICE MARK
PRINCIPAL REGISTER**

HARLEM S.E.A.LS

ARZU, LUIS (UNITED STATES INDIVIDUAL)
2227 HOMER AVENUE
BRONX, NY 10473 AND
NORTON, DWIGHT (UNITED STATES INDIVIDUAL)
2227 HOMER AVENUE
BRONX, NY 10473

FOR: PHYSICAL FITNESS INSTRUCTION; PRODUCTION OF VIDEO CASSETTES; PRODUCTION OF VIDEO DISCS AND TAPES, IN CLASS 41 (U.S. CLS. 100, 101 AND 107).

FIRST USE 10-29-2007; IN COMMERCE 12-18-2007.

THE MARK CONSISTS OF STANDARD CHARACTERS WITHOUT CLAIM TO ANY PARTICULAR FONT, STYLE, SIZE, OR COLOR.

NO CLAIM IS MADE TO THE EXCLUSIVE RIGHT TO USE "HARLEM", APART FROM THE MARK AS SHOWN.

SER. NO. 77-355,601, FILED 12-19-2007.

WANDA KAY PRICE, EXAMINING ATTORNEY

Int. Cls.: 35 and 42

Prior U.S. Cls.: 100, 101 and 102

United States Patent and Trademark Office

Reg. No. 3,574,818

Registered Feb. 17, 2009

**SERVICE MARK
PRINCIPAL REGISTER**

SPORTSTEC

SPORTSTEC LIMITED (AUSTRALIA CORPORATION)
19-22/6A PROSPERITY PARADE
WARRIEWOOD NSW, AUSTRALIA NSW2102

FOR: RETAIL STORE SERVICES AND DISTRIBUTORSHIP SERVICES IN THE FIELD OF COMPUTER SOFTWARE, AND COMPUTER PRODUCTS; ONLINE ADVERTISING AND MARKETING ON A COMPUTER NETWORK, IN CLASS 35 (U.S. CLS. 100, 101 AND 102).

FIRST USE 11-27-2000; IN COMMERCE 11-27-2000.

FOR: DEVELOPMENT OF COMPUTER SOFTWARE; INSTALLATION AND MAINTENANCE OF

COMPUTER SOFTWARE; UPDATING COMPUTER SOFTWARE; UPGRADING COMPUTER SOFTWARE, IN CLASS 42 (U.S. CLS. 100 AND 101).

FIRST USE 11-27-2000; IN COMMERCE 11-27-2000.

THE MARK CONSISTS OF STANDARD CHARACTERS WITHOUT CLAIM TO ANY PARTICULAR FONT, STYLE, SIZE, OR COLOR.

SEC. 2(F).

SER. NO. 77-355,713, FILED 12-19-2007.

ANDREA HACK, EXAMINING ATTORNEY

Int. Cl.: 35

Prior U.S. Cls.: 100, 101 and 102

United States Patent and Trademark Office

Reg. No. 3,574,819

Registered Feb. 17, 2009

**SERVICE MARK
PRINCIPAL REGISTER**

REUNION

GINN-LA ORLANDO, LTD., LLLP (GEORGIA
LIMITED LIABILITY LIMITED PARTNER-
SHIP)
SUITE 200
215 CELEBRATION PLACE
CELEBRATION, FL 34747

FOR: ADVERTISING AND MARKETING SERVI-
CES, NAMELY, PROMOTING PROPERTY SALES
AND VACATION TRAVEL TO AN UPSCALE RESI-
DENTIAL GOLF COMMUNITY AND RESORT FEAT-
URING HOMES BUILT BY OTHERS AND
PROPERTIES OFFERED FOR SALE OR RENT BY
OTHERS, IN CLASS 35 (U.S. CLS. 100, 101 AND 102).

FIRST USE 7-9-2002; IN COMMERCE 7-9-2002.

THE MARK CONSISTS OF STANDARD CHAR-
ACTERS WITHOUT CLAIM TO ANY PARTICULAR
FONT, STYLE, SIZE, OR COLOR.

OWNER OF U.S. REG. NO. 3,153,164.

SER. NO. 77-355,819, FILED 12-19-2007.

AISHA CLARKE, EXAMINING ATTORNEY

Int. Cl.: 16

Prior U.S. Cls.: 2, 5, 22, 23, 29, 37, 38 and 50

United States Patent and Trademark Office

Reg. No. 3,574,820

Registered Feb. 17, 2009

**TRADEMARK
PRINCIPAL REGISTER**

**PSYCHIATRIC ISSUES IN
EMERGENCY CARE SETTINGS**

CMPMEDICA LLC (DELAWARE LIMITED LIABILITY COMPANY)

600 HARRISON STREET

SAN FRANCISCO, CA 94107

FOR: PRINTED MEDICAL PERIODICALS, IN CLASS 16 (U.S. CLS. 2, 5, 22, 23, 29, 37, 38 AND 50).

FIRST USE 2-2-2002; IN COMMERCE 2-2-2005.

THE MARK CONSISTS OF STANDARD CHARACTERS WITHOUT CLAIM TO ANY PARTICULAR FONT, STYLE, SIZE, OR COLOR.

OWNER OF U.S. REG. NO. 2,652,965.

SEC. 2(F).

SER. NO. 77-355,889, FILED 12-19-2007.

BARBARA RUTLAND, EXAMINING ATTORNEY

Int. Cl.: 8

Prior U.S. Cls.: 23, 28 and 44

Reg. No. 3,574,821

United States Patent and Trademark Office

Registered Feb. 17, 2009

**TRADEMARK
PRINCIPAL REGISTER**



DRANNIKOV, ALEXANDER (UNITED STATES
INDIVIDUAL)
6502 COLBATH AVE.
VAN NUYS, CA 91401

FIRST USE 9-26-2007; IN COMMERCE 9-26-2007.

SER. NO. 77-356,374, FILED 12-19-2007.

FOR: MANUALLY OPERATED HAND TOOLS,
NAMELY, SCRAPERS, NON-ELECTRIC CAN
OPENERS, AND PLANERS, IN CLASS 8 (U.S. CLS.
23, 28 AND 44).

CARRIE GENOVESE, EXAMINING ATTORNEY

Int. Cl.: 19

Prior U.S. Cls.: 1, 12, 33 and 50

United States Patent and Trademark Office

Reg. No. 3,574,822

Registered Feb. 17, 2009

**TRADEMARK
PRINCIPAL REGISTER**

Worthington

BOATWRIGHT, KYLE (UNITED STATES INDIVIDUAL)
10175 FORTUNE PARKWAY, SUITE 502
JACKSONVILLE, FL 32258

THE MARK CONSISTS OF STANDARD CHARACTERS WITHOUT CLAIM TO ANY PARTICULAR FONT, STYLE, SIZE, OR COLOR.

FOR: PRE-FABRICATED NONMETAL ARCHITECTURAL COLUMNS, IN CLASS 19 (U.S. CLS. 1, 12, 33 AND 50).

SER. NO. 77-356,615, FILED 12-20-2007.

FIRST USE 6-20-1985; IN COMMERCE 6-20-1985.

ANDREA SAUNDERS, EXAMINING ATTORNEY

Int. Cl.: 36

Prior U.S. Cls.: 100, 101 and 102

United States Patent and Trademark Office

Reg. No. 3,574,823

Registered Feb. 17, 2009

**SERVICE MARK
PRINCIPAL REGISTER**



EVOLUTION MARKETS, INC. (DELAWARE CORPORATION)
10 BANK STREET
WHITE PLAINS, NY 10606

FOR: FINANCIAL SERVICES, NAMELY, TRADING COMMODITIES AND PROVIDING FINAN-

CIAL MARKET DATA AND ANALYTICS, IN CLASS 36 (U.S. CLS. 100, 101 AND 102).

FIRST USE 10-0-2007; IN COMMERCE 10-0-2007.

SER. NO. 77-356,901, FILED 12-20-2007.

VERNA BETH RIRIE, EXAMINING ATTORNEY

Int. Cls.: 6, 16, 18, 21, 25 and 41

Prior U.S. Cls.: 1, 2, 3, 5, 12, 13, 14, 22, 23, 25, 29, 30, 33, 37, 38, 39, 40, 41, 50, 100, 101 and 107

Reg. No. 3,574,824

United States Patent and Trademark Office

Registered Feb. 17, 2009

**TRADEMARK
SERVICE MARK
PRINCIPAL REGISTER**

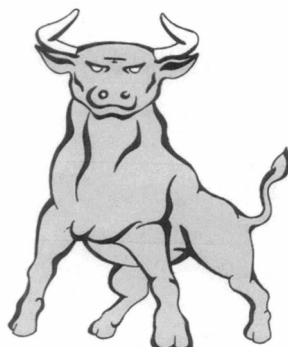

JOHNSON C. SMITH UNIVERSITY (NORTH CAROLINA CORPORATION)
100-300 BEATTIES FORD ROAD
CHARLOTTE, NC 28216

FOR: METAL KEY RINGS, IN CLASS 6 (U.S. CLS. 2, 12, 13, 14, 23, 25 AND 50).

FIRST USE 1-1-2004; IN COMMERCE 1-1-2004.

FOR: DECALS, BUMPER STICKERS, NOTEBOOKS, NOTEPADS, WRITING PAPER AND ENVELOPES, BINDERS, NOTEPAD HOLDERS, CALENDARS, PENS, PENCILS, PAPER STATIONERY, BUSINESS CARDS, BOOK COVERS, PAPER NAPKINS AND PAPER PLACEMATS, IN CLASS 16 (U.S. CLS. 2, 5, 22, 23, 29, 37, 38 AND 50).

FIRST USE 1-1-2004; IN COMMERCE 1-1-2004.

FOR: BACKPACKS, LUGGAGE, AND UMBRELLAS, IN CLASS 18 (U.S. CLS. 1, 2, 3, 22 AND 41).

FIRST USE 1-1-2004; IN COMMERCE 1-1-2004.

FOR: DRINKING GLASSES, MUGS, PITCHERS AND VASES, IN CLASS 21 (U.S. CLS. 2, 13, 23, 29, 30, 33, 40 AND 50).

FIRST USE 1-1-2004; IN COMMERCE 1-1-2004.

FOR: APPAREL, NAMELY, SHIRTS, JACKETS, SWEATERS, CAPS, PARKAS, SHORTS, JOGGING SUITS, SWEAT SUITS, NECKTIES, LEISURE SUITS, SCARVES, SLEEPWEAR, SOCKS, ATHLETIC JERSEYS AND SHORTS, IN CLASS 25 (U.S. CLS. 22 AND 39).

FIRST USE 1-1-2004; IN COMMERCE 1-1-2004.

FOR: ENCOURAGING AMATEUR SPORTS AND PHYSICAL EDUCATION BY ORGANIZING, PROMOTING, SPONSORING, SANCTIONING, CONDUCTING, ADMINISTERING, REGULATING AND GOVERNING AMATEUR ATHLETIC PROGRAMS AND ACTIVITIES, IN CLASS 41 (U.S. CLS. 100, 101 AND 107).

FIRST USE 1-1-2004; IN COMMERCE 1-1-2004.

THE MARK CONSISTS OF DRAWING OF A BULL.

SER. NO. 77-357,181, FILED 12-20-2007.

GILBERT SWIFT, EXAMINING ATTORNEY

Int. Cl.: 29

Prior U.S. Cl.: 46

United States Patent and Trademark Office

Reg. No. 3,574,825

Registered Feb. 17, 2009

TRADEMARK
PRINCIPAL REGISTER

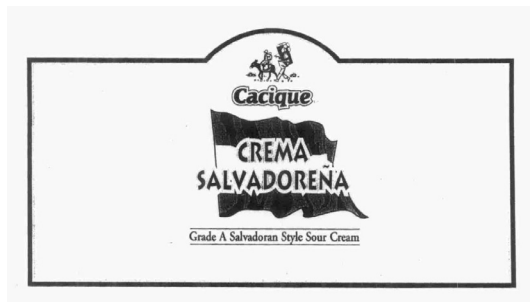

CACIQUE, INC. (CALIFORNIA CORPORATION)
14940 PROCTOR AVENUE
CITY OF INDUSTRY, CA 91744

FOR: DAIRY PRODUCTS EXCLUDING ICE
CREAM, ICE MILK AND FROZEN YOGURT, IN
CLASS 29 (U.S. CL. 46).

FIRST USE 0-0-1999; IN COMMERCE 0-0-1999.

OWNER OF U.S. REG. NOS. 1,152,572, 2,915,613
AND OTHERS.

NO CLAIM IS MADE TO THE EXCLUSIVE
RIGHT TO USE "CREMA" AND "GRADE A SAL-
VADORAN STYLE SOUR CREAM", APART FROM
THE MARK AS SHOWN.

THE MARK CONSISTS OF MAN ON BURRO
FOLLOWED BY MAN CARRYING GOODS IN
BASKET; FLAG; AND WORDS "CACIQUE; CREMA
SALVADOREÑA; GRADE A SALVADORAN STYLE
SOUR CREAM".

THE FOREIGN WORDING IN THE MARK
TRANSLATES INTO ENGLISH AS CREAM OF
THE SALVADORIAN FOR "CREMA SALVADORE-
ÑA" AND PRINCE, NOBLEMAN AMONG THE
INDIANS, POLITICAL LEADER OR BOSS FOR
"CACIQUE".

SEC. 2(F) AS TO "SALVADOREÑA".

SER. NO. 77-357,263, FILED 12-20-2007.

JAY FLOWERS, EXAMINING ATTORNEY

Int. Cl.: 45

Prior U.S. Cls.: 100 and 101

United States Patent and Trademark Office

Reg. No. 3,574,826

Registered Feb. 17, 2009

**SERVICE MARK
PRINCIPAL REGISTER**

EXECUTIVE SOURCE

STATE AND FEDERAL COMMUNICATIONS,
INC. (OHIO CORPORATION)
SUITE 100
80 SOUTH SUMMIT STREET
AKRON, OH 44308

FOR: PROVIDING LEGAL INFORMATION IN
THE FIELDS OF LOBBYING, POLITICAL CONTRI-
BUTIONS, CAMPAIGN FINANCE, AND PROCURE-
MENT LAWS IN STATES AND SELECTED
MUNICIPALITIES, IN CLASS 45 (U.S. CLS. 100
AND 101).

FIRST USE 7-1-2007; IN COMMERCE 7-1-2007.

THE MARK CONSISTS OF STANDARD CHAR-
ACTERS WITHOUT CLAIM TO ANY PARTICULAR
FONT, STYLE, SIZE, OR COLOR.

NO CLAIM IS MADE TO THE EXCLUSIVE
RIGHT TO USE "SOURCE", APART FROM THE
MARK AS SHOWN.

SER. NO. 77-357,698, FILED 12-21-2007.

MYRIAH HABEEB, EXAMINING ATTORNEY

Int. Cl.: 42

Prior U.S. Cls.: 100 and 101

United States Patent and Trademark Office

Reg. No. 3,574,827

Registered Feb. 17, 2009

**SERVICE MARK
PRINCIPAL REGISTER**

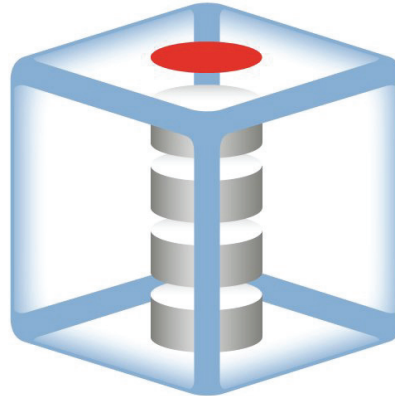

CARINGO, INC. (DELAWARE CORPORATION)
BUILDING II, SUITE 410
901 SOUTH MOPAC EXPRESSWAY
AUSTIN, TX 78746

FOR: DESIGN, DEVELOPMENT AND IMPLEMENTATION OF SOFTWARE, IN CLASS 42 (U.S. CLS. 100 AND 101).

FIRST USE 10-10-2007; IN COMMERCE 10-10-2007.

THE COLOR(S) RED, BLUE, GREY IS/ARE CLAIMED AS A FEATURE OF THE MARK.

THE MARK CONSISTS OF A BLUE 3-DIMENSIONAL CUBE WITH FOUR (4) GRAY STACKED DISKS INSIDE AND RED OVAL ON TOP. THE COLOR WHITE IS PART OF THE BACKGROUND AND NOT PART OF THE MARK.

SER. NO. 77-357,775, FILED 12-21-2007.

AMY ALFIERI, EXAMINING ATTORNEY

Int. Cl.: 10

Prior U.S. Cls.: 26, 39 and 44

United States Patent and Trademark Office

Reg. No. 3,574,828

Registered Feb. 17, 2009

**TRADEMARK
PRINCIPAL REGISTER**

MEDOTECH

MEDOTECH A/S (DENMARK COMPANY)
KONGSVANG ALLÉ 30, BYG 22
DK-8000 ARHUS C, DENMARK

FOR: ELECTRONIC MEDICAL INSTRUMENTS
FOR DIAGNOSIS OF BRUXISM; ELECTRONIC
MEDICAL INSTRUMENTS FOR TREATING BRUX-
ISM, ELECTROMYOGRAPHS; MEDICAL ELEC-
TRODES FOR ELECTROMYOGRAPHIC
INSTRUMENTS , IN CLASS 10 (U.S. CLS. 26, 39
AND 44).

THE MARK CONSISTS OF STANDARD CHAR-
ACTERS WITHOUT CLAIM TO ANY PARTICULAR
FONT, STYLE, SIZE, OR COLOR.

PRIORITY CLAIMED UNDER SEC. 44(D) ON
ERPNTY TM OFC APPLICATION NO.
006035745, FILED 6-25-2007, REG. NO. 006035745,
DATED 5-29-2008, EXPIRES 6-25-2017.

SER. NO. 77-357,798, FILED 12-21-2007.

EUGENIA MARTIN, EXAMINING ATTORNEY

Int. Cl.: 36

Prior U.S. Cls.: 100, 101 and 102

United States Patent and Trademark Office

Reg. No. 3,574,829

Registered Feb. 17, 2009

**SERVICE MARK
PRINCIPAL REGISTER**

THE PJ LIBRARY

THE HAROLD GRINSPOON FOUNDATION
(MASSACHUSETTS NON-PROFIT ORGANI-
ZATION)
380 UNION STREET
WEST SPRINGFIELD, MA 01089

FOR: CHARITABLE FUNDRAISING SERVICES,
NAMELY, BY PROVIDING INDIVIDUALS WITH
THE INFORMATION AND OPPORTUNITY TO
MAKE MONETARY DONATIONS TO THEIR FA-
VORITE CHARITY, IN CLASS 36 (U.S. CLS. 100, 101
AND 102).

FIRST USE 12-6-2007; IN COMMERCE 12-6-2007.

THE MARK CONSISTS OF STANDARD CHAR-
ACTERS WITHOUT CLAIM TO ANY PARTICULAR
FONT, STYLE, SIZE, OR COLOR.

SER. NO. 77-358,200, FILED 12-21-2007.

TEJBIR SINGH, EXAMINING ATTORNEY

Int. Cl.: 35

Prior U.S. Cls.: 100, 101 and 102

United States Patent and Trademark Office

Reg. No. 3,574,830

Registered Feb. 17, 2009

**SERVICE MARK
PRINCIPAL REGISTER**

VisByte

BOARDMAN, SIMON (ENGLAND INDIVIDUAL)
4180 GLENGARY DRIVE
ATLANTA, GA 30342

THE MARK CONSISTS OF STANDARD CHAR-
ACTERS WITHOUT CLAIM TO ANY PARTICULAR
FONT, STYLE, SIZE, OR COLOR.

FOR: DIRECT MARKETING ADVERTISING FOR
OTHERS, IN CLASS 35 (U.S. CLS. 100, 101 AND 102).

SER. NO. 77-358,207, FILED 12-21-2007.

FIRST USE 11-10-2007; IN COMMERCE 11-19-2007.

ERIN FALK, EXAMINING ATTORNEY

Int. Cl.: 6

Prior U.S. Cls.: 2, 12, 13, 14, 23, 25 and 50

Reg. No. 3,574,831

United States Patent and Trademark Office

Registered Feb. 17, 2009

**TRADEMARK
PRINCIPAL REGISTER**



TRACO INTELLECTUAL, INC. (DELAWARE CORPORATION)
71 PROGRESS AVENUE
CRANBERRY TOWNSHIP, PA 16066

FOR: METAL WINDOWS AND DOORS, IN CLASS 6 (U.S. CLS. 2, 12, 13, 14, 23, 25 AND 50).

FIRST USE 3-31-2007; IN COMMERCE 7-3-2007.

NO CLAIM IS MADE TO THE EXCLUSIVE RIGHT TO USE "WINDOWS AND DOORS", APART FROM THE MARK AS SHOWN.

THE MARK CONSISTS OF A DESIGN OF A SHIP WITH THE WORDS "BISCAYNE WINDOWS AND DOORS".

SER. NO. 77-358,341, FILED 12-21-2007.

MARK SPARACINO, EXAMINING ATTORNEY

Int. Cl.: 6

Prior U.S. Cls.: 2, 12, 13, 14, 23, 25 and 50

Reg. No. 3,574,832

United States Patent and Trademark Office

Registered Feb. 17, 2009

**TRADEMARK
PRINCIPAL REGISTER**

BISCAYNE WINDOWS AND DOORS

TRACO INTELLECTUAL, INC. (DELAWARE
CORPORATION)

71 PROGRESS AVENUE

CRANBERRY TOWNSHIP, PA 16066

FOR: METAL WINDOWS AND DOORS, IN CLASS
6 (U.S. CLS. 2, 12, 13, 14, 23, 25 AND 50).

FIRST USE 3-31-2007; IN COMMERCE 7-3-2007.

THE MARK CONSISTS OF STANDARD CHAR-
ACTERS WITHOUT CLAIM TO ANY PARTICULAR
FONT, STYLE, SIZE, OR COLOR.

NO CLAIM IS MADE TO THE EXCLUSIVE
RIGHT TO USE "WINDOWS AND DOORS", APART
FROM THE MARK AS SHOWN.

SER. NO. 77-358,356, FILED 12-21-2007.

MARK SPARACINO, EXAMINING ATTORNEY

Int. Cl.: 37

Prior U.S. Cls.: 100, 103 and 106

United States Patent and Trademark Office

Reg. No. 3,574,833

Registered Feb. 17, 2009

**SERVICE MARK
PRINCIPAL REGISTER**

**Authentically Austin,
Absolutely Clean**

WB DRY CLEANING, LTD. (TEXAS LIMITED
PARTNERSHIP)
ATTENTION: WILLIAM F. CHARNES
1300 EAST 38 1/2 STREET
AUSTIN, TX 78722

FOR: CLEANING OF CLOTHING; CLEANING OF
GARMENTS, UNIFORMS, CLOTHING, FABRICS,
TEXTILES, CLOTH, UPHOLSTERY, LINENS, COM-
FORTERS, QUILTS AND BLANKETS; DRY CLEAN-
ING; LEATHER CLEANING AND REPAIR;
TEXTILE CLEANING; CLOTH LAUNDRY; CLOTH-
ING LAUNDRY; FABRIC LAUNDRY; LAUNDRY
SERVICES; LAUNDRY SERVICES FOR GAR-
MENTS, UNIFORMS, CLOTHING, FABRICS, TEX-
TILES, CLOTH, UPHOLSTERY, LINENS,

COMFORTERS, QUILTS AND BLANKETS, IN
CLASS 37 (U.S. CLS. 100, 103 AND 106).

FIRST USE 7-1-2003; IN COMMERCE 7-1-2003.

THE MARK CONSISTS OF STANDARD CHAR-
ACTERS WITHOUT CLAIM TO ANY PARTICULAR
FONT, STYLE, SIZE, OR COLOR.

NO CLAIM IS MADE TO THE EXCLUSIVE
RIGHT TO USE "AUSTIN", APART FROM THE
MARK AS SHOWN.

SER. NO. 77-359,114, FILED 12-24-2007.

SKYE YOUNG, EXAMINING ATTORNEY

Int. Cl.: 14

Prior U.S. Cls.: 2, 27, 28 and 50

United States Patent and Trademark Office

Reg. No. 3,574,834

Registered Feb. 17, 2009

TRADEMARK
PRINCIPAL REGISTER



ARISTA, LLC (OKLAHOMA LIMITED LIABILITY COMPANY)
P.O. BOX 272553
OKLAHOMA CITY, OK 73137

FOR: JEWELRY FOR PERSONAL WEAR INCLUDING RINGS, BRACELETS, NECKLACES, EARRINGS, PENDANTS, AND OTHER PERSONAL ADORNMENTS WITH ALL OF THE AFOREMENTIONED ITEMS OF JEWELRY MADE IN WHOLE OR IN PART OF PRECIOUS METALS AND USING PRECIOUS AND SEMI-PRECIOUS GEMSTONES, IN CLASS 14 (U.S. CLS. 2, 27, 28 AND 50).

FIRST USE 9-10-2007; IN COMMERCE 10-8-2007.

THE MARK CONSISTS OF (6) LETTERS IN STYLIZED FORM SPELLING THE WORD "ARISTA" WITH A STAR DIRECTLY ABOVE THE "I".

SER. NO. 77-359,355, FILED 12-26-2007.

LEIGH CAROLINE CASE, EXAMINING ATTORNEY

Int. Cls.: 18 and 25

Prior U.S. Cls.: 1, 2, 3, 22, 39 and 41

United States Patent and Trademark Office

Reg. No. 3,574,835

Registered Feb. 17, 2009

**TRADEMARK
PRINCIPAL REGISTER**

LODI

IÑIGUEZ ALBERT, S.L. (SPAIN CORPORATION)
AVENIDA JOSE MARTINEZ GONZALEZ, 23-4 D
ELDA, ALICANTE, SPAIN 03600

FOR: PURSES, IN CLASS 18 (U.S. CLS. 1, 2, 3, 22
AND 41).

FOR: FOOTWEAR FOR WOMEN, IN CLASS 25
(U.S. CLS. 22 AND 39).

OWNER OF SPAIN REG. NO. 2.547.850, DATED 6-
25-2003, EXPIRES 6-25-2013.

THE WORDING "LODI" APPEARING IN THE
MARK HAS NO MEANING IN A FOREIGN LAN-
GUAGE.

SER. NO. 77-359,522, FILED 12-26-2007.

DAVID I, EXAMINING ATTORNEY

Int. Cl.: 35

Prior U.S. Cls.: 100, 101 and 102

United States Patent and Trademark Office

Reg. No. 3,574,836

Registered Feb. 17, 2009

**SERVICE MARK
PRINCIPAL REGISTER**



DEUTSCHE TELEKOM (FED REP GERMANY
AG CORPORATION)
FRIEDRICH-EBERT-ALLEE 140
BONN, FED REP GERMANY 53113

FOR: ADVERTISING SERVICES, NAMELY, PREPARING AND PLACING ADVERTISEMENTS FOR OTHERS, PROMOTING THE GOODS AND SERVICES OF OTHERS THROUGH PRINTED ADVERTISING, PRINTED DIRECTORIES, ENCODED MEDIA, DISSEMINATION OF PROMOTIONAL MATERIALS, DIRECT MAIL ADVERTISING, ELECTRONIC BILLBOARD ADVERTISING AND PREPARING AUDIO-VISUAL PRESENTATIONS FOR USE IN ADVERTISING; BUSINESS INFORMATION SERVICES RELATING TO BUSINESS MATTERS IN THE FIELDS OF TELECOMMUNICATIONS, ADVERTISING, INFORMATION TECHNOLOGY, IN CLASS 35 (U.S. CLS. 100, 101 AND 102).

PRIORITY CLAIMED UNDER SEC. 44(D) ON FED REP GERMANY APPLICATION NO. 30741658,

FILED 6-26-2007, REG. NO. 30741658, DATED 8-29-2007, EXPIRES 6-30-2017.

OWNER OF U.S. REG. NOS. 3,190,981 AND 3,219,373.

THE COLOR(S) MAGENTA AND WHITE IS/ARE CLAIMED AS A FEATURE OF THE MARK.

THE MARK CONSISTS OF A MAGENTA RECTANGLE CONTAINING THE TERM "PARTNER" IN WHITE. IN THE TOP SECTION, THE COLOR WHITE APPEARS AS THE BACKGROUND AND THE COLOR MAGENTA APPEARS IN THE 10 SMALL SQUARES AND THE LETTER "T".

SER. NO. 77-359,550, FILED 12-26-2007.

CYNTHIA SLOAN, EXAMINING ATTORNEY

Int. Cl.: 36

Prior U.S. Cls.: 100, 101 and 102

United States Patent and Trademark Office

Reg. No. 3,574,837

Registered Feb. 17, 2009

**SERVICE MARK
PRINCIPAL REGISTER**



DEUTSCHE TELEKOM (FED REP GERMANY
AG CORPORATION)
FRIEDRICH-EBERT-ALLEE 140
BONN, FED REP GERMANY 53113

FOR: TELEPHONE CALLING CARD SERVICES;
ELECTRONIC COMMERCE SERVICES, NAMELY,
ELECTRONIC DEBIT AND CREDIT CARD PRO-
CESSING SERVICES; PROVIDING FINANCIAL IN-
FORMATION VIA THE TELEPHONE AND THE
GLOBAL COMMUNICATION NETWORKS, IN
CLASS 36 (U.S. CLS. 100, 101 AND 102).

PRIORITY CLAIMED UNDER SEC. 44(D) ON FED
REP GERMANY APPLICATION NO. 30741658,
FILED 6-26-2007, REG. NO. 30741658, DATED 8-29-
2007, EXPIRES 6-30-2017.

OWNER OF U.S. REG. NOS. 3,190,981 AND
3,219,373.

THE COLOR(S) MAGENTA AND WHITE IS/ARE
CLAIMED AS A FEATURE OF THE MARK.

THE MARK CONSISTS OF A MAGENTA REC-
TANGLE CONTAINING THE TERM "PARTNER"
IN WHITE. IN THE TOP SECTION, THE COLOR
WHITE APPEARS AS THE BACKGROUND AND
THE COLOR MAGENTA APPEARS IN THE 10
SMALL SQUARES AND THE LETTER "T".

SER. NO. 77-359,576, FILED 12-26-2007.

CYNTHIA SLOAN, EXAMINING ATTORNEY

Int. Cl.: 38

Prior U.S. Cls.: 100, 101 and 104

United States Patent and Trademark Office

Reg. No. 3,574,838

Registered Feb. 17, 2009

SERVICE MARK
PRINCIPAL REGISTER



DEUTSCHE TELEKOM (FED REP GERMANY
AG CORPORATION)
FRIEDRICH-EBERT-ALLEE 140
BONN, FED REP GERMANY 53113

FOR: TELECOMMUNICATIONS SERVICES, NAMELY ELECTRIC, DIGITAL, CELLULAR AND WIRELESS TRANSMISSION OF VOICE, DATA, INFORMATION, IMAGES, SIGNALS, MESSAGES AND TRANSMISSION OF VOICE, DATA, IMAGES, AUDIO, VIDEO AND INFORMATION VIA TELEPHONE, TELEVISION AND GLOBAL COMMUNICATION NETWORKS; PROVIDING TELECOMMUNICATIONS CONNECTIONS OVER A GLOBAL COMMUNICATIONS NETWORK; ELECTRONIC MAIL, VOICE MAIL AND MESSAGING SERVICES, NAMELY, THE RECORDING AND STORAGE AND SUBSEQUENT TRANSMISSION OF VOICE MESSAGES BY TELEPHONE; AUDIO AND VIDEO TELECONFERENCING; RENTAL OF TELECOMMUNICATIONS EQUIPMENT, NAMELY, EQUIPMENT FOR ELECTRONIC ACCESS TO GLOBAL TELECOMMUNICATIONS NETWORK, EQUIPMENT FOR TRANSMITTING, RECEIVING, RECORDING AND MONITORING VOICE, DATA, INFORMATION, IMAGES, SIGNALS AND MESSAGES; RENTAL OF EQUIPMENT FOR TRANSMITTING, RECEIVING, RECORDING AND MONITORING COMPUTER PROGRAMS FOR USE IN OPERATING AND ACCESSING TELECOMMUNICATIONS SYSTEMS; PROVIDING MULTIPLE USE ACCESS TO COMPUTER INFORMATION NETWORKS; TELECOMMUNICATIONS SERVICES,

NAMELY, PERSONAL COMMUNICATIONS SERVICES; TELECOMMUNICATIONS SERVICES FOR PAGERS; ELECTRONIC MAIL SERVICES; TRANSMISSION AND BROADCAST OF AUDIO AND VIDEO PROGRAMMING; PROVIDING MULTIPLE-USER ACCESS TO A GLOBAL COMMUNICATION NETWORK, IN CLASS 38 (U.S. CLS. 100, 101 AND 104).

PRIORITY CLAIMED UNDER SEC. 44(D) ON FED REP GERMANY APPLICATION NO. 30741658, FILED 6-26-2007, REG. NO. 30741658, DATED 8-29-2007, EXPIRES 6-30-2017.

OWNER OF U.S. REG. NOS. 3,190,981 AND 3,219,373.

THE COLOR(S) MAGENTA AND WHITE IS/ARE CLAIMED AS A FEATURE OF THE MARK.

THE MARK CONSISTS OF A MAGENTA RECTANGLE CONTAINING THE TERM "PARTNER" IN WHITE. IN THE TOP SECTION, THE COLOR WHITE APPEARS AS THE BACKGROUND AND THE COLOR MAGENTA APPEARS IN THE 10 SMALL SQUARES AND THE LETTER "T".

SER. NO. 77-359,585, FILED 12-26-2007.

CYNTHIA SLOAN, EXAMINING ATTORNEY

Int. Cl.: 37

Prior U.S. Cls.: 100, 103 and 106

United States Patent and Trademark Office

Reg. No. 3,574,839

Registered Feb. 17, 2009

SERVICE MARK
PRINCIPAL REGISTER



DEUTSCHE TELEKOM (FED REP GERMANY
AG CORPORATION)

FRIEDRICH-EBERT-ALLEE 140

BONN, FED REP GERMANY 53113

FOR: BUILDING CONSTRUCTION; INSTALLATION OF COMPUTER AND TELECOMMUNICATIONS EQUIPMENT; REPAIR AND MAINTENANCE OF COMPUTER AND TELECOMMUNICATIONS EQUIPMENT, IN CLASS 37 (U.S. CLS. 100, 103 AND 106).

PRIORITY CLAIMED UNDER SEC. 44(D) ON FED REP GERMANY APPLICATION NO. 30741658, FILED 6-26-2007, REG. NO. 30741658, DATED 8-29-2007, EXPIRES 6-30-2017.

OWNER OF U.S. REG. NOS. 3,190,981 AND 3,219,373.

THE COLOR(S) MAGENTA AND WHITE IS/ARE CLAIMED AS A FEATURE OF THE MARK.

THE MARK CONSISTS OF A MAGENTA RECTANGLE CONTAINING THE TERM "PARTNER" IN WHITE. IN THE TOP SECTION, THE COLOR WHITE APPEARS AS THE BACKGROUND AND THE COLOR MAGENTA APPEARS IN THE 10 SMALL SQUARES AND THE LETTER "T".

SER. NO. 77-359,603, FILED 12-26-2007.

CYNTHIA SLOAN, EXAMINING ATTORNEY

Int. Cl.: 1

Prior U.S. Cls.: 1, 5, 6, 10, 26 and 46

Reg. No. 3,574,840

United States Patent and Trademark Office

Registered Feb. 17, 2009

**TRADEMARK
PRINCIPAL REGISTER**

STIMULOX

CARUS CORPORATION (DELAWARE CORPORATION)
315 5TH STREET
PERU, IL 61354

THE MARK CONSISTS OF STANDARD CHARACTERS WITHOUT CLAIM TO ANY PARTICULAR FONT, STYLE, SIZE, OR COLOR.

FOR: CRYSTALLINE POWDER CONSISTING PRIMARILY OF PEROXYGEN CHEMICALS USED FOR GROUNDWATER REMEDIATION, IN CLASS 1 (U.S. CLS. 1, 5, 6, 10, 26 AND 46).

SER. NO. 77-359,604, FILED 12-26-2007.

FIRST USE 11-30-2007; IN COMMERCE 11-30-2007.

CARRIE GENOVESE, EXAMINING ATTORNEY

Int. Cl.: 41

Prior U.S. Cls.: 100, 101 and 107

United States Patent and Trademark Office

Reg. No. 3,574,841

Registered Feb. 17, 2009

**SERVICE MARK
PRINCIPAL REGISTER**

QLN quantum learning network

QUANTUM LEARNING NETWORK (CALIFORNIA CORPORATION)
1938 AVENIDA DEL ORO
OCEANSIDE, CA 92056

FOR: EDUCATIONAL SERVICES, NAMELY, CONDUCTING LECTURES AND COURSES FOR STUDENTS EMPHASIZING ACCELERATED LEARNING SKILLS, ACADEMICS AND PERSONAL CONFIDENCE DEVELOPMENT; AND CONDUCTING IN-SERVICE SEMINARS AND WORKSHOPS FOR EDUCATORS IN THE FIELD OF EFFECTIVE LEARNING ENVIRONMENTS, EFFECTIVE TEACHING AND TRAINING METHODS AND LEARNING SKILLS; CONDUCTING WORKSHOPS AND SEMINARS IN THE FIELD OF TRAINING DEVELOPMENT DIRECTED TO BUSINESSES AND PROFESSIONALS TO IMPROVE TRAINING AND WORKPLACE ENVIRONMENTS, IN CLASS 41 (U.S. CLS. 100, 101 AND 107).

FIRST USE 10-31-2004; IN COMMERCE 10-31-2004.

OWNER OF U.S. REG. NOS. 2,291,803, 3,266,223 AND OTHERS.

NO CLAIM IS MADE TO THE EXCLUSIVE RIGHT TO USE "LEARNING NETWORK", APART FROM THE MARK AS SHOWN.

THE MARK CONSISTS OF A STYLIZED LETTER "Q" POSITIONED BETWEEN THE WORD ELEMENTS "QLN" AND "QUANTUM LEARNING NETWORK".

SER. NO. 77-359,638, FILED 12-26-2007.

JANICE L. MCMORROW, EXAMINING ATTORNEY

Int. Cl.: 44

Prior U.S. Cls.: 100 and 101

United States Patent and Trademark Office

Reg. No. 3,574,842

Registered Feb. 17, 2009

**SERVICE MARK
PRINCIPAL REGISTER**

the Whitening Tooth Fairy

DSBV INC. (FLORIDA CORPORATION)
#170
21346 ST. ANDREWS BLVD.
BOCA RATON, FL 33434

FOR: TEETH WHITENING SERVICES, IN CLASS
44 (U.S. CLS. 100 AND 101).

FIRST USE 12-1-2007; IN COMMERCE 12-1-2007.

THE MARK CONSISTS OF STANDARD CHAR-
ACTERS WITHOUT CLAIM TO ANY PARTICULAR
FONT, STYLE, SIZE, OR COLOR.

NO CLAIM IS MADE TO THE EXCLUSIVE
RIGHT TO USE "WHITENING", APART FROM
THE MARK AS SHOWN.

SER. NO. 77-359,779, FILED 12-26-2007.

ANNE MADDEN, EXAMINING ATTORNEY

Int. Cl.: 25

Prior U.S. Cls.: 22 and 39

United States Patent and Trademark Office

Reg. No. 3,574,843

Registered Feb. 17, 2009

**TRADEMARK
PRINCIPAL REGISTER**

Foxy Monster

LARSON, ASHLEY WYATT (UNITED STATES
INDIVIDUAL), DBA FOXY MONSTER
6231 BERNHARD AVE
RICHMOND, CA 94805

FOR: BELTS; CLOTHING, NAMELY, ARM WARMERS; CLOTHING, NAMELY, HAND-WARMERS; CORSETS; EAR WARMERS; FUR HATS; HAT BANDS; HATS; HEADGEAR, NAMELY, HATS, HOODS, SCARFS; HOODS; LEG WARMERS; LEGGINGS; SHOULDER WRAPS; SMALL HATS, IN CLASS 25 (U.S. CLS. 22 AND 39).

FIRST USE 5-1-2005; IN COMMERCE 1-2-2007.

THE MARK CONSISTS OF STANDARD CHARACTERS WITHOUT CLAIM TO ANY PARTICULAR FONT, STYLE, SIZE, OR COLOR.

SER. NO. 77-359,814, FILED 12-26-2007.

CURTIS FRENCH, EXAMINING ATTORNEY

Int. Cl.: 35

Prior U.S. Cls.: 100, 101 and 102

United States Patent and Trademark Office

Reg. No. 3,574,844

Registered Feb. 17, 2009

**SERVICE MARK
PRINCIPAL REGISTER**

SPANSOFT

SPANSOFT INC (MICHIGAN CORPORATION)
3 PARK HILL, SUITE # 2
MENANDS, NY 12204

FOR: BUSINESS CONSULTATION SERVICES, IN
CLASS 35 (U.S. CLS. 100, 101 AND 102).

FIRST USE 8-5-1998; IN COMMERCE 1-31-2004.

THE MARK CONSISTS OF STANDARD CHAR-
ACTERS WITHOUT CLAIM TO ANY PARTICULAR
FONT, STYLE, SIZE, OR COLOR.

SER. NO. 77-359,872, FILED 12-27-2007.

WILLIAM BRECKENFELD, EXAMINING ATTOR-
NEY

Int. Cl.: 29

Prior U.S. Cl.: 46

United States Patent and Trademark Office

Reg. No. 3,574,845

Registered Feb. 17, 2009

TRADEMARK
PRINCIPAL REGISTER



A&P GROWERS COOPERATIVE (CALIFORNIA CORPORATION)

26487 N. HWY. 99
TULARE, CA 93274

FOR: DRIED FRUITS; PROCESSED NUTS; ROASTED NUTS, IN CLASS 29 (U.S. CL. 46).

FIRST USE 12-22-2005; IN COMMERCE 12-22-2005.

OWNER OF U.S. REG. NO. 2,424,978.

NO CLAIM IS MADE TO THE EXCLUSIVE RIGHT TO USE "FARMS", APART FROM THE MARK AS SHOWN.

THE STIPPLING IS FOR SHADING PURPOSES ONLY.

THE MARK CONSISTS OF FARMHOUSES AND SILOS SURROUNDED BY ORCHARDS AND MOUNTAINS APPEARING IN AN OVAL WITH THE WORDING "SAN JOAQUIN VALLEY FARMS" APPEARING ABOVE THE OVAL IN STYLIZED LETTERING.

SEC. 2(F) AS TO "SAN JOAQUIN VALLEY FARMS".

SER. NO. 77-360,105, FILED 12-27-2007.

LINDSEY RUBIN, EXAMINING ATTORNEY

Int. Cl.: 41

Prior U.S. Cls.: 100, 101 and 107

United States Patent and Trademark Office

Reg. No. 3,574,846

Registered Feb. 17, 2009

**SERVICE MARK
PRINCIPAL REGISTER**

MACY'S GREAT TREE

MACY'S DEPARTMENT STORES, INC. (DELA-
WARE CORPORATION)
11 PENN PLAZA
NEW YORK, NY 10001

FOR: ENTERTAINMENT SERVICES, NAMELY,
PRODUCTION OF ONGOING TELEVISION PRO-
GRAMS FEATURING LIVE MUSIC, DANCING,
AND LIVE APPEARANCES BY TELEVISION CE-
LEBRITIES, ALL RELATED TO THE CHRISTMAS
SEASON; AND ENTERTAINMENT SERVICES,
NAMELY, ORGANIZING AND CONDUCTING A
CHRISTMAS DISPLAY FEATURING LIVE MUSIC,
DANCING, AND LIVE APPEARANCES BY TELEVI-
SION CELEBRITIES, ALL RELATED TO THE

CHRISTMAS SEASON, IN CLASS 41 (U.S. CLS. 100,
101 AND 107).

FIRST USE 0-0-1947; IN COMMERCE 0-0-1947.

THE MARK CONSISTS OF STANDARD CHAR-
ACTERS WITHOUT CLAIM TO ANY PARTICULAR
FONT, STYLE, SIZE, OR COLOR.

SER. NO. 77-360,283, FILED 12-27-2007.

MATTHEW MCDOWELL, EXAMINING ATTOR-
NEY

Int. Cls.: 35, 37 and 42

Prior U.S. Cls.: 100, 101, 102, 103 and 106

United States Patent and Trademark Office

Reg. No. 3,574,847

Registered Feb. 17, 2009

**SERVICE MARK
PRINCIPAL REGISTER**

Vision Packaged. Delivered.

IDHASOFT PRIVATE LIMITED (INDIA CORPORATION)
SECTOR 30A, VASHI
B-407, BSEL TECHPARK, 4TH FLOOR
NAVI MUMBAI, INDIA 400705

FOR: DATABASE MANAGEMENT, IN CLASS 35 (U.S. CLS. 100, 101 AND 102).

FIRST USE 1-1-2007; IN COMMERCE 1-1-2007.

FOR: INSTALLATION OF COMPUTER INFORMATION SYSTEMS FOR BUSINESSES AND BUSINESSES IN THE RETAIL, TELECOMMUNICATIONS, AND HEALTHCARE INDUSTRIES, IN CLASS 37 (U.S. CLS. 100, 103 AND 106).

FIRST USE 1-1-2007; IN COMMERCE 1-1-2007.

FOR: TECHNICAL SUPPORT SERVICES, NAMELY, MONITORING OF INFORMATION NETWORK SYSTEMS FOR BUSINESSES, BUSINESSES IN THE RETAIL, TELECOMMUNICATIONS AND HEALTHCARE INDUSTRIES; INFORMATION TECHNOLOGY SYSTEM CONSULTANCY FOR BUSINESSES AND BUSINESSES IN THE RETAIL, TELECOMMU-

NICATIONS, AND HEALTHCARE INDUSTRIES; COMPUTER PROGRAMMING, COMPUTER SOFTWARE DESIGN, COMPUTER SYSTEM ANALYSIS, COMPUTER SYSTEM INTEGRATION, COMPUTER SERVICES, NAMELY, REMOTE MANAGEMENT OF COMPUTER APPLICATIONS FOR OTHERS; TESTING OF COMPUTER APPLICATIONS FOR OTHERS; PROVIDING QUALITY ASSURANCE SERVICES IN THE FIELDS OF BANKING AND FINANCIAL SERVICES, HEALTHCARE, GOVERNMENT, MANUFACTURING, TELECOMMUNICATIONS, RETAIL, TECHNOLOGY AND MEDIA; AND PRODUCT ENGINEERING SERVICES FOR OTHERS, IN CLASS 42 (U.S. CLS. 100 AND 101).

FIRST USE 1-1-2007; IN COMMERCE 1-1-2007.

THE MARK CONSISTS OF STANDARD CHARACTERS WITHOUT CLAIM TO ANY PARTICULAR FONT, STYLE, SIZE, OR COLOR.

SER. NO. 77-360,322, FILED 12-27-2007.

CHRISTOPHER BUONGIORNO, EXAMINING ATTORNEY

Int. Cl.: 35

Prior U.S. Cls.: 100, 101 and 102

United States Patent and Trademark Office

Reg. No. 3,574,848

Registered Feb. 17, 2009

**SERVICE MARK
PRINCIPAL REGISTER**

FENCE SITTERS

NATURAL MARKETING INSTITUTE (PENN-
SYLVANIA CORPORATION)
272 RUTH ROAD
HARLEYSVILLE, PA 19438

THE MARK CONSISTS OF STANDARD CHAR-
ACTERS WITHOUT CLAIM TO ANY PARTICULAR
FONT, STYLE, SIZE, OR COLOR.

FOR: CONSULTING AND RESEARCHING IN
THE FIELD OF CONSUMERS OF GENERAL
HEALTH AND WELLNESS PRODUCTS AND SER-
VICES, IN CLASS 35 (U.S. CLS. 100, 101 AND 102).

SER. NO. 77-360,360, FILED 12-27-2007.

FIRST USE 3-1-2001; IN COMMERCE 3-1-2001.

HEATHER THOMPSON, EXAMINING ATTORNEY

Int. Cl.: 35

Prior U.S. Cls.: 100, 101 and 102

United States Patent and Trademark Office

Reg. No. 3,574,849

Registered Feb. 17, 2009

**SERVICE MARK
PRINCIPAL REGISTER**

Big Dot of Happiness

BIG DOT OF HAPPINESS, LLC (WISCONSIN
LIMITED LIABILITY COMPANY)
1921 TALEN STREET
MENOMONIE, WI 54751

FOR: ONLINE RETAIL STORE SERVICES FEATURING INVITATIONS AND THEMED PRODUCTS FOR BABY SHOWERS, BRIDAL SHOWERS, BACHELORETTE PARTIES AND BIRTHDAY PARTIES, IN CLASS 35 (U.S. CLS. 100, 101 AND 102).

FIRST USE 12-31-2005; IN COMMERCE 12-31-2005.

THE MARK CONSISTS OF STANDARD CHARACTERS WITHOUT CLAIM TO ANY PARTICULAR FONT, STYLE, SIZE, OR COLOR.

SER. NO. 77-360,363, FILED 12-27-2007.

HEATHER THOMPSON, EXAMINING ATTORNEY

Int. Cls.: 9 and 35

Prior U.S. Cls.: 21, 23, 26, 36, 38, 100, 101 and 102

United States Patent and Trademark Office

Reg. No. 3,574,850

Registered Feb. 17, 2009

**TRADEMARK
SERVICE MARK
PRINCIPAL REGISTER**

The Quiet Pro

SERIOUS MATERIALS, LLC (DELAWARE LIMITED LIABILITY COMPANY)
522 ALMANOR AVENUE
SUNNYVALE, CA 94085

FOR: PROVIDING DOWNLOADABLE ELECTRONIC NEWSLETTERS IN THE FIELD OF SOUND-PROOFING AND NOISE ATTENUATION FOR CONSTRUCTION PROFESSIONALS, IN CLASS 9 (U.S. CLS. 21, 23, 26, 36 AND 38).

FIRST USE 8-1-2007; IN COMMERCE 8-1-2007.

FOR: PROFESSIONAL BUSINESS CONSULTATION, IN CLASS 35 (U.S. CLS. 100, 101 AND 102).

FIRST USE 8-1-2007; IN COMMERCE 8-1-2007.

THE MARK CONSISTS OF STANDARD CHARACTERS WITHOUT CLAIM TO ANY PARTICULAR FONT, STYLE, SIZE, OR COLOR.

SER. NO. 77-360,410, FILED 12-27-2007.

BARBARA BROWN, EXAMINING ATTORNEY

Int. Cl.: 35

Prior U.S. Cls.: 100, 101 and 102

United States Patent and Trademark Office

Reg. No. 3,574,851

Registered Feb. 17, 2009

**SERVICE MARK
PRINCIPAL REGISTER**

**LOHAS Consumer Trends
Database**

NATURAL MARKETING INSTITUTE (PENNSYLVANIA CORPORATION)
272 RUTH ROAD
HARLEYSVILLE, PA 19438

FOR: PROVIDING A DATABASE FEATURING DATA ABOUT CONSUMER PURCHASING TRENDS IN THE FIELD OF LIFESTYLES OF HEALTH AND SUSTAINABILITY, IN CLASS 35 (U.S. CLS. 100, 101 AND 102).

FIRST USE 6-1-2002; IN COMMERCE 6-1-2002.

THE MARK CONSISTS OF STANDARD CHARACTERS WITHOUT CLAIM TO ANY PARTICULAR FONT, STYLE, SIZE, OR COLOR.

NO CLAIM IS MADE TO THE EXCLUSIVE RIGHT TO USE "DATABASE", APART FROM THE MARK AS SHOWN.

SEC. 2(F).

SER. NO. 77-360,693, FILED 12-28-2007.

HEATHER THOMPSON, EXAMINING ATTORNEY

Int. Cl.: 9

Prior U.S. Cls.: 21, 23, 26, 36 and 38

United States Patent and Trademark Office

Reg. No. 3,574,852

Registered Feb. 17, 2009

**TRADEMARK
PRINCIPAL REGISTER**

RLH/Run Like Hell

INTERPLAY ENTERTAINMENT CORP (DELA-
WARE CORPORATION)
100 NORTH CRESCENT DRIVE SUITE 324
BEVERLY HILLS, CA 90210

FOR: COMPUTER PROGRAMS FOR VIDEO
GAMES AND COMPUTER GAMES AND INSTRUC-
TION MANUALS SOLD AS A UNIT WITH THE
GAMES, AND COMPUTER PROGRAMS FOR VI-
DEO GAMES AND COMPUTER GAMES WHICH
MAY BE DOWNLOADED FROM A GLOBAL COM-
PUTER NETWORK, IN CLASS 9 (U.S. CLS. 21, 23, 26,
36 AND 38).

FIRST USE 1-1-2002; IN COMMERCE 1-1-2003.

THE MARK CONSISTS OF STANDARD CHAR-
ACTERS WITHOUT CLAIM TO ANY PARTICULAR
FONT, STYLE, SIZE, OR COLOR.

SER. NO. 77-360,704, FILED 12-28-2007.

THEODORE MCBRIDE, EXAMINING ATTORNEY

Int. Cl.: 9

Prior U.S. Cls.: 21, 23, 26, 36 and 38

United States Patent and Trademark Office

Reg. No. 3,574,853

Registered Feb. 17, 2009

**TRADEMARK
PRINCIPAL REGISTER**

RUN LIKE HELL

INTERPLAY ENTERTAINMENT CORP (DELA-
WARE CORPORATION)
100 NORTH CRESCENT DRIVE SUITE 324
BEVERLY HILLS, CA 90210

FOR: COMPUTER PROGRAMS FOR VIDEO
GAMES AND COMPUTER GAMES AND INSTRUC-
TION MANUALS SOLD AS A UNIT WITH THE
GAMES, AND COMPUTER PROGRAMS FOR VI-
DEO GAMES AND COMPUTER GAMES WHICH
MAY BE DOWNLOADED FROM A GLOBAL COM-
PUTER NETWORK, IN CLASS 9 (U.S. CLS. 21, 23, 26,
36 AND 38).

FIRST USE 1-1-2002; IN COMMERCE 1-1-2003.

THE MARK CONSISTS OF STANDARD CHAR-
ACTERS WITHOUT CLAIM TO ANY PARTICULAR
FONT, STYLE, SIZE, OR COLOR.

SER. NO. 77-360,707, FILED 12-28-2007.

THEODORE MCBRIDE, EXAMINING ATTORNEY

Int. Cl.: 16

Prior U.S. Cls.: 2, 5, 22, 23, 29, 37, 38 and 50

United States Patent and Trademark Office

Reg. No. 3,574,854

Registered Feb. 17, 2009

**TRADEMARK
PRINCIPAL REGISTER**

**Organic Consumer Trends
Report**

NATURAL MARKETING INSTITUTE (PENNSYLVANIA CORPORATION)

272 RUTH ROAD

HARLEYSVILLE, PA 19438

FOR: RESEARCH REPORTS FEATURING INFORMATION ABOUT PURCHASING TRENDS AMONG CONSUMERS OF ORGANIC PRODUCTS, IN CLASS 16 (U.S. CLS. 2, 5, 22, 23, 29, 37, 38 AND 50).

FIRST USE 0-0-2001; IN COMMERCE 0-0-2001.

THE MARK CONSISTS OF STANDARD CHARACTERS WITHOUT CLAIM TO ANY PARTICULAR FONT, STYLE, SIZE, OR COLOR.

NO CLAIM IS MADE TO THE EXCLUSIVE RIGHT TO USE "REPORT", APART FROM THE MARK AS SHOWN.

SEC. 2(F).

SER. NO. 77-360,715, FILED 12-28-2007.

HEATHER THOMPSON, EXAMINING ATTORNEY

Int. Cl.: 9

Prior U.S. Cls.: 21, 23, 26, 36 and 38

Reg. No. 3,574,855

United States Patent and Trademark Office

Registered Feb. 17, 2009

**TRADEMARK
PRINCIPAL REGISTER**

SACRIFICE

INTERPLAY ENTERTAINMENT CORP (DELA-
WARE CORPORATION)
100 NORTH CRESCENT DRIVE SUITE 324
BEVERLY HILLS, CA 90210

FOR: COMPUTER PROGRAMS FOR VIDEO
GAMES AND COMPUTER GAMES AND INSTRUC-
TION MANUALS SOLD AS A UNIT WITH THE
GAMES, AND COMPUTER PROGRAMS FOR VI-
DEO GAMES AND COMPUTER GAMES WHICH
MAY BE DOWNLOADED FROM A GLOBAL COM-
PUTER NETWORK, IN CLASS 9 (U.S. CLS. 21, 23, 26,
36 AND 38).

FIRST USE 1-1-1997; IN COMMERCE 1-1-1998.

THE MARK CONSISTS OF STANDARD CHAR-
ACTERS WITHOUT CLAIM TO ANY PARTICULAR
FONT, STYLE, SIZE, OR COLOR.

SER. NO. 77-360,716, FILED 12-28-2007.

THEODORE MCBRIDE, EXAMINING ATTORNEY

Int. Cl.: 9

Prior U.S. Cls.: 21, 23, 26, 36 and 38

Reg. No. 3,574,856

United States Patent and Trademark Office

Registered Feb. 17, 2009

**TRADEMARK
PRINCIPAL REGISTER**

STONEKEEP

INTERPLAY ENTERTAINMENT CORP (DELA-
WARE CORPORATION)
100 NORTH CRESCENT DRIVE SUITE 324
BEVERLY HILLS, CA 90210

FOR: COMPUTER PROGRAMS FOR VIDEO
GAMES AND COMPUTER GAMES AND INSTRUC-
TION MANUALS SOLD AS A UNIT WITH THE
GAMES, AND COMPUTER PROGRAMS FOR VI-
DEO GAMES AND COMPUTER GAMES WHICH
MAY BE DOWNLOADED FROM A GLOBAL COM-
PUTER NETWORK, IN CLASS 9 (U.S. CLS. 21, 23, 26,
36 AND 38).

FIRST USE 11-22-1995; IN COMMERCE 11-22-1995.

THE MARK CONSISTS OF STANDARD CHAR-
ACTERS WITHOUT CLAIM TO ANY PARTICULAR
FONT, STYLE, SIZE, OR COLOR.

SER. NO. 77-360,725, FILED 12-28-2007.

THEODORE MCBRIDE, EXAMINING ATTORNEY

Int. Cl.: 15

Prior U.S. Cls.: 2, 21 and 36

United States Patent and Trademark Office

Reg. No. 3,574,857

Registered Feb. 17, 2009

**TRADEMARK
PRINCIPAL REGISTER**

GUITAR BRA

SILVER, MARCUS (UNITED STATES INDIVIDUAL)
8613 FRANKLIN AVE
LOS ANGELES, CA 90069

THE MARK CONSISTS OF STANDARD CHARACTERS WITHOUT CLAIM TO ANY PARTICULAR FONT, STYLE, SIZE, OR COLOR.

FOR: GUITAR COVER, IN CLASS 15 (U.S. CLS. 2, 21 AND 36).

SER. NO. 77-361,027, FILED 12-28-2007.

FIRST USE 8-22-2007; IN COMMERCE 8-22-2007.

JAY FLOWERS, EXAMINING ATTORNEY

Int. Cl.: 37

Prior U.S. Cls.: 100, 103 and 106

United States Patent and Trademark Office

Reg. No. 3,574,858

Registered Feb. 17, 2009

SERVICE MARK
PRINCIPAL REGISTER



TOP TO BOTTOM RENOVATIONS, LLC (GEORGIA LIMITED LIABILITY COMPANY)

#11

110 SOUTH COLUMBIA DRIVE
DECATUR, GA 30030

FOR: RENOVATION IN THE FIELD OF BATHROOMS, KITCHENS AND DECKS, IN CLASS 37 (U.S. CLS. 100, 103 AND 106).

FIRST USE 11-15-2007; IN COMMERCE 11-15-2007.

NO CLAIM IS MADE TO THE EXCLUSIVE RIGHT TO USE "RENOVATIONS, LLC", APART FROM THE MARK AS SHOWN.

THE MARK CONSISTS OF TWO ARROWS AROUND THE STYLIZED TEXT "T2B". TO THE RIGHT OF THE TEXT "T2B" AND THE ARROWS ARE THE STYLIZED WORDS "TOP TO BOTTOM RENOVATIONS, LLC".

SER. NO. 77-361,039, FILED 12-28-2007.

KHANH LE, EXAMINING ATTORNEY

Int. Cls.: 40 and 42

Prior U.S. Cls.: 100, 101, 103 and 106

United States Patent and Trademark Office

Reg. No. 3,574,859

Registered Feb. 17, 2009

**SERVICE MARK
PRINCIPAL REGISTER**

KEYLON

QUADRANT CHEMPLAST (PTY) LTD (SOUTH
AFRICA CORPORATION)
PO BOX 8049
52 KRAFT ROAD
ELANDSFONTEIN, SOUTH AFRICA 1406

FOR: CUSTOM MANUFACTURE OF SHAPED
PARTS AND ASSEMBLIES MADE OF PLASTIC, IN
CLASS 40 (U.S. CLS. 100, 103 AND 106).

FIRST USE 9-30-1999; IN COMMERCE 9-30-1999.

FOR: CUSTOM DESIGN OF SHAPED PARTS
AND ASSEMBLIES MADE OF PLASTIC, IN CLASS
42 (U.S. CLS. 100 AND 101).

FIRST USE 9-30-1999; IN COMMERCE 9-30-1999.

THE MARK CONSISTS OF STANDARD CHAR-
ACTERS WITHOUT CLAIM TO ANY PARTICULAR
FONT, STYLE, SIZE, OR COLOR.

SEC. 2(F).

SER. NO. 77-361,086, FILED 12-28-2007.

MARK SPARACINO, EXAMINING ATTORNEY

Int. Cl.: 19

Prior U.S. Cls.: 1, 12, 33 and 50

United States Patent and Trademark Office

Reg. No. 3,574,860

Registered Feb. 17, 2009

TRADEMARK
PRINCIPAL REGISTER



100% PURE GREEN 

CERTIFIED FOREST PRODUCTS, LLC (CALIFORNIA LIMITED LIABILITY COMPANY)
21-C ORINDA WAY, #234
ORINDA, CA 94563

FOR: PLYWOOD; LUMBER, IN CLASS 19 (U.S. CLS. 1, 12, 33 AND 50).

FIRST USE 12-25-2005; IN COMMERCE 1-1-2006.

NO CLAIM IS MADE TO THE EXCLUSIVE RIGHT TO USE "CERTIFIED FOREST PRODUCTS"; "100% PURE GREEN", APART FROM THE MARK AS SHOWN.

THE COLOR(S) WHITE, BLACK, ORANGE, GREEN AND BLUE IS/ARE CLAIMED AS A FEATURE OF THE MARK.

THE MARK CONSISTS OF THE COLOR WHITE APPEARS IN THE WORDS "CERTIFIED FOREST PRODUCTS" AND THE COLOR GREEN APPEARS IN THE DESIGN OF A TREE AND THE COLOR ORANGE APPEARS IN A SERIES OF ARROWS, ALL ON A BLUE BACKGROUND; THE COLOR BLACK APPEARS IN "100% PURE" AND THE COLOR GREEN APPEARS IN THE WORD "GREEN" WITH A GREEN LEAF.

SEC. 2(F).

SER. NO. 77-361,172, FILED 12-28-2007.

CAROLYN GRAY, EXAMINING ATTORNEY

Int. Cls.: 21 and 22

**Prior U.S. Cls.: 1, 2, 7, 13, 19, 22, 23, 29, 30, 33, 40, 42
and 50**

Reg. No. 3,574,861

United States Patent and Trademark Office

Registered Feb. 17, 2009

**TRADEMARK
PRINCIPAL REGISTER**

CAMPER SPECIALTIES

THE COAST DISTRIBUTION SYSTEM, INC. (DE-
LAWARE CORPORATION)
350 WOODVIEW AVENUE
MORGAN HILL, CA 95037

FOR: RECREATIONAL VEHICLE ACCESSORIES,
NAMELY, SHOE AND BOOT CLEANERS COM-
PRISED OF FREE STANDING BRUSHES IN THE
NATURE OF BRUSHES FOR FOOTWEAR, IN
CLASS 21 (U.S. CLS. 2, 13, 23, 29, 30, 33, 40 AND 50).

FIRST USE 2-0-1999; IN COMMERCE 2-0-1999.

FOR: RECREATIONAL VEHICLE ACCESSORIES,
NAMELY, TIE DOWN KITS FOR USE WITH AWN-
INGS COMPRISING TIE DOWN STRAPS, NON-
METAL STRAPPING, METAL TENT STAKES AND
METAL HARDWARE SPRINGS, IN CLASS 22 (U.S.
CLS. 1, 2, 7, 19, 22, 42 AND 50).

FIRST USE 2-0-1999; IN COMMERCE 2-0-1999.

THE MARK CONSISTS OF STANDARD CHAR-
ACTERS WITHOUT CLAIM TO ANY PARTICULAR
FONT, STYLE, SIZE, OR COLOR.

OWNER OF U.S. REG. NO. 2,113,490.

NO CLAIM IS MADE TO THE EXCLUSIVE
RIGHT TO USE "CAMPER", APART FROM THE
MARK AS SHOWN.

SEC. 2(F).

SER. NO. 77-361,297, FILED 12-28-2007.

SONYA STEPHENS, EXAMINING ATTORNEY

Int. Cl.: 11

Prior U.S. Cls.: 13, 21, 23, 31 and 34

Reg. No. 3,574,862

United States Patent and Trademark Office

Registered Feb. 17, 2009

**TRADEMARK
PRINCIPAL REGISTER**



ACORN ENGINEERING COMPANY (CALIFORNIA CORPORATION)
P.O. BOX 3527
CITY OF INDUSTRY, CA 91744

THE MARK CONSISTS OF THE WORD "MINI-LOO" AND A STYLIZED GEOMETRIC FIGURE CONSISTING OF A CIRCULAR BALL SITTING TWO SLANTED LINES.

FOR: LAVATORIES; TOILETS; TOILET BOWLS; TOILET SEATS; AND TOILET TANKS, IN CLASS 11 (U.S. CLS. 13, 21, 23, 31 AND 34).

SER. NO. 77-361,425, FILED 12-29-2007.

FIRST USE 6-30-2007; IN COMMERCE 6-30-2007.

PAULA MAHONEY, EXAMINING ATTORNEY

Int. Cl.: 41

Prior U.S. Cls.: 100, 101 and 107

United States Patent and Trademark Office

Reg. No. 3,574,863

Registered Feb. 17, 2009

**SERVICE MARK
PRINCIPAL REGISTER**

PR QUICKSTART

PUBLIC RELATIONS SOCIETY OF AMERICA,
INC. (NEW YORK NON-PROFIT CORPORATION)
33 MAIDEN LANE, 11TH FLOOR
NEW YORK, NY 10038 AND
COUNCIL OF PUBLIC RELATIONS FIRMS, INC.
(NEW YORK NON-PROFIT CORPORATION)
SUITE 2320
317 MADISON AVENUE
NEW YORK, NY 10017

FOR: EDUCATIONAL SERVICES, NAMELY,
PROVIDING WEB-BASED TRAINING IN THE
FIELD OF PUBLIC RELATIONS, IN CLASS 41 (U.S.
CLS. 100, 101 AND 107).

FIRST USE 0-0-2000; IN COMMERCE 0-0-2000.

THE MARK CONSISTS OF STANDARD CHAR-
ACTERS WITHOUT CLAIM TO ANY PARTICULAR
FONT, STYLE, SIZE, OR COLOR.

NO CLAIM IS MADE TO THE EXCLUSIVE
RIGHT TO USE "PR", APART FROM THE MARK
AS SHOWN.

SER. NO. 77-361,571, FILED 12-30-2007.

MARIA-VICTORIA SUAREZ, EXAMINING ATTOR-
NEY

Int. Cl.: 41

Prior U.S. Cls.: 100, 101 and 107

United States Patent and Trademark Office

Reg. No. 3,574,864

Registered Feb. 17, 2009

**SERVICE MARK
PRINCIPAL REGISTER**



COLOR MEDIA GROUP, LLC (MASSACHUSETTS LIMITED LIABILITY COMPANY)
378 RUSSETT ROAD
BROOKLINE, MA 02467

FOR: MAGAZINE PUBLISHING, IN CLASS 41 (U.S. CLS. 100, 101 AND 107).

FIRST USE 11-30-2007; IN COMMERCE 11-30-2007.

NO CLAIM IS MADE TO THE EXCLUSIVE RIGHT TO USE "MEDIA GROUP, LLC", APART FROM THE MARK AS SHOWN.

THE COLOR(S) BLACK, RED, BROWN, WHITE AND YELLOW IS/ARE CLAIMED AS A FEATURE OF THE MARK.

THE MARK CONSISTS OF THE WORD "COLOR" ON THE FIRST LINE. THE 2ND "O" IN "COLOR" CONTAINS THE COLORS BLACK, RED, BROWN, WHITE AND YELLOW. THE BLACK BLEEDS INTO THE RED, THE RED BLEEDS INTO THE BROWN, THE BROWN BLEEDS INTO THE WHITE AND THE WHITE BLEEDS INTO THE YELLOW. THE 2ND LINE CONTAINS THE WORD "MEDIA GROUP, LLC" IN BLACK.

SER. NO. 77-361,575, FILED 12-30-2007.

MARIA-VICTORIA SUAREZ, EXAMINING ATTORNEY

Int. Cl.: 7

Prior U.S. Cls.: 13, 19, 21, 23, 31, 34 and 35

United States Patent and Trademark Office

Reg. No. 3,574,865

Registered Feb. 17, 2009

**TRADEMARK
PRINCIPAL REGISTER**

ENGINEERED TO BE NATURAL

MARS FISHCARE EUROPE (FRANCE CORPORATION)
LA RAVOIRE
74370 METZ TESSY, FRANCE

FOR: AIR PUMPS FOR AQUARIUMS AND PONDS; WATER PUMPS FOR AQUARIUMS AND PONDS; FILTERING MACHINES FOR AQUARIUMS AND PONDS; AERATORS, IN CLASS 7 (U.S. CLS. 13, 19, 21, 23, 31, 34 AND 35).

FIRST USE 5-31-2007; IN COMMERCE 5-31-2007.

THE MARK CONSISTS OF STANDARD CHARACTERS WITHOUT CLAIM TO ANY PARTICULAR FONT, STYLE, SIZE, OR COLOR.

SER. NO. 77-361,717, FILED 12-31-2007.

KATHERINE E. HALMEN, EXAMINING ATTORNEY

Int. Cl.: 5

Prior U.S. Cls.: 6, 18, 44, 46, 51 and 52

Reg. No. 3,574,866

United States Patent and Trademark Office

Registered Feb. 17, 2009

**TRADEMARK
PRINCIPAL REGISTER**

Sentia

HERBQUEST INNOVATIONS, LLC (ARIZONA
LIMITED LIABILITY COMPANY)
2122 W. LONE CACTUS DR., #1
PHOENIX, AZ 85027

THE MARK CONSISTS OF STANDARD CHAR-
ACTERS WITHOUT CLAIM TO ANY PARTICULAR
FONT, STYLE, SIZE, OR COLOR.

FOR: ALL NATURAL NUTRITIONAL SUPPLE-
MENT FOR FEMALE ENHANCEMENT, IN CLASS 5
(U.S. CLS. 6, 18, 44, 46, 51 AND 52).

SER. NO. 77-361,784, FILED 12-31-2007.

FIRST USE 7-30-2004; IN COMMERCE 7-30-2004.

KELLY MCCOY, EXAMINING ATTORNEY

Int. Cls.: 35 and 36

Prior U.S. Cls.: 100, 101 and 102

United States Patent and Trademark Office

Reg. No. 3,574,867

Registered Feb. 17, 2009

**SERVICE MARK
PRINCIPAL REGISTER**

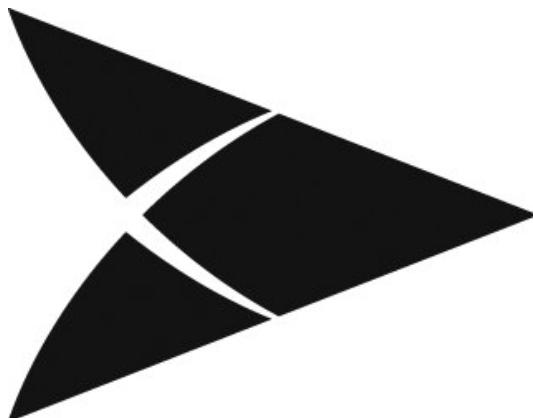

THE BANK OF NEW YORK MELLON COR-
PORATION (DELAWARE CORPORATION)
15TH FLOOR
ONE WALL STREET
NEW YORK, NY 10286

FOR: FUND AND PORTFOLIO ACCOUNTING,
ADMINISTRATION AND RECONCILIATION OF
ACCOUNTS ON BEHALF OF OTHERS, AND BUSI-
NESS MANAGEMENT AND ADMINISTRATION
SERVICES, IN CLASS 35 (U.S. CLS. 100, 101 AND 102).

FIRST USE 10-1-2007; IN COMMERCE 10-1-2007.

FOR: BANKING AND FINANCIAL SERVICES;
INVESTMENT MANAGEMENT AND ADVISORY
SERVICES; CORPORATE TRUST SERVICES; TRUST
AND ESTATE MANAGEMENT SERVICES; SECURITIES
CUSTODY, PROCESSING, LENDING,
CLEARING AND EXECUTION SERVICES; AND
DEPOSITARY RECEIPTS SERVICES, IN CLASS 36
(U.S. CLS. 100, 101 AND 102).

FIRST USE 10-1-2007; IN COMMERCE 10-1-2007.

SER. NO. 77-361,898, FILED 12-31-2007.

ALICE BENMAMAN, EXAMINING ATTORNEY

Int. Cl.: 3

Prior U.S. Cls.: 1, 4, 6, 50, 51 and 52

United States Patent and Trademark Office

Reg. No. 3,574,868

Registered Feb. 17, 2009

**TRADEMARK
PRINCIPAL REGISTER**

pa nail collective

KABUSHIKI KAISHA DEAR LAURA (JAPAN CORPORATION)
SHINJUKU-KU
4-32-13 NISHI-SHINJUKU
TOKYO, JAPAN 160-0023

FOR: NAIL VARNISH AND THE OTHER COSMETICS FOR NAILS, NAMELY, NAIL CREAM AND GLITTER, NAIL VARNISH, NAMELY, SEALS FOR DECORATING NAILS, FALSE NAILS, ADHESIVES FOR AFFIXING ARTIFICIAL NAILS, ADHESIVES FOR AFFIXING FALSE NAILS, GLUE REMOVING AGENTS FOR FALSE NAILS, NAMELY, GLUE REMOVERS, POLISHING PAPER FOR NAILS AND FALSE NAILS, ABRASIVE PAPER FOR NAILS AND FALSE NAILS, ABRASIVE CLOTH FOR NAILS AND FALSE NAILS, ABRASIVE SAND FOR NAILS AND FALSE NAILS, ARTIFICIAL PUMICE STONE FOR

PERSONAL USE FOR NAILS AND FALSE NAILS, IMPREGNATED POLISHING CLOTH FOR NAILS AND FALSE NAILS AND SOAPS AND DETERGENTS FOR NAILS, IN CLASS 3 (U.S. CLS. 1, 4, 6, 50, 51 AND 52).

OWNER OF JAPAN REG. NO. 4985081, DATED 9-8-2006, EXPIRES 9-16-2016.

NO CLAIM IS MADE TO THE EXCLUSIVE RIGHT TO USE "NAIL COLLECTIVE", APART FROM THE MARK AS SHOWN.

SER. NO. 77-361,973, FILED 12-31-2007.

SETH A. RAPPAPORT, EXAMINING ATTORNEY

Int. Cl.: 35

Prior U.S. Cls.: 100, 101 and 102

United States Patent and Trademark Office

Reg. No. 3,574,869

Registered Feb. 17, 2009

**SERVICE MARK
PRINCIPAL REGISTER**

Greening Innovations

WILTON, STEPHEN S. (UNITED STATES INDIVIDUAL)
1923 KRISTY COURT
LONGMONT, CO 80504

FOR: CONSULTING SERVICES IN THE AREA OF SUSTAINABLE BUSINESS SOLUTIONS, IN CLASS 35 (U.S. CLS. 100, 101 AND 102).

FIRST USE 10-28-2007; IN COMMERCE 10-28-2007.

THE MARK CONSISTS OF STANDARD CHARACTERS WITHOUT CLAIM TO ANY PARTICULAR FONT, STYLE, SIZE, OR COLOR.

NO CLAIM IS MADE TO THE EXCLUSIVE RIGHT TO USE "GREENING", APART FROM THE MARK AS SHOWN.

SER. NO. 77-361,992, FILED 12-31-2007.

MARY CRAWFORD, EXAMINING ATTORNEY

Int. Cl.: 25

Prior U.S. Cls.: 22 and 39

United States Patent and Trademark Office

Reg. No. 3,574,870

Registered Feb. 17, 2009

**TRADEMARK
PRINCIPAL REGISTER**



THIAM, ALIAUNE (UNITED STATES INDIVIDUAL)
C/O 191 PEACHTREE STREET, SUITE 3300
ATLANTA, GA 30303

FOR: CLOTHING, NAMELY, SHIRTS, PANTS, T-SHIRTS, JERSEYS, JACKETS, SHOES, DRESSES, COATS, BLOUSES, SUITS, HATS, UNDERWEAR, SOCKS, TIES, SLEEPWEAR, IN CLASS 25 (U.S. CLS. 22 AND 39).

FIRST USE 9-14-2007; IN COMMERCE 10-26-2007.

OWNER OF U.S. REG. NO. 3,324,225.

THE MARK CONSISTS OF MULTIPLE USES OF THE "KON VICT" MARK AND DESIGNS OF KEYS AND HANDCUFFS.

SER. NO. 77-362,096, FILED 12-31-2007.

BRENDAN REGAN, EXAMINING ATTORNEY

Int. Cl.: 25

Prior U.S. Cls.: 22 and 39

United States Patent and Trademark Office

Reg. No. 3,574,871

Registered Feb. 17, 2009

**TRADEMARK
PRINCIPAL REGISTER**



THIAM, ALIAUNE (UNITED STATES INDIVIDUAL)
C/O 191 PEACHTREE STREET, SUITE 3300
ATLANTA, GA 30303

FOR: CLOTHING, NAMELY, SHIRTS, PANTS, T-SHIRTS, JERSEYS, JACKETS, SHOES, DRESSES, COATS, BLOUSES, SUITS, HATS, UNDERWEAR, SOCKS, TIES, SLEEPWEAR, IN CLASS 25 (U.S. CLS. 22 AND 39).

FIRST USE 9-14-2007; IN COMMERCE 10-26-2007.

OWNER OF U.S. REG. NO. 3,324,225.

THE MARK CONSISTS OF USE OF THE "KONVICT" MARK AND DESIGNS OF KEYS AND HANDCUFFS.

SER. NO. 77-362,114, FILED 12-31-2007.

BRENDAN REGAN, EXAMINING ATTORNEY

Int. Cl.: 25

Prior U.S. Cls.: 22 and 39

United States Patent and Trademark Office

Reg. No. 3,574,872

Registered Feb. 17, 2009

**TRADEMARK
PRINCIPAL REGISTER**



THIAM, ALIAUNE (UNITED STATES INDIVIDUAL)
C/O 191 PEACHTREE STREET, SUITE 3300
ATLANTA, GA 30303

OWNER OF U.S. REG. NO. 3,324,225.

FOR: CLOTHING, NAMELY, SHIRTS, PANTS, T-SHIRTS, JERSEYS, JACKETS, SHOES, DRESSES, COATS, BLOUSES, SUITS, HATS, UNDERWEAR, SOCKS, TIES, SLEEPWEAR, IN CLASS 25 (U.S. CLS. 22 AND 39).

THE MARK CONSISTS OF USE OF THE "KON VICT" MARK AND DESIGNS OF KEYS AND HANDCUFFS.

SER. NO. 77-362,122, FILED 12-31-2007.

FIRST USE 9-14-2007; IN COMMERCE 10-26-2007.

BRENDAN REGAN, EXAMINING ATTORNEY

Int. Cl.: 25

Prior U.S. Cls.: 22 and 39

United States Patent and Trademark Office

Reg. No. 3,574,873

Registered Feb. 17, 2009

**TRADEMARK
PRINCIPAL REGISTER**



THIAM, ALIAUNE (UNITED STATES INDIVIDUAL)
C/O 191 PEACHTREE STREET, SUITE 3300
ATLANTA, GA 30303

FOR: CLOTHING, NAMELY, SHIRTS, PANTS, T-SHIRTS, JERSEYS, JACKETS, SHOES, DRESSES, COATS, BLOUSES, SUITS, HATS, UNDERWEAR, SOCKS, TIES, SLEEPWEAR, IN CLASS 25 (U.S. CLS. 22 AND 39).

FIRST USE 9-14-2007; IN COMMERCE 10-26-2007.

THE MARK CONSISTS OF HANDCUFFS AND A KEY.

SER. NO. 77-362,131, FILED 12-31-2007.

BRENDAN REGAN, EXAMINING ATTORNEY

Int. Cl.: 25

Prior U.S. Cls.: 22 and 39

United States Patent and Trademark Office

Reg. No. 3,574,874

Registered Feb. 17, 2009

TRADEMARK
PRINCIPAL REGISTER



THIAM, ALIAUNE (UNITED STATES INDIVIDUAL)
C/O 191 PEACHTREE STREET, SUITE 3300
ATLANTA, GA 30303

FOR: CLOTHING, NAMELY, SHIRTS, PANTS, T-SHIRTS, JERSEYS, JACKETS, SHOES, DRESSES, COATS, BLOUSES, SUITS, HATS, UNDERWEAR, SOCKS, TIES, SLEEPWEAR, IN CLASS 25 (U.S. CLS. 22 AND 39).

FIRST USE 9-14-2007; IN COMMERCE 10-26-2007.

OWNER OF U.S. REG. NO. 3,324,225.

THE MARK CONSISTS OF THE WORDING "KON VICT" AND "CHILDREN RISK THEIR LIVES IN THE DREAM OF FINDING THE BIG ONE" AND A CHILD'S FACE.

SER. NO. 77-362,146, FILED 12-31-2007.

BRENDAN REGAN, EXAMINING ATTORNEY

Prior U.S. Cl.: B

United States Patent and Trademark Office

Reg. No. 3,574,875

Registered Feb. 17, 2009

CERTIFICATION MARK
PRINCIPAL REGISTER

Accredited Investment
Fiduciary

CENTER FOR FIDUCIARY STUDIES, LLC
(PENNSYLVANIA LIMITED LIABILITY COMPANY)
438 DIVISION STREET
SEWICKLEY, PA 15143

FOR: FIDUCIARY REPRESENTATIVES, IN
CLASS B (U.S. CL. B).

FIRST USE 10-1-2002; IN COMMERCE 10-1-2002.

THE MARK CONSISTS OF STANDARD CHARACTERS WITHOUT CLAIM TO ANY PARTICULAR FONT, STYLE, SIZE, OR COLOR.

OWNER OF U.S. REG. NOS. 3,059,727 AND 3,059,728.

NO CLAIM IS MADE TO THE EXCLUSIVE RIGHT TO USE "INVESTMENT FIDUCIARY", APART FROM THE MARK AS SHOWN.

THE CERTIFICATION MARK, AS USED BY AUTHORIZED PERSONS, CERTIFIES THAT THEY HAVE MET CERTAIN STANDARDS, TESTS OF COMPETENCY AND COMPLETED TRAINING SET BY THE CERTIFIER.

SEC. 2(F).

SER. NO. 77-362,330, FILED 1-2-2008.

DAVID MILLER, EXAMINING ATTORNEY

Int. Cls.: 35, 40 and 42

Prior U.S. Cls.: 100, 101, 102, 103 and 106

United States Patent and Trademark Office

Reg. No. 3,574,876

Registered Feb. 17, 2009

**SERVICE MARK
PRINCIPAL REGISTER**

JUICEGRAPE.COM

M&M WINE GRAPE COMPANY, LLC (CONNECTICUT LIMITED LIABILITY COMPANY)
101 RESERVE ROAD
HARTFORD, CT 06114

FOR: RETAIL STORE SERVICES AND ON-LINE STORE SERVICES FEATURING INGREDIENTS, SUPPLIES AND EQUIPMENT FOR MAKING WINE, NAMELY, JUICE AND MUST IN FRESH, STERILE OR CONCENTRATED FORM, GRAPES, TANKS, GLASSWARE, CHEMICALS AND TESTING EQUIPMENT, IN CLASS 35 (U.S. CLS. 100, 101 AND 102).

FIRST USE 10-31-2007; IN COMMERCE 10-31-2007.

FOR: CONSULTING IN THE FIELD OF WINE MAKING; PROVIDING INFORMATION ABOUT MAKING WINE OVER THE INTERNET, IN CLASS 40 (U.S. CLS. 100, 103 AND 106).

FIRST USE 10-31-2007; IN COMMERCE 10-31-2007.

FOR: CHEMICAL ANALYSIS SERVICES IN THE FIELD OF WINE MAKING, IN CLASS 42 (U.S. CLS. 100 AND 101).

FIRST USE 10-31-2007; IN COMMERCE 10-31-2007.

THE MARK CONSISTS OF STANDARD CHARACTERS WITHOUT CLAIM TO ANY PARTICULAR FONT, STYLE, SIZE, OR COLOR.

SER. NO. 77-362,395, FILED 1-2-2008.

REBECCA EISINGER, EXAMINING ATTORNEY

Int. Cl.: 20

Prior U.S. Cls.: 2, 13, 22, 25, 32 and 50

United States Patent and Trademark Office

Reg. No. 3,574,877

Registered Feb. 17, 2009

**TRADEMARK
PRINCIPAL REGISTER**

COMPACTA

ANTHRO CORPORATION (OREGON CORPORATION)
10450 SW MANHASSET DRIVE
TUALATIN, OR 97062

FOR: MOBILE WORKSTATION FURNITURE, NAMELY, MODULAR EQUIPMENT CARTS AND ACCESSORIES THEREFORE, COMPRISED OF SHELVES, STORAGE BASKETS, BOOKENDS, ADJUSTABLE DOCUMENT HOLDERS, KEYBOARD CADDIES, WRIST SUPPORTS, ADJUSTABLE PLATFORMS FOR COMPUTER MONITORS AND TELEPHONES, AND CABLE MANAGEMENT SYSTEMS USED TO CONNECT CABLES TO EACH OTHER AND TO THE WORKSTATION, IN CLASS 20 (U.S. CLS. 2, 13, 22, 25, 32 AND 50).

FIRST USE 7-27-1993; IN COMMERCE 7-27-1993.

THE MARK CONSISTS OF STANDARD CHARACTERS WITHOUT CLAIM TO ANY PARTICULAR FONT, STYLE, SIZE, OR COLOR.

THE TERM "COMPACTA" HAS NO MEANING IN A FOREIGN LANGUAGE.

SER. NO. 77-362,670, FILED 1-2-2008.

WILLIAM P. SHANAHAN, EXAMINING ATTORNEY

Int. Cl.: 28

Prior U.S. Cls.: 22, 23, 38 and 50

United States Patent and Trademark Office

Reg. No. 3,574,878

Registered Feb. 17, 2009

**TRADEMARK
PRINCIPAL REGISTER**

NANO COPTER

DANBAR INTERNATIONAL LTD. (UNITED
KINGDOM CORPORATION)
DIXONS HILL ROAD
UNIT 2 A1 (M) BUSINESS CENTRE
WELHAM GREEN, UNITED KINGDOM AL97JE

FOR: REMOTE CONTROL TOYS, NAMELY, HELICOPTERS, ROAD VEHICLES, AIR PLANES, TANKS, UFOS, AND HELICOPTERS , IN CLASS 28 (U.S. CLS. 22, 23, 38 AND 50).

FIRST USE 12-1-2007; IN COMMERCE 12-1-2007.

THE MARK CONSISTS OF STANDARD CHARACTERS WITHOUT CLAIM TO ANY PARTICULAR FONT, STYLE, SIZE, OR COLOR.

NO CLAIM IS MADE TO THE EXCLUSIVE RIGHT TO USE "COPTER", APART FROM THE MARK AS SHOWN.

SER. NO. 77-362,903, FILED 1-2-2008.

ANDREA K. NADELMAN, EXAMINING ATTORNEY

Int. Cl.: 9

Prior U.S. Cls.: 21, 23, 26, 36 and 38

United States Patent and Trademark Office

Reg. No. 3,574,879

Registered Feb. 17, 2009

**TRADEMARK
PRINCIPAL REGISTER**

**MAX MECHANIZED ASSAULT &
EXPLORATION**

INTERPLAY ENTERTAINMENT CORP (DELA-
WARE CORPORATION)
100 NORTH CRESCENT DRIVE SUITE 324
BEVERLY HILLS, CA 90210

FOR: COMPUTER PROGRAMS FOR VIDEO
GAMES AND COMPUTER GAMES AND INSTRUC-
TION MANUALS SOLD AS A UNIT WITH THE
GAMES, AND COMPUTER PROGRAMS FOR VI-
DEO GAMES AND COMPUTER GAMES WHICH
MAY BE DOWNLOADED FROM A GLOBAL COM-
PUTER NETWORK, IN CLASS 9 (U.S. CLS. 21, 23, 26,
36 AND 38).

FIRST USE 1-1-1997; IN COMMERCE 1-1-1997.

THE MARK CONSISTS OF STANDARD CHAR-
ACTERS WITHOUT CLAIM TO ANY PARTICULAR
FONT, STYLE, SIZE, OR COLOR.

SER. NO. 77-363,082, FILED 1-3-2008.

THEODORE MCBRIDE, EXAMINING ATTORNEY

Int. Cl.: 9

Prior U.S. Cls.: 21, 23, 26, 36 and 38

Reg. No. 3,574,880

United States Patent and Trademark Office

Registered Feb. 17, 2009

**TRADEMARK
PRINCIPAL REGISTER**

MDK

INTERPLAY ENTERTAINMENT CORP (DELA-
WARE CORPORATION)
100 NORTH CRESCENT DRIVE SUITE 324
BEVERLY HILLS, CA 90210

FOR: COMPUTER PROGRAMS FOR VIDEO
GAMES AND COMPUTER GAMES AND INSTRUC-
TION MANUALS SOLD AS A UNIT WITH THE
GAMES, AND COMPUTER PROGRAMS FOR VI-
DEO GAMES AND COMPUTER GAMES WHICH
MAY BE DOWNLOADED FROM A GLOBAL COM-
PUTER NETWORK, IN CLASS 9 (U.S. CLS. 21, 23, 26,
36 AND 38).

FIRST USE 1-1-1997; IN COMMERCE 1-1-1997.

THE MARK CONSISTS OF STANDARD CHAR-
ACTERS WITHOUT CLAIM TO ANY PARTICULAR
FONT, STYLE, SIZE, OR COLOR.

SER. NO. 77-363,087, FILED 1-3-2008.

THEODORE MCBRIDE, EXAMINING ATTORNEY

Int. Cl.: 9

Prior U.S. Cls.: 21, 23, 26, 36 and 38

United States Patent and Trademark Office

Reg. No. 3,574,881

Registered Feb. 17, 2009

**TRADEMARK
PRINCIPAL REGISTER**

SHATTERED STEEL

INTERPLAY ENTERTAINMENT CORP (DELA-
WARE CORPORATION)
100 NORTH CRESCENT DRIVE SUITE 324
BEVERLY HILLS, CA 90210

FOR: COMPUTER PROGRAMS FOR VIDEO
GAMES AND COMPUTER GAMES AND INSTRUC-
TION MANUALS SOLD AS A UNIT WITH THE
GAMES, AND COMPUTER PROGRAMS FOR VI-
DEO GAMES AND COMPUTER GAMES WHICH
MAY BE DOWNLOADED FROM A GLOBAL COM-
PUTER NETWORK, IN CLASS 9 (U.S. CLS. 21, 23, 26,
36 AND 38).

FIRST USE 1-1-1996; IN COMMERCE 1-1-1996.

THE MARK CONSISTS OF STANDARD CHAR-
ACTERS WITHOUT CLAIM TO ANY PARTICULAR
FONT, STYLE, SIZE, OR COLOR.

SER. NO. 77-363,094, FILED 1-3-2008.

THEODORE MCBRIDE, EXAMINING ATTORNEY

Int. Cls.: 9, 35 and 38

Prior U.S. Cls.: 21, 23, 26, 36, 38, 100, 101, 102 and 104

United States Patent and Trademark Office

Reg. No. 3,574,882

Registered Feb. 17, 2009

**TRADEMARK
SERVICE MARK
PRINCIPAL REGISTER**

LADA POR COBRAR

TELEFONOS DE MEXICO, S.A. DE C.V. (MEXICO CORPORATION)

PARQUE VIA NO. 198. COL. CUAUHEMOC.

MEXICO CITY D.F., MEXICO 06599

FOR: ELECTRIC APPARATUS, NAMELY, INTEGRATED CIRCUITS, CAPACITORS, RESISTORS AND ELECTRICAL CONTROLLERS FOR USE IN TELECOMMUNICATION APPARATUS; SCIENTIFIC APPARATUS, NAMELY, SENSING AND SIGNALING DEVICES FOR MEASUREMENT AND QUALITY CONTROL OF MATERIALS PROCESSING BY LASER; APPARATUS FOR RECORDING, TRANSMISSION OR REPRODUCTION OF SOUND OR IMAGES; DATA PROCESSOR FOR DATA TREATMENT EQUIPMENT; COMPUTER HARDWARE FOR DATA TREATMENT EQUIPMENT; WIRELESS TELEPHONY APPARATUS; TELEPHONES; RECEIVER CAPS, NAMELY, COVERS FOR RECEIVERS NOT MADE OF PAPER; MAGNETIC TELEPHONE WIRES; BLANK INTEGRATED CIRCUITS; PRINTED CIRCUITS; INTERCOMMUNICATION APPARATUS AND INSTRUMENTS, NAMELY, TELEPHONES, CELLULAR TELEPHONES, INTERCOMS, TELEPHONE RECEIVERS, TELEPHONE TRANSMITTERS, TELEPHONE WIRES; ELBOW RESTS FOR USE WITH TELEPHONES; ELECTROSTATIC EMISSION CONTROL DEVICES, NAMELY, ELECTROSTATIC PRECIPITATORS FOR REDUCING PARTICULATE EMISSION IN INDUSTRIAL APPLICATIONS; CROSS-CONNECTING TERMINAL DEVICES, NAMELY, CABLE MODEMS; ANALOGOUS AND DIGITAL CENTRAL OFFICE SWITCHING, NAMELY, AUTOMATIC SWITCHING APPARATUS FOR TELECOMMUNICATIONS; METERING APPARATUS AND QUALITY CONTROL APPARATUS FOR THE TELEPHONE PUBLIC SERVICES, ACOUSTIC METERS, IN CLASS 9 (U.S. CLS. 21, 23, 26, 36 AND 38).

FOR: ADVERTISING AND MARKETING FOR THE TELECOMMUNICATIONS INDUSTRY, IN CLASS 35 (U.S. CLS. 100, 101 AND 102).

FOR: BASIC TELEPHONE COMMUNICATION SERVICES; FINAL TELECOMMUNICATION SERVICES, NAMELY, LOCAL AND LONG DISTANCE TRANSMISSION OF VOICE, DATA, GRAPHICS BY MEANS OF TELEPHONE, TELEGRAPHIC, CABLE, AND SATELLITE TRANSMISSIONS; TRANSMISSION OF SOUND, PICTURE AND DATA SIGNALS FOR VIDEO CONFERENCES AND VIDEO TELEPHONE FOR PUBLIC, LOCAL, URBAN, SUBURBAN, RURAL, NATIONAL AND INTERNATIONAL LONG DISTANCE TELEVISION, VIA SATELLITE; SIGNALS DISTRIBUTING SERVICES, NAMELY, RADIO AND TELEVISION BROADCASTING SERVICES; DATA COMMUNICATION BY ELECTRONIC MAIL; RENTAL OF TELECOMMUNICATIONS EQUIPMENT IN THE FORM OF PRIVATE CIRCUITS AND TELEPHONE LINES; RENTAL OF TELEPHONE BOOTHS; MOBILE TELEPHONY; COMMUNICATION VIA RADIO TRANSMISSION; RADIO PAGING; AND TELEVISION BROADCASTING, IN CLASS 38 (U.S. CLS. 100, 101 AND 104).

THE MARK CONSISTS OF STANDARD CHARACTERS WITHOUT CLAIM TO ANY PARTICULAR FONT, STYLE, SIZE, OR COLOR.

OWNER OF MEXICO REG. NO. 543724, DATED 2-3-1997, EXPIRES 2-3-2017.

OWNER OF MEXICO REG. NO. 543726, DATED 2-3-1997, EXPIRES 2-3-2017.

OWNER OF MEXICO REG. NO. 543725, DATED 2-3-1997, EXPIRES 2-3-2017.

OWNER OF U.S. REG. NO. 3,227,272.

THE ENGLISH TRANSLATION OF "POR CO-
BRAR" IS "TO CHARGE".

SER. NO. 77-363,160, FILED 1-3-2008.

MELVIN AXILBUND, EXAMINING ATTORNEY

Int. Cl.: 33

Prior U.S. Cls.: 47 and 49

United States Patent and Trademark Office

Reg. No. 3,574,883

Registered Feb. 17, 2009

TRADEMARK
PRINCIPAL REGISTER

methow valley winery

METHOW TRADING COMPANY (WASHING-
TON LIMITED LIABILITY COMPANY)
409 HWY 153
PATEROS, WA 98846

NO CLAIM IS MADE TO THE EXCLUSIVE
RIGHT TO USE "WINERY", APART FROM THE
MARK AS SHOWN.

FOR: WINE, IN CLASS 33 (U.S. CLS. 47 AND 49).

SEC. 2(F).

FIRST USE 4-0-2002; IN COMMERCE 4-0-2002.

SER. NO. 77-363,193, FILED 1-3-2008.

THE MARK CONSISTS OF STANDARD CHAR-
ACTERS WITHOUT CLAIM TO ANY PARTICULAR
FONT, STYLE, SIZE, OR COLOR.

CAROLINE WOOD, EXAMINING ATTORNEY

Int. Cls.: 29 and 30

Prior U.S. Cl.: 46

United States Patent and Trademark Office

Reg. No. 3,574,884

Registered Feb. 17, 2009

TRADEMARK
PRINCIPAL REGISTER



CORE-MARK INTERNATIONAL, INC. (DELAWARE CORPORATION)
SUITE 415
395 OYSTER POINT BOULEVARD
SOUTH SAN FRANCISCO, CA 94080

FOR: CANDIED NUTS; PROCESSED NUTS; ROASTED NUTS, IN CLASS 29 (U.S. CL. 46).

FIRST USE 6-27-1979; IN COMMERCE 6-27-1979.

FOR: CANDY; CHEWING GUM; CANDY CORN; CANDY NECKLACES; GUM DROPS; JELLY BEANS; STARLIGHT MINTS; VANILLA CARAMELS; CANDY, NAMELY, BUTTERSCOTCH DISCS, CHERRY SOURS, CINNAMON BEARS, SOUR BEARS, SOUR NEON WORMS, LEMON DROPS AND SPICE DROPS; SOFT GELATIN CANDIES, NAMELY, APPLE RINGS, ORANGE SLICES AND PEACH RINGS; SOFT GELATIN CANDIES IN THE NATURE OF GUMMY BEARS, GUMMY BLUE SHARKS, GUMMY WORMS; SNACK MIX CONSISTING OF CANDY; RED LICORICE TWISTS, IN CLASS 30 (U.S. CL. 46).

FIRST USE 6-27-1979; IN COMMERCE 6-27-1979.

OWNER OF U.S. REG. NOS. 929,258, 1,810,976, AND 2,108,906.

NO CLAIM IS MADE TO THE EXCLUSIVE RIGHT TO USE "SINCE 1890" AND "QUALITY CANDIES", APART FROM THE MARK AS SHOWN.

THE MARK CONSISTS OF A CIRCLE WITH A CABLE CAR IN THE CENTER. ABOVE THE CABLE CAR AND INSIDE OF THE CIRCLE ARE THE WORDS "CABLE CAR." ON THE SIDE OF THE CABLE CAR AND INSIDE A RECTANGLE IS THE WORD "SINCE" AND THE NUMBER "1890." UNDERNEATH THE CABLE CAR AND INSIDE OF THE CIRCLE ARE THE WORDS "QUALITY CANDIES" .

SER. NO. 77-363,344, FILED 1-3-2008.

CHRISTINE COOPER, EXAMINING ATTORNEY

Int. Cl.: 29

Prior U.S. Cl.: 46

United States Patent and Trademark Office

Reg. No. 3,574,885

Registered Feb. 17, 2009

**TRADEMARK
PRINCIPAL REGISTER**

ANGEL FLAKE

KRAFT FOODS GLOBAL BRANDS LLC (DELA-
WARE LIMITED LIABILITY COMPANY)
THREE LAKES DRIVE
NORTHFIELD, IL 60093

FOR: PREPARED COCONUT; FLAKED COCO-
NUT; PROCESSED COCONUT, IN CLASS 29 (U.S.
CL. 46).

FIRST USE 9-15-1954; IN COMMERCE 9-15-1954.

THE MARK CONSISTS OF STANDARD CHAR-
ACTERS WITHOUT CLAIM TO ANY PARTICULAR
FONT, STYLE, SIZE, OR COLOR.

OWNER OF U.S. REG. NO. 656,192.

SER. NO. 77-363,430, FILED 1-3-2008.

DOMINICK J. SALEMI, EXAMINING ATTORNEY

Int. Cl.: 41

Prior U.S. Cls.: 100, 101 and 107

United States Patent and Trademark Office

Reg. No. 3,574,886

Registered Feb. 17, 2009

**SERVICE MARK
PRINCIPAL REGISTER**

TOW-AT

VARNES, MITCH (UNITED STATES INDIVIDUAL)
503 PEREGRINE DRIVE
INDIALANTIC, FL 32903

THE MARK CONSISTS OF STANDARD CHARACTERS WITHOUT CLAIM TO ANY PARTICULAR FONT, STYLE, SIZE, OR COLOR.

FOR: ENTERTAINMENT IN THE NATURE OF COMPETITIONS IN THE FIELD OF SURFING, IN CLASS 41 (U.S. CLS. 100, 101 AND 107).

SER. NO. 77-363,629, FILED 1-3-2008.

FIRST USE 1-5-2005; IN COMMERCE 1-5-2005.

JORDAN BAKER, EXAMINING ATTORNEY

Int. Cls.: 7, 9 and 42

**Prior U.S. Cls.: 13, 19, 21, 23, 26, 31, 34, 35, 36, 38, 100
and 101**

Reg. No. 3,574,887

United States Patent and Trademark Office

Registered Feb. 17, 2009

**TRADEMARK
SERVICE MARK
PRINCIPAL REGISTER**

NANNI COMPACT COOLING

NANNI INDUSTRIES (FRANCE SOCIÉTÉ PAR
ACTIONS SIMPLIFIÉE (SAS))
22 AVENUE ABBE EDME MARIOTTE
LA TESTE DE BUCH, FRANCE F-33260

FOR: BOAT ENGINES; DIESEL ENGINES NOT
FOR LAND VEHICLES; ENGINE EXHAUST TIPS;
ENGINE MUFFLERS; ENGINE OR MOTOR MUF-
FLERS; EXHAUST MANIFOLD FOR ENGINES;
EXHAUST SILENCERS FOR ENGINES; HEAT EX-
CHANGERS BEING PARTS OF MACHINES; HEAT
EXCHANGERS BEING PARTS OF ENGINES NOT
FOR LAND VEHICLES; RADIATORS FOR MOTORS
AND ENGINES; WATER PUMPS FOR USE IN
MOTORS AND ENGINES, IN CLASS 7 (U.S. CLS.
13, 19, 21, 23, 31, 34 AND 35).

FOR: ELECTRIC AND ELECTRONIC CONTROL
DEVICES FOR COOLING CIRCUIT IN ENGINES
FOR BOATS, NAMELY, TEMPERATURE, PRES-
SURE AND COOLING LIQUID LEVEL CONTROL
DEVICES; ELECTRIC OR ELECTRONIC SENSORS
FOR TEMPERATURE IN AN ENGINE FOR BOATS;
AUTOMATIC PRESSURE CONTROL MACHINES
AND INSTRUMENTS; PRESSURE INDICATORS;
PRESSURE SENSORS, IN CLASS 9 (U.S. CLS. 21, 23,
26, 36 AND 38).

FOR: DESIGN OF APPARATUS AND MACHINES
FOR HEAT EXCHANGERS FOR BOAT ENGINES;
RESEARCH, DEVELOPMENT, CONSUMER PRO-
DUCT SAFETY TESTING IN THE NATURE OF
CALCULATING AND TESTING COOLING SYS-
TEMS WITH EXCHANGERS FOR BOAT ENGINES;
RESEARCH AND DEVELOPMENT OF NEW PRO-
DUCTS IN THE FIELD OF COOLING SYSTEM FOR
BOAT ENGINES, IN CLASS 42 (U.S. CLS. 100 AND
101).

THE MARK CONSISTS OF STANDARD CHAR-
ACTERS WITHOUT CLAIM TO ANY PARTICULAR
FONT, STYLE, SIZE, OR COLOR.

OWNER OF FRANCE REG. NO. 073509141, DA-
TED 6-26-2007, EXPIRES 6-26-2017.

NO CLAIM IS MADE TO THE EXCLUSIVE
RIGHT TO USE "COMPACT COOLING", APART
FROM THE MARK AS SHOWN.

SER. NO. 77-363,731, FILED 1-3-2008.

CARYN GLASSER, EXAMINING ATTORNEY

Int. Cl.: 41

Prior U.S. Cls.: 100, 101 and 107

United States Patent and Trademark Office

Reg. No. 3,574,888

Registered Feb. 17, 2009

**SERVICE MARK
PRINCIPAL REGISTER**



GENII CREATION L.L.C. (CALIFORNIA LIMITED LIABILITY COMPANY)
19925 STEVENS CREEK BOULEVARD
CUPERTINO, CA 95014

FOR: EDUCATIONAL SERVICES, NAMELY, PROVIDING COURSES OF INSTRUCTION AT THE PRESCHOOL AND ELEMENTARY LEVEL AND DISTRIBUTION OF COURSE MATERIAL IN CONNECTION THEREWITH, IN CLASS 41 (U.S. CLS. 100, 101 AND 107).

FIRST USE 2-1-2007; IN COMMERCE 2-1-2007.

NO CLAIM IS MADE TO THE EXCLUSIVE RIGHT TO USE "STUDIO", APART FROM THE MARK AS SHOWN.

THE COLOR(S) LIGHT GREEN, DARK GREEN, YELLOW, WHITE, BLACK AND RED IS/ARE CLAIMED AS A FEATURE OF THE MARK.

THE MARK CONSISTS OF A DIAMOND WHICH FADES FROM DARK TO LIGHT GREEN AND YELLOW NEAR THE TOP, WITH WHITE LETTERS "GENII STUDIO" IN THE MIDDLE, HAVING RED AND GREY BANDS ACROSS THE LETTERS AND BLACK SHADOWING AROUND THE LETTERS.

SER. NO. 77-363,824, FILED 1-3-2008.

FRANK LATTUCA, EXAMINING ATTORNEY

Int. Cl.: 30

Prior U.S. Cl.: 46

United States Patent and Trademark Office

Reg. No. 3,574,889

Registered Feb. 17, 2009

TRADEMARK
PRINCIPAL REGISTER



PROMOTION IN MOTION, INC. (DELAWARE CORPORATION)
3 REUTEN DRIVE
CLOSTER, NJ 07624

FOR: CHEWABLE YOGURT COVERED PROCESSED FRUIT, IN CLASS 30 (U.S. CL. 46).

FIRST USE 12-28-2007; IN COMMERCE 12-28-2007.

NO CLAIM IS MADE TO THE EXCLUSIVE RIGHT TO USE "LIVE & ACTIVE CULTURES", APART FROM THE MARK AS SHOWN.

THE COLOR(S) GREEN, BLUE AND WHITE IS/ARE CLAIMED AS A FEATURE OF THE MARK.

THE MARK CONSISTS OF A CIRCULAR SUN DESIGN IN GREEN WITH A WHITE CIRCULAR LINE NEAR THE OUTER PERIPHERY, A RECTANGLE WITH A RIBBON END ON THE RIGHT SIDE, WITH THE RECTANGULAR AND RIBBON END IN BLUE, THE WORDS "LIVE & ACTIVE CULTURES" INSIDE THE RECTANGLE, WITH THE WORD "LIVE, ACTIVE" AND CULTURES" BEING IN BLUE AND THE SYMBOL & BEING A WHITE BUBBLE FORM WITH A BLUE EDGING, AND A CHECK MARK TO THE RIGHT AND BELOW THE RECTANGLE IN A WHITE BUBBLE FORM WITH A BLUE EDGING.

SER. NO. 77-364,018, FILED 1-4-2008.

EMILY CARLSEN, EXAMINING ATTORNEY

Int. Cl.: 35

Prior U.S. Cls.: 100, 101 and 102

United States Patent and Trademark Office

Reg. No. 3,574,890

Registered Feb. 17, 2009

**SERVICE MARK
PRINCIPAL REGISTER**

creativeplacement

CREATIVE PLACEMENT AGENCY (CONNECTI-
CUT LIMITED LIABILITY COMPANY)
13 NORTH MAIN STREET
SOUTH NORWALK, CT 06854

FOR: PERSONNEL PLACEMENT AND RE-
CRUITMENT, IN CLASS 35 (U.S. CLS. 100, 101 AND
102).

FIRST USE 7-1-2001; IN COMMERCE 7-1-2001.

THE MARK CONSISTS OF STANDARD CHAR-
ACTERS WITHOUT CLAIM TO ANY PARTICULAR
FONT, STYLE, SIZE, OR COLOR.

SEC. 2(F).

SER. NO. 77-364,429, FILED 1-4-2008.

TRICIA SONNEBORN, EXAMINING ATTORNEY

Int. Cls.: 25 and 41

Prior U.S. Cls.: 22, 39, 100, 101 and 107

United States Patent and Trademark Office

Reg. No. 3,574,891

Registered Feb. 17, 2009

**TRADEMARK
SERVICE MARK
PRINCIPAL REGISTER**

PURPLE EAGLES

NIAGARA UNIVERSITY (NEW YORK NON-PROFIT CORPORATION)
P.O. BOX 2036
NIAGARA UNIVERSITY, NY 14109

FOR: CLOTHING, NAMELY, SWEATSHIRTS, SHORTS, T-SHIRTS, HATS, IN CLASS 25 (U.S. CLS. 22 AND 39).

FIRST USE 12-31-1954; IN COMMERCE 12-31-1954.

FOR: ENTERTAINMENT SERVICES, NAMELY, ORGANIZING COLLEGE SPORTING EVENTS IN THE FIELDS OF BASKETBALL, BASEBALL, SOFTBALL, CROSS COUNTRY, GOLF, TENNIS, SOCCER, SWIMMING AND DIVING, LACROSSE, HOCKEY

AND VOLLEYBALL; PROVIDING A WEB SITE FEATURING INFORMATION REGARDING UNIVERSITY ATHLETIC PROGRAMS, IN CLASS 41 (U.S. CLS. 100, 101 AND 107).

FIRST USE 0-0-1960; IN COMMERCE 0-0-1960.

THE MARK CONSISTS OF STANDARD CHARACTERS WITHOUT CLAIM TO ANY PARTICULAR FONT, STYLE, SIZE, OR COLOR.

SER. NO. 77-364,465, FILED 1-4-2008.

ANNE E. GUSTASON, EXAMINING ATTORNEY

Int. Cl.: 9

Prior U.S. Cls.: 21, 23, 26, 36 and 38

Reg. No. 3,574,892

United States Patent and Trademark Office

Registered Feb. 17, 2009

**TRADEMARK
PRINCIPAL REGISTER**



WILLIAM H. YARBROUGH (GEORGIA CORPORATION), DBA WILBE PRODUCTIONS, INC.
STE. 105
5436 RIVERDALE ROAD
COLLEGE PARK, GA 30349

FOR: PRE-RECORDED CDS, VIDEO TAPES, LASER DISKS AND DVDS FEATURING MUSIC, IN CLASS 9 (U.S. CLS. 21, 23, 26, 36 AND 38).

FIRST USE 10-15-1999; IN COMMERCE 10-15-1999.

THE COLOR(S) WHITE, BLACK, GOLD IS/ARE CLAIMED AS A FEATURE OF THE MARK.

THE MARK CONSISTS OF WHITE BACKGROUND, BLACK "W" AND "B", GOLD "IL" AND "E" .

SER. NO. 77-364,471, FILED 1-4-2008.

THOMAS MANOR, EXAMINING ATTORNEY

Int. Cl.: 12

Prior U.S. Cls.: 19, 21, 23, 31, 35 and 44

United States Patent and Trademark Office

Reg. No. 3,574,893

Registered Feb. 17, 2009

**TRADEMARK
PRINCIPAL REGISTER**

SILENTARMOR

THE GOODYEAR TIRE & RUBBER COMPANY
(OHIO CORPORATION)
DEPT. 823
1144 EAST MARKET STREET
AKRON, OH 443160001

FOR: TIRES, IN CLASS 12 (U.S. CLS. 19, 21, 23, 31,
35 AND 44).

FIRST USE 5-27-2005; IN COMMERCE 5-27-2005.

THE MARK CONSISTS OF STANDARD CHAR-
ACTERS WITHOUT CLAIM TO ANY PARTICULAR
FONT, STYLE, SIZE, OR COLOR.

OWNER OF U.S. REG. NO. 3,389,724.

SER. NO. 77-364,529, FILED 1-4-2008.

CHRISTINE COOPER, EXAMINING ATTORNEY

Int. Cls.: 9 and 42

Prior U.S. Cls.: 21, 23, 26, 36, 38, 100 and 101

United States Patent and Trademark Office

Reg. No. 3,574,894

Registered Feb. 17, 2009

**TRADEMARK
SERVICE MARK
PRINCIPAL REGISTER**

AUTOMATION'S BEST FRIEND

KEPWARE, INC. (MAINE CORPORATION)
P.O. BOX 579
PORTLAND, ME 041120579

FOR: COMPUTER SOFTWARE FOR USE IN THE PROCESS CONTROL AND INDUSTRIAL AUTOMATION INDUSTRIES, NAMELY, FOR USE AS COMMUNICATION DRIVERS TO AUTOMATION CONTROLLERS, I/O AND FIELD DEVICES, IN CLASS 9 (U.S. CLS. 21, 23, 26, 36 AND 38).

FIRST USE 3-22-2006; IN COMMERCE 3-22-2006.

FOR: COMPUTER SOFTWARE DEVELOPMENT AND DESIGN SERVICES IN THE PROCESS CONTROL AND INDUSTRIAL AUTOMATION INDUSTRIES, IN CLASS 42 (U.S. CLS. 100 AND 101).

FIRST USE 3-22-2006; IN COMMERCE 3-22-2006.

THE MARK CONSISTS OF STANDARD CHARACTERS WITHOUT CLAIM TO ANY PARTICULAR FONT, STYLE, SIZE, OR COLOR.

SER. NO. 77-364,607, FILED 1-4-2008.

DANIEL CAPSHAW, EXAMINING ATTORNEY

Int. Cl.: 30

Prior U.S. Cl.: 46

United States Patent and Trademark Office

Reg. No. 3,574,895

Registered Feb. 17, 2009

**TRADEMARK
PRINCIPAL REGISTER**

Summer of Sorbetto

GELATO PARADISO, LLC (DELAWARE LIMITED LIABILITY COMPANY)
SUITE 5000
17795 SKY PARK CIRCLE
IRVINE, CA 92614

NO CLAIM IS MADE TO THE EXCLUSIVE RIGHT TO USE "SORBETTO", APART FROM THE MARK AS SHOWN.

FOR: SORBET, NAMELY, FRESH, FRUIT FLAVORED, FAT-FREE SORBETS, IN CLASS 30 (U.S. CL. 46).

THE FOREIGN WORDING IN THE MARK TRANSLATES INTO ENGLISH AS SORBET.

FIRST USE 8-25-2007; IN COMMERCE 8-25-2007.

SER. NO. 77-364,740, FILED 1-4-2008.

THE MARK CONSISTS OF STANDARD CHARACTERS WITHOUT CLAIM TO ANY PARTICULAR FONT, STYLE, SIZE, OR COLOR.

ALYSSA STEEL, EXAMINING ATTORNEY

Int. Cl.: 35

Prior U.S. Cls.: 100, 101 and 102

United States Patent and Trademark Office

Reg. No. 3,574,896

Registered Feb. 17, 2009

**SERVICE MARK
PRINCIPAL REGISTER**

JangoMail

SILICOMM CORPORATION (OHIO CORPORATION), DBA JANGOMAIL
6302 FAR HILLS AVENUE
DAYTON, OH 45459

FOR: ADVERTISING AGENCY SPECIALIZING IN THE DESIGN AND EXECUTION OF WORD OF MOUTH, VIRAL, BUZZ AND EXPERIENTIAL MARKETING PROGRAMS; ADVERTISING AND MARKETING; ADVERTISING, PROMOTION AND MARKETING SERVICES IN THE NATURE OF E-MAIL BLAST CAMPAIGNS FOR OTHERS, IN CLASS 35 (U.S. CLS. 100, 101 AND 102).

FIRST USE 9-20-2002; IN COMMERCE 9-20-2002.

THE MARK CONSISTS OF STANDARD CHARACTERS WITHOUT CLAIM TO ANY PARTICULAR FONT, STYLE, SIZE, OR COLOR.

OWNER OF U.S. REG. NO. 2,685,852.

SER. NO. 77-365,048, FILED 1-6-2008.

LYDIA BELZER, EXAMINING ATTORNEY

Int. Cl.: 9

Prior U.S. Cls.: 21, 23, 26, 36 and 38

United States Patent and Trademark Office

Reg. No. 3,574,897

Registered Feb. 17, 2009

**TRADEMARK
PRINCIPAL REGISTER**

CAMVU

ANGLO DESIGN HOLDINGS PLC (UNITED
KINGDOM PUBLIC LIMITED COMPANY
(PLC))

UNIT 1200

DARESBURY PARK

DARESBURY, UNITED KINGDOM WA44HS

FOR: VIDEO CAMERAS FOR SURVEILLANCE
INSTALLATIONS; AND PARTS FOR THE AFORE-
SAID EQUIPMENT, IN CLASS 9 (U.S. CLS. 21, 23, 26,
36 AND 38).

THE MARK CONSISTS OF STANDARD CHAR-
ACTERS WITHOUT CLAIM TO ANY PARTICULAR
FONT, STYLE, SIZE, OR COLOR.

PRIORITY CLAIMED UNDER SEC. 44(D) ON
ERPNTY TM OFC APPLICATION NO.
006125199, FILED 7-23-2007, REG. NO. 06125199,
DATED 7-14-2008, EXPIRES 7-23-2017.

SER. NO. 77-365,610, FILED 1-7-2008.

RONALD AIKENS, EXAMINING ATTORNEY

Int. Cl.: 5

Prior U.S. Cls.: 6, 18, 44, 46, 51 and 52

United States Patent and Trademark Office

Reg. No. 3,574,898

Registered Feb. 17, 2009

**TRADEMARK
PRINCIPAL REGISTER**

TRUEFILL

HOME DIAGNOSTICS, INC. (DELAWARE CORPORATION)
2400 N.W. 55TH COURT
FT. LAUDERDALE, FL 33309

THE MARK CONSISTS OF STANDARD CHARACTERS WITHOUT CLAIM TO ANY PARTICULAR FONT, STYLE, SIZE, OR COLOR.

FOR: MEDICAL DIAGNOSTIC TEST STRIPS FOR USE IN THE FIELD OF BLOOD GLUCOSE TESTING, IN CLASS 5 (U.S. CLS. 6, 18, 44, 46, 51 AND 52).

SER. NO. 77-365,791, FILED 1-7-2008.

FIRST USE 1-7-2008; IN COMMERCE 1-7-2008.

WILLIAM ROSSMAN, EXAMINING ATTORNEY

Int. Cl.: 5

Prior U.S. Cls.: 6, 18, 44, 46, 51 and 52

Reg. No. 3,574,899

United States Patent and Trademark Office

Registered Feb. 17, 2009

**TRADEMARK
PRINCIPAL REGISTER**

The logo for Truefill features the word "TRUE" in a bold, dark blue, sans-serif font. The letter "U" is stylized with a red blood drop shape inside its upper curve. To the right of "TRUE" is the word "fill" in a lighter blue, lowercase, sans-serif font.

HOME DIAGNOSTICS, INC. (DELAWARE CORPORATION)
2400 N.W. 55TH COURT
FT. LAUDERDALE, FL 33309

FOR: MEDICAL DIAGNOSTIC TEST STRIPS FOR USE IN THE FIELD OF BLOOD GLUCOSE TESTING, IN CLASS 5 (U.S. CLS. 6, 18, 44, 46, 51 AND 52).

FIRST USE 1-7-2008; IN COMMERCE 1-7-2008.

THE COLOR(S) DARK BLUE, LIGHT BLUE, AND RED IS/ARE CLAIMED AS A FEATURE OF THE MARK.

THE MARK CONSISTS OF THE WORD "TRUE-FILL" IN STYLIZED LETTERS. THE WORD "TRUE" IS DARK BLUE AND THE WORD "FILL" IS LIGHT BLUE. INSIDE THE LETTER "U" APPEARS A FANCIFUL DESIGN OF A RED BLOOD DROP.

SER. NO. 77-365,917, FILED 1-7-2008.

WILLIAM ROSSMAN, EXAMINING ATTORNEY

Int. Cl.: 9

Prior U.S. Cls.: 21, 23, 26, 36 and 38

United States Patent and Trademark Office

Reg. No. 3,574,900

Registered Feb. 17, 2009

**TRADEMARK
PRINCIPAL REGISTER**

BIOSWIPE

COGENT, INC. (DELAWARE CORPORATION)
209 FAIR OAKS AVENUE
SO. PASADENA, CA 91030

THE MARK CONSISTS OF STANDARD CHAR-
ACTERS WITHOUT CLAIM TO ANY PARTICULAR
FONT, STYLE, SIZE, OR COLOR.

FOR: COMPUTER SOFTWARE FOR BIOMETRIC
IDENTIFICATION AND VERIFICATION, IN CLASS
9 (U.S. CLS. 21, 23, 26, 36 AND 38).

SER. NO. 77-365,945, FILED 1-7-2008.

FIRST USE 3-31-2005; IN COMMERCE 3-31-2005.

JAY FLOWERS, EXAMINING ATTORNEY

Int. Cl.: 3

Prior U.S. Cls.: 1, 4, 6, 50, 51 and 52

United States Patent and Trademark Office

Reg. No. 3,574,901

Registered Feb. 17, 2009

**TRADEMARK
PRINCIPAL REGISTER**



L'OREAL (FRANCE SOCIÉTÉ ANONYME (SA))
14 RUE ROYALE
PARIS, FRANCE 75008

FOR: HAIR STYLING MOUSSE, CREAM, GEL,
LOTION AND SPRAY, IN CLASS 3 (U.S. CLS. 1, 4, 6,
50, 51 AND 52).

FIRST USE 1-0-2005; IN COMMERCE 1-0-2005.

OWNER OF U.S. REG. NOS. 1,381,997 AND
2,914,840.

THE COLOR(S) SILVER, BLUE, YELLOW, RED,
BLACK AND WHITE IS/ARE CLAIMED AS A
FEATURE OF THE MARK.

THE MARK CONSISTS OF A SILVER RECTAN-
GLE DISPOSED HORIZONTALLY, CONNECTED

TO A SMALLER RECTANGLE DISPOSED VERTI-
CALLY, BELOW WHICH APPEAR TWO NEARLY
SQUARE BLUE SHAPES, ONE OF WHICH IS PAR-
Tially SUPERIMPOSED ON A YELLOW SQUARE
THAT IS ATTACHED TO A YELLOW RECTANGLE,
TWO NEARLY SQUARE RED SHAPES, ONE OF
WHICH IS PARTIALLY SUPERIMPOSED ON THE
YELLOW SQUARE, A BLUE RECTANGLE CON-
NECTED TO A BLUE SQUARE WITHIN WHICH
APPEARS A WHITE CIRCLE, AND THE WORD
"STUDIOLINE" WITH "STUDIO" APPEARING IN
BLACK AND "LINE" APPEARING IN SILVER,
TURNED 90 DEGREES AND RUNNING FROM
BOTTOM TO TOP.

SER. NO. 77-366,177, FILED 1-8-2008.

BARNEY CHARLON, EXAMINING ATTORNEY

Int. Cl.: 7

Prior U.S. Cls.: 13, 19, 21, 23, 31, 34 and 35

Reg. No. 3,574,902

United States Patent and Trademark Office

Registered Feb. 17, 2009

**TRADEMARK
PRINCIPAL REGISTER**

SNAPPER SHEAR

PACTOOL INTERNATIONAL LTD. (WASHINGTON CORPORATION)
26139 UNITED ROAD
KINGSTON, WA 98346

FOR: POWER OPERATED SHEARS FOR USE ON FIBER CEMENT AND SIDING PRODUCTS, IN CLASS 7 (U.S. CLS. 13, 19, 21, 23, 31, 34 AND 35).

FIRST USE 10-3-1994; IN COMMERCE 12-5-1994.

THE MARK CONSISTS OF STANDARD CHARACTERS WITHOUT CLAIM TO ANY PARTICULAR FONT, STYLE, SIZE, OR COLOR.

NO CLAIM IS MADE TO THE EXCLUSIVE RIGHT TO USE "SHEAR", APART FROM THE MARK AS SHOWN.

SER. NO. 77-366,420, FILED 1-8-2008.

LINDA POWELL, EXAMINING ATTORNEY

Int. Cl.: 21

Prior U.S. Cls.: 2, 13, 23, 29, 30, 33, 40 and 50

United States Patent and Trademark Office

Reg. No. 3,574,903

Registered Feb. 17, 2009

**TRADEMARK
PRINCIPAL REGISTER**

OLANJI

FI DESIGN INC. (CALIFORNIA CORPORATION)
15318 EL PRADO ROAD
CHINO, CA 91710

FOR: (SEC 1(A); AND SEC 44(E)) PLASTIC CONTAINERS AND HOLDERS FOR CONDOMS SOLD EMPTY; (SEC. 44(E)) CONTAINERS FOR HOUSEHOLD OR KITCHEN USE; HOUSEHOLD UTENSILS, NAMELY, POT AND PAN SCRAPERS, ROLLING PINS, SPATULAS, TURNERS, AND WHISKS; COMBS; SPONGES FOR HOUSEHOLD PURPOSES; DUSTING BRUSHES; HAIR BRUSHES; MATERIAL FOR BRUSH-MAKING; ARTICLES FOR CLEANING PURPOSES, NAMELY, CLEANING CLOTHS, CLEANING PADS, CLEANING RAGS, CLEANING SPONGES, AND CLEANING MITTS OF FABRIC; GLASS BEVERAGeware; EARTHENWARE MUGS; PORCELAIN MUGS; CUPS; FLASKS; DRINKING GLASSES; DRINKING

TROUGHS; DRINKING VESSELS; MOPS; AND MUGS, IN CLASS 21 (U.S. CLS. 2, 13, 23, 29, 30, 33, 40 AND 50).

FIRST USE 7-15-2007; IN COMMERCE 7-15-2007.

PRIORITY CLAIMED UNDER SEC. 44(D) ON HONG KONG APPLICATION NO. 301011383, FILED 12-11-2007, REG. NO. 301011383, DATED 4-18-2008, EXPIRES 12-10-2017.

THE WORDING "OLANJI" HAS NO MEANING IN A FOREIGN LANGUAGE.

SER. NO. 77-366,501, FILED 1-8-2008.

ALEXANDER L. POWERS, EXAMINING ATTORNEY

Int. Cl.: 25

Prior U.S. Cls.: 22 and 39

United States Patent and Trademark Office

Reg. No. 3,574,904

Registered Feb. 17, 2009

**TRADEMARK
PRINCIPAL REGISTER**



NEGRO LEAGUES BASEBALL MUSEUM, INC.
(MISSOURI NON-PROFIT CORPORATION)
1616 EAST 18TH STREET
KANSAS CITY, MO 64108

FOR: CAPS, SHIRTS, JERSEYS AND FOOTWEAR,
IN CLASS 25 (U.S. CLS. 22 AND 39).

FIRST USE 6-0-2007; IN COMMERCE 6-0-2007.

OWNER OF U.S. REG. NO. 2,821,358.

NO CLAIM IS MADE TO THE EXCLUSIVE
RIGHT TO USE "GENUINE", APART FROM THE
MARK AS SHOWN.

THE STIPLING IS FOR SHADING PURPOSES
ONLY.

THE MARK CONSISTS OF THE DESIGN OF A
BUS WITH THE WORDS "BARNSTORMERS"
ABOVE AND "NLB GENUINE" BELOW, WITH
BASEBALLS IN FOUR CORNERS, ALL WITHIN A
RECTANGLE.

SER. NO. 77-366,579, FILED 1-8-2008.

ALYSSA STEEL, EXAMINING ATTORNEY

Int. Cl.: 16

Prior U.S. Cls.: 2, 5, 22, 23, 29, 37, 38 and 50

United States Patent and Trademark Office

Reg. No. 3,574,905

Registered Feb. 17, 2009

**TRADEMARK
PRINCIPAL REGISTER**

City Arts

ENCORE PUBLISHING INC (WASHINGTON CORPORATION)
425 N 85TH ST
SEATTLE, WA 98103

FOR: GENERAL FEATURE MAGAZINES; MAGAZINES FEATURING ARTICLES ON MUSIC, COMICS, ARTISTS, AN EVENTS CALENDAR, PHOTO ESSAYS, ART GALLERIES, FILM FESTIVALS, BOOK EXCERPTS AND THEATRE, IN CLASS 16 (U.S. CLS. 2, 5, 22, 23, 29, 37, 38 AND 50).

FIRST USE 4-1-2006; IN COMMERCE 9-1-2006.

THE MARK CONSISTS OF STANDARD CHARACTERS WITHOUT CLAIM TO ANY PARTICULAR FONT, STYLE, SIZE, OR COLOR.

NO CLAIM IS MADE TO THE EXCLUSIVE RIGHT TO USE "ARTS", APART FROM THE MARK AS SHOWN.

SER. NO. 77-366,640, FILED 1-8-2008.

TINA BROWN, EXAMINING ATTORNEY

Int. Cl.: 16

Prior U.S. Cls.: 2, 5, 22, 23, 29, 37, 38 and 50

Reg. No. 3,574,906

United States Patent and Trademark Office

Registered Feb. 17, 2009

**TRADEMARK
PRINCIPAL REGISTER**

TRIBECA FILM FESTIVAL

TRIBECA ENTERPRISES, LLC (DELAWARE
LIMITED LIABILITY COMPANY)
375 GREENWICH STREET
NEW YORK, NY 10013

FOR: PRINTED MATERIALS, NAMELY, FLYERS, BROCHURES, LEAFLETS, SCHEDULES, BOOKLETS, STUDY GUIDES WITH DISCUSSION QUESTIONS AND GUIDES ABOUT FILMS AND ENTERTAINMENT; EVENT PROGRAMS; ANNOUNCEMENT CARDS; CALENDARS; NOTE CARDS; BLANK CARDS; PAPER BANNERS; PRINTED PAPER SIGNS; AND MAPS, IN CLASS 16 (U.S. CLS. 2, 5, 22, 23, 29, 37, 38 AND 50).

FIRST USE 12-6-2001; IN COMMERCE 12-6-2001.

THE MARK CONSISTS OF STANDARD CHARACTERS WITHOUT CLAIM TO ANY PARTICULAR FONT, STYLE, SIZE, OR COLOR.

OWNER OF U.S. REG. NOS. 2,539,192, 2,795,380, AND 2,947,322.

NO CLAIM IS MADE TO THE EXCLUSIVE RIGHT TO USE "FILM FESTIVAL", APART FROM THE MARK AS SHOWN.

SEC. 2(F).

SER. NO. 77-366,703, FILED 1-8-2008.

ALICIA COLLINS, EXAMINING ATTORNEY

Int. Cl.: 35

Prior U.S. Cls.: 100, 101 and 102

United States Patent and Trademark Office

Reg. No. 3,574,907

Registered Feb. 17, 2009

**SERVICE MARK
PRINCIPAL REGISTER**

PERSPECTICA

TELMETRICS INC. (CANADA CORPORATION)
2680 SKYMARK AVENUE, SUITE 900
MISSISSAUGA, ONTARIO, CANADA L4W5L6

FOR: MARKET RESEARCH SERVICES IN THE NATURE OF TELEPHONE CALL MEASUREMENT ANALYSIS AND REPORTING; AND MARKETING CONSULTING SERVICES FEATURING MEASURING THE EFFECTIVENESS AND VALUE OF ADVERTISING MEDIA BY COUNTING THE NUMBER OF TELEPHONE CALLS PLACED BY THE PUBLIC

IN RESPONSE TO A PARTICULAR ADVERTISEMENT, IN CLASS 35 (U.S. CLS. 100, 101 AND 102).

FIRST USE 2-28-2007; IN COMMERCE 2-28-2007.

THE MARK CONSISTS OF STANDARD CHARACTERS WITHOUT CLAIM TO ANY PARTICULAR FONT, STYLE, SIZE, OR COLOR.

SER. NO. 77-366,725, FILED 1-8-2008.

REBECCA GILBERT, EXAMINING ATTORNEY

Int. Cl.: 35

Prior U.S. Cls.: 100, 101 and 102

United States Patent and Trademark Office

Reg. No. 3,574,908

Registered Feb. 17, 2009

**SERVICE MARK
PRINCIPAL REGISTER**



TELMETRICS INC. (CANADA CORPORATION)
2680 SKYMARK AVENUE, SUITE 900
MISSISSAUGA, ONTARIO, CANADA L4W5L6

FOR: MARKET RESEARCH SERVICES IN THE NATURE OF TELEPHONE CALL MEASUREMENT ANALYSIS AND REPORTING; AND MARKETING CONSULTING SERVICES FEATURING MEASURING THE EFFECTIVENESS AND VALUE OF ADVERTISING MEDIA BY COUNTING THE NUMBER OF TELEPHONE CALLS PLACED BY THE PUBLIC IN RESPONSE TO A PARTICULAR ADVERTISEMENT, IN CLASS 35 (U.S. CLS. 100, 101 AND 102).

FIRST USE 2-28-2007; IN COMMERCE 2-28-2007.

THE MARK CONSISTS OF THE WORD "PERSPECTICA" AND A LOGO DESIGN. THE LOGO COMPRISES A TRANSFORMED LETTER "S" ROTATE ANTICLOCKWISE 90 DEGREE. A SOLID SQUARE IS IN THE CENTER OF THE LEFT SEMICIRCLE AND A SOLID CIRCLE IS IN THE CENTER OF THE RIGHT SEMICIRCLE.

SER. NO. 77-366,767, FILED 1-8-2008.

REBECCA GILBERT, EXAMINING ATTORNEY

Int. Cl.: 25

Prior U.S. Cls.: 22 and 39

United States Patent and Trademark Office

Reg. No. 3,574,909

Registered Feb. 17, 2009

**TRADEMARK
PRINCIPAL REGISTER**

Tees For Change

TEES FOR CHANGE (COLORADO LIMITED
LIABILITY COMPANY)
PO BOX 905
BOULDER, CO 80306

FOR: SHIRTS; SHORT-SLEEVED OR LONG-
SLEEVED T-SHIRTS; T-SHIRTS; TEE SHIRTS; YOGA
SHIRTS; SPORTS SHIRTS; SHORT-SLEEVED
SHIRTS, IN CLASS 25 (U.S. CLS. 22 AND 39).

FIRST USE 1-1-2007; IN COMMERCE 1-1-2007.

THE MARK CONSISTS OF STANDARD CHAR-
ACTERS WITHOUT CLAIM TO ANY PARTICULAR
FONT, STYLE, SIZE, OR COLOR.

NO CLAIM IS MADE TO THE EXCLUSIVE
RIGHT TO USE "TEES", APART FROM THE MARK
AS SHOWN.

SER. NO. 77-366,890, FILED 1-8-2008.

EMILY CARLSEN, EXAMINING ATTORNEY

Int. Cls.: 25 and 41

Prior U.S. Cls.: 22, 39, 100, 101 and 107

United States Patent and Trademark Office

Reg. No. 3,574,910

Registered Feb. 17, 2009

TRADEMARK
SERVICE MARK
PRINCIPAL REGISTER



VAIL PARK AND RECREATION DISTRICT
(COLORADO QUASI-MUNICIPAL CORPORATION), DBA VAIL RECREATION DISTRICT
700 SOUTH FRONTAGE ROAD EAST
VAIL, CO 81657

FOR: HATS; HEADWEAR; JACKETS; SWEATERS;
BLOUSES; SHIRTS; VESTS; INFANT WEAR; FOOTWEAR;
RAINWEAR; SOCKS; PANTS; SHORTS; TROUSERS, IN CLASS 25 (U.S. CLS. 22 AND 39).

FIRST USE 0-0-1984; IN COMMERCE 0-0-1984.

FOR: GOLF CLUB SERVICES, IN CLASS 41 (U.S. CLS. 100, 101 AND 107).

FIRST USE 0-0-1984; IN COMMERCE 0-0-1984.

NO CLAIM IS MADE TO THE EXCLUSIVE RIGHT TO USE "VAIL" AND "GOLF CLUB", APART FROM THE MARK AS SHOWN.

THE MARK CONSISTS OF THE WORDS "VAIL GOLF CLUB" AND A BOOT CONTAINING FLOWERS.

SER. NO. 77-366,982, FILED 1-8-2008.

NATALIE POLZER, EXAMINING ATTORNEY

Int. Cl.: 43

Prior U.S. Cls.: 100 and 101

United States Patent and Trademark Office

Reg. No. 3,574,911

Registered Feb. 17, 2009

SERVICE MARK
PRINCIPAL REGISTER

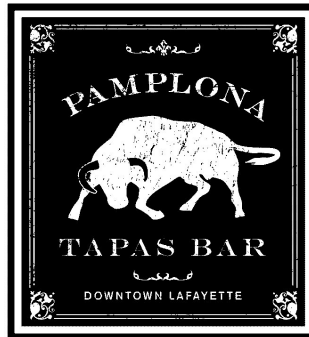

PAMPLONA TAPAS BAR AND RESTAURANT,
LLC (LOUISIANA LIMITED LIABILITY COM-
PANY)
631 JEFFERSON ST
LAFAYETTE, LA 70501

FOR: BAR AND RESTAURANT SERVICES; RES-
TAURANT SERVICES; RESTAURANTS, IN CLASS
43 (U.S. CLS. 100 AND 101).

FIRST USE 10-0-2007; IN COMMERCE 10-0-2007.

NO CLAIM IS MADE TO THE EXCLUSIVE
RIGHT TO USE "TAPAS BAR AND DOWNTOWN

LAFAYETTE", APART FROM THE MARK AS
SHOWN.

THE MARK CONSISTS OF THE IMAGE OF A
BULL WITH THE WORD "PAMPLONA" LOCATED
ABOVE IT, AND THE WORDS "TAPAS BAR" AND
"DOWNTOWN LAFAYETTE" LOCATED BELOW
IT.

SER. NO. 77-367,116, FILED 1-9-2008.

SHANNON TWOHIG, EXAMINING ATTORNEY

Int. Cl.: 36

Prior U.S. Cls.: 100, 101 and 102

United States Patent and Trademark Office

Reg. No. 3,574,912

Registered Feb. 17, 2009

**SERVICE MARK
PRINCIPAL REGISTER**

THE PROGRAM PEOPLE

MEADOWBROOK, INC. (MICHIGAN CORPORATION)
26255 AMERICAN DRIVE
SOUTHFIELD, MI 48034

FOR: INSURANCE UNDERWRITING IN THE FIELD OF PROPERTY AND CASUALTY INSURANCE; CLAIMS ADMINISTRATION IN THE FIELD OF WORKERS COMPENSATION; INSURANCE CLAIMS ADMINISTRATION; INSURANCE CLAIMS PROCESSING; INSURANCE SERVICES IN THE NATURE OF LOSS CONTROL MANAGE-

MENT FOR OTHERS, IN CLASS 36 (U.S. CLS. 100, 101 AND 102).

FIRST USE 12-0-2007; IN COMMERCE 12-0-2007.

THE MARK CONSISTS OF STANDARD CHARACTERS WITHOUT CLAIM TO ANY PARTICULAR FONT, STYLE, SIZE, OR COLOR.

SER. NO. 77-367,232, FILED 1-9-2008.

RUSS HERMAN, EXAMINING ATTORNEY

Int. Cl.: 9

Prior U.S. Cls.: 21, 23, 26, 36 and 38

Reg. No. 3,574,913

United States Patent and Trademark Office

Registered Feb. 17, 2009

**TRADEMARK
PRINCIPAL REGISTER**



MONOSCOOP, B.V. (NETHERLANDS CORPORATION)
OUDEGRACHT 202
ALKMAAR, NETHERLANDS 1811CR

6248132, FILED 9-3-2007, REG. NO. 6248132, DATED 7-22-2008, EXPIRES 9-3-2017.

NO CLAIM IS MADE TO THE EXCLUSIVE RIGHT TO USE "SUDOKU" AND "BINGO", APART FROM THE MARK AS SHOWN.

FOR: GAMING DEVICES, NAMELY, GAMING MACHINES, SLOT MACHINES, BINGO MACHINES, WITH OR WITHOUT VIDEO OUTPUT; COMPUTER SOFTWARE AND FIRMWARE FOR GAMES OF CHANCE ON ANY COMPUTERIZED PLATFORM, INCLUDING DEDICATED GAMING CONSOLES, VIDEO BASED SLOT MACHINES, REEL BASED SLOT MACHINES, AND VIDEO LOTTERY TERMINALS, IN CLASS 9 (U.S. CLS. 21, 23, 26, 36 AND 38).

THE MARK CONSISTS OF A CIRCLE CONTAINING A SILHOUETTE OF A SAMURAI HOLDING A SWORD WITH THE WORD "SUDOKU" ON THE RIGHT SIDE BEHIND THE STYLIZED WORD "SAMURAI" IN LARGE THREE-DIMENSIONAL LETTERING AND THE WORD "BINGO" IN SMALLER LETTERING UNDERNEATH.

PRIORITY CLAIMED UNDER SEC. 44(D) ON ERPN CMNTY TM OFC APPLICATION NO.

SER. NO. 77-367,249, FILED 1-9-2008.

MAYUR VAGHANI, EXAMINING ATTORNEY

Int. Cl.: 9

Prior U.S. Cls.: 21, 23, 26, 36 and 38

United States Patent and Trademark Office

Reg. No. 3,574,914

Registered Feb. 17, 2009

**TRADEMARK
PRINCIPAL REGISTER**



MONOSCOOP, B.V. (NETHERLANDS CORPORATION)
OUDEGRACHT 202
ALKMAAR, NETHERLANDS 1811CR

FOR: GAMING DEVICES, NAMELY, GAMING MACHINES, SLOT MACHINES, BINGO MACHINES, WITH OR WITHOUT VIDEO OUTPUT; COMPUTER SOFTWARE AND FIRMWARE FOR GAMES OF CHANCE ON ANY COMPUTERIZED PLATFORM, INCLUDING DEDICATED GAMING CONSOLES, VIDEO BASED SLOT MACHINES, REEL BASED SLOT MACHINES, AND VIDEO LOTTERY TERMINALS, IN CLASS 9 (U.S. CLS. 21, 23, 26, 36 AND 38).

PRIORITY CLAIMED UNDER SEC. 44(D) ON ERPN CMNTY TM OFC APPLICATION NO. 6269575, FILED 9-12-2007, REG. NO. 6269575, DATED 7-2-2008, EXPIRES 9-12-2017.

THE MARK CONSISTS OF STYLIZED WORD "FISHMANIA" IN THREE-DIMENSIONAL LETTERING WITH A FISH CENTERED BENEATH THE LETTERING.

SER. NO. 77-367,286, FILED 1-9-2008.

MAYUR VAGHANI, EXAMINING ATTORNEY

Int. Cl.: 35

Prior U.S. Cls.: 100, 101 and 102

United States Patent and Trademark Office

Reg. No. 3,574,915

Registered Feb. 17, 2009

**SERVICE MARK
PRINCIPAL REGISTER**

**Gateway to the Cherokee
National Forest**

POLK COUNTY CHAMBER OF COMMERCE
(TENNESSEE CORPORATION)
PO BOX 560
BENTON, TN 37307

FOR: CHAMBER OF COMMERCE SERVICES,
NAMELY, PROMOTING BUSINESS AND TOURISM
IN THE POLK COUNTY, TENNESSEE AREA; PRO-
MOTING TOURISM IN POLK COUNTY AND
OCOEE RIVER AREA IN THE STATE OF TENNES-
SEE; PROMOTING THE GOODS AND SERVICES OF
OTHERS; PROMOTING THE ECONOMIC DEVEL-
OPMENT OF POLK COUNTY, TENNESSEE; PRO-
MOTING, ADVERTISING AND MARKETING OF

ONLINE WEBSITES OF OTHERS, IN CLASS 35 (U.S.
CLS. 100, 101 AND 102).

FIRST USE 2-1-1996; IN COMMERCE 5-1-1996.

THE MARK CONSISTS OF STANDARD CHAR-
ACTERS WITHOUT CLAIM TO ANY PARTICULAR
FONT, STYLE, SIZE, OR COLOR.

SER. NO. 77-367,363, FILED 1-9-2008.

TRACY FLETCHER, EXAMINING ATTORNEY

Int. Cl.: 41

Prior U.S. Cls.: 100, 101 and 107

United States Patent and Trademark Office

Reg. No. 3,574,916

Registered Feb. 17, 2009

SERVICE MARK
PRINCIPAL REGISTER

The logo features the word "TEEN" in large, bold, black-outlined block letters. The word "IMPACT" is written in a smaller, grey, graffiti-style font, overlapping the right side of the "TEEN" letters.

TEEN IMPACT MARKETING SOLUTIONS IN-
CORPORATED (UTAH CORPORATION)
6890 CLERNATES DRIVE
WEST JORDAN, UT 84084

FOR: PUBLISHING OF BOOKS, MAGAZINES;
MULTIMEDIA PUBLISHING OF BOOKS, MAGA-
ZINES, JOURNALS, SOFTWARE, GAMES, MUSIC,
AND ELECTRONIC PUBLICATIONS , IN CLASS 41
(U.S. CLS. 100, 101 AND 107).

FIRST USE 9-15-2006; IN COMMERCE 9-15-2006.

NO CLAIM IS MADE TO THE EXCLUSIVE
RIGHT TO USE "TEEN", APART FROM THE MARK
AS SHOWN.

THE MARK CONSISTS OF THE WORD TEEN IS
IN BLOCK LETTERS WITH THE WORD IMPACT IN
A GRAFFITI STYLE OVERLAPPING THE RIGHT
BOTTOM OF THE WORD TEEN.

SER. NO. 77-367,372, FILED 1-9-2008.

KELLY MCCOY, EXAMINING ATTORNEY

Int. Cl.: 41

Prior U.S. Cls.: 100, 101 and 107

United States Patent and Trademark Office

Reg. No. 3,574,917

Registered Feb. 17, 2009

**SERVICE MARK
PRINCIPAL REGISTER**



AHRA, INC. (KENTUCKY CORPORATION)
P.O. BOX 380
EDMONTON, KY 42129

FOR: ENTERTAINMENT SERVICES, IN THE NATURE OF HORSE SHOWS AND COMPETITIONS; CONDUCTING HORSE SHOWS AND COMPETITIONS; AND HORSE SHOWING, IN CLASS 41 (U.S. CLS. 100, 101 AND 107).

FIRST USE 1-6-2004; IN COMMERCE 1-6-2004.

NO CLAIM IS MADE TO THE EXCLUSIVE RIGHT TO USE "AMERICAN RANCH HORSE ASSOCIATION", APART FROM THE MARK AS SHOWN.

THE COLOR(S) RED, WHITE, BLUE AND BLACK IS/ARE CLAIMED AS A FEATURE OF THE MARK.

THE MARK CONSISTS OF THE WORDING "ARHA" WITH TWO STRIPES BEHIND THE LETTERS "RHA", THE WORDING "AMERICAN RANCH HORSE ASSOCIATION" BELOW THE WORDING "ARHA" AND THE SILHOUETTE OF A MAN ON A HORSE ABOVE THE TOP STRIPE. THERE ARE STARS ON THE LETTER A IN THE WORDING "ARHA". THE COLOR BLACK APPEARS IN THE OUTLINE OF THE WORDING "ARHA", THE WORDING "AMERICAN HORSE RANCH ASSOCIATION", THE OUTLINE OF THE STRIPES, THE OUTLINE OF THE STARS AND THE SILHOUETTE OF THE MAN ON THE HORSE. THE COLOR BLUE APPEARS IN THE LETTER A IN THE WORDING "ARHA". THE COLOR WHITE APPEARS IN THE STARS AND THE WORDING "RHA". THE COLOR RED APPEARS IN THE TWO STRIPES.

SER. NO. 77-367,428, FILED 1-9-2008.

TINA BROWN, EXAMINING ATTORNEY

Int. Cl.: 42

Prior U.S. Cls.: 100 and 101

United States Patent and Trademark Office

Reg. No. 3,574,918

Registered Feb. 17, 2009

**SERVICE MARK
PRINCIPAL REGISTER**

MAISON SIMONE

KSN VENTURES, LLC (CALIFORNIA LIMITED
LIABILITY COMPANY)
1285 CRESCENT HEIGHTS, APARTMENT M
LOS ANGELOS, CA 90046

FOR: DESIGN FOR OTHERS IN THE FIELD OF
CLOTHING, NAMELY, DRESSES, IN CLASS 42 (U.S.
CLS. 100 AND 101).

FIRST USE 1-1-2007; IN COMMERCE 1-2-2007.

THE MARK CONSISTS OF STANDARD CHAR-
ACTERS WITHOUT CLAIM TO ANY PARTICULAR
FONT, STYLE, SIZE, OR COLOR.

OWNER OF U.S. REG. NO. 3,354,436.

NO CLAIM IS MADE TO THE EXCLUSIVE
RIGHT TO USE "MAISON", APART FROM THE
MARK AS SHOWN.

THE FOREIGN WORDING IN THE MARK
TRANSLATES INTO ENGLISH AS HOUSE.

SER. NO. 77-367,484, FILED 1-9-2008.

WILLIAM ROSSMAN, EXAMINING ATTORNEY

Int. Cl.: 35

Prior U.S. Cls.: 100, 101 and 102

United States Patent and Trademark Office

Reg. No. 3,574,919

Registered Feb. 17, 2009

**SERVICE MARK
PRINCIPAL REGISTER**

SYTELOGIC

P.G.S. INC. (MICHIGAN CORPORATION)
2565 INDUSTRIAL ROW DRIVE
TROY, MI 48084

FOR: ONSITE AND ONLINE MANAGEMENT SERVICES FOR SUPPLIERS, MANUFACTURERS, AND SEQUENCING FACILITIES, NAMELY, SUPPLY CHAIN MANAGEMENT SERVICES; INVENTORY CONTROL SERVICES FOR SUPPLIERS, MANUFACTURERS AND SEQUENCING FACILITIES; AND LOGISTICS MANAGEMENT SERVICES FOR SUPPLIERS, MANUFACTURERS, AND SE-

QUENCING FACILITIES, IN CLASS 35 (U.S. CLS. 100, 101 AND 102).

FIRST USE 11-12-2007; IN COMMERCE 11-12-2007.

THE MARK CONSISTS OF STANDARD CHARACTERS WITHOUT CLAIM TO ANY PARTICULAR FONT, STYLE, SIZE, OR COLOR.

SER. NO. 77-367,499, FILED 1-9-2008.

BRENDAN MCCAULEY, EXAMINING ATTORNEY

Int. Cl.: 42

Prior U.S. Cls.: 100 and 101

United States Patent and Trademark Office

Reg. No. 3,574,920

Registered Feb. 17, 2009

**SERVICE MARK
PRINCIPAL REGISTER**

**"We've got widgets comin'
out our ads."**

MEDIA FORUM, INC. (UTAH CORPORATION)
6405 SOUTH 3000 EAST, SUITE 203
SALT LAKE CITY, UT 84121

THE MARK CONSISTS OF STANDARD CHAR-
ACTERS WITHOUT CLAIM TO ANY PARTICULAR
FONT, STYLE, SIZE, OR COLOR.

FOR: PROVIDING TEMPORARY USE OF ON-
LINE NON-DOWNLOADABLE COMPUTER SOFT-
WARE FOR USE IN CREATING MULTIMEDIA
SOFTWARE, IN CLASS 42 (U.S. CLS. 100 AND 101).

SER. NO. 77-367,827, FILED 1-9-2008.

FIRST USE 11-1-2007; IN COMMERCE 11-1-2007.

SHAUNIA CARLYLE, EXAMINING ATTORNEY

Int. Cl.: 35

Prior U.S. Cls.: 100, 101 and 102

United States Patent and Trademark Office

Reg. No. 3,574,921

Registered Feb. 17, 2009

**SERVICE MARK
PRINCIPAL REGISTER**

Petro Design Co

MISERLIS, PETER (UNITED STATES INDIVIDUAL)
12056 EASTBOURNE ROAD
SAN DIEGO, CA 92128

FOR: BUSINESS CARD DESIGN SERVICES; CREATIVE MARKETING DESIGN SERVICES; DESIGN OF ADVERTISING MATERIALS FOR OTHERS; DESIGN OF INTERNET ADVERTISING; ADVERTISING SERVICES; ADVERTISING SERVICES, NAMELY, CREATING CORPORATE LOGOS FOR OTHERS, IN CLASS 35 (U.S. CLS. 100, 101 AND 102).

FIRST USE 1-1-2000; IN COMMERCE 1-1-2000.

THE MARK CONSISTS OF STANDARD CHARACTERS WITHOUT CLAIM TO ANY PARTICULAR FONT, STYLE, SIZE, OR COLOR.

NO CLAIM IS MADE TO THE EXCLUSIVE RIGHT TO USE "DESIGN CO", APART FROM THE MARK AS SHOWN.

THE FOREIGN WORDING IN THE MARK TRANSLATES INTO ENGLISH AS PETER.

SER. NO. 77-367,832, FILED 1-9-2008.

SETH A. RAPPAPORT, EXAMINING ATTORNEY

Int. Cl.: 9

Prior U.S. Cls.: 21, 23, 26, 36 and 38

United States Patent and Trademark Office

Reg. No. 3,574,922

Registered Feb. 17, 2009

**TRADEMARK
PRINCIPAL REGISTER**

BEAMPATH

OMNIGUIDE, INC. (DELAWARE CORPORATION)
ONE KENDALL SQUARE, BUILDING 100
BOSTON, MA 02139

THE MARK CONSISTS OF STANDARD CHARACTERS WITHOUT CLAIM TO ANY PARTICULAR FONT, STYLE, SIZE, OR COLOR.

FOR: HOLLOW-CORE PHOTONIC BANDGAP FIBERS, IN CLASS 9 (U.S. CLS. 21, 23, 26, 36 AND 38).

SER. NO. 77-367,855, FILED 1-9-2008.

FIRST USE 11-10-2005; IN COMMERCE 11-10-2005.

AISHA SALEM, EXAMINING ATTORNEY

Int. Cl.: 30

Prior U.S. Cl.: 46

United States Patent and Trademark Office

Reg. No. 3,574,923

Registered Feb. 17, 2009

**TRADEMARK
PRINCIPAL REGISTER**

SEZME

AGROS TRADING CONFECTIONERY SPOLKA Z
O.O (POLAND SPÓLKA Z OGRANICZONA
ODPOWIEDZIALNOSCIA (SP. Z.O.O.))
AL. JANA PAWLA II 15
WARSAW, POLAND 00-828

THE MARK CONSISTS OF STANDARD CHAR-
ACTERS WITHOUT CLAIM TO ANY PARTICULAR
FONT, STYLE, SIZE, OR COLOR.

FOR: COOKIES, NAMELY, SESAME BARS, IN
CLASS 30 (U.S. CL. 46).

SER. NO. 77-367,880, FILED 1-9-2008.

FIRST USE 0-0-1990; IN COMMERCE 0-0-1990.

JAMES LOVELACE, EXAMINING ATTORNEY

Int. Cl.: 35

Prior U.S. Cls.: 100, 101 and 102

United States Patent and Trademark Office

Reg. No. 3,574,924

Registered Feb. 17, 2009

**SERVICE MARK
PRINCIPAL REGISTER**

BEGREEN NOW!

GREEN MOUNTAIN ENERGY COMPANY (DE-
LAWARE CORPORATION)
300 WEST SIXTH STREET, SUITE 900
AUSTIN, TX 78701

FOR: ENERGY USAGE MANAGEMENT SERVI-
CES THROUGH THE ESTABLISHMENT OF A SYS-
TEM OF ALLOWANCES, REDUCTIONS, CREDITS
AND OFFSETS FOR CARBON DIOXIDE AND
OTHER GREENHOUSE GAS EMISSIONS, AND
THROUGH PROVIDING RENEWABLE ENERGY
CERTIFICATES, INVESTMENT IN FOREST SE-
QUESTRATION, ENERGY EFFICIENCY AND CAR-

BON OFFSET PRODUCTS AND SERVICES, IN
CLASS 35 (U.S. CLS. 100, 101 AND 102).

FIRST USE 10-23-2006; IN COMMERCE 10-23-2006.

THE MARK CONSISTS OF STANDARD CHAR-
ACTERS WITHOUT CLAIM TO ANY PARTICULAR
FONT, STYLE, SIZE, OR COLOR.

SER. NO. 77-367,990, FILED 1-9-2008.

JAMES STEIN, EXAMINING ATTORNEY

Int. Cl.: 35

Prior U.S. Cls.: 100, 101 and 102

United States Patent and Trademark Office

Reg. No. 3,574,925

Registered Feb. 17, 2009

**SERVICE MARK
PRINCIPAL REGISTER**

LIVE THE OUTDOORS

PLUM CREEK TIMBER COMPANY, INC. (DELA-
WARE CORPORATION)
SUITE 4300
999 THIRD AVENUE
SEATTLE, WA 98104

FOR: REAL ESTATE SALES MANAGEMENT, IN
CLASS 35 (U.S. CLS. 100, 101 AND 102).

FIRST USE 7-10-2007; IN COMMERCE 7-10-2007.

THE MARK CONSISTS OF STANDARD CHAR-
ACTERS WITHOUT CLAIM TO ANY PARTICULAR
FONT, STYLE, SIZE, OR COLOR.

SER. NO. 77-368,074, FILED 1-9-2008.

KIMBERLY PERRY, EXAMINING ATTORNEY

Int. Cl.: 15

Prior U.S. Cls.: 2, 21 and 36

United States Patent and Trademark Office

Reg. No. 3,574,926

Registered Feb. 17, 2009

**TRADEMARK
PRINCIPAL REGISTER**

H44

EASTWOOD GUITARS INC. (CANADA COR-
PORATION)
75 MAIN STREET
SOUTH BRAMPTON, CANADA L6Y1M9

THE MARK CONSISTS OF STANDARD CHAR-
ACTERS WITHOUT CLAIM TO ANY PARTICULAR
FONT, STYLE, SIZE, OR COLOR.

FOR: STRINGED MUSICAL INSTRUMENTS, IN
CLASS 15 (U.S. CLS. 2, 21 AND 36).

SER. NO. 77-368,426, FILED 1-10-2008.

FIRST USE 8-29-2006; IN COMMERCE 8-29-2006.

TRACY FLETCHER, EXAMINING ATTORNEY

Int. Cl.: 13

Prior U.S. Cls.: 2 and 9

United States Patent and Trademark Office

Reg. No. 3,574,927

Registered Feb. 17, 2009

**TRADEMARK
PRINCIPAL REGISTER**



**FEDERAL
PREMIUM
A M M U N I T I O N**

FEDERAL CARTRIDGE COMPANY (MINNESOTA CORPORATION)

900 EHLEN DRIVE
ANOKA, MN 55303

FOR: AMMUNITION AND AMMUNITION COMPONENTS, IN CLASS 13 (U.S. CLS. 2 AND 9).

FIRST USE 1-17-2003; IN COMMERCE 2-7-2003.

OWNER OF U.S. REG. NOS. 2,359,927 AND 3,012,085.

NO CLAIM IS MADE TO THE EXCLUSIVE RIGHT TO USE "AMMUNITION", APART FROM THE MARK AS SHOWN.

SER. NO. 77-368,438, FILED 1-10-2008.

SIMON TENG, EXAMINING ATTORNEY

Int. Cl.: 33

Prior U.S. Cls.: 47 and 49

United States Patent and Trademark Office

Reg. No. 3,574,928

Registered Feb. 17, 2009

TRADEMARK
PRINCIPAL REGISTER



SKYY SPIRITS, LLC (DELAWARE LIMITED LIABILITY COMPANY)
ONE BEACH STREET, SUITE 300
SAN FRANCISCO, CA 94133

FOR: ALCOHOLIC BEVERAGES, NAMELY, LIQUEURS, IN CLASS 33 (U.S. CLS. 47 AND 49).

FIRST USE 0-0-2004; IN COMMERCE 0-0-2004.

OWNER OF U.S. REG. NOS. 3,149,625, 3,200,805, AND 3,220,537.

NO CLAIM IS MADE TO THE EXCLUSIVE RIGHT TO USE "LIQUEUR", AND "A SENSUOUS FUSION OF ULTRA PREMIUM FRENCH VODKA & PROVENCE BLOOD ORANGE MINGLING WITH MANGO & PASSION FRUITS", AND "LIQUEUR", AND "PRODUIT DE FRANCE, AND 1 LITER "17% ALC./VOL" AND THE SHAPE OF THE BOTTLE AND THE CAP, AND THE COLOR OF THE LIQUID IN THE BOTTLE, APART FROM THE MARK AS SHOWN.

THE COLOR(S) PINK AND WHITE IS/ARE CLAIMED AS A FEATURE OF THE MARK.

THE MARK CONSISTS OF A FROSTED CLEAR BOTTLE THROUGH WHICH THE PINK LIQUID WITHIN THE BOTTLE MAY BE SEEN, AND WITH

A PINK CAP; THE BOTTLE BEARS THE DESIGN CONSISTING OF A LARGE WHITE VERTICAL LETTER "X" WITH THE WORD "RATED" IN WHITE DIRECTLY UNDERNEATH THE LETTER "X" AND THE WORD "RATED", PRECEDED BY A HYPHEN, DEPICTED BY AN ABSENCE OF FROSTING OF THE BOTTLE EMANATING FROM THE CENTER OF THE LETTER "X" TO THE RIGHT, AND IN REVERSE PRINT, TO THE LEFT; BENEATH THE WORD "RATED" IN WHITE APPEARS THE WORDING "FUSION LIQUEUR" IN WHITE. NO CLAIM IS MADE TO THE SHAPE OF THE BOTTLE OR CAP. NO CLAIM IS MADE TO THE COLOR OF THE LIQUID IN THE BOTTLE APART FROM THE MARK AS SHOWN. NO CLAIM IS MADE TO THE OTHER WORDING ON THE BOTTLE, WHICH READS, "A SENSUOUS FUSION OF ULTRA PREMIUM FRENCH VODKA & PROVENCE BLOOD ORANGE MINGLING WITH MANGO & PASSION FRUITS," AND "LIQUEUR," AND "PRODUIT DE FRANCE," AND "1 LITER 17% ALC./VOL". THE COLOR PINK APPEARS AS THE COLOR OF THE BOTTLE CAP AND THE COLOR OF THE LIQUID SHOWING THROUGH THE BOTTLE. THE COLOR WHITE APPEARS AS THE COLOR OF THE WORDING "X RATED FUSION LIQUEUR"

SER. NO. 77-368,465, FILED 1-10-2008.

ANDREA HACK, EXAMINING ATTORNEY

Int. Cls.: 35, 39 and 43

Prior U.S. Cls.: 100, 101, 102 and 105

United States Patent and Trademark Office

Reg. No. 3,574,929

Registered Feb. 17, 2009

**SERVICE MARK
PRINCIPAL REGISTER**

EXPLORE ST. LOUIS

REGIONAL CONVENTION AND VISITORS
COMMISSION (MISSOURI POLITICAL SUBDI-
VISION OF THE STATE OF MISSOURI), DBA
ST. LOUIS CONVENTION & VISITORS COM-
MISSION

SUITE 300
701 CONVENTION PLAZA
ST. LOUIS, MO 63101

FOR: ADVERTISING, MARKETING, AND PRO-
MOTION OF TOURISM, ENTERTAINMENT, CON-
VENTIONS, AND CIVIC AND CULTURAL EVENTS
IN THE ST. LOUIS, MISSOURI AREA, IN CLASS 35
(U.S. CLS. 100, 101 AND 102).

FIRST USE 1-0-1999; IN COMMERCE 1-0-1999.

FOR: PROVIDING TRAVEL INFORMATION
SERVICES, IN CLASS 39 (U.S. CLS. 100 AND 105).

FIRST USE 1-0-1999; IN COMMERCE 1-0-1999.

FOR: TRAVEL PLANNING SERVICES, NAMELY,
MAKING RESERVATIONS AND BOOKINGS FOR
LODGING AND RESTAURANTS, IN CLASS 43 (U.S.
CLS. 100 AND 101).

FIRST USE 1-0-1999; IN COMMERCE 1-0-1999.

THE MARK CONSISTS OF STANDARD CHAR-
ACTERS WITHOUT CLAIM TO ANY PARTICULAR
FONT, STYLE, SIZE, OR COLOR.

OWNER OF U.S. REG. NO. 2,375,027.

NO CLAIM IS MADE TO THE EXCLUSIVE
RIGHT TO USE "ST. LOUIS", APART FROM THE
MARK AS SHOWN.

SER. NO. 77-368,764, FILED 1-10-2008.

DAWN FELDMAN, EXAMINING ATTORNEY

Int. Cls.: 1 and 40

Prior U.S. Cls.: 1, 5, 6, 10, 26, 46, 100, 103 and 106

United States Patent and Trademark Office

Reg. No. 3,574,930

Registered Feb. 17, 2009

**TRADEMARK
SERVICE MARK
PRINCIPAL REGISTER**

GREEN SCENE

CEDAR GROVE COMPOSTING, INC. (WASHINGTON CORPORATION)
7343 E. MARGINAL WAY SOUTH
SEATTLE, WA 98108

FOR: COMPOST; LOAM; MANURE; PLANTING SOIL; POTTING SOIL; SOIL AMENDMENTS, IN CLASS 1 (U.S. CLS. 1, 5, 6, 10, 26 AND 46).

FIRST USE 3-1-2007; IN COMMERCE 3-1-2007.

FOR: RECYCLING; RECYCLING OF WASTE AND TRASH, IN CLASS 40 (U.S. CLS. 100, 103 AND 106).

FIRST USE 10-1-2006; IN COMMERCE 10-1-2006.

THE MARK CONSISTS OF STANDARD CHARACTERS WITHOUT CLAIM TO ANY PARTICULAR FONT, STYLE, SIZE, OR COLOR.

SER. NO. 77-368,822, FILED 1-10-2008.

JANET LEE, EXAMINING ATTORNEY

Int. Cl.: 29

Prior U.S. Cl.: 46

United States Patent and Trademark Office

Reg. No. 3,574,931

Registered Feb. 17, 2009

**TRADEMARK
PRINCIPAL REGISTER**

SLICE RITE

WEST LIBERTY FOODS, LLC (IOWA LIMITED
LIABILITY COMPANY)

207 WEST 2ND STREET

WEST LIBERTY, IA 52776

FOR: HAM; ROAST BEEF, IN CLASS 29 (U.S. CL.
46).

FIRST USE 10-0-2006; IN COMMERCE 10-0-2006.

THE MARK CONSISTS OF STANDARD CHAR-
ACTERS WITHOUT CLAIM TO ANY PARTICULAR
FONT, STYLE, SIZE, OR COLOR.

NO CLAIM IS MADE TO THE EXCLUSIVE
RIGHT TO USE SLICE, APART FROM THE MARK
AS SHOWN.

SER. NO. 77-368,862, FILED 1-10-2008.

ELISSA GARBER KON, EXAMINING ATTORNEY

Int. Cl.: 12

Prior U.S. Cls.: 19, 21, 23, 31, 35 and 44

United States Patent and Trademark Office

Reg. No. 3,574,932

Registered Feb. 17, 2009

**TRADEMARK
PRINCIPAL REGISTER**

Strongback

GROS EUGENE W. (UNITED STATES INDIVIDUAL)
7905 AGATE ROAD
WHITE CITY, OR 97503

FOR: TRUCK BED PRODUCTS, NAMELY, FITTED BED LINERS, TRUCK BED STORAGE ORGANIZERS, CAB GUARD, CAB RACK, IN CLASS 12 (U.S. CLS. 19, 21, 23, 31, 35 AND 44).

FIRST USE 1-25-2005; IN COMMERCE 1-25-2005.

THE MARK CONSISTS OF STANDARD CHARACTERS WITHOUT CLAIM TO ANY PARTICULAR FONT, STYLE, SIZE, OR COLOR.

SER. NO. 77-368,876, FILED S.R. 1-10-2008 AM. P.R. 9-22-2008.

MICHAEL WEBSTER, EXAMINING ATTORNEY

Int. Cl.: 41

Prior U.S. Cls.: 100, 101 and 107

United States Patent and Trademark Office

Reg. No. 3,574,933

Registered Feb. 17, 2009

**SERVICE MARK
PRINCIPAL REGISTER**

Detroit Music Awards

DETROIT MUSIC AWARDS FOUNDATION (MI-
CHIGAN NON-PROFIT CORPORATION), DBA
MOTOR CITY MUSIC FOUNDATION
SUITE 300
1760 S. TELEGRAPH
BLOOMFIELD HILLS, MI 48302

FOR: AN AWARDS SHOW THAT RECOGNIZES
DETROIT AREA MUSICIANS WORKING ON A
NATIONAL, REGIONAL AND LOCAL LEVEL,
WHOSE PURPOSE IS TO SUPPORT AND NURTURE
THE MUSICAL COMMUNITY AND TO CREATE A
NETWORK FOR MUSICIANS THAT ALLOWS
THEM TO SHOWCASE THEIR TALENT AND CUTS
ACROSS GENRES AND STYLES, IN CLASS 41 (U.S.
CLS. 100, 101 AND 107).

FIRST USE 4-1-1998; IN COMMERCE 4-1-1998.

THE MARK CONSISTS OF STANDARD CHAR-
ACTERS WITHOUT CLAIM TO ANY PARTICULAR
FONT, STYLE, SIZE, OR COLOR.

NO CLAIM IS MADE TO THE EXCLUSIVE
RIGHT TO USE "MUSIC AWARDS", APART FROM
THE MARK AS SHOWN.

SEC. 2(F).

SER. NO. 77-368,891, FILED 1-10-2008.

PATRICIA EVANKO, EXAMINING ATTORNEY

Int. Cl.: 12

Prior U.S. Cls.: 19, 21, 23, 31, 35 and 44

Reg. No. 3,574,934

United States Patent and Trademark Office

Registered Feb. 17, 2009

**TRADEMARK
PRINCIPAL REGISTER**

Silverback

GROS EUGENE W. (UNITED STATES INDIVIDUAL)
7905 AGATE ROAD
WHITE CITY, OR 97503

FOR: TRUCK BED AND SUV PRODUCTS, NAMELY, FITTED BED LINERS, TRUCK BED STORAGE ORGANIZERS, CARGO STORAGE BINS ESPECIALLY ADAPTED TO FIT IN TRUCKS OR SUVS, TOOL BOXES FITTED FOR TRUCKS, IN CLASS 12 (U.S. CLS. 19, 21, 23, 31, 35 AND 44).

FIRST USE 2-15-2006; IN COMMERCE 2-15-2006.

THE MARK CONSISTS OF STANDARD CHARACTERS WITHOUT CLAIM TO ANY PARTICULAR FONT, STYLE, SIZE, OR COLOR.

SER. NO. 77-368,915, FILED S.R. 1-10-2008 AM. P.R. 9-22-2008.

MICHAEL WEBSTER, EXAMINING ATTORNEY

Int. Cl.: 35

Prior U.S. Cls.: 100, 101 and 102

United States Patent and Trademark Office

Reg. No. 3,574,935

Registered Feb. 17, 2009

**SERVICE MARK
PRINCIPAL REGISTER**

STARDUST CELEBRITIES

STARDUST VISIONS, INC. (CALIFORNIA CORPORATION)
SUITE 570
1438 NORTH GOWER STREET
HOLLYWOOD, CA 90028

FOR: CELEBRITY TALENT CASTING FOR ADVERTISING, MEDIA, MARKETING, AND PROMOTIONAL PURPOSES; ADVERTISING AND MARKETING SERVICES, NAMELY, BROKERING CELEBRITY TALENT FOR THE PURPOSE OF PROMOTING THE GOODS AND SERVICES OF OTHERS, IN CLASS 35 (U.S. CLS. 100, 101 AND 102).

FIRST USE 0-0-1993; IN COMMERCE 0-0-1993.

THE MARK CONSISTS OF STANDARD CHARACTERS WITHOUT CLAIM TO ANY PARTICULAR FONT, STYLE, SIZE, OR COLOR.

NO CLAIM IS MADE TO THE EXCLUSIVE RIGHT TO USE "CELEBRITIES", APART FROM THE MARK AS SHOWN.

SER. NO. 77-368,978, FILED 1-10-2008.

LINDA LAVACHE, EXAMINING ATTORNEY

Int. Cl.: 33

Prior U.S. Cls.: 47 and 49

United States Patent and Trademark Office

Reg. No. 3,574,936

Registered Feb. 17, 2009

TRADEMARK
PRINCIPAL REGISTER



DBC BREWING, LLC (MICHIGAN LIMITED LIABILITY COMPANY)
322 N. OLD WOODWARD AVE.
BIRMINGHAM, MI 48009

FOR: ALCOHOLIC BEVERAGE PRODUCED FROM A BREWED MALT BASE WITH NATURAL FLAVORS, IN CLASS 33 (U.S. CLS. 47 AND 49).

FIRST USE 12-1-2007; IN COMMERCE 12-1-2007.

NO CLAIM IS MADE TO THE EXCLUSIVE RIGHT TO USE "DETROIT BREWING CO. AND EST. IN DETROIT, MICHIGAN", APART FROM THE MARK AS SHOWN.

THE COLOR(S) RED, BROWN, BLACK, AND WHITE IS/ARE CLAIMED AS A FEATURE OF THE MARK.

THE MARK CONSISTS OF A MASTER OVAL SHAPE OUTLINED IN BLACK WITH SEVERAL BROWN AND BLACK OVALS WITHIN THE MASTER OVAL. THE FINAL OVAL WITHIN THE MASTER OVAL IS RED. AT THE TOP OF THE MASTER OVAL IS A BLACK CIRCLE WITHIN A CIRCLE, AND WITHIN THE INNERMOST BLACK CIRCLE IS A PROPRIETARY VARIATION OF THE OLD-ENG-

LISH LETTER "D" IN WHITE. THERE IS AN ANGLED RED SCROLL ACROSS THE MASTER OVAL WITH BLACK, OUTLINED LETTERS COMPRISING THE WORD "DETROIT" ON TOP OF THE ANGLED SCROLL. ABOVE THE ANGLED SCROLL AND WITHIN THE FINAL RED OVAL IS A BLACK AND WHITE ILLUSTRATION OF THE DETROIT SKYLINE. BELOW THE ANGLED SCROLL AND WITHIN THE FINAL RED OVAL IS A BROWN ILLUSTRATION OF A HOPS PLANT. BELOW THE HOPS PLANT IS A SEPARATE OVAL SHAPE, AND WITHIN THE SEPARATE OVAL SHAPE ARE RED LETTERS OUTLINED IN BLACK COMPRISING THE WORDS "BREWING CO.," AND THE REMAINING BACKGROUND OF THE SEPARATE OVAL SHAPE IS SHADED IN BROWN. THE REMAINING BACKGROUND WITHIN THE FINAL RED OVAL HAS BLACK HORIZONTAL LINES FROM TOP TO BOTTOM. ON THE BOTTOM OF THE MASTER OVAL SHAPE ARE BLACK LETTERS COMPRISING THE WORDS "EST. IN DETROIT, MICHIGAN" THAT ARE RUNNING ALONG THE ARCH OF THE MASTER OVAL SHAPE IN BETWEEN TWO ILLUSTRATED HOPS PLANTS.

SER. NO. 77-368,982, FILED 1-10-2008.

GINA HAYES, EXAMINING ATTORNEY

Int. Cl.: 42

Prior U.S. Cls.: 100 and 101

United States Patent and Trademark Office

Reg. No. 3,574,937

Registered Feb. 17, 2009

**SERVICE MARK
PRINCIPAL REGISTER**

STIZO

WASSELUK, VINCE (UNITED STATES INDIVIDUAL)
600 S. DEARBORN AVENUE, #610
CHICAGO, IL 60605

FOR: GRAPHIC DESIGN SERVICES, IN CLASS 42
(U.S. CLS. 100 AND 101).

FIRST USE 3-23-1999; IN COMMERCE 3-23-1999.

THE MARK CONSISTS OF STANDARD CHARACTERS WITHOUT CLAIM TO ANY PARTICULAR FONT, STYLE, SIZE, OR COLOR.

THE WORDING "STIZO" HAS NO MEANING IN A FOREIGN LANGUAGE.

SER. NO. 77-369,292, FILED 1-11-2008.

BILL DAWE, EXAMINING ATTORNEY

Int. Cl.: 35

Prior U.S. Cls.: 100, 101 and 102

United States Patent and Trademark Office

Reg. No. 3,574,938

Registered Feb. 17, 2009

**SERVICE MARK
PRINCIPAL REGISTER**

PATIO.COM

R&R POOL & PATIO, INC. (CONNECTICUT CORPORATION)
58 LARGO DRIVE
STAMFORD, CT 06907

FOR: RETAIL STORE AND ONLINE RETAIL STORE SERVICES FEATURING SEASONAL SPECIALTY GOODS, NAMELY, OUTDOOR FURNITURE, UMBRELLAS, AND LIGHTING FIXTURES, SWIMMING POOL SUPPLIES AND TOYS, BILLIARD TABLES AND SUPPLIES, ARTIFICIAL CHRISTMAS TREES AND HOLIDAY ITEMS, NAMELY, HOLIDAY TREE ORNAMENTS AND MENORAHS, AND BARBECUE GRILLS, IN CLASS 35 (U.S. CLS. 100, 101 AND 102).

FIRST USE 8-11-1999; IN COMMERCE 8-11-1999.

THE MARK CONSISTS OF STANDARD CHARACTERS WITHOUT CLAIM TO ANY PARTICULAR FONT, STYLE, SIZE, OR COLOR.

OWNER OF U.S. REG. NO. 2,551,256.

SEC. 2(F).

SER. NO. 77-369,450, FILED 1-11-2008.

SUSAN LESLIE DUBOIS, EXAMINING ATTORNEY

Int. Cl.: 9

Prior U.S. Cls.: 21, 23, 26, 36 and 38

Reg. No. 3,574,939

United States Patent and Trademark Office

Registered Feb. 17, 2009

**TRADEMARK
PRINCIPAL REGISTER**

InfoManager

INFOMANAGER, INC. (TEXAS CORPORATION)
SUITE 200
8777 PURDUE ROAD
INDIANAPOLIS, IN 46268

FOR: COMPUTER SOFTWARE FOR USE IN THE
FIELD OF EXECUTIVE INFORMATION SYSTEMS,
NAMELY, SOFTWARE WHICH ASSISTS THE USER
TO IDENTIFY TRENDS AND EXCEPTIONS IN
INFORMATION CONTAINED IN DATA BASES, IN
CLASS 9 (U.S. CLS. 21, 23, 26, 36 AND 38).

FIRST USE 10-0-1990; IN COMMERCE 11-0-1990.

THE MARK CONSISTS OF STANDARD CHAR-
ACTERS WITHOUT CLAIM TO ANY PARTICULAR
FONT, STYLE, SIZE, OR COLOR.

OWNER OF U.S. REG. NO. 1,765,625.

SEC. 2(F).

SER. NO. 77-369,492, FILED 1-11-2008.

HANNO RITTNER, EXAMINING ATTORNEY

Int. Cl.: 11

Prior U.S. Cls.: 13, 21, 23, 31 and 34

United States Patent and Trademark Office

Reg. No. 3,574,940

Registered Feb. 17, 2009

**TRADEMARK
PRINCIPAL REGISTER**

METALMASTER

IPSEN, INC. (DELAWARE CORPORATION)
984 IPSEN ROAD
CHERRY VALLEY, IL 61016

THE MARK CONSISTS OF STANDARD CHAR-
ACTERS WITHOUT CLAIM TO ANY PARTICULAR
FONT, STYLE, SIZE, OR COLOR.

FOR: INDUSTRIAL FURNACES FOR HEAT
TREATING AND BRAZING METAL PARTS, IN
CLASS 11 (U.S. CLS. 13, 21, 23, 31 AND 34).

SER. NO. 77-369,523, FILED 1-11-2008.

FIRST USE 0-0-1984; IN COMMERCE 0-0-1984.

STEVEN JACKSON, EXAMINING ATTORNEY

Int. Cl.: 16

Prior U.S. Cls.: 2, 5, 22, 23, 29, 37, 38 and 50

United States Patent and Trademark Office

Reg. No. 3,574,941

Registered Feb. 17, 2009

**TRADEMARK
PRINCIPAL REGISTER**

GRUPO GONDI

GONDI, S.A. DE C.V. (MEXICO CORPORATION)
BLVD. MANUEL AVILA CAMACHO NO.36 PISO 21
LOMAS DE CHAPULTEPEC, MEXICO 11000

FOR: PAPER; CARDBOARD; PLASTIC BAGS FOR
PACKAGING; PLASTIC BUBBLE PACKS FOR
PACKAGING OR PACKAGING IN THE NATURE
OF WRAPPING; BOXES OF PAPER OR CARD-
BOARD; PACKING CARDBOARD; PACKING PA-
PER, IN CLASS 16 (U.S. CLS. 2, 5, 22, 23, 29, 37, 38 AND
50).

THE MARK CONSISTS OF STANDARD CHAR-
ACTERS WITHOUT CLAIM TO ANY PARTICULAR
FONT, STYLE, SIZE, OR COLOR.

OWNER OF MEXICO REG. NO. 752421, DATED
11-15-2001, EXPIRES 11-15-2011.

NO CLAIM IS MADE TO THE EXCLUSIVE
RIGHT TO USE "GRUPO", APART FROM THE
MARK AS SHOWN.

THE FOREIGN WORDING IN THE MARK
TRANSLATES INTO ENGLISH AS "GROUP".

SER. NO. 77-369,645, FILED 1-11-2008.

TRACY WHITTAKER-BROWN, EXAMINING AT-
TORNEY

Int. Cl.: 42

Prior U.S. Cls.: 100 and 101

United States Patent and Trademark Office

Reg. No. 3,574,942

Registered Feb. 17, 2009

**SERVICE MARK
PRINCIPAL REGISTER**



SELECT SELLING LIMITED (IRELAND PRIVATE LIMITED COMPANY)
1ST FLOOR, HARMONY COURT
HARMONY ROW
DUBLIN, IRELAND 2

FOR: PROVIDING TEMPORARY USE OF NON-DOWNLOADABLE WEB-BASED COMPUTER SOFTWARE APPLICATION USED TO PERFORM SALES EFFECTIVENESS TRAINING AND TO REINFORCE METHODOLOGIES FOR SALES EFFECTIVENESS, IN CLASS 42 (U.S. CLS. 100 AND 101).

FIRST USE 1-31-2005; IN COMMERCE 1-31-2005.

THE MARK CONSISTS OF THE WORD "DEALMAKER" IN CAPITAL LETTERS, WITH A CURVED LINE EXTENDING ABOVE THE WORD FROM THE TOP OF THE LETTER "D" TO A POINT ABOVE THE SECOND LETTER "A." AT THE END OF THE LINE IS A SOLID CIRCLE.

SER. NO. 77-369,705, FILED 1-11-2008.

ELISSA GARBER KON, EXAMINING ATTORNEY

Int. Cl.: 10

Prior U.S. Cls.: 26, 39 and 44

United States Patent and Trademark Office

Reg. No. 3,574,943

Registered Feb. 17, 2009

**TRADEMARK
PRINCIPAL REGISTER**

burcs

WALRUS BRANDS, LLC (DELAWARE LIMITED
LIABILITY COMPANY)
2444 W. 16TH STREET, 5TH FLOOR
CHICAGO, IL 60608

FOR: MEDICAL TREATMENT APPAREL, IN
CLASS 10 (U.S. CLS. 26, 39 AND 44).

FIRST USE 9-1-2007; IN COMMERCE 12-1-2007.

THE MARK CONSISTS OF STANDARD CHAR-
ACTERS WITHOUT CLAIM TO ANY PARTICULAR
FONT, STYLE, SIZE, OR COLOR.

SER. NO. 77-369,735, FILED S.R. 1-11-2008 AM. P.R.
1-17-2008.

NAAKWAMA ANKRAH, EXAMINING ATTORNEY

Int. Cl.: 6

Prior U.S. Cls.: 2, 12, 13, 14, 23, 25 and 50

Reg. No. 3,574,944

United States Patent and Trademark Office

Registered Feb. 17, 2009

**TRADEMARK
PRINCIPAL REGISTER**

CANTRUSS

GROUPE CANAM INC./CANAM GROUP INC.
(CANADA CORPORATION)
270 CHEMIN DU TREMBLAY
BOUCHERVILLE, QUEBEC, CANADA J4B5X9

THE MARK CONSISTS OF STANDARD CHARACTERS WITHOUT CLAIM TO ANY PARTICULAR FONT, STYLE, SIZE, OR COLOR.

FOR: METAL JOIST GIRDERS, IN CLASS 6 (U.S. CLS. 2, 12, 13, 14, 23, 25 AND 50).

SER. NO. 77-369,832, FILED 1-11-2008.

FIRST USE 12-31-1975; IN COMMERCE 12-31-1975.

WILLIAM P. SHANAHAN, EXAMINING ATTORNEY

Int. Cl.: 41

Prior U.S. Cls.: 100, 101 and 107

United States Patent and Trademark Office

Reg. No. 3,574,945

Registered Feb. 17, 2009

**SERVICE MARK
PRINCIPAL REGISTER**

Camp Electric

JOHN SANDERS (UNITED STATES INDIVIDUAL), DBA D/B/A CAMP ELECTRIC
SUITE 104
2756 APPLING CENTER COVE
MEMPHIS, TN 38133

FOR: A WORSHIP AND ROCK AND ROLL
MUSIC CAMP FOR YOUTH, IN CLASS 41 (U.S.
CLS. 100, 101 AND 107).

FIRST USE 2-21-2006; IN COMMERCE 2-21-2006.

THE MARK CONSISTS OF STANDARD CHARACTERS WITHOUT CLAIM TO ANY PARTICULAR FONT, STYLE, SIZE, OR COLOR.

NO CLAIM IS MADE TO THE EXCLUSIVE RIGHT TO USE "CAMP", APART FROM THE MARK AS SHOWN.

SER. NO. 77-370,478, FILED 1-14-2008.

ALYSSA STEEL, EXAMINING ATTORNEY

Int. Cl.: 10

Prior U.S. Cls.: 26, 39 and 44

United States Patent and Trademark Office

Reg. No. 3,574,946

Registered Feb. 17, 2009

**TRADEMARK
PRINCIPAL REGISTER**

WRINKLE TERMINATOR

JUDA LEVIN (UNITED STATES INDIVIDUAL)
341 11TH STREET
LAKEWOOD, NJ 08701

FOR: ELECTRONIC WAND FOR REDUCING
THE APPEARANCE OF SKIN WRINKLES BY AP-
PLYING PERIODICALLY REPEATING ELECTRIC
MICRO-CURRENTS TO THE SKIN, IN CLASS 10
(U.S. CLS. 26, 39 AND 44).

FIRST USE 4-30-2006; IN COMMERCE 4-30-2006.

THE MARK CONSISTS OF STANDARD CHAR-
ACTERS WITHOUT CLAIM TO ANY PARTICULAR
FONT, STYLE, SIZE, OR COLOR.

NO CLAIM IS MADE TO THE EXCLUSIVE
RIGHT TO USE "WRINKLE", APART FROM THE
MARK AS SHOWN.

SER. NO. 77-370,907, FILED 1-14-2008.

ALYSSA STEEL, EXAMINING ATTORNEY

Int. Cls.: 35, 41, 44 and 45

Prior U.S. Cls.: 100, 101, 102 and 107

United States Patent and Trademark Office

Reg. No. 3,574,947

Registered Feb. 17, 2009

**SERVICE MARK
PRINCIPAL REGISTER**

HAMASPIK

PROVIDER-HAMASPIK OF KINGS COUNTY,
INC. (NEW YORK NON-PROFIT CORPORATION)
69 SOUTH 9TH STREET
BROOKLYN, NY 11211

FOR: CHARITABLE HOUSING SERVICES,
NAMESLY, PROVIDING ADMINISTRATION AND
MANAGEMENT OF CARE FACILITIES AND
HOUSING FACILITIES FOR OTHERS, NAMESLY,
DEVELOPMENTALLY AND PHYSICALLY DIS-
ABLED INDIVIDUALS AND ELDERLY INDIVI-
DUALS, IN CLASS 35 (U.S. CLS. 100, 101 AND 102).

FIRST USE 3-1-1997; IN COMMERCE 3-1-1997.

FOR: PROVIDING EDUCATION FOR CHILDREN
WITH DISABILITIES AND SPECIAL NEEDS,
NAMESLY, PROVIDING CLASSES AND ONE-TO-
ONE INSTRUCTION IN THE FIELD OF DAILY
LIVING SKILLS AND HOME-MANAGEMENT
SKILLS, IN CLASS 41 (U.S. CLS. 100, 101 AND 107).

FIRST USE 3-1-1997; IN COMMERCE 3-1-1997.

FOR: IN-HOME NURSING CARE AND IN-HOME
THERAPY SERVICES, NAMESLY, SPEECH THER-
APY, PHYSICAL THERAPY, OCCUPATIONAL
THERAPY AND VISION THERAPY, IN CLASS 44
(U.S. CLS. 100 AND 101).

FIRST USE 3-1-1997; IN COMMERCE 3-1-1997.

FOR: PERSONAL AND SOCIAL SERVICES FOR
INDIVIDUALS WITH DISABILITIES AND SPECIAL
NEEDS, IN THE NATURE OF CASE-MANAGE-
MENT SERVICES, NAMESLY, COORDINATION OF
SOCIAL, MEDICAL, VOCATIONAL AND EDUCA-
TIONAL SERVICES; PROVIDING PERSONAL AD-
VOCACY SERVICES FOR INDIVIDUALS WITH
DISABILITIES AND SPECIAL NEEDS , IN CLASS
45 (U.S. CLS. 100 AND 101).

FIRST USE 3-1-1997; IN COMMERCE 3-1-1997.

THE MARK CONSISTS OF STANDARD CHAR-
ACTERS WITHOUT CLAIM TO ANY PARTICULAR
FONT, STYLE, SIZE, OR COLOR.

CONSIDERING THE MARK IN PARTS, THE
WORD "HA" IS A TRANSLITERATION FROM
HEBREW MEANING "THE" AND THE WORD
"MASPIK" IS A TRANSLITERATION FROM HE-
BREW MEANING "ENOUGH". THE COMBINED
WORD, "HAMASPIK", HAS NO MEANING IN A
FOREIGN LANGUAGE.

SER. NO. 77-371,219, FILED 1-14-2008.

PAUL CROWLEY, EXAMINING ATTORNEY

Int. Cl.: 9

Prior U.S. Cls.: 21, 23, 26, 36 and 38

Reg. No. 3,574,948

United States Patent and Trademark Office

Registered Feb. 17, 2009

**TRADEMARK
PRINCIPAL REGISTER**

CLOSEDLOOP

MEDIWARE INFORMATION SYSTEMS, INC.
(NEW YORK CORPORATION)
11711 WEST 79TH STREET
LENEXA, KS 66214

FOR: COMPUTER HARDWARE AND SOFTWARE FOR MANAGING MEDICAL DEVICES AND FOR MANAGING INFORMATION IN THE MEDICAL AND PHARMACEUTICAL INDUSTRIES , IN CLASS 9 (U.S. CLS. 21, 23, 26, 36 AND 38).

FIRST USE 7-31-2007; IN COMMERCE 7-31-2007.

THE MARK CONSISTS OF STANDARD CHARACTERS WITHOUT CLAIM TO ANY PARTICULAR FONT, STYLE, SIZE, OR COLOR.

SER. NO. 77-371,230, FILED 1-14-2008.

DOMINIC FATHY, EXAMINING ATTORNEY

Int. Cl.: 41

Prior U.S. Cls.: 100, 101 and 107

United States Patent and Trademark Office

Reg. No. 3,574,949

Registered Feb. 17, 2009

**SERVICE MARK
PRINCIPAL REGISTER**

Amerinda

HEFFERAN, ROGER L (UNITED STATES INDIVIDUAL), DBA STAG LIGHTNINGFEATHER
7009 BACKLICK
SPRINGFIELD, VA 22151

THE MARK CONSISTS OF STANDARD CHARACTERS WITHOUT CLAIM TO ANY PARTICULAR FONT, STYLE, SIZE, OR COLOR.

FOR: TEACHING IN THE FIELD OF NATIVE AMERICAN MEDICINE WAYS, IN CLASS 41 (U.S. CLS. 100, 101 AND 107).

SER. NO. 77-371,270, FILED 1-14-2008.

FIRST USE 6-30-1983; IN COMMERCE 6-30-1983.

GINA FINK, EXAMINING ATTORNEY

Int. Cl.: 45

Prior U.S. Cls.: 100 and 101

United States Patent and Trademark Office

Reg. No. 3,574,950

Registered Feb. 17, 2009

**SERVICE MARK
PRINCIPAL REGISTER**

MARI

CHOICEPOINT ASSET COMPANY LLC (DELA-
WARE LIMITED LIABILITY COMPANY)
1000 ALDERMAN DRIVE
ALPHARETTA, GA 30005

FOR: FRAUD DETECTION AND PREVENTION
SERVICES IN THE NATURE OF RISK MITIGATION
SERVICES, NAMELY, COLLECTING, ANALYZING
AND PROVIDING MORTGAGE FRAUD INFOR-
MATION; FRAUD ALERT SERVICES; NATIONAL
MORTGAGE FRAUD REPORTING SERVICES, IN
CLASS 45 (U.S. CLS. 100 AND 101).

FIRST USE 11-15-1990; IN COMMERCE 11-15-1990.

THE MARK CONSISTS OF STANDARD CHAR-
ACTERS WITHOUT CLAIM TO ANY PARTICULAR
FONT, STYLE, SIZE, OR COLOR.

OWNER OF U.S. REG. NO. 1,930,660.

SER. NO. 77-371,311, FILED 1-14-2008.

DANIEL CAPSHAW, EXAMINING ATTORNEY

Int. Cl.: 33

Prior U.S. Cls.: 47 and 49

United States Patent and Trademark Office

Reg. No. 3,574,951

Registered Feb. 17, 2009

**TRADEMARK
PRINCIPAL REGISTER**



VINEBURG LLC (CALIFORNIA LIMITED LIABILITY COMPANY)

P.O. BOX 1

VINEBURG, CA 95487

OWNER OF U.S. REG. NOS. 1,362,313, 3,243,608, AND 3,286,081.

THE MARK CONSISTS OF STYLIZED LETTERS "G", "B" AND "W".

FOR: WINE, IN CLASS 33 (U.S. CLS. 47 AND 49).

SER. NO. 77-371,462, FILED 1-14-2008.

FIRST USE 12-31-1918; IN COMMERCE 12-31-1918.

LINDA M. KING, EXAMINING ATTORNEY

Int. Cl.: 35

Prior U.S. Cls.: 100, 101 and 102

United States Patent and Trademark Office

Reg. No. 3,574,952

Registered Feb. 17, 2009

**SERVICE MARK
PRINCIPAL REGISTER**

INTELLIGENT BEAUTY

INTELLIGENT BEAUTY LLC (DELAWARE LIMITED LIABILITY COMPANY)
SUITE 4100
2301 ROSECRANS AVENUE
EL SEGUNDO, CA 902454967

FOR: BUSINESS, MARKETING AND ADVERTISING CONSULTING SERVICES; ADVERTISING AGENCY SERVICES, NAMELY, PROVIDING COMPETITIVE AND MARKET RESEARCH, COMPILATION AND ANALYSIS OF BUSINESS STATISTICS, AGENCIES FOR ADVERTISING TIME AND SPACE, PROVIDING INVENTORY MANAGEMENT, ACCOUNTING, AND CUSTOMER SERVICE, NAMELY, CUSTOMER RELATIONSHIPS MANAGEMENT; BUSINESS AND MARKETING MONITORING SERVICES, NAMELY, TRACKING WEBSITES OF OTHERS TO PROVIDE DETAILS ABOUT USER CLICK TRAFFIC OR VISITS TO THE WEB SITE IN ORDER TO ENHANCE MARKETING METHODS AND BRAND RECOGNITION; ADVERTISING AND MARKETING SERVICES, NAMELY, DISSEMINATION OF ADVERTISING FOR OTHERS ON THE INTERNET; SERVICES OF AN ADVERTISING AGENCY, NAMELY, DISSEMINATION AND DISTRIBUTION OF ADVERTISING MATTER AND MATERIALS, ISSUING AND UPDATING OF ADVERTISING TEXTS, PUBLICATION OF PUBLICITY TEXTS, AND DEMONSTRATION OF PRODUCTS FOR OTHERS; SERVICES OF A MULTIMEDIA AGENCY, NAMELY, ADVERTISING CONSULTATION IN THE NATURE OF PLANNING AND DESIGN OF MULTIMEDIA ADVERTISING STRATEGIES AND PROMOTIONS; ORGANIZATIONAL SERVICES FOR BUSINESS PURPOSES, NAMELY, ORGANIZATIONAL PROJECT PLANNING AND ORGANIZATIONAL PRO-

JECT MANAGEMENT FOR ADVERTISING; DESIGN OF INTERNET ADVERTISING; PROVIDING HOME SHOPPING SERVICES IN THE FIELD OF SKIN CARE PREPARATIONS BY MEANS OF TELEVISION; BUSINESS MARKETING SERVICES, NAMELY, PROCUREMENT OF CONTRACTS FOR OTHERS FOR THE PURCHASE OF GOODS AND LABOR CONTRACTING SERVICES; PROMOTING THE GOODS AND SERVICES OF OTHERS BY PROVIDING HYPERTEXT LINKS TO THE WEB SITES OF OTHERS; SERVICES RELATING TO THE ANALYSIS, EVALUATION, CREATION, DEVELOPMENT, AND ESTABLISHMENT OF TRADEMARKS, LOGOS, DOMAIN NAME, AND BRAND NAMES FOR OTHERS; ORDER FULFILLMENT SERVICES, NAMELY, ELECTRONIC PROCESSING OF ORDERS FOR GOODS OR SERVICES FOR OTHERS; PROVIDING CONSUMER PRODUCT INFORMATION VIA THE INTERNET; INVOICING SERVICES, NAMELY, PROCESSING AND INVOICING OF CONTRACTS ON SALES OF GOODS OF OTHERS VIA COMPUTER NETWORKS FOR E-COMMERCE SERVICES AND ONLINE SHOPPING; PROVISION OF A WEB SITE FEATURING INFORMATION ON SHOPPING, IN CLASS 35 (U.S. CLS. 100, 101 AND 102).

FIRST USE 6-7-2007; IN COMMERCE 6-7-2007.

THE MARK CONSISTS OF STANDARD CHARACTERS WITHOUT CLAIM TO ANY PARTICULAR FONT, STYLE, SIZE, OR COLOR.

SER. NO. 77-371,466, FILED 1-14-2008.

KAREN BRACEY, EXAMINING ATTORNEY

Int. Cl.: 9

Prior U.S. Cls.: 21, 23, 26, 36 and 38

United States Patent and Trademark Office

Reg. No. 3,574,953

Registered Feb. 17, 2009

TRADEMARK
PRINCIPAL REGISTER



HAMPTON, WILLIAM S. (UNITED STATES INDIVIDUAL)
PO BOX 6057
SPRING HILL, FL 34611

FOR: COMPUTER SOFTWARE FOR ORGANIZING, MANAGING, DOCUMENTING, SHARING, AND SEARCHING FOR VEHICLE INFORMATION AND VEHICLE HISTORY, FOR USE BY CLASSIC CAR COLLECTORS, RESTORERS AND MUSEUMS, IN CLASS 9 (U.S. CLS. 21, 23, 26, 36 AND 38).

FIRST USE 1-15-2008; IN COMMERCE 1-15-2008.

NO CLAIM IS MADE TO THE EXCLUSIVE RIGHT TO USE "CLASSIC CAR SYSTEMS.COM", APART FROM THE MARK AS SHOWN.

THE COLOR(S) BLUE, BLACK, WHITE AND YELLOW IS/ARE CLAIMED AS A FEATURE OF THE MARK.

THE MARK CONSISTS OF A YELLOW OVAL WITH THE WORDS "CLASSIC CAR SYSTEMS.COM" LOCATED WITHIN THE OVAL. THE COLOR BLUE APPEARS IN THE WORD "CLASSIC". THE COLOR WHITE APPEARS IN THE WORDING "CAR SYSTEMS.COM". THE COLOR YELLOW APPEARS IN THE CIRCULAR BAND DESIGN AND THE COLOR BLACK APPEARS IN THE RECTANGULAR SHAPED BACKGROUND DESIGN.

SER. NO. 77-371,652, FILED 1-15-2008.

RUSS HERMAN, EXAMINING ATTORNEY

Int. Cl.: 28

Prior U.S. Cls.: 22, 23, 38 and 50

United States Patent and Trademark Office

Reg. No. 3,574,954

Registered Feb. 17, 2009

**TRADEMARK
PRINCIPAL REGISTER**

MEGA SOUND-OFFS

MATTEL, INC. (DELAWARE CORPORATION)
M1-1518
333 CONTINENTAL BLVD.
EL SEGUNDO, CA 90245

THE MARK CONSISTS OF STANDARD CHAR-
ACTERS WITHOUT CLAIM TO ANY PARTICULAR
FONT, STYLE, SIZE, OR COLOR.

FOR: TOYS, GAMES AND PLAYTHINGS, NAME-
LY, TOY VEHICLES AND ACCESSORIES THERE-
FOR, IN CLASS 28 (U.S. CLS. 22, 23, 38 AND 50).

SER. NO. 77-371,872, FILED 1-15-2008.

FIRST USE 6-4-2008; IN COMMERCE 6-4-2008.

JAY FLOWERS, EXAMINING ATTORNEY

Int. Cls.: 5 and 44

Prior U.S. Cls.: 6, 18, 44, 46, 51, 52, 100 and 101

United States Patent and Trademark Office

Reg. No. 3,574,955

Registered Feb. 17, 2009

**TRADEMARK
SERVICE MARK
PRINCIPAL REGISTER**

my
Victory!

NSE PRODUCTS, INC. (DELAWARE CORPORATION)
LEGAL DEPARTMENT
75 WEST CENTER STREET
PROVO, UT 84601

FOR: NUTRITIONAL AND DIETARY SUPPLEMENTS, MEAL REPLACEMENT DRINKS AND POWDERS, DIETARY SUPPLEMENT DRINKS, MEAL REPLACEMENT SHAKES, VITAMIN ENHANCED DRINKS, MEAL REPLACEMENT BARS, IN CLASS 5 (U.S. CLS. 6, 18, 44, 46, 51 AND 52).

FIRST USE 9-5-2007; IN COMMERCE 9-5-2007.

FOR: WEIGHT MANAGEMENT PROGRAM, IN CLASS 44 (U.S. CLS. 100 AND 101).

FIRST USE 9-5-2007; IN COMMERCE 9-5-2007.

THE MARK CONSISTS OF THE TERMS "MY" AND "VICTORY" ALONG WITH AN EXCLAMATION POINT.

SER. NO. 77-371,952, FILED 1-15-2008.

ANGELA M. MICHELI, EXAMINING ATTORNEY

Int. Cl.: 42

Prior U.S. Cls.: 100 and 101

United States Patent and Trademark Office

Reg. No. 3,574,956

Registered Feb. 17, 2009

**SERVICE MARK
PRINCIPAL REGISTER**



THE ABOVE NETWORK, LLC (DELAWARE LIMITED LIABILITY COMPANY)
SUITE 2000
450 SEVENTH AVENUE
NEW YORK, NY 10123

FOR: HOSTING AN ONLINE COMMUNITY WEB SITE FEATURING INFORMATION CONCERNING UFO SIGHTINGS, EXTRATERRESTRIALS, CONSPIRACIES, SECRET SOCIETIES, PARANORMAL INCIDENTS, IN CLASS 42 (U.S. CLS. 100 AND 101).

FIRST USE 1-1-2005; IN COMMERCE 1-1-2005.

THE MARK CONSISTS OF THE STYLIZED LETTERS "ATS" AND THE STYLIZED WORD "ABOVE-TOPSECRET.COM." THE CAPITAL LETTERS "ATS" ARE SITUATED ABOVE THE WORD "ABOVETOP-SECRET.COM." THE WHOLE MARK IS FRAMED BY A RECTANGLE WITH CURVED CORNERS.

SER. NO. 77-372,115, FILED 1-15-2008.

MICHELE SWAIN, EXAMINING ATTORNEY

Int. Cl.: 41

Prior U.S. Cls.: 100, 101 and 107

United States Patent and Trademark Office

Reg. No. 3,574,957

Registered Feb. 17, 2009

**SERVICE MARK
PRINCIPAL REGISTER**



THE ABOVE NETWORK, LLC (DELAWARE LIMITED LIABILITY COMPANY)
SUITE 2000
450 SEVENTH AVENUE
NEW YORK, NY 10123

FOR: ENTERTAINMENT SERVICES, NAMELY, PROVIDING A WEBSITE FEATURING CURRENT EVENT NEWS RELATING TO ENTERTAINMENT, CONSPIRACIES, AND TECHNOLOGY, IN CLASS 41 (U.S. CLS. 100, 101 AND 107).

FIRST USE 1-5-2005; IN COMMERCE 5-1-2005.

THE MARK CONSISTS OF THE STYLIZED LETTERS "BTS" AND THE STYLIZED WORD "BELOWTOPSECRET.COM." THE CAPITAL LETTERS "BTS" ARE SITUATED ABOVE THE WORD "ABOVETOPSECRET.COM." THE WHOLE MARK IS FRAMED BY A RECTANGLE WITH CURVED CORNERS.

SER. NO. 77-372,136, FILED 1-15-2008.

MICHELE SWAIN, EXAMINING ATTORNEY

Int. Cl.: 35

Prior U.S. Cls.: 100, 101 and 102

United States Patent and Trademark Office

Reg. No. 3,574,958

Registered Feb. 17, 2009

SERVICE MARK
PRINCIPAL REGISTER

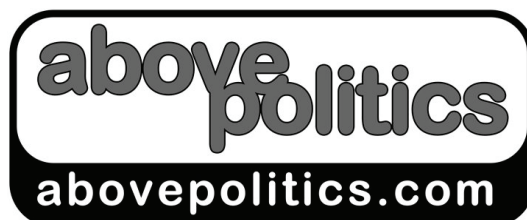

THE ABOVE NETWORK, LLC (DELAWARE LIMITED LIABILITY COMPANY)
SUITE 2000
450 SEVENTH AVENUE
NEW YORK, NY 10123

FOR: PROVIDING A WEBSITE IN THE FIELD OF POLITICS, IN CLASS 35 (U.S. CLS. 100, 101 AND 102).

FIRST USE 6-1-2006; IN COMMERCE 6-1-2006.

THE MARK CONSISTS OF WORDS "ABOVE" AND "POLITICS" IN STYLIZED LETTERS AND THE WORD "ABOVEPOLITICS.COM" IN STYLIZED LETTERS. THE WHOLE MARK IS FRAMED BY A

RECTANGLE WITH CURVED CORNERS. THE WORD "ABOVE" IS SITUATED IN THE UPPER LEFT CORNER OF THE RECTANGLE, THE WORD "POLITICS" IS POSITIONED BENEATH THE WORD "ABOVE" AND IS ALIGNED TO THE RIGHT OF THE RECTANGLE. THE LETTERS "VE" OF THE WORD "ABOVE" AND THE LETTERS "PO" OF THE WORD "POLITICS" ARE INTERTWINED. THE WORD "ABOVEPOLITICS.COM" IS SITUATED AT THE BOTTOM OF THE RECTANGLE.

SER. NO. 77-372,171, FILED 1-15-2008.

MICHELE SWAIN, EXAMINING ATTORNEY

Int. Cl.: 16

Prior U.S. Cls.: 2, 5, 22, 23, 29, 37, 38 and 50

United States Patent and Trademark Office

Reg. No. 3,574,959

Registered Feb. 17, 2009

**TRADEMARK
PRINCIPAL REGISTER**

**Georgia Manufacturers
Register**

MANUFACTURERS NEWS, INC. (ILLINOIS
CORPORATION)
1633 CENTRAL STREET
EVANSTON, IL 60201

FOR: DIRECTORIES OF BUSINESS PROFILES
AND PRODUCT INFORMATION, IN CLASS 16 (U.S.
CLS. 2, 5, 22, 23, 29, 37, 38 AND 50).

FIRST USE 1-1-1988; IN COMMERCE 1-1-1988.

THE MARK CONSISTS OF STANDARD CHAR-
ACTERS WITHOUT CLAIM TO ANY PARTICULAR
FONT, STYLE, SIZE, OR COLOR.

OWNER OF U.S. REG. NO. 779,223.

NO CLAIM IS MADE TO THE EXCLUSIVE
RIGHT TO USE "REGISTER", APART FROM THE
MARK AS SHOWN.

SEC. 2(F).

SER. NO. 77-372,222, FILED 1-15-2008.

COURTNEY MCCORMICK, EXAMINING ATTOR-
NEY

Int. Cl.: 14

Prior U.S. Cls.: 2, 27, 28 and 50

United States Patent and Trademark Office

Reg. No. 3,574,960

Registered Feb. 17, 2009

**TRADEMARK
PRINCIPAL REGISTER**

VINTAGE BEAST

RENATO WATCHES, INC. (FLORIDA CORPORATION)
14051 N.W. 14TH STREET
SUNRISE, FL 33323

FOR: JEWELRY, NAMELY, WATCHES AND PARTS THEREOF, IN CLASS 14 (U.S. CLS. 2, 27, 28 AND 50).

FIRST USE 4-8-2008; IN COMMERCE 4-8-2008.

THE MARK CONSISTS OF STANDARD CHARACTERS WITHOUT CLAIM TO ANY PARTICULAR FONT, STYLE, SIZE, OR COLOR.

OWNER OF U.S. REG. NO. 3,305,765.

SER. NO. 77-372,250, FILED 1-15-2008.

JOHN DWYER, EXAMINING ATTORNEY

Int. Cl.: 41

Prior U.S. Cls.: 100, 101 and 107

United States Patent and Trademark Office

Reg. No. 3,574,961

Registered Feb. 17, 2009

**SERVICE MARK
PRINCIPAL REGISTER**

CHURCH BASEMENT LADIES

TROUPE AMERICA, INC. (MINNESOTA CORPORATION)
528 HENNEPIN AVENUE, SUITE 206
MINNEAPOLIS, MN 55403

FOR: ENTERTAINMENT SERVICES IN THE NATURE OF AN ON-GOING THEATRICAL PRODUCTION, IN CLASS 41 (U.S. CLS. 100, 101 AND 107).

FIRST USE 1-31-2005; IN COMMERCE 1-31-2005.

THE MARK CONSISTS OF STANDARD CHARACTERS WITHOUT CLAIM TO ANY PARTICULAR FONT, STYLE, SIZE, OR COLOR.

SER. NO. 77-372,281, FILED 1-15-2008.

TRICIA SONNEBORN, EXAMINING ATTORNEY

Int. Cl.: 35

Prior U.S. Cls.: 100, 101 and 102

United States Patent and Trademark Office

Reg. No. 3,574,962

Registered Feb. 17, 2009

SERVICE MARK
PRINCIPAL REGISTER

SpoiledGrandKids.com
Shouldn't yours be one?

KRISE, ARVEY (UNITED STATES INDIVIDUAL)
1417 STEELE STREET
FORT MYERS, FL 33901

FOR: ON-LINE RETAIL STORE SERVICES FEATURING A VARIETY OF GIFTS FOR CHILDREN, GRANDPARENTS, AUNTS, UNCLES, BIG BROTHERS AND SISTERS AND ANY FAMILY MEMBER INCLUDING PERSONALITY WEAR WITH CUTE PICTURES AND SAYINGS, ROBES AND PAJAMAS, CHILDREN'S CLOTHING, ADULT CLOTHING, PICTURE FRAMES, TOYS, ACCESSORIES SUCH AS HAIR WEAR, BELTS AND SHOES, ART, WALL

DECOR, SPA WEAR AND ANYTHING THAT FALLS UNDER THE GIFT CATEGORY, IN CLASS 35 (U.S. CLS. 100, 101 AND 102).

FIRST USE 5-1-2007; IN COMMERCE 11-1-2007.

THE MARK CONSISTS OF THE STYLIZED WORDS "SPOILEDGRANDKIDS.COM SHOULDN'T YOURS BE ONE?".

SER. NO. 77-372,435, FILED 1-15-2008.

CAROLINE WOOD, EXAMINING ATTORNEY

Int. Cl.: 45

Prior U.S. Cls.: 100 and 101

United States Patent and Trademark Office

Reg. No. 3,574,963

Registered Feb. 17, 2009

**SERVICE MARK
PRINCIPAL REGISTER**



LIFE DISCOVERIES INC (WISCONSIN CORPORATION)
735 MARGEO DRIVE
NEENAH, WI 54956

THE COLOR(S) GREEN YELLOW, BLUE, RED, GOLD IS/ARE CLAIMED AS A FEATURE OF THE MARK.

FOR: INFORMATION IN THE FIELD OF PARENTING CONCERNING INTRAFAMILY RELATIONSHIPS, IN CLASS 45 (U.S. CLS. 100 AND 101).

THE MARK CONSISTS OF KIDS IN RED BOX WITHIN FLAG, WITH ADDITION OF GREEN YELLOW AND BLUE BOXES IN FLAG. BLUE FLAG POLE. RED "F", BLUE "L", GREEN "A", GOLD "G", RED "P", GOLD "A", GREEN "G" AND BLUE "E".

FIRST USE 6-15-2008; IN COMMERCE 6-15-2008.

NO CLAIM IS MADE TO THE EXCLUSIVE RIGHT TO USE "KIDS", APART FROM THE MARK AS SHOWN.

SER. NO. 77-372,460, FILED 1-15-2008.

CHRIS WELLS, EXAMINING ATTORNEY

Int. Cls.: 28 and 35

Prior U.S. Cls.: 22, 23, 38, 50, 100, 101 and 102

United States Patent and Trademark Office

Reg. No. 3,574,964

Registered Feb. 17, 2009

**TRADEMARK
SERVICE MARK
PRINCIPAL REGISTER**

ILLOOM BALLOONS

MELLOWGRAPHIC LIMITED (UNITED KING-
DOM LIMITED COMPANY (LTD.))
THE COACH HOUSE, CREWE GREEN
CREWE, UNITED KINGDOM CW15UN

FOR: BALLOONS, IN CLASS 28 (U.S. CLS. 22, 23, 38
AND 50).

FOR: ONLINE RETAIL STORE SERVICES IN THE
FIELD OF BALLOONS, IN CLASS 35 (U.S. CLS. 100,
101 AND 102).

THE MARK CONSISTS OF STANDARD CHAR-
ACTERS WITHOUT CLAIM TO ANY PARTICULAR
FONT, STYLE, SIZE, OR COLOR.

PRIORITY CLAIMED UNDER SEC. 44(D) ON
ERPNTM CMNTY TM OFC APPLICATION NO.
006355689, FILED 10-11-2007, REG. NO. 006355689,
DATED 7-17-2008, EXPIRES 10-11-2017.

NO CLAIM IS MADE TO THE EXCLUSIVE
RIGHT TO USE "BALLOONS", APART FROM THE
MARK AS SHOWN.

SER. NO. 77-372,686, FILED 1-16-2008.

LESLIE RICHARDS, EXAMINING ATTORNEY

Int. Cl.: 37

Prior U.S. Cls.: 100, 103 and 106

United States Patent and Trademark Office

Reg. No. 3,574,965

Registered Feb. 17, 2009

**SERVICE MARK
PRINCIPAL REGISTER**



PROFESSIONAL RESTORATION SERVICES, INC.
(VIRGINIA CORPORATION)
3627 WOODLYNNE PLACE
RICHMOND, VA 23233

FOR: BUILDING CONSTRUCTION AND REPAIR; BUILDING CONSTRUCTION SERVICES; CONSTRUCTING DECKS; CONSTRUCTING PORCHES; CONSTRUCTING SUNROOMS; CONSTRUCTION AND RENOVATION OF BUILDINGS; CONSTRUCTION AND REPAIR OF BUILDINGS; CONSTRUCTION CONSULTANCY; CONSTRUCTION CONSULTATION; CONSTRUCTION MANAGEMENT; CONSTRUCTION SUPERVISION; CONSTRUCTION, MAINTENANCE AND RENOVATION OF PROPERTY; CONSULTATION IN BUILDING CONSTRUCTION SUPERVISION; CUSTOM CONSTRUCTION AND BUILDING RENOVATION; CUSTOM CONSTRUCTION OF HOMES; GENERAL CONSTRUCTION CONTRACTING; RESIDENTIAL AND BUILDING CONSTRUCTION CONSULTING;

RESIDENTIAL AND COMMERCIAL BUILDING CONSTRUCTION, IN CLASS 37 (U.S. CLS. 100, 103 AND 106).

FIRST USE 3-0-2007; IN COMMERCE 4-0-2007.

THE COLOR(S) GOLD AND GREEN IS/ARE CLAIMED AS A FEATURE OF THE MARK.

THE MARK CONSISTS OF A GOLD INCOMPLETE OUTLINE OF A CIRCLE WITH A GOLD HOUSE ON TOP OF THE INCOMPLETE PORTION ON ITS LEFT SIDE, WITH THE GREEN LETTERS "PRS" IN THE CENTER OF THE CIRCLE.

SER. NO. 77-372,869, FILED 1-16-2008.

LYDIA BELZER, EXAMINING ATTORNEY

Int. Cls.: 35 and 40

Prior U.S. Cls.: 100, 101, 102, 103 and 106

United States Patent and Trademark Office

Reg. No. 3,574,966

Registered Feb. 17, 2009

**SERVICE MARK
PRINCIPAL REGISTER**

PHOTO PORCELAIN DOMINIC

PHOTO PORCELAIN DOMINIC INC. (CANADA CORPORATION)
4645 JARRY EAST
MONTREAL, CANADA H1R1X6

FOR: WHOLESALE DISTRIBUTORSHIPS FEATURING PORCELAIN AND METAL-BASED MEMORIAL PORTRAITS WHICH ARE PLACED ON CRYPT FRONTS, URNS OR MONUMENTS; WHOLESALE DISTRIBUTORSHIPS FEATURING SILVER AND GOLD PLATED LOCKETS AND PENDANTS, IN CLASS 35 (U.S. CLS. 100, 101 AND 102).

FIRST USE 12-31-1993; IN COMMERCE 12-31-1993.

FOR: CREATION OF CUSTOM PORCELAIN AND METAL-BASED MEMORIAL PORTRAITS WHICH ARE PLACED ON CRYPT FRONTS, URNS OR MONUMENTS; CREATION OF CUSTOM SILVER AND GOLD PLATED LOCKETS AND PENDANTS

BASED ON PHOTOGRAPHS, SNAPSHOTS OR IMAGES PROVIDED BY CUSTOMER OR CHOSEN BY THE CUSTOMER, IN CLASS 40 (U.S. CLS. 100, 103 AND 106).

FIRST USE 12-31-1993; IN COMMERCE 12-31-1993.

THE MARK CONSISTS OF STANDARD CHARACTERS WITHOUT CLAIM TO ANY PARTICULAR FONT, STYLE, SIZE, OR COLOR.

NO CLAIM IS MADE TO THE EXCLUSIVE RIGHT TO USE "PHOTO PORCELAIN", APART FROM THE MARK AS SHOWN.

SER. NO. 77-372,890, FILED 1-16-2008.

SHANNON TWOHIG, EXAMINING ATTORNEY

Int. Cl.: 35

Prior U.S. Cls.: 100, 101 and 102

United States Patent and Trademark Office

Reg. No. 3,574,967

Registered Feb. 17, 2009

SERVICE MARK
PRINCIPAL REGISTER



BUSTERPRO, INC. (CALIFORNIA CORPORATION)
10676 WILKINS AVENUE
LOS ANGELES, CA 90024

FOR: ONLINE RETAIL SERVICES FEATURING
CLOTHING AND APPAREL, HEADGEAR AND
ACCESSORIES, IN CLASS 35 (U.S. CLS. 100, 101
AND 102).

FIRST USE 12-1-2007; IN COMMERCE 12-1-2007.

THE MARK CONSISTS OF THE TERM "BUSTER-
PRO" CONTAINED IN A RECTANGULAR DESIGN
WITH A TENNIS BALL DESIGN COMPRISING THE
LETTER "O".

SER. NO. 77-372,899, FILED 1-16-2008.

BILL DAWE, EXAMINING ATTORNEY

Int. Cls.: 9 and 10

Prior U.S. Cls.: 21, 23, 26, 36, 38, 39 and 44

Reg. No. 3,574,968

United States Patent and Trademark Office

Registered Feb. 17, 2009

**TRADEMARK
PRINCIPAL REGISTER**

HM_sERG

RETVET CORPORATION, INC. (MISSOURI CORPORATION)
5606 AUTUMN RIDGE CT.
COLUMBIA, MO 65203

FOR: PORTABLE DEVICE PRIMARILY COMPRISED OF PHOTOSTIMULATOR WITH LIGHT EMITTING DIODES, COMPACT FLASH MEMORY CARD, LIQUID CRYSTAL DISPLAY COLOR SCREEN, MICROPROCESSOR INTERACTING WITH THE COMPACT FLASH MEMORY CARD, RECHARGEABLE BATTERIES AND POD FOR ELECTRODE CONNECTIONS DESIGNED FOR OBTAINING ELECTRORETINOGRAPHIC RECORDINGS IN VARIOUS SPECIES OF ANIMALS AND IN HUMANS, IN CLASS 9 (U.S. CLS. 21, 23, 26, 36 AND 38).

FIRST USE 10-15-2007; IN COMMERCE 10-15-2007.

FOR: PORTABLE DEVICE, NAMELY, AN ELECTRORETINOGRAPH, DESIGNED FOR OBTAINING ELECTRORETINOGRAPHIC RECORDINGS IN MANY SPECIES OF ANIMALS AND IN HUMANS, IN CLASS 10 (U.S. CLS. 26, 39 AND 44).

FIRST USE 10-15-2007; IN COMMERCE 10-15-2007.

THE MARK CONSISTS OF STANDARD CHARACTERS WITHOUT CLAIM TO ANY PARTICULAR FONT, STYLE, SIZE, OR COLOR.

SER. NO. 77-372,970, FILED 1-16-2008.

CHARISMA HAMPTON, EXAMINING ATTORNEY

Int. Cls.: 9, 16, 35 and 41

**Prior U.S. Cls.: 2, 5, 21, 22, 23, 26, 29, 36, 37, 38, 50,
100, 101, 102 and 107**

Reg. No. 3,574,969

United States Patent and Trademark Office

Registered Feb. 17, 2009

**TRADEMARK
SERVICE MARK
PRINCIPAL REGISTER**



INTERNATIONAL CODE COUNCIL, INC. (CALIFORNIA CORPORATION)
5360 WORKMAN MILL ROAD
WHITTIER, CA 90601

FOR: ELECTRONIC PUBLICATIONS, NAMELY, BOOKS AND MANUALS IN THE FIELD OF BUILDING, CONSTRUCTION AND SAFETY CODES AND STANDARDS RECORDED ON COMPUTER MEDIA AND DOWNLOADABLE BOOKS AND MANUALS IN THE FIELD OF BUILDING, CONSTRUCTION AND SAFETY CODES AND STANDARDS, IN CLASS 9 (U.S. CLS. 21, 23, 26, 36 AND 38).

FIRST USE 1-5-2007; IN COMMERCE 1-5-2007.

FOR: SERIES OF MONOGRAPHS, SERIES OF BOOKS, PAMPHLETS AND PRINTED MATERIALS IN THE NATURE OF BOOKS, BOOKLETS, AND HAND-OUTS COMPILED IN LOOSE-LEAF AND BOUND VOLUME FORMAT, ALL FEATURING BUILDING, CONSTRUCTION AND SAFETY CODES AND STANDARDS, IN CLASS 16 (U.S. CLS. 2, 5, 22, 23, 29, 37, 38 AND 50).

FIRST USE 1-31-2007; IN COMMERCE 1-31-2007.

FOR: ASSOCIATION SERVICES, NAMELY, PROMOTING THE INTERESTS OF BUILDING, CONSTRUCTION AND SAFETY CODES AND STANDARDS DEVELOPERS, ENFORCERS AND USERS, IN CLASS 35 (U.S. CLS. 100, 101 AND 102).

FIRST USE 1-5-2007; IN COMMERCE 1-5-2007.

FOR: TRAINING SERVICES IN THE FIELD OF BUILDING, CONSTRUCTION AND SAFETY CODES AND STANDARDS; EDUCATIONAL SERVICES, NAMELY, CONDUCTING CLASSES, SEMINARS, CONFERENCES, AND WORKSHOPS IN THE FIELD OF BUILDING, CONSTRUCTION AND SAFETY CODES AND STANDARDS, IN CLASS 41 (U.S. CLS. 100, 101 AND 107).

FIRST USE 1-5-2007; IN COMMERCE 1-5-2007.

OWNER OF U.S. REG. NOS. 2,242,343, 3,259,781 AND OTHERS.

THE MARK CONSISTS OF THE STYLIZED LETTERS "ICC", THE STYLIZED WORDING "INTERNATIONAL CODE COUNCIL" AND THE DESIGN OF A PORTION OF A GLOBE FORMED BY LINES INSIDE A SHADED SQUARE. THE LETTERS "ICC" APPEAR IN THE TOP RIGHT OF THE SHADED SQUARE, AND THE WORDING "INTERNATIONAL CODE COUNCIL" APPEARS BELOW THE SHADED SQUARE.

SEC. 2(F) AS TO "INTERNATIONAL CODE COUNCIL".

SER. NO. 77-373,331, FILED 1-16-2008.

JAY BESCH, EXAMINING ATTORNEY

Int. Cl.: 36

Prior U.S. Cls.: 100, 101 and 102

United States Patent and Trademark Office

Reg. No. 3,574,970

Registered Feb. 17, 2009

**SERVICE MARK
PRINCIPAL REGISTER**

BELL ROCK CAPITAL

BELL ROCK CAPITAL, LLC (PENNSYLVANIA
LIMITED LIABILITY COMPANY)
1800 E. LANCASTER AVENUE
PAOLI, PA 19301

FOR: FINANCIAL ADVISORY AND CONSUL-
TANCY SERVICES, IN CLASS 36 (U.S. CLS. 100, 101
AND 102).

FIRST USE 10-1-2007; IN COMMERCE 10-1-2007.

THE MARK CONSISTS OF STANDARD CHAR-
ACTERS WITHOUT CLAIM TO ANY PARTICULAR
FONT, STYLE, SIZE, OR COLOR.

NO CLAIM IS MADE TO THE EXCLUSIVE
RIGHT TO USE "CAPITAL", APART FROM THE
MARK AS SHOWN.

SER. NO. 77-373,460, FILED 1-16-2008.

MATTHEW PAPPAS, EXAMINING ATTORNEY

Int. Cl.: 36

Prior U.S. Cls.: 100, 101 and 102

United States Patent and Trademark Office

Reg. No. 3,574,971

Registered Feb. 17, 2009

**SERVICE MARK
PRINCIPAL REGISTER**



BELL ROCK CAPITAL, LLC (PENNSYLVANIA
LIMITED LIABILITY COMPANY)
1800 E. LANCASTER AVENUE
PAOLI, PA 19301

FOR: FINANCIAL ADVISORY AND CONSUL-
TANCY SERVICES, IN CLASS 36 (U.S. CLS. 100, 101
AND 102).

FIRST USE 10-1-2007; IN COMMERCE 10-1-2007.

NO CLAIM IS MADE TO THE EXCLUSIVE
RIGHT TO USE "CAPITAL", APART FROM THE
MARK AS SHOWN.

THE MARK INCLUDES A BELL TOWER TO THE
LEFT OF THREE ROWS OF SHADED CIRCLES.

SER. NO. 77-373,476, FILED 1-16-2008.

MATTHEW PAPPAS, EXAMINING ATTORNEY

Int. Cl.: 12

Prior U.S. Cls.: 19, 21, 23, 31, 35 and 44

Reg. No. 3,574,972

United States Patent and Trademark Office

Registered Feb. 17, 2009

**TRADEMARK
PRINCIPAL REGISTER**

NOSE - DRAGGER DRAGGER

SKYLINE ADVERTISING, INC. (MICHIGAN
CORPORATION)
3372 ANN DRIVE
FLUSHING, MI 48433

THE MARK CONSISTS OF STANDARD CHAR-
ACTERS WITHOUT CLAIM TO ANY PARTICULAR
FONT, STYLE, SIZE, OR COLOR.

FOR: POWERED AND NON-POWERED DOLLIES
AND CARTS FOR MOVING NOSE WHEEL AIR-
PLANES AND HELICOPTERS ON THE GROUND,
IN CLASS 12 (U.S. CLS. 19, 21, 23, 31, 35 AND 44).

SEC. 2(F).

SER. NO. 77-373,511, FILED 1-16-2008.

FIRST USE 8-30-1996; IN COMMERCE 8-30-1996.

REBECCA GILBERT, EXAMINING ATTORNEY

Int. Cls.: 14, 16, 21 and 25

**Prior U.S. Cls.: 2, 5, 13, 22, 23, 27, 28, 29, 30, 33, 37,
38, 39, 40 and 50**

Reg. No. 3,574,973

United States Patent and Trademark Office

Registered Feb. 17, 2009

**TRADEMARK
PRINCIPAL REGISTER**

SB4G

SB4G, INC (ALABAMA NON-PROFIT CORPORATION)
3997 ALSTON WAY
BIRMINGHAM, AL 35242

FOR: JEWELRY, IN CLASS 14 (U.S. CLS. 2, 27, 28
AND 50).

FIRST USE 12-15-2007; IN COMMERCE 12-15-2007.

FOR: CARDS, SIGNS, STICKERS, BUMPER
STICKERS, PAPERWEIGHTS, BOOKS IN THE
FIELD OF RELIGION, IN CLASS 16 (U.S. CLS. 2, 5,
22, 23, 29, 37, 38 AND 50).

FIRST USE 12-15-2007; IN COMMERCE 12-15-2007.

FOR: MUGS, PLATES, AND GLASS VASES, IN
CLASS 21 (U.S. CLS. 2, 13, 23, 29, 30, 33, 40 AND 50).

FIRST USE 12-15-2007; IN COMMERCE 12-15-2007.

FOR: SHIRTS, HATS, PANTS, SWEATERS, AND
JACKETS, IN CLASS 25 (U.S. CLS. 22 AND 39).

FIRST USE 12-15-2007; IN COMMERCE 12-15-2007.

THE MARK CONSISTS OF STANDARD CHAR-
ACTERS WITHOUT CLAIM TO ANY PARTICULAR
FONT, STYLE, SIZE, OR COLOR.

SER. NO. 77-373,543, FILED 1-16-2008.

MARK RADEMACHER, EXAMINING ATTORNEY

Int. Cl.: 16

Prior U.S. Cls.: 2, 5, 22, 23, 29, 37, 38 and 50

Reg. No. 3,574,974

United States Patent and Trademark Office

Registered Feb. 17, 2009

**TRADEMARK
PRINCIPAL REGISTER**

CYCLE OF CARE RESOURCE BOOK

THE AMERICAN SOCIETY FOR AESTHETIC
PLASTIC SURGERY, INC. (GEORGIA COR-
PORATION)
11081 WINNERS CIRCLE
LOS ALAMITOS, CA 94720

FOR: EDUCATIONAL MANUAL CONTAINING
PATIENT INSTRUCTIONS, OPERATING ROOM
FORMS, LETTERS AND DISCLOSURES FOR PLAS-
TIC SURGEONS, IN CLASS 16 (U.S. CLS. 2, 5, 22, 23,
29, 37, 38 AND 50).

FIRST USE 10-25-2005; IN COMMERCE 10-25-2005.

THE MARK CONSISTS OF STANDARD CHAR-
ACTERS WITHOUT CLAIM TO ANY PARTICULAR
FONT, STYLE, SIZE, OR COLOR.

NO CLAIM IS MADE TO THE EXCLUSIVE
RIGHT TO USE "CARE RESOURCE BOOK", APART
FROM THE MARK AS SHOWN.

SER. NO. 77-373,598, FILED 1-16-2008.

HENRY S. ZAK, EXAMINING ATTORNEY

Int. Cls.: 9 and 36

Prior U.S. Cls.: 21, 23, 26, 36, 38, 100, 101 and 102

Reg. No. 3,574,975

United States Patent and Trademark Office

Registered Feb. 17, 2009

**TRADEMARK
SERVICE MARK
PRINCIPAL REGISTER**

WRAPS

WALZAK RISK ANALYSIS, LLC (FLORIDA LIMITED LIABILITY COMPANY)
5550 GLADES ROAD
SUITE 303
BOCA RATON, FL 33431

FOR: COMPUTER PROGRAM FOR THE AUTOMATED PREDICTION OF LOAN PERFORMANCE, IN CLASS 9 (U.S. CLS. 21, 23, 26, 36 AND 38).

FIRST USE 11-1-2005; IN COMMERCE 11-1-2005.

FOR: MORTGAGE SERVICES, NAMELY, BUYER PRE-QUALIFICATION OF MORTGAGES FOR

MORTGAGE BROKERS AND BANKS; CREDIT RISK MANAGEMENT, IN CLASS 36 (U.S. CLS. 100, 101 AND 102).

FIRST USE 11-1-2005; IN COMMERCE 11-1-2005.

THE MARK CONSISTS OF STANDARD CHARACTERS WITHOUT CLAIM TO ANY PARTICULAR FONT, STYLE, SIZE, OR COLOR.

SER. NO. 77-373,613, FILED 1-16-2008.

MICHAEL KEATING, EXAMINING ATTORNEY

Int. Cl.: 5

Prior U.S. Cls.: 6, 18, 44, 46, 51 and 52

United States Patent and Trademark Office

Reg. No. 3,574,976

Registered Feb. 17, 2009

**TRADEMARK
PRINCIPAL REGISTER**

Coolant Mints

ABANAKI CORPORATION (OHIO CORPORATION)
17387 MUNN RD.
CHAGRIN FALLS, OH 44023

FOR: ODOR NEUTRALIZING PREPARATIONS
FOR USE ON CUTTING FLUIDS, IN CLASS 5 (U.S.
CLS. 6, 18, 44, 46, 51 AND 52).

FIRST USE 10-1-2002; IN COMMERCE 1-7-2004.

THE MARK CONSISTS OF STANDARD CHARACTERS WITHOUT CLAIM TO ANY PARTICULAR FONT, STYLE, SIZE, OR COLOR.

NO CLAIM IS MADE TO THE EXCLUSIVE RIGHT TO USE "COOLANT", APART FROM THE MARK AS SHOWN.

SER. NO. 77-374,051, FILED 1-17-2008.

ANTHONY RINKER, EXAMINING ATTORNEY

Int. Cls.: 12, 18 and 25

Prior U.S. Cls.: 1, 2, 3, 19, 21, 22, 23, 31, 35, 39, 41 and 44

United States Patent and Trademark Office

Reg. No. 3,574,977

Registered Feb. 17, 2009

**TRADEMARK
PRINCIPAL REGISTER**



NELSON-RIGG USA, INC. (CALIFORNIA CORPORATION)
3518-A LAKE CENTER DRIVE
SANTA ANA, CA 92704

FOR: MOTORCYCLE ACCESSORIES, NAMELY, MOTORCYCLE COVERS, USED WITH SAID MOTORCYCLES, IN CLASS 12 (U.S. CLS. 19, 21, 23, 31, 35 AND 44).

FIRST USE 1-1-2005; IN COMMERCE 1-1-2005.

FOR: MOTORCYCLE ACCESSORIES, NAMELY, MOTORCYCLE SOFT LUGGAGE, USED WITH SAID MOTORCYCLES, IN CLASS 18 (U.S. CLS. 1, 2, 3, 22 AND 41).

FIRST USE 1-1-2005; IN COMMERCE 1-1-2005.

FOR: MOTORCYCLE ACCESSORIES, NAMELY, RAINWEAR USED WITH SAID MOTORCYCLES, IN CLASS 25 (U.S. CLS. 22 AND 39).

FIRST USE 1-1-2005; IN COMMERCE 1-1-2005.

OWNER OF U.S. REG. NO. 2,703,536.

THE MARK CONSISTS OF DOUBLED UPSIDE DOWN TRIANGLE WITH A CENTER RECTANGULAR BOX WITH "NELSON-RIGG" WITHIN THE BOX AND THREE LINED BORDERS ALONG RIGHT AND BOTTOM OF TRIANGLES.

SER. NO. 77-374,076, FILED 1-17-2008.

NAKIA HENRY, EXAMINING ATTORNEY

Int. Cls.: 9 and 16

Prior U.S. Cls.: 2, 5, 21, 22, 23, 26, 29, 36, 37, 38 and 50

Reg. No. 3,574,978

United States Patent and Trademark Office

Registered Feb. 17, 2009

**TRADEMARK
PRINCIPAL REGISTER**

TH-F

TEMPTIME CORPORATION (DELAWARE CORPORATION)
116 AMERICAN ROAD
MORRIS PLAINS, NJ 07950

FOR: HEAT MEASURING INDICATORS, NAME-
LY, TEMPERATURE SENSITIVE LABELS WHICH
ARE USED TO ENSURE THAT FOODS, BEVERA-
GES, AND PHARMACEUTICALS HAVE BEEN
MAINTAINED BELOW SPECIFIC TEMPERA-
TURES, IN CLASS 9 (U.S. CLS. 21, 23, 26, 36 AND 38).

FIRST USE 12-4-2007; IN COMMERCE 12-4-2007.

FOR: HEAT-SENSITIVE PAPER LABELS FOR
INSURING THAT FOODS, BEVERAGES, AND
PHARMACEUTICALS HAVE BEEN MAINTAINED

BELOW SPECIFIC TEMPERATURES, IN CLASS 16
(U.S. CLS. 2, 5, 22, 23, 29, 37, 38 AND 50).

FIRST USE 12-4-2007; IN COMMERCE 12-4-2007.

THE MARK CONSISTS OF STANDARD CHAR-
ACTERS WITHOUT CLAIM TO ANY PARTICULAR
FONT, STYLE, SIZE, OR COLOR.

THE MARK "TH-F" AND "TH" HAS NO MEAN-
ING IN A FOREIGN LANGUAGE.

SER. NO. 77-374,188, FILED 1-17-2008.

LAURIE KAUFMAN, EXAMINING ATTORNEY

Int. Cl.: 5

Prior U.S. Cls.: 6, 18, 44, 46, 51 and 52

Reg. No. 3,574,979

United States Patent and Trademark Office

Registered Feb. 17, 2009

**TRADEMARK
PRINCIPAL REGISTER**

STAMAN-T

ALLIANZ PHARMA, LLC (GEORGIA LIMITED
LIABILITY COMPANY)
SUITE 1700
1200 ABERNATHY ROAD, NE
ATLANTA, GA 30328

THE MARK CONSISTS OF STANDARD CHAR-
ACTERS WITHOUT CLAIM TO ANY PARTICULAR
FONT, STYLE, SIZE, OR COLOR.

FOR: INJECTIBLE MEDICATION FOR THE
TREATMENT OF ERECTILE DYSFUNCTION, IN
CLASS 5 (U.S. CLS. 6, 18, 44, 46, 51 AND 52).

SER. NO. 77-374,446, FILED 1-17-2008.

FIRST USE 9-5-2006; IN COMMERCE 9-5-2006.

MIDGE BUTLER, EXAMINING ATTORNEY

Int. Cl.: 11

Prior U.S. Cls.: 13, 21, 23, 31 and 34

United States Patent and Trademark Office

Reg. No. 3,574,980

Registered Feb. 17, 2009

**TRADEMARK
PRINCIPAL REGISTER**



PAMPERIN, INC. (TEXAS CORPORATION)
3812 62ND DR.
LUBBOCK, TX 79413

FOR: SWIMMING POOL WATER CLEANING
AND FILTERING UNITS, IN CLASS 11 (U.S. CLS.
13, 21, 23, 31 AND 34).

FIRST USE 1-11-2008; IN COMMERCE 1-11-2008.

THE MARK CONSISTS OF A LEAF FLOATING
ON WATER WITH A CIRCLE CONTAINING A
BACKSLASH OVERLAYING THE LEAF AND WA-
TER.

SER. NO. 77-374,574, FILED 1-17-2008.

REBECCA SMITH, EXAMINING ATTORNEY

Int. Cl.: 6

Prior U.S. Cls.: 2, 12, 13, 14, 23, 25 and 50

United States Patent and Trademark Office

Reg. No. 3,574,981

Registered Feb. 17, 2009

**TRADEMARK
PRINCIPAL REGISTER**

COREBRACE

CORE-BRACE, LLC (UTAH LIMITED LIABILITY
COMPANY)
5789 W. WELLS PARK ROAD
WEST JORDAN, UT 84088

THE MARK CONSISTS OF STANDARD CHAR-
ACTERS WITHOUT CLAIM TO ANY PARTICULAR
FONT, STYLE, SIZE, OR COLOR.

FOR: CONSTRUCTION ELEMENTS MADE OF
STEEL, NAMELY, BRACES, IN CLASS 6 (U.S. CLS. 2,
12, 13, 14, 23, 25 AND 50).

SER. NO. 77-374,686, FILED 1-17-2008.

FIRST USE 6-0-2002; IN COMMERCE 6-0-2002.

AMY HELLA, EXAMINING ATTORNEY

Int. Cl.: 35

Prior U.S. Cls.: 100, 101 and 102

United States Patent and Trademark Office

Reg. No. 3,574,982

Registered Feb. 17, 2009

**SERVICE MARK
PRINCIPAL REGISTER**



BEER & POLITICS LLC (CALIFORNIA LIMITED
LIABILITY COMPANY)
6475 E PACIFIC COAST HIGHWAY #339
LONG BEACH, CA 90803

FOR: COMPUTERIZED ON-LINE ORDERING
FEATURING GENERAL MERCHANDISE AND
GENERAL CONSUMER GOODS, IN CLASS 35 (U.S.
CLS. 100, 101 AND 102).

FIRST USE 5-1-2007; IN COMMERCE 9-25-2007.

THE COLOR(S) GREY, WHITE, AND BLACK IS/
ARE CLAIMED AS A FEATURE OF THE MARK.

THE MARK CONSISTS OF THE WORDS "BEER"
AND "POLITICS" BOTH WHITE WITH A BLACK
BORDER. THE "&" IS GREY WITH A BLACK
BORDER. BEHIND THE WORDS THERE IS A
GREEN CIRCLE WITH A WHITE RING THEN A
BLACK BORDER.

SER. NO. 77-374,687, FILED 1-17-2008.

BRENDAN REGAN, EXAMINING ATTORNEY

Int. Cl.: 9

Prior U.S. Cls.: 21, 23, 26, 36 and 38

Reg. No. 3,574,983

United States Patent and Trademark Office

Registered Feb. 17, 2009

**TRADEMARK
PRINCIPAL REGISTER**

The logo for SATA DOM features the word "SATA DOM" in a bold, black, sans-serif font. The letters are closely spaced. A thick, black horizontal bar is positioned above the letters, extending from the left edge of the 'S' to the right edge of the 'M', effectively acting as a top underline for the entire word.

INNODISK CORPORATION (TAIWAN CORPORATION)
ZHONGXIAO E. RD., NANGANG DISTRICT
TAIPEI, TAIWAN 115

FOR: FLOppy DISC DRIVES; COMPUTER MEMORIES; READ-ONLY-MEMORIES FOR COMPUTERS; MAGNETIC MEMORIES CONTAINED ON DISKS; PLUG-IN COMPUTER MEMORY CARTRIDGES; DATA STORAGE APPARATUS FOR COMPUTERS, NAMELY, MEMORY CARDS AND HARD DRIVES; RAM (RANDOM ACCESS MEMORY) CARD; COMPUTER MEMORY DEVICES; FLASH

MEMORY CARD; EXTERNAL COMPUTER HARD DRIVES, IN CLASS 9 (U.S. CLS. 21, 23, 26, 36 AND 38).

FIRST USE 10-5-2006; IN COMMERCE 12-10-2006.

THE MARK CONSISTS OF THE WORD "SATA-DOM" IN STYLIZED LETTERS. THE TOP STROKE OF THE "S" EXTENDS OVER THE ENTIRE WORD.

SER. NO. 77-374,847, FILED 1-18-2008.

RONALD DELGIZZI, EXAMINING ATTORNEY

Int. Cl.: 41

Prior U.S. Cls.: 100, 101 and 107

United States Patent and Trademark Office

Reg. No. 3,574,984

Registered Feb. 17, 2009

**SERVICE MARK
PRINCIPAL REGISTER**

DOGONEWS

DOLASIA, MEERA (UNITED STATES INDIVIDUAL), DBA DOGONEWS
152 MISSION DRIVE
MILL VALLEY, CA 94941

THE MARK CONSISTS OF STANDARD CHARACTERS WITHOUT CLAIM TO ANY PARTICULAR FONT, STYLE, SIZE, OR COLOR.

FOR: PROVIDING A WEB SITE FEATURING ONLINE PUBLICATIONS IN THE FIELD OF NEWS ARTICLES FOR CHILDREN, IN CLASS 41 (U.S. CLS. 100, 101 AND 107).

SER. NO. 77-375,127, FILED 1-18-2008.

FIRST USE 10-27-2007; IN COMMERCE 10-27-2007.

KOURTNEE HODGES, EXAMINING ATTORNEY

Int. Cl.: 41

Prior U.S. Cls.: 100, 101 and 107

United States Patent and Trademark Office

Reg. No. 3,574,985

Registered Feb. 17, 2009

**SERVICE MARK
PRINCIPAL REGISTER**

Janes on the Run

HALSCH, ELIZABETH L. (UNITED STATES INDIVIDUAL), DBA JANES ON THE RUN
1901 ASHWOOD CT. SUITE D
GREENSBORO, NC 27455

THE MARK CONSISTS OF STANDARD CHARACTERS WITHOUT CLAIM TO ANY PARTICULAR FONT, STYLE, SIZE, OR COLOR.

FOR: PERSONAL COACHING SERVICES IN THE FIELD OF RUNNING AND FITNESS, IN CLASS 41 (U.S. CLS. 100, 101 AND 107).

SER. NO. 77-375,247, FILED 1-18-2008.

FIRST USE 9-1-2007; IN COMMERCE 9-15-2007.

GIANCARLO CASTRO, EXAMINING ATTORNEY

Int. Cl.: 35

Prior U.S. Cls.: 100, 101 and 102

United States Patent and Trademark Office

Reg. No. 3,574,986

Registered Feb. 17, 2009

**SERVICE MARK
PRINCIPAL REGISTER**



NYC & COMPANY, INC. (NEW YORK NON-PROFIT CORPORATION)
810 SEVENTH AVENUE
NEW YORK, NY 10019

FOR: PROMOTING BUSINESS AND TOURISM IN NEW YORK CITY BY PROMOTING THE SERVICES OF APPLICANT'S RESTAURANT BUSINESS MEMBERS, IN CLASS 35 (U.S. CLS. 100, 101 AND 102).

FIRST USE 12-26-2007; IN COMMERCE 12-26-2007.

OWNER OF U.S. REG. NOS. 2,510,974, 3,057,629 AND OTHERS.

NO CLAIM IS MADE TO THE EXCLUSIVE RIGHT TO USE "NYC RESTAURANT WEEK", APART FROM THE MARK AS SHOWN.

THE MARK CONSISTS OF "NYC RESTAURANT WEEK" AND UTENSILS FORK, KNIFE AND SPOON.

SER. NO. 77-375,667, FILED 1-18-2008.

LINDSEY RUBIN, EXAMINING ATTORNEY

Int. Cl.: 9

Prior U.S. Cls.: 21, 23, 26, 36 and 38

United States Patent and Trademark Office

Reg. No. 3,574,987

Registered Feb. 17, 2009

**TRADEMARK
PRINCIPAL REGISTER**



CASA GRANDE COMMUNICATIONS, INC.
(PUERTO RICO CORPORATION)
701 PONCE DE LEÓN AVE
SAN JUAN, PUERTO RICO 00907

FOR: INTERACTIVE MULTIMEDIA COMPUTER PROGRAM FOR PROVIDING EDUCATIONAL SERVICES THROUGH COMPETITION, IN CLASS 9 (U.S. CLS. 21, 23, 26, 36 AND 38).

FIRST USE 9-1-2007; IN COMMERCE 9-1-2007.

THE COLOR(S) GRAY, WHITE, BLUE AND BLACK IS/ARE CLAIMED AS A FEATURE OF THE MARK.

THE MARK CONSISTS OF THE LETTERS "O" "S" COMPRISED WITHIN A CIRCLE. THE COLOR GRAY APPEARS IN THE OUTERMOST CIRCLE AND IN THE SEMI-CIRCLE; THE COLOR WHITE APPEARS IN THE CIRCLE WITHIN THE GRAY CIRCLE AND IN THE WORDING "OPERATION SUCESS.COM"; THE COLOR BLUE APPEARS IN THE CIRCLE WITHIN THE WHITE CIRCLE AND IN THE LETTERING "O-S"; AND THE COLOR BLACK APPEARS IN THE CENTER CIRCLE.

SER. NO. 77-375,926, FILED 1-18-2008.

CYNTHIA SLOAN, EXAMINING ATTORNEY

Int. Cl.: 9

Prior U.S. Cls.: 21, 23, 26, 36 and 38

Reg. No. 3,574,988

United States Patent and Trademark Office

Registered Feb. 17, 2009

**TRADEMARK
PRINCIPAL REGISTER**

GUNGATE DIGITSCAN

THE GUNGATE COMPANY (GEORGIA CORPORATION)
3722 PLEASANTDALE ROAD
ATLANTA, GA 30340

THE MARK CONSISTS OF STANDARD CHARACTERS WITHOUT CLAIM TO ANY PARTICULAR FONT, STYLE, SIZE, OR COLOR.

FOR: METAL DETECTORS, IN CLASS 9 (U.S. CLS. 21, 23, 26, 36 AND 38).

SER. NO. 77-376,166, FILED 1-20-2008.

FIRST USE 8-15-2007; IN COMMERCE 8-15-2007.

ELLEN BURNS, EXAMINING ATTORNEY

Int. Cl.: 28

Prior U.S. Cls.: 22, 23, 38 and 50

United States Patent and Trademark Office

Reg. No. 3,574,989

Registered Feb. 17, 2009

**TRADEMARK
PRINCIPAL REGISTER**

Twinkle Talker

SMITH, APRIL ANN (UNITED STATES INDIVIDUAL)
3313 SCHMIDTKE RD.
BANDERA, TX 78003

THE MARK CONSISTS OF STANDARD CHARACTERS WITHOUT CLAIM TO ANY PARTICULAR FONT, STYLE, SIZE, OR COLOR.

FOR: INTERACTIVE, EDUCATIONAL THREE-DIMENSIONAL SOFT SCULPTURE ACTIVITY TOY FOR USE IN SPEECH DEVELOPMENT ACTIVITIES, IN CLASS 28 (U.S. CLS. 22, 23, 38 AND 50).

SER. NO. 77-376,171, FILED 1-20-2008.

FIRST USE 1-1-2008; IN COMMERCE 1-1-2008.

ELLEN BURNS, EXAMINING ATTORNEY

Int. Cls.: 7 and 42

Prior U.S. Cls.: 13, 19, 21, 23, 31, 34, 35, 100 and 101

United States Patent and Trademark Office

Reg. No. 3,574,990

Registered Feb. 17, 2009

**TRADEMARK
SERVICE MARK
PRINCIPAL REGISTER**

SPEED SHOE

FRANK'S CASING CREW & RENTAL TOOLS,
INC. (LOUISIANA CORPORATION)
700 E. VEROT SCHOOL ROAD
LAFAYETTE, LA 70508

FOR: OIL AND GAS WELL TOOLS AND EQUIP-
MENT, NAMELY, GUIDE SHOES AND DRIVE
SHOES FOR OIL AND GAS WELL TUBULARS , IN
CLASS 7 (U.S. CLS. 13, 19, 21, 23, 31, 34 AND 35).

FIRST USE 5-20-2000; IN COMMERCE 5-20-2000.

FOR: OIL FIELD SERVICES, NAMELY, TOOL
DESIGN AND ENGINEERING SPECIFICATION OF
GUIDE SHOES AND DRIVE SHOES FOR OIL AND
GAS WELL TUBULARS, IN CLASS 42 (U.S. CLS. 100
AND 101).

FIRST USE 5-20-2000; IN COMMERCE 5-20-2000.

THE MARK CONSISTS OF STANDARD CHAR-
ACTERS WITHOUT CLAIM TO ANY PARTICULAR
FONT, STYLE, SIZE, OR COLOR.

NO CLAIM IS MADE TO THE EXCLUSIVE
RIGHT TO USE "SHOE" , APART FROM THE MARK
AS SHOWN.

SER. NO. 77-376,521, FILED 1-21-2008.

KELLY MCCOY, EXAMINING ATTORNEY

Int. Cl.: 42

Prior U.S. Cls.: 100 and 101

United States Patent and Trademark Office

Reg. No. 3,574,991

Registered Feb. 17, 2009

**SERVICE MARK
PRINCIPAL REGISTER**



NATIONAL TRANSPORTATION RESEARCH
CENTER, INC. (TENNESSEE CORPORATION)
2360 CERAHALLA BLVD
KNOXVILLE, TN 37932

FOR: RESEARCH AND DEVELOPMENT AND
CONSULTATION RELATED THERETO IN THE
FIELD OF AUTOMOTIVE AND VEHICULAR TECH-
NOLOGY, IN CLASS 42 (U.S. CLS. 100 AND 101).

FIRST USE 5-16-2007; IN COMMERCE 5-16-2007.

NO CLAIM IS MADE TO THE EXCLUSIVE
RIGHT TO USE "AUTOMOTIVE RESEARCH ALLI-
ANCE", APART FROM THE MARK AS SHOWN.

THE MARK CONSISTS OF A STARBURST DE-
SIGN TO THE LEFT OF "AUTOMOTIVE" ABOVE
"RESEARCH" ABOVE "ALLIANCE".

SER. NO. 77-377,093, FILED 1-22-2008.

LINDSEY RUBIN, EXAMINING ATTORNEY

Int. Cl.: 32

Prior U.S. Cls.: 45, 46 and 48

Reg. No. 3,574,992

United States Patent and Trademark Office

Registered Feb. 17, 2009

**TRADEMARK
PRINCIPAL REGISTER**

LES PETITS

SOCIÉTÉ ANONYME DES EAUX MINÉRALES
D'EVIAN (FRANCE CORPORATION)

22, AVENUE DES SOURCES

EVIAN LES BAINS, FRANCE 74500

FOR: MINERAL WATERS, IN CLASS 32 (U.S. CLS.
45, 46 AND 48).

FIRST USE 8-1-2008; IN COMMERCE 8-1-2008.

THE MARK CONSISTS OF STANDARD CHAR-
ACTERS WITHOUT CLAIM TO ANY PARTICULAR
FONT, STYLE, SIZE, OR COLOR.

THE FOREIGN WORDING IN THE MARK
TRANSLATES INTO ENGLISH AS THE SMALL
ONES.

SER. NO. 77-377,347, FILED 1-22-2008.

ESTHER A. BORSUK, EXAMINING ATTORNEY

Prior U.S. Cl.: A

United States Patent and Trademark Office

Reg. No. 3,574,993

Registered Feb. 17, 2009

CERTIFICATION MARK
PRINCIPAL REGISTER

GREEN WISE

COATINGS RESEARCH GROUP INCORPORATED (DELAWARE CORPORATION)
SUITE 225
6801 BRECKSVILLE ROAD
INDEPENDENCE, OH 441315066

FOR: PAINTS, IN CLASS A (U.S. CL. A).

FIRST USE 6-1-2008; IN COMMERCE 6-1-2008.

THE MARK CONSISTS OF STANDARD CHARACTERS WITHOUT CLAIM TO ANY PARTICULAR FONT, STYLE, SIZE, OR COLOR.

NO CLAIM IS MADE TO THE EXCLUSIVE RIGHT TO USE "GREEN", APART FROM THE MARK AS SHOWN.

THE CERTIFICATION MARK, AS INTENDED TO BE USED BY AUTHORIZED PERSONS, IS INTENDED TO CERTIFY THAT THE GOODS TESTED PERFORMED TO ENVIRONMENTAL AND OTHER COATINGS PERFORMANCE STANDARDS SET BY THE CERTIFIER.

SER. NO. 77-377,409, FILED 1-22-2008.

RONALD MCMORROW, EXAMINING ATTORNEY

Int. Cl.: 9

Prior U.S. Cls.: 21, 23, 26, 36 and 38

Reg. No. 3,574,994

United States Patent and Trademark Office

Registered Feb. 17, 2009

TRADEMARK
PRINCIPAL REGISTER



JANIECE H. WILLIAMSON (UNITED STATES
INDIVIDUAL)
4513 RIDGEWOOD ROAD
MEMPHIS, TN 381167211 AND
KENNETH H. WILLIAMSON (UNITED STATES
INDIVIDUAL)
4513 RIDGEWOOD RD.
MEMPHIS, TN 381167211

FOR: GLOVES FOR PROTECTION AGAINST
ACCIDENTS, PROTECTIVE GLOVES FOR INDUS-
TRIAL USE, PROTECTIVE WORK GLOVES, IN
CLASS 9 (U.S. CLS. 21, 23, 26, 36 AND 38).

FIRST USE 7-1-2007; IN COMMERCE 7-1-2007.

NO CLAIM IS MADE TO THE EXCLUSIVE
RIGHT TO USE "PROTECTORS", APART FROM
THE MARK AS SHOWN.

THE MARK CONSISTS OF A UTILITY POLE ON
A SMALL HILL WITH TWO BARS PLACED HOR-
IZONTALLY ON THE UPPER HALF OF THE POLE.
A LIGHTNING BOLT IS HITTING THE TOP OF THE
UTILITY POLE. TO THE RIGHT OF THE POLE ARE
THE WORDS "PARAGON PROTECTORS".

SER. NO. 77-377,414, FILED S.R. 1-22-2008 AM. P.R.
10-26-2008.

GIANCARLO CASTRO, EXAMINING ATTORNEY

Int. Cl.: 35

Prior U.S. Cls.: 100, 101 and 102

United States Patent and Trademark Office

Reg. No. 3,574,995

Registered Feb. 17, 2009

**SERVICE MARK
PRINCIPAL REGISTER**

GIFTVALUES.COM

BOBLEY-HARMANN CORPORATION (NEW
YORK CORPORATION)
SUITE 1
95 HOPPER STREET
WESTBURY, NY 11590

FOR: RETAIL SERVICES, NAMELY, MAIL OR-
DER CATALOG SERVICES AND ONLINE RETAIL
STORE SERVICES IN THE FIELD OF GIFTS FOR
OTHERS, SUCH AS WRITING INSTRUMENTS,
HOLDERS FOR WRITING INSTRUMENTS,
WATCHES, ENGRAVEABLE MEMORY GIFTS
FOR MEN AND WOMEN, AND ACCESSORY ITEMS

FOR MEN AND WOMEN, IN CLASS 35 (U.S. CLS.
100, 101 AND 102).

FIRST USE 8-6-1997; IN COMMERCE 8-6-1997.

THE MARK CONSISTS OF STANDARD CHAR-
ACTERS WITHOUT CLAIM TO ANY PARTICULAR
FONT, STYLE, SIZE, OR COLOR.

SER. NO. 77-377,417, FILED 1-22-2008.

ANDREA SAUNDERS, EXAMINING ATTORNEY

Int. Cl.: 9

Prior U.S. Cls.: 21, 23, 26, 36 and 38

Reg. No. 3,574,996

United States Patent and Trademark Office

Registered Feb. 17, 2009

**TRADEMARK
PRINCIPAL REGISTER**

Super Alerts

LIFFRIG, MICHAEL, GEORGE (UNITED STATES INDIVIDUAL)
2815 28TH STREET
MANDAN, ND 58554

FOR: COMPUTER SOFTWARE PLATFORMS FOR CUSTOMIZED DESKTOP ALERTS, IN CLASS 9 (U.S. CLS. 21, 23, 26, 36 AND 38).

FIRST USE 10-10-2006; IN COMMERCE 12-29-2006.

THE MARK CONSISTS OF STANDARD CHARACTERS WITHOUT CLAIM TO ANY PARTICULAR FONT, STYLE, SIZE, OR COLOR.

NO CLAIM IS MADE TO THE EXCLUSIVE RIGHT TO USE "ALERTS", APART FROM THE MARK AS SHOWN.

SER. NO. 77-377,516, FILED 1-22-2008.

BILL DAWE, EXAMINING ATTORNEY

Int. Cl.: 44

Prior U.S. Cls.: 100 and 101

United States Patent and Trademark Office

Reg. No. 3,574,997

Registered Feb. 17, 2009

**SERVICE MARK
PRINCIPAL REGISTER**

ACTIVE LIFE DENTISTRY

BLUME, CHRIS (UNITED STATES INDIVIDUAL), DBA CHRIS BLUME, D.D.S.
SUITE 220
13611 SKINNER
CYPRESS, TX 77429

FOR: DENTISTRY, IN CLASS 44 (U.S. CLS. 100 AND 101).

FIRST USE 12-10-2005; IN COMMERCE 12-10-2005.

THE MARK CONSISTS OF STANDARD CHARACTERS WITHOUT CLAIM TO ANY PARTICULAR FONT, STYLE, SIZE, OR COLOR.

NO CLAIM IS MADE TO THE EXCLUSIVE RIGHT TO USE "DENTISTRY", APART FROM THE MARK AS SHOWN.

SER. NO. 77-377,748, FILED 1-22-2008.

KAREN SEVERSON, EXAMINING ATTORNEY

Int. Cl.: 6

Prior U.S. Cls.: 2, 12, 13, 14, 23, 25 and 50

Reg. No. 3,574,998

United States Patent and Trademark Office

Registered Feb. 17, 2009

**TRADEMARK
PRINCIPAL REGISTER**

SunArx

WAHL, ERIC R. (UNITED STATES INDIVIDUAL), DBA COLORADO SOLAR, INC.
38150 RIVER FRONTAGE ROAD #1D
NEW CASTLE, CO 81647

THE MARK CONSISTS OF STANDARD CHARACTERS WITHOUT CLAIM TO ANY PARTICULAR FONT, STYLE, SIZE, OR COLOR.

FOR: METAL STRUCTURES FOR MOUNTING SOLAR PANELS, IN CLASS 6 (U.S. CLS. 2, 12, 13, 14, 23, 25 AND 50).

SER. NO. 77-377,812, FILED 1-22-2008.

FIRST USE 12-26-2007; IN COMMERCE 12-26-2007.

KOURTNEE HODGES, EXAMINING ATTORNEY

Int. Cl.: 38

Prior U.S. Cls.: 100, 101 and 104

United States Patent and Trademark Office

Reg. No. 3,574,999

Registered Feb. 17, 2009

**SERVICE MARK
PRINCIPAL REGISTER**



CONSUMER CELLULAR, INC. (OREGON CORPORATION)
7204 SW DURHAM RD., SUITE 300
PORTLAND, OR 972247574

FOR: CONSUMER CELLULAR TELEPHONE SERVICES, IN CLASS 38 (U.S. CLS. 100, 101 AND 104).

FIRST USE 10-1-1998; IN COMMERCE 10-1-1998.

NO CLAIM IS MADE TO THE EXCLUSIVE RIGHT TO USE "CELLULAR", APART FROM THE MARK AS SHOWN.

SEC. 2(F) "CONSUMER CELLULAR".

SER. NO. 77-377,833, FILED 1-22-2008.

KATHERINE CHANG, EXAMINING ATTORNEY

Int. Cl.: 12

Prior U.S. Cls.: 19, 21, 23, 31, 35 and 44

Reg. No. 3,575,000

United States Patent and Trademark Office

Registered Feb. 17, 2009

**TRADEMARK
PRINCIPAL REGISTER**

DRAGON TRAILERS

THE MODERN GROUP, LTD. (TEXAS CORPORATION)
1655 LOUISIANA
BEAUMONT, TX 77701

FOR: TRAILERS, NAMELY, CARGO TRAILERS, CAR HAULER TRAILERS, FLAT BED TRAILERS, EQUIPMENT TRAILERS, LOWBOY TRAILERS, EQUIPMENT TRAILERS, GOOSENECK TRAILERS, GOOSENECK PAN TRAILERS, GOOSENECK DUMP TRAILERS, PINTLE HITCH TRAILERS, STOCK TRAILERS, END DUMP TRAILERS, ROLL-OFF TRAILERS, VACUUM TRAILERS, TANKER TRAILERS, DUMP TRAILERS, FREIGHT TRAILERS, IN CLASS 12 (U.S. CLS. 19, 21, 23, 31, 35 AND 44).

FIRST USE 1-1-1993; IN COMMERCE 1-1-1993.

THE MARK CONSISTS OF STANDARD CHARACTERS WITHOUT CLAIM TO ANY PARTICULAR FONT, STYLE, SIZE, OR COLOR.

OWNER OF U.S. REG. NO. 3,094,785.

NO CLAIM IS MADE TO THE EXCLUSIVE RIGHT TO USE "TRAILERS" , APART FROM THE MARK AS SHOWN.

SER. NO. 77-378,146, FILED 1-23-2008.

SEAN CROWLEY, EXAMINING ATTORNEY

Int. Cl.: 45

Prior U.S. Cls.: 100 and 101

United States Patent and Trademark Office

Reg. No. 3,575,001

Registered Feb. 17, 2009

**SERVICE MARK
PRINCIPAL REGISTER**

LECTIONAUTAS

UNITED BIBLE SOCIETIES ASSOCIATION, INC.
(FLORIDA CORPORATION)
1989 NW 88TH COURT
MIAMI, FL 33172

THE MARK CONSISTS OF STANDARD CHAR-
ACTERS WITHOUT CLAIM TO ANY PARTICULAR
FONT, STYLE, SIZE, OR COLOR.

FOR: PROVIDING A WEB SITE FEATURING
INFORMATION ABOUT RELIGION, IN CLASS 45
(U.S. CLS. 100 AND 101).

SER. NO. 77-378,811, FILED 1-23-2008.

FIRST USE 0-0-1995; IN COMMERCE 0-0-1995.

SUSAN LESLIE DUBOIS, EXAMINING ATTORNEY

Int. Cl.: 36

Prior U.S. Cls.: 100, 101 and 102

United States Patent and Trademark Office

Reg. No. 3,575,002

Registered Feb. 17, 2009

**SERVICE MARK
PRINCIPAL REGISTER**

Neanderthal Ball

ORLANDO SCIENCE CENTER, INC. (FLORIDA CORPORATION)
777 EAST PRINCETON STREET
ORLANDO, FL 32803

FOR: CHARITABLE FUND RAISING SERVICES BY MEANS OF AN ENTERTAINMENT EVENT, IN CLASS 36 (U.S. CLS. 100, 101 AND 102).

FIRST USE 7-1-2007; IN COMMERCE 7-1-2007.

THE MARK CONSISTS OF STANDARD CHARACTERS WITHOUT CLAIM TO ANY PARTICULAR FONT, STYLE, SIZE, OR COLOR.

NO CLAIM IS MADE TO THE EXCLUSIVE RIGHT TO USE "BALL", APART FROM THE MARK AS SHOWN.

SER. NO. 77-379,207, FILED 1-24-2008.

MARCIE MILONE, EXAMINING ATTORNEY

Int. Cl.: 44

Prior U.S. Cls.: 100 and 101

United States Patent and Trademark Office

Reg. No. 3,575,003

Registered Feb. 17, 2009

**SERVICE MARK
PRINCIPAL REGISTER**

The logo for "AlignerExpert" is displayed in a stylized, bold, white font with a black outline, set against a solid black rectangular background. The letters are slightly shadowed, giving the logo a three-dimensional appearance.

ALIGNEREXPERT, LLC (NORTH CAROLINA
LIMITED LIABILITY COMPANY)
PO BOX 70
NAGS HEAD, NC 27959

FIRST USE 9-30-2007; IN COMMERCE 9-30-2007.

NO CLAIM IS MADE TO THE EXCLUSIVE
RIGHT TO USE "ALIGNER EXPERT", APART
FROM THE MARK AS SHOWN.

FOR: CONSULTING SERVICES IN THE FIELD
OF DENTAL HEALTH, AND SPECIFICALLY ON
THE INCORPORATION OF ORTHODONTIC
ALIGNER SYSTEMS INTO ORTHODONTIC PRAC-
TICES, IN CLASS 44 (U.S. CLS. 100 AND 101).

SER. NO. 77-379,610, FILED 1-24-2008.

GRETTA YAO, EXAMINING ATTORNEY

Int. Cl.: 35

Prior U.S. Cls.: 100, 101 and 102

United States Patent and Trademark Office

Reg. No. 3,575,004

Registered Feb. 17, 2009

**SERVICE MARK
PRINCIPAL REGISTER**



MARTIN EAGLE OIL COMPANY, INC. (TEXAS CORPORATION)
2700 JAMES STREET
DENTON, TX 76205

FOR: RETAIL GAS STATION AND CONVENIENCE STORE SERVICES FEATURING GASOLINE, CONVENIENCE ITEMS, AND AUTOMOTIVE AND PETROLEUM PRODUCTS, IN CLASS 35 (U.S. CLS. 100, 101 AND 102).

FIRST USE 3-1-2008; IN COMMERCE 3-1-2008.

THE COLOR(S) GREEN, YELLOW, WHITE, RED, BLACK IS/ARE CLAIMED AS A FEATURE OF THE MARK.

THE MARK CONSISTS OF : THE COLOR GREEN APPEARS IN THE BACKGROUND; THE COLOR

YELLOW APPEARS IN THE WORDING " RÁPIDO " AND IN A HORIZONTAL BAND NEAR THE BOTTOM OF THE MARK; THE COLOR WHITE APPEARS IN THE WORDING "RÁPIDO" AND AROUND THE CURVY LINE THAT APPEARS AT THE TOP OF THE MARK; THE COLOR RED APPEARS IN THE HORIZONTAL BAND AT THE BOTTOM OF THE MARK AND IN THE CURVY LINE THAT APPEARS AT THE TOP OF THE MARK; AND THE COLOR BLACK APPEARS IN THE CURVY LINE AT THE TOP OF THE MARK.

THE FOREIGN WORDING IN THE MARK TRANSLATES INTO ENGLISH AS "RAPID" OR "FAST".

SER. NO. 77-380,568, FILED 1-25-2008.

PATRICIA EVANKO, EXAMINING ATTORNEY

Int. Cls.: 7 and 40

Prior U.S. Cls.: 13, 19, 21, 23, 31, 34, 35, 100, 103 and 106

Reg. No. 3,575,005

United States Patent and Trademark Office

Registered Feb. 17, 2009

**TRADEMARK
SERVICE MARK
PRINCIPAL REGISTER**

**PRECISION METAL TOOLING,
INC.**

PRECISION METAL TOOLING, INC. (CALIFORNIA CORPORATION)
5101 SAN LEANDRO STREET
OAKLAND, CA 94601

FOR: DIES FOR USE WITH MACHINE TOOLS, IN CLASS 7 (U.S. CLS. 13, 19, 21, 23, 31, 34 AND 35).

FIRST USE 7-13-1987; IN COMMERCE 7-13-1987.

FOR: CUSTOM TOOL AND DIE MANUFACTURING TO ORDER AND/OR THE SPECIFICATION OF OTHERS, IN CLASS 40 (U.S. CLS. 100, 103 AND 106).

FIRST USE 7-13-1987; IN COMMERCE 7-13-1987.

THE MARK CONSISTS OF STANDARD CHARACTERS WITHOUT CLAIM TO ANY PARTICULAR FONT, STYLE, SIZE, OR COLOR.

NO CLAIM IS MADE TO THE EXCLUSIVE RIGHT TO USE "METAL TOOLING, INC.", APART FROM THE MARK AS SHOWN.

SEC. 2(F).

SER. NO. 77-380,683, FILED 1-25-2008.

JAMES LOVELACE, EXAMINING ATTORNEY

Int. Cl.: 40

Prior U.S. Cls.: 100, 103 and 106

United States Patent and Trademark Office

Reg. No. 3,575,006

Registered Feb. 17, 2009

**SERVICE MARK
PRINCIPAL REGISTER**

"Building your intellectual properties"



SQUILLACE, MICHAEL P. (INDIANA LIMITED LIABILITY COMPANY), DBA IMPRESSIVE PROTOTYPES LLC
9633 MOLLIE CT.
INDIANAPOLIS, IN 46259

FOR: PROTOTYPE FABRICATION OF NEW PRODUCTS FOR OTHERS, IN CLASS 40 (U.S. CLS. 100, 103 AND 106).

FIRST USE 1-1-2006; IN COMMERCE 1-1-2006.

NO CLAIM IS MADE TO THE EXCLUSIVE RIGHT TO USE "INTELLECTUAL PROPERTIES, IP AND PROTOTYPES LLC", APART FROM THE MARK AS SHOWN.

THE COLOR(S) BLUE, BLACK, WHITE IS/ARE CLAIMED AS A FEATURE OF THE MARK.

THE MARK CONSISTS OF A CIRCLE OUTLINED IN BLACK AND FILLED IN BLUE WITH A LOWER CASE "I" FILLED IN BLACK AND A LOWER CASE "P" OUTLINED IN BLACK AND FILLED IN WHITE INSIDE THE CIRCLE, THE WORD "IMPRESSIVE" IN LOWER CASE FILLED IN BLACK, THE WORDS "PROTOTYPES" AND "LLC" IN LOWER CASE ITALICS FILLED IN BLUE AND THE WORDING "BUILDING YOUR INTELLECTUAL PROPERTIES" ITALICIZED AND IN BLUE ABOVE THE "IP" AND CIRCLE DESIGN.

SER. NO. 77-380,941, FILED 1-25-2008.

KELLEY WELLS, EXAMINING ATTORNEY

Int. Cl.: 41

Prior U.S. Cls.: 100, 101 and 107

United States Patent and Trademark Office

Reg. No. 3,575,007

Registered Feb. 17, 2009

**SERVICE MARK
PRINCIPAL REGISTER**

FG

MANDT BROS. PRODUCTIONS, LLC (CALIFORNIA LIMITED LIABILITY COMPANY)
6910 SANTA MONICA BLVD
LOS ANGELES, CA 90038

FOR: ENTERTAINMENT SERVICES IN THE NATURE OF MAKING ONGOING PERSONAL APPEARANCES, INCLUDING LIVE PERSONAL APPEARANCES AND ON WEBSITES FEATURING FANTASY SPORTS NEWS AND INFORMATION, IN CLASS 41 (U.S. CLS. 100, 101 AND 107).

FIRST USE 9-1-2007; IN COMMERCE 9-1-2007.

THE MARK CONSISTS OF STANDARD CHARACTERS WITHOUT CLAIM TO ANY PARTICULAR FONT, STYLE, SIZE, OR COLOR.

SER. NO. 77-381,291, FILED 1-25-2008.

CHRISTINA SOBRAL, EXAMINING ATTORNEY

Int. Cl.: 9

Prior U.S. Cls.: 21, 23, 26, 36 and 38

Reg. No. 3,575,008

United States Patent and Trademark Office

Registered Feb. 17, 2009

**TRADEMARK
PRINCIPAL REGISTER**

TALEND

TALEND, INC. (DELAWARE CORPORATION)
SUITE F
105 FREMONT AV
LOS ALTOS, CA 94022

THE MARK CONSISTS OF STANDARD CHARACTERS WITHOUT CLAIM TO ANY PARTICULAR FONT, STYLE, SIZE, OR COLOR.

FOR: COMPUTER SOFTWARE FOR DATA PROCESSING, NAMELY, DATA MANAGEMENT, DATA INTEGRATION, DATA CONSOLIDATION, DATA SYNCHRONIZATION, DATA TRANSFORMATION, DATA EXTRACTION, DATA MIGRATION, DATA LOADING, DATA QUALITY, DATA CLEANSING AND ETL PROCESSING, IN CLASS 9 (U.S. CLS. 21, 23, 26, 36 AND 38).

OWNER OF FRANCE REG. NO. 3376639, DATED 8-24-2005, EXPIRES 8-24-2015.

SER. NO. 77-381,387, FILED 1-26-2008.

KIMBERLY PERRY, EXAMINING ATTORNEY

Int. Cl.: 41

Prior U.S. Cls.: 100, 101 and 107

United States Patent and Trademark Office

Reg. No. 3,575,009

Registered Feb. 17, 2009

**SERVICE MARK
PRINCIPAL REGISTER**

ABOUTFACE

FAGIEN, STEVEN (UNITED STATES INDIVIDUAL)
SUITE 210
660 GLADES ROAD
BOCA RATON, FL 33431

FOR: EDUCATIONAL SERVICES, NAMELY, CONDUCTING LIVE MEETINGS IN THE FIELDS OF PLASTIC SURGERY, COSMETIC SURGERY, SKIN CARE AND REJUVENATION, IN CLASS 41 (U.S. CLS. 100, 101 AND 107).

FIRST USE 12-0-1999; IN COMMERCE 12-0-1999.

THE MARK CONSISTS OF STANDARD CHARACTERS WITHOUT CLAIM TO ANY PARTICULAR FONT, STYLE, SIZE, OR COLOR.

OWNER OF U.S. REG. NO. 2,534,381.

SER. NO. 77-381,678, FILED 1-28-2008.

KEVIN DINALLO, EXAMINING ATTORNEY

Int. Cls.: 7 and 9

Prior U.S. Cls.: 13, 19, 21, 23, 26, 31, 34, 35, 36 and 38

United States Patent and Trademark Office

Reg. No. 3,575,010

Registered Feb. 17, 2009

**TRADEMARK
PRINCIPAL REGISTER**



SPARTAN TOOL LLC (DELAWARE LIMITED LIABILITY COMPANY)
1506 W. DIVISION ST.
MENDOTA, IL 61342

FOR: POWER-OPERATED SEWER, DRAIN AND WASTE LINE CLEANING MACHINES; POWER-OPERATED SEWER RODS, SEWER SNAKES, SEWER CABLES, AND SEWER JETTERS; POWER-OPERATED PIPE BURSTING EQUIPMENT COMPRISING CABLE ACTUATED MOLES AND CABLE PULLERS AND PARTS THEREOF, IN CLASS 7 (U.S. CLS. 13, 19, 21, 23, 31, 34 AND 35).

FIRST USE 1-31-2007; IN COMMERCE 1-31-2007.

FOR: SEWER LOCATING DEVICES, NAMELY, ELECTRONIC SIGNAL TRANSMITTERS FOR DIRECTION INTO UNDERGROUND LINES AND ABOVE GROUND SIGNAL DETECTORS; SEWER CAMERAS, IN CLASS 9 (U.S. CLS. 21, 23, 26, 36 AND 38).

FIRST USE 1-31-2007; IN COMMERCE 1-31-2007.

THE MARK CONSISTS OF THE DEPICTION OF A SPARTAN WITHIN A CIRCLE.

SER. NO. 77-382,008, FILED 1-28-2008.

KEVON CHISOLM, EXAMINING ATTORNEY

Int. Cls.: 7 and 9

Prior U.S. Cls.: 13, 19, 21, 23, 26, 31, 34, 35, 36 and 38

United States Patent and Trademark Office

Reg. No. 3,575,011

Registered Feb. 17, 2009

**TRADEMARK
PRINCIPAL REGISTER**

SPARTAN SINCE 1943

SPARTAN TOOL LLC (DELAWARE CORPORATION)
1506 W. DIVISION ST.
MENDOTA, IL 61342

FOR: POWER-OPERATED SEWER, DRAIN AND WASTE LINE CLEANING MACHINES; POWER-OPERATED SEWER RODS, SEWER SNAKES, SEWER CABLES, AND SEWER JETTERS; POWER-OPERATED PIPE BURSTING EQUIPMENT COMPRISING CABLE ACTUATED MOLES AND CABLE PULLERS AND PARTS THEREOF, IN CLASS 7 (U.S. CLS. 13, 19, 21, 23, 31, 34 AND 35).

FIRST USE 1-31-2007; IN COMMERCE 1-31-2007.

FOR: SEWER LOCATING DEVICES, NAMELY, ELECTRONIC SIGNAL TRANSMITTERS FOR DIRECTION INTO UNDERGROUND LINES AND

ABOVE GROUND SIGNAL DETECTORS; SEWER CAMERAS, IN CLASS 9 (U.S. CLS. 21, 23, 26, 36 AND 38).

FIRST USE 1-31-2007; IN COMMERCE 1-31-2007.

THE MARK CONSISTS OF STANDARD CHARACTERS WITHOUT CLAIM TO ANY PARTICULAR FONT, STYLE, SIZE, OR COLOR.

NO CLAIM IS MADE TO THE EXCLUSIVE RIGHT TO USE "SINCE 1943", APART FROM THE MARK AS SHOWN.

SER. NO. 77-382,026, FILED 1-28-2008.

KEVON CHISOLM, EXAMINING ATTORNEY

Int. Cls.: 35 and 45

Prior U.S. Cls.: 100, 101 and 102

United States Patent and Trademark Office

Reg. No. 3,575,012

Registered Feb. 17, 2009

**SERVICE MARK
PRINCIPAL REGISTER**

DOZIER INTERNET LAW, P.C.

DOZIER INTERNET LAW, P.C. (VIRGINIA CORPORATION)
11520 NUCKOLS ROAD, SUITE 101
301 CONCOURSE BLVD.
GLEN ALLEN, VA 23059

FOR: BUSINESS E-COMMERCE CONSULTATION SERVICES, IN CLASS 35 (U.S. CLS. 100, 101 AND 102).

FIRST USE 6-1-2004; IN COMMERCE 6-1-2004.

FOR: LEGAL SERVICES AND COUNSELING; LEGAL SERVICES RELATING TO THE INTERNET, INTELLECTUAL PROPERTY AND TECHNOLOGY, IN CLASS 45 (U.S. CLS. 100 AND 101).

FIRST USE 6-1-2004; IN COMMERCE 6-1-2004.

THE MARK CONSISTS OF STANDARD CHARACTERS WITHOUT CLAIM TO ANY PARTICULAR FONT, STYLE, SIZE, OR COLOR.

NO CLAIM IS MADE TO THE EXCLUSIVE RIGHT TO USE "INTERNET LAW" AND "P.C.", APART FROM THE MARK AS SHOWN.

SER. NO. 77-382,163, FILED 1-28-2008.

RENEE SERVANCE, EXAMINING ATTORNEY

Int. Cl.: 41

Prior U.S. Cls.: 100, 101 and 107

United States Patent and Trademark Office

Reg. No. 3,575,013

Registered Feb. 17, 2009

**SERVICE MARK
PRINCIPAL REGISTER**

KATIE THOMAS

DIRECTECH, INC. (ARIZONA CORPORATION)
SUITE 200-517
10645 N. TATUM
PHOENIX, AZ 85028

FOR: ENTERTAINMENT SERVICES, NAMELY,
PROVIDING A WEB SITE FEATURING ADULT
ENTERTAINMENT; PROVIDING INFORMATION
IN THE FIELD OF ADULT ENTERTAINMENT VIA
A GLOBAL COMPUTER NETWORK, IN CLASS 41
(U.S. CLS. 100, 101 AND 107).

FIRST USE 6-12-2006; IN COMMERCE 6-12-2006.

THE MARK CONSISTS OF STANDARD CHAR-
ACTERS WITHOUT CLAIM TO ANY PARTICULAR
FONT, STYLE, SIZE, OR COLOR.

THE NAME "KATIE THOMAS" DOES NOT IDEN-
TIFY A LIVING INDIVIDUAL.

SER. NO. 77-382,194, FILED 1-28-2008.

MICHAEL WIENER, EXAMINING ATTORNEY

Int. Cl.: 41

Prior U.S. Cls.: 100, 101 and 107

United States Patent and Trademark Office

Reg. No. 3,575,014

Registered Feb. 17, 2009

**SERVICE MARK
PRINCIPAL REGISTER**

RUTH BLACKWELL

DIRECTECH, INC. (ARIZONA CORPORATION)
SUITE 200-517
10645 N. TATUM
PHOENIX, AZ 85028

FOR: ENTERTAINMENT SERVICES, NAMELY,
PROVIDING A WEB SITE FEATURING ADULT
ENTERTAINMENT; PROVIDING INFORMATION
IN THE FIELD OF ADULT ENTERTAINMENT VIA
A GLOBAL COMPUTER NETWORK, IN CLASS 41
(U.S. CLS. 100, 101 AND 107).

FIRST USE 1-25-2007; IN COMMERCE 1-25-2007.

THE MARK CONSISTS OF STANDARD CHAR-
ACTERS WITHOUT CLAIM TO ANY PARTICULAR
FONT, STYLE, SIZE, OR COLOR.

THE NAME "RUTH BLACKWELL" DOES NOT
IDENTIFY A LIVING INDIVIDUAL.

SER. NO. 77-382,200, FILED 1-28-2008.

MICHAEL WIENER, EXAMINING ATTORNEY

Int. Cl.: 39

Prior U.S. Cls.: 100 and 105

United States Patent and Trademark Office

Reg. No. 3,575,015

Registered Feb. 17, 2009

**SERVICE MARK
PRINCIPAL REGISTER**

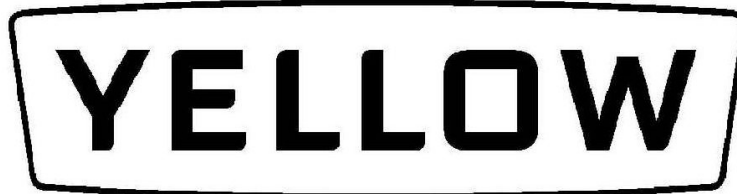

YRC WORLDWIDE INC. (DELAWARE CORPORATION)
10990 ROE AVENUE
OVERLAND PARK, KS 66211

FIRST USE 12-7-2005; IN COMMERCE 12-7-2005.

OWNER OF U.S. REG. NOS. 1,212,749, 3,239,903
AND OTHERS.

FOR: DOMESTIC AND INTERNATIONAL COMMON CARRIER FREIGHT TRANSPORTATION BY MEANS OF TRUCK, AIR, OR SEA, AND DOMESTIC AND INTERNATIONAL FREIGHT FORWARDING SERVICES, IN CLASS 39 (U.S. CLS. 100 AND 105).

SER. NO. 77-382,468, FILED 1-28-2008.

LOURDES AYALA, EXAMINING ATTORNEY

Int. Cl.: 32

Prior U.S. Cls.: 45, 46 and 48

United States Patent and Trademark Office

Reg. No. 3,575,016

Registered Feb. 17, 2009

**TRADEMARK
PRINCIPAL REGISTER**

BOONT AMBER ALE

ANDERSON VALLEY BREWING INC. (CALI-
FORNIA CORPORATION)
17700 BOONVILLE ROAD, HIGHWAY 253
BOONVILLE, CA 95415

NO CLAIM IS MADE TO THE EXCLUSIVE
RIGHT TO USE "AMBER ALE", APART FROM
THE MARK AS SHOWN.

FOR: BEER, ALE, LAGER, STOUT AND PORTER;
MALT LIQUOR, IN CLASS 32 (U.S. CLS. 45, 46 AND
48).

SEC. 2(F).

FIRST USE 12-26-1987; IN COMMERCE 12-26-1987.

SER. NO. 77-382,560, FILED 1-28-2008.

THE MARK CONSISTS OF STANDARD CHAR-
ACTERS WITHOUT CLAIM TO ANY PARTICULAR
FONT, STYLE, SIZE, OR COLOR.

LINDA LAVACHE, EXAMINING ATTORNEY

Int. Cl.: 32

Prior U.S. Cls.: 45, 46 and 48

United States Patent and Trademark Office

Reg. No. 3,575,017

Registered Feb. 17, 2009

**TRADEMARK
PRINCIPAL REGISTER**

HOP OTTIN' IPA

ANDERSON VALLEY BREWING, INC. (CALI-
FORNIA CORPORATION)

17700 BOONVILLE ROAD, HIGHWAY 253

BOONVILLE, CA 95415

FOR: BEER, ALE, LAGER, STOUT AND PORTER;
MALT LIQUOR, IN CLASS 32 (U.S. CLS. 45, 46 AND
48).

FIRST USE 5-10-1991; IN COMMERCE 5-10-1991.

THE MARK CONSISTS OF STANDARD CHAR-
ACTERS WITHOUT CLAIM TO ANY PARTICULAR
FONT, STYLE, SIZE, OR COLOR.

NO CLAIM IS MADE TO THE EXCLUSIVE
RIGHT TO USE "HOP" AND "IPA", APART FROM
THE MARK AS SHOWN.

SER. NO. 77-382,570, FILED 1-28-2008.

SAMUEL E. SHARPER JR., EXAMINING ATTOR-
NEY

Int. Cl.: 41

Prior U.S. Cls.: 100, 101 and 107

United States Patent and Trademark Office

Reg. No. 3,575,018

Registered Feb. 17, 2009

**SERVICE MARK
PRINCIPAL REGISTER**

WWEHD

WORLD WRESTLING ENTERTAINMENT, INC.
(DELAWARE CORPORATION)
1241 EAST MAIN STREET
STAMFORD, CT 06902

FOR: ENTERTAINMENT SERVICES, NAMELY,
THE PRODUCTION AND EXHIBITION OF PRO-
FESSIONAL WRESTLING EVENTS RENDERED
LIVE AND THROUGH THE MEDIA OF TELEVI-
SION; PROVIDING WRESTLING NEWS AND IN-
FORMATION VIA A GLOBAL COMPUTER
NETWORK, IN CLASS 41 (U.S. CLS. 100, 101 AND
107).

FIRST USE 1-21-2008; IN COMMERCE 1-21-2008.

THE MARK CONSISTS OF STANDARD CHAR-
ACTERS WITHOUT CLAIM TO ANY PARTICULAR
FONT, STYLE, SIZE, OR COLOR.

OWNER OF U.S. REG. NOS. 2,772,683, 3,081,964,
AND 3,154,803.

SER. NO. 77-382,786, FILED 1-29-2008.

COLLEEN DOMBROW, EXAMINING ATTORNEY

Int. Cl.: 8

Prior U.S. Cls.: 23, 28 and 44

United States Patent and Trademark Office

Reg. No. 3,575,019

Registered Feb. 17, 2009

**TRADEMARK
PRINCIPAL REGISTER**

Cam Claw

NEHRKE JR, FRED (BRAZIL INDIVIDUAL)
4316 BOULDER PARK DRIVE
EULESS, TX 76040

FOR: HAND TOOL, NAMELY, AN EXTRACTOR
FOR REMOVING AUTOMOBILE SEALS, IN CLASS
8 (U.S. CLS. 23, 28 AND 44).

FIRST USE 1-1-2007; IN COMMERCE 1-8-2008.

THE MARK CONSISTS OF STANDARD CHAR-
ACTERS WITHOUT CLAIM TO ANY PARTICULAR
FONT, STYLE, SIZE, OR COLOR.

NO CLAIM IS MADE TO THE EXCLUSIVE
RIGHT TO USE "CAM", APART FROM THE MARK
AS SHOWN.

SER. NO. 77-382,908, FILED 1-29-2008.

EMILY CARLSEN, EXAMINING ATTORNEY

Int. Cl.: 9

Prior U.S. Cls.: 21, 23, 26, 36 and 38

United States Patent and Trademark Office

Reg. No. 3,575,020

Registered Feb. 17, 2009

**TRADEMARK
PRINCIPAL REGISTER**

PEACELABS

PEACELABS MUSIC, INC. (CALIFORNIA CORPORATION)
280 GRANVILLE WAY
SAN FRANCISCO, CA 94127

THE MARK CONSISTS OF STANDARD CHARACTERS WITHOUT CLAIM TO ANY PARTICULAR FONT, STYLE, SIZE, OR COLOR.

FOR: SOUND RECORDINGS FEATURING MUSIC, IN CLASS 9 (U.S. CLS. 21, 23, 26, 36 AND 38).

SER. NO. 77-383,140, FILED 1-29-2008.

FIRST USE 11-0-2003; IN COMMERCE 11-0-2003.

TOBY BULLOFF, EXAMINING ATTORNEY

Int. Cl.: 29

Prior U.S. Cl.: 46

United States Patent and Trademark Office

Reg. No. 3,575,021

Registered Feb. 17, 2009

**TRADEMARK
PRINCIPAL REGISTER**

Cape Cod Bay

SEA JEM IMPORTS, INC. (MASSACHUSETTS
CORPORATION)
549 COLUMBIAN STREET #3N
SOUTH WEYMOUTH, MA 02190

FOR: FISH, NAMELY, FRESH, PROCESSED,
FROZEN AND SEASONED FISH, IN CLASS 29
(U.S. CL. 46).

FIRST USE 1-1-1993; IN COMMERCE 1-1-1993.

THE MARK CONSISTS OF STANDARD CHAR-
ACTERS WITHOUT CLAIM TO ANY PARTICULAR
FONT, STYLE, SIZE, OR COLOR.

SEC. 2(F).

SER. NO. 77-383,647, FILED 1-29-2008.

BRENDAN REGAN, EXAMINING ATTORNEY

Int. Cl.: 33

Prior U.S. Cls.: 47 and 49

United States Patent and Trademark Office

Reg. No. 3,575,022

Registered Feb. 17, 2009

**TRADEMARK
PRINCIPAL REGISTER**

BENEVA

MEZCAL BENEVA, S.A. DE C.V. (MEXICO CORPORATION)
COL. CENTRO OAXACA
COLON 518-A
OAXACA, MEXICO

FOR: ALCOHOLIC BEVERAGES EXCEPT BEERS,
IN CLASS 33 (U.S. CLS. 47 AND 49).

FIRST USE 9-30-1990; IN COMMERCE 12-31-1997.

THE MARK CONSISTS OF STANDARD CHARACTERS WITHOUT CLAIM TO ANY PARTICULAR FONT, STYLE, SIZE, OR COLOR.

OWNER OF MEXICO REG. NO. 390845, DATED 2-21-1991, EXPIRES 9-25-2015.

THE FOREIGN WORDING IN THE MARK TRANSLATES INTO ENGLISH AS "AGED".

SEC. 2(F).

SER. NO. 77-383,996, FILED 1-30-2008.

ZACHARY BELLO, EXAMINING ATTORNEY

Int. Cls.: 37 and 41

Prior U.S. Cls.: 100, 101, 103, 106 and 107

United States Patent and Trademark Office

Reg. No. 3,575,023

Registered Feb. 17, 2009

**SERVICE MARK
PRINCIPAL REGISTER**

**REGENCY AT BRIER CREEK
COUNTRY CLUB**

TB PROPRIETARY CORP. (DELAWARE CORPORATION)
SUITE 612
1105 NORTH MARKET STREET
WILMINGTON, DE 19801

FOR: LAND DEVELOPMENT SERVICES, NAME-
LY, PLANNING AND LAYING OUT OF RESIDEN-
TIAL COMMUNITIES; CUSTOM CONSTRUCTION
OF HOMES, IN CLASS 37 (U.S. CLS. 100, 103 AND
106).

FIRST USE 9-29-2007; IN COMMERCE 9-29-2007.

FOR: PROVIDING RECREATIONAL SERVICES
IN THE NATURE OF GOLF COURSES, SWIMMING
POOLS, TENNIS COURTS, AND PLAYGROUNDS;
PROVIDING FITNESS AND EXERCISE FACIL-
ITIES, IN CLASS 41 (U.S. CLS. 100, 101 AND 107).

FIRST USE 9-29-2007; IN COMMERCE 9-29-2007.

THE MARK CONSISTS OF STANDARD CHAR-
ACTERS WITHOUT CLAIM TO ANY PARTICULAR
FONT, STYLE, SIZE, OR COLOR.

OWNER OF U.S. REG. NOS. 2,702,408 AND
2,792,387.

NO CLAIM IS MADE TO THE EXCLUSIVE
RIGHT TO USE "BRIER CREEK COUNTRY CLUB",
APART FROM THE MARK AS SHOWN.

SER. NO. 77-384,199, FILED 1-30-2008.

ANDREA HACK, EXAMINING ATTORNEY

Int. Cl.: 37

Prior U.S. Cls.: 100, 103 and 106

United States Patent and Trademark Office

Reg. No. 3,575,024

Registered Feb. 17, 2009

**SERVICE MARK
PRINCIPAL REGISTER**

PIMP YOUR YACHT

FOSTER'S MARINE GROUP, INC. (FLORIDA CORPORATION)

3001 W. STATE ROAD 84

FORT LAUDERDALE, FL 33312

FOR: YACHT REPAIR, CUSTOMIZATION, RENOVATION, MAKEOVER, REFIT AND RESTORATION SERVICES, IN CLASS 37 (U.S. CLS. 100, 103 AND 106).

FIRST USE 8-0-2007; IN COMMERCE 8-0-2007.

THE MARK CONSISTS OF STANDARD CHARACTERS WITHOUT CLAIM TO ANY PARTICULAR FONT, STYLE, SIZE, OR COLOR.

OWNER OF U.S. REG. NO. 3,356,926.

NO CLAIM IS MADE TO THE EXCLUSIVE RIGHT TO USE "YACHT", APART FROM THE MARK AS SHOWN.

SER. NO. 77-384,365, FILED 1-30-2008.

DEZMONA MIZELLE, EXAMINING ATTORNEY

Int. Cl.: 1

Prior U.S. Cls.: 1, 5, 6, 10, 26 and 46

Reg. No. 3,575,025

United States Patent and Trademark Office

Registered Feb. 17, 2009

**TRADEMARK
PRINCIPAL REGISTER**

Bioscot

MILLIPORE CORPORATION (MASSACHUSETTS
CORPORATION)
290 CONCORD ROAD
BILLERICA, MA 01821

FOR: DIAGNOSTIC BLOOD TYPING REAGENTS
FOR CLINICAL OR MEDICAL LABORATORY USE,
IN CLASS 1 (U.S. CLS. 1, 5, 6, 10, 26 AND 46).

FIRST USE 0-0-1984; IN COMMERCE 12-31-1988.

THE MARK CONSISTS OF STANDARD CHAR-
ACTERS WITHOUT CLAIM TO ANY PARTICULAR
FONT, STYLE, SIZE, OR COLOR.

OWNER OF U.S. REG. NO. 2,536,890.

SER. NO. 77-384,407, FILED 1-30-2008.

ANGELA M. MICHELI, EXAMINING ATTORNEY

Int. Cl.: 21

Prior U.S. Cls.: 2, 13, 23, 29, 30, 33, 40 and 50

United States Patent and Trademark Office

Reg. No. 3,575,026

Registered Feb. 17, 2009

**TRADEMARK
PRINCIPAL REGISTER**

DRAGON PRODUCTS

THE MODERN GROUP, LTD. (TEXAS CORPORATION)
1655 LOUISIANA
BEAUMONT, TX 77701

FOR: REFUSE CONTAINERS, METALLIC ROLL-OFF REFUSE CONTAINERS, FRONT-LOAD REFUSE CONTAINERS, TOP-LOAD REFUSE CONTAINERS, AND REAR-LOAD REFUSE CONTAINERS, ALL IN THE NATURE OF REFUSE BINS, IN CLASS 21 (U.S. CLS. 2, 13, 23, 29, 30, 33, 40 AND 50).

FIRST USE 12-31-1995; IN COMMERCE 12-31-1995.

THE MARK CONSISTS OF STANDARD CHARACTERS WITHOUT CLAIM TO ANY PARTICULAR FONT, STYLE, SIZE, OR COLOR.

OWNER OF U.S. REG. NOS. 1,533,908, 3,094,785 AND OTHERS.

NO CLAIM IS MADE TO THE EXCLUSIVE RIGHT TO USE "PRODUCTS", APART FROM THE MARK AS SHOWN.

SER. NO. 77-384,458, FILED 1-30-2008.

SEAN CROWLEY, EXAMINING ATTORNEY

Int. Cl.: 7

Prior U.S. Cls.: 13, 19, 21, 23, 31, 34 and 35

United States Patent and Trademark Office

Reg. No. 3,575,027

Registered Feb. 17, 2009

**TRADEMARK
PRINCIPAL REGISTER**

DRAGON RIGS

THE MODERN GROUP, LTD. (TEXAS CORPORATION)
1655 LOUISIANA
BEAUMONT, TX 77701

FOR: DRILLING RIGS; POWER-OPERATED DRILLING RIGS, IN CLASS 7 (U.S. CLS. 13, 19, 21, 23, 31, 34 AND 35).

FIRST USE 1-31-2005; IN COMMERCE 1-31-2005.

THE MARK CONSISTS OF STANDARD CHARACTERS WITHOUT CLAIM TO ANY PARTICULAR FONT, STYLE, SIZE, OR COLOR.

NO CLAIM IS MADE TO THE EXCLUSIVE RIGHT TO USE "RIGS", APART FROM THE MARK AS SHOWN.

SER. NO. 77-384,482, FILED 1-30-2008.

SEAN CROWLEY, EXAMINING ATTORNEY

Int. Cl.: 12

Prior U.S. Cls.: 19, 21, 23, 31, 35 and 44

United States Patent and Trademark Office

Reg. No. 3,575,028

Registered Feb. 17, 2009

**TRADEMARK
PRINCIPAL REGISTER**

DRAGON ESP

THE MODERN GROUP, LTD. (TEXAS CORPORATION)

1655 LOUISIANA

BEAUMONT, TX 77701

FOR: TRAILERS, NAMELY, ROLL-OFF WASTE CONTAINER TRAILERS, ROLL-OFF REFUSE CONTAINER TRAILERS, ROLL-OFF CONTAINER TRAILERS, IN CLASS 12 (U.S. CLS. 19, 21, 23, 31, 35 AND 44).

FIRST USE 1-31-2003; IN COMMERCE 1-31-2003.

THE MARK CONSISTS OF STANDARD CHARACTERS WITHOUT CLAIM TO ANY PARTICULAR FONT, STYLE, SIZE, OR COLOR.

OWNER OF U.S. REG. NOS. 1,533,908, 3,094,785 AND OTHERS.

NO CLAIM IS MADE TO THE EXCLUSIVE RIGHT TO USE "ESP", APART FROM THE MARK AS SHOWN.

SER. NO. 77-384,596, FILED 1-30-2008.

SEAN CROWLEY, EXAMINING ATTORNEY

Int. Cl.: 14

Prior U.S. Cls.: 2, 27, 28 and 50

United States Patent and Trademark Office

Reg. No. 3,575,029

Registered Feb. 17, 2009

**TRADEMARK
PRINCIPAL REGISTER**

BEVERLY HILLS WATCH COMPANY

EIJ, INC. (CALIFORNIA CORPORATION)
227 SOUTH BEVERLY DRIVE
BEVERLY HILLS, CA 91202

FOR: JEWELLERY AND WATCHES, IN CLASS 14
(U.S. CLS. 2, 27, 28 AND 50).

FIRST USE 1-15-1979; IN COMMERCE 1-15-1979.

THE MARK CONSISTS OF STANDARD CHAR-
ACTERS WITHOUT CLAIM TO ANY PARTICULAR
FONT, STYLE, SIZE, OR COLOR.

OWNER OF U.S. REG. NO. 2,797,095.

NO CLAIM IS MADE TO THE EXCLUSIVE
RIGHT TO USE "WATCH COMPANY", APART
FROM THE MARK AS SHOWN.

SEC. 2(F).

SER. NO. 77-384,887, FILED 1-30-2008.

MELISSA VALLILLO, EXAMINING ATTORNEY

Int. Cl.: 5

Prior U.S. Cls.: 6, 18, 44, 46, 51 and 52

United States Patent and Trademark Office

Reg. No. 3,575,030

Registered Feb. 17, 2009

**TRADEMARK
PRINCIPAL REGISTER**

MAXIMIZEDLIVING

MAXIMIZED LIVING HEALTH CENTERS, LLC
(FLORIDA LIMITED LIABILITY COMPANY)
604 FRONT STREET
CELEBRATION, FL 34747 AND
MAX 3, LLC (FLORIDA LIMITED LIABILITY COM-
PANY)
610 SYCAMORE STREET
CELEBRATION, FL 34747

FIRST USE 10-31-2006; IN COMMERCE 10-31-2006.

THE MARK CONSISTS OF STANDARD CHAR-
ACTERS WITHOUT CLAIM TO ANY PARTICULAR
FONT, STYLE, SIZE, OR COLOR.

SER. NO. 77-385,443, FILED 1-31-2008.

FOR: VITAMIN AND MINERAL SUPPLEMENTS;
NUTRITIONALLY FORTIFIED BEVERAGES, IN
CLASS 5 (U.S. CLS. 6, 18, 44, 46, 51 AND 52).

ANDREA HACK, EXAMINING ATTORNEY

Int. Cl.: 41

Prior U.S. Cls.: 100, 101 and 107

United States Patent and Trademark Office

Reg. No. 3,575,031

Registered Feb. 17, 2009

**SERVICE MARK
PRINCIPAL REGISTER**

RACE THE WORLD

MATTEL, INC. (DELAWARE CORPORATION)
M1-1518
333 CONTINENTAL BLVD.
EL SEGUNDO, CA 90245

FOR: ENTERTAINMENT SERVICES, NAMELY,
PROVIDING ONLINE GAMES, IN CLASS 41 (U.S.
CLS. 100, 101 AND 107).

FIRST USE 10-1-2008; IN COMMERCE 10-1-2008.

THE MARK CONSISTS OF STANDARD CHAR-
ACTERS WITHOUT CLAIM TO ANY PARTICULAR
FONT, STYLE, SIZE, OR COLOR.

OWNER OF U.S. REG. NO. 3,075,480.

SER. NO. 77-385,444, FILED 1-31-2008.

JULIE WATSON, EXAMINING ATTORNEY

Int. Cl.: 15

Prior U.S. Cls.: 2, 21 and 36

United States Patent and Trademark Office

Reg. No. 3,575,032

Registered Feb. 17, 2009

**TRADEMARK
PRINCIPAL REGISTER**



PAUL REED SMITH GUITARS, LIMITED PART-
NERSHIP (MARYLAND LIMITED PARTNER-
SHIP)
380 LOG CANOE CIRCLE
STEVENSVILLE, MD 21666

FOR: GUITARS, IN CLASS 15 (U.S. CLS. 2, 21 AND
36).

FIRST USE 1-17-2008; IN COMMERCE 1-17-2008.

OWNER OF U.S. REG. NOS. 3,018,560, 3,337,768
AND OTHERS.

THE MARK CONSISTS OF A SERIES OF BIRDS
IN DIFFERENT FLIGHT PATTERNS ON THE GUI-
TAR NECK, EACH BIRD ON A DIFFERENT FRET
OF THE NECK. THE DOTTED LINES ARE FOR
PLACEMENT PURPOSES ONLY AND NOT PART
OF THE MARK.

SER. NO. 77-385,564, FILED 1-31-2008.

JULIE VEPPUMTHARA, EXAMINING ATTORNEY

Int. Cl.: 30

Prior U.S. Cl.: 46

United States Patent and Trademark Office

Reg. No. 3,575,033

Registered Feb. 17, 2009

**TRADEMARK
PRINCIPAL REGISTER**



BORELLI TEA HOLDINGS LIMITED (UNITED
KINGDOM CORPORATION)
2ND FLOOR
BIRCHWOOD HOUSE, VICTORIA ROAD
DARTFORD, KENT, UNITED KINGDOM DA15TG

FOR: TEA AND GREEN TEA; TEA; TEA FOR
INFUSIONS; TEA-BASED DRINKS; COFFEE; COF-
FEE-BASED DRINKS; ARTIFICIAL COFFEE, IN
CLASS 30 (U.S. CL. 46).

FIRST USE 6-0-2006; IN COMMERCE 7-23-2006.

OWNER OF UNITED KINGDOM REG. NO.
2450891, DATED 12-7-2007, EXPIRES 3-27-2017.

OWNER OF U.S. REG. NO. 2,651,474.

THE MARK CONSISTS OF AN ELEPHANT IN-
SIDE A BROKEN CIRCLE.

SER. NO. 77-385,666, FILED 1-31-2008.

AMOS T. MATTHEWS, JR., EXAMINING ATTOR-
NEY

Int. Cl.: 35

Prior U.S. Cls.: 100, 101 and 102

United States Patent and Trademark Office

Reg. No. 3,575,034

Registered Feb. 17, 2009

**SERVICE MARK
PRINCIPAL REGISTER**



TWIRL, INC. (ARIZONA CORPORATION)
6137 N. SCOTTSDALE ROAD, SUITE B101
SCOTTSDALE, AZ 85250

FIRST USE 5-1-2004; IN COMMERCE 5-1-2004.

FOR: RETAIL CLOTHING BOUTIQUE, NAMELY,
BRIDESMAID, BRIDAL, AND FLOWERGIRL
CLOTHING AND ACCESSORIES, IN CLASS 35
(U.S. CLS. 100, 101 AND 102).

SER. NO. 77-385,777, FILED 1-31-2008.

DEIRDRE ROBERTSON, EXAMINING ATTORNEY

Int. Cl.: 41

Prior U.S. Cls.: 100, 101 and 107

United States Patent and Trademark Office

Reg. No. 3,575,035

Registered Feb. 17, 2009

**SERVICE MARK
PRINCIPAL REGISTER**

BLOODY-DISGUSTING

BLOODY DISGUSTING, LLC (CALIFORNIA
LIMITED LIABILITY COMPANY)
9100 WILSHIRE BLVD, 700 WEST
BEVERLY HILLS, CA 90212

THE MARK CONSISTS OF STANDARD CHAR-
ACTERS WITHOUT CLAIM TO ANY PARTICULAR
FONT, STYLE, SIZE, OR COLOR.

FOR: PROVIDING ENTERTAINMENT INFOR-
MATION IN THE FIELD OF THE HORROR GENRE
VIA THE INTERNET, IN CLASS 41 (U.S. CLS. 100, 101
AND 107).

SER. NO. 77-385,783, FILED 1-31-2008.

FIRST USE 2-28-2002; IN COMMERCE 2-28-2002.

FRED CARL, EXAMINING ATTORNEY

Int. Cl.: 41

Prior U.S. Cls.: 100, 101 and 107

United States Patent and Trademark Office

Reg. No. 3,575,036

Registered Feb. 17, 2009

**SERVICE MARK
PRINCIPAL REGISTER**



LAWSCOPE COACHING

ELENA KASPI (UNITED STATES INDIVIDUAL)
211 EAST 43 STREET, SUITE 2301
NEW YORK, NY 10017

NO CLAIM IS MADE TO THE EXCLUSIVE
RIGHT TO USE "COACHING", APART FROM THE
MARK AS SHOWN.

FOR: PROFESSIONAL COACHING SERVICES IN
THE FIELD OF LEGAL CAREER DEVELOPMENT,
IN CLASS 41 (U.S. CLS. 100, 101 AND 107).

SER. NO. 77-386,562, FILED 2-1-2008.

FIRST USE 4-20-2005; IN COMMERCE 4-20-2005.

ANDREW RHIM, EXAMINING ATTORNEY

Int. Cl.: 30

Prior U.S. Cl.: 46

United States Patent and Trademark Office

Reg. No. 3,575,037

Registered Feb. 17, 2009

**TRADEMARK
PRINCIPAL REGISTER**

CRISPERS

PUBLIX ASSET MANAGEMENT COMPANY
(FLORIDA CORPORATION)
3300 PUBLIX CORPORATE PARKWAY
LAKELAND, FL 33811

FOR: MILK SHAKES, IN CLASS 30 (U.S. CL. 46).

FIRST USE 1-0-1999; IN COMMERCE 1-0-1999.

THE MARK CONSISTS OF STANDARD CHARACTERS WITHOUT CLAIM TO ANY PARTICULAR FONT, STYLE, SIZE, OR COLOR.

OWNER OF U.S. REG. NO. 2,857,718.

SER. NO. 77-386,630, FILED 2-1-2008.

BRIAN CALLAGHAN, EXAMINING ATTORNEY

Int. Cl.: 42

Prior U.S. Cls.: 100 and 101

United States Patent and Trademark Office

Reg. No. 3,575,038

Registered Feb. 17, 2009

**SERVICE MARK
PRINCIPAL REGISTER**

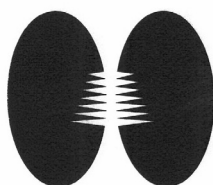

SPORTON LAB.

SPORTON INTERNATIONAL INC. (TAIWAN CORPORATION)

6F

NO.106, SEC.1, HSIN TAI WU RD., HSI CHIH TAIPEI HSIEN, TAIWAN

FOR: PRODUCT SAFETY TESTING; PRODUCT TESTING; COMPUTER HARDWARE AND SOFTWARE CONSULTING SERVICES; TESTING, ANALYSIS AND EVALUATION OF THE GOODS AND SERVICES OF OTHERS FOR THE PURPOSE OF CERTIFICATION; ACCREDITATION SERVICES, NAMELY, DEVELOPING, EVALUATING, AND TESTING STANDARDS FOR MOBILE PHONES, INFORMATION TECHNOLOGY PRODUCTS, WIRELESS PRODUCTS FOR THE PURPOSE OF ACCREDITATION; CONSUMER PRODUCT SAFETY TESTING AND CONSULTATION; PRODUCT DEVELOPMENT CONSULTATION, IN CLASS 42 (U.S. CLS. 100 AND 101).

FIRST USE 7-16-1998; IN COMMERCE 7-16-1998.

NO CLAIM IS MADE TO THE EXCLUSIVE RIGHT TO USE "LAB.", APART FROM THE MARK AS SHOWN.

THE MARK CONSISTS OF TWO OVAL CONTOURS ADJACENT EACH OTHER HAVING SERRATED EDGES FACING EACH OTHER WITH BOTH OVALS ABOVE THE WORDS "SPORTON LAB".

SER. NO. 77-387,152, FILED 2-2-2008.

JANICE L. MCMORROW, EXAMINING ATTORNEY

Int. Cl.: 9

Prior U.S. Cls.: 21, 23, 26, 36 and 38

United States Patent and Trademark Office

Reg. No. 3,575,039

Registered Feb. 17, 2009

**TRADEMARK
PRINCIPAL REGISTER**



LG ELECTRONICS INC. (REPUBLIC OF KOREA CORPORATION)
20, YOIDO-DONG, YONGDUNGPO-GU
SEOUL, REPUBLIC OF KOREA

OWNER OF REPUBLIC OF KOREA REG. NO. 40-0725803-0, DATED 10-12-2007, EXPIRES 10-12-2017.

FOR: AUDIO COMPONENT AND SOUND RECORDING AND REPRODUCING APPARATUS COMPRISING CD PLAYERS, COMPACT DISC PLAYERS, DVD PLAYERS, MP3, VIDEO PLAYERS, DIGITAL AUDIO PLAYERS; HOME THEATER EQUIPMENT, NAMELY, PROJECTORS, STEREOS, SPEAKERS, MODULATORS; DIGITAL VERSATILE DISK PLAYERS; TELEVISION RECEIVERS; AUDIO SPEAKERS; VIDEO CASSETTE RECORDER, IN CLASS 9 (U.S. CLS. 21, 23, 26, 36 AND 38).

NO CLAIM IS MADE TO THE EXCLUSIVE RIGHT TO USE "MEDIA", APART FROM THE MARK AS SHOWN.

THE MARK CONSISTS OF THE WORDS "MEDIA HOST" WITH THE DESIGN OF A USB CABLE.

SER. NO. 77-387,976, FILED 2-4-2008.

KATINA MISTER, EXAMINING ATTORNEY

Int. Cl.: 9

Prior U.S. Cls.: 21, 23, 26, 36 and 38

United States Patent and Trademark Office

Reg. No. 3,575,040

Registered Feb. 17, 2009

**TRADEMARK
PRINCIPAL REGISTER**



LG ELECTRONICS INC. (REPUBLIC OF KOREA CORPORATION)
20, YOIDO-DONG, YONGDUNGPO-GU
SEOUL, REPUBLIC OF KOREA

FOR: AUDIO COMPONENT AND SOUND RECORDING AND REPRODUCING APPARATUS COMPRISING CD PLAYERS, COMPACT DISC PLAYERS, DVD PLAYERS, MP3, VIDEO PLAYERS, DIGITAL AUDIO PLAYERS; HOME THEATER EQUIPMENT, NAMELY, PROJECTORS, STEREOs, SPEAKERS, MODULATORS; DIGITAL VERSATILE DISK PLAYERS; TELEVISION RECEIVERS; AUDIO SPEAKERS; VIDEO CASSETTE RECORDER, IN CLASS 9 (U.S. CLS. 21, 23, 26, 36 AND 38).

OWNER OF REPUBLIC OF KOREA REG. NO. 40-0725802-0, DATED 10-12-2007, EXPIRES 10-12-2017.

NO CLAIM IS MADE TO THE EXCLUSIVE RIGHT TO USE "MEDIA", APART FROM THE MARK AS SHOWN.

THE MARK CONSISTS OF THE WORDS "MEDIA PLUS" WITH THE DESIGN OF A USB CABLE.

SER. NO. 77-387,982, FILED 2-4-2008.

KATINA MISTER, EXAMINING ATTORNEY

Int. Cl.: 9

Prior U.S. Cls.: 21, 23, 26, 36 and 38

United States Patent and Trademark Office

Reg. No. 3,575,041

Registered Feb. 17, 2009

**TRADEMARK
PRINCIPAL REGISTER**

OMNIMUSIC

FRANKLIN-DOUGLAS, INC. (NEW YORK CORPORATION)
52 MAIN STREET
NEW YORK, NY 11030

FOR: DOWNLOADABLE SOUND RECORDINGS
FEATURING MUSIC VIA THE INTERNET, IN
CLASS 9 (U.S. CLS. 21, 23, 26, 36 AND 38).

FIRST USE 12-31-2004; IN COMMERCE 12-31-2004.

THE MARK CONSISTS OF STANDARD CHARACTERS WITHOUT CLAIM TO ANY PARTICULAR FONT, STYLE, SIZE, OR COLOR.

OWNER OF U.S. REG. NOS. 1,470,525 AND 1,475,502.

SER. NO. 77-388,507, FILED 2-5-2008.

LINDA LAVACHE, EXAMINING ATTORNEY

Int. Cl.: 18

Prior U.S. Cls.: 1, 2, 3, 22 and 41

Reg. No. 3,575,042

United States Patent and Trademark Office

Registered Feb. 17, 2009

**TRADEMARK
PRINCIPAL REGISTER**

MUXO

COCO LE DUNE (CALIFORNIA CORPORATION)
5858 S. PCH
REDONDO BEACH, CA 90277

THE MARK CONSISTS OF STANDARD CHAR-
ACTERS WITHOUT CLAIM TO ANY PARTICULAR
FONT, STYLE, SIZE, OR COLOR.

FOR: LEATHER BAGS, NAMELY, HANDMADE
LEATHER HANDBAGS, TRAVEL BAGS AND PUR-
SES, IN CLASS 18 (U.S. CLS. 1, 2, 3, 22 AND 41).

SER. NO. 77-388,634, FILED 2-5-2008.

FIRST USE 1-1-2006; IN COMMERCE 11-1-2006.

ERIN FALK, EXAMINING ATTORNEY

Int. Cls.: 35 and 41

Prior U.S. Cls.: 100, 101, 102 and 107

United States Patent and Trademark Office

Reg. No. 3,575,043

Registered Feb. 17, 2009

**SERVICE MARK
PRINCIPAL REGISTER**

DEALSCAPE

THE DEAL, LLC (DELAWARE LIMITED LIABILITY COMPANY)
105 MADISON AVENUE
NEW YORK, NY 10016

FOR: PROVIDING INFORMATION IN THE FIELD OF BUSINESS ACQUISITIONS AND MERGERS VIA THE INTERNET, IN CLASS 35 (U.S. CLS. 100, 101 AND 102).

FIRST USE 2-12-2001; IN COMMERCE 2-12-2001.

FOR: PROVIDING ONLINE MAGAZINES AND NEWSLETTERS IN THE FIELD OF BUSINESS AND

FINANCE; BLOGS FEATURING INFORMATION IN THE FIELD OF BUSINESS AND FINANCE, IN CLASS 41 (U.S. CLS. 100, 101 AND 107).

FIRST USE 2-12-2001; IN COMMERCE 2-12-2001.

THE MARK CONSISTS OF STANDARD CHARACTERS WITHOUT CLAIM TO ANY PARTICULAR FONT, STYLE, SIZE, OR COLOR.

SER. NO. 77-389,029, FILED 2-5-2008.

VERNA BETH RIRIE, EXAMINING ATTORNEY

Int. Cl.: 32

Prior U.S. Cls.: 45, 46 and 48

United States Patent and Trademark Office

Reg. No. 3,575,044

Registered Feb. 17, 2009

**TRADEMARK
PRINCIPAL REGISTER**

RJ ROCKERS

R.J. ROCKERS, INC. (SOUTH CAROLINA CORPORATION)
113D BELTON DRIVE
SPARTANBURG, SC 29301

THE NAME "RJ ROCKERS" IDENTIFIES A LIVING INDIVIDUAL WHOSE CONSENT IS OF RECORD.

FOR: BEER, IN CLASS 32 (U.S. CLS. 45, 46 AND 48).

FIRST USE 4-30-1997; IN COMMERCE 4-30-1997.

SER. NO. 77-390,076, FILED 2-6-2008.

THE MARK CONSISTS OF STANDARD CHARACTERS WITHOUT CLAIM TO ANY PARTICULAR FONT, STYLE, SIZE, OR COLOR.

BILL DAWE, EXAMINING ATTORNEY

Int. Cl.: 7

Prior U.S. Cls.: 13, 19, 21, 23, 31, 34 and 35

United States Patent and Trademark Office

Reg. No. 3,575,045

Registered Feb. 17, 2009

**TRADEMARK
PRINCIPAL REGISTER**

MightyAxe

MIGHTY AXE, INC. (KANSAS CORPORATION)
2649 CR 2300
INDEPENDENCE, KS 67301

THE MARK CONSISTS OF STANDARD CHAR-
ACTERS WITHOUT CLAIM TO ANY PARTICULAR
FONT, STYLE, SIZE, OR COLOR.

FOR: HYDRAULICALLY OPERATED ATTACH-
MENTS FOR VEHICLES, NAMELY, TREE SHEARS
AND BRUSH HANDLING EQUIPMENT, IN CLASS 7
(U.S. CLS. 13, 19, 21, 23, 31, 34 AND 35).

SER. NO. 77-390,131, FILED 2-6-2008.

FIRST USE 8-15-1999; IN COMMERCE 8-15-1999.

KOURTNEE HODGES, EXAMINING ATTORNEY

Int. Cl.: 35

Prior U.S. Cls.: 100, 101 and 102

United States Patent and Trademark Office

Reg. No. 3,575,046

Registered Feb. 17, 2009

**SERVICE MARK
PRINCIPAL REGISTER**

On Your Side  **Volunteer Network**

NATIONWIDE MUTUAL INSURANCE COMPAN-
NY (OHIO CORPORATION)
OFFICE OF GENERAL COUNSEL 1-07-14
ONE NATIONWIDE PLAZA
COLUMBUS, OH 432152220

FOR: CHARITABLE SERVICES, NAMELY, OR-
GANIZING AND CONDUCTING VOLUNTEER
PROGRAMS AND COMMUNITY SERVICE PRO-
JECTS, IN CLASS 35 (U.S. CLS. 100, 101 AND 102).

FIRST USE 6-30-2006; IN COMMERCE 6-30-2006.

OWNER OF U.S. REG. NOS. 3,038,893, 3,331,297,
AND 3,333,915.

NO CLAIM IS MADE TO THE EXCLUSIVE
RIGHT TO USE "VOLUNTEER NETWORK", APART
FROM THE MARK AS SHOWN.

THE MARK CONSISTS OF THE WORDS "ON
YOUR SIDE VOLUNTEER NETWORK", WITH THE
IMAGE OF STYLIZED PERSONS WITH ARMS
UPRAISED, APPEARING BETWEEN THE WORDS
"SIDE" AND "VOLUNTEER".

SER. NO. 77-390,343, FILED 2-6-2008.

MAUREEN DALL, EXAMINING ATTORNEY

Int. Cl.: 19

Prior U.S. Cls.: 1, 12, 33 and 50

United States Patent and Trademark Office

Reg. No. 3,575,047

Registered Feb. 17, 2009

**TRADEMARK
PRINCIPAL REGISTER**

AIRE GUARDIAN

ABATEMENT TECHNOLOGIES, INC. (GEORGIA CORPORATION)
SUITE 300
605 SATELLITE BOULEVARD
SUWANEE, GA 30024

FOR: PRIMARILY NON-METAL MODULAR ENCLOSURES SOLD AS A UNIT AND DESIGNED FOR USE AS TEMPORARY ANTE ROOMS DURING ISOLATION OF INFECTIOUS OR IMMUNE-COMPROMISED PATIENTS; PRIMARILY NON-METAL TEMPORARY ENCLOSURES SOLD AS A UNIT AND DESIGNED TO PREVENT THE RELEASE OF CONSTRUCTION DUST AND OTHER AIRBORNE CONTAMINANTS AND AIRBORNE PATHOGENS, IN CLASS 19 (U.S. CLS. 1, 12, 33 AND 50).

FIRST USE 9-5-2007; IN COMMERCE 9-5-2007.

THE MARK CONSISTS OF STANDARD CHARACTERS WITHOUT CLAIM TO ANY PARTICULAR FONT, STYLE, SIZE, OR COLOR.

NO CLAIM IS MADE TO THE EXCLUSIVE RIGHT TO USE "AIRE", APART FROM THE MARK AS SHOWN.

THE ENGLISH TRANSLATION OF THE WORD "AIRE" IN THE MARK IS AIR.

SER. NO. 77-390,849, FILED 2-7-2008.

ELLEN BURNS, EXAMINING ATTORNEY

Int. Cl.: 16

Prior U.S. Cls.: 2, 5, 22, 23, 29, 37, 38 and 50

Reg. No. 3,575,048

United States Patent and Trademark Office

Registered Feb. 17, 2009

**TRADEMARK
PRINCIPAL REGISTER**

THE GREEN PHARMACY

RODALE INC. (PENNSYLVANIA CORPORATION)
33 EAST MINOR STREET
EMMAUS, PA 180980099

THE MARK CONSISTS OF STANDARD CHARACTERS WITHOUT CLAIM TO ANY PARTICULAR FONT, STYLE, SIZE, OR COLOR.

FOR: SERIES OF BOOKS IN THE FIELD OF NATURAL REMEDIES, HERBS AND MEDICINAL PLANTS AND FOODS, IN CLASS 16 (U.S. CLS. 2, 5, 22, 23, 29, 37, 38 AND 50).

SER. NO. 77-390,951, FILED 2-7-2008.

FIRST USE 10-13-2000; IN COMMERCE 10-13-2000.

WILLIAM ROSSMAN, EXAMINING ATTORNEY

Int. Cl.: 7

Prior U.S. Cls.: 13, 19, 21, 23, 31, 34 and 35

United States Patent and Trademark Office

Reg. No. 3,575,049

Registered Feb. 17, 2009

**TRADEMARK
PRINCIPAL REGISTER**

X-TREME

BUNTING MAGNETICS CO. (KANSAS CORPORATION)
500 SOUTH SPENCER AVENUE
NEWTON, KS 67114

FOR: POWER OPERATED SHEET MATERIAL DIE CUTTING ASSEMBLIES, NAMELY, ROLL ASSEMBLIES CONSISTING PRIMARILY OF A CYLINDER HAVING SURFACE EMBEDDED MAGNETS AND HAVING A MAGNETICALLY ATTACHED WRAP-AROUND SHEET MATERIAL CUTTING DIE, IN CLASS 7 (U.S. CLS. 13, 19, 21, 23, 31, 34 AND 35).

FIRST USE 10-15-2005; IN COMMERCE 10-15-2005.

THE MARK CONSISTS OF STANDARD CHARACTERS WITHOUT CLAIM TO ANY PARTICULAR FONT, STYLE, SIZE, OR COLOR.

SER. NO. 77-391,026, FILED 2-7-2008.

SUE LAWRENCE, EXAMINING ATTORNEY

Int. Cls.: 21 and 34

Prior U.S. Cls.: 2, 8, 9, 13, 17, 23, 29, 30, 33, 40 and 50

United States Patent and Trademark Office

Reg. No. 3,575,050

Registered Feb. 17, 2009

**TRADEMARK
PRINCIPAL REGISTER**



STEELITE INTERNATIONAL, PLC (UNITED KINGDOM PUBLIC LIMITED COMPANY (PLC))
ORME STREET
STROKE-ON-TRENT, UNITED KINGDOM ST63RB

FOR: TABLEWARE, NAMELY, PLATES, BOWLS, CUPS, SAUCERS, MUGS, DRINKING GLASSES, DISHES, VASES, CONDIMENT SETS COMPRISING OF SALT AND PEPPER SHAKERS, JUGS, SUGAR BOWLS NOT OF PRECIOUS METAL, TEAPOTS NOT OF PRECIOUS METAL, COFFEE POTS NOT OF PRECIOUS METAL, POTS AND COASTERS NOT OF PAPER AND NOT BEING TABLE LINEN, IN CLASS 21 (U.S. CLS. 2, 13, 23, 29, 30, 33, 40 AND 50).

FIRST USE 2-0-2004; IN COMMERCE 2-0-2004.

FOR: ASHTRAYS NOT OF PRECIOUS METALS, IN CLASS 34 (U.S. CLS. 2, 8, 9 AND 17).

FIRST USE 2-0-2004; IN COMMERCE 2-0-2004.

OWNER OF U.S. REG. NO. 907,184.

NO CLAIM IS MADE TO THE EXCLUSIVE RIGHT TO USE "INTERNATIONAL", APART FROM THE MARK AS SHOWN.

THE MARK CONSISTS OF THE TERMS "STEELITE INTERNATIONAL" AND TO THE LEFT A DESIGN OF THREE ROWS OF THREE SMALL DOTS EACH. ONE OF THE DOTS IS SHADED.

SER. NO. 77-391,352, FILED 2-7-2008.

GISELLE AGOSTO, EXAMINING ATTORNEY

Int. Cl.: 19

Prior U.S. Cls.: 1, 12, 33 and 50

United States Patent and Trademark Office

Reg. No. 3,575,051

Registered Feb. 17, 2009

**TRADEMARK
PRINCIPAL REGISTER**

DYMONDWOOD

RUTLAND PLYWOOD CORPORATION (VER-
MONT CORPORATION)
P.O. BOX 6180
RUTLAND, VT 05702

THE MARK CONSISTS OF STANDARD CHAR-
ACTERS WITHOUT CLAIM TO ANY PARTICULAR
FONT, STYLE, SIZE, OR COLOR.

FOR: WOOD VENEER LAMINATES, SPECIFI-
CALLY, MULTI-LAYERED WOOD VENEERS FOR
USE IN FURTHER MANUFACTURE, IN CLASS 19
(U.S. CLS. 1, 12, 33 AND 50).

SER. NO. 77-391,393, FILED 2-7-2008.

FIRST USE 2-0-1994; IN COMMERCE 2-0-1994.

JAMES STEIN, EXAMINING ATTORNEY

Int. Cl.: 35

Prior U.S. Cls.: 100, 101 and 102

United States Patent and Trademark Office

Reg. No. 3,575,052

Registered Feb. 17, 2009

**SERVICE MARK
PRINCIPAL REGISTER**



CROCHET GUILD OF AMERICA (ILLINOIS CORPORATION)
1100-H BRANDYWINE BLVD.
ZANESVILLE, OH 43701

FOR: ASSOCIATION SERVICES NAMELY PROMOTING THE INTERESTS AND PROVIDING A NETWORK FOR HOBBYISTS AND PROFESSIONAL CROCHETERS AND COLLECTORS OF CROCHETED WORKS AND CROCHET HOOKS, IN CLASS 35 (U.S. CLS. 100, 101 AND 102).

FIRST USE 6-7-2005; IN COMMERCE 6-7-2005.

OWNER OF U.S. REG. NO. 2,628,082.

NO CLAIM IS MADE TO THE EXCLUSIVE RIGHT TO USE "CROCHET GUILD OF AMERICA AND SINCE 1994", APART FROM THE MARK AS SHOWN.

THE COLOR(S) PURPLE AND VARIATIONS OF PURPLE, LAVENDER, GOLD, WHITE AND BLACK IS/ARE CLAIMED AS A FEATURE OF THE MARK.

THE MARK CONSISTS OF AN OVAL DESIGN WITH THE INTERIOR SHOWN IN VARIATIONS OF THE COLOR PURPLE WITH AN OUTSIDE LAVENDER BAND AND A GOLD CROCHET HOOK AND THREAD; "CGOA CROCHET GUILD OF AMERICA" IS IN WHITE INSIDE THE OVAL AND THE WORDING "SINCE 1994" IS IN BLACK BELOW THE DESIGN.

SER. NO. 77-391,458, FILED 2-7-2008.

ANDREA SAUNDERS, EXAMINING ATTORNEY

Int. Cl.: 16

Prior U.S. Cls.: 2, 5, 22, 23, 29, 37, 38 and 50

United States Patent and Trademark Office

Reg. No. 3,575,053

Registered Feb. 17, 2009

**TRADEMARK
PRINCIPAL REGISTER**

BELIEFLETS

TERRY A. O'CONNELL (UNITED STATES INDIVIDUAL)
212 SPRINGWOOD LANE
IDAHO FALLS, ID 83404

FOR: SELF-HELP BOOKLETS FOR THOSE ENGAGED IN ALTERNATIVE HEALING, WHETHER AS A PRACTITIONER OR CLIENT, TO ALIGN THEIR PERSONAL BELIEFS TO HELP THEM MEET THEIR HEALTH AND LIFE GOALS, IN CLASS 16 (U.S. CLS. 2, 5, 22, 23, 29, 37, 38 AND 50).

FIRST USE 1-1-2007; IN COMMERCE 11-15-2007.

THE MARK CONSISTS OF STANDARD CHARACTERS WITHOUT CLAIM TO ANY PARTICULAR FONT, STYLE, SIZE, OR COLOR.

SER. NO. 77-391,793, FILED S.R. 2-7-2008 AM. P.R. 10-28-2008.

JIM RINGLE, EXAMINING ATTORNEY

Int. Cl.: 35

Prior U.S. Cls.: 100, 101 and 102

United States Patent and Trademark Office

Reg. No. 3,575,054

Registered Feb. 17, 2009

**SERVICE MARK
PRINCIPAL REGISTER**



SINGLE SOURCE, INC. (GEORGIA CORPORATION)
SUITE 415
1000 HOLCOMB WOODS PARKWAY
ROSWELL, GA 30076

FOR: DISTRIBUTORSHIPS FEATURING PRODUCTS FOR USE IN THE AUTOMOTIVE PAINT AND RESTORATION INDUSTRY, NAMELY, PAINTS, VARNISHES, LACQUERS, ENAMELS, PRESERVATIVES AGAINST RUST, PAINT THINERS, PAINT HARDENERS, PAINT DRIERS, AND PLASTICIZING ADDITIVES FOR PAINT, IN CLASS 35 (U.S. CLS. 100, 101 AND 102).

FIRST USE 5-5-1995; IN COMMERCE 8-1-1995.

NO CLAIM IS MADE TO THE EXCLUSIVE RIGHT TO USE "INC.", APART FROM THE MARK AS SHOWN.

THE COLOR(S) BLACK, WHITE, TEAL IS/ARE CLAIMED AS A FEATURE OF THE MARK.

THE MARK CONSISTS OF A RECTANGLE SHADED IN BLACK CONTAINING THE WORD "SINGLE" IN WHITE EXCEPT FOR THE NUMBER "1" IN TEAL, WHICH IS POSITIONED ABOVE A THIN WHITE RECTANGLE THAT IS ABOVE A TEAL RECTANGLE CONTAINING THE WORD "SOURCE" IN WHITE, AND THE WORD "INC." IN WHITE POSITIONED VERTICALLY.

SER. NO. 77-391,922, FILED 2-8-2008.

ANTHONY RINKER, EXAMINING ATTORNEY

Int. Cl.: 7

Prior U.S. Cls.: 13, 19, 21, 23, 31, 34 and 35

United States Patent and Trademark Office

Reg. No. 3,575,055

Registered Feb. 17, 2009

**TRADEMARK
PRINCIPAL REGISTER**

IMPRESSION

BUNTING MAGNETICS CO. (KANSAS CORPORATION)
500 SOUTH SPENCER AVENUE
NEWTON, KS 67114

FOR: POWER OPERATED SHEET MATERIAL EMBOSsing ASSEMBLIES, NAMELY, ROLL ASSEMBLIES CONSISTING PRIMARILY OF A CYLINDER HAVING SURFACE EMBEDDED MAGNETS AND HAVING A MAGNETICALLY ATTACHED WRAP-AROUND EMBOSsing DIE, IN CLASS 7 (U.S. CLS. 13, 19, 21, 23, 31, 34 AND 35).

FIRST USE 10-15-2005; IN COMMERCE 10-15-2005.

THE MARK CONSISTS OF STANDARD CHARACTERS WITHOUT CLAIM TO ANY PARTICULAR FONT, STYLE, SIZE, OR COLOR.

SER. NO. 77-392,409, FILED 2-8-2008.

SUE LAWRENCE, EXAMINING ATTORNEY

Int. Cl.: 42

Prior U.S. Cls.: 100 and 101

United States Patent and Trademark Office

Reg. No. 3,575,056

Registered Feb. 17, 2009

**SERVICE MARK
PRINCIPAL REGISTER**

LabLinker

INTEGRATED DNA TECHNOLOGIES, INC.
(IOWA CORPORATION)
1710 COMMERCIAL PARK
CORALVILLE, IA 52241

FOR: WEB BASED SERVICES, NAMELY, HOSTING AND MAINTAINING AN ONLINE WEBSITE FOR RESEARCHERS IN BIOTECHNOLOGY TO COLLABORATE AND EXCHANGE INFORMATION, IN CLASS 42 (U.S. CLS. 100 AND 101).

FIRST USE 1-24-2008; IN COMMERCE 1-24-2008.

THE MARK CONSISTS OF STANDARD CHARACTERS WITHOUT CLAIM TO ANY PARTICULAR FONT, STYLE, SIZE, OR COLOR.

SER. NO. 77-393,626, FILED 2-11-2008.

LINDA ESTRADA, EXAMINING ATTORNEY

Int. Cl.: 42

Prior U.S. Cls.: 100 and 101

United States Patent and Trademark Office

Reg. No. 3,575,057

Registered Feb. 17, 2009

**SERVICE MARK
PRINCIPAL REGISTER**



SOFTWARE ENGINEERING PROFESSIONALS,
INC. (INDIANA CORPORATION)
8TH FLOOR
11611 NORTH MERIDIAN STREET
CARMEL, IN 46032

FOR: ANALYSIS, DESIGN, DEVELOPMENT,
TESTING AND IMPLEMENTATION OF SOFT-
WARE, SOFTWARE APPLICATIONS, AND COMPU-
TER SYSTEMS FOR OTHERS; CONSULTATION
SERVICES IN THE FIELDS OF SELECTION, IMPLI-
MENTATION AND USE OF COMPUTER HARD-
WARE AND SOFTWARE SYSTEMS FOR OTHERS
AND TECHNICAL SUPPORT SERVICES, NAMELY,

TROUBLESHOOTING OF COMPUTER SOFTWARE
PROBLEMS, IN CLASS 42 (U.S. CLS. 100 AND 101).

FIRST USE 1-2-2008; IN COMMERCE 1-2-2008.

THE MARK CONSISTS OF THE LETTERS "SEP"
DISPLAYED IN A STYLIZED MANNER ALONG
WITH A GEOMETRIC DESIGN.

SER. NO. 77-393,720, FILED 2-11-2008.

SCOTT BIBB, EXAMINING ATTORNEY

Int. Cl.: 9

Prior U.S. Cls.: 21, 23, 26, 36 and 38

United States Patent and Trademark Office

Reg. No. 3,575,058

Registered Feb. 17, 2009

**TRADEMARK
PRINCIPAL REGISTER**

SEALINK

KEY COMPONENTS, LLC (DELAWARE LIMITED LIABILITY COMPANY)
13000 WEST SILVER SPRING DRIVE
BUTLER, WI 53007

FOR: ELECTRICAL CONNECTORS, NAMELY, ELECTRICAL PLUGS AND RECEPTACLES, IN CLASS 9 (U.S. CLS. 21, 23, 26, 36 AND 38).

FIRST USE 2-28-1997; IN COMMERCE 2-28-1997.

THE MARK CONSISTS OF STANDARD CHARACTERS WITHOUT CLAIM TO ANY PARTICULAR FONT, STYLE, SIZE, OR COLOR.

OWNER OF U.S. REG. NO. 2,321,499.

SER. NO. 77-393,860, FILED 2-11-2008.

SUE LAWRENCE, EXAMINING ATTORNEY

Int. Cl.: 29

Prior U.S. Cl.: 46

United States Patent and Trademark Office

Reg. No. 3,575,059

Registered Feb. 17, 2009

**TRADEMARK
PRINCIPAL REGISTER**

FRUIT-N-ICE

KANAWATI ENTERPRISES (NEW JERSEY LIMITED LIABILITY COMPANY)
94 RAILROAD AVE
HACKENSACK, NJ 07601

FOR: FRUIT-BASED FOOD BEVERAGE, IN CLASS 29 (U.S. CL. 46).

FIRST USE 1-1-2000; IN COMMERCE 1-1-2000.

THE COLOR(S) BLUE, LIGHT BLUE , WHITE , BLACK IS/ARE CLAIMED AS A FEATURE OF THE MARK.

THE MARK CONSISTS OF THE WORDING "FRUIT-N-ICE" IN THE COLOR BLUE WHICH FADES IN AND OUT OF THE WORDS AND STARTS DARKER BLUE ON THE LEFT-END TO LIGHT BLUE AND WHITE ON THE RIGHT-END WITH BLACK SHADOW BEHIND THE LETTERS.

SEC. 2(F).

SER. NO. 77-394,027, FILED 2-11-2008.

DAWN FELDMAN, EXAMINING ATTORNEY

Int. Cl.: 25

Prior U.S. Cls.: 22 and 39

United States Patent and Trademark Office

Reg. No. 3,575,060

Registered Feb. 17, 2009

**TRADEMARK
PRINCIPAL REGISTER**



EARTHENSILK
san francisco

RISING PHOENIX (CALIFORNIA CORPORATION)
44317 ARAPAHO AVENUE
FREMONT, CA 94539

FOR: SILK FABRIC SOLD AS AN INTEGRAL COMPONENT OF FINISHED CLOTHING, NAMELY, JACKETS, SHIRTS, DRESSES, PANTS, SKIRTS, SCARVES, SHAWLS AND VESTS, IN CLASS 25 (U.S. CLS. 22 AND 39).

FIRST USE 3-1-2007; IN COMMERCE 3-1-2007.

NO CLAIM IS MADE TO THE EXCLUSIVE RIGHT TO USE "SAN FRANCISCO", APART FROM THE MARK AS SHOWN.

THE COLOR(S) GREEN AND WHITE IS/ARE CLAIMED AS A FEATURE OF THE MARK.

THE WORDING "EARTHENSILK" IS GREEN, THE WORDING "SAN FRANCISCO" IS GREEN, THE TAIL OF THE WHALE IS WHITE WITH GREEN DOTS, ON A GREEN BACKGROUND, SURROUNDED BY A WHITE CIRCLE AND AN OUTER GREEN CIRCLE.

SER. NO. 77-394,041, FILED 2-11-2008.

PATRICIA EVANKO, EXAMINING ATTORNEY

Int. Cl.: 30

Prior U.S. Cl.: 46

Reg. No. 3,575,061

United States Patent and Trademark Office

Registered Feb. 17, 2009

TRADEMARK
PRINCIPAL REGISTER



THE COOKIE CORNER (HAWAII PARTNER-
SHIP)
1550 HART STREET
BAY 14
HONOLULU, HI 96817

RUNNING VERTICALLY AND THE WORD "COO-
KIE" SET ABOVE THE WORD "CORNER" WITH
THIRTEEN SMALL SQUARES IN A RANDOM
PATTERN.

FOR: COOKIES, IN CLASS 30 (U.S. CL. 46).

SER. NO. 77-394,186, FILED 2-11-2008.

FIRST USE 12-0-1992; IN COMMERCE 12-0-1992.

THE MARK CONSISTS OF A RECTANGLE WITH
ROUNDED CORNERS WITH THE WORD "THE"

DOMINIC J. FERRAIUOLO, EXAMINING ATTOR-
NEY

Int. Cl.: 35

Prior U.S. Cls.: 100, 101 and 102

United States Patent and Trademark Office

Reg. No. 3,575,062

Registered Feb. 17, 2009

**SERVICE MARK
PRINCIPAL REGISTER**

THE COOKIE CORNER

THE COOKIE CORNER (HAWAII PARTNER-
SHIP)
1550 HART STREET
BAY 14
HONOLULU, HI 96817

FOR: RETAIL STORE SERVICES FEATURING
COOKIES; ON-LINE RETAIL STORE SERVICES
FEATURING COOKIES, IN CLASS 35 (U.S. CLS.
100, 101 AND 102).

FIRST USE 12-0-1982; IN COMMERCE 12-0-1982.

THE MARK CONSISTS OF STANDARD CHAR-
ACTERS WITHOUT CLAIM TO ANY PARTICULAR
FONT, STYLE, SIZE, OR COLOR.

NO CLAIM IS MADE TO THE EXCLUSIVE
RIGHT TO USE "COOKIE", APART FROM THE
MARK AS SHOWN.

SER. NO. 77-394,239, FILED 2-11-2008.

DOMINIC J. FERRAIUOLO, EXAMINING ATTOR-
NEY

Int. Cl.: 35

Prior U.S. Cls.: 100, 101 and 102

United States Patent and Trademark Office

Reg. No. 3,575,063

Registered Feb. 17, 2009

SERVICE MARK
PRINCIPAL REGISTER



THE COOKIE CORNER (HAWAII PARTNER-
SHIP)
1550 HART STREET
BAY 14
HONOLULU, HI 96817

FOR: RETAIL STORE SERVICES FEATURING
COOKIES; ON-LINE RETAIL STORE SERVICES
FEATURING COOKIES, IN CLASS 35 (U.S. CLS.
100, 101 AND 102).

FIRST USE 12-0-1992; IN COMMERCE 12-0-1992.

THE MARK CONSISTS OF A RECTANGLE WITH
ROUNDED CORNERS WITH THE WORD "THE"
RUNNING VERTICALLY AND THE WORD "COO-
KIE" SET ABOVE THE WORD "CORNER" WITH
THIRTEEN SMALL SQUARES IN A RANDOM
PATTERN.

SER. NO. 77-394,252, FILED 2-11-2008.

DOMINIC J. FERRAIUOLO, EXAMINING ATTOR-
NEY

Int. Cl.: 16

Prior U.S. Cls.: 2, 5, 22, 23, 29, 37, 38 and 50

Reg. No. 3,575,064

United States Patent and Trademark Office

Registered Feb. 17, 2009

**TRADEMARK
PRINCIPAL REGISTER**

UNDER THE HOOD

UNITED BUSINESS MEDIA LLC (DELAWARE
LIMITED LIABILITY COMPANY)
600 COMMUNITY DRIVE
4TH FLOOR
MANHASSET, NY 11030

FOR: PRINT PUBLICATIONS, NAMELY, A MA-
GAZINE IN THE FIELDS OF INFORMATION
TECHNOLOGY, HIGH TECHNOLOGY, ELECTRO-
NICS AND ENGINEERING DESIGN, IN CLASS 16
(U.S. CLS. 2, 5, 22, 23, 29, 37, 38 AND 50).

FIRST USE 10-8-2007; IN COMMERCE 10-8-2007.

THE MARK CONSISTS OF STANDARD CHAR-
ACTERS WITHOUT CLAIM TO ANY PARTICULAR
FONT, STYLE, SIZE, OR COLOR.

SER. NO. 77-395,345, FILED 2-12-2008.

WILLIAM P. SHANAHAN, EXAMINING ATTOR-
NEY

Int. Cl.: 41

Prior U.S. Cls.: 100, 101 and 107

United States Patent and Trademark Office

Reg. No. 3,575,065

Registered Feb. 17, 2009

**SERVICE MARK
PRINCIPAL REGISTER**



GLOBAL DISCIPLES (PENNSYLVANIA CORPORATION)
315 WEST JAMES STREET, SUITE 202
LANCASTER, PA 17603

FOR: RELIGIOUS INSTRUCTION SERVICES, IN CLASS 41 (U.S. CLS. 100, 101 AND 107).

FIRST USE 4-18-2006; IN COMMERCE 4-18-2006.

NO CLAIM IS MADE TO THE EXCLUSIVE RIGHT TO USE "GLOBAL DISCIPLES", APART FROM THE MARK AS SHOWN.

THE COLOR(S) BLUE AND BROWN IS/ARE CLAIMED AS A FEATURE OF THE MARK.

THE MARK CONSISTS OF THE WORDING "GLOBAL" IN BLUE, THE WORDING "DISCIPLES" IN BROWN, AND THE DESIGN OF AN INCOMPLETE CIRCLE AND TWO OF THE FACE PROFILES THEREIN IN BROWN COLOR.

SER. NO. 77-395,591, FILED 2-13-2008.

DAWN HAN, EXAMINING ATTORNEY

Int. Cl.: 21

Prior U.S. Cls.: 2, 13, 23, 29, 30, 33, 40 and 50

United States Patent and Trademark Office

Reg. No. 3,575,066

Registered Feb. 17, 2009

**TRADEMARK
PRINCIPAL REGISTER**

COMING HOME

SEARS BRANDS, LLC (ILLINOIS LIMITED LIABILITY COMPANY)
3333 BEVERLY ROAD
HOFFMAN ESTATES, IL 60179

FOR: TRASH CANS, BUFFET CADDIES, KITCHEN UTENSILS, NAMELY, GRATERS, SIEVES, SPATULAS, STRAINERS, TURNERS, SCRAPERS, ROLLING PINS, WHISKS, SKIMMERS, SPLATTER SCREENS, TONGS, SERVING FORKS; KITCHEN TOOL SETS, NAMELY, MIXING SPOON, SLOTTED SPOON, LADLE, SKIMMER LADLE, PASTA SERVER FORK, IN CLASS 21 (U.S. CLS. 2, 13, 23, 29, 30, 33, 40 AND 50).

FIRST USE 7-14-2005; IN COMMERCE 7-14-2005.

THE MARK CONSISTS OF STANDARD CHARACTERS WITHOUT CLAIM TO ANY PARTICULAR FONT, STYLE, SIZE, OR COLOR.

OWNER OF U.S. REG. NOS. 3,259,572 AND 3,330,396.

SER. NO. 77-396,283, FILED 2-13-2008.

SALLY SHIH, EXAMINING ATTORNEY

Int. Cl.: 41

Prior U.S. Cls.: 100, 101 and 107

United States Patent and Trademark Office

Reg. No. 3,575,067

Registered Feb. 17, 2009

**SERVICE MARK
PRINCIPAL REGISTER**

i Tutor

ITUTOR, INC. (DELAWARE CORPORATION)
1301 SOUTH KING STREET
HONOLULU, HI 96814

FOR: EDUCATION SERVICES, NAMELY, PROVIDING TUTORING AND INSTRUCTION VIA ON-LINE NETWORKS IN THE FIELD OF CALCULUS, CHEMISTRY, AND PHYSICS, IN CLASS 41 (U.S. CLS. 100, 101 AND 107).

FIRST USE 5-1-1997; IN COMMERCE 1-24-2000.

NO CLAIM IS MADE TO THE EXCLUSIVE RIGHT TO USE "TUTOR", APART FROM THE MARK AS SHOWN.

THE MARK CONSISTS OF THE SYLIZED FORM OF THE WORD "ITUTOR" WITH A DRAWING OF A MORTARBOARD AS THE DOT ON THE "I".

SER. NO. 77-396,555, FILED 2-13-2008.

LINDA LAVACHE, EXAMINING ATTORNEY

Int. Cl.: 3

Prior U.S. Cls.: 1, 4, 6, 50, 51 and 52

Reg. No. 3,575,068

United States Patent and Trademark Office

Registered Feb. 17, 2009

**TRADEMARK
PRINCIPAL REGISTER**

GOODYEAR

THE GOODYEAR TIRE & RUBBER COMPANY
(OHIO CORPORATION)
DEPT. 823
1144 EAST MARKET STREET
AKRON, OH 443160001

THE MARK CONSISTS OF STANDARD CHAR-
ACTERS WITHOUT CLAIM TO ANY PARTICULAR
FONT, STYLE, SIZE, OR COLOR.

FOR: DISPOSABLE WIPES IMPREGNATED
WITH CLEANING CHEMICALS OR COMPOUNDS
FOR CLEANING AND PROTECTING AUTOMO-
TIVE SURFACES, IN CLASS 3 (U.S. CLS. 1, 4, 6, 50, 51
AND 52).

OWNER OF U.S. REG. NO. 2,051,565.

SER. NO. 77-397,294, FILED 2-14-2008.

FIRST USE 5-22-2005; IN COMMERCE 5-22-2005.

CHRISTINE COOPER, EXAMINING ATTORNEY

Int. Cl.: 5

Prior U.S. Cls.: 6, 18, 44, 46, 51 and 52

Reg. No. 3,575,069

United States Patent and Trademark Office

Registered Feb. 17, 2009

TRADEMARK
PRINCIPAL REGISTER



DOG-EQUINE, LLC (CALIFORNIA LIMITED
LIABILITY COMPANY)
P.O. BOX 3563
SAN CLEMENTE, CA 92674

THE MARK CONSISTS OF THE LITERAL ELE-
MENT "IMMUNEKARE" TOGETHER WITH A SER-
IES OF DOTS ARRANGED IN A CIRCULAR
PATTERN AROUND THE LETTERS "I" AND "M".

FOR: DIETARY SUPPLEMENTS FOR ANIMALS;
VITAMINS AND DIETARY FOOD SUPPLEMENTS
FOR ANIMALS, IN CLASS 5 (U.S. CLS. 6, 18, 44, 46, 51
AND 52).

SER. NO. 77-397,742, FILED 2-14-2008.

FIRST USE 4-11-2008; IN COMMERCE 4-11-2008.

LOURDES AYALA, EXAMINING ATTORNEY

Int. Cl.: 9

Prior U.S. Cls.: 21, 23, 26, 36 and 38

Reg. No. 3,575,070

United States Patent and Trademark Office

Registered Feb. 17, 2009

**TRADEMARK
PRINCIPAL REGISTER**

idMatch

BAIG, A K H (UNITED STATES INDIVIDUAL),
DBA ARIZCON CORPORATION
2797 PARK AVE #200
SANTA CLARA, CA 95050

THE MARK CONSISTS OF STANDARD CHAR-
ACTERS WITHOUT CLAIM TO ANY PARTICULAR
FONT, STYLE, SIZE, OR COLOR.

FOR: COMPUTER SEARCH ENGINE SOFT-
WARE; COMPUTER SOFTWARE DEVELOPMENT
TOOLS, IN CLASS 9 (U.S. CLS. 21, 23, 26, 36 AND 38).

SER. NO. 77-397,748, FILED 2-14-2008.

FIRST USE 7-1-2007; IN COMMERCE 7-1-2007.

JOHN DALIER, EXAMINING ATTORNEY

Int. Cls.: 35, 36 and 41

Prior U.S. Cls.: 100, 101, 102 and 107

United States Patent and Trademark Office

Reg. No. 3,575,071

Registered Feb. 17, 2009

**SERVICE MARK
PRINCIPAL REGISTER**

Ask Kidder.

KIDDER BENEFITS CONSULTANTS, INC.
(IOWA CORPORATION)
5700 WESTOWN PARKWAY, SUITE 100
WEST DES MOINES, IA 50266

FOR: COST MANAGEMENT CONSULTING FOR
THE EMPLOYEE PENSION PLANS OF OTHERS, IN
CLASS 35 (U.S. CLS. 100, 101 AND 102).

FIRST USE 9-30-2007; IN COMMERCE 9-30-2007.

FOR: ADMINISTRATION CONSULTING SERVI-
CES IN THE FIELD OF EMPLOYEE PENSION
PLANS; ADMINISTRATION OF EMPLOYEE PEN-
SION PLANS, IN CLASS 36 (U.S. CLS. 100, 101 AND
102).

FIRST USE 9-30-2007; IN COMMERCE 9-30-2007.

FOR: EDUCATION SERVICES, NAMELY, PRO-
VIDING SEMINARS IN THE FIELD OF EMPLOYEE
PENSION PLANS, IN CLASS 41 (U.S. CLS. 100, 101
AND 107).

FIRST USE 9-30-2007; IN COMMERCE 9-30-2007.

THE MARK CONSISTS OF STANDARD CHAR-
ACTERS WITHOUT CLAIM TO ANY PARTICULAR
FONT, STYLE, SIZE, OR COLOR.

SER. NO. 77-397,948, FILED 2-15-2008.

RAMONA ORTIGA, EXAMINING ATTORNEY

Int. Cls.: 5 and 10

Prior U.S. Cls.: 6, 18, 26, 39, 44, 46, 51 and 52

United States Patent and Trademark Office

Reg. No. 3,575,072

Registered Feb. 17, 2009

**TRADEMARK
PRINCIPAL REGISTER**

XCELLENCE

HENKEL AG & CO. KGAA (FED REP GERMANY
PARTNERSHIP LIMITED BY SHARES)
HENKELSTRASSE 67
DUESSELDORF, FED REP GERMANY 40589

FOR: ADHESIVES AND TISSUE BONDING SUB-
STANCES USED FOR SURGICAL AND MEDICAL
PURPOSES, IN CLASS 5 (U.S. CLS. 6, 18, 44, 46, 51
AND 52).

FOR: APPLICATORS TO BE USED IN CONNec-
TION WITH ADHESIVES AND TISSUE BONDING
SUBSTANCES USED FOR SURGICAL AND MEDI-
CAL PURPOSES, IN CLASS 10 (U.S. CLS. 26, 39 AND
44).

THE MARK CONSISTS OF STANDARD CHAR-
ACTERS WITHOUT CLAIM TO ANY PARTICULAR
FONT, STYLE, SIZE, OR COLOR.

PRIORITY CLAIMED UNDER SEC. 44(D) ON FED
REP GERMANY APPLICATION NO. 30753640.8,
FILED 8-16-2007, REG. NO. 30753640, DATED 11-9-
2007, EXPIRES 8-31-2017.

SER. NO. 77-398,003, FILED 2-15-2008.

JACLYN KIDWELL, EXAMINING ATTORNEY

Int. Cl.: 10

Prior U.S. Cls.: 26, 39 and 44

United States Patent and Trademark Office

Reg. No. 3,575,073

Registered Feb. 17, 2009

**TRADEMARK
PRINCIPAL REGISTER**

SPIRITUS

INNOMED TECHNOLOGIES, INC. (NEVADA CORPORATION)
BUILDING B1,4
6601 LYONS ROAD
COCONUT CREEK, FL 33073

FOR: NASAL VENTILATORS FOR MEDICAL PURPOSES AND RESPIRATORS FOR ARTIFICIAL RESPIRATION FOR MEDICAL PURPOSES; CONTINUOUS POSITIVE AIRWAY PRESSURE (CPAP) COMPRESSORS AND MONITORS FOR MEDICAL USE FOR REGULATING AND MONITORING BREATHING; BI-LEVEL POSITIVE AIRWAY PRESSURE COMPRESSORS AND MONITORS FOR MEDICAL USE FOR REGULATING AND MONITORING BREATHING; AND RESPIRATORY FACIAL MASKS FOR USE IN CONNECTION WITH NASAL VENTILATION INTERFACE AND RESPIRATORS, CONTINUOUS POSITIVE AIRWAY PRESSURE

(CPAP) COMPRESSORS, AND BI-LEVEL POSITIVE AIRWAY PRESSURE COMPRESSORS, ALL FOR MEDICAL PURPOSES, IN CLASS 10 (U.S. CLS. 26, 39 AND 44).

FIRST USE 0-0-2002; IN COMMERCE 0-0-2002.

THE MARK CONSISTS OF STANDARD CHARACTERS WITHOUT CLAIM TO ANY PARTICULAR FONT, STYLE, SIZE, OR COLOR.

THE FOREIGN WORDING IN THE MARK TRANSLATES INTO ENGLISH AS SPIRIT.

SER. NO. 77-398,019, FILED 2-15-2008.

Laurie Mayes, Examining Attorney

Int. Cl.: 35

Prior U.S. Cls.: 100, 101 and 102

United States Patent and Trademark Office

Reg. No. 3,575,074

Registered Feb. 17, 2009

**SERVICE MARK
PRINCIPAL REGISTER**



VOYAGE IP, LLC (FLORIDA LIMITED LIABILITY COMPANY)
SUITE 2051
1485 INTERNATIONAL PARKWAY
HEATHROW, FL 32746

FOR: EMPLOYMENT SERVICES, NAMELY, RECRUITING, PLACEMENT, STAFFING, CAREER NETWORKING SERVICES, AND PLACEMENT OF PERSONNEL ON A TEMPORARY OR PERMANENT BASIS IN THE FIELDS OF NURSING, LICENSED PRACTICAL NURSING, NURSE ANESTHETISTS AND NURSE PRACTITIONERS, IN CLASS 35 (U.S. CLS. 100, 101 AND 102).

FIRST USE 5-8-2007; IN COMMERCE 5-8-2007.

NO CLAIM IS MADE TO THE EXCLUSIVE RIGHT TO USE "NURSING", APART FROM THE MARK AS SHOWN.

THE MARK CONSISTS OF THE UNDERLINED WORD "VOYAGE" OVER THE WORD "NURSING" WITH A STYLIZED MEDICAL CROSS INSIDE THE LETTER "O".

SER. NO. 77-398,309, FILED 2-15-2008.

KIMBERLY FRYE, EXAMINING ATTORNEY

Int. Cl.: 33

Prior U.S. Cls.: 47 and 49

United States Patent and Trademark Office

Reg. No. 3,575,075

Registered Feb. 17, 2009

**TRADEMARK
PRINCIPAL REGISTER**

KULETO ESTATE

KULETO VILLA, LLC (CALIFORNIA LIMITED
LIABILITY COMPANY)
2470 SAGE CANYON ROAD
ST. HELENA, CA 94574

NO CLAIM IS MADE TO THE EXCLUSIVE
RIGHT TO USE "ESTATE", APART FROM THE
MARK AS SHOWN.

FOR: WINES, IN CLASS 33 (U.S. CLS. 47 AND 49).

FIRST USE 10-0-2001; IN COMMERCE 10-0-2001.

SER. NO. 77-398,556, FILED 2-15-2008.

THE MARK CONSISTS OF STANDARD CHAR-
ACTERS WITHOUT CLAIM TO ANY PARTICULAR
FONT, STYLE, SIZE, OR COLOR.

SUSAN LESLIE DUBOIS, EXAMINING ATTORNEY

Int. Cl.: 18

Prior U.S. Cls.: 1, 2, 3, 22 and 41

United States Patent and Trademark Office

Reg. No. 3,575,076

Registered Feb. 17, 2009

**TRADEMARK
PRINCIPAL REGISTER**

PortaPocket

UNDERCOVER SOLUTIONS, LLC (ILLINOIS
LIMITED LIABILITY COMPANY)
109 E. OLIVE AVENUE
PROSPECT HEIGHTS, IL 60070

FOR: WEARABLE STRAP-ON POUCH TO BE
OPTIONALLY DETACHABLE AND OPTIONALLY
WORN OVER OR UNDER CLOTHING TO CARRY
SMALL ITEMS OF PERSONAL IMPORTANCE , IN
CLASS 18 (U.S. CLS. 1, 2, 3, 22 AND 41).

FIRST USE 10-12-2007; IN COMMERCE 12-8-2007.

THE MARK CONSISTS OF COMPOUND WORD
"PORTAPOCKET" WITH A STYLIZED 2ND "O"
THAT ITSELF RESEMBLES A POCKET.

SER. NO. 77-398,746, FILED 2-15-2008.

JENNY PARK, EXAMINING ATTORNEY

Int. Cl.: 41

Prior U.S. Cls.: 100, 101 and 107

United States Patent and Trademark Office

Reg. No. 3,575,077

Registered Feb. 17, 2009

**SERVICE MARK
PRINCIPAL REGISTER**

Last Call Brawlers

LAST CALL BRAWLERS PARTNERSHIP (ARI-
ZONA PARTNERSHIP)
11411 E. EDISON
TUCSON, AZ 85749

THE MARK CONSISTS OF STANDARD CHAR-
ACTERS WITHOUT CLAIM TO ANY PARTICULAR
FONT, STYLE, SIZE, OR COLOR.

FOR: ENTERTAINMENT, NAMELY, LIVE PER-
FORMANCES BY A MUSICAL BAND, IN CLASS 41
(U.S. CLS. 100, 101 AND 107).

SER. NO. 77-399,428, FILED 2-18-2008.

FIRST USE 10-10-1999; IN COMMERCE 8-13-2003.

JENNIFER DIXON, EXAMINING ATTORNEY

Int. Cl.: 7

Prior U.S. Cls.: 13, 19, 21, 23, 31, 34 and 35

United States Patent and Trademark Office

Reg. No. 3,575,078

Registered Feb. 17, 2009

TRADEMARK
PRINCIPAL REGISTER



ESRMCO INC. (DELAWARE CORPORATION)
2366 BERNVILLE ROAD
READING, PA 19605

FOR: BATTERY HANDLING EQUIPMENT EX-
CLUSIVE OF ELECTRIC STORAGE BATTERIES,
NAMELY, BATTERY WASHERS, BATTERY
STANDS, CHARGE STATIONS, TUGGERS,
CHANGE CARS AND CRANES, IN CLASS 7 (U.S.
CLS. 13, 19, 21, 23, 31, 34 AND 35).

FIRST USE 1-15-2006; IN COMMERCE 2-1-2006.

OWNER OF U.S. REG. NO. 3,474,523.

NO CLAIM IS MADE TO THE EXCLUSIVE
RIGHT TO USE "PRO SERIES", APART FROM
THE MARK AS SHOWN.

THE MARK CONSISTS OF THE WORD "PRO" IN
BOLD UPPER CASE CHARACTERS AND THE
WORD "SERIES" IN STYLIZED TITLE CASE WITH
THE "S" OF "SERIES" INTERSECTING WITH THE
"O" OF "PRO".

SER. NO. 77-399,549, FILED 2-18-2008.

KYLE PEETE, EXAMINING ATTORNEY

Int. Cl.: 10

Prior U.S. Cls.: 26, 39 and 44

United States Patent and Trademark Office

Reg. No. 3,575,079

Registered Feb. 17, 2009

**TRADEMARK
PRINCIPAL REGISTER**

A Better Back

CLAUDAVERI, LLC (FLORIDA LIMITED LIABILITY COMPANY)

289

10097 CLEARLY BLVD (#289)

PLANTATION, FL 33324

FOR: PILLOWS FOR LUMBAR SUPPORT FOR MEDICAL AND THERAPEUTIC USE, IN CLASS 10 (U.S. CLS. 26, 39 AND 44).

FIRST USE 12-30-2006; IN COMMERCE 12-30-2006.

THE MARK CONSISTS OF STANDARD CHARACTERS WITHOUT CLAIM TO ANY PARTICULAR FONT, STYLE, SIZE, OR COLOR.

NO CLAIM IS MADE TO THE EXCLUSIVE RIGHT TO USE "BACK", APART FROM THE MARK AS SHOWN.

SER. NO. 77-399,670, FILED 2-18-2008.

MICHELE SWAIN, EXAMINING ATTORNEY

Int. Cl.: 9

Prior U.S. Cls.: 21, 23, 26, 36 and 38

Reg. No. 3,575,080

United States Patent and Trademark Office

Registered Feb. 17, 2009

**TRADEMARK
PRINCIPAL REGISTER**

Dance Mania

CHAMBERS, CHARLES (UNITED STATES INDIVIDUAL), DBA DANCE MANIA RECORDS
904 SOUTH 5TH AVENUE
MAYWOOD, IL 60153

THE MARK CONSISTS OF STANDARD CHARACTERS WITHOUT CLAIM TO ANY PARTICULAR FONT, STYLE, SIZE, OR COLOR.

FOR: AUDIO RECORDINGS FEATURING GHETTO HOUSE MUSIC, IN CLASS 9 (U.S. CLS. 21, 23, 26, 36 AND 38).

SER. NO. 77-399,851, FILED 2-18-2008.

FIRST USE 2-18-2008; IN COMMERCE 2-18-2008.

CHRISTINA SOBRAL, EXAMINING ATTORNEY

Int. Cl.: 3

Prior U.S. Cls.: 1, 4, 6, 50, 51 and 52

United States Patent and Trademark Office

Reg. No. 3,575,081

Registered Feb. 17, 2009

**TRADEMARK
PRINCIPAL REGISTER**



OTSUKA PHARMACEUTICAL CO., LTD. (JAPAN CORPORATION)
2-9, KANDA-TSUKASAMACHI, CHIYODA-KU
TOKYO, JAPAN

FOR: COSMETIC PREPARATIONS FOR BODY CARE, NAMELY, BODY CREAM, BODY MILKY LOTION AND BODY LOTION; COSMETICS; SOAPS, IN CLASS 3 (U.S. CLS. 1, 4, 6, 50, 51 AND 52).

PRIORITY CLAIMED UNDER SEC. 44(D) ON JAPAN APPLICATION NO. 2008-000710, FILED 1-9-

2008, REG. NO. 5149418, DATED 7-11-2008, EXPIRES 7-11-2018.

THE MARK CONSISTS OF A SHADOW OF A HUMAN FIGURE WALKING COMPRISED OF DOTS.

SER. NO. 77-400,231, FILED 2-19-2008.

RENEE SERVANCE, EXAMINING ATTORNEY

Int. Cl.: 41

Prior U.S. Cls.: 100, 101 and 107

United States Patent and Trademark Office

Reg. No. 3,575,082

Registered Feb. 17, 2009

**SERVICE MARK
PRINCIPAL REGISTER**

ESQUIRE

HEARST COMMUNICATIONS, INC. (DELA-
WARE CORPORATION)
959 EIGHTH AVENUE
NEW YORK, NY 10019

FOR: PROVIDING ON-LINE PUBLICATIONS IN
THE NATURE OF MAGAZINES IN THE FIELD OF
MEN'S INTERESTS, NAMELY, FASHION, HEALTH
AND FITNESS, RELATIONSHIPS, FINANCES, EN-
TERTAINMENT, ARTS AND CULTURE, PHILOSO-
PHY, HISTORY, HUMOR, AND TECHNOLOGY, IN
CLASS 41 (U.S. CLS. 100, 101 AND 107).

FIRST USE 6-19-2000; IN COMMERCE 6-19-2000.

THE MARK CONSISTS OF STANDARD CHAR-
ACTERS WITHOUT CLAIM TO ANY PARTICULAR
FONT, STYLE, SIZE, OR COLOR.

OWNER OF U.S. REG. NOS. 168,186, 1,413,197 AND
OTHERS.

SER. NO. 77-400,547, FILED 2-19-2008.

DAVID I, EXAMINING ATTORNEY

Int. Cl.: 38

Prior U.S. Cls.: 100, 101 and 104

United States Patent and Trademark Office

Reg. No. 3,575,083

Registered Feb. 17, 2009

**SERVICE MARK
PRINCIPAL REGISTER**

FANSONLY.COM

CSTV ONLINE INC. (DELAWARE CORPORATION)
85 TENTH AVENUE, THIRD FLOOR
NEW YORK, NY 10011

FOR: BROADCASTING SERVICES, NAMELY, TRANSMITTING, DOWNLOADING AND STREAMING DIGITAL AUDIO, VIDEO, GRAPHICS, TEXT AND DATA IN THE FIELD OF SPORTS AND ATHLETICS, RENDERED VIA THE INTERNET, AND PORTABLE AND WIRELESS COMMUNICATION DEVICES, IN CLASS 38 (U.S. CLS. 100, 101 AND 104).

FIRST USE 1-24-2008; IN COMMERCE 1-24-2008.

THE MARK CONSISTS OF STANDARD CHARACTERS WITHOUT CLAIM TO ANY PARTICULAR FONT, STYLE, SIZE, OR COLOR.

OWNER OF U.S. REG. NO. 2,320,066.

NO CLAIM IS MADE TO THE EXCLUSIVE RIGHT TO USE ".COM", APART FROM THE MARK AS SHOWN.

SER. NO. 77-400,675, FILED 2-19-2008.

CAROLYN GRAY, EXAMINING ATTORNEY

Int. Cl.: 38

Prior U.S. Cls.: 100, 101 and 104

United States Patent and Trademark Office

Reg. No. 3,575,084

Registered Feb. 17, 2009

**SERVICE MARK
PRINCIPAL REGISTER**

Conferendum

CONFERENDUM GMBH (FED REP GERMANY
LIMITED LIABILITY COMPANY)
AGNES-POCKELS-BOGEN 1
MÜNCHEN, FED REP GERMANY 80992

FOR: PROVIDING PLATFORMS FOR THE IN-
TERNET, NAMELY, PROVIDING WEB CONFER-
ENCING SERVICES, IN CLASS 38 (U.S. CLS. 100, 101
AND 104).

FIRST USE 9-0-2007; IN COMMERCE 10-0-2007.

THE MARK CONSISTS OF STANDARD CHAR-
ACTERS WITHOUT CLAIM TO ANY PARTICULAR
FONT, STYLE, SIZE, OR COLOR.

OWNER OF FED REP GERMANY REG. NO.
30756850.4, DATED 12-17-2007, EXPIRES 8-31-2017.

SER. NO. 77-401,018, FILED 2-20-2008.

KATHRYN COWARD, EXAMINING ATTORNEY

Int. Cl.: 35

Prior U.S. Cls.: 100, 101 and 102

United States Patent and Trademark Office

Reg. No. 3,575,085

Registered Feb. 17, 2009

**SERVICE MARK
PRINCIPAL REGISTER**

NEWFOUND NAMES

DUNN, ALAN (UNITED STATES INDIVIDUAL)
2800 NE 59 COURT
FORT LAUDERDALE, FL 33308

FIRST USE 12-0-2007; IN COMMERCE 12-0-2007.

FOR: BUSINESS SERVICES RELATING TO THE ACQUISITION AND DEVELOPMENT OF DOMAIN NAMES; SERVICES RELATING TO THE ANALYSIS, EVALUATION, CREATION AND BRAND ESTABLISHMENT OF TRADEMARKS, TRADE NAMES AND DOMAIN NAMES, IN CLASS 35 (U.S. CLS. 100, 101 AND 102).

THE MARK CONSISTS OF STANDARD CHARACTERS WITHOUT CLAIM TO ANY PARTICULAR FONT, STYLE, SIZE, OR COLOR.

SER. NO. 77-401,150, FILED 2-20-2008.

THOMAS MANOR, EXAMINING ATTORNEY

Int. Cl.: 41

Prior U.S. Cls.: 100, 101 and 107

United States Patent and Trademark Office

Reg. No. 3,575,086

Registered Feb. 17, 2009

**SERVICE MARK
PRINCIPAL REGISTER**



ADVERMOTION, LLC (COLORADO LIMITED
LIABILITY COMPANY)
1117 CHEROKEE STREET, SUITE 100
DENVER, CO 80204

FOR: PROVIDING A WEB SITE ALLOWING WEB
SITE USERS TO UPLOAD ONLINE VIDEOS AUDIO
FILES AND PHOTOS FOR SHARING WITH OTH-
ERS FOR ENTERTAINMENT PURPOSES ALSO
FEATURING LIVE STREAMING EVENTS FROM
WITHIN NIGHTCLUBS BARS AND PAY PER VIEW
EVENTS THAT USERS OF THE WEBSITE MAY
PURCHASE, IN CLASS 41 (U.S. CLS. 100, 101 AND
107).

FIRST USE 5-1-2007; IN COMMERCE 2-10-2008.

NO CLAIM IS MADE TO THE EXCLUSIVE
RIGHT TO USE "CLUB", APART FROM THE MARK
AS SHOWN.

THE COLOR(S) BLACK AND BLUE GRADIENT
COLORS IS/ARE CLAIMED AS A FEATURE OF
THE MARK.

THE MARK CONSISTS OF "CLUB": BLACK IN
LETTERING "OPTIC": BLUE GRADIENT IN COL-
OR WITH A HALO AROUND THE "O".

SER. NO. 77-401,340, FILED 2-20-2008.

ANNE MADDEN, EXAMINING ATTORNEY

Int. Cl.: 41

Prior U.S. Cls.: 100, 101 and 107

United States Patent and Trademark Office

Reg. No. 3,575,087

Registered Feb. 17, 2009

**SERVICE MARK
PRINCIPAL REGISTER**

WHAT IVE LEARNED

HEARST COMMUNICATIONS, INC. (DELA-
WARE CORPORATION)
959 EIGHTH AVENUE
NEW YORK, NY 10019

FOR: PROVIDING ON-LINE PUBLICATIONS IN
THE NATURE OF MAGAZINES IN THE FIELD OF
MENS INTERESTS, NAMELY, FASHION, HEALTH
AND FITNESS, RELATIONSHIPS, FINANCES, EN-
TERTAINMENT, ARTS AND CULTURE, PHILOSO-
PHY, HISTORY, HUMOR, AND TECHNOLOGY, IN
CLASS 41 (U.S. CLS. 100, 101 AND 107).

FIRST USE 1-31-1999; IN COMMERCE 1-31-1999.

THE MARK CONSISTS OF STANDARD CHAR-
ACTERS WITHOUT CLAIM TO ANY PARTICULAR
FONT, STYLE, SIZE, OR COLOR.

SER. NO. 77-401,390, FILED 2-20-2008.

DAVID I, EXAMINING ATTORNEY

Int. Cl.: 40

Prior U.S. Cls.: 100, 103 and 106

United States Patent and Trademark Office

Reg. No. 3,575,088

Registered Feb. 17, 2009

**SERVICE MARK
PRINCIPAL REGISTER**

REINVENTING
RADIOGRAPHY...ONE IMAGE AT
A TIME

X RAY CASSETTE REPAIR CO., INC. (ILLINOIS
CORPORATION), DBA REINA IMAGING
6107 WEST LOU STREET
CRYSTAL LAKE, IL 60014

FOR: CUSTOM MANUFACTURE OF ANTI SCAT-
TER GRIDS, CABINETS, ENCASEMENTS, HOLD-
ERS, CASSETTES, AND GENERAL PRODUCTS IN
THE FIELD OF RADIOGRAPHY , IN CLASS 40 (U.S.
CLS. 100, 103 AND 106).

FIRST USE 7-1-2007; IN COMMERCE 7-1-2007.

THE MARK CONSISTS OF STANDARD CHAR-
ACTERS WITHOUT CLAIM TO ANY PARTICULAR
FONT, STYLE, SIZE, OR COLOR.

NO CLAIM IS MADE TO THE EXCLUSIVE
RIGHT TO USE RADIOGRAPHY, APART FROM
THE MARK AS SHOWN.

SER. NO. 77-402,008, FILED 2-20-2008.

KAREN K. BUSH, EXAMINING ATTORNEY

Int. Cls.: 19, 20, 21, 26, 28 and 34

**Prior U.S. Cls.: 1, 2, 8, 9, 12, 13, 17, 22, 23, 25, 29, 30,
32, 33, 37, 38, 39, 40, 42 and 50**

Reg. No. 3,575,089

United States Patent and Trademark Office

Registered Feb. 17, 2009

**TRADEMARK
PRINCIPAL REGISTER**

GIMLI

THE SAUL ZAENTZ COMPANY (DELAWARE
CORPORATION)
2600 TENTH STREET
BERKELEY, CA 94710

FOR: COLLECTIBLE CERAMIC TILES, IN CLASS
19 (U.S. CLS. 1, 12, 33 AND 50).

FIRST USE 6-1-2005; IN COMMERCE 2-13-2008.

FOR: ORNAMENTS MADE OF RESIN; NON-
METAL AND NON-LEATHER KEYCHAINS, IN
CLASS 20 (U.S. CLS. 2, 13, 22, 25, 32 AND 50).

FIRST USE 4-21-2002; IN COMMERCE 2-13-2008.

FOR: COOKIE JARS, PEWTER SHOT GLASSES,
PEWTER GOBLETS, DECORATIVE PLATES, IN
CLASS 21 (U.S. CLS. 2, 13, 23, 29, 30, 33, 40 AND 50).

FIRST USE 6-18-2002; IN COMMERCE 2-13-2008.

FOR: ORNAMENTAL CLOTH PATCHES; ORNA-
MENTAL NOVELTY ENAMEL PINS, IN CLASS 26
(U.S. CLS. 37, 39, 40, 42 AND 50).

FIRST USE 5-17-2004; IN COMMERCE 2-13-2008.

FOR: TOY AXES; TOY ACCESSORY KIT CON-
SISTING PRIMARILY OF A TOY AX AND COS-
TUME, NAMELY, A HEADPIECE, CLOAK AND
BEARD FOR USE IN ROLE-PLAYING GAMES, IN
CLASS 28 (U.S. CLS. 22, 23, 38 AND 50).

FIRST USE 11-12-2003; IN COMMERCE 2-13-2008.

FOR: COLLECTIBLE TOBACCO PIPES, IN CLASS
34 (U.S. CLS. 2, 8, 9 AND 17).

FIRST USE 3-15-2005; IN COMMERCE 2-13-2008.

THE MARK CONSISTS OF STANDARD CHAR-
ACTERS WITHOUT CLAIM TO ANY PARTICULAR
FONT, STYLE, SIZE, OR COLOR.

OWNER OF U.S. REG. NOS. 2,679,480, 2,987,679
AND OTHERS.

SER. NO. 77-402,020, FILED 2-20-2008.

BRENDAN REGAN, EXAMINING ATTORNEY

Int. Cl.: 25

Prior U.S. Cls.: 22 and 39

United States Patent and Trademark Office

Reg. No. 3,575,090

Registered Feb. 17, 2009

**TRADEMARK
PRINCIPAL REGISTER**

WHAT MATTERS 2 YOU

WHAT MATTERS, LLC (CALIFORNIA LIMITED
LIABILITY COMPANY)
3033 LUNADA LANE
ALAMO, CA 94507

FIRST USE 6-17-2008; IN COMMERCE 8-16-2008.

FOR: CLOTHING AND ACCESSORIES, NAMELY,
TEE-SHIRTS, SHIRTS, HOODED SWEATSHIRTS,
SWEATSHIRTS, UNDERWEAR, BOXER BRIEFS,
BOXER SHORTS, PANTS, SWEAT JACKETS,
SWEAT PANTS, SWEAT SHORTS, SWEAT SUITS,
PAJAMAS, SOCKS, HEADBANDS, BANDANAS,
BELTS, HATS, BASEBALL CAPS, IN CLASS 25 (U.S.
CLS. 22 AND 39).

THE MARK CONSISTS OF STANDARD CHAR-
ACTERS WITHOUT CLAIM TO ANY PARTICULAR
FONT, STYLE, SIZE, OR COLOR.

SER. NO. 77-402,121, FILED 2-20-2008.

ESTHER BELENKER, EXAMINING ATTORNEY

Int. Cl.: 10

Prior U.S. Cls.: 26, 39 and 44

United States Patent and Trademark Office

Reg. No. 3,575,091

Registered Feb. 17, 2009

**TRADEMARK
PRINCIPAL REGISTER**

JASTY

JAPAN STENT TECHNOLOGY CO., LTD (JAPAN CORPORATION)
5303 HAGA, OKAYAMA-SHI
OKAYAMA, 701-1221, JAPAN

FOR: MEDICAL APPARATUS AND INSTRUMENTS, NAMELY, CATHETERS, GUIDEWIRES AND STENTS, IN CLASS 10 (U.S. CLS. 26, 39 AND 44).

THE MARK CONSISTS OF STANDARD CHARACTERS WITHOUT CLAIM TO ANY PARTICULAR FONT, STYLE, SIZE, OR COLOR.

PRIORITY CLAIMED UNDER SEC. 44(D) ON JAPAN APPLICATION NO. 2007-129392, FILED 12-25-2007, REG. NO. 5154995, DATED 8-1-2008, EXPIRES 8-1-2018.

SER. NO. 77-402,320, FILED 2-21-2008.

CYNTHIA TRIPI, EXAMINING ATTORNEY

Int. Cl.: 28

Prior U.S. Cls.: 22, 23, 38 and 50

United States Patent and Trademark Office

Reg. No. 3,575,092

Registered Feb. 17, 2009

**TRADEMARK
PRINCIPAL REGISTER**

POWER CHARGE

SRI SPORTS KABUSHIKI KAISHA (JAPAN CORPORATION), TA SRI SPORTS LIMITED
6-9 WAKINOHAMA-CHO 3-CHOME, CHUO-KU
KOBE-SHI, HYOGO, JAPAN

FOR: GOLF CLUBS, GOLF BALLS, GOLF BAGS,
GOLF CADDIE BAGS, IN CLASS 28 (U.S. CLS. 22, 23,
38 AND 50).

THE MARK CONSISTS OF STANDARD CHARACTERS WITHOUT CLAIM TO ANY PARTICULAR FONT, STYLE, SIZE, OR COLOR.

PRIORITY CLAIMED UNDER SEC. 44(D) ON
REPUBLIC OF KOREA APPLICATION NO. 2007-
0045984, FILED 8-30-2007, REG. NO. 40-0752888, DATED 7-8-2008, EXPIRES 7-8-2018.

SER. NO. 77-402,398, FILED 2-21-2008.

SETH A. RAPPAPORT, EXAMINING ATTORNEY

Int. Cl.: 10

Prior U.S. Cls.: 26, 39 and 44

Reg. No. 3,575,093

United States Patent and Trademark Office

Registered Feb. 17, 2009

**TRADEMARK
PRINCIPAL REGISTER**

I.T.S.

BLACKHAWK INDUSTRIES PRODUCT GROUP
UNLIMITED LLC (VIRGINIA LIMITED LIABILITY COMPANY)
6160 COMMANDER PARKWAY
NORFOLK, VA 23502

FOR: MEDICAL APPARATUS, NAMELY, A
TOURNIQUET SOLD AS AN INTEGRAL COMPONENT OF GARMENTS AND GARMENTS INCORPORATING A TOURNIQUET , IN CLASS 10 (U.S. CLS. 26, 39 AND 44).

FIRST USE 9-25-2006; IN COMMERCE 9-5-2007.

THE MARK CONSISTS OF STANDARD CHARACTERS WITHOUT CLAIM TO ANY PARTICULAR FONT, STYLE, SIZE, OR COLOR.

SER. NO. 77-402,664, FILED 2-21-2008.

ALEX KEAM, EXAMINING ATTORNEY

Int. Cls.: 35 and 36

Prior U.S. Cls.: 100, 101 and 102

United States Patent and Trademark Office

Reg. No. 3,575,094

Registered Feb. 17, 2009

**SERVICE MARK
PRINCIPAL REGISTER**

INSTIL HEALTH INTRUST

BLUE CROSS AND BLUE SHIELD OF SOUTH
CAROLINA (SOUTH CAROLINA CORPORATION)
I-20 AT ALPINE ROAD
COLUMBIA, SC 29219

FOR: HEALTH CARE CASE MANAGEMENT;
HEALTH CARE UTILIZATION MANAGEMENT
AND UTILIZATION REVIEW SERVICES; COST
MANAGEMENT FOR THE HEALTH CARE BENEFIT
PLANS OF OTHERS; HEALTH CARE COST
CONTAINMENT; HEALTH CARE COST REVIEW;
MANAGED CARE SERVICES, NAMELY, ELECTRONIC
PROCESSING OF HEALTH CARE INFORMATION,
IN CLASS 35 (U.S. CLS. 100, 101 AND 102).

FIRST USE 11-15-2007; IN COMMERCE 11-15-2007.

FOR: HEALTH CARE AND PRESCRIPTION
DRUG CLAIM ADMINISTRATION AND MANAGEMENT;
HEALTH CARE AND PRESCRIPTION

DRUG CLAIMS PROCESSING; PROVIDING
HEALTH CARE AND PRESCRIPTION DRUG
CLAIM INFORMATION; ADMINISTRATION OF
PRE-PAID HEALTH CARE PLANS; UNDERWRITING
HEALTH INSURANCE, IN CLASS 36 (U.S. CLS.
100, 101 AND 102).

FIRST USE 11-15-2007; IN COMMERCE 11-15-2007.

THE MARK CONSISTS OF STANDARD CHARACTERS
WITHOUT CLAIM TO ANY PARTICULAR FONT,
STYLE, SIZE, OR COLOR.

NO CLAIM IS MADE TO THE EXCLUSIVE
RIGHT TO USE "HEALTH", APART FROM THE
MARK AS SHOWN.

SER. NO. 77-402,778, FILED 2-21-2008.

CAROLYN GRAY, EXAMINING ATTORNEY

Int. Cls.: 36 and 37

Prior U.S. Cls.: 100, 101, 102, 103 and 106

United States Patent and Trademark Office

Reg. No. 3,575,095

Registered Feb. 17, 2009

**SERVICE MARK
PRINCIPAL REGISTER**

SMART & HANDY

DAVID M. GOULD, JR. (UNITED STATES INDIVIDUAL)
10251 HILL ROAD
GARDEN GROVE, CA 92840

FOR: MANAGEMENT OF RESIDENTIAL AND COMMERCIAL PROPERTY, IN CLASS 36 (U.S. CLS. 100, 101 AND 102).

FIRST USE 10-11-2002; IN COMMERCE 10-11-2002.

FOR: MAINTENANCE AND REPAIR OF RESIDENTIAL AND COMMERCIAL BUILDINGS; BUILDING CONSTRUCTION; INSTALLATION OF ROOFING, FLOORS, WALLS, DRYWALL, ELECTRICAL FIXTURES, PLUMBING FIXTURES,

BUILDING INSULATION, KITCHEN CABINETS, DOORS, WINDOWS, BASE BOARDS, AND CROWN MOLDING, IN CLASS 37 (U.S. CLS. 100, 103 AND 106).

FIRST USE 10-11-2002; IN COMMERCE 10-11-2002.

THE MARK CONSISTS OF STANDARD CHARACTERS WITHOUT CLAIM TO ANY PARTICULAR FONT, STYLE, SIZE, OR COLOR.

SER. NO. 77-402,815, FILED 2-21-2008.

LINDA LAVACHE, EXAMINING ATTORNEY

Int. Cl.: 41

Prior U.S. Cls.: 100, 101 and 107

United States Patent and Trademark Office

Reg. No. 3,575,096

Registered Feb. 17, 2009

**SERVICE MARK
PRINCIPAL REGISTER**



A Priori Press

A PRIORI PRESS LLC (FLORIDA LIMITED LIABILITY COMPANY)
6447 TABOGI TRAIL
WESLEY CHAPEL, FL 33544

FOR: BOOK PUBLISHING, NEWSPAPER PUBLISHING, MAGAZINE PUBLISHING, PUBLISHING OF REVIEWS, PUBLISHING OF ELECTRONIC PUBLICATIONS, IN CLASS 41 (U.S. CLS. 100, 101 AND 107).

FIRST USE 9-1-2007; IN COMMERCE 9-1-2007.

NO CLAIM IS MADE TO THE EXCLUSIVE RIGHT TO USE "PRESS", APART FROM THE MARK AS SHOWN.

SER. NO. 77-402,843, FILED 2-21-2008.

LINDSEY RUBIN, EXAMINING ATTORNEY

Int. Cl.: 9

Prior U.S. Cls.: 21, 23, 26, 36 and 38

United States Patent and Trademark Office

Reg. No. 3,575,097

Registered Feb. 17, 2009

**TRADEMARK
PRINCIPAL REGISTER**

WaveTrap

THINKOM SOLUTIONS, INC. (CALIFORNIA
CORPORATION)
20000 MARINER AVENUE SUITE 500
TORRANCE, CA 90503

THE MARK CONSISTS OF STANDARD CHAR-
ACTERS WITHOUT CLAIM TO ANY PARTICULAR
FONT, STYLE, SIZE, OR COLOR.

FOR: ANTENNAS; ANTENNAS FOR WIRELESS
COMMUNICATIONS APPARATUS; MICROWAVE
ANTENNAE, IN CLASS 9 (U.S. CLS. 21, 23, 26, 36 AND
38).

SER. NO. 77-403,170, FILED 2-21-2008.

FIRST USE 0-0-2006; IN COMMERCE 0-0-2006.

IRA J. GOODSaid, EXAMINING ATTORNEY

Int. Cl.: 9

Prior U.S. Cls.: 21, 23, 26, 36 and 38

Reg. No. 3,575,098

United States Patent and Trademark Office

Registered Feb. 17, 2009

**TRADEMARK
PRINCIPAL REGISTER**

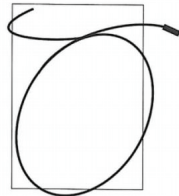

Synergistic Research

DENNEY, THEODORE W., III (UNITED STATES
INDIVIDUAL)

#102

17401 ARMSTRONG AVENUE
IRVINE, CA 92614

FOR: ELECTRICAL AUDIO AND VIDEO
CABLES, AC POWER CABLES, ELECTRICAL
CABLES WHICH TRANSMIT DIGITAL DATA,
ELECTRICAL AUDIO SPEAKER WIRES, AND DC
VOLTAGE GENERATORS, IN CLASS 9 (U.S. CLS. 21,
23, 26, 36 AND 38).

FIRST USE 8-0-1992; IN COMMERCE 8-0-1992.

THE MARK CONSISTS OF LOOPED CABLE IN-
SIDE A RECTANGULAR BOX

SER. NO. 77-403,625, FILED 2-22-2008.

CARYN GLASSER, EXAMINING ATTORNEY

Int. Cl.: 1

Prior U.S. Cls.: 1, 5, 6, 10, 26 and 46

Reg. No. 3,575,099

United States Patent and Trademark Office

Registered Feb. 17, 2009

**TRADEMARK
PRINCIPAL REGISTER**



OIL-DRI CORPORATION OF AMERICA (DELA-
WARE CORPORATION)
SUITE 400
410 NORTH MICHIGAN AVENUE
CHICAGO, IL 60611

OWNER OF U.S. REG. NO. 2,271,997.

FOR: MINERAL SOIL CONDITIONERS, DRYING
AGENTS AND PACKING CLAY IN THE NATURE
OF GRANULAR MATERIAL, ALL FOR USE ON
SPORTS FIELDS, IN CLASS 1 (U.S. CLS. 1, 5, 6, 10, 26
AND 46).

NO CLAIM IS MADE TO THE EXCLUSIVE
RIGHT TO USE "SPORTS FIELD PRODUCTS",
APART FROM THE MARK AS SHOWN.

SER. NO. 77-403,978, FILED 2-22-2008.

FIRST USE 9-30-2006; IN COMMERCE 9-30-2006.

CARRIE GENOVESE, EXAMINING ATTORNEY

Int. Cl.: 5

Prior U.S. Cls.: 6, 18, 44, 46, 51 and 52

Reg. No. 3,575,100

United States Patent and Trademark Office

Registered Feb. 17, 2009

**TRADEMARK
PRINCIPAL REGISTER**

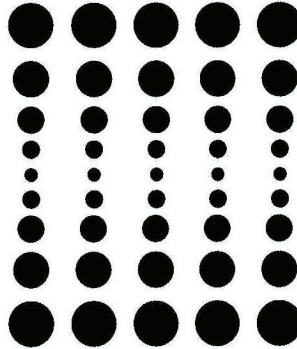

QUINNOVA PHARMACEUTICALS, INC. (DELA-
WARE CORPORATION)
411 SOUTH STATE STREET, THIRD FLOOR
NEWTOWN, PA 18940

FOR: DERMATOLOGICAL PHARMACEUTICAL
PRODUCTS; PHARMACEUTICAL PREPARATIONS
FOR TREATING SKIN DISORDERS; PHARMACEU-
TICAL PREPARATIONS FOR USE IN DERMATOL-
OGY; PHARMACEUTICAL SKIN LOTIONS, IN
CLASS 5 (U.S. CLS. 6, 18, 44, 46, 51 AND 52).

FIRST USE 6-1-2007; IN COMMERCE 6-1-2007.

THE MARK CONSISTS OF FIVE VERTICAL
ROWS EACH WITH NINE CIRCLES OF VARIOUS
SIZES.

SER. NO. 77-404,063, FILED 2-22-2008.

RENEE SERVANCE, EXAMINING ATTORNEY

Int. Cl.: 42

Prior U.S. Cls.: 100 and 101

United States Patent and Trademark Office

Reg. No. 3,575,101

Registered Feb. 17, 2009

**SERVICE MARK
PRINCIPAL REGISTER**

TWOFISH

TWOFISH, INC. (DELAWARE CORPORATION)
580 COLLEGE AVENUE
PALO ALTO, CA 94306

FOR: COMPUTER SOFTWARE DESIGN FOR OTHERS; COMPUTER SERVICES, NAMELY, DESIGNING, CONSULTING, DEVELOPING, INSTALLING, ADMINISTERING AND IMPLEMENTING COMPUTER SOFTWARE AND SOFTWARE APPLICATIONS TO ENABLE INTEGRATION OF ADVANCED COMMERCE, ASSET MANAGEMENT, AND ANALYTICS INTO ONLINE GAMES, VIRTUAL WORLDS, SOCIAL NETWORKS, AND WEBSITES; COMPUTER SERVICES, NAMELY, HOSTING SOFTWARE SERVERS FOR OTHER AND PROVIDING TEMPORARY USE OF NON-DOWNLOADABLE SOFTWARE TO ENABLE THE ACCESS, MANAGEMENT, BUYING, SELLING, TRADING, TRANSFER, ASSIGNMENT, AND AUCTIONING OF VIRTUAL AND REAL-WORLD ITEMS AND ASSETS, INCLUDING CURRENCIES; COMPUTER SERVICES, NAMELY, PROVIDING HOSTING SOFTWARE SERVERS FOR USE BY OTHER AND TEMPORARY USE OF NON-DOWNLOADABLE SOFTWARE FOR THE MANAGEMENT AND ADMINISTRATION OF ONLINE ASSET INVENTORY SYSTEMS IN VIRTUAL WORLDS, COM-

PUTER GAMES AND SOCIAL NETWORKING WEBSITES, INCLUDING ASSET LIFECYCLE MANAGEMENT, REPORTING AND ANALYTICS, CUSTOMER PROFILING, DECISION SUPPORT, AND OPTIMIZATION; PROVIDING TEMPORARY USE OF NON-DOWNLOADABLE COMPUTER SOFTWARE FOR THE MANAGEMENT, TRANSMISSION, STORAGE, AND SHARING OF ELECTRONICALLY STORED INFORMATION IN VIRTUAL WORLDS, COMPUTER GAMES AND SOCIAL NETWORKING WEBSITES ACROSS COMPUTER NETWORKS; COMPUTER SERVICES, NAMELY, CREATING AN ONLINE COMMUNITY FOR USERS TO FORM VIRTUAL COMMUNITIES AND ENGAGE IN SOCIAL NETWORKING, IN CLASS 42 (U.S. CLS. 100 AND 101).

FIRST USE 2-9-2007; IN COMMERCE 2-9-2007.

THE MARK CONSISTS OF STANDARD CHARACTERS WITHOUT CLAIM TO ANY PARTICULAR FONT, STYLE, SIZE, OR COLOR.

SER. NO. 77-404,367, FILED 2-22-2008.

DAYNA BROWNE, EXAMINING ATTORNEY

Int. Cl.: 33

Prior U.S. Cls.: 47 and 49

United States Patent and Trademark Office

Reg. No. 3,575,102

Registered Feb. 17, 2009

TRADEMARK
PRINCIPAL REGISTER



CASONI FABBRICAZIONE LIQUORI S.P.A. (ITALY CORPORATION)
VIA VENEZIA 5A - POLO INDUSTRIALE
FINALE EMILIA (MODENA), ITALY I-41034

FOR: LEMON BASED LIQUEURS AND SPIRITS,
IN CLASS 33 (U.S. CLS. 47 AND 49).

FIRST USE 7-31-2007; IN COMMERCE 7-31-2007.

OWNER OF U.S. REG. NO. 2,670,712.

NO CLAIM IS MADE TO THE EXCLUSIVE RIGHT TO USE "LIMONCELLO DI SORRENTO LIQUEUR", APART FROM THE MARK AS SHOWN.

THE MARK CONSISTS OF A SQUARE BACKGROUND WITH INDENTED CURVED CORNERS AND AN OUTWARD CURVE TO THE TOP AND BOTTOM PLANES OF THE SQUARE. THERE IS A THIN CONTRASTING BORDER INSIDE THE SQUARE. AT THE TOP RIGHT HAND CORNER

OF THE SQUARE IS A DRAWING OF A CHERUB RIDING ATOP A LEMON THAT HAS WINGS ON EITHER SIDE OF THE LEMON. TO THE RIGHT OF THIS DESIGN ARE THE WORDS "LA LIMONCETTA". CENTERED IN THE SQUARE ARE THE WORDS "LIMONCELLO DI SORRENTO" IN SCRIPT ABOVE THE WORD "LIQUEUR" IN CAPITAL LETTERS, ALL ABOVE THE WORD "CASONI" IN SHADED LETTERING, WHICH IS WITHIN A LOZENGE SHAPED FIELD THAT HAS A CONTRASTING BORDER.

THE ENGLISH TRANSLATION OF THE WORD "LA LIMONCETTA" "LIMONCELLO DI SORRENTO LIQUEUR CASONI" IN THE MARK IS THE; LEMON LIQUEUR OF SORRENTO.

SER. NO. 77-404,870, FILED 2-25-2008.

DAVID COLLIER, EXAMINING ATTORNEY

Int. Cl.: 41

Prior U.S. Cls.: 100, 101 and 107

United States Patent and Trademark Office

Reg. No. 3,575,103

Registered Feb. 17, 2009

**SERVICE MARK
PRINCIPAL REGISTER**



RESULTS
Personal Training

MIKHAEL, JEAN-PIERRE (ITALY INDIVIDUAL)
26 PROSPECT STREET
RIDGEFIELD, CT 06877

FOR: PROVIDING INSTRUCTION IN THE FIELD
OF PHYSICAL EXERCISE, NAMELY, PERSONAL
TRAINER SERVICES, IN CLASS 41 (U.S. CLS. 100, 101
AND 107).

FIRST USE 4-20-2002; IN COMMERCE 4-20-2002.

NO CLAIM IS MADE TO THE EXCLUSIVE
RIGHT TO USE "PERSONAL TRAINING", APART
FROM THE MARK AS SHOWN.

THE MARK CONSISTS OF A BENT HUMAN
ARM HOLDING A CIRCULAR OBJECT WITH
LINES EMANATING FROM IT.

SER. NO. 77-405,096, FILED 2-25-2008.

KATHERINE E. HALMEN, EXAMINING ATTOR-
NEY

Int. Cl.: 9

Prior U.S. Cls.: 21, 23, 26, 36 and 38

Reg. No. 3,575,104

United States Patent and Trademark Office

Registered Feb. 17, 2009

**TRADEMARK
PRINCIPAL REGISTER**

MOBILE ASPECTS

MOBILE ASPECTS, INC. (PENNSYLVANIA CORPORATION)
SUITE 300
24 SOUTH 18TH STREET
PITTSBURGH, PA 15203

FOR: INVENTORY TRACKING AND MANAGEMENT SYSTEM FOR PHARMACEUTICALS, MEDICAL DEVICES, MEDICAL SUPPLIES, HEALTH CARE EQUIPMENT AND PATIENTS CONSISTING OF INTEGRATED RFID-ENABLED CABINETS, RFID TAGS AND COMPUTER SOFTWARE AND HARDWARE, IN CLASS 9 (U.S. CLS. 21, 23, 26, 36 AND 38).

FIRST USE 5-31-2002; IN COMMERCE 5-31-2002.

THE MARK CONSISTS OF STANDARD CHARACTERS WITHOUT CLAIM TO ANY PARTICULAR FONT, STYLE, SIZE, OR COLOR.

NO CLAIM IS MADE TO THE EXCLUSIVE RIGHT TO USE "MOBILE", APART FROM THE MARK AS SHOWN.

SER. NO. 77-405,251, FILED 2-25-2008.

STEVEN R. FINE, EXAMINING ATTORNEY

Int. Cl.: 25

Prior U.S. Cls.: 22 and 39

United States Patent and Trademark Office

Reg. No. 3,575,105

Registered Feb. 17, 2009

TRADEMARK
PRINCIPAL REGISTER

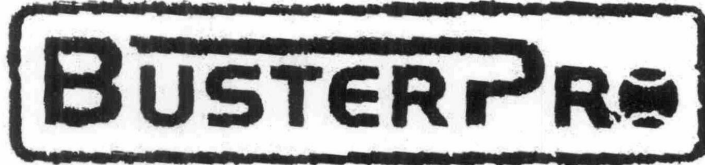

BUSTERPRO, INC. (CALIFORNIA CORPORATION)
10676 WILKINS AVENUE
LOS ANGELES, CA 90024

FOR: CLOTHING FOR MEN, WOMEN, AND CHILDREN, NAMELY, SHIRTS, TANK TOPS, T-SHIRTS, LONG-SLEEVED T-SHIRTS, HOODED SWEATSHIRTS, PANTS, BASEBALL HATS, SKORTS, THERMAL SHIRTS, JACKETS, COLLARED SHIRTS, RAGLAN SHIRTS, IN CLASS 25 (U.S. CLS. 22 AND 39).

FIRST USE 12-1-2007; IN COMMERCE 12-1-2007.

THE MARK CONSISTS OF THE TERM "BUSTERPRO" CONTAINED IN A RECTANGULAR DESIGN WITH A TENNIS BALL DESIGN COMPRISING THE LETTER "O".

SER. NO. 77-405,281, FILED 2-25-2008.

BILL DAWE, EXAMINING ATTORNEY

Int. Cl.: 9

Prior U.S. Cls.: 21, 23, 26, 36 and 38

Reg. No. 3,575,106

United States Patent and Trademark Office

Registered Feb. 17, 2009

**TRADEMARK
PRINCIPAL REGISTER**

SimBiotic Software

SIMBIOTIC SOFTWARE FOR TEACHING AND RESEARCH, INC. (NEW YORK CORPORATION)
148 GRANDVIEW COURT
ITHACA, NY 14850

FOR: EDUCATIONAL COMPUTER SOFTWARE AND CONSULTING ON COMPUTER SOFTWARE FOR TEACHING AND CONDUCTING SCIENTIFIC RESEARCH IN THE FIELDS OF ECOLOGY, EVOLUTION, CELL BIOLOGY AND OTHER SCIENTIFIC FIELDS, IN CLASS 9 (U.S. CLS. 21, 23, 26, 36 AND 38).

FIRST USE 1-1-2003; IN COMMERCE 0-0-2003.

THE MARK CONSISTS OF STANDARD CHARACTERS WITHOUT CLAIM TO ANY PARTICULAR FONT, STYLE, SIZE, OR COLOR.

NO CLAIM IS MADE TO THE EXCLUSIVE RIGHT TO USE "SOFTWARE", APART FROM THE MARK AS SHOWN.

SER. NO. 77-405,395, FILED 2-25-2008.

JOHN E. MICHOS, EXAMINING ATTORNEY

Int. Cl.: 44

Prior U.S. Cls.: 100 and 101

United States Patent and Trademark Office

Reg. No. 3,575,107

Registered Feb. 17, 2009

SERVICE MARK
PRINCIPAL REGISTER



CORAM, INC. (DELAWARE CORPORATION)
1675 BROADWAY, SUITE 900
DENVER, CO 80202

OWNER OF U.S. REG. NOS. 3,374,859, 3,374,861
AND OTHERS.

FOR: MEDICAL SERVICES, NAMELY, PROVIDING IN-HOME AND AMBULATORY DISPENSING AND ADMINISTERING OF INFUSION PHARMACEUTICALS, AND PROVIDING HEMOPHILIA, ANTI-INFECTIVES, PAIN REMEDIATION, PALLIATIVE CARE, CARDIAC, INOTROPIC, ANTITRYPSIN DEFICIENCY, PRE-TRANSPLANT, POST-TRANSPLANT, GROWTH HORMONE, HEPATITIS, OSTEOARTHRITIS, STEROID, IMMUNE DEFICIENCY, RHEUMATOID ARTHRITIS, MULTIPLE SCLEROSIS, INTERFERON, ALCOHOL DEPENDENCY, ONCOLOGY, FERTILITY, VACCINE AND NUTRITIONAL THERAPY SERVICES, IN CLASS 44 (U.S. CLS. 100 AND 101).

NO CLAIM IS MADE TO THE EXCLUSIVE RIGHT TO USE "SPECIALTY INFUSION SERVICES" AND "HEALTHCARE COMPANY", APART FROM THE MARK AS SHOWN.

THE MARK CONSISTS OF THE STYLIZED LETTERS "RX" WITH THE LETTER "X" COMPRISED OF A STYLIZED WATER DROPLET SUPERIMPOSED OVER A DIAMOND DESIGN WITH THE WORDING "CORAM," "SPECIALTY INFUSION SERVICES" AND "AN APRIA HEALTHCARE COMPANY" TO THE RIGHT OF THE RX AND DESIGN ELEMENTS.

FIRST USE 12-3-2007; IN COMMERCE 12-3-2007.

SER. NO. 77-405,464, FILED 2-25-2008.

MARTHA FROMM, EXAMINING ATTORNEY

Int. Cl.: 44

Prior U.S. Cls.: 100 and 101

United States Patent and Trademark Office

Reg. No. 3,575,108

Registered Feb. 17, 2009

**SERVICE MARK
PRINCIPAL REGISTER**

**CORAM specialty infusion
services An Apria
Healthcare Company**

CORAM, INC. (DELAWARE CORPORATION)
1675 BROADWAY, SUITE 900
DENVER, CO 80202

FOR: MEDICAL SERVICES, NAMELY, PROVIDING IN-HOME AND AMBULATORY DISPENSING AND ADMINISTERING OF INFUSION PHARMACEUTICALS, AND PROVIDING HEMOPHILIA, ANTI-INFECTIVES, PAIN REMEDIATION, PALLIATIVE CARE, CARDIAC, INOTROPIC, ANTITRYPSIN DEFICIENCY, PRE-TRANSPLANT, POST-TRANSPLANT, GROWTH HORMONE, HEPATITIS, OSTEOARTHRITIS, STEROID, IMMUNE DEFICIENCY, RHEUMATOID ARTHRITIS, MULTIPLE SCLEROSIS, INTERFERON, ALCOHOL DEPENDENCY, ONCOLOGY, FERTILITY, VACCINE AND NUTRITIONAL THERAPY SERVICES, IN CLASS 44 (U.S. CLS. 100 AND 101).

FIRST USE 12-3-2007; IN COMMERCE 12-3-2007.

THE MARK CONSISTS OF STANDARD CHARACTERS WITHOUT CLAIM TO ANY PARTICULAR FONT, STYLE, SIZE, OR COLOR.

OWNER OF U.S. REG. NOS. 3,374,859, 3,374,862 AND OTHERS.

NO CLAIM IS MADE TO THE EXCLUSIVE RIGHT TO USE "SPECIALTY INFUSION SERVICES" AND "HEALTHCARE COMPANY", APART FROM THE MARK AS SHOWN.

SER. NO. 77-405,468, FILED 2-25-2008.

MARTHA FROMM, EXAMINING ATTORNEY

Int. Cl.: 44

Prior U.S. Cls.: 100 and 101

United States Patent and Trademark Office

Reg. No. 3,575,109

Registered Feb. 17, 2009

SERVICE MARK
PRINCIPAL REGISTER



CORAM, INC. (DELAWARE CORPORATION)
1675 BROADWAY, SUITE 900
DENVER, CO 80202

FOR: MEDICAL SERVICES, NAMELY, PROVIDING IN-HOME INFUSION, INJECTABLE AND ORAL PHARMACEUTICALS TO OTHERS, AND PROVIDING HEMOPHILIA, ANTI-INFECTIVES, PAIN REMEDIATION, PALLIATIVE CARE, CARDIAC, INOTROPIC, ANTITRYPSIN DEFICIENCY, PRE-TRANSPLANT, POST-TRANSPLANT, GROWTH HORMONE, HEPATITIS, OSTEOARTHRITIS, STEROID, IMMUNE DEFICIENCY, RHEUMATOID ARTHRITIS, MULTIPLE SCLEROSIS, INTERFERON, ALCOHOL DEPENDENCY, ONCOLOGY, FERTILITY, VACCINE AND NUTRITIONAL THERAPY SERVICES, IN CLASS 44 (U.S. CLS. 100 AND 101).

FIRST USE 12-3-2007; IN COMMERCE 12-3-2007.

OWNER OF U.S. REG. NOS. 3,374,864, 3,374,867 AND OTHERS.

NO CLAIM IS MADE TO THE EXCLUSIVE RIGHT TO USE "SPECIALTY PHARMACY SERVICES" AND "HEALTHCARE COMPANY", APART FROM THE MARK AS SHOWN.

THE MARK CONSISTS OF THE STYLIZED LETTERS "RX" WITH THE LETTER "X" COMPRISED OF A STYLIZED WATER DROPLET SUPERIMPOSED OVER A DIAMOND DESIGN WITH THE WORDING "CORAMRX," "SPECIALTY PHARMACY SERVICES" AND "AN APRIA HEALTHCARE COMPANY" TO THE RIGHT OF THE STYLIZED RX AND DIAMOND DESIGN.

SER. NO. 77-405,473, FILED 2-25-2008.

MARTHA FROMM, EXAMINING ATTORNEY

Int. Cl.: 44

Prior U.S. Cls.: 100 and 101

United States Patent and Trademark Office

Reg. No. 3,575,110

Registered Feb. 17, 2009

**SERVICE MARK
PRINCIPAL REGISTER**

**CORAMRx specialty pharmacy
services An Apria Healthcare
Company**

CORAM, INC. (DELAWARE CORPORATION)
1675 BROADWAY, SUITE 900
DENVER, CO 80202

FOR: MEDICAL SERVICES, NAMELY, PROVIDING IN-HOME INFUSION, INJECTABLE AND ORAL PHARMACEUTICALS TO OTHERS, AND PROVIDING HEMOPHILIA, ANTI-INFECTIVES, PAIN REMEDIATION, PALLIATIVE CARE, CARDIAC, INOTROPIC, ANTITRYPSIN DEFICIENCY, PRE-TRANSPLANT, POST-TRANSPLANT, GROWTH HORMONE, HEPATITIS, OSTEOARTHRITIS, STEROID, IMMUNE DEFICIENCY, RHEUMATOID ARTHRITIS, MULTIPLE SCLEROSIS, INTERFERON, ALCOHOL DEPENDENCY, ONCOLOGY, FERTILITY, VACCINE AND NUTRITIONAL THERAPY SERVICES, IN CLASS 44 (U.S. CLS. 100 AND 101).

FIRST USE 12-3-2007; IN COMMERCE 12-3-2007.

THE MARK CONSISTS OF STANDARD CHARACTERS WITHOUT CLAIM TO ANY PARTICULAR FONT, STYLE, SIZE, OR COLOR.

OWNER OF U.S. REG. NOS. 3,374,863, 3,374,866 AND OTHERS.

NO CLAIM IS MADE TO THE EXCLUSIVE RIGHT TO USE "SPECIALTY PHARMACY SERVICES" AND "HEALTHCARE COMPANY", APART FROM THE MARK AS SHOWN.

SER. NO. 77-405,479, FILED 2-25-2008.

MARTHA FROMM, EXAMINING ATTORNEY

Int. Cl.: 35

Prior U.S. Cls.: 100, 101 and 102

United States Patent and Trademark Office

Reg. No. 3,575,111

Registered Feb. 17, 2009

SERVICE MARK
PRINCIPAL REGISTER



CORAM, INC. (DELAWARE CORPORATION)
1675 BROADWAY, SUITE 900
DENVER, CO 80202

FOR: PROCUREMENT, NAMELY, PURCHASING PHARMACEUTICALS FOR OTHERS; SUPPLYING PRESCRIPTION DRUGS TO HEALTH PLAN PARTICIPANTS FOR THE FUNDING ORGANIZATIONS, IN CLASS 35 (U.S. CLS. 100, 101 AND 102).

FIRST USE 12-3-2007; IN COMMERCE 12-3-2007.

OWNER OF U.S. REG. NOS. 3,374,863, 3,374,867 AND OTHERS.

NO CLAIM IS MADE TO THE EXCLUSIVE RIGHT TO USE "SPECIALTY PHARMACY SERVI-

CES" AND "HEALTHCARE COMPANY", APART FROM THE MARK AS SHOWN.

THE MARK CONSISTS OF THE STYLIZED LETTERS "RX" WITH THE LETTER "X" FORMING A WATER DROPLET SUPERIMPOSED OVER A DIAMOND DESIGN WITH THE WORDING "CORAMRX," "SPECIALTY PHARMACY SERVICES" AND "AN APRIA HEALTHCARE COMPANY" TO THE RIGHT OF THE STYLIZED RX AND DIAMOND DESIGN.

SER. NO. 77-405,483, FILED 2-25-2008.

MARTHA FROMM, EXAMINING ATTORNEY

Int. Cl.: 35

Prior U.S. Cls.: 100, 101 and 102

United States Patent and Trademark Office

Reg. No. 3,575,112

Registered Feb. 17, 2009

**SERVICE MARK
PRINCIPAL REGISTER**

**CORAMRx specialty pharmacy
services An Apria Healthcare
Company**

CORAM, INC. (DELAWARE CORPORATION)
1675 BROADWAY, SUITE 900
DENVER, CO 80202

OWNER OF U.S. REG. NOS. 3,374,863, 3,374,867
AND OTHERS.

FOR: PROCUREMENT, NAMELY, PURCHASING
PHARMACEUTICALS FOR OTHERS; SUPPLYING
PRESCRIPTION DRUGS TO HEALTH PLAN PAR-
TICIPANTS FOR THE FUNDING ORGANIZA-
TIONS, IN CLASS 35 (U.S. CLS. 100, 101 AND 102).

NO CLAIM IS MADE TO THE EXCLUSIVE
RIGHT TO USE "SPECIALTY PHARMACY SERVI-
CES" AND "HEALTHCARE COMPANY", APART
FROM THE MARK AS SHOWN.

FIRST USE 12-3-2007; IN COMMERCE 12-3-2007.

SER. NO. 77-405,488, FILED 2-25-2008.

THE MARK CONSISTS OF STANDARD CHAR-
ACTERS WITHOUT CLAIM TO ANY PARTICULAR
FONT, STYLE, SIZE, OR COLOR.

MARTHA FROMM, EXAMINING ATTORNEY

Int. Cl.: 35

Prior U.S. Cls.: 100, 101 and 102

United States Patent and Trademark Office

Reg. No. 3,575,113

Registered Feb. 17, 2009

SERVICE MARK
PRINCIPAL REGISTER



CORAM, INC. (DELAWARE CORPORATION)
1675 BROADWAY, SUITE 900
DENVER, CO 80202

FOR: PROCUREMENT, NAMELY, PURCHASING PHARMACEUTICALS FOR OTHERS; SUPPLYING PRESCRIPTION DRUGS TO HEALTH PLAN PARTICIPANTS FOR THE FUNDING ORGANIZATIONS, IN CLASS 35 (U.S. CLS. 100, 101 AND 102).

FIRST USE 12-3-2007; IN COMMERCE 12-3-2007.

OWNER OF U.S. REG. NOS. 3,374,859, 3,374,861 AND OTHERS.

NO CLAIM IS MADE TO THE EXCLUSIVE RIGHT TO USE "SPECIALTY INFUSION SERVICES"

AND "HEALTHCARE COMPANY", APART FROM THE MARK AS SHOWN.

THE MARK CONSISTS OF THE STYLIZED LETTERS "RX" WITH THE LETTER "X" COMPRISED OF A STYLIZED WATER DROPLET SUPERIMPOSED OVER A DIAMOND DESIGN WITH THE WORDING "CORAM," "SPECIALTY INFUSION SERVICES" AND "AN APRIA HEALTHCARE COMPANY" TO THE RIGHT OF THE RX AND DESIGN ELEMENTS.

SER. NO. 77-405,496, FILED 2-25-2008.

MARTHA FROMM, EXAMINING ATTORNEY

Int. Cl.: 35

Prior U.S. Cls.: 100, 101 and 102

United States Patent and Trademark Office

Reg. No. 3,575,114

Registered Feb. 17, 2009

**SERVICE MARK
PRINCIPAL REGISTER**

**CORAM specialty infusion
services An Apria
Healthcare Company**

CORAM, INC. (DELAWARE CORPORATION)
1675 BROADWAY, SUITE 900
DENVER, CO 80202

OWNER OF U.S. REG. NOS. 3,374,859, 3,374,861
AND OTHERS.

FOR: PROCUREMENT, NAMELY, PURCHASING
PHARMACEUTICALS FOR OTHERS; SUPPLYING
PRESCRIPTION DRUGS TO HEALTH PLAN PAR-
TICIPANTS FOR THE FUNDING ORGANIZA-
TIONS, IN CLASS 35 (U.S. CLS. 100, 101 AND 102).

NO CLAIM IS MADE TO THE EXCLUSIVE
RIGHT TO USE "SPECIALTY INFUSION SERVICES"
AND "HEALTHCARE COMPANY", APART FROM
THE MARK AS SHOWN.

FIRST USE 12-3-2007; IN COMMERCE 12-3-2007.

SER. NO. 77-405,503, FILED 2-25-2008.

THE MARK CONSISTS OF STANDARD CHAR-
ACTERS WITHOUT CLAIM TO ANY PARTICULAR
FONT, STYLE, SIZE, OR COLOR.

MARTHA FROMM, EXAMINING ATTORNEY

Int. Cl.: 25

Prior U.S. Cls.: 22 and 39

United States Patent and Trademark Office

Reg. No. 3,575,115

Registered Feb. 17, 2009

**TRADEMARK
PRINCIPAL REGISTER**

love your family

FOOTSTEPS CLOTHING LLC (NORTH CAROLINA LIMITED LIABILITY COMPANY)
702 RED TOP HILLS COURT
CARY, NC 27513

FOR: HOODS; INFANT AND TODDLER ONE PIECE CLOTHING; JERSEYS; TOPS; INFANT WEAR; LONG-SLEEVED SHIRTS; SHIRTS; SHORT-SLEEVED OR LONG-SLEEVED T-SHIRTS; SHORT-SLEEVED SHIRTS; SPORT SHIRTS; SWEAT SHIRTS; T-SHIRTS; TEE SHIRTS; TANK TOPS; PAJAMAS; SLEEPWEAR; LOUNGE PANTS; SWEAT PANTS; YOGA PANTS; CAPS; SWEAT SHORTS, IN CLASS 25 (U.S. CLS. 22 AND 39).

FIRST USE 10-0-2007; IN COMMERCE 10-0-2007.

THE MARK CONSISTS OF STANDARD CHARACTERS WITHOUT CLAIM TO ANY PARTICULAR FONT, STYLE, SIZE, OR COLOR.

SER. NO. 77-405,745, FILED 2-25-2008.

JOHN SCHUYLER YARD, EXAMINING ATTORNEY

Int. Cl.: 28

Prior U.S. Cls.: 22, 23, 38 and 50

United States Patent and Trademark Office

Reg. No. 3,575,116

Registered Feb. 17, 2009

**TRADEMARK
PRINCIPAL REGISTER**

KAMUI

KABUSHIKI KAISHA KAMUI WORKS JAPAN
(JAPAN LIMITED CORPORATION)
77-1 KUROSAKI, TOYAMA-SHI
TOYAMA, JAPAN 939

OWNER OF U.S. REG. NO. 2,202,062.

FOR: GOLF CLUBS, IN CLASS 28 (U.S. CLS. 22, 23,
38 AND 50).

THE ENGLISH TRANSLATION OF "KAMUI" IS
THE NAME OF A JAPANESE GOD.

FIRST USE 10-1-2007; IN COMMERCE 10-1-2007.

SER. NO. 77-405,966, FILED 2-26-2008.

THE MARK CONSISTS OF STANDARD CHAR-
ACTERS WITHOUT CLAIM TO ANY PARTICULAR
FONT, STYLE, SIZE, OR COLOR.

LESLEY LAMOTHE, EXAMINING ATTORNEY

Int. Cl.: 3

Prior U.S. Cls.: 1, 4, 6, 50, 51 and 52

United States Patent and Trademark Office

Reg. No. 3,575,117

Registered Feb. 17, 2009

**TRADEMARK
PRINCIPAL REGISTER**



TECH ENTERPRISES, INC. (WISCONSIN CORPORATION)

PO BOX 259294

MADISON, WI 53725

FOR: PET STAIN AND ODOR REMOVERS, IN CLASS 3 (U.S. CLS. 1, 4, 6, 50, 51 AND 52).

FIRST USE 1-23-2008; IN COMMERCE 1-23-2008.

THE MARK CONSISTS OF THE WORD "PET PURE" WITH TWO CIRCLES OF DIFFERENT SIZE ABOVE THE LETTER "R". INSIDE THE SMALLER CIRCLE IS AN ANIMAL PAW PRINT AND INSIDE THE LARGER CIRCLE IS THE FOOTPRINT OF A CHILD.

SER. NO. 77-406,172, FILED 2-26-2008.

JILL C. ALT, EXAMINING ATTORNEY

Int. Cl.: 41

Prior U.S. Cls.: 100, 101 and 107

United States Patent and Trademark Office

Reg. No. 3,575,118

Registered Feb. 17, 2009

**SERVICE MARK
PRINCIPAL REGISTER**

**DANIEL JOHNNES PRESENTS LA
PAULEE DE NEW YORK**

JOHNNES, DANIEL (UNITED STATES INDIVIDUAL)
SUITE 460
285 WEST BROADWAY
NEW YORK, NY 10013

FOR: ORGANIZING AND CONDUCTING DINING AND WINE TASTING FESTIVALS, IN CLASS 41 (U.S. CLS. 100, 101 AND 107).

FIRST USE 3-12-2005; IN COMMERCE 3-12-2005.

THE MARK CONSISTS OF STANDARD CHARACTERS WITHOUT CLAIM TO ANY PARTICULAR FONT, STYLE, SIZE, OR COLOR.

NO CLAIM IS MADE TO THE EXCLUSIVE RIGHT TO USE "LA PAULEE DE NEW YORK", APART FROM THE MARK AS SHOWN.

THE ENGLISH TRANSLATION OF "LA PAULEE DE NEW YORK" IS THE WINE DINNER OF NEW YORK.

SER. NO. 77-406,387, FILED 2-26-2008.

NICHOLAS ALTREE, EXAMINING ATTORNEY

Int. Cl.: 41

Prior U.S. Cls.: 100, 101 and 107

United States Patent and Trademark Office

Reg. No. 3,575,119

Registered Feb. 17, 2009

**SERVICE MARK
PRINCIPAL REGISTER**

**DANIEL JOHNNES PRESENTS LA
PAULEE DE SAN FRANCISCO**

JOHNNES, DANIEL (UNITED STATES INDIVIDUAL)
SUITE 460
285 WEST BROADWAY
NEW YORK, NY 10013

FOR: ORGANIZING AND CONDUCTING DINING AND WINE TASTING FESTIVALS, IN CLASS 41 (U.S. CLS. 100, 101 AND 107).

FIRST USE 10-1-2007; IN COMMERCE 10-1-2007.

THE MARK CONSISTS OF STANDARD CHARACTERS WITHOUT CLAIM TO ANY PARTICULAR FONT, STYLE, SIZE, OR COLOR.

NO CLAIM IS MADE TO THE EXCLUSIVE RIGHT TO USE "LA PAULEE DE SAN FRANCISCO", APART FROM THE MARK AS SHOWN.

THE ENGLISH TRANSLATION OF "LA PAULEE DE SAN FRANCISCO" IS THE WINE DINNER OF SAN FRANCISCO.

SER. NO. 77-406,424, FILED 2-26-2008.

NICHOLAS ALTREE, EXAMINING ATTORNEY

Int. Cl.: 41

Prior U.S. Cls.: 100, 101 and 107

United States Patent and Trademark Office

Reg. No. 3,575,120

Registered Feb. 17, 2009

SERVICE MARK
PRINCIPAL REGISTER



A SOCIAL SCENE , LLC (GEORGIA LIMITED
LIABILITY COMPANY)
SUITE 103
8491 HOSPITAL DRIVE
DOUGLASVILLE, GA 30134

FIRST USE 9-18-2006; IN COMMERCE 9-18-2006.

THE MARK CONSISTS OF THE WORDS "A
SOCIAL SCENE" WITH A DEPICTION OF TWO
PEOPLE DANCING SUPERIMPOSED WITHIN THE
LETTER " O " OF THE WORD "SOCIAL".

FOR: ENTERTAINMENT SERVICES, NAMELY,
CONDUCTING PARTIES FOR THE PURPOSE OF
SOCIAL INTRODUCTION; ORGANIZING PREMIER
ACTIVITIES, NAMELY, ORGANIZING CULTURAL
EVENTS FOR THE PURPOSE OF SOCIAL
INTRODUCTION, IN CLASS 41 (U.S. CLS. 100, 101
AND 107).

SER. NO. 77-406,903, FILED 2-26-2008.

SAIMA MAKHDOOM, EXAMINING ATTORNEY

Int. Cl.: 35

Prior U.S. Cls.: 100, 101 and 102

United States Patent and Trademark Office

Reg. No. 3,575,121

Registered Feb. 17, 2009

SERVICE MARK
PRINCIPAL REGISTER

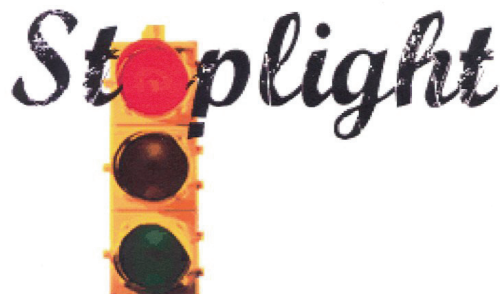

FOCUS ON THE FAMILY ACTION (COLORADO CORPORATION)
LEGAL DEPARTMENT
8655 EXPLORER DRIVE
COLORADO SPRINGS, CO 80920

FOR: PROVIDING ON-LINE INFORMATION, NAMELY, COMMENTARY IN THE FIELD OF PUBLIC POLICY, IN CLASS 35 (U.S. CLS. 100, 101 AND 102).

FIRST USE 5-23-2007; IN COMMERCE 5-23-2007.

THE COLOR(S) RED, BROWN, GREEN, YELLOW, BLACK AND WHITE IS/ARE CLAIMED AS A FEATURE OF THE MARK.

THE MARK CONSISTS OF THE TERM "STOP-LIGHT" WITH A REPRESENTATION OF A TRAFFIC SIGNAL FORMING THE LETTER "O". THE LETTERS "ST PLIGHT" APPEAR IN BLACK WITH WHITE STIPPLING. THE TRAFFIC SIGNAL IS YELLOW WITH RED, BROWN AND GREEN LIGHTS. THE REMAINING WHITE IN THE MARK INDICATES BACKGROUND ONLY AND IS NOT INTENDED AS PART OF THE MARK.

SER. NO. 77-407,096, FILED 2-27-2008.

AMY ALFIERI, EXAMINING ATTORNEY

Int. Cl.: 11

Prior U.S. Cls.: 13, 21, 23, 31 and 34

United States Patent and Trademark Office

Reg. No. 3,575,122

Registered Feb. 17, 2009

**TRADEMARK
PRINCIPAL REGISTER**

**ENERGIZER HARD CASE
TACTICAL**

EVEREADY BATTERY COMPANY, INC. (DELA-
WARE CORPORATION)
533 MARYVILLE UNIVERSITY DRIVE
ST. LOUIS, MO 63141

FOR: FLASHLIGHTS, IN CLASS 11 (U.S. CLS. 13,
21, 23, 31 AND 34).

FIRST USE 12-15-2006; IN COMMERCE 12-15-2006.

THE MARK CONSISTS OF STANDARD CHAR-
ACTERS WITHOUT CLAIM TO ANY PARTICULAR
FONT, STYLE, SIZE, OR COLOR.

OWNER OF U.S. REG. NOS. 2,670,053, 3,456,413
AND OTHERS.

NO CLAIM IS MADE TO THE EXCLUSIVE
RIGHT TO USE "TACTICAL", APART FROM THE
MARK AS SHOWN.

SEC. 2(F) AS TO "HARD CASE".

SER. NO. 77-407,689, FILED 2-27-2008.

NANCY CLARKE, EXAMINING ATTORNEY

Int. Cl.: 25

Prior U.S. Cls.: 22 and 39

United States Patent and Trademark Office

Reg. No. 3,575,123

Registered Feb. 17, 2009

**TRADEMARK
PRINCIPAL REGISTER**



**DANIEL
JACOB**

HUSKY FASHIONS, LLC (NEW JERSEY LIMITED LIABILITY COMPANY)
44 OAK TAVERN CIRCLE
BRANCBURG, NJ 08876

FOR: CHILDREN'S AND MEN'S CLOTHING, NAMELY, PANTS, ATHLETIC PANTS, SHIRTS, SHORTS, PAJAMAS, HATS, SOCKS, UNDERWEAR, SWEATERS, T-SHIRTS, BLAZERS, POLO SHIRTS, SWEAT SHIRTS, SWEAT PANTS, JEANS, CHINOS AND BATHING SUITS, IN CLASS 25 (U.S. CLS. 22 AND 39).

FIRST USE 10-13-2004; IN COMMERCE 10-13-2004.

THE NAME "DANIEL JACOB NAPLES" IDENTIFIES A LIVING INDIVIDUAL WHOSE CONSENT IS OF RECORD.

THE MARK CONSISTS OF THE WORDS "DANIEL JACOB" IN A STYLIZED FONT WITH A DESIGN OF A STAR CONTAINING THE LETTERS "D" AND "J" APPEARING WITHIN THE LETTER "O" IN "JACOB".

SER. NO. 77-407,745, FILED 2-27-2008.

RENEE MCCRAY, EXAMINING ATTORNEY

Int. Cl.: 3

Prior U.S. Cls.: 1, 4, 6, 50, 51 and 52

United States Patent and Trademark Office

Reg. No. 3,575,124

Registered Feb. 17, 2009

TRADEMARK
PRINCIPAL REGISTER



NUNEZ-GONZALEZ, ODANIS J. (PUERTO RICO CORPORATION)
PO BOX 2302
MANATI, PUERTO RICO 00674

FOR: CLEANER FOR USE ON MOTORCYCLES,
IN CLASS 3 (U.S. CLS. 1, 4, 6, 50, 51 AND 52).

FIRST USE 1-14-2008; IN COMMERCE 1-23-2008.

NO CLAIM IS MADE TO THE EXCLUSIVE
RIGHT TO USE "MOTORCYCLE CLEANER",
APART FROM THE MARK AS SHOWN.

THE COLOR(S) RED, BLACK, WHITE, AND
GRAY IS/ARE CLAIMED AS A FEATURE OF THE
MARK.

THE MARK CONSISTS OF AN OVAL WITH A
GRAY BACKGROUND AND RED BORDERS. IN-
SIDE THE OVAL A STYLIZED WORD "MOTOLUX",
WHICH LETTERS ARE WHITE WITH RED BOR-
DERS. TWO CHECKER FLAGS ARE LOCATED AT
EACH SIDE OF THE OVAL. BELOW THE OVAL
THERE IS A BLACK DESIGN LIKE A TATTOO AND
ABOVE THE OVAL THE STYLIZED WORDS "MO-
TORCYCLE CLEANER" IN BLACK.

SER. NO. 77-408,252, FILED 2-28-2008.

PAULA MAHONEY, EXAMINING ATTORNEY

Int. Cl.: 25

Prior U.S. Cls.: 22 and 39

United States Patent and Trademark Office

Reg. No. 3,575,125

Registered Feb. 17, 2009

**TRADEMARK
PRINCIPAL REGISTER**

HYDROGEN

PHILHOBAR DESIGN CANADA LTD. (CANADA
LIMITED LIABILITY COMPANY)

365 LOUVAIN OUEST

MONTREAL, QUEBEC, CANADA H2N2J1

FOR: T-SHIRTS; POLO SHIRTS; SWEATERS;
SHIRTS; BLOUSES; PANTS; OVERALLS; SHORTS;
SKIRTS; COATS; JACKETS; VESTS; TURTLE-
NECKS; UNDERGARMENTS; SLEEPWEAR; ROBES
, IN CLASS 25 (U.S. CLS. 22 AND 39).

THE MARK CONSISTS OF STANDARD CHAR-
ACTERS WITHOUT CLAIM TO ANY PARTICULAR
FONT, STYLE, SIZE, OR COLOR.

PRIORITY CLAIMED UNDER SEC. 44(D) ON
CANADA APPLICATION NO. 1361571, FILED 8-29-
2007, REG. NO. TMA723220, DATED 9-9-2008, EX-
PIRES 9-9-2023.

SER. NO. 77-408,693, FILED 2-28-2008.

MARY BOAGNI, EXAMINING ATTORNEY

Int. Cl.: 41

Prior U.S. Cls.: 100, 101 and 107

United States Patent and Trademark Office

Reg. No. 3,575,126

Registered Feb. 17, 2009

**SERVICE MARK
PRINCIPAL REGISTER**

**CHANGING THE WORLD BY
CHANGING THE WAY WE SEE
THE WORLD**

URBANSPRIT/KB MINISTRIES, INC. (KENTUCKY CORPORATION), DBA URBANSPRIT
PO BOX 11434
LOUISVILLE, KY 40251

FOR: EDUCATION SERVICES, NAMELY, PROVIDING SEMINARS AND RETREATS IN THE FIELDS OF POVERTY AWARENESS, EFFECTIVE ADVOCACY, AND COMMUNITY LEADERSHIP; EDUCATIONAL SERVICES, NAMELY, PROVIDING INTERNSHIPS AND APPRENTICESHIPS IN THE FIELD OF POVERTY AWARENESS, EFFECTIVE ADVOCACY, AND COMMUNITY LEADERSHIP; EDUCATIONAL SERVICES, NAMELY, CONDUCTING PROGRAMS IN THE FIELD OF POVERTY

AWARENESS, EFFECTIVE ADVOCACY, AND COMMUNITY LEADERSHIP, IN CLASS 41 (U.S. CLS. 100, 101 AND 107).

FIRST USE 0-0-2003; IN COMMERCE 0-0-2003.

THE MARK CONSISTS OF STANDARD CHARACTERS WITHOUT CLAIM TO ANY PARTICULAR FONT, STYLE, SIZE, OR COLOR.

SER. NO. 77-408,747, FILED 2-28-2008.

DOUGLAS LEE, EXAMINING ATTORNEY

Int. Cl.: 41

Prior U.S. Cls.: 100, 101 and 107

United States Patent and Trademark Office

Reg. No. 3,575,127

Registered Feb. 17, 2009

**SERVICE MARK
PRINCIPAL REGISTER**

URBANSPIRIT

URBANSPIRIT/KB MINISTRIES, INC. (KENTUCKY CORPORATION), DBA URBANSPIRIT
PO BOX 11434
LOUISVILLE, KY 40251

FOR: EDUCATION SERVICES, NAMELY, PROVIDING RETREATS AND SEMINARS IN THE FIELDS OF POVERTY AWARENESS, EFFECTIVE ADVOCACY, AND COMMUNITY LEADERSHIP; EDUCATIONAL SERVICES, NAMELY, CONDUCTING PROGRAMS IN THE FIELD OF POVERTY AWARENESS, EFFECTIVE ADVOCACY, AND COMMUNITY LEADERSHIP; EDUCATIONAL SERVICES, NAMELY, PROVIDING INTERNSHIPS AND APPRENTICESHIPS IN THE FIELDS OF POVERTY

AWARENESS, EFFECTIVE ADVOCACY, AND COMMUNITY LEADERSHIP, IN CLASS 41 (U.S. CLS. 100, 101 AND 107).

FIRST USE 9-7-2001; IN COMMERCE 9-7-2001.

THE MARK CONSISTS OF STANDARD CHARACTERS WITHOUT CLAIM TO ANY PARTICULAR FONT, STYLE, SIZE, OR COLOR.

SER. NO. 77-408,789, FILED 2-28-2008.

DOUGLAS LEE, EXAMINING ATTORNEY

Int. Cl.: 9

Prior U.S. Cls.: 21, 23, 26, 36 and 38

United States Patent and Trademark Office

Reg. No. 3,575,128

Registered Feb. 17, 2009

**TRADEMARK
PRINCIPAL REGISTER**



SPRINGSOURCE INC. (DELAWARE CORPORATION)
411 BOREL AVENUE, SUITE 101
SAN MATEO, CA 944023525

FOR: COMPUTER SOFTWARE PLATFORMS AND TOOLS FOR DEVELOPMENT OF ENTERPRISE APPLICATIONS; PRE-RECORDED VIDEO DISCS AND COMPUTER SOFTWARE CONTAINING TRAINING COURSES RELATED TO USE OF COMPUTER SOFTWARE PLATFORMS AND TOOLS FOR DEVELOPMENT OF ENTERPRISE APPLICATIONS, IN CLASS 9 (U.S. CLS. 21, 23, 26, 36 AND 38).

FIRST USE 12-15-2007; IN COMMERCE 12-15-2007.

NO CLAIM IS MADE TO THE EXCLUSIVE RIGHT TO USE "SOURCE", APART FROM THE MARK AS SHOWN.

THE MARK CONSISTS OF AN OVAL SHAPE WITH THE LETTER "S" IN THE MIDDLE OF THE OVAL SHAPE.

SER. NO. 77-409,029, FILED 2-28-2008.

DOMINIC J. FERRAIUOLO, EXAMINING ATTORNEY

Int. Cl.: 16

Prior U.S. Cls.: 2, 5, 22, 23, 29, 37, 38 and 50

Reg. No. 3,575,129

United States Patent and Trademark Office

Registered Feb. 17, 2009

**TRADEMARK
PRINCIPAL REGISTER**



SPACE COAST CREDIT UNION (FLORIDA CORPORATION)
8045 NORTH WICKHAM ROAD
MELBOURNE, FL 32940

FOR: PAPER GOODS AND PUBLICATIONS, NAMELY, POST CARDS AND NEWSLETTERS IN CONNECTION WITH CREDIT UNION SERVICES, LOAN AND BANKING SERVICES, IN CLASS 16 (U.S. CLS. 2, 5, 22, 23, 29, 37, 38 AND 50).

FIRST USE 1-16-2008; IN COMMERCE 2-14-2008.

OWNER OF U.S. REG. NOS. 2,874,475 AND 2,906,241.

NO CLAIM IS MADE TO THE EXCLUSIVE RIGHT TO USE "CREDIT UNION" AND "BUSINESS SERVICES", APART FROM THE MARK AS SHOWN.

THE MARK CONSISTS OF A CIRCLE AROUND THE WORDS "SPACE COAST" WITH THE WORDS "CREDIT UNION" UNDERNEATH. UNDERNEATH THE WORDS "CREDIT UNION" ARE THE WORDS "BUSINESS SERVICES" WITH A LINE BELOW THE WORDS "BUSINESS SERVICES" AND A LINE BETWEEN THE WORDS "BUSINESS SERVICES" AND "CREDIT UNION".

SEC. 2(F) AS TO "SPACE COAST".

SER. NO. 77-409,469, FILED 2-29-2008.

BRENDAN MCCAULEY, EXAMINING ATTORNEY

Int. Cl.: 36

Prior U.S. Cls.: 100, 101 and 102

United States Patent and Trademark Office

Reg. No. 3,575,130

Registered Feb. 17, 2009

**SERVICE MARK
PRINCIPAL REGISTER**

Matrix Financial Solutions

MATRIX FINANCIAL SOLUTIONS, INC. (COL-
ORADO CORPORATION)
SUITE 300
700 17TH STREET
DENVER, CO 802023531

FOR: FINANCIAL AND TRUST SERVICES,
NAMELY, CUSTODIAN SERVICES IN THE NAT-
URE OF HOLDING STOCKS, BONDS, SECURITIES
AND OTHER FINANCIAL AND INVESTMENT IN-
STRUMENTS FOR OTHERS; CASH AGENT SERVI-
CES, NAMELY, PERFORMING AND PROCESSING
DEPOSITS, WITHDRAWALS, AND MONEY WIR-
ING SERVICES FOR OTHERS; FINANCIAL SERVI-
CES, NAMELY, ADVISING OTHERS IN SELECTING
SECURITIES FOR INVESTMENTS; FINANCIAL
TRUST OPERATIONS; SETTLEMENT OF SECURI-
TIES TRADES, NAMELY, ASSISTING OTHERS

WITH THE COMPLETION OF FINANCIAL TRANS-
ACTIONS FOR SECURITIES, IN CLASS 36 (U.S. CLS.
100, 101 AND 102).

FIRST USE 8-3-2007; IN COMMERCE 8-3-2007.

THE MARK CONSISTS OF STANDARD CHAR-
ACTERS WITHOUT CLAIM TO ANY PARTICULAR
FONT, STYLE, SIZE, OR COLOR.

NO CLAIM IS MADE TO THE EXCLUSIVE
RIGHT TO USE "FINANCIAL SOLUTIONS", APART
FROM THE MARK AS SHOWN.

SER. NO. 77-409,737, FILED 2-29-2008.

BRIAN CALLAGHAN, EXAMINING ATTORNEY

Int. Cl.: 25

Prior U.S. Cls.: 22 and 39

United States Patent and Trademark Office

Reg. No. 3,575,131

Registered Feb. 17, 2009

**TRADEMARK
PRINCIPAL REGISTER**

SNAZAL

THADHA, SULEMAN (UNITED KINGDOM INDIVIDUAL)

220 ABBEY LANE

LEICESTER, UNITED KINGDOM LE53EF

FOR: FOOTWEAR, HEADWEAR, BEACHWEAR, SWIMWEAR, LOUNGEWEAR, NECKWEAR, SLEEPWEAR, UNDERWEAR, INFANTWEAR, RAINWEAR, JACKETS, COATS, SHIRTS, T-SHIRTS, SWEAT SHIRTS, SWEAT PANTS, PANTS, JEANS, TROUSERS, SLACKS, SHORTS, DRESSES, SKIRTS, SOCKS, BELTS, SUITS, SWEATERS, SCARVES, GLOVES, NECKTIES, IN CLASS 25 (U.S. CLS. 22 AND 39).

THE MARK CONSISTS OF STANDARD CHARACTERS WITHOUT CLAIM TO ANY PARTICULAR FONT, STYLE, SIZE, OR COLOR.

PRIORITY CLAIMED UNDER SEC. 44(D) ON UNITED KINGDOM APPLICATION NO. 2480785, FILED 2-26-2008, REG. NO. 2480785, DATED 2-26-2008, EXPIRES 2-26-2018.

THE WORDING "SNAZAL" APPEARING IN THE MARK HAS NO MEANING IN A FOREIGN LANGUAGE.

SER. NO. 77-409,915, FILED 2-29-2008.

MATTHEW PAPPAS, EXAMINING ATTORNEY

Int. Cl.: 35

Prior U.S. Cls.: 100, 101 and 102

United States Patent and Trademark Office

Reg. No. 3,575,132

Registered Feb. 17, 2009

**SERVICE MARK
PRINCIPAL REGISTER**

SNAZAL

THADHA, SULEMAN (UNITED KINGDOM IN-
DIVIDUAL)

220 ABBEY LANE

LEICESTER, UNITED KINGDOM LE53EF

FOR: THE BRINGING TOGETHER, FOR THE
BENEFIT OF OTHERS, OF A VARIETY OF BOOKS
AND PRINTED MATTER ENABLING CUSTOMERS
TO CONVENIENTLY VIEW AND PURCHASE
THOSE BOOKS FROM A CATALOGUE BY MAIL
ORDER OR BY MEANS OF TELECOMMUNICA-
TIONS OR OVER THE INTERNET, IN CLASS 35 (U.S.
CLS. 100, 101 AND 102).

THE MARK CONSISTS OF STANDARD CHAR-
ACTERS WITHOUT CLAIM TO ANY PARTICULAR
FONT, STYLE, SIZE, OR COLOR.

OWNER OF UNITED KINGDOM REG. NO.
2461598, DATED 7-17-2007, EXPIRES 7-17-2017.

THE WORDING "SNAZAL" APPEARING IN THE
MARK HAS NO MEANING IN A FOREIGN LAN-
GUAGE.

SER. NO. 77-409,927, FILED 2-29-2008.

MATTHEW PAPPAS, EXAMINING ATTORNEY

Int. Cl.: 44

Prior U.S. Cls.: 100 and 101

United States Patent and Trademark Office

Reg. No. 3,575,133

Registered Feb. 17, 2009

**SERVICE MARK
PRINCIPAL REGISTER**



JOSEPH C. ROGERS (UNITED STATES INDIVIDUAL)
18603 PARKE LANE
GROSSE ILE, MI 48138

FOR: PROVIDING AN INTERNET WEB SITE FOR MEDICAL PROFESSIONALS AND MEDICAL PATIENTS THAT ALLOWS FOR THE EXCHANGE OF INFORMATION FROM REMOTE LOCATIONS USING DEVICES THAT FEED INFORMATION AND MANUAL INPUT TO THE WEB SITE THAT IS THEN PROCESSED AND CAN BE ACCESSED IN REAL-TIME BY USERS FOR THE PURPOSE OF MONITORING AND MANAGING HEALTH ISSUES AND WRITING AND RENEWING PRESCRIPTIONS AS WELL AS DISPENSING MEDICAL AND WELLNESS ADVICE AND ALSO TO PROVIDE GENERAL HEALTH-RELATED INFORMATION AND SERVICES, NAMELY, RECOMMENDATIONS ON THE TREATMENT OF COMMON CONDITIONS, IN CLASS 44 (U.S. CLS. 100 AND 101).

FIRST USE 12-1-2007; IN COMMERCE 12-1-2007.

NO CLAIM IS MADE TO THE EXCLUSIVE RIGHT TO USE "CLINIC", APART FROM THE MARK AS SHOWN.

THE COLOR(S) BLUE, WHITE, BLACK IS/ARE CLAIMED AS A FEATURE OF THE MARK.

THE MARK CONSISTS OF THE WORDING "NETCARE" IN BLUE TO THE LEFT OF A BLUE BUTTON OUTLINED IN BLACK WITH WHITE CROSS ON IT AND A BLACK CURSOR ARROW OUTLINED IN WHITE POINTING AT IT. ALL OF THIS IS POSITIONED ABOVE THE WORD "CLINIC" IN BLUE.

SER. NO. 77-410,697, FILED 3-2-2008.

KATHERINE CHANG, EXAMINING ATTORNEY

Int. Cl.: 36

Prior U.S. Cls.: 100, 101 and 102

United States Patent and Trademark Office

Reg. No. 3,575,134

Registered Feb. 17, 2009

**SERVICE MARK
PRINCIPAL REGISTER**



CORNERSTONE SOLUTIONS, INC (NEVADA CORPORATION)
#100
3225 MCLEOD DR.
LAS VEGAS, NV 89121

THE MARK CONSISTS OF THE STYLIZED WORDS "AMERICANS PROTECTING FAMILIES". AN OUTLINE OF A SHIELD IN WITH TWO PERSON FIGURE CONTAINED INSIDE THE SHIELD.

FOR: INSURANCE BROKERAGE IN THE FIELD OF HEALTH AND LIFE INSURANCE, IN CLASS 36 (U.S. CLS. 100, 101 AND 102).

SER. NO. 77-411,005, FILED 3-3-2008.

FIRST USE 11-1-2007; IN COMMERCE 11-1-2007.

TINA KUAN, EXAMINING ATTORNEY

Int. Cl.: 3

Prior U.S. Cls.: 1, 4, 6, 50, 51 and 52

United States Patent and Trademark Office

Reg. No. 3,575,135

Registered Feb. 17, 2009

**TRADEMARK
PRINCIPAL REGISTER**

**DON'T TAKE A CHANCE. TRUST
WOOLITE.**

RECKITT & COLMAN (OVERSEAS) LIMITED
(ENGLAND PRIVATE LIMITED COMPANY)
DANSOM LANE
HULL, ENGLAND HU87DS

FOR: BLEACHING PREPARATIONS AND DETERGENTS FOR LAUNDRY USE; SOAPS; LAUNDRY PREPARATIONS AND ADDITIVES, NAMELY, LAUNDRY STARCH, LAUNDRY BLEACH, LAUNDRY BLUEING, LAUNDRY PRE-SOAK, AND FABRIC SOFTENERS; LAUNDRY PREPARATIONS FOR DRY CLEANERS, NAMELY, DRY CLEANING FLUIDS, SOLVENTS AND SPOT REMOVERS; CARPET CLEANERS AND SHAMPOOS; DECALCIFYING AND DESCALING PREPARATIONS FOR HOUSEHOLD PURPOSES; STAIN REMOVING PREPARATIONS, IN CLASS 3 (U.S. CLS. 1, 4, 6, 50, 51 AND 52).

FIRST USE 3-31-2007; IN COMMERCE 3-31-2007.

THE MARK CONSISTS OF STANDARD CHARACTERS WITHOUT CLAIM TO ANY PARTICULAR FONT, STYLE, SIZE, OR COLOR.

PRIORITY CLAIMED UNDER SEC. 44(D) ON ERPN CMNTY TM OFC APPLICATION NO. 006248017, FILED 9-3-2007, REG. NO. 6248017, DATED 7-31-2008, EXPIRES 9-3-2017.

OWNER OF U.S. REG. NOS. 2,708,638 AND 2,715,155.

SER. NO. 77-411,056, FILED 3-3-2008.

KIM MONINGHOFF, EXAMINING ATTORNEY

Int. Cls.: 18, 21, 24, 25 and 28

Prior U.S. Cls.: 1, 2, 3, 13, 22, 23, 29, 30, 33, 38, 39, 40,
41, 42 and 50

Reg. No. 3,575,136

Registered Feb. 17, 2009

United States Patent and Trademark Office

**TRADEMARK
PRINCIPAL REGISTER**



INTERNATIONAL TENNIS HALL OF FAME INCORPORATED (RHODE ISLAND NON-PROFIT CORPORATION)
194 BELLEVUE AVENUE
NEWPORT, RI 02840

FOR: TOTE BAGS, IN CLASS 18 (U.S. CLS. 1, 2, 3, 22 AND 41).

FIRST USE 0-0-1999; IN COMMERCE 0-0-1999.

FOR: MUGS, GLASSES AND SHOT GLASSES, IN CLASS 21 (U.S. CLS. 2, 13, 23, 29, 30, 33, 40 AND 50).

FIRST USE 0-0-1999; IN COMMERCE 0-0-1999.

FOR: TOWELS, IN CLASS 24 (U.S. CLS. 42 AND 50).

FIRST USE 0-0-1999; IN COMMERCE 0-0-1999.

FOR: CLOTHING, NAMELY, HEADWEAR, TOPS, BOTTOMS, JACKETS, SHIRTS, SWEATERS, SHORTS, IN CLASS 25 (U.S. CLS. 22 AND 39).

FIRST USE 0-0-1999; IN COMMERCE 0-0-1999.

FOR: TENNIS BALLS, IN CLASS 28 (U.S. CLS. 22, 23, 38 AND 50).

FIRST USE 0-0-1999; IN COMMERCE 0-0-1999.

NO CLAIM IS MADE TO THE EXCLUSIVE RIGHT TO USE "TENNIS", APART FROM THE MARK AS SHOWN.

THE MARK CONSISTS OF AN OVAL SHAPED DESIGN FEATURING A TROPHY IN THE CENTER WITH TWO CROSSED TENNIS RACQUETS IN THE MIDDLE OF THE TROPHY, ON A BACKGROUND SUGGESTING A TENNIS NET, ENCIRCLED BY AN OVAL BORDER CONTAINING THE WORDING "INTERNATIONAL TENNIS HALL OF FAME".

SER. NO. 77-411,502, FILED 3-3-2008.

KRISTIN DAHLING, EXAMINING ATTORNEY

Int. Cl.: 33

Prior U.S. Cls.: 47 and 49

United States Patent and Trademark Office

Reg. No. 3,575,137

Registered Feb. 17, 2009

TRADEMARK
PRINCIPAL REGISTER



Gumfields
of New Zealand

IVICEVICH, ANTHONY MICHAEL (NEW ZEALAND INDIVIDUAL)
215 ARARIMU VALLEY ROAD
WAIMAUKU, NEW ZEALAND

FOR: ALCOHOLIC BEVERAGES EXCEPT BEER;
WINES, IN CLASS 33 (U.S. CLS. 47 AND 49).

PRIORITY CLAIMED UNDER SEC. 44(D) ON
NEW ZEALAND APPLICATION NO. 775480, FILED
9-7-2007.

OWNER OF NEW ZEALAND REG. NO. 775480,
DATED 9-7-2007, EXPIRES 9-7-2017.

NO CLAIM IS MADE TO THE EXCLUSIVE
RIGHT TO USE "NEW ZEALAND", APART FROM
THE MARK AS SHOWN.

THE MARK CONSISTS OF TEAR DROPS ELE-
MENTS ABOVE THE WORDING "GUMFIELDS OF
NEW ZEALAND".

SER. NO. 77-412,152, FILED 3-4-2008.

HANNO RITTNER, EXAMINING ATTORNEY

Int. Cl.: 37

Prior U.S. Cls.: 100, 103 and 106

United States Patent and Trademark Office

Reg. No. 3,575,138

Registered Feb. 17, 2009

**SERVICE MARK
PRINCIPAL REGISTER**

live bug free

SEMLOH CORP. (CALIFORNIA CORPORATION)
380 W. ST. ANDREWS AVE.
LA HABRA, CA 90631

FOR: TERMITE AND PEST CONTROL SERVICE,
IN CLASS 37 (U.S. CLS. 100, 103 AND 106).

FIRST USE 2-1-2008; IN COMMERCE 2-1-2008.

THE MARK CONSISTS OF STANDARD CHARACTERS WITHOUT CLAIM TO ANY PARTICULAR FONT, STYLE, SIZE, OR COLOR.

NO CLAIM IS MADE TO THE EXCLUSIVE RIGHT TO USE "BUG FREE", APART FROM THE MARK AS SHOWN.

SER. NO. 77-412,201, FILED 3-4-2008.

ROBERT C. CLARK JR., EXAMINING ATTORNEY

Int. Cl.: 35

Prior U.S. Cls.: 100, 101 and 102

United States Patent and Trademark Office

Reg. No. 3,575,139

Registered Feb. 17, 2009

**SERVICE MARK
PRINCIPAL REGISTER**



WANK BRICKNER MARKETING LLC (OHIO LIMITED LIABILITY COMPANY), DBA WB MARKETING

5515 PEARL ROAD
PARMA, OH 44129

FOR: ADVERTISING AND MARKETING, IN CLASS 35 (U.S. CLS. 100, 101 AND 102).

FIRST USE 4-0-1991; IN COMMERCE 4-0-1991.

NO CLAIM IS MADE TO THE EXCLUSIVE RIGHT TO USE "MARKETING", APART FROM THE MARK AS SHOWN.

THE COLOR(S) BLUE AND GRAY IS/ARE CLAIMED AS A FEATURE OF THE MARK.

THE COLOR(S) BLUE APPEARS IN THE RECTANGLE WHICH CARRIES THE TERM "MARKETING", IN THE LETTERS "WB" WHERE THE COLOR FADES AWAY FROM BOTTOM TO TOP AND IT OUTLINES THE ENTIRE LETTERS OF "WB"; AND THE COLOR GRAY APPEARS IN THE TERM "MARKETING".

SER. NO. 77-412,454, FILED 3-4-2008.

BILL DAWE, EXAMINING ATTORNEY

Int. Cl.: 43

Prior U.S. Cls.: 100 and 101

United States Patent and Trademark Office

Reg. No. 3,575,140

Registered Feb. 17, 2009

**SERVICE MARK
PRINCIPAL REGISTER**

THE POD HOTEL

BD HOTELS, LLC (NEW YORK LIMITED LIABILITY COMPANY)

871 SEVENTH AVENUE

NEW YORK, NY 10019

FOR: HOTEL, BAR AND RESTAURANT SERVICES, IN CLASS 43 (U.S. CLS. 100 AND 101).

FIRST USE 1-1-2007; IN COMMERCE 1-1-2007.

THE MARK CONSISTS OF STANDARD CHARACTERS WITHOUT CLAIM TO ANY PARTICULAR FONT, STYLE, SIZE, OR COLOR.

NO CLAIM IS MADE TO THE EXCLUSIVE RIGHT TO USE "HOTEL", APART FROM THE MARK AS SHOWN.

SER. NO. 77-412,632, FILED 3-4-2008.

FRED CARL, EXAMINING ATTORNEY

Int. Cl.: 45

Prior U.S. Cls.: 100 and 101

United States Patent and Trademark Office

Reg. No. 3,575,141

Registered Feb. 17, 2009

**SERVICE MARK
PRINCIPAL REGISTER**

THE POD HOTEL

BD HOTELS, LLC (NEW YORK LIMITED LIABILITY COMPANY)

871 SEVENTH AVENUE

NEW YORK, NY 10019

FOR: HOTEL CONCIERGE SERVICES, IN CLASS 45 (U.S. CLS. 100 AND 101).

FIRST USE 1-1-2007; IN COMMERCE 1-1-2007.

THE MARK CONSISTS OF STANDARD CHARACTERS WITHOUT CLAIM TO ANY PARTICULAR FONT, STYLE, SIZE, OR COLOR.

NO CLAIM IS MADE TO THE EXCLUSIVE RIGHT TO USE "HOTEL", APART FROM THE MARK AS SHOWN.

SER. NO. 77-412,663, FILED 3-4-2008.

FRED CARL, EXAMINING ATTORNEY

Int. Cl.: 41

Prior U.S. Cls.: 100, 101 and 107

United States Patent and Trademark Office

Reg. No. 3,575,142

Registered Feb. 17, 2009

**SERVICE MARK
PRINCIPAL REGISTER**

Renewal For Life

LUTHERANS FOR LIFE, INC. (MINNESOTA CORPORATION)
1120 S. G AVE.
NEVADA, IA 50201

FOR: EDUCATION SERVICES, NAMELY, DEVELOPING CURRICULA FOR OTHERS, PROVIDING SPEAKERS, AND CONDUCTING CONFERENCES, ALL IN THE FIELD OF PRO-LIFE MINISTRY, IN CLASS 41 (U.S. CLS. 100, 101 AND 107).

FIRST USE 10-1-2007; IN COMMERCE 10-1-2007.

THE MARK CONSISTS OF STANDARD CHARACTERS WITHOUT CLAIM TO ANY PARTICULAR FONT, STYLE, SIZE, OR COLOR.

SER. NO. 77-413,966, FILED 3-5-2008.

NICHOLAS ALTREE, EXAMINING ATTORNEY

Int. Cls.: 41 and 45

Prior U.S. Cls.: 100, 101 and 107

United States Patent and Trademark Office

Reg. No. 3,575,143

Registered Feb. 17, 2009

**SERVICE MARK
PRINCIPAL REGISTER**

HYPEBEAST

101 MEDIA LAB LIMITED (HONG KONG CORPORATION)

UNIT 12A 12/F, REGENCY CENTRE PHASE 1

NO. 39 WONG CHUK HANG ROAD

HONG KONG, HONG KONG

FOR: PROVIDING INFORMATION, NEWS AND COMMENTARY IN THE FIELD OF POPULAR CULTURE, IN CLASS 41 (U.S. CLS. 100, 101 AND 107).

FIRST USE 12-20-2004; IN COMMERCE 1-15-2005.

FOR: PROVIDING INFORMATION, NEWS AND COMMENTARY IN THE FIELD OF FASHION, IN CLASS 45 (U.S. CLS. 100 AND 101).

FIRST USE 12-20-2004; IN COMMERCE 1-15-2005.

THE MARK CONSISTS OF STANDARD CHARACTERS WITHOUT CLAIM TO ANY PARTICULAR FONT, STYLE, SIZE, OR COLOR.

SER. NO. 77-414,063, FILED 3-5-2008.

AMY C. KEAN, EXAMINING ATTORNEY

Int. Cl.: 35

Prior U.S. Cls.: 100, 101 and 102

United States Patent and Trademark Office

Reg. No. 3,575,144

Registered Feb. 17, 2009

**SERVICE MARK
PRINCIPAL REGISTER**



THE SENIOR ALLIANCE, INC. (MICHIGAN CORPORATION), DBA AREA AGENCY ON AGING 1-C

SUITE 201
3850 SECOND STREET
WAYNE, MI 48184

FOR: ASSOCIATION SERVICES, NAMELY, PROMOTING THE INTERESTS OF SENIOR CITIZENS, IN CLASS 35 (U.S. CLS. 100, 101 AND 102).

FIRST USE 4-0-2000; IN COMMERCE 4-0-2000.

THE COLOR(S) BLACK AND BLUE IS/ARE CLAIMED AS A FEATURE OF THE MARK.

THE MARK CONSISTS OF A BLACK TRIANGLE OVERLAPPING WITH A BLUE TRIANGLE AND THE LETTERS "TSA" APPEAR WHERE THE TRIANGLES OVERLAP. THE LETTER "T" IS IN BLACK AND THE LETTERS "SA" ARE IN BLUE.

SER. NO. 77-414,091, FILED 3-5-2008.

YAT SYE, LEE, EXAMINING ATTORNEY

Int. Cl.: 7

Prior U.S. Cls.: 13, 19, 21, 23, 31, 34 and 35

United States Patent and Trademark Office

Reg. No. 3,575,145

Registered Feb. 17, 2009

**TRADEMARK
PRINCIPAL REGISTER**

EDGE TECHNOLOGIES

HYDROMAT, INC. (MISSOURI CORPORATION)
11600 ADIE ROAD
ST. LOUIS, MO 63043

FOR: BAR FEEDER AND BAR LOADING MACHINES FOR INTRODUCING BAR OR PROFILED STOCK INTO METALWORKING MACHINES FOR MANUFACTURE OF PRECISION COMPONENTS, IN CLASS 7 (U.S. CLS. 13, 19, 21, 23, 31, 34 AND 35).

FIRST USE 1-31-2006; IN COMMERCE 1-31-2006.

THE MARK CONSISTS OF STANDARD CHARACTERS WITHOUT CLAIM TO ANY PARTICULAR FONT, STYLE, SIZE, OR COLOR.

NO CLAIM IS MADE TO THE EXCLUSIVE RIGHT TO USE "TECHNOLOGIES", APART FROM THE MARK AS SHOWN.

SER. NO. 77-414,158, FILED 3-5-2008.

KAELIE KUNG, EXAMINING ATTORNEY

Int. Cl.: 5

Prior U.S. Cls.: 6, 18, 44, 46, 51 and 52

United States Patent and Trademark Office

Reg. No. 3,575,146

Registered Feb. 17, 2009

**TRADEMARK
PRINCIPAL REGISTER**

SUPER ENERGY PAKS

PACIFIC PACKAGING CONCEPTS, INC. (CALIFORNIA CORPORATION), DBA FRESH START VITAMINS CO., DBA C & A ENTERPRISES, INC.

1067 E. BEDMAR STREET
CARSON, CA 90746

FOR: VITAMINS AND NUTRITIONAL SUPPLEMENTS, IN CLASS 5 (U.S. CLS. 6, 18, 44, 46, 51 AND 52).

FIRST USE 7-24-2001; IN COMMERCE 7-24-2001.

THE MARK CONSISTS OF STANDARD CHARACTERS WITHOUT CLAIM TO ANY PARTICULAR FONT, STYLE, SIZE, OR COLOR.

SEC. 2(F).

SER. NO. 77-415,302, FILED 3-6-2008.

APRIL HESIK, EXAMINING ATTORNEY

Int. Cl.: 43

Prior U.S. Cls.: 100 and 101

United States Patent and Trademark Office

Reg. No. 3,575,147

Registered Feb. 17, 2009

**SERVICE MARK
PRINCIPAL REGISTER**

UNIVERSAL STUDENT HOUSING

USH, INC. (CALIFORNIA CORPORATION)
424 KELTON AVENUE, SUITE 514
LOS ANGELES, CA 90024

FOR: ARRANGING TEMPORARY HOUSING ACCOMMODATIONS; PROVIDING TEMPORARY HOUSING ACCOMMODATIONS; PROVIDING TEMPORARY ACCOMMODATION, IN CLASS 43 (U.S. CLS. 100 AND 101).

FIRST USE 9-0-1998; IN COMMERCE 9-0-1998.

THE MARK CONSISTS OF STANDARD CHARACTERS WITHOUT CLAIM TO ANY PARTICULAR FONT, STYLE, SIZE, OR COLOR.

NO CLAIM IS MADE TO THE EXCLUSIVE RIGHT TO USE "STUDENT HOUSING", APART FROM THE MARK AS SHOWN.

SER. NO. 77-416,376, FILED 3-7-2008.

JUSTINE D. PARKER, EXAMINING ATTORNEY

Int. Cls.: 18 and 25

Prior U.S. Cls.: 1, 2, 3, 22, 39 and 41

United States Patent and Trademark Office

Reg. No. 3,575,148

Registered Feb. 17, 2009

**TRADEMARK
PRINCIPAL REGISTER**



NESIAN, INC. (CALIFORNIA CORPORATION)
#27
2212 HUNTINGTON POINT RD.
CHULA VISTA, CA 91914

FOR: BACKPACKS; DOG LEASHES; HANDBAGS;
PURSES; UMBRELLAS; WALLETS, IN CLASS 18
(U.S. CLS. 1, 2, 3, 22 AND 41).

FIRST USE 4-12-2007; IN COMMERCE 4-12-2007.

FOR: BANDANAS; BATHING SUITS; BEANIES;
BELTS; BIKINIS; BOARD SHORTS; GLOVES; HATS;
JACKETS; KNIT SHIRTS; PANTS; PULLOVERS;
RASH GUARDS; SANDALS; SHOES; SHORTS;
SOCKS; SWEATERS; T-SHIRTS; TANK TOPS; UN-

DER GARMENTS; VISORS; WET SUITS; WRIST-
BANDS, IN CLASS 25 (U.S. CLS. 22 AND 39).

FIRST USE 4-12-2007; IN COMMERCE 4-12-2007.

THE STIPPLING IS FOR SHADING PURPOSES
ONLY.

THE MARK CONSISTS OF A BOX WITH A
TRIBAL STYLE FLAME ABOVE THE STYLIZED
TEXT "NESIAN".

SER. NO. 77-416,656, FILED 3-7-2008.

LESLEY LAMOTHE, EXAMINING ATTORNEY

Int. Cl.: 1

Prior U.S. Cls.: 1, 5, 6, 10, 26 and 46

United States Patent and Trademark Office

Reg. No. 3,575,149

Registered Feb. 17, 2009

**TRADEMARK
PRINCIPAL REGISTER**

IN-SPEC

GFS CHEMICALS, INC. (OHIO CORPORATION)
P. O. BOX 245
POWELL, OH 43065

FIRST USE 8-1-1998; IN COMMERCE 11-1-1998.

FOR: SCIENTIFIC FLUID TESTING PREPARATIONS, NAMELY, SUSPENSIONS OF POLYMER SPHERES IN AQUEOUS MEDIA USED AS STANDARD SOLUTIONS FOR CALIBRATION OF LABORATORY TESTS AND OPTICAL LABORATORY INSTRUMENTS, IN CLASS 1 (U.S. CLS. 1, 5, 6, 10, 26 AND 46).

THE MARK CONSISTS OF STANDARD CHARACTERS WITHOUT CLAIM TO ANY PARTICULAR FONT, STYLE, SIZE, OR COLOR.

SER. NO. 77-417,187, FILED 3-10-2008.

MATTHEW EINSTEIN, EXAMINING ATTORNEY

Int. Cls.: 29 and 31

Prior U.S. Cls.: 1 and 46

United States Patent and Trademark Office

Reg. No. 3,575,150

Registered Feb. 17, 2009

**TRADEMARK
PRINCIPAL REGISTER**

C.H. Belt's Worlds Finest

C.H. BELT & ASSOCIATES, INC. (CALIFORNIA CORPORATION)
SUITE 311
20532 EL TORO ROAD
MISSION VIEJO, CA 92692

FOR: CUT FRUITS; CUT VEGETABLES; FROSTED FRUITS; FROZEN FRUITS; FROZEN VEGETABLES; FRUIT AND VEGETABLE SALADS; FRUIT SALADS; FRUIT SALADS AND VEGETABLE SALADS; PRE-CUT VEGETABLE SALAD; PRESERVED FRUIT AND VEGETABLES; PRESERVED FRUITS; PRESERVED FRUITS AND VEGETABLES; VEGETABLES, INSTANT FROZEN, IN CLASS 29 (U.S. CL. 46).

FIRST USE 1-6-2006; IN COMMERCE 1-6-2006.

FOR: FRESH FRUIT AND VEGETABLES; FRESH FRUITS; FRESH VEGETABLES; RAW FRUITS; RAW VEGETABLES; UNPROCESSED FRUITS; UN-

PROCESSED VEGETABLES, IN CLASS 31 (U.S. CLS. 1 AND 46).

FIRST USE 1-6-2006; IN COMMERCE 1-6-2006.

THE MARK CONSISTS OF STANDARD CHARACTERS WITHOUT CLAIM TO ANY PARTICULAR FONT, STYLE, SIZE, OR COLOR.

NO CLAIM IS MADE TO THE EXCLUSIVE RIGHT TO USE "WORLDS FINEST", APART FROM THE MARK AS SHOWN.

THE NAME "C.H. BELT'S" DOES NOT IDENTIFY A LIVING INDIVIDUAL.

SER. NO. 77-417,545, FILED 3-10-2008.

KELLY CHOE, EXAMINING ATTORNEY

Int. Cls.: 29 and 31

Prior U.S. Cls.: 1 and 46

United States Patent and Trademark Office

Reg. No. 3,575,151

Registered Feb. 17, 2009

**TRADEMARK
PRINCIPAL REGISTER**

C.H. Belt's Ready Fix

C.H. BELT & ASSOCIATES, INC. (CALIFORNIA CORPORATION)
SUITE 311
20532 EL TORO ROAD
MISSION VIEJO, CA 92962

FOR: CUT FRUITS; CUT VEGETABLES; FROSTED FRUITS; FROZEN FRUITS; FROZEN VEGETABLES; FRUIT AND VEGETABLE SALADS; FRUIT SALADS; FRUIT SALADS AND VEGETABLE SALADS; PRE-CUT VEGETABLE SALAD; PRESERVED FRUIT AND VEGETABLES; PRESERVED FRUITS; PRESERVED FRUITS AND VEGETABLES; SLICED FRUITS; SLICED VEGETABLES; VEGETABLE SALADS; VEGETABLES, INSTANT FROZEN, IN CLASS 29 (U.S. CL. 46).

FIRST USE 1-6-2006; IN COMMERCE 1-6-2006.

FOR: FRESH FRUIT AND VEGETABLES; FRESH FRUITS; FRESH VEGETABLES; RAW FRUITS;

RAW VEGETABLES; UNPROCESSED FRUITS; UNPROCESSED VEGETABLES, IN CLASS 31 (U.S. CLS. 1 AND 46).

FIRST USE 1-6-2006; IN COMMERCE 1-6-2006.

THE MARK CONSISTS OF STANDARD CHARACTERS WITHOUT CLAIM TO ANY PARTICULAR FONT, STYLE, SIZE, OR COLOR.

NO CLAIM IS MADE TO THE EXCLUSIVE RIGHT TO USE "READY FIX", APART FROM THE MARK AS SHOWN.

THE NAME "C.H. BELT'S" DOES NOT IDENTIFY A LIVING INDIVIDUAL.

SER. NO. 77-417,598, FILED 3-10-2008.

KELLY CHOE, EXAMINING ATTORNEY

Int. Cl.: 5

Prior U.S. Cls.: 6, 18, 44, 46, 51 and 52

Reg. No. 3,575,152

United States Patent and Trademark Office

Registered Feb. 17, 2009

**TRADEMARK
PRINCIPAL REGISTER**

NUOSEPT

ISP INVESTMENTS INC. (DELAWARE CORPORATION)
SUITE 303
300 DELAWARE AVENUE
WILMINGTON, DE 19801

THE MARK CONSISTS OF STANDARD CHARACTERS WITHOUT CLAIM TO ANY PARTICULAR FONT, STYLE, SIZE, OR COLOR.

FOR: BIOCIDES AND FUNGICIDES, IN CLASS 5 (U.S. CLS. 6, 18, 44, 46, 51 AND 52).

SER. NO. 77-417,738, FILED 3-10-2008.

FIRST USE 10-17-1956; IN COMMERCE 10-17-1956.

ALLISON SCHRODY, EXAMINING ATTORNEY

Int. Cl.: 41

Prior U.S. Cls.: 100, 101 and 107

United States Patent and Trademark Office

Reg. No. 3,575,153

Registered Feb. 17, 2009

**SERVICE MARK
PRINCIPAL REGISTER**



SPORTS DATA HUB, INC. (COLORADO CORPORATION)

2340 S. FRANKLIN ST.

DENVER, CO 80210

FOR: PROVIDING INFORMATION IN THE FIELD OF SPORTS FOR USE BY SPORTS FANS TO ANALYZE SPORTS DATA, IN CLASS 41 (U.S. CLS. 100, 101 AND 107).

FIRST USE 7-31-2007; IN COMMERCE 7-31-2007.

NO CLAIM IS MADE TO THE EXCLUSIVE RIGHT TO USE "SPORTS DATA HUB", APART FROM THE MARK AS SHOWN.

THE COLOR(S) ORANGE, GREY, WHITE AND BLACK IS/ARE CLAIMED AS A FEATURE OF THE MARK.

THE MARK CONSISTS OF A ELLIPSE WITH AN ORANGE BACKGROUND AND TWO SHADED AREAS CONTAINING GRAY AND WHITE, WITH THE WORD "SPORTS" IN WHITE LETTERING TO THE RIGHT OF THE ELLIPSE AND THE WORDS "DATA HUB" IN ORANGE UNDERNEATH THE WORD "SPORTS", ALL ON A BLACK BACKGROUND.

SER. NO. 77-419,028, FILED 3-11-2008.

SEAN CROWLEY, EXAMINING ATTORNEY

Int. Cl.: 35

Prior U.S. Cls.: 100, 101 and 102

United States Patent and Trademark Office

Reg. No. 3,575,154

Registered Feb. 17, 2009

**SERVICE MARK
PRINCIPAL REGISTER**

InfoMaker

INFOMAKER, INC. (ILLINOIS CORPORATION)
P.O. BOX 2201
DEL MAR, CA 92014

THE MARK CONSISTS OF STANDARD CHAR-
ACTERS WITHOUT CLAIM TO ANY PARTICULAR
FONT, STYLE, SIZE, OR COLOR.

FOR: MANAGEMENT AND BUSINESS CON-
SULTING SERVICES IN THE FIELD OF STATISTICS
AND ANALYTICS, IN CLASS 35 (U.S. CLS. 100, 101
AND 102).

SER. NO. 77-419,677, FILED 3-12-2008.

FIRST USE 3-1-1994; IN COMMERCE 3-1-1994.

DARRYL SPRUILL, EXAMINING ATTORNEY

Int. Cl.: 32

Prior U.S. Cls.: 45, 46 and 48

Reg. No. 3,575,155

United States Patent and Trademark Office

Registered Feb. 17, 2009

TRADEMARK
PRINCIPAL REGISTER



CHERRYPHARM, INC. (DELAWARE CORPORATION)
500 TECHNOLOGY FARM DRIVE
GENEVA, NY 14456

NO CLAIM IS MADE TO THE EXCLUSIVE RIGHT TO USE "NUTRITION," "NATURAL HEALTH" AND DESIGN OF THE CADUCEUS, APART FROM THE MARK AS SHOWN.

FOR: SPORTS DRINKS; FRUIT JUICE BASED BEVERAGES; NON-ALCOHOLIC BEVERAGES CONTAINING CHERRIES OR EXTRACTS THEREOF, IN CLASS 32 (U.S. CLS. 45, 46 AND 48).

SER. NO. 77-419,980, FILED 3-12-2008.

FIRST USE 2-29-2008; IN COMMERCE 2-29-2008.

DAYNA BROWNE, EXAMINING ATTORNEY

Int. Cl.: 9

Prior U.S. Cls.: 21, 23, 26, 36 and 38

United States Patent and Trademark Office

Reg. No. 3,575,156

Registered Feb. 17, 2009

**TRADEMARK
PRINCIPAL REGISTER**

WORLD OF DARKNESS

CCP HF (ICELAND CORPORATION)
GRANDAGARDUR 8
101 REYKJAVIK, ICELAND

FOR: DOWNLOADABLE ROLE-PLAYING
BOOKS AND MANUALS VIA THE INTERNET
AND WIRELESS DEVICES, IN CLASS 9 (U.S. CLS.
21, 23, 26, 36 AND 38).

FIRST USE 4-16-2004; IN COMMERCE 4-16-2004.

THE MARK CONSISTS OF STANDARD CHAR-
ACTERS WITHOUT CLAIM TO ANY PARTICULAR
FONT, STYLE, SIZE, OR COLOR.

OWNER OF U.S. REG. NOS. 2,144,698 AND
2,144,699.

SER. NO. 77-420,156, FILED 3-12-2008.

JULIE VEPPUMTHARA, EXAMINING ATTORNEY

Int. Cl.: 9

Prior U.S. Cls.: 21, 23, 26, 36 and 38

United States Patent and Trademark Office

Reg. No. 3,575,157

Registered Feb. 17, 2009

**TRADEMARK
PRINCIPAL REGISTER**

ABERRANT

CCP HF (ICELAND CORPORATION)
GRANDAGARDUR 8
101 REYKJAVIK, ICELAND

FOR: DOWNLOADABLE ROLE-PLAYING
BOOKS AND MANUALS VIA THE INTERNET
AND WIRELESS DEVICES, IN CLASS 9 (U.S. CLS.
21, 23, 26, 36 AND 38).

FIRST USE 4-12-2004; IN COMMERCE 4-12-2004.

THE MARK CONSISTS OF STANDARD CHAR-
ACTERS WITHOUT CLAIM TO ANY PARTICULAR
FONT, STYLE, SIZE, OR COLOR.

OWNER OF U.S. REG. NO. 2,427,185.

SER. NO. 77-420,194, FILED 3-12-2008.

JULIE VEPPUMTHARA, EXAMINING ATTORNEY

Int. Cl.: 9

Prior U.S. Cls.: 21, 23, 26, 36 and 38

United States Patent and Trademark Office

Reg. No. 3,575,158

Registered Feb. 17, 2009

TRADEMARK
PRINCIPAL REGISTER

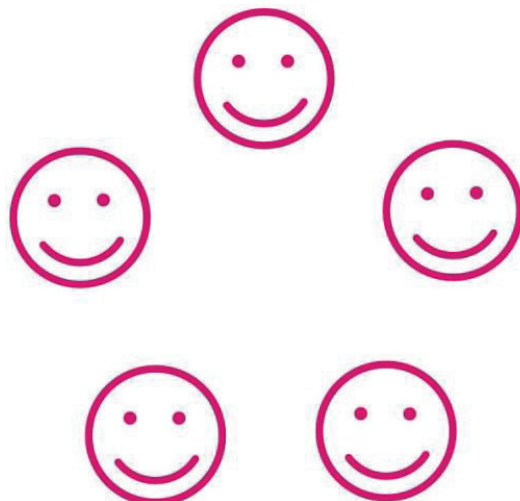

DEUTSCHE TELEKOM (FED REP GERMANY
AG CORPORATION)
FRIEDRICH-EBERT-ALLEE 140
BONN, FED REP GERMANY 53113

FOR: MOBILE PHONES; COMPUTER APPLICATION SOFTWARE FOR MOBILE PHONES; ELECTRIC, ELECTRONIC, OPTICAL, MEASURING, SIGNALING, CONTROLLING AND TEACHING APPARATUS AND INSTRUMENTS, ALL FOR USE WITH TELECOMMUNICATIONS, NAMELY, APPARATUS FOR REPRODUCING SOUND, IMAGES OR DATA, NAMELY, MOBILE PHONES; BLANK MAGNETIC AND OPTICAL DATA CARRIERS; DATA PROCESSORS AND COMPUTERS, NAMELY, MICROCOMPUTERS, MINICOMPUTERS, COMPUTER CENTRAL PROCESSORS, COMPUTER MONITORS, COMPUTER KEYBOARDS, COMPUTER TERMINALS, COMPUTER OPERATING SYSTEMS; COMPUTER PROGRAMS AND DATABASES FOR USE IN OPERATING TELECOMMUNICATIONS AND BUSINESS MANAGEMENT SYSTEMS AND RELATED INSTRUCTION MANUALS SOLD AS A UNIT; COMPUTER PROGRAMS, NAMELY, SOFTWARE USED FOR THE PROVISION OF ON-LINE INFORMATION SERVICES, NETWORK MANAGEMENT SOFTWARE, COMPUTER PROXY SOFTWARE FOR USE WITH OTHER SOFTWARE PROGRAMS, COMPUTER PROGRAMS FOR ACCESSING A GLOBAL COMPUTER NETWORK AND INTERACTIVE COMPUTER COMMUNICATIONS NETWORK; AUDIO, VIDEO AND DATA COMMUNICATIONS SYSTEMS, COMPRISED PRIMARILY

OF DIGITAL AND ANALOGUE SIGNAL TRANSMITTERS, RECEIVERS AND CONVERTERS, RADIO AND TELEPHONE TRANSMITTERS, RECEIVERS AND STATIONARY SERVERS, WIRELESS AND CELLULAR TELEPHONE SETS AND ANSWERING MACHINES, TELECOMMUNICATION TRANSMISSION, RECEIVING AND STORAGE APPARATUS, NAMELY, MOBILE TELEPHONES, TELECOMMUNICATIONS TRANSMITTING SETS, NAMELY, TELECOMMUNICATIONS TRANSMITTERS, ELECTRONIC DATA TRANSMITTERS, FACSIMILE MACHINES, ELECTRONIC MAIL SOFTWARE FOR ELECTRONIC EXCHANGE OF DATA IMAGES AND MESSAGES; AUDIO AND VIDEO RECORDINGS IN THE FIELD OF TELECOMMUNICATIONS, INFORMATION TECHNOLOGY, SAFETY; MACHINE READABLE, MAGNETICALLY ENCODED CARDS, NAMELY, TELEPHONE CALLING CARD SMART CARDS; DATA PROCESSORS AND READERS, NAMELY, WORD PROCESSORS, MAGNETIC CODED CARD READERS, MAGNETIC CODED CARDS CONTAINING PROGRAMMING USED TO STORE PERSONAL IDENTIFICATION INFORMATION, ELECTRONIC ENCRYPTION UNITS, BLANK MAGNETIC DATA CARRIERS AND STRUCTURAL PARTS THEREFOR; INTERCOMS; TELEPHONES, TELEPHONE SWITCHES, TELEPHONE ANSWERING MACHINES, TELEPHONE TRANSMITTERS, TELEPHONE NETWORKS, NAMELY, TELEPHONE TERMINALS, TELEPHONE HARDWARE, TELEPHONE SOFTWARE; TELEPHONE WIRES, TELE-

PRINTERS, TELETYPEWRITERS, AND PARTS THEREOF, NAMELY, CALLER IDENTIFICATION BOXES; RADIO TELEPHONES AND STRUCTURAL PARTS THEREFOR, NAMELY, CALL BOXES AND SYSTEMS COMPRISED PRIMARILY OF DIALING ASSEMBLIES, TELEPHONE UNITS, AUDIO OPERATED RELAYS, SIGNALING DEVICES, RECEIVING DEVICES, TERMINATION EQUIPMENT, FILTERS, PROTECTORS AND AUTOMATIC SIGNALING AND CONTROL EQUIPMENT; TELEMETERS; WIRELESS AND CELLULAR TELEPHONES, PAGERS, PAGING EQUIPMENT; PERSONAL COMMUNICATIONS EQUIPMENT, NAMELY, PERSONAL DIGITAL ASSISTANTS (PDA), CALCULATORS; SATELLITE PROCESSORS, AUDIO AND VIDEO RECORDINGS IN THE FIELD OF NEWS, SPORTS, ENTERTAINMENT, CULTURE, BUSINESS AND FINANCE, WEATHER AND TRAVEL, IN CLASS 9 (U.S. CLS. 21, 23, 26, 36 AND 38).

PRIORITY CLAIMED UNDER SEC. 44(D) ON FED REP GERMANY APPLICATION NO. 30760203.6/3, FILED 9-13-2007, REG. NO. 30760203, DATED 11-7-2007, EXPIRES 9-30-2017.

THE COLOR(S) MAGENTA IS/ARE CLAIMED AS A FEATURE OF THE MARK.

THE MARK CONSISTS OF FIVE SMILEY FACES DRAWN IN MAGENTA ARRANGED IN A CIRCULAR FORMAT. WHITE IN THE DRAWING REPRESENTS A TRANSPARENT BACKGROUND.

SER. NO. 77-420,680, FILED 3-13-2008.

REBECCA EISINGER, EXAMINING ATTORNEY

Int. Cl.: 16

Prior U.S. Cls.: 2, 5, 22, 23, 29, 37, 38 and 50

United States Patent and Trademark Office

Reg. No. 3,575,159

Registered Feb. 17, 2009

TRADEMARK
PRINCIPAL REGISTER

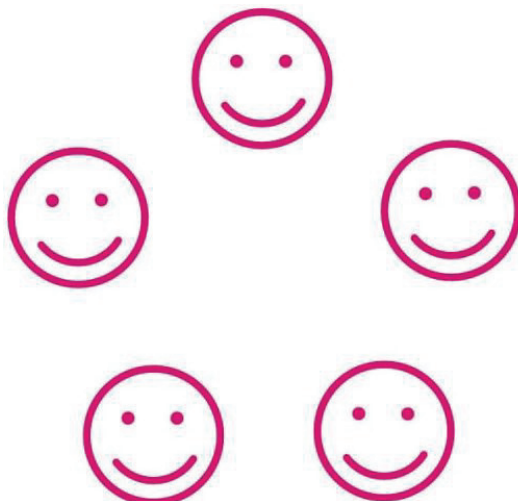

DEUTSCHE TELEKOM (FED REP GERMANY
AG CORPORATION)
FRIEDRICH-EBERT-ALLEE 140
BONN, FED REP GERMANY 53113

FOR: PRINTED MATTER, NAMELY, PAMPHLETS, BROCHURES, AND PRINTED INFORMATIONAL SHEETS AND GREETING CARDS, ALL IN THE FIELD OF TELECOMMUNICATIONS, PRINTED AND STAMPED PLASTIC AND CARDBOARD GREETING CARDS, BLANK, NOTE, AND INDEX CARDS, AS WELL AS BOOKS AND MAGAZINES, ALL IN THE FIELD OF TELECOMMUNICATIONS; NOTE PAPER AND ENVELOPES, RUBBER STAMPS, NAME TAGS AND LABELS MADE FROM PAPER OR CARDBOARD; NOTEBOOKS, DIARIES, NOTE PAPERS, NOTE PADS, ADDRESS BOOKS, FOLDERS FOR LETTERS, FILES OR LOOSE PAPER, CLEAR HOLE REINFORCEMENTS IN THE NATURE OF ADHESIVE LABELS, STUDENT CALENDARS, STAMP ALBUMS AND PHOTO-ALBUMS; PRINTED INSTRUCTIONAL AND TEACHING MATERIALS ALL IN THE FIELDS OF TELECOMMU-

NICATIONS, INFORMATION TECHNOLOGY, SAFETY, NEWS, SPORTS, ENTERTAINMENT, CULTURE, BUSINESS AND FINANCE, WEATHER AND TRAVEL, IN CLASS 16 (U.S. CLS. 2, 5, 22, 23, 29, 37, 38 AND 50).

PRIORITY CLAIMED UNDER SEC. 44(D) ON FED REP GERMANY APPLICATION NO. 30760203.6/3, FILED 9-13-2007, REG. NO. 30760203, DATED 11-7-2007, EXPIRES 9-30-2017.

THE COLOR(S) MAGENTA IS/ARE CLAIMED AS A FEATURE OF THE MARK.

THE MARK CONSISTS OF FIVE SMILEY FACES DRAWN IN MAGENTA ARRANGED IN A CIRCULAR FORMAT. WHITE IN THE DRAWING REPRESENTS A TRANSPARENT BACKGROUND.

SER. NO. 77-420,690, FILED 3-13-2008.

REBECCA EISINGER, EXAMINING ATTORNEY

Int. Cl.: 36

Prior U.S. Cls.: 100, 101 and 102

United States Patent and Trademark Office

Reg. No. 3,575,160

Registered Feb. 17, 2009

**SERVICE MARK
PRINCIPAL REGISTER**

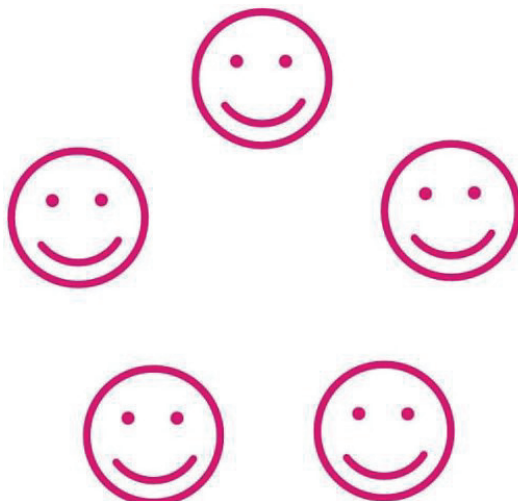

DEUTSCHE TELEKOM (FED REP GERMANY
AG CORPORATION)
FRIEDRICH-EBERT-ALLEE 140
BONN, FED REP GERMANY 53113

FOR: TELEPHONE CALLING CARD SERVICES;
ELECTRONIC COMMERCE SERVICES, NAMELY,
ELECTRONIC DEBIT AND CREDIT CARD TRANS-
ACTION PROCESSING SERVICES; PROVIDING IN-
FORMATION VIA TELEPHONE AND THE GLOBAL
COMMUNICATION NETWORKS IN THE FIELD OF
FINANCE, IN CLASS 36 (U.S. CLS. 100, 101 AND 102).

PRIORITY CLAIMED UNDER SEC. 44(D) ON FED
REP GERMANY APPLICATION NO. 30760203.6/3,

FILED 9-13-2007, REG. NO. 30760203, DATED 11-7-
2007, EXPIRES 9-30-2017.

THE COLOR(S) MAGENTA IS/ARE CLAIMED AS
A FEATURE OF THE MARK.

THE MARK CONSISTS OF FIVE SMILEY FACES
DRAWN IN MAGENTA ARRANGED IN A CIRCULAR
FORMAT. WHITE IN THE DRAWING REPRESENTS A
TRANSPARENT BACKGROUND.

SER. NO. 77-420,705, FILED 3-13-2008.

CARRIE GENOVESE, EXAMINING ATTORNEY

Int. Cl.: 37

Prior U.S. Cls.: 100, 103 and 106

United States Patent and Trademark Office

Reg. No. 3,575,161

Registered Feb. 17, 2009

**SERVICE MARK
PRINCIPAL REGISTER**

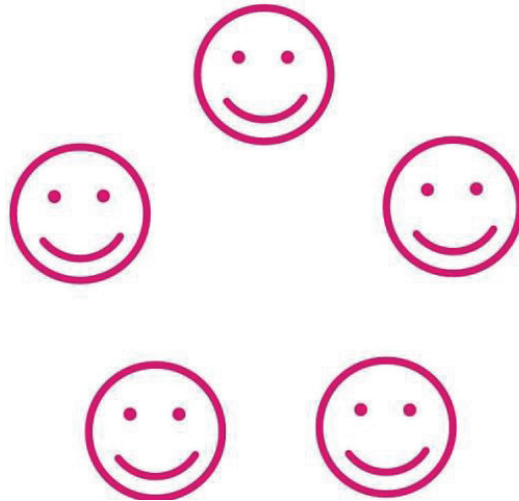

DEUTSCHE TELEKOM (FED REP GERMANY
AG CORPORATION)
FRIEDRICH-EBERT-ALLEE 140
BONN, FED REP GERMANY 53113

THE COLOR(S) MAGENTA IS/ARE CLAIMED AS
A FEATURE OF THE MARK.

FOR: BUILDING CONSTRUCTION; INSTALLA-
TION SERVICES, NAMELY, INSTALLATION OF
TELECOMMUNICATIONS NETWORKS, APPARA-
TUS, INSTRUMENTS AND COMPUTER SYSTEMS;
REPAIR AND MAINTENANCE OF COMPUTER
AND TELECOMMUNICATIONS EQUIPMENT, IN
CLASS 37 (U.S. CLS. 100, 103 AND 106).

THE MARK CONSISTS OF FIVE SMILEY FACES
DRAWN IN MAGENTA ARRANGED IN A CIRCUL-
LAR FORMAT. WHITE IN THE DRAWING REPRESENTS A TRANSPARENT BACKGROUND.

SER. NO. 77-420,713, FILED 3-13-2008.

OWNER OF FED REP GERMANY REG. NO.
30760203, DATED 7-11-2007, EXPIRES 9-30-2017.

CARRIE GENOVESE, EXAMINING ATTORNEY

Int. Cl.: 38

Prior U.S. Cls.: 100, 101 and 104

United States Patent and Trademark Office

Reg. No. 3,575,162

Registered Feb. 17, 2009

**SERVICE MARK
PRINCIPAL REGISTER**

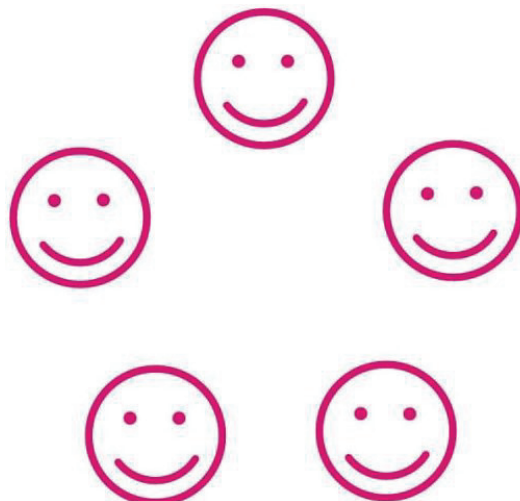

DEUTSCHE TELEKOM (FED REP GERMANY
AG CORPORATION)
FRIEDRICH-EBERT-ALLEE 140
BONN, FED REP GERMANY 53113

FOR: TELECOMMUNICATIONS SERVICES, NAMELY WIRELESS PHONE SERVICES, ELECTRIC, DIGITAL, CELLULAR AND WIRELESS TRANSMISSION OF VOICE, DATA, INFORMATION, IMAGES, SIGNALS, MESSAGES AND TRANSMISSION OF VOICE, DATA, IMAGES, AUDIO, VIDEO AND INFORMATION VIA TELEPHONE, TELEVISION AND GLOBAL COMMUNICATION NETWORKS; PROVIDING TELECOMMUNICATIONS CONNECTIONS OVER A GLOBAL COMMUNICATIONS NETWORK; ELECTRONIC MAIL, VOICE MAIL AND MESSAGING SERVICES, NAMELY, THE RECORDING AND STORAGE AND SUBSEQUENT TRANSMISSION OF VOICE MESSAGES BY TELEPHONE; AUDIO AND VIDEO TELECONFERENCING; RENTAL OF TELECOMMUNICATIONS EQUIPMENT, NAMELY, EQUIPMENT FOR ELECTRONIC ACCESS TO GLOBAL TELECOMMUNICATIONS NETWORK, EQUIPMENT FOR TRANSMITTING, RECEIVING, RECORDING AND MONITORING VOICE, DATA, INFORMATION, IMAGES, SIGNALS, MESSAGES AND TELECOMMUNICATIONS HARDWARE AND SOFTWARE INCLUDING COMPONENTS AND PERIPHERALS THEREOF FOR USE IN THE TELECOMMUNICATIONS INDUSTRY; RENTAL OF EQUIPMENT FOR TELECOMMUNICATIONS, NAMELY, EQUIPMENT FOR

TRANSMITTING, RECEIVING AND RECORDING, AND COMPUTER PROGRAMS USED FOR MONITORING, OPERATING AND ACCESSING TELECOMMUNICATIONS SYSTEMS; AUDIO AND VIDEO BROADCASTING FEATURING ENTERTAINMENT IN THE NATURE OF LIVE VISUAL AND AUDIO PERFORMANCES OF MUSICAL, VARIETY, NEWS AND COMEDY SHOWS; PROVIDING ACCESS TO COMPUTER INFORMATION NETWORKS; TELECOMMUNICATIONS SERVICES, NAMELY, PERSONAL COMMUNICATIONS SERVICES; PAGER SERVICES; ELECTRONIC MAIL SERVICES; TRANSMISSION AND BROADCAST OF AUDIO AND VIDEO PROGRAMMING; PROVIDING MULTIPLE-USER ACCESS TO A GLOBAL COMMUNICATION NETWORK; LEASING TELECOMMUNICATIONS EQUIPMENT, COMPONENTS, SYSTEMS AND SUPPLIES, IN CLASS 38 (U.S. CLS. 100, 101 AND 104).

OWNER OF FED REP GERMANY REG. NO. 30760203, DATED 7-11-2007, EXPIRES 9-30-2017.

THE COLOR(S) MAGENTA IS/ARE CLAIMED AS A FEATURE OF THE MARK.

THE MARK CONSISTS OF FIVE SMILEY FACES DRAWN IN MAGENTA ARRANGED IN A CIRCULAR FORMAT. WHITE IN THE DRAWING REPRESENTS A TRANSPARENT BACKGROUND.

SER. NO. 77-420,727, FILED 3-13-2008.

CARRIE GENOVESE, EXAMINING ATTORNEY

Int. Cl.: 42

Prior U.S. Cls.: 100 and 101

United States Patent and Trademark Office

Reg. No. 3,575,163

Registered Feb. 17, 2009

**SERVICE MARK
PRINCIPAL REGISTER**

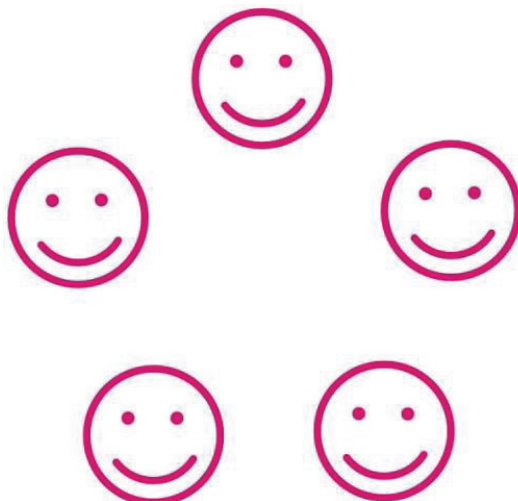

DEUTSCHE TELEKOM (FED REP GERMANY
AG CORPORATION)
FRIEDRICH-EBERT-ALLEE 140
BONN, FED REP GERMANY 53113

FOR: COMPUTER PROGRAMMING SERVICES FOR OTHERS, NAMELY, DEVELOPMENT OF DATA PROCESSING PROGRAMS FOR OTHERS; CONSULTING IN THE FIELD OF TELECOMMUNICATIONS TECHNOLOGY; RENTAL OF COMPUTER SOFTWARE AND COMPUTER HARDWARE FOR ONLINE ACCESS; DEVELOPMENT AND CREATION OF DATA PROCESSING PROGRAMS BY ORDER OF THIRD PARTIES; PROFESSIONAL CONSULTANCY IN THE FIELD OF DATA PROCESSING TECHNOLOGY; WEB PAGE HOSTING SERVICES; CONSULTING AND DESIGN SERVICES IN THE FIELD OF INFORMATION TECHNOLOGY, COMPUTER PROGRAMMING, TELECOMMUNICATIONS TECHNOLOGY AND GLOBAL COMMU-

NICATION NETWORK TECHNOLOGY; INSTALLATION, MAINTENANCE AND REPAIR OF COMPUTER SOFTWARE, IN CLASS 42 (U.S. CLS. 100 AND 101).

OWNER OF FED REP GERMANY REG. NO. 30760203, DATED 11-7-2007, EXPIRES 9-30-2017.

THE COLOR(S) MAGENTA IS/ARE CLAIMED AS A FEATURE OF THE MARK.

THE MARK CONSISTS OF FIVE SMILEY FACES DRAWN IN MAGENTA ARRANGED IN A CIRCULAR FORMAT. WHITE IN THE DRAWING REPRESENTS A TRANSPARENT BACKGROUND.

SER. NO. 77-420,752, FILED 3-13-2008.

CARRIE GENOVESE, EXAMINING ATTORNEY

Int. Cl.: 42

Prior U.S. Cls.: 100 and 101

United States Patent and Trademark Office

Reg. No. 3,575,164

Registered Feb. 17, 2009

**SERVICE MARK
PRINCIPAL REGISTER**



THE OSBORN ENGINEERING COMPANY (OHIO CORPORATION)
1300 EAST NINTH STREET
SUITE 1500
CLEVELAND, OH 44114

FOR: CIVIL, STRUCTURAL, MECHANICAL, ELECTRICAL AND PLUMBING ENGINEERING SERVICES FOR THE DESIGN OF BUILDINGS AND INFRASTRUCTURE; CONDUCTING OF FEASIBILITY STUDIES FOR BUILDINGS AND INFRASTRUCTURE; FORENSIC ENGINEERING FOR BUILDINGS AND INFRASTRUCTURE, IN CLASS 42 (U.S. CLS. 100 AND 101).

FIRST USE 10-18-2007; IN COMMERCE 10-18-2007.

NO CLAIM IS MADE TO THE EXCLUSIVE RIGHT TO USE "ENGINEERING", APART FROM THE MARK AS SHOWN.

THE COLOR(S) DARK BLUE AND PALE BLUE IS/ ARE CLAIMED AS A FEATURE OF THE MARK.

THE MARK CONSISTS OF THE LOGO WHICH IS A LENGTHWISE OVAL SHAPE, SPLIT IN THE MIDDLE, WITH DARK BLUE IN THE TOP HALF OF THE OVAL, AND PALE BLUE IN THE LOWER HALF OF THE OVAL. THE OVAL ALSO INCLUDES VERTICAL BARS ON THE RIGHT HALF OF THE OVAL, AND THESE ARE ALSO SPLIT IN THE MIDDLE. THE WORDS "OSBORN ENGINEERING" APPEAR BELOW THE OVAL IN DARK BLUE. THE WORD "OSBORN" IS BOLDED AND LARGER IN COMPARISON TO THE WORD "ENGINEERING".

SER. NO. 77-421,104, FILED 3-13-2008.

CHRISTINA SOBRAL, EXAMINING ATTORNEY

Int. Cl.: 37

Prior U.S. Cls.: 100, 103 and 106

United States Patent and Trademark Office

Reg. No. 3,575,165

Registered Feb. 17, 2009

**SERVICE MARK
PRINCIPAL REGISTER**

SUNSHINE CONNECTIONS, INC.

SUNSHINE CONNECTIONS, INC. (ARIZONA CORPORATION)
637 THIRD AVENUE STE F
CHULA VISTA, CA 91910

OWNER OF U.S. REG. NO. 3,377,414.

FOR: INSTALLATION OF CABLE, DATA, VIDEO, AND TELEPHONE SERVICE CONNECTIONS, IN CLASS 37 (U.S. CLS. 100, 103 AND 106).

NO CLAIM IS MADE TO THE EXCLUSIVE RIGHT TO USE "CONNECTIONS, INC.", APART FROM THE MARK AS SHOWN.

FIRST USE 6-15-2005; IN COMMERCE 6-15-2005.

SER. NO. 77-421,514, FILED 3-13-2008.

THE MARK CONSISTS OF STANDARD CHARACTERS WITHOUT CLAIM TO ANY PARTICULAR FONT, STYLE, SIZE, OR COLOR.

SETH A. RAPPAPORT, EXAMINING ATTORNEY

Int. Cl.: 35

Prior U.S. Cls.: 100, 101 and 102

United States Patent and Trademark Office

Reg. No. 3,575,166

Registered Feb. 17, 2009

**SERVICE MARK
PRINCIPAL REGISTER**



HS TM, LLC (DELAWARE LIMITED LIABILITY
COMPANY)
220 CONTINENTAL DRIVE SUITE 115
NEWARK, DE 19713

FOR: INTERNET-BASED DISTRIBUTORSHIP
FEATURING HEALTHCARE PRODUCTS AND
SERVICES TO OFFICE-BASED PRACTITIONERS,
IN CLASS 35 (U.S. CLS. 100, 101 AND 102).

FIRST USE 3-0-2000; IN COMMERCE 3-0-2000.

OWNER OF U.S. REG. NO. 2,532,652.

THE MARK CONSISTS OF THE LITERAL ELE-
MENT "SURG" AND A STYLIZED "E" IN A PAR-
TICAL CIRCLE.

SER. NO. 77-422,034, FILED 3-14-2008.

MARTHA SANTOMARTINO, EXAMINING ATTOR-
NEY

Int. Cl.: 25

Prior U.S. Cls.: 22 and 39

United States Patent and Trademark Office

Reg. No. 3,575,167

Registered Feb. 17, 2009

**TRADEMARK
PRINCIPAL REGISTER**

SUPRA-FIT

THE TRANZONIC COMPANIES (OHIO COR-
PORATION)
670 ALPHA DRIVE
HIGHLAND HEIGHTS, OH 44143

THE MARK CONSISTS OF STANDARD CHAR-
ACTERS WITHOUT CLAIM TO ANY PARTICULAR
FONT, STYLE, SIZE, OR COLOR.

FOR: DISPOSABLE ADULT BRIEFS, IN CLASS 25
(U.S. CLS. 22 AND 39).

SER. NO. 77-422,172, FILED 3-14-2008.

FIRST USE 8-22-2007; IN COMMERCE 3-14-2008.

LINDA ORNDORFF, EXAMINING ATTORNEY

Int. Cls.: 5 and 10

Prior U.S. Cls.: 6, 18, 26, 39, 44, 46, 51 and 52

United States Patent and Trademark Office

Reg. No. 3,575,168

Registered Feb. 17, 2009

**TRADEMARK
PRINCIPAL REGISTER**

OPTIJECT

HOECHST GMBH (FED REP GERMANY CORPORATION)
BRUNINGSTRASSE 50
FRANKFURT AM MAIN, FED REP GERMANY
65926

FOR: INSULIN; INSULIN INJECTORS SOLD FILLED WITH INSULIN, IN CLASS 5 (U.S. CLS. 6, 18, 44, 46, 51 AND 52).

FOR: INSULIN INJECTORS SOLD EMPTY, IN CLASS 10 (U.S. CLS. 26, 39 AND 44).

THE MARK CONSISTS OF STANDARD CHARACTERS WITHOUT CLAIM TO ANY PARTICULAR FONT, STYLE, SIZE, OR COLOR.

OWNER OF FED REP GERMANY REG. NO. 39748043, DATED 12-9-1997, RENEWED AS REG. NO. 39748043, DATED 8-10-2007, EXPIRES 10-31-2017.

OWNER OF U.S. REG. NO. 2,590,139.

SER. NO. 77-422,654, FILED 3-14-2008.

GISELLE AGOSTO, EXAMINING ATTORNEY

Int. Cl.: 41

Prior U.S. Cls.: 100, 101 and 107

United States Patent and Trademark Office

Reg. No. 3,575,169

Registered Feb. 17, 2009

**SERVICE MARK
PRINCIPAL REGISTER**

ETHICALLY ENGAGED YOUTH

VAIL MOUNTAIN SCHOOL (COLORADO NON-
PROFIT CORPORATION)
3000 BOOTH FALLS ROAD
VAIL, CO 81657

FOR: EDUCATIONAL SERVICES, NAMELY, IN-
STRUCTION, PROGRAMS AND FIELD TRIP AC-
TIVITIES IN THE FIELD OF MORAL EDUCATION,
ETHICS, COMMUNITY SERVICE, ENVIRONMEN-
TAL PROTECTION, WORLD AFFAIRS, AND DI-
PLOMACY AND DISTRIBUTING
INSTRUCTIONAL COURSE MATERIALS IN CON-
NECTION THEREWITH, IN CLASS 41 (U.S. CLS. 100,
101 AND 107).

FIRST USE 8-1-2006; IN COMMERCE 8-1-2006.

THE MARK CONSISTS OF STANDARD CHAR-
ACTERS WITHOUT CLAIM TO ANY PARTICULAR
FONT, STYLE, SIZE, OR COLOR.

NO CLAIM IS MADE TO THE EXCLUSIVE
RIGHT TO USE "YOUTH", APART FROM THE
MARK AS SHOWN.

SER. NO. 77-422,664, FILED 3-14-2008.

SIMON TENG, EXAMINING ATTORNEY

Int. Cl.: 11

Prior U.S. Cls.: 13, 21, 23, 31 and 34

United States Patent and Trademark Office

Reg. No. 3,575,170

Registered Feb. 17, 2009

**TRADEMARK
PRINCIPAL REGISTER**

ALBERTINE

LA CORNUE (FRANCE SOCIÉTÉ PAR ACTIONS
SIMPLIFIÉE (SAS))

14, RUE DU BOIS DU PONT

ZI LES BÉTHUNES, 95310

SAINT-OUEN L'AUMONE, FRANCE

FOR: COOKING INSTALLATIONS AND APPA-
RATUS, NAMELY, GAS AND ELECTRIC COO-
KERS, GAS AND ELECTRIC OVENS AND GAS
AND ELECTRIC RANGES, IN CLASS 11 (U.S. CLS.
13, 21, 23, 31 AND 34).

THE MARK CONSISTS OF STANDARD CHAR-
ACTERS WITHOUT CLAIM TO ANY PARTICULAR
FONT, STYLE, SIZE, OR COLOR.

PRIORITY CLAIMED UNDER SEC. 44(D) ON
FRANCE APPLICATION NO. 08/3557634, FILED 2-
21-2008, REG. NO. 083557634, DATED 2-21-2008, EX-
PIRES 2-21-2018.

SER. NO. 77-423,363, FILED 3-17-2008.

MARK RADEMACHER, EXAMINING ATTORNEY

Int. Cl.: 36

Prior U.S. Cls.: 100, 101 and 102

United States Patent and Trademark Office

Reg. No. 3,575,171

Registered Feb. 17, 2009

**SERVICE MARK
PRINCIPAL REGISTER**

Bright Spirit

BRIGHT SPIRIT CHILDREN'S FOUNDATION,
INC. (MASSACHUSETTS CORPORATION)
12 CANAVAN CIRCLE
NEEDHAM, MA 02492

FOR: CHARITABLE SERVICES, NAMELY, FUN-
DRAISING AND PROVIDING GOODS AND SERVI-
CES TO SERIOUSLY ILL CHILDREN, IN CLASS 36
(U.S. CLS. 100, 101 AND 102).

FIRST USE 3-0-2008; IN COMMERCE 3-0-2008.

THE MARK CONSISTS OF STANDARD CHAR-
ACTERS WITHOUT CLAIM TO ANY PARTICULAR
FONT, STYLE, SIZE, OR COLOR.

SER. NO. 77-423,481, FILED 3-17-2008.

HEATHER SAPP, EXAMINING ATTORNEY

Int. Cl.: 36

Prior U.S. Cls.: 100, 101 and 102

United States Patent and Trademark Office

Reg. No. 3,575,172

Registered Feb. 17, 2009

**SERVICE MARK
PRINCIPAL REGISTER**



OPTION INVESTMENTS, INC. (CALIFORNIA CORPORATION)
SUITE 1030
8001 IRVINE CENTER DRIVE
IRVINE, CA 92618

FOR: BROKERAGE HOUSES IN THE FIELD OF STOCKS, COMMODITIES, AND FUTURES; FINANCIAL AND INVESTMENT SERVICES, NAMELY, MANAGEMENT AND BROKERAGE IN THE FIELDS OF STOCKS, BONDS, OPTIONS, COMMODITIES, FUTURES AND OTHER SECURITIES, AND THE INVESTMENT OF FUNDS OF OTHERS, IN CLASS 36 (U.S. CLS. 100, 101 AND 102).

FIRST USE 1-1-2008; IN COMMERCE 1-1-2008.

NO CLAIM IS MADE TO THE EXCLUSIVE RIGHT TO USE "OPTION INVESTMENTS, INC.", APART FROM THE MARK AS SHOWN.

THE COLOR(S) LIGHT BLUE, DARK BLUE, GRAY, WHITE IS/ARE CLAIMED AS A FEATURE OF THE MARK.

THE MARK CONSISTS OF THE LETTER "OP" STYLIZED IN WHITE ON IN A LIGHT BLUE SQUARE. THE LETTERS "VEST" IN TYPE FACE UTOPIA IN LIGHT GRAY ON A DARK BLUE RECTANGLE THE SQUARE AND RECTANGLE ARE SEPARATED BY A VERTICAL WHITE LINE. THE WORDS "OPTION INVESTMENTS, INC." IN DARK BLUE, APPEAR HORIZONTALLY BENEATH THE TWO BOXES ON A LIGHT GRAY RECTANGLE.

SER. NO. 77-424,365, FILED 3-17-2008.

MARTHA SANTOMARTINO, EXAMINING ATTORNEY

Int. Cl.: 40

Prior U.S. Cls.: 100, 103 and 106

United States Patent and Trademark Office

Reg. No. 3,575,173

Registered Feb. 17, 2009

**SERVICE MARK
PRINCIPAL REGISTER**

The logo for NORWOOD features the word "NORWOOD" in a bold, black, sans-serif font. A horizontal line passes through the middle of the letters "O", "O", and "D". To the right of the "D", a thick, black, curved line starts from the top and sweeps upwards and to the right, ending in a hook-like shape.

NORWOOD OPERATING COMPANY, LLC (DE-
LAWARE LIMITED LIABILITY COMPANY)
10 WEST MARKET STREET, SUITE 1400
INDIANAPOLIS, IN 46204

NAMELY, WORDS, PHRASES, DECORATIVE DE-
SIGNS ON ADVERTISING MATTER, IN CLASS 40
(U.S. CLS. 100, 103 AND 106).

FOR: CUSTOM IMPRINTING FOR OTHERS OF
COMPANY NAME, TRADE NAME, LOGO OR
OTHER COPY, NAMELY, WORDS, PHRASES,
AND DECORATIVE DESIGNS ON PROMOTIONAL
PRODUCTS, NAMELY, PROMOTIONAL MER-
CHANDISE, APPAREL, AND CORPORATE GIFTS;
CUSTOM PRINTING FOR OTHERS OF COMPANY
NAME, TRADE NAME, LOGO OR OTHER COPY,

FIRST USE 1-1-2001; IN COMMERCE 1-1-2001.

OWNER OF U.S. REG. NO. 2,894,578.

SER. NO. 77-424,403, FILED 3-17-2008.

MARY MUNSON, EXAMINING ATTORNEY

Int. Cl.: 12

Prior U.S. Cls.: 19, 21, 23, 31, 35 and 44

Reg. No. 3,575,174

United States Patent and Trademark Office

Registered Feb. 17, 2009

**TRADEMARK
PRINCIPAL REGISTER**



JMEDIAGROUP.COM INC. (SOUTH CAROLINA CORPORATION), DBA GR8TOPS
158 FOX CROSSING RD.
WEST COLUMBIA, SC 29170

FOR: AUTOMOTIVE AFTERMARKET PARTS, NAMELY, ENCLOSURES FOR OFF-ROAD VEHICLE CABS, IN CLASS 12 (U.S. CLS. 19, 21, 23, 31, 35 AND 44).

FIRST USE 4-30-2007, THE MARK WAS FIRST USED ANYWHERE IN A DIFFERENT FORM OTHER THAN THAT SOUGHT TO BE REGISTERED ON 12/31/2003.; IN COMMERCE 4-30-2007, THE MARK WAS FIRST USED IN COMMERCE IN A DIFFERENT FORM OTHER

THAN THAT SOUGHT TO BE REGISTERED ON 12/31/2003..

THE MARK CONSISTS OF A LARGE STYLIZED LETTER "T" FLANKED BY THE STYLIZED WORDING "GR8" AND "OPS" WITH DEPICTIONS OF SCREW HEADS IN EACH LETTER AND NUMBER. THE WORDING "WWW.GR8TOPS.COM" APPEARS INSIDE THE TOP OF THE LARGE STYLIZED LETTER "T".

SER. NO. 77-424,524, FILED 3-18-2008.

ANDREA HACK, EXAMINING ATTORNEY

Int. Cl.: 6

Prior U.S. Cls.: 2, 12, 13, 14, 23, 25 and 50

Reg. No. 3,575,175

United States Patent and Trademark Office

Registered Feb. 17, 2009

**TRADEMARK
PRINCIPAL REGISTER**

ZINCALUME

BLUESCOPE STEEL LIMITED (AUSTRALIA
COMPANY)
LEVEL 11
120 COLLINS STREET
MELBOURNE, VIC 3000, AUSTRALIA

FOR: COMMON METALS AND ALLOYS OF
COMMON METALS; PRECOATED METAL SHEET,
PRECOATED METAL IN THE FORM OF COILS
AND STRIPS; PRECOATED METAL BUILDING
MATERIALS, NAMELY, COMPOSITE PANELS
COMPOSED PRIMARILY OF METAL, SOFFITS,
FASCIA; PREPAINTED METAL SHEET, PREPAINTED
METAL IN THE FORM OF COILS AND STRIPS;
PREPAINTED METAL BUILDING MATERIALS,
NAMELY, COMPOSITE PANELS COMPOSED
PRIMARILY OF METAL, SOFFITS, FASCIA; METAL IN
THE FORM OF SHEETS, COILS, STRIPS, PLATES,
BARS, RODS, SLABS AND INGOTS; METAL ROOF
AND WALL CLADDING FOR CONSTRUCTION
AND BUILDING, METAL CEILING BATTENS,
TRUSSES, PURLINS, STRUCTURAL DECKING,
METAL FORMWORK AND REINFORCING MATE-
RIALS FOR BUILDINGS, NAMELY, RODS, PLATES
AND BARS, METAL MESH, STEEL IN EXPANDED
METAL FORM, METAL RAINWATER PRODUCTS,

NAMELY, METAL FACIAS, METAL GUTTERS,
METAL RIDGE CAPPINGS, METAL DOWNPIPE
FOR DRAINING WATER AND METAL RAINWA-
TER TANKS; METAL BUILDING FRAMES, METAL
FRAMING SECTIONS FOR HOUSES AND COM-
MERCIAL BUILDINGS; TRANSPORTABLE BUILD-
INGS OF METAL; METAL FENCING MATERIALS,
NAMELY, PANELS, STAYS; METAL POSTS AND
PANELS; PIPES AND TUBES OF METAL; METAL
FACIAS, METAL CHANNELS, METAL ANGLES,
BRACKETS, CLIPS AND CLAMPS, ALL OF METAL,
IN CLASS 6 (U.S. CLS. 2, 12, 13, 14, 23, 25 AND 50).

FIRST USE 1-1-2001; IN COMMERCE 1-1-2001.

THE MARK CONSISTS OF STANDARD CHAR-
ACTERS WITHOUT CLAIM TO ANY PARTICULAR
FONT, STYLE, SIZE, OR COLOR.

OWNER OF U.S. REG. NO. 1,154,514.

SER. NO. 77-424,576, FILED 3-18-2008.

YAT SYE, LEE, EXAMINING ATTORNEY

Int. Cl.: 8

Prior U.S. Cls.: 23, 28 and 44

United States Patent and Trademark Office

Reg. No. 3,575,176

Registered Feb. 17, 2009

**TRADEMARK
PRINCIPAL REGISTER**

ETS MOTORSPORTS

EQUIPMENT, TOOL & SUPPLIES, INC. (ILLINOIS CORPORATION)
742 LORDS MILL ROAD
COMMERCE, GA 30529

FOR: AUTOMOTIVE HAND TOOLS, NAMELY, TORQUE WRENCHES, RATCHET WRENCHES AND RATCHET SOCKET WRENCHES, HOSE WRENCHES, HOSE SHEARS, SAFETY PLIERS, ANGLE GRINDERS, METAL VISE JAWS, SANDERS, RIVETERS, NAMELY, HAND TOOLS FOR DRIVING RIVETS, TUBING BENDERS, IN CLASS 8 (U.S. CLS. 23, 28 AND 44).

FIRST USE 10-15-2004; IN COMMERCE 10-15-2004.

THE MARK CONSISTS OF STANDARD CHARACTERS WITHOUT CLAIM TO ANY PARTICULAR FONT, STYLE, SIZE, OR COLOR.

OWNER OF U.S. REG. NO. 3,229,674.

NO CLAIM IS MADE TO THE EXCLUSIVE RIGHT TO USE "MOTORSPORTS", APART FROM THE MARK AS SHOWN.

SER. NO. 77-424,578, FILED 3-18-2008.

YAT SYE, LEE, EXAMINING ATTORNEY

Int. Cl.: 32

Prior U.S. Cls.: 45, 46 and 48

Reg. No. 3,575,177

United States Patent and Trademark Office

Registered Feb. 17, 2009

**TRADEMARK
PRINCIPAL REGISTER**

HANDCRAFTED. EVERY BEER.
EVERY DROP. EVERY TIME.

R.J. ROCKERS, INC. (SOUTH CAROLINA COR-
PORATION)
113D BELTON DRIVE
SPARTANBURG, SC 29301

NO CLAIM IS MADE TO THE EXCLUSIVE
RIGHT TO USE "HANDCRAFTED" AND "BEER",
APART FROM THE MARK AS SHOWN.

FOR: BEER, IN CLASS 32 (U.S. CLS. 45, 46 AND 48).

FIRST USE 3-4-2008; IN COMMERCE 3-4-2008.

SER. NO. 77-424,879, FILED 3-18-2008.

THE MARK CONSISTS OF STANDARD CHAR-
ACTERS WITHOUT CLAIM TO ANY PARTICULAR
FONT, STYLE, SIZE, OR COLOR.

BILL DAWE, EXAMINING ATTORNEY

Int. Cls.: 16 and 28

Prior U.S. Cls.: 2, 5, 22, 23, 29, 37, 38 and 50

United States Patent and Trademark Office

Reg. No. 3,575,178

Registered Feb. 17, 2009

**TRADEMARK
PRINCIPAL REGISTER**



CCA AND B, LLC (GEORGIA LIMITED LIABILITY COMPANY)
SUITE 106
1590 NORTH ROBERTS ROAD
KENNESAW, GA 30144

FOR: CHILDREN'S ACTIVITY BOOKS; CHILDREN'S BOOKS, IN CLASS 16 (U.S. CLS. 2, 5, 22, 23, 29, 37, 38 AND 50).

FIRST USE 6-1-2007; IN COMMERCE 6-1-2007.

FOR: DOLLS AND CHILDREN'S BOOKS SOLD AS A UNIT, IN CLASS 28 (U.S. CLS. 22, 23, 38 AND 50).

FIRST USE 6-1-2007; IN COMMERCE 6-1-2007.

THE MARK CONSISTS OF A CIRCULAR SEAL WITH SCALLOPED EDGES. THE CENTER OF THE

CIRCULAR SEAL CONSISTS OF A PICTURE OF SANTA CLAUSE WITH HIS FINGER POINTED INTO THE AIR. THAT PICTURE IS ENCLOSED BY A THIN CIRCLE. DIRECTLY OUTSIDE OF THAT CIRCLE APPEARS THE WORDS "SPECIAL DELIVERY FROM THE NORTH POLE" WHICH ARE WRITTEN AROUND THE OUTSIDE PERIMETER OF THE CIRCLE. THOSE WORDS ARE ENCLOSED BY A SECOND THIN CIRCLE. THE SECOND THIN CIRCLE IS ENCLOSED BY SCALLOPED EDGES IN THE FORM OF A CIRCLE CREATING THE LOOK OF A SEAL.

SER. NO. 77-424,946, FILED 3-18-2008.

PRISCILLA MILTON, EXAMINING ATTORNEY

Int. Cl.: 25

Prior U.S. Cls.: 22 and 39

United States Patent and Trademark Office

Reg. No. 3,575,179

Registered Feb. 17, 2009

**TRADEMARK
PRINCIPAL REGISTER**



SAVVMARI LLC (NEW YORK LIMITED LIABILITY COMPANY)
PO BOX 462165
AURORA, CO 80046

FOR: T-SHIRTS, IN CLASS 25 (U.S. CLS. 22 AND 39).

FIRST USE 3-7-2008; IN COMMERCE 3-7-2008.

NO CLAIM IS MADE TO THE EXCLUSIVE RIGHT TO USE "LLC", APART FROM THE MARK AS SHOWN.

THE COLOR(S) LIGHT GREY, GREY, ORANGE AND LIGHT BLUE IS/ARE CLAIMED AS A FEATURE OF THE MARK.

THE MARK CONSISTS OF A STYLIZED HUMAN IN A FLOTATION DEVICE IN WHICH THE COLOR LIGHT GREY APPEARS IN THE WORD "SAVVMARI LLC", IN A MISTRAL FONT AND PORTIONS OF THE FLOTATION DEVICE, THE COLOR GREY APPEARS IN THE CIRCULAR PORTION OF THE FLOTATION DEVICE, THE COLOR ORANGE APPEARS IN THE STYLIZED HEAD AND ARMS OF THE HUMAN AND IN BANDS ON THE FLOTATION DEVICE, AND THE COLOR LIGHT BLUE REPRESENTING WATER APPEARS BETWEEN THE HUMAN AND FLOTATION DEVICE.

SER. NO. 77-425,328, FILED 3-18-2008.

HANNO RITTNER, EXAMINING ATTORNEY

Int. Cl.: 43

Prior U.S. Cls.: 100 and 101

United States Patent and Trademark Office

Reg. No. 3,575,180

Registered Feb. 17, 2009

**SERVICE MARK
PRINCIPAL REGISTER**

BLANCO BALLROOM

ROQUE R. GARCIA (UNITED STATES INDIVIDUAL), DBA BLANCO BALLROOM
3719 BLANCO RD
SAN ANTONIO, TX 78212 AND
VELMA GARCIA (UNITED STATES INDIVIDUAL)
446 CONCORD
SAN ANTONIO, TX 78201

FOR: PROVIDING BANQUET AND SOCIAL FUNCTION FACILITIES FOR SPECIAL OCCASIONS, NAMELY, WEDDINGS, RECEPTIONS, DEBUTS, PARTIES, FUNDRAISERS, ANNIVERSARIES, PROMS, GRADUATION, BINGO PLAYING AND CONCERTS, IN CLASS 43 (U.S. CLS. 100 AND 101).

FIRST USE 3-19-1978; IN COMMERCE 3-19-1978.

THE MARK CONSISTS OF STANDARD CHARACTERS WITHOUT CLAIM TO ANY PARTICULAR FONT, STYLE, SIZE, OR COLOR.

NO CLAIM IS MADE TO THE EXCLUSIVE RIGHT TO USE "BALLROOM", APART FROM THE MARK AS SHOWN.

THE ENGLISH TRANSLATION OF "BLANCO" IS "WHITE".

SER. NO. 77-425,357, FILED 3-18-2008.

JOHN GARTNER, EXAMINING ATTORNEY

Int. Cl.: 42

Prior U.S. Cls.: 100 and 101

United States Patent and Trademark Office

Reg. No. 3,575,181

Registered Feb. 17, 2009

**SERVICE MARK
PRINCIPAL REGISTER**

T-Basix

DEUTSCHE TELEKOM (FED REP GERMANY
AG CORPORATION)
FRIEDRICH-EBERT-ALLEE 140
BONN, FED REP GERMANY 53113

FOR: COMPUTER PROGRAMMING SERVICES FOR OTHERS, NAMELY, DATA PROCESSING PROGRAMS FOR OTHERS; CONSULTING IN THE FIELD OF TELECOMMUNICATION; RENTAL OF SOFTWARE AND HARDWARE FOR ONLINE ACCESS; SERVICES OF AN INTERNET TRUST CENTER, NAMELY, ASSURANCE AND ADMINISTRATION OF DIGITAL KEYS AND/OR DIGITAL CERTIFICATES; RENTAL OF DATA PROCESSING EQUIPMENT; GENERATION OF DATA PROCESSING PROGRAMS; PROFESSIONAL CONSULTANCY IN THE FIELD OF DATA PROCESSING; WEB PAGE HOSTING SERVICES; OPERATING ELECTRONIC INFORMATION NETWORKS; CONSULTING AND DESIGN SERVICES IN THE FIELD OF INFORMATION TECHNOLOGY, COMPUTER PROGRAMMING, TELECOMMUNI-

CATIONS AND GLOBAL COMMUNICATION NETWORKS; INSTALLATION, MAINTENANCE AND REPAIR OF COMPUTER SOFTWARE, IN CLASS 42 (U.S. CLS. 100 AND 101).

THE MARK CONSISTS OF STANDARD CHARACTERS WITHOUT CLAIM TO ANY PARTICULAR FONT, STYLE, SIZE, OR COLOR.

PRIORITY CLAIMED UNDER SEC. 44(D) ON FED REP GERMANY APPLICATION NO. 30762178.2/3, FILED 9-21-2007, REG. NO. 30762178, DATED 11-5-2007, EXPIRES 9-30-2017.

OWNER OF U.S. REG. NOS. 3,408,035 AND 3,408,036.

SER. NO. 77-425,818, FILED 3-19-2008.

REGINA DRUMMOND, EXAMINING ATTORNEY

Int. Cl.: 45

Prior U.S. Cls.: 100 and 101

United States Patent and Trademark Office

Reg. No. 3,575,182

Registered Feb. 17, 2009

**SERVICE MARK
PRINCIPAL REGISTER**

T-Basix

DEUTSCHE TELEKOM (FED REP GERMANY
AG CORPORATION)
FRIEDRICH-EBERT-ALLEE 140
BONN, FED REP GERMANY 53113

FOR: LICENSING OF INDUSTRIAL PROPERTY
RIGHTS, IN CLASS 45 (U.S. CLS. 100 AND 101).

THE MARK CONSISTS OF STANDARD CHAR-
ACTERS WITHOUT CLAIM TO ANY PARTICULAR
FONT, STYLE, SIZE, OR COLOR.

PRIORITY CLAIMED UNDER SEC. 44(D) ON FED
REP GERMANY APPLICATION NO. 30762178.2/3,
FILED 9-21-2007, REG. NO. 30762178, DATED 11-5-
2007, EXPIRES 9-30-2017.

OWNER OF U.S. REG. NOS. 3,408,035 AND
3,408,036.

SER. NO. 77-425,828, FILED 3-19-2008.

REGINA DRUMMOND, EXAMINING ATTORNEY

Int. Cl.: 41

Prior U.S. Cls.: 100, 101 and 107

United States Patent and Trademark Office

Reg. No. 3,575,183

Registered Feb. 17, 2009

**SERVICE MARK
PRINCIPAL REGISTER**

Extreme Strings Orchestra

EXTREME STRINGS ACADEMY (PENNSYLVANIA CORPORATION)
3525 WOODLAKE DRIVE
ALLISON PARK, PA 15101

FOR: ORCHESTRA SERVICES; ENTERTAINMENT, NAMELY, LIVE MUSIC CONCERTS; ENTERTAINMENT SERVICES IN THE NATURE OF LIVE MUSICAL PERFORMANCES, IN CLASS 41 (U.S. CLS. 100, 101 AND 107).

FIRST USE 1-17-2007; IN COMMERCE 1-17-2007.

THE MARK CONSISTS OF STANDARD CHARACTERS WITHOUT CLAIM TO ANY PARTICULAR FONT, STYLE, SIZE, OR COLOR.

NO CLAIM IS MADE TO THE EXCLUSIVE RIGHT TO USE "STRINGS ORCHESTRA", APART FROM THE MARK AS SHOWN.

SER. NO. 77-425,953, FILED 3-19-2008.

LAURA HAMMEL, EXAMINING ATTORNEY

Int. Cl.: 35

Prior U.S. Cls.: 100, 101 and 102

United States Patent and Trademark Office

Reg. No. 3,575,184

Registered Feb. 17, 2009

**SERVICE MARK
PRINCIPAL REGISTER**

T-Complete

DEUTSCHE TELEKOM (FED REP GERMANY
AG CORPORATION)

FRIEDRICH-EBERT-ALLEE 140

BONN, FED REP GERMANY 53113

FOR: BUSINESS SERVICES, NAMELY, BUSINESS
INFORMATION SERVICES IN THE FIELD OF
TELECOMMUNICATIONS, ADVERTISING, IN-
FORMATION TECHNOLOGY; RENTAL OF AUTO-
MATIC VENDING MACHINES, IN CLASS 35 (U.S.
CLS. 100, 101 AND 102).

THE MARK CONSISTS OF STANDARD CHAR-
ACTERS WITHOUT CLAIM TO ANY PARTICULAR
FONT, STYLE, SIZE, OR COLOR.

OWNER OF FED REP GERMANY REG. NO.
30762179, DATED 11-5-2007, EXPIRES 9-30-2017.

OWNER OF U.S. REG. NOS. 3,076,000, 3,219,515
AND OTHERS.

SER. NO. 77-426,085, FILED 3-19-2008.

ANNE E. GUSTASON, EXAMINING ATTORNEY

Int. Cl.: 36

Prior U.S. Cls.: 100, 101 and 102

United States Patent and Trademark Office

Reg. No. 3,575,185

Registered Feb. 17, 2009

**SERVICE MARK
PRINCIPAL REGISTER**

T-Complete

DEUTSCHE TELEKOM (FED REP GERMANY
AG CORPORATION)
FRIEDRICH-EBERT-ALLEE 140
BONN, FED REP GERMANY 53113

FOR: TELEPHONE CALLING CARD SERVICES;
ELECTRONIC COMMERCE SERVICES, NAMELY,
ELECTRONIC DEBIT AND CREDIT CARD TRANS-
ACTION PROCESSING SERVICES; PROVIDING IN-
FORMATION VIA TELEPHONE AND THE GLOBAL
COMMUNICATION NETWORKS IN THE FIELD OF
FINANCE, IN CLASS 36 (U.S. CLS. 100, 101 AND 102).

THE MARK CONSISTS OF STANDARD CHAR-
ACTERS WITHOUT CLAIM TO ANY PARTICULAR
FONT, STYLE, SIZE, OR COLOR.

OWNER OF FED REP GERMANY REG. NO.
30762179, DATED 11-5-2007, EXPIRES 9-30-2017.

OWNER OF U.S. REG. NOS. 3,076,000, 3,219,515
AND OTHERS.

SER. NO. 77-426,091, FILED 3-19-2008.

ANNE E. GUSTASON, EXAMINING ATTORNEY

Int. Cl.: 37

Prior U.S. Cls.: 100, 103 and 106

United States Patent and Trademark Office

Reg. No. 3,575,186

Registered Feb. 17, 2009

**SERVICE MARK
PRINCIPAL REGISTER**

T-Complete

DEUTSCHE TELEKOM (FED REP GERMANY
AG CORPORATION)
FRIEDRICH-EBERT-ALLEE 140
BONN, FED REP GERMANY 53113

FOR: BUILDING CONSTRUCTION; INSTALLATION SERVICES, NAMELY, INSTALLATION OF TELECOMMUNICATIONS NETWORKS, APPARATUS, INSTRUMENTS AND COMPUTER SYSTEMS; REPAIR AND MAINTENANCE OF COMPUTER AND TELECOMMUNICATIONS EQUIPMENT, IN CLASS 37 (U.S. CLS. 100, 103 AND 106).

THE MARK CONSISTS OF STANDARD CHARACTERS WITHOUT CLAIM TO ANY PARTICULAR FONT, STYLE, SIZE, OR COLOR.

OWNER OF FED REP GERMANY REG. NO. 30762179, DATED 11-5-2007, EXPIRES 9-30-2017.

OWNER OF U.S. REG. NOS. 3,076,000, 3,219,515 AND OTHERS.

SER. NO. 77-426,102, FILED 3-19-2008.

ANNE E. GUSTASON, EXAMINING ATTORNEY

Int. Cl.: 38

Prior U.S. Cls.: 100, 101 and 104

United States Patent and Trademark Office

Reg. No. 3,575,187

Registered Feb. 17, 2009

**SERVICE MARK
PRINCIPAL REGISTER**

T-Complete

DEUTSCHE TELEKOM (FED REP GERMANY
AG CORPORATION)
FRIEDRICH-EBERT-ALLEE 140
BONN, FED REP GERMANY 53113

FOR: TELECOMMUNICATIONS SERVICES, NAMELY, WIRELESS PHONE SERVICES, ELECTRIC, DIGITAL, CELLULAR AND WIRELESS TRANSMISSION OF VOICE, DATA, INFORMATION, IMAGES, SIGNALS, MESSAGES AND TRANSMISSION OF VOICE, DATA, IMAGES, AUDIO, VIDEO AND INFORMATION VIA TELEPHONE, TELEVISION AND GLOBAL COMMUNICATION NETWORKS; PROVIDING TELECOMMUNICATIONS CONNECTIONS OVER A GLOBAL COMMUNICATIONS NETWORK; ELECTRONIC MAIL, VOICE MAIL AND MESSAGING SERVICES, NAMELY, THE RECORDING AND STORAGE AND SUBSEQUENT TRANSMISSION OF VOICE MESSAGES BY TELEPHONE; AUDIO AND VIDEO TELECONFERENCING; RENTAL OF TELECOMMUNICATIONS EQUIPMENT, NAMELY, EQUIPMENT FOR ELECTRONIC ACCESS TO GLOBAL TELECOMMUNICATIONS NETWORK, EQUIPMENT FOR TRANSMITTING, RECEIVING, RECORDING AND MONITORING VOICE, DATA, INFORMATION, IMAGES, SIGNALS, MESSAGES AND TELECOMMUNICATIONS HARDWARE AND SOFTWARE INCLUDING COMPONENTS AND PERIPHERALS THEREOF FOR USE IN THE TELECOMMUNICATIONS INDUSTRY; RENTAL OF EQUIPMENT FOR TELECOMMUNICATIONS, NAMELY, EQUIPMENT FOR TRANSMITTING, RECEIVING AND RECORDING,

AND COMPUTER PROGRAMS USED FOR MONITORING, OPERATING AND ACCESSING TELECOMMUNICATIONS SYSTEMS; AUDIO AND VIDEO BROADCASTING FEATURING ENTERTAINMENT IN THE NATURE OF LIVE VISUAL AND AUDIO PERFORMANCES OF MUSICAL, VARIETY, NEWS AND COMEDY SHOWS; PROVIDING ACCESS TO COMPUTER INFORMATION NETWORKS; TELECOMMUNICATIONS SERVICES, NAMELY, PERSONAL COMMUNICATIONS SERVICES; PAGER SERVICES; ELECTRONIC MAIL SERVICES; TRANSMISSION AND BROADCAST OF AUDIO AND VIDEO PROGRAMMING; PROVIDING MULTIPLE-USER ACCESS TO A GLOBAL COMMUNICATION NETWORK; LEASING TELECOMMUNICATIONS EQUIPMENT, COMPONENTS, SYSTEMS AND SUPPLIES, IN CLASS 38 (U.S. CLS. 100, 101 AND 104).

THE MARK CONSISTS OF STANDARD CHARACTERS WITHOUT CLAIM TO ANY PARTICULAR FONT, STYLE, SIZE, OR COLOR.

OWNER OF FED REP GERMANY REG. NO. 30762179, DATED 11-5-2007, EXPIRES 9-30-2017.

OWNER OF U.S. REG. NOS. 3,076,000, 3,219,515 AND OTHERS.

SER. NO. 77-426,131, FILED 3-19-2008.

ANNE E. GUSTASON, EXAMINING ATTORNEY

Int. Cl.: 45

Prior U.S. Cls.: 100 and 101

United States Patent and Trademark Office

Reg. No. 3,575,188

Registered Feb. 17, 2009

**SERVICE MARK
PRINCIPAL REGISTER**

T-Complete

DEUTSCHE TELEKOM (FED REP GERMANY
AG CORPORATION)
FRIEDRICH-EBERT-ALLEE 140
BONN, FED REP GERMANY 53113

FOR: LICENSING OF INDUSTRIAL PROPERTY
RIGHTS, IN CLASS 45 (U.S. CLS. 100 AND 101).

THE MARK CONSISTS OF STANDARD CHAR-
ACTERS WITHOUT CLAIM TO ANY PARTICULAR
FONT, STYLE, SIZE, OR COLOR.

OWNER OF FED REP GERMANY REG. NO.
30762179, DATED 11-5-2007, EXPIRES 9-30-2017.

OWNER OF U.S. REG. NOS. 3,076,000, 3,219,515
AND OTHERS.

SER. NO. 77-426,153, FILED 3-19-2008.

ANNE E. GUSTASON, EXAMINING ATTORNEY

Int. Cl.: 35

Prior U.S. Cls.: 100, 101 and 102

United States Patent and Trademark Office

Reg. No. 3,575,189

Registered Feb. 17, 2009

**SERVICE MARK
PRINCIPAL REGISTER**

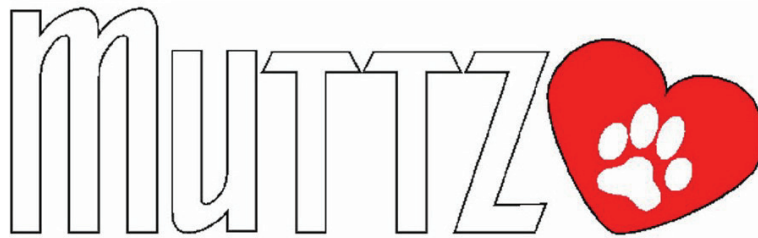

MUTTZ PET GOODS & GIFTS, INC. (COLORADO CORPORATION)
11225 DECATUR ST.
WESTMINSTER, CO 80234

FOR: RETAIL PET STORES, IN CLASS 35 (U.S. CLS. 100, 101 AND 102).

FIRST USE 2-1-2004; IN COMMERCE 5-22-2004.

THE COLOR(S) RED, WHITE AND BLACK IS/ ARE CLAIMED AS A FEATURE OF THE MARK.

THE COLOR RED APPEARS AS THE BACKGROUND COLOR IN THE HEART DESIGN; THE COLOR WHITE APPEARS AS THE BACKGROUND COLOR IN EACH LETTER OF THE WORD "MUTTZ" AND IN THE PAW DESIGN WHICH APPEARS INSIDE THE HEART DESIGN; AND COLOR BLACK OUTLINES THE HEART DESIGN AND IN EACH LETTER IN THE WORD "MUTTZ".

SER. NO. 77-426,703, FILED 3-19-2008.

BILL DAWE, EXAMINING ATTORNEY

Int. Cl.: 39

Prior U.S. Cls.: 100 and 105

United States Patent and Trademark Office

Reg. No. 3,575,190

Registered Feb. 17, 2009

**SERVICE MARK
PRINCIPAL REGISTER**

EAGLE'S WINGS AIR

EAGLE'S WINGS AIR, LLC. (INDIANA LIMITED
LIABILITY COMPANY)
1140 LAKE AVENUE
FORT WAYNE, IN 46805

FOR: TRAVEL AGENCY SERVICES, NAMELY,
MAKING RESERVATIONS AND BOOKINGS FOR
TRANSPORTATION; AIR TRANSPORT SERVICES,
IN CLASS 39 (U.S. CLS. 100 AND 105).

FIRST USE 3-0-2008; IN COMMERCE 3-0-2008.

THE MARK CONSISTS OF STANDARD CHAR-
ACTERS WITHOUT CLAIM TO ANY PARTICULAR
FONT, STYLE, SIZE, OR COLOR.

NO CLAIM IS MADE TO THE EXCLUSIVE
RIGHT TO USE "AIR", APART FROM THE MARK
AS SHOWN.

SER. NO. 77-427,361, FILED 3-20-2008.

DAWN FELDMAN, EXAMINING ATTORNEY

Int. Cl.: 41

Prior U.S. Cls.: 100, 101 and 107

United States Patent and Trademark Office

Reg. No. 3,575,191

Registered Feb. 17, 2009

**SERVICE MARK
PRINCIPAL REGISTER**

BLUE BOX BOB

JEWISH NATIONAL FUND (KEREN KAYE-
METH LEISRAEL), INC. (NEW YORK COR-
PORATION)
42 EAST 69TH STREET
NEW YORK, NY 10021

FOR: EDUCATIONAL SERVICES, NAMELY,
CLASSES, STORY TELLING AND ACTIVITIES IN
THE NATURE OF MUSIC, DANCING, SINGING,
PARADES, GAMES AND QUIZZES ON THE SUB-
JECTS OF ISRAEL, JEWISH VALUES AND THE
ENVIRONMENT, IN CLASS 41 (U.S. CLS. 100, 101
AND 107).

FIRST USE 4-0-2004; IN COMMERCE 4-0-2004.

THE MARK CONSISTS OF STANDARD CHAR-
ACTERS WITHOUT CLAIM TO ANY PARTICULAR
FONT, STYLE, SIZE, OR COLOR.

SER. NO. 77-427,485, FILED 3-20-2008.

MICHAEL KEATING, EXAMINING ATTORNEY

Int. Cl.: 25

Prior U.S. Cls.: 22 and 39

United States Patent and Trademark Office

Reg. No. 3,575,192

Registered Feb. 17, 2009

**TRADEMARK
PRINCIPAL REGISTER**



LYONS, JEAN (UNITED STATES INDIVIDUAL)
7003 BENTON DRIVE
PANAMA CITY, FL 32404

FOR: SHIRTS; SWEAT SHIRTS; T-SHIRTS; BASE-
BALL CAPS; HEADWEAR, IN CLASS 25 (U.S. CLS. 22
AND 39).

FIRST USE 9-21-2007; IN COMMERCE 9-21-2007.

THE COLOR(S) RED AND BLACK IS/ARE
CLAIMED AS A FEATURE OF THE MARK.

THE MARK CONSISTS OF A STYLIZED HEART
IN THE COLOR RED, A STYLIZED HAND IN
BLACK UNDERNEATH THE HEART DESIGN,
AND THE RED TEXT "BE KIND TO YOURSELF..."
AT THE BOTTOM OF THE MARK.

SER. NO. 77-427,518, FILED 3-20-2008.

JORDAN BAKER, EXAMINING ATTORNEY

Int. Cls.: 9, 35 and 42

Prior U.S. Cls.: 21, 23, 26, 36, 38, 100, 101 and 102

Reg. No. 3,575,193

United States Patent and Trademark Office

Registered Feb. 17, 2009

**TRADEMARK
SERVICE MARK
PRINCIPAL REGISTER**



VARICENT SOFTWARE INCORPORATED (CANADA CORPORATION)
36 YORK MILLS ROAD, SUITE 200
TORONTO, CANADA M2P2E9

FOR: COMPUTER SOFTWARE FOR THE DESIGN AND MANAGEMENT OF INCENTIVE AWARD PROGRAMS, AND USER MANUALS SOLD AS A UNIT THEREWITH, IN CLASS 9 (U.S. CLS. 21, 23, 26, 36 AND 38).

FIRST USE 5-31-2006; IN COMMERCE 5-31-2006.

FOR: BUSINESS MANAGEMENT CONSULTATION AND INFORMATION SERVICES RELATING TO REPORTING, MODELING, AND ANALYZING SALES INCENTIVE PLANS, IN CLASS 35 (U.S. CLS. 100, 101 AND 102).

FIRST USE 5-31-2006; IN COMMERCE 5-31-2006.

FOR: DESIGNING COMPUTER SOFTWARE FOR OTHERS FOR USE IN CREATING, CUSTOMIZING,

MAINTAINING AND CONDUCTING AND PROCESSING INCENTIVE AWARD PROGRAMS; INFORMATION SERVICES RELATING TO COMPUTER SOFTWARE FOR INCENTIVE AWARD PROGRAMS; PROVIDING TEMPORARY USE OF NON-DOWNLOADABLE COMPUTER SOFTWARE FOR THE DESIGN AND MANAGEMENT OF INCENTIVE AWARD PROGRAMS, AND USER MANUALS SOLD AS A UNIT, IN CLASS 42 (U.S. CLS. 100 AND 101).

FIRST USE 5-31-2006; IN COMMERCE 5-31-2006.

PRIORITY CLAIMED UNDER SEC. 44(D) ON CANADA APPLICATION NO. 1387351, FILED 3-13-2008.

SER. NO. 77-427,612, FILED 3-20-2008.

CHRISTINE BLOMQUIST, EXAMINING ATTORNEY

Int. Cls.: 7 and 21

**Prior U.S. Cls.: 2, 13, 19, 21, 23, 29, 30, 31, 33, 34, 35,
40 and 50**

Reg. No. 3,575,194

United States Patent and Trademark Office

Registered Feb. 17, 2009

**TRADEMARK
PRINCIPAL REGISTER**



WEBER BUERSTENSYSTEME GMBH (FED REP
GERMANY CORPORATION)

KLEINMUEHLE

BAD CAMBERG-ERBACH, FED REP GERMANY D-
65520

FOR: BRUSHES AND BODIES FOR BRUSHES AS PARTS OF MACHINES, NAMELY, ROLLER BRUSHES, SIDE-BROOMS, CIRCULAR BROOMS AND CIRCULAR BRUSHES, BRUSH RINGS, AND BRISTLE BUNDLES FOR MACHINES USED IN LAWN MAINTENANCE AND THE MAINTENANCE OF SPORTS FIELDS, FOR THE CLEANING OF STREETS AND FOOTPATHS, FOR SNOW REMOVAL, FOR INDUSTRIAL CLEANING AND FLOOR CLEANING, FOR THE CONCRETE INDUSTRY AND FOR WASTE PLANTS; BRUSHES AND BODIES FOR BRUSHES AS PARTS OF CAR WASHING MACHINES AND FOR MACHINES USED IN THE CLEANING OF REFLECTION POSTS AND MACHINES USED FOR REMOVAL OF WEEDS; ELECTRICAL, MOTOR-POWERED AND MANUALLY OPERATED CLEANING MACHINES AND DEVICES, NAMELY, ROAD SWEEPERS AND FLOOR

CLEANING MACHINES AND PARTS THEREFOR, IN CLASS 7 (U.S. CLS. 13, 19, 21, 23, 31, 34 AND 35).

FOR: BROOMS; BRUSHES, NAMELY, ACID-PROOF WASH BRUSHES USED FOR THE APPLICATION OF ACID TO VEHICLES FOR CLEANING PURPOSES; AUTOMOBILE WHEEL CLEANING BRUSHES; BRUSHES FOR FOOTWEAR; BRUSHES USED FOR CLEANING MEDICAL INSTRUMENTS; BRUSHES FOR CATTLE HAIR; CLOTHES BRUSHES; COSMETIC BRUSHES; DUSTING BRUSHES; HORSE BRUSHES; HORSE BRUSHES OF WIRE; PET BRUSHES; WIRE BRUSHES, NOT BEING MACHINE PARTS, IN CLASS 21 (U.S. CLS. 2, 13, 23, 29, 30, 33, 40 AND 50).

OWNER OF FED REP GERMANY REG. NO. 30028622, DATED 6-16-2000, EXPIRES 6-16-2010.

THE MARK CONSISTS OF THE LETTER "W" SURROUNDED BY A CIRCULAR DESIGN.

SER. NO. 77-427,758, FILED 3-20-2008.

TARA PATE, EXAMINING ATTORNEY

Int. Cl.: 16

Prior U.S. Cls.: 2, 5, 22, 23, 29, 37, 38 and 50

Reg. No. 3,575,195

United States Patent and Trademark Office

Registered Feb. 17, 2009

**TRADEMARK
PRINCIPAL REGISTER**

SANIWRAP

THE TRANZONIC COMPANIES (OHIO CORPORATION)
670 ALPHA DRIVE
HIGHLAND HEIGHTS, OH 44143

FOR: PAPER OR PLASTIC DISPOSABLE WRAP THAT IS PLACED AROUND INDIVIDUAL SANITARY NAPKINS WHEN SOLD AND THAT IS ALSO USED TO DISPOSE OF SANITARY NAPKINS , IN CLASS 16 (U.S. CLS. 2, 5, 22, 23, 29, 37, 38 AND 50).

FIRST USE 1-10-2008; IN COMMERCE 1-10-2008.

THE MARK CONSISTS OF STANDARD CHARACTERS WITHOUT CLAIM TO ANY PARTICULAR FONT, STYLE, SIZE, OR COLOR.

SER. NO. 77-428,016, FILED 3-21-2008.

LINDA ORNDORFF, EXAMINING ATTORNEY

Int. Cl.: 36

Prior U.S. Cls.: 100, 101 and 102

United States Patent and Trademark Office

Reg. No. 3,575,196

Registered Feb. 17, 2009

**SERVICE MARK
PRINCIPAL REGISTER**

**FIRST REPUBLIC TRUST
COMPANY**

MERRILL LYNCH BANK & TRUST CO., FSB
(UNITED STATES FEDERAL SAVINGS
BANK), DBA FIRST REPUBLIC BANK

4 WORLD FINANCIAL CENTER

NEW YORK, NY 10038

FOR: FIDUCIARY SERVICES, NAMELY, FIDUCIARY REPRESENTATIVE SERVICES, ESTATE TRUST MANAGEMENT, TRUST MANAGEMENT ACCOUNTS, ESTATE PLANNING, IN CLASS 36 (U.S. CLS. 100, 101 AND 102).

FIRST USE 1-17-2000; IN COMMERCE 9-29-2000.

THE MARK CONSISTS OF STANDARD CHARACTERS WITHOUT CLAIM TO ANY PARTICULAR FONT, STYLE, SIZE, OR COLOR.

OWNER OF U.S. REG. NOS. 2,699,808, 3,185,144 AND OTHERS.

NO CLAIM IS MADE TO THE EXCLUSIVE RIGHT TO USE "TRUST COMPANY", APART FROM THE MARK AS SHOWN.

SER. NO. 77-428,733, FILED 3-21-2008.

ALEXANDER L. POWERS, EXAMINING ATTORNEY

Int. Cl.: 36

Prior U.S. Cls.: 100, 101 and 102

United States Patent and Trademark Office

Reg. No. 3,575,197

Registered Feb. 17, 2009

**SERVICE MARK
PRINCIPAL REGISTER**

**FIRST REPUBLIC SECURITIES
COMPANY**

MERRILL LYNCH BANK & TRUST CO., FSB
(UNITED STATES FEDERAL SAVINGS
BANK), DBA FIRST REPUBLIC BANK
4 WORLD FINANCIAL CENTER
NEW YORK, NY 10038

FOR: INVESTMENT SERVICES, NAMELY, PROVIDING INVESTMENT ANALYSIS, CONSULTATION, PLANNING, MANAGEMENT, ADVISORY, BROKERAGE, BANKING, AND RESEARCH SERVICES WITH RESPECT TO STOCKS, MUTUAL FUNDS, SECURITIES, BONDS, COMMODITIES, REAL ESTATE AND OTHER INSTRUMENTS OF INVESTMENT; FINANCIAL INFORMATION PROVIDED BY ELECTRONIC MEANS; PROVIDING STOCK/SECURITIES MARKET INFORMATION; FINANCIAL SERVICES, NAMELY, ASSISTING OTHERS WITH THE COMPLETION OF FINANCIAL TRANSACTIONS FOR STOCKS, BONDS, SECURITIES AND EQUITIES; MANAGEMENT OF PORTFOLIOS COMPRISING SECURITIES; PRIVATE PLACEMENTS OF HEDGE FUNDS, PRIVATE EQUITY

FUNDS, SECURITIES AND DERIVATIVES FOR OTHERS, IN CLASS 36 (U.S. CLS. 100, 101 AND 102).

FIRST USE 6-1-2001; IN COMMERCE 6-1-2001.

THE MARK CONSISTS OF STANDARD CHARACTERS WITHOUT CLAIM TO ANY PARTICULAR FONT, STYLE, SIZE, OR COLOR.

OWNER OF U.S. REG. NOS. 2,699,808, 3,185,144 AND OTHERS.

NO CLAIM IS MADE TO THE EXCLUSIVE RIGHT TO USE "SECURITIES COMPANY", APART FROM THE MARK AS SHOWN.

SER. NO. 77-428,739, FILED 3-21-2008.

ALEXANDER L. POWERS, EXAMINING ATTORNEY

Int. Cl.: 9

Prior U.S. Cls.: 21, 23, 26, 36 and 38

Reg. No. 3,575,198

United States Patent and Trademark Office

Registered Feb. 17, 2009

**TRADEMARK
PRINCIPAL REGISTER**

FIRST REPUBLIC BANK

MERRILL LYNCH BANK & TRUST CO., FSB
(UNITED STATES FEDERAL SAVINGS
BANK), DBA FIRST REPUBLIC BANK

4 WORLD FINANCIAL CENTER

NEW YORK, NY 10038

FOR: AUTOMATED TELLER MACHINES;
MAGNETICALLY ENCODED PLASTIC ACCESS
CARDS FOR USE IN BANKING, FINANCIAL,
AND INVESTMENT INDUSTRIES, IN CLASS 9
(U.S. CLS. 21, 23, 26, 36 AND 38).

FIRST USE 8-10-1998; IN COMMERCE 10-12-2001.

THE MARK CONSISTS OF STANDARD CHAR-
ACTERS WITHOUT CLAIM TO ANY PARTICULAR
FONT, STYLE, SIZE, OR COLOR.

OWNER OF U.S. REG. NOS. 2,699,808, 3,185,144
AND OTHERS.

NO CLAIM IS MADE TO THE EXCLUSIVE
RIGHT TO USE "BANK", APART FROM THE
MARK AS SHOWN.

SER. NO. 77-428,750, FILED 3-21-2008.

ALEXANDER L. POWERS, EXAMINING ATTOR-
NEY

Int. Cl.: 9

Prior U.S. Cls.: 21, 23, 26, 36 and 38

United States Patent and Trademark Office

Reg. No. 3,575,199

Registered Feb. 17, 2009

**TRADEMARK
PRINCIPAL REGISTER**



SECWARD TECHNOLOGIES, INC (DELAWARE CORPORATION)
RODNEY BUILDING #104
3411 SILVERSIDE ROAD
WILMINGTON, DE 19810

FOR: PRE-RECORDED DIGITAL MEDIA, NAME-
LY, CDS, VCDS, AND DVDS, FEATURING COM-
PUTER PROGRAMS, NAMELY, COMPUTER
SECURITY PROGRAMS, DATA SECURITY PRO-
GRAMS, DATA LOSS PREVENTION PROGRAMS,
AND FILE SECURITY PROGRAMS; USB (UNIVER-
SAL SERIAL BUS) HARDWARE FOR USE WITH
COMPUTERS; COMPUTER PROGRAMS, NAMELY,
COMPUTER SECURITY PROGRAMS, DATA SE-
CURITY PROGRAMS, DATA LOSS PREVENTION
PROGRAMS, FILE SECURITY PROGRAMS; COM-
PUTER SOFTWARE FOR USE IN THE ENCRYP-
TION AND DECRYPTION OF DIGITAL FILES;

NETWORK SECURITY SOFTWARE, IN CLASS 9
(U.S. CLS. 21, 23, 26, 36 AND 38).

FIRST USE 3-31-2006; IN COMMERCE 4-30-2007.

THE COLOR(S) PURPLE, BLUE AND WHITE IS/
ARE CLAIMED AS A FEATURE OF THE MARK.

THE MARK CONSISTS OF A STYLIZED LETTER
OF "S" WITH THE COLOR PURPLE ON TOP AND
WHITE AT THE BOTTOM WITH SHADES IN PUR-
PLE AND WITH LETTERS "ECWARD" IN COLOR
BLUE.

SER. NO. 77-429,586, FILED 3-24-2008.

LESLIE RICHARDS, EXAMINING ATTORNEY

Int. Cls.: 9, 16 and 41

**Prior U.S. Cls.: 2, 5, 21, 22, 23, 26, 29, 36, 37, 38, 50,
100, 101 and 107**

Reg. No. 3,575,200

United States Patent and Trademark Office

Registered Feb. 17, 2009

**TRADEMARK
SERVICE MARK
PRINCIPAL REGISTER**



UNIVERSITY OF WASHINGTON (WASHINGTON STATE AGENCY)
3900 7TH AVENUE, BOX 359000
SEATTLE, WA 98195

FOR: PRE-RECORDED DVDS, VIDEO TAPES, CD-ROMS AND OTHER ELECTRONIC DOCUMENTS, NAMELY, CURRICULA, TRAINING MANUALS, AND COMPUTER GENERATED SLIDE PRESENTATIONS, ALL RELATED TO HIV AND AIDS, IN CLASS 9 (U.S. CLS. 21, 23, 26, 36 AND 38).

FIRST USE 10-0-2006; IN COMMERCE 10-0-2006.

FOR: PRINTED EDUCATIONAL AND TRAINING MATERIALS IN THE FIELD OF HIV/AIDS, IN CLASS 16 (U.S. CLS. 2, 5, 22, 23, 29, 37, 38 AND 50).

FIRST USE 10-0-2002; IN COMMERCE 10-0-2002.

FOR: TRAINING SERVICES IN THE FIELD OF HIV/AIDS TREATMENT AND COUNSELING, IN CLASS 41 (U.S. CLS. 100, 101 AND 107).

FIRST USE 10-0-2002; IN COMMERCE 10-0-2002.

SER. NO. 77-430,106, FILED 3-24-2008.

HOWARD SMIGA, EXAMINING ATTORNEY

Int. Cl.: 9

Prior U.S. Cls.: 21, 23, 26, 36 and 38

Reg. No. 3,575,201

United States Patent and Trademark Office

Registered Feb. 17, 2009

**TRADEMARK
PRINCIPAL REGISTER**

FLEXFIT

TYCO THERMAL CONTROLS, LLC (DELAWARE
LIMITED LIABILITY COMPANY)
2415 BAY ROAD
REDWOOD CITY, CA 94063

FOR: KITS FOR ELECTRICAL POWER CONNEC-
TION AND SEALING OF HEATING CABLE COM-
PRISING AN ELECTRICAL POWER PLUG WITH
SIGNAL LIGHT, AN END SEAL AND INSTALLA-
TION INSTRUCTIONS, IN CLASS 9 (U.S. CLS. 21, 23,
26, 36 AND 38).

FIRST USE 11-16-1998; IN COMMERCE 11-16-1998.

THE MARK CONSISTS OF STANDARD CHAR-
ACTERS WITHOUT CLAIM TO ANY PARTICULAR
FONT, STYLE, SIZE, OR COLOR.

SER. NO. 77-430,483, FILED 3-25-2008.

KATHERINE M. DUBRAY, EXAMINING ATTOR-
NEY

Int. Cl.: 11

Prior U.S. Cls.: 13, 21, 23, 31 and 34

United States Patent and Trademark Office

Reg. No. 3,575,202

Registered Feb. 17, 2009

**TRADEMARK
PRINCIPAL REGISTER**

PALLENE

KOHLER CO. (WISCONSIN CORPORATION)
444 HIGHLAND DRIVE
KOHLER, WI 53044

THE MARK CONSISTS OF STANDARD CHAR-
ACTERS WITHOUT CLAIM TO ANY PARTICULAR
FONT, STYLE, SIZE, OR COLOR.

FOR: LAVATORIES, IN CLASS 11 (U.S. CLS. 13, 21,
23, 31 AND 34).

SER. NO. 77-430,616, FILED 3-25-2008.

FIRST USE 4-11-2008; IN COMMERCE 4-11-2008.

KOURTNEE HODGES, EXAMINING ATTORNEY

Int. Cl.: 11

Prior U.S. Cls.: 13, 21, 23, 31 and 34

United States Patent and Trademark Office

Reg. No. 3,575,203

Registered Feb. 17, 2009

**TRADEMARK
PRINCIPAL REGISTER**

TORIC

KOHLER CO. (WISCONSIN CORPORATION)
444 HIGHLAND DRIVE
KOHLER, WI 53044

THE MARK CONSISTS OF STANDARD CHAR-
ACTERS WITHOUT CLAIM TO ANY PARTICULAR
FONT, STYLE, SIZE, OR COLOR.

FOR: LAVATORIES, IN CLASS 11 (U.S. CLS. 13, 21,
23, 31 AND 34).

SER. NO. 77-430,661, FILED 3-25-2008.

FIRST USE 4-11-2008; IN COMMERCE 4-11-2008.

KOURTNEE HODGES, EXAMINING ATTORNEY

Int. Cl.: 36

Prior U.S. Cls.: 100, 101 and 102

United States Patent and Trademark Office

Reg. No. 3,575,204

Registered Feb. 17, 2009

**SERVICE MARK
PRINCIPAL REGISTER**

PROMENADE ON THE PENINSULA

STOLTZ MANAGEMENT OF DELAWARE, INC.
(DELAWARE CORPORATION)
725 CONSHOHOCKEN STATE ROAD
BALA CYNWYD, PA 19004

FOR: SHOPPING CENTER AND MIXED-USE
DEVELOPMENT SERVICES, NAMELY, MANAGE-
MENT AND LEASING OF RENTAL COMMERCIAL,
RETAIL, ENTERTAINMENT, AND MIXED USE
SPACE, IN CLASS 36 (U.S. CLS. 100, 101 AND 102).

FIRST USE 3-15-2008; IN COMMERCE 3-15-2008.

THE MARK CONSISTS OF STANDARD CHAR-
ACTERS WITHOUT CLAIM TO ANY PARTICULAR
FONT, STYLE, SIZE, OR COLOR.

NO CLAIM IS MADE TO THE EXCLUSIVE
RIGHT TO USE "PENINSULA", APART FROM
THE MARK AS SHOWN.

SER. NO. 77-430,952, FILED 3-25-2008.

GRETTA YAO, EXAMINING ATTORNEY

Int. Cl.: 36

Prior U.S. Cls.: 100, 101 and 102

United States Patent and Trademark Office

Reg. No. 3,575,205

Registered Feb. 17, 2009

**SERVICE MARK
PRINCIPAL REGISTER**



STOLTZ MANAGEMENT OF DELAWARE, INC.
(DELAWARE CORPORATION)
725 CONSHOHOCKEN STATE ROAD
BALA CYNWYD, PA 19004

FOR: SHOPPING CENTER AND MIXED-USE
DEVELOPMENT SERVICES, NAMELY, MANAGE-
MENT AND LEASING OF RENTAL COMMERCIAL,
RETAIL, ENTERTAINMENT, AND MIXED USE
SPACE , IN CLASS 36 (U.S. CLS. 100, 101 AND 102).

FIRST USE 3-15-2008; IN COMMERCE 3-15-2008.

NO CLAIM IS MADE TO THE EXCLUSIVE
RIGHT TO USE "PENINSULA", APART FROM
THE MARK AS SHOWN.

SER. NO. 77-430,959, FILED 3-25-2008.

GRETТА YAO, EXAMINING ATTORNEY

Int. Cl.: 9

Prior U.S. Cls.: 21, 23, 26, 36 and 38

Reg. No. 3,575,206

United States Patent and Trademark Office

Registered Feb. 17, 2009

**TRADEMARK
PRINCIPAL REGISTER**

INTELLIGENCE IN EVERY DROP

AQUASPY GROUP PTY LTD (AUSTRALIA PROPRIETARY LIMITED COMPANY (P/L OR PTY. LTD.))
16 PHILLIPS STREET
THEBARTON, AUSTRALIA 5031

FOR: ELECTRONIC SENSORS FOR WATER MANAGEMENT AND ENVIRONMENTAL USE, NAMELY, METEOROLOGICAL SENSORS, SENSORS FOR MONITORING SOIL CONDITIONS, WATER LEVEL SENSORS, AND PUMP MONITORING SENSORS, SENSORS FOR THE MEASUREMENT OF SOIL CONDITIONS, NAMELY, SOIL MOISTURE, SOIL NUTRIENT CONTENT AND SALINITY, ELECTRONIC DEVICES FOR THE TRANSMISSION, COLLECTION, STORAGE AND ANALYSIS OF SIGNALS REPRESENTATIVE OF SOIL MOISTURE, SOIL NUTRIENT CONTENT AND SALINITY; COMPUTER HARDWARE AND COMPUTER SOFTWARE FOR USE IN WATER MANAGEMENT AND MONITORING, COMPUTER HARDWARE AND COMPUTER SOFTWARE FOR THE INTEGRATION OF INFORMATION FROM ELECTRONIC SENSORS, NAMELY, METEOROLOGICAL SENSORS, SENSORS FOR MONITORING SOIL CONDITIONS, WATER LEVEL

SENSORS, AND PUMP MONITORING SENSORS, TO PROVIDE STATISTICAL ANALYSIS, AND PRODUCE NOTIFICATIONS AND REPORTS, OPERATING PLATFORMS CONSISTING OF DATA TRANSCEIVERS, WIRELESS NETWORKS AND GATEWAYS FOR COLLECTION AND MANAGEMENT OF DATA, ELECTRONIC DATA RELAYS FOR SENSORS, ELECTRICAL CONTROLS FOR IRRIGATION SPRINKLER SYSTEMS, DEVICES FOR WIRELESS RADIO TRANSMISSION, IN CLASS 9 (U.S. CLS. 21, 23, 26, 36 AND 38).

THE MARK CONSISTS OF STANDARD CHARACTERS WITHOUT CLAIM TO ANY PARTICULAR FONT, STYLE, SIZE, OR COLOR.

PRIORITY CLAIMED UNDER SEC. 44(D) ON AUSTRALIA APPLICATION NO. 1201747, FILED 9-27-2007, REG. NO. 1201747, DATED 9-27-2007, EXPIRES 9-27-2017.

SER. NO. 77-431,533, FILED 3-26-2008.

MATTHEW EINSTEIN, EXAMINING ATTORNEY

Int. Cl.: 42

Prior U.S. Cls.: 100 and 101

United States Patent and Trademark Office

Reg. No. 3,575,207

Registered Feb. 17, 2009

**SERVICE MARK
PRINCIPAL REGISTER**

web2review

WEB2REVIEW LLC (WASHINGTON LIMITED
LIABILITY COMPANY)
14011 SE 51ST PL.
BELLEVUE, WA 98006

FOR: PROVIDING A WEBSITE FEATURING
COMPREHENSIVE AND CONTENT RICH RE-
VIEWS OF ONLINE COMPUTER APPLICATIONS
AND TOOLS, ONLINE COMMUNITIES, AND
TECHNOLOGICAL SERVICES FOR PERSONAL,
BUSINESS, AND ENTERPRISE USE, IN CLASS 42
(U.S. CLS. 100 AND 101).

FIRST USE 10-11-2007; IN COMMERCE 1-1-2008.

THE MARK CONSISTS OF STANDARD CHAR-
ACTERS WITHOUT CLAIM TO ANY PARTICULAR
FONT, STYLE, SIZE, OR COLOR.

SER. NO. 77-432,619, FILED 3-26-2008.

MARTHA SANTOMARTINO, EXAMINING ATTOR-
NEY

Int. Cl.: 29

Prior U.S. Cl.: 46

United States Patent and Trademark Office

Reg. No. 3,575,208

Registered Feb. 17, 2009

TRADEMARK
PRINCIPAL REGISTER



VALDEZ FISHERIES DEVELOPMENT ASSOCIATION, INC. (ALASKA NON-PROFIT CORPORATION)

1815 MINERAL CREEK LOOP ROAD
VALDEZ, AK 99686

FOR: FROZEN APPETIZERS CONSISTING PRIMARILY OF CHICKEN OR SEAFOOD; MARINATED SALMON; PRE-PACKAGED DINNERS CONSISTING OF SALMON; SEAFOOD; SEASONED SALMON, IN CLASS 29 (U.S. CL. 46).

FIRST USE 5-0-2006; IN COMMERCE 5-0-2006.

OWNER OF U.S. REG. NO. 3,216,502.

THE LINING IS A FEATURE OF THE MARK AND DOES NOT INDICATE COLOR.

THE MARK CONSISTS OF A RECTANGULAR DESIGN CONTAINING THE WORDS "SOLOMON FALLS" OVER A SCENE WITH THE SIDE VIEW OF A SALMON OVER WATERFALLS AND MOUNTAINS WITH THE SKY AND CLOUDS ABOVE THE WATERFALLS AND MOUNTAIN SCENERY.

SER. NO. 77-433,422, FILED 3-27-2008.

ANNE FARRELL, EXAMINING ATTORNEY

Int. Cl.: 9

Prior U.S. Cls.: 21, 23, 26, 36 and 38

Reg. No. 3,575,209

United States Patent and Trademark Office

Registered Feb. 17, 2009

**TRADEMARK
PRINCIPAL REGISTER**



LIL' JOE RECORDS, INC. (FLORIDA CORPORATION)
6157 NW 167TH STREET, SUITE F-17
HIALEAH, FL 330154356

FOR: PHONOGRAPH RECORDS, PRE-RECORDED AUDIOTAPES, VIDEOTAPES, DVDS AND COMPACT DISCS FEATURING MUSIC AND MUSICAL PERFORMANCES, IN CLASS 9 (U.S. CLS. 21, 23, 26, 36 AND 38).

FIRST USE 11-16-1993; IN COMMERCE 11-16-1993.

NO CLAIM IS MADE TO THE EXCLUSIVE RIGHT TO USE "RECORDS", APART FROM THE MARK AS SHOWN.

THE MARK CONSISTS OF STYLIZED GOLFER APPEARING TO DRIVE RECORDS OR COMPACT DISCS WITH A GOLF CLUB, ABOVE THE TERMS "RIP IT RECORDS" ON A HALF-CIRCLE BACKGROUND.

SER. NO. 77-433,441, FILED 3-27-2008.

JULIE VEPPUMTHARA, EXAMINING ATTORNEY

Int. Cls.: 5 and 10

Prior U.S. Cls.: 6, 18, 26, 39, 44, 46, 51 and 52

United States Patent and Trademark Office

Reg. No. 3,575,210

Registered Feb. 17, 2009

**TRADEMARK
PRINCIPAL REGISTER**

VETLOC

HENKEL AG & CO. KGAA (FED REP GERMANY
PARTNERSHIP LIMITED BY SHARES)
HENKELSTRASSE 67
DUESSELDORF, FED REP GERMANY 40589

FOR: ADHESIVES AND TISSUE BONDING SUB-
STANCES USED FOR SURGICAL AND VETERIN-
ARY PURPOSES, NAMELY, ADHESIVE
BANDAGES, MEDICAL ADHESIVES FOR BINDING
WOUNDS, MEDICAL ADHESIVE TAPE, AND SELF
ADHESIVE DRESSINGS; APPLICATORS FOR ALL
OF THE FOREGOING GOODS, SOLD TOGETHER
AS A UNIT, IN CLASS 5 (U.S. CLS. 6, 18, 44, 51
AND 52).

FOR: ADHESIVES AND TISSUE BONDING SUB-
STANCES USED FOR SURGICAL AND VETERIN-
ARY PURPOSES, NAMELY, ADHESIVE BANDS
FOR MEDICAL PURPOSES, AND SURGICAL
GLUES; APPLICATORS FOR ALL OF THE FORE-

GOING GOODS, SOLD TOGETHER AS A UNIT, IN
CLASS 10 (U.S. CLS. 26, 39 AND 44).

THE MARK CONSISTS OF STANDARD CHAR-
ACTERS WITHOUT CLAIM TO ANY PARTICULAR
FONT, STYLE, SIZE, OR COLOR.

PRIORITY CLAIMED UNDER SEC. 44(D) ON FED
REP GERMANY APPLICATION NO. 30763677.1/0,
FILED 9-28-2007, REG. NO. 30763677, DATED 11-5-
2007, EXPIRES 9-30-2017.

OWNER OF FED REP GERMANY REG. NO.
30763677, DATED 11-5-2007, EXPIRES 9-30-2017.

SER. NO. 77-434,186, FILED 3-28-2008.

JASON BLAIR, EXAMINING ATTORNEY

Int. Cl.: 7

Prior U.S. Cls.: 13, 19, 21, 23, 31, 34 and 35

Reg. No. 3,575,211

United States Patent and Trademark Office

Registered Feb. 17, 2009

**TRADEMARK
PRINCIPAL REGISTER**



PREMIER PNEUMATICS, INC. (KANSAS CORPORATION)
606 NORTH FRONT STREET; PO BOX
SALINA, KS 67402

FOR: PNEUMATIC CONVEYORS AND BULK MATERIAL HANDLING MACHINE SYSTEMS COMPRISED OF CONTROL PANELS, BLOWER ASSEMBLIES, CYCLONE SEPARATORS, RECEIVERS, FILTERS, LOADERS, FEEDERS, MIXERS, HOPPERS, SURGE BINS, DRYERS, VALVES, RAIL-CARLOADERS/UNLOADERS, SOLD AS A UNIT, AND STRUCTURAL COMPONENTS AND PARTS THEREOF, IN CLASS 7 (U.S. CLS. 13, 19, 21, 23, 31, 34 AND 35).

FIRST USE 12-0-2006; IN COMMERCE 12-0-2006.

OWNER OF U.S. REG. NOS. 1,185,429, 1,756,538 AND OTHERS.

NO CLAIM IS MADE TO THE EXCLUSIVE RIGHT TO USE "PNEUMATICS INC.", APART FROM THE MARK AS SHOWN.

THE MARK CONSISTS OF THE LITERAL ELEMENT "PP PREMIER PNEUMATICS INC." WITH A DIAMOND SHAPE ABOVE THE LETTER I IN "PREMIER", AND THE WORD "PREMIER" ABOVE THE WORDS "PNEUMATICS INC.", ALL INSIDE A RECTANGULAR SHAPE, AND TO THE RIGHT OF TWO STYLIZED LETTERS "P" INSIDE A RECTANGULAR SHAPE.

SER. NO. 77-434,187, FILED 3-28-2008.

ELISSA GARBER KON, EXAMINING ATTORNEY

Int. Cl.: 28

Prior U.S. Cls.: 22, 23, 38 and 50

Reg. No. 3,575,212

United States Patent and Trademark Office

Registered Feb. 17, 2009

**TRADEMARK
PRINCIPAL REGISTER**

VEGA

WATERMAN'S GUILD, INC. (CALIFORNIA
CORPORATION)
260 EAST DYER ROAD, SUITE L&M
SANTA ANA, CA 92707

THE MARK CONSISTS OF STANDARD CHAR-
ACTERS WITHOUT CLAIM TO ANY PARTICULAR
FONT, STYLE, SIZE, OR COLOR.

FOR: SURFBOARDS, IN CLASS 28 (U.S. CLS. 22,
23, 38 AND 50).

SER. NO. 77-434,320, FILED 3-28-2008.

FIRST USE 10-31-1984; IN COMMERCE 10-31-1984.

MICHAEL KEATING, EXAMINING ATTORNEY

Int. Cl.: 16

Prior U.S. Cls.: 2, 5, 22, 23, 29, 37, 38 and 50

United States Patent and Trademark Office

Reg. No. 3,575,213

Registered Feb. 17, 2009

**TRADEMARK
PRINCIPAL REGISTER**



PSS WORLD MEDICAL, INC. (FLORIDA CORPORATION)
4345 SOUTHPOINT BOULEVARD
JACKSONVILLE, FL 32216

FOR: PRINTED MATERIALS, NAMELY, BOOKLETS FOR USE BY HOSPICES CONTAINING A FORMULARY OF HEALTH PRODUCTS, ESTIMATED CALCULATIONS FOR NECESSARY PRODUCT INVENTORY, DECISION TOOLS FOR IDENTIFYING A DISEASE STATE, UNDERSTAND-

ING WHAT IS NEEDED FOR TREATMENT AND IDENTIFYING APPROPRIATE MEDICAL PRODUCTS FOR TREATING PARTICULAR DISEASES, IN CLASS 16 (U.S. CLS. 2, 5, 22, 23, 29, 37, 38 AND 50).

FIRST USE 2-0-2008; IN COMMERCE 2-0-2008.

SER. NO. 77-434,350, FILED 3-28-2008.

HAI-LY LAM, EXAMINING ATTORNEY

Int. Cl.: 43

Prior U.S. Cls.: 100 and 101

United States Patent and Trademark Office

Reg. No. 3,575,214

Registered Feb. 17, 2009

**SERVICE MARK
PRINCIPAL REGISTER**



BURGER BAR, LLC (NEVADA LIMITED LIABILITY COMPANY)
PBM 233
2654 W. HORIZON RIDGE PKWY B5
HENDERSON, NV 89052

FOR: BAR AND RESTAURANT SERVICES, IN CLASS 43 (U.S. CLS. 100 AND 101).

FIRST USE 2-9-2004; IN COMMERCE 2-9-2004.

NO CLAIM IS MADE TO THE EXCLUSIVE RIGHT TO USE "BURGER BAR", APART FROM THE MARK AS SHOWN.

THE MARK CONSISTS OF A MARTINI-SHAPED GLASS TILTED TO THE RIGHT WITH A TOOTH PICKED HAMBURGER INSIDE OF THE GLASS AND THE WORDING "BURGER BAR" BENEATH THE GLASS.

SER. NO. 77-434,545, FILED 3-28-2008.

TINA BROWN, EXAMINING ATTORNEY

Int. Cls.: 35 and 42

Prior U.S. Cls.: 100, 101 and 102

United States Patent and Trademark Office

Reg. No. 3,575,215

Registered Feb. 17, 2009

**SERVICE MARK
PRINCIPAL REGISTER**



GETUPDATED AB (SWEDEN LIMITED LIABILITY COMPANY)
BYANGSGRAND 22
120 40 STOCKHOLM, SWEDEN

FOR: ADVERTISING SERVICES, NAMELY, PROVIDING END-TO-END INTERNET MARKETING SOLUTIONS, PRODUCING INTERNET ADVERTISEMENTS INCLUDING BANNERS; BUSINESS MONITORING SERVICES, NAMELY, TRACKING WEB SITES OF OTHERS TO PROVIDE DETAILS ABOUT USER CLICK TRAFFIC OR VISITS TO THE WEB SITE, MONITORING AND MANAGING PAY PER CLICK TRAFFIC OR VISITS TO OTHER'S WEBSITES; PROMOTING THE WEBSITES OF OTHERS; AFFILIATE MARKETING OF WEBSITES OF OTHERS; UPDATING WEB-BASED ADVERTISING MATERIALS; PROMOTION, ADVERTISING AND MARKETING OF ON-LINE WEBSITES OF OTHERS, IN CLASS 35 (U.S. CLS. 100, 101 AND 102).

FIRST USE 4-0-2007; IN COMMERCE 4-0-2007.

FOR: CONSULTATION SERVICES IN THE FIELD OF SEARCH ENGINE OPTIMIZATION AND DEVELOPMENT OF SOFTWARE FOR COMMUNICA-

TION SYSTEMS SUCH AS INTERNET AND INTRANETS; PROVIDING TEMPORARY USE OF WEB-BASED COMPUTER SOFTWARE TO ANALYZE WEBSITE VISIBILITY, EXPOSURE, AND RANKING OF THE WEBSITE OF OTHERS; DESIGN, DEVELOPMENT AND IMPLEMENTATION OF SOFTWARE FOR COMPUTERS; UPDATING WEBSITES FOR OTHERS, IN CLASS 42 (U.S. CLS. 100 AND 101).

FIRST USE 4-0-2007; IN COMMERCE 4-0-2007.

NO CLAIM IS MADE TO THE EXCLUSIVE RIGHT TO USE "INTERNET MARKETING", APART FROM THE MARK AS SHOWN.

THE MARK CONSISTS OF THE WORDS "GETUPDATED" WITH THE WORDS "INTERNET MARKETING" UNDERNEATH THE WORDS "GETUPDATED" BEGINNING UNDERNEATH THE LETTER "P".

SER. NO. 77-434,677, FILED 3-28-2008.

NATALIE POLZER, EXAMINING ATTORNEY

Int. Cl.: 41

Prior U.S. Cls.: 100, 101 and 107

United States Patent and Trademark Office

Reg. No. 3,575,216

Registered Feb. 17, 2009

**SERVICE MARK
PRINCIPAL REGISTER**



LAUNDRY DESIGN LLC (CALIFORNIA LIMITED LIABILITY COMPANY)

#25

717 NORTH HIGHLAND AVENUE
LOS ANGELES, CA 90038

FOR: ANIMATION PRODUCTION SERVICES; MULTIMEDIA ENTERTAINMENT SERVICES IN THE NATURE OF RECORDING, PRODUCTION AND POST-PRODUCTION SERVICES IN THE FIELDS OF MUSIC, VIDEO, AND FILMS; PRODUCTION OF VIDEO AND CREATION OF VISUAL EFFECTS FOR OTHERS FOR USE IN DVDS, TELE-

VISION PROGRAMS AND ON WEB SITES; SPECIAL EFFECTS ANIMATION SERVICES FOR FILM AND VIDEO, IN CLASS 41 (U.S. CLS. 100, 101 AND 107).

FIRST USE 11-1-2005; IN COMMERCE 1-1-2006.

THE MARK CONSISTS OF A STENCIL-LIKE IMAGE OF A VERTICAL CLOTHES PIN.

SER. NO. 77-436,282, FILED 3-31-2008.

LIEF MARTIN, EXAMINING ATTORNEY

Int. Cl.: 36

Prior U.S. Cls.: 100, 101 and 102

United States Patent and Trademark Office

Reg. No. 3,575,217

Registered Feb. 17, 2009

**SERVICE MARK
PRINCIPAL REGISTER**



BILLEON Q. LE (UNITED STATES INDIVIDUAL)
SUITE 160
111 EAST TOUHY AVENUE
DES PLAINES, IL 60018

NO CLAIM IS MADE TO THE EXCLUSIVE
RIGHT TO USE "FINANCIAL GROUP, INC.",
APART FROM THE MARK AS SHOWN.

FOR: INSURANCE AND FINANCIAL INFORMA-
TION AND CONSULTANCY SERVICES, IN CLASS
36 (U.S. CLS. 100, 101 AND 102).

SER. NO. 77-436,826, FILED 4-1-2008.

FIRST USE 1-1-2008; IN COMMERCE 1-1-2008.

HELENE LIWINSKI, EXAMINING ATTORNEY

Int. Cl.: 36

Prior U.S. Cls.: 100, 101 and 102

United States Patent and Trademark Office

Reg. No. 3,575,218

Registered Feb. 17, 2009

**SERVICE MARK
PRINCIPAL REGISTER**

BUILDING VALUE FOR LIFE

LE, BILLEON Q. (UNITED STATES INDIVIDUAL)
SUITE 160
1111 EAST TOUHY AVENUE
DES PLAINES, IL 60018

FOR: INSURANCE AND FINANCIAL INFORMATION AND CONSULTANCY SERVICES, IN CLASS 36 (U.S. CLS. 100, 101 AND 102).

FIRST USE 1-1-2008; IN COMMERCE 1-1-2008.

THE MARK CONSISTS OF STANDARD CHARACTERS WITHOUT CLAIM TO ANY PARTICULAR FONT, STYLE, SIZE, OR COLOR.

SER. NO. 77-436,834, FILED 4-1-2008.

HELENE LIWINSKI, EXAMINING ATTORNEY

Int. Cls.: 35, 38, 42 and 45

Prior U.S. Cls.: 100, 101, 102 and 104

United States Patent and Trademark Office

Reg. No. 3,575,219

Registered Feb. 17, 2009

**SERVICE MARK
PRINCIPAL REGISTER**

WIGGIO

LAMPERT HOLDINGS, INC. (DELAWARE CORPORATION), DBA WIGGIO
25 WYMAN DRIVE
SUDBURY, MA 01776

FOR: ADVERTISING, NAMELY, PROMOTING THE GOODS AND SERVICES OF OTHERS OVER THE INTERNET FOR THOSE WHO WISH TO TARGET USERS OF ONLINE TOOLS SUCH AS SHARED CALENDARS, MASS MESSAGING, CHAT ROOMS, FILE STORAGE, DOCUMENT RETRIEVAL, CONFERENCE CALLING, AND POLLING SERVICES FOR GROUPS OF PEOPLE, IN CLASS 35 (U.S. CLS. 100, 101 AND 102).

FIRST USE 3-31-2008; IN COMMERCE 3-31-2008.

FOR: PROVIDING ACCESS TO ONLINE TELECOMMUNICATION NETWORKS TO ENABLE TEXT MESSAGING, REAL-TIME AUDIO AND VOICE COMMUNICATIONS, AND VISUAL COMMUNICATIONS AMONG REGISTERED USERS; PROVIDING ONLINE CHAT ROOMS AND ELECTRONIC BULLETIN BOARDS FOR TRANSMISSION OF MESSAGES AMONG USERS IN THE FIELD OF GENERAL INTEREST; TELECOMMUNICATIONS SERVICES, NAMELY, TELEPHONE COMMUNICATION SERVICES IN THE NATURE OF CONFERENCE CALLING, IN CLASS 38 (U.S. CLS. 100, 101 AND 104).

FIRST USE 3-31-2008; IN COMMERCE 3-31-2008.

FOR: COMPUTER SERVICES, NAMELY, HOSTING AND MAINTAINING AN ONLINE WEB SITE FOR OTHERS TO SHARE, COMMUNICATE AND STORE INFORMATION; ASSISTANCE IN INFOR-

MATION MANAGEMENT, NAMELY, ACTING AS AN APPLICATION SERVICE PROVIDER IN THE FIELD OF KNOWLEDGE MANAGEMENT TO HOST COMPUTER APPLICATION SOFTWARE FOR THE COLLECTION, EDITING, ORGANIZING, MODIFYING, BOOK MARKING, TRANSMISSION, STORAGE AND SHARING OF DATA AND INFORMATION; COMPUTER SERVICES, NAMELY, HOSTING ONLINE INTERACTIVE CALENDARS THAT ALLOW MULTIPLE PARTICIPANTS TO SHARE EVENT SCHEDULES AND SET TIMELINES; ONLINE SERVICES IN THE NATURE OF RETRIEVING DOCUMENTS POSTED BY GROUP MEMBERS; APPLICATION SERVICE PROVIDER (ASP) FEATURING SOFTWARE FOR USE IN PROVIDING ONLINE TOOLS IN THE NATURE OF CALENDARS, MASS MESSAGING, CHAT ROOMS, FILE STORAGE, DOCUMENT RETRIEVAL, CONFERENCE CALLING, AND POLLING SERVICES FOR GROUPS OF PEOPLE, IN CLASS 42 (U.S. CLS. 100 AND 101).

FIRST USE 3-31-2008; IN COMMERCE 3-31-2008.

FOR: ONLINE SOCIAL NETWORKING SERVICES, IN CLASS 45 (U.S. CLS. 100 AND 101).

FIRST USE 3-31-2008; IN COMMERCE 3-31-2008.

THE MARK CONSISTS OF STANDARD CHARACTERS WITHOUT CLAIM TO ANY PARTICULAR FONT, STYLE, SIZE, OR COLOR.

SER. NO. 77-436,909, FILED 4-1-2008.

JAY BESCH, EXAMINING ATTORNEY

Int. Cls.: 41 and 43

Prior U.S. Cls.: 100, 101 and 107

United States Patent and Trademark Office

Reg. No. 3,575,220

Registered Feb. 17, 2009

**SERVICE MARK
PRINCIPAL REGISTER**



COURTNEY & KYLIE RAMSAY (LOUISIANA
PARTNERSHIP), DBA PHARVIEW STABLES,
LLP
309 LA RUE FRANCE #100
LAFAYETTE, LA 70508

FOR: HORSE SHOWING; HORSE TRAINING, IN
CLASS 41 (U.S. CLS. 100, 101 AND 107).

FIRST USE 1-1-2001; IN COMMERCE 1-1-2001.

FOR: PROVIDING HORSE STABLE FACILITIES,
IN CLASS 43 (U.S. CLS. 100 AND 101).

FIRST USE 1-1-2001; IN COMMERCE 1-1-2001.

NO CLAIM IS MADE TO THE EXCLUSIVE
RIGHT TO USE "STABLES", APART FROM THE
MARK AS SHOWN.

THE COLOR(S) GRAY AND NAVY BLUE IS/ARE
CLAIMED AS A FEATURE OF THE MARK.

THE MARK CONSISTS OF "PS" - GRAY "PHAR-
VIEW STABLES" - NAVY BLUE.

SER. NO. 77-436,961, FILED 4-1-2008.

GIANCARLO CASTRO, EXAMINING ATTORNEY

Int. Cls.: 35 and 40

Prior U.S. Cls.: 100, 101, 102, 103 and 106

United States Patent and Trademark Office

Reg. No. 3,575,221

Registered Feb. 17, 2009

**SERVICE MARK
PRINCIPAL REGISTER**

BEXXIM

BEXXIM INTERNATIONAL, INC. (CALIFORNIA CORPORATION)
5161 CALIFORNIA AVENUE
SUITE 250
IRVINE, CA 92617

FOR: IMPORT AND EXPORT AGENCIES IN THE FIELD OF BUILDING CONSTRUCTION MATERIALS, IN CLASS 35 (U.S. CLS. 100, 101 AND 102).

FIRST USE 0-0-2006; IN COMMERCE 0-0-2006.

FOR: MANUFACTURING SERVICES FOR OTHERS IN THE FIELD OF BUILDING CONSTRUCTION

MATERIALS, IN CLASS 40 (U.S. CLS. 100, 103 AND 106).

FIRST USE 0-0-2006; IN COMMERCE 0-0-2006.

THE MARK CONSISTS OF STANDARD CHARACTERS WITHOUT CLAIM TO ANY PARTICULAR FONT, STYLE, SIZE, OR COLOR.

SER. NO. 77-437,509, FILED 4-2-2008.

KATHERINE CONNOLLY, EXAMINING ATTORNEY

Int. Cls.: 40 and 42

Prior U.S. Cls.: 100, 101, 103 and 106

United States Patent and Trademark Office

Reg. No. 3,575,222

Registered Feb. 17, 2009

**SERVICE MARK
PRINCIPAL REGISTER**

AVENGER

AVENGER AIRCRAFT AND SERVICES, LLC
(SOUTH CAROLINA LIMITED LIABILITY
COMPANY)
SUITE 106
103 N. MAIN STREET
GREENVILLE, SC 29601

FOR: CUSTOM MANUFACTURE OF AIRCRAFT
PARTS, IN CLASS 40 (U.S. CLS. 100, 103 AND 106).

FIRST USE 8-3-2004; IN COMMERCE 8-3-2004.

FOR: AIRCRAFT STRUCTURAL DESIGN; TECH-
NICAL RESEARCH IN THE FIELD OF AERONAU-
TICS; TESTING, ANALYZING, AND EVALUATION
OF THE GOODS AND SERVICES OTHERS FOR THE

PURPOSE OF FEDERAL AVIATION ADMINISTRA-
TION CERTIFICATION FOR THE AEROSPACE IN-
DUSTRY, IN CLASS 42 (U.S. CLS. 100 AND 101).

FIRST USE 8-3-2004; IN COMMERCE 8-3-2004.

THE MARK CONSISTS OF STANDARD CHAR-
ACTERS WITHOUT CLAIM TO ANY PARTICULAR
FONT, STYLE, SIZE, OR COLOR.

OWNER OF U.S. REG. NO. 3,212,854.

SER. NO. 77-437,543, FILED 4-2-2008.

GEOFFREY FOSDICK, EXAMINING ATTORNEY

Int. Cl.: 43

Prior U.S. Cls.: 100 and 101

United States Patent and Trademark Office

Reg. No. 3,575,223

Registered Feb. 17, 2009

SERVICE MARK
PRINCIPAL REGISTER



Family Mexican Restaurant

JOSE NICHOLAS MORALES (MEXICO INDIVIDUAL)

16689 WELD COUNTY ROAD 13
PLATTEVILLE, CO 80651 AND

MANUAL MORALES (MEXICO INDIVIDUAL)
150 WOLFENSBERGER ROAD
CASTLE ROCK, CO 80104

FOR: BAR AND RESTAURANT SERVICES, IN
CLASS 43 (U.S. CLS. 100 AND 101).

FIRST USE 1-1-1989; IN COMMERCE 1-1-1989.

NO CLAIM IS MADE TO THE EXCLUSIVE
RIGHT TO USE "3 MARGARITAS FAMILY MEXI-
CAN RESTAURANT", APART FROM THE MARK
AS SHOWN.

THE COLOR(S) GREEN, GOLD, RED IS/ARE
CLAIMED AS A FEATURE OF THE MARK.

THE MARK CONSISTS OF GREEN FLOWER
PETALS, GOLD FLOWER CENTER, RED LETTER-
ING OF "3 MARGARITAS", GREEN LETTERING
OF "FAMILY MEXICAN RESTAURANT", RED
FRAMING AROUND "3 MARGARITAS".

SER. NO. 77-437,741, FILED 4-2-2008.

VIVIAN MICZNIK FIRST, EXAMINING ATTOR-
NEY

Int. Cl.: 33

Prior U.S. Cls.: 47 and 49

United States Patent and Trademark Office

Reg. No. 3,575,224

Registered Feb. 17, 2009

TRADEMARK
PRINCIPAL REGISTER

COTE DE COLUMBIA

STEELE, JEDEDIAH TECUMSEH (UNITED STATES INDIVIDUAL)
4350 THOMAS LANE
KELSEYVILLE, CA 95453

FOR: GRAPE WINE, IN CLASS 33 (U.S. CLS. 47 AND 49).

FIRST USE 6-15-1995; IN COMMERCE 7-15-1995.

THE MARK CONSISTS OF STANDARD CHARACTERS WITHOUT CLAIM TO ANY PARTICULAR FONT, STYLE, SIZE, OR COLOR.

NO CLAIM IS MADE TO THE EXCLUSIVE RIGHT TO USE "COLUMBIA", APART FROM THE MARK AS SHOWN.

THE ENGLISH TRANSLATION OF THE WORDING IN THE MARK IS "COAST OF COLUMBIA".

SER. NO. 77-437,898, FILED 4-2-2008.

JASON BLAIR, EXAMINING ATTORNEY

Int. Cl.: 9

Prior U.S. Cls.: 21, 23, 26, 36 and 38

United States Patent and Trademark Office

Reg. No. 3,575,225

Registered Feb. 17, 2009

**TRADEMARK
PRINCIPAL REGISTER**

WEBALERT

WALCHEM CORPORATION (MASSACHUSETTS
CORPORATION)
5 BOYNTON ROAD HOPPING BROOK PARK
HOLLISTON, MA 01746

FOR: ELECTRONIC DEVICES FOR REMOTE
INTERFACING WITH INDUSTRIAL WATER
TREATMENT, METAL FINISHING AND INDUS-
TRIAL WATER PROCESSING SYSTEMS, NAMELY,
COMPUTER HARDWARE AND SOFTWARE FOR
DATA MONITORING, STORAGE AND COMMUNI-
CATION, AND FOR SETTING AND RESETTING
SYSTEM PARAMETERS SUCH AS ANALYTICAL
MEASUREMENTS AND CHEMICAL INVENTORY
LEVELS, IN CLASS 9 (U.S. CLS. 21, 23, 26, 36 AND 38).

FIRST USE 3-31-2003; IN COMMERCE 3-31-2003.

THE MARK CONSISTS OF STANDARD CHAR-
ACTERS WITHOUT CLAIM TO ANY PARTICULAR
FONT, STYLE, SIZE, OR COLOR.

SEC. 2(F).

SER. NO. 77-438,640, FILED 4-3-2008.

TRACY FLETCHER, EXAMINING ATTORNEY

Int. Cl.: 38

Prior U.S. Cls.: 100, 101 and 104

United States Patent and Trademark Office

Reg. No. 3,575,226

Registered Feb. 17, 2009

SERVICE MARK
PRINCIPAL REGISTER



ADAPTION TECHNOLOGIES VENTURES, LTD.
(TEXAS PARTNERSHIP)
1029 PRUITT ROAD
THE WOODLANDS, TX 77380

FOR: INTERNET PROTOCOL BASED COMMUNICATIONS SERVICES, NAMELY, HOSTED AND TRUNK-BASED VOICE OVER INTERNET PROTOCOL SERVICES, IN CLASS 38 (U.S. CLS. 100, 101 AND 104).

FIRST USE 6-1-2007; IN COMMERCE 6-1-2007.

NO CLAIM IS MADE TO THE EXCLUSIVE RIGHT TO USE "TECHNOLOGIES", APART FROM THE MARK AS SHOWN.

THE MARK CONSISTS OF THE STYLIZED WORDS "ADAPTION TECHNOLOGIES". TO THE LEFT OF THE TEXT IS IMAGE OF A GECKO.

SER. NO. 77-438,785, FILED 4-3-2008.

TEJBIR SINGH, EXAMINING ATTORNEY

Int. Cls.: 37 and 40

Prior U.S. Cls.: 100, 103 and 106

United States Patent and Trademark Office

Reg. No. 3,575,227

Registered Feb. 17, 2009

**SERVICE MARK
PRINCIPAL REGISTER**

Tankco

USES CORP. (DELAWARE CORPORATION)
ONE CANAL PLACE, SUITE 2500
365 CANAL STREET
NEW ORLEANS, LA 70130

FOR: PROVISION OF ELECTRIC UTILITY SUPPORT SERVICES, NAMELY, TRANSFORMER MAINTENANCE, CLEANING OF TRANSFORMERS, AND RESTORATION OF TRANSFORMERS; INDUSTRIAL CLEANING SERVICES AT INDUSTRIAL FACILITIES AND OTHER COMMERCIAL LOCATIONS, NAMELY, HYDROBLASTING, VACUUM AND CHEMICAL CLEANING SERVICES AND PRESSURE WASHING; CLEANING OF STORAGE TANKS AND PIPING; CLEANING OF HAZARDOUS MATERIAL SPILLS AND DUMPING AT INDUSTRIAL FACILITIES; CLEANING OF OIL SPILLS AT INDUSTRIAL FACILITIES FROM PIPELINES AND OTHER SOURCES, IN CLASS 37 (U.S. CLS. 100, 103 AND 106).

FIRST USE 9-1-1996; IN COMMERCE 9-1-1996.

FOR: DECONTAMINATION AND WASTE MANAGEMENT OF HAZARDOUS MATERIAL SPILLS AND DUMPING AT INDUSTRIAL FACILITIES; DECONTAMINATION AND WASTE TREATMENT OF OIL SPILLS AT INDUSTRIAL FACILITIES FROM PIPELINES AND OTHER SOURCES; WASTE SEGREGATION, NAMELY, SORTING OF WASTE, AND WASTE MANAGEMENT, IN CLASS 40 (U.S. CLS. 100, 103 AND 106).

FIRST USE 9-1-1996; IN COMMERCE 9-1-1996.

THE MARK CONSISTS OF STANDARD CHARACTERS WITHOUT CLAIM TO ANY PARTICULAR FONT, STYLE, SIZE, OR COLOR.

SER. NO. 77-439,233, FILED 4-3-2008.

AMEETA JORDAN, EXAMINING ATTORNEY

Int. Cls.: 37 and 40

Prior U.S. Cls.: 100, 103 and 106

United States Patent and Trademark Office

Reg. No. 3,575,228

Registered Feb. 17, 2009

**SERVICE MARK
PRINCIPAL REGISTER**



USES CORP. (DELAWARE CORPORATION)
ONE CANAL PLACE, SUITE 2500
365 CANAL STREET
NEW ORLEANS, LA 70130

FOR: CLEANING OF CARGO HOLDS AND OTHER COMPARTMENTS ON VESSELS; INDUSTRIAL CLEANING SERVICES FOR INDUSTRIAL FACILITIES AND OTHER COMMERCIAL LOCATIONS, NAMELY, HYDROBLASTING, VACUUM AND CHEMICAL CLEANING SERVICES AND PRESSURE WASHING; CLEANING OF STORAGE TANKS AND PIPING; CLEANING OF HAZARDOUS MATERIAL SPILLS AND DUMPING AT INDUSTRIAL FACILITIES AND ON SHIPS; CLEANING OF OIL SPILLS ON SHIPS, AT INDUSTRIAL FACILITIES FROM PIPELINES AND OTHER SOURCES, IN CLASS 37 (U.S. CLS. 100, 103 AND 106).

FIRST USE 8-1-1998; IN COMMERCE 8-1-1998.

FOR: DECONTAMINATION AND WASTE MANAGEMENT OF HAZARDOUS MATERIAL SPILLS AND DUMPING AT INDUSTRIAL FACILITIES AND ON SHIPS; DECONTAMINATION AND WASTE MANAGEMENT OF OIL SPILLS ON SHIPS, AT INDUSTRIAL FACILITIES FROM PIPELINES

AND OTHER SOURCES; WASTE SEGREGATION, NAMELY, SORTING OF WASTE, AND WASTE MANAGEMENT, IN CLASS 40 (U.S. CLS. 100, 103 AND 106).

FIRST USE 9-1-1996; IN COMMERCE 9-1-1996.

NO CLAIM IS MADE TO THE EXCLUSIVE RIGHT TO USE "UNITED STATES INDUSTRIAL SERVICES, L.L.C.", APART FROM THE MARK AS SHOWN.

THE COLOR(S) RED, WHITE AND BLUE IS/ARE CLAIMED AS A FEATURE OF THE MARK.

THE MARK CONSISTS OF THE LETTERS "USIS" IN WHITE WITHIN THE SHAPE OF A VESSEL WITH BLUE ANCHOR AND GLOBE INSIGNIA, ITS MIDSHIPS AND BOW IN BLUE AND STERN IN RED, WITH STYLIZED BLUE WAVES AND THE WORDS "UNITED STATES INDUSTRIAL SERVICES, L.L.C." IN BLUE UNDERNEATH.

SER. NO. 77-439,256, FILED 4-3-2008.

AMEETA JORDAN, EXAMINING ATTORNEY

Int. Cls.: 37 and 40

Prior U.S. Cls.: 100, 103 and 106

United States Patent and Trademark Office

Reg. No. 3,575,229

Registered Feb. 17, 2009

**SERVICE MARK
PRINCIPAL REGISTER**



USES CORP. (DELAWARE CORPORATION)
ONE CANAL PLACE, SUITE 2500
365 CANAL STREET
NEW ORLEANS, LA 70130

FOR: CLEANING OF CARGO HOLDS AND OTHER COMPARTMENTS ON VESSELS; THE PROVISION OF ELECTRIC UTILITY SUPPORT SERVICES, NAMELY, TRANSFORMER MAINTENANCE, CLEANING OF TRANSFORMERS, AND RESTORATION OF TRANSFORMERS; INDUSTRIAL CLEANING SERVICES FOR INDUSTRIAL FACILITIES AND OTHER COMMERCIAL LOCATIONS, NAMELY, HYDROBLASTING, VACUUM AND CHEMICAL CLEANING SERVICES AND PRESSURE WASHING; CLEANING OF STORAGE TANKS AND PIPING; CLEANING OF HAZARDOUS MATERIAL SPILLS AND DUMPING AT INDUSTRIAL FACILITIES, COMMERCIAL AND RESIDENTIAL SITES, ON HIGHWAYS, ON RAILROADS, ON SHIPS AND ON WATERWAYS; CLEANING OF OIL SPILLS ON THE MISSISSIPPI RIVER AND OTHER WATERWAYS, ON SHIPS, AT INDUSTRIAL FACILITIES, COMMERCIAL AND RESIDENTIAL SITES, FROM PIPELINES AND OTHER SOURCES; ENVIRONMENTAL REMEDIATION SERVICES, NAMELY, REMOVAL AND CLEANING OF CONTAMINANTS FOUND IN SOIL OR THE SURROUNDING WATER SOURCES, IN CLASS 37 (U.S. CLS. 100, 103 AND 106).

FIRST USE 1-1-1999; IN COMMERCE 1-1-1999.

FOR: DECONTAMINATION AND WASTE MANAGEMENT OF HAZARDOUS MATERIAL SPILLS AND DUMPING AT INDUSTRIAL FACILITIES,

COMMERCIAL AND RESIDENTIAL SITES, ON HIGHWAYS, ON RAILROADS, ON SHIPS AND ON WATERWAYS; DECONTAMINATION AND WASTE MANAGEMENT OF OIL SPILLS ON THE MISSISSIPPI RIVER AND OTHER WATERWAYS, ON SHIPS, AT INDUSTRIAL FACILITIES, COMMERCIAL AND RESIDENTIAL SITES, FROM PIPELINES AND OTHER SOURCES; DEMOLITION AND DISMANTLING OF INDUSTRIAL FACILITIES; WASTE SEGREGATION, NAMELY, SORTING OF WASTE, AND WASTE MANAGEMENT, IN CLASS 40 (U.S. CLS. 100, 103 AND 106).

FIRST USE 1-1-1999; IN COMMERCE 1-1-1999.

NO CLAIM IS MADE TO THE EXCLUSIVE RIGHT TO USE "UNITED STATES SERVICES GROUP", APART FROM THE MARK AS SHOWN.

THE COLOR(S) RED, WHITE AND BLUE IS/ARE CLAIMED AS A FEATURE OF THE MARK.

THE MARK CONSISTS OF THE LETTERS "USSG" IN WHITE WITHIN THE SHAPE OF A VESSEL WITH BLUE ANCHOR AND GLOBE INSIGNIA, ITS MIDSHIPS AND BOW IN BLUE AND STERN IN RED, WITH STYLIZED BLUE WAVES AND THE WORDS "UNITED STATES SERVICES GROUP" IN BLUE UNDERNEATH.

SER. NO. 77-439,329, FILED 4-3-2008.

AMEETA JORDAN, EXAMINING ATTORNEY

Int. Cls.: 37 and 40

Prior U.S. Cls.: 100, 103 and 106

United States Patent and Trademark Office

Reg. No. 3,575,230

Registered Feb. 17, 2009

**SERVICE MARK
PRINCIPAL REGISTER**

LB FOSTER

L.B. FOSTER COMPANY (PENNSYLVANIA CORPORATION)
415 HOLIDAY DRIVE
PITTSBURGH, PA 15220

FOR: PIPE PROCESSING SERVICES, NAMELY, APPLYING PROTECTIVE COATING TO PIPES; RENTAL SERVICES INVOLVING THE RENTAL TO THIRD PARTIES OF STEEL SHEET PILING, PIPE PILING, H-BEARING PILES, LIGHTWEIGHT PILING, AND PILE HAMMERS AND EXTRACTORS ALL FOR CONSTRUCTION PURPOSES; TRACK-REMOVAL SERVICES, NAMELY, THE TAKING UP AND REMOVAL OF RAILS, TIES, AND BALLAST OF INDUSTRIAL SIDINGS AND IN-PLANT TRACKAGE, IN CLASS 37 (U.S. CLS. 100, 103 AND 106).

FIRST USE 6-30-1955; IN COMMERCE 6-30-1955.

FOR: PIPE PROCESSING SERVICES, NAMELY, CUSTOM MANUFACTURE OF PIPE, PIPE VALVES AND FITTINGS THEREFORE TO THE ORDER

AND/OR SPECIFICATION OF OTHERS; PIPE PROCESSING SERVICES, NAMELY, PIPE CUTTING, BENDING, THREADING, AND WRAPPING SERVICES, IN CLASS 40 (U.S. CLS. 100, 103 AND 106).

FIRST USE 6-30-1955; IN COMMERCE 6-30-1955.

THE MARK CONSISTS OF STANDARD CHARACTERS WITHOUT CLAIM TO ANY PARTICULAR FONT, STYLE, SIZE, OR COLOR.

OWNER OF U.S. REG. NOS. 874,026 AND 1,113,882.

THE NAME(S), PORTRAIT(S), AND/OR SIGNATURE(S) SHOWN IN THE MARK DOES NOT IDENTIFY A PARTICULAR LIVING INDIVIDUAL.

SEC. 2(F).

SER. NO. 77-439,330, FILED 4-3-2008.

AMY HELLA, EXAMINING ATTORNEY

Int. Cls.: 37 and 40

Prior U.S. Cls.: 100, 103 and 106

United States Patent and Trademark Office

Reg. No. 3,575,231

Registered Feb. 17, 2009

SERVICE MARK
PRINCIPAL REGISTER



USES CORP. (DELAWARE CORPORATION)
ONE CANAL PLACE, SUITE 2500
365 CANAL STREET
NEW ORLEANS, LA 70130

FOR: INDUSTRIAL CLEANING SERVICES FOR INDUSTRIAL FACILITIES AND OTHER COMMERCIAL LOCATIONS, NAMELY, HYDROBLASTING, VACUUM AND CHEMICAL CLEANING SERVICES AND PRESSURE WASHING; CLEANING OF STORAGE TANKS AND PIPING; CLEANING OF HAZARDOUS MATERIAL SPILLS AND DUMPING AT INDUSTRIAL FACILITIES; CLEANING OF OIL SPILLS AT INDUSTRIAL FACILITIES FROM PIPELINES AND OTHER SOURCES; ENVIRONMENTAL REMEDIATION SERVICES, NAMELY, REMOVAL AND CLEANING OF CONTAMINANTS FOUND IN SOIL OR THE SURROUNDING WATER SOURCES, IN CLASS 37 (U.S. CLS. 100, 103 AND 106).

FIRST USE 4-1-1992; IN COMMERCE 4-1-1992.

FOR: DECONTAMINATION AND WASTE MANAGEMENT OF HAZARDOUS MATERIAL SPILLS AND DUMPING AT INDUSTRIAL FACILITIES; DECONTAMINATION AND WASTE MANAGEMENT OF OIL SPILLS AT INDUSTRIAL FACILITIES FROM PIPELINES AND OTHER SOURCES; WASTE SEGREGATION, NAMELY, SORTING OF

WASTE, AND WASTE MANAGEMENT, IN CLASS 40 (U.S. CLS. 100, 103 AND 106).

FIRST USE 4-1-1992; IN COMMERCE 4-1-1992.

NO CLAIM IS MADE TO THE EXCLUSIVE RIGHT TO USE "ENVIRONMENTAL AND INDUSTRIAL CLEANING SERVICES", APART FROM THE MARK AS SHOWN.

THE COLOR(S) RED, GREEN, BLUE AND WHITE IS/ARE CLAIMED AS A FEATURE OF THE MARK.

THE MARK CONSISTS OF THE COLOR GREEN APPEARS IN THE WORDING "ABCLEAN" AND IN THE LINE. THE COLOR RED APPEARS IN THE WORDING "ENVIRONMENTAL AND INDUSTRIAL CLEANING SERVICES". THE COLOR BLUE APPEARS AS SHADING ABOVE THE WORDING "ABCLEAN" AND BELOW "ENVIRONMENTAL AND INDUSTRIAL CLEANING SERVICES". THE COLOR WHITE APPEARS IN THE OUTLINING AROUND "ABCLEAN".

SER. NO. 77-439,380, FILED 4-3-2008.

AMEETA JORDAN, EXAMINING ATTORNEY

Int. Cls.: 37 and 40

Prior U.S. Cls.: 100, 103 and 106

United States Patent and Trademark Office

Reg. No. 3,575,232

Registered Feb. 17, 2009

**SERVICE MARK
PRINCIPAL REGISTER**



USES CORP. (DELAWARE CORPORATION)
ONE CANAL PLACE, SUITE 2500
365 CANAL STREET
NEW ORLEANS, LA 70130

FOR: CLEANING OF CARGO HOLDS AND OTHER COMPARTMENTS ON VESSELS; CLEANING SERVICES, NAMELY, HYDROBLASTING, VACUUM AND CHEMICAL CLEANING SERVICES AND PRESSURE WASHING SHIPS AND BARGES; CLEANING OF HAZARDOUS MATERIAL SPILLS AND DUMPING ON SHIPS AND BARGES; CLEANING OF OIL SPILLS ON SHIPS AND BARGES, IN CLASS 37 (U.S. CLS. 100, 103 AND 106).

FIRST USE 9-1-1996; IN COMMERCE 9-1-1996.

FOR: DECONTAMINATION AND WASTE MANAGEMENT OF HAZARDOUS MATERIAL SPILLS AND DUMPING ON SHIPS AND BARGES; DECONTAMINATION AND WASTE MANAGEMENT OF OIL SPILLS ON SHIPS AND BARGES; WASTE SEGREGATION, NAMELY, SORTING OF WASTE, AND WASTE MANAGEMENT, IN CLASS 40 (U.S. CLS. 100, 103 AND 106).

FIRST USE 6-6-1992; IN COMMERCE 6-6-1992.

NO CLAIM IS MADE TO THE EXCLUSIVE RIGHT TO USE "UNITED STATES MARITIME SERVICES, INC.", APART FROM THE MARK AS SHOWN.

THE COLOR(S) RED, WHITE AND BLUE IS/ARE CLAIMED AS A FEATURE OF THE MARK.

THE MARK CONSISTS OF THE LETTERS "USM-SI" IN WHITE WITHIN THE SHAPE OF A VESSEL WITH BLUE ANCHOR AND GLOBE INSIGNIA, ITS MIDSHIPS AND BOW IN BLUE AND STERN IN RED, WITH STYLIZED BLUE WAVES AND THE WORDS "UNITED STATES MARITIME SERVICES, INC" IN BLUE UNDERNEATH.

SER. NO. 77-439,421, FILED 4-3-2008.

AMEETA JORDAN, EXAMINING ATTORNEY

Int. Cls.: 37 and 40

Prior U.S. Cls.: 100, 103 and 106

United States Patent and Trademark Office

Reg. No. 3,575,233

Registered Feb. 17, 2009

**SERVICE MARK
PRINCIPAL REGISTER**



USES CORP. (DELAWARE CORPORATION)
ONE CANAL PLACE, SUITE 2500
365 CANAL STREET
NEW ORLEANS, LA 70130

FOR: CLEANING OF CARGO HOLDS AND OTHER COMPARTMENTS ON VESSELS; THE PROVISION OF ELECTRIC UTILITY SUPPORT SERVICES, NAMELY, TRANSFORMER MAINTENANCE, CLEANING OF TRANSFORMERS, AND RESTORATION OF TRANSFORMERS; INDUSTRIAL CLEANING SERVICES FOR INDUSTRIAL FACILITIES AND OTHER COMMERCIAL LOCATIONS, NAMELY, HYDROBLASTING, VACUUM AND CHEMICAL CLEANING SERVICES AND PRESSURE WASHING; CLEANING OF STORAGE TANKS AND PIPING; CLEANING OF HAZARDOUS MATERIAL SPILLS AND DUMPING AT INDUSTRIAL FACILITIES COMMERCIAL AND RESIDENTIAL SITES, ON HIGHWAYS, ON RAILROADS, ON SHIPS AND ON WATERWAYS; CLEANING OF OIL SPILLS ON THE MISSISSIPPI RIVER AND OTHER WATERWAYS, ON SHIPS, AT INDUSTRIAL FACILITIES, COMMERCIAL AND RESIDENTIAL SITES, FROM PIPELINES AND OTHER SOURCES; ENVIRONMENTAL REMEDIATION SERVICES, NAMELY, REMOVAL AND CLEANING OF CONTAMINANTS FOUND IN SOIL OR THE SURROUNDING WATER SOURCES, IN CLASS 37 (U.S. CLS. 100, 103 AND 106).

FIRST USE 9-1-1996; IN COMMERCE 9-1-1996.

FOR: DECONTAMINATION AND WASTE MANAGEMENT OF HAZARDOUS MATERIAL SPILLS AND DUMPING AT INDUSTRIAL FACILITIES,

COMMERCIAL AND RESIDENTIAL SITES, ON HIGHWAYS, ON RAILROADS, ON SHIPS AND ON WATERWAYS; DECONTAMINATION AND WASTE MANAGEMENT OF OIL SPILLS ON THE MISSISSIPPI RIVER AND OTHER WATERWAYS, ON SHIPS, AT INDUSTRIAL FACILITIES, COMMERCIAL AND RESIDENTIAL SITES, FROM PIPELINES AND OTHER SOURCES; DEMOLITION AND DISMANTLING OF INDUSTRIAL FACILITIES; WASTE SEGREGATION, NAMELY, SORTING OF WASTE, AND WASTE MANAGEMENT, IN CLASS 40 (U.S. CLS. 100, 103 AND 106).

FIRST USE 9-1-1996; IN COMMERCE 9-1-1996.

NO CLAIM IS MADE TO THE EXCLUSIVE RIGHT TO USE "UNITED STATES ENVIRONMENTAL SERVICES, L.L.C.", APART FROM THE MARK AS SHOWN.

THE COLOR(S) RED, WHITE AND BLUE IS/ARE CLAIMED AS A FEATURE OF THE MARK.

THE MARK CONSISTS OF THE LETTERS "USES" IN WHITE WITHIN THE SHAPE OF A VESSEL WITH BLUE ANCHOR AND GLOBE INSIGNIA, ITS MIDSHIPS AND BOW IN BLUE AND STERN IN RED, WITH STYLIZED BLUE WAVES AND THE WORDS "UNITED STATES ENVIRONMENTAL SERVICES, L.L.C." IN BLUE UNDERNEATH.

SER. NO. 77-439,452, FILED 4-3-2008.

AMEETA JORDAN, EXAMINING ATTORNEY

Int. Cl.: 28

Prior U.S. Cls.: 22, 23, 38 and 50

Reg. No. 3,575,234

United States Patent and Trademark Office

Registered Feb. 17, 2009

**TRADEMARK
PRINCIPAL REGISTER**

AirPong

AIELLO, DAVID J, JR. (UNITED STATES INDIVIDUAL)
36 ARMAND WAY
SCITUATE, RI 02831

THE MARK CONSISTS OF STANDARD CHARACTERS WITHOUT CLAIM TO ANY PARTICULAR FONT, STYLE, SIZE, OR COLOR.

FOR: PARTY GAMES, EXCLUDING TABLE TENNIS TABLES AND TABLE TENNIS EQUIPMENT, IN CLASS 28 (U.S. CLS. 22, 23, 38 AND 50).

SER. NO. 77-439,635, FILED 4-3-2008.

FIRST USE 3-1-2008; IN COMMERCE 3-3-2008.

KAELIE KUNG, EXAMINING ATTORNEY

Int. Cl.: 8

Prior U.S. Cls.: 23, 28 and 44

United States Patent and Trademark Office

Reg. No. 3,575,235

Registered Feb. 17, 2009

**TRADEMARK
PRINCIPAL REGISTER**

THE RIGHT WAY TO SPRAY

H.D. HUDSON MANUFACTURING COMPANY
(MINNESOTA CORPORATION)
500 N. MICHIGAN AVENUE
CHICAGO, IL 60611

THE MARK CONSISTS OF STANDARD CHAR-
ACTERS WITHOUT CLAIM TO ANY PARTICULAR
FONT, STYLE, SIZE, OR COLOR.

FOR: HAND-OPERATED SPRAYERS FOR HER-
BICIDES, PESTICIDES, FERTILIZERS, AND/OR IN-
SECTICIDES, IN CLASS 8 (U.S. CLS. 23, 28 AND 44).

SER. NO. 77-439,973, FILED 4-4-2008.

FIRST USE 6-30-1997; IN COMMERCE 6-30-1997.

ROBERT LAVACHE, EXAMINING ATTORNEY

Int. Cl.: 2

Prior U.S. Cls.: 6, 11 and 16

United States Patent and Trademark Office

Reg. No. 3,575,236

Registered Feb. 17, 2009

**TRADEMARK
PRINCIPAL REGISTER**

Point Guard

QUANTUM INNOVATIONS, INC (NEVADA
CORPORATION)
549 E VILAS RD STE A
CENTRAL POINT, OR 97502

FOR: PROTECTIVE COATINGS FOR OPHTHAL-
MIC LENSES, IN CLASS 2 (U.S. CLS. 6, 11 AND 16).

FIRST USE 4-4-2008; IN COMMERCE 4-4-2008.

THE MARK CONSISTS OF STANDARD CHAR-
ACTERS WITHOUT CLAIM TO ANY PARTICULAR
FONT, STYLE, SIZE, OR COLOR.

SER. NO. 77-440,153, FILED 4-4-2008.

WILLIAM P. SHANAHAN, EXAMINING ATTOR-
NEY

Int. Cl.: 32

Prior U.S. Cls.: 45, 46 and 48

United States Patent and Trademark Office

Reg. No. 3,575,237

Registered Feb. 17, 2009

**TRADEMARK
PRINCIPAL REGISTER**



LING, WILSON (UNITED STATES INDIVIDUAL)
3332 CLAY STREET
SAN FRANCISCO, CA 94118

FOR: ENERGY DRINKS, IN CLASS 32 (U.S. CLS.
45, 46 AND 48).

FIRST USE 3-7-2008; IN COMMERCE 3-7-2008.

THE MARK CONSISTS OF THE STYLIZED
WORDING "LIVE" AND A RIBBON DESIGN RE-

PRESENTING THE LETTER "V". THE DASHED
LINES ARE NOT CLAIMED AS A FEATURE OF
THE MARK AND ARE USED MERELY TO INDI-
CATE THE POSITION OR PLACEMENT OF THE
MARK ON THE CONTAINER FOR THE GOODS.

SER. NO. 77-440,793, FILED 4-4-2008.

KAREN BRACEY, EXAMINING ATTORNEY

Int. Cl.: 25

Prior U.S. Cls.: 22 and 39

United States Patent and Trademark Office

Reg. No. 3,575,238

Registered Feb. 17, 2009

**TRADEMARK
PRINCIPAL REGISTER**

CHIKNY

A 1 MARKET, INC. (CALIFORNIA CORPORATION)
1155 CALLE DE DAMASCO
CHULA VISTA, CA 91910

THE MARK CONSISTS OF STANDARD CHARACTERS WITHOUT CLAIM TO ANY PARTICULAR FONT, STYLE, SIZE, OR COLOR.

FOR: APPAREL, NAMELY, JEANS, IN CLASS 25 (U.S. CLS. 22 AND 39).

SER. NO. 77-440,896, FILED 4-5-2008.

FIRST USE 8-31-2006; IN COMMERCE 8-31-2006.

DAVID C. REIHNER, EXAMINING ATTORNEY

Int. Cl.: 16

Prior U.S. Cls.: 2, 5, 22, 23, 29, 37, 38 and 50

United States Patent and Trademark Office

Reg. No. 3,575,239

Registered Feb. 17, 2009

**TRADEMARK
PRINCIPAL REGISTER**

IN PART

GENERAL CONFERENCE OF THE BRETHREN
IN CHRIST (PENNSYLVANIA CORPORATION)
431 GRANTHAM ROAD, PO BOX 290
GRANTHAM, PA 17027

THE MARK CONSISTS OF STANDARD CHARACTERS WITHOUT CLAIM TO ANY PARTICULAR FONT, STYLE, SIZE, OR COLOR.

FOR: MAGAZINES FEATURING RELIGIOUS TOPICS, IN CLASS 16 (U.S. CLS. 2, 5, 22, 23, 29, 37, 38 AND 50).

SER. NO. 77-441,287, FILED 4-7-2008.

FIRST USE 10-5-2007; IN COMMERCE 10-5-2007.

MICHAEL SOUDERS, EXAMINING ATTORNEY

Int. Cls.: 41, 42 and 45

Prior U.S. Cls.: 100, 101 and 107

United States Patent and Trademark Office

Reg. No. 3,575,240

Registered Feb. 17, 2009

**SERVICE MARK
PRINCIPAL REGISTER**

TimesPeople

THE NEW YORK TIMES COMPANY (NEW YORK CORPORATION)
620 EIGHTH AVENUE
NEW YORK, NY 10018

FOR: PROVIDING A WEBSITE THAT ALLOW USERS TO POST RATINGS, REVIEWS AND RECOMMENDATIONS OF NEW ARTICLES, NEW FEEDS, MOVIES BLOGS FEATURING DISCUSSION ABOUT MOVIE STARS, CULTURAL EVENTS, ENTERTAINMENT AND ITEMS TYPICALLY COVERED IN GENERAL NEWSPAPERS AND MAGAZINES, IN CLASS 41 (U.S. CLS. 100, 101 AND 107).

FIRST USE 6-17-2008; IN COMMERCE 6-17-2008.

FOR: COMPUTER SERVICES IN THE NATURE OF CUSTOMIZED WEB PAGES AND OTHER DATA FEED FORMATS FEATURING USER-DEFINED INFORMATION, PERSONAL PROFILES AND INFORMATION; COMPUTER SERVICES, NAMELY, HOSTING SERVICES WHICH ALLOW THE USER TO PUBLISH AND SHARE THEIR CONTENT AND IMAGES ON-LINE; COMPUTER SERVICES, NAMELY, HOSTING ON-LINE WEB FACILITIES FOR OTHERS FOR CONDUCTING ONLINE INTERAC-

TIVE DISCUSSIONS; CREATING ONLINE COMMUNITIES THAT ALLOW USERS TO POST RATINGS, REVIEWS AND RECOMMENDATIONS OF NEW ARTICLES, NEW FEEDS, MOVIES BLOGS FEATURING DISCUSSION ABOUT MOVIE STARS, CULTURAL EVENTS, ENTERTAINMENT AND ITEMS TYPICALLY COVERED IN GENERAL NEWSPAPERS AND MAGAZINES, IN CLASS 42 (U.S. CLS. 100 AND 101).

FIRST USE 6-17-2008; IN COMMERCE 6-17-2008.

FOR: ONLINE SOCIAL NETWORKING SERVICES, IN CLASS 45 (U.S. CLS. 100 AND 101).

FIRST USE 6-17-2008; IN COMMERCE 6-17-2008.

THE MARK CONSISTS OF STANDARD CHARACTERS WITHOUT CLAIM TO ANY PARTICULAR FONT, STYLE, SIZE, OR COLOR.

SER. NO. 77-441,356, FILED 4-7-2008.

SAMUEL E. SHARPER JR., EXAMINING ATTORNEY

Int. Cl.: 35

Prior U.S. Cls.: 100, 101 and 102

United States Patent and Trademark Office

Reg. No. 3,575,241

Registered Feb. 17, 2009

**SERVICE MARK
PRINCIPAL REGISTER**



O'ROURKE, LAWRENCE WILLIAM (UNITED STATES INDIVIDUAL)
921 S.W. 115TH AVENUE
PEMBROKE PINES, FL 33025 AND
O'ROURKE, ANGELA PASTORA (UNITED STATES INDIVIDUAL)
921 S.W. 115TH AVENUE
PEMBROKE PINES, FL 33025

FOR: PROVIDING A WEB SITE THAT ENABLES USERS TO POST ITEMS FOR SALE THROUGH ONLINE CLASSIFIED ADVERTISEMENTS, IN CLASS 35 (U.S. CLS. 100, 101 AND 102).

FIRST USE 3-31-2008; IN COMMERCE 3-31-2008.

NO CLAIM IS MADE TO THE EXCLUSIVE RIGHT TO USE "MOTORSPORT SOLUTIONS ONLINE", APART FROM THE MARK AS SHOWN.

THE COLOR(S) BLACK, WHITE, RED, BLUE IS/ARE CLAIMED AS A FEATURE OF THE MARK.

THE MARK CONSISTS OF CENTERED BLACK, WHITE, AND RED UPPER AND LOWER CASE STYLIZED LETTERS "MOTORSPORT SOLUTIONS ONLINE", WITH A AGGIEURWTNOR FONT AND A BLACK UNDER AND SIDELINE WITH CHECKERED BLACK AND WHITE SQUARES LOCATED ON CENTER TOP OF A WHITE AND BLUE GRADIENT BACKGROUND WITH BLACK FRAME.

SER. NO. 77-441,507, FILED 4-7-2008.

BONNIE LUKEN, EXAMINING ATTORNEY

Int. Cl.: 6

Prior U.S. Cls.: 2, 12, 13, 14, 23, 25 and 50

Reg. No. 3,575,242

United States Patent and Trademark Office

Registered Feb. 17, 2009

**TRADEMARK
PRINCIPAL REGISTER**

 FOOT MASTER

G-DOK INDUSTRIES CO., LTD. (REPUBLIC OF
KOREA CORPORATION)

DANGJIN-GUN

408-17 HANJIN-RI, SONGAK-MYEON

CHUNGHEONNAM-DO, REPUBLIC OF KOREA

FOR: METAL CASTERS, IN CLASS 6 (U.S. CLS. 2,
12, 13, 14, 23, 25 AND 50).

FIRST USE 12-31-1998; IN COMMERCE 12-31-1998.

NO CLAIM IS MADE TO THE EXCLUSIVE
RIGHT TO USE "FOOT", APART FROM THE MARK
AS SHOWN.

THE MARK CONSISTS OF THE WORDS "FOOT
MASTER" AND A SILHOUETTE DESIGN OF A
CASTER.

SER. NO. 77-441,626, FILED 4-7-2008.

JANICE L. MCMORROW, EXAMINING ATTOR-
NEY

Int. Cl.: 9

Prior U.S. Cls.: 21, 23, 26, 36 and 38

Reg. No. 3,575,243

United States Patent and Trademark Office

Registered Feb. 17, 2009

**TRADEMARK
PRINCIPAL REGISTER**



PHL AUDIO (FRANCE CORPORATION)
461 RUE DES CHENES, Z.A.
CHARTRETTES, FRANCE 77590

FOR: ELECTRO-ACOUSTICAL TRANSDUCERS,
LOUDSPEAKERS, ELECTRO-ACOUSTICAL
SPEAKER SYSTEMS, IN CLASS 9 (U.S. CLS. 21, 23,
26, 36 AND 38).

FIRST USE 11-4-2002; IN COMMERCE 11-4-2002.

NO CLAIM IS MADE TO THE EXCLUSIVE
RIGHT TO USE "AUDIO", APART FROM THE
MARK AS SHOWN.

THE MARK CONSISTS OF A STYLIZED DESIGN
OF A DOLPHIN UNDER WHICH APPEARS THE
LETTERS "PHL" AND THE WORD "AUDIO".

SER. NO. 77-443,031, FILED 4-8-2008.

MATTHEW EINSTEIN, EXAMINING ATTORNEY

Int. Cl.: 9

Prior U.S. Cls.: 21, 23, 26, 36 and 38

Reg. No. 3,575,244

United States Patent and Trademark Office

Registered Feb. 17, 2009

**TRADEMARK
PRINCIPAL REGISTER**

CELERITY

QUANTUM3D (CALIFORNIA CORPORATION)
6330 SAN IGNACIO AVE
SAN JOSE, CA 95119

FIRST USE 10-30-2005; IN COMMERCE 10-30-2005.

FOR: COMPUTER SOFTWARE FOR USE WITH
DATABASE PUBLISHING THAT OPTIMIZES SYN-
THETIC ENVIRONMENT DATABASES FOR REAL-
TIME OPERATION ON IMAGE GENERATORS, IN
CLASS 9 (U.S. CLS. 21, 23, 26, 36 AND 38).

THE MARK CONSISTS OF STANDARD CHAR-
ACTERS WITHOUT CLAIM TO ANY PARTICULAR
FONT, STYLE, SIZE, OR COLOR.

SER. NO. 77-443,739, FILED 4-9-2008.

MICHAEL LITZAU, EXAMINING ATTORNEY

Int. Cls.: 35, 36 and 37

Prior U.S. Cls.: 100, 101, 102, 103 and 106

United States Patent and Trademark Office

Reg. No. 3,575,245

Registered Feb. 17, 2009

SERVICE MARK
PRINCIPAL REGISTER



NEW URBAN WEST, INC. (CALIFORNIA CORPORATION)
1733 OCEAN AVENUE, SUITE 350
SANTA MONICA, CA 90401

FOR: REAL ESTATE MARKETING SERVICES FOR RESIDENTIAL AND FIFTY-FIVE AND OLDER AND MIXED-USE COMMUNITIES, IN CLASS 35 (U.S. CLS. 100, 101 AND 102).

FIRST USE 2-17-1994; IN COMMERCE 2-17-1994.

FOR: REAL ESTATE MANAGEMENT FOR RESIDENTIAL AND FIFTY-FIVE AND OLDER AND MIXED-USE COMMUNITIES, IN CLASS 36 (U.S. CLS. 100, 101 AND 102).

FIRST USE 2-17-1994; IN COMMERCE 2-17-1994.

FOR: REAL ESTATE DEVELOPMENT OF RESIDENTIAL AND FIFTY FIVE AND OLDER AND MIXED-USE COMMUNITIES AND CONSTRUCTION SERVICES, NAMELY, RESIDENTIAL ATTACHED SINGLE-FAMILY HOMES AND SINGLE HOME CONSTRUCTION, IN CLASS 37 (U.S. CLS. 100, 103 AND 106).

FIRST USE 2-17-1994; IN COMMERCE 2-17-1994.

NO CLAIM IS MADE TO THE EXCLUSIVE RIGHT TO USE "INC", APART FROM THE MARK AS SHOWN.

THE MARK CONSISTS OF THE WORDS "NEW", "URBAN", "WEST", "INC", EACH CAPITALIZED WORD AND ABBREVIATION UNDER EACH OTHER IN A COLUMN FORMAT AND EACH WORD UNDERLINED EXCEPT FOR "INC"..

SER. NO. 77-443,784, FILED 4-9-2008.

ANGELA M. MICHELI, EXAMINING ATTORNEY

Int. Cl.: 28

Prior U.S. Cls.: 22, 23, 38 and 50

United States Patent and Trademark Office

Reg. No. 3,575,246

Registered Feb. 17, 2009

**TRADEMARK
PRINCIPAL REGISTER**

CARDIOTECH

726929 ONTARIO LTD. (CANADA CORPORATION), DBA T-ZONE HEALTH
25 CURITY AVENUE, UNIT 2A
TORONTO, CANADA

FOR: EXERCISE EQUIPMENT, NAMELY, TREADMILLS, STATIONARY EXERCISE BICYCLES, ROWING MACHINES, WEIGHT LIFTING MACHINES, IN CLASS 28 (U.S. CLS. 22, 23, 38 AND 50).

FIRST USE 1-1-2008; IN COMMERCE 1-1-2008.

THE MARK CONSISTS OF STANDARD CHARACTERS WITHOUT CLAIM TO ANY PARTICULAR FONT, STYLE, SIZE, OR COLOR.

SER. NO. 77-444,129, FILED 4-9-2008.

ANDREW RHIM, EXAMINING ATTORNEY

Int. Cls.: 7 and 9

Prior U.S. Cls.: 13, 19, 21, 23, 26, 31, 34, 35, 36 and 38

United States Patent and Trademark Office

Reg. No. 3,575,247

Registered Feb. 17, 2009

**TRADEMARK
PRINCIPAL REGISTER**

KMT ROBOTIC SOLUTIONS

KMT ROBOTIC SOLUTIONS, INC. (MICHIGAN CORPORATION)
1255 HARMON ROAD
AUBURN HILLS, MI 48326

FOR: INDUSTRIAL ROBOTS; INDUSTRIAL ROBOTIC MACHINERY SYSTEMS FOR MATERIAL SEPARATION, CUTTING AND REMOVAL, NAMELY, INDUSTRIAL ROBOTIC MACHINES FOR AUTOMATED ROUTING, CUTTING AND DEBURRING; INDUSTRIAL VACUUMS FOR HOLDING PARTS INTO A FIXTURE AND FOR REMOVING WATER AND WASTE; INDUSTRIAL ROBOTS, NAMELY, ROBOTIC SYSTEMS IN THE NATURE OF SELF-CONTAINED ROBOTIC WORK CELLS INCORPORATING SOFTWARE FOR CONTROLLING AND EXCHANGING INFORMATION AMONG ROBOTIC SYSTEMS AND OTHER ELECTRONIC DEVICES, IN CLASS 7 (U.S. CLS. 13, 19, 21, 23, 31, 34 AND 35).

FIRST USE 2-28-2007; IN COMMERCE 2-28-2007.

FOR: COMPUTER HARDWARE FOR USE IN THE FIELD OF ROBOTICS; COMPUTER SOFTWARE FOR USE IN CONNECTION WITH CONTROLLING AND OPERATING INDUSTRIAL ROBOTS AND INDUSTRIAL ROBOTIC SYSTEMS

AND IN CONNECTION WITH TRAINING USERS TO PROGRAM ROBOTS THROUGH SIMULATION; ROBOTIC SYSTEMS, NAMELY, SOFTWARE FOR SELF-CONTAINED ROBOTIC WORK CELLS FOR CONTROLLING AND EXCHANGING INFORMATION AMONG ROBOTIC SYSTEMS AND OTHER DEVICES; ELECTRIC AND ELECTRONIC SENSORS FOR USE WITH ROBOTS IN DETERMINING THE LOCATION OF PARTS WITH WHICH THE ROBOT IS INTERACTING, AND FOR USE IN LOCATING SPECIFIC FEATURES ON PARTS WITH WHICH THE ROBOT IS INTERACTING, IN CLASS 9 (U.S. CLS. 21, 23, 26, 36 AND 38).

FIRST USE 2-28-2007; IN COMMERCE 2-28-2007.

THE MARK CONSISTS OF STANDARD CHARACTERS WITHOUT CLAIM TO ANY PARTICULAR FONT, STYLE, SIZE, OR COLOR.

NO CLAIM IS MADE TO THE EXCLUSIVE RIGHT TO USE "ROBOTIC SOLUTIONS", APART FROM THE MARK AS SHOWN.

SER. NO. 77-444,299, FILED 4-9-2008.

MAYUR VAGHANI, EXAMINING ATTORNEY

Int. Cl.: 35

Prior U.S. Cls.: 100, 101 and 102

United States Patent and Trademark Office

Reg. No. 3,575,248

Registered Feb. 17, 2009

**SERVICE MARK
PRINCIPAL REGISTER**



THE RECLAIM GROUP, L.L.C.

THE RECLAIM GROUP, LLC (MARYLAND LIMITED LIABILITY COMPANY)
SUITE 306
4948 SAINT ELMO AVENUE
BETHESDA, MD 20814

FOR: INSURANCE CLAIMS AUDITING SERVICES, IN CLASS 35 (U.S. CLS. 100, 101 AND 102).

FIRST USE 1-15-2001; IN COMMERCE 1-15-2001.

NO CLAIM IS MADE TO THE EXCLUSIVE RIGHT TO USE "THE RECLAIM GROUP, L.L.C.", APART FROM THE MARK AS SHOWN.

THE COLOR(S) GREEN, BLACK AND WHITE IS/ ARE CLAIMED AS A FEATURE OF THE MARK.

THE MARK CONSISTS OF THE COLOR GREEN WHICH APPEARS IN THE DIAMOND-SHAPED RECTANGLE; THE COLOR WHITE APPEARS AS FORWARD AND REARWARD OVERLAPPING HOOKS WITHIN THE GREEN DIAMOND-SHAPED RECTANGLE; AND THE COLOR BLACK APPEARS IN THE WORDING "THE RECLAIM GROUP, L.L.C.".

SER. NO. 77-444,552, FILED 4-10-2008.

MAYUR VAGHANI, EXAMINING ATTORNEY

Int. Cl.: 10

Prior U.S. Cls.: 26, 39 and 44

Reg. No. 3,575,249

United States Patent and Trademark Office

Registered Feb. 17, 2009

**TRADEMARK
PRINCIPAL REGISTER**

FOR SURGERY. FOR LIFE.

MICROAIRE SURGICAL INSTRUMENTS, LLC
(DELAWARE LIMITED LIABILITY COMPAN-
NY)
1641 EDLICH DRIVE
CHARLOTTESVILLE, VA 22911

FOR: SURGICAL AND MEDICAL APPARATUS AND INSTRUMENTS FOR USE IN GENERAL SURGERY; SURGICAL INSTRUMENTS AND APPARATUS FOR USE IN PLASTIC SURGERY; SURGICAL APPARATUS AND INSTRUMENTS FOR MEDICAL, DENTAL OR VETERINARY USE; MEDICAL AND SURGICAL CUTTERS FOR CUTTING HUMAN OR ANIMAL TISSUE AND ORGANS; SURGICAL BLADES; SURGICAL BURS; SURGICAL APPARATUS, NAMELY, SUBCUTANEOUS DISSECTION DEVICES FOR USE IN GENERAL SURGERY; SURGICAL APPARATUS, NAMELY, EPITHELIUM REMOVAL DEVICES FOR USE IN GENERAL SURGERY; SURGICAL INSTRUMENTS FOR DRILLING, PINNING, REAMING, SAWING, AND LAVAGING; MODULAR ELECTRIC SURGICAL INSTRUMENTS FOR SMALL BONE SURGERY; PNEUMATICALLY AND ELECTRICALLY OPERATED SURGICAL INSTRUMENTS, NAMELY, DRILLS, BUFFS, SAWS AND WIRE DRIVERS, SUR-

GICAL IRRIGATORS, ENDOSCOPIC CARPAL TUNNEL RELEASE SURGICAL INSTRUMENTS; PNEUMATICALLY AND ELECTRICALLY OPERATED LIPOPLASTY SURGICAL INSTRUMENTS, HANDPIECES, CANNULAE AND PARTS THEREOF; STERILIZATION CASES AND ACCESSORY TRAYS FOR SURGICAL INSTRUMENTS; SURGICAL K-WIRES, SURGICAL PINS AND SURGICAL WIRE AND PIN PROTECTORS, IN CLASS 10 (U.S. CLS. 26, 39 AND 44).

FIRST USE 3-4-2008; IN COMMERCE 3-4-2008.

THE MARK CONSISTS OF STANDARD CHARACTERS WITHOUT CLAIM TO ANY PARTICULAR FONT, STYLE, SIZE, OR COLOR.

NO CLAIM IS MADE TO THE EXCLUSIVE RIGHT TO USE "FOR SURGERY", APART FROM THE MARK AS SHOWN.

SER. NO. 77-444,971, FILED 4-10-2008.

GRETTA YAO, EXAMINING ATTORNEY

Int. Cl.: 16

Prior U.S. Cls.: 2, 5, 22, 23, 29, 37, 38 and 50

United States Patent and Trademark Office

Reg. No. 3,575,250

Registered Feb. 17, 2009

**TRADEMARK
PRINCIPAL REGISTER**

SPIRITUAL GREEN CARD

HUNN, JERRY (UNITED STATES INDIVIDUAL)
227 S. HOLLOWAY STREET
HENDERSON, KY 42420

FOR: PRINTED MATTER IN THE NATURE OF A
MEMBERSHIP CARD THAT IS DISTRIBUTED FOR
PURPOSES OF SPIRITUAL OUTREACH, IN CLASS
16 (U.S. CLS. 2, 5, 22, 23, 29, 37, 38 AND 50).

FIRST USE 7-1-2005; IN COMMERCE 7-1-2005.

THE MARK CONSISTS OF STANDARD CHAR-
ACTERS WITHOUT CLAIM TO ANY PARTICULAR
FONT, STYLE, SIZE, OR COLOR.

NO CLAIM IS MADE TO THE EXCLUSIVE
RIGHT TO USE "SPIRITUAL" AND "CARD",
APART FROM THE MARK AS SHOWN.

SER. NO. 77-445,210, FILED 4-10-2008.

GEOFFREY FOSDICK, EXAMINING ATTORNEY

Int. Cl.: 40

Prior U.S. Cls.: 100, 103 and 106

United States Patent and Trademark Office

Reg. No. 3,575,251

Registered Feb. 17, 2009

**SERVICE MARK
PRINCIPAL REGISTER**

PROTEXIC

A stylized, grey, curved line that starts above the 'X' and sweeps downwards to the right, ending below the 'X', creating a dynamic, modern look for the letter.

TEGRANT DIVERSIFIED BRANDS, INC. (PENNSYLVANIA CORPORATION)
800 FIFTH AVENUE
NEW BRIGHTON, PA 15066

THE MARK CONSISTS OF THE WORD "PROTEXIC" WITH STYLIZED "X".

FOR: MANUFACTURING SERVICES FOR OTHERS IN THE FIELD OF PACKAGING MATERIALS, IN CLASS 40 (U.S. CLS. 100, 103 AND 106).

SER. NO. 77-445,790, FILED 4-11-2008.

FIRST USE 2-8-2008; IN COMMERCE 2-8-2008.

SHANNON TWOHIG, EXAMINING ATTORNEY

Int. Cl.: 15

Prior U.S. Cls.: 2, 21 and 36

United States Patent and Trademark Office

Reg. No. 3,575,252

Registered Feb. 17, 2009

**TRADEMARK
PRINCIPAL REGISTER**

COOL STRAPS

SHS INTERNATIONAL, INC. (INDIANA CORPORATION)

1922 BANTA ROAD

INDIANAPOLIS, IN 46217

FOR: GUITAR STRAPS, IN CLASS 15 (U.S. CLS. 2, 21 AND 36).

FIRST USE 7-1-2007; IN COMMERCE 7-1-2007.

THE MARK CONSISTS OF STANDARD CHARACTERS WITHOUT CLAIM TO ANY PARTICULAR FONT, STYLE, SIZE, OR COLOR.

NO CLAIM IS MADE TO THE EXCLUSIVE RIGHT TO USE "STRAPS", APART FROM THE MARK AS SHOWN.

SER. NO. 77-445,801, FILED 4-11-2008.

SHANNON TWOHIG, EXAMINING ATTORNEY

Int. Cl.: 43

Prior U.S. Cls.: 100 and 101

United States Patent and Trademark Office

Reg. No. 3,575,253

Registered Feb. 17, 2009

SERVICE MARK
PRINCIPAL REGISTER



SAITO STEAK HOUSE, INC. (FLORIDA CORPORATION)
10240 FOREST HILL BLVD, #140
WELLINGTON, FL 33414

FOR: RESTAURANT SERVICES, IN CLASS 43
(U.S. CLS. 100 AND 101).

FIRST USE 5-31-2001; IN COMMERCE 5-31-2001.

NO CLAIM IS MADE TO THE EXCLUSIVE RIGHT TO USE "JAPANESE STEAKHOUSE", APART FROM THE MARK AS SHOWN.

THE NAME(S), PORTRAIT(S), AND/OR SIGNATURE(S) SHOWN IN THE MARK DOES NOT IDENTIFY A PARTICULAR LIVING INDIVIDUAL.

THE COLOR(S) RED AND WHITE IS/ARE CLAIMED AS A FEATURE OF THE MARK.

THE MARK CONSISTS OF THE WORD "SAITO'S" OVER AN IRREGULAR UNDERSCORE, AND THE WORDS "JAPANESE STEAKHOUSE" IN THE IRREGULAR UNDERSCORE. A SUBSTANTIALLY HORIZONTAL LINE IS IN THE IRREGULAR UNDERSCORE AND EXTENDS ABOVE A PORTION OF THE WORDS "JAPANESE STEAKHOUSE" AND ANOTHER SUBSTANTIALLY HORIZONTAL LINE IS IN THE IRREGULAR UNDERSCORE AND EXTENDS BELOW A PORTION OF THE WORDS "JAPANESE STEAKHOUSE". THE WORD "SAITO'S" IS RED, THE IRREGULAR UNDERSCORE IS RED, THE WORDS "JAPANESE STEAKHOUSE" ARE WHITE, AND THE SUBSTANTIALLY HORIZONTAL LINES ARE WHITE.

SEC. 2(F).

SER. NO. 77-446,695, FILED 4-11-2008.

ANDREA HACK, EXAMINING ATTORNEY

Int. Cl.: 25

Prior U.S. Cls.: 22 and 39

United States Patent and Trademark Office

Reg. No. 3,575,254

Registered Feb. 17, 2009

TRADEMARK
PRINCIPAL REGISTER



HONG, ALYSSA U (REPUBLIC OF KOREA IN-
DIVIDUAL)
7018 HAWAII KAI DR. #407
HONOLULU, HI 96825

FOR: HOODED SWEAT SHIRTS; LONG-
SLEEVED SHIRTS; SHIRTS; SHORT-SLEEVED OR
LONG-SLEEVED T-SHIRTS; SHORT-SLEEVED
SHIRTS; T-SHIRTS; TANK TOPS; TANK-TOPS; TEE
SHIRTS, IN CLASS 25 (U.S. CLS. 22 AND 39).

FIRST USE 1-1-2008; IN COMMERCE 4-13-2008.

THE COLOR(S) BLACK AND PINK IS/ARE
CLAIMED AS A FEATURE OF THE MARK.

THE MARK CONSISTS OF BLACK LETTERS
SPELLING OUT THE WORD "BABYEE" NEXT TO
A PINK HEART OUTLINED IN BLACK.

SER. NO. 77-446,924, FILED 4-13-2008.

CARRIE GENOVESE, EXAMINING ATTORNEY

Int. Cl.: 25

Prior U.S. Cls.: 22 and 39

United States Patent and Trademark Office

Reg. No. 3,575,255

Registered Feb. 17, 2009

**TRADEMARK
PRINCIPAL REGISTER**

FECHHEIMER

THE FECHHEIMER BROTHERS COMPANY (DE-
LAWARE CORPORATION)
4545 MALSARY ROAD
CINCINNATI, OH 45242

FOR: UNIFORMS FOR LAW ENFORCEMENT,
FIRE, POSTAL, MARCHING BAND CAREER APPA-
REL, AND OTHER SPECIAL USES, NAMELY,
COATS, JACKETS, TROUSERS, SHIRTS, SWEA-
TERS, UNDERGARMENTS AND HEADWEAR, IN
CLASS 25 (U.S. CLS. 22 AND 39).

FIRST USE 1-1-1842; IN COMMERCE 1-1-1842.

THE MARK CONSISTS OF STANDARD CHAR-
ACTERS WITHOUT CLAIM TO ANY PARTICULAR
FONT, STYLE, SIZE, OR COLOR.

OWNER OF U.S. REG. NO. 2,702,264.

SEC. 2(F).

SER. NO. 77-447,066, FILED 4-14-2008.

LINDSEY RUBIN, EXAMINING ATTORNEY

Int. Cl.: 35

Prior U.S. Cls.: 100, 101 and 102

United States Patent and Trademark Office

Reg. No. 3,575,256

Registered Feb. 17, 2009

**SERVICE MARK
PRINCIPAL REGISTER**

MSL

MOORE STEPHENS LOVELACE, P.A. (FLORIDA CORPORATION)
1201 S. ORLANDO AVENUE
SUITE 400
WINTER PARK, FL 32789

FOR: ACCOUNT AUDITING; ACCOUNTANCY SERVICES; ACCOUNTING CONSULTATION; ACCOUNTING SERVICES; ACCOUNTS RECEIVABLE SERVICES; ACQUISITION AND MERGER CONSULTATION; ADMINISTRATION, BILLING AND RECONCILIATION OF ACCOUNTS ON BEHALF OF OTHERS; ADMINISTRATIVE ACCOUNTING; BUSINESS INFORMATION AND ACCOUNTING ADVISORY SERVICES; BUSINESS MANAGEMENT AND CONSULTING SERVICES FOR THE HEALTH CARE INDUSTRY, NAMELY, CUSTOMER SERVICE, AND ACCOUNTING SERVICES; COMPUTERIZED ACCOUNTING SERVICES; COST ACCOUNTING; PROVIDING AN ON-LINE COMPU-

TER WEB SITE THAT PROVIDES COMMERCIAL FINANCIAL TRANSACTION DATA, ACCOUNT MANAGEMENT, FINANCIAL REPORTING, ACCOUNTING FEATURES AND RELATED REFERENCE INFORMATION; DATA MANAGEMENT SERVICE FOR USE IN REPORTING DEBT COLLECTION ACCOUNTS TO A COLLECTION AGENCY, IN CLASS 35 (U.S. CLS. 100, 101 AND 102).

FIRST USE 7-17-1986; IN COMMERCE 7-17-1986.

THE MARK CONSISTS OF STANDARD CHARACTERS WITHOUT CLAIM TO ANY PARTICULAR FONT, STYLE, SIZE, OR COLOR.

SER. NO. 77-447,218, FILED 4-14-2008.

ALEX KEAM, EXAMINING ATTORNEY

Int. Cl.: 36

Prior U.S. Cls.: 100, 101 and 102

United States Patent and Trademark Office

Reg. No. 3,575,257

Registered Feb. 17, 2009

**SERVICE MARK
PRINCIPAL REGISTER**

SMARTBOOK

SCHAEFER, MARK (UNITED STATES INDIVIDUAL)
1220 SHERMAN AVE.
EVANSTON, IL 60202

THE MARK CONSISTS OF STANDARD CHARACTERS WITHOUT CLAIM TO ANY PARTICULAR FONT, STYLE, SIZE, OR COLOR.

FOR: PROVIDING AN ON LINE ELECTRONIC DATABASE FOR VIEWING, SEARCHING, AND MAINTAINING LEASING DATA FOR REAL ESTATE, IN CLASS 36 (U.S. CLS. 100, 101 AND 102).

SER. NO. 77-447,599, FILED 4-14-2008.

FIRST USE 10-9-2003; IN COMMERCE 10-9-2003.

KATHERINE CHANG, EXAMINING ATTORNEY

Int. Cls.: 6, 19 and 35

**Prior U.S. Cls.: 1, 2, 12, 13, 14, 23, 25, 33, 50, 100, 101
and 102**

Reg. No. 3,575,258

United States Patent and Trademark Office

Registered Feb. 17, 2009

**TRADEMARK
SERVICE MARK
PRINCIPAL REGISTER**

NAS DOORS

NAS UNLIMITED DOORS, LLC. (FLORIDA LIMITED LIABILITY COMPANY)
2450 PALM AVENUE
HIALEAH, FL 33010

FOR: DOORS OF METAL, IN CLASS 6 (U.S. CLS. 2, 12, 13, 14, 23, 25 AND 50).

FIRST USE 4-1-2007; IN COMMERCE 4-1-2007.

FOR: VINYL AND WOOD DOORS, IN CLASS 19 (U.S. CLS. 1, 12, 33 AND 50).

FIRST USE 4-1-2007; IN COMMERCE 4-1-2007.

FOR: WHOLESALE DISTRIBUTORSHIP FEATURING DOORS AND RETAIL STORE SERVICES

FEATURING DOORS, IN CLASS 35 (U.S. CLS. 100, 101 AND 102).

FIRST USE 4-1-2007; IN COMMERCE 4-1-2007.

THE MARK CONSISTS OF STANDARD CHARACTERS WITHOUT CLAIM TO ANY PARTICULAR FONT, STYLE, SIZE, OR COLOR.

NO CLAIM IS MADE TO THE EXCLUSIVE RIGHT TO USE "DOORS" , APART FROM THE MARK AS SHOWN.

SER. NO. 77-448,814, FILED 4-15-2008.

DAYNA BROWNE, EXAMINING ATTORNEY

Int. Cl.: 43

Prior U.S. Cls.: 100 and 101

United States Patent and Trademark Office

Reg. No. 3,575,259

Registered Feb. 17, 2009

**SERVICE MARK
PRINCIPAL REGISTER**

KING EGGROLL

ROYAL KING EGGROLL I, INC. (CALIFORNIA
CORPORATION)
980 LUNDY AVENUE
SAN JOSE, CA 95133

FOR: FAST-FOOD RESTAURANTS; PROVIDING
OF FOOD AND DRINK, IN CLASS 43 (U.S. CLS. 100
AND 101).

FIRST USE 6-13-1988; IN COMMERCE 6-13-1988.

THE MARK CONSISTS OF STANDARD CHAR-
ACTERS WITHOUT CLAIM TO ANY PARTICULAR
FONT, STYLE, SIZE, OR COLOR.

NO CLAIM IS MADE TO THE EXCLUSIVE
RIGHT TO USE "EGGROLL", APART FROM THE
MARK AS SHOWN.

SER. NO. 77-448,988, FILED 4-15-2008.

LAURIE KAUFMAN, EXAMINING ATTORNEY

Int. Cl.: 9

Prior U.S. Cls.: 21, 23, 26, 36 and 38

Reg. No. 3,575,260

United States Patent and Trademark Office

Registered Feb. 17, 2009

**TRADEMARK
PRINCIPAL REGISTER**

Alchemy

RMI CORPORATION (DELAWARE CORPORATION), DBA RAZA MICROELECTRONICS, INC.
LEGAL DEPARTMENT
18920 FORGE DRIVE
CUPERTINO, CA 95014

FOR: SEMICONDUCTOR CHIPS; SEMICONDUCTOR DEVICES; SEMICONDUCTORS; ELECTRONIC CHIPS FOR THE MANUFACTURER OF INTEGRATED CIRCUITS; ELECTRONIC INTEGRATED CIRCUITS; INTEGRATED CIRCUITS; INTEGRATED CIRCUITS AND INTEGRATED CIRCUIT CORES FOR USE IN WIRELESS COMMUNICATIONS AND WIRELESS COMMUNICATION EQUIPMENT AND

APPARATI AND DIGITAL SIGNAL PROCESSORS (DSP); LARGE SCALE INTEGRATED CIRCUITS, IN CLASS 9 (U.S. CLS. 21, 23, 26, 36 AND 38).

FIRST USE 8-31-2002; IN COMMERCE 10-31-2002.

THE MARK CONSISTS OF STANDARD CHARACTERS WITHOUT CLAIM TO ANY PARTICULAR FONT, STYLE, SIZE, OR COLOR.

SER. NO. 77-449,006, FILED 4-15-2008.

HANNO RITTNER, EXAMINING ATTORNEY

Int. Cl.: 9

Prior U.S. Cls.: 21, 23, 26, 36 and 38

United States Patent and Trademark Office

Reg. No. 3,575,261

Registered Feb. 17, 2009

**TRADEMARK
PRINCIPAL REGISTER**

eXpertManager

SATEC INC. (DELAWARE CORPORATION)
10 MILLTOWN COURT
UNION, NJ 07083

THE MARK CONSISTS OF STANDARD CHAR-
ACTERS WITHOUT CLAIM TO ANY PARTICULAR
FONT, STYLE, SIZE, OR COLOR.

FOR: ELECTRICAL ENERGY UTILIZATION ME-
TERING DEVICES COMPLETE WITH RELATED
SOFTWARE, IN CLASS 9 (U.S. CLS. 21, 23, 26, 36 AND
38).

SER. NO. 77-449,160, FILED 4-15-2008.

FIRST USE 4-14-2008; IN COMMERCE 4-14-2008.

G. MAYERSCHOFF, EXAMINING ATTORNEY

Int. Cls.: 35, 37, 42 and 43

Prior U.S. Cls.: 100, 101, 102, 103 and 106

United States Patent and Trademark Office

Reg. No. 3,575,262

Registered Feb. 17, 2009

**SERVICE MARK
PRINCIPAL REGISTER**

IOWA 80 TRUCKSTOP

IOWA 80 TRUCKSTOP, INC. (IOWA CORPORATION)
515 STERLING DRIVE, P.O. BOX 639
WALCOTT, IA 52773

FOR: RETAIL STORE SERVICES FEATURING TOY TRUCKS, GIFTS, HOOD ORNAMENTS, AND TRUCK ACCESSORIES; TRUCK STOP SERVICES, NAMELY, RETAIL GASOLINE AND DIESEL FUEL SUPPLY, RETAIL STORE SERVICES FEATURING GROCERIES AND SUNDRIES, IN CLASS 35 (U.S. CLS. 100, 101 AND 102).

FIRST USE 1-1-1997; IN COMMERCE 1-1-1997.

FOR: TRUCK STOP SERVICES, NAMELY, VEHICLE MAINTENANCE AND REPAIR, TRUCK WASHING, IN CLASS 37 (U.S. CLS. 100, 103 AND 106).

FIRST USE 0-0-1982; IN COMMERCE 0-0-1982.

FOR: TRUCK STOP SERVICES, NAMELY, TRUCK WEIGHING, IN CLASS 42 (U.S. CLS. 100 AND 101).

FIRST USE 0-0-1982; IN COMMERCE 0-0-1982.

FOR: TRUCK STOP SERVICES, NAMELY, RESTAURANT SERVICES, HOTEL SERVICES, IN CLASS 43 (U.S. CLS. 100 AND 101).

FIRST USE 6-4-1964; IN COMMERCE 6-4-1964.

THE MARK CONSISTS OF STANDARD CHARACTERS WITHOUT CLAIM TO ANY PARTICULAR FONT, STYLE, SIZE, OR COLOR.

OWNER OF U.S. REG. NOS. 2,036,666, 2,975,794 AND OTHERS.

NO CLAIM IS MADE TO THE EXCLUSIVE RIGHT TO USE "TRUCKSTOP", APART FROM THE MARK AS SHOWN.

SEC. 2(F).

SER. NO. 77-449,243, FILED 4-16-2008.

SALLY SHIH, EXAMINING ATTORNEY

Int. Cl.: 41

Prior U.S. Cls.: 100, 101 and 107

United States Patent and Trademark Office

Reg. No. 3,575,263

Registered Feb. 17, 2009

**SERVICE MARK
PRINCIPAL REGISTER**

THE MAGIC PARTIES

THE MAGIC PARTIES, LLC (MASSACHUSETTS
LIMITED LIABILITY COMPANY)
14 ANNE TERESA WAY
WESTFORD, MA 01886

FOR: ENTERTAINMENT SERVICES, NAMELY, CONDUCTING PARTIES AND FAIRS TO PROVIDE WOMEN WITH THE TOOLS, TRAINING AND RESOURCES TO SUPPORT AND INSPIRE WOMEN TO BECOME THEIR BEST SELVES, TO HAVE SOCIAL TIME, MEDITATE AND EAT CHOCOLATE; EDUCATIONAL AND ENTERTAINMENT SERVICES, NAMELY, PROVIDING MOTIVATIONAL AND EDUCATIONAL SPEAKERS ON TOPICS OF HEALING AND CELEBRATING THE SPIRIT OF WOMEN; EDUCATION SERVICES, NAMELY, PROVIDING WORKSHOPS AND SEMINARS FOR TEACHING PERSONAL DEVELOPMENT AND PERSONAL TRANSFORMATION SKILLS TO STRENGTHEN AND GROW WOMEN INTO THEIR NEXT CAREER OR LIFE ON A PERSONAL LEVEL; PROVIDING LEADERSHIP TRAINING FOR WOMEN; PERSONAL COACHING SERVICES IN THE FIELD OF CAREERS AND CAREER COUNSELING SERVICES IN THE NATURE OF WORKING ONE ON ONE WITH WOMEN TO HELP THEM CLARIFY THEIR LIFE PURPOSE AND THE ACTION STEPS

NECESSARY TO MOVE FORWARD; PROVIDING ON-LINE INFORMATION VIA A WEBSITE IN THE FIELD OF EDUCATIONAL SERVICES, ENTERTAINMENT, PERSONAL COACHING SERVICES, AND CAREER COUNSELING SERVICES FOR WOMEN; PERSONAL COACHING SERVICES IN THE FIELD OF LEADERSHIP TRAINING; AT HOME TRAINING IN THE FIELD OF LEADERSHIP TRAINING; PROVIDING ONLINE INFORMATION IN THE FIELDS OF TRAINING IN THE FIELDS OF PERSONAL SUPPORT FOR WOMEN AND LEADERSHIP, IN CLASS 41 (U.S. CLS. 100, 101 AND 107).

FIRST USE 9-13-2006; IN COMMERCE 9-13-2006.

THE MARK CONSISTS OF STANDARD CHARACTERS WITHOUT CLAIM TO ANY PARTICULAR FONT, STYLE, SIZE, OR COLOR.

NO CLAIM IS MADE TO THE EXCLUSIVE RIGHT TO USE "PARTIES", APART FROM THE MARK AS SHOWN.

SER. NO. 77-450,900, FILED 4-17-2008.

SETH A. RAPPAPORT, EXAMINING ATTORNEY

Int. Cl.: 41

Prior U.S. Cls.: 100, 101 and 107

United States Patent and Trademark Office

Reg. No. 3,575,264

Registered Feb. 17, 2009

**SERVICE MARK
PRINCIPAL REGISTER**

Invisible Magic Wand

WICKSTROM, LOIS J (UNITED STATES INDIVIDUAL)
787 N 24TH STREET
PHILADELPHIA, PA 19130

FOR: ENTERTAINMENT IN THE NATURE OF MAGIC SHOWS, IN CLASS 41 (U.S. CLS. 100, 101 AND 107).

FIRST USE 4-17-2008; IN COMMERCE 8-27-2008.

THE MARK CONSISTS OF STANDARD CHARACTERS WITHOUT CLAIM TO ANY PARTICULAR FONT, STYLE, SIZE, OR COLOR.

NO CLAIM IS MADE TO THE EXCLUSIVE RIGHT TO USE "MAGIC WAND", APART FROM THE MARK AS SHOWN.

SER. NO. 77-451,224, FILED 4-17-2008.

KAREN K. BUSH, EXAMINING ATTORNEY

Int. Cl.: 9

Prior U.S. Cls.: 21, 23, 26, 36 and 38

Reg. No. 3,575,265

United States Patent and Trademark Office

Registered Feb. 17, 2009

**TRADEMARK
PRINCIPAL REGISTER**

SimBio

SIMBIOTIC SOFTWARE FOR TEACHING AND
RESEARCH, INC. (NEW YORK CORPORATION)
148 GRANDVIEW COURT
ITHACA, NY 14850

FOR: EDUCATIONAL COMPUTER SOFTWARE
FOR TEACHING AND CONDUCTING SCIENTIFIC
RESEARCH IN THE FIELDS OF ECOLOGY, EVOLU-
TION, CELL BIOLOGY AND OTHER SCIENTIFI-
C FIELDS, IN CLASS 9 (U.S. CLS. 21, 23, 26, 36 AND
38).

FIRST USE 4-10-2002; IN COMMERCE 12-12-2007.

THE MARK CONSISTS OF STANDARD CHAR-
ACTERS WITHOUT CLAIM TO ANY PARTICULAR
FONT, STYLE, SIZE, OR COLOR.

SER. NO. 77-451,362, FILED 4-17-2008.

JOHN E. MICHOS, EXAMINING ATTORNEY

Int. Cl.: 41

Prior U.S. Cls.: 100, 101 and 107

United States Patent and Trademark Office

Reg. No. 3,575,266

Registered Feb. 17, 2009

**SERVICE MARK
PRINCIPAL REGISTER**

**Sisterhood. Spirit. And a
little chocolate.**

THE MAGIC PARTIES, LLC (MASSACHUSETTS
LIMITED LIABILITY COMPANY)
14 ANNE TERESA WAY
WESTFORD, MA 01886

FOR: ENTERTAINMENT SERVICES, NAMELY, CONDUCTING PARTIES AND FAIRS TO PROVIDE WOMEN WITH THE TOOLS, TRAINING AND RESOURCES TO SUPPORT AND INSPIRE WOMEN TO BECOME THEIR BEST SELVES, TO HAVE SOCIAL TIME, MEDITATE AND EAT CHOCOLATE; EDUCATIONAL AND ENTERTAINMENT SERVICES, NAMELY, PROVIDING MOTIVATIONAL AND EDUCATIONAL SPEAKERS ON TOPICS OF HEALING AND CELEBRATING THE SPIRIT OF WOMEN; EDUCATION SERVICES, NAMELY, PROVIDING WORKSHOPS AND SEMINARS FOR TEACHING PERSONAL DEVELOPMENT AND PERSONAL TRANSFORMATION SKILLS TO STRENGTHEN AND GROW WOMEN INTO THEIR NEXT CAREER OR LIFE ON A PERSONAL LEVEL; PROVIDING LEADERSHIP TRAINING FOR WOMEN; PERSONAL COACHING SERVICES IN THE FIELD OF CAREERS AND CAREER COUNSELING SERVICES IN THE NATURE OF WORKING ONE

ON ONE WITH WOMEN TO HELP THEM CLARIFY THEIR LIFE PURPOSE AND THE ACTION STEPS NECESSARY TO MOVE FORWARD; PROVIDING ON-LINE INFORMATION VIA A WEBSITE IN THE FIELD OF EDUCATIONAL SERVICES, ENTERTAINMENT, PERSONAL COACHING SERVICES, AND CAREER COUNSELING SERVICES FOR WOMEN; PERSONAL COACHING SERVICES IN THE FIELD OF LEADERSHIP TRAINING; AT HOME TRAINING IN THE FIELD OF LEADERSHIP TRAINING; PROVIDING ONLINE INFORMATION IN THE FIELDS OF TRAINING IN THE FIELDS OF PERSONAL SUPPORT FOR WOMEN AND LEADERSHIP, IN CLASS 41 (U.S. CLS. 100, 101 AND 107).

FIRST USE 2-14-2007; IN COMMERCE 2-14-2007.

THE MARK CONSISTS OF STANDARD CHARACTERS WITHOUT CLAIM TO ANY PARTICULAR FONT, STYLE, SIZE, OR COLOR.

SER. NO. 77-451,566, FILED 4-18-2008.

SETH A. RAPPAPORT, EXAMINING ATTORNEY

Int. Cl.: 9

Prior U.S. Cls.: 21, 23, 26, 36 and 38

United States Patent and Trademark Office

Reg. No. 3,575,267

Registered Feb. 17, 2009

**TRADEMARK
PRINCIPAL REGISTER**

AeroPoint

B.E. MEYERS & COMPANY, INC. (WASHINGTON CORPORATION)
14540 NE 91ST STREET
REDMOND, WA 980526553

FOR: LASERS NOT FOR MEDICAL USE; LASER OBJECT DETECTORS FOR USE ON VEHICLES; LASER POINTERS; LASER POINTING DEVICE FOR USE WITH FIREARMS , IN CLASS 9 (U.S. CLS. 21, 23, 26, 36 AND 38).

FIRST USE 4-1-2008; IN COMMERCE 4-1-2008.

THE MARK CONSISTS OF STANDARD CHARACTERS WITHOUT CLAIM TO ANY PARTICULAR FONT, STYLE, SIZE, OR COLOR.

SER. NO. 77-451,896, FILED S.R. 4-18-2008 AM. P.R. 10-10-2008.

HANNO RITTNER, EXAMINING ATTORNEY

Int. Cl.: 27

Prior U.S. Cls.: 19, 20, 37, 42 and 50

Reg. No. 3,575,268

United States Patent and Trademark Office

Registered Feb. 17, 2009

**TRADEMARK
PRINCIPAL REGISTER**

Exclusive ValueSource

M & C ENTERPRISES OF SEBRING, INC. (FLORIDA CORPORATION), DBA PROSOURCE OF ORLANDO
4426 NORTH ORANGE BLOSSOM TRAIL
ORLANDO, FL 32804

FOR: FLOOR COVERINGS; LINOLEUM FOR USE ON FLOORS; PROTECTIVE FLOOR COVERINGS; VINYL FLOOR COVERINGS; HARD SURFACE COVERINGS FOR FLOORS, IN CLASS 27 (U.S. CLS. 19, 20, 37, 42 AND 50).

FIRST USE 11-1-2007; IN COMMERCE 11-1-2007.

THE MARK CONSISTS OF STANDARD CHARACTERS WITHOUT CLAIM TO ANY PARTICULAR FONT, STYLE, SIZE, OR COLOR.

SER. NO. 77-451,906, FILED 4-18-2008.

NAAKWAMA ANKRAH, EXAMINING ATTORNEY

Int. Cl.: 9

Prior U.S. Cls.: 21, 23, 26, 36 and 38

Reg. No. 3,575,269

United States Patent and Trademark Office

Registered Feb. 17, 2009

**TRADEMARK
PRINCIPAL REGISTER**

SKi

SILICON KINETICS, INC. (CALIFORNIA CORPORATION)
10455 PACIFIC CENTER COURT
SAN DIEGO, CA 92121

FIRST USE 4-16-2008; IN COMMERCE 4-16-2008.

FOR: BIO-MOLECULAR OPTICAL INTERFEROMETRIC PRODUCTS, NAMELY, LABEL FREE BINDING INSTRUMENTS WHICH MEASURE PROTEIN INTERACTIONS USING WHITE LIGHT INTERFEROMETRY AND COMPONENT PARTS ESPECIALLY ADAPTED FOR THE AFOREMENTIONED PRODUCTS, IN CLASS 9 (U.S. CLS. 21, 23, 26, 36 AND 38).

THE MARK CONSISTS OF STANDARD CHARACTERS WITHOUT CLAIM TO ANY PARTICULAR FONT, STYLE, SIZE, OR COLOR.

SER. NO. 77-452,772, FILED 4-19-2008.

JUSTINE D. PARKER, EXAMINING ATTORNEY

Int. Cl.: 43

Prior U.S. Cls.: 100 and 101

United States Patent and Trademark Office

Reg. No. 3,575,270

Registered Feb. 17, 2009

**SERVICE MARK
PRINCIPAL REGISTER**

Mirabar

D.J.B., INC. (RHODE ISLAND CORPORATION),
DBA MIRABAR
35 RICHMOND ST.
PROVIDENCE, RI 02903

FOR: BAR SERVICES, LOUNGE SERVICES,
WHISKEY BAR SERVICES, PROVIDING COMMU-
NITY CENTER FOR MEETINGS, WINE BAR SER-
VICES, MARTINI BAR SERVICES, MUSIC BAR
SERVICES AND PIANO BAR SERVICES, IN CLASS
43 (U.S. CLS. 100 AND 101).

FIRST USE 3-20-1984; IN COMMERCE 3-20-1984.

THE MARK CONSISTS OF STANDARD CHAR-
ACTERS WITHOUT CLAIM TO ANY PARTICULAR
FONT, STYLE, SIZE, OR COLOR.

SER. NO. 77-453,000, FILED 4-20-2008.

ANDREA K. NADELMAN, EXAMINING ATTOR-
NEY

Int. Cl.: 35

Prior U.S. Cls.: 100, 101 and 102

United States Patent and Trademark Office

Reg. No. 3,575,271

Registered Feb. 17, 2009

**SERVICE MARK
PRINCIPAL REGISTER**



APOTHECARYRX, LLC (OKLAHOMA LIMITED
LIABILITY COMPANY)
SUITE 210
5500 WAYZATA BOULEVARD
GOLDEN VALLEY, MN 55416

FOR: BUSINESS CONSULTATION IN THE FIELD
OF RETAIL PHARMACIES; BUSINESS MANAGE-
MENT CONSULTING AND ADVISORY SERVICES,
IN CLASS 35 (U.S. CLS. 100, 101 AND 102).

FIRST USE 7-3-2006; IN COMMERCE 7-3-2006.

NO CLAIM IS MADE TO THE EXCLUSIVE
RIGHT TO USE "APOTHECARY RX", APART
FROM THE MARK AS SHOWN.

THE MARK CONSISTS OF A PILL LYING HOR-
IZONTALLY WITH THE WORD APOTHECARY
INSIDE THE PILL AND RX IMMEDIATELY TO
THE RIGHT.

SER. NO. 77-453,337, FILED 4-21-2008.

SETH A. RAPPAPORT, EXAMINING ATTORNEY

Int. Cl.: 43

Prior U.S. Cls.: 100 and 101

United States Patent and Trademark Office

Reg. No. 3,575,272

Registered Feb. 17, 2009

**SERVICE MARK
PRINCIPAL REGISTER**



LI, RUI (CHINA INDIVIDUAL)
GROUP 20
CHANG DIAN LI MIN WEI, TIE DONG DISTRICT
ANSHAN CITY, LIAONING, CHINA

FOR: ARRANGING TEMPORARY HOUSING ACCOMMODATIONS; PROVIDING HOTEL ACCOMMODATION; PROVIDING TEMPORARY ACCOMMODATION; CAFES; CAFETERIAS; CANTEEN SERVICES; HOTELS; RESTAURANTS; SNACK-BARS; BAR SERVICES; MOBILE CAFE SERVICES FOR PROVIDING FOOD AND DRINK; TEA ROOMS, IN CLASS 43 (U.S. CLS. 100 AND 101).

OWNER OF CHINA REG. NO. 3760830, DATED 2-28-2006, EXPIRES 2-27-2016.

"QIAN" MEANS "ONE THOUSAND" IN ENGLISH AND "HE" MEANS "STANDING GRAIN" IN ENGLISH.

THE NON-LATIN CHARACTERS IN THE MARK TRANSLITERATE TO "QIAN" AND "HE". WHEN USED IN COMBINATION, THE CHARACTERS HAVE NO MEANING IN ENGLISH.

SER. NO. 77-453,930, FILED 4-21-2008.

LIEF MARTIN, EXAMINING ATTORNEY

Int. Cl.: 35

Prior U.S. Cls.: 100, 101 and 102

United States Patent and Trademark Office

Reg. No. 3,575,273

Registered Feb. 17, 2009

**SERVICE MARK
PRINCIPAL REGISTER**

YOUNGJOBS

YOUNG JOBS INC. (CALIFORNIA CORPORATION)
812 ROSECRANS AVENUE
MANHATTAN BEACH, CA 90266

FOR: PROVIDING ON-LINE INFORMATION IN THE FIELDS OF EMPLOYMENT, RECRUITMENT, CAREERS, PERSONAL ISSUES RELATED TO CAREERS AND WORK LIFE, JOB RESOURCES, JOB LISTINGS AND RESUMES; PROVIDING ON-LINE INTERACTIVE EMPLOYMENT COUNSELING AND RECRUITMENT SERVICES; PROVIDING ON-LINE EMPLOYMENT PLACEMENT SERVICES, NAMELY, RESUME MATCHING SERVICES VIA A

GLOBAL COMPUTER NETWORK, IN CLASS 35 (U.S. CLS. 100, 101 AND 102).

FIRST USE 7-5-2000; IN COMMERCE 7-5-2000.

THE MARK CONSISTS OF STANDARD CHARACTERS WITHOUT CLAIM TO ANY PARTICULAR FONT, STYLE, SIZE, OR COLOR.

SER. NO. 77-454,026, FILED 4-21-2008.

ODESSA BIBBINS, EXAMINING ATTORNEY

Int. Cl.: 37

Prior U.S. Cls.: 100, 103 and 106

United States Patent and Trademark Office

Reg. No. 3,575,274

Registered Feb. 17, 2009

**SERVICE MARK
PRINCIPAL REGISTER**

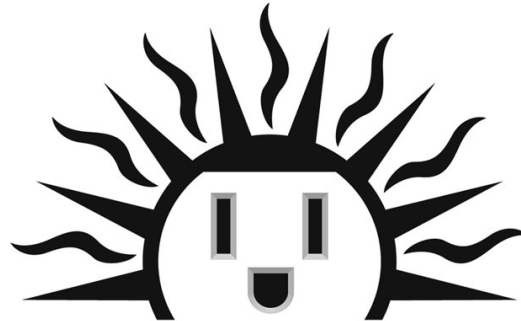

SUN'S FREE SOLAR (CALIFORNIA CORPORATION), DBA SUN'S FREE SOLAR
420 FAIR HAVEN ROAD
ALAMEDA, CA 94501

FOR: (BASED ON USE IN COMMERCE) INSTALLATION AND MAINTENANCE OF PHOTOVOLTAIC/SOLAR THERMAL HYBRID INSTALLATIONS, IN CLASS 37 (U.S. CLS. 100, 103 AND 106).

FIRST USE 4-5-2008; IN COMMERCE 4-19-2008.

THE MARK CONSISTS OF THE MARK IS A RADIATING SUN WITH A FACE WITHIN IT. THE FACE IS DERIVED FROM A GROUNDED THREE PRONG ELECTRICAL SOCKET. THE GROUND (LOWER HOLE) OF THE SOCKET IS INVERTED, CREATING A SMILEY FACE.

SER. NO. 77-454,179, FILED 4-22-2008.

DANNEAN HETZEL, EXAMINING ATTORNEY

Int. Cl.: 16

Prior U.S. Cls.: 2, 5, 22, 23, 29, 37, 38 and 50

United States Patent and Trademark Office

Reg. No. 3,575,275

Registered Feb. 17, 2009

TRADEMARK
PRINCIPAL REGISTER



GRAPHIK DIMENSIONS LIMITED (NORTH
CAROLINA CORPORATION)
2103 BRENTWOOD STREET
HIGH POINT, NC 27263

FOR: ART PICTURES; PICTURE BOOKS; PICTURES; PRINTS IN THE NATURE OF PHOTOGRAPHS AND FINE ART AND COMMERCIAL ART LITHOGRAPHS, PHOTOGRAPHS AND DRAWINGS; WATERCOLOR PICTURES, IN CLASS 16 (U.S. CLS. 2, 5, 22, 23, 29, 37, 38 AND 50).

FIRST USE 4-21-2008; IN COMMERCE 4-21-2008.

NO CLAIM IS MADE TO THE EXCLUSIVE RIGHT TO USE "IMAGE", APART FROM THE MARK AS SHOWN.

THE COLOR(S) BLACK, PINK, YELLOW AND CYAN IS/ARE CLAIMED AS A FEATURE OF THE MARK.

THE MARK CONSISTS OF THE WORDS "IMAGE HAPPY" WITH A SMILEY FACE DESIGN BETWEEN THE WORDS, ALL OUTLINED IN THE COLOR BLACK, WITH THE FIRST LETTER "A" AND THE SECOND LETTER "P" FILLED IN WITH THE COLOR PINK, THE LETTER "G", THE FIRST LETTER "P" AND THE SMILEY FACE DESIGN FILLED IN WITH THE COLOR YELLOW AND THE SECOND LETTER "A" FILLED IN WITH THE COLOR CYAN.

SER. NO. 77-454,821, FILED 4-22-2008.

JOHN GARTNER, EXAMINING ATTORNEY

Int. Cl.: 6

Prior U.S. Cls.: 2, 12, 13, 14, 23, 25 and 50

United States Patent and Trademark Office

Reg. No. 3,575,276

Registered Feb. 17, 2009

**TRADEMARK
PRINCIPAL REGISTER**

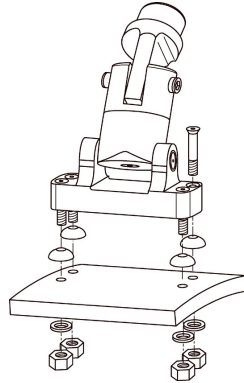

TAYLOR, STEVE B. (UNITED STATES INDIVIDUAL)
4908 HAWKINS, N.E.
ALBUQUERQUE, NM 87109

FOR: APPARATUS FOR MOUNTING WAKEBOARD TOWERS ON A BOAT, NAMELY, A METAL COUPLER, IN CLASS 6 (U.S. CLS. 2, 12, 13, 14, 23, 25 AND 50).

FIRST USE 4-14-2008; IN COMMERCE 4-14-2008.

THE MARK CONSISTS OF A DEPICTION OF A COUPLE THAT INCLUDES A BOOM-SWIVEL DEVICE ABOVE A BASE, AND BALL WASHER ASSEMBLIES APPEARING ABOVE AND BELOW THE BASE.

SER. NO. 77-454,994, FILED 4-22-2008.

JENNY PARK, EXAMINING ATTORNEY

Int. Cl.: 37

Prior U.S. Cls.: 100, 103 and 106

United States Patent and Trademark Office

Reg. No. 3,575,277

Registered Feb. 17, 2009

**SERVICE MARK
PRINCIPAL REGISTER**



TERESA'S FAMILY CLEANING (NEW YORK CORPORATION)

341 ROUTE 25A

ROCKY POINT, NY 11778

FOR: WINDOW CLEANING; CLEANING OF RESIDENTIAL HOUSES, IN CLASS 37 (U.S. CLS. 100, 103 AND 106).

FIRST USE 4-18-2008; IN COMMERCE 4-18-2008.

NO CLAIM IS MADE TO THE EXCLUSIVE RIGHT TO USE "CLEANING", APART FROM THE MARK AS SHOWN.

THE LIKENESS IN THE MARK DOES NOT IDENTIFY A LIVING INDIVIDUAL.

THE COLOR(S) RED, WHITE, YELLOW, GRAY, BROWN, BLUE, AND GREEN IS/ARE CLAIMED AS A FEATURE OF THE MARK.

THE MARK CONSISTS OF A WOMAN IN A GREEN BLOUSE WITH ARMS FOLDED. THERE IS A BROWN HOME IN BACKGROUND. A RED CIRCLE STATING "TERESA'S FAMILY CLEANING" ENCIRCLES WOMAN AND HOME. BLUE RIBBON AT BOTTOM READS "OUR REPUTATION IS SPOTLESS". STARS ARE YELLOW. LAWN AND TREES ARE GREEN. WINDOWS IN HOUSE ARE BLUE. THE SKY IS BLUE AND WHITE. ROOF OF HOUSE IS GRAY.

SER. NO. 77-455,048, FILED 4-22-2008.

BENJAMIN ALLEN, EXAMINING ATTORNEY

Int. Cl.: 11

Prior U.S. Cls.: 13, 21, 23, 31 and 34

United States Patent and Trademark Office

Reg. No. 3,575,278

Registered Feb. 17, 2009

**TRADEMARK
PRINCIPAL REGISTER**



ARTE MARMOL CHICLANA, S.L.L. (SPAIN LIMITED LIABILITY COMPANY)
CIF-11485810 POLIGONO PELAGATOS
LOS TÉCNICOS ST.
CHICLANA DELA FRONTERA, SPAIN

FOR: SINKS, NATURAL STONE SINKS, IN CLASS 11 (U.S. CLS. 13, 21, 23, 31 AND 34).

FIRST USE 3-1-2007; IN COMMERCE 11-1-2007.

THE COLOR(S) GRAY, ORANGE AND WHITE IS/ ARE CLAIMED AS A FEATURE OF THE MARK.

THE MARK CONSISTS OF THE WORD "AQUARTZ" IN WHITE HAVING THE STRIPE OR

LINE OF THE LETTER "Q" ON A DESCENDING POSITION FROM RIGHT TO LEFT IN THE COLOR ORANGE; ABOVE THE WORD THERE IS A LOGO IN WHITE FORMED BY JOINING THE LETTER "A" AND THE LETTER "Q", WHEREIN THE RIGHT SIDE OF THE LETTER "A" IS JOINED TO THE LEFT SIDE OF THE LETTER "Q" AND WHEREIN THE STRIPE OR LINE OF THE LETTER "Q" IS IN DESCENDING POSITION FROM RIGHT TO LEFT AND IS ORANGE IN COLOR; THE ENTIRE MARK HAS A GRAY BACKGROUND.

SER. NO. 77-455,701, FILED 4-23-2008.

ELLEN PERKINS, EXAMINING ATTORNEY

Int. Cl.: 9

Prior U.S. Cls.: 21, 23, 26, 36 and 38

Reg. No. 3,575,279

United States Patent and Trademark Office

Registered Feb. 17, 2009

**TRADEMARK
PRINCIPAL REGISTER**

IZLID

B.E. MEYERS & COMPANY, INC. (WASHINGTON CORPORATION), DBA MEYERS
ACCOUNTS PAYABLE FOR INVOICES
14540 NE 91ST STREET
REDMOND, WA 980526553

FOR: LASER OBJECT DETECTORS FOR USE ON VEHICLES; LASER POINTERS; LASER POINTING DEVICE FOR USE WITH FIREARMS; LASERS NOT FOR MEDICAL USE, IN CLASS 9 (U.S. CLS. 21, 23, 26, 36 AND 38).

FIRST USE 4-1-1990; IN COMMERCE 4-1-1990.

THE MARK CONSISTS OF STANDARD CHARACTERS WITHOUT CLAIM TO ANY PARTICULAR FONT, STYLE, SIZE, OR COLOR.

SER. NO. 77-455,957, FILED S.R. 4-23-2008 AM. P.R. 10-9-2008.

DAYNA BROWNE, EXAMINING ATTORNEY

Int. Cl.: 43

Prior U.S. Cls.: 100 and 101

United States Patent and Trademark Office

Reg. No. 3,575,280

Registered Feb. 17, 2009

**SERVICE MARK
PRINCIPAL REGISTER**



THE LINEAGE GROUP, LLC. (GEORGIA LIMITED LIABILITY COMPANY)
110 FORTSON DRIVE
ATHENS, GA 30606

FOR: RESTAURANT SERVICES FEATURING PIZZA, IN CLASS 43 (U.S. CLS. 100 AND 101).

FIRST USE 3-12-2008; IN COMMERCE 4-12-2008.

NO CLAIM IS MADE TO THE EXCLUSIVE RIGHT TO USE "YOUR PIE", APART FROM THE MARK AS SHOWN.

THE COLOR(S) RED, BLACK, WHITE IS/ARE CLAIMED AS A FEATURE OF THE MARK.

THE MARK CONSISTS OF A BLACK BACKGROUND IN THE SHAPE OF A SQUARE. IN THE UPPER LEFT HAND CORNER IS THE WORD "YOUR" IN RED LETTERS. IN THE BOTTOM LEFT HAND CORNER IS THE WORD "PIE" IN RED LETTERS. SEPARATING THE TWO WORDS IN THE MIDDLE IS A PIZZA PADDLE. THE PIZZA PADDLE IS WHITE. IN THE HEAD OF THE PADDLE IS A THIN BLACK CIRCLE CONTAINING A SOLID RED CIRCLE. COMING FROM THE TOP LEFT HAND CORNER OF THE SOLID RED CIRCLE ARE THREE THIN BLACK WAVY LINES REPRESENTING HEAT.

SER. NO. 77-456,137, FILED 4-23-2008.

GINA HAYES, EXAMINING ATTORNEY

Int. Cls.: 29 and 30

Prior U.S. Cl.: 46

United States Patent and Trademark Office

Reg. No. 3,575,281

Registered Feb. 17, 2009

TRADEMARK
PRINCIPAL REGISTER

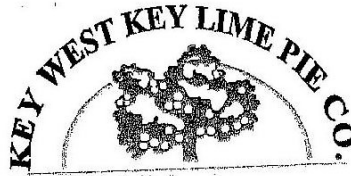

KEY WEST KEY LIME PIE CO., LLC (FLORIDA
LIMITED LIABILITY COMPANY)
225 KEY DEER BLVD.
BIG PINE KEY, FL 33043

FOR: FRUIT BASED PIE FILLING, IN CLASS 29
(U.S. CL. 46).

FIRST USE 2-9-2006; IN COMMERCE 7-27-2006.

FOR: PIES, PASTRIES, CUSTARD AND CHOCO-
LATE BASED PIE FILLING, FROZEN DESSERTS
CONSISTING OF FRUIT AND CREAM OR CREAM
SUBSTITUTES, IN CLASS 30 (U.S. CL. 46).

FIRST USE 2-9-2006; IN COMMERCE 7-27-2006.

NO CLAIM IS MADE TO THE EXCLUSIVE
RIGHT TO USE "KEY WEST KEY LIME PIE CO.",
APART FROM THE MARK AS SHOWN.

THE MARK CONSISTS OF DESIGN OF UNDER-
LINED KEY LIME TREE UNDERNEATH A HALF
CIRCLE LINE WITH THE WORDS "KEY WEST KEY
LIME PIE CO." ARCHING OVER THE TOP.

SER. NO. 77-456,185, FILED 4-23-2008.

JOHN HWANG, EXAMINING ATTORNEY

Int. Cl.: 35

Prior U.S. Cls.: 100, 101 and 102

United States Patent and Trademark Office

Reg. No. 3,575,282

Registered Feb. 17, 2009

**SERVICE MARK
PRINCIPAL REGISTER**

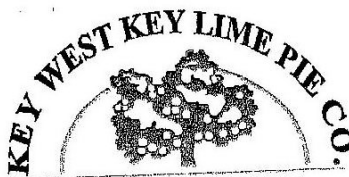

KEY WEST KEY LIME PIE CO., LLC (FLORIDA
LIMITED LIABILITY COMPANY)
225 KEY DEER BLVD.
BIG PINE KEY, FL 33043

FOR: RETAIL AND WHOLESALE STORE IN
BOTH PHYSICAL AND ONLINE FORMATS FEATURING
FOOD AND HEALTHCARE PRODUCTS MADE FROM
KEY LIMES OR KEY LIME JUICE, IN CLASS 35
(U.S. CLS. 100, 101 AND 102).

FIRST USE 2-9-2006; IN COMMERCE 7-27-2006.

NO CLAIM IS MADE TO THE EXCLUSIVE
RIGHT TO USE "KEY WEST KEY LIME PIE CO.",
APART FROM THE MARK AS SHOWN.

THE MARK CONSISTS OF DESIGN OF UNDER-
LINED KEY LIME TREE UNDERNEATH A HALF
CIRCLE LINE WITH THE WORDS "KEY WEST KEY
LIME PIE CO." ARCHING OVER THE TOP.

SER. NO. 77-456,241, FILED 4-23-2008.

JOHN HWANG, EXAMINING ATTORNEY

Int. Cl.: 9

Prior U.S. Cls.: 21, 23, 26, 36 and 38

United States Patent and Trademark Office

Reg. No. 3,575,283

Registered Feb. 17, 2009

TRADEMARK
PRINCIPAL REGISTER



BFM DIGITAL, LLC (CALIFORNIA LIMITED LIABILITY COMPANY)

#203

12650 RIVERSIDE DR.
VALLEY VILLAGE, CA 91607

FOR: DOWNLOADABLE RING TONES, MUSIC, ELECTRONIC GAMES VIA THE INTERNET AND WIRELESS DEVICES, DOWNLOADABLE AUDIO FILES, MULTIMEDIA FILES, TEXT FILES, EMAILS, WRITTEN DOCUMENTS, AUDIO MATERIAL, VIDEO MATERIAL AND GAMES FEATURING INFORMATION IN THE FORM OF DOWNLOADABLE SHORT, DOWNLOADABLE MP3 FILES, MP3 RECORDINGS, ONLINE DISCUSSION BOARDS, WEBCASTS AND PODCASTS FEATURING MUSIC, AUDIO BOOKS AND NEWS BROADCASTS, DOWNLOADABLE MULTIMEDIA FILE CONTAINING ARTWORK, TEXT, AUDIO, VIDEO, GAMES, AND INTERNET WEB LINKS, DOWNLOADABLE MUSICAL SOUND RECORD-

INGS, DOWNLOADABLE RING TONES AND GRAPHICS FOR MOBILE PHONES, AND DOWNLOADABLE RING TONES FOR MOBILE PHONES, IN CLASS 9 (U.S. CLS. 21, 23, 26, 36 AND 38).

FIRST USE 1-1-2008; IN COMMERCE 1-1-2008.

NO CLAIM IS MADE TO THE EXCLUSIVE RIGHT TO USE "DIGITAL", APART FROM THE MARK AS SHOWN.

THE MARK CONSISTS OF A CARTOON FISH CHARACTER JUMPING OUT OF A POND WHILE WEARING HEADPHONES. TO THE RIGHT OF THE FISH IS THE STYLIZED TEXT "BFM DIGITAL".

SER. NO. 77-456,366, FILED 4-23-2008.

CAROLYN GRAY, EXAMINING ATTORNEY

Int. Cls.: 35 and 45

Prior U.S. Cls.: 100, 101 and 102

United States Patent and Trademark Office

Reg. No. 3,575,284

Registered Feb. 17, 2009

**SERVICE MARK
PRINCIPAL REGISTER**

chictini

CHICTINI LLC. (NEW YORK LIMITED LIABILITY COMPANY)
84-57 RADNOR STREET
JAMAICA, NY 11432

FOR: AN INTERACTIVE WEB SITE FOR USERS TO REVIEW AND RATE INTERNET CONTENT, PEOPLE, COMPANIES, PRODUCTS AND/OR SERVICES UTILIZING A SOFTWARE APPLICATION TO AWARD POINTS WHEREBY WEB SITE USERS ARE ELIGIBLE TO EXCHANGE POINTS EARNED FOR PROMOTIONAL ITEMS CONSISTING; OF COUPONS, REBATES, DISCOUNTS OR SPECIAL OFFERINGS ON GOODS AND/OR SERVICE PROVIDED BY WEB SITE SPONSORS; PROVIDING CONSUMER PRODUCT INFORMATION VIA THE INTERNET; THE BRINGING TOGETHER, FOR THE BENEFIT OF OTHERS, OF A VARIETY OF GOODS AND SERVICES, ENABLING CUSTOMERS TO CONVENIENTLY VIEW AND PURCHASE THOSE GOODS AND SERVICES FROM AN INTERNET WEBSITE PARTICULARLY SPECIALIZING IN THE MARKETING OF THE SALE OF GOODS AND

SERVICES OF OTHERS; PROVIDING A SEARCHABLE ONLINE ADVERTISING GUIDE FEATURING THE GOODS AND SERVICES OF OTHER ONLINE VENDORS ON THE INTERNET, IN CLASS 35 (U.S. CLS. 100, 101 AND 102).

FIRST USE 8-1-2007; IN COMMERCE 8-1-2007.

FOR: INTERNET BASED SOCIAL NETWORKING AND INTRODUCTION SERVICES, IN CLASS 45 (U.S. CLS. 100 AND 101).

FIRST USE 8-1-2007; IN COMMERCE 8-1-2007.

THE MARK CONSISTS OF STANDARD CHARACTERS WITHOUT CLAIM TO ANY PARTICULAR FONT, STYLE, SIZE, OR COLOR.

SER. NO. 77-456,551, FILED 4-24-2008.

SCOTT BIBB, EXAMINING ATTORNEY

Int. Cls.: 9, 35 and 42

Prior U.S. Cls.: 21, 23, 26, 36, 38, 100, 101 and 102

United States Patent and Trademark Office

Reg. No. 3,575,285

Registered Feb. 17, 2009

**TRADEMARK
SERVICE MARK
PRINCIPAL REGISTER**

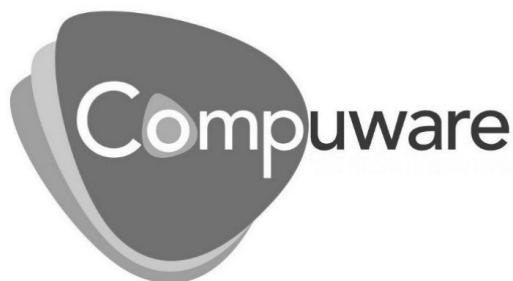

COMPUWARE CORPORATION (MICHIGAN CORPORATION)
LEGAL DEPT.
ONE CAMPUS MARTIUS
DETROIT, MI 48226

FOR: COMPUTER SOFTWARE FOR THE DESIGN, DEVELOPMENT, AND MANAGEMENT OF INFORMATION TECHNOLOGY SYSTEMS, PLATFORMS AND APPLICATIONS AND FOR MONITORING THE PERFORMANCE OF THE SAME, IN CLASS 9 (U.S. CLS. 21, 23, 26, 36 AND 38).

FIRST USE 5-16-2008; IN COMMERCE 5-16-2008.

FOR: BUSINESS MANAGEMENT CONSULTING SERVICES IN THE FIELD OF INFORMATION TECHNOLOGY; EMPLOYMENT STAFFING IN THE FIELD OF INFORMATION TECHNOLOGY, IN CLASS 35 (U.S. CLS. 100, 101 AND 102).

FIRST USE 5-16-2008; IN COMMERCE 5-16-2008.

FOR: INFORMATION TECHNOLOGY CONSULTATION SERVICES IN THE FIELDS OF IDENTITY AND ACCESS MANAGEMENT, PORTAL AND COLLABORATION FUNCTIONALITY, BUSINESS TO BUSINESS MESSAGING, AND APPLICATION MAINTENANCE; PROVIDING QUALITY ASSURANCE SERVICES IN THE FIELD OF INFORMATION TECHNOLOGY; COMPUTER PROJECT MANAGEMENT SERVICES; COMPUTER SYSTEM ANALYSIS; INDUSTRIAL RESEARCH IN THE FIELDS OF COMPUTING AND INFORMATION TECHNOLOGY; COMPUTER SOFTWARE CONSULTING SERVICES; TECHNICAL SUPPORT SERVICES, NAMELY, TROUBLESHOOTING OF COMPUTER HARDWARE AND SOFTWARE PRO-

BLEMS; DESIGN, DEVELOPMENT, CUSTOMIZATION AND IMPLEMENTATION OF COMPUTER SOFTWARE FOR OTHERS; DESIGN, DEVELOPMENT, CUSTOMIZATION, INTEGRATION AND IMPLEMENTATION OF INTERNAL AND EXTERNAL COMPUTER NETWORKS FOR OTHERS; PROVIDING COMPUTER NETWORK SERVICES FOR OTHERS, NAMELY, REMOTE AND ON-SITE MANAGEMENT OF ELECTRONIC MESSAGING SYSTEMS AND APPLICATIONS FOR OTHERS, INTEGRATION OF COMPUTER SYSTEMS AND NETWORKS, PORTAL AND COLLABORATION SERVICES, NAMELY, PROVIDING ONLINE NON-DOWNLOADABLE COMPUTER SOFTWARE TO FACILITATE E-COMMERCE AND BUSINESS-TO-BUSINESS TRANSACTIONS AND SUPPLY CHAIN MANAGEMENT, COMPUTER SECURITY SERVICES FOR IDENTITY MANAGEMENT IN THE NATURE OF RESTRICTING ACCESS TO AND BY COMPUTER NETWORKS TO AND OF UNDESIRE WEB SITES, MEDIA AND INDIVIDUALS AND FACILITIES, IMPLEMENTING WEB SITES FOR OTHERS, DESIGN AND DEVELOPMENT OF WIRELESS COMMUNICATION SYSTEMS FOR TRANSMISSION AND RECEPTION OF DATA, INTEGRATION OF COMPUTER SYSTEMS AND NETWORKS FOR MODERNIZATION, AND IMPLEMENTATION OF SOFTWARE APPLICATIONS, IN CLASS 42 (U.S. CLS. 100 AND 101).

FIRST USE 5-16-2008; IN COMMERCE 5-16-2008.

OWNER OF U.S. REG. NOS. 1,341,600, 2,531,967 AND OTHERS.

THE MARK CONSISTS OF THREE SHADED TRIANGLES WITH ROUNDED SIDES OVERLAPPING ONE ANOTHER. THE MARK ALSO CON-

SISTS OF THE TERM "COMPUWARE" WITH "COMP" APPEARING ON THE TOP SHADED TRIANGLE AND WITH "UWARE" APPEARING OUTSIDE AND TO THE RIGHT OF THE DESIGN OF SHADED TRIANGLES. THE "O" IN "COMPUWARE" IS SUPERIMPOSED UPON A SMALLER

FOURTH SHADED TRIANGLE WITH ROUNDED SIDES.

SER. NO. 77-456,721, FILED 4-24-2008.

ZHALEH DELANEY, EXAMINING ATTORNEY

Prior U.S. Cl.: A

United States Patent and Trademark Office

Reg. No. 3,575,286

Registered Feb. 17, 2009

CERTIFICATION MARK
PRINCIPAL REGISTER



NATIONAL OCEANIC AND ATMOSPHERIC ADMINISTRATION (UNITED STATES AGENCY OF THE UNITED STATES GOVERNMENT)
1401 CONSTITUTION AVENUE, NW
WASHINGTON, DC 20230

FOR: ALL HAZARDS RADIO RECEIVERS, IN CLASS A (U.S. CL. A).

FIRST USE 4-17-2007; IN COMMERCE 4-17-2007.

OWNER OF U.S. REG. NOS. 2,001,267, 2,304,371 AND OTHERS.

NO CLAIM IS MADE TO THE EXCLUSIVE RIGHT TO USE "ALL HAZARDS" AND "WEATHER RADIO" AND "NATIONAL WEATHER SERVICE", APART FROM THE MARK AS SHOWN.

THE MARK CONSISTS OF THE WORDS "ALL HAZARDS" AND "NOAA" AND "WEATHER RADIO" AND "NOAA'S NATIONAL WEATHER SERVICE", AND ATOP THE "A" IN "NOAA" THERE IS A BEACON EMITTING A SIGNAL WITH WAVES EMANATING FROM THE SOURCE.

THE CERTIFICATION MARK, AS USED BY AUTHORIZED PERSONS, CERTIFIES A RADIO RECEIVER BEARING THE MARK IS A RADIO RECEIVERS THAT IS CAPABLE OF RECEIVING WEATHER AND/OR WARNING INFORMATION FROM NATIONAL WEATHER SERVICE FORECAST OFFICES, APPROVED DEPARTMENT OF HOMELAND SECURITY OFFICES RESPONSIBLE FOR THE DISSEMINATION OF WARNING INFORMATION, AND THOSE EMERGENCY OPERATION CENTERS THAT HAVE BEEN SPECIFICALLY AUTHORIZED TO DISSEMINATE WARNINGS ON THE NOAA WEATHER RADIO OPERATIONAL FREQUENCIES. TO BE CALLED A NOAA WEATHER RADIO ALL HAZARDS RECEIVER, AND DISPLAY THE MARK, THE DEVICE MUST POSSESS SPECIFIC RECEIVER REQUIREMENTS.

SER. NO. 77-456,754, FILED 4-24-2008.

JAY FLOWERS, EXAMINING ATTORNEY

Int. Cl.: 41

Prior U.S. Cls.: 100, 101 and 107

United States Patent and Trademark Office

Reg. No. 3,575,287

Registered Feb. 17, 2009

**SERVICE MARK
PRINCIPAL REGISTER**

A Beautiful Education

AMERICAN BEAUTY SCHOOL (NEW YORK
CORPORATION)
1380 METROPOLITAN AVENUE
BRONX, NY 10462

FOR: EDUCATIONAL SERVICES IN THE NAT-
URE OF BEAUTY SCHOOLS; TRAINING SERVICES
IN THE FIELD OF COSMETOLOGY, IN CLASS 41
(U.S. CLS. 100, 101 AND 107).

FIRST USE 1-1-2007; IN COMMERCE 1-1-2007.

THE MARK CONSISTS OF STANDARD CHAR-
ACTERS WITHOUT CLAIM TO ANY PARTICULAR
FONT, STYLE, SIZE, OR COLOR.

NO CLAIM IS MADE TO THE EXCLUSIVE
RIGHT TO USE "EDUCATION", APART FROM
THE MARK AS SHOWN.

SER. NO. 77-457,182, FILED 4-24-2008.

CHRIS WELLS, EXAMINING ATTORNEY

Int. Cl.: 36

Prior U.S. Cls.: 100, 101 and 102

United States Patent and Trademark Office

Reg. No. 3,575,288

Registered Feb. 17, 2009

**SERVICE MARK
PRINCIPAL REGISTER**



GRINDSTONE FOUNDATION (WASHINGTON CORPORATION)

5224 OLYMPIC DR NW, #101
GIG HARBOR, WA 98335

FOR: CHARITABLE FOUNDATION SERVICES, NAMELY, PROVIDING FUNDING TO INDIVIDUALS AND ENTITIES THAT ADVANCE PATRIOTISM, SUPPORT TRADITIONAL NUCLEAR FAMILIES, EDUCATE YOUNG PEOPLE, PRESERVE AMERICAN HISTORY, PROTECT ANIMALS, AND ENCOURAGE ENTREPRENEURIAL VISIONARIES, IN CLASS 36 (U.S. CLS. 100, 101 AND 102).

FIRST USE 3-1-2008; IN COMMERCE 3-1-2008.

NO CLAIM IS MADE TO THE EXCLUSIVE RIGHT TO USE "FOUNDATION", APART FROM THE MARK AS SHOWN.

THE COLOR(S) BROWN, BLACK, BEIGE, AND CREAM IS/ARE CLAIMED AS A FEATURE OF THE MARK.

THE MARK CONSISTS OF THE DESIGN ELEMENT OF A GRINDSTONE, MADE UP OF A BEIGE WHEEL WITH A BLACK CENTER, BISECTED HORIZONTALLY BY A BROWN TABLE, WITH A BLACK HANDLE COMING OUT OF THE MIDDLE OF ITS SIDE, AND WITH THE ENTIRE DESIGN ELEMENT SITUATED AGAINST A CREAM-COLORED BACKGROUND. THE BROWN WORDING "GRINDSTONE" APPEARS BELOW THE DESIGN OF THE GRINDSTONE AND ABOVE A BROWN RECTANGLE THAT HAS THE WORDING "FOUNDATION" CUT OUT OF THE RECTANGLE.

SER. NO. 77-457,572, FILED 4-24-2008.

DAVID I, EXAMINING ATTORNEY

Int. Cl.: 35

Prior U.S. Cls.: 100, 101 and 102

United States Patent and Trademark Office

Reg. No. 3,575,289

Registered Feb. 17, 2009

**SERVICE MARK
PRINCIPAL REGISTER**

TANISHQ

TITAN INTERNATIONAL HOLDINGS B.V.
(NETHERLANDS LIMITED LIABILITY COMPANY)
TELESTONE 8 - TELPORT, NARITAWEG 165
1043 BW, AMSTERDAM, NETHERLANDS

FOR: RETAIL STORE SERVICES FEATURING
PRECIOUS METALS AND THEIR ALLOYS AND
GOODS IN PRECIOUS METALS OR COATED
THEREWITH, NAMELY, JEWELRY BOXES, DEC-
ORATIVE BOXES, JEWELRY CASES, KEY CHAINS,
CIGARETTE CASES, CIGARETTE HOLDERS, MON-
EY CLIPS, ASHTRAYS, PIGGY BANKS, FIGURES,
FIGURINES, TROPHIES, CANDLESTICKS AND
CANDLE SNUFFERS, JEWELLERY, PRECIOUS
STONES, HOROLOGICAL AND CHRONOMETRIC
INSTRUMENTS, IN CLASS 35 (U.S. CLS. 100, 101
AND 102).

THE MARK CONSISTS OF STANDARD CHAR-
ACTERS WITHOUT CLAIM TO ANY PARTICULAR
FONT, STYLE, SIZE, OR COLOR.

PRIORITY CLAIMED UNDER SEC. 44(D) ON
BENELUX APPLICATION NO. 1156699, FILED 4-3-
2008, REG. NO. 841020, DATED 4-3-2008, EXPIRES 4-
3-2018.

OWNER OF U.S. REG. NOS. 2,323,655 AND
2,323,656.

SER. NO. 77-458,154, FILED 4-25-2008.

KAELIE KUNG, EXAMINING ATTORNEY

Int. Cl.: 33

Prior U.S. Cls.: 47 and 49

United States Patent and Trademark Office

Reg. No. 3,575,290

Registered Feb. 17, 2009

**TRADEMARK
PRINCIPAL REGISTER**

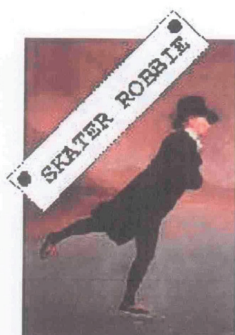

MASLYUKOV, PAVEL (RUSSIAN FED. INDIVIDUAL)

111401

3-IA VLADIMIRSKAIYA 12-2-9
MOSCOW, RUSSIAN FED.

FOR: ALCOHOLIC BEVERAGES EXCEPT BEERS, NAMELY, WHISKY PRODUCED IN SCOTLAND, IN CLASS 33 (U.S. CLS. 47 AND 49).

OWNER OF UNITED KINGDOM REG. NO. 2396153, DATED 7-6-2005, EXPIRES 7-6-2015.

THE NAME(S), PORTRAIT(S), AND/OR SIGNATURE(S) SHOWN IN THE MARK DOES NOT IDENTIFY A PARTICULAR LIVING INDIVIDUAL.

THE COLOR(S) BROWN, BLACK, YELLOW, WHITE, TAN AND GRAY IS/ARE CLAIMED AS A FEATURE OF THE MARK.

THE MARK CONSISTS OF THE WORDING "SKATER ROBBIE" IN BLACK ON A WHITE BANNER OUTLINED IN BLACK, AFFIXED BY TWO PINS IN BLACK ACROSS THE UPPER LEFT CORNER OF A PAINTING BY SIR HENRY RAEBURN SHOWING MR. ROBERT WALKER SKATING ON DUDDINGSTON LOCH. THE SKATER HAS A TAN FACE, WHITE COLLAR, BLACK CLOTHES AND HAT, AND BLACK SKATES WITH YELLOW LACES AND GRAY SKATE BLADES. THE FROZEN LOCH IS GRAY AND THE SKY IS BROWN.

SER. NO. 77-458,249, FILED 4-25-2008.

KATHY DE JONGE, EXAMINING ATTORNEY

Int. Cl.: 30

Prior U.S. Cl.: 46

United States Patent and Trademark Office

Reg. No. 3,575,291

Registered Feb. 17, 2009

**TRADEMARK
PRINCIPAL REGISTER**

VANILLA BELLA

WELLS' DAIRY, INC. (IOWA CORPORATION)
P.O. BOX 1310, ONE BLUE BUNNY DRIVE
LE MARS, IA 51031

FOR: FROZEN CONFECTIONS, IN CLASS 30 (U.S.
CL. 46).

FIRST USE 6-9-2008; IN COMMERCE 6-9-2008.

THE MARK CONSISTS OF STANDARD CHAR-
ACTERS WITHOUT CLAIM TO ANY PARTICULAR
FONT, STYLE, SIZE, OR COLOR.

NO CLAIM IS MADE TO THE EXCLUSIVE
RIGHT TO USE "VANILLA", APART FROM THE
MARK AS SHOWN.

THE ENGLISH TRANSLATION OF THE WORD
"BELLA" IN THE MARK IS BEAUTIFUL.

SER. NO. 77-458,383, FILED 4-25-2008.

BRENDAN MCCAULEY, EXAMINING ATTORNEY

Int. Cl.: 36

Prior U.S. Cls.: 100, 101 and 102

United States Patent and Trademark Office

Reg. No. 3,575,292

Registered Feb. 17, 2009

**SERVICE MARK
PRINCIPAL REGISTER**

H & W RISK MANAGEMENT

HAAS AND WILKERSON, INC. (MISSOURI CORPORATION)
4300 SHAWNEE MISSION PARKWAY
FAIRWAY, KS 66205

FOR: INSURANCE SERVICES IN THE NATURE OF LOSS CONTROL MANAGEMENT FOR OTHERS AND INSURANCE CLAIMS ADMINISTRATION, DIRECTED TO THE AMUSEMENT AND RECREATION INDUSTRY, IN CLASS 36 (U.S. CLS. 100, 101 AND 102).

FIRST USE 2-19-2000; IN COMMERCE 2-19-2000.

THE MARK CONSISTS OF STANDARD CHARACTERS WITHOUT CLAIM TO ANY PARTICULAR FONT, STYLE, SIZE, OR COLOR.

NO CLAIM IS MADE TO THE EXCLUSIVE RIGHT TO USE "RISK MANAGEMENT", APART FROM THE MARK AS SHOWN.

SER. NO. 77-458,517, FILED 4-25-2008.

JOHN DWYER, EXAMINING ATTORNEY

Int. Cl.: 36

Prior U.S. Cls.: 100, 101 and 102

United States Patent and Trademark Office

Reg. No. 3,575,293

Registered Feb. 17, 2009

**SERVICE MARK
PRINCIPAL REGISTER**



HAAS AND WILKERSON, INC. (MISSOURI CORPORATION)
4300 SHAWNEE MISSION PARKWAY
FAIRWAY, KS 66205

FOR: INSURANCE BROKERAGE DIRECTED TO THE AMUSEMENT AND RECREATION INDUSTRY, IN THE FIELD OF PROPERTY AND CASUALTY INSURANCE, WEATHER INSURANCE, RAIN INSURANCE, CANCELLATION OR NON-APPEARANCE INSURANCE, VOLUNTEER AND PARTICIPANT ACCIDENT INSURANCE, PRIZE INDEMNITY INSURANCE AND SURETY BONDS; INSURANCE BROKERAGE IN THE FIELD OF COMMERCIAL INSURANCE; INSURANCE BROKERAGE IN THE FIELD OF PERSONAL INSURANCE, INCLUDING GENERAL LIABILITY, ACCIDENT, HEALTH, LIFE, HOMEOWNERS, VEHICLES, BOAT OWNERS, RECREATIONAL VEHICLES, PERSONAL RECREATIONAL VEHICLES, DISABILITY INCOME INSURANCE, DWELLING AND FIRE INSURANCE, PERSONAL ARTICLE FLOATERS, PERSONAL EXCESS AND UMBRELLA INSURANCE, INSURANCES AGAINST FLOOD AND EXCESS FLOOD, FAIR PLAN DIC COVERAGE AND FAIR PLAN WRAP COVERAGE; INSURANCE BROKERAGE DIRECTED TO GROUP INSURANCE PRODUCTS, IN THE FIELD OF MEDICAL INSURANCE, PRESCRIPTION DRUG BENEFITS AND SERVICES, DENTAL BENEFITS, LIFE INSURANCE, ACCIDENTAL DEATH AND DISMEMBERMENT, DISABILITY PROTECTION, BOTH SHORT TERM AND LONG TERM, ACCIDENT BENEFITS, RETIREMENT PLANS, GROUP ALTERNATE FUNDING APPROACHES, AND CAFETERIA PLANS; INSURANCE BROKERAGE SERVICES IN THE

FIELD OF SURETY BONDS, FIDELITY BONDS AND FINANCIAL INSTITUTION BONDS; INSURANCE BROKERAGE DIRECTED TO THE CONSTRUCTION INDUSTRY, IN THE FIELD OF PROPERTY, CASUALTY AND GENERAL LIABILITY INSURANCE; INSURANCE BROKERAGE DIRECTED TO THE FOREST PRODUCTS INDUSTRY, IN THE FIELD OF PROPERTY, CASUALTY AND GENERAL LIABILITY INSURANCES; INSURANCE BROKERAGE DIRECTED TO GENERAL BUSINESS, IN THE FIELD OF PROPERTY, CASUALTY AND PROFESSIONAL INSURANCE; INSURANCE BROKERAGE DIRECTED TO THE E-COMMERCE INDUSTRY, IN THE FIELD OF PROPERTY, CASUALTY AND GENERAL LIABILITY INSURANCES AGAINST LOSSES RESULTING FROM ELECTRONIC AND INFORMATION TECHNOLOGY, ERRORS AND OMISSIONS, AND INTELLECTUAL PROPERTY AND COMMUNICATIONS LIABILITY, AND BUSINESS INCOME INSURANCE AGAINST LOSS OF INCOME RESULTING FROM LOSS OF UTILITIES, INTERCONNECTING CARRIERS AND COMPUTER VIRUSES; AND INSURANCE SERVICES IN THE NATURE OF LOSS CONTROL MANAGEMENT FOR OTHERS AND INSURANCE CLAIMS ADMINISTRATION, DIRECTED TO THE AMUSEMENT AND RECREATION INDUSTRY, IN CLASS 36 (U.S. CLS. 100, 101 AND 102).

FIRST USE 9-0-2007; IN COMMERCE 9-0-2007.

SER. NO. 77-458,575, FILED 4-25-2008.

JOHN DWYER, EXAMINING ATTORNEY

Int. Cl.: 36

Prior U.S. Cls.: 100, 101 and 102

United States Patent and Trademark Office

Reg. No. 3,575,294

Registered Feb. 17, 2009

**SERVICE MARK
PRINCIPAL REGISTER**

HAAS & WILKERSON

HAAS AND WILKERSON, INC. (MISSOURI CORPORATION)
4300 SHAWNEE MISSION PARKWAY
FAIRWAY, KS 66205

FOR: INSURANCE BROKERAGE DIRECTED TO THE AMUSEMENT AND RECREATION INDUSTRY, IN THE FIELD OF PROPERTY AND CASUALTY INSURANCE, WEATHER INSURANCE, RAIN INSURANCE, CANCELLATION OR NON-APPEARANCE INSURANCE, VOLUNTEER AND PARTICIPANT ACCIDENT INSURANCE, PRIZE INDEMNITY INSURANCE AND SURETY BONDS; INSURANCE BROKERAGE IN THE FIELD OF COMMERCIAL INSURANCE; INSURANCE BROKERAGE IN THE FIELD OF PERSONAL INSURANCE, INCLUDING GENERAL LIABILITY, ACCIDENT, HEALTH, LIFE, HOMEOWNERS, VEHICLES, BOAT OWNERS, RECREATIONAL VEHICLES, PERSONAL RECREATIONAL VEHICLES, DISABILITY INCOME INSURANCE, DWELLING AND FIRE INSURANCE, PERSONAL ARTICLE FLOATERS, PERSONAL EXCESS AND UMBRELLA INSURANCE, INSURANCES AGAINST FLOOD AND EXCESS FLOOD, FAIR PLAN DIC COVERAGE AND FAIR PLAN WRAP COVERAGE; INSURANCE BROKERAGE DIRECTED TO GROUP INSURANCE PRODUCTS, IN THE FIELD OF MEDICAL INSURANCE, PRESCRIPTION DRUG BENEFITS AND SERVICES, DENTAL BENEFITS, LIFE INSURANCE, ACCIDENTAL DEATH AND DISMEMBERMENT, DISABILITY PROTECTION, BOTH SHORT TERM AND LONG TERM, ACCIDENT BENEFITS, RETIREMENT PLANS, GROUP ALTERNATE FUNDING APPROACHES, AND CAFETERIA PLANS; INSURANCE BROKERAGE SERVICES IN THE FIELD OF SURETY BONDS, FIDELITY BONDS AND FINANCIAL INSTITUTION BONDS; INSURANCE BROKERAGE DIRECTED TO THE CONSTRUCTION INDUSTRY, IN THE FIELD OF PROPERTY, CASUALTY AND GENERAL LIABILITY INSURANCE; INSURANCE BROKERAGE DI-

RECTED TO THE FOREST PRODUCTS INDUSTRY, IN THE FIELD OF PROPERTY, CASUALTY AND GENERAL LIABILITY INSURANCES; INSURANCE BROKERAGE DIRECTED TO GENERAL BUSINESS, IN THE FIELD OF PROPERTY, CASUALTY AND PROFESSIONAL INSURANCE; INSURANCE BROKERAGE DIRECTED TO THE E-COMMERCE INDUSTRY, IN THE FIELD OF PROPERTY, CASUALTY AND GENERAL LIABILITY INSURANCES AGAINST LOSSES RESULTING FROM ELECTRONIC AND INFORMATION TECHNOLOGY, ERRORS AND OMISSIONS, AND INTELLECTUAL PROPERTY AND COMMUNICATIONS LIABILITY, AND BUSINESS INCOME INSURANCE AGAINST LOSS OF INCOME RESULTING FROM LOSS OF UTILITIES, INTERCONNECTING CARRIERS AND COMPUTER VIRUSES; INSURANCE BROKERAGE DIRECTED TO THE RODEO, LIVESTOCK SHOW, HORSE SHOW, HORSE EXPO, PENNING, ROPING, BARREL RACING, AND FARM AND RANCH INDUSTRIES, IN THE FIELD OF PROPERTY, CASUALTY, GENERAL LIABILITY INSURANCE, ACCIDENT, AND HEALTH INSURANCE, GROUP CONTESTANT ACCIDENT AND GROUP VOLUNTEER ACCIDENT INSURANCE, AND MORTALITY INSURANCE ON ANIMALS; INSURANCE BROKERAGE DIRECTED TO AMATEUR SPORTS TEAMS, LEAGUES, ASSOCIATIONS AND ORGANIZATIONS, IN THE FIELD OF GENERAL LIABILITY, ACCIDENT, AND HEALTH INSURANCE; AND INSURANCE SERVICES IN THE NATURE OF LOSS CONTROL MANAGEMENT FOR OTHERS, DIRECTED TO THE AMUSEMENT AND RECREATION INDUSTRY, IN CLASS 36 (U.S. CLS. 100, 101 AND 102).

FIRST USE 0-0-1939; IN COMMERCE 0-0-1939.

THE MARK CONSISTS OF STANDARD CHARACTERS WITHOUT CLAIM TO ANY PARTICULAR FONT, STYLE, SIZE, OR COLOR.

SER. NO. 77-458,595, FILED 4-25-2008.

JOHN DWYER, EXAMINING ATTORNEY

Int. Cl.: 36

Prior U.S. Cls.: 100, 101 and 102

United States Patent and Trademark Office

Reg. No. 3,575,295

Registered Feb. 17, 2009

**SERVICE MARK
PRINCIPAL REGISTER**

HAAS & WILKERSON INSURANCE

HAAS AND WILKERSON, INC. (MISSOURI CORPORATION)
4300 SHAWNEE MISSION PARKWAY
FAIRWAY, KS 66205

FOR: INSURANCE BROKERAGE DIRECTED TO THE AMUSEMENT AND RECREATION INDUSTRY, IN THE FIELD OF PROPERTY AND CASUALTY INSURANCE, WEATHER INSURANCE, RAIN INSURANCE, CANCELLATION OR NON-APPEARANCE INSURANCE, VOLUNTEER AND PARTICIPANT ACCIDENT INSURANCE, PRIZE INDEMNITY INSURANCE AND SURETY BONDS; INSURANCE BROKERAGE IN THE FIELD OF COMMERCIAL INSURANCE; INSURANCE BROKERAGE IN THE FIELD OF PERSONAL INSURANCE, INCLUDING GENERAL LIABILITY, ACCIDENT, HEALTH, LIFE, HOMEOWNERS, VEHICLES, BOAT OWNERS, RECREATIONAL VEHICLES, PERSONAL RECREATIONAL VEHICLES, DISABILITY INCOME INSURANCE, DWELLING AND FIRE INSURANCE, PERSONAL ARTICLE FLOATERS, PERSONAL EXCESS AND UMBRELLA INSURANCE, INSURANCES AGAINST FLOOD AND EXCESS FLOOD, FAIR PLAN DIC COVERAGE AND FAIR PLAN WRAP COVERAGE; INSURANCE BROKERAGE DIRECTED TO GROUP INSURANCE PRODUCTS, IN THE FIELD OF MEDICAL INSURANCE, PRESCRIPTION DRUG BENEFITS AND SERVICES, DENTAL BENEFITS, LIFE INSURANCE, ACCIDENTAL DEATH AND DISMEMBERMENT, DISABILITY PROTECTION, BOTH SHORT TERM AND LONG TERM, ACCIDENT BENEFITS, RETIREMENT PLANS, GROUP ALTERNATE FUNDING APPROACHES, AND CAFETERIA PLANS; INSURANCE BROKERAGE SERVICES IN THE FIELD OF SURETY BONDS, FIDELITY BONDS AND FINANCIAL INSTITUTION BONDS; INSURANCE BROKERAGE DIRECTED TO THE CONSTRUCTION INDUSTRY, IN THE FIELD OF PROPERTY, CASUALTY AND GENERAL LIABILITY INSURANCE; INSURANCE BROKERAGE DI-

RECTED TO THE FOREST PRODUCTS INDUSTRY, IN THE FIELD OF PROPERTY, CASUALTY AND GENERAL LIABILITY INSURANCES; INSURANCE BROKERAGE DIRECTED TO GENERAL BUSINESS, IN THE FIELD OF PROPERTY, CASUALTY AND PROFESSIONAL INSURANCE; INSURANCE BROKERAGE DIRECTED TO THE E-COMMERCE INDUSTRY, IN THE FIELD OF PROPERTY, CASUALTY AND GENERAL LIABILITY INSURANCES AGAINST LOSSES RESULTING FROM ELECTRONIC AND INFORMATION TECHNOLOGY, ERRORS AND OMISSIONS, AND INTELLECTUAL PROPERTY AND COMMUNICATIONS LIABILITY, AND BUSINESS INCOME INSURANCE AGAINST LOSS OF INCOME RESULTING FROM LOSS OF UTILITIES, INTERCONNECTING CARRIERS AND COMPUTER VIRUSES; INSURANCE BROKERAGE DIRECTED TO THE RODEO, LIVESTOCK SHOW, HORSE SHOW, HORSE EXPO, PENNING, ROPING, BARREL RACING, AND FARM AND RANCH INDUSTRIES, IN THE FIELD OF PROPERTY, CASUALTY, GENERAL LIABILITY INSURANCE, ACCIDENT, AND HEALTH INSURANCE, GROUP CONTESTANT ACCIDENT AND GROUP VOLUNTEER ACCIDENT INSURANCE, AND MORTALITY INSURANCE ON ANIMALS; INSURANCE BROKERAGE DIRECTED TO AMATEUR SPORTS TEAMS, LEAGUES, ASSOCIATIONS AND ORGANIZATIONS, IN THE FIELD OF GENERAL LIABILITY, ACCIDENT, AND HEALTH INSURANCE; AND INSURANCE SERVICES IN THE NATURE OF CLAIMS AND LOSS CONTROL MANAGEMENT FOR OTHERS, DIRECTED TO THE AMUSEMENT AND RECREATION INDUSTRY, IN CLASS 36 (U.S. CLS. 100, 101 AND 102).

FIRST USE 0-0-1939; IN COMMERCE 0-0-1939.

THE MARK CONSISTS OF STANDARD CHARACTERS WITHOUT CLAIM TO ANY PARTICULAR FONT, STYLE, SIZE, OR COLOR.

NO CLAIM IS MADE TO THE EXCLUSIVE
RIGHT TO USE "INSURANCE", APART FROM
THE MARK AS SHOWN.

SER. NO. 77-458,613, FILED 4-25-2008.

JOHN DWYER, EXAMINING ATTORNEY

Int. Cl.: 36

Prior U.S. Cls.: 100, 101 and 102

United States Patent and Trademark Office

Reg. No. 3,575,296

Registered Feb. 17, 2009

**SERVICE MARK
PRINCIPAL REGISTER**

BWS Financial

BEATING WALL STREET, INC. (DELAWARE CORPORATION)
10915 DANBE AVE
GRANADA HILLS, CA 91344

FOR: AGENCIES FOR BROKERAGE OF SECURITIES TRADING IN OVERSEAS SECURITIES MARKETS AND OF TRANSACTIONS ON COMMISSION OF OVERSEAS MARKET SECURITIES FUTURES; AGENCIES OR BROKERAGE FOR LEASING OR RENTING OF LAND; AGENCIES OR BROKERAGE FOR RENTING LAND; AGENCIES OR BROKERAGE FOR RENTING OF BUILDINGS; AGENCIES OR BROKERAGE FOR TRADING OF SECURITIES, SECURITIES INDEX FUTURES, SECURITIES OPTIONS, AND OVERSEAS MARKET SECURITIES FUTURES; AIRCRAFT BROKERAGE; ART BROKERAGE; AUTOMATED SECURITIES BROKERAGE; BROKERAGE FOR HIRE-PURCHASE; BROKERAGE HOUSES IN THE FIELD OF STOCKS, COMMODITIES, AND FUTURES; BROKERAGE IN THE FIELD OF STOCKS, MUTUAL FUNDS, COMMODITIES, OPTIONS, INSURANCE, ANNUITIES, FUTURES, REAL ESTATE, MORTGAGE; BROKERAGE OF ENERGY, NAMELY, GAS AND ELECTRICITY; BROKERAGE OF SHARES AND OTHER SECURITIES; BROKERAGE OF SHARES OR STOCKS AND OTHER SECURITIES; BUSINESS BROKERAGE; COMMODITY BROKERAGE; CRUISE SHIP PROPERTY SERVICES, NAMELY, LISTING, LEASING, BROKERAGE, AND MANAGEMENT OF RESIDENTIAL AND COMMERCIAL UNITS ABOARD CRUISE SHIPS AND FINANCING OF SAME; CUSTOMS BROKERAGE; DISCOUNT SECURITIES BROKERAGE SERVICES; FINANCIAL AND INVESTMENT SERVICES, NAMELY, MANAGEMENT AND BROKERAGE IN THE FIELDS OF STOCKS, BONDS, OPTIONS, COMMODITIES, FUTURES AND OTHER SECURITIES, AND THE INVESTMENT OF FUNDS OF OTHERS; INSURANCE BROKERAGE; INSURANCE BROKERAGE IN THE FIELD OF LIFE, HEALTH,

AUTO, HOMEOWNER, ESTATE, AND LONG-TERM CARE; INVESTMENT BROKERAGE; LIFE INSURANCE BROKERAGE; MORTGAGE BANKING SERVICES, NAMELY, ORIGINATION, ACQUISITION, SERVICING, SECURITIZATION AND BROKERAGE OF MORTGAGE LOANS; MORTGAGE BROKERAGE; MUTUAL FUND BROKERAGE; REAL ESTATE BROKERAGE; SECURITIES BROKERAGE; SECURITY BROKERAGE; STOCK BROKERAGE; INSURANCE AGENCY AND BROKERAGE; ASSUMING FINANCIAL RISK OF OTHERS BY ENTERING INTO OPTIONS AND SWAPS; CHARITABLE FOUNDATION SERVICES, NAMELY, PROVIDING FINANCIAL SUPPORT TO INDIVIDUALS WHO ARE SEEKING TO BE WITH FAMILY DURING THE HOLIDAYS BUT ARE UNABLE DUE TO FINANCIAL CONSTRAINTS; CREDIT AND FINANCIAL CONSULTATION; ELECTRONIC FINANCIAL SERVICE FOR THE PURCHASE OF SAVINGS BONDS; FINANCIAL ADMINISTRATION OF RETIREMENT PLANS; FINANCIAL ADVICE; FINANCIAL ADVICE AND CONSULTANCY SERVICES; FINANCIAL ADVISORY AND CONSULTANCY SERVICES; FINANCIAL ADVISORY AND CONSULTANCY SERVICES RELATING TO MICRO CREDITS, MICRO FINANCE AND ENERGY PRODUCTS; FINANCIAL ANALYSES; FINANCIAL ANALYSIS AND CONSULTATION; FINANCIAL ANALYSIS AND RESEARCH SERVICES; FINANCIAL CLEARING HOUSES; FINANCIAL CONSULTANCY; FINANCIAL CONSULTANCY AND INSURANCE CONSULTANCY; FINANCIAL CONSULTATION; FINANCIAL CONSULTATION IN THE FIELD OF STOCKS, MUTUAL FUNDS, COMMODITIES, OPTIONS, INSURANCE, ANNUITIES, FUTURES, REAL ESTATE, MORTGAGE; FINANCIAL CONSULTING; FINANCIAL DUE DILIGENCE; FINANCIAL EVALUATION FOR INSURANCE PURPOSES; FINANCIAL EXCHANGE; FINANCIAL FORECASTING; FINANCIAL GUARANTEE AND SURETY; FINANCIAL INFORMATION AND ADVISORY

SERVICES; FINANCIAL INFORMATION AND EVALUATIONS; FINANCIAL INFORMATION IN THE NATURE OF RATES OF EXCHANGE; FINANCIAL INFORMATION PROCESSING; FINANCIAL INFORMATION PROVIDED BY ELECTRONIC MEANS; FINANCIAL INVESTMENT IN THE FIELD OF STOCKS, MUTUAL FUNDS, COMMODITIES, OPTIONS, INSURANCE, ANNUITIES, FUTURES, REAL ESTATE, MORTGAGE; FINANCIAL INVESTMENT SERVICES, NAMELY, ADMINISTERING THE ISSUANCE, UNDERWRITING AND DISTRIBUTION OF SECURITIES; FINANCIAL LOAN CONSULTATION; FINANCIAL MANAGEMENT; FINANCIAL PLANNING; FINANCIAL PLANNING AND INVESTMENT ADVISORY SERVICES; FINANCIAL PLANNING CONSULTATION; FINANCIAL PLANNING FOR RETIREMENT; FINANCIAL PLANNING, NAMELY, THE CREATION OF PERSONALIZED STRATEGIES TO ACHIEVE FINANCIAL INDEPENDENCE; FINANCIAL PORTFOLIO ANALYSIS SERVICES; FINANCIAL PORTFOLIO MANAGEMENT; FINANCIAL RESEARCH; FINANCIAL RESEARCH AND INFORMATION SERVICES; FINANCIAL RISK MANAGEMENT; FINANCIAL RISK MANAGEMENT CONSULTATION; FINANCIAL SERVICES IN THE FIELD OF MONEY LENDING; FINANCIAL SERVICES IN THE NATURE OF AN INVESTMENT SECURITY; FINANCIAL SERVICES, NAMELY, A TOTAL PORTFOLIO OFFERING FOR HIGH NET WORTH CLIENTS CONSISTING OF BOTH SEPARATE ACCOUNTS AND MUTUAL FUNDS FOR EQUITY AND FIXED INCOME INVESTMENTS; FINANCIAL SERVICES, NAMELY, ASSISTING OTHERS WITH THE COMPLETION OF FINANCIAL TRANSACTIONS FOR STOCKS, BONDS, SECURITIES AND EQUITIES; FINANCIAL SERVICES, NAMELY, CREDIT REPAIR AND RESTORATION; FINANCIAL SERVICES, NAMELY, DEBT SETTLEMENT; FINANCIAL SERVICES, NAMELY, ESTATE SETTLEMENT SERVICES; FINANCIAL SERVICES, NAMELY, INVESTMENT FUND TRANSFER AND TRANSACTION SERVICES; FINANCIAL SERVICES, NAMELY, ISSUANCE AND MANAGEMENT OF CERTIFICATES BACKED BY LOAN PORTFOLIOS WHICH ARE SUBSEQUENTLY MANAGED TO INSURE THE INTEGRITY OF THE CERTIFICATES; FINANCIAL SERVICES, NAMELY, MONEY LENDING; FINANCIAL SERVICES, NAMELY, MORTGAGE PLANNING; FINANCIAL SERVICES, NAMELY, PROVIDING A VIRTUAL CURRENCY FOR USE BY MEMBERS OF AN ONLINE COMMUNITY VIA A GLOBAL COMPUTER NETWORK; FINANCIAL SERVICES, NAMELY, PROVIDING FOR THE EXCHANGE OF FOREIGN CURRENCY, COMMODITIES, FINANCIAL DERIVATIVES, INTEREST RATE PRODUCTS, AND EQUITIES VIA THE INTERNET AND INTRANET SYSTEMS; FINANCIAL SERVICES, NAMELY, PROVIDING INFORMATION IN THE FIELDS OF FOREIGN CURRENCY, COMMODITIES, FINANCIAL DERIVATIVES, INTEREST RATE PRODUCTS, AND EQUITIES VIA THE INTERNET AND INTRANET SYSTEMS; FINANCIAL SERVICES, NAMELY, PROVIDING ON-LINE STORED VALUE ACCOUNTS IN AN ELECTRONIC ENVIRONMENT; FINANCIAL SERVICES, NAMELY, SAVINGS PROGRAMS FOR YOUTHS; FINAN-

CIAL SERVICES, NAMELY, THE PURCHASE OF RESIDENTIAL MORTGAGES ON BEHALF OF OTHERS AND THE ISSUANCE OF MORTGAGE-BACKED SECURITIES; FINANCIAL TRUST OPERATIONS; FINANCIAL VALUATION OF PERSONAL PROPERTY AND REAL ESTATE; FINANCIALLY-GUARANTEED FINANCING; INSURANCE AND FINANCIAL INFORMATION AND CONSULTANCY SERVICES; LEVERAGED BUY OUTS AND INVESTMENTS IN FINANCIALLY DISTRESSED OR UNDER PERFORMING COMPANIES; MORTGAGE COMPLIANCE CONSULTING SERVICES CONCERNING FINANCIAL REQUIREMENTS FOR MORTGAGES FOR MORTGAGE LENDERS AND SERVICERS AND MORTGAGE BROKERS; NEWS REPORTING SERVICES IN THE FIELD OF FINANCIAL NEWS; ONLINE FINANCIAL PLANNING SERVICES; ORGANIZATION OF STOCK EXCHANGES FOR THE BENEFIT OF THE TRADE OF STOCKS AND OTHER FINANCIAL VALUES; PROVIDING A WEB SITE WHERE USERS CAN POST RATINGS, REVIEWS AND RECOMMENDATIONS ON STOCKS, BONDS, MUTUAL FUNDS AND OTHER FINANCIAL INSTRUMENTS; PROVIDING A WEBSITE FEATURING PERSONAL FINANCIAL INFORMATION AND FINANCIAL ADVICE; PROVIDING FINANCIAL INFORMATION; PROVIDING FINANCIAL RISK MANAGEMENT SERVICES FOR ELECTRONIC FUNDS TRANSFER, CREDIT AND DEBIT CARD AND ELECTRONIC CHECK TRANSACTIONS VIA A GLOBAL COMPUTER NETWORK; PROVIDING INFORMATION AND ADVICE IN THE FIELD OF FINANCE, FINANCIAL INVESTMENTS, FINANCIAL VALUATIONS, AND THE FINANCIAL ASPECTS OF RETIREMENT; PROVIDING ON-LINE FINANCIAL CALCULATORS; PROVIDING ON-LINE INFORMATION IN THE FIELD OF CHARITABLE MONETARY GIVING THROUGH FINANCIAL AND ESTATE PLANNING; PROVIDING POST-COMPLIANCE FINANCIAL REVIEWS FOR THE MORTGAGE INDUSTRY; PROVISION OF FINANCIAL INFORMATION; REPAIR COST EVALUATION; CASH MANAGEMENT; INVESTMENT MANAGEMENT; INVESTMENT MANAGEMENT OF AND DISTRIBUTION OF ANNUITIES; INVESTMENT MANAGEMENT OF AND DISTRIBUTION OF VARIABLE ANNUITIES; INVESTMENT MANAGEMENT SERVICES IN THE FIELD OF ACQUIRING JOINT VENTURES; INVESTMENT SERVICES, NAMELY, ASSET ACQUISITION, CONSULTATION, DEVELOPMENT AND MANAGEMENT SERVICES; MANAGEMENT OF A CAPITAL INVESTMENT FUND; MANAGEMENT OF PORTFOLIOS COMPRISING SECURITIES; MANAGEMENT OF PORTFOLIOS OF TRANSFERABLE SECURITIES; MANAGEMENT OF PRIVATE EQUITY FUNDS; PUBLIC EQUITY INVESTMENT MANAGEMENT; REAL ESTATE EQUITY SHARING, NAMELY, MANAGING AND ARRANGING FOR CO-OWNERSHIP OF REAL ESTATE; REAL ESTATE MANAGEMENT; REAL ESTATE MANAGEMENT CONSULTATION; TRUST MANAGEMENT ACCOUNTS; FUND INVESTMENT CONSULTATION; FUND INVESTMENT SERVICES FEATURING SECURITIES OFFERED ACCORDING TO PREVIOUSLY ESTABLISHED CRITERIA IN ORDER TO

MAINTAIN A PREDETERMINED LEVEL OF PAYMENTS TO THE ACCOUNT HOLDER; FUND INVESTMENT SERVICES FEATURING THE TRADING OF AN ACCOUNT HOLDER'S SECURITIES ACCORDING TO PREVIOUSLY ESTABLISHED CRITERIA IN ORDER TO MAINTAIN A PREDETERMINED LEVEL OF PAYMENTS TO THE ACCOUNT HOLDER; FUND RAISING SERVICES, NAMELY, SHARING PROFITS FROM THE SALE OF SOCIALLY RESPONSIBLE PRODUCTS WITH NOT-FOR-PROFIT ORGANIZATIONS, SCHOOLS, AND CIVIC GROUPS; HEDGE FUND INVESTMENT SERVICES; INVESTMENT OF FUNDS FOR OTHERS; MUTUAL FUND DISTRIBUTION; MUTUAL FUND INVESTMENT; MUTUAL FUNDS AND CAPITAL INVESTMENT; PROVIDING STOCK MARKET INFORMATION; PROVIDING STOCK/SECURITIES MARKET INFORMATION; STOCK EXCHANGE PRICE QUOTATIONS; STOCK EX-

CHANGE QUOTATION AND LISTING SERVICES , IN CLASS 36 (U.S. CLS. 100, 101 AND 102).

FIRST USE 9-21-2003; IN COMMERCE 9-21-2003.

THE MARK CONSISTS OF STANDARD CHARACTERS WITHOUT CLAIM TO ANY PARTICULAR FONT, STYLE, SIZE, OR COLOR.

OWNER OF U.S. REG. NO. 3,271,269.

NO CLAIM IS MADE TO THE EXCLUSIVE RIGHT TO USE "FINANCIAL", APART FROM THE MARK AS SHOWN.

SER. NO. 77-458,817, FILED 4-26-2008.

JANET LEE, EXAMINING ATTORNEY

Int. Cl.: 42

Prior U.S. Cls.: 100 and 101

United States Patent and Trademark Office

Reg. No. 3,575,297

Registered Feb. 17, 2009

**SERVICE MARK
PRINCIPAL REGISTER**



INKLING INCORPORATED (COLORADO CORPORATION)
796 WEST BIRCH COURT
LOUISVILLE, CO 80027

FOR: PRODUCT DEVELOPMENT; PRODUCT DEVELOPMENT AND ENGINEERING SERVICES FOR OTHERS; PRODUCT DEVELOPMENT CONSULTATION; PRODUCT DEVELOPMENT FOR OTHERS; PRODUCT RESEARCH AND DEVELOPMENT; RESEARCH AND DEVELOPMENT OF NEW PRODUCTS; GRAPHIC DESIGN; INDUSTRIAL DESIGN; DESIGN AND TESTING FOR NEW PRO-

DUCT DEVELOPMENT; DESIGN FOR OTHERS IN THE FIELD OF OUTDOOR RECREATION PRODUCTS, IN CLASS 42 (U.S. CLS. 100 AND 101).

FIRST USE 4-20-2000; IN COMMERCE 3-13-2003.

THE MARK CONSISTS OF A STYLIZED ASTERISK SYMBOL.

SER. NO. 77-458,906, FILED 4-26-2008.

AISHA SALEM, EXAMINING ATTORNEY

Int. Cl.: 28

Prior U.S. Cls.: 22, 23, 38 and 50

United States Patent and Trademark Office

Reg. No. 3,575,298

Registered Feb. 17, 2009

**TRADEMARK
PRINCIPAL REGISTER**



SOLO SPORTS GROUP INC. (CALIFORNIA CORPORATION)
105 COPPERWOOD WAY, SUITE G
OCEANSIDE, CA 92058

FOR: ELLIPTICAL EXERCISE MACHINES; EXERCISE BALLS; EXERCISE BARS; EXERCISE BENCHES; EXERCISE EQUIPMENT, NAMELY, ROWING MACHINES; EXERCISE EQUIPMENT, NAMELY, ABDOMINAL BOARDS; EXERCISE EQUIPMENT, NAMELY, STAIR-STEPPING MACHINES; EXERCISE EQUIPMENT, NAMELY, STATIONARY CYCLES; EXERCISE MACHINES; EXERCISE TABLES; EXERCISE TREADMILLS; EXERCISE WEIGHTS; STATIONARY EXERCISE BICYCLES; EXERCISING EQUIPMENT, NAMELY, WEIGHT LIFTING MACHINES, IN CLASS 28 (U.S. CLS. 22, 23, 38 AND 50).

FIRST USE 3-25-2008; IN COMMERCE 3-25-2008.

NO CLAIM IS MADE TO THE EXCLUSIVE RIGHT TO USE "FITNESS", APART FROM THE MARK AS SHOWN.

THE COLOR(S) BLACK, RED IS/ARE CLAIMED AS A FEATURE OF THE MARK.

THE MARK CONSISTS OF SYMBOL DESIGN IS AN ELONGATED STYLIZED BLACK "E" WITH A RED CIRCLE, FOLLOWED IN RED BY THE WORD "ELITE", AND THEN IN BLACK THE WORD "FITNESS".

SER. NO. 77-459,104, FILED 4-28-2008.

BRIAN NEVILLE, EXAMINING ATTORNEY

Int. Cl.: 36

Prior U.S. Cls.: 100, 101 and 102

United States Patent and Trademark Office

Reg. No. 3,575,299

Registered Feb. 17, 2009

**SERVICE MARK
PRINCIPAL REGISTER**

PWA REAL ESTATE, LLC

PWA REAL ESTATE, LLC (PENNSYLVANIA
LIMITED LIABILITY COMPANY)

4900 PERRY HIGHWAY

PITTSBURGH, PA 15229

FOR: REAL ESTATE BROKERAGE, IN CLASS 36
(U.S. CLS. 100, 101 AND 102).

FIRST USE 6-30-2008; IN COMMERCE 6-30-2008.

THE MARK CONSISTS OF STANDARD CHAR-
ACTERS WITHOUT CLAIM TO ANY PARTICULAR
FONT, STYLE, SIZE, OR COLOR.

NO CLAIM IS MADE TO THE EXCLUSIVE
RIGHT TO USE "REAL ESTATE, LLC", APART
FROM THE MARK AS SHOWN.

SER. NO. 77-459,335, FILED 4-28-2008.

MATTHEW PAPPAS, EXAMINING ATTORNEY

Int. Cl.: 30

Prior U.S. Cl.: 46

United States Patent and Trademark Office

Reg. No. 3,575,300

Registered Feb. 17, 2009

**TRADEMARK
PRINCIPAL REGISTER**

**Little Willie's Grenade
Sauce**

GOODMAN, EUGENE D. (UNITED STATES IN-
DIVIDUAL)
4113 AQUARIUM PLACE
BALTIMORE, MD 21215

FOR: HOT SAUCE; PICANTE SAUCE; READY-
MADE SAUCES; SAUCES; CHILI SAUCE; CONDI-
MENT, NAMELY, PEPPER SAUCE; DIPPING SAU-
CES; SALSA; MARINADES, IN CLASS 30 (U.S. CL.
46).

FIRST USE 8-0-2004; IN COMMERCE 9-27-2004.

THE MARK CONSISTS OF STANDARD CHAR-
ACTERS WITHOUT CLAIM TO ANY PARTICULAR
FONT, STYLE, SIZE, OR COLOR.

NO CLAIM IS MADE TO THE EXCLUSIVE
RIGHT TO USE "SAUCE", APART FROM THE
MARK AS SHOWN.

SER. NO. 77-459,667, FILED 4-28-2008.

SANJEEV VOHRA, EXAMINING ATTORNEY

Int. Cl.: 42

Prior U.S. Cls.: 100 and 101

United States Patent and Trademark Office

Reg. No. 3,575,301

Registered Feb. 17, 2009

SERVICE MARK
PRINCIPAL REGISTER



ADVANCED OBJECTS, INC. (ILLINOIS CORPORATION)
SUITE 409
155 NORTH MICHIGAN AVENUE
CHICAGO, IL 60601

FOR: CONSULTING SERVICES IN THE FIELD OF IDENTIFICATION, SUPPORT AND IMPLEMENTATION OF COMPUTER-BASED INFORMATION SYSTEMS FOR BUSINESSES IN THE FINANCIAL SERVICES INDUSTRY; COMPUTER SERVICES, NAMELY, HOSTING AND MAINTAINING ON-LINE WEB SITES FOR OTHERS FOR CONDUCTING FINANCIAL SERVICES; CUSTOM DEVELOPMENT AND DESIGN OF SOFTWARE AND NEW PRODUCTS FOR OTHERS FOR USE IN THE FINANCIAL INDUSTRY; PROVIDING ON-LINE, NON-DOWNLOADABLE SOFTWARE FOR FINANCIAL PORTFOLIO ANALYSIS; COMPUTER PROJECT MANAGEMENT SERVICES; TECHNOLOGY CONSULTING SERVICES, NAMELY, STRATEGIC

TECHNOLOGY PLANNING IN THE FIELD OF FINANCIAL PLANNING AND FINANCIAL PORTFOLIO MANAGEMENT; AND PROVIDING ON-LINE NON-DOWNLOADABLE SOFTWARE FOR GENERATING PROPOSALS IN THE FIELD OF FINANCIAL PLANNING AND FINANCIAL PORTFOLIO MANAGEMENT, IN CLASS 42 (U.S. CLS. 100 AND 101).

FIRST USE 11-21-2005; IN COMMERCE 11-21-2005.

THE MARK CONSISTS OF A STYLIZED LOWER CASE LETTER A WITH A SMALL STYLIZED LETTER "O" FOLLOWING THE LETTER A ON THE UPPER RIGHT SIDE.

SER. NO. 77-459,717, FILED 4-28-2008.

SETH A. RAPPAPORT, EXAMINING ATTORNEY

Int. Cl.: 17

Prior U.S. Cls.: 1, 5, 12, 13, 35 and 50

United States Patent and Trademark Office

Reg. No. 3,575,302

Registered Feb. 17, 2009

**TRADEMARK
PRINCIPAL REGISTER**

BALLISTIC

METRA ELECTRONICS CORPORATION (FLOR-
IDA CORPORATION)
460 WALKER STREET
HOLLY HILL, FL 321172699

FOR: SOUND DEADENING MATERIALS FOR
AUTOSOUND INSTALLATIONS COMPRISING PRI-
MARILY A RUBBER LAYER AND AN ALUMINUM
FOIL LAYER, IN CLASS 17 (U.S. CLS. 1, 5, 12, 13, 35
AND 50).

FIRST USE 9-15-2008; IN COMMERCE 9-15-2008.

THE MARK CONSISTS OF STANDARD CHAR-
ACTERS WITHOUT CLAIM TO ANY PARTICULAR
FONT, STYLE, SIZE, OR COLOR.

SER. NO. 77-459,753, FILED 4-28-2008.

SUE LAWRENCE, EXAMINING ATTORNEY

Int. Cl.: 17

Prior U.S. Cls.: 1, 5, 12, 13, 35 and 50

United States Patent and Trademark Office

Reg. No. 3,575,303

Registered Feb. 17, 2009

**TRADEMARK
PRINCIPAL REGISTER**



METRA ELECTRONICS CORPORATION (FLOR-
IDA CORPORATION)
460 WALKER STREET
HOLLY HILL, FL 321172699

FOR: SOUND DEADENING MATERIALS FOR
AUTOSOUND INSTALLATIONS COMPRISING PRI-
MARILY A RUBBER LAYER AND AN ALUMINUM
FOIL LAYER, IN CLASS 17 (U.S. CLS. 1, 5, 12, 13, 35
AND 50).

FIRST USE 9-15-2008; IN COMMERCE 9-15-2008.

THE MARK CONSISTS OF "BALLISTIC" IN A
STYLIZED LOWER CASE FORM.

SER. NO. 77-459,767, FILED 4-28-2008.

SUE LAWRENCE, EXAMINING ATTORNEY

Int. Cl.: 36

Prior U.S. Cls.: 100, 101 and 102

United States Patent and Trademark Office

Reg. No. 3,575,304

Registered Feb. 17, 2009

**SERVICE MARK
PRINCIPAL REGISTER**

PROVIDENT ROYALTIES

PROVIDENT ROYALTIES, LLC (DELAWARE
LIMITED LIABILITY COMPANY)
SUITE 700
15660 N. DALLAS PARKWAY
DALLAS, TX 75248

FOR: INVESTMENT SERVICES, NAMELY, AC-
QUISITION, DEVELOPMENT AND MANAGE-
MENT OF ASSETS IN THE NATURE OF
MINERAL RIGHTS, INTERESTS AND LEASES , IN
CLASS 36 (U.S. CLS. 100, 101 AND 102).

FIRST USE 1-0-2007; IN COMMERCE 1-0-2007.

THE MARK CONSISTS OF STANDARD CHAR-
ACTERS WITHOUT CLAIM TO ANY PARTICULAR
FONT, STYLE, SIZE, OR COLOR.

NO CLAIM IS MADE TO THE EXCLUSIVE
RIGHT TO USE "ROYALTIES", APART FROM
THE MARK AS SHOWN.

SER. NO. 77-459,845, FILED 4-28-2008.

CHRISTINE BLOMQUIST, EXAMINING ATTOR-
NEY

Int. Cl.: 44

Prior U.S. Cls.: 100 and 101

United States Patent and Trademark Office

Reg. No. 3,575,305

Registered Feb. 17, 2009

**SERVICE MARK
PRINCIPAL REGISTER**

AMANGANI

AMANRESORTS LIMITED (HONG KONG LIMITED LIABILITY COMPANY)
8/F KAILEY TOWER, 16 STANLEY STREET
CENTRAL, HONG KONG

FOR: PROVISION OF SPA SERVICES, NAMELY, HEALTH SPA SERVICES FOR HEALTH AND WELLNESS OF BODY AND SPIRIT OFFERED FROM A HEALTH RESORT, HOTEL, OR IN OR FROM A REMOTE, MOBILE, PERMANENT OR TEMPORARY ON-SITE LOCATION; SAUNA SERVICES; PROVIDING SOLARIUM AND SUN DECK FACILITIES; MASSAGE SERVICES; HEALTH CARE RELATING TO THERAPEUTIC MASSAGE; HEALTH CARE SERVICES; SKIN CARE SERVICES; BEAUTY TREATMENT SERVICES; HAIR CARE SERVICES; PEDICURE AND MANICURE SERVICES; BEAUTY SALONS; HAIR DRESSING SALONS; WEIGHT LOSS, WEIGHT GAIN AND WEIGHT CONTROL PLANNING AND SUPERVISION; IN-

FORMATION, ADVISORY AND CONSULTANCY SERVICES RELATED TO ALL OF THE AFOREMENTIONED, IN CLASS 44 (U.S. CLS. 100 AND 101).

FIRST USE 12-31-1998; IN COMMERCE 12-31-1998.

THE MARK CONSISTS OF STANDARD CHARACTERS WITHOUT CLAIM TO ANY PARTICULAR FONT, STYLE, SIZE, OR COLOR.

OWNER OF U.S. REG. NO. 2,590,185.

THE FOREIGN WORDING IN THE MARK TRANSLATES INTO ENGLISH AS PEACEFUL HOME.

SER. NO. 77-460,004, FILED 4-28-2008.

JUSTINE D. PARKER, EXAMINING ATTORNEY

Int. Cl.: 35

Prior U.S. Cls.: 100, 101 and 102

United States Patent and Trademark Office

Reg. No. 3,575,306

Registered Feb. 17, 2009

**SERVICE MARK
PRINCIPAL REGISTER**

InterMed

STAAB, RICHARD A. (UNITED STATES INDIVIDUAL)
13351 PROGRESS BLVD.
ALACHUA, FL 32615 AND
BAUERLE, DAVID C. (UNITED STATES INDIVIDUAL)
13351 PROGRESS BLVD.
ALACHUA, FL 32615

FOR: RETAIL SERVICES BY DIRECT SOLICITATION BY SALES AGENTS IN THE FIELD OF MEDICAL SURGICAL, CLINICAL, DIAGNOSTIC,

TEST AND IMAGING EQUIPMENT, IN CLASS 35 (U.S. CLS. 100, 101 AND 102).

FIRST USE 5-1-1989; IN COMMERCE 5-1-1989.

THE MARK CONSISTS OF STANDARD CHARACTERS WITHOUT CLAIM TO ANY PARTICULAR FONT, STYLE, SIZE, OR COLOR.

SER. NO. 77-460,644, FILED 4-29-2008.

DAVID C. REIHNER, EXAMINING ATTORNEY

Int. Cl.: 25

Prior U.S. Cls.: 22 and 39

United States Patent and Trademark Office

Reg. No. 3,575,307

Registered Feb. 17, 2009

**TRADEMARK
PRINCIPAL REGISTER**

L. B. EVANS SINCE 1804

ELAN-POLO, INC. (MISSOURI CORPORATION)
630 MELROSE AVENUE
NASHVILLE, TN 372112161

FOR: FOOTWEAR, IN CLASS 25 (U.S. CLS. 22 AND 39).

FIRST USE 0-0-1984; IN COMMERCE 0-0-1984.

THE MARK CONSISTS OF STANDARD CHARACTERS WITHOUT CLAIM TO ANY PARTICULAR FONT, STYLE, SIZE, OR COLOR.

NO CLAIM IS MADE TO THE EXCLUSIVE RIGHT TO USE "SINCE 1804", APART FROM THE MARK AS SHOWN.

"L.B. EVANS" DOES NOT IDENTIFY A LIVING INDIVIDUAL.

SER. NO. 77-460,708, FILED 4-29-2008.

ALICE BENMAMAN, EXAMINING ATTORNEY

Int. Cl.: 12

Prior U.S. Cls.: 19, 21, 23, 31, 35 and 44

Reg. No. 3,575,308

United States Patent and Trademark Office

Registered Feb. 17, 2009

TRADEMARK
PRINCIPAL REGISTER



GREAT BIKE GEAR, INC. (CALIFORNIA CORPORATION), DBA GREAT BIKE GEAR, INC.
3070 COMMERCE WAY
TURLOCK, CA 95380

FOR: MOTORCYCLE PARTS, NAMELY, A DETACHABLE BRACKET FOR LEATHER SADDLEBAGS, IN CLASS 12 (U.S. CLS. 19, 21, 23, 31, 35 AND 44).

FIRST USE 2-1-2002; IN COMMERCE 4-10-2002.

NO CLAIM IS MADE TO THE EXCLUSIVE RIGHT TO USE "BRACKETS", APART FROM THE MARK AS SHOWN.

THE COLOR(S) BLACK, ORANGE AND YELLOW IS/ARE CLAIMED AS A FEATURE OF THE MARK.

THE MARK CONSISTS OF THE WORDING "EASY BRACKETS" IN WHICH THE LETTER "Y" IS STYLIZED TO REPRESENT MOTORCYCLE EXHAUST PIPES EMITTING FLAMES, IN WHICH THE COLOR BLACK APPEARS IN THE WORD "EASY", THE EXHAUST PIPES, AND THE OUTLINING AROUND THE WORD "BRACKETS" AND THE FLAMES, AND THE COLORS ORANGE AND YELLOW APPEAR GRADUATED ACROSS THE WORDING "BRACKETS" AND THE FLAMES.

SER. NO. 77-460,865, FILED 4-29-2008.

HANNO RITTNER, EXAMINING ATTORNEY

Int. Cls.: 35 and 42

Prior U.S. Cls.: 100, 101 and 102

United States Patent and Trademark Office

Reg. No. 3,575,309

Registered Feb. 17, 2009

**SERVICE MARK
PRINCIPAL REGISTER**

The logo for 'uFollowit' features the word 'uFollowit' in a bold, sans-serif font. The letter 'o' in 'Followit' is replaced by a magnifying glass icon, with the handle of the magnifying glass extending downwards and to the left.

TVIRTUAL (TEXAS LIMITED LIABILITY COMPANY)
1101 S CAPITAL OF TX HWY, BLDG K STE 250
AUSTIN, TX 78746

FOR: COMPUTERIZED TRACKING AND TRACKING OF PACKAGES, CARGO AND FREIGHT IN TRANSIT; INFORMATION MANAGEMENT SERVICES, NAMELY, SHIPMENT PROCESSING, PREPARING SHIPPING DOCUMENTS AND INVOICES, TRACKING DOCUMENTS, PACKAGES AND FREIGHT OVER COMPUTER NETWORKS AND THE INTERNET; MONITORING AND TRACKING OF PACKAGE, CARGO AND FREIGHT SHIPMENTS; PROVIDING ELECTRONIC TRACKING OF PACKAGES, CARGO AND FREIGHT INFORMATION TO OTHERS; PROVIDING TRACKING SERVICES AND INFORMATION CONCERNING TRACKING OF ASSETS IN TRANSIT, NAMELY, PACKAGES, CARGO, FREIGHT AND DELIVERY CONTAINERS, IN CLASS 35 (U.S. CLS. 100, 101 AND 102).

FIRST USE 11-0-2007; IN COMMERCE 11-0-2007.

FOR: PROVIDING TEMPORARY USE OF NON-DOWNLOADABLE COMPUTER SOFTWARE FOR TRACKING PACKAGES AND FREIGHT OVER COMPUTER NETWORKS, INTRANETS AND THE INTERNET, IN CLASS 42 (U.S. CLS. 100 AND 101).

FIRST USE 11-0-2007; IN COMMERCE 11-0-2007.

OWNER OF U.S. REG. NO. 3,476,398.

THE MARK CONSISTS OF THE FANCIFUL NAME "UFOLLOWIT" WITH THE SECOND "O" BEING A MAGNIFYING GLASS.

SER. NO. 77-460,950, FILED 4-29-2008.

TRACY WHITTAKER-BROWN, EXAMINING ATTORNEY

Int. Cl.: 41

Prior U.S. Cls.: 100, 101 and 107

United States Patent and Trademark Office

Reg. No. 3,575,310

Registered Feb. 17, 2009

**SERVICE MARK
PRINCIPAL REGISTER**

TOTAL BIOLOGY

CHOISY-ROSSI, CAROLINE (FRANCE INDIVIDUAL)
7 LOOSESTRIFE DRIVE
HOPEWELL JUNCTION, NY 12533

FOR: EDUCATIONAL SERVICES, NAMELY, PROVIDING SEMINARS, CLASSES, COURSES, CONFERENCES AND WORKSHOPS IN THE FIELDS OF SELF-HELP AND ALTERNATIVE HEALING, IN CLASS 41 (U.S. CLS. 100, 101 AND 107).

FIRST USE 2-0-2006; IN COMMERCE 2-0-2006.

THE MARK CONSISTS OF STANDARD CHARACTERS WITHOUT CLAIM TO ANY PARTICULAR FONT, STYLE, SIZE, OR COLOR.

NO CLAIM IS MADE TO THE EXCLUSIVE RIGHT TO USE "BIOLOGY", APART FROM THE MARK AS SHOWN.

SER. NO. 77-461,419, FILED 4-29-2008.

ROBIN MITTLER, EXAMINING ATTORNEY

Int. Cl.: 4

Prior U.S. Cls.: 1, 6 and 15

United States Patent and Trademark Office

Reg. No. 3,575,311

Registered Feb. 17, 2009

**TRADEMARK
PRINCIPAL REGISTER**

PELLET MASTER

ENVIROTECH SERVICES, INC. (COLORADO CORPORATION)
910 54TH AVENUE, SUITE 230
GREELEY, CO 80634

FOR: DUST BINDING COMPOSITIONS; DUST BINDING COMPOSITIONS WITH A POLYMER BASE USED TO BIND PARTICULATE MATTER TO IMPROVE HANDLING AND CONTROL DUST, IN CLASS 4 (U.S. CLS. 1, 6 AND 15).

FIRST USE 5-23-2008; IN COMMERCE 5-23-2008.

THE MARK CONSISTS OF STANDARD CHARACTERS WITHOUT CLAIM TO ANY PARTICULAR FONT, STYLE, SIZE, OR COLOR.

NO CLAIM IS MADE TO THE EXCLUSIVE RIGHT TO USE "PELLET", APART FROM THE MARK AS SHOWN.

SER. NO. 77-461,669, FILED 4-30-2008.

GINA HAYES, EXAMINING ATTORNEY

Int. Cl.: 42

Prior U.S. Cls.: 100 and 101

United States Patent and Trademark Office

Reg. No. 3,575,312

Registered Feb. 17, 2009

**SERVICE MARK
PRINCIPAL REGISTER**



KEPHART

community ■ planning ■ architecture

KEPHART ARCHITECTS, INC. (COLORADO CORPORATION)
2555 WALNUT STREET
DENVER, CO 80205

FOR: ARCHITECTURAL DESIGN, IN CLASS 42 (U.S. CLS. 100 AND 101).

FIRST USE 1-0-2003; IN COMMERCE 1-0-2003.

NO CLAIM IS MADE TO THE EXCLUSIVE RIGHT TO USE "COMMUNITY PLANNING ARCHITECTURE", APART FROM THE MARK AS SHOWN.

THE COLOR(S) BURGUNDY, BLUE, GOLD, GRAY, AND BLACK IS/ARE CLAIMED AS A FEATURE OF THE MARK.

THE COLOR BLACK APPEARS IN THE WORDING "KEPHART COMMUNITY PLANNING ARCHITECTURE". THE COLORS BURGUNDY, BLUE, GOLD, AND GRAY APPEAR IN THE SQUARE AND RECTANGLE DESIGN ELEMENTS.

SER. NO. 77-461,953, FILED 4-30-2008.

JENNIFER HETU, EXAMINING ATTORNEY

Int. Cl.: 7

Prior U.S. Cls.: 13, 19, 21, 23, 31, 34 and 35

United States Patent and Trademark Office

Reg. No. 3,575,313

Registered Feb. 17, 2009

**TRADEMARK
PRINCIPAL REGISTER**

VERITRAN

VERITRAN, INC. (NEW MEXICO CORPORATION)
P.O. BOX 19006
ALBUQUERQUE, NM 871190006

THE MARK CONSISTS OF STANDARD CHARACTERS WITHOUT CLAIM TO ANY PARTICULAR FONT, STYLE, SIZE, OR COLOR.

FOR: VARIABLE TRANSMISSIONS FOR ROTARY DEVICES, NAMELY, FOR NON-LAND-BASED VEHICLES, IN CLASS 7 (U.S. CLS. 13, 19, 21, 23, 31, 34 AND 35).

SER. NO. 77-462,338, FILED 4-30-2008.

FIRST USE 7-10-2007; IN COMMERCE 7-10-2007.

DANIEL CAPSHAW, EXAMINING ATTORNEY

Int. Cl.: 37

Prior U.S. Cls.: 100, 103 and 106

United States Patent and Trademark Office

Reg. No. 3,575,314

Registered Feb. 17, 2009

**SERVICE MARK
PRINCIPAL REGISTER**

FLIP

FREEDOM SHOPPING, INC. (NORTH CAROLINA CORPORATION)
SUITES 103/104
920 TATE BLVD SE
HICKORY, NC 28602

FOR: PROVIDING SERVICES, NAMELY, INSTALLATION OF RFID EQUIPMENT TO CONVERT A NON-RFID STORE TO AN RFID STORE, IN CLASS 37 (U.S. CLS. 100, 103 AND 106).

FIRST USE 4-30-2008; IN COMMERCE 4-30-2008.

THE MARK CONSISTS OF STANDARD CHARACTERS WITHOUT CLAIM TO ANY PARTICULAR FONT, STYLE, SIZE, OR COLOR.

SER. NO. 77-462,445, FILED 4-30-2008.

LEIGH CAROLINE CASE, EXAMINING ATTORNEY

Int. Cls.: 44 and 45

Prior U.S. Cls.: 100 and 101

United States Patent and Trademark Office

Reg. No. 3,575,315

Registered Feb. 17, 2009

**SERVICE MARK
PRINCIPAL REGISTER**

TOTAL BIOLOGY

CHOISY-ROSSI, CAROLINE (FRANCE INDIVIDUAL)
7 LOOSESTRIFE DRIVE
HOPEWELL JUNCTION, NY 12533

FOR: ALTERNATIVE AND COMPLEMENTARY MEDICINE SERVICES; CONSULTATION SERVICES IN THE FIELDS OF ALTERNATIVE AND COMPLEMENTARY MEDICINE, IN CLASS 44 (U.S. CLS. 100 AND 101).

FIRST USE 2-0-2006; IN COMMERCE 2-0-2006.

FOR: CONSULTATION SERVICES IN THE FIELD OF SELF-HELP, IN CLASS 45 (U.S. CLS. 100 AND 101).

FIRST USE 2-0-2006; IN COMMERCE 2-0-2006.

THE MARK CONSISTS OF STANDARD CHARACTERS WITHOUT CLAIM TO ANY PARTICULAR FONT, STYLE, SIZE, OR COLOR.

NO CLAIM IS MADE TO THE EXCLUSIVE RIGHT TO USE "BIOLOGY", APART FROM THE MARK AS SHOWN.

SER. NO. 77-462,602, FILED 4-30-2008.

ROBIN MITTLER, EXAMINING ATTORNEY

Int. Cl.: 35

Prior U.S. Cls.: 100, 101 and 102

United States Patent and Trademark Office

Reg. No. 3,575,316

Registered Feb. 17, 2009

**SERVICE MARK
PRINCIPAL REGISTER**



MAD ART, L.L.C. (MISSOURI LIMITED LIABILITY COMPANY)

2727 S. 12TH STREET

ST. LOUIS, MO 63118

FOR: ART GALLERIES, IN CLASS 35 (U.S. CLS. 100, 101 AND 102).

FIRST USE 7-27-2000; IN COMMERCE 7-27-2000.

NO CLAIM IS MADE TO THE EXCLUSIVE RIGHT TO USE "ART GALLERY", APART FROM THE MARK AS SHOWN.

THE MARK CONSISTS OF THE STYLIZED WORDING "MAD ART GALLERY" SUPERIMPOSED ON A COG DESIGN.

SER. NO. 77-463,318, FILED 5-1-2008.

ERIN FALK, EXAMINING ATTORNEY

Int. Cl.: 42

Prior U.S. Cls.: 100 and 101

United States Patent and Trademark Office

Reg. No. 3,575,317

Registered Feb. 17, 2009

**SERVICE MARK
PRINCIPAL REGISTER**

2030 Blueprint

2030, INC. (NEW MEXICO CORPORATION)
607 CERRILLOS ROAD, SUITE G
SANTA FE, NM 87505

FOR: DEVELOPMENT OF VOLUNTARY STANDARDS FOR ENERGY CONSUMPTION AND GREENHOUSE GAS EMISSIONS OF BUILDINGS, IN CLASS 42 (U.S. CLS. 100 AND 101).

FIRST USE 3-1-2008; IN COMMERCE 3-1-2008.

THE MARK CONSISTS OF STANDARD CHARACTERS WITHOUT CLAIM TO ANY PARTICULAR FONT, STYLE, SIZE, OR COLOR.

NO CLAIM IS MADE TO THE EXCLUSIVE RIGHT TO USE "2030", APART FROM THE MARK AS SHOWN.

SER. NO. 77-463,369, FILED 5-1-2008.

WARREN L. OLANDRIA, EXAMINING ATTORNEY

Int. Cl.: 42

Prior U.S. Cls.: 100 and 101

United States Patent and Trademark Office

Reg. No. 3,575,318

Registered Feb. 17, 2009

**SERVICE MARK
PRINCIPAL REGISTER**



MY CONSULTANT, INC. (NEW JERSEY CORPORATION)

318 HAZEL AVENUE

DELANCO, NJ 08075

FOR: INFORMATION TECHNOLOGY CONSULTATION SERVICES TO HEALTHCARE ORGANIZATIONS, IN CLASS 42 (U.S. CLS. 100 AND 101).

FIRST USE 8-10-2004; IN COMMERCE 10-29-2004.

NO CLAIM IS MADE TO THE EXCLUSIVE RIGHT TO USE "MY CONSULTANT INCORPORATED", APART FROM THE MARK AS SHOWN.

THE MARK CONSISTS OF THE WORDING, "MY CONSULTANT INCORPORATED", WHICH APPEARS BENEATH A SQUARE DESIGN DEPICTING THE LETTER "H" WITH BINARY CODE.

SER. NO. 77-463,567, FILED 5-1-2008.

KELLY CHOE, EXAMINING ATTORNEY

Int. Cl.: 5

Prior U.S. Cls.: 6, 18, 44, 46, 51 and 52

United States Patent and Trademark Office

Reg. No. 3,575,319

Registered Feb. 17, 2009

**TRADEMARK
PRINCIPAL REGISTER**

CALIFORNIA CAR SCENTS

CALIFORNIA SCENTS (CALIFORNIA CORPORATION)
SUITE 200
18850 VON KARMAN AVENUE
IRVINE, CA 92612

FOR: AIR FRESHENERS, IN CLASS 5 (U.S. CLS. 6, 18, 44, 46, 51 AND 52).

FIRST USE 3-24-1999; IN COMMERCE 3-24-1999.

THE MARK CONSISTS OF STANDARD CHARACTERS WITHOUT CLAIM TO ANY PARTICULAR FONT, STYLE, SIZE, OR COLOR.

OWNER OF U.S. REG. NOS. 1,940,353 AND 2,554,315.

NO CLAIM IS MADE TO THE EXCLUSIVE RIGHT TO USE "CAR SCENTS", APART FROM THE MARK AS SHOWN.

SEC. 2(F).

SER. NO. 77-463,948, FILED 5-2-2008.

JENNIFER MARTIN, EXAMINING ATTORNEY

Int. Cl.: 10

Prior U.S. Cls.: 26, 39 and 44

United States Patent and Trademark Office

Reg. No. 3,575,320

Registered Feb. 17, 2009

**TRADEMARK
PRINCIPAL REGISTER**

KOFF KUSHION

MUFFIN ENTERPRISES, INC. (PENNSYLVANIA
CORPORATION)
1135 HARRISBURG PIKE
CARLISLE, PA 17013

FOR: MEDICAL DEVICE, NAMELY, POST-OP-
ERATIVE PILLOW, IN CLASS 10 (U.S. CLS. 26, 39
AND 44).

FIRST USE 4-30-2001; IN COMMERCE 4-30-2001.

THE MARK CONSISTS OF STANDARD CHAR-
ACTERS WITHOUT CLAIM TO ANY PARTICULAR
FONT, STYLE, SIZE, OR COLOR.

NO CLAIM IS MADE TO THE EXCLUSIVE
RIGHT TO USE "CUSHION", APART FROM THE
MARK AS SHOWN.

SEC. 2(F).

SER. NO. 77-463,961, FILED 5-2-2008.

STEPHEN AQUILA, EXAMINING ATTORNEY

Int. Cls.: 35 and 41

Prior U.S. Cls.: 100, 101, 102 and 107

United States Patent and Trademark Office

Reg. No. 3,575,321

Registered Feb. 17, 2009

**SERVICE MARK
PRINCIPAL REGISTER**

CBIZ Women's Advantage

CBIZ, INC. (DELAWARE CORPORATION), DBA
CENTURY BUSINESS SERVICES, INC.
6050 OAK TREE BLVD., SOUTH, SUITE 500
CLEVELAND, OH 44131

FOR: BUSINESS NETWORKING, IN CLASS 35
(U.S. CLS. 100, 101 AND 102).

FIRST USE 2-1-2007; IN COMMERCE 2-1-2007.

FOR: BUSINESS TRAINING SERVICES; EDUCATIONAL SERVICES, NAMELY, CONDUCTING CONFERENCES, SEMINARS, AND WORKSHOPS IN THE FIELD OF ACCOUNTING AND TAX SERVICES AND EMPLOYEE BENEFITS CONSULTING, IN CLASS 41 (U.S. CLS. 100, 101 AND 107).

FIRST USE 2-1-2007; IN COMMERCE 2-1-2007.

THE MARK CONSISTS OF STANDARD CHARACTERS WITHOUT CLAIM TO ANY PARTICULAR FONT, STYLE, SIZE, OR COLOR.

OWNER OF U.S. REG. NOS. 2,376,672, 2,608,976 AND OTHERS.

NO CLAIM IS MADE TO THE EXCLUSIVE RIGHT TO USE "WOMEN'S", APART FROM THE MARK AS SHOWN.

SER. NO. 77-464,115, FILED 5-2-2008.

STEVEN R. FOSTER, EXAMINING ATTORNEY

Int. Cl.: 41

Prior U.S. Cls.: 100, 101 and 107

United States Patent and Trademark Office

Reg. No. 3,575,322

Registered Feb. 17, 2009

**SERVICE MARK
PRINCIPAL REGISTER**



AMERICAN ANTI-VIVISECTION SOCIETY
(PENNSYLVANIA NON-PROFIT CORPORATION)
SUITE 204
801 OLD YORK ROAD
JENKINTOWN, PA 190461685

FOR: EDUCATIONAL SERVICES, NAMELY, LENDING LIBRARY SERVICES FEATURING EDUCATIONAL SOFTWARE AND EDUCATIONAL PRODUCTS, NAMELY, BOOKS AND VIDEOS, THAT ENABLE EDUCATORS AND STUDENTS TO LEARN ANATOMY, PHYSIOLOGY, AND PSYCHOLOGY LESSONS WITHOUT HARMING ANIMALS, THEMSELVES OR THE EARTH, IN CLASS 41 (U.S. CLS. 100, 101 AND 107).

FIRST USE 9-0-2006; IN COMMERCE 9-0-2006.

NO CLAIM IS MADE TO THE EXCLUSIVE RIGHT TO USE "SCIENCE" AND "ALTERNATIVES TO ANIMAL USE IN EDUCATION", APART FROM THE MARK AS SHOWN.

THE MARK CONSISTS OF THREE INTERSECTING OVALS OVER TWO NON-INTERSECTING OVALS. TO THE RIGHT ARE THREE LINES OF TEXT. THE FIRST LINE CONSISTS OF THE WORD "THE". THE SECOND CONSISTS OF THE WORDS "SCIENCE BANK" AND THE THIRD CONSISTS OF THE WORDS "ALTERNATIVES TO ANIMAL USE IN EDUCATION".

SER. NO. 77-464,154, FILED 5-2-2008.

MEGHAN REINHART, EXAMINING ATTORNEY

Int. Cls.: 35 and 42

Prior U.S. Cls.: 100, 101 and 102

United States Patent and Trademark Office

Reg. No. 3,575,323

Registered Feb. 17, 2009

SERVICE MARK
PRINCIPAL REGISTER



KEN HATLEY AND ASSOCIATES, INC. (FLORIDA CORPORATION)
688 WEST MONTROSE ST.
CLERMONT, FL 34711

FOR: DISTRIBUTORSHIP SERVICES IN THE FIELD OF MUSICAL SOUND RECORDINGS; ON-LINE RETAIL STORE SERVICES FEATURING MUSICAL SOUND RECORDINGS , IN CLASS 35 (U.S. CLS. 100, 101 AND 102).

FIRST USE 1-1-1998; IN COMMERCE 1-1-1998.

FOR: SOUND ENGINEERING, IN CLASS 42 (U.S. CLS. 100 AND 101).

FIRST USE 1-1-1998; IN COMMERCE 1-1-1998.

NO CLAIM IS MADE TO THE EXCLUSIVE RIGHT TO USE "RECORDS", APART FROM THE MARK AS SHOWN.

THE MARK CONSISTS OF CARTOON TYPE IMAGE OF A CAT "CATBONE" AND "RECORDS" IN SCRIPT ABOVE CAT.

SER. NO. 77-464,429, FILED 5-2-2008.

TRACY FLETCHER, EXAMINING ATTORNEY

Int. Cl.: 41

Prior U.S. Cls.: 100, 101 and 107

United States Patent and Trademark Office

Reg. No. 3,575,324

Registered Feb. 17, 2009

**SERVICE MARK
PRINCIPAL REGISTER**



MYSPLACE, INC. (DELAWARE CORPORATION)
407 N. MAPLE DRIVE
BEVERLY HILLS, CA 90210

FOR: ENTERTAINMENT SERVICES, NAMELY, PROVIDING A WEBSITE IN THE NATURE OF KARAOKE ALLOWING USERS TO SING, RECORD, PLAYBACK AND SEND PERSONALIZED RENDITIONS OF SONGS; ENTERTAINMENT SERVICES, NAMELY, PROVIDING A WEB SITE FEATURING AUDIO, VIDEO, GRAPHICS, TEXT AND OTHER MULTIMEDIA CONTENT IN THE FIELDS OF VIDEO ENTERTAINMENT, MUSIC VIDEOS, RELATED FILM AND AUDIO CLIPS, PHOTOGRAPHS, AND OTHER MULTIMEDIA MATERIALS; PROVIDING ON-LINE INFORMATION IN THE FIELD OF AND ENTERTAINMENT VIA THE INTERNET; PROVIDING AN ON-LINE COMPUTER DATABASE FEATURING INFORMATION IN THE FIELDS OF KARAOKE MUSIC AND ENTERTAINMENT-RELATED TOPICS; ENTERTAINMENT SERVICES IN THE NATURE OF AUDIO VISUAL ENTERTAINMENT, NAMELY, LIVE MUSICAL PERFORMANCES, AND LIVE AND RECORDED PERFORMANCES TRANSMITTED VIA COMMU-

NICATION NETWORKS AND WIRELESS DEVICES; PRESENTATION OF MUSICAL PERFORMANCES TRANSMITTED VIA COMMUNICATION NETWORKS AND WIRELESS DEVICES; MUSIC PUBLISHING; ENTERTAINMENT SERVICES, NAMELY, PROVIDING ON-LINE KARAOKE GAMES; PUBLISHING OF ELECTRONIC PUBLICATIONS; ON-LINE JOURNALS, NAMELY, BLOGS FEATURING PERSONAL INFORMATION AND OPINIONS IN FIELDS OF GENERAL INTEREST AND KARAOKE PERFORMANCES, IN CLASS 41 (U.S. CLS. 100, 101 AND 107).

FIRST USE 2-21-2008; IN COMMERCE 2-21-2008.

OWNER OF U.S. REG. NOS. 3,183,151, 3,399,651 AND OTHERS.

NO CLAIM IS MADE TO THE EXCLUSIVE RIGHT TO USE "KARAOKE", APART FROM THE MARK AS SHOWN.

SER. NO. 77-464,469, FILED 5-2-2008.

SUSAN LESLIE DUBOIS, EXAMINING ATTORNEY

Int. Cl.: 24

Prior U.S. Cls.: 42 and 50

United States Patent and Trademark Office

Reg. No. 3,575,325

Registered Feb. 17, 2009

**TRADEMARK
PRINCIPAL REGISTER**

GOURMET CLASSICS

KA & F GROUP, LLC (ILLINOIS LIMITED
LIABILITY COMPANY)
2860 GREENWOOD AVENUE
HIGHLAND PARK, IL 60035

FOR: HAND TOWELS; HAND TOWELS OF TEXTILE; KITCHEN TOWELS; OVEN MITTS; PLACE MATS OF TEXTILE MATERIAL; TABLE NAPKINS OF TEXTILE; TERRY TOWELS; TEXTILE NAPKINS; TEXTILE PLACE MATS; TOWELS, IN CLASS 24 (U.S. CLS. 42 AND 50).

FIRST USE 11-8-2002; IN COMMERCE 11-8-2002.

THE MARK CONSISTS OF STANDARD CHARACTERS WITHOUT CLAIM TO ANY PARTICULAR FONT, STYLE, SIZE, OR COLOR.

NO CLAIM IS MADE TO THE EXCLUSIVE RIGHT TO USE "GOURMET", APART FROM THE MARK AS SHOWN.

SER. NO. 77-464,474, FILED 5-2-2008.

JENNIFER VASQUEZ, EXAMINING ATTORNEY

Int. Cl.: 25

Prior U.S. Cls.: 22 and 39

United States Patent and Trademark Office

Reg. No. 3,575,326

Registered Feb. 17, 2009

**TRADEMARK
PRINCIPAL REGISTER**

GOURMET CLASSICS

KA & F GROUP, LLC (ILLINOIS LIMITED
LIABILITY COMPANY)
2860 GREENWOOD AVENUE
HIGHLAND PARK, IL 60035

NO CLAIM IS MADE TO THE EXCLUSIVE
RIGHT TO USE "GOURMET", APART FROM THE
MARK AS SHOWN.

FOR: APRONS, IN CLASS 25 (U.S. CLS. 22 AND 39).

FIRST USE 11-8-2002; IN COMMERCE 11-8-2002.

SER. NO. 77-464,507, FILED 5-2-2008.

THE MARK CONSISTS OF STANDARD CHAR-
ACTERS WITHOUT CLAIM TO ANY PARTICULAR
FONT, STYLE, SIZE, OR COLOR.

JENNIFER VASQUEZ, EXAMINING ATTORNEY

Int. Cl.: 41

Prior U.S. Cls.: 100, 101 and 107

United States Patent and Trademark Office

Reg. No. 3,575,327

Registered Feb. 17, 2009

**SERVICE MARK
PRINCIPAL REGISTER**

E-VIDEOCOACHING

BOWMAN, DAVID J (UNITED STATES INDIVIDUAL)
SUITE 430
4201 WILSHIRE BOULEVARD
LOS ANGELES, CA 90010

FOR: CAREER COUNSELING SERVICES PROVIDED VIA THE INTERNET, IN CLASS 41 (U.S. CLS. 100, 101 AND 107).

FIRST USE 1-1-2000; IN COMMERCE 1-1-2000.

THE MARK CONSISTS OF STANDARD CHARACTERS WITHOUT CLAIM TO ANY PARTICULAR FONT, STYLE, SIZE, OR COLOR.

SEC. 2(F).

SER. NO. 77-464,510, FILED 5-2-2008.

JENNIFER VASQUEZ, EXAMINING ATTORNEY

Int. Cl.: 38

Prior U.S. Cls.: 100, 101 and 104

United States Patent and Trademark Office

Reg. No. 3,575,328

Registered Feb. 17, 2009

SERVICE MARK
PRINCIPAL REGISTER



EDUCATION NETWORKS OF AMERICA, INC.
(DELAWARE CORPORATION)
1101 MCGAVOCK STREET
NASHVILLE, TN 37203

FOR: PROVIDING TECHNOLOGY SOLUTIONS IN THE NATURE OF LOCAL AND LONG DISTANCE TELEPHONE SERVICES; PROVIDING MULTIPLE USER ACCESS TO A COMPREHENSIVE, FULLY MANAGED GLOBAL COMPUTER INFORMATION NETWORK WHICH ENHANCES THE K-12 LEARNING ENVIRONMENT AND LINKS STUDENTS AND TEACHERS TO ELECTRONIC INFORMATION WORLDWIDE, IN CLASS 38 (U.S. CLS. 100, 101 AND 104).

FIRST USE 8-4-2006; IN COMMERCE 8-4-2006.

NO CLAIM IS MADE TO THE EXCLUSIVE RIGHT TO USE "SERVICES" AND "COMPANY", APART FROM THE MARK AS SHOWN.

THE COLOR(S) BLACK, BLUE AND RED IS/ARE CLAIMED AS A FEATURE OF THE MARK.

THE MARK CONSISTS OF THE WORDS "ENA" AND "SERVICES" ARE IN BLACK, WITH THE WORD "SERVICES" BEING BELOW THE WORD "ENA". A BLUE FLOURISH, BEGINS TO THE LEFT OF AND CURVES ABOVE THE "E" IN "ENA", APPEARS TO GO THROUGH THE "N" OF "ENA" AND THE "I" OF "SERVICES", CURVING BELOW THE "CES" OF "SERVICES" AND UPWARDS TO THE RIGHT OF THE "CES" IN "SERVICES" AND THE "A" IN "ENA". BLUE FLOURISHES ALSO APPEAR IN THE SPACE INSIDE THE "V" IN THE WORD "SERVICE". BENEATH THE WORDS "ENA SERVICES" IS THE PHRASE "AN EN@ COMPANY". ALL THE LETTER IN THE WORDS OF THIS PHRASE ARE SHOWN IN BLACK WITH THE EXCEPTION OF THE AT SIGN OR "@" WHICH IS RED IN COLOR.

SER. NO. 77-464,928, FILED 5-2-2008.

ALICIA COLLINS, EXAMINING ATTORNEY

Int. Cl.: 41

Prior U.S. Cls.: 100, 101 and 107

United States Patent and Trademark Office

Reg. No. 3,575,329

Registered Feb. 17, 2009

**SERVICE MARK
PRINCIPAL REGISTER**

FIT BEGINNINGS

FIT BEGINNINGS, LLC (NEW JERSEY LIMITED
LIABILITY COMPANY)
9 HICKORY ROAD
HIGHLAND LAKES, NJ 07422

THE MARK CONSISTS OF STANDARD CHAR-
ACTERS WITHOUT CLAIM TO ANY PARTICULAR
FONT, STYLE, SIZE, OR COLOR.

FOR: PHYSICAL FITNESS CONDITIONING
CLASSES, IN CLASS 41 (U.S. CLS. 100, 101 AND 107).

SER. NO. 77-465,004, FILED 5-3-2008.

FIRST USE 10-1-2005; IN COMMERCE 10-1-2005.

PAUL F. GAST, EXAMINING ATTORNEY

Int. Cl.: 25

Prior U.S. Cls.: 22 and 39

United States Patent and Trademark Office

Reg. No. 3,575,330

Registered Feb. 17, 2009

**TRADEMARK
PRINCIPAL REGISTER**

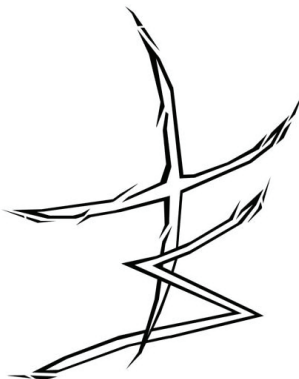

HARVEL, KEITH R (CALIFORNIA SOLE PROPRIETORSHIP), DBA TUFF SPORTS
1748 CANYON CREEK DR
ROSEVILLE, CA 95747

FOR: SHORT-SLEEVED OR LONG-SLEEVED T-SHIRTS; CREWNECK SWEATERS; SWEATERS; BERMUDA SHORTS; BOXER SHORTS; FLEECE SHORTS; GYM SHORTS; PANTIES, SHORTS AND BRIEFS; BEANIES; BASEBALL CAPS; TANK-TOPS; CARGO PANTS; DENIMS; JOGGING PANTS; LOUNGE PANTS; SNOW PANTS; SNOWBOARD

PANTS; SPORTS PANTS; STRETCH PANTS; SWEAT PANTS, IN CLASS 25 (U.S. CLS. 22 AND 39).

FIRST USE 3-10-2008; IN COMMERCE 3-10-2008.

THE MARK CONSISTS OF THE LETTERS "TS" IN STYLIZED FORM.

SER. NO. 77-465,011, FILED 5-3-2008.

STEVEN R. FINE, EXAMINING ATTORNEY

Int. Cls.: 5 and 32

Prior U.S. Cls.: 6, 18, 44, 45, 46, 48, 51 and 52

United States Patent and Trademark Office

Reg. No. 3,575,331

Registered Feb. 17, 2009

TRADEMARK
PRINCIPAL REGISTER



COVEX FARMA, S.L. (SPAIN CORPORATION)
RONDA DE VALDECARRIZO 41C, 10.
TRES CANTOS (MADRID), SPAIN 28760

FOR: DIETARY FOOD SUPPLEMENTS; DIETARY SUPPLEMENTAL DRINKS, DIETARY SUPPLEMENTS; FOOD SUPPLEMENTS; NUTRACEUTICALS FOR USE AS A DIETARY SUPPLEMENT; NUTRITIONAL SUPPLEMENTS, IN CLASS 5 (U.S. CLS. 6, 18, 44, 46, 51 AND 52).

FIRST USE 3-19-2007; IN COMMERCE 3-19-2007.

FOR: COFFEE FLAVORED SOFT DRINK; SOFT DRINKS, NAMELY, COLAS; CONCENTRATES, SYRUPS OR POWDERS USED IN THE PREPARATION OF SOFT DRINKS; FRUIT FLAVORED SOFT DRINKS; FRUIT-BASED SOFT DRINKS FLAVORED WITH TEA; FRUIT-FLAVORED DRINKS; LEMONADE; BEVERAGES, NAMELY, SMOOTHIES; CARBONATED, LOW CALORIES, AND NON-CARBONATED SOFT DRINKS; SOFT DRINKS FLAVORED WITH TEA; SPORTS DRINKS, SWEET CIDER, IN CLASS 32 (U.S. CLS. 45, 46 AND 48).

FIRST USE 3-19-2007; IN COMMERCE 3-19-2007.

OWNER OF U.S. REG. NOS. 2,834,410, 2,913,323 AND OTHERS.

NO CLAIM IS MADE TO THE EXCLUSIVE RIGHT TO USE "SWEET", APART FROM THE MARK AS SHOWN.

THE COLOR(S) BLUE, ORANGE AND WHITE IS/ ARE CLAIMED AS A FEATURE OF THE MARK.

THE MARK CONSISTS OF THE WORD "MEMOSWEET" IN STYLIZED LETTERS. THE LETTERS "MEMO" APPEAR IN WHITE WITH BLUE OUTER LINING AND THE LETTERS "E" AND THE SECOND "M" APPEAR OVER A BLUE DIAMOND SHAPE FIGURE. THE LETTERS "SWEET" APPEAR IN ORANGE COLOR.

SER. NO. 77-465,281, FILED 5-4-2008.

SUE LAWRENCE, EXAMINING ATTORNEY

Int. Cl.: 41

Prior U.S. Cls.: 100, 101 and 107

United States Patent and Trademark Office

Reg. No. 3,575,332

Registered Feb. 17, 2009

**SERVICE MARK
PRINCIPAL REGISTER**

USBGA

JONES, MICHAEL W (UNITED STATES INDIVIDUAL)
3821 TAWNY BIRCH CT
DECATUR, GA 300345142

FOR: ENTERTAINMENT IN THE NATURE OF GOLF TOURNAMENTS; GOLF INSTRUCTION; ORGANIZATION OF GOLF TOURNAMENTS; PROVIDING A WEB SITE THROUGH WHICH GOLFERS LOCATE INFORMATION ABOUT GOLF COURSES AND GOLF TOURNAMENTS; PROVIDING A WEB SITE THROUGH WHICH GOLFERS RESERVE TEE TIMES AT GOLF COURSES; PROVIDING NEWS AND INFORMATION ON THE SPORT OF GOLF;

ENTERTAINMENT IN THE NATURE OF GOLF TOURNAMENTS, IN CLASS 41 (U.S. CLS. 100, 101 AND 107).

FIRST USE 5-26-2001; IN COMMERCE 5-26-2001.

THE MARK CONSISTS OF STANDARD CHARACTERS WITHOUT CLAIM TO ANY PARTICULAR FONT, STYLE, SIZE, OR COLOR.

SER. NO. 77-465,708, FILED 5-5-2008.

TARA PATE, EXAMINING ATTORNEY

Int. Cl.: 31

Prior U.S. Cls.: 1 and 46

United States Patent and Trademark Office

Reg. No. 3,575,333

Registered Feb. 17, 2009

**TRADEMARK
PRINCIPAL REGISTER**

ROYAL GLISSADE

UNIVERSITY OF FLORIDA BOARD OF TRUSTEES (FLORIDA STATE UNIVERSITY)
PO BOX 110200
1022 MCCARTY HALL D
GAINESVILLE, FL 326110200

THE MARK CONSISTS OF STANDARD CHARACTERS WITHOUT CLAIM TO ANY PARTICULAR FONT, STYLE, SIZE, OR COLOR.

FOR: LIVE PLANTS, NAMELY, COLEUS, IN CLASS 31 (U.S. CLS. 1 AND 46).

SER. NO. 77-465,889, FILED 5-5-2008.

FIRST USE 0-0-2006; IN COMMERCE 4-0-2006.

KAREN BRACEY, EXAMINING ATTORNEY

Int. Cl.: 33

Prior U.S. Cls.: 47 and 49

United States Patent and Trademark Office

Reg. No. 3,575,334

Registered Feb. 17, 2009

**TRADEMARK
PRINCIPAL REGISTER**

THOMAS BARTON

BARTON & GUESTIER S.A.S. (FRANCE SOCIÉTÉ
PAR ACTIONS SIMPLIFIÉE (SAS))
87 RUE DU DEHEZ CHATEAU MAGNOL
BLANQUEFORT, FRANCE 33290

FOR: ALCOHOLIC BEVERAGES, NAMELY,
WINES, IN CLASS 33 (U.S. CLS. 47 AND 49).

FIRST USE 2-23-2007; IN COMMERCE 2-23-2007.

THE MARK CONSISTS OF STANDARD CHAR-
ACTERS WITHOUT CLAIM TO ANY PARTICULAR
FONT, STYLE, SIZE, OR COLOR.

OWNER OF U.S. REG. NOS. 1,546,560 AND
1,977,965.

THE NAME(S), PORTRAIT(S), AND/OR SIGNA-
TURE(S) SHOWN IN THE MARK DOES NOT IDEN-
TIFY A PARTICULAR LIVING INDIVIDUAL.

SER. NO. 77-466,114, FILED 5-5-2008.

WON TEAK OH, EXAMINING ATTORNEY

Int. Cl.: 16

Prior U.S. Cls.: 2, 5, 22, 23, 29, 37, 38 and 50

United States Patent and Trademark Office

Reg. No. 3,575,335

Registered Feb. 17, 2009

**TRADEMARK
PRINCIPAL REGISTER**

**FACES People, Places, and
Cultures**

CARUS PUBLISHING COMPANY (ILLINOIS
CORPORATION)
315 FIFTH STREET
PERU, IL 61354

FOR: CHILDREN'S ANTHROPOLOGICAL AND
EDUCATIONAL MAGAZINE, IN CLASS 16 (U.S.
CLS. 2, 5, 22, 23, 29, 37, 38 AND 50).

FIRST USE 9-1-1997; IN COMMERCE 9-1-1997.

THE MARK CONSISTS OF STANDARD CHAR-
ACTERS WITHOUT CLAIM TO ANY PARTICULAR
FONT, STYLE, SIZE, OR COLOR.

NO CLAIM IS MADE TO THE EXCLUSIVE
RIGHT TO USE "PEOPLE, PLACES AND CUL-
TURES", APART FROM THE MARK AS SHOWN.

SER. NO. 77-466,196, FILED 5-5-2008.

SEAN CROWLEY, EXAMINING ATTORNEY

Int. Cl.: 35

Prior U.S. Cls.: 100, 101 and 102

United States Patent and Trademark Office

Reg. No. 3,575,336

Registered Feb. 17, 2009

**SERVICE MARK
PRINCIPAL REGISTER**



REBEKAH YAEL GROSSMAN (UNITED STATES
INDIVIDUAL)

3A
226 E. 14TH ST
NY, NY 10003

FOR: ASSOCIATION SERVICES, NAMELY, PROMOTING THE INTERESTS OF JEWISH DEMOCRATS THROUGH A SOCIAL, CULTURAL, POLITICAL, AND RELIGIOUS NETWORKING GROUP, IN CLASS 35 (U.S. CLS. 100, 101 AND 102).

FIRST USE 1-5-2008; IN COMMERCE 1-5-2008.

THE COLOR(S) RED, BLUE, AND WHITE IS/ARE CLAIMED AS A FEATURE OF THE MARK.

THE MARK CONSISTS OF THE BLUE WORDING "DEMJEWS BUILDING OUR FUTURE, ONE JEW AT A TIME" AND DONKEY SUPERIMPOSED OVER A JEWISH STAR; THE UPPER PART OF THE DONKEY IS IN BLUE WITH THREE WHITE STARS, AND THE LOWER PART OF THE DONKEY IS IN RED.

SER. NO. 77-466,561, FILED 5-6-2008.

JORDAN BAKER, EXAMINING ATTORNEY

Int. Cl.: 37

Prior U.S. Cls.: 100, 103 and 106

United States Patent and Trademark Office

Reg. No. 3,575,337

Registered Feb. 17, 2009

**SERVICE MARK
PRINCIPAL REGISTER**

**An eco-friendly place to
live, work and play.**

BICYCLE CITY LLC (DELAWARE LIMITED
LIABILITY COMPANY)
SUITE 203
6740 CLOUGH PIKE
CINCINNATI, OH 45244

FOR: LAND DEVELOPMENT SERVICES, NAME-
LY, PLANNING AND LAYING OUT OF RESIDEN-
TIAL AND/OR COMMERCIAL COMMUNITIES;
REAL ESTATE DEVELOPMENT , IN CLASS 37
(U.S. CLS. 100, 103 AND 106).

FIRST USE 6-30-2007; IN COMMERCE 6-30-2007.

THE MARK CONSISTS OF STANDARD CHAR-
ACTERS WITHOUT CLAIM TO ANY PARTICULAR
FONT, STYLE, SIZE, OR COLOR.

SER. NO. 77-466,803, FILED 5-6-2008.

THOMAS MANOR, EXAMINING ATTORNEY

Int. Cl.: 35

Prior U.S. Cls.: 100, 101 and 102

United States Patent and Trademark Office

Reg. No. 3,575,338

Registered Feb. 17, 2009

**SERVICE MARK
PRINCIPAL REGISTER**



PATTERSON, LORI (UNITED STATES INDIVIDUAL)
1156 ADONIS COURT
ST. PETERS, MO 63376

FOR: BUSINESS CONSULTATION SERVICES, NAMELY, PROVIDING BUSINESS MODEL CONSULTATION TO GROUP PHYSICAL FITNESS TRAINING AND INSTRUCTION BUSINESSES, IN CLASS 35 (U.S. CLS. 100, 101 AND 102).

FIRST USE 4-1-2006; IN COMMERCE 4-1-2006.

OWNER OF U.S. REG. NOS. 3,428,502 AND 3,428,506.

NO CLAIM IS MADE TO THE EXCLUSIVE RIGHT TO USE "BOOT CAMP", APART FROM THE MARK AS SHOWN.

SER. NO. 77-467,114, FILED 5-6-2008.

WILLIAM VERHOSEK, EXAMINING ATTORNEY

Int. Cl.: 20

Prior U.S. Cls.: 2, 13, 22, 25, 32 and 50

United States Patent and Trademark Office

Reg. No. 3,575,339

Registered Feb. 17, 2009

**TRADEMARK
PRINCIPAL REGISTER**

AXIOM 1

JEFFCO FIBRES, INC., (MASSACHUSETTS COR-
PORATION)
12 PARK ST.
WEBSTER, MA 01570

THE MARK CONSISTS OF STANDARD CHAR-
ACTERS WITHOUT CLAIM TO ANY PARTICULAR
FONT, STYLE, SIZE, OR COLOR.

FOR: MATTRESS TOPPERS; MATTRESSES, IN
CLASS 20 (U.S. CLS. 2, 13, 22, 25, 32 AND 50).

SER. NO. 77-467,124, FILED 5-6-2008.

FIRST USE 3-1-2007; IN COMMERCE 3-1-2007.

MELVIN AXILBUND, EXAMINING ATTORNEY

Int. Cl.: 28

Prior U.S. Cls.: 22, 23, 38 and 50

United States Patent and Trademark Office

Reg. No. 3,575,340

Registered Feb. 17, 2009

**TRADEMARK
PRINCIPAL REGISTER**



KENON INC. (CALIFORNIA CORPORATION)
135 E. SANTA CLARA STREET, SUITE D
ARCADIA, CA 91006

FOR: RADIO CONTROLLED TOY VEHICLES, IN
CLASS 28 (U.S. CLS. 22, 23, 38 AND 50).

FIRST USE 6-30-2002; IN COMMERCE 1-1-2004.

NO CLAIM IS MADE TO THE EXCLUSIVE
RIGHT TO USE "RACING", APART FROM THE
MARK AS SHOWN.

THE COLOR(S) ORANGE AND BLACK IS/ARE
CLAIMED AS A FEATURE OF THE MARK.

THE MARK CONSISTS OF THE COLORS OR-
ANGE AND BLACK. THE COLOR ORANGE AP-
PEARS IN THE STYLIZED LETTERS "PN", THE
COLOR BLACK APPEARS IN THE STYLIZED
TERMS "PN RACING". THE COLOR WHITE IN
THE MARK IS FOR BACKGROUND PURPOSES
ONLY AND IS NOT CLAIMED AS A FEATURE OF
THE MARK.

SER. NO. 77-467,290, FILED 5-6-2008.

CHRISTINE BLOMQUIST, EXAMINING ATTOR-
NEY

Int. Cls.: 9 and 10

Prior U.S. Cls.: 21, 23, 26, 36, 38, 39 and 44

United States Patent and Trademark Office

Reg. No. 3,575,341

Registered Feb. 17, 2009

**TRADEMARK
PRINCIPAL REGISTER**

MIDKNIGHT

MICROFLEX CORPORATION (DELAWARE
CORPORATION)
2301 ROBB DRIVE
RENO, NV 89523

FOR: PROTECTIVE GLOVES FOR INDUSTRIAL
USE, IN CLASS 9 (U.S. CLS. 21, 23, 26, 36 AND 38).

FIRST USE 11-20-2007; IN COMMERCE 11-20-2007.

FOR: DISPOSABLE GLOVES FOR MEDICAL USE
AND DENTAL USE, IN CLASS 10 (U.S. CLS. 26, 39
AND 44).

FIRST USE 11-20-2007; IN COMMERCE 11-20-2007.

THE MARK CONSISTS OF STANDARD CHAR-
ACTERS WITHOUT CLAIM TO ANY PARTICULAR
FONT, STYLE, SIZE, OR COLOR.

SER. NO. 77-467,402, FILED 5-6-2008.

SIMON TENG, EXAMINING ATTORNEY

Int. Cl.: 9

Prior U.S. Cls.: 21, 23, 26, 36 and 38

Reg. No. 3,575,342

United States Patent and Trademark Office

Registered Feb. 17, 2009

**TRADEMARK
PRINCIPAL REGISTER**

PROPHIT

ADVANCED MICRO APPLICATIONS, INC. (CALIFORNIA CORPORATION)
1555 HAWK VIEW DRIVE
ENCINITAS, CA 92024

THE MARK CONSISTS OF STANDARD CHARACTERS WITHOUT CLAIM TO ANY PARTICULAR FONT, STYLE, SIZE, OR COLOR.

FOR: COMPUTER SOFTWARE FOR USE IN FINANCIAL MODELING SOLD AS AN INTEGRAL COMPONENT OF CUSTOMIZED INDUSTRY-SPECIFIC CORPORATE OR ENTERPRISE SOFTWARE APPLICATIONS, IN CLASS 9 (U.S. CLS. 21, 23, 26, 36 AND 38).

OWNER OF U.S. REG. NO. 952,915.

SER. NO. 77-467,444, FILED 5-6-2008.

FIRST USE 0-0-1986; IN COMMERCE 0-0-1986.

ALYSSA STEEL, EXAMINING ATTORNEY

Int. Cl.: 37

Prior U.S. Cls.: 100, 103 and 106

United States Patent and Trademark Office

Reg. No. 3,575,343

Registered Feb. 17, 2009

**SERVICE MARK
PRINCIPAL REGISTER**

**Designed for people,
animals and the earth.**

BICYCLE CITY LLC (DELAWARE LIMITED
LIABILITY COMPANY)
SUITE 203
6740 CLOUGH PIKE
CINCINNATI, OH 45244

FOR: LAND DEVELOPMENT SERVICES, NAME-
LY, PLANNING AND LAYING OUT OF RESIDEN-
TIAL AND/OR COMMERCIAL COMMUNITIES;
REAL ESTATE DEVELOPMENT , IN CLASS 37
(U.S. CLS. 100, 103 AND 106).

FIRST USE 6-30-2007; IN COMMERCE 6-30-2007.

THE MARK CONSISTS OF STANDARD CHAR-
ACTERS WITHOUT CLAIM TO ANY PARTICULAR
FONT, STYLE, SIZE, OR COLOR.

SER. NO. 77-467,687, FILED 5-7-2008.

THOMAS MANOR, EXAMINING ATTORNEY

Int. Cl.: 41

Prior U.S. Cls.: 100, 101 and 107

United States Patent and Trademark Office

Reg. No. 3,575,344

Registered Feb. 17, 2009

**SERVICE MARK
PRINCIPAL REGISTER**

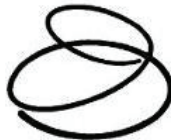

GLOBAL CREATIVE LEADERSHIP SUMMIT

LOUISE T. BLOUIN FOUNDATION (UNITED
KINGDOM NON-PROFIT CORPORATION)
3 OLAF STREET
LONDON W111 4BE, UNITED KINGDOM

NO CLAIM IS MADE TO THE EXCLUSIVE
RIGHT TO USE "GLOBAL" AND "LEADERSHIP
SUMMIT", APART FROM THE MARK AS SHOWN.

FOR: ORGANIZATION OF CONFERENCES AND
SYMPOSIA IN THE FIELD OF GLOBALIZATION,
THE ENVIRONMENT AND FOREIGN POLICY, IN
CLASS 41 (U.S. CLS. 100, 101 AND 107).

SER. NO. 77-467,694, FILED 5-7-2008.

FIRST USE 5-31-2006; IN COMMERCE 5-31-2006.

DAWN HAN, EXAMINING ATTORNEY

Int. Cl.: 38

Prior U.S. Cls.: 100, 101 and 104

United States Patent and Trademark Office

Reg. No. 3,575,345

Registered Feb. 17, 2009

**SERVICE MARK
PRINCIPAL REGISTER**

ASME PEERLINK

THE AMERICAN SOCIETY OF MECHANICAL
ENGINEERS (NEW YORK NON-PROFIT COR-
PORATION)

THREE PARK AVENUE
NEW YORK, NY 100165990

FOR: PROVIDING ON-LINE FORUMS FOR THE
EXCHANGE OF MESSAGES ON THE SUBJECTS OF
SCIENCE, ENGINEERING, MANUFACTURING,
PRODUCT DESIGN, INDUSTRY, AND PROFES-
SIONAL DEVELOPMENT IN THE SAME FIELDS,
IN CLASS 38 (U.S. CLS. 100, 101 AND 104).

FIRST USE 4-7-2008; IN COMMERCE 4-7-2008.

THE MARK CONSISTS OF STANDARD CHAR-
ACTERS WITHOUT CLAIM TO ANY PARTICULAR
FONT, STYLE, SIZE, OR COLOR.

OWNER OF U.S. REG. NOS. 1,174,662, 3,015,964
AND OTHERS.

NO CLAIM IS MADE TO THE EXCLUSIVE
RIGHT TO USE "PEERLINK", APART FROM THE
MARK AS SHOWN.

SER. NO. 77-468,177, FILED 5-7-2008.

MATTHEW PAPPAS, EXAMINING ATTORNEY

Int. Cl.: 25

Prior U.S. Cls.: 22 and 39

United States Patent and Trademark Office

Reg. No. 3,575,346

Registered Feb. 17, 2009

**TRADEMARK
PRINCIPAL REGISTER**

FRESHPINK

FRESHPAIR, INC. (DELAWARE CORPORATION)
611 BROADWAY, SUITE 523
NEW YORK, NY 10012

FOR: CLOTHING, NAMELY, T-SHIRTS, UNDER-
SHIRTS, UNDERWEAR, BOXERS AND BRIEFS, IN
CLASS 25 (U.S. CLS. 22 AND 39).

FIRST USE 5-1-2008; IN COMMERCE 5-1-2008.

THE MARK CONSISTS OF STANDARD CHAR-
ACTERS WITHOUT CLAIM TO ANY PARTICULAR
FONT, STYLE, SIZE, OR COLOR.

OWNER OF U.S. REG. NO. 2,759,415.

SER. NO. 77-468,531, FILED 5-7-2008.

STEVEN JACKSON, EXAMINING ATTORNEY

Int. Cl.: 41

Prior U.S. Cls.: 100, 101 and 107

United States Patent and Trademark Office

Reg. No. 3,575,347

Registered Feb. 17, 2009

**SERVICE MARK
PRINCIPAL REGISTER**

ZYDEFEST

BOYD GAMING CORPORATION (NEVADA
CORPORATION)
ATTN: MR. LOU NUNZIATA
6465 SOUTH RAINBOW BOULEVARD
LAS VEGAS, NV 89118

FOR: ENTERTAINMENT IN THE NATURE OF
CULTURAL FESTIVALS, CREOLE FESTIVALS,
LIVE BANDS AND LIVE MUSIC, LIVE DANCING,
DANCES, HERITAGE MARKETS AND BOOTHS
THAT DISTRIBUTE LITERATURE AND INFOR-
MATION ON CREOLE AND ZYDECO MUSIC, IN
CLASS 41 (U.S. CLS. 100, 101 AND 107).

FIRST USE 6-15-2006; IN COMMERCE 6-15-2006.

THE MARK CONSISTS OF STANDARD CHAR-
ACTERS WITHOUT CLAIM TO ANY PARTICULAR
FONT, STYLE, SIZE, OR COLOR.

SER. NO. 77-468,649, FILED 5-7-2008.

ROBERT C. CLARK JR., EXAMINING ATTORNEY

Int. Cl.: 37

Prior U.S. Cls.: 100, 103 and 106

United States Patent and Trademark Office

Reg. No. 3,575,348

Registered Feb. 17, 2009

**SERVICE MARK
PRINCIPAL REGISTER**



COASTAL GENERAL CONTRACTORS LLC
(SOUTH CAROLINA LIMITED LIABILITY
COMPANY), DBA COASTAL STEEL & ACOUS-
TICS

7011 HWY 90
LONGS, SC 29568

FOR: DRYWALL CONTRACTOR SERVICES;
FRAMING CONTRACTOR SERVICES, IN CLASS
37 (U.S. CLS. 100, 103 AND 106).

FIRST USE 7-1-2004; IN COMMERCE 7-1-2004.

NO CLAIM IS MADE TO THE EXCLUSIVE
RIGHT TO USE "STEEL & ACOUSTICS", APART
FROM THE MARK AS SHOWN.

THE MARK CONSISTS OF WORDING "CSA
COASTAL STEEL & ACOUSTICS BUILDING ON
OUR REPUTATION OF EXCELLENCE". A SINGLE
LINE APPEARS UNDER THE WORD "COASTAL".

SER. NO. 77-468,837, FILED 5-8-2008.

DAVID MURRAY, EXAMINING ATTORNEY

Int. Cl.: 12

Prior U.S. Cls.: 19, 21, 23, 31, 35 and 44

Reg. No. 3,575,349

United States Patent and Trademark Office

Registered Feb. 17, 2009

**TRADEMARK
PRINCIPAL REGISTER**

SANTA CRUZ YACHTS

SANTA CRUZ YACHTS, INC. (FLORIDA CORPORATION)

124 HARBOURMASTER COURT

PONTE VEDRA BEACH, FL 32082

FOR: SAILBOATS AND POWER BOATS, IN CLASS 12 (U.S. CLS. 19, 21, 23, 31, 35 AND 44).

FIRST USE 0-0-1971; IN COMMERCE 0-0-1971.

THE MARK CONSISTS OF STANDARD CHARACTERS WITHOUT CLAIM TO ANY PARTICULAR FONT, STYLE, SIZE, OR COLOR.

NO CLAIM IS MADE TO THE EXCLUSIVE RIGHT TO USE "YACHTS", APART FROM THE MARK AS SHOWN.

SER. NO. 77-469,220, FILED 5-8-2008.

KIMBERLY PERRY, EXAMINING ATTORNEY

Int. Cl.: 35

Prior U.S. Cls.: 100, 101 and 102

United States Patent and Trademark Office

Reg. No. 3,575,350

Registered Feb. 17, 2009

**SERVICE MARK
PRINCIPAL REGISTER**

SERVICESTYLE

SEARS BRANDS, LLC (ILLINOIS LIMITED LIABILITY COMPANY)
3333 BEVERLY ROAD
HOFFMAN ESTATES, IL 60179

FOR: ELECTRONIC CATALOG SERVICES FEATURING CLOTHING, CLOTHING ACCESSORIES AND FOOTWEAR, IN CLASS 35 (U.S. CLS. 100, 101 AND 102).

FIRST USE 6-3-2008; IN COMMERCE 6-3-2008.

THE MARK CONSISTS OF STANDARD CHARACTERS WITHOUT CLAIM TO ANY PARTICULAR FONT, STYLE, SIZE, OR COLOR.

SER. NO. 77-469,569, FILED 5-8-2008.

CHRISTINE COOPER, EXAMINING ATTORNEY

Int. Cl.: 9

Prior U.S. Cls.: 21, 23, 26, 36 and 38

United States Patent and Trademark Office

Reg. No. 3,575,351

Registered Feb. 17, 2009

**TRADEMARK
PRINCIPAL REGISTER**

MACE

DRAGON OPTICAL, INC. (WASHINGTON CORPORATION)
5803 NEWTON DRIVE, SUITE C
CARLSBAD, WA 92008

FOR: GOGGLES FOR SNOW SPORTS AND PARTS AND ACCESSORIES THEREFORE, NAMELY, REPLACEMENT LENSES, STRAPS, NOSE PIECES AND FOAM STRIPS; AND CASES SPECIALLY ADAPTED FOR GOGGLES, IN CLASS 9 (U.S. CLS. 21, 23, 26, 36 AND 38).

FIRST USE 8-31-2005; IN COMMERCE 8-31-2005.

THE MARK CONSISTS OF STANDARD CHARACTERS WITHOUT CLAIM TO ANY PARTICULAR FONT, STYLE, SIZE, OR COLOR.

OWNER OF U.S. REG. NO. 2,217,561.

SER. NO. 77-469,650, FILED 5-8-2008.

RONALD AIKENS, EXAMINING ATTORNEY

Int. Cls.: 37 and 42

Prior U.S. Cls.: 100, 101, 103 and 106

United States Patent and Trademark Office

Reg. No. 3,575,352

Registered Feb. 17, 2009

**SERVICE MARK
PRINCIPAL REGISTER**



PHILADELPHIA GEAR CORPORATION (PENN-
SYLVANIA CORPORATION)
CEDAR RUN CORPORATE CENTER
901 EAST 8TH AVE., SUITE 100
KING OF PRUSSIA, PA 19406

FOR: MAINTENANCE AND REPAIR SERVICES FOR GEAR BOXES, MIXER DRIVERS, IMPELLERS, AND AERATORS IN THE FIELDS OF PROCESS SOLUTIONS, INDUSTRIAL MIXING, AERATION, AND WASTE TREATMENT; OVERHAUL SERVICES, NAMELY, COMPREHENSIVE REPAIR OF GEAR BOXES, MIXER DRIVERS, IMPELLERS, AND AERATORS IN THE FIELDS OF PROCESS SOLUTIONS, INDUSTRIAL MIXING, AERATION, AND WASTE TREATMENT; MAINTENANCE AND REPAIR SERVICES, NAMELY, INSTALLING MECHANICAL UPGRADES FOR GEAR BOXES, MIXER DRIVERS, IMPELLERS, AND AERATORS IN THE FIELDS OF PROCESS SOLUTIONS, INDUSTRIAL MIXING, AERATION, AND WASTE TREATMENT; MAINTENANCE AND REPAIR SERVICES, NAMELY, MAINTAINING AND CORRECTING THE MECHANICAL ALIGNMENT OF GEAR BOXES, MIXER DRIVERS, IMPELLERS, AND AERATORS IN THE FIELDS OF PROCESS SOLUTIONS, INDUSTRIAL MIXING, AERATION, AND WASTE TREATMENT, IN CLASS 37 (U.S. CLS. 100, 103 AND 106).

FIRST USE 3-4-2008; IN COMMERCE 3-4-2008.

FOR: TECHNICAL SERVICES IN THE FIELDS OF PROCESS SOLUTIONS, INDUSTRIAL MIXING, AERATION, AND WASTE TREATMENT, NAMELY,

PROVIDING DIAGNOSTIC SERVICES FOR GEAR BOXES, MIXER DRIVERS, IMPELLERS, AND AERATORS, IN CLASS 42 (U.S. CLS. 100 AND 101).

FIRST USE 3-4-2008; IN COMMERCE 3-4-2008.

OWNER OF U.S. REG. NOS. 2,910,298, 2,926,858 AND OTHERS.

NO CLAIM IS MADE TO THE EXCLUSIVE RIGHT TO USE "GEAR" AND "ONSITE TECHNICAL SERVICES", APART FROM THE MARK AS SHOWN.

THE COLOR(S) BLACK, RED, AND GRAY IS/ ARE CLAIMED AS A FEATURE OF THE MARK.

THE MARK CONSISTS OF THE WORDS "PHILADELPHIA GEAR" IN BLACK ABOVE THE LETTERS "OTS" IN RED, WHEREBY THE LETTER "O" IS SHAPED LIKE A GEAR AND HAS A BLACK WRENCH IN THE CENTER, WHICH IS ABOVE THE WORDS "ONSITE TECHNICAL SERVICES" IN BLACK. THE AFOREMENTIONED WORDING IS SUPERIMPOSED OVER ADJACENT HALVES OF TWO GEARS, BOTH IN GRAY.

SEC. 2(F) AS TO "PHILADELPHIA".

SER. NO. 77-470,138, FILED 5-9-2008.

ROBERT LAVACHE, EXAMINING ATTORNEY

Int. Cls.: 16, 18 and 20

**Prior U.S. Cls.: 1, 2, 3, 5, 13, 22, 23, 25, 29, 32, 37, 38,
41 and 50**

United States Patent and Trademark Office

Reg. No. 3,575,353

Registered Feb. 17, 2009

**TRADEMARK
PRINCIPAL REGISTER**

SOF-TOUCH

QUIKEY MANUFACTURING CO., INC. (OHIO CORPORATION)
1500 INDUSTRIAL PARKWAY
AKRON, OH 44310

FOR: A PLASTIC MATERIAL SOLD AS AN INTEGRAL PART OF DESK STANDS AND PLASTIC PEN HOLDERS FOR LANYARDS, IN CLASS 16 (U.S. CLS. 2, 5, 22, 23, 29, 37, 38 AND 50).

FIRST USE 4-22-2008; IN COMMERCE 4-22-2008.

FOR: A PLASTIC MATERIAL SOLD AS AN INTEGRAL PART OF LUGGAGE TAGS, FLEXIBLE COIN PURSES, BUSINESS CARD CASES, AND ID TAGS FOR LUGGAGE, IN CLASS 18 (U.S. CLS. 1, 2, 3, 22 AND 41).

FIRST USE 4-21-2008; IN COMMERCE 4-21-2008.

FOR: A PLASTIC MATERIAL SOLD AS AN INTEGRAL PART OF PLASTIC KEY TAGS, AND MIRRORS, IN CLASS 20 (U.S. CLS. 2, 13, 22, 25, 32 AND 50).

FIRST USE 4-18-2008; IN COMMERCE 4-18-2008.

THE MARK CONSISTS OF STANDARD CHARACTERS WITHOUT CLAIM TO ANY PARTICULAR FONT, STYLE, SIZE, OR COLOR.

SER. NO. 77-470,252, FILED 5-9-2008.

CYNTHIA SLOAN, EXAMINING ATTORNEY

Int. Cl.: 5

Prior U.S. Cls.: 6, 18, 44, 46, 51 and 52

United States Patent and Trademark Office

Reg. No. 3,575,354

Registered Feb. 17, 2009

**TRADEMARK
PRINCIPAL REGISTER**



CELGENE CORPORATION (DELAWARE CORPORATION)
86 MORRIS AVENUE
SUMMIT, NJ 07901

FOR: PHARMACEUTICAL PREPARATIONS
USED TO TREAT CANCERS AND IMMUNE RELATED DISEASES, IN CLASS 5 (U.S. CLS. 6, 18, 44, 46, 51 AND 52).

PRIORITY CLAIMED UNDER SEC. 44(D) ON
SWITZERLAND APPLICATION NO. 55620/2008,
FILED 4-30-2008, REG. NO. 575991, DATED 4-30-
2008, EXPIRES 4-30-2018.

OWNER OF U.S. REG. NOS. 2,691,321, 3,171,609
AND OTHERS.

NO CLAIM IS MADE TO THE EXCLUSIVE
RIGHT TO USE "THALIDOMIDE", APART FROM
THE MARK AS SHOWN.

THE MARK CONSISTS OF THE WORDS "THA-
LIDOMIDE PHARMION" APPEARING IN BLACK
LETTERS TO THE RIGHT.

SER. NO. 77-470,287, FILED 5-9-2008.

SUSAN LESLIE DUBOIS, EXAMINING ATTORNEY

Int. Cl.: 35

Prior U.S. Cls.: 100, 101 and 102

United States Patent and Trademark Office

Reg. No. 3,575,355

Registered Feb. 17, 2009

**SERVICE MARK
PRINCIPAL REGISTER**

The logo for NextWine features the word "next" in a lowercase, sans-serif font, followed by a stylized "T" that incorporates a wine opener. To the right of the "T" is the word "WINE" in a bold, uppercase, sans-serif font.

BENCHMARK WINE GROUP, INC (CALIFORNIA CORPORATION)
474 TECHNOLOGY WAY
NAPA, CA 94558

FOR: ONLINE WHOLESALE AND RETAIL STORE SERVICES FEATURING WINE AND SPIRITS; RETAIL AND WHOLESALE STORE SERVICES, AND DISTRIBUTORSHIP SERVICES FEATURING WINES AND SPIRITS , IN CLASS 35 (U.S. CLS. 100, 101 AND 102).

FIRST USE 12-15-1999; IN COMMERCE 9-7-2000.

THE MARK CONSISTS OF "NEXTWINE" WITH A COMBINATION OF TYPE STYLES AND A WINE OPENER AS THE "T" IN "NEXTWINE".

SER. NO. 77-470,307, FILED 5-9-2008.

SANJEEV VOHRA, EXAMINING ATTORNEY

Int. Cl.: 16

Prior U.S. Cls.: 2, 5, 22, 23, 29, 37, 38 and 50

United States Patent and Trademark Office

Reg. No. 3,575,356

Registered Feb. 17, 2009

**TRADEMARK
PRINCIPAL REGISTER**

Footnotes for life

THE EXECUTORS OF THE KATHLEEN J. SMITH
REVOCABLE TRUST DATED APRIL 15, 1996,
AS AMENDED. (KANSAS TRUST)
PO BOX 860525
SHAWNEE, KS 662860525

FOR: A SERIES OF BOOKS AND WRITTEN
ARTICLES IN THE FIELD OF LIFESTYLE WELL-
NESS, SELF-ESTEEM AND INSPIRATIONAL STOR-
IES, IN CLASS 16 (U.S. CLS. 2, 5, 22, 23, 29, 37, 38 AND
50).

FIRST USE 3-24-2008; IN COMMERCE 4-27-2008.

THE MARK CONSISTS OF STANDARD CHAR-
ACTERS WITHOUT CLAIM TO ANY PARTICULAR
FONT, STYLE, SIZE, OR COLOR.

SER. NO. 77-470,548, FILED 5-9-2008.

RENEE SERVANCE, EXAMINING ATTORNEY

Int. Cl.: 37

Prior U.S. Cls.: 100, 103 and 106

United States Patent and Trademark Office

Reg. No. 3,575,357

Registered Feb. 17, 2009

**SERVICE MARK
PRINCIPAL REGISTER**

**BUILDING GOODNESS
FOUNDATION**

BUILDING GOODNESS FOUNDATION (VIRGINIA CORPORATION)
PO BOX 4325
CHARLOTTESVILLE, VA 22905

FOR: CONSTRUCTION AND RENOVATION OF BUILDINGS FOR COMMUNITIES IN NEED USING SKILLED AND UNSKILLED VOLUNTEERS, IN CLASS 37 (U.S. CLS. 100, 103 AND 106).

FIRST USE 10-17-2000; IN COMMERCE 10-17-2000.

THE MARK CONSISTS OF STANDARD CHARACTERS WITHOUT CLAIM TO ANY PARTICULAR FONT, STYLE, SIZE, OR COLOR.

NO CLAIM IS MADE TO THE EXCLUSIVE RIGHT TO USE "FOUNDATION", APART FROM THE MARK AS SHOWN.

SER. NO. 77-470,655, FILED 5-9-2008.

DOMINICK J. SALEMI, EXAMINING ATTORNEY

Int. Cl.: 36

Prior U.S. Cls.: 100, 101 and 102

United States Patent and Trademark Office

Reg. No. 3,575,358

Registered Feb. 17, 2009

**SERVICE MARK
PRINCIPAL REGISTER**

PRE-TRADE ANALYST

QUANTITATIVE SERVICES GROUP LLC (ILLINOIS LIMITED LIABILITY COMPANY)

SUITE 334

1560 WALL STREET

NAPERVILLE, IL 60563

FOR: FINANCIAL SERVICES, NAMELY, ANALYZING SECURITIES TRADE TRANSACTION COSTS, IN CLASS 36 (U.S. CLS. 100, 101 AND 102).

FIRST USE 6-6-2001; IN COMMERCE 6-6-2001.

THE MARK CONSISTS OF STANDARD CHARACTERS WITHOUT CLAIM TO ANY PARTICULAR FONT, STYLE, SIZE, OR COLOR.

NO CLAIM IS MADE TO THE EXCLUSIVE RIGHT TO USE "ANALYST", APART FROM THE MARK AS SHOWN.

SEC. 2(F).

SER. NO. 77-470,841, FILED 5-9-2008.

MAYUR VAGHANI, EXAMINING ATTORNEY

Int. Cl.: 36

Prior U.S. Cls.: 100, 101 and 102

United States Patent and Trademark Office

Reg. No. 3,575,359

Registered Feb. 17, 2009

**SERVICE MARK
PRINCIPAL REGISTER**

FACTOR ANALYST

QUANTITATIVE SERVICES GROUP LLC (ILLINOIS LIMITED LIABILITY COMPANY)
SUITE 334
1560 WALL STREET
NAPERVILLE, IL 60563

FOR: FINANCIAL SERVICES, NAMELY, RESEARCHING AND REPORTING STOCK PERFORMANCE BASED ON SELECTED CRITERIA, IN CLASS 36 (U.S. CLS. 100, 101 AND 102).

FIRST USE 6-6-2001; IN COMMERCE 6-6-2001.

THE MARK CONSISTS OF STANDARD CHARACTERS WITHOUT CLAIM TO ANY PARTICULAR FONT, STYLE, SIZE, OR COLOR.

NO CLAIM IS MADE TO THE EXCLUSIVE RIGHT TO USE "ANALYST", APART FROM THE MARK AS SHOWN.

SEC. 2(F).

SER. NO. 77-470,860, FILED 5-9-2008.

MAYUR VAGHANI, EXAMINING ATTORNEY

Int. Cl.: 36

Prior U.S. Cls.: 100, 101 and 102

United States Patent and Trademark Office

Reg. No. 3,575,360

Registered Feb. 17, 2009

**SERVICE MARK
PRINCIPAL REGISTER**

VIRTUAL RESEARCH ANALYST

QUANTITATIVE SERVICES GROUP LLC (ILLINOIS LIMITED LIABILITY COMPANY)
SUITE 334
1560 WALL STREET
NAPERVILLE, IL 60563

FOR: FINANCIAL SERVICES, NAMELY, RESEARCHING AND REPORTING CUSTOMIZED STOCK SELECTION SOLUTIONS, IN CLASS 36 (U.S. CLS. 100, 101 AND 102).

FIRST USE 6-6-2001; IN COMMERCE 6-6-2001.

THE MARK CONSISTS OF STANDARD CHARACTERS WITHOUT CLAIM TO ANY PARTICULAR FONT, STYLE, SIZE, OR COLOR.

NO CLAIM IS MADE TO THE EXCLUSIVE RIGHT TO USE "RESEARCH ANALYST", APART FROM THE MARK AS SHOWN.

SEC. 2(F).

SER. NO. 77-470,878, FILED 5-9-2008.

MAYUR VAGHANI, EXAMINING ATTORNEY

Int. Cl.: 42

Prior U.S. Cls.: 100 and 101

United States Patent and Trademark Office

Reg. No. 3,575,361

Registered Feb. 17, 2009

**SERVICE MARK
PRINCIPAL REGISTER**

MICROPLUMBERS

MICROPLUMBERS MICROFLUIDIC SCIENCES
LLC (WASHINGTON LIMITED LIABILITY
COMPANY), DBA MICROPLUMBERS LLC
915 217TH STREET SW
BOTHELL, WA 98021

FOR: PRODUCT DEVELOPMENT AND DESIGN
SERVICES IN THE FIELD OF SMALL MICROFLUI-
DIC DEVICES USED FOR SENSING OR MEASURE-
MENT AND CONTAINING MINIATURE FLUID-
FILLED CHANNELS HAVING AT LEAST ONE
DIMENSION SMALLER THAN A MILLIMETER,
IN CLASS 42 (U.S. CLS. 100 AND 101).

FIRST USE 9-23-2002; IN COMMERCE 9-28-2002.

THE MARK CONSISTS OF STANDARD CHAR-
ACTERS WITHOUT CLAIM TO ANY PARTICULAR
FONT, STYLE, SIZE, OR COLOR.

SER. NO. 77-471,110, FILED 5-10-2008.

CARRIE GENOVESE, EXAMINING ATTORNEY

Int. Cls.: 7 and 9

Prior U.S. Cls.: 13, 19, 21, 23, 26, 31, 34, 35, 36 and 38

United States Patent and Trademark Office

Reg. No. 3,575,362

Registered Feb. 17, 2009

**TRADEMARK
PRINCIPAL REGISTER**

ADI

AIR DIMENSIONS, INC. (FLORIDA CORPORATION)

SUITE 101

1371 WEST NEWPORT CENTER DRIVE

DEERFIELD BEACH, FL 33442

FOR: MOTOR DRIVEN AIR PUMPS; DIAPHRAGM PUMPS; DIAPHRAGM COMPRESSORS; VACUUM PUMPS; PUMPS FOR TAKING GAS SAMPLES WHICH ARE THEN ANALYZED, IN CLASS 7 (U.S. CLS. 13, 19, 21, 23, 31, 34 AND 35).

FIRST USE 4-7-1978; IN COMMERCE 4-7-1978.

FOR: SAMPLING PUMPS FOR PERFORMING GAS SAMPLE ANALYSIS, IN CLASS 9 (U.S. CLS. 21, 23, 26, 36 AND 38).

FIRST USE 0-0-1978; IN COMMERCE 0-0-1978.

THE MARK CONSISTS OF STANDARD CHARACTERS WITHOUT CLAIM TO ANY PARTICULAR FONT, STYLE, SIZE, OR COLOR.

OWNER OF U.S. REG. NO. 1,240,012.

SER. NO. 77-471,752, FILED 5-12-2008.

KAREN K. BUSH, EXAMINING ATTORNEY

Int. Cl.: 17

Prior U.S. Cls.: 1, 5, 12, 13, 35 and 50

Reg. No. 3,575,363

United States Patent and Trademark Office

Registered Feb. 17, 2009

**TRADEMARK
PRINCIPAL REGISTER**

711

DIVERSIFIED SPECIALTIES, INC. (MINNESOTA CORPORATION)
14551 JUDICIAL ROAD, SUITE 115
BURNSVILLE, MN 55306

FOR: ADHESIVE SEALANTS FOR GENERAL USE TO SEAL STEEL, GLASS, CERAMIC TILE, WOOD, BRICK, STONE, CINDER BLOCK, CONCRETE, FIBERGLASS, PLASTICS, RUBBER AND SPONGE, IN CLASS 17 (U.S. CLS. 1, 5, 12, 13, 35 AND 50).

FIRST USE 7-0-1980; IN COMMERCE 7-0-1980.

THE MARK CONSISTS OF STANDARD CHARACTERS WITHOUT CLAIM TO ANY PARTICULAR FONT, STYLE, SIZE, OR COLOR.

SER. NO. 77-471,847, FILED 5-12-2008.

ZHALEH DELANEY, EXAMINING ATTORNEY

Int. Cl.: 9

Prior U.S. Cls.: 21, 23, 26, 36 and 38

Reg. No. 3,575,364

United States Patent and Trademark Office

Registered Feb. 17, 2009

TRADEMARK
PRINCIPAL REGISTER

UniPhyer

PHYBRIDGE INC. (CANADA CORPORATION)
SUITE 37
1200 SPEERS ROAD
OAKVILLE, CANADA L6L2X4

FOR: AUTOMATIC SWITCHING APPARATUS, CHANGE-OVER SWITCHES, COMPUTER HARDWARE FOR TELECOMMUNICATIONS, SIGNAL BAND SEPARATORS FOR USE IN TELECOMMUNICATIONS APPLICATIONS, TELECOMMUNICATION SWITCHES, CONTINGENCY RESPONSE COMMUNICATION SYSTEM DESIGNED TO PROVIDE RADIO INTEROPERABILITY, STREAMING VIDEO, WIRELESS INTERNET, AND VOIP PHONE, TELECOMMUNICATIONS AND DATA NETWORKING HARDWARE, NAMELY, DEVICES FOR TRANSPORTING AND AGGREGATING VOICE, DATA, AND VIDEO COMMUNICATIONS ACROSS MULTIPLE NETWORK INFRASTRUCTURES AND COMMUNICATIONS PROTOCOLS, ETHERNET SWITCHES, ETHERNET TRANSCEIVERS, COMPUTER NETWORK ADAPTERS, SWITCHES, ROUTERS AND HUBS, COMPUTER NETWORK BRIDGES, COMPUTER NETWORK HUBS, SWITCHES AND ROUTERS, LAN (LOCAL AREA NETWORK) HARDWARE, LAN (LOCAL AREA NETWORK) ACCESS POINTS FOR CONNECTING

NETWORK COMPUTER USERS, LAN (LOCAL AREA NETWORK) COMPUTER CARDS FOR CONNECTING PORTABLE COMPUTER DEVICES TO COMPUTER NETWORKS, VPN (VIRTUAL PRIVATE NETWORK) HARDWARE, VPN (VIRTUAL PRIVATE NETWORK) OPERATING SOFTWARE, COMPUTER NETWORK BRIDGES, TELEPHONE CALL ROUTERS, TELEPHONE CALL ROUTER, FOR HOME AND OFFICE TOUCHTONE PHONES, FOR INTERNATIONAL AND LONG DISTANCE CALLS MADE FROM VARIOUS TELEPHONY PLATFORMS INCLUDING VOIP PLATFORM WITHOUT THE REQUIREMENT FOR INTERNET, TELECOMMUNICATION SWITCHES, COMMUNICATION HUBS, AND APPARATUS FOR TRANSMISSION OF COMMUNICATION, IN CLASS 9 (U.S. CLS. 21, 23, 26, 36 AND 38).

FIRST USE 1-1-2008; IN COMMERCE 1-1-2008.

THE MARK CONSISTS OF STANDARD CHARACTERS WITHOUT CLAIM TO ANY PARTICULAR FONT, STYLE, SIZE, OR COLOR.

SER. NO. 77-472,094, FILED 5-12-2008.

H. M. FISHER, EXAMINING ATTORNEY

Int. Cl.: 30

Prior U.S. Cl.: 46

United States Patent and Trademark Office

Reg. No. 3,575,365

Registered Feb. 17, 2009

**TRADEMARK
PRINCIPAL REGISTER**

SOHNA

PUNJAB TRADING INC. (CANADA CORPORATION)

1236 CARDIFF BLVD.

MISSISSAUGA, CANADA L5S1P6

FOR: CORN FLOUR; WHEAT FLOUR; PULSE FLOUR; RICE FLOUR; FLOUR BLENDS; FLOUR BLENDS CONSISTING PRIMARILY OF WHEAT FLOUR, CORN FLOUR, RICE FLOUR, PULSE FLOUR, BARLEY FLOUR, BUCKWHEAT FLOUR OR SOYA FLOUR, IN CLASS 30 (U.S. CL. 46).

THE MARK CONSISTS OF STANDARD CHARACTERS WITHOUT CLAIM TO ANY PARTICULAR FONT, STYLE, SIZE, OR COLOR.

OWNER OF CANADA REG. NO. TMA689498, DATED 6-11-2007, EXPIRES 6-11-2022.

THE FOREIGN WORDING IN THE MARK TRANSLATES INTO ENGLISH AS "BEAUTIFUL"

SER. NO. 77-472,598, FILED 5-12-2008.

DOMINIC FATHY, EXAMINING ATTORNEY

Int. Cl.: 42

Prior U.S. Cls.: 100 and 101

United States Patent and Trademark Office

Reg. No. 3,575,366

Registered Feb. 17, 2009

**SERVICE MARK
PRINCIPAL REGISTER**

MESH

EASTERDAY, MARK (UNITED STATES INDIVIDUAL)
P.O. BOX 3115
SARATOGA, CA 95070 AND
SABRINA HUANG (UNITED STATES INDIVIDUAL)
P.O. BOX 3115
SARATOGA, CA 95070

FOR: REMODELING OF RESIDENTIAL REAL PROPERTIES, NAMELY, INTERIOR DESIGN SERVICES, IN CLASS 42 (U.S. CLS. 100 AND 101).

FIRST USE 7-28-2006; IN COMMERCE 4-16-2008.

THE MARK CONSISTS OF STANDARD CHARACTERS WITHOUT CLAIM TO ANY PARTICULAR FONT, STYLE, SIZE, OR COLOR.

SER. NO. 77-472,864, FILED 5-13-2008.

MICHELLE DUBOIS, EXAMINING ATTORNEY

Int. Cl.: 9

Prior U.S. Cls.: 21, 23, 26, 36 and 38

Reg. No. 3,575,367

United States Patent and Trademark Office

Registered Feb. 17, 2009

**TRADEMARK
PRINCIPAL REGISTER**

E-BRAIN

E-BRAIN POWER LLC (GEORGIA LIMITED LIABILITY COMPANY)
3186 FOXWOOD TRAIL
SMYRNA, GA 30082

FOR: ELECTRONIC DEVICE FOR SIMULATING NEURAL NETWORKS FOR USE IN ROBOTICS AND OTHER APPLICATIONS, NAMELY, CONTROL SYSTEMS, IDENTIFICATION AND CATEGORIZATION OF SENSORY STIMULI, NEUROSCIENCE RESEARCH AND ELECTRONIC NEUROLOGICAL SYSTEMS, IN CLASS 9 (U.S. CLS. 21, 23, 26, 36 AND 38).

FIRST USE 8-1-2008; IN COMMERCE 8-1-2008.

THE MARK CONSISTS OF STANDARD CHARACTERS WITHOUT CLAIM TO ANY PARTICULAR FONT, STYLE, SIZE, OR COLOR.

THE MARK "E-BRAIN" HAS NO MEANING IN A FOREIGN LANGUAGE.

SER. NO. 77-472,914, FILED 5-13-2008.

SETH A. RAPPAPORT, EXAMINING ATTORNEY

Int. Cl.: 45

Prior U.S. Cls.: 100 and 101

United States Patent and Trademark Office

Reg. No. 3,575,368

Registered Feb. 17, 2009

**SERVICE MARK
PRINCIPAL REGISTER**

Teklicon

TEKLICON, INC. (CALIFORNIA CORPORATION)
3031 TISCH WAY, SUITE 1010
SAN JOSE, CA 95128

FOR: LITIGATION CONSULTANCY, NAMELY, EXPERT WITNESS SERVICES IN LEGAL MATTERS IN THE FIELDS OF ENGINEERING AND OTHER CUTTING-EDGE AND SPECIALIZED TECHNOLOGIES, IN CLASS 45 (U.S. CLS. 100 AND 101).

FIRST USE 4-21-1986; IN COMMERCE 4-21-1986.

THE MARK CONSISTS OF STANDARD CHARACTERS WITHOUT CLAIM TO ANY PARTICULAR FONT, STYLE, SIZE, OR COLOR.

SER. NO. 77-473,287, FILED 5-13-2008.

KIM MONINGHOFF, EXAMINING ATTORNEY

Prior U.S. Cl.: B

United States Patent and Trademark Office

Reg. No. 3,575,369

Registered Feb. 17, 2009

CERTIFICATION MARK
PRINCIPAL REGISTER



YACHT BROKERS ASSOCIATION OF AMERICA,
INC. (NEW YORK CORPORATION)
SUITE 104
105 EASTERN AVENUE
ANNAPOLIS, MD 214033300

FOR: YACHT BROKERAGE SERVICES, IN CLASS
B (U.S. CL. B).

FIRST USE 11-15-2002; IN COMMERCE 11-15-2002.

NO CLAIM IS MADE TO THE EXCLUSIVE
RIGHT TO USE "CERTIFIED PROFESSIONAL
YACHT BROKER", APART FROM THE MARK AS
SHOWN.

THE CERTIFICATION MARK, AS USED BY
AUTHORIZED PERSONS, CERTIFIES THAT SUCH
PERSONS MEET THE CERTIFIER'S STANDARDS
AS TO EXPERIENCE AND COMPETENCE AS RE-
FLECTED BY THE SUCCESSFUL COMPLETION OF
A WRITTEN EXAMINATION AND FULFILLMENT
OF PRESCRIBED STANDARDS OF PERFOR-
MANCE AND CONDUCT IN THE FIELD OF
YACHT BROKERAGE.

SER. NO. 77-473,365, FILED 5-13-2008.

MARY CRAWFORD, EXAMINING ATTORNEY

Int. Cl.: 34

Prior U.S. Cls.: 2, 8, 9 and 17

United States Patent and Trademark Office

Reg. No. 3,575,370

Registered Feb. 17, 2009

TRADEMARK
PRINCIPAL REGISTER



LORILLARD LICENSING COMPANY, LLC
(NORTH CAROLINA LIMITED LIABILITY
COMPANY)
1601 WACHOVIA TOWER, 300 N. GREENE ST.
GREENSBORO, NC 27401

FOR: CIGARETTES, IN CLASS 34 (U.S. CLS. 2, 8, 9
AND 17).

FIRST USE 5-0-2007; IN COMMERCE 5-0-2007.

OWNER OF U.S. REG. NOS. 1,178,413, 1,191,816,
AND 2,624,399.

NO CLAIM IS MADE TO THE EXCLUSIVE
RIGHT TO USE "LIGHTS" AND "MENTHOL",
APART FROM THE MARK AS SHOWN.

THE MARK CONSISTS OF A RECTANGLE DE-
SIGN DIVIDED INTO A PORTION ON THE LEFT, A
VERTICAL LINE ADJACENT TO THE LEFT POR-
TION AND A HORIZONTAL STRIPE PATTERN TO
THE RIGHT OF THE VERTICAL LINE. A BAND
ACROSS THE RECTANGLE CONTAINS THE
WORDS "NEWPORT LIGHTS". THE LOWER RIGHT
CORNER HAS A SPINNAKER WITH THE WORDS
"MENTHOL GOLD" BELOW THE SPINNAKER.

SER. NO. 77-473,422, FILED 5-13-2008.

KELLY MCCOY, EXAMINING ATTORNEY

Int. Cl.: 9

Prior U.S. Cls.: 21, 23, 26, 36 and 38

United States Patent and Trademark Office

Reg. No. 3,575,371

Registered Feb. 17, 2009

**TRADEMARK
PRINCIPAL REGISTER**

bp Salsa

DATADANCER MEDICAL SYSTEMS (CALIFORNIA CORPORATION)
1644 LAUREL STREET
CHICO, CA 959286655

FOR: MEDICAL SOFTWARE FOR RECORDING BLOOD PRESSURE RESULTS, IN CLASS 9 (U.S. CLS. 21, 23, 26, 36 AND 38).

FIRST USE 2-15-2007; IN COMMERCE 2-15-2007.

THE MARK CONSISTS OF STANDARD CHARACTERS WITHOUT CLAIM TO ANY PARTICULAR FONT, STYLE, SIZE, OR COLOR.

NO CLAIM IS MADE TO THE EXCLUSIVE RIGHT TO USE "BP", APART FROM THE MARK AS SHOWN.

SER. NO. 77-473,459, FILED 5-13-2008.

BRIAN NEVILLE, EXAMINING ATTORNEY

Int. Cl.: 35

Prior U.S. Cls.: 100, 101 and 102

United States Patent and Trademark Office

Reg. No. 3,575,372

Registered Feb. 17, 2009

**SERVICE MARK
PRINCIPAL REGISTER**

bloosky interactive

BLOOSKY INTERACTIVE, LLC (NEVADA LIMITED LIABILITY COMPANY)
SUITE 100
201 AVENIDA FABRICANTE
SAN CLEMENTE, CA 92672

FOR: MANAGEMENT AND COMPILATION OF COMPUTERISED DATABASES, IN CLASS 35 (U.S. CLS. 100, 101 AND 102).

FIRST USE 1-3-2007; IN COMMERCE 1-3-2007.

THE MARK CONSISTS OF STANDARD CHARACTERS WITHOUT CLAIM TO ANY PARTICULAR FONT, STYLE, SIZE, OR COLOR.

NO CLAIM IS MADE TO THE EXCLUSIVE RIGHT TO USE "INTERACTIVE", APART FROM THE MARK AS SHOWN.

SER. NO. 77-473,576, FILED 5-13-2008.

ASMAT KHAN, EXAMINING ATTORNEY

Int. Cls.: 21 and 25

Prior U.S. Cls.: 2, 13, 22, 23, 29, 30, 33, 39, 40 and 50

United States Patent and Trademark Office

Reg. No. 3,575,373

Registered Feb. 17, 2009

**TRADEMARK
PRINCIPAL REGISTER**

GLOVEABLES

KUMMINGS, LINDY (UNITED STATES INDIVIDUAL)
165 N ANITA AVE
LOS ANGELES, CA 90049

FOR: INTERNATIONAL CLASS 21: LATEX GLOVES FOR GENERAL HOUSEHOLD USE AND FOR GARDENING, IN CLASS 21 (U.S. CLS. 2, 13, 23, 29, 30, 33, 40 AND 50).

FIRST USE 8-24-2001; IN COMMERCE 8-24-2001.

FOR: HOUSEHOLD APRONS, IN CLASS 25 (U.S. CLS. 22 AND 39).

FIRST USE 8-24-2001; IN COMMERCE 8-24-2001.

THE MARK CONSISTS OF STANDARD CHARACTERS WITHOUT CLAIM TO ANY PARTICULAR FONT, STYLE, SIZE, OR COLOR.

OWNER OF U.S. REG. NO. 2,702,157.

SER. NO. 77-473,640, FILED 5-13-2008.

ASMAT KHAN, EXAMINING ATTORNEY

Int. Cl.: 45

Prior U.S. Cls.: 100 and 101

United States Patent and Trademark Office

Reg. No. 3,575,374

Registered Feb. 17, 2009

**SERVICE MARK
PRINCIPAL REGISTER**

HD GROUP

HUA DING INTERNATIONAL INTELLECTUAL
PROPERTY (TAIWAN CORPORATION)
12F, NO. 107, SEC. 2, ROOSEVELT RD.
TAIPEI, TAIWAN 106

FOR: ARBITRATION SERVICES; COPYRIGHT
MANAGEMENT; LEGAL RESEARCH; LEGAL SER-
VICES; LICENSING OF INTELLECTUAL PROPER-
TY; INTELLECTUAL PROPERTY CONSULTATION;
INTELLECTUAL PROPERTY WATCH SERVICES,
IN CLASS 45 (U.S. CLS. 100 AND 101).

FIRST USE 4-15-2003; IN COMMERCE 4-15-2003.

NO CLAIM IS MADE TO THE EXCLUSIVE
RIGHT TO USE "GROUP", APART FROM THE
MARK AS SHOWN.

THE MARK CONSISTS OF HD STANDING FOR
HWA DING OF THE COMPANY NAME AND THE
DESIGN OF THREE PARTIAL CIRCLES AND A
DOT BETWEEN LEFT TWO PARTIAL CIRCLES IN
A LETTER "O" .

SER. NO. 77-473,776, FILED 5-13-2008.

RAUL CORDOVA, EXAMINING ATTORNEY

Int. Cl.: 11

Prior U.S. Cls.: 13, 21, 23, 31 and 34

United States Patent and Trademark Office

Reg. No. 3,575,375

Registered Feb. 17, 2009

TRADEMARK
PRINCIPAL REGISTER



It's what's on the inside that counts!

TREAT YOURSELF, INC. (CALIFORNIA CORPORATION), DBA WARM WHISKERS

SUITE 441

21781 VENTURA BLVD.

WOODLAND HILLS, CA 91364

FOR: HEATING ELEMENTS; COLD PACKS FOR COOLING THE BODY AND NOT FOR MEDICAL PURPOSES, IN CLASS 11 (U.S. CLS. 13, 21, 23, 31 AND 34).

FIRST USE 4-3-2008; IN COMMERCE 4-3-2008.

NO CLAIM IS MADE TO THE EXCLUSIVE RIGHT TO USE "MICROWAVEABLE WARM", APART FROM THE MARK AS SHOWN.

THE COLOR(S) LAVENDER, PURPLE AND WHITE IS/ARE CLAIMED AS A FEATURE OF THE MARK.

THE MARK CONSISTS OF A LAVENDER OUTLINE OF A DOG WITH A LAVENDER FILLED CAT WITHIN THE OUTLINE OF THE DOG. A WHITE HEART IS LOCATED AT THE BASE OF THE TAIL ON THE CAT. THE WORDS "MICROWAVEABLE" AND "WHISKERS" ARE IN LAVENDER, WHILE THE WORD "WARM" AND THE PHRASE "IT'S WHAT'S ON THE INSIDE THAT COUNTS!" IS IN PURPLE.

SER. NO. 77-473,791, FILED 5-14-2008.

MARILYN IZZI, EXAMINING ATTORNEY

Int. Cl.: 35

Prior U.S. Cls.: 100, 101 and 102

United States Patent and Trademark Office

Reg. No. 3,575,376

Registered Feb. 17, 2009

**SERVICE MARK
PRINCIPAL REGISTER**

tjoos

TJOOS PTY LTD (AUSTRALIA CORPORATION)
UNIT 12 / 19 PITTWATER ROAD
MANLY, AUSTRALIA 2095

THE MARK CONSISTS OF STANDARD CHARACTERS WITHOUT CLAIM TO ANY PARTICULAR FONT, STYLE, SIZE, OR COLOR.

FOR: PROMOTING THE GOODS AND SERVICES OF OTHERS BY PROVIDING A COMMUNITY-DRIVEN WEB SITE FEATURING USER-SUBMITTED CONTENT IN THE NATURE OF COUPONS, REBATES, PRICE-COMPARISON INFORMATION, PRODUCT REVIEWS, LINKS TO THE RETAIL WEB SITES OF OTHERS, AND DISCOUNT INFORMATION, IN CLASS 35 (U.S. CLS. 100, 101 AND 102).

PRIORITY CLAIMED UNDER SEC. 44(D) ON AUSTRALIA APPLICATION NO. 10644216, FILED 5-14-2008.

SER. NO. 77-473,804, FILED 5-14-2008.

FIRST USE 6-16-2007; IN COMMERCE 7-23-2007.

PATRICIA EVANKO, EXAMINING ATTORNEY

Int. Cls.: 6, 17 and 42

**Prior U.S. Cls.: 1, 2, 5, 12, 13, 14, 23, 25, 35, 50, 100
and 101**

Reg. No. 3,575,377

United States Patent and Trademark Office

Registered Feb. 17, 2009

**TRADEMARK
SERVICE MARK
PRINCIPAL REGISTER**

ATP

ADVANCED TRACK PRODUCTS, LLC (NEW
YORK LIMITED LIABILITY COMPANY)
P.O. BOX 92
13355 MAIN ROAD
MATTITUCK, NY 11952

FOR: TRACK FASTENERS MADE IN PART OF
METAL, AND IN PART OF RUBBER, USED TO
KEEP RAILS AND TIES FIRMLY IN PLACE AND
FOR SECURING METAL TRACK RAILS TO RAIL-
ROAD TIES, IN CLASS 6 (U.S. CLS. 2, 12, 13, 14, 23, 25
AND 50).

FIRST USE 12-31-1991; IN COMMERCE 12-31-1991.

FOR: RUBBER BALLAST MATS AND RUBBER
BALLAST MAT PADS USED TO PRESERVE THE
LIFE OF THE BALLAST AND PROTECT ADJA-
CENT PROPERTY FROM SECONDARY NOISE, IN
CLASS 17 (U.S. CLS. 1, 5, 12, 13, 35 AND 50).

FIRST USE 12-31-1991; IN COMMERCE 12-31-1991.

FOR: DESIGN OF RAILROAD TRACK FASTEN-
ERS FOR OTHERS; DESIGN OF BALLAST MATS
AND BALLAST MAT PADS FOR OTHERS USED TO
PROTECT ADJACENT PROPERTY FROM SECOND-
ARY NOISE, IN CLASS 42 (U.S. CLS. 100 AND 101).

FIRST USE 12-31-1991; IN COMMERCE 12-31-1991.

THE MARK CONSISTS OF STANDARD CHAR-
ACTERS WITHOUT CLAIM TO ANY PARTICULAR
FONT, STYLE, SIZE, OR COLOR.

SER. NO. 77-473,922, FILED 5-14-2008.

MIDGE BUTLER, EXAMINING ATTORNEY

Int. Cls.: 6, 17 and 42

Prior U.S. Cls.: 1, 2, 5, 12, 13, 14, 23, 25, 35, 50, 100
and 101

Reg. No. 3,575,378

United States Patent and Trademark Office

Registered Feb. 17, 2009

**TRADEMARK
SERVICE MARK
PRINCIPAL REGISTER**

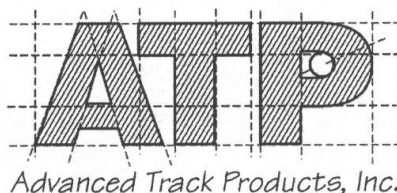

ADVANCED TRACK PRODUCTS, LLC (NEW
YORK LIMITED LIABILITY COMPANY)
P.O. BOX 92
13355 MAIN ROAD
MATTITUCK, NY 11952

FOR: DESIGN OF RAILROAD TRACK FASTENERS FOR OTHER; DESIGN OF BALLAST MATS AND BALLAST MAT PADS FOR OTHERS USED TO PROTECT ADJACENT PROPERTY FOR SECONDARY NOISE, IN CLASS 42 (U.S. CLS. 100 AND 101).

FOR: TRACK FASTENERS MADE IN PART OF METAL, AND IN PART OF RUBBER, USED TO KEEP RAILS AND TIES FIRMLY IN PLACE AND FOR SECURING METAL TRACK RAILS TO RAILROAD TIES, IN CLASS 6 (U.S. CLS. 2, 12, 13, 14, 23, 25 AND 50).

FIRST USE 12-31-1991; IN COMMERCE 12-31-1991.

FIRST USE 12-31-1991; IN COMMERCE 12-31-1991.

FOR: RUBBER BALLAST MATS AND RUBBER BALLAST MAT PADS USED TO PRESERVE THE LIFE OF THE BALLAST AND PROTECT ADJACENT PROPERTY FROM SECONDARY NOISE, IN CLASS 17 (U.S. CLS. 1, 5, 12, 13, 35 AND 50).

NO CLAIM IS MADE TO THE EXCLUSIVE RIGHT TO USE "TRACK PRODUCTS, INC.", APART FROM THE MARK AS SHOWN.

THE MARK CONSISTS OF THE LETTERS "ATP" WITH A SERIES OF DIAGONAL LINES ON THE FACE OF EACH LETTER AND A BACKGROUND GRID PATTERN OF BROKEN LINES ALL ABOVE THE WORDS "ADVANCED TRACK PRODUCTS, INC."

SER. NO. 77-474,012, FILED 5-14-2008.

FIRST USE 12-31-1991; IN COMMERCE 12-31-1991.

MIDGE BUTLER, EXAMINING ATTORNEY

Int. Cls.: 35 and 36

Prior U.S. Cls.: 100, 101 and 102

United States Patent and Trademark Office

Reg. No. 3,575,379

Registered Feb. 17, 2009

**SERVICE MARK
PRINCIPAL REGISTER**



AL-SAYRAFI, FAISAL (SAUDI ARABIA INDIVIDUAL)
P.O. BOX 24368
JEDDAH, SAUDI ARABIA 21446

FOR: BUSINESS CONSULTATION RELATED TO CORPORATE AND OTHER BUSINESS ENTITY MERGERS, ACQUISITIONS, MANAGEMENT, STRUCTURE AND RESTRUCTURING; ACQUISITION AND MERGER CONSULTATION; BUSINESS ACQUISITION AND MERGER CONSULTATION; BUSINESS APPRAISAL SERVICES; BUSINESS INVESTIGATIONS, EVALUATIONS, EXPERT APPRAISALS, INFORMATION AND RESEARCH; BUSINESS ADVISORY SERVICES IN CONNECTION WITH THE PURCHASE AND SALE OF BUSINESS ASSETS; CONNECTING BUYERS AND SELLERS OF FINANCIAL ASSETS; PROVIDING BUSINESS ADVISORY SERVICES TO BUYERS AND SELLERS IN CORPORATE AND BUSINESS TRANSACTIONS; ANALYZING AND COMPILING DATA FOR MEASURING THE PERFORMANCE OF FINANCIAL MARKETS, IN CLASS 35 (U.S. CLS. 100, 101 AND 102).

FIRST USE 5-12-2008; IN COMMERCE 5-12-2008.

FOR: BUSINESS BROKERAGE SERVICES RELATED TO CORPORATE AND OTHER BUSINESS ENTITY MERGERS, ACQUISITIONS, MANAGEMENT, STRUCTURE AND RESTRUCTURING; FINANCIAL CONSULTING SERVICES RELATED TO

CORPORATE AND BUSINESS INVESTMENTS AND FINANCING; PROVIDING FINANCIAL ADVISORY SERVICES TO BUYERS AND SELLERS IN CORPORATE AND BUSINESS TRANSACTIONS; INVESTMENT BANKING SERVICES; FISCAL VALUATIONS AND ASSESSMENTS; FINANCIAL ANALYSIS AND CONSULTATION; FINANCIAL INFORMATION AND EVALUATIONS; FINANCIAL RESEARCH; FINANCIAL MARKET RESEARCH; CORPORATE FINANCE ADVISORY SERVICES, IN CLASS 36 (U.S. CLS. 100, 101 AND 102).

FIRST USE 5-12-2008; IN COMMERCE 5-12-2008.

OWNER OF U.S. REG. NOS. 3,173,686, 3,331,603, AND 3,467,027.

NO CLAIM IS MADE TO THE EXCLUSIVE RIGHT TO USE "FINANCIAL TRANSACTION HOUSE", APART FROM THE MARK AS SHOWN.

THE MARK CONSISTS OF A LITERAL COMPONENT "FTH FINANCIAL TRANSACTION HOUSE" PLUS A DESIGN OF A SPINNING GLOBE APPEARING TO THE LEFT OF THE WORDS.

SER. NO. 77-474,304, FILED 5-14-2008.

TINA L. SNAPP, EXAMINING ATTORNEY

Int. Cl.: 34

Prior U.S. Cls.: 2, 8, 9 and 17

United States Patent and Trademark Office

Reg. No. 3,575,380

Registered Feb. 17, 2009

TRADEMARK
PRINCIPAL REGISTER

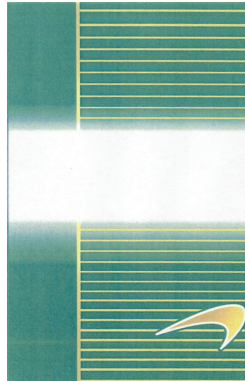

LORILLARD LICENSING COMPANY, LLC
(NORTH CAROLINA LIMITED LIABILITY
COMPANY)
1601 WACHOVIA TOWER, 300 N. GREENE ST.
GREENSBORO, NC 27401

FOR: CIGARETTES, IN CLASS 34 (U.S. CLS. 2, 8, 9
AND 17).

FIRST USE 5-0-2007; IN COMMERCE 5-0-2007.

OWNER OF U.S. REG. NO. 1,178,413.

THE COLOR(S) GREEN, WHITE AND GOLD IS/
ARE CLAIMED AS A FEATURE OF THE MARK.

THE MARK CONSISTS OF A RECTANGLE DE-
SIGN, DIVIDED INTO A PORTION ON THE LEFT
OF A SOLID GREEN COLOR, A GOLD VERTICAL
LINE ADJACENT THE LEFT PORTION, A HORI-
ZONTAL STRIPE PATTERN OF GOLD AND
GREEN TO THE RIGHT OF THE GOLD VERTICAL
LINE, AND A WHITE BAND ACROSS THE PACK-
AGE. A GOLD SPINNAKER OUTLINED IN WHITE
IS IN THE LOWER RIGHT CORNER.

SER. NO. 77-474,374, FILED 5-14-2008.

KELLY MCCOY, EXAMINING ATTORNEY

Int. Cl.: 34

Prior U.S. Cls.: 2, 8, 9 and 17

United States Patent and Trademark Office

Reg. No. 3,575,381

Registered Feb. 17, 2009

TRADEMARK
PRINCIPAL REGISTER



LORILLARD LICENSING COMPANY, LLC
(NORTH CAROLINA LIMITED LIABILITY
COMPANY)
1601 WACHOVIA TOWER, 300 N. GREENE ST.
GREENSBORO, NC 27401

FOR: CIGARETTES, IN CLASS 34 (U.S. CLS. 2, 8, 9
AND 17).

FIRST USE 5-0-2006; IN COMMERCE 5-0-2006.

OWNER OF U.S. REG. NO. 1,178,413.

THE MARK CONSISTS OF A RECTANGLE DE-
SIGN DIVIDED INTO A PORTION ON THE LEFT, A
VERTICAL LINE ADJACENT THE LEFT PORTION,
A HORIZONTAL STRIPE PATTERN TO THE RIGHT
OF THE VERTICAL LINE AND A BAND ACROSS
THE PACKAGE. THE LOWER RIGHT CORNER
HAS A SPINNAKER.

SER. NO. 77-474,475, FILED 5-14-2008.

KELLY MCCOY, EXAMINING ATTORNEY

Int. Cl.: 9

Prior U.S. Cls.: 21, 23, 26, 36 and 38

United States Patent and Trademark Office

Reg. No. 3,575,382

Registered Feb. 17, 2009

TRADEMARK
PRINCIPAL REGISTER



ED HUMPERT, LLC (MICHIGAN LIMITED LIABILITY COMPANY)
13720 DEMPSEY ROAD
ST. CHARLES, MI 48655

FOR: ARCHERY EQUIPMENT, NAMELY, ARCHERY RANGE FINDERS, ARCHERY TELESCOPIC BOW SITES AND RIFLE SCOPES, IN CLASS 9 (U.S. CLS. 21, 23, 26, 36 AND 38).

FIRST USE 4-4-2008; IN COMMERCE 4-4-2008.

NO CLAIM IS MADE TO THE EXCLUSIVE RIGHT TO USE "OUTDOORS", APART FROM THE MARK AS SHOWN.

THE COLOR(S) ORANGE, BLACK AND BLUE IS/ARE CLAIMED AS A FEATURE OF THE MARK.

THE MARK CONSISTS OF ORANGE COLORED STEPS WITH THE WORDS "BAD RIVER OUTDOORS" HAVING THE LETTERS "B", "R", AND "O" IN ORANGE, AND THE OTHER LETTERS IN THE WORDS IN BLACK, ALL OVER AN ARROW WITH BLUE FEATHERS AND A BLUE POINT WITH A BODY CHANGING FROM ORANGE TO BLUE.

SER. NO. 77-475,223, FILED 5-15-2008.

RUSS HERMAN, EXAMINING ATTORNEY

Int. Cl.: 37

Prior U.S. Cls.: 100, 103 and 106

United States Patent and Trademark Office

Reg. No. 3,575,383

Registered Feb. 17, 2009

**SERVICE MARK
PRINCIPAL REGISTER**

SAVANT

SAVANT SYSTEMS, LLC (MASSACHUSETTS
LIMITED LIABILITY COMPANY)
32 WIANNO AVENUE
OSTERVILLE, MA 02655

FOR: INTEGRATION AND AUTOMATION OF
ENTERTAINMENT AND OTHER ELECTRONIC
DEVICES IN HOMES AND BUSINESSES, NAMELY,
AUDIO AND VIDEO PLAYERS AND RECORDERS,
RADIOS, TELEVISIONS, VIDEO CAMERAS, VIDEO
DISPLAY MONITORS, TELEPHONES, INTERCOM
SYSTEMS, LIGHTING SYSTEMS, HVAC SYSTEMS,
SECURITY SYSTEMS, COMPUTER NETWORKS,
AND INTERNET CONNECTIONS, IN CLASS 37
(U.S. CLS. 100, 103 AND 106).

FIRST USE 9-30-2006; IN COMMERCE 9-30-2006.

THE MARK CONSISTS OF STANDARD CHAR-
ACTERS WITHOUT CLAIM TO ANY PARTICULAR
FONT, STYLE, SIZE, OR COLOR.

OWNER OF U.S. REG. NO. 3,442,907.

SER. NO. 77-475,301, FILED 5-15-2008.

STEVEN R. FINE, EXAMINING ATTORNEY

Int. Cl.: 44

Prior U.S. Cls.: 100 and 101

United States Patent and Trademark Office

Reg. No. 3,575,384

Registered Feb. 17, 2009

**SERVICE MARK
PRINCIPAL REGISTER**

HOWELL MEDICAL GROUP

HOWELL MEDICAL GROUP, LLC (FLORIDA
LIMITED LIABILITY COMPANY)
5370 SPRING HILL DRIVE
SPRING HILL, FL 34606

FOR: WEIGHT LOSS AND VEIN CARE MEDICAL
SERVICES, NAMELY, PROFESSIONAL WEIGHT
MANAGEMENT AND VEIN CARE SERVICES, IN
CLASS 44 (U.S. CLS. 100 AND 101).

FIRST USE 2-1-2007; IN COMMERCE 2-1-2007.

THE MARK CONSISTS OF STANDARD CHAR-
ACTERS WITHOUT CLAIM TO ANY PARTICULAR
FONT, STYLE, SIZE, OR COLOR.

NO CLAIM IS MADE TO THE EXCLUSIVE
RIGHT TO USE "MEDICAL GROUP", APART
FROM THE MARK AS SHOWN.

SER. NO. 77-475,364, FILED 5-15-2008.

PAULA MAHONEY, EXAMINING ATTORNEY

Int. Cl.: 44

Prior U.S. Cls.: 100 and 101

United States Patent and Trademark Office

Reg. No. 3,575,385

Registered Feb. 17, 2009

**SERVICE MARK
PRINCIPAL REGISTER**

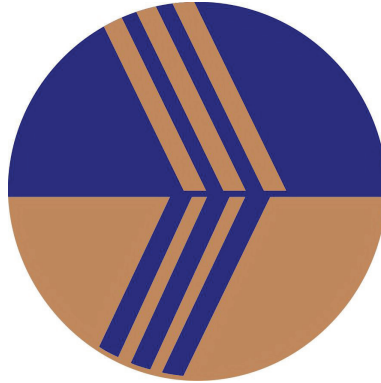

HOWELL MEDICAL GROUP, LLC (FLORIDA
LIMITED LIABILITY COMPANY)
5370 SPRING HILL DRIVE
SPRING HILL, FL 34606

FOR: WEIGHT LOSS AND VEIN CARE MEDICAL
SERVICES, NAMELY, PROFESSIONAL WEIGHT
MANAGEMENT AND VEIN CARE SERVICES, IN
CLASS 44 (U.S. CLS. 100 AND 101).

FIRST USE 2-1-2007; IN COMMERCE 2-1-2007.

THE COLOR(S) BLUE AND GOLD IS/ARE
CLAIMED AS A FEATURE OF THE MARK.

THE MARK CONSISTS OF A CIRCLE HAVING A
BLUE HALF AND A GOLD HALF WITH ANGLED
LINES. THE TOP PORTION OF THE CIRCLE IS
BLUE WITH GOLD ANGLED LINES. THE BOTTOM
HALF OF THE CIRCLE IS GOLD WITH BLUE
LINES.

SER. NO. 77-475,705, FILED 5-15-2008.

PAULA MAHONEY, EXAMINING ATTORNEY

Int. Cl.: 1

Prior U.S. Cls.: 1, 5, 6, 10, 26 and 46

Reg. No. 3,575,386

United States Patent and Trademark Office

Registered Feb. 17, 2009

**TRADEMARK
PRINCIPAL REGISTER**

UNIBASE

GALLIPOT, INC. (MINNESOTA CORPORATION)
2400 PILOT KNOB ROAD
MENDOTA HEIGHTS, MN 55120

THE MARK CONSISTS OF STANDARD CHARACTERS WITHOUT CLAIM TO ANY PARTICULAR FONT, STYLE, SIZE, OR COLOR.

FOR: CHEMICALS IN THE NATURE OF INACTIVE VEHICLES AND BASES FOR USE IN THE COMPOUNDING OF PHARMACEUTICALS, IN CLASS 1 (U.S. CLS. 1, 5, 6, 10, 26 AND 46).

SER. NO. 77-475,727, FILED 5-15-2008.

FIRST USE 5-15-2008; IN COMMERCE 5-15-2008.

MEGHAN REINHART, EXAMINING ATTORNEY

Int. Cl.: 39

Prior U.S. Cls.: 100 and 105

United States Patent and Trademark Office

Reg. No. 3,575,387

Registered Feb. 17, 2009

**SERVICE MARK
PRINCIPAL REGISTER**

UNOVILLAGE TRAVEL GROUP

UNOVILLAGE TRAVEL GROUP, LLC (NEW
YORK LIMITED LIABILITY COMPANY)
244 FIFTH AVENUE, P244
NEW YORK, NY 10001

FOR: TRAVEL AGENCY SERVICES, NAMELY,
MAKING RESERVATIONS AND BOOKINGS FOR
TRANSPORTATION, IN CLASS 39 (U.S. CLS. 100
AND 105).

FIRST USE 5-15-2008; IN COMMERCE 5-15-2008.

THE MARK CONSISTS OF STANDARD CHAR-
ACTERS WITHOUT CLAIM TO ANY PARTICULAR
FONT, STYLE, SIZE, OR COLOR.

NO CLAIM IS MADE TO THE EXCLUSIVE
RIGHT TO USE "TRAVEL GROUP", APART FROM
THE MARK AS SHOWN.

SER. NO. 77-476,245, FILED 5-16-2008.

CHRISTINE COOPER, EXAMINING ATTORNEY

Int. Cl.: 45

Prior U.S. Cls.: 100 and 101

United States Patent and Trademark Office

Reg. No. 3,575,388

Registered Feb. 17, 2009

**SERVICE MARK
PRINCIPAL REGISTER**

LAWYERS ADVANTAGE

LAWYERS ADVANTAGE TITLE GROUP, INC.
(MARYLAND CORPORATION)
3355 ST. JOHNS LANE, SUITE J
ELLCOTT CITY, MD 21042

OWNER OF U.S. REG. NO. 2,806,558.

FOR: REAL ESTATE CLOSING SERVICES; REAL
ESTATE SETTLEMENT SERVICES, IN CLASS 45
(U.S. CLS. 100 AND 101).

NO CLAIM IS MADE TO THE EXCLUSIVE
RIGHT TO USE "LAWYERS", APART FROM THE
MARK AS SHOWN.

FIRST USE 8-30-1989; IN COMMERCE 8-30-1989.

SER. NO. 77-476,747, FILED 5-16-2008.

THE MARK CONSISTS OF STANDARD CHAR-
ACTERS WITHOUT CLAIM TO ANY PARTICULAR
FONT, STYLE, SIZE, OR COLOR.

MARY CRAWFORD, EXAMINING ATTORNEY

Int. Cl.: 35

Prior U.S. Cls.: 100, 101 and 102

United States Patent and Trademark Office

Reg. No. 3,575,389

Registered Feb. 17, 2009

**SERVICE MARK
PRINCIPAL REGISTER**

Grade Your Lawyer

WARREN R. TRAZENFELD (UNITED STATES
INDIVIDUAL)
3225 AVIATION AVE SUITE 600
MIAMI, FL 33133

FOR: PROVIDING A WEB SITE WHERE USERS
CAN POST RATINGS, REVIEWS AND RECOMMEN-
DATIONS ON LEGAL SERVICES, IN CLASS 35 (U.S.
CLS. 100, 101 AND 102).

FIRST USE 4-1-2008; IN COMMERCE 4-1-2008.

THE MARK CONSISTS OF STANDARD CHAR-
ACTERS WITHOUT CLAIM TO ANY PARTICULAR
FONT, STYLE, SIZE, OR COLOR.

NO CLAIM IS MADE TO THE EXCLUSIVE
RIGHT TO USE "LAWYER", APART FROM THE
MARK AS SHOWN.

SER. NO. 77-476,770, FILED 5-16-2008.

WILLIAM BRECKENFELD, EXAMINING ATTOR-
NEY

Int. Cl.: 20

Prior U.S. Cls.: 2, 13, 22, 25, 32 and 50

Reg. No. 3,575,390

United States Patent and Trademark Office

Registered Feb. 17, 2009

**TRADEMARK
PRINCIPAL REGISTER**

HUNTWOOD

T.R.A. INDUSTRIES, INC. (WASHINGTON CORPORATION)
23800 E. APPLEWAY AVE.
LIBERTY LAKE, WA 99019

FOR: CABINET DOORS FOR FURNITURE CABINETS; CABINET DRAWERS FOR FURNITURE CABINETS; CABINETS; CUPBOARDS FOR TEA-THINGS CABINETS (CHADANSU); FILING CABINETS; GUN CABINETS; KEY CABINETS; KITCHEN CABINETS; KITCHEN-TYPE CABINETS FOR OUTDOOR USE; MEDICINE CABINETS; MIRRORED

CABINETS; SECURITY CABINETS; SHOE CABINETS, IN CLASS 20 (U.S. CLS. 2, 13, 22, 25, 32 AND 50).

FIRST USE 9-1-1988; IN COMMERCE 9-1-1988.

THE MARK CONSISTS OF STANDARD CHARACTERS WITHOUT CLAIM TO ANY PARTICULAR FONT, STYLE, SIZE, OR COLOR.

SER. NO. 77-477,117, FILED 5-16-2008.

ELLEN PERKINS, EXAMINING ATTORNEY

Int. Cl.: 25

Prior U.S. Cls.: 22 and 39

United States Patent and Trademark Office

Reg. No. 3,575,391

Registered Feb. 17, 2009

**TRADEMARK
PRINCIPAL REGISTER**

PLANECLOTHESMAN

MICEK, BRUCE JOHN (UNITED STATES INDIVIDUAL)
14850 E. LEVY STREET
WILLISTON, FL 32696

THE MARK CONSISTS OF STANDARD CHARACTERS WITHOUT CLAIM TO ANY PARTICULAR FONT, STYLE, SIZE, OR COLOR.

FOR: UNIFORMS, IN CLASS 25 (U.S. CLS. 22 AND 39).

SER. NO. 77-477,437, FILED 5-18-2008.

FIRST USE 3-1-2008; IN COMMERCE 3-1-2008.

DARRYL SPRUILL, EXAMINING ATTORNEY

Int. Cl.: 25

Prior U.S. Cls.: 22 and 39

United States Patent and Trademark Office

Reg. No. 3,575,392

Registered Feb. 17, 2009

**TRADEMARK
PRINCIPAL REGISTER**

Desire In Design

REICHMAN, SAMUEL C (UNITED STATES IN-
DIVIDUAL)

555 PEARL STREET LOFT 311

READING, PA 19602

FOR: JEANS; SHIRTS, IN CLASS 25 (U.S. CLS. 22
AND 39).

FIRST USE 3-16-2008; IN COMMERCE 5-13-2008.

THE MARK CONSISTS OF STANDARD CHAR-
ACTERS WITHOUT CLAIM TO ANY PARTICULAR
FONT, STYLE, SIZE, OR COLOR.

NO CLAIM IS MADE TO THE EXCLUSIVE
RIGHT TO USE "DESIGN", APART FROM THE
MARK AS SHOWN.

SER. NO. 77-477,493, FILED 5-18-2008.

LESLEY LAMOTHE, EXAMINING ATTORNEY

Int. Cls.: 9, 16, 28 and 41

**Prior U.S. Cls.: 2, 5, 21, 22, 23, 26, 29, 36, 37, 38, 50,
100, 101 and 107**

Reg. No. 3,575,393

United States Patent and Trademark Office

Registered Feb. 17, 2009

**TRADEMARK
SERVICE MARK
PRINCIPAL REGISTER**

CRYSIS WARZONE

CRYTEK GMBH (FED REP GERMANY CORPORATION)
HANAUER LANDSTRASSE 523
FRANKFURT, FED REP GERMANY 60386

FOR: COMPUTER GAMES SOFTWARE AND ELECTRONIC GAMES, NAMELY, SOFTWARE GAMES RECORDED ON CD-ROM AND DVDS AND OTHER PHYSICAL MEDIAS, AND CARTRIDGES FOR COMPUTERS, CONSOLE AND INDIVIDUAL, PORTABLE GAMING SYSTEMS; SOFTWARE GAMES DOWNLOADABLE FROM A LOCAL OR GLOBAL COMPUTER NETWORK; SOFTWARE GAMES FOR MOBILE PHONES, PERSONAL DIGITAL ASSISTANTS, AND HANDHELD COMPUTERS; AND MANUALS SOLD TOGETHER AS A UNIT OR PROVIDED VIA DOWNLOAD OR ONLINE WITH ANY OF THE FOREGOING; MOTION PICTURE FILMS, NAMELY, MOTION PICTURE FILMS FEATURING COMEDY, DRAMA, ACTION, ADVENTURE AND/OR ANIMATION, FOR BROADCAST ON TELEVISION, FOR PRIVATE OR HOME VIEWING ON COMPUTERS, TELEVISIONS, HAND-HELD VIEWERS OR PROJECTORS, PRERECORDED IN WHOLE OR IN PART ON DATA MEDIA, IN CLASS 9 (U.S. CLS. 21, 23, 26, 36 AND 38).

FOR: BOOKS AND BOOKLETS FEATURING COMEDY, DRAMA, ACTION, ADVENTURE, ANIMATION AND MUSIC; PUBLICATIONS, NAMELY, BROCHURES, BOOKLETS, MANUALS AND TEACHING MATERIALS IN THE FIELD OF COMPUTER AND VIDEO, IN CLASS 16 (U.S. CLS. 2, 5, 22, 23, 29, 37, 38 AND 50).

FOR: TOYS, NAMELY, TOY ACTION FIGURES AND ACTION FIGURE ACCESSORIES, NAMELY, POSITIONABLE TOY FIGURES, MUSIC BOX TOYS, INFLATABLE TOYS, PAPER DOLLS, ARTICULATED AND NON-ARTICULATED DOLLS, PUPPETS,

TOY BALLOONS; TOY ACTION BALLS; TOY BANKS, TOY BUILDING BLOCKS, TOY CONSTRUCTION PLAYSETS, TOY MOBILES, TOY VEHICLES, YO-YOS; HAND-HELD UNITS FOR PLAYING ELECTRONIC GAMES, VIDEO GAMES, AND ELECTRONIC GAMES IN THE NATURE OF A VIRTUAL PET; VIDEO GAME SYSTEMS, COMPRISING HAND-HELD UNITS FOR PLAYING VIDEO GAMES AND ASSOCIATED GAME CARTRIDGES SOLD AS A UNIT; ACTION SKILL GAMES; ELECTRONIC GAME EQUIPMENT WITH A VIEWING FUNCTION; PROMOTIONAL GAME CARDS; STAND ALONE VIDEO GAME MACHINES; HAND-HELD ELECTRIC AND NON-ELECTRIC PINBALL GAMES, AND MANIPULATIVE PUZZLES; SKATES, NAMELY IN-LINE SKATES, ROLLER SKATES, SKATEBOARDS; JIGSAW PUZZLES; JUMP ROPES; KITES; GAMES, NAMELY, BOARD GAMES, PARLOR GAMES AND ROLE PLAYING GAMES; SNOW BOARDS; SNOW SKIS; SPORTS BALLS, IN CLASS 28 (U.S. CLS. 22, 23, 38 AND 50).

FOR: ENTERTAINMENT SERVICES NAMELY, PROVIDING ON-LINE COMPUTER GAMES OVER LOCAL AREA COMPUTER NETWORKS AND PROVIDING INFORMATION ON-LINE RELATING TO COMPUTER GAMES, VIDEO GAMES, COMPUTER ENHANCEMENTS FOR GAMES; MULTIMEDIA PUBLISHING OF BOOKS, MAGAZINES, JOURNALS, SOFTWARE, GAMES, MUSIC AND ELECTRONIC PUBLICATIONS; PRODUCTION OF VIDEO AND COMPUTER GAME SOFTWARE; PROVIDING A COMPUTER GAME THAT MAY BE ACCESSED NETWORK-WIDE BY NETWORK USERS, IN CLASS 41 (U.S. CLS. 100, 101 AND 107).

THE MARK CONSISTS OF STANDARD CHARACTERS WITHOUT CLAIM TO ANY PARTICULAR FONT, STYLE, SIZE, OR COLOR.

PRIORITY CLAIMED UNDER SEC. 44(D) ON FED
REP GERMANY APPLICATION NO. 302008031354,
FILED 5-13-2008, REG. NO. 302008031354, DATED 7-
31-2008, EXPIRES 5-31-2018.

OWNER OF U.S. REG. NOS. 3,422,854 AND
3,429,523.

SER. NO. 77-477,582, FILED 5-19-2008.

EVELYN BRADLEY, EXAMINING ATTORNEY

Int. Cl.: 35

Prior U.S. Cls.: 100, 101 and 102

United States Patent and Trademark Office

Reg. No. 3,575,394

Registered Feb. 17, 2009

SERVICE MARK
PRINCIPAL REGISTER

Flexible
Assembly **Systems inc.**

FLEXIBLE ASSEMBLY SYSTEMS INC. (CALIFORNIA CORPORATION)
SUITE N
8451 MIRALANI DRIVE
SAN DIEGO, CA 92126

FOR: DISTRIBUTORSHIP SERVICES IN THE FIELD OF TOOLS AND EQUIPMENT USED IN AUTOMOTIVE, INDUSTRIAL AND ASSEMBLY ENVIRONMENTS; ON-LINE RETAIL STORE SERVICES FEATURING TOOLS AND EQUIPMENT USED IN AUTOMOTIVE, INDUSTRIAL AND ASSEMBLY ENVIRONMENTS, IN CLASS 35 (U.S. CLS. 100, 101 AND 102).

FIRST USE 4-25-2003; IN COMMERCE 4-25-2003.

NO CLAIM IS MADE TO THE EXCLUSIVE RIGHT TO USE "ASSEMBLY SYSTEMS INC.", APART FROM THE MARK AS SHOWN.

THE MARK CONSISTS OF THE STYLIZED TEXT "FLEXIBLE ASSEMBLY SYSTEMS INC."

SER. NO. 77-477,786, FILED 5-19-2008.

DOMINIC J. FERRAIUOLO, EXAMINING ATTORNEY

Int. Cl.: 35

Prior U.S. Cls.: 100, 101 and 102

United States Patent and Trademark Office

Reg. No. 3,575,395

Registered Feb. 17, 2009

**SERVICE MARK
PRINCIPAL REGISTER**

Judge Your Lawyers

WARREN R. TRAZENFELD (UNITED STATES
INDIVIDUAL)
3225 AVIATION AVE SUITE 600
MIAMI, FL 33133

FOR: PROVIDING A WEB SITE WHERE USERS
CAN POST RATINGS, REVIEWS AND RECOMMEN-
DATIONS ON LEGAL SERVICES, IN CLASS 35 (U.S.
CLS. 100, 101 AND 102).

FIRST USE 4-1-2008; IN COMMERCE 4-1-2008.

THE MARK CONSISTS OF STANDARD CHAR-
ACTERS WITHOUT CLAIM TO ANY PARTICULAR
FONT, STYLE, SIZE, OR COLOR.

NO CLAIM IS MADE TO THE EXCLUSIVE
RIGHT TO USE "LAWYERS", APART FROM THE
MARK AS SHOWN.

SER. NO. 77-477,943, FILED 5-19-2008.

WILLIAM BRECKENFELD, EXAMINING ATTOR-
NEY

Int. Cls.: 1 and 42

Prior U.S. Cls.: 1, 5, 6, 10, 26, 46, 100 and 101

United States Patent and Trademark Office

Reg. No. 3,575,396

Registered Feb. 17, 2009

**TRADEMARK
SERVICE MARK
PRINCIPAL REGISTER**

POLYGREEN

BP P.L.C. (UNITED KINGDOM PUBLIC LIMITED
COMPANY (PLC))
1 ST. JAMES'S SQUARE
LONDON SW1Y 4 PD, UNITED KINGDOM

FOR: CHEMICALS FOR USE IN INDUSTRY AND
MANUFACTURE, NAMELY, ETHYLENE, POLYE-
THYLENE, ETHANOL, POLYALPHAOLEFINS, LIN-
EAR ALPHA OLEFINS, POLYOLEFINS AND
DERIVATIVES THEREOF ALL BEING CHEMICAL
SUBSTANCES; CHEMICALS PREPARED FROM
POLYOLEFINS AND DERIVATIVES THEREOF
ALL FOR USE IN THE MANUFACTURE OF PLAS-
TICS AND ARTICLES MADE FROM PLASTICS;
CHEMICALS FOR USE IN OIL DRILLING PROCES-
SES, IN CLASS 1 (U.S. CLS. 1, 5, 6, 10, 26 AND 46).

FOR: SCIENTIFIC RESEARCH AND DEVELOP-
MENT OF NEW CHEMICAL AND PETROCHEM-
ICAL PROCESSES; ADVISORY AND
CONSULTANCY SERVICES RELATING TO PRO-
CESS TECHNOLOGY IN THE FIELD OF CHEMI-
CAL PRODUCTION; INDUSTRIAL DESIGN
SERVICES; PREPARATION OF ENGINEERING

DRAWINGS AND RELATED TECHNICAL DOCU-
MENTATION AND REPORTS; ANALYTICAL SER-
VICES, NAMELY, CHEMICAL ANALYSES OF
SUBSTANCES DRAWN FROM VARIOUS POINTS
IN MANUFACTURING PROCESSES; INSPECTION
OF INDUSTRIAL PLANTS, INDUSTRIAL MACHIN-
ERY AND INDUSTRIAL APPARATUS, NAMELY,
POLYMERIZATION APPARATUS, IN CLASS 42
(U.S. CLS. 100 AND 101).

THE MARK CONSISTS OF STANDARD CHAR-
ACTERS WITHOUT CLAIM TO ANY PARTICULAR
FONT, STYLE, SIZE, OR COLOR.

PRIORITY CLAIMED UNDER SEC. 44(D) ON
UNITED KINGDOM APPLICATION NO. 2472682,
FILED 11-19-2007, REG. NO. 2472682, DATED 7-18-
2008, EXPIRES 11-19-2017.

SER. NO. 77-477,964, FILED 5-19-2008.

MATTHEW MCDOWELL, EXAMINING ATTOR-
NEY

Int. Cl.: 35

Prior U.S. Cls.: 100, 101 and 102

United States Patent and Trademark Office

Reg. No. 3,575,397

Registered Feb. 17, 2009

SERVICE MARK
PRINCIPAL REGISTER

IVGSTORES

IVGSTORES, LLC (FLORIDA LIMITED LIABILITY COMPANY)

2169 N.W. 140 AVENUE

PEMBROKE PINES, FL 33028

FOR: ON-LINE RETAIL STORE SERVICES FEATURING BAR STOOLS, BEACH CHAIRS, BENCHES, CHAIRS, CHAISE LOUNGES, COUNTER STOOLS, FOLDING CHAIRS, FOLDING TABLES, FUTONS, GAME CHAIRS, LEATHER CHAIRS, LOUNGE CHAIRS, MASSAGE CHAIRS, OTTOMANS, RECLINERS, RESTAURANT AND BAR FURNITURE, ROCKING CHAIRS, SLEEPER SOFAS, STACKING CHAIRS, BISTRO TABLES, COFFEE TABLES, CONSOLE TABLES, DRAFTING TABLES, FOLDING TABLES, PUB TABLES, TABLE BASES AND TOPS, BAMBOO FURNITURE, CLOCKS, COAT RACKS, CONTEMPORARY FURNITURE, COUNTRY FURNITURE, CUCKOO AND GRANDFATHER CLOCKS, CURIOS, DORM ROOM, FIREPLACES, FIREPLACE SCREENS AND GAS LOGS, GARAGE CABINETS, HALL TREES, HOME BARS, HOPE CHESTS, JEWELRY ARMOIRES, LIVING ROOM FURNITURE, MAGAZINE RACKS, MAILBOXES, MEDIEVAL, MIRRORS, NAUTICAL, RETRO, ROOM DIVIDERS, RUSTIC FURNITURE, STORAGE CABINETS, VANITIES, VASES, WICKER, WINDOW TREATMENTS, WOOD STOVES, AIR HOCKEY, BOARD GAMES, BADMINTON, BOCCE BALL, CROQUET, CHESS SETS, FOOSBALL, GAME TABLES AND CHAIRS, PING PONG, POKER TABLES, POOL CUES AND POOL TABLES, BASEBALL EQUIPMENT, BASKETBALL HOOPS, BLEACHERS, BOXING EQUIPMENT, EXERCISE BIKES, FIELD HOCKEY, FITNESS EQUIPMENT, FOOTBALL EQUIPMENT, GOLF BAGS, GOLF CARTS AND GOLF TRAINING AIDS, GYMNASTICS EQUIPMENTS, HOCKEY, INFLATABLE BOATS, LACROSSE EQUIPMENT, NIGHT VISION SCOPES, RACQUETBALL EQUIPMENT, SCOREBOARDS, SOCCER GOALS, SPORTS LOGOS, SPOTTING SCOPES, TENNIS EQUIPMENT, TIMERS, TRAMPO-

LINES, TREADMILLS, VOLLEYBALL, WATER-SPORTS, BEAN BAGS, BUNK BEDS, CHILDREN'S FURNITURE, CRIBS, DOLLHOUSES, EDUCATIONAL TOYS, KIDS BEDS, MUSIC BOXES, PEDAL CARS, PLAYGROUNDS, PLAYHOUSES, ROCKING TOYS, SWING SETS, STROLLERS, STUFFED ANIMALS, TODDLER BEDS, TOY BOXES, TOYS, ADIRONDACK, ARBORS, BEACH CHAIRS, BINOCULARS, BIRD BATHS, CAMPING EQUIPMENT, CARPORTS, FIRE PITS, FOUNTAINS, GARDEN FURNITURE, GARDEN STATUES, GAZEBOS, GREENHOUSES, GRILLS, HAMMOCKS, HOSE REELS, LAWN CHAIRS, PATIO CHAIRS, PATIO FURNITURE, PATIO HEATERS, PICNIC TABLES, PLANT STANDS, PLANTERS, PORCH SWINGS, SMOKERS, SOLAR LIGHTS, STORAGE SHEDS, SUNDIALS, TEAK, TENTS, UMBRELLAS, WEATHER INSTRUMENTS, WEATHERVANES, BOOK CASES, COMPUTER DESKS, CONFERENCE TABLES, DRAFTING TABLES, EASELS, FILE CABINETS, GLOBES, HOME OFFICE, OFFICE CHAIRS, PODIUMS, PA SYSTEMS, SAFES, SCHOOL FURNITURE, WHITEBOARDS, WORKSTATIONS, WRITING DESKS, AIR BEDS, ARMOIRES, BEDROOM FURNITURE, BEDDING, BEDROOM SETS, CANOPY BEDS, CLOSET ORGANIZERS, DAYBEDS, HEADBOARDS, LOFT BEDS, NIGHT STANDS, PLATFORM BEDS, POSTER BEDS, SLEIGH BEDS, STORAGE BEDS, TRUNDLE BEDS, BAKERS RACKS, CHINA CABINETS, COFFEE MAKERS AND COOKWARE AND DINETTE SETS, DINING CHAIRS, DINING ROOM FURNITURE, DINING TABLES, ESPRESSO MACHINES, KITCHEN APPLIANCES, KITCHEN CARTS, KITCHEN ISLANDS AND KITCHEN FURNITURE, PANS, POT RACKS, REFRIGERATORS AND FREEZERS, SIDEBOARDS, TRASH CANS, TV TRAYS, WINE RACKS, WINE REFRIGERATORS, AQUARIUMS, DOG BEDS, GPS TRACKING, HOME ENTERTAINMENT CENTERS, HOME THEATER EQUIPMENT, HUMIDORS, JEWELRY, JEWELRY BOXES, TOOL BOXES, SEWING MACHINES, TV STANDS, WALL ART, WATCHES,

AREA RUGS, CEILING FANS, CHANDELIERS, DESK LAMPS, DOORMATS, FLOOR LAMPS, FLOORING, LIGHTING, OUTDOOR RUGS AND OUTDOOR LIGHTING, ORIENTAL RUGS, PENDANT LIGHTS, POOL TABLE LIGHTS, RUGS, SOLAR LIGHTS, TABLE LAMPS, AND TIFFANY LAMPS, IN CLASS 35 (U.S. CLS. 100, 101 AND 102).

FIRST USE 3-1-2007; IN COMMERCE 3-1-2007.

THE MARK CONSISTS OF STANDARD CHARACTERS WITHOUT CLAIM TO ANY PARTICULAR FONT, STYLE, SIZE, OR COLOR.

SER. NO. 77-478,262, FILED 5-19-2008.

DOMINIC J. FERRAIUOLO, EXAMINING ATTORNEY

Int. Cl.: 43

Prior U.S. Cls.: 100 and 101

United States Patent and Trademark Office

Reg. No. 3,575,398

Registered Feb. 17, 2009

**SERVICE MARK
PRINCIPAL REGISTER**

Garza Blanca Preserve

PROMOTORA ARENA BLANCA, SA DE CV
(MEXICO CORPORATION)
C/O THE LAW OFFICE OF MARK F. NELSON
31423 SOUTH COAST HIGHWAY, SUITE 7100
LAGUNA BEACH, CA 92651

FOR: HEALTH RESORT SERVICES, NAMELY,
PROVIDING FOOD AND LODGING THAT SPECIALIZE
IN PROMOTING PATRONS' GENERAL HEALTH AND
WELL-BEING; RESORT HOTELS; RESORT LODGING
SERVICES, IN CLASS 43 (U.S. CLS. 100 AND 101).

FIRST USE 8-1-2007; IN COMMERCE 8-1-2007.

THE MARK CONSISTS OF STANDARD CHARACTERS
WITHOUT CLAIM TO ANY PARTICULAR FONT,
STYLE, SIZE, OR COLOR.

NO CLAIM IS MADE TO THE EXCLUSIVE
RIGHT TO USE "PRESERVE", APART FROM THE
MARK AS SHOWN.

THE FOREIGN WORDING IN THE MARK
TRANSLATES INTO ENGLISH AS WHITE HERON.

SER. NO. 77-478,431, FILED 5-19-2008.

LINDA LAVACHE, EXAMINING ATTORNEY

Int. Cl.: 44

Prior U.S. Cls.: 100 and 101

United States Patent and Trademark Office

Reg. No. 3,575,399

Registered Feb. 17, 2009

**SERVICE MARK
PRINCIPAL REGISTER**

QUIET AWAKENING

GAYLE S. ROZANTINE (UNITED STATES INDIVIDUAL)
400 COMMERCIAL COURT
SAVANNAH, GA 31406

FOR: PSYCHIATRIC AND PSYCHOLOGICAL SERVICES, NAMELY, PROVIDING NEW MULTI-DIMENSIONAL PSYCHOTHERAPEUTIC TREATMENT SERVICES INCORPORATING MULTIPLE LEVELS OF THERAPEUTIC RELAXATION TECHNIQUES AND VISUALIZATION EXERCISES WITH TRADITIONAL PSYCHIATRIC AND PSYCHOLOGICAL MODALITIES FOR THE MENTAL, EMOTIONAL, PHYSICAL AND SPIRITUAL HEALING OF THE MIND AND BODY, AND THE DISSEMINATION OF PRINTED AND MULTI-MEDIA MATERI-

ALS IN CONNECTION THEREWITH, IN CLASS 44 (U.S. CLS. 100 AND 101).

FIRST USE 9-20-2004; IN COMMERCE 9-20-2004.

THE MARK CONSISTS OF STANDARD CHARACTERS WITHOUT CLAIM TO ANY PARTICULAR FONT, STYLE, SIZE, OR COLOR.

OWNER OF U.S. REG. NOS. 3,012,798, 3,014,722 AND OTHERS.

SER. NO. 77-478,560, FILED 5-19-2008.

TAMARA FRAZIER, EXAMINING ATTORNEY

Int. Cl.: 44

Prior U.S. Cls.: 100 and 101

United States Patent and Trademark Office

Reg. No. 3,575,400

Registered Feb. 17, 2009

**SERVICE MARK
PRINCIPAL REGISTER**

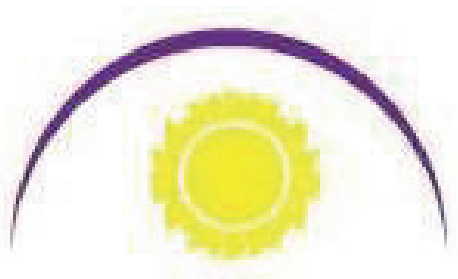

GAYLE S. ROZANTINE (UNITED STATES INDIVIDUAL)
400 COMMERCIAL COURT
SAVANNAH, GA 31406

FIRST USE 9-20-2004; IN COMMERCE 9-20-2004.

OWNER OF U.S. REG. NO. 2,578,198.

FOR: PSYCHIATRIC AND PSYCHOLOGICAL SERVICES, NAMELY, PROVIDING NEW MULTI-DIMENSIONAL PSYCHOTHERAPEUTIC TREATMENT SERVICES INCORPORATING MULTIPLE LEVELS OF THERAPEUTIC RELAXATION TECHNIQUES AND VISUALIZATION EXERCISES WITH TRADITIONAL PSYCHIATRIC AND PSYCHOLOGICAL MODALITIES FOR THE MENTAL, EMOTIONAL, PHYSICAL AND SPIRITUAL HEALING OF THE MIND AND BODY, AND THE DISSEMINATION OF PRINTED AND MULTI-MEDIA MATERIALS IN CONNECTION THEREWITH, IN CLASS 44 (U.S. CLS. 100 AND 101).

THE COLOR(S) PURPLE, WHITE AND YELLOW IS/ARE CLAIMED AS A FEATURE OF THE MARK.

THE MARK CONSISTS OF A PURPLE ARCH OVER A YELLOW STYLIZED SUN WITH A WHITE CIRCLE INSIDE.

SER. NO. 77-478,566, FILED 5-19-2008.

TAMARA FRAZIER, EXAMINING ATTORNEY

Int. Cl.: 35

Prior U.S. Cls.: 100, 101 and 102

Reg. No. 3,575,401

United States Patent and Trademark Office

Registered Feb. 17, 2009

**SERVICE MARK
PRINCIPAL REGISTER**

IVG

IVGSTORES, LLC (FLORIDA LIMITED LIABILITY COMPANY)

2169 N.W. 140 AVENUE

PEMBROKE PINES, FL 33028

FOR: ON-LINE RETAIL STORE SERVICES FEATURING BAR STOOLS, BEACH CHAIRS, BENCHES, CHAIRS, CHAISE LOUNGES, COUNTER STOOLS, FOLDING CHAIRS, FOLDING TABLES, FUTONS, GAME CHAIRS, LEATHER CHAIRS, LOUNGE CHAIRS, MASSAGE CHAIRS, OTTOMANS, RECLINERS, RESTAURANT AND BAR FURNITURE, ROCKING CHAIRS, SLEEPER SOFAS, STACKING CHAIRS, BISTRO TABLES, COFFEE TABLES, CONSOLE TABLES, DRAFTING TABLES, FOLDING TABLES, PUB TABLES, TABLE BASES AND TOPS, BAMBOO FURNITURE, CLOCKS, COAT RACKS, CONTEMPORARY FURNITURE, COUNTRY FURNITURE, CUCKOO AND GRANDFATHER CLOCKS, CURIOS, DORM ROOM, FIREPLACES, FIREPLACE SCREENS AND GAS LOGS, GARAGE CABINETS, HALL TREES, HOME BARS, HOPE CHESTS, JEWELRY ARMOIRES, LIVING ROOM FURNITURE, MAGAZINE RACKS, MAILBOXES, MEDIEVAL, MIRRORS, NAUTICAL, RETRO, ROOM DIVIDERS, RUSTIC FURNITURE, STORAGE CABINETS, VANITIES, VASES, WICKER, WINDOW TREATMENTS, WOOD STOVES, AIR HOCKEY, BOARD GAMES, BADMINTON, BOCCE BALL, CROQUET, CHESS SETS, FOOSBALL, GAME TABLES AND CHAIRS, PING PONG, POKER TABLES, POOL CUES AND POOL TABLES, BASEBALL EQUIPMENT, BASKETBALL HOOPS, BLEACHERS, BOXING EQUIPMENT, EXERCISE BIKES, FIELD HOCKEY, FITNESS EQUIPMENT, FOOTBALL EQUIPMENT, GOLF BAGS, GOLF CARTS AND GOLF TRAINING AIDS, GYMNASTICS EQUIPMENTS, HOCKEY, INFLATABLE BOATS, LACROSSE EQUIPMENT, NIGHT VISION SCOPES, RACQUETBALL EQUIPMENT, SCOREBOARDS, SOCCER GOALS, SPORTS LOGOS, SPOTTING SCOPES, TENNIS EQUIPMENT, TIMERS, TRAMPO-

LINES, TREADMILLS, VOLLEYBALL, WATER-SPORTS, BEAN BAGS, BUNK BEDS, CHILDREN'S FURNITURE, CRIBS, DOLLHOUSES, EDUCATIONAL TOYS, KIDS BEDS, MUSIC BOXES, PEDAL CARS, PLAYGROUNDS, PLAYHOUSES, ROCKING TOYS, SWING SETS, STROLLERS, STUFFED ANIMALS, TODDLER BEDS, TOY BOXES, TOYS, ADIRONDACK, ARBORS, BEACH CHAIRS, BINOCULARS, BIRD BATHS, CAMPING EQUIPMENT, CARPORTS, FIRE PITS, FOUNTAINS, GARDEN FURNITURE, GARDEN STATUES, GAZEBOS, GREENHOUSES, GRILLS, HAMMOCKS, HOSE REELS, LAWN CHAIRS, PATIO CHAIRS, PATIO FURNITURE, PATIO HEATERS, PICNIC TABLES, PLANT STANDS, PLANTERS, PORCH SWINGS, SMOKERS, SOLAR LIGHTS, STORAGE SHEDS, SUNDIALS, TEAK, TENTS, UMBRELLAS, WEATHER INSTRUMENTS, WEATHERVANES, BOOK CASES, COMPUTER DESKS, CONFERENCE TABLES, DRAFTING TABLES, EASELS, FILE CABINETS, GLOBES, HOME OFFICE, OFFICE CHAIRS, PODIUMS, PA SYSTEMS, SAFES, SCHOOL FURNITURE, WHITEBOARDS, WORKSTATIONS, WRITING DESKS, AIR BEDS, ARMOIRES, BEDROOM FURNITURE, BEDDING, BEDROOM SETS, CANOPY BEDS, CLOSET ORGANIZERS, DAYBEDS, HEADBOARDS, LOFT BEDS, NIGHT STANDS, PLATFORM BEDS, POSTER BEDS, SLEIGH BEDS, STORAGE BEDS, TRUNDLE BEDS, BAKERS RACKS, CHINA CABINETS, COFFEE MAKERS AND COOKWARE AND DINETTE SETS, DINING CHAIRS, DINING ROOM FURNITURE, DINING TABLES, ESPRESSO MACHINES, KITCHEN APPLIANCES, KITCHEN CARTS, KITCHEN ISLANDS AND KITCHEN FURNITURE, PANS, POT RACKS, REFRIGERATORS AND FREEZERS, SIDEBOARDS, TRASH CANS, TV TRAYS, WINE RACKS, WINE REFRIGERATORS, AQUARIUMS, DOG BEDS, GPS TRACKING, HOME ENTERTAINMENT CENTERS, HOME THEATER EQUIPMENT, HUMIDORS, JEWELRY, JEWELRY BOXES, TOOL BOXES, SEWING MACHINES, TV STANDS, WALL ART, WATCHES,

AREA RUGS, CEILING FANS, CHANDELIERS, DESK LAMPS, DOORMATS, FLOOR LAMPS, FLOORING, LIGHTING, OUTDOOR RUGS AND OUTDOOR LIGHTING, ORIENTAL RUGS, PENDANT LIGHTS, POOL TABLE LIGHTS, RUGS, SOLAR LIGHTS, TABLE LAMPS, AND TIFFANY LAMPS, IN CLASS 35 (U.S. CLS. 100, 101 AND 102).

FIRST USE 3-1-2007; IN COMMERCE 3-1-2007.

THE MARK CONSISTS OF STANDARD CHARACTERS WITHOUT CLAIM TO ANY PARTICULAR FONT, STYLE, SIZE, OR COLOR.

SER. NO. 77-479,296, FILED 5-20-2008.

DOMINIC J. FERRAIUOLO, EXAMINING ATTORNEY

Int. Cl.: 36

Prior U.S. Cls.: 100, 101 and 102

United States Patent and Trademark Office

Reg. No. 3,575,402

Registered Feb. 17, 2009

**SERVICE MARK
PRINCIPAL REGISTER**

GUARANTEED PROTECTION UL

THE PENN MUTUAL LIFE INSURANCE COM-
PANY (PENNSYLVANIA CORPORATION)

600 DRESHER ROAD

HORSHAM, PA 19044

FOR: LIFE INSURANCE UNDERWRITING, IN
CLASS 36 (U.S. CLS. 100, 101 AND 102).

FIRST USE 8-6-2008; IN COMMERCE 8-6-2008.

THE MARK CONSISTS OF STANDARD CHAR-
ACTERS WITHOUT CLAIM TO ANY PARTICULAR
FONT, STYLE, SIZE, OR COLOR.

NO CLAIM IS MADE TO THE EXCLUSIVE
RIGHT TO USE "UL", APART FROM THE MARK
AS SHOWN.

SER. NO. 77-479,843, FILED 5-21-2008.

JORDAN BAKER, EXAMINING ATTORNEY

Int. Cl.: 9

Prior U.S. Cls.: 21, 23, 26, 36 and 38

United States Patent and Trademark Office

Reg. No. 3,575,403

Registered Feb. 17, 2009

**TRADEMARK
PRINCIPAL REGISTER**

LIVE NATION ARTISTS

LIVE NATION WORLDWIDE, INC. (DELAWARE CORPORATION)
9348 CIVIC CENTER DRIVE
BEVERLY HILLS, CA 90210

OWNER OF U.S. REG. NOS. 3,223,721, 3,349,859 AND OTHERS.

FOR: PRE-RECORDED CDS AND DVDS FEATURING MUSICAL PERFORMANCES, IN CLASS 9 (U.S. CLS. 21, 23, 26, 36 AND 38).

NO CLAIM IS MADE TO THE EXCLUSIVE RIGHT TO USE "LIVE" AND "ARTISTS", APART FROM THE MARK AS SHOWN.

FIRST USE 2-27-2008; IN COMMERCE 2-27-2008.

SER. NO. 77-480,419, FILED 5-21-2008.

THE MARK CONSISTS OF STANDARD CHARACTERS WITHOUT CLAIM TO ANY PARTICULAR FONT, STYLE, SIZE, OR COLOR.

HAI-LY LAM, EXAMINING ATTORNEY

Int. Cl.: 36

Prior U.S. Cls.: 100, 101 and 102

United States Patent and Trademark Office

Reg. No. 3,575,404

Registered Feb. 17, 2009

**SERVICE MARK
PRINCIPAL REGISTER**

Platinum Performance

PLATINUM BANK, INC. (FLORIDA CORPORATION)
802 WEST LUMSDEN ROAD
BRANDON, FL 33511

FOR: BANKING SERVICES, IN CLASS 36 (U.S. CLS. 100, 101 AND 102).

FIRST USE 8-1-1997; IN COMMERCE 8-1-1997.

THE MARK CONSISTS OF STANDARD CHARACTERS WITHOUT CLAIM TO ANY PARTICULAR FONT, STYLE, SIZE, OR COLOR.

OWNER OF U.S. REG. NOS. 2,520,557 AND 3,414,489.

SER. NO. 77-480,504, FILED 5-21-2008.

JAY BESCH, EXAMINING ATTORNEY

Int. Cls.: 7, 16, 27, 35, 37 and 41

**Prior U.S. Cls.: 2, 5, 13, 19, 20, 21, 22, 23, 29, 31, 34,
35, 37, 38, 42, 50, 100, 101, 102, 103, 106 and 107**

Reg. No. 3,575,405

United States Patent and Trademark Office

Registered Feb. 17, 2009

**TRADEMARK
SERVICE MARK
PRINCIPAL REGISTER**

TECHART

TECHART AUTOMOBILDESIGN GMBH (FED
REP GERMANY CORPORATION)
ROENTGENSTR, 47
LEONBERG, FED REP GERMANY 71229

FOR: ENGINE EXHAUST TIPS; ENGINE OR
MOTOR MUFFLERS; CATALYTIC CONVERTERS
FOR MOTORS AND ENGINES; COMPRESSORS AS
PARTS OF MACHINES, MOTORS AND ENGINES;
TURBOCHARGERS FOR MACHINES; VEHICLE
ENGINE PARTS, NAMELY, OIL COOLERS; EX-
HAUST PIPES FOR LAND VEHICLES; EXHAUST
MANIFOLD FOR ENGINES; AIR FILTERS FOR
VEHICLE MOTORS AND ENGINES; VEHICLE
PARTS, NAMELY, INTAKE MANIFOLDS, IN
CLASS 7 (U.S. CLS. 13, 19, 21, 23, 31, 34 AND 35).

FIRST USE 4-3-1987; IN COMMERCE 1-1-1995.

FOR: BOXES OF CARDBOARD OR PAPER; PRIN-
TED PRODUCTS, NAMELY, PRODUCT GUIDES
FEATURING AUTOMOBILES OR AUTOMOTIVE
SUBJECTS; CALENDARS; PHOTOGRAPHS, IN
CLASS 16 (U.S. CLS. 2, 5, 22, 23, 29, 37, 38 AND 50).

FIRST USE 4-3-1987; IN COMMERCE 1-1-1995.

FOR: CARPETS FOR AUTOMOBILES; FLOOR
MATS FOR VEHICLES, IN CLASS 27 (U.S. CLS. 19,
20, 37, 42 AND 50).

FIRST USE 4-2-1987; IN COMMERCE 8-1-2006.

FOR: AUTOMOBILE DEALERSHIPS, IN CLASS 35
(U.S. CLS. 100, 101 AND 102).

FIRST USE 4-2-1987; IN COMMERCE 1-1-1996.

FOR: AUTOMOBILE CUSTOMIZATION SERVI-
CES; AUTOMOBILE DETAILING; AUTOMOTIVE
CONVERSION SERVICES, NAMELY, INSTALLING
SPECIALTY AUTOMOTIVE EQUIPMENT; AUTO-
MOTIVE REFINISHING; INSTALLATION, MAIN-
TENANCE AND REPAIR OF ENGINE PARTS,
TRANSMISSIONS, EXHAUST SYSTEMS, ELECTRIC
AND ELECTRONIC EQUIPMENT IN AUTOMO-
BILES, IN CLASS 37 (U.S. CLS. 100, 103 AND 106).

FIRST USE 4-2-1987; IN COMMERCE 1-1-1999.

FOR: ENTERTAINMENT IN THE NATURE OF
AUTOMOBILE RACES; DRIVER SAFETY TRAIN-
ING, IN CLASS 41 (U.S. CLS. 100, 101 AND 107).

FIRST USE 1-1-1996; IN COMMERCE 6-13-2001.

THE MARK CONSISTS OF STANDARD CHAR-
ACTERS WITHOUT CLAIM TO ANY PARTICULAR
FONT, STYLE, SIZE, OR COLOR.

OWNER OF U.S. REG. NOS. 2,991,302 AND
2,991,303.

SER. NO. 77-480,587, FILED 5-21-2008.

APRIL ROACH, EXAMINING ATTORNEY

Int. Cl.: 36

Prior U.S. Cls.: 100, 101 and 102

United States Patent and Trademark Office

Reg. No. 3,575,406

Registered Feb. 17, 2009

**SERVICE MARK
PRINCIPAL REGISTER**

Platinum Value

PLATINUM BANK (FLORIDA CORPORATION)
802 LUMSDEN ROAD
BRANDON, FL 33511

FOR: BANKING SERVICES, IN CLASS 36 (U.S.
CLS. 100, 101 AND 102).

FIRST USE 8-1-1997; IN COMMERCE 8-1-1997.

THE MARK CONSISTS OF STANDARD CHAR-
ACTERS WITHOUT CLAIM TO ANY PARTICULAR
FONT, STYLE, SIZE, OR COLOR.

OWNER OF U.S. REG. NOS. 2,520,557 AND
3,414,489.

SER. NO. 77-480,637, FILED 5-21-2008.

JAY BESCH, EXAMINING ATTORNEY

Int. Cl.: 36

Prior U.S. Cls.: 100, 101 and 102

United States Patent and Trademark Office

Reg. No. 3,575,407

Registered Feb. 17, 2009

SERVICE MARK
PRINCIPAL REGISTER



BIKERS BATTLING BREAST CANCER, INC.
(GEORGIA CORPORATION)
2035 NORTH HIGHWAY 113
CARROLLTON, GA 30117

FOR: CHARITABLE FUNDRAISING SERVICES,
IN CLASS 36 (U.S. CLS. 100, 101 AND 102).

FIRST USE 2-11-2008; IN COMMERCE 2-11-2008.

NO CLAIM IS MADE TO THE EXCLUSIVE
RIGHT TO USE "BIKERS BATTLING BREAST CAN-
CER, INC.", APART FROM THE MARK AS SHOWN.

THE COLOR(S) BLACK AND PINK IS/ARE
CLAIMED AS A FEATURE OF THE MARK.

THE MARK CONSISTS OF A BLACK MOTOR-
CYCLE WITH A PINK RIBBON AROUND THE
MIDDLE AND THE WORDS IN BLACK ENCIR-
CLING THE DESIGN.

SER. NO. 77-481,163, FILED 5-22-2008.

AMY HELLA, EXAMINING ATTORNEY

Int. Cls.: 5, 35 and 44

Prior U.S. Cls.: 6, 18, 44, 46, 51, 52, 100, 101 and 102

United States Patent and Trademark Office

Reg. No. 3,575,408

Registered Feb. 17, 2009

**TRADEMARK
SERVICE MARK
PRINCIPAL REGISTER**

GLOBAL HEALING CENTER

GHC ND LICENSING, LTD. (ST.LUCIA CORPORATION)
C/O HEWANORRA CORPORATE SERVICES, LTD.
46 MICOUD STREET, P. O. BOX 1209
CASTRIES, ST.LUCIA

FOR: NUTRITIONAL AND DIETARY SUPPLEMENTS; PHARMACEUTICAL PREPARATIONS FOR PROTECTION FROM DEGENERATIVE DISEASES AND PURIFICATION OF THE MIND, BODY AND SOUL, IN CLASS 5 (U.S. CLS. 6, 18, 44, 46, 51 AND 52).

FIRST USE 3-5-1998; IN COMMERCE 3-5-1998.

FOR: ON-LINE, RETAIL AND WHOLESALE STORE SERVICES FEATURING DIETARY SUPPLEMENTS AND PHARMACEUTICAL PREPARATIONS, IN CLASS 35 (U.S. CLS. 100, 101 AND 102).

FIRST USE 3-5-1998; IN COMMERCE 3-5-1998.

FOR: NUTRITION CONSULTATION AND COUNSELING; PROVIDING INFORMATION ABOUT DIETARY SUPPLEMENTS AND NUTRITION; DIETARY AND NUTRITIONAL GUIDANCE; PRO-

VIDING HEALTH INFORMATION; PROVIDING HEALTH CARE INFORMATION BY TELEPHONE, MAIL, AND ELECTRONIC MAIL; PROVIDING COUNSELING AND NUTRITIONAL SUPPORT FOR DEGENERATIVE DISEASES AND FOR HEALING OF THE MIND, BODY AND SOUL; PROVIDING MEDICAL INFORMATION, NAMELY, INFORMATION ON ALTERNATIVE MEDICAL CARE AND NUTRITIONAL SUPPLEMENTATION, IN CLASS 44 (U.S. CLS. 100 AND 101).

FIRST USE 3-5-1998; IN COMMERCE 3-5-1998.

THE MARK CONSISTS OF STANDARD CHARACTERS WITHOUT CLAIM TO ANY PARTICULAR FONT, STYLE, SIZE, OR COLOR.

NO CLAIM IS MADE TO THE EXCLUSIVE RIGHT TO USE "HEALING CENTER", APART FROM THE MARK AS SHOWN.

SER. NO. 77-481,691, FILED 5-22-2008.

JENNIFER MARTIN, EXAMINING ATTORNEY

Int. Cl.: 9

Prior U.S. Cls.: 21, 23, 26, 36 and 38

United States Patent and Trademark Office

Reg. No. 3,575,409

Registered Feb. 17, 2009

**TRADEMARK
PRINCIPAL REGISTER**

INTELLISCREEN

INTELLIBORN CORPORATION (COLORADO
CORPORATION)
15823 WOODMEADOW CT
COLORADO SPRINGS, CO 80921

FOR: COMPUTER APPLICATION SOFTWARE
FOR MOBILE PHONES THAT PROVIDE INTEGRA-
TED USER DATA IN A SINGLE DISPLAY, IN CLASS
9 (U.S. CLS. 21, 23, 26, 36 AND 38).

FIRST USE 5-1-2008; IN COMMERCE 5-1-2008.

THE MARK CONSISTS OF STANDARD CHAR-
ACTERS WITHOUT CLAIM TO ANY PARTICULAR
FONT, STYLE, SIZE, OR COLOR.

SER. NO. 77-482,276, FILED 5-23-2008.

CARYN GLASSER, EXAMINING ATTORNEY

Int. Cls.: 16 and 41

Prior U.S. Cls.: 2, 5, 22, 23, 29, 37, 38, 50, 100, 101 and 107

Reg. No. 3,575,410

United States Patent and Trademark Office

Registered Feb. 17, 2009

**TRADEMARK
SERVICE MARK
PRINCIPAL REGISTER**

The Jerk Whisperer

STEPHEN BIRCHAK (UNITED STATES INDIVIDUAL)
197 SUNRISE DR.
GLOVERSVILLE, NY 12078

FOR: A SERIES OF BOOKS, WRITTEN ARTICLES, HANDOUTS, DVD'S, PROFESSIONAL SPEAKER'S SERVICES, CORPORATE WORKSHOP SERIES TITLES, EDUCATIONAL WORKSHOP SERIES TITLES, WEBSITE ADVERTISEMENTS, CONFERENCE ADVERTISEMENTS, SPEAKER'S BUREAUS ADVERTISEMENTS, SELF-HELP BOOKS, LITERARY ADVERTISEMENTS, AND WORKSHEETS IN THE FIELD OF SELF-HELP, IN CLASS 16 (U.S. CLS. 2, 5, 22, 23, 29, 37, 38 AND 50).

FIRST USE 10-1-2006; IN COMMERCE 2-9-2007.

FOR: EDUCATIONAL AND ENTERTAINMENT SERVICES, NAMELY, PROVIDING MOTIVATION-

AL AND EDUCATIONAL SPEAKERS IN THE FIELD OF SELF- AND PERSONAL IMPROVEMENT. MARK WILL BE USED FOR BOOKS, DVD'S, BROCHURES, ADVERTISING, WORKSHOP TITLES, CONSULTATION SERVICES, AND SPEAKER'S BUREAUS, IN CLASS 41 (U.S. CLS. 100, 101 AND 107).

FIRST USE 10-6-2006; IN COMMERCE 2-9-2007.

THE MARK CONSISTS OF STANDARD CHARACTERS WITHOUT CLAIM TO ANY PARTICULAR FONT, STYLE, SIZE, OR COLOR.

SER. NO. 77-482,364, FILED 5-23-2008.

HEATHER SAPP, EXAMINING ATTORNEY

Int. Cl.: 36

Prior U.S. Cls.: 100, 101 and 102

United States Patent and Trademark Office

Reg. No. 3,575,411

Registered Feb. 17, 2009

**SERVICE MARK
PRINCIPAL REGISTER**

Platinum Prestige

PLATINUM BANK (FLORIDA CORPORATION)
802 LUMSDEN ROAD
BRANDON, FL 33511

FOR: BANKING SERVICES, IN CLASS 36 (U.S.
CLS. 100, 101 AND 102).

FIRST USE 8-1-1997; IN COMMERCE 8-1-1997.

THE MARK CONSISTS OF STANDARD CHAR-
ACTERS WITHOUT CLAIM TO ANY PARTICULAR
FONT, STYLE, SIZE, OR COLOR.

OWNER OF U.S. REG. NOS. 2,520,557 AND
3,414,489.

SER. NO. 77-482,693, FILED 5-23-2008.

JAY BESCH, EXAMINING ATTORNEY

Int. Cl.: 45

Prior U.S. Cls.: 100 and 101

United States Patent and Trademark Office

Reg. No. 3,575,412

Registered Feb. 17, 2009

**SERVICE MARK
PRINCIPAL REGISTER**



THE LIGHTHOUSE COMMUNITY (WASHING-
TON CORPORATION)
11108 WOODLAND AVE. E.
PUYALLUP, WA 98373

FOR: ONLINE SOCIAL NETWORKING SERVI-
CES PROVIDED THROUGH AN ONLINE SOCIAL
NETWORK THAT ALLOWS THOSE SUFFERING
FROM A SERIOUS ILLNESS TO CONNECT WITH
ONE ANOTHER, WITH THEIR FAMILIES AND
FRIENDS, AND WITH POTENTIAL DONORS IN A
SUPPORTIVE ONLINE ENVIRONMENT, IN CLASS
45 (U.S. CLS. 100 AND 101).

FIRST USE 4-20-2005; IN COMMERCE 4-20-2005.

THE MARK CONSISTS OF A STYLIZED LIGHT-
HOUSE SET IN THE CENTER OF AND ATOP FIVE
SMALL HOUSES.

SER. NO. 77-482,901, FILED 5-23-2008.

THEODORE MCBRIDE, EXAMINING ATTORNEY

Int. Cl.: 45

Prior U.S. Cls.: 100 and 101

United States Patent and Trademark Office

Reg. No. 3,575,413

Registered Feb. 17, 2009

**SERVICE MARK
PRINCIPAL REGISTER**

THE LIGHTHOUSE COMMUNITY

THE LIGHTHOUSE COMMUNITY (WASHING-
TON CORPORATION)
11108 WOODLAND AVE. E.
PUYALLUP, WA 98373

FOR: ONLINE SOCIAL NETWORKING SERVI-
CES PROVIDED THROUGH AN ONLINE SOCIAL
NETWORK THAT ALLOWS THOSE SUFFERING
FROM A SERIOUS ILLNESS TO CONNECT WITH
ONE ANOTHER, WITH THEIR FAMILIES AND
FRIENDS, AND WITH POTENTIAL DONORS IN A
SUPPORTIVE ONLINE ENVIRONMENT, IN CLASS
45 (U.S. CLS. 100 AND 101).

FIRST USE 4-20-2005; IN COMMERCE 4-20-2005.

THE MARK CONSISTS OF STANDARD CHAR-
ACTERS WITHOUT CLAIM TO ANY PARTICULAR
FONT, STYLE, SIZE, OR COLOR.

NO CLAIM IS MADE TO THE EXCLUSIVE
RIGHT TO USE "COMMUNITY", APART FROM
THE MARK AS SHOWN.

SER. NO. 77-482,909, FILED 5-23-2008.

THEODORE MCBRIDE, EXAMINING ATTORNEY

Int. Cl.: 45

Prior U.S. Cls.: 100 and 101

United States Patent and Trademark Office

Reg. No. 3,575,414

Registered Feb. 17, 2009

**SERVICE MARK
PRINCIPAL REGISTER**

**OFFERING HOPE ONE PERSON
AT A TIME**

THE LIGHTHOUSE COMMUNITY (WASHING-
TON CORPORATION)
11108 WOODLAND AVE. E.
PUYALLUP, WA 98373

FOR: ONLINE SOCIAL NETWORKING SERVI-
CES PROVIDED THROUGH AN ON-LINE SOCIAL
NETWORK THAT ALLOWS THOSE SUFFERING
FROM A SERIOUS ILLNESS TO CONNECT WITH
ONE ANOTHER, WITH THEIR FAMILIES AND
FRIENDS, AND WITH POTENTIAL DONORS IN A
SUPPORTIVE ONLINE ENVIRONMENT, IN CLASS
45 (U.S. CLS. 100 AND 101).

FIRST USE 4-20-2005; IN COMMERCE 4-20-2005.

THE MARK CONSISTS OF STANDARD CHAR-
ACTERS WITHOUT CLAIM TO ANY PARTICULAR
FONT, STYLE, SIZE, OR COLOR.

SER. NO. 77-482,920, FILED 5-23-2008.

THEODORE MCBRIDE, EXAMINING ATTORNEY

Int. Cl.: 44

Prior U.S. Cls.: 100 and 101

United States Patent and Trademark Office

Reg. No. 3,575,415

Registered Feb. 17, 2009

SERVICE MARK
PRINCIPAL REGISTER



SALON OXYGEN LLC (FLORIDA LIMITED LIABILITY COMPANY)
400 MASHES SANDS ROAD
PANACEA, FL 32346

FOR: COSMETOLOGY SERVICES, IN CLASS 44
(U.S. CLS. 100 AND 101).

FIRST USE 5-1-2007; IN COMMERCE 5-1-2007.

NO CLAIM IS MADE TO THE EXCLUSIVE RIGHT TO USE "SALON OXYGEN" AND "O2", APART FROM THE MARK AS SHOWN.

THE MARK CONSISTS, IN PART, OF A STYLIZED "O2".

SER. NO. 77-483,223, FILED 5-25-2008.

PAUL E. FAHRENKOPF, EXAMINING ATTORNEY

Int. Cl.: 42

Prior U.S. Cls.: 100 and 101

United States Patent and Trademark Office

Reg. No. 3,575,416

Registered Feb. 17, 2009

**SERVICE MARK
PRINCIPAL REGISTER**

ILOGON

ILOGON INC. (ARIZONA CORPORATION)
2327 E SILVERWOOD DRIVE
PHOENIX, AZ 85048

FIRST USE 5-22-2008; IN COMMERCE 7-10-2008.

FOR: COMPUTER SERVICES, NAMELY, PROVIDING A WEB-BASED SYSTEM AND ONLINE PORTAL FOR CUSTOMERS TO REMOTELY MANAGE, ADMINISTER, MODIFY AND CONTROL THEIR ACCESS TO SUBSCRIPTION BASED WEBSITES, IN CLASS 42 (U.S. CLS. 100 AND 101).

THE MARK CONSISTS OF STANDARD CHARACTERS WITHOUT CLAIM TO ANY PARTICULAR FONT, STYLE, SIZE, OR COLOR.

SER. NO. 77-483,229, FILED 5-25-2008.

JESSICA A. POWERS, EXAMINING ATTORNEY

Int. Cl.: 13

Prior U.S. Cls.: 2 and 9

United States Patent and Trademark Office

Reg. No. 3,575,417

Registered Feb. 17, 2009

TRADEMARK
PRINCIPAL REGISTER

DGS

HORNADY MANUFACTURING COMPANY (NE-
BRASKA CORPORATION)
PO BOX 1848
GRAND ISLAND, NE 68802

THE MARK CONSISTS OF STANDARD CHAR-
ACTERS WITHOUT CLAIM TO ANY PARTICULAR
FONT, STYLE, SIZE, OR COLOR.

FOR: BULLETS, IN CLASS 13 (U.S. CLS. 2 AND 9).

SER. NO. 77-483,377, FILED 5-26-2008.

FIRST USE 0-0-2007; IN COMMERCE 0-0-2007.

JASON TURNER, EXAMINING ATTORNEY

Int. Cl.: 35

Prior U.S. Cls.: 100, 101 and 102

United States Patent and Trademark Office

Reg. No. 3,575,418

Registered Feb. 17, 2009

**SERVICE MARK
PRINCIPAL REGISTER**

**Good Business
International
Building Better Business
For a Better World**

MONIKA MITCHELL RESSLER (UNITED STATES INDIVIDUAL)
1123 BROADWAY SUITE 1117
NEW YORK, NY 10010 AND
PETER RESSLER (UNITED STATES INDIVIDUAL)
1123 BROADWAY SUITE 1117
NEW YORK, NY 10010

FIRST USE 5-26-2008; IN COMMERCE 5-26-2008.

THE MARK CONSISTS OF STANDARD CHARACTERS WITHOUT CLAIM TO ANY PARTICULAR FONT, STYLE, SIZE, OR COLOR.

FOR: BUSINESS INFORMATION IN THE FIELD OF GROWING YOUR BUSINESS; BUSINESS RESEARCH; INFORMATION IN BUSINESS MATTERS; INFORMATION, ADVISORY AND CONSULTANCY SERVICES RELATING TO BUSINESS AND MANAGEMENT OR BUSINESS ADMINISTRATION, INCLUDING SUCH SERVICES PROVIDED ON LINE OR VIA THE INTERNET, IN CLASS 35 (U.S. CLS. 100, 101 AND 102).

NO CLAIM IS MADE TO THE EXCLUSIVE RIGHT TO USE "GOOD BUSINESS INTERNATIONAL" , APART FROM THE MARK AS SHOWN.

SER. NO. 77-483,729, FILED 5-27-2008.

KRISTIN CARLSON, EXAMINING ATTORNEY

Int. Cl.: 9

Prior U.S. Cls.: 21, 23, 26, 36 and 38

United States Patent and Trademark Office

Reg. No. 3,575,419

Registered Feb. 17, 2009

**TRADEMARK
PRINCIPAL REGISTER**



SHERRILL-LUBINSKI CORPORATION (CALI-
FORNIA CORPORATION)
240 TAMAL VISTA BLVD.
CORTE MADERA, CA 94925

FIRST USE 2-19-2002; IN COMMERCE 2-19-2002.

OWNER OF U.S. REG. NO. 2,585,502.

FOR: COMPUTER SOFTWARE FOR APPLICA-
TIONS USED IN MONITORING, AGGREGATING,
ANALYZING, OR VIEWING DATA, MESSAGES,
APPLICATIONS, GRIDS, SERVICES, OR EVENTS;
COMPUTER SOFTWARE FOR CREATING AND
DELIVERING RULES, ALERTS, REPORTS, COM-
MANDS OR ACTIONS BASED ON DATA, MESSA-
GES, APPLICATIONS, GRIDS, SERVICES, OR
EVENTS, IN CLASS 9 (U.S. CLS. 21, 23, 26, 36 AND 38).

THE MARK CONSISTS OF CURVED LINES
AROUND THE LETTERS "SL".

SER. NO. 77-483,754, FILED 5-27-2008.

NAPOLEON SHARMA, EXAMINING ATTORNEY

Int. Cl.: 9

Prior U.S. Cls.: 21, 23, 26, 36 and 38

United States Patent and Trademark Office

Reg. No. 3,575,420

Registered Feb. 17, 2009

**TRADEMARK
PRINCIPAL REGISTER**

2DFlow

DYNAFLOW, INC. (MARYLAND CORPORATION)
10621-J IRON BRIDGE RD
JESSUP, MD 20794

THE MARK CONSISTS OF STANDARD CHARACTERS WITHOUT CLAIM TO ANY PARTICULAR FONT, STYLE, SIZE, OR COLOR.

FOR: COMPUTER SOFTWARE FOR VISUALIZING THE FLOW OF LIQUIDS AND GASES, IN CLASS 9 (U.S. CLS. 21, 23, 26, 36 AND 38).

SER. NO. 77-484,168, FILED 5-27-2008.

FIRST USE 0-0-1993; IN COMMERCE 0-0-1993.

MARGERY A. TIERNEY, EXAMINING ATTORNEY

Int. Cl.: 35

Prior U.S. Cls.: 100, 101 and 102

United States Patent and Trademark Office

Reg. No. 3,575,421

Registered Feb. 17, 2009

SERVICE MARK
PRINCIPAL REGISTER

Carbon *Free*

CARBON FREE CORP. (TEXAS CORPORATION)
11221 RICHMOND AVENUE, STE 107C
HOUSTON, TX 77082

FOR: BUSINESS CONSULTING SERVICES REGARDING CARBON CAPTURE AND GEOLOGICAL SEQUESTRATION METHODS AND TECHNOLOGIES, IN CLASS 35 (U.S. CLS. 100, 101 AND 102).

FIRST USE 1-31-2008; IN COMMERCE 5-1-2008.

NO CLAIM IS MADE TO THE EXCLUSIVE RIGHT TO USE "CARBON", APART FROM THE MARK AS SHOWN.

THE COLOR(S) BLACK AND GREEN IS/ARE CLAIMED AS A FEATURE OF THE MARK.

THE MARK CONSISTS OF "CARBON" IN BLACK FONT. "FREE" IN GREEN ITALIC FONT.

SER. NO. 77-484,393, FILED 5-27-2008.

GINA HAYES, EXAMINING ATTORNEY

Int. Cl.: 28

Prior U.S. Cls.: 22, 23, 38 and 50

United States Patent and Trademark Office

Reg. No. 3,575,422

Registered Feb. 17, 2009

TRADEMARK
PRINCIPAL REGISTER



LINDSAY LOU GAMES, LLC (MICHIGAN LIMITED LIABILITY COMPANY)
18680 SOUTHAMPTON STREET
LIVONIA, MI 48152

FOR: CARD GAMES, IN CLASS 28 (U.S. CLS. 22, 23, 38 AND 50).

FIRST USE 2-0-2008; IN COMMERCE 5-0-2008.

NO CLAIM IS MADE TO THE EXCLUSIVE RIGHT TO USE "A CARD GAME FOR COUPLES", APART FROM THE MARK AS SHOWN.

THE COLOR(S) LIGHT BLUE, RED, BLACK AND WHITE IS/ARE CLAIMED AS A FEATURE OF THE MARK.

THE MARK CONSISTS OF A STYLIZED VERSION OF THE WORD "STOP" IN LIGHT BLUE OUTLINED IN BLACK. UNDERNEATH THIS IS A STYLIZED AMPERSAND ("&") IN WHITE SURROUNDED BY A BLACK CIRCLE, WHICH IS OUTLINED IN RED. UNDERNEATH, IS A STYLIZED VERSION OF THE WORD "KISS" IN RED OUTLINED IN BLACK. UNDERNEATH ARE THE WORDS, IN BLACK, "A CARD GAME FOR COUPLES".

SER. NO. 77-484,549, FILED 5-27-2008.

ANGELA M. MICHELI, EXAMINING ATTORNEY

Int. Cl.: 45

Prior U.S. Cls.: 100 and 101

United States Patent and Trademark Office

Reg. No. 3,575,423

Registered Feb. 17, 2009

**SERVICE MARK
PRINCIPAL REGISTER**

**Southern Minnesota
Regional Legal Services**

SOUTHERN MINNESOTA REGIONAL LEGAL
SERVICES, INC. (MINNESOTA CORPOR-
ATION)

SUITE 200
166 E. 4TH STREET
ST. PAUL, MN 55101

FOR: LEGAL SERVICES, IN CLASS 45 (U.S. CLS.
100 AND 101).

FIRST USE 7-1-1977; IN COMMERCE 7-1-1982.

THE MARK CONSISTS OF STANDARD CHAR-
ACTERS WITHOUT CLAIM TO ANY PARTICULAR
FONT, STYLE, SIZE, OR COLOR.

NO CLAIM IS MADE TO THE EXCLUSIVE
RIGHT TO USE "REGIONAL LEGAL SERVICES",
APART FROM THE MARK AS SHOWN.

SEC. 2(F).

SER. NO. 77-484,661, FILED 5-28-2008.

HEATHER SAPP, EXAMINING ATTORNEY

Int. Cl.: 19

Prior U.S. Cls.: 1, 12, 33 and 50

United States Patent and Trademark Office

Reg. No. 3,575,424

Registered Feb. 17, 2009

**TRADEMARK
PRINCIPAL REGISTER**

Energy Vault Technology

YOST MANUFACTURING AND SUPPLY, INC.
(CONNECTICUT CORPORATION)
1018 HARTFORD TURNPIKE
WATERFORD, CT 06385

THE MARK CONSISTS OF STANDARD CHAR-
ACTERS WITHOUT CLAIM TO ANY PARTICULAR
FONT, STYLE, SIZE, OR COLOR.

FOR: INSULATED VINYL SIDING AND INSU-
LATED NON-METAL WINDOWS, IN CLASS 19 (U.S.
CLS. 1, 12, 33 AND 50).

SER. NO. 77-484,694, FILED 5-28-2008.

FIRST USE 5-13-2008; IN COMMERCE 5-13-2008.

DAVID MILLER, EXAMINING ATTORNEY

Int. Cl.: 36

Prior U.S. Cls.: 100, 101 and 102

United States Patent and Trademark Office

Reg. No. 3,575,425

Registered Feb. 17, 2009

**SERVICE MARK
PRINCIPAL REGISTER**



TRADINGBLOCK HOLDINGS, INC. (ILLINOIS CORPORATION)
SUITE 1525
311 S. WACKER DRIVE
CHICAGO, IL 60606

FIRST USE 4-1-2008; IN COMMERCE 4-1-2008.

THE COLOR(S) BLACK, WHITE AND ORANGE IS/ARE CLAIMED AS A FEATURE OF THE MARK.

FOR: AGENCIES FOR BROKERAGE OF SECURITIES TRADING IN OVERSEAS SECURITIES MARKETS AND OF TRANSACTIONS ON COMMISSION OF OVERSEAS MARKET SECURITIES FUTURES; AGENCIES OR BROKERAGE FOR TRADING OF SECURITIES, SECURITIES INDEX FUTURES, SECURITIES OPTIONS, AND OVERSEAS MARKET SECURITIES FUTURES; ONLINE SECURITIES BROKERAGE AND TRADING SERVICES; FINANCIAL SERVICES, NAMELY FINANCIAL ANALYSES AND RESEARCH, FINANCIAL ADVICE AND CONSULTATION, IN CLASS 36 (U.S. CLS. 100, 101 AND 102).

THE MARK CONSISTS OF THE WORDING "TRADINGBLOCK", WHEREIN "TRADING" IS IN ORANGE, "BL" AND "CK" ARE IN BLACK, AND "O" IS FORMED BY AN ORANGE HUMANIZED BLOCK FIGURE WITH WHITE EYES AND MOUTH.

SER. NO. 77-484,699, FILED 5-28-2008.

REBECCA POVARCHUK, EXAMINING ATTORNEY

Int. Cl.: 40

Prior U.S. Cls.: 100, 103 and 106

United States Patent and Trademark Office

Reg. No. 3,575,426

Registered Feb. 17, 2009

**SERVICE MARK
PRINCIPAL REGISTER**

SIMTEC

SIMTEC SILICONE PARTS, LLC (WISCONSIN
LIMITED LIABILITY COMPANY)
1902 WRIGHT STREET
MADISON, WI 53704

THE MARK CONSISTS OF STANDARD CHAR-
ACTERS WITHOUT CLAIM TO ANY PARTICULAR
FONT, STYLE, SIZE, OR COLOR.

FOR: CUSTOM MANUFACTURE OF LIQUID
SILICONE RUBBER PARTS, TWO SHOT AND/OR
OVERMOLDED LIQUID SILICONE RUBBER COM-
PONENTS, IN CLASS 40 (U.S. CLS. 100, 103 AND 106).

SER. NO. 77-484,843, FILED 5-28-2008.

FIRST USE 2-0-2001; IN COMMERCE 2-0-2001.

MARTHA FROMM, EXAMINING ATTORNEY

Int. Cl.: 40

Prior U.S. Cls.: 100, 103 and 106

United States Patent and Trademark Office

Reg. No. 3,575,427

Registered Feb. 17, 2009

**SERVICE MARK
PRINCIPAL REGISTER**

The logo for SIMTEC SILICONE PARTS. The word "SIMTEC" is written in a large, bold, outlined font. The letter "I" has a solid black square at its top. The letter "C" has a solid black square at its right end. Below "SIMTEC", the words "SILICONE PARTS" are written in a smaller, bold, outlined font.

SIMTEC SILICONE PARTS, LLC (WISCONSIN
LIMITED LIABILITY COMPANY)
1902 WRIGHT STREET
MADISON, WI 53704

FOR: CUSTOM MANUFACTURE OF LIQUID
SILICONE RUBBER PARTS, TWO SHOT AND/OR
OVERMOLDED LIQUID SILICONE RUBBER COM-
PONENTS, IN CLASS 40 (U.S. CLS. 100, 103 AND 106).

FIRST USE 2-0-2001; IN COMMERCE 2-0-2001.

NO CLAIM IS MADE TO THE EXCLUSIVE
RIGHT TO USE "SILICONE PARTS", APART FROM
THE MARK AS SHOWN.

THE MARK CONSISTS OF THE WORD SIMTEC
STYLIZED WITH A SMALL SQUARE AFTER THE
LETTER "C" AND THE WORDS SILICONE PARTS
UNDERNEATH.

SER. NO. 77-484,846, FILED 5-28-2008.

MARTHA FROMM, EXAMINING ATTORNEY

Int. Cl.: 9

Prior U.S. Cls.: 21, 23, 26, 36 and 38

United States Patent and Trademark Office

Reg. No. 3,575,428

Registered Feb. 17, 2009

TRADEMARK
PRINCIPAL REGISTER

helium

ELIXIR INTERNATIONAL (DELAWARE LIMITED LIABILITY COMPANY)
2100 RIVER HAVEN DRIVE, SUITE 220
BIRMINGHAM, AL 35244

FOR: COMPUTER SOFTWARE FOR CREATING SEARCHABLE DATABASES OF INFORMATION AND DATA; COMPUTER SOFTWARE FOR USE IN CUSTOMER RELATIONSHIP MANAGEMENT (CRM); COMPUTER SOFTWARE FOR MANAGING ELECTRONIC MEDICAL RECORDS AND RELATED BUSINESS, REGULATORY, AND INDUSTRY INFORMATION, NAMELY, COMPUTER SOFTWARE FOR CAPTURING, ORGANIZING, ANALYZING, AND MANAGING PATIENT INFORMATION, ELECTRONIC MEDICAL RECORDS, MEDICAL BILLING AND CLAIM INFORMATION, RESOURCE AND PARTNER INFORMATION, MEDICAL CODES, MEDICATION

INFORMATION, ACCOUNTING, CUSTOMER SERVICE, LOGISTICS, APPOINTMENT SCHEDULING, PLANNING AND RELATED INFORMATION, LOGIC, TOOLS AND UTILITIES; COMPUTER SOFTWARE THAT PROVIDES WEB-BASED ACCESS TO APPLICATIONS AND SERVICES THROUGH A WEB OPERATING SYSTEM OR PORTAL INTERFACE, IN CLASS 9 (U.S. CLS. 21, 23, 26, 36 AND 38).

FIRST USE 3-21-2008; IN COMMERCE 3-21-2008.

THE MARK CONSISTS OF STANDARD CHARACTERS WITHOUT CLAIM TO ANY PARTICULAR FONT, STYLE, SIZE, OR COLOR.

SER. NO. 77-485,164, FILED 5-28-2008.

KIM MONINGHOFF, EXAMINING ATTORNEY

Int. Cls.: 41 and 42

Prior U.S. Cls.: 100, 101 and 107

United States Patent and Trademark Office

Reg. No. 3,575,429

Registered Feb. 17, 2009

**SERVICE MARK
PRINCIPAL REGISTER**



STAN JOHNSON (UNITED STATES INDIVIDUAL)

P.O. BOX 618413

ORLANDO, FL 32861

FOR: DIGITAL IMAGING SERVICES; ENTERTAINMENT SERVICES, NAMELY, PRODUCTION OF SPECIAL EFFECTS INCLUDING MODEL-MAKING SERVICES, COMPUTER-GENERATED IMAGERY AND COMPUTER-GENERATED GRAPHICS FOR THE PRODUCTION OF MOTION PICTURES, VIDEOS, AND MOVIE TRAILERS; ENTERTAINMENT, NAMELY, PREPARATION OF SPECIAL EFFECTS; FILM AND VIDEO PRODUCTION; PHOTOGRAPHIC AND VIDEO SERVICES, NAMELY, PHOTOGRAPHIC AND VIDEO CAPTURE; PHOTOGRAPHY SERVICES; POST-PRODUCTION EDITING SERVICES IN THE FIELD OF MUSIC, VIDEOS AND FILMS; PRODUCTION OF VISUAL EFFECTS FOR VIDEOS, DVDS, TELEVISION AND FOR INTERNET WEB SITES; SPECIAL EFFECTS ANIMATION SERVICES FOR FILM AND VIDEO; VIDEO EDITING, IN CLASS 41 (U.S. CLS. 100, 101 AND 107).

FIRST USE 0-0-1992; IN COMMERCE 10-0-1993.

FOR: ANIMATION AND SPECIAL-EFFECTS DESIGN FOR OTHERS; COMPUTER GRAPHICS SERVICES; COMPUTER PROGRAMMING SERVICES; DESIGNING AND DEVELOPING WEBPAGES ON THE INTERNET; GRAPHIC DESIGN SERVICES, IN CLASS 42 (U.S. CLS. 100 AND 101).

FIRST USE 0-0-1992; IN COMMERCE 10-0-1993.

THE COLOR(S) ORANGE BLACK GRAY WHITE IS/ARE CLAIMED AS A FEATURE OF THE MARK.

THE MARK CONSISTS OF THE WORDS "THE PIXEL FACTORY" AND A PORTION OF A GEAR WITH PIECES OR "PIXELS" COMING OFF OF IT. THE WORD "PIXEL" IS IN ORANGE WITH BLACK SHADOWING AND "FACTORY" IN WHITE INSIDE AN OVAL WITH A BLACK BACKGROUND AND ORANGE BORDER AND BLACK SHADOWING. THE WORD "THE" IS BLACK. THE GEAR DESIGN IS GRAY WITH BLACK AND WHITE HIGHLIGHTS.

SER. NO. 77-485,640, FILED 5-28-2008.

AMY HELLA, EXAMINING ATTORNEY

Int. Cls.: 6, 11 and 19

**Prior U.S. Cls.: 1, 2, 12, 13, 14, 21, 23, 25, 31, 33, 34
and 50**

Reg. No. 3,575,430

United States Patent and Trademark Office

Registered Feb. 17, 2009

**TRADEMARK
PRINCIPAL REGISTER**

MAINE ORNAMENTAL

UNIVERSAL CONSUMER PRODUCTS, INC. (MI-
CHIGAN CORPORATION)
2801 E. BELTLINE NE
GRAND RAPIDS, MI 49525

FOR: METAL POST CAPS, IN CLASS 6 (U.S. CLS. 2,
12, 13, 14, 23, 25 AND 50).

FIRST USE 4-0-2005; IN COMMERCE 4-0-2005.

FOR: SOLAR LIGHT FIXTURES, NAMELY, OUT-
DOOR SOLAR POWERED LIGHTING FIXTURES,
IN CLASS 11 (U.S. CLS. 13, 21, 23, 31 AND 34).

FIRST USE 4-0-2005; IN COMMERCE 4-0-2005.

FOR: NON-METAL RAILS; NON-METAL POST
CAPS, IN CLASS 19 (U.S. CLS. 1, 12, 33 AND 50).

FIRST USE 0-0-1989; IN COMMERCE 0-0-1989.

THE MARK CONSISTS OF STANDARD CHAR-
ACTERS WITHOUT CLAIM TO ANY PARTICULAR
FONT, STYLE, SIZE, OR COLOR.

NO CLAIM IS MADE TO THE EXCLUSIVE
RIGHT TO USE "ORNAMENTAL" , APART FROM
THE MARK AS SHOWN.

SER. NO. 77-485,867, FILED 5-29-2008.

DOMINIC J. FERRAIUOLO, EXAMINING ATTOR-
NEY

Int. Cl.: 41

Prior U.S. Cls.: 100, 101 and 107

United States Patent and Trademark Office

Reg. No. 3,575,431

Registered Feb. 17, 2009

**SERVICE MARK
PRINCIPAL REGISTER**

**INTERNATIONAL HIGH SCHOOL
POWER SHOWCASE**

POWER SHOWCASE, INC. (FLORIDA CORPORATION)
9721 SADDLE BROOK DIVE
BOCA RATON, FL 33496

FOR: ARRANGING AND CONDUCTING ATHLETIC COMPETITIONS; ENTERTAINMENT IN THE NATURE OF COMPETITION IN THE FIELD OF ATHLETICS, IN CLASS 41 (U.S. CLS. 100, 101 AND 107).

FIRST USE 1-0-2006; IN COMMERCE 1-0-2006.

THE MARK CONSISTS OF STANDARD CHARACTERS WITHOUT CLAIM TO ANY PARTICULAR FONT, STYLE, SIZE, OR COLOR.

NO CLAIM IS MADE TO THE EXCLUSIVE RIGHT TO USE "INTERNATIONAL HIGH SCHOOL" AND "SHOWCASE", APART FROM THE MARK AS SHOWN.

SER. NO. 77-486,005, FILED 5-29-2008.

JILL PRATER, EXAMINING ATTORNEY

Int. Cl.: 25

Prior U.S. Cls.: 22 and 39

United States Patent and Trademark Office

Reg. No. 3,575,432

Registered Feb. 17, 2009

TRADEMARK
PRINCIPAL REGISTER

fresh junky

CAMACHO, REI (UNITED STATES INDIVIDUAL)
PO BOX 259
VAN NUYS, CA 91408

FOR: BALLOON PANTS; BERMUDA SHORTS; BOARD SHORTS; BOXER SHORTS; BUTTON-FRONT ALOHA SHIRTS; CAMP SHIRTS; CAPRI PANTS; CARGO PANTS; DENIMS; DRESS SHIRTS; FLEECE SHORTS; GOLF SHIRTS; GYM SHORTS; HOODED SWEAT SHIRTS; JOGGING PANTS; KNIT SHIRTS; LEATHER PANTS; LONG-SLEEVED SHIRTS; LOUNGE PANTS; MOISTURE-WICKING SPORTS PANTS; MOISTURE-WICKING SPORTS SHIRTS; NIGHT SHIRTS; NON-DISPOSABLE CLOTH TRAINING PANTS; NURSE PANTS; OPEN-NECKED SHIRTS; PANTIES, SHORTS AND BRIEFS; PANTS; PETTI-PANTS; PIQUE SHIRTS; POLO SHIRTS; RUGBY SHIRTS; RUGBY SHORTS; SHIRT FRONTS; SHIRT YOKES; SHIRTS; SHIRTS FOR SUITS; SHORT OVERCOAT FOR KIMONO (HAORI); SHORT PETTICOATS; SHORT SETS; SHORT TROUSERS; SHORT-SLEEVED OR LONG-SLEEVED T-SHIRTS; SHORT-SLEEVED SHIRTS; SHORTS; SKI PANTS; SLEEP SHIRTS; SLIDING

SHORTS; SNOW PANTS; SNOWBOARD PANTS; SPORT SHIRTS; SPORTS PANTS; SPORTS SHIRTS; SPORTS SHIRTS WITH SHORT SLEEVES; STRETCH PANTS; SWEAT PANTS; SWEAT SHIRTS; SWEAT SHORTS; T-SHIRTS; TAP PANTS; TEE SHIRTS; TOBOGGAN HATS, PANTS AND CAPS; TRACK PANTS; TRIATHLON CLOTHING, NAMELY, TRIATHLON TIGHTS, TRIATHLON SHORTS, TRIATHLON SINGLET, TRIATHLON SHIRTS, TRIATHLON SUITS; UNDERWEAR, NAMELY, BOY SHORTS; WALKING SHORTS; WATERPROOF JACKETS AND PANTS; WIND PANTS; WIND SHIRTS; YOGA PANTS; YOGA SHIRTS, IN CLASS 25 (U.S. CLS. 22 AND 39).

FIRST USE 6-1-1999; IN COMMERCE 11-1-2001.

THE MARK CONSISTS OF STANDARD CHARACTERS WITHOUT CLAIM TO ANY PARTICULAR FONT, STYLE, SIZE, OR COLOR.

SER. NO. 77-486,561, FILED 5-29-2008.

INGRID C. EULIN, EXAMINING ATTORNEY

Int. Cl.: 44

Prior U.S. Cls.: 100 and 101

United States Patent and Trademark Office

Reg. No. 3,575,433

Registered Feb. 17, 2009

**SERVICE MARK
PRINCIPAL REGISTER**



MIRACLES DETOX/RECOVERY PROGRAM AT
BROTMAN MEDICAL CENTER (CALIFOR-
NIA CORPORATION)
3828 DELMAS TERRACE
CULVER CITY, CA 90232

FOR: ADDICTION TREATMENT SERVICES, IN
CLASS 44 (U.S. CLS. 100 AND 101).

FIRST USE 4-0-2008; IN COMMERCE 4-0-2008.

NO CLAIM IS MADE TO THE EXCLUSIVE
RIGHT TO USE "DETOX RECOVERY PROGRAM"
AND "MEDICAL CENTER", APART FROM THE
MARK AS SHOWN.

THE MARK CONSISTS OF THE STYLIZED TEXT
"MIRACLES DETOX/RECOVERY PROGRAM AT
BROTMAN MEDICAL CENTER". THE TEXT "AT
BROTMAN MEDICAL CENTER" IS LOCATED IN-
SIDE OF A BANNER. THERE IS A STYLIZED STICK
FIGURE MAN HOLDING A STAR OVERLAYED ON
THE "A" IN "MIRACLES".

SER. NO. 77-486,662, FILED 5-29-2008.

RENEE SERVANCE, EXAMINING ATTORNEY

Int. Cl.: 38

Prior U.S. Cls.: 100, 101 and 104

United States Patent and Trademark Office

Reg. No. 3,575,434

Registered Feb. 17, 2009

**SERVICE MARK
PRINCIPAL REGISTER**

Mobile-Stream

CODE-STREAM TECHNOLOGIES (NEW YORK
CORPORATION)
15 CHURCH LANE
WEST ISLIP, NY 11795

FOR: TEXT AND NUMERIC WIRELESS DIGITAL
MESSAGING SERVICES; ELECTRONIC TRANS-
MISSION OF MESSAGES; WORLDWIDE SWIT-
CHED TEXT AND MESSAGE TRANSMISSION
SERVICES, IN CLASS 38 (U.S. CLS. 100, 101 AND 104).

FIRST USE 9-1-2007; IN COMMERCE 9-1-2007.

THE MARK CONSISTS OF STANDARD CHAR-
ACTERS WITHOUT CLAIM TO ANY PARTICULAR
FONT, STYLE, SIZE, OR COLOR.

SER. NO. 77-486,939, FILED 5-30-2008.

ANDREA SAUNDERS, EXAMINING ATTORNEY

Int. Cl.: 41

Prior U.S. Cls.: 100, 101 and 107

United States Patent and Trademark Office

Reg. No. 3,575,435

Registered Feb. 17, 2009

**SERVICE MARK
PRINCIPAL REGISTER**

MELODIA!

CLASSICAL MOVEMENTS, INC. (VIRGINIA CORPORATION)
319 CAMERON STREET
ALEXANDRIA, VA 22314

FOR: ENTERTAINMENT SERVICES, NAMELY, ORGANIZING LIVE MUSIC CONCERTS AND LIVE PERFORMANCES AND CONCERTS BY CHOIRS, AND EDUCATION SERVICES, NAMELY, ORGANIZING AND CONDUCTING MUSICAL WORKSHOPS AND CLASSES, IN CLASS 41 (U.S. CLS. 100, 101 AND 107).

FIRST USE 10-20-2005; IN COMMERCE 10-20-2005.

THE MARK CONSISTS OF STANDARD CHARACTERS WITHOUT CLAIM TO ANY PARTICULAR FONT, STYLE, SIZE, OR COLOR.

THE ENGLISH TRANSLATION OF "MELODIA" IS MELODY.

SER. NO. 77-487,146, FILED 5-30-2008.

MARK RADEMACHER, EXAMINING ATTORNEY

Int. Cl.: 25

Prior U.S. Cls.: 22 and 39

United States Patent and Trademark Office

Reg. No. 3,575,436

Registered Feb. 17, 2009

**TRADEMARK
PRINCIPAL REGISTER**

BEANSOUP

BEANSOUP LLC (CALIFORNIA LIMITED LIABILITY COMPANY)
2539 HOLLISTER TERRACE
GLENDALE, CA 91206

THE MARK CONSISTS OF STANDARD CHARACTERS WITHOUT CLAIM TO ANY PARTICULAR FONT, STYLE, SIZE, OR COLOR.

FOR: APRONS; COBBLER'S APRONS; CLOTHING FOR CHILDREN, NAMELY, TOPS; CHILDREN'S CLOTH BIBS, IN CLASS 25 (U.S. CLS. 22 AND 39).

SER. NO. 77-487,910, FILED 5-30-2008.

FIRST USE 9-1-2007; IN COMMERCE 9-1-2007.

JENNIFER DIXON, EXAMINING ATTORNEY

Int. Cl.: 9

Prior U.S. Cls.: 21, 23, 26, 36 and 38

United States Patent and Trademark Office

Reg. No. 3,575,437

Registered Feb. 17, 2009

**TRADEMARK
PRINCIPAL REGISTER**

SoundVisor

SURROUNDFX, LLC (FLORIDA LIMITED LIABILITY COMPANY)
2851 BANYAN BLVD. CIRCLE
BOCA RATON, FL 33431

FOR: APPARATUS FOR RECORDING, TRANSMISSION OR REPRODUCTION OF SOUND AND IMAGES; APPARATUS FOR TRANSMITTING AND REPRODUCING SOUND OR IMAGES; AUDIO SPEAKERS; COMPUTER SOFTWARE TO CONTROL AND IMPROVE COMPUTER AND AUDIO EQUIPMENT SOUND QUALITY; PERSONAL HEADPHONES FOR USE WITH SOUND TRANSMITTING SYSTEMS; SOFTWARE TO CONTROL

AND IMPROVE AUDIO EQUIPMENT SOUND QUALITY, IN CLASS 9 (U.S. CLS. 21, 23, 26, 36 AND 38).

FIRST USE 5-1-2008; IN COMMERCE 5-28-2008.

THE MARK CONSISTS OF STANDARD CHARACTERS WITHOUT CLAIM TO ANY PARTICULAR FONT, STYLE, SIZE, OR COLOR.

SER. NO. 77-487,914, FILED 5-30-2008.

ALICIA COLLINS, EXAMINING ATTORNEY

Int. Cl.: 41

Prior U.S. Cls.: 100, 101 and 107

United States Patent and Trademark Office

Reg. No. 3,575,438

Registered Feb. 17, 2009

**SERVICE MARK
PRINCIPAL REGISTER**

TVissimo

BARON, ROBERT (UNITED STATES INDIVIDUAL)
POBOX 653
1450 ROUTE 6A
EAST DENNIS, MA 026410653

FOR: CABLE TELEVISION PROGRAMMING;
TELEVISION AND RADIO PROGRAMMING; TELEVISION PROGRAMMING; TELEVISION SCHEDULING, IN CLASS 41 (U.S. CLS. 100, 101 AND 107).

FIRST USE 5-30-2008; IN COMMERCE 5-30-2008.

THE MARK CONSISTS OF STANDARD CHARACTERS WITHOUT CLAIM TO ANY PARTICULAR FONT, STYLE, SIZE, OR COLOR.

SER. NO. 77-487,930, FILED 5-31-2008.

DOMINIC FATHY, EXAMINING ATTORNEY

Int. Cl.: 35

Prior U.S. Cls.: 100, 101 and 102

United States Patent and Trademark Office

Reg. No. 3,575,439

Registered Feb. 17, 2009

**SERVICE MARK
PRINCIPAL REGISTER**



FGP INTERNATIONAL, INC. (SOUTH CAROLINA CORPORATION)
15 BRENDAN WAY, SUITE 140
GREENVILLE, SC 29615

FOR: RECRUITING AND PLACEMENT OF PROFESSIONAL PERSONNEL; AND TEMPORARY EMPLOYMENT AGENCIES, IN CLASS 35 (U.S. CLS. 100, 101 AND 102).

FIRST USE 7-13-2007; IN COMMERCE 7-13-2007.

OWNER OF U.S. REG. NO. 2,894,760.

NO CLAIM IS MADE TO THE EXCLUSIVE RIGHT TO USE "INTERNATIONAL", APART FROM THE MARK AS SHOWN.

THE COLOR(S) BLACK, WHITE AND RED IS/ ARE CLAIMED AS A FEATURE OF THE MARK.

THE MARK CONSISTS OF LARGE CAPITAL LETTERS "FGP" CENTERED IN A BLACK SQUARE, "F" AND "P" BEING WHITE AND "G" BEING RED. UNDERNEATH THEM IN SMALLER WHITE CAPITAL LETTERS IS "INTERNATIONAL" .

SER. NO. 77-488,281, FILED 6-2-2008.

ALEXANDER L. POWERS, EXAMINING ATTORNEY

Int. Cl.: 35

Prior U.S. Cls.: 100, 101 and 102

United States Patent and Trademark Office

Reg. No. 3,575,440

Registered Feb. 17, 2009

**SERVICE MARK
PRINCIPAL REGISTER**

**A BRILLIANT DIAMOND BUYING
EXPERIENCE**

WHITEFLASH.COM, INC. (TEXAS CORPORATION)
6222 RICHMOND AVE.
SUITE 700
HOUSTON, TX 77057

FOR: ONLINE RETAIL STORE SERVICES FEATURING DIAMONDS, PRECIOUS STONES, JEWELRY, JEWELRY MADE OF DIAMONDS, JEWELRY MADE OF PRECIOUS STONES, AND RINGS BEING JEWELRY, IN CLASS 35 (U.S. CLS. 100, 101 AND 102).

FIRST USE 6-30-2004; IN COMMERCE 6-30-2004.

THE MARK CONSISTS OF STANDARD CHARACTERS WITHOUT CLAIM TO ANY PARTICULAR FONT, STYLE, SIZE, OR COLOR.

SER. NO. 77-488,529, FILED 6-2-2008.

ROBERT LAVACHE, EXAMINING ATTORNEY

Int. Cl.: 36

Prior U.S. Cls.: 100, 101 and 102

United States Patent and Trademark Office

Reg. No. 3,575,441

Registered Feb. 17, 2009

**SERVICE MARK
PRINCIPAL REGISTER**

**GENERATION PROTECTOR II
PARTNERSHIP**

ALLIANZ LIFE INSURANCE COMPANY OF
NORTH AMERICA (MINNESOTA CORPORATION)
5701 GOLDEN HILL DRIVE
MINNEAPOLIS, MN 55416

FOR: INSURANCE SERVICES, NAMELY, UNDERWRITING, CLAIMS PROCESSING, CLAIMS ADMINISTRATION, CONSULTATION AND BROKERAGE, IN THE FIELDS OF LIFE INSURANCE, HEALTH INSURANCE AND LONG-TERM CARE INSURANCE, IN CLASS 36 (U.S. CLS. 100, 101 AND 102).

FIRST USE 8-7-2007; IN COMMERCE 8-7-2007.

THE MARK CONSISTS OF STANDARD CHARACTERS WITHOUT CLAIM TO ANY PARTICULAR FONT, STYLE, SIZE, OR COLOR.

OWNER OF U.S. REG. NOS. 2,817,540 AND 3,295,229.

NO CLAIM IS MADE TO THE EXCLUSIVE RIGHT TO USE "PARTNERSHIP", APART FROM THE MARK AS SHOWN.

SER. NO. 77-488,617, FILED 6-2-2008.

CYNTHIA TRIPI, EXAMINING ATTORNEY

Int. Cl.: 6

Prior U.S. Cls.: 2, 12, 13, 14, 23, 25 and 50

Reg. No. 3,575,442

United States Patent and Trademark Office

Registered Feb. 17, 2009

**TRADEMARK
PRINCIPAL REGISTER**

OCAL-BLUE

THOMAS & BETTS INTERNATIONAL, INC.
(TENNESSEE CORPORATION)
SUITE 67
501 SILVERSIDE ROAD
WILMINGTON, DE 19809

FOR: METAL CONDUITS FOR ELECTRICAL
CABLES, IN CLASS 6 (U.S. CLS. 2, 12, 13, 14, 23, 25
AND 50).

FIRST USE 8-1-2006; IN COMMERCE 8-1-2006.

THE MARK CONSISTS OF STANDARD CHAR-
ACTERS WITHOUT CLAIM TO ANY PARTICULAR
FONT, STYLE, SIZE, OR COLOR.

OWNER OF U.S. REG. NOS. 2,498,239 AND
2,651,188.

SER. NO. 77-488,688, FILED 6-2-2008.

SARA THOMAS, EXAMINING ATTORNEY

Int. Cl.: 41

Prior U.S. Cls.: 100, 101 and 107

United States Patent and Trademark Office

Reg. No. 3,575,443

Registered Feb. 17, 2009

**SERVICE MARK
PRINCIPAL REGISTER**

ROOT CAPITAL

ROOT CAPITAL, INC. (MASSACHUSETTS NON-
PROFIT CORPORATION)
8TH FLOOR
675 MASSACHUSETTS AVENUE
CAMBRIDGE, MA 02139

FOR: PROVIDING TRAINING IN FINANCIAL
MANAGEMENT AND BASIC BUSINESS SKILLS, IN
CLASS 41 (U.S. CLS. 100, 101 AND 107).

FIRST USE 5-31-2007; IN COMMERCE 5-31-2007.

THE MARK CONSISTS OF STANDARD CHAR-
ACTERS WITHOUT CLAIM TO ANY PARTICULAR
FONT, STYLE, SIZE, OR COLOR.

NO CLAIM IS MADE TO THE EXCLUSIVE
RIGHT TO USE "CAPITAL", APART FROM THE
MARK AS SHOWN.

SER. NO. 77-488,846, FILED 6-2-2008.

LESLEY LAMOTHE, EXAMINING ATTORNEY

Int. Cl.: 36

Prior U.S. Cls.: 100, 101 and 102

United States Patent and Trademark Office

Reg. No. 3,575,444

Registered Feb. 17, 2009

**SERVICE MARK
PRINCIPAL REGISTER**

ROOT CAPITAL

ROOT CAPITAL, INC. (MASSACHUSETTS NON-
PROFIT CORPORATION)
8TH FLOOR
675 MASSACHUSETTS AVENUE
CAMBRIDGE, MA 02139

FOR: PROVIDING FUNDING TO BUSINESSES IN
DEVELOPING COUNTRIES FOR THE PURPOSE OF
PROMOTING ECONOMIC DEVELOPMENT AND
SOUND ENVIRONMENTAL PRACTICES , IN
CLASS 36 (U.S. CLS. 100, 101 AND 102).

FIRST USE 5-31-2007; IN COMMERCE 5-31-2007.

THE MARK CONSISTS OF STANDARD CHAR-
ACTERS WITHOUT CLAIM TO ANY PARTICULAR
FONT, STYLE, SIZE, OR COLOR.

NO CLAIM IS MADE TO THE EXCLUSIVE
RIGHT TO USE "CAPITAL", APART FROM THE
MARK AS SHOWN.

SER. NO. 77-488,864, FILED 6-2-2008.

LESLEY LAMOTHE, EXAMINING ATTORNEY

Int. Cl.: 41

Prior U.S. Cls.: 100, 101 and 107

United States Patent and Trademark Office

Reg. No. 3,575,445

Registered Feb. 17, 2009

**SERVICE MARK
PRINCIPAL REGISTER**

Wounded By Design

HARGAN, JAMES, A.F. (UNITED STATES INDIVIDUAL)
3146 W. HEARN RD.
PHOENIX, AZ 85053

THE MARK CONSISTS OF STANDARD CHARACTERS WITHOUT CLAIM TO ANY PARTICULAR FONT, STYLE, SIZE, OR COLOR.

FOR: ENTERTAINMENT SERVICES IN THE NATURE OF LIVE MUSICAL PERFORMANCES, IN CLASS 41 (U.S. CLS. 100, 101 AND 107).

SER. NO. 77-489,080, FILED 6-2-2008.

FIRST USE 3-8-2008; IN COMMERCE 5-9-2008.

C. DIONNE CLYBURN, EXAMINING ATTORNEY

Int. Cl.: 41

Prior U.S. Cls.: 100, 101 and 107

United States Patent and Trademark Office

Reg. No. 3,575,446

Registered Feb. 17, 2009

SERVICE MARK
PRINCIPAL REGISTER

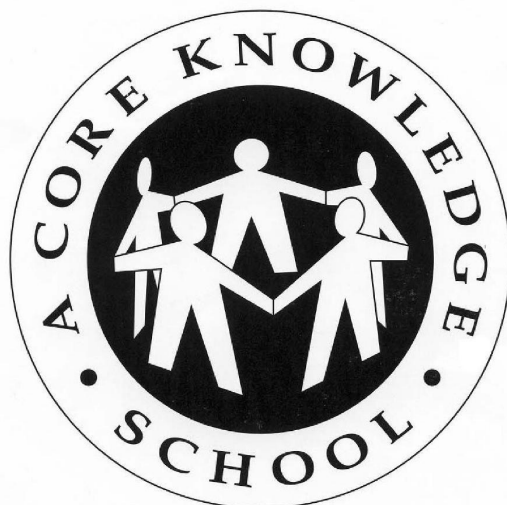

CORE KNOWLEDGE FOUNDATION CORPORATION (VIRGINIA CORPORATION)

801 EAST HIGH STREET

CHARLOTTESVILLE, VA 22902

FOR: EDUCATIONAL SERVICES IN THE NATURE OF CURRICULUM DEVELOPMENT IN GRADES K- 12, IN CLASS 41 (U.S. CLS. 100, 101 AND 107).

FIRST USE 6-30-1997; IN COMMERCE 6-30-1997.

NO CLAIM IS MADE TO THE EXCLUSIVE RIGHT TO USE "CORE" AND "SCHOOL", APART FROM THE MARK AS SHOWN.

THE MARK CONSISTS OF FIVE HUMAN FIGURES STANDING IN A CIRCLE AND HOLDING HANDS WITHIN A DARK CIRCLE, SURROUNDED BY THE PHRASE "A CORE KNOWLEDGE SCHOOL", SURROUNDED BY ANOTHER CIRCLE.

SER. NO. 77-489,126, FILED 6-2-2008.

KIM MONINGHOFF, EXAMINING ATTORNEY

Int. Cl.: 41

Prior U.S. Cls.: 100, 101 and 107

United States Patent and Trademark Office

Reg. No. 3,575,447

Registered Feb. 17, 2009

**SERVICE MARK
PRINCIPAL REGISTER**



CORE KNOWLEDGE FOUNDATION CORPORATION (VIRGINIA CORPORATION)

801 EAST HIGH STREET

CHARLOTTESVILLE, VA 22902

FOR: EDUCATIONAL SERVICES IN THE NATURE OF PRESCHOOL CURRICULUM DEVELOPMENT, IN CLASS 41 (U.S. CLS. 100, 101 AND 107).

FIRST USE 3-31-2005; IN COMMERCE 3-31-2005.

NO CLAIM IS MADE TO THE EXCLUSIVE RIGHT TO USE "CORE" AND "PRESCHOOL", APART FROM THE MARK AS SHOWN.

THE MARK CONSISTS OF FIVE HUMAN FIGURES STANDING IN A CIRCLE AND HOLDING HANDS WITHIN A DARK CIRCLE, SURROUNDED BY THE PHRASE "A CORE KNOWLEDGE PRESCHOOL", SURROUNDED BY ANOTHER CIRCLE.

SER. NO. 77-489,139, FILED 6-2-2008.

KIM MONINGHOFF, EXAMINING ATTORNEY

Int. Cl.: 25

Prior U.S. Cls.: 22 and 39

United States Patent and Trademark Office

Reg. No. 3,575,448

Registered Feb. 17, 2009

**TRADEMARK
PRINCIPAL REGISTER**



J&K PARIS INC. (CALIFORNIA CORPORATION)

#127

807 E. 12TH STREET

LOS ANGELES, CA 90021

FOR: WOMEN'S CLOTHING, NAMELY, BLOUSES, SHIRTS, PANTS, JEANS, JACKETS, SWEATERS, SKIRTS, DRESSES, UNDERWEAR, SLEEPWEAR, SCARVES, SHOES, IN CLASS 25 (U.S. CLS. 22 AND 39).

FIRST USE 5-23-2008; IN COMMERCE 5-23-2008.

NO CLAIM IS MADE TO THE EXCLUSIVE RIGHT TO USE "1999", APART FROM THE MARK AS SHOWN.

THE NAME "MISS KELLY" DOES NOT IDENTIFY A LIVING INDIVIDUAL.

THE MARK CONSISTS OF STYLIZED WORDING AND NUMBERS "MISS KELLY 1999" ON A RECTANGULAR BACKGROUND.

SER. NO. 77-489,234, FILED 6-3-2008.

RUDY R. SINGLETON, EXAMINING ATTORNEY

Int. Cl.: 38

Prior U.S. Cls.: 100, 101 and 104

United States Patent and Trademark Office

Reg. No. 3,575,449

Registered Feb. 17, 2009

**SERVICE MARK
PRINCIPAL REGISTER**

THE FIRST IMPRESSION PEOPLE

DATA-TRACK SERVICES, INC. (MASSACHU-
SETTS CORPORATION), DBA MARKETING
MESSAGES
51 WINCHESTER STREET
NEWTON, MA 02461

THE MARK CONSISTS OF STANDARD CHAR-
ACTERS WITHOUT CLAIM TO ANY PARTICULAR
FONT, STYLE, SIZE, OR COLOR.

FOR: TELEPHONE VOICE MESSAGING, IN
CLASS 38 (U.S. CLS. 100, 101 AND 104).

SER. NO. 77-489,730, FILED 6-3-2008.

FIRST USE 3-11-1984; IN COMMERCE 1-15-1985.

MARY BOAGNI, EXAMINING ATTORNEY

Int. Cl.: 25

Prior U.S. Cls.: 22 and 39

United States Patent and Trademark Office

Reg. No. 3,575,450

Registered Feb. 17, 2009

**TRADEMARK
PRINCIPAL REGISTER**

THE RULE

ROSARY MCCASKILL (UNITED STATES INDIVIDUAL)
1800 HICKORY AVE. APT. C
HARAHAN, LA 70123

FOR: JERSEYS, IN CLASS 25 (U.S. CLS. 22 AND 39).

FIRST USE 1-31-1999; IN COMMERCE 1-31-1999.

THE MARK CONSISTS OF STANDARD CHARACTERS WITHOUT CLAIM TO ANY PARTICULAR FONT, STYLE, SIZE, OR COLOR.

SER. NO. 77-489,791, FILED 6-3-2008.

JOHN SCHUYLER YARD, EXAMINING ATTORNEY

Int. Cl.: 9

Prior U.S. Cls.: 21, 23, 26, 36 and 38

United States Patent and Trademark Office

Reg. No. 3,575,451

Registered Feb. 17, 2009

**TRADEMARK
PRINCIPAL REGISTER**

**CLEARWELL E-DISCOVERY
PLATFORM**

CLEARWELL SYSTEMS, INC. (DELAWARE CORPORATION)
2901 TASMAN DRIVE, SUITE 100
SANTA CLARA, CA 95054

FOR: COMPUTER HARDWARE AND COMPUTER SOFTWARE FOR INFORMATION MANAGEMENT, IDENTIFICATION, COLLECTION, PRESERVATION, PROCESSING, ANALYSIS, REVIEW, PRODUCTION AND PRESENTATION OF ALL ELECTRONICALLY STORED DOCUMENTS AND DATA, IN CLASS 9 (U.S. CLS. 21, 23, 26, 36 AND 38).

FIRST USE 2-0-2008; IN COMMERCE 2-0-2008.

THE MARK CONSISTS OF STANDARD CHARACTERS WITHOUT CLAIM TO ANY PARTICULAR FONT, STYLE, SIZE, OR COLOR.

OWNER OF U.S. REG. NO. 3,139,079.

NO CLAIM IS MADE TO THE EXCLUSIVE RIGHT TO USE "E-DISCOVERY" AND "PLATFORM", APART FROM THE MARK AS SHOWN.

SER. NO. 77-489,801, FILED 6-3-2008.

JOHN SCHUYLER YARD, EXAMINING ATTORNEY

Int. Cl.: 41

Prior U.S. Cls.: 100, 101 and 107

United States Patent and Trademark Office

Reg. No. 3,575,452

Registered Feb. 17, 2009

SERVICE MARK
PRINCIPAL REGISTER



GABE & IZZY INC. (MICHIGAN CORPORATION)
409 RIGGS STREET
FENTON, MI 48430

FOR: EDUCATIONAL AND ENTERTAINMENT SERVICES, NAMELY, PROVIDING MOTIVATIONAL SPEAKING SERVICES IN THE FIELD OF ANTI-SCHOOL BULLYING AND VIOLENCE FOR CLASSES, ASSEMBLIES, AND YOUTH CONFERENCES, IN CLASS 41 (U.S. CLS. 100, 101 AND 107).

FIRST USE 9-6-2005; IN COMMERCE 9-6-2005.

NO CLAIM IS MADE TO THE EXCLUSIVE RIGHT TO USE "NO SCHOOL BULLYING", APART FROM THE MARK AS SHOWN.

THE MARK CONSISTS OF A PORTRAIT-STYLE IMAGE OF A DOG NAMED "IZZY", THE PHRASE "WWW.GABEANDIZZY.COM" LOCATED IN A SEMI-CIRCULAR MANNER SYMMETRICALLY ABOUT THE TOP OF THE IMAGE AND THE PHRASE "IZZY SAYS, 'NO SCHOOL BULLYING!'" LOCATED IN A SEMI-CIRCULAR MANNER SYMMETRICALLY ABOUT THE BOTTOM OF THE IMAGE SUCH THAT THE PHRASES IN COMBINATION WITH EACH OTHER SYMMETRICALLY ENCIRCLE THE IMAGE, AND THE NAME "IZZY" LOCATED IN A LINEAR, STYLIZED MANNER ON THE TORSO OF THE DOG.

SER. NO. 77-489,849, FILED 6-3-2008.

MEGHAN REINHART, EXAMINING ATTORNEY

Int. Cl.: 37

Prior U.S. Cls.: 100, 103 and 106

United States Patent and Trademark Office

Reg. No. 3,575,453

Registered Feb. 17, 2009

**SERVICE MARK
PRINCIPAL REGISTER**

**DAVID J. DESCHAIINE
INSTALLATIONS**

DESCHAIINE, DAVID J. (UNITED STATES INDIVIDUAL)
14 DUNSCOMBE STREET
SOUTH PORTLAND, ME 04106

OWNER OF U.S. REG. NO. 3,442,912.

FOR: CONSTRUCTION, MAINTENANCE AND RENOVATION OF PROPERTY, IN CLASS 37 (U.S. CLS. 100, 103 AND 106).

NO CLAIM IS MADE TO THE EXCLUSIVE RIGHT TO USE "INSTALLATIONS", APART FROM THE MARK AS SHOWN.

FIRST USE 6-1-1999; IN COMMERCE 6-1-1999.

SER. NO. 77-490,892, FILED 6-4-2008.

THE MARK CONSISTS OF STANDARD CHARACTERS WITHOUT CLAIM TO ANY PARTICULAR FONT, STYLE, SIZE, OR COLOR.

JOHN E. MICHOS, EXAMINING ATTORNEY

Int. Cl.: 9

Prior U.S. Cls.: 21, 23, 26, 36 and 38

Reg. No. 3,575,454

United States Patent and Trademark Office

Registered Feb. 17, 2009

**TRADEMARK
PRINCIPAL REGISTER**

SAFETYCRUISE

MONACO COACH CORPORATION (DELAWARE
CORPORATION)
91320 COBURG INDUSTRIAL WAY
COBURG, OR 97408

FOR: ELECTRONIC COLLISION WARNING DE-
VICE FOR A RECREATIONAL VEHICLE; COLLI-
SION WARNING SYSTEM FOR A RECREATIONAL
VEHICLE COMPRISED OF A HIGH-FREQUENCY
RADAR, TRANSMITTER, RECEIVER, PROCESSOR,
DISPLAY UNIT, WARNING LIGHTS AND AUDI-
BLE WARNING TONES, IN CLASS 9 (U.S. CLS. 21, 23,
26, 36 AND 38).

FIRST USE 7-0-2008; IN COMMERCE 7-0-2008.

THE MARK CONSISTS OF STANDARD CHAR-
ACTERS WITHOUT CLAIM TO ANY PARTICULAR
FONT, STYLE, SIZE, OR COLOR.

SER. NO. 77-490,937, FILED 6-4-2008.

KAREN K. BUSH, EXAMINING ATTORNEY

Int. Cl.: 6

Prior U.S. Cls.: 2, 12, 13, 14, 23, 25 and 50

Reg. No. 3,575,455

United States Patent and Trademark Office

Registered Feb. 17, 2009

**TRADEMARK
PRINCIPAL REGISTER**

QUALITY FOR LIFE

PARAMOUNT WINDOWS CORP. (ARIZONA
CORPORATION)
550 WEST SOUTHERN AVENUE
TEMPE, AZ 85282

THE MARK CONSISTS OF STANDARD CHAR-
ACTERS WITHOUT CLAIM TO ANY PARTICULAR
FONT, STYLE, SIZE, OR COLOR.

FOR: BUILDING MATERIALS MADE PRIMAR-
ILY OF METAL, NAMELY, WINDOWS, GLASS
DOORS AND SKYLIGHTS, IN CLASS 6 (U.S. CLS.
2, 12, 13, 14, 23, 25 AND 50).

SER. NO. 77-491,065, FILED 6-4-2008.

FIRST USE 12-29-2003; IN COMMERCE 7-21-2004.

MIDGE BUTLER, EXAMINING ATTORNEY

Int. Cl.: 35

Prior U.S. Cls.: 100, 101 and 102

United States Patent and Trademark Office

Reg. No. 3,575,456

Registered Feb. 17, 2009

**SERVICE MARK
PRINCIPAL REGISTER**

SPATHECARY

STARFLOWER ESSENTIALS (NEW MEXICO
SOLE PROPRIETORSHIP)
8712 BLAZYK DR.
AUSTIN, TX 78737

FOR: RETAIL AND WHOLESALE STORE AND
ON-LINE RETAIL AND WHOLESALE STORE SER-
VICES FEATURING SKIN CARE PREPARATIONS,
NAMELY, COSMETIC CREAMS, ANTIBACTERIAL
SKIN SOAPS, COSMETIC PREPARATIONS FOR
SKIN RENEWAL, COSMETIC PREPARATIONS
FOR DRY SKIN, SKIN CREAMS IN LIQUID AND
SOLID FORM, MAKE-UP, PATCHES CONTAINING
SUN SCREEN AND SUN BLOCK FOR USE ON THE
SKIN , SUN SCREEN, NON-MEDICATED SKIN
CARE PREPARATIONS, NAMELY, CREAMS, LO-
TIONS, GELS, TONERS, CLEANERS AND PEELS,
SKIN ABRASIVE PREPARATIONS, SKIN CARE
PREPARATIONS, NAMELY, FRUIT ACID PEELS
AND CHEMICAL PEELS FOR SKIN, BODY POLISH,

BODY BALM, SKIN SERUM, SKIN CLARIFIERS,
SKIN CLEANSING CREAM, SKIN CONDITIONERS,
SKIN EMOLLIENTS, SKIN TEXTURIZERS, SKIN
TONERS, SKIN WHITENING CREAMS, SKIN
MASK, SKIN BRONZERS, TOPICAL SKIN SPRAYS
FOR COSMETIC PURPOSES, WRINKLE REMOV-
ING SKIN CARE PREPARATIONS, HAIR SHAM-
POOS AND CONDITIONERS, ESSENTIAL OILS, IN
CLASS 35 (U.S. CLS. 100, 101 AND 102).

FIRST USE 2-5-2005; IN COMMERCE 2-5-2005.

THE MARK CONSISTS OF STANDARD CHAR-
ACTERS WITHOUT CLAIM TO ANY PARTICULAR
FONT, STYLE, SIZE, OR COLOR.

SER. NO. 77-491,375, FILED 6-5-2008.

ELLEN BURNS, EXAMINING ATTORNEY

Int. Cl.: 5

Prior U.S. Cls.: 6, 18, 44, 46, 51 and 52

United States Patent and Trademark Office

Reg. No. 3,575,457

Registered Feb. 17, 2009

**TRADEMARK
PRINCIPAL REGISTER**



DURAMED PHARMACEUTICALS, INC. (DELA-
WARE CORPORATION)
225 SUMMIT AVENUE
MONTVALE, NJ 07645

FOR: NON-INVASIVE DETECTION AND DIAG-
NOSTIC TEST KIT, NAMELY, A CHEMICALLY-
TREATED PANTY LINER AND TRAY FOR THE
DETECTION AND DIAGNOSIS OF AMNIOTIC
FLUID LEAKAGE, IN CLASS 5 (U.S. CLS. 6, 18, 44,
46, 51 AND 52).

FIRST USE 2-21-2008; IN COMMERCE 2-21-2008.

OWNER OF U.S. REG. NO. 3,454,330.

THE COLOR(S) PURPLE AND PALE GREEN IS/
ARE CLAIMED AS A FEATURE OF THE MARK.

THE MARK CONSISTS OF THE WORDING "AM-
NISCREEN" IN THE COLOR PURPLE, APPEARING
BENEATH A STYLIZED PALE GREEN "A" INTER-
SECTING WITH A HORIZONTAL PURPLE "S".

SER. NO. 77-491,539, FILED 6-5-2008.

ROBERT LAVACHE, EXAMINING ATTORNEY

Int. Cl.: 35

Prior U.S. Cls.: 100, 101 and 102

United States Patent and Trademark Office

Reg. No. 3,575,458

Registered Feb. 17, 2009

**SERVICE MARK
PRINCIPAL REGISTER**

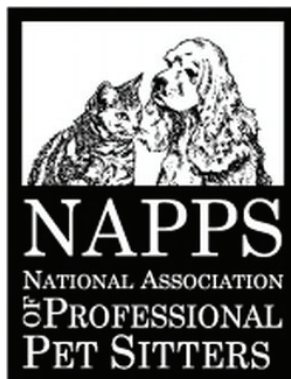

NATIONAL ASSOCIATION OF PROFESSIONAL
PET SITTERS, INC. (D.C. NON-PROFIT COR-
PORATION)

15000 COMMERCE PARKWAY, SUITE C
MT. LAUREL, NJ 08054

FOR: ASSOCIATION SERVICES, NAMELY, PRO-
MOTING THE INTERESTS OF THE PET SITTING
INDUSTRY , IN CLASS 35 (U.S. CLS. 100, 101 AND
102).

FIRST USE 1-0-1994; IN COMMERCE 1-0-1994.

NO CLAIM IS MADE TO THE EXCLUSIVE
RIGHT TO USE "NATIONAL ASSOCIATION",
APART FROM THE MARK AS SHOWN.

THE MARK CONSISTS OF A BACKGROUND
RECTANGLE WITH THE IMAGE OF A CAT AND A
DOG INSIDE A SMALLER RECTANGLE IN THE
TOP THIRD OF THE MARK. UNDERNEATH THE
IMAGE OF THE CAT AND DOG, IN THE BOTTOM
TWO THIRDS OF THE MARK IS THE WORDING
"NAPPS NATIONAL ASSOCIATION OF PROFES-
SIONAL PET SITTERS", WITH THE WORD "OF"
APPEARING VERTICALLY RATHER THAN HOR-
IZONTALLY.

SEC. 2(F) AS TO "NATIONAL ASSOCIATION OF
PROFESSIONAL PET SITTERS".

SER. NO. 77-491,693, FILED 6-5-2008.

COLLEEN KEARNEY, EXAMINING ATTORNEY

Int. Cl.: 5

Prior U.S. Cls.: 6, 18, 44, 46, 51 and 52

United States Patent and Trademark Office

Reg. No. 3,575,459

Registered Feb. 17, 2009

**TRADEMARK
PRINCIPAL REGISTER**

The logo for AmniScreen features a stylized, cursive letter 'A' positioned above the word 'AmniScreen' in a bold, sans-serif font.

DURAMED PHARMACEUTICALS, INC. (DELA-
WARE CORPORATION)
225 SUMMIT AVENUE
MONTVALE, NJ 07645

OWNER OF U.S. REG. NO. 3,454,330.

FOR: NON-INVASIVE DETECTION AND DIAG-
NOSTIC TEST KIT, NAMELY, A CHEMICALLY-
TREATED PANTY LINER AND TRAY FOR THE
DETECTION AND DIAGNOSIS OF AMNIOTIC
FLUID LEAKAGE, IN CLASS 5 (U.S. CLS. 6, 18, 44,
46, 51 AND 52).

THE MARK CONSISTS OF THE WORDING "AM-
NISCREEN" APPEARING BENEATH A STYLIZED
"A" INTERSECTING WITH A HORIZONTAL "S".

SER. NO. 77-491,697, FILED 6-5-2008.

FIRST USE 2-21-2008; IN COMMERCE 2-21-2008.

ROBERT LAVACHE, EXAMINING ATTORNEY

Int. Cls.: 41 and 42

Prior U.S. Cls.: 100, 101 and 107

United States Patent and Trademark Office

Reg. No. 3,575,460

Registered Feb. 17, 2009

**SERVICE MARK
PRINCIPAL REGISTER**

**The Freedom to Grow Your
Business**

TAMARAC, INC. (WASHINGTON CORPORATION)
811 FIRST AVE., SUITE 340
SEATTLE, WA 98104

FOR: EDUCATIONAL SERVICES IN THE FIELD OF TRAINING IN THE USE AND IMPLEMENTATION OF INVESTMENT STRATEGY MANAGEMENT AND SOFTWARE USE, IN CLASS 41 (U.S. CLS. 100, 101 AND 107).

FIRST USE 1-1-2008; IN COMMERCE 1-1-2008.

FOR: APPLICATION SERVICE PROVIDER FEATURING SOFTWARE FOR USE IN FINANCIAL

ACCOUNT BALANCING AND MONITORING IN THE FIELD OF INVESTMENT PLANNING AND MANAGEMENT, IN CLASS 42 (U.S. CLS. 100 AND 101).

FIRST USE 1-1-2008; IN COMMERCE 1-1-2008.

THE MARK CONSISTS OF STANDARD CHARACTERS WITHOUT CLAIM TO ANY PARTICULAR FONT, STYLE, SIZE, OR COLOR.

SER. NO. 77-491,751, FILED 6-5-2008.

JOHN WILKE, EXAMINING ATTORNEY

Int. Cl.: 3

Prior U.S. Cls.: 1, 4, 6, 50, 51 and 52

United States Patent and Trademark Office

Reg. No. 3,575,461

Registered Feb. 17, 2009

**TRADEMARK
PRINCIPAL REGISTER**

RED LION

DIVINE BROTHERS COMPANY (NEW YORK
CORPORATION)
200 SEWARD AVENUE
UTICA, NY 13503

FOR: BUFFING AND POLISHING COMPOUNDS,
NAMELY, PASTES, BARS, GREASELESS MATERI-
ALS, LIQUIDS FOR SURFACING AND COLORING
METAL SURFACES, IN CLASS 3 (U.S. CLS. 1, 4, 6, 50,
51 AND 52).

FIRST USE 6-5-1988; IN COMMERCE 6-5-1988.

THE MARK CONSISTS OF STANDARD CHAR-
ACTERS WITHOUT CLAIM TO ANY PARTICULAR
FONT, STYLE, SIZE, OR COLOR.

SER. NO. 77-491,779, FILED 6-5-2008.

DAWN FELDMAN, EXAMINING ATTORNEY

Int. Cl.: 21

Prior U.S. Cls.: 2, 13, 23, 29, 30, 33, 40 and 50

United States Patent and Trademark Office

Reg. No. 3,575,462

Registered Feb. 17, 2009

TRADEMARK
PRINCIPAL REGISTER



JEANNE BEATRICE, LLC (MINNESOTA LIMITED LIABILITY COMPANY)

5013 ARDEN AVENUE
EDINA, MN 55424

FOR: MARKET BASKETS WOVEN OUT OF SEA GRASS, WATER REEDS, OR PALM LEAVES, WITH HANDLES, IN CLASS 21 (U.S. CLS. 2, 13, 23, 29, 30, 33, 40 AND 50).

FIRST USE 10-0-2007; IN COMMERCE 10-0-2007.

NO CLAIM IS MADE TO THE EXCLUSIVE RIGHT TO USE "TRADE MARK", APART FROM THE MARK AS SHOWN.

THE NAME(S), PORTRAIT(S), AND/OR SIGNATURE(S) SHOWN IN THE MARK DOES NOT IDENTIFY A PARTICULAR LIVING INDIVIDUAL.

THE MARK CONSISTS OF A CIRCLE WITH A SMALLER CIRCLE IN THE CENTER CONTAINING THE LETTERS "JB" WITH A LEAFY BRANCH COMING OUT OF THE "J". THE MARK CONTAINS THE WORDING "JEANNE BEATRICE" IN A CIRCLE AND THE WORDING "THE EARTH THANKS YOU" BORDERING THE INNER SOLID CIRCLE. THE WORDING "TRADE MARK" APPEARS OUTSIDE THE CIRCLES BELOW.

SER. NO. 77-492,622, FILED 6-6-2008.

KAPIL BHANOT, EXAMINING ATTORNEY

Int. Cl.: 42

Prior U.S. Cls.: 100 and 101

United States Patent and Trademark Office

Reg. No. 3,575,463

Registered Feb. 17, 2009

**SERVICE MARK
PRINCIPAL REGISTER**

OrthoWorld

ORTHOWORLD INC. (OHIO CORPORATION)
8401 CHAGRIN ROAD
SUITE 18
CHAGRIN FALLS, OH 44023

THE MARK CONSISTS OF STANDARD CHARACTERS WITHOUT CLAIM TO ANY PARTICULAR FONT, STYLE, SIZE, OR COLOR.

FOR: COMPUTER SERVICES, NAMELY, HOSTING AND MAINTAINING AN ON-LINE WEB SITE FOR OTHERS TO ACCESS ORTHOPEDIC MUSCULOSKELETAL INDUSTRY INFORMATION VIA THE GLOBAL COMPUTER NETWORK , IN CLASS 42 (U.S. CLS. 100 AND 101).

OWNER OF U.S. REG. NOS. 2,435,191 AND 3,273,958.

SER. NO. 77-492,686, FILED 6-6-2008.

FIRST USE 12-0-1997; IN COMMERCE 12-0-1997.

MARY ROSSMAN, EXAMINING ATTORNEY

Int. Cls.: 16 and 35

Prior U.S. Cls.: 2, 5, 22, 23, 29, 37, 38, 50, 100, 101 and 102

United States Patent and Trademark Office

Reg. No. 3,575,464

Registered Feb. 17, 2009

**TRADEMARK
SERVICE MARK
PRINCIPAL REGISTER**



ACMP ASSOCIATED CHAMBER MUSIC PLAYERS, INC. (NEW YORK CORPORATION)
1123 BROADWAY, SUITE 904
NEW YORK, NY 10010

FOR: DIRECTORY OF CHAMBER MUSIC LOVERS, IN CLASS 16 (U.S. CLS. 2, 5, 22, 23, 29, 37, 38 AND 50).

FIRST USE 8-0-2006; IN COMMERCE 8-0-2006.

FOR: ASSOCIATION SERVICES, NAMELY, PROMOTING THE INTERESTS OF CHAMBER MUSIC

ENTHUSIASTS, IN CLASS 35 (U.S. CLS. 100, 101 AND 102).

FIRST USE 8-0-2006; IN COMMERCE 8-0-2006.

THE MARK CONSISTS OF FOUR MUSIC STANDS INSIDE A RECTANGLE.

SER. NO. 77-493,093, FILED 6-6-2008.

ALICE SUE CARRUTHERS, EXAMINING ATTORNEY

Int. Cl.: 44

Prior U.S. Cls.: 100 and 101

United States Patent and Trademark Office

Reg. No. 3,575,465

Registered Feb. 17, 2009

**SERVICE MARK
PRINCIPAL REGISTER**

Health Care For Your Eyes

KURTIN, STEVEN C. (UNITED STATES INDIVIDUAL)
5323 WILLOW WOOD LANE
DALLAS, TX 75252

FOR: OPTOMETRY SERVICES, IN CLASS 44 (U.S. CLS. 100 AND 101).

FIRST USE 8-1-1999; IN COMMERCE 8-1-1999.

THE MARK CONSISTS OF STANDARD CHARACTERS WITHOUT CLAIM TO ANY PARTICULAR FONT, STYLE, SIZE, OR COLOR.

NO CLAIM IS MADE TO THE EXCLUSIVE RIGHT TO USE "HEALTH CARE", APART FROM THE MARK AS SHOWN.

SEC. 2(F).

SER. NO. 77-493,708, FILED 6-8-2008.

AISHA SALEM, EXAMINING ATTORNEY

Int. Cl.: 36

Prior U.S. Cls.: 100, 101 and 102

United States Patent and Trademark Office

Reg. No. 3,575,466

Registered Feb. 17, 2009

**SERVICE MARK
PRINCIPAL REGISTER**

ALL IN FOR ALS

MUSCULAR DYSTROPHY ASSOCIATION, INC.
(NEW YORK NON-PROFIT CORPORATION)
3300 EAST SUNRISE DRIVE
TUCSON, AZ 85718

FOR: CHARITABLE FUNDRAISING SERVICES
FOR BASIC AND APPLIED RESEARCH INTO NEU-
ROMUSCULAR DISORDERS AND FOR FUNDING
SERVICES TO PERSONS AFFLICTED BY SUCH
DISORDERS, IN CLASS 36 (U.S. CLS. 100, 101 AND
102).

FIRST USE 1-29-2005; IN COMMERCE 1-29-2005.

THE MARK CONSISTS OF STANDARD CHAR-
ACTERS WITHOUT CLAIM TO ANY PARTICULAR
FONT, STYLE, SIZE, OR COLOR.

NO CLAIM IS MADE TO THE EXCLUSIVE
RIGHT TO USE "ALS", APART FROM THE MARK
AS SHOWN.

SER. NO. 77-494,135, FILED 6-9-2008.

YONG KIM, EXAMINING ATTORNEY

Int. Cl.: 41

Prior U.S. Cls.: 100, 101 and 107

United States Patent and Trademark Office

Reg. No. 3,575,467

Registered Feb. 17, 2009

**SERVICE MARK
PRINCIPAL REGISTER**

MARTIN LUTHER KING, JR.
COMMUNITY CHOIR SAN DIEGO

MARTIN LUTHER KING, JR. COMMUNITY
CHOIR SAN DIEGO (CALIFORNIA NON-
PROFIT CORPORATION)
P.O. BOX 40362
SAN DIEGO, CA 921640362

FOR: ENTERTAINMENT IN THE NATURE OF
LIVE PERFORMANCES BY A CHOIR, IN CLASS 41
(U.S. CLS. 100, 101 AND 107).

FIRST USE 0-0-1998; IN COMMERCE 0-0-1998.

THE MARK CONSISTS OF STANDARD CHAR-
ACTERS WITHOUT CLAIM TO ANY PARTICULAR
FONT, STYLE, SIZE, OR COLOR.

NO CLAIM IS MADE TO THE EXCLUSIVE
RIGHT TO USE "COMMUNITY CHOIR SAN DIE-
GO", APART FROM THE MARK AS SHOWN.

THE NAME "MARTIN LUTHER KING, JR."
DOES NOT IDENTIFY A LIVING INDIVIDUAL.

SER. NO. 77-494,145, FILED 6-9-2008.

LINDA LAVACHE, EXAMINING ATTORNEY

Int. Cl.: 19

Prior U.S. Cls.: 1, 12, 33 and 50

United States Patent and Trademark Office

Reg. No. 3,575,468

Registered Feb. 17, 2009

**TRADEMARK
PRINCIPAL REGISTER**

PANOPLY

HERBERT MALARKEY ROOFING COMPANY
(OREGON CORPORATION)
3131 N. COLUMBIA BLVD.
PORTLAND, OR 97217

FOR: NON-METAL SHINGLES; ROOFING MEM-
BRANES; ROOFING UNDERLAYMENT, IN CLASS
19 (U.S. CLS. 1, 12, 33 AND 50).

FIRST USE 4-12-1993; IN COMMERCE 7-31-1993.

THE MARK CONSISTS OF STANDARD CHAR-
ACTERS WITHOUT CLAIM TO ANY PARTICULAR
FONT, STYLE, SIZE, OR COLOR.

OWNER OF U.S. REG. NO. 2,101,258.

SER. NO. 77-494,152, FILED 6-9-2008.

DARRYL SPRUILL, EXAMINING ATTORNEY

Int. Cl.: 42

Prior U.S. Cls.: 100 and 101

United States Patent and Trademark Office

Reg. No. 3,575,469

Registered Feb. 17, 2009

**SERVICE MARK
PRINCIPAL REGISTER**

**HIC Network Security
Solutions**

HIC NETWORK SECURITY SOLUTIONS (DELA-
WARE LIMITED LIABILITY COMPANY)
331 W 57TH STREET, #448
NEW YORK, NY 10019

FOR: COMPUTER CONSULTATION IN THE
FIELD OF COMPUTER SECURITY, IN CLASS 42
(U.S. CLS. 100 AND 101).

FIRST USE 3-20-2006; IN COMMERCE 4-3-2006.

THE MARK CONSISTS OF STANDARD CHAR-
ACTERS WITHOUT CLAIM TO ANY PARTICULAR
FONT, STYLE, SIZE, OR COLOR.

NO CLAIM IS MADE TO THE EXCLUSIVE
RIGHT TO USE "NETWORK SECURITY SOLU-
TIONS", APART FROM THE MARK AS SHOWN.

SER. NO. 77-494,246, FILED 6-9-2008.

MARK RADEMACHER, EXAMINING ATTORNEY

Int. Cl.: 35

Prior U.S. Cls.: 100, 101 and 102

United States Patent and Trademark Office

Reg. No. 3,575,470

Registered Feb. 17, 2009

**SERVICE MARK
PRINCIPAL REGISTER**



NATIONAL AGRICULTURAL AVIATION ASSO-
CIATION (D.C. NON-PROFIT CORPORATION)
1005 E. STREET, S.E.
WASHINGTON, DC 20003

FOR: ASSOCIATION SERVICES, NAMELY, PRO-
MOTING THE RESEARCH, TECHNOLOGY TRANS-
FER AND ADVANCED EDUCATION AMONG
AERIAL APPLICATORS, ALLIED INDUSTRIES,
GOVERNMENT AGENCIES AND ACADEMIC IN-
STITUTIONS AND THE PUBLIC, IN CLASS 35 (U.S.
CLS. 100, 101 AND 102).

FIRST USE 0-0-1998; IN COMMERCE 0-0-1998.

OWNER OF U.S. REG. NO. 2,573,409.

THE MARK CONSISTS OF A SHADED SQUARE
HAVING AN OVAL WITHIN, WITH AN AIRPLANE
IN THE TOP PORTION OF THE OVAL AND A GRID
IN THE BOTTOM PORTION OF THE OVAL WITH
THE LETTERS "NAAREF".

SER. NO. 77-494,345, FILED 6-9-2008.

RUDY R. SINGLETON, EXAMINING ATTORNEY

Int. Cl.: 11

Prior U.S. Cls.: 13, 21, 23, 31 and 34

Reg. No. 3,575,471

United States Patent and Trademark Office

Registered Feb. 17, 2009

**TRADEMARK
PRINCIPAL REGISTER**

Warm Whiskers

TREAT YOURSELF, INC. (CALIFORNIA CORPORATION), DBA WARM WHISKERS
SUITE 441
21781 VENTURA BOULEVARD
WOODLAND HILLS, CA 91364

FOR: BED WARMERS; COLD PACKS FOR COOLING THE BODY AND NOT FOR MEDICAL PURPOSES; HEAT ACCUMULATORS; HEATING ELEMENTS; HEATING INSERTS FOR PET BEDS; HOT WATER BOTTLE HOLDER WITH POUCH OF MICROWAVABLE MATERIAL FOR SUSTAINED WARMTH; HOT WATER BOTTLES, IN CLASS 11 (U.S. CLS. 13, 21, 23, 31 AND 34).

FIRST USE 6-1-2000; IN COMMERCE 9-1-2000.

THE MARK CONSISTS OF STANDARD CHARACTERS WITHOUT CLAIM TO ANY PARTICULAR FONT, STYLE, SIZE, OR COLOR.

NO CLAIM IS MADE TO THE EXCLUSIVE RIGHT TO USE "WARM", APART FROM THE MARK AS SHOWN.

SER. NO. 77-494,384, FILED 6-9-2008.

MARILYN IZZI, EXAMINING ATTORNEY

Int. Cls.: 16 and 41

Prior U.S. Cls.: 2, 5, 22, 23, 29, 37, 38, 50, 100, 101 and 107

Reg. No. 3,575,472

United States Patent and Trademark Office

Registered Feb. 17, 2009

**TRADEMARK
SERVICE MARK
PRINCIPAL REGISTER**



BEGIN SMART LLC (NEW YORK LIMITED LIABILITY COMPANY)
387 PARK AVENUE SOUTH
NEW YORK, NY 10016

FOR: CHILDREN'S BOOKS, EDUCATIONAL BOOKS FEATURING A DEVELOPMENTAL PROGRAM FOR CHILDREN , IN CLASS 16 (U.S. CLS. 2, 5, 22, 23, 29, 37, 38 AND 50).

FIRST USE 6-4-2008; IN COMMERCE 6-4-2008.

FOR: BOOK PUBLISHING SERVICES; PROVIDING EDUCATION INFORMATION AND EDUCATION MULTIMEDIA CONTENT VIA A WEB SITE ON CHILDHOOD DEVELOPMENT AND A DEVELOPMENTAL PROGRAM FOR CHILDREN THAT ENCOURAGES THE PHYSICAL, SOCIAL, EMOTIONAL AND INTELLECTUAL GROWTH OF BABIES AND TODDLERS, IN CLASS 41 (U.S. CLS. 100, 101 AND 107).

FIRST USE 6-4-2008; IN COMMERCE 6-4-2008.

OWNER OF U.S. REG. NOS. 3,481,351 AND 3,482,352.

THE COLOR(S) BLACK, WHITE, ORANGE AND YELLOW IS/ARE CLAIMED AS A FEATURE OF THE MARK.

THE MARK CONSISTS OF THE WORD "BEGIN" IN BLACK LETTERS, THE WORD "SMART" IN WHITE LETTERS WITH A YELLOW BABY CHICK COMING OUT OF A WHITE SHELL WITHIN A BLACK SEMICIRCLE, THE COLOR ORANGE APPEARS IN THE BEAK OF THE CHICK, AND ALL WITHIN A YELLOW CIRCLE WITH A WAVY YELLOW LINE THROUGH THE MIDDLE OF THE MARK.

SER. NO. 77-494,443, FILED 6-9-2008.

WARREN L. OLANDRIA, EXAMINING ATTORNEY

Int. Cl.: 42

Prior U.S. Cls.: 100 and 101

United States Patent and Trademark Office

Reg. No. 3,575,473

Registered Feb. 17, 2009

**SERVICE MARK
PRINCIPAL REGISTER**

Signal Oil and Gas Company

JAMES E. VAN BLARIACUM (UNITED STATES
INDIVIDUAL)
SUITE 100
5208 AIRPORT FRW
FORT WORTH, TX 76117

FOR: GAS EXPLORATION; GEOPHYSICAL EX-
PLORATION FOR THE OIL, GAS AND MINING
INDUSTRIES; OIL EXPLORATION, IN CLASS 42
(U.S. CLS. 100 AND 101).

FIRST USE 10-23-2000; IN COMMERCE 10-23-2000.

THE MARK CONSISTS OF STANDARD CHAR-
ACTERS WITHOUT CLAIM TO ANY PARTICULAR
FONT, STYLE, SIZE, OR COLOR.

NO CLAIM IS MADE TO THE EXCLUSIVE
RIGHT TO USE "OIL AND GAS COMPANY",
APART FROM THE MARK AS SHOWN.

SER. NO. 77-494,453, FILED 6-9-2008.

KIM SAITO, EXAMINING ATTORNEY

Int. Cl.: 25

Prior U.S. Cls.: 22 and 39

United States Patent and Trademark Office

Reg. No. 3,575,474

Registered Feb. 17, 2009

**TRADEMARK
PRINCIPAL REGISTER**

ECO LOVE

WIESNER PRODUCTS, INC. (NEW YORK COR-
PORATION)
4TH FLOOR
20 WEST 33RD STREET
NEW YORK, NY 10001

FOR: CLOTHING, NAMELY, SHIRTS, PANTS,
SWEATSHIRT, T-SHIRTS, JACKETS, SOCKS, SLIP-
PERS, AND SANDALS FOR MEN, WOMEN AND
CHILDREN, IN CLASS 25 (U.S. CLS. 22 AND 39).

FIRST USE 8-7-2007; IN COMMERCE 8-7-2007.

THE MARK CONSISTS OF STANDARD CHAR-
ACTERS WITHOUT CLAIM TO ANY PARTICULAR
FONT, STYLE, SIZE, OR COLOR.

SER. NO. 77-494,558, FILED 6-9-2008.

ANDREA BUTLER, EXAMINING ATTORNEY

Int. Cls.: 39, 41 and 43

Prior U.S. Cls.: 100, 101, 105 and 107

United States Patent and Trademark Office

Reg. No. 3,575,475

Registered Feb. 17, 2009

**SERVICE MARK
PRINCIPAL REGISTER**

TREND TRACKER

EXPEDIA, INC. (WASHINGTON CORPORATION)
3150 139TH AVENUE SE
BELLEVUE, WA 98005

FOR: TRAVEL AGENCY SERVICES, NAMELY, MAKING RESERVATIONS AND BOOKINGS FOR TRANSPORTATION; PROVIDING INFORMATION, NEWS AND REVIEWS CONCERNING TRAVEL BY MEANS OF A TELEPHONE OR FACSIMILE, OVER ELECTRONIC COMMUNICATION NETWORKS; PROVIDING A WEBSITE AND WEBSITE LINKS TO TRAVEL INFORMATION, GEOGRAPHIC INFORMATION, MAPS, MAP IMAGES AND TRIP ROUTING; ORGANIZING AND ARRANGING TRAVEL ACTIVITIES, NAMELY, TOURS, TRAVEL TO EVENTS AND TRAVEL TO ATTRACTIONS; MAKING RESERVATIONS FOR TRAVEL ACTIVITIES, NAMELY, FOR TOURS, TRAVEL TO EVENTS AND TRAVEL TO ATTRACTIONS; PROVIDING INFORMATION ABOUT TOURS AND TRAVEL TO EVENTS AND ATTRACTIONS; ORGANIZING SIGHT-SEEING TOURS; TRAVEL AND TOUR INFORMATION SERVICES; TRAVEL AND TOUR TICKET RESERVATION SERVICES; ARRANGING BOOKINGS OF DAY TRIPS AND SIGHT-SEEING TOURS, IN CLASS 39 (U.S. CLS. 100 AND 105).

FIRST USE 5-5-2008; IN COMMERCE 5-5-2008.

FOR: PROVIDING INFORMATION ABOUT ENTERTAINMENT ACTIVITIES, AND MAKING RESERVATIONS AND BOOKINGS FOR SHOWS AND

OTHER ENTERTAINMENT EVENTS, IN CLASS 41 (U.S. CLS. 100, 101 AND 107).

FIRST USE 5-5-2008; IN COMMERCE 5-5-2008.

FOR: TRAVEL AGENCY SERVICES, NAMELY, MAKING RESERVATIONS AND BOOKINGS FOR TEMPORARY ACCOMMODATIONS; HOTEL AND LODGING SERVICES, NAMELY, PROVIDING AND RELAYING INFORMATION AND SECURING PAYMENT IN CONNECTION WITH RESERVATIONS AND BOOKINGS FOR TEMPORARY LODGING AND PROVIDING REVIEWS OF HOTELS BY MEANS OF A TELEPHONE, FACSIMILE OR OVER ELECTRONIC COMMUNICATION NETWORKS; TRAVEL AGENCY SERVICES, NAMELY, MAKING RESERVATIONS AND BOOKINGS FOR RESTAURANTS AND MEALS, IN CLASS 43 (U.S. CLS. 100 AND 101).

FIRST USE 5-5-2008; IN COMMERCE 5-5-2008.

THE MARK CONSISTS OF STANDARD CHARACTERS WITHOUT CLAIM TO ANY PARTICULAR FONT, STYLE, SIZE, OR COLOR.

NO CLAIM IS MADE TO THE EXCLUSIVE RIGHT TO USE "TREND", APART FROM THE MARK AS SHOWN.

SER. NO. 77-494,685, FILED 6-9-2008.

WILLIAM BRECKENFELD, EXAMINING ATTORNEY

Int. Cl.: 25

Prior U.S. Cls.: 22 and 39

United States Patent and Trademark Office

Reg. No. 3,575,476

Registered Feb. 17, 2009

TRADEMARK
PRINCIPAL REGISTER



NGAMJIRAPHAK, PRINCE (THAILAND INDIVIDUAL)
13220 MOORE STREET
CERRITOS, CA 90703

FOR: CLOTHING FOR MEN, WOMEN AND CHILDREN, NAMELY, SHIRTS, T-SHIRTS, POLO SHIRTS, PANTS, SHORTS, DENIM JEANS, WARM-UP SUITS, JACKETS, CAPS, SOCKS, BOXER BRIEFS, SLEEPWEAR, IN CLASS 25 (U.S. CLS. 22 AND 39).

FIRST USE 1-1-2008; IN COMMERCE 1-1-2008.

OWNER OF U.S. REG. NOS. 3,208,779, 3,224,779, AND 3,224,780.

NO CLAIM IS MADE TO THE EXCLUSIVE RIGHT TO USE "SINCE 1978" OR "BRAND", APART FROM THE MARK AS SHOWN.

THE MARK CONSISTS OF THE TERMS "NBN BRAND SINCE 1978" IN STYLIZED LETTERS; AN ACCENT IS LOCATED OVER EACH "N" IN "NBN", OVER EACH OF THE LETTERS "I" "N" AND "E" IN THE WORD "SINCE" AND OVER THE "N" IN THE WORD "BRAND"; AN ELEPHANT AND RIDER SITTING IN FRONT OF A FLAG IS LOCATED UNDER THE TERM "NBN", BETWEEN THE TERMS "SINCE" AND "1978" AND ABOVE THE WORD "BRAND". CURVED LINES IS LOCATED UNDER EACH TERM "SINCE" AND "1978".

SER. NO. 77-495,004, FILED 6-10-2008.

MARK RADEMACHER, EXAMINING ATTORNEY

Int. Cls.: 9 and 42

Prior U.S. Cls.: 21, 23, 26, 36, 38, 100 and 101

United States Patent and Trademark Office

Reg. No. 3,575,477

Registered Feb. 17, 2009

**TRADEMARK
SERVICE MARK
PRINCIPAL REGISTER**

SEGGER

SEGGER MICROCONTROLLER GMBH & CO.
KG (FED REP GERMANY CORPORATION)
IN DEN WEIDEN 11
HILDEN, FED REP GERMANY 40721

FOR: COMPUTER SOFTWARE FOR USE IN THE
CREATION AND USE OF EMBEDDED APPLICA-
TIONS FOR ELECTRONIC DEVICES THROUGH
SOFTWARE AND MIDDLEWARE TO CREATE EM-
BEDDED SYSTEMS IN THE TELECOMMUNICA-
TIONS, MEDICAL TECHNOLOGY, CONSUMER
ELECTRONICS AND AUTOMOTIVE INDUSTRIES
AND FOR INDUSTRIAL AUTOMATION, IN CLASS
9 (U.S. CLS. 21, 23, 26, 36 AND 38).

FIRST USE 0-0-1991; IN COMMERCE 0-0-1991.

FOR: DESIGN AND DEVELOPMENT OF HARD-
WARE AND SOFTWARE, IN CLASS 42 (U.S. CLS. 100
AND 101).

FIRST USE 0-0-1991; IN COMMERCE 0-0-1991.

THE MARK CONSISTS OF STANDARD CHAR-
ACTERS WITHOUT CLAIM TO ANY PARTICULAR
FONT, STYLE, SIZE, OR COLOR.

SER. NO. 77-495,036, FILED 6-10-2008.

HENRY S. ZAK, EXAMINING ATTORNEY

Int. Cl.: 10

Prior U.S. Cls.: 26, 39 and 44

United States Patent and Trademark Office

Reg. No. 3,575,478

Registered Feb. 17, 2009

**TRADEMARK
PRINCIPAL REGISTER**



STEPHAN, TANJA (FED REP GERMANY INDIVIDUAL)

HAUS TRÜMMERBORN

ALTE KEMMENAUER STRASSE

BAD EMS, FED REP GERMANY D-56130

FOR: TECHNICAL MEDICAL APPARATUS FOR ARTIFICIAL RESPIRATION AND ANESTHESIA, IN CLASS 10 (U.S. CLS. 26, 39 AND 44).

OWNER OF ERPN CMNTY TM OFC REG. NO. 004884797, DATED 2-2-2007, EXPIRES 2-2-2016.

NO CLAIM IS MADE TO THE EXCLUSIVE RIGHT TO USE "MEDICAL", APART FROM THE MARK AS SHOWN.

SER. NO. 77-495,053, FILED 6-10-2008.

ALEX KEAM, EXAMINING ATTORNEY

Int. Cls.: 25 and 40

Prior U.S. Cls.: 22, 39, 100, 103 and 106

United States Patent and Trademark Office

Reg. No. 3,575,479

Registered Feb. 17, 2009

**TRADEMARK
SERVICE MARK
PRINCIPAL REGISTER**



ALL AMERICAN MUSCLE CARS, LTD. (MICHIGAN CORPORATION)
2199 PRAIRIE VIEW
GRAND BLANC, MI 48439

FOR: HATS; JACKETS; PANTS; POLO SHIRTS; SHORTS; SWEAT SHIRTS; T-SHIRTS, IN CLASS 25 (U.S. CLS. 22 AND 39).

FIRST USE 4-0-2008; IN COMMERCE 4-0-2008.

FOR: MANUFACTURING SERVICES FOR OTHERS IN THE FIELD OF AUTOMOBILES, IN CLASS 40 (U.S. CLS. 100, 103 AND 106).

FIRST USE 6-0-2002; IN COMMERCE 6-0-2008.

NO CLAIM IS MADE TO THE EXCLUSIVE RIGHT TO USE "MUSCLE CARS", APART FROM THE MARK AS SHOWN.

THE MARK CONSISTS OF A STYLIZED DESIGN OF AN EAGLE'S HEAD AND THE WORDING "ALL AMERICAN MUSCLE CARS" BELOW IT. THE DESIGN OF THE EAGLE'S HEAD CONSISTS OF THE BEAK AND EYE POINTING LEFT, A STAR TO THE RIGHT OF THE EYE, AND FLAMES TRAILING THE EAGLE'S HEAD.

SEC. 2(F) AS TO "ALL AMERICAN".

SER. NO. 77-495,118, FILED 6-10-2008.

CORY BOONE, EXAMINING ATTORNEY

Prior U.S. Cl.: 200

United States Patent and Trademark Office

Reg. No. 3,575,480

Registered Feb. 17, 2009

COLLECTIVE MEMBERSHIP
PRINCIPAL REGISTER



GOLD WING ROAD RIDERS ASSOCIATION
(ARIZONA CORPORATION)
21423 NORTH 11TH AVENUE
PHOENIX, AZ 85027

FOR: INDICATING MEMBERSHIP IN A SINGLE-MARQUE ORGANIZATION FOR OWNERS AND RIDERS OF MOTORCYCLES, IN CLASS 200 (U.S. CL. 200).

FIRST USE 12-1-1996; IN COMMERCE 12-1-1996.

NO CLAIM IS MADE TO THE EXCLUSIVE RIGHT TO USE "FUN", "SAFETY", "KNOWL-

EDGE", AND "EST. 1977", APART FROM THE MARK AS SHOWN.

THE MARK CONSISTS OF THE LETTERS "GWRRRA", THE WORDING "FUN", "SAFETY", "KNOWLEDGE", AND "EST. 1977", AND THE DESIGN A SHIELD WITH A GRIFFIN, HORIZONTAL LINES, OVAL, CIRCLE, AND BANNER.

SER. NO. 77-495,526, FILED 6-10-2008.

MARGARET POWER, EXAMINING ATTORNEY

Int. Cls.: 35 and 41

Prior U.S. Cls.: 100, 101, 102 and 107

United States Patent and Trademark Office

Reg. No. 3,575,481

Registered Feb. 17, 2009

**SERVICE MARK
PRINCIPAL REGISTER**

MCM

INSURANCE REGULATORY EXAMINERS SOCIETY (MISSOURI NON-PROFIT CORPORATION)

SUITE 200

12710 S. PFLUMM ROAD

OLATHE, KS 66062

FOR: ASSOCIATION SERVICES, NAMELY, PROMOTING THE INTERESTS OF INSURANCE REGULATORY EXAMINERS, IN CLASS 35 (U.S. CLS. 100, 101 AND 102).

FIRST USE 11-12-2006; IN COMMERCE 11-12-2006.

FOR: EDUCATIONAL SERVICES, NAMELY, PROVIDING CLASSES IN THE FIELD OF INSURANCE REGULATION, IN CLASS 41 (U.S. CLS. 100, 101 AND 107).

FIRST USE 11-12-2006; IN COMMERCE 11-12-2006.

THE MARK CONSISTS OF STANDARD CHARACTERS WITHOUT CLAIM TO ANY PARTICULAR FONT, STYLE, SIZE, OR COLOR.

SER. NO. 77-495,701, FILED 6-10-2008.

PAUL CROWLEY, EXAMINING ATTORNEY

Int. Cl.: 40

Prior U.S. Cls.: 100, 103 and 106

United States Patent and Trademark Office

Reg. No. 3,575,482

Registered Feb. 17, 2009

SERVICE MARK
PRINCIPAL REGISTER



JACKSON, FREDDIE JR. (UNITED STATES INDIVIDUAL), DBA JACKSON'S COMMERCIAL CONTAINERS & RECYCLING INC.
181 GREENWOOD ST.
WORCESTER, MA 01607

FOR: SCRAP METAL RECYCLING, IN CLASS 40 (U.S. CLS. 100, 103 AND 106).

FIRST USE 4-28-2006; IN COMMERCE 4-28-2006.

NO CLAIM IS MADE TO THE EXCLUSIVE RIGHT TO USE "COMMERCIAL CONTAINERS & RECYCLING INC." AND "METAL DISMANTLING & REMOVAL CO.", APART FROM THE MARK AS SHOWN.

THE COLOR(S) GREEN, GOLD, WHITE, SILVER, BLACK IS/ARE CLAIMED AS A FEATURE OF THE MARK.

THE MARK CONSISTS OF A GREEN SHIELD WITH WHITE TRIM OUTLINED IN BLACK BEHIND DIAGONAL "C","C","R" IN GOLD LETTERING OUTLINED IN BLACK. THERE ARE SILVER GRAPE LEAVES TO EITHER SIDE OF THE SHIELD. THERE IS A GOLD BANNER OUTLINED WITH BLACK WITH THE WORDS "METAL DISMANTLING & REMOVAL CO." IN BLACK LETTERING IN FRONT OF THE SHIELD AND GRAPE LEAVES. THE WORDS "COMMERCIAL CONTAINERS" IN GOLD WITH A BLACK SHADOW ABOVE THE SHIELD AND THE WORDS "& RECYCLING INC." IN GOLD WITH A BLACK SHADOW BELOW THE SHIELD.

SER. NO. 77-496,052, FILED 6-11-2008.

CHRISTINE COOPER, EXAMINING ATTORNEY

Int. Cl.: 9

Prior U.S. Cls.: 21, 23, 26, 36 and 38

Reg. No. 3,575,483

United States Patent and Trademark Office

Registered Feb. 17, 2009

**TRADEMARK
PRINCIPAL REGISTER**

FLO SMART

MOCON, INC. (MINNESOTA CORPORATION)
7500 BOONE AVENUE NORTH
MINNEAPOLIS, MN 55428

FOR: COMPUTER SOFTWARE AND HARDWARE FOR ENABLING ELECTRONIC AND ELECTROCHEMICAL DEVICES FOR MEASURING CONCENTRATIONS OF GASES IN PACKAGES TO DETERMINE IF AN ADEQUATE AMOUNT OF SAMPLE GAS IS BEING DELIVERED TO THE DEVICE, SOLD AS AN INTEGRAL COMPONENT OF AN ELECTRONIC OR ELECTROCHEMICAL DEVICE FOR MEASURING CONCENTRATIONS

OF GASES IN PACKAGES, IN CLASS 9 (U.S. CLS. 21, 23, 26, 36 AND 38).

FIRST USE 11-30-1995; IN COMMERCE 11-30-1995.

THE MARK CONSISTS OF STANDARD CHARACTERS WITHOUT CLAIM TO ANY PARTICULAR FONT, STYLE, SIZE, OR COLOR.

SEC. 2(F).

SER. NO. 77-496,257, FILED 6-11-2008.

CHARLOTTE CORWIN, EXAMINING ATTORNEY

Prior U.S. Cl.: A

United States Patent and Trademark Office

Reg. No. 3,575,484

Registered Feb. 17, 2009

CERTIFICATION MARK
PRINCIPAL REGISTER



US ENVIRONMENTAL PROTECTION AGENCY
(UNITED STATES FEDERAL AGENCY)
MC 2377A
1200 PENNSYLVANIA AVENUE., NW
WASHINGTON, DC 20460

FOR: CONSUMER ELECTRONICS, KITCHEN AND HOUSEHOLD APPLIANCES, HOUSEHOLD FANS, ROOF PRODUCTS, COMMERCIAL AND RESIDENTIAL SPACE CONDITIONING EQUIPMENT, FENESTRATION PRODUCTS, COMMERCIAL AND RESIDENTIAL LIGHTING PRODUCTS, OFFICE EQUIPMENT, COMMERCIAL FOOD SERVICE EQUIPMENT, NEW AND EXISTING HOMES AND COMMERCIAL AND INDUSTRIAL BUILDINGS, IN CLASS A (U.S. CL. A).

FIRST USE 1-31-2002; IN COMMERCE 1-31-2002.

OWNER OF U.S. REG. NOS. 1,999,485, 2,817,628 AND OTHERS.

NO CLAIM IS MADE TO THE EXCLUSIVE RIGHT TO USE "ENERGY", APART FROM THE MARK AS SHOWN.

THE MARK CONSISTS OF A BOX WITH WRITING AND TRIM CONTAINING THE WORD "ENERGY" AND A STAR BELOW A CURVED LINE, WITH THE WORDS "ENERGY STAR" IN A SMALL BOX BELOW THE DESIGN.

THE CERTIFICATION MARK, AS USED BY AUTHORIZED PERSONS, CERTIFIES THAT THE ITEMS ARE MORE ENERGY EFFICIENT THAN MOST ITEMS SOLD IN THE SAME CATEGORY.

SER. NO. 77-496,436, FILED 6-11-2008.

KAPIL BHANOT, EXAMINING ATTORNEY

Int. Cls.: 11 and 41

Prior U.S. Cls.: 13, 21, 23, 31, 34, 100, 101 and 107

United States Patent and Trademark Office

Reg. No. 3,575,485

Registered Feb. 17, 2009

**TRADEMARK
SERVICE MARK
PRINCIPAL REGISTER**

STARCENTER

DALLAS STARS, L.P. (DELAWARE LIMITED
PARTNERSHIP)
SUITE 400
1000 BALLPARK WAY
ARLINGTON, TX 76011

FOR: ICE SKATING RINKS, IN CLASS 11 (U.S.
CLS. 13, 21, 23, 31 AND 34).

FIRST USE 8-3-1998; IN COMMERCE 8-3-1998.

FOR: PROVIDING SKATING RINKS FOR ICE
SKATING, ICE SKATING INSTRUCTION, AND
PROVIDING FACILITIES FOR ICE HOCKEY LEA-

GUES AND FIGURE SKATING COMPETITIONS, IN
CLASS 41 (U.S. CLS. 100, 101 AND 107).

FIRST USE 8-3-1998; IN COMMERCE 8-3-1998.

THE MARK CONSISTS OF STANDARD CHAR-
ACTERS WITHOUT CLAIM TO ANY PARTICULAR
FONT, STYLE, SIZE, OR COLOR.

OWNER OF U.S. REG. NO. 2,241,690.

SER. NO. 77-496,451, FILED 6-11-2008.

MARY MUNSON, EXAMINING ATTORNEY

Int. Cl.: 45

Prior U.S. Cls.: 100 and 101

United States Patent and Trademark Office

Reg. No. 3,575,486

Registered Feb. 17, 2009

**SERVICE MARK
PRINCIPAL REGISTER**

**PATENT
THIS**

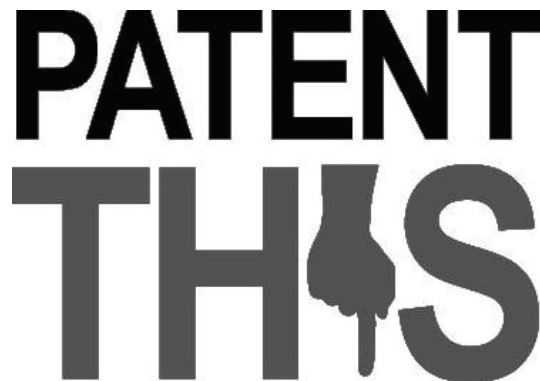

HANLEY, FLIGHT & ZIMMERMAN, LLC (ILLINOIS LIMITED LIABILITY COMPANY)
SUITE 2100
150 SOUTH WACKER DRIVE
CHICAGO, IL 60606

FOR: INTELLECTUAL PROPERTY CONSULTATION; INTELLECTUAL PROPERTY WATCH SERVICES; LEGAL DOCUMENT PREPARATION AND RESEARCH SERVICES FOR ATTORNEYS; LEGAL RESEARCH; LEGAL SERVICES; LEGAL SERVICES, NAMELY, PREPARATION OF APPLICATIONS FOR TRADEMARK REGISTRATION; LEGAL SERVICES, NAMELY, TRADEMARK MAINTENANCE SERVICES; LEGAL SERVICES, NAMELY, TRADEMARK SEARCHING AND CLEARANCE SERVICES; LICENSING OF INTELLECTUAL PROPERTY; PATENT AGENT SERVICES; PATENT AND INDUSTRIAL PROPERTY CONSULTATION; PATENT LICENSING; PROVIDING INFORMATION RELATING TO LEGAL AFFAIRS; REGISTRATION OF DOMAIN NAMES FOR IDENTIFICATION OF

USERS ON A GLOBAL COMPUTER NETWORK; REVIEWING STANDARDS AND PRACTICES TO ASSURE COMPLIANCE WITH INTELLECTUAL PROPERTY LAWS AND REGULATIONS, IN CLASS 45 (U.S. CLS. 100 AND 101).

FIRST USE 1-26-2008; IN COMMERCE 2-20-2008.

NO CLAIM IS MADE TO THE EXCLUSIVE RIGHT TO USE "PATENT", APART FROM THE MARK AS SHOWN.

THE MARK CONSISTS OF THE WORDS "PATENT THIS", THE LETTER "I" IN THE WORD "THIS" IS REPLACED AND REPRESENTED BY A PORTION OF AN ARM AND A HAND WITH THE INDEX FINGER POINTING DOWNWARD.

SER. NO. 77-496,562, FILED 6-11-2008.

KAREN SEVERSON, EXAMINING ATTORNEY

Int. Cl.: 45

Prior U.S. Cls.: 100 and 101

United States Patent and Trademark Office

Reg. No. 3,575,487

Registered Feb. 17, 2009

**SERVICE MARK
PRINCIPAL REGISTER**

PATENT THIS

HANLEY, FLIGHT & ZIMMERMAN, LLC (ILLINOIS LIMITED LIABILITY COMPANY)
SUITE 2100
150 SOUTH WACKER DRIVE
CHICAGO, IL 60606

FOR: INTELLECTUAL PROPERTY CONSULTATION; INTELLECTUAL PROPERTY WATCH SERVICES; LEGAL DOCUMENT PREPARATION AND RESEARCH SERVICES FOR ATTORNEYS; LEGAL RESEARCH; LEGAL SERVICES; LEGAL SERVICES, NAMELY, PREPARATION OF APPLICATIONS FOR TRADEMARK REGISTRATION; LEGAL SERVICES, NAMELY, TRADEMARK MAINTENANCE SERVICES; LEGAL SERVICES, NAMELY, TRADEMARK SEARCHING AND CLEARANCE SERVICES; LICENSING OF INTELLECTUAL PROPERTY; PATENT AGENT SERVICES; PATENT AND INDUSTRIAL PROPERTY CONSULTATION; PATENT LICENSING; PROVIDING INFORMATION RELATING TO LEGAL AFFAIRS; REGISTRATION

OF DOMAIN NAMES FOR IDENTIFICATION OF USERS ON A GLOBAL COMPUTER NETWORK; REVIEWING STANDARDS AND PRACTICES TO ASSURE COMPLIANCE WITH INTELLECTUAL PROPERTY LAWS AND REGULATIONS, IN CLASS 45 (U.S. CLS. 100 AND 101).

FIRST USE 1-26-2008; IN COMMERCE 2-20-2008.

THE MARK CONSISTS OF STANDARD CHARACTERS WITHOUT CLAIM TO ANY PARTICULAR FONT, STYLE, SIZE, OR COLOR.

NO CLAIM IS MADE TO THE EXCLUSIVE RIGHT TO USE "PATENT", APART FROM THE MARK AS SHOWN.

SER. NO. 77-496,594, FILED 6-11-2008.

KAREN SEVERSON, EXAMINING ATTORNEY

Int. Cl.: 35

Prior U.S. Cls.: 100, 101 and 102

United States Patent and Trademark Office

Reg. No. 3,575,488

Registered Feb. 17, 2009

**SERVICE MARK
PRINCIPAL REGISTER**



NDSI HEALTHCARE, INC. (DELAWARE CORPORATION)
11846 ROCK LANDING DRIVE - SUITE C
NEWPORT NEWS, VA 23606

FOR: DATA MANAGEMENT SERVICES FOR THE HEALTHCARE INDUSTRY, IN CLASS 35 (U.S. CLS. 100, 101 AND 102).

FIRST USE 9-29-1998; IN COMMERCE 9-29-1998.

NO CLAIM IS MADE TO THE EXCLUSIVE RIGHT TO USE "HEALTHCARE, INC.", APART FROM THE MARK AS SHOWN.

THE MARK CONSISTS OF THE LETTERS "NDSI", THE TERM "NDSI HEALTHCARE, INC." AND TWO PARALLEL BARS.

SER. NO. 77-496,676, FILED 6-11-2008.

COLLEEN KEARNEY, EXAMINING ATTORNEY

Int. Cl.: 25

Prior U.S. Cls.: 22 and 39

United States Patent and Trademark Office

Reg. No. 3,575,489

Registered Feb. 17, 2009

**TRADEMARK
PRINCIPAL REGISTER**

Manchester Esc.

MONARCHY GROUP, INC. (DELAWARE COR-
PORATION)
23RD FLOOR
101 NORTH WACKER DRIVE
CHICAGO, IL 60606

FOR: CLOTHING, NAMELY, SHIRTS, BLAZERS,
JACKETS, HOODED-JACKETS, T-SHIRTS, SHORTS,
DRESSES, LEATHER BELTS, HATS, SWEATERS,
SLACKS, DENIMWEAR, NAMELY, PANTS AND
JEANS, IN CLASS 25 (U.S. CLS. 22 AND 39).

FIRST USE 1-23-2008; IN COMMERCE 1-31-2008.

THE MARK CONSISTS OF STANDARD CHAR-
ACTERS WITHOUT CLAIM TO ANY PARTICULAR
FONT, STYLE, SIZE, OR COLOR.

SER. NO. 77-496,954, FILED 6-11-2008.

WON TEAK OH, EXAMINING ATTORNEY

Int. Cl.: 41

Prior U.S. Cls.: 100, 101 and 107

United States Patent and Trademark Office

Reg. No. 3,575,490

Registered Feb. 17, 2009

**SERVICE MARK
PRINCIPAL REGISTER**

QUEEN OF HEARTS FOUNDATION

THE QUEEN OF HEARTS FOUNDATION INC.
(GEORGIA CORPORATION)
500 CLAUDEL COURT SW
ATLANTA, GA 30331

FOR: CHARITABLE AND EDUCATIONAL SERVICES, NAMELY, CONDUCTING SEMINARS, COURSES, CONFERENCES, MEETINGS, LECTURES, AND WORKSHOPS IN THE FIELD OF CARDIOVASCULAR HEALTH, FITNESS, NUTRITION, DETECTION, PREVENTION, AND REDUCTION OF CARDIOVASCULAR DISEASE AND STROKE, AND DISTRIBUTING MATERIALS IN CONNECTION THEREWITH, IN CLASS 41 (U.S. CLS. 100, 101 AND 107).

FIRST USE 3-15-2008; IN COMMERCE 3-15-2008.

THE MARK CONSISTS OF STANDARD CHARACTERS WITHOUT CLAIM TO ANY PARTICULAR FONT, STYLE, SIZE, OR COLOR.

NO CLAIM IS MADE TO THE EXCLUSIVE RIGHT TO USE "FOUNDATION", APART FROM THE MARK AS SHOWN.

SER. NO. 77-497,018, FILED 6-12-2008.

CHRISTINE BLOMQUIST, EXAMINING ATTORNEY

Int. Cl.: 30

Prior U.S. Cl.: 46

United States Patent and Trademark Office

Reg. No. 3,575,491

Registered Feb. 17, 2009

TRADEMARK
PRINCIPAL REGISTER



DEBBIE L INGSTAD (UNITED STATES INDIVIDUAL)
SUITE 110
300 FIRST AVENUE NORTH
MINNEAPOLIS, MN 55401

FOR: SALSA, IN CLASS 30 (U.S. CL. 46).

FIRST USE 5-1-2005; IN COMMERCE 5-1-2005.

NO CLAIM IS MADE TO THE EXCLUSIVE RIGHT TO USE "RED SALSA", APART FROM THE MARK AS SHOWN.

THE NAME "JUDGE ROY BEAN'S" DOES NOT IDENTIFY A LIVING INDIVIDUAL.

THE COLOR(S) MAROON, TAN, WHITE IS/ARE CLAIMED AS A FEATURE OF THE MARK.

THE MARK CONSISTS OF STYLIZED WRITING OF "JUDGE ROY BEAN'S RED SALSA" IN MAROON COLOR, WITH TAN LINES ON A WHITE BACKGROUND.

SER. NO. 77-497,111, FILED 6-12-2008.

STEPHEN AQUILA, EXAMINING ATTORNEY

Int. Cl.: 30

Prior U.S. Cl.: 46

United States Patent and Trademark Office

Reg. No. 3,575,492

Registered Feb. 17, 2009

TRADEMARK
PRINCIPAL REGISTER



INGSTAD, DEBBIE L. (UNITED STATES INDIVIDUAL)
SUITE 110
300 FIRST AVENUE NORTH
MINNEAPOLIS, MN 55401

FOR: SALSA, IN CLASS 30 (U.S. CL. 46).

FIRST USE 5-1-2005; IN COMMERCE 5-1-2005.

NO CLAIM IS MADE TO THE EXCLUSIVE RIGHT TO USE "PEPPER COMPANY MEDIUM 0 TRANS FAT" , APART FROM THE MARK AS SHOWN.

THE COLOR(S) BLACK, TAN, WHITE, MAROON IS/ARE CLAIMED AS A FEATURE OF THE MARK.

THE MARK CONSISTS OF A BLACK HORSESHOE WITH A BLACK PEPPER INSIDE THE HORSESHOE, ON TOP OF WHICH ARE THE WORDS "RUSTY HORSESHOE PEPPER COMPANY" WRITTEN IN MAROON, WITH A MAROON BORDER AROUND THE MARK. BEHIND THE DESIGN IS A TAN FEED SACK. THE BACKGROUND IS WHITE.

SER. NO. 77-497,187, FILED 6-12-2008.

DORITT L. CARROLL, EXAMINING ATTORNEY

Int. Cl.: 41

Prior U.S. Cls.: 100, 101 and 107

United States Patent and Trademark Office

Reg. No. 3,575,493

Registered Feb. 17, 2009

SERVICE MARK
PRINCIPAL REGISTER



KANSAS STATE DEPARTMENT OF EDUCATION (KANSAS STATE AGENCY)
120 SE 10TH AVENUE
TOPEKA, KS 666121182

FOR: CONDUCTING EDUCATIONAL EXHIBITIONS IN THE NATURE OF EDUCATIONAL PROGRAMS FOR ELEMENTARY STUDENTS CONSISTING OF INTERACTIVE EDUCATIONAL EXHIBITS FEATURING INFORMATION IN THE FIELD OF HEALTH, IN CLASS 41 (U.S. CLS. 100, 101 AND 107).

FIRST USE 3-7-2008; IN COMMERCE 3-7-2008.

NO CLAIM IS MADE TO THE EXCLUSIVE RIGHT TO USE "BODY", APART FROM THE MARK AS SHOWN.

THE COLOR(S) BLACK, GREEN, PINK, LIGHT PINK, RED, DARK RED, WHITE, BLUE, YELLOW, AND GRAY IS/ARE CLAIMED AS A FEATURE OF THE MARK.

THE MARK CONSISTS OF THE WORDING "BODY VENTURE" WITH THE "O" IN "BODY"

FORMED BY A STYLIZED FACE WITH AN OPEN MOUTH. THE COLOR BLACK APPEARS IN THE EDGING OF THE LETTERING AND IN THE OUTLINE OF THE STYLIZED FACE AND ITS FEATURES. THE COLOR GREEN APPEARS IN THE LETTER "B." THE COLOR LIGHT PINK APPEARS IN THE FACE AND THE COLOR PINK APPEARS IN THE SHADING OF THE FACE AND IN THE UVULA SHOWN IN THE MOUTH. THE COLOR DARK RED APPEARS IN SHADING OF THE MOUTH. THE COLOR WHITE APPEARS IN THE TEETH. THE COLOR BLUE APPEARS IN THE LETTER "D." THE COLOR RED APPEARS IN THE LETTER "Y." THE COLOR YELLOW APPEARS IN THE WORD "VENTURE." THE COLOR GRAY APPEARS IN THE SHADING AROUND THE WORD "VENTURE." THE COLOR WHITE THAT APPEARS IN THE LETTERS "B" AND "D" REPRESENTS TRANSPARENT MATTER AND IS NOT A PART OF THE MARK.

SER. NO. 77-497,266, FILED 6-12-2008.

ROBERT LAVACHE, EXAMINING ATTORNEY

Int. Cl.: 36

Prior U.S. Cls.: 100, 101 and 102

United States Patent and Trademark Office

Reg. No. 3,575,494

Registered Feb. 17, 2009

**SERVICE MARK
PRINCIPAL REGISTER**

We Know Commercial Real
Estate

DEAN, ROBERT CARLTON JR. (UNITED STATES INDIVIDUAL)

2065 THOMASVILLE ROAD

TALLAHASSEE, FL 32308

FOR: REAL ESTATE BROKERAGE, IN CLASS 36 (U.S. CLS. 100, 101 AND 102).

FIRST USE 4-2-2008; IN COMMERCE 4-2-2008.

THE MARK CONSISTS OF STANDARD CHARACTERS WITHOUT CLAIM TO ANY PARTICULAR FONT, STYLE, SIZE, OR COLOR.

NO CLAIM IS MADE TO THE EXCLUSIVE RIGHT TO USE "COMMERCIAL REAL ESTATE", APART FROM THE MARK AS SHOWN.

SER. NO. 77-497,571, FILED 6-12-2008.

DARRYL SPRUILL, EXAMINING ATTORNEY

Int. Cl.: 44

Prior U.S. Cls.: 100 and 101

United States Patent and Trademark Office

Reg. No. 3,575,495

Registered Feb. 17, 2009

**SERVICE MARK
PRINCIPAL REGISTER**



RENEGY HOLDINGS, INC. (DELAWARE CORPORATION)
60 E. RIO SALADO PARKWAY, SUITE 1012
TEMPE, AZ 85281

FOR: HORTICULTURAL SERVICES, NAMELY, HARVESTING OF PLANT MATTER BIOMASS FROM CONSUMERS, FOREST SERVICE LANDS, GREEN WASTE SITES, LANDFILLS, AND AGRICULTURAL WASTE SITES FOR USE IN RENEWABLE ENERGY PLANTS, IN CLASS 44 (U.S. CLS. 100 AND 101).

FIRST USE 10-1-2007; IN COMMERCE 10-1-2007.

NO CLAIM IS MADE TO THE EXCLUSIVE RIGHT TO USE "GENERATION", APART FROM THE MARK AS SHOWN.

THE COLOR(S) BLACK, BLUE, RED, GREEN AND YELLOW IS/ARE CLAIMED AS A FEATURE OF THE MARK.

THE MARK CONSISTS OF THE WORD "RENEGY" ABOVE THE WORDS "ENLIGHTENED GENERATION" ALL IN BLACK LETTERING. TO THE RIGHT OF THE WORD PORTION OF THE MARK IS A CIRCULAR DESIGN CONSISTING OF TWO BLUE ARCS, TWO RED ARCS, TWO GREEN ARCS AND TWO YELLOW ARCS IN A CIRCULAR LAYOUT.

SER. NO. 77-497,578, FILED 6-12-2008.

KELLY MCCOY, EXAMINING ATTORNEY

Int. Cl.: 9

Prior U.S. Cls.: 21, 23, 26, 36 and 38

United States Patent and Trademark Office

Reg. No. 3,575,496

Registered Feb. 17, 2009

**TRADEMARK
PRINCIPAL REGISTER**

QueryNet

THE ANALYTICAL GROUP, INC. (ILLINOIS
CORPORATION)
16638 N. 90TH ST.
SCOTTSDALE, AZ 85260

FOR: COMPUTER SOFTWARE FOR USE IN THE
CREATION OF QUESTIONNAIRES, CONDUCTING
OF INTERVIEWS AND MANAGEMENT OF CLIENT
STUDIES, IN CLASS 9 (U.S. CLS. 21, 23, 26, 36 AND
38).

FIRST USE 6-2-2008; IN COMMERCE 6-2-2008.

THE MARK CONSISTS OF STANDARD CHAR-
ACTERS WITHOUT CLAIM TO ANY PARTICULAR
FONT, STYLE, SIZE, OR COLOR.

SER. NO. 77-498,227, FILED 6-13-2008.

SANJEEV VOHRA, EXAMINING ATTORNEY

Int. Cl.: 35

Prior U.S. Cls.: 100, 101 and 102

United States Patent and Trademark Office

Reg. No. 3,575,497

Registered Feb. 17, 2009

**SERVICE MARK
PRINCIPAL REGISTER**

chaddle

CHADDLE LLC. (ARIZONA LIMITED LIABILITY COMPANY)
21610 S. 140TH ST.
CHANDLER, AZ 852869311

THE MARK CONSISTS OF STANDARD CHARACTERS WITHOUT CLAIM TO ANY PARTICULAR FONT, STYLE, SIZE, OR COLOR.

FOR: PROVIDING INFORMATION ABOUT POLITICAL ISSUES, POLITICAL ELECTIONS AND GOVERNMENT AFFAIRS VIA A WEBSITE, IN CLASS 35 (U.S. CLS. 100, 101 AND 102).

SER. NO. 77-498,442, FILED 6-13-2008.

FIRST USE 4-16-2008; IN COMMERCE 6-1-2008.

RONALD MCMORROW, EXAMINING ATTORNEY

Int. Cl.: 9

Prior U.S. Cls.: 21, 23, 26, 36 and 38

United States Patent and Trademark Office

Reg. No. 3,575,498

Registered Feb. 17, 2009

TRADEMARK
PRINCIPAL REGISTER



INERTIA ENGINEERING & MACHINE WORKS,
INC. (CALIFORNIA CORPORATION)
4690 E WATERLOO RD
STOCKTON, CA 95215

FOR: AUTOMATIC ELECTRICAL DISTRIBUTION APPARATUS, IN CLASS 9 (U.S. CLS. 21, 23, 26, 36 AND 38).

FIRST USE 2-1-2001; IN COMMERCE 2-1-2001.

NO CLAIM IS MADE TO THE EXCLUSIVE RIGHT TO USE "ENGINEERING & MACHINE WORKS, INC.", APART FROM THE MARK AS SHOWN.

THE COLOR(S) RED AND BLUE IS/ARE CLAIMED AS A FEATURE OF THE MARK.

THE MARK CONSISTS OF THE COLORS BLUE AND RED. THE TERM "INERTIA" IS BLUE. THE DESIGN AND WORDING "ENGINEERING & MACHINE WORKS, INC." IS RED.

SER. NO. 77-498,506, FILED 6-13-2008.

JOHN DWYER, EXAMINING ATTORNEY

Int. Cl.: 35

Prior U.S. Cls.: 100, 101 and 102

United States Patent and Trademark Office

Reg. No. 3,575,499

Registered Feb. 17, 2009

SERVICE MARK
PRINCIPAL REGISTER



PARTNERSHIP *for*
PERSONALIZED MEDICINE

TRANSLATIONAL GENOMICS RESEARCH INSTITUTE (ARIZONA CORPORATION), DBA TGEN
445 N. 5TH ST.
PHOENIX, AZ 85004

FOR: PROMOTING COLLABORATION WITHIN THE SCIENTIFIC, RESEARCH AND MEDICAL COMMUNITIES TO ACHIEVE ADVANCES IN THE FIELD OF HEALTHCARE, IN CLASS 35 (U.S. CLS. 100, 101 AND 102).

FIRST USE 4-23-2008; IN COMMERCE 4-23-2008.

NO CLAIM IS MADE TO THE EXCLUSIVE RIGHT TO USE "PARTNERSHIP FOR PERSONALIZED MEDICINE", APART FROM THE MARK AS SHOWN.

THE COLOR(S) GREEN BLUE BLACK IS/ARE CLAIMED AS A FEATURE OF THE MARK.

THE MARK CONSISTS OF GREEN AND BLUE SYMBOL COMPRISED OF SETS OF BLOCKS ARRANGED VERTICALLY WITH SIZES OF THE BLOCKS INCREASING THE CLOSER THE BLOCKS ARE TO THE CENTER OF THE SYMBOL. STARTING FROM THE LEFT, THE FIRST, THIRD, FOURTH, AND SIXTH SETS OF BLOCKS (SETS ARRANGED VERTICALLY) ARE BLUE. THE SECOND, FIFTH, AND SEVENTH SETS OF BLOCKS ARE GREEN. BLACK TEXT SPELLING OUT THE TEXT "PARTNERSHIP FOR PERSONALIZED MEDICINE" IS TO THE LEFT OF THE SYMBOL IN TWO LINES. THE WORD "FOR" IS ITALICIZED.

SER. NO. 77-498,787, FILED 6-13-2008.

DANNAN HETZEL, EXAMINING ATTORNEY

Int. Cl.: 41

Prior U.S. Cls.: 100, 101 and 107

United States Patent and Trademark Office

Reg. No. 3,575,500

Registered Feb. 17, 2009

**SERVICE MARK
PRINCIPAL REGISTER**

WISHING WELL PHOTOGRAPHY

ESPANO, KATHERINE (UNITED STATES INDIVIDUAL)
6350 FORDHAM CIRCLE EAST
JACKSONVILLE, FL 32217

FOR: PORTRAIT PHOTOGRAPHY AND PHOTOGRAPHY SERVICES, IN CLASS 41 (U.S. CLS. 100, 101 AND 107).

FIRST USE 4-18-2008; IN COMMERCE 4-18-2008.

THE MARK CONSISTS OF STANDARD CHARACTERS WITHOUT CLAIM TO ANY PARTICULAR FONT, STYLE, SIZE, OR COLOR.

NO CLAIM IS MADE TO THE EXCLUSIVE RIGHT TO USE "PHOTOGRAPHY", APART FROM THE MARK AS SHOWN.

SER. NO. 77-498,930, FILED 6-13-2008.

CAROLYN GRAY, EXAMINING ATTORNEY

Int. Cls.: 30 and 35

Prior U.S. Cls.: 46, 100, 101 and 102

United States Patent and Trademark Office

Reg. No. 3,575,501

Registered Feb. 17, 2009

**TRADEMARK
SERVICE MARK
PRINCIPAL REGISTER**



CHOCOLATS DU CALIBRESSAN, INC. (CALIFORNIA CORPORATION)
4193 CARPINTERIA AVE., SUITE 4
CARPINTERIA, CA 93013

FOR: CONFECTIONERY, NAMELY, CANDIES, CHOCOLATE, CHOCOLATE COVERED NUTS, FINE CHOCOLATES, CHOCOLATE CANDIES, SWEETS AND CHOCOLATE TRUFFLES, SINGLE ORIGIN CHOCOLATES, BON BONS AND HAND-DIPPED CHOCOLATES, IN CLASS 30 (U.S. CL. 46).

FIRST USE 11-19-2007; IN COMMERCE 11-19-2007.

FOR: RETAIL STORE SERVICES AND RETAIL STORE SERVICES VIA THE INTERNET FEATUR-

ING CONFECTIONERY, NAMELY, CANDIES, CHOCOLATE, CHOCOLATE COVERED NUTS, FINE CHOCOLATES, BON BONS, AND HAND-DIPPED CHOCOLATES, IN CLASS 35 (U.S. CLS. 100, 101 AND 102).

FIRST USE 11-19-2007; IN COMMERCE 11-19-2007.

THE MARK CONSISTS OF A PALM TREE TO THE LEFT OF A DEPICTION OF THE EIFFEL TOWER.

SER. NO. 77-499,093, FILED 6-13-2008.

ALICIA COLLINS, EXAMINING ATTORNEY

Int. Cl.: 45

Prior U.S. Cls.: 100 and 101

United States Patent and Trademark Office

Reg. No. 3,575,502

Registered Feb. 17, 2009

**SERVICE MARK
PRINCIPAL REGISTER**



WILSON, DENNIS P. (UNITED STATES INDIVIDUAL), DBA LAW OFFICES OF DENNIS P. WILSON

3322 W. VICTORY BOULEVARD
BURBANK, CA 915051542

FOR: ATTORNEY SERVICES, IN CLASS 45 (U.S. CLS. 100 AND 101).

FIRST USE 5-15-1978; IN COMMERCE 6-1-1998.

THE COLOR(S) GOLD AND WHITE IS/ARE CLAIMED AS A FEATURE OF THE MARK.

THE MARK CONSISTS OF A STYLIZED REPRESENTATION OF THE INITIALS "DPW", WITH THE COLOR GOLD IN THE OUTER BORDER OF THE ENTIRE MARK, THE SHADED HALF-CIRCLE ON THE LEFT SIDE OF THE MARK, THE SHADED TRIANGLE ON THE BOTTOM OF THE MARK AND THE SHADED HALF-CIRCLE ON THE RIGHT SIDE OF THE MARK, AND WITH THE COLOR WHITE APPEARING IN THE PART OF THE MARK ABOVE THE LETTER "W".

SER. NO. 77-499,240, FILED 6-14-2008.

TINA KUAN, EXAMINING ATTORNEY

Int. Cl.: 41

Prior U.S. Cls.: 100, 101 and 107

United States Patent and Trademark Office

Reg. No. 3,575,503

Registered Feb. 17, 2009

**SERVICE MARK
PRINCIPAL REGISTER**

ASSEMBLY LINE STUDIOS

GUTIERREZ, KEVIN (UNITED STATES INDIVIDUAL)
9222 BRIAN DRIVE
VIENNA, VA 22180

FOR: AUDIO RECORDING AND PRODUCTION; MULTIMEDIA ENTERTAINMENT SERVICES IN THE NATURE OF RECORDING, PRODUCTION AND POST-PRODUCTION SERVICES IN THE FIELDS OF MUSIC, VIDEO, AND FILMS , IN CLASS 41 (U.S. CLS. 100, 101 AND 107).

FIRST USE 5-1-1994; IN COMMERCE 5-1-1994.

THE MARK CONSISTS OF STANDARD CHARACTERS WITHOUT CLAIM TO ANY PARTICULAR FONT, STYLE, SIZE, OR COLOR.

NO CLAIM IS MADE TO THE EXCLUSIVE RIGHT TO USE "STUDIOS", APART FROM THE MARK AS SHOWN.

SER. NO. 77-500,158, FILED 6-16-2008.

GINA HAYES, EXAMINING ATTORNEY

Int. Cl.: 33

Prior U.S. Cls.: 47 and 49

United States Patent and Trademark Office

Reg. No. 3,575,504

Registered Feb. 17, 2009

**TRADEMARK
PRINCIPAL REGISTER**

Homefire

STERLING, MICHAEL L. (CALIFORNIA SOLE
PROPRIETORSHIP), DBA HOMEFIRE CEL-
LARS
11 MIRAMAR AVE.
SAN RAFAEL, CA 94901

THE MARK CONSISTS OF STANDARD CHAR-
ACTERS WITHOUT CLAIM TO ANY PARTICULAR
FONT, STYLE, SIZE, OR COLOR.

FOR: RED WINE; WINE, IN CLASS 33 (U.S. CLS. 47
AND 49).

SER. NO. 77-500,268, FILED 6-16-2008.

FIRST USE 9-1-2002; IN COMMERCE 3-1-2004.

JAMES A. RAUEN, EXAMINING ATTORNEY

Int. Cl.: 35

Prior U.S. Cls.: 100, 101 and 102

United States Patent and Trademark Office

Reg. No. 3,575,505

Registered Feb. 17, 2009

**SERVICE MARK
PRINCIPAL REGISTER**



PLANET FORWARD, LLC (ILLINOIS LIMITED LIABILITY COMPANY)
1324 REID STREET
WESTERN SPRINGS, IL 60558

FOR: EMPLOYMENT HIRING, RECRUITING, PLACEMENT, STAFFING AND CAREER NETWORKING SERVICES; EMPLOYMENT STAFFING IN THE FIELD OF ENVIRONMENTAL, ENERGY AND ENGINEERING; PERSONNEL RECRUITMENT SERVICES AND EMPLOYMENT AGENCIES; TEMPORARY EMPLOYMENT AGENCIES, IN CLASS 35 (U.S. CLS. 100, 101 AND 102).

FIRST USE 6-9-2008; IN COMMERCE 6-9-2008.

THE COLOR(S) GREEN, BLUE AND WHITE IS/ ARE CLAIMED AS A FEATURE OF THE MARK.

THE MARK CONSISTS OF THE WORDING "PLANET" IN THE COLOR GREEN PLACED ABOVE A BLUE ARROW WITH THE WORDING "FORWARD" IN THE COLOR WHITE PLACED INSIDE THE ARROW.

SER. NO. 77-500,342, FILED 6-16-2008.

LESLIE RICHARDS, EXAMINING ATTORNEY

Int. Cl.: 30

Prior U.S. Cl.: 46

United States Patent and Trademark Office

Reg. No. 3,575,506

Registered Feb. 17, 2009

TRADEMARK
PRINCIPAL REGISTER

日の味
HINOAJI

EASY & BUSY LTD (HONG KONG LIMITED
LIABILITY COMPANY)
21B CHEUNG LEE IND BLDG
9 CHEUNG LEE STREET
CHAIWAN, HONG KONG

FOR: BEAN-STARCH NOODLES (HARUSAME,
UNCOOKED); CHINESE NOODLES; CHINESE RICE
NOODLES (BIFUN, UNCOOKED); RICE NOODLES,
IN CLASS 30 (U.S. CL. 46).

OWNER OF HONG KONG REG. NO. 300067158,
DATED 8-22-2003, EXPIRES 8-22-2013.

THE FOREIGN WORDING "HINOAJI" IN THE
MARK TRANSLATES INTO ENGLISH AS "JAPA-
NESE TASTE".

THE NON-LATIN CHARACTER(S) IN THE
MARK TRANSLITERATES INTO "HI NOA JI",
AND THIS MEANS "JAPANESE TASTE" IN ENG-
LISH.

SER. NO. 77-500,372, FILED 6-16-2008.

CARRIE GENOVESE, EXAMINING ATTORNEY

Int. Cl.: 30

Prior U.S. Cl.: 46

United States Patent and Trademark Office

Reg. No. 3,575,507

Registered Feb. 17, 2009

**TRADEMARK
PRINCIPAL REGISTER**

CHILITO LINDO

SALSAS CASTILLO, S.A. DE C.V. (MEXICO CORPORATION)

PARQUE INDUSTRIAL

ASTEROIDES Y SATÉLITES 7

HERMOSILLO, MEXICO 83290

FOR: HOT PEPPER POWDER, IN CLASS 30 (U.S. CL. 46).

FIRST USE 1-2-2007; IN COMMERCE 3-6-2007.

THE MARK CONSISTS OF STANDARD CHARACTERS WITHOUT CLAIM TO ANY PARTICULAR FONT, STYLE, SIZE, OR COLOR.

THE ENGLISH TRANSLATION OF THE WORD "CHILITO LINDO" IN THE MARK IS BEAUTIFUL LITTLE CHILLI PEPPER.

SER. NO. 77-500,406, FILED 6-17-2008.

CHRISTOPHER BUONGIORNO, EXAMINING ATTORNEY

Int. Cls.: 40 and 42

Prior U.S. Cls.: 100, 101, 103 and 106

United States Patent and Trademark Office

Reg. No. 3,575,508

Registered Feb. 17, 2009

**SERVICE MARK
PRINCIPAL REGISTER**

PharmaSuitable

BIND-RITE/UNION GRAPHICS, L.L.C. (NEW
JERSEY LIMITED LIABILITY COMPANY)
351 MICHELE PLACE
CARLSTADT, NJ 08540

FOR: PRINTING AND PRINTING SERVICES, IN
CLASS 40 (U.S. CLS. 100, 103 AND 106).

FIRST USE 6-23-2008; IN COMMERCE 6-23-2008.

FOR: DESIGNING OF PACKAGING AND WRAP-
PING MATERIALS; PACKAGING DESIGN FOR
OTHERS, IN CLASS 42 (U.S. CLS. 100 AND 101).

FIRST USE 6-23-2008; IN COMMERCE 6-23-2008.

THE MARK CONSISTS OF STANDARD CHAR-
ACTERS WITHOUT CLAIM TO ANY PARTICULAR
FONT, STYLE, SIZE, OR COLOR.

SER. NO. 77-500,680, FILED 6-17-2008.

DAWN FELDMAN, EXAMINING ATTORNEY

Int. Cl.: 40

Prior U.S. Cls.: 100, 103 and 106

United States Patent and Trademark Office

Reg. No. 3,575,509

Registered Feb. 17, 2009

SERVICE MARK
PRINCIPAL REGISTER



WHITEFIELD, WILLIAM H. (UNITED STATES INDIVIDUAL), DBA WHITEFIELD PLASTICS CORPORATION
2300 W.W. THORNE BLVD.
HOUSTON, TX 770733316

FOR: MANUFACTURE OF CUSTOM URETHANE PRODUCTS TO ORDER AND/OR SPECIFICATION OF OTHERS, IN CLASS 40 (U.S. CLS. 100, 103 AND 106).

FIRST USE 1-1-1984; IN COMMERCE 1-1-1984.

NO CLAIM IS MADE TO THE EXCLUSIVE RIGHT TO USE "DESIGNING AND MOLDING CUSTOM URETHANE PRODUCTS SINCE 1961", "PLASTICS", "THE DESIGN OF THE MOLECULAR BOND DIAGRAM", "CL", AND "H₂N", APART FROM THE MARK AS SHOWN.

THE COLOR(S) RED, BLUE, GRAY, AND WHITE IS/ARE CLAIMED AS A FEATURE OF THE MARK.

THE MARK CONSISTS OF GRAY LINES REPRESENTING CHEMICAL BONDS WITH THE TERMS "CL" AND "H₂N" ALSO PRESENTED IN GRAY AT THE FOUR OUTSIDE CORNERS OF THE GRAY LINES; THE TERM "DESIGNING AND MOLDING CUSTOM URETHANE PRODUCTS SINCE 1961" APPEARS IN SMALL RED LETTERING CENTERED ABOVE THE TERM "WHITEFIELD PLASTICS" IN LARGE BLUE LETTERING; THE BACKGROUND OF THE MARK IS WHITE.

SER. NO. 77-500,844, FILED 6-17-2008.

JIM RINGLE, EXAMINING ATTORNEY

Int. Cls.: 16 and 41

Prior U.S. Cls.: 2, 5, 22, 23, 29, 37, 38, 50, 100, 101 and 107

Reg. No. 3,575,510

United States Patent and Trademark Office

Registered Feb. 17, 2009

**TRADEMARK
SERVICE MARK
PRINCIPAL REGISTER**

MEGASKILLS

DOROTHY RICH ASSOCIATES INCORPORATED
(D.C. CORPORATION)
3301 NEWARK STREET, N.W.
WASHINGTON, DC 20008

FOR: A SERIES OF BOOKS, WRITTEN ARTICLES
AND NEWSLETTERS IN THE FIELD OF EDUCA-
TION, CHILD CARE AND PARENTING , IN CLASS
16 (U.S. CLS. 2, 5, 22, 23, 29, 37, 38 AND 50).

FIRST USE 12-31-1988; IN COMMERCE 12-31-1988.

FOR: PROVIDING A WEBSITE WHICH PRO-
VIDES INFORMATION IN THE FIELD OF EDUCA-
TION; PROVIDING A WEBSITE WHICH PROVIDES
INFORMATION IN THE FIELD OF PARENTING

CONCERNING EDUCATION OF CHILDREN, IN
CLASS 41 (U.S. CLS. 100, 101 AND 107).

FIRST USE 12-31-1998; IN COMMERCE 12-31-1998.

THE MARK CONSISTS OF STANDARD CHAR-
ACTERS WITHOUT CLAIM TO ANY PARTICULAR
FONT, STYLE, SIZE, OR COLOR.

OWNER OF U.S. REG. NO. 1,472,272.

SER. NO. 77-500,865, FILED 6-17-2008.

MARLENE BELL, EXAMINING ATTORNEY

Int. Cl.: 16

Prior U.S. Cls.: 2, 5, 22, 23, 29, 37, 38 and 50

United States Patent and Trademark Office

Reg. No. 3,575,511

Registered Feb. 17, 2009

TRADEMARK
PRINCIPAL REGISTER



FRANK FRAZETTA (UNITED STATES INDIVIDUAL)
ROUTE 209
MARSHALL CREEK,, PA 18335

THE NAME "FRANK FRAZETTA" IDENTIFIES A LIVING INDIVIDUAL WHOSE CONSENT IS OF RECORD.

FOR: BOOK COVERS; BOOKS IN THE FIELD OF ART; COMIC BOOKS; MANUSCRIPT BOOKS; PICTURE BOOKS; PUBLICATIONS, NAMELY, BOOKS, MAGAZINES, CALENDARS IN THE FIELDS OF ART; REFERENCE BOOKS IN THE FIELD OF ART; SERIES OF FICTION BOOKS; SERIES OF NON-FICTION BOOKS IN THE FIELD OF ART; STORY BOOKS, IN CLASS 16 (U.S. CLS. 2, 5, 22, 23, 29, 37, 38 AND 50).

THE MARK CONSISTS OF STYLIZED SIGNATURE "FRAZETTA".

SEC. 2(F).

SER. NO. 77-501,185, FILED 6-17-2008.

FIRST USE 1-1-1944; IN COMMERCE 1-1-1950.

EMILY CARLSEN, EXAMINING ATTORNEY

Int. Cl.: 25

Prior U.S. Cls.: 22 and 39

United States Patent and Trademark Office

Reg. No. 3,575,512

Registered Feb. 17, 2009

**TRADEMARK
PRINCIPAL REGISTER**



ROBIN REED TABANA (CALIFORNIA LIMITED
LIABILITY COMPANY)
4867 EAST MOUNTAIN VIEW DRIVE
SAN DIEGO, CA 92116

FOR: BEANIES; BELTS; BRAS; CLOTHING,
NAMELY, KHAKIS; DRESSES; HATS; JACKETS;
JEANS; NECKTIES; PANTS; SCARVES; SHIRTS;
SHOES; SHORTS; SKIRTS; SLACKS; SOCKS; SUIT
COATS; SUITS; SWEATERS; SWIMWEAR; TOPS;
UNDERWEAR; VESTS, IN CLASS 25 (U.S. CLS. 22
AND 39).

FIRST USE 1-6-1997; IN COMMERCE 2-17-1998.

THE MARK CONSISTS OF A STYLIZED "P", AND
"E" ; COMBINED.

SER. NO. 77-501,381, FILED 6-18-2008.

CAROLYN GRAY, EXAMINING ATTORNEY

Int. Cl.: 7

Prior U.S. Cls.: 13, 19, 21, 23, 31, 34 and 35

United States Patent and Trademark Office

Reg. No. 3,575,513

Registered Feb. 17, 2009

**TRADEMARK
PRINCIPAL REGISTER**

ROTRON

AMETEK, INC. (DELAWARE CORPORATION)
627 LAKE STREET
KENT, OH 44240

FOR: ELECTRIC MOTORS FOR MACHINES;
ELECTRIC FANS; POWER OPERATED BLOWERS
FOR MOVING AIR, LIQUIDS, OR SOLIDS; CEN-
TRIFUGAL PUMPS FOR MOVING AIR, LIQUIDS,
OR SOLIDS, IN CLASS 7 (U.S. CLS. 13, 19, 21, 23, 31, 34
AND 35).

FIRST USE 2-28-1947; IN COMMERCE 2-28-1947.

THE MARK CONSISTS OF STANDARD CHAR-
ACTERS WITHOUT CLAIM TO ANY PARTICULAR
FONT, STYLE, SIZE, OR COLOR.

SER. NO. 77-501,437, FILED 6-18-2008.

IRA J. GOODSaid, EXAMINING ATTORNEY

Int. Cl.: 41

Prior U.S. Cls.: 100, 101 and 107

United States Patent and Trademark Office

Reg. No. 3,575,514

Registered Feb. 17, 2009

SERVICE MARK
PRINCIPAL REGISTER



RYAN SEACREST PRODUCTIONS, INC. (CALIFORNIA CORPORATION)
C/O LOEB & LOEB LLP
10100 SANTA MONICA BLVD STE 2200
LOS ANGELES, CA 90067

FOR: ENTERTAINMENT SERVICES, NAMELY, RADIO AND TELEVISION PROGRAMS FEATURING PERFORMANCES BY A TELEVISION AND RADIO PERSONALITY, IN CLASS 41 (U.S. CLS. 100, 101 AND 107).

FIRST USE 4-0-2008; IN COMMERCE 4-0-2008.

OWNER OF U.S. REG. NOS. 2,964,302, 2,995,854, AND 3,234,453.

NO CLAIM IS MADE TO THE EXCLUSIVE RIGHT TO USE "ON AIR", APART FROM THE MARK AS SHOWN.

THE NAME SHOWN IN THE MARK IDENTIFIES "RYAN SEACREST" WHOSE CONSENT IS OF RECORD.

THE MARK CONSISTS OF A PARALLELOGRAM SPLIT IN HALF AND CONTAINING THE WORDS "ON AIR" OVER THE WORDS "WITH RYAN SEACREST".

SER. NO. 77-501,560, FILED 6-18-2008.

GILBERT SWIFT, EXAMINING ATTORNEY

Int. Cls.: 16 and 41

Prior U.S. Cls.: 2, 5, 22, 23, 29, 37, 38, 50, 100, 101 and 107

Reg. No. 3,575,515

United States Patent and Trademark Office

Registered Feb. 17, 2009

**TRADEMARK
SERVICE MARK
PRINCIPAL REGISTER**



Fresh Energy

FRESH ENERGY (MINNESOTA CORPORATION)
408 SAINT PETER STREET, SUITE 220
SAINT PAUL, MN 55102

FOR: PRINTED PUBLICATIONS, NAMELY, NEWSLETTERS, NEWS RELEASES, BROCHURES, AND HANDOUTS IN THE FIELD OF ENERGY POLICY, IN CLASS 16 (U.S. CLS. 2, 5, 22, 23, 29, 37, 38 AND 50).

FIRST USE 5-22-2006; IN COMMERCE 5-22-2006.

FOR: EDUCATIONAL SERVICES, NAMELY, CONDUCTING PRESENTATIONS IN THE FIELD OF ENERGY POLICY; ONLINE PUBLICATIONS, NAMELY, NEWSLETTERS, NEWS RELEASES, ARTICLES, REPORTS, POLICY POSITIONS, AND FACT

SHEETS IN THE FIELD OF ENERGY POLICY, IN CLASS 41 (U.S. CLS. 100, 101 AND 107).

FIRST USE 5-22-2006; IN COMMERCE 5-22-2006.

NO CLAIM IS MADE TO THE EXCLUSIVE RIGHT TO USE "ENERGY", APART FROM THE MARK AS SHOWN.

THE MARK CONSISTS OF A CIRCLE WITH STYLIZED ELEMENTS ABOVE THE WORDS "FRESH ENERGY".

SER. NO. 77-501,576, FILED 6-18-2008.

JORDAN BAKER, EXAMINING ATTORNEY

Int. Cls.: 16 and 41

Prior U.S. Cls.: 2, 5, 22, 23, 29, 37, 38, 50, 100, 101 and 107

Reg. No. 3,575,516

United States Patent and Trademark Office

Registered Feb. 17, 2009

**TRADEMARK
SERVICE MARK
PRINCIPAL REGISTER**

FRESH ENERGY

FRESH ENERGY (MINNESOTA CORPORATION)
408 SAINT PETER STREET, SUITE 220
SAINT PAUL, MN 55102

FOR: PRINTED PUBLICATIONS, NAMELY, NEWSLETTERS, NEWS RELEASES, BROCHURES, AND HANDOUTS IN THE FIELD OF ENERGY POLICY, IN CLASS 16 (U.S. CLS. 2, 5, 22, 23, 29, 37, 38 AND 50).

FIRST USE 5-22-2006; IN COMMERCE 5-22-2006.

FOR: EDUCATIONAL SERVICES, NAMELY, CONDUCTING PRESENTATIONS IN THE FIELD OF ENERGY POLICY; ONLINE PUBLICATIONS, NAMELY, NEWSLETTERS, NEWS RELEASES, ARTICLES, REPORTS, POLICY POSITIONS, AND FACT

SHEETS IN THE FIELD OF ENERGY POLICY, IN CLASS 41 (U.S. CLS. 100, 101 AND 107).

FIRST USE 5-22-2006; IN COMMERCE 5-22-2006.

THE MARK CONSISTS OF STANDARD CHARACTERS WITHOUT CLAIM TO ANY PARTICULAR FONT, STYLE, SIZE, OR COLOR.

NO CLAIM IS MADE TO THE EXCLUSIVE RIGHT TO USE "ENERGY", APART FROM THE MARK AS SHOWN.

SER. NO. 77-501,609, FILED 6-18-2008.

JORDAN BAKER, EXAMINING ATTORNEY

Int. Cl.: 35

Prior U.S. Cls.: 100, 101 and 102

United States Patent and Trademark Office

Reg. No. 3,575,517

Registered Feb. 17, 2009

**SERVICE MARK
PRINCIPAL REGISTER**

ACHIEVE

ACHIEVE, INC. (DELAWARE CORPORATION)
1775 EYE STREET NW, SUITE 410
WASHINGTON, DC 20006

FOR: EVALUATING, PROPOSING, AND RECOMMENDING THE IMPLEMENTATION OF BEST PRACTICES IN ASSESSMENT OF ACADEMIC PERFORMANCE; PROVIDING ASSESSMENTS AND SURVEYS IN ORDER TO HELP STATES DEVELOP HIGH-QUALITY STANDARDS, ASSESSMENTS AND ACCOUNTABILITY SYSTEMS FOR ACA-

DEMIC ACHIEVEMENT, IN CLASS 35 (U.S. CLS. 100, 101 AND 102).

FIRST USE 10-17-1996; IN COMMERCE 10-17-1996.

THE MARK CONSISTS OF STANDARD CHARACTERS WITHOUT CLAIM TO ANY PARTICULAR FONT, STYLE, SIZE, OR COLOR.

SER. NO. 77-502,214, FILED 6-18-2008.

RENEE SERVANCE, EXAMINING ATTORNEY

Int. Cl.: 41

Prior U.S. Cls.: 100, 101 and 107

United States Patent and Trademark Office

Reg. No. 3,575,518

Registered Feb. 17, 2009

**SERVICE MARK
PRINCIPAL REGISTER**

ANY TICKET ANYWHERE ANY
TIME

6413862 CANADA INC. (CANADA CORPORATION)
SUITE 100
5200 PARÉ STREET
MONTREAL, CANADA H3B4W5

FOR: ENTERTAINMENT TICKET AGENCY SERVICES; ARRANGING FOR TICKET RESERVATIONS FOR SHOWS AND OTHER ENTERTAINMENT EVENTS; BOOKING OF SEATS FOR SHOWS AND SPORTS EVENTS; PROVIDING A WEB SITE THROUGH WHICH PEOPLE LOCATE INFORMATION ABOUT THEATRICAL, PERFORMANCE, MUSICAL, OR SPORTING EVENTS, IN CLASS 41 (U.S. CLS. 100, 101 AND 107).

FIRST USE 0-0-2005; IN COMMERCE 0-0-2005.

THE MARK CONSISTS OF STANDARD CHARACTERS WITHOUT CLAIM TO ANY PARTICULAR FONT, STYLE, SIZE, OR COLOR.

OWNER OF CANADA REG. NO. TMA697,263, DATED 9-25-2007, EXPIRES 9-25-2022.

SER. NO. 77-502,271, FILED 6-18-2008.

ANGELA M. MICHELI, EXAMINING ATTORNEY

Int. Cl.: 35

Prior U.S. Cls.: 100, 101 and 102

United States Patent and Trademark Office

Reg. No. 3,575,519

Registered Feb. 17, 2009

**SERVICE MARK
PRINCIPAL REGISTER**

BAILEY'S

BAILEY'S INC. (CALIFORNIA CORPORATION)
44650 HIGHWAY 101
LAYTONVILLE, CA 95454

THE MARK CONSISTS OF STANDARD CHAR-
ACTERS WITHOUT CLAIM TO ANY PARTICULAR
FONT, STYLE, SIZE, OR COLOR.

FOR: ON-LINE RETAIL STORE SERVICES FEA-
TURING OUTDOOR POWER EQUIPMENT AND
ACCESSORIES THEREFOR, IN CLASS 35 (U.S. CLS.
100, 101 AND 102).

OWNER OF U.S. REG. NO. 1,333,750.

SER. NO. 77-502,358, FILED 6-18-2008.

FIRST USE 11-30-1996; IN COMMERCE 1-1-1999.

JENNIFER VASQUEZ, EXAMINING ATTORNEY

Int. Cl.: 35

Prior U.S. Cls.: 100, 101 and 102

United States Patent and Trademark Office

Reg. No. 3,575,520

Registered Feb. 17, 2009

**SERVICE MARK
PRINCIPAL REGISTER**



EMERGENCY EXCELLENCE LLC (DELAWARE
LIMITED LIABILITY COMPANY)
4241 ANTHONY DRIVE
BETHLEHEM, PA 18020

FOR: BUSINESS CONSULTING AND INFORMATION SERVICES; EXPERT EVALUATIONS AND REPORTS RELATING TO BUSINESS MATTERS, IN CLASS 35 (U.S. CLS. 100, 101 AND 102).

FIRST USE 6-10-2008; IN COMMERCE 6-10-2008.

NO CLAIM IS MADE TO THE EXCLUSIVE RIGHT TO USE "EMERGENCY MEDICINE", APART FROM THE MARK AS SHOWN.

THE COLOR(S) BLUE, WHITE, AND BLACK IS/ARE CLAIMED AS A FEATURE OF THE MARK.

THE MARK CONSISTS OF A WHITE COLUMN ON A BLUE BACKGROUND, SURROUNDED BY A WHITE CIRCLE, WHICH IS SURROUNDED BY A BLUE 32 SPIKED EMBLEM. THE FREE SPACE WITHIN THE WHITE CIRCLE IS FILLED IN THE COLOR BLUE. THE WORDS "EMERGENCY MEDICINE" ARE CAPITALIZED AND WRITTEN IN BOLD BLACK TEXT ABOVE AND WRAPPING AROUND THE TOP HALF OF THE EMBLEM. THE WORDS "CENTER OF EXCELLENCE" ARE CAPITALIZED AND WRITTEN IN BOLD BLACK TEXT (EXCEPT THE WORD "OF" IS LOWERCASE AND NOT BOLD) IN TWO LINES AND LOCATED BELOW THE EMBLEM.

SER. NO. 77-502,414, FILED 6-18-2008.

SHAILA SETTLES, EXAMINING ATTORNEY

Int. Cl.: 44

Prior U.S. Cls.: 100 and 101

United States Patent and Trademark Office

Reg. No. 3,575,521

Registered Feb. 17, 2009

**SERVICE MARK
PRINCIPAL REGISTER**



ALLERGY, ASTHMA AND IMMUNOLOGY CENTER, PC (OKLAHOMA CORPORATION)
SUITE: 209
6565 S. YALE AVE.
TULSA, OK 741368303

FOR: MEDICAL CLINICS, IN CLASS 44 (U.S. CLS. 100 AND 101).

FIRST USE 8-1-2007; IN COMMERCE 8-1-2007.

THE COLOR(S) RED, BLUE, GREEN, BLACK AND WHITE IS/ARE CLAIMED AS A FEATURE OF THE MARK.

THE MARK CONSISTS OF A BLUE KITE CONTAINING A WHITE CROSS IN THE MIDDLE WITH A BLACK TAIL CONTAINING THREE BOWS. TWO GREEN TUBE DESIGNS WITH A WHITE OPENING APPEAR BELOW THE KITE WITH TWO RED CURVED BANDS APPEARING BELOW THE GREEN TUBES.

SER. NO. 77-502,595, FILED 6-19-2008.

EMILY CHUO, EXAMINING ATTORNEY

Int. Cl.: 10

Prior U.S. Cls.: 26, 39 and 44

United States Patent and Trademark Office

Reg. No. 3,575,522

Registered Feb. 17, 2009

**TRADEMARK
PRINCIPAL REGISTER**



KANGAROO PUMP POCKETS, INC. (FLORIDA CORPORATION)
27743 WATER ASH DR.
WESLEY CHAPEL, FL 33544

FOR: SPECIALTY CLOTHING FOR HOLDING EQUIPMENT, NAMELY, UNDERGARMENTS, SHIRTS, SHORTS, PANTS AND SWIMWEAR FITTED WITH A POCKET FOR HOLDING MEDICAL EQUIPMENT, DIABETES RELATED DEVICES, COCHLEAR IMPLANT DEVICES, AND MEDICATION DELIVERY DEVICES, IN CLASS 10 (U.S. CLS. 26, 39 AND 44).

FIRST USE 3-1-2007; IN COMMERCE 3-2-2007.

THE COLOR(S) RED IS/ARE CLAIMED AS A FEATURE OF THE MARK.

THE MARK CONSISTS OF A LARGE, RED KANGAROO SHAPE HOPPING TOWARDS THE LETTERS "KPP" IN UPPER CASE COOPER BLACK (OPEN TYPE) FONT IN RED. THE LETTERS ARE LEANING TOWARDS THE RIGHT AS THOUGH ITALICIZED.

SER. NO. 77-502,729, FILED 6-19-2008.

KOURTNEE HODGES, EXAMINING ATTORNEY

Int. Cl.: 36

Prior U.S. Cls.: 100, 101 and 102

United States Patent and Trademark Office

Reg. No. 3,575,523

Registered Feb. 17, 2009

**SERVICE MARK
PRINCIPAL REGISTER**



WYNNCHURCH | CAPITAL

WYNNCHURCH CAPITAL, LTD. (DELAWARE CORPORATION)
6250 NORTH RIVER ROAD, SUITE 10-100
ROSEMONT, IL 60018

FOR: FINANCIAL SERVICES, NAMELY, PROVIDING FINANCING RELATING TO VARIOUS TYPES OF TRANSACTIONS; PRIVATE EQUITY FUND MANAGEMENT SERVICES AND INVESTMENT ADVICE IN THE FIELD OF PRIVATE EQUITY CAPITAL MANAGEMENT, IN CLASS 36 (U.S. CLS. 100, 101 AND 102).

FIRST USE 11-30-2006; IN COMMERCE 11-30-2006.

OWNER OF U.S. REG. NO. 2,552,407.

NO CLAIM IS MADE TO THE EXCLUSIVE RIGHT TO USE "CAPITAL", APART FROM THE MARK AS SHOWN.

THE MARK CONSISTS OF A SQUARE BOX CONTAINING THE LETTERS "WC" FOLLOWED BY THE WORDS "WYNNCHURCH CAPITAL" WITH A VERTICAL LINE APPEARING BETWEEN THE WORDS "WYNNCHURCH" AND "CAPITAL".

SER. NO. 77-502,804, FILED 6-19-2008.

JENNIFER DIXON, EXAMINING ATTORNEY

Int. Cl.: 35

Prior U.S. Cls.: 100, 101 and 102

United States Patent and Trademark Office

Reg. No. 3,575,524

Registered Feb. 17, 2009

SERVICE MARK
PRINCIPAL REGISTER

The logo for Bailey's is written in a bold, cursive script. The letters are thick and rounded, with a slight shadow or outline effect. The 'B' is particularly large and prominent, starting with a high arch. The 'i' has a dot, and the 'y' has a tail that loops back. The overall style is classic and handwritten.

BAILEY'S INC. (CALIFORNIA CORPORATION)
44650 HIGHWAY 101
LAYTONVILLE, CA 95454

FIRST USE 11-30-1996; IN COMMERCE 1-1-1999.

OWNER OF U.S. REG. NO. 1,333,750.

FOR: MAIL ORDER CATALOG SERVICES FEATURING OUTDOOR POWER EQUIPMENT AND ACCESSORIES THEREFOR; MAIL ORDER SERVICES FEATURING OUTDOOR POWER EQUIPMENT AND ACCESSORIES THEREFOR; ON-LINE RETAIL STORE SERVICES FEATURING OUTDOOR POWER EQUIPMENT AND ACCESSORIES THEREFOR, IN CLASS 35 (U.S. CLS. 100, 101 AND 102).

THE MARK CONSISTS OF THE WORD "BAILEY'S" IN STYLIZED FORMAT.

SER. NO. 77-502,948, FILED 6-19-2008.

JENNIFER VASQUEZ, EXAMINING ATTORNEY

Int. Cl.: 35

Prior U.S. Cls.: 100, 101 and 102

United States Patent and Trademark Office

Reg. No. 3,575,525

Registered Feb. 17, 2009

**SERVICE MARK
PRINCIPAL REGISTER**

EPI TECHNOLOGIES

EPI TECHNOLOGIES, INC. (ILLINOIS CORPORATION)
41258 N. WESTLAKE AVENUE
ANTIOCH, IL 60002

FOR: MANUFACTURER REPRESENTATIVES IN THE FIELD OF COMMUNICATIONS AND TEST EQUIPMENT PRODUCTS, IN CLASS 35 (U.S. CLS. 100, 101 AND 102).

FIRST USE 1-22-2003; IN COMMERCE 1-22-2003.

THE MARK CONSISTS OF STANDARD CHARACTERS WITHOUT CLAIM TO ANY PARTICULAR FONT, STYLE, SIZE, OR COLOR.

NO CLAIM IS MADE TO THE EXCLUSIVE RIGHT TO USE "TECHNOLOGIES", APART FROM THE MARK AS SHOWN.

SER. NO. 77-502,965, FILED 6-19-2008.

ANN E. SAPPENFIELD, EXAMINING ATTORNEY

Int. Cl.: 14

Prior U.S. Cls.: 2, 27, 28 and 50

United States Patent and Trademark Office

Reg. No. 3,575,526

Registered Feb. 17, 2009

**TRADEMARK
PRINCIPAL REGISTER**

beattitudes

BE INSPIRED JEWELRY, LLC (COLORADO LIMITED LIABILITY COMPANY)
2258 COUNTRY CLUB LOOP
WESTMINSTER, CO 80234

THE MARK CONSISTS OF STANDARD CHARACTERS WITHOUT CLAIM TO ANY PARTICULAR FONT, STYLE, SIZE, OR COLOR.

FOR: JEWELRY, IN CLASS 14 (U.S. CLS. 2, 27, 28 AND 50).

SER. NO. 77-503,321, FILED 6-19-2008.

FIRST USE 5-27-2008; IN COMMERCE 5-27-2008.

JANICE KIM, EXAMINING ATTORNEY

Int. Cl.: 35

Prior U.S. Cls.: 100, 101 and 102

United States Patent and Trademark Office

Reg. No. 3,575,527

Registered Feb. 17, 2009

**SERVICE MARK
PRINCIPAL REGISTER**



ACHIEVE, INC. (DELAWARE CORPORATION)
1775 EYE STREET NW, SUITE 410
WASHINGTON, DC 20006

FIRST USE 6-30-1999; IN COMMERCE 6-30-1999.

FOR: EVALUATING, PROPOSING, AND RECOMMENDING THE IMPLEMENTATION OF BEST PRACTICES IN ASSESSMENT OF ACADEMIC PERFORMANCE; PROVIDING ASSESSMENTS AND SURVEYS IN ORDER TO HELP STATES DEVELOP HIGH-QUALITY STANDARDS, ASSESSMENTS AND ACCOUNTABILITY SYSTEMS FOR ACADEMIC ACHIEVEMENT, IN CLASS 35 (U.S. CLS. 100, 101 AND 102).

THE MARK CONSISTS OF A STYLIZED MORTARBOARD HAT WITH TASSEL ON RIGHT; THE MORTARBOARD ITSELF IS EMBLAZONED WITH A SUN DESIGN.

SER. NO. 77-503,396, FILED 6-19-2008.

RENEE SERVANCE, EXAMINING ATTORNEY

Int. Cl.: 36

Prior U.S. Cls.: 100, 101 and 102

United States Patent and Trademark Office

Reg. No. 3,575,528

Registered Feb. 17, 2009

**SERVICE MARK
PRINCIPAL REGISTER**

Dig Pink

THE SIDE-OUT FOUNDATION (VIRGINIA CORPORATION)
5807 OAK LADDER COURT
BURKE, VA 22015

FOR: CHARITABLE FUNDRAISING SERVICES, NAMELY, CONDUCTING VOLLEYBALL EVENTS IN THE NATURE OF TOURNAMENTS, CLINICS, AND AWARENESS RALLIES TO RAISE FUNDS FOR BREAST CANCER RESEARCH AND EDUCATION AT THE LOCAL AND NATIONAL LEVEL, IN CLASS 36 (U.S. CLS. 100, 101 AND 102).

FIRST USE 6-1-2008; IN COMMERCE 6-1-2008.

THE MARK CONSISTS OF STANDARD CHARACTERS WITHOUT CLAIM TO ANY PARTICULAR FONT, STYLE, SIZE, OR COLOR.

SER. NO. 77-503,542, FILED 6-19-2008.

ANDREA BUTLER, EXAMINING ATTORNEY

Int. Cl.: 9

Prior U.S. Cls.: 21, 23, 26, 36 and 38

Reg. No. 3,575,529

United States Patent and Trademark Office

Registered Feb. 17, 2009

**TRADEMARK
PRINCIPAL REGISTER**

HOMAC

THOMAS & BETTS INTERNATIONAL, INC. (DE-
LAWARE CORPORATION)
SUITE 67
501 SILVERSIDE ROAD
WILMINGTON, DE 19809

FOR: ELECTRICAL CONNECTORS, IN CLASS 9
(U.S. CLS. 21, 23, 26, 36 AND 38).

FIRST USE 5-31-2008; IN COMMERCE 5-31-2008.

THE MARK CONSISTS OF STANDARD CHAR-
ACTERS WITHOUT CLAIM TO ANY PARTICULAR
FONT, STYLE, SIZE, OR COLOR.

OWNER OF U.S. REG. NO. 1,019,689.

SER. NO. 77-503,900, FILED 6-20-2008.

SARA THOMAS, EXAMINING ATTORNEY

Int. Cl.: 35

Prior U.S. Cls.: 100, 101 and 102

United States Patent and Trademark Office

Reg. No. 3,575,530

Registered Feb. 17, 2009

**SERVICE MARK
PRINCIPAL REGISTER**

BizVotes

PARKER, RICHARD S. (UNITED STATES INDIVIDUAL)
3440 BELL, SUITE 320
AMARILLO, TX 79109

FOR: RATING SERVICES, NAMELY, PROVIDING A WEB SITE WHERE USERS CAN POST REAL TIME VOTE RATINGS, REVIEWS AND RECOMMENDATIONS ON THE PRODUCTS AND SERVICES OF LOCAL BUSINESSES , IN CLASS 35 (U.S. CLS. 100, 101 AND 102).

FIRST USE 2-1-2008; IN COMMERCE 2-1-2008.

THE MARK CONSISTS OF STANDARD CHARACTERS WITHOUT CLAIM TO ANY PARTICULAR FONT, STYLE, SIZE, OR COLOR.

SER. NO. 77-503,926, FILED 6-20-2008.

INGRID C. EULIN, EXAMINING ATTORNEY

Int. Cl.: 42

Prior U.S. Cls.: 100 and 101

United States Patent and Trademark Office

Reg. No. 3,575,531

Registered Feb. 17, 2009

**SERVICE MARK
PRINCIPAL REGISTER**

ActionTRAK

BEYOND COMPLIANCE INC. (CANADA CORPORATION)
SUITE 240, 600 CROWFOOT CRESCENT NW
CALGARY, CANADA T3G0B4

FOR: COMPUTER SERVICES, NAMELY, ACTING AS AN APPLICATION SERVICE PROVIDER FEATURING SOFTWARE THAT MANAGES REGULATORY INFORMATION PERTAINING TO A COMPANY'S OPERATIONS, DISPLAYS COMPLIANCE INFORMATION IN A CALENDAR AND/OR MAP-BASED FORMAT, TRACKS AND IDENTIFIES NON-CONFORMANCE AND CORRECTIVE ACTIONS FOR REGULATORY AND CORPORATE

REQUIREMENTS, AND PROVIDES HIERARCHICAL NOTIFICATION OF NON-CONFORMANCE, IN CLASS 42 (U.S. CLS. 100 AND 101).

FIRST USE 3-1-2008; IN COMMERCE 3-1-2008.

THE MARK CONSISTS OF STANDARD CHARACTERS WITHOUT CLAIM TO ANY PARTICULAR FONT, STYLE, SIZE, OR COLOR.

SER. NO. 77-503,943, FILED 6-20-2008.

ANTHONY RINKER, EXAMINING ATTORNEY

Int. Cl.: 41

Prior U.S. Cls.: 100, 101 and 107

United States Patent and Trademark Office

Reg. No. 3,575,532

Registered Feb. 17, 2009

**SERVICE MARK
PRINCIPAL REGISTER**

SEDUCTION MEALS

TARA DEL MAR PRODUCTIONS INC. (NEW
YORK CORPORATION)
77 HORATIO STREET
NEW YORK, NY 10014

FOR: PUBLISHING OF ELECTRONIC PUBLICA-
TIONS, REVIEWS AND WEB MAGAZINES; ON-
LINE JOURNALS, NAMELY, BLOGS FEATURING
CULINARY ARTS, MUSIC AND PERSONAL RELA-
TIONSHPIS, IN CLASS 41 (U.S. CLS. 100, 101 AND
107).

FIRST USE 8-10-2007; IN COMMERCE 8-10-2007.

THE MARK CONSISTS OF STANDARD CHAR-
ACTERS WITHOUT CLAIM TO ANY PARTICULAR
FONT, STYLE, SIZE, OR COLOR.

NO CLAIM IS MADE TO THE EXCLUSIVE
RIGHT TO USE "MEALS", APART FROM THE
MARK AS SHOWN.

SER. NO. 77-503,964, FILED 6-20-2008.

SANDRA MANIOS, EXAMINING ATTORNEY

Int. Cl.: 35

Prior U.S. Cls.: 100, 101 and 102

United States Patent and Trademark Office

Reg. No. 3,575,533

Registered Feb. 17, 2009

SERVICE MARK
PRINCIPAL REGISTER



INFORMEDRX, INC. (DELAWARE CORPORATION)
2441 WARRENVILLE ROAD
LISLE, IL 60532

FOR: MAIL ORDER PHARMACY SERVICES, IN CLASS 35 (U.S. CLS. 100, 101 AND 102).

FIRST USE 5-1-2008; IN COMMERCE 5-1-2008.

OWNER OF U.S. REG. NOS. 2,952,497 AND 3,092,121.

NO CLAIM IS MADE TO THE EXCLUSIVE RIGHT TO USE "SPECIALTY RX", APART FROM THE MARK AS SHOWN.

THE MARK CONSISTS OF "ASCEND SPECIALTYRX SIMPLIFYING CARE. ACHIEVING OUTCOMES." WITH A STYLIZED LETTER "X".

SER. NO. 77-504,113, FILED 6-20-2008.

MARGERY A. TIERNEY, EXAMINING ATTORNEY

Int. Cls.: 35, 36, 37 and 42

Prior U.S. Cls.: 100, 101, 102, 103 and 106

United States Patent and Trademark Office

Reg. No. 3,575,534

Registered Feb. 17, 2009

**SERVICE MARK
PRINCIPAL REGISTER**

OUTLAND RENEWABLE ENERGY

OUTLAND RENEWABLE ENERGY, LLC (MINNESOTA LIMITED LIABILITY COMPANY)
207 NORTH CHESNUT STREET, SUITE 225
CHASKA, MN 55318

FOR: CONSULTING SERVICES IN THE BUSINESS OPERATIONS OF RENEWABLE ENERGY EQUIPMENT AND PROJECTS , IN CLASS 35 (U.S. CLS. 100, 101 AND 102).

FIRST USE 8-15-2005; IN COMMERCE 8-15-2005.

FOR: FINANCIAL SERVICES, NAMELY, INVESTMENT MANAGEMENT FOR INVESTMENTS IN RENEWAL ENERGY EQUIPMENT AND WIND POWER PROJECTS; CONSULTANCY CONCERNING FINANCING OF RENEWABLE ENERGY PROJECTS, IN CLASS 36 (U.S. CLS. 100, 101 AND 102).

FIRST USE 8-15-2005; IN COMMERCE 8-15-2005.

FOR: TECHNICAL SUPPORT SERVICES, NAMELY, PROVIDING TECHNICAL ADVICE IN THE FIELDS OF MAINTENANCE OF RENEWABLE EN-

ERGY EQUIPMENT, IN CLASS 37 (U.S. CLS. 100, 103 AND 106).

FIRST USE 8-15-2005; IN COMMERCE 8-15-2005.

FOR: WIND POWER PLANT PROJECTS DESIGN, DEVELOPMENT AND TESTING OF PRODUCT EQUIPMENT FOR RENEWABLE ENERGY PROJECTS, IN CLASS 42 (U.S. CLS. 100 AND 101).

FIRST USE 8-15-2005; IN COMMERCE 8-15-2005.

THE MARK CONSISTS OF STANDARD CHARACTERS WITHOUT CLAIM TO ANY PARTICULAR FONT, STYLE, SIZE, OR COLOR.

NO CLAIM IS MADE TO THE EXCLUSIVE RIGHT TO USE "RENEWABLE ENERGY", APART FROM THE MARK AS SHOWN.

SER. NO. 77-504,116, FILED 6-20-2008.

MARGERY A. TIERNEY, EXAMINING ATTORNEY

Int. Cl.: 42

Prior U.S. Cls.: 100 and 101

United States Patent and Trademark Office

Reg. No. 3,575,535

Registered Feb. 17, 2009

SERVICE MARK
PRINCIPAL REGISTER

next | strategy

NEXT STRATEGY, INC. (D.C. CORPORATION)
4TH FLOOR
3222 N. STREET N.W.
WASHINGTON, DC 20007

FOR: COMPUTER SERVICES, NAMELY, DESIGNING AND IMPLEMENTING WEB SITES FOR OTHERS; CREATING, DESIGNING AND MAINTAINING WEB SITES, IN CLASS 42 (U.S. CLS. 100 AND 101).

FIRST USE 3-31-2003; IN COMMERCE 3-31-2003.

THE MARK CONSISTS OF THE STYLIZED WORDS "NEXT STRATEGY". AN IMAGE OF A THIN VERTICAL LINE BETWEEN THE WORDS "NEXT" AND "STRATEGY".

SER. NO. 77-504,535, FILED 6-20-2008.

YONG KIM, EXAMINING ATTORNEY

Int. Cl.: 41

Prior U.S. Cls.: 100, 101 and 107

United States Patent and Trademark Office

Reg. No. 3,575,536

Registered Feb. 17, 2009

**SERVICE MARK
PRINCIPAL REGISTER**



SHAHPAR, BIZHAN (UNITED STATES INDIVIDUAL)
6611 N. ASHLAND
CHICAGO, IL 60626 AND
ROCHA, ANTHONY (UNITED STATES INDIVIDUAL)
6611 N. ASHLAND
CHICAGO, IL 60626

FOR: AUDIO AND VIDEO RECORDING SERVICES; AUDIO RECORDING AND PRODUCTION; MULTIMEDIA ENTERTAINMENT SERVICES IN THE NATURE OF RECORDING, PRODUCTION AND POST-PRODUCTION SERVICES IN THE FIELDS OF MUSIC, VIDEO, AND FILMS; PRODUCTION OF SOUND RECORDINGS; RECORD MASTER PRODUCTION, IN CLASS 41 (U.S. CLS. 100, 101 AND 107).

FIRST USE 9-20-2005; IN COMMERCE 1-6-2007.

NO CLAIM IS MADE TO THE EXCLUSIVE RIGHT TO USE "RECORDS" AND THE OUTLINE OF THE STATE OF ILLINOIS, APART FROM THE MARK AS SHOWN.

THE MARK CONSISTS OF AN IMAGE OF THE STATE OF ILLINOIS OUTLINE WITH THE CHICAGO SKYLINE INSIDE THE BOTTOM HALF. THE STYLIZED WORDS "CHI-STEE RECORDS" IS ABOVE THE SKYLINE INSIDE THE OUTLINE OF THE STATE OF ILLINOIS.

SER. NO. 77-504,539, FILED 6-20-2008.

EDWARD FENNESSY, EXAMINING ATTORNEY

Int. Cls.: 9 and 42

Prior U.S. Cls.: 21, 23, 26, 36, 38, 100 and 101

United States Patent and Trademark Office

Reg. No. 3,575,537

Registered Feb. 17, 2009

**TRADEMARK
SERVICE MARK
PRINCIPAL REGISTER**

StaffCop

MEDVEDNIKOV, EVGENY (RUSSIAN FED. INDIVIDUAL)
APT. 69
UL. DREZDENSKAJA 11, BUILDING 2,
SAINT-PETERSBURG, RUSSIAN FED. 194017

FOR: COMPUTER UTILITY SOFTWARE, DOWNLOADABLE COMPUTER SOFTWARE AND COMPUTER SOFTWARE FOR TIME AND APPLICATION TRACKING, MONITORING CORPORATE SECURITY, AND NETWORK AND COMPUTER PROTECTION, IN CLASS 9 (U.S. CLS. 21, 23, 26, 36 AND 38).

FIRST USE 1-1-2005; IN COMMERCE 1-1-2005.

FOR: APPLICATION SERVICE PROVIDER FEATURING SOFTWARE FOR TIME AND APPLICATION TRACKING, MONITORING CORPORATE SECURITY, AND NETWORK AND COMPUTER PROTECTION; PROVIDING TECHNICAL OPERATING INFORMATION FOR SOFTWARE PROGRAMS

FOR TIME AND APPLICATION TRACKING, MONITORING CORPORATE SECURITY, AND NETWORK AND COMPUTER PROTECTION; ON-LINE TECHNICAL SUPPORT SERVICES, NAMELY, PROVIDING AN INTERACTIVE WEBSITE FOR TROUBLESHOOTING PROBLEMS RELATING TO SOFTWARE FOR TIME AND APPLICATION TRACKING, MONITORING CORPORATE SECURITY, AND NETWORK AND COMPUTER PROTECTION, IN CLASS 42 (U.S. CLS. 100 AND 101).

FIRST USE 1-1-2005; IN COMMERCE 1-1-2005.

THE MARK CONSISTS OF STANDARD CHARACTERS WITHOUT CLAIM TO ANY PARTICULAR FONT, STYLE, SIZE, OR COLOR.

SER. NO. 77-504,570, FILED 6-20-2008.

MICHELE SWAIN, EXAMINING ATTORNEY

Int. Cl.: 33

Prior U.S. Cls.: 47 and 49

United States Patent and Trademark Office

Reg. No. 3,575,538

Registered Feb. 17, 2009

**TRADEMARK
PRINCIPAL REGISTER**

CABANA RITA

TEXAS TACO CABANA, L.P. (TEXAS LIMITED
PARTNERSHIP)
8918 TESORO DRIVE, SUITE 200
SAN ANTONIO, TX 78217

THE MARK CONSISTS OF STANDARD CHAR-
ACTERS WITHOUT CLAIM TO ANY PARTICULAR
FONT, STYLE, SIZE, OR COLOR.

FOR: PREPARED ALCOHOLIC BEVERAGE,
NAMELY, A PREPARED ALCOHOLIC COCKTAIL,
IN CLASS 33 (U.S. CLS. 47 AND 49).

SER. NO. 77-504,803, FILED 6-21-2008.

FIRST USE 4-16-1999; IN COMMERCE 4-16-1999.

ELLEN PERKINS, EXAMINING ATTORNEY

Int. Cl.: 25

Prior U.S. Cls.: 22 and 39

United States Patent and Trademark Office

Reg. No. 3,575,539

Registered Feb. 17, 2009

**TRADEMARK
PRINCIPAL REGISTER**

**MUCH MORE THAN A COMFORT
SHOE**

ORTHOFEET (DELAWARE CORPORATION)
152A VETERANS DRIVE
NORTHVALE, NJ 07642

FOR: ATHLETIC FOOTWEAR; ATHLETIC SHOES; FOOTWEAR; FOOTWEAR FOR MEN; FOOTWEAR FOR MEN AND WOMEN; FOOTWEAR FOR WOMEN; GOLF SHOES; LEATHER SHOES; PUMPS; RUNNING SHOES; WOMEN'S SHOES; WORK SHOES AND BOOTS, IN CLASS 25 (U.S. CLS. 22 AND 39).

FIRST USE 12-9-2005; IN COMMERCE 1-10-2006.

THE MARK CONSISTS OF STANDARD CHARACTERS WITHOUT CLAIM TO ANY PARTICULAR FONT, STYLE, SIZE, OR COLOR.

NO CLAIM IS MADE TO THE EXCLUSIVE RIGHT TO USE "SHOE", APART FROM THE MARK AS SHOWN.

SER. NO. 77-504,906, FILED 6-22-2008.

MEGHAN REINHART, EXAMINING ATTORNEY

Int. Cl.: 36

Prior U.S. Cls.: 100, 101 and 102

United States Patent and Trademark Office

Reg. No. 3,575,540

Registered Feb. 17, 2009

**SERVICE MARK
PRINCIPAL REGISTER**



**TRANSACTION
REALTY**

2ACK, INC. (OHIO CORPORATION)
SUITE 200
ONE PARK CTR., 6100 OAK TREE BLVD.
INDEPENDENCE, OH 45131

FOR: REAL ESTATE AGENCIES, IN CLASS 36
(U.S. CLS. 100, 101 AND 102).

FIRST USE 2-24-2008; IN COMMERCE 2-24-2008.

NO CLAIM IS MADE TO THE EXCLUSIVE
RIGHT TO USE "TRANSACTION REALTY", APART
FROM THE MARK AS SHOWN.

THE MARK CONSISTS OF TWO SQUARES, ONE
SQUARE WITH ONE ROUNDED TOP LEFT COR-
NER WITH THE LETTER "T" INSIDE, AND THE
OTHER SQUARE WITH ONE ROUNDED BOTTOM
RIGHT CORNER WITH THE LETTER "R" INSIDE,
ABOVE THE WORDS "TRANSACTION REALTY".

SER. NO. 77-505,034, FILED 6-23-2008.

MICHELE SWAIN, EXAMINING ATTORNEY

Int. Cl.: 36

Prior U.S. Cls.: 100, 101 and 102

United States Patent and Trademark Office

Reg. No. 3,575,541

Registered Feb. 17, 2009

**SERVICE MARK
PRINCIPAL REGISTER**

**Transaction Realty
"we put the action in your
transaction"**

2ACK, INC. (OHIO CORPORATION)
SUITE 200
ONE PARK CTR., 6100 OAK TREE BLVD.
INDEPENDENCE, OH 45131

FOR: REAL ESTATE AGENCIES, IN CLASS 36
(U.S. CLS. 100, 101 AND 102).

FIRST USE 7-8-2002; IN COMMERCE 7-8-2002.

THE MARK CONSISTS OF STANDARD CHAR-
ACTERS WITHOUT CLAIM TO ANY PARTICULAR
FONT, STYLE, SIZE, OR COLOR.

NO CLAIM IS MADE TO THE EXCLUSIVE
RIGHT TO USE "TRANSACTION REALTY", APART
FROM THE MARK AS SHOWN.

SER. NO. 77-505,037, FILED 6-23-2008.

MICHELE SWAIN, EXAMINING ATTORNEY

Int. Cl.: 6

Prior U.S. Cls.: 2, 12, 13, 14, 23, 25 and 50

Reg. No. 3,575,542

United States Patent and Trademark Office

Registered Feb. 17, 2009

**TRADEMARK
PRINCIPAL REGISTER**

PHARMAPRO

HOFFMAN ENCLOSURES INC. (MINNESOTA
CORPORATION)
2100 HOFFMAN WAY
ANOKA, MN 55303

FOR: METAL ENCLOSURES TO HOUSE ELECTRICAL COMPONENTS, CONTROLS AND UTILITIES USED IN PHARMACEUTICAL MANUFACTURING ENVIRONMENTS, IN CLASS 6 (U.S. CLS. 2, 12, 13, 14, 23, 25 AND 50).

FIRST USE 10-25-2005; IN COMMERCE 10-25-2005.

THE MARK CONSISTS OF STANDARD CHARACTERS WITHOUT CLAIM TO ANY PARTICULAR FONT, STYLE, SIZE, OR COLOR.

SER. NO. 77-505,038, FILED 6-23-2008.

MICHELE SWAIN, EXAMINING ATTORNEY

Int. Cl.: 21

Prior U.S. Cls.: 2, 13, 23, 29, 30, 33, 40 and 50

United States Patent and Trademark Office

Reg. No. 3,575,543

Registered Feb. 17, 2009

**TRADEMARK
PRINCIPAL REGISTER**

KINETIC GO GREEN

PATHWAY INVESTMENT CORPORATION (NEW
JERSEY CORPORATION)
401 NEW YORK AVENUE
WYCKOFF, NJ 07481

FOR: CONTAINERS FOR FOODSTUFF; CHAN-
HAP, NAMELY, KOREAN NESTS OF BOXES FOR
STORING AND CARRYING FOODS; MESS-TINS;
CONTAINERS FOR KIMCHI; GLASS BOWLS; CUPS
OF GLASS; CRUETS, NOT OF PRECIOUS METAL;
DRINKING TROUGHS; THERMOBOTTLES FOR
COLD WATER; HEATPROOF EARTHENWARE
AND GLASS PANS; SPICE SETS, IN CLASS 21 (U.S.
CLS. 2, 13, 23, 29, 30, 33, 40 AND 50).

FIRST USE 7-15-2008; IN COMMERCE 7-15-2008.

THE MARK CONSISTS OF STANDARD CHAR-
ACTERS WITHOUT CLAIM TO ANY PARTICULAR
FONT, STYLE, SIZE, OR COLOR.

NO CLAIM IS MADE TO THE EXCLUSIVE
RIGHT TO USE "GREEN", APART FROM THE
MARK AS SHOWN.

SER. NO. 77-505,338, FILED 6-23-2008.

INGA ERVIN, EXAMINING ATTORNEY

Int. Cl.: 9

Prior U.S. Cls.: 21, 23, 26, 36 and 38

Reg. No. 3,575,544

United States Patent and Trademark Office

Registered Feb. 17, 2009

**TRADEMARK
PRINCIPAL REGISTER**



NATIONAL FLOOR SAFETY INSTITUTE (TEXAS
NON-PROFIT CORPORATION)
P.O. BOX 92607
SOUTHLAKE, TX 76092

FOR: COMPUTERIZED FLOOR TESTING DE-
VICE DESIGNED TO PROVIDE READINGS RELAT-
ING TO STATIC AND DYNAMIC COEFFICIENT OF
FRICTION ON BOTH WET AND DRY SURFACES ,
IN CLASS 9 (U.S. CLS. 21, 23, 26, 36 AND 38).

FIRST USE 7-1-1996; IN COMMERCE 7-1-1996.

THE MARK CONSISTS OF AN IMAGE OF PER-
SON FALLING WITH NFSI BELOW.

SER. NO. 77-505,381, FILED 6-23-2008.

ANN E. SAPPENFIELD, EXAMINING ATTORNEY

Int. Cl.: 9

Prior U.S. Cls.: 21, 23, 26, 36 and 38

United States Patent and Trademark Office

Reg. No. 3,575,545

Registered Feb. 17, 2009

**TRADEMARK
PRINCIPAL REGISTER**

Exercise Pro

BIOEX SYSTEMS, INC. (DELAWARE CORPORATION)
PO BOX 926
SMITHVILLE, TX 78957

FOR: COMPUTER SOFTWARE FOR THE DATABASE MANAGEMENT OF EXERCISES USED FOR THE CREATION OF EXERCISE PROGRAM HAND-OUTS IN BOTH PAPER AND ELECTRONIC FORMATS, IN CLASS 9 (U.S. CLS. 21, 23, 26, 36 AND 38).

FIRST USE 6-1-1995; IN COMMERCE 6-1-1995.

THE MARK CONSISTS OF STANDARD CHARACTERS WITHOUT CLAIM TO ANY PARTICULAR FONT, STYLE, SIZE, OR COLOR.

NO CLAIM IS MADE TO THE EXCLUSIVE RIGHT TO USE "EXERCISE", APART FROM THE MARK AS SHOWN.

SER. NO. 77-505,393, FILED 6-23-2008.

KELLY MCCOY, EXAMINING ATTORNEY

Int. Cl.: 9

Prior U.S. Cls.: 21, 23, 26, 36 and 38

Reg. No. 3,575,546

United States Patent and Trademark Office

Registered Feb. 17, 2009

**TRADEMARK
PRINCIPAL REGISTER**

Fitness Maker

BIOEX SYSTEMS, INC. (DELAWARE CORPORATION)
PO BOX 926
SMITHVILLE, TX 78957

FOR: EDUCATIONAL COMPUTER SOFTWARE IN THE FIELD OF FITNESS ASSESSMENT, FITNESS TESTING, FITNESS GOAL ACHIEVEMENT, AND DEVELOPMENT OF FITNESS PROGRAMS, IN CLASS 9 (U.S. CLS. 21, 23, 26, 36 AND 38).

FIRST USE 4-1-2002; IN COMMERCE 4-1-2002.

THE MARK CONSISTS OF STANDARD CHARACTERS WITHOUT CLAIM TO ANY PARTICULAR FONT, STYLE, SIZE, OR COLOR.

NO CLAIM IS MADE TO THE EXCLUSIVE RIGHT TO USE "FITNESS", APART FROM THE MARK AS SHOWN.

SER. NO. 77-505,497, FILED 6-23-2008.

KELLY MCCOY, EXAMINING ATTORNEY

Int. Cl.: 9

Prior U.S. Cls.: 21, 23, 26, 36 and 38

Reg. No. 3,575,547

United States Patent and Trademark Office

Registered Feb. 17, 2009

**TRADEMARK
PRINCIPAL REGISTER**

Nutrition Maker

BIOEX SYSTEMS, INC. (DELAWARE CORPORATION)
PO BOX 926
SMITHVILLE, TX 78957

THE MARK CONSISTS OF STANDARD CHARACTERS WITHOUT CLAIM TO ANY PARTICULAR FONT, STYLE, SIZE, OR COLOR.

FOR: EDUCATIONAL COMPUTER SOFTWARE IN THE FIELD OF DIETARY ANALYSIS, MEAL PLANS, RECIPES, NUTRITIONAL GOALS, AND DOWNLOADABLE ELECTRONIC PUBLICATIONS IN THE NATURE OF HANDOUTS AND REPORTS IN THE FIELD OF NUTRITION, IN CLASS 9 (U.S. CLS. 21, 23, 26, 36 AND 38).

NO CLAIM IS MADE TO THE EXCLUSIVE RIGHT TO USE "NUTRITION", APART FROM THE MARK AS SHOWN.

SER. NO. 77-505,718, FILED 6-23-2008.

FIRST USE 4-1-2003; IN COMMERCE 4-1-2003.

KELLY MCCOY, EXAMINING ATTORNEY

Int. Cl.: 35

Prior U.S. Cls.: 100, 101 and 102

United States Patent and Trademark Office

Reg. No. 3,575,548

Registered Feb. 17, 2009

**SERVICE MARK
PRINCIPAL REGISTER**

Flex-agility

EXIGEN SERVICES, LTD. (BERMUDA CORPORATION)
CLARENDON HOUSE 2 CHURCH STREET
HAMILTON, BERMUDA HM11

THE MARK CONSISTS OF STANDARD CHARACTERS WITHOUT CLAIM TO ANY PARTICULAR FONT, STYLE, SIZE, OR COLOR.

FOR: BUSINESS CONSULTING SERVICES, IN CLASS 35 (U.S. CLS. 100, 101 AND 102).

SER. NO. 77-505,723, FILED 6-23-2008.

FIRST USE 5-19-2008; IN COMMERCE 5-19-2008.

SUZANNE BLANE, EXAMINING ATTORNEY

Int. Cl.: 9

Prior U.S. Cls.: 21, 23, 26, 36 and 38

Reg. No. 3,575,549

United States Patent and Trademark Office

Registered Feb. 17, 2009

**TRADEMARK
PRINCIPAL REGISTER**

Management Maker

BIOEX SYSTEMS, INC. (DELAWARE CORPORATION)
PO BOX 926
SMITHVILLE, TX 78957

FOR: COMPUTER SOFTWARE FOR BILLING, SCHEDULING, MARKETING CAMPAIGN MANAGEMENT, AND CLIENT RETENTION MANAGEMENT FOR SMALL BUSINESS, IN CLASS 9 (U.S. CLS. 21, 23, 26, 36 AND 38).

FIRST USE 6-1-2007; IN COMMERCE 1-15-2008.

THE MARK CONSISTS OF STANDARD CHARACTERS WITHOUT CLAIM TO ANY PARTICULAR FONT, STYLE, SIZE, OR COLOR.

NO CLAIM IS MADE TO THE EXCLUSIVE RIGHT TO USE "MANAGEMENT", APART FROM THE MARK AS SHOWN.

SER. NO. 77-505,751, FILED 6-23-2008.

KELLY MCCOY, EXAMINING ATTORNEY

Int. Cl.: 9

Prior U.S. Cls.: 21, 23, 26, 36 and 38

United States Patent and Trademark Office

Reg. No. 3,575,550

Registered Feb. 17, 2009

**TRADEMARK
PRINCIPAL REGISTER**

Exercise Expert

BIOEX SYSTEMS, INC. (DELAWARE CORPORATION)
PO BOX 926
SMITHVILLE, TX 78957

FOR: COMPUTER SOFTWARE FOR DATABASE MANAGEMENT OF EXERCISES USED FOR GENERATING PRINTED AND ELECTRONIC EXERCISE HANDOUTS, IN CLASS 9 (U.S. CLS. 21, 23, 26, 36 AND 38).

FIRST USE 5-1-1999; IN COMMERCE 5-1-1999.

THE MARK CONSISTS OF STANDARD CHARACTERS WITHOUT CLAIM TO ANY PARTICULAR FONT, STYLE, SIZE, OR COLOR.

NO CLAIM IS MADE TO THE EXCLUSIVE RIGHT TO USE "EXERCISE", APART FROM THE MARK AS SHOWN.

SER. NO. 77-505,771, FILED 6-23-2008.

KELLY MCCOY, EXAMINING ATTORNEY

Int. Cl.: 35

Prior U.S. Cls.: 100, 101 and 102

United States Patent and Trademark Office

Reg. No. 3,575,551

Registered Feb. 17, 2009

**SERVICE MARK
PRINCIPAL REGISTER**



SOILMOISTURE EQUIPMENT CORP. (CALIFORNIA CORPORATION)
801 S. KELLOGG AVE.
GOLETA, CA 93117

FOR: MAIL ORDER CATALOG AND ONLINE CATALOG SERVICES, FEATURING INSTRUMENTS AND ACCESSORIES FOR THE EXTRACTION OF SOIL AND WATER AND THE MEASUREMENT OF SOIL AND WATER PROPERTIES, TIME DOMAIN REFLECTOMETERS, TIME DOMAIN REFLECTOMETER ACCESSORIES, AIR PRESSURE REGULATORS, VACUUM PUMPS, AND CERAMIC FILTERS, IN CLASS 35 (U.S. CLS. 100, 101 AND 102).

FIRST USE 2-0-2000; IN COMMERCE 2-0-2000.

OWNER OF U.S. REG. NO. 2,675,025.

NO CLAIM IS MADE TO THE EXCLUSIVE RIGHT TO USE "SOILMOISTURE", APART FROM THE MARK AS SHOWN.

THE COLOR(S) BLUE, BLACK AND BROWN IS/ARE CLAIMED AS A FEATURE OF THE MARK.

THE MARK CONSISTS OF A TEARDROP SHAPE SPLIT HORIZONTALLY INTO TWO DISCONNECTED SECTIONS. THE TOP SECTION IS BLUE, THE BOTTOM SECTION IS BROWN. THE WORD "SOILMOISTURE" APPEARS IN BLACK BETWEEN THE TWO SECTIONS.

SER. NO. 77-505,849, FILED 6-23-2008.

JAMES A. RAUEN, EXAMINING ATTORNEY

Int. Cl.: 36

Prior U.S. Cls.: 100, 101 and 102

United States Patent and Trademark Office

Reg. No. 3,575,552

Registered Feb. 17, 2009

**SERVICE MARK
PRINCIPAL REGISTER**

MerchantGateway



MERCHANT GATEWAY (DELAWARE LIMITED
LIABILITY COMPANY)
8184 WOODLAND CENTER BLVD.
TAMPA, FL 33614

FOR: PAYMENT PROCESSING SERVICES,
NAMELY, CREDIT CARD AND DEBIT CARD
TRANSACTION PROCESSING SERVICES, IN
CLASS 36 (U.S. CLS. 100, 101 AND 102).

FIRST USE 11-16-2007; IN COMMERCE 11-16-2007.

NO CLAIM IS MADE TO THE EXCLUSIVE
RIGHT TO USE "MERCHANT GATEWAY", APART
FROM THE MARK AS SHOWN.

THE STIPPLING IS FOR SHADING PURPOSES
ONLY.

THE MARK CONSISTS OF THE STYLIZED TEXT
"MERCHANT GATEWAY", WITH AN ABSTRACT
DESIGN PLACED UNDERNEATH THE WORD
"MERCHANT".

SER. NO. 77-505,945, FILED 6-23-2008.

KELLY MCCOY, EXAMINING ATTORNEY

Int. Cl.: 29

Prior U.S. Cl.: 46

United States Patent and Trademark Office

Reg. No. 3,575,553

Registered Feb. 17, 2009

**TRADEMARK
PRINCIPAL REGISTER**

Bocco Boards

VIAVANTI, LLC (NEW YORK LIMITED LIABILITY COMPANY)
226 SOUTH GREELEY AVE.
CHAPPAQUA, NY 10514

THE MARK CONSISTS OF STANDARD CHARACTERS WITHOUT CLAIM TO ANY PARTICULAR FONT, STYLE, SIZE, OR COLOR.

FOR: CHEESE; MEAT; VEGETABLES, NAMELY, ASSORTED PROCESSED VEGETABLES, IN CLASS 29 (U.S. CL. 46).

SER. NO. 77-506,030, FILED 6-24-2008.

FIRST USE 8-1-2007; IN COMMERCE 9-1-2007.

JASON TURNER, EXAMINING ATTORNEY

Int. Cl.: 43

Prior U.S. Cls.: 100 and 101

United States Patent and Trademark Office

Reg. No. 3,575,554

Registered Feb. 17, 2009

**SERVICE MARK
PRINCIPAL REGISTER**

Festa d'Italia

VIAVANTI, LLC (NEW YORK LIMITED LIABILITY COMPANY)
226 SOUTH GREELEY AVE.
CHAPPAQUA, NY 10514

FOR: RESTAURANTS, IN CLASS 43 (U.S. CLS. 100 AND 101).

FIRST USE 8-1-2007; IN COMMERCE 9-1-2007.

THE MARK CONSISTS OF STANDARD CHARACTERS WITHOUT CLAIM TO ANY PARTICULAR FONT, STYLE, SIZE, OR COLOR.

NO CLAIM IS MADE TO THE EXCLUSIVE RIGHT TO USE "D'ITALIA", APART FROM THE MARK AS SHOWN.

THE FOREIGN WORDING IN THE MARK TRANSLATES INTO ENGLISH AS ITALIAN FESTIVAL.

SER. NO. 77-506,035, FILED 6-24-2008.

JASON TURNER, EXAMINING ATTORNEY

Int. Cl.: 30

Prior U.S. Cl.: 46

United States Patent and Trademark Office

Reg. No. 3,575,555

Registered Feb. 17, 2009

**TRADEMARK
PRINCIPAL REGISTER**

Samurai Caesar

VIAVANTI, LLC (NEW YORK LIMITED LIABILITY COMPANY)

226 SOUTH GREELEY AVE.

CHAPPAQUA, NY 10514

FOR: SALAD DRESSING, IN CLASS 30 (U.S. CL. 46).

FIRST USE 8-1-2007; IN COMMERCE 9-1-2007.

THE MARK CONSISTS OF STANDARD CHARACTERS WITHOUT CLAIM TO ANY PARTICULAR FONT, STYLE, SIZE, OR COLOR.

NO CLAIM IS MADE TO THE EXCLUSIVE RIGHT TO USE "CAESAR", APART FROM THE MARK AS SHOWN.

SER. NO. 77-506,040, FILED 6-24-2008.

JASON TURNER, EXAMINING ATTORNEY

Int. Cl.: 33

Prior U.S. Cls.: 47 and 49

United States Patent and Trademark Office

Reg. No. 3,575,556

Registered Feb. 17, 2009

**TRADEMARK
PRINCIPAL REGISTER**

Roman Holiday

VIAVANTI, LLC (NEW YORK LIMITED LIABILITY COMPANY)
226 SOUTH GREELEY AVE.
CHAPPAQUA, NY 10514

THE MARK CONSISTS OF STANDARD CHARACTERS WITHOUT CLAIM TO ANY PARTICULAR FONT, STYLE, SIZE, OR COLOR.

FOR: ALCOHOLIC COFFEE-BASED BEVERAGE,
IN CLASS 33 (U.S. CLS. 47 AND 49).

SER. NO. 77-506,052, FILED 6-24-2008.

FIRST USE 8-1-2007; IN COMMERCE 9-1-2007.

JASON TURNER, EXAMINING ATTORNEY

Int. Cl.: 41

Prior U.S. Cls.: 100, 101 and 107

United States Patent and Trademark Office

Reg. No. 3,575,557

Registered Feb. 17, 2009

**SERVICE MARK
PRINCIPAL REGISTER**



Sandler Training

SANDLER SYSTEMS, INC. (MARYLAND CORPORATION)
300 RED BROOK BOULEVARD, SUITE 400
OWINGS MILLS, MD 21117

FOR: EDUCATIONAL SERVICES, NAMELY, CONDUCTING TRAINING THROUGH SEMINARS, MEETINGS, WORKSHOPS AND ON-LINE PRESENTATIONS IN THE FIELD OF INCREASING THE EFFECTIVENESS OF PERSONS WHOSE GOAL IS TO EFFECTUATE PURCHASES OF PRODUCTS OR SERVICES, AND DISTRIBUTION OF COURSE MATERIAL IN CONNECTION THEREWITH, IN CLASS 41 (U.S. CLS. 100, 101 AND 107).

FIRST USE 6-18-2008; IN COMMERCE 6-18-2008.

OWNER OF U.S. REG. NOS. 2,654,595, 3,430,984 AND OTHERS.

NO CLAIM IS MADE TO THE EXCLUSIVE RIGHT TO USE "TRAINING", APART FROM THE MARK AS SHOWN.

THE MARK CONSISTS OF "S SANDLER TRAINING" (WORDS AND DESIGN).

SER. NO. 77-506,114, FILED 6-24-2008.

PAUL MORENO, EXAMINING ATTORNEY

Int. Cl.: 14

Prior U.S. Cls.: 2, 27, 28 and 50

United States Patent and Trademark Office

Reg. No. 3,575,558

Registered Feb. 17, 2009

**TRADEMARK
PRINCIPAL REGISTER**

AMANDA PINSON JEWELRY

PINSON, AMANDA (UNITED STATES INDIVIDUAL)
12 WEST 13TH STREET
CHATTANOOGA, TN 37402

FOR: JEWELRY, IN CLASS 14 (U.S. CLS. 2, 27, 28 AND 50).

FIRST USE 11-30-2004; IN COMMERCE 12-31-2004.

THE MARK CONSISTS OF STANDARD CHARACTERS WITHOUT CLAIM TO ANY PARTICULAR FONT, STYLE, SIZE, OR COLOR.

NO CLAIM IS MADE TO THE EXCLUSIVE RIGHT TO USE "JEWELRY", APART FROM THE MARK AS SHOWN.

THE NAME "AMANDA PINSON" IDENTIFIES A LIVING INDIVIDUAL WHOSE CONSENT IS OF RECORD.

SER. NO. 77-506,147, FILED 6-24-2008.

JOHN DWYER, EXAMINING ATTORNEY

Int. Cl.: 31

Prior U.S. Cls.: 1 and 46

United States Patent and Trademark Office

Reg. No. 3,575,559

Registered Feb. 17, 2009

**TRADEMARK
PRINCIPAL REGISTER**

SWEETEST THINGS ON EARTH!

DRIVER, JOHN A. (UNITED STATES INDIVIDUAL)
2601 TIM BELL RD.
WATERFORD, CA 953868734

THE MARK CONSISTS OF STANDARD CHARACTERS WITHOUT CLAIM TO ANY PARTICULAR FONT, STYLE, SIZE, OR COLOR.

FOR: RAW APRICOT FRUITS, IN CLASS 31 (U.S. CLS. 1 AND 46).

SER. NO. 77-506,198, FILED 6-24-2008.

FIRST USE 1-11-2008; IN COMMERCE 1-11-2008.

ANGELA GAW, EXAMINING ATTORNEY

Int. Cl.: 36

Prior U.S. Cls.: 100, 101 and 102

United States Patent and Trademark Office

Reg. No. 3,575,560

Registered Feb. 17, 2009

**SERVICE MARK
PRINCIPAL REGISTER**

GreatGASB

GREAT GASB GROUP, LLC (PENNSYLVANIA
LIMITED LIABILITY COMPANY)
SUITE 301
201 SOUTH JOHNSON ROAD
HOUSTON, PA 15342

FOR: CONSULTING, ADMINISTRATION, AC-
TUARIAL, AND FINANCIAL SERVICES FOR RE-
TIREMENT HEALTH SAVINGS ACCOUNTS, IN
CLASS 36 (U.S. CLS. 100, 101 AND 102).

FIRST USE 10-4-2007; IN COMMERCE 10-4-2007.

THE MARK CONSISTS OF STANDARD CHAR-
ACTERS WITHOUT CLAIM TO ANY PARTICULAR
FONT, STYLE, SIZE, OR COLOR.

SER. NO. 77-506,211, FILED 6-24-2008.

ANTHONY RINKER, EXAMINING ATTORNEY

Int. Cl.: 35

Prior U.S. Cls.: 100, 101 and 102

United States Patent and Trademark Office

Reg. No. 3,575,561

Registered Feb. 17, 2009

**SERVICE MARK
PRINCIPAL REGISTER**



C-ZONE LEGACY CONSULTANTS, INC. (MAINE CORPORATION)
11400 WEST OLYMPIC BLVD.
WEST LOS ANGELES, CA 90064

FOR: CONSULTING SERVICES, NAMELY, ASSISTING BUSINESSES WITH ORGANIZATIONAL, SUCCESSION AND TRANSITION PLANNING, IN CLASS 35 (U.S. CLS. 100, 101 AND 102).

FIRST USE 6-23-2008; IN COMMERCE 6-23-2008.

OWNER OF U.S. REG. NO. 3,186,672.

NO CLAIM IS MADE TO THE EXCLUSIVE RIGHT TO USE "LEGACY CONSULTING", APART FROM THE MARK AS SHOWN.

THE MARK CONSISTS OF THE LETTER "C" WITHIN A CIRCLE IN FRONT OF THE WORD "ZONE" WHICH IS ABOVE THE WORDS "LEGACY CONSULTING".

SER. NO. 77-506,250, FILED 6-24-2008.

ALEXANDER L. POWERS, EXAMINING ATTORNEY

Int. Cl.: 10

Prior U.S. Cls.: 26, 39 and 44

United States Patent and Trademark Office

Reg. No. 3,575,562

Registered Feb. 17, 2009

**TRADEMARK
PRINCIPAL REGISTER**

**WOOD'S APOTHECARY CENTER
MEDICINE BAGS**



WOOD, JAMES W. (UNITED STATES INDIVIDUAL)
12 SILVER AVE.
BELLINGHAM, MA 02019

FOR: CORN FILLED PACKS FOR THERAPEUTIC PURPOSES THAT ARE HEATED IN MICROWAVE OVENS, IN CLASS 10 (U.S. CLS. 26, 39 AND 44).

FIRST USE 7-1-2007; IN COMMERCE 7-1-2007.

NO CLAIM IS MADE TO THE EXCLUSIVE RIGHT TO USE "APOTHECARY CENTER MEDI-

CINE BAGS", APART FROM THE MARK AS SHOWN.

THE MARK CONSISTS OF THE WORDS "WOOD'S APOTHECARY CENTER MEDICINE BAGS" ALONG WITH A PICTURE OF AN OLD MAN SITTING NEXT TO A LOG POSITIONED THEREBENEATH.

SER. NO. 77-506,367, FILED 6-24-2008.

ALEXANDER L. POWERS, EXAMINING ATTORNEY

Int. Cl.: 3

Prior U.S. Cls.: 1, 4, 6, 50, 51 and 52

United States Patent and Trademark Office

Reg. No. 3,575,563

Registered Feb. 17, 2009

**TRADEMARK
PRINCIPAL REGISTER**

ALLSPICE

DAVIES GATE LLC (CALIFORNIA LIMITED
LIABILITY COMPANY)
P.O. BOX 2046
IRWINDALE, CA 91706

FOR: BATH SOAP, BATH SALTS, AND HAND
AND BODY LOTION, IN CLASS 3 (U.S. CLS. 1, 4, 6,
50, 51 AND 52).

FIRST USE 6-1-2003; IN COMMERCE 6-1-2003.

THE MARK CONSISTS OF STANDARD CHAR-
ACTERS WITHOUT CLAIM TO ANY PARTICULAR
FONT, STYLE, SIZE, OR COLOR.

OWNER OF U.S. REG. NO. 3,346,510.

SEC. 2(F).

SER. NO. 77-506,411, FILED 6-24-2008.

SUZANNE BLANE, EXAMINING ATTORNEY

Int. Cl.: 36

Prior U.S. Cls.: 100, 101 and 102

United States Patent and Trademark Office

Reg. No. 3,575,564

Registered Feb. 17, 2009

**SERVICE MARK
PRINCIPAL REGISTER**

Boots for OUR Troops

BANK, RICHARD M. (UNITED STATES INDIVIDUAL)
6614 S. DORSEY LN
TEMPE, AZ 85283

THE MARK CONSISTS OF STANDARD CHARACTERS WITHOUT CLAIM TO ANY PARTICULAR FONT, STYLE, SIZE, OR COLOR.

FOR: CHARITABLE FUND RAISING, IN CLASS 36 (U.S. CLS. 100, 101 AND 102).

SER. NO. 77-506,430, FILED 6-24-2008.

FIRST USE 5-17-2008; IN COMMERCE 5-17-2008.

MARY ROSSMAN, EXAMINING ATTORNEY

Int. Cl.: 36

Prior U.S. Cls.: 100, 101 and 102

United States Patent and Trademark Office

Reg. No. 3,575,565

Registered Feb. 17, 2009

**SERVICE MARK
PRINCIPAL REGISTER**

CARE. COMMIT. CHANGE.

CAROLYN'S COMPASSIONATE CHILDREN,
INC. (FLORIDA CORPORATION)
2255 GLADES ROAD, SUITE 221A
BOCA RATON, FL 33431

THE MARK CONSISTS OF STANDARD CHAR-
ACTERS WITHOUT CLAIM TO ANY PARTICULAR
FONT, STYLE, SIZE, OR COLOR.

FOR: RAISING FINANCIAL SUPPORT
THROUGH CHARITABLE FUNDRAISING FOR
YOUNG ADULT CANCER SURVIVORS, IN CLASS
36 (U.S. CLS. 100, 101 AND 102).

SER. NO. 77-506,500, FILED 6-24-2008.

FIRST USE 12-31-2007; IN COMMERCE 12-31-2007.

MARC LEIPZIG, EXAMINING ATTORNEY

Int. Cl.: 42

Prior U.S. Cls.: 100 and 101

United States Patent and Trademark Office

Reg. No. 3,575,566

Registered Feb. 17, 2009

**SERVICE MARK
PRINCIPAL REGISTER**

**Designer Show House
The Drama of Art & Design**

THE NAPLES PLAYERS, INC. (FLORIDA CORPORATION)

THE SUGDEN THEATER

701 5TH AVENUE SOUTH

NAPLES, FL 34102

FOR: DESIGN OF INTERIOR DECOR, IN CLASS 42 (U.S. CLS. 100 AND 101).

FIRST USE 4-11-2008; IN COMMERCE 4-11-2008.

THE MARK CONSISTS OF STANDARD CHARACTERS WITHOUT CLAIM TO ANY PARTICULAR FONT, STYLE, SIZE, OR COLOR.

NO CLAIM IS MADE TO THE EXCLUSIVE RIGHT TO USE "DESIGNER SHOW HOUSE" AND "ART & DESIGN", APART FROM THE MARK AS SHOWN.

SER. NO. 77-506,572, FILED 6-24-2008.

ERIN FALK, EXAMINING ATTORNEY

Int. Cl.: 35

Prior U.S. Cls.: 100, 101 and 102

United States Patent and Trademark Office

Reg. No. 3,575,567

Registered Feb. 17, 2009

**SERVICE MARK
PRINCIPAL REGISTER**

ACKER AUCTIONS

ACKER, MERRALL & CONDIT COMPANY
(NEW YORK CORPORATION)
160 WEST 72ND STREET
NEW YORK, NY 10023

NO CLAIM IS MADE TO THE EXCLUSIVE
RIGHT TO USE "AUCTIONS", APART FROM THE
MARK AS SHOWN.

FOR: ARRANGING AND CONDUCTING AUC-
TIONS FEATURING WINE, IN CLASS 35 (U.S. CLS.
100, 101 AND 102).

SEC. 2(F).

FIRST USE 12-31-1999; IN COMMERCE 12-31-1999.

SER. NO. 77-506,668, FILED 6-24-2008.

THE MARK CONSISTS OF STANDARD CHAR-
ACTERS WITHOUT CLAIM TO ANY PARTICULAR
FONT, STYLE, SIZE, OR COLOR.

ANTHONY RINKER, EXAMINING ATTORNEY

Int. Cl.: 18

Prior U.S. Cls.: 1, 2, 3, 22 and 41

United States Patent and Trademark Office

Reg. No. 3,575,568

Registered Feb. 17, 2009

**TRADEMARK
PRINCIPAL REGISTER**



VALERIE ANN PUGH (UNITED STATES INDIVIDUAL), DBA VANNP
171 BIRCH STREET APT A
WATERBURY, CT 06704

FIRST USE 3-8-2008; IN COMMERCE 3-8-2008.

FOR: BACKPACKS, BOOK BAGS, SPORTS BAGS, BUM BAGS, WALLETS AND HANDBAGS; EVENING HANDBAGS; HANDBAG FRAMES; HANDBAGS; HANDBAGS FOR MEN; HANDBAGS, PURSES AND WALLETS; LEATHER HANDBAGS; STRAPS FOR HANDBAGS, IN CLASS 18 (U.S. CLS. 1, 2, 3, 22 AND 41).

THE MARK CONSISTS OF A "V" MADE INTO A "P" WITH THE NAME "ANN" UNDER THE "P" INSIDE A TRIANGLE.

SER. NO. 77-506,862, FILED 6-24-2008.

KELLY BOULTON, EXAMINING ATTORNEY

Int. Cls.: 16 and 41

Prior U.S. Cls.: 2, 5, 22, 23, 29, 37, 38, 50, 100, 101 and 107

United States Patent and Trademark Office

Reg. No. 3,575,569

Registered Feb. 17, 2009

**TRADEMARK
SERVICE MARK
PRINCIPAL REGISTER**

Deep & Wide Youth Ministry

DARE 2 SHARE MINISTRIES INTERNATIONAL,
INC. (COLORADO CORPORATION)
SUITE 103
5181 WARD ROAD
WHEAT RIDGE, CO 80033

FOR: PRINTED INSTRUCTIONAL, EDUCATIONAL, AND TEACHING MATERIALS IN THE FIELD OF RELIGIOUS TRAINING, PROMOTING THE GOSPEL OF JESUS CHRIST, IN CLASS 16 (U.S. CLS. 2, 5, 22, 23, 29, 37, 38 AND 50).

FIRST USE 9-24-2007; IN COMMERCE 11-2-2007.

FOR: EDUCATIONAL SERVICES, NAMELY, CONDUCTING CONFERENCES, SEMINARS, WORKSHOPS, AND PROVIDING ONLINE INFORMATION VIA EMAIL AND WEBSITE ARTICLES,

ALL RELATING TO THE FIELD OF RELIGIOUS TRAINING, IN CLASS 41 (U.S. CLS. 100, 101 AND 107).

FIRST USE 9-24-2007; IN COMMERCE 11-2-2007.

THE MARK CONSISTS OF STANDARD CHARACTERS WITHOUT CLAIM TO ANY PARTICULAR FONT, STYLE, SIZE, OR COLOR.

NO CLAIM IS MADE TO THE EXCLUSIVE RIGHT TO USE "YOUTH MINISTRY", APART FROM THE MARK AS SHOWN.

SER. NO. 77-506,912, FILED 6-24-2008.

KATINA MISTER, EXAMINING ATTORNEY

Int. Cl.: 16

Prior U.S. Cls.: 2, 5, 22, 23, 29, 37, 38 and 50

Reg. No. 3,575,570

United States Patent and Trademark Office

Registered Feb. 17, 2009

**TRADEMARK
PRINCIPAL REGISTER**

SWITCH

NATIONAL INSTITUTE ON MEDIA AND THE
FAMILY (MINNESOTA NON-PROFIT COR-
PORATION)
606 24TH AVENUE SOUTH
SUITE 606
MINNEAPOLIS, MN 55454

FOR: PAPER ACTIVITY WHEELS USED TO AL-
LOT TELEVISION VIEWING TIME FOR CHIL-
DREN, POSTERS, PRINTED ACTIVITY CARDS
CONTAINING ACTIVITY IDEAS FOR CHILDREN,
ACTIVITY BOOKS FOR USE BY CHILDREN AND
PARENTS, MAGAZINES IN THE FIELD OF CHILD-
HOOD FITNESS AND OBESITY PREVENTION, LOG
BOOKS, PRINTED RECIPE CARDS, PRINTED
MEAL PLANNERS IN THE NATURE OF LOG
BOOKS CONTAINING MEAL IDEAS AND SHOP-

PING LISTS, STICKERS, BROCHURES AND NEWS-
LETTERS IN THE FIELD OF CHILDHOOD FITNESS
AND OBESITY PREVENTION, IN CLASS 16 (U.S.
CLS. 2, 5, 22, 23, 29, 37, 38 AND 50).

FIRST USE 4-1-2008; IN COMMERCE 4-10-2008.

THE MARK CONSISTS OF STANDARD CHAR-
ACTERS WITHOUT CLAIM TO ANY PARTICULAR
FONT, STYLE, SIZE, OR COLOR.

OWNER OF U.S. REG. NO. 3,353,624.

SER. NO. 77-506,939, FILED 6-24-2008.

LAURIE MAYES, EXAMINING ATTORNEY

Int. Cl.: 25

Prior U.S. Cls.: 22 and 39

United States Patent and Trademark Office

Reg. No. 3,575,571

Registered Feb. 17, 2009

**TRADEMARK
PRINCIPAL REGISTER**

BANDANO

BALTIC RISE, LLC (NEW YORK LIMITED LIABILITY COMPANY)
SUITE 2
140 FIRST AVENUE
NEW YORK, NY 10009

FOR: CLOTHING, NAMELY, MULTIPURPOSE HEADWEAR, HEAD BANDS, EARMUFFS, HATS, CAPS, VISORS, NECK WARMERS, SCARVES, BANDANAS, SHAWLS, ARM WARMER BANDS, WRIST BANDS, LEG BANDS, LEG WARMERS, LEGGINGS, TUBE TOPS, T-SHIRTS, POLO SHIRTS, RUGBY SHIRTS, GOLF SHIRTS, TANK TOPS, JERSEYS, TIGHTS, SHORTS, PANTS, STOCKINGS, LEOTARDS, UNITARDS, BODY SUITS, SOCKS, GLOVES, ATHLETIC UNIFORMS, JACKETS, PARKAS, PONCHOS, SWEATERS, FLEECE PULL-OVERS, SKI WEAR, SWEAT SUITS, JOGGING

SUITS, RAIN SUITS, BOOTS, SLIPPERS, SANDALS, ATHLETIC FOOTWEAR, SWIMWEAR, ROBES, SLEEPWEAR, LOUNGEWEAR, TIES, VESTS, UNDERGARMENTS AND ALL PURPOSE FOOTWEAR EXCLUDING ORTHOPEDIC FOOTWEAR, IN CLASS 25 (U.S. CLS. 22 AND 39).

FIRST USE 4-0-2007; IN COMMERCE 6-0-2007.

THE MARK CONSISTS OF STANDARD CHARACTERS WITHOUT CLAIM TO ANY PARTICULAR FONT, STYLE, SIZE, OR COLOR.

SER. NO. 77-507,142, FILED 6-24-2008.

DAVID HOFFMAN, EXAMINING ATTORNEY

Int. Cl.: 15

Prior U.S. Cls.: 2, 21 and 36

United States Patent and Trademark Office

Reg. No. 3,575,572

Registered Feb. 17, 2009

TRADEMARK
PRINCIPAL REGISTER



COMPLETELY OBLIVIOUS, INC. (MICHIGAN CORPORATION)
PO BOX 1299
HIGHLAND, MI 48357

FOR: GUITAR PICKS, IN CLASS 15 (U.S. CLS. 2, 21 AND 36).

FIRST USE 2-28-2008; IN COMMERCE 6-22-2008.

NO CLAIM IS MADE TO THE EXCLUSIVE RIGHT TO USE "PICKS" , APART FROM THE MARK AS SHOWN.

THE COLOR(S) TEAL IS/ARE CLAIMED AS A FEATURE OF THE MARK.

THE MARK CONSISTS OF THE WORDS "POINTLESS PICKS" IN TEAL BLUE, AND THE LETTERS "P" AND "L" APPEAR AS A BOOMERANG SHAPE WITH A COLOR GRADIENT.

SER. NO. 77-507,164, FILED 6-24-2008.

GISELLE AGOSTO, EXAMINING ATTORNEY

Int. Cl.: 35

Prior U.S. Cls.: 100, 101 and 102

United States Patent and Trademark Office

Reg. No. 3,575,573

Registered Feb. 17, 2009

**SERVICE MARK
PRINCIPAL REGISTER**

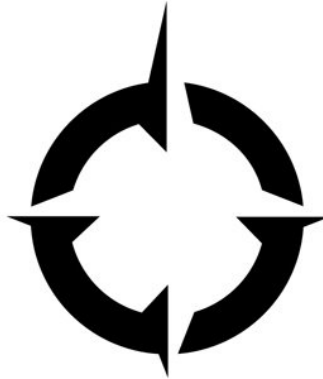

FRANKLIN COVEY CO. (UTAH CORPORATION)
2200 WEST PARKWAY BLVD. MS 0213
SALT LAKE CITY, UT 84119

FOR: BUSINESS CONSULTING SERVICES, NAMELY, CONSULTING REGARDING ORGANIZATIONAL AND WORK PROCESS CHANGE, DESIGN AND DEVELOPMENT, AGENDA AND TIME MANAGEMENT, LEADERSHIP, MANAGEMENT, EDUCATION, SALES, COMMUNICATION, CORPORATE AND PERSONAL ASSESSMENT AND MEASUREMENT, AND PROFESSIONAL AND PERSONAL DEVELOPMENT, IN CLASS 35 (U.S. CLS. 100, 101 AND 102).

FIRST USE 9-18-1997; IN COMMERCE 9-18-1997.

OWNER OF U.S. REG. NOS. 2,322,868, 2,475,867 AND OTHERS.

THE MARK CONSISTS OF A COMPASS SHOWING FOUR DIRECTIONAL COMPASS POINTS, WITH A THICK BLACK LINE THAT SURROUNDS THE COMPASS AT THE RIM.

SER. NO. 77-507,396, FILED 6-25-2008.

DAVID ELTON, EXAMINING ATTORNEY

Int. Cl.: 30

Prior U.S. Cl.: 46

United States Patent and Trademark Office

Reg. No. 3,575,574

Registered Feb. 17, 2009

**TRADEMARK
PRINCIPAL REGISTER**

BOSTON MARKET

BOSTON MARKET CORPORATION (DELA-
WARE CORPORATION)
14103 DENVER WEST PARKWAY
GOLDEN, CO 80401

OWNER OF U.S. REG. NOS. 1,940,179, 2,248,593
AND OTHERS.

FOR: GRAVY, IN CLASS 30 (U.S. CL. 46).

SEC. 2(F) AS TO "BOSTON".

FIRST USE 8-31-2000; IN COMMERCE 8-31-2000.

SER. NO. 77-507,422, FILED 6-25-2008.

THE MARK CONSISTS OF STANDARD CHAR-
ACTERS WITHOUT CLAIM TO ANY PARTICULAR
FONT, STYLE, SIZE, OR COLOR.

DOMINICK J. SALEMI, EXAMINING ATTORNEY

Int. Cl.: 25

Prior U.S. Cls.: 22 and 39

United States Patent and Trademark Office

Reg. No. 3,575,575

Registered Feb. 17, 2009

**TRADEMARK
PRINCIPAL REGISTER**

SEAMLESS ESSENTIALS

NOUVELLE SEAMLESS INTIMATES INC. (CANADA CORPORATION)
9500 MEILLER STREET, SUITE 400
MONTREAL, CANADA H2N2B7

FOR: INTIMATE APPAREL AND FOUNDATION GARMENTS, NAMELY, PANTIES, CAMISOLES, BODY SUITS, SUPPORT TOPS, BODYWEAR, NAMELY, LEOTARDS AND TIGHTS, UNITARDS, AND BODYSUITS, AND FIGURE SHAPING UNDERWEAR, IN CLASS 25 (U.S. CLS. 22 AND 39).

FIRST USE 8-31-2006; IN COMMERCE 8-31-2006.

THE MARK CONSISTS OF STANDARD CHARACTERS WITHOUT CLAIM TO ANY PARTICULAR FONT, STYLE, SIZE, OR COLOR.

NO CLAIM IS MADE TO THE EXCLUSIVE RIGHT TO USE "SEAMLESS", APART FROM THE MARK AS SHOWN.

SER. NO. 77-507,571, FILED 6-25-2008.

THEODORE MCBRIDE, EXAMINING ATTORNEY

Int. Cls.: 41 and 43

Prior U.S. Cls.: 100, 101 and 107

United States Patent and Trademark Office

Reg. No. 3,575,576

Registered Feb. 17, 2009

**SERVICE MARK
PRINCIPAL REGISTER**



KARPA HOLDINGS, LLC (FLORIDA LIMITED
LIABILITY COMPANY)
237 ALCAZAR AVENUE
CORAL GABLES, FL 33134

FOR: ENTERTAINMENT SERVICES IN THE
NATURE OF LIVE THEATRICAL AND MUSICAL
PERFORMANCES; ENTERTAINMENT SERVICES,
NAMELY, AMUSEMENT ARCADES FEATURING
VIDEO AND COIN-OPERATED GAME SERVICES;
EDUCATIONAL SERVICES, NAMELY, PROVIDING
CLASSES AND WORKSHOPS TO CHILDREN AND
THEIR CARE-GIVERS IN THE FIELDS OF THEA-
TER, STORYTELLING, MOVEMENT AND DANCE,
MUSIC, ARTS AND CRAFTS, PARENTING,
HEALTH AND NUTRITION, IN CLASS 41 (U.S.
CLS. 100, 101 AND 107).

FIRST USE 4-18-2008; IN COMMERCE 4-18-2008.

FOR: RESTAURANT SERVICES, IN CLASS 43
(U.S. CLS. 100 AND 101).

FIRST USE 4-18-2008; IN COMMERCE 4-18-2008.

OWNER OF U.S. REG. NO. 3,489,830.

THE MARK CONSISTS OF A LIQUID SPLATTER
CONTAINING A CIRCLE TO THE LEFT OF THE
WORDING "COOL DE.SAC".

SER. NO. 77-507,727, FILED 6-25-2008.

YAT SYE, LEE, EXAMINING ATTORNEY

Int. Cl.: 35

Prior U.S. Cls.: 100, 101 and 102

United States Patent and Trademark Office

Reg. No. 3,575,577

Registered Feb. 17, 2009

**SERVICE MARK
PRINCIPAL REGISTER**



REALCOMP II LTD. (MICHIGAN CORPORATION)
28555 ORCHARD LAKE ROAD, STE. 200
FARMINGTON HILLS, MI 48334

FOR: ADVERTISING AND PUBLICITY SERVICES, NAMELY, PROMOTING SERVICES, BRAND IDENTITY AND COMMERCIAL INFORMATION AND NEWS OF SUBSCRIBERS THROUGH PRINT, AUDIO, VIDEO, DIGITAL AND ON-LINE MEDIUM, IN CLASS 35 (U.S. CLS. 100, 101 AND 102).

FIRST USE 6-23-2008; IN COMMERCE 6-23-2008.

NO CLAIM IS MADE TO THE EXCLUSIVE RIGHT TO USE "MICHIGAN" AND THE GEOGRA-

PHICALLY DESCRIPTIVE DESIGN OF THE STATE OF MICHIGAN, APART FROM THE MARK AS SHOWN.

THE MARK CONSISTS OF A HOUSE WITH A WINDOW NEAR ITS PEAK AND AN OUTLINE OF THE STATE OF MICHIGAN WITHIN. THE LITERAL ELEMENTS "MI TIME TO BUY" ARE WITHIN THE HOUSE AND THE LITERAL ELEMENTS "IT'S TIME TO BUY IN MICHIGAN!" ARE OUTSIDE AND AT THE BOTTOM OF THE HOUSE.

SER. NO. 77-507,744, FILED 6-25-2008.

ANTHONY RINKER, EXAMINING ATTORNEY

Int. Cl.: 25

Prior U.S. Cls.: 22 and 39

United States Patent and Trademark Office

Reg. No. 3,575,578

Registered Feb. 17, 2009

**TRADEMARK
PRINCIPAL REGISTER**



HUMAN RIGHTS CAMPAIGN FOUNDATION
(D.C. CORPORATION)
1640 RHODE ISLAND AVENUE, NW
WASHINGTON, DC 20009

FOR: CLOTHING, NAMELY, T-SHIRTS, IN
CLASS 25 (U.S. CLS. 22 AND 39).

FIRST USE 4-23-2008; IN COMMERCE 4-23-2008.

OWNER OF U.S. REG. NOS. 2,331,645, 3,178,886
AND OTHERS.

NO CLAIM IS MADE TO THE EXCLUSIVE
RIGHT TO USE "08", APART FROM THE MARK
AS SHOWN.

THE COLOR(S) BLUE, WHITE AND YELLOW IS/
ARE CLAIMED AS A FEATURE OF THE MARK.

THE MARK CONSISTS OF THE WORDING
"CAMP EQUALITY 08 HUMAN RIGHTS CAM-
PAIGN" AND THE HUMAN RIGHTS LOGO,
WHICH APPEARS ON A WHITE BACKGROUND
INSIDE A BLUE RECTANGULAR CARRIER. THE
WORDING IN THE MARK APPEARS IN THE
COLOR BLUE AND THE HUMAN RIGHTS LOGO
APPEARS IN THE COLORS BLUE AND YELLOW.

SER. NO. 77-507,877, FILED 6-25-2008.

ANDREA BUTLER, EXAMINING ATTORNEY

Int. Cls.: 11 and 37

Prior U.S. Cls.: 13, 21, 23, 31, 34, 100, 103 and 106

United States Patent and Trademark Office

Reg. No. 3,575,579

Registered Feb. 17, 2009

**TRADEMARK
SERVICE MARK
PRINCIPAL REGISTER**



BLUE CANYON HEALTHY HOME SYSTEM
(VIRGINIA LIMITED LIABILITY COMPANY),
DBA B-DRY, LLC
455 SOUTH 4TH STREET, SUITE 350
LOUISVILLE, KY 40202

FOR: AIR VENTILATION AND QUALITY CONTROL SYSTEMS COMPRISED OF WATER REMOVAL PUMPS AND PIPING, WATERPROOFING PIPING AND SEALANT, RADON EXHAUST EQUIPMENT, DUAL FLOW VENTILATION INFRASTRUCTURE, ENCAPSULATION SHEETING, MICROBIAL SPRAY TREATMENT, AND ONGOING AIR MONITORING AND SUPPORT EQUIPMENT, IN CLASS 11 (U.S. CLS. 13, 21, 23, 31 AND 34).

FIRST USE 2-15-2008; IN COMMERCE 2-15-2008.

FOR: REPAIR, MAINTENANCE AND CONSULTATION IN THE FIELDS OF WATERPROOFING OF BASEMENTS AND CRAWL SPACES, FOUNDATION REPAIR SERVICES AND CONSULTATION WITH RESPECT THERETO, AND INSTALLATION AND MAINTENANCE OF AIR VENTILATION AND QUALITY CONTROL SYSTEMS AND CONSULTA-

TION WITH RESPECT THERETO, IN CLASS 37 (U.S. CLS. 100, 103 AND 106).

FIRST USE 2-15-2008; IN COMMERCE 2-15-2008.

NO CLAIM IS MADE TO THE EXCLUSIVE RIGHT TO USE "HEALTHY HOME SYSTEM", APART FROM THE MARK AS SHOWN.

THE COLOR(S) BLUE, YELLOW AND WHITE IS/ ARE CLAIMED AS A FEATURE OF THE MARK.

THE MOUNTAINS ARE BLUE, SKY IS BLUE WITH LIGHT BLUE CLOUDS, THE RIVER IS BLUE, THE OUTER OVAL DESIGN IS BLUE TRIMMED WITH YELLOW, THE INNER OVAL IS OUTLINED IN YELLOW, THE TWO CIRCLES ARE YELLOW, AND THE WORDING IS WHITE.

SER. NO. 77-508,016, FILED 6-25-2008.

PATRICIA EVANKO, EXAMINING ATTORNEY

Int. Cl.: 44

Prior U.S. Cls.: 100 and 101

United States Patent and Trademark Office

Reg. No. 3,575,580

Registered Feb. 17, 2009

**SERVICE MARK
PRINCIPAL REGISTER**

Beauty By Design

A NEW REFLECTION COSMETIC SURGERY
CENTER (TEXAS CORPORATION)
SUITE 100
17110 DALLAS NORTH PARKWAY
DALLAS, TX 75248

FOR: PLASTIC AND RECONSTRUCTIVE SUR-
GERY ; HAND SURGERY, IN CLASS 44 (U.S. CLS.
100 AND 101).

FIRST USE 3-1-2008; IN COMMERCE 3-1-2008.

THE MARK CONSISTS OF STANDARD CHAR-
ACTERS WITHOUT CLAIM TO ANY PARTICULAR
FONT, STYLE, SIZE, OR COLOR.

NO CLAIM IS MADE TO THE EXCLUSIVE
RIGHT TO USE "BEAUTY", APART FROM THE
MARK AS SHOWN.

SER. NO. 77-508,040, FILED 6-25-2008.

JAMES GRIFFIN, EXAMINING ATTORNEY

Int. Cl.: 36

Prior U.S. Cls.: 100, 101 and 102

United States Patent and Trademark Office

Reg. No. 3,575,581

Registered Feb. 17, 2009

**SERVICE MARK
PRINCIPAL REGISTER**

NORTHWEST PROTECT

NORTHWEST COMMUNITY CREDIT UNION
(OREGON CREDIT UNION)
3660 GATEWAY STREET
SPRINGFIELD, OR 97477

FOR: CREDIT UNION SERVICES IN THE FIELD
OF LOAN PROTECTION, NAMELY, DEBT CAN-
CELLATION SERVICES, IN CLASS 36 (U.S. CLS. 100,
101 AND 102).

FIRST USE 10-1-2008; IN COMMERCE 10-1-2008.

THE MARK CONSISTS OF STANDARD CHAR-
ACTERS WITHOUT CLAIM TO ANY PARTICULAR
FONT, STYLE, SIZE, OR COLOR.

NO CLAIM IS MADE TO THE EXCLUSIVE
RIGHT TO USE "NORTHWEST", APART FROM
THE MARK AS SHOWN.

SER. NO. 77-508,173, FILED 6-25-2008.

JEAN IM, EXAMINING ATTORNEY

Int. Cl.: 9

Prior U.S. Cls.: 21, 23, 26, 36 and 38

Reg. No. 3,575,582

United States Patent and Trademark Office

Registered Feb. 17, 2009

**TRADEMARK
PRINCIPAL REGISTER**

TAKEN

DREAMWORKS L.L.C. (DELAWARE LIMITED
LIABILITY COMPANY)
100 UNIVERSAL CITY PLAZA
UNIVERSAL CITY, CA 91608

FOR: PRERECORDED DVDS FEATURING A
SERIES OF DRAMATIC TELEVISION PROGRAMS,
IN CLASS 9 (U.S. CLS. 21, 23, 26, 36 AND 38).

FIRST USE 10-21-2003; IN COMMERCE 10-21-2003.

THE MARK CONSISTS OF STANDARD CHAR-
ACTERS WITHOUT CLAIM TO ANY PARTICULAR
FONT, STYLE, SIZE, OR COLOR.

OWNER OF U.S. REG. NO. 2,738,339.

SER. NO. 77-508,257, FILED 6-25-2008.

LANA PHAM, EXAMINING ATTORNEY

Int. Cl.: 25

Prior U.S. Cls.: 22 and 39

United States Patent and Trademark Office

Reg. No. 3,575,583

Registered Feb. 17, 2009

**TRADEMARK
PRINCIPAL REGISTER**

VEGAS BADA BABES

WOLF, RAYMOND (UNITED STATES INDIVIDUAL), DBA RAY WOLF PRODUCTIONS
65 RYERSON AVE.
MANORVILLE, NY 11949

FOR: ATHLETIC APPAREL, NAMELY, SHIRTS, PANTS, JACKETS, FOOTWEAR, HATS AND CAPS, ATHLETIC UNIFORMS; DANCE COSTUMES; HATS; JACKETS; LINGERIE; PANTS; SHIRTS; SHOES; SHORTS; SWIMSUITS; UNDERWEAR; WEARABLE GARMENTS AND CLOTHING, NAMELY, SHIRTS, IN CLASS 25 (U.S. CLS. 22 AND 39).

FIRST USE 6-1-2008; IN COMMERCE 6-1-2008.

THE MARK CONSISTS OF STANDARD CHARACTERS WITHOUT CLAIM TO ANY PARTICULAR FONT, STYLE, SIZE, OR COLOR.

OWNER OF U.S. REG. NO. 3,476,429.

NO CLAIM IS MADE TO THE EXCLUSIVE RIGHT TO USE "VEGAS", APART FROM THE MARK AS SHOWN.

SER. NO. 77-508,432, FILED 6-26-2008.

YAT SYE, LEE, EXAMINING ATTORNEY

Int. Cls.: 16 and 41

Prior U.S. Cls.: 2, 5, 22, 23, 29, 37, 38, 50, 100, 101 and 107

Reg. No. 3,575,584

United States Patent and Trademark Office

Registered Feb. 17, 2009

**TRADEMARK
SERVICE MARK
PRINCIPAL REGISTER**

MODERN ARABIAN HORSE

ARABIAN HORSE ASSOCIATION (COLORADO
NON-PROFIT CORPORATION)
10805 E. BETHANY DRIVE
AURORA, CO 80014

THE MARK CONSISTS OF STANDARD CHARACTERS WITHOUT CLAIM TO ANY PARTICULAR FONT, STYLE, SIZE, OR COLOR.

FOR: MAGAZINES FEATURING HORSES, IN CLASS 16 (U.S. CLS. 2, 5, 22, 23, 29, 37, 38 AND 50).

NO CLAIM IS MADE TO THE EXCLUSIVE RIGHT TO USE "ARABIAN HORSE", APART FROM THE MARK AS SHOWN.

FIRST USE 4-0-2007; IN COMMERCE 4-0-2007.

FOR: PROVIDING ON-LINE PUBLICATIONS IN THE NATURE OF MAGAZINES IN THE FIELD OF HORSES, IN CLASS 41 (U.S. CLS. 100, 101 AND 107).

SER. NO. 77-508,607, FILED 6-26-2008.

FIRST USE 4-0-2007; IN COMMERCE 4-0-2007.

EMILY CARLSEN, EXAMINING ATTORNEY

Int. Cl.: 11

Prior U.S. Cls.: 13, 21, 23, 31 and 34

Reg. No. 3,575,585

United States Patent and Trademark Office

Registered Feb. 17, 2009

**TRADEMARK
PRINCIPAL REGISTER**



B AMERICA CORPORATION (FLORIDA CORPORATION)
8005 N.W. 29TH AVENUE
DORAL, FL 33122

FOR: BARBECUE GRILLS; BARBECUES AND GRILLS; CHARCOAL GRILLS; GAS GRILLS, IN CLASS 11 (U.S. CLS. 13, 21, 23, 31 AND 34).

FIRST USE 6-1-2008; IN COMMERCE 6-1-2008.

NO CLAIM IS MADE TO THE EXCLUSIVE RIGHT TO USE "GRILL", APART FROM THE MARK AS SHOWN.

THE MARK CONSISTS OF THE WORD "BRASSA" ABOVE THE WORD "GRILL" ON A RECTANGULAR BACKGROUND WITH A BORDER AROUND THAT BACKGROUND. THE WORD "BRASS" IS LARGER THAN THE WORD "GRILL" .

SER. NO. 77-508,675, FILED 6-26-2008.

JESSICA A. POWERS, EXAMINING ATTORNEY

Int. Cl.: 12

Prior U.S. Cls.: 19, 21, 23, 31, 35 and 44

United States Patent and Trademark Office

Reg. No. 3,575,586

Registered Feb. 17, 2009

**TRADEMARK
PRINCIPAL REGISTER**

PROWLER

FLEETWOOD ENTERPRISES, INC. (DELAWARE
CORPORATION)
3125 MYERS STREET, POST OFFICE BOX 7638
RIVERSIDE, CA 925137638

FOR: TRAVEL TRAILERS, IN CLASS 12 (U.S. CLS.
19, 21, 23, 31, 35 AND 44).

FIRST USE 2-0-1966; IN COMMERCE 2-0-1966.

THE MARK CONSISTS OF STANDARD CHAR-
ACTERS WITHOUT CLAIM TO ANY PARTICULAR
FONT, STYLE, SIZE, OR COLOR.

OWNER OF U.S. REG. NOS. 2,826,461 AND
3,295,241.

SER. NO. 77-508,823, FILED 6-26-2008.

BONNIE LUKEN, EXAMINING ATTORNEY

Int. Cl.: 45

Prior U.S. Cls.: 100 and 101

United States Patent and Trademark Office

Reg. No. 3,575,587

Registered Feb. 17, 2009

**SERVICE MARK
PRINCIPAL REGISTER**

THE SECURITY GURU

SPICER, MICHAEL (UNITED STATES INDIVIDUAL)

2408 TEAKWOOD COURT

HANFORD, CA 93230

FOR: PERSONAL SECURITY CONSULTATION,
IN CLASS 45 (U.S. CLS. 100 AND 101).

FIRST USE 1-1-2008; IN COMMERCE 1-1-2008.

THE MARK CONSISTS OF STANDARD CHARACTERS WITHOUT CLAIM TO ANY PARTICULAR FONT, STYLE, SIZE, OR COLOR.

NO CLAIM IS MADE TO THE EXCLUSIVE RIGHT TO USE "SECURITY", APART FROM THE MARK AS SHOWN.

SER. NO. 77-508,850, FILED 6-26-2008.

DAWN HAN, EXAMINING ATTORNEY

Int. Cl.: 42

Prior U.S. Cls.: 100 and 101

United States Patent and Trademark Office

Reg. No. 3,575,588

Registered Feb. 17, 2009

**SERVICE MARK
PRINCIPAL REGISTER**



SPRINGFIELD COLLEGE (MASSACHUSETTS
CORPORATION)
263 ALDEN STREET
SPRINGFIELD, MA 01109

FOR: HOSTING AN ON-LINE COMMUNITY WEB
SITE FEATURING INFORMATION REGARDING
EDUCATIONAL AND ENTERTAINMENT EVENTS,
LEISURE ACTIVITIES, AND SOCIAL NETWORK-
ING, IN CLASS 42 (U.S. CLS. 100 AND 101).

FIRST USE 2-0-2007; IN COMMERCE 2-0-2007.

THE MARK CONSISTS OF A BASKETBALL NET
WITH AN INVERTED TRIANGLE AS A HOOP,
FOLLOWED BY THE WORD "PRIDENET" WITH
LOWER CASE "R, I, D", AND "E", AND CAPITAL "P,
N, E", AND "T".

SER. NO. 77-508,977, FILED 6-26-2008.

MARC LEIPZIG, EXAMINING ATTORNEY

Int. Cls.: 35 and 42

Prior U.S. Cls.: 100, 101 and 102

United States Patent and Trademark Office

Reg. No. 3,575,589

Registered Feb. 17, 2009

**SERVICE MARK
PRINCIPAL REGISTER**

VISTRADA

VISTRADA, LLC (NEW YORK CORPORATION)
245 PARK AVENUE, 24TH FLOOR
NEW YORK, NY 10167

FOR: BUSINESS CONSULTING, MANAGEMENT,
PLANNING AND SUPERVISION, CUSTOMER RE-
LATIONSHIP MANAGEMENT SERVICES, INFOR-
MATION AND DATA COMPILING AND
ANALYZING RELATING TO BUSINESS MANAGE-
MENT, BUSINESS VENTURE DEVELOPMENT
AND FORMATION CONSULTING SERVICES, IN
CLASS 35 (U.S. CLS. 100, 101 AND 102).

FIRST USE 5-15-2008; IN COMMERCE 5-15-2008.

FOR: CONSULTING IN THE FIELD OF INFOR-
MATION TECHNOLOGY, COMPUTER GRAPHIC
SERVICES, IN CLASS 42 (U.S. CLS. 100 AND 101).

FIRST USE 5-15-2008; IN COMMERCE 5-15-2008.

THE MARK CONSISTS OF STANDARD CHAR-
ACTERS WITHOUT CLAIM TO ANY PARTICULAR
FONT, STYLE, SIZE, OR COLOR.

SER. NO. 77-509,116, FILED 6-26-2008.

JOHN SCHUYLER YARD, EXAMINING ATTOR-
NEY

Int. Cl.: 41

Prior U.S. Cls.: 100, 101 and 107

United States Patent and Trademark Office

Reg. No. 3,575,590

Registered Feb. 17, 2009

**SERVICE MARK
PRINCIPAL REGISTER**



TALLBROAD LLC (MISSOURI LIMITED LIABILITY COMPANY)
7716 ARTHUR AVENUE
ST. LOUIS, MO 63117

FOR: AUDIO RECORDING AND PRODUCTION; MULTIMEDIA ENTERTAINMENT SERVICES IN THE NATURE OF RECORDING, PRODUCTION AND POST-PRODUCTION SERVICES IN THE FIELDS OF MUSIC, VIDEO, AND FILMS; PRODUCTION OF VISUAL EFFECTS FOR VIDEOS, DVDS, TELEVISION AND FOR INTERNET WEB SITES, IN CLASS 41 (U.S. CLS. 100, 101 AND 107).

FIRST USE 2-28-2008; IN COMMERCE 3-24-2008.

NO CLAIM IS MADE TO THE EXCLUSIVE RIGHT TO USE "LLC", APART FROM THE MARK AS SHOWN.

THE MARK CONSISTS OF A STICK FIGURE GIRL WITH ONE CURL FOR HAIR AND A SKIRT. HER LEGS AND FEET FORM THE TWO "LL'S OF THE WORD "TALLBROAD" WHICH IS LOCATED AT THE BOTTOM OF THE DRAWING. THE DESIGNATION "LLC" APPEARS BENEATH THE LETTERS "AD" AT THE END OF THE WORD "TALLBROAD".

SER. NO. 77-509,274, FILED 6-26-2008.

KELLY MCCOY, EXAMINING ATTORNEY

Int. Cl.: 11

Prior U.S. Cls.: 13, 21, 23, 31 and 34

United States Patent and Trademark Office

Reg. No. 3,575,591

Registered Feb. 17, 2009

TRADEMARK
PRINCIPAL REGISTER



HANGZHOU SINGBEE TECHNOLOGY COMPANY LIMITED (CHINA LIMITED LIABILITY COMPANY)

XIAOSHAN ECONOMIC & TECHNOLOGY DEVELOPMENT AREA

NO 18, JIANSHE SAN ROAD
HANGZHOU, ZHEJIANG PROVINCE, CHINA

FOR: LIGHT BULBS; LAMPS; LAMP GLASSES; LABORATORY LAMPS; LUMINOUS TUBES FOR LIGHTING; STANDARD LAMPS; STREET LAMPS; FLUORESCENT LAMP TUBE, IN CLASS 11 (U.S. CLS. 13, 21, 23, 31 AND 34).

FIRST USE 1-10-2006; IN COMMERCE 3-15-2007.

NO CLAIM IS MADE TO THE EXCLUSIVE RIGHT TO USE THE NON-LATIN CHARACTERS THAT MEAN "BLUISH GREEN", APART FROM THE MARK AS SHOWN.

THE MARK CONSISTS OF A CALLIGRAPHIC LETTER "B" ON THE LEFT SIDE WITH A STAR DESIGN INSIDE THE "B". ON THE RIGHT SIDE IS THE WORD "SINGBEE" ON TOP AND 2 CHINESE CHARACTERS BELOW.

THE WORDING "SINGBEE" HAS NO MEANING IN A FOREIGN LANGUAGE.

THE NON-LATIN CHARACTER(S) IN THE MARK TRANSLITERATES INTO "XING BI", AND THIS MEANS A "STAR" AND "BLUISH GREEN" IN ENGLISH.

SER. NO. 77-509,530, FILED 6-27-2008.

ANDREW RHIM, EXAMINING ATTORNEY

Int. Cl.: 35

Prior U.S. Cls.: 100, 101 and 102

United States Patent and Trademark Office

Reg. No. 3,575,592

Registered Feb. 17, 2009

SERVICE MARK
PRINCIPAL REGISTER



AIR FORCE SERGEANTS ASSOCIATION (D.C.
CORPORATION)
5211 AUTH ROAD
SUITLAND, MD 20746

FOR: LOBBYING SERVICES, NAMELY, PROMOTING THE INTERESTS OF UNITED STATES AIR FORCE ENLISTED MEN AND WOMEN AND THEIR FAMILIES IN THE FIELDS OF LEGISLATION AND REGULATION, IN CLASS 35 (U.S. CLS. 100, 101 AND 102).

FIRST USE 0-0-1973; IN COMMERCE 0-0-1973.

NO CLAIM IS MADE TO THE EXCLUSIVE RIGHT TO USE "AIR FORCE SERGEANTS ASSO-

CIATION" AND "AUXILIARY", APART FROM THE MARK AS SHOWN.

THE MARK CONSISTS OF A CIRCLE WITH THE WORDS "AIR FORCE SERGEANTS ASSOCIATION" INSCRIBED AROUND THE INSIDE EDGE WITH A SECOND CIRCLE INSCRIBED INSIDE WITH 9 STARS AND THE WORD "AUXILIARY" INSCRIBED AROUND THE INSIDE EDGE WITH THE LETTERS "AFSA" INSIDE OF A CIRCLE DESIGN WITH 2 WINGS ON EITHER SIDE.

SER. NO. 77-509,577, FILED 6-27-2008.

HAI-LY LAM, EXAMINING ATTORNEY

Int. Cl.: 35

Prior U.S. Cls.: 100, 101 and 102

United States Patent and Trademark Office

Reg. No. 3,575,593

Registered Feb. 17, 2009

**SERVICE MARK
PRINCIPAL REGISTER**



SOUTH CENTRAL SERVICE COOPERATIVE
(MINNESOTA SERVICE COOPERATIVE)
2075 LOOKOUT DRIVE
NORTH MANKATO, MN 56003

FOR: BUSINESS MANAGEMENT, BUSINESS CONSULTATION, AND BUSINESS ADMINISTRATION DIRECTED TO GOVERNMENTAL ENTITIES RELATING TO ADMINISTRATIVE SIMPLIFICATION AND COLLABORATION IN THE FIELD OF PROCUREMENT AND HUMAN RESOURCES, IN CLASS 35 (U.S. CLS. 100, 101 AND 102).

FIRST USE 1-8-2008; IN COMMERCE 1-8-2008.

NO CLAIM IS MADE TO THE EXCLUSIVE RIGHT TO USE "MINNESOTA SERVICE COOPERATIVES", APART FROM THE MARK AS SHOWN.

THE COLOR(S) RED, BLUE AND WHITE IS/ARE CLAIMED AS A FEATURE OF THE MARK.

THE MARK CONSISTS OF A RED OUTLINE OF THE GEOGRAPHIC BOUNDARIES OF THE STATE OF MINNESOTA WITH THE WORDING "THE" IN BLUE STANDARD FONT WITHIN THE STATE OUTLINE. THE BLUE WORDING "MINNESOTA" IS AT THE SIDE OF THE STATE OUTLINE IN LARGER CURSIVE FONT WITH THE "M" IN "MINNESOTA" BISECTING THE STATE OUTLINE. UNDER THE WORDING, "MINNESOTA" IS THE BLUE WORDING "SERVICE COOPERATIVES" IN STANDARD FONT ALL APPEARING ON A WHITE BACKGROUND.

SER. NO. 77-509,626, FILED 6-27-2008.

KIMBERLY PERRY, EXAMINING ATTORNEY

Int. Cl.: 36

Prior U.S. Cls.: 100, 101 and 102

United States Patent and Trademark Office

Reg. No. 3,575,594

Registered Feb. 17, 2009

**SERVICE MARK
PRINCIPAL REGISTER**



WYNNCHURCH CAPITAL, LTD. (DELAWARE CORPORATION)
6250 NORTH RIVER ROAD, SUITE 10-100
ROSEMONT, IL 60018

FOR: FINANCIAL SERVICES, NAMELY, PROVIDING FINANCING RELATING TO VARIOUS TYPES OF TRANSACTIONS; PRIVATE EQUITY FUND MANAGEMENT SERVICES AND INVESTMENT ADVICE IN THE FIELD OF PRIVATE EQUITY CAPITAL MANAGEMENT, IN CLASS 36 (U.S. CLS. 100, 101 AND 102).

FIRST USE 11-30-2006; IN COMMERCE 11-30-2006.

OWNER OF U.S. REG. NO. 2,552,407.

THE MARK CONSISTS OF A SQUARE BOX CONTAINING THE LETTERS "WC".

SER. NO. 77-509,779, FILED 6-27-2008.

JENNIFER DIXON, EXAMINING ATTORNEY

Int. Cl.: 30

Prior U.S. Cl.: 46

United States Patent and Trademark Office

Reg. No. 3,575,595

Registered Feb. 17, 2009

**TRADEMARK
PRINCIPAL REGISTER**

CHEWY LEMONHEAD

FERRARA PAN CANDY CO., INC. (ILLINOIS
CORPORATION)
7301 WEST HARRISON STREET
FOREST PARK, IL 60130

FOR: CANDY, IN CLASS 30 (U.S. CL. 46).

FIRST USE 9-30-2007; IN COMMERCE 9-30-2007.

THE MARK CONSISTS OF STANDARD CHAR-
ACTERS WITHOUT CLAIM TO ANY PARTICULAR
FONT, STYLE, SIZE, OR COLOR.

OWNER OF U.S. REG. NOS. 781,824, 2,205,625,
AND 2,205,626.

NO CLAIM IS MADE TO THE EXCLUSIVE
RIGHT TO USE "CHEWY", APART FROM THE
MARK AS SHOWN.

SER. NO. 77-509,798, FILED 6-27-2008.

JACQUELINE A. LAVINE, EXAMINING ATTOR-
NEY

Int. Cl.: 41

Prior U.S. Cls.: 100, 101 and 107

United States Patent and Trademark Office

Reg. No. 3,575,596

Registered Feb. 17, 2009

**SERVICE MARK
PRINCIPAL REGISTER**



PREPS2GO, INC. (WASHINGTON CORPORATION)
5510 EAST 25TH
SPOKANE, WA 99223

FOR: PROVIDING NEWS AND INFORMATION
IN THE FIELD OF SPORTS, IN CLASS 41 (U.S. CLS.
100, 101 AND 107).

FIRST USE 5-22-2008; IN COMMERCE 5-22-2008.

THE COLOR(S) BLACK AND RED IS/ARE
CLAIMED AS A FEATURE OF THE MARK.

THE MARK CONSISTS OF A STYLIZED DEPICTION OF THE PHRASE "PREPS2GO." THE WORDS "PREPS" AND "GO" ARE BLACK. THE NUMBER "2" IS RED.

SER. NO. 77-509,915, FILED 6-27-2008.

REGINA DRUMMOND, EXAMINING ATTORNEY

Int. Cl.: 41

Prior U.S. Cls.: 100, 101 and 107

United States Patent and Trademark Office

Reg. No. 3,575,597

Registered Feb. 17, 2009

**SERVICE MARK
PRINCIPAL REGISTER**

ART RENEWAL CENTER

FOUNDATION FOR THE ART RENEWAL CENTER, INC. (NEW JERSEY NON-PROFIT CORPORATION)
100 MARKLEY STREET
PORT READING, NJ 07064

FOR: MUSEUM SERVICES AND EDUCATIONAL SERVICES, NAMELY, PROVIDING AN INTERACTIVE ONLINE ART MUSEUM THROUGH A WEB SITE ON A GLOBAL COMPUTER INFORMATION NETWORK; ENTERTAINMENT SERVICES, NAMELY, CONDUCTING ART COMPETITIONS AND EXHIBITIONS, IN CLASS 41 (U.S. CLS. 100, 101 AND 107).

FIRST USE 12-0-1999; IN COMMERCE 10-0-2000.

THE MARK CONSISTS OF STANDARD CHARACTERS WITHOUT CLAIM TO ANY PARTICULAR FONT, STYLE, SIZE, OR COLOR.

NO CLAIM IS MADE TO THE EXCLUSIVE RIGHT TO USE "CENTER", APART FROM THE MARK AS SHOWN.

SEC. 2(F).

SER. NO. 77-510,068, FILED 6-27-2008.

JANET LEE, EXAMINING ATTORNEY

Int. Cls.: 35 and 37

Prior U.S. Cls.: 100, 101, 102, 103 and 106

United States Patent and Trademark Office

Reg. No. 3,575,598

Registered Feb. 17, 2009

**SERVICE MARK
PRINCIPAL REGISTER**

Minnesota Computers

MINNESOTA COMPUTERS CORPORATION
(MINNESOTA CORPORATION)
5733 INTERNATIONAL PARKWAY
MINNEAPOLIS, MN 55428

FOR: ONLINE AND TELEPHONE RETAIL
STORE SERVICES FEATURING COMPUTERS,
COMPUTER SYSTEMS, COMPUTER STORAGE DE-
VICES, NAMELY, TAPE DRIVES, DISK DRIVES
AND OPTICAL DRIVES, PRINTERS, AND RELA-
TED PARTS, ACCESSORIES AND PERIPHERALS,
IN CLASS 35 (U.S. CLS. 100, 101 AND 102).

FIRST USE 12-31-1985; IN COMMERCE 12-31-1985.

FOR: MAINTENANCE AND REPAIR SERVICES
OF COMPUTERS, COMPUTER SYSTEMS, COMPU-
TER STORAGE DEVICES AND PRINTERS, IN
CLASS 37 (U.S. CLS. 100, 103 AND 106).

FIRST USE 12-31-1985; IN COMMERCE 12-31-1985.

THE MARK CONSISTS OF STANDARD CHAR-
ACTERS WITHOUT CLAIM TO ANY PARTICULAR
FONT, STYLE, SIZE, OR COLOR.

NO CLAIM IS MADE TO THE EXCLUSIVE
RIGHT TO USE "COMPUTERS", APART FROM
THE MARK AS SHOWN.

SEC. 2(F).

SER. NO. 77-510,070, FILED 6-27-2008.

CAROL SPILS, EXAMINING ATTORNEY

Int. Cl.: 25

Prior U.S. Cls.: 22 and 39

United States Patent and Trademark Office

Reg. No. 3,575,599

Registered Feb. 17, 2009

**TRADEMARK
PRINCIPAL REGISTER**



MILITTI SALES & PROMOTIONS, LLC (NEBRASKA LIMITED LIABILITY COMPANY)
13436 INDUSTRIAL ROAD
OMAHA, NE 68145

FOR: HEADGEAR, NAMELY, HATS, CAPS, IN CLASS 25 (U.S. CLS. 22 AND 39).

FIRST USE 2-10-2003; IN COMMERCE 3-15-2003.

NO CLAIM IS MADE TO THE EXCLUSIVE RIGHT TO USE "GEAR", APART FROM THE MARK AS SHOWN.

THE MARK CONSISTS OF AN OVAL WITH THE TEXT "TRUE GEAR" INSIDE IT.

SER. NO. 77-510,239, FILED 6-27-2008.

SHAUNIA CARLYLE, EXAMINING ATTORNEY

Int. Cl.: 5

Prior U.S. Cls.: 6, 18, 44, 46, 51 and 52

Reg. No. 3,575,600

United States Patent and Trademark Office

Registered Feb. 17, 2009

**TRADEMARK
PRINCIPAL REGISTER**

RIPPED LEAN

NUTRASTAR LABORATORIES, LLC (DELA-
WARE LIMITED LIABILITY COMPANY)
6622 SELFRIDGE ST.
FOREST HILLS, NY 11375

THE MARK CONSISTS OF STANDARD CHAR-
ACTERS WITHOUT CLAIM TO ANY PARTICULAR
FONT, STYLE, SIZE, OR COLOR.

FOR: DIETARY AND NUTRITIONAL SUPPLE-
MENTS; HERBAL SUPPLEMENTS, IN CLASS 5 (U.S.
CLS. 6, 18, 44, 46, 51 AND 52).

SER. NO. 77-510,271, FILED 6-27-2008.

FIRST USE 1-31-2007; IN COMMERCE 1-31-2007.

ANGELA GAW, EXAMINING ATTORNEY

Int. Cls.: 16, 35 and 41

**Prior U.S. Cls.: 2, 5, 22, 23, 29, 37, 38, 50, 100, 101, 102
and 107**

Reg. No. 3,575,601

United States Patent and Trademark Office

Registered Feb. 17, 2009

**TRADEMARK
SERVICE MARK
PRINCIPAL REGISTER**

Tulsa World

WORLD PUBLISHING COMPANY (OKLAHOMA CORPORATION)
315 SOUTH BOULDER
TULSA, OK 74103

FOR: NEWSPAPERS, IN CLASS 16 (U.S. CLS. 2, 5, 22, 23, 29, 37, 38 AND 50).

FIRST USE 1-1-1905; IN COMMERCE 1-1-1905.

FOR: ADVERTISING SERVICES; AND PROMOTING THE SERVICES OF OTHERS BY PREPARING AND PLACING ADVERTISEMENTS IN NEWSPAPERS AND IN ON-LINE NEWSPAPER PUBLICATIONS, IN CLASS 35 (U.S. CLS. 100, 101 AND 102).

FIRST USE 1-1-1905; IN COMMERCE 1-1-1905.

FOR: PROVIDING ON-LINE PUBLICATIONS IN THE NATURE OF NEWSPAPERS IN THE FIELD OF CURRENT EVENTS, IN CLASS 41 (U.S. CLS. 100, 101 AND 107).

FIRST USE 1-1-1996; IN COMMERCE 1-1-1996.

THE MARK CONSISTS OF STANDARD CHARACTERS WITHOUT CLAIM TO ANY PARTICULAR FONT, STYLE, SIZE, OR COLOR.

SEC. 2(F) AS TO TULSA.

SER. NO. 77-510,435, FILED 6-27-2008.

CIMMERIAN COLEMAN, EXAMINING ATTORNEY

Int. Cl.: 35

Prior U.S. Cls.: 100, 101 and 102

United States Patent and Trademark Office

Reg. No. 3,575,602

Registered Feb. 17, 2009

SERVICE MARK
PRINCIPAL REGISTER

Mystery Shop DDS

DENTAL GENIUS, LLC (MISSISSIPPI LIMITED
LIABILITY COMPANY)
1401 FRANCES SQUARE
TUPELO, MS 38804

FOR: SHOPPING BY RESEARCHERS WHO POSE
AS CUSTOMERS TO EVALUATE THE QUALITY OF
SERVICE DELIVERED, IN CLASS 35 (U.S. CLS. 100,
101 AND 102).

FIRST USE 8-1-2005; IN COMMERCE 9-1-2005.

NO CLAIM IS MADE TO THE EXCLUSIVE
RIGHT TO USE "MYSTERY SHOP DDS", APART
FROM THE MARK AS SHOWN.

THE MARK CONSISTS OF A MAGNIFYING
GLASS, WITH THE GLASS PORTION OF THE TOOL
REPRESENTING THE "O" IN STYLIZED TEXT
"SHOP"; THE STYLIZED TEXT "MYSTERY" AP-
PEARS IN FRONT OF "SHOP" AND DDS APPEARS
AFTER.

SER. NO. 77-510,494, FILED 6-27-2008.

NICHOLAS COLEMAN, EXAMINING ATTORNEY

Int. Cl.: 41

Prior U.S. Cls.: 100, 101 and 107

United States Patent and Trademark Office

Reg. No. 3,575,603

Registered Feb. 17, 2009

**SERVICE MARK
PRINCIPAL REGISTER**

Palmito Tour of Costa Rica

KTFF LIMITED PARTNERSHIP (TEXAS LIMITED PARTNERSHIP), DBA REGENCY FOOD COMPANY
2764 BINGLE RD
HOUSTON, TX 77055

FOR: GUIDED TOURS OF A FARM, IN CLASS 41 (U.S. CLS. 100, 101 AND 107).

FIRST USE 6-27-2008; IN COMMERCE 6-28-2008.

THE MARK CONSISTS OF STANDARD CHARACTERS WITHOUT CLAIM TO ANY PARTICULAR FONT, STYLE, SIZE, OR COLOR.

NO CLAIM IS MADE TO THE EXCLUSIVE RIGHT TO USE "TOUR OF COSTA RICA", APART FROM THE MARK AS SHOWN.

THE FOREIGN WORDING IN THE MARK TRANSLATES INTO ENGLISH AS "HEARTS OF PALM".

SER. NO. 77-510,570, FILED 6-28-2008.

ESTHER A. BORSUK, EXAMINING ATTORNEY

Int. Cl.: 42

Prior U.S. Cls.: 100 and 101

United States Patent and Trademark Office

Reg. No. 3,575,604

Registered Feb. 17, 2009

**SERVICE MARK
PRINCIPAL REGISTER**

**HEALTHY TECHNOLOGY
ANSWERS**

HEALTHY TECHNOLOGY ANSWERS INC.
(MARYLAND CORPORATION)
2825 MERCHANT CT
WALDORF, MD 20603

FOR: PROVIDING TECHNOLOGICAL INFORMATION ABOUT ENVIRONMENTALLY-CONSCIOUS AND GREEN INNOVATIONS FOR INDOOR ENVIRONMENTS OF RESIDENTIAL AND COMMERCIAL BUSINESSES TO AID IN CREATING SUSTAINABLE ENVIRONMENTS FOR THE SAME FEATURING PURE CLEAN AIR, WATER AND POWER TECHNOLOGIES, IN CLASS 42 (U.S. CLS. 100 AND 101).

FIRST USE 2-8-2008; IN COMMERCE 4-29-2008.

THE MARK CONSISTS OF STANDARD CHARACTERS WITHOUT CLAIM TO ANY PARTICULAR FONT, STYLE, SIZE, OR COLOR.

NO CLAIM IS MADE TO THE EXCLUSIVE RIGHT TO USE "HEALTHY TECHNOLOGY", APART FROM THE MARK AS SHOWN.

SER. NO. 77-510,696, FILED 6-28-2008.

ZHALEH DELANEY, EXAMINING ATTORNEY

Int. Cl.: 30

Prior U.S. Cl.: 46

United States Patent and Trademark Office

Reg. No. 3,575,605

Registered Feb. 17, 2009

**TRADEMARK
PRINCIPAL REGISTER**

KOOL KREME

HDN DEVELOPMENT CORPORATION (KEN-
TUCKY CORPORATION)
SUITE 500
370 KNOLLWOOD STREET
WINSTON-SALEM, NC 27103

FOR: SEMI-FROZEN DESSERTS, NAMELY, SOFT
SERVE ICE CREAM SUBSTITUTE, IN CLASS 30 (U.S.
CL. 46).

FIRST USE 11-0-2007; IN COMMERCE 11-0-2007.

THE MARK CONSISTS OF STANDARD CHAR-
ACTERS WITHOUT CLAIM TO ANY PARTICULAR
FONT, STYLE, SIZE, OR COLOR.

OWNER OF U.S. REG. NOS. 539,165, 3,386,344 AND
OTHERS.

SER. NO. 77-510,966, FILED 6-30-2008.

EDWARD NELSON, EXAMINING ATTORNEY

Int. Cl.: 43

Prior U.S. Cls.: 100 and 101

United States Patent and Trademark Office

Reg. No. 3,575,606

Registered Feb. 17, 2009

**SERVICE MARK
PRINCIPAL REGISTER**

KOOL KREME

HDN DEVELOPMENT CORPORATION (KEN-
TUCKY CORPORATION)
SUITE 500
370 KNOLLWOOD STREET
WINSTON-SALEM, NC 27103

FOR: RESTAURANT SERVICES, IN CLASS 43
(U.S. CLS. 100 AND 101).

FIRST USE 11-0-2007; IN COMMERCE 11-0-2007.

THE MARK CONSISTS OF STANDARD CHAR-
ACTERS WITHOUT CLAIM TO ANY PARTICULAR
FONT, STYLE, SIZE, OR COLOR.

OWNER OF U.S. REG. NOS. 539,165, 3,386,344 AND
OTHERS.

SER. NO. 77-510,972, FILED 6-30-2008.

EDWARD NELSON, EXAMINING ATTORNEY

Int. Cl.: 2

Prior U.S. Cls.: 6, 11 and 16

United States Patent and Trademark Office

Reg. No. 3,575,607

Registered Feb. 17, 2009

**TRADEMARK
PRINCIPAL REGISTER**

SIMPLICITY

THE SHERWIN-WILLIAMS COMPANY (OHIO
CORPORATION)
101 PROSPECT AVENUE NW
CLEVELAND, OH 441151075

THE MARK CONSISTS OF STANDARD CHAR-
ACTERS WITHOUT CLAIM TO ANY PARTICULAR
FONT, STYLE, SIZE, OR COLOR.

FOR: WOOD STAINS, IN CLASS 2 (U.S. CLS. 6, 11
AND 16).

SER. NO. 77-511,035, FILED 6-30-2008.

FIRST USE 9-2-2008; IN COMMERCE 9-2-2008.

MARK PILARO, EXAMINING ATTORNEY

Int. Cl.: 29

Prior U.S. Cl.: 46

United States Patent and Trademark Office

Reg. No. 3,575,608

Registered Feb. 17, 2009

**TRADEMARK
PRINCIPAL REGISTER**

SIDE HILL FARM

GREAT NORTH ENTERPRISES, INC. (VER-
MONT CORPORATION)

P.O. BOX 1558

BRATTLEBORO, VT 05301

FOR: JELLIES AND JAMS, FRUIT TOPPINGS,
AND FRUIT PRESERVES, IN CLASS 29 (U.S. CL. 46).

FIRST USE 0-0-1979; IN COMMERCE 0-0-1979.

THE MARK CONSISTS OF STANDARD CHAR-
ACTERS WITHOUT CLAIM TO ANY PARTICULAR
FONT, STYLE, SIZE, OR COLOR.

NO CLAIM IS MADE TO THE EXCLUSIVE
RIGHT TO USE "FARM", APART FROM THE
MARK AS SHOWN.

SER. NO. 77-511,359, FILED 6-30-2008.

INGA ERVIN, EXAMINING ATTORNEY

Int. Cls.: 26 and 44

Prior U.S. Cls.: 37, 39, 40, 42, 50, 100 and 101

United States Patent and Trademark Office

Reg. No. 3,575,609

Registered Feb. 17, 2009

**TRADEMARK
SERVICE MARK
PRINCIPAL REGISTER**

The Look Hair and Makeup

THE LOOK ARTISTRY (CALIFORNIA LIMITED LIABILITY COMPANY), DBA THE LOOK HAIR AND MAKEUP
5324 1/2 LOMA LINDA AVE
LOS ANGELES, CA 90027

FOR: WIGS, HAIRPIECES, AND ADD-IN AND ADD-ON HAIR ACCESSORIES CONSTRUCTED PRIMARILY OF SYNTHETIC AND/OR HUMAN HAIR, IN CLASS 26 (U.S. CLS. 37, 39, 40, 42 AND 50).

FIRST USE 3-1-2008; IN COMMERCE 5-1-2008.

FOR: CONSULTATION SERVICES IN THE FIELD OF MAKEUP, NAMELY, ON-LINE MAKEUP CONSULTATION SERVICES AND IN-PERSON MAKEUP CONSULTATION AND APPLICATION SERVICES; HYGIENIC AND BEAUTY CARE; PROVIDING IN-

FORMATION ABOUT BEAUTY, IN CLASS 44 (U.S. CLS. 100 AND 101).

FIRST USE 3-1-2008; IN COMMERCE 5-1-2008.

THE MARK CONSISTS OF STANDARD CHARACTERS WITHOUT CLAIM TO ANY PARTICULAR FONT, STYLE, SIZE, OR COLOR.

NO CLAIM IS MADE TO THE EXCLUSIVE RIGHT TO USE "HAIR AND MAKEUP", APART FROM THE MARK AS SHOWN.

SER. NO. 77-511,489, FILED 6-30-2008.

HEATHER SAPP, EXAMINING ATTORNEY

Int. Cls.: 11 and 12

Prior U.S. Cls.: 13, 19, 21, 23, 31, 34, 35 and 44

United States Patent and Trademark Office

Reg. No. 3,575,610

Registered Feb. 17, 2009

**TRADEMARK
PRINCIPAL REGISTER**



TUNG THIH ELECTRONIC CO., LTD. (TAIWAN CORPORATION)
NO. 42, NEI-TSO ST., LUCHU TOWNSHIP
TAOYUAN COUNTY, TAIWAN 33852

FOR: AUTO LIGHTS FOR USE ON VEHICLES, IN CLASS 11 (U.S. CLS. 13, 21, 23, 31 AND 34).

FIRST USE 5-9-2008; IN COMMERCE 5-9-2008.

FOR: REAR VIEW MIRRORS FOR VEHICLES, IN CLASS 12 (U.S. CLS. 19, 21, 23, 31, 35 AND 44).

FIRST USE 5-9-2008; IN COMMERCE 5-9-2008.

OWNER OF U.S. REG. NOS. 3,104,388, 3,397,107, AND 3,397,111.

THE MARK CONSISTS OF THE LETTERS "TTE" SET INSIDE A CIRCLE.

SER. NO. 77-511,767, FILED 6-30-2008.

TASNEEM HUSSAIN, EXAMINING ATTORNEY

Int. Cl.: 35

Prior U.S. Cls.: 100, 101 and 102

United States Patent and Trademark Office

Reg. No. 3,575,611

Registered Feb. 17, 2009

**SERVICE MARK
PRINCIPAL REGISTER**

WEEBSWORLD

WEEBSWORLD, INC. (VIRGINIA CORPORATION)
11537 W. BROAD STREET
RICHMOND, VA 23223

THE MARK CONSISTS OF STANDARD CHARACTERS WITHOUT CLAIM TO ANY PARTICULAR FONT, STYLE, SIZE, OR COLOR.

FOR: RETAIL STORE SERVICES FEATURING
BABY AND CHILDREN'S GOODS, IN CLASS 35
(U.S. CLS. 100, 101 AND 102).

SER. NO. 77-511,993, FILED 7-1-2008.

FIRST USE 6-1-2008; IN COMMERCE 6-1-2008.

JULIE VEPPUMTHARA, EXAMINING ATTORNEY

Int. Cl.: 1

Prior U.S. Cls.: 1, 5, 6, 10, 26 and 46

United States Patent and Trademark Office

Reg. No. 3,575,612

Registered Feb. 17, 2009

**TRADEMARK
PRINCIPAL REGISTER**



OSSIAN, INC. (IOWA CORPORATION)
635 S. ELMWOOD AVENUE, P.O. BOX 4076
DAVENPORT, IA 52808

FOR: CHEMICAL ICE MELTING COMPOSITION,
IN CLASS 1 (U.S. CLS. 1, 5, 6, 10, 26 AND 46).

FIRST USE 9-0-2007; IN COMMERCE 9-0-2007.

OWNER OF U.S. REG. NO. 2,161,556.

NO CLAIM IS MADE TO THE EXCLUSIVE
RIGHT TO USE "WALKWAY TRACTION ICE MEL-
TER", APART FROM THE MARK AS SHOWN.

THE MARK CONSISTS OF THE TERM "WALK-
WAY" SURROUNDED BY A RECTANGULAR
BACKGROUND CARRIER ABOVE THE TERM
"TRACK TION ICE MELTER". ABOVE ALL WORD-
ING APPEARS THE DESIGN OF THREE RAILWAY
LOCOMOTIVES.

SER. NO. 77-512,010, FILED 7-1-2008.

JIM RINGLE, EXAMINING ATTORNEY

Int. Cl.: 41

Prior U.S. Cls.: 100, 101 and 107

United States Patent and Trademark Office

Reg. No. 3,575,613

Registered Feb. 17, 2009

**SERVICE MARK
PRINCIPAL REGISTER**



DETROIT RECEIVING HOSPITAL (MICHIGAN CORPORATION)
SUITE W514
4707 SAINT ANTOINE
DETROIT, MI 48201

FOR: PROVIDING ASSISTANCE, PERSONAL TRAINING AND PHYSICAL FITNESS CONSULTATION TO INDIVIDUALS TO HELP THEM MAKE PHYSICAL FITNESS, STRENGTH, CONDITIONING, AND EXERCISE IMPROVEMENT IN THEIR DAILY LIVING, IN CLASS 41 (U.S. CLS. 100, 101 AND 107).

FIRST USE 5-28-2008; IN COMMERCE 6-5-2008.

NO CLAIM IS MADE TO THE EXCLUSIVE RIGHT TO USE "WALK", APART FROM THE MARK AS SHOWN.

THE COLOR(S) BLUE, DARK BLUE, YELLOW AND WHITE IS/ARE CLAIMED AS A FEATURE OF THE MARK.

THE MARK CONSISTS OF A YELLOW AND WHITE SUN OVER A DARK BLUE AND WHITE BUILDING AGAINST A BLUE SKY BACKGROUND WITH A DARK BLUE, BLUE AND WHITE WATER WAVE UNDER THE WAVE; A YELLOW FISH WITH A WHITE EYE IN DARK BLUE WATER APPEARS UNDER THE WAVE. AT THE TOP OF THE MARK APPEARS THE TERM "RIVERWALKERS" WITH THE TERM "RIVER" IN DARK BLUE AND THE TERM "WALKERS" IN BLUE; AT THE BOTTOM OF THE MARK APPEARS THE TERM "WALK THE WATER'S EDGE" IN BLUE; THE BACKGROUND OF THE ENTIRE MARK IS WHITE.

SER. NO. 77-512,014, FILED 7-1-2008.

JIM RINGLE, EXAMINING ATTORNEY

Prior U.S. Cl.: B

United States Patent and Trademark Office

Reg. No. 3,575,614

Registered Feb. 17, 2009

**CERTIFICATION MARK
PRINCIPAL REGISTER**

CEC

AMERICAN CULINARY FEDERATION (NEW YORK CORPORATION)
180 CENTER PLACE WAY
ST. AUGUSTINE, FL 32095

FOR: COOKING SERVICES, IN CLASS B (U.S. CL. B).

FIRST USE 0-0-1975; IN COMMERCE 0-0-1975.

THE MARK CONSISTS OF STANDARD CHARACTERS WITHOUT CLAIM TO ANY PARTICULAR FONT, STYLE, SIZE, OR COLOR.

THE CERTIFICATION MARK, AS USED BY AUTHORIZED PERSONS, CERTIFIES THAT THE PERSON USING THE MARK IS A PROFESSIONAL CHEF WHO HAS DEMONSTRATED ADVANCED

KNOWLEDGE AND SKILLS PERTAINING TO PROFESSIONAL COOKING AND SUPERVISION AS DETERMINED BY A TEST OF CULINARY SKILL AND KNOWLEDGE AUTHORIZED BY THE CERTIFIER. THE CULINARY SKILL AND KNOWLEDGE CAN BE DOCUMENTED BY BEING SUCCESSFULLY EMPLOYED FOR A MINIMUM OF 3 YEARS AS A SOUS CHEF, EXECUTIVE SOUS CHEF, OR KITCHEN MANAGER AND BY PASSING THE CERTIFICATION KNOWLEDGE AND SKILL PROFICIENCY TESTS ESTABLISHED BY THE CERTIFIER.

SER. NO. 77-512,090, FILED 7-1-2008.

MICHAEL KEATING, EXAMINING ATTORNEY

Int. Cls.: 39 and 43

Prior U.S. Cls.: 100, 101 and 105

United States Patent and Trademark Office

Reg. No. 3,575,615

Registered Feb. 17, 2009

**SERVICE MARK
PRINCIPAL REGISTER**

BEACHFRONT SKY MASSAGE

UNIQUE BRANDS ENTERPRISES, LLC (FLORIDA LIMITED LIABILITY COMPANY)
550 BILTMORE WAY, SUITE 200
CORAL GABLES, FL 33134

FOR: TRAVEL SERVICES, NAMELY, PROVIDING AND ARRANGING ALL-INCLUSIVE TRAVEL VACATIONS, VACATIONS WITH OPTIONAL MEAL PLANS, AND TRAVEL TOUR PACKAGES, IN CLASS 39 (U.S. CLS. 100 AND 105).

FIRST USE 1-0-2007; IN COMMERCE 1-0-2007.

FOR: PROVIDING INFORMATION ABOUT HOTEL RESORT ACCOMMODATIONS AND SERVICES, IN CLASS 43 (U.S. CLS. 100 AND 101).

FIRST USE 1-0-2007; IN COMMERCE 1-0-2007.

THE MARK CONSISTS OF STANDARD CHARACTERS WITHOUT CLAIM TO ANY PARTICULAR FONT, STYLE, SIZE, OR COLOR.

NO CLAIM IS MADE TO THE EXCLUSIVE RIGHT TO USE "BEACHFRONT" AND "MASSAGE", APART FROM THE MARK AS SHOWN.

SER. NO. 77-512,240, FILED 7-1-2008.

BRIDGETT SMITH, EXAMINING ATTORNEY

Int. Cl.: 35

Prior U.S. Cls.: 100, 101 and 102

United States Patent and Trademark Office

Reg. No. 3,575,616

Registered Feb. 17, 2009

**SERVICE MARK
PRINCIPAL REGISTER**

BEAUTY BUNDLES

ALPHA GIRL, INC. (CALIFORNIA CORPORATION)
3830 VALLEY CTR. DRIVE, #705 PMB
SAN DIEGO, CA 92130

FOR: COMPUTERIZED ON-LINE RETAIL STORE SERVICES AND MAIL ORDER SERVICES IN THE FIELDS OF GIFTWARE, IN CLASS 35 (U.S. CLS. 100, 101 AND 102).

FIRST USE 9-30-2007; IN COMMERCE 9-30-2007.

THE MARK CONSISTS OF STANDARD CHARACTERS WITHOUT CLAIM TO ANY PARTICULAR FONT, STYLE, SIZE, OR COLOR.

NO CLAIM IS MADE TO THE EXCLUSIVE RIGHT TO USE "BEAUTY", APART FROM THE MARK AS SHOWN.

SER. NO. 77-512,247, FILED 7-1-2008.

BRIDGETT SMITH, EXAMINING ATTORNEY

Int. Cl.: 10

Prior U.S. Cls.: 26, 39 and 44

United States Patent and Trademark Office

Reg. No. 3,575,617

Registered Feb. 17, 2009

**TRADEMARK
PRINCIPAL REGISTER**

CATH-MATE

BIRD & CRONIN, INC. (MINNESOTA CORPORATION)
1200 TRAPP ROAD
EAGAN, MN 55121

THE MARK CONSISTS OF STANDARD CHARACTERS WITHOUT CLAIM TO ANY PARTICULAR FONT, STYLE, SIZE, OR COLOR.

FOR: MEDICAL APPARATUS, NAMELY, A CATHETER POSITIONING AND HOLDING DEVICE, IN CLASS 10 (U.S. CLS. 26, 39 AND 44).

SER. NO. 77-512,321, FILED 7-1-2008.

FIRST USE 7-0-1992; IN COMMERCE 12-0-1999.

DAWN HAN, EXAMINING ATTORNEY

Int. Cl.: 22

Prior U.S. Cls.: 1, 2, 7, 19, 22, 42 and 50

United States Patent and Trademark Office

Reg. No. 3,575,618

Registered Feb. 17, 2009

**TRADEMARK
PRINCIPAL REGISTER**

Lock-n-Sack

SEAT SACK, INC (FLORIDA CORPORATION)
PO BOX 9732
NAPLES, FL 34101

FOR: A SCHOOL SUPPLY POUCH MADE OF FABRIC THAT MAGNETICALLY ATTACHES TO A METAL SURFACE AND MAGNETICALLY FOLDS TO CLOSE, IN CLASS 22 (U.S. CLS. 1, 2, 7, 19, 22, 42 AND 50).

FIRST USE 9-9-2007; IN COMMERCE 9-18-2007.

THE MARK CONSISTS OF STANDARD CHARACTERS WITHOUT CLAIM TO ANY PARTICULAR FONT, STYLE, SIZE, OR COLOR.

SER. NO. 77-512,347, FILED 7-1-2008.

BRIAN PINO, EXAMINING ATTORNEY

Int. Cl.: 27

Prior U.S. Cls.: 19, 20, 37, 42 and 50

United States Patent and Trademark Office

Reg. No. 3,575,619

Registered Feb. 17, 2009

**TRADEMARK
PRINCIPAL REGISTER**

ALASONIA

ALASONIA, LLC (MARYLAND LIMITED LIABILITY COMPANY)

401 PHELPS ST.

GAITHERSBURG, MD 20878

FOR: CARPETS AND RUGS, IN CLASS 27 (U.S. CLS. 19, 20, 37, 42 AND 50).

FIRST USE 4-14-2008; IN COMMERCE 4-14-2008.

THE MARK CONSISTS OF STANDARD CHARACTERS WITHOUT CLAIM TO ANY PARTICULAR FONT, STYLE, SIZE, OR COLOR.

THE NAME(S), PORTRAIT(S), AND/OR SIGNATURE(S) SHOWN IN THE MARK DOES NOT IDENTIFY A PARTICULAR LIVING INDIVIDUAL.

SER. NO. 77-512,369, FILED 7-1-2008.

GINA HAYES, EXAMINING ATTORNEY

Int. Cl.: 41

Prior U.S. Cls.: 100, 101 and 107

United States Patent and Trademark Office

Reg. No. 3,575,620

Registered Feb. 17, 2009

**SERVICE MARK
PRINCIPAL REGISTER**



SPINSHEET PUBLISHING COMPANY (MARY-
LAND CORPORATION)
SUITE 3C
612 THIRD STREET
ANNAPOLIS, MD 21403

FOR: PUBLICATION OF BOOKS, OF MAGA-
ZINES, OF JOURNALS, OF NEWSPAPERS, OF PER-
IODICALS, OF CATALOGS, OF BROCHURES, IN
CLASS 41 (U.S. CLS. 100, 101 AND 107).

FIRST USE 7-15-1995; IN COMMERCE 7-15-1995.

THE COLOR(S) BLUE AND GOLD IS/ARE
CLAIMED AS A FEATURE OF THE MARK.

THE MARK CONSISTS OF THE COLOR BLUE IN
THE WORDS "SPINSHEET" AND THE COLOR
GOLD APPEARS IN THE DESIGN OF THE TWO
MASTS.

SER. NO. 77-512,382, FILED 7-1-2008.

GINA HAYES, EXAMINING ATTORNEY

Int. Cl.: 41

Prior U.S. Cls.: 100, 101 and 107

United States Patent and Trademark Office

Reg. No. 3,575,621

Registered Feb. 17, 2009

**SERVICE MARK
PRINCIPAL REGISTER**

The Hoola Hoop Paradigm

HICKEY, RONALD T. (UNITED STATES INDIVIDUAL)
1074 KENSINGTON DRIVE
ROSEVILLE, CA 95661

FOR: CONDUCTING WORKSHOPS AND SEMINARS IN PERSONAL AND PROFESSIONAL DEVELOPMENT, IN CLASS 41 (U.S. CLS. 100, 101 AND 107).

FIRST USE 6-29-2008; IN COMMERCE 7-1-2008.

THE MARK CONSISTS OF STANDARD CHARACTERS WITHOUT CLAIM TO ANY PARTICULAR FONT, STYLE, SIZE, OR COLOR.

SER. NO. 77-512,606, FILED 7-1-2008.

JANICE KIM, EXAMINING ATTORNEY

Int. Cl.: 10

Prior U.S. Cls.: 26, 39 and 44

United States Patent and Trademark Office

Reg. No. 3,575,622

Registered Feb. 17, 2009

**TRADEMARK
PRINCIPAL REGISTER**

TRACH-MATE

BIRD & CRONIN, INC. (MINNESOTA CORPORATION)
1200 TRAPP ROAD
EAGAN, MN 55121

FOR: MEDICAL APPARATUS, NAMELY, TRACHEOSTOMY TUBE POSITIONING AND HOLDING APPARATUS, IN CLASS 10 (U.S. CLS. 26, 39 AND 44).

FIRST USE 7-0-1992; IN COMMERCE 12-0-1999.

THE MARK CONSISTS OF STANDARD CHARACTERS WITHOUT CLAIM TO ANY PARTICULAR FONT, STYLE, SIZE, OR COLOR.

SER. NO. 77-512,637, FILED 7-1-2008.

DAWN HAN, EXAMINING ATTORNEY

Int. Cl.: 39

Prior U.S. Cls.: 100 and 105

United States Patent and Trademark Office

Reg. No. 3,575,623

Registered Feb. 17, 2009

**SERVICE MARK
PRINCIPAL REGISTER**

LimoTheme

LIMOTHEME, LLC (FLORIDA LIMITED LIABILITY COMPANY)
4343 KINGSTON LOOP
SARASOTA, FL 34238

THE MARK CONSISTS OF STANDARD CHARACTERS WITHOUT CLAIM TO ANY PARTICULAR FONT, STYLE, SIZE, OR COLOR.

FOR: LIMOUSINE SERVICES, IN CLASS 39 (U.S. CLS. 100 AND 105).

SER. NO. 77-512,641, FILED 7-1-2008.

FIRST USE 6-16-2008; IN COMMERCE 6-16-2008.

DAWN HAN, EXAMINING ATTORNEY

Int. Cl.: 45

Prior U.S. Cls.: 100 and 101

United States Patent and Trademark Office

Reg. No. 3,575,624

Registered Feb. 17, 2009

**SERVICE MARK
PRINCIPAL REGISTER**

Psychic Bartender

SHAUNA BARROW (UNITED STATES INDIVIDUAL)
706 FRONT STREET
LOUISVILLE, CO 80027

FOR: ENTERTAINMENT SERVICES, NAMELY, PROVIDING METAPHYSICAL AND PSYCHIC READINGS IN RETAIL AND NIGHTCLUB ENVIRONMENTS, IN CLASS 45 (U.S. CLS. 100 AND 101).

FIRST USE 6-1-2007; IN COMMERCE 6-1-2007.

THE MARK CONSISTS OF STANDARD CHARACTERS WITHOUT CLAIM TO ANY PARTICULAR FONT, STYLE, SIZE, OR COLOR.

NO CLAIM IS MADE TO THE EXCLUSIVE RIGHT TO USE "PSYCHIC", APART FROM THE MARK AS SHOWN.

SER. NO. 77-512,712, FILED 7-1-2008.

ANDREA BUTLER, EXAMINING ATTORNEY

Int. Cl.: 35

Prior U.S. Cls.: 100, 101 and 102

United States Patent and Trademark Office

Reg. No. 3,575,625

Registered Feb. 17, 2009

**SERVICE MARK
PRINCIPAL REGISTER**



MAGICDUST LLC (ARIZONA LIMITED LIABILITY COMPANY)
9633 SOUTH 48TH STREET, SUITE 185
PHOENIX, AZ 85044

FOR: PROVIDING INFORMATION, NEWS AND COMMENTARY IN THE FIELD OF SHOPPING, IN CLASS 35 (U.S. CLS. 100, 101 AND 102).

FIRST USE 1-31-2008; IN COMMERCE 1-31-2008.

THE MARK CONSISTS OF THE LETTERS "TS" IN A CARTOON BUBBLE ABOVE THE WORD "TALKINGSHOPPING" WITH ALL LETTERS IN A STYLIZED TYPEFACE.

SER. NO. 77-512,925, FILED 7-1-2008.

MICHELLE DUBOIS, EXAMINING ATTORNEY

Int. Cls.: 40 and 42

Prior U.S. Cls.: 100, 101, 103 and 106

United States Patent and Trademark Office

Reg. No. 3,575,626

Registered Feb. 17, 2009

**SERVICE MARK
PRINCIPAL REGISTER**

RANDY TAISHOFF

EDEN DESIGNS LLC (NEW MEXICO LIMITED
LIABILITY COMPANY)
1340 TURQUOISE TRL.
CERRILLOS, NM 87010

FOR: MANUFACTURING SERVICES FOR OTHERS IN THE FIELD OF JEWELRY AND CLOTHING, IN CLASS 40 (U.S. CLS. 100, 103 AND 106).

FIRST USE 1-1-1991; IN COMMERCE 11-1-1993.

FOR: DESIGN FOR OTHERS IN THE FIELD OF JEWELRY AND CLOTHING, IN CLASS 42 (U.S. CLS. 100 AND 101).

FIRST USE 1-1-1991; IN COMMERCE 11-1-1993.

THE MARK CONSISTS OF STANDARD CHARACTERS WITHOUT CLAIM TO ANY PARTICULAR FONT, STYLE, SIZE, OR COLOR.

THE NAME "RANDY TAISHOFF" IDENTIFIES A LIVING INDIVIDUAL WHOSE CONSENT IS OF RECORD.

SER. NO. 77-512,949, FILED 7-1-2008.

MICHELLE DUBOIS, EXAMINING ATTORNEY

Int. Cl.: 11

Prior U.S. Cls.: 13, 21, 23, 31 and 34

United States Patent and Trademark Office

Reg. No. 3,575,627

Registered Feb. 17, 2009

**TRADEMARK
PRINCIPAL REGISTER**

TrapBlaster

FSX EQUIPMENT INC. (WASHINGTON COR-
PORATION)
P.O. BOX 1617
GRANITE FALLS, WA 982521617

THE MARK CONSISTS OF STANDARD CHAR-
ACTERS WITHOUT CLAIM TO ANY PARTICULAR
FONT, STYLE, SIZE, OR COLOR.

FOR: AIR CLEANING UNITS, NAMELY, AIR
CLEANERS FOR EXTRACTING DIESEL PARTICU-
LATE FROM FILTERS USED ON DIESEL EQUIP-
MENT, IN CLASS 11 (U.S. CLS. 13, 21, 23, 31 AND 34).

SER. NO. 77-512,989, FILED 7-1-2008.

FIRST USE 6-5-2008; IN COMMERCE 6-5-2008.

B. PARADEWELAI, EXAMINING ATTORNEY

Int. Cl.: 9

Prior U.S. Cls.: 21, 23, 26, 36 and 38

Reg. No. 3,575,628

United States Patent and Trademark Office

Registered Feb. 17, 2009

TRADEMARK
PRINCIPAL REGISTER

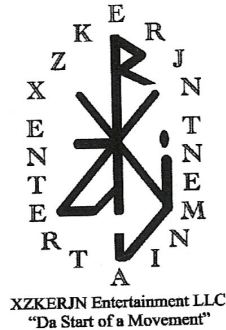

XZKERJN ENTERTAINMENT, LLC (MISSISSIPPI
LIMITED LIABILITY COMPANY)
2590 SNAKE CREEK RD
RAYMOND, MS 39154

FOR: AUDIO AND VIDEO RECORDINGS FEATURING MUSIC FOR ENTERTAINMENT PURPOSES; DIGITAL MEDIA, NAMELY, PRE-RECORDED VIDEO CASSETTES, DIGITAL VIDEO DISCS, DIGITAL VERSATILE DISCS, DOWNLOADABLE AUDIO AND VIDEO RECORDINGS, DVDS, AND HIGH DEFINITION DIGITAL DISKS FEATURING MUSIC FOR ENTERTAINMENT PURPOSES; DOWNLOADABLE AUDIO FILES, MULTIMEDIA FILES, TEXT FILES, E-MAILS, WRITTEN DOCUMENTS, AUDIO MATERIAL, VIDEO MATERIAL AND GAMES FEATURING INFORMATION IN THE FORM OF DOWNLOADABLE SHORT EDUCATIONAL/TRAINING COMMUNICATIONS IN THE FIELD OF HUMAN RESOURCE DEVELOPMENT FOR THE PROMOTION OF EMPLOYEE RETENTION, CAREER GROWTH AND INCREASED PRODUCTIVITY FOR EMPLOYEES AND EMPLOYERS; DOWNLOADABLE MP3 FILES, MP3 RECORDINGS, ON-LINE DISCUSSION BOARDS, WEBCASTS AND PODCASTS FEATURING MUSIC, AUDIO BOOKS AND NEWS BROADCASTS; DOWNLOADABLE MULTIMEDIA FILE CONTAINING ARTWORK, TEXT, AUDIO, VIDEO, GAMES, AND INTERNET WEB LINKS RELATING TO MUSIC FOR ENTER-

TAINMENT PURPOSES; DOWNLOADABLE MUSICAL SOUND RECORDINGS; DOWNLOADABLE RING TONES, GRAPHICS AND MUSIC VIA A GLOBAL COMPUTER NETWORK AND WIRELESS DEVICES; DOWNLOADABLE VIDEO RECORDINGS FEATURING MUSIC FOR ENTERTAINMENT PURPOSES, IN CLASS 9 (U.S. CLS. 21, 23, 26, 36 AND 38).

FIRST USE 1-1-1999; IN COMMERCE 2-2-2005.

NO CLAIM IS MADE TO THE EXCLUSIVE RIGHT TO USE "ENTERTAINMENT" AND "ENTERTAINMENT LLC", APART FROM THE MARK AS SHOWN.

THE MARK CONSISTS OF THE WORDING "XZKERJN ENTERTAINMENT", SURROUNDING AN "X" WITH AN "R" GOING THROUGH IT AT THE TOP, A "Z" AT THE LOWER LEFT, AND A "J" AT THE LOWER RIGHT, ALL MESHED INTO A GENERAL POLYGONAL SHAPE. BELOW THAT IS THE WORDING "XZKERJN ENTERTAINMENT LLC 'DA START OF A MOVEMENT".

SER. NO. 77-513,003, FILED 7-1-2008.

JASON BLAIR, EXAMINING ATTORNEY

Int. Cl.: 41

Prior U.S. Cls.: 100, 101 and 107

United States Patent and Trademark Office

Reg. No. 3,575,629

Registered Feb. 17, 2009

**SERVICE MARK
PRINCIPAL REGISTER**

THE BIG C SOCIETY

THE BIG C SOCIETY (CALIFORNIA CORPORATION)
P.O. BOX 5075
BERKELEY, CA 947055075

FOR: ENCOURAGING INTERCOLLEGIATE ATHLETIC PROGRAMS BY ORGANIZING AND CONDUCTING SOCIAL EVENTS AND ACTIVITIES FOR INTERCOLLEGIATE ATHLETES AND ALUMNI, IN CLASS 41 (U.S. CLS. 100, 101 AND 107).

FIRST USE 2-12-1908; IN COMMERCE 2-12-1908.

THE MARK CONSISTS OF STANDARD CHARACTERS WITHOUT CLAIM TO ANY PARTICULAR FONT, STYLE, SIZE, OR COLOR.

SER. NO. 77-513,005, FILED 7-1-2008.

SANJEEV VOHRA, EXAMINING ATTORNEY

Int. Cl.: 9

Prior U.S. Cls.: 21, 23, 26, 36 and 38

United States Patent and Trademark Office

Reg. No. 3,575,630

Registered Feb. 17, 2009

**TRADEMARK
PRINCIPAL REGISTER**



DAHL, JAMES (UNITED STATES INDIVIDUAL),
DBA GLOBAL DETECTOR
409 IPSWICH ROAD
BOXFORD, MA 01921

FOR: GAMMA RADIATION DETECTOR FOR
ELECTRONIC DETECTION OF HIDDEN CONTRA-
BAND; GAMMA SCINTILLATION DETECTORS;
RADIATION-MEASURING INSTRUMENTS, IN
CLASS 9 (U.S. CLS. 21, 23, 26, 36 AND 38).

FIRST USE 3-10-2008; IN COMMERCE 4-16-2008.

NO CLAIM IS MADE TO THE EXCLUSIVE
RIGHT TO USE "RAD" AND THE RADIATION
SYMBOL, APART FROM THE MARK AS SHOWN.

THE COLOR(S) YELLOW, BLACK IS/ARE
CLAIMED AS A FEATURE OF THE MARK.

THE MARK CONSISTS OF THE WORDS "RAD
SAFE" IN POWDERWORKS BRK FONT TO THE
LEFT AND RIGHT OF THE RADIATION SYMBOL,
WITH "RAD" IN BLACK, "SAFE" IN YELLOW, AND
THE RADIATION SYMBOL IN YELLOW AND
BLACK.

SER. NO. 77-513,055, FILED 7-2-2008.

KATHY DE JONGE, EXAMINING ATTORNEY

Prior U.S. Cl.: B

United States Patent and Trademark Office

Reg. No. 3,575,631

Registered Feb. 17, 2009

**CERTIFICATION MARK
PRINCIPAL REGISTER**

CERTIFIED CULINARIAN

AMERICAN CULINARY FEDERATION (NEW
YORK CORPORATION)
180 CENTER PLACE WAY
ST. AUGUSTINE, FL 32095

FOR: COOKING SERVICES, IN CLASS B (U.S. CL.
B).

FIRST USE 0-0-1975; IN COMMERCE 0-0-1975.

THE MARK CONSISTS OF STANDARD CHAR-
ACTERS WITHOUT CLAIM TO ANY PARTICULAR
FONT, STYLE, SIZE, OR COLOR.

THE CERTIFICATION MARK, AS USED BY
AUTHORIZED PERSONS, CERTIFIES THAT THE
PERSON USING THE MARK IS A PROFESSIONAL
COOK WHO HAS DEMONSTRATED BASIC
KNOWLEDGE AND SKILLS PERTAINING TO PRO-
FESSIONAL COOKING AS DETERMINED BY A

TEST OF CULINARY SKILL AND KNOWLEDGE
DEMONSTRATED BY MEETING THE GRADUA-
TION REQUIREMENTS OF AN ACCREDITED COL-
LEGE GRANTING A TWO YEAR DEGREE IN
CULINARY ARTS OR HIGHER, GRADUATING
FROM A FORMAL CULINARY APPRENTICESHIP
TRAINING PROGRAM, OR BY DOCUMENTING A
MINIMUM OF A HIGH SCHOOL EDUCATION (12
YEARS) PLUS 3 YEARS EXPERIENCE AS A PRO-
FESSIONAL COOK AND PASSING A CERTIFICA-
TION KNOWLEDGE AND SKILL PROFICIENCY
TESTS ESTABLISHED FOR THE CERTIFICATION
LEVEL.

SEC. 2(F).

SER. NO. 77-513,128, FILED 7-2-2008.

MICHAEL KEATING, EXAMINING ATTORNEY

Int. Cl.: 4

Prior U.S. Cls.: 1, 6 and 15

United States Patent and Trademark Office

Reg. No. 3,575,632

Registered Feb. 17, 2009

**TRADEMARK
PRINCIPAL REGISTER**

LOKKII

GREAT HARBOUR HOLDINGS COMPANY LIM-
ITED (HONG KONG CORPORATION)
228 QUEENS ROAD, EAST
JONSIM PLACE 3RD FLOOR
WANCHAI, HONG KONG

FOR: COMBUSTIBLE BRIQUETTES, IN CLASS 4
(U.S. CLS. 1, 6 AND 15).

FIRST USE 5-0-2007; IN COMMERCE 5-0-2007.

THE MARK CONSISTS OF STANDARD CHAR-
ACTERS WITHOUT CLAIM TO ANY PARTICULAR
FONT, STYLE, SIZE, OR COLOR.

THE FOREIGN WORDING IN THE MARK
TRANSLATES INTO ENGLISH AS A ROUGH IN-
TERPRETATION OF THE NORSE GOD LOKI.

SER. NO. 77-513,137, FILED 7-2-2008.

BRENDAN MCCAULEY, EXAMINING ATTORNEY

Int. Cl.: 9

Prior U.S. Cls.: 21, 23, 26, 36 and 38

Reg. No. 3,575,633

United States Patent and Trademark Office

Registered Feb. 17, 2009

**TRADEMARK
PRINCIPAL REGISTER**

TAO OF CACAO

ARTISAN CONFECTIONS COMPANY (CALI-
FORNIA CORPORATION)
LAW DEPT.
100 CRYSTAL A DRIVE
HERSHEY, PA 17033

THE MARK CONSISTS OF STANDARD CHAR-
ACTERS WITHOUT CLAIM TO ANY PARTICULAR
FONT, STYLE, SIZE, OR COLOR.

FOR: DOWNLOADABLE ELECTRONIC NEWS-
LETTERS IN THE FIELD OF CHOCOLATE, IN
CLASS 9 (U.S. CLS. 21, 23, 26, 36 AND 38).

SER. NO. 77-513,166, FILED 7-2-2008.

FIRST USE 10-31-2005; IN COMMERCE 10-31-2005.

ROSELLE HERRERA, EXAMINING ATTORNEY

Prior U.S. Cl.: B

United States Patent and Trademark Office

Reg. No. 3,575,634

Registered Feb. 17, 2009

**CERTIFICATION MARK
PRINCIPAL REGISTER**

CERTIFIED CHEF DE CUISINE

AMERICAN CULINARY FEDERATION (NEW
YORK CORPORATION)
180 CENTER PLACE WAY
ST. AUGUSTINE, FL 32095

FOR: COOKING SERVICES, IN CLASS B (U.S. CL.
B).

FIRST USE 0-0-1999; IN COMMERCE 0-0-1999.

THE MARK CONSISTS OF STANDARD CHAR-
ACTERS WITHOUT CLAIM TO ANY PARTICULAR
FONT, STYLE, SIZE, OR COLOR.

THE ENGLISH TRANSLATION OF THE WORD
"CHEF DU CUISINE" IN THE MARK IS "KITCHEN
CHEF".

THE CERTIFICATION MARK, AS USED BY
AUTHORIZED PERSONS, CERTIFIES THE USER
OF THE MARK IS A PROFESSIONAL CHEF WHO

HAS DEMONSTRATED ADVANCED KNOWL-
EDGE AND SKILLS PERTAINING TO PROFES-
SIONAL COOKING AND SUPERVISION AS
DETERMINED BY A TEST OF CULINARY SKILL
AND KNOWLEDGE AUTHORIZED BY THE CER-
TIFIER. THE SKILL AND KNOWLEDGE CAN BE
DOCUMENTED BY BEING SUCCESSFULLY EM-
PLOYED FOR A MINIMUM OF THREE YEARS AS
A SOUS CHEF, OR KITCHEN MANAGER AND BY
PASSING CERTIFICATION KNOWLEDGE AND
SKILL PROFICIENCY TESTS ESTABLISHED BY
THE CERTIFIER FOR THE CERTIFICATION LE-
VEL.

SEC. 2(F).

SER. NO. 77-513,178, FILED 7-2-2008.

MICHAEL KEATING, EXAMINING ATTORNEY

Prior U.S. Cl.: B

United States Patent and Trademark Office

Reg. No. 3,575,635

Registered Feb. 17, 2009

**CERTIFICATION MARK
PRINCIPAL REGISTER**

CERTIFIED EXECUTIVE CHEF

AMERICAN CULINARY FEDERATION (NEW
YORK CORPORATION)
180 CENTER PLACE WAY
ST. AUGUSTINE, FL 32095

FOR: COOKING SERVICES, IN CLASS B (U.S. CL.
B).

FIRST USE 0-0-1975; IN COMMERCE 0-0-1975.

THE MARK CONSISTS OF STANDARD CHAR-
ACTERS WITHOUT CLAIM TO ANY PARTICULAR
FONT, STYLE, SIZE, OR COLOR.

THE CERTIFICATION MARK, AS USED BY
AUTHORIZED PERSONS, CERTIFIES THAT THE
PERSON IS A PROFESSIONAL CHEF WHO HAS
DEMONSTRATED ADVANCED KNOWLEDGE

AND SKILLS PERTAINING TO PROFESSIONAL
COOKING AND SUPERVISION AS DETERMINED
BY A TEST OF CULINARY SKILL AND KNOWL-
EDGE AUTHORIZED BY THE CERTIFIER. THIS
CAN BE DOCUMENTED BY BEING SUCCESSFUL-
LY EMPLOYED FOR A MINIMUM OF THREE
YEARS AS A SOUS CHEF, EXECUTIVE SOUS CHEF
OR KITCHEN MANAGER AND BY PASSING THE
CERTIFICATION KNOWLEDGE AND SKILL PRO-
FICIENCY TESTS ESTABLISHED FOR THE CERTI-
FICATION LEVEL.

SEC. 2(F).

SER. NO. 77-513,196, FILED 7-2-2008.

MICHAEL KEATING, EXAMINING ATTORNEY

Int. Cl.: 44

Prior U.S. Cls.: 100 and 101

United States Patent and Trademark Office

Reg. No. 3,575,636

Registered Feb. 17, 2009

**SERVICE MARK
PRINCIPAL REGISTER**

Better Balance, Better Life

PHYSICAL TBERAPY IN YOUR HOME, INC.
(FLORIDA CORPORATION)
SUITE 101
7200 WEST CAMINO REAL
BOCA RATON, FL 33433

THE MARK CONSISTS OF STANDARD CHAR-
ACTERS WITHOUT CLAIM TO ANY PARTICULAR
FONT, STYLE, SIZE, OR COLOR.

FOR: COUNSELING SERVICES IN THE FIELDS
OF HEALTH, NUTRITION AND LIFESTYLE WELL-
NESS, IN CLASS 44 (U.S. CLS. 100 AND 101).

SER. NO. 77-513,198, FILED 7-2-2008.

FIRST USE 7-25-2007; IN COMMERCE 7-25-2007.

THEODORE MCBRIDE, EXAMINING ATTORNEY

Int. Cl.: 35

Prior U.S. Cls.: 100, 101 and 102

United States Patent and Trademark Office

Reg. No. 3,575,637

Registered Feb. 17, 2009

**SERVICE MARK
PRINCIPAL REGISTER**

**STAPLES PROMOTIONAL
PRODUCTS**

STAPLES THE OFFICE SUPERSTORE, LLC. (DE-
LAWARE LIMITED LIABILITY COMPANY)
500 STAPLES DRIVE
FRAMINGHAM, MA 01702

FOR: ONLINE RETAIL STORE SERVICES AND
MAIL ORDER CATALOG SERVICES FEATURING
PROMOTIONAL GENERAL MERCHANDISE AND
GENERAL CONSUMER GOODS WITH COMPANY
BRAND LOGOS AND TAG LINES TO THE ORDER
AND SPECIFICATION OF THE CUSTOMER; COM-
PUTERIZED ONLINE ORDERING FEATURING
BUSINESS PROMOTIONAL GENERAL MERCHAN-
DISE AND GENERAL CONSUMER GOODS WITH
COMPANY BRAND LOGOS AND TAG LINES TO
THE ORDER AND SPECIFICATION OF THE CUS-
TOMER; PROMOTING THE SALE OF GOODS AND
SERVICES OF OTHERS THROUGH THE CUSTOM
PREPARATION OF SPECIALTY APPAREL, PRO-

MOTIONAL ITEMS AND INCENTIVE MERCHAN-
DISE, IN CLASS 35 (U.S. CLS. 100, 101 AND 102).

FIRST USE 3-0-2008; IN COMMERCE 3-0-2008.

THE MARK CONSISTS OF STANDARD CHAR-
ACTERS WITHOUT CLAIM TO ANY PARTICULAR
FONT, STYLE, SIZE, OR COLOR.

NO CLAIM IS MADE TO THE EXCLUSIVE
RIGHT TO USE "PROMOTIONAL PRODUCTS",
APART FROM THE MARK AS SHOWN.

SER. NO. 77-513,199, FILED 7-2-2008.

KARANENDRA S. CHHINA, EXAMINING ATTOR-
NEY

Int. Cl.: 35

Prior U.S. Cls.: 100, 101 and 102

United States Patent and Trademark Office

Reg. No. 3,575,638

Registered Feb. 17, 2009

**SERVICE MARK
PRINCIPAL REGISTER**



STAPLES THE OFFICE SUPERSTORE, LLC. (DE-
LAWARE LIMITED LIABILITY COMPANY)
500 STAPLES DRIVE
FRAMINGHAM, MA 01702

FOR: ONLINE RETAIL STORE SERVICES AND
MAIL ORDER CATALOG SERVICES FEATURING
PROMOTIONAL GENERAL MERCHANDISE AND
GENERAL CONSUMER GOODS WITH COMPANY
BRAND LOGOS AND TAG LINES TO THE ORDER
AND SPECIFICATION OF THE CUSTOMER; COM-
PUTERIZED ONLINE ORDERING FEATURING
BUSINESS PROMOTIONAL GENERAL MERCHAN-
DISE AND GENERAL CONSUMER GOODS WITH
COMPANY BRAND LOGOS AND TAG LINES TO
THE ORDER AND SPECIFICATION OF THE CUS-
TOMER; PROMOTING THE SALE OF GOODS AND
SERVICES OF OTHERS THROUGH THE CUSTOM
PREPARATION OF SPECIALTY APPAREL, PRO-

MOTIONAL ITEMS AND INCENTIVE MERCHAN-
DISE, IN CLASS 35 (U.S. CLS. 100, 101 AND 102).

FIRST USE 3-0-2008; IN COMMERCE 3-0-2008.

NO CLAIM IS MADE TO THE EXCLUSIVE
RIGHT TO USE "PROMOTIONAL PRODUCTS",
APART FROM THE MARK AS SHOWN.

THE MARK CONSISTS OF A STYLIZED STAPLES
WITHIN A RECTANGULAR BOX TO THE LEFT OF
THE WORDING PROMOTIONAL PRODUCTS.

SER. NO. 77-513,200, FILED 7-2-2008.

KARANENDRA S. CHHINA, EXAMINING ATTOR-
NEY

Int. Cl.: 16

Prior U.S. Cls.: 2, 5, 22, 23, 29, 37, 38 and 50

United States Patent and Trademark Office

Reg. No. 3,575,639

Registered Feb. 17, 2009

TRADEMARK
PRINCIPAL REGISTER



SHARON SPANGLER (UNITED STATES INDIVIDUAL)
370 SKULLEY DRIVE
ALPHARETTA, GA 30004

THE MARK CONSISTS OF THE WORDS "HERE 'N AFTER" ARCHED OVER A DECORATIVE SYMBOL.

FOR: BEREAVEMENT CARDS FOR THE DECEASED, IN CLASS 16 (U.S. CLS. 2, 5, 22, 23, 29, 37, 38 AND 50).

SER. NO. 77-513,222, FILED 7-2-2008.

FIRST USE 6-18-2008; IN COMMERCE 6-18-2008.

ANNE MADDEN, EXAMINING ATTORNEY

Prior U.S. Cl.: B

United States Patent and Trademark Office

Reg. No. 3,575,640

Registered Feb. 17, 2009

**CERTIFICATION MARK
PRINCIPAL REGISTER**

CERTIFIED MASTER CHEF

AMERICAN CULINARY FEDERATION (NEW YORK CORPORATION)
180 CENTER PLACE WAY
ST. AUGUSTINE, FL 32095

FOR: COOKING SERVICES, IN CLASS B (U.S. CL. B).

FIRST USE 0-0-1981; IN COMMERCE 0-0-1981.

THE MARK CONSISTS OF STANDARD CHARACTERS WITHOUT CLAIM TO ANY PARTICULAR FONT, STYLE, SIZE, OR COLOR.

THE CERTIFICATION MARK, AS USED BY AUTHORIZED PERSONS, CERTIFIES THAT THE PERSON IS A PROFESSIONAL CHEF WHO HAS DEMONSTRATED ADVANCED KNOWLEDGE

AND SKILLS PERTAINING TO PROFESSIONAL COOKING AND SUPERVISION AS DETERMINED BY A TEST OF CULINARY SKILL AND KNOWLEDGE AUTHORIZED BY THE CERTIFIER. THIS CAN BE DOCUMENTED BY BEING SUCCESSFULLY EMPLOYED FOR A MINIMUM OF TWO YEARS AS AN EXECUTIVE CHEF OR KITCHEN MANAGER AND BY PASSING THE CERTIFICATION KNOWLEDGE AND SKILL PROFICIENCY TESTS ESTABLISHED FOR THE CERTIFICATION LEVEL.

SEC. 2(F).

SER. NO. 77-513,231, FILED 7-2-2008.

KIMBERLY PERRY, EXAMINING ATTORNEY

Prior U.S. Cl.: B

United States Patent and Trademark Office

Reg. No. 3,575,641

Registered Feb. 17, 2009

**CERTIFICATION MARK
PRINCIPAL REGISTER**

CERTIFIED PASTRY CULINARIAN

AMERICAN CULINARY FEDERATION (NEW YORK CORPORATION)
180 CENTER PLACE WAY
ST. AUGUSTINE, FL 32095

FOR: COOKING SERVICES, IN CLASS B (U.S. CL. B).

FIRST USE 0-0-1999; IN COMMERCE 0-0-1999.

THE MARK CONSISTS OF STANDARD CHARACTERS WITHOUT CLAIM TO ANY PARTICULAR FONT, STYLE, SIZE, OR COLOR.

THE CERTIFICATION MARK, AS USED BY AUTHORIZED PERSONS, CERTIFIES THAT THE PERSON IS A PROFESSIONAL BAKER OR PASTRY HELPER WHO HAS DEMONSTRATED BASIC KNOWLEDGE AND SKILLS PERTAINING TO PROFESSIONAL BAKING AND PASTRIES AS DETERMINED BY A TEST OF BAKING SKILL AND

KNOWLEDGE AUTHORIZED BY THE CERTIFIER. THIS CAN BE DOCUMENTED BY MEETING THE GRADUATION REQUIREMENTS OF AN ACCREDITED COLLEGE GRANTING A TWO YEAR DEGREE IN BAKING AND PASTRY OR HIGHER, GRADUATING FROM A FORMAL BAKING APRENTICESHIP TRAINING PROGRAM, OR BY DOCUMENTING A MINIMUM OF A HIGH SCHOOL EDUCATION PLUS THREE YEARS EXPERIENCE AS A PROFESSIONAL BAKER OR PASTRY WORKER AND PASSING THE CERTIFICATION KNOWLEDGE AND SKILL PROFICIENCY TESTS ESTABLISHED FOR THE CERTIFICATION LEVEL.

SEC. 2(F).

SER. NO. 77-513,246, FILED 7-2-2008.

KIMBERLY PERRY, EXAMINING ATTORNEY

Prior U.S. Cl.: B

United States Patent and Trademark Office

Reg. No. 3,575,642

Registered Feb. 17, 2009

**CERTIFICATION MARK
PRINCIPAL REGISTER**

**CERTIFIED EXECUTIVE PASTRY
CHEF**

AMERICAN CULINARY FEDERATION (NEW
YORK CORPORATION)
180 CENTER PLACE WAY
ST. AUGUSTINE, FL 32095

FOR: COOKING SERVICES, IN CLASS B (U.S. CL.
B).

FIRST USE 0-0-1999; IN COMMERCE 0-0-1999.

THE MARK CONSISTS OF STANDARD CHAR-
ACTERS WITHOUT CLAIM TO ANY PARTICULAR
FONT, STYLE, SIZE, OR COLOR.

THE CERTIFICATION MARK, AS USED BY
AUTHORIZED PERSONS, CERTIFIES THAT THE
PERSON IS A PROFESSIONAL PASTRY CHEF WHO
HAS DEMONSTRATED ADVANCED KNOWL-

EDGE AND SKILLS PERTAINING TO PROFES-
SIONAL BAKING AND PASTRY AND
SUPERVISION AS DETERMINED BY A TEST OF
BAKING AND PASTRY SKILL AND KNOWLEDGE
AUTHORIZED BY THE CERTIFIER. THIS CAN BE
DOCUMENTED BY BEING SUCCESSFULLY EM-
PLOYED FOR A MINIMUM OF THREE YEARS AS
A PASTRY CHEF AND BY PASSING THE CERTIFI-
CATION KNOWLEDGE AND SKILL PROFICIENCY
TESTS ESTABLISHED FOR THE CERTIFICATION
LEVEL.

SEC. 2(F).

SER. NO. 77-513,270, FILED 7-2-2008.

KIMBERLY PERRY, EXAMINING ATTORNEY

Int. Cl.: 9

Prior U.S. Cls.: 21, 23, 26, 36 and 38

United States Patent and Trademark Office

Reg. No. 3,575,643

Registered Feb. 17, 2009

**TRADEMARK
PRINCIPAL REGISTER**

SmartCrop

ACCENT ENGINEERING, INC. (TEXAS CORPORATION)
5738 82ND STREET - SUITE A
LUBBOCK, TX 79424

FOR: COMPUTER HARDWARE AND SOFTWARE SYSTEM FOR REMOTELY MONITORING ENVIRONMENTAL CONDITIONS AND CONTROLLING DEVICES WITHIN A BUILDING, FACILITY, GROUNDS, OR DESIGNATED SPATIAL AREA; ELECTRONIC PLANT MOISTURE SENSOR; ENVIRONMENTAL MONITORING SYSTEM COMPRISED OF METERS AND SENSORS THAT MEASURE PRESSURE, HUMIDITY, TEMPERATURE AND INCLUDES ALARM AND REPORTING FUNCTIONS; SOFTWARE FOR MONITORING AND CONTROLLING COMMUNICATION BETWEEN COMPUTERS AND AUTOMATED MACHINE SYSTEMS; WIRELESS CONTROLLER TO MONITOR AND CONTROL THE FUNCTIONING

OF OTHER ELECTRONIC DEVICES, IN CLASS 9 (U.S. CLS. 21, 23, 26, 36 AND 38).

FIRST USE 6-1-2007; IN COMMERCE 12-1-2007.

THE COLOR(S) GREEN IS/ARE CLAIMED AS A FEATURE OF THE MARK.

THE MARK CONSISTS OF GREEN, STYLIZED TEXT WITH A PLANT LEAF AS PART OF THE LETTER "R" IN TWO LOCATIONS, WITH THE LETTERS "S" AND "C" CAPITALIZED, AND WITH ALL OTHER LETTERS AS LOWER CASE LETTERS.

SER. NO. 77-513,305, FILED 7-2-2008.

LINDA POWELL, EXAMINING ATTORNEY

Prior U.S. Cl.: B

United States Patent and Trademark Office

Reg. No. 3,575,644

Registered Feb. 17, 2009

**CERTIFICATION MARK
PRINCIPAL REGISTER**

**CERTIFIED MASTER PASTRY
CHEF**

AMERICAN CULINARY FEDERATION (NEW
YORK CORPORATION)
180 CENTER PLACE WAY
ST. AUGUSTINE, FL 32095

FOR: COOKING SERVICES, IN CLASS B (U.S. CL.
B).

FIRST USE 0-0-1993; IN COMMERCE 0-0-1993.

THE MARK CONSISTS OF STANDARD CHAR-
ACTERS WITHOUT CLAIM TO ANY PARTICULAR
FONT, STYLE, SIZE, OR COLOR.

THE CERTIFICATION MARK, AS USED BY
AUTHORIZED PERSONS, CERTIFIES THAT THE
PERSON IS A PROFESSIONAL PASTRY CHEF WHO
HAS DEMONSTRATED ADVANCED KNOWL-

EDGE AND SKILLS PERTAINING TO PROFES-
SIONAL BAKING AND PASTRY AND
SUPERVISION AS DETERMINED BY A TEST OF
CULINARY SKILL AND KNOWLEDGE AUTHOR-
IZED BY THE CERTIFIER. THIS CAN BE DOCU-
MENTED BY BEING SUCCESSFULLY EMPLOYED
FOR A MINIMUM OF TWO YEARS AS AN EXECU-
TIVE PASTRY CHEF OR PASTRY DEPARTMENT
HEAD AND BY PASSING THE CERTIFICATION
KNOWLEDGE AND SKILL PROFICIENCY TESTS
ESTABLISHED FOR THE CERTIFICATION LEVEL.

SEC. 2(F).

SER. NO. 77-513,313, FILED 7-2-2008.

KIMBERLY PERRY, EXAMINING ATTORNEY

Int. Cl.: 36

Prior U.S. Cls.: 100, 101 and 102

United States Patent and Trademark Office

Reg. No. 3,575,645

Registered Feb. 17, 2009

**SERVICE MARK
PRINCIPAL REGISTER**



BANCINSURE, INC. (OKLAHOMA CORPORATION)
5005 NORTH LINCOLN BOULEVARD
OKLAHOMA CITY, OK 73105

FOR: INSURANCE SERVICES, NAMELY, WRITING PROPERTY AND CASUALTY INSURANCE, IN CLASS 36 (U.S. CLS. 100, 101 AND 102).

FIRST USE 6-1-2008; IN COMMERCE 6-1-2008.

THE COLOR(S) RED, BLUE, AND GRAY IS/ARE CLAIMED AS A FEATURE OF THE MARK.

THE MARK CONSISTS OF THE STYLIZED WORD "BUILDERSEGE", "BUILDERS" IN BLUE AND "EDGE" IN GRAY, WITH A STYLIZED ROOF-LINE IN RED AND BLUE ATOP.

SER. NO. 77-513,335, FILED 7-2-2008.

VIVIAN MICZNIK FIRST, EXAMINING ATTORNEY

Int. Cl.: 43

Prior U.S. Cls.: 100 and 101

United States Patent and Trademark Office

Reg. No. 3,575,646

Registered Feb. 17, 2009

**SERVICE MARK
PRINCIPAL REGISTER**

FIVE STAR CLUB

EISENHOWER MEDICAL CENTER (CALIFORNIA CORPORATION)
39000 BOB HOPE DRIVE
RANCHO MIRAGE, CA 92270

FOR: ADULT DAY CARE CENTERS FOR THE ELDERLY AND INFIRM, IN CLASS 43 (U.S. CLS. 100 AND 101).

FIRST USE 1-31-1989; IN COMMERCE 1-31-1989.

THE MARK CONSISTS OF STANDARD CHARACTERS WITHOUT CLAIM TO ANY PARTICULAR FONT, STYLE, SIZE, OR COLOR.

NO CLAIM IS MADE TO THE EXCLUSIVE RIGHT TO USE "CLUB", APART FROM THE MARK AS SHOWN.

SER. NO. 77-513,373, FILED 7-2-2008.

GEOFFREY FOSDICK, EXAMINING ATTORNEY

Int. Cl.: 21

Prior U.S. Cls.: 2, 13, 23, 29, 30, 33, 40 and 50

Reg. No. 3,575,647

United States Patent and Trademark Office

Registered Feb. 17, 2009

**TRADEMARK
PRINCIPAL REGISTER**

PURE

LENTRADE, INC. (TEXAS CORPORATION), DBA
CHANTAL CORP.
5425 NORTH SAM HOUSTON PARKWAY WEST
HOUSTON, TX 77086

FOR: HOUSEHOLD OR KITCHEN UTENSILS
AND CONTAINERS, NAMELY, CERAMIC PIE
DISHES, SQUARE OR RECTANGULAR BAKING
DISHES, AND CASSEROLE DISHES NOT OF PRE-
CIOUS METAL; TABLEWARE, NAMELY, PLATES,
SAUCERS AND OTHER DISHES, SERVING TRAYS
NOT OF PRECIOUS METAL, CERAMIC PITCHERS,
BOWLS, TEA POTS, MUGS, TEA INFUSERS NOT OF
PRECIOUS METAL, SUGAR BOWLS NOT OF PRE-
CIOUS METAL; KITCHEN COOKWARE, NAMELY,

METAL TEA KETTLES, POTS, CASSEROLES, AND
LIDS FOR POTS AND PANS, IN CLASS 21 (U.S. CLS.
2, 13, 23, 29, 30, 33, 40 AND 50).

FIRST USE 11-19-2007; IN COMMERCE 12-5-2007.

THE MARK CONSISTS OF STANDARD CHAR-
ACTERS WITHOUT CLAIM TO ANY PARTICULAR
FONT, STYLE, SIZE, OR COLOR.

SER. NO. 77-513,378, FILED 7-2-2008.

JIM RINGLE, EXAMINING ATTORNEY

Int. Cls.: 35 and 36

Prior U.S. Cls.: 100, 101 and 102

United States Patent and Trademark Office

Reg. No. 3,575,648

Registered Feb. 17, 2009

**SERVICE MARK
PRINCIPAL REGISTER**



WCS LENDING, LLC (FLORIDA LIMITED LIABILITY COMPANY)
6501 CONGRESS AVENUE, 3RD FLOOR
BOCA RATON, FL 33487

FOR: MATCHING BORROWERS WITH POTENTIAL LENDERS IN THE FIELD OF CONSUMER AND MORTGAGE LENDING, IN CLASS 35 (U.S. CLS. 100, 101 AND 102).

FIRST USE 6-1-2008; IN COMMERCE 6-1-2008.

FOR: FINANCIAL SERVICES, NAMELY, THE PURCHASE OF RESIDENTIAL MORTGAGES ON BEHALF OF OTHERS AND THE ISSUANCE OF MORTGAGE-BACKED SECURITIES; MORTGAGE BANKING; MORTGAGE BANKING SERVICES, NAMELY, ORIGINATION, ACQUISITION, SERVICING, SECURITIZATION AND BROKERAGE OF MORTGAGE LOANS; MORTGAGE BROKERAGE; MORTGAGE LENDING; MORTGAGE PROCUREMENT FOR OTHERS; MORTGAGE SERVICES, NAMELY, BUYER PRE-QUALIFICATION OF

MORTGAGES FOR MORTGAGE BROKERS AND BANKS, IN CLASS 36 (U.S. CLS. 100, 101 AND 102).

FIRST USE 6-1-2008; IN COMMERCE 6-1-2008.

OWNER OF U.S. REG. NO. 3,380,228.

NO CLAIM IS MADE TO THE EXCLUSIVE RIGHT TO USE "LENDING" AND "MORTGAGES", APART FROM THE MARK AS SHOWN.

THE MARK CONSISTS OF AN IMAGE OF A STAR WITH FOUR POINTS ON THE LEFT SIDE; THE WORDING "WCS LENDING" APPEARS TO THE RIGHT OF THE DESIGN AND ABOVE THE WORDING "MORTGAGES MADE EASIER".

SER. NO. 77-513,403, FILED 7-2-2008.

KATHERINE E. HALMEN, EXAMINING ATTORNEY

Int. Cl.: 35

Prior U.S. Cls.: 100, 101 and 102

United States Patent and Trademark Office

Reg. No. 3,575,649

Registered Feb. 17, 2009

**SERVICE MARK
PRINCIPAL REGISTER**

**Range Forward: Risk
Management**

M. WELLES & ASSOCIATES, INC. (ILLINOIS
CORPORATION)
446 N. WELLS ST. SUITE 103
CHICAGO, IL 60654

FOR: ADVISORY SERVICES RELATING TO
BUSINESS MANAGEMENT AND BUSINESS OP-
ERATIONS, IN CLASS 35 (U.S. CLS. 100, 101 AND
102).

FIRST USE 5-20-2008; IN COMMERCE 7-2-2008.

THE MARK CONSISTS OF STANDARD CHAR-
ACTERS WITHOUT CLAIM TO ANY PARTICULAR
FONT, STYLE, SIZE, OR COLOR.

NO CLAIM IS MADE TO THE EXCLUSIVE
RIGHT TO USE "RISK MANAGEMENT", APART
FROM THE MARK AS SHOWN.

SER. NO. 77-513,404, FILED 7-2-2008.

HAI-LY LAM, EXAMINING ATTORNEY

Int. Cl.: 9

Prior U.S. Cls.: 21, 23, 26, 36 and 38

United States Patent and Trademark Office

Reg. No. 3,575,650

Registered Feb. 17, 2009

**TRADEMARK
PRINCIPAL REGISTER**

OMANO

THE MICROSCOPE STORE, LLC (CONNECTI-
CUT LIMITED LIABILITY COMPANY)
7195 BOOKER T WASHINGTON HIGHWAY
WIRTZ, VA 24184

FOR: MICROSCOPES AND THEIR PARTS; MI-
CROSCOPE CAMERAS; MICROSCOPE ACCESSOR-
IES, NAMELY, EYEPIECES, MAGNIFYING
LENSES, OPTICAL FILTERS, SLIDES, ALUMINUM
CASES, MICROSCOPE OBJECTIVES IN THE NAT-
URE OF OPTICAL LENSES AND MICROSCOPE
STANDS; BINOCULARS AND ACCESSORIES
THEREFOR, NAMELY, CASES, IN CLASS 9 (U.S.
CLS. 21, 23, 26, 36 AND 38).

FIRST USE 6-0-2003; IN COMMERCE 6-0-2003.

THE MARK CONSISTS OF STANDARD CHAR-
ACTERS WITHOUT CLAIM TO ANY PARTICULAR
FONT, STYLE, SIZE, OR COLOR.

OWNER OF U.S. REG. NO. 3,120,113.

SER. NO. 77-513,408, FILED 7-2-2008.

KATHERINE E. HALMEN, EXAMINING ATTOR-
NEY

Int. Cl.: 35

Prior U.S. Cls.: 100, 101 and 102

United States Patent and Trademark Office

Reg. No. 3,575,651

Registered Feb. 17, 2009

**SERVICE MARK
PRINCIPAL REGISTER**

HI-BRID INSIGHTS

HARRIS INTERACTIVE, INC. (DELAWARE
CORPORATION)
60 CORPORATE WOODS
ROCHESTER, NY 146231457

FOR: MARKET RESEARCH AND SURVEY SER-
VICES; PROVIDING A WEB SITE TO CONDUCT
QUALITATIVE AND QUANTITATIVE MARKET
RESEARCH FOR BUSINESS CLIENTS, IN CLASS
35 (U.S. CLS. 100, 101 AND 102).

FIRST USE 1-25-2008; IN COMMERCE 1-25-2008.

THE MARK CONSISTS OF STANDARD CHAR-
ACTERS WITHOUT CLAIM TO ANY PARTICULAR
FONT, STYLE, SIZE, OR COLOR.

SER. NO. 77-513,464, FILED 7-2-2008.

LAURA KOVALSKY, EXAMINING ATTORNEY

Int. Cl.: 3

Prior U.S. Cls.: 1, 4, 6, 50, 51 and 52

Reg. No. 3,575,652

United States Patent and Trademark Office

Registered Feb. 17, 2009

TRADEMARK
PRINCIPAL REGISTER

sefidé

SEFIDE ROU LLC (NEW YORK LIMITED LIABILITY COMPANY)

170 EAST 61ST STREET, FLOOR 2
NEW YORK, NY 10065

FOR: 3-IN-1 HAIR CONDITIONERS; 3-IN-1 HAIR SHAMPOOS; AFTER SUN CREAMS; AFTER-SUN GELS; AFTER-SUN LOTIONS; AFTER-SUN MILKS; AFTER-SUN OILS; ALMOND SOAPS; ANTIBACTERIAL SKIN SOAPS; ANTIBACTERIAL SOAP; AROMATHERAPY BODY CARE PRODUCTS, NAMELY, BODY LOTION, SHOWER GEL, CUTICLE CREAM, SHAMPOO, CONDITIONER, NON-MEDICATED LIP BALM, SOAP, BODY POLISH, BODY AND FOOT SCRUB AND NON-MEDICATED FOOT CREAM; AROMATHERAPY PILLOWS THAT MAY BE USED TO FRESHEN CLOTHING OR LAY OVER THE EYES; BABY SHAMPOO; BAR SOAP; BATH SOAPS; BATH SOAPS IN LIQUID, SOLID OR GEL FORM; BLUSH PENCILS; BODY AND BEAUTY CARE COSMETICS; BODY CREAM SOAP; BODY DEODORANTS; CAKES OF TOILET SOAP; CONCEALERS FOR SKIN; COSMETIC PENCILS; COSMETIC PREPARATIONS FOR EYE LASHES; COSMETIC ROUGES; COSMETIC SOAPS; COSMETIC SUN-PROTECTING PREPARATIONS; COSMETIC SUN-TANNING PREPARATIONS; COSMETICS, NAMELY, LIP PRIMER; COSMETICS, NAMELY, LIP REPAIRERS; CREAM SOAPS; CREAMY ROUGES; CUTICLE REMOVING PREPARATIONS; DEODORANT SOAP; DEODORANTS FOR PERSONAL USE; DEPILATORY WAX; DETERGENT SOAP; DISINFECTANT SOAPS; DISINFECTING PERFUMED SOAPS; EXFOLIANT CREAMS; EXFOLIANTS FOR SKIN; EYE COMPRESSES FOR COSMETIC PURPOSES; EYE CREAM; EYE GELS; EYE LINER; EYE LOTIONS; EYE MAKE-UP; EYE MAKE-UP REMOVER; EYE PENCILS; EYE SHADOW; EYEBROW PENCILS; EYELINER PENCILS; EYES MAKE-UP; FACE AND BODY BEAUTY CREAMS; FACIAL CLEANSERS; FACIAL CONCEALER; FACIAL

MAKE-UP; FOAMS CONTAINING COSMETICS AND SUNSCREENS; FOUNDATION MAKE-UP; FRAGRANCES AND PERFUMERY; GEL EYE MASKS; GRANULATED SOAPS; HAIR MASCARA; HAIR RINSES; HAIR SHAMPOOS AND CONDITIONERS; HAIR STYLING FIXATIVE IN THE NATURE OF HAIR WAX; HAIR STYLING GEL; HAIR STYLING PREPARATIONS; HAIR STYLING SPRAY; HAIR WAX; HAND SOAPS; INDUSTRIAL SOAP; LAUNDRY SOAP; LIP BALM; LIP BALM; LIP CREAM; LIP GLOSS; LIP GLOSS PALATTE; LIP LINER; LIP POLISHER; LIQUID BATH SOAPS; LIQUID SOAP; LIQUID SOAP USED IN FOOT BATH; LIQUID SOAPS; LIQUID SOAPS FOR HANDS AND FACE; LIQUID SOAPS FOR HANDS, FACE AND BODY; MAKE-UP FOR THE FACE AND BODY; MAKE-UP PENCILS; MAKE-UP POWDER; MAKE-UP PREPARATIONS; MAKE-UP REMOVER; MAKE-UP REMOVING LOTIONS; MAKE-UP REMOVING MILK, GEL, LOTIONS AND CREAMS; MAKE-UP REMOVING MILKS; MASCARAS; MEDICATED SOAP; MEDICATED SOAPS; MOISTURIZING CREAMS; MOISTURIZING MILKS; MUSTACHE WAX; NATURAL MINERAL MAKE-UP; NON-MEDICATED ACNE TREATMENT PREPARATIONS; NON-MEDICATED LIP CARE PREPARATIONS; NON-MEDICATED LIP PROTECTORS; NON-MEDICATED OINTMENTS FOR THE PREVENTION AND TREATMENT OF SUNBURN; NON-MEDICATED SCALP TREATMENT CREAM; NON-MEDICATED SKIN CARE PREPARATIONS, NAMELY, CREAMS, LOTIONS, GELS, TONERS, CLEANERS AND PEELS; NON-MEDICATED SUN CARE PREPARATIONS; PARAFFIN WAX FOR COSMETIC PURPOSES; PATCHES CONTAINING SUN SCREEN AND SUN BLOCK FOR USE ON THE SKIN; PERFUMED SOAP; PERFUMED SOAPS; ROUGES; SADDLE SOAP; SHAVING SOAP; SHAVING SOAPS; SHAVING SPRITZ IN THE NATURE OF A MOISTURIZING SOLUTION FOR SHAVING; SKIN CLEANSERS; SKIN MOIST-

URIZER; SKIN MOISTURIZER MASKS; SKIN SOAP; SKIN TONERS; SOAP POWDER; SOAPS FOR BODY CARE; SOAPS FOR HOUSEHOLD USE; SOAPS FOR PERSONAL USE; SOAPS FOR TOILET PURPOSES; STYLING CLAY FOR HAIR; STYLING FOAM FOR HAIR; STYLING GELS; STYLING LOTIONS; STYLING MOUSSE; STYLING PASTE FOR HAIR; SUN BLOCK; SUN BLOCK PREPARATIONS; SUN CARE LOTIONS; SUN CREAMS; SUN SCREEN PREPARATIONS; SUN TAN GEL; SUN TAN LOTION; SUN TAN OIL; SUN-BLOCK LOTIONS; SUN-TANNING OILS; SUN-TANNING OILS AND LOTIONS; SUN-TANNING PREPARATIONS; SUNSCREEN CREAMS; THEATRICAL MAKE-UP; WATERLESS SOAP; WAX FOR REMOVING BODY HAIR; WAX STRIPPING PREPARATIONS; WAX STRIPS FOR

REMOVING BODY HAIR, IN CLASS 3 (U.S. CLS. 1, 4, 6, 50, 51 AND 52).

FIRST USE 6-1-2008; IN COMMERCE 6-18-2008.

THE MARK CONSISTS OF THE WORD "SEFIDE" WITH A STYLIZED LETTER F AND AN ACCENT MARK, SIMILAR TO THE FRENCH ACCENT AIGU, OVER THE LAST LETTER E. ALL LETTERS IN THE MARK ARE IN LOWER CASE.

THE WORDING "SEFIDE" HAS NO MEANING IN A FOREIGN LANGUAGE.

SER. NO. 77-513,476, FILED 7-2-2008.

ANDREW RHIM, EXAMINING ATTORNEY

Int. Cl.: 10

Prior U.S. Cls.: 26, 39 and 44

United States Patent and Trademark Office

Reg. No. 3,575,653

Registered Feb. 17, 2009

**TRADEMARK
PRINCIPAL REGISTER**

CINDY

BIRD & CRONIN, INC. (MINNESOTA CORPORATION)
1200 TRAPP ROAD
EAGAN, MN 55121

THE MARK CONSISTS OF STANDARD CHARACTERS WITHOUT CLAIM TO ANY PARTICULAR FONT, STYLE, SIZE, OR COLOR.

FOR: ORTHOPEDIC SUPPORTS, NAMELY, WRIST BRACES AND SUPPORTS, IN CLASS 10 (U.S. CLS. 26, 39 AND 44).

SER. NO. 77-513,480, FILED 7-2-2008.

FIRST USE 11-0-1993; IN COMMERCE 12-0-1999.

DAWN HAN, EXAMINING ATTORNEY

Int. Cls.: 3, 6, 9, 21, 25 and 27

Prior U.S. Cls.: 1, 2, 4, 6, 12, 13, 14, 19, 20, 21, 22, 23, 25, 26, 29, 30, 33, 36, 37, 38, 39, 40, 42, 50, 51 and 52

Reg. No. 3,575,654

United States Patent and Trademark Office

Registered Feb. 17, 2009

**TRADEMARK
PRINCIPAL REGISTER**



SIERRA SCIENTIFIC, INC (ARIZONA CORPORATION)
1005 N. 50TH ST.
PHOENIX, AZ 85008

FOR: DISPOSABLE WIPES IMPREGNATED WITH CLEANING CHEMICALS OR COMPOUNDS FOR INDUSTRIAL AND COMMERCIAL USE, IN CLASS 3 (U.S. CLS. 1, 4, 6, 50, 51 AND 52).

FIRST USE 10-1-1988; IN COMMERCE 10-1-1988.

FOR: METAL BROOM HANDLES, IN CLASS 6 (U.S. CLS. 2, 12, 13, 14, 23, 25 AND 50).

FIRST USE 10-1-1988; IN COMMERCE 10-1-1988.

FOR: PROTECTIVE CLOTHING AND HEADGEAR, NAMELY, CAPS, GOWNS, MASKS, IN CLASS 9 (U.S. CLS. 21, 23, 26, 36 AND 38).

FIRST USE 10-1-1988; IN COMMERCE 10-1-1988.

FOR: MOPS, REPLACEMENT MOP HEADS; DISPOSABLE LATEX GLOVES FOR GENERAL USE; DISPOSABLE LATEX FINGER FITTING SLEEVES IN THE NATURE OF LATEX FINGER COVERS FOR GENERAL USE, IN CLASS 21 (U.S. CLS. 2, 13, 23, 29, 30, 33, 40 AND 50).

FIRST USE 10-1-1988; IN COMMERCE 10-1-1988.

FOR: LAB COATS, DISPOSABLE SHOE COVERS NOT FOR SURGICAL OR MEDICAL USE, IN CLASS 25 (U.S. CLS. 22 AND 39).

FIRST USE 10-1-1988; IN COMMERCE 10-1-1988.

FOR: FLOOR MATS AND DISPOSABLE ABSORBENT FLOOR PADS, ALL FOR USE IN CLEAN ROOM AND CONTROLLED ENVIRONMENTS IN RESEARCH AND MANUFACTURING FACILITIES, IN CLASS 27 (U.S. CLS. 19, 20, 37, 42 AND 50).

FIRST USE 10-1-1988; IN COMMERCE 10-1-1988.

THE COLOR(S) RED, DARK GREEN, LIGHT GREEN, BLUE, ORANGE, YELLOW, PURPLE, BURGUNDY, AND WHITE IS/ARE CLAIMED AS A FEATURE OF THE MARK.

THE MARK CONSISTS OF A DESIGN COMPRISED OF AN AMALGAMATION OF COLORED SQUARES, NAMELY, SQUARES IN THE COLORS RED, DARK GREEN, LIGHT GREEN, BLUE, ORANGE, YELLOW, PURPLE, AND BURGUNDY, WITH THE WORD, "VALUTEK" IN THE COLOR WHITE SUPERIMPOSED OVER THE DESIGN.

SER. NO. 77-513,516, FILED 7-2-2008.

PAUL CROWLEY, EXAMINING ATTORNEY

Int. Cl.: 10

Prior U.S. Cls.: 26, 39 and 44

United States Patent and Trademark Office

Reg. No. 3,575,655

Registered Feb. 17, 2009

**TRADEMARK
PRINCIPAL REGISTER**

M&S

M & S TECHNOLOGIES, INC. (ILLINOIS CORPORATION)
5557 WEST HOWARD STREET
SKOKIE, IL 60077

THE MARK CONSISTS OF STANDARD CHARACTERS WITHOUT CLAIM TO ANY PARTICULAR FONT, STYLE, SIZE, OR COLOR.

FOR: COMPUTERIZED EYE TESTING MACHINES AND APPARATUS WHICH UTILIZE FIXATION TARGETS TO TEST VISUAL ACUITY, IN CLASS 10 (U.S. CLS. 26, 39 AND 44).

SER. NO. 77-513,551, FILED 7-2-2008.

FIRST USE 0-0-1992; IN COMMERCE 0-0-1992.

IRA J. GOODSaid, EXAMINING ATTORNEY

Int. Cl.: 41

Prior U.S. Cls.: 100, 101 and 107

United States Patent and Trademark Office

Reg. No. 3,575,656

Registered Feb. 17, 2009

**SERVICE MARK
PRINCIPAL REGISTER**

YOUR TALENT, POWERED

POTOMAC COLLEGE, LLC (DELAWARE LIMITED LIABILITY COMPANY), DBA POTOMAC UNIVERSITY, LLC
4000 CHESAPEAKE ST. NW
WASHINGTON, DC 20016

FOR: EDUCATIONAL SERVICES, NAMELY, PROVIDING COURSES OF INSTRUCTION AT THE POST-SECONDARY LEVEL AND DISTRIBUTION OF COURSE MATERIAL IN CONNECTION THEREWITH, IN CLASS 41 (U.S. CLS. 100, 101 AND 107).

FIRST USE 5-21-2008; IN COMMERCE 5-21-2008.

THE MARK CONSISTS OF STANDARD CHARACTERS WITHOUT CLAIM TO ANY PARTICULAR FONT, STYLE, SIZE, OR COLOR.

SER. NO. 77-513,680, FILED 7-2-2008.

AMOS T. MATTHEWS, JR., EXAMINING ATTORNEY

Int. Cl.: 24

Prior U.S. Cls.: 42 and 50

United States Patent and Trademark Office

Reg. No. 3,575,657

Registered Feb. 17, 2009

**TRADEMARK
PRINCIPAL REGISTER**



GENIE B'S SPECIALTIES (NEBRASKA CORPORATION), DBA G.B.S. ENTERPRISES
1006 E. MAPLE STREET
SUTTON, NE 68979

FOR: MATTRESS AND PILLOW PROTECTORS,
IN CLASS 24 (U.S. CLS. 42 AND 50).

FIRST USE 9-1-2004; IN COMMERCE 9-1-2004.

THE MARK CONSISTS OF FOUR TRIANGLES,
ONE INSIDE THE OTHER INCREASING IN THICK-

NESS WITH THE FOURTH AND MOST INNER
TRIANGLE CONTAINING A STYLIZED "PA" IN
THE UPPER PORTION OF THE TRIANGLE, THE
WORDS "PROTECT ALL" IN THE LOWER POR-
TION OF THE TRIANGLE AND A THICK LINE
POSITIONED UNDERNEATH AND INTERSECT-
ING THE LETTERS "PA".

SER. NO. 77-513,686, FILED 7-2-2008.

LINDA M. KING, EXAMINING ATTORNEY

Int. Cl.: 35

Prior U.S. Cls.: 100, 101 and 102

United States Patent and Trademark Office

Reg. No. 3,575,658

Registered Feb. 17, 2009

SERVICE MARK
PRINCIPAL REGISTER



OSHKOSH ACES MOTORCYCLE CLUB, INC.
(WISCONSIN NON-PROFIT CORPORATION)
210 N. MAIN STREET
OSHKOSH, WI 54901

FOR: PROMOTIONAL SERVICES, NAMELY,
PROMOTING THE CHARITIES OF OTHERS, IN
CLASS 35 (U.S. CLS. 100, 101 AND 102).

FIRST USE 1-1-1999; IN COMMERCE 1-1-1999.

NO CLAIM IS MADE TO THE EXCLUSIVE
RIGHT TO USE "OSHKOSH WI MC EST. 1929",
APART FROM THE MARK AS SHOWN.

THE COLOR(S) RED, GOLD, AND BLACK IS/ARE
CLAIMED AS A FEATURE OF THE MARK.

THE MARK CONSISTS OF 4 ACE CARDS FAN-
NED IN CENTER OF LOGO. ABOVE CARDS THE
WORD "OSHKOSH" ARCHED IN GOLD LETTERS
ON A RED BACKGROUND WITH A GOLD BOR-
DER. BELOW THE CARDS, THE WORDS "EST.
1928" IN SMALL PRINT AND THE WORD "ACES"
IN GOLD LETTERS ON A RED BACKGROUND
WITH A GOLD BORDER. TO THE LEFT OF THE
CARDS A RED BOX WITH GOLD BORDER CON-
TAINING THE WORD "WI" IN GOLD. TO THE
RIGHT OF THE CARDS, A RED BOX WITH A GOLD
BORDER CONTAINING THE WORD "MC" IN
GOLD.

SER. NO. 77-513,693, FILED 7-2-2008.

JANICE L. MCMORROW, EXAMINING ATTOR-
NEY

Int. Cl.: 16

Prior U.S. Cls.: 2, 5, 22, 23, 29, 37, 38 and 50

United States Patent and Trademark Office

Reg. No. 3,575,659

Registered Feb. 17, 2009

**TRADEMARK
PRINCIPAL REGISTER**

SKILCRAFT BIO-WRITE

NATIONAL INDUSTRIES FOR THE BLIND
(NEW YORK NON-PROFIT CORPORATION)
1310 BRADDOCK PLACE
ALEXANDRIA, VA 223141691

FOR: WRITING INSTRUMENTS, IN CLASS 16
(U.S. CLS. 2, 5, 22, 23, 29, 37, 38 AND 50).

FIRST USE 5-13-2008; IN COMMERCE 5-13-2008.

THE MARK CONSISTS OF STANDARD CHAR-
ACTERS WITHOUT CLAIM TO ANY PARTICULAR
FONT, STYLE, SIZE, OR COLOR.

SER. NO. 77-513,695, FILED 7-2-2008.

JANICE L. MCMORROW, EXAMINING ATTOR-
NEY

Int. Cls.: 10 and 44

Prior U.S. Cls.: 26, 39, 44, 100 and 101

United States Patent and Trademark Office

Reg. No. 3,575,660

Registered Feb. 17, 2009

**TRADEMARK
SERVICE MARK
PRINCIPAL REGISTER**

DAYLINK

ALERE MEDICAL, INC. (DELAWARE CORPORATION)
SUITE 1000
595 DOUBLE EAGLE COURT
RENO, NV 89521

FOR: MEDICAL MONITORING APPARATUS USED TO MONITOR AND COMMUNICATE DATA SUCH AS WEIGHT, BLOOD PRESSURE, BLOOD GLUCOSE LEVELS, OTHER BLOOD CHEMISTRY DATA, HEART RATE, EKG, COAGULATION TIME, PEAK FLOW OR OTHER MEASUREMENTS OF RESPIRATORY FUNCTION IN PATIENTS WITH CHRONIC DISEASES SUCH AS HEART DISEASE, IN CLASS 10 (U.S. CLS. 26, 39 AND 44).

FIRST USE 12-13-1996; IN COMMERCE 12-13-1996.

FOR: HEALTH CARE SERVICES, IN CLASS 44 (U.S. CLS. 100 AND 101).

FIRST USE 12-13-1996; IN COMMERCE 12-13-1996.

THE MARK CONSISTS OF STANDARD CHARACTERS WITHOUT CLAIM TO ANY PARTICULAR FONT, STYLE, SIZE, OR COLOR.

SER. NO. 77-513,696, FILED 7-2-2008.

JANICE L. MCMORROW, EXAMINING ATTORNEY

Int. Cl.: 41

Prior U.S. Cls.: 100, 101 and 107

Reg. No. 3,575,661

United States Patent and Trademark Office

Registered Feb. 17, 2009

**SERVICE MARK
PRINCIPAL REGISTER**

**WARNING: The Surgeon
General has determined that
music, dance, and theatre will
cause happiness in most
individuals**

MOONVISION ENTERPRISES, INC. (NORTH
CAROLINA CORPORATION)
1304 MINUETTE PLACE
GREENVILLE, NC 27858

FIRST USE 6-1-1999; IN COMMERCE 6-1-1999.

SER. NO. 77-513,771, FILED 7-2-2008.

FOR: DANCE INSTRUCTION FOR CHILDREN,
IN CLASS 41 (U.S. CLS. 100, 101 AND 107).

MARK PILARO, EXAMINING ATTORNEY

Int. Cl.: 45

Prior U.S. Cls.: 100 and 101

United States Patent and Trademark Office

Reg. No. 3,575,662

Registered Feb. 17, 2009

**SERVICE MARK
PRINCIPAL REGISTER**

**New Nation Church
International**

NEW NATION CHURCH INTERNATIONAL,
INC. (CALIFORNIA CORPORATION)

1159 CUNEO COURT

CONCORD, CA 94518

FOR: CONDUCTING RELIGIOUS PRAYER SER-
VICES, IN CLASS 45 (U.S. CLS. 100 AND 101).

FIRST USE 2-1-2008; IN COMMERCE 2-1-2008.

THE MARK CONSISTS OF STANDARD CHAR-
ACTERS WITHOUT CLAIM TO ANY PARTICULAR
FONT, STYLE, SIZE, OR COLOR.

NO CLAIM IS MADE TO THE EXCLUSIVE
RIGHT TO USE "CHURCH INTERNATIONAL",
APART FROM THE MARK AS SHOWN.

SER. NO. 77-513,957, FILED 7-2-2008.

BILL DAWE, EXAMINING ATTORNEY

Int. Cl.: 42

Prior U.S. Cls.: 100 and 101

United States Patent and Trademark Office

Reg. No. 3,575,663

Registered Feb. 17, 2009

**SERVICE MARK
PRINCIPAL REGISTER**

**Peak Performance
Technologies**

PEAK PERFORMANCE TECHNOLOGIES, INC.
(NEVADA CORPORATION)
3830 PRESERVE CROSSING LANE
CUMMING, GA 30040

FOR: CONSULTING IN THE FIELD OF INFORMATION TECHNOLOGY, IN CLASS 42 (U.S. CLS. 100 AND 101).

FIRST USE 1-10-2008; IN COMMERCE 1-10-2008.

THE MARK CONSISTS OF STANDARD CHARACTERS WITHOUT CLAIM TO ANY PARTICULAR FONT, STYLE, SIZE, OR COLOR.

NO CLAIM IS MADE TO THE EXCLUSIVE RIGHT TO USE "TECHNOLOGIES", APART FROM THE MARK AS SHOWN.

SER. NO. 77-514,044, FILED 7-2-2008.

KEVON CHISOLM, EXAMINING ATTORNEY

Int. Cl.: 44

Prior U.S. Cls.: 100 and 101

United States Patent and Trademark Office

Reg. No. 3,575,664

Registered Feb. 17, 2009

**SERVICE MARK
PRINCIPAL REGISTER**

Frameworks Eyewear

FRAMEWORKS EYEWEAR, LLC (UTAH LIMITED LIABILITY COMPANY)
SUITE E-200
9720 SOUTH 1300 EAST
SANDY, UT 84094

FOR: FITTING OF OPTICAL LENSES, IN CLASS 44 (U.S. CLS. 100 AND 101).

FIRST USE 12-1-2001; IN COMMERCE 12-1-2001.

THE MARK CONSISTS OF STANDARD CHARACTERS WITHOUT CLAIM TO ANY PARTICULAR FONT, STYLE, SIZE, OR COLOR.

NO CLAIM IS MADE TO THE EXCLUSIVE RIGHT TO USE "EYEWEAR", APART FROM THE MARK AS SHOWN.

SER. NO. 77-514,047, FILED 7-2-2008.

KEVON CHISOLM, EXAMINING ATTORNEY

Int. Cl.: 41

Prior U.S. Cls.: 100, 101 and 107

United States Patent and Trademark Office

Reg. No. 3,575,665

Registered Feb. 17, 2009

**SERVICE MARK
PRINCIPAL REGISTER**

**BUY FROM THE SOURCE, SAVE
MONEY**

PROMINENT TICKET SERVICE (NEW JERSEY
CORPORATION)
13 GARDEN STATE PLAZA
PARAMUS, NJ 07652

FOR: ARRANGING FOR TICKET RESERVA-
TIONS FOR SHOWS AND OTHER ENTERTAIN-
MENT EVENTS; ENTERTAINMENT TICKET
AGENCY SERVICES; ON-LINE ENTERTAINMENT
TICKET AGENCY SERVICES, IN CLASS 41 (U.S.
CLS. 100, 101 AND 107).

FIRST USE 5-12-2008; IN COMMERCE 5-12-2008.

THE MARK CONSISTS OF STANDARD CHAR-
ACTERS WITHOUT CLAIM TO ANY PARTICULAR
FONT, STYLE, SIZE, OR COLOR.

SER. NO. 77-514,051, FILED 7-2-2008.

KEVON CHISOLM, EXAMINING ATTORNEY

Prior U.S. Cl.: B

United States Patent and Trademark Office

Reg. No. 3,575,666

Registered Feb. 17, 2009

**CERTIFICATION MARK
PRINCIPAL REGISTER**

**CERTIFIED WORKING PASTRY
CHEF**

AMERICAN CULINARY FEDERATION (NEW YORK CORPORATION)
180 CENTER PLACE WAY
ST. AUGUSTINE, FL 32095

FOR: COOKING SERVICES, IN CLASS B (U.S. CL. B).

FIRST USE 0-0-1999; IN COMMERCE 0-0-1999.

THE MARK CONSISTS OF STANDARD CHARACTERS WITHOUT CLAIM TO ANY PARTICULAR FONT, STYLE, SIZE, OR COLOR.

THE CERTIFICATION MARK, AS USED BY AUTHORIZED PERSONS, CERTIFIES THAT THE PERSON IS A PROFESSIONAL BAKER OR PASTRY WORKER WHO HAS DEMONSTRATED BASIC AND ADVANCED KNOWLEDGE AND SKILLS PERTAINING TO PROFESSIONAL BAKING AND PASTRIES AS DETERMINED BY A TEST OF BAKING SKILL AND KNOWLEDGE AUTHORIZED BY

THE CERTIFIER. THIS CAN BE DOCUMENTED BY BEING SUCCESSFULLY EMPLOYED FOR A MINIMUM OF THREE YEARS AFTER GRADUATING FROM AN ACCREDITED COLLEGE WITH A TWO YEAR DEGREE IN BAKING AND PASTRY ARTS OR HIGHER, GRADUATING FROM A FORMAL BAKING AND PASTRY APPRENTICESHIP TRAINING PROGRAM, BY DOCUMENTING A MINIMUM OF A HIGH SCHOOL EDUCATION PLUS FIVE YEARS EXPERIENCE AS A PROFESSIONAL BAKER OR PASTRY WORKER AND BY PASSING THE CERTIFICATION KNOWLEDGE AND SKILL PROFICIENCY TESTS ESTABLISHED BY THE CERTIFIER FOR THE CERTIFICATION LEVEL.

SEC. 2(F).

SER. NO. 77-514,092, FILED 7-2-2008.

KIMBERLY PERRY, EXAMINING ATTORNEY

Int. Cl.: 41

Prior U.S. Cls.: 100, 101 and 107

United States Patent and Trademark Office

Reg. No. 3,575,667

Registered Feb. 17, 2009

**SERVICE MARK
PRINCIPAL REGISTER**

SANITWICE

MANN, JAMES I. (UNITED STATES INDIVIDUAL)
1216 FLAMINGO PKWY.
LIBERTYVILLE, IL 60048

FOR: EDUCATIONAL SERVICES, NAMELY, CONDUCTING SEMINARS, WORKSHOPS, CONFERENCES, CLASSES AND INDIVIDUAL TRAINING IN THE FIELD OF HEALTH AND HYGIENE, AND ON THE SUBJECT OF EDUCATING OTHERS REGARDING HEALTH AND HYGIENE, IN CLASS 41 (U.S. CLS. 100, 101 AND 107).

FIRST USE 4-0-2006; IN COMMERCE 4-0-2006.

THE MARK CONSISTS OF STANDARD CHARACTERS WITHOUT CLAIM TO ANY PARTICULAR FONT, STYLE, SIZE, OR COLOR.

SER. NO. 77-514,147, FILED 7-3-2008.

CHRISTINE COOPER, EXAMINING ATTORNEY

Int. Cl.: 41

Prior U.S. Cls.: 100, 101 and 107

Reg. No. 3,575,668

United States Patent and Trademark Office

Registered Feb. 17, 2009

**SERVICE MARK
PRINCIPAL REGISTER**

LDA

LATINO DIABETES ASSOCIATION (CALIFORNIA CORPORATION)
870 S. WESTCHESTER PLACE
LOS ANGELES, CA 90005

FOR: EDUCATIONAL SERVICES, NAMELY, CONDUCTING INSTRUCTIONAL COURSES, SEMINARS AND LECTURES IN THE FIELD OF DIABETES MANAGEMENT, SELF HELP RELATED TO DIABETES AND INFORMATION REGARDING DISEASES CAUSED BY DIABETES, AND DISSEMINATION OF PRINTED MATERIALS, VIDEOS, RECORDINGS AND COMPUTER SOFTWARE RELATED THERETO; TRAINING IN THE FIELD OF CHANGING LIFESTYLE TO AVOID DIABETES; TRAINING RELATED TO COOKING, NUTRITION AND EXERCISE FOR DIABETES MANAGEMENT;

ARRANGING AND CONDUCTING SPORTS EVENTS, MUSICAL EVENTS AND CULTURAL ACTIVITIES TO PROMOTE AWARENESS OF DIABETES MANAGEMENT AND SELF HELP, IN CLASS 41 (U.S. CLS. 100, 101 AND 107).

FIRST USE 7-5-2004; IN COMMERCE 7-5-2004.

THE MARK CONSISTS OF STANDARD CHARACTERS WITHOUT CLAIM TO ANY PARTICULAR FONT, STYLE, SIZE, OR COLOR.

SER. NO. 77-514,176, FILED 7-3-2008.

SHAUNIA CARLYLE, EXAMINING ATTORNEY

Int. Cl.: 38

Prior U.S. Cls.: 100, 101 and 104

United States Patent and Trademark Office

Reg. No. 3,575,669

Registered Feb. 17, 2009

**SERVICE MARK
PRINCIPAL REGISTER**

GOODNITES KIDS

KIMBERLY-CLARK WORLDWIDE, INC. (DELA-
WARE CORPORATION)
401 NORTH LAKE STREET
NEENAH, WI 54956

FOR: PROVIDING ON-LINE CHAT ROOM AND
ELECTRONIC BULLETIN BOARD FOR TRANSMIS-
SION OF MESSAGES AMONG USERS IN THE
FIELD OF PARENTING AND CHILD CARE CON-
CERNING BED-WETTING AND POTTY TRAINING
SOLUTIONS, IN CLASS 38 (U.S. CLS. 100, 101 AND
104).

FIRST USE 5-29-2003; IN COMMERCE 5-29-2003.

THE MARK CONSISTS OF STANDARD CHAR-
ACTERS WITHOUT CLAIM TO ANY PARTICULAR
FONT, STYLE, SIZE, OR COLOR.

OWNER OF U.S. REG. NO. 2,905,043.

NO CLAIM IS MADE TO THE EXCLUSIVE
RIGHT TO USE "KIDS", APART FROM THE MARK
AS SHOWN.

SER. NO. 77-514,344, FILED 7-3-2008.

STEVEN R. FOSTER, EXAMINING ATTORNEY

Int. Cl.: 25

Prior U.S. Cls.: 22 and 39

United States Patent and Trademark Office

Reg. No. 3,575,670

Registered Feb. 17, 2009

**TRADEMARK
PRINCIPAL REGISTER**

**LINCS
DAVID CHU**

DC LICENSING LLC (CONNECTICUT LIMITED
LIABILITY COMPANY)
599 WEST PUTNAM AVENUE
GREENWICH, CT 06830

FOR: CAPS; COATS; DRESS SHIRTS; GOLF
SHIRTS; HATS; JACKETS; PANTS; POLO SHIRTS;
PULLOVERS; SHIRTS; SHORTS; SLACKS; SPORT
SHIRTS; SWEAT PANTS; SWEAT SHIRTS; SWEA-
TERS; T-SHIRTS; TOPS; TROUSERS; VESTS, IN
CLASS 25 (U.S. CLS. 22 AND 39).

FIRST USE 1-31-2008; IN COMMERCE 1-31-2008.

THE MARK CONSISTS OF STANDARD CHAR-
ACTERS WITHOUT CLAIM TO ANY PARTICULAR
FONT, STYLE, SIZE, OR COLOR.

OWNER OF U.S. REG. NO. 3,177,569.

THE NAME "DAVID CHU" IDENTIFIES A LIV-
ING INDIVIDUAL WHOSE CONSENT IS OF RE-
CORD.

SER. NO. 77-514,362, FILED 7-3-2008.

NICHOLAS COLEMAN, EXAMINING ATTORNEY

Int. Cl.: 12

Prior U.S. Cls.: 19, 21, 23, 31, 35 and 44

Reg. No. 3,575,671

United States Patent and Trademark Office

Registered Feb. 17, 2009

**TRADEMARK
PRINCIPAL REGISTER**

BRENNER

BRENNER TANK LLC (WISCONSIN LIMITED
LIABILITY COMPANY)

PO BOX 670

FOND DU LAC, WI 549360670

FOR: TANKERS, IN CLASS 12 (U.S. CLS. 19, 21, 23,
31, 35 AND 44).

FIRST USE 0-0-1957; IN COMMERCE 0-0-1957.

THE MARK CONSISTS OF STANDARD CHAR-
ACTERS WITHOUT CLAIM TO ANY PARTICULAR
FONT, STYLE, SIZE, OR COLOR.

OWNER OF U.S. REG. NO. 2,584,454.

SEC. 2(F).

SER. NO. 77-514,373, FILED 7-3-2008.

NICHOLAS COLEMAN, EXAMINING ATTORNEY

Int. Cl.: 21

Prior U.S. Cls.: 2, 13, 23, 29, 30, 33, 40 and 50

United States Patent and Trademark Office

Reg. No. 3,575,672

Registered Feb. 17, 2009

**TRADEMARK
PRINCIPAL REGISTER**

MAGPPIE

MAGPPIE N.A. LLC (TEXAS LIMITED LIABILITY COMPANY)

#10

800 FULGHAM ROAD
PLANO, TX 75093

FOR: DINNERWARE, NAMELY, PLATES, CUPS, SAUCERS, MUGS, TEAPOTS, COFFEE POTS, MILK AND SUGAR POTS, SALT AND PEPPER SETS, BREAD BASKETS, CANDY BOWLS, FRUIT BOWLS, WATER PITCHERS, NAPKIN HOLDERS, CANDLE HOLDERS, SALAD BOWLS, SERVING TRAYS, SALAD SERVERS, SNACK SERVERS, SUSHI SERVERS, AND SERVING CONTAINERS; BARWARE, NAMELY, WINE COOLERS, ICE BUCKETS, CHAMPAGNE BUCKETS, BAR TRAYS, COCKTAIL SHAKERS,

CORKSCREWS, BOTTLE OPENERS, BEVERAGE STRAINERS, BEVERAGE STIRRERS, AND COASTERS, NOT OF PAPER AND NOT OF TABLE LINEN, IN CLASS 21 (U.S. CLS. 2, 13, 23, 29, 30, 33, 40 AND 50).

FIRST USE 6-0-2006; IN COMMERCE 6-0-2006.

THE MARK CONSISTS OF STANDARD CHARACTERS WITHOUT CLAIM TO ANY PARTICULAR FONT, STYLE, SIZE, OR COLOR.

SER. NO. 77-514,435, FILED 7-3-2008.

KIM MONINGHOFF, EXAMINING ATTORNEY

Int. Cl.: 43

Prior U.S. Cls.: 100 and 101

United States Patent and Trademark Office

Reg. No. 3,575,673

Registered Feb. 17, 2009

**SERVICE MARK
PRINCIPAL REGISTER**

SPLENDID PLATES

**CBBI, LLC LTD (MICHIGAN LIMITED LIABILITY COMPANY)
4199 MARCY
WARREN, MI 48091**

THE MARK CONSISTS OF STANDARD CHARACTERS WITHOUT CLAIM TO ANY PARTICULAR FONT, STYLE, SIZE, OR COLOR.

FOR: PROVIDING FOOD AND DRINK IN THE NATURE OF CARRY-OUT RESTAURANTS AND CATERING, IN CLASS 43 (U.S. CLS. 100 AND 101).

SER. NO. 77-514,440, FILED 7-3-2008.

FIRST USE 10-16-2006; IN COMMERCE 10-16-2006.

DANNEAN HETZEL, EXAMINING ATTORNEY

Int. Cl.: 43

Prior U.S. Cls.: 100 and 101

United States Patent and Trademark Office

Reg. No. 3,575,674

Registered Feb. 17, 2009

SERVICE MARK
PRINCIPAL REGISTER



CORNELIA STREET GROUP, INC. (NEW YORK CORPORATION)
257 BLEECKER STREET
NEW YORK, NY 10014

FOR: CATERING SERVICES, NAMELY, THE CATERING OF CHEESE, CHEESE SPREADS AND CHEESE SUBSTITUTES, AS WELL AS SANDWICHES, SALADS, ENTREES AND DESSERTS, IN CLASS 43 (U.S. CLS. 100 AND 101).

FIRST USE 11-0-2004; IN COMMERCE 11-0-2004.

OWNER OF U.S. REG. NOS. 2,230,051, 2,859,620, AND 2,864,447.

THE COLOR(S) WHITE AND RED IS/ARE CLAIMED AS A FEATURE OF THE MARK.

THE MARK CONSISTS OF WHITE BACKGROUND WITH A RED CIRCLE MADE UP OF SEVERAL SMALL RED SQUARES IN AN ALTERNATING PATTERN, INSIDE THE CIRCLE, FORMING AN ARCH ON THE UPPER PORTION OF THE CIRCLE IS THE WORDS "MADE BY" IN RED, IN THE MIDDLE OF THE CIRCLE IS THE WORD "MURRAY'S" IN A SCRIPT FONT IN RED AND THE WORD IS UNDERLINED AS EXTENDING FROM THE LETTER "Y", IN THE BOTTOM PORTION OF THE CIRCLE, IN AN INVERSE ARCH, IS THE WORDS "WE KNOW FOOD" IN RED.

SER. NO. 77-514,457, FILED 7-3-2008.

TARA PATE, EXAMINING ATTORNEY

Int. Cl.: 43

Prior U.S. Cls.: 100 and 101

United States Patent and Trademark Office

Reg. No. 3,575,675

Registered Feb. 17, 2009

**SERVICE MARK
PRINCIPAL REGISTER**



CBBI, LLC LTD (MICHIGAN LIMITED LIABILITY COMPANY)
4199 MARCY
WARREN, MI 48091

THE MARK CONSISTS OF STYLIZED FONTS WITH WORDS SUPERIMPOSED OVER STYLIZED IMAGES OF DINNINGWARE.

FOR: PROVIDING FOOD AND DRINK IN THE NATURE OF CARRY-OUT RESTAURANTS AND CATERING, IN CLASS 43 (U.S. CLS. 100 AND 101).

SER. NO. 77-514,463, FILED 7-3-2008.

FIRST USE 10-16-2006; IN COMMERCE 10-16-2006.

DANNEAN HETZEL, EXAMINING ATTORNEY

Int. Cl.: 6

Prior U.S. Cls.: 2, 12, 13, 14, 23, 25 and 50

Reg. No. 3,575,676

United States Patent and Trademark Office

Registered Feb. 17, 2009

**TRADEMARK
PRINCIPAL REGISTER**

Perry Pole

PERRY POLE LLC. (FLORIDA LIMITED LIABILITY COMPANY)

321 SHORE DR. EAST

OLDSMAR, FL 34677

FOR: ANCHORS, IN CLASS 6 (U.S. CLS. 2, 12, 13, 14, 23, 25 AND 50).

FIRST USE 9-1-2007; IN COMMERCE 4-9-2008.

THE MARK CONSISTS OF STANDARD CHARACTERS WITHOUT CLAIM TO ANY PARTICULAR FONT, STYLE, SIZE, OR COLOR.

NO CLAIM IS MADE TO THE EXCLUSIVE RIGHT TO USE "POLE", APART FROM THE MARK AS SHOWN.

SER. NO. 77-514,481, FILED 7-3-2008.

JULIE GUTTADAURO, EXAMINING ATTORNEY

Int. Cl.: 36

Prior U.S. Cls.: 100, 101 and 102

United States Patent and Trademark Office

Reg. No. 3,575,677

Registered Feb. 17, 2009

**SERVICE MARK
PRINCIPAL REGISTER**

Carina Wealth Management

SCHALL, JASON (UNITED STATES INDIVIDUAL)
PO BOX 21450
CHARLESTON, SC 29413

FOR: FINANCIAL ADVISORY AND CONSULTANCY SERVICES; FINANCIAL RESEARCH AND INFORMATION SERVICES; FINANCIAL SERVICES, NAMELY, MONEY LENDING; FINANCIAL PLANNING; SECURITIES BROKERAGE; COMMODITIES BROKERAGE, IN CLASS 36 (U.S. CLS. 100, 101 AND 102).

FIRST USE 6-1-2007; IN COMMERCE 10-5-2007.

THE MARK CONSISTS OF STANDARD CHARACTERS WITHOUT CLAIM TO ANY PARTICULAR FONT, STYLE, SIZE, OR COLOR.

NO CLAIM IS MADE TO THE EXCLUSIVE RIGHT TO USE "WEALTH MANAGEMENT", APART FROM THE MARK AS SHOWN.

SER. NO. 77-514,533, FILED 7-3-2008.

MICHAEL GAAFAR, EXAMINING ATTORNEY

Int. Cl.: 42

Prior U.S. Cls.: 100 and 101

United States Patent and Trademark Office

Reg. No. 3,575,678

Registered Feb. 17, 2009

**SERVICE MARK
PRINCIPAL REGISTER**

Interfolio

INTERFOLIO, INC. (DELAWARE CORPORATION)
SUITE #603
1900 L STREET NW
WASHINGTON, DC 20036

FOR: COMPUTER SERVICES, NAMELY, PROVIDING AN INTERACTIVE WEB SITE THAT ALLOWS USERS TO COLLECT, STORE, MANAGE, DELIVER AND SHOWCASE ELECTRONIC AND PAPER-BASED CONTENT , IN CLASS 42 (U.S. CLS. 100 AND 101).

FIRST USE 8-23-1999; IN COMMERCE 8-23-1999.

THE MARK CONSISTS OF STANDARD CHARACTERS WITHOUT CLAIM TO ANY PARTICULAR FONT, STYLE, SIZE, OR COLOR.

SER. NO. 77-514,576, FILED 7-3-2008.

TARA PATE, EXAMINING ATTORNEY

Int. Cl.: 36

Prior U.S. Cls.: 100, 101 and 102

United States Patent and Trademark Office

Reg. No. 3,575,679

Registered Feb. 17, 2009

**SERVICE MARK
PRINCIPAL REGISTER**

**CASH YOU NEED. RESPECT YOU
DESERVE.**

EZCORP, INC. (DELAWARE CORPORATION)
1901 CAPITAL PARKWAY
AUSTIN, TX 78746

THE MARK CONSISTS OF STANDARD CHAR-
ACTERS WITHOUT CLAIM TO ANY PARTICULAR
FONT, STYLE, SIZE, OR COLOR.

FOR: SHORT TERM CONSUMER LOAN SERVI-
CES, LENDING SERVICES, CREDIT SERVICES,
PAWN BROKERAGE SERVICES, CHECK CASHING
SERVICES, IN CLASS 36 (U.S. CLS. 100, 101 AND 102).

SER. NO. 77-514,581, FILED 7-3-2008.

FIRST USE 3-12-2008; IN COMMERCE 3-12-2008.

KIM MONINGHOFF, EXAMINING ATTORNEY

Int. Cl.: 36

Prior U.S. Cls.: 100, 101 and 102

United States Patent and Trademark Office

Reg. No. 3,575,680

Registered Feb. 17, 2009

**SERVICE MARK
PRINCIPAL REGISTER**

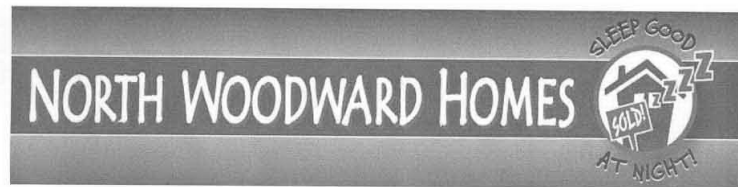

MOROF, LEE H. (UNITED STATES INDIVIDUAL)
1795 LATHAM STREET
BIRMINGHAM, MI 48009

FOR: REAL ESTATE SERVICES, NAMELY, MANAGEMENT, LISTING, PRE-SALE FINANCIAL CONSULTING, AGENCY AND BROKERAGE SERVICES, IN CLASS 36 (U.S. CLS. 100, 101 AND 102).

FIRST USE 2-15-2008; IN COMMERCE 2-15-2008.

NO CLAIM IS MADE TO THE EXCLUSIVE RIGHT TO USE "NORTH WOODWARD" AND "HOMES" AND "SOLD", APART FROM THE MARK AS SHOWN.

SER. NO. 77-514,597, FILED 7-3-2008.

BRENDAN MCCAULEY, EXAMINING ATTORNEY

Int. Cl.: 25

Prior U.S. Cls.: 22 and 39

United States Patent and Trademark Office

Reg. No. 3,575,681

Registered Feb. 17, 2009

TRADEMARK
PRINCIPAL REGISTER



JEFFERY YOKOYAMA (UNITED STATES INDIVIDUAL)

6705 SEASHORE DRIVE
NEWPORT BEACH, CA 92663

FOR: CLOTHING, NAMELY, T-SHIRTS, SHIRTS, TANK TOPS, SWEAT SHIRTS, SWEAT PANTS, SWEAT SUITS, JEANS, PANTS, SHORTS, OVERALLS, JUMPSUITS, SKIRTS, DRESSES, BLOUSES, JACKETS, SWEATERS, VESTS, SWIMWEAR, BATHING SUITS, COVER-UPS, SLEEPWEAR, PAJAMAS, ROBES, NIGHTGOWNS, LEOTARDS, LINGERIE, PANTIES, BRAS, BOXER SHORTS, UNDERWEAR, SCARVES, BELTS, SOCKS, STOCKINGS, TIGHTS, LEGGINGS, GLOVES; OUTERWEAR, NAMELY, COATS AND RAINCOATS; HEADGEAR, NAMELY, HATS, CAPS, HEADBANDS, VISORS AND BANDANAS; FOOTWEAR, NAMELY, SHOES, SLIPPERS, BOOTS, SANDALS, FLIP-FLOPS, AND ATHLETIC SHOES, IN CLASS 25 (U.S. CLS. 22 AND 39).

FIRST USE 7-1-2008; IN COMMERCE 7-1-2008.

NO CLAIM IS MADE TO THE EXCLUSIVE RIGHT TO USE "THE ORIGINAL BEACH TOWEL ZIP FRONT HOODED SWEATSHIRT", APART FROM THE MARK AS SHOWN.

THE NAME(S), PORTRAIT(S), AND/OR SIGNATURE(S) SHOWN IN THE MARK IDENTIFIES "JEFFERY YOKOYAMA", WHOSE CONSENT(S) TO REGISTER IS SUBMITTED.

THE COLOR(S) AQUAMARINE, ORANGE, TAN, BLACK AND WHITE IS/ARE CLAIMED AS A FEATURE OF THE MARK.

THE MARK CONSISTS OF THE WORDING "THE ORIGINAL BEACH TOWEL ZIP FRONT HOODED SWEATSHIRT BY JEFF YOKOYAMA" IN STYLIZED LETTERING IN THE COLOR BLACK SURROUNDING A CARTOON CARICATURE DRAWING OUTLINED IN BLACK OF A PELICAN. THE BODY OF THE PELICAN IS IN THE COLOR TAN, THE POUCH OF THE PELICAN APPEARS IN THE COLOR ORANGE WITH A BEARD STUBBLE IN THE COLOR BLACK, AND THE FEET, EYES, AND A TUFT OF HAIR ON THE PELICAN'S HEAD APPEAR IN THE COLOR WHITE. THE WORDING AND THE PELICAN APPEAR ON A CIRCULAR BACKGROUND IN THE COLOR AQUAMARINE.

SER. NO. 77-514,615, FILED 7-3-2008.

KATHLEEN LORENZO, EXAMINING ATTORNEY

Int. Cl.: 5

Prior U.S. Cls.: 6, 18, 44, 46, 51 and 52

United States Patent and Trademark Office

Reg. No. 3,575,682

Registered Feb. 17, 2009

**TRADEMARK
PRINCIPAL REGISTER**

Enhanca

DREAMPAK (VIRGINIA LIMITED LIABILITY
COMPANY)
4717B EISENHOWER AVE.
ALEXANDRIA, VA 22304

THE MARK CONSISTS OF STANDARD CHAR-
ACTERS WITHOUT CLAIM TO ANY PARTICULAR
FONT, STYLE, SIZE, OR COLOR.

FOR: DIETARY SUPPLEMENTS, IN CLASS 5 (U.S.
CLS. 6, 18, 44, 46, 51 AND 52).

SER. NO. 77-514,717, FILED 7-3-2008.

FIRST USE 6-1-2008; IN COMMERCE 6-10-2008.

RAMONA ORTIGA, EXAMINING ATTORNEY

Int. Cls.: 1 and 17

Prior U.S. Cls.: 1, 5, 6, 10, 12, 13, 26, 35, 46 and 50

United States Patent and Trademark Office

Reg. No. 3,575,683

Registered Feb. 17, 2009

**TRADEMARK
PRINCIPAL REGISTER**

AKOALIT

LYONDELLBASELL INDUSTRIES HOLDINGS
B.V. (NETHERLANDS PRIVATE LIMITED
LIABILITY COMPANY)
HOEKSTEEN 66
HOOFDDORP, NETHERLANDS 2132

FOR: UNPROCESSED OLEFIN POLYMERS, OLE-
FIN COPOLYMERS AND COMPOSITIONS THERE-
OF, ALL FOR INDUSTRIAL USE , IN CLASS 1 (U.S.
CLS. 1, 5, 6, 10, 26 AND 46).

FOR: SEMI-PROCESSED OLEFIN POLYMERS
AND COPOLYMERS, SEMI-PROCESSED OLEFIN
POLYMER AND COPOLYMER COMPOSITIONS
ALL FOR INDUSTRIAL USE, IN CLASS 17 (U.S.
CLS. 1, 5, 12, 13, 35 AND 50).

THE MARK CONSISTS OF STANDARD CHAR-
ACTERS WITHOUT CLAIM TO ANY PARTICULAR
FONT, STYLE, SIZE, OR COLOR.

PRIORITY CLAIMED UNDER SEC. 44(D) ON
BENELUX APPLICATION NO. 1150963, FILED 1-11-
2008, REG. NO. 0836460, DATED 1-15-2008, EXPIRES
1-11-2018.

SER. NO. 77-514,724, FILED 7-3-2008.

JAMES LOVELACE, EXAMINING ATTORNEY

Int. Cls.: 1 and 17

Prior U.S. Cls.: 1, 5, 6, 10, 12, 13, 26, 35, 46 and 50

United States Patent and Trademark Office

Reg. No. 3,575,684

Registered Feb. 17, 2009

**TRADEMARK
PRINCIPAL REGISTER**

AKOAFLOOR

LYONDELLBASELL INDUSTRIES HOLDINGS
B.V. (NETHERLANDS PRIVATE LIMITED
LIABILITY COMPANY)
HOEKSTEEN 66
HOOFDDORP, NETHERLANDS 2132

FOR: UNPROCESSED OLEFIN POLYMERS, OLE-
FIN COPOLYMERS AND COMPOSITIONS THERE-
OF, ALL FOR INDUSTRIAL USE , IN CLASS 1 (U.S.
CLS. 1, 5, 6, 10, 26 AND 46).

FOR: SEMI-PROCESSED OLEFIN POLYMERS
AND COPOLYMERS, SEMI-PROCESSED OLEFIN
POLYMER AND COPOLYMER COMPOSITIONS
ALL FOR INDUSTRIAL USE, IN CLASS 17 (U.S.
CLS. 1, 5, 12, 13, 35 AND 50).

THE MARK CONSISTS OF STANDARD CHAR-
ACTERS WITHOUT CLAIM TO ANY PARTICULAR
FONT, STYLE, SIZE, OR COLOR.

PRIORITY CLAIMED UNDER SEC. 44(D) ON
BENELUX APPLICATION NO. 1150962, FILED 1-11-
2008, REG. NO. 0836459, DATED 1-15-2008, EXPIRES
1-11-2018.

SER. NO. 77-514,746, FILED 7-3-2008.

JAMES LOVELACE, EXAMINING ATTORNEY

Int. Cl.: 28

Prior U.S. Cls.: 22, 23, 38 and 50

United States Patent and Trademark Office

Reg. No. 3,575,685

Registered Feb. 17, 2009

**TRADEMARK
PRINCIPAL REGISTER**

CG14

ROGER CLEVELAND GOLF COMPANY, INC.
(CALIFORNIA CORPORATION)
5601 SKYLAB ROAD
HUNTINGTON BEACH, CA 92647

FOR: GOLF CLUBS, NAMELY, WEDGES, IN
CLASS 28 (U.S. CLS. 22, 23, 38 AND 50).

FIRST USE 1-0-2008; IN COMMERCE 1-0-2008.

THE MARK CONSISTS OF STANDARD CHAR-
ACTERS WITHOUT CLAIM TO ANY PARTICULAR
FONT, STYLE, SIZE, OR COLOR.

OWNER OF U.S. REG. NOS. 3,421,090 AND
3,421,091.

SER. NO. 77-514,760, FILED 7-3-2008.

VERNA BETH RIRIE, EXAMINING ATTORNEY

Int. Cl.: 9

Prior U.S. Cls.: 21, 23, 26, 36 and 38

United States Patent and Trademark Office

Reg. No. 3,575,686

Registered Feb. 17, 2009

**TRADEMARK
PRINCIPAL REGISTER**



The image shows the word "Gravitant" in a bold, orange, sans-serif font. A blue semi-circle is positioned above the letter "i", pointing downwards towards it. The entire logo is centered on a white background.

SHEARDIGITAL INC. (TEXAS CORPORATION)
11940 JOLLYVILLE ROAD, SUITE 325N
AUSTIN, TX 78759

FOR: COMPUTER SOFTWARE FOR PLANNING AND DEFINING BUSINESS STRATEGY AND BUSINESS MODELS, AND FOR ANALYZING, MANAGING, MONITORING AND OPTIMIZING BUSINESS MODEL PERFORMANCE, CONTRACT PERFORMANCE, SERVICE LEVEL AGREEMENT PERFORMANCE AND COMPLIANCE, CORRECTIVE ACTIONS, OUTSOURCING RELATIONSHIPS AND VENDOR PERFORMANCE IN THE FIELD OF BUSINESS TRANSFORMATION MANAGEMENT, IN CLASS 9 (U.S. CLS. 21, 23, 26, 36 AND 38).

FIRST USE 6-29-2007; IN COMMERCE 6-29-2007.

THE COLOR(S) ORANGE AND BLUE IS/ARE CLAIMED AS A FEATURE OF THE MARK.

THE MARK CONSISTS OF THE WORD "GRAVITANT" APPEARING IN ORANGE WITH A STYLIZED LETTER "I". THE LETTER "I" HAS A SEMI-CIRCLE FACING UPWARDS IN BLUE.

THE FOREIGN WORDING IN THE MARK TRANSLATES INTO ENGLISH AS "GRAVITATING" OR "REVOLVING".

SER. NO. 77-514,790, FILED 7-3-2008.

JOHN E. MICHOS, EXAMINING ATTORNEY

Int. Cl.: 35

Prior U.S. Cls.: 100, 101 and 102

United States Patent and Trademark Office

Reg. No. 3,575,687

Registered Feb. 17, 2009

**SERVICE MARK
PRINCIPAL REGISTER**

PRISE

EQUIPMENT RELIABILITY SOLUTIONS LLC
(TEXAS LIMITED LIABILITY COMPANY)
105 WILDWOOD DRIVE, SUITE 103-128
GEORGETOWN, TX 78633

FOR: BUSINESS SERVICES, NAMELY, PROVIDING AN ONLINE COMPUTER DATABASE IN THE FIELD OF RECORDS MANAGEMENT SERVICES, NAMELY, THE OPERATIONAL HISTORY OF MECHANICAL EQUIPMENT CONCERNING INSPECTIONS, REMEDIATION AND REPAIR, MAINTENANCE AND DESIGN AND SPECIFICATION; COMPILATION AND SYSTEMIZATION OF INFORMATION INTO AN ONLINE COMPUTER DATABASE; MANAGEMENT AND COMPILATION OF AN ONLINE COMPUTER DATABASE; PROVIDING AN ONLINE COMPUTER DATABASE FEATURING

INFORMATION IN THE FIELD OF MECHANICAL EQUIPMENT RELIABILITY MANAGEMENT, INSPECTION, REMEDIATION AND REPAIR, MAINTENANCE, AND DESIGN AND SPECIFICATION, IN CLASS 35 (U.S. CLS. 100, 101 AND 102).

FIRST USE 10-3-2006; IN COMMERCE 10-10-2006.

THE MARK CONSISTS OF STANDARD CHARACTERS WITHOUT CLAIM TO ANY PARTICULAR FONT, STYLE, SIZE, OR COLOR.

SER. NO. 77-514,823, FILED 7-3-2008.

BILL DAWE, EXAMINING ATTORNEY

Int. Cl.: 36

Prior U.S. Cls.: 100, 101 and 102

United States Patent and Trademark Office

Reg. No. 3,575,688

Registered Feb. 17, 2009

**SERVICE MARK
PRINCIPAL REGISTER**

BEANS FOR BOOKS

CAFÉ FEMENINO FOUNDATION (WASHING-
TON CORPORATION)

P.O. BOX 1603

BATTLE GROUND, WA 98604

FOR: CHARITABLE FUND RAISING, IN CLASS
36 (U.S. CLS. 100, 101 AND 102).

FIRST USE 10-17-2000; IN COMMERCE 10-17-2000.

THE MARK CONSISTS OF STANDARD CHAR-
ACTERS WITHOUT CLAIM TO ANY PARTICULAR
FONT, STYLE, SIZE, OR COLOR.

NO CLAIM IS MADE TO THE EXCLUSIVE
RIGHT TO USE "BOOKS", APART FROM THE
MARK AS SHOWN.

SER. NO. 77-514,851, FILED 7-3-2008.

DAVID YONTEF, EXAMINING ATTORNEY

Int. Cl.: 10

Prior U.S. Cls.: 26, 39 and 44

Reg. No. 3,575,689

United States Patent and Trademark Office

Registered Feb. 17, 2009

TRADEMARK
PRINCIPAL REGISTER



YOUNG PS ACQUISITIONS, LLC (DELAWARE LIMITED LIABILITY COMPANY), DBA PLAK SMACKER

755 TRADEMARK CIRCLE
CORONA, CA 92879

FOR: EXAMINATION GLOVES FOR USE BY DOCTORS AND DENTISTS FOR PATIENT EXAMINING PURPOSES, IN CLASS 10 (U.S. CLS. 26, 39 AND 44).

FIRST USE 6-17-2008; IN COMMERCE 6-17-2008.

OWNER OF U.S. REG. NOS. 1,626,886, 2,688,330, AND 2,693,077.

NO CLAIM IS MADE TO THE EXCLUSIVE RIGHT TO USE "CHERRY", APART FROM THE MARK AS SHOWN.

THE MARK CONSISTS OF THE WORDS "PERFECT TOUCH" AND "CHERRY" AND ARTISTIC RENDERINGS OF FOUR CHERRIES HANGING FROM STEMS AROUND AN OVAL AND THE WORDS "PERFECT TOUCH ONE MORE REASON YOUR PATIENTS WILL LOVE YOU!" WITHIN AN OVAL AND ALONGSIDE A LINE PARTIALLY INDENTED IN THE MIDDLE.

SER. NO. 77-514,852, FILED 7-3-2008.

DAVID YONTEF, EXAMINING ATTORNEY

Int. Cl.: 8

Prior U.S. Cls.: 23, 28 and 44

United States Patent and Trademark Office

Reg. No. 3,575,690

Registered Feb. 17, 2009

**TRADEMARK
PRINCIPAL REGISTER**

TERMINUS

TERMINUS TECHNOLOGIES, INC. (MISSOURI
CORPORATION)
11640 ADIE ROAD
ST. LOUIS, MO 63043

FOR: HAND TOOLS, NAMELY, ENGRAVERS;
KNIVES, IN CLASS 8 (U.S. CLS. 23, 28 AND 44).

FIRST USE 6-30-1991; IN COMMERCE 6-30-1991.

THE MARK CONSISTS OF STANDARD CHAR-
ACTERS WITHOUT CLAIM TO ANY PARTICULAR
FONT, STYLE, SIZE, OR COLOR.

OWNER OF U.S. REG. NO. 3,474,817.

SER. NO. 77-514,854, FILED 7-3-2008.

CURTIS FRENCH, EXAMINING ATTORNEY

Int. Cl.: 9

Prior U.S. Cls.: 21, 23, 26, 36 and 38

Reg. No. 3,575,691

United States Patent and Trademark Office

Registered Feb. 17, 2009

**TRADEMARK
PRINCIPAL REGISTER**

Gold on Gold

MAM-A INC. (DELAWARE CORPORATION),
DBA MITSUI ADVANCED MEDIA INC.
10045 FEDERAL DRIVE
COLORADO SPRINGS, CO 809084509

THE MARK CONSISTS OF STANDARD CHAR-
ACTERS WITHOUT CLAIM TO ANY PARTICULAR
FONT, STYLE, SIZE, OR COLOR.

FOR: BLANK RECORDABLE OPTICAL DISC, IN
CLASS 9 (U.S. CLS. 21, 23, 26, 36 AND 38).

SER. NO. 77-514,868, FILED 7-3-2008.

FIRST USE 1-1-1997; IN COMMERCE 4-1-1998.

LESLIE RICHARDS, EXAMINING ATTORNEY

Int. Cl.: 5

Prior U.S. Cls.: 6, 18, 44, 46, 51 and 52

United States Patent and Trademark Office

Reg. No. 3,575,692

Registered Feb. 17, 2009

**TRADEMARK
PRINCIPAL REGISTER**



REUNION INVESTMENT GROUP (TEXAS LIMITED LIABILITY COMPANY)
2424 DAMSEL KATIE DRIVE
LEWISVILLE, TX 75056

FOR: NUTRITIONAL SUPPLEMENTS, IN CLASS 5 (U.S. CLS. 6, 18, 44, 46, 51 AND 52).

FIRST USE 1-0-2008; IN COMMERCE 1-0-2008.

THE STIPPLING IS FOR SHADING PURPOSES ONLY.

THE MARK CONSISTS OF A ROUND CIRCLE LIKE SHELL A STYLIZED TRIM, WITH TWO DOLPHINS JUMPING OUT OF THE SEA, INSIDE THE SHELL.

SER. NO. 77-514,986, FILED 7-3-2008.

TAMARA FRAZIER, EXAMINING ATTORNEY

Int. Cl.: 25

Prior U.S. Cls.: 22 and 39

United States Patent and Trademark Office

Reg. No. 3,575,693

Registered Feb. 17, 2009

**TRADEMARK
PRINCIPAL REGISTER**

**Jews Rock! A Celebration
of Rock and Roll's Jewish
Heritage**

MACOSKA, JANET (UNITED STATES INDIVIDUAL)
13411 SHERRY AVENUE
CLEVELAND, OH 44135

FOR: CLOTHING, NAMELY, SHIRTS, GOLF SHIRTS, T-SHIRTS, TANK TOPS, SWEATERS, JERSEYS, DRESS SHIRTS, SHORTS, SWEATPANTS, WARM-UP SUITS, BLAZERS, SPORT COATS, JEANS, SUITS, VESTS, JACKETS, COATS, PARKAS, PONCHOS, SWIMWEAR, RAINWEAR, SLEEPWEAR, TIES, SCARVES, FOOTWEAR, AND HEADGEAR, NAMELY, HATS, BASEBALL CAPS,

YARMULKES, HEADBANDS, STOCKING CAPS, IN CLASS 25 (U.S. CLS. 22 AND 39).

FIRST USE 1-15-2008; IN COMMERCE 2-7-2008.

THE MARK CONSISTS OF STANDARD CHARACTERS WITHOUT CLAIM TO ANY PARTICULAR FONT, STYLE, SIZE, OR COLOR.

SER. NO. 77-514,991, FILED 7-3-2008.

BRENDAN REGAN, EXAMINING ATTORNEY

Int. Cl.: 35

Prior U.S. Cls.: 100, 101 and 102

United States Patent and Trademark Office

Reg. No. 3,575,694

Registered Feb. 17, 2009

**SERVICE MARK
PRINCIPAL REGISTER**

ALLIED 100

ALLIED 100, LLC (WISCONSIN LIMITED LIABILITY COMPANY)
51N 1800 U.S. HIGHWAY
WOODRUFF, WI 54568

FOR: ONLINE RETAIL STORE SERVICES FEATURING AUTOMATED EXTERNAL DEFIBRILLATORS, CPR TRAINING MASKS, CPR AND AUTOMATED EXTERNAL DEFIBRILLATION TRAINING DEVICES, CPR TRAINING MANNEQUINS, FIRST-AID OXYGEN TANKS, AND AUTOMATED EXTERNAL DEFIBRILLATION ACCESSORIES, INCLUDING TRAINING DEFIBRILLATION PADS, DEFIBRILLATION PADS,

AND CARRYING CASES, IN CLASS 35 (U.S. CLS. 100, 101 AND 102).

FIRST USE 7-9-2003; IN COMMERCE 7-9-2003.

THE MARK CONSISTS OF STANDARD CHARACTERS WITHOUT CLAIM TO ANY PARTICULAR FONT, STYLE, SIZE, OR COLOR.

SER. NO. 77-515,005, FILED 7-3-2008.

JAY BESCH, EXAMINING ATTORNEY

Int. Cl.: 41

Prior U.S. Cls.: 100, 101 and 107

United States Patent and Trademark Office

Reg. No. 3,575,695

Registered Feb. 17, 2009

**SERVICE MARK
PRINCIPAL REGISTER**

DIGITAL TWEED

KENNETH C. GREEN DBA THE CAMPUS COMPUTING PROJECT (UNITED STATES INDIVIDUAL)
P.O. BOX 261242
ENCINO, CA 91426

FOR: ON-LINE JOURNALS, NAMELY, BLOGS, INFORMATION AND DISCUSSION BOARDS, FEATURING COMPUTER TECHNOLOGY AND EDUCATION, IN CLASS 41 (U.S. CLS. 100, 101 AND 107).

FIRST USE 7-15-1999; IN COMMERCE 7-15-1999.

THE MARK CONSISTS OF STANDARD CHARACTERS WITHOUT CLAIM TO ANY PARTICULAR FONT, STYLE, SIZE, OR COLOR.

NO CLAIM IS MADE TO THE EXCLUSIVE RIGHT TO USE "DIGITAL", APART FROM THE MARK AS SHOWN.

SER. NO. 77-515,012, FILED 7-3-2008.

KELLY MCCOY, EXAMINING ATTORNEY

Int. Cl.: 9

Prior U.S. Cls.: 21, 23, 26, 36 and 38

United States Patent and Trademark Office

Reg. No. 3,575,696

Registered Feb. 17, 2009

**TRADEMARK
PRINCIPAL REGISTER**

ANGEL SWORD

DVIDE ARTS INCORPORATED (TENNESSEE
CORPORATION)
910 81ST STREET
BROOKLYN, NY 11228

FOR: COMPUTER GAME PROGRAMS; COMPUTER GAME SOFTWARE; ELECTRONIC GAME PROGRAMS; ELECTRONIC GAME SOFTWARE; INTERACTIVE MULTIMEDIA COMPUTER GAME PROGRAM; INTERACTIVE VIDEO GAME PROGRAMS; VIDEO AND COMPUTER GAME PROGRAMS; VIDEO GAME SOFTWARE, IN CLASS 9 (U.S. CLS. 21, 23, 26, 36 AND 38).

FIRST USE 6-6-2006; IN COMMERCE 6-6-2006.

THE MARK CONSISTS OF STANDARD CHARACTERS WITHOUT CLAIM TO ANY PARTICULAR FONT, STYLE, SIZE, OR COLOR.

SER. NO. 77-515,049, FILED 7-4-2008.

BILL DAWE, EXAMINING ATTORNEY

Int. Cl.: 41

Prior U.S. Cls.: 100, 101 and 107

United States Patent and Trademark Office

Reg. No. 3,575,697

Registered Feb. 17, 2009

**SERVICE MARK
PRINCIPAL REGISTER**

TERPexpo

THE BLUE MOON COMPANY, LLC (FLORIDA
LIMITED LIABILITY COMPANY)
17105 CYPRESSWOOD WAY
CLERMONT, FL 34714

THE MARK CONSISTS OF STANDARD CHAR-
ACTERS WITHOUT CLAIM TO ANY PARTICULAR
FONT, STYLE, SIZE, OR COLOR.

FOR: CONTINUING EDUCATION SERVICES,
NAMELY, PROVIDING EXHIBITIONS AND CON-
FERENCES FOR INTERPRETERS, IN CLASS 41
(U.S. CLS. 100, 101 AND 107).

SER. NO. 77-515,060, FILED 7-4-2008.

FIRST USE 5-1-2007; IN COMMERCE 5-20-2008.

DANNEAN HETZEL, EXAMINING ATTORNEY

Int. Cl.: 35

Prior U.S. Cls.: 100, 101 and 102

United States Patent and Trademark Office

Reg. No. 3,575,698

Registered Feb. 17, 2009

**SERVICE MARK
PRINCIPAL REGISTER**



SCIOTO RIDGE JOB NETWORKING GROUP,
LLC (OHIO LIMITED LIABILITY COMPANY)
3491 FAIRWAY COMMONS DRIVE
HILLIARD, OH 43026

FOR: EMPLOYMENT HIRING, RECRUITING,
PLACEMENT, STAFFING AND CAREER NET-
WORKING SERVICES, IN CLASS 35 (U.S. CLS. 100,
101 AND 102).

FIRST USE 9-1-2007; IN COMMERCE 9-1-2007.

NO CLAIM IS MADE TO THE EXCLUSIVE
RIGHT TO USE "SCIOTO RIDGE JOB NETWORK-
ING GROUP", APART FROM THE MARK AS
SHOWN.

THE COLOR(S) BLUE, GREEN, BLACK IS/ARE
CLAIMED AS A FEATURE OF THE MARK.

THE MARK CONSISTS OF THREE CONCENTRIC
CIRCULAR ELEMENTS, THE OUTER CIRCLE
BEING BLUE THE SECOND CIRCLE BEING
GREEN AND THE INNER CIRCLE BEING
BLACK. THE WORDS "SCIOTO RIDGE" ARE IN BLUE, THE
WORDS "JOB NETWORKING" ARE IN GREEN
AND THE WORD "GROUP" IS IN BLACK.

SER. NO. 77-515,115, FILED 7-4-2008.

JOHN HWANG, EXAMINING ATTORNEY

Int. Cl.: 6

Prior U.S. Cls.: 2, 12, 13, 14, 23, 25 and 50

United States Patent and Trademark Office

Reg. No. 3,575,699

Registered Feb. 17, 2009

**TRADEMARK
PRINCIPAL REGISTER**

TURN CONCRETE INTO GOLD

SOUTHERN STANDARD MOLDS (MISSOURI
CORPORATION)
P.O. BOX 336
NEOSHO, MO 64850

THE MARK CONSISTS OF STANDARD CHAR-
ACTERS WITHOUT CLAIM TO ANY PARTICULAR
FONT, STYLE, SIZE, OR COLOR.

FOR: ALUMINUM ALLOY MOLDS FOR CON-
CRETE STATUARY UTILITARIAN AND ORNA-
MENTAL ITEMS, IN CLASS 6 (U.S. CLS. 2, 12, 13, 14,
23, 25 AND 50).

SER. NO. 77-515,119, FILED 7-4-2008.

FIRST USE 10-18-1951; IN COMMERCE 10-18-1951.

HELENE LIWINSKI, EXAMINING ATTORNEY

Int. Cl.: 35

Prior U.S. Cls.: 100, 101 and 102

United States Patent and Trademark Office

Reg. No. 3,575,700

Registered Feb. 17, 2009

**SERVICE MARK
PRINCIPAL REGISTER**

UpperBid

UPPERBID LLC (ARIZONA LIMITED LIABILITY
COMPANY), DBA UPPERBID.COM
PO BOX 11538
CASA GRANDE, AZ 85230

FOR: PROVIDING A WEB SITE THAT FEATURES
AN ON-LINE MARKET FOR USERS TO LIST OF-
FERED OR WANTED PERSONAL AND BUSINESS
ASSETS AND SKILLS FOR HIRE, RENT, SALE OR
AUCTION TRANSACTED ON THE BASIS OF PRE-
DEFINED PERFORMANCE AND CLOSING TERMS
AND CONDITIONS, IN CLASS 35 (U.S. CLS. 100, 101
AND 102).

FIRST USE 5-30-2001; IN COMMERCE 6-1-2001.

THE MARK CONSISTS OF STANDARD CHAR-
ACTERS WITHOUT CLAIM TO ANY PARTICULAR
FONT, STYLE, SIZE, OR COLOR.

SEC. 2(F).

SER. NO. 77-515,172, FILED 7-5-2008.

BRIAN PINO, EXAMINING ATTORNEY

Int. Cl.: 35

Prior U.S. Cls.: 100, 101 and 102

United States Patent and Trademark Office

Reg. No. 3,575,701

Registered Feb. 17, 2009

SERVICE MARK
PRINCIPAL REGISTER



HEALTHY KIDS RX, LLC (PENNSYLVANIA
LIMITED LIABILITY COMPANY)
181 DAVIDSON ROAD
MARS, PA 16046

FOR: RETAIL PHARMACY SERVICES, IN CLASS
35 (U.S. CLS. 100, 101 AND 102).

FIRST USE 9-1-2007; IN COMMERCE 11-19-2007.

NO CLAIM IS MADE TO THE EXCLUSIVE
RIGHT TO USE "KIDS" AND "RX", APART FROM
THE MARK AS SHOWN.

THE COLOR(S) BLUE, RED, AND GREEN IS/ARE
CLAIMED AS A FEATURE OF THE MARK.

THE MARK CONSISTS OF OVERSIZED AND
STYLIZED LETTER K WITH STYLIZED LETTERS
IDS (RED IN COLOR), STYLIZED LETTERS RX
(GREEN IN COLOR), STYLIZED CURVED LET-
TERS HEALTHY (BLUE IN COLOR) AND TAG
LINE THE PRESCRIPTION FOR A HEALTHY KID!
(BLUE IN COLOR) ALL ON WHITE BACK-
GROUND.

SER. NO. 77-515,180, FILED 7-5-2008.

JEAN IM, EXAMINING ATTORNEY

Int. Cl.: 5

Prior U.S. Cls.: 6, 18, 44, 46, 51 and 52

Reg. No. 3,575,702

United States Patent and Trademark Office

Registered Feb. 17, 2009

**TRADEMARK
PRINCIPAL REGISTER**

CANDIDA FREEDOM

MASSEY MEDICINALS (GEORGIA LIMITED
LIABILITY COMPANY)
SUITE 9
1630 BUFORD HWY
BUFORD, GA 30518

FOR: NATURAL SUPPLEMENTS FOR TREAT-
ING CANDIDA, IN CLASS 5 (U.S. CLS. 6, 18, 44, 46, 51
AND 52).

FIRST USE 1-1-2008; IN COMMERCE 1-1-2008.

THE MARK CONSISTS OF STANDARD CHAR-
ACTERS WITHOUT CLAIM TO ANY PARTICULAR
FONT, STYLE, SIZE, OR COLOR.

NO CLAIM IS MADE TO THE EXCLUSIVE
RIGHT TO USE "CANDIDA", APART FROM THE
MARK AS SHOWN.

SER. NO. 77-515,185, FILED 7-5-2008.

JEAN IM, EXAMINING ATTORNEY

Int. Cl.: 43

Prior U.S. Cls.: 100 and 101

United States Patent and Trademark Office

Reg. No. 3,575,703

Registered Feb. 17, 2009

SERVICE MARK
PRINCIPAL REGISTER



MGI ENTERPRISES INC. (HAWAII CORPORATION)
#220
1261 KILAUEA AVENUE
HILO, HI 96720

FOR: CAFE AND RESTAURANT SERVICES;
COFFEE SHOPS, IN CLASS 43 (U.S. CLS. 100 AND
101).

FIRST USE 3-1-2004; IN COMMERCE 3-1-2004.

NO CLAIM IS MADE TO THE EXCLUSIVE
RIGHT TO USE "KOPE" AND "ESPRESSO", APART
FROM THE MARK AS SHOWN.

THE MARK CONSISTS OF THE STYLIZED
WORDING "KOPE KOPE ESPRESSO" ALONG
WITH A DESIGN ELEMENT COMPRISED OF A
STYLIZED DEPICTION OF A COCONUT TREE
RISING OUT OF A COFFEE CUP SET ON A
SAUCER.

THE FOREIGN WORDING IN THE MARK
TRANSLATES INTO ENGLISH AS COFFEE COFFEE.

SER. NO. 77-515,257, FILED 7-5-2008.

MICHAEL GAAFAR, EXAMINING ATTORNEY

Int. Cl.: 35

Prior U.S. Cls.: 100, 101 and 102

United States Patent and Trademark Office

Reg. No. 3,575,704

Registered Feb. 17, 2009

SERVICE MARK
PRINCIPAL REGISTER

HOODRYDEZ

K BLUE, INC. (FLORIDA CORPORATION)
P.O. BOX 5274
CLEARWATER, FL 33758

FIRST USE 1-1-2008; IN COMMERCE 5-1-2008.

THE MARK CONSISTS OF THE STYLIZED TEXT
"HOODRYDEZ".

FOR: PUBLICITY AND SALES PROMOTION RE-
LATING TO GOODS AND SERVICES, OFFERED
AND ORDERED BY TELECOMMUNICATION OR
THE ELECTRONIC WAY, IN CLASS 35 (U.S. CLS.
100, 101 AND 102).

SER. NO. 77-515,259, FILED 7-5-2008.

C. DIONNE CLYBURN, EXAMINING ATTORNEY

Int. Cl.: 41

Prior U.S. Cls.: 100, 101 and 107

United States Patent and Trademark Office

Reg. No. 3,575,705

Registered Feb. 17, 2009

**SERVICE MARK
PRINCIPAL REGISTER**

COME & CREATE

DEPOLO, JOANN (UNITED STATES INDIVIDUAL)
26906 WESTWOOD LANE
OLMSTED FALLS, OH 44138

FOR: INSTRUCTION IN THE FIELDS OF MUSIC, PERFORMING AND VISUAL ARTS AND COLLABORATIVE COMMUNITY MURAL PROJECTS, IN CLASS 41 (U.S. CLS. 100, 101 AND 107).

FIRST USE 9-1-2005; IN COMMERCE 9-1-2005.

THE MARK CONSISTS OF STANDARD CHARACTERS WITHOUT CLAIM TO ANY PARTICULAR FONT, STYLE, SIZE, OR COLOR.

SER. NO. 77-515,260, FILED 7-5-2008.

C. DIONNE CLYBURN, EXAMINING ATTORNEY

Int. Cl.: 45

Prior U.S. Cls.: 100 and 101

United States Patent and Trademark Office

Reg. No. 3,575,706

Registered Feb. 17, 2009

**SERVICE MARK
PRINCIPAL REGISTER**



GIVESUPPORT INTERNATIONAL (CALIFORNIA CORPORATION)
SUITE 308
5800 GREEN VALLEY CIRCLE
CULVER CITY, CA 90230

FOR: LICENSING OF PROMOTIONAL CAMPAIGNS THAT RAISE AWARENESS ABOUT AMERICAN ALLEGIANCE, NATIONAL SOVEREIGNTY, AND INDEPENDENCE TO BUSINESSES AND ORGANIZATIONS FOR USE IN THEIR CORPORATE IDENTITY, ADVERTISING, CAUSE-RELATED MARKETING, AND/OR PROMOTION OF THEIR PRODUCTS AND/OR SERVICES, IN CLASS 45 (U.S. CLS. 100 AND 101).

FIRST USE 7-4-2008; IN COMMERCE 7-4-2008.

THE MARK CONSISTS OF THE DESIGN OF A STYLIZED EAGLE FEATURING THREE STARS ALIGNED VERTICALLY ALONG THE RIGHT SIDE OF THE MARK AND TWO STRIPED WINGS AT THE LEFT SIDE OF THE MARK.

SER. NO. 77-515,268, FILED 7-5-2008.

MARK PILARO, EXAMINING ATTORNEY

Int. Cl.: 9

Prior U.S. Cls.: 21, 23, 26, 36 and 38

United States Patent and Trademark Office

Reg. No. 3,575,707

Registered Feb. 17, 2009

**TRADEMARK
PRINCIPAL REGISTER**

SCADE CVK

ESTEREL TECHNOLOGIES, INC. (CALIFORNIA
CORPORATION)
SUITE 818
444 CASTRO STREE
MOUNTAIN VIEW, CA 94041

FOR: COMPILER VERIFICATION SOFTWARE,
IN CLASS 9 (U.S. CLS. 21, 23, 26, 36 AND 38).

FIRST USE 0-0-2006; IN COMMERCE 0-0-2006.

THE MARK CONSISTS OF STANDARD CHAR-
ACTERS WITHOUT CLAIM TO ANY PARTICULAR
FONT, STYLE, SIZE, OR COLOR.

OWNER OF U.S. REG. NOS. 3,020,031 AND
3,144,740.

SER. NO. 77-515,276, FILED 7-6-2008.

KRISTIN CARLSON, EXAMINING ATTORNEY

Int. Cl.: 9

Prior U.S. Cls.: 21, 23, 26, 36 and 38

Reg. No. 3,575,708

United States Patent and Trademark Office

Registered Feb. 17, 2009

**TRADEMARK
PRINCIPAL REGISTER**

SCADE KCG

ESTEREL TECHNOLOGIES, INC. (CALIFORNIA
CORPORATION)
SUITE 818
444 CASTRO STREE
MOUNTAIN VIEW, CA 94041

FOR: COMPUTER SOFTWARE FOR CODE GEN-
ERATION IN THE FIELD OF SAFETY-CRITICAL
EMBEDDED SOFTWARE, IN CLASS 9 (U.S. CLS. 21,
23, 26, 36 AND 38).

FIRST USE 0-0-2002; IN COMMERCE 0-0-2002.

THE MARK CONSISTS OF STANDARD CHAR-
ACTERS WITHOUT CLAIM TO ANY PARTICULAR
FONT, STYLE, SIZE, OR COLOR.

OWNER OF U.S. REG. NOS. 3,020,031 AND
3,144,740.

SER. NO. 77-515,277, FILED 7-6-2008.

KRISTIN CARLSON, EXAMINING ATTORNEY

Int. Cl.: 9

Prior U.S. Cls.: 21, 23, 26, 36 and 38

Reg. No. 3,575,709

United States Patent and Trademark Office

Registered Feb. 17, 2009

**TRADEMARK
PRINCIPAL REGISTER**

SCADE SUITE

ESTEREL TECHNOLOGIES, INC. (CALIFORNIA CORPORATION)
SUITE 818
444 CASTRO STREE
MOUNTAIN VIEW, CA 94041

FOR: COMPUTER SOFTWARE FOR CREATING EMBEDDED SOFTWARE USED FOR CRITICAL FUNCTIONS AND TO CREATE EXECUTABLE SPECIFICATIONS, FORMAL TESTS, AND AUTOMATICALLY GENERATED CODE, IN CLASS 9 (U.S. CLS. 21, 23, 26, 36 AND 38).

FIRST USE 0-0-2006; IN COMMERCE 0-0-2006.

THE MARK CONSISTS OF STANDARD CHARACTERS WITHOUT CLAIM TO ANY PARTICULAR FONT, STYLE, SIZE, OR COLOR.

OWNER OF U.S. REG. NOS. 3,020,031 AND 3,144,740.

NO CLAIM IS MADE TO THE EXCLUSIVE RIGHT TO USE "SUITE", APART FROM THE MARK AS SHOWN.

SER. NO. 77-515,280, FILED 7-6-2008.

KRISTIN CARLSON, EXAMINING ATTORNEY

Int. Cl.: 41

Prior U.S. Cls.: 100, 101 and 107

United States Patent and Trademark Office

Reg. No. 3,575,710

Registered Feb. 17, 2009

**SERVICE MARK
PRINCIPAL REGISTER**

VOCADOKU

BERGER, ROSS (UNITED STATES INDIVIDUAL)
923 1/2 NORTH BEAUDRY AVENUE
LOS ANGELES, CA 90012

THE MARK CONSISTS OF STANDARD CHAR-
ACTERS WITHOUT CLAIM TO ANY PARTICULAR
FONT, STYLE, SIZE, OR COLOR.

FOR: ENTERTAINMENT SERVICES, NAMELY,
PROVIDING ON-LINE COMPUTER GAMES, IN
CLASS 41 (U.S. CLS. 100, 101 AND 107).

SER. NO. 77-515,352, FILED 7-6-2008.

FIRST USE 9-8-2008; IN COMMERCE 9-8-2008.

MAYUR VAGHANI, EXAMINING ATTORNEY

Int. Cl.: 9

Prior U.S. Cls.: 21, 23, 26, 36 and 38

United States Patent and Trademark Office

Reg. No. 3,575,711

Registered Feb. 17, 2009

**TRADEMARK
PRINCIPAL REGISTER**

Famouse

MISKELL, BRENDON J (AUSTRALIA INDIVIDUAL)
UNIT 6/1-5 LINDA ST, HORNSBY
SYDNEY, AUSTRALIA 2077

FOR: COMPUTER SOFTWARE FOR USE IN RELATION TO DIGITAL ANIMATION AND SPECIAL EFFECTS OF IMAGES; VIDEO DISKS AND VIDEO TAPES WITH RECORDED ANIMATED CARTOONS; VIDEOTAPES AND VIDEO DISKS RECORDED WITH ANIMATION; VISUAL RECORDINGS AND AUDIOVISUAL RECORDINGS FEATURING MUSIC AND ANIMATION, IN CLASS 9 (U.S. CLS. 21, 23, 26, 36 AND 38).

THE MARK CONSISTS OF STANDARD CHARACTERS WITHOUT CLAIM TO ANY PARTICULAR FONT, STYLE, SIZE, OR COLOR.

OWNER OF AUSTRALIA REG. NO. 1215637, DATED 12-17-2007, EXPIRES 12-17-2017.

SER. NO. 77-515,408, FILED 7-6-2008.

DOMINICK J. SALEMI, EXAMINING ATTORNEY

Int. Cl.: 44

Prior U.S. Cls.: 100 and 101

United States Patent and Trademark Office

Reg. No. 3,575,712

Registered Feb. 17, 2009

**SERVICE MARK
PRINCIPAL REGISTER**

**SU RECETA PARA LA BUENA
SALUD**

COMPREHENSIVE MEDICAL ACCESS (CMA),
INC. (FLORIDA CORPORATION), DBA CEN-
TROS MEDICOS LAS AMERICAS

8000 BISCAYNE BLVD
MIAMI, FL 33138

FOR: HEALTH CARE, IN CLASS 44 (U.S. CLS. 100
AND 101).

FIRST USE 1-1-2008; IN COMMERCE 1-1-2008.

THE MARK CONSISTS OF STANDARD CHAR-
ACTERS WITHOUT CLAIM TO ANY PARTICULAR
FONT, STYLE, SIZE, OR COLOR.

THE FOREIGN WORDING IN THE MARK
TRANSLATES INTO ENGLISH AS YOUR PRE-
SCRIPTION FOR GOOD HEALTH.

SER. NO. 77-515,420, FILED 7-6-2008.

DOMINICK J. SALEMI, EXAMINING ATTORNEY

Int. Cl.: 35

Prior U.S. Cls.: 100, 101 and 102

United States Patent and Trademark Office

Reg. No. 3,575,713

Registered Feb. 17, 2009

**SERVICE MARK
PRINCIPAL REGISTER**

WE PUT BRANDS TO WORK.

HAGGIN MARKETING, INC. (CALIFORNIA CORPORATION)
100 SHORELINE HIGHWAY
MILL VALLEY, CA 94941

FOR: ADVERTISING AND PROMOTIONAL SERVICES; DIRECT MARKETING ADVERTISING FOR OTHERS; DIRECT MARKETING CONSULTING SERVICES; DIRECT MARKETING SERVICES, IN CLASS 35 (U.S. CLS. 100, 101 AND 102).

FIRST USE 5-16-2008; IN COMMERCE 5-16-2008.

THE MARK CONSISTS OF STANDARD CHARACTERS WITHOUT CLAIM TO ANY PARTICULAR FONT, STYLE, SIZE, OR COLOR.

SER. NO. 77-515,422, FILED 7-6-2008.

DOMINICK J. SALEMI, EXAMINING ATTORNEY

Int. Cl.: 16

Prior U.S. Cls.: 2, 5, 22, 23, 29, 37, 38 and 50

United States Patent and Trademark Office

Reg. No. 3,575,714

Registered Feb. 17, 2009

**TRADEMARK
PRINCIPAL REGISTER**

JOTMARKS

MONDAY SMILES, LLC (CALIFORNIA LIMITED
LIABILITY COMPANY)
9354 BURNET AVENUE, SUITE 120
LOS ANGELES, CA 91343

THE MARK CONSISTS OF STANDARD CHAR-
ACTERS WITHOUT CLAIM TO ANY PARTICULAR
FONT, STYLE, SIZE, OR COLOR.

FOR: BOOKMARKS, PICTURE POSTCARDS, NO-
TEBOOKS, TRAVEL BOOKS, COFFEE TABLE
BOOKS, IN CLASS 16 (U.S. CLS. 2, 5, 22, 23, 29, 37, 38
AND 50).

SER. NO. 77-515,435, FILED 7-7-2008.

FIRST USE 11-27-2007; IN COMMERCE 7-1-2008.

SUSAN LESLIE DUBOIS, EXAMINING ATTORNEY

Int. Cl.: 42

Prior U.S. Cls.: 100 and 101

United States Patent and Trademark Office

Reg. No. 3,575,715

Registered Feb. 17, 2009

**SERVICE MARK
PRINCIPAL REGISTER**

orderTalk

ORDERTALK INC. (DELAWARE CORPORATION), DBA ORDERTALK
SUITE 107 - 173
2201 LONG PRAIRIE ROAD
FLOWER MOUND, TX 75022

FOR: APPLICATION SERVICE PROVIDER (ASP), NAMELY, HOSTING COMPUTER SOFTWARE APPLICATIONS OF OTHERS; APPLICATION SERVICE PROVIDER, NAMELY, PROVIDING, HOSTING, MANAGING, DEVELOPING, RESEARCHING, ANALYZING, REPORTING, AND MAINTAINING APPLICATIONS, SOFTWARE, WEB SITES, AND DATABASES OF OTHERS IN THE FIELDS OF HEALTHCARE, BENEFITS PROGRAMS, EMPLOYEE PRODUCTIVITY, RISK MANAGEMENT; COMPUTER SERVICES, NAMELY, HOSTING AND MAINTAINING AN ON-LINE WEB SITE FOR OTHERS TO PROCESS ONLINE ORDERS FOR THE

FOOD INDUSTRY; DESIGN, CREATION, HOSTING AND MAINTENANCE OF INTERNET SITES FOR THIRD PARTIES; HOSTING OF DIGITAL CONTENT ON THE INTERNET; HOSTING OF WEB SITES; HOSTING THE WEB SITES OF OTHERS; WEB SITE HOSTING SERVICES, IN CLASS 42 (U.S. CLS. 100 AND 101).

FIRST USE 1-1-1999; IN COMMERCE 4-1-2004.

THE MARK CONSISTS OF STANDARD CHARACTERS WITHOUT CLAIM TO ANY PARTICULAR FONT, STYLE, SIZE, OR COLOR.

SER. NO. 77-515,456, FILED 7-7-2008.

TOBY BULLOFF, EXAMINING ATTORNEY

Int. Cl.: 35

Prior U.S. Cls.: 100, 101 and 102

United States Patent and Trademark Office

Reg. No. 3,575,716

Registered Feb. 17, 2009

**SERVICE MARK
PRINCIPAL REGISTER**

COUNTY2COUNTY

COUNTY TO COUNTY INC. (FLORIDA CORPORATION)
115 W OLYMPIA AVE
PUNTA GORDA, FL 33950

THE MARK CONSISTS OF STANDARD CHARACTERS WITHOUT CLAIM TO ANY PARTICULAR FONT, STYLE, SIZE, OR COLOR.

FOR: PROVIDING A WEB SITE THAT ENABLES USERS TO POST ITEMS FOR SALE THROUGH ON-LINE CLASSIFIED ADVERTISEMENTS, IN CLASS 35 (U.S. CLS. 100, 101 AND 102).

SER. NO. 77-515,469, FILED 7-7-2008.

FIRST USE 11-23-2007; IN COMMERCE 11-23-2007.

JEAN IM, EXAMINING ATTORNEY

Int. Cl.: 42

Prior U.S. Cls.: 100 and 101

United States Patent and Trademark Office

Reg. No. 3,575,717

Registered Feb. 17, 2009

**SERVICE MARK
PRINCIPAL REGISTER**

Embeddex

EMBEDDEX LTD. (OHIO LIMITED LIABILITY
COMPANY)
474 GRENSBORO DR.
CENTERVILLE, OH 45459

FOR: COMPUTER PROGRAMMING AND COM-
PUTER SYSTEM ANALYSIS; DESIGN, DEVELOP-
MENT AND IMPLEMENTATION OF SOFTWARE;
DESIGN, MAINTENANCE, DEVELOPMENT AND
UPDATING OF COMPUTER SOFTWARE; DEVEL-
OPMENT OF TECHNOLOGIES FOR THE FABRICA-
TION OF CIRCUITS FOR WIRELESS
COMMUNICATION, ELECTRONIC DATA PROCES-
SING, CONSUMER ELECTRONIC, AUTOMOTIVE

ELECTRONICS, IN CLASS 42 (U.S. CLS. 100 AND
101).

FIRST USE 5-1-2001; IN COMMERCE 5-1-2001.

THE MARK CONSISTS OF STANDARD CHAR-
ACTERS WITHOUT CLAIM TO ANY PARTICULAR
FONT, STYLE, SIZE, OR COLOR.

SER. NO. 77-515,472, FILED 7-7-2008.

REBECCA SMITH, EXAMINING ATTORNEY

Int. Cl.: 41

Prior U.S. Cls.: 100, 101 and 107

United States Patent and Trademark Office

Reg. No. 3,575,718

Registered Feb. 17, 2009

**SERVICE MARK
PRINCIPAL REGISTER**

LIVE & LEARN

AARP (D.C. NON-PROFIT CORPORATION)
601 E STREET, N.W.
WASHINGTON, DC 20049

FOR: PROVIDING ON-LINE PUBLICATIONS IN
THE NATURE OF NEWSLETTERS, PERIODICALS,
AND BULLETINS IN THE FIELDS OF RETIRED
EDUCATORS, MATURE INDIVIDUALS, RETIRE-
MENT, MATURE OR RETIRED LIFESTYLES,
AGING AND FAMILY RELATIONSHIPS, IN CLASS
41 (U.S. CLS. 100, 101 AND 107).

FIRST USE 12-0-2007; IN COMMERCE 12-0-2007.

THE MARK CONSISTS OF STANDARD CHAR-
ACTERS WITHOUT CLAIM TO ANY PARTICULAR
FONT, STYLE, SIZE, OR COLOR.

OWNER OF U.S. REG. NO. 2,960,188.

SER. NO. 77-515,477, FILED 7-7-2008.

BRIDGETT SMITH, EXAMINING ATTORNEY

Int. Cl.: 29

Prior U.S. Cl.: 46

United States Patent and Trademark Office

Reg. No. 3,575,719

Registered Feb. 17, 2009

**TRADEMARK
PRINCIPAL REGISTER**

BEAR CREEK COUNTRY KITCHENS

BEAR CREEK COUNTRY KITCHENS, LLC (DE-
LAWARE LIMITED LIABILITY COMPANY)
SUITE 103
1400 OLD COUNTRY ROAD
WESTBURY, NY 11590

THE MARK CONSISTS OF STANDARD CHAR-
ACTERS WITHOUT CLAIM TO ANY PARTICULAR
FONT, STYLE, SIZE, OR COLOR.

FOR: SOUP MIXES; SOUPS, IN CLASS 29 (U.S. CL.
46).

SER. NO. 77-515,479, FILED 7-7-2008.

FIRST USE 3-1-1992; IN COMMERCE 3-1-1992.

GRETTA YAO, EXAMINING ATTORNEY

Int. Cl.: 30

Prior U.S. Cl.: 46

United States Patent and Trademark Office

Reg. No. 3,575,720

Registered Feb. 17, 2009

**TRADEMARK
PRINCIPAL REGISTER**

ROCKETS

CE DE CANDY, INC. (NEW JERSEY CORPORATION)
1091 LOUSONS RD
UNION, NJ 07083

FOR: CANDY, IN CLASS 30 (U.S. CL. 46).

FIRST USE 10-0-1995; IN COMMERCE 10-0-1995.

THE MARK CONSISTS OF STANDARD CHARACTERS WITHOUT CLAIM TO ANY PARTICULAR FONT, STYLE, SIZE, OR COLOR.

OWNER OF U.S. REG. NO. 2,173,443.

SER. NO. 77-515,482, FILED 7-7-2008.

GRETTA YAO, EXAMINING ATTORNEY

Int. Cl.: 36

Prior U.S. Cls.: 100, 101 and 102

United States Patent and Trademark Office

Reg. No. 3,575,721

Registered Feb. 17, 2009

**SERVICE MARK
PRINCIPAL REGISTER**

BOOT CAMP WITH A PURPOSE

SGRO, MATTHEW (UNITED STATES INDIVIDUAL)
571 WEST UWCHLAN AVENUE
EXTON, PA 19341

FOR: CHARITABLE FUNDRAISING SERVICES, NAMELY, ORGANIZING AND CONDUCTING PHYSICAL FITNESS TRAINING SERVICES TO RAISE MONEY FOR DISABLED CHILDREN, IN CLASS 36 (U.S. CLS. 100, 101 AND 102).

FIRST USE 6-0-2008; IN COMMERCE 6-0-2008.

THE MARK CONSISTS OF STANDARD CHARACTERS WITHOUT CLAIM TO ANY PARTICULAR FONT, STYLE, SIZE, OR COLOR.

SER. NO. 77-515,494, FILED 7-7-2008.

DANIEL CAPSHAW, EXAMINING ATTORNEY

Int. Cl.: 28

Prior U.S. Cls.: 22, 23, 38 and 50

United States Patent and Trademark Office

Reg. No. 3,575,722

Registered Feb. 17, 2009

**TRADEMARK
PRINCIPAL REGISTER**

StowPen

BRIGHT II, DONALD S. (UNITED STATES IN-
DIVIDUAL)
110 VILLAGE CT
GARNER, NC 27529

FOR: FISHING BAIT HOLDER; FISHING
CREELS; FISHING TACKLE; HAND-HELD FISH-
ING NETS; HAND-HELD FISHING NETS FOR
SPORTSMEN, IN CLASS 28 (U.S. CLS. 22, 23, 38
AND 50).

FIRST USE 4-18-2008; IN COMMERCE 6-13-2008.

THE MARK CONSISTS OF STANDARD CHAR-
ACTERS WITHOUT CLAIM TO ANY PARTICULAR
FONT, STYLE, SIZE, OR COLOR.

SER. NO. 77-515,539, FILED 7-7-2008.

LINDA ORNDORFF, EXAMINING ATTORNEY

Int. Cl.: 25

Prior U.S. Cls.: 22 and 39

United States Patent and Trademark Office

Reg. No. 3,575,723

Registered Feb. 17, 2009

**TRADEMARK
PRINCIPAL REGISTER**

Bring The Hope

WHAT IF WEAR LLC (INDIANA LIMITED LIABILITY COMPANY), DBA BRING THE HOPE
35 SOUTH MAIN STREET
FORTVILLE, IN 46040

THE MARK CONSISTS OF STANDARD CHARACTERS WITHOUT CLAIM TO ANY PARTICULAR FONT, STYLE, SIZE, OR COLOR.

FOR: SHORT-SLEEVED OR LONG-SLEEVED T-SHIRTS, IN CLASS 25 (U.S. CLS. 22 AND 39).

SER. NO. 77-515,569, FILED 7-7-2008.

FIRST USE 5-22-2008; IN COMMERCE 6-16-2008.

ALICE BENMAMAN, EXAMINING ATTORNEY

Int. Cl.: 6

Prior U.S. Cls.: 2, 12, 13, 14, 23, 25 and 50

Reg. No. 3,575,724

United States Patent and Trademark Office

Registered Feb. 17, 2009

**TRADEMARK
PRINCIPAL REGISTER**

SLIDE & GLIDE

PRIEFERT MANUFACTURING CO., INC.
(TEXAS CORPORATION)
P.O. BOX 1540
MT. PLEASANT, TX 75456

THE MARK CONSISTS OF STANDARD CHAR-
ACTERS WITHOUT CLAIM TO ANY PARTICULAR
FONT, STYLE, SIZE, OR COLOR.

FOR: METAL HORSE STALLS, IN CLASS 6 (U.S.
CLS. 2, 12, 13, 14, 23, 25 AND 50).

SER. NO. 77-515,587, FILED 7-7-2008.

FIRST USE 9-9-2005; IN COMMERCE 9-9-2005.

ESTHER A. BORSUK, EXAMINING ATTORNEY

Int. Cl.: 5

Prior U.S. Cls.: 6, 18, 44, 46, 51 and 52

Reg. No. 3,575,725

United States Patent and Trademark Office

Registered Feb. 17, 2009

**TRADEMARK
PRINCIPAL REGISTER**

AVALON

PROKOZ, INC (GEORGIA CORPORATION)
100 NORTH POINT CENTER EAST SUITE 330
ALPHARETTA, GA 300228242

THE MARK CONSISTS OF STANDARD CHAR-
ACTERS WITHOUT CLAIM TO ANY PARTICULAR
FONT, STYLE, SIZE, OR COLOR.

FOR: FUNGICIDES, IN CLASS 5 (U.S. CLS. 6, 18,
44, 46, 51 AND 52).

SER. NO. 77-515,598, FILED 7-7-2008.

FIRST USE 1-1-2007; IN COMMERCE 1-1-2007.

KIM SAITO, EXAMINING ATTORNEY

Int. Cl.: 41

Prior U.S. Cls.: 100, 101 and 107

United States Patent and Trademark Office

Reg. No. 3,575,726

Registered Feb. 17, 2009

**SERVICE MARK
PRINCIPAL REGISTER**

FEAC

FEAC INSTITUTE, INC. (D.C. CORPORATION)
SUITE 460
420 EUILLE STREET
ALEXANDRIA, VA 22314

FOR: EDUCATION SERVICES, NAMELY, PROVIDING TUTORIAL SESSIONS, CLASSES, SEMINARS AND WORKSHOPS IN THE FIELD OF ENTERPRISE ARCHITECTURE AND INFORMATION TECHNOLOGY, IN CLASS 41 (U.S. CLS. 100, 101 AND 107).

FIRST USE 12-31-2002; IN COMMERCE 12-31-2002.

THE MARK CONSISTS OF STANDARD CHARACTERS WITHOUT CLAIM TO ANY PARTICULAR FONT, STYLE, SIZE, OR COLOR.

SER. NO. 77-515,627, FILED 7-7-2008.

STEVEN R. FINE, EXAMINING ATTORNEY

Int. Cl.: 1

Prior U.S. Cls.: 1, 5, 6, 10, 26 and 46

United States Patent and Trademark Office

Reg. No. 3,575,727

Registered Feb. 17, 2009

**TRADEMARK
PRINCIPAL REGISTER**

COMPRESS WSG

PROKOZ, INC (GEORGIA CORPORATION)
100 NORTH POINT CENTER EAST SUITE 330
ALPHARETTA, GA 30022

FOR: PLANT GROWTH REGULATORS FOR
AGRICULTURAL USE, IN CLASS 1 (U.S. CLS. 1, 5,
6, 10, 26 AND 46).

FIRST USE 1-1-2007; IN COMMERCE 1-1-2008.

THE MARK CONSISTS OF STANDARD CHAR-
ACTERS WITHOUT CLAIM TO ANY PARTICULAR
FONT, STYLE, SIZE, OR COLOR.

NO CLAIM IS MADE TO THE EXCLUSIVE
RIGHT TO USE "WSG", APART FROM THE MARK
AS SHOWN.

SER. NO. 77-515,635, FILED 7-7-2008.

KIM SAITO, EXAMINING ATTORNEY

Int. Cls.: 35, 36 and 41

Prior U.S. Cls.: 100, 101, 102 and 107

United States Patent and Trademark Office

Reg. No. 3,575,728

Registered Feb. 17, 2009

**SERVICE MARK
PRINCIPAL REGISTER**

VistaLynk Solutions

VISTALYNK SOLUTIONS, LLC (OHIO LIMITED LIABILITY COMPANY)
7527C STATE ROAD
CINCINNATI, OH 45255

FOR: MANAGEMENT AND BUSINESS CONSULTING SERVICES IN THE FIELD OF DAILY MONEY MANAGEMENT AND ELDER CARE MANAGEMENT, IN CLASS 35 (U.S. CLS. 100, 101 AND 102).

FIRST USE 0-0-2003; IN COMMERCE 0-0-2003.

FOR: FINANCIAL CONSULTATION IN THE FIELD OF ELDER CARE MANAGEMENT AND DAILY MONEY MANAGEMENT, IN CLASS 36 (U.S. CLS. 100, 101 AND 102).

FIRST USE 0-0-2003; IN COMMERCE 0-0-2003.

FOR: EDUCATION SERVICES, NAMELY, PROVIDING WORKSHOPS TO EMPLOYERS, EMPLOYEES, AND INDIVIDUALS IN THE FIELD OF ELDER CARE AND FAMILY CAREGIVING, IN CLASS 41 (U.S. CLS. 100, 101 AND 107).

FIRST USE 0-0-2003; IN COMMERCE 0-0-2003.

THE MARK CONSISTS OF STANDARD CHARACTERS WITHOUT CLAIM TO ANY PARTICULAR FONT, STYLE, SIZE, OR COLOR.

NO CLAIM IS MADE TO THE EXCLUSIVE RIGHT TO USE "SOLUTIONS", APART FROM THE MARK AS SHOWN.

SER. NO. 77-515,638, FILED 7-7-2008.

SUSAN STIGLITZ, EXAMINING ATTORNEY

Int. Cl.: 42

Prior U.S. Cls.: 100 and 101

United States Patent and Trademark Office

Reg. No. 3,575,729

Registered Feb. 17, 2009

**SERVICE MARK
PRINCIPAL REGISTER**

Jaysec Technologies

JAYSEC TECHNOLOGIES, LLC (TENNESSEE
LIMITED LIABILITY COMPANY)
1303 FRYE STREET
ATHENS, TN 37303

FOR: APPLICATION SERVICE PROVIDER,
NAMELY, PROVIDING, HOSTING, MANAGING,
DEVELOPING AND MAINTAINING APPLICA-
TIONS, SOFTWARE, WEB SITES AND DATABASES
IN THE FIELD OF HEALTHCARE AND HEALTH-
CARE EQUIPMENT PURCHASE AND DISTRIBUTION,
IN CLASS 42 (U.S. CLS. 100 AND 101).

FIRST USE 1-1-2004; IN COMMERCE 1-1-2004.

THE MARK CONSISTS OF STANDARD CHAR-
ACTERS WITHOUT CLAIM TO ANY PARTICULAR
FONT, STYLE, SIZE, OR COLOR.

NO CLAIM IS MADE TO THE EXCLUSIVE
RIGHT TO USE "TECHNOLOGIES", APART FROM
THE MARK AS SHOWN.

SER. NO. 77-515,753, FILED 7-7-2008.

BARBARA BROWN, EXAMINING ATTORNEY

Int. Cl.: 37

Prior U.S. Cls.: 100, 103 and 106

United States Patent and Trademark Office

Reg. No. 3,575,730

Registered Feb. 17, 2009

**SERVICE MARK
PRINCIPAL REGISTER**

**"ELECTRICITY IS NOT A
HOBBY"**

KONIGSMARK, GARY (UNITED STATES INDIVIDUAL)
P.O. BOX 2261
358 METROPOLE AVE
AVALON, CA 90704

FOR: ELECTRICAL CONTRACTING; ELECTRICAL REPAIRS AND INSTALLATION FOR RESIDENTIAL AND COMMERCIAL BUILDINGS, IN CLASS 37 (U.S. CLS. 100, 103 AND 106).

FIRST USE 3-26-1984; IN COMMERCE 3-26-1984.

THE MARK CONSISTS OF STANDARD CHARACTERS WITHOUT CLAIM TO ANY PARTICULAR FONT, STYLE, SIZE, OR COLOR.

SER. NO. 77-515,771, FILED 7-7-2008.

WON TEAK OH, EXAMINING ATTORNEY

Int. Cl.: 9

Prior U.S. Cls.: 21, 23, 26, 36 and 38

United States Patent and Trademark Office

Reg. No. 3,575,731

Registered Feb. 17, 2009

TRADEMARK
PRINCIPAL REGISTER



HOUSTON, WILLIAM (UNITED STATES INDIVIDUAL)
7384 MANUAL RD
BAINBRIDGE ISLAND, WA 98110

FOR: MAGNETIC MICROPHONE USED SPECIFICALLY FOR ELECTRIC GUITARS TO AID IN THE PROCESS OF AMPLIFYING SOUNDS, IN CLASS 9 (U.S. CLS. 21, 23, 26, 36 AND 38).

FIRST USE 4-0-2004; IN COMMERCE 11-0-2005.

NO CLAIM IS MADE TO THE EXCLUSIVE RIGHT TO USE "GUITAR PICKUPS", APART FROM THE MARK AS SHOWN.

THE MARK CONSISTS OF A ROCKET SHIP WITH THE STYLIZED TEXT "ROCKET" IN THE MIDDLE OF THE PLANET. THE STYLIZED TEXT "GUITAR" APPEARS ON THE TOP AND THE STYLIZED TEXT "PICKUPS" APPEARS AT THE BOTTOM OF THE ROCKET SHIP. ON THE BACKGROUND, THERE IS TWO STARS.

SER. NO. 77-515,781, FILED 7-7-2008.

TRACY FLETCHER, EXAMINING ATTORNEY

Int. Cl.: 35

Prior U.S. Cls.: 100, 101 and 102

United States Patent and Trademark Office

Reg. No. 3,575,732

Registered Feb. 17, 2009

**SERVICE MARK
PRINCIPAL REGISTER**

ENDURA

NELSON, JEROME (UNITED STATES INDIVIDUAL)
1814 JENNIFER DRIVE
LITTLE ROCK, AR 72212

THE MARK CONSISTS OF STANDARD CHARACTERS WITHOUT CLAIM TO ANY PARTICULAR FONT, STYLE, SIZE, OR COLOR.

FOR: ADVERTISING AGENCIES, IN CLASS 35 (U.S. CLS. 100, 101 AND 102).

SER. NO. 77-515,801, FILED 7-7-2008.

FIRST USE 2-15-2004; IN COMMERCE 12-4-2005.

MARGERY A. TIERNEY, EXAMINING ATTORNEY

Int. Cl.: 35

Prior U.S. Cls.: 100, 101 and 102

United States Patent and Trademark Office

Reg. No. 3,575,733

Registered Feb. 17, 2009

**SERVICE MARK
PRINCIPAL REGISTER**



DOREL E-COMMERCE INC. (DELAWARE CORPORATION)
410 EAST FIRST STREET SOUTH
WRIGHT CITY, MO 63390

FOR: THE BRINGING TOGETHER, FOR THE BENEFIT OF OTHERS, OF A VARIETY OF GOODS AND SERVICES, ENABLING CUSTOMERS TO CONVENIENTLY VIEW AND PURCHASE THOSE GOODS AND SERVICES FROM AN INTERNET WEBSITE PARTICULARLY SPECIALIZING IN THE MARKETING OF THE SALE OF GOODS AND SERVICES OF OTHERS, IN CLASS 35 (U.S. CLS. 100, 101 AND 102).

FIRST USE 4-24-2008; IN COMMERCE 4-24-2008.

THE MARK CONSISTS OF A CARICATURE OF A SMILING CRICKET WEARING A V-NECK SHIRT AND STANDING ON ITS BACK LEGS WITH ITS RIGHT HAND RESTING ON ITS RIGHT HIP AND THE LEFT ARM PARTIALLY EXTENDED WITH THE PALM SIDE OF ITS HAND FACING UPWARD.

SER. NO. 77-515,813, FILED 7-7-2008.

BRIAN CALLAGHAN, EXAMINING ATTORNEY

Int. Cl.: 42

Prior U.S. Cls.: 100 and 101

United States Patent and Trademark Office

Reg. No. 3,575,734

Registered Feb. 17, 2009

**SERVICE MARK
PRINCIPAL REGISTER**



AMERICAN COLLEGE OF RHEUMATOLOGY
(ILLINOIS NON-PROFIT CORPORATION)
SUITE 250
1800 CENTURY PLACE
ATLANTA, GA 30345

OWNER OF U.S. REG. NO. 1,611,667.

THE MARK CONSISTS OF A TRIANGLE WITH A
BURSTING RAY WITHIN A SECOND TRIANGLE.

FOR: ASSOCIATION SERVICES, NAMELY, PRO-
MOTING STUDY, TREATMENT AND RESEARCH
IN RHEUMATOLOGY, IN CLASS 42 (U.S. CLS. 100
AND 101).

SER. NO. 77-515,830, FILED 7-7-2008.

FIRST USE 12-0-2002; IN COMMERCE 12-0-2002.

KIMBERLY PERRY, EXAMINING ATTORNEY

Int. Cl.: 38

Prior U.S. Cls.: 100, 101 and 104

United States Patent and Trademark Office

Reg. No. 3,575,735

Registered Feb. 17, 2009

**SERVICE MARK
PRINCIPAL REGISTER**

MY1HIE

UNITED PHYSICIANS, P.C. (MICHIGAN CORPORATION)
30800 TELEGRAPH RD., SUITE 2800
BINGHAM FARMS, MI 48025

FOR: COMMUNICATION SERVICES, NAMELY, ELECTRONIC TRANSMISSION OF DATA AND DOCUMENTS AMONG USERS OF COMPUTERS; ELECTRONIC TRANSMISSION OF MESSAGES; PROVISION OF ACCESS TO DATA OR DOCUMENTS STORED ELECTRONICALLY IN CENTRAL FILES FOR REMOTE CONSULTATION; TRANSMISSION OF INFORMATION BY DATA COMMU-

NICATIONS FOR ASSISTING DECISION MAKING, IN CLASS 38 (U.S. CLS. 100, 101 AND 104).

FIRST USE 2-21-2008; IN COMMERCE 10-1-2008.

THE MARK CONSISTS OF STANDARD CHARACTERS WITHOUT CLAIM TO ANY PARTICULAR FONT, STYLE, SIZE, OR COLOR.

SER. NO. 77-515,833, FILED 7-7-2008.

KIMBERLY PERRY, EXAMINING ATTORNEY

Int. Cl.: 42

Prior U.S. Cls.: 100 and 101

United States Patent and Trademark Office

Reg. No. 3,575,736

Registered Feb. 17, 2009

**SERVICE MARK
PRINCIPAL REGISTER**

Go Jaysec

JAYSEC TECHNOLOGIES, LLC (TENNESSEE
LIMITED LIABILITY COMPANY)
1303 FRYE STREET
ATHENS, TN 37303

FOR: APPLICATION SERVICE PROVIDER,
NAMELY, PROVIDING, HOSTING, MANAGING,
DEVELOPING AND MAINTAINING APPLICA-
TIONS, SOFTWARE, WEB SITES AND DATABASES
IN THE FIELD OF HEALTHCARE AND HEALTH-
CARE EQUIPMENT PURCHASE AND DISTRIBUTION,
IN CLASS 42 (U.S. CLS. 100 AND 101).

FIRST USE 2-1-2007; IN COMMERCE 2-1-2007.

THE MARK CONSISTS OF STANDARD CHAR-
ACTERS WITHOUT CLAIM TO ANY PARTICULAR
FONT, STYLE, SIZE, OR COLOR.

SER. NO. 77-515,844, FILED 7-7-2008.

BARBARA BROWN, EXAMINING ATTORNEY

Int. Cl.: 21

Prior U.S. Cls.: 2, 13, 23, 29, 30, 33, 40 and 50

United States Patent and Trademark Office

Reg. No. 3,575,737

Registered Feb. 17, 2009

**TRADEMARK
PRINCIPAL REGISTER**

REDUCE

BASE BRANDS, LLC (GEORGIA LIMITED LIABILITY COMPANY)
887 W. MARIETTA ST. NW, STUDIO M-204
ATLANTA, GA 30318

FOR: BOTTLES, SOLD EMPTY; CONTAINERS FOR HOUSEHOLD OR KITCHEN USE; PLASTIC WATER BOTTLES SOLD EMPTY; SPORTS BOTTLES SOLD EMPTY, IN CLASS 21 (U.S. CLS. 2, 13, 23, 29, 30, 33, 40 AND 50).

FIRST USE 6-23-2008; IN COMMERCE 6-23-2008.

THE MARK CONSISTS OF STANDARD CHARACTERS WITHOUT CLAIM TO ANY PARTICULAR FONT, STYLE, SIZE, OR COLOR.

SER. NO. 77-515,866, FILED 7-7-2008.

TIMOTHY FINNEGAN, EXAMINING ATTORNEY

Int. Cl.: 35

Prior U.S. Cls.: 100, 101 and 102

United States Patent and Trademark Office

Reg. No. 3,575,738

Registered Feb. 17, 2009

**SERVICE MARK
PRINCIPAL REGISTER**

KIBICRICKET

DOREL E-COMMERCE INC. (DELAWARE CORPORATION)
410 EAST FIRST STREET SOUTH
WRIGHT CITY, MO 63390

FOR: THE BRINGING TOGETHER, FOR THE BENEFIT OF OTHERS, OF A VARIETY OF GOODS AND SERVICES, ENABLING CUSTOMERS TO CONVENIENTLY VIEW AND PURCHASE THOSE GOODS AND SERVICES FROM AN INTERNET WEBSITE PARTICULARLY SPECIALIZING IN THE MARKETING OF THE SALE OF GOODS

AND SERVICES OF OTHERS, IN CLASS 35 (U.S. CLS. 100, 101 AND 102).

FIRST USE 4-24-2008; IN COMMERCE 4-24-2008.

THE MARK CONSISTS OF STANDARD CHARACTERS WITHOUT CLAIM TO ANY PARTICULAR FONT, STYLE, SIZE, OR COLOR.

SER. NO. 77-515,940, FILED 7-7-2008.

BRIAN CALLAGHAN, EXAMINING ATTORNEY

Int. Cls.: 35 and 41

Prior U.S. Cls.: 100, 101, 102 and 107

United States Patent and Trademark Office

Reg. No. 3,575,739

Registered Feb. 17, 2009

**SERVICE MARK
PRINCIPAL REGISTER**

Dawnbreaker

DAWNBREAKER, INC. (DELAWARE CORPORATION)
2117 BUFFALO ROAD, SUITE 193
ROCHESTER, NY 14624

FOR: BUSINESS CONSULTING, BUSINESS PLANNING AND MARKET RESEARCH, IN CLASS 35 (U.S. CLS. 100, 101 AND 102).

FIRST USE 3-1-1988; IN COMMERCE 11-1-1988.

FOR: EDUCATIONAL SERVICES, NAMELY, OFFERING SEMINARS AND INDIVIDUAL INSTRU-

TION IN THE FIELD OF BUSINESS PLANNING, IN CLASS 41 (U.S. CLS. 100, 101 AND 107).

FIRST USE 3-1-1988; IN COMMERCE 11-1-1988.

THE MARK CONSISTS OF STANDARD CHARACTERS WITHOUT CLAIM TO ANY PARTICULAR FONT, STYLE, SIZE, OR COLOR.

SER. NO. 77-515,975, FILED 7-7-2008.

WON TEAK OH, EXAMINING ATTORNEY

Int. Cl.: 28

Prior U.S. Cls.: 22, 23, 38 and 50

United States Patent and Trademark Office

Reg. No. 3,575,740

Registered Feb. 17, 2009

**TRADEMARK
PRINCIPAL REGISTER**

POP SHOTZ

OZWEST, INC. (OREGON CORPORATION)
P.O. BOX 747
BANKS, OR 97106

THE MARK CONSISTS OF STANDARD CHAR-
ACTERS WITHOUT CLAIM TO ANY PARTICULAR
FONT, STYLE, SIZE, OR COLOR.

FOR: SQUEEZE TOYS; TOY AIRPLANES; TOY
GLIDERS; TOY GUNS; TOY PISTOLS; TOY ROCK-
ETS; TOY WEAPONS, IN CLASS 28 (U.S. CLS. 22, 23,
38 AND 50).

SER. NO. 77-515,989, FILED 7-7-2008.

FIRST USE 1-1-2008; IN COMMERCE 1-1-2008.

ARETHA SOMERVILLE, EXAMINING ATTORNEY

Int. Cls.: 9 and 41

Prior U.S. Cls.: 21, 23, 26, 36, 38, 100, 101 and 107

Reg. No. 3,575,741

United States Patent and Trademark Office

Registered Feb. 17, 2009

**TRADEMARK
SERVICE MARK
PRINCIPAL REGISTER**

POLITICAL LUNCH

HUDSON STREET MEDIA LLC (NEW YORK
LIMITED LIABILITY COMPANY)
SUITE 301
145 HUDSON STREET
NEW YORK, NY 10013

FOR: DIGITAL MEDIA, NAMELY, DOWNLOAD-
ABLE AUDIO AND VIDEO FILES, AND SATELLITE
RADIO BROADCASTS FEATURING NEWS, COME-
DY, AND COMMENTARY; DOWNLOADABLE
PODCASTS IN THE FIELD OF NEWS, COMEDY,
AND COMMENTARY; DOWNLOADABLE WEB-
CASTS IN THE FIELD OF NEWS, COMEDY, AND
COMMENTARY, IN CLASS 9 (U.S. CLS. 21, 23, 26, 36
AND 38).

FIRST USE 4-23-2007; IN COMMERCE 4-23-2007.

FOR: ENTERTAINMENT SERVICES, NAMELY,
PROVIDING PODCASTS IN THE FIELD OF NEWS,
COMEDY, AND COMMENTARY; ENTERTAIN-
MENT SERVICES, NAMELY, PROVIDING WEB-

CASTS IN THE FIELD OF NEWS, COMEDY, AND
COMMENTARY; ENTERTAINMENT, NAMELY, A
CONTINUING NEWS, COMEDY, AND COMMEN-
TARY SHOW BROADCAST OVER TELEVISION,
SATELLITE, AUDIO, AND VIDEO MEDIA, IN
CLASS 41 (U.S. CLS. 100, 101 AND 107).

FIRST USE 4-23-2007; IN COMMERCE 4-23-2007.

THE MARK CONSISTS OF STANDARD CHAR-
ACTERS WITHOUT CLAIM TO ANY PARTICULAR
FONT, STYLE, SIZE, OR COLOR.

NO CLAIM IS MADE TO THE EXCLUSIVE
RIGHT TO USE "POLITICAL", APART FROM THE
MARK AS SHOWN.

SER. NO. 77-516,003, FILED 7-7-2008.

DAVID TOOLEY, EXAMINING ATTORNEY

Int. Cl.: 42

Prior U.S. Cls.: 100 and 101

United States Patent and Trademark Office

Reg. No. 3,575,742

Registered Feb. 17, 2009

**SERVICE MARK
PRINCIPAL REGISTER**

**PROTECT YOUR PATIENTS.
PROTECT YOUR PRACTICE.**

AMERITOX, LTD. (TEXAS LIMITED LIABILITY
COMPANY)
BUILDING B, SUITE 200,
3510 NORTH A STREET,
MIDLAND, TX 79705

FOR: MEDICAL LABORATORY SERVICES, IN
CLASS 42 (U.S. CLS. 100 AND 101).

FIRST USE 7-11-2005; IN COMMERCE 7-31-2005.

THE MARK CONSISTS OF STANDARD CHAR-
ACTERS WITHOUT CLAIM TO ANY PARTICULAR
FONT, STYLE, SIZE, OR COLOR.

SER. NO. 77-516,005, FILED 7-7-2008.

KOURTNEE HODGES, EXAMINING ATTORNEY

Int. Cl.: 35

Prior U.S. Cls.: 100, 101 and 102

United States Patent and Trademark Office

Reg. No. 3,575,743

Registered Feb. 17, 2009

**SERVICE MARK
PRINCIPAL REGISTER**

PRECISETRACK

MAYFLOWER TRANSIT, LLC (MISSOURI LIMITED LIABILITY COMPANY)
ONE MAYFLOWER DRIVE
FENTON, MO 63026

FOR: BAR-CODED, COMPUTERIZED INVENTORY AND TRACKING OF INTERSTATE AND INTERNATIONAL FREIGHT SHIPMENTS, NAMELY, COMPUTERIZED TRACKING AND TRACING OF PACKAGES IN TRANSIT, IN CLASS 35 (U.S. CLS. 100, 101 AND 102).

FIRST USE 7-1-2000; IN COMMERCE 7-1-2000.

THE MARK CONSISTS OF STANDARD CHARACTERS WITHOUT CLAIM TO ANY PARTICULAR FONT, STYLE, SIZE, OR COLOR.

OWNER OF U.S. REG. NO. 2,574,675.

SEC. 2(F).

SER. NO. 77-516,012, FILED 7-7-2008.

BRIAN PINO, EXAMINING ATTORNEY

Int. Cl.: 5

Prior U.S. Cls.: 6, 18, 44, 46, 51 and 52

United States Patent and Trademark Office

Reg. No. 3,575,744

Registered Feb. 17, 2009

**TRADEMARK
PRINCIPAL REGISTER**

EAT YOUR VOOTS

LAUNCH PAD LLC (COLORADO LIMITED LIABILITY COMPANY)
SUITE 100
7315 E. ORCHARD ROAD
GREENWOOD VILLAGE, CO 80111

FOR: DIETARY SUPPLEMENTS, IN CLASS 5 (U.S. CLS. 6, 18, 44, 46, 51 AND 52).

FIRST USE 2-2-2008; IN COMMERCE 2-2-2008.

THE MARK CONSISTS OF STANDARD CHARACTERS WITHOUT CLAIM TO ANY PARTICULAR FONT, STYLE, SIZE, OR COLOR.

OWNER OF U.S. REG. NO. 3,499,976.

SER. NO. 77-516,020, FILED 7-7-2008.

KIM SAITO, EXAMINING ATTORNEY

Int. Cl.: 11

Prior U.S. Cls.: 13, 21, 23, 31 and 34

United States Patent and Trademark Office

Reg. No. 3,575,745

Registered Feb. 17, 2009

**TRADEMARK
PRINCIPAL REGISTER**

MICRO-Z

MUNTERS CORPORATION (NEW YORK COR-
PORATION)
79 MONROE STREET
AMESBURY, MA 01913

THE MARK CONSISTS OF STANDARD CHAR-
ACTERS WITHOUT CLAIM TO ANY PARTICULAR
FONT, STYLE, SIZE, OR COLOR.

FOR: HEAT RECOVERY VENTILATOR, IN
CLASS 11 (U.S. CLS. 13, 21, 23, 31 AND 34).

SER. NO. 77-516,022, FILED 7-7-2008.

FIRST USE 9-14-1988; IN COMMERCE 9-14-1988.

JILL C. ALT, EXAMINING ATTORNEY

Int. Cl.: 28

Prior U.S. Cls.: 22, 23, 38 and 50

United States Patent and Trademark Office

Reg. No. 3,575,746

Registered Feb. 17, 2009

**TRADEMARK
PRINCIPAL REGISTER**

POP FLYZ

OZWEST, INC. (OREGON CORPORATION)
P.O. BOX 747
BANKS, OR 97106

THE MARK CONSISTS OF STANDARD CHAR-
ACTERS WITHOUT CLAIM TO ANY PARTICULAR
FONT, STYLE, SIZE, OR COLOR.

FOR: HAND-POWERED NON-MECHANICAL
FLYING TOY; SQUEEZE TOYS; TOY AIRPLANES;
TOY GLIDERS; TOY GUNS; TOY PISTOLS; TOY
ROCKETS, IN CLASS 28 (U.S. CLS. 22, 23, 38 AND 50).

SER. NO. 77-516,024, FILED 7-7-2008.

FIRST USE 1-1-2008; IN COMMERCE 1-1-2008.

ARETHA SOMERVILLE, EXAMINING ATTORNEY

Int. Cl.: 9

Prior U.S. Cls.: 21, 23, 26, 36 and 38

Reg. No. 3,575,747

United States Patent and Trademark Office

Registered Feb. 17, 2009

**TRADEMARK
PRINCIPAL REGISTER**

ezSpace

EZGEAR (UTAH LIMITED LIABILITY COMPANY)
6553 S COTTONWOOD ST.
MURRAY, UT 84107

FOR: CONSUMER ELECTRONIC PRODUCTS, NAMELY, AUDIO AMPLIFIERS, AUDIO SPEAKERS, AUDIO RECEIVERS, ELECTRICAL AUDIO AND SPEAKER CABLES AND CONNECTORS, HOME THEATER SYSTEMS, AUDIO DECODERS, VIDEO DECODERS, SPEAKERS, POWER CONVERSION DEVICES, POWER CONVERTERS, AND POW-

ER INVERTERS; VOLTAGE SURGE PROTECTORS, IN CLASS 9 (U.S. CLS. 21, 23, 26, 36 AND 38).

FIRST USE 1-5-2008; IN COMMERCE 3-1-2008.

THE MARK CONSISTS OF STANDARD CHARACTERS WITHOUT CLAIM TO ANY PARTICULAR FONT, STYLE, SIZE, OR COLOR.

SER. NO. 77-516,075, FILED 7-7-2008.

GIANCARLO CASTRO, EXAMINING ATTORNEY

Int. Cl.: 9

Prior U.S. Cls.: 21, 23, 26, 36 and 38

Reg. No. 3,575,748

United States Patent and Trademark Office

Registered Feb. 17, 2009

**TRADEMARK
PRINCIPAL REGISTER**

ezBlast

EZGEAR, LLC. (UTAH LIMITED LIABILITY
COMPANY), DBA AUDIOOUTFITTERS
6553 S COTTONWOOD ST
SALT LAKE CITY, UT 84107

THE MARK CONSISTS OF STANDARD CHAR-
ACTERS WITHOUT CLAIM TO ANY PARTICULAR
FONT, STYLE, SIZE, OR COLOR.

FOR: CHARGERS FOR ELECTRIC BATTERIES;
RADIO TRANSMITTERS, IN CLASS 9 (U.S. CLS. 21,
23, 26, 36 AND 38).

SER. NO. 77-516,106, FILED 7-7-2008.

FIRST USE 8-1-2007; IN COMMERCE 8-1-2007.

DAVID ELTON, EXAMINING ATTORNEY

Int. Cl.: 41

Prior U.S. Cls.: 100, 101 and 107

United States Patent and Trademark Office

Reg. No. 3,575,749

Registered Feb. 17, 2009

**SERVICE MARK
PRINCIPAL REGISTER**

PRESENTING FOR ACTION

BRADLEY COMMUNICATIONS GROUP, INC.,
(NEW YORK CORPORATION), DBA BOYER
COMMUNICATIONS GROUP
23 EAST 128TH STREET, SUITE 4-F
NEW YORK, NY 10035

FOR: EDUCATIONAL SERVICES, NAMELY, DE-
VELOPING AND CONDUCTING WORKSHOPS
AND SEMINARS ON DEVELOPING AND TRAIN-
ING PUBLIC PRESENTATION SKILLS FOR INDI-
VIDUALS, IN CLASS 41 (U.S. CLS. 100, 101 AND 107).

FIRST USE 11-1-1987; IN COMMERCE 11-1-1987.

THE MARK CONSISTS OF STANDARD CHAR-
ACTERS WITHOUT CLAIM TO ANY PARTICULAR
FONT, STYLE, SIZE, OR COLOR.

NO CLAIM IS MADE TO THE EXCLUSIVE
RIGHT TO USE "PRESENTING", APART FROM
THE MARK AS SHOWN.

SER. NO. 77-516,170, FILED 7-7-2008.

KELLY CHOE, EXAMINING ATTORNEY

Int. Cl.: 41

Prior U.S. Cls.: 100, 101 and 107

United States Patent and Trademark Office

Reg. No. 3,575,750

Registered Feb. 17, 2009

**SERVICE MARK
PRINCIPAL REGISTER**

WRITING FOR ACTION

BRADLEY COMMUNICATIONS GROUP, INC.,
(NEW YORK CORPORATION), DBA BOYER
COMMUNICATIONS GROUP
23 EAST 128TH STREET, SUITE 4-F
NEW YORK, NY 10035

FOR: EDUCATIONAL SERVICES, NAMELY, DE-
VELOPING AND CONDUCTING WORKSHOPS
AND SEMINARS ON DEVELOPING AND TRAIN-
ING BUSINESS WRITING SKILLS FOR INDIVI-
DUALS, IN CLASS 41 (U.S. CLS. 100, 101 AND 107).

FIRST USE 5-1-1994; IN COMMERCE 5-1-1994.

THE MARK CONSISTS OF STANDARD CHAR-
ACTERS WITHOUT CLAIM TO ANY PARTICULAR
FONT, STYLE, SIZE, OR COLOR.

NO CLAIM IS MADE TO THE EXCLUSIVE
RIGHT TO USE "WRITING", APART FROM THE
MARK AS SHOWN.

SER. NO. 77-516,202, FILED 7-7-2008.

KELLY CHOE, EXAMINING ATTORNEY

Int. Cl.: 12

Prior U.S. Cls.: 19, 21, 23, 31, 35 and 44

United States Patent and Trademark Office

Reg. No. 3,575,751

Registered Feb. 17, 2009

**TRADEMARK
PRINCIPAL REGISTER**



CONTRACT MANUFACTURER, L.L.C. (OKLAHOMA LIMITED LIABILITY COMPANY)
P.O. BOX 680
MADILL, OK 73446

THE MARK CONSISTS OF THE STYLIZED LETTERS "S & H" PARTIALLY SURROUNDED BY AN OVAL SHAPE ON A DIAGONAL.

FOR: TRAILERS, IN CLASS 12 (U.S. CLS. 19, 21, 23, 31, 35 AND 44).

SER. NO. 77-516,280, FILED 7-7-2008.

FIRST USE 11-1-2005; IN COMMERCE 12-15-2005.

RON FAIRBANKS, EXAMINING ATTORNEY

Int. Cl.: 44

Prior U.S. Cls.: 100 and 101

United States Patent and Trademark Office

Reg. No. 3,575,752

Registered Feb. 17, 2009

**SERVICE MARK
PRINCIPAL REGISTER**



Egg Freezing Center

SANTA MONICA ASSISTED REPRODUCTIVE
TECHNOLOGIES, INC. (CALIFORNIA COR-
PORATION)
2825 SANTA MONICA BLVD., SUITE 100A
SANTA MONICA, CA 90404

FOR: MEDICAL SERVICES, NAMELY, HUMAN
EGG FREEZING SERVICES FOR IN VITRO FERTI-
LIZATION, IN CLASS 44 (U.S. CLS. 100 AND 101).

FIRST USE 10-1-2007; IN COMMERCE 10-1-2007.

NO CLAIM IS MADE TO THE EXCLUSIVE
RIGHT TO USE "EGG FREEZING CENTER",
APART FROM THE MARK AS SHOWN.

THE MARK CONSISTS OF THE WORDS "EGG
FREEZING CENTER" WITH A STYLIZED FLOWER
DESIGN ABOVE THE "E" IN "EGG".

SER. NO. 77-516,298, FILED 7-7-2008.

MARK RADEMACHER, EXAMINING ATTORNEY

Int. Cl.: 44

Prior U.S. Cls.: 100 and 101

United States Patent and Trademark Office

Reg. No. 3,575,753

Registered Feb. 17, 2009

**SERVICE MARK
PRINCIPAL REGISTER**

EMBRYOICU

JOHN K. JAIN, M.D. (UNITED STATES INDIVIDUAL)
2825 SANTA MONICA BLVD., SUITE 100
SANTA MONICA, CA 90404

FOR: MEDICAL SERVICES, NAMELY, IN VITRO FERTILIZATION, IN CLASS 44 (U.S. CLS. 100 AND 101).

FIRST USE 10-1-2007; IN COMMERCE 10-1-2007.

THE MARK CONSISTS OF THE LETTERS "EMBRYOICU" WITH THE "O" ALTERED TO SHOW AN OVOID TRIANGLE WITHIN THE CIRCLE OF THE "O".

SER. NO. 77-516,322, FILED 7-7-2008.

RON FAIRBANKS, EXAMINING ATTORNEY

Int. Cl.: 41

Prior U.S. Cls.: 100, 101 and 107

United States Patent and Trademark Office

Reg. No. 3,575,754

Registered Feb. 17, 2009

SERVICE MARK
PRINCIPAL REGISTER



KRIDER, RYAN EDWARD (UNITED STATES
INDIVIDUAL)

5224 WAKONDA DR.

NORWALK, IA 50211 AND

BROMMEL, WESLEY SCOTT (UNITED STATES
INDIVIDUAL)

5224 WAKONDA DR.

NORWALK, IA 50211

FOR: ENTERTAINMENT IN THE NATURE OF
VISUAL AND AUDIO PERFORMANCES, NAMELY,
MUSICAL BAND, ROCK GROUP, GYMNASTIC,
DANCE, AND BALLET PERFORMANCES; ENTER-
TAINMENT, NAMELY, LIVE PERFORMANCES BY
A MUSICAL BAND, IN CLASS 41 (U.S. CLS. 100, 101
AND 107).

FIRST USE 1-31-2007; IN COMMERCE 2-13-2008.

THE MARK CONSISTS OF ALL CAPS TEXT
STARTING WITH A STYLIZED "PERIOD", FOL-
LOWED BY A STYLIZED LETTER "H", FOLLOWED
BY A STYLIZED LETTER "A", FOLLOWED BY A
STYLIZED LETTER "Z", FOLLOWED BY A STY-
LIZED LETTER "E", AND THEN A STYLIZED
LETTER "R".

SER. NO. 77-516,324, FILED 7-7-2008.

RON FAIRBANKS, EXAMINING ATTORNEY

Int. Cl.: 36

Prior U.S. Cls.: 100, 101 and 102

United States Patent and Trademark Office

Reg. No. 3,575,755

Registered Feb. 17, 2009

**SERVICE MARK
PRINCIPAL REGISTER**

NCA CREDIT REPAIR

INSTALLLOGIC, INC. (OREGON CORPORATION), DBA NCA CREDIT REPAIR, INC.
18455 S. CADLE CREEK LANE
OREGON CITY, OR 97045

FOR: FINANCIAL SERVICES, NAMELY, CREDIT REPAIR AND RESTORATION, IN CLASS 36 (U.S. CLS. 100, 101 AND 102).

FIRST USE 8-1-2003; IN COMMERCE 10-9-2003.

THE MARK CONSISTS OF STANDARD CHARACTERS WITHOUT CLAIM TO ANY PARTICULAR FONT, STYLE, SIZE, OR COLOR.

NO CLAIM IS MADE TO THE EXCLUSIVE RIGHT TO USE "CREDIT REPAIR", APART FROM THE MARK AS SHOWN.

SER. NO. 77-516,327, FILED 7-7-2008.

FRANK LATTUCA, EXAMINING ATTORNEY

Int. Cl.: 9

Prior U.S. Cls.: 21, 23, 26, 36 and 38

Reg. No. 3,575,756

United States Patent and Trademark Office

Registered Feb. 17, 2009

**TRADEMARK
PRINCIPAL REGISTER**

VeloTones

SOUNDOFMOTION TECHNOLOGIES INC. (CANADA CORPORATION), DBA SOUNDOFMOTION
#119 101-1001 W. BROADWAY
VANCOUVER, CANADA V6H4E4

FOR: DOWNLOADABLE SOUND AND MULTIMEDIA FILES VIA THE INTERNET AND WIRELESS DEVICES, IN CLASS 9 (U.S. CLS. 21, 23, 26, 36 AND 38).

FIRST USE 1-8-2008; IN COMMERCE 1-10-2008.

THE MARK CONSISTS OF STANDARD CHARACTERS WITHOUT CLAIM TO ANY PARTICULAR FONT, STYLE, SIZE, OR COLOR.

THE FOREIGN WORDING IN THE MARK TRANSLATES INTO ENGLISH AS CYCLING OR BICYCLE.

SER. NO. 77-516,338, FILED 7-7-2008.

ANNE E. GUSTASON, EXAMINING ATTORNEY

Int. Cls.: 35 and 43

Prior U.S. Cls.: 100, 101 and 102

United States Patent and Trademark Office

Reg. No. 3,575,757

Registered Feb. 17, 2009

**SERVICE MARK
PRINCIPAL REGISTER**



SANTE, LLC (NORTH CAROLINA LIMITED
LIABILITY COMPANY)
SUITE 152/146
1 PAGE AVENUE
ASHEVILLE, NC 28801

FOR: RETAIL STORE SERVICES FEATURING
WINE AND WINE ACCESSORIES, IN CLASS 35 (U.S.
CLS. 100, 101 AND 102).

FIRST USE 6-1-2006; IN COMMERCE 8-31-2006.

FOR: WINE BARS, IN CLASS 43 (U.S. CLS. 100
AND 101).

FIRST USE 6-1-2006; IN COMMERCE 8-31-2006.

NO CLAIM IS MADE TO THE EXCLUSIVE
RIGHT TO USE "WINE BAR", APART FROM THE
MARK AS SHOWN.

THE MARK CONSISTS OF AN OUTLINE OF A
WINE GLASS ON A STYLIZED BACKGROUND
WITH THE WORD "SANTÉ" ABOVE THE GLASS
AND THE WORDS "WINE BAR" BELOW THE
GLASS.

THE FOREIGN WORDING IN THE MARK
TRANSLATES INTO ENGLISH AS HEALTH.

SER. NO. 77-516,361, FILED 7-7-2008.

ANDREA K. NADELMAN, EXAMINING ATTOR-
NEY

Int. Cl.: 42

Prior U.S. Cls.: 100 and 101

United States Patent and Trademark Office

Reg. No. 3,575,758

Registered Feb. 17, 2009

**SERVICE MARK
PRINCIPAL REGISTER**

Image Enable

BEEGLE, JEFFREY B (UNITED STATES INDIVIDUAL)
1701 SE 24TH RD #1301
OCALA, FL 34471

FOR: COMPUTER GRAPHICS SERVICES; GRAPHIC ART DESIGN; GRAPHIC ARTS DESIGNING; GRAPHIC DESIGN; GRAPHIC DESIGN SERVICES; GRAPHIC ILLUSTRATION AND DRAWING SERVICES, NAMELY, PROVIDING GRAPHIC ILLUSTRATIONS AND DRAWINGS OF COMMERCIAL AND INDUSTRIAL BUILDING DESIGNS, AND CONVERTING BUILDING DESIGNS OR MARKUPS TO ELECTRONIC CAD DRAWINGS; GRAPHIC ILLUSTRATION SERVICES FOR OTHERS; PROVIDING GRAPHIC AND MULTIMEDIA DESIGN SERVICES FOR THE PURPOSE OF PROMOTING THE

GOODS AND SERVICES OF OTHERS, IN CLASS 42 (U.S. CLS. 100 AND 101).

FIRST USE 4-25-2005; IN COMMERCE 5-25-2005.

THE MARK CONSISTS OF STANDARD CHARACTERS WITHOUT CLAIM TO ANY PARTICULAR FONT, STYLE, SIZE, OR COLOR.

NO CLAIM IS MADE TO THE EXCLUSIVE RIGHT TO USE "IMAGE", APART FROM THE MARK AS SHOWN.

SER. NO. 77-516,362, FILED 7-7-2008.

MARK RADEMACHER, EXAMINING ATTORNEY

Int. Cl.: 30

Prior U.S. Cl.: 46

United States Patent and Trademark Office

Reg. No. 3,575,759

Registered Feb. 17, 2009

**TRADEMARK
PRINCIPAL REGISTER**

LUNA DE MIEL

GAUGHEN HOLDINGS LLC (CALIFORNIA LIMITED LIABILITY COMPANY)
4954 NAUTILUS ST.
OXNARD, CA 93035

FOR: BONBONS, CANDIES, CANDY CONTAINING ALCOHOLIC BEVERAGE CONTENT AND FLAVOR, CHOCOLATE AND CHOCOLATES, NOUGAT, IN CLASS 30 (U.S. CL. 46).

FIRST USE 3-22-2002; IN COMMERCE 3-23-2002.

THE MARK CONSISTS OF STANDARD CHARACTERS WITHOUT CLAIM TO ANY PARTICULAR FONT, STYLE, SIZE, OR COLOR.

OWNER OF U.S. REG. NOS. 2,692,857, 3,414,442 AND OTHERS.

NO CLAIM IS MADE TO THE EXCLUSIVE RIGHT TO USE "MIEL", APART FROM THE MARK AS SHOWN.

THE FOREIGN WORDING IN THE MARK TRANSLATES INTO ENGLISH AS HONEYMOON.

SER. NO. 77-516,388, FILED 7-7-2008.

CHRIS WELLS, EXAMINING ATTORNEY

Int. Cl.: 35

Prior U.S. Cls.: 100, 101 and 102

United States Patent and Trademark Office

Reg. No. 3,575,760

Registered Feb. 17, 2009

**SERVICE MARK
PRINCIPAL REGISTER**

United States-China Exchange Council

美國舊金山美中交流協會

UNITED STATES-CHINA EXCHANGE COUNCIL
(CALIFORNIA NON-PROFIT ORGANIZATION)

22290 FOOTHILL BLVD., #2
HAYWARD, CA 94541

FOR: ASSOCIATION SERVICES, NAMELY, PROMOTING THE INTERESTS OF AND UNDERSTANDING BETWEEN THE BUSINESS SECTORS OF THE UNITED STATES AND THE PEOPLE'S REPUBLIC OF CHINA BY PROMOTING COOPERATIVE PROJECTS, THE DEVELOPMENT OF BUSINESS CONTACTS AND THE EXCHANGE OF MARKET AND EDUCATIONAL INFORMATION, IN CLASS 35 (U.S. CLS. 100, 101 AND 102).

FIRST USE 2-12-1998; IN COMMERCE 2-12-1998.

NO CLAIM IS MADE TO THE EXCLUSIVE RIGHT TO USE "COUNCIL", APART FROM THE MARK AS SHOWN.

THE MARK CONSISTS OF THE WORDING "UNITED STATES-CHINA EXCHANGE COUNCIL" AND CHINESE SCRIPTS WRITTEN BELOW IT.

THE NON-LATIN CHARACTER(S) IN THE MARK TRANSLITERATE INTO MEI GUO JIU JIN SHAN MEI ZHONG JIAO LIU XIE HUI, AND THIS MEANS SAN FRANCISCO UNITED STATES-CHINA EXCHANGE COUNCIL IN ENGLISH.

SEC. 2(F).

SER. NO. 77-516,394, FILED 7-7-2008.

HENRY S. ZAK, EXAMINING ATTORNEY

Int. Cl.: 41

Prior U.S. Cls.: 100, 101 and 107

United States Patent and Trademark Office

Reg. No. 3,575,761

Registered Feb. 17, 2009

**SERVICE MARK
PRINCIPAL REGISTER**

United States-China Exchange Council

美國舊金山美中交流協會

UNITED STATES-CHINA EXCHANGE COUNCIL
(CALIFORNIA NON-PROFIT ORGANIZATION)

22290 FOOTHILL BLVD., #2
HAYWARD, CA 94541

FOR: EDUCATION SERVICES, NAMELY, PROVIDING PROFESSIONAL TRAINING, SEMINARS, AND WORKSHOPS IN THE FIELDS OF ECONOMICS, COMMERCE, MANUFACTURING, SCIENCE, TECHNOLOGY, FINANCE, NEWS, MEDIA, EDUCATION, ARTS, CULTURAL, LEGAL SERVICES, HEALTH CARE FOR CHINESE DELEGATIONS IN THE UNITED STATES WITH GOVERNMENT AGENCIES, UNIVERSITIES AND OTHER INSTITUTIONS; SPONSORING, DEVELOPING, AND CARRYING OUT INTERNATIONAL STUDENT EXCHANGE PROGRAMS, IN CLASS 41 (U.S. CLS. 100, 101 AND 107).

FIRST USE 2-12-1998; IN COMMERCE 2-12-1998.

NO CLAIM IS MADE TO THE EXCLUSIVE RIGHT TO USE "COUNCIL", APART FROM THE MARK AS SHOWN.

THE MARK CONSISTS OF THE WORDING "UNITED STATES-CHINA EXCHANGE COUNCIL" AND CHINESE SCRIPTS WRITTEN BELOW IT.

THE NON-LATIN CHARACTER(S) IN THE MARK TRANSLITERATE INTO MEI GUO JIU JIN SHAN MEI ZHONG JIAO LIU XIE HUI, AND THIS MEANS SAN FRANCISCO UNITED STATES-CHINA EXCHANGE COUNCIL IN ENGLISH.

SEC. 2(F).

SER. NO. 77-516,399, FILED 7-7-2008.

HENRY S. ZAK, EXAMINING ATTORNEY

Int. Cl.: 9

Prior U.S. Cls.: 21, 23, 26, 36 and 38

Reg. No. 3,575,762

United States Patent and Trademark Office

Registered Feb. 17, 2009

**TRADEMARK
PRINCIPAL REGISTER**

Trim-Stix

GONZALEZ, JASON (UNITED STATES INDIVIDUAL)
57-36 246 CRES
DOUGLASTON, NY 11362

THE MARK CONSISTS OF STANDARD CHARACTERS WITHOUT CLAIM TO ANY PARTICULAR FONT, STYLE, SIZE, OR COLOR.

FOR: DISTANCE MEASURING APPARATUS, IN CLASS 9 (U.S. CLS. 21, 23, 26, 36 AND 38).

SER. NO. 77-516,432, FILED 7-8-2008.

FIRST USE 12-3-2007; IN COMMERCE 3-21-2008.

SUSAN LESLIE DUBOIS, EXAMINING ATTORNEY

Int. Cl.: 30

Prior U.S. Cl.: 46

United States Patent and Trademark Office

Reg. No. 3,575,763

Registered Feb. 17, 2009

**TRADEMARK
PRINCIPAL REGISTER**

CHILLI SWAMI

SPICEMART, INC. (CALIFORNIA CORPORATION)
2733 MCCONE AVE
HAYWARD, CA 94545

FOR: SPICES; SPICE MIXES; SEASONINGS; CON-
DIMENT SAUCES, NAMELY, SALSA AND REL-
ISHES; AND CHUTNEY, IN CLASS 30 (U.S. CL. 46).

FIRST USE 9-10-2007; IN COMMERCE 9-10-2007.

THE MARK CONSISTS OF STANDARD CHAR-
ACTERS WITHOUT CLAIM TO ANY PARTICULAR
FONT, STYLE, SIZE, OR COLOR.

NO CLAIM IS MADE TO THE EXCLUSIVE
RIGHT TO USE "CHILLI", APART FROM THE
MARK AS SHOWN.

SER. NO. 77-516,435, FILED 7-8-2008.

BILL DAWE, EXAMINING ATTORNEY

Int. Cl.: 41

Prior U.S. Cls.: 100, 101 and 107

United States Patent and Trademark Office

Reg. No. 3,575,764

Registered Feb. 17, 2009

**SERVICE MARK
PRINCIPAL REGISTER**

DIVA GIRLZ & ADVENTURE BOYZ

DIVA GIRLZ & ADVENTURE BOYZ, LLC (CALIFORNIA LIMITED LIABILITY COMPANY)
18399 VENTURA BLVD., SUITE 14
TARZANA, CA 91356

THE MARK CONSISTS OF STANDARD CHARACTERS WITHOUT CLAIM TO ANY PARTICULAR FONT, STYLE, SIZE, OR COLOR.

FOR: ENTERTAINMENT SERVICES, NAMELY, CONDUCTING PARTIES, IN CLASS 41 (U.S. CLS. 100, 101 AND 107).

SER. NO. 77-516,440, FILED 7-8-2008.

FIRST USE 6-10-2008; IN COMMERCE 6-10-2008.

EDWARD FENNESSY, EXAMINING ATTORNEY

Int. Cl.: 36

Prior U.S. Cls.: 100, 101 and 102

United States Patent and Trademark Office

Reg. No. 3,575,765

Registered Feb. 17, 2009

**SERVICE MARK
PRINCIPAL REGISTER**

JET QUEST

JET QUEST, INC. (FLORIDA CORPORATION)
2419 S.E. DIXIE HIGHWAY
STUART, FL 34996

FOR: BROKERAGE IN THE FIELD OF CORPORATE AND BUSINESS AIRCRAFT, IN CLASS 36 (U.S. CLS. 100, 101 AND 102).

FIRST USE 7-1-1999; IN COMMERCE 7-1-1999.

THE MARK CONSISTS OF STANDARD CHARACTERS WITHOUT CLAIM TO ANY PARTICULAR FONT, STYLE, SIZE, OR COLOR.

NO CLAIM IS MADE TO THE EXCLUSIVE RIGHT TO USE "JET", APART FROM THE MARK AS SHOWN.

SER. NO. 77-516,462, FILED 7-8-2008.

STEVEN R. FOSTER, EXAMINING ATTORNEY

Int. Cl.: 11

Prior U.S. Cls.: 13, 21, 23, 31 and 34

United States Patent and Trademark Office

Reg. No. 3,575,766

Registered Feb. 17, 2009

**TRADEMARK
PRINCIPAL REGISTER**

META WHITE

METAPHASE TECHNOLOGIES, INC (PENNSYLVANIA CORPORATION)
3580 PROGRESS DRIVE, UNIT A
BENSALEM, PA 19020

THE MARK CONSISTS OF STANDARD CHARACTERS WITHOUT CLAIM TO ANY PARTICULAR FONT, STYLE, SIZE, OR COLOR.

FOR: LED (LIGHT EMITTING DIODE) LIGHTING FIXTURES; LIGHTING FIXTURES, IN CLASS 11 (U.S. CLS. 13, 21, 23, 31 AND 34).

SER. NO. 77-516,477, FILED 7-8-2008.

FIRST USE 6-15-2005; IN COMMERCE 6-15-2005.

JIM RINGLE, EXAMINING ATTORNEY

Int. Cl.: 35

Prior U.S. Cls.: 100, 101 and 102

United States Patent and Trademark Office

Reg. No. 3,575,767

Registered Feb. 17, 2009

SERVICE MARK
PRINCIPAL REGISTER



FERRO, SALVATORE (UNITED STATES INDIVIDUAL)

1 COMMERCIAL COURT
PLAINVIEW, NY 11803 AND

HYMAN, CARL (UNITED STATES INDIVIDUAL)

1 COMMERCIAL COURT
PLAINVIEW, NY 11803 AND

HYMAN, ROBERT (UNITED STATES INDIVIDUAL)

1 COMMERCIAL COURT
PLAINVIEW, NY 11803

FOR: RESIDENTIAL ENERGY EFFICIENCY AUDIT SERVICES, IN CLASS 35 (U.S. CLS. 100, 101 AND 102).

FIRST USE 2-4-2008; IN COMMERCE 2-4-2008.

OWNER OF U.S. REG. NO. 1,728,166.

NO CLAIM IS MADE TO THE EXCLUSIVE RIGHT TO USE "HOME PERFORMANCE", APART FROM THE MARK AS SHOWN.

THE COLOR(S) GREEN, TAN, AND DARK RED IS/ARE CLAIMED AS A FEATURE OF THE MARK.

THE MARK CONSISTS OF THE WORD "HOME" IN LARGE GREEN UPPERCASE LETTERS, THE WORD "PERFORMANCE" IN GREEN UPPERCASE LETTERS OF A SMALLER SIZE BELOW AND TO THE RIGHT, THE OUTLINE OF A ROOF OF A HOUSE IN GREEN AND TAN TO THE RIGHT AND ABOVE THE WORDS "HOME" AND "PERFORMANCE" WITH THE WORD "BY" IN GREEN SCRIPT AND THE "ALURE" LOGO IN DARK RED, BOTH IMMEDIATELY BELOW THE WORD "PERFORMANCE".

SER. NO. 77-516,493, FILED 7-8-2008.

EMILY CARLSEN, EXAMINING ATTORNEY

Int. Cl.: 41

Prior U.S. Cls.: 100, 101 and 107

United States Patent and Trademark Office

Reg. No. 3,575,768

Registered Feb. 17, 2009

**SERVICE MARK
PRINCIPAL REGISTER**

COSMIC MIKE

NORTH MUSEUM CORPORATION (PENNSYLVANIA CORPORATION), DBA NORTH MUSEUM OF NATURAL HISTORY AND SCIENCE
400 COLLEGE AVENUE
LANCASTER, PA 17603

FOR: EDUCATION SERVICES, NAMELY, PROVIDING CLASSES, SEMINARS AND WORKSHOPS IN THE FIELD OF SCIENCE AND ASTRONOMY , IN CLASS 41 (U.S. CLS. 100, 101 AND 107).

FIRST USE 11-1-2006; IN COMMERCE 11-1-2006.

THE MARK CONSISTS OF STANDARD CHARACTERS WITHOUT CLAIM TO ANY PARTICULAR FONT, STYLE, SIZE, OR COLOR.

SER. NO. 77-516,494, FILED 7-8-2008.

SUSAN LESLIE DUBOIS, EXAMINING ATTORNEY

Int. Cl.: 35

Prior U.S. Cls.: 100, 101 and 102

United States Patent and Trademark Office

Reg. No. 3,575,769

Registered Feb. 17, 2009

**SERVICE MARK
PRINCIPAL REGISTER**

ANIMAL LEGAL DEFENSE FUND

ANIMAL LEGAL DEFENSE FUND (CALIFORNIA NON-PROFIT CORPORATION)

170 EAST COTATI AVENUE

COTATI, CA 94931

FOR: PROMOTING PUBLIC AWARENESS OF ANIMAL RIGHTS PROTECTION AND ANIMAL WELFARE, IN CLASS 35 (U.S. CLS. 100, 101 AND 102).

FIRST USE 12-31-1985; IN COMMERCE 12-31-1985.

THE MARK CONSISTS OF STANDARD CHARACTERS WITHOUT CLAIM TO ANY PARTICULAR FONT, STYLE, SIZE, OR COLOR.

OWNER OF U.S. REG. NOS. 2,690,359 AND 2,690,360.

SEC. 2(F).

SER. NO. 77-516,503, FILED 7-8-2008.

MATTHEW EINSTEIN, EXAMINING ATTORNEY

Int. Cl.: 35

Prior U.S. Cls.: 100, 101 and 102

United States Patent and Trademark Office

Reg. No. 3,575,770

Registered Feb. 17, 2009

**SERVICE MARK
PRINCIPAL REGISTER**

ALDF

ANIMAL LEGAL DEFENSE FUND (CALIFORNIA NON-PROFIT CORPORATION)
170 EAST COTATI AVENUE
COTATI, CA 94931

FOR: PROMOTING PUBLIC AWARENESS OF ANIMAL RIGHTS PROTECTION AND ANIMAL WELFARE, IN CLASS 35 (U.S. CLS. 100, 101 AND 102).

FIRST USE 12-31-1985; IN COMMERCE 12-31-1985.

THE MARK CONSISTS OF STANDARD CHARACTERS WITHOUT CLAIM TO ANY PARTICULAR FONT, STYLE, SIZE, OR COLOR.

OWNER OF U.S. REG. NOS. 2,690,359 AND 2,690,360.

SER. NO. 77-516,505, FILED 7-8-2008.

MATTHEW EINSTEIN, EXAMINING ATTORNEY

Int. Cl.: 35

Prior U.S. Cls.: 100, 101 and 102

United States Patent and Trademark Office

Reg. No. 3,575,771

Registered Feb. 17, 2009

**SERVICE MARK
PRINCIPAL REGISTER**

SALDF

ANIMAL LEGAL DEFENSE FUND (CALIFORNIA NON-PROFIT CORPORATION)
170 EAST COTATI AVENUE
COTATI, CA 94931

FOR: PROMOTING PUBLIC AWARENESS OF ANIMAL RIGHTS PROTECTION AND ANIMAL WELFARE, IN CLASS 35 (U.S. CLS. 100, 101 AND 102).

FIRST USE 9-1-1993; IN COMMERCE 9-1-1993.

THE MARK CONSISTS OF STANDARD CHARACTERS WITHOUT CLAIM TO ANY PARTICULAR FONT, STYLE, SIZE, OR COLOR.

OWNER OF U.S. REG. NOS. 2,690,359 AND 2,690,360.

SER. NO. 77-516,507, FILED 7-8-2008.

MATTHEW EINSTEIN, EXAMINING ATTORNEY

Int. Cl.: 35

Prior U.S. Cls.: 100, 101 and 102

United States Patent and Trademark Office

Reg. No. 3,575,772

Registered Feb. 17, 2009

**SERVICE MARK
PRINCIPAL REGISTER**

**STUDENT ANIMAL LEGAL
DEFENSE FUND**

ANIMAL LEGAL DEFENSE FUND (CALIFORNIA NON-PROFIT CORPORATION)

170 EAST COTATI AVENUE

COTATI, CA 94931

FOR: PROMOTING PUBLIC AWARENESS OF ANIMAL RIGHTS PROTECTION AND ANIMAL WELFARE, IN CLASS 35 (U.S. CLS. 100, 101 AND 102).

FIRST USE 9-1-1993; IN COMMERCE 9-1-1993.

THE MARK CONSISTS OF STANDARD CHARACTERS WITHOUT CLAIM TO ANY PARTICULAR FONT, STYLE, SIZE, OR COLOR.

OWNER OF U.S. REG. NOS. 2,690,359 AND 2,690,360.

SEC. 2(F).

SER. NO. 77-516,508, FILED 7-8-2008.

MATTHEW EINSTEIN, EXAMINING ATTORNEY

Int. Cl.: 35

Prior U.S. Cls.: 100, 101 and 102

United States Patent and Trademark Office

Reg. No. 3,575,773

Registered Feb. 17, 2009

**SERVICE MARK
PRINCIPAL REGISTER**

WE MAY BE THE ONLY LAWYERS
ON EARTH WHOSE CLIENTS ARE
ALL INNOCENT

ANIMAL LEGAL DEFENSE FUND (CALIFOR-
NIA NON-PROFIT CORPORATION)
170 EAST COTATI AVENUE
COTATI, CA 94931

FOR: PROMOTING PUBLIC AWARENESS OF
ANIMAL RIGHTS PROTECTION AND ANIMAL
WELFARE, IN CLASS 35 (U.S. CLS. 100, 101 AND 102).

FIRST USE 7-1-1990; IN COMMERCE 7-1-1990.

THE MARK CONSISTS OF STANDARD CHAR-
ACTERS WITHOUT CLAIM TO ANY PARTICULAR
FONT, STYLE, SIZE, OR COLOR.

SER. NO. 77-516,510, FILED 7-8-2008.

MATTHEW EINSTEIN, EXAMINING ATTORNEY

Int. Cl.: 35

Prior U.S. Cls.: 100, 101 and 102

United States Patent and Trademark Office

Reg. No. 3,575,774

Registered Feb. 17, 2009

SERVICE MARK
PRINCIPAL REGISTER



ANIMAL LEGAL DEFENSE FUND (CALIFORNIA NON-PROFIT CORPORATION)
170 EAST COTATI AVENUE
COTATI, CA 94931

FOR: PROMOTING PUBLIC AWARENESS OF ANIMAL RIGHTS PROTECTION AND ANIMAL WELFARE, IN CLASS 35 (U.S. CLS. 100, 101 AND 102).

FIRST USE 12-31-1985; IN COMMERCE 12-31-1985.

OWNER OF U.S. REG. NO. 2,690,360.

THE MARK CONSISTS OF THE WORDS "ANIMAL LEGAL DEFENSE FUND" UNDERNEATH THE DESIGNS OF A PRIMATE AND FELINE WITH A SCALE AND A SHIELD.

SEC. 2(F) AS TO THE WORDING "ANIMAL LEGAL DEFENSE FUND".

SER. NO. 77-516,515, FILED 7-8-2008.

MATTHEW EINSTEIN, EXAMINING ATTORNEY

Int. Cl.: 35

Prior U.S. Cls.: 100, 101 and 102

United States Patent and Trademark Office

Reg. No. 3,575,775

Registered Feb. 17, 2009

**SERVICE MARK
PRINCIPAL REGISTER**

**WINNING THE CASE AGAINST
CRUELTY**

ANIMAL LEGAL DEFENSE FUND (CALIFORNIA NON-PROFIT CORPORATION)
170 EAST COTATI AVENUE
COTATI, CA 94931

THE MARK CONSISTS OF STANDARD CHARACTERS WITHOUT CLAIM TO ANY PARTICULAR FONT, STYLE, SIZE, OR COLOR.

FOR: PROMOTING PUBLIC AWARENESS OF ANIMAL RIGHTS PROTECTION AND ANIMAL WELFARE, IN CLASS 35 (U.S. CLS. 100, 101 AND 102).

SER. NO. 77-516,521, FILED 7-8-2008.

FIRST USE 7-1-2005; IN COMMERCE 7-1-2005.

MATTHEW EINSTEIN, EXAMINING ATTORNEY

Int. Cl.: 42

Prior U.S. Cls.: 100 and 101

United States Patent and Trademark Office

Reg. No. 3,575,776

Registered Feb. 17, 2009

**SERVICE MARK
PRINCIPAL REGISTER**

MY MEDICATION ADVISOR

ABACUS MANAGEMENT TECHNOLOGIES,
LLC. (RHODE ISLAND CORPORATION)
1210 PONTIAC AVE.
CRANSTON, RI 02920

FOR: NON-DOWNLOADABLE, WEB-ENABLED,
INTERACTIVE AND EDUCATIONAL COMPUTER
SOFTWARE FOR USE BY PHARMACISTS, PA-
TIENTS, AND THEIR PHYSICIANS AND CARE
MANAGERS TO INCREASE MEDICATION EFFI-
CACY AND PATIENT SAFETY AND MANUAL
SOLD THEREWITH, IN CLASS 42 (U.S. CLS. 100
AND 101).

FIRST USE 4-24-2002; IN COMMERCE 4-24-2002.

THE MARK CONSISTS OF STANDARD CHAR-
ACTERS WITHOUT CLAIM TO ANY PARTICULAR
FONT, STYLE, SIZE, OR COLOR.

OWNER OF U.S. REG. NO. 2,687,620.

SEC. 2(F).

SER. NO. 77-516,525, FILED 7-8-2008.

MATTHEW EINSTEIN, EXAMINING ATTORNEY

Int. Cl.: 11

Prior U.S. Cls.: 13, 21, 23, 31 and 34

United States Patent and Trademark Office

Reg. No. 3,575,777

Registered Feb. 17, 2009

**TRADEMARK
PRINCIPAL REGISTER**

ROBOLIGHT

METAPHASE TECHNOLOGIES, INC (PENNSYLVANIA CORPORATION)
3580 PROGRESS DRIVE, UNIT A
BENSALEM, PA 19020

FOR: ELECTRIC LIGHTING FIXTURES; LED (LIGHT EMITTING DIODE) LIGHTING FIXTURES; LED AND HID LIGHT FIXTURES; LIGHTING FIXTURES, IN CLASS 11 (U.S. CLS. 13, 21, 23, 31 AND 34).

FIRST USE 1-15-2008; IN COMMERCE 1-15-2008.

THE MARK CONSISTS OF STANDARD CHARACTERS WITHOUT CLAIM TO ANY PARTICULAR FONT, STYLE, SIZE, OR COLOR.

SER. NO. 77-516,530, FILED 7-8-2008.

JIM RINGLE, EXAMINING ATTORNEY

Int. Cl.: 44

Prior U.S. Cls.: 100 and 101

United States Patent and Trademark Office

Reg. No. 3,575,778

Registered Feb. 17, 2009

**SERVICE MARK
PRINCIPAL REGISTER**

PRANCE AROUND

PRANCE AROUND (MARYLAND LIMITED LIABILITY COMPANY)
APT. #37A
14015 VISTA DRIVE
LAUREL, MD 20707

THE MARK CONSISTS OF STANDARD CHARACTERS WITHOUT CLAIM TO ANY PARTICULAR FONT, STYLE, SIZE, OR COLOR.

FOR: DOG WALKING; PET MEDICATION ADMINISTERING; PET GROOMING, IN CLASS 44 (U.S. CLS. 100 AND 101).

SER. NO. 77-516,554, FILED 7-8-2008.

FIRST USE 5-15-2006; IN COMMERCE 5-15-2006.

VERNA BETH RIRIE, EXAMINING ATTORNEY

Int. Cl.: 9

Prior U.S. Cls.: 21, 23, 26, 36 and 38

United States Patent and Trademark Office

Reg. No. 3,575,779

Registered Feb. 17, 2009

**TRADEMARK
PRINCIPAL REGISTER**

ISO-HEALTHY

PLAY VISIONS, INC. (WASHINGTON CORPORATION)
19180 144TH AVE, N.E.
WOODINVILLE, PA 98072

THE MARK CONSISTS OF STANDARD CHARACTERS WITHOUT CLAIM TO ANY PARTICULAR FONT, STYLE, SIZE, OR COLOR.

FOR: ELECTRONIC PERSONAL ORGANIZER; HANDHELD COMPUTERS, IN CLASS 9 (U.S. CLS. 21, 23, 26, 36 AND 38).

SER. NO. 77-516,558, FILED 7-8-2008.

FIRST USE 2-1-2008; IN COMMERCE 2-1-2008.

MICHAEL KEATING, EXAMINING ATTORNEY

Int. Cl.: 25

Prior U.S. Cls.: 22 and 39

United States Patent and Trademark Office

Reg. No. 3,575,780

Registered Feb. 17, 2009

TRADEMARK
PRINCIPAL REGISTER



WALTERS, MICHELLE (UNITED STATES INDIVIDUAL)

805 N. CORDOVA ST.

BURBANK, CA 91505 AND

WALTERS, JOHN (UNITED STATES INDIVIDUAL)

805 N. CORDOVA ST.

BURBANK, CA 91505

FOR: ORGANIC COTTON, HEMP OR BAMBOO BABY WRAP IN THE NATURE OF CLOTHING DESIGNED TO BE USED IN MOST CAR SEATS, IN CLASS 25 (U.S. CLS. 22 AND 39).

FIRST USE 5-26-2008; IN COMMERCE 5-26-2008.

NO CLAIM IS MADE TO THE EXCLUSIVE RIGHT TO USE "WRAP", APART FROM THE MARK AS SHOWN.

THE MARK CONSISTS OF AN IMAGE OF A CAR MADE OUT OF THE STYLIZED WORDS "GOGO", WITH TIRES FOR THE LETTERS "O". THE CAR SITS ON TOP OF A ROAD, USING TWO LINES AS THE ROAD. UNDERNEATH THE ROAD IS THE STYLIZED WORD "WRAP".

SER. NO. 77-516,562, FILED 7-8-2008.

MICHAEL KEATING, EXAMINING ATTORNEY

Int. Cl.: 34

Prior U.S. Cls.: 2, 8, 9 and 17

United States Patent and Trademark Office

Reg. No. 3,575,781

Registered Feb. 17, 2009

**TRADEMARK
PRINCIPAL REGISTER**



TABACALERA GARCIA, INC. (FLORIDA CORPORATION)
13273 N.W. 7 TERRACE
MIAMI, FL 33182

FOR: CIGARS, IN CLASS 34 (U.S. CLS. 2, 8, 9 AND 17).

FIRST USE 7-14-2008; IN COMMERCE 7-14-2008.

THE MARK CONSISTS OF THE STYLIZED LETTERS "MF" IN THE MIDDLE OF A DESIGN FEATURING DRAPERY, CORDS, AND TASSELS. THE WORDING "MY FATHER" APPEARS IN A BANNER BELOW THE DESIGN.

SER. NO. 77-516,564, FILED 7-8-2008.

MICHAEL SOUDERS, EXAMINING ATTORNEY

Int. Cl.: 36

Prior U.S. Cls.: 100, 101 and 102

United States Patent and Trademark Office

Reg. No. 3,575,782

Registered Feb. 17, 2009

**SERVICE MARK
PRINCIPAL REGISTER**

93 CENTS FOR FLIGHT 93

THE HALO FOUNDATION, INC. (OHIO COR-
PORATION)
SUITE 201
115 E. MARKET STREET
AKRON, OH 44308

THE MARK CONSISTS OF STANDARD CHAR-
ACTERS WITHOUT CLAIM TO ANY PARTICULAR
FONT, STYLE, SIZE, OR COLOR.

FOR: CHARITABLE FUND RAISING SERVICES,
IN CLASS 36 (U.S. CLS. 100, 101 AND 102).

SER. NO. 77-516,571, FILED 7-8-2008.

FIRST USE 11-30-2007; IN COMMERCE 5-0-2008.

JAY FLOWERS, EXAMINING ATTORNEY

Int. Cl.: 28

Prior U.S. Cls.: 22, 23, 38 and 50

United States Patent and Trademark Office

Reg. No. 3,575,783

Registered Feb. 17, 2009

**TRADEMARK
PRINCIPAL REGISTER**

DEMOPOLIT

GARCIA, ORLANDO D. (CANADA INDIVIDUAL)
28 CHAPMAN RD
TORONTO, CANADA M9P1E5

THE MARK CONSISTS OF STANDARD CHARACTERS WITHOUT CLAIM TO ANY PARTICULAR FONT, STYLE, SIZE, OR COLOR.

FOR: BOARD GAMES, IN CLASS 28 (U.S. CLS. 22, 23, 38 AND 50).

SER. NO. 77-516,620, FILED 7-8-2008.

FIRST USE 10-14-2006; IN COMMERCE 2-28-2007.

MIDGE BUTLER, EXAMINING ATTORNEY

Int. Cl.: 43

Prior U.S. Cls.: 100 and 101

United States Patent and Trademark Office

Reg. No. 3,575,784

Registered Feb. 17, 2009

**SERVICE MARK
PRINCIPAL REGISTER**

Daikanyama

DAIKANYAMA CORPORATION (MASSACHU-
SETTS CORPORATION), DBA DAIKANYAMA
JAPANESE CUISINE
43 WALTHAM STREET
LEXINGTON, MA 02421

FOR: BAR AND RESTAURANT SERVICES; CAFE
AND RESTAURANT SERVICES; CARRY-OUT RES-
TAURANTS; CATERING, IN CLASS 43 (U.S. CLS. 100
AND 101).

FIRST USE 0-0-2007; IN COMMERCE 0-0-2007.

THE MARK CONSISTS OF STANDARD CHAR-
ACTERS WITHOUT CLAIM TO ANY PARTICULAR
FONT, STYLE, SIZE, OR COLOR.

SEC. 2(F).

SER. NO. 77-516,624, FILED 7-8-2008.

REBECCA SMITH, EXAMINING ATTORNEY

Int. Cl.: 28

Prior U.S. Cls.: 22, 23, 38 and 50

United States Patent and Trademark Office

Reg. No. 3,575,785

Registered Feb. 17, 2009

**TRADEMARK
PRINCIPAL REGISTER**

FROBRO

ZING TOYS, INC. (OREGON CORPORATION)
P.O. BOX 520
BANKS, OR 97106

THE MARK CONSISTS OF STANDARD CHAR-
ACTERS WITHOUT CLAIM TO ANY PARTICULAR
FONT, STYLE, SIZE, OR COLOR.

FOR: DISC TOSS TOYS; POP UP TOYS; RUBBER
CHARACTER TOYS, IN CLASS 28 (U.S. CLS. 22, 23,
38 AND 50).

SER. NO. 77-516,665, FILED 7-8-2008.

FIRST USE 9-1-2007; IN COMMERCE 9-1-2007.

KATHLEEN LORENZO, EXAMINING ATTORNEY

Int. Cl.: 42

Prior U.S. Cls.: 100 and 101

United States Patent and Trademark Office

Reg. No. 3,575,786

Registered Feb. 17, 2009

**SERVICE MARK
PRINCIPAL REGISTER**

EATLIME

EATLIME, INC. (DELAWARE CORPORATION)
440 N. WOLFE ROAD
SUNNYVALE, CA 94085

FIRST USE 4-5-2008; IN COMMERCE 4-5-2008.

FOR: PROVIDING A WEB SITE FEATURING
TEMPORARY USE OF NON-DOWNLOADABLE
SOFTWARE ALLOWING WEB SITE USERS TO UP-
LOAD ON-LINE VIDEOS FOR SHARING WITH
OTHERS FOR ENTERTAINMENT PURPOSES , IN
CLASS 42 (U.S. CLS. 100 AND 101).

THE MARK CONSISTS OF STANDARD CHAR-
ACTERS WITHOUT CLAIM TO ANY PARTICULAR
FONT, STYLE, SIZE, OR COLOR.

SER. NO. 77-516,674, FILED 7-8-2008.

IRA J. GOODSaid, EXAMINING ATTORNEY

Int. Cl.: 42

Prior U.S. Cls.: 100 and 101

United States Patent and Trademark Office

Reg. No. 3,575,787

Registered Feb. 17, 2009

**SERVICE MARK
PRINCIPAL REGISTER**

IRONKEEP

IRONKEEP TECHNOLOGIES, L.L.C. (MICHIGAN
LIMITED LIABILITY COMPANY)
1129 WOODMERE AVENUE, SUITE J
TRAVERSE CITY, MI 49686

FOR: WEB SITE DEVELOPMENT FOR OTHERS;
COMPUTER CONSULTATION; COMPUTER SERVI-
CES, NAMELY, HOSTING ONLINE WEB FACIL-
ITIES FOR OTHERS FOR ORGANIZING AND
CONDUCTING ONLINE MEETINGS, GATHER-
INGS AND INTERACTIVE DISCUSSIONS; DESIGN
AND DEVELOPMENT OF NETWORKS; COMPU-
TER SERVICES, NAMELY, CREATING AN ON-
LINE COMMUNITY FOR REGISTERED USERS TO
PARTICIPATE IN DISCUSSIONS, GET FEEDBACK
FROM THEIR PEERS, FORM VIRTUAL COMMU-
NITIES AND ENGAGE IN SOCIAL NETWORKING;

COMPUTER SERVICE, NAMELY, ACTING AS AN
APPLICATION SERVICE PROVIDER IN THE FIELD
OF KNOWLEDGE MANAGEMENT TO HOST COM-
PUTER APPLICATION SOFTWARE FOR STORAGE
OF DATA AND INFORMATION; PRODUCT RE-
SEARCH, IN CLASS 42 (U.S. CLS. 100 AND 101).

FIRST USE 7-31-2000; IN COMMERCE 7-31-2000.

THE MARK CONSISTS OF STANDARD CHAR-
ACTERS WITHOUT CLAIM TO ANY PARTICULAR
FONT, STYLE, SIZE, OR COLOR.

SER. NO. 77-516,679, FILED 7-8-2008.

IRA J. GOODSaid, EXAMINING ATTORNEY

Int. Cl.: 28

Prior U.S. Cls.: 22, 23, 38 and 50

United States Patent and Trademark Office

Reg. No. 3,575,788

Registered Feb. 17, 2009

**TRADEMARK
PRINCIPAL REGISTER**

FLIP SHOT

ZING TOYS, INC. (OREGON CORPORATION)
P.O. BOX 520
BANKS, OR 19020

THE MARK CONSISTS OF STANDARD CHAR-
ACTERS WITHOUT CLAIM TO ANY PARTICULAR
FONT, STYLE, SIZE, OR COLOR.

FOR: DART GAMES; DARTS; TARGET GAMES;
TARGET LAUNCHERS FOR DARTS; TOSSING
DISC TOYS, IN CLASS 28 (U.S. CLS. 22, 23, 38 AND
50).

SER. NO. 77-516,681, FILED 7-8-2008.

FIRST USE 9-1-2007; IN COMMERCE 9-1-2007.

KATHLEEN LORENZO, EXAMINING ATTORNEY

Int. Cl.: 35

Prior U.S. Cls.: 100, 101 and 102

United States Patent and Trademark Office

Reg. No. 3,575,789

Registered Feb. 17, 2009

**SERVICE MARK
PRINCIPAL REGISTER**

music44

MUSIC44.COM, INC. (INDIANA CORPORATION)
8230 MEADOWBROOK DRIVE
INDIANAPOLIS, IN 46240

THE MARK CONSISTS OF STANDARD CHAR-
ACTERS WITHOUT CLAIM TO ANY PARTICULAR
FONT, STYLE, SIZE, OR COLOR.

FOR: RETAIL STORES FEATURING SHEET MU-
SIC, MUSICAL INSTRUMENTS, MUSICAL EQUIP-
MENT AND MUSICAL ACCESSORIES, IN CLASS 35
(U.S. CLS. 100, 101 AND 102).

SER. NO. 77-516,692, FILED 7-8-2008.

FIRST USE 11-26-2003; IN COMMERCE 11-26-2003.

CURTIS FRENCH, EXAMINING ATTORNEY

Int. Cl.: 41

Prior U.S. Cls.: 100, 101 and 107

United States Patent and Trademark Office

Reg. No. 3,575,790

Registered Feb. 17, 2009

**SERVICE MARK
PRINCIPAL REGISTER**

**GLOBAL REACH. GLOBAL
IMPACT.**

BOARD OF TRUSTEES OF THE UNIVERSITY OF
MASSACHUSETTS (MASSACHUSETTS STATE
UNIVERSITY)
TRADEMARK/LICENSING OFFICE ROOM 817
ONE CAMPUS CENTER WAY
AMHERST, MA 01003

FOR: EDUCATING AT UNIVERSITY OR COLLE-
GES, IN CLASS 41 (U.S. CLS. 100, 101 AND 107).

FIRST USE 11-9-2007; IN COMMERCE 11-14-2007.

THE MARK CONSISTS OF STANDARD CHAR-
ACTERS WITHOUT CLAIM TO ANY PARTICULAR
FONT, STYLE, SIZE, OR COLOR.

SER. NO. 77-516,702, FILED 7-8-2008.

CURTIS FRENCH, EXAMINING ATTORNEY

Int. Cl.: 37

Prior U.S. Cls.: 100, 103 and 106

United States Patent and Trademark Office

Reg. No. 3,575,791

Registered Feb. 17, 2009

**SERVICE MARK
PRINCIPAL REGISTER**

**Restoring Shattered Lives
& Dreams**

MAHER CONSTRUCTION COMPANY (MICHIGAN CORPORATION), DBA MAHER CONSTRUCTION COMPANY
937 N. PONTIAC TRAIL
WALLED LAKE, MI 48390

FOR: BUILDING CONSTRUCTION AND REPAIR; BUILDING CONSTRUCTION SERVICES; BUILDING CONSTRUCTION, REMODELING AND REPAIR; CARPENTRY CONTRACTOR SERVICES; CONSTRUCTION AND RENOVATION OF BUILDINGS; CONSTRUCTION AND REPAIR OF BUILDINGS; CONSTRUCTION OF BUILDINGS; CONSTRUCTION, MAINTENANCE AND RENOVATION OF PROPERTY; CUSTOM CONSTRUCTION AND BUILDING RENOVATION; FRAMING CON-

TRACTOR SERVICES; GENERAL CONSTRUCTION CONTRACTING; RESIDENTIAL AND BUILDING CONSTRUCTION CONSULTING; RESIDENTIAL AND COMMERCIAL BUILDING CONSTRUCTION, IN CLASS 37 (U.S. CLS. 100, 103 AND 106).

FIRST USE 6-14-2008; IN COMMERCE 6-14-2008.

THE MARK CONSISTS OF STANDARD CHARACTERS WITHOUT CLAIM TO ANY PARTICULAR FONT, STYLE, SIZE, OR COLOR.

SER. NO. 77-516,709, FILED 7-8-2008.

CURTIS FRENCH, EXAMINING ATTORNEY

Int. Cl.: 41

Prior U.S. Cls.: 100, 101 and 107

United States Patent and Trademark Office

Reg. No. 3,575,792

Registered Feb. 17, 2009

**SERVICE MARK
PRINCIPAL REGISTER**

Ancient Wings

THEISS, ROBERT (UNITED STATES INDIVIDUAL)
80445 LOST CREEK ROAD
DEXTER, OR 97431

FOR: EDUCATIONAL SERVICES, NAMELY, CONDUCTING WORKSHOPS, RETREATS, AND COMMUNITY EVENTS IN THE FIELDS OF SPIRITUALITY, HEALING AND PERSONAL GROWTH, IN CLASS 41 (U.S. CLS. 100, 101 AND 107).

FIRST USE 1-1-2000; IN COMMERCE 1-1-2000.

THE MARK CONSISTS OF STANDARD CHARACTERS WITHOUT CLAIM TO ANY PARTICULAR FONT, STYLE, SIZE, OR COLOR.

SER. NO. 77-516,768, FILED 7-8-2008.

SUSAN LESLIE DUBOIS, EXAMINING ATTORNEY

Int. Cl.: 35

Prior U.S. Cls.: 100, 101 and 102

United States Patent and Trademark Office

Reg. No. 3,575,793

Registered Feb. 17, 2009

**SERVICE MARK
PRINCIPAL REGISTER**



HYSON MUSIC, INC (NEW YORK CORPORATION)
600 WOODBURY ROAD
PLAINVIEW, NY 11803

FOR: ON-LINE RETAIL STORE SERVICES FEATURING MUSICAL INSTRUMENTS AND ACCESSORIES, IN CLASS 35 (U.S. CLS. 100, 101 AND 102).

FIRST USE 1-1-2007; IN COMMERCE 1-1-2007.

NO CLAIM IS MADE TO THE EXCLUSIVE RIGHT TO USE "MUSIC", APART FROM THE MARK AS SHOWN.

THE STIPLING IS FOR SHADING PURPOSES ONLY.

THE MARK CONSISTS OF THE STYLIZED TEXT "H HYSON MUSIC" WHERE "HYSON MUSIC" APPEARS IN TWO LINES.

SER. NO. 77-516,788, FILED 7-8-2008.

JANICE L. MCMORROW, EXAMINING ATTORNEY

Int. Cl.: 35

Prior U.S. Cls.: 100, 101 and 102

United States Patent and Trademark Office

Reg. No. 3,575,794

Registered Feb. 17, 2009

**SERVICE MARK
PRINCIPAL REGISTER**

ALLERNEEDS.COM

ALLERNEEDS LLC (CALIFORNIA LIMITED
LIABILITY COMPANY)
811 S. BLUEBIRD CIRCLE
ANAHEIM, CA 92807

THE MARK CONSISTS OF STANDARD CHAR-
ACTERS WITHOUT CLAIM TO ANY PARTICULAR
FONT, STYLE, SIZE, OR COLOR.

FOR: ONLINE STORE SERVICES FEATURING
ALLERGEN FREE FOODS, IN CLASS 35 (U.S. CLS.
100, 101 AND 102).

SER. NO. 77-516,801, FILED 7-8-2008.

FIRST USE 12-13-2006; IN COMMERCE 3-15-2008.

JANICE L. MCMORROW, EXAMINING ATTOR-
NEY

Int. Cl.: 35

Prior U.S. Cls.: 100, 101 and 102

United States Patent and Trademark Office

Reg. No. 3,575,795

Registered Feb. 17, 2009

**SERVICE MARK
PRINCIPAL REGISTER**

IRW.COM

RIVAD MEDIA, LLC (PENNSYLVANIA LIMITED
LIABILITY COMPANY)
260 LYCEUM
PHILADELPHIA, PA 19128

FOR: ADVERTISING SERVICES, NAMELY, THE
PROMOTION OF GOODS AND SERVICES OF OTHERS THROUGH ONLINE DISTRIBUTION OF PRODUCT REVIEWS AND ELECTRONIC SHOPPING OFFERS, IN CLASS 35 (U.S. CLS. 100, 101 AND 102).

FIRST USE 6-15-2008; IN COMMERCE 6-15-2008.

THE MARK CONSISTS OF STANDARD CHARACTERS WITHOUT CLAIM TO ANY PARTICULAR FONT, STYLE, SIZE, OR COLOR.

SER. NO. 77-516,826, FILED 7-8-2008.

SETH A. RAPPAPORT, EXAMINING ATTORNEY

Int. Cl.: 35

Prior U.S. Cls.: 100, 101 and 102

United States Patent and Trademark Office

Reg. No. 3,575,796

Registered Feb. 17, 2009

**SERVICE MARK
PRINCIPAL REGISTER**

Jobvana

HOBJOB, INC. (WASHINGTON CORPORATION)
3216 N. 32ND ST.
TACOMA, WA 98407

AND SERVICES OF OTHERS, IN CLASS 35 (U.S.
CLS. 100, 101 AND 102).

FIRST USE 7-2-2008; IN COMMERCE 7-2-2008.

FOR: THE BRINGING TOGETHER, FOR THE
BENEFIT OF OTHERS, OF A VARIETY OF GOODS
AND SERVICES, ENABLING CUSTOMERS TO
CONVENIENTLY VIEW AND PURCHASE THOSE
GOODS AND SERVICES FROM AN INTERNET
WEB SITE PARTICULARLY SPECIALIZING IN
THE MARKETING OF THE SALE OF GOODS

THE MARK CONSISTS OF STANDARD CHAR-
ACTERS WITHOUT CLAIM TO ANY PARTICULAR
FONT, STYLE, SIZE, OR COLOR.

SER. NO. 77-516,858, FILED 7-8-2008.

KATHERINE CHANG, EXAMINING ATTORNEY

Int. Cl.: 7

Prior U.S. Cls.: 13, 19, 21, 23, 31, 34 and 35

United States Patent and Trademark Office

Reg. No. 3,575,797

Registered Feb. 17, 2009

**TRADEMARK
PRINCIPAL REGISTER**

DIRECTFEED

ASTEC INDUSTRIES, INC. (TENNESSEE COR-
PORATION)
1725 SHEPHERD ROAD
CHATTANOOGA, TN 37421

THE MARK CONSISTS OF STANDARD CHAR-
ACTERS WITHOUT CLAIM TO ANY PARTICULAR
FONT, STYLE, SIZE, OR COLOR.

FOR: VEHICLE-MOUNTED VIBRATORY
SCREENING AND CLASSIFYING APPARATUS,
NAMELY, VIBRATORY SCREEN SEPARATORS,
IN CLASS 7 (U.S. CLS. 13, 19, 21, 23, 31, 34 AND 35).

SER. NO. 77-516,861, FILED 7-8-2008.

FIRST USE 6-25-2008; IN COMMERCE 6-25-2008.

MORGAN WYNNE, EXAMINING ATTORNEY

Int. Cl.: 18

Prior U.S. Cls.: 1, 2, 3, 22 and 41

United States Patent and Trademark Office

Reg. No. 3,575,798

Registered Feb. 17, 2009

**TRADEMARK
PRINCIPAL REGISTER**

NINTHALA

NIN POUIPHANVONGRAY (UNITED STATES
INDIVIDUAL)
13900 NOEL RD.
DALLAS, TX 75240

THE MARK CONSISTS OF STANDARD CHAR-
ACTERS WITHOUT CLAIM TO ANY PARTICULAR
FONT, STYLE, SIZE, OR COLOR.

FOR: HANDBAGS, PURSES AND WALLETS;
LEATHER PURSES; MULTI-PURPOSE PURSES;
PURSES; SMALL PURSES, IN CLASS 18 (U.S. CLS.
1, 2, 3, 22 AND 41).

SER. NO. 77-516,887, FILED 7-8-2008.

FIRST USE 2-26-2008; IN COMMERCE 6-23-2008.

MATTHEW EINSTEIN, EXAMINING ATTORNEY

Int. Cl.: 42

Prior U.S. Cls.: 100 and 101

United States Patent and Trademark Office

Reg. No. 3,575,799

Registered Feb. 17, 2009

**SERVICE MARK
PRINCIPAL REGISTER**

WEB PROMISES

CGI TECHNOLOGIES AND SOLUTIONS INC.
(DELAWARE CORPORATION)
4050 LEGATO ROAD
FAIRFAX, VA 22033

FOR: PROVIDING TEMPORARY USE OF ON-
LINE NON-DOWNLOADABLE SOFTWARE FOR
MANAGING DEBT COLLECTION, NEGOTIATION
AND SETTLEMENT, IN CLASS 42 (U.S. CLS. 100
AND 101).

FIRST USE 8-14-2008; IN COMMERCE 8-14-2008.

THE MARK CONSISTS OF STANDARD CHAR-
ACTERS WITHOUT CLAIM TO ANY PARTICULAR
FONT, STYLE, SIZE, OR COLOR.

NO CLAIM IS MADE TO THE EXCLUSIVE
RIGHT TO USE "WEB", APART FROM THE MARK
AS SHOWN.

SER. NO. 77-516,913, FILED 7-8-2008.

DAVID COLLIER, EXAMINING ATTORNEY

Int. Cl.: 42

Prior U.S. Cls.: 100 and 101

United States Patent and Trademark Office

Reg. No. 3,575,800

Registered Feb. 17, 2009

**SERVICE MARK
PRINCIPAL REGISTER**

FIRSTHAND

FIRSTHAND TECHNOLOGY, INC. (WASHINGTON CORPORATION), DBA IMPRINT INTERACTIVE TECHNOLOGY
3550 NE 147TH ST
LAKE FOREST PARK, WA 98155

FOR: DESIGN, CONSULTING, RESEARCH, AND DEVELOPMENT SERVICES FOR COMPUTER SOFTWARE, INTERACTIVE MEDIA COMPUTER SOFTWARE, AND VIRTUAL REALITY SOFTWARE AND COMPUTER HARDWARE FOR ENTERTAINMENT, THERAPEUTIC, AND TRAINING PURPOSES, IN CLASS 42 (U.S. CLS. 100 AND 101).

FIRST USE 7-2-2008; IN COMMERCE 7-2-2008.

THE MARK CONSISTS OF STANDARD CHARACTERS WITHOUT CLAIM TO ANY PARTICULAR FONT, STYLE, SIZE, OR COLOR.

SER. NO. 77-516,920, FILED 7-8-2008.

KAPIL BHANOT, EXAMINING ATTORNEY

Int. Cl.: 35

Prior U.S. Cls.: 100, 101 and 102

United States Patent and Trademark Office

Reg. No. 3,575,801

Registered Feb. 17, 2009

**SERVICE MARK
PRINCIPAL REGISTER**

DON'T STAND BY, STAND UP!

GENOCIDE INTERVENTION NETWORK (DELA-
WARE NON-PROFIT ORGANIZATION)
1333 H STREET NW, FIRST FLOOR
WASHINGTON, DC 20005

FOR: CHARITABLE SERVICES, NAMELY, PRO-
MOTING PUBLIC AWARENESS OF GENOCIDE,
DEVELOPING AND COORDINATING VOLUN-
TEER PROJECTS; ORGANIZING ADVOCATE
GROUPS TO UNDERTAKE CHARITABLE PRO-
JECTS IN THE FIELD OF GENOCIDE INTERVEN-
TION; PUBLIC ADVOCACY TO PROMOTE THE

AWARENESS AND PREVENTION OF GENOCIDE,
IN CLASS 35 (U.S. CLS. 100, 101 AND 102).

FIRST USE 8-0-2006; IN COMMERCE 8-0-2006.

THE MARK CONSISTS OF STANDARD CHAR-
ACTERS WITHOUT CLAIM TO ANY PARTICULAR
FONT, STYLE, SIZE, OR COLOR.

SER. NO. 77-516,950, FILED 7-8-2008.

LINDA ORNDORFF, EXAMINING ATTORNEY

Int. Cl.: 10

Prior U.S. Cls.: 26, 39 and 44

United States Patent and Trademark Office

Reg. No. 3,575,802

Registered Feb. 17, 2009

**TRADEMARK
PRINCIPAL REGISTER**

GOMCO

ALLIED HEALTHCARE PRODUCTS, INC. (DE-
LAWARE CORPORATION)
1720 SUBLETTE AVENUE
ST. LOUIS, MO 63110

FOR: PRODUCTS FOR MEDICAL USE, NAMELY,
SUCTION, VACUUM, PRESSURE AND DRAINAGE
PUMPS; ASPIRATORS; BREAST PUMPS; COLLEC-
TION CANNISTERS FOR USE IN CONNECTION
WITH THE FOREGOING PRODUCTS; CIRCUMCI-
SION CLAMPS; PORTABLE STANDS FOR ASPIRA-
TORS; AND HANDLES AND TIPS FOR DENTAL
TOOLS, IN CLASS 10 (U.S. CLS. 26, 39 AND 44).

FIRST USE 12-31-1931; IN COMMERCE 12-31-1931.

THE MARK CONSISTS OF STANDARD CHAR-
ACTERS WITHOUT CLAIM TO ANY PARTICULAR
FONT, STYLE, SIZE, OR COLOR.

SER. NO. 77-516,963, FILED 7-8-2008.

SAMUEL E. SHARPER JR., EXAMINING ATTOR-
NEY

Int. Cl.: 28

Prior U.S. Cls.: 22, 23, 38 and 50

United States Patent and Trademark Office

Reg. No. 3,575,803

Registered Feb. 17, 2009

**TRADEMARK
PRINCIPAL REGISTER**

TALES OF GLORY

BEVERLY HILLS TEDDY BEAR COMPANY (CALIFORNIA CORPORATION)
24876 APPLE STREET, SUITE F
NEWHALL, CA 91321

FOR: DOLLS; MODELED PLASTIC TOY FIGURINES; STUFFED AND PLUSH TOYS, IN CLASS 28 (U.S. CLS. 22, 23, 38 AND 50).

FIRST USE 8-1-2005; IN COMMERCE 8-1-2005.

THE MARK CONSISTS OF STANDARD CHARACTERS WITHOUT CLAIM TO ANY PARTICULAR FONT, STYLE, SIZE, OR COLOR.

SER. NO. 77-517,003, FILED 7-8-2008.

CHRISTINE BLOMQUIST, EXAMINING ATTORNEY

Int. Cl.: 41

Prior U.S. Cls.: 100, 101 and 107

United States Patent and Trademark Office

Reg. No. 3,575,804

Registered Feb. 17, 2009

**SERVICE MARK
PRINCIPAL REGISTER**

**BEST FILM NOT PLAYING AT A
THEATER NEAR YOU**

THE INDEPENDENT FEATURE PROJECT, INC.
(NEW YORK NON-PROFIT CORPORATION)
104 WEST 29TH STREET
NEW YORK, NY 100015310

THE MARK CONSISTS OF STANDARD CHAR-
ACTERS WITHOUT CLAIM TO ANY PARTICULAR
FONT, STYLE, SIZE, OR COLOR.

FOR: PROVIDING RECOGNITION BY WAY OF
AWARDS TO DEMONSTRATE EXCELLENCE IN
THE FIELD OF INDEPENDENT FILMMAKING, IN
CLASS 41 (U.S. CLS. 100, 101 AND 107).

SER. NO. 77-517,012, FILED 7-8-2008.

FIRST USE 1-0-2005; IN COMMERCE 1-0-2005.

KRISTIN CARLSON, EXAMINING ATTORNEY

Int. Cl.: 39

Prior U.S. Cls.: 100 and 105

United States Patent and Trademark Office

Reg. No. 3,575,805

Registered Feb. 17, 2009

**SERVICE MARK
PRINCIPAL REGISTER**

Teagram

THE ORANGE BLOSSOM TEA HOUSE (CALI-
FORNIA PARTNERSHIP)
17130 COLE AVE
RIVERSIDE, CA 92508

FOR: DELIVERY OF GIFT BASKETS WITH SE-
LECTED ITEMS REGARDING A PARTICULAR
OCCASION OR THEME; DELIVERY OF GOODS
AND MESSAGES ACCOMPANIED BY BALLOONS
AND/OR NOVELTY PRESENTATIONS , IN CLASS
39 (U.S. CLS. 100 AND 105).

FIRST USE 4-15-2008; IN COMMERCE 4-15-2008.

THE MARK CONSISTS OF STANDARD CHAR-
ACTERS WITHOUT CLAIM TO ANY PARTICULAR
FONT, STYLE, SIZE, OR COLOR.

SER. NO. 77-517,026, FILED 7-8-2008.

RONALD MCMORROW, EXAMINING ATTORNEY

Int. Cl.: 25

Prior U.S. Cls.: 22 and 39

United States Patent and Trademark Office

Reg. No. 3,575,806

Registered Feb. 17, 2009

**TRADEMARK
PRINCIPAL REGISTER**

McKEVLIN'S SURF SHOP

MCKEVLIN, TIMOTHY C. (UNITED STATES
INDIVIDUAL)
16 CHARLOTTE STREET
CHARLESTON, SC 29401

NO CLAIM IS MADE TO THE EXCLUSIVE
RIGHT TO USE "SURF SHOP", APART FROM THE
MARK AS SHOWN.

FOR: SURF WEAR, NAMELY, HATS, T-SHIRTS,
BATHING SUITS, SHORTS, PANTS, SHIRTS, WET
SUITS, IN CLASS 25 (U.S. CLS. 22 AND 39).

SEC. 2(F).

FIRST USE 1-1-1966; IN COMMERCE 1-1-1966.

SER. NO. 77-517,031, FILED 7-8-2008.

THE MARK CONSISTS OF STANDARD CHAR-
ACTERS WITHOUT CLAIM TO ANY PARTICULAR
FONT, STYLE, SIZE, OR COLOR.

ZHALEH DELANEY, EXAMINING ATTORNEY

Int. Cl.: 43

Prior U.S. Cls.: 100 and 101

United States Patent and Trademark Office

Reg. No. 3,575,807

Registered Feb. 17, 2009

**SERVICE MARK
PRINCIPAL REGISTER**

GARDEN CATERING

CARPENTERI, FRANK J. (UNITED STATES IN-
DIVIDUAL)
185 1/2 SOUND BEACH AVENUE
OLD GREENWICH, CT 06870

OWNER OF U.S. REG. NO. 2,790,475.

FOR: CATERING; RESTAURANTS; TAKE-OUT
RESTAURANT SERVICES, IN CLASS 43 (U.S. CLS.
100 AND 101).

NO CLAIM IS MADE TO THE EXCLUSIVE
RIGHT TO USE "CATERING", APART FROM THE
MARK AS SHOWN.

FIRST USE 0-0-1978; IN COMMERCE 0-0-1978.

SER. NO. 77-517,050, FILED 7-8-2008.

THE MARK CONSISTS OF STANDARD CHAR-
ACTERS WITHOUT CLAIM TO ANY PARTICULAR
FONT, STYLE, SIZE, OR COLOR.

ANDREW RHIM, EXAMINING ATTORNEY

Int. Cls.: 37 and 42

Prior U.S. Cls.: 100, 101, 103 and 106

United States Patent and Trademark Office

Reg. No. 3,575,808

Registered Feb. 17, 2009

**SERVICE MARK
PRINCIPAL REGISTER**

InspectAPedia

DANIEL J FRIEDMAN (UNITED STATES INDIVIDUAL), DBA INSPECTAPEDIA.COM
3 WILLOWBROOK HGTS.
POUGHKEEPSIE, NY 126035707

FOR: BUILDING INSPECTION; CONSULTING IN THE FIELD OF BUILDING CONSTRUCTION; CONSULTING SERVICES FOR REPAIR AND RESTORATION OF HISTORIC BUILDINGS AND STRUCTURES; PROVIDING INFORMATION CONCERNING THE PHYSICAL STRUCTURES IN WHICH PEOPLE LIVE THAT ALLOW THE ELDERLY TO REMAIN IN THEIR OWN HOMES AS THEY AGE; PROVIDING INFORMATION IN THE FIELD OF HOME RENOVATIONS AND REPAIRS; REPAIR OF BUILDINGS, IN CLASS 37 (U.S. CLS. 100, 103 AND 106).

FIRST USE 4-11-2007; IN COMMERCE 4-17-2007.

FOR: ENGINEERING SERVICES FOR BUILDING AND PROPERTY CONDITION ASSESSMENT, FACILITY MANAGEMENT, REPAIR AND RESTORATION, BUILDING INSTRUMENTATION AND MONITORING, AND ENVIRONMENTAL CONSULTING; ENVIRONMENTAL TESTING AND IN-

SPECTION SERVICES; INSPECTING BUILDINGS FOR THE EXISTENCE OF MOLD; INSPECTIONS OF HOUSES, APARTMENTS, OFFICE BUILDINGS, RETAIL STORES FOR OWNERS, BUYERS, RENTERS, INSURANCE COMPANIES, ATTORNEYS TO DIAGNOSE PROBLEMS AND RECOMMEND REPAIRS; PROVIDING A DATABASE IN THE FIELD OF ASTHMA AND ALLERGY INFORMATION AND ALSO ALLOWS INPUTTING AND COLLECTION OF DATA AND INFORMATION ALL FOR RESEARCH PURPOSES; TECHNOLOGY SUPERVISION AND INSPECTION IN THE FIELD OF HOUSE CONSTRUCTION, IN CLASS 42 (U.S. CLS. 100 AND 101).

FIRST USE 4-11-2007; IN COMMERCE 4-17-2007.

THE MARK CONSISTS OF STANDARD CHARACTERS WITHOUT CLAIM TO ANY PARTICULAR FONT, STYLE, SIZE, OR COLOR.

SER. NO. 77-517,070, FILED 7-8-2008.

LINDA POWELL, EXAMINING ATTORNEY

Int. Cl.: 30

Prior U.S. Cl.: 46

United States Patent and Trademark Office

Reg. No. 3,575,809

Registered Feb. 17, 2009

**TRADEMARK
PRINCIPAL REGISTER**

GOLDEN GROVE

GOLDEN GROVE CANDY COMPANY, INC.
(NORTH CAROLINA CORPORATION)
PO BOX 921
364 WEST PARK DRIVE
WARSAW, NC 28398

THE MARK CONSISTS OF STANDARD CHAR-
ACTERS WITHOUT CLAIM TO ANY PARTICULAR
FONT, STYLE, SIZE, OR COLOR.

FOR: CANDY, IN CLASS 30 (U.S. CL. 46).

SER. NO. 77-517,073, FILED 7-8-2008.

FIRST USE 3-20-2008; IN COMMERCE 3-20-2008.

G. MAYERSCHOFF, EXAMINING ATTORNEY

Int. Cl.: 9

Prior U.S. Cls.: 21, 23, 26, 36 and 38

Reg. No. 3,575,810

United States Patent and Trademark Office

Registered Feb. 17, 2009

**TRADEMARK
PRINCIPAL REGISTER**

CADB

PRECISION PHOTONICS (DELAWARE CORPORATION)
3180 STERLING CIRCLE
BOULDER, CO 80301

FOR: FILTERS FOR OPTICAL DEVICES; SCIENTIFIC AND TECHNICAL APPARATUS, NAMELY, OPTICAL MIRRORS, IN CLASS 9 (U.S. CLS. 21, 23, 26, 36 AND 38).

FIRST USE 6-1-2006; IN COMMERCE 3-1-2007.

THE MARK CONSISTS OF STANDARD CHARACTERS WITHOUT CLAIM TO ANY PARTICULAR FONT, STYLE, SIZE, OR COLOR.

SER. NO. 77-517,103, FILED 7-8-2008.

JACQUELINE A. LAVINE, EXAMINING ATTORNEY

Int. Cl.: 30

Prior U.S. Cl.: 46

United States Patent and Trademark Office

Reg. No. 3,575,811

Registered Feb. 17, 2009

**TRADEMARK
PRINCIPAL REGISTER**



GOLDEN GROVE CANDY COMPANY, INC.
(NORTH CAROLINA CORPORATION)
PO BOX 921
364 WEST PARK DRIVE
WARSAW, NC 28398

THE MARK CONSISTS OF THE LITERAL ELEMENTS "GOLDEN GROVE" LISTED ABOVE THE LITERAL ELEMENTS "CANDY CO." ALL INSIDE A PEANUT-SHAPED DESIGN.

FOR: CANDY, IN CLASS 30 (U.S. CL. 46).

FIRST USE 3-20-2008; IN COMMERCE 3-20-2008.

SER. NO. 77-517,123, FILED 7-8-2008.

NO CLAIM IS MADE TO THE EXCLUSIVE RIGHT TO USE "CANDY CO." , APART FROM THE MARK AS SHOWN.

G. MAYERSCHOFF, EXAMINING ATTORNEY

Int. Cls.: 25 and 28

Prior U.S. Cls.: 22, 23, 38, 39 and 50

United States Patent and Trademark Office

Reg. No. 3,575,812

Registered Feb. 17, 2009

**TRADEMARK
PRINCIPAL REGISTER**

BOARDFISHER

BOARDFISHER PRODUCTS LLC (CALIFORNIA
LIMITED LIABILITY COMPANY)
2445 NEWPORT AVE.
CARDIFF, CA 92007

FOR: WEARABLE GARMENTS AND CLOTHING,
NAMELY, SHIRTS, IN CLASS 25 (U.S. CLS. 22 AND
39).

FIRST USE 1-1-2007; IN COMMERCE 1-1-2007.

FOR: FISHING TACKLE, IN CLASS 28 (U.S. CLS.
22, 23, 38 AND 50).

FIRST USE 1-1-2007; IN COMMERCE 1-1-2007.

THE MARK CONSISTS OF STANDARD CHAR-
ACTERS WITHOUT CLAIM TO ANY PARTICULAR
FONT, STYLE, SIZE, OR COLOR.

SER. NO. 77-517,130, FILED 7-8-2008.

GRETTA YAO, EXAMINING ATTORNEY

Int. Cl.: 41

Prior U.S. Cls.: 100, 101 and 107

United States Patent and Trademark Office

Reg. No. 3,575,813

Registered Feb. 17, 2009

**SERVICE MARK
PRINCIPAL REGISTER**

FACE OF THE FUTURE

WOMEN IN FILM (CALIFORNIA CORPORATION)
SUITE 201
8857 W. OLYMPIC BOULEVARD
LOS ANGELES, CA 90211

FOR: ENTERTAINMENT SERVICES, NAMELY,
AWARD PRESENTATIONS IN THE FIELD OF MOTION
PICTURES AND TELEVISION, IN CLASS 41
(U.S. CLS. 100, 101 AND 107).

FIRST USE 0-0-2006; IN COMMERCE 0-0-2006.

THE MARK CONSISTS OF STANDARD CHARACTERS
WITHOUT CLAIM TO ANY PARTICULAR FONT,
STYLE, SIZE, OR COLOR.

SER. NO. 77-517,134, FILED 7-8-2008.

ANDREA K. NADELMAN, EXAMINING ATTORNEY

Int. Cl.: 30

Prior U.S. Cl.: 46

United States Patent and Trademark Office

Reg. No. 3,575,814

Registered Feb. 17, 2009

**TRADEMARK
PRINCIPAL REGISTER**

CAROLINA CRISP

GOLDEN GROVE CANDY COMPANY, INC.
(NORTH CAROLINA CORPORATION)

PO BOX 921

364 WEST PARK DRIVE

WARSAW, NC 28398

FOR: CANDY BARS, IN CLASS 30 (U.S. CL. 46).

FIRST USE 3-20-2008; IN COMMERCE 3-20-2008.

THE MARK CONSISTS OF STANDARD CHARACTERS WITHOUT CLAIM TO ANY PARTICULAR FONT, STYLE, SIZE, OR COLOR.

NO CLAIM IS MADE TO THE EXCLUSIVE RIGHT TO USE "CAROLINA", APART FROM THE MARK AS SHOWN.

SER. NO. 77-517,160, FILED 7-8-2008.

G. MAYERSCHOFF, EXAMINING ATTORNEY

Int. Cl.: 41

Prior U.S. Cls.: 100, 101 and 107

United States Patent and Trademark Office

Reg. No. 3,575,815

Registered Feb. 17, 2009

**SERVICE MARK
PRINCIPAL REGISTER**

FV PRODUCTIONS

FV PRODUCTIONS, LLC (DELAWARE LIMITED
LIABILITY COMPANY)
2350 NW 96TH AVE
MIAMI, FL 33172

FOR: ENTERTAINMENT SERVICES, NAMELY,
THE PRODUCTION OF TELEVISION PROGRAM-
MING, IN CLASS 41 (U.S. CLS. 100, 101 AND 107).

FIRST USE 2-0-2004; IN COMMERCE 2-0-2004.

THE MARK CONSISTS OF STANDARD CHAR-
ACTERS WITHOUT CLAIM TO ANY PARTICULAR
FONT, STYLE, SIZE, OR COLOR.

NO CLAIM IS MADE TO THE EXCLUSIVE
RIGHT TO USE "PRODUCTIONS", APART FROM
THE MARK AS SHOWN.

SER. NO. 77-517,180, FILED 7-8-2008.

BENJAMIN ALLEN, EXAMINING ATTORNEY

Int. Cl.: 3

Prior U.S. Cls.: 1, 4, 6, 50, 51 and 52

Reg. No. 3,575,816

United States Patent and Trademark Office

Registered Feb. 17, 2009

**TRADEMARK
PRINCIPAL REGISTER**

SOUTHERN SUDS

EARLY, DIANNE P. (UNITED STATES INDIVIDUAL)
3749 CRICKLEWOOD DRIVE
MONTGOMERY, AL 36109

FOR: HANDMADE SOAP; BATH AND BODY PRODUCTS, NAMELY, LOTION, IN CLASS 3 (U.S. CLS. 1, 4, 6, 50, 51 AND 52).

FIRST USE 4-25-2006; IN COMMERCE 10-2-2006.

THE MARK CONSISTS OF STANDARD CHARACTERS WITHOUT CLAIM TO ANY PARTICULAR FONT, STYLE, SIZE, OR COLOR.

NO CLAIM IS MADE TO THE EXCLUSIVE RIGHT TO USE "SUDS", APART FROM THE MARK AS SHOWN.

SER. NO. 77-517,184, FILED 7-8-2008.

DORITT L. CARROLL, EXAMINING ATTORNEY

Int. Cl.: 45

Prior U.S. Cls.: 100 and 101

United States Patent and Trademark Office

Reg. No. 3,575,817

Registered Feb. 17, 2009

**SERVICE MARK
PRINCIPAL REGISTER**

TOUCH OF CH'I

SINGER, PHYLLIS (UNITED STATES INDIVIDUAL)
7211 10TH STREET SOUTH
ST. PETERSBURG, FL 33705

FOR: PROVIDING BOTH IN-PERSON AND ON-LINE HOLISTIC SPIRITUAL COUNSELING SERVICES; PROVIDING INFORMATION IN THE FIELD OF PERSONAL DEVELOPMENT, NAMELY, SELF-IMPROVEMENT, SELF-FULFILLMENT, AND INTERPERSONAL COMMUNICATION; PROVIDING ON-LINE INFORMATION IN THE FIELD OF SPIRITUALITY, SELF-HELP, AND PERSONAL EMPOWERMENT SUBJECT MATTERS, IN CLASS 45 (U.S. CLS. 100 AND 101).

FIRST USE 7-7-2008; IN COMMERCE 7-7-2008.

THE MARK CONSISTS OF STANDARD CHARACTERS WITHOUT CLAIM TO ANY PARTICULAR FONT, STYLE, SIZE, OR COLOR.

THE FOREIGN WORDING IN THE MARK TRANSLATES INTO ENGLISH AS LIFE FORCE.

SER. NO. 77-517,190, FILED 7-8-2008.

KATINA MISTER, EXAMINING ATTORNEY

Int. Cl.: 44

Prior U.S. Cls.: 100 and 101

United States Patent and Trademark Office

Reg. No. 3,575,818

Registered Feb. 17, 2009

**SERVICE MARK
PRINCIPAL REGISTER**



NATURAL ELEMENTS SPA & ACADEMY, INC.
(VIRGINIA CORPORATION)
717 EDEN WAY NORTH, SUITE 612
CHESAPEAKE, VA 23320

MASSAGE; MASSAGE AND THERAPEUTIC SHIATSU MASSAGE; SKIN CARE SALONS; AND PROVIDING IN-PERSON VIBRATIONAL HEALING SERVICES, IN CLASS 44 (U.S. CLS. 100 AND 101).

FOR: AROMATHERAPY SERVICES; BODY WAXING SERVICES; BODYWORK THERAPY; COSMETICIAN SERVICES; FACIAL TREATMENT SERVICES, NAMELY, COSMETIC PEELS; FOOD NUTRITION CONSULTATION; HEALTH CARE SERVICES, NAMELY, WELLNESS PROGRAMS; METABOLIC TESTING FOR NUTRACEUTICAL NEEDS; NAIL CARE SALONS; HEALTH SPA SERVICES, NAMELY, COSMETIC BODY CARE SERVICES; INFORMATION RELATING TO MASSAGE;

FIRST USE 9-27-2007; IN COMMERCE 9-27-2007.

NO CLAIM IS MADE TO THE EXCLUSIVE RIGHT TO USE "SPA", APART FROM THE MARK AS SHOWN.

SER. NO. 77-517,191, FILED 7-8-2008.

KATHERINE CHANG, EXAMINING ATTORNEY

Int. Cl.: 9

Prior U.S. Cls.: 21, 23, 26, 36 and 38

Reg. No. 3,575,819

United States Patent and Trademark Office

Registered Feb. 17, 2009

**TRADEMARK
PRINCIPAL REGISTER**

LinenHelperNet

COMPUTER SOFTWARE ARCHITECTS, LLC
(MAINE LIMITED LIABILITY COMPANY)
101 CENTRE STREET
BATH, ME 04530

THE MARK CONSISTS OF STANDARD CHARACTERS WITHOUT CLAIM TO ANY PARTICULAR FONT, STYLE, SIZE, OR COLOR.

FOR: COMPUTER SOFTWARE FOR THE MANAGEMENT OF LINEN CLEANING AND DISTRIBUTION, IN CLASS 9 (U.S. CLS. 21, 23, 26, 36 AND 38).

SER. NO. 77-517,197, FILED 7-8-2008.

FIRST USE 9-1-2003; IN COMMERCE 9-1-2003.

JENNIFER MARTIN, EXAMINING ATTORNEY

Int. Cl.: 41

Prior U.S. Cls.: 100, 101 and 107

United States Patent and Trademark Office

Reg. No. 3,575,820

Registered Feb. 17, 2009

**SERVICE MARK
PRINCIPAL REGISTER**



FV PRODUCTIONS, LLC (DELAWARE LIMITED LIABILITY COMPANY)

2350 NW 96TH AVE

MIAMI, FL 33172

FOR: ENTERTAINMENT SERVICES, NAMELY, THE PRODUCTION OF TELEVISION PROGRAMMING, IN CLASS 41 (U.S. CLS. 100, 101 AND 107).

FIRST USE 2-0-2004; IN COMMERCE 2-0-2004.

NO CLAIM IS MADE TO THE EXCLUSIVE RIGHT TO USE "PRODUCTIONS", APART FROM THE MARK AS SHOWN.

THE COLOR(S) BLACK, RED, GREEN, BLUE AND GOLD. IS/ARE CLAIMED AS A FEATURE OF THE MARK.

THE MARK CONSISTS OF THE LETTERS "F" AND "V" IN THE COLOR GOLD, DRAWN OVER THREE GEOMETRIC SHAPES ARRANGED FROM LEFT TO RIGHT IN THE COLORS RED, GREEN AND BLUE, AND THE WORD "PRODUCTIONS" IN THE COLOR BLACK DRAWN BELOW THE GEOMETRIC SHAPES.

SER. NO. 77-517,206, FILED 7-8-2008.

BENJAMIN ALLEN, EXAMINING ATTORNEY

Int. Cl.: 35

Prior U.S. Cls.: 100, 101 and 102

United States Patent and Trademark Office

Reg. No. 3,575,821

Registered Feb. 17, 2009

**SERVICE MARK
PRINCIPAL REGISTER**

LIGHT GREENER, LIGHT BETTER

LUTRON ELECTRONICS CO., INC. (PENNSYLVANIA CORPORATION)
7200 SUTER ROAD
COOPERSBURG, PA 18036

THE MARK CONSISTS OF STANDARD CHARACTERS WITHOUT CLAIM TO ANY PARTICULAR FONT, STYLE, SIZE, OR COLOR.

FOR: INFORMATION IN THE FIELD OF ENERGY EFFICIENCY, IN CLASS 35 (U.S. CLS. 100, 101 AND 102).

SER. NO. 77-517,218, FILED 7-8-2008.

FIRST USE 11-0-2007; IN COMMERCE 11-0-2007.

JULIE GUTTADAURO, EXAMINING ATTORNEY

Int. Cl.: 33

Prior U.S. Cls.: 47 and 49

United States Patent and Trademark Office

Reg. No. 3,575,822

Registered Feb. 17, 2009

**TRADEMARK
PRINCIPAL REGISTER**

SUNSET SPLASH

C&N CORPORATION (WISCONSIN CORPORATION), DBA D/B/A DOOR PENINSULA WINE-
RY
5806 HIGHWAY 42
STURGEON BAY, WI 54235

FOR: WINE, IN CLASS 33 (U.S. CLS. 47 AND 49).

FIRST USE 7-2-2007; IN COMMERCE 7-2-2007.

THE MARK CONSISTS OF STANDARD CHAR-
ACTERS WITHOUT CLAIM TO ANY PARTICULAR
FONT, STYLE, SIZE, OR COLOR.

SER. NO. 77-517,241, FILED 7-8-2008.

ANDREA K. NADELMAN, EXAMINING ATTOR-
NEY

Int. Cl.: 12

Prior U.S. Cls.: 19, 21, 23, 31, 35 and 44

Reg. No. 3,575,823

United States Patent and Trademark Office

Registered Feb. 17, 2009

**TRADEMARK
PRINCIPAL REGISTER**

ROCK N' ROLLER

DAHL, GARY MICHAEL (UNITED STATES IN-
DIVIDUAL)
875 PROSPECT, SUITE 305
LA JOLLA, CA 92037

THE MARK CONSISTS OF STANDARD CHAR-
ACTERS WITHOUT CLAIM TO ANY PARTICULAR
FONT, STYLE, SIZE, OR COLOR.

FOR: CARTS, IN CLASS 12 (U.S. CLS. 19, 21, 23, 31,
35 AND 44).

SER. NO. 77-517,253, FILED 7-8-2008.

FIRST USE 9-11-1989; IN COMMERCE 9-11-1989.

BRENDAN MCCAULEY, EXAMINING ATTORNEY

Int. Cl.: 9

Prior U.S. Cls.: 21, 23, 26, 36 and 38

Reg. No. 3,575,824

United States Patent and Trademark Office

Registered Feb. 17, 2009

**TRADEMARK
PRINCIPAL REGISTER**

LinenMasterNet

COMPUTER SOFTWARE ARCHITECTS, LLC
(MAINE LIMITED LIABILITY COMPANY)
101 CENTRE STREET
BATH, ME 04530

FOR: COMPUTER SOFTWARE FOR THE MAN-
AGEMENT OF LINEN CLEANING AND DISTRIBU-
TION, IN CLASS 9 (U.S. CLS. 21, 23, 26, 36 AND 38).

FIRST USE 9-1-2003; IN COMMERCE 9-1-2003.

THE MARK CONSISTS OF STANDARD CHAR-
ACTERS WITHOUT CLAIM TO ANY PARTICULAR
FONT, STYLE, SIZE, OR COLOR.

OWNER OF U.S. REG. NO. 2,014,386.

SER. NO. 77-517,271, FILED 7-8-2008.

JENNIFER MARTIN, EXAMINING ATTORNEY

Int. Cl.: 10

Prior U.S. Cls.: 26, 39 and 44

United States Patent and Trademark Office

Reg. No. 3,575,825

Registered Feb. 17, 2009

**TRADEMARK
PRINCIPAL REGISTER**

SOUNMED

SOUNMED, INC. (FLORIDA CORPORATION)
6800 NW 77 COURT
MIAMI, FL 33166

FIRST USE 2-22-2005; IN COMMERCE 2-22-2005.

FOR: MEDICAL EQUIPMENT AND DEVICES
FOR IMAGING AND OTHER USES IN THE FIELDS
OF OBSTETRICS AND GYNECOLOGY, NAMELY,
MEDICAL ULTRASOUND APPARATUSES AND
MEDICAL IMAGING APPARATUSES IN THE NAT-
URE OF COLPOSCOPES, IN CLASS 10 (U.S. CLS. 26,
39 AND 44).

THE MARK CONSISTS OF STANDARD CHAR-
ACTERS WITHOUT CLAIM TO ANY PARTICULAR
FONT, STYLE, SIZE, OR COLOR.

SER. NO. 77-517,281, FILED 7-8-2008.

ZHALEH DELANEY, EXAMINING ATTORNEY

Int. Cl.: 37

Prior U.S. Cls.: 100, 103 and 106

United States Patent and Trademark Office

Reg. No. 3,575,826

Registered Feb. 17, 2009

**SERVICE MARK
PRINCIPAL REGISTER**



OFFICE MAIDS (PENNSYLVANIA LIMITED
LIABILITY COMPANY)
900 PORTER STREET
EASTON, PA 18042

THE MARK CONSISTS OF AN IMAGE OF A
SUITED MAN HOLDING A BREIFCASE, A MOP
AND A BUCKET. BELOW THE IMAGE OF THE
MAN IS THE STYLIZED WORDS "OFFICE MAIDS".

FOR: JANITORIAL SERVICES, IN CLASS 37 (U.S.
CLS. 100, 103 AND 106).

FIRST USE 5-1-2008; IN COMMERCE 5-1-2008.

SER. NO. 77-517,304, FILED 7-8-2008.

NO CLAIM IS MADE TO THE EXCLUSIVE
RIGHT TO USE "OFFICE MAIDS", APART FROM
THE MARK AS SHOWN.

DAVID H. STINE, EXAMINING ATTORNEY

Int. Cl.: 25

Prior U.S. Cls.: 22 and 39

United States Patent and Trademark Office

Reg. No. 3,575,827

Registered Feb. 17, 2009

**TRADEMARK
PRINCIPAL REGISTER**

K-Mode

ANNIE & JANE, INC. (CALIFORNIA CORPORATION), DBA K MODE
909 SOUTH SANTA FE AVENUE
LOS ANGELES, CA 90021

FOR: MEN'S AND WOMEN'S CLOTHING, NAMELY, JEANS, JACKETS, COATS, SKIRTS, PANTS, SLACKS, SHIRTS, UNDERSHIRTS, T-SHIRTS, BOTTOMS, TOPS, BELTS, TIES, HATS, SHOES FOR MEN AND WOMEN, IN CLASS 25 (U.S. CLS. 22 AND 39).

FIRST USE 1-1-2004; IN COMMERCE 1-1-2004.

THE MARK CONSISTS OF STANDARD CHARACTERS WITHOUT CLAIM TO ANY PARTICULAR FONT, STYLE, SIZE, OR COLOR.

SER. NO. 77-517,350, FILED 7-8-2008.

GINA FINK, EXAMINING ATTORNEY

Int. Cl.: 35

Prior U.S. Cls.: 100, 101 and 102

United States Patent and Trademark Office

Reg. No. 3,575,828

Registered Feb. 17, 2009

**SERVICE MARK
PRINCIPAL REGISTER**

MID-K

MID-K DISTRIBUTORS, INC. (ILLINOIS CORPORATION)
3048 W. 48TH ST.
CHICAGO, IL 60632

THE MARK CONSISTS OF STANDARD CHARACTERS WITHOUT CLAIM TO ANY PARTICULAR FONT, STYLE, SIZE, OR COLOR.

FOR: RETAIL BEAUTY AND HAIR CARE PRODUCT STORES; WHOLESALE DISTRIBUTORSHIP FEATURING BEAUTY AND HAIR CARE PRODUCTS, IN CLASS 35 (U.S. CLS. 100, 101 AND 102).

SER. NO. 77-517,362, FILED 7-8-2008.

FIRST USE 3-1-1982; IN COMMERCE 3-1-1982.

WILLIAM VERHOSEK, EXAMINING ATTORNEY

Int. Cl.: 37

Prior U.S. Cls.: 100, 103 and 106

United States Patent and Trademark Office

Reg. No. 3,575,829

Registered Feb. 17, 2009

**SERVICE MARK
PRINCIPAL REGISTER**

**CREATIVITY IS OUR MOST
IMPORTANT TOOL**

TOP GRADE CONSTRUCTION, INC. (CALIFORNIA CORPORATION)
50 CONTRACTORS STREET
LIVERMORE, CA 94551

THE MARK CONSISTS OF STANDARD CHARACTERS WITHOUT CLAIM TO ANY PARTICULAR FONT, STYLE, SIZE, OR COLOR.

FOR: PAVING CONTRACTOR SERVICES; CONSTRUCTION GRADING SERVICES, IN CLASS 37 (U.S. CLS. 100, 103 AND 106).

SER. NO. 77-517,363, FILED 7-8-2008.

FIRST USE 7-2-2008; IN COMMERCE 7-2-2008.

TOBY BULLOFF, EXAMINING ATTORNEY

Int. Cl.: 45

Prior U.S. Cls.: 100 and 101

United States Patent and Trademark Office

Reg. No. 3,575,830

Registered Feb. 17, 2009

**SERVICE MARK
PRINCIPAL REGISTER**

**CHICAGO TITLE ADVANTEX
ONLINE**

CHICAGO TITLE INSURANCE COMPANY (NE-
BRASKA CORPORATION)
11TH FLOOR
601 RIVERSIDE AVENUE
JACKSONVILLE, FL 32204

FOR: REAL ESTATE SERVICES, NAMELY, PRO-
VIDING REAL ESTATE CLOSING, TITLE AND
RELATED REAL ESTATE FORMS AND INFORMA-
TION BY MEANS OF A GLOBAL COMPUTER
NETWORK, IN CLASS 45 (U.S. CLS. 100 AND 101).

FIRST USE 3-24-2008; IN COMMERCE 3-24-2008.

THE MARK CONSISTS OF STANDARD CHAR-
ACTERS WITHOUT CLAIM TO ANY PARTICULAR
FONT, STYLE, SIZE, OR COLOR.

OWNER OF U.S. REG. NOS. 2,550,503 AND
3,380,020.

NO CLAIM IS MADE TO THE EXCLUSIVE
RIGHT TO USE "ONLINE", APART FROM THE
MARK AS SHOWN.

SEC. 2(F) AS TO CHICAGO TITLE.

SER. NO. 77-517,380, FILED 7-8-2008.

MARK T. MULLEN, EXAMINING ATTORNEY

Int. Cl.: 36

Prior U.S. Cls.: 100, 101 and 102

United States Patent and Trademark Office

Reg. No. 3,575,831

Registered Feb. 17, 2009

**SERVICE MARK
PRINCIPAL REGISTER**

**CHICAGO TITLE CONSTRUCTION
EDGE ONLINE**

CHICAGO TITLE INSURANCE COMPANY (NE-
BRASKA CORPORATION)

11TH FLOOR

601 RIVERSIDE AVENUE

JACKSONVILLE, FL 32204

FOR: REAL ESTATE ESCROW SERVICES, NAME-
LY, PROVIDING ESCROW FORMS AND INFOR-
MATION FOR CONSTRUCTION PROJECTS BY
MEANS OF A GLOBAL COMPUTER NETWORK ,
IN CLASS 36 (U.S. CLS. 100, 101 AND 102).

FIRST USE 6-2-2008; IN COMMERCE 6-2-2008.

THE MARK CONSISTS OF STANDARD CHAR-
ACTERS WITHOUT CLAIM TO ANY PARTICULAR
FONT, STYLE, SIZE, OR COLOR.

OWNER OF U.S. REG. NO. 3,380,020.

NO CLAIM IS MADE TO THE EXCLUSIVE
RIGHT TO USE "CONSTRUCTION" AND "ON-
LINE", APART FROM THE MARK AS SHOWN.

SEC. 2(F) AS TO "CHICAGO TITLE".

SER. NO. 77-517,381, FILED 7-8-2008.

MARK T. MULLEN, EXAMINING ATTORNEY

Int. Cl.: 41

Prior U.S. Cls.: 100, 101 and 107

United States Patent and Trademark Office

Reg. No. 3,575,832

Registered Feb. 17, 2009

**SERVICE MARK
PRINCIPAL REGISTER**



BOOT CAMP LAS VEGAS, LLC. (NEVADA LIMITED LIABILITY COMPANY)
4395 EAST ST. LOUIS AVE.
LAS VEGAS, NV 89104

FOR: SPORT CAMP SERVICES; HEALTH CLUB SERVICES, NAMELY, PROVIDING INSTRUCTION AND EQUIPMENT IN THE FIELD OF PHYSICAL EXERCISE; PHYSICAL FITNESS INSTRUCTION; PERSONAL TRAINING SERVICES, NAMELY, STRENGTH AND CONDITIONING TRAINING; PROVIDING INFORMATION IN THE FIELD OF EXERCISE TRAINING; PROVIDING INSTRUCTION IN THE FIELD OF PHYSICAL EXERCISE AND WORK OUT PROGRAMS, IN CLASS 41 (U.S. CLS. 100, 101 AND 107).

FIRST USE 11-1-2005; IN COMMERCE 12-2-2005.

NO CLAIM IS MADE TO THE EXCLUSIVE RIGHT TO USE "BOOT CAMP LAS VEGAS", APART FROM THE MARK AS SHOWN.

THE COLOR(S) BLACK, BROWNISH-GOLD AND WHITE IS/ARE CLAIMED AS A FEATURE OF THE MARK.

THE MARK CONSISTS OF AN ILLUSTRATION OF A RHINOCEROS HEAD IN THE COLOR BLACK OUTLINED IN A LIGHT BROWNISH-GOLD COLOR. THE NOSTRIL AND MOUTH OPENING OF THE RHINOCEROS BOTH APPEAR IN THE COLOR WHITE. THE EYE OF THE RHINOCEROS APPEARS IN THE COLORS BLACK AND WHITE. POSITIONED TO THE RIGHT OF THE RHINOCEROS HEAD IS THE WORDING "BOOT CAMP" IN LARGE, STYLIZED CAPITAL LETTERS IN THE COLOR BLACK OUTLINED IN BROWNISH-GOLD. THE WORDING "LAS VEGAS" APPEARS BELOW THE WORDING "BOOT CAMP" IN THE SAME STYLIZED FONT BUT SMALLER IN SIZE, AND ALSO IN THE COLOR BLACK OUTLINED IN BROWNISH-GOLD.

SER. NO. 77-517,398, FILED 7-8-2008.

ZHALEH DELANEY, EXAMINING ATTORNEY

Int. Cls.: 9 and 41

Prior U.S. Cls.: 21, 23, 26, 36, 38, 100, 101 and 107

Reg. No. 3,575,833

United States Patent and Trademark Office

Registered Feb. 17, 2009

**TRADEMARK
SERVICE MARK
PRINCIPAL REGISTER**

REACHING THE HIGH-END BRIDE

MIKE COLON LLC (CALIFORNIA LIMITED
LIABILITY COMPANY)
91 OLD COURSE DRIVE
NEWPORT BEACH, CA 92660

FOR: PRE-RECORDED EDUCATIONAL DVDS
FEATURING ADVICE AND INFORMATION FOR
PHOTOGRAPHERS, IN CLASS 9 (U.S. CLS. 21, 23, 26,
36 AND 38).

FIRST USE 3-25-2005; IN COMMERCE 3-25-2005.

FOR: EDUCATIONAL SERVICES, NAMELY,
PROVIDING WORKSHOPS, SEMINARS, AND
TRAINING IN THE FIELD OF PHOTOGRAPHY,

AND DISTRIBUTION OF COURSE MATERIALS IN
CONNECTION THEREWITH, IN CLASS 41 (U.S.
CLS. 100, 101 AND 107).

FIRST USE 7-27-2004; IN COMMERCE 7-27-2004.

THE MARK CONSISTS OF STANDARD CHAR-
ACTERS WITHOUT CLAIM TO ANY PARTICULAR
FONT, STYLE, SIZE, OR COLOR.

SER. NO. 77-517,410, FILED 7-8-2008.

TOBY BULLOFF, EXAMINING ATTORNEY

Int. Cl.: 35

Prior U.S. Cls.: 100, 101 and 102

United States Patent and Trademark Office

Reg. No. 3,575,834

Registered Feb. 17, 2009

**SERVICE MARK
PRINCIPAL REGISTER**

SHELL SHOCKER

NEWEGG INC. (CALIFORNIA CORPORATION)
16839 EAST GALE AVENUE
CITY OF INDUSTRY, CA 91745

FOR: COMPUTERIZED ON-LINE RETAIL STORE SERVICES IN THE FIELDS OF COMPUTER SOFTWARE, COMPUTER HARDWARE, COMPUTER PERIPHERALS, TELEVISIONS, CAMERAS, DVDS, COMPUTER GAME CONSOLES AND GAMES, GPS RECEIVERS, SATELLITE RADIO RECEIVERS, HOME THEATER EQUIPMENT, OFFICE EQUIPMENT, ELECTRONIC GADGETS, MOBILE ELECTRONICS, TELEPHONES AND OTHER COMMUNICATION DEVICES, MP3 PLAYERS, HOME APPLIANCES, AND ALL ACCESSORIES RELATED THERETO; ON-LINE RETAIL STORE SERVICES IN THE FIELDS OF COMPUTER SOFTWARE, COMPUTER HARDWARE, COMPUTER PERIPHERALS, TELEVISIONS, CAMERAS, DVDS,

COMPUTER GAME CONSOLES AND GAMES, GPS RECEIVERS, SATELLITE RADIO RECEIVERS, HOME THEATER EQUIPMENT, OFFICE EQUIPMENT, ELECTRONIC GADGETS, MOBILE ELECTRONICS, TELEPHONES AND OTHER COMMUNICATION DEVICES, MP3 PLAYERS, HOME APPLIANCES, AND ALL ACCESSORIES RELATED THERETO, IN CLASS 35 (U.S. CLS. 100, 101 AND 102).

FIRST USE 3-31-2008; IN COMMERCE 3-31-2008.

THE MARK CONSISTS OF STANDARD CHARACTERS WITHOUT CLAIM TO ANY PARTICULAR FONT, STYLE, SIZE, OR COLOR.

SER. NO. 77-517,433, FILED 7-8-2008.

SUSAN LESLIE DUBOIS, EXAMINING ATTORNEY

Int. Cl.: 3

Prior U.S. Cls.: 1, 4, 6, 50, 51 and 52

United States Patent and Trademark Office

Reg. No. 3,575,835

Registered Feb. 17, 2009

**TRADEMARK
PRINCIPAL REGISTER**

Bravado

J75, INC. (CALIFORNIA CORPORATION)
10375 JEFFERSON BLVD.
CULVER CITY, CA 90232

FIRST USE 1-1-1975; IN COMMERCE 1-1-1975.

FOR: MEN'S COLOGNE ; HAIR SHAMPOO ;
BODY SHAMPOO ; MOISTURIZING BALM ; BATH
AND BODY OIL ; SKINCARE BALM ; SKIN CON-
DITIONER ; DEODORANT ; SHAVING CREAM
AND SOAP, IN CLASS 3 (U.S. CLS. 1, 4, 6, 50, 51
AND 52).

THE MARK CONSISTS OF STANDARD CHAR-
ACTERS WITHOUT CLAIM TO ANY PARTICULAR
FONT, STYLE, SIZE, OR COLOR.

SER. NO. 77-517,436, FILED 7-8-2008.

SUSAN LESLIE DUBOIS, EXAMINING ATTORNEY

Int. Cl.: 35

Prior U.S. Cls.: 100, 101 and 102

United States Patent and Trademark Office

Reg. No. 3,575,836

Registered Feb. 17, 2009

**SERVICE MARK
PRINCIPAL REGISTER**

Zero Unintentional Deaths

LIFESOURCE (UTAH NON-PROFIT ORGANIZATION)
3838 SOUTH 700 EAST, STE. 200
SALT LAKE CITY, UT 84106

FOR: PUBLIC ADVOCACY TO PROMOTE
AWARENESS OF PRESCRIPTION DRUG SAFETY,
IN CLASS 35 (U.S. CLS. 100, 101 AND 102).

FIRST USE 3-15-2006; IN COMMERCE 4-1-2006.

THE MARK CONSISTS OF STANDARD CHARACTERS WITHOUT CLAIM TO ANY PARTICULAR FONT, STYLE, SIZE, OR COLOR.

SER. NO. 77-517,449, FILED 7-8-2008.

NICHOLAS COLEMAN, EXAMINING ATTORNEY

Int. Cl.: 25

Prior U.S. Cls.: 22 and 39

United States Patent and Trademark Office

Reg. No. 3,575,837

Registered Feb. 17, 2009

TRADEMARK
PRINCIPAL REGISTER



LUCKYSTRIPES, LLC (MARYLAND LIMITED
LIABILITY COMPANY)
1003 RADIANCE DRIVE
CAMBRIDGE, MD 21613

THE MARK CONSISTS OF THE STYLIZED TEXT
"LUCKYSTRIPES".

FOR: JACKETS; LINGERIE; PANTS; SHOES;
SOCKS; SWEAT SHIRTS; T-SHIRTS; UNDERWEAR,
IN CLASS 25 (U.S. CLS. 22 AND 39).

SER. NO. 77-517,453, FILED 7-8-2008.

FIRST USE 1-1-2008; IN COMMERCE 1-1-2008.

GEOFFREY FOSDICK, EXAMINING ATTORNEY

Int. Cls.: 21 and 25

Prior U.S. Cls.: 2, 13, 22, 23, 29, 30, 33, 39, 40 and 50

United States Patent and Trademark Office

Reg. No. 3,575,838

Registered Feb. 17, 2009

TRADEMARK
PRINCIPAL REGISTER

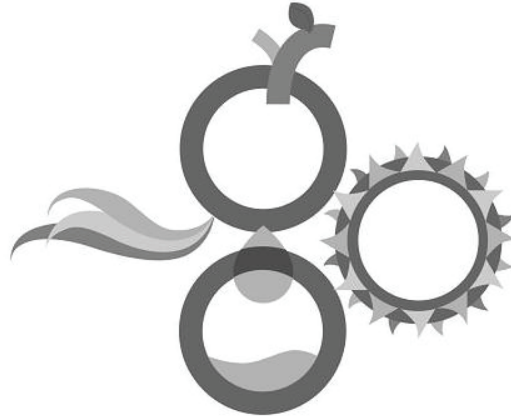

O'DONOHUE, JOHN A. (UNITED STATES INDIVIDUAL)
624 S. ASHLAND AVE.
LA GRANGE, IL 60525 AND
HISCHIER, BRIAN R. (UNITED STATES INDIVIDUAL)
UNIT 2
1413 W. ARGYLE
CHICAGO, IL 60640

FOR: BEER MUGS; CARDBOARD CUPS; COFFEE CUPS; COFFEE CUPS, TEA CUPS AND MUGS; CUPS; CUPS AND MUGS; CUPS, NOT OF PRECIOUS METAL; DRINKING GLASSES; EARTHENWARE MUGS; GLASS BEVERAGeware; GLASS CARAFES; GLASS DISHES; GLASS JARS; GLASS MUGS; GLASS STORAGE JARS; MUGS; MUGS, NOT OF PRECIOUS METAL; PAPER AND PLASTIC CUPS; PAPER CUPS; PLASTIC CUPS; PORCELAIN MUGS; SHOT GLASSES, IN CLASS 21 (U.S. CLS. 2, 13, 23, 29, 30, 33, 40 AND 50).

FIRST USE 7-2-2008; IN COMMERCE 7-2-2008.

FOR: ANKLE SOCKS; ANKLETS; APRES-SKI SHOES; ATHLETIC FOOTWEAR; ATHLETIC SHOES; ATHLETIC UNIFORMS; BASEBALL CAPS; BASEBALL SHOES; BASKETBALL SNEAKERS; BATHING COSTUMES; BATHING COSTUMES FOR WOMEN; BATHING SUITS; BATHING SUITS FOR MEN; BATHING TRUNKS; BEACH SHOES; BELTS; BELTS MADE OF LEATHER; BELTS OF TEXTILE; BERMUDA SHORTS; BIKINIS; BOARD SHORTS; BODY SUITS; BOLO TIES; BOW TIES;

BOWLING SHOES; BOXER BRIEFS; BOXER SHORTS; BOXING SHOES; BRAS; BRIEFS; CAMP SHIRTS; CANVAS SHOES; CAP VISORS; CAPRI PANTS; CAPS; CAPS WITH VISORS; CARGO PANTS; COATS; COATS FOR MEN AND WOMEN; COATS MADE OF COTTON; COATS OF DENIM; CYCLING SHOES; DANCE SHOES; DECK-SHOES; DENIM JACKETS; DENIMS; DOWN JACKETS; DRESS SHIRTS; DRESS SUITS; DRESSES; DRIVERS; DRY SUITS; FABRIC BELTS; FISHERMEN'S JACKETS; FITTED SWIMMING COSTUMES WITH BRA CUPS; FLEECE SHORTS; FLEECE VESTS; FOOTBALL SHOES; FOOTWEAR FOR TRACK AND FIELD ATHLETICS; FUR COATS AND JACKETS; FUR HATS; GOLF CAPS; GOLF SHIRTS; GOLF SHOES; GOLF TROUSERS; GYM SHORTS; GYM SUITS; GYMNASTIC SHOES; HANDBALL SHOES; HATS; HEADBANDS; HEADBANDS AGAINST SWEATING; HEAVY JACKETS; HOCKEY SHOES; JACKET LINERS; JACKETS; JOGGING PANTS; JOGGING SUITS; JUDO SUITS; KARATE SUITS; KNIT SHIRTS; KNITTED CAPS; KNITTED UNDERWEAR; LADIES' UNDERWEAR; LEATHER BELTS; LEATHER JACKETS; LEATHER PANTS; LIGHT-REFLECTING COATS; LONG JACKETS; LONG SLEEVED VESTS; LONG UNDERWEAR; LONG-SLEEVED SHIRTS; MEN'S SOCKS; MEN'S SUITS; WOMEN'S SUITS; NIGHT SHIRTS; OVER COATS; PANTIES; PANTIES, SHORTS AND BRIEFS; PANTS; PAPER HATS FOR USE AS CLOTHING ITEMS; PIQUE SHIRTS; POLO SHIRTS; RAIN COATS; RAIN JACKETS; RAINPROOF JACKETS; RIDING COATS; RUGBY SHIRTS; RUGBY SHOES; RUGBY SHORTS; RUNNING SHOES; SANDALS; SHELL JACKETS;

SHIRTS; SHIRTS FOR SUITS; SHOES; SHORT-SLEEVED OR LONG-SLEEVED T-SHIRTS; SHORT-SLEEVED SHIRTS; SHORTS; SKI AND SNOWBOARD SHOES AND PARTS THEREOF; SKI JACKETS; SKI PANTS; SKI SUITS; SKIING SHOES; SKIRT SUITS; SKULL CAPS; SLEEP SHIRTS; SLEEPING GARMENTS; SLEEVED OR SLEEVELESS JACKETS; SMALL HATS; SNOW BOARDING SUITS; SNOW PANTS; SNOW SUITS; SNOWBOARD PANTS; SOCCER BOOTS; SOCCER SHOES; SOCKS; SOCKS AND STOCKINGS; SPORT COATS; SPORT SHIRTS; SPORTS BRAS; SPORTS JACKETS; SPORTS JERSEYS; SPORTS JERSEYS AND BREECHES FOR SPORTS; SPORTS OVERUNIFORMS; SPORTS SHIRTS; SPORTS SHIRTS WITH SHORT SLEEVES; SUEDE JACKETS; SUIT COATS; SUITS; SWEAT PANTS; SWEAT SHIRTS; SWEAT SHORTS; SWEAT SUITS; SWIM CAPS; SWIM TRUNKS; SWIM WEAR; SWIMMING CAPS; SWIMMING TRUNKS; T-SHIRTS; TEE SHIRTS; TENNIS SHOES; THERMAL SOCKS; THERMAL UNDERWEAR; THONGS; TIES; TOBOGGAN HATS, PANTS AND CAPS; TOP COATS; TRACK AND FIELD SHOES; TRACK PANTS; TRACK SUITS; TRAINING SHOES; TRAINING SUITS; TRENCH COATS; TRIATHLON CLOTHING, NAMELY TRIATHLON TIGHTS, TRIATHLON SHORTS, TRIATHLON SINGLETS, TRIATHLON SHIRTS, TRIATHLON SUITS; UNDERSHIRTS; UNDERWEAR; UNDERWEAR, NAMELY, BOY SHORTS; VESTS; VOLLEYBALL SHOES; WAIST BELTS; WALKING SHORTS; WARM UP SUITS; WATER SOCKS; WATERPROOF JACKETS AND PANTS; WET SUITS; WIND COATS; WIND PANTS; WIND RESISTANT JACKETS; WIND SHIRTS; WIND VESTS; WIND-JACKETS; WOMEN'S SHOES; WOMEN'S UNDERWEAR; WOOLLEN SOCKS; WOOL-

LY HATS; WORK SHOES AND BOOTS; WOVEN OR KNITTED UNDERWEAR; WRISTBANDS; WRISTBANDS CONTAINING A COOLING SUBSTANCE TO COOL THE WEARER; YOGA PANTS; YOGA SHIRTS, IN CLASS 25 (U.S. CLS. 22 AND 39).

FIRST USE 7-2-2008; IN COMMERCE 7-2-2008.

OWNER OF U.S. REG. NOS. 3,467,152 AND 3,467,165.

THE MARK CONSISTS OF THE LETTERS GO IN A STYLIZED FORM WITH A LOWERCASE 'G' AND 'O.' 3 CIRCLES OF EQUAL SIZE, 2 VERTICALLY STACKED, WITH THE THIRD CENTERED TO THE RIGHT OF THE FIRST 2. TO THE LEFT OF THE CIRCLES APPEARS THREE OVERLAPPING WAVES, NARROWING AT THEIR TIPS, REPRESENTING WIND. PROTRUDING FROM THE TOP CIRCLE IS AN ABSTRACT BRANCH, AN ARC POINTED TOWARDS THE RIGHT, WITH A SMALL BRANCH AND LEAF POINTING TOWARDS THE LEFT (PARALLEL TO ONE ANOTHER). THE TWO VERTICALLY STACKED CIRCLES ARE CONNECTED BY A WATER DROP. THE LOWER CIRCLE HAS A WAVY LINE THAT IS SHADED IN, REPRESENTING COLLECTED WATER. THE CIRCLE TO THE RIGHT HAS BENT TRIANGLES PROTRUDING FROM IT IN 2 ROWS, 12 PER ROW, THE OUTER ROW BEING SMALLER IN SIZE, REPRESENTING THE RAYS OF THE SUN. .

SER. NO. 77-517,475, FILED 7-8-2008.

MARIAM MAHMOUDI, EXAMINING ATTORNEY

Int. Cl.: 43

Prior U.S. Cls.: 100 and 101

United States Patent and Trademark Office

Reg. No. 3,575,839

Registered Feb. 17, 2009

**SERVICE MARK
PRINCIPAL REGISTER**

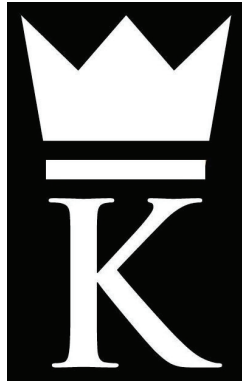

KING'S SEAFOOD CO., LLC (DELAWARE LIMITED LIABILITY COMPANY)
3185 AIRWAY AVE., BLDG. J
COSTA MESA, CA 92626

FIRST USE 11-0-2006; IN COMMERCE 11-0-2006.

SER. NO. 77-517,480, FILED 7-8-2008.

FOR: RESTAURANT SERVICES, IN CLASS 43
(U.S. CLS. 100 AND 101).

INGA ERVIN, EXAMINING ATTORNEY

Int. Cls.: 18 and 25

Prior U.S. Cls.: 1, 2, 3, 22, 39 and 41

United States Patent and Trademark Office

Reg. No. 3,575,840

Registered Feb. 17, 2009

TRADEMARK
PRINCIPAL REGISTER



O'DONOHUE, JOHN A. (UNITED STATES INDIVIDUAL)
624 S. ASHLAND AVE.
LA GRANGE, IL 60525 AND
HISCHIER, BRIAN R. (UNITED STATES INDIVIDUAL)
UNIT 2
1413 W. ARGYLE
CHICAGO, IL 60640

FIRST USE 7-2-2008; IN COMMERCE 7-2-2008.

FOR: ALL PURPOSE SPORT BAGS; ALL-PURPOSE ATHLETIC BAGS; ALL-PURPOSE CARRYING BAGS; ATHLETIC BAGS; BABY CARRYING BAGS; BACKPACKS, BOOK BAGS, SPORTS BAGS, BUM BAGS, WALLETS AND HANDBAGS; BAGS FOR CARRYING BABIES' ACCESSORIES; BAGS FOR SPORTS; BAGS FOR UMBRELLAS; BEACH BAGS; BELT BAGS AND HIP BAGS; BOOK BAGS; BUM BAGS; CANVAS SHOPPING BAGS; CARRY-ALL BAGS; CARRY-ON BAGS; CLUTCH BAGS; DUFFEL BAGS; DUFFEL BAGS FOR TRAVEL; DUFFLE BAGS; GARMENT BAGS FOR TRAVEL; GYM BAGS; HIKING BAGS; LEATHER AND IMITATION LEATHER BAGS; MEN'S CLUTCH BAGS; MESH SHOPPING BAGS; MESSENGER BAGS; OVER-NIGHT BAGS; SCHOOL BAGS; SCHOOL BOOK BAGS; SHOE BAGS FOR TRAVEL; SHOPPING BAGS MADE OF SKIN; SHOPPING BAGS WITH WHEELS ATTACHED; SHOULDER BAGS; SLING BAGS; SMALL BAGS FOR MEN; SOUVENIR BAGS; SPORT BAGS; SPORTS BAGS; STRING BAGS FOR SHOPPING; TEXTILE SHOPPING BAGS; TOILETRY BAGS SOLD EMPTY; TOTE BAGS; TRAVEL BAGS; TRAVELING BAGS; TRAVELLING BAGS; WAIST BAGS; WASH BAGS FOR CARRYING TOILETRIES; WHEELED BAGS, IN CLASS 18 (U.S. CLS. 1, 2, 3, 22 AND 41).

FOR: ANKLE SOCKS; ANKLETS; APRES-SKI SHOES; ATHLETIC FOOTWEAR; ATHLETIC SHOES; ATHLETIC UNIFORMS; BASEBALL CAPS; BASEBALL SHOES; BASKETBALL SNEAKERS; BATHING COSTUMES; BATHING COSTUMES FOR WOMEN; BATHING SUITS; BATHING SUITS FOR MEN; BATHING TRUNKS; BEACH SHOES; BELTS; BELTS MADE OF LEATHER; BELTS OF TEXTILE; BERMUDA SHORTS; BIKINIS; BOARD SHORTS; BODY SUITS; BOLO TIES; BOW TIES; BOWLING SHOES; BOXER BRIEFS; BOXER SHORTS; BOXING SHOES; BRAS; BRIEFS; CAMP SHIRTS; CANVAS SHOES; CAP VISORS; CAPRI PANTS; CAPS; CAPS WITH VISORS; CARGO PANTS; COATS; COATS FOR MEN AND WOMEN; COATS MADE OF COTTON; COATS OF DENIM; CYCLING SHOES; DANCE SHOES; DECK-SHOES; DENIM JACKETS; DENIMS; DOWN JACKETS; DRESS SHIRTS; DRESS SUITS; DRESSES; DRIVERS; DRY SUITS; FABRIC BELTS; FISHERMEN'S JACKETS; FITTED SWIMMING COSTUMES WITH BRA CUPS; FLEECE SHORTS; FLEECE VESTS; FOOTBALL SHOES; FOOTWEAR FOR TRACK AND FIELD ATHLETICS; FUR COATS AND JACKETS; FUR HATS; GOLF CAPS; GOLF SHIRTS; GOLF SHOES; GOLF TROUSERS; GYM SHORTS; GYM SUITS; GYMNASTIC SHOES; HANDBALL SHOES; HATS; HEADBANDS; HEADBANDS AGAINST SWEATING; HEAVY JACKETS; HOCKEY SHOES; JACKET LINERS; JACKETS; JOGGING PANTS; JOGGING SUITS; JUDO SUITS; KARATE SUITS; KNIT SHIRTS; KNITTED CAPS; KNITTED UNDERWEAR; LADIES' UNDERWEAR; LEATHER BELTS; LEATHER JACKETS; LEATHER PANTS; LIGHT-REFLECTING COATS; LONG JACKETS; LONG

SLEEVED VESTS; LONG UNDERWEAR; LONG-SLEEVED SHIRTS; MEN'S SOCKS; MEN'S SUITS; WOMEN'S SUITS; NIGHT SHIRTS; OVER COATS; PANTIES; PANTIES, SHORTS AND BRIEFS; PANTS; PAPER HATS FOR USE AS CLOTHING ITEMS; PIQUE SHIRTS; POLO SHIRTS; RAIN COATS; RAIN JACKETS; RAINPROOF JACKETS; RIDING COATS; RUGBY SHIRTS; RUGBY SHOES; RUGBY SHORTS; RUNNING SHOES; SANDALS; SHELL JACKETS; SHIRTS; SHIRTS FOR SUITS; SHOES; SHORT-SLEEVED OR LONG-SLEEVED T-SHIRTS; SHORT-SLEEVED SHIRTS; SHORTS; SKI AND SNOWBOARD SHOES AND PARTS THEREOF; SKI JACKETS; SKI PANTS; SKI SUITS; SKIING SHOES; SKIRT SUITS; SKULL CAPS; SLEEP SHIRTS; SLEEPING GARMENTS; SLEEVED OR SLEEVELESS JACKETS; SMALL HATS; SNOW BOARDING SUITS; SNOW PANTS; SNOW SUITS; SNOWBOARD PANTS; SOCCER BOOTS; SOCCER SHOES; SOCKS; SOCKS AND STOCKINGS; SPORT COATS; SPORT SHIRTS; SPORTS BRAS; SPORTS JACKETS; SPORTS JERSEYS; SPORTS JERSEYS AND BREECHES FOR SPORTS; SPORTS OVERUNIFORMS; SPORTS SHIRTS; SPORTS SHIRTS WITH SHORT SLEEVES; SUEDE JACKETS; SUIT COATS; SUITS; SWEAT PANTS; SWEAT SHIRTS; SWEAT SHORTS; SWEAT SUITS; SWIM CAPS; SWIM TRUNKS; SWIM WEAR; SWIMMING CAPS; SWIMMING TRUNKS; T-SHIRTS; TEE SHIRTS; TENNIS SHOES; THERMAL SOCKS; THERMAL UNDERWEAR; THONGS; TIES; TOBOGGAN HATS, PANTS AND CAPS; TOP COATS; TRACK AND FIELD SHOES; TRACK PANTS; TRACK SUITS; TRAINING SHOES; TRAINING SUITS; TRENCH COATS; TRIATHLON CLOTHING, NAMELY TRIATHLON TIGHTS, TRIATHLON SHORTS, TRIATHLON SINGLET, TRIATHLON SHIRTS, TRIATHLON SUITS; UNDERSHIRTS; UNDERWEAR; UNDERWEAR, NAMELY, BOY SHORTS; VESTS; VOLLEYBALL SHOES; WAIST BELTS; WALKING SHORTS; WARM UP SUITS;

WATER SOCKS; WATERPROOF JACKETS AND PANTS; WET SUITS; WIND COATS; WIND PANTS; WIND RESISTANT JACKETS; WIND SHIRTS; WIND VESTS; WIND-JACKETS; WOMEN'S SHOES; WOMEN'S UNDERWEAR; WOOLLEN SOCKS; WOOLLY HATS; WORK SHOES AND BOOTS; WOVEN OR KNITTED UNDERWEAR; WRISTBANDS; WRISTBANDS CONTAINING A COOLING SUBSTANCE TO COOL THE WEARER; YOGA PANTS; YOGA SHIRTS, IN CLASS 25 (U.S. CLS. 22 AND 39).

FIRST USE 7-2-2008; IN COMMERCE 7-2-2008.

THE MARK CONSISTS OF AN OBLONG RECTANGLE, WITH A DARK BAND ON THE TOP QUARTER (WITH 'CONSIDER' WRITTEN OUT IN ALL CAPS IN A MODERN FONT, LIGHTER THAN THE BACKGROUND) AND THE BOTTOM QUARTER (WITH 'CIVILIZATION' WRITTEN OUT IN ALL CAPS IN A MODERN FONT, LIGHTER THAN THE BACKGROUND). IN THE CENTER APPEAR FOUR SYMBOLS FROM LEFT TO RIGHT - THREE OVERLAPPING WAVES, NARROWING AT THEIR TIPS, REPRESENTING WIND, AN ABSTRACT BRANCH, AN ARC POINTED TOWARDS THE RIGHT, WITH A SMALL BRANCH AND LEAF POINTING TOWARDS THE LEFT (PARALLEL TO ONE ANOTHER), A WATER DROP, AND A ROUND CIRCLE, WITH AN OPEN CENTER, WITH BENT TRIANGLES PROTRUDING FROM IT IN 2 ROWS, 12 PER ROW, THE OUTER ROW BEING SMALLER IN SIZE, REPRESENTING THE RAYS OF THE SUN. BELOW THE FOUR SYMBOLS APPEAR THE WORDS: 'GO 4 ELEMENTAL POWER!' IN A CURVED STYLIZED FONT..

SER. NO. 77-517,498, FILED 7-8-2008.

MARIAM MAHMOUDI, EXAMINING ATTORNEY

Int. Cl.: 35

Prior U.S. Cls.: 100, 101 and 102

United States Patent and Trademark Office

Reg. No. 3,575,841

Registered Feb. 17, 2009

**SERVICE MARK
PRINCIPAL REGISTER**

FAT ATOM

MUFFLEY, TODD (UNITED STATES INDIVIDUAL)
13295 ILLINOIS STREET
CARMEL, IN 46032

FOR: ADVERTISING AND COMMERCIAL INFORMATION SERVICES, VIA THE INTERNET; ADVERTISING AND MARKETING; ADVERTISING VIA ELECTRONIC MEDIA AND SPECIFICALLY THE INTERNET; ADVERTISING, MARKETING AND PROMOTION SERVICES; ADVERTISING, PROMOTION AND MARKETING SERVICES IN THE NATURE OF E-MAIL BLAST CAMPAIGNS FOR OTHERS; BUSINESS MARKETING SERVICES; COMPILATION OF ADVERTISEMENTS FOR USE AS WEB PAGES ON THE INTERNET; DESIGN OF INTERNET ADVERTISING; DISSEMINATION OF ADVERTISING FOR OTHERS VIA THE INTERNET; INTERNET ADVERTISING SERVICES; MARKET-

ING CONSULTING; ON-LINE ADVERTISING AND MARKETING SERVICES; PROMOTING, ADVERTISING AND MARKETING OF THE ON-LINE WEB SITES OF OTHERS; PROMOTION AND MARKETING SERVICES AND RELATED CONSULTING; PROMOTION, ADVERTISING AND MARKETING OF ON-LINE WEB SITES, IN CLASS 35 (U.S. CLS. 100, 101 AND 102).

FIRST USE 5-28-2008; IN COMMERCE 5-28-2008.

THE MARK CONSISTS OF STANDARD CHARACTERS WITHOUT CLAIM TO ANY PARTICULAR FONT, STYLE, SIZE, OR COLOR.

SER. NO. 77-517,548, FILED 7-9-2008.

MICHAEL GAAFAR, EXAMINING ATTORNEY

Int. Cl.: 35

Prior U.S. Cls.: 100, 101 and 102

United States Patent and Trademark Office

Reg. No. 3,575,842

Registered Feb. 17, 2009

**SERVICE MARK
PRINCIPAL REGISTER**



PIT BULL ADVOCATE, INC. (NEW YORK CORPORATION)
2 BAY BLUB DRIVE APT. 18X
BAYSIDE, NY 11360

FOR: PUBLIC ADVOCACY TO PROMOTE AWARENESS OF PIT BULL DOG BREEDS, THE INJUSTICES OF BREED SPECIFIC LEGISLATION, PIT BULLS AND CARE OF PIT BULLS, IN CLASS 35 (U.S. CLS. 100, 101 AND 102).

FIRST USE 1-1-2008; IN COMMERCE 4-25-2008.

THE COLOR(S) RED, BLACK AND WHITE IS/ ARE CLAIMED AS A FEATURE OF THE MARK.

THE MARK CONSISTS OF A WHITE CIRCLE WITH BLACK LETTERING READING "DON'T BE BULLIED" AT THE TOP OF THE CIRCLE AND "PIT BULL ADVOCATE 101.COM" ON THE BOTTOM OF THE CIRCLE, THE LETTERS "BSL" IN RED WITH A WHITE DIAGONAL LINE RUNNING THROUGH THE LETTERS, ALL ON A BLACK BACKGROUND.

SER. NO. 77-517,584, FILED 7-9-2008.

KATINA MISTER, EXAMINING ATTORNEY

Int. Cl.: 25

Prior U.S. Cls.: 22 and 39

United States Patent and Trademark Office

Reg. No. 3,575,844

Registered Feb. 17, 2009

**TRADEMARK
PRINCIPAL REGISTER**

BEING NATURAL IS A WAY OF
LIFE

BRUIN, ALEXANDRA J. (UNITED STATES IN-
DIVIDUAL)
7420 S. RAWSON BRIDGE ROAD
CARY, IL 60013

THE MARK CONSISTS OF STANDARD CHAR-
ACTERS WITHOUT CLAIM TO ANY PARTICULAR
FONT, STYLE, SIZE, OR COLOR.

FOR: TOPS, IN CLASS 25 (U.S. CLS. 22 AND 39).

SER. NO. 77-517,621, FILED 7-9-2008.

FIRST USE 6-12-2008; IN COMMERCE 6-12-2008.

TOBY BULLOFF, EXAMINING ATTORNEY

Int. Cl.: 30

Prior U.S. Cl.: 46

United States Patent and Trademark Office

Reg. No. 3,575,845

Registered Feb. 17, 2009

**TRADEMARK
PRINCIPAL REGISTER**

MARSHMALLOW ZEBRAS

SB GLOBAL FOODS, INC. (PENNSYLVANIA
CORPORATION)

1330 N. BROAD ST.

LANSDALE, PA 19446

FOR: CANDY; CHOCOLATE CANDIES; MARSH-
MALLOW, IN CLASS 30 (U.S. CL. 46).

FIRST USE 1-14-2008; IN COMMERCE 1-14-2008.

THE MARK CONSISTS OF STANDARD CHAR-
ACTERS WITHOUT CLAIM TO ANY PARTICULAR
FONT, STYLE, SIZE, OR COLOR.

NO CLAIM IS MADE TO THE EXCLUSIVE
RIGHT TO USE "MARSHMALLOW", APART FROM
THE MARK AS SHOWN.

SER. NO. 77-517,703, FILED 7-9-2008.

CARYN GLASSER, EXAMINING ATTORNEY

Int. Cl.: 41

Prior U.S. Cls.: 100, 101 and 107

United States Patent and Trademark Office

Reg. No. 3,575,846

Registered Feb. 17, 2009

**SERVICE MARK
PRINCIPAL REGISTER**

DallasDirt

D MAGAZINE PARTNERS, L.P. (TEXAS LIMITED PARTNERSHIP)
4311 OAK LAWN, FIRST FLOOR
DALLAS, TX 75219

THE MARK CONSISTS OF STANDARD CHARACTERS WITHOUT CLAIM TO ANY PARTICULAR FONT, STYLE, SIZE, OR COLOR.

FOR: ON-LINE JOURNALS, NAMELY, BLOGS FEATURING A DISCUSSION ABOUT THE REAL ESTATE MARKET, IN CLASS 41 (U.S. CLS. 100, 101 AND 107).

SER. NO. 77-517,712, FILED 7-9-2008.

FIRST USE 12-12-2007; IN COMMERCE 12-12-2007.

VERNA BETH RIRIE, EXAMINING ATTORNEY

Int. Cl.: 35

Prior U.S. Cls.: 100, 101 and 102

United States Patent and Trademark Office

Reg. No. 3,575,847

Registered Feb. 17, 2009

**SERVICE MARK
PRINCIPAL REGISTER**

POSITRAC

ALLIED SOLUTIONS, LLC (INDIANA LIMITED
LIABILITY COMPANY)
SUITE 300
1320 CITY CENTER DRIVE
CARMEL, IN 46032

THE MARK CONSISTS OF STANDARD CHAR-
ACTERS WITHOUT CLAIM TO ANY PARTICULAR
FONT, STYLE, SIZE, OR COLOR.

FOR: SALES VOLUME TRACKING OF LOAN
PRODUCTION AND PRODUCT SALES FOR OTH-
ERS, IN CLASS 35 (U.S. CLS. 100, 101 AND 102).

SER. NO. 77-517,729, FILED 7-9-2008.

FIRST USE 6-24-2008; IN COMMERCE 6-24-2008.

BARBARA A. GOLD, EXAMINING ATTORNEY

Int. Cl.: 24

Prior U.S. Cls.: 42 and 50

United States Patent and Trademark Office

Reg. No. 3,575,848

Registered Feb. 17, 2009

**TRADEMARK
PRINCIPAL REGISTER**

BEST FIT!

PACIFIC COAST FEATHER COMPANY (WA-
SHINGTON CORPORATION)

P.O. BOX 80385

SEATTLE, WA 98108

FOR: BED SHEETS AND PILLOW CASES, IN
CLASS 24 (U.S. CLS. 42 AND 50).

FIRST USE 5-1-2003; IN COMMERCE 5-1-2003.

THE MARK CONSISTS OF STANDARD CHAR-
ACTERS WITHOUT CLAIM TO ANY PARTICULAR
FONT, STYLE, SIZE, OR COLOR.

OWNER OF U.S. REG. NO. 2,896,446.

SEC. 2(F).

SER. NO. 77-517,777, FILED 7-9-2008.

KIM SAITO, EXAMINING ATTORNEY

Int. Cl.: 35

Prior U.S. Cls.: 100, 101 and 102

United States Patent and Trademark Office

Reg. No. 3,575,849

Registered Feb. 17, 2009

**SERVICE MARK
PRINCIPAL REGISTER**

Dorea International

DOREA INTERNATIONAL, INC. (NEW YORK CORPORATION)
SUITE 4C
200 WEST 86TH STREET
NEW YORK, NY 10024

FOR: ADVISORY AND CONSULTANCY SERVICES RELATING TO EXPORT, EXPORT SERVICES, EXPORT PROMOTION INFORMATION AND SERVICES; BUSINESS CONSULTING SERVICES RELATING TO PRODUCT DISTRIBUTION, OPERATIONS MANAGEMENT SERVICES, LOGISTICS, REVERSE LOGISTICS, SUPPLY CHAIN, AND PRODUCTION SYSTEMS AND DISTRIBUTION SOLUTIONS; CUSTOMS CLEARANCE SERVICES; IMPORT AND EXPORT AGENCIES, IN CLASS 35 (U.S. CLS. 100, 101 AND 102).

FIRST USE 9-23-1992; IN COMMERCE 9-23-1992.

THE MARK CONSISTS OF STANDARD CHARACTERS WITHOUT CLAIM TO ANY PARTICULAR FONT, STYLE, SIZE, OR COLOR.

NO CLAIM IS MADE TO THE EXCLUSIVE RIGHT TO USE "INTERNATIONAL", APART FROM THE MARK AS SHOWN.

THE FOREIGN WORDING, DOREA, IN THE MARK TRANSLATES INTO ENGLISH AS OF THE SEA.

SER. NO. 77-517,786, FILED 7-9-2008.

RICHARD A. STRASER, EXAMINING ATTORNEY

Int. Cls.: 39 and 43

Prior U.S. Cls.: 100, 101 and 105

United States Patent and Trademark Office

Reg. No. 3,575,850

Registered Feb. 17, 2009

**SERVICE MARK
PRINCIPAL REGISTER**

PREMIER COLLECTION

AAA AUTO CLUB SOUTH, INC. (FLORIDA CORPORATION)
1515 N. WESTSHORE BOULEVARD
TAMPA, FL 33067

FOR: TRAVEL AGENCY SERVICES, NAMELY, MAKING RESERVATIONS AND BOOKINGS FOR TRANSPORTATION; TRAVEL BOOKING AGENCIES; ARRANGING FOR TRAVEL VISAS, PASSPORTS AND TRAVEL DOCUMENTS FOR PERSONS TRAVELING ABROAD; TRAVEL CLUB SERVICES; TRAVEL GUIDE SERVICES; TRAVEL INFORMATION SERVICES; TOUR GUIDE SERVICES; ARRANGING TRAVEL TOURS; ARRANGING OF CRUISES; ARRANGING EXCURSIONS FOR TOURISTS, IN CLASS 39 (U.S. CLS. 100 AND 105).

FIRST USE 4-30-1999; IN COMMERCE 4-30-1999.

FOR: TRAVEL AGENCY SERVICES, NAMELY, MAKING RESERVATIONS AND BOOKINGS FOR

TEMPORARY LODGING, MAKING HOTEL RESERVATIONS FOR OTHERS, IN CLASS 43 (U.S. CLS. 100 AND 101).

FIRST USE 4-30-1999; IN COMMERCE 4-30-1999.

THE MARK CONSISTS OF STANDARD CHARACTERS WITHOUT CLAIM TO ANY PARTICULAR FONT, STYLE, SIZE, OR COLOR.

OWNER OF U.S. REG. NOS. 2,576,847 AND 2,611,767.

SEC. 2(F).

SER. NO. 77-517,791, FILED 7-9-2008.

PAUL F. GAST, EXAMINING ATTORNEY

Int. Cl.: 41

Prior U.S. Cls.: 100, 101 and 107

United States Patent and Trademark Office

Reg. No. 3,575,851

Registered Feb. 17, 2009

**SERVICE MARK
PRINCIPAL REGISTER**

Brigitte Barhot

ABERNATHY, SARAH (UNITED STATES INDIVIDUAL)
56 HAWTHORNE
BROOKLYN, NY 11225

FOR: ENTERTAINMENT IN THE NATURE OF ROLLER DERBY GAMES; ENTERTAINMENT SERVICES, NAMELY, PARTICIPATION IN ROLLER DERBY COMPETITIONS; ENTERTAINMENT SERVICES, NAMELY, PERSONAL APPEARANCES BY A ROLLER DERBY COMPETITOR, IN CLASS 41 (U.S. CLS. 100, 101 AND 107).

FIRST USE 3-1-2006; IN COMMERCE 3-1-2006.

THE MARK CONSISTS OF STANDARD CHARACTERS WITHOUT CLAIM TO ANY PARTICULAR FONT, STYLE, SIZE, OR COLOR.

THE NAME(S), PORTRAIT(S), AND/OR SIGNATURE(S) SHOWN IN THE MARK IDENTIFIES THE PSEUDONYM OF SARAH ABERNATHY, WHOSE CONSENT(S) TO REGISTER IS SUBMITTED.

SER. NO. 77-517,798, FILED 7-9-2008.

JENNY PARK, EXAMINING ATTORNEY

Int. Cl.: 38

Prior U.S. Cls.: 100, 101 and 104

United States Patent and Trademark Office

Reg. No. 3,575,852

Registered Feb. 17, 2009

**SERVICE MARK
PRINCIPAL REGISTER**

NEWSWARE

TRACK DATA CORPORATION (DELAWARE
CORPORATION)
95 ROCKWELL PLACE
BROOKLYN, NY 11217

THE MARK CONSISTS OF STANDARD CHAR-
ACTERS WITHOUT CLAIM TO ANY PARTICULAR
FONT, STYLE, SIZE, OR COLOR.

FOR: TRANSMISSION OF NEWS, IN CLASS 38
(U.S. CLS. 100, 101 AND 104).

SER. NO. 77-517,802, FILED 7-9-2008.

FIRST USE 12-15-1997; IN COMMERCE 12-15-1997.

ANDREW RHIM, EXAMINING ATTORNEY

Int. Cls.: 14 and 35

Prior U.S. Cls.: 2, 27, 28, 50, 100, 101 and 102

United States Patent and Trademark Office

Reg. No. 3,575,853

Registered Feb. 17, 2009

**TRADEMARK
SERVICE MARK
PRINCIPAL REGISTER**



HOUMAN, INC. (CALIFORNIA CORPORATION)
953 ORANGE AVE.
CORONADO, CA 92118

FOR: JEWELRY, IN CLASS 14 (U.S. CLS. 2, 27, 28
AND 50).

FIRST USE 1-1-1996; IN COMMERCE 1-1-1996.

FOR: RETAIL JEWELRY STORES, IN CLASS 35
(U.S. CLS. 100, 101 AND 102).

FIRST USE 1-1-1996; IN COMMERCE 1-1-1996.

THE MARK CONSISTS OF A STYLIZED DIA-
MOND SHAPE, HAVING CURVED TRAILING
LINES FLOWING THEREFROM WITH THE WORD-
ING "HOUMAN".

SER. NO. 77-517,832, FILED 7-9-2008.

BERNICE MIDDLETON, EXAMINING ATTORNEY

Int. Cl.: 35

Prior U.S. Cls.: 100, 101 and 102

United States Patent and Trademark Office

Reg. No. 3,575,854

Registered Feb. 17, 2009

**SERVICE MARK
PRINCIPAL REGISTER**

ADVANTAGE GPO

AMERICAN HARDWARE MANUFACTURERS
ASSOCIATION (DELAWARE CORPORATION)
801 N. PLAZA DRIVE
SCHAUMBURG, IL 60173

FOR: ASSISTING PROSPECTIVE AND CURRENT MEMBERS OF AN ASSOCIATION, AS WELL AS OTHER COMPANIES, BY PROVIDING ACCESS TO A GROUP PURCHASING PROGRAM FOR PRODUCTS AND SERVICES OF OTHERS IN THE FIELD OF HOME IMPROVEMENT; GROUP COOPERATIVE PURCHASING AGENT SERVICES; PROCUREMENT, NAMELY, GROUP PURCHASING OF EQUIPMENT AND SERVICES FOR OTHERS APPLICABLE TO THE HOME IMPROVEMENT INDUSTRY; GROUP PURCHASING SERVICES, NAMELY, PROVIDING REDUCED CONTRACT PRICING THROUGH NEGOTIATIONS FOR PRODUCTS AND SERVICES OF OTHERS IN THE HOME IMPROVEMENT INDUSTRY; DEVELOPMENT AND

ADMINISTRATION OF GROUP PURCHASING PROGRAMS AS A VALUE ADDED BENEFIT OF MEMBERSHIP OR PARTICIPATION, IN CLASS 35 (U.S. CLS. 100, 101 AND 102).

FIRST USE 4-4-2008; IN COMMERCE 4-4-2008.

THE MARK CONSISTS OF STANDARD CHARACTERS WITHOUT CLAIM TO ANY PARTICULAR FONT, STYLE, SIZE, OR COLOR.

NO CLAIM IS MADE TO THE EXCLUSIVE RIGHT TO USE "GPO", APART FROM THE MARK AS SHOWN.

SER. NO. 77-517,864, FILED 7-9-2008.

DAVID MILLER, EXAMINING ATTORNEY

Int. Cl.: 41

Prior U.S. Cls.: 100, 101 and 107

United States Patent and Trademark Office

Reg. No. 3,575,855

Registered Feb. 17, 2009

**SERVICE MARK
PRINCIPAL REGISTER**

E-MOMENTS

FUTURE FARMERS OF AMERICA (UNITED STATES CONGRESSIONALLY CHARTERED NON-PROFIT CORPORATION), DBA NATIONAL FFA ORGANIZATION
P.O. BOX 68960
6060 FFA DRIVE
INDIANAPOLIS, IN 46268

FOR: PROVIDING INFORMATION IN THE FIELD OF TEACHING METHODOLOGY AND EDUCATION , IN CLASS 41 (U.S. CLS. 100, 101 AND 107).

FIRST USE 4-24-2006; IN COMMERCE 4-24-2006.

THE MARK CONSISTS OF STANDARD CHARACTERS WITHOUT CLAIM TO ANY PARTICULAR FONT, STYLE, SIZE, OR COLOR.

SER. NO. 77-517,876, FILED 7-9-2008.

EDWARD NELSON, EXAMINING ATTORNEY

Int. Cl.: 5

Prior U.S. Cls.: 6, 18, 44, 46, 51 and 52

United States Patent and Trademark Office

Reg. No. 3,575,856

Registered Feb. 17, 2009

**TRADEMARK
PRINCIPAL REGISTER**

BITE-AID

CASTILLO, MIGUEL A. (UNITED STATES INDIVIDUAL)
109 MOORING BUOY
HILTON HEAD ISLAND, SC 29928

THE MARK CONSISTS OF STANDARD CHARACTERS WITHOUT CLAIM TO ANY PARTICULAR FONT, STYLE, SIZE, OR COLOR.

FOR: COMPOSITIONS TO BE APPLIED TO THE SKIN, NAMELY, OINTMENTS, CREAMS, AND LIQUIDS FOR RELIEVING PAIN AND ITCHING, IN CLASS 5 (U.S. CLS. 6, 18, 44, 46, 51 AND 52).

SER. NO. 77-517,898, FILED 7-9-2008.

FIRST USE 8-31-2007; IN COMMERCE 8-31-2007.

DANNEAN HETZEL, EXAMINING ATTORNEY

Int. Cl.: 16

Prior U.S. Cls.: 2, 5, 22, 23, 29, 37, 38 and 50

United States Patent and Trademark Office

Reg. No. 3,575,857

Registered Feb. 17, 2009

**TRADEMARK
PRINCIPAL REGISTER**

Mule Hair

MULE HAIR WORLDWIDE (ST.CHRIST-NEVIS
LIMITED LIABILITY COMPANY)
SUITE 2168
21200 KITTRIDGE STREET
WOODLAND HILLS, CA 91303

THE MARK CONSISTS OF STANDARD CHAR-
ACTERS WITHOUT CLAIM TO ANY PARTICULAR
FONT, STYLE, SIZE, OR COLOR.

FOR: NOVELS, IN CLASS 16 (U.S. CLS. 2, 5, 22, 23,
29, 37, 38 AND 50).

SER. NO. 77-517,901, FILED 7-9-2008.

FIRST USE 6-1-2008; IN COMMERCE 6-1-2008.

DANNEAN HETZEL, EXAMINING ATTORNEY

Int. Cl.: 39

Prior U.S. Cls.: 100 and 105

United States Patent and Trademark Office

Reg. No. 3,575,858

Registered Feb. 17, 2009

**SERVICE MARK
PRINCIPAL REGISTER**

Live!Traffic

INTELLIONE TECHNOLOGIES CORPORATION
(GEORGIA CORPORATION)
SUITE 100
3100 INTERSTATE NORTH CIRCLE SE
ATLANTA, GA 30339

THE MARK CONSISTS OF STANDARD CHAR-
ACTERS WITHOUT CLAIM TO ANY PARTICULAR
FONT, STYLE, SIZE, OR COLOR.

FOR: PROVIDING ROAD AND TRAFFIC INFOR-
MATION, IN CLASS 39 (U.S. CLS. 100 AND 105).

SER. NO. 77-517,905, FILED 7-9-2008.

FIRST USE 11-16-2007; IN COMMERCE 11-16-2007.

DANNEAN HETZEL, EXAMINING ATTORNEY

Int. Cl.: 9

Prior U.S. Cls.: 21, 23, 26, 36 and 38

Reg. No. 3,575,859

United States Patent and Trademark Office

Registered Feb. 17, 2009

**TRADEMARK
PRINCIPAL REGISTER**

AWM

AERES SOGE, LLC (ALABAMA LIMITED LIABILITY COMPANY)
191 DEER MOUNTAIN CIRCLE
INDIAN SPRINGS, AL 35124

FOR: COMPUTER SOFTWARE FOR AUTOMATING, ORGANIZING, AND MANAGING INFORMATION AND FORMS USED IN THE FUNERAL INDUSTRY, IN CLASS 9 (U.S. CLS. 21, 23, 26, 36 AND 38).

FIRST USE 5-1-2008; IN COMMERCE 5-1-2008.

THE MARK CONSISTS OF STANDARD CHARACTERS WITHOUT CLAIM TO ANY PARTICULAR FONT, STYLE, SIZE, OR COLOR.

SER. NO. 77-517,913, FILED 7-9-2008.

CHRISTINA SOBRAL, EXAMINING ATTORNEY

Int. Cl.: 42

Prior U.S. Cls.: 100 and 101

United States Patent and Trademark Office

Reg. No. 3,575,860

Registered Feb. 17, 2009

**SERVICE MARK
PRINCIPAL REGISTER**

AERES SOGE

AERES SOGE, LLC (ALABAMA LIMITED LIABILITY COMPANY)
191 DEER MOUNTAIN CIRCLE
INDIAN SPRINGS, AL 35124

THE MARK CONSISTS OF STANDARD CHARACTERS WITHOUT CLAIM TO ANY PARTICULAR FONT, STYLE, SIZE, OR COLOR.

FOR: COMPUTER SOFTWARE DESIGN, DEVELOPMENT, MAINTENANCE, AND UPDATING, IN CLASS 42 (U.S. CLS. 100 AND 101).

SER. NO. 77-517,926, FILED 7-9-2008.

FIRST USE 6-30-2007; IN COMMERCE 6-30-2007.

CHRISTINA SOBRAL, EXAMINING ATTORNEY

Int. Cl.: 25

Prior U.S. Cls.: 22 and 39

United States Patent and Trademark Office

Reg. No. 3,575,861

Registered Feb. 17, 2009

TRADEMARK
PRINCIPAL REGISTER

diverse culture

BAQUI, RYAN (UNITED STATES INDIVIDUAL)
909 N. HOPOE PL.
LAHIANA, HI 96761 AND
BALAGSO, HEATHER (UNITED STATES INDIVIDUAL)
909 N. HOPOE PL.
LAHIANA, HI 96761

FOR: BATHING SUITS; BEANIES; BELTS; BOARD SHORTS; DRESS SHIRTS; DRESSES; HATS; JACKETS; LONG-SLEEVED SHIRTS; PANTS; SHIRTS; SHORTS; SKIRTS; SOCKS; SWEATERS; TANK

TOPS; TOWNS; UNDERGARMENTS, IN CLASS 25 (U.S. CLS. 22 AND 39).

FIRST USE 5-1-2007; IN COMMERCE 11-1-2007.

THE MARK CONSISTS OF STANDARD CHARACTERS WITHOUT CLAIM TO ANY PARTICULAR FONT, STYLE, SIZE, OR COLOR.

SER. NO. 77-517,940, FILED 7-9-2008.

DAVID MILLER, EXAMINING ATTORNEY

Int. Cl.: 25

Prior U.S. Cls.: 22 and 39

United States Patent and Trademark Office

Reg. No. 3,575,862

Registered Feb. 17, 2009

**TRADEMARK
PRINCIPAL REGISTER**

FOREVER FABULOUS

JONES & MITCHELL SPORTSWEAR, INC. (KAN-
SAS CORPORATION)
560 N. ROGERS ROAD
OLATHE, KS 66062

FOR: CLOTHING AND APPAREL, NAMELY, T-
SHIRTS, FASHION TOPS, FLEECE PULLOVERS,
FLEECE ZIPPED HOODED SWEATSHIRTS, BOT-
TOMS, AND LOUNGEWEAR, IN CLASS 25 (U.S.
CLS. 22 AND 39).

FIRST USE 12-0-2007; IN COMMERCE 5-10-2008.

THE MARK CONSISTS OF STANDARD CHAR-
ACTERS WITHOUT CLAIM TO ANY PARTICULAR
FONT, STYLE, SIZE, OR COLOR.

SER. NO. 77-517,949, FILED 7-9-2008.

KATHERINE CHANG, EXAMINING ATTORNEY

Int. Cl.: 41

Prior U.S. Cls.: 100, 101 and 107

United States Patent and Trademark Office

Reg. No. 3,575,863

Registered Feb. 17, 2009

**SERVICE MARK
PRINCIPAL REGISTER**

Jewels of DeNile

MICHELLE HEBERT (UNITED STATES INDIVIDUAL)
3702 BASALT LANE
MADISON, WI 53719

FOR: ENTERTAINMENT IN THE NATURE OF ROLLER DERBY GAMES; ENTERTAINMENT SERVICES, NAMELY, PARTICIPATION IN ROLLER DERBY COMPETITIONS; ENTERTAINMENT SERVICES, NAMELY, PERSONAL APPEARANCES BY A ROLLER DERBY COMPETITOR, IN CLASS 41 (U.S. CLS. 100, 101 AND 107).

FIRST USE 8-1-2004; IN COMMERCE 8-1-2004.

THE MARK CONSISTS OF STANDARD CHARACTERS WITHOUT CLAIM TO ANY PARTICULAR FONT, STYLE, SIZE, OR COLOR.

SER. NO. 77-517,952, FILED 7-9-2008.

TINA L. SNAPP, EXAMINING ATTORNEY

Int. Cl.: 35

Prior U.S. Cls.: 100, 101 and 102

United States Patent and Trademark Office

Reg. No. 3,575,864

Registered Feb. 17, 2009

**SERVICE MARK
PRINCIPAL REGISTER**

TELL YOUR TALE

PABON, ELIZABETH (UNITED STATES INDIVIDUAL)
2310 SHELTER COVE COURT
ROCKLIN, CA 95765

FOR: ADVERTISING AND MARKETING; BUSINESS ADVICE AND ANALYSIS OF MARKETS; BUSINESS CONSULTATION AND MANAGEMENT REGARDING MARKETING ACTIVITIES AND LAUNCHING OF NEW PRODUCTS; BUSINESS MARKETING SERVICES; CREATIVE MARKETING DESIGN SERVICES; DEVELOPMENT OF MARKETING STRATEGIES AND CONCEPTS; MARKETING CONSULTATION IN THE FIELD OF BOOK PUB-

LISHING AND BOOK PROMOTION; ON-LINE ADVERTISING AND MARKETING SERVICES, IN CLASS 35 (U.S. CLS. 100, 101 AND 102).

FIRST USE 7-9-2008; IN COMMERCE 7-9-2008.

THE MARK CONSISTS OF STANDARD CHARACTERS WITHOUT CLAIM TO ANY PARTICULAR FONT, STYLE, SIZE, OR COLOR.

SER. NO. 77-517,994, FILED 7-9-2008.

ALYSSA STEEL, EXAMINING ATTORNEY

Int. Cl.: 35

Prior U.S. Cls.: 100, 101 and 102

United States Patent and Trademark Office

Reg. No. 3,575,865

Registered Feb. 17, 2009

**SERVICE MARK
PRINCIPAL REGISTER**



ALLIED SOLUTIONS, LLC (INDIANA LIMITED
LIABILITY COMPANY)
SUITE 300
1320 CITY CENTER DRIVE
CARMEL, IN 46032

FOR: SALES VOLUME TRACKING OF LOAN
PRODUCTION AND PRODUCT SALES FOR OTH-
ERS, IN CLASS 35 (U.S. CLS. 100, 101 AND 102).

FIRST USE 6-24-2008; IN COMMERCE 6-24-2008.

THE MARK CONSISTS OF THE TERM "POSI-
TRAC" WITHIN THE DESIGN OF A RECTANGLE
DIVIDED ONCE INTO TWO EQUAL SECTIONS,
AND THE DESIGN OF A CURVED LINE THROUGH
THE "O", WITH THE LEFT HALF OF THE REC-
TANGLE SHOWN IN DARKER SHADING THAN
THE RIGHT SIDE.

SER. NO. 77-518,007, FILED 7-9-2008.

BARBARA A. GOLD, EXAMINING ATTORNEY

Int. Cl.: 42

Prior U.S. Cls.: 100 and 101

United States Patent and Trademark Office

Reg. No. 3,575,866

Registered Feb. 17, 2009

**SERVICE MARK
PRINCIPAL REGISTER**

SENDOUTCARDS

SEND OUT CARDS, LLC (UTAH LIMITED LIABILITY COMPANY)
346 EAST 3300 SOUTH
SALT LAKE CITY, UT 84115

FOR: PROVIDING TEMPORARY USE OF ON-LINE NON-DOWNLOADABLE SOFTWARE FOR CREATING AND SENDING STANDARD AND PERSONALIZED PRINTED ARTICLES, NAMELY, PRINTED GREETING CARDS AND POSTCARDS, IN CLASS 42 (U.S. CLS. 100 AND 101).

FIRST USE 7-1-2003; IN COMMERCE 7-1-2003.

THE MARK CONSISTS OF STANDARD CHARACTERS WITHOUT CLAIM TO ANY PARTICULAR FONT, STYLE, SIZE, OR COLOR.

OWNER OF U.S. REG. NO. 3,310,171.

SEC. 2(F).

SER. NO. 77-518,014, FILED 7-9-2008.

BARBARA A. GOLD, EXAMINING ATTORNEY

Int. Cls.: 25, 26 and 32

Prior U.S. Cls.: 22, 37, 39, 40, 42, 45, 46, 48 and 50

United States Patent and Trademark Office

Reg. No. 3,575,867

Registered Feb. 17, 2009

**TRADEMARK
PRINCIPAL REGISTER**

TROEGENATOR

TROEGS BREWING COMPANY (PENNSYLVANIA CORPORATION)
800 PAXTON STREET
HARRISBURG, PA 17111

FOR: T-SHIRTS, IN CLASS 25 (U.S. CLS. 22 AND 39).

FIRST USE 6-4-2006; IN COMMERCE 6-4-2006.

FOR: BELT BUCKLES, IN CLASS 26 (U.S. CLS. 37, 39, 40, 42 AND 50).

FIRST USE 6-4-2006; IN COMMERCE 6-4-2006.

FOR: BEER, IN CLASS 32 (U.S. CLS. 45, 46 AND 48).

FIRST USE 6-4-2006; IN COMMERCE 6-4-2006.

OWNER OF U.S. REG. NO. 2,720,925.

THE MARK CONSISTS OF THE WORD "TROE-GENATOR" IN STYLIZED FORM.

SER. NO. 77-518,018, FILED 7-9-2008.

ROSELLE HERRERA, EXAMINING ATTORNEY

Int. Cl.: 3

Prior U.S. Cls.: 1, 4, 6, 50, 51 and 52

United States Patent and Trademark Office

Reg. No. 3,575,868

Registered Feb. 17, 2009

**TRADEMARK
PRINCIPAL REGISTER**

THRRROB

BENEFIT COSMETICS LLC (DELAWARE LIMITED LIABILITY COMPANY)
685 MARKET STREET
SAN FRANCISCO, CA 94105

THE MARK CONSISTS OF STANDARD CHARACTERS WITHOUT CLAIM TO ANY PARTICULAR FONT, STYLE, SIZE, OR COLOR.

FOR: COSMETICS, IN CLASS 3 (U.S. CLS. 1, 4, 6, 50, 51 AND 52).

SER. NO. 77-518,027, FILED 7-9-2008.

FIRST USE 12-31-2007; IN COMMERCE 12-31-2007.

STEVEN JACKSON, EXAMINING ATTORNEY

Int. Cl.: 25

Prior U.S. Cls.: 22 and 39

United States Patent and Trademark Office

Reg. No. 3,575,869

Registered Feb. 17, 2009

**TRADEMARK
PRINCIPAL REGISTER**

SAVAGE REPUBLIC

LUIS A. PULIDO (UNITED STATES INDIVIDUAL)
2324 EAST PORTER STREET
LOS ANGELES, CA 90021

THE MARK CONSISTS OF STANDARD CHARACTERS WITHOUT CLAIM TO ANY PARTICULAR FONT, STYLE, SIZE, OR COLOR.

FOR: BELTS; HATS; JACKETS; JEANS; PANTS; POLO SHIRTS; SHIRTS; SHOES; SHORTS; SLEEPWEAR; SOCKS; SPORT SHIRTS; T-SHIRTS; UNDERWEAR, IN CLASS 25 (U.S. CLS. 22 AND 39).

SER. NO. 77-518,093, FILED 7-9-2008.

FIRST USE 6-24-2008; IN COMMERCE 6-24-2008.

TEJBIR SINGH, EXAMINING ATTORNEY

Int. Cls.: 35 and 39

Prior U.S. Cls.: 100, 101, 102 and 105

United States Patent and Trademark Office

Reg. No. 3,575,870

Registered Feb. 17, 2009

**SERVICE MARK
PRINCIPAL REGISTER**

...relocation made simple

EUREKA, INC. (LOUISIANA CORPORATION)
631 MAIN STREET
BATON ROUGE, LA 70801

FOR: PERSONAL AND CORPORATE RELOCA-
TION SERVICES; REFERRALS IN THE FIELD OF
HOUSING, IN CLASS 35 (U.S. CLS. 100, 101 AND 102).

FIRST USE 1-20-2008; IN COMMERCE 1-20-2008.

FOR: TRANSPORTATION OF HOUSEHOLD
GOODS, AUTOMOBILES, FREIGHT, HIGH VALUE
PRODUCTS, AND OFFICE EQUIPMENT OF OTH-

ERS BY MEANS OF TRUCK, AIR AND SHIP, IN
CLASS 39 (U.S. CLS. 100 AND 105).

FIRST USE 1-20-2008; IN COMMERCE 1-20-2008.

THE MARK CONSISTS OF STANDARD CHAR-
ACTERS WITHOUT CLAIM TO ANY PARTICULAR
FONT, STYLE, SIZE, OR COLOR.

SER. NO. 77-518,098, FILED 7-9-2008.

JULIE WATSON, EXAMINING ATTORNEY

Int. Cls.: 16 and 41

Prior U.S. Cls.: 2, 5, 22, 23, 29, 37, 38, 50, 100, 101 and 107

Reg. No. 3,575,871

United States Patent and Trademark Office

Registered Feb. 17, 2009

**TRADEMARK
SERVICE MARK
PRINCIPAL REGISTER**

BLACK INK

CERTIFIED ANGUS BEEF, LLC (DELAWARE
LIMITED LIABILITY COMPANY)
206 RIFFEL ROAD
WOOSTER, OH 44691

FOR: SYNDICATED COLUMNS AND EDUCATIONAL BULLETINS ON THE SUBJECT OF BEEF PRODUCTION FOR CATTLE PRODUCERS, NAMELY, SEED STOCK OPERATORS, COW-CALF OPERATORS, STOCKER OPERATORS, AND FEEDLOTS, IN CLASS 16 (U.S. CLS. 2, 5, 22, 23, 29, 37, 38 AND 50).

FIRST USE 7-0-1999; IN COMMERCE 7-0-1999.

FOR: EDUCATION SERVICES, NAMELY, PROVIDING CLASSES, SEMINARS AND WORKSHOPS

IN THE FIELD OF BEEF PRODUCTION FOR CATTLE PRODUCERS, NAMELY, SEED STOCK OPERATORS, COW-CALF OPERATORS, STOCKER OPERATORS, AND FEEDLOTS, IN CLASS 41 (U.S. CLS. 100, 101 AND 107).

FIRST USE 12-0-2003; IN COMMERCE 12-0-2003.

THE MARK CONSISTS OF STANDARD CHARACTERS WITHOUT CLAIM TO ANY PARTICULAR FONT, STYLE, SIZE, OR COLOR.

SER. NO. 77-518,099, FILED 7-9-2008.

RENEE MCCRAY, EXAMINING ATTORNEY

Int. Cls.: 16 and 41

Prior U.S. Cls.: 2, 5, 22, 23, 29, 37, 38, 50, 100, 101 and 107

Reg. No. 3,575,872

United States Patent and Trademark Office

Registered Feb. 17, 2009

**TRADEMARK
SERVICE MARK
PRINCIPAL REGISTER**

Burden of P-R-O-O-F

ATKINSON, ANDELSON, LOYA, RUUD &
ROMO (CALIFORNIA CORPORATION)
17871 PARK PLAZA DRIVE, SUITE 200
CERRITOS, CA 90703

FOR: PRINTED INSTRUCTIONAL, EDUCATIONAL, AND TEACHING MATERIALS IN THE FIELD OF CONDUCTING WORKPLACE AND SCHOOL SITE INVESTIGATIONS CONCERNING EMPLOYEE, STUDENT, AND CITIZEN COMPLAINTS, DISCIPLINE, OR MISCONDUCT, NAMELY, TEXT BOOKS, GUIDE BOOKS, WORK BOOKS, MANUALS, BROCHURES, BULLETINS, INFORMATIONAL FLYERS, TRADE JOURNALS, LEAFLETS, MAGAZINES, NEWSPAPERS, NEWSLETTERS, AND PAMPHLETS, IN CLASS 16 (U.S. CLS. 2, 5, 22, 23, 29, 37, 38 AND 50).

FIRST USE 4-4-2007; IN COMMERCE 7-27-2007.

FOR: EDUCATIONAL SERVICES, NAMELY, CONDUCTING CLASSES, SEMINARS, CONFERENCES, WORKSHOPS, SYMPOSIUMS, AND ONLINE

INSTRUCTION IN THE FIELD OF WORKPLACE AND SCHOOL SITE INVESTIGATIONS CONCERNING EMPLOYEE, STUDENT, AND CITIZEN COMPLAINTS, DISCIPLINE, OR MISCONDUCT, AND DISTRIBUTION OF COURSE MATERIAL IN CONNECTION THEREWITH, IN CLASS 41 (U.S. CLS. 100, 101 AND 107).

FIRST USE 4-4-2007; IN COMMERCE 7-27-2007.

THE MARK CONSISTS OF STANDARD CHARACTERS WITHOUT CLAIM TO ANY PARTICULAR FONT, STYLE, SIZE, OR COLOR.

NO CLAIM IS MADE TO THE EXCLUSIVE RIGHT TO USE "BURDEN" , APART FROM THE MARK AS SHOWN.

SER. NO. 77-518,108, FILED 7-9-2008.

CHRIS WELLS, EXAMINING ATTORNEY

Int. Cl.: 10

Prior U.S. Cls.: 26, 39 and 44

United States Patent and Trademark Office

Reg. No. 3,575,873

Registered Feb. 17, 2009

**TRADEMARK
PRINCIPAL REGISTER**

SNUGGLEHOSE

SNUGGLEHOSE, LLC (UTAH LIMITED LIABILITY COMPANY)
459 EAST 1300 SOUTH
SALT LAKE CITY, UT 84115

THE MARK CONSISTS OF STANDARD CHARACTERS WITHOUT CLAIM TO ANY PARTICULAR FONT, STYLE, SIZE, OR COLOR.

FOR: TEXTILE COVERS FOR MEDICAL VENTILATOR TUBING, IN CLASS 10 (U.S. CLS. 26, 39 AND 44).

SER. NO. 77-518,112, FILED 7-9-2008.

FIRST USE 2-3-2003; IN COMMERCE 2-3-2003.

CHRIS WELLS, EXAMINING ATTORNEY

Int. Cl.: 6

Prior U.S. Cls.: 2, 12, 13, 14, 23, 25 and 50

Reg. No. 3,575,874

United States Patent and Trademark Office

Registered Feb. 17, 2009

**TRADEMARK
PRINCIPAL REGISTER**

SAMSON STEEL

P.I. INC. (TENNESSEE CORPORATION)
1712 CONGRESS PARKWAY
ATHENS, TN 37371

FOR: METAL SWIMMING POOLS, IN CLASS 6
(U.S. CLS. 2, 12, 13, 14, 23, 25 AND 50).

FIRST USE 4-1-2008; IN COMMERCE 4-1-2008.

THE MARK CONSISTS OF STANDARD CHARACTERS WITHOUT CLAIM TO ANY PARTICULAR FONT, STYLE, SIZE, OR COLOR.

NO CLAIM IS MADE TO THE EXCLUSIVE RIGHT TO USE "STEEL", APART FROM THE MARK AS SHOWN.

SER. NO. 77-518,138, FILED 7-9-2008.

EMILY CARLSEN, EXAMINING ATTORNEY

Int. Cl.: 34

Prior U.S. Cls.: 2, 8, 9 and 17

United States Patent and Trademark Office

Reg. No. 3,575,875

Registered Feb. 17, 2009

**TRADEMARK
PRINCIPAL REGISTER**

Sun Blessed

HUMICON LLC (NEW YORK LIMITED LIABILITY COMPANY)
SUITE 500
400 OSER AVENUE
HAUPPAUGE, NY 11788

FOR: CIGAR BANDS; CIGAR BOXES; CIGAR BOXES NOT OF PRECIOUS METAL; CIGARS, IN CLASS 34 (U.S. CLS. 2, 8, 9 AND 17).

FIRST USE 5-31-2007; IN COMMERCE 6-30-2007.

THE MARK CONSISTS OF STANDARD CHARACTERS WITHOUT CLAIM TO ANY PARTICULAR FONT, STYLE, SIZE, OR COLOR.

SER. NO. 77-518,168, FILED 7-9-2008.

CHRISTINE BLOMQUIST, EXAMINING ATTORNEY

Int. Cl.: 41

Prior U.S. Cls.: 100, 101 and 107

United States Patent and Trademark Office

Reg. No. 3,575,876

Registered Feb. 17, 2009

**SERVICE MARK
PRINCIPAL REGISTER**

YTI

YORK TECHNICAL INSTITUTE, LLC (PENN-
SYLVANIA LIMITED LIABILITY COMPANY)
1405 WILLIAMS ROAD
YORK, PA 17402

FOR: EDUCATIONAL SERVICES, NAMELY,
PROVIDING ASSOCIATE DEGREE, DIPLOMA,
AND CERTIFICATION COURSES OF INSTRU-
TION IN THE FIELDS OF BUSINESS; COMPUTERS;
ELECTRONICS; AUTOMATION; ACCOUNTING;
CULINARY ARTS AND FOOD SERVICES; ME-
CHANICS; PUBLIC SAFETY AND SECURITY;
HEATING, AIR CONDITIONING, AND REFRIG-
ERATION TECHNOLOGY; DRAFTING AND DE-
SIGN; SPORTS, TRAVEL, TOURISM AND

HOSPITALITY; MOTOR SPORTS TECHNOLOGY;
CRIMINAL JUSTICE; NETWORK AND INTERNET
SECURITY; AND MEDICAL, HEALTH, AND PHAR-
MACY, IN CLASS 41 (U.S. CLS. 100, 101 AND 107).

FIRST USE 2-28-1972; IN COMMERCE 2-28-1972.

THE MARK CONSISTS OF STANDARD CHAR-
ACTERS WITHOUT CLAIM TO ANY PARTICULAR
FONT, STYLE, SIZE, OR COLOR.

SER. NO. 77-518,169, FILED 7-9-2008.

ROBIN CHOSID, EXAMINING ATTORNEY

Int. Cl.: 3

Prior U.S. Cls.: 1, 4, 6, 50, 51 and 52

United States Patent and Trademark Office

Reg. No. 3,575,877

Registered Feb. 17, 2009

**TRADEMARK
PRINCIPAL REGISTER**

TALK TO THE TAN

BENEFIT COSMETICS LLC (DELAWARE LIMITED LIABILITY COMPANY)
685 MARKET STREET
SAN FRANCISCO, CA 94105

THE MARK CONSISTS OF STANDARD CHARACTERS WITHOUT CLAIM TO ANY PARTICULAR FONT, STYLE, SIZE, OR COLOR.

FOR: COSMETICS, IN CLASS 3 (U.S. CLS. 1, 4, 6, 50, 51 AND 52).

SER. NO. 77-518,210, FILED 7-9-2008.

FIRST USE 2-25-2008; IN COMMERCE 2-25-2008.

STEVEN JACKSON, EXAMINING ATTORNEY

Int. Cl.: 41

Prior U.S. Cls.: 100, 101 and 107

United States Patent and Trademark Office

Reg. No. 3,575,878

Registered Feb. 17, 2009

**SERVICE MARK
PRINCIPAL REGISTER**

SASSISTAS!

SHARON J. ANDERSON (UNITED STATES IN-
DIVIDUAL)
34L RIDGE ROAD
GREENBELT, MD 20770

FOR: ONLINE JOURNALS, NAMELY, BLOGS
FEATURING COMMENTARY AND OPINIONS
CONCERNING CURRENT EVENTS, LIFESTYLE,
ENTERTAINMENT, FASHION, MOVIES, FOOD
AND DRINK, POLITICS, RELIGION, SCIENCE,
SPORTS, TELEVISION, TRAVEL, TECHNOLOGY,
AND GENERAL INTEREST NEWS, IN CLASS 41
(U.S. CLS. 100, 101 AND 107).

FIRST USE 3-5-2008; IN COMMERCE 3-5-2008.

THE MARK CONSISTS OF STANDARD CHAR-
ACTERS WITHOUT CLAIM TO ANY PARTICULAR
FONT, STYLE, SIZE, OR COLOR.

SER. NO. 77-518,212, FILED 7-9-2008.

KAPIL BHANOT, EXAMINING ATTORNEY

Int. Cl.: 35

Prior U.S. Cls.: 100, 101 and 102

United States Patent and Trademark Office

Reg. No. 3,575,879

Registered Feb. 17, 2009

**SERVICE MARK
PRINCIPAL REGISTER**

**BECAUSE GOOD BRANDS ARE
HARD TO FIND**

THE WHITE SPACE, LLC (MISSOURI LIMITED
LIABILITY COMPANY)
SUITE 250
6677 DELMAR
ST. LOUIS, MO 63130

FOR: PREPARING AND PLACING ADVERTISE-
MENTS AND ADVERTISING, PARTICULARLY
SERVICES FOR THE PROMOTION OF GOODS
AND SERVICES, ADVERTISING AGENCY SERVI-
CES, AND BUSINESS CONSULTATION IN THE
FIELDS OF MARKETING, COMMUNICATIONS,
NAME GENERATION, BRAND IMAGE, BRAND
DEVELOPMENT, EVENT MARKETING, PACKAGE

DESIGN AND ADVERTISING, IN CLASS 35 (U.S.
CLS. 100, 101 AND 102).

FIRST USE 2-13-2008; IN COMMERCE 2-13-2008.

THE MARK CONSISTS OF STANDARD CHAR-
ACTERS WITHOUT CLAIM TO ANY PARTICULAR
FONT, STYLE, SIZE, OR COLOR.

SER. NO. 77-518,220, FILED 7-9-2008.

BRIAN PINO, EXAMINING ATTORNEY

Int. Cl.: 43

Prior U.S. Cls.: 100 and 101

United States Patent and Trademark Office

Reg. No. 3,575,880

Registered Feb. 17, 2009

SERVICE MARK
PRINCIPAL REGISTER



FENWEST, INC. (MAINE CORPORATION), DBA
JOHNSON'S SEAFOOD & STEAK
POST OFFICE BOX 216
NEW DURHAM, NH 038550216

FOR: RESTAURANT AND BAR SERVICES, IN
CLASS 43 (U.S. CLS. 100 AND 101).

FIRST USE 0-0-2001; IN COMMERCE 0-0-2001.

NO CLAIM IS MADE TO THE EXCLUSIVE
RIGHT TO USE "SEAFOOD & STEAK", APART
FROM THE MARK AS SHOWN.

THE COLOR(S) YELLOW, ORANGE, BLUE,
WHITE, RED, BLACK, BROWN, GREEN AND
GRAY IS/ARE CLAIMED AS A FEATURE OF THE
MARK.

THE MARK CONSISTS OF A STANDING RED
LOBSTER OUTLINED IN BLACK WITH ONE CLAW
AROUND THE BACK OF A STANDING BROWN

STEER WITH WHITE HORNS AND HOOVES
WEARING BLUE OVERALLS, OUTLINED IN
BLACK AND HOLDING A GRAY PITCHFORK,
BOTH STANDING IN A GREEN FIELD WITH A
RED BARN AND TWO RED SILOS WITH BLUE
ROOFS IN THE BACKGROUND, WITH BLUE SKY
AND TWO WHITE CLOUDS ON EITHER SIDE OF
THE ANIMALS, WITH THE WORD "JOHNSON'S"
IN YELLOW AND ORANGE STYLIZED CAPITAL
LETTERS ABOVE THE OVAL IN WHICH THE
ANIMALS APPEAR, AND THE WORDS "SEAFOOD
& STEAK" IN BLUE STYLIZED CAPITAL LETTERS
ON A BROWN SCROLL AROUND THE TAIL OF
THE LOBSTER AND THE REAR HOOVES OF THE
STEER. THE WHITE BACKGROUND IS NOT
CLAIMED AS A FEATURE OF THE MARK.

SER. NO. 77-518,239, FILED 7-9-2008.

CHRISTINE BLOMQUIST, EXAMINING ATTOR-
NEY

Int. Cl.: 16

Prior U.S. Cls.: 2, 5, 22, 23, 29, 37, 38 and 50

Reg. No. 3,575,881

United States Patent and Trademark Office

Registered Feb. 17, 2009

**TRADEMARK
PRINCIPAL REGISTER**

**GENERAL BOARD OF HIGHER
EDUCATION & MINISTRY**

GENERAL BOARD OF HIGHER EDUCATION
AND MINISTRY OF THE UNITED METHO-
DIST CHURCH (TENNESSEE NON-PROFIT
CORPORATION)
1001 19TH AVENUE SOUTH
NASHVILLE, TN 37212

FOR: PRINTED MATERIALS, NAMELY, BOOKS,
MAGAZINES, NEWSPAPERS, PAMPHLETS AND
OTHER PRINTED INSTRUCTIONAL MATERIAL
IN THE FIELD OF RELIGIOUS EDUCATION AND
PROMOTION OF RELIGIOUS CONFERENCES,
EVENTS, ORGANIZATIONS AND RELIGION IN
GENERAL, IN CLASS 16 (U.S. CLS. 2, 5, 22, 23, 29,
37, 38 AND 50).

FIRST USE 0-0-1972; IN COMMERCE 0-0-1972.

THE MARK CONSISTS OF STANDARD CHAR-
ACTERS WITHOUT CLAIM TO ANY PARTICULAR
FONT, STYLE, SIZE, OR COLOR.

SEC. 2(F).

SER. NO. 77-518,255, FILED 7-9-2008.

ZHALEH DELANEY, EXAMINING ATTORNEY

Int. Cls.: 9, 10 and 21

**Prior U.S. Cls.: 2, 13, 21, 23, 26, 29, 30, 33, 36, 38, 39,
40, 44 and 50**

Reg. No. 3,575,882

United States Patent and Trademark Office

Registered Feb. 17, 2009

**TRADEMARK
PRINCIPAL REGISTER**

New Age

TRONEX INTERNATIONAL, INC. (NEW JERSEY CORPORATION)
ONE TRONEX CENTRE, 2 CRANBERRY ROAD
PARSIPPANY, NJ 07054

FOR: DISPOSABLE PLASTIC GLOVES FOR LABORATORY USE; GLOVES FOR PROTECTION AGAINST ACCIDENTS; PROTECTIVE GLOVES FOR INDUSTRIAL USE, IN CLASS 9 (U.S. CLS. 21, 23, 26, 36 AND 38).

FIRST USE 11-0-2006; IN COMMERCE 11-0-2006.

FOR: DENTAL GLOVES; GLOVES FOR MEDICAL PURPOSES; GLOVES FOR MEDICAL USE; GLOVES FOR USE IN HOSPITALS; MEDICAL EXAMINATION GLOVES; MEDICAL GLOVES; PROTECTIVE GLOVES FOR MEDICAL USE, IN CLASS 10 (U.S. CLS. 26, 39 AND 44).

FIRST USE 11-0-2006; IN COMMERCE 11-0-2006.

FOR: DISPOSABLE GLOVES FOR HOME USE; DISPOSABLE LATEX AND NITRILE GLOVES FOR GENERAL USE; DISPOSABLE PLASTIC GLOVES FOR GENERAL USE; DISPOSABLE PLASTIC GLOVES FOR USE IN THE FOOD SERVICE INDUSTRY; GLOVES FOR HOUSEHOLD PURPOSES; HOUSEHOLD GLOVES FOR GENERAL USE; HOUSEHOLD PLASTIC GLOVES; PLASTIC HOUSEHOLD GLOVES; RUBBER HOUSEHOLD GLOVES, IN CLASS 21 (U.S. CLS. 2, 13, 23, 29, 30, 33, 40 AND 50).

FIRST USE 11-0-2006; IN COMMERCE 11-0-2006.

THE MARK CONSISTS OF STANDARD CHARACTERS WITHOUT CLAIM TO ANY PARTICULAR FONT, STYLE, SIZE, OR COLOR.

SER. NO. 77-518,265, FILED 7-9-2008.

GEOFFREY FOSDICK, EXAMINING ATTORNEY

Int. Cl.: 9

Prior U.S. Cls.: 21, 23, 26, 36 and 38

United States Patent and Trademark Office

Reg. No. 3,575,883

Registered Feb. 17, 2009

**TRADEMARK
PRINCIPAL REGISTER**



STOOPID, INC. (NEVADA CORPORATION)
P.O. BOX 10927
TRUCKEE, CA 96162

THE MARK CONSISTS OF AN IMAGE OF A PAIR
OF SUNGLASSES VIEWED FROM THE FRONT
WITH PAINT SPLATTERED ON THE LENSES.

FOR: SUNGLASSES, IN CLASS 9 (U.S. CLS. 21, 23,
26, 36 AND 38).

SER. NO. 77-518,285, FILED 7-9-2008.

FIRST USE 10-15-2007; IN COMMERCE 10-15-2007.

LANA PHAM, EXAMINING ATTORNEY

Int. Cl.: 29

Prior U.S. Cl.: 46

United States Patent and Trademark Office

Reg. No. 3,575,884

Registered Feb. 17, 2009

**TRADEMARK
PRINCIPAL REGISTER**

PORKITO

OLÉ MEXICAN FOODS, INC. (GEORGIA COR-
PORATION)
6585 CRESCENT DRIVE
NORCROSS, GA 30071

THE MARK CONSISTS OF STANDARD CHAR-
ACTERS WITHOUT CLAIM TO ANY PARTICULAR
FONT, STYLE, SIZE, OR COLOR.

FOR: MEXICAN STYLE FOOD PRODUCTS,
NAMELY, CHICHARRONES, IN CLASS 29 (U.S.
CL. 46).

SER. NO. 77-518,297, FILED 7-9-2008.

FIRST USE 2-0-2004; IN COMMERCE 2-0-2004.

CURTIS FRENCH, EXAMINING ATTORNEY

Int. Cl.: 28

Prior U.S. Cls.: 22, 23, 38 and 50

Reg. No. 3,575,885

United States Patent and Trademark Office

Registered Feb. 17, 2009

**TRADEMARK
PRINCIPAL REGISTER**

TITAN

RAWLINGS SPORTING GOODS COMPANY,
INC. (DELAWARE CORPORATION)
2100 N. JACKSON STREET
TULLAHOMA, TN 37388

THE MARK CONSISTS OF STANDARD CHAR-
ACTERS WITHOUT CLAIM TO ANY PARTICULAR
FONT, STYLE, SIZE, OR COLOR.

FOR: SPORTING GOODS, NAMELY, SOFTBALL
BATS, BASEBALL BATS, IN CLASS 28 (U.S. CLS. 22,
23, 38 AND 50).

SER. NO. 77-518,305, FILED 7-9-2008.

FIRST USE 2-8-2008; IN COMMERCE 2-8-2008.

NAAKWAMA ANKRAH, EXAMINING ATTORNEY

Int. Cl.: 28

Prior U.S. Cls.: 22, 23, 38 and 50

United States Patent and Trademark Office

Reg. No. 3,575,886

Registered Feb. 17, 2009

**TRADEMARK
PRINCIPAL REGISTER**

SILENCER

RAWLINGS SPORTING GOODS COMPANY,
INC. (DELAWARE CORPORATION)
2100 N. JACKSON STREET
TULLAHOMA, TN 37388

FOR: SPORTING GOODS, NAMELY, BASEBALL
BATS, SOFTBALL BATS, BASEBALL GLOVES,
SOFTBALL GLOVES, BASEBALL MITTS, SOFT-
BALL MITTS, BASEBALL BAT GRIP TAPE, SOFT-
BALL BAT GRIP TAPE, IN CLASS 28 (U.S. CLS. 22, 23,
38 AND 50).

FIRST USE 7-1-2005; IN COMMERCE 7-1-2005.

THE MARK CONSISTS OF STANDARD CHAR-
ACTERS WITHOUT CLAIM TO ANY PARTICULAR
FONT, STYLE, SIZE, OR COLOR.

SER. NO. 77-518,310, FILED 7-9-2008.

NAAKWAMA ANKRAH, EXAMINING ATTORNEY

Int. Cl.: 44

Prior U.S. Cls.: 100 and 101

United States Patent and Trademark Office

Reg. No. 3,575,887

Registered Feb. 17, 2009

**SERVICE MARK
PRINCIPAL REGISTER**

WISEGRASS

D.Z. STOLTZFUS LANDSCAPING, INC. (PENNSYLVANIA CORPORATION)
229 SNAKE HILL RD.
BIRD IN HAND, PA 17505

THE MARK CONSISTS OF STANDARD CHARACTERS WITHOUT CLAIM TO ANY PARTICULAR FONT, STYLE, SIZE, OR COLOR.

FOR: LAWN CARE, IN CLASS 44 (U.S. CLS. 100 AND 101).

SER. NO. 77-518,314, FILED 7-9-2008.

FIRST USE 6-1-2008; IN COMMERCE 6-1-2008.

JUDITH HELFMAN, EXAMINING ATTORNEY

Int. Cl.: 20

Prior U.S. Cls.: 2, 13, 22, 25, 32 and 50

Reg. No. 3,575,888

United States Patent and Trademark Office

Registered Feb. 17, 2009

**TRADEMARK
PRINCIPAL REGISTER**



IBC GROUP, INC. (DELAWARE CORPORATION)
730 W. MCNAB ROAD
FT. LAUDERDALE, FL 33309

FOR: SLEEP PRODUCTS, NAMELY, MATTRESSES, SPRING MATTRESSES, BOX SPRINGS AND MATTRESS FOUNDATIONS, IN CLASS 20 (U.S. CLS. 2, 13, 22, 25, 32 AND 50).

FIRST USE 3-1-2008; IN COMMERCE 3-1-2008.

THE COLOR(S) BLACK, WHITE AND GREEN IS/ARE CLAIMED AS A FEATURE OF THE MARK.

THE MARK CONSISTS OF THE WORDS "ORIGINS WHERE DREAMS BEGIN" IN STYLIZED LETTERING AND ASSOCIATED DESIGN. THE WORDING "ORIGINS WHERE DREAMS BEGIN" APPEARS IN WHITE AND IS LOCATED BELOW THE DESIGN. THE DESIGN APPEARS IN THE COLOR GREEN AND IS AN ABSTRACT REPRESENTATION OF THE LETTER "X," FORMED BY MULTIPLE SPHERES THAT VARY IN SIZE. THE BACKGROUND COLOR OF THE MARK IS BLACK.

SER. NO. 77-518,316, FILED 7-9-2008.

JUDITH HELFMAN, EXAMINING ATTORNEY

Int. Cl.: 35

Prior U.S. Cls.: 100, 101 and 102

United States Patent and Trademark Office

Reg. No. 3,575,889

Registered Feb. 17, 2009

**SERVICE MARK
PRINCIPAL REGISTER**

**GENERAL BOARD OF HIGHER
EDUCATION & MINISTRY**

GENERAL BOARD OF HIGHER EDUCATION
AND MINISTRY OF THE UNITED METHO-
DIST CHURCH (TENNESSEE NON-PROFIT
CORPORATION)
1001 19TH AVENUE SOUTH
NASHVILLE, TN 37212

FOR: PROVIDING ASSOCIATION SERVICES,
NAMELY, PROMOTING THE INTERESTS OF
CHRISTIAN LAY AND CLERGY LEADERS; PRO-
VIDING CAREER INFORMATION TO CHRISTIAN
LAY AND CLERGY LEADERS; CONSULTING IN
THE FIELD OF HUMAN RESOURCES DEVELOP-
MENT FOR RELIGIOUS ORGANIZATIONS, NAME-
LY, FOR THE PROMOTION OF CHRISTIAN LAY
AND CLERGY LEADER RETENTION AND CA-

REER GROWTH, IN CLASS 35 (U.S. CLS. 100, 101
AND 102).

FIRST USE 0-0-1972; IN COMMERCE 0-0-1972.

THE MARK CONSISTS OF STANDARD CHAR-
ACTERS WITHOUT CLAIM TO ANY PARTICULAR
FONT, STYLE, SIZE, OR COLOR.

SEC. 2(F).

SER. NO. 77-518,329, FILED 7-9-2008.

ZHALEH DELANEY, EXAMINING ATTORNEY

Int. Cl.: 7

Prior U.S. Cls.: 13, 19, 21, 23, 31, 34 and 35

United States Patent and Trademark Office

Reg. No. 3,575,890

Registered Feb. 17, 2009

**TRADEMARK
PRINCIPAL REGISTER**

APSTAR

FOSHAN NANHAI DONGFANG CARTON MACHINERY CO., LTD. (CHINA LIMITED LIABILITY COMPANY)
SHISHAN TECHNICAL INDUSTRIAL ZONE
SHISHAN ROAD NORTH, NANHAI DISTRICT
FOSHAN CITY, GUANGDONG, CHINA

FOR: EMBOSsing MACHINES; FLEXOGRAPHIC PRINTING MACHINES; INKING APPARATUS FOR PRINTING BLOCKS; INTAGLIO PRINTING MACHINES; MACHINE PARTS, NAMELY, CYLINDERS; MACHINE-OPERATED PLATFORMS FOR STORING PAPER IN PRINTING PRESSES DURING THE PRINTING PROCESS; PACKAGING MACHINES; PACKING MACHINES; PAPER BAG MAKING MACHINES; PAPER CALENDERING MACHINES; PAPER COATING MACHINES; PAPER CUTTING MACHINES; PAPER REELING MACHINES; PAPER SHREDDING MACHINES; PHOTOGRAVURE PRINTING PRESSES; PHOTOTYPESETTING OR COMPOSING MA-

CHINES; PLANOGRAPHIC PRINTING MACHINES; PRESS FABRIC FOR PAPER MAKING MACHINES; PRINTING MACHINES FOR COMMERCIAL OR INDUSTRIAL USE; PRINTING PLATES; PRINTING PRESSES; PRINTING PRESSES FOR CERAMIC MATERIAL; ROLLERS FOR ROTARY PRINTING MACHINES; SHEAF-BINDING MACHINES; SHREDDING MACHINES; TYPESETTING MACHINES; WRAPPING MACHINES, IN CLASS 7 (U.S. CLS. 13, 19, 21, 23, 31, 34 AND 35).

FIRST USE 9-6-2004; IN COMMERCE 3-31-2006.

THE MARK CONSISTS OF CAPITALIZED LETTERS APSTAR, WHICH HAS NO SPECIFIC MEANINGS IN ENGLISH.

SER. NO. 77-518,339, FILED 7-9-2008.

EMILY CARLSEN, EXAMINING ATTORNEY

Int. Cl.: 35

Prior U.S. Cls.: 100, 101 and 102

United States Patent and Trademark Office

Reg. No. 3,575,891

Registered Feb. 17, 2009

**SERVICE MARK
PRINCIPAL REGISTER**

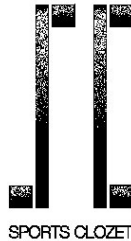

EXCEED MANAGEMENT SERVICES, LLC
(TEXAS LIMITED LIABILITY COMPANY),
DBA SPORTS CLOZET
P.O. BOX 6929
KINGWOOD, TX 77325

FOR: RETAIL SPORTING GOODS STORES, IN
CLASS 35 (U.S. CLS. 100, 101 AND 102).

FIRST USE 3-20-2008; IN COMMERCE 3-24-2008.

NO CLAIM IS MADE TO THE EXCLUSIVE
RIGHT TO USE "SPORTS", APART FROM THE
MARK AS SHOWN.

THE STIPPLING IS FOR SHADING PURPOSES
ONLY.

THE MARK CONSISTS OF THE STYLIZED
WORDS "SPORTS CLOZET". ABOVE THE STY-
LIZED WORDS IS AN IMAGE OF A TWO VERTI-
CAL LINES IN SERIES. THE LEFT LINE IN SERIES
HAS A SQUARE AT THE LEFT BASE AND AN-
OTHER SQUARE AT THE RIGHT TOP. THE RIGHT
LINE IN SERIES HAS A SQUARE AT THE RIGHT
BASE AND ANOTHER SQUARE AT THE RIGHT
TOP.

SER. NO. 77-518,346, FILED 7-9-2008.

EMILY CARLSEN, EXAMINING ATTORNEY

Int. Cl.: 36

Prior U.S. Cls.: 100, 101 and 102

United States Patent and Trademark Office

Reg. No. 3,575,892

Registered Feb. 17, 2009

**SERVICE MARK
PRINCIPAL REGISTER**

**GENERAL BOARD OF HIGHER
EDUCATION & MINISTRY**

GENERAL BOARD OF HIGHER EDUCATION
AND MINISTRY OF THE UNITED METHO-
DIST CHURCH (TENNESSEE NON-PROFIT
CORPORATION)
1001 19TH AVENUE SOUTH
NASHVILLE, TN 37212

FOR: CHARITABLE FUNDRAISING SERVICES
FOR A PARTICULAR RELIGIOUS ORGANIZA-
TION; CHARITABLE SERVICES, NAMELY,
GRANTING FUNDS TO EDUCATIONAL INSTITU-
TIONS AFFILIATED WITH A PARTICULAR RELI-
GIOUS ORGANIZATION; LOAN FINANCING
PROVIDED TO EDUCATIONAL INSTITUTIONS
AFFILIATED WITH A PARTICULAR RELIGIOUS
ORGANIZATION; PROVIDING STUDENT LOAN
SERVICES AND EDUCATIONAL SCHOLARSHIPS

TO STUDENTS OF EDUCATIONAL INSTITUTIONS
AFFILIATED WITH A PARTICULAR RELIGIOUS
ORGANIZATION, IN CLASS 36 (U.S. CLS. 100, 101
AND 102).

FIRST USE 0-0-1972; IN COMMERCE 0-0-1972.

THE MARK CONSISTS OF STANDARD CHAR-
ACTERS WITHOUT CLAIM TO ANY PARTICULAR
FONT, STYLE, SIZE, OR COLOR.

SEC. 2(F).

SER. NO. 77-518,362, FILED 7-9-2008.

ZHALEH DELANEY, EXAMINING ATTORNEY

Int. Cl.: 16

Prior U.S. Cls.: 2, 5, 22, 23, 29, 37, 38 and 50

United States Patent and Trademark Office

Reg. No. 3,575,893

Registered Feb. 17, 2009

TRADEMARK
PRINCIPAL REGISTER



DIANE R. JEFFERSON (UNITED STATES INDIVIDUAL)
P.O. BOX 44
29500 HWY M
MIDDLETOWN, MO 63359

FOR: GREETING CARDS, IN CLASS 16 (U.S. CLS. 2, 5, 22, 23, 29, 37, 38 AND 50).

FIRST USE 6-1-2008; IN COMMERCE 6-1-2008.

NO CLAIM IS MADE TO THE EXCLUSIVE RIGHT TO USE "DESIGNS", APART FROM THE MARK AS SHOWN.

THE MARK CONSISTS OF THE WORDS "DI'S DESIGNS" IN STYLIZED LETTERING AND THE ASSOCIATED DESIGN, LOCATED IMMEDIATELY TO THE RIGHT OF THE WORDS, OF A LEFT-FACING BIRD, RESEMBLING A BIRD OF PARADISE, PERCHED ON A LEAFLESS TREE BRANCH.

SER. NO. 77-518,392, FILED 7-9-2008.

JUDITH HELFMAN, EXAMINING ATTORNEY

Int. Cl.: 44

Prior U.S. Cls.: 100 and 101

United States Patent and Trademark Office

Reg. No. 3,575,894

Registered Feb. 17, 2009

**SERVICE MARK
PRINCIPAL REGISTER**

MANA ROCKS

MANA MASSAGE LLC (OREGON LIMITED LIABILITY COMPANY)
811 E BURNSIDE ST STE 218
PORTLAND, OR 97214

THE MARK CONSISTS OF STANDARD CHARACTERS WITHOUT CLAIM TO ANY PARTICULAR FONT, STYLE, SIZE, OR COLOR.

FOR: MASSAGE THERAPY SERVICES, IN CLASS 44 (U.S. CLS. 100 AND 101).

SER. NO. 77-518,402, FILED 7-9-2008.

FIRST USE 9-10-2007; IN COMMERCE 9-10-2007.

MARGERY A. TIERNEY, EXAMINING ATTORNEY

Int. Cl.: 25

Prior U.S. Cls.: 22 and 39

United States Patent and Trademark Office

Reg. No. 3,575,895

Registered Feb. 17, 2009

TRADEMARK
PRINCIPAL REGISTER

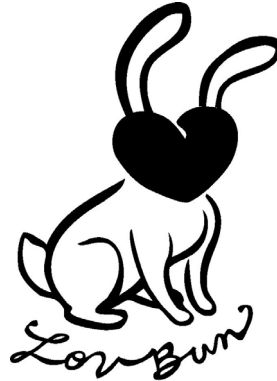

DOWELL, MICHAEL (UNITED STATES INDIVIDUAL)
579 W. LOMA ALTA DR.
ALTADENA, CA 91001

FOR: JACKETS; PANTS; SHIRTS; SHOES; SHORTS; SOCKS; UNDERWEAR, IN CLASS 25 (U.S. CLS. 22 AND 39).

FIRST USE 9-15-2001; IN COMMERCE 3-1-2002.

THE MARK CONSISTS OF A HEART-SHAPED HEAD WITH BUNNY EARS. THE HEART SHAPE IS POSITIONED IN THE PLACE WHERE THE BUNNY'S HEAD WOULD APPEAR AND IS CONNECTED TO THE EARS. BELOW THE STYLIZED TEXT "LOVBUN" APPEARS.

SER. NO. 77-518,405, FILED 7-9-2008.

MARGERY A. TIERNEY, EXAMINING ATTORNEY

Int. Cl.: 41

Prior U.S. Cls.: 100, 101 and 107

United States Patent and Trademark Office

Reg. No. 3,575,896

Registered Feb. 17, 2009

**SERVICE MARK
PRINCIPAL REGISTER**

GO DEEP

MANDALAY RESORT GROUP (NEVADA COR-
PORATION)
3950 LAS VEGAS BOULEVARD SOUTH
LAS VEGAS, NV 89119

FOR: ENTERTAINMENT SERVICES IN THE
NATURE OF PROVIDING AQUARIUM FACILITIES
TO THE PUBLIC, IN CLASS 41 (U.S. CLS. 100, 101
AND 107).

FIRST USE 8-17-2007; IN COMMERCE 8-17-2007.

THE MARK CONSISTS OF STANDARD CHAR-
ACTERS WITHOUT CLAIM TO ANY PARTICULAR
FONT, STYLE, SIZE, OR COLOR.

SER. NO. 77-518,414, FILED 7-9-2008.

JUDITH HELFMAN, EXAMINING ATTORNEY

Int. Cl.: 25

Prior U.S. Cls.: 22 and 39

United States Patent and Trademark Office

Reg. No. 3,575,897

Registered Feb. 17, 2009

**TRADEMARK
PRINCIPAL REGISTER**

MANIFESTO

A & E STORES INC. (NEW YORK CORPORATION)
1000 HUYLER STREET
TETERBORO, NJ 07608

THE MARK CONSISTS OF STANDARD CHARACTERS WITHOUT CLAIM TO ANY PARTICULAR FONT, STYLE, SIZE, OR COLOR.

FOR: BLOUSES; COTTON KNIT TOPS; PANTS; JACKETS; BLAZERS; CAMISOLES, VESTS, IN CLASS 25 (U.S. CLS. 22 AND 39).

SER. NO. 77-518,426, FILED 7-9-2008.

FIRST USE 8-22-1985; IN COMMERCE 9-20-1985.

LOURDES AYALA, EXAMINING ATTORNEY

Int. Cl.: 28

Prior U.S. Cls.: 22, 23, 38 and 50

United States Patent and Trademark Office

Reg. No. 3,575,898

Registered Feb. 17, 2009

**TRADEMARK
PRINCIPAL REGISTER**

KITEWORKS

ALONSO, FRANK (UNITED STATES INDIVIDUAL)
30765 PACIFIC COAST HWY
MALIBU, CA 89120

THE MARK CONSISTS OF STANDARD CHARACTERS WITHOUT CLAIM TO ANY PARTICULAR FONT, STYLE, SIZE, OR COLOR.

FOR: KITES AND KITE ACCESSORIES, NAMELY, HANDLES, LINES, PARTS, REELS, STRING AND TAILS, IN CLASS 28 (U.S. CLS. 22, 23, 38 AND 50).

SER. NO. 77-518,431, FILED 7-9-2008.

FIRST USE 9-1-2007; IN COMMERCE 5-22-2008.

LINDSEY RUBIN, EXAMINING ATTORNEY

Int. Cl.: 16

Prior U.S. Cls.: 2, 5, 22, 23, 29, 37, 38 and 50

Reg. No. 3,575,899

United States Patent and Trademark Office

Registered Feb. 17, 2009

**TRADEMARK
PRINCIPAL REGISTER**

ETI-KITS

AMOROSO, SHARYN KENNEDY (UNITED STATES INDIVIDUAL)
149 WILKIE DRIVE
WALNUT CREEK, CA 94598

FIRST USE 3-1-2005; IN COMMERCE 1-9-2006.

FOR: MANUALS, PAMPHLETS, BOOKS, GUIDES, NOTE CARDS, REMINDER CARDS AND BOOKLETS FOR TEACHING MANNERS AND/OR ETIQUETTE, IN CLASS 16 (U.S. CLS. 2, 5, 22, 23, 29, 37, 38 AND 50).

THE MARK CONSISTS OF STANDARD CHARACTERS WITHOUT CLAIM TO ANY PARTICULAR FONT, STYLE, SIZE, OR COLOR.

SER. NO. 77-518,445, FILED 7-9-2008.

LOURDES AYALA, EXAMINING ATTORNEY

Int. Cl.: 44

Prior U.S. Cls.: 100 and 101

United States Patent and Trademark Office

Reg. No. 3,575,900

Registered Feb. 17, 2009

**SERVICE MARK
PRINCIPAL REGISTER**

The logo features the word "wink" in a bold, lowercase, sans-serif font. The letter "k" is significantly larger and more stylized than the other letters, with a long, thin vertical stroke extending upwards. Below "wink", the word "SALON" is written in a smaller, all-caps, spaced-out sans-serif font.

THE LUDLOW GROUP, INC. (VIRGINIA CORPORATION)
SUITE 108
228 N LYNNHAVEN ROAD
VIRGINIA BEACH, VA 23452

FOR: HAIR SALON SERVICES, IN CLASS 44 (U.S. CLS. 100 AND 101).

FIRST USE 8-18-2006; IN COMMERCE 8-18-2006.

NO CLAIM IS MADE TO THE EXCLUSIVE RIGHT TO USE "SALON", APART FROM THE MARK AS SHOWN.

THE MARK CONSISTS OF THE STYLIZED TEXT "WINK" ON TOP AND THE STYLIZED TEXT "SALON" AT THE BOTTOM.

SER. NO. 77-518,446, FILED 7-9-2008.

MICHAEL KEATING, EXAMINING ATTORNEY

Int. Cl.: 35

Prior U.S. Cls.: 100, 101 and 102

United States Patent and Trademark Office

Reg. No. 3,575,901

Registered Feb. 17, 2009

**SERVICE MARK
PRINCIPAL REGISTER**

The City At Your Fingertips

D'AMICO, ADRIAN (UNITED STATES INDIVIDUAL)
577 DORSEYVILLE ROAD
PITTSBURGH, PA 15238

FOR: ADVERTISING AND PUBLICITY SERVICES, NAMELY, PROMOTING THE GOODS, SERVICES, BRAND IDENTITY AND COMMERCIAL INFORMATION AND NEWS OF THIRD PARTIES THROUGH PRINT, AUDIO, VIDEO, DIGITAL AND ON-LINE MEDIUM, IN CLASS 35 (U.S. CLS. 100, 101 AND 102).

FIRST USE 5-0-2007; IN COMMERCE 3-0-2008.

THE MARK CONSISTS OF STANDARD CHARACTERS WITHOUT CLAIM TO ANY PARTICULAR FONT, STYLE, SIZE, OR COLOR.

SER. NO. 77-518,452, FILED 7-9-2008.

LIEF MARTIN, EXAMINING ATTORNEY

Int. Cl.: 29

Prior U.S. Cl.: 46

United States Patent and Trademark Office

Reg. No. 3,575,902

Registered Feb. 17, 2009

TRADEMARK
PRINCIPAL REGISTER

Emily G's

jam of love



EMILY G'S (GEORGIA LIMITED LIABILITY
COMPANY)
PMB 164
5588 CHAMBLEE DUNWOODY ROAD
DUNWOODY, GA 30338

FOR: JAMS, IN CLASS 29 (U.S. CL. 46).

FIRST USE 5-1-2008; IN COMMERCE 5-10-2008.

NO CLAIM IS MADE TO THE EXCLUSIVE
RIGHT TO USE "JAM" , APART FROM THE MARK
AS SHOWN.

THE NAME IN THE MARK DOES NOT IDENTIFY
A LIVING INDIVIDUAL.

THE MARK CONSISTS OF THE STYLIZED TEXT
"EMILY G'S JAM OF LOVE". BELOW THE TEXT A
HEART APPEARS.

SER. NO. 77-518,473, FILED 7-9-2008.

KEVIN DINALLO, EXAMINING ATTORNEY

Int. Cl.: 35

Prior U.S. Cls.: 100, 101 and 102

United States Patent and Trademark Office

Reg. No. 3,575,903

Registered Feb. 17, 2009

**SERVICE MARK
PRINCIPAL REGISTER**

280 CAPITAL PARTNERS

280 CAPITAL PARTNERS LLC (DELAWARE
LIMITED LIABILITY COMPANY)

1560 SUNNYVALE SARATOGA ROAD

SUNNYVALE, CA 94087

FOR: BUSINESS CONSULTATION SERVICES, IN
CLASS 35 (U.S. CLS. 100, 101 AND 102).

FIRST USE 12-14-2007; IN COMMERCE 12-14-2007.

THE MARK CONSISTS OF STANDARD CHAR-
ACTERS WITHOUT CLAIM TO ANY PARTICULAR
FONT, STYLE, SIZE, OR COLOR.

NO CLAIM IS MADE TO THE EXCLUSIVE
RIGHT TO USE "CAPITAL" AND "PARTNERS",
APART FROM THE MARK AS SHOWN.

SER. NO. 77-518,475, FILED 7-9-2008.

RENEE SERVANCE, EXAMINING ATTORNEY

Int. Cl.: 41

Prior U.S. Cls.: 100, 101 and 107

United States Patent and Trademark Office

Reg. No. 3,575,904

Registered Feb. 17, 2009

**SERVICE MARK
PRINCIPAL REGISTER**

MY SENSUAL GIFT

NOLAN CONLEY, INC. (TEXAS CORPORATION)
4823 MARYWOOD DRIVE
SPRING, TX 77388

THE MARK CONSISTS OF STANDARD CHAR-
ACTERS WITHOUT CLAIM TO ANY PARTICULAR
FONT, STYLE, SIZE, OR COLOR.

FOR: PHOTOGRAPHY SERVICES, IN CLASS 41
(U.S. CLS. 100, 101 AND 107).

SER. NO. 77-518,476, FILED 7-9-2008.

FIRST USE 5-12-2007; IN COMMERCE 5-12-2007.

JOHN WILKE, EXAMINING ATTORNEY

Int. Cl.: 36

Prior U.S. Cls.: 100, 101 and 102

United States Patent and Trademark Office

Reg. No. 3,575,905

Registered Feb. 17, 2009

**SERVICE MARK
PRINCIPAL REGISTER**

280 CAPITAL PARTNERS

280 CAPITAL PARTNERS LLC (DELAWARE
LIMITED LIABILITY COMPANY)
1560 SUNNYVALE SARATOGA ROAD
SUNNYVALE, CA 94087

FOR: INVESTMENT MANAGEMENT; INVEST-
MENT ADVICE; VENTURE CAPITAL FINANCING
SERVICES, IN CLASS 36 (U.S. CLS. 100, 101 AND 102).

FIRST USE 12-14-2007; IN COMMERCE 12-14-2007.

THE MARK CONSISTS OF STANDARD CHAR-
ACTERS WITHOUT CLAIM TO ANY PARTICULAR
FONT, STYLE, SIZE, OR COLOR.

NO CLAIM IS MADE TO THE EXCLUSIVE
RIGHT TO USE "CAPITAL" AND "PARTNERS",
APART FROM THE MARK AS SHOWN.

SER. NO. 77-518,478, FILED 7-9-2008.

RENEE SERVANCE, EXAMINING ATTORNEY

Int. Cl.: 35

Prior U.S. Cls.: 100, 101 and 102

United States Patent and Trademark Office

Reg. No. 3,575,906

Registered Feb. 17, 2009

**SERVICE MARK
PRINCIPAL REGISTER**



280 CAPITAL PARTNERS LLC (DELAWARE
LIMITED LIABILITY COMPANY)
1560 SUNNYVALE SARATOGA ROAD
SUNNYVALE, CA 94087

FOR: BUSINESS CONSULTATION SERVICES, IN
CLASS 35 (U.S. CLS. 100, 101 AND 102).

FIRST USE 12-14-2007; IN COMMERCE 12-14-2007.

NO CLAIM IS MADE TO THE EXCLUSIVE
RIGHT TO USE "CAPITAL" AND "PARTNERS",
APART FROM THE MARK AS SHOWN.

THE COLOR(S) LIGHT BLUE, DARK BLUE,
GRAY AND WHITE IS/ARE CLAIMED AS A FEAT-
TURE OF THE MARK.

THE MARK CONSISTS OF A DIVIDED PARTIAL-
LY SHADED DIAMOND CONTAINING THE COL-
ORS LIGHT BLUE, DARK BLUE, GREY AND
WHITE. TO THE RIGHT OF THE DESIGN IS THE
NUMBER "280" IN DARK BLUE AND THE WORD-
ING "CAPITAL" IN GREY AND "PARTNERS" IN
DARK BLUE.

SER. NO. 77-518,499, FILED 7-9-2008.

RENEE SERVANCE, EXAMINING ATTORNEY

Int. Cl.: 36

Prior U.S. Cls.: 100, 101 and 102

United States Patent and Trademark Office

Reg. No. 3,575,907

Registered Feb. 17, 2009

**SERVICE MARK
PRINCIPAL REGISTER**



280 CAPITAL PARTNERS LLC (DELAWARE
LIMITED LIABILITY COMPANY)
1560 SUNNYVALE SARATOGA ROAD
SUNNYVALE, CA 94087

FOR: INVESTMENT MANAGEMENT; INVEST-
MENT ADVICE; VENTURE CAPITAL FINANCING
SERVICES, IN CLASS 36 (U.S. CLS. 100, 101 AND 102).

FIRST USE 12-14-2007; IN COMMERCE 12-14-2007.

NO CLAIM IS MADE TO THE EXCLUSIVE
RIGHT TO USE "CAPITAL" AND "PARTNERS",
APART FROM THE MARK AS SHOWN.

THE COLOR(S) LIGHT BLUE, DARK BLUE,
WHITE AND GRAY IS/ARE CLAIMED AS A FEAT-
URE OF THE MARK.

THE MARK CONSISTS OF A DIVIDED PARTIAL-
LY SHADED DIAMOND CONTAINING THE COL-
ORS LIGHT BLUE, DARK BLUE, GREY AND
WHITE. TO THE RIGHT OF THE DESIGN IS THE
NUMBER "280" IN DARK BLUE AND THE WORD-
ING "CAPITAL" IN GREY AND "PARTNERS" IN
DARK BLUE.

SER. NO. 77-518,512, FILED 7-9-2008.

RENEE SERVANCE, EXAMINING ATTORNEY

Int. Cl.: 10

Prior U.S. Cls.: 26, 39 and 44

United States Patent and Trademark Office

Reg. No. 3,575,908

Registered Feb. 17, 2009

**TRADEMARK
PRINCIPAL REGISTER**

element

EVAN MORGANSTERN (UNITED STATES INDIVIDUAL)
106 SOUTH KIHRRIDGE
ENCINITAS, CA 92024

FOR: MASSAGE APPARATUS; MASSAGE APPARATUS AND INSTRUMENTS; MASSAGING APPARATUS FOR PERSONAL USE, IN CLASS 10 (U.S. CLS. 26, 39 AND 44).

FIRST USE 8-17-2007; IN COMMERCE 8-20-2007.

THE MARK CONSISTS OF STANDARD CHARACTERS WITHOUT CLAIM TO ANY PARTICULAR FONT, STYLE, SIZE, OR COLOR.

SER. NO. 77-518,537, FILED 7-9-2008.

MICHAEL SOUDERS, EXAMINING ATTORNEY

Int. Cl.: 16

Prior U.S. Cls.: 2, 5, 22, 23, 29, 37, 38 and 50

United States Patent and Trademark Office

Reg. No. 3,575,909

Registered Feb. 17, 2009

**TRADEMARK
PRINCIPAL REGISTER**

The Pinstriped Bible

GOLDMAN, STEVEN, B. (UNITED STATES IN-
DIVIDUAL)
8 WINTERBERRY COURT
EAST BRUNSWICK, NJ 08816

FOR: COLUMNS ON THE SUBJECT OF SPORTS,
POPULAR CULTURE, HISTORY, AND POLITICS,
IN CLASS 16 (U.S. CLS. 2, 5, 22, 23, 29, 37, 38 AND 50).

FIRST USE 5-20-2001; IN COMMERCE 5-20-2001.

THE MARK CONSISTS OF STANDARD CHAR-
ACTERS WITHOUT CLAIM TO ANY PARTICULAR
FONT, STYLE, SIZE, OR COLOR.

SER. NO. 77-518,570, FILED 7-10-2008.

NAAKWAMA ANKRAH, EXAMINING ATTORNEY

Int. Cl.: 41

Prior U.S. Cls.: 100, 101 and 107

United States Patent and Trademark Office

Reg. No. 3,575,910

Registered Feb. 17, 2009

**SERVICE MARK
PRINCIPAL REGISTER**

Gyrenes

AVE MARIA UNIVERSITY, INC. (FLORIDA
CORPORATION)
5050 AVE MARIA BLVD.
AVE MARIA, FL 341429505

THE MARK CONSISTS OF STANDARD CHAR-
ACTERS WITHOUT CLAIM TO ANY PARTICULAR
FONT, STYLE, SIZE, OR COLOR.

FOR: ENTERTAINMENT IN THE NATURE OF
COMPETITIONS IN THE FIELD OF INTERCOL-
LEGIATE ATHLETICS, IN CLASS 41 (U.S. CLS. 100,
101 AND 107).

SER. NO. 77-518,579, FILED 7-10-2008.

FIRST USE 6-1-2008; IN COMMERCE 6-1-2008.

NAAKWAMA ANKRAH, EXAMINING ATTORNEY

Int. Cl.: 38

Prior U.S. Cls.: 100, 101 and 104

United States Patent and Trademark Office

Reg. No. 3,575,911

Registered Feb. 17, 2009

**SERVICE MARK
PRINCIPAL REGISTER**

DISCUMENTARY

PITTSBURGH COMMUNITY BROADCASTING
CORPORATION (PENNSYLVANIA CORPORATION)
67 BEDFORD SQUARE
PITTSBURGH, PA 15203

FOR: BROADCASTING OF RADIO PROGRAMMES, IN CLASS 38 (U.S. CLS. 100, 101 AND 104).

FIRST USE 10-9-1999; IN COMMERCE 10-9-1999.

THE MARK CONSISTS OF STANDARD CHARACTERS WITHOUT CLAIM TO ANY PARTICULAR FONT, STYLE, SIZE, OR COLOR.

SER. NO. 77-518,582, FILED 7-10-2008.

ROBIN CHOSID, EXAMINING ATTORNEY

Int. Cl.: 42

Prior U.S. Cls.: 100 and 101

United States Patent and Trademark Office

Reg. No. 3,575,912

Registered Feb. 17, 2009

**SERVICE MARK
PRINCIPAL REGISTER**

SECURE PASSAGE

SECURE PASSAGE, LLC (MISSOURI LIMITED
LIABILITY COMPANY)
SUITE 440
300 WYANDOTTE STREET
KANSAS CITY, MO 64105

FOR: COMPUTER NETWORK SERVICES, NAME-
LY, COMPUTER SOFTWARE AND NETWORK DE-
SIGN FOR OTHERS; COMPUTER SECURITY
SERVICES, NAMELY, RESTRICTING ACCESS TO
AND BY COMPUTER NETWORKS TO AND OF
UNDESIRE WEB SITES, MEDIA, INDIVIDUALS
AND FACILITIES; COMPUTER CONSULTATION
IN THE FIELD OF COMPUTER SECURITY; DEVEL-

OPMENT OF CUSTOMIZED SOFTWARE FOR OTH-
ERS FOR USE IN INFORMATION AND NETWORK
SECURITY, IN CLASS 42 (U.S. CLS. 100 AND 101).

FIRST USE 7-25-2003; IN COMMERCE 1-0-2004.

THE MARK CONSISTS OF STANDARD CHAR-
ACTERS WITHOUT CLAIM TO ANY PARTICULAR
FONT, STYLE, SIZE, OR COLOR.

SER. NO. 77-518,605, FILED 7-10-2008.

NAAKWAMA ANKRAH, EXAMINING ATTORNEY

Int. Cl.: 41

Prior U.S. Cls.: 100, 101 and 107

United States Patent and Trademark Office

Reg. No. 3,575,913

Registered Feb. 17, 2009

SERVICE MARK
PRINCIPAL REGISTER



NEW MEXICO LOTTERY AUTHORITY (NEW MEXICO BODY POLITIC AND CORPORATE)
4511 OSUNA RD. NE
ALBUQUERQUE, NM 87109

FOR: LOTTERY SERVICES, IN CLASS 41 (U.S. CLS. 100, 101 AND 107).

FIRST USE 5-26-2000; IN COMMERCE 8-5-2000.

NO CLAIM IS MADE TO THE EXCLUSIVE RIGHT TO USE "LOTTERY", APART FROM THE MARK AS SHOWN.

THE COLOR(S) GREEN, BLACK, RED, YELLOW AND ORANGE IS/ARE CLAIMED AS A FEATURE OF THE MARK.

THE MARK CONSISTS OF GREEN LETTERS WHICH SPELL "NEW MEXICO LOTTERY" ABOVE LARGE BLACK LETTERS WHICH SPELL "PICK" ABOVE A RED CHILE PEPPER WITH A GREEN STEM ALL ADJACENT TO A LARGE NUMERAL "3" IN GRADIENT SHADES OF RED, ORANGE AND YELLOW.

SEC. 2(F) AS TO "NEW MEXICO LOTTERY PICK 3".

SER. NO. 77-518,714, FILED 7-10-2008.

ANDREA BUTLER, EXAMINING ATTORNEY

Int. Cl.: 37

Prior U.S. Cls.: 100, 103 and 106

United States Patent and Trademark Office

Reg. No. 3,575,914

Registered Feb. 17, 2009

**SERVICE MARK
PRINCIPAL REGISTER**

TRUEPERFORMANCE

TRUEPERFORMANCE, INC. (OHIO CORPORATION)
7854 INDUSTRIAL PARKWAY
PLAIN CITY, OH 43064

THE MARK CONSISTS OF THE WORD "TRUE PERFORMANCE" IN STYLIZED LETTERS.

FOR: AUTOMOTIVE MAINTENANCE AND REPAIR, IN CLASS 37 (U.S. CLS. 100, 103 AND 106).

SER. NO. 77-518,722, FILED 7-10-2008.

FIRST USE 1-19-1991; IN COMMERCE 1-19-1991.

RENEE MCCRAY, EXAMINING ATTORNEY

Int. Cl.: 1

Prior U.S. Cls.: 1, 5, 6, 10, 26 and 46

Reg. No. 3,575,915

United States Patent and Trademark Office

Registered Feb. 17, 2009

**TRADEMARK
PRINCIPAL REGISTER**

MFA CROP ADVANTAGE

MFA INCORPORATED (MISSOURI CORPORATION)
201 RAY YOUNG DRIVE
COLUMBIA, MO 652013599

THE MARK CONSISTS OF STANDARD CHARACTERS WITHOUT CLAIM TO ANY PARTICULAR FONT, STYLE, SIZE, OR COLOR.

FOR: AGRICULTURAL ADJUVANTS AND SPRAY ADDITIVES FOR THE PURPOSE OF ENHANCING HERBICIDE, PESTICIDE, AND FUNGICIDE PERFORMANCE, IN CLASS 1 (U.S. CLS. 1, 5, 6, 10, 26 AND 46).

OWNER OF U.S. REG. NOS. 1,025,063, 2,199,792 AND OTHERS.

SER. NO. 77-518,750, FILED 7-10-2008.

FIRST USE 10-0-1999; IN COMMERCE 10-0-1999.

TASNEEM HUSSAIN, EXAMINING ATTORNEY

Int. Cl.: 39

Prior U.S. Cls.: 100 and 105

United States Patent and Trademark Office

Reg. No. 3,575,916

Registered Feb. 17, 2009

**SERVICE MARK
PRINCIPAL REGISTER**



CONTEXT WALKS LLC (DELAWARE LIMITED LIABILITY COMPANY), DBA CONTEXT ROME, CONTEXT PARIS, CONTEXT TRAVEL
2222 LOMBARD ST.
PHILADELPHIA, PA 19146

THE MARK CONSISTS OF THE STYLIZED WORD "CONTEXT" INSERTED BETWEEN TWO LINES.

FOR: TOUR GUIDE SERVICES; TOUR OPERATING AND ORGANISING, IN CLASS 39 (U.S. CLS. 100 AND 105).

SER. NO. 77-518,753, FILED 7-10-2008.

FIRST USE 1-1-2004; IN COMMERCE 1-1-2004.

TASNEEM HUSSAIN, EXAMINING ATTORNEY

Int. Cl.: 42

Prior U.S. Cls.: 100 and 101

United States Patent and Trademark Office

Reg. No. 3,575,917

Registered Feb. 17, 2009

**SERVICE MARK
PRINCIPAL REGISTER**

CaseSpace

SANFORD J. ASMAN (UNITED STATES INDIVIDUAL)
570 VININGTON COURT
ATLANTA, GA 303505710

FOR: PROVIDING ON-LINE NON-DOWNLOADABLE COMPUTER SOFTWARE FOR PROVIDING NETWORK BASED ACCESS TO LEGAL MATTERS; PROVIDING ON-LINE NON-DOWNLOADABLE COMPUTER SOFTWARE FOR PROVIDING ACCESS OVER THE INTERNET AND INTRANETS TO LITIGATION DOCUMENTS; AND PROVIDING ON-LINE NON-DOWNLOADABLE COMPUTER SOFTWARE FOR PROVIDING NETWORK BASED ACCESS TO LEGAL FILES OVER THE INTERNET AND

OVER INTRANETS, IN CLASS 42 (U.S. CLS. 100 AND 101).

FIRST USE 7-10-2008; IN COMMERCE 7-10-2008.

THE MARK CONSISTS OF STANDARD CHARACTERS WITHOUT CLAIM TO ANY PARTICULAR FONT, STYLE, SIZE, OR COLOR.

OWNER OF U.S. REG. NO. 3,316,614.

SER. NO. 77-518,783, FILED 7-10-2008.

KATINA MISTER, EXAMINING ATTORNEY

Int. Cl.: 35

Prior U.S. Cls.: 100, 101 and 102

United States Patent and Trademark Office

Reg. No. 3,575,918

Registered Feb. 17, 2009

**SERVICE MARK
PRINCIPAL REGISTER**



FIZOOK INC. (UTAH CORPORATION)
#220
10619 S. JORDAN GATEWAY
SOUTH JORDAN, UT 84095

FOR: ON-LINE AUCTION SERVICES, IN CLASS
35 (U.S. CLS. 100, 101 AND 102).

FIRST USE 1-1-2006; IN COMMERCE 11-1-2006.

THE STIPPLING IS FOR SHADING PURPOSES
ONLY.

THE MARK CONSISTS OF THE STYLIZED TEXT
"FIZOOK".

SER. NO. 77-518,798, FILED 7-10-2008.

KRISTIN CARLSON, EXAMINING ATTORNEY

Int. Cl.: 41

Prior U.S. Cls.: 100, 101 and 107

United States Patent and Trademark Office

Reg. No. 3,575,919

Registered Feb. 17, 2009

**SERVICE MARK
PRINCIPAL REGISTER**



TURNER NETWORK TELEVISION, INC. (GEORGIA CORPORATION)
C/O TURNER BROADCASTING SYSTEM, INC.
ONE CNN CENTER, 13 NORTH
ATLANTA, GA 30303

FOR: ENTERTAINMENT SERVICES, NAMELY, PROVISION OF ON-GOING MULTIMEDIA PROGRAMS IN THE FIELD OF ACTION, ADVENTURE, COMEDY, DRAMA AND SPORTS DISTRIBUTED VIA VARIOUS PLATFORMS ACROSS MULTIPLE FORMS OF TRANSMISSION MEDIA, IN CLASS 41 (U.S. CLS. 100, 101 AND 107).

FIRST USE 6-12-2001; IN COMMERCE 6-12-2001.

OWNER OF U.S. REG. NOS. 2,679,935 AND 2,845,431.

THE MARK CONSISTS OF THE LETTERS "TNT" ENCLOSED IN A CIRCLE.

SER. NO. 77-518,812, FILED 7-10-2008.

ELIZABETH KAJUBI, EXAMINING ATTORNEY

Int. Cl.: 31

Prior U.S. Cls.: 1 and 46

United States Patent and Trademark Office

Reg. No. 3,575,920

Registered Feb. 17, 2009

**TRADEMARK
PRINCIPAL REGISTER**

MERIT O' PRIDE

PRIDE PACKING CO. (WASHINGTON COR-
PORATION)
8448 NE 33RD DRIVE SUITE 200
PORTLAND, OR 97211

THE MARK CONSISTS OF STANDARD CHAR-
ACTERS WITHOUT CLAIM TO ANY PARTICULAR
FONT, STYLE, SIZE, OR COLOR.

FOR: FRESH FRUIT AND VEGETABLES, IN
CLASS 31 (U.S. CLS. 1 AND 46).

SER. NO. 77-518,829, FILED 7-10-2008.

FIRST USE 1-1-1988; IN COMMERCE 1-1-1988.

KELLY MCCOY, EXAMINING ATTORNEY

Int. Cl.: 38

Prior U.S. Cls.: 100, 101 and 104

United States Patent and Trademark Office

Reg. No. 3,575,921

Registered Feb. 17, 2009

**SERVICE MARK
PRINCIPAL REGISTER**

JetNumbers

JET NUMBERS INC (DELAWARE CORPORATION)
6718 NW 72AV, SUITE B 2059
MIAMI, FL 33166

FOR: TELECOMMUNICATION SERVICES IN THE NATURE OF PROVIDING TELEPHONE FEATURES, NAMELY, CALL WAITING, CALL IDENTIFICATION, CALL FORWARDING, AND MESSAGE WAITING; TELECOMMUNICATION SERVICES IN THE NATURE OF PROVIDING TELEPHONE SERVICES WITH VARIOUS TELEPHONE FEATURES, NAMELY, A DEDICATED TOLL-FREE NUMBER, VOICEMAIL, MULTIPLE MAILBOX EXTENSIONS, TELEPHONE MESSAGE NOTIFICATION, FAX CAPABILITIES, DETAILED CALL REPORTS, CALL WAITING, CALL IDENTIFICATION, CALL FORWARDING, AND MESSAGE WAITING; TELECOMMUNICATION SERVICES, NAMELY, LOCAL AND LONG DISTANCE TRANSMISSION OF VOICE, DATA, GRAPHICS AND VIDEO BY MEANS OF

BROADBAND, COPPER AND OPTICAL OR WIRELESS NETWORKS; TELECOMMUNICATION SERVICES, NAMELY, LOCAL AND LONG DISTANCE TRANSMISSION OF VOICE, DATA, GRAPHICS BY MEANS OF TELEPHONE, TELEGRAPHIC, CABLE, AND SATELLITE TRANSMISSIONS; TELECOMMUNICATIONS RESELLER SERVICES, NAMELY, PROVIDING LONG DISTANCE TELECOMMUNICATION SERVICES, IN CLASS 38 (U.S. CLS. 100, 101 AND 104).

FIRST USE 4-1-2006; IN COMMERCE 4-1-2006.

THE MARK CONSISTS OF STANDARD CHARACTERS WITHOUT CLAIM TO ANY PARTICULAR FONT, STYLE, SIZE, OR COLOR.

SER. NO. 77-518,860, FILED 7-10-2008.

ROBIN MITTLER, EXAMINING ATTORNEY

Int. Cl.: 11

Prior U.S. Cls.: 13, 21, 23, 31 and 34

Reg. No. 3,575,922

United States Patent and Trademark Office

Registered Feb. 17, 2009

**TRADEMARK
PRINCIPAL REGISTER**

AK INDUSTRIES

A.K. INDUSTRIES, INC. (INDIANA CORPORATION)
2055 PIDCO DRIVE
PLYMOUTH, IN 46563

FOR: WASTE WATER PURIFICATION UNITS
AND PARTS THEREOF FOR COMMERCIAL AND
RESIDENTIAL USE, IN CLASS 11 (U.S. CLS. 13, 21,
23, 31 AND 34).

FIRST USE 6-15-1981; IN COMMERCE 6-15-1981.

THE MARK CONSISTS OF STANDARD CHARACTERS WITHOUT CLAIM TO ANY PARTICULAR FONT, STYLE, SIZE, OR COLOR.

NO CLAIM IS MADE TO THE EXCLUSIVE RIGHT TO USE "INDUSTRIES", APART FROM THE MARK AS SHOWN.

SER. NO. 77-518,870, FILED 7-10-2008.

KEVIN DINALLO, EXAMINING ATTORNEY

Int. Cl.: 44

Prior U.S. Cls.: 100 and 101

United States Patent and Trademark Office

Reg. No. 3,575,923

Registered Feb. 17, 2009

**SERVICE MARK
PRINCIPAL REGISTER**

Making Every Smile Count

ANDREA TRUJILLO (UNITED STATES INDIVIDUAL)
9933 PINES BLVD.
PEMBROKE PINES, FL 33024

THE MARK CONSISTS OF STANDARD CHARACTERS WITHOUT CLAIM TO ANY PARTICULAR FONT, STYLE, SIZE, OR COLOR.

FOR: DENTAL SERVICES, NAMELY, COSMETIC AND GENERAL DENTISTRY, IN CLASS 44 (U.S. CLS. 100 AND 101).

SER. NO. 77-518,873, FILED 7-10-2008.

FIRST USE 7-1-2002; IN COMMERCE 7-1-2002.

SHAILA SETTLES, EXAMINING ATTORNEY

Int. Cl.: 9

Prior U.S. Cls.: 21, 23, 26, 36 and 38

Reg. No. 3,575,924

United States Patent and Trademark Office

Registered Feb. 17, 2009

**TRADEMARK
PRINCIPAL REGISTER**

PICOFLY

SIERRA INSTRUMENTS, INC. (CALIFORNIA
CORPORATION)
5 HARRIS COURT, BUILDING L
MONTEREY, CA 93940

FOR: FLOW METERS AND CONTROLLERS
THEREFOR, NAMELY, INSTRUMENTS FOR MEASURING,
CALCULATING, AND CONTROLLING MASS AND OTHER
PARAMETERS OF FLUIDS AND GASSES FLOWING IN
PIPELINES, IN CLASS 9 (U.S. CLS. 21, 23, 26, 36 AND 38).

FIRST USE 8-24-2007; IN COMMERCE 8-24-2007.

THE MARK CONSISTS OF STANDARD CHARACTERS
WITHOUT CLAIM TO ANY PARTICULAR FONT, STYLE,
SIZE, OR COLOR.

SER. NO. 77-518,882, FILED 7-10-2008.

MICHAEL ENGEL, EXAMINING ATTORNEY

Int. Cl.: 11

Prior U.S. Cls.: 13, 21, 23, 31 and 34

United States Patent and Trademark Office

Reg. No. 3,575,925

Registered Feb. 17, 2009

**TRADEMARK
PRINCIPAL REGISTER**



A.K. INDUSTRIES, INC. (INDIANA CORPORATION)
2055 PIDCO DRIVE
PLYMOUTH, IN 46563

THE MARK CONSISTS OF STYLIZED WATER DRIPPINGS AROUND THE WORDS "HYDRO-ACTION".

FOR: WASTE WATER PURIFICATION UNITS AND PARTS THEREOF FOR COMMERCIAL AND RESIDENTIAL USE, IN CLASS 11 (U.S. CLS. 13, 21, 23, 31 AND 34).

SER. NO. 77-518,904, FILED 7-10-2008.

FIRST USE 4-1-2003; IN COMMERCE 4-1-2003.

KEVIN DINALLO, EXAMINING ATTORNEY

Int. Cl.: 4

Prior U.S. Cls.: 1, 6 and 15

United States Patent and Trademark Office

Reg. No. 3,575,926

Registered Feb. 17, 2009

**TRADEMARK
PRINCIPAL REGISTER**

Cast your glow

KENNEDY, SUE L. (CALIFORNIA SOLE PROPRIETORSHIP), DBA SEAGLOW CANDLES
243 PRINCETON DRIVE
SEBASTOPOL, CA 95472

THE MARK CONSISTS OF STANDARD CHARACTERS WITHOUT CLAIM TO ANY PARTICULAR FONT, STYLE, SIZE, OR COLOR.

FOR: CANDLES, IN CLASS 4 (U.S. CLS. 1, 6 AND 15).

SER. NO. 77-518,937, FILED 7-10-2008.

FIRST USE 1-16-2007; IN COMMERCE 4-29-2007.

KATHRYN COWARD, EXAMINING ATTORNEY

Int. Cl.: 11

Prior U.S. Cls.: 13, 21, 23, 31 and 34

United States Patent and Trademark Office

Reg. No. 3,575,927

Registered Feb. 17, 2009

**TRADEMARK
PRINCIPAL REGISTER**

TURTLED RIP

A.K. INDUSTRIES, INC. (INDIANA CORPORATION)
2055 PIDCO DRIVE
PLYMOUTH, IN 46563

THE MARK CONSISTS OF STANDARD CHARACTERS WITHOUT CLAIM TO ANY PARTICULAR FONT, STYLE, SIZE, OR COLOR.

FOR: UNDERGROUND IRRIGATION SYSTEMS, COMPRISED OF TREATMENT TANKS, VALVES, PUMPS, PIPES, FILTERS AND REGULATORS, IN CLASS 11 (U.S. CLS. 13, 21, 23, 31 AND 34).

SER. NO. 77-518,953, FILED 7-10-2008.

FIRST USE 4-1-2003; IN COMMERCE 4-1-2003.

KEVIN DINALLO, EXAMINING ATTORNEY

Int. Cl.: 45

Prior U.S. Cls.: 100 and 101

United States Patent and Trademark Office

Reg. No. 3,575,928

Registered Feb. 17, 2009

**SERVICE MARK
PRINCIPAL REGISTER**



KEISLING PIEPER & SCOTT PLC (ARKANSAS
LIMITED LIABILITY COMPANY)
3739 STEELE BLVD. STE. 340
FAYETTEVILLE, AR 72703

FIRST USE 7-10-2008; IN COMMERCE 7-10-2008.

SER. NO. 77-518,988, FILED 7-10-2008.

FOR: LEGAL SERVICES, IN CLASS 45 (U.S. CLS.
100 AND 101).

COLLEEN DOMBROW, EXAMINING ATTORNEY

Int. Cl.: 7

Prior U.S. Cls.: 13, 19, 21, 23, 31, 34 and 35

United States Patent and Trademark Office

Reg. No. 3,575,929

Registered Feb. 17, 2009

**TRADEMARK
PRINCIPAL REGISTER**

ACCURPRESS

ACCURPRESS AMERICA INC. (SOUTH DAKOTA
CORPORATION)
450 CONCOURSE DRIVE
RAPID CITY, SD 57703

THE MARK CONSISTS OF STANDARD CHAR-
ACTERS WITHOUT CLAIM TO ANY PARTICULAR
FONT, STYLE, SIZE, OR COLOR.

FOR: INDUSTRIAL MACHINES, NAMELY,
PRESS BRAKES FOR PRECISION FORMING OF
SHEET METAL, IN CLASS 7 (U.S. CLS. 13, 19, 21, 23,
31, 34 AND 35).

SER. NO. 77-519,004, FILED 7-10-2008.

FIRST USE 0-0-1973; IN COMMERCE 0-0-1973.

CHRISTINA SOBRAL, EXAMINING ATTORNEY

Int. Cl.: 2

Prior U.S. Cls.: 6, 11 and 16

United States Patent and Trademark Office

Reg. No. 3,575,930

Registered Feb. 17, 2009

**TRADEMARK
PRINCIPAL REGISTER**

TRU-TOP

OTS MANUFACTURING & SUPPLY, INC.
(SOUTH CAROLINA CORPORATION)
206 INDUSTRIAL DRIVE
LEXINGTON, SC 29072

THE MARK CONSISTS OF STANDARD CHAR-
ACTERS WITHOUT CLAIM TO ANY PARTICULAR
FONT, STYLE, SIZE, OR COLOR.

FOR: COATINGS IN THE NATURE OF PAINT
FOR RECONDITIONING RUBBER AND RUBBER-
IZED SURFACES, IN CLASS 2 (U.S. CLS. 6, 11 AND
16).

SER. NO. 77-519,034, FILED 7-10-2008.

FIRST USE 12-31-1997; IN COMMERCE 12-31-1997.

YAT SYE, LEE, EXAMINING ATTORNEY

Int. Cl.: 35

Prior U.S. Cls.: 100, 101 and 102

United States Patent and Trademark Office

Reg. No. 3,575,931

Registered Feb. 17, 2009

**SERVICE MARK
PRINCIPAL REGISTER**

Brand Verve

BRAND VERVE, LLC (MARYLAND LIMITED
LIABILITY COMPANY)
PO BOX 15297
CHEVY CHASE, MD 20825

FOR: BRAND IMAGERY CONSULTING SERVI-
CES; CONSULTANCY SERVICES REGARDING
BUSINESS STRATEGIES, IN CLASS 35 (U.S. CLS.
100, 101 AND 102).

FIRST USE 4-1-2008; IN COMMERCE 4-1-2008.

THE MARK CONSISTS OF STANDARD CHAR-
ACTERS WITHOUT CLAIM TO ANY PARTICULAR
FONT, STYLE, SIZE, OR COLOR.

NO CLAIM IS MADE TO THE EXCLUSIVE
RIGHT TO USE "BRAND", APART FROM THE
MARK AS SHOWN.

SER. NO. 77-519,059, FILED 7-10-2008.

SETH A. RAPPAPORT, EXAMINING ATTORNEY

Int. Cl.: 25

Prior U.S. Cls.: 22 and 39

United States Patent and Trademark Office

Reg. No. 3,575,932

Registered Feb. 17, 2009

**TRADEMARK
PRINCIPAL REGISTER**



CASEY C JORGENSEN (OREGON SOLE PROPRIETORSHIP)
PO BOX 2510
EUGENE, OR 97402

FOR: BANDANAS; HALTER TOPS; HOODED SWEAT SHIRTS; KNIT SHIRTS; LONG-SLEEVED SHIRTS; MUSCLE TOPS; OPEN-NECKED SHIRTS; SHIRTS; SHORT-SLEEVED SHIRTS; SWEAT SHIRTS; T-SHIRTS; TANK TOPS; TANK-TOPS; TEE SHIRTS; TOPS; TUBE TOPS, IN CLASS 25 (U.S. CLS. 22 AND 39).

FIRST USE 6-6-2008; IN COMMERCE 6-9-2008.

NO CLAIM IS MADE TO THE EXCLUSIVE RIGHT TO USE "CLOTHING", APART FROM THE MARK AS SHOWN.

THE COLOR(S) BLACK, LIGHT ORANGE AND WHITE IS/ARE CLAIMED AS A FEATURE OF THE MARK.

THE MARK CONSISTS OF A GIRAFFE DESIGN AND THE WORDING "PULPIT CLOTHING", WITH THE COLOR BLACK APPEARING IN THE GIRAFFE DESIGN, THE COLOR WHITE APPEARING IN THE WORD "PULPIT", AND THE COLOR LIGHT ORANGE APPEARING IN THE DOT ABOVE THE "I" IN "PULPIT" AND IN THE WORD "CLOTHING".

SER. NO. 77-519,079, FILED 7-10-2008.

MARY MUNSON, EXAMINING ATTORNEY

Int. Cl.: 30

Prior U.S. Cl.: 46

United States Patent and Trademark Office

Reg. No. 3,575,933

Registered Feb. 17, 2009

**TRADEMARK
PRINCIPAL REGISTER**

BOULEVARDS

BOULEVARDS, LLC (FLORIDA LIMITED LIABILITY COMPANY)
P.O. BOX 21276
BRADENTON, FL 34209

FOR: COCOA MIXES, IN CLASS 30 (U.S. CL. 46).

FIRST USE 3-30-2008; IN COMMERCE 4-20-2008.

THE MARK CONSISTS OF STANDARD CHARACTERS WITHOUT CLAIM TO ANY PARTICULAR FONT, STYLE, SIZE, OR COLOR.

OWNER OF U.S. REG. NO. 3,500,129.

SER. NO. 77-519,091, FILED 7-10-2008.

JERI J. FICKES, EXAMINING ATTORNEY

Int. Cl.: 37

Prior U.S. Cls.: 100, 103 and 106

United States Patent and Trademark Office

Reg. No. 3,575,934

Registered Feb. 17, 2009

**SERVICE MARK
PRINCIPAL REGISTER**

JOIN THE SUNNY GENERATION

AMERICAN SOLAR ELECTRIC, INC. (ARIZONA CORPORATION)
1475 NORTH SCOTTSDALE ROAD, SUITE 410
SCOTTSDALE, AZ 85257

FOR: INSTALLATION AND MAINTENANCE OF SOLAR ELECTRIC SYSTEMS, IN CLASS 37 (U.S. CLS. 100, 103 AND 106).

FIRST USE 6-0-2008; IN COMMERCE 6-0-2008.

THE MARK CONSISTS OF STANDARD CHARACTERS WITHOUT CLAIM TO ANY PARTICULAR FONT, STYLE, SIZE, OR COLOR.

SER. NO. 77-519,101, FILED 7-10-2008.

WILLIAM VERHOSEK, EXAMINING ATTORNEY

Int. Cl.: 42

Prior U.S. Cls.: 100 and 101

United States Patent and Trademark Office

Reg. No. 3,575,935

Registered Feb. 17, 2009

**SERVICE MARK
PRINCIPAL REGISTER**

JOIN THE SUNNY GENERATION

AMERICAN SOLAR ELECTRIC, INC. (ARIZONA CORPORATION)
1475 NORTH SCOTTSDALE ROAD, SUITE 410
SCOTTSDALE, AZ 85257

FOR: DESIGN, ENGINEERING AND CONSULTATION SERVICES THERETO IN THE FIELD OF SOLAR ELECTRIC SYSTEMS, IN CLASS 42 (U.S. CLS. 100 AND 101).

FIRST USE 6-0-2008; IN COMMERCE 6-0-2008.

THE MARK CONSISTS OF STANDARD CHARACTERS WITHOUT CLAIM TO ANY PARTICULAR FONT, STYLE, SIZE, OR COLOR.

SER. NO. 77-519,114, FILED 7-10-2008.

WILLIAM VERHOSEK, EXAMINING ATTORNEY

Int. Cl.: 44

Prior U.S. Cls.: 100 and 101

United States Patent and Trademark Office

Reg. No. 3,575,936

Registered Feb. 17, 2009

**SERVICE MARK
PRINCIPAL REGISTER**



MASSAGELUXE INTERNATIONAL, LLC (MISSOURI LIMITED LIABILITY COMPANY)
11 CHAMPION DRIVE
FENTON, MO 63026

FOR: BEAUTY SALON AND SPA SERVICES, NAMELY, COSMETIC BODY CARE SERVICES AND MASSAGE THERAPY, IN CLASS 44 (U.S. CLS. 100 AND 101).

FIRST USE 5-10-2008; IN COMMERCE 5-10-2008.

OWNER OF U.S. REG. NO. 3,463,781.

THE MARK CONSISTS OF THE LETTER "M" WITH THE LETTER "L" SHOWN TO THE RIGHT AND PARTIALLY OVERLAPPING THE LETTER "M".

SER. NO. 77-519,118, FILED 7-10-2008.

KAPIL BHANOT, EXAMINING ATTORNEY

Int. Cl.: 36

Prior U.S. Cls.: 100, 101 and 102

United States Patent and Trademark Office

Reg. No. 3,575,937

Registered Feb. 17, 2009

**SERVICE MARK
PRINCIPAL REGISTER**

**Strength. Innovation.
Community.**

ALLIANCE BANK (MINNESOTA CORPORATION)
SUITE 115
55 EAST 5TH STREET
SAINT PAUL, MN 55101

THE MARK CONSISTS OF STANDARD CHARACTERS WITHOUT CLAIM TO ANY PARTICULAR FONT, STYLE, SIZE, OR COLOR.

FOR: BANKING AND FINANCING SERVICES,
IN CLASS 36 (U.S. CLS. 100, 101 AND 102).

SER. NO. 77-519,143, FILED 7-10-2008.

FIRST USE 5-30-2008; IN COMMERCE 5-30-2008.

DAWN FELDMAN, EXAMINING ATTORNEY

Int. Cl.: 11

Prior U.S. Cls.: 13, 21, 23, 31 and 34

Reg. No. 3,575,938

United States Patent and Trademark Office

Registered Feb. 17, 2009

**TRADEMARK
PRINCIPAL REGISTER**

SOLAR ST★R

SOLATUBE INTERNATIONAL, INC. (DELA-
WARE CORPORATION)
2210 OAK RIDGE WAY
VISTA, CA 92081

NO CLAIM IS MADE TO THE EXCLUSIVE
RIGHT TO USE "SOLAR", APART FROM THE
MARK AS SHOWN.

FOR: SOLAR POWERED ATTIC FANS, IN CLASS
11 (U.S. CLS. 13, 21, 23, 31 AND 34).

SER. NO. 77-519,157, FILED 7-10-2008.

FIRST USE 1-1-1999; IN COMMERCE 1-1-1999.

OWNER OF U.S. REG. NO. 2,562,233.

WILLIAM VERHOSEK, EXAMINING ATTORNEY

Int. Cl.: 25

Prior U.S. Cls.: 22 and 39

United States Patent and Trademark Office

Reg. No. 3,575,939

Registered Feb. 17, 2009

**TRADEMARK
PRINCIPAL REGISTER**

UPPER 90°

YALE SPORTSWEAR CORPORATION (MARY-
LAND CORPORATION)
1500 INDUSTRIAL PARK BLVD.
FEDERALSBURG, MD 21632

FOR: ATHLETIC UNIFORMS; GYM SHORTS;
PANTS; SHORTS; SWEAT PANTS; SWEAT SHIRTS;
SWEAT SHORTS; SWEAT SUITS; TEE SHIRTS, IN
CLASS 25 (U.S. CLS. 22 AND 39).

FIRST USE 12-11-2006; IN COMMERCE 12-11-2006.

THE MARK CONSISTS OF STANDARD CHAR-
ACTERS WITHOUT CLAIM TO ANY PARTICULAR
FONT, STYLE, SIZE, OR COLOR.

SER. NO. 77-519,177, FILED 7-10-2008.

WILLIAM VERHOSEK, EXAMINING ATTORNEY

Int. Cl.: 30

Prior U.S. Cl.: 46

United States Patent and Trademark Office

Reg. No. 3,575,940

Registered Feb. 17, 2009

**TRADEMARK
PRINCIPAL REGISTER**

SALBA SMART

SALBA CORP. NA (CANADA CORPORATION)
SUITE 1506
80 ANTIBES DRIVE
NORTH YORK, CANADA M2R3N5

FOR: SNACK FOODS, NAMELY, CORN-BASED
TORTILLA CHIPS, CORN-BASED AND FLOUR-
BASED TORTILLAS IN VARIOUS FLAVORS, TOS-
TADA SHELLS, TACO SHELLS, EXTRUDED
SNACKS, NAMELY, CORN SNACKS AND WHEAT
SNACKS, PRETZELS AND DIPPING SAUCES, IN
CLASS 30 (U.S. CL. 46).

FIRST USE 5-15-2006; IN COMMERCE 5-15-2006.

THE MARK CONSISTS OF STANDARD CHAR-
ACTERS WITHOUT CLAIM TO ANY PARTICULAR
FONT, STYLE, SIZE, OR COLOR.

SER. NO. 77-519,216, FILED 7-10-2008.

TRACY FLETCHER, EXAMINING ATTORNEY

Int. Cl.: 36

Prior U.S. Cls.: 100, 101 and 102

United States Patent and Trademark Office

Reg. No. 3,575,941

Registered Feb. 17, 2009

**SERVICE MARK
PRINCIPAL REGISTER**

TONTI PROPERTIES

CREEKWOOD PROPERTY CORPORATION
(TEXAS CORPORATION)
4949 WESTGROVE DRIVE, SUITE 100
DALLAS, TX 75248

NO CLAIM IS MADE TO THE EXCLUSIVE
RIGHT TO USE "PROPERTIES", APART FROM
THE MARK AS SHOWN.

FOR: MANAGEMENT AND LEASING OF REAL
ESTATE PROPERTIES, IN CLASS 36 (U.S. CLS. 100,
101 AND 102).

SEC. 2(F).

FIRST USE 1-1-1988; IN COMMERCE 1-1-1988.

SER. NO. 77-519,219, FILED 7-10-2008.

THE MARK CONSISTS OF STANDARD CHAR-
ACTERS WITHOUT CLAIM TO ANY PARTICULAR
FONT, STYLE, SIZE, OR COLOR.

JOHN GARTNER, EXAMINING ATTORNEY

Int. Cls.: 35 and 40

Prior U.S. Cls.: 100, 101, 102, 103 and 106

United States Patent and Trademark Office

Reg. No. 3,575,942

Registered Feb. 17, 2009

**SERVICE MARK
PRINCIPAL REGISTER**

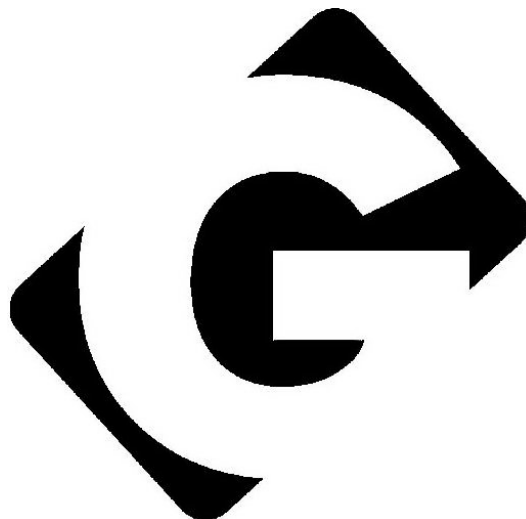

GRIMCO, INC. (MISSOURI CORPORATION)
1585 FENCORP DRIVE
FENTON, MO 63026

FOR: ONLINE RETAIL STORE SERVICES FEATURING SIGNS, VINYLs, AND RELATED ITEMS SPECIFICALLY USED IN SIGN MANUFACTURING; MAIL ORDER CATALOG SERVICES FEATURING SIGNS, VINYLs, AND RELATED ITEMS SPECIFICALLY USED IN SIGN MANUFACTURING; DISTRIBUTORSHIPS FEATURING SIGNS, VINYLs, AND RELATED ITEMS SPECIFICALLY USED IN SIGN MANUFACTURING, IN CLASS 35 (U.S. CLS. 100, 101 AND 102).

FIRST USE 2-1-2008; IN COMMERCE 2-1-2008.

FOR: CUSTOM MANUFACTURE OF SIGNS TO THE ORDER AND SPECIFICATION OF OTHERS, IN CLASS 40 (U.S. CLS. 100, 103 AND 106).

FIRST USE 2-1-2008; IN COMMERCE 2-1-2008.

THE MARK CONSISTS OF THE LETTER "G" IMPOSED OVER A DARKER RECTANGULAR BACKGROUND WHICH HAS ROUNDED CORNERS AND IS ON A DIAGONAL SLANT LEANING FROM THE LOWER LEFT SIDE TO THE UPPER RIGHT SIDE.

SER. NO. 77-519,278, FILED 7-10-2008.

MARTHA FROMM, EXAMINING ATTORNEY

Int. Cl.: 11

Prior U.S. Cls.: 13, 21, 23, 31 and 34

United States Patent and Trademark Office

Reg. No. 3,575,943

Registered Feb. 17, 2009

**TRADEMARK
PRINCIPAL REGISTER**

SMOKENATOR

THOMPSON, DONALD E. (UNITED STATES IN-
DIVIDUAL)
6189 MANCUSO ST.
SAN JOSE, CA 95120

THE MARK CONSISTS OF STANDARD CHAR-
ACTERS WITHOUT CLAIM TO ANY PARTICULAR
FONT, STYLE, SIZE, OR COLOR.

FOR: BARBECUE COOKING ACCESSORY,
NAMELY, A PORTABLE BARBECUE SMOKER
FOR PLACEMENT IN NON-GAS GRILLS, IN CLASS
11 (U.S. CLS. 13, 21, 23, 31 AND 34).

SER. NO. 77-519,306, FILED 7-10-2008.

FIRST USE 4-1-2006; IN COMMERCE 6-1-2006.

LINDA M. KING, EXAMINING ATTORNEY

Int. Cls.: 16 and 41

Prior U.S. Cls.: 2, 5, 22, 23, 29, 37, 38, 50, 100, 101 and 107

United States Patent and Trademark Office

Reg. No. 3,575,944

Registered Feb. 17, 2009

**TRADEMARK
SERVICE MARK
PRINCIPAL REGISTER**

CHIEF OF STAFF BOOT CAMP

SUSAN REYNOLDS AND ASSOCIATES (CALIFORNIA CORPORATION)
652 JACON WAY
PACIFIC PALISADES, CA 90272

FOR: EDUCATIONAL PUBLICATIONS, NAME-
LY, TRAINING MANUALS IN THE FIELD OF
HOSPITAL AND HEALTH SYSTEM LEADERSHIP
AND MANAGEMENT, IN CLASS 16 (U.S. CLS. 2, 5,
22, 23, 29, 37, 38 AND 50).

FIRST USE 10-0-2003; IN COMMERCE 10-0-2003.

FOR: CONDUCTING WORKSHOPS AND SEMI-
NARS IN THE FIELD OF HOSPITAL AND HEALTH

SYSTEM LEADERSHIP DEVELOPMENT, MAN-
AGEMENT AND STRATEGIC PLANNING, IN
CLASS 41 (U.S. CLS. 100, 101 AND 107).

FIRST USE 10-0-2003; IN COMMERCE 10-0-2003.

THE MARK CONSISTS OF STANDARD CHAR-
ACTERS WITHOUT CLAIM TO ANY PARTICULAR
FONT, STYLE, SIZE, OR COLOR.

SER. NO. 77-519,312, FILED 7-10-2008.

KAPIL BHANOT, EXAMINING ATTORNEY

Int. Cl.: 36

Prior U.S. Cls.: 100, 101 and 102

United States Patent and Trademark Office

Reg. No. 3,575,945

Registered Feb. 17, 2009

SERVICE MARK
PRINCIPAL REGISTER



CREEKWOOD STARWOOD LIMITED PARTNER-
SHIP (TEXAS LIMITED PARTNERSHIP)
4949 WESTGROVE DRIVE, SUITE 100
DALLAS, TX 75248

FOR: MANAGEMENT AND LEASING OF REAL
ESTATE PROPERTIES, IN CLASS 36 (U.S. CLS. 100,
101 AND 102).

FIRST USE 6-25-2007; IN COMMERCE 6-25-2007.

NO CLAIM IS MADE TO THE EXCLUSIVE
RIGHT TO USE "STARWOOD", APART FROM
THE MARK AS SHOWN.

THE MARK CONSISTS OF THE WORDS "LA
VALENCIA" WITH A STYLIZED CAPITAL "V"
BEHIND THE SMALL "V" IN "VALENCIA" AND
"AT STARWOOD" IN SMALLER TEXT ABOVE
"VALENCIA".

SER. NO. 77-519,330, FILED 7-10-2008.

KAPIL BHANOT, EXAMINING ATTORNEY

Int. Cl.: 41

Prior U.S. Cls.: 100, 101 and 107

United States Patent and Trademark Office

Reg. No. 3,575,946

Registered Feb. 17, 2009

**SERVICE MARK
PRINCIPAL REGISTER**

**GENERAL BOARD OF HIGHER
EDUCATION & MINISTRY**

GENERAL BOAZRD OF HIGHER EDUCATION
AND MINISTRY OF THE UNITED METHO-
DIST CHURCH (TENNESSEE NON-PROFIT
CORPORATION)
1001 16TH AVENUE SOUTH
NASHVILLE, TN 37212

FOR: EDUCATIONAL SERVICES, NAMELY,
CONDUCTING CLASSES, SEMINARS, CONFEREN-
CES, AND WORKSHOPS IN THE FIELD OF
WORLDWIDE PROFESSIONAL MINISTRY AND
RELIGIOUS-RELATED HIGHER EDUCATION;
PUBLICATION OF BOOKS, JOURNALS, MAGA-
ZINES AND OTHER PRINTED EDUCATIONAL
MATERIALS, IN CLASS 41 (U.S. CLS. 100, 101 AND
107).

FIRST USE 12-31-1972; IN COMMERCE 12-31-1972.

THE MARK CONSISTS OF STANDARD CHAR-
ACTERS WITHOUT CLAIM TO ANY PARTICULAR
FONT, STYLE, SIZE, OR COLOR.

NO CLAIM IS MADE TO THE EXCLUSIVE
RIGHT TO USE "HIGHER EDUCATION", APART
FROM THE MARK AS SHOWN.

SEC. 2(F).

SER. NO. 77-519,339, FILED 7-10-2008.

ZHALEH DELANEY, EXAMINING ATTORNEY

Int. Cl.: 2

Prior U.S. Cls.: 6, 11 and 16

United States Patent and Trademark Office

Reg. No. 3,575,947

Registered Feb. 17, 2009

**TRADEMARK
PRINCIPAL REGISTER**

T.O.P. TALL OIL PITCH

ENSSOLUTIONS CORPORATION (ARIZONA
CORPORATION)
SUITE 4
5610 WEST MARYLAND AVENUE
GLENDALE, AZ 85301

FOR: NATURAL RESIN-MODIFIED EMULSIONS
USED FOR DUST CONTROL AND SITE STABIL-
IZATION, IN CLASS 2 (U.S. CLS. 6, 11 AND 16).

FIRST USE 5-31-2005; IN COMMERCE 5-31-2005.

THE MARK CONSISTS OF STANDARD CHAR-
ACTERS WITHOUT CLAIM TO ANY PARTICULAR
FONT, STYLE, SIZE, OR COLOR.

NO CLAIM IS MADE TO THE EXCLUSIVE
RIGHT TO USE "TALL OIL PITCH", APART FROM
THE MARK AS SHOWN.

SER. NO. 77-519,376, FILED 7-10-2008.

RENEE MCCRAY, EXAMINING ATTORNEY

Int. Cl.: 28

Prior U.S. Cls.: 22, 23, 38 and 50

United States Patent and Trademark Office

Reg. No. 3,575,948

Registered Feb. 17, 2009

**TRADEMARK
PRINCIPAL REGISTER**

CRAFTABLES

DYNO LLC (DELAWARE LIMITED LIABILITY
COMPANY)
SUITE 105
1571 W. COPANS ROAD
POMPANO BEACH, FL 33064

FOR: HOBBY CRAFT KITS OF A DO-IT-YOUR-
SELF NATURE COMPRISED OF YARN, SEWING
PATTERNS, MARKERS, PAINTS, PAPER, EVA
FOAM, BEADS, CHARMS, FABRIC, WIRE,
THREAD, WOOD AND METAL CRAFT PATTERNS
AND PIECES FOR CREATING CRAFTS, IN CLASS
28 (U.S. CLS. 22, 23, 38 AND 50).

FIRST USE 6-2-2008; IN COMMERCE 6-2-2008.

THE MARK CONSISTS OF STANDARD CHAR-
ACTERS WITHOUT CLAIM TO ANY PARTICULAR
FONT, STYLE, SIZE, OR COLOR.

SER. NO. 77-519,396, FILED 7-10-2008.

ROBIN CHOSID, EXAMINING ATTORNEY

Int. Cl.: 32

Prior U.S. Cls.: 45, 46 and 48

United States Patent and Trademark Office

Reg. No. 3,575,949

Registered Feb. 17, 2009

**TRADEMARK
PRINCIPAL REGISTER**



DESNOES & GEDDES LIMITED (JAMAICA CORPORATION)

214 SPANISH TOWN ROAD, P.O. BOX 190
KINGSTON 11, JAMAICA

FOR: BEER, IN CLASS 32 (U.S. CLS. 45, 46 AND 48).

FIRST USE 8-31-1928; IN COMMERCE 12-31-1969.

OWNER OF U.S. REG. NOS. 1,359,560, 1,803,372 AND OTHERS.

THE MARK CONSISTS OF THE STYLIZED LETTERS "D G" WITHIN A CIRCLE WITH SCALLOPED EDGES.

SER. NO. 77-519,422, FILED 7-10-2008.

JANICE KIM, EXAMINING ATTORNEY

Int. Cl.: 20

Prior U.S. Cls.: 2, 13, 22, 25, 32 and 50

Reg. No. 3,575,950

United States Patent and Trademark Office

Registered Feb. 17, 2009

**TRADEMARK
PRINCIPAL REGISTER**



LEGACY WINDOW COVERINGS, LLC (ARIZONA LIMITED LIABILITY COMPANY)
1145 WEST GARY AVENUE
GILBERT, AZ 85233

FOR: INDOOR WINDOW BLINDS; WINDOW BLINDS; WINDOW SHADES, IN CLASS 20 (U.S. CLS. 2, 13, 22, 25, 32 AND 50).

FIRST USE 6-13-2008; IN COMMERCE 6-13-2008.

NO CLAIM IS MADE TO THE EXCLUSIVE RIGHT TO USE "ROLLER SHADES", APART FROM THE MARK AS SHOWN.

THE MARK CONSISTS OF THE WORD "AXIS" WITH A STYLIZED "A" APPEARING LIKE THE END/SIDE VIEW OF THE ROLLED UP PORTION OF A WINDOW ROLLER SHADE. "AXIS" IS UNDERLINED AND BOLD AND BELOW IT APPEARS THE WORDS "ROLLER SHADES".

SER. NO. 77-519,430, FILED 7-10-2008.

SUSAN LESLIE DUBOIS, EXAMINING ATTORNEY

Int. Cl.: 41

Prior U.S. Cls.: 100, 101 and 107

United States Patent and Trademark Office

Reg. No. 3,575,951

Registered Feb. 17, 2009

**SERVICE MARK
PRINCIPAL REGISTER**

COMPUCADEMY

COMPUCADEMY LLC (MISSOURI LIMITED
LIABILITY COMPANY)
2115 NEW SUN DRIVE
FLORISSANT, MO 63031

THE MARK CONSISTS OF STANDARD CHAR-
ACTERS WITHOUT CLAIM TO ANY PARTICULAR
FONT, STYLE, SIZE, OR COLOR.

FOR: EDUCATION SERVICES, NAMELY, PRO-
VIDING TUTORIAL SESSIONS IN THE FIELD(S) OF
COMPUTERS, IN CLASS 41 (U.S. CLS. 100, 101 AND
107).

SER. NO. 77-519,446, FILED 7-10-2008.

FIRST USE 4-20-2008; IN COMMERCE 4-20-2008.

JANICE KIM, EXAMINING ATTORNEY

Int. Cl.: 25

Prior U.S. Cls.: 22 and 39

United States Patent and Trademark Office

Reg. No. 3,575,952

Registered Feb. 17, 2009

**TRADEMARK
PRINCIPAL REGISTER**

icare

ERIC M PERLMAN (UNITED STATES INDIVIDUAL)
10343 RUBIO AVE
GRANADA HILLS, CA 91344

THE MARK CONSISTS OF STANDARD CHARACTERS WITHOUT CLAIM TO ANY PARTICULAR FONT, STYLE, SIZE, OR COLOR.

FOR: A-SHIRTS; ATHLETIC APPAREL, NAMELY, SHIRTS, PANTS, JACKETS, FOOTWEAR, HATS AND CAPS, ATHLETIC UNIFORMS, IN CLASS 25 (U.S. CLS. 22 AND 39).

SER. NO. 77-519,458, FILED 7-10-2008.

FIRST USE 2-1-2005; IN COMMERCE 1-1-2006.

JANICE KIM, EXAMINING ATTORNEY

Int. Cl.: 12

Prior U.S. Cls.: 19, 21, 23, 31, 35 and 44

United States Patent and Trademark Office

Reg. No. 3,575,953

Registered Feb. 17, 2009

**TRADEMARK
PRINCIPAL REGISTER**

W8LESS

BENMAXX, LLC (WASHINGTON LIMITED LIABILITY COMPANY)
SUITE #D
4310 BRIDGEPORT WAY W.
UNIVERSITY PLACE, WA 98466

THE MARK CONSISTS OF STANDARD CHARACTERS WITHOUT CLAIM TO ANY PARTICULAR FONT, STYLE, SIZE, OR COLOR.

FOR: BRAKES FOR VEHICLES, IN CLASS 12 (U.S. CLS. 19, 21, 23, 31, 35 AND 44).

SER. NO. 77-519,460, FILED 7-10-2008.

FIRST USE 4-29-2004; IN COMMERCE 4-29-2004.

PAUL F. GAST, EXAMINING ATTORNEY

Int. Cl.: 12

Prior U.S. Cls.: 19, 21, 23, 31, 35 and 44

Reg. No. 3,575,954

United States Patent and Trademark Office

Registered Feb. 17, 2009

**TRADEMARK
PRINCIPAL REGISTER**

W8LESS ROTORS

BENMAXX, LLC (WASHINGTON LIMITED LIABILITY COMPANY)

SUITE #D

4310 BRIDGEPORT WAY W.

UNIVERSITY PLACE, WA 98466

FOR: BRAKES FOR VEHICLES, IN CLASS 12 (U.S. CLS. 19, 21, 23, 31, 35 AND 44).

FIRST USE 4-29-2004; IN COMMERCE 4-29-2004.

THE MARK CONSISTS OF STANDARD CHARACTERS WITHOUT CLAIM TO ANY PARTICULAR FONT, STYLE, SIZE, OR COLOR.

NO CLAIM IS MADE TO THE EXCLUSIVE RIGHT TO USE "ROTORS", APART FROM THE MARK AS SHOWN.

SER. NO. 77-519,462, FILED 7-10-2008.

PAUL F. GAST, EXAMINING ATTORNEY

Int. Cl.: 16

Prior U.S. Cls.: 2, 5, 22, 23, 29, 37, 38 and 50

United States Patent and Trademark Office

Reg. No. 3,575,955

Registered Feb. 17, 2009

**TRADEMARK
PRINCIPAL REGISTER**

DIRECTIONS

GENOPTIX, INC. (DELAWARE CORPORATION)
2110 RUTHERFORD ROAD
CARLSBAD, CA 92008

FOR: PRINTED PUBLICATIONS, NAMELY,
NEWSLETTERS, BROCHURES AND MAGAZINES
IN THE FIELD OF MEDICAL LABORATORY TEST-
ING SERVICES, IN CLASS 16 (U.S. CLS. 2, 5, 22, 23, 29,
37, 38 AND 50).

FIRST USE 2-0-2006; IN COMMERCE 2-0-2006.

THE MARK CONSISTS OF STANDARD CHAR-
ACTERS WITHOUT CLAIM TO ANY PARTICULAR
FONT, STYLE, SIZE, OR COLOR.

SER. NO. 77-519,484, FILED 7-10-2008.

BILL DAWE, EXAMINING ATTORNEY

Int. Cl.: 35

Prior U.S. Cls.: 100, 101 and 102

United States Patent and Trademark Office

Reg. No. 3,575,956

Registered Feb. 17, 2009

**SERVICE MARK
PRINCIPAL REGISTER**

WHERE INSPIRATION GROWS

VINTAJ NATURAL BRASS CO. (ILLINOIS CORPORATION)
8933 W. STAGECOACH TRAIL
GALENA, IL 61036

FOR: RETAIL STORE AND ONLINE RETAIL STORE SERVICES FEATURING JEWELRY, JEWELRY FINDINGS, CLOTHING, PAPER GOODS, CRAFTS AND HOUSEWARES, IN CLASS 35 (U.S. CLS. 100, 101 AND 102).

FIRST USE 6-30-2008; IN COMMERCE 6-30-2008.

THE MARK CONSISTS OF STANDARD CHARACTERS WITHOUT CLAIM TO ANY PARTICULAR FONT, STYLE, SIZE, OR COLOR.

SER. NO. 77-519,492, FILED 7-10-2008.

BILL DAWE, EXAMINING ATTORNEY

Int. Cl.: 42

Prior U.S. Cls.: 100 and 101

United States Patent and Trademark Office

Reg. No. 3,575,957

Registered Feb. 17, 2009

**SERVICE MARK
PRINCIPAL REGISTER**

**GENERAL BOARD OF HIGHER
EDUCATION & MINISTRY**

GENERAL BOARD OF HIGHER EDUCATION
AND MINISTRY OF THE UNITED METHO-
DIST CHURCH (TENNESSEE NON-PROFIT
CORPORATION)

1001 19TH AVENUE SOUTH
NASHVILLE, TN 37212

FOR: ACCREDITATION SERVICES, NAMELY,
DEVELOPING, EVALUATING AND TESTING
STANDARDS FOR THE PURPOSE OF ACCREDI-
TATION OF LOCAL CLERGY AND SPECIALIZED
MINISTRIES IN THE NATURE OF CAMP/RE-
TREAT, CHRISTIAN EDUCATION, EVANGELISM,
MUSIC, OLDER ADULT , SPIRITUAL FORMA-

TION, AND YOUTH MINISTRIES, IN CLASS 42
(U.S. CLS. 100 AND 101).

FIRST USE 0-0-1972; IN COMMERCE 0-0-1972.

THE MARK CONSISTS OF STANDARD CHAR-
ACTERS WITHOUT CLAIM TO ANY PARTICULAR
FONT, STYLE, SIZE, OR COLOR.

SEC. 2(F).

SER. NO. 77-519,493, FILED 7-10-2008.

ZHALEH DELANEY, EXAMINING ATTORNEY

Int. Cl.: 41

Prior U.S. Cls.: 100, 101 and 107

United States Patent and Trademark Office

Reg. No. 3,575,958

Registered Feb. 17, 2009

**SERVICE MARK
PRINCIPAL REGISTER**

SONORA SANTANERA

LA UNICA INTERNACIONAL SONORA SANTANERA, S. DE R.L. (MEXICO CORPORATION),
DBA LA INTERNACIONAL SONORA SANTANERA, S.A. DE C.V.

CONSTANTINO NO. 120 ESQ. LEON CABALLO
MEXICO, MEXICO 07870

FOR: ENTERTAINMENT IN THE NATURE OF
LIVE PERFORMANCES BY A MUSICAL GROUP ,
IN CLASS 41 (U.S. CLS. 100, 101 AND 107).

FIRST USE 12-30-1960; IN COMMERCE 0-0-1983.

THE MARK CONSISTS OF STANDARD CHARACTERS WITHOUT CLAIM TO ANY PARTICULAR FONT, STYLE, SIZE, OR COLOR.

THE FOREIGN WORDING IN THE MARK TRANSLATES INTO ENGLISH AS SONOROUS.

SER. NO. 77-519,521, FILED 7-10-2008.

BRENDAN MCCAULEY, EXAMINING ATTORNEY

Int. Cl.: 3

Prior U.S. Cls.: 1, 4, 6, 50, 51 and 52

United States Patent and Trademark Office

Reg. No. 3,575,959

Registered Feb. 17, 2009

**TRADEMARK
PRINCIPAL REGISTER**

LISA HOFFMAN

HOFFMAN, LISA (UNITED STATES INDIVIDUAL)
11661 SAN VICENTE BLVD., SUITE 222
LOS ANGELES, CA 90049

FOR: NON-MEDICATED FACIAL SKIN CARE PREPARATIONS, NAMELY, FACIAL CLEANSERS, FACIAL CLEANSERS WITH MAKEUP REMOVER, FACIAL TONERS, FACIAL TONERS WITH MAKEUP REMOVER, FACIAL MOISTURIZERS, FACIAL CREAMS, FACIAL EXFOLIANTS, FACIAL MASKS, FACIAL SERUMS, EYE CREAMS, EYE SERUMS, LIP CONDITIONERS, LIP SERUMS, LIP MOISTURIZERS AND LIP POLISHERS, AND AMPOULES CONTAINING THE SAME; BODY CARE PREPARATIONS, NAMELY, BODY CLEANSERS, BODY MOISTURIZERS, BODY SCRUBS, BODY OILS,

HAND AND FOOT CREAMS, HAND AND FOOT BUTTERS, SHOWER GELS, AND AMPOULES CONTAINING THE SAME; FRAGRANCES, IN CLASS 3 (U.S. CLS. 1, 4, 6, 50, 51 AND 52).

FIRST USE 1-0-2007; IN COMMERCE 1-0-2007.

THE MARK CONSISTS OF STANDARD CHARACTERS WITHOUT CLAIM TO ANY PARTICULAR FONT, STYLE, SIZE, OR COLOR.

OWNER OF U.S. REG. NO. 3,349,055.

SER. NO. 77-519,540, FILED 7-10-2008.

MARK RADEMACHER, EXAMINING ATTORNEY

Int. Cl.: 3

Prior U.S. Cls.: 1, 4, 6, 50, 51 and 52

Reg. No. 3,575,960

United States Patent and Trademark Office

Registered Feb. 17, 2009

**TRADEMARK
PRINCIPAL REGISTER**



LISA HOFFMAN

HOFFMAN, LISA (UNITED STATES INDIVIDUAL)

11661 SAN VICENTE BLVD., SUITE 222
LOS ANGELES, CA 90049

FOR: NON-MEDICATED FACIAL SKIN CARE PREPARATIONS, NAMELY, FACIAL CLEANSERS, FACIAL CLEANSERS WITH MAKEUP REMOVER, FACIAL TONERS, FACIAL TONERS WITH MAKEUP REMOVER, FACIAL MOISTURIZERS, FACIAL CREAMS, FACIAL EXFOLIANTS, FACIAL MASKS, FACIAL SERUMS, EYE CREAMS, EYE SERUMS, LIP CONDITIONERS, LIP SERUMS, LIP MOISTURIZERS AND LIP POLISHERS, AND AMPOULES CONTAINING THE SAME; BODY CARE PREPARATIONS, NAMELY, BODY CLEANSERS, BODY MOISTURIZERS, BODY SCRUBS, BODY OILS, HAND AND FOOT CREAMS, HAND AND FOOT

BUTTERS, SHOWER GELS, AND AMPOULES CONTAINING THE SAME; FRAGRANCES, IN CLASS 3 (U.S. CLS. 1, 4, 6, 50, 51 AND 52).

FIRST USE 1-0-2007; IN COMMERCE 1-0-2007.

OWNER OF U.S. REG. NO. 3,349,055.

THE MARK CONSISTS OF THE LETTERS "LH" WRITTEN INSIDE A SMALL CIRCLE WITH A LARGER CIRCLE AROUND THE SMALLER CIRCLE AND THE NAME "LISA HOFFMAN" WRITTEN UNDERNEATH THE TWO CIRCLES.

SER. NO. 77-519,552, FILED 7-10-2008.

MARK RADEMACHER, EXAMINING ATTORNEY

Int. Cl.: 35

Prior U.S. Cls.: 100, 101 and 102

United States Patent and Trademark Office

Reg. No. 3,575,961

Registered Feb. 17, 2009

**SERVICE MARK
PRINCIPAL REGISTER**

GATEWAY TO NEBRASKA

CITY OF KIMBALL, NEBRASKA (NEBRASKA
CITY GOVERNMENT)
223 S. CHESTNUT STREET
KIMBALL, NE 69145

THE MARK CONSISTS OF STANDARD CHAR-
ACTERS WITHOUT CLAIM TO ANY PARTICULAR
FONT, STYLE, SIZE, OR COLOR.

FOR: PROMOTING TOURISM IN THE KIMBALL
NEBRASKA AREA, IN CLASS 35 (U.S. CLS. 100, 101
AND 102).

SER. NO. 77-519,573, FILED 7-10-2008.

FIRST USE 5-12-2008; IN COMMERCE 5-12-2008.

JOHN HWANG, EXAMINING ATTORNEY

Int. Cl.: 20

Prior U.S. Cls.: 2, 13, 22, 25, 32 and 50

United States Patent and Trademark Office

Reg. No. 3,575,962

Registered Feb. 17, 2009

**TRADEMARK
PRINCIPAL REGISTER**

Endless Possibilities

THE PICTUREWALL COMPANY, INC. (NEW
YORK CORPORATION)
1140 IDYLBERRY ROAD
SAN RAFAEL, CA 94903

THE MARK CONSISTS OF STANDARD CHAR-
ACTERS WITHOUT CLAIM TO ANY PARTICULAR
FONT, STYLE, SIZE, OR COLOR.

FOR: PICTURE AND PHOTOGRAPH FRAMES;
PICTURE FRAMES, IN CLASS 20 (U.S. CLS. 2, 13, 22,
25, 32 AND 50).

SER. NO. 77-519,598, FILED 7-10-2008.

FIRST USE 3-1-2005; IN COMMERCE 6-1-2005.

JOHN HWANG, EXAMINING ATTORNEY

Int. Cl.: 35

Prior U.S. Cls.: 100, 101 and 102

United States Patent and Trademark Office

Reg. No. 3,575,963

Registered Feb. 17, 2009

**SERVICE MARK
PRINCIPAL REGISTER**

3 TUNA

3 TUNA PRODUCTIONS, INC. (PENNSYLVANIA
CORPORATION)
33 MEGINNES ROAD
KINTNERSVILLE, PA 18930

THE MARK CONSISTS OF STANDARD CHAR-
ACTERS WITHOUT CLAIM TO ANY PARTICULAR
FONT, STYLE, SIZE, OR COLOR.

FOR: ADVERTISING AND MARKETING, IN
CLASS 35 (U.S. CLS. 100, 101 AND 102).

SER. NO. 77-519,604, FILED 7-10-2008.

FIRST USE 11-1-2001; IN COMMERCE 11-1-2001.

JOHN HWANG, EXAMINING ATTORNEY

Int. Cl.: 41

Prior U.S. Cls.: 100, 101 and 107

United States Patent and Trademark Office

Reg. No. 3,575,964

Registered Feb. 17, 2009

**SERVICE MARK
PRINCIPAL REGISTER**

CRYSTAL + LUCY AWARDS

WOMEN IN FILM (CALIFORNIA CORPORATION)
SUITE 201
8857 W. OLYMPIC BOULEVARD
LOS ANGELES, CA 90211

FOR: ENTERTAINMENT SERVICES, NAMELY, AWARD PRESENTATIONS IN THE FIELD OF MOTION PICTURES AND TELEVISION, IN CLASS 41 (U.S. CLS. 100, 101 AND 107).

FIRST USE 0-0-2003; IN COMMERCE 0-0-2003.

THE MARK CONSISTS OF STANDARD CHARACTERS WITHOUT CLAIM TO ANY PARTICULAR FONT, STYLE, SIZE, OR COLOR.

OWNER OF U.S. REG. NO. 1,699,528.

NO CLAIM IS MADE TO THE EXCLUSIVE RIGHT TO USE "AWARDS", APART FROM THE MARK AS SHOWN.

SER. NO. 77-519,607, FILED 7-10-2008.

ANDREA K. NADELMAN, EXAMINING ATTORNEY

Int. Cl.: 36

Prior U.S. Cls.: 100, 101 and 102

United States Patent and Trademark Office

Reg. No. 3,575,965

Registered Feb. 17, 2009

**SERVICE MARK
PRINCIPAL REGISTER**

Alipse

ALIPSE, INC. (IDAHO CORPORATION)
76 MAIN STREET, SECOND FLOOR
DRIGGS, ID 83422

FIRST USE 1-31-2008; IN COMMERCE 1-31-2008.

FOR: BANKING SERVICES, NAMELY, MERCHANT BANKING SERVICES; CREDIT CARD AND DEBIT CARD SERVICES, NAMELY, CREDIT CARD AND DEBIT CARD TRANSACTION PROCESSING SERVICES, IN CLASS 36 (U.S. CLS. 100, 101 AND 102).

THE MARK CONSISTS OF STANDARD CHARACTERS WITHOUT CLAIM TO ANY PARTICULAR FONT, STYLE, SIZE, OR COLOR.

SER. NO. 77-519,623, FILED 7-10-2008.

JACLYN KIDWELL, EXAMINING ATTORNEY

Int. Cl.: 41

Prior U.S. Cls.: 100, 101 and 107

United States Patent and Trademark Office

Reg. No. 3,575,966

Registered Feb. 17, 2009

**SERVICE MARK
PRINCIPAL REGISTER**

SLOPE

LINDA H. DIXON (UNITED STATES INDIVIDUAL)
741 N. KALAHEO AVE.
KAILUA, HI 96734

FOR: EDUCATION SERVICES, NAMELY, PROVIDING LIVE AND ON-LINE CLASSES, SEMINARS, AND WORKSHOPS IN THE FIELD OF TATTOOING, COSMETIC TATTOOING, AND MEDICAL TATTOOING AND DISTRIBUTION OF COURSE MATERIALS IN CONNECTION THEREWITH, IN CLASS 41 (U.S. CLS. 100, 101 AND 107).

FIRST USE 7-1-2006; IN COMMERCE 7-1-2006.

THE MARK CONSISTS OF STANDARD CHARACTERS WITHOUT CLAIM TO ANY PARTICULAR FONT, STYLE, SIZE, OR COLOR.

SER. NO. 77-519,627, FILED 7-10-2008.

SHAUNIA CARLYLE, EXAMINING ATTORNEY

Int. Cl.: 35

Prior U.S. Cls.: 100, 101 and 102

United States Patent and Trademark Office

Reg. No. 3,575,967

Registered Feb. 17, 2009

**SERVICE MARK
PRINCIPAL REGISTER**

PEOPLE LITERACY

JOHN E. PHILBIN JR. (UNITED STATES INDIVIDUAL)
2245 CATHERINE STREET
NORTHBROOK, IL 60062

THE MARK CONSISTS OF STANDARD CHARACTERS WITHOUT CLAIM TO ANY PARTICULAR FONT, STYLE, SIZE, OR COLOR.

FOR: BUSINESS CONSULTATION IN THE FIELD OF HUMAN RESOURCES TRAINING, DEVELOPMENT, AND COACHING, IN CLASS 35 (U.S. CLS. 100, 101 AND 102).

SER. NO. 77-519,628, FILED 7-10-2008.

FIRST USE 3-3-2008; IN COMMERCE 3-3-2008.

SHAUNIA CARLYLE, EXAMINING ATTORNEY

Int. Cl.: 25

Prior U.S. Cls.: 22 and 39

United States Patent and Trademark Office

Reg. No. 3,575,968

Registered Feb. 17, 2009

TRADEMARK
PRINCIPAL REGISTER



DUDIAK, PHILLIP (UNITED STATES INDIVIDUAL)
825 SOUTH ROHLWING RD
ADDISON, IL 60101

NO CLAIM IS MADE TO THE EXCLUSIVE RIGHT TO USE "CLOTHING", APART FROM THE MARK AS SHOWN.

FOR: BELTS; DRESS SHIRTS; HATS; JACKETS; PANTS; POLO SHIRTS; SHIRTS; SHOES; SWEAT SHIRTS; T-SHIRTS; TANK TOPS, IN CLASS 25 (U.S. CLS. 22 AND 39).

SER. NO. 77-519,637, FILED 7-10-2008.

FIRST USE 4-16-2008; IN COMMERCE 4-16-2008.

MARK RADEMACHER, EXAMINING ATTORNEY

Int. Cl.: 26

Prior U.S. Cls.: 37, 39, 40, 42 and 50

United States Patent and Trademark Office

Reg. No. 3,575,969

Registered Feb. 17, 2009

**TRADEMARK
PRINCIPAL REGISTER**

Bowettes

VELEZ, CHARITY L. (UNITED STATES INDIVIDUAL)
8133 N. BRIDGE WAY
MAUMEE, OH 43537

FOR: BARRETTES; BOWS FOR GIFT WRAPPING;
BOWS FOR WRAPPING; HAIR BARRETTES; HAIR
BOWS; HAIR ORNAMENTS, IN CLASS 26 (U.S. CLS.
37, 39, 40, 42 AND 50).

FIRST USE 6-2-2008; IN COMMERCE 6-2-2008.

THE MARK CONSISTS OF STANDARD CHARACTERS WITHOUT CLAIM TO ANY PARTICULAR FONT, STYLE, SIZE, OR COLOR.

SER. NO. 77-519,640, FILED 7-10-2008.

KATHERINE E. HALMEN, EXAMINING ATTORNEY

Int. Cl.: 3

Prior U.S. Cls.: 1, 4, 6, 50, 51 and 52

United States Patent and Trademark Office

Reg. No. 3,575,970

Registered Feb. 17, 2009

**TRADEMARK
PRINCIPAL REGISTER**

INFINITE BEAUTY

KOSZTOLANYI, NORA (UNITED STATES INDIVIDUAL)

108

8196 HALL BLVD

BEAVERTON, OR 97008

THE MARK CONSISTS OF STANDARD CHARACTERS WITHOUT CLAIM TO ANY PARTICULAR FONT, STYLE, SIZE, OR COLOR.

FOR: COSMETICS, IN CLASS 3 (U.S. CLS. 1, 4, 6, 50, 51 AND 52).

SER. NO. 77-519,645, FILED 7-10-2008.

FIRST USE 4-22-2004; IN COMMERCE 4-22-2004.

THOMAS MANOR, EXAMINING ATTORNEY

Int. Cl.: 43

Prior U.S. Cls.: 100 and 101

United States Patent and Trademark Office

Reg. No. 3,575,971

Registered Feb. 17, 2009

**SERVICE MARK
PRINCIPAL REGISTER**

PRIMO'S PIZZA RESTAURANT

ABMG CORPORATION (NEW YORK CORPORATION)

87 SPRING VALLEY ST.

BEACON, NY 12508

FOR: RESTAURANT SERVICES, IN CLASS 43
(U.S. CLS. 100 AND 101).

FIRST USE 10-30-2005; IN COMMERCE 10-30-2005.

THE MARK CONSISTS OF STANDARD CHARACTERS WITHOUT CLAIM TO ANY PARTICULAR FONT, STYLE, SIZE, OR COLOR.

NO CLAIM IS MADE TO THE EXCLUSIVE RIGHT TO USE "PIZZA RESTAURANT", APART FROM THE MARK AS SHOWN.

SER. NO. 77-519,651, FILED 7-10-2008.

SHAILA SETTLES, EXAMINING ATTORNEY

Int. Cl.: 20

Prior U.S. Cls.: 2, 13, 22, 25, 32 and 50

United States Patent and Trademark Office

Reg. No. 3,575,972

Registered Feb. 17, 2009

**TRADEMARK
PRINCIPAL REGISTER**

Flexi-Felt

6227945 CANADA INC (CANADA CORPORATION), DBA INNOVATION ENGINEERING GROUP
SUITE 100
15 VILLEBOIS
GATINEAU, CANADA J8T8J7

FIRST USE 5-1-2004; IN COMMERCE 8-25-2004.

THE MARK CONSISTS OF STANDARD CHARACTERS WITHOUT CLAIM TO ANY PARTICULAR FONT, STYLE, SIZE, OR COLOR.

FOR: FITTED FURNITURE LEG COVERS FOR FLOOR PROTECTION PURPOSES, IN CLASS 20 (U.S. CLS. 2, 13, 22, 25, 32 AND 50).

SER. NO. 77-519,674, FILED 7-10-2008.

JANICE KIM, EXAMINING ATTORNEY

Int. Cl.: 3

Prior U.S. Cls.: 1, 4, 6, 50, 51 and 52

Reg. No. 3,575,973

United States Patent and Trademark Office

Registered Feb. 17, 2009

**TRADEMARK
PRINCIPAL REGISTER**



KALM COMPANY (TEXAS PARTNERSHIP), DBA
SCENTS OF KALM
APT 1022
54 RAINEY STREET
AUSTIN, TX 78701

FIRST USE 10-16-2006; IN COMMERCE 10-16-2006.

FOR: BODY BUTTER; BODY LOTION; BODY
LOTIONS; BODY MILK; BODY SCRUB; BODY
SPRAY USED AS A PERSONAL DEODORANT
AND AS FRAGRANCE; BODY WASHES; LIQUID
SOAPS FOR HANDS, FACE AND BODY; LOTIONS
FOR FACE AND BODY CARE; SCENTED BODY
LOTIONS AND CREAMS; SCENTED BODY SPRAY;
SOAPS FOR BODY CARE, IN CLASS 3 (U.S. CLS. 1, 4,
6, 50, 51 AND 52).

THE MARK CONSISTS OF A SILHOUETTE OF A
WOMAN, THE OUTLINE OF WHICH IS MADE UP
OF THE LETTERS "K", "A", "L" AND "M", AND THE
NAME OF THE BUSINESS: "SCENTS OF KALM", IN
SCRIPT12 BT FONT, UNDERLINED WITH THE
"M".

SER. NO. 77-519,678, FILED 7-10-2008.

JANICE KIM, EXAMINING ATTORNEY

Int. Cl.: 10

Prior U.S. Cls.: 26, 39 and 44

United States Patent and Trademark Office

Reg. No. 3,575,974

Registered Feb. 17, 2009

**TRADEMARK
PRINCIPAL REGISTER**

element massager

EVAN MORGANSTERN (UNITED STATES INDIVIDUAL)
106 SOUTH KIHRRIDGE
ENCINITAS, CA 92024

FOR: MESSAGE APPARATUS; MESSAGE APPARATUS AND INSTRUMENTS; MASSAGING APPARATUS FOR PERSONAL USE, IN CLASS 10 (U.S. CLS. 26, 39 AND 44).

FIRST USE 8-17-2007; IN COMMERCE 8-20-2007.

THE MARK CONSISTS OF STANDARD CHARACTERS WITHOUT CLAIM TO ANY PARTICULAR FONT, STYLE, SIZE, OR COLOR.

NO CLAIM IS MADE TO THE EXCLUSIVE RIGHT TO USE "MASSAGER", APART FROM THE MARK AS SHOWN.

SER. NO. 77-519,711, FILED 7-11-2008.

MICHAEL SOUDERS, EXAMINING ATTORNEY

Int. Cl.: 29

Prior U.S. Cl.: 46

United States Patent and Trademark Office

Reg. No. 3,575,975

Registered Feb. 17, 2009

**TRADEMARK
PRINCIPAL REGISTER**

BISONLO

BARREIRO, ANA H. (UNITED STATES INDIVIDUAL)
10204 PANDORA LN NW
ALBUQUERQUE, NM 87114

THE MARK CONSISTS OF STANDARD CHARACTERS WITHOUT CLAIM TO ANY PARTICULAR FONT, STYLE, SIZE, OR COLOR.

FOR: MEAT-BASED SNACK FOODS, IN CLASS 29 (U.S. CL. 46).

SER. NO. 77-519,716, FILED 7-11-2008.

FIRST USE 7-10-2008; IN COMMERCE 7-10-2008.

EDWARD FENNESSY, EXAMINING ATTORNEY

Int. Cl.: 19

Prior U.S. Cls.: 1, 12, 33 and 50

United States Patent and Trademark Office

Reg. No. 3,575,976

Registered Feb. 17, 2009

**TRADEMARK
PRINCIPAL REGISTER**

THE CONCRETE SPECIALISTS

THOMAS CONCRETE INDUSTRIES, INC. (DE-
LAWARE CORPORATION)
SUITE 200
2500 CUMBERLAND PARKWAY
ATLANTA, GA 303393922

FOR: CONCRETE MANUFACTURED FOR RESI-
DENTIAL, COMMERCIAL AND PUBLIC CON-
STRUCTION PROJECTS, IN CLASS 19 (U.S. CLS. 1,
12, 33 AND 50).

FIRST USE 5-1-1986; IN COMMERCE 5-1-1986.

THE MARK CONSISTS OF STANDARD CHAR-
ACTERS WITHOUT CLAIM TO ANY PARTICULAR
FONT, STYLE, SIZE, OR COLOR.

OWNER OF U.S. REG. NOS. 1,673,117 AND
1,697,220.

SEC. 2(F).

SER. NO. 77-519,757, FILED 7-11-2008.

GRETTA YAO, EXAMINING ATTORNEY

Int. Cl.: 42

Prior U.S. Cls.: 100 and 101

United States Patent and Trademark Office

Reg. No. 3,575,977

Registered Feb. 17, 2009

**SERVICE MARK
PRINCIPAL REGISTER**

THE CONCRETE SPECIALISTS

THOMAS CONCRETE INDUSTRIES, INC. (DE-
LAWARE CORPORATION)
SUITE 200
2500 CUMBERLAND PARKWAY
ATLANTA, GA 303393922

FOR: CONCRETE QUALITY CONTROL, ASSESS-
MENT AND FEASIBILITY ANALYSIS FOR RESI-
DENTIAL, COMMERCIAL, AND PUBLIC
CONSTRUCTION PROJECTS , IN CLASS 42 (U.S.
CLS. 100 AND 101).

FIRST USE 5-1-1986; IN COMMERCE 5-1-1986.

THE MARK CONSISTS OF STANDARD CHAR-
ACTERS WITHOUT CLAIM TO ANY PARTICULAR
FONT, STYLE, SIZE, OR COLOR.

OWNER OF U.S. REG. NOS. 1,673,117 AND
1,697,220.

SEC. 2(F).

SER. NO. 77-519,807, FILED 7-11-2008.

GRETTA YAO, EXAMINING ATTORNEY

Int. Cl.: 41

Prior U.S. Cls.: 100, 101 and 107

Reg. No. 3,575,978

United States Patent and Trademark Office

Registered Feb. 17, 2009

**SERVICE MARK
PRINCIPAL REGISTER**



JOHN D. HARDY (UNITED STATES INDIVIDUAL)
10869 CHAPADA WAY
SANDY, UT 84094

FOR: TRAINING IN THE FIELD OF DEVELOPMENT, IMPROVEMENT, REMEDIATION, AND REHABILITATION OF NEURO-SENSORY PROCESSING SKILLS RELATED TO COGNITIVE-MOTOR FUNCTIONS INCLUDING NEUROLOGICAL PROCESSES OF MOTOR PLANNING AND SEQUENCING, SUSTAINED ATTENTION, LANGUAGE FORMATION, MOTOR COORDINATION, BALANCE, FOCUSED ATTENTION, FILTERING OUT INTERNAL/EXTERNAL DISTRACTIONS, ENHANCING INFORMATION PROCESSING, WORKING MEMORY, SHORT-TERM AND LONG-TERM MEMORY, MENTAL CONCENTRATION, PSYCHOMOTOR SPEED AND ACCURACY, PERCEPTUAL PROCESSING, PHYSICAL ENDURANCE, STAMINA, AND MOTOR COORDINATION; TRAINING IN THE FIELD OF FOCUSED TREATMENT, REMEDIATION, AND ENHANCEMENT OF NEURO-SENSORY PROCESSING SKILLS RELATED TO COGNITIVE-MOTOR FUNCTIONS INCLUDING NEUROLOGICAL PROCESSES OF MOTOR PLANNING AND SEQUENCING, SUSTAINED ATTENTION, LANGUAGE FORMATION, MOTOR COORDINATION, BALANCE, FOCUSED ATTENTION, FILTERING OUT INTERNAL/EXTERNAL DISTRACTIONS, ENHANCING INFORMATION PROCESSING, WORKING MEMORY, SHORT-TERM AND LONG-TERM MEMORY, MENTAL

CONCENTRATION, PSYCHOMOTOR SPEED AND ACCURACY, PERCEPTUAL PROCESSING, PHYSICAL ENDURANCE, STAMINA, AND MOTOR COORDINATION RELATED TO DYSLEXIA, ACADEMIC PROBLEMS, SPEECH/LANGUAGE DELAYS, INFORMATION PROCESSING AND RELATED PROCESSING DISORDERS, MEMORY AND LEARNING DEFICITS, LEARNING PROBLEMS OF READING, MATHEMATICS AND WRITTEN LANGUAGE, SENSORY INTEGRATION DISORDER, ATTENTION DEFICIT DISORDER WITH AND WITHOUT HYPERACTIVITY, TRAUMATIC BRAIN INJURY (TBI), CEREBRAL VASCULAR ACCIDENT (CVA), AUTISM SPECTRUM DISORDERS, PARKINSON'S DISEASE, MULTIPLE SCLEROSIS AND OTHER NEUROLOGICAL CONDITIONS; TRAINING IN THE FIELD OF ENHANCING NEURO-SENSORY PROCESSING SKILLS RELATED TO COGNITIVE-MOTOR FUNCTIONS INCLUDING NEUROLOGICAL PROCESSES OF MOTOR PLANNING AND SEQUENCING, SUSTAINED ATTENTION, LANGUAGE FORMATION, MOTOR COORDINATION, BALANCE, FOCUSED ATTENTION, FILTERING OUT INTERNAL/EXTERNAL DISTRACTIONS, ENHANCING INFORMATION PROCESSING, WORKING MEMORY, SHORT-TERM AND LONG-TERM MEMORY, MENTAL CONCENTRATION, PSYCHOMOTOR SPEED AND ACCURACY, PERCEPTUAL PROCESSING, PHYSICAL ENDURANCE, STAMINA, AND MOTOR COORDINATION, FEATURING USE OF BOTH COMPUTER-ASSISTED AND NON-COMPUTER-AS-

SISTED TECHNIQUES FROM PSYCHOLOGY, SPEECH PATHOLOGY, PHYSICAL THERAPY, OCCUPATIONAL THERAPY, EDUCATION, SPECIAL EDUCATION AND NEUROSCIENCES, IN CLASS 41 (U.S. CLS. 100, 101 AND 107).

FIRST USE 7-1-2001; IN COMMERCE 7-1-2001.

THE MARK CONSISTS OF TWO HUMAN TORSOS AND HEADS WITH A BOOK BETWEEN THEM, ALL INSIDE THE LETTER "U".

SER. NO. 77-519,885, FILED 7-11-2008.

HANNO RITTNER, EXAMINING ATTORNEY

Int. Cl.: 45

Prior U.S. Cls.: 100 and 101

United States Patent and Trademark Office

Reg. No. 3,575,979

Registered Feb. 17, 2009

**SERVICE MARK
PRINCIPAL REGISTER**

what life can be

ABUNDANT LIVING FAITH CENTER CHURCH,
INC. (TEXAS CORPORATION)
2019 E. MISSOURI
EL PASO, TX 79903

FOR: RELIGIOUS AND SPIRITUAL SERVICES,
NAMELY, CONDUCTING RELIGIOUS WORSHIP,
EVANGELICAL, AND MINISTERIAL SERVICES, IN
CLASS 45 (U.S. CLS. 100 AND 101).

FIRST USE 12-31-2007; IN COMMERCE 12-31-2007.

THE MARK CONSISTS OF STYLIZED WORD-
ING.

SER. NO. 77-519,896, FILED 7-11-2008.

RONALD AIKENS, EXAMINING ATTORNEY

Int. Cl.: 20

Prior U.S. Cls.: 2, 13, 22, 25, 32 and 50

United States Patent and Trademark Office

Reg. No. 3,575,980

Registered Feb. 17, 2009

**TRADEMARK
PRINCIPAL REGISTER**

VOYAGES

LEGACY WINDOW COVERINGS, LLC (ARIZONA LIMITED LIABILITY COMPANY)
1145 WEST GARY AVENUE
GILBERT, AZ 85233

THE MARK CONSISTS OF STANDARD CHARACTERS WITHOUT CLAIM TO ANY PARTICULAR FONT, STYLE, SIZE, OR COLOR.

FOR: INDOOR WINDOW BLINDS; WINDOW BLINDS; WINDOW SHADES, IN CLASS 20 (U.S. CLS. 2, 13, 22, 25, 32 AND 50).

SER. NO. 77-519,923, FILED 7-11-2008.

FIRST USE 6-13-2008; IN COMMERCE 6-13-2008.

SUSAN LESLIE DUBOIS, EXAMINING ATTORNEY

Int. Cl.: 42

Prior U.S. Cls.: 100 and 101

United States Patent and Trademark Office

Reg. No. 3,575,981

Registered Feb. 17, 2009

**SERVICE MARK
PRINCIPAL REGISTER**

Vonoa

VONOA INC. (DELAWARE CORPORATION)
313 68TH STREET
DARIEN, IL 60561

THE MARK CONSISTS OF STANDARD CHAR-
ACTERS WITHOUT CLAIM TO ANY PARTICULAR
FONT, STYLE, SIZE, OR COLOR.

FOR: CONSULTING IN THE FIELD OF INFOR-
MATION TECHNOLOGY, IN CLASS 42 (U.S. CLS.
100 AND 101).

SER. NO. 77-519,973, FILED 7-11-2008.

FIRST USE 4-1-2008; IN COMMERCE 5-24-2008.

GEORGE LORENZO, EXAMINING ATTORNEY

Int. Cl.: 41

Prior U.S. Cls.: 100, 101 and 107

United States Patent and Trademark Office

Reg. No. 3,575,982

Registered Feb. 17, 2009

**SERVICE MARK
PRINCIPAL REGISTER**

CARBONRALLY

CARBON CHALLENGE, INC. (DELAWARE CORPORATION)
42 IVALOO STREET
SOMERVILLE, MA 02143

FOR: ARRANGING OF CONTESTS; CONDUCTING WORKSHOPS AND SEMINARS IN THE FIELD OF ENVIRONMENTALISM; EDUCATIONAL SERVICES, NAMELY, CONDUCTING WORKSHOPS AND SEMINARS IN THE FIELD OF ENVIRONMENTALISM AND DISTRIBUTION OF COURSE MATERIAL IN CONNECTION THEREWITH; ON-LINE JOURNALS, NAMELY, BLOGS FEATURING INFORMATION ABOUT ENVIRONMENTALISM; PROVIDING NEWSLETTERS IN THE FIELD OF ENVIRONMENTALISM VIA E-MAIL; PROVIDING

RECOGNITION AND INCENTIVES BY THE WAY OF AWARDS AND CONTESTS TO DEMONSTRATE EXCELLENCE IN THE FIELD OF ENVIRONMENTALISM, IN CLASS 41 (U.S. CLS. 100, 101 AND 107).

FIRST USE 10-23-2007; IN COMMERCE 10-23-2007.

THE MARK CONSISTS OF STANDARD CHARACTERS WITHOUT CLAIM TO ANY PARTICULAR FONT, STYLE, SIZE, OR COLOR.

SER. NO. 77-520,016, FILED 7-11-2008.

CYNTHIA TRIPI, EXAMINING ATTORNEY

Int. Cl.: 9

Prior U.S. Cls.: 21, 23, 26, 36 and 38

United States Patent and Trademark Office

Reg. No. 3,575,983

Registered Feb. 17, 2009

**TRADEMARK
PRINCIPAL REGISTER**

LOKAD

VERMOREL, JOANNES (FRANCE INDIVIDUAL)
70 RUE LEMERCIER
PARIS, FRANCE 75017

FOR: COMPUTER SOFTWARE FOR PROVIDING AN ON-LINE DATABASE IN THE FIELD OF TRANSACTION PROCESSING TO UPLOAD TRANSACTIONAL DATA, PROVIDE STATISTICAL ANALYSIS, AND PRODUCE NOTIFICATIONS AND REPORTS; COMPUTER SOFTWARE FOR THE FIELD OF WAREHOUSING AND DISTRIBUTION, TO MANAGE TRANSACTIONAL DATA, PROVIDE STATISTICAL ANALYSIS, AND PRODUCE NOTI-

FICATIONS AND REPORTS, IN CLASS 9 (U.S. CLS. 21, 23, 26, 36 AND 38).

FIRST USE 4-6-2006; IN COMMERCE 4-6-2006.

THE MARK CONSISTS OF STANDARD CHARACTERS WITHOUT CLAIM TO ANY PARTICULAR FONT, STYLE, SIZE, OR COLOR.

SER. NO. 77-520,034, FILED 7-11-2008.

DAVID H. STINE, EXAMINING ATTORNEY

Int. Cl.: 41

Prior U.S. Cls.: 100, 101 and 107

United States Patent and Trademark Office

Reg. No. 3,575,984

Registered Feb. 17, 2009

**SERVICE MARK
PRINCIPAL REGISTER**



STRATEGIC SAFETY ASSOCIATES, INC. (ORE-
GON CORPORATION)
POST OFFICE BOX 80161
PORTLAND, OR 972801161

FOR: TRAINING SERVICES, NAMELY, IN-
STRUCTING EXECUTIVES, MANAGERS, AND/OR
SUPERVISORS IN MANAGEMENT STRATEGIES
AND METHODS FOR ACHIEVING SAFE WORK-
PLACE PRACTICES, IN CLASS 41 (U.S. CLS. 100, 101
AND 107).

FIRST USE 1-0-2005; IN COMMERCE 1-0-2005.

THE MARK CONSISTS OF A DEPICTION OF
THREE STYLIZED HUMAN BEINGS WITHIN A
CIRCLE, BISECTED BY A WAVY LINE WITH THE
CONTRAST REVERSED ON EITHER SIDE OF THE
LINE.

SER. NO. 77-520,035, FILED 7-11-2008.

SARA THOMAS, EXAMINING ATTORNEY

Int. Cl.: 42

Prior U.S. Cls.: 100 and 101

United States Patent and Trademark Office

Reg. No. 3,575,985

Registered Feb. 17, 2009

**SERVICE MARK
PRINCIPAL REGISTER**

CARBONRALLY

CARBON CHALLENGE, INC. (DELAWARE CORPORATION)
42 IVALOO STREET
SOMERVILLE, MA 02143

FOR: PROVIDING A WEB SITE FEATURING INFORMATION ABOUT GLOBAL WARMING AND ITS EFFECT ON NATURE AND THE ENVIRONMENT; PROVIDING A WEB-SITE FEATURING ENVIRONMENTAL INFORMATION ABOUT CLIMATE CHANGE AND BIO-DIVERSITY, IN CLASS 42 (U.S. CLS. 100 AND 101).

FIRST USE 10-23-2007; IN COMMERCE 10-23-2007.

THE MARK CONSISTS OF STANDARD CHARACTERS WITHOUT CLAIM TO ANY PARTICULAR FONT, STYLE, SIZE, OR COLOR.

SER. NO. 77-520,037, FILED 7-11-2008.

CYNTHIA TRIPI, EXAMINING ATTORNEY

Int. Cl.: 16

Prior U.S. Cls.: 2, 5, 22, 23, 29, 37, 38 and 50

United States Patent and Trademark Office

Reg. No. 3,575,986

Registered Feb. 17, 2009

**TRADEMARK
PRINCIPAL REGISTER**

MINT-X

JAD CORPORATION OF AMERICA (CONNECTI-
CUT CORPORATION)
20-48 119TH STREET
COLLEGE POINT, NY 113562123

FOR: PLASTIC TRASH AND GARBAGE BAGS,
AND GENERAL PURPOSE PLASTIC BAGS, IN
CLASS 16 (U.S. CLS. 2, 5, 22, 23, 29, 37, 38 AND 50).

FIRST USE 2-27-2008; IN COMMERCE 2-27-2008.

THE MARK CONSISTS OF STANDARD CHAR-
ACTERS WITHOUT CLAIM TO ANY PARTICULAR
FONT, STYLE, SIZE, OR COLOR.

SER. NO. 77-520,067, FILED 7-11-2008.

LEIGH CAROLINE CASE, EXAMINING ATTOR-
NEY

Int. Cl.: 16

Prior U.S. Cls.: 2, 5, 22, 23, 29, 37, 38 and 50

United States Patent and Trademark Office

Reg. No. 3,575,987

Registered Feb. 17, 2009

**TRADEMARK
PRINCIPAL REGISTER**

PROTECTIVE POWER OF MINT

JAD CORPORATION OF AMERICA (CONNECTI-
CUT CORPORATION)
20-48 119TH STREET
COLLEGE POINT, NY 113562123

FOR: PLASTIC TRASH AND GARBAGE BAGS,
AND GENERAL PURPOSE PLASTIC BAGS, IN
CLASS 16 (U.S. CLS. 2, 5, 22, 23, 29, 37, 38 AND 50).

FIRST USE 2-27-2008; IN COMMERCE 2-27-2008.

THE MARK CONSISTS OF STANDARD CHAR-
ACTERS WITHOUT CLAIM TO ANY PARTICULAR
FONT, STYLE, SIZE, OR COLOR.

SER. NO. 77-520,079, FILED 7-11-2008.

LEIGH CAROLINE CASE, EXAMINING ATTOR-
NEY

Int. Cl.: 42

Prior U.S. Cls.: 100 and 101

United States Patent and Trademark Office

Reg. No. 3,575,988

Registered Feb. 17, 2009

**SERVICE MARK
PRINCIPAL REGISTER**

BSA  RADAR

DOMINIC SUSZEK (UNITED STATES INDIVIDUAL)
13245 ORTEGA LANE
NORTH MIAMI, FL 33181

FOR: PROVIDING TEMPORARY USE OF ON-LINE NON-DOWNLOADABLE SOFTWARE FOR ENSURING COMPLIANCE WITH ANTI-MONEY LAUNDERING PROVISIONS OF THE PATRIOT ACT, IN CLASS 42 (U.S. CLS. 100 AND 101).

FIRST USE 11-30-2005; IN COMMERCE 11-30-2005.

OWNER OF U.S. REG. NO. 3,451,514.

NO CLAIM IS MADE TO THE EXCLUSIVE RIGHT TO USE "BSA", APART FROM THE MARK AS SHOWN.

THE MARK CONSISTS OF THE WORDING "BSA RADAR" WITH A STAR IN THE MIDDLE OF THE "A" IN "BSA" AND THE IMAGE OF A RADAR DISPLAY BETWEEN "BSA" AND "RADAR".

SER. NO. 77-520,109, FILED 7-11-2008.

LAURIE KAUFMAN, EXAMINING ATTORNEY

Int. Cl.: 9

Prior U.S. Cls.: 21, 23, 26, 36 and 38

Reg. No. 3,575,989

United States Patent and Trademark Office

Registered Feb. 17, 2009

**TRADEMARK
PRINCIPAL REGISTER**

TOUR de FORCE

THE MRH TECHNOLOGY GROUP (OHIO CORPORATION)
SUITE 201
1219 WEST MAIN CROSS STREET
FINDLAY, OH 458400702

FOR: SOFTWARE FOR CUSTOMER RELATIONSHIP MANAGEMENT AND SALES FORCE AUTOMATION, IN CLASS 9 (U.S. CLS. 21, 23, 26, 36 AND 38).

FIRST USE 10-1-2001; IN COMMERCE 10-1-2001.

THE MARK CONSISTS OF STANDARD CHARACTERS WITHOUT CLAIM TO ANY PARTICULAR FONT, STYLE, SIZE, OR COLOR.

SER. NO. 77-520,122, FILED 7-11-2008.

MARK PILARO, EXAMINING ATTORNEY

Int. Cl.: 36

Prior U.S. Cls.: 100, 101 and 102

United States Patent and Trademark Office

Reg. No. 3,575,990

Registered Feb. 17, 2009

**SERVICE MARK
PRINCIPAL REGISTER**

SUPER IRA

MCCONNELL-MONROE, INC. (INDIANA CORPORATION)
6415 CASTLEWAY W. DR. SUITE 106
INDIANAPOLIS, IN 46250

FOR: ANNUITY UNDERWRITING; FINANCIAL PLANNING AND INVESTMENT ADVISORY SERVICES; FINANCIAL PLANNING FOR RETIREMENT; FINANCIAL PLANNING, NAMELY, THE CREATION OF PERSONALIZED STRATEGIES TO ACHIEVE FINANCIAL INDEPENDENCE; ISSUANCE AND ADMINISTRATION OF ANNUITIES, IN CLASS 36 (U.S. CLS. 100, 101 AND 102).

FIRST USE 1-2-1997; IN COMMERCE 1-2-1997.

THE MARK CONSISTS OF STANDARD CHARACTERS WITHOUT CLAIM TO ANY PARTICULAR FONT, STYLE, SIZE, OR COLOR.

OWNER OF U.S. REG. NO. 2,258,281.

NO CLAIM IS MADE TO THE EXCLUSIVE RIGHT TO USE "IRA", APART FROM THE MARK AS SHOWN.

SEC. 2(F).

SER. NO. 77-520,125, FILED 7-11-2008.

ANNE E. GUSTASON, EXAMINING ATTORNEY

Int. Cl.: 36

Prior U.S. Cls.: 100, 101 and 102

United States Patent and Trademark Office

Reg. No. 3,575,991

Registered Feb. 17, 2009

**SERVICE MARK
PRINCIPAL REGISTER**

Retire with Dignity

CATHEDRAL FINANCIAL GROUP, INC. (CALIFORNIA CORPORATION)
SUITE 202
8080 CAPWELL DRIVE
OAKLAND, CA 94621

FOR: ADVICE RELATING TO INVESTMENTS; ANNUITY SERVICES, NAMELY, ACCOUNT AND INVESTMENT ADMINISTRATION; BROKERAGE OF SHARES AND OTHER SECURITIES; CHARITABLE FUND RAISING; ESTABLISHING MUTUAL FUNDS FOR OTHERS; FINANCIAL ADMINISTRATION OF RETIREMENT PLANS; FINANCIAL ADVICE AND CONSULTANCY SERVICES; FINANCIAL ANALYSIS AND CONSULTATION; FINANCIAL AND INVESTMENT SERVICES, NAMELY, MANAGEMENT AND BROKERAGE IN THE FIELDS OF STOCKS, BONDS, OPTIONS, COMMODITIES, FUTURES AND OTHER SECURITIES, AND THE INVESTMENT OF FUNDS OF OTHERS; FINANCIAL CONSULTANCY AND INSURANCE CONSULTANCY; FINANCIAL CONSULTING; FINANCIAL MANAGEMENT; FINANCIAL PLANNING AND INVESTMENT ADVISORY SERVICES; FINANCIAL PLANNING CONSULTATION; FINANCIAL PLANNING FOR RETIREMENT; FINANCIAL PLANNING SERVICES, NAMELY, DEVELOPING AND MANAGING CHARITABLE GIVING PROGRAMS ON BEHALF OF WEALTHY INDIVIDUALS OR FAMILIES; FINANCIAL PLANNING, NAMELY, THE CREATION OF PERSONALIZED STRATEGIES TO ACHIEVE FINANCIAL INDEPENDENCE; FINANCIAL PORTFOLIO ANALYSIS SERVICES; FINANCIAL PORTFOLIO MANAGEMENT; FINANCIAL SERVICES, NAMELY, A TOTAL PORTFOLIO OFFERING FOR HIGH NET WORTH CLIENTS CONSISTING OF BOTH SEPARATE ACCOUNTS AND MUTUAL FUNDS FOR EQUITY AND FIXED INCOME INVESTMENTS; FINANCIAL SERVICES, NAMELY, ASSISTING OTHERS WITH

THE COMPLETION OF FINANCIAL TRANSACTIONS FOR STOCKS, BONDS, SECURITIES AND EQUITIES; INSURANCE AND FINANCIAL INFORMATION AND CONSULTANCY SERVICES; INSURANCE CONSULTANCY; INVESTMENT ADVICE; INVESTMENT ADVISORY SERVICES; INVESTMENT CLUBS; INVESTMENT CONSULTATION; INVESTMENT MANAGEMENT; INVESTMENT MANAGEMENT OF AND DISTRIBUTION OF ANNUITIES; MUTUAL FUND INVESTMENT; ON-LINE FINANCIAL PLANNING SERVICES; PROVIDING A WEB SITE FEATURING PERSONAL FINANCIAL INFORMATION AND FINANCIAL ADVICE; PROVIDING FINANCIAL INFORMATION; PROVIDING INFORMATION AND ADVICE IN THE FIELD OF FINANCE, FINANCIAL INVESTMENTS, FINANCIAL VALUATIONS, AND THE FINANCIAL ASPECTS OF RETIREMENT; PROVIDING INFORMATION IN INSURANCE MATTERS; PROVIDING ON-LINE FINANCIAL CALCULATORS; PROVIDING ON-LINE NEWS IN THE FIELD OF FINANCE; SECURITIES TRADING AND INVESTING SERVICES FOR OTHERS VIA THE INTERNET; SOCIAL SECURITY AND MEDICARE CLAIMS ADMINISTRATION AND CONSULTING SERVICES RENDERED TO INDIVIDUALS; TRUST MANAGEMENT ACCOUNTS, IN CLASS 36 (U.S. CLS. 100, 101 AND 102).

FIRST USE 6-4-2008; IN COMMERCE 7-11-2008.

THE MARK CONSISTS OF STANDARD CHARACTERS WITHOUT CLAIM TO ANY PARTICULAR FONT, STYLE, SIZE, OR COLOR.

SER. NO. 77-520,132, FILED 7-11-2008.

MICHAEL LITZAU, EXAMINING ATTORNEY

Int. Cl.: 9

Prior U.S. Cls.: 21, 23, 26, 36 and 38

United States Patent and Trademark Office

Reg. No. 3,575,992

Registered Feb. 17, 2009

**TRADEMARK
PRINCIPAL REGISTER**

KOHAN

TIMEGATE STUDIOS, INC. (TEXAS CORPORATION)
14140 SOUTHWEST FREEWAY, SUITE 400
SUGAR LAND, TX 77478

FOR: COMPUTER GAME SOFTWARE; INTERACTIVE MULTIMEDIA COMPUTER GAME PROGRAM; INTERACTIVE VIDEO GAME PROGRAMS; VIDEO AND COMPUTER GAME PROGRAMS, IN CLASS 9 (U.S. CLS. 21, 23, 26, 36 AND 38).

FIRST USE 9-30-2000; IN COMMERCE 9-30-2000.

THE MARK CONSISTS OF STANDARD CHARACTERS WITHOUT CLAIM TO ANY PARTICULAR FONT, STYLE, SIZE, OR COLOR.

OWNER OF U.S. REG. NOS. 2,606,179, 2,988,312, AND 3,005,169.

SEC. 2(F).

SER. NO. 77-520,133, FILED 7-11-2008.

LANA PHAM, EXAMINING ATTORNEY

Int. Cl.: 9

Prior U.S. Cls.: 21, 23, 26, 36 and 38

United States Patent and Trademark Office

Reg. No. 3,575,993

Registered Feb. 17, 2009

**TRADEMARK
PRINCIPAL REGISTER**

BeamMaker

REVERB NETWORKS, INC. (VIRGINIA CORPORATION)
20099 ASHBROOK PLACE, SUITE 105
ASHBURN, VA 20147

FOR: COMPUTER SOFTWARE AND HARDWARE FOR INTEGRATED ANTENNA ARRAYS THAT ALLOWS THE CONTROL OF UPLINK AND DOWNLINK SIGNAL PATTERNS TO ACCOMMODATE FREQUENCY SELECTION, SPACIAL LOCATION AND BEAM SHAPES; GRAPHICAL USER INTERFACE SOFTWARE, IN CLASS 9 (U.S. CLS. 21, 23, 26, 36 AND 38).

FIRST USE 10-1-2007; IN COMMERCE 1-24-2008.

THE MARK CONSISTS OF STANDARD CHARACTERS WITHOUT CLAIM TO ANY PARTICULAR FONT, STYLE, SIZE, OR COLOR.

SER. NO. 77-520,135, FILED 7-11-2008.

FLORENTINA BLANDU, EXAMINING ATTORNEY

Int. Cl.: 1

Prior U.S. Cls.: 1, 5, 6, 10, 26 and 46

Reg. No. 3,575,994

United States Patent and Trademark Office

Registered Feb. 17, 2009

**TRADEMARK
PRINCIPAL REGISTER**

THIOSTAR

LUMINOS, LLC (MICHIGAN LIMITED LIABILITY COMPANY)
1514 EISENHOWER PLACE
ANN ARBOR, MI 48108

THE MARK CONSISTS OF STANDARD CHARACTERS WITHOUT CLAIM TO ANY PARTICULAR FONT, STYLE, SIZE, OR COLOR.

FOR: REAGENTS FOR SCIENTIFIC OR MEDICAL RESEARCH USE, NAMELY, FLUORESCENT THIOL DETECTION REAGENTS, IN CLASS 1 (U.S. CLS. 1, 5, 6, 10, 26 AND 46).

SER. NO. 77-520,151, FILED 7-11-2008.

FIRST USE 7-7-2008; IN COMMERCE 7-7-2008.

KAREN K. BUSH, EXAMINING ATTORNEY

Int. Cl.: 9

Prior U.S. Cls.: 21, 23, 26, 36 and 38

Reg. No. 3,575,995

United States Patent and Trademark Office

Registered Feb. 17, 2009

**TRADEMARK
PRINCIPAL REGISTER**

FIMCO

FIMCO MANUFACTURING INC. (FLORIDA
CORPORATION)
15795 CORPORATE ROAD NORTH
JUPITER, FL 33478

THE MARK CONSISTS OF STANDARD CHAR-
ACTERS WITHOUT CLAIM TO ANY PARTICULAR
FONT, STYLE, SIZE, OR COLOR.

FOR: AUTOMATIC VALVE, IN CLASS 9 (U.S. CLS.
21, 23, 26, 36 AND 38).

SER. NO. 77-520,169, FILED 7-11-2008.

FIRST USE 10-31-1968; IN COMMERCE 10-31-1968.

MATTHEW KLINE, EXAMINING ATTORNEY

Int. Cl.: 41

Prior U.S. Cls.: 100, 101 and 107

United States Patent and Trademark Office

Reg. No. 3,575,996

Registered Feb. 17, 2009

**SERVICE MARK
PRINCIPAL REGISTER**

**MANKIND ENLIGHTENMENT LOVE
(M.E.L.)**

MANKIND ENLIGHTENMENT LOVE, INC. (MISSOURI CORPORATION)
4448 TELEGRAPH ROAD
ST. LOUIS, MO 63129

FOR: EDUCATIONAL SERVICES, NAMELY, CONDUCTING CLASSES, SEMINARS, CONFERENCES, AND WORKSHOPS IN THE FIELD OF YOGA, MEDITATION, AND SELF-HEALING, AND DISTRIBUTING COURSE MATERIALS IN CONNECTION THEREWITH, IN CLASS 41 (U.S. CLS. 100, 101 AND 107).

FIRST USE 3-31-2000; IN COMMERCE 3-31-2000.

THE MARK CONSISTS OF STANDARD CHARACTERS WITHOUT CLAIM TO ANY PARTICULAR FONT, STYLE, SIZE, OR COLOR.

OWNER OF U.S. REG. NOS. 2,461,659, 2,495,931, AND 3,129,206.

SER. NO. 77-520,215, FILED 7-11-2008.

DORITT L. CARROLL, EXAMINING ATTORNEY

Int. Cl.: 36

Prior U.S. Cls.: 100, 101 and 102

United States Patent and Trademark Office

Reg. No. 3,575,997

Registered Feb. 17, 2009

**SERVICE MARK
PRINCIPAL REGISTER**

COLLEGE ROW

CAMPUS APARTMENTS, LLC (PENNSYLVANIA
LIMITED LIABILITY COMPANY)
4043 WALNUT STREET
PHILADELPHIA, PA 19104

THE MARK CONSISTS OF STANDARD CHAR-
ACTERS WITHOUT CLAIM TO ANY PARTICULAR
FONT, STYLE, SIZE, OR COLOR.

FOR: REAL ESTATE MANAGEMENT, IN CLASS
36 (U.S. CLS. 100, 101 AND 102).

SER. NO. 77-520,300, FILED 7-11-2008.

FIRST USE 8-1-2007; IN COMMERCE 8-1-2007.

SANJEEV VOHRA, EXAMINING ATTORNEY

Int. Cl.: 9

Prior U.S. Cls.: 21, 23, 26, 36 and 38

Reg. No. 3,575,998

United States Patent and Trademark Office

Registered Feb. 17, 2009

**TRADEMARK
PRINCIPAL REGISTER**

VANISH

NATIONAL VISION, INC. (GEORGIA CORPORATION)

ATTN: LEGAL DEPT. / CHARLES MINGLE
296 GRAYSON HIGHWAY
LAWRENCEVILLE, GA 300455750

FOR: EYEGLOSS FRAMES; EYEGASSES;
FRAMES FOR SPECTACLES; OPTICAL FRAMES;
SPECTACLE FRAMES, IN CLASS 9 (U.S. CLS. 21, 23,
26, 36 AND 38).

FIRST USE 8-21-2007; IN COMMERCE 8-21-2007.

THE MARK CONSISTS OF STANDARD CHARACTERS WITHOUT CLAIM TO ANY PARTICULAR FONT, STYLE, SIZE, OR COLOR.

SER. NO. 77-520,334, FILED 7-11-2008.

ALYSSA STEEL, EXAMINING ATTORNEY

Int. Cl.: 28

Prior U.S. Cls.: 22, 23, 38 and 50

United States Patent and Trademark Office

Reg. No. 3,575,999

Registered Feb. 17, 2009

**TRADEMARK
PRINCIPAL REGISTER**

LOCUST

EPIC GAMES, INC. (MARYLAND CORPORATION)
620 CROSSROADS BOULEVARD
CARY, NC 27518

THE MARK CONSISTS OF STANDARD CHARACTERS WITHOUT CLAIM TO ANY PARTICULAR FONT, STYLE, SIZE, OR COLOR.

FOR: TOY ACTION FIGURES, IN CLASS 28 (U.S. CLS. 22, 23, 38 AND 50).

SER. NO. 77-520,357, FILED 7-11-2008.

FIRST USE 5-15-2008; IN COMMERCE 5-15-2008.

IRA J. GOODSaid, EXAMINING ATTORNEY

Int. Cl.: 28

Prior U.S. Cls.: 22, 23, 38 and 50

United States Patent and Trademark Office

Reg. No. 3,576,000

Registered Feb. 17, 2009

**TRADEMARK
PRINCIPAL REGISTER**

MARCUS FENIX

EPIC GAMES, INC. (MARYLAND CORPORATION)
620 CROSSROADS BOULEVARD
CARY, NC 27518

FOR: TOY ACTION FIGURES, IN CLASS 28 (U.S. CLS. 22, 23, 38 AND 50).

FIRST USE 5-15-2008; IN COMMERCE 5-15-2008.

THE MARK CONSISTS OF STANDARD CHARACTERS WITHOUT CLAIM TO ANY PARTICULAR FONT, STYLE, SIZE, OR COLOR.

THE NAME, "MARCUS FENIX" DOES NOT IDENTIFY A PARTICULAR LIVING INDIVIDUAL.

SER. NO. 77-520,372, FILED 7-11-2008.

IRA J. GOODSaid, EXAMINING ATTORNEY

Int. Cl.: 16

Prior U.S. Cls.: 2, 5, 22, 23, 29, 37, 38 and 50

Reg. No. 3,576,001

United States Patent and Trademark Office

Registered Feb. 17, 2009

**TRADEMARK
PRINCIPAL REGISTER**



GENERAL BOARD OF HIGHER EDUCATION
AND MINISTRY OF THE UNITED METHO-
DIST CHURCH (TENNESSEE NON-PROFIT
CORPORATION)

1001 19TH AVENUE SOUTH
NASHVILLE, TN 37212

FOR: PRINTED MATERIALS, NAMELY, BOOKS,
MAGAZINES, NEWSPAPERS, PAMPHLETS AND
OTHER PRINTED INSTRUCTIONAL MATERIAL
IN THE FIELD OF RELIGIOUS EDUCATION AND
PROMOTION OF RELIGIOUS CONFERENCES,
EVENTS, ORGANIZATIONS AND RELIGION IN

GENERAL, IN CLASS 16 (U.S. CLS. 2, 5, 22, 23, 29,
37, 38 AND 50).

FIRST USE 0-0-1986; IN COMMERCE 0-0-1986.

THE MARK CONSISTS OF A CROSS, FLAME,
AND CURVED LINE DESIGN FORMING, IN PART,
A STYLIZED VERSION OF AN ANCIENT LAMP
REPRESENTING HIGHER LEARNING.

SER. NO. 77-520,396, FILED 7-11-2008.

ZHALEH DELANEY, EXAMINING ATTORNEY

Int. Cl.: 7

Prior U.S. Cls.: 13, 19, 21, 23, 31, 34 and 35

Reg. No. 3,576,002

United States Patent and Trademark Office

Registered Feb. 17, 2009

**TRADEMARK
PRINCIPAL REGISTER**

PALMER

HARRY MILLER CO., INC. (MASSACHUSETTS
CORPORATION)
850 ALBANY STREET
BOSTON, MA 02119

FOR: ELEVATOR PADS; ELEVATOR PARTS AND
ACCESSORIES, NAMELY, HANDRAILS, RAIL
MOUNT, HOOKS, STUDS, AND CLAMPS FOR
HANGING ELEVATOR PADS, IN CLASS 7 (U.S.
CLS. 13, 19, 21, 23, 31, 34 AND 35).

FIRST USE 0-0-1917; IN COMMERCE 0-0-1917.

THE MARK CONSISTS OF STANDARD CHAR-
ACTERS WITHOUT CLAIM TO ANY PARTICULAR
FONT, STYLE, SIZE, OR COLOR.

THE NAME "PALMER" DOES NOT IDENTIFY A
LIVING INDIVIDUAL.

SEC. 2(F).

SER. NO. 77-520,442, FILED 7-11-2008.

GEORGE LORENZO, EXAMINING ATTORNEY

Int. Cl.: 35

Prior U.S. Cls.: 100, 101 and 102

United States Patent and Trademark Office

Reg. No. 3,576,003

Registered Feb. 17, 2009

**SERVICE MARK
PRINCIPAL REGISTER**



GENERAL BOARD OF HIGHER EDUCATION
AND MINISTRY OF THE UNITED METHO-
DIST CHURCH (TENNESSEE NON-PROFIT
CORPORATION)

1001 19TH AVENUE SOUTH
NASHVILLE, TN 37212

FOR: PROVIDING ASSOCIATION SERVICES,
NAMELY, PROMOTING THE INTERESTS OF
CHRISTIAN LAY AND CLERGY LEADERS; PRO-
VIDING CAREER INFORMATION TO CHRISTIAN
LAY AND CLERGY LEADERS; CONSULTING IN
THE FIELD OF HUMAN RESOURCES DEVELOP-
MENT FOR RELIGIOUS ORGANIZATIONS, NAME-
LY, FOR THE PROMOTION OF CHRISTIAN LAY

AND CLERGY LEADER RETENTION AND CA-
REER GROWTH, IN CLASS 35 (U.S. CLS. 100, 101
AND 102).

FIRST USE 0-0-1986; IN COMMERCE 0-0-1986.

THE MARK CONSISTS OF A CROSS, FLAME,
AND CURVED LINE DESIGN FORMING, IN PART,
A STYLIZED VERSION OF AN ANCIENT LAMP
REPRESENTING HIGHER LEARNING.

SER. NO. 77-520,443, FILED 7-11-2008.

ZHALEH DELANEY, EXAMINING ATTORNEY

Int. Cls.: 5 and 32

Prior U.S. Cls.: 6, 18, 44, 45, 46, 48, 51 and 52

United States Patent and Trademark Office

Reg. No. 3,576,004

Registered Feb. 17, 2009

**TRADEMARK
PRINCIPAL REGISTER**

LEAN WITH IT

MOONEY LEASING, LLC (TEXAS LIMITED LIABILITY COMPANY)
17413 FM 2920
TOMBALL, TX 77377

FOR: DIETARY SUPPLEMENTAL DRINKS; NUTRITIONAL SUPPLEMENTS, IN CLASS 5 (U.S. CLS. 6, 18, 44, 46, 51 AND 52).

FIRST USE 5-1-2008; IN COMMERCE 5-1-2008.

FOR: ENERGY DRINKS; FRUIT FLAVORED DRINKS; FRUIT FLAVORED SOFT DRINKS; SOFT

DRINKS; SPORTS DRINKS, IN CLASS 32 (U.S. CLS. 45, 46 AND 48).

FIRST USE 5-1-2008; IN COMMERCE 5-1-2008.

THE MARK CONSISTS OF STANDARD CHARACTERS WITHOUT CLAIM TO ANY PARTICULAR FONT, STYLE, SIZE, OR COLOR.

SER. NO. 77-520,446, FILED 7-11-2008.

KHANH LE, EXAMINING ATTORNEY

Int. Cl.: 35

Prior U.S. Cls.: 100, 101 and 102

United States Patent and Trademark Office

Reg. No. 3,576,005

Registered Feb. 17, 2009

**SERVICE MARK
PRINCIPAL REGISTER**



CONSCIOUS COLLECTING LLC (NEW YORK
LIMITED LIABILITY COMPANY)
4961 HENRY HUDSON PARKWAY
RIVERDALE, NY 10471

FOR: ART GALLERIES, IN CLASS 35 (U.S. CLS.
100, 101 AND 102).

FIRST USE 2-7-2008; IN COMMERCE 2-7-2008.

THE COLOR(S) RED AND WHITE IS/ARE
CLAIMED AS A FEATURE OF THE MARK.

THE MARK CONSISTS OF IS AN ARBITRARY
AND FANCIFUL RED HELICAL SWIRL SUGGES-
TIVE OF AN ARTIST PAINT BRUSH BRUSH-
STROKE IN RED ON A WHITE BACKGROUND.
THE COLORS RED AND WHITE ARE CLAIMED AS
FEATURES OF THE MARK.

SER. NO. 77-520,450, FILED 7-11-2008.

GEORGE LORENZO, EXAMINING ATTORNEY

Int. Cls.: 5 and 32

Prior U.S. Cls.: 6, 18, 44, 45, 46, 48, 51 and 52

United States Patent and Trademark Office

Reg. No. 3,576,006

Registered Feb. 17, 2009

**TRADEMARK
PRINCIPAL REGISTER**

BERRY CALMING

MOONEY LEASING, LLC (TEXAS LIMITED LIABILITY COMPANY)

#H

17413 FM 2920

TOMBALL, TX 77377

FOR: DIETARY SUPPLEMENTAL DRINKS; NUTRITIONAL SUPPLEMENTS, IN CLASS 5 (U.S. CLS. 6, 18, 44, 46, 51 AND 52).

FIRST USE 5-1-2008; IN COMMERCE 5-1-2008.

FOR: ENERGY DRINKS; FRUIT FLAVORED DRINKS; FRUIT FLAVORED SOFT DRINKS; SOFT

DRINKS; SPORTS DRINKS, IN CLASS 32 (U.S. CLS. 45, 46 AND 48).

FIRST USE 5-1-2008; IN COMMERCE 5-1-2008.

THE MARK CONSISTS OF STANDARD CHARACTERS WITHOUT CLAIM TO ANY PARTICULAR FONT, STYLE, SIZE, OR COLOR.

SER. NO. 77-520,460, FILED 7-11-2008.

KHANH LE, EXAMINING ATTORNEY

Int. Cl.: 36

Prior U.S. Cls.: 100, 101 and 102

United States Patent and Trademark Office

Reg. No. 3,576,007

Registered Feb. 17, 2009

**SERVICE MARK
PRINCIPAL REGISTER**



GENERAL BOARD OF HIGHER EDUCATION
AND MINISTRY OF THE UNITED METHO-
DIST CHURCH (TENNESSEE NON-PROFIT
CORPORATION)
1001 19TH AVENUE SOUTH
NASHVILLE, TN 37212

FOR: CHARITABLE FUNDRAISING SERVICES
FOR A PARTICULAR RELIGIOUS ORGANIZA-
TION; CHARITABLE SERVICES, NAMELY,
GRANTING FUNDS TO EDUCATIONAL INSTITU-
TIONS AFFILIATED WITH A PARTICULAR RELI-
GIOUS ORGANIZATION; LOAN FINANCING
PROVIDED TO EDUCATIONAL INSTITUTIONS
AFFILIATED WITH A PARTICULAR RELIGIOUS
ORGANIZATION; PROVIDING STUDENT LOAN
SERVICES AND EDUCATIONAL SCHOLARSHIPS

TO STUDENTS OF EDUCATIONAL INSTITUTIONS
AFFILIATED WITH A PARTICULAR RELIGIOUS
ORGANIZATION, IN CLASS 36 (U.S. CLS. 100, 101
AND 102).

FIRST USE 0-0-1986; IN COMMERCE 0-0-1986.

THE MARK CONSISTS OF A CROSS, FLAME,
AND CURVED LINE DESIGN FORMING, IN PART,
A STYLIZED VERSION OF AN ANCIENT LAMP
REPRESENTING HIGHER LEARNING.

SER. NO. 77-520,470, FILED 7-11-2008.

ZHALEH DELANEY, EXAMINING ATTORNEY

Int. Cl.: 35

Prior U.S. Cls.: 100, 101 and 102

United States Patent and Trademark Office

Reg. No. 3,576,008

Registered Feb. 17, 2009

**SERVICE MARK
PRINCIPAL REGISTER**

PROACTIVE

URDA, JULIE A. (UNITED STATES INDIVIDUAL)
4933 JUMANO AVE.
SAN DIEGO, CA 92117

THE MARK CONSISTS OF STANDARD CHARACTERS WITHOUT CLAIM TO ANY PARTICULAR FONT, STYLE, SIZE, OR COLOR.

FOR: MEDICAL BILLING SUPPORT SERVICES,
IN CLASS 35 (U.S. CLS. 100, 101 AND 102).

SER. NO. 77-520,505, FILED 7-11-2008.

FIRST USE 2-23-2005; IN COMMERCE 6-1-2005.

TINA L. SNAPP, EXAMINING ATTORNEY

Int. Cl.: 41

Prior U.S. Cls.: 100, 101 and 107

United States Patent and Trademark Office

Reg. No. 3,576,009

Registered Feb. 17, 2009

**SERVICE MARK
PRINCIPAL REGISTER**



GENERAL BOARD OF HIGHER EDUCATION
AND MINISTRY OF THE UNITED METHO-
DIST CHURCH (TENNESSEE NON-PROFIT
CORPORATION)
1001 19TH AVENUE SOUTH
NASHVILLE, TN 37212

FOR: EDUCATIONAL SERVICES, NAMELY,
CONDUCTING CLASSES, SEMINARS, CONFEREN-
CES, AND WORKSHOPS IN THE FIELD OF
WORLDWIDE PROFESSIONAL MINISTRY AND
RELIGIOUS-RELATED HIGHER EDUCATION;
PUBLICATION OF BOOKS, JOURNALS, MAGA-
ZINES AND OTHER PRINTED EDUCATIONAL

MATERIALS, IN CLASS 41 (U.S. CLS. 100, 101 AND
107).

FIRST USE 0-0-1986; IN COMMERCE 0-0-1986.

THE MARK CONSISTS OF A CROSS, FLAME,
AND CURVED LINE DESIGN FORMING, IN PART,
A STYLIZED VERSION OF AN ANCIENT LAMP
REPRESENTING HIGHER LEARNING.

SER. NO. 77-520,517, FILED 7-11-2008.

ZHALEH DELANEY, EXAMINING ATTORNEY

Int. Cl.: 42

Prior U.S. Cls.: 100 and 101

United States Patent and Trademark Office

Reg. No. 3,576,010

Registered Feb. 17, 2009

**SERVICE MARK
PRINCIPAL REGISTER**



GENERAL BOARD OF HIGHER EDUCATION
AND MINISTRY OF THE UNITED METHO-
DIST CHURCH (TENNESSEE NON-PROFIT
CORPORATION)
1001 19TH AVENUE SOUTH
NASHVILLE, TN 37212

FOR: ACCREDITATION SERVICES, NAMELY,
DEVELOPING, EVALUATING AND TESTING
STANDARDS FOR THE PURPOSE OF ACCREDI-
TATION OF LOCAL CLERGY AND SPECIALIZED
MINISTRIES IN THE NATURE OF CAMP/RE-
TREAT, CHRISTIAN EDUCATION, EVANGELISM,
MUSIC, OLDER ADULT, SPIRITUAL FORMATION,

AND YOUTH MINISTRIES, IN CLASS 42 (U.S. CLS.
100 AND 101).

FIRST USE 0-0-1986; IN COMMERCE 0-0-1986.

THE MARK CONSISTS OF A CROSS, FLAME,
AND CURVED LINE DESIGN FORMING, IN PART,
A STYLIZED VERSION OF AN ANCIENT LAMP
REPRESENTING HIGHER LEARNING.

SER. NO. 77-520,552, FILED 7-11-2008.

ZHALEH DELANEY, EXAMINING ATTORNEY

Int. Cls.: 9 and 42

Prior U.S. Cls.: 21, 23, 26, 36, 38, 100 and 101

United States Patent and Trademark Office

Reg. No. 3,576,011

Registered Feb. 17, 2009

**TRADEMARK
SERVICE MARK
PRINCIPAL REGISTER**

PEOPLECENTER

LEARN.COM, INC. (DELAWARE CORPORATION)
14001 NW 4TH STREET
SUNRISE, FL 33325

FOR: COMPUTER SOFTWARE FOR ORGANIZATIONAL MANAGEMENT, NAMELY, RECRUITING, PERFORMANCE MANAGEMENT, ONBOARDING, COLLABORATION, SUCCESSION PLANNING, WORKFORCE PLANNING, COMPENSATION MANAGEMENT AND OTHER HUMAN RESOURCE FUNCTIONS, IN CLASS 9 (U.S. CLS. 21, 23, 26, 36 AND 38).

FIRST USE 8-15-2007; IN COMMERCE 8-15-2007.

FOR: APPLICATION SERVICE PROVIDER (ASP) FEATURING SOFTWARE FOR USE IN ORGANIZATIONAL MANAGEMENT, NAMELY, RECRUIT-

ING, PERFORMANCE MANAGEMENT, ONBOARDING, COLLABORATION, SUCCESSION PLANNING, WORKFORCE PLANNING, COMPENSATION MANAGEMENT AND OTHER HUMAN RESOURCE FUNCTIONS, IN CLASS 42 (U.S. CLS. 100 AND 101).

FIRST USE 8-15-2007; IN COMMERCE 8-15-2007.

THE MARK CONSISTS OF STANDARD CHARACTERS WITHOUT CLAIM TO ANY PARTICULAR FONT, STYLE, SIZE, OR COLOR.

OWNER OF U.S. REG. NO. 3,422,126.

SER. NO. 77-520,559, FILED 7-11-2008.

ALLISON HOLTZ, EXAMINING ATTORNEY

Int. Cl.: 9

Prior U.S. Cls.: 21, 23, 26, 36 and 38

Reg. No. 3,576,012

United States Patent and Trademark Office

Registered Feb. 17, 2009

**TRADEMARK
PRINCIPAL REGISTER**

AppMarket

LEARN.COM, INC. (DELAWARE CORPORATION)
14001 NW 4TH STREET
SUNRISE, FL 33325

FOR: COMPUTER SOFTWARE PLATFORMS FOR FACILITATING DISTRIBUTION OF SOFTWARE DEVELOPED BY APPLICANT AND THIRD PARTIES, IN CLASS 9 (U.S. CLS. 21, 23, 26, 36 AND 38).

FIRST USE 6-6-2008; IN COMMERCE 6-6-2008.

THE MARK CONSISTS OF STANDARD CHARACTERS WITHOUT CLAIM TO ANY PARTICULAR FONT, STYLE, SIZE, OR COLOR.

SER. NO. 77-520,564, FILED 7-11-2008.

ALLISON HOLTZ, EXAMINING ATTORNEY

Int. Cl.: 16

Prior U.S. Cls.: 2, 5, 22, 23, 29, 37, 38 and 50

Reg. No. 3,576,013

United States Patent and Trademark Office

Registered Feb. 17, 2009

**TRADEMARK
PRINCIPAL REGISTER**

EGOR FROGINELLI

API INVESTIGATIONS, LLC (COLORADO LIMITED LIABILITY COMPANY)
P.O. BOX 6414
DENVER, CO 80206

FOR: IDENTIFICATION KITS USED TO IDENTIFY MISSING PERSONS COMPRISED OF PRINTED FORMS FOR RECORDING PERSONAL, PHYSICAL, MEDICAL AND DENTAL INFORMATION, INK PADS, GLOVES, COTTON SWABS FOR COLLECTING DNA INFORMATION, AND INSTRUCTIONAL CD; FINGERPRINT KITS, IN CLASS 16 (U.S. CLS. 2, 5, 22, 23, 29, 37, 38 AND 50).

FIRST USE 6-16-2008; IN COMMERCE 6-16-2008.

THE MARK CONSISTS OF STANDARD CHARACTERS WITHOUT CLAIM TO ANY PARTICULAR FONT, STYLE, SIZE, OR COLOR.

THE NAME "EGOR FROGINELLI" DOES NOT IDENTIFY A LIVING INDIVIDUAL.

SER. NO. 77-520,577, FILED 7-11-2008.

MORGAN WYNNE, EXAMINING ATTORNEY

Int. Cl.: 39

Prior U.S. Cls.: 100 and 105

United States Patent and Trademark Office

Reg. No. 3,576,014

Registered Feb. 17, 2009

**SERVICE MARK
PRINCIPAL REGISTER**

Travelers411

ABRAMS, DRU (MASSACHUSETTS SOLE PROPRIETORSHIP)
167 NORTH MAIN STREET #1N
SUNDERLAND, MA 01375

FOR: PROVIDING AN ON-LINE COMPUTER DATABASE IN THE FIELD OF TRAVEL INFORMATION SERVICES; PROVIDING INFORMATION, NEWS AND COMMENTARY IN THE FIELD OF TRAVEL; PROVIDING LINKS TO WEB SITES OF OTHERS FEATURING TRAVEL; PROVIDING REVIEWS OF TRAVEL SERVICE PROVIDERS; TRAVEL AND TOUR INFORMATION SERVICE; TRAVEL GUIDE AND TRAVEL INFORMATION

SERVICES; TRAVEL GUIDE SERVICES; TRAVEL INFORMATION; TRAVEL INFORMATION SERVICES, IN CLASS 39 (U.S. CLS. 100 AND 105).

FIRST USE 6-30-2006; IN COMMERCE 9-30-2006.

THE MARK CONSISTS OF STANDARD CHARACTERS WITHOUT CLAIM TO ANY PARTICULAR FONT, STYLE, SIZE, OR COLOR.

SER. NO. 77-520,580, FILED 7-11-2008.

MORGAN WYNNE, EXAMINING ATTORNEY

Int. Cls.: 24, 25, 43 and 45

Prior U.S. Cls.: 22, 39, 42, 50, 100 and 101

United States Patent and Trademark Office

Reg. No. 3,576,015

Registered Feb. 17, 2009

**TRADEMARK
SERVICE MARK
PRINCIPAL REGISTER**



MISSION LINEN SUPPLY (CALIFORNIA CORPORATION)
702 E. MONTECITO STREET
SANTA BARBARA, CA 93102

FOR: BED AND TABLE LINEN, IN CLASS 24 (U.S. CLS. 42 AND 50).

FIRST USE 1-1-1977; IN COMMERCE 1-1-1977.

FOR: UNIFORMS, IN CLASS 25 (U.S. CLS. 22 AND 39).

FIRST USE 1-1-1977; IN COMMERCE 1-1-1977.

FOR: RENTAL OF BED AND BATH LINENS;
RENTAL OF TABLE LINENS, IN CLASS 43 (U.S. CLS. 100 AND 101).

FIRST USE 1-1-1977; IN COMMERCE 1-1-1977.

FOR: RENTAL OF UNIFORMS, IN CLASS 45 (U.S. CLS. 100 AND 101).

FIRST USE 1-1-1977; IN COMMERCE 1-1-1977.

OWNER OF U.S. REG. NO. 1,257,891.

THE MARK CONSISTS OF A STYLIZED REPRESENTATION OF A BUILDING.

SER. NO. 77-520,581, FILED 7-11-2008.

SUNG IN, EXAMINING ATTORNEY

Int. Cls.: 9 and 42

Prior U.S. Cls.: 21, 23, 26, 36, 38, 100 and 101

United States Patent and Trademark Office

Reg. No. 3,576,016

Registered Feb. 17, 2009

**TRADEMARK
SERVICE MARK
PRINCIPAL REGISTER**

METROQUEST

ENVISION SUSTAINABILITY TOOLS INC. (CANADA CORPORATION)
SUITE 300, ONE ALEXANDER STREET
VANCOUVER, CANADA V6A1B2

FOR: COMPUTER SOFTWARE AND ELECTRONIC DATABASES RECORDED ON COMPUTER MEDIA FOR USE IN CREATING AND DISPLAYING FUTURE DEVELOPMENT SCENARIOS OF CITIES AND REGIONS CREATED THROUGH COMPUTER MODELING OF THE IMPACTS OF POLICY OPTIONS, IN CLASS 9 (U.S. CLS. 21, 23, 26, 36 AND 38).

FIRST USE 8-0-2007; IN COMMERCE 8-0-2007.

FOR: COMPUTER SERVICES, NAMELY, THE DEVELOPMENT OF COMPUTER SOFTWARE AND DATABASES FOR CREATING AND DISPLAYING FUTURE DEVELOPMENT SCENARIOS OF CITIES AND REGIONS THROUGH COMPUTER MODELING OF THE IMPACTS OF POLICY OPTIONS; CONSULTING SERVICES IN THE FIELD OF

DEVELOPING COMPUTER SOFTWARE AND DATABASES USED IN CREATING AND DISPLAYING FUTURE DEVELOPMENT SCENARIOS OF CITIES AND REGIONS CREATED THROUGH COMPUTER MODELING OF THE IMPACTS OF POLICY OPTIONS; CONSULTING SERVICES IN THE FIELD OF USING COMPUTER SOFTWARE AND DATABASES FOR THE DISPLAY AND COMMUNICATION OF FUTURE DEVELOPMENT SCENARIOS OF CITIES AND REGIONS CREATED THROUGH COMPUTER MODELING OF THE IMPACTS OF POLICY OPTIONS, IN CLASS 42 (U.S. CLS. 100 AND 101).

FIRST USE 8-0-2007; IN COMMERCE 8-0-2007.

THE MARK CONSISTS OF STANDARD CHARACTERS WITHOUT CLAIM TO ANY PARTICULAR FONT, STYLE, SIZE, OR COLOR.

SER. NO. 77-520,610, FILED 7-11-2008.

CARRIE GENOVESE, EXAMINING ATTORNEY

Int. Cl.: 9

Prior U.S. Cls.: 21, 23, 26, 36 and 38

Reg. No. 3,576,017

United States Patent and Trademark Office

Registered Feb. 17, 2009

**TRADEMARK
PRINCIPAL REGISTER**

Cortexa

CORTEXA SYSTEMS (TEXAS LIMITED LIABILITY COMPANY)
SUITE 350-393
12400 STATE HIGHWAY 71 WEST
AUSTIN, TX 78738

THE MARK CONSISTS OF STANDARD CHARACTERS WITHOUT CLAIM TO ANY PARTICULAR FONT, STYLE, SIZE, OR COLOR.

FOR: CUSTOMIZED ELECTRICAL CONTROLLER TO AUTOMATE HOME FUNCTIONS, IN CLASS 9 (U.S. CLS. 21, 23, 26, 36 AND 38).

SER. NO. 77-520,661, FILED 7-11-2008.

FIRST USE 5-13-2008; IN COMMERCE 5-13-2008.

JOHN GARTNER, EXAMINING ATTORNEY

Int. Cl.: 35

Prior U.S. Cls.: 100, 101 and 102

United States Patent and Trademark Office

Reg. No. 3,576,018

Registered Feb. 17, 2009

**SERVICE MARK
PRINCIPAL REGISTER**

REMALO

REVERSE MORTGAGE ASSOCIATION FOR
LOAN OFFICERS LLC (DELAWARE LIMITED
LIABILITY COMPANY)
22 POLLY DRUMMOND HILL RD.
NEWARK, DE 19711

FOR: ASSOCIATION SERVICES, NAMELY, PRO-
MOTING THE INTERESTS OF REVERSE MORT-
GAGE LOAN OFFICERS, IN CLASS 35 (U.S. CLS. 100,
101 AND 102).

FIRST USE 7-1-2008; IN COMMERCE 7-1-2008.

THE MARK CONSISTS OF STANDARD CHAR-
ACTERS WITHOUT CLAIM TO ANY PARTICULAR
FONT, STYLE, SIZE, OR COLOR.

SER. NO. 77-520,669, FILED 7-11-2008.

DAVID COLLIER, EXAMINING ATTORNEY

Int. Cls.: 25 and 28

Prior U.S. Cls.: 22, 23, 38, 39 and 50

United States Patent and Trademark Office

Reg. No. 3,576,019

Registered Feb. 17, 2009

**TRADEMARK
PRINCIPAL REGISTER**

PETERBILT

PACCAR INC (DELAWARE CORPORATION),
DBA PETERBILT MOTORS COMPANY
777 106TH AVENUE NE
BELLEVUE, WA 98004

FOR: WEARING APPAREL, NAMELY, HATS,
JACKETS, SHIRTS, TEE-SHIRTS AND VESTS, IN
CLASS 25 (U.S. CLS. 22 AND 39).

FIRST USE 4-1-1975; IN COMMERCE 4-1-1975.

FOR: TOY TRUCKS AND HOBBYCRAFT KITS
USED FOR MAKING MODEL TRUCKS, IN CLASS
28 (U.S. CLS. 22, 23, 38 AND 50).

FIRST USE 1-1-1975; IN COMMERCE 1-1-1975.

THE MARK CONSISTS OF STANDARD CHAR-
ACTERS WITHOUT CLAIM TO ANY PARTICULAR
FONT, STYLE, SIZE, OR COLOR.

OWNER OF U.S. REG. NOS. 752,836, 1,283,473 AND
OTHERS.

SER. NO. 77-520,670, FILED 7-11-2008.

KATHERINE E. HALMEN, EXAMINING ATTOR-
NEY

Int. Cl.: 37

Prior U.S. Cls.: 100, 103 and 106

United States Patent and Trademark Office

Reg. No. 3,576,020

Registered Feb. 17, 2009

SERVICE MARK
PRINCIPAL REGISTER

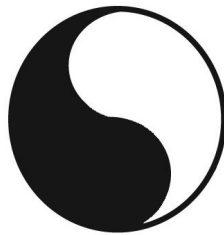

TAO, LTD.

TAO MECHANICAL, LTD. (WASHINGTON CORPORATION)

4023 FIRST STREET

LIVERMORE, CA 94550

FOR: PLUMBING CONTRACTOR SERVICES, IN CLASS 37 (U.S. CLS. 100, 103 AND 106).

FIRST USE 3-30-1987; IN COMMERCE 3-30-1987.

NO CLAIM IS MADE TO THE EXCLUSIVE RIGHT TO USE "LTD.", APART FROM THE MARK AS SHOWN.

THE MARK CONSISTS OF A VARIANT OF THE CHINESE TAIJITU (AKA YIN AND YANG) SYMBOL TO THE LEFT OF THE WORDS "TAO, LTD." .

SER. NO. 77-520,679, FILED 7-11-2008.

KATHY DE JONGE, EXAMINING ATTORNEY

Int. Cls.: 38 and 41

Prior U.S. Cls.: 100, 101, 104 and 107

United States Patent and Trademark Office

Reg. No. 3,576,021

Registered Feb. 17, 2009

**SERVICE MARK
PRINCIPAL REGISTER**



SITV, INC. (DELAWARE CORPORATION)
3030 ANDRITA STREET
LOS ANGELES, CA 90065

FOR: CABLE TELEVISION BROADCASTING SERVICES; TELEVISION BROADCASTING SERVICES, SATELLITE AND DIRECT TELEVISION TRANSMISSION SERVICES; BROADCASTING PROGRAMS VIA A GLOBAL COMPUTER NETWORK, AND BROADCASTING PROGRAMS VIA CELL PHONES AND MOBILE DEVICES, IN CLASS 38 (U.S. CLS. 100, 101 AND 104).

FIRST USE 2-4-2008; IN COMMERCE 2-4-2008.

FOR: ENTERTAINMENT SERVICES IN THE NATURE OF ON-GOING TELEVISION PROGRAMS IN THE FIELD OF MUSIC, ENTERTAINMENT,

NEWS, REALITY AND GENERAL INTEREST TOPICS; PROVIDING INFORMATION IN THE FIELD OF ENTERTAINMENT OVER COMPUTER NETWORKS AND GLOBAL COMMUNICATION NETWORKS, IN CLASS 41 (U.S. CLS. 100, 101 AND 107).

FIRST USE 2-4-2008; IN COMMERCE 2-4-2008.

OWNER OF U.S. REG. NOS. 2,963,310, 3,010,687 AND OTHERS.

THE MARK CONSISTS OF THE WORD "SITV" IN STYLIZED BLOCK LETTERS.

SER. NO. 77-520,682, FILED 7-11-2008.

CHRISTINE BLOMQUIST, EXAMINING ATTORNEY

Int. Cl.: 29

Prior U.S. Cl.: 46

United States Patent and Trademark Office

Reg. No. 3,576,022

Registered Feb. 17, 2009

**TRADEMARK
PRINCIPAL REGISTER**

BISALO

ANA H. BARREIRO (UNITED STATES INDIVIDUAL)
10204 PANDORA LN NW
ALBUQUERQUE, NM 87114

THE MARK CONSISTS OF STANDARD CHARACTERS WITHOUT CLAIM TO ANY PARTICULAR FONT, STYLE, SIZE, OR COLOR.

FOR: PREPARED MEAT, IN CLASS 29 (U.S. CL. 46).

SER. NO. 77-520,719, FILED 7-12-2008.

FIRST USE 7-10-2008; IN COMMERCE 7-10-2008.

EDWARD FENNESSY, EXAMINING ATTORNEY

Int. Cl.: 36

Prior U.S. Cls.: 100, 101 and 102

United States Patent and Trademark Office

Reg. No. 3,576,023

Registered Feb. 17, 2009

**SERVICE MARK
PRINCIPAL REGISTER**

MHDO

WMU OF TEXAS (TEXAS CORPORATION), DBA
WOMAN'S MISSIONARY UNION OF TEXAS
333 N. WASHINGTON AVE.
DALLAS, TX 75246

THE MARK CONSISTS OF STANDARD CHAR-
ACTERS WITHOUT CLAIM TO ANY PARTICULAR
FONT, STYLE, SIZE, OR COLOR.

FOR: CHARITABLE FUNDRAISING SERVICES,
IN CLASS 36 (U.S. CLS. 100, 101 AND 102).

SER. NO. 77-520,751, FILED 7-12-2008.

FIRST USE 1-5-2007; IN COMMERCE 1-5-2007.

NATALIE POLZER, EXAMINING ATTORNEY

Int. Cl.: 30

Prior U.S. Cl.: 46

United States Patent and Trademark Office

Reg. No. 3,576,024

Registered Feb. 17, 2009

**TRADEMARK
PRINCIPAL REGISTER**

CURLYFYED CREATIONS

CURLY'S CREATIONS, LLC (PENNSYLVANIA
LIMITED LIABILITY COMPANY)
47 HOLLYBROOKE DR.
LANGHORNE, PA 19047

THE MARK CONSISTS OF STANDARD CHAR-
ACTERS WITHOUT CLAIM TO ANY PARTICULAR
FONT, STYLE, SIZE, OR COLOR.

FOR: COMESTIBLE PRODUCTS, NAMELY, HOT
SAUCE, MARINADE, WING SAUCE AND SPICE
RUBS, IN CLASS 30 (U.S. CL. 46).

SER. NO. 77-520,759, FILED 7-12-2008.

FIRST USE 7-7-2008; IN COMMERCE 7-10-2008.

DAVID MURRAY, EXAMINING ATTORNEY

Int. Cl.: 41

Prior U.S. Cls.: 100, 101 and 107

United States Patent and Trademark Office

Reg. No. 3,576,025

Registered Feb. 17, 2009

**SERVICE MARK
PRINCIPAL REGISTER**

Fit4D

FITNESS4DIABETICS.COM LLC (DELAWARE
LIMITED LIABILITY COMPANY)
1601 THIRD AVENUE
SUITE 11J
NEW YORK, NY 10128

FOR: PHYSICAL FITNESS CONSULTATION;
PROVIDING A WEB SITE FEATURING INFORMATION
ON EXERCISE AND FITNESS; PROVIDING
ASSISTANCE, PERSONAL TRAINING AND PHYSICAL
FITNESS CONSULTATION TO CORPORATE
CLIENTS TO HELP THEIR EMPLOYEES MAKE
PHYSICAL FITNESS, STRENGTH, CONDITIONING,
AND EXERCISE ALTERATIONS IN THEIR
DAILY LIVING; PROVIDING ASSISTANCE, PERSONAL
TRAINING AND PHYSICAL FITNESS CONSULTATION
TO INDIVIDUALS TO HELP THEM

MAKE PHYSICAL FITNESS, STRENGTH, CONDITIONING,
AND EXERCISE IMPROVEMENT IN THEIR DAILY
LIVING, IN CLASS 41 (U.S. CLS. 100, 101 AND 107).

FIRST USE 6-15-2007; IN COMMERCE 6-15-2007.

THE MARK CONSISTS OF STANDARD CHARACTERS
WITHOUT CLAIM TO ANY PARTICULAR FONT,
STYLE, SIZE, OR COLOR.

SER. NO. 77-520,767, FILED 7-12-2008.

ALICE SUE CARRUTHERS, EXAMINING ATTORNEY

Int. Cl.: 35

Prior U.S. Cls.: 100, 101 and 102

United States Patent and Trademark Office

Reg. No. 3,576,026

Registered Feb. 17, 2009

**SERVICE MARK
PRINCIPAL REGISTER**

**CONNECTION DENTAL REWARDS
PROGRAM**

GOVERNMENT EMPLOYEES HEALTH ASSO-
CIATION, INC. (MISSOURI NON-PROFIT
CORPORATION)
17306 E. 24 HWY
INDEPENDENCE, MO 64056

FOR: ARRANGING AND CONDUCTING INCEN-
TIVE AWARD PROGRAMS TO ENCOURAGE DEN-
TISTS TO BECOME AND REMAIN
PARTICIPATING PROVIDERS IN DENTAL
HEALTH PLAN , IN CLASS 35 (U.S. CLS. 100, 101
AND 102).

FIRST USE 7-8-2008; IN COMMERCE 7-8-2008.

THE MARK CONSISTS OF STANDARD CHAR-
ACTERS WITHOUT CLAIM TO ANY PARTICULAR
FONT, STYLE, SIZE, OR COLOR.

OWNER OF U.S. REG. NOS. 2,812,918 AND
2,812,919.

NO CLAIM IS MADE TO THE EXCLUSIVE
RIGHT TO USE "DENTAL REWARDS PROGRAM",
APART FROM THE MARK AS SHOWN.

SER. NO. 77-520,770, FILED 7-12-2008.

LAURIE MAYES, EXAMINING ATTORNEY

Int. Cl.: 44

Prior U.S. Cls.: 100 and 101

United States Patent and Trademark Office

Reg. No. 3,576,027

Registered Feb. 17, 2009

SERVICE MARK
PRINCIPAL REGISTER



SPECTACULAR HEALTH HOLDINGS, INC. (CALIFORNIA CORPORATION)
72205 PAINTERS PATH
PALM DESERT, CA 92260

FOR: PROVIDING WELLNESS SERVICES, NAMELY, PERSONAL ASSESSMENTS, PERSONALIZED ROUTINES, MAINTENANCE SCHEDULES, AND COUNSELING, IN CLASS 44 (U.S. CLS. 100 AND 101).

FIRST USE 6-13-2008; IN COMMERCE 6-13-2008.

NO CLAIM IS MADE TO THE EXCLUSIVE RIGHT TO USE "HEALTH", APART FROM THE MARK AS SHOWN.

THE COLOR(S) BURGANDY, TAN, AND BLACK IS/ARE CLAIMED AS A FEATURE OF THE MARK.

THE MARK CONSISTS OF THE WORD "SPECTACULAR" IN BURGANDY, "HEALTH" IN TAN, "WE ADD LIFE TO YOUR LIFE FOR LIFE" IN BLACK, AND TWO BUTTERFLIES IN BURGANDY AND TAN.

SER. NO. 77-520,773, FILED 7-12-2008.

TOBY BULLOFF, EXAMINING ATTORNEY

Int. Cl.: 11

Prior U.S. Cls.: 13, 21, 23, 31 and 34

United States Patent and Trademark Office

Reg. No. 3,576,028

Registered Feb. 17, 2009

**TRADEMARK
PRINCIPAL REGISTER**

HYDRO SHIELD

ONSITE WASTEWATER PRODUCTS, LTD. (CANADA CORPORATION)
23867 40TH AVE. RR 12
LANGLEY, CANADA V2Z2J9

THE MARK CONSISTS OF STANDARD CHARACTERS WITHOUT CLAIM TO ANY PARTICULAR FONT, STYLE, SIZE, OR COLOR.

FOR: WASTEWATER DISCHARGE DIFFUSERS FOR ON-SITE PRESSURE TREATMENT DISTRIBUTION LINES, IN CLASS 11 (U.S. CLS. 13, 21, 23, 31 AND 34).

SER. NO. 77-520,780, FILED 7-12-2008.

FIRST USE 8-29-2005; IN COMMERCE 8-29-2005.

REBECCA GILBERT, EXAMINING ATTORNEY

Int. Cl.: 41

Prior U.S. Cls.: 100, 101 and 107

United States Patent and Trademark Office

Reg. No. 3,576,029

Registered Feb. 17, 2009

**SERVICE MARK
PRINCIPAL REGISTER**

The Collared Scholar

METROPAWLITAN DOG, INC (CALIFORNIA
CORPORATION)
811 13TH STREET
SAN DIEGO, CA 92101

THE MARK CONSISTS OF STANDARD CHAR-
ACTERS WITHOUT CLAIM TO ANY PARTICULAR
FONT, STYLE, SIZE, OR COLOR.

FOR: PET TRAINING SERVICES, IN CLASS 41
(U.S. CLS. 100, 101 AND 107).

SER. NO. 77-520,796, FILED 7-12-2008.

FIRST USE 4-1-2007; IN COMMERCE 4-1-2007.

JESSICA A. POWERS, EXAMINING ATTORNEY

Int. Cl.: 28

Prior U.S. Cls.: 22, 23, 38 and 50

Reg. No. 3,576,030

United States Patent and Trademark Office

Registered Feb. 17, 2009

**TRADEMARK
PRINCIPAL REGISTER**

slotstik

FACIANE, KIRBY A. (UNITED STATES INDIVIDUAL)
143 N. RIOS AVE.
SOLANA BEACH, CA 92075

THE MARK CONSISTS OF STANDARD CHARACTERS WITHOUT CLAIM TO ANY PARTICULAR FONT, STYLE, SIZE, OR COLOR.

FOR: SKIM BOARDS, IN CLASS 28 (U.S. CLS. 22, 23, 38 AND 50).

SER. NO. 77-520,863, FILED 7-13-2008.

FIRST USE 12-15-1985; IN COMMERCE 12-15-1985.

DORITT L. CARROLL, EXAMINING ATTORNEY

Int. Cl.: 45

Prior U.S. Cls.: 100 and 101

United States Patent and Trademark Office

Reg. No. 3,576,031

Registered Feb. 17, 2009

**SERVICE MARK
PRINCIPAL REGISTER**

POWER TO THE DATERS

DATING REVOLUTION, INC. (NEW YORK CORPORATION)
1 UNIVERSITY PLACE, #5P
NEW YORK, NY 10003

FIRST USE 5-19-2008; IN COMMERCE 5-19-2008.

SER. NO. 77-520,904, FILED 7-13-2008.

FOR: COMPUTER DATING SERVICES, IN CLASS
45 (U.S. CLS. 100 AND 101).

REBECCA GILBERT, EXAMINING ATTORNEY

Int. Cl.: 41

Prior U.S. Cls.: 100, 101 and 107

United States Patent and Trademark Office

Reg. No. 3,576,032

Registered Feb. 17, 2009

**SERVICE MARK
PRINCIPAL REGISTER**

K9-CONNECTION

K9-CONNECTION, LLC (MINNESOTA LIMITED
LIABILITY COMPANY)
457 NEWTON AVENUE SOUTH
MINNEAPOLIS, MN 55405

THE MARK CONSISTS OF STANDARD CHAR-
ACTERS WITHOUT CLAIM TO ANY PARTICULAR
FONT, STYLE, SIZE, OR COLOR.

FOR: ENTERTAINMENT SERVICES, NAMELY,
CONDUCTING PARTIES FOR THE PURPOSE OF
DATING AND SOCIAL INTRODUCTION FOR
ADULTS, IN CLASS 41 (U.S. CLS. 100, 101 AND 107).

SER. NO. 77-520,949, FILED 7-13-2008.

FIRST USE 2-15-2007; IN COMMERCE 8-10-2007.

MARK PILARO, EXAMINING ATTORNEY

Int. Cl.: 41

Prior U.S. Cls.: 100, 101 and 107

United States Patent and Trademark Office

Reg. No. 3,576,033

Registered Feb. 17, 2009

**SERVICE MARK
PRINCIPAL REGISTER**

LEAHPATRA

WALTON, LEAH BETH (UNITED STATES INDIVIDUAL)
7543 TRASK AVE
PLAYA DEL REY, CA 90293

THE MARK CONSISTS OF STANDARD CHARACTERS WITHOUT CLAIM TO ANY PARTICULAR FONT, STYLE, SIZE, OR COLOR.

FOR: ENTERTAINMENT IN THE NATURE OF VISUAL AND AUDIO PERFORMANCES, AND MUSICAL, VARIETY, NEWS AND COMEDY SHOWS, IN CLASS 41 (U.S. CLS. 100, 101 AND 107).

SER. NO. 77-520,964, FILED 7-13-2008.

FIRST USE 1-1-1984; IN COMMERCE 1-1-1984.

IRA J. GOODSaid, EXAMINING ATTORNEY

Int. Cl.: 15

Prior U.S. Cls.: 2, 21 and 36

United States Patent and Trademark Office

Reg. No. 3,576,034

Registered Feb. 17, 2009

**TRADEMARK
PRINCIPAL REGISTER**



LIEBER THOMAS G (UNITED STATES INDIVIDUAL)
6439 STATE HWY 28
FLY CREEK, NY 13337

FOR: MUSICAL INSTRUMENTS; MUSICAL INSTRUMENT ACCESSORIES, NAMELY, GUITAR STRAPS, GUITAR PICKS, MOUTHPIECES FOR MUSICAL INSTRUMENTS, STANDS, CASES, CARRYING BAGS AND STORAGE BAGS , IN CLASS 15 (U.S. CLS. 2, 21 AND 36).

FIRST USE 7-9-2008; IN COMMERCE 7-11-2008.

THE MARK CONSISTS OF STICK LINE DRAWING OF UPRIGHT BASS PLAYER.

SER. NO. 77-520,965, FILED 7-13-2008.

IRA J. GOODSaid, EXAMINING ATTORNEY

Int. Cl.: 35

Prior U.S. Cls.: 100, 101 and 102

United States Patent and Trademark Office

Reg. No. 3,576,035

Registered Feb. 17, 2009

**SERVICE MARK
PRINCIPAL REGISTER**

WRITE AWAY

WRITE AWAY INC. (ILLINOIS CORPORATION)
1530 LIVINGSTON DR.
ROCKFORD, IL 61107

FOR: WRITING OF GRANT PROPOSALS FOR
NON-PROFIT ORGANIZATIONS, EDUCATIONAL
INSTITUTIONS AND OTHER COMMUNITY ORGA-
NIZATIONS, IN CLASS 35 (U.S. CLS. 100, 101 AND
102).

FIRST USE 6-1-2006; IN COMMERCE 1-1-2007.

THE MARK CONSISTS OF STANDARD CHAR-
ACTERS WITHOUT CLAIM TO ANY PARTICULAR
FONT, STYLE, SIZE, OR COLOR.

SER. NO. 77-520,968, FILED 7-13-2008.

BRIDGETT SMITH, EXAMINING ATTORNEY

Int. Cl.: 16

Prior U.S. Cls.: 2, 5, 22, 23, 29, 37, 38 and 50

United States Patent and Trademark Office

Reg. No. 3,576,036

Registered Feb. 17, 2009

**TRADEMARK
PRINCIPAL REGISTER**

YIPPEE SKIPPY

SERGEANT'S PET CARE PRODUCTS, INC. (NE-
VADA CORPORATION)
2625 S 158TH PLAZA
OMAHA, NE 681301770

THE MARK CONSISTS OF STANDARD CHAR-
ACTERS WITHOUT CLAIM TO ANY PARTICULAR
FONT, STYLE, SIZE, OR COLOR.

FOR: PLASTIC BAGS FOR DISPOSING OF PET
WASTE, IN CLASS 16 (U.S. CLS. 2, 5, 22, 23, 29, 37, 38
AND 50).

SER. NO. 77-521,118, FILED 7-14-2008.

FIRST USE 5-0-2008; IN COMMERCE 5-0-2008.

LIEF MARTIN, EXAMINING ATTORNEY

Int. Cl.: 3

Prior U.S. Cls.: 1, 4, 6, 50, 51 and 52

Reg. No. 3,576,037

United States Patent and Trademark Office

Registered Feb. 17, 2009

**TRADEMARK
PRINCIPAL REGISTER**

REFRESHINGLYFLORAL

THE PROCTER & GAMBLE COMPANY (OHIO
CORPORATION)
ONE PROCTER & GAMBLE PLAZA
CINCINNATI, OH 45202

THE MARK CONSISTS OF STANDARD CHAR-
ACTERS WITHOUT CLAIM TO ANY PARTICULAR
FONT, STYLE, SIZE, OR COLOR.

FOR: ANTIPERSPIRANTS AND DEODORANTS
FOR PERSONAL USE; BODY SPRAYS, IN CLASS 3
(U.S. CLS. 1, 4, 6, 50, 51 AND 52).

SER. NO. 77-521,128, FILED 7-14-2008.

FIRST USE 4-19-2008; IN COMMERCE 4-19-2008.

MEGHAN REINHART, EXAMINING ATTORNEY

Int. Cl.: 12

Prior U.S. Cls.: 19, 21, 23, 31, 35 and 44

Reg. No. 3,576,038

United States Patent and Trademark Office

Registered Feb. 17, 2009

**TRADEMARK
PRINCIPAL REGISTER**



SABERTOOTH MOTORCYCLES, LLC (DELA-
WARE LIMITED LIABILITY COMPANY)
100 HURRICANE CREEK RD.
PIEDMONT, SC 29673

THE MARK CONSISTS OF STYLIZED CAT HEAD
LOGO.

FOR: MOTORCYCLES, IN CLASS 12 (U.S. CLS. 19,
21, 23, 31, 35 AND 44).

SER. NO. 77-521,200, FILED 7-14-2008.

FIRST USE 12-1-2005; IN COMMERCE 2-1-2006.

REBECCA GILBERT, EXAMINING ATTORNEY

Int. Cl.: 35

Prior U.S. Cls.: 100, 101 and 102

United States Patent and Trademark Office

Reg. No. 3,576,039

Registered Feb. 17, 2009

**SERVICE MARK
PRINCIPAL REGISTER**



SUMMIT HUT, LTD (ARIZONA CORPORATION)
5045 E SPEEDWAY BLVD
TUCSON, AZ 85712

FOR: RETAIL STORE SERVICES, MAIL ORDER SERVICES, AND ONLINE RETAIL STORE SERVICES FEATURING APPAREL AND OUTDOOR SPORTING AND TRAVEL EQUIPMENT, IN CLASS 35 (U.S. CLS. 100, 101 AND 102).

FIRST USE 3-28-2008; IN COMMERCE 3-28-2008.

OWNER OF U.S. REG. NOS. 2,002,722, 2,002,724, AND 2,005,862.

THE MARK CONSISTS OF LETTERS COMPRISING THE WORD "SUMMIT HUT" LAID OUT IN A SLIGHT ARC AND UNDERLINED WITH A BRUSH STROKE, ALL UNDER STYLIZED MOUNTAINS AND SKY RENDERED IN SILHOUETTE AND REVERSE SILHOUETTE.

SER. NO. 77-521,279, FILED 7-14-2008.

SHANNON TWOHIG, EXAMINING ATTORNEY

Int. Cl.: 25

Prior U.S. Cls.: 22 and 39

United States Patent and Trademark Office

Reg. No. 3,576,040

Registered Feb. 17, 2009

**TRADEMARK
PRINCIPAL REGISTER**

Tatyana

TATYANA, LLC (NEVADA LIMITED LIABILITY
COMPANY)
3850 PLACITA DEL RICO
LAS VEGAS, NV 89120

THE MARK CONSISTS OF STANDARD CHAR-
ACTERS WITHOUT CLAIM TO ANY PARTICULAR
FONT, STYLE, SIZE, OR COLOR.

FOR: BLOUSES; DRESSES; LINGERIE; SKIRTS,
IN CLASS 25 (U.S. CLS. 22 AND 39).

SER. NO. 77-521,287, FILED 7-14-2008.

FIRST USE 11-5-2007; IN COMMERCE 11-5-2007.

DANIEL CAPSHAW, EXAMINING ATTORNEY

Int. Cl.: 35

Prior U.S. Cls.: 100, 101 and 102

United States Patent and Trademark Office

Reg. No. 3,576,041

Registered Feb. 17, 2009

**SERVICE MARK
PRINCIPAL REGISTER**



ORANGES & LEMONS, LLC (DELAWARE LIMITED LIABILITY COMPANY)

3828 KENNETT PIKE

GREENVILLE, DE 19807

FOR: RETAIL CLOTHING BOUTIQUES; RETAIL GIFT SHOPS; RETAIL STORE AND ON-LINE RETAIL STORE SERVICES FEATURING CHILDRENS CLOTHING AND GIFTS , IN CLASS 35 (U.S. CLS. 100, 101 AND 102).

FIRST USE 1-1-2004; IN COMMERCE 8-17-2004.

THE COLOR(S) YELLOW, ORANGE, AND GREEN IS/ARE CLAIMED AS A FEATURE OF THE MARK.

THE MARK CONSISTS OF A PICTURE OF A LEMON (FRUIT ON THE LEFT) AND AN ORANGE (FRUIT ON THE RIGHT) WITH TWO LEAVES. THE LEFT FRUIT IS THE COLOR YELLOW AND THE RIGHT FRUIT IS THE COLOR ORANGE, WHILE THE TWO LEAVES ARE GREEN.

SER. NO. 77-521,505, FILED 7-14-2008.

LINDA MICKLEBURGH, EXAMINING ATTORNEY

Int. Cl.: 30

Prior U.S. Cl.: 46

United States Patent and Trademark Office

Reg. No. 3,576,042

Registered Feb. 17, 2009

**TRADEMARK
PRINCIPAL REGISTER**

CHOCADORABLES!

WISCONSIN FOOD GIFT COMPANY LLC (WIS-
CONSIN LIMITED LIABILITY COMPANY)
PO BOX 1
MADISON, WI 53701

THE MARK CONSISTS OF STANDARD CHAR-
ACTERS WITHOUT CLAIM TO ANY PARTICULAR
FONT, STYLE, SIZE, OR COLOR.

FOR: CHOCOLATE CANDIES, IN CLASS 30 (U.S.
CL. 46).

SER. NO. 77-521,508, FILED 7-14-2008.

FIRST USE 11-16-2007; IN COMMERCE 11-16-2007.

GIANCARLO CASTRO, EXAMINING ATTORNEY

Int. Cl.: 16

Prior U.S. Cls.: 2, 5, 22, 23, 29, 37, 38 and 50

United States Patent and Trademark Office

Reg. No. 3,576,043

Registered Feb. 17, 2009

**TRADEMARK
PRINCIPAL REGISTER**



JAD CORPORATION OF AMERICA (CONNECTI-
CUT CORPORATION)
20-48 119TH STREET
COLLEGE POINT, NY 113562123

FOR: PLASTIC TRASH AND GARBAGE BAGS,
AND GENERAL PURPOSE PLASTIC BAGS, IN
CLASS 16 (U.S. CLS. 2, 5, 22, 23, 29, 37, 38 AND 50).

FIRST USE 2-27-2008; IN COMMERCE 2-27-2008.

THE MARK CONSISTS OF THE WORD "MINT X"
OVER A SHIELD DRAWING WITH A SIDEWAYS
TRIANGLE BETWEEN THE "T" IN "MINT" & THE
"X".

SER. NO. 77-521,674, FILED 7-14-2008.

LEIGH CAROLINE CASE, EXAMINING ATTOR-
NEY

Int. Cl.: 33

Prior U.S. Cls.: 47 and 49

United States Patent and Trademark Office

Reg. No. 3,576,044

Registered Feb. 17, 2009

**TRADEMARK
PRINCIPAL REGISTER**

JERSEY GIRL

JACK JOHN INVESTMENTS, INC. (FLORIDA
CORPORATION)
1509 SOUTH FLORIDA AVENUE
LAKELAND, FL 33803

THE MARK CONSISTS OF STANDARD CHAR-
ACTERS WITHOUT CLAIM TO ANY PARTICULAR
FONT, STYLE, SIZE, OR COLOR.

FOR: WINES, IN CLASS 33 (U.S. CLS. 47 AND 49).

SER. NO. 77-521,680, FILED 7-14-2008.

FIRST USE 10-23-2007; IN COMMERCE 10-23-2007.

LAURIE MAYES, EXAMINING ATTORNEY

Int. Cl.: 36

Prior U.S. Cls.: 100, 101 and 102

United States Patent and Trademark Office

Reg. No. 3,576,045

Registered Feb. 17, 2009

**SERVICE MARK
PRINCIPAL REGISTER**

RESPONSE IS EVERYTHING

SELECTIVE INSURANCE GROUP, INC. (NEW
JERSEY CORPORATION)
40 WANTAGE AVENUE
BRANCHVILLE, NJ 07890

FOR: INSURANCE ADMINISTRATION IN THE
FIELD OF AUTOMOTIVE, PROPERTY, FIRE,
FLOOD, ACCIDENT AND CASUALTY INSUR-
ANCE; INSURANCE CLAIMS ADMINISTRATION;
INSURANCE CLAIMS PROCESSING; INSURANCE
SERVICES IN THE NATURE OF LOSS CONTROL
MANAGEMENT FOR OTHERS; INSURANCE UN-
DERWRITING IN THE FIELD OF AUTOMOTIVE,
PROPERTY, FIRE, FLOOD, ACCIDENT AND CA-

SUALTY INSURANCE, IN CLASS 36 (U.S. CLS. 100,
101 AND 102).

FIRST USE 7-1-2008; IN COMMERCE 7-1-2008.

THE MARK CONSISTS OF STANDARD CHAR-
ACTERS WITHOUT CLAIM TO ANY PARTICULAR
FONT, STYLE, SIZE, OR COLOR.

SER. NO. 77-521,715, FILED 7-14-2008.

EMILY CHUO, EXAMINING ATTORNEY

Int. Cl.: 35

Prior U.S. Cls.: 100, 101 and 102

United States Patent and Trademark Office

Reg. No. 3,576,046

Registered Feb. 17, 2009

**SERVICE MARK
PRINCIPAL REGISTER**

**WE UNDERSTAND WHAT'S ON
YOUR PLATE**

MORAN FOODS, INC. (MISSOURI CORPORATION)
100 CORPORATE OFFICE DRIVE
EARTH CITY, MO 63045

THE MARK CONSISTS OF STANDARD CHARACTERS WITHOUT CLAIM TO ANY PARTICULAR FONT, STYLE, SIZE, OR COLOR.

FOR: RETAIL SUPERMARKET SERVICES, IN CLASS 35 (U.S. CLS. 100, 101 AND 102).

SER. NO. 77-521,734, FILED 7-14-2008.

FIRST USE 6-30-2008; IN COMMERCE 6-30-2008.

MARGERY A. TIERNEY, EXAMINING ATTORNEY

Int. Cl.: 35

Prior U.S. Cls.: 100, 101 and 102

United States Patent and Trademark Office

Reg. No. 3,576,047

Registered Feb. 17, 2009

**SERVICE MARK
PRINCIPAL REGISTER**

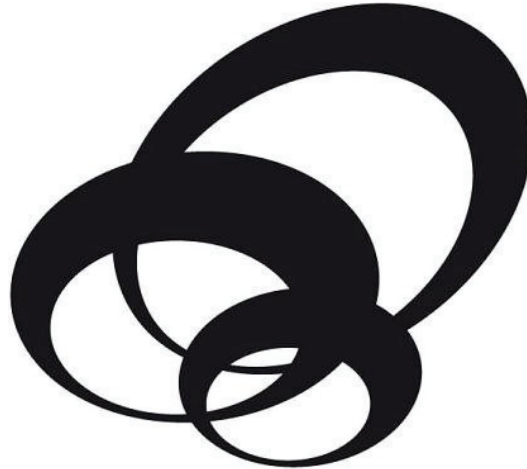

PALAZZO INTERCREATIVE, INC. (WASHINGTON CORPORATION)
SUITE 200
308 OCCIDENTAL AVENUE SOUTH
SEATTLE, WA 98104

FOR: ADVERTISING AND PUBLICITY SERVICES, NAMELY, PROMOTING THE GOODS, SERVICES, BRAND IDENTITY AND COMMERCIAL INFORMATION AND NEWS OF THIRD PARTIES THROUGH PRINT, AUDIO, VIDEO, DIGITAL AND ON-LINE MEDIUM; ADVERTISING SERVICES, NAMELY, CREATING CORPORATE AND BRAND IDENTITY FOR OTHERS; BRAND IMAGERY CONSULTING SERVICES; DESIGN OF ADVERTISING

MATERIALS FOR OTHERS; SERVICES RELATING TO THE ANALYSIS, EVALUATION, CREATION AND BRAND ESTABLISHMENT OF TRADEMARKS, TRADE NAMES AND DOMAIN NAMES, IN CLASS 35 (U.S. CLS. 100, 101 AND 102).

FIRST USE 10-13-1997; IN COMMERCE 10-13-1997.

THE MARK CONSISTS OF THREE INTERCONNECTED RINGS.

SER. NO. 77-521,750, FILED 7-14-2008.

ALLISON SCHRODY, EXAMINING ATTORNEY

Int. Cl.: 36

Prior U.S. Cls.: 100, 101 and 102

United States Patent and Trademark Office

Reg. No. 3,576,048

Registered Feb. 17, 2009

**SERVICE MARK
PRINCIPAL REGISTER**

**We Serve the People who
Serve the People**

CIVIL SERVICE EMPLOYEES INSURANCE
COMPANY (CALIFORNIA CORPORATION),
DBA CSE INSURANCE GROUP
50 CALIFORNIA STREET, SUITE 2500
SAN FRANCISCO, CA 94111

THE MARK CONSISTS OF STANDARD CHAR-
ACTERS WITHOUT CLAIM TO ANY PARTICULAR
FONT, STYLE, SIZE, OR COLOR.

FOR: INSURANCE SERVICES, NAMELY, WRIT-
ING PROPERTY AND CASUALTY INSURANCE, IN
CLASS 36 (U.S. CLS. 100, 101 AND 102).

SER. NO. 77-521,777, FILED 7-14-2008.

FIRST USE 1-31-2007; IN COMMERCE 1-31-2007.

LAURIE KAUFMAN, EXAMINING ATTORNEY

Int. Cl.: 3

Prior U.S. Cls.: 1, 4, 6, 50, 51 and 52

Reg. No. 3,576,049

United States Patent and Trademark Office

Registered Feb. 17, 2009

**TRADEMARK
PRINCIPAL REGISTER**

CONSOLIDECK

BOYER INDUSTRIES CORPORATION (KANSAS
CORPORATION)
3741 GREENWAY CIRCLE
LAWRENCE, KS 66046

THE MARK CONSISTS OF STANDARD CHAR-
ACTERS WITHOUT CLAIM TO ANY PARTICULAR
FONT, STYLE, SIZE, OR COLOR.

FOR: DETERGENTS AND CLEANERS FOR USE
ON CONCRETE, STONE AND TILE SURFACES;
PAINT AND CLEARCOAT REMOVER FOR MA-
SONRY, CONCRETE, WOOD AND METAL, IN
CLASS 3 (U.S. CLS. 1, 4, 6, 50, 51 AND 52).

OWNER OF U.S. REG. NO. 3,026,169.

SER. NO. 77-521,795, FILED 7-14-2008.

FIRST USE 1-31-2008; IN COMMERCE 1-31-2008.

SARA THOMAS, EXAMINING ATTORNEY

Int. Cl.: 41

Prior U.S. Cls.: 100, 101 and 107

United States Patent and Trademark Office

Reg. No. 3,576,050

Registered Feb. 17, 2009

**SERVICE MARK
PRINCIPAL REGISTER**

NACURH

NATIONAL ASSOCIATION OF COLLEGE AND
UNIVERSITY RESIDENCE HALLS, INC. (OK-
LAHOMA CORPORATION)

C-3 LEVEL
75 3RD AVENUE
NEW YORK, NY 10003

FOR: ARRANGING AND CONDUCTING EDU-
CATIONAL CONFERENCES; EDUCATIONAL SER-
VICES, NAMELY, DEVELOPING, ARRANGING,
AND CONDUCTING EDUCATIONAL CONFEREN-
CES AND PROGRAMS AND PROVIDING COURSES
OF INSTRUCTION IN THE FIELD OF RESIDENCE
LIFE; EDUCATIONAL SERVICES, NAMELY, PRO-
VIDING INCENTIVES TO COLLEGE STUDENTS TO
DEMONSTRATE EXCELLENCE IN THE FIELD OF
RESIDENCE LIFE THROUGH THE ISSUANCE OF

AWARDS; PROVIDING RECOGNITION AND IN-
CENTIVES BY THE WAY OF AWARDS AND CON-
TESTS TO DEMONSTRATE EXCELLENCE IN THE
FIELD OF RESIDENCE LIFE, IN CLASS 41 (U.S. CLS.
100, 101 AND 107).

FIRST USE 0-0-1961; IN COMMERCE 0-0-1961.

THE MARK CONSISTS OF STANDARD CHAR-
ACTERS WITHOUT CLAIM TO ANY PARTICULAR
FONT, STYLE, SIZE, OR COLOR.

SER. NO. 77-521,858, FILED 7-14-2008.

REBECCA GILBERT, EXAMINING ATTORNEY

Int. Cl.: 41

Prior U.S. Cls.: 100, 101 and 107

United States Patent and Trademark Office

Reg. No. 3,576,051

Registered Feb. 17, 2009

**SERVICE MARK
PRINCIPAL REGISTER**

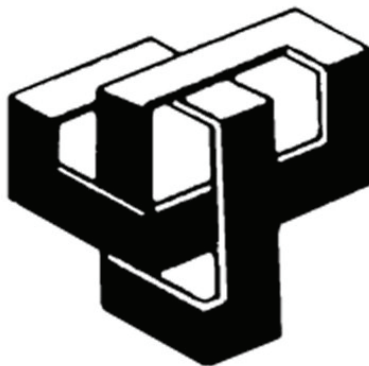

NATIONAL ASSOCIATION OF COLLEGE AND
UNIVERSITY RESIDENCE HALLS, INC. (OK-
LAHOMA CORPORATION)

C-3 LEVEL
75 3RD AVENUE
NEW YORK, NY 10003

FOR: ARRANGING AND CONDUCTING EDU-
CATIONAL CONFERENCES; EDUCATIONAL SER-
VICES, NAMELY, DEVELOPING, ARRANGING,
AND CONDUCTING EDUCATIONAL CONFEREN-
CES AND PROGRAMS AND PROVIDING COURSES
OF INSTRUCTION IN THE FIELD OF RESIDENCE
LIFE; EDUCATIONAL SERVICES, NAMELY, PRO-
VIDING INCENTIVES TO COLLEGE STUDENTS TO
DEMONSTRATE EXCELLENCE IN THE FIELD OF
RESIDENCE LIFE THROUGH THE ISSUANCE OF
AWARDS; PROVIDING RECOGNITION AND IN-

CENTIVES BY THE WAY OF AWARDS AND CON-
TESTS TO DEMONSTRATE EXCELLENCE IN THE
FIELD OF RESIDENCE LIFE, IN CLASS 41 (U.S. CLS.
100, 101 AND 107).

FIRST USE 0-0-1971; IN COMMERCE 0-0-1971.

THE MARK CONSISTS OF A SERIES OF INTER-
WOVEN LINES FORMING A CONTINUOUS CHAIN
IN THREE MAIN PARTS. EACH RECTANGULAR
AREA BOTH OVERLAPS AND UNDER LAPS AN-
OTHER RECTANGULAR AREA.

SER. NO. 77-521,861, FILED 7-14-2008.

REBECCA GILBERT, EXAMINING ATTORNEY

Int. Cl.: 41

Prior U.S. Cls.: 100, 101 and 107

United States Patent and Trademark Office

Reg. No. 3,576,052

Registered Feb. 17, 2009

**SERVICE MARK
PRINCIPAL REGISTER**

NRHH

NATIONAL ASSOCIATION OF COLLEGE AND
UNIVERSITY RESIDENCE HALLS, INC. (OK-
LAHOMA CORPORATION)

C-3 LEVEL
75 3RD AVENUE
NEW YORK, NY 10003

FOR: EDUCATIONAL SERVICES, NAMELY,
PROVIDING INCENTIVES TO COLLEGE STU-
DENTS TO DEMONSTRATE EXCELLENCE IN
THE FIELD OF STUDENT LEADERSHIP
THROUGH THE ISSUANCE OF AWARDS; PROVID-
ING RECOGNITION AND INCENTIVES BY THE
WAY OF AWARDS AND CONTESTS TO DEMON-

STRATE EXCELLENCE IN THE FIELD OF STU-
DENT LEADERSHIP, IN CLASS 41 (U.S. CLS. 100, 101
AND 107).

FIRST USE 0-0-1980; IN COMMERCE 0-0-1980.

THE MARK CONSISTS OF STANDARD CHAR-
ACTERS WITHOUT CLAIM TO ANY PARTICULAR
FONT, STYLE, SIZE, OR COLOR.

SER. NO. 77-521,918, FILED 7-14-2008.

REBECCA GILBERT, EXAMINING ATTORNEY

Int. Cl.: 7

Prior U.S. Cls.: 13, 19, 21, 23, 31, 34 and 35

United States Patent and Trademark Office

Reg. No. 3,576,053

Registered Feb. 17, 2009

**TRADEMARK
PRINCIPAL REGISTER**

ACCELL

ACCURPRESS AMERICA INC. (SOUTH DAKOTA
CORPORATION)
450 CONCOURSE DRIVE
RAPID CITY, SD 57703

THE MARK CONSISTS OF STANDARD CHAR-
ACTERS WITHOUT CLAIM TO ANY PARTICULAR
FONT, STYLE, SIZE, OR COLOR.

FOR: INDUSTRIAL MACHINES, NAMELY,
PRESS BRAKES FOR PRECISION FORMING OF
SHEET METAL, IN CLASS 7 (U.S. CLS. 13, 19, 21, 23,
31, 34 AND 35).

SER. NO. 77-521,970, FILED 7-14-2008.

FIRST USE 0-0-2001; IN COMMERCE 0-0-2001.

CHRISTINA SOBRAL, EXAMINING ATTORNEY

Int. Cl.: 30

Prior U.S. Cl.: 46

United States Patent and Trademark Office

Reg. No. 3,576,054

Registered Feb. 17, 2009

TRADEMARK
PRINCIPAL REGISTER



FRESHLUNCHES INC. (CALIFORNIA CORPORATION)
1738 KELTON AVENUE
LOS ANGELES, CA 90024

FOR: PREPARED MEALS CONSISTING PRIMARILY OF PASTA OR RICE AND ALSO CONTAINING MEAT, SANDWICHES, VEGETABLES, MUFFINS, COOKIES, FRUIT, OR GRAIN-BASED SNACK FOODS, SOLD AS A UNIT, IN CLASS 30 (U.S. CL. 46).

FIRST USE 8-31-2006; IN COMMERCE 11-1-2006.

NO CLAIM IS MADE TO THE EXCLUSIVE RIGHT TO USE "FRESH LUNCHES", APART FROM THE MARK AS SHOWN.

THE MARK CONSISTS OF THE WORD "FRESH" WITH THE "R" STYLED AS A PLANT/LEAF AND THE WORD "LUNCHES" IN CURSIVE WRITING, INSIDE AN APPLE SHAPE WITH A LEAF.

SER. NO. 77-521,975, FILED 7-14-2008.

ELLEN B. AWRICH, EXAMINING ATTORNEY

Int. Cl.: 42

Prior U.S. Cls.: 100 and 101

United States Patent and Trademark Office

Reg. No. 3,576,055

Registered Feb. 17, 2009

**SERVICE MARK
PRINCIPAL REGISTER**



KAANHAA INC (NEW JERSEY CORPORATION)
76 NOTTINGHAM COURT
MONTVALE, NJ 07645

FOR: CUSTOMIZED SOFTWARE DEVELOPMENT SERVICES; INFORMATION TECHNOLOGY CONSULTATION; RESEARCH, DEVELOPMENT, DESIGN AND UPGRADING OF COMPUTER SOFTWARE; SOFTWARE DESIGN AND DEVELOPMENT, IN CLASS 42 (U.S. CLS. 100 AND 101).

FIRST USE 8-1-2007; IN COMMERCE 11-1-2007.

NO CLAIM IS MADE TO THE EXCLUSIVE RIGHT TO USE "IT SOLUTIONS 'DELIVERED' ", APART FROM THE MARK AS SHOWN.

THE MARK CONSISTS OF THE STYLIZED NAME "KAANHAA" AND THE PUNCHLINE "IT SOLUTIONS 'DELIVERED' ". ON TOP OF THE LETTER "H" A STYLIZED RISING SUN HAS BEEN DEPICTED.

SER. NO. 77-521,982, FILED 7-14-2008.

RICHARD A. STRASER, EXAMINING ATTORNEY

Int. Cls.: 35 and 42

Prior U.S. Cls.: 100, 101 and 102

United States Patent and Trademark Office

Reg. No. 3,576,056

Registered Feb. 17, 2009

**SERVICE MARK
PRINCIPAL REGISTER**

Earlywine Design

EARLYWINE DESIGN (CALIFORNIA LIMITED
LIABILITY COMPANY)
1427 CASTILLO AVENUE
BURLINGAME, CA 94010

FOR: ADVERTISING AND MARKETING; ADVERTISING AND PROMOTIONAL SERVICES; ADVERTISING SERVICES, NAMELY, CREATING CORPORATE AND BRAND IDENTITY FOR OTHERS; DEVELOPING PROMOTIONAL CAMPAIGNS FOR BUSINESS; DIRECT MAIL ADVERTISING; SOCIAL MEDIA STRATEGY AND MARKETING CONSULTANCY FOCUSING ON HELPING CLIENTS CREATE AND EXTEND THEIR PRODUCT AND BRAND STRATEGIES BY BUILDING VIRALLY ENGAGING MARKETING SOLUTIONS, IN CLASS 35 (U.S. CLS. 100, 101 AND 102).

FIRST USE 1-1-1985; IN COMMERCE 1-1-1987.

FOR: GRAPHIC DESIGN SERVICES, IN CLASS 42 (U.S. CLS. 100 AND 101).

FIRST USE 1-1-1985; IN COMMERCE 1-1-1987.

THE MARK CONSISTS OF STANDARD CHARACTERS WITHOUT CLAIM TO ANY PARTICULAR FONT, STYLE, SIZE, OR COLOR.

NO CLAIM IS MADE TO THE EXCLUSIVE RIGHT TO USE "DESIGN", APART FROM THE MARK AS SHOWN.

SER. NO. 77-521,984, FILED 7-14-2008.

DAVID MURRAY, EXAMINING ATTORNEY

Int. Cl.: 38

Prior U.S. Cls.: 100, 101 and 104

United States Patent and Trademark Office

Reg. No. 3,576,057

Registered Feb. 17, 2009

**SERVICE MARK
PRINCIPAL REGISTER**

payrolltalk

TEKNON CORPORATION (ARIZONA CORPORATION), DBA SYMMETRY SOFTWARE
14350 N. 87TH STREET, SUITE 170
SCOTTSDALE, AZ 85260

FOR: PROVIDING ON-LINE FORUMS FOR TRANSMISSION OF MESSAGES AMONG COMPUTER USERS CONCERNING PAYROLL AND PAYROLL TAXATION, IN CLASS 38 (U.S. CLS. 100, 101 AND 104).

FIRST USE 5-29-2008; IN COMMERCE 5-29-2008.

THE MARK CONSISTS OF STANDARD CHARACTERS WITHOUT CLAIM TO ANY PARTICULAR FONT, STYLE, SIZE, OR COLOR.

SER. NO. 77-521,995, FILED 7-14-2008.

BILL DAWE, EXAMINING ATTORNEY

Int. Cl.: 37

Prior U.S. Cls.: 100, 103 and 106

United States Patent and Trademark Office

Reg. No. 3,576,058

Registered Feb. 17, 2009

**SERVICE MARK
PRINCIPAL REGISTER**

SCOOP LE POOP

SCOOP LE POOP PET WASTE REMOVAL SERVICE, LLC (TEXAS LIMITED LIABILITY COMPANY)
PO BOX 70975
HOUSTON, TX 77270

FOR: PET WASTE REMOVAL SERVICES; WASTE DISPOSAL FOR OTHERS, IN CLASS 37 (U.S. CLS. 100, 103 AND 106).

FIRST USE 11-0-1999; IN COMMERCE 1-0-2000.

THE MARK CONSISTS OF STANDARD CHARACTERS WITHOUT CLAIM TO ANY PARTICULAR FONT, STYLE, SIZE, OR COLOR.

NO CLAIM IS MADE TO THE EXCLUSIVE RIGHT TO USE "POOP", APART FROM THE MARK AS SHOWN.

SER. NO. 77-522,055, FILED 7-14-2008.

DAVID MILLER, EXAMINING ATTORNEY

Int. Cl.: 7

Prior U.S. Cls.: 13, 19, 21, 23, 31, 34 and 35

United States Patent and Trademark Office

Reg. No. 3,576,059

Registered Feb. 17, 2009

**TRADEMARK
PRINCIPAL REGISTER**

MotionRoll

AUTOMATED CONTROL TECHNOLOGIES, LLC
(ARIZONA LIMITED LIABILITY COMPANY)
2414 WEST 14TH ST STE B
TEMPE, AZ 85281

THE MARK CONSISTS OF STANDARD CHAR-
ACTERS WITHOUT CLAIM TO ANY PARTICULAR
FONT, STYLE, SIZE, OR COLOR.

FOR: CONVEYORS; TRAY CONVEYORS, IN
CLASS 7 (U.S. CLS. 13, 19, 21, 23, 31, 34 AND 35).

SER. NO. 77-522,059, FILED 7-14-2008.

FIRST USE 0-0-2000; IN COMMERCE 0-0-2000.

REBECCA SMITH, EXAMINING ATTORNEY

Int. Cls.: 9, 41 and 42

Prior U.S. Cls.: 21, 23, 26, 36, 38, 100, 101 and 107

United States Patent and Trademark Office

Reg. No. 3,576,060

Registered Feb. 17, 2009

**TRADEMARK
SERVICE MARK
PRINCIPAL REGISTER**

TIMEGATE

TIMEGATE STUDIOS, INC. (TEXAS CORPORATION)
14140 SOUTHWEST FREEWAY, SUITE 400
SUGAR LAND, TX 77478

FOR: COMPUTER GAME SOFTWARE; INTERACTIVE MULTIMEDIA COMPUTER GAME PROGRAM; INTERACTIVE VIDEO GAME PROGRAMS; VIDEO AND COMPUTER GAME PROGRAMS, IN CLASS 9 (U.S. CLS. 21, 23, 26, 36 AND 38).

FIRST USE 12-31-2001; IN COMMERCE 12-31-2001.

FOR: ENTERTAINMENT SERVICES, NAMELY, PROVIDING ON-LINE VIDEO AND COMPUTER GAMES; PRODUCTION OF VIDEO AND COMPUTER GAME SOFTWARE, IN CLASS 41 (U.S. CLS. 100, 101 AND 107).

FIRST USE 12-31-2001; IN COMMERCE 12-31-2001.

FOR: DESIGNING AND DEVELOPING COMPUTER GAME SOFTWARE AND VIDEO GAME SOFTWARE FOR USE WITH COMPUTERS, VIDEO GAME PROGRAM SYSTEMS AND COMPUTER NETWORKS, IN CLASS 42 (U.S. CLS. 100 AND 101).

FIRST USE 12-31-2001; IN COMMERCE 12-31-2001.

THE MARK CONSISTS OF STANDARD CHARACTERS WITHOUT CLAIM TO ANY PARTICULAR FONT, STYLE, SIZE, OR COLOR.

OWNER OF U.S. REG. NOS. 2,318,288, 2,466,094, AND 2,512,222.

SER. NO. 77-522,271, FILED 7-15-2008.

LANA PHAM, EXAMINING ATTORNEY

Int. Cl.: 10

Prior U.S. Cls.: 26, 39 and 44

United States Patent and Trademark Office

Reg. No. 3,576,061

Registered Feb. 17, 2009

**TRADEMARK
PRINCIPAL REGISTER**

SHOK BOX

ALLIED 100, LLC (WISCONSIN LIMITED LIABILITY COMPANY)
51N 1800 U.S. HIGHWAY
WOODRUFF, WI 54568

FOR: ACCESSORIES FOR AUTOMATIC EXTERNAL DEFIBRILLATORS (AEDS), NAMELY, CARRYING CASES SPECIFICALLY ADAPTED FOR AUTOMATIC EXTERNAL DEFIBRILLATORS (AEDS), IN CLASS 10 (U.S. CLS. 26, 39 AND 44).

FIRST USE 11-30-2004; IN COMMERCE 11-30-2004.

THE MARK CONSISTS OF STANDARD CHARACTERS WITHOUT CLAIM TO ANY PARTICULAR FONT, STYLE, SIZE, OR COLOR.

NO CLAIM IS MADE TO THE EXCLUSIVE RIGHT TO USE "BOX", APART FROM THE MARK AS SHOWN.

SER. NO. 77-522,994, FILED 7-15-2008.

JAY BESCH, EXAMINING ATTORNEY

Int. Cl.: 41

Prior U.S. Cls.: 100, 101 and 107

United States Patent and Trademark Office

Reg. No. 3,576,062

Registered Feb. 17, 2009

**SERVICE MARK
PRINCIPAL REGISTER**



THE JUNIOR GOLF ACADEMY INC. (NEVADA CORPORATION)
263 DELFINO WAY
HENDERSON, NV 89074

FOR: EDUCATION SERVICES IN THE NATURE OF EARLY CHILDHOOD INSTRUCTION; EDUCATIONAL SERVICES, NAMELY, CONDUCTING CLASSES IN THE FIELD OF GOLF INSTRUCTION AND DISTRIBUTION OF COURSE MATERIAL IN CONNECTION THEREWITH; EDUCATIONAL SERVICES, NAMELY, CONDUCTING CLASSES IN THE FIELD OF GOLF INSTRUCTION AND DISTRIBUTION OF TRAINING MATERIAL IN CONNECTION THEREWITH; EDUCATIONAL SERVICES, NAMELY, DEVELOPING, ARRANGING, AND CONDUCTING EDUCATIONAL CONFERENCES AND PROGRAMS AND PROVIDING COURSES OF INSTRUCTION IN THE FIELD OF GOLF INSTRUCTION; EDUCATIONAL SERVICES, NAMELY, PROVIDING COURSES OF INSTRUCTION AT THE PRIMARY LEVEL; EDUCATIONAL SERVICES, NAMELY, PROVIDING COURSES OF INSTRUCTION AT THE SECONDARY LEVEL AND DISTRIBUTION OF COURSE MATERIAL IN CONNECTION THEREWITH; EDUCATIONAL SERVICES, NAMELY, CONDUCTING CLASSES IN THE

FIELD OF GOLF INSTRUCTION, IN CLASS 41 (U.S. CLS. 100, 101 AND 107).

FIRST USE 2-1-2005; IN COMMERCE 2-1-2005.

NO CLAIM IS MADE TO THE EXCLUSIVE RIGHT TO USE "JUNIOR GOLF ACADEMY", APART FROM THE MARK AS SHOWN.

THE COLOR(S) RED, BLACK AND WHITE IS/ ARE CLAIMED AS A FEATURE OF THE MARK.

THE MARK CONSISTS OF A RED SHIELD WITH BLACK OUTLINE IN WHICH APPEARS A WHITE GOLF BALL OUTLINED IN BLACK WITH THE BLACK LETTERS "JGA" THEREON. BEHIND THE GOLF BALL DESIGN ARE BLACK CROSSED GOLF CLUBS. BELOW THE SHIELD DESIGN IS THE BLACK STYLIZED WORDING "JUNIOR GOLF ACADEMY".

SER. NO. 77-523,000, FILED 7-15-2008.

BRIAN PINO, EXAMINING ATTORNEY

Int. Cl.: 9

Prior U.S. Cls.: 21, 23, 26, 36 and 38

United States Patent and Trademark Office

Reg. No. 3,576,063

Registered Feb. 17, 2009

**TRADEMARK
PRINCIPAL REGISTER**

MATCHLESS

MATCHLESS, LLC (CALIFORNIA LIMITED LIABILITY COMPANY)
1933 PONTIUS AVENUE
LOS ANGELES, CA 90025

FOR: AMPLIFIERS AND PARTS THEREOF, AUDIO AMPLIFIERS AND AUDIO SIGNAL PROCESSORS; PRE-AMPLIFIERS; AND SPEAKER ENCLOSURES, IN CLASS 9 (U.S. CLS. 21, 23, 26, 36 AND 38).

FIRST USE 8-31-1991; IN COMMERCE 8-31-1991.

THE MARK CONSISTS OF STANDARD CHARACTERS WITHOUT CLAIM TO ANY PARTICULAR FONT, STYLE, SIZE, OR COLOR.

SER. NO. 77-523,028, FILED 7-15-2008.

JULIE VEPPUMTHARA, EXAMINING ATTORNEY

Int. Cl.: 41

Prior U.S. Cls.: 100, 101 and 107

United States Patent and Trademark Office

Reg. No. 3,576,064

Registered Feb. 17, 2009

**SERVICE MARK
PRINCIPAL REGISTER**

WE KNOW DRAMA

TURNER NETWORK TELEVISION, INC. (GEORGIA CORPORATION)
C/O TURNER BROADCASTING SYSTEM, INC.
ONE CNN CENTER, 13 NORTH
ATLANTA, GA 30303

FOR: ENTERTAINMENT SERVICES, NAMELY, PROVISION OF ON-GOING MULTIMEDIA PROGRAMS IN THE FIELD OF ACTION, ADVENTURE, COMEDY, DRAMA AND SPORTS DISTRIBUTED VIA VARIOUS PLATFORMS ACROSS MULTIPLE FORMS OF TRANSMISSION MEDIA, IN CLASS 41 (U.S. CLS. 100, 101 AND 107).

FIRST USE 6-12-2001; IN COMMERCE 6-12-2001.

THE MARK CONSISTS OF STANDARD CHARACTERS WITHOUT CLAIM TO ANY PARTICULAR FONT, STYLE, SIZE, OR COLOR.

OWNER OF U.S. REG. NOS. 2,629,305 AND 3,171,089.

SER. NO. 77-523,167, FILED 7-16-2008.

ELIZABETH KAJUBI, EXAMINING ATTORNEY

Int. Cl.: 41

Prior U.S. Cls.: 100, 101 and 107

United States Patent and Trademark Office

Reg. No. 3,576,065

Registered Feb. 17, 2009

**SERVICE MARK
PRINCIPAL REGISTER**

Rettig to Rumble

BRANDY RETTIG (UNITED STATES INDIVIDUAL)
9450 14TH AVE SW
SEATTLE, WA 98106

FOR: ENTERTAINMENT IN THE NATURE OF ROLLER DERBY GAMES; ENTERTAINMENT SERVICES, NAMELY, PARTICIPATION IN ROLLER DERBY COMPETITIONS; ENTERTAINMENT SERVICES, NAMELY, PERSONAL APPEARANCES BY A ROLLER DERBY COMPETITOR, IN CLASS 41 (U.S. CLS. 100, 101 AND 107).

FIRST USE 9-1-2004; IN COMMERCE 9-1-2004.

THE MARK CONSISTS OF STANDARD CHARACTERS WITHOUT CLAIM TO ANY PARTICULAR FONT, STYLE, SIZE, OR COLOR.

THE NAME "RETTIG TO RUMBLE" IDENTIFIES A LIVING INDIVIDUAL WHOSE CONSENT IS OF RECORD.

SER. NO. 77-523,344, FILED 7-16-2008.

IRA J. GOODSaid, EXAMINING ATTORNEY

Int. Cl.: 16

Prior U.S. Cls.: 2, 5, 22, 23, 29, 37, 38 and 50

Reg. No. 3,576,066

United States Patent and Trademark Office

Registered Feb. 17, 2009

**TRADEMARK
PRINCIPAL REGISTER**

SPC SERIES

SPC RESOURCES, INC. (DELAWARE CORPORATION)
MAIL DROP Y-11
125 W. HOME AVENUE
HARTSVILLE, SC 29550

FOR: PAPER AND PAPERBOARD SUITABLE
FOR THE MANUFACTURE OF PAPER TUBES
AND PAPER CORES, IN CLASS 16 (U.S. CLS. 2, 5,
22, 23, 29, 37, 38 AND 50).

FIRST USE 3-20-2008; IN COMMERCE 3-20-2008.

THE MARK CONSISTS OF STANDARD CHARACTERS WITHOUT CLAIM TO ANY PARTICULAR FONT, STYLE, SIZE, OR COLOR.

NO CLAIM IS MADE TO THE EXCLUSIVE RIGHT TO USE "SERIES", APART FROM THE MARK AS SHOWN.

SER. NO. 77-523,504, FILED 7-16-2008.

RUSS HERMAN, EXAMINING ATTORNEY

Int. Cls.: 21 and 22

**Prior U.S. Cls.: 1, 2, 7, 13, 19, 22, 23, 29, 30, 33, 40, 42
and 50**

Reg. No. 3,576,067

United States Patent and Trademark Office

Registered Feb. 17, 2009

**TRADEMARK
PRINCIPAL REGISTER**



PATRICK YARN MILL, INC. (NORTH CAROLINA CORPORATION)
501 YORK ROAD
P. O. BOX 1847
KINGS MOUNTAIN, NC 28086

FOR: INSULATING SLEEVE HOLDERS, IN CLASS 21 (U.S. CLS. 2, 13, 23, 29, 30, 33, 40 AND 50).

FIRST USE 4-7-2008; IN COMMERCE 4-7-2008.

FOR: TEXTILES AND TEXTILE GOODS, NAME-
LY, RE-CLAIMED OR RECYCLED FIBERS, RE-
CLAIMED PET FROM PLASTIC BOTTLES, AND
OTHER NATURAL FIBERS, NAMELY, ORGANIC
COTTON, FLAX, HEMP, KNAF, BAMBOO, SOY-

BEAN PROTEIN, MILK PROTEIN, AND CORN, ALL
FOR THE MANUFACTURE OF YARNS, FABRICS,
APPAREL AND RELATED ITEMS, NAMELY, HATS,
HOSIERY, SHOES, GLOVES, TARPS, RUGS, MOPS,
UPHOLSTERY AND BLANKETS, IN CLASS 22 (U.S.
CLS. 1, 2, 7, 19, 22, 42 AND 50).

FIRST USE 4-7-2008; IN COMMERCE 4-7-2008.

THE MARK CONSISTS OF A LEAF WITHIN THE
CIRCLE OF THE LETTER E.

SER. NO. 77-523,594, FILED 7-16-2008.

FLORENTINA BLANDU, EXAMINING ATTORNEY

Int. Cl.: 25

Prior U.S. Cls.: 22 and 39

United States Patent and Trademark Office

Reg. No. 3,576,068

Registered Feb. 17, 2009

**TRADEMARK
PRINCIPAL REGISTER**

WRANGLER JEAN CO.

WRANGLER APPAREL CORP. (DELAWARE
CORPORATION)
3411 SILVERSIDE RD.
WILMINGTON, DE 19810

OWNER OF U.S. REG. NOS. 1,075,094, 1,259,491
AND OTHERS.

FOR: TOPS AND BOTTOMS, IN CLASS 25 (U.S.
CLS. 22 AND 39).

NO CLAIM IS MADE TO THE EXCLUSIVE
RIGHT TO USE "JEAN CO.", APART FROM THE
MARK AS SHOWN.

FIRST USE 12-31-1994; IN COMMERCE 12-31-1994.

SER. NO. 77-523,802, FILED 7-16-2008.

THE MARK CONSISTS OF STANDARD CHAR-
ACTERS WITHOUT CLAIM TO ANY PARTICULAR
FONT, STYLE, SIZE, OR COLOR.

KIMBERLY FRYE, EXAMINING ATTORNEY

Int. Cls.: 35, 36 and 41

Prior U.S. Cls.: 100, 101, 102 and 107

United States Patent and Trademark Office

Reg. No. 3,576,069

Registered Feb. 17, 2009

**SERVICE MARK
PRINCIPAL REGISTER**

THINKPANMURE

THINKPANMURE, LLC (DELAWARE LIMITED
LIABILITY COMPANY)
600 MONTGOMERY STREET
SAN FRANCISCO, CA 94111

FOR: BUSINESS MERGERS AND ACQUISITIONS
CONSULTATION; BUSINESS SERVICES, NAMELY,
MATCHING POTENTIAL PRIVATE INVESTORS
WITH ENTREPRENEURS NEEDING FUNDING,
IN CLASS 35 (U.S. CLS. 100, 101 AND 102).

FIRST USE 4-1-2008; IN COMMERCE 4-1-2008.

FOR: INVESTMENT RESEARCH SERVICES; IN-
VESTMENT RESEARCH; INVESTMENT BANKING
SERVICES; CAPITAL INVESTMENT CONSULTA-
TION; VENTURE CAPITAL SERVICES, NAMELY,
PROVIDING FINANCING OPTIONS TO EMER-
GING AND START-UP COMPANIES; FINANCIAL
INVESTMENT IN THE FIELD OF SECURITIES;
FINANCIAL SERVICES IN THE NATURE OF AN
INVESTMENT SECURITY; FINANCIAL SERVICES;
NAMELY, INVESTMENT FUND TRANSFER AND
TRANSACTION SERVICES; FUND INVESTMENT
CONSULTATION; FUNDS INVESTMENT; INVEST-
MENT ADVICE; INVESTMENT BROKERAGE; IN-
VESTMENT CONSULTATION; INVESTMENT
MANAGEMENT; INVESTMENT OF FUNDS FOR
OTHERS, IN CLASS 36 (U.S. CLS. 100, 101 AND 102).

FIRST USE 4-1-2008; IN COMMERCE 4-1-2008.

FOR: CONDUCTING CONFERENCES, WORK-
SHOPS AND SEMINARS IN THE FIELD OF FINAN-
CIAL SERVICES, INVESTMENT, INVESTMENT
BANKING, RAISING CAPITAL, MERGERS AND
ACQUISITIONS, VENTURE CAPITAL, AND DIS-
TRIBUTING COURSE MATERIALS IN CONNEC-
TION THEREWITH; PROVIDING ON-LINE
NEWSLETTER IN THE FIELD OF INVESTMENTS
AND FINANCIAL SERVICES AND ADVICE, IN
CLASS 41 (U.S. CLS. 100, 101 AND 107).

FIRST USE 4-1-2008; IN COMMERCE 4-1-2008.

THE MARK CONSISTS OF STANDARD CHAR-
ACTERS WITHOUT CLAIM TO ANY PARTICULAR
FONT, STYLE, SIZE, OR COLOR.

OWNER OF U.S. REG. NOS. 3,132,138, 3,156,343
AND OTHERS.

SER. NO. 77-524,226, FILED 7-16-2008.

GINA HAYES, EXAMINING ATTORNEY

Int. Cl.: 15

Prior U.S. Cls.: 2, 21 and 36

United States Patent and Trademark Office

Reg. No. 3,576,070

Registered Feb. 17, 2009

**TRADEMARK
PRINCIPAL REGISTER**



ASKA CO., LTD. (JAPAN CORPORATION)
7071-3, OOAZA-SASAGA, MATSUMOTO-SHI
NAGANO-KEN, JAPAN

FOR: GUITARS, IN CLASS 15 (U.S. CLS. 2, 21 AND
36).

OWNER OF JAPAN REG. NO. 4610525, DATED 10-
4-2002, EXPIRES 10-4-2012.

NO CLAIM IS MADE TO THE EXCLUSIVE
RIGHT TO USE "GUITARS", APART FROM THE
MARK AS SHOWN.

THE MARK CONSISTS OF THE WORD "HEAD-
WAY" CURVED OVER THE WORD "GUITARS".

SER. NO. 77-524,383, FILED 7-17-2008.

SAMUEL E. SHARPER JR., EXAMINING ATTOR-
NEY

Int. Cl.: 35

Prior U.S. Cls.: 100, 101 and 102

United States Patent and Trademark Office

Reg. No. 3,576,071

Registered Feb. 17, 2009

**SERVICE MARK
PRINCIPAL REGISTER**

UNCORK NEW YORK!

NEW YORK WINE/GRAPE FOUNDATION (NEW
YORK NON-PROFIT CORPORATION), DBA
THE NEW YORK WINE & GRAPE FOUNDATION

SUITE 200
800 SOUTH MAIN STREET
CANANDAIGUA, NY 14422

FOR: ASSOCIATION SERVICES, NAMELY, PROMOTING THE INTERESTS OF WINE AND GRAPE PRODUCERS, IN CLASS 35 (U.S. CLS. 100, 101 AND 102).

FIRST USE 0-0-1990; IN COMMERCE 0-0-1990.

THE MARK CONSISTS OF STANDARD CHARACTERS WITHOUT CLAIM TO ANY PARTICULAR FONT, STYLE, SIZE, OR COLOR.

NO CLAIM IS MADE TO THE EXCLUSIVE RIGHT TO USE "NEW YORK", APART FROM THE MARK AS SHOWN.

SER. NO. 77-524,452, FILED 7-17-2008.

REBECCA SMITH, EXAMINING ATTORNEY

Int. Cl.: 35

Prior U.S. Cls.: 100, 101 and 102

United States Patent and Trademark Office

Reg. No. 3,576,072

Registered Feb. 17, 2009

**SERVICE MARK
PRINCIPAL REGISTER**

**Intentionally Designed
Culture (IDC)**

SYMETOSPHERE LLC (OHIO LIMITED LIABILITY COMPANY)
6515 EQUESTRAIN TRAIL
MEDINA, OH 44256

FOR: BUSINESS CONSULTING SERVICES IN THE FIELD OF ORGANIZATIONAL CHANGE MANAGEMENT, IN CLASS 35 (U.S. CLS. 100, 101 AND 102).

FIRST USE 10-1-1982; IN COMMERCE 10-1-1982.

THE MARK CONSISTS OF STANDARD CHARACTERS WITHOUT CLAIM TO ANY PARTICULAR FONT, STYLE, SIZE, OR COLOR.

SER. NO. 77-524,517, FILED 7-17-2008.

KATHERINE E. HALMEN, EXAMINING ATTORNEY

Int. Cl.: 7

Prior U.S. Cls.: 13, 19, 21, 23, 31, 34 and 35

United States Patent and Trademark Office

Reg. No. 3,576,073

Registered Feb. 17, 2009

**TRADEMARK
PRINCIPAL REGISTER**

ACCURSHEAR

ACCURPRESS AMERICA INC. (SOUTH DAKOTA
CORPORATION)
DEAN ALBRECHT
450 CONCOURSE DRIVE
RAPID CITY, SD 57703

FOR: INDUSTRIAL MACHINES, NAMELY,
SHEARS FOR PRECISION SHEARING OF SHEET
METAL, IN CLASS 7 (U.S. CLS. 13, 19, 21, 23, 31, 34
AND 35).

FIRST USE 0-0-1977; IN COMMERCE 0-0-1977.

THE MARK CONSISTS OF STANDARD CHAR-
ACTERS WITHOUT CLAIM TO ANY PARTICULAR
FONT, STYLE, SIZE, OR COLOR.

SER. NO. 77-524,996, FILED 7-17-2008.

CHRISTINA SOBRAL, EXAMINING ATTORNEY

Int. Cl.: 7

Prior U.S. Cls.: 13, 19, 21, 23, 31, 34 and 35

Reg. No. 3,576,074

United States Patent and Trademark Office

Registered Feb. 17, 2009

**TRADEMARK
PRINCIPAL REGISTER**

EDGE

ACCURPRESS AMERICA INC. (SOUTH DAKOTA
CORPORATION)
DEAN ALBRECHT
450 CONCOURSE DRIVE
RAPID CITY, SD 57703

FIRST USE 11-29-2007; IN COMMERCE 11-29-2007.

THE MARK CONSISTS OF STANDARD CHAR-
ACTERS WITHOUT CLAIM TO ANY PARTICULAR
FONT, STYLE, SIZE, OR COLOR.

FOR: INDUSTRIAL MACHINES, NAMELY,
PRESS BRAKES FOR PRECISION FORMING OF
SHEET METAL, IN CLASS 7 (U.S. CLS. 13, 19, 21, 23,
31, 34 AND 35).

SER. NO. 77-525,070, FILED 7-17-2008.

CHRISTINA SOBRAL, EXAMINING ATTORNEY

Int. Cl.: 37

Prior U.S. Cls.: 100, 103 and 106

United States Patent and Trademark Office

Reg. No. 3,576,075

Registered Feb. 17, 2009

**SERVICE MARK
PRINCIPAL REGISTER**

TECHZILLA BY QWEST

QWEST COMMUNICATIONS INTERNATIONAL
INC. (DELAWARE CORPORATION)
1801 CALIFORNIA STREET
DENVER, CO 80202

THE MARK CONSISTS OF STANDARD CHAR-
ACTERS WITHOUT CLAIM TO ANY PARTICULAR
FONT, STYLE, SIZE, OR COLOR.

FOR: COMPUTER INSTALLATION AND RE-
PAIR, IN CLASS 37 (U.S. CLS. 100, 103 AND 106).

SER. NO. 77-525,316, FILED 7-17-2008.

FIRST USE 8-19-2008; IN COMMERCE 8-19-2008.

JENNIFER VASQUEZ, EXAMINING ATTORNEY

Int. Cl.: 41

Prior U.S. Cls.: 100, 101 and 107

United States Patent and Trademark Office

Reg. No. 3,576,076

Registered Feb. 17, 2009

SERVICE MARK
PRINCIPAL REGISTER



PABLO CRUISE ENTERPRISES (CALIFORNIA
PARTNERSHIP)
4414 FAIRWAY COURT
WESTLAKE VILLAGE, CA 91362

FOR: ENTERTAINMENT IN THE NATURE OF
LIVE PERFORMANCES BY A MUSICAL GROUP;
ENTERTAINMENT IN THE NATURE OF VISUAL
AND AUDIO PERFORMANCES BY A MUSICAL
GROUP; ENTERTAINMENT, NAMELY, LIVE MU-
SIC CONCERTS; ENTERTAINMENT SERVICES,
NAMELY, PROVIDING A WEB SITE FEATURING
MUSICAL PERFORMANCES AND RELATED PHO-
TOGRAPHS, AND OTHER MULTIMEDIA MATERI-
ALS, IN CLASS 41 (U.S. CLS. 100, 101 AND 107).

FIRST USE 8-0-1973; IN COMMERCE 8-0-1973.

OWNER OF U.S. REG. NO. 1,132,171.

THE NAME(S), PORTRAIT(S), AND/OR SIGNA-
TURE(S) SHOWN IN THE MARK DOES NOT IDEN-
TIFY A PARTICULAR LIVING INDIVIDUAL.

THE MARK CONSISTS OF THE WORDS "PABLO
CRUISE" IN STYLIZED LETTERING WITH THE
FANCIFUL DESIGN OF A PALM TREE SUPER-
IMPOSED OVER THE DESIGN.

SER. NO. 77-525,405, FILED 7-17-2008.

WON TEAK OH, EXAMINING ATTORNEY

Int. Cl.: 41

Prior U.S. Cls.: 100, 101 and 107

United States Patent and Trademark Office

Reg. No. 3,576,077

Registered Feb. 17, 2009

**SERVICE MARK
PRINCIPAL REGISTER**

PABLO CRUISE

PABLO CRUISE ENTERPRISES (CALIFORNIA
PARTNERSHIP)
4414 FAIRWAY COURT
WESTLAKE VILLAGE, CA 91362

FOR: ENTERTAINMENT IN THE NATURE OF
LIVE PERFORMANCES BY A MUSICAL GROUP;
ENTERTAINMENT IN THE NATURE OF VISUAL
AND AUDIO PERFORMANCES BY A MUSICAL
GROUP; ENTERTAINMENT, NAMELY, LIVE MU-
SIC CONCERTS; ENTERTAINMENT SERVICES,
NAMELY, PROVIDING A WEB SITE FEATURING
MUSICAL PERFORMANCES AND RELATED PHO-
TOGRAPHS, AND OTHER MULTIMEDIA MATERI-
ALS, IN CLASS 41 (U.S. CLS. 100, 101 AND 107).

FIRST USE 8-0-1973; IN COMMERCE 8-0-1973.

THE MARK CONSISTS OF STANDARD CHAR-
ACTERS WITHOUT CLAIM TO ANY PARTICULAR
FONT, STYLE, SIZE, OR COLOR.

OWNER OF U.S. REG. NO. 1,132,171.

THE NAME(S), PORTRAIT(S), AND/OR SIGNA-
TURE(S) SHOWN IN THE MARK DOES NOT IDEN-
TIFY A PARTICULAR LIVING INDIVIDUAL.

SER. NO. 77-525,414, FILED 7-17-2008.

WON TEAK OH, EXAMINING ATTORNEY

Int. Cl.: 35

Prior U.S. Cls.: 100, 101 and 102

United States Patent and Trademark Office

Reg. No. 3,576,078

Registered Feb. 17, 2009

**SERVICE MARK
PRINCIPAL REGISTER**



ALLOGISTX INTERNATIONAL, INC. (CALIFORNIA CORPORATION)
267 ST. ALBANS AVENUE
SOUTH GATE, CA 91030

FOR: BUSINESS CONSULTING SERVICES RELATING TO PRODUCT DISTRIBUTION, OPERATIONS MANAGEMENT SERVICES, LOGISTICS, REVERSE LOGISTICS, SUPPLY CHAIN, AND PRODUCTION SYSTEMS AND DISTRIBUTION SOLUTIONS, IN CLASS 35 (U.S. CLS. 100, 101 AND 102).

FIRST USE 2-1-2008; IN COMMERCE 2-1-2008.

NO CLAIM IS MADE TO THE EXCLUSIVE RIGHT TO USE "INTERNATIONAL INC.", APART FROM THE MARK AS SHOWN.

THE STIPPLING IS FOR SHADING PURPOSES ONLY.

THE MARK CONSISTS OF THE STYLIZED TEXT "ALLOGISTX INTERNATIONAL INC." WITH THE "X" SURROUNDING A GLOBE OF THE WORLD.

SER. NO. 77-526,486, FILED 7-18-2008.

CURTIS FRENCH, EXAMINING ATTORNEY

Int. Cl.: 41

Prior U.S. Cls.: 100, 101 and 107

United States Patent and Trademark Office

Reg. No. 3,576,079

Registered Feb. 17, 2009

SERVICE MARK
PRINCIPAL REGISTER



FITNESS4DIABETICS.COM LLC (DELAWARE
LIMITED LIABILITY COMPANY)
SUITE 11J
1601 THIRD AVENUE
NEW YORK, NY 101283454

FOR: PHYSICAL FITNESS CONDITIONING
CLASSES; PHYSICAL FITNESS CONSULTATION;
PHYSICAL FITNESS INSTRUCTION; PROVIDING
A WEB SITE FEATURING INFORMATION ON
EXERCISE AND FITNESS; PROVIDING ASSIS-
TANCE, PERSONAL TRAINING AND PHYSICAL
FITNESS CONSULTATION TO CORPORATE CLI-
ENTS TO HELP THEIR EMPLOYEES MAKE PHY-
SICAL FITNESS, STRENGTH, CONDITIONING,
AND EXERCISE ALTERATIONS IN THEIR DAILY
LIVING; PROVIDING ASSISTANCE, PERSONAL
TRAINING AND PHYSICAL FITNESS CONSULTA-
TION TO INDIVIDUALS TO HELP THEM MAKE
PHYSICAL FITNESS, STRENGTH, CONDITION-

ING, AND EXERCISE IMPROVEMENT IN THEIR
DAILY LIVING, IN CLASS 41 (U.S. CLS. 100, 101 AND
107).

FIRST USE 8-11-2007; IN COMMERCE 8-11-2007.

OWNER OF U.S. REG. NO. 3,314,956.

THE MARK CONSISTS OF A STYLIZED REPRE-
SENTATION OF A PERSON EXERCISING, INSIDE
AND BELOW A SEMICIRCLE TERMINATING IN A
STARBURST, WITH THE WORDS "FIT4D.COM" AT
THE LOWER LEVEL OF THE FIGURE.

SER. NO. 77-526,571, FILED 7-19-2008.

ALICE SUE CARRUTHERS, EXAMINING ATTOR-
NEY

Int. Cl.: 42

Prior U.S. Cls.: 100 and 101

United States Patent and Trademark Office

Reg. No. 3,576,080

Registered Feb. 17, 2009

**SERVICE MARK
PRINCIPAL REGISTER**



SECURE PASSAGE, LLC (MISSOURI LIMITED LIABILITY COMPANY)
SUITE 440
300 WYANDOTTE STREET
KANSAS CITY, MO 64105

FOR: COMPUTER NETWORK SERVICES, NAME-
LY, COMPUTER SOFTWARE AND NETWORK DE-
SIGN FOR OTHERS; COMPUTER SECURITY
SERVICES, NAMELY, RESTRICTING ACCESS TO
AND BY COMPUTER NETWORKS TO AND OF
UNDESIRE WEB SITES, MEDIA, INDIVIDUALS
AND FACILITIES; COMPUTER CONSULTATION
IN THE FIELD OF COMPUTER SECURITY; DEVEL-

OPMENT OF CUSTOMIZED SOFTWARE FOR OTH-
ERS FOR USE IN INFORMATION AND NETWORK
SECURITY, IN CLASS 42 (U.S. CLS. 100 AND 101).

FIRST USE 9-0-2003; IN COMMERCE 1-0-2004.

THE MARK CONSISTS OF A LETTER "S" AND
AN OVAL ENCAPSULATED WITHIN A BOX.

SER. NO. 77-526,980, FILED 7-21-2008.

NAKWAMA ANKRAH, EXAMINING ATTORNEY

Int. Cl.: 39

Prior U.S. Cls.: 100 and 105

United States Patent and Trademark Office

Reg. No. 3,576,081

Registered Feb. 17, 2009

**SERVICE MARK
PRINCIPAL REGISTER**

AA Automovers

AA AUTOMOVERS INC. (NEW JERSEY COR-
PORATION)
SUITE 200
333 LITTLETON RD
PARSIPPANY, NJ 07054

FOR: CAR TRANSPORT; TRANSPORT BROKER-
AGE, IN CLASS 39 (U.S. CLS. 100 AND 105).

FIRST USE 1-1-2005; IN COMMERCE 1-1-2005.

THE MARK CONSISTS OF STANDARD CHAR-
ACTERS WITHOUT CLAIM TO ANY PARTICULAR
FONT, STYLE, SIZE, OR COLOR.

NO CLAIM IS MADE TO THE EXCLUSIVE
RIGHT TO USE "AUTO MOVERS", APART FROM
THE MARK AS SHOWN.

SER. NO. 77-527,386, FILED 7-21-2008.

MELVIN AXILBUND, EXAMINING ATTORNEY

Int. Cls.: 35 and 41

Prior U.S. Cls.: 100, 101, 102 and 107

United States Patent and Trademark Office

Reg. No. 3,576,082

Registered Feb. 17, 2009

**SERVICE MARK
PRINCIPAL REGISTER**

BEYOND MEASURE

BROWN, JANICE (UNITED STATES INDIVIDUAL)
600 B STREET, SUITE 1650
SAN DIEGO, CA 92101

FOR: BUSINESS CONSULTATION; BUSINESS CONSULTATION SERVICES; BUSINESS MANAGEMENT CONSULTATION IN THE FIELD OF EXECUTIVE AND LEADERSHIP DEVELOPMENT; PROFESSIONAL BUSINESS CONSULTATION; BUSINESS CONSULTING AND BUSINESS INFORMATION FOR ENTERPRISES; BUSINESS MARKETING CONSULTING SERVICES; MARKETING CONSULTING; BUSINESS LEADERSHIP DEVELOPMENT; AND CONSULTATION SERVICES IN THE FIELD OF BUSINESS NETWORKING, IN CLASS 35 (U.S. CLS. 100, 101 AND 102).

FIRST USE 1-31-2007; IN COMMERCE 1-31-2007.

FOR: EDUCATIONAL SERVICES, NAMELY, CONDUCTING SEMINARS AND CONFERENCES

IN THE FIELDS OF LEADERSHIP, BUSINESS DEVELOPMENT, RAINMAKING, NETWORKING, AND MARKETING (AND DISTRIBUTION OF COURSE MATERIALS IN CONNECTION THEREWITH); EDUCATIONAL AND ENTERTAINMENT SERVICES, NAMELY, PROVIDING MOTIVATIONAL AND EDUCATIONAL SPEAKERS; PROFESSIONAL COACHING SERVICES IN THE FIELDS OF LEADERSHIP, BUSINESS DEVELOPMENT, RAINMAKING, NETWORKING, AND MARKETING, IN CLASS 41 (U.S. CLS. 100, 101 AND 107).

FIRST USE 1-31-2007; IN COMMERCE 1-31-2007.

THE MARK CONSISTS OF STANDARD CHARACTERS WITHOUT CLAIM TO ANY PARTICULAR FONT, STYLE, SIZE, OR COLOR.

SER. NO. 77-527,709, FILED 7-21-2008.

CARRIE GENOVESE, EXAMINING ATTORNEY

Int. Cl.: 35

Prior U.S. Cls.: 100, 101 and 102

United States Patent and Trademark Office

Reg. No. 3,576,083

Registered Feb. 17, 2009

**SERVICE MARK
PRINCIPAL REGISTER**

PRICEGYM

SUN HOME & GARDEN INC. (FLORIDA CORPORATION)
SUITE V19
1326 CAPE CORAL PKWY E
CAPE CORAL, FL 33904

FOR: PROMOTING THE GOODS AND SERVICES OF OTHERS BY PROVIDING A WEB SITE FEATURING COUPONS, REBATES, PRICE-COMPARISON INFORMATION, PRODUCT REVIEWS, LINKS TO THE RETAIL WEB SITES OF OTHERS, AND DISCOUNT INFORMATION, IN CLASS 35 (U.S. CLS. 100, 101 AND 102).

FIRST USE 6-2-2008; IN COMMERCE 7-1-2008.

THE MARK CONSISTS OF STANDARD CHARACTERS WITHOUT CLAIM TO ANY PARTICULAR FONT, STYLE, SIZE, OR COLOR.

SER. NO. 77-527,846, FILED 7-22-2008.

AMY ALFIERI, EXAMINING ATTORNEY

Int. Cls.: 6 and 7

**Prior U.S. Cls.: 2, 12, 13, 14, 19, 21, 23, 25, 31, 34, 35
and 50**

Reg. No. 3,576,084

United States Patent and Trademark Office

Registered Feb. 17, 2009

**TRADEMARK
PRINCIPAL REGISTER**

POWERFAB

POWERSECURE, INC. (DELAWARE CORPORATION)
1609 HERITAGE COMMERCE COURT
WAKE FOREST, NC 27587

FOR: ENCLOSURES OF METAL FOR ELECTRICAL EQUIPMENT, IN CLASS 6 (U.S. CLS. 2, 12, 13, 14, 23, 25 AND 50).

FIRST USE 1-10-2008; IN COMMERCE 7-14-2008.

FOR: ELECTRIC POWER GENERATORS, IN CLASS 7 (U.S. CLS. 13, 19, 21, 23, 31, 34 AND 35).

FIRST USE 1-10-2008; IN COMMERCE 7-14-2008.

THE MARK CONSISTS OF STANDARD CHARACTERS WITHOUT CLAIM TO ANY PARTICULAR FONT, STYLE, SIZE, OR COLOR.

OWNER OF U.S. REG. NO. 3,484,704.

SER. NO. 77-528,157, FILED 7-22-2008.

STEVEN JACKSON, EXAMINING ATTORNEY

Int. Cl.: 45

Prior U.S. Cls.: 100 and 101

United States Patent and Trademark Office

Reg. No. 3,576,085

Registered Feb. 17, 2009

**SERVICE MARK
PRINCIPAL REGISTER**



DATING REVOLUTION, INC. (NEW YORK CORPORATION)
1 UNIVERSITY PLACE, #5P
NEW YORK, NY 10003

FOR: COMPUTER DATING SERVICES, IN CLASS
45 (U.S. CLS. 100 AND 101).

FIRST USE 5-19-2008; IN COMMERCE 5-19-2008.

THE STIPPLING IS A FEATURE OF THE MARK
AND DOES NOT INDICATE COLOR.

THE MARK CONSISTS OF COMPANY LOGO OF
TWO HANDS GRASPING ONE ANOTHER EN-
CASED IN A HEART SHAPE, WITH HEART SHAPE
CRISS-CROSSED WITH STYLIZED (STIPPLING)
LINES.

SER. NO. 77-528,507, FILED 7-22-2008.

REBECCA GILBERT, EXAMINING ATTORNEY

Int. Cl.: 8

Prior U.S. Cls.: 23, 28 and 44

Reg. No. 3,576,086

United States Patent and Trademark Office

Registered Feb. 17, 2009

**TRADEMARK
PRINCIPAL REGISTER**

SLOPE

LINDA H. DIXON (UNITED STATES INDIVIDUAL)
741 KALAHEO AVE.
KAILUA, HI 96734

THE MARK CONSISTS OF STANDARD CHARACTERS WITHOUT CLAIM TO ANY PARTICULAR FONT, STYLE, SIZE, OR COLOR.

FOR: TATTOO NEEDLES, IN CLASS 8 (U.S. CLS. 23, 28 AND 44).

SER. NO. 77-528,784, FILED 7-22-2008.

FIRST USE 5-1-2001; IN COMMERCE 5-1-2001.

SHAUNIA CARLYLE, EXAMINING ATTORNEY

Int. Cl.: 45

Prior U.S. Cls.: 100 and 101

United States Patent and Trademark Office

Reg. No. 3,576,087

Registered Feb. 17, 2009

**SERVICE MARK
PRINCIPAL REGISTER**

CALIFORNIA HIGHWAY PATROL

DEPARTMENT OF THE CALIFORNIA HIGH-
WAY PATROL (CALIFORNIA STATE AGEN-
CY)
2555 FIRST AVENUE
SACRAMENTO, CA 95818

NO CLAIM IS MADE TO THE EXCLUSIVE
RIGHT TO USE "HIGHWAY PATROL", APART
FROM THE MARK AS SHOWN.

FOR: POLICE AND CIVIL PROTECTION SERVI-
CES, IN CLASS 45 (U.S. CLS. 100 AND 101).

SEC. 2(F).

FIRST USE 8-14-1929; IN COMMERCE 8-14-1929.

SER. NO. 77-528,800, FILED 7-22-2008.

THE MARK CONSISTS OF STANDARD CHAR-
ACTERS WITHOUT CLAIM TO ANY PARTICULAR
FONT, STYLE, SIZE, OR COLOR.

JEFFERY COWARD, EXAMINING ATTORNEY

Int. Cl.: 14

Prior U.S. Cls.: 2, 27, 28 and 50

United States Patent and Trademark Office

Reg. No. 3,576,088

Registered Feb. 17, 2009

**TRADEMARK
PRINCIPAL REGISTER**

ROCK CANDY

SENO JEWELRY LLC (NEW YORK LIMITED
LIABILITY COMPANY)
10TH FLOOR, 259 WEST 30TH STREET
NEW YORK, NY 10001

THE MARK CONSISTS OF STANDARD CHAR-
ACTERS WITHOUT CLAIM TO ANY PARTICULAR
FONT, STYLE, SIZE, OR COLOR.

FOR: JEWELRY, IN CLASS 14 (U.S. CLS. 2, 27, 28
AND 50).

SER. NO. 77-529,692, FILED 7-23-2008.

FIRST USE 12-0-2003; IN COMMERCE 3-0-2004.

HELENE LIWINSKI, EXAMINING ATTORNEY

Int. Cl.: 14

Prior U.S. Cls.: 2, 27, 28 and 50

United States Patent and Trademark Office

Reg. No. 3,576,089

Registered Feb. 17, 2009

**TRADEMARK
PRINCIPAL REGISTER**

A stylized, handwritten signature in black ink, appearing to read 'IPPOLITA' with a long, sweeping flourish extending to the right.

SENO JEWELRY LLC (NEW YORK LIMITED
LIABILITY COMPANY)
10TH FLOOR, 259 WEST 30TH STREET
NEW YORK, NY 10001

OWNER OF U.S. REG. NO. 2,829,602.

THE MARK CONSISTS OF THE SIGNATURE OF
"IPPOLITA".

FOR: JEWELRY, IN CLASS 14 (U.S. CLS. 2, 27, 28
AND 50).

SER. NO. 77-529,712, FILED 7-23-2008.

FIRST USE 12-0-2007; IN COMMERCE 3-0-2008.

HELENE LIWINSKI, EXAMINING ATTORNEY

Int. Cl.: 41

Prior U.S. Cls.: 100, 101 and 107

United States Patent and Trademark Office

Reg. No. 3,576,090

Registered Feb. 17, 2009

**SERVICE MARK
PRINCIPAL REGISTER**

**CHIEF EXECUTIVES
ORGANIZATION**

CHIEF EXECUTIVES ORGANIZATION, INC.
(DELAWARE NON-PROFIT CORPORATION)
SUITE 400
7920 NORFOLK AVENUE
BETHESDA, MD 20814

FOR: EDUCATIONAL ASSOCIATION SERVICES,
NAMELY, CONDUCTING SEMINARS AND FORA
IN THE FIELDS OF HEALTH, BUSINESS, FINANCE,
GOVERNMENT AND THE ARTS IN ORDER TO
ENHANCE THE PERSONAL AND PROFESSIONAL
DEVELOPMENT OF EXECUTIVES, IN CLASS 41
(U.S. CLS. 100, 101 AND 107).

FIRST USE 9-1-1982; IN COMMERCE 9-1-1982.

THE MARK CONSISTS OF STANDARD CHAR-
ACTERS WITHOUT CLAIM TO ANY PARTICULAR
FONT, STYLE, SIZE, OR COLOR.

OWNER OF U.S. REG. NOS. 1,509,589, 1,509,590,
AND 1,519,244.

SEC. 2(F).

SER. NO. 77-529,907, FILED 7-23-2008.

AMY ALFIERI, EXAMINING ATTORNEY

Int. Cl.: 5

Prior U.S. Cls.: 6, 18, 44, 46, 51 and 52

Reg. No. 3,576,091

United States Patent and Trademark Office

Registered Feb. 17, 2009

**TRADEMARK
PRINCIPAL REGISTER**

SENSUVIVE

DUOIBES, ALBERT (UNITED STATES INDIVIDUAL)
SUITE #C-600
4460 44TH STREET S.E.
GRAND RAPIDS, MI 49512

THE MARK CONSISTS OF STANDARD CHARACTERS WITHOUT CLAIM TO ANY PARTICULAR FONT, STYLE, SIZE, OR COLOR.

FOR: DIETARY SUPPLEMENTS, IN CLASS 5 (U.S. CLS. 6, 18, 44, 46, 51 AND 52).

SER. NO. 77-530,185, FILED 7-24-2008.

FIRST USE 4-23-2007; IN COMMERCE 6-14-2007.

ROBIN MITTLER, EXAMINING ATTORNEY

Int. Cl.: 27

Prior U.S. Cls.: 19, 20, 37, 42 and 50

United States Patent and Trademark Office

Reg. No. 3,576,092

Registered Feb. 17, 2009

**TRADEMARK
PRINCIPAL REGISTER**

COLORDESIGN CARPET

ENVIRONMENTS, INC. (SOUTH CAROLINA
CORPORATION)

P.O. BOX 1348

BEAUFORT, SC 29901

FOR: CARPETS, IN CLASS 27 (U.S. CLS. 19, 20, 37,
42 AND 50).

FIRST USE 7-21-2008; IN COMMERCE 7-21-2008.

THE MARK CONSISTS OF STANDARD CHAR-
ACTERS WITHOUT CLAIM TO ANY PARTICULAR
FONT, STYLE, SIZE, OR COLOR.

NO CLAIM IS MADE TO THE EXCLUSIVE
RIGHT TO USE "CARPET", APART FROM THE
MARK AS SHOWN.

SER. NO. 77-530,635, FILED 7-24-2008.

GRETTA YAO, EXAMINING ATTORNEY

Int. Cl.: 5

Prior U.S. Cls.: 6, 18, 44, 46, 51 and 52

United States Patent and Trademark Office

Reg. No. 3,576,093

Registered Feb. 17, 2009

**TRADEMARK
PRINCIPAL REGISTER**

MENOPOL

DUOIBES, ALBERT (UNITED STATES INDIVIDUAL)
SUITE C-600
4460 44TH ST. S.E.
GRAND RAPIDS, MI 49512

THE MARK CONSISTS OF STANDARD CHARACTERS WITHOUT CLAIM TO ANY PARTICULAR FONT, STYLE, SIZE, OR COLOR.

FOR: DIETARY SUPPLEMENTS, IN CLASS 5 (U.S. CLS. 6, 18, 44, 46, 51 AND 52).

SER. NO. 77-531,081, FILED 7-24-2008.

FIRST USE 10-30-2006; IN COMMERCE 10-30-2006.

ROBIN MITTLER, EXAMINING ATTORNEY

Int. Cl.: 5

Prior U.S. Cls.: 6, 18, 44, 46, 51 and 52

United States Patent and Trademark Office

Reg. No. 3,576,094

Registered Feb. 17, 2009

**TRADEMARK
PRINCIPAL REGISTER**

HEALTHSLIM

DUOIBES, ALBERT (UNITED STATES INDIVIDUAL)
SUITE C-600
4460 44TH ST. S.E.
GRAND RAPIDS, MI 49512

THE MARK CONSISTS OF STANDARD CHARACTERS WITHOUT CLAIM TO ANY PARTICULAR FONT, STYLE, SIZE, OR COLOR.

FOR: DIETARY SUPPLEMENTS, IN CLASS 5 (U.S. CLS. 6, 18, 44, 46, 51 AND 52).

SER. NO. 77-531,083, FILED 7-24-2008.

FIRST USE 11-29-2006; IN COMMERCE 11-29-2006.

ROBIN MITTLER, EXAMINING ATTORNEY

Int. Cl.: 3

Prior U.S. Cls.: 1, 4, 6, 50, 51 and 52

United States Patent and Trademark Office

Reg. No. 3,576,095

Registered Feb. 17, 2009

**TRADEMARK
PRINCIPAL REGISTER**

LICENEX

DUOIBES, ALBERT (UNITED STATES INDIVIDUAL)
SUITE C-600
4460 44TH ST S.E.
GRAND RAPIDS, MI 49512

THE MARK CONSISTS OF STANDARD CHARACTERS WITHOUT CLAIM TO ANY PARTICULAR FONT, STYLE, SIZE, OR COLOR.

FOR: SHAMPOOS, IN CLASS 3 (U.S. CLS. 1, 4, 6, 50, 51 AND 52).

SER. NO. 77-531,641, FILED 7-25-2008.

FIRST USE 4-28-2007; IN COMMERCE 7-5-2007.

ROBIN MITTLER, EXAMINING ATTORNEY

Int. Cls.: 5 and 32

Prior U.S. Cls.: 6, 18, 44, 45, 46, 48, 51 and 52

United States Patent and Trademark Office

Reg. No. 3,576,096

Registered Feb. 17, 2009

**TRADEMARK
PRINCIPAL REGISTER**

Quench your appetite

NUVITAE, INC. (FLORIDA CORPORATION)
8625 ALTON AVENUE, UNIT 2
JACKSONVILLE, FL 32211

FIRST USE 6-25-2007; IN COMMERCE 6-25-2007.

FOR: NUTRITIONALLY FORTIFIED BEVERAGES; VITAMIN FORTIFIED BEVERAGES, IN CLASS 5 (U.S. CLS. 6, 18, 44, 46, 51 AND 52).

THE MARK CONSISTS OF STANDARD CHARACTERS WITHOUT CLAIM TO ANY PARTICULAR FONT, STYLE, SIZE, OR COLOR.

FIRST USE 6-25-2007; IN COMMERCE 6-25-2007.

SER. NO. 77-532,441, FILED 7-28-2008.

FOR: NON-ALCOHOLIC BEVERAGES, NAMELY, CARBONATED BEVERAGES, IN CLASS 32 (U.S. CLS. 45, 46 AND 48).

JOHN E. MICHOS, EXAMINING ATTORNEY

Int. Cl.: 1

Prior U.S. Cls.: 1, 5, 6, 10, 26 and 46

United States Patent and Trademark Office

Reg. No. 3,576,097

Registered Feb. 17, 2009

**TRADEMARK
PRINCIPAL REGISTER**

DERAKANE MOMENTUM

ASHLAND LICENSING AND INTELLECTUAL
PROPERTY LLC (DELAWARE LIMITED LIA-
BILITY COMPANY)
5200 BLAZER PARKWAY
DUBLIN, OH 43017

FOR: SYNTHETIC RESINS FOR INDUSTRIAL
USE, IN CLASS 1 (U.S. CLS. 1, 5, 6, 10, 26 AND 46).

FIRST USE 6-1-2000; IN COMMERCE 6-1-2000.

THE MARK CONSISTS OF STANDARD CHAR-
ACTERS WITHOUT CLAIM TO ANY PARTICULAR
FONT, STYLE, SIZE, OR COLOR.

OWNER OF U.S. REG. NOS. 797,933, 915,737, AND
3,147,432.

SER. NO. 77-532,791, FILED 7-28-2008.

EDWARD FENNESSY, EXAMINING ATTORNEY

Int. Cl.: 41

Prior U.S. Cls.: 100, 101 and 107

United States Patent and Trademark Office

Reg. No. 3,576,098

Registered Feb. 17, 2009

SERVICE MARK
PRINCIPAL REGISTER



NATURAL ELEMENTS SPA & ACADEMY, INC.
(VIRGINIA CORPORATION)
717 EDEN WAY NORTH, SUITE 612
CHESAPEAKE, VA 23320

FOR: EDUCATIONAL SERVICES, NAMELY, CONDUCTING TRAINING, SEMINARS, COURSES AND CLASSES IN THE FIELDS OF HOLISTIC HEALTH CARE, AWARENESS OF MIND, BODY AND SPIRITUAL HEALTH, MEDITATION, REFLEXOLOGY, MASSAGE, FENG SHUI, REIKI, AROMATHERAPY, RAINDROP TECHNIQUE MASSAGE, PERCEPTIVE AWARENESS TECHNIQUE, ALL FORMS OF SPA THERAPIES, YOGA, PILATES, BELLY DANCING, SALSA DANCE, MOVEMENT AND DANCE; PROFESSIONAL AND TEACHER TRAINING IN THE FIELDS OF HOLISTIC HEALTH CARE, REFLEXOLOGY, REFLEXOLOGY WITH HOT STONES, AROMATHERAPY, RAINDROP TECHNIQUE MASSAGE, MASSAGE, MASSAGE ETHICS, FINANCIAL MANAGEMENT

FOR BODYWORKERS, ALL FORMS OF SPA THERAPIES AND BODYWORK, SHIATSU, REIKI, TRADITIONAL CHINESE MEDICINE, IRIDOLOGY, JAPANESE HARA STUDY, ACUPRESSURE MASSAGE, COLONICS, HERBAL MEDICINE, HOMEOPATHY, SUPPLEMENTS AND ESSENTIAL OILS; PROVIDING LITERATURE AND TRAINING MATERIALS IN CONNECTION WITH THE FOREGOING; MOVEMENT AND DANCE STUDIO SERVICES, IN CLASS 41 (U.S. CLS. 100, 101 AND 107).

FIRST USE 9-27-2007; IN COMMERCE 9-27-2007.

NO CLAIM IS MADE TO THE EXCLUSIVE RIGHT TO USE "SPA", APART FROM THE MARK AS SHOWN.

SER. NO. 77-532,934, FILED 7-28-2008.

KATHERINE CHANG, EXAMINING ATTORNEY

Int. Cl.: 41

Prior U.S. Cls.: 100, 101 and 107

United States Patent and Trademark Office

Reg. No. 3,576,099

Registered Feb. 17, 2009

**SERVICE MARK
PRINCIPAL REGISTER**

MOVIES FOR GROWNUPS

AARP (D.C. NON-PROFIT CORPORATION)
601 E STREET, N.W.
WASHINGTON, DC 20049

FOR: PROVIDING ONLINE MAGAZINES IN THE FIELD OF MOTION PICTURE AND RADIO ENTERTAINMENT; PROVIDING RECOGNITION AND INCENTIVES BY THE WAY OF AWARDS TO DEMONSTRATE EXCELLENCE IN THE FIELDS OF MOTION PICTURE ENTERTAINMENT AND PUBLIC SERVICE, SIGNIFICANT ACHIEVEMENTS, MILESTONES AND CHARITABLE CONTRIBUTIONS IN THE FIELDS OF RETIREMENT, MATURE OR RETIRED LIFESTYLES; ENTERTAINMENT SERVICES, NAMELY, PROVIDING ONLINE COMPUTER GAMES AND TRIVIA QUIZZES; PROVIDING ENTERTAINMENT INFORMATION IN THE FIELD OF MOTION PICTURES AND RADIO PROGRAMS VIA WEBSITES ON COM-

PUTER NETWORKS; AND PROVIDING RADIO PROGRAMS IN THE FIELD OF MOTION PICTURE ENTERTAINMENT VIA GLOBAL COMPUTER NETWORKS, IN CLASS 41 (U.S. CLS. 100, 101 AND 107).

FIRST USE 5-31-2002; IN COMMERCE 5-31-2002.

THE MARK CONSISTS OF STANDARD CHARACTERS WITHOUT CLAIM TO ANY PARTICULAR FONT, STYLE, SIZE, OR COLOR.

OWNER OF U.S. REG. NO. 3,094,528.

SEC. 2(F).

SER. NO. 77-532,957, FILED 7-28-2008.

BRIDGETT SMITH, EXAMINING ATTORNEY

Int. Cl.: 41

Prior U.S. Cls.: 100, 101 and 107

United States Patent and Trademark Office

Reg. No. 3,576,100

Registered Feb. 17, 2009

**SERVICE MARK
PRINCIPAL REGISTER**

STUBB'S

ONE WORLD FOODS, INC. (DELAWARE CORPORATION)
STE. 605
811 BARTON SPRINGS ROAD
AUSTIN, TX 78704

FOR: ENTERTAINMENT VENUE SERVICES, NAMELY, PROVIDING FACILITIES FOR MOVIES, SHOWS, PLAYS, OR MUSIC; MUSIC HALLS; PROVIDING FACILITIES FOR MUSIC; ENTERTAINMENT SERVICES, NAMELY, PRODUCTION OF LIVE MUSICAL PERFORMANCES; ENTERTAINMENT IN THE NATURE OF THEATER PRODUCTIONS; ENTERTAINMENT IN THE NATURE OF LIVE MUSICAL PERFORMANCES; MUSIC PRODUCTION; ENTERTAINMENT SERVICES, NAMELY, PROVIDING PRE-RECORDED MUSIC ON-

LINE VIA A GLOBAL COMPUTER NETWORK, IN CLASS 41 (U.S. CLS. 100, 101 AND 107).

FIRST USE 3-15-1995; IN COMMERCE 3-15-1995.

THE MARK CONSISTS OF STANDARD CHARACTERS WITHOUT CLAIM TO ANY PARTICULAR FONT, STYLE, SIZE, OR COLOR.

OWNER OF U.S. REG. NOS. 3,122,375, 3,275,845 AND OTHERS.

SEC. 2(F).

SER. NO. 77-533,540, FILED 7-29-2008.

MICHAEL GAAFAR, EXAMINING ATTORNEY

Int. Cl.: 43

Prior U.S. Cls.: 100 and 101

United States Patent and Trademark Office

Reg. No. 3,576,101

Registered Feb. 17, 2009

**SERVICE MARK
PRINCIPAL REGISTER**

**SPLENDID PLATES
DISTINCTIVE CATERING**

CBBI, LLC LTD (MICHIGAN LIMITED LIABILITY COMPANY)
4199 MARCY
WARREN, MI 48091

FOR: PROVIDING FOOD AND DRINK IN THE NATURE OF CARRY-OUT RESTAURANTS AND CATERING, IN CLASS 43 (U.S. CLS. 100 AND 101).

FIRST USE 6-23-2008; IN COMMERCE 6-23-2008.

THE MARK CONSISTS OF STANDARD CHARACTERS WITHOUT CLAIM TO ANY PARTICULAR FONT, STYLE, SIZE, OR COLOR.

NO CLAIM IS MADE TO THE EXCLUSIVE RIGHT TO USE "CATERING", APART FROM THE MARK AS SHOWN.

SER. NO. 77-534,799, FILED 7-30-2008.

DANNEAN HETZEL, EXAMINING ATTORNEY

Int. Cls.: 35, 36 and 41

Prior U.S. Cls.: 100, 101, 102 and 107

United States Patent and Trademark Office

Reg. No. 3,576,102

Registered Feb. 17, 2009

**SERVICE MARK
PRINCIPAL REGISTER**



**GREATER PHILADELPHIA URBAN AFFAIRS
COALITION (PENNSYLVANIA NON-PROFIT
CORPORATION)**

**SUITE 700
1207 CHESTNUT STREET
PHILADELPHIA, PA 19107**

FOR: PROMOTING THE INTERESTS OF CHARITABLE ORGANIZATIONS AND COMMUNITY ORGANIZATIONS BY OFFERING THE ORGANIZATIONS PROFESSIONAL SERVICES, NAMELY, ACCOUNTING SERVICES, MARKETING, PAYROLL AND ADMINISTRATION, PROVIDING OFFICE SPACE AND PROVIDING BUSINESS NETWORKING SERVICES, NAMELY, MATCHING THE CHARITABLE AND COMMUNITY ORGANIZATIONS WITH THIRD PARTIES IN THE FIELDS OF EDUCATION AND TECHNICAL COMPUTER ASSISTANCE, IN CLASS 35 (U.S. CLS. 100, 101 AND 102).

FIRST USE 2-0-1991; IN COMMERCE 2-0-1991.

FOR: CHARITABLE SERVICES, NAMELY, FINANCIAL SPONSORSHIP OF CHARITABLE AND COMMUNITY ORGANIZATIONS AND BENEFITS ADMINISTRATION FOR CHARITABLE AND COMMUNITY ORGANIZATIONS, IN CLASS 36 (U.S. CLS. 100, 101 AND 102).

FIRST USE 2-0-1991; IN COMMERCE 2-0-1991.

FOR: EDUCATIONAL SERVICES, NAMELY, ARRANGING PROFESSIONAL WORKSHOPS IN THE FIELDS OF WEALTH-BUILDING AND ENTREPRENEURSHIP FOR CHARITABLE AND COMMUNITY ORGANIZATIONS, IN CLASS 41 (U.S. CLS. 100, 101 AND 107).

FIRST USE 2-0-1991; IN COMMERCE 2-0-1991.

SER. NO. 77-535,027, FILED 7-30-2008.

TRACY WHITTAKER-BROWN, EXAMINING ATTORNEY

Int. Cl.: 10

Prior U.S. Cls.: 26, 39 and 44

United States Patent and Trademark Office

Reg. No. 3,576,103

Registered Feb. 17, 2009

**TRADEMARK
PRINCIPAL REGISTER**

SELENIA

HOLOGIC, INC. (DELAWARE CORPORATION)
35 CROSBY DRIVE
BEFORD, MA 01730

THE MARK CONSISTS OF STANDARD CHAR-
ACTERS WITHOUT CLAIM TO ANY PARTICULAR
FONT, STYLE, SIZE, OR COLOR.

FOR: MAMMOGRAPHY IMAGING SYSTEM, IN
CLASS 10 (U.S. CLS. 26, 39 AND 44).

SER. NO. 77-536,171, FILED 7-31-2008.

FIRST USE 4-24-2003; IN COMMERCE 4-24-2003.

MONIQUE MILLER, EXAMINING ATTORNEY

Int. Cls.: 38 and 42

Prior U.S. Cls.: 100, 101 and 104

United States Patent and Trademark Office

Reg. No. 3,576,104

Registered Feb. 17, 2009

**SERVICE MARK
PRINCIPAL REGISTER**

YOUR WORLD. DELIVERED.

AT&T INTELLECTUAL PROPERTY II, L.P. (NEVADA LIMITED PARTNERSHIP)
645 EAST PLUMB LANE
RENO, NV 89502

FOR: TELECOMMUNICATIONS SERVICES, NAMELY, PROVIDING TELEPHONE COMMUNICATION AND INTERNET TELEPHONY SERVICES, PROVIDE TELEPHONE COMMUNICATIONS SERVICES WHICH PROVIDE A GROUP OF SPECIALIZED TELEPHONE SERVICES WITH CUSTOM CALLING FEATURES AND TELEPHONE CALLING PLANS; ELECTRONIC VOICE MESSAGING, NAMELY THE RECORDING, AND SUBSEQUENT TRANSMISSION OF VOICE MESSAGES BY TELEPHONE; PROVIDING MULTIPLE USER DIAL-UP, HIGH-SPEED AND DEDICATED ACCESS TO THE INTERNET; ELECTRONIC TRANSMISSION OF MESSAGES, DATA, IMAGES, VIDEO AND INFORMATION VIA THE INTERNET; WIRELESS TRANSMISSION OF VOICE, MESSAGES, DATA AND INFORMATION; HIGH-SPEED ACCESS SERVICES AND WIRELESS ACCESS SERVICES TO THE INTERNET; TELEVISION TRANSMISSION SERVICES; TELECOMMUNICATIONS SERVICES IN THE NATURE OF PROVIDING VOICE AND DATA NETWORKING SERVICES, NAMELY, PROVIDING DIGITAL AND ANALOG NETWORKING SERVICES TO TRANSMIT DATA AND VOICE; TELECONFERENCING, VIDEOCONFERENCING AND WEB CONFERENCING SERVICES; CELLULAR AND MOBILE TELEPHONE COMMUNICATIONS; TELECOMMUNICATIONS CONSULTATION; VOICE OVER INTERNET PROTOCOL (VOIP) SERVICES; TELECOMMUNICATIONS CONSULTATION IN THE FIELD OF DATA, VOICE AND VIDEO COMMUNICATIONS NETWORKS, IN CLASS 38 (U.S. CLS. 100, 101 AND 104).

FIRST USE 11-24-2005; IN COMMERCE 11-24-2005.

FOR: HOSTING THE WEB SITES OF OTHERS ON A COMPUTER SERVER FOR A GLOBAL COMPUTER NETWORK; DEVELOPMENT AND MAINTENANCE OF WEB SERVER SOFTWARE FOR OTHERS; COMPUTER CONSULTATION; DESIGN AND DEVELOPMENT OF TELECOMMUNICATIONS NETWORK, IN CLASS 42 (U.S. CLS. 100 AND 101).

FIRST USE 11-24-2005; IN COMMERCE 11-24-2005.

THE MARK CONSISTS OF STANDARD CHARACTERS WITHOUT CLAIM TO ANY PARTICULAR FONT, STYLE, SIZE, OR COLOR.

SER. NO. 77-536,204, FILED 7-31-2008.

RENEE MCCRAY, EXAMINING ATTORNEY

Int. Cl.: 26

Prior U.S. Cls.: 37, 39, 40, 42 and 50

United States Patent and Trademark Office

Reg. No. 3,576,105

Registered Feb. 17, 2009

**TRADEMARK
PRINCIPAL REGISTER**

Karina

HELEN OF TROY LIMITED (BARBADOS COR-
PORATION)
P.O. BOX 836E
13 8TH AVENUE, BELLEVILLE
ST. MICHAEL, BARBADOS

FOR: HAIR BANDS; HAIR BARRETTES; HAIR
CLIPS; HAIR ORNAMENTS, IN CLASS 26 (U.S. CLS.
37, 39, 40, 42 AND 50).

FIRST USE 6-27-1977; IN COMMERCE 6-27-1977.

THE MARK CONSISTS OF STANDARD CHAR-
ACTERS WITHOUT CLAIM TO ANY PARTICULAR
FONT, STYLE, SIZE, OR COLOR.

OWNER OF U.S. REG. NOS. 1,105,155, 3,251,477
AND OTHERS.

SER. NO. 77-536,214, FILED 7-31-2008.

MARC LEIPZIG, EXAMINING ATTORNEY

Int. Cl.: 35

Prior U.S. Cls.: 100, 101 and 102

United States Patent and Trademark Office

Reg. No. 3,576,106

Registered Feb. 17, 2009

**SERVICE MARK
PRINCIPAL REGISTER**

TREK STOP

TREK BICYCLE CORPORATION (WISCONSIN
CORPORATION)
801 WEST MADISON
WATERLOO, WI 53594

FOR: RETAIL VENDING SERVICES IN THE
FIELD OF AUTOMATED VENDING MACHINES
THAT DISPENSES BICYCLE PARTS, BICYCLE AC-
CESSORIES, ENERGY BARS, BEVERAGES AND
GELS, IN CLASS 35 (U.S. CLS. 100, 101 AND 102).

FIRST USE 6-30-2008; IN COMMERCE 6-30-2008.

THE MARK CONSISTS OF STANDARD CHAR-
ACTERS WITHOUT CLAIM TO ANY PARTICULAR
FONT, STYLE, SIZE, OR COLOR.

SER. NO. 77-536,257, FILED 7-31-2008.

MELVIN AXILBUND, EXAMINING ATTORNEY

Int. Cl.: 19

Prior U.S. Cls.: 1, 12, 33 and 50

United States Patent and Trademark Office

Reg. No. 3,576,107

Registered Feb. 17, 2009

**TRADEMARK
PRINCIPAL REGISTER**

ULTRASTOCK

TIN INC. (DELAWARE CORPORATION)
1300 SOUTH MOPAC EXPRESSWAY, 3RD FLOOR
AUSTIN, TX 78746

THE MARK CONSISTS OF STANDARD CHAR-
ACTERS WITHOUT CLAIM TO ANY PARTICULAR
FONT, STYLE, SIZE, OR COLOR.

FOR: BUILDING MATERIALS, NAMELY, MED-
IUM DENSITY FIBERBOARDS, IN CLASS 19 (U.S.
CLS. 1, 12, 33 AND 50).

SER. NO. 77-537,892, FILED 8-4-2008.

FIRST USE 9-1-2005; IN COMMERCE 9-1-2005.

IRA J. GOODSaid, EXAMINING ATTORNEY

Int. Cl.: 16

Prior U.S. Cls.: 2, 5, 22, 23, 29, 37, 38 and 50

United States Patent and Trademark Office

Reg. No. 3,576,108

Registered Feb. 17, 2009

**TRADEMARK
PRINCIPAL REGISTER**

TEMPLE-INLAND

TIN INC. (DELAWARE CORPORATION)
1300 SOUTH MOPAC EXPRESSWAY, 3RD FLOOR
AUSTIN, TX 78746

FOR: CARDBOARD PACKAGING; CORRUGATED BOARD; CORRUGATED BOXES; CORRUGATED CARDBOARD; CORRUGATED CARDBOARD BOXES; CORRUGATED CONTAINERS; CORRUGATED PAPER; INDUSTRIAL PACKAGING CONTAINERS OF PAPER; LINERBOARD FOR CORRUGATED CARDBOARD; PACKAGING CONTAINERS OF PAPER; PAPER DISPLAY BOXES; PAPERBOARD; PAPERBOARD BLANKS; PAPER-

BOARD BOXES; WHITE PAPERBOARD, IN CLASS 16 (U.S. CLS. 2, 5, 22, 23, 29, 37, 38 AND 50).

FIRST USE 12-31-2004; IN COMMERCE 12-31-2004.

THE MARK CONSISTS OF STANDARD CHARACTERS WITHOUT CLAIM TO ANY PARTICULAR FONT, STYLE, SIZE, OR COLOR.

OWNER OF U.S. REG. NO. 1,525,702.

SER. NO. 77-537,934, FILED 8-4-2008.

IRA J. GOODSaid, EXAMINING ATTORNEY

Int. Cl.: 36

Prior U.S. Cls.: 100, 101 and 102

United States Patent and Trademark Office

Reg. No. 3,576,109

Registered Feb. 17, 2009

**SERVICE MARK
PRINCIPAL REGISTER**



CHARLES SCHWAB & CO., INC. (CALIFORNIA CORPORATION)
SF 120-KNY 04-239
101 MONTGOMERY STREET
SAN FRANCISCO, CA 94104

FOR: BROKERAGE SERVICES IN THE FIELDS OF FINANCIAL SECURITIES, STOCKS, BONDS, MONEY MARKET FUNDS, MUTUAL FUNDS, COMMODITIES, FUTURES, STOCK OPTIONS, AND INDICES OF FINANCIAL SECURITIES; INVESTMENT SERVICES IN THE FIELDS OF FINANCIAL SECURITIES, STOCKS, BONDS, MONEY MARKET FUNDS, MUTUAL FUNDS, COMMODITIES, FUTURES, STOCK OPTIONS, AND INDICES OF FINANCIAL SECURITIES; INVESTMENT ADVICE IN THE FIELDS OF FINANCIAL SECURITIES, STOCKS, BONDS, MONEY MARKET FUNDS, MUTUAL FUNDS, COMMODITIES, FUTURES, STOCK OPTIONS, AND INDICES OF FINANCIAL SECURITIES; SECURITIES BROKERAGE ACCOUNT SERVICES THAT FEATURE AN INTEREST BEARING FEATURE FOR CASH BETWEEN INVESTMENTS, ELECTRONIC CASH TRANSACTIONS, AND MARGIN LOAN SERVICES; DEBIT CARD SERVICES; CHECK PROCESSING AND BILL PAYMENT SERVICES; ANNUITY INVESTMENT SERVICES; FINANCIAL INVESTMENT IN THE FIELD OF VARIABLE INSURANCE; FINANCIAL INFORMATION PROVIDED BY ELECTRONIC MEANS; ADMINISTRATION OF EMPLOYEE PENSION PLANS; FINANCIAL PLANNING; INSURANCE BROKERAGE; CASH MANAGEMENT ACCOUNT SERVICES; FIXED INCOME INVESTMENT SERVICES; ELEC-

TRONIC FUNDS TRANSFER; PROVIDING INFORMATION AND ANALYSIS IN THE FIELDS OF FINANCE, ECONOMICS, INVESTMENT, BUSINESS, FINANCIAL PLANNING, AND INVESTMENT STRATEGY; PROVIDING PORTFOLIO MANAGEMENT SERVICES; PROVIDING AN INTERACTIVE ONLINE COMPUTER DATABASE IN THE FIELD OF FINANCIAL PORTFOLIO MANAGEMENT, FINANCIAL DECISION MAKING, INVESTMENT RESEARCH, MONITORING INVESTMENT VALUE AND PERFORMANCE OF INVESTMENTS, ANALYZING INVESTMENT PERFORMANCE, EVALUATING ASSET ALLOCATION, RISK TOLERANCE, FINANCIAL ALTERNATIVE PLANS AND INVESTMENT TIME FRAMES; PROVIDING INFORMATION BY PHONE AND BY ONLINE MEANS IN THE FIELD OF INVESTMENT ACCOUNT INFORMATION AND FINANCIAL RESEARCH; PROVIDING AN ONLINE COMPUTER DATABASE IN THE FIELDS OF INVESTING, FINANCE, FINANCIAL PLANNING, FINANCIAL NEWS, FINANCIAL INFORMATION, AND ANALYSIS IN THE FIELDS OF INVESTING, FINANCE, AND FINANCIAL PLANNING, IN CLASS 36 (U.S. CLS. 100, 101 AND 102).

FIRST USE 4-0-2005; IN COMMERCE 4-0-2005.

OWNER OF U.S. REG. NO. 3,124,831.

THE COLOR(S) BLUE, TAN AND WHITE IS/ARE CLAIMED AS A FEATURE OF THE MARK.

THE COLOR BLUE IS USED ON THE WORDS
"TALK TO CHUCK," THE COLOR TAN IS USED ON
THE OUTER PORTION OF THE BOX ELEMENT,
AND THE COLOR WHITE IS USED ON THE INNER
PORTION OF THE BOX ELEMENT.

SER. NO. 77-540,514, FILED 8-6-2008.

DAVID ELTON, EXAMINING ATTORNEY

Int. Cl.: 9

Prior U.S. Cls.: 21, 23, 26, 36 and 38

Reg. No. 3,576,110

United States Patent and Trademark Office

Registered Feb. 17, 2009

**TRADEMARK
PRINCIPAL REGISTER**

SERAPH

CENTRAL LAKE ARMOR EXPRESS, INC. (MI-
CHIGAN CORPORATION)
1554 EAST TORCH LAKE DRIVE
CENTRAL LAKE, MI 49622

THE MARK CONSISTS OF STANDARD CHAR-
ACTERS WITHOUT CLAIM TO ANY PARTICULAR
FONT, STYLE, SIZE, OR COLOR.

FOR: BODY ARMOR, IN CLASS 9 (U.S. CLS. 21, 23,
26, 36 AND 38).

SER. NO. 77-541,350, FILED 8-7-2008.

FIRST USE 11-29-2007; IN COMMERCE 11-29-2007.

ESTHER A. BORSUK, EXAMINING ATTORNEY

Int. Cl.: 9

Prior U.S. Cls.: 21, 23, 26, 36 and 38

Reg. No. 3,576,111

United States Patent and Trademark Office

Registered Feb. 17, 2009

**TRADEMARK
PRINCIPAL REGISTER**

LO-PRO

CENTRAL LAKE ARMOR EXPRESS, INC. (MI-
CHIGAN CORPORATION)
1554 EAST TORCH LAKE DRIVE
CENTRAL LAKE, MI 49622

THE MARK CONSISTS OF STANDARD CHAR-
ACTERS WITHOUT CLAIM TO ANY PARTICULAR
FONT, STYLE, SIZE, OR COLOR.

FOR: VESTS FOR HOLDING BODY ARMOR
INSERTS, IN CLASS 9 (U.S. CLS. 21, 23, 26, 36 AND
38).

SER. NO. 77-541,387, FILED 8-7-2008.

FIRST USE 3-27-2006; IN COMMERCE 3-27-2006.

ESTHER A. BORSUK, EXAMINING ATTORNEY

Int. Cl.: 9

Prior U.S. Cls.: 21, 23, 26, 36 and 38

Reg. No. 3,576,112

United States Patent and Trademark Office

Registered Feb. 17, 2009

**TRADEMARK
PRINCIPAL REGISTER**

EZMESH

CENTRAL LAKE ARMOR EXPRESS, INC. (MI-
CHIGAN CORPORATION)
1554 EAST TORCH LAKE DRIVE
CENTRAL LAKE, MI 49622

THE MARK CONSISTS OF STANDARD CHAR-
ACTERS WITHOUT CLAIM TO ANY PARTICULAR
FONT, STYLE, SIZE, OR COLOR.

FOR: VESTS FOR HOLDING BODY ARMOR
INSERTS, IN CLASS 9 (U.S. CLS. 21, 23, 26, 36 AND
38).

SER. NO. 77-541,399, FILED 8-7-2008.

FIRST USE 5-8-2007; IN COMMERCE 5-8-2007.

ESTHER A. BORSUK, EXAMINING ATTORNEY

Int. Cl.: 9

Prior U.S. Cls.: 21, 23, 26, 36 and 38

United States Patent and Trademark Office

Reg. No. 3,576,113

Registered Feb. 17, 2009

**TRADEMARK
PRINCIPAL REGISTER**

LIGHTHAWK

CENTRAL LAKE ARMOR EXPRESS, INC. (MI-
CHIGAN CORPORATION)
1554 EAST TORCH LAKE DRIVE
CENTRAL LAKE, MI 49622

THE MARK CONSISTS OF STANDARD CHAR-
ACTERS WITHOUT CLAIM TO ANY PARTICULAR
FONT, STYLE, SIZE, OR COLOR.

FOR: VESTS FOR HOLDING BODY ARMOR
INSERTS, IN CLASS 9 (U.S. CLS. 21, 23, 26, 36 AND
38).

SER. NO. 77-541,409, FILED 8-7-2008.

FIRST USE 3-7-2007; IN COMMERCE 3-7-2007.

ESTHER A. BORSUK, EXAMINING ATTORNEY

Int. Cl.: 9

Prior U.S. Cls.: 21, 23, 26, 36 and 38

Reg. No. 3,576,114

United States Patent and Trademark Office

Registered Feb. 17, 2009

**TRADEMARK
PRINCIPAL REGISTER**

WOLVERINE

CENTRAL LAKE ARMOR EXPRESS, INC. (MI-
CHIGAN CORPORATION)
1554 EAST TORCH LAKE DRIVE
CENTRAL LAKE, MI 49622

THE MARK CONSISTS OF STANDARD CHAR-
ACTERS WITHOUT CLAIM TO ANY PARTICULAR
FONT, STYLE, SIZE, OR COLOR.

FOR: VESTS FOR HOLDING BODY ARMOR
INSERTS, IN CLASS 9 (U.S. CLS. 21, 23, 26, 36 AND
38).

SER. NO. 77-541,416, FILED 8-7-2008.

FIRST USE 2-28-2006; IN COMMERCE 2-28-2006.

ESTHER A. BORSUK, EXAMINING ATTORNEY

Int. Cl.: 9

Prior U.S. Cls.: 21, 23, 26, 36 and 38

United States Patent and Trademark Office

Reg. No. 3,576,115

Registered Feb. 17, 2009

**TRADEMARK
PRINCIPAL REGISTER**

BULLDOG

CENTRAL LAKE ARMOR EXPRESS, INC. (MI-
CHIGAN CORPORATION)
1554 EAST TORCH LAKE DRIVE
CENTRAL LAKE, MI 49622

THE MARK CONSISTS OF STANDARD CHAR-
ACTERS WITHOUT CLAIM TO ANY PARTICULAR
FONT, STYLE, SIZE, OR COLOR.

FOR: VESTS FOR HOLDING BODY ARMOR
INSERTS, IN CLASS 9 (U.S. CLS. 21, 23, 26, 36 AND
38).

SER. NO. 77-541,425, FILED 8-7-2008.

FIRST USE 11-29-2006; IN COMMERCE 11-29-2006.

ESTHER A. BORSUK, EXAMINING ATTORNEY

Int. Cl.: 9

Prior U.S. Cls.: 21, 23, 26, 36 and 38

Reg. No. 3,576,116

United States Patent and Trademark Office

Registered Feb. 17, 2009

**TRADEMARK
PRINCIPAL REGISTER**

GAZELLE

CENTRAL LAKE ARMOR EXPRESS, INC. (MI-
CHIGAN CORPORATION)
1554 EAST TORCH LAKE DRIVE
CENTRAL LAKE, MI 49622

THE MARK CONSISTS OF STANDARD CHAR-
ACTERS WITHOUT CLAIM TO ANY PARTICULAR
FONT, STYLE, SIZE, OR COLOR.

FOR: VESTS FOR HOLDING BODY ARMOR
INSERTS, IN CLASS 9 (U.S. CLS. 21, 23, 26, 36 AND
38).

SER. NO. 77-541,436, FILED 8-7-2008.

FIRST USE 1-8-2008; IN COMMERCE 1-8-2008.

ESTHER A. BORSUK, EXAMINING ATTORNEY

Int. Cl.: 9

Prior U.S. Cls.: 21, 23, 26, 36 and 38

Reg. No. 3,576,117

United States Patent and Trademark Office

Registered Feb. 17, 2009

**TRADEMARK
PRINCIPAL REGISTER**

RESPONDER

CENTRAL LAKE ARMOR EXPRESS, INC. (MI-
CHIGAN CORPORATION)
1554 EAST TORCH LAKE DRIVE
CENTRAL LAKE, MI 49622

THE MARK CONSISTS OF STANDARD CHAR-
ACTERS WITHOUT CLAIM TO ANY PARTICULAR
FONT, STYLE, SIZE, OR COLOR.

FOR: VESTS FOR HOLDING BODY ARMOR
INSERTS, IN CLASS 9 (U.S. CLS. 21, 23, 26, 36 AND
38).

SER. NO. 77-541,442, FILED 8-7-2008.

FIRST USE 1-8-2008; IN COMMERCE 1-8-2008.

ESTHER A. BORSUK, EXAMINING ATTORNEY

Int. Cl.: 9

Prior U.S. Cls.: 21, 23, 26, 36 and 38

Reg. No. 3,576,118

United States Patent and Trademark Office

Registered Feb. 17, 2009

**TRADEMARK
PRINCIPAL REGISTER**

RECON

CENTRAL LAKE ARMOR EXPRESS, INC. (MI-
CHIGAN CORPORATION)
1554 EAST TORCH LAKE DRIVE
CENTRAL LAKE, MI 49622

THE MARK CONSISTS OF STANDARD CHAR-
ACTERS WITHOUT CLAIM TO ANY PARTICULAR
FONT, STYLE, SIZE, OR COLOR.

FOR: VESTS FOR HOLDING BODY ARMOR
INSERTS, IN CLASS 9 (U.S. CLS. 21, 23, 26, 36 AND
38).

SER. NO. 77-541,448, FILED 8-7-2008.

FIRST USE 1-8-2008; IN COMMERCE 1-8-2008.

ESTHER A. BORSUK, EXAMINING ATTORNEY

Int. Cl.: 9

Prior U.S. Cls.: 21, 23, 26, 36 and 38

Reg. No. 3,576,119

United States Patent and Trademark Office

Registered Feb. 17, 2009

**TRADEMARK
PRINCIPAL REGISTER**

TRITON

CENTRAL LAKE ARMOR EXPRESS, INC. (MI-
CHIGAN CORPORATION)
1554 EAST TORCH LAKE DRIVE
CENTRAL LAKE, MI 49622

THE MARK CONSISTS OF STANDARD CHAR-
ACTERS WITHOUT CLAIM TO ANY PARTICULAR
FONT, STYLE, SIZE, OR COLOR.

FOR: BALLISTIC RESISTANT BODY ARMOR
PLATES, IN CLASS 9 (U.S. CLS. 21, 23, 26, 36 AND 38).

SER. NO. 77-541,472, FILED 8-7-2008.

FIRST USE 3-6-2006; IN COMMERCE 3-6-2006.

ESTHER A. BORSUK, EXAMINING ATTORNEY

Int. Cl.: 9

Prior U.S. Cls.: 21, 23, 26, 36 and 38

Reg. No. 3,576,120

United States Patent and Trademark Office

Registered Feb. 17, 2009

**TRADEMARK
PRINCIPAL REGISTER**

TAURUS

CENTRAL LAKE ARMOR EXPRESS, INC. (MI-
CHIGAN CORPORATION)
1554 EAST TORCH LAKE DRIVE
CENTRAL LAKE, MI 49622

THE MARK CONSISTS OF STANDARD CHAR-
ACTERS WITHOUT CLAIM TO ANY PARTICULAR
FONT, STYLE, SIZE, OR COLOR.

FOR: BODY ARMOR, IN CLASS 9 (U.S. CLS. 21, 23,
26, 36 AND 38).

SER. NO. 77-541,522, FILED 8-7-2008.

FIRST USE 2-24-2006; IN COMMERCE 2-24-2006.

ESTHER A. BORSUK, EXAMINING ATTORNEY

Int. Cl.: 9

Prior U.S. Cls.: 21, 23, 26, 36 and 38

Reg. No. 3,576,121

United States Patent and Trademark Office

Registered Feb. 17, 2009

**TRADEMARK
PRINCIPAL REGISTER**

GEMINI

CENTRAL LAKE ARMOR EXPRESS, INC. (MI-
CHIGAN CORPORATION)
1554 EAST TORCH LAKE DRIVE
CENTRAL LAKE, MI 49622

THE MARK CONSISTS OF STANDARD CHAR-
ACTERS WITHOUT CLAIM TO ANY PARTICULAR
FONT, STYLE, SIZE, OR COLOR.

FOR: BODY ARMOR, IN CLASS 9 (U.S. CLS. 21, 23,
26, 36 AND 38).

SER. NO. 77-541,531, FILED 8-7-2008.

FIRST USE 2-24-2006; IN COMMERCE 2-24-2006.

ESTHER A. BORSUK, EXAMINING ATTORNEY

Int. Cl.: 9

Prior U.S. Cls.: 21, 23, 26, 36 and 38

Reg. No. 3,576,122

United States Patent and Trademark Office

Registered Feb. 17, 2009

**TRADEMARK
PRINCIPAL REGISTER**

QUANTUM

CENTRAL LAKE ARMOR EXPRESS, INC. (MI-
CHIGAN CORPORATION)
1554 EAST TORCH LAKE DRIVE
CENTRAL LAKE, MI 49622

THE MARK CONSISTS OF STANDARD CHAR-
ACTERS WITHOUT CLAIM TO ANY PARTICULAR
FONT, STYLE, SIZE, OR COLOR.

FOR: BODY ARMOR, IN CLASS 9 (U.S. CLS. 21, 23,
26, 36 AND 38).

SER. NO. 77-541,541, FILED 8-7-2008.

FIRST USE 3-29-2007; IN COMMERCE 3-29-2007.

ESTHER A. BORSUK, EXAMINING ATTORNEY

Int. Cl.: 5

Prior U.S. Cls.: 6, 18, 44, 46, 51 and 52

United States Patent and Trademark Office

Reg. No. 3,576,123

Registered Feb. 17, 2009

**TRADEMARK
PRINCIPAL REGISTER**

Q-LUDE

NUTRASTAR LABORATORIES, LLC (DELA-
WARE LIMITED LIABILITY COMPANY)
C/O CHAIM BERKOWITZ
268 WILLOUGHBY AVE.
BROOKLYN, NY 11205

THE MARK CONSISTS OF STANDARD CHAR-
ACTERS WITHOUT CLAIM TO ANY PARTICULAR
FONT, STYLE, SIZE, OR COLOR.

FOR: DIETARY AND NUTRITIONAL SUPPLE-
MENTS; HERBAL SUPPLEMENTS, IN CLASS 5 (U.S.
CLS. 6, 18, 44, 46, 51 AND 52).

SER. NO. 77-541,848, FILED 8-7-2008.

FIRST USE 1-1-2008; IN COMMERCE 8-7-2008.

ANGELA GAW, EXAMINING ATTORNEY

Int. Cl.: 29

Prior U.S. Cl.: 46

United States Patent and Trademark Office

Reg. No. 3,576,124

Registered Feb. 17, 2009

TRADEMARK
PRINCIPAL REGISTER



OLÉ MEXICAN FOODS, INC. (GEORGIA CORPORATION)
6585 CRESCENT DRIVE
NORCROSS, GA 30071

FOR: SOFT WHITE CHEESE, IN CLASS 29 (U.S. CL. 46).

FIRST USE 11-0-1995; IN COMMERCE 11-0-1995.

OWNER OF U.S. REG. NOS. 2,040,257, 3,153,309, AND 3,164,393.

THE COLOR(S) RED, WHITE, GREEN AND BLACK IS/ARE CLAIMED AS A FEATURE OF THE MARK.

THE MARK CONSISTS OF AN RED CIRCLE WITH THE WORDS "LA BANDERITA" IN WHITE INSIDE THE CIRCLE AT THE TOP; INSIDE THE CIRCLE IS A FLAG WITH A DRAWING OF A COW'S HEAD IN THE CENTER OF THE FLAG. THE LEFT-HAND SIDE OF THE FLAG IS GREEN, THE CENTER OF THE FLAG IS WHITE WITH THE DRAWING OF THE COW'S HEAD IN BLACK, AND THE RIGHT-HAND SIDE OF THE FLAG IS RED.

THE FOREIGN WORDING IN THE MARK TRANSLATES INTO ENGLISH AS THE LITTLE FLAG.

SER. NO. 77-542,005, FILED 8-7-2008.

CURTIS FRENCH, EXAMINING ATTORNEY

Int. Cl.: 36

Prior U.S. Cls.: 100, 101 and 102

United States Patent and Trademark Office

Reg. No. 3,576,125

Registered Feb. 17, 2009

**SERVICE MARK
PRINCIPAL REGISTER**

**IMAGINE LIFE WITHOUT
BREAST CANCER**

THE SUSAN G. KOMEN BREAST CANCER
FOUNDATION, INC. (TEXAS NON-PROFIT
CORPORATION)
5005 LBJ FREEWAY, SUITE 250
DALLAS, TX 75244

FOR: CHARITABLE FUNDRAISING SERVICES,
NAMELY, RAISING MONEY FOR BREAST CAN-
CER RESEARCH AND RAISING MONEY FOR
LOCAL COMMUNITY BREAST HEALTH AWARE-
NESS, IN CLASS 36 (U.S. CLS. 100, 101 AND 102).

FIRST USE 7-7-2008; IN COMMERCE 7-7-2008.

THE MARK CONSISTS OF STANDARD CHAR-
ACTERS WITHOUT CLAIM TO ANY PARTICULAR
FONT, STYLE, SIZE, OR COLOR.

SER. NO. 77-542,198, FILED 8-8-2008.

ODESSA BIBBINS, EXAMINING ATTORNEY

Int. Cl.: 14

Prior U.S. Cls.: 2, 27, 28 and 50

United States Patent and Trademark Office

Reg. No. 3,576,126

Registered Feb. 17, 2009

**TRADEMARK
PRINCIPAL REGISTER**

SHEER GLAMOUR

COLUMBIA INSURANCE COMPANY (NEBRASKA CORPORATION)
3024 HARNEY STREET
OMAHA, NE 68131

THE MARK CONSISTS OF STANDARD CHARACTERS WITHOUT CLAIM TO ANY PARTICULAR FONT, STYLE, SIZE, OR COLOR.

FOR: DIAMOND ENGAGEMENT AND WEDDING RINGS, IN CLASS 14 (U.S. CLS. 2, 27, 28 AND 50).

SER. NO. 77-542,425, FILED 8-8-2008.

FIRST USE 3-0-2007; IN COMMERCE 3-0-2007.

STEVEN R. FINE, EXAMINING ATTORNEY

Int. Cl.: 14

Prior U.S. Cls.: 2, 27, 28 and 50

United States Patent and Trademark Office

Reg. No. 3,576,127

Registered Feb. 17, 2009

**TRADEMARK
PRINCIPAL REGISTER**

LYRICAL ALLURE

COLUMBIA INSURANCE COMPANY (NEBRASKA CORPORATION)
3024 HARNEY STREET
OMAHA, NE 68131

THE MARK CONSISTS OF STANDARD CHARACTERS WITHOUT CLAIM TO ANY PARTICULAR FONT, STYLE, SIZE, OR COLOR.

FOR: DIAMOND JEWELRY, IN CLASS 14 (U.S. CLS. 2, 27, 28 AND 50).

SER. NO. 77-542,429, FILED 8-8-2008.

FIRST USE 3-0-2007; IN COMMERCE 3-0-2007.

STEVEN R. FINE, EXAMINING ATTORNEY

Int. Cl.: 14

Prior U.S. Cls.: 2, 27, 28 and 50

United States Patent and Trademark Office

Reg. No. 3,576,128

Registered Feb. 17, 2009

**TRADEMARK
PRINCIPAL REGISTER**

DESIGNED TO SHINE

COLUMBIA INSURANCE COMPANY (NEBRASKA CORPORATION)
3024 HARNEY STREET
OMAHA, NE 68131

THE MARK CONSISTS OF STANDARD CHARACTERS WITHOUT CLAIM TO ANY PARTICULAR FONT, STYLE, SIZE, OR COLOR.

FOR: DIAMONDS AND DIAMOND JEWELRY, IN CLASS 14 (U.S. CLS. 2, 27, 28 AND 50).

SER. NO. 77-542,438, FILED 8-8-2008.

FIRST USE 10-4-2006; IN COMMERCE 10-4-2006.

STEVEN R. FINE, EXAMINING ATTORNEY

Int. Cl.: 29

Prior U.S. Cl.: 46

United States Patent and Trademark Office

Reg. No. 3,576,129

Registered Feb. 17, 2009

**TRADEMARK
PRINCIPAL REGISTER**

PORKITO

OLÉ MEXICAN FOODS, INC. (GEORGIA CORPORATION)
6585 CRESCENT DRIVE
NORCROSS, GA 30071

THE MARK CONSISTS OF STANDARD CHARACTERS WITHOUT CLAIM TO ANY PARTICULAR FONT, STYLE, SIZE, OR COLOR.

FOR: FRIED PORK SKINS, IN CLASS 29 (U.S. CL. 46).

SER. NO. 77-543,036, FILED 8-8-2008.

FIRST USE 2-0-2004; IN COMMERCE 2-0-2004.

CURTIS FRENCH, EXAMINING ATTORNEY

Int. Cl.: 43

Prior U.S. Cls.: 100 and 101

United States Patent and Trademark Office

Reg. No. 3,576,130

Registered Feb. 17, 2009

**SERVICE MARK
PRINCIPAL REGISTER**



HOT STUFF FOODS, LLC (SOUTH DAKOTA
LIMITED LIABILITY COMPANY)
P.O. BOX 85210
SIOUX FALLS, SD 57118

FOR: RESTAURANT SERVICES AND CARRY-
OUT RESTAURANT SERVICES, IN CLASS 43 (U.S.
CLS. 100 AND 101).

FIRST USE 6-17-2008; IN COMMERCE 6-17-2008.

OWNER OF U.S. REG. NOS. 1,934,188, 1,934,189,
AND 3,146,096.

NO CLAIM IS MADE TO THE EXCLUSIVE
RIGHT TO USE "TAKE & BAKE", APART FROM
THE MARK AS SHOWN.

THE MARK CONSISTS OF THE WORDS "TAKE &
BAKE BY" IN A BANNER, FOLLOWED BY THE
WORDS "HOT STUFF" ALL OVER A STYLIZED
RENDITION OF A PIECE OF PIZZA THAT AP-
PEARS AS A BANNER.

SER. NO. 77-544,689, FILED 8-12-2008.

BRIDGETT SMITH, EXAMINING ATTORNEY

Int. Cl.: 11

Prior U.S. Cls.: 13, 21, 23, 31 and 34

United States Patent and Trademark Office

Reg. No. 3,576,131

Registered Feb. 17, 2009

**TRADEMARK
PRINCIPAL REGISTER**

HYDRO-ACTION

A.K. INDUSTRIES, INC. (INDIANA CORPORATION)
2055 PIDCO DRIVE
PLYMOUTH, IN 46563

THE MARK CONSISTS OF STANDARD CHARACTERS WITHOUT CLAIM TO ANY PARTICULAR FONT, STYLE, SIZE, OR COLOR.

FOR: WASTE WATER PURIFICATION UNITS AND PARTS THEREOF FOR COMMERCIAL AND RESIDENTIAL USE, IN CLASS 11 (U.S. CLS. 13, 21, 23, 31 AND 34).

SER. NO. 77-544,864, FILED 8-12-2008.

FIRST USE 4-1-2003; IN COMMERCE 4-1-2003.

KEVIN DINALLO, EXAMINING ATTORNEY

Int. Cl.: 5

Prior U.S. Cls.: 6, 18, 44, 46, 51 and 52

Reg. No. 3,576,132

United States Patent and Trademark Office

Registered Feb. 17, 2009

**TRADEMARK
PRINCIPAL REGISTER**

**GOOD SCIENCE STARTS WITH
PEOPLE**

GENETIC TESTING INSTITUTE, INC. (WISCONSIN CORPORATION), DBA GTI DIAGNOSTICS
20925 CROSSROADS CIRCLE
WAUKESHA, WI 53186

FOR: DIAGNOSTIC REAGENTS FOR MEDICAL USE AND KITS COMPRISED OF DIAGNOSTIC REAGENTS FOR MEDICAL USE, NAMELY, FOR AIDING IN DETERMINING MEDICAL CONDITIONS, IN CLASS 5 (U.S. CLS. 6, 18, 44, 46, 51 AND 52).

FIRST USE 5-1-2006; IN COMMERCE 11-15-2006.

THE MARK CONSISTS OF STANDARD CHARACTERS WITHOUT CLAIM TO ANY PARTICULAR FONT, STYLE, SIZE, OR COLOR.

SER. NO. 77-544,906, FILED 8-12-2008.

KATHERINE E. HALMEN, EXAMINING ATTORNEY

Int. Cl.: 3

Prior U.S. Cls.: 1, 4, 6, 50, 51 and 52

United States Patent and Trademark Office

Reg. No. 3,576,133

Registered Feb. 17, 2009

**TRADEMARK
PRINCIPAL REGISTER**

PHILOSOPHY: LET'S PARTY!

PHILOSOPHY, INC. (ARIZONA CORPORATION)
3809 EAST WATKINS STREET
PHOENIX, AZ 85034

FOR: COSMETICS; NON-MEDICATED SKIN
CARE PREPARATIONS; SHOWER AND BATH
GEL, IN CLASS 3 (U.S. CLS. 1, 4, 6, 50, 51 AND 52).

FIRST USE 9-18-2008; IN COMMERCE 9-18-2008.

THE MARK CONSISTS OF STANDARD CHAR-
ACTERS WITHOUT CLAIM TO ANY PARTICULAR
FONT, STYLE, SIZE, OR COLOR.

OWNER OF U.S. REG. NOS. 2,016,208, 2,388,010
AND OTHERS.

SER. NO. 77-545,835, FILED 8-13-2008.

DAVID I, EXAMINING ATTORNEY

Int. Cl.: 41

Prior U.S. Cls.: 100, 101 and 107

United States Patent and Trademark Office

Reg. No. 3,576,134

Registered Feb. 17, 2009

**SERVICE MARK
PRINCIPAL REGISTER**



TESSA JOLLS (UNITED STATES INDIVIDUAL)
SUITE 472
23852 PACIFIC COAST HIGHWAY
MALIBU, CA 90265

FIRST USE 9-20-2000; IN COMMERCE 9-20-2000.

OWNER OF U.S. REG. NO. 3,504,123.

FOR: EDUCATIONAL SERVICES, NAMELY,
CONDUCTING ONLINE PROGRAMS IN THE
FIELD OF MEDIA COMMUNICATIONS AND DIS-
TRIBUTION OF COURSE MATERIAL IN CONNEC-
TION THEREWITH, IN CLASS 41 (U.S. CLS. 100, 101
AND 107).

SER. NO. 77-547,549, FILED 8-14-2008.

REBECCA POVARCHUK, EXAMINING ATTOR-
NEY

Int. Cl.: 32

Prior U.S. Cls.: 45, 46 and 48

United States Patent and Trademark Office

Reg. No. 3,576,135

Registered Feb. 17, 2009

**TRADEMARK
PRINCIPAL REGISTER**

Tui

FACIANE, KIRBY A. (UNITED STATES INDIVIDUAL)
143 N. RIOS AVE.
SOLANA BEACH, CA 92075

THE MARK CONSISTS OF STANDARD CHARACTERS WITHOUT CLAIM TO ANY PARTICULAR FONT, STYLE, SIZE, OR COLOR.

FOR: BEER, ALE, LAGER, STOUT, PORTER, SHANDY, IN CLASS 32 (U.S. CLS. 45, 46 AND 48).

SER. NO. 77-548,810, FILED 8-16-2008.

FIRST USE 9-2-1996; IN COMMERCE 9-2-1996.

DORITT L. CARROLL, EXAMINING ATTORNEY

Int. Cl.: 3

Prior U.S. Cls.: 1, 4, 6, 50, 51 and 52

United States Patent and Trademark Office

Reg. No. 3,576,136

Registered Feb. 17, 2009

**TRADEMARK
PRINCIPAL REGISTER**

COLOURAGE

TRESSA, INC. (OHIO CORPORATION)
2711 CIRCLEPORT DRIVE
ERLANGER, KY 41018

FOR: HAIR COLOR, IN CLASS 3 (U.S. CLS. 1, 4, 6,
50, 51 AND 52).

FIRST USE 5-31-1990; IN COMMERCE 5-31-1990.

THE MARK CONSISTS OF STANDARD CHAR-
ACTERS WITHOUT CLAIM TO ANY PARTICULAR
FONT, STYLE, SIZE, OR COLOR.

OWNER OF U.S. REG. NO. 1,526,403.

SER. NO. 77-549,010, FILED 8-18-2008.

ALICE SUE CARRUTHERS, EXAMINING ATTOR-
NEY

Int. Cls.: 35 and 41

Prior U.S. Cls.: 100, 101, 102 and 107

United States Patent and Trademark Office

Reg. No. 3,576,137

Registered Feb. 17, 2009

**SERVICE MARK
PRINCIPAL REGISTER**

AARP INTERNATIONAL

AARP (D.C. NON-PROFIT CORPORATION)
601 E STREET, N.W.
WASHINGTON, DC 20049

FOR: PUBLIC POLICY RESEARCH SERVICES; PUBLIC ADVOCACY TO PROMOTE AWARENESS OF SOLUTIONS AND POLICIES TO ADDRESS ISSUES IN THE FIELDS OF HEALTH, MEDICAL SERVICES, ELDERCARE, INSURANCE, REAL ESTATE, LIVABLE COMMUNITIES, OLDER WORKERS, EMPLOYMENT, RETIREMENT INCOME, RETIREMENT, MATURE OR RETIRED LIFESTYLES, FINANCE, AGING, CONSUMER ISSUES, AND ECONOMIC SECURITY; PROMOTING PUBLIC AWARENESS OF THE NEED FOR SOLUTIONS AND POLICIES TO ADDRESS ISSUES IN THE FIELDS OF HEALTH, MEDICAL SERVICES, ELDERCARE, INSURANCE, REAL ESTATE, LIVABLE COMMUNITIES, OLDER WORKERS, EMPLOYMENT, RETIREMENT INCOME, RETIREMENT, MATURE OR RETIRED LIFESTYLES, FINANCE, AGING, CONSUMER ISSUES, AND ECONOMIC SECURITY; AND PROVIDING PUBLIC ADVOCACY INFORMATION IN THE FIELDS OF HEALTH, MEDICAL SERVICES, ELDERCARE, INSURANCE, REAL ESTATE, LIVABLE COMMUNITIES, OLDER WORKERS, EMPLOYMENT, RETIREMENT INCOME, RETIREMENT, MATURE OR RETIRED LIFESTYLES, FINANCE, AGING, CONSUMER ISSUES, AND ECONOMIC SECURITY, IN CLASS 35 (U.S. CLS. 100, 101 AND 102).

FIRST USE 7-0-2007; IN COMMERCE 7-0-2007.

FOR: PROVIDING ONLINE JOURNALS AND NEWSLETTERS PROMOTING THE INTERESTS OF

MATURE INDIVIDUALS AND IN THE FIELDS OF HEALTH, MEDICAL SERVICES, ELDERCARE, INSURANCE, REAL ESTATE, LIVABLE COMMUNITIES, OLDER WORKERS, EMPLOYMENT, RETIREMENT INCOME, RETIREMENT, MATURE OR RETIRED LIFESTYLES, FINANCE, AGING, CONSUMER ISSUES, ECONOMIC SECURITY AND FITNESS; AND EDUCATIONAL SERVICES, NAMELY, ARRANGING AND CONDUCTING SEMINARS AND CONFERENCES IN THE FIELDS OF HEALTH, MEDICAL SERVICES, ELDERCARE, INSURANCE, REAL ESTATE, LIVABLE COMMUNITIES, OLDER WORKERS, EMPLOYMENT, RETIREMENT INCOME, RETIREMENT, MATURE OR RETIRED LIFESTYLES, FINANCE, AGING, CONSUMER ISSUES, AND ECONOMIC SECURITY, AND THE DISTRIBUTION OF COURSE MATERIALS IN CONNECTION THEREWITH, IN CLASS 41 (U.S. CLS. 100, 101 AND 107).

FIRST USE 7-0-2007; IN COMMERCE 7-0-2007.

THE MARK CONSISTS OF STANDARD CHARACTERS WITHOUT CLAIM TO ANY PARTICULAR FONT, STYLE, SIZE, OR COLOR.

OWNER OF U.S. REG. NOS. 3,229,121, 3,481,274 AND OTHERS.

NO CLAIM IS MADE TO THE EXCLUSIVE RIGHT TO USE "INTERNATIONAL", APART FROM THE MARK AS SHOWN.

SER. NO. 77-549,930, FILED 8-18-2008.

BRIDGETT SMITH, EXAMINING ATTORNEY

Int. Cl.: 34

Prior U.S. Cls.: 2, 8, 9 and 17

United States Patent and Trademark Office

Reg. No. 3,576,138

Registered Feb. 17, 2009

**TRADEMARK
PRINCIPAL REGISTER**

The image shows the trademark '07' in a bold, stylized font. The '0' is a simple, thick, rounded shape. The '7' is more decorative, with a curved top and a small hook at the bottom right.

JACK DANIEL'S PROPERTIES, INC. (DELA-
WARE CORPORATION)
SUITE 528
4040 CIVIC CENTER DRIVE
SAN RAFAEL, CA 94903

OWNER OF U.S. REG. NO. 3,190,188.

THE MARK CONSISTS OF THE STYLIZED NUM-
BERS "0" AND "7".

FOR: CIGARETTE LIGHTERS NOT OF PRE-
CIOUS METAL, IN CLASS 34 (U.S. CLS. 2, 8, 9 AND
17).

SER. NO. 77-550,566, FILED 8-19-2008.

FIRST USE 2-1-2005; IN COMMERCE 2-1-2005.

KIMBERLY PERRY, EXAMINING ATTORNEY

Int. Cl.: 16

Prior U.S. Cls.: 2, 5, 22, 23, 29, 37, 38 and 50

United States Patent and Trademark Office

Reg. No. 3,576,139

Registered Feb. 17, 2009

**TRADEMARK
PRINCIPAL REGISTER**

AARP INTERNATIONAL

AARP (D.C. NON-PROFIT CORPORATION)
601 E STREET, N.W.
WASHINGTON, DC 20049

FOR: PRINTED MATERIALS, NAMELY, JOURNALS AND NEWSLETTERS IN THE FIELDS OF MATURE INDIVIDUALS, MATURE POPULATIONS, WORLDWIDE AGING ISSUES AND POLICY, NON-PROFIT AND ADVOCACY ASSOCIATIONS, MEDICAL SERVICES, ELDER-CARE, EMPLOYMENT, LEGAL ASSISTANCE, BUSINESS, INSURANCE, REAL ESTATE, TRAVEL, ELDER ASSISTANCE, RETIREMENT, MATURE OR RETIRED LIFESTYLES, FINANCE, HEALTH, AGING, CONSUMER ISSUES, ECONOMIC SECURITY, AND FITNESS, IN CLASS 16 (U.S. CLS. 2, 5, 22, 23, 29, 37, 38 AND 50).

FIRST USE 7-0-2007; IN COMMERCE 7-0-2007.

THE MARK CONSISTS OF STANDARD CHARACTERS WITHOUT CLAIM TO ANY PARTICULAR FONT, STYLE, SIZE, OR COLOR.

OWNER OF U.S. REG. NOS. 2,461,155, 3,135,601 AND OTHERS.

NO CLAIM IS MADE TO THE EXCLUSIVE RIGHT TO USE "INTERNATIONAL", APART FROM THE MARK AS SHOWN.

SER. NO. 77-550,616, FILED 8-19-2008.

BRIDGETT SMITH, EXAMINING ATTORNEY

Int. Cl.: 33

Prior U.S. Cls.: 47 and 49

United States Patent and Trademark Office

Reg. No. 3,576,140

Registered Feb. 17, 2009

**TRADEMARK
PRINCIPAL REGISTER**

MONOGRAM

JACK DANIEL'S PROPERTIES, INC. (DELA-
WARE CORPORATION)
SUITE 528
4040 CIVIC CENTER DRIVE
SAN RAFAEL, CA 94903

FOR: ALCOHOLIC BEVERAGES, NAMELY, DIS-
TILLED SPIRITS, IN CLASS 33 (U.S. CLS. 47 AND 49).

FIRST USE 12-1-1997; IN COMMERCE 12-1-1997.

THE MARK CONSISTS OF STANDARD CHAR-
ACTERS WITHOUT CLAIM TO ANY PARTICULAR
FONT, STYLE, SIZE, OR COLOR.

OWNER OF U.S. REG. NO. 2,476,018.

SER. NO. 77-550,942, FILED 8-19-2008.

KIMBERLY PERRY, EXAMINING ATTORNEY

Int. Cls.: 30 and 35

Prior U.S. Cls.: 46, 100, 101 and 102

United States Patent and Trademark Office

Reg. No. 3,576,141

Registered Feb. 17, 2009

**TRADEMARK
SERVICE MARK
PRINCIPAL REGISTER**

Chocolats du CaliBressan

CHOCOLATS DU CALIBRESSAN, INC. (CALIFORNIA CORPORATION)
4193 CARPINTERIA AVE. SUITE 4
CARPINTERIA, CA 93013

FOR: CONFECTIONERY, NAMELY, CANDIES, CHOCOLATE, CHOCOLATE COVERED NUTS, FINE CHOCOLATES, CHOCOLATE CANDIES, SWEETS AND CHOCOLATE TRUFFLES, SINGLE ORIGIN CHOCOLATES, BON BONS AND HAND-DIPPED CHOCOLATES, IN CLASS 30 (U.S. CL. 46).

FIRST USE 11-19-2007; IN COMMERCE 11-19-2007.

FOR: RETAIL STORE SERVICES AND RETAIL STORE SERVICES VIA THE INTERNET FEATURING CONFECTIONERY, NAMELY, CANDIES, CHOCOLATE, CHOCOLATE COVERED NUTS, FINE CHOCOLATES, CHOCOLATE CANDIES, SWEETS AND TRUFFLES, SINGLE ORIGIN CHO-

COLATES, BON BONS AND HAND-DIPPED CHOCOLATES, IN CLASS 35 (U.S. CLS. 100, 101 AND 102).

FIRST USE 11-19-2007; IN COMMERCE 11-19-2007.

THE MARK CONSISTS OF STANDARD CHARACTERS WITHOUT CLAIM TO ANY PARTICULAR FONT, STYLE, SIZE, OR COLOR.

NO CLAIM IS MADE TO THE EXCLUSIVE RIGHT TO USE "CHOCOLATS", APART FROM THE MARK AS SHOWN.

THE FOREIGN WORDING IN THE MARK TRANSLATES INTO ENGLISH AS CHOCOLATES OF CALIBRESSAN (A BRANDNAME).

SER. NO. 77-550,944, FILED 8-19-2008.

ALICIA COLLINS, EXAMINING ATTORNEY

Int. Cl.: 33

Prior U.S. Cls.: 47 and 49

United States Patent and Trademark Office

Reg. No. 3,576,142

Registered Feb. 17, 2009

**TRADEMARK
PRINCIPAL REGISTER**

JD

JACK DANIEL'S PROPERTIES, INC. (DELA-
WARE CORPORATION)
SUITE 528
4040 CIVIC CENTER DRIVE
SAN RAFAEL, CA 94903

THE MARK CONSISTS OF STANDARD CHAR-
ACTERS WITHOUT CLAIM TO ANY PARTICULAR
FONT, STYLE, SIZE, OR COLOR.

FOR: ALCOHOLIC BEVERAGES, NAMELY, DIS-
TILLED SPIRITS, IN CLASS 33 (U.S. CLS. 47 AND 49).

SER. NO. 77-550,947, FILED 8-19-2008.

FIRST USE 12-1-1997; IN COMMERCE 12-1-1997.

KIMBERLY PERRY, EXAMINING ATTORNEY

Int. Cl.: 29

Prior U.S. Cl.: 46

United States Patent and Trademark Office

Reg. No. 3,576,143

Registered Feb. 17, 2009

**TRADEMARK
PRINCIPAL REGISTER**

RAO'S

RAO'S SPECIALTY FOODS, INC. (NEW YORK CORPORATION)
SUITE 610
17 BATTERY PLACE
NEW YORK, NY 10004

FOR: CANNED TOMATOES; EDIBLE OILS; OLIVE OIL; PRESERVED VEGETABLES (IN OIL); PROCESSED PEPPERS, IN CLASS 29 (U.S. CL. 46).

FIRST USE 9-16-1992; IN COMMERCE 9-16-1992.

OWNER OF U.S. REG. NO. 2,670,863.

THE COLOR(S) RED AND DARK BROWN IS/ARE CLAIMED AS A FEATURE OF THE MARK.

THE MARK CONSISTS OF STYLIZED LETTERS "RAO'S". THE RED COLOR IS THE PROMINENT (FOREGROUND) COLOR OF THE STYLIZED LETTERS AND THE DARK BROWN COLOR IS THE SHADOW COLOR FOR THE STYLIZED LETTERS LOCATED BEHIND THE RED COLOR.

SEC. 2(F).

SER. NO. 77-551,242, FILED 8-20-2008.

RUSS HERMAN, EXAMINING ATTORNEY

Int. Cl.: 30

Prior U.S. Cl.: 46

United States Patent and Trademark Office

Reg. No. 3,576,144

Registered Feb. 17, 2009

TRADEMARK
PRINCIPAL REGISTER

RAO'S

RAO'S SPECIALTY FOODS, INC (NEW YORK CORPORATION)
SUITE 610
17 BATTERY PLACE
NEW YORK, NY 10004

FOR: PASTA, PASTA SAUCE, MARINADES, VINEGAR, WINE VINEGAR, SALAD DRESSINGS, IN CLASS 30 (U.S. CL. 46).

FIRST USE 9-16-1992; IN COMMERCE 9-16-1992.

THE COLOR(S) RED AND DARK BROWN IS/ARE CLAIMED AS A FEATURE OF THE MARK.

THE MARK CONSISTS OF STYLIZED LETTERS "RAO'S". THE RED COLOR IS THE PROMINENT (FOREGROUND) COLOR OF THE STYLIZED LETTERS AND THE DARK BROWN COLOR IS THE SHADOW COLOR FOR THE STYLIZED LETTERS LOCATED BEHIND THE RED COLOR.

SEC. 2(F).

SER. NO. 77-551,280, FILED 8-20-2008.

RUSS HERMAN, EXAMINING ATTORNEY

Int. Cl.: 35

Prior U.S. Cls.: 100, 101 and 102

United States Patent and Trademark Office

Reg. No. 3,576,145

Registered Feb. 17, 2009

**SERVICE MARK
PRINCIPAL REGISTER**

**HELPING DYNAMIC FAMILIES
MANAGE FAMILY DYNAMICS**

C-ZONE LEGACY CONSULTANTS, INC. (MAINE CORPORATION)
11400 WEST OLYMPIC BLVD.
WEST LOS ANGELES, CA 90064

FOR: CONSULTING SERVICES, NAMELY, ASSISTING BUSINESSES WITH ORGANIZATIONAL, SUCCESSION AND TRANSITION PLANNING, IN CLASS 35 (U.S. CLS. 100, 101 AND 102).

FIRST USE 6-23-2008; IN COMMERCE 6-23-2008.

THE MARK CONSISTS OF STANDARD CHARACTERS WITHOUT CLAIM TO ANY PARTICULAR FONT, STYLE, SIZE, OR COLOR.

SER. NO. 77-551,887, FILED 8-20-2008.

ALEXANDER L. POWERS, EXAMINING ATTORNEY

Int. Cl.: 1

Prior U.S. Cls.: 1, 5, 6, 10, 26 and 46

United States Patent and Trademark Office

Reg. No. 3,576,146

Registered Feb. 17, 2009

**TRADEMARK
PRINCIPAL REGISTER**

RAIN VISION

BLUE MAGIC, INC. (TEXAS CORPORATION)
1304 FM 3083
CONROE, TX 773031827

THE MARK CONSISTS OF STANDARD CHAR-
ACTERS WITHOUT CLAIM TO ANY PARTICULAR
FONT, STYLE, SIZE, OR COLOR.

FOR: CHEMICAL-BASED SNOW AND WATER
REPELLENT PREPARATION TO BE APPLIED TO
GLASS, IN CLASS 1 (U.S. CLS. 1, 5, 6, 10, 26 AND 46).

SER. NO. 77-551,907, FILED 8-20-2008.

FIRST USE 10-19-1988; IN COMMERCE 2-2-1989.

RENEE SERVANCE, EXAMINING ATTORNEY

Int. Cl.: 41

Prior U.S. Cls.: 100, 101 and 107

United States Patent and Trademark Office

Reg. No. 3,576,147

Registered Feb. 17, 2009

**SERVICE MARK
PRINCIPAL REGISTER**

GOOD HOUSEKEEPING

HEARST COMMUNICATIONS, INC. (DELA-
WARE CORPORATION)
300 WEST 57TH STREET
NEW YORK, NY 10019

FOR: ENTERTAINMENT SERVICES, NAMELY,
PROVIDING A WEB SITE FEATURING PHOTO-
GRAPHIC, VIDEO AND PROSE PRESENTATIONS
FEATURING FASHION, BEAUTY, TRAVEL, HOME
DECORATING, RELATIONSHIPS, LUXURY
GOODS, HEALTH AND FITNESS, TECHNOLOGY,
CAREERS, AND CELEBRITY NEWS; PROVIDING
ON-LINE MAGAZINES IN THE FIELD OF FASH-
ION, BEAUTY, TRAVEL, HOME DECORATING,
RELATIONSHIPS, LUXURY GOODS, HEALTH
AND FITNESS, TECHNOLOGY, CAREERS, AND

CELEBRITY NEWS, IN CLASS 41 (U.S. CLS. 100, 101
AND 107).

FIRST USE 12-23-1996; IN COMMERCE 12-23-1996.

THE MARK CONSISTS OF STANDARD CHAR-
ACTERS WITHOUT CLAIM TO ANY PARTICULAR
FONT, STYLE, SIZE, OR COLOR.

OWNER OF U.S. REG. NOS. 46,028, 2,311,471 AND
OTHERS.

SER. NO. 77-552,163, FILED 8-21-2008.

LAURA KOVALSKY, EXAMINING ATTORNEY

Int. Cl.: 35

Prior U.S. Cls.: 100, 101 and 102

United States Patent and Trademark Office

Reg. No. 3,576,148

Registered Feb. 17, 2009

**SERVICE MARK
PRINCIPAL REGISTER**

BOLDXL

CMRG APPAREL, LLC (DELAWARE LIMITED
LIABILITY COMPANY)
555 TURNPIKE STREET
CANTON, MA 02021

FOR: RETAIL ONLINE STORE SERVICES FEATURING CLOTHING, FOOTWEAR AND ACCESSORIES, IN CLASS 35 (U.S. CLS. 100, 101 AND 102).

FIRST USE 7-0-2005; IN COMMERCE 7-0-2005.

THE MARK CONSISTS OF STANDARD CHARACTERS WITHOUT CLAIM TO ANY PARTICULAR FONT, STYLE, SIZE, OR COLOR.

OWNER OF U.S. REG. NOS. 3,180,088, 3,391,690, AND 3,482,602.

SER. NO. 77-552,287, FILED 8-21-2008.

NICHOLAS COLEMAN, EXAMINING ATTORNEY

Int. Cl.: 41

Prior U.S. Cls.: 100, 101 and 107

United States Patent and Trademark Office

Reg. No. 3,576,149

Registered Feb. 17, 2009

**SERVICE MARK
PRINCIPAL REGISTER**

SPORTS OF ALL SORTS

SCRIPPS HOWARD BROADCASTING COMPANY
(OHIO CORPORATION), DBA WCPO-TV
SUITE 2800
312 WALNUT STREET
CINCINNATI, OH 45202

FOR: ENTERTAINMENT, NAMELY, A CONTINUING INTERACTIVE SPORTS TALK SHOW ACCESSIBLE BY TELEVISION, CABLE, FIBER OPTIC NETWORKS, WIRELESS NETWORKS, SATELLITE, AND COMPUTER NETWORKS, IN CLASS 41 (U.S. CLS. 100, 101 AND 107).

FIRST USE 12-21-1980; IN COMMERCE 12-21-1980.

THE MARK CONSISTS OF STANDARD CHARACTERS WITHOUT CLAIM TO ANY PARTICULAR FONT, STYLE, SIZE, OR COLOR.

SER. NO. 77-552,413, FILED 8-21-2008.

DOUGLAS LEE, EXAMINING ATTORNEY

Int. Cl.: 43

Prior U.S. Cls.: 100 and 101

United States Patent and Trademark Office

Reg. No. 3,576,150

Registered Feb. 17, 2009

**SERVICE MARK
PRINCIPAL REGISTER**

PS AIRPUB

HMSHOST CORPORATION (DELAWARE COR-
PORATION)
6905 ROCKLEDGE DRIVE MS 7-1
BETHESDA, MD 20817

THE MARK CONSISTS OF STANDARD CHAR-
ACTERS WITHOUT CLAIM TO ANY PARTICULAR
FONT, STYLE, SIZE, OR COLOR.

FOR: RESTAURANT AND BAR SERVICES, IN
CLASS 43 (U.S. CLS. 100 AND 101).

SER. NO. 77-552,433, FILED 8-21-2008.

FIRST USE 1-0-1995; IN COMMERCE 1-0-1995.

JOHN DWYER, EXAMINING ATTORNEY

Int. Cls.: 5 and 30

Prior U.S. Cls.: 6, 18, 44, 46, 51 and 52

United States Patent and Trademark Office

Reg. No. 3,576,151

Registered Feb. 17, 2009

**TRADEMARK
PRINCIPAL REGISTER**

Essentialyte

RALCO NUTRITION, INC. (MINNESOTA CORPORATION)
PO BOX 1083
1600 HAHN ROAD
MARSHALL, MN 56258

FOR: ELECTROLYTES; LIQUID NUTRITIONAL SUPPLEMENT; NON-MEDICATED ADDITIVES FOR ANIMAL FEED FOR USE AS NUTRITIONAL SUPPLEMENTS; NUTRITIONAL SUPPLEMENTS; VITAMIN AND MINERAL SUPPLEMENTS, IN CLASS 5 (U.S. CLS. 6, 18, 44, 46, 51 AND 52).

FIRST USE 1-1-2007; IN COMMERCE 1-1-2007.

FOR: FLAVORING ADDITIVES FOR NON-NUTRITIONAL PURPOSES, IN CLASS 30 (U.S. CL. 46).

FIRST USE 1-1-2007; IN COMMERCE 1-1-2007.

THE MARK CONSISTS OF STANDARD CHARACTERS WITHOUT CLAIM TO ANY PARTICULAR FONT, STYLE, SIZE, OR COLOR.

SER. NO. 77-552,562, FILED 8-21-2008.

GEORGE LORENZO, EXAMINING ATTORNEY

Int. Cl.: 16

Prior U.S. Cls.: 2, 5, 22, 23, 29, 37, 38 and 50

United States Patent and Trademark Office

Reg. No. 3,576,152

Registered Feb. 17, 2009

**TRADEMARK
PRINCIPAL REGISTER**

WALKER TALK

CYGNUS BUSINESS MEDIA, INC. (DELAWARE
CORPORATION)
1233 JANESVILLE AVENUE
FORT ATKINSON, WI 53538

THE MARK CONSISTS OF STANDARD CHAR-
ACTERS WITHOUT CLAIM TO ANY PARTICULAR
FONT, STYLE, SIZE, OR COLOR.

FOR: MAGAZINES FEATURING INFORMA-
TION IN THE FIELD OF LAWN MAINTENANCE,
IN CLASS 16 (U.S. CLS. 2, 5, 22, 23, 29, 37, 38 AND 50).

SER. NO. 77-552,919, FILED 8-21-2008.

FIRST USE 10-0-1992; IN COMMERCE 10-0-1992.

BRIDGETT SMITH, EXAMINING ATTORNEY

Int. Cl.: 41

Prior U.S. Cls.: 100, 101 and 107

United States Patent and Trademark Office

Reg. No. 3,576,153

Registered Feb. 17, 2009

**SERVICE MARK
PRINCIPAL REGISTER**

WAG REFLEX

AMAZON TECHNOLOGIES, INC. (NEVADA
CORPORATION)
ATTN: TRADEMARKS
PO BOX 8102
RENO, NV 89507

FOR: ON-LINE JOURNALS, NAMELY, BLOGS
FEATURING NEWS, STORIES, TRAINING TIPS,
PRODUCT REVIEWS, VETERINARY RECOMMEN-
DATIONS, IMAGES AND HEALTH INFORMATION
RELEVANT TO PETS AND PET ENTHUSIASTS, IN
CLASS 41 (U.S. CLS. 100, 101 AND 107).

FIRST USE 7-21-2008; IN COMMERCE 7-21-2008.

THE MARK CONSISTS OF STANDARD CHAR-
ACTERS WITHOUT CLAIM TO ANY PARTICULAR
FONT, STYLE, SIZE, OR COLOR.

SER. NO. 77-553,889, FILED 8-22-2008.

KATHLEEN LORENZO, EXAMINING ATTORNEY

Int. Cl.: 32

Prior U.S. Cls.: 45, 46 and 48

United States Patent and Trademark Office

Reg. No. 3,576,154

Registered Feb. 17, 2009

**TRADEMARK
PRINCIPAL REGISTER**

Piddle

FACIANE, KIRBY A. (UNITED STATES INDIVIDUAL)
143 N. RIOS AVE.
SOLANA BEACH, CA 92075

THE MARK CONSISTS OF STANDARD CHARACTERS WITHOUT CLAIM TO ANY PARTICULAR FONT, STYLE, SIZE, OR COLOR.

FOR: BEER, ALE, LAGER, STOUT, PORTER, SHANDY, IN CLASS 32 (U.S. CLS. 45, 46 AND 48).

SER. NO. 77-554,177, FILED 8-23-2008.

FIRST USE 5-1-1994; IN COMMERCE 5-1-1994.

DORITT L. CARROLL, EXAMINING ATTORNEY

Int. Cls.: 39 and 43

Prior U.S. Cls.: 100, 101 and 105

United States Patent and Trademark Office

Reg. No. 3,576,155

Registered Feb. 17, 2009

**SERVICE MARK
PRINCIPAL REGISTER**



UNIQUE BRANDS ENTERPRISES, LLC (FLORIDA LIMITED LIABILITY COMPANY)
550 BILTMORE WAY, SUITE 200
CORAL GABLES, FL 33134

FOR: TRAVEL SERVICES, NAMELY, PROVIDING AND ARRANGING ALL-INCLUSIVE TRAVEL VACATIONS, VACATIONS WITH OPTIONAL MEAL PLANS, AND TRAVEL TOUR PACKAGES, IN CLASS 39 (U.S. CLS. 100 AND 105).

FIRST USE 8-13-2008; IN COMMERCE 8-13-2008.

FOR: MAKING HOTEL RESERVATIONS FOR OTHERS; PROVIDING INFORMATION ABOUT HOTEL RESORT ACCOMMODATIONS AND SERVICES, IN CLASS 43 (U.S. CLS. 100 AND 101).

FIRST USE 8-13-2008; IN COMMERCE 8-13-2008.

NO CLAIM IS MADE TO THE EXCLUSIVE RIGHT TO USE "VACATION PLANNER", APART FROM THE MARK AS SHOWN.

THE MARK CONSISTS OF A BORDERED SQUARE WITH ROUNDED CORNERS, WITH THE WORDS "FAMILY AND FRIENDS VACATION PLANNER" SHAPED INTO THE FORM OF A SQUARE INSIDE THE SQUARE, WITH FOUR SETS OF FOOT PRINTS IN THE MIDDLE OF THE SQUARE.

SER. NO. 77-554,832, FILED 8-25-2008.

BRIDGETT SMITH, EXAMINING ATTORNEY

Int. Cl.: 30

Prior U.S. Cl.: 46

United States Patent and Trademark Office

Reg. No. 3,576,156

Registered Feb. 17, 2009

**TRADEMARK
PRINCIPAL REGISTER**

REESE'S

HERSHEY CHOCOLATE & CONFECTIONERY
CORPORATION (DELAWARE CORPORATION)

4860 ROBB STREET, SUITE 204
WHEAT RIDGE, CO 80033

FOR: COOKIES, IN CLASS 30 (U.S. CL. 46).

FIRST USE 8-8-2006; IN COMMERCE 8-8-2006.

THE MARK CONSISTS OF STANDARD CHARACTERS WITHOUT CLAIM TO ANY PARTICULAR FONT, STYLE, SIZE, OR COLOR.

OWNER OF U.S. REG. NOS. 1,074,163, 1,215,096,
AND 1,834,806.

SER. NO. 77-555,028, FILED 8-25-2008.

NICHOLAS COLEMAN, EXAMINING ATTORNEY

Int. Cl.: 41

Prior U.S. Cls.: 100, 101 and 107

United States Patent and Trademark Office

Reg. No. 3,576,157

Registered Feb. 17, 2009

**SERVICE MARK
PRINCIPAL REGISTER**

COUNTRY LIVING

HEARST COMMUNICATIONS, INC. (DELA-
WARE CORPORATION)
300 WEST 57TH STREET
NEW YORK, NY 10019

FOR: ENTERTAINMENT SERVICES, NAMELY,
PROVIDING A WEB SITE FEATURING PHOTO-
GRAPHIC, VIDEO AND PROSE PRESENTATIONS
FEATURING FASHION, BEAUTY, TRAVEL, HOME
DECORATING, RELATIONSHIPS, LUXURY
GOODS, HEALTH AND FITNESS, TECHNOLOGY,
CAREERS, AND CELEBRITY NEWS; PROVIDING
ON-LINE MAGAZINES IN THE FIELD OF FASH-
ION, BEAUTY, TRAVEL, HOME DECORATING,
RELATIONSHIPS, LUXURY GOODS, HEALTH
AND FITNESS, TECHNOLOGY, CAREERS, AND

CELEBRITY NEWS, IN CLASS 41 (U.S. CLS. 100, 101
AND 107).

FIRST USE 4-12-1997; IN COMMERCE 4-12-1997.

THE MARK CONSISTS OF STANDARD CHAR-
ACTERS WITHOUT CLAIM TO ANY PARTICULAR
FONT, STYLE, SIZE, OR COLOR.

OWNER OF U.S. REG. NOS. 2,357,985, 2,620,095
AND OTHERS.

SER. NO. 77-555,114, FILED 8-25-2008.

LAURA KOVALSKY, EXAMINING ATTORNEY

Int. Cl.: 36

Prior U.S. Cls.: 100, 101 and 102

United States Patent and Trademark Office

Reg. No. 3,576,158

Registered Feb. 17, 2009

**SERVICE MARK
PRINCIPAL REGISTER**

WELCOME TO THE COMFORT ZONE

MANUFACTURERS AND TRADERS TRUST
COMPANY (NEW YORK CORPORATION)
ONE M&T PLAZA
BUFFALO, NY 14203

THE MARK CONSISTS OF STANDARD CHAR-
ACTERS WITHOUT CLAIM TO ANY PARTICULAR
FONT, STYLE, SIZE, OR COLOR.

FOR: BANKING SERVICES, IN CLASS 36 (U.S.
CLS. 100, 101 AND 102).

SER. NO. 77-556,037, FILED 8-26-2008.

FIRST USE 2-11-2008; IN COMMERCE 2-11-2008.

TERESA M. RUPP, EXAMINING ATTORNEY

Int. Cl.: 16

Prior U.S. Cls.: 2, 5, 22, 23, 29, 37, 38 and 50

United States Patent and Trademark Office

Reg. No. 3,576,159

Registered Feb. 17, 2009

**TRADEMARK
PRINCIPAL REGISTER**

ATD TECHNOLOGY

SPC RESOURCES, INC. (DELAWARE CORPORATION)
MAIL DROP Y11
125 W HOME AVENUE
HARTSVILLE, SC 29550

FOR: PAPER PRODUCTS, NAMELY, PAPER TUBES AND PAPER CORES, IN CLASS 16 (U.S. CLS. 2, 5, 22, 23, 29, 37, 38 AND 50).

FIRST USE 6-0-2008; IN COMMERCE 6-0-2008.

THE MARK CONSISTS OF STANDARD CHARACTERS WITHOUT CLAIM TO ANY PARTICULAR FONT, STYLE, SIZE, OR COLOR.

NO CLAIM IS MADE TO THE EXCLUSIVE RIGHT TO USE "TECHNOLOGY", APART FROM THE MARK AS SHOWN.

SER. NO. 77-556,683, FILED 8-27-2008.

RUSS HERMAN, EXAMINING ATTORNEY

Int. Cl.: 35

Prior U.S. Cls.: 100, 101 and 102

United States Patent and Trademark Office

Reg. No. 3,576,160

Registered Feb. 17, 2009

**SERVICE MARK
PRINCIPAL REGISTER**

THE LEADER IN FOOTWEAR

BROWN SHOE COMPANY, INC. (NEW YORK
CORPORATION)
8300 MARYLAND AVENUE
ST. LOUIS, MO 63105

FOR: WHOLESALE AND DISTRIBUTORSHIP
SERVICES FEATURING FOOTWEAR, IN CLASS 35
(U.S. CLS. 100, 101 AND 102).

FIRST USE 5-27-1999; IN COMMERCE 5-27-1999.

THE MARK CONSISTS OF STANDARD CHAR-
ACTERS WITHOUT CLAIM TO ANY PARTICULAR
FONT, STYLE, SIZE, OR COLOR.

OWNER OF U.S. REG. NO. 2,568,543.

SEC. 2(F).

SER. NO. 77-558,017, FILED 8-28-2008.

CURTIS FRENCH, EXAMINING ATTORNEY

Int. Cl.: 42

Prior U.S. Cls.: 100 and 101

United States Patent and Trademark Office

Reg. No. 3,576,161

Registered Feb. 17, 2009

**SERVICE MARK
PRINCIPAL REGISTER**

AWS

AMAZON TECHNOLOGIES, INC. (NEVADA
CORPORATION)
ATTN: TRADEMARKS
PO BOX 8102
RENO, NV 89507

FOR: APPLICATION SERVICE PROVIDER,
NAMELY, PROVIDING, HOSTING, MANAGING,
DEVELOPING AND MAINTAINING APPLICA-
TIONS, SOFTWARE, WEBSITES AND DATABASES
IN THE FIELDS OF ECOMMERCE, ONLINE PAY-
MENTS, ORDER QUEUING, WEBSITE DESIGN,
DATA STORAGE AND SHARED COMPUTING CA-

PACITY SCALING SERVICES, IN CLASS 42 (U.S.
CLS. 100 AND 101).

FIRST USE 7-31-2002; IN COMMERCE 7-31-2002.

THE MARK CONSISTS OF STANDARD CHAR-
ACTERS WITHOUT CLAIM TO ANY PARTICULAR
FONT, STYLE, SIZE, OR COLOR.

SER. NO. 77-558,031, FILED 8-28-2008.

KATHLEEN LORENZO, EXAMINING ATTORNEY

Int. Cl.: 11

Prior U.S. Cls.: 13, 21, 23, 31 and 34

United States Patent and Trademark Office

Reg. No. 3,576,162

Registered Feb. 17, 2009

**TRADEMARK
PRINCIPAL REGISTER**

DRAGONFLY

MUNTERS CORPORATION (NEW YORK COR-
PORATION)
79 MONROE ST.
AMESBURY, MA 01913

THE MARK CONSISTS OF STANDARD CHAR-
ACTERS WITHOUT CLAIM TO ANY PARTICULAR
FONT, STYLE, SIZE, OR COLOR.

FOR: DAMPERS, NAMELY, CONTROL DEVICES
USED TO REGULATE THE FLOW OF AIR, IN
CLASS 11 (U.S. CLS. 13, 21, 23, 31 AND 34).

SER. NO. 77-561,963, FILED 9-4-2008.

FIRST USE 3-18-2008; IN COMMERCE 3-18-2008.

JILL C. ALT, EXAMINING ATTORNEY

Int. Cl.: 35

Prior U.S. Cls.: 100, 101 and 102

United States Patent and Trademark Office

Reg. No. 3,576,163

Registered Feb. 17, 2009

**SERVICE MARK
PRINCIPAL REGISTER**

LET'S FIGHT FLU TOGETHER!

NOVARTIS AG (SWITZERLAND CORPORATION)
CH-4002
BASEL, SWITZERLAND

FOR: PROVIDING A PUBLIC AWARENESS PROGRAM IN THE FIELD OF FLU AWARENESS AND PREVENTION, IN CLASS 35 (U.S. CLS. 100, 101 AND 102).

FIRST USE 8-0-2008; IN COMMERCE 8-0-2008.

THE MARK CONSISTS OF STANDARD CHARACTERS WITHOUT CLAIM TO ANY PARTICULAR FONT, STYLE, SIZE, OR COLOR.

SER. NO. 77-564,864, FILED 9-8-2008.

WILLIAM ROSSMAN, EXAMINING ATTORNEY

Int. Cl.: 41

Prior U.S. Cls.: 100, 101 and 107

United States Patent and Trademark Office

Reg. No. 3,576,164

Registered Feb. 17, 2009

**SERVICE MARK
PRINCIPAL REGISTER**



**Center
for Media
Literacy**

JOLLS, TESSA (UNITED STATES INDIVIDUAL)
SUITE 472
23852 PACIFIC COAST HIGHWAY
MALIBU, CA 90265

OWNER OF U.S. REG. NO. 3,504,123.

FOR: EDUCATIONAL SERVICES, NAMELY,
CONDUCTING ONLINE PROGRAMS IN THE
FIELD OF MEDIA COMMUNICATIONS AND DIS-
TRIBUTION OF COURSE MATERIAL IN CONNEC-
TION THEREWITH, IN CLASS 41 (U.S. CLS. 100, 101
AND 107).

NO CLAIM IS MADE TO THE EXCLUSIVE
RIGHT TO USE "CENTER FOR MEDIA LITERA-
CY", APART FROM THE MARK AS SHOWN.

SER. NO. 77-565,900, FILED 9-9-2008.

FIRST USE 9-20-2000; IN COMMERCE 9-8-2008.

REBECCA POVARCHUK, EXAMINING ATTOR-
NEY

Int. Cl.: 5

Prior U.S. Cls.: 6, 18, 44, 46, 51 and 52

United States Patent and Trademark Office

Reg. No. 3,576,165

Registered Feb. 17, 2009

**TRADEMARK
PRINCIPAL REGISTER**

**MINERAL NUTRITION DONE
RIGHT**

MFA INCORPORATED (MISSOURI CORPORATION)
201 RAY YOUNG DRIVE
COLUMBIA, MO 652013599

THE MARK CONSISTS OF STANDARD CHARACTERS WITHOUT CLAIM TO ANY PARTICULAR FONT, STYLE, SIZE, OR COLOR.

FOR: VITAMIN AND MINERAL SUPPLEMENTS FOR LIVESTOCK, IN CLASS 5 (U.S. CLS. 6, 18, 44, 46, 51 AND 52).

SER. NO. 77-566,830, FILED 9-10-2008.

FIRST USE 8-19-2008; IN COMMERCE 8-19-2008.

TASNEEM HUSSAIN, EXAMINING ATTORNEY

Int. Cls.: 35, 39 and 43

Prior U.S. Cls.: 100, 101, 102 and 105

United States Patent and Trademark Office

Reg. No. 3,576,166

Registered Feb. 17, 2009

**SERVICE MARK
PRINCIPAL REGISTER**

CHEAPOAIR

FAREPORTAL, INC. (NEW YORK CORPORATION)
213 WEST 35TH STREET, STE 1201
NEW YORK, NY 10001

FOR: ADVERTISING SERVICES FOR TRAVEL SERVICES, NAMELY, PROMOTING THE GOODS, SERVICES, BRAND IDENTITY AND COMMERCIAL INFORMATION AND NEWS OF TRAVEL AND TRAVEL RELATED COMPANIES ON THE INTERNET, IN CLASS 35 (U.S. CLS. 100, 101 AND 102).

FIRST USE 7-1-2005; IN COMMERCE 7-1-2005.

FOR: PROVIDING AN ON-LINE COMPUTER DATABASE IN THE FIELD OF TRAVEL INFORMATION SERVICES; TRAVEL AND TOUR INFORMATION SERVICE; TRAVEL AND TOUR TICKET RESERVATION SERVICE; TRAVEL SERVICES, NAMELY, PROVIDING FARE AND RATE INFORMATION FOR TRANSPORTATION BOOKINGS AND RESERVATIONS FOR FLIGHTS, CAR REN-

TALS, CRUISES, RAIL TRAVEL, AND TOURS VIA COMPUTER; PROVIDING TRAVEL INFORMATION AND NEWS VIA COMPUTER; PROVIDING LINKS TO WEBSITES OF OTHERS FEATURING TRAVEL, IN CLASS 39 (U.S. CLS. 100 AND 105).

FIRST USE 7-1-2005; IN COMMERCE 7-1-2005.

FOR: PROVIDING TRAVEL LODGING INFORMATION SERVICES AND TRAVEL LODGING BOOKING AGENCY SERVICES FOR TRAVELERS, IN CLASS 43 (U.S. CLS. 100 AND 101).

FIRST USE 7-1-2005; IN COMMERCE 7-1-2005.

THE MARK CONSISTS OF STANDARD CHARACTERS WITHOUT CLAIM TO ANY PARTICULAR FONT, STYLE, SIZE, OR COLOR.

SER. NO. 77-567,343, FILED 9-11-2008.

SUNG IN, EXAMINING ATTORNEY

Int. Cl.: 35

Prior U.S. Cls.: 100, 101 and 102

United States Patent and Trademark Office

Reg. No. 3,576,167

Registered Feb. 17, 2009

**SERVICE MARK
PRINCIPAL REGISTER**

SMARTSAMPLING

NEWS AMERICA MARKETING PROPERTIES,
LLC (DELAWARE LIMITED LIABILITY COM-
PANY)
303 E. WACKER DRIVE
CHICAGO, IL 60601

FOR: ADVERTISING AND PROMOTIONAL SER-
VICES, NAMELY, PROMOTING THE GOODS OF
OTHERS TO CONSUMERS THROUGH COUPON-
ING EVENTS, DISTRIBUTION OF SAMPLES, PRO-
VISION OF MARKETING DATA ANALYSIS,
DIRECT MAIL CONSULTING SERVICES AND PRO-
MOTION SAMPLING IN THE NATURE OF PROVI-
SION, SET-UP AND MAINTENANCE OF IN-STORE
DISPLAYS, IN CLASS 35 (U.S. CLS. 100, 101 AND 102).

FIRST USE 9-11-2008; IN COMMERCE 9-11-2008.

THE MARK CONSISTS OF STANDARD CHAR-
ACTERS WITHOUT CLAIM TO ANY PARTICULAR
FONT, STYLE, SIZE, OR COLOR.

OWNER OF U.S. REG. NOS. 2,186,735, 2,554,497
AND OTHERS.

SER. NO. 77-567,988, FILED 9-11-2008.

PAUL CROWLEY, EXAMINING ATTORNEY

Int. Cl.: 35

Prior U.S. Cls.: 100, 101 and 102

United States Patent and Trademark Office

Reg. No. 3,576,168

Registered Feb. 17, 2009

**SERVICE MARK
PRINCIPAL REGISTER**

EMPLOYER VIP

NOVARTIS AG (SWITZERLAND CORPORATION)
CH-4002
BASEL, SWITZERLAND

FOR: PROVIDING A PUBLIC AWARENESS PROGRAM IN THE FIELD OF FLU AWARENESS AND PREVENTION, IN CLASS 35 (U.S. CLS. 100, 101 AND 102).

FIRST USE 6-0-2007; IN COMMERCE 6-0-2007.

THE MARK CONSISTS OF STANDARD CHARACTERS WITHOUT CLAIM TO ANY PARTICULAR FONT, STYLE, SIZE, OR COLOR.

SER. NO. 77-568,059, FILED 9-11-2008.

WILLIAM ROSSMAN, EXAMINING ATTORNEY

Int. Cl.: 34

Prior U.S. Cls.: 2, 8, 9 and 17

United States Patent and Trademark Office

Reg. No. 3,576,169

Registered Feb. 17, 2009

**TRADEMARK
PRINCIPAL REGISTER**

Meritage

HUMICON LLC (NEW YORK LIMITED LIABILITY COMPANY)
SUITE 500
400 OSER AVENUE
HAUPPAUGE, NY 11788

FOR: CIGAR BANDS; CIGAR BOXES; CIGARS, IN CLASS 34 (U.S. CLS. 2, 8, 9 AND 17).

FIRST USE 4-30-2007; IN COMMERCE 9-30-2007.

THE MARK CONSISTS OF STANDARD CHARACTERS WITHOUT CLAIM TO ANY PARTICULAR FONT, STYLE, SIZE, OR COLOR.

SER. NO. 77-568,320, FILED 9-11-2008.

CHRISTINE BLOMQUIST, EXAMINING ATTORNEY

Int. Cl.: 38

Prior U.S. Cls.: 100, 101 and 104

United States Patent and Trademark Office

Reg. No. 3,576,170

Registered Feb. 17, 2009

**SERVICE MARK
PRINCIPAL REGISTER**

**Sometimes a channel
changes you.**

WLVT PBS 39 (PENNSYLVANIA CORPORATION)
123 SESAME STREET
BETHLEHEM, PA 18015

THE MARK CONSISTS OF STANDARD CHAR-
ACTERS WITHOUT CLAIM TO ANY PARTICULAR
FONT, STYLE, SIZE, OR COLOR.

FOR: TELEVISION BROADCASTING, IN CLASS
38 (U.S. CLS. 100, 101 AND 104).

SER. NO. 77-568,389, FILED 9-12-2008.

FIRST USE 4-1-2007; IN COMMERCE 4-1-2007.

STEVEN R. FINE, EXAMINING ATTORNEY

Int. Cl.: 41

Prior U.S. Cls.: 100, 101 and 107

United States Patent and Trademark Office

Reg. No. 3,576,171

Registered Feb. 17, 2009

**SERVICE MARK
PRINCIPAL REGISTER**

THE HARD FAX INTERNATIONAL

AMERICAN HARDWARE MANUFACTURERS
ASSOCIATION (DELAWARE CORPORATION)
801 NORTH PLAZA DRIVE
SCHAUMBURG, IL 60173

OWNER OF U.S. REG. NOS. 3,507,539 AND
3,507,540.

FOR: PROVIDING ONLINE NEWSLETTERS FEATURING INFORMATION AND NEWS ARTICLES IN THE FIELD OF HOME IMPROVEMENT, IN CLASS 41 (U.S. CLS. 100, 101 AND 107).

NO CLAIM IS MADE TO THE EXCLUSIVE RIGHT TO USE "INTERNATIONAL", APART FROM THE MARK AS SHOWN.

FIRST USE 9-8-2008; IN COMMERCE 9-8-2008.

SER. NO. 77-568,596, FILED 9-12-2008.

THE MARK CONSISTS OF STANDARD CHARACTERS WITHOUT CLAIM TO ANY PARTICULAR FONT, STYLE, SIZE, OR COLOR.

DAVID MILLER, EXAMINING ATTORNEY

Int. Cl.: 9

Prior U.S. Cls.: 21, 23, 26, 36 and 38

Reg. No. 3,576,172

United States Patent and Trademark Office

Registered Feb. 17, 2009

**TRADEMARK
PRINCIPAL REGISTER**

DIGIMAX

NATIONAL VISION, INC. (GEORGIA CORPORATION)
ATTN: LEGAL DEPT. / CHARLES MINGLE
296 GRAYSON HIGHWAY
LAWRENCEVILLE, GA 300455750

THE MARK CONSISTS OF STANDARD CHARACTERS WITHOUT CLAIM TO ANY PARTICULAR FONT, STYLE, SIZE, OR COLOR.

FOR: EYEGLOSS LENSES; OPHTHALMIC LENSES; OPTICAL LENSES, IN CLASS 9 (U.S. CLS. 21, 23, 26, 36 AND 38).

SER. NO. 77-569,181, FILED 9-12-2008.

FIRST USE 12-10-2006; IN COMMERCE 12-10-2006.

ALYSSA STEEL, EXAMINING ATTORNEY

Int. Cl.: 41

Prior U.S. Cls.: 100, 101 and 107

United States Patent and Trademark Office

Reg. No. 3,576,173

Registered Feb. 17, 2009

**SERVICE MARK
PRINCIPAL REGISTER**

**THE HARD FAX INTERNATIONAL
HOME IMPROVEMENT INDUSTRY
NEWS FROM AROUND THE WORLD**

AMERICAN HARDWARE MANUFACTURERS
ASSOCIATION (DELAWARE CORPORATION)
801 NORTH PLAZA DRIVE
SCHAUMBURG, IL 60173

FOR: PROVIDING ONLINE NEWSLETTERS FEATURING INFORMATION AND NEWS ARTICLES IN THE FIELD OF HOME IMPROVEMENT, IN CLASS 41 (U.S. CLS. 100, 101 AND 107).

FIRST USE 9-8-2008; IN COMMERCE 9-8-2008.

THE MARK CONSISTS OF STANDARD CHARACTERS WITHOUT CLAIM TO ANY PARTICULAR FONT, STYLE, SIZE, OR COLOR.

OWNER OF U.S. REG. NOS. 3,507,539 AND 3,507,540.

NO CLAIM IS MADE TO THE EXCLUSIVE RIGHT TO USE "INTERNATIONAL" AND "HOME IMPROVEMENT INDUSTRY NEWS FROM AROUND THE WORLD", APART FROM THE MARK AS SHOWN.

SER. NO. 77-570,338, FILED 9-15-2008.

DAVID MILLER, EXAMINING ATTORNEY

Int. Cl.: 7

Prior U.S. Cls.: 13, 19, 21, 23, 31, 34 and 35

United States Patent and Trademark Office

Reg. No. 3,576,174

Registered Feb. 17, 2009

**TRADEMARK
PRINCIPAL REGISTER**

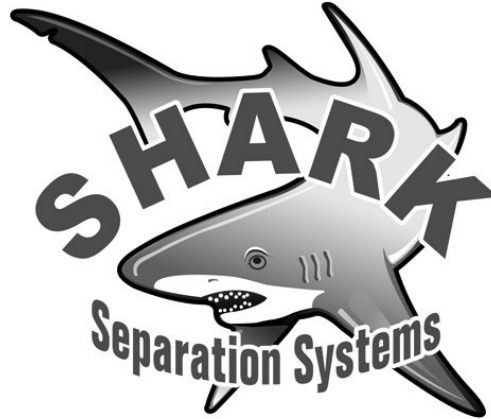

FENDLEY, BRIAN K. (UNITED STATES INDIVIDUAL)
122 SWANSON SOUTHWARD ROAD
ELKIN, NC 28621

FOR: HYDRAULIC CLASSIFIERS, NAMELY, MACHINES FOR SEPARATING SOLID TARGET MATERIALS FROM MIXTURES OF MATERIALS BY CONTROLLED RATES OF SETTLING, IN CLASS 7 (U.S. CLS. 13, 19, 21, 23, 31, 34 AND 35).

FIRST USE 1-14-2008; IN COMMERCE 1-14-2008.

NO CLAIM IS MADE TO THE EXCLUSIVE RIGHT TO USE "SEPARATION SYSTEMS", APART FROM THE MARK AS SHOWN.

THE MARK CONSISTS OF THE STYLIZED WORDING "SHARK" IN A ARC SHAPED ORIENTATION ABOVE THE STYLIZED WORDING "SEPARATION SYSTEMS" IN AN ARC SHAPED ORIENTATION, WITH THE DESIGN OF A SHARK BEHIND THE WORDING, HAVING ITS TAIL ABOVE ITS HEAD.

SER. NO. 77-570,689, FILED 9-16-2008.

JAY BESCH, EXAMINING ATTORNEY

Int. Cl.: 12

Prior U.S. Cls.: 19, 21, 23, 31, 35 and 44

Reg. No. 3,576,175

United States Patent and Trademark Office

Registered Feb. 17, 2009

**TRADEMARK
PRINCIPAL REGISTER**

MAXEY

MAXEY COMPANIES, INC. (COLORADO CORPORATION)

2101 AIRWAY AVE.

FORT COLLINS, CO 80524

FOR: TRUCK BODIES, TRAILERS, IN CLASS 12
(U.S. CLS. 19, 21, 23, 31, 35 AND 44).

FIRST USE 6-1-1969; IN COMMERCE 8-31-1970.

THE MARK CONSISTS OF STANDARD CHARACTERS WITHOUT CLAIM TO ANY PARTICULAR FONT, STYLE, SIZE, OR COLOR.

OWNER OF U.S. REG. NO. 3,498,032.

SEC. 2(F).

SER. NO. 77-573,530, FILED 9-18-2008.

STEVEN R. FINE, EXAMINING ATTORNEY

Int. Cl.: 41

Prior U.S. Cls.: 100, 101 and 107

United States Patent and Trademark Office

Reg. No. 3,576,176

Registered Feb. 17, 2009

**SERVICE MARK
PRINCIPAL REGISTER**

EXPECT GRAND

THE CORPORATE COMMISSION OF THE MILLE LACS BAND OF OJIBWE INDIANS, A TRIBAL GOVERNMENTAL ENTITY OF THE MILLE LACS BAND OF OJIBWE INDIANS (UNITED STATES FEDERALLY-RECOGNIZED INDIAN TRIBE)

BOX 194
700 GRAND AVENUE
ONAMIA, MN 56359

FOR: PROVIDING CASINO FACILITIES AND GAMING SERVICES; ARRANGING AND CONDUCTING CONCERTS, ATHLETIC COMPETITIONS, NAMELY, BOXING, FIGHTING, AND MIXED MARTIAL ARTS CONTESTS; ARRANGING

AND CONDUCTING DINNER THEATER PERFORMANCES AND OTHER LIVE SHOW PERFORMANCES; GOLF COURSE SERVICES, IN CLASS 41 (U.S. CLS. 100, 101 AND 107).

FIRST USE 8-17-2008; IN COMMERCE 8-17-2008.

THE MARK CONSISTS OF STANDARD CHARACTERS WITHOUT CLAIM TO ANY PARTICULAR FONT, STYLE, SIZE, OR COLOR.

SER. NO. 77-574,739, FILED 9-19-2008.

KATHY DE JONGE, EXAMINING ATTORNEY

Int. Cl.: 43

Prior U.S. Cls.: 100 and 101

United States Patent and Trademark Office

Reg. No. 3,576,177

Registered Feb. 17, 2009

**SERVICE MARK
PRINCIPAL REGISTER**

EXPECT GRAND

CORPORATE COMMISSION OF THE MILLE
LACS BAND OF OJIBWE INDIANS, A TRIBAL
GOVERNMENTAL ENTITY OF THE MILLE
LACS BAND OF OJIBWE INDIANS (UNITED
STATES FEDERALLY-RECOGNIZED INDIAN
TRIBE)

BOX 194
700 GRAND AVENUE
ONAMIA, MN 56359

FOR: RESORT HOTEL, RESTAURANT AND BAR
SERVICES, IN CLASS 43 (U.S. CLS. 100 AND 101).

FIRST USE 8-17-2008; IN COMMERCE 8-17-2008.

THE MARK CONSISTS OF STANDARD CHAR-
ACTERS WITHOUT CLAIM TO ANY PARTICULAR
FONT, STYLE, SIZE, OR COLOR.

SER. NO. 77-574,774, FILED 9-19-2008.

KATHLEEN M. VANSTON, EXAMINING ATTOR-
NEY

Int. Cl.: 44

Prior U.S. Cls.: 100 and 101

United States Patent and Trademark Office

Reg. No. 3,576,178

Registered Feb. 17, 2009

**SERVICE MARK
PRINCIPAL REGISTER**

EXPECT GRAND

THE CORPORATE COMMISSION OF THE
MILLE LACS BAND OF OJIBWE INDIANS, A
TRIBAL GOVERNMENTAL ENTITY OF THE
MILLE LACS BAND OF OJIBWE INDIANS
(UNITED STATES FEDERALLY-RECOG-
NIZED INDIAN TRIBE)

BOX 194
700 GRAND AVENUE
ONAMIA, MN 56359

FOR: RESORT HEALTH SPA SERVICES FOR
HEALTH AND WELLNESS OF THE BODY AND
SPIRIT, IN CLASS 44 (U.S. CLS. 100 AND 101).

FIRST USE 9-19-2008; IN COMMERCE 9-19-2008.

THE MARK CONSISTS OF STANDARD CHAR-
ACTERS WITHOUT CLAIM TO ANY PARTICULAR
FONT, STYLE, SIZE, OR COLOR.

SER. NO. 77-574,785, FILED 9-19-2008.

KATHY DE JONGE, EXAMINING ATTORNEY

Int. Cls.: 37 and 42

Prior U.S. Cls.: 100, 101, 103 and 106

United States Patent and Trademark Office

Reg. No. 3,576,179

Registered Feb. 17, 2009

**SERVICE MARK
PRINCIPAL REGISTER**

ELEMCO

ELEMCO TESTING CO., INC. (NEW YORK CORPORATION)
505-3 JOHNSON AVENUE
BOHEMIA, NY 11716

FOR: MAINTENANCE AND REPAIR OF ELECTRICAL EQUIPMENT, LOW VOLTAGE CIRCUIT BREAKERS, METERS, RELAYS AND STATION BATTERIES; RETROFITTING OF CIRCUIT BREAKERS, LIGHTNING PROTECTION UNITS, SPECIALTY GROUNDING UNITS AND LOW VOLTAGE CIRCUIT BREAKERS, IN CLASS 37 (U.S. CLS. 100, 103 AND 106).

FIRST USE 12-31-1969; IN COMMERCE 12-31-1976.

FOR: ELECTRICAL TESTING SERVICES, NAMELY, TESTING OF TRANSFORMERS, CIRCUIT BREAKERS, CABLES, METERS, RELAYS AND ELECTRICAL INSTRUMENTS; HARMONICS AND POWER QUALITY TESTING; ACCEPTANCE TEST-

ING OF NEW ELECTRICAL EQUIPMENT; ELECTRICAL ENGINEERING SERVICES; POWER QUALITY ANALYSIS SERVICES, NAMELY, IN-FRA-RED SCANNING OF ELECTRICAL EQUIPMENT; MARK OUT OF UNDER GROUND UTILITIES; CABLE FAULT LOCATING; METER AND RELAY CALIBRATION; CALIBRATION OF LOW VOLTAGE CIRCUIT BREAKERS, IN CLASS 42 (U.S. CLS. 100 AND 101).

FIRST USE 12-31-1969; IN COMMERCE 12-31-1976.

THE MARK CONSISTS OF STANDARD CHARACTERS WITHOUT CLAIM TO ANY PARTICULAR FONT, STYLE, SIZE, OR COLOR.

SER. NO. 77-575,945, FILED 9-22-2008.

KEVIN DINALLO, EXAMINING ATTORNEY

Int. Cl.: 41

Prior U.S. Cls.: 100, 101 and 107

United States Patent and Trademark Office

Reg. No. 3,576,180

Registered Feb. 17, 2009

**SERVICE MARK
PRINCIPAL REGISTER**

ITSOHIP

CABA, MARTIN A. (UNITED STATES INDIVIDUAL)
45 PIKE STREET APT. 11A
NEW YORK, NY 10002

FOR: MULTIMEDIA ENTERTAINMENT SERVICES IN THE NATURE OF RECORDING STUDIO SERVICES, PRODUCTION SERVICES IN THE FIELDS OF MUSIC, VIDEO, AND FILMS, IN CLASS 41 (U.S. CLS. 100, 101 AND 107).

FIRST USE 11-1-2000; IN COMMERCE 11-1-2000.

THE MARK CONSISTS OF STANDARD CHARACTERS WITHOUT CLAIM TO ANY PARTICULAR FONT, STYLE, SIZE, OR COLOR.

SER. NO. 77-580,310, FILED 9-26-2008.

CARYN GLASSER, EXAMINING ATTORNEY

Int. Cl.: 44

Prior U.S. Cls.: 100 and 101

United States Patent and Trademark Office

Reg. No. 3,576,181

Registered Feb. 17, 2009

**SERVICE MARK
PRINCIPAL REGISTER**

Precious Kittens Cattery

PRECIOUS MACKAY (UNITED STATES INDIVIDUAL)
5355 SUMMERLIN ROAD
PORT SAINT LUCIE, FL 34987

FOR: ANIMAL BREEDING; STUD AND BREEDING SERVICES FOR PERSIAN CATS, IN CLASS 44 (U.S. CLS. 100 AND 101).

FIRST USE 1-1-2000; IN COMMERCE 1-1-2000.

THE MARK CONSISTS OF STANDARD CHARACTERS WITHOUT CLAIM TO ANY PARTICULAR FONT, STYLE, SIZE, OR COLOR.

NO CLAIM IS MADE TO THE EXCLUSIVE RIGHT TO USE "KITTENS CATTERY", APART FROM THE MARK AS SHOWN.

SER. NO. 77-580,315, FILED 9-26-2008.

JUDITH HELFMAN, EXAMINING ATTORNEY

Int. Cl.: 32

Prior U.S. Cls.: 45, 46 and 48

United States Patent and Trademark Office

Reg. No. 3,576,182

Registered Feb. 17, 2009

**TRADEMARK
PRINCIPAL REGISTER**

CASINO DEL SOL

PASCUA YAQUI TRIBE (UNITED STATES FED-
ERALLY-RECOGNIZED INDIAN TRIBE)
7474 S. CAMINO DE OESTE
TUCSON, AZ 85746

OWNER OF U.S. REG. NOS. 2,800,090, 3,027,158
AND OTHERS.

FOR: BOTTLED DRINKING WATER, IN CLASS
32 (U.S. CLS. 45, 46 AND 48).

THE FOREIGN WORDING IN THE MARK
TRANSLATES INTO ENGLISH AS OF THE SUN.

FIRST USE 10-1-2001; IN COMMERCE 10-1-2001.

SER. NO. 77-589,315, FILED 10-9-2008.

THE MARK CONSISTS OF STANDARD CHAR-
ACTERS WITHOUT CLAIM TO ANY PARTICULAR
FONT, STYLE, SIZE, OR COLOR.

KATHY DE JONGE, EXAMINING ATTORNEY

Int. Cl.: 32

Prior U.S. Cls.: 45, 46 and 48

United States Patent and Trademark Office

Reg. No. 3,576,183

Registered Feb. 17, 2009

**TRADEMARK
PRINCIPAL REGISTER**

CASINO OF THE SUN

PASCUA YAQUI TRIBE (UNITED STATES FED-
ERALLY-RECOGNIZED INDIAN TRIBE)

7474 S. CAMINO DE OESTE

TUCSON, AZ 85746

FOR: BOTTLED DRINKING WATER, IN CLASS
32 (U.S. CLS. 45, 46 AND 48).

FIRST USE 10-1-2001; IN COMMERCE 10-1-2001.

THE MARK CONSISTS OF STANDARD CHAR-
ACTERS WITHOUT CLAIM TO ANY PARTICULAR
FONT, STYLE, SIZE, OR COLOR.

OWNER OF U.S. REG. NOS. 2,211,188, 2,213,044,
AND 2,213,045.

SER. NO. 77-589,332, FILED 10-9-2008.

KATHLEEN M. VANSTON, EXAMINING ATTOR-
NEY

Int. Cl.: 43

Prior U.S. Cls.: 100 and 101

United States Patent and Trademark Office

Reg. No. 3,576,184

Registered Feb. 17, 2009

**SERVICE MARK
PRINCIPAL REGISTER**

THE BIGFOOT LODGE

BA2, LLC (CALIFORNIA LIMITED LIABILITY
COMPANY), FORMERLY KNOWN AS THE
BIGFOOT LODGE, LLC

1936 MATEO STREET
LOS ANGELES, CA 90021

FOR: COCKTAIL LOUNGES; BAR SERVICES, IN
CLASS 43 (U.S. CLS. 100 AND 101).

FIRST USE 10-13-1998; IN COMMERCE 6-30-1999.

THE MARK CONSISTS OF STANDARD CHAR-
ACTERS WITHOUT CLAIM TO ANY PARTICULAR
FONT, STYLE, SIZE, OR COLOR.

NO CLAIM IS MADE TO THE EXCLUSIVE
RIGHT TO USE "LODGE", APART FROM THE
MARK AS SHOWN.

SER. NO. 77-975,741, FILED 4-29-2008.

DEIRDRE ROBERTSON, EXAMINING ATTORNEY

Int. Cl.: 42

Prior U.S. Cls.: 100 and 101

United States Patent and Trademark Office

Reg. No. 3,576,185

Registered Feb. 17, 2009

**SERVICE MARK
PRINCIPAL REGISTER**



TUTCO, INC. (PENNSYLVANIA CORPORATION), DBA FARNAM CUSTOM PRODUCTS
500 GOULD DRIVE
COOKEVILLE, TN 38506

FOR: CUSTOM DESIGN OF COMMERCIAL
ELECTRIC HEATING DEVICES FOR END USERS
OF COMMERCIAL ELECTRIC HEATING DEVICES,
IN CLASS 42 (U.S. CLS. 100 AND 101).

FIRST USE 8-0-2002; IN COMMERCE 8-0-2002.

THE MARK CONSISTS OF A CAPITAL "F" INSIDE OF A CIRCLE.

SER. NO. 77-976,064, FILED 5-1-2007.

CAROLYN GRAY, EXAMINING ATTORNEY

Int. Cl.: 25

Prior U.S. Cls.: 22 and 39

United States Patent and Trademark Office

Reg. No. 3,576,186

Registered Feb. 17, 2009

**TRADEMARK
PRINCIPAL REGISTER**

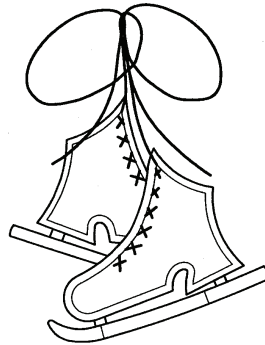

GRIEGER, MELINDA A. (UNITED STATES INDIVIDUAL), DBA LINDY Z
6520 PLATT AVENUE, #856
WEST HILLS, CA 913073218

FOR: CLOTHING AND ACCESSORIES FOR SKATERS, NAMELY, TEE-SHIRTS, JACKETS, PAJAMAS, SHORTS, SCARVES, HEADBANDS, BATHROBES, SLIPPERS, SWEATPANTS, TANK TOPS, BASEBALL SHIRTS AND BASEBALL CAPS, IN CLASS 25 (U.S. CLS. 22 AND 39).

FIRST USE 10-31-2004; IN COMMERCE 10-31-2004.

THE MARK CONSISTS OF PAIR OF ICE SKATES TIED TOGETHER WITH A BOW.

SER. NO. 77-976,082, FILED 6-26-2007.

ANDREA BUTLER, EXAMINING ATTORNEY

Int. Cl.: 39

Prior U.S. Cls.: 100 and 105

United States Patent and Trademark Office

Reg. No. 3,576,187

Registered Feb. 17, 2009

**SERVICE MARK
PRINCIPAL REGISTER**

ENVIROSTONE

NORFOLK SOUTHERN CORPORATION (VIRGINIA CORPORATION)
THREE COMMERCIAL PLACE
NORFOLK, VA 23510

FOR: RAIL FREIGHT TRANSPORTATION, STORAGE AND TRANSLOAD CARGO HANDLING OF STONE AND STONE PRODUCTS FOR OTHERS, IN CLASS 39 (U.S. CLS. 100 AND 105).

FIRST USE 9-29-2006; IN COMMERCE 9-29-2006.

THE MARK CONSISTS OF STANDARD CHARACTERS WITHOUT CLAIM TO ANY PARTICULAR FONT, STYLE, SIZE, OR COLOR.

OWNER OF U.S. REG. NO. 3,288,499.

SER. NO. 77-976,205, FILED 8-28-2007.

ANDREW RHIM, EXAMINING ATTORNEY

Int. Cl.: 41

Prior U.S. Cls.: 100, 101 and 107

United States Patent and Trademark Office

Reg. No. 3,576,188

Registered Feb. 17, 2009

**SERVICE MARK
PRINCIPAL REGISTER**

THE ONCOLOGIST

THE ALPHAMED COMPANY, INC. (NORTH
CAROLINA CORPORATION)
318 BLACKWELL STREET, SUITE 260
DURHAM, NC 27701

FOR: PROVIDING CONTINUING MEDICAL
EDUCATION, CME, IN THE FIELD OF ONCOLOGY
VIA THE INTERNET, IN CLASS 41 (U.S. CLS. 100, 101
AND 107).

FIRST USE 11-9-1999; IN COMMERCE 11-9-1999.

THE MARK CONSISTS OF STANDARD CHAR-
ACTERS WITHOUT CLAIM TO ANY PARTICULAR
FONT, STYLE, SIZE, OR COLOR.

OWNER OF U.S. REG. NO. 2,655,990.

SEC. 2(F).

SER. NO. 77-976,423, FILED 7-5-2007.

LINDA ORNDORFF, EXAMINING ATTORNEY

Int. Cls.: 9, 16, 35, 36, 38, 39, 41 and 42

**Prior U.S. Cls.: 2, 5, 21, 22, 23, 26, 29, 36, 37, 38, 50,
100, 101, 102, 104, 105 and 107**

Reg. No. 3,576,189

United States Patent and Trademark Office

Registered Feb. 17, 2009

**TRADEMARK
SERVICE MARK
PRINCIPAL REGISTER**



DEUTSCHE TELEKOM AG (FED REP GERMA-
NY CORPORATION)

FRIEDRICH-EBERT-ALLEE 140
BONN, FED REP GERMANY 53113

FOR: ELECTRIC, ELECTRONIC, OPTICAL, MEASURING, SIGNALING, CONTROLLING AND TEACHING APPARATUS AND INSTRUMENTS, ALL FOR USE WITH TELECOMMUNICATIONS, NAMELY, APPARATUS FOR PRODUCING SOUND, IMAGES OR DATA, NAMELY, MAGNETIC AND OPTICAL DATA CARRIERS, DATA PROCESSORS AND COMPUTERS, NAMELY, MICROCOMPUTERS, MINICOMPUTERS, COMPUTER CENTRAL PROCESSORS, COMPUTER MONITORS, COMPUTER KEYBOARDS, COMPUTER TERMINALS, COMPUTER INTERFACE BOARDS, COMPUTER MEMORIES, COMPUTER LASER PRINTERS, COMPUTER IMPACT PRINTERS, COMPUTER DOT MATRIX PRINTERS, COMPUTER OPERATING SYSTEMS, COMPUTERS AND INSTRUCTIONAL MANUALS SOLD AS A UNIT, COMPUTER INTERFACE APPARATUS, NAMELY, COMPUTER MODEMS, COMPUTER MOUSE AND MOUSE PAD, COMPUTER PERIPHERALS AND PARTS THEREOF; COMPUTER PROGRAMS AND DATABASES FOR USE IN OPERATING TELECOMMUNICATIONS AND BUSINESS MANAGEMENT SYSTEMS AND RELATED INSTRUCTION MANUALS SOLD AS A UNIT; COMPUTER PROGRAMS, NAMELY, FINANCIAL ACCOUNTING SYSTEM SOFTWARE, SOFTWARE USED FOR THE PROVISION OF ONLINE INFORMATION SERVICES, NETWORK MANAGEMENT SOFTWARE, COMPUTER PROXY SOFTWARE FOR USE WITH OTHER SOFTWARE PROGRAMS, ALARM MONITORING SOFTWARE, BILLING ANALYSIS SOFTWARE, AND SOFTWARE FOR NETWORK ACCESS CONTROL,

CREATING AND MAINTAINING FIREWALLS; COMPUTER PROGRAMS FOR ACCESSING A GLOBAL COMPUTER NETWORK AND INTERACTIVE COMPUTER COMMUNICATIONS NETWORK; OPTICAL CABLES, OPTIC FILTERS, OPTICAL SCANNERS, OPTICAL CHARACTER READERS, OPTICAL DISCS, OPTICAL FIBERS, OPTICAL GLASS FOR SIGNAL TRANSMISSION, OPTIC TRANSMITTERS, OPTIC RECEIVERS, OPTICAL SIGNAL PROCESSING APPARATUS, OPTIC SWITCHES, OPTICAL ATTENUATORS, OPTICAL AMPLIFIERS, OPTICAL CHARACTER RECOGNITION APPARATUS, AND PARTS THEREOF, AUDIO, VIDEO AND DATA COMMUNICATIONS SYSTEMS, NAMELY, DIGITAL AND ANALOGUE SIGNAL TRANSMITTERS, RECEIVERS AND CONVERTERS, RADIO AND TELEPHONE TRANSMITTERS, RECEIVERS AND SERVERS, ANSWERING MACHINES, TELECOMMUNICATION TRANSMISSION, RECEIVING AND STORAGE APPARATUS, NAMELY, TELECOMMUNICATIONS TRANSMITTING SETS, DATA TRANSMITTERS, FACSIMILE MACHINES, ELECTRONIC MAIL APPARATUS FOR ELECTRONIC EXCHANGE OF DATA IMAGES AND MESSAGES, REMOTE CONTROLS AND SET-UP UNITS FOR TELEVISION, CINEMATOGRAPHIC TELEVISION AND AMUSEMENT EQUIPMENT, NAMELY, SIGNAL DECODERS, ELECTRICAL WIRE, ELECTRICAL WIRE CONNECTORS, INTEGRATED CIRCUITS, PRINTED CIRCUITS, ELECTRIC CIRCUITS, CIRCUIT BREAKERS, PRINTED CIRCUIT BOARDS, ELECTRIC CIRCUIT BOARDS, CIRCUIT CONNECTORS, ELECTRICAL CONTROLLERS, ELECTRICAL CONVERTERS, ELECTRICAL FUSES, ELECTRIC LUMINESCENT DISPLAY PANELS, ELECTRICAL SWITCH PLATES, ELECTRIC PLUGS, ANTENNAS, ELECTRICAL CABLES, COMPUTER CABLES, COMPUTER CHIPS, SILICON

CHIPS, CHRONOGRAPHS FOR USE AS SPECIALIZED TIME RECORDING APPARATUS, ELECTRIC COILS, COMPUTER BUFFERS, BLANK COMPUTER DISCS, BLANK COMPUTER FLOPPY DISKS, COMPUTER HARD DISCS, ELECTRICAL CONDUCTORS, ACOUSTIC CONDUITS, ELECTRICAL CONDUITS, FIBER OPTIC CONDUITS AND PARTS THEREOF; COMPACT DISC PLAYERS, AUDIO AND VIDEO TAPE RECORDERS, AUDIO AND VIDEO TAPE PLAYERS, AUDIO AND VIDEO CASSETTE RECORDERS, AUDIO AND VIDEO CASSETTE PLAYERS, BLANK AUDIO AND VIDEO TAPES, CASSETTES, DISCS AND MICROFICHE; AUDIO AND VIDEO TAPES, CASSETTES, DISCS AND MICROFICHE FEATURING INFORMATION CONCERNING TELECOMMUNICATIONS, AND CONCERNING PERSONAL AND BUSINESS MANAGEMENT SYSTEMS; AUDIO AND VIDEO RECORDINGS IN THE FIELD OF TELECOMMUNICATIONS, INFORMATION TECHNOLOGY, AND SAFETY; TELEVISION AND TELEVISION PERIPHERAL EQUIPMENT, NAMELY CAMERAS, SET BOXES, REMOTE CONTROL UNITS FOR INTERACTIVE AND NON-INTERACTIVE USE; COMPUTER MEMORY, COMPUTER PERIPHERALS AND MODEMS; VIDEO MONITORS, AUTOMATIC VENDING MACHINES AND TIMING MECHANISMS THEREFOR, AND PARTS THEREOF; MACHINE READABLE, MAGNETICALLY ENCODED CARDS, NAMELY, TELEPHONE CALLING CARDS AND CREDIT CARDS; BLANK SMART CARDS; DATA PROCESSORS AND READERS, WORD PROCESSORS, MAGNETIC CODED CARD READERS, MAGNETIC CODED CARDS, ELECTRONIC ENCRYPTION UNITS, LASERS NOT FOR MEDICAL USE, LIGHT EMITTING DIODES, LIGHT EMITTING DIODE DISPLAYS, MICROPROCESSORS, BLANK DATA CARRIERS, DEMAGNETIZERS FOR MAGNETIC TAPES, AND PARTS THEREOF TELECONFERENCING EQUIPMENT AND AUDIOVISUAL TEACHING EQUIPMENT IN THE NATURE OF OVERHEAD FILM, PHOTOGRAPHIC AND SLIDE PROJECTORS, PROJECTION SCREENS, COMPUTER BASED INFORMATION DISPLAY EQUIPMENT, NAMELY, COMPUTERS WHICH DISPLAY INFORMATION ON AN OVERHEAD SCREEN, INTERCOMS; TELEPHONES, TELEPHONE ANSWERING MACHINES, TELEPHONE TRANSMITTERS, TELEPHONE NETWORKS, TELEPHONE WIRES, TELEPRINTERS, TELETYPEWRITERS, AND PARTS THEREOF, NAMELY, CALLER IDENTIFICATION BOXES, DIALING ASSEMBLIES, TELEPHONE UNIT AND AUDIO OPERATED RELAYS, AUDIO OPERATED RELAYS, AUDIO/VIDEO SIGNAL AND OPTICAL FILTERS, PROTECTORS AND AUTOMATIC SIGNALING AND CONTROL EQUIPMENT, TELEMETERS, WIRELESS AND CELLULAR TELEPHONES, RADIO PAGERS, PORTABLE COMPUTER DEVICES, NAMELY LAPTOPS, HANDHELD AND POCKET COMPUTERS, FACSIMILE TRANSMITTERS AND RECEIVERS, WIRELESS FAX MACHINES, PERSONAL COMMUNICATIONS EQUIPMENT, NAMELY, PERSONAL DIGITAL ASSISTANTS, CALCULATORS AND RELATED PERIPHERALS; SATELLITE PROCESSORS, SATELLITES AND SATELLITE COMMUNICATION EARTH STATIONS BOTH

STATIONARY AND MOVEABLE; AUDIO AND VIDEO RECORDINGS IN THE FIELD OF NEWS, SPORTS, ENTERTAINMENT, CULTURE, BUSINESS AND FINANCE, WEATHER AND TRAVEL; PRE-RECORDED COMPACT DISCS, AUDIO CASSETTE TAPES, VIDEO CASSETTE TAPES, DIGITAL AUDIO TAPES AND DIGITAL VIDEO DISCS FEATURING MUSICAL, VARIETY, NEWS AND COMEDY SHOWS; COMPUTER GAME PROGRAMS FOR CHILDREN AND ADULTS; VIDEO AND COMPUTER GAME CARTRIDGES, IN CLASS 9 (U.S. CLS. 21, 23, 26, 36 AND 38).

FOR: PRINTED MATTER, NAMELY, TELEPHONE DIRECTORIES, BOOKS, NEWSLETTERS, PAMPHLETS, BROCHURES, MAGAZINES AND PAPERBACKS ALL IN THE FIELD OF TELECOMMUNICATIONS, PRINTED AND STAMPED PLASTIC AND CARDBOARD GREETING, BLANK, NOTE, AND INDEX CARDS; NOTE PAPER AND ENVELOPES, RUBBER STAMPS, NAME TAGS AND LABELS MADE FROM PAPER OR CARDBOARD, NOTEBOOKS, DIARIES, NOTE PAPERS, NOTE PADS, ADDRESS BOOKS, FOLDERS FOR LETTERS, FILES OR LOOSE PAPER, CLEAR HOLE REINFORCEMENTS, STUDENT CALENDARS, STAMP ALBUMS AND PHOTO-ALBUMS; PAPER WEIGHTS, LETTER OPENERS, BLOTTING PADS; DESK TRAYS, DESK STANDS AND HOLDERS FOR HOLDING STATIONERY AND OFFICE IMPLEMENTS; PRINTED INSTRUCTIONAL AND TEACHING MATERIALS ALL IN THE FIELDS OF TELECOMMUNICATIONS, INFORMATION TECHNOLOGY, SAFETY, NEWS, SPORTS, ENTERTAINMENT, CULTURE, BUSINESS AND FINANCE, WEATHER AND TRAVEL; STATIONERY, DRAWING AND UNGRADUATED RULERS, ERASERS, STAPLERS, STAPLES, PAPER CLIPS, BOOK MARKERS, CUTOUT SAMPLES AND STENCILS; SCRATCH PICTURES, PAPER, NAMELY, BOND PAPER AND ART PAPER, PVC STICKERS, GIFT WRAP PAPER; BLACKBOARDS, CHALK STICKS, ADHESIVES FOR STATIONERY OR HOUSEHOLD PURPOSES; DRAWING AND PAINTING MATERIALS, NAMELY, PENCILS, DRAWING PENCILS, PENS, DRAWING PENS, PAINT TRAYS, PAINTING SETS FOR ARTISTS, PAINTING SETS FOR CHILDREN, PAINT KITS, AND PENCIL CASES; NON-MAGNETICALLY ENCODED, PREPAID TELEPHONE CALLING CARDS, IN CLASS 16 (U.S. CLS. 2, 5, 22, 23, 29, 37, 38 AND 50).

FOR: ADVERTISING SERVICES, NAMELY, PREPARING AND PLACING ADVERTISEMENTS FOR OTHERS PROMOTING THE GOODS AND SERVICES OF OTHERS THROUGH PRINTED ADVERTISING, PRINTED DIRECTORIES, THROUGH ENCODED MEDIA, THROUGH THE DISSEMINATION OF PROMOTIONAL MATERIALS, THROUGH DIRECT MAIL ADVERTISING, THROUGH ELECTRONIC BILLBOARD ADVERTISING, PREPARING AUDIO-VISUAL PRESENTATIONS FOR USE IN ADVERTISING; BUSINESS SERVICES, NAMELY, BUSINESS APPRAISALS, BUSINESS AUDITING, PROVIDING BUSINESS INFORMATION, NAMELY, PREPARING BUSINESS REPORTS AND CONDUCTING BUSINESS RE-

SEARCH, ANALYSIS AND SURVEYS, BUSINESS MANAGEMENT PLANNING, BUSINESS MANAGEMENT CONSULTATION, BUSINESS MANAGEMENT SUPERVISION, CONDUCTING BUSINESS NETWORKING FOR OTHERS; BUSINESS MANAGEMENT AND CONSULTING SERVICES EXCLUDING AGRICULTURAL BUSINESS MANAGEMENT AND CONSULTING SERVICES; BUSINESS INFORMATION SERVICES IN THE FIELD OF TELECOMMUNICATIONS, ADVERTISING, INFORMATION TECHNOLOGY, MARKETING AND RELATED FIELDS; RENTAL OF AUTOMATIC VENDING MACHINES; ORGANIZING JOB FAIRS; RENTAL OF DATA PROCESSING EQUIPMENT; PROFESSIONAL CONSULTANCY IN THE FIELD OF DATA PROCESSING; PROVIDING INFORMATION VIA THE TELEPHONE AND THE GLOBAL COMMUNICATION NETWORKS IN THE FIELD OF BUSINESS; RENTAL OF DATA PROCESSING EQUIPMENT, IN CLASS 35 (U.S. CLS. 100, 101 AND 102).

FOR: CLEARING OF SECURE FINANCIAL TRANSACTIONS THROUGH ONLINE SERVICES; FINANCIAL AND MONETARY AFFAIRS, NAMELY FINANCIAL ANALYSIS AND CONSULTATION, PROVIDING FINANCIAL INFORMATION, ISSUANCE OF SECURITIES, COMMERCIAL LENDING SERVICES, FINANCIAL PORTFOLIO MANAGEMENT, DISCOUNT BROKERAGE SERVICES, BROKERAGE OF SHARES, OF SETS AND BUSINESS VENTURES, BROKERAGE OF FUND SHARES, SECURITIES CONSULTING AND SAFE KEEPING, BROKERAGE OF PRODUCTIVE INVESTMENTS AND FUNDS; FINANCIAL SPONSORSHIP OF SPORTS, EDUCATIONAL AND ENTERTAINMENT PROGRAMS AND EVENTS; REAL ESTATE SERVICES, NAMELY BROKERAGE, MANAGEMENT, LEASING, APPRAISAL OF REAL PROPERTY; CUSTOMS BROKERAGE FOR THIRD PARTIES; MONETARY EXCHANGE; CREDIT CARD SERVICES; TELEPHONE CALLING CARD SERVICES; ELECTRONIC COMMERCE SERVICES, NAMELY, ELECTRONIC DEBIT AND CREDIT CARD PROCESSING SERVICES, FUNDS TRANSFER AND PAYMENT PROCESSING SERVICES; PROVIDING INFORMATION VIA THE TELEPHONE AND THE GLOBAL COMMUNICATION NETWORKS IN THE FIELD OF FINANCE, IN CLASS 36 (U.S. CLS. 100, 101 AND 102).

FOR: TELECOMMUNICATIONS AND INFORMATION TECHNOLOGY SERVICES, NAMELY ELECTRIC, DIGITAL, CELLULAR AND WIRELESS TRANSMISSION OF VOICE, DATA, INFORMATION, IMAGES, SIGNALS AND MESSAGES AND TRANSMISSION OF VOICE, DATA, IMAGES, AUDIO, VIDEO AND INFORMATION VIA TELEPHONE, TELEVISION AND GLOBAL COMMUNICATION NETWORKS; PROVIDING TELECOMMUNICATIONS CONNECTIONS OVER A GLOBAL COMMUNICATIONS NETWORK, ELECTRONIC MAIL, VOICE MAIL AND MESSAGING SERVICES, NAMELY, THE RECORDING AND STORAGE AND SUBSEQUENT TRANSMISSION OF VOICE MESSAGES BY TELEPHONE; RENTAL OF TELECOMMUNICATIONS EQUIP-

MENT, NAMELY, EQUIPMENT FOR ELECTRONIC ACCESS TO GLOBAL TELECOMMUNICATIONS NETWORK, EQUIPMENT FOR TRANSMITTING, RECEIVING, RECORDING AND MONITORING VOICE, DATA, INFORMATION, IMAGES, SIGNALS, MESSAGES, COMPRISED OF DATA AND WORD PROCESSORS, AND TELECOMMUNICATIONS HARDWARE AND SOFTWARE INCLUDING COMPONENTS AND PERIPHERALS THEREOF FOR USE IN THE TELECOMMUNICATIONS INDUSTRY, AND RENTAL OF EQUIPMENT FOR TRANSMITTING, RECEIVING, RECORDING AND MONITORING COMPUTER PROGRAMS FOR USE IN OPERATING AND ACCESSING TELECOMMUNICATIONS SYSTEMS; AUDIO AND VIDEO BROADCASTING FEATURING ENTERTAINMENT IN THE NATURE OF LIVE VISUAL AND AUDIO PERFORMANCES, AND MUSICAL, VARIETY, NEWS AND COMEDY SHOWS; PROVIDING ACCESS TO COMPUTER INFORMATION NETWORKS; PERSONAL COMMUNICATIONS SERVICES; PAGER SERVICES; ELECTRONIC MAIL SERVICES; TRANSMISSION AND BROADCAST OF AUDIO AND VIDEO PROGRAMMING; PROVIDING MULTIPLE-USER ACCESS TO A GLOBAL COMMUNICATION NETWORK; LEASING TELECOMMUNICATIONS EQUIPMENT, COMPONENTS, SYSTEMS AND SUPPLIES; CONSULTING IN THE FIELD OF TELECOMMUNICATIONS AND GLOBAL COMMUNICATION NETWORKS, IN CLASS 38 (U.S. CLS. 100, 101 AND 104).

FOR: WAREHOUSE STORAGE OF GOODS; STORAGE OF GOODS RELATING TO TELECOMMUNICATIONS, COMPUTERS AND OTHER INFORMATION TECHNOLOGY DEVICES; TRANSPORTATION OF GOODS BY TRUCK, SHIP, RAILWAY AND PLANE; PROVIDING INFORMATION VIA TELEPHONE AND GLOBAL COMPUTER NETWORKS IN THE FIELD OF TRAVEL; ELECTRONIC STORAGE OF INFORMATION IN THE NATURE OF FILES AND DOCUMENTS, IN CLASS 39 (U.S. CLS. 100 AND 105).

FOR: EDUCATION AND INSTRUCTION, NAMELY, EDUCATIONAL SERVICES IN THE NATURE OF CLASSES AND SEMINARS IN THE FIELDS OF BUSINESS, TELECOMMUNICATIONS AND INFORMATION TECHNOLOGY, AND THE DISTRIBUTION OF COURSE MATERIALS THEREWITH; ENTERTAINMENT IN THE NATURE OF VISUAL AND AUDIO LIVE PERFORMANCES, NAMELY, MUSICAL BAND, ROCK GROUP, GYMNASTIC, DANCE, AND BALLET PERFORMANCES; ENTERTAINMENT SERVICES, NAMELY, PROVIDING ONLINE COMPUTER GAMES FOR CHILDREN AND ADULTS; PROVIDING GENERAL INFORMATION VIA TELEPHONE, TELEVISION AND GLOBAL COMMUNICATIONS NETWORKS IN THE FIELD OF ENTERTAINMENT; ORGANIZING COMMUNITY SPORTING AND CULTURAL EVENTS; PUBLICATION OF BOOKS, MAGAZINES, JOURNALS, MANUALS, BROCHURES AND LEAFLETS ON THE SUBJECT OF TELECOMMUNICATIONS; ELECTRONIC PUBLISHING SERVICES, NAMELY, PUB-

LICATION OF TEXT AND GRAPHIC WORKS OF OTHERS ON TELECOMMUNICATIONS RECORDED ON ELECTRONIC MEDIA; ORGANIZING FAIRS AND EXHIBITIONS IN THE FIELD OF LIVE VISUAL AND AUDIO PERFORMANCES, NAMELY, ROCK GROUP, GYMNAS TIC, DANCE, AND BALLET PERFORMANCES, IN CLASS 41 (U.S. CLS. 100, 101 AND 107).

FOR: COMPUTER PROGRAMMING SERVICES FOR OTHERS; RENTAL OF SOFTWARE AND HARDWARE FOR ONLINE ACCESS; SERVICES OF AN INTERNET TRUST CENTER, NAMELY, ASSURANCE AND ADMINISTRATION OF DIGITAL KEYS AND/OR DIGITAL CERTIFICATES; GENERATION OF DATA PROCESSING PROGRAMS; WEB PAGE HOSTING SERVICES; COMPUTER SERVICES, NAMELY, CREATING INDEXES OF INFORMATION AVAILABLE ON COMPUTER NETWORKS; CONSULTING AND DESIGN SERVICES IN THE FIELD OF INFORMATION TECHNOLOGY, AND COMPUTER PROGRAMMING; DESIGN SERVICES IN THE FIELD OF TELECOMMUNICATIONS AND GLOBAL COM-

MUNICATION NETWORKS; INSTALLATION, MAINTENANCE AND REPAIR OF COMPUTER SOFTWARE, IN CLASS 42 (U.S. CLS. 100 AND 101).

PRIORITY CLAIMED UNDER SEC. 44(D) ON FED REP GERMANY APPLICATION NO. 30224473.5/0, FILED 5-15-2002, REG. NO. 30224473, DATED 8-6-2002, EXPIRES 5-31-2012.

OWNER OF U.S. REG. NO. 2,367,890.

THE MARK CONSISTS OF THE FOLLOWING COLORS: THE CIRCLE AROUND THE LETTER "T" IS MAGENTA; THE LETTER "T" IN THE CIRCLE AND THE LINE FOLLOWING FROM THE LETTER "T" ARE WHITE; AND THE WORD "ZONES" IS GREY. THE APPLICANT CLAIMS THE COLORS MAGENTA, GREY AND WHITE AS A FEATURE OF THE MARK.

SER. NO. 78-184,591, FILED 11-13-2002.

JOHN KELLY, EXAMINING ATTORNEY

Int. Cls.: 5 and 31

Prior U.S. Cls.: 1, 6, 18, 44, 46, 51 and 52

United States Patent and Trademark Office

Reg. No. 3,576,190

Registered Feb. 17, 2009

**TRADEMARK
PRINCIPAL REGISTER**



TADEUSZ OGRODNIK (POLAND PRIVATE ENTERPRISE), DBA TROPICAL
UL. WOLNOSCI 69
41-500 CHORZOW, POLAND

FOR: VETERINARY, THERAPEUTIC PRODUCTS, DISINFECTING AND SANITARY PRODUCTS AND PREPARATIONS FOR USE IN AQUARISTICS, TERRARISTICS, FAUNA BREEDING, NAMELY, MEDICATIONS, ANTISEPTICS, BIOCIDES, IN PARTICULAR, BACTERICIDES AND FUNGICIDES; DISINFECTANTS AND SANITARY PRODUCTS AND PREPARATIONS FOR USE IN FLORA CULTIVATION, NAMELY, ALGAE-CIDES, BIOCIDES, IN PARTICULAR, BACTERICIDES AND FUNGICIDES; DISINFECTANTS FOR CONDITIONING WATER; PREPARATIONS FOR PROTECTING ANIMALS AGAINST INFECTIONS; HEALTH AIDS AND NUTRITIONAL ADDITIVES FOR ANIMALS, NAMELY, DIET SUPPLEMENTS IN THE NATURE OF VITAMIN, MACRO-COMPONENTS AND TRACE-ELEMENTS FORMULATIONS FOR FISH, ORNAMENTAL FISH, BIRDS, REPTILES, AMPHIBIANS AND BREEDED SMALL DOMESTIC ANIMALS; NUTRITIONAL ADDITIVES FOR ANIMALS AND SUPPLEMENTS FOR ANIMAL FOODSTUFFS, IN CLASS 5 (U.S. CLS. 6, 18, 44, 46, 51 AND 52).

FOR: FOODS, IN PARTICULAR, IN THE FORM OF FLAKES, TABLETS, PASTES, POWDERS, GRANULATES, GRAINS AND EXTRUDATES, DRIED AND LYOPHILIZED NATURAL FOODS FOR FAUNA, ESPECIALLY FOR FISH, ORNAMENTAL FISH, BIRDS, REPTILES, AMPHIBIANS AND BREEDED SMALL ANIMALS, FOODS FOR FAUNA CONTAINING NUTRITIVES, STRENGTHENING IMMUNITY,

VITALITY AND COLORATION, IN CLASS 31 (U.S. CLS. 1 AND 46).

OWNER OF SPAIN REG. NO. 003435773, DATED 9-7-2007, EXPIRES 10-31-2013.

NO CLAIM IS MADE TO THE EXCLUSIVE RIGHT TO USE "TROPICAL" AS TO DISINFECTANTS AND SANITARY PRODUCTS AND PREPARATIONS FOR USE IN FLORA CULTIVATION, NAMELY, ALGAE-CIDES, BIOCIDES, IN PARTICULAR, BACTERICIDES AND FUNGICIDES; PREPARATIONS FOR PROTECTING ANIMALS AGAINST INFECTIONS; HEALTH AIDS AND NUTRITIONAL ADDITIVES FOR ANIMALS, NAMELY, DIET SUPPLEMENTS IN THE NATURE OF VITAMIN, MACRO-COMPONENTS AND TRACE-ELEMENTS FORMULATIONS FOR FISH AND ORNAMENTAL FISH; NUTRITIONAL ADDITIVES FOR ANIMALS AND SUPPLEMENTS FOR ANIMAL FOODSTUFFS, IN INTERNATIONAL CLASS 5; FOODS, IN PARTICULAR, IN THE FORM OF FLAKES, TABLETS, PASTES, POWDERS, GRANULATES, GRAINS AND EXTRUDATES, DRIED AND LYOPHILIZED NATURAL FOODS FOR FAUNA, ESPECIALLY FOR FISH, ORNAMENTAL FISH, BIRDS, REPTILES, AMPHIBIANS AND BREEDED SMALL ANIMALS, FOODS FOR FAUNA CONTAINING NUTRITIVES, STRENGTHENING IMMUNITY, VITALITY AND COLORATION, IN INTERNATIONAL CLASS 31, APART FROM THE MARK AS SHOWN.

SER. NO. 78-206,986, FILED 1-24-2003.

MARY I. SPARROW, EXAMINING ATTORNEY

Int. Cls.: 9, 16, 35, 36, 38, 39, 41 and 42

**Prior U.S. Cls.: 2, 5, 21, 22, 23, 26, 29, 36, 37, 38, 50,
100, 101, 102, 104, 105 and 107**

Reg. No. 3,576,191

United States Patent and Trademark Office

Registered Feb. 17, 2009

**TRADEMARK
SERVICE MARK
PRINCIPAL REGISTER**



DEUTSCHE TELEKOM AG (FED REP GERMA-
NY CORPORATION)
FRIEDRICH-EBERT-ALLEE 140
BONN, FED REP GERMANY 53113

FOR: ELECTRIC, ELECTRONIC, OPTICAL, MEASURING, SIGNALING, CONTROLLING AND TEACHING APPARATUS AND INSTRUMENTS, ALL FOR USE WITH TELECOMMUNICATIONS, NAMELY, APPARATUS FOR PRODUCING SOUND, IMAGES OR DATA, NAMELY, MAGNETIC AND OPTICAL DATA CARRIERS AND DATA PROCESSORS; COMPUTER PROGRAMS AND DATABASES FOR USE IN OPERATING TELECOMMUNICATIONS AND BUSINESS MANAGEMENT SYSTEMS AND RELATED INSTRUCTION MANUALS SOLD AS A UNIT; COMPUTER PROGRAMS, NAMELY, FINANCIAL ACCOUNTING SYSTEM SOFTWARE, COMMUNICATIONS SOFTWARE FOR CONNECTING TO GLOBAL COMPUTER NETWORKS, NETWORK MANAGEMENT SOFTWARE, COMPUTER PROXY SOFTWARE FOR USE WITH OTHER SOFTWARE PROGRAMS, COMPUTER PROGRAMS AND SOFTWARE FOR CONTROLLING ACCESS AND ALARM MONITORING OF HOMES, APARTMENTS, BUILDINGS AND OTHER PROPERTIES, BILLING ANALYSIS SOFTWARE, AND SOFTWARE FOR NETWORK ACCESS CONTROL AND FOR CREATING AND MAINTAINING FIREWALLS; COMPUTER PROGRAMS FOR ACCESSING A GLOBAL COMPUTER NETWORK AND INTERACTIVE COMPUTER COMMUNICATIONS NETWORK; OPTICAL CABLES, OPTIC FILTERS, OPTICAL SCANNERS, OPTICAL CHARACTER READERS, OPTICAL DISCS, OPTICAL FIBERS, OPTICAL GLASS FOR SIGNAL TRANSMISSION, OPTIC TRANSMITTERS, OPTIC RECEIVERS, OPTICAL SIGNAL PROCESSING APPARATUS, OPTIC SWITCHES, OPTICAL ATTENUATORS, OPTICAL AMPLIFIERS, OPTICAL CHARACTER RECOGNITION

APPARATUS, AND PARTS THEREOF, AUDIO, VIDEO AND DATA COMMUNICATIONS SYSTEMS, NAMELY, DIGITAL AND ANALOGUE SIGNAL TRANSMITTERS, RECEIVERS AND CONVERTERS, RADIO AND TELEPHONE TRANSMITTERS, RECEIVERS AND SERVERS, ANSWERING MACHINES, TELECOMMUNICATION TRANSMISSION, RECEIVING AND STORAGE APPARATUS, NAMELY; TELECOMMUNICATIONS TRANSMITTING SETS, DATA TRANSMITTERS, FACSIMILE MACHINES, ELECTRONIC MAIL APPARATUS FOR ELECTRONIC EXCHANGE OF DATA IMAGES AND MESSAGES, REMOTE CONTROLS AND SET-TOP UNITS FOR TELEVISION, CINEMATOGRAPHIC TELEVISION AND AMUSEMENT EQUIPMENT, NAMELY, SIGNAL DECODERS, ELECTRICAL WIRE, ELECTRICAL WIRE CONNECTORS, INTEGRATED CIRCUITS, PRINTED CIRCUITS, ELECTRIC CIRCUITS, CIRCUIT BREAKERS, PRINTED CIRCUIT BOARDS, ELECTRIC CIRCUIT BOARDS, CIRCUIT CONNECTORS, ELECTRICAL CONTROLLERS, ELECTRICAL CONVERTERS, ELECTRICAL USES, ELECTRIC LUMINESCENT DISPLAY PANELS, ELECTRICAL PLATES, ELECTRIC PLUGS, ANTENNAS, ELECTRICAL CABLES, COMPUTER CABLES, COMPUTER CHIPS; SILICON CHIPS, CHRONOGRAPHS FOR USE AS SPECIALIZED TIME RECORDING APPARATUS, ELECTRIC COILS, COMPUTER BUFFERS, BLANK COMPUTER DISCS, BLANK COMPUTER FLOPPY DISKS, COMPUTER HARD DISCS, ELECTRICAL CONDUCTORS, ACOUSTIC CONDUITS, ELECTRICAL CONDUITS, FIBER OPTIC CONDUITS AND PARTS THEREOF; COMPACT DISC PLAYERS, AUDIO AND VIDEO TAPE RECORDERS, AUDIO AND VIDEO TAPE PLAYERS, AUDIO AND VIDEO CASSETTE RECORDERS, AUDIO AND VIDEO CASSETTE PLAYERS, BLANK AUDIO AND VIDEO TAPES, CASSETTES, DISCS AND MICROFICHE; AUDIO AND VIDEO TAPES, CASSETTES, DISCS

AND MICROFICHE FEATURING INFORMATION CONCERNING TELECOMMUNICATIONS, AND CONCERNING PERSONAL AND BUSINESS MANAGEMENT SYSTEMS; AUDIO AND VIDEO RECORDINGS IN THE FIELD OF TELECOMMUNICATIONS, INFORMATION TECHNOLOGY, SAFETY; TELEVISION AND TELEVISION PERIPHERAL EQUIPMENT, NAMELY CAMERAS, SET BOXES, REMOTE CONTROL UNITS FOR INTERACTIVE AND NON-INTERACTIVE USE; COMPUTER MEMORY, COMPUTER PERIPHERALS AND MODEMS; VIDEO MONITORS, AUTOMATIC VENDING MACHINES AND TIMING MECHANISMS THEREFOR, AND PARTS THEREOF; MACHINE READABLE, MAGNETICALLY ENCODED CARDS, NAMELY, PREPAID TELEPHONE CALLING CARDS AND CREDIT CARDS; BLANK SMART CARDS; DATA PROCESSORS AND READERS, WORD PROCESSORS, MAGNETIC CODED CARD READERS, MAGNETIC CODED CARDS, NAMELY, FIDELITY CARDS, ELECTRONIC ENCRYPTION UNITS, LASERS NOT FOR MEDICAL USE, LIGHT EMITTING DIODES, LIGHT EMITTING DIODE DISPLAYS, MICROPROCESSORS, BLANK DATA CARRIERS, DEMAGNETIZERS FOR MAGNETIC TAPES, AND PARTS THEREOF, TELECONFERENCING EQUIPMENT AND AUDIOVISUAL TEACHING EQUIPMENT IN THE NATURE OF OVERHEAD FILM, PHOTOGRAPHIC AND SLIDE PROJECTORS, PROJECTION SCREENS, COMPUTER BASED INFORMATION DISPLAY EQUIPMENT, NAMELY, COMPUTERS WHICH DISPLAY INFORMATION ON AN OVERHEAD SCREEN, INTERCOMS; TELEPHONES, TELEPHONE ANSWERING MACHINES, TELEPHONE TRANSMITTERS, TELEPHONE NETWORKS, TELEPHONE WIRES, TELEPRINTERS, TELETYPEWRITERS, AND PARTS THEREOF, NAMELY, CALLER IDENTIFICATION BOXES, DIALING ASSEMBLIES, TELEPHONE UNIT AND AUDIO OPERATED RELAYS, AUDIO OPERATED RELAYS, AUDIO/VIDEO SIGNAL AND OPTICAL FILTERS, PROTECTORS AND AUTOMATIC SIGNALING AND CONTROL EQUIPMENT, TELEMETERS, WIRELESS AND CELLULAR TELEPHONES, RADIO PAGERS, PORTABLE COMPUTER DEVICES, NAMELY LAPTOPS, HANDHELD AND POCKET COMPUTERS, FACSIMILE TRANSMITTERS AND RECEIVERS, WIRELESS FAX MACHINES, PERSONAL COMMUNICATIONS EQUIPMENT, NAMELY, PERSONAL DIGITAL ASSISTANTS, CALCULATORS AND RELATED PERIPHERALS; SATELLITE PROCESSORS, SATELLITES AND SATELLITE COMMUNICATION EARTH STATIONS BOTH STATIONARY AND MOVEABLE; AUDIO AND VIDEO RECORDINGS IN THE FIELD OF NEWS, SPORTS, ENTERTAINMENT, CULTURE, BUSINESS AND FINANCE, WEATHER AND TRAVEL; PRE-RECORDED COMPACT DISCS, AUDIO CASSETTE TAPES, VIDEO CASSETTE TAPES, DIGITAL AUDIO TAPES AND DIGITAL VIDEO DISCS FEATURING MUSICAL, VARIETY, NEWS AND COMEDY SHOWS; COMPUTER GAME PROGRAMS FOR CHILDREN AND ADULTS; VIDEO AND COMPUTER GAME CARTRIDGES, IN CLASS 9 (U.S. CLS. 21, 23, 26, 36 AND 38).

FOR: PRINTED MATTER, NAMELY, TELEPHONE DIRECTORIES, BOOKS, NEWSLETTERS, PAMPHLETS, BROCHURES, MAGAZINES AND PAPERBACKS ALL IN THE FIELD OF TELECOMMUNICATIONS, STAMPED AND/OR PRINTED CARDS OF CARDBOARD OR PLASTIC, NAMELY, BASEBALL CARDS, GREETING CARDS, TRADING CARDS, TRIVIA CARDS; NOTE PAPER AND ENVELOPES, RUBBER STAMPS, NAME TAGS AND LABELS MADE FROM PAPER OR CARDBOARD, NOTEBOOKS, DIARIES, NOTE PAPERS, NOTE PADS, ADDRESS BOOKS, FOLDERS FOR LETTERS OR LOOSE PAPERS, CLEAR HOLE REINFORCEMENTS, STUDENT CALENDARS, STAMP ALBUMS AND PHOTO-ALBUMS; PAPER WEIGHTS, LETTER OPENERS, BLOTTING PADS; DESK TRAYS, DESK STANDS AND HOLDERS FOR HOLDING STATIONERY AND OFFICE IMPLEMENTS; PRINTED INSTRUCTIONAL AND TEACHING MATERIALS ALL IN THE FIELDS OF TELECOMMUNICATIONS, INFORMATION TECHNOLOGY, SAFETY, NEWS, SPORTS, ENTERTAINMENT, CULTURE, BUSINESS AND FINANCE, WEATHER AND TRAVEL; STATIONERY, DRAWING AND UNGRADUATED RULERS, ERASERS, STAPLERS, STAPLES, PAPER CLIPS, BOOK MARKERS, CUTOUT SAMPLES AND STENCILS; SCRATCH PICTURES, PAPER, NAMELY, BOND PAPER AND ART PAPER, PVC STICKERS, GIFT WRAP PAPER; BLACKBOARDS, CHALK STICKS, ADHESIVES FOR STATIONERY OR HOUSEHOLD PURPOSES; DRAWING AND PAINTING MATERIALS, NAMELY, PENCILS, DRAWING PENCILS, PENS, DRAWING PENS, PAINT TRAYS, PAINTING SETS FOR ARTISTS, PAINTING SETS FOR CHILDREN, CRAFT PAINT KITS, AND PENCIL CASES; NON-MAGNETICALLY ENCODED, PREPAID TELEPHONE CALLING CARDS, IN CLASS 16 (U.S. CLS. 2, 5, 22, 23, 29, 37, 38 AND 50).

FOR: ADVERTISING SERVICES, NAMELY, PREPARING AND PLACING ADVERTISEMENTS FOR OTHERS PROMOTING THE GOODS AND SERVICES OF OTHERS THROUGH PRINTED ADVERTISING, PRINTED DIRECTORIES, THROUGH ENCODED MEDIA, THROUGH THE DISSEMINATION OF PROMOTIONAL MATERIALS, THROUGH DIRECT MAIL ADVERTISING, THROUGH ELECTRONIC BILLBOARD ADVERTISING, PREPARING AUDIO-VISUAL PRESENTATIONS FOR USE IN ADVERTISING; BUSINESS SERVICES, NAMELY, BUSINESS APPRAISALS, BUSINESS AUDITING, PROVIDING BUSINESS INFORMATION, NAMELY, PREPARING BUSINESS REPORTS AND CONDUCTING BUSINESS RESEARCH, ANALYSIS AND SURVEYS, BUSINESS MANAGEMENT PLANNING, BUSINESS MANAGEMENT CONSULTATION, BUSINESS MANAGEMENT SUPERVISION, CONDUCTING BUSINESS NETWORKING FOR OTHERS; BUSINESS MANAGEMENT AND CONSULTING SERVICES EXCLUDING AGRICULTURAL BUSINESS MANAGEMENT AND CONSULTING SERVICES; BUSINESS INFORMATION SERVICES IN THE FIELD OF TELECOMMUNICATIONS, ADVERTISING, INFORMATION TECHNOLOGY AND MARKETING; RENTAL OF AUTOMATIC VENDING

MACHINES; ORGANIZING JOB FAIRS; PROFESSIONAL CONSULTANCY IN THE FIELD OF DATA PROCESSING; RENTAL OF DATA PROCESSING EQUIPMENT; PROVIDING INFORMATION VIA THE TELEPHONE AND THE GLOBAL COMMUNICATION NETWORKS IN THE FIELD OF ADVERTISING AND BUSINESS MARKETING, IN CLASS 35 (U.S. CLS. 100, 101 AND 102).

FOR: CLEARING OF SECURE FINANCIAL TRANSACTIONS THROUGH ONLINE SERVICES; FINANCIAL AND MONETARY SERVICES, NAMELY FINANCIAL ANALYSIS AND CONSULTATION, PROVIDING FINANCIAL INFORMATION, ISSUANCE OF SECURITIES, COMMERCIAL LENDING SERVICES, FINANCIAL PORTFOLIO MANAGEMENT, DISCOUNT BROKERAGE SERVICES, BROKERAGE OF SHARES AND BUSINESS VENTURES, BROKERAGE OF FUND SHARES, SECURITIES CONSULTING AND SAFE KEEPING, BROKERAGE OF PRODUCTIVE INVESTMENTS AND FUNDS; FINANCIAL SPONSORSHIP OF SPORTS, EDUCATIONAL AND ENTERTAINMENT PROGRAMS AND EVENTS; MONETARY EXCHANGE; CREDIT CARD SERVICES; TELEPHONE CALLING CARD SERVICES; ELECTRONIC COMMERCE SERVICES, NAMELY, ELECTRONIC DEBIT AND CREDIT CARD PROCESSING SERVICES, FUNDS TRANSFER AND PAYMENT PROCESSING SERVICES; PROVIDING INFORMATION VIA THE TELEPHONE AND THE GLOBAL COMMUNICATION NETWORKS IN THE FIELD OF FINANCE, IN CLASS 36 (U.S. CLS. 100, 101 AND 102).

FOR: TELECOMMUNICATIONS AND INFORMATION TECHNOLOGY SERVICES, NAMELY ELECTRIC, DIGITAL, CELLULAR AND WIRELESS TRANSMISSION OF VOICE, DATA, INFORMATION, IMAGES, SIGNALS AND MESSAGES AND TRANSMISSION OF VOICE, DATA, IMAGES, AUDIO, VIDEO AND INFORMATION VIA TELEPHONE, TELEVISION AND GLOBAL COMMUNICATION NETWORKS; PROVIDING TELECOMMUNICATIONS CONNECTIONS OVER A GLOBAL COMMUNICATIONS NETWORK, ELECTRONIC MAIL, VOICE MAIL AND MESSAGING SERVICES, NAMELY, THE RECORDING AND STORAGE AND SUBSEQUENT TRANSMISSION OF VOICE MESSAGES BY TELEPHONE; RENTAL OF TELECOMMUNICATIONS EQUIPMENT, NAMELY, EQUIPMENT FOR ELECTRONIC ACCESS TO GLOBAL TELECOMMUNICATIONS NETWORK, EQUIPMENT FOR TRANSMITTING, RECEIVING, RECORDING AND MONITORING VOICE, DATA, INFORMATION, IMAGES, SIGNALS, MESSAGES, COMPRISED OF DATA AND WORD PROCESSORS, AND TELECOMMUNICATIONS HARDWARE AND SOFTWARE INCLUDING COMPONENTS AND PERIPHERALS THEREOF FOR USE IN THE TELECOMMUNICATIONS INDUSTRY, AND RENTAL OF EQUIPMENT FOR TRANSMITTING, RECEIVING, RECORDING AND MONITORING COMPUTER PROGRAMS FOR USE IN OPERATING AND ACCESSING TELECOMMUNICATIONS SYSTEMS; AUDIO AND VIDEO BROADCASTING FEATURING ENTERTAINMENT IN THE NATURE OF LIVE VISUAL AND AUDIO

PERFORMANCES, AND MUSICAL, VARIETY, NEWS AND COMEDY SHOWS; PROVIDING MULTIPLE-USER DIAL-UP AND DEDICATED ACCESS TO THE INTERNET; PERSONAL COMMUNICATIONS SERVICES; PAGER SERVICES; ELECTRONIC MAIL SERVICES; TRANSMISSION AND BROADCAST OF AUDIO AND VIDEO PROGRAMMING; PROVIDING MULTIPLE-USER ACCESS TO A GLOBAL COMMUNICATION NETWORK; LEASING TELECOMMUNICATIONS EQUIPMENT, COMPONENTS, SYSTEMS AND SUPPLIES; CONSULTING IN THE FIELD OF TELECOMMUNICATIONS; CONSULTING IN THE FIELD OF TELECOMMUNICATIONS; CONSULTING IN THE FIELDS OF TELECOMMUNICATIONS AND GLOBAL COMMUNICATION NETWORKS, IN CLASS 38 (U.S. CLS. 100, 101 AND 104).

FOR: WAREHOUSE STORAGE OF GOODS; STORAGE OF GOODS RELATING TO TELECOMMUNICATIONS, COMPUTERS AND OTHER INFORMATION TECHNOLOGY DEVICES; TRANSPORTATION OF GOODS BY TRUCK, SHIP, RAILWAY AND PLANE; ELECTRONIC STORAGE OF INFORMATION IN THE NATURE OF FILES AND DOCUMENTS, IN CLASS 39 (U.S. CLS. 100 AND 105).

FOR: EDUCATION AND INSTRUCTION, NAMELY, EDUCATIONAL SERVICES IN THE NATURE OF CLASSES AND SEMINARS IN THE FIELDS OF BUSINESS, TELECOMMUNICATIONS AND COMPUTERS, AND THE DISTRIBUTION OF COURSE MATERIALS THEREWITH; ENTERTAINMENT IN THE NATURE OF VISUAL AND AUDIO PERFORMANCES, NAMELY, MUSICAL BAND, ROCK GROUP, GYMNASTIC, DANCE, AND BALLET PERFORMANCES; ENTERTAINMENT SERVICES, NAMELY, PROVIDING MUSICAL, VARIETY, NEWS AND COMEDY SHOWS VIA A GLOBAL COMPUTER INFORMATION NETWORK; ENTERTAINMENT SERVICES, NAMELY, PROVIDING ONLINE COMPUTER GAMES FOR CHILDREN AND ADULTS; PROVIDING ENTERTAINMENT INFORMATION AT THE SPECIFIC REQUEST OF END-USERS BY MEANS OF TELEPHONE OR GLOBAL COMMUNICATIONS NETWORKS; ORGANIZING COMMUNITY SPORTING AND CULTURAL EVENTS; PUBLICATION OF BOOKS, MAGAZINES, JOURNALS, MANUALS, BROCHURES AND LEAFLETS ON THE SUBJECT OF TELECOMMUNICATIONS; ELECTRONIC PUBLISHING SERVICES, NAMELY, PUBLICATION OF TEXT AND GRAPHIC WORKS OF OTHERS ON TELECOMMUNICATIONS RECORDED ON ELECTRONIC MEDIA; ORGANIZING FAIRS AND EXHIBITIONS IN THE FIELD OF VISUAL AND AUDIO PERFORMANCES, NAMELY, ROCK GROUP, GYMNASTIC, DANCE, AND BALLET PERFORMANCES, IN CLASS 41 (U.S. CLS. 100, 101 AND 107).

FOR: COMPUTER PROGRAMMING SERVICES FOR OTHERS; RENTAL OF SOFTWARE AND HARDWARE FOR ONLINE ACCESS; SERVICES OF AN INTERNET TRUST CENTER, NAMELY, ASSURANCE AND ADMINISTRATION OF DIGITAL KEYS AND/OR DIGITAL CERTIFICATES; DEVELOPMENT OF DATA PROCESSING PRO-

GRAMS FOR OTHERS; WEB PAGE HOSTING SERVICES; COMPUTER SERVICES NAMELY CREATING INDEXES OF INFORMATION AVAILABLE ON COMPUTER NETWORKS; CONSULTING AND DESIGN SERVICES IN THE FIELD OF INFORMATION TECHNOLOGY, AND COMPUTER PROGRAMMING; DESIGN SERVICES IN THE FIELDS OF TELECOMMUNICATIONS AND GLOBAL COMMUNICATION NETWORKS; INSTALLATION, MAINTENANCE AND REPAIR OF COMPUTER SOFTWARE; PROVIDING GENERAL INFORMATION AT THE SPECIFIC REQUEST OF END-USERS BY MEANS OF TELEPHONE OR GLOBAL COMMUNICATIONS NETWORKS, IN CLASS 42 (U.S. CLS. 100 AND 101).

PRIORITY CLAIMED UNDER SEC. 44(D) ON FED REP GERMANY APPLICATION NO. 30239851.1, FILED 8-14-2002, REG. NO. 30239851, DATED 12-23-2004, EXPIRES 8-31-2012.

OWNER OF U.S. REG. NO. 2,367,890.

NO CLAIM IS MADE TO THE EXCLUSIVE RIGHT TO USE "GAMES", APART FROM THE MARK AS SHOWN.

THE MARK CONSISTS OF THE LETTER "T" IN A CIRCLE AND THE LINE FOLLOWING FROM THE LETTER "T", WHICH ARE WHITE; A CIRCLE AROUND THE LETTER "T", WHICH IS MAGENTA; AND THE WORD "GAMES", WHICH IS GREY. THE APPLICANT IS CLAIMING THE COLORS WHITE, MAGENTA AND GREY AS FEATURES OF THE MARK.

SER. NO. 78-214,540, FILED 2-13-2003.

JOHN KELLY, EXAMINING ATTORNEY

Int. Cls.: 9, 16, 35, 36, 38, 39, 41 and 42

**Prior U.S. Cls.: 2, 5, 21, 22, 23, 26, 29, 36, 37, 38, 50,
100, 101, 102, 104, 105 and 107**

Reg. No. 3,576,192

United States Patent and Trademark Office

Registered Feb. 17, 2009

**TRADEMARK
SERVICE MARK
PRINCIPAL REGISTER**



DEUTSCHE TELEKOM AG (FED REP GERMA-
NY CORPORATION)
FRIEDRICH-EBERT-ALLEE 140
BONN, FED REP GERMANY 53113

FOR: ELECTRIC, ELECTRONIC, OPTICAL, MEASURING, SIGNALING, CONTROLLING AND TEACHING APPARATUS AND INSTRUMENTS, ALL FOR USE WITH TELECOMMUNICATIONS, NAMELY, APPARATUS FOR PRODUCING SOUND, IMAGES OR DATA, NAMELY, MAGNETIC AND OPTICAL DATA CARRIERS, DATA PROCESSORS AND COMPUTERS, NAMELY, MICROCOMPUTERS, MINICOMPUTERS, COMPUTER CENTRAL PROCESSORS, COMPUTER MONITORS, COMPUTER KEYBOARDS, COMPUTER TERMINALS, COMPUTER INTERFACE BOARDS, COMPUTER MEMORIES, COMPUTER LASER PRINTERS, COMPUTER IMPACT PRINTERS, COMPUTER DOT MATRIX PRINTERS, COMPUTER OPERATING SYSTEMS, COMPUTERS AND INSTRUCTIONAL MANUALS SOLD AS A UNIT, COMPUTER INTERFACE APPARATUS, NAMELY, COMPUTER MODEMS, COMPUTER MOUSE AND MOUSE PAD, COMPUTER PERIPHERALS AND PARTS THEREOF; COMPUTER PROGRAMS AND DATABASES FOR USE IN OPERATING TELECOMMUNICATIONS AND BUSINESS MANAGEMENT SYSTEMS AND RELATED INSTRUCTION MANUALS SOLD AS A UNIT; COMPUTER PROGRAMS, NAMELY, FINANCIAL ACCOUNTING SYSTEM SOFTWARE, SOFTWARE USED FOR THE PROVISION OF ONLINE INFORMATION SERVICES, NETWORK MANAGEMENT SOFTWARE, COMPUTER PROXY SOFTWARE FOR USE WITH OTHER SOFTWARE PROGRAMS, COMPUTER PROGRAMS AND SOFTWARE FOR CONTROLLING ACCESS AND ALARM MONITORING OF HOMES, APART-

MENTS, BUILDINGS AND OTHER PROPERTIES, BILLING ANALYSIS SOFTWARE, AND SOFTWARE FOR NETWORK ACCESS CONTROL AND FOR CREATING AND MAINTAINING FIREWALLS; COMPUTER PROGRAMS FOR ACCESSING A GLOBAL COMPUTER NETWORK AND INTERACTIVE COMPUTER COMMUNICATIONS NETWORK; OPTICAL CABLES, OPTIC FILTERS, OPTICAL SCANNERS, OPTICAL CHARACTER READERS, OPTICAL DISCS, OPTICAL FIBERS, OPTICAL GLASS FOR SIGNAL TRANSMISSION, OPTIC TRANSMITTERS, OPTIC RECEIVERS, OPTICAL SIGNAL PROCESSING APPARATUS, OPTIC SWITCHES, OPTICAL ATTENUATORS, OPTICAL AMPLIFIERS, OPTICAL CHARACTER RECOGNITION APPARATUS, AND PARTS THEREOF AUDIO, VIDEO AND DATA COMMUNICATIONS SYSTEMS, NAMELY, DIGITAL AND ANALOGUE SIGNAL TRANSMITTERS, RECEIVERS AND CONVERTERS, RADIO AND TELEPHONE TRANSMITTERS, RECEIVERS AND SERVERS, ANSWERING MACHINES, TELECOMMUNICATION TRANSMISSION, RECEIVING AND STORAGE APPARATUS, NAMELY, TELECOMMUNICATIONS TRANSMITTING SETS, DATA TRANSMITTERS, FACSIMILE MACHINES, ELECTRONIC MAIL APPARATUS FOR ELECTRONIC EXCHANGE OF DATA IMAGES AND MESSAGES, REMOTE CONTROLS AND SET-TOP UNITS FOR TELEVISION, CINEMATOGRAPHIC TELEVISION AND AMUSEMENT EQUIPMENT, NAMELY, SIGNAL DECODERS, ELECTRICAL WIRE, ELECTRICAL WIRE CONNECTORS, INTEGRATED CIRCUITS, PRINTED CIRCUITS, ELECTRIC CIRCUITS, CIRCUIT BREAKERS, PRINTED CIRCUIT BOARDS, ELECTRIC CIRCUIT BOARDS, CIRCUIT CONNECTORS, ELECTRICAL CONTROLLERS, ELECTRICAL CONVERTERS, ELECTRICAL FUSES, ELECTRIC LUMINESCENT DISPLAY PA-

NELS, ELECTRICAL SWITCH PLATES, ELECTRIC PLUGS, ANTENNAS, ELECTRICAL CABLES, COMPUTER CABLES, COMPUTER CHIPS, SILICON CHIPS, CHRONOGRAPHS FOR USE AS SPECIALIZED TIME RECORDING APPARATUS, ELECTRIC COILS, COMPUTER BUFFERS, BLANK COMPUTER DISCS, BLANK COMPUTER FLOPPY DISKS, COMPUTER HARD DISCS, ELECTRICAL CONDUCTORS, ACOUSTIC CONDUITS, ELECTRICAL CONDUITS, FIBER OPTIC CONDUITS AND PARTS THEREOF; COMPACT DISC PLAYERS, AUDIO AND VIDEO TAPE RECORDERS, AUDIO AND VIDEO TAPE PLAYERS, AUDIO AND VIDEO CASSETTE RECORDERS, AUDIO AND VIDEO CASSETTE PLAYERS, BLANK AUDIO AND VIDEO TAPES, CASSETTES, DISCS AND MICROFICHE; AUDIO AND VIDEO TAPES, CASSETTES, DISCS AND MICROFICHE FEATURING INFORMATION CONCERNING TELECOMMUNICATIONS, AND CONCERNING PERSONAL AND BUSINESS MANAGEMENT SYSTEMS; AUDIO AND VIDEO RECORDINGS IN THE FIELD OF TELECOMMUNICATIONS, INFORMATION TECHNOLOGY, SAFETY; TELEVISION AND TELEVISION PERIPHERAL EQUIPMENT, NAMELY CAMERAS, SET BOXES, REMOTE CONTROL UNITS FOR INTERACTIVE AND NON-INTERACTIVE USE; COMPUTER MEMORY, COMPUTER PERIPHERALS AND MODEMS; VIDEO MONITORS, AUTOMATIC VENDING MACHINES AND TIMING MECHANISMS THEREFOR, AND PARTS THEREOF; MACHINE READABLE, MAGNETICALLY ENCODED CARDS, NAMELY, PREPAID TELEPHONE CALLING CARDS AND CREDIT CARDS; SMART CARDS; DATA PROCESSORS AND READERS, WORD PROCESSORS, MAGNETIC CODED CARD READERS, MAGNETIC CODED CARDS, NAMELY, FIDELITY CARDS, ELECTRONIC ENCRYPTION UNITS, LASERS NOT FOR MEDICAL USE, LIGHT EMITTING DIODES, LIGHT EMITTING DIODE DISPLAYS, MICROPROCESSORS, BLANK DATA CARRIERS, DEMAGNETIZERS FOR MAGNETIC TAPES, AND PARTS THEREOF; COMPUTER, DATA AND VIDEO NETWORKING AND CONFERENCING EQUIPMENT, NAMELY, TELECONFERENCING EQUIPMENT AND AUDIO-VISUAL TEACHING EQUIPMENT IN THE NATURE OF OVERHEAD FILM, PHOTOGRAPHIC AND SLIDE PROJECTORS, PROJECTION SCREENS, COMPUTER BASED INFORMATION DISPLAY EQUIPMENT, NAMELY, COMPUTERS WHICH DISPLAY INFORMATION ON AN OVERHEAD SCREEN, INTERCOMS; TELEPHONES, TELEPHONE ANSWERING MACHINES, TELEPHONE TRANSMITTERS, TELEPHONE NETWORKS, TELEPHONE WIRES, TELEPRINTERS, TELETYPEWRITERS, AND PARTS THEREOF, NAMELY, CALLER IDENTIFICATION BOXES, DIALING ASSEMBLIES, TELEPHONE UNITS, AUDIO OPERATED RELAYS, AUDIO OPERATED RELAYS, AUDIO/VIDEO SIGNAL AND OPTICAL FILTERS, PROTECTORS AND AUTOMATIC SIGNALING AND CONTROL EQUIPMENT, TELEMETERS, WIRELESS AND CELLULAR TELEPHONES, RADIO PAGERS, PORTABLE COMPUTER DEVICES, NAMELY LAPTOPS, HANDHELD AND POCKET COMPUTERS, FACSIMILE TRANSMITTERS AND RECEIVERS, WIRELESS

FAX MACHINES, PERSONAL COMMUNICATIONS EQUIPMENT, NAMELY, PERSONAL DIGITAL ASSISTANTS (PDA), CALCULATORS AND RELATED PERIPHERALS; SATELLITE PROCESSORS, SATELLITES AND SATELLITE COMMUNICATION EARTH STATIONS BOTH STATIONARY AND MOVEABLE; AUDIO AND VIDEO RECORDINGS IN THE FIELD OF NEWS, SPORTS, ENTERTAINMENT, CULTURE, BUSINESS AND FINANCE, WEATHER AND TRAVEL; PRERECORDED COMPACT DISCS, AUDIO CASSETTE TAPES, VIDEO CASSETTE TAPES, DIGITAL AUDIO TAPES AND DIGITAL VIDEO DISCS FEATURING MUSICAL, VARIETY, NEWS AND COMEDY SHOWS; COMPUTER GAME PROGRAMS FOR CHILDREN AND ADULTS; VIDEO AND COMPUTER GAME CARTRIDGES, IN CLASS 9 (U.S. CLS. 21, 23, 26, 36 AND 38).

FOR: PRINTED MATTER, NAMELY, TELEPHONE DIRECTORIES, BOOKS, NEWSLETTERS, PAMPHLETS, BROCHURES, MAGAZINES AND PAPERBACKS ALL IN THE FIELD OF TELECOMMUNICATIONS, PRINTED AND STAMPED PLASTIC AND CARDBOARD GREETING, BLANK, NOTE, AND INDEX CARDS; NOTE PAPER AND ENVELOPES, RUBBER STAMPS, NAME TAGS AND LABELS MADE FROM PAPER OR CARDBOARD, NOTEBOOKS, DIARIES, NOTE PAPERS, NOTE PADS, ADDRESS BOOKS, FOLDERS FOR LETTERS AND LOOSE PAPERS, CLEAR HOLE REINFORCEMENTS, STUDENT CALENDARS, STAMP ALBUMS AND PHOTO-ALBUMS; PAPER WEIGHTS, LETTER OPENERS, BLOTTING PADS; DESK TRAYS, DESK STANDS AND HOLDERS FOR HOLDING STATIONERY AND OFFICE IMPLEMENTS; PRINTED INSTRUCTIONAL AND TEACHING MATERIALS ALL IN THE FIELDS OF TELECOMMUNICATIONS, INFORMATION TECHNOLOGY, SAFETY, NEWS, SPORTS, ENTERTAINMENT, CULTURE, BUSINESS AND FINANCE, WEATHER AND TRAVEL; STATIONERY, DRAWING AND UNGRADUATED RULERS, ERASERS, STAPLERS, STAPLES, PAPER CLIPS, BOOK MARKERS, CUTOUT SAMPLES AND STENCILS; SCRATCH PICTURES, PAPER, NAMELY, BOND PAPER AND ART PAPER, PVC STICKERS, GIFT WRAP PAPER; BLACKBOARDS, CHALK STICKS, ADHESIVES FOR STATIONERY OR HOUSEHOLD PURPOSES; DRAWING AND PAINTING MATERIALS, NAMELY, PENCILS, DRAWING PENCILS, PENS, DRAWING PENS, PAINT TRAYS, PAINTING SETS FOR ARTISTS, PAINTING SETS FOR CHILDREN, CRAFT PAINT KITS, AND PENCIL CASES; NON-MAGNETICALLY ENCODED, PREPAID TELEPHONE CALLING CARDS, IN CLASS 16 (U.S. CLS. 2, 5, 22, 23, 29, 37, 38 AND 50).

FOR: ADVERTISING SERVICES, NAMELY, PREPARING AND PLACING ADVERTISEMENTS FOR OTHERS PROMOTING THE GOODS AND SERVICES OF OTHERS THROUGH PRINTED ADVERTISING, PRINTED DIRECTORIES, THROUGH ENCODED MEDIA, THROUGH THE DISSEMINATION OF PROMOTIONAL MATERIALS, THROUGH DIRECT MAIL ADVERTISING, THROUGH ELECTRONIC BILLBOARD ADVERTIS-

ING, PREPARING AUDIO-VISUAL PRESENTATIONS FOR USE IN ADVERTISING; BUSINESS SERVICES, NAMELY, BUSINESS APPRAISALS, BUSINESS AUDITING, PROVIDING BUSINESS INFORMATION, NAMELY, PREPARING BUSINESS REPORTS AND CONDUCTING BUSINESS RESEARCH, ANALYSIS AND SURVEYS, BUSINESS MANAGEMENT PLANNING, BUSINESS MANAGEMENT CONSULTATION, BUSINESS MANAGEMENT SUPERVISION, CONDUCTING BUSINESS NETWORKING FOR OTHERS; BUSINESS MANAGEMENT AND CONSULTING SERVICES EXCLUDING AGRICULTURAL BUSINESS MANAGEMENT AND CONSULTING SERVICES; BUSINESS INFORMATION SERVICES IN THE FIELD OF TELECOMMUNICATIONS, ADVERTISING, INFORMATION TECHNOLOGY, MARKETING AND RELATED FIELDS; RENTAL OF AUTOMATIC VENDING MACHINES; ORGANIZING JOB FAIRS; RENTAL OF DATA PROCESSING EQUIPMENT; PROVIDING INFORMATION VIA THE TELEPHONE AND THE GLOBAL COMMUNICATION NETWORKS IN THE FIELD OF ADVERTISING AND BUSINESS MARKETING; PROFESSIONAL CONSULTANCY IN THE FIELD OF DATA PROCESSING, IN CLASS 35 (U.S. CLS. 100, 101 AND 102).

FOR: INSURANCE SERVICES, NAMELY, INSURANCE BROKERAGE, INSURANCE CLAIMS PROCESSING; FINANCIAL SERVICES, NAMELY, CLEARING OF SECURE FINANCIAL TRANSACTIONS THROUGH ONLINE SERVICES; FINANCIAL ANALYSIS AND CONSULTATION, PROVIDING FINANCIAL INFORMATION, ISSUANCE OF SECURITIES, COMMERCIAL LENDING SERVICES, FINANCIAL PORTFOLIO MANAGEMENT, DISCOUNT BROKERAGE SERVICES, BROKERAGE OF SHARES AND BUSINESS VENTURES, BROKERAGE OF FUND SHARES, SECURITIES CONSULTING AND SAFE KEEPING, BROKERAGE OF PRODUCTIVE INVESTMENTS AND FUNDS; FINANCIAL SPONSORSHIP OF SPORTS, EDUCATIONAL AND ENTERTAINMENT PROGRAMS AND EVENTS; REAL ESTATE SERVICES, NAMELY BROKERAGE, MANAGEMENT, LEASING, APPRAISAL OF REAL PROPERTY; CUSTOMS BROKERAGE FOR THIRD PARTIES; MONETARY EXCHANGE; CREDIT CARD SERVICES; TELEPHONE CALLING CARD SERVICES; ELECTRONIC COMMERCE SERVICES, NAMELY, ELECTRONIC DEBIT AND CREDIT CARD PROCESSING SERVICES, FUNDS TRANSFER AND PAYMENT PROCESSING SERVICES; PROVIDING INFORMATION VIA THE TELEPHONE AND THE GLOBAL COMMUNICATION NETWORKS IN THE FIELD OF FINANCE, IN CLASS 36 (U.S. CLS. 100, 101 AND 102).

FOR: TELECOMMUNICATIONS AND INFORMATION TECHNOLOGY SERVICES, NAMELY ELECTRIC, DIGITAL, CELLULAR AND WIRELESS TRANSMISSION OF VOICE, DATA, INFORMATION, IMAGES, SIGNALS AND MESSAGES AND TRANSMISSION OF VOICE, DATA, IMAGES, AUDIO, VIDEO AND INFORMATION VIA TELEPHONE, TELEVISION AND GLOBAL COMMUNICATION NETWORKS; PROVIDING

TELECOMMUNICATIONS CONNECTIONS OVER A GLOBAL COMMUNICATIONS NETWORK, ELECTRONIC MAIL, VOICE MAIL AND MESSAGING SERVICES, NAMELY, THE RECORDING AND STORAGE AND SUBSEQUENT TRANSMISSION OF VOICE MESSAGES BY TELEPHONE; RENTAL OF TELECOMMUNICATIONS EQUIPMENT, NAMELY, EQUIPMENT FOR ELECTRONIC ACCESS TO GLOBAL TELECOMMUNICATIONS NETWORK, EQUIPMENT FOR TRANSMITTING, RECEIVING, RECORDING AND MONITORING VOICE, DATA, INFORMATION, IMAGES, SIGNALS, MESSAGES, COMPRISED OF DATA AND WORD PROCESSORS, AND TELECOMMUNICATIONS HARDWARE AND SOFTWARE AND COMPONENTS AND PERIPHERALS THEREOF FOR USE IN THE TELECOMMUNICATIONS INDUSTRY, AND RENTAL OF EQUIPMENT FOR TRANSMITTING, RECEIVING, RECORDING AND MONITORING COMPUTER PROGRAMS FOR USE IN OPERATING AND ACCESSING TELECOMMUNICATIONS SYSTEMS; AUDIO AND VIDEO BROADCASTING FEATURING ENTERTAINMENT IN THE NATURE OF LIVE VISUAL AND AUDIO PERFORMANCES, AND MUSICAL, VARIETY, NEWS AND COMEDY SHOWS; PROVIDING MULTIPLE-USER DIAL-UP AND DEDICATED ACCESS TO THE INTERNET; PERSONAL COMMUNICATIONS SERVICES; PAGER SERVICES; ELECTRONIC MAIL SERVICES; TRANSMISSION AND BROADCAST OF AUDIO AND VIDEO PROGRAMMING; PROVIDING MULTIPLE-USER ACCESS TO A GLOBAL COMMUNICATION NETWORK; LEASING TELECOMMUNICATIONS EQUIPMENT, COMPONENTS, SYSTEMS AND SUPPLIES; CONSULTING IN THE FIELD OF TELECOMMUNICATIONS; CONSULTING IN THE FIELDS OF TELECOMMUNICATIONS AND GLOBAL COMMUNICATION NETWORKS, IN CLASS 38 (U.S. CLS. 100, 101 AND 104).

FOR: WAREHOUSE STORAGE OF GOODS; STORAGE OF GOODS RELATING TO TELECOMMUNICATIONS, COMPUTERS AND OTHER INFORMATION TECHNOLOGY DEVICES; TRANSPORTATION OF GOODS BY TRUCK, SHIP, RAILWAY AND PLANE; ELECTRONIC STORAGE OF INFORMATION IN THE NATURE OF FILES AND DOCUMENTS, IN CLASS 39 (U.S. CLS. 100 AND 105).

FOR: EDUCATION AND INSTRUCTION, NAMELY, EDUCATIONAL SERVICES IN THE NATURE OF CLASSES AND SEMINARS IN THE FIELDS OF BUSINESS, TELECOMMUNICATIONS AND COMPUTERS, AND THE DISTRIBUTION OF COURSE MATERIALS THEREWITH; ENTERTAINMENT IN THE NATURE OF VISUAL AND AUDIO PERFORMANCES, NAMELY, MUSICAL BAND, ROCK GROUP, GYMNASTIC, DANCE, AND BALLET PERFORMANCES; ENTERTAINMENT SERVICES, NAMELY, PROVIDING MUSICAL, VARIETY, NEWS AND COMEDY SHOWS VIA A GLOBAL COMPUTER INFORMATION NETWORK; ENTERTAINMENT SERVICES, NAMELY, PROVIDING ONLINE COMPUTER GAMES FOR CHILDREN AND ADULTS; PROVIDING ENTERTAINMENT INFORMATION AT THE SPECIFIC REQUEST OF END-

USERS BY MEANS OF TELEPHONE OR GLOBAL COMMUNICATIONS NETWORKS; ORGANIZING COMMUNITY SPORTING AND CULTURAL EVENTS; PUBLICATION OF BOOKS, MAGAZINES, JOURNALS, MANUALS, BROCHURES AND LEAFLETS ON THE SUBJECT OF TELECOMMUNICATIONS; ELECTRONIC PUBLISHING SERVICES, NAMELY, PUBLICATION OF TEXT AND GRAPHIC WORKS OF OTHERS ON TELECOMMUNICATIONS RECORDED ON ELECTRONIC MEDIA; ORGANIZING FAIRS AND EXHIBITIONS IN THE FIELD OF VISUAL AND AUDIO PERFORMANCES, NAMELY, ROCK GROUP, GYMNASTIC, DANCE, AND BALLET PERFORMANCES, IN CLASS 41 (U.S. CLS. 100, 101 AND 107).

FOR: COMPUTER PROGRAMMING SERVICES FOR OTHERS; RENTAL OF SOFTWARE AND HARDWARE FOR ONLINE ACCESS; SERVICES OF AN INTERNET TRUST CENTER, NAMELY, ASSURANCE AND ADMINISTRATION OF DIGITAL KEYS AND/OR DIGITAL CERTIFICATES; WEB PAGE HOSTING SERVICES; COMPUTER SERVICES, NAMELY, CREATING INDEXES OF INFORMATION AVAILABLE ON COMPUTER NETWORKS; CONSULTING AND DESIGN SERVICES IN THE FIELD OF INFORMATION TECHNOLOGY, AND COMPUTER PROGRAMMING; DESIGN SERVICES IN THE FIELDS OF TELECOMMUNICATIONS AND GLOBAL COMMUNICATION NET-

WORKS; INSTALLATION, MAINTENANCE AND REPAIR OF COMPUTER SOFTWARE; PROVIDING GENERAL INFORMATION AT THE SPECIFIC REQUEST OF END-USERS BY MEANS OF TELEPHONE OR GLOBAL COMMUNICATIONS NETWORKS, IN CLASS 42 (U.S. CLS. 100 AND 101).

PRIORITY CLAIMED UNDER SEC. 44(D) ON FED REP GERMANY APPLICATION NO. 30239850.3, FILED 8-14-2002, REG. NO. 30239850, DATED 12-23-2004, EXPIRES 8-31-2012.

OWNER OF U.S. REG. NO. 2,367,890.

NO CLAIM IS MADE TO THE EXCLUSIVE RIGHT TO USE NEWS, APART FROM THE MARK AS SHOWN.

THE MARK CONSISTS OF THE LETTER "T" IN A CIRCLE AND THE LINE FOLLOWING FROM THE LETTER "T", WHICH ARE WHITE; A CIRCLE AROUND THE LETTER "T", WHICH IS MAGENTA; AND THE WORD "NEWS", WHICH IS GREY. THE COLORS WHITE, MAGENTA, AND GREY ARE CLAIMED AS A FEATURE OF THE MARK.

SER. NO. 78-214,543, FILED 2-13-2003.

JOHN KELLY, EXAMINING ATTORNEY

Int. Cls.: 9, 16, 35, 36, 38, 41 and 42

**Prior U.S. Cls.: 2, 5, 21, 22, 23, 26, 29, 36, 37, 38, 50,
100, 101, 102, 104 and 107**

Reg. No. 3,576,193

United States Patent and Trademark Office

Registered Feb. 17, 2009

**TRADEMARK
SERVICE MARK
PRINCIPAL REGISTER**



DEUTSCHE TELEKOM AG (FED REP GERMA-
NY CORPORATION)
FRIEDRICH-EBERT-ALLEE 140
BONN, FED REP GERMANY 53113

FOR: ELECTRIC, ELECTRONIC, OPTICAL, MEASURING, SIGNALING, CONTROLLING AND TEACHING APPARATUS AND INSTRUMENTS, ALL FOR USE WITH TELECOMMUNICATIONS, NAMELY, VIDEO CASSETTE AND AUDIOCASSETTE RECORDERS, DATA PROCESSORS AND DIGITAL CAMERAS; BLANK MAGNETIC AND OPTICAL DATA CARRIERS; DATA PROCESSORS; COMPUTERS, NAMELY, MICROCOMPUTERS, MINICOMPUTERS, COMPUTER CENTRAL PROCESSORS, COMPUTER MONITORS, COMPUTER KEYBOARDS, COMPUTER TERMINALS, COMPUTER MEMORIES, COMPUTER LASER PRINTERS, COMPUTER IMPACT PRINTERS, COMPUTER DOT MATRIX PRINTERS, COMPUTERS AND INSTRUCTIONAL MANUALS SOLD AS A UNIT; COMPUTER MEMORY HARDWARE; COMPUTER INTERFACE APPARATUS, NAMELY, COMPUTER INTERFACE BOARDS, COMPUTER MOUSE AND MOUSE PAD, COMPUTER PERIPHERALS AND PARTS THEREOF; COMPUTER SOFTWARE PROGRAMS FOR USE IN OPERATING TELECOMMUNICATIONS AND BUSINESS MANAGEMENT SYSTEMS AND RELATED INSTRUCTION MANUALS SOLD AS A UNIT; COMPUTER SOFTWARE FOR FINANCIAL ACCOUNTING, FOR THE PROVISION OF ONLINE INFORMATION SERVICES IN THE FIELD OF NEWS, SPORTS, ENTERTAINMENT, CULTURE, BUSINESS AND FINANCE, WEATHER AND TRAVEL, NETWORK MANAGEMENT, COMPUTER PROXY, FOR CONTROLLING ACCESS AND ALARM MONITORING OF HOMES, APARTMENTS, BUILDINGS AND OTHER PROPERTIES, BILLING ANALYSIS, NETWORK ACCESS CON-

TROL AND FOR CREATING AND MAINTAINING FIREWALLS; COMPUTER SOFTWARE PROGRAMS FOR ACCESSING A GLOBAL COMPUTER NETWORK AND INTERACTIVE COMPUTER COMMUNICATIONS NETWORKS; OPTICAL FIBERS SOLD AS A COMPONENT OF FIBER OPTICAL CABLES; FIBER OPTIC CABLES; OPTICAL SCANNERS; OPTICAL CHARACTER READERS; OPTICAL BLANK DISCS; OPTICAL GLASS FOR SIGNAL TRANSMISSION; OPTIC TRANSMITTERS FOR RADIO, TELEPHONE; OPTIC RECEIVERS FOR TELEPHONE, AUDIO, VIDEO; OPTICAL SIGNAL PROCESSORS; OPTIC TELECOMMUNICATIONS SWITCHES; OPTICAL ATTENUATORS; OPTICAL AMPLIFIERS; OPTICAL CHARACTER RECOGNITION APPARATUS, FOR USE IN THE TELECOMMUNICATIONS FIELD, AND PARTS THEREOF; TELEPHONE LOCAL AREA NETWORKS; TELECOMMUNICATION AUDIO, VIDEO AND DATA COMMUNICATIONS SYSTEMS, NAMELY, DIGITAL AND ANALOGUE SIGNAL TRANSMITTERS; RECEIVERS AND CONVERTERS FOR USE WITH TELEPHONE, AUDIO, VIDEO; RADIO AND TELEPHONE TRANSMITTERS; COMMUNICATION RECEIVERS AND SERVERS FOR TELEPHONE, AUDIO, VIDEO; TELEPHONE ANSWERING MACHINES; TELEPROMPTERS; TELETYPEWRITERS AND PARTS THEREOF, NAMELY, CALLER IDENTIFICATION BOXES, DIALING ASSEMBLIES, TELEPHONE UNITS, AUDIO OPERATED RELAYS, AUDIO/VIDEO SIGNAL AND OPTICAL FILTERS, PROTECTORS AND AUTOMATIC SIGNALING AND CONTROL EQUIPMENT, TELEMETERS, WIRELESS AND CELLULAR TELEPHONES, AND RADIO PAGERS; INTERCOMS; FACSIMILE MACHINE; ELECTRONIC MAIL APPARATUS FOR ELECTRONIC EXCHANGE OF DATA IMAGES AND MESSAGES; ELECTRICAL WIRE; ELECTRI-

CAL WIRE CONNECTORS; INTEGRATED CIRCUITS; PRINTED CIRCUITS; ELECTRIC CIRCUITS; CIRCUIT BREAKERS; PRINTED CIRCUIT BOARDS; CIRCUIT CONNECTORS; ELECTRICAL CONTROLLERS; ELECTRICAL CONVERTERS; ELECTRICAL CONDUCTORS; ELECTRICAL FUSES; ELECTRIC LUMINESCENT DISPLAY PANELS; ELECTRICAL SWITCH PLATES; ELECTRIC PLUGS; ELECTRIC COILS; ANTENNAS; ELECTRICAL CABLES; COMPUTER CABLES; COMPUTER CHIPS; SILICON CHIPS; CHRONOGRAPHS FOR USE AS SPECIALIZED TIME RECORDING APPARATUS; COMPUTER BUFFERS; BLANK COMPUTER DISCS; BLANK COMPUTER FLOPPY DISKS; COMPUTER HARD DISCS; ACOUSTIC CONDUITS; ELECTRICAL CONDUITS; FIBER OPTIC CONDUITS AND PANS THEREOF; COMPACT DISC PLAYERS; AUDIO AND VIDEO TAPE RECORDERS; AUDIO AND VIDEOTAPE PLAYERS; AUDIO AND VIDEOCASSETTE RECORDERS; AUDIO AND VIDEOCASSETTE PLAYERS; BLANK AUDIO AND VIDEOTAPES, CASSETTES, DISCS AND MICROFICHE; AUDIO AND VIDEO TAPES, CASSETTES, DISCS AND MICROFICHE FEATURING INFORMATION CONCERNING TELECOMMUNICATIONS, AND CONCERNING PERSONAL AND BUSINESS MANAGEMENT SYSTEMS; AUDIO AND VIDEO RECORDINGS IN THE FIELD OF TELECOMMUNICATIONS, INFORMATION TECHNOLOGY AND SAFETY; TELEVISION AND TELEVISION PERIPHERAL EQUIPMENT, NAMELY, CAMERAS, SET TOP BOXES, REMOTE CONTROL UNITS FOR - AND NON-INTERACTIVE USE; VIDEO MONITORS; AUTOMATIC VENDING MACHINES AND TIMING MECHANISMS THEREFOR AND PARTS THEREOF; MACHINE READABLE, MAGNETICALLY ENCODED CARDS, NAMELY, PREPAID TELEPHONE CALLING CARDS AND CREDIT CARDS; BLANK SMART CARDS; MAGNETIC CODED CARD READERS; DATA PROCESSORS AND READERS; WORD PROCESSORS; MICROPROCESSORS; ELECTRONIC ENCRYPTION UNITS; DEMAGNETIZERS FOR MAGNETIC TAPES AND PARTS THEREOF; LASERS NOT FOR MEDICAL USE; LIGHT EMITTING DIODES; LIGHT EMITTING DIODE DISPLAYS; COMPUTER, DATA AND VIDEO NETWORKING AND CONFERENCING EQUIPMENT, NAMELY, TELECONFERENCING EQUIPMENT AND AUDIOVISUAL TEACHING EQUIPMENT IN THE NATURE OF OVERHEAD FILM; PHOTOGRAPHIC AND SLIDE PROJECTORS; PROJECTION SCREENS; COMPUTER BASED INFORMATION DISPLAY EQUIPMENT, NAMELY, COMPUTERS WHICH DISPLAY INFORMATION ON AN OVERHEAD SCREEN; PORTABLE DEVICES, NAMELY, LAPTOPS, HANDHELD AND POCKET COMPUTERS, WIRELESS FAX MACHINES; PERSONAL COMMUNICATIONS EQUIPMENT, NAMELY, PERSONAL DIGITAL ASSISTANTS; CALCULATORS AND RELATED PERIPHERALS; SATELLITE PROCESSORS, SATELLITE AND SATELLITE COMMUNICATION EARTH STATIONS BOTH STATIONARY AND MOVEABLE COMPUTER GAME PROGRAMS FOR CHILDREN AND ADULTS; VIDEO AND COMPUTER; GAME CARTRIDGES; AUDIO AND VIDEO RECORDINGS IN THE FIELD OF NEWS, SPORTS, ENTERTAIN-

MENT, CULTURE, BUSINESS AND FINANCE, WEATHER AND TRAVEL; PRERECORDED COMPACT DISCS, AUDIOCASSETTE TAPES, VIDEOCASSETTE TAPES, DIGITAL AUDIOTAPES AND DIGITAL VIDEO DISCS FEATURING MUSICAL, VARIETY, NEWS AND COMEDY SHOWS; CARRYING CASES FOR POCKET CALCULATORS AND CELLPHONES; TELECOMMUNICATIONS SOFTWARE FOR USE IN THE TELECOMMUNICATIONS INDUSTRY, IN CLASS 9 (U.S. CLS. 21, 23, 26, 36 AND 38).

FOR: PRINTED MATTER, NAMELY, TELEPHONE DIRECTORIES, SERIES OF BOOKS, NEWSLETTERS, PAMPHLETS, BROCHURES, MAGAZINES AND; PAPERBACKS, ALL IN THE FIELD OF TELECOMMUNICATIONS; PRINTED AND STAMPED PLASTIC AND CARDBOARD GREETING, BLANK, NOTE, AND INDEX CARDS; NOTE PAPER AND ENVELOPES; NAMETAGS AND LABELS MADE FROM PAPER OR CARDBOARD; NOTEBOOKS; NOTE PADS; STATIONERY; PAPER, NAMELY; BOND PAPER AND ART PAPER; GIFT-WRAP PAPER; DIARIES; ADDRESS BOOKS, STUDENT CALENDARS; STAMP ALBUMS AND PHOTO-ALBUMS; FOLDERS FOR LETTERS AND LOOSE PAPERS; STATIONERY CLEAR HOLE TAB REINFORCEMENTS; RUBBER STAMPS AND IMPRESSION STAMPS; PAPER WEIGHTS; LETTER OPENERS; DRAWING AND UNGRADUATED RULERS; ERASERS; STAPLERS; PAPER CLIPS; BLOT- TING PADS; DESK FILE TRAYS; DESK STANDS AND HOLDERS FOR HOLDING STATIONERY AND OFFICE IMPLEMENTS; PRINTED INSTRUCTIONAL AND TEACHING MATERIALS, ALL IN THE FIELDS OF TELECOMMUNICATIONS, INFORMATION TECHNOLOGY, SAFETY, NEWS, SPORTS ENTERTAINMENT, CULTURE, BUSINESS AND FINANCE, WEATHER AND TRAVEL; BOOK-MARKERS; STENCILS; SCRATCH PICTURES; PVC STICKERS; BLACKBOARDS; CHALK STICKS; ADHESIVES FOR STATIONERY OR HOUSEHOLD PURPOSES; DRAWING AND PAINTING MATERIALS, NAMELY, PENCILS, DRAWING PENCILS, PENS, DRAWING PENS, PAINT TRAYS, PAINTING SETS FOR ARTISTS, PAINTING SETS FOR CHILDREN, ARTS AND CRAFT PAINT KITS, AND PENCIL CASES; NON-MAGNETICALLY ENCODED PREPAID TELEPHONE CALLING CARDS, IN CLASS 16 (U.S. CLS. 2, 5, 22, 23, 29, 37, 38 AND 50).

FOR: TELEPHONE DIRECTORY ASSISTANCE SERVICES; ADVERTISING SERVICES, NAMELY, PREPARING AND PLACING ADVERTISEMENTS FOR OTHERS PROMOTING THE GOODS AND SERVICES OF OTHERS THROUGH PRINTED ADVERTISING, PRINTED DIRECTORIES, THROUGH ENCODED MEDIA, THROUGH THE DISSEMINATION OF PROMOTIONAL MATERIALS, THROUGH DIRECT MAIL ADVERTISING, THROUGH ELECTRONIC BILLBOARD ADVERTISING, PREPARING AUDIO-VISUAL PRESENTATIONS FOR USE IN ADVERTISING; BUSINESS MANAGEMENT SERVICES, NAMELY, BUSINESS APPRAISALS, BUSINESS AUDITING, PROVIDING BUSINESS INFORMATION, NAMELY, PREPARING BUSINESS REPORTS AND CONDUCTING BUSI-

NESS RESEARCH, ANALYSIS AND SURVEYS, BUSINESS MANAGEMENT PLANNING, BUSINESS MANAGEMENT CONSULTATION, BUSINESS MANAGEMENT SUPERVISION, CONDUCTING BUSINESS NETWORKING FOR OTHERS; BUSINESS MANAGEMENT AND CONSULTING SERVICES, EXCLUDING AGRICULTURAL BUSINESS MANAGEMENT AND CONSULTING SERVICES; PROVIDING INFORMATION VIA THE TELEPHONE AND THE GLOBAL COMMUNICATION NETWORKS IN THE FIELD OF ADVERTISING AND BUSINESS MARKETING; PROFESSIONAL CONSULTANCY IN THE FIELD OF DATA PROCESSING; RENTAL OF AUTOMATIC VENDING MACHINES; RENTAL OF DATA PROCESSING EQUIPMENT; ORGANIZING JOB FAIRS, IN CLASS 35 (U.S. CLS. 100, 101 AND 102).

FOR: INSURANCE SERVICES, NAMELY, INSURANCE BROKERAGE, INSURANCE CLAIMS PROCESSING; FINANCIAL SERVICES, NAMELY, CLEARING OF SECURE FINANCIAL TRANSACTIONS THROUGH ONLINE SERVICES; FINANCIAL ANALYSIS AND CONSULTATION; FINANCIAL INFORMATION PROVIDED BY ELECTRONIC MEANS; FINANCIAL INFORMATION PROCESSING; FINANCIAL PORTFOLIO MANAGEMENT; FINANCIAL SERVICES, NAMELY, SECURITIES CONSULTING AND SAFE KEEPING; FINANCIAL SPONSORSHIP OF SPORTS, EDUCATIONAL AND ENTERTAINMENT PROGRAMS AND EVENTS; COMMERCIAL LENDING SERVICES; MONETARY EXCHANGE; CREDIT CARD SERVICES; TELEPHONE CALLING CARD SERVICES; ELECTRONIC COMMERCE SERVICES, NAMELY, ELECTRONIC DEBIT AND CREDIT CARD TRANSACTION PROCESSING SERVICES, FUNDS TRANSFER AND BILL PAYMENT-PROCESSING SERVICES; DISCOUNT BROKERAGE SERVICES; SECURITY BROKERAGE; BROKERAGE IN THE FIELD OF INSURANCE, STOCKS, COMMODITIES; CUSTOM BROKERAGE FOR THIRD PARTIES IN THE FIELD OF INSURANCE, STOCKS, COMMODITIES; BROKERAGE OF SHARES AND VENTURE CAPITAL FUNDING SERVICES TO START-UP COMPANIES; BROKERAGE OF FUND SHARES; BROKERAGE OF PRODUCTIVE INVESTMENT OF FUNDS; REAL ESTATE SERVICES, NAMELY, BROKERAGE, MANAGEMENT, LEASING, AND APPRAISAL OF REAL PROPERTY; CONSULTING SERVICES RELATING TO INSURANCE SERVICES, NAMELY, PROVIDING INFORMATION AND BROKERAGE OF INSURANCES IN THE FIELD OF HOME INSURANCE, ACCIDENT INSURANCE AND HEALTH INSURANCE; CONSULTING SERVICES RELATING TO BANK SERVICES; PROVIDING INFORMATION VIA THE TELEPHONE AND THE GLOBAL COMMUNICATION NETWORKS IN THE FIELD OF FINANCE, IN CLASS 36 (U.S. CLS. 100, 101 AND 102).

FOR: TELECOMMUNICATION AND INFORMATION TECHNOLOGY SERVICES, NAMELY, ELECTRIC, DIGITAL, CELLULAR AND WIRELESS TRANSMISSION OR VOICE, DATA, INFORMATION IMAGES, SIGNALS AND MESSAGES AND

TRANSMISSION OF VOICE, DATA, IMAGES, AUDIO, VIDEO AND INFORMATION VIA TELEPHONE, TELEVISION AND GLOBAL COMMUNICATION NETWORKS; PROVIDING TELECOMMUNICATIONS CONNECTIONS OVER A GLOBAL COMMUNICATIONS NETWORK, ELECTRONIC MAIL, VOICE MAIL AND MESSAGING SERVICES, NAMELY, THE RECORDING AND SUBSEQUENT TRANSMISSION OF VOICE MESSAGES BY TELEPHONE; RENTAL OF TELECOMMUNICATIONS EQUIPMENT, NAMELY, EQUIPMENT FOR ELECTRONIC ACCESS TO GLOBAL TELECOMMUNICATIONS NETWORK, EQUIPMENT FOR TRANSMITTING, RECEIVING, RECORDING AND MONITORING VOICE, DATA, INFORMATION IMAGES, SIGNALS, MESSAGES COMPRISED OF DATA AND WORD PROCESSORS; AND TELECOMMUNICATIONS HARDWARE COMPONENTS AND PERIPHERALS THEREOF FOR USE IN THE TELECOMMUNICATIONS INDUSTRY, AND RENTAL OF EQUIPMENT FOR TRANSMITTING, RECEIVING, RECORDING AND MONITORING COMPUTER PROGRAMS FOR USE IN OPERATING AND ACCESSING TELECOMMUNICATIONS SYSTEMS; AUDIO AND VIDEO BROADCASTING; PROVIDING MULTIPLE-USER DIAL-UP AND DEDICATED ACCESS TO THE INTERNET; PERSONAL COMMUNICATIONS SERVICES; PAGER SERVICES; TRANSMISSION AND BROADCAST OF AUDIO AND VIDEO PROGRAMMING; LEASING OF TELECOMMUNICATIONS EQUIPMENT, COMPONENTS AND SYSTEMS; PROVIDING INFORMATION VIA THE TELEPHONE AND THE GLOBAL COMMUNICATION NETWORKS IN THE FIELD OF TELECOMMUNICATIONS; CONSULTING IN THE FIELD OF TELECOMMUNICATIONS, IN CLASS 38 (U.S. CLS. 100, 101 AND 104).

FOR: EDUCATION AND INSTRUCTION, NAMELY, EDUCATIONAL SERVICES IN THE NATURE OF CLASSES AND SEMINARS IN THE FIELDS OF BUSINESS, TELECOMMUNICATIONS AND COMPUTERS, AND THE DISTRIBUTION OF COURSE MATERIALS THEREWITH; ENTERTAINMENT IN THE NATURE OF VISUAL AND AUDIO PERFORMANCES, NAMELY, MUSICAL BANDS, GYMNASIAC, DANCE, AND BALLET PERFORMANCES; ENTERTAINMENT SERVICES, NAMELY, PROVIDING MUSICAL, VARIETY, NEWS AND COMEDY SHOWS VIA A GLOBAL COMPUTER INFORMATION NETWORK; PROVIDING ENTERTAINMENT INFORMATION AT THE SPECIFIC REQUEST OF END-USERS BY MEANS OF TELEPHONE OR GLOBAL COMMUNICATIONS NETWORKS; ENTERTAINMENT SERVICES, NAMELY, PROVIDING ON-LINE COMPUTER GAMES FOR CHILDREN AND ADULTS; ORGANIZING COMMUNITY SPORTING AND CULTURAL EVENTS; PUBLICATION OF BOOKS, MAGAZINES, JOURNALS, MANUALS, BROCHURES AND LEAFLETS ON THE SUBJECT OF TELECOMMUNICATIONS; ELECTRONIC PUBLISHING SERVICES, NAMELY, PUBLICATION OF TEXT AND GRAPHIC WORKS OF OTHERS ON TELECOMMUNICATIONS RECORDED ON ELECTRONIC MEDIA, NAMELY, CD, DVD AND ONLINE; ORGANIZING FAIRS AND

EXHIBITIONS IN THE FIELD OF VISUAL AND AUDIO PERFORMANCES, NAMELY, ROCK GROUP, GYMNASTIC, DANCE, AND BALLET PERFORMANCES, IN CLASS 41 (U.S. CLS. 100, 101 AND 107).

FOR: COMPUTER PROGRAMMING SERVICES FOR OTHERS; RENTAL OF COMPUTER SOFTWARE AND HARDWARE FOR ONLINE ACCESS; DATA ENCRYPTION SERVICES, NAMELY, ADMINISTRATION OF DIGITAL KEYS AND DIGITAL CERTIFICATES; APPLICATION SERVICE PROVIDER, NAMELY, HOSTING COMPUTER SOFTWARE APPLICATIONS FOR OTHERS, HOSTING OF DIGITAL CONTENT ON THE INTERNET; HOSTING THE WEBSITES OF OTHERS ON A COMPUTER SERVER FOR A GLOBAL COMPUTER NETWORK; COMPUTER SERVICES, NAMELY, CREATING INDEXES OF INFORMATION AVAILABLE ON COMPUTER NETWORKS; PROVIDING INFORMATION VIA THE TELEPHONE AND THE GLOBAL COMMUNICATION NETWORKS IN THE FIELD OF INFORMATION TECHNOLOGY; CONSULTING SERVICES IN THE FIELD OF DESIGN, SELECTION, IMPLEMENTATION AND USE OF COMPUTER HARDWARE AND SOFTWARE SYSTEMS FOR OTHERS; INSTALLATION, MAINTENANCE AND REPAIR OF COMPUTER SOFTWARE; TELECOMMUNICATIONS EQUIPMENT CONSUL-

TATION, NAMELY, PROJECTING AND PLANNING SERVICES RELATED TO TELECOMMUNICATIONS EQUIPMENT; PROVIDING GENERAL INFORMATION AT THE SPECIFIC REQUEST OF END-USERS BY MEANS OF TELEPHONE OR GLOBAL COMMUNICATIONS NETWORKS, IN CLASS 42 (U.S. CLS. 100 AND 101).

OWNER OF FED REP GERMANY REG. NO. 30217928, DATED 6-18-2002, EXPIRES 4-30-2012.

OWNER OF U.S. REG. NO. 2,367,890.

NO CLAIM IS MADE TO THE EXCLUSIVE RIGHT TO USE "FINANCE", APART FROM THE MARK AS SHOWN.

THE MARK CONSISTS OF THE LETTER "T", WHICH IS WHITE; A CIRCLE AROUND THE LETTER "T", WHICH IS MAGENTA; AND THE WORD "FINANCE", WHICH IS GREY. THE APPLICANT IS CLAIMING THE COLORS WHITE, MAGENTA AND GREY AS A FEATURE OF THE MARK.

SER. NO. 78-219,684, FILED 2-27-2003.

JOHN KELLY, EXAMINING ATTORNEY

Int. Cls.: 1 and 40

Prior U.S. Cls.: 1, 5, 6, 10, 26, 46, 100, 103 and 106

United States Patent and Trademark Office

Reg. No. 3,576,194

Registered Feb. 17, 2009

**TRADEMARK
SERVICE MARK
PRINCIPAL REGISTER**



DEVAN CHEMICALS NV (BELGIUM CORPORATION)
NINOOFSESTEENWEG 539
RONSE, BELGIUM B-9600

FILED 3-6-2003, REG. NO. 003086832, DATED 11-28-2007, EXPIRES 3-6-2013.

FOR: CHEMICALS FOR USE IN FIRE RETARDANT APPLICATIONS; UNPROCESSED PLASTICS IN THE NATURE OF FILTERING MATERIALS FOR USE IN FLAME RETARDANT APPLICATIONS; SOLDERING CHEMICALS, TEMPERING CHEMICALS FOR USE IN METALWORKING AND SOLDERING; FOOD PRESERVATIVE COMPOSITIONS; TANNING AGENTS FOR USE IN THE MANUFACTURE OF LEATHER; ADHESIVES FOR GENERAL INDUSTRIAL USE, IN CLASS 1 (U.S. CLS. 1, 5, 6, 10, 26 AND 46).

THE COLOR(S) BLACK AND GREEN IS/ARE CLAIMED AS A FEATURE OF THE MARK.

FOR: TREATMENT OF TEXTILES AND POLYURETHANE FOAM IN THE NATURE OF FLAME-PROOFING, IN CLASS 40 (U.S. CLS. 100, 103 AND 106).

THE MARK CONSISTS OF WORDING "ECO-FLAM" IN BLACK STYLIZED LETTERING APPEARING NEXT TO THE GRAPHIC REPRESENTATION OF A TREE IN GREEN, SPECIFICALLY PANTONE 368. APPLICANT CLAIMS THE SHADE BLACK WHICH APPEARS IN THE LETTERING OF THE WORD "ECO-FLAM" AND THE COLOR GREEN WHICH APPEARS IN THE GRAPHIC REPRESENTATION OF THE TREE AS A FEATURE OF THE MARK.

PRIORITY CLAIMED UNDER SEC. 44(D) ON FAROE ISLANDS APPLICATION NO. 3086832,

SER. NO. 78-261,258, FILED 6-11-2003.

PAM WILLIS, EXAMINING ATTORNEY

Int. Cl.: 43

Prior U.S. Cls.: 100 and 101

United States Patent and Trademark Office

Reg. No. 3,576,195

Registered Feb. 17, 2009

SERVICE MARK
PRINCIPAL REGISTER



PENTAGON ENTERPRISES, LLC (INDIANA
LIMITED LIABILITY COMPANY)
3535 EAST 96TH ST. SUITE 101
INDIANAPOLIS, IN 46240

FOR: RESTAURANTS, IN CLASS 43 (U.S. CLS. 100
AND 101).

FIRST USE 11-1-2001; IN COMMERCE 11-1-2001.

NO CLAIM IS MADE TO THE EXCLUSIVE
RIGHT TO USE "BAR-B-Q AND THE OUTLINE OF

THE STATE OF TEXAS", APART FROM THE MARK
AS SHOWN.

THE MARK CONSISTS OF THE STATE OF TEXAS
WITH STYLIZED TEXT READING DICK'S BODA-
CIOUS BAR-B-Q.

SER. NO. 78-284,138, FILED 8-6-2003.

JOHN SCHUYLER YARD, EXAMINING ATTOR-
NEY

Int. Cls.: 39 and 41

Prior U.S. Cls.: 100, 101, 105 and 107

United States Patent and Trademark Office

Reg. No. 3,576,196

Registered Feb. 17, 2009

**SERVICE MARK
PRINCIPAL REGISTER**

SHERLOCK

APPLE INC. (CALIFORNIA CORPORATION)
1 INFINITE LOOP
CUPERTINO, CA 95014

FOR: PROVIDING ONLINE GEOGRAPHIC INFORMATION AND MAP IMAGES, IN CLASS 39 (U.S. CLS. 100 AND 105).

FIRST USE 9-30-1998; IN COMMERCE 9-30-1998.

FOR: TRANSLATION SERVICES , IN CLASS 41 (U.S. CLS. 100, 101 AND 107).

FIRST USE 9-30-1998; IN COMMERCE 9-30-1998.

OWNER OF U.S. REG. NOS. 2,336,753 AND 2,871,876.

SER. NO. 78-308,503, FILED 10-2-2003.

MICHAEL WEBSTER, EXAMINING ATTORNEY

Int. Cl.: 42

Prior U.S. Cls.: 100 and 101

United States Patent and Trademark Office

Reg. No. 3,576,197

Registered Feb. 17, 2009

**SERVICE MARK
PRINCIPAL REGISTER**



W O N D E R B O X
T E C H N O L O G I E S

WONDERBOX TECHNOLOGIES, LLC (WISCONSIN LIMITED LIABILITY COMPANY)
SUITE 205
1017 WEST GLEN OAKS LANE
MEQUON, WI 53092

FOR: PROVIDING TEMPORARY USE OF NON-DOWNLOADABLE COMPUTER SOFTWARE IN THE FIELD OF MANAGING HEALTHCARE BENEFITS FOR THE PROCESSING OF REIMBURSEMENTS TO HEALTH CARE PROVIDERS BY INSURANCE ADMINISTRATORS, IN CLASS 42 (U.S. CLS. 100 AND 101).

FIRST USE 10-1-2003; IN COMMERCE 1-1-2004.

OWNER OF U.S. REG. NO. 2,933,049.

NO CLAIM IS MADE TO THE EXCLUSIVE RIGHT TO USE "TECHNOLOGIES", APART FROM THE MARK AS SHOWN.

THE COLOR(S) GOLD, WHITE AND BLACK IS/ARE CLAIMED AS A FEATURE OF THE MARK.

THE MARK CONSISTS OF TWO PARALLEL WHITE HORIZONTAL LINES EXTENDING TO BOTH EDGES OF THE MARK AND A CENTRAL WHITE OVAL WHICH EXTENDS BELOW THE LOWER WHITE LINE AND ABOVE THE UPPER WHITE LINE. TO THE LEFT AND RIGHT OF THE CENTRAL WHITE OVAL, AND BETWEEN THE PARALLEL WHITE LINES, ARE BANDS OF GOLD COLOR. THE REMAINDER OF THE MARK IS BLACK.

SER. NO. 78-362,766, FILED 2-4-2004.

MONIQUE MILLER, EXAMINING ATTORNEY

Int. Cl.: 3

Prior U.S. Cls.: 1, 4, 6, 50, 51 and 52

United States Patent and Trademark Office

Reg. No. 3,576,198

Registered Feb. 17, 2009

**TRADEMARK
PRINCIPAL REGISTER**

xilara
eau de toilette

JAFER LIMITED (BERMUDA CORPORATION)
CLARENDON HOUSE, 2 CHURCH STREET
HAMILTON, BERMUDA HM12

FOR: PERFUMES, FRAGRANCES FOR PERSONAL USE, TOILET WATER, COLOGNE, AFTER SHAVING LOTIONS; LOTIONS FOR THE FACE, HANDS, AND BODY; CREAM FOR THE HAND, FACE AND BODY; TOILET SOAP, BATH SALTS; DEODORANT FOR PERSONAL USE, ANTIPERSPIRANT; TALCUM POWDER; HAIR SHAMPOO, HAIR CONDITIONERS, HAIR BALMS, HAIR GELS,

HAIR RINSES, HAIR STYLING PREPARATIONS, IN CLASS 3 (U.S. CLS. 1, 4, 6, 50, 51 AND 52).

OWNER OF BERMUDA REG. NO. 00098284, DATED 6-30-2004, EXPIRES 6-30-2014.

NO CLAIM IS MADE TO THE EXCLUSIVE RIGHT TO USE "EAU DE TOILETTE", APART FROM THE MARK AS SHOWN.

SER. NO. 78-404,361, FILED 4-19-2004.

BRIDGETT SMITH, EXAMINING ATTORNEY

Int. Cl.: 36

Prior U.S. Cls.: 100, 101 and 102

United States Patent and Trademark Office

Reg. No. 3,576,199

Registered Feb. 17, 2009

SERVICE MARK
PRINCIPAL REGISTER



CELEBRITY RESORTS, INC. (FLORIDA CORPORATION)
SUITE 600
4700 MILLENIA BLVD
ORLANDO, FL 32839

FOR: VACATION TIMESHARE SERVICES, NAMELY FINANCING, MANAGEMENT, BROKERAGE AND LEASING OF LAND-BASED TIME-SHARE PROPERTIES, IN CLASS 36 (U.S. CLS. 100, 101 AND 102).

FIRST USE 8-1-2001; IN COMMERCE 8-1-2001.

NO CLAIM IS MADE TO THE EXCLUSIVE RIGHT TO USE "RESORTS", APART FROM THE MARK AS SHOWN.

THE MARK CONSISTS OF "CELEBRITY RESORTS" WITH STYLIZED "C".

SER. NO. 78-424,631, FILED 5-25-2004.

DAVID MILLER, EXAMINING ATTORNEY

Int. Cl.: 21

Prior U.S. Cls.: 2, 13, 23, 29, 30, 33, 40 and 50

United States Patent and Trademark Office

Reg. No. 3,576,200

Registered Feb. 17, 2009

TRADEMARK
PRINCIPAL REGISTER

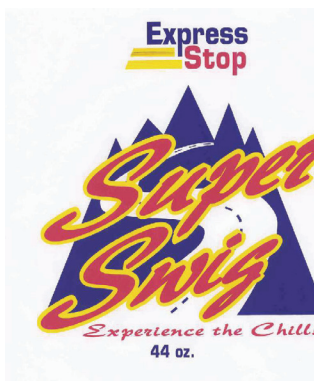

GALEN E. WILSON PETROLEUM CO. (MICHIGAN CORPORATION)
3057 DAVENPORT AVENUE
SAGINAW, MI 48602

FOR: BEVERAGEWARE, IN CLASS 21 (U.S. CLS. 2, 13, 23, 29, 30, 33, 40 AND 50).

FIRST USE 11-24-2003; IN COMMERCE 11-24-2003.

NO CLAIM IS MADE TO THE EXCLUSIVE RIGHT TO USE "44 OZ.", APART FROM THE MARK AS SHOWN.

THE COLOR(S) RED, BLUE AND YELLOW IS/ARE CLAIMED AS A FEATURE OF THE MARK.

THE MARK CONSISTS OF "EXPRESS" (IN BLUE) OVER TWO YELLOW LINES AND "STOP" (IN RED) OVER BLUE MOUNTAINS WITH A WHITE ROAD WITH BLUE DASH MARKS IN THE ROAD WITH "SUPER SWIG" (IN RED AND YELLOW) SUPERIMPOSED OVER THE MOUNTAINS WITH "EXPERIENCE THE CHILL" (IN RED) UNDER THE MOUNTAINS AND "44 OZ." (IN BLUE) UNDER THAT.

SER. NO. 78-432,567, FILED 6-9-2004.

RUDY R. SINGLETON, EXAMINING ATTORNEY

Int. Cl.: 42

Prior U.S. Cls.: 100 and 101

United States Patent and Trademark Office

Reg. No. 3,576,201

Registered Feb. 17, 2009

**SERVICE MARK
PRINCIPAL REGISTER**

NetBlue

REYMAN, JOSEPH E. (UNITED STATES INDIVIDUAL)
121 NORTH THIRD STREET UNIT B
ALHAMBRA, CA 91801

NO CLAIM IS MADE TO THE EXCLUSIVE RIGHT TO USE "NET", APART FROM THE MARK AS SHOWN.

FOR: COMPUTER SERVICES, NAMELY, DESIGNING AND IMPLEMENTING WEB SITES FOR OTHERS, IN CLASS 42 (U.S. CLS. 100 AND 101).

SER. NO. 78-432,826, FILED 6-10-2004.

FIRST USE 2-12-2003; IN COMMERCE 2-12-2003.

LOURDES AYALA, EXAMINING ATTORNEY

Int. Cls.: 9 and 41

Prior U.S. Cls.: 21, 23, 26, 36, 38, 100, 101 and 107

Reg. No. 3,576,202

United States Patent and Trademark Office

Registered Feb. 17, 2009

**TRADEMARK
SERVICE MARK
PRINCIPAL REGISTER**

BEFORE CRISIS

KABUSHIKI KAISHA SQUARE ENIX (JAPAN CORPORATION), TA SQUARE ENIX CO., LTD.
3-22-7 YOYOGI, SHIBUYA-KU
TOKYO, JAPAN

FOR: COMPUTER GAME SOFTWARE; VIDEO GAME SOFTWARE; SOUND RECORDINGS IN THE FORM OF OPTICAL DISCS AND MAGNETIC DISCS FEATURING MUSIC OR NON-MUSICAL AUDIO FICTIONAL STORIES; VISUAL RECORDINGS IN THE FORM OF OPTICAL DISCS, MAGNETIC DISCS AND TAPES AND SEMICONDUCTOR ROMS FEATURING ANIMATED FICTIONAL STORIES AND AUDIO VISUAL RECORDINGS IN THE FORM OF OPTICAL DISCS AND MAGNETIC DISCS FEATURING MUSIC AND/OR ANIMATED FICTIONAL STORIES; PRERECORDED COMPACT DISCS FEATURING MUSIC; PRERECORDED DIGITAL VIDEO DISCS FEATURING ANIMATED FICTIONAL STORIES; PRERECORDED VIDEO CASSETTES FEATURING ANIMATED FICTIONAL STORIES; COMPUTER KEYBOARDS; JOYSTICKS; VIDEO GAME CONTROLLERS; STRAPS FOR CELLULAR PHONES; SUNGLASSES; DOWNLOADABLE WALLPAPERS OR DOWNLOADABLE SCREENSAVERS FOR THE SCREENS OF COMPUTER DISPLAYS OR MOBILE PHONE DISPLAYS; DOWNLOADABLE ANIMATED ACTIVE WALLPAPERS OR DOWNLOADABLE ANIMATED SCREENSAVERS FOR

THE SCREENS OF COMPUTER DISPLAYS OR MOBILE PHONE DISPLAYS; DOWNLOADABLE MUSICAL SOUND RECORDINGS; DOWNLOADABLE ELECTRONIC PUBLICATIONS IN THE NATURE OF MAGAZINES AND NEWSLETTERS IN THE FIELD OF COMPUTER GAMES, VIDEO GAMES AND GENERAL ENTERTAINMENT, IN CLASS 9 (U.S. CLS. 21, 23, 26, 36 AND 38).

FOR: PROVIDING ONLINE COMPUTER GAMES AND/OR ONLINE VIDEO GAMES; PROVIDING INFORMATION ON COMPUTER GAME STRATEGIES AND VIDEO GAME STRATEGIES VIA COMPUTER NETWORKS AND/OR GLOBAL COMMUNICATION NETWORKS; PROVIDING ONLINE NON-DOWNLOADABLE COMICS AND MAGAZINES IN THE FIELD OF COMPUTER GAMES, IN CLASS 41 (U.S. CLS. 100, 101 AND 107).

THE MARK CONSISTS OF STANDARD CHARACTERS WITHOUT CLAIM TO ANY PARTICULAR FONT, STYLE, SIZE, OR COLOR.

OWNER OF JAPAN REG. NO. 4,817,212, DATED 11-12-2004, EXPIRES 11-12-2014.

SER. NO. 78-454,075, FILED 7-21-2004.

GENE MACIOL, EXAMINING ATTORNEY

Int. Cl.: 9

Prior U.S. Cls.: 21, 23, 26, 36 and 38

Reg. No. 3,576,203

United States Patent and Trademark Office

Registered Feb. 17, 2009

TRADEMARK
PRINCIPAL REGISTER



INNOVATIVE GOLF CORPORATION (NEVADA CORPORATION)
14500 N. NORTHSIGHT BLVD., SUITE 205
SCOTTSDALE, AZ 85260

FOR: SCIENTIFIC APPARATUS, NAMELY, A MONITORING DEVICE TO MEASURE AND CALCULATE CARRY DISTANCE, TOTAL DISTANCE AND BALL VELOCITY FOR A STRUCK GOLF BALL, IN CLASS 9 (U.S. CLS. 21, 23, 26, 36 AND 38).

FIRST USE 2-1-2004; IN COMMERCE 3-1-2004.

THE COLORS GREEN, BLUE, WHITE, AND BLACK ARE CLAIMED AS A FEATURE OF THE MARK.

THE COLOR GREEN APPEARS IN THE WORD "PURE", THE COLOR BLUE APPEARS IN THE WORD "CONTACT", THE COLOR WHITE APPEARS IN THE WORDING "BY ZELOCITY", AND THE COLOR BLACK APPEARS IN THE BACKGROUND RECTANGLE SURROUNDING THE MARK.

SER. NO. 78-461,741, FILED 8-4-2004.

JASON LOTT, EXAMINING ATTORNEY

Int. Cl.: 31

Prior U.S. Cls.: 1 and 46

United States Patent and Trademark Office

Reg. No. 3,576,204

Registered Feb. 17, 2009

TRADEMARK
PRINCIPAL REGISTER



KARING BY KRISTINA, LLC (VIRGINIA CORPORATION)
P.O. BOX 10724
ALEXANDRIA, VA 22310

FOR: DOG BISCUITS; DOG TREATS, IN CLASS 31
(U.S. CLS. 1 AND 46).

FIRST USE 12-1-2003; IN COMMERCE 12-1-2003.

NO CLAIM IS MADE TO THE EXCLUSIVE
RIGHT TO USE "GOURMET DOG BAKERY" AND
"BOUTIQUE", APART FROM THE MARK AS
SHOWN.

SER. NO. 78-466,106, FILED 8-11-2004.

LINDA ESTRADA, EXAMINING ATTORNEY

Int. Cl.: 3

Prior U.S. Cls.: 1, 4, 6, 50, 51 and 52

United States Patent and Trademark Office

Reg. No. 3,576,205

Registered Feb. 17, 2009

**TRADEMARK
PRINCIPAL REGISTER**

Liquid Lustre

LIQUID LUSTRE (TEXAS CORPORATION)
P.O. BOX 2388
BULL HEAD, AZ 86430

NO CLAIM IS MADE TO THE EXCLUSIVE
RIGHT TO USE "LIQUID" , APART FROM THE
MARK AS SHOWN.

FOR: AUTOMOBILE WAX, IN CLASS 3 (U.S. CLS.
1, 4, 6, 50, 51 AND 52).

SER. NO. 78-495,374, FILED 10-6-2004.

FIRST USE 10-1-1987; IN COMMERCE 10-1-1987.

RUDY R. SINGLETON, EXAMINING ATTORNEY

Int. Cl.: 30

Prior U.S. Cl.: 46

United States Patent and Trademark Office

Reg. No. 3,576,206

Registered Feb. 17, 2009

TRADEMARK
PRINCIPAL REGISTER

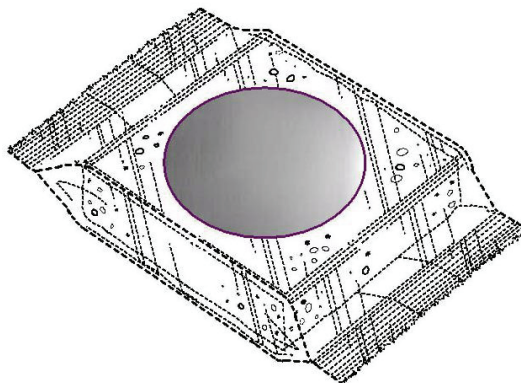

FAIRYTALE BROWNIES, INC. (ARIZONA CORPORATION)
4610 E. COTTON CENTER BLVD
SUITE 100
PHOENIX, AZ 85040

FOR: BAKED GOODS, NAMELY, BROWNIES, IN CLASS 30 (U.S. CL. 46).

FIRST USE 11-0-1992; IN COMMERCE 11-0-1992.

OWNER OF U.S. REG. NO. 3,110,845.

THE COLOR(S) METALLIC SILVER AND PURPLE IS/ARE CLAIMED AS A FEATURE OF THE MARK.

THE MARK CONSISTS OF THE PLACEMENT AND APPEARANCE OF AN EMBLEM ON THE PACKAGING FOR THE GOODS. EACH APPROXIMATELY 3-INCH SQUARE, 3/4-INCH THICK BROWNIE IS ENCLOSED IN A TRANSPARENT WRAPPER, WITH THE TRANSPARENT WRAPPER SEALED ON OPPOSING ENDS. CENTERED ON THE FRONT OF THE WRAPPER IS A ROUND

EMBLEM APPROXIMATELY 2-3/8 INCHES IN DIAMETER. THE EMBLEM CONSISTS OF A METALLIC SILVER CIRCLE SURROUNDED BY A PURPLE RIM ABOUT 1/16TH INCH WIDE. THE ENTIRE PACKAGE MEASURES APPROXIMATELY 3-1/4 INCHES HIGH, BY 4-5/8 INCHES WIDE, BY 3/4 INCH THICK. THE DIMENSIONS OF THE BROWNIE AND OF THE OVERALL PACKAGE, AND THE TRANSPARENT WRAPPING SEALED ON OPPOSING ENDS ARE NOT CLAIMED AS FEATURES OF THE MARK AND ARE REPRESENTED IN DOTTED LINES TO SHOW PLACEMENT OF THE MARK. THE MARK COMPRISES THE ROUND, METALLIC SILVER EMBLEM WITH A PURPLE RIM. THE COLORS BLACK, WHITE AND NON-METALLIC GRAY APPEARING IN THE MARK REPRESENT BACKGROUND OUTLINING, SHADING AND/OR TRANSPARENT AREAS AND ARE NOT PART OF THE MARK.

SEC. 2(F).

SER. NO. 78-524,765, FILED 11-30-2004.

SANI KHOURI, EXAMINING ATTORNEY

Int. Cls.: 9 and 28

Prior U.S. Cls.: 21, 22, 23, 26, 36, 38 and 50

Reg. No. 3,576,207

United States Patent and Trademark Office

Registered Feb. 17, 2009

**TRADEMARK
PRINCIPAL REGISTER**

CRAZY NEST

ATRONIC INTERNATIONAL GMBH (FED REP
GERMANY CORPORATION)
BORSIGSTRASSE 26
32312 LUBBECKE, FED REP GERMANY 32312

FOR: ELECTRIC AND ELECTRONIC APPARATUS, INSTRUMENTS, DEVICES AND MACHINES, NAMELY, GAMING AND GAMBLING MACHINES; COIN OPERATED MACHINES AND MACHINES OPERABLE WITH BILLS, MAGNETIC CARDS, COMPUTER CHIPS, MICRO-PROCESSOR DEVICES AND TOKENS, NAMELY, GAMING AND GAMBLING MACHINES, MECHANISMS FOR COIN OPERATED AND COIN CONTROLLED MACHINES, NAMELY, MECHANICAL UNITS FOR DISPENSING COINS, NAMELY, COIN HOPPERS; COIN, CURRENCY AND TOKEN-CONTROLLED GAMING MACHINES, APPARATUSES FOR BILLING OPERATIONS OF COIN-OPERATED MACHINES, NAMELY, COMPUTERS AND COMPUTER SOFTWARE USED TO GENERATE BILLS IN CONNECTION WITH COIN OPERATED GAMING MACHINES; AUTOMATED DATA STORAGE MACHINES IN THE NATURE OF COMPUTERS, COMPUTER DATA PRINTER FOR DISPLAYING TOTAL WINNINGS IN FRONT OF GAMING MACHINES; ELECTRONIC PRINTED CIRCUIT BOARDS; COIN CHANGERS; VENDING MACHINES WHICH PROVIDE TOKENS, COUPONS AND GAME CARDS; ELECTRIC AND ELECTRONIC MACHINES AND APPARATUSES FOR GAMES, AMUSEMENT, ENTERTAINMENT AND GAMING, NAMELY, SLOT MACHINES, GAMING EQUIPMENT, NAMELY, GAMING MACHINES, VIDEO SLOT MACHINES; CASINO GAMBLING DEVICES, NAMELY, SLOT MACHINES AND PARTS THEREFOR, GAME SYM-

BOL CYLINDERS FOR SLOT MACHINES; DROP-DOWN CAROUSELS FOR SLOT MACHINES AND GAMING MACHINES; TV MONITORS, LCD-DISPLAY MONITORS, ALL FOR GAMBLING MACHINES; ELECTRONIC CASINO GAMING MACHINES; ELECTRIC AND ELECTRONIC GAMING AND GAMBLING MACHINES; MACHINES FOR PLAYING GAMES OF CHANCE; COMPUTER GAME CASSETTES AND CARTRIDGES FOR ELECTRONIC POCKET GAMES VIDEO GAME MACHINES FOR USE WITH TELEVISION; PRERECORDED DATA CARRIERS PROGRAMMED FOR ELECTRONIC VIDEO AND AUDIO DISPLAY FOR PLAYING ELECTRONIC GAMES, IN CLASS 9 (U.S. CLS. 21, 23, 26, 36 AND 38).

FOR: ELECTRIC AND ELECTRONIC STAND ALONE VIDEO MACHINES FEATURING GAMES, AMUSEMENT, SPORTS AND ENTERTAINMENT ALL FOR USE INDIVIDUALLY OR AS A NETWORK, COIN-OPERATED STAND ALONE COMPACT VIDEO GAME SPORTS MACHINES; HANDHELD UNIT FOR PLAYING ELECTRONIC GAMES, NAMELY, COMPACT SPORTS MACHINES FOR PLAYING IN SMALL AREAS, NAMELY, DARTS, TABLE SOCCER, POOL-BILLIARD, SNOOKER, SHOOTING GALLERIES, PINBALL GAMES; HAND HELD CONSOLES FOR ELECTRONIC GAMES, ELECTRONIC PARLOR GAMES, VIDEO GAMES AND INSTRUMENTS, NAMELY, HANDHELD UNIT FOR PLAYING VIDEO GAMES, STAND ALONE VIDEO GAME MACHINES, IN CLASS 28 (U.S. CLS. 22, 23, 38 AND 50).

THE MARK CONSISTS OF STANDARD CHARACTERS WITHOUT CLAIM TO ANY PARTICULAR FONT, STYLE, SIZE, OR COLOR.

PRIORITY CLAIMED UNDER SEC. 44(D) ON ERPNTY TM OFC APPLICATION NO.

004096558, FILED 11-4-2004, REG. NO. 004096558, DATED 1-18-2006, EXPIRES 11-4-2014.

SER. NO. 78-525,721, FILED 12-2-2004.

JULIE GUTTADAURO, EXAMINING ATTORNEY

Int. Cl.: 35

Prior U.S. Cls.: 100, 101 and 102

United States Patent and Trademark Office

Reg. No. 3,576,208

Registered Feb. 17, 2009

**SERVICE MARK
PRINCIPAL REGISTER**

HUSH

PLAYBOY.COM, INC. (DELAWARE CORPORATION)
680 NORTH LAKE SHORE DRIVE
CHICAGO, IL 60611

FOR: DIRECT MARKETING ADVERTISING SERVICES FOR OTHERS; ONLINE RETAIL STORE SERVICES, HOME SHOPPING SERVICES BY MEANS OF TELEPHONE, AND MAIL ORDER CATALOGUE SERVICES ALL FEATURING AUDIO VISUAL RECORDINGS AND DVDS WITH ADULT ENTERTAINMENT, AND ADULT INTIMATE SEX TOYS AND SEX AIDS TO ENHANCE SEXUAL

PLEASURE AND STIMULATION, IN CLASS 35 (U.S. CLS. 100, 101 AND 102).

FIRST USE 1-28-2005; IN COMMERCE 1-28-2005.

THE MARK CONSISTS OF STANDARD CHARACTERS WITHOUT CLAIM TO ANY PARTICULAR FONT, STYLE, SIZE, OR COLOR.

SER. NO. 78-565,047, FILED 2-10-2005.

ZHALEH DELANEY, EXAMINING ATTORNEY

Int. Cl.: 34

Prior U.S. Cls.: 2, 8, 9 and 17

United States Patent and Trademark Office

Reg. No. 3,576,209

Registered Feb. 17, 2009

**TRADEMARK
PRINCIPAL REGISTER**

Bull's • Eye

FINK CIGAR COMPANY, LLP (TEXAS PART-
NERSHIP)
414 VERA CRUZ STREET
SAN ANTONIO, TX 78207

FIRST USE 11-15-1995; IN COMMERCE 11-15-1995.

SER. NO. 78-575,514, FILED 2-25-2005.

FOR: CIGAR CUTTER, IN CLASS 34 (U.S. CLS. 2, 8,
9 AND 17).

JOHN SCHUYLER YARD, EXAMINING ATTOR-
NEY

Int. Cl.: 5

Prior U.S. Cls.: 6, 18, 44, 46, 51 and 52

United States Patent and Trademark Office

Reg. No. 3,576,210

Registered Feb. 17, 2009

**TRADEMARK
PRINCIPAL REGISTER**

HOODIALYTE

HOODIALYTE (FLORIDA LIMITED LIABILITY
COMPANY)
4630 N. UNIVERSITY DR. #363
CORAL SPRINGS, FL 33067

THE MARK CONSISTS OF STANDARD CHAR-
ACTERS WITHOUT CLAIM TO ANY PARTICULAR
FONT, STYLE, SIZE, OR COLOR.

FOR: DIETARY SUPPLEMENTS, IN CLASS 5 (U.S.
CLS. 6, 18, 44, 46, 51 AND 52).

SER. NO. 78-577,501, FILED 3-1-2005.

FIRST USE 3-29-2005; IN COMMERCE 3-29-2005.

SUSAN STIGLITZ, EXAMINING ATTORNEY

Int. Cl.: 38

Prior U.S. Cls.: 100, 101 and 104

United States Patent and Trademark Office

Reg. No. 3,576,211

Registered Feb. 17, 2009

**SERVICE MARK
PRINCIPAL REGISTER**



OCC ESTABLISHMENT (LIECHTENSTEIN AN-
STALT)
STAEDTLE 36
VADUZ, LIECHTENSTEIN FL-9490

FOR: TELEVISION BROADCASTING SERVICES
FEATURING ARABIC PROGRAMMING, IN CLASS
38 (U.S. CLS. 100, 101 AND 104).

PRIORITY CLAIMED UNDER SEC. 44(D) ON
LIECHTENSTEIN APPLICATION NO. 13535, FILED
3-11-2005, REG. NO. 13535, DATED 3-11-2005, EX-
PIRES 3-11-2015.

SER. NO. 78-602,215, FILED 4-5-2005.

SUNG IN, EXAMINING ATTORNEY

Int. Cls.: 7 and 11

Prior U.S. Cls.: 13, 19, 21, 23, 31, 34 and 35

United States Patent and Trademark Office

Reg. No. 3,576,212

Registered Feb. 17, 2009

**TRADEMARK
PRINCIPAL REGISTER**

Nexxt Premium

BSH HOME APPLIANCES CORPORATION (DE-
LAWARE CORPORATION)
5551 MCFADDEN AVENUE
HUNTINGTON BEACH, CA 92649

FOR: HOUSEHOLD AND KITCHEN MACHINES AND EQUIPMENT, NAMELY, MINCING MACHINES, MIXING AND KNEADING MACHINES, PRESSING MACHINES, JUICE EXTRACTORS, JUICE CENTRIFUGES, GRINDERS, SLICING MACHINES; ELECTRIC MOTOR-DRIVEN TOOLS, NAMELY, ELECTRIC CAN OPENERS, ELECTRIC KNIFE SHARPENERS; FOOD MACHINES AND DEVICES FOR THE PREPARATION OF BEVERAGES AND/OR FOODS, NAMELY, ELECTRIC FOOD PROCESSORS, ELECTRIC BLENDERS; ELECTRIC WASTE DISPOSAL UNITS, NAMELY, WASTE MASTICATORS AND COMPRESSORS; DISHWASHERS; ELECTRIC MACHINES AND APPLIANCES FOR TREATING LAUNDRY AND CLOTHING, NAMELY, WASHING MACHINES, MANGLES; ELECTRIC CLEANING EQUIPMENT FOR HOUSEHOLD USE, NAMELY, VACUUM CLEANERS; REPLACEMENT PARTS OF ALL AFOREMENTIONED GOODS, IN CLASS 7 (U.S. CLS. 13, 19, 21, 23, 31, 34 AND 35).

FIRST USE 2-1-2004; IN COMMERCE 2-1-2004.

FOR: HEATING, STEAM PRODUCING, AND COOKING DEVICES, NAMELY, DOMESTIC COOKING OVENS, ELECTRIC AND GAS RANGES, COOKTOPS, IMMERSION HEATERS; COOKING POTS WITH INTEGRATED HEATING, NAMELY, ELECTRIC COOKING POTS; MICROWAVE APPLIANCES, NAMELY, MICROWAVE OVENS; WARMING DRAWERS; TEA- AND COFFEE-MAKING

APPARATUS, NAMELY, ELECTRIC COFFEE MACHINES AND TEAPOTS; COOLING DEVICES, NAMELY, REFRIGERATORS, FREEZERS, COMBINATION REFRIGERATOR-FREEZERS, DEEP FREEZERS, ICEMAKERS, ICE CREAM MACHINES; DRYERS, NAMELY, SPIN CLOTHES DRYERS, TUMBLE LAUNDRY DRYERS, HAND DRYERS, HAIR DRYERS; VENTILATION DEVICES, NAMELY, VENTILATORS, GREASE FILTER DEVICES; EXTRACTOR DEVICES, NAMELY, EXTRACTOR HOODS; AIR CONDITIONING DEVICES AND DEVICES TO IMPROVE AIR QUALITY, NAMELY, AIR HUMIDIFIERS, PIPES BEING PARTS OF SANITARY FACILITIES; WARM WATER DEVICES, NAMELY, STORAGE WATER HEATERS AND CONTINUOUS-FLOW WATER HEATERS; KITCHEN SINKS; HEAT PUMPS; REPLACEMENT PARTS OF ALL AFOREMENTIONED GOODS, IN CLASS 11 (U.S. CLS. 13, 21, 23, 31 AND 34).

FIRST USE 2-1-2004; IN COMMERCE 2-1-2004.

THE MARK CONSISTS OF STANDARD CHARACTERS WITHOUT CLAIM TO ANY PARTICULAR FONT, STYLE, SIZE, OR COLOR.

OWNER OF U.S. REG. NO. 3,018,304.

NO CLAIM IS MADE TO THE EXCLUSIVE RIGHT TO USE "PREMIUM", APART FROM THE MARK AS SHOWN.

SER. NO. 78-604,525, FILED 4-8-2005.

ALICE SUE CARRUTHERS, EXAMINING ATTORNEY

Int. Cl.: 41

Prior U.S. Cls.: 100, 101 and 107

United States Patent and Trademark Office

Reg. No. 3,576,213

Registered Feb. 17, 2009

**SERVICE MARK
PRINCIPAL REGISTER**

The Brand YU Life.

THE FLEMINGS GROUP, LLC (MICHIGAN LIMITED LIABILITY COMPANY)

#232

46036 MICHIGAN AVENUE

CANTON, MI 48188

FOR: EDUCATIONAL SERVICES, NAMELY, CONDUCTING SEMINARS, CLASSES, AND WORKSHOPS IN THE FIELD OF BRANDING, BUSINESS, PERSONAL AND LEADERSHIP DEVELOPMENT , IN CLASS 41 (U.S. CLS. 100, 101 AND 107).

FIRST USE 4-16-2005; IN COMMERCE 4-16-2005.

THE MARK CONSISTS OF STANDARD CHARACTERS WITHOUT CLAIM TO ANY PARTICULAR FONT, STYLE, SIZE, OR COLOR.

NO CLAIM IS MADE TO THE EXCLUSIVE RIGHT TO USE "BRAND" AND "LIFE", APART FROM THE MARK AS SHOWN.

SER. NO. 78-611,474, FILED 4-19-2005.

MARLENE BELL, EXAMINING ATTORNEY

Int. Cls.: 9, 11, 20 and 21

Prior U.S. Cls.: 2, 13, 21, 22, 23, 25, 26, 29, 30, 31, 32, 33, 34, 36, 38, 40 and 50

Reg. No. 3,576,214

United States Patent and Trademark Office

Registered Feb. 17, 2009

**TRADEMARK
PRINCIPAL REGISTER**

**GROHE. Performance you can
feel.**

GROHE AG (FED REP GERMANY CORPORATION)
HAUPTSTRASSE 137
58675 HEMER, FED REP GERMANY

FOR: THERMOSTATS FOR CONTROL OF HOT WATER IN WATER MIXERS AND WATER FAUCETS; THERMOSTATICALLY, ELECTRICALLY, OR ULTRASONICALLY CONTROLLED VALVES FOR CONTROLLING WATER, IN CLASS 9 (U.S. CLS. 21, 23, 26, 36 AND 38).

FOR: PLUMBING FITTINGS, NAMELY, VALVES, MIXER FAUCETS FOR WATER PIPES; SHOWERS; HAND SHOWERS; SHOWER HEADS; A FULL LINE OF PLUMBING FITTINGS FOR WATER VALVES, WATER MIXING VALVES, WATER MIXERS, WATER FAUCETS, AND SHOWERS, IN CLASS 11 (U.S. CLS. 13, 21, 23, 31 AND 34).

FOR: GLASS MIRRORS FOR BATHROOMS AND WASHROOMS; METAL FURNITURE FOR BATHROOMS AND WASHROOMS; PLASTIC FURNITURE FOR BATHROOMS AND WASHROOMS; GLASS FURNITURE FOR BATHROOMS AND WASHROOMS; NON-METAL HOOKS, IN CLASS 20 (U.S. CLS. 2, 13, 22, 25, 32 AND 50).

FOR: BATHROOM AND WASHROOM ACCESSORIES, NAMELY, TOWEL RINGS, TOWEL BARS,

TOILET PAPER HOLDERS, TOILET BRUSH SETS CONSISTING OF A TOILET BRUSH AND TOILET BRUSH HOLDER; KITCHEN ACCESSORIES, NAMELY, POT AND PAN SCRAPERS, POT CLEANING BRUSHES HAVING A WATER HOSE COMPONENT THEREOF; KITCHEN, BATHROOM AND WASHROOM ACCESSORIES, NAMELY, WATER POWERED BODY SCRUBBING BRUSHES, WASTE PAPER BASKETS, SOAP HOLDERS, SOAP DISHES, DRINKING GLASSES AND DRINKING GLASS HOLDERS; SOAP DISPENSERS, TOILET TISSUE DISPENSERS, FACIAL TISSUE DISPENSERS, PAPER NAPKIN DISPENSERS AND PAPER TOWEL DISPENSERS, IN CLASS 21 (U.S. CLS. 2, 13, 23, 29, 30, 33, 40 AND 50).

THE MARK CONSISTS OF STANDARD CHARACTERS WITHOUT CLAIM TO ANY PARTICULAR FONT, STYLE, SIZE, OR COLOR.

OWNER OF ERPN CMNTY TM OFC REG. NO. 004392031, DATED 10-24-2006, EXPIRES 4-18-2015.

OWNER OF U.S. REG. NOS. 1,151,616, 2,781,356 AND OTHERS.

SER. NO. 78-614,305, FILED 4-21-2005.

EVELYN BRADLEY, EXAMINING ATTORNEY

Int. Cl.: 35

Prior U.S. Cls.: 100, 101 and 102

United States Patent and Trademark Office

Reg. No. 3,576,215

Registered Feb. 17, 2009

**SERVICE MARK
PRINCIPAL REGISTER**

NAVMAN

MITAC INTERNATIONAL CORPORATION (TAIWAN CORPORATION)
1, R&D ROAD 2
SCIENCE PARK
HSINCHU, TAIWAN

FOR: RETAIL OUTLETS AND WHOLESALE DISTRIBUTORSHIPS FEATURING NAVIGATIONAL APPARATUS AND EQUIPMENT, GLOBAL POSITIONING SYSTEMS EQUIPMENT AND APPARATUS, ELECTRICAL AND ELECTRONIC COMMUNICATIONS EQUIPMENT, SATELLITES AND SATELLITE COMMUNICATIONS EQUIPMENT, EMERGENCY LOCATOR BEACONS, AND COMPUTER SOFTWARE AND HARDWARE, INCLUDING COMPUTER SOFTWARE AND HARDWARE RELATING TO NAVIGATIONAL APPARATUS AND EQUIPMENT AND GPS APPA-

RATUS AND EQUIPMENT, IN CLASS 35 (U.S. CLS. 100, 101 AND 102).

THE MARK CONSISTS OF STANDARD CHARACTERS WITHOUT CLAIM TO ANY PARTICULAR FONT, STYLE, SIZE, OR COLOR.

PRIORITY CLAIMED UNDER SEC. 44(D) ON NEW ZEALAND APPLICATION NO. 728572, FILED 4-22-2005, REG. NO. 728572, DATED 10-27-2005, EXPIRES 4-22-2015.

OWNER OF U.S. REG. NO. 2,153,250.

SER. NO. 78-616,791, FILED 4-26-2005.

ZHALEH DELANEY, EXAMINING ATTORNEY

Int. Cl.: 41

Prior U.S. Cls.: 100, 101 and 107

United States Patent and Trademark Office

Reg. No. 3,576,216

Registered Feb. 17, 2009

**SERVICE MARK
PRINCIPAL REGISTER**



EPICENTER MUSIC

EPICENTER MUSIC (CALIFORNIA SOLE PROPRIETORSHIP)

9302 TAIDSWOOD DR

SPRING, TX 77379

FOR: MUSIC PRODUCTION SERVICES, IN CLASS 41 (U.S. CLS. 100, 101 AND 107).

FIRST USE 6-0-1994; IN COMMERCE 9-0-1999.

NO CLAIM IS MADE TO THE EXCLUSIVE RIGHT TO USE "MUSIC", APART FROM THE MARK AS SHOWN.

THE MARK CONSISTS OF THE WORDING "EPICENTER MUSIC" WITH A HIGHLY STYLIZED SWIRLING "E" DESIGN ABOVE THE WORDING.

SER. NO. 78-624,993, FILED 5-6-2005.

LINDA E. BLOHM, EXAMINING ATTORNEY

Int. Cls.: 29, 30 and 33

Prior U.S. Cls.: 46, 47 and 49

United States Patent and Trademark Office

Reg. No. 3,576,217

Registered Feb. 17, 2009

**TRADEMARK
PRINCIPAL REGISTER**



LINDISFARNE LIMITED (UNITED KINGDOM COMPANY)
ST AIDAN'S WINERY
THE HOLY ISLAND OF LINDISFARNE
NORTHUMBERLAND, UNITED KINGDOM

FOR: MEAT, FISH, POULTRY AND GAME, MEAT EXTRACTS, PRESERVED, DRIED AND COOKED FRUITS AND VEGETABLES; JELLIES, JAMS, MARMALADE, CURD, LEMON CURD, ORANGE CURD, CRANBERRY SAUCE, APPLE SAUCE, FRUIT PRESERVES; EGGS, MILK AND MILK PRODUCTS EXCLUDING ICE CREAM, ICE MILK AND FROZEN YOGURT; EDIBLE OILS AND FATS, IN CLASS 29 (U.S. CL. 46).

FOR: COFFEE, TEA, COCOA, SUGAR, RICE, TAPIOCA, SAGO, ARTIFICIAL COFFEE; BREAD, PASTRIES AND CONFECTIONERY, NAMELY, CANDY, CAKES, COOKIES, CHOCOLATE BARS, CHOCOLATES, TREACLE; YEAST, BAKING POWDER; SALT, MUSTARD; VINEGAR, SAUCES; CONDIMENTS, NAMELY, CHUTNEY, KETCHUP, MAYONNAISE, COOKING SAUCES; SPICES; ICE; ICE CREAM, ICE CREAM DRINKS; FRUIT ICES; FLAVORED ICES; CHOCOLATE, SHORTBREAD,

HONEY, BISCUITS, FUDGE, IN CLASS 30 (U.S. CL. 46).

FOR: ALCOHOLIC BEVERAGES, NAMELY, HONEY WINE WITH ADDED GRAPE JUICE, MEAD WITH ADDED GRAPE JUICE ALCOHOLIC BEVERAGES OF FRUIT, APERITIFS, APERITIF WINES, BRANDY, CHAMPAGNE, COGNAC, DISTILLED SPIRITS, GIN, FRUIT WINES, SLOE GIN, DAMSON GIN, SPARKLING WINE, LIQUEURS, MEAD, WINES, NATURAL SPARKLING WINE, RED WINE, WHITE WINE, PORT WINE, RUM, SHERRY, VODKA, WHISKY, IN CLASS 33 (U.S. CLS. 47 AND 49).

PRIORITY CLAIMED UNDER SEC. 44(D) ON ERPN CMNTY TM OFC APPLICATION NO. 2390356, FILED 4-25-2005, REG. NO. 2390256, DATED 2-22-2008, EXPIRES 4-25-2015.

THE FOREIGN WORDING IN THE MARK TRANSLATES INTO ENGLISH AS HOLY ISLAND.

SER. NO. 78-628,025, FILED 5-11-2005.

GINA FINK, EXAMINING ATTORNEY

Int. Cls.: 7, 9, 11, 12 and 17

**Prior U.S. Cls.: 1, 5, 12, 13, 19, 21, 23, 26, 31, 34, 35,
36, 38, 44 and 50**

Reg. No. 3,576,218

United States Patent and Trademark Office

Registered Feb. 17, 2009

**TRADEMARK
PRINCIPAL REGISTER**

JTEKT

JTEKT CORPORATION (JAPAN CORPORATION)
5-8, MINAMISEMBA 3-CHOME, CHUO-KU
OSAKA, JAPAN 542-0081

FOR: INDUSTRIAL ROBOTS USED FOR WELDING; INDUSTRIAL ROBOTS USED FOR METALWORKING; METALWORKING MACHINES AND MACHINE TOOLS EXCEPT FOR ROBOTS, NAMELY, PUNCHING PRESSES, SHAPING MACHINES, METAL SAWING MACHINES, GRINDING MACHINES, PERFORATING MACHINES, CUTTING MACHINES, LATHES, SLOTTING MACHINES, BORING MACHINES, THREADING MACHINES, NUT-TAPPING MACHINES, GEAR CUTTING AND FINISHING MACHINES, MILLING MACHINES, BROACHING MACHINES, PLANING MACHINES, HORNING MACHINES, DRILLING MACHINES, LAPPING MACHINES, ROLLING MILLS, TUBING MILLS, WIRE EXTRUDING MACHINES, WIRE DRAWING MACHINES, MECHANICAL PRESSES, MANUAL PRESSES, HYDRAULIC PRESSES, SHEARING MACHINES, FORGING MACHINES, BENDING MACHINES, OIL HYDRAULIC PRESSES, WIRE FORMING MACHINES, GAS WELDING MACHINES, OXY-ACETYLENE WELDING AND CUTTING MACHINES, ELECTRIC WELDING MACHINES, POWER-OPERATED AND MACHINE TOOLS, NAMELY, PNEUMATIC DRILLS, PNEUMATIC HAMMERS, GRINDERS, SANDERS, ELECTRIC DRILLS, ELECTRIC HAMMERS, SCREWDRIVERS, NUT RUNNERS, BUFFERS, POLISHERS, WRENCHES; GEAR CUTTERS, MACHINE TOOLS IN THE NATURE OF TAPS, CHASERS, POWER DRILL BITS, THREAD MILLING CUTTERS, TURNING POINT TOOLS, BROACHES, MILLING CUTTERS, REAMERS, CEMENTED CARBIDE TOOLS, DIAMOND TOOLS, MOULDS AND DIES FOR METAL-FORMING, FORGING MOULDS, AND PRESS DIES FOR METAL FORMING; ELECTRIC WELDING MACHINES; INDUSTRIAL ROBOTS FOR MINING; MINING MA-

CHINES AND APPARATUS EXCEPT FOR ROBOTS, NAMELY, CUTTER LOADERS, COAL CUTTING MACHINES, OIL-WELL PUMPING MACHINES, ROCK DRILLS, WELL DRILLING MACHINES, MINING DRILL SHARPENERS, MINE BORERS, COAL LOADERS, TRUCK MILLS FOR MINING PURPOSES, AND COAL PLOUGHS; INDUSTRIAL ROBOTS FOR CONSTRUCTION. CONSTRUCTION MACHINES AND POWER-OPERATED APPARATUS EXCEPT FOR ROBOTS, NAMELY, SLACK-LINES, TRUCK CRANES, POWER SHOVELS, ROOTERS, EARTH AUGERS, PILE DRIVERS, PILE EXTRACTORS, GROUT PUMPS, GRADERS, EARTH SCRAPERS, TAMPING MACHINES, BULL-DOZERS, RAMMERS, ROAD ROLLERS, CONCRETE PLACING MACHINES, CONCRETE VIBRATORS, CONCRETE PAVING MACHINES, CONCRETE MIXERS, BATCHER PLANTS, ASPHALT DISTRIBUTORS, ASPHALT FINISHERS, ASPHALT PLANTS IN THE NATURE OF ASPHALT PAVING MACHINES, ASPHALT MIXERS, MUD DREDGING MACHINES, AND DIPPERS; INDUSTRIAL ROBOTS FOR LOADING AND UNLOADING; LOADING AND UNLOADING MACHINES EXCEPT FOR ROBOTS; INDUSTRIAL ROBOTS FOR FISHING; FISHING MACHINE SAND INSTRUMENTS EXCEPT FOR ROBOTS, NAMELY, NET HAULING MACHINES, TRAWL WINCHES, LINE-HAULERS; INDUSTRIAL ROBOTS FOR CHEMICAL PROCESSING; CHEMICAL PROCESSING MACHINES AND APPARATUS EXCEPT FOR ROBOTS, NAMELY, PRESSES, AGITATING MACHINES, DRYING MACHINES, ABSORBING MACHINES, MIXING AND BLENDING MACHINES, DUST COLLECTING MACHINES, SINTERING MACHINES, CALCINING MACHINES, SORTING MACHINES, GRANULATING MACHINES, EXTRACTING MACHINES, EMULSIFYING MACHINES, KNEADING MACHINES, ROASTING MACHINES, DISINTEGRATORS, STRUCTURAL PARTS OF CHEMICAL PROCES-

SING MACHINES, NAMELY, REACTOR VESSELS FOR USE IN FURNACES, PARTIAL AIR CONDENSERS, SEPARATING MACHINES, GRINDING MILLS, DISSOLVING MACHINES, AND FILTERING MACHINES; INDUSTRIAL ROBOTS FOR TEXTILE MANUFACTURE; TEXTILE MACHINES AND APPARATUS EXCEPT FOR ROBOTS, NAMELY, SILK YARN RE-REELING MACHINES, COCOON DRYING MACHINES, SILK YARN BUNDLING MACHINES, SILK YARN REELING MACHINES, CHEMICAL FIBER DRYING MACHINES, STAPLE FIBER CUTTING MACHINES, CHEMICAL FIBER SPINNING MACHINES, YARN SPINNING MACHINES, WEAVING LOOMS, KNITTING MACHINES, FISH-NETTING MACHINES, EMBROIDERY MACHINES, ROPE MAKING MACHINES, BRAIDING MACHINES, HOSIERY LOOMS, LACE MAKING MACHINES, FELT MANUFACTURING MACHINES, TEXTILE DYEING AND FINISHING MACHINES; INDUSTRIAL ROBOTS FOR FOOD AND BEVERAGE PROCESSING. FOOD AND BEVERAGE PROCESSING MACHINES AND APPARATUS EXCEPT FOR ROBOTS, NAMELY, CEREAL PROCESSING MACHINES, BREWING AND FERMENTING MACHINES AND APPARATUS, ICE-CREAM MAKING MACHINES, MILK HOMOGENIZING MACHINES, CHEESE MAKING MACHINES, BUTTER MACHINES, POWDERED MILK MAKING MACHINES, CONDENSED MILK MAKING MACHINES, MEAT PROCESSING MACHINES, FISHERY PRODUCT PROCESSING MACHINES, CANNING MACHINES, ROOT SLICING MACHINES, SODA-POP MAKING MACHINES, TEA PROCESSING MACHINES, SUGAR MAKING MACHINES, OIL PROCESSING MACHINES, BOTTLING MACHINES, MINERAL WATER MAKING MACHINES, AND VEGETABLE GRATING MACHINES; INDUSTRIAL ROBOTS FOR LUMBERING, WOODWORKING AND VENEER OR PLYWOOD MAKING; LUMBERING, WOODWORKING, AND VENEER OR PLYWOOD MAKING MACHINES AND POWER-OPERATED APPARATUS EXCEPT FOR ROBOTS, NAMELY, LUMBERING BAND SAWS, CHAIN SAWS, SPECIAL SAWING MACHINES, SAW-TOOTH SETTING MACHINES, CIRCULAR SAWS, WOODEN-CLOG SHAPING MACHINES, SANDING MACHINES, TENONING MACHINES, WOOD PLANING MACHINES, WOOD LATHES, WOOD MILLING MACHINES, WOOD DRILLING MACHINES, WOOD SAWING MACHINES, WOODWORKING SAW-TOOTH SETTING MACHINES, VENEER MANUFACTURING MACHINES, PLYWOOD FINISHING MACHINES, PLYWOOD DRYING MACHINES, PLYWOOD PRESSES, PLYWOOD CLIPPING MACHINES, PLYWOOD JOINTING MACHINES, AND PLYWOOD GLUING MACHINES; INDUSTRIAL ROBOTS FOR PULP MAKING, PAPER MAKING AND PAPER-WORKING; PULP MAKING, PAPERMAKING AND PAPER-WORKING MACHINES AND APPARATUS EXCEPT FOR ROBOTS, NAMELY, WOOD GRINDING MACHINES, WOOD CHIPPING MACHINES, BARKING MACHINES, PULPING MACHINES, WOOD BEATING MACHINES, PULP REFINING MACHINES, PAPER CALENDARING MACHINES, PAPER COATING MACHINES, PAPER MAKING MACHINES, PAPER CUTTING MACHINES, DRIER

PARTS FOR PAPER MAKING MACHINES, PRESS PARTS FOR PAPER MAKING MACHINES, PAPER REELING MACHINES, WIRE PARTS FOR PAPER MAKING MACHINES, CORRUGATED PAPERBOARD MAKING MACHINES, PAPER BOX MAKING MACHINES, AND PAPER BAG MAKING MACHINES; INDUSTRIAL ROBOTS FOR PRINTING OR BOOKBINDING. PRINTING AND BOOKBINDING MACHINES EXCEPT FOR ROBOTS; SEWING MACHINES; INDUSTRIAL ROBOTS FOR AGRICULTURAL USE; AGRICULTURAL MACHINES AND POWER-OPERATED APPARATUS EXCEPT FOR ROBOTS, NAMELY, PLOWING MACHINES AND IMPLEMENTS THEREFOR, CULTIVATING MACHINES AND IMPLEMENTS THEREFOR, HARVESTING MACHINES AND IMPLEMENTS THEREFOR, PLANT FIBER PROCESSING MACHINES AND IMPLEMENTS THEREFOR, FODDER PRESSES, FODDER CUTTING MACHINES IN THE NATURE OF FEED CUTTERS, FODDER MIXING MACHINES IN THE NATURE OF FEED MIXERS, CAKE-FODDER CRUSHING MACHINES IN THE NATURE OF FEED MILLS, MILK FILTERS FOR INDUSTRIAL PURPOSES, MILKING MACHINES, CHICK BROODERS; INCUBATORS FOR EGGS, SERICULTURAL MACHINES AND IMPLEMENTS THEREFORE; INDUSTRIAL ROBOTS FOR SHOE MAKING; SHOE MAKING MACHINES, NAMELY, MACHINE LASTS FOR MAKING SHOES AND HEEL-MAKING MACHINES; INDUSTRIAL ROBOTS FOR TOBACCO PROCESSING; TOBACCO PROCESSING MACHINES EXCEPT FOR ROBOTS, NAMELY, TOBACCO CURING MACHINES AND MACHINES FOR CUTTING AND SORTING TOBACCO; INDUSTRIAL ROBOTS FOR GLASSWARE MANUFACTURING; GLASSWARE MANUFACTURING MACHINES AND POWER-OPERATED APPARATUS EXCEPT FOR ROBOTS, NAMELY, GLASS WORKING MACHINES AND GLAZIERS' DIAMONDS AS PARTS FOR GLASS WORKING MACHINES; INDUSTRIAL ROBOTS FOR PAINTING; PAINTING MACHINES AND APPARATUS EXCEPT FOR ROBOTS, NAMELY, AIR BRUSHES FOR APPLYING COLOR, COLOR WASHING MACHINES, SPRAY GUNS FOR PAINT, TARRING MACHINES, AND WHITEWASHING MACHINES; INDUSTRIAL ROBOTS FOR PACKAGING AND WRAPPING; PACKAGING AND WRAPPING MACHINES EXCEPT FOR ROBOTS; POWER-OPERATED POTTER'S WHEELS; INDUSTRIAL ROBOTS FOR PLASTIC PROCESSING; PLASTIC PROCESSING MACHINES AND POWER-OPERATED APPARATUS EXCEPT FOR ROBOTS, NAMELY, COMPRESSION MOLDING MACHINES, EXTRUSION MOLDING MACHINES, INJECTION MOLDING MACHINES, AND MOLDS FOR USE IN THE MANUFACTURE OF PLASTIC; INDUSTRIAL ROBOTS FOR SEMICONDUCTOR MANUFACTURING; SEMICONDUCTOR MANUFACTURING MACHINES, EXCEPT FOR ROBOTS. INDUSTRIAL ROBOTS FOR RUBBER-GOODS MANUFACTURING; RUBBER-GOODS MANUFACTURING MACHINES AND POWER-OPERATED APPARATUS EXCEPT FOR ROBOTS, NAMELY, RUBBER VULCANIZING APPARATUS, RUBBER MIXING MACHINES, RUBBER FORMING MACHINES,

RUBBER MIXING ROLLS, AND MOLDS FOR RUBBER MANUFACTURE; INDUSTRIAL ROBOTS FOR STONE WORKING; STONE WORKING MACHINES AND POWER-OPERATED APPARATUS EXCEPT FOR ROBOTS, NAMELY, MORTISING MACHINES, MACHINING AND DRESSING MACHINES, CHISELS FOR MACHINES, PARING MACHINES, ENGRAVING MACHINES, TRIMMING MACHINES, MILLSTONES, CUTTERS FOR STONE WORKING MACHINES, CUTTING MACHINES, AND ELECTRIC MACHINES FOR POLISHING; POWER MACHINERIES AND TOOLS, EXCEPT FOR LAND VEHICLES, NAMELY, INTERNAL COMBUSTION ENGINES, STEAM ENGINES, JET ENGINES, ROCKET ENGINES, TURBINES, COMPRESSED AIR ENGINES, NUCLEAR PRIME MOVERS, WATER MILLS, AND WIND MILLS; PNEUMATIC OR HYDRAULIC MACHINES AND POWER-OPERATED INSTRUMENTS, NAMELY, PUMPS, VACUUM PUMPS, BLOWERS, AND COMPRESSORS; ADHESIVE TAPE DISPENSING MACHINES; AUTOMATIC STAMPING MACHINES; DISH WASHING MACHINES; ELECTRIC WAX-POLISHING MACHINES FOR HOUSEHOLD AND INDUSTRIAL PURPOSES; ELECTRIC WASHING MACHINES FOR INDUSTRIAL PURPOSES; VACUUM CLEANERS; FOOD MIXING MACHINES, NAMELY, ELECTRIC FOOD PROCESSORS; MECHANICAL PARKING SYSTEM, NAMELY, MECHANICAL PARKING SYSTEMS COMPRISED OF MECHANICAL STACKERS, VEHICLE LIFTS AND PRE-ASSEMBLED PARKING STRUCTURES FOR HOUSING OF AUTOMOBILES; VEHICLE WASHING INSTALLATIONS; POWER SPRAYER FOR DISINFECTING, INSECTICIDES AND DEODORANTS, NOT FOR AGRICULTURAL PURPOSES; MACHINE ELEMENTS INCLUDING BEARINGS AND POWER TRANSMISSION APPARATUS EXCEPT FOR LAND VEHICLES, NAMELY, SHAFTS, AXLES, SPINDLES, BEARINGS, SHAFT COUPLINGS AND CONNECTORS, IDLING PULLEYS, PULLEYS, CAMS, REVERSING GEARS, REDUCTION GEARS, HYDRAULIC ACCUMULATORS, HYDRAULIC INTENSIFIERS, BELT PULLEYS, POWER TRANSMISSION BELTS, TOOTHED WHEELS AND GEARS, SPEED CHANGE GEARS, FLUID COUPLINGS, HYDRAULIC TORQUE CONVERTERS, LINKS, ROLLER CHAINS, SHOCK ABSORBERS, SPRINGS, BRAKES AND VALVES; LAWNMOWERS. ELECTRICALLY OPERATED CURTAIN DRAWERS; INDUSTRIAL TRASH COMPACTING MACHINES; WASTE CRUSHING MACHINES; STARTERS FOR MOTORS AND ENGINES; AC MOTORS AND DC MOTORS, EXCEPT FOR LAND VEHICLES; AC GENERATORS; DC GENERATORS; BRUSHES BEING PARTS OF MOTORS, GENERATORS AND DYNAMOS; METAL CUTTING MACHINES; FORAGE DRYING APPARATUS, NAMELY, HARVEST DRYING MACHINES; MACHINE ELEMENTS, NAMELY, ENGINE BEARINGS FOR LAND VEHICLES, IN CLASS 7 (U.S. CLS. 13, 19, 21, 23, 31, 34 AND 35).

FOR: EAR PLUGS NOT FOR MEDICAL USE; WORKED GLASS, NOT FOR CONSTRUCTION, NAMELY, ULTRAVIOLET-RAY TRANSMITTING GLASS, INFRARED-RAY ABSORBING GLASS AND LENS GLASS; ELECTRIC WELDING APPA-

RATUS, NAMELY, WELDING TORCHES, ELECTRODES, AND TRANSFORMERS; OZONIZERS; ELECTROLYZERS; EGG-CANDLERS; CASH REGISTERS; MONEY COUNTING AND SORTING MACHINES; OPERATION RECORDING APPARATUS, NAMELY, ELECTRIC SIGN BOARDS FOR DISPLAYING TARGET FIGURES, CURRENT OUTPUT, OR THE LIKE; PHOTOCOPIERS; MANUAL CALCULATORS; MATHEMATICAL INSTRUMENTS, NAMELY, ELECTRONIC DESK CALCULATORS; TIME AND DATE RECORDING STAMPING MACHINE; TIME RECORDING DEVICES, NAMELY TIME CLOCKS; PUNCHED CARD MACHINES, NAMELY, PUNCH CLOCKS; VOTING MACHINES; BILLING MACHINES, NAMELY, INVOICING MACHINES; POSTAGE METERS; AUTOMATIC DISTRIBUTION MACHINE, NAMELY, VENDING MACHINES; APPARATUS FOR GASOLINE STATIONS, NAMELY, METERED GASOLINE PUMPS, FUEL DISPENSING PUMPS, SELF-REGULATING FUEL PUMPS; COIN OPERATED GATES FOR CAR PARKING FACILITIES; LIFE SAVING APPARATUS AND EQUIPMENT, NAMELY, LIFE NETS, LIFE BELTS, LIFE JACKETS, AND LIFE-BUOYS; FIRE EXTINGUISHERS; FIRE HYDRANTS; FIRE HOSE NOZZLES; SPRINKLER SYSTEMS FOR FIRE PROTECTION; FIRE ALARMS; GAS LEAK ALARMS; ANTI-THEFT WARNING APPARATUS, NAMELY, THEFT ALARMS NOT FOR VEHICLES; PROTECTIVE HELMETS; RAILWAY TRAFFIC SIGNALS; VEHICLE BREAKDOWN WARNING TRIANGLES; ROAD SIGNS, LUMINOUS OR MECHANICAL; DIVING MACHINES AND APPARATUS, NAMELY, REBREATHERS, SODA LIME CARTRIDGES, DE-COMPRESSION CHAMBERS, DIVER'S MASKS AND DIVING SUITS; AMUSEMENT APPARATUS ADAPTED FOR USE WITH TELEVISION, NAMELY, VIDEO GAME MACHINES FOR USE WITH TELEVISION; ELECTRICALLY OPERATED AUTOMATIC DOOR OPENER AND CLOSER; SIMULATORS FOR THE STEERING AND CONTROL OF VEHICLES. LABORATORY APPARATUS AND INSTRUMENTS, NAMELY, AIR-GAS PRODUCERS, CONSTANT TEMPERATURE INCUBATORS, CONSTANT HUMIDITY INCUBATORS, GLASSWARE FOR SCIENTIFIC EXPERIMENTS IN LABORATORIES, PORCELAIN WARE FOR SCIENTIFIC EXPERIMENTS IN LABORATORIES, FURNACES FOR LABORATORY EXPERIMENTS; PHOTOGRAPHIC MACHINES AND APPARATUS, NAMELY, TILTING HEADS, CAMERAS, CCD CAMERAS, RANGE FINDERS, PHOTO-DEVELOPING MACHINES, PRINTING MACHINES, ENLARGING MACHINES, FINISHING MACHINES AND APPARATUS; TRIPODS, SHUTTERS, BELLOWS, SPOOLS, SLIDE PROJECTORS, SELF-TIMERS, PHOTOGRAPHIC FLASH UNITS, FLASH LAMPS, VIEWFINDERS, LENS FILTERS, LENS HOODS, FLASHGUNS, FILM MAGAZINES, SHUTTER RELEASES, LENSES FOR PHOTOGRAPHIC APPARATUS, AND EXPOSURE METERS; CINEMATOGRAPHIC MACHINES AND APPARATUS; OPTICAL APPARATUS AND INSTRUMENTS, NAMELY, BODY-TUBES FOR TELESCOPES IN THE NATURE OF LENS BARRELS, TRIPODS FOR TELESCOPES, PERISCOPES, BINOCULARS, REFLECTORS FOR TELESCOPES, PRISMS FOR TELESCOPES, TELESCOPES, LENSES

FOR TELESCOPES, AND MICROSCOPES; MEASURING AND TESTING MACHINES, NAMELY, STANDARD-UNIT MEASURING MACHINES, DERIVED-UNIT MEASURING MACHINES AND APPARATUS, PRECISION MEASURING MACHINES AND INSTRUMENTS, AUTOMATIC ADJUSTING/REGULATING MACHINES AND INSTRUMENTS, MATERIAL TESTING MACHINES AND INSTRUMENTS, SURVEYING MACHINES AND INSTRUMENTS, ASTRONOMETRIC MEASURING MACHINES AND INSTRUMENTS, CHARTS FOR IDENTIFYING HIDING POWER OF PAINT, THERMOSENSITIVE TEMPERATURE INDICATOR STRIPS, AND TEST PIECES FOR RUST FORMATION TESTING; INSTRUMENTS AND MACHINES FOR DISTRIBUTING, SWITCHING OR CONTROLLING ELECTRIC CURRENT; ROTATING ALTERNATOR FOR VEHICLES; SYNCHRONOUS PHASE MODIFIERS AND SYNCHRONOUS CAPACITORS; ELECTRIC CELLS; ELECTRIC BATTERIES. ELECTRIC OR MAGNETIC METERS AND TESTERS, NAMELY, PHASE INDICATORS, OSCILLOGRAPHS, CIRCUIT TESTERS, ANTENNA PARAMETER MEASURING APPARATUS, TORQUE DETECTORS FOR VEHICLES FOR SENSING TORQUE FORCE INPUT TO THE STEERING WHEEL, GROUND DETECTORS IN THE NATURE OF ELECTRIC LEAKAGE DETECTORS, MAGNETOMETERS, FREQUENCY METERS, VACUUM TUBE CHARACTERISTIC TESTERS, WATT HOUR METERS, RESISTANCE MEASURING INSTRUMENTS, VOLTMETERS, WAVE METERS, AMMETERS, WATTMETERS, OSCILLATORS, AND CAPACITY MEASURING METERS; ELECTRICAL CONDUCTORS; ELECTRIC FLAT IRONS; ELECTRIC HAIRCURLERS; ELECTRIC BUZZERS; ELECTRONIC MACHINES AND, APPARATUS AND THEIR PARTS, NAMELY, COMPUTER PROGRAMS FOR CONTROLLING AND OPERATING MACHINE TOOLS AND ELECTRIC POWER STEERING; COMPUTER PROGRAMS FOR CONTROLLING AND DRIVING AUTOMOBILES; PROGRAMMABLE CAM CONTROLLERS, ELECTRONIC COUNTERS, PROXIMITY SENSORS, PHOTOELECTRIC SENSORS, TORQUE SENSOR FOR STEERING, KEYLESS SWITCHES FOR LAND VEHICLES, MOTION CONTROL CIRCUIT FOR LAND VEHICLES, AND TOUCH PANELS; MAGNETIC CORES; RESISTANCE WIRES; ELECTRODES; FIRE ENGINES; CIGAR LIGHTERS FOR AUTOMOBILES; GLOVES FOR PROTECTION AGAINST ACCIDENTS; RESPIRATORS FOR FILTERING AIR; MASKS, NAMELY, DUST MASKS, GAS MASKS AND WELDING MASKS; GARMENTS FOR PROTECTION AGAINST FIRE; EYEGLASSES; AMUSEMENT APPARATUS ADAPTED FOR USE WITH TELEVISION RECEIVERS ONLY, NAMELY, CONSUMER VIDEO GAMES; VIDEO GAME CARTRIDGES; SLOT MACHINES; WEIGHT BELTS FOR DIVERS; WET SUITS; FLOATS FOR BATHING AND SWIMMING; PROTECTIVE HELMETS FOR SPORTS, NAMELY, FOOTBALL, HOCKEY, AND BASEBALL; AIR TANKS; PADDLE BOARDS REGULATORS FOR SCUBA DIVING; METRONOMES; COMPUTER HARDWARE AND COMPUTER PROGRAMS STORED ON CD-ROM FOR AUTOMATICALLY PERFORMING ELECTRIC MUSICAL INSTRUMENTS;

SLIDE-RULES; EXPOSED CINEMATOGRAPHIC FILMS; EXPOSED SLIDE FILMS; MOUNTINGS FOR PHOTOGRAPHIC TRANSPARENCIES; DOWNLOADABLE ELECTRONIC PUBLICATIONS, NAMELY, BOOKS, MAGAZINES AND MANUALS IN THE FIELD OF VEHICLES; ELECTRONIC PUBLICATIONS, NAMELY, BOOKS, MAGAZINES AND MANUALS IN THE FIELD OF VEHICLES RECORDED ON COMPUTER MEDIA, IN CLASS 9 (U.S. CLS. 21, 23, 26, 36 AND 38).

FOR: WATER CLOSETS; BATH INSTALLATIONS, NAMELY, BATH TUBS; DRYING APPARATUS, NAMELY, CLOTHES DRYING MACHINES; RECUPERATORS, NAMELY, RECUPERATORS FOR CHEMICAL PROCESSING; STEAMERS, NAMELY, STEAMERS FOR CHEMICAL PROCESSING; DISTILLERS; HEAT EXCHANGERS; PASTEURIZERS OR STERILIZERS FOR MILK; INDUSTRIAL FURNACES; NUCLEAR REACTORS; BOILERS, NAMELY, INDUSTRIAL BOILERS; HEATING AND COOLING APPARATUS, NAMELY, AIR CONDITIONING APPARATUS FOR INDUSTRIAL PURPOSES; FREEZING MACHINES AND APPARATUS, NAMELY, GAS REFRIGERATORS, ICE MACHINES, REFRIGERATING MACHINES, COOLING EVAPORATORS, COOLING DOMES, FREEZERS, REFRIGERATING AND FREEZING SHOWCASES; ELECTRIC LAUNDRY DRYERS; MACHINES AND APPARATUS FOR HAIR SALON OR BARBER SHOP EXCEPT FOR CHAIRS, NAMELY, TOWEL STEAMERS FOR HAIRDRESSING PURPOSES, HAIR DRYING MACHINES FOR BEAUTY SALON USE, HAIR STEAMERS FOR BEAUTY SALON USE, SHAMPOO BASINS FOR BARBER SHOP USE; COOKING MACHINES AND APPARATUS, NAMELY, INDUSTRIAL DEEP FRYERS, INDUSTRIAL RICE COOKERS, ELECTROMAGNETIC INDUCTION COOKERS FOR INDUSTRIAL PURPOSES, INDUSTRIAL COOKING POTS, INDUSTRIAL ROASTERS, AND INDUSTRIAL COOKING OVENS; DISH DRYING APPARATUS, NAMELY, INDUSTRIAL DISH DRYING MACHINE; DISH DISINFECTING APPARATUS FOR INDUSTRIAL PURPOSES; HYDRANTS NOT BEING FIRE HYDRANTS; METAL VALVES FOR CONTROLLING WATER STORAGE LEVELS IN TANKS; PIPELINE SPIGOT COCKS; WATER-PURIFIER TANKS; NIGHT SOIL TREATMENT TANKS, NAMELY, HUMAN AND ANIMAL WASTE TREATMENT TANKS; INCINERATORS; SOLAR CALORIFIERS, NAMELY, SOLAR WATER HEATERS; WATER FILTERING DEVICES, NAMELY, WATER PURIFICATION INSTALLATIONS FOR WASTE WATER AND SEWAGE. ELECTRIC LIGHT BULBS AND LIGHTING DEVICES, NAMELY, ARC LAMPS, POCKET SEARCH LIGHTS, LAMP SHADES, FLUORESCENT LAMPS, SAFETY LAMPS FOR UNDERGROUND USE, GERMICIDAL LAMPS, CHANDELIERS, FISHLURING LIGHTS, MERCURY LAMPS, SPOTLIGHTS, INFRARED LAMPS, DIVING LIGHTS, ARTIFICIAL SUNLIGHTS, SEARCHLIGHTS, VEHICLE DYNAMO LAMPS, INCANDESCENT LAMPS AND THEIR FITTINGS, DISCHARGE LAMPS AND THEIR FITTINGS, AND MINIATURE LIGHT BULBS; ELECTRIC HEATING DEVICE AND INSTALLATIONS, NAMELY, CLOTHES DRYING AP-

PARATUS, HUMIDIFIERS, ELECTRIC BATH-WATER PURIFYING APPARATUS FOR HOUSEHOLD PURPOSES, AIR PURIFIERS, DEHUMIDIFIERS, ELECTRIC FANS, WATER IONIZERS, ELECTRICALLY HEATED CARPETS, ELECTRIC COOKING POTS, ELECTRIC COFFEE MAKERS, JAPANESE ELECTRIC LEG-WARMING APPARATUS IN THE NATURE OF ELECTRIC KOTATSU, ELECTRIC COOKING STOVES, ELECTRIC RADIANT HEATERS, ELECTRIC FOOT WARMERS, ELECTRIC TOASTERS, JAPANESE HAND WARMING APPARATUS IN THE NATURE OF ELECTRIC HIBACHI, ELECTRIC SLEEPING MATTRESSES, ELECTRIC KETTLES, ELECTRIC BLANKETS, ELECTRIC REFRIGERATORS, ELECTRIC FREEZERS, ELECTRIC COOKING OVENS, MICROWAVE OVENS FOR COOKING, ELECTROMAGNETIC INDUCTION COOKERS, FUTON DRYERS, HOT PLATES, ELECTRIC SPACE COOLING APPARATUS, AND RANGE HOODS; GAS WATER HEATERS; HEATERS, NAMELY, GAS COOKING OVENS, JAPANESE KITCHEN FURNACES IN THE NATURE OF KAMADO, JAPANESE CHARCOAL COOKING STOVES FOR HOUSEHOLD PURPOSES IN THE NATURE OF SHICHIRIN, OIL COOKING STOVES, BAKING OVENS, AND BARBECUE GRILLS; KITCHEN WORK TOPS; KITCHEN SINKS; NON-PORTABLE ICE CHESTS FOR HOUSEHOLD PURPOSES; ICE CHAMBERS, NAMELY, ICE-COOLED REFRIGERATORS; WATER PURIFICATION UNITS; BATH FITTINGS, NAMELY, BATHTUB UNITS INTEGRAL WITH A BATHROOM FLOOR, BUBBLE BATHS, SHOWERS, BATHTUB UNITS INTEGRAL A BATHROOM FLOOR AND A SINK, BATH TUBS, AND BATH BOILERS; ELECTRIC JAPANESE LANTERNS; ELECTRIC CHINESE LANTERNS; GAS LAMPS; KEROSENE LAMPS; CHIMNEYS; WARMING PANS FOR BEDS. BODY WARMERS, NAMELY, POCKET BODY WARMERS; HOT-WATER BAGS; TOILET SEATS WITH WASHING FUNCTION, NAMELY, TOILET STOOL UNITS WITH A WASHING WATER SQUIRTER; DISINFECTANT DISTRIBUTORS FOR TOILETS; TOILET BOWL; CHAIRS FOR JAPANESE-STYLE TOILET; THERMAL INSULATED DEVICES FILLED WITH CHEMICAL MATERIALS FOR PROVIDING HEAT; ELECTRIC COOK TOPS, NAMELY, BRAZIER, IN CLASS 11 (U.S. CLS. 13, 21, 23, 31 AND 34).

FOR: CABLE CARS; ELECTRIC AERIAL TRAMWAY CARS; DAMPERS, NAMELY, CAR DAMPERS; MINE CAR PUSHERS; MINE CAR PULLERS; ENGINES FOR LAND VEHICLES, NAMELY, TRACTION ENGINES; POWER MACHINERIES AND TOOLS FOR LAND VEHICLES, EXCEPT FOR OTHER PARTS, NAMELY, INTERNAL COMBUSTION ENGINES FOR LAND VEHICLES, STEAM ENGINES FOR LAND VEHICLES, JET ENGINES FOR LAND VEHICLES, TURBINES FOR LAND VEHICLES; MACHINE ELEMENTS, NAMELY, WHEEL AND AXLE BEARINGS FOR LAND VEHICLES, POWER TRANSMISSIONS FOR LAND VEHICLES, SHAFTS FOR LAND VEHICLES, AXLES FOR LAND VEHICLES, SPINDLES FOR LAND VEHICLES, SHAFT COUPLINGS AND CONNECTORS FOR LAND VEHICLES, IDLING PULLEYS FOR LAND VEHICLES, CAMS FOR LAND VEHICLES,

REVERSING GEARS FOR LAND VEHICLES, REDUCTION GEARS FOR LAND VEHICLES, BELT PULLEYS FOR LAND VEHICLES, POWER TRANSMISSION BELTS FOR LAND VEHICLES, TOOTHED WHEELS AND GEARS FOR LAND VEHICLES, SPEED CHANGE GEARS FOR LAND VEHICLES, FLUID COUPLINGS FOR LAND VEHICLES, HYDRAULIC TORQUE CONVERTERS FOR LAND VEHICLES, LINKS FOR LAND VEHICLES, ROLLER CHAINS FORELAND VEHICLES, SHOCK ABSORBERS FOR LAND VEHICLES, SPRINGS FOR LAND VEHICLES, BRAKES FOR LAND VEHICLES; PARACHUTES; ANTI-THEFT ALARMS FOR VEHICLES; WHEELCHAIRS; AC MOTORS AND DC MOTORS FOR LAND VEHICLES, NAMELY, ELECTRIC MOTORS FOR MOTOR CARS; VESSELS AND STRUCTURAL PARTS THEREFOR; AIRCRAFT AND STRUCTURAL PARTS THEREFOR; RAILWAY ROLLING STOCK AND STRUCTURAL PARTS THEREFOR; AUTOMOBILES AND STRUCTURAL PARTS THEREFOR; TWO-WHEELED MOTOR VEHICLES; BICYCLES AND STRUCTURAL PARTS THEREFOR; BABY CARRIAGES; RICKSHAWS; SLEIGHS; HAND CARTS FOR HANDLING GOODS; CARTS; CARRIAGES, NAMELY, BABY CARRIAGES AND HORSE-DRAWN CARRIAGES; REAR CARS, NAMELY, BICYCLE TRAILERS; RUBBER BITS FOR REPAIRING TIRES OR TUBES, NAMELY, ADHESIVE RUBBER PATCHES FOR REPAIRING TIRES OR TUBES; FIRE BOATS, IN CLASS 12 (U.S. CLS. 19, 21, 23, 31, 35 AND 44).

FOR: MICA; VALVES OF RUBBER OR VULCANIZED FIBER, EXCEPT FOR THOSE CORRESPONDING TO MECHANICAL ELEMENTS; GASKETS, NAMELY, PIPE GASKETS; JOINTS FOR PIPES, EXCEPT FOR THOSE MADE OF METAL; PACKING MATERIAL FOR FORMING SEALS, SEALS, EXCEPT FOR THOSE MADE OF METAL, AND NOT FOR CONSTRUCTION; FIRE HOSE; SAFETY CURTAINS MADE OF ASBESTOS; FLOATING ANTI-POLLUTION BARRIERS; INSULATING MATERIAL, NAMELY, ELECTRICAL INSULATORS, ELECTRICAL INSULATING TAPES, ELECTRICAL INSULATING PAINTS, ELECTRICAL INSULATING OILS, ELECTRICAL INSULATING MICA PRODUCTS, ELECTRICAL INSULATING PAPER PRODUCTS, ELECTRICAL INSULATING RUBBER PRODUCTS, ELECTRICAL INSULATING FABRIC PRODUCTS; WASHERS OF RUBBER OR VULCANIZED FIBER; HORSESHOES, EXCEPT FOR THOSE MADE OF METAL; CHEMICAL FIBER THREAD, NOT FOR TEXTILE USE; ROCK FIBERS FOR INSULATION; SLAG WOOL FOR USE AS BUILDING INSULATION; THREADS OF RUBBER, NOT FOR USE IN TEXTILES; ASBESTOS STRINGS; ASBESTOS FABRICS FOR USE AS CABLE INSULATION; ASBESTOS FELT; INSULATING GLOVES; CORDS OF RUBBER; CORDS OF ASBESTOS; ASBESTOS NETTING; RUBBER STOPPERS; RUBBER LIDS AND CAPS FOR INDUSTRIAL PACKING CONTAINERS; PLASTIC SHEETING FOR AGRICULTURAL PURPOSES; INSULATING PAPERS FOR ELECTRICAL CAPACITORS AND CONDENSERS; ASBESTOS PAPER; VULCANIZED FIBER; RUBBER, NAMELY, NATURAL RUBBER, SYNTHETIC RUBBER, AND RUBBER DERIVATIVES;

SOUNDPROOFING MATERIALS OF ROCK WOOL AND RUBBER, NOT FOR CONSTRUCTION; ASBESTOS BOARDS; POWDER OF ASBESTOS, IN CLASS 17 (U.S. CLS. 1, 5, 12, 13, 35 AND 50).

THE MARK CONSISTS OF STANDARD CHARACTERS WITHOUT CLAIM TO ANY PARTICULAR FONT, STYLE, SIZE, OR COLOR.

PRIORITY CLAIMED UNDER SEC. 44(D) ON JAPAN APPLICATION NO. JP2005-16005, FILED 2-10-2005, REG. NO. 4900110, DATED 10-7-2005, EXPIRES 10-7-2015.

SER. NO. 78-628,701, FILED 5-12-2005.

ELISSA GARBER KON, EXAMINING ATTORNEY

Int. Cl.: 41

Prior U.S. Cls.: 100, 101 and 107

United States Patent and Trademark Office

Reg. No. 3,576,219

Registered Feb. 17, 2009

**SERVICE MARK
PRINCIPAL REGISTER**

MISSIONmarket

A.B.C. HOME FURNISHINGS, INC. (NEW YORK CORPORATION)
888 BROADWAY
NEW YORK, NY 10003

FOR: CHARITABLE SERVICES, NAMELY, PROVIDING EDUCATIONAL INFORMATION DESCRIBING ENVIRONMENTAL, SOCIAL SERVICES, AND HUMAN RIGHT ORGANIZATIONS WORLDWIDE AND ORGANIZATIONS THAT RECEIVE FUNDING AND MONETARY RELIEF, IN CLASS 41 (U.S. CLS. 100, 101 AND 107).

FIRST USE 11-19-2004; IN COMMERCE 11-19-2004.

THE MARK CONSISTS OF STANDARD CHARACTERS WITHOUT CLAIM TO ANY PARTICULAR FONT, STYLE, SIZE, OR COLOR.

SER. NO. 78-633,338, FILED 5-19-2005.

INGRID C. EULIN, EXAMINING ATTORNEY

Int. Cl.: 41

Prior U.S. Cls.: 100, 101 and 107

United States Patent and Trademark Office

Reg. No. 3,576,220

Registered Feb. 17, 2009

**SERVICE MARK
PRINCIPAL REGISTER**

MOTOGIRO USA

UNITED STATES CLASSIC RACING ASSOCIATION INC. (NEW HAMPSHIRE CORPORATION)
441 ATHOL ROAD
RICHMOND, NH 03470

FOR: VINTAGE MOTORCYCLE ROAD RALLY,
IN CLASS 41 (U.S. CLS. 100, 101 AND 107).

FIRST USE 12-15-2003; IN COMMERCE 0-0-2004.

THE MARK CONSISTS OF STANDARD CHARACTERS WITHOUT CLAIM TO ANY PARTICULAR FONT, STYLE, SIZE, OR COLOR.

NO CLAIM IS MADE TO THE EXCLUSIVE RIGHT TO USE "MOTOGIRO", APART FROM THE MARK AS SHOWN.

SEC. 2(F).

SER. NO. 78-643,213, FILED 6-3-2005.

HOWARD B. LEVINE, EXAMINING ATTORNEY

Int. Cl.: 35

Prior U.S. Cls.: 100, 101 and 102

United States Patent and Trademark Office

Reg. No. 3,576,221

Registered Feb. 17, 2009

**SERVICE MARK
PRINCIPAL REGISTER**

RELISH

RELISH GIFT DESIGN, INC. (CALIFORNIA CORPORATION)
208 PIER AVENUE
SANTA MONICA, CA 90405

FOR: RETAIL SHOP FEATURING GIFT DESIGNS AND CUSTOM GIFT BASKETS WITH TOILETRIES, ROBES, PAJAMAS, MUSIC, PET CARE ITEMS AND TREATS, PERFUME, AROMATHERAPY, CANDLES, GAMES, STATIONERY AND ALBUMS, GIFT WRAP, GOURMET ITEMS, CANDY, TEA, TEA WARE, SPECIALTY CULINARY ITEMS AND GLASSWARE, HOME DECOR ITEMS INCLUDING CLOCKS, BLANKETS, PERSONAL ACCESSORIES INCLUDING HATS, SCARVES AND JEWELRY,

HANDBAGS, SHAVING TOOLS, BABY ITEMS, INCLUDING BLANKETS, TOYS, DIAPER BAGS, BIBS, HATS, CLOTHES, TOILETRIES, IN CLASS 35 (U.S. CLS. 100, 101 AND 102).

FIRST USE 1-0-1999; IN COMMERCE 1-0-1999.

THE MARK CONSISTS OF STANDARD CHARACTERS WITHOUT CLAIM TO ANY PARTICULAR FONT, STYLE, SIZE, OR COLOR.

SER. NO. 78-643,725, FILED 6-4-2005.

INGA ERVIN, EXAMINING ATTORNEY

Int. Cls.: 9, 28 and 41

Prior U.S. Cls.: 21, 22, 23, 26, 36, 38, 50, 100, 101 and 107

Reg. No. 3,576,222

United States Patent and Trademark Office

Registered Feb. 17, 2009

**TRADEMARK
SERVICE MARK
PRINCIPAL REGISTER**

3 MONKEYS

ATRONIC INTERNATIONAL GMBH (FED REP GERMANY CORPORATION)
BORSIGSTRABE 26
32312 LÜBBECKE, FED REP GERMANY

FOR: ELECTRIC AND ELECTRONIC APPARATUS, INSTRUMENTS, DEVICES AND MACHINES NAMELY, COIN OPERATED MACHINES AND MACHINES OPERABLE WITH BILLS, MAGNETIC CARDS, COMPUTER CHIPS, MICRO-PROCESSOR DEVICES AND TOKENS NAMELY GAMING AND GAMBLING MACHINES; MECHANISMS FOR OPERATING ELECTRONIC GAMING AND GAMBLING MACHINES THAT ARE COIN-OPERATED AND COIN-CONTROLLED; MECHANICAL UNITS FOR DISPENSING COINS NAMELY HOPPERS; GAMING MACHINES OPERABLE WITH COINS, MONEY BILLS AND TOKENS; APPARATUSES FOR BILLING OPERATIONS OF COIN-OPERATED MACHINES, NAMELY COMPUTER SOFTWARE USED TO GENERATE BILLS IN CONNECTION WITH COIN OPERATED GAMING AND GAMBLING MACHINES; AUTOMATED DATA STORAGE MACHINES IN THE NATURE OF COMPUTERS; COMPUTER PRINTERS; ELECTRONIC PRINTED CIRCUIT BOARDS; COIN CHANGER MACHINES-VENDING MACHINES WHICH PROVIDE TOKENS, COUPONS AND GAME CARDS; ELECTRIC AND ELECTRONIC MACHINES AND APPARATUSES FOR GAMES, AMUSEMENT, ENTERTAINMENT AND GAMING, NAMELY, SLOT MACHINES, GAMING EQUIPMENT, NAMELY GAMING MACHINES; VIDEO SLOT MACHINES; CASINO GAMBLING MACHINES; SLOT MACHINES AND STRUCTURAL PARTS AND FITTINGS THEREFOR; BETTING MACHINES FOR PLACING BETS ON BETTING EVENTS; COMPUTER GAME CASSETTES AND CARTRIDGES FOR ELECTRONIC POCKET GAMES; PRERECORDED MAGNETIC DATA CARRIERS PROGRAMMED FOR ELECTRONIC VIDEO

AND AUDIO DISPLAY FOR PLAYING ELECTRONIC GAMES IN INTERNATIONAL, IN CLASS 9 (U.S. CLS. 21, 23, 26, 36 AND 38).

FOR: ELECTRIC AND ELECTRONIC STAND ALONE VIDEO MACHINES FEATURING GAMES, AMUSEMENT AND SPORTS-AND ENTERTAINMENT ALL FOR USE INDIVIDUALLY OR AS A NETWORK, NAMELY COMPACT VIDEO GAME SPORTS MACHINES FOR PLAYING ELECTRONIC GAMES IN SMALL AREAS, NAMELY, DARTS, TABLE SOCCER, POOL-BILLIARD, SNOOKER, SHOOTING GALLERIES, PINBALL GAMES THAT ARE OPERABLE BY COINS OR EQUIVALENTS THEREOF; HAND OPERATED CONSOLES FOR ELECTRONIC GAMES, ELECTRONIC PARLOR GAMES, VIDEO GAMES AND INSTRUMENTS, NAMELY HAND-HELD UNIT FOR PLAYING VIDEO GAMES, STAND ALONE VIDEO GAME MACHINES, IN CLASS 28 (U.S. CLS. 22, 23, 38 AND 50).

FOR: CASINO ENTERTAINMENT SERVICES NAMELY ENTERTAINMENT IN THE NATURE OF HOSTING A GAME FEATURING A PROGRESSIVE SLOT MACHINE JACKPOT, NAMELY A JACKPOT OR PRIZE WITH A FIXED MINIMUM VALUE THAT GROWS, UNTIL WON, IN PROPORTION TO PLAY UPON DESIGNATED SLOT MACHINES LINKED TO THAT JACKPOT, IN CLASS 41 (U.S. CLS. 100, 101 AND 107).

THE MARK CONSISTS OF STANDARD CHARACTERS WITHOUT CLAIM TO ANY PARTICULAR FONT, STYLE, SIZE, OR COLOR.

PRIORITY CLAIMED UNDER SEC. 44(D) ON ERPN CMNTY TM OFC APPLICATION NO. 004410122, FILED 5-24-2005, REG. NO. 004410122, DATED 6-6-2006, EXPIRES 5-24-2015.

SER. NO. 78-645,509, FILED 6-7-2005.

CHRISIE B. KING, EXAMINING ATTORNEY

Int. Cl.: 19

Prior U.S. Cls.: 1, 12, 33 and 50

United States Patent and Trademark Office

Reg. No. 3,576,223

Registered Feb. 17, 2009

**TRADEMARK
PRINCIPAL REGISTER**

MONOCAPA

LOSAS NUEVO ESTILO, INC. (PUERTO RICO CORPORATION)

P.O. BOX 6451

MAYAGUEZ, PUERTO RICO 00681

FOR: CONCENTRATED MORTAR, NAMELY, MIXTURES FEATURING CEMENT AND SAND, IN CLASS 19 (U.S. CLS. 1, 12, 33 AND 50).

FIRST USE 6-1-2005; IN COMMERCE 6-1-2005.

THE MARK CONSISTS OF STANDARD CHARACTERS WITHOUT CLAIM TO ANY PARTICULAR FONT, STYLE, SIZE, OR COLOR.

OWNER OF U.S. REG. NO. 3,427,248.

THE TERM "MONOCAPA" HAS NO MEANING IN A FOREIGN LANGUAGE

SER. NO. 78-667,836, FILED 7-11-2005.

MICHAEL GAAFAR, EXAMINING ATTORNEY

Int. Cl.: 3

Prior U.S. Cls.: 1, 4, 6, 50, 51 and 52

United States Patent and Trademark Office

Reg. No. 3,576,224

Registered Feb. 17, 2009

**TRADEMARK
PRINCIPAL REGISTER**

CHEEKHUE

MAKE-UP ART COSMETICS INC. (DELAWARE
CORPORATION)
767 FIFTH AVENUE
NEW YORK, NY 10153

THE MARK CONSISTS OF STANDARD CHAR-
ACTERS WITHOUT CLAIM TO ANY PARTICULAR
FONT, STYLE, SIZE, OR COLOR.

FOR: COSMETICS, IN CLASS 3 (U.S. CLS. 1, 4, 6, 50,
51 AND 52).

SER. NO. 78-685,972, FILED 8-4-2005.

FIRST USE 7-2-2001; IN COMMERCE 7-2-2001.

AMY C. KEAN, EXAMINING ATTORNEY

Int. Cl.: 9

Prior U.S. Cls.: 21, 23, 26, 36 and 38

Reg. No. 3,576,225

United States Patent and Trademark Office

Registered Feb. 17, 2009

**TRADEMARK
PRINCIPAL REGISTER**



DEUTSCHE TELEKOM AG (FED REP GERMA-
NY CORPORATION)
FRIEDRICH-EBERT-ALLEE 140
BONN, FED REP GERMANY 53113

FOR: ELECTRIC, ELECTRONIC, OPTICAL, MEASURING, SIGNALING, CONTROLLING AND TEACHING APPARATUS AND INSTRUMENTS, ALL FOR USE WITH TELECOMMUNICATIONS, NAMELY, APPARATUS FOR PRODUCING SOUND, IMAGES OR DATA; BLANK MAGNETIC AND OPTICAL DATA CARRIERS; DATA PROCESSORS; COMPUTERS, NAMELY, MICROCOMPUTERS, MINICOMPUTERS, COMPUTER CENTRAL PROCESSORS, COMPUTER MONITORS, COMPUTER KEYBOARDS, COMPUTER TERMINALS, COMPUTER MEMORIES, COMPUTER LASER PRINTERS, COMPUTER IMPACT PRINTERS, COMPUTER DOT MATRIX PRINTERS, COMPUTERS AND INSTRUCTIONAL MANUALS SOLD AS A UNIT; COMPUTER MEMORY HARDWARE; COMPUTER INTERFACE APPARATUS, NAMELY, COMPUTER INTERFACE BOARDS, COMPUTER MOUSE AND MOUSE PAD, COMPUTER PERIPHERALS AND PARTS THEREOF; COMPUTER SOFTWARE PROGRAMS FOR USE IN OPERATING TELECOMMUNICATIONS AND BUSINESS MANAGEMENT SYSTEMS AND RELATED INSTRUCTION MANUALS SOLD AS A UNIT; COMPUTER SOFTWARE FOR FINANCIAL ACCOUNTING, FOR THE PROVISION OF ONLINE INFORMATION SERVICES IN THE FIELD OF NEWS, SPORTS, ENTERTAINMENT, CULTURE, BUSINESS AND FINANCE, WEATHER AND TRAVEL, NETWORK MANAGEMENT, COMPUTER PROXY, FOR CONTROLLING ACCESS AND ALARM MONITORING OF HOMES, APARTMENTS, BUILDINGS AND OTHER PROPERTIES, BILLING ANALYSIS, NETWORK ACCESS CONTROL AND FOR CREATING AND MAINTAINING FIREWALLS; COMPUTER SOFTWARE PROGRAMS FOR ACCESSING A GLOBAL COMPUTER NETWORK AND INTERACTIVE COMPUTER COM-

MUNICATIONS NETWORKS; OPTICAL FIBERS SOLD AS A COMPONENT OF FIBER OPTICAL CABLES; FIBER OPTIC CABLES; OPTICAL SCANNERS; OPTICAL CHARACTER READERS; OPTICAL BLANK DISCS; OPTICAL GLASS FOR SIGNAL TRANSMISSION; OPTIC TRANSMITTERS FOR RADIO, TELEPHONE; OPTIC RECEIVERS FOR TELEPHONE, AUDIO, VIDEO; OPTICAL SIGNAL PROCESSORS; OPTIC TELECOMMUNICATIONS SWITCHES; OPTICAL ATTENUATORS; OPTICAL AMPLIFIERS; OPTICAL CHARACTER RECOGNITION APPARATUS, FOR USE IN THE TELECOMMUNICATIONS FIELD, AND PARTS THEREOF; TELEPHONE LOCAL AREA NETWORKS; TELECOMMUNICATION AUDIO, VIDEO AND DATA COMMUNICATIONS SYSTEMS, NAMELY, DIGITAL AND ANALOGUE SIGNAL TRANSMITTERS; RECEIVERS AND CONVERTERS FOR USE WITH TELEPHONE, AUDIO, VIDEO; RADIO AND TELEPHONE TRANSMITTERS; COMMUNICATION RECEIVERS AND SERVERS FOR TELEPHONE, AUDIO, VIDEO; TELEPHONE ANSWERING MACHINES; TELEPROMPTERS; TELETYPEWRITERS AND PARTS THEREOF, NAMELY, CALLER IDENTIFICATION BOXES, DIALING ASSEMBLIES, TELEPHONE UNITS, AUDIO OPERATED RELAYS, AUDIO/VIDEO SIGNAL AND OPTICAL FILTERS, PROTECTORS AND AUTOMATIC SIGNALING AND CONTROL EQUIPMENT, TELEMETERS, WIRELESS AND CELLULAR TELEPHONES, AND RADIO PAGERS; INTERCOMS; FACSIMILE MACHINE; ELECTRONIC MAIL APPARATUS FOR ELECTRONIC EXCHANGE OF DATA IMAGES AND MESSAGES; ELECTRICAL WIRE; ELECTRICAL WIRE CONNECTORS; INTEGRATED CIRCUITS; PRINTED CIRCUITS; ELECTRIC CIRCUITS; CIRCUIT BREAKERS; PRINTED CIRCUIT BOARDS; CIRCUIT CONNECTORS; ELECTRICAL CONTROLLERS; ELECTRICAL CONVERTERS; ELECTRICAL CONDUCTORS; ELECTRICAL FUSES; ELECTRIC LUMINESCENT DISPLAY PANELS; ELECTRICAL SWITCH PLATES;

ELECTRIC PLUGS; ELECTRIC COILS; ANTENNAS; ELECTRICAL CABLES; COMPUTER CABLES; COMPUTER CHIPS; SILICON CHIPS; CHRONOGRAPHS FOR USE AS SPECIALIZED TIME RECORDING APPARATUS; COMPUTER BUFFERS; BLANK COMPUTER DISCS; BLANK COMPUTER FLOPPY DISKS; COMPUTER HARD DISCS; ACOUSTIC CONDUITS; ELECTRICAL CONDUITS; FIBER OPTIC CONDUITS AND PARTS THEREOF; COMPACT DISC PLAYERS; AUDIO AND VIDEO TAPE RECORDERS; AUDIO AND VIDEOTAPE PLAYERS; AUDIO AND VIDEOCASSETTE RECORDERS; AUDIO AND VIDEOCASSETTE PLAYERS; BLANK AUDIO AND VIDEOTAPES, CASSETTES, DISCS AND MICROFICHE; AUDIO AND VIDEO TAPES, CASSETTES, DISCS AND MICROFICHE FEATURING INFORMATION CONCERNING TELECOMMUNICATIONS, AND CONCERNING PERSONAL AND BUSINESS MANAGEMENT SYSTEMS; AUDIO AND VIDEO RECORDINGS IN THE FIELD OF TELECOMMUNICATIONS, INFORMATION TECHNOLOGY AND SAFETY; TELEVISION AND TELEVISION PERIPHERAL EQUIPMENT, NAMELY, CAMERAS, SET TOP BOXES, REMOTE CONTROL UNITS FOR INTERACTIVE AND NON-INTERACTIVE USE; VIDEO MONITORS; AUTOMATIC VENDING MACHINES AND TIMING MECHANISMS THEREFOR AND PARTS THEREOF; MACHINE READABLE, MAGNETICALLY ENCODED CARDS, NAMELY, PREPAID TELEPHONE CALLING CARDS AND CREDIT CARDS; BLANK SMART CARDS; MAGNETIC CODED CARD READERS; DATA PROCESSORS AND READERS; WORD PROCESSORS; MICROPROCESSORS; ELECTRONIC ENCRYPTION UNITS; DEMAGNETIZERS FOR MAGNETIC TAPES AND PARTS THEREOF; LASERS NOT FOR MEDICAL USE; LIGHT EMITTING DIODES; LIGHT EMITTING DIODE DISPLAYS; COMPUTER, DATA AND VIDEO NETWORKING AND CONFERENCING EQUIPMENT, NAMELY, TELECONFERENCING EQUIPMENT AND AUDIO-VISUAL TEACHING EQUIPMENT IN THE NATURE OF OVERHEAD FILM, PHOTOGRAPHIC AND SLIDE PROJECTORS; PROJECTION SCREENS; COMPUTER BASED INFORMATION DISPLAY EQUIPMENT, NAMELY, COMPUTERS WHICH DISPLAY INFORMATION ON AN OVERHEAD SCREEN; PORTABLE DEVICES, NAMELY, LAP-TOPS, HANDHELD AND POCKET COMPUTERS, WIRELESS FAX MACHINES; PERSONAL COMMU-

NICATIONS EQUIPMENT, NAMELY, PERSONAL DIGITAL ASSISTANTS; CALCULATORS AND RELATED PERIPHERALS; SATELLITE PROCESSORS, SATELLITE AND SATELLITE COMMUNICATION EARTH STATIONS BOTH STATIONARY AND MOVEABLE; COMPUTER GAME PROGRAMS FOR CHILDREN AND ADULTS; VIDEO AND COMPUTER GAME CARTRIDGES; AUDIO AND VIDEO RECORDINGS IN THE FIELD OF NEWS, SPORTS, ENTERTAINMENT, CULTURE, BUSINESS AND FINANCE, WEATHER AND TRAVEL; PRE-RECORDED COMPACT DISCS, AUDIOCASSETTE TAPES, VIDEOCASSETTE TAPES, DIGITAL AUDIO-TAPES AND DIGITAL VIDEO DISCS FEATURING MUSICAL, VARIETY, NEWS AND COMEDY SHOWS; CARRYING CASES FOR POCKET CALCULATORS AND CELLPHONES; TELECOMMUNICATIONS SOFTWARE, NAMELY, SOFTWARE FOR WIRELESS CONTENT DELIVERY, SOFTWARE TO ENABLE THE TRANSMISSION OF PHOTOGRAPHS TO MOBILE TELEPHONES, SOFTWARE FOR ACCESSING INFORMATION DIRECTORIES THAT MAY BE DOWNLOADED FROM THE GLOBAL COMPUTER, AND COMPUTER APPLICATION SOFTWARE FOR MOBILE PHONES, IN CLASS 9 (U.S. CLS. 21, 23, 26, 36 AND 38).

OWNER OF FED REP GERMANY REG. NO. 30217929, DATED 6-18-2002, EXPIRES 4-30-2012.

OWNER OF U.S. REG. NOS. 2,367,890, 2,975,016 AND OTHERS.

NO CLAIM IS MADE TO THE EXCLUSIVE RIGHT TO USE "HEALTH", APART FROM THE MARK AS SHOWN.

THE COLOR(S) WHITE, MAGENTA AND GRAY IS/ARE CLAIMED AS A FEATURE OF THE MARK.

THE MARK CONSISTS OF THE LETTER "T", WHICH IS WHITE; A CIRCLE AROUND THE LETTER "T", WHICH IS MAGENTA; AND THE WORD "HEALTH", WHICH IS GRAY.

SER. NO. 78-695,389, FILED 8-18-2005.

Laurie Mayes, Examining Attorney

Int. Cl.: 9

Prior U.S. Cls.: 21, 23, 26, 36 and 38

Reg. No. 3,576,226

United States Patent and Trademark Office

Registered Feb. 17, 2009

TRADEMARK
PRINCIPAL REGISTER



DEUTSCHE TELEKOM AG (FED REP GERMA-
NY CORPORATION)
FRIEDRICH-EBERT-ALLEE 140
BONN, FED REP GERMANY 53113

FOR: ELECTRIC, ELECTRONIC, OPTICAL, MEASURING, SIGNALING, CONTROLLING AND TEACHING APPARATUS AND INSTRUMENTS, ALL FOR USE WITH TELECOMMUNICATIONS, NAMELY, APPARATUS FOR PRODUCING SOUND, IMAGES OR DATA; BLANK MAGNETIC AND OPTICAL DATA CARRIERS; DATA PROCESSORS; COMPUTERS, NAMELY, MICROCOMPUTERS, MINICOMPUTERS, COMPUTER CENTRAL PROCESSORS, COMPUTER MONITORS, COMPUTER KEYBOARDS, COMPUTER TERMINALS, COMPUTER MEMORIES, COMPUTER LASER PRINTERS, COMPUTER IMPACT PRINTERS, COMPUTER DOT MATRIX PRINTERS, COMPUTERS AND INSTRUCTIONAL MANUALS SOLD AS A UNIT; COMPUTER MEMORY HARDWARE; COMPUTER INTERFACE APPARATUS, NAMELY, COMPUTER INTERFACE BOARDS, COMPUTER MOUSE AND MOUSE PAD, COMPUTER PERIPHERALS AND PARTS THEREOF; COMPUTER SOFTWARE PROGRAMS FOR USE IN OPERATING TELECOMMUNICATIONS AND BUSINESS MANAGEMENT SYSTEMS AND RELATED INSTRUCTION MANUALS SOLD AS A UNIT; COMPUTER SOFTWARE FOR FINANCIAL ACCOUNTING, FOR THE PROVISION OF ONLINE INFORMATION SERVICES IN THE FIELD OF NEWS, SPORTS, ENTERTAINMENT, CULTURE, BUSINESS AND FINANCE, WEATHER AND TRAVEL, NETWORK MANAGEMENT, COMPUTER PROXY, FOR CONTROLLING ACCESS AND ALARM MONITORING OF HOMES, APARTMENTS, BUILDINGS AND OTHER PROPERTIES, BILLING ANALYSIS, NETWORK ACCESS CONTROL AND FOR CREATING AND MAINTAINING FIREWALLS; COMPUTER SOFTWARE PROGRAMS FOR ACCESSING A GLOBAL COMPUTER NETWORK AND INTERACTIVE COMPUTER COM-

MUNICATIONS NETWORKS; OPTICAL FIBERS SOLD AS A COMPONENT OF FIBER OPTICAL CABLES; FIBER OPTIC CABLES; OPTICAL SCANNERS; OPTICAL CHARACTER READERS; OPTICAL BLANK DISCS; OPTICAL GLASS FOR SIGNAL TRANSMISSION; OPTIC TRANSMITTERS FOR RADIO, TELEPHONE; OPTIC RECEIVERS FOR TELEPHONE, AUDIO, VIDEO; OPTICAL SIGNAL PROCESSORS; OPTIC TELECOMMUNICATIONS SWITCHES; OPTICAL ATTENUATORS; OPTICAL AMPLIFIERS; OPTICAL CHARACTER RECOGNITION APPARATUS, FOR USE IN THE TELECOMMUNICATIONS FIELD, AND PARTS THEREOF; TELEPHONE LOCAL AREA NETWORKS; TELECOMMUNICATION AUDIO, VIDEO AND DATA COMMUNICATIONS SYSTEMS, NAMELY, DIGITAL AND ANALOGUE SIGNAL TRANSMITTERS; RECEIVERS AND CONVERTERS FOR USE WITH TELEPHONE, AUDIO, VIDEO; RADIO AND TELEPHONE TRANSMITTERS; COMMUNICATION RECEIVERS AND SERVERS FOR TELEPHONE, AUDIO, VIDEO; TELEPHONE ANSWERING MACHINES; TELEPROMPTERS; TELETYPEWRITERS AND PARTS THEREOF, NAMELY, CALLER IDENTIFICATION BOXES, DIALING ASSEMBLIES, TELEPHONE UNITS, AUDIO OPERATED RELAYS, AUDIO/VIDEO SIGNAL AND OPTICAL FILTERS, PROTECTORS AND AUTOMATIC SIGNALING AND CONTROL EQUIPMENT, TELEMETERS, WIRELESS AND CELLULAR TELEPHONES, AND RADIO PAGERS; INTERCOMS; FACSIMILE MACHINE; ELECTRONIC MAIL APPARATUS FOR ELECTRONIC EXCHANGE OF DATA IMAGES AND MESSAGES; ELECTRICAL WIRE; ELECTRICAL WIRE CONNECTORS; INTEGRATED CIRCUITS; PRINTED CIRCUITS; ELECTRIC CIRCUITS; CIRCUIT BREAKERS; PRINTED CIRCUIT BOARDS; CIRCUIT CONNECTORS; ELECTRICAL CONTROLLERS; ELECTRICAL CONVERTERS; ELECTRICAL CONDUCTORS; ELECTRICAL FUSES; ELECTRIC LUMINESCENT DISPLAY PANELS; ELECTRICAL SWITCH PLATES;

ELECTRIC PLUGS; ELECTRIC COILS; ANTENNAS; ELECTRICAL CABLES; COMPUTER CABLES; COMPUTER CHIPS; SILICON CHIPS; CHRONOGRAPHS FOR USE AS SPECIALIZED TIME RECORDING APPARATUS; COMPUTER BUFFERS; BLANK COMPUTER DISCS; BLANK COMPUTER FLOPPY DISKS; COMPUTER HARD DISCS; ACOUSTIC CONDUITS; ELECTRICAL CONDUITS; FIBER OPTIC CONDUITS AND PARTS THEREOF; COMPACT DISC PLAYERS; AUDIO AND VIDEO TAPE RECORDERS; AUDIO AND VIDEOTAPE PLAYERS; AUDIO AND VIDEOCASSETTE RECORDERS; AUDIO AND VIDEOCASSETTE PLAYERS; BLANK AUDIO AND VIDEOTAPES, CASSETTES, DISCS AND MICROFICHE; AUDIO AND VIDEO TAPES, CASSETTES, DISCS AND MICROFICHE FEATURING INFORMATION CONCERNING TELECOMMUNICATIONS, AND CONCERNING PERSONAL AND BUSINESS MANAGEMENT SYSTEMS; AUDIO AND VIDEO RECORDINGS IN THE FIELD OF TELECOMMUNICATIONS, INFORMATION TECHNOLOGY AND SAFETY; TELEVISION AND TELEVISION PERIPHERAL EQUIPMENT, NAMELY, CAMERAS, SET TOP BOXES, REMOTE CONTROL UNITS FOR INTERACTIVE AND NON-INTERACTIVE USE; VIDEO MONITORS; AUTOMATIC VENDING MACHINES AND TIMING MECHANISMS THEREFOR AND PARTS THEREOF; MACHINE READABLE, MAGNETICALLY ENCODED CARDS, NAMELY, PREPAID TELEPHONE CALLING CARDS AND CREDIT CARDS; BLANK SMART CARDS; MAGNETIC CODED CARD READERS; DATA PROCESSORS AND READERS; WORD PROCESSORS; MICROPROCESSORS; ELECTRONIC ENCRYPTION UNITS; DEMAGNETIZERS FOR MAGNETIC TAPES AND PARTS THEREOF; LASERS NOT FOR MEDICAL USE; LIGHT EMITTING DIODES; LIGHT EMITTING DIODE DISPLAYS; COMPUTER, DATA AND VIDEO NETWORKING AND CONFERENCING EQUIPMENT, NAMELY, TELECONFERENCING EQUIPMENT AND AUDIO-VISUAL TEACHING EQUIPMENT IN THE NATURE OF OVERHEAD FILM, PHOTOGRAPHIC AND SLIDE PROJECTORS; PROJECTION SCREENS; COMPUTER BASED INFORMATION DISPLAY EQUIPMENT, NAMELY, COMPUTERS WHICH DISPLAY INFORMATION ON AN OVERHEAD SCREEN; PORTABLE DEVICES, NAMELY, LAP-

TOPS, HANDHELD AND POCKET COMPUTERS, WIRELESS FAX MACHINES; PERSONAL COMMUNICATIONS EQUIPMENT, NAMELY, PERSONAL DIGITAL ASSISTANTS; CALCULATORS AND RELATED PERIPHERALS; SATELLITE PROCESSORS, SATELLITE AND SATELLITE COMMUNICATION EARTH STATIONS BOTH STATIONARY AND MOVEABLE; COMPUTER GAME PROGRAMS FOR CHILDREN AND ADULTS; VIDEO AND COMPUTER GAME CARTRIDGES; AUDIO AND VIDEO RECORDINGS IN THE FIELD OF NEWS, SPORTS, ENTERTAINMENT, CULTURE, BUSINESS AND FINANCE, WEATHER AND TRAVEL; PRE-RECORDED COMPACT DISCS, AUDIOCASSETTE TAPES, VIDEOCASSETTE TAPES, DIGITAL AUDIO-TAPES AND DIGITAL VIDEO DISCS FEATURING MUSICAL, VARIETY, NEWS AND COMEDY SHOWS; CARRYING CASES FOR POCKET CALCULATORS AND CELLPHONES; TELECOMMUNICATIONS SOFTWARE, NAMELY, SOFTWARE FOR WIRELESS CONTENT DELIVERY, SOFTWARE TO ENABLE THE TRANSMISSION OF PHOTOGRAPHS TO MOBILE TELEPHONES, SOFTWARE FOR ACCESSING INFORMATION DIRECTORIES THAT MAY BE DOWNLOADED FROM THE GLOBAL COMPUTER, AND COMPUTER APPLICATION SOFTWARE FOR MOBILE PHONES., IN CLASS 9 (U.S. CLS. 21, 23, 26, 36 AND 38).

OWNER OF FED REP GERMANY REG. NO. 30217931, DATED 6-18-2002, EXPIRES 4-30-2012.

OWNER OF U.S. REG. NOS. 2,367,890, 2,975,016 AND OTHERS.

THE COLOR(S) WHITE, MAGENTA AND GRAY IS/ARE CLAIMED AS A FEATURE OF THE MARK.

THE MARK CONSISTS OF THE LETTER "T", WHICH IS WHITE; A CIRCLE AROUND THE LETTER "T", WHICH IS MAGENTA; AND THE WORD "JUNIOR", WHICH IS GRAY.

SER. NO. 78-695,703, FILED 8-18-2005.

Laurie Mayes, Examining Attorney

Int. Cls.: 29 and 30

Prior U.S. Cl.: 46

United States Patent and Trademark Office

Reg. No. 3,576,227

Registered Feb. 17, 2009

TRADEMARK
PRINCIPAL REGISTER

duBreton

LES VIANDES DU BRETON INC. (CANADA CORPORATION)

150, CHEMIN DES RAYMOND

RIVIERE-DU-LOUP, CANADA G5R 5X8

FOR: MEAT PRODUCTS, NAMELY, FRESH PORK MEAT; MEAT PRODUCTS, NAMELY, FRESH AND FROZEN POULTRY, MEAT PIECES AND CUTS; MEAT AND POULTRY THAT HAS BEEN MARINATED AND PREPARED BY SMOKING, BY COOKING, WITH BRINE, AND WITH SALT; DELICATESSEN PRODUCTS, NAMELY, BLACK PUDDING, HAM, SLICED HAM, BACON, SAUSAGE, PORK PATE, LIVER PATE' AND DELICATESSEN PRODUCTS, NAMELY, PROCESSED PORK, POULTRY, AND BEEF BAKED BEANS; FOOD, NAMELY, PREPARED READY-TO-GO MEALS MADE PRIMARILY OF MEAT VEGETABLES, FISH AND POULTRY, IN CLASS 29 (U.S. CL. 46).

FIRST USE 10-0-2000; IN COMMERCE 3-0-2002.

FOR: FOOD, NAMELY, PREPARED READY-TO-GO MEALS MADE PRIMARILY OF PASTA; SALMON PIES, CHICKEN PIES AND MEAT PIES, PIES, QUICHES LORRAINE, MUSHROOMS AND BACON QUICHES, BROCCOLI AND CALIFORNIAN QUICHES, SPAGHETTI SAUCE, MEAT SAUCE; CONDIMENTS, NAMELY, FRUIT CHUTNEYS, GREEN AND RED KETCHUP, IN CLASS 30 (U.S. CL. 46).

THE MARK CONSISTS OF STANDARD CHARACTERS WITHOUT CLAIM TO ANY PARTICULAR FONT, STYLE, SIZE, OR COLOR.

PRIORITY CLAIMED UNDER SEC. 44(D) ON CANADA APPLICATION NO. 1256737, FILED 5-5-2005, REG. NO. TMA703259, DATED 12-17-2007, EXPIRES 12-17-2022.

SER. NO. 78-709,031, FILED 9-8-2005.

ALEXANDER L. POWERS, EXAMINING ATTORNEY

Int. Cl.: 35

Prior U.S. Cls.: 100, 101 and 102

United States Patent and Trademark Office

Reg. No. 3,576,228

Registered Feb. 17, 2009

**SERVICE MARK
PRINCIPAL REGISTER**



LAI LAI DEPARTMENT STORE CO., LTD. (TAI-
WAN CORPORATION)
3F.-1, NO. 87, LANE 155, DUNHUA N. RD.,
SONGSHAN DISTRICT;
TAIPEI CITY, TAIWAN 105

FOR: IMPORT AND EXPORT AGENCIES, BUSI-
NESS CONSULTING AND INFORMATION SERVI-
CES, NAMELY, PROVIDING INFORMATION
ABOUT VARIOUS GOODS SOLD IN THE RETAIL
DEPARTMENT STORES, SUPERMARKETS, RE-
TAIL CONVENIENCE STORES, RETAIL STORES
FEATURING FOOD AND BEVERAGE PRODUCTS,
RETAIL DEPARTMENT STORES; SUPERMAR-
KETS; RETAIL CONVENIENCE STORES; RETAIL
STORES FEATURING FOOD AND BEVERAGE
PRODUCTS, NAMELY, COFFEE, TEA, IN CLASS
35 (U.S. CLS. 100, 101 AND 102).

PRIORITY CLAIMED UNDER SEC. 44(D) ON
TAIWAN APPLICATION NO. 94031725, FILED 7-1-
2005, REG. NO. 01214860, DATED 6-16-2006, EXPIRES
6-15-2016.

THE COLOR(S) RED IS/ARE CLAIMED AS A
FEATURE OF THE MARK.

THE MARK CONSISTS OF THE STYLIZED
WORD "OK" IN RED WITHIN A RED MISCELLA-
NEOUS DESIGN.

SER. NO. 78-720,147, FILED 9-26-2005.

ALEX KEAM, EXAMINING ATTORNEY

Int. Cls.: 9 and 10

Prior U.S. Cls.: 21, 23, 26, 36, 38, 39 and 44

Reg. No. 3,576,229

United States Patent and Trademark Office

Registered Feb. 17, 2009

**TRADEMARK
PRINCIPAL REGISTER**

MIRRORCLE RAY

PHOTON PRODUCTION LABORATORY, LTD.
(JAPAN LIMITED LIABILITY COMPANY)
4-2-1 (808), TAKAKAI-CHO, MINAMI
OUMIHACHIMAN-SHI, SHIGA-KEN, JAPAN

FOR: PARTICLE ACCELERATORS; X-RAYS PRODUCING APPARATUS AND INSTALLATION, NOT FOR MEDICAL PURPOSES; X-RAY MICROSCOPES; NON-DESTRUCTIVE TESTING APPARATUS USING RADIATION COMPRISING A RADIATION SOURCE AND SENSOR FOR THE IDENTIFICATION AND ANALYSIS OF DEFECTS SUCH AS CRACKS, CAVITIES, AIR BUBBLES AND FOREIGN SUBSTANCES WITHIN THE INTERNAL STRUCTURE OF AN ORGANIC OR INORGANIC TEST OBJECT OR MATERIAL SAMPLE; INDUSTRIAL STERILIZING APPARATUS USING RADIATION; PROTEIN STRUCTURE ANALYSIS APPARATUS; X-RAY FLUORESCENCE SPECTROMETER, IN CLASS 9 (U.S. CLS. 21, 23, 26, 36 AND 38).

FOR: X-RAYS PRODUCING APPARATUS AND INSTALLATION, FOR MEDICAL PURPOSES; MEDICAL X-RAY APPARATUS; RADIOTHERAPY APPARATUS COMPRISING A RADIATION SOURCE AND AN IRRADIATION DEVICE; MEDICAL STERILIZING APPARATUS USING RADIATION COM-

PRISING A RADIATION SOURCE AND AN IRRADIATION DEVICE, IN CLASS 10 (U.S. CLS. 26, 39 AND 44).

THE MARK CONSISTS OF STANDARD CHARACTERS WITHOUT CLAIM TO ANY PARTICULAR FONT, STYLE, SIZE, OR COLOR.

PRIORITY CLAIMED UNDER SEC. 44(D) ON JAPAN APPLICATION NO. 30863/2005, FILED 4-7-2005, REG. NO. 5047813, DATED 5-18-2007, EXPIRES 5-18-2017.

OWNER OF JAPAN REG. NO. 5118371, DATED 3-14-2008, EXPIRES 3-14-2018.

OWNER OF JAPAN REG. NO. 5053358, DATED 6-8-2007, EXPIRES 6-8-2017.

NO CLAIM IS MADE TO THE EXCLUSIVE RIGHT TO USE "RAY", APART FROM THE MARK AS SHOWN.

SER. NO. 78-728,180, FILED 10-6-2005.

RICHARD A. STRASER, EXAMINING ATTORNEY

Int. Cl.: 3

Prior U.S. Cls.: 1, 4, 6, 50, 51 and 52

United States Patent and Trademark Office

Reg. No. 3,576,230

Registered Feb. 17, 2009

**TRADEMARK
PRINCIPAL REGISTER**

OXI MAGIC

THE CLOROX COMPANY (DELAWARE COR-
PORATION)
1221 BROADWAY
OAKLAND, CA 94612

THE MARK CONSISTS OF STANDARD CHAR-
ACTERS WITHOUT CLAIM TO ANY PARTICULAR
FONT, STYLE, SIZE, OR COLOR.

FOR: GENERAL HOUSEHOLD CLEANER;
STAIN REMOVER, IN CLASS 3 (U.S. CLS. 1, 4, 6, 50,
51 AND 52).

SER. NO. 78-741,190, FILED 10-26-2005.

FIRST USE 6-30-1999; IN COMMERCE 6-30-1999.

KAELIE KUNG, EXAMINING ATTORNEY

Int. Cl.: 3

Prior U.S. Cls.: 1, 4, 6, 50, 51 and 52

United States Patent and Trademark Office

Reg. No. 3,576,231

Registered Feb. 17, 2009

**TRADEMARK
PRINCIPAL REGISTER**

**CLEAN
KIDS
NATURALLY**



GABRIEL COSMETICS, INC. (WASHINGTON CORPORATION)
PO BOX 50130
BELLEVUE, WA 98015

FIRST USE 11-1-1996; IN COMMERCE 11-1-1996.

FOR: SKIN CARE PREPARATIONS, NAMELY, ALL NATURAL BODY LOTIONS, SOAPS AND SHAMPOOS, IN CLASS 3 (U.S. CLS. 1, 4, 6, 50, 51 AND 52).

SER. NO. 78-741,918, FILED 10-27-2005.

SHARON MEIER, EXAMINING ATTORNEY

Int. Cl.: 41

Prior U.S. Cls.: 100, 101 and 107

United States Patent and Trademark Office

Reg. No. 3,576,232

Registered Feb. 17, 2009

**SERVICE MARK
PRINCIPAL REGISTER**



TELIGENCE (CANADA), INC. (CANADA CORPORATION)
1045 HOWE STREET STE. 700
VANCOUVER, CANADA V6Z 2A9

FOR: ENTERTAINMENT SERVICES, NAMELY, PROVIDING ONLINE COMPUTER GAMES; ENTERTAINMENT SERVICES, NAMELY, PROVIDING A WEB SITE FEATURING MUSICAL PERFORMANCES, MUSICAL VIDEOS, RELATED FILM CLIPS, PHOTOGRAPHS, AND OTHER MULTIMEDIA MATERIALS AND RELATED INFORMATION PROVIDED ONLINE, AND THROUGH WIRELESS,

TELEPHONIC, MOBILE, AND DIGITAL DEVICES, IN CLASS 41 (U.S. CLS. 100, 101 AND 107).

FIRST USE 9-8-2005; IN COMMERCE 9-8-2005.

THE MARK CONSISTS OF LETTER "T" STYLIZED WITH SPHERICAL BACKGROUND.

SER. NO. 78-744,774, FILED 11-1-2005.

CURTIS FRENCH, EXAMINING ATTORNEY

Int. Cl.: 36

Prior U.S. Cls.: 100, 101 and 102

United States Patent and Trademark Office

Reg. No. 3,576,233

Registered Feb. 17, 2009

**SERVICE MARK
PRINCIPAL REGISTER**



U.S. MONEY EXPRESS CO. (ILLINOIS CORPORATION)

5395 N. MILWAUKEE AVE.

CHICAGO, IL 606301251

FOR: FINANCIAL SERVICES, NAMELY, MONEY TRANSFER SERVICES, MONEY ORDER SERVICES, TRAVELERS' CHECKS ISSUANCE, ELECTRONIC PAYMENT, NAMELY, ELECTRONIC PROCESSING AND TRANSMISSION OF BILL PAYMENT DATA, BILL PAYMENT SERVICES, AND PREPAID TELECOMMUNICATIONS CALLING CARD SERVICES, IN CLASS 36 (U.S. CLS. 100, 101 AND 102).

FIRST USE 11-1-2005; IN COMMERCE 11-1-2005.

NO CLAIM IS MADE TO THE EXCLUSIVE RIGHT TO USE "US MONEY EXPRESS", APART FROM THE MARK AS SHOWN.

THE COLOR(S) BLUE, GREEN AND YELLOW IS/ARE CLAIMED AS A FEATURE OF THE MARK.

THE COLOR GREEN APPEARS IN THE WORDING "MONEY EXPRESS" AND IN THE LETTER "U", THE COLOR BLUE APPEARS IN THE LETTER "S" AND IN THE DOLLAR SYMBOL, AND THE COLOR YELLOW APPEARS IN THE STARS.

SER. NO. 78-752,624, FILED 11-11-2005.

CAROLYN CATALDO, EXAMINING ATTORNEY

Int. Cls.: 16 and 20

Prior U.S. Cls.: 2, 5, 13, 22, 23, 25, 29, 32, 37, 38 and 50

Reg. No. 3,576,234

United States Patent and Trademark Office

Registered Feb. 17, 2009

**TRADEMARK
PRINCIPAL REGISTER**



POWER RETAILING GROUP (MEXICO CORPORATION)
COLONIA 16 DE SEPTIEMBRE
AV. CONSTITUYENTES NO. 605
MEXICO, DISTRITO FEDERAL C.P., MEXICO 1181

FOR: PAPER, CARDBOARD AND GOODS MADE FROM THESE MATERIALS, NOT INCLUDED IN OTHER CLASSES, NAMELY, CARDBOARD EXHIBITORS IN THE NATURE OF FLOOR DISPLAY UNITS FOR MERCHANDISING PRODUCTS, IN CLASS 16 (U.S. CLS. 2, 5, 22, 23, 29, 37, 38 AND 50).

FOR: CONTAINERS-EXHIBITORS, PACKAGING, PACKAGING STRUCTURE FOR CONTAINMENT, TRANSPORTATION, EXHIBITION AND DISPENSING OF GREAT VOLUMES OF PRODUCTS, NAMELY, EXHIBITORS IN THE NATURE OF DISPLAY CASES OR DISPLAY CASES FOR MERCHANDISING PRODUCTS, IN CLASS 20 (U.S. CLS. 2, 13, 22, 25, 32 AND 50).

PRIORITY CLAIMED UNDER SEC. 44(D) ON MEXICO APPLICATION NO. 751,470, FILED 11-18-2005, REG. NO. 914021, DATED 12-15-2005, EXPIRES 11-18-2015.

PRIORITY CLAIMED UNDER SEC. 44(D) ON MEXICO APPLICATION NO. 751,472, FILED 11-18-2005, REG. NO. 914840, DATED 12-20-2005, EXPIRES 11-18-2015.

NO CLAIM IS MADE TO THE EXCLUSIVE RIGHT TO USE "SHIP," "DISPLAY," OR "SELL", APART FROM THE MARK AS SHOWN.

SER. NO. 78-759,655, FILED 11-22-2005.

BRIAN PINO, EXAMINING ATTORNEY

Int. Cl.: 28

Prior U.S. Cls.: 22, 23, 38 and 50

United States Patent and Trademark Office

Reg. No. 3,576,235

Registered Feb. 17, 2009

**TRADEMARK
PRINCIPAL REGISTER**



BC SPORTS, INC. (OREGON CORPORATION)
411 NW 13TH AVENUE
PORTLAND, OR 97209

FIRST USE 4-7-2004; IN COMMERCE 4-7-2004.

OWNER OF U.S. REG. NO. 2,928,815.

FOR: ATHLETIC EQUIPMENT, NAMELY, FOOTBALL, BASEBALL, SOFTBALL, BASKETBALL, SOCCER, RUNNING AND VOLLEYBALL TRAINING PRODUCTS FOR SPEED, AGILITY AND QUICKNESS, IN CLASS 28 (U.S. CLS. 22, 23, 38 AND 50).

SER. NO. 78-787,495, FILED 1-9-2006.

SEAN CROWLEY, EXAMINING ATTORNEY

Int. Cls.: 35 and 44

Prior U.S. Cls.: 100, 101 and 102

United States Patent and Trademark Office

Reg. No. 3,576,236

Registered Feb. 17, 2009

**SERVICE MARK
PRINCIPAL REGISTER**

DUBUIS HEALTH SYSTEM

DUBUIS HEALTH SYSTEMS, INC. (LOUISIANA
NON-STOCK CORPORATION)
10333 RICHMOND AVENUE SUITE 300
HOUSTON, TX 77042

FOR: HEALTH CARE FACILITIES MANAGE-
MENT FOR OTHERS; RETAIL PHARMACY SERVI-
CES, IN CLASS 35 (U.S. CLS. 100, 101 AND 102).

FIRST USE 11-28-2000; IN COMMERCE 11-28-2000.

FOR: MEDICAL SERVICES IN THE FIELD OF
OCCUPATIONAL MEDICINE; MENTAL AND PHY-
SICAL REHABILITATION CONSULTING SERVI-
CES; MINOR EMERGENCY MEDICAL SERVICES;
OCCUPATIONAL AND PHYSICAL THERAPY AND
REHABILITATION SERVICES; DRUG TESTING
FOR SUBSTANCE ABUSE; MEDICAL TESTING,
NAMELY, INSURANCE PRE-QUALIFICATION
PHYSICAL EXAMINATIONS AND PHYSICAL EX-
AMINATIONS; NURSING CARE; MEDICAL OUT-
PATIENT SERVICES; HEALTH CARE SERVICES,
NAMELY, WELLNESS PROGRAMS; HEALTH
CARE SERVICES, NAMELY, WOMEN'S WELLNESS

PROGRAMS; MANAGED HEALTH CARE SERVI-
CES; GENERAL MEDICINE AND SURGERY SER-
VICES; HOSPITALS; MEDICAL CLINICS; HOME
HEALTH CARE SERVICES; HOSPICES; PROVIDING
LONG TERM HEALTH CARE, IN CLASS 44 (U.S.
CLS. 100 AND 101).

FIRST USE 11-28-2000; IN COMMERCE 11-28-2000.

THE MARK CONSISTS OF STANDARD CHAR-
ACTERS WITHOUT CLAIM TO ANY PARTICULAR
FONT, STYLE, SIZE, OR COLOR.

NO CLAIM IS MADE TO THE EXCLUSIVE
RIGHT TO USE "HEALTH SYSTEM", APART FROM
THE MARK AS SHOWN.

SEC. 2(F).

SER. NO. 78-795,872, FILED 1-20-2006.

APRIL ROACH, EXAMINING ATTORNEY

Int. Cl.: 3

Prior U.S. Cls.: 1, 4, 6, 50, 51 and 52

Reg. No. 3,576,237

United States Patent and Trademark Office

Registered Feb. 17, 2009

**TRADEMARK
PRINCIPAL REGISTER**

OILMD

DR. JAMES L. GEIGER, M.D., OILMD, P.C.
(ARIZONA CORPORATION)
1042 E. TYSON CT.
GILBERT, AZ 85296

FOR: AROMATHERAPY OILS; ESSENTIAL OILS;
ESSENTIAL OILS FOR PERSONAL USE; ESSEN-
TIAL OILS FOR USE IN MANUFACTURING OF
PRODUCTS TO PROMOTE WELLNESS, IN CLASS 3
(U.S. CLS. 1, 4, 6, 50, 51 AND 52).

FIRST USE 11-14-2005; IN COMMERCE 11-14-2005.

THE MARK CONSISTS OF STANDARD CHAR-
ACTERS WITHOUT CLAIM TO ANY PARTICULAR
FONT, STYLE, SIZE, OR COLOR.

SER. NO. 78-803,886, FILED 1-31-2006.

RONALD DELGIZZI, EXAMINING ATTORNEY

Int. Cl.: 38

Prior U.S. Cls.: 100, 101 and 104

United States Patent and Trademark Office

Reg. No. 3,576,238

Registered Feb. 17, 2009

**SERVICE MARK
PRINCIPAL REGISTER**

PODSHOW

PODSHOW, INC. (DELAWARE CORPORATION)
577 2ND STREET
SUITE 203
SAN FRANCISCO, CA 94107

THE MARK CONSISTS OF STANDARD CHARACTERS WITHOUT CLAIM TO ANY PARTICULAR FONT, STYLE, SIZE, OR COLOR.

FOR: DISTRIBUTION OF AUDIO AND VISUAL CONTENT FILES OVER A COMPUTER NETWORK SUCH AS THE INTERNET, NAMELY, PODCASTING, IN CLASS 38 (U.S. CLS. 100, 101 AND 104).

SEC. 2(F).

SER. NO. 78-811,606, FILED 2-9-2006.

FIRST USE 0-0-2004; IN COMMERCE 3-14-2005.

HANNO RITTNER, EXAMINING ATTORNEY

Int. Cls.: 9, 41, 42 and 43

Prior U.S. Cls.: 21, 23, 26, 36, 38, 100, 101 and 107

Reg. No. 3,576,239

United States Patent and Trademark Office

Registered Feb. 17, 2009

**TRADEMARK
SERVICE MARK
PRINCIPAL REGISTER**

耀 中

YEW CHUNG ADMINISTRATION SERVICES
LIMITED (BR.VIRGIN ISLANDS CORPORATION)
20 SOMERSET ROAD, KOWLOON TONG, KOWLOON
HONG KONG, HONG KONG

FOR: APPARATUS, INSTRUMENTS AND EQUIPMENT FOR TEACHING, EDUCATION, TRAINING, COACHING AND SCHOOLING, NAMELY, SOUND RECORDING APPARATUS; COMPUTERS; COMPUTER HARDWARE; COMPUTER SOFTWARE FOR TEACHING THE SUBJECTS OF MATHEMATICS, CHINESE LANGUAGE AND LITERATURE, CHINESE CULTURE, ARTS AND CRAFTS, SPORTS, LANGUAGES, COMPUTERS AND COMMERCE; PRERECORDED CDS FEATURING TEACHING MATERIAL ON THE SUBJECTS OF MATHEMATICS, CHINESE LANGUAGE AND LITERATURE, CHINESE CULTURE, ARTS AND CRAFTS, SPORTS, LANGUAGES, COMPUTERS AND COMMERCE; APPARATUS AND INSTRUMENTS FOR RECORDING, TRANSMISSION OR REPRODUCTION OF SOUND AND IMAGES, IN CLASS 9 (U.S. CLS. 21, 23, 26, 36 AND 38).

FIRST USE 6-17-1975; IN COMMERCE 6-17-1975.

FOR: PROVISION OF ACADEMIC COURSES OF INSTRUCTION BELOW UNIVERSITY LEVEL AND AT PRESCHOOL, KINDERGARTEN, ELEMENTARY SCHOOL, MIDDLE SCHOOL AND HIGH SCHOOL LEVELS; DEVELOPMENT AND DISSEMINATION OF AUDIO VISUAL EDUCATIONAL MATERIALS OF OTHERS IN THE FIELD OF EDUCATION, CULTURE AND MUSIC; EDUCATION SERVICES, NAMELY, PROVIDING CLASSES, COURSES, SEMINARS AND WORKSHOPS IN ACADEMIC SUBJECTS IN PSYCHOLOGY, HUMAN DEVELOPMENT, PARENTING, CHINESE CULTURE, ARTS AND SPORTS, LANGUAGES, COMPUTERS, COMMERCE TO ADULTS OF 16 YEARS AND ABOVE; TUTORIAL SERVICES IN ACADEMIC SUBJECTS IN MATHEMATICS, CHINESE LANGUAGE AND LITERATURE, CHINESE CULTURE, ARTS AND CRAFTS, SPORTS, LANGUAGES, COMPUTERS AND COMMERCE TO STUDENTS OF 5-19 YEARS OLD; PROVISION OF CORRESPONDENCE COURSES FOR STUDENTS OF 5-19 YEARS OLD AND ADULTS IN ACADEMIC SUBJECTS IN CHINESE LANGUAGE, CHINESE LITERATURE, CHINESE CULTURE AND FURTHER EDUCATION ON THE SUBJECTS OF TEACHING CHINESE AS FIRST LANGUAGE, TEACHING CHINESE AS ADDITIONAL LANGUAGE, COMPARATIVE STUDIES IN CHINESE AND WESTERN CULTURES; RESEARCH ON EDUCATION, IN CLASS 41 (U.S. CLS. 100, 101 AND 107).

FIRST USE 6-17-1975; IN COMMERCE 6-17-1975.

FOR: RESEARCH ON CHILD DEVELOPMENT AND ADOLESCENT DEVELOPMENT, IN CLASS 42 (U.S. CLS. 100 AND 101).

FIRST USE 6-17-1975; IN COMMERCE 6-17-1975.

FOR: CHILD CARE CENTRE PROVIDING CARE FOR CHILDREN OF 2-6 YEARS OLD; CRÈCHE SERVICES; PROVISION OF FOOD, DRINKS, LODGING AND BOARDING IN CONNECTION WITH OR RELATED TO THE PROVISION OF TRAINING, EDUCATIONAL, INSTRUCTIONAL OR COACHING AND CHILDCARE SERVICES, IN CLASS 43 (U.S. CLS. 100 AND 101).

FIRST USE 6-17-1975; IN COMMERCE 6-17-1975.

PRIORITY CLAIMED UNDER SEC. 44(D) ON HONG KONG APPLICATION NO. 300508509, FILED

10-10-2005, REG. NO. 300508509, DATED 10-10-2005,
EXPIRES 10-10-2015.

OWNER OF HONG KONG REG. NO. 199405873,
DATED 9-4-1992, RENEWED AS REG. NO. 199405873,
DATED 7-13-1999, EXPIRES 9-4-2013.

OWNER OF HONG KONG REG. NO. 199403407,
DATED 3-2-1992, RENEWED AS REG. NO. 199403407,
DATED 3-1-1999, EXPIRES 3-2-2013.

THE NAME SHOWN IN THE MARK DOES NOT
IDENTIFY A PARTICULAR LIVING INDIVIDUAL.

THE NON-LATIN CHARACTER(S) IN THE
MARK TRANSLITERATES INTO YEW CHUNG,
AND THIS MEANS BRIGHTNESS, THE MIDDLE
IN ENGLISH.

SER. NO. 78-813,882, FILED 2-14-2006.

AMY HELLA, EXAMINING ATTORNEY

Int. Cls.: 26 and 44

Prior U.S. Cls.: 37, 39, 40, 42, 50, 100 and 101

United States Patent and Trademark Office

Reg. No. 3,576,240

Registered Feb. 17, 2009

**TRADEMARK
SERVICE MARK
PRINCIPAL REGISTER**



HairTech

HAIR TECH, INC. (GEORGIA CORPORATION)
MEZANINE SUITE
9255 SUNSET BLVD
WEST HOLLYWOOD, CA 90069

FOR: HAIR EXTENSIONS, IN CLASS 26 (U.S. CLS. 37, 39, 40, 42 AND 50).

FIRST USE 4-6-2004; IN COMMERCE 4-8-2005.

FOR: HAIRDRESSING CLINICS AND SALONS FOR HAIR AND SCALP TREATMENT USING LASERS AND HAIR FORMULATIONS, IN CLASS 44 (U.S. CLS. 100 AND 101).

FIRST USE 4-6-2004; IN COMMERCE 4-8-2005.

THE COLOR(S) BROWN, YELLOW, AND BLACK IS/ARE CLAIMED AS A FEATURE OF THE MARK.

THE MARK CONSISTS OF TWO HEADS THAT ARE CONNECTED ON THE BACKSIDE AND ARE FACING OUTWARD IN A BOX ABOVE THE WORDING "HAIRTECH". THE MARK CONSISTS OF A FEMALE BROWN SILHOUETTE HEAD, WITH YELLOW LONG HAIR AND ON A BLACK BACKGROUND AND A MALE BLACK HEAD, WITH BLACK AND BROWN SHORT HAIR ON A BROWN BACKGROUND, BOTH HEADS ARE ATTACHED AT THE BACK AND ARE SITUATED IN A SQUARE WITH A BROWN AND YELLOW LINING; THE MARK "HAIRTECH" IS BELOW THE DESIGN AND IS BROWN WITH A YELLOW OUTLINE.

SER. NO. 78-823,208, FILED 2-24-2006.

NAKIA HENRY, EXAMINING ATTORNEY

Int. Cl.: 32

Prior U.S. Cls.: 45, 46 and 48

United States Patent and Trademark Office

Reg. No. 3,576,241

Registered Feb. 17, 2009

**TRADEMARK
PRINCIPAL REGISTER**

SIDRAL AGA

EMBOTELLADORA AGA DEL PACIFICO, S.A.
DE C.V. (MEXICO CORPORATION)
CALZADA DEL AGUILA #122 COLONIA MODER-
NA
GUADALAJARA, MEXICO 44090

FOR: BEVERAGES, NAMELY, SOFT DRINKS
AND FLAVORED SODA, IN CLASS 32 (U.S. CLS.
45, 46 AND 48).

FIRST USE 0-0-1988; IN COMMERCE 0-0-1988.

THE MARK CONSISTS OF STANDARD CHAR-
ACTERS WITHOUT CLAIM TO ANY PARTICULAR
FONT, STYLE, SIZE, OR COLOR.

OWNER OF U.S. REG. NOS. 2,718,087, 3,271,997,
AND 3,445,208.

NO CLAIM IS MADE TO THE EXCLUSIVE
RIGHT TO USE "SIDRAL", APART FROM THE
MARK AS SHOWN.

THE FOREIGN WORDING IN THE MARK
TRANSLATES INTO ENGLISH AS APPLE CIDER.

SER. NO. 78-826,455, FILED 3-1-2006.

SETH A. RAPPAPORT, EXAMINING ATTORNEY

Int. Cl.: 9

Prior U.S. Cls.: 21, 23, 26, 36 and 38

Reg. No. 3,576,242

United States Patent and Trademark Office

Registered Feb. 17, 2009

**TRADEMARK
PRINCIPAL REGISTER**

PIXELSTORM

PIXELSTORM ENTERTAINMENT STUDIOS INC.
(CANADA CORPORATION)
11135 23 A AVENUE
EDMONTON, ALBERTA, CANADA T6J 4W5

PRIORITY CLAIMED UNDER SEC. 44(D) ON
CANADA APPLICATION NO. 1273102, FILED 9-22-
2005, REG. NO. TMA724,171, DATED 9-22-2008, EX-
PIRES 9-22-2023.

FOR: COMPUTER GAME SOFTWARE, IN CLASS
9 (U.S. CLS. 21, 23, 26, 36 AND 38).

SER. NO. 78-836,751, FILED 3-14-2006.

THE MARK CONSISTS OF STANDARD CHAR-
ACTERS WITHOUT CLAIM TO ANY PARTICULAR
FONT, STYLE, SIZE, OR COLOR.

JAY BESCH, EXAMINING ATTORNEY

Int. Cl.: 25

Prior U.S. Cls.: 22 and 39

United States Patent and Trademark Office

Reg. No. 3,576,243

Registered Feb. 17, 2009

**TRADEMARK
PRINCIPAL REGISTER**

Ya Girl!



GLABICKY, JAMES (UNITED STATES INDIVIDUAL)
200 WOODLAND DRIVE
JAY, VT 05859

FOR: CLOTHING, NAMELY, WOMEN'S PANTS, SHORTS, SKIRTS, JACKETS, HATS AND T-SHIRTS, IN CLASS 25 (U.S. CLS. 22 AND 39).

FIRST USE 3-15-2006; IN COMMERCE 3-15-2006.

NO CLAIM IS MADE TO THE EXCLUSIVE RIGHT TO USE "GIRL", APART FROM THE MARK AS SHOWN.

THE COLOR(S) BLACK, BROWN AND PINK IS/ARE CLAIMED AS A FEATURE OF THE MARK.

THE MARK CONSISTS OF THE WORDS "YA GIRL!" IN BLACK ABOVE A DEPICTION OF A PAIR OF HIKING BOOTS, WITH PINK BOOT LACES AND COLLARS AND BROWN UPPER SURFACES OF THE BOOTS, WHICH ARE OUTLINED IN BLACK AND HAVE BLACK SOLES.

SER. NO. 78-839,003, FILED 3-16-2006.

LAURA KOVALSKY, EXAMINING ATTORNEY

Int. Cl.: 35

Prior U.S. Cls.: 100, 101 and 102

United States Patent and Trademark Office

Reg. No. 3,576,244

Registered Feb. 17, 2009

**SERVICE MARK
PRINCIPAL REGISTER**



The Garden City Group, Inc.

THE GARDEN CITY GROUP, INC. (DELAWARE CORPORATION)
105 MAXESS ROAD
MELVILLE, NY 11747

FOR: BUSINESS SERVICES, NAMELY, PROVIDING LEGAL ADMINISTRATION SERVICES IN THE NATURE OF CLASS ACTION SETTLEMENT ADMINISTRATION AND BUSINESS REORGANIZATION ADMINISTRATION, IN CLASS 35 (U.S. CLS. 100, 101 AND 102).

FIRST USE 9-1-2001; IN COMMERCE 9-1-2001.

NO CLAIM IS MADE TO THE EXCLUSIVE RIGHT TO USE "GROUP, INC.", APART FROM THE MARK AS SHOWN.

THE MARK CONSISTS OF THE LETTERS "GCG" WITHIN AN OVAL DESIGN WITH THE WORDING "THE GARDEN CITY GROUP, INC." BELOW IT.

SEC. 2(F).

SER. NO. 78-842,841, FILED 3-21-2006.

ANN E. SAPPENFIELD, EXAMINING ATTORNEY

Int. Cl.: 42

Prior U.S. Cls.: 100 and 101

United States Patent and Trademark Office

Reg. No. 3,576,245

Registered Feb. 17, 2009

**SERVICE MARK
PRINCIPAL REGISTER**

iPodiums

NEESSEN, JAMES (UNITED STATES INDIVIDUAL)
P.O. BOX 182
MECHANICSBURG, PA 17055

FOR: PROVIDING CUSTOMIZED ON-LINE WEB PAGES FEATURING USER-DEFINED INFORMATION, WHICH INCLUDES SEARCH ENGINES AND ON-LINE WEB LINKS TO OTHER WEB SITES, IN CLASS 42 (U.S. CLS. 100 AND 101).

FIRST USE 4-24-2005; IN COMMERCE 5-11-2005.

THE MARK CONSISTS OF STANDARD CHARACTERS WITHOUT CLAIM TO ANY PARTICULAR FONT, STYLE, SIZE, OR COLOR.

SER. NO. 78-843,841, FILED 3-22-2006.

BARNEY CHARLON, EXAMINING ATTORNEY

Int. Cl.: 41

Prior U.S. Cls.: 100, 101 and 107

United States Patent and Trademark Office

Reg. No. 3,576,246

Registered Feb. 17, 2009

**SERVICE MARK
PRINCIPAL REGISTER**

Violet Says 5

BURNSFURY, EAON (UNITED STATES INDIVIDUAL)
P.O. BOX 7417
SILVER SPRING, MD 20907

FOR: ENTERTAINMENT SERVICES, NAMELY, LIVE MUSICAL PERFORMANCES BY A VOCAL AND INSTRUMENTAL GROUP, IN CLASS 41 (U.S. CLS. 100, 101 AND 107).

FIRST USE 8-30-2003, THE MARK WAS FIRST USED ANYWHERE IN A DIFFERENT FORM OTHER THAN THAT SOUGHT TO BE REGISTERED ON 04/01/1998.; IN COMMERCE 8-30-2003, THE MARK WAS FIRST USED IN

COMMERCE IN A DIFFERENT FORM OTHER THAN THAT SOUGHT TO BE REGISTERED ON 05/10/1999..

THE MARK CONSISTS OF STANDARD CHARACTERS WITHOUT CLAIM TO ANY PARTICULAR FONT, STYLE, SIZE, OR COLOR.

OWNER OF U.S. REG. NOS. 2,470,937 AND 2,993,568.

SER. NO. 78-856,242, FILED 4-7-2006.

GIANCARLO CASTRO, EXAMINING ATTORNEY

Int. Cls.: 35, 39 and 44

Prior U.S. Cls.: 100, 101, 102 and 105

United States Patent and Trademark Office

Reg. No. 3,576,247

Registered Feb. 17, 2009

**SERVICE MARK
PRINCIPAL REGISTER**

WHEN SECONDS COUNT

AIR EVAC EMS, INC. (MISSOURI CORPORATION)
P.O. BOX 768
WEST PLAINS, MO 65775

FOR: ADMINISTRATION OF A MEMBERSHIP PROGRAM THAT ENABLES PARTICIPANTS TO OBTAIN AIR AMBULANCE SERVICES FOR EMERGENCIES AT NO ADDITIONAL COST, IN CLASS 35 (U.S. CLS. 100, 101 AND 102).

FIRST USE 0-0-1986; IN COMMERCE 0-0-1986.

FOR: AIR AMBULANCE SERVICES; PROVIDING AIR TRANSPORTATION FEATURING EMERGENCY MEDICAL CARE BY AIR TRANSPORT; PROVIDING AIR AMBULANCE SERVICES FEATURING AN AIR AMBULANCE SERVICE MEMBERSHIP PROGRAM FOR RURAL COMMUNITIES; TRANSPORTING VIA AIRCRAFT LIFE-SAVING EQUIPMENT AND MEDICAL PERSONNEL TO DISASTER OR MEDICAL EMERGENCY LOCATIONS, IN CLASS 39 (U.S. CLS. 100 AND 105).

FIRST USE 0-0-1986; IN COMMERCE 0-0-1986.

FOR: AMBULANT MEDICAL CARE; PROVIDING REGISTERED NURSES AND PARAMEDICS IN MEDICAL EMERGENCY AND LIFE-THREATENING SITUATIONS; PROVIDING MEDICAL CARE SERVICES USING CRITICAL CARE EQUIPMENT AND EMERGENCY MEDICAL PERSONNEL, IN CLASS 44 (U.S. CLS. 100 AND 101).

FIRST USE 0-0-1986; IN COMMERCE 0-0-1986.

THE MARK CONSISTS OF STANDARD CHARACTERS WITHOUT CLAIM TO ANY PARTICULAR FONT, STYLE, SIZE, OR COLOR.

SER. NO. 78-856,578, FILED 4-7-2006.

RUDY R. SINGLETON, EXAMINING ATTORNEY

Int. Cl.: 36

Prior U.S. Cls.: 100, 101 and 102

United States Patent and Trademark Office

Reg. No. 3,576,248

Registered Feb. 17, 2009

**SERVICE MARK
PRINCIPAL REGISTER**

RESOURCE BANK

FULTON BANK (PENNSYLVANIA CORPORATION)
ONE PENN SQUARE
P.O. BOX 4887
LANCASTER, PA 17604

FOR: BANKING, IN CLASS 36 (U.S. CLS. 100, 101 AND 102).

FIRST USE 9-0-1988; IN COMMERCE 9-0-1988.

THE MARK CONSISTS OF STANDARD CHARACTERS WITHOUT CLAIM TO ANY PARTICULAR FONT, STYLE, SIZE, OR COLOR.

REGISTRATION LIMITED TO THE AREA COMPRISING THE ENTIRE UNITED STATES EXCEPT

FOR THE STATES OF NEW JERSEY, PENNSYLVANIA, MARYLAND, DELAWARE, WEST VIRGINIA, VIRGINIA, NORTH CAROLINA, SOUTH CAROLINA, GEORGIA, AND THE DISTRICT OF COLUMBIA. PURSUANT TO CONCURRENT USE PROCEEDING NO. 94002073. CONCURRENT USE WITH REGISTRATION NO. 2999433.

NO CLAIM IS MADE TO THE EXCLUSIVE RIGHT TO USE "BANK", APART FROM THE MARK AS SHOWN.

SER. NO. 78-856,591, FILED 4-7-2006.

KIM MONINGHOFF, EXAMINING ATTORNEY

Int. Cl.: 35

Prior U.S. Cls.: 100, 101 and 102

United States Patent and Trademark Office

Reg. No. 3,576,249

Registered Feb. 17, 2009

**SERVICE MARK
PRINCIPAL REGISTER**



FIRST WORLD TRADE CORP. (CANADA CORPORATION)
194 MCMORRAN CRESCENT
THORNHILL, CANADA L4J3S6

FOR: EXCHANGE SERVICES, NAMELY, BAR-
TERING OF GOODS FOR OTHERS, IN CLASS 35
(U.S. CLS. 100, 101 AND 102).

PRIORITY CLAIMED UNDER SEC. 44(D) ON
CANADA APPLICATION NO. 1293147, FILED 3-10-
2006.

OWNER OF CANADA REG. NO. TMA725860,
DATED 10-10-2008, EXPIRES 10-10-2023.

THE COLOR(S) RED, BLUE, AND GRAY IS/ARE
CLAIMED AS A FEATURE OF THE MARK.

THE MARK CONSISTS OF THREE STYLIZED
BUSTS OF MEN WITH A BLUE ONE BETWEEN
TWO RED ONES. EACH IMAGE IS OUTLINED IN
LIGHT GRAY WITH DARKER GRAY HIGHLIGHT-
ING. TO THE RIGHT OF THE IMAGES, THE
WORDING "PARTNERSINTRADE" APPEARS
WITH "PARTNERS" AND "TRADE" IN BLUE AND
"IN" IN RED, WITH EACH OF THE WORDS BEING
HIGHLIGHTED WITH GRAY.

SER. NO. 78-863,030, FILED 4-17-2006.

BARBARA BROWN, EXAMINING ATTORNEY

Int. Cl.: 28

Prior U.S. Cls.: 22, 23, 38 and 50

Reg. No. 3,576,250

United States Patent and Trademark Office

Registered Feb. 17, 2009

**TRADEMARK
PRINCIPAL REGISTER**

NINJA ACADEMY

MATTEL, INC. (DELAWARE CORPORATION)
M1-1518
333 CONTINENTAL BLVD.
EL SEGUNDO, CA 902455012

FOR: TOYS, GAMES AND PLAYTHINGS, NAME-
LY, TOY ACTION FIGURES, TOY FIGURES, AND
ACCESSORIES FOR ALL OF THE FOREGOING, IN
CLASS 28 (U.S. CLS. 22, 23, 38 AND 50).

FIRST USE 10-23-2006; IN COMMERCE 10-23-2006.

THE MARK CONSISTS OF STANDARD CHAR-
ACTERS WITHOUT CLAIM TO ANY PARTICULAR
FONT, STYLE, SIZE, OR COLOR.

NO CLAIM IS MADE TO THE EXCLUSIVE
RIGHT TO USE "NINJA", APART FROM THE
MARK AS SHOWN.

SER. NO. 78-867,963, FILED 4-24-2006.

JOHN GARTNER, EXAMINING ATTORNEY

Int. Cls.: 9 and 38

Prior U.S. Cls.: 21, 23, 26, 36, 38, 100, 101 and 104

United States Patent and Trademark Office

Reg. No. 3,576,251

Registered Feb. 17, 2009

**TRADEMARK
SERVICE MARK
PRINCIPAL REGISTER**

EQUITYREACH

EUROCLEAR PLC (UNITED KINGDOM COMPANY)
BAARERMATTE
CH-6340 BAAR, SWITZERLAND

FOR: SOFTWARE FOR ELECTRONIC DATA PROCESSING AND ELECTRONIC TRANSMISSION OF FUNDS, DATA AND DOCUMENTS RELATING TO FINANCIAL SERVICES, IN CLASS 9 (U.S. CLS. 21, 23, 26, 36 AND 38).

FOR: ELECTRONIC TRANSMISSION OF FINANCIAL DATA AND DOCUMENTS VIA A GLOBAL

COMPUTER NETWORK, IN CLASS 38 (U.S. CLS. 100, 101 AND 104).

THE MARK CONSISTS OF STANDARD CHARACTERS WITHOUT CLAIM TO ANY PARTICULAR FONT, STYLE, SIZE, OR COLOR.

OWNER OF ERPN CMNTY TM OFC REG. NO. 005066352, DATED 5-4-2007, EXPIRES 5-9-2016.

SER. NO. 78-868,681, FILED 4-25-2006.

AMY C. KEAN, EXAMINING ATTORNEY

Int. Cls.: 35, 41 and 42

Prior U.S. Cls.: 100, 101, 102 and 107

United States Patent and Trademark Office

Reg. No. 3,576,252

Registered Feb. 17, 2009

**SERVICE MARK
PRINCIPAL REGISTER**

ICON

SUNCOR ENERGY INC. (CANADA CORPORATION)
112-4TH AVENUE S.W.
P.O. BOX 38
CALGARY, CANADA T2P 2V5

FOR: INFORMATION SERVICES, NAMELY, PROVIDING INFORMATION TO THE PUBLIC VIA THE INTERNET IN THE FIELD OF ENERGY USE, IN CLASS 35 (U.S. CLS. 100, 101 AND 102).

FOR: TRAINING SERVICES AND EDUCATIONAL PROGRAMS, NAMELY, SEMINARS, WORKSHOPS, AND LECTURES IN THE FIELD OF ENVIRONMENTALLY RESPONSIBLE TECHNOLOGIES, IN CLASS 41 (U.S. CLS. 100, 101 AND 107).

FOR: TECHNICAL CONSULTING, DESIGN, AND DEVELOPMENT SERVICES FOR OTHERS IN THE FIELDS OF ENVIRONMENTAL MANAGEMENT SYSTEMS AND ENVIRONMENTALLY RESPONSIBLE ENERGY TECHNOLOGIES, NAMELY, CONVERSION OF RENEWABLE AND NON-RENEWABLE ENERGY RESOURCES INTO ENERGY PRODUCTS THROUGH THE USE OF TECHNOLOGY, GREENHOUSE EMISSION REDUCTIONS, AND CAPTURE, USE AND TRANS-

PORT OF CARBON DIOXIDE; REGULATORY COMPLIANCE CONSULTING, NAMELY, REVIEW OF STANDARDS AND PRACTICES TO ENSURE COMPLIANCE WITH ENERGY AND ENVIRONMENTAL LAW; TECHNICAL SUPPORT SERVICES, NAMELY, TROUBLESHOOTING OF ENERGY PROCESSING AND TRANSMISSION EQUIPMENT FOR OTHERS; PROVIDING TECHNOLOGICAL INFORMATION IN THE NATURE OF REPORTS ABOUT ENVIRONMENTALLY RESPONSIBLE ENERGY TECHNOLOGIES, IN CLASS 42 (U.S. CLS. 100 AND 101).

THE MARK CONSISTS OF STANDARD CHARACTERS WITHOUT CLAIM TO ANY PARTICULAR FONT, STYLE, SIZE, OR COLOR.

PRIORITY CLAIMED UNDER SEC. 44(D) ON CANADA APPLICATION NO. 1278722, FILED 11-7-2005, REG. NO. TMA705580, DATED 1-24-2008, EXPIRES 1-24-2023.

SER. NO. 78-877,660, FILED 5-5-2006.

KATHERINE M. DUBRAY, EXAMINING ATTORNEY

Int. Cls.: 35, 41 and 42

Prior U.S. Cls.: 100, 101, 102 and 107

United States Patent and Trademark Office

Reg. No. 3,576,253

Registered Feb. 17, 2009

**SERVICE MARK
PRINCIPAL REGISTER**

ICON₂

SUNCOR ENERGY INC. (CANADA CORPORATION)
112-4TH AVENUE S.W.
P.O. BOX 38
CALGARY, CANADA T2P 2V5

FOR: INFORMATION SERVICES, NAMELY, PROVIDING INFORMATION TO THE PUBLIC VIA THE INTERNET IN THE FIELD OF ENERGY USE, IN CLASS 35 (U.S. CLS. 100, 101 AND 102).

FOR: TRAINING SERVICES AND EDUCATIONAL PROGRAMS, NAMELY, SEMINARS, WORKSHOPS, AND LECTURES IN THE FIELD OF ENVIRONMENTALLY RESPONSIBLE TECHNOLOGIES, IN CLASS 41 (U.S. CLS. 100, 101 AND 107).

FOR: TECHNICAL CONSULTING, DESIGN, AND DEVELOPMENT SERVICES FOR OTHERS IN THE FIELDS OF ENVIRONMENTAL MANAGEMENT SYSTEMS AND ENVIRONMENTALLY RESPONSIBLE ENERGY TECHNOLOGIES, NAMELY, CONVERSION OF RENEWABLE AND NON-RENEWABLE ENERGY RESOURCES INTO ENERGY PRODUCTS THROUGH THE USE OF TECH-

NOLOGY, GREENHOUSE EMISSION REDUCTIONS, AND CAPTURE, USE AND TRANSPORT OF CARBON DIOXIDE; REGULATORY COMPLIANCE CONSULTING, NAMELY, REVIEW OF STANDARDS AND PRACTICES TO ENSURE COMPLIANCE WITH ENERGY AND ENVIRONMENTAL LAW; TECHNICAL SUPPORT SERVICES, NAMELY, TROUBLESHOOTING OF ENERGY PROCESSING AND TRANSMISSION EQUIPMENT FOR OTHERS; PROVIDING TECHNOLOGICAL INFORMATION IN THE NATURE OF REPORTS ABOUT ENVIRONMENTALLY RESPONSIBLE ENERGY TECHNOLOGIES, IN CLASS 42 (U.S. CLS. 100 AND 101).

PRIORITY CLAIMED UNDER SEC. 44(D) ON CANADA APPLICATION NO. 1278728, FILED 11-7-2005, REG. NO. TMA700865, DATED 11-15-2007, EXPIRES 11-15-2022.

SER. NO. 78-877,702, FILED 5-5-2006.

KATHERINE M. DUBRAY, EXAMINING ATTORNEY

Int. Cls.: 35 and 36

Prior U.S. Cls.: 100, 101 and 102

United States Patent and Trademark Office

Reg. No. 3,576,254

Registered Feb. 17, 2009

**SERVICE MARK
PRINCIPAL REGISTER**

NEWDEA

NEWDEA INC. (DELAWARE CORPORATION)
4B INVERNESS COURT EAST
SUITE 110
ENGLEWOOD, CO 80112

FOR: PROCUREMENT SERVICES, NAMELY, PROCURING OF REPORTS FOR MONETARY DONORS AND DONORS OF PHILANTHROPIC GIFTS RELATING TO FOUNDATIONS, ORGANIZATIONS, PROJECTS AND ACTIVITIES WHICH HAVE RECEIVED CHARITABLE AND PHILANTHROPIC DONATIONS; MARKETING, ADVERTISEMENT AND PROMOTION OF CHARITABLE AND PHILANTHROPIC SERVICES FOR OTHERS; BUSINESS OPERATION AND BUSINESS MANAGEMENT OF PHILANTHROPIC FOUNDATIONS AND ORGANIZATIONS AND BUSINESS ADMINISTRATION SERVICES FOR CHARITABLE AND PHILANTHROPIC FOUNDATIONS AND ORGANIZATIONS; PROVIDING BUSINESS AND COMMERCIAL INFORMATION CONCERNING CHARITABLE AND PHILANTHROPIC FOUNDATIONS, ORGANIZATIONS, PROJECTS AND ACTIVITIES BY MEANS OF AN INTERNET WEBSITE, IN CLASS 35 (U.S. CLS. 100, 101 AND 102).

FIRST USE 12-31-2000; IN COMMERCE 12-31-2000.

FOR: ADMINISTERING MONETARY CHARITABLE AND PHILANTHROPIC DONATIONS; MANAGEMENT OF FUNDS, NAMELY, CHARITABLE AND PHILANTHROPIC DONATION FUNDS; IN-

VESTMENT MANAGEMENT SERVICES; PROVIDING FINANCIAL ACCOUNT AND INVESTMENT INFORMATION BY MEANS OF AN INTERNET WEBSITE; DONOR-ADVISED INVESTMENT OF FUNDS FOR CHARITABLE PURPOSES; CONSULTING SERVICES IN THE FIELD OF INVESTMENT OF FUNDS FOR CHARITABLE PURPOSES; PROVIDING FINANCIAL MONITORING AND REPORTING SERVICES IN THE FIELD OF CHARITABLE MONETARY GIVING, NAMELY, MONITORING AND REPORTING THE FINANCIAL STATUS OF ACTIVITIES FUNDED BY CHARITABLE AND PHILANTHROPIC DONATIONS; FISCAL ASSESSMENT SERVICES RELATING TO THE FINANCIAL PERFORMANCE OF CHARITABLE AND PHILANTHROPIC FOUNDATIONS FOR PURPOSES OF DETERMINING WHETHER SUCH FOUNDATIONS QUALIFY FOR DONATION; FINANCIAL MANAGEMENT, NAMELY, MANAGING CHARITABLE DONATIONS BY MEANS OF AN INTERNET WEBSITE, IN CLASS 36 (U.S. CLS. 100, 101 AND 102).

FIRST USE 12-31-2000; IN COMMERCE 12-31-2000.

THE MARK CONSISTS OF STANDARD CHARACTERS WITHOUT CLAIM TO ANY PARTICULAR FONT, STYLE, SIZE, OR COLOR.

SER. NO. 78-879,876, FILED 5-9-2006.

SONYA STEPHENS, EXAMINING ATTORNEY

Int. Cls.: 9, 28 and 41

Prior U.S. Cls.: 21, 22, 23, 26, 36, 38, 50, 100, 101 and 107

Reg. No. 3,576,255

United States Patent and Trademark Office

Registered Feb. 17, 2009

**TRADEMARK
SERVICE MARK
PRINCIPAL REGISTER**

WIZARD'S FORTUNE

ATRONIC INTERNATIONAL GMBH (FED REP GERMANY CORPORATION)
BORSIGSTR. 26
32312 LÜBBECKE, FED REP GERMANY

FOR: ELECTRIC AND ELECTRONIC, COIN AND TOKEN-OPERATED GAMING MACHINES AND HOUSINGS, NAMELY, SLOT MACHINES WITH OR WITHOUT VIDEO OUTPUT AND VIDEO LOTTERY TERMINALS; MULTI-USER AND NETWORKED GAMING MACHINES WITH OR WITHOUT VIDEO OUTPUT OR VIDEO LOTTERY TERMINALS, COMPUTER PROGRAMS FOR OPERATING ELECTRIC AND ELECTRONIC MACHINES FOR GAMING AND/OR AMUSEMENT PURPOSES; ACCOUNTING APPARATUS FOR COIN AND TOKEN OPERATED MACHINES FOR GAMING AND AMUSEMENT PURPOSES, AND STRUCTURAL AND REPLACEMENT PARTS FOR THE AFORESAID GOODS; GAMING MACHINES FOR USE IN NETWORKED OPERATION; BETTING MACHINES, NAMELY, MACHINES FOR PLAYING GAMES OF CHANCE FOR USE IN NETWORKED OPERATION, IN CLASS 9 (U.S. CLS. 21, 23, 26, 36 AND 38).

FOR: ELECTRIC AND ELECTRONIC MACHINES FOR GAMES, AMUSEMENT, ENTERTAINMENT,

SPORTS AND ENTERTAINMENT, NAMELY, STAND ALONE VIDEO GAME MACHINES FOR USE IN NETWORKED OPERATION, IN CLASS 28 (U.S. CLS. 22, 23, 38 AND 50).

FOR: ENTERTAINMENT IN THE NATURE OF CASINO SERVICES FEATURING A PROGRESSIVE GAMING MACHINE JACKPOT INVOLVING ONE OR MORE GAMING MACHINES, NAMELY, A JACKPOT OR PRIZE WITH A FIXED MINIMUM VALUE WHICH INCREASES UNTIL THE JACKPOT IS WON, IN CLASS 41 (U.S. CLS. 100, 101 AND 107).

THE MARK CONSISTS OF STANDARD CHARACTERS WITHOUT CLAIM TO ANY PARTICULAR FONT, STYLE, SIZE, OR COLOR.

PRIORITY CLAIMED UNDER SEC. 44(D) ON ERPN CMNTY TM OFC APPLICATION NO. 005064878, FILED 5-9-2006, REG. NO. 005064878, DATED 4-27-2007, EXPIRES 5-9-2016.

SER. NO. 78-880,536, FILED 5-10-2006.

KYLE PEETE, EXAMINING ATTORNEY

Int. Cls.: 9, 28, 41 and 42

Prior U.S. Cls.: 21, 22, 23, 26, 36, 38, 50, 100, 101 and 107

Reg. No. 3,576,256

United States Patent and Trademark Office

Registered Feb. 17, 2009

**TRADEMARK
SERVICE MARK
PRINCIPAL REGISTER**

A PRIVATE AFFAIR

SELLICK, TODD/SELLICK, JANET (CANADA PARTNERSHIP)
185 CLARE AVENUE
WINNIPEG, MANITOBA, CANADA R3L 1R5

FOR: DOWNLOADABLE COMPUTER SOFTWARE FOR ENTERTAINMENT PURPOSES, NAMELY, COMPUTER GAMES; DOWNLOADABLE MULTIMEDIA FILE CONTAINING ARTWORK, TEXT, AUDIO, VIDEO, GAMES AND INTERNET WEB LINKS RELATING TO CARD GAMES, IN CLASS 9 (U.S. CLS. 21, 23, 26, 36 AND 38).

FOR: CARD GAMES COMPRISING NOTEPADS USED AS AN INTEGRAL PART OF THE GAMES, IN CLASS 28 (U.S. CLS. 22, 23, 38 AND 50).

FOR: ENTERTAINMENT SERVICES, NAMELY, PROVIDING ON-LINE COMPUTER GAMES; PROVIDING INFORMATION ON-LINE RELATING TO COMPUTER GAMES AND COMPUTER ENHANCE-

MENTS FOR GAMES, IN CLASS 41 (U.S. CLS. 100, 101 AND 107).

FOR: PROVIDING TEMPORARY USE OF ON-LINE NON-DOWNLOADABLE COMPUTER GAME SOFTWARE WHICH CAN BE ACCESSED THROUGH WEBSITES OR BY MOBILE PHONES, IN CLASS 42 (U.S. CLS. 100 AND 101).

THE MARK CONSISTS OF STANDARD CHARACTERS WITHOUT CLAIM TO ANY PARTICULAR FONT, STYLE, SIZE, OR COLOR.

PRIORITY CLAIMED UNDER SEC. 44(D) ON CANADA APPLICATION NO. 1286088, FILED 1-4-2006, REG. NO. TMA719594, DATED 7-28-2008, EXPIRES 7-28-2023.

SER. NO. 78-884,449, FILED 5-16-2006.

DAVID HOFFMAN, EXAMINING ATTORNEY

Int. Cl.: 30

Prior U.S. Cl.: 46

United States Patent and Trademark Office

Reg. No. 3,576,257

Registered Feb. 17, 2009

**TRADEMARK
PRINCIPAL REGISTER**



WHITMORE FAMILY ENTERPRISES, LLC (MAS-
SACHUSETTS CORPORATION)
561 WINDSOR ST.
SOMERVILLE, MA 02143

FOR: CHOCOLATE, IN CLASS 30 (U.S. CL. 46).

FIRST USE 10-18-2005; IN COMMERCE 10-18-2005.

NO CLAIM IS MADE TO THE EXCLUSIVE
RIGHT TO USE "TAZA CHOCOLATE" , APART
FROM THE MARK AS SHOWN.

THE MARK CONSISTS OF A CUT AWAY OF A
COCOA BEAN WITH THE WORDS "TAZA" AND
"CHOCOLATE" SITUATED BENEATH THE BEAN.

THE FOREIGN WORDING IN THE MARK
TRANSLATES INTO ENGLISH AS CUP.

SER. NO. 78-884,837, FILED 5-16-2006.

ANTHONY RINKER, EXAMINING ATTORNEY

Int. Cl.: 25

Prior U.S. Cls.: 22 and 39

United States Patent and Trademark Office

Reg. No. 3,576,258

Registered Feb. 17, 2009

**TRADEMARK
PRINCIPAL REGISTER**

CFL

CANADIAN FOOTBALL LEAGUE (CANADA CORPORATION)
3RD FLOOR
50 WELLINGTON STREET EAST
TORONTO, CANADA M5E 1C8

FOR: INFANT, CHILD, YOUTH, FEMALE ADULT AND MALE ADULT APPAREL, NAMELY, PARKAS, VESTS, NYLON AND MELTON JERSEYS, PANTS, SWEATSHIRTS, T-SHIRTS, SHORTS, JERSEYS, GOLF SHIRTS, JUMPSUITS, POLO SHIRTS, WIND SHIRTS, VESTS, INFANT SLEEPERS, BUT-TON DOWN SHIRTS, JACKETS, REPLICAS AND AUTHENTIC JERSEYS, BATH ROBES; FLEECE WEAR, NAMELY, PANTS, SWEATSHIRTS, T-SHIRTS, SHORTS, JERSEYS, GOLF SHIRTS, JUMPSUITS, POLO SHIRTS, WIND SHIRTS, VESTS, INFANT SLEEPERS, JACKETS, REPLICAS AND

AUTHENTIC JERSEYS AND BATH ROBES ALL MADE OF FLEECE; HEADWEAR, NAMELY, BANDANNAS, SCARVES, HEADBANDS, TOQUES, CAPS, IN CLASS 25 (U.S. CLS. 22 AND 39).

THE MARK CONSISTS OF STANDARD CHARACTERS WITHOUT CLAIM TO ANY PARTICULAR FONT, STYLE, SIZE, OR COLOR.

OWNER OF CANADA REG. NO. TMA621791, DATED 5-12-2005, EXPIRES 5-12-2020.

OWNER OF U.S. REG. NO. 1,530,169.

SER. NO. 78-887,444, FILED 5-19-2006.

THEODORE MCBRIDE, EXAMINING ATTORNEY

Int. Cls.: 6 and 19

Prior U.S. Cls.: 1, 2, 12, 13, 14, 23, 25, 33 and 50

United States Patent and Trademark Office

Reg. No. 3,576,259

Registered Feb. 17, 2009

**TRADEMARK
PRINCIPAL REGISTER**



NEUHOFFER HOLZ GMBH (AUSTRIA GMBH)
HASLAU 56
ZELL AM MOOS, AUSTRIA 4893

FOR: WALL PROFILES, FLOOR PROFILES AND CEILING PROFILES MADE OF METAL; METAL FASTENING FIXTURES FOR THESE GOODS, NAMELY, BOLTS, NAILS, RIVETS, SCREWS, METAL BINDING STRIPS FOR WALL PROFILES, FLOOR PROFILES AND CEILING PROFILES, METAL BARS AND METAL BOTTOM BARS, IN CLASS 6 (U.S. CLS. 2, 12, 13, 14, 23, 25 AND 50).

FOR: NON-METAL WALL PROFILES, FLOOR PROFILES AND CEILING PROFILES, IN CLASS 19 (U.S. CLS. 1, 12, 33 AND 50).

PRIORITY CLAIMED UNDER SEC. 44(D) ON ERPN CMNTY TM OFC APPLICATION NO. 004797288, FILED 12-21-2005, REG. NO. 004797288, DATED 12-15-2006, EXPIRES 12-21-2015.

THE MARK CONSISTS OF THE WORDS "LOCK-ON" IN FRONT OF A CIRCLE CONTAINING A LARGE FASTENING FIXTURE, WITH A BOOT OVER A SMALL FASTENING FIXTURE, WITHIN THE CIRCLE AND ABOVE THE WORDS "LOCK-ON".

SER. NO. 78-895,863, FILED 5-30-2006.

JESSICA A. POWERS, EXAMINING ATTORNEY

Int. Cl.: 16

Prior U.S. Cls.: 2, 5, 22, 23, 29, 37, 38 and 50

Reg. No. 3,576,260

United States Patent and Trademark Office

Registered Feb. 17, 2009

**TRADEMARK
PRINCIPAL REGISTER**

CMA AWARDS

COUNTRY MUSIC ASSOCIATION, INC. (TENNESSEE CORPORATION)
ONE MUSIC CIRCLE SOUTH
NASHVILLE, TN 37203

FOR: PAPER GOODS AND PRINTED MATTER, NAMELY, INFORMATIONAL FLYERS, CIRCULARS AND PRINTED HAND-OUTS FEATURING INFORMATION ABOUT COUNTRY MUSIC PERFORMERS; PRINTED TICKETS; PRINTED INVITATIONS, POSTERS, BOOKLETS, BROCHURES, BULLETINS, NEWSLETTERS, MAGAZINES FEATURING INFORMATION ABOUT THE FIELD OF COUNTRY MUSIC, PAMPHLETS AND PRINTED EVENT PROGRAMS IN THE FIELD OF COUNTRY MUSIC, IN CLASS 16 (U.S. CLS. 2, 5, 22, 23, 29, 37, 38 AND 50).

FIRST USE 8-0-1967; IN COMMERCE 8-0-1967.

THE MARK CONSISTS OF STANDARD CHARACTERS WITHOUT CLAIM TO ANY PARTICULAR FONT, STYLE, SIZE, OR COLOR.

OWNER OF U.S. REG. NO. 3,164,448.

NO CLAIM IS MADE TO THE EXCLUSIVE RIGHT TO USE "AWARDS", APART FROM THE MARK AS SHOWN.

SER. NO. 78-900,838, FILED 6-6-2006.

JEFFERY COWARD, EXAMINING ATTORNEY

Int. Cl.: 31

Prior U.S. Cls.: 1 and 46

United States Patent and Trademark Office

Reg. No. 3,576,261

Registered Feb. 17, 2009

**TRADEMARK
PRINCIPAL REGISTER**

BUG TUB

WAGGERS PET PRODUCTS INC. (CANADA
CORPORATION)
179 ROYAL OAK POINT N.W.
CALGARY, CANADA T3G 5C6

FOR: LIVE INSECTS, IN CLASS 31 (U.S. CLS. 1
AND 46).

THE MARK CONSISTS OF STANDARD CHAR-
ACTERS WITHOUT CLAIM TO ANY PARTICULAR
FONT, STYLE, SIZE, OR COLOR.

PRIORITY CLAIMED UNDER SEC. 44(D) ON
CANADA APPLICATION NO. 1304305, FILED 6-6-
2006, REG. NO. TMA710,504, DATED 3-31-2008, EX-
PIRES 3-31-2023.

NO CLAIM IS MADE TO THE EXCLUSIVE
RIGHT TO USE "BUG", APART FROM THE MARK
AS SHOWN.

SER. NO. 78-906,556, FILED 6-13-2006.

LINDA ORNDORFF, EXAMINING ATTORNEY

Int. Cls.: 25 and 28

Prior U.S. Cls.: 22, 23, 38, 39 and 50

Reg. No. 3,576,262

United States Patent and Trademark Office

Registered Feb. 17, 2009

**TRADEMARK
PRINCIPAL REGISTER**

POWER BOLT

AMERICAN SPORTS LICENSING, INC. (DELAWARE CORPORATION)
300 DELAWARE AVENUE, SUITE 548
WILMINGTON, DE 19801

FOR: APPAREL, NAMELY, SHIRTS, JERSEYS, PANTS, FOOTBALL PANTS, BASEBALL PANTS, JACKETS, AND SOCKS; FOOTWEAR, NAMELY, BASEBALL, SOFTBALL AND FOOTBALL CLEATS, ATHLETIC SHOES, BASEBALL SHOES, FOOTBALL SHOES, CYCLING SHOES, GYMNASTIC SHOES, HOCKEY SHOES, RUGBY SHOES, SOCCER SHOES, TENNIS SHOES, TRACK AND FIELD SHOES; CLEATS FOR ATTACHMENT TO SPORTS SHOES, IN CLASS 25 (U.S. CLS. 22 AND 39).

FIRST USE 10-1-1999; IN COMMERCE 10-1-1999.

FOR: SPORTING GOODS EQUIPMENT, NAMELY, SOCCER EQUIPMENT, NAMELY, SOCCER BALLS, SOCCER GOALS, TARGETS AND SOCCER REBOUNDERS; BASEBALL AND SOFTBALL EQUIPMENT, NAMELY BATS, GLOVES, MITTS, CATCHERS MITTS, FIRST BASEMAN MITTS, BASEBALLS, SOFTBALLS, TRAINING AIDS AND ACCESSORIES, NAMELY, BATTING CAGES, NETS FOR BALL GAMES, AND TARGETS, BASEBALL AND SOFTBALLS, TRAINING BATS, BASEBALL BATTING TEES, BATTING GLOVES, CATCHING AND FIELDERS PADDED GLOVES; BAT PROTECTION SLEEVES, WEIGHTS FOR BASEBALL AND

SOFTBALL BATS, LACROSSE EQUIPMENT, NAMELY, STICKS, GLOVES, GOALS, TRAINING AIDS AND ACCESSORIES, NAMELY, LACROSSE REBOUNDERS, NETS FOR LACROSSE AND TARGETS; FOOTBALL EQUIPMENT, NAMELY, FOOTBALLS, FOOTBALL TRAINING AIDS, NAMELY, NETS AND TARGETS, HOCKEY REBOUNDERS; ATHLETIC PROTECTIVE EQUIPMENT AND PADS USED FOR BASEBALL, SOFTBALL, SOCCER, LACROSSE, HOCKEY; BAGS USED FOR ATHLETIC EQUIPMENT, NAMELY, SOCCER BALL BAGS, BASEBALL AND SOFTBALL BAGS FOR BATS AND BALLS AND GLOVES, LACROSSE STICK BAGS".THE AMENDMENT DELETES "ATHLETIC PROTECTIVE EQUIPMENT AND PADS USED FOR FOOTBALL" FROM THE IDENTIFICATION OF GOODS, IN CLASS 28 (U.S. CLS. 22, 23, 38 AND 50).

FIRST USE 10-1-1999; IN COMMERCE 10-1-1999.

THE MARK CONSISTS OF STANDARD CHARACTERS WITHOUT CLAIM TO ANY PARTICULAR FONT, STYLE, SIZE, OR COLOR.

OWNER OF U.S. REG. NO. 2,592,243.

SER. NO. 78-915,177, FILED 6-23-2006.

SETH A. RAPPAPORT, EXAMINING ATTORNEY

Int. Cl.: 19

Prior U.S. Cls.: 1, 12, 33 and 50

United States Patent and Trademark Office

Reg. No. 3,576,263

Registered Feb. 17, 2009

**TRADEMARK
PRINCIPAL REGISTER**

SOLAR-GOLD SPACERGLASS

POLAR WINDOW OF CANADA LTD. (CANADA
CORPORATION)
672 KIMBERLY AVENUE
WINNIPEG, MANITOBA, CANADA R2K 0Y2

FOR: NON-METAL SEALED WINDOW UNITS, IN
CLASS 19 (U.S. CLS. 1, 12, 33 AND 50).

THE MARK CONSISTS OF STANDARD CHAR-
ACTERS WITHOUT CLAIM TO ANY PARTICULAR
FONT, STYLE, SIZE, OR COLOR.

OWNER OF CANADA REG. NO. TMA456101,
DATED 3-22-1996, EXPIRES 3-22-2011.

OWNER OF U.S. REG. NO. 2,071,033.

SER. NO. 78-924,699, FILED 7-7-2006.

PRISCILLA MILTON, EXAMINING ATTORNEY

Int. Cl.: 19

Prior U.S. Cls.: 1, 12, 33 and 50

United States Patent and Trademark Office

Reg. No. 3,576,264

Registered Feb. 17, 2009

**TRADEMARK
PRINCIPAL REGISTER**

POLY-MATRIX POWER FRAME

POLAR WINDOW OF CANADA LTD. (CANADA CORPORATION)
672 KIMBERLY AVENUE
WINNIPEG, MANITOBA, CANADA R2K 0Y2

FOR: WINDOW FRAMES, IN CLASS 19 (U.S. CLS. 1, 12, 33 AND 50).

THE MARK CONSISTS OF STANDARD CHARACTERS WITHOUT CLAIM TO ANY PARTICULAR FONT, STYLE, SIZE, OR COLOR.

OWNER OF CANADA REG. NO. TMA455562, DATED 3-1-1996, EXPIRES 3-1-2011.

OWNER OF U.S. REG. NO. 2,026,436.

NO CLAIM IS MADE TO THE EXCLUSIVE RIGHT TO USE "FRAME", APART FROM THE MARK AS SHOWN.

SER. NO. 78-925,680, FILED 7-10-2006.

PRISCILLA MILTON, EXAMINING ATTORNEY

Int. Cl.: 9

Prior U.S. Cls.: 21, 23, 26, 36 and 38

Reg. No. 3,576,265

United States Patent and Trademark Office

Registered Feb. 17, 2009

**TRADEMARK
PRINCIPAL REGISTER**

TAGTEAM

LONGWOOD SOFTWARE, INC. (MASSACHU-
SETTS CORPORATION)
SUITE 200
36 NASON STREET
MAYNARD, MA 01754

FOR: COMPUTER SOFTWARE FOR STORING
MARKETING AND SALES MATERIALS AND FOR
TRANSMITTING SUCH MATERIALS VIA A GLO-
BAL COMPUTER NETWORK , IN CLASS 9 (U.S.
CLS. 21, 23, 26, 36 AND 38).

FIRST USE 10-1-1997; IN COMMERCE 10-1-1997.

THE MARK CONSISTS OF STANDARD CHAR-
ACTERS WITHOUT CLAIM TO ANY PARTICULAR
FONT, STYLE, SIZE, OR COLOR.

SER. NO. 78-928,474, FILED 7-13-2006.

STEVEN R. FINE, EXAMINING ATTORNEY

Int. Cl.: 36

Prior U.S. Cls.: 100, 101 and 102

United States Patent and Trademark Office

Reg. No. 3,576,266

Registered Feb. 17, 2009

**SERVICE MARK
PRINCIPAL REGISTER**

CHEAP AUTO INSURANCE

COMBINED INSURANCE GROUP LTD. (DELA-
WARE CORPORATION)

618 SOUTH BROAD STREET

LANSDALE, PA 19446

FOR: INSURANCE SERVICES, NAMELY, INSUR-
ANCE BROKERAGE SERVICES AND INSURANCE
AGENCY SERVICES, IN CLASS 36 (U.S. CLS. 100, 101
AND 102).

FIRST USE 4-1-1993; IN COMMERCE 4-1-1993.

THE MARK CONSISTS OF STANDARD CHAR-
ACTERS WITHOUT CLAIM TO ANY PARTICULAR
FONT, STYLE, SIZE, OR COLOR.

NO CLAIM IS MADE TO THE EXCLUSIVE
RIGHT TO USE "AUTO INSURANCE", APART
FROM THE MARK AS SHOWN.

SEC. 2(F).

SER. NO. 78-938,799, FILED 7-27-2006.

WENDY GOODMAN, EXAMINING ATTORNEY

Int. Cls.: 9 and 42

Prior U.S. Cls.: 21, 23, 26, 36, 38, 100 and 101

United States Patent and Trademark Office

Reg. No. 3,576,267

Registered Feb. 17, 2009

**TRADEMARK
SERVICE MARK
PRINCIPAL REGISTER**

xpress

NUESOFT TECHNOLOGIES, INC. (GEORGIA CORPORATION)
1685 TERRELL MILL ROAD
MARIETTA, GA 30067

FOR: COMPUTER SOFTWARE FOR USE IN THE FIELD OF MEDICAL AND CLINICAL PRACTICE MANAGEMENT SYSTEMS FOR USE BY PHYSICIANS AND CLINICS IN BUSINESS AND OFFICE ADMINISTRATION, THE ORGANIZATION, MAINTENANCE, AND DISSEMINATION OF ELECTRONIC MEDICAL AND HEALTH RECORDS, AND FINANCIAL, CLINICAL, AND INSURANCE INFORMATION, AND IN ACCESSING AND PROVIDING SUCH INFORMATION BY MEANS OF A GLOBAL COMPUTER NETWORK, IN CLASS 9 (U.S. CLS. 21, 23, 26, 36 AND 38).

FIRST USE 5-17-2005; IN COMMERCE 5-17-2005.

FOR: APPLICATION SERVICE PROVIDER (ASP) FEATURING SOFTWARE IN THE FIELD OF MED-

ICAL AND CLINICAL PRACTICE MANAGEMENT SYSTEMS FOR USE BY PHYSICIANS AND CLINICS IN BUSINESS AND OFFICE ADMINISTRATION, THE ORGANIZATION, MAINTENANCE, AND DISSEMINATION OF ELECTRONIC MEDICAL AND HEALTH RECORDS, AND FINANCIAL, CLINICAL, AND INSURANCE INFORMATION, AND IN ACCESSING AND PROVIDING SUCH INFORMATION BY MEANS OF A GLOBAL COMPUTER NETWORK, IN CLASS 42 (U.S. CLS. 100 AND 101).

FIRST USE 5-17-2005; IN COMMERCE 5-17-2005.

THE MARK CONSISTS OF STANDARD CHARACTERS WITHOUT CLAIM TO ANY PARTICULAR FONT, STYLE, SIZE, OR COLOR.

SER. NO. 78-938,958, FILED 7-27-2006.

SUNG IN, EXAMINING ATTORNEY

Int. Cl.: 9

Prior U.S. Cls.: 21, 23, 26, 36 and 38

Reg. No. 3,576,268

United States Patent and Trademark Office

Registered Feb. 17, 2009

TRADEMARK
PRINCIPAL REGISTER

MALVERN

MALVERN INSTRUMENTS LIMITED (UNITED KINGDOM CORPORATION)
ENIGMA BUSINESS PARK, GROVEWOOD ROAD
MALVERN, UNITED KINGDOM WR14 1XZ

FOR: ELECTRICAL, OPTICAL, ACOUSTICAL, ULTRASONIC AND/OR LASER SCIENTIFIC AND LABORATORY INSTRUMENTS FOR COUNTING, SIZING, CLASSIFYING, DIFFERENTIATING AND IDENTIFYING PARTICLES IN SOLIDS, LIQUIDS OR GASES, FOR USE IN CLINICAL, BIOLOGICAL, INDUSTRIAL, MEDICAL, ENVIRONMENTAL, ACADEMIC AND/OR SCIENTIFIC RESEARCH AND COMMERCIAL LABORATORIES; INSTRUMENTS FOR MEASURING RHEOLOGICAL PROPERTIES, NAMELY, VISCOMETERS, ROTARY AND CAPILLARY RHEOMETERS; INSTRUMENTS FOR MEASURING DIMENSIONAL INFORMATION OF PARTICLES THROUGH IMAGE FORMATION AND ANALYSIS, NAMELY, PARTICLE SIZE, SHAPE, STRUCTURE AND COMPOSITION ANALYSERS; PARTICLE SIZE AND SHAPE DISTRIBUTION AND CONCENTRATION MEASURING INSTRUMENTS, NAMELY, PARTICLE COUNTING INSTRUMENTS, AIR AND LIQUID PARTICLE COUNTERS, PHOTOCORRELATION SPECTROSCOPY INSTRUMENTS, INSTRUMENTS FOR PRODUCING ZIMM PLOTS TO DETERMINE THE MOLECULAR WEIGHT OF POLYMERS, ACOUSTIC SPECTROSCOPY INSTRUMENTS, LASER DIFFRACTION MEASURING INSTRUMENTS, ALL FOR USE IN CLINICAL, BIOLOGICAL, INDUSTRIAL, MEDICAL, ACADEMIC AND/OR SCIENTIFIC RESEARCH AND COMMERCIAL LABORATORIES; PARTICLE CHARGE MEASURING INSTRUMENTS, NAMELY, ZETA POTENTIAL MEASURING INSTRUMENTS, ELECTROPHORETIC MOBILITY MEASURING INSTRUMENTS, PARTICLE MOBILITY MEASURING INSTRUMENTS,

PH MEASURING INSTRUMENTS, MICRO ELECTROPHORESIS MEASURING INSTRUMENTS, ALL FOR USE IN CLINICAL, BIOLOGICAL, INDUSTRIAL, MEDICAL, ACADEMIC AND/OR SCIENTIFIC RESEARCH AND COMMERCIAL LABORATORIES; APPARATUS FOR PREPARING SAMPLES, SUSPENSIONS, SPRAYS, AND EMULSIONS OF PARTICLES FOR USE WITH ANY OF THE AFORESAID GOODS, NAMELY, SAMPLE DISPERSION UNITS, STIRRED CELLS, AUTOSAMPLERS, DRY POWDER FEEDERS, DISPENSERS, AUTO TITRATORS, NEBULIZERS, ULTRASONIC BATHS, AND TEMPERATURE CONTROLLERS; INSTRUMENT CONTROLLERS, NAMELY, COMPUTERS, DIGITAL SIGNAL PROCESSORS AND MICROPROCESSORS, COMPUTER PRINTERS, COMPUTER SOFTWARE FOR CONTROLLING AND OPERATING ALL OF THE AFORESAID GOODS; MACHINE READABLE DATA CARRIERS, NAMELY, SOLID STATE MEMORY DEVICES, OPTICAL AND/OR MAGNETIC STORAGE MEDIA DISKS, MAGNETIC TAPES, ALL SOLD PRE-PROGRAMMED WITH CONTROL OR ANALYSIS PROGRAMS FOR USE WITH THE FOREGOING GOODS, IN CLASS 9 (U.S. CLS. 21, 23, 26, 36 AND 38).

THE MARK CONSISTS OF STANDARD CHARACTERS WITHOUT CLAIM TO ANY PARTICULAR FONT, STYLE, SIZE, OR COLOR.

OWNER OF UNITED KINGDOM REG. NO. 2364672, DATED 12-31-2004, EXPIRES 5-29-2014.

OWNER OF U.S. REG. NO. 3,084,564.

SER. NO. 78-939,822, FILED 7-28-2006.

MICHAEL ENGEL, EXAMINING ATTORNEY

Int. Cl.: 16

Prior U.S. Cls.: 2, 5, 22, 23, 29, 37, 38 and 50

Reg. No. 3,576,269

United States Patent and Trademark Office

Registered Feb. 17, 2009

**TRADEMARK
PRINCIPAL REGISTER**

**Wonderfully Made
Photography**

WONDERFULLY MADE PHOTOGRAPHY
(SOUTH CAROLINA SOLE PROPRIETORSHIP)

218 ELMWOOD AVE.

LADSON, SC 29456

FOR: PHOTOGRAPHS, IN CLASS 16 (U.S. CLS. 2, 5,
22, 23, 29, 37, 38 AND 50).

FIRST USE 11-27-2004; IN COMMERCE 11-27-2004.

THE MARK CONSISTS OF STANDARD CHAR-
ACTERS WITHOUT CLAIM TO ANY PARTICULAR
FONT, STYLE, SIZE, OR COLOR.

NO CLAIM IS MADE TO THE EXCLUSIVE
RIGHT TO USE "PHOTOGRAPHY", APART FROM
THE MARK AS SHOWN.

SER. NO. 78-941,048, FILED 7-31-2006.

MARLENE BELL, EXAMINING ATTORNEY

Int. Cl.: 35

Prior U.S. Cls.: 100, 101 and 102

United States Patent and Trademark Office

Reg. No. 3,576,270

Registered Feb. 17, 2009

**SERVICE MARK
PRINCIPAL REGISTER**

BOHN

GPI LTD. (TEXAS LIMITED PARTNERSHIP)
950 ECHO LANE, SUITE 100
HOUSTON, TX 77024

FOR: AUTOMOBILE DEALERSHIPS; RETAIL
STORE SERVICES OF AUTO PARTS AND ACCES-
SORIES, IN CLASS 35 (U.S. CLS. 100, 101 AND 102).

FIRST USE 9-16-1986; IN COMMERCE 9-16-1986.

THE MARK CONSISTS OF STANDARD CHAR-
ACTERS WITHOUT CLAIM TO ANY PARTICULAR
FONT, STYLE, SIZE, OR COLOR.

SEC. 2(F).

SER. NO. 78-941,175, FILED 7-31-2006.

DAWN HAN, EXAMINING ATTORNEY

Int. Cl.: 25

Prior U.S. Cls.: 22 and 39

United States Patent and Trademark Office

Reg. No. 3,576,271

Registered Feb. 17, 2009

**TRADEMARK
PRINCIPAL REGISTER**

LA SENZA TECHNOLITE

LA SENZA CORPORATION (3209893) (CANADA CORPORATION UNDER THE NOVA SCOTIA COMPANIES ACT)
1608 ST. REGIS BLVD.
DORVAL, QUEBEC, CANADA H9P 1H6

FOR: BRASSIERES AND PANTIES, IN CLASS 25 (U.S. CLS. 22 AND 39).

THE MARK CONSISTS OF STANDARD CHARACTERS WITHOUT CLAIM TO ANY PARTICULAR FONT, STYLE, SIZE, OR COLOR.

PRIORITY CLAIMED UNDER SEC. 44(D) ON CANADA APPLICATION NO. 1,302,238, FILED 5-19-

2006, REG. NO. TMA718511, DATED 7-15-2008, EXPIRES 7-15-2023.

OWNER OF U.S. REG. NOS. 2,614,315, 3,043,189 AND OTHERS.

THE FOREIGN WORDING IN THE MARK TRANSLATES INTO ENGLISH AS THE WITHOUT.

SER. NO. 78-943,351, FILED 8-2-2006.

MATTHEW PAPPAS, EXAMINING ATTORNEY

Int. Cl.: 1

Prior U.S. Cls.: 1, 5, 6, 10, 26 and 46

United States Patent and Trademark Office

Reg. No. 3,576,272

Registered Feb. 17, 2009

**TRADEMARK
PRINCIPAL REGISTER**

BOILERCARE

BENHAM, ROGER (UNITED STATES INDIVIDUAL)
655 LONE OAK DRIVE
MAIL STOP ESC-F7
EAGAN, MN 55121

THE MARK CONSISTS OF STANDARD CHARACTERS WITHOUT CLAIM TO ANY PARTICULAR FONT, STYLE, SIZE, OR COLOR.

FOR: CHEMICAL PRODUCTS FOR PREVENTING SCALE, IN CLASS 1 (U.S. CLS. 1, 5, 6, 10, 26 AND 46).

SER. NO. 78-944,758, FILED 8-3-2006.

FIRST USE 1-1-2003; IN COMMERCE 6-6-2004.

FLORENTINA BLANDU, EXAMINING ATTORNEY

Int. Cl.: 35

Prior U.S. Cls.: 100, 101 and 102

United States Patent and Trademark Office

Reg. No. 3,576,273

Registered Feb. 17, 2009

**SERVICE MARK
PRINCIPAL REGISTER**

VICTORIA

NOVADAQ TECHNOLOGIES INC. (CANADA CORPORATION)
SUITE 306
2585 SKYMARK AVENUE
MISSISSAUGA, ONTARIO, CANADA L4W 4L5

FOR: PROVIDING AN ON-LINE CLINICAL REGISTRY TO OTHERS FOR RESEARCH, DEVELOPMENT AND ANALYSIS, THE REGISTRY COMPRISING CLINICAL STUDY DATA AND ARTERIOGRAPHY IMAGES FROM INVASIVE SURGICAL PROCEDURES OR MINIMALLY INVASIVE SURGICAL PROCEDURES; MAINTAINING A CLINICAL REGISTRY FOR RESEARCH, DEVELOPMENT AND ANALYSIS OF INVASIVE AND MINIMALLY INVASIVE SURGICAL PROCEDURES AND IMAGING RELATED THERETO, COMPRIS-

ING CLINICAL STUDY DATA AND ARTERIOGRAPHY IMAGES FROM INVASIVE INTRA-OPERATIVE SURGICAL PROCEDURES OR MINIMALLY INVASIVE SURGICAL PROCEDURES, IN CLASS 35 (U.S. CLS. 100, 101 AND 102).

THE MARK CONSISTS OF STANDARD CHARACTERS WITHOUT CLAIM TO ANY PARTICULAR FONT, STYLE, SIZE, OR COLOR.

OWNER OF CANADA REG. NO. TMA703147, DATED 12-14-2007, EXPIRES 12-14-2022.

SER. NO. 78-944,847, FILED 8-4-2006.

TRACY FLETCHER, EXAMINING ATTORNEY

Int. Cl.: 42

Prior U.S. Cls.: 100 and 101

United States Patent and Trademark Office

Reg. No. 3,576,274

Registered Feb. 17, 2009

**SERVICE MARK
PRINCIPAL REGISTER**

**OPTIMAL SERVICE EXPERIENCE
(OSE)**

RADIALPOINT SAFECARE INC. (CANADA CORPORATION)
2050 RUE DE BLEURY, SUITE 300
MONTREAL, QUEBEC, CANADA H3A 2J5

FOR: TECHNICAL CONSULTATION IN THE FIELD OF TELECOMMUNICATIONS PROVIDED TO BROADBAND SERVICE PROVIDERS AND TELECOMMUNICATIONS COMPANIES TO PERMIT THEM TO OFFER ADDITIONAL AND ENHANCED SERVICES TO THEIR CUSTOMERS OR SUBSCRIBERS, INCREASE SALES AND TO ENHANCE THE DEGREE OF USER FRIENDLINESS OF THE DELIVERED SERVICES TO THE END USER, IN CLASS 42 (U.S. CLS. 100 AND 101).

THE MARK CONSISTS OF STANDARD CHARACTERS WITHOUT CLAIM TO ANY PARTICULAR FONT, STYLE, SIZE, OR COLOR.

PRIORITY CLAIMED UNDER SEC. 44(D) ON CANADA APPLICATION NO. 1311664, FILED 8-3-2006, REG. NO. TMA708224, DATED 2-26-2008, EXPIRES 2-26-2023.

NO CLAIM IS MADE TO THE EXCLUSIVE RIGHT TO USE "OPTIMAL SERVICE EXPERIENCE", APART FROM THE MARK AS SHOWN.

SER. NO. 78-948,264, FILED 8-9-2006.

ELISSA GARBER KON, EXAMINING ATTORNEY

Int. Cls.: 9 and 42

Prior U.S. Cls.: 21, 23, 26, 36, 38, 100 and 101

United States Patent and Trademark Office

Reg. No. 3,576,275

Registered Feb. 17, 2009

**TRADEMARK
SERVICE MARK
PRINCIPAL REGISTER**

SERVICEPOINT AGENT

RADIALPOINT SAFECARE INC. (CANADA CORPORATION)
2050 RUE DE BLEURY, SUITE 300
MONTREAL, QUEBEC, CANADA H3A 2J5

FOR: COMPUTER PROGRAMS, NAMELY, SOFTWARE APPLICATIONS THAT PERMIT BROADBAND SERVICE PROVIDERS AND TELECOMMUNICATIONS COMPANIES TO DELIVER, DEPLOY, MONITOR, CUSTOMIZE, INTEGRATE AND PROVIDE SUPPORT SERVICES TO CUSTOMERS OR SUBSCRIBERS AND TO MANAGE THEIR OPERATIONS AND CUSTOMER RELATIONSHIPS, IN CLASS 9 (U.S. CLS. 21, 23, 26, 36 AND 38).

FOR: APPLICATION SERVICE PROVIDER, ASP, SERVICES FEATURING SOFTWARE APPLICATIONS THAT PERMIT BROADBAND SERVICE PROVIDERS AND TELECOMMUNICATIONS COMPANIES TO DELIVER, DEPLOY, MONITOR, CUSTOMIZE, INTEGRATE AND PROVIDE SUPPORT SERVICES TO CUSTOMERS OR SUBSCRIBERS

AND TO MANAGE THEIR OPERATIONS AND CUSTOMER RELATIONSHIPS; TECHNICAL SUPPORT SERVICES, NAMELY, TROUBLESHOOTING OF COMPUTER SOFTWARE PROBLEMS, IN CLASS 42 (U.S. CLS. 100 AND 101).

THE MARK CONSISTS OF STANDARD CHARACTERS WITHOUT CLAIM TO ANY PARTICULAR FONT, STYLE, SIZE, OR COLOR.

PRIORITY CLAIMED UNDER SEC. 44(D) ON CANADA APPLICATION NO. 1311640, FILED 8-3-2006, REG. NO. 701229, DATED 11-21-2007, EXPIRES 11-21-2022.

NO CLAIM IS MADE TO THE EXCLUSIVE RIGHT TO USE "AGENT" , APART FROM THE MARK AS SHOWN.

SER. NO. 78-948,268, FILED 8-9-2006.

ELISSA GARBER KON, EXAMINING ATTORNEY

Int. Cl.: 9

Prior U.S. Cls.: 21, 23, 26, 36 and 38

Reg. No. 3,576,276

United States Patent and Trademark Office

Registered Feb. 17, 2009

**TRADEMARK
PRINCIPAL REGISTER**

BioQT

OXFORD BIOSIGNALS LIMITED (UNITED
KINGDOM CORPORATION)
THE MAGDALEN CENTRE
OXFORD SCIENCE PARK
OXFORD, UNITED KINGDOM OX4 4GA

FOR: DIAGNOSTIC COMPUTER SOFTWARE
FOR USE IN THE ANALYSIS OF SIGNALS FROM
ELECTROCARDIOGRAPHS AND OTHER ELEC-
TRONIC MEDICAL EQUIPMENT FOR DIAGNOS-
TIC USE, IN CLASS 9 (U.S. CLS. 21, 23, 26, 36 AND 38).

FIRST USE 12-6-2007; IN COMMERCE 12-6-2007.

THE MARK CONSISTS OF STANDARD CHAR-
ACTERS WITHOUT CLAIM TO ANY PARTICULAR
FONT, STYLE, SIZE, OR COLOR.

PRIORITY CLAIMED UNDER SEC. 44(D) ON
UNITED KINGDOM APPLICATION NO. 2415641,
FILED 3-3-2006, REG. NO. 2415641, DATED 9-8-2006,
EXPIRES 3-3-2016.

SER. NO. 78-948,386, FILED 8-9-2006.

STEVEN JACKSON, EXAMINING ATTORNEY

Int. Cl.: 21

Prior U.S. Cls.: 2, 13, 23, 29, 30, 33, 40 and 50

United States Patent and Trademark Office

Reg. No. 3,576,277

Registered Feb. 17, 2009

**TRADEMARK
PRINCIPAL REGISTER**

FRESH-LOCK

REYNOLDS CONSUMER PRODUCTS, INC. (DE-
LAWARE CORPORATION)
6603 WEST BROAD STREET
RICHMOND, VA 23239

FOR: PLASTIC STORAGE CONTAINERS FOR
DOMESTIC USE; PORTABLE PLASTIC CONTAIN-
ERS FOR STORING HOUSEHOLD AND KITCHEN
GOODS, IN CLASS 21 (U.S. CLS. 2, 13, 23, 29, 30, 33, 40
AND 50).

FIRST USE 5-14-2004; IN COMMERCE 5-14-2004.

THE MARK CONSISTS OF STANDARD CHAR-
ACTERS WITHOUT CLAIM TO ANY PARTICULAR
FONT, STYLE, SIZE, OR COLOR.

SER. NO. 78-948,533, FILED 8-9-2006.

DAVID TAYLOR, EXAMINING ATTORNEY

Int. Cl.: 41

Prior U.S. Cls.: 100, 101 and 107

United States Patent and Trademark Office

Reg. No. 3,576,278

Registered Feb. 17, 2009

**SERVICE MARK
PRINCIPAL REGISTER**

Physiotraining

TIMOTEO BARBOSA, CRISTIANE S. (UNITED STATES INDIVIDUAL)
1200 N.W. 99TH AVENUE
20320 N.E. 3RD COURT
PEMBROKE PINES, FL 33009

FOR: PROVIDING ASSISTANCE, PERSONAL TRAINING AND PHYSICAL FITNESS CONSULTATION TO INDIVIDUALS TO HELP THEM MAKE PHYSICAL FITNESS, STRENGTH, CONDITIONING, AND EXERCISE IMPROVEMENT IN THEIR DAILY LIVING, IN CLASS 41 (U.S. CLS. 100, 101 AND 107).

FIRST USE 8-12-2006; IN COMMERCE 8-12-2006.

THE MARK CONSISTS OF STANDARD CHARACTERS WITHOUT CLAIM TO ANY PARTICULAR FONT, STYLE, SIZE, OR COLOR.

SER. NO. 78-950,934, FILED 8-12-2006.

SOPHIA S. KIM, EXAMINING ATTORNEY

Int. Cl.: 9

Prior U.S. Cls.: 21, 23, 26, 36 and 38

Reg. No. 3,576,279

United States Patent and Trademark Office

Registered Feb. 17, 2009

**TRADEMARK
PRINCIPAL REGISTER**

LWP

PACIFIC AEROSPACE & ELECTRONICS, INC.
(WASHINGTON CORPORATION)
434 OLDS STATION ROAD
WENATCHEE, WA 98801

THE MARK CONSISTS OF STANDARD CHARACTERS WITHOUT CLAIM TO ANY PARTICULAR FONT, STYLE, SIZE, OR COLOR.

FOR: ELECTRONIC COMPONENTS, NAMELY, ELECTRONIC CONNECTORS AND HERMETIC SEALING DEVICES, NAMELY, RF CONNECTORS, IN CLASS 9 (U.S. CLS. 21, 23, 26, 36 AND 38).

SER. NO. 78-957,032, FILED 8-21-2006.

FIRST USE 10-1-1994; IN COMMERCE 10-1-1994.

JUSTINE D. PARKER, EXAMINING ATTORNEY

Int. Cl.: 9

Prior U.S. Cls.: 21, 23, 26, 36 and 38

Reg. No. 3,576,280

United States Patent and Trademark Office

Registered Feb. 17, 2009

**TRADEMARK
PRINCIPAL REGISTER**

LLWP

PACIFIC AEROSPACE & ELECTRONICS, INC.
(WASHINGTON CORPORATION)
434 OLDS STATION ROAD
WENATCHEE, WA 98801

THE MARK CONSISTS OF STANDARD CHARACTERS WITHOUT CLAIM TO ANY PARTICULAR FONT, STYLE, SIZE, OR COLOR.

FOR: ELECTRONIC COMPONENTS, NAMELY, ELECTRONIC CONNECTORS AND HERMETIC SEALING DEVICES, NAMELY, RF CONNECTORS, IN CLASS 9 (U.S. CLS. 21, 23, 26, 36 AND 38).

SER. NO. 78-957,039, FILED 8-21-2006.

FIRST USE 10-1-1994; IN COMMERCE 10-1-1994.

JUSTINE D. PARKER, EXAMINING ATTORNEY

Int. Cls.: 29 and 30

Prior U.S. Cl.: 46

United States Patent and Trademark Office

Reg. No. 3,576,281

Registered Feb. 17, 2009

TRADEMARK
PRINCIPAL REGISTER

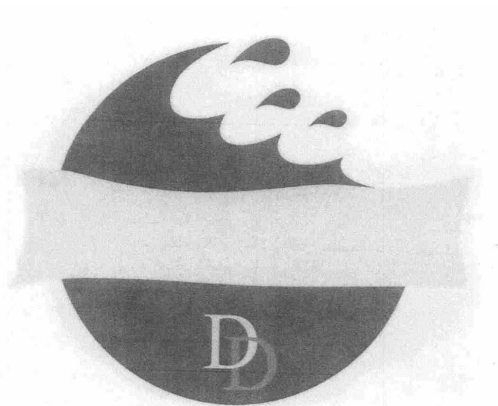

IMPEX CORPORATION (NEW JERSEY CORPORATION)
399 ST. PAULS AVENUE
JERSEY CITY, NJ 07306

FOR: FROZEN FOODS, NAMELY, SEAFOOD AND PREPARED SIDE DISHES AND ENTREES CONSISTING PREDOMINANTLY OF SEAFOOD, MEAT, AND/OR PROCESSED VEGETABLES; FRESH, FROZEN, PASTEURIZED AND PROCESSED SEAFOOD, FISH, AND SHELLFISH; FROZEN FRUITS, IN CLASS 29 (U.S. CL. 46).

FIRST USE 11-2-1998; IN COMMERCE 11-2-1998.

FOR: FROZEN FOODS, NAMELY, RICE BASED AND WHEAT-BASED ENTREES; FROZEN FOODS, NAMELY PREPARED SIDE DISHES AND ENTREES

CONSISTING PREDOMINANTLY OF RICE, WHEAT, AND/OR PASTA; BAKERY PRODUCTS; DESSERT PUDDINGS, DESSERT SOUFFLÉS, DESSERT MOUSSE; BAKERY DESSERTS, IN CLASS 30 (U.S. CL. 46).

FIRST USE 11-2-1998; IN COMMERCE 11-2-1998.

OWNER OF U.S. REG. NO. 3,361,287.

THE MARK CONSISTS OF THE LETTERS "DD," A PARTIAL CIRCLE WITH WAVES AND A BANNER ACROSS THE MIDDLE OF THE CIRCLE.

SER. NO. 78-970,424, FILED 9-8-2006.

AISHA SALEM, EXAMINING ATTORNEY

Int. Cl.: 32

Prior U.S. Cls.: 45, 46 and 48

United States Patent and Trademark Office

Reg. No. 3,576,282

Registered Feb. 17, 2009

**TRADEMARK
PRINCIPAL REGISTER**

UNIQUE

BADEL 1862 D.D. (CROATIA JOINT STOCK
COMPANY)

VLAKA 116

ZAGREB, HR-10000, CROATIA

FOR: BOTTLED WATER, MINERAL WATER
AND CARBONATED WATER, IN CLASS 32 (U.S.
CLS. 45, 46 AND 48).

THE MARK CONSISTS OF STANDARD CHAR-
ACTERS WITHOUT CLAIM TO ANY PARTICULAR
FONT, STYLE, SIZE, OR COLOR.

OWNER OF CROATIA REG. NO. Z200621181,
DATED 11-8-2006, EXPIRES 11-8-2016.

SER. NO. 78-973,260, FILED 9-13-2006.

CAROLYN CATALDO, EXAMINING ATTORNEY

Int. Cls.: 35 and 42

Prior U.S. Cls.: 100, 101 and 102

United States Patent and Trademark Office

Reg. No. 3,576,283

Registered Feb. 17, 2009

**SERVICE MARK
PRINCIPAL REGISTER**

**CREATE, SHARE & THINK AS
ONE**

RICOH COMPANY, LTD. (JAPAN CORPORATION)
3-6, 1-CHOME, NAKA-MAGOME, OHTA-KU
TOKYO, JAPAN

FOR: ADVERTISING AND PUBLICITY; BUSINESS MANAGEMENT ANALYSIS AND BUSINESS CONSULTANCY REGARDING INFORMATION SECURITIES MANAGEMENT SYSTEM; BUSINESS CONSULTANCY REGARDING INTRODUCTION OF INFORMATION TECHNOLOGY; BUSINESS MANAGEMENT ANALYSIS AND BUSINESS CONSULTANCY; MARKETING RESEARCH; PROVIDING INFORMATION ON COMMODITY SALES REGARDING PRINTERS, FACSIMILE MACHINES, ELECTRONIC COPYING MACHINES WITH MULTI-FUNCTIONS OF PRINTER, SCANNER AND FACSIMILE MACHINE AND COMPUTER SOFTWARE FOR ELECTRONIC COPYING MACHINES AND PRINTERS; RECORDS MANAGEMENT SERVICES, NAMELY, DOCUMENT INDEXING; RENTAL OF OFFICE EQUIPMENT, NAMELY, TYPEWRITERS AND COPYING MACHINES/WORD PROCESSORS, IN CLASS 35 (U.S. CLS. 100, 101 AND 102).

FOR: DESIGN, PROGRAMMING AND MAINTENANCE OF COMPUTER SOFTWARE FOR ELEC-

TRONIC COPYING MACHINES, INK-JET PRINTERS AND LASER-BEAM PRINTERS; COMPUTER SOFTWARE DESIGN, COMPUTER PROGRAMMING, MAINTENANCE OF COMPUTER SOFTWARE; CONSULTANCY REGARDING DESIGN AND CREATION OF COMPUTER SYSTEMS FOR ELECTRONIC COPYING MACHINES; RENTAL OF COMPUTERS; PROVIDING ON-LINE NON-DOWNLOADABLE SOFTWARE FOR CONNECTING PERSONAL COMPUTERS WITH PRINTERS, FACSIMILE MACHINES AND ELECTRONIC COPYING MACHINES WITH MULTI-FUNCTIONS OF PRINTER, SCANNER AND FACSIMILE MACHINE, IN CLASS 42 (U.S. CLS. 100 AND 101).

THE MARK CONSISTS OF STANDARD CHARACTERS WITHOUT CLAIM TO ANY PARTICULAR FONT, STYLE, SIZE, OR COLOR.

PRIORITY CLAIMED UNDER SEC. 44(D) ON JAPAN APPLICATION NO. 2006-004533, FILED 1-23-2006, REG. NO. 5083018, DATED 10-12-2007, EXPIRES 10-12-2017.

SER. NO. 78-977,864, FILED 1-25-2006.

CURTIS FRENCH, EXAMINING ATTORNEY

Int. Cls.: 35 and 41

Prior U.S. Cls.: 100, 101, 102 and 107

United States Patent and Trademark Office

Reg. No. 3,576,284

Registered Feb. 17, 2009

**SERVICE MARK
PRINCIPAL REGISTER**

ROCKAMERICA

RETAIL ENTERTAINMENT DESIGN, LLC (DE-
LAWARE LIMITED LIABILITY COMPANY)
SUITE 300
14205 S.E. 36TH STREET
BELLEVUE, WA 98006

FOR: LICENSING OF VIDEO CONTENT, NAME-
LY, MUSIC VIDEOS AND TELEVISION PROGRAMS
TO OTHERS FOR DISTRIBUTION; VIDEO PROMO-
TION SERVICES, NAMELY, PROMOTION USING
AUDIOVISUAL MEDIA, IN CLASS 35 (U.S. CLS. 100,
101 AND 102).

FIRST USE 9-0-1980; IN COMMERCE 9-0-1980.

FOR: RENTAL OF DVDS AND DIGITAL ASSETS
FEATURING MUSIC VIDEOS TO NIGHT CLUBS,
INCLUDING BARS, AND PRE-RECORDED MUSIC

AND VIDEO STORES; PRODUCTION OF TELEVI-
SION AND CABLE TELEVISION PROGRAMS; PRE-
PARING COMPILATIONS OF MUSIC VIDEOS,
NAMELY, PRODUCTION OF DVDS AND DIGITAL
ASSETS FEATURING MUSIC VIDEOS, IN CLASS 41
(U.S. CLS. 100, 101 AND 107).

FIRST USE 9-0-1980; IN COMMERCE 9-0-1980.

THE MARK CONSISTS OF STANDARD CHAR-
ACTERS WITHOUT CLAIM TO ANY PARTICULAR
FONT, STYLE, SIZE, OR COLOR.

SER. NO. 78-980,546, FILED 2-8-2006.

JEFF DEFORD, EXAMINING ATTORNEY

Int. Cls.: 35, 36 and 39

Prior U.S. Cls.: 100, 101, 102 and 105

United States Patent and Trademark Office

Reg. No. 3,576,285

Registered Feb. 17, 2009

**SERVICE MARK
PRINCIPAL REGISTER**

DF Young

DANIEL F. YOUNG, INCORPORATED (NEW YORK CORPORATION)

SECOND FLOOR

1 JOURNAL SQUARE

JERSEY CITY, NJ 073064004

FOR: COST PRICE ANALYSIS; COMPUTERIZED DATABASE MANAGEMENT; RELOCATION SERVICES FOR BUSINESSES; NEGOTIATION AND SETTLEMENT OF COMMERCIAL TRANSACTIONS FOR THIRD PARTIES; DIRECT MAIL ADVERTISING; CUSTOMS CLEARANCE SERVICES FOR THIRD PARTIES; COMPUTERIZED TRACKING AND TRACING OF PACKAGES IN TRANSIT VIA THE INTERNET; INFORMATION MANAGEMENT SERVICES, NAMELY, SHIPMENT ORDER PROCESSING AND TRACKING DOCUMENTS, PACKAGES AND FREIGHT OVER THE INTERNET; TRANSPORTATION LOGISTICS SERVICES, NAMELY, PLANNING AND SCHEDULING SHIPMENTS FOR USERS OF TRANSPORTATION SERVICES; DATA PROCESSING SERVICES AND CONSULTATION RELATING THERETO , IN CLASS 35 (U.S. CLS. 100, 101 AND 102).

FIRST USE 7-1-1903; IN COMMERCE 7-1-1903.

FOR: INSURANCE BROKERAGE SERVICES IN THE FIELD OF TRANSPORTATION; CUSTOMS BROKERAGE SERVICES FOR THIRD PARTIES; ELECTRONIC PAYMENT SERVICES, NAMELY, ELECTRONIC PROCESSING AND TRANSMISSION OF BILL PAYMENT DATA; MONETARY EXCHANGE SERVICES; REAL ESTATE BROKERAGE SERVICES, IN CLASS 36 (U.S. CLS. 100, 101 AND 102).

FIRST USE 7-1-1903; IN COMMERCE 7-1-1903.

FOR: PROVIDING A COMPUTERIZED DATABASE IN THE FIELDS OF FREIGHT FORWARDING, STORAGE AND SHIPMENT STATUS; TRANSPORTATION OF GOODS AND WARES VIA MOTOR VEHICLES, AUTOMOBILES, TRUCKS, RAILROADS, SHIPS AND AIRPLANES; WAREHOUSING SERVICES, NAMELY, STORAGE AND PACKING FOR SHIPMENT OF GOODS FOR OTHERS; TRANSPORTATION INFORMATION; FREIGHT BROKERAGE SERVICES; UNLOADING CARGO; WAREHOUSE STORAGE INFORMATION; COURIER SERVICES; SUPPLY CHAIN, LOGISTICS AND REVERSE LOGISTICS SERVICES, NAMELY, STORAGE, TRANSPORTATION AND DELIVERY OF DOCUMENTS, PARCELS, PACKETS, LETTERS AND PALLETS FOR OTHERS BY AIR, RAIL, SHIP OR TRUCK; WAREHOUSING SERVICES; RENTAL OF WAREHOUSE SPACE; RENTAL OF WAREHOUSE STORAGE CONTAINERS; ELECTRONIC STORAGE OF DATA FOR OTHERS; PROVIDING AN ON-LINE COMPUTER DATABASE IN THE FIELD OF TRANSPORTATION, IN CLASS 39 (U.S. CLS. 100 AND 105).

FIRST USE 7-1-1903; IN COMMERCE 7-1-1903.

THE MARK CONSISTS OF STANDARD CHARACTERS WITHOUT CLAIM TO ANY PARTICULAR FONT, STYLE, SIZE, OR COLOR.

THE NAME SHOWN IN THE MARK DOES NOT IDENTIFY A PARTICULAR LIVING INDIVIDUAL.

SER. NO. 78-980,848, FILED 1-11-2005.

COLLEEN DOMBROW, EXAMINING ATTORNEY

Int. Cl.: 9

Prior U.S. Cls.: 21, 23, 26, 36 and 38

Reg. No. 3,576,286

United States Patent and Trademark Office

Registered Feb. 17, 2009

TRADEMARK
PRINCIPAL REGISTER

COMTRAC

THALES (FRANCE SOCIÉTÉ ANONYME)
45 RUE DE VILLIERS
F-92526 NEUILLY SUR SEINE CEDEX, FRANCE

FOR: APPARATUS, EQUIPMENT AND DEVICES FOR VIDEO SURVEILLANCE, ALARMS AND WARNING SIGNALS FOR USE IN RAILWAY TRANSPORT, NAMELY, COMPUTER HARDWARE AND SOFTWARE FOR USE IN VIDEO SURVEILLANCE OF RAIL TRAFFIC AND CONTROL AND OPERATION OF ALARM AND WARNING SIGNALS FOR RAIL TRAFFIC, VIDEO CAMERAS, VIDEO MONITORS, WIRELESS TRANSMITTERS AND RECEIVERS, ANTENNAS, ON-BOARD ELECTRICAL CONTROLLERS, WAY-SIDE ELECTRICAL CONTROLLERS, ACCESS CONTROL AND MONITORING SYSTEMS COMPRISED OF COMPUTER HARDWARE; APPARATUS, EQUIPMENT AND DEVICES FOR COMMUNICATION AND SIGNALING BY MEANS OF RADIO, LIGHT, MECHANICALLY, ELECTRICALLY, ELECTRONICALLY, ELECTROMECHANICALLY OR ACOUSTICALLY TO GIVE INFORMATION TO RAIL TRANSPORT USERS AND OPERATE A RAILWAY NETWORK, NAMELY, COMPUTER HARDWARE AND SOFTWARE

FOR MONITORING RAILWAY TRAFFIC, LIGHT-EMITTING DIODE, ELECTROMECHANICAL VIDEO MONITORS AND VIDEO MONITORS, ELECTRONIC AND ELECTROMECHANICAL NOTICE AND INDICATOR BOARDS, INDUCTIVE DATA TRANSMISSION SYSTEMS COMPRISED OF DATA PROCESSORS AND COMPUTER HARDWARE, RAILWAY SIGNALS, IN CLASS 9 (U.S. CLS. 21, 23, 26, 36 AND 38).

THE MARK CONSISTS OF STANDARD CHARACTERS WITHOUT CLAIM TO ANY PARTICULAR FONT, STYLE, SIZE, OR COLOR.

PRIORITY DATE OF 3-15-2005 IS CLAIMED.

OWNER OF INTERNATIONAL REGISTRATION
0864255 DATED 9-14-2005, EXPIRES 9-14-2015.

SER. NO. 79-016,116, FILED 9-14-2005.

ERNEST SHOSHO, EXAMINING ATTORNEY

Int. Cl.: 25

Prior U.S. Cls.: 22 and 39

United States Patent and Trademark Office

Reg. No. 3,576,287

Registered Feb. 17, 2009

**TRADEMARK
PRINCIPAL REGISTER**



BOND-EYE TRADERS PTY LTD
SUITE 6, LEVEL 7,
46 HOLT STREETSURRY HILLS NSW 2010
AUSTRALIA

FOR: MENS', WOMENS', BOYS' AND GIRLS'
SWIMWEAR; CLOTHING, NAMELY, COVER-UPS,
SARONGS, CAFTANS, DRESSES, SKIRTS, SHIRTS,
TOPS, T-SHIRTS, SINGLETs, SHORTS AND PANTS;
FOOTWEAR THONGS; SLIDES, SANDALS AND

FOOTWEAR; CAPS, HATS, VISORS AND HEAD
WEAR, IN CLASS 25 (U.S. CLS. 22 AND 39).

OWNER OF INTERNATIONAL REGISTRATION
0868554 DATED 9-29-2005, EXPIRES 9-29-2015.

SER. NO. 79-017,764, FILED 9-29-2005.

JOHN KELLY, EXAMINING ATTORNEY

Int. Cls.: 35, 36, 41 and 42

Prior U.S. Cls.: 100, 101, 102 and 107

United States Patent and Trademark Office

Reg. No. 3,576,288

Registered Feb. 17, 2009

**SERVICE MARK
PRINCIPAL REGISTER**



AKTIVA NALOZBE, INVESTIRANJE IN UP-
RAVLJANJE NALOZB, D.D. (SLOVENIA LIM-
ITED LIABILITY COMPANY)
DUNAJSKA CESTA 156
SI-1000 LJUBLJANA, SLOVENIA

FOR: BUSINESS DEVELOPMENT SERVICES,
NAMELY, PROVIDING START-UP SUPPORT FOR
BUSINESSES OF OTHERS; COMPUTER FILE MAN-
AGEMENT; IMPORT-EXPORT AGENCIES; PRO-
VIDING OFFICE SUPPORT STAFF SERVICES TO
THIRD PARTIES; PROVIDING OFFICE FUNC-
TIONS, IN CLASS 35 (U.S. CLS. 100, 101 AND 102).

FOR: EQUITY CAPITAL INVESTMENT, NOT
INCLUDING INVESTMENT MANAGEMENT AND
MUTUAL FUND INVESTMENT, VENTURE CAP-
ITAL SERVICES, NAMELY, PROVIDING FINAN-
CING TO EMERGING AND START-UP
COMPANIES; PAYMENT CARD ISSUING SER-
VICES, NAMELY, CREDIT CARD, CASH CARD, AND
DEBIT CARD SERVICES; CLAIMS ADJUSTMENT
IN THE FIELD OF INSURANCE; INSURANCE
CONSULTANCY; CHARITABLE FUND-RAISING
SERVICES FOR HUMANITARIAN WORKS; ELEC-
TRONIC FUNDS TRANSFER; INSTALLMENT
LOANS; INSURANCE BROKERAGE; APARTMENT
RENTAL FOR PERMANENT ACCOMMODATION,
IN CLASS 36 (U.S. CLS. 100, 101 AND 102).

FOR: ARRANGING OF COURSES AND SEMI-
NARS ON THE SETTING-UP OF FIRMS AND
MARKETING; PUBLISHING AND PUBLISHING
HOUSE SERVICES, NAMELY, MULTIMEDIA P-
UBLISHING OF BOOKS, MAGAZINES, JOURNALS,
SOFTWARE, GAMES, MUSIC AND ELECTRONIC
PUBLICATIONS; ARRANGING OF SEMINARS
AND EDUCATIONAL ACTIVITIES, NAMELY, EDU-
CATIONAL CONFERENCES; OPERATING LOT-
TERIES, NAMELY, CONDUCTING LOTTERIES
FOR OTHERS; TRANSLATION SERVICES, IN
CLASS 41 (U.S. CLS. 100, 101 AND 107).

FOR: LEGAL RESEARCH; LEGAL SERVICES;
PROFESSIONAL COMPUTER CONSULTATION
SERVICES UNRELATED TO BUSINESS DEALINGS
AND COMPUTER CONSULTING SERVICES IN
CONNECTION WITH SETTING UP FIRMS; MAN-
AGEMENT AND CONSULTATION IN THE FIELD
OF HUMAN FACTORING ENGINEERING; CON-
SULTING SERVICES IN THE FIELD OF OFFICE
AND WORK PLACE AUTOMATION; SCIENTIFIC
RESEARCH USING DATA AND STATISTICAL
METHODS; DESIGNING AND CONDUCTING
QUALITY CONTROL PROGRAMS, IN CLASS 42
(U.S. CLS. 100 AND 101).

OWNER OF INTERNATIONAL REGISTRATION
0873632 DATED 12-8-2005, EXPIRES 12-8-2015.

NO CLAIM IS MADE TO THE EXCLUSIVE
RIGHT TO USE "GROUP", APART FROM THE
MARK AS SHOWN.

THE COLOR(S) BLUE AND GRAY IS/ARE
CLAIMED AS A FEATURE OF THE MARK.

THE MARK CONSISTS OF THE COLOR BLUE IN
THE TEXT OF THE WORD "ACTIVA", AND GRAY
IN THE TEXT OF THE WORD "GROUP" AND IN
THE TWO HORIZONTAL PARALLEL LINES
ABOVE AND BELOW THE WORD "ACTIVA".

THE FOREIGN WORDING IN THE MARK
TRANSLATES INTO ENGLISH AS ASSETS.

SER. NO. 79-019,745, FILED 12-8-2005.

ELI HELLMAN, EXAMINING ATTORNEY

Int. Cls.: 35, 36, 41 and 42

Prior U.S. Cls.: 100, 101, 102 and 107

United States Patent and Trademark Office

Reg. No. 3,576,289

Registered Feb. 17, 2009

**SERVICE MARK
PRINCIPAL REGISTER**

A K T I V A

AKTIVA NALOZBE, INVESTIRANJE IN UP-
RAVLJANJE NALOZB, D.D. (SLOVENIA LIM-
ITED LIABILITY COMPANY)
DUNAJSKA CESTA 156
SI-1000 LJUBLJANA, SLOVENIA

FOR: BUSINESS DEVELOPMENT SERVICES,
NAMELY, PROVIDING START-UP SUPPORT FOR
BUSINESSES OF OTHERS; COMPUTER FILE MAN-
AGEMENT; IMPORT-EXPORT AGENCIES; PRO-
VIDING OFFICE SUPPORT STAFF SERVICES TO
THIRD PARTIES; PROVIDING OFFICE FUNC-
TIONS, IN CLASS 35 (U.S. CLS. 100, 101 AND 102).

FOR: EQUITY CAPITAL INVESTMENT, NOT
INCLUDING INVESTMENT MANAGEMENT AND
MUTUAL FUND INVESTMENT, VENTURE CAP-
ITAL SERVICES, NAMELY, PROVIDING FINAN-
CING TO EMERGING AND START-UP
COMPANIES; PAYMENT CARD ISSUING SER-
VICES, NAMELY, CREDIT CARD, CASH CARD, AND
DEBIT CARD SERVICES; CLAIMS ADJUSTMENT
IN THE FIELD OF INSURANCE; INSURANCE
CONSULTANCY; CHARITABLE FUND-RAISING
SERVICES FOR HUMANITARIAN WORKS; ELEC-
TRONIC FUNDS TRANSFER; INSTALLMENT
LOANS; INSURANCE BROKERAGE; APARTMENT
RENTAL FOR PERMANENT ACCOMMODATION,
IN CLASS 36 (U.S. CLS. 100, 101 AND 102).

FOR: ARRANGING OF COURSES AND SEMI-
NARS ON THE SETTING-UP OF FIRMS AND
MARKETING; PUBLISHING AND PUBLISHING
HOUSE SERVICES, NAMELY MULTIMEDIA PUB-
LISHING OF BOOKS, MAGAZINES, JOURNALS,
SOFTWARE, GAMES, MUSIC AND ELECTRONIC
PUBLICATIONS; ARRANGING OF SEMINARS
AND EDUCATIONAL ACTIVITIES, NAMELY, EDU-

CATIONAL CONFERENCES; OPERATING LOT-
TERIES, NAMELY, CONDUCTING LOTTERIES
FOR OTHERS; TRANSLATION SERVICES, IN
CLASS 41 (U.S. CLS. 100, 101 AND 107).

FOR: LEGAL RESEARCH; LEGAL SERVICES;
PROFESSIONAL COMPUTER CONSULTATION
SERVICES UNRELATED TO BUSINESS DEALINGS
AND COMPUTER CONSULTING SERVICES IN
CONNECTION WITH SETTING UP FIRMS; MAN-
AGEMENT AND CONSULTATION IN THE FIELD
OF HUMAN FACTORING ENGINEERING; CON-
SULTING SERVICES IN THE FIELD OF OFFICE
AND WORK PLACE AUTOMATION; SCIENTIFIC
RESEARCH USING DATA AND STATISTICAL
METHODS; DESIGNING AND CONDUCTING
QUALITY CONTROL PROGRAMS, IN CLASS 42
(U.S. CLS. 100 AND 101).

OWNER OF INTERNATIONAL REGISTRATION
0873633 DATED 12-8-2005, EXPIRES 12-8-2015.

THE COLOR(S) BLUE AND GRAY IS/ARE
CLAIMED AS A FEATURE OF THE MARK.

THE MARK CONSISTS OF THE WORD "AKTI-
VA" IN BLUE BETWEEN TWO PARALLEL GRAY
HORIZONTAL LINES.

THE FOREIGN WORDING IN THE MARK
TRANSLATES INTO ENGLISH AS ASSETS.

SER. NO. 79-019,746, FILED 12-8-2005.

ELI HELLMAN, EXAMINING ATTORNEY

Int. Cl.: 19

Prior U.S. Cls.: 1, 12, 33 and 50

United States Patent and Trademark Office

Reg. No. 3,576,290

Registered Feb. 17, 2009

**TRADEMARK
PRINCIPAL REGISTER**

OMEGA

TERRE ARMÉE INTERNATIONALE, (FRANCE
SOCIÉTÉ PAR ACTIONS SIMPLIFIÉE)
1 BIS, RUE DU PETIT CLAMART
F-78140 VELIZY VILLACOUBLAY
FRANCE

FOR: REINFORCING BANDS OR STRIPS, NOT OF METAL, FOR BUILDING PURPOSES FOR USE IN BUILDING LARGE MECHANICALLY STABILIZED SOIL OR EARTH STRUCTURES IN CIVIL ENGINEERING PROJECTS AND NOT FOR HOUSES OR OTHER BUILDINGS; CONCRETE PANELS FOR USE IN BUILDING LARGE MECHANICALLY STABILIZED SOIL OR EARTH STRUCTURES IN CIVIL ENGINEERING PROJECTS AND NOT FOR HOUSES OR OTHER BUILDINGS, IN CLASS 19 (U.S. CLS. 1, 12, 33 AND 50).

THE MARK CONSISTS OF STANDARD CHARACTERS WITHOUT CLAIM TO ANY PARTICULAR FONT, STYLE, SIZE, OR COLOR.

PRIORITY DATE OF 7-22-2005 IS CLAIMED.

OWNER OF INTERNATIONAL REGISTRATION
0873984 DATED 12-2-2005, EXPIRES 12-2-2015.

SER. NO. 79-019,883, FILED 12-2-2005.

ALLISON HOLTZ, EXAMINING ATTORNEY

Int. Cl.: 25

Prior U.S. Cls.: 22 and 39

United States Patent and Trademark Office

Reg. No. 3,576,291

Registered Feb. 17, 2009

**TRADEMARK
PRINCIPAL REGISTER**

NEW WAVE

NEW WAVE GROUP AB (SWEDEN A SWEDISH
JOINT STOCK LIMITED COMPANY)
HOLLANDSGATAN 5
SE-442 50 YTTERBY
SWEDEN

FOR: LADIES' AND MEN'S READY MADE
CLOTHING, NAMELY, SHIRTS, T-SHIRTS, SWEAT-
SHIRTS, SWEATERS, POLO SHIRTS, ROLLNECKS,
SINGLETs, SLEEVELESS TOPS, PULLOVERS, CAR-
DIGANS, TRACKSUITS, SWEAT PANTS, UNDER-
WEAR, SHORTS, TROUSERS, JACKETS, VESTS,
BLAZERS, SKIRTS, CAPS, IN CLASS 25 (U.S. CLS.
22 AND 39).

THE MARK CONSISTS OF STANDARD CHAR-
ACTERS WITHOUT CLAIM TO ANY PARTICULAR
FONT, STYLE, SIZE, OR COLOR.

OWNER OF INTERNATIONAL REGISTRATION
0832599 DATED 4-5-2004, EXPIRES 4-5-2014.

SER. NO. 79-020,656, FILED 11-14-2005.

PAULA MAHONEY, EXAMINING ATTORNEY

Int. Cls.: 16, 35, 36, 39 and 41

Prior U.S. Cls.: 2, 5, 22, 23, 29, 37, 38, 50, 100, 101, 102, 105 and 107

Reg. No. 3,576,292

United States Patent and Trademark Office

Registered Feb. 17, 2009

**TRADEMARK
SERVICE MARK
PRINCIPAL REGISTER**

MotivWorld

P&MM GROUP PLC (UNITED KINGDOM PUBLIC LIMITED COMPANY)

C/O P&MM LIMITED,

ROCKINGHAM DRIVE, LINFORD WOOD; MILTON KEYNES, BUCKINGHAMSHIRE MK14 6LY UNITED KINGDOM

FOR: POSTERS, FLYERS, LETTERS, PAPER AND CARDBOARD BANNERS, BROCHURES, PAPER AND CARDBOARD SACKS AND BAGS FOR WRAPPING AND PACKAGING, POSTCARDS, WRITING PAPER, WRITING PADS, PHOTOGRAPHS, STATIONERY, STICKERS, ADHESIVE MATERIALS FOR OFFICE USE, PENS, DIARIES, CALENDARS, PAPER CLIPS AND PRINTED INSTRUCTIONAL AND TEACHING MATERIALS, ALL OF THE AFOREMENTIONED GOODS FOR USE IN RELATION TO THE PROVISION OF INCENTIVE AND MOTIVATION PROGRAMS, SALES PROMOTIONS AND EMPLOYEE BENEFIT PROGRAMS, AND NONE BEING USED IN RELATION TO THE PROVISION OF BILLING SERVICES, ORDER OR JOB TRACKING SERVICES, TIME AND EXPENSE RECORDAL SERVICES, BUSINESS MILEAGE TRACKING SERVICES, SECRETARIAL AND ADMINISTRATIVE SERVICES OR PROJECT COORDINATION AND MANAGEMENT, IN CLASS 16 (U.S. CLS. 2, 5, 22, 23, 29, 37, 38 AND 50).

FOR: INFORMATION SERVICES RELATING TO BUSINESS MATTERS; BUSINESS INFORMATION REFERRAL SERVICES, NAMELY, PROVIDING REFERRAL INFORMATION FOR DEVELOPING AND IMPLEMENTING MOTIVATION AND INCENTIVE PROGRAMS FOR BUSINESSES, THEIR EMPLOYEES, AND THIRD PARTIES; ADVERTISING AND PUBLICITY SERVICES; COMPILATION OF BUSINESS DIRECTORIES FOR USE IN CONNECTION WITH THE PROVISION OF EMPLOYEE AND THIRD PARTY INCENTIVE AND MOTIVATION

PROGRAMS, SALES PROMOTIONS AND BENEFIT PROGRAMS; BUSINESS MANAGEMENT; BUSINESS ADVISORY AND BUSINESS ADMINISTRATION SERVICES; BUSINESS MARKETING SERVICES; BUSINESS PUBLICITY SERVICES; PUBLIC RELATIONS AND PROMOTIONAL SERVICES FOR BUSINESSES; ALL OF AFOREMENTIONED SERVICES FOR USE IN RELATION TO THE PROVISION OF INCENTIVE AND MOTIVATION PROGRAMS, SALES PROMOTIONS AND EMPLOYEE BENEFIT PROGRAMS; ONLINE ADVERTISING AND DIRECT MARKETING SERVICES, NAMELY, THE ORGANIZATION AND SUPERVISION OF LOYALTY AND INCENTIVE SCHEMES, NAMELY CONDUCTING CUSTOMER LOYALTY AND INCENTIVE PROGRAMS AND SCHEMES FOR COMMERCIAL PROMOTION AND ADVERTISING PURPOSES; PROMOTING THE GOODS AND SERVICES OF OTHERS THROUGH THE OPERATION AND ADMINISTRATION OF LOYALTY MARKETING AND OTHER SALES AND PROMOTIONAL INCENTIVE LOYALTY SCHEMES; AND FRANCHISE SERVICES, NAMELY, OFFERING TECHNICAL AND BUSINESS MANAGEMENT ASSISTANCE FOR DEVELOPING AND IMPLEMENTING MOTIVATION AND INCENTIVE PROGRAMS FOR BUSINESSES, THEIR EMPLOYEES, AND THIRD PARTIES; NONE OF THE AFOREMENTIONED SERVICES BEING FOR USE IN THE PROVISION OF BILLING SERVICES, ORDER OR JOB TRACKING SERVICES, TIME AND EXPENSE RECORDAL SERVICES, BUSINESS MILEAGE TRACKING SERVICES, SECRETARIAL AND ADMINISTRATIVE SERVICES, IN CLASS 35 (U.S. CLS. 100, 101 AND 102).

FOR: FINANCIAL SERVICES IN RELATION TO THE PROVISION OF INCENTIVE AND MOTIVATION PROGRAMS, SALES PROMOTIONS AND EMPLOYEE BENEFIT PROGRAMS, NAMELY, BANKING SERVICES INVOLVING THE ISSUANCE

OF REWARD POINTS HAVING MONETARY VALUE; FINANCIAL SERVICES, NAMELY, THE ISSUANCE OF TOKENS AND VOUCHERS OF VALUE VIA THE TELEPHONE AND INTERNET IN CONNECTION WITH THE PROVISION OF INCENTIVE AND MOTIVATION PROGRAMS, SALES PROMOTIONS AND EMPLOYEE BENEFIT PROGRAMS, IN CLASS 36 (U.S. CLS. 100, 101 AND 102).

FOR: TRANSPORT, TRAVEL AND TOURIST AGENCY SERVICES, NAMELY, ARRANGING AND PROVIDING FACILITIES FOR CRUISES, TOURS, EXCURSION AND VACATIONS; ORGANIZATION AND BOOKING OF EXCURSIONS, SIGHT-SEEING TOURS, VACATIONS DEALS, TOURS AND TRAVEL; AIR CARGO HANDLING, NAMELY, BAGGAGE STORAGE, CHECK IN, TRANSPORT AND RETRIEVAL SERVICES; TRANSPORT OF PASSENGERS; FREIGHT HANDLING AND FORWARDING, AND WAREHOUSING SERVICES; CONDUCTING TRAVEL BASED INCENTIVE AWARD PROGRAMS TO PROMOTE THE SALE OF PRODUCTS AND SERVICES OF OTHERS; COORDINATING TRAVEL ARRANGEMENTS FOR GROUPS; TRAVEL INFORMATION SERVICES; ARRANGING, BOOKING AND ORGANIZING THE TRANSPORTATION OF PERSONS, CURRENCY, VALUABLES, AND GOODS IN PARTICULAR BY ROAD, RAIL, SEA AND AIR; AIR TRANSPORTATION SERVICES FEATURING A FREQUENT FLY-

ER BONUS PROGRAM, IN CLASS 39 (U.S. CLS. 100 AND 105).

FOR: TRAINING AND EDUCATIONAL SERVICES DESIGNED TO FACILITATE BUSINESS, BUSINESS PARTNERSHIPS, AND EMPLOYEE IMPROVEMENT, OFFERED THROUGH CLASSES, CONFERENCES, CONGRESSES, WORKSHOPS, SEMINARS, AND SYMPOSIA; PROVISION OF HEALTH CLUB SERVICES, NAMELY, PROVIDING INSTRUCTION AND EQUIPMENT IN THE FIELD OF PHYSICAL EXERCISE; ARRANGING SPORTS EVENTS AND COMPETITIONS; PUBLICATION OF MAGAZINES; ARRANGING CONFERENCES, CONGRESSES, WORKSHOPS, SEMINARS AND SYMPOSIA AND ADVICE, CONSULTATION AND INFORMATION SERVICES RELATING THERETO, IN CLASS 41 (U.S. CLS. 100, 101 AND 107).

PRIORITY DATE OF 6-28-2005 IS CLAIMED.

OWNER OF INTERNATIONAL REGISTRATION 0892031 DATED 7-8-2005, EXPIRES 7-8-2015.

SER. NO. 79-026,449, FILED 7-8-2005.

JULIE GUTTADAURO, EXAMINING ATTORNEY

Int. Cls.: 7 and 9

Prior U.S. Cls.: 13, 19, 21, 23, 26, 31, 34, 35, 36 and 38

Reg. No. 3,576,293

United States Patent and Trademark Office

Registered Feb. 17, 2009

**TRADEMARK
PRINCIPAL REGISTER**

TAPERADER

WEINHOLD, WOLFGANG (FED REP GERMANY
INDIVIDUAL)
HAUGERRING 6
97070 WÜRZBURG
FED REP GERMANY

FOR: COMPRESSED-AIR MACHINES; MILLING MACHINES; ELECTRICAL WAX-POLISHING AND ABRASION MACHINES FOR HOUSEHOLD AND INDUSTRIAL PURPOSES; ELECTRICAL CLEANING MACHINES AND ELECTRICAL CLEANING APPARATUS, NAMELY, FOR FLOOR ABRADING MACHINES LABORATORY CLEANING MACHINES, DRY-CLEANING MACHINES, CARPET-CLEANING MACHINES, SURFACE CLEANING MACHINES USING HIGH PRESSURE WATER, AND FLOOR CLEANING MACHINES; SHARPENING MACHINES, NAMELY, ELECTRIC AND POWER-OPERATED KNIFE-SHARPENERS, POWER-OPERATED DRILL SHARPENERS; GRINDING MACHINES; MACHINE PARTS, NAMELY, GRIND-STONES; CUTTING MACHINES, IN CLASS 7 (U.S. CLS. 13, 19, 21, 23, 31, 34 AND 35).

FOR: SURVEYING, MEASURING, CHECKING AND SUPERVISING APPARATUS, INSTRUMENTS AND MACHINES FOR MEASURING, REGULATING AND CONTROLLING THE BEHAVIOR OF ABRASION AND WEAR OF LACQUER, PLASTIC, METAL, RUBBER, GLASS, CONCRETE COMPOSITE, WOOD, AND TEXTILES; DATA PROCESSORS AND COMPUTERS FOR USE IN THE FIELD OF INSPECTION OF MATERIALS AND SURFACES; ALARM APPARATUSES NAMELY, ALARMS FOR THE DETECTION OF SURFACE IMPURITY AND MATERIAL VARIATION; TESTING APPARATU-

SES, NOT FOR MEDICAL PURPOSES FOR TESTING OF MATERIALS AND SURFACES, NAMELY, PLASTIC, METAL COMPRESSION, HARDNESS AND STRENGTH, GLASS, WOOD, PAINT, LACQUER, CONCRETE, AND STONE; DIAGNOSTIC APPARATUSES, NOT FOR MEDICAL PURPOSES, FOR DIAGNOSING PROPERTIES OF MATERIALS AND SURFACES, NAMELY, PLASTIC, METAL COMPRESSION, HARDNESS AND STRENGTH, GLASS, WOOD, RUBBER, PAINT, LACQUER, CONCRETE, AND STONE; MATERIAL-TESTING AND SURFACE-TESTING INSTRUMENTS AND MACHINES, NAMELY, CEMENT TESTING MACHINES, SURFACE ROUGHNESS TESTING MACHINES, PLASTIC TESTING MACHINES, SURFACE ABRASION TESTING MACHINES, METAL COMPRESSION, HARDNESS AND STRENGTH TESTING MACHINES; PRECISION MEASURING APPARATUSES, NAMELY ABRASION GAUGES, ABRASION DIGITIZERS, FRICTION GAUGES AND DIGITIZERS, IN CLASS 9 (U.S. CLS. 21, 23, 26, 36 AND 38).

PRIORITY DATE OF 1-11-2006 IS CLAIMED.

OWNER OF INTERNATIONAL REGISTRATION
0892889 DATED 7-5-2006, EXPIRES 7-5-2016.

THE WORDING "TAPERADER" HAS NO MEANING IN A FOREIGN LANGUAGE

SER. NO. 79-026,726, FILED 7-5-2006.

SHANNON TWOHIG, EXAMINING ATTORNEY

Int. Cls.: 9 and 10

Prior U.S. Cls.: 21, 23, 26, 36, 38, 39 and 44

United States Patent and Trademark Office

Reg. No. 3,576,294

Registered Feb. 17, 2009

**TRADEMARK
PRINCIPAL REGISTER**

MEDISIZE CREATING SMARTER SOLUTIONS

MEDISIZE B.V. (NETHERLANDS B.V.)
1, EDISONSTRAAT
NL-2181 AB HILLEGOM
NETHERLANDS

FOR: SCIENTIFIC APPARATUS AND INSTRUMENTS, NAMELY, RESPIRATORY THERAPY MACHINES IN THE NATURE OF SELF-RESCUE APPARATUS, NAMELY, OXYGEN BREATHING UNITS; FILTERS FOR RESPIRATORY MASKS; APPARATUS FOR RECORDING, TRANSMISSION OR REPRODUCTION OF SOUND OR IMAGES, IN CLASS 9 (U.S. CLS. 21, 23, 26, 36 AND 38).

FOR: MEDICAL DISPOSABLE ARTICLES, NAMELY, DRAINAGE TUBES, MEDICAL TUBES ON A ROLL, SUCTION DRAINS IN THE NATURE OF WOUND DRAINS; MEDICAL APPARATUS FOR TREATING RESPIRATORY CONDITIONS IN THE NATURE OF HEAT AND MOISTURE EXCHANGER FILTERS; ANESTHESIA MASKS, BREATHING CIR-

CUITS IN THE NATURE OF RESPIRATORY HOSES AND MEDICAL INSTRUMENTS FOR PARTS AND FITTINGS FOR CATHETERS, NAMELY, CATHETER MOUNTS, IN CLASS 10 (U.S. CLS. 26, 39 AND 44).

THE MARK CONSISTS OF STANDARD CHARACTERS WITHOUT CLAIM TO ANY PARTICULAR FONT, STYLE, SIZE, OR COLOR.

PRIORITY DATE OF 6-27-2006 IS CLAIMED.

OWNER OF INTERNATIONAL REGISTRATION 0893645 DATED 7-6-2006, EXPIRES 7-6-2016.

SER. NO. 79-027,012, FILED 7-6-2006.

ALLISON HOLTZ, EXAMINING ATTORNEY

Int. Cl.: 42

Prior U.S. Cls.: 100 and 101

United States Patent and Trademark Office

Reg. No. 3,576,295

Registered Feb. 17, 2009

**SERVICE MARK
PRINCIPAL REGISTER**

I P M A Level B

IPMA INTERNATIONAL PROJECT MANAGE-
MENT ASSOCIATION C/O MAUER & STÄGER
FRAUMÜNSTERSTRASSE 17
CH-8001 ZÜRICH
SWITZERLAND

FOR: TESTING, ANALYSIS AND EVALUATION
OF THE SERVICES OF OTHERS FOR THE PUR-
POSE OF CERTIFICATION, NAMELY, CERTIFY-
ING THAT PROCESSES LINKED TO PROJECTS,
ADMINISTRATIVE PROCESSES, AND MANAGE-
MENT CONDITIONS ARE SUITABLE FOR REACH-
ING PRE-ESTABLISHED BUSINESS OBJECTIVES
FOR A GIVEN LEVEL, IN CLASS 42 (U.S. CLS. 100
AND 101).

THE MARK CONSISTS OF STANDARD CHAR-
ACTERS WITHOUT CLAIM TO ANY PARTICULAR
FONT, STYLE, SIZE, OR COLOR.

PRIORITY DATE OF 1-24-2006 IS CLAIMED.

OWNER OF INTERNATIONAL REGISTRATION
0902383 DATED 5-21-2006, EXPIRES 5-21-2016.

NO CLAIM IS MADE TO THE EXCLUSIVE
RIGHT TO USE "LEVEL B" , APART FROM THE
MARK AS SHOWN.

SER. NO. 79-030,467, FILED 5-21-2006.

PAULA MAHONEY, EXAMINING ATTORNEY

Int. Cl.: 42

Prior U.S. Cls.: 100 and 101

United States Patent and Trademark Office

Reg. No. 3,576,296

Registered Feb. 17, 2009

**SERVICE MARK
PRINCIPAL REGISTER**

I P M A Level D

IPMA INTERNATIONAL PROJECT MANAGE-
MENT ASSOCIATION C/O MAUER & STÄGER
FRAUMÜNSTERSTRASSE 17
CH-8001 ZÜRICH
SWITZERLAND

FOR: TESTING, ANALYSIS AND EVALUATION
OF THE SERVICES OF OTHERS FOR THE PUR-
POSE OF CERTIFICATION, NAMELY, CERTIFY-
ING THAT PROCESSES LINKED TO PROJECTS,
ADMINISTRATIVE PROCESSES, AND MANAGE-
MENT CONDITIONS ARE SUITABLE FOR REACH-
ING PRE-ESTABLISHED BUSINESS OBJECTIVES
FOR A GIVEN LEVEL, IN CLASS 42 (U.S. CLS. 100
AND 101).

THE MARK CONSISTS OF STANDARD CHAR-
ACTERS WITHOUT CLAIM TO ANY PARTICULAR
FONT, STYLE, SIZE, OR COLOR.

PRIORITY DATE OF 1-24-2006 IS CLAIMED.

OWNER OF INTERNATIONAL REGISTRATION
0902384 DATED 5-21-2006, EXPIRES 5-21-2016.

NO CLAIM IS MADE TO THE EXCLUSIVE
RIGHT TO USE "LEVEL D" , APART FROM THE
MARK AS SHOWN.

SER. NO. 79-030,468, FILED 5-21-2006.

PAULA MAHONEY, EXAMINING ATTORNEY

Int. Cl.: 14

Prior U.S. Cls.: 2, 27, 28 and 50

United States Patent and Trademark Office

Reg. No. 3,576,297

Registered Feb. 17, 2009

**TRADEMARK
PRINCIPAL REGISTER**

AIRFIELD



ROBERT JAEGER (FED REP GERMANY INDIVIDUAL)
FRIEDENSTRASSE 106
75173 PFORZHEIM
FED REP GERMANY

OWNER OF INTERNATIONAL REGISTRATION
0904376 DATED 10-13-2006, EXPIRES 10-13-2016.

FOR: JEWELRY, PRECIOUS STONES; HOROLOGICAL AND CHRONOMETRIC INSTRUMENTS, IN CLASS 14 (U.S. CLS. 2, 27, 28 AND 50).

SER. NO. 79-031,262, FILED 10-13-2006.

PRIORITY DATE OF 5-18-2006 IS CLAIMED.

JAMES STEIN, EXAMINING ATTORNEY

Int. Cl.: 30

Prior U.S. Cl.: 46

United States Patent and Trademark Office

Reg. No. 3,576,298

Registered Feb. 17, 2009

**TRADEMARK
PRINCIPAL REGISTER**

HEIDI - KAFFEE

ROST AG (SWITZERLAND CORPORATION)
3A, FRIESLIRAIN,
CH-6210 SURSEE
SWITZERLAND

NO CLAIM IS MADE TO THE EXCLUSIVE
RIGHT TO USE "KAFFEE", APART FROM THE
MARK AS SHOWN.

FOR: COFFEE (ROASTED), IN CLASS 30 (U.S. CL.
46).

THE ENGLISH TRANSLATION OF THE WORD
"KAFFEE" IN THE MARK IS COFFEE.

THE MARK CONSISTS OF STANDARD CHAR-
ACTERS WITHOUT CLAIM TO ANY PARTICULAR
FONT, STYLE, SIZE, OR COLOR.

SER. NO. 79-031,380, FILED 9-16-2006.

OWNER OF INTERNATIONAL REGISTRATION
0904703 DATED 9-16-2006, EXPIRES 9-16-2016.

ANDREA HACK, EXAMINING ATTORNEY

Int. Cl.: 43

Prior U.S. Cls.: 100 and 101

United States Patent and Trademark Office

Reg. No. 3,576,299

Registered Feb. 17, 2009

**SERVICE MARK
PRINCIPAL REGISTER**

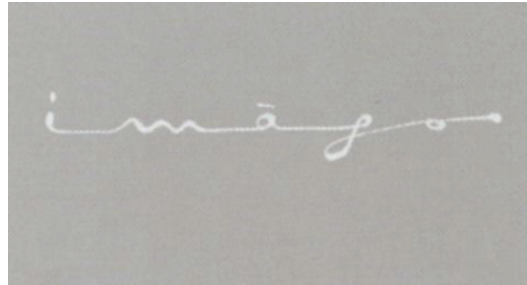

HASSLER ROMA S.P.A. (ITALY SOCIÉTÉ PAR
ACTIONS)
PIAZZA TRINITÀ DEI MONTI, 6
I-00187 ROMA, ITALY

FOR: HOTEL AND RESTAURANT SERVICES, IN
CLASS 43 (U.S. CLS. 100 AND 101).

PRIORITY DATE OF 8-9-2006 IS CLAIMED.

OWNER OF INTERNATIONAL REGISTRATION
0906099 DATED 10-11-2006, EXPIRES 10-11-2016.

THE COLOR(S) WHITE AND SILVER IS/ARE
CLAIMED AS A FEATURE OF THE MARK.

THE COLOR WHITE APPEARS IN THE TEXT OF
THE WORDING "IMAGO". THE COLOR SILVER
SERVES AS THE BACKGROUND FOR THE MARK.

THE ENGLISH TRANSLATION OF "IMAGO" IS
IMAGE.

SER. NO. 79-031,956, FILED 10-11-2006.

ELI HELLMAN, EXAMINING ATTORNEY

Int. Cl.: 25

Prior U.S. Cls.: 22 and 39

United States Patent and Trademark Office

Reg. No. 3,576,300

Registered Feb. 17, 2009

**TRADEMARK
PRINCIPAL REGISTER**

Ermenegildo Zegna
COUTURE

ERMENEGILDO ZEGNA CORPORATION (NEW
YORK CORPORATION)

100 WEST FOREST AVENUE

ENGLEWOOD, NJ 07631

UNITED STATES

FOR: CLOTHING, NAMELY, OVERCOATS,
COATS, SUITS, TUXEDOS, JACKETS, SPORTS
COATS, BLAZERS, PANTS, TROUSERS, SHIRTS,
SWEATERS, PULLOVERS, CARDIGANS, VESTS,
TIES, POCKET SQUARES, SCARVES; BELTS; FOOT-
WEAR AND HEADWEAR, IN CLASS 25 (U.S. CLS. 22
AND 39).

PRIORITY DATE OF 9-27-2006 IS CLAIMED.

OWNER OF INTERNATIONAL REGISTRATION
0906808A DATED 11-21-2006, EXPIRES 11-21-2016.

NO CLAIM IS MADE TO THE EXCLUSIVE
RIGHT TO USE "COUTURE", APART FROM THE
MARK AS SHOWN.

THE NAME(S), PORTRAIT(S), AND/OR SIGNA-
TURE(S) SHOWN IN THE MARK DOES NOT IDEN-
TIFY A PARTICULAR LIVING INDIVIDUAL.

SER. NO. 79-032,226, FILED 11-21-2006.

WILLIAM P. SHANAHAN, EXAMINING ATTOR-
NEY

Int. Cl.: 2

Prior U.S. Cls.: 6, 11 and 16

United States Patent and Trademark Office

Reg. No. 3,576,301

Registered Feb. 17, 2009

**TRADEMARK
PRINCIPAL REGISTER**

LUCIDOT

CLARIANT AG (SWITZERLAND AKTIENGESELLSCHAFT)

ROTHAUSSTRASSE 61

CH-4132 MUTTENZ

SWITZERLAND

FOR: DYES AND STAINS FOR USE IN INDUSTRY FOR DYEING AND MODIFICATION OF PLASTICS, FOR APPLICATION IN SOLAR ENERGY APPARATUS, IN (O)LED AND OTHER PHOTO-ELECTRONIC DEVICES , IN CLASS 2 (U.S. CLS. 6, 11 AND 16).

THE MARK CONSISTS OF STANDARD CHARACTERS WITHOUT CLAIM TO ANY PARTICULAR FONT, STYLE, SIZE, OR COLOR.

PRIORITY DATE OF 7-27-2006 IS CLAIMED.

OWNER OF INTERNATIONAL REGISTRATION 0906859 DATED 11-15-2006, EXPIRES 11-15-2016.

SER. NO. 79-032,250, FILED 11-15-2006.

LINDA M. KING, EXAMINING ATTORNEY

Int. Cl.: 6

Prior U.S. Cls.: 2, 12, 13, 14, 23, 25 and 50

United States Patent and Trademark Office

Reg. No. 3,576,302

Registered Feb. 17, 2009

**TRADEMARK
PRINCIPAL REGISTER**

SPECTRE

SPANSET INTER AG
SAMSTAGERSTRASSE 45
CH-8832 WOLLERAU
SWITZERLAND

LIFTING GEAR AND INDUSTRIAL BELTS, IN
CLASS 6 (U.S. CLS. 2, 12, 13, 14, 23, 25 AND 50).

PRIORITY DATE OF 11-11-2005 IS CLAIMED.

FOR: DEVICES OF METAL FOR LIFTING AND
SECURING LOADS, NAMELY CHAINS, STEEL
CABLES AND LOAD EQUALIZERS; DEVICES OF
METAL FOR LIFTING AND SECURING LOADS,
NAMELY DEVICES AND EQUIPMENT TO PRO-
TECT THE AFORESAID GOODS AGAINST DA-
MAGE AND OVERLOADING, NAMELY BELTS OF
METAL FOR HANDLING LOADS; SMALL IRON
FITTINGS FOR SLING BANDS, LIFTING SLINGS,

OWNER OF INTERNATIONAL REGISTRATION
0908304 DATED 4-26-2006, EXPIRES 4-26-2016.

SER. NO. 79-032,816, FILED 4-26-2006.

SUZANNE BLANE, EXAMINING ATTORNEY

Int. Cls.: 1, 3, 5, 29, 30, 32, 35, 40 and 42

Prior U.S. Cls.: 1, 4, 5, 6, 10, 18, 26, 44, 45, 46, 48, 50,
51, 52, 100, 101, 102, 103 and 106

Reg. No. 3,576,303

United States Patent and Trademark Office

Registered Feb. 17, 2009

**TRADEMARK
SERVICE MARK
PRINCIPAL REGISTER**



TOYO SHINYAKU CO., LTD. (JAPAN JOINT
STOCK COMPANY)
19-27, HAKATAEKIMAE 2-CHOME
HAKATA-KU.; FUKUOKA-SHI; FUKUOKA-KEN
812-0011
JAPAN

FOR: CHEMICALS FOR USE IN INDUSTRY, NAMELY, FRAGRANCES FOR USE IN MANUFACTURING COSMETICS, ANTI-CREASING AGENTS, NAMELY, CHEMICAL AGENTS FOR PREVENTING TEXTILES FROM WRINKLING; HEAT RETAINING PREPARATIONS, NAMELY, POLYMER GEL USED IN HEATING PADS, HEAT TRANSFER FLUIDS FOR INDUSTRIAL USE; CHEMICALS AS RAW MATERIALS FOR COSMETICS, NAMELY, CHEMICAL ADDITIVES FOR USE IN THE MANUFACTURE OF COSMETICS, MAINLY CONTAINING PROTEINS; CHEMICALS AS RAW MATERIALS FOR COSMETICS, NAMELY, CHEMICAL ADDITIVES FOR USE IN THE MANUFACTURE OF COSMETICS, MAINLY CONTAINING ENZYMES; CHEMICALS AS RAW MATERIALS FOR COSMETICS, NAMELY, CHEMICAL ADDITIVES FOR USE IN THE MANUFACTURE OF COSMETICS, MAINLY CONTAINING COLLAGEN; CHEMICALS AS RAW MATERIALS FOR COSMETICS, NAMELY, CHEMICAL ADDITIVES FOR USE IN THE MANUFACTURE OF COSMETICS, MAINLY CONTAINING OLIGOMERIC PROANTHOCYANIDINS EXTRACTED FROM PINE BARK; CHEMICALS AS RAW MATERIALS FOR COSMETICS, NAMELY, CHEMICAL ADDITIVES FOR USE IN THE MANUFACTURE OF COSMETICS, MAINLY CONTAINING SWEET POTATO FIBER; CHEMICALS AS RAW MATERIALS FOR COSMETICS, NAMELY, CHEMICAL ADDITIVES FOR USE IN THE MANUFACTURE OF COSMETICS, MAINLY CONTAINING TUBER VEGETABLE FIBER; CHEMICALS AS RAW MATERIALS FOR COSMETICS, NAMELY, CHEMICAL ADDITIVES FOR USE IN

THE MANUFACTURE OF COSMETICS, MAINLY CONTAINING YOUNG BARLEY LEAF FIBER; CHEMICALS AS RAW MATERIALS FOR COSMETICS, NAMELY, CHEMICAL ADDITIVES FOR USE IN THE MANUFACTURE OF COSMETICS, MAINLY CONTAINING YOUNG SWEET-POTATO LEAF FIBER; CHEMICALS AS RAW MATERIALS FOR COSMETICS, NAMELY, CHEMICAL ADDITIVES FOR USE IN THE MANUFACTURE OF COSMETICS, MAINLY CONTAINING KALE FIBER; CHEMICALS AS RAW MATERIALS FOR COSMETICS, NAMELY, CHEMICAL ADDITIVES FOR USE IN THE MANUFACTURE OF COSMETICS, MAINLY CONTAINING TERMINALIA BELLIRICA EXTRACT; CHEMICALS AS RAW MATERIALS FOR COSMETICS, NAMELY, CHEMICAL ADDITIVES FOR USE IN THE MANUFACTURE OF COSMETICS, MAINLY CONTAINING KUDZU VINE FLOWER EXTRACT; CHEMICALS AS RAW MATERIALS FOR COSMETICS, NAMELY, CHEMICAL ADDITIVES FOR USE IN THE MANUFACTURE OF COSMETICS, MAINLY CONTAINING LOQUAT LEAF EXTRACT; CHEMICALS AS RAW MATERIALS FOR COSMETICS, NAMELY, CHEMICAL ADDITIVES FOR USE IN THE MANUFACTURE OF COSMETICS, MAINLY CONTAINING GANODERMA LUCIDUM EXTRACT; CHEMICALS AS RAW MATERIALS FOR COSMETICS, NAMELY, CHEMICAL ADDITIVES FOR USE IN THE MANUFACTURE OF COSMETICS, MAINLY CONTAINING BLACK VINEGAR; CHEMICALS AS RAW MATERIALS FOR COSMETICS, NAMELY, CHEMICAL ADDITIVES FOR USE IN THE MANUFACTURE OF COSMETICS, MAINLY CONTAINING CABBAGE, ORANGE, ONION, CARROT AND GREEN CHILI EXTRACT; CHEMICALS AS RAW MATERIALS FOR COSMETICS, NAMELY, CHEMICAL ADDITIVES FOR USE

IN THE MANUFACTURE OF COSMETICS, MAINLY CONTAINING S-ADENOSYLMETHIONINE; CHEMICALS AS RAW MATERIALS FOR COSMETICS, NAMELY, CHEMICAL ADDITIVES FOR USE IN THE MANUFACTURE OF COSMETICS, MAINLY CONTAINING NATA DE COCO FIBER , IN CLASS 1 (U.S. CLS. 1, 5, 6, 10, 26 AND 46).

FOR: FACE CREAM, BODY CREAM, EYE CREAM, HAIR CREAM, FACE LOTION, MILKY LOTION FOR SKIN, ANTI-AGING BEAUTY SERA FOR SKIN, WHITENING BEAUTY SERA FOR SKIN, OIL-CONTROLLING BEAUTY SERA FOR SKIN, MOISTURIZING BEAUTY SERA FOR SKIN, LIFTING BEAUTY SERA FOR SKIN, ANTI-WRINKLE BEAUTY SERA FOR SKIN, FACIAL CLEANSING FOAM, MAKEUP REMOVING CREAM AND OTHER COSMETICS MAINLY CONTAINING OLIGOMERIC PROANTHOCYANIDINS EXTRACTED FROM PINE BARK; SOAPS AND SHAMPOOS MAINLY CONTAINING OLIGOMERIC PROANTHOCYANIDINS EXTRACTED FROM PINE BARK; TOOTH PASTE MAINLY CONTAINING OLIGOMERIC PROANTHOCYANIDINS EXTRACTED FROM PINE BARK; MOUTHWASH MAINLY CONTAINING OLIGOMERIC PROANTHOCYANIDINS EXTRACTED FROM PINE BARK; PERFUMERY MAINLY CONTAINING OLIGOMERIC PROANTHOCYANIDINS EXTRACTED FROM PINE BARK; NON-MEDICATED BATH SALTS MAINLY CONTAINING OLIGOMERIC PROANTHOCYANIDINS EXTRACTED FROM PINE BARK; FACE CREAM, BODY CREAM, EYE CREAM, HAIR CREAM, FACE LOTION, MILKY LOTION FOR SKIN, ANTI-AGING BEAUTY SERA FOR SKIN, WHITENING BEAUTY SERA FOR SKIN, OIL-CONTROLLING BEAUTY SERA FOR SKIN, MOISTURIZING BEAUTY SERA FOR SKIN, LIFTING BEAUTY SERA FOR SKIN, ANTI-WRINKLE BEAUTY SERA FOR SKIN, FACIAL CLEANSING FOAM, MAKEUP REMOVING CREAM AND OTHER COSMETICS MAINLY CONTAINING SWEET POTATO FIBER; SOAPS AND SHAMPOOS MAINLY CONTAINING SWEET POTATO FIBER; TOOTH PASTE MAINLY CONTAINING SWEET POTATO FIBER; MOUTHWASH MAINLY CONTAINING SWEET POTATO FIBER; PERFUMERY MAINLY CONTAINING SWEET POTATO FIBER; NON-MEDICATED BATH SALTS MAINLY CONTAINING SWEET POTATO FIBER, FACE CREAM, BODY CREAM, EYE CREAM, HAIR CREAM, FACE LOTION, MILKY LOTION FOR SKIN, ANTI-AGING BEAUTY SERA FOR SKIN, WHITENING BEAUTY SERA FOR SKIN, OIL-CONTROLLING BEAUTY SERA FOR SKIN, MOISTURIZING BEAUTY SERA FOR SKIN, LIFTING BEAUTY SERA FOR SKIN, ANTI-WRINKLE BEAUTY SERA FOR SKIN, FACIAL CLEANSING FOAM, MAKEUP REMOVING CREAM AND OTHER COSMETICS MAINLY CONTAINING TUBER VEGETABLE FIBER; SOAPS AND SHAMPOOS MAINLY CONTAINING TUBER VEGETABLE FIBER; TOOTH PASTE MAINLY CONTAINING TUBER VEGETABLE FIBER; MOUTHWASH MAINLY CONTAINING TUBER VEGETABLE FIBER; PERFUMERY MAINLY CONTAINING TUBER VEGETABLE FIBER; NON-MEDICATED BATH SALTS MAINLY CONTAINING TUBER VEGETABLE FI-

BER; FACE CREAM, BODY CREAM, EYE CREAM, HAIR CREAM, FACE LOTION, MILKY LOTION FOR SKIN, ANTI-AGING BEAUTY SERA FOR SKIN, WHITENING BEAUTY SERA FOR SKIN, OIL-CONTROLLING BEAUTY SERA FOR SKIN, MOISTURIZING BEAUTY SERA FOR SKIN, LIFTING BEAUTY SERA FOR SKIN, ANTI-WRINKLE BEAUTY SERA FOR SKIN, FACIAL CLEANSING FOAM, MAKEUP REMOVING CREAM AND OTHER COSMETICS MAINLY CONTAINING YOUNG BARLEY LEAF FIBER; SOAPS AND SHAMPOOS MAINLY CONTAINING YOUNG BARLEY LEAF FIBER; TOOTH PASTE MAINLY CONTAINING YOUNG BARLEY LEAF FIBER; MOUTHWASH MAINLY CONTAINING YOUNG BARLEY LEAF FIBER; PERFUMERY MAINLY CONTAINING YOUNG BARLEY LEAF FIBER; NON-MEDICATED BATH SALTS MAINLY CONTAINING YOUNG BARLEY LEAF FIBER; FACE CREAM, BODY CREAM, EYE CREAM, HAIR CREAM, FACE LOTION, MILKY LOTION FOR SKIN, ANTI-AGING BEAUTY SERA FOR SKIN, WHITENING BEAUTY SERA FOR SKIN, OIL-CONTROLLING BEAUTY SERA FOR SKIN, MOISTURIZING BEAUTY SERA FOR SKIN, LIFTING BEAUTY SERA FOR SKIN, ANTI-WRINKLE BEAUTY SERA FOR SKIN, FACIAL CLEANSING FOAM, MAKEUP REMOVING CREAM AND OTHER COSMETICS MAINLY CONTAINING YOUNG SWEET-POTATO LEAF FIBER, SOAPS AND SHAMPOOS MAINLY CONTAINING YOUNG SWEET-POTATO LEAF FIBER; TOOTH PASTE MAINLY CONTAINING YOUNG SWEET-POTATO LEAF FIBER; MOUTHWASH MAINLY CONTAINING YOUNG SWEET-POTATO LEAF FIBER; PERFUMERY MAINLY CONTAINING YOUNG SWEET-POTATO LEAF FIBER; NON-MEDICATED BATH SALTS MAINLY CONTAINING YOUNG SWEET-POTATO LEAF FIBER; FACE CREAM, BODY CREAM, EYE CREAM, HAIR CREAM, FACE LOTION, MILKY LOTION FOR SKIN, ANTI-AGING BEAUTY SERA FOR SKIN, WHITENING BEAUTY SERA FOR SKIN, OIL-CONTROLLING BEAUTY SERA FOR SKIN, MOISTURIZING BEAUTY SERA FOR SKIN, LIFTING BEAUTY SERA FOR SKIN, ANTI-WRINKLE BEAUTY SERA FOR SKIN, FACIAL CLEANSING FOAM, MAKEUP REMOVING CREAM AND OTHER COSMETICS MAINLY CONTAINING TERMINALIA BELLIRICA EXTRACT; SOAPS AND SHAMPOOS MAINLY CONTAINING TERMINALIA BELLIRICA EXTRACT; TOOTH PASTE MAINLY CONTAINING TERMINALIA BELLIRICA EXTRACT; MOUTHWASH MAINLY CONTAINING TERMINALIA BELLIRICA EXTRACT; PERFUMERY MAINLY CONTAINING TERMINALIA BELLIRICA EXTRACT; NON-MEDICATED BATH SALTS MAINLY CONTAINING TERMINALIA BELLIRICA EXTRACT; FACE CREAM, BODY CREAM, EYE CREAM, HAIR CREAM, FACE LOTION, MILKY LOTION FOR SKIN, ANTI-AGING BEAUTY SERA FOR SKIN, WHITENING BEAUTY SERA FOR SKIN, OIL-CONTROLLING BEAUTY SERA FOR SKIN, MOISTURIZING BEAUTY SERA FOR SKIN, LIFTING BEAUTY SERA FOR SKIN, ANTI-WRINKLE BEAUTY SERA FOR SKIN, FACIAL CLEANSING FOAM, MAKEUP REMOVING CREAM AND OTHER COSMETICS MAINLY CONTAINING KUD-

ZU VINE FLOWER EXTRACT; SOAPS AND SHAMPOOS MAINLY CONTAINING KUDZU VINE FLOWER EXTRACT; TOOTHPASTE MAINLY CONTAINING KUDZU VINE FLOWER EXTRACT; MOUTHWASH MAINLY CONTAINING KUDZU VINE FLOWER EXTRACT; PERFUMERY MAINLY CONTAINING KUDZU VINE FLOWER EXTRACT; NON-MEDICATED BATH SALTS MAINLY CONTAINING KUDZU VINE FLOWER EXTRACT; FACE CREAM, BODY CREAM, EYE CREAM, HAIR CREAM, FACE LOTION, MILKY LOTION FOR SKIN, ANTI-AGING BEAUTY SERA FOR SKIN, WHITENING BEAUTY SERA FOR SKIN, OIL-CONTROLLING BEAUTY SERA FOR SKIN, MOISTURIZING BEAUTY SERA FOR SKIN, LIFTING BEAUTY SERA FOR SKIN, ANTI-WRINKLE BEAUTY SERA FOR SKIN, FACIAL CLEANSING FOAM, MAKEUP REMOVING CREAM AND OTHER COSMETICS MAINLY CONTAINING LOQUAT LEAF EXTRACT; SOAPS AND SHAMPOOS MAINLY CONTAINING LOQUAT LEAF EXTRACT; TOOTHPASTE MAINLY CONTAINING LOQUAT LEAF EXTRACT; MOUTHWASH MAINLY CONTAINING LOQUAT LEAF EXTRACT; PERFUMERY MAINLY CONTAINING LOQUAT LEAF EXTRACT; NON-MEDICATED BATH SALTS MAINLY CONTAINING LOQUAT LEAF EXTRACT; FACE CREAM, BODY CREAM, EYE CREAM, HAIR CREAM, FACE LOTION, MILKY LOTION FOR SKIN, ANTI-AGING BEAUTY SERA FOR SKIN, WHITENING BEAUTY SERA FOR SKIN, OIL-CONTROLLING BEAUTY SERA FOR SKIN, MOISTURIZING BEAUTY SERA FOR SKIN, LIFTING BEAUTY SERA FOR SKIN, ANTI-WRINKLE BEAUTY SERA FOR SKIN, FACIAL CLEANSING FOAM, MAKEUP REMOVING CREAM AND OTHER COSMETICS MAINLY CONTAINING KALE FIBER; SOAPS AND SHAMPOOS MAINLY CONTAINING KALE FIBER; TOOTHPASTE MAINLY CONTAINING KALE FIBER; MOUTHWASH MAINLY CONTAINING KALE FIBER; PERFUMERY MAINLY CONTAINING KALE FIBER; NON-MEDICATED BATH SALTS MAINLY CONTAINING KALE FIBER; FACE CREAM, BODY CREAM, EYE CREAM, HAIR CREAM, FACE LOTION, MILKY LOTION FOR SKIN, ANTI-AGING BEAUTY SERA FOR SKIN, WHITENING BEAUTY SERA FOR SKIN, OIL-CONTROLLING BEAUTY SERA FOR SKIN, MOISTURIZING BEAUTY SERA FOR SKIN, LIFTING BEAUTY SERA FOR SKIN, ANTI-WRINKLE BEAUTY SERA FOR SKIN, FACIAL CLEANSING FOAM, MAKEUP REMOVING CREAM AND OTHER COSMETICS MAINLY CONTAINING GANODERMA LUCIDUM EXTRACT; SOAPS AND SHAMPOOS MAINLY CONTAINING GANODERMA LUCIDUM EXTRACT; TOOTHPASTE MAINLY CONTAINING GANODERMA LUCIDUM EXTRACT; MOUTHWASH MAINLY CONTAINING GANODERMA LUCIDUM EXTRACT; PERFUMERY MAINLY CONTAINING GANODERMA LUCIDUM EXTRACT; NON-MEDICATED BATH SALTS MAINLY CONTAINING GANODERMA LUCIDUM EXTRACT; FACE CREAM, BODY CREAM, EYE CREAM, HAIR CREAM, FACE LOTION, MILKY LOTION FOR SKIN, ANTI-AGING BEAUTY SERA FOR SKIN, WHITENING BEAUTY SERA FOR SKIN, OIL-CONTROLLING BEAUTY SERA FOR SKIN, MOISTUR-

IZING BEAUTY SERA FOR SKIN, LIFTING BEAUTY SERA FOR SKIN, ANTI-WRINKLE BEAUTY SERA FOR SKIN, FACIAL CLEANSING FOAM, MAKEUP REMOVING CREAM AND OTHER COSMETICS MAINLY CONTAINING BLACK VINEGAR; SOAPS AND SHAMPOOS MAINLY CONTAINING BLACK VINEGAR; TOOTHPASTE MAINLY CONTAINING BLACK VINEGAR; MOUTHWASH MAINLY CONTAINING BLACK VINEGAR; PERFUMERY MAINLY CONTAINING BLACK VINEGAR; NON-MEDICATED BATH SALTS MAINLY CONTAINING BLACK VINEGAR; FACE CREAM, BODY CREAM, EYE CREAM, HAIR CREAM, FACE LOTION, MILKY LOTION FOR SKIN, ANTI-AGING BEAUTY SERA FOR SKIN, WHITENING BEAUTY SERA FOR SKIN, OIL-CONTROLLING BEAUTY SERA FOR SKIN, MOISTURIZING BEAUTY SERA FOR SKIN, LIFTING BEAUTY SERA FOR SKIN, ANTI-WRINKLE BEAUTY SERA FOR SKIN, FACIAL CLEANSING FOAM, MAKEUP REMOVING CREAM AND OTHER COSMETICS MAINLY CONTAINING MACA EXTRACT; SOAPS AND SHAMPOOS MAINLY CONTAINING MACA EXTRACT; TOOTHPASTE MAINLY CONTAINING MACA EXTRACT; MOUTHWASH MAINLY CONTAINING MACA EXTRACT; PERFUMERY MAINLY CONTAINING MACA EXTRACT; NON-MEDICATED BATH SALTS MAINLY CONTAINING MACA EXTRACT, FACE CREAM, BODY CREAM, EYE CREAM, HAIR CREAM, FACE LOTION, MILKY LOTION FOR SKIN, ANTI-AGING BEAUTY SERA FOR SKIN, WHITENING BEAUTY SERA FOR SKIN, OIL-CONTROLLING BEAUTY SERA FOR SKIN, MOISTURIZING BEAUTY SERA FOR SKIN, LIFTING BEAUTY SERA FOR SKIN, ANTI-WRINKLE BEAUTY SERA FOR SKIN, FACIAL CLEANSING FOAM, MAKEUP REMOVING CREAM AND OTHER COSMETICS MAINLY CONTAINING EXTRACTS OF CABBAGE, ORANGE, ONION, CARROT AND GREEN CHILI; SOAPS AND SHAMPOOS MAINLY CONTAINING EXTRACTS OF CABBAGE, ORANGE, ONION, CARROT AND GREEN CHILI; TOOTHPASTE MAINLY CONTAINING EXTRACTS OF CABBAGE, ORANGE, ONION, CARROT AND GREEN CHILI; MOUTHWASH MAINLY CONTAINING EXTRACTS OF CABBAGE, ORANGE, ONION, CARROT AND GREEN CHILI; PERFUMERY MAINLY CONTAINING EXTRACTS OF CABBAGE, ORANGE, ONION, CARROT AND GREEN CHILI; NON-MEDICATED BATH SALTS MAINLY CONTAINING EXTRACTS OF CABBAGE, ORANGE, ONION, CARROT AND GREEN CHILI; FACE CREAM, BODY CREAM, EYE CREAM, HAIR CREAM, FACE LOTION, MILKY LOTION FOR SKIN, ANTI-AGING BEAUTY SERA FOR SKIN, WHITENING BEAUTY SERA FOR SKIN, OIL-CONTROLLING BEAUTY SERA FOR SKIN, MOISTURIZING BEAUTY SERA FOR SKIN, LIFTING BEAUTY SERA FOR SKIN, ANTI-WRINKLE BEAUTY SERA FOR SKIN, FACIAL CLEANSING FOAM, MAKEUP REMOVING CREAM AND OTHER COSMETICS MAINLY CONTAINING S-ADENOSYLMETHIONINE; SOAPS AND SHAMPOOS MAINLY CONTAINING S-ADENOSYLMETHIONINE; TOOTHPASTE MAINLY CONTAINING S-ADENOSYLMETHIONINE; MOUTHWASH MAINLY CONTAINING S-ADENOSYLMETHIONINE;

PERFUMERY MAINLY CONTAINING S-ADENOSYLMETHIONINE; NON-MEDICATED BATH SALTS MAINLY CONTAINING S-ADENOSYLMETHIONINE; COSMETIC BODY, FACIAL, AND SKIN MASKS MAINLY CONTAINING NATA DE COCO FIBER; MASKS MAINLY CONTAINING NATA DE COCO FIBER; SHEET-SHAPED SOAP MAINLY CONTAINING NATA DE COCO FIBER, FACE CREAM, BODY CREAM, EYE CREAM, HAIR CREAM, FACE LOTION, MILKY LOTION FOR SKIN, ANTI-AGING BEAUTY SERA FOR SKIN, WHITENING BEAUTY SERA FOR SKIN, OIL-CONTROLLING BEAUTY SERA FOR SKIN, MOISTURIZING BEAUTY SERA FOR SKIN, LIFTING BEAUTY SERA FOR SKIN, ANTI-WRINKLE BEAUTY SERA FOR SKIN, FACIAL CLEANSING FOAM, MAKEUP REMOVING CREAM AND OTHER COSMETICS MAINLY CONTAINING NATA DE COCO FIBER; SOAPS AND SHAMPOOS MAINLY CONTAINING NATA DE COCO FIBER; TOOTHPASTE MAINLY CONTAINING NATA DE COCO FIBER; MOUTHWASH MAINLY CONTAINING NATA DE COCO FIBER; PERFUMERY MAINLY CONTAINING NATA DE COCO FIBER; NON-MEDICATED BATH SALTS MAINLY CONTAINING NATA DE COCO FIBER; SOAPS AND DETERGENTS; DENTIFRICES; COSMETICS AND NON-MEDICATED TOILETRIES; COSMETICS AND NON-MEDICATED TOILETRIES IN SHEET FORM; PERFUMERY, FRAGRANCES, NAMELY, ROOM FRAGRANCES AND FRAGRANCES FOR COSMETICS, NAMELY, FRAGRANCES FOR PERSONAL USE, AND INCENSES, IN CLASS 3 (U.S. CLS. 1, 4, 6, 50, 51 AND 52).

FOR: SHEET-SHAPED PHARMACEUTICALS MAINLY CONTAINING NATA DE COCO FIBER FOR THE TREATMENT OF DERMATOLOGICAL DISORDERS, CARDIAC DISORDERS, MENOPAUSAL SYMPTOMS AND ASTHMA, AND USED AS NICOTINE PATCHES FOR SMOKING CESSATION; SHEET-SHAPED ANTIPHLOGISTIC REFRIGERANTS, NAMELY, ANTI-INFLAMMATORIES, MAINLY CONTAINING NATA DE COCO FIBER; SHEET-SHAPED THERAPEUTIC REFRIGERANTS, NAMELY, ANTIPYRETICS MAINLY CONTAINING NATA DE COCO FIBER; SHEET-SHAPED PATCHES MAINLY CONTAINING NATA DE COCO FIBER, NAMELY, TRANSDERMAL PATCHES, NAMELY, CATAPLASM AND POULTICE, FOR USE IN THE TREATMENT OF CONTUSIONS AND WOUNDS; PHARMACEUTICALS MAINLY CONTAINING OLIGOMERIC PROANTHOCYANIDINS EXTRACTED FROM PINE BARK FOR THE TREATMENT OF DISORDERS IN THE CENTRAL NERVOUS SYSTEM, THE PERIPHERAL NERVOUS SYSTEM, THE RESPIRATORY ORGANS, THE DIGESTIVE ORGANS, THE URO-GENITAL AND ANAL ORGANS, AND THE EPIDERMIS, AND THE TREATMENT OF RHINITIC DISEASES, OTITIC DISEASES, HEPATIC DISEASES, DIABETES, GOUT, ALLERGIC DISEASES, ADDICTIONS, GYNECOLOGICAL DISEASES AND CARDIOVASCULAR DISEASES; PHARMACEUTICALS MAINLY CONTAINING OLIGOMERIC PROANTHOCYANIDINS EXTRACTED FROM PINE BARK, NAMELY, CONTRACEPTIVES, EYE DROPS, SOLUTIONS FOR CONTACT LENSES, PHARMACEUTICALS FOR DENTAL TREAT-

MENTS, HEMOSTATS, ALEXIPHARMICS; PHARMACEUTICALS MAINLY CONTAINING OLIGOMERIC PROANTHOCYANIDINS EXTRACTED FROM PINE BARK, NAMELY, PHARMACEUTICALS FOR TREATING SUBSTANCE ABUSES AND ADDICTIONS; NUTRITIONAL ADDITIVES FOR USE IN FOODS AND DIETARY SUPPLEMENTS FOR HUMAN CONSUMPTION FOR MEDICAL USE MAINLY CONTAINING OLIGOMERIC PROANTHOCYANIDINS EXTRACTED FROM PINE BARK; DIETARY CURE FOODS, NAMELY, DIETETIC FOODS ADAPTED FOR MEDICAL USE, MAINLY CONTAINING OLIGOMERIC PROANTHOCYANIDINS EXTRACTED FROM PINE BARK, PHARMACEUTICALS MAINLY CONTAINING SWEET POTATO FIBER FOR THE TREATMENT OF DISORDERS IN THE CENTRAL NERVOUS SYSTEM, THE PERIPHERAL NERVOUS SYSTEM, THE RESPIRATORY ORGANS, THE DIGESTIVE ORGANS, THE URO-GENITAL AND ANAL ORGANS, AND THE EPIDERMIS, AND THE TREATMENT OF RHINITIC DISEASES, OTITIC DISEASES, HEPATIC DISEASES, DIABETES, GOUT, ALLERGIC DISEASES, ADDICTIONS, GYNECOLOGICAL DISEASES AND CARDIOVASCULAR DISEASES; PHARMACEUTICALS MAINLY CONTAINING SWEET POTATO FIBER, NAMELY, CONTRACEPTIVES, EYE DROPS, SOLUTIONS FOR CONTACT LENSES, PHARMACEUTICALS FOR DENTAL TREATMENTS, HEMOSTATS, ALEXIPHARMICS; PHARMACEUTICALS MAINLY CONTAINING SWEET POTATO FIBER, NAMELY, PHARMACEUTICALS FOR TREATING SUBSTANCE ABUSES AND ADDICTIONS; NUTRITIONAL ADDITIVES FOR USE IN FOODS AND DIETARY SUPPLEMENTS FOR HUMAN CONSUMPTION FOR MEDICAL USE MAINLY CONTAINING SWEET POTATO FIBER; DIETARY CURE FOODS, NAMELY, DIETETIC FOODS ADAPTED FOR MEDICAL USE, MAINLY CONTAINING SWEET POTATO FIBER; PHARMACEUTICALS MAINLY CONTAINING TUBER VEGETABLE FIBER FOR THE TREATMENT OF DISORDERS IN THE CENTRAL NERVOUS SYSTEM, THE PERIPHERAL NERVOUS SYSTEM, THE RESPIRATORY ORGANS, THE DIGESTIVE ORGANS, THE URO-GENITAL AND ANAL ORGANS, AND THE EPIDERMIS, AND THE TREATMENT OF RHINITIC DISEASES, OTITIC DISEASES, HEPATIC DISEASES, DIABETES, GOUT, ALLERGIC DISEASES, ADDICTIONS, GYNECOLOGICAL DISEASES AND CARDIOVASCULAR DISEASES; PHARMACEUTICALS MAINLY CONTAINING TUBER VEGETABLE FIBER, NAMELY, CONTRACEPTIVES, EYE DROPS, SOLUTIONS FOR CONTACT LENSES, PHARMACEUTICALS FOR DENTAL TREATMENTS, HEMOSTATS, ALEXIPHARMICS; PHARMACEUTICALS MAINLY CONTAINING TUBER VEGETABLE FIBER, NAMELY, PHARMACEUTICALS FOR TREATING SUBSTANCE ABUSES AND ADDICTIONS; NUTRITIONAL ADDITIVES FOR USE IN FOODS AND DIETARY SUPPLEMENTS FOR HUMAN CONSUMPTION FOR MEDICAL USE MAINLY CONTAINING TUBER VEGETABLE FIBER, DIETARY CURE FOODS, NAMELY, DIETETIC FOODS ADAPTED FOR MEDICAL USE, MAINLY CONTAINING TUBER VEGETABLE FIBER; PHAR-

MACEUTICALS MAINLY CONTAINING YOUNG BARLEY LEAF FIBER FOR THE TREATMENT OF DISORDERS IN THE CENTRAL NERVOUS SYSTEM, THE PERIPHERAL NERVOUS SYSTEM, THE RESPIRATORY ORGANS, THE DIGESTIVE ORGANS, THE URO-GENITAL AND ANAL ORGANS, AND THE EPIDERMIS, AND THE TREATMENT OF RHINITIC DISEASES, OTITIC DISEASES, HEPATIC DISEASES, DIABETES, GOUT, ALLERGIC DISEASES, ADDICTIONS, GYNECOLOGICAL DISEASES AND CARDIOVASCULAR DISEASES; PHARMACEUTICALS MAINLY CONTAINING YOUNG BARLEY LEAF FIBER, NAMELY, CONTRACEPTIVES, EYE DROPS, SOLUTIONS FOR CONTACT LENSES, PHARMACEUTICALS FOR DENTAL TREATMENTS, HEMOSTATS, ALEXIPHARMICS; PHARMACEUTICALS MAINLY CONTAINING YOUNG BARLEY LEAF FIBER, NAMELY, PHARMACEUTICALS FOR TREATING SUBSTANCE ABUSES AND ADDICTIONS; NUTRITIONAL ADDITIVES FOR USE IN FOODS AND DIETARY SUPPLEMENTS FOR HUMAN CONSUMPTION FOR MEDICAL USE MAINLY CONTAINING YOUNG BARLEY LEAVES; DIETARY CURE FOODS, NAMELY, DIETETIC FOODS ADAPTED FOR MEDICAL USE, MAINLY CONTAINING YOUNG BARLEY LEAVES; PHARMACEUTICALS MAINLY CONTAINING YOUNG SWEET POTATO LEAF FIBER FOR THE TREATMENT OF DISORDERS IN THE CENTRAL NERVOUS SYSTEM, THE PERIPHERAL NERVOUS SYSTEM, THE RESPIRATORY ORGANS, THE DIGESTIVE ORGANS, THE URO-GENITAL AND ANAL ORGANS, AND THE EPIDERMIS, AND THE TREATMENT OF RHINITIC DISEASES, OTITIC DISEASES, HEPATIC DISEASES, DIABETES, GOUT, ALLERGIC DISEASES, ADDICTIONS, GYNECOLOGICAL DISEASES AND CARDIOVASCULAR DISEASES; PHARMACEUTICALS MAINLY CONTAINING YOUNG SWEET POTATO LEAF FIBER, NAMELY, CONTRACEPTIVES, EYE DROPS, SOLUTIONS FOR CONTACT LENSES, PHARMACEUTICALS FOR DENTAL TREATMENTS, HEMOSTATS, ALEXIPHARMICS; PHARMACEUTICALS MAINLY CONTAINING YOUNG SWEET POTATO LEAF FIBER, NAMELY, PHARMACEUTICALS FOR TREATING SUBSTANCE ABUSES AND ADDICTIONS; NUTRITIONAL ADDITIVES FOR USE IN FOODS AND DIETARY SUPPLEMENTS FOR HUMAN CONSUMPTION FOR MEDICAL USE MAINLY CONTAINING YOUNG SWEET POTATO LEAF FIBER; DIETARY CURE FOODS, NAMELY, DIETETIC FOODS ADAPTED FOR MEDICAL USE, MAINLY CONTAINING YOUNG SWEET POTATO LEAF FIBER; PHARMACEUTICALS MAINLY CONTAINING TERMINALIA BELLIRICA EXTRACT FOR THE TREATMENT OF DISORDERS IN THE CENTRAL NERVOUS SYSTEM, THE PERIPHERAL NERVOUS SYSTEM, THE RESPIRATORY ORGANS, THE DIGESTIVE ORGANS, THE URO-GENITAL AND ANAL ORGANS, AND THE EPIDERMIS, AND THE TREATMENT OF RHINITIC DISEASES, OTITIC DISEASES, HEPATIC DISEASES, DIABETES, GOUT, ALLERGIC DISEASES, ADDICTIONS, GYNECOLOGICAL DISEASES AND CARDIOVASCULAR DISEASES; PHARMACEUTICALS MAINLY CONTAINING TERMINALIA BELLIRICA EXTRACT, NAMELY, CONTRACEPTIVES, EYE

DROPS, SOLUTIONS FOR CONTACT LENSES, PHARMACEUTICALS FOR DENTAL TREATMENTS, HEMOSTATS, ALEXIPHARMICS; PHARMACEUTICALS MAINLY CONTAINING TERMINALIA BELLIRICA EXTRACT, NAMELY, PHARMACEUTICALS FOR TREATING SUBSTANCE ABUSES AND ADDICTIONS; NUTRITIONAL ADDITIVES FOR USE IN FOODS AND DIETARY SUPPLEMENTS FOR HUMAN CONSUMPTION FOR MEDICAL USE MAINLY CONTAINING TERMINALIA BELLIRICA EXTRACT; DIETARY CURE FOODS, NAMELY, DIETETIC FOODS ADAPTED FOR MEDICAL USE, MAINLY CONTAINING TERMINALIA BELLIRICA EXTRACT, PHARMACEUTICALS MAINLY CONTAINING KUDZU VINE FLOWER EXTRACT FOR THE TREATMENT OF DISORDERS IN THE CENTRAL NERVOUS SYSTEM, THE PERIPHERAL NERVOUS SYSTEM, THE RESPIRATORY ORGANS, THE DIGESTIVE ORGANS, THE URO-GENITAL AND ANAL ORGANS, AND THE EPIDERMIS, AND THE TREATMENT OF RHINITIC DISEASES, OTITIC DISEASES, HEPATIC DISEASES, DIABETES, GOUT, ALLERGIC DISEASES, ADDICTIONS, GYNECOLOGICAL DISEASES AND CARDIOVASCULAR DISEASES; PHARMACEUTICALS MAINLY CONTAINING KUDZU VINE FLOWER EXTRACT, NAMELY, CONTRACEPTIVES, EYE DROPS, SOLUTIONS FOR CONTACT LENSES, PHARMACEUTICALS FOR DENTAL TREATMENTS, HEMOSTATS, ALEXIPHARMICS; PHARMACEUTICALS MAINLY CONTAINING KUDZU VINE FLOWER EXTRACT, NAMELY, PHARMACEUTICALS FOR TREATING SUBSTANCE ABUSES AND ADDICTIONS; NUTRITIONAL ADDITIVES FOR USE IN FOODS AND DIETARY SUPPLEMENTS FOR HUMAN CONSUMPTION FOR MEDICAL USE MAINLY CONTAINING KUDZU VINE FLOWER EXTRACT; DIETARY CURE FOODS, NAMELY, DIETETIC FOODS ADAPTED FOR MEDICAL USE, MAINLY CONTAINING KUDZU VINE FLOWER EXTRACT; PHARMACEUTICALS MAINLY CONTAINING LOQUAT LEAF EXTRACT FOR THE TREATMENT OF DISORDERS IN THE CENTRAL NERVOUS SYSTEM, THE PERIPHERAL NERVOUS SYSTEM, THE RESPIRATORY ORGANS, THE DIGESTIVE ORGANS, THE URO-GENITAL AND ANAL ORGANS, AND THE EPIDERMIS, AND THE TREATMENT OF RHINITIC DISEASES, OTITIC DISEASES, HEPATIC DISEASES, DIABETES, GOUT, ALLERGIC DISEASES, ADDICTIONS, GYNECOLOGICAL DISEASES AND CARDIOVASCULAR DISEASES; PHARMACEUTICALS MAINLY CONTAINING LOQUAT LEAF EXTRACT, NAMELY, CONTRACEPTIVES, EYE DROPS, SOLUTIONS FOR CONTACT LENSES, PHARMACEUTICALS FOR DENTAL TREATMENTS, HEMOSTATS, ALEXIPHARMICS; PHARMACEUTICALS MAINLY CONTAINING LOQUAT LEAF EXTRACT, NAMELY, PHARMACEUTICALS FOR TREATING SUBSTANCE ABUSES AND ADDICTIONS; NUTRITIONAL ADDITIVES FOR USE IN FOODS AND DIETARY SUPPLEMENTS FOR HUMAN CONSUMPTION FOR MEDICAL USE MAINLY CONTAINING LOQUAT LEAF EXTRACT, DIETARY CURE FOODS, NAMELY, DIETETIC FOODS ADAPTED FOR MEDICAL USE, MAINLY CONTAINING LOQUAT LEAF EXTRACT; PHAR-

MACEUTICALS MAINLY CONTAINING KALE FIBER FOR THE TREATMENT OF DISORDERS IN THE CENTRAL NERVOUS SYSTEM, THE PERIPHERAL NERVOUS SYSTEM, THE RESPIRATORY ORGANS, THE DIGESTIVE ORGANS, THE URO-GENITAL AND ANAL ORGANS, AND THE EPIDERMIS, AND THE TREATMENT OF RHINITIC DISEASES, OTITIC DISEASES, HEPATIC DISEASES, DIABETES, GOUT, ALLERGIC DISEASES, ADDICTIONS, GYNECOLOGICAL DISEASES AND CARDIOVASCULAR DISEASES; PHARMACEUTICALS MAINLY CONTAINING KALE FIBER, NAMELY, CONTRACEPTIVES, EYE DROPS, SOLUTIONS FOR CONTACT LENSES, PHARMACEUTICALS FOR DENTAL TREATMENTS, HEMOSTATS, ALEXIPHARMICS; PHARMACEUTICALS MAINLY CONTAINING KALE FIBER, NAMELY, PHARMACEUTICALS FOR TREATING SUBSTANCE ABUSES AND ADDICTIONS; NUTRITIONAL ADDITIVES FOR USE IN FOODS AND DIETARY SUPPLEMENTS FOR HUMAN CONSUMPTION FOR MEDICAL USE MAINLY CONTAINING KALE FIBER; DIETARY CURE FOODS, NAMELY, DIETETIC FOODS ADAPTED FOR MEDICAL USE, MAINLY CONTAINING KALE FIBER; PHARMACEUTICALS MAINLY CONTAINING GANODERMA LUCIDUM EXTRACT FOR THE TREATMENT OF DISORDERS IN THE CENTRAL NERVOUS SYSTEM, THE PERIPHERAL NERVOUS SYSTEM, THE RESPIRATORY ORGANS, THE DIGESTIVE ORGANS, THE URO-GENITAL AND ANAL ORGANS, AND THE EPIDERMIS, AND THE TREATMENT OF RHINITIC DISEASES, OTITIC DISEASES, HEPATIC DISEASES, DIABETES, GOUT, ALLERGIC DISEASES, ADDICTIONS, GYNECOLOGICAL DISEASES AND CARDIOVASCULAR DISEASES; PHARMACEUTICALS MAINLY CONTAINING GANODERMA LUCIDUM EXTRACT, NAMELY, CONTRACEPTIVES, EYE DROPS, SOLUTIONS FOR CONTACT LENSES, PHARMACEUTICALS FOR DENTAL TREATMENTS, HEMOSTATS, ALEXIPHARMICS; PHARMACEUTICALS MAINLY CONTAINING GANODERMA LUCIDUM EXTRACT, NAMELY, PHARMACEUTICALS FOR TREATING SUBSTANCE ABUSES AND ADDICTIONS; NUTRITIONAL ADDITIVES FOR USE IN FOODS AND DIETARY SUPPLEMENTS FOR HUMAN CONSUMPTION FOR MEDICAL USE MAINLY CONTAINING GANODERMA LUCIDUM EXTRACT; DIETARY CURE FOODS, NAMELY, DIETETIC FOODS ADAPTED FOR MEDICAL USE, MAINLY CONTAINING GANODERMA LUCIDUM EXTRACT; PHARMACEUTICALS MAINLY CONTAINING BLACK VINEGAR FOR THE TREATMENT OF DISORDERS IN THE CENTRAL NERVOUS SYSTEM, THE PERIPHERAL NERVOUS SYSTEM, THE RESPIRATORY ORGANS, THE DIGESTIVE ORGANS, THE URO-GENITAL AND ANAL ORGANS, AND THE EPIDERMIS, AND THE TREATMENT OF RHINITIC DISEASES, OTITIC DISEASES, HEPATIC DISEASES, DIABETES, GOUT, ALLERGIC DISEASES, ADDICTIONS, GYNECOLOGICAL DISEASES AND CARDIOVASCULAR DISEASES; PHARMACEUTICALS MAINLY CONTAINING BLACK VINEGAR, NAMELY, CONTRACEPTIVES, EYE DROPS, SOLUTIONS FOR CONTACT LENSES, PHARMA-

CEUTICALS FOR DENTAL TREATMENTS, HEMOSTATS, ALEXIPHARMICS; PHARMACEUTICALS MAINLY CONTAINING BLACK VINEGAR, NAMELY, PHARMACEUTICALS FOR TREATING SUBSTANCE ABUSES AND ADDICTIONS; NUTRITIONAL ADDITIVES FOR USE IN FOODS AND DIETARY SUPPLEMENTS FOR HUMAN CONSUMPTION FOR MEDICAL USE MAINLY CONTAINING BLACK VINEGAR; DIETARY CURE FOODS, NAMELY, DIETETIC FOODS ADAPTED FOR MEDICAL USE, MAINLY CONTAINING BLACK VINEGAR; PHARMACEUTICALS MAINLY CONTAINING MACA EXTRACT FOR THE TREATMENT OF DISORDERS IN THE CENTRAL NERVOUS SYSTEM, THE PERIPHERAL NERVOUS SYSTEM, THE RESPIRATORY ORGANS, THE DIGESTIVE ORGANS, THE URO-GENITAL AND ANAL ORGANS, AND THE EPIDERMIS, AND THE TREATMENT OF RHINITIC DISEASES, OTITIC DISEASES, HEPATIC DISEASES, DIABETES, GOUT, ALLERGIC DISEASES, ADDICTIONS, GYNECOLOGICAL DISEASES AND CARDIOVASCULAR DISEASES; PHARMACEUTICALS MAINLY CONTAINING MACA EXTRACT, NAMELY, CONTRACEPTIVES, EYE DROPS, SOLUTIONS FOR CONTACT LENSES, PHARMACEUTICALS FOR DENTAL TREATMENTS, HEMOSTATS, ALEXIPHARMICS; PHARMACEUTICALS MAINLY CONTAINING MACA EXTRACT, NAMELY, PHARMACEUTICALS FOR TREATING SUBSTANCE ABUSES AND ADDICTIONS; NUTRITIONAL ADDITIVES FOR USE IN FOODS AND DIETARY SUPPLEMENTS FOR HUMAN CONSUMPTION FOR MEDICAL USE MAINLY CONTAINING MACA EXTRACT; DIETARY CURE FOODS, NAMELY, DIETETIC FOODS ADAPTED FOR MEDICAL USE, MAINLY CONTAINING MACA EXTRACT; PHARMACEUTICALS MAINLY CONTAINING EXTRACTS OF CABBAGE, ORANGE, ONION, CARROT AND GREEN CHILI FOR THE TREATMENT OF DISORDERS IN THE CENTRAL NERVOUS SYSTEM, THE PERIPHERAL NERVOUS SYSTEM, THE RESPIRATORY ORGANS, THE DIGESTIVE ORGANS, THE URO-GENITAL AND ANAL ORGANS, AND THE EPIDERMIS, AND THE TREATMENT OF RHINITIC DISEASES, OTITIC DISEASES, HEPATIC DISEASES, DIABETES, GOUT, ALLERGIC DISEASES, ADDICTIONS, GYNECOLOGICAL DISEASES AND CARDIOVASCULAR DISEASES; PHARMACEUTICALS MAINLY CONTAINING EXTRACTS OF CABBAGE, ORANGE, ONION, CARROT AND GREEN CHILI, NAMELY, CONTRACEPTIVES, EYE DROPS, SOLUTIONS FOR CONTACT LENSES, PHARMACEUTICALS FOR DENTAL TREATMENTS, HEMOSTATS, ALEXIPHARMICS; PHARMACEUTICALS MAINLY CONTAINING EXTRACTS OF CABBAGE, ORANGE, ONION, CARROT AND GREEN CHILI, NAMELY, PHARMACEUTICALS FOR TREATING SUBSTANCE ABUSES AND ADDICTIONS; NUTRITIONAL ADDITIVES FOR USE IN FOODS AND DIETARY SUPPLEMENTS FOR HUMAN CONSUMPTION FOR MEDICAL USE MAINLY CONTAINING EXTRACTS OF CABBAGE, ORANGE, ONION, CARROT AND GREEN CHILI; DIETARY CURE FOODS, NAMELY, DIETETIC FOODS ADAPTED FOR MEDICAL USE, MAINLY CONTAINING

EXTRACTS OF CABBAGE, ORANGE, ONION, CARROT AND GREEN CHILI, PHARMACEUTICALS MAINLY CONTAINING S-ADENOSYLMETHIONINE FOR THE TREATMENT OF DISORDERS IN THE CENTRAL NERVOUS SYSTEM, THE PERIPHERAL NERVOUS SYSTEM, THE RESPIRATORY ORGANS, THE DIGESTIVE ORGANS, THE URO-GENITAL AND ANAL ORGANS, AND THE EPIDERMIS, AND THE TREATMENT OF RHINITIC DISEASES, OTITIC DISEASES, HEPATIC DISEASES, DIABETES, GOUT, ALLERGIC DISEASES, ADDICTIONS, GYNECOLOGICAL DISEASES AND CARDIOVASCULAR DISEASES; PHARMACEUTICALS MAINLY CONTAINING S-ADENOSYLMETHIONINE FOR THE TREATMENT OF DISORDERS IN THE CENTRAL NERVOUS SYSTEM, NAMELY, CONTRACEPTIVES, EYE DROPS, SOLUTIONS FOR CONTACT LENSES, PHARMACEUTICALS FOR DENTAL TREATMENTS, HEMOSTATS, ALEXIPHARMICS; PHARMACEUTICALS MAINLY CONTAINING S-ADENOSYLMETHIONINE FOR THE TREATMENT OF DISORDERS IN THE CENTRAL NERVOUS SYSTEM, NAMELY, PHARMACEUTICALS FOR TREATING SUBSTANCE ABUSES AND ADDICTIONS; NUTRITIONAL ADDITIVES FOR USE IN FOODS AND DIETARY SUPPLEMENTS FOR HUMAN CONSUMPTION FOR MEDICAL USE MAINLY CONTAINING S-ADENOSYLMETHIONINE; DIETARY CURE FOODS, NAMELY, DIETETIC FOODS ADAPTED FOR MEDICAL USE, MAINLY CONTAINING S-ADENOSYLMETHIONINE; PHARMACEUTICALS MAINLY CONTAINING METHYLSULFONYLMETHANE COMPOSED OF SULFUR AND METHYL GROUPS FOR THE TREATMENT OF DISORDERS IN THE CENTRAL NERVOUS SYSTEM, THE PERIPHERAL NERVOUS SYSTEM, THE RESPIRATORY ORGANS, THE DIGESTIVE ORGANS, THE URO-GENITAL AND ANAL ORGANS, AND THE EPIDERMIS, AND THE TREATMENT OF RHINITIC DISEASES, OTITIC DISEASES, HEPATIC DISEASES, DIABETES, GOUT, ALLERGIC DISEASES, ADDICTIONS, GYNECOLOGICAL DISEASES AND CARDIOVASCULAR DISEASES; PHARMACEUTICALS MAINLY CONTAINING METHYLSULFONYLMETHANE COMPOSED OF SULFUR AND METHYL GROUPS, NAMELY, CONTRACEPTIVES, EYE DROPS, SOLUTIONS FOR CONTACT LENSES, PHARMACEUTICALS FOR DENTAL TREATMENTS, HEMOSTATS, ALEXIPHARMICS; PHARMACEUTICALS MAINLY CONTAINING METHYLSULFONYLMETHANE COMPOSED OF SULFUR AND METHYL GROUPS, NAMELY, PHARMACEUTICALS FOR TREATING SUBSTANCE ABUSES AND ADDICTIONS; NUTRITIONAL ADDITIVES FOR USE IN FOODS AND DIETARY SUPPLEMENTS FOR HUMAN CONSUMPTION FOR MEDICAL USE MAINLY CONTAINING METHYLSULFONYLMETHANE COMPOSED OF SULFUR AND METHYL GROUPS, DIETARY CURE FOODS, NAMELY, DIETETIC FOODS ADAPTED FOR MEDICAL USE, MAINLY CONTAINING METHYLSULFONYLMETHANE COMPOSED OF SULFUR AND METHYL GROUPS; PHARMACEUTICALS MAINLY CONTAINING BEAR'S GARLIC FOR THE TREATMENT OF DISORDERS IN THE CENTRAL NERVOUS SYSTEM, THE PERIPHERAL NERVOUS SYSTEM, THE RE-

SPIRATORY ORGANS, THE DIGESTIVE ORGANS, THE URO-GENITAL AND ANAL ORGANS, AND THE EPIDERMIS, AND THE TREATMENT OF RHINITIC DISEASES, OTITIC DISEASES, HEPATIC DISEASES, DIABETES, GOUT, ALLERGIC DISEASES, ADDICTIONS, GYNECOLOGICAL DISEASES AND CARDIOVASCULAR DISEASES; PHARMACEUTICALS MAINLY CONTAINING BEAR'S GARLIC, NAMELY, CONTRACEPTIVES, EYE DROPS, SOLUTIONS FOR CONTACT LENSES, PHARMACEUTICALS FOR DENTAL TREATMENTS, HEMOSTATS, ALEXIPHARMICS; PHARMACEUTICALS MAINLY CONTAINING BEAR'S GARLIC, NAMELY, PHARMACEUTICALS FOR TREATING SUBSTANCE ABUSES AND ADDICTIONS; NUTRITIONAL ADDITIVES FOR USE IN FOODS AND DIETARY SUPPLEMENTS FOR HUMAN CONSUMPTION FOR MEDICAL USE MAINLY CONTAINING BEAR'S GARLIC; DIETARY CURE FOODS, NAMELY, DIETETIC FOODS ADAPTED FOR MEDICAL USE, MAINLY CONTAINING BEAR'S GARLIC; PHARMACEUTICALS MAINLY CONTAINING SOYBEANS FOR THE TREATMENT OF DISORDERS IN THE CENTRAL NERVOUS SYSTEM, THE PERIPHERAL NERVOUS SYSTEM, THE RESPIRATORY ORGANS, THE DIGESTIVE ORGANS, THE URO-GENITAL AND ANAL ORGANS, AND THE EPIDERMIS, AND THE TREATMENT OF RHINITIC DISEASES, OTITIC DISEASES, HEPATIC DISEASES, DIABETES, GOUT, ALLERGIC DISEASES, ADDICTIONS, GYNECOLOGICAL DISEASES AND CARDIOVASCULAR DISEASES; PHARMACEUTICALS MAINLY CONTAINING SOYBEANS, NAMELY, CONTRACEPTIVES, EYE DROPS, SOLUTIONS FOR CONTACT LENSES, PHARMACEUTICALS FOR DENTAL TREATMENTS, HEMOSTATS, ALEXIPHARMICS; PHARMACEUTICALS MAINLY CONTAINING SOYBEANS, NAMELY, PHARMACEUTICALS FOR TREATING SUBSTANCE ABUSES AND ADDICTIONS; NUTRITIONAL ADDITIVES FOR USE IN FOODS AND DIETARY SUPPLEMENTS FOR HUMAN CONSUMPTION FOR MEDICAL USE MAINLY CONTAINING SOYBEANS; DIETARY CURE FOODS, NAMELY, DIETETIC FOODS ADAPTED FOR MEDICAL USE, MAINLY CONTAINING SOYBEANS; PHARMACEUTICALS MAINLY CONTAINING DRAGON'S BLOOD FOR THE TREATMENT OF DISORDERS IN THE CENTRAL NERVOUS SYSTEM, THE PERIPHERAL NERVOUS SYSTEM, THE RESPIRATORY ORGANS, THE DIGESTIVE ORGANS, THE URO-GENITAL AND ANAL ORGANS, AND THE EPIDERMIS, AND THE TREATMENT OF RHINITIC DISEASES, OTITIC DISEASES, HEPATIC DISEASES, DIABETES, GOUT, ALLERGIC DISEASES, ADDICTIONS, GYNECOLOGICAL DISEASES AND CARDIOVASCULAR DISEASES; PHARMACEUTICALS MAINLY CONTAINING DRAGON'S BLOOD, NAMELY, CONTRACEPTIVES, EYE DROPS, SOLUTIONS FOR CONTACT LENSES, PHARMACEUTICALS FOR DENTAL TREATMENTS, HEMOSTATS, ALEXIPHARMICS; PHARMACEUTICALS MAINLY CONTAINING DRAGON'S BLOOD, NAMELY, PHARMACEUTICALS FOR TREATING SUBSTANCE ABUSES AND ADDICTIONS; NUTRITIONAL ADDITIVES FOR USE IN FOODS AND DIETARY SUPPLEMENTS

FOR HUMAN CONSUMPTION FOR MEDICAL USE MAINLY CONTAINING DRAGON'S BLOOD; DIETARY CURE FOODS, NAMELY, DIETETIC FOODS ADAPTED FOR MEDICAL USE, MAINLY CONTAINING DRAGON'S BLOOD; AGENTS AFFECTING THE CENTRAL NERVOUS SYSTEM, NAMELY, PHARMACEUTICAL PREPARATIONS ACTING ON THE CENTRAL NERVOUS SYSTEM; AGENTS AFFECTING THE PERIPHERAL NERVOUS SYSTEM, NAMELY, PHARMACEUTICAL PREPARATIONS ACTING ON THE PERIPHERAL NERVOUS SYSTEM; AGENTS AFFECTING SENSORY ORGANS, NAMELY, PHARMACEUTICAL PREPARATIONS FOR THE TREATMENT OF INNER EAR DISORDERS AND AUDITORY DISORDERS; ANTI-ALLERGIC AGENTS, NAMELY, ALLERGY MEDICATIONS; CARDIOVASCULAR AGENTS, NAMELY, CARDIOVASCULAR TREATMENT PREPARATIONS; AGENTS AFFECTING RESPIRATORY ORGANS, NAMELY, RESPIRATORY STIMULANTS; AGENTS AFFECTING DIGESTIVE ORGANS, NAMELY, ANTACIDS; HORMONES FOR MEDICAL PURPOSES, AGENTS FOR URO-GENITAL AND ANAL ORGANS, NAMELY, OXYTOCICS, TOCOLYTIC AGENTS, ANTIHEMORRHOIDALS, EMMENAGOGUES, ANTIBIOTICS FOR TREATING URINARY INFECTIONS, CONTRACEPTIVES, PREPARATIONS FOR TREATING AND PREVENTING UROLITHIASIS; AGENTS FOR EPIDERMIS, NAMELY, MEDICATED SKIN CARE PREPARATIONS; VITAMIN PREPARATIONS; AMINO ACID PREPARATIONS FOR MEDICAL, VETERINARY AND NUTRITIONAL PURPOSES; NUTRIENTS, TONICS AND ALTERATIVES, NAMELY, NUTRITIONAL SUPPLEMENTS; ANTICOAGULANTS; AGENTS AFFECTING METABOLISM, NAMELY, PHARMACEUTICAL PREPARATIONS FOR THE TREATMENT OF CONSTIPATION, SWELLING, AND ACCOMPANYING SYMPTOMS, NAMELY, PALPITATION, SHOULDER STIFFNESS, AND HOT FLASHES ASSOCIATED WITH OBESITY, DIABETES, AND HYPERTENSION; CELLULAR FUNCTION ACTIVATING AGENTS, NAMELY, PHARMACEUTICAL PREPARATIONS FOR THE TREATMENT OF SKIN BURN OR DIFFICULT-TO-TREAT CUTANEOUS ULCERS, LEUCOPENIA FROM EXPOSURE TO EXCESSIVE LEVELS OF RADIATION OR CHEMICAL DRUGS, SYMPTOMS ASSOCIATED WITH STROKE OR SABARACHNOID HEMORRHAGE, SUBJECTIVE OR OBJECTIVE SYMPTOMS ASSOCIATED WITH GASTRIC OR DUODENAL ULCERS, ACUTE GINGIVITIS, AND PERIPHERAL GINGIVITIS; TUMOR SUPPRESSING AGENTS; AGENTS FOR TREATING PHYSICALLY CAUSED LESIONS, NAMELY, PHARMACEUTICAL PREPARATIONS FOR TREATING SKIN DISORDERS; ANTIBIOTICS; MIXED ANTIBIOTIC PREPARATIONS; CHEMOTHERAPEUTICS; BIOLOGICAL PREPARATIONS FOR MEDICAL PURPOSES; AGENTS AGAINST PARASITES, NAMELY, PREPARATIONS FOR DESTROYING PARASITES; AGENTS FOR DISPENSING PURPOSES, NAMELY, EXCIPIENTS, OINTMENT BASE, SOLVENTS, FLAVORING, COLORANTS AND EMULSIFIERS; DIAGNOSTIC PREPARATIONS FOR CLINICAL, MEDICAL LABORATORY, MEDICAL, AND VETERINARY PURPOSES; RADIO-ISO-

TOPE MARKERS FOR THERAPEUTIC OR DIAGNOSTIC USE; SYNTHETIC NARCOTICS; CRUDE DRUGS, NAMELY, MEDICINAL HERBS IN DRIED OR PRESERVED FORM, CHARRED DRUGS, NAMELY, CHARRED PLANTS AND ANIMALS USED AS FOLK MEDICINE FOR THE TREATMENT OF PAIN, COLD, FEVER, ANEMIA, AND FOR USE AS DIURETICS, MUSCLE STIFFNESS AND MENTAL FATIGUE, AND PLANT EXTRACTS FOR MEDICAL, VETERINARY AND PHARMACEUTICAL PURPOSES, NAMELY, MOXA; MOSQUITO-REPELLENT INCENSES; GERMICIDES AND FUNGICIDES; RODENTICIDES; INSECTICIDES; FUMIGANTS; HERBICIDES FOR USE AS WEEDKILLERS; DEODORANTS, NAMELY, AIR DEODORANTS, CAR DEODORANTS, AND HOUSEHOLD DEODORANTS; INSECT REPELLENTS; ANTISEPTICS, IN CLASS 5 (U.S. CLS. 6, 18, 44, 46, 51 AND 52).

FOR: POWDER, GRANULAR, HARD CAPSULAR, SOFT CAPSULAR, PASTED, LIQUID, COOKIE AND TABLET-SHAPED VEGETABLE-BASED PROCESSED FOODS MAINLY CONTAINING OLIGOMERIC PROANTHOCYANIDINS EXTRACTED FROM PINE BARK, NAMELY, EDIBLE, PROCESSED BARLEY LEAVES; POWDER, GRANULAR, HARD CAPSULAR, SOFT CAPSULAR, PASTED, LIQUID, COOKIE AND TABLET-SHAPED VEGETABLE-BASED PROCESSED FOODS MAINLY CONTAINING SWEET POTATO FIBER, NAMELY, EDIBLE, PROCESSED BARLEY LEAVES; POWDER, GRANULAR, HARD CAPSULAR, SOFT CAPSULAR, PASTED, LIQUID, COOKIE AND TABLET-SHAPED VEGETABLE-BASED PROCESSED FOODS MAINLY CONTAINING TUBER VEGETABLE FIBER, NAMELY, EDIBLE, PROCESSED BARLEY LEAVES; POWDER, GRANULAR, HARD CAPSULAR, SOFT CAPSULAR, PASTED, LIQUID, COOKIE AND TABLET-SHAPED VEGETABLE-BASED PROCESSED FOODS MAINLY CONTAINING YOUNG BARLEY LEAF EXTRACT, NAMELY, EDIBLE, PROCESSED BARLEY LEAVES; POWDER, GRANULAR, HARD CAPSULAR, SOFT CAPSULAR, PASTED, LIQUID, COOKIE AND TABLET-SHAPED VEGETABLE-BASED PROCESSED FOODS MAINLY CONTAINING KALE FIBER, NAMELY, EDIBLE, PROCESSED BARLEY LEAVES; POWDER, GRANULAR, HARD CAPSULAR, SOFT CAPSULAR, PASTED, LIQUID, COOKIE AND VEGETABLE-BASED PROCESSED FOODS MAINLY CONTAINING YOUNG SWEET POTATO LEAF FIBER, NAMELY, EDIBLE, PROCESSED BARLEY LEAVES; POWDER, GRANULAR, HARD CAPSULAR, SOFT CAPSULAR, PASTED, LIQUID, COOKIE AND TABLET-SHAPED VEGETABLE-BASED PROCESSED FOODS MAINLY CONTAINING TERMINALIA BELLIRICA EXTRACT, NAMELY, EDIBLE, PROCESSED BARLEY LEAVES; POWDER, GRANULAR, HARD CAPSULAR, SOFT CAPSULAR, PASTED, LIQUID, COOKIE AND TABLET-SHAPED VEGETABLE-BASED PROCESSED FOODS MAINLY CONTAINING LOQUAT LEAF EXTRACT, NAMELY, EDIBLE, PROCESSED BARLEY LEAVES; POWDER, GRANULAR, HARD CAPSULAR, SOFT CAPSULAR, PASTED, LIQUID, COOKIE AND TABLET-SHAPED VEGETABLE-BASED PROCESSED FOODS MAINLY

CONTAINING GANODERMA LUCIDUM EXTRACT, NAMELY, EDIBLE, PROCESSED BARLEY LEAVES; POWDER, GRANULAR, HARD CAPSULAR, SOFT CAPSULAR, PASTED, LIQUID, COOKIE AND TABLET-SHAPED VEGETABLE-BASED PROCESSED FOODS MAINLY CONTAINING BLACK VINEGAR, NAMELY, EDIBLE, PROCESSED BARLEY LEAVES; POWDER, GRANULAR, HARD CAPSULAR, SOFT CAPSULAR, PASTED, LIQUID, COOKIE AND TABLET-SHAPED VEGETABLE-BASED PROCESSED FOODS MAINLY CONTAINING MACA EXTRACT, NAMELY, EDIBLE, PROCESSED BARLEY LEAVES; POWDER, GRANULAR, HARD CAPSULAR, SOFT CAPSULAR, PASTED, LIQUID, COOKIE AND TABLET-SHAPED VEGETABLE-BASED PROCESSED FOODS MAINLY CONTAINING EXTRACTS OF CABBAGE, ORANGE, ONION, CARROT AND GREEN CHILI, NAMELY, EDIBLE, PROCESSED BARLEY LEAVES; POWDER, GRANULAR, HARD CAPSULAR, SOFT CAPSULAR, PASTED, LIQUID, COOKIE AND TABLET-SHAPED VEGETABLE-BASED PROCESSED FOODS MAINLY CONTAINING S-ADENOSYLMETHIONINE, NAMELY, EDIBLE, PROCESSED BARLEY LEAVES; POWDER, GRANULAR, HARD CAPSULAR, SOFT CAPSULAR, PASTED, LIQUID, COOKIE AND TABLET-SHAPED VEGETABLE-BASED PROCESSED FOODS MAINLY CONTAINING METHYLSULFONYLMETHANE COMPOSED OF SULFUR AND METHYL GROUPS, NAMELY, EDIBLE, PROCESSED BARLEY LEAVES; POWDER, GRANULAR, HARD CAPSULAR, SOFT CAPSULAR, PASTED, LIQUID, COOKIE AND TABLET-SHAPED VEGETABLE-BASED PROCESSED FOODS MAINLY CONTAINING BEAR'S GARLIC EXTRACT, NAMELY, EDIBLE, PROCESSED BARLEY LEAVES; POWDER, GRANULAR, HARD CAPSULAR, SOFT CAPSULAR, PASTED, LIQUID, COOKIE AND TABLET-SHAPED VEGETABLE-BASED PROCESSED FOODS MAINLY CONTAINING SOYBEAN EXTRACT, NAMELY, EDIBLE, PROCESSED BARLEY LEAVES; POWDER, GRANULAR, HARD CAPSULAR, SOFT CAPSULAR, PASTED, LIQUID, COOKIE AND TABLET-SHAPED VEGETABLE-BASED PROCESSED FOODS MAINLY CONTAINING DRAGON'S BLOOD EXTRACT, NAMELY, EDIBLE, PROCESSED BARLEY LEAVES; VEGETABLE OILS AND FATS FOR FOOD; ANIMAL OILS AND FATS FOR FOOD; PROCESSED OILS AND FATS FOR FOOD; MILK PRODUCTS EXCLUDING ICE CREAM, ICE MILK AND FROZEN YOGURT; FRESH, CHILLED OR FROZEN MEAT FOR HUMAN CONSUMPTION; EGGS; FRESH, CHILLED OR FROZEN EDIBLE AQUATIC ANIMALS, NAMELY, FISH AND SHELLFISH; FROZEN VEGETABLES; FROZEN FRUITS; PROCESSED MEAT; PROCESSED FISHERIES PRODUCTS, NAMELY, PROCESSED FISH ROE; PROCESSED VEGETABLES AND FRUITS; FRIED TOFU PIECES (ABURA-AGE); FREEZE-DRIED TOFU PIECES (KOHRI-DOFU); JELLY MAINLY CONTAINING DEVIL'S TONGUE ROOT (KONNYAKU); SOYBEAN MILK; TOFU; FERMENTED SOYBEANS (NATTO); PROCESSED EGGS; STEW AND SOUP MIXES; DRIED FLAKES OF LAVER FOR SPRINKLING ON RICE IN HOT WATER (OCHAZUKE-NORI), CONDIMENTS, NAMELY, FERMENTED SOYBEAN PASTE; PROTEIN BEING FOODSTUFFS

FOR HUMAN CONSUMPTION, IN CLASS 29 (U.S. CL. 46).

FOR: TEA MAINLY CONTAINING YOUNG BARLEY LEAVES; TEA MAINLY CONTAINING KALE FIBER; TEA MAINLY CONTAINING YOUNG SWEET-POTATO LEAF FIBER; COOKIES; PASTRIES; CONFECTIONERY, NAMELY, RICE CRACKERS, RICE DUMPLINGS WITH SWEET RED BEAN PASTE, RICE CAKES, ICE CREAMS, CANDIES, COOKIES, CRACKERS, SORBETS, CREAM PUFFS, CAKES, CHEWING GUMS, CHOCOLATES, DOUGHNUTS, BISCUITS, FROZEN YOGURTS, POPCORN, WAFFLES, BREAD AND BUNS; AROMATIC PREPARATIONS FOR FOOD NOT FROM ESSENTIAL OILS, NAMELY, FRAGRANT HERBAL INFUSIONS; SEASONINGS; SPICES; CEREAL PREPARATIONS, NAMELY, PROCESSED CEREALS; INSTANT CONFECTIONERY MIXES, NAMELY, CAKE MIXES, COOKIE MIXES AND SHERBET MIXES; BISCUITS; TEA MAINLY CONTAINING PINE BARK EXTRACTED FROM OLIGOMERIC PROANTHOCYANIDINS; TEA MAINLY CONTAINING SWEET POTATO FIBER; TEA MAINLY CONTAINING TUBER VEGETABLE FIBER; TEA MAINLY CONTAINING TERMINALIA BELLIRICA EXTRACT; TEA MAINLY CONTAINING KUDZU VINE FLOWER EXTRACT; TEA MAINLY CONTAINING LOQUAT LEAF EXTRACT; TEA MAINLY CONTAINING GANODERMA LUCIDUM EXTRACT; TEA MAINLY CONTAINING BLACK VINEGAR; TEA MAINLY CONTAINING MACA EXTRACT; TEA MAINLY CONTAINING EXTRACTS OF CABBAGE, ORANGE, ONION, CARROT AND GREEN CHILI; TEA MAINLY CONTAINING S-ADENOSYLMETHIONINE; TEA MAINLY CONTAINING METHYLSULFONYLMETHANE COMPOSED OF SULFUR AND METHYL GROUPS; TEA MAINLY CONTAINING BEAR'S GARLIC EXTRACT; TEA MAINLY CONTAINING SOYBEAN EXTRACT; TEA MAINLY CONTAINING DRAGON'S BLOOD, IN CLASS 30 (U.S. CL. 46).

FOR: SOFT DRINKS MAINLY CONTAINING OLIGOMERIC PROANTHOCYANIDINS EXTRACTED FROM PINE BARK; CONCENTRATES, SYRUPS OR POWDERS USED IN THE PREPARATION OF SOFT DRINKS MAINLY CONTAINING OLIGOMERIC PROANTHOCYANIDINS EXTRACTED FROM PINE BARK; FRUIT BEVERAGES CONTAINING OLIGOMERIC PROANTHOCYANIDINS EXTRACTED FROM PINE BARK; VEGETABLE JUICES CONTAINING OLIGOMERIC PROANTHOCYANIDINS EXTRACTED FROM PINE BARK; WHEY-BASED BEVERAGES CONTAINING OLIGOMERIC PROANTHOCYANIDINS EXTRACTED FROM PINE BARK; SOFT DRINKS MAINLY CONTAINING KALE FIBER; PREPARATIONS FOR SOFT DRINKS MAINLY CONTAINING KALE FIBER; FRUIT BEVERAGES CONTAINING KALE FIBER; VEGETABLE JUICES CONTAINING KALE FIBER; WHEY-BASED BEVERAGES CONTAINING KALE FIBER; SOFT DRINKS MAINLY CONTAINING YOUNG BARLEY LEAF FIBER; PREPARATIONS FOR SOFT DRINKS MAINLY CONTAINING YOUNG BARLEY LEAF FIBER; FRUIT BEVERA-

GES CONTAINING YOUNG BARLEY LEAF FIBER; VEGETABLE JUICES CONTAINING YOUNG BARLEY LEAF FIBER; WHEY-BASED BEVERAGES CONTAINING YOUNG BARLEY LEAF FIBER; SOFT DRINKS MAINLY CONTAINING YOUNG SWEET-POTATO LEAF FIBER; PREPARATIONS FOR SOFT DRINKS MAINLY CONTAINING YOUNG SWEET-POTATO LEAF FIBER; FRUIT BEVERAGES CONTAINING YOUNG SWEET-POTATO LEAF FIBER; VEGETABLE JUICES MAINLY CONTAINING YOUNG SWEET-POTATO LEAF FIBER; WHEY-BASED BEVERAGES CONTAINING YOUNG SWEET-POTATO LEAF FIBER; SOFT DRINKS MAINLY CONTAINING SWEET POTATO FIBER; PREPARATIONS FOR SOFT DRINKS MAINLY CONTAINING SWEET POTATO FIBER; FRUIT BEVERAGES CONTAINING SWEET POTATO FIBER; VEGETABLE JUICES MAINLY CONTAINING SWEET POTATO FIBER; WHEY-BASED BEVERAGES CONTAINING SWEET POTATO FIBER; SOFT DRINKS MAINLY CONTAINING TUBER VEGETABLE FIBER; PREPARATIONS FOR SOFT DRINKS MAINLY CONTAINING TUBER VEGETABLE FIBER; FRUIT BEVERAGES CONTAINING TUBER VEGETABLE FIBER; VEGETABLE JUICES MAINLY CONTAINING TUBER VEGETABLE FIBER; WHEY-BASED BEVERAGES CONTAINING TUBER VEGETABLE FIBER; SOFT DRINKS MAINLY CONTAINING TERMINALIA BELLIRICA EXTRACT; PREPARATIONS FOR SOFT DRINKS MAINLY CONTAINING TERMINALIA BELLIRICA EXTRACT; FRUIT BEVERAGES CONTAINING TERMINALIA BELLIRICA EXTRACT; VEGETABLE JUICES CONTAINING TERMINALIA BELLIRICA EXTRACT; WHEY-BASED BEVERAGES CONTAINING TERMINALIA BELLIRICA EXTRACT; SOFT DRINKS MAINLY CONTAINING KUDZU VINE FLOWER EXTRACT; PREPARATIONS FOR SOFT DRINKS MAINLY CONTAINING KUDZU VINE FLOWER EXTRACT; FRUIT BEVERAGES CONTAINING KUDZU VINE FLOWER EXTRACT; VEGETABLE JUICES CONTAINING KUDZU VINE FLOWER EXTRACT; WHEY-BASED BEVERAGES CONTAINING KUDZU VINE FLOWER EXTRACT; SOFT DRINKS MAINLY CONTAINING LOQUAT LEAF EXTRACT; PREPARATIONS FOR SOFT DRINKS MAINLY CONTAINING LOQUAT LEAF EXTRACT; FRUIT BEVERAGES CONTAINING LOQUAT LEAF EXTRACT; VEGETABLE JUICES CONTAINING LOQUAT LEAF EXTRACT; WHEY-BASED BEVERAGES CONTAINING LOQUAT LEAF EXTRACT; SOFT DRINKS MAINLY CONTAINING GANODERMA LUCIDUM EXTRACT; PREPARATIONS FOR SOFT DRINKS MAINLY CONTAINING GANODERMA LUCIDUM EXTRACT; FRUIT BEVERAGES CONTAINING GANODERMA LUCIDUM EXTRACT; VEGETABLE JUICES CONTAINING GANODERMA LUCIDUM EXTRACT; WHEY-BASED BEVERAGES CONTAINING GANODERMA LUCIDUM EXTRACT; SOFT DRINKS MAINLY CONTAINING BLACK VINEGAR; PREPARATIONS FOR SOFT DRINKS MAINLY CONTAINING BLACK VINEGAR; FRUIT BEVERAGES CONTAINING BLACK VINEGAR; VEGETABLE JUICES CONTAINING BLACK VINEGAR; WHEY-BASED BEVERAGES CONTAINING BLACK VINEGAR; SOFT DRINKS MAINLY CON-

TAINING MACA EXTRACT; PREPARATIONS FOR SOFT DRINKS MAINLY CONTAINING MACA EXTRACT; FRUIT BEVERAGES CONTAINING MACA EXTRACT; VEGETABLE JUICES CONTAINING MACA EXTRACT; WHEY-BASED BEVERAGES CONTAINING MACA EXTRACT; SOFT DRINKS MAINLY CONTAINING EXTRACTS OF CABBAGE, ORANGE, ONION, CARROT AND GREEN CHILI; PREPARATIONS FOR SOFT DRINKS MAINLY CONTAINING EXTRACTS OF CABBAGE, ORANGE, ONION, CARROT AND GREEN CHILI; FRUIT BEVERAGES MAINLY CONTAINING EXTRACTS OF CABBAGE, ORANGE, ONION, CARROT AND GREEN CHILI; VEGETABLE JUICES MAINLY CONTAINING EXTRACTS OF CABBAGE, ORANGE, ONION, CARROT AND GREEN CHILI; SOFT DRINKS MAINLY CONTAINING S-ADENOSYLMETHIONINE; PREPARATIONS FOR SOFT DRINKS MAINLY CONTAINING S-ADENOSYLMETHIONINE; FRUIT BEVERAGES CONTAINING S-ADENOSYLMETHIONINE; VEGETABLE JUICES CONTAINING S-ADENOSYLMETHIONINE; WHEY-BASED BEVERAGES CONTAINING S-ADENOSYLMETHIONINE; SOFT DRINKS MAINLY CONTAINING METHYLSULFONYLMETHANE COMPOSED OF SULFUR AND METHYL GROUPS; PREPARATIONS FOR SOFT DRINKS MAINLY CONTAINING METHYLSULFONYLMETHANE COMPOSED OF SULFUR AND METHYL GROUPS; FRUIT BEVERAGES CONTAINING METHYLSULFONYLMETHANE COMPOSED OF SULFUR AND METHYL GROUPS; VEGETABLE JUICES CONTAINING METHYLSULFONYLMETHANE COMPOSED OF SULFUR AND METHYL GROUPS; WHEY-BASED BEVERAGES CONTAINING METHYLSULFONYLMETHANE COMPOSED OF SULFUR AND METHYL GROUPS; SOFT DRINKS MAINLY CONTAINING BEAR'S GARLIC EXTRACT; PREPARATIONS FOR SOFT DRINKS MAINLY CONTAINING BEAR'S GARLIC EXTRACT; FRUIT BEVERAGES CONTAINING BEAR'S GARLIC EXTRACT; VEGETABLE JUICES CONTAINING BEAR'S GARLIC EXTRACT; WHEY-BASED BEVERAGES CONTAINING BEAR'S GARLIC EXTRACT; SOFT DRINKS MAINLY CONTAINING SOYBEAN EXTRACT; PREPARATIONS FOR SOFT DRINKS MAINLY CONTAINING SOYBEAN EXTRACT; FRUIT BEVERAGES CONTAINING SOYBEAN EXTRACT; VEGETABLE JUICES CONTAINING SOYBEAN EXTRACT; WHEY-BASED BEVERAGES CONTAINING SOYBEAN EXTRACT; SOFT DRINKS MAINLY CONTAINING DRAGON'S BLOOD EXTRACT; PREPARATIONS FOR SOFT DRINKS MAINLY CONTAINING DRAGON'S BLOOD EXTRACT; FRUIT BEVERAGES CONTAINING DRAGON'S BLOOD EXTRACT; VEGETABLE JUICES CONTAINING DRAGON'S BLOOD EXTRACT; AND WHEY-BASED BEVERAGES CONTAINING DRAGON'S BLOOD EXTRACT; BEER; CARBONATED SOFT DRINKS; NON-ALCOHOLIC FRUIT JUICE BEVERAGES; EXTRACTS OF HOPS FOR MAKING BEER; WHEY BEVERAGES; VEGETABLE JUICES, IN CLASS 32 (U.S. CLS. 45, 46 AND 48).

FOR: MARKETING RESEARCH; PUBLICITY MATERIAL RENTAL; BUSINESS APPRAISALS; BUSINESS ORGANIZATION CONSULTANCY; BUSINESS RESEARCH; COMMERCIAL INFORMATION AGENCIES; DEMONSTRATION OF GOODS BY ELECTRONIC MEANS, ALSO FOR THE BENEFIT OF THE SO-CALLED TEleshopping AND HOMESHopping SERVICES; DIRECT MAIL ADVERTISING; DISSEMINATION OF ADVERTISING MATTER; DISTRIBUTION OF SAMPLES; ORGANIZATION OF EXHIBITIONS FOR COMMERCIAL AND ADVERTISING PURPOSES IN THE FIELDS OF MANUFACTURING AND ADVERTISING OF HEALTH FOODS AND COSMETICS; SALES PROMOTION FOR OTHERS; BUSINESS PLANNING FOR ORGANIZING OVERSEA BASES FOR PRODUCTION, RESEARCH AND PHYSICAL DISTRIBUTION; DATA COLLECTION FOR NEW PRODUCT DEVELOPMENT, SALES PROMOTION PLANNING, NAMELY, BUSINESS CONSULTING IN THE FIELD OF SALES PROMOTION; PROVIDING INFORMATION IN THE FIELD OF MARKETING, IN CLASS 35 (U.S. CLS. 100, 101 AND 102).

FOR: PREPARING AND MIXING TO ORDER OF OTHERS OF CHEMICALS, MEDICINES, COSMETICS, PROCESSED FOODS, AND DIETARY SUPPLEMENTS; MANUFACTURE TO ORDER OF OTHERS OF FRUIT JUICE, SOFT DRINKS, WHEY BEVERAGES AND LIQUEURS; FOOD PROCESSING; FOOD AND DRINK PRESERVATION; FRUIT CRUSHING; EXTRACTING, REFINING AND COMPOSING OF CHEMICALS AND MEDICINES, NAMELY, PROCESSING CHEMICALS AND MEDICINES TO THE ORDER OF OTHERS; ASSEMBLY OF PRODUCTS FOR OTHERS, NAMELY, PIECE WRAPPING, BOTTLING AND FINAL ENCASING OF CHEMICALS, MEDICINES, COSMETICS, OR PROCESSED FOODS, AND DIETARY SUPPLEMENTS; RENTAL OF MANUFACTURING MACHINES FOR CHEMICALS, MEDICINES, COSMETICS, PROCESSED FOODS, AND DIETARY SUPPLEMENTS; PHOTOGRAPHIC ENLARGING; PHOTOGRAPHIC PRINTING; PHOTOGRAPHIC FILM DEVELOPMENT; BOOKBINDING; RENTAL OF MACHINES AND APPARATUS FOR PROCESSING FOODS OR BEVERAGES, IN CLASS 40 (U.S. CLS. 100, 103 AND 106).

FOR: BACTERIOLOGICAL RESEARCH; BIOLOGICAL RESEARCH; CHEMICAL RESEARCH; PHARMACEUTICAL RESEARCH; COSMETIC RESEARCH; RESEARCH ON PROCESSED FOODS AND DIETARY SUPPLEMENTS; MATERIAL TESTING; QUALITY CONTROL FOR OTHERS; RESEARCH RELATING TO MEDICAL TREATMENT, HEALTH PRESERVATION AND SANITATION; DEVELOPMENT AND RESEARCH OF NEW PRODUCTS TO THE ORDER OF OTHERS, NAMELY, CHEMICALS, MEDICINES, COSMETICS, PROCESSED FOOD, AND DIETARY SUPPLEMENTS; TECH-

NICAL CONSULTANCY FOR THE MANUFACTURE OF MEDICINES, CHEMICALS, COSMETICS, PROCESSED FOODS, AND DIETARY SUPPLEMENTS; PROVIDING INFORMATION ON SCIENTIFIC RESEARCH RELATING TO INGREDIENTS, EFFECTS, USAGE AND PHARMACOLOGY OF CHEMICALS, MEDICINES, COSMETICS, PROCESSED FOOD, AND DIETARY SUPPLEMENTS; PROVIDING INFORMATION ON SCIENTIFIC RESEARCH USEFUL TO RESEARCH OF MOLECULAR BIOLOGY, CELL CULTURE AND IMMUNOLOGY; TESTING OF MATERIALS, TESTING OF COMMODITIES, NAMELY, TRIALS IN THE FIELD OF MANUFACTURE OF FOOD AND COSMETICS, AND FOOD AND COSMETICS SAFETY AND STABILITY TESTING IN FACTORIES; TECHNICAL CONSULTATION RELATING TO ENVIRONMENTALLY-FRIENDLY DESIGN OF FOOD MANUFACTURING FACTORIES; TESTING, INSPECTION OR RESEARCH OF PHARMACEUTICALS, COSMETICS OR FOODSTUFF; AGENCIES FOR LEGAL CONSULTING ON PROCEDURES RELATING TO INDUSTRIAL PROPERTY RIGHTS, PREPARATION OF EXPERT OPINIONS ON INDUSTRIAL PROPERTY RIGHTS; AGENCIES FOR LEGAL CONSULTING ON LEGAL PROCEDURES RELATING TO LAWSUITS OR OTHER LEGAL ISSUES; AGENCIES PROVIDING COPYRIGHT LICENSING SERVICES, IN CLASS 42 (U.S. CLS. 100 AND 101).

PRIORITY DATE OF 10-26-2005 IS CLAIMED.

OWNER OF INTERNATIONAL REGISTRATION 0910865 DATED 11-7-2005, EXPIRES 11-7-2015.

NO CLAIM IS MADE TO THE EXCLUSIVE RIGHT TO USE "BIO-PHARMA", APART FROM THE MARK AS SHOWN.

THE COLOR(S) RED AND WHITE IS/ARE CLAIMED AS A FEATURE OF THE MARK.

THE MARK CONSISTS OF A BOLD CAPITAL LETTER "T" IN WHITE AND OVAL ABOVE IS PLACED IN THE CENTER OF RED SQUARE AND LETTERS "TOYO BIO-PHARMA" IN RED IS NEXT TO THE ABOVE MENTIONED DEVICE.

THE FOREIGN WORDING IN THE MARK TRANSLATES INTO ENGLISH AS "THE EAST."

SER. NO. 79-033,649, FILED 11-7-2005.

KATHERINE CHANG, EXAMINING ATTORNEY

Int. Cls.: 39 and 43

Prior U.S. Cls.: 100, 101 and 105

United States Patent and Trademark Office

Reg. No. 3,576,304

Registered Feb. 17, 2009

**SERVICE MARK
PRINCIPAL REGISTER**

ROYAL TULIP

KENMARK BRAND B.V. (NETHERLANDS PRIVATE LIMITED COMPANY)
VONDELLAAN 35
NL-3818 WN AMERSFOORT
NETHERLANDS

FOR: TRAVEL AND TOUR AGENCY SERVICES, NAMELY, TOUR AND TRAVEL BOOKING AGENCIES, ARRANGING TRANSPORT FOR TRAVELERS BY LAND, AIR AND SEA, AND ARRANGING TRAVEL TOURS; TICKET RESERVATION SERVICES, NAMELY, MAKING BOOKINGS FOR TRAVEL AND TOURS; TOURIST AGENCY SERVICES; INFORMATION ADVISORY AND CONSULTANCY SERVICES RELATING TO TRAVEL, AND ALL THE AFORESAID SERVICES, PROVIDED BY ELECTRONIC MEDIA, INCLUDING THE INTERNET, AND NON-ELECTRONIC MEDIA, IN CLASS 39 (U.S. CLS. 100 AND 105).

FOR: HOTEL SERVICES; RESTAURANT AND BAR SERVICES; PROVISION OF FOOD AND DRINK FOR GUESTS; CATERING SERVICES; HOTEL RESERVATION SERVICES; HOTEL ACCOM-

MODATION AND RESORT RESERVATION SERVICES; PROVISION OF TEMPORARY ACCOMMODATION; INFORMATION, ADVISORY AND CONSULTANCY SERVICES RELATING TO ALL THE AFORESAID SERVICES, PROVIDED BY ELECTRONIC MEDIA, INCLUDING THE INTERNET, AND NON-ELECTRONIC MEDIA, IN CLASS 43 (U.S. CLS. 100 AND 101).

THE MARK CONSISTS OF STANDARD CHARACTERS WITHOUT CLAIM TO ANY PARTICULAR FONT, STYLE, SIZE, OR COLOR.

PRIORITY DATE OF 9-4-2006 IS CLAIMED.

OWNER OF INTERNATIONAL REGISTRATION 0916923 DATED 11-10-2006, EXPIRES 11-10-2016.

SER. NO. 79-035,746, FILED 11-10-2006.

DAYNA BROWNE, EXAMINING ATTORNEY

Int. Cls.: 39 and 43

Prior U.S. Cls.: 100, 101 and 105

United States Patent and Trademark Office

Reg. No. 3,576,305

Registered Feb. 17, 2009

**SERVICE MARK
PRINCIPAL REGISTER**



ROYAL TULIP

KENMARK BRAND B.V. (NETHERLANDS PRIVATE LIMITED COMPANY)
VONDELLAAN 35
NL-3818 WN AMERSFOORT
NETHERLANDS

FOR: TRAVEL AND TOUR AGENCY SERVICES, NAMELY, TOUR AND TRAVEL BOOKING AGENCIES, ARRANGING TRANSPORT FOR TRAVELERS BY LAND, AIR AND SEA, AND ARRANGING TRAVEL TOURS; TICKET RESERVATION SERVICES, NAMELY, MAKING BOOKINGS FOR TRAVEL AND TOURS; TOURIST AGENCY SERVICES; INFORMATION ADVISORY AND CONSULTANCY SERVICES RELATING TO TRAVEL, AND ALL THE AFORESAID SERVICES, PROVIDED BY ELECTRONIC MEDIA, INCLUDING THE INTERNET, AND NON-ELECTRONIC MEDIA, IN CLASS 39 (U.S. CLS. 100 AND 105).

FOR: HOTEL SERVICES; RESTAURANT AND BAR SERVICES; PROVISION OF FOOD AND

DRINK FOR GUESTS; CATERING SERVICES; HOTEL RESERVATION SERVICES; HOTEL ACCOMMODATION AND RESORT RESERVATION SERVICES; PROVISION OF TEMPORARY ACCOMMODATION; INFORMATION, ADVISORY AND CONSULTANCY SERVICES RELATING TO ALL THE AFORESAID SERVICES, PROVIDED BY ELECTRONIC MEDIA, INCLUDING THE INTERNET, AND NON-ELECTRONIC MEDIA, IN CLASS 43 (U.S. CLS. 100 AND 101).

PRIORITY DATE OF 9-4-2006 IS CLAIMED.

OWNER OF INTERNATIONAL REGISTRATION 0916924 DATED 11-10-2006, EXPIRES 11-10-2016.

SER. NO. 79-035,747, FILED 11-10-2006.

DAYNA BROWNE, EXAMINING ATTORNEY

Int. Cls.: 9, 38 and 42

Prior U.S. Cls.: 21, 23, 26, 36, 38, 100, 101 and 104

Reg. No. 3,576,306

United States Patent and Trademark Office

Registered Feb. 17, 2009

**TRADEMARK
SERVICE MARK
PRINCIPAL REGISTER**



MEDIABEAM GMBH (FED REP GERMANY GESELLSCHAFT MIT BESCHRÄNKTER HAFTUNG (GMBH))

PARALLELSTRASSE 38

48683 AHAUS

FED REP GERMANY

FOR: COMPUTER PROGRAMS AND SOFTWARE FOR CREATING, EDITING, STORING, SAVING AND MANAGING DOCUMENTS; COMPUTER PROGRAMS AND SOFTWARE FOR MOBILE COMMUNICATIONS, TELECOMMUNICATIONS, FAXING, CALENDARING, COMPUTER VIRUS PREVENTION, VOICE MESSAGING, TEXT MESSAGING, AND ELECTRONIC MAIL; INTERFACES FOR COMPUTERS, IN CLASS 9 (U.S. CLS. 21, 23, 26, 36 AND 38).

FOR: TRANSMISSION OF NEWS AND PICTURE INFORMATION BY COMPUTERS; PROVIDING TELECOMMUNICATION CONNECTIONS TO A COMPUTER NETWORK, PARTICULARLY ON THE INTERNET; E-MAIL SERVICES; TRANSMISSION, ROUTING AND CONNECTION SERVICES FOR TELECOMMUNICATION; FORWARDING OF MESSAGES VIA THE INTERNET OR TELECOMMUNICATION CONNECTIONS, IN CLASS 38 (U.S. CLS. 100, 101 AND 104).

FOR: UPDATING OF COMPUTER SOFTWARE; PROVIDING TEMPORARY USE OF NON-DOWNLOADABLE COMPUTER PROGRAMS AND SOFTWARE FOR CREATING, EDITING, STORING, SAVING AND MANAGING THE DOCUMENTS THAT MAY BE DOWNLOADED FROM A GLOBAL COMPUTER NETWORK; PROVIDING TEMPORARY USE OF NON-DOWNLOADABLE WEB MAIL SOFTWARE AND COMPUTER PROGRAMS FOR

MANAGEMENT INFORMATION SYSTEMS, NAMELY, COMPUTER PROGRAMS AND SOFTWARE FOR CREATING, EDITING, STORING, SAVING AND MANAGING THE DOCUMENTS; COMPUTER SOFTWARE CONSULTANCY; DESIGN OF COMPUTER SOFTWARE; SERVICES OF A COMPUTER PROGRAMMER; COMPUTER CONSULTANCY, IMPLEMENTATION OF COMPUTER PROGRAMS ON NETWORKS; CONVERSION OF COMPUTER PROGRAMS AND DATA CONVERSION OF COMPUTER PROGRAM DATA; PROVIDING OF SEARCH ENGINES FOR OBTAINING DATA ON THE INTERNET; DATA ADMINISTRATION ON SERVERS, NAMELY, COMPUTER SYSTEM ADMINISTRATION SERVICES FOR OTHERS; SERVICES OF DATA BASE COMPUTER PROGRAMMING; HOSTING OF DIGITAL CONTENT ON THE INTERNET, NAMELY, PROVIDING MEMORY SPACE ON THE INTERNET; PROVIDING OF SOFTWARE PLATFORMS ON THE INTERNET FOR MOBILE COMMUNICATIONS, TELECOMMUNICATIONS, FAXING, CALENDARING, COMPUTER VIRUS PREVENTION, VOICE MESSAGING, TEXT MESSAGING, AND ELECTRONIC MAIL; APPLICATION SERVICE PROVIDER SERVICES, NAMELY, HOSTING COMPUTER SOFTWARE APPLICATIONS OF OTHERS, PROVIDING OF PORTALS ON THE INTERNET, NAMELY, PROVIDING CUSTOMIZED ON-LINE WEB PAGES FEATURING USER-DEFINED INFORMATION, WHICH INCLUDES SEARCH ENGINES AND ON-LINE WEB LINKS TO OTHER WEB SITES; APPLICATION SERVICE PROVIDER SERVICES, NAMELY, HOSTING COMPUTER SOFTWARE APPLICATIONS OF OTHERS, IN CLASS 42 (U.S. CLS. 100 AND 101).

PRIORITY DATE OF 3-21-2006 IS CLAIMED.

OWNER OF INTERNATIONAL REGISTRATION
0918900 DATED 9-21-2006, EXPIRES 9-21-2016.

SER. NO. 79-036,520, FILED 9-21-2006.

NO CLAIM IS MADE TO THE EXCLUSIVE
RIGHT TO USE "PAD", APART FROM THE MARK
AS SHOWN.

DEBRA LEE, EXAMINING ATTORNEY

Int. Cls.: 7, 9, 12, 35, 37 and 39

**Prior U.S. Cls.: 13, 19, 21, 23, 26, 31, 34, 35, 36, 38, 44,
100, 101, 102, 103, 105 and 106**

Reg. No. 3,576,307

United States Patent and Trademark Office

Registered Feb. 17, 2009

**TRADEMARK
SERVICE MARK
PRINCIPAL REGISTER**



BOLLORE
ODET
F-29500 ERGUE GABERIC
FRANCE

FOR: ELECTRIC MOTORS FOR MACHINES, TRANSMISSION ASSEMBLIES COMPRISING TRANSMISSION GEARS FOR MACHINES AND BEARINGS FOR TRANSMISSION SHAFTS, BEING PART OF MACHINES; ELECTRIC DRIVE CLEANING MACHINES AS WELL AS THEIR ELECTRIC MOTORS AND TRANSMISSION ASSEMBLIES, NAMELY, CARPET CLEANING MACHINES AND STEAM CLEANING MACHINES AND ELECTRIC MOTORS AND TRANSMISSIONS THEREFOR; ELECTRIC-DRIVE CONSTRUCTION MACHINES, NAMELY, ASPHALT PAVING MACHINES, CENTRIFUGAL GRINDING MACHINES, CONCRETE FINISHING MACHINES AND CONCRETE PAVING MACHINES; ELECTRIC-DRIVE CONSTRUCTION MACHINES, NAMELY, BULLDOZERS AND TRANSMISSIONS AND MOTORS FOR BULLDOZERS, IN CLASS 7 (U.S. CLS. 13, 19, 21, 23, 31, 34 AND 35).

FOR: BATTERIES, BATTERY CHARGERS, CAPACITORS, CONTROL PANELS FOR CONTROLLING ELECTRIC VEHICLES, NAMELY, ELECTRIC-DRIVE CARS, ELECTRIC-DRIVE VANS, ELECTRIC-DRIVE TRAMWAYS, ELECTRIC-DRIVE CYCLES, ELECTRIC-DRIVE SCOOTERS, ELECTRIC-DRIVE CONSTRUCTION MACHINES, ELECTRIC-DRIVE CLEANING VEHICLES AND ELECTRIC-DRIVE BOATS; ONBOARD COMPUTERS IN THE NATURE OF A NAVIGATION APPARATUS FOR VEHICLES AND OPERATIONAL SOFTWARE THEREFOR; SATELLITE NAVIGATIONAL SYSTEM, NAMELY, A GLOBAL POSITIONING SYSTEM (GPS), IN CLASS 9 (U.S. CLS. 21, 23, 26, 36 AND 38).

FOR: VEHICLES AND APPARATUS FOR LOCOMOTION BY LAND, AIR AND WATER, NAMELY, ELECTRIC-DRIVE LAND VEHICLES, ELECTRIC-DRIVE CYCLES AND ELECTRIC-DRIVE SCOOTERS; GOODS HANDLING CARTS, ELECTRIC-DRIVE TROLLEYS FOR CLEANING, ELECTRIC-DRIVE FORK-LIFT TRUCKS AND ELECTRIC-DRIVE BOATS; LAND VEHICLE TRANSMISSIONS, NAMELY, TRANSMISSIONS FOR ELECTRIC-DRIVE LAND VEHICLES, ELECTRIC-DRIVE CYCLES AND ELECTRIC-DRIVE SCOOTERS; MOTORS FOR ELECTRIC-DRIVE LAND VEHICLES, ELECTRIC-DRIVE CYCLES, ELECTRIC-DRIVE SCOOTERS, ELECTRIC-DRIVE TROLLEYS FOR CLEANING AND ELECTRIC-DRIVE FORK-LIFT TRUCKS, IN CLASS 12 (U.S. CLS. 19, 21, 23, 31, 35 AND 44).

FOR: RETAIL STORE SERVICES FEATURING CARS AND THEIR SPARE PARTS; ADVERTISING SERVICES, BUSINESS MANAGEMENT SERVICES, BUSINESS ADMINISTRATION; MANAGEMENT AND COMPILATION OF COMPUTERIZED DATABASES; ORGANIZATION OF EXHIBITIONS FOR COMMERCIAL PURPOSES IN THE FIELD OF ELECTRIC BATTERY CARS AND ELECTRIC CARS, IN CLASS 35 (U.S. CLS. 100, 101 AND 102).

FOR: VEHICLE MAINTENANCE, SERVICING AND REPAIR SERVICES; INFORMATION ON VEHICLE MAINTENANCE, IN CLASS 37 (U.S. CLS. 100, 103 AND 106).

FOR: BUS, TRAMWAY, TRUCKS, SCOOTERS, RAIL, AIR, BOAT AND FERRY TRANSPORTATION SERVICES AND WAREHOUSING SERVICES; RENTAL OF MOTOR VEHICLES; VEHICLE PARKING GARAGE SERVICES AND RENTAL OF GARAGE SPACE; VEHICLE BREAKDOWN ASSISTANCE IN

THE NATURE OF VEHICLE TOWING SERVICES;
INFORMATION WITH RESPECT TO AIR, LAND
AND WATER TRANSPORT SERVICES, AND WITH
RESPECT TO VEHICLE RENTAL, IN CLASS 39 (U.S.
CLS. 100 AND 105).

PRIORITY DATE OF 3-20-2006 IS CLAIMED.

OWNER OF INTERNATIONAL REGISTRATION
0920019 DATED 9-19-2006, EXPIRES 9-19-2016.

THE COLOR(S) BLUE AND GREEN IS/ARE
CLAIMED AS A FEATURE OF THE MARK.

THE COLOR BLUE APPEARS IN THE LETTER-
ING "BLU" "E" "CAR" AND IN THE CURVED
BAND ON THE RIGHT HAND SIDE OF THE "E".
THE COLOR GREEN APPEARS IN THE CURVED
BAND ON THE LEFT HAND SIDE OF THE "E".

SER. NO. 79-036,907, FILED 9-19-2006.

COLLEEN KEARNEY, EXAMINING ATTORNEY

Int. Cls.: 9, 16 and 38

**Prior U.S. Cls.: 2, 5, 21, 22, 23, 26, 29, 36, 37, 38, 50,
100, 101 and 104**

Reg. No. 3,576,308

United States Patent and Trademark Office

Registered Feb. 17, 2009

**TRADEMARK
SERVICE MARK
PRINCIPAL REGISTER**

BEBE LILLY

HEBEN MUSIC (FRANCE SOCIÉTÉ PAR AC-
TIONS SIMPLIFIÉE)
126 RUE DU LANDY
F-93400 SAINT-OUEN
FRANCE

FOR: APPARATUS FOR RECORDING, TRANS-
MITTING, REPRODUCING AND PROCESSING
SOUND OR IMAGES; BLANK MAGNETIC RE-
CORDING MEDIA, NAMELY, BLANK ACOUSTIC
AND OPTICAL DISCS AND BLANK FLOPPY COM-
PUTER DISCS; CALCULATORS; COMPUTER
GAMES SOFTWARE; DIVING SUITS, DIVING
GLOVES AND DIVING FACE MASKS; OPTICS,
NAMELY, SPECTACLES, EYEGLASSES, SUNGLAS-
SES; SPECTACLE CASES, IN CLASS 9 (U.S. CLS. 21,
23, 26, 36 AND 38).

FOR: PRINTED MATTER, NAMELY, MAGA-
ZINES, BROCHURES AND CATALOGUES WHOSE
SUBJECT MATTER FEATURES MUSIC; MAPS,
PRINTED GUIDE BOOKS FEATURING TRAVEL;
BOOKBINDING MATERIAL, NAMELY, BOOK
BINDINGS, BOOKBINDING WIRE, BOOKBINDING
TAPE, CLOTH FOR BOOKBINDING; PHOTO-
GRAPHS; STATIONERY; ADHESIVES FOR STA-
TIONERY OR HOUSEHOLD PURPOSES;
MATERIALS FOR ARTISTS, NAMELY, PAINTBRU-
SHES, CRAYONS, PENCILS, DRAWING PAPER;
TYPEWRITERS; PRINTERS' TYPE; PRINTING
BLOCKS; PAPER; CARDBOARD; PAPER BOXES;
POSTERS; PHOTOGRAPH ALBUMS; BLANK NOTE
CARDS; CALENDARS; WRITING INSTRUMENTS;
LITHOGRAPHS AND ENGRAVINGS; PAINTINGS;
WATERCOLORS; SEWING PATTERNS FOR DRES-
SES; GRAPHIC PRINTS; DRAWING INSTRU-
MENTS; PAPER HANDKERCHIEFS; FACE
TOWELS OF PAPER; TABLE LINEN OF PAPER;
TOILET PAPER; DISPOSABLE BABIES' DIAPERS
OF PAPER AND CELLULOSE; PAPER BAGS,
SMALL PAPER BAGS AS WRAPPINGS AND POU-
CHES FOR PACKAGING PURPOSES; PAPER AND
PLASTIC GARBAGE BAGS, IN CLASS 16 (U.S. CLS.
2, 5, 22, 23, 29, 37, 38 AND 50).

FOR: TELECOMMUNICATIONS SERVICES,
NAMELY, PERSONAL COMMUNICATION SERVI-
CES, ISDN SERVICES, TELECOMMUNICATIONS
ACCESS SERVICES, DATA TRANSMISSION AND
RECEPTION SERVICES VIA TELECOMMUNICA-
TION MEANS, TELECOMMUNICATIONS GATE-
WAY SERVICES; PROVIDING INFORMATION ON
TELECOMMUNICATIONS SUBSCRIPTION SERVI-
CES, NAMELY, SUBSCRIPTION TELEVISION
BROADCASTING; COMMUNICATIONS VIA COM-
PUTER TERMINALS; RADIO AND TELEPHONE
COMMUNICATION SERVICES; MOBILE RADIO-
TELEPHONY SERVICES; PROVIDING MULTIPLE-
USER ACCESS TO A GLOBAL COMPUTER INFOR-
MATION NETWORK AND WIRELESS COMMUNI-
CATION NETWORK; PROVIDING MULTIPLE USE
ACCESS TO GLOBAL COMPUTER INFORMATION
NETWORKS FOR THE TRANSFER AND DISSEMI-
NATION OF A WIDE RANGE OF INFORMATION;
NEWS AGENCIES, NAMELY, THE TRANSMISSION
OF NEWS ITEMS TO NEWS REPORTING ORGANI-
ZATIONS; RENTAL OF TELECOMMUNICATION
APPARATUS, NAMELY, TELEPHONES; RADIO
AND TELEVISION BROADCASTING; AUDIO AND
VIDEO TELECONFERENCING SERVICES; ELEC-
TRONIC MAIL SERVICES, IN CLASS 38 (U.S. CLS.
100, 101 AND 104).

PRIORITY DATE OF 6-1-2006 IS CLAIMED.

OWNER OF INTERNATIONAL REGISTRATION
0920900 DATED 11-27-2006, EXPIRES 11-27-2016.

THE ENGLISH TRANSLATION OF "BEBE" IS
BABY.

SER. NO. 79-037,254, FILED 11-27-2006.

DAVID MILLER, EXAMINING ATTORNEY

Int. Cl.: 12

Prior U.S. Cls.: 19, 21, 23, 31, 35 and 44

Reg. No. 3,576,309

United States Patent and Trademark Office

Registered Feb. 17, 2009

**TRADEMARK
PRINCIPAL REGISTER**

VIAQUA

GIBBS TECHNOLOGIES LIMITED (UNITED KINGDOM COMPANY)
AVENUE ROAD
NUNEATON, WARWICKSHIRE CV11 4LY
UNITED KINGDOM

FOR: LAND VEHICLES, BOATS, AMPHIBIOUS VEHICLES, ACCESSORIES, FITTINGS AND REPLACEMENT PARTS FOR THE AFORESAID, NAMELY, FITTED AND SEMI-FITTED COVERS FOR VEHICLES, CHILDREN'S SAFETY SEATS FOR VEHICLES, SEAT COVERS FOR VEHICLES, AIRBAGS, BEING SAFETY DEVICES FOR VEHICLES, AIR PUMPS FOR VEHICLES, ANTI-THEFT ALARMS FOR VEHICLES, TYRES, LUGGAGE NETS FOR VEHICLES, LUGGAGE CARRIERS, VEHICLE ANTI-SKID CHAINS, HEAD RESTS FOR VEHICLE SEATS, WHEELS FOR VEHICLES, VEHICLE ROLL BARS, TONNEAU COVERS, BEING FITTED COVERS FOR VEHICLES, BIMINIS, BEING SOFT TOPS FOR VEHICLES, REMOVABLE HARD ROOFS FOR VEHICLES, FABRIC ROOFS FOR VEHICLES, WINDSCREEN WIPERS, HOODS FOR VEHICLE ENGINES, HOODS FOR VEHICLES, DIRECTION

SIGNALS FOR VEHICLES, ANTI-DAZZLE DEVICES FOR VEHICLES, NOT INCLUDING LAMP FITTINGS, REAR VIEW MIRRORS FOR VEHICLES, BUMPERS FOR VEHICLES, BODIES FOR VEHICLES, CHASSIS FOR VEHICLES, WINDSCREENS FOR VEHICLES, STEERING WHEELS FOR VEHICLES, SEATS FOR VEHICLES, RUNNING BOARDS FOR VEHICLES, SECURITY HARNESES FOR VEHICLE SEATS, IN CLASS 12 (U.S. CLS. 19, 21, 23, 31, 35 AND 44).

THE MARK CONSISTS OF STANDARD CHARACTERS WITHOUT CLAIM TO ANY PARTICULAR FONT, STYLE, SIZE, OR COLOR.

OWNER OF INTERNATIONAL REGISTRATION
0921058 DATED 3-23-2007, EXPIRES 3-23-2017.

SER. NO. 79-037,306, FILED 3-23-2007.

DOMINIC FATHY, EXAMINING ATTORNEY

Int. Cl.: 33

Prior U.S. Cls.: 47 and 49

United States Patent and Trademark Office

Reg. No. 3,576,310

Registered Feb. 17, 2009

TRADEMARK
PRINCIPAL REGISTER



I.L.A.R. (INDUSTRIA LIQUORI; AFFINI ROMA)
S.P.A. (ITALY JOINT STOCK COMPANY)
VIA TIBURTINA, 1314
I-00131 ROMA
ITALY

FOR: ALCOHOLIC BEVERAGES, NAMELY, LIQUEURS, CREAM LIQUEURS, SPIRITS, FRUIT BASED ALCOHOLIC BEVERAGES, EXCLUDING BEER, IN CLASS 33 (U.S. CLS. 47 AND 49).

OWNER OF INTERNATIONAL REGISTRATION
0922859 DATED 2-15-2007, EXPIRES 2-15-2017.

OWNER OF U.S. REG. NOS. 2,450,341 AND
3,261,302.

NO CLAIM IS MADE TO THE EXCLUSIVE
RIGHT TO USE "LIQUORI" AND "CASA FONDATA
NEL 1875", APART FROM THE MARK AS SHOWN.

THE TRADEMARK CONSISTS OF THE WORD "PALLINI", WRITTEN IN CAPITAL LETTERS, INSCRIBED IN A RECTANGULAR LABEL HAVING A QUADRUPLE FRAME, PARTIALLY BROKEN AT THE BOTTOM IN CORRESPONDENCE WITH THE LETTERS "LL", AND WITH THE SHORT SIDES ROUNDED; ABOVE SAID WORD IS PICTURED A COAT OF ARMS ESSENTIALLY CHARACTERIZED BY FLORAL PATTERNS AND, IN THE CENTRE, BY THE FIGURE OF AN EAGLE; INSIDE THE COAT OF ARMS, THERE ARE THE WORDINGS "PALLINI LIQUORI CASA FONDATA NEL 1875".

THE ENGLISH TRANSLATION OF THE FOREIGN WORD(S) IN THE MARK IS: OBJECT BALLS; LIQUEURS, HOUSE FOUNDED IN 1875.

SER. NO. 79-038,030, FILED 2-15-2007.

ASMAT KHAN, EXAMINING ATTORNEY

Int. Cls.: 9, 38 and 42

Prior U.S. Cls.: 21, 23, 26, 36, 38, 100, 101 and 104

United States Patent and Trademark Office

Reg. No. 3,576,311

Registered Feb. 17, 2009

**TRADEMARK
SERVICE MARK
PRINCIPAL REGISTER**

VCT-MotionD

MICRONAS GMBH (FED REP GERMANY LIMITED LIABILITY COMPANY)

HANS-BUNTE-STRASSE 19

79108 FREIBURG, FED REP GERMANY

FOR: MICROPROCESSORS, SIGNAL PROCESSORS AND MICROCONTROLLERS; DECODERS, NAMELY, TELEVISION, VIDEO AND AUDIO DECODERS; SEMICONDUCTORS; SEMI-CONDUCTOR DEVICES, NAMELY, TRANSISTORS, DIODES, MEMORIES, ELECTRONIC SENSORS, INTEGRATED CIRCUITS, SILICON WAFERS; STRUCTURAL PARTS OF ALL THE AFORESAID GOODS, IN CLASS 9 (U.S. CLS. 21, 23, 26, 36 AND 38).

FOR: PROVIDING TELECOMMUNICATIONS CONNECTIONS TO THE INTERNET OR DATABASES; PROVIDING REMOTE ACCESS TO THE INTERNET; ELECTRONIC TRANSMISSION OF MESSAGES; COMMUNICATION VIA FIBER-OPTIC NETWORKS; PROVIDING USER ACCESS TO A GLOBAL COMPUTER INFORMATION NETWORK; COMPUTER-ASSISTED TRANSMISSION OF TEXTS AND IMAGES; INFORMATION TRANSMISSION VIA ELECTRONIC COMMUNICATIONS NETWORKS, NAMELY, TRANSMISSION OF INFORMATION ABOUT INTEGRATED CIRCUITS AND ELECTRONIC DEVICES VIA THE INTERNET, IN CLASS 38 (U.S. CLS. 100, 101 AND 104).

FOR: DESIGN AND DEVELOPMENT OF SEMICONDUCTOR COMPONENTS, MICROPROCESSORS, SIGNAL PROCESSORS, ELECTRIC AND ELECTRONIC CIRCUITS; PROVIDING TEMPORARY USE OF ON-LINE NON-DOWNLOADABLE COMPUTER PROGRAMS IN DATA NETWORKS IN THE NATURE OF OPERATING SYSTEMS SOFTWARE AND CONTROL SOFTWARE FOR IMPROVING AUDIO EQUIPMENT AND SOUND QUALITY, IN CLASS 42 (U.S. CLS. 100 AND 101).

THE MARK CONSISTS OF STANDARD CHARACTERS WITHOUT CLAIM TO ANY PARTICULAR FONT, STYLE, SIZE, OR COLOR.

PRIORITY DATE OF 7-20-2006 IS CLAIMED.

OWNER OF INTERNATIONAL REGISTRATION 0923846 DATED 1-10-2007, EXPIRES 1-10-2017.

THE WORDING "VCT" HAS NO MEANING IN A FOREIGN LANGUAGE.

SER. NO. 79-038,368, FILED 1-10-2007.

DAWN HAN, EXAMINING ATTORNEY

Int. Cls.: 5 and 21

Prior U.S. Cls.: 2, 6, 13, 18, 23, 29, 30, 33, 40, 44, 46,
50, 51 and 52

Reg. No. 3,576,312

United States Patent and Trademark Office

Registered Feb. 17, 2009

TRADEMARK
PRINCIPAL REGISTER

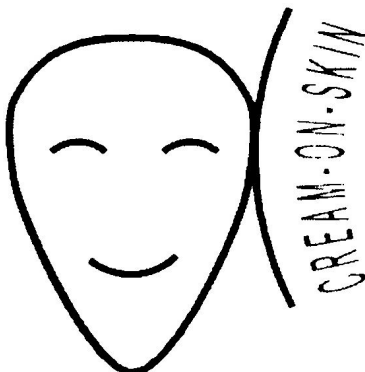

MARC SCHERRER (SWITZERLAND INDIVIDUAL)
BLUMENRAIN 25
ZOLLIKON, SWITZERLAND CH8702

FOR: PHARMACEUTICAL AND MEDICAL PRODUCTS AND MEDICAL CARE PREPARATIONS, NAMELY, ANTI-ITCH CREAM, MULTIPURPOSE MEDICATED CREAM, ANALGESIC BALM AND MENTHOLATED SALVE, CALAMINE LOTION, MEDICATED SKIN CARE PREPARATIONS IN THE NATURE OF OILS, IN CLASS 5 (U.S. CLS. 6, 18, 44, 46, 51 AND 52).

FOR: FOAM APPLICATOR FITTED WITH HANDLE FOR SPREADING COSMETIC OR MEDICAL PREPARATIONS, PREFERABLY ON THE SKIN OF

THE HUMAN BACK; REPLACEMENT SPONGES, IN CLASS 21 (U.S. CLS. 2, 13, 23, 29, 30, 33, 40 AND 50).

PRIORITY DATE OF 7-18-2006 IS CLAIMED.

OWNER OF INTERNATIONAL REGISTRATION 0923874 DATED 1-15-2007, EXPIRES 1-15-2017.

NO CLAIM IS MADE TO THE EXCLUSIVE RIGHT TO USE "CREAM ON SKIN", APART FROM THE MARK AS SHOWN.

SER. NO. 79-038,379, FILED 1-15-2007.

ALLISON HOLTZ, EXAMINING ATTORNEY

Int. Cls.: 1 and 17

Prior U.S. Cls.: 1, 5, 6, 10, 12, 13, 26, 35, 46 and 50

United States Patent and Trademark Office

Reg. No. 3,576,313

Registered Feb. 17, 2009

**TRADEMARK
PRINCIPAL REGISTER**

Biograde

FKUR KUNSTSTOFF GMBH (FED REP GERMA-
NY LIMITED LIABILITY COMPANY)
SIEMENSRING 79
47877 WILLICH, FED REP GERMANY

FOR: BIODEGRADABLE CELLULOSE COM-
POUNDS AND BLENDS; BIODEGRADABLE CEL-
LULOSE COMPOUNDS AND BLENDS IN THE
FORM OF PELLETS; BIODEGRADABLE CELLU-
LOSE COMPOUNDS AND BLENDS, NAMELY, CEL-
LULOSE/ALLOY COMPOSITIONS USED FOR
BLOWN FILMS, EXTRUDED SHEETS, PROFILES,
CONTAINERS, FOAMED OR MOLDED, AND
THERMOFORMED PRODUCTS, IN CLASS 1 (U.S.
CLS. 1, 5, 6, 10, 26 AND 46).

FOR: SEMI-FINISHED PRODUCTS MADE FROM
BIODEGRADABLE CELLULOSE COMPOUNDS
AND BLENDS, NAMELY, FILMS, SHEETS, PRO-

FILES, PACKAGING MATERIALS AND INJECTION
MOLDED AND COMPRESSION MOLDED PARTS,
CAST AND THERMOFORMED FILMS AND
SHEETS, IN CLASS 17 (U.S. CLS. 1, 5, 12, 13, 35 AND
50).

THE MARK CONSISTS OF STANDARD CHAR-
ACTERS WITHOUT CLAIM TO ANY PARTICULAR
FONT, STYLE, SIZE, OR COLOR.

OWNER OF INTERNATIONAL REGISTRATION
0924193 DATED 1-15-2007, EXPIRES 1-15-2017.

SER. NO. 79-038,486, FILED 1-15-2007.

ALLISON HOLTZ, EXAMINING ATTORNEY

Int. Cls.: 3, 15, 24, 25 and 43

**Prior U.S. Cls.: 1, 2, 4, 6, 21, 22, 36, 39, 42, 50, 51, 52,
100 and 101**

Reg. No. 3,576,314

United States Patent and Trademark Office

Registered Feb. 17, 2009

**TRADEMARK
SERVICE MARK
PRINCIPAL REGISTER**



KITZBÜHEL TOURISMUS (AUSTRIA CORPORATION OF PUBLIC LAW)
HINTERSTADT 18
A-6370 KITZBÜHEL
AUSTRIA

FOR: COSMETICS, IN CLASS 3 (U.S. CLS. 1, 4, 6, 50, 51 AND 52).

FOR: MUSICAL INSTRUMENTS , IN CLASS 15 (U.S. CLS. 2, 21 AND 36).

FOR: TEXTILES AND TEXTILE GOODS, NAME-
LY, TOWELS; BED COVERS AND TABLE CLOTHS,
BLANKETS, PILLOWS, IN CLASS 24 (U.S. CLS. 42
AND 50).

FOR: CLOTHING, NAMELY, COATS AND JACK-
ETS, VESTS AND WAISTCOATS, BODY WARMERS,
NAMELY, SCARVES AND WAISTCOATS, SHIRTS,
BLOUSES, T-SHIRTS, POLO SHIRTS, POLO NECKS,
PULLOVERS, SWEATERS, SWEATSHIRTS, SWEAT-
PANTS, JOGGING PANTS, LADIES' TOPS, TROU-
SERS, SHORTS, STOCKINGS AND SOCKS,
PAJAMAS, AND SUITS, BATH ROBES, DRESSING
GOWNS, GLOVES, FOULARDS, BANDANNAS,
SCARVES, CRAVATS AND NECKTIES, BELTS;
HEADGEAR, NAMELY, HATS, CAPS, BONNETS,

FRONTLETS BEING HEADBANDS AND HEAD-
BANDS; FOOTWEAR, NAMELY, SHOES, SNEA-
KERS, BOOTS, SNOW BOOTS, IN CLASS 25 (U.S.
CLS. 22 AND 39).

FOR: PROVIDING OF FOOD AND DRINK; TEM-
PORARY ACCOMMODATION, IN CLASS 43 (U.S.
CLS. 100 AND 101).

PRIORITY DATE OF 9-21-2006 IS CLAIMED.

OWNER OF INTERNATIONAL REGISTRATION
0924414 DATED 12-14-2006, EXPIRES 12-14-2016.

THE COLOR(S) RED AND WHITE IS/ARE
CLAIMED AS A FEATURE OF THE MARK.

THE COLOR RED APPEARS ON THE CHAMOIS
IMAGE, AND THE COLOR WHITE APPEARS ON
THE BACKGROUND.

SER. NO. 79-038,577, FILED 12-14-2006.

DEBRA LEE, EXAMINING ATTORNEY

Int. Cls.: 18, 24 and 25

Prior U.S. Cls.: 1, 2, 3, 22, 39, 41, 42 and 50

United States Patent and Trademark Office

Reg. No. 3,576,315

Registered Feb. 17, 2009

TRADEMARK
PRINCIPAL REGISTER



AMERICAN RETRO (FRANCE SOCIÉTÉ À RESPONSABILITÉ LIMITÉE)
32, RUE ETIENNE MARCEL
F-75002 PARIS
FRANCE

FOR: TRUNKS AND SUITCASES; UMBRELLAS; WALLETS; PURSES NOT OF PRECIOUS METAL; HANDBAGS, BACKPACKS, WHEELED BAGS; BAGS FOR CLIMBERS, BAGS FOR CAMPERS, TRAVELING BAGS, BEACH BAGS, SCHOOL BAGS; COLLARS OR CLOTHING FOR ANIMALS, IN CLASS 18 (U.S. CLS. 1, 2, 3, 22 AND 41).

FOR: FABRICS FOR THE MANUFACTURE OF CLOTHES; FABRICS FOR TEXTILE USE; BED LINEN; HOUSEHOLD LINEN; TABLE LINEN NOT OF PAPER; BATH LINEN EXCEPT CLOTHING, IN CLASS 24 (U.S. CLS. 42 AND 50).

FOR: CLOTHING, NAMELY, TIGHTS, STOCKINGS, SOCKS, PETTICOATS, OVERALLS, APRONS, COMBINATIONS, SUITS, UNIFORMS, SKIRTS, DRESSES, SARIS, PANTS, SHORTS, BERMUDA SHORTS, WAISTCOATS, PULLOVERS, SWEATSHIRTS, TEE-SHIRTS, SHIRTS, SHORT-SLEEVE SHIRTS, STUFF JACKETS, JACKETS, PELERINES, COATS, FURS, NAMELY, STUFF JACKETS, JACKETS, COATS, WAISTCOATS, BOLEROS; PARKAS, RAINCOATS, NECKTIES, BELTS, GLOVES, SCARVES, SASHES FOR WEAR, TURBANS, HEADBANDS, BANDANAS, SWIMSUITS, SWIMMING TRUNKS, BATHROBES, PAJAMAS, NIGHT

GOWNS, DRESSING GOWNS; UNDERWEAR, NAMELY, BREECHES FOR WEAR, UNDERPANTS, BOXER SHORTS, WOMEN'S LINGERIE, TEDDIES; FOOTWEAR; BEACH, SKI OR SPORTS FOOTWEAR; HEADGEAR, NAMELY, BASEBALL CAPS, VISORS, HATS, CAPS, BERETS, BATHING CAPS; LEATHER OR IMITATION LEATHER CLOTHING, NAMELY, UNDERWEAR, OVERALLS, COMBINATIONS, UNIFORMS, DRESSES, PANTS, SHIRTS, STUFF JACKETS, JACKETS, COATS, RAINCOATS, NECKTIES, BELTS, AND GLOVES, IN CLASS 25 (U.S. CLS. 22 AND 39).

PRIORITY DATE OF 9-18-2006 IS CLAIMED.

OWNER OF INTERNATIONAL REGISTRATION
0924421 DATED 3-13-2007, EXPIRES 3-13-2017.

THE NAME(S), PORTRAIT(S), AND/OR SIGNATURE(S) SHOWN IN THE MARK DOES NOT IDENTIFY A PARTICULAR LIVING INDIVIDUAL.

THE MARK CONSISTS OF THE WORDING "ZOETEE'S" ENCLOSED IN A HEART SHAPE DESIGN, AND ALL ENCLOSED IN AN ORNAMENTAL BANNER DECORATED WITH VOLUTES, HEARTS AND STARS.

SER. NO. 79-038,579, FILED 3-13-2007.

DARRYL SPRUILL, EXAMINING ATTORNEY

Int. Cls.: 16, 21, 25 and 33

Prior U.S. Cls.: 2, 5, 13, 22, 23, 29, 30, 33, 37, 38, 39,
40, 47, 49 and 50

Reg. No. 3,576,316

United States Patent and Trademark Office

Registered Feb. 17, 2009

TRADEMARK
PRINCIPAL REGISTER



ALLIED DOMEQ SPIRITS & WINE LIMITED
(UNITED KINGDOM LIMITED LIABILITY
COMPANY)
CHIVAS HOUSE
72 CHANCELLORS ROAD; LONDON W6 9RS
UNITED KINGDOM

FOR: STATIONERY; PAPER, CARDBOARD AND
GOODS MADE OF THESE MATERIALS, NAMELY,
CHECKBOOK HOLDERS, BILL CASES IN THE
NATURE OF FOLDERS FOR BILLS, DOCUMENT
FOLDERS, STATIONERY CASES FOR DIARIES,
PAPER SOUVENIR BAGS, PAPER GIFT BAGS,
NOTEBOOKS, NOTEBOOK COVERS, PHOTO-
GRAPH ALBUMS, FOLDERS, POSTCARDS, POS-
TERS, PRINTED MENUS, COCKTAIL MATS IN THE
NATURE OF PAPER COASTERS, DRINK MATS IN
THE NATURE OF PAPER COASTERS, GREETING
CARDS, PAPER TABLECLOTHS, PAPER PARTY
BANNERS, PAPER PARTY DECORATIONS, PAPER
NAPKINS; DIARIES; CALENDARS; STICKERS;
BOOK MARKERS, IN CLASS 16 (U.S. CLS. 2, 5, 22,
23, 29, 37, 38 AND 50).

FOR: HOUSEHOLD OR KITCHEN UTENSILS
AND CONTAINERS, NAMELY, ICE BUCKETS,
COCKTAIL STIRRERS, DRINK STIRRERS, COCK-
TAIL STICKS, STRAINERS, NON-ELECTRIC FRUIT
SQUEEZERS, HOLDERS FOR NAPKINS, CANDLE
HOLDERS, HOLDERS FOR BAR ACCESSORIES IN
THE NATURE OF BUCKETS AND TRAYS, BOTTLE
OPENERS, CORKSCREWS, CONDIMENT HOLD-
ERS, SERVING TRAYS, ICE TRAYS, BAR UTENSIL
TRAYS, JUGS, STANDS FOR BOTTLES, DRIP-
TRAYS FOR BARS, BOTTLE BUCKETS, CONTAIN-

ERS FOR BAR USE, DECANTER STANDS, HIP
FLASKS; GLASSWARE AND PORCELAIN, NAME-
LY, MIXING GLASSES, MENU CARD HOLDERS
AND BILL HOLDERS IN THE NATURE OF TRAYS,
CANDLE HOLDERS, JUGS, STANDS FOR BOT-
TLES, BOTTLE BUCKETS, CONTAINERS FOR
BAR USE, DECANTER STANDS, COCKTAIL JUGS,
PLATES, DISHES AND CUPS OF GLASS OR POR-
CELAIN, AND VASES; DRINKING GLASSES; DE-
CANTERS; COCKTAIL SHAKERS AND SWIZZLE
STICKS; TRAYS; CORKSCREWS, IN CLASS 21 (U.S.
CLS. 2, 13, 23, 29, 30, 33, 40 AND 50).

FOR: ARTICLES OF CLOTHING, NAMELY,
SCARVES, COATS, JACKETS, SHIRTS, T-SHIRTS,
POLO SHIRTS, BLOUSES, SWEATSHIRTS, SWEA-
TERS, FLEECE TOPS, PANTS, SHORTS, SKIRTS,
PAJAMAS, UNDER GARMENTS, APRONS, DRES-
SES, TRACK SUITS, SWIM WEAR, CLOTHING
ADAPTED FOR SPORTS, NAMELY, WATERPROOF
JACKETS AND PANTS, WIND PANTS, TRACK
JACKETS AND PANTS, SKI JACKETS AND PANTS,
SNOW BOARD PANTS AND JACKETS, SNOW
PANTS AND JACKETS, MOISTURE WICKING
SPORTS PANTS AND JACKETS, JOGGING PANTS,
SHORTS AND SHIRTS, GOLF SHIRTS AND PANTS,
RUGBY SHIRTS AND SHORTS, SPORT JERSEYS,
BREECHES FOR SPORTS, SPORTS BRAS; ARTI-
CLES OF HEADGEAR, NAMELY, HATS, CAPS AND
BANDANAS; SOCKS, IN CLASS 25 (U.S. CLS. 22 AND
39).

FOR: ALCOHOLIC BEVERAGES, NAMELY,
WINES, SPIRITS, SPIRIT BASED DRINKS, LI-
QUEURS, PREPARED ALCOHOLIC COCKTAILS

AND GIN BASED DRINKS; GINS, IN CLASS 33 (U.S. CLS. 47 AND 49).

PRIORITY DATE OF 1-17-2007 IS CLAIMED.

OWNER OF INTERNATIONAL REGISTRATION 0925033 DATED 5-9-2007, EXPIRES 5-9-2017.

OWNER OF U.S. REG. NOS. 678,610, 2,879,340 AND OTHERS.

THE COLOR(S) RED, WHITE, BLACK, GRAY, YELLOW, PEACH, AND BROWN IS/ARE CLAIMED AS A FEATURE OF THE MARK.

THE COLOR RED APPEARS IN THE CLOTHING, SHOES AND HAT WORN BY THE STYLIZED MAN IN THE DESIGN; THE COLOR WHITE APPEARS IN

THE CLOTHING, GLOVES AND HAT WORN BY THE STYLIZED MAN IN THE DESIGN, AND AS HIGHLIGHTS ON THE SPEAR DESIGN; THE COLOR BLACK APPEARS IN THE CLOTHING, SHOES AND HAT WORN BY THE STYLIZED MAN IN THE DESIGN, ON THE SPEAR DESIGN, AND ON THE HAIR, FACIAL HAIR AND FACIAL FEATURES OF THE STYLIZED MAN IN THE DESIGN; THE COLOR GRAY APPEARS IN THE CLOTHING, GLOVES AND HAT WORN BY THE STYLIZED MAN IN THE DESIGN; THE COLOR YELLOW APPEARS IN THE CLOTHING WORN BY THE STYLIZED MAN IN THE DESIGN; THE COLOR PEACH APPEARS IN THE FACE OF THE STYLIZED MAN IN THE DESIGN; AND THE COLOR BROWN APPEARS IN THE SPEAR DESIGN.

SER. NO. 79-038,808, FILED 5-9-2007.

KAELIE KUNG, EXAMINING ATTORNEY

Int. Cls.: 7, 37, 39, 40 and 42

**Prior U.S. Cls.: 13, 19, 21, 23, 31, 34, 35, 100, 101, 103,
105 and 106**

Reg. No. 3,576,317

United States Patent and Trademark Office

Registered Feb. 17, 2009

**TRADEMARK
SERVICE MARK
PRINCIPAL REGISTER**

KROMI

KROMI LOGISTIK AG (FED REP GERMANY
JOINT-STOCK COMPANY)
TARPENRING 7-11
22419 HAMBURG
FED REP GERMANY

FOR: PRECISION MACHINE TOOLS, NAMELY, HARD METAL TOOLS, HIGH SPEED STEEL (HSS) TOOLS, CARBIDE TOOLS, CERAMIC TOOLS, POLY CRYSTALLINE DIAMOND (PCD) TOOLS, DIAMOND-COATED AND DIAMOND-UNCOATED TOOLS, ALL FOR USE IN THE CUTTING AND FORMING OF MATERIALS BY OTHERS, IN CLASS 7 (U.S. CLS. 13, 19, 21, 23, 31, 34 AND 35).

FOR: REPAIR AND MAINTENANCE OF VENDING MACHINES THAT AUTOMATE THE STORAGE AND DISPENSING OF MACHINE TOOLS, IN CLASS 37 (U.S. CLS. 100, 103 AND 106).

FOR: TRANSPORT, DELIVERY, PACKAGING AND STORAGE OF GOODS, NAMELY, PRECISION MACHINE TOOLS, IN CLASS 39 (U.S. CLS. 100 AND 105).

FOR: ASSEMBLY OF AUTOMATED MACHINE TOOL STORAGE AND DISPENSING EQUIPMENT FOR OTHERS, IN CLASS 40 (U.S. CLS. 100, 103 AND 106).

FOR: TECHNOLOGICAL CONSULTATION SERVICES IN THE TECHNOLOGY FIELD OF MACHINE TOOLS; AND DESIGNING MACHINE TOOLS, IN CLASS 42 (U.S. CLS. 100 AND 101).

THE MARK CONSISTS OF STANDARD CHARACTERS WITHOUT CLAIM TO ANY PARTICULAR FONT, STYLE, SIZE, OR COLOR.

OWNER OF INTERNATIONAL REGISTRATION
0746553 DATED 7-6-2000, EXPIRES 7-6-2010.

SER. NO. 79-038,884, FILED 2-8-2007.

LESLEY LAMOTHE, EXAMINING ATTORNEY

Int. Cls.: 7, 8, 9 and 12

**Prior U.S. Cls.: 13, 19, 21, 23, 26, 28, 31, 34, 35, 36, 38
and 44**

Reg. No. 3,576,318

United States Patent and Trademark Office

Registered Feb. 17, 2009

**TRADEMARK
PRINCIPAL REGISTER**

Hanning & Kahl

HANNING & KAHL GMBH & CO. KG (FED REP
GERMANY GMBH & CO. KG)
RUDOLF-DIESEL-STR. 6
33813 OERLINGHAUSEN, FED REP GERMANY

FOR: ELECTROMECHANICAL BRAKES FOR
WIND ENERGY MACHINES; BRAKE FOR ALIGN-
MENT OF A ROTORARY AXIS OF A ROTOR FOR
MACHINES AND NOT FOR LAND VEHICLES;
BRAKE FOR CIRCULAR MOTION OF A ROTOR
FOR MACHINES AND NOT FOR LAND VEHICLES,
IN CLASS 7 (U.S. CLS. 13, 19, 21, 23, 31, 34 AND 35).

FOR: HAND PUMPS FOR RELEASING BRAKES,
IN CLASS 8 (U.S. CLS. 23, 28 AND 44).

FOR: MEASURING, SIGNALLING, CONTROL,
REGULATING AND MONITORING APPARATUS
FOR BRAKES, NAMELY, MECHANICALLY, HY-
DRAULICALLY AND ELECTRICALLY OPERATED
BRAKE CONTROLLERS; PRINT CIRCUIT, BRAKE
PAD, GASKET, BOLTS, EMITTER, ACCUMULA-
TOR, MOTOR, SOLD AS AN INTEGRAL COMPO-
NENT PART OF BRAKE CONTROLLERS;
ELECTRICAL, ELECTRIC AND MECHANICAL
SWITCHING APPARATUS FOR BRAKES; DATA
PROCESSING EQUIPMENT FOR SETTING UP
AND MONITORING ROUTES OF TRAINS, LIGHT
RAIL VEHICLES, TRAMS, METROS AND BUSES,
NAMELY, CENTRAL PROCESSOR UNIT, ELECTRI-
CALLY ERASABLE PROGRAMMABLE READ
ONLY MEMORY (EPROM), ELECTRICALLY ERA-
SABLE READ-ONLY MEMORY (EEPROM), PRINT-
ED CIRCUIT BOARD; SAFETY CONTROLLERS
FOR SINGLE-TRACK RAILWAYS LINES, SAFETY
CONTROLLERS FOR LEVEL CROSSINGS; RADIOS,
WALKIE-TALKIES AND RADIO TRANSMITTERS
FOR DISPATCH MANAGEMENT FOR VEHICLES
IN DEPOT; SAFETY AND SIGNALLING APPARA-
TUS FOR RAIL TRAFFIC, NAMELY, MANUALLY

AND ELECTRICALLY OPERATED SWITCH MA-
CHINES, TRAFFIC SIGNAL SYSTEMS, SWITCH
CONTROLLERS, AND ELECTRICALLY LOCAL-
LY-SET POINTS; SWITCHING APPARATUS FOR
DETECTING RAILWAY VEHICLES, NAMELY,
TRACK CIRCUITS, LOCKING CIRCUITS, LOCAT-
ING CIRCUITS; TEST AND SERVICE APPARATUS
FOR BRAKES, POINT MACHINE, SWITCH MA-
CHINE, SWITCH CONTROLLERS AND PARTS OF
THE BRAKES; ELECTRO-DYNAMIC APPARATUS
FOR REMOTE CONTROL OF RAILWAY POINTS,
IN CLASS 9 (U.S. CLS. 21, 23, 26, 36 AND 38).

FOR: MECHANICALLY, HYDRAULICALLY
AND ELECTRICALLY OPERATED AND MONI-
TORED VEHICLE BRAKES AND INDIVIDUAL
PARTS THEREOF, NAMELY, BRAKE DISCS,
BRAKE DRUMS, BRAKE FACINGS, BRAKE AC-
TUATOR, HYDRAULIC POWER UNIT, BRAKE
RIGGINGS, AND TRACK BRAKE; BRAKE DISCS,
BRAKE DRUMS, BRAKE FACINGS, BRAKE AC-
TUATOR, HYDRAULIC POWER UNIT, BRAKE
DISCS, AND BRAKE DRUMS FOR CONTROLLING,
REGULATING, INFLUENCING AND MONITOR-
ING LAND VEHICLE BRAKES; BRAKES FOR USE
WITH LAND VEHICLES THAT RUN ON RAILS, IN
CLASS 12 (U.S. CLS. 19, 21, 23, 31, 35 AND 44).

PRIORITY DATE OF 11-14-2006 IS CLAIMED.

OWNER OF INTERNATIONAL REGISTRATION
0925973 DATED 12-19-2006, EXPIRES 12-19-2016.

SER. NO. 79-039,229, FILED 12-19-2006.

MARILYN IZZI, EXAMINING ATTORNEY

Int. Cls.: 35 and 38

Prior U.S. Cls.: 100, 101, 102 and 104

United States Patent and Trademark Office

Reg. No. 3,576,319

Registered Feb. 17, 2009

**SERVICE MARK
PRINCIPAL REGISTER**

ZOOM & DRAG

INTELLECTUAL PROPERTY HOLDINGS LTD.
(UNITED KINGDOM LIMITED COMPANY
UNDER THE LAWS OF ENGLAND AND
WALES)

39 BRUTON PLACE
BERKELEY SQUARE; LONDON W1J 6LF
UNITED KINGDOM

FOR: ADMINISTRATION OF A DISCOUNT PROGRAM FOR ENABLING PARTICIPANTS TO OBTAIN DISCOUNTS ON GOODS AND SERVICES; PROVIDING A WEBSITE FEATURING ONLINE REGISTRATION SERVICES FOR MEMBERSHIP TO AN ONLINE COMMERCIAL INFORMATION DATABASE RELATING TO HAIR-CARE, SKIN-CARE AND BEAUTY PRODUCTS, TREATMENTS AND SERVICES, MAKEUP, COSMETICS, APPAREL, BAGS, FOOTWEAR, JEWELLERY AND ACCESSORIES, IN CLASS 35 (U.S. CLS. 100, 101 AND 102).

FOR: PROVIDING AND OPERATING AN ONLINE BULLETIN BOARD FOR BUYERS OF GOODS AND SERVICES, NAMELY, HAIR-CARE, SKIN-

CARE AND BEAUTY PRODUCTS, TREATMENTS AND SERVICES, MAKEUP, COSMETICS, APPAREL, BAGS, FOOTWEAR, JEWELLERY AND ACCESSORIES VIA THE INTERNET, AN INTRANET OR AN EXTRANET, IN CLASS 38 (U.S. CLS. 100, 101 AND 104).

THE MARK CONSISTS OF STANDARD CHARACTERS WITHOUT CLAIM TO ANY PARTICULAR FONT, STYLE, SIZE, OR COLOR.

PRIORITY DATE OF 8-25-2006 IS CLAIMED.

OWNER OF INTERNATIONAL REGISTRATION 0926036 DATED 2-21-2007, EXPIRES 2-21-2017.

SER. NO. 79-039,256, FILED 2-21-2007.

REBECCA POVARCHUK, EXAMINING ATTORNEY

Int. Cl.: 25

Prior U.S. Cls.: 22 and 39

United States Patent and Trademark Office

Reg. No. 3,576,320

Registered Feb. 17, 2009

**TRADEMARK
PRINCIPAL REGISTER**

CORAL BLUE

ARTCRAFTS INTERNATIONAL S.P.A. (ITALY
SOCIETA PER AZIONI (SPA))
LUNGARNO SODERINI, 1
I-50124 FIRENZE
ITALY

FOR: ARTICLES OF CLOTHING FOR MEN,
WOMEN, BOYS AND GIRLS, NAMELY, SHOES,
HATS, CAPS, SCARVES, GLOVES, JACKETS, TROU-
SERS, SKIRTS, SHIRTS , IN CLASS 25 (U.S. CLS. 22
AND 39).

THE MARK CONSISTS OF STANDARD CHAR-
ACTERS WITHOUT CLAIM TO ANY PARTICULAR
FONT, STYLE, SIZE, OR COLOR.

OWNER OF INTERNATIONAL REGISTRATION
0926439 DATED 5-15-2007, EXPIRES 5-15-2017.

SER. NO. 79-039,394, FILED 5-15-2007.

CARYN GLASSER, EXAMINING ATTORNEY

Int. Cl.: 16

Prior U.S. Cls.: 2, 5, 22, 23, 29, 37, 38 and 50

Reg. No. 3,576,321

United States Patent and Trademark Office

Registered Feb. 17, 2009

**TRADEMARK
PRINCIPAL REGISTER**



EDITIONS NIVEALES (FRANCE SOCIÉTÉ À RE-
SPONSABILITÉ LIMITÉE)
6, RUE IRVOY
F-38000 GRENOBLE
FRANCE

FOR: PRINTED MATTER, NAMELY, CONSUMER MAGAZINES, PUBLICATIONS, BOOKS FEATURING THE FOLLOWING ACTIVITIES: CLIMBING, MOUNTAINEERING, ALPINISM, IN CLASS 16 (U.S. CLS. 2, 5, 22, 23, 29, 37, 38 AND 50).

OWNER OF INTERNATIONAL REGISTRATION
0926735 DATED 7-26-2006, EXPIRES 7-26-2016.

THE COLOR(S) RED AND WHITE IS/ARE CLAIMED AS A FEATURE OF THE MARK.

THE COLOR WHITE APPEARS ON THE WORD "VERTICAL" AND THE COLOR RED APPEARS AS THE MARK'S BACKGROUND COLOR.

SER. NO. 79-039,519, FILED 7-26-2006.

DEBRA LEE, EXAMINING ATTORNEY

Int. Cls.: 9, 16 and 42

**Prior U.S. Cls.: 2, 5, 21, 22, 23, 26, 29, 36, 37, 38, 50,
100 and 101**

Reg. No. 3,576,322

United States Patent and Trademark Office

Registered Feb. 17, 2009

**TRADEMARK
SERVICE MARK
PRINCIPAL REGISTER**

SeaTrend

FORCE TECHNOLOGY (DENMARK PUBLIC
LIMITED COMPANY)
PARK ALLÉ 345
DK-2605 BRØNDBY, DENMARK

FOR: COMPUTER PROGRAMS FOR MONITORING OF SHIP BEHAVIOR, FOR REPORTING OF VOYAGE RELATED DATA, FOR SHIP PERFORMANCE MONITORING, HULL AND PROPELLER FOULING MONITORING, FOR VOYAGE MONITORING, AND FOR MEASUREMENT OF TEMPERATURES, POSITIONS, DISTANCES, WIND SPEED, WIND DIRECTION AND WIND PERIOD, WAVE HEIGHT, WAVE DIRECTION AND WAVE PERIOD, WATER DEPTH, SEA CURRENT, LOADING CONDITION, TRIM, SWELL HEIGHT, SWELL DIRECTION AND SWELL PERIOD, SHIPS HEADING, SPEED, ENGINE POWER AND RPM, FUEL CONSUMPTION AND LEVELS; DOWNLOADABLE SOFTWARE FOR MONITORING OF SHIP BEHAVIOR FOR REPORTING OF VOYAGE RELATED DATA, FOR SHIP PERFORMANCE MONITORING, HULL AND PROPELLER FOULING MONITORING, FOR VOYAGE MONITORING, AND FOR MEASUREMENT OF TEMPERATURES, POSITIONS, DISTANCES, WIND SPEED, WIND DIRECTION AND WIND PERIOD, WAVE HEIGHT, WAVE DIRECTION AND WAVE PERIOD, WATER DEPTH, SEA CURRENT, LOADING CONDITION, TRIM, SWELL HEIGHT, SWELL DIRECTION AND SWELL PERIOD, SHIPS HEADING, SPEED, ENGINE POWER AND RPM, FUEL CONSUMPTION AND LEVELS; DATA PROCESSING APPARATUS, NAMELY, DATA PROCESSORS; NAVIGATION APPARATUS AND INSTRUMENTS, NAMELY, GLOBAL POSITIONING SYSTEM (GPS), COMPUTER, COMPUTER SOFTWARE FOR SHIP PERFORMANCE CONTROL, TRANSPONDER, TRANSDUCER, TRANSMITTERS, RECEIVERS, INTERFACES FOR COMPUTERS, AND INTERFACES FOR DE-

TECTORS, IN CLASS 9 (U.S. CLS. 21, 23, 26, 36 AND 38).

FOR: PRINTED MATTER, NAMELY, MANUALS, HANDBOOKS AND INSTRUCTIONAL AND TEACHING MATERIAL IN THE FIELD OF METROLOGY, SENSING AND MEASURING SYSTEMS; COMPUTER PROGRAM MANUALS FOR MONITORING OF SHIP BEHAVIOR, AND ANALYSIS AND REPORTING OF VOYAGE RELATED DATA, FOR SHIP PERFORMANCE MONITORING, HULL AND PROPELLER FOULING MONITORING, AND FOR VOYAGE MONITORING, IN CLASS 16 (U.S. CLS. 2, 5, 22, 23, 29, 37, 38 AND 50).

FOR: SCIENTIFIC SERVICES, NAMELY, SCIENTIFIC RESEARCH AND DEVELOPMENT, SCIENCE SERVICES IN THE NATURE OF REPORTING OF VOYAGE RELATED DATA, SHIP PERFORMANCE MONITORING, HULL AND PROPELLER FOULING MONITORING, AND FOR VOYAGE MONITORING; DESIGN AND DEVELOPMENT OF CONTROL PROGRAMS FOR AUTOMATED MEASUREMENT, ASSEMBLY, ADJUSTMENT, AND RELATED VISUALIZATION; DATA ACQUISITION FOR COORDINATE-MEASUREMENT PURPOSES, MEASUREMENT EVALUATIONS IN THE FIELD OF MARITIME NAVIGATION, SHIP PERFORMANCE AND MONITORING, TECHNOLOGICAL SERVICES, NAMELY, TECHNOLOGICAL CONSULTATION IN THE FIELD OF MARITIME TECHNOLOGY, METROLOGY, SENSOR BASED PROCESS CONTROL, COMPUTER HARDWARE SYSTEMS, AND SENSOR AND MEASUREMENT TECHNOLOGIES; DESIGN AND DEVELOPMENT OF NAVIGATION AND METEOROLOGICAL COMPUTERIZED SYSTEMS; INSTALLATION, DESIGN AND DEVELOPMENT OF COMPUTER SOFTWARE, IN CLASS 42 (U.S. CLS. 100 AND 101).

THE MARK CONSISTS OF STANDARD CHARACTERS WITHOUT CLAIM TO ANY PARTICULAR FONT, STYLE, SIZE, OR COLOR.

OWNER OF INTERNATIONAL REGISTRATION 0927572 DATED 4-18-2007, EXPIRES 4-18-2017.

SER. NO. 79-039,832, FILED 4-18-2007.

PRIORITY DATE OF 10-18-2006 IS CLAIMED.

DAYNA BROWNE, EXAMINING ATTORNEY

Int. Cl.: 5

Prior U.S. Cls.: 6, 18, 44, 46, 51 and 52

Reg. No. 3,576,323

United States Patent and Trademark Office

Registered Feb. 17, 2009

TRADEMARK
PRINCIPAL REGISTER

好医生

SICHUAN GOODDOCTOR; PHARMACEUTICAL
CO., LTD (CHINA CORPORATION)

SHENGKE ROAD, HUAJIE TOWN
AN COUNTY; SICHUAN
CHINA

FOR: MEDICINES FOR HUMAN PURPOSES, NAMELY, ANTIALLERGIC MEDICINES, MEDICINES FOR THE TREATMENT OF GASTROINTESTINAL DISEASES, PHARMACEUTICAL PREPARATIONS, NAMELY, A BLOOD CLOTTING AID AND DELIVERY SYSTEM FOR USE IN HUMAN AND VETERINARY MEDICINE, RADIOACTIVE SUBSTANCES FOR USE IN NUCLEAR MEDICINE, PREPARATIONS FOR THE TREATMENT OF COLDS, ANALGESICS; PHARMACEUTICAL PREPARATIONS FOR THE TREATMENT OF HIGH BLOOD PRESSURE; VITAMIN TABLETS; PHARMACEUTICAL PREPARATIONS FOR THE TREATMENT OF ALIMENTARY CANAL DISEASES; PHARMACEUTICAL PREPARATIONS FOR TREATING DIABETES; MEDICINES FOR THE PREVENTION OF DIARRHEA; PHARMACEUTICAL PREPARATIONS FOR THE TREATMENT OF MUSCLE RIGIDITY AND TO PROMOTE BLOOD CIRCULATION; CHINESE MEDICINAL PREPARATIONS, NAMELY, ORAL LIQUID USED TO REMOVE TOXIC SUBSTANCES AND DISSIPATE HEAT IN THE BODY FOR USE IN THE TREATMENT OF FEVERS, THROAT PAIN CAUSED BY HEAT TOXICITY IN THE BODY, INFLUENZA AND UPPER RESPIRATORY TRACT INFECTION UNDER PRINCIPLES OF CHINESE MEDICINE; CHINESE MEDICINAL PREPARATIONS, NAMELY, ORAL LIQUID USED TO REMOVE TOXIC SUBSTANCES AND DISSIPATE HEAT IN THE BODY DURING THE SUMMER, FOR USE IN THE TREATMENT OF COLDS CAUSED BY SUMMER HEAT, HEADACHES, FEELINGS OF BODY HEAVINESS AND CONSTRICTION OF THE CHEST, ABDOMIN-

AL DISTENTION AND PAIN, VOMITING AND DIARRHEA UNDER PRINCIPLES OF CHINESE MEDICINE; PHARMACEUTICAL PREPARATIONS USED TO STIMULATE THE HEART AND INVIGORATE THE BRAIN, NAMELY, MEDICINE COMPRISED OF RED SAGE ROOT, ROOT OF PSEUDOGINSENG AND BORNEOL, FOR THE PURPOSE OF STIMULATING BLOOD CIRCULATION, DISSIPATING BLOOD STASIS, REGULATING QI, ALLEVIATING PAIN, AND FOR THE TREATMENT OF SUCH ILLNESSES AS CORONARY HEART DISEASE AND ANGINA PECTORIS; EDIBLE PLANT FIBERS, NAMELY, PLANT EXTRACTS FOR MEDICAL, VETERINARY AND PHARMACEUTICAL PURPOSES; MEDICINAL TEA, NAMELY, HERBAL TEAS FOR MEDICINAL PURPOSES; LOTIONS FOR PHARMACEUTICAL PURPOSES, NAMELY, ANTIBACTERIAL HAND LOTIONS, ATHLETES' FOOT LOTIONS, BARRIER LOTION FOR PROTECTION FROM TOXIC OILS OF POISONOUS PLANTS, CALAMINE LOTION, MEDICATED DIAPER RASH OINTMENTS AND LOTIONS, MEDICATED LOTIONS FOR SKIN, HAIR, SUNBURN, FACE, AND BODY, MEDICATED SKIN CARE PREPARATIONS, NAMELY, CREAMS, LOTIONS, GELS, TONERS, CLEANERS AND PEELS, MEDICATED SUNBURN LOTIONS, NUTRITIONAL SUPPLEMENTS IN LOTION FORM SOLD AS A COMPONENT OF NUTRITIONAL SKIN CARE PRODUCTS, PHARMACEUTICAL SKIN LOTIONS; BIOLOGICAL PREPARATIONS FOR MEDICAL PURPOSES, DIETETIC SUBSTANCES ADAPTED FOR MEDICAL USE, NAMELY, DIETARY FOOD SUPPLEMENTS, DIETARY FIBER AS AN ADDITIVE FOR FOOD PRODUCTS; DIETETIC FOODS ADAPTED FOR MEDICAL PURPOSES, NUTRITIONAL ADDITIVES FOR MEDICAL PURPOSES FOR USE IN FOODS AND DIETARY SUPPLEMENTS FOR HUMAN CONSUMPTION, IN CLASS 5 (U.S. CLS. 6, 18, 44, 46, 51 AND 52).

OWNER OF INTERNATIONAL REGISTRATION
0928862 DATED 4-10-2007, EXPIRES 4-10-2017.

NO CLAIM IS MADE TO THE EXCLUSIVE
RIGHT TO USE THE NON-LATIN CHARACTERS
THAT MEAN MEDICINE, APART FROM THE
MARK AS SHOWN.

THE FOREIGN WORDING IN THE MARK
TRANSLATES INTO ENGLISH AS GOOD MEDI-
CINE.

THE TRANSLITERATION OF THE NON-LATIN
CHARACTERS IN THE MARK IS HAO YI SHENG.

SER. NO. 79-040,260, FILED 4-10-2007.

CHARISMA HAMPTON, EXAMINING ATTORNEY

Int. Cls.: 9, 10, 12, 17, 18, 24, 25, 26 and 28

Prior U.S. Cls.: 1, 2, 3, 5, 12, 13, 19, 21, 22, 23, 26, 31, 35, 36, 37, 38, 39, 40, 41, 42, 44 and 50

Reg. No. 3,576,324

United States Patent and Trademark Office

Registered Feb. 17, 2009

TRADEMARK
PRINCIPAL REGISTER

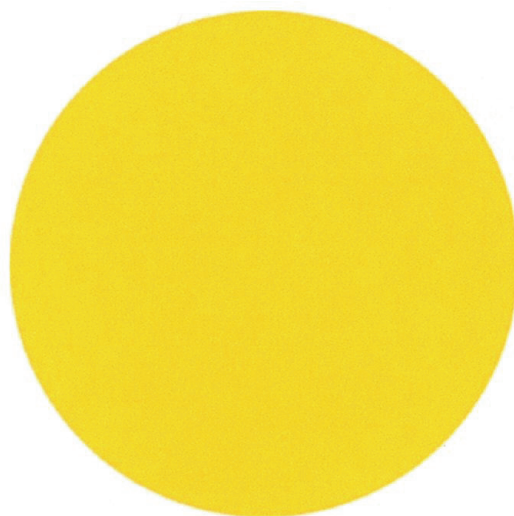

VIBRAM S.P.A. (ITALY CORPORATION)
VIA CRISTOFORO COLOMBO, 5
I-21041 ALBIZZATE (VA), ITALY

FOR: OPTICAL AND PHOTOGRAPHIC APPARATUS AND INSTRUMENTS, NAMELY, SUNGLASSES, EYEGASSES AND SAFETY GOGGLES, FRAMES FOR SUNGLASSES AND REPLACEMENT PARTS THEREOF, STRAPS USED FOR SUNGLASSES, CONTACT LENSES, SPECTACLE LENSES, CORRECTIVE EYEGASS LENSES, CONTACT LENSES CASES, PHOTOGRAPHIC CAMERAS, SHUTTERS FOR CAMERAS, CAMERA STANDS, FILTERS FOR ULTRAVIOLET RAYS FOR PHOTOGRAPHY, TELESCOPES, BINOCULARS, NIGHT VISION GOGGLES, PROTECTIVE EYE PIECES, VIEWFINDERS, LENSES, NAMELY, OPTICAL AND OPHTHALMIC LENSES; PRISMS, LENS FILTERS, POLARIZING LENSES FOR CAMERAS, OPTICAL MIRRORS FOR SCIENTIFIC AND TECHNICAL USE, TRIPODS, MOUNTS AND BALANCE WEIGHTS FOR TELESCOPES, MICROSCOPES, ADAPTERS FOR MOUNTING PHOTOGRAPHIC EQUIPMENT TO TELESCOPES, FOCUSING MECHANISMS FOR TELESCOPES, ELECTRONIC DRIVE APPARATUS FOR TELESCOPES, KEYPADS AND HAND CONTROLLERS FOR TELESCOPES, ELECTRONIC FOCUSING APPARATUS FOR TELESCOPES, OPTICAL IMAGING APPARATUS FOR TELESCOPES AND BINOCULARS, AND CHARGE COUPLED IMAGING DE-

VICE FOR CAMERAS; LIFESAVING APPARATUS AND INSTRUMENTS, NAMELY, PROTECTIVE FOOTWEAR, PROTECTIVE WORK FOOTWEAR, PROTECTIVE INTERIOR LININGS FOR SHOES, BOOT UPPERS, TIPS FOR FOOTWEAR, FOOTWEAR UPPERS, WELTS FOR BOOTS AND SHOES, COMPONENTS FOR USE IN FOOTWEAR FOR PROTECTION AGAINST ACCIDENTS, IRRADIATION AND FIRE IN THE NATURE OF SOLES, INSOLES AND HEELS; SAFETY CLOTHING AND PROTECTIVE CLOTHING, NAMELY, DIVING SUITS, WET AND DRY SUITS, DIVERS' CLOTHING, DIVERS' BOOTS, DIVERS' FACE MASKS, DIVERS' GLOVES, DIVERS' GOGGLES, DIVERS' HOODS, DIVERS' INSTRUMENTS, DIVERS' KNEE PADS, DIVERS' LIFEJACKETS, DIVERS' NOSE CLIPS, DIVERS' SUITS, DIVERS' WEIGHT BELTS, LIFE SAVING APPARATUS FOR DIVERS, IN CLASS 9 (U.S. CLS. 21, 23, 26, 36 AND 38).

FOR: ORTHOPEDIC ARTICLES, NAMELY, ORTHOPEDIC FOOTWEAR, SOLES FOR ORTHOPEDIC FOOTWEAR, AND AIR AND FOAM MATTRESSES FOR MEDICAL PURPOSES, IN CLASS 10 (U.S. CLS. 26, 39 AND 44).

FOR: VEHICLES, NAMELY, BICYCLES AND MOTORCYCLES; PARTS FOR MOTORCYCLES AND BICYCLES, NAMELY, CHAIN GUARDS, HANDLEBAR GRIPS, HANDLEBARS, SADDLES, BRAKES, BRAKE LEVELS, WHEELS, MUD-

GUARDS, PEDALS, TOE-CLIPS, GEAR LEVERS, REAR LIGHTS, CARRIERS, NAMELY, CARGO CARRIERS FOR MOTORCYCLES AND BICYCLES, IN CLASS 12 (U.S. CLS. 19, 21, 23, 31, 35 AND 44).

FOR: RUBBER, GUM, GUTTA-PERCHA, ALL IN THE FORM OF SHEETS FOR USE IN THE MANUFACTURE OF SHOE PARTS, NAMELY, OUTER SOLES AND INNER SOLES, HEELS, TOE-CAPS, VAMPS AND TONGUES, IN CLASS 17 (U.S. CLS. 1, 5, 12, 13, 35 AND 50).

FOR: BAGS, NAMELY, ALL PURPOSE SPORT, ATHLETIC, BEACH, HAND, AND COSMETICS BAGS SOLD EMPTY; SHAVING BAGS SOLD EMPTY; VANITY BAGS SOLD EMPTY; BOOK BAGS; SCHOOL BAGS; BRIEFCASES; CARRY-ON BAGS; CLUTCH BAGS; DUFFLE BAGS; GYM BAGS; LEATHER SHOPPING BAGS; MESH SHOPPING BAGS; SHOULDER BAGS; SUIT AND GARMENT BAGS; TOTE BAGS; TRAVEL BAGS; OVERNIGHT BAGS; WRIST MOUNTED CARRY-ALL BAGS; CARRY-ALL BAGS; ROLL BAGS; BACKPACKS; BACKPACK COMPONENTS IN THE NATURE OF HARNESES AND HIP BELTS; VENTILATED BACK PANEL BACKPACKS; BACKPACKS FOR USE BY SKIERS; BACKPACKS FOR USE BY CLIMBERS; DAY-PACKS; PACKS FOR CARRYING ATTACHMENTS, NAMELY, PACKS FOR CARRYING HIKING AND BICYCLE ATTACHMENTS AND ACCESSORIES; MESSENGER BAGS; COURIER BAGS; SLING BAGS; BACKPACK COVERS; BACKPACK ACCESSORIES IN THE NATURE OF RAIN COVERS; BAGS AND BACKPACKS FOR USE BY BIRDPATCHERS; TRAVEL BAGS; WHEELED TRAVEL BAGS AND CARGO BAGS; BUM BAGS; BAGS IN THE NATURE OF HAVERSACKS, RUCKSACKS AND KNAPSACKS; BEGGAR'S BAGS; HANDBAGS; BEACH BAGS; SATCHELS; TROLLEY BAGS WITH WHEELS; BAGS FOR CAMPERS; BAGS OF LEATHER FOR PACKAGING IN THE NATURE OF ENVELOPES AND POUCHES; FANNY PACKS; SPORTS PACKS; WAIST PACKS; GYM BAGS; HAND BAGS; PURSES; CLUTCH PURSES; CHANGE PURSES; GARMENT BAGS FOR TRAVEL; BEACH BAGS; SATCHELS; LUGGAGE; LUGGAGE TAGS, TRUNKS; SUITCASES; COSMETIC CASES SOLD EMPTY; TOILETRY CASES SOLD EMPTY; VANITY CASES SOLD EMPTY; TOOL BAGS SOLD EMPTY; ATTACHÉ CASES; BRIEFCASE-TYPE PORTFOLIOS; MEN'S CLUTCHES; BUSINESS CASES; BUSINESS CARD CASES; CREDIT CARD CASES; CALLING CARD CASES; KEY CASES; LEATHER KEY CHAINS; COIN POUCHES; WALLETS; BILL-FOLDS; UMBRELLAS AND PARASOLS, BICYCLE TOURING BAGS IN THE NATURE OF FANNY PACKS FOR BICYCLE TOURING; LUGGAGE AND EQUIPMENT BAGS IN THE NATURE OF CARRY-ALL BAGS; HORSE PACKS, NAMELY, HORSE PACKS IN THE NATURE OF BAGS WORN BY HORSES FOR CARRYING ITEMS RELATED TO HORSEBACK RIDING; DOG PACKS, NAMELY, DOG PACKS IN THE NATURE OF BAGS WORN BY DOGS FOR CARRYING ITEMS RELATED TO DOGS; ANIMAL PACKS, NAMELY, BAGS USED BY PEOPLE FOR CARRYING ITEMS RELATED TO

DOMESTIC PETS; BACKPACK FRAMES; PACK BAGS, NAMELY, CARRY-ALL BAGS TO BE WORN BY THE USER; COLLARS AND LEASHES FOR ANIMALS, IN CLASS 18 (U.S. CLS. 1, 2, 3, 22 AND 41).

FOR: TEXTILES, NAMELY, OILCLOTH, RUBBERIZED CANVAS, GUMMED WATER-PROOF CLOTH; RUBBERIZED TEXTILE AND WATER-PROOF TEXTILE FABRIC FOR USE IN THE MANUFACTURE OF CLOTHING, HOUSEHOLD AND GENERAL INDUSTRIAL PRODUCTS, IN CLASS 24 (U.S. CLS. 42 AND 50).

FOR: CLOTHING, NAMELY, COATS, MANTLES, RAINCOATS, DRESSES, SUITS, SKIRTS, JACKETS, TROUSERS, JEANS, WAISTCOATS, SHIRTS, T-SHIRTS, BLOUSES, JERSEYS, SWEATERS, BLAZERS, CARDIGANS, STOCKINGS, SOCKS, UNDERWEAR, CORSETS, NIGHTGOWNS, PAJAMAS, BATHROBES, BATHING SUITS, SUN SUITS, SPORT JACKETS, WIND RESISTANT JACKETS, ANORAKS, SWEAT SUITS, TIES, NECKTIES, SCARVES, SHAWLS, FOULARDS, CAPS, HATS, GLOVES, SASHES, BELTS; FOOTWEAR, BOOTS, SKATEBOARD BOOTS, SKI BOOTS, SHOES AND SLIPPERS, IN CLASS 25 (U.S. CLS. 22 AND 39).

FOR: CLOTH PATCHES FOR CLOTHING; EMBROIDERED PATCHES FOR CLOTHING; ORNAMENTAL PATCHES FOR CLOTHING; PATCHES FOR CLOTHING MADE OF RUBBER, PLASTIC AND VINYL; PATCHES FOR REPAIRING TEXTILE ARTICLES; BUTTONS FOR CLOTHING; ORNAMENTAL NOVELTY BUTTONS; PRESS BUTTONS; RIVET BUTTONS; SHIRT BUTTONS; ZIPPER FASTENERS; ZIPPER PULLS; ZIPPERS; SLIDE FASTENERS, SNAP FASTENERS, IN CLASS 26 (U.S. CLS. 37, 39, 40, 42 AND 50).

FOR: RUBBER BALLS EXCEPT GOLF BALLS; TOYS FOR ANIMALS; BAGS FOR SKIS, BOOTS WITH SKATES ATTACHED, CLIMBERS' HARNESS, SOLE COVERING FOR SKIS, EDGES OF SKIS, ELBOW GUARDS, KNEE GUARDS, SCOOTER TOY, SKATEBOARD, SKIS, SNOW BOARD, SURF BOARD, TOYS FOR DOMESTIC PETS, WATER SKIS, IN CLASS 28 (U.S. CLS. 22, 23, 38 AND 50).

PRIORITY DATE OF 2-5-2007 IS CLAIMED.

OWNER OF INTERNATIONAL REGISTRATION 0929272 DATED 4-5-2007, EXPIRES 4-5-2017.

THE COLOR(S) YELLOW IS/ARE CLAIMED AS A FEATURE OF THE MARK.

THE MARK CONSISTS OF A FULLY-SHADED YELLOW CIRCLE.

SER. NO. 79-040,447, FILED 4-5-2007.

MARILYN IZZI, EXAMINING ATTORNEY

Int. Cls.: 9, 35, 38, 41 and 42

**Prior U.S. Cls.: 21, 23, 26, 36, 38, 100, 101, 102, 104
and 107**

Reg. No. 3,576,325

United States Patent and Trademark Office

Registered Feb. 17, 2009

**TRADEMARK
SERVICE MARK
PRINCIPAL REGISTER**

NO BRAINER

HEMISPHERE GROUP, (FRANCE SOCIÉTÉ PAR
ACTIONS SIMPLIFIÉE)
23/25 RUE FERDINAND BUISSON
F-92110 CLICHY
FRANCE

FOR: ELECTRONIC AGENDAS; CAMERAS; VIDEO CAMERAS; MEMORY OR MICROPROCESSOR CARDS; MAGNETIC CARDS; PRINTED CIRCUITS; INTEGRATED CIRCUITS; COMPUTER KEYBOARDS; ELECTRONIC PENCILS; VIDEO SCREENS; TAPE RECORDERS; CASSETTE PLAYERS; COMPACT DISC PLAYERS; OPTICAL READERS; COMPUTER DISK DRIVES; COMPUTER MEMORIES; MICROPHONES; COMPUTER SOFTWARE TO MONITOR AND CONTROL FACTORY MANUFACTURING PROCESSES; COMPUTERS; NOTEBOOK COMPUTERS; CENTRAL PROCESSING UNITS; RECORDED OPERATING SYSTEM PROGRAMS; COMPUTER MOUSE PADS, IN CLASS 9 (U.S. CLS. 21, 23, 26, 36 AND 38).

FOR: ADVERTISING AND MARKETING; PUBLIC RELATIONS; PUBLICITY SERVICES; BUSINESS MANAGEMENT ASSISTANCE; BUSINESS ORGANIZATION AND MANAGEMENT CONSULTING; BUSINESS INFORMATION; BUSINESS RESEARCH AND BUSINESS INVESTIGATIONS; BUSINESS INQUIRIES; BUSINESS ADMINISTRATION; ADVERTISING AGENCIES; ADVERTISING; ONLINE ADVERTISING ON A COMPUTER NETWORK; PUBLIC RELATIONS; RADIO ADVERTISING AGENCIES; TELEVISION ADVERTISING AGENCIES; UPDATING OF ADVERTISING MATERIAL; ADVERTISING MAILING; SHOP-WINDOW DRESSING; OUTDOOR ADVERTISING; DISTRIBUTION AND DISSEMINATION OF ADVERTISING MATERIAL IN THE NATURE OF LEAFLETS, PROSPECTUSES, PRINTED MATTER AND SAMPLES; DISSEMINATION OF ADVERTISEMENTS; DISTRIBUTION OF ADVERTISING TEXTS; ORGANIZATION OF EXHIBITIONS OR FAIRS FOR COMMERCIAL AND ADVERTISING PURPOSES; DATABASE MANAGEMENT, NAMELY, DATA

COMPILATION AND SYSTEMATIZATION IN A DATABASE; COMPUTER FILE MANAGEMENT; COMPILATION OF INFORMATION HELD IN COMPUTER DATABASES; PROMOTION OF BUSINESS OPPORTUNITIES; SUBSCRIPTION SERVICES FOR THIRD PARTIES TO AN INFORMATION DATA MEDIA PACKAGE COMPRISING TEXTS, AUDIO, AND IMAGES, IN THE FORM OF DIGITAL, ELECTRONIC PUBLICATIONS, AUDIOVISUAL OR MULTIMEDIA PRODUCTS; DEMONSTRATION OF GOODS; RESEARCH AND DEVELOPMENT OF NEW CONCEPTS IN THE ADVERTISING AND MARKETING SECTOR FOR THIRD PARTIES; BUSINESS AUDITING OF NEW GOODS AND SERVICES DEVELOPED BY COMPANIES; BUSINESS MANAGEMENT OF PERFORMING ARTISTS; MARKET STUDY; MARKET RESEARCH; PUBLICATION OF ADVERTISING TEXTS; ADVERTISING AND COMMERCIAL INFORMATION SERVICES PROVIDED ON THE INTERNET; PROVIDING STATISTICAL INFORMATION; BUSINESS RESEARCH; DEVELOPMENT OF CONCEPTS FOR BUSINESS ECONOMY; CONDUCTING PUBLIC OPINION POLLS; COMMERCIAL INFORMATION AGENCY; BUSINESS MARKETING SERVICES; MARKET ANALYSIS; BUSINESS CONSULTING AND INFORMATION SERVICES; INTERACTIVE BUSINESS MARKETING SERVICES; BUSINESS MANAGEMENT CONSULTING FOR THE DESIGN, ORGANIZATION AND OPERATION OF PRACTICE DEVELOPMENT AND CUSTOMER LOYALTY SYSTEMS, ESPECIALLY BY MEANS OF BONUS PROGRAMMES, VOUCHERS, REDUCTIONS AND DIRECT MAIL ADVERTISING, WINNING GAMES AND QUIZ EVENTS AS ADVERTISING ACTIVITIES, INCLUDED IN THIS CLASS; CUSTOMER LOYALTY SERVICES AND CUSTOMER CLUB SERVICES, FOR COMMERCIAL, PROMOTIONAL AND ADVERTISING PURPOSES, NAMELY, KEEPING CUSTOMER ACCOUNTS FOR LOYALTY, REDUCTIONS, VOUCHERS AND BONUSES, IN CLASS 35 (U.S. CLS. 100, 101 AND 102).

FOR: PROVIDING TELECOMMUNICATIONS CONNECTIONS TO A GLOBAL COMPUTER NETWORK; ELECTRONIC DELIVERY OF IMAGES AND PHOTOGRAPHS VIA A GLOBAL COMPUTER NETWORK; COMMUNICATION VIA FIBER OPTIC NETWORKS, VIA COMPUTER TERMINALS, RADIO; TELEPHONE COMMUNICATIONS; PROVIDING ACCESS TO A GLOBAL COMPUTER NETWORK; PROVIDING TELECOMMUNICATIONS INFORMATION; ELECTRONIC MAIL SERVICES; ELECTRONIC MESSAGE SENDING; COMPUTER-ASSISTED MESSAGE AND IMAGE TRANSMISSION; COMPUTER-ASSISTED TRANSMISSION OF MESSAGES, IMAGES, AND DATA; CONNECTION TO A GLOBAL COMPUTER NETWORK BY TELECOMMUNICATION MEANS; MOBILE RADIOTELEPHONY; TRANSMITTING BY SATELLITE; AUDIO AND VIDEO TELECONFERENCING SERVICES; FACSIMILE TRANSMISSION; TRANSMISSION OF TELEGRAMS; RENTAL OF ACCESS TIME TO GLOBAL COMPUTER NETWORKS; CONSULTING IN TELECOMMUNICATIONS; BROADCASTING TELEVISION PROGRAMMES, RADIO PROGRAMMES, AND TELEVISION AND RADIO BROADCASTS; NEWS AGENCIES, NAMELY, TRANSMISSION OF NEWS; LEASING ACCESS TIME TO A GLOBAL COMPUTER NETWORKS VIA A DATABASE SERVER CENTRE; PROFESSIONAL TECHNICAL CONSULTING IN THE FIELD OF TELECOMMUNICATIONS IN THE NATURE OF TECHNICAL CONSULTING IN THE FIELD OF AUDIO, TEXT AND VISUAL DATA TRANSMISSION AND COMMUNICATION, IN CLASS 38 (U.S. CLS. 100, 101 AND 104).

FOR: VIDEO TAPE FILMING, VIDEO TAPE EDITING, WRITTEN TEXT EDITING OF COMPUTER DATA FOR USE ON COMPUTER NETWORKS; WRITING OF INTERACTIVE SCRIPTS; ORGANIZING COMMUNITY SPORTING AND CULTURAL EVENTS; PRODUCTION OF RADIO AND TELEVISION PROGRAMMES; RADIO AND TELEVISION ENTERTAINMENT PRODUCTION; PHOTOGRAPHIC REPORTING; VIDEO TAPE RECORDING; RENTAL OF VIDEO TAPES; VIDEO TAPE FILM PRODUCTION; NIGHT CLUBS; CINEMA AND FILM STUDIO OPERATION; MOTION PICTURE RENTAL; MUSICAL COMPOSITION SERVICES; DISCOTHEQUE SERVICES; RENTAL OF SOUND RECORDINGS; MOTION PICTURE FILM PRODUCTION; MOTION PICTURE FILM PRODUCTION ON OPTICAL DATA MEDIA; DIGITAL IMAGING SERVICES; LENDING LIBRARIES; DESKTOP PUBLISHING; RENTAL OF KARAOKE EQUIPMENT; EDITING OF SOUND AND IMAGES RECORDED ON OPTICAL DATA MEDIA; EDITING OF RADIO AND TELEVISION PROGRAMMES; MUSIC-HALLS; ORCHESTRA SERVICES, NAMELY, ENTERTAINMENT IN THE NATURE OF ORCHESTRA PERFORMANCE; PARTY PLANNING; DUBBING; SERVICES PROVIDED BY NEWS

REPORTERS; RECORDING STUDIO SERVICES, IN CLASS 41 (U.S. CLS. 100, 101 AND 107).

FOR: WEB SITE DESIGN; COMPUTER SYSTEM CONFIGURATION ANALYSIS; DATABASE RECONSTRUCTION; COMPUTER SYSTEM DESIGN; CONSULTING IN COMPUTERS, ELECTRONIC APPARATUS AND INSTRUMENTS, NAMELY, COMPUTER CONSULTATION AND INFORMATION TECHNOLOGY CONSULTATION; PROFESSIONAL TECHNICAL CONSULTING IN THE FIELD OF COMPUTING AND ELECTRONICS; DATA CONVERSION OF COMPUTER PROGRAM INFORMATION AND DATA OTHER THAN PHYSICAL CONVERSION; CONVERSION OF DATA OR DOCUMENTS FROM PHYSICAL TO ELECTRONIC MEDIA; CREATION AND MAINTENANCE OF WEB SITES FOR OTHERS; INTERNET SITE DESIGN; HOSTING OF INTERNET SITES; CREATION OF INTERNET SITES; QUALITY CONTROL; DUPLICATION OF COMPUTER PROGRAMS; DEVELOPMENT AND DESIGN OF SOFTWARE; DESIGN OF COMPUTER SOFTWARE FEATURING INTERACTIVE APPLICATIONS ON MULTIMEDIA CARRIERS AND ON THE INTERNET; MATERIALS TESTING; COMPUTER CONSULTATION FEATURING EXPERT REPORTS IN THE COMPUTING, ELECTRONICS AND TELECOMMUNICATIONS FIELD; ENGINEERING; INSTALLATION OF COMPUTER SOFTWARE; GRANTING OF INTELLECTUAL PROPERTY LICENSES; RENTAL OF COMPUTER SOFTWARE; COMPUTER RENTAL; MAINTENANCE OF COMPUTER SOFTWARE; SOFTWARE UPDATING; COMPUTER PROGRAMMING; COMPUTER PROGRAMMING IN THE FIELDS OF MARKETING AND ADVERTISING; TECHNICAL RESEARCH IN THE FIELD OF COMPUTER SOFTWARE FOR MARKETING AND ADVERTISING; COMPUTER SOFTWARE TESTING; DESIGN FOR NEW PRODUCT DEVELOPMENT FEATURING DESIGN OF MODELS, PROTOTYPES AND LOGOTYPES; RESEARCH AND DEVELOPMENT OF NEW PRODUCTS FOR THIRD PARTIES; GRAPHIC ARTS DESIGN SERVICES, IN CLASS 42 (U.S. CLS. 100 AND 101).

THE MARK CONSISTS OF STANDARD CHARACTERS WITHOUT CLAIM TO ANY PARTICULAR FONT, STYLE, SIZE, OR COLOR.

PRIORITY DATE OF 6-27-2006 IS CLAIMED.

OWNER OF INTERNATIONAL REGISTRATION 0929443 DATED 12-1-2006, EXPIRES 12-1-2016.

SER. NO. 79-040,517, FILED 12-1-2006.

KRISTINA MORRIS, EXAMINING ATTORNEY

Int. Cls.: 3, 8, 14, 24, 25, 35 and 43

Prior U.S. Cls.: 1, 2, 4, 6, 22, 23, 27, 28, 39, 42, 44, 50,
51, 52, 100, 101 and 102

Reg. No. 3,576,326

United States Patent and Trademark Office

Registered Feb. 17, 2009

TRADEMARK
SERVICE MARK
PRINCIPAL REGISTER



FINGEN S.P.A. (ITALY JOINT STOCK COMPANY)
VIA VITTORIO VENETO, 169
I-00187 ROMA
ITALY

FOR: PERSONAL SOAPS, LIQUID SOAPS FOR HANDS, FACE AND BODY, PERFUMES, EAU DE PARFUM, COLOGNE, TOILET WATER, ESSENTIAL OILS, COLD CREAM, CLEANSING MILK, PERSONAL DEODORANTS, ANTIPERSPIRANTS, SKIN MOISTURIZER, BODY OIL, SKIN EMOLLIENT, BATH AND SHOWER GEL, BATH SALTS, BODY LOTIONS, SKIN LOTIONS, SHAVE CREAM, AFTERSHAVE LOTIONS, SUNTAN LOTION, TALCUM POWDER, HAIR CONDITIONER, HAIR SHAMPOO, HAIR SPRAY, TOOTHPASTE, EYE MAKEUP, EYE SHADOW, FOUNDATION MAKEUP, MASCARA, FACE POWDER, EYE MAKEUP REMOVER, EYEBROW PENCIL, EYELINER, NAIL HARDENER, NAIL POLISH, NAIL POLISH REMOVER, LIP GLOSS, LIPSTICK; ALL THE ABOVE MENTIONED GOODS FOR COSMETIC PURPOSES, IN CLASS 3 (U.S. CLS. 1, 4, 6, 50, 51 AND 52).

FOR: TABLEWARE, NAMELY, KNIVES, FORKS, SPOONS, NUTCRACKERS, SUGAR TONGS, IN CLASS 8 (U.S. CLS. 23, 28 AND 44).

FOR: JEWELLERY, COSTUME JEWELLERY, WATCHES, CLOCKS, WRISTWATCHES, WATCH

BANDS AND STRAPS, WATCH CHAINS, WATCH CASES; JEWEL CASES, CUFF LINKS, IN CLASS 14 (U.S. CLS. 2, 27, 28 AND 50).

FOR: BATH AND BED SHEETS, PILLOW SHAMS, MATTRESS COVERS, DUVETS, BEDSPREADS, BED BLANKETS, BED COVERS, CURTAINS FOR THE BEDROOM, TABLE LINEN, TABLE CLOTHS AND NAPKINS OF TEXTILE, BATH LINEN, FACE TOWELS, BEACH TOWELS, HANDKERCHIEFS OF TEXTILE; DISHCLOTHS, IN CLASS 24 (U.S. CLS. 42 AND 50).

FOR: ARTICLES OF CLOTHING FOR MEN, WOMEN AND CHILDREN, NAMELY, PULL-OVERS, CARDIGANS, SWEATERS, JERSEYS, JUMPERS, JACKETS, SWEATSHIRTS, PARKAS, BATHING SUITS, BLOUSES, SHIRTS, TROUSERS, JEANS, WAISTCOATS, SKIRTS, SHORTS, T-SHIRTS, DRESSES, MEN'S SUITS, COATS, RAINCOATS, OVERCOATS, OVERALLS, UNDERWEAR, VESTS, HOSIERY AND PANTY HOSES, BATHROBES, SHAWLS, SCARVES, NECKTIES, GLOVES FOR CLOTHING, BELTS FOR CLOTHING, SHOES, BOOTS, SANDALS, SLIPPERS, CLOGS, HATS AND CAPS, IN CLASS 25 (U.S. CLS. 22 AND 39).

FOR: RETAIL STORE SERVICES, FEATURING PERFUMERY AND COSMETICS, CUTLERY, NAMELY, KNIVES, FORKS AND SPOONS, JEWELLERY, COSTUME JEWELRY, WATCHES AND

CLOCKS, FASHION, CLOTHING, FOOTWEAR AND HAIR ACCESSORIES, BAGS, WALLET AND OTHER LEATHER GOODS, TEXTILES, FABRICS, HOUSE LINEN , IN CLASS 35 (U.S. CLS. 100, 101 AND 102).

FOR: PROVIDING OF FOOD AND DRINK, BARS, DESSERT RESTAURANTS, ICE-CREAM SHOPS, TEA-ROOMS, COCKTAIL LOUNGE, RESTAURANTS, CATERING SERVICES; TEMPORARY ACCOMMODATION, NAMELY, PROVIDING TEMPORARY HOUSING HOTEL SERVICES, IN CLASS 43 (U.S. CLS. 100 AND 101).

PRIORITY DATE OF 12-5-2006 IS CLAIMED.

OWNER OF INTERNATIONAL REGISTRATION 0929475 DATED 2-23-2007, EXPIRES 2-23-2017.

NO CLAIM IS MADE TO THE EXCLUSIVE RIGHT TO USE "FIRENZE" , APART FROM THE MARK AS SHOWN.

THE ENGLISH TRANSLATION OF "PALAZZO TORNABUONI" WOULD BE TRANSLATED AS THE PALACE TORNABUONI. THE ENGLISH TRANSLATION OF "FIRENZE" IS FLORENCE.

SER. NO. 79-040,526, FILED 2-23-2007.

ALICIA COLLINS, EXAMINING ATTORNEY

Int. Cl.: 9

Prior U.S. Cls.: 21, 23, 26, 36 and 38

United States Patent and Trademark Office

Reg. No. 3,576,327

Registered Feb. 17, 2009

TRADEMARK
PRINCIPAL REGISTER

SCAIME

SCAIME (FRANCE SOCIÉTÉ PAR ACTIONS SIMPLIFIÉE)
F-74100 JUVIGNY
FRANCE

FOR: ELECTRONIC AND MEASURING INSTRUMENTS AND SENSORS, NAMELY, LOAD CELLS USED FOR WEIGHING, FORCE SENSORS USED TO MEASURE TENSION AND COMPRESSION FORCES, TORQUE SENSORS TO MEASURE TORQUES ON ROTATING PARTS AND FIXED PARTS, CABLE DISPLACEMENT SENSORS, STRAIN TRANSDUCERS TO MEASURE DEFORMATIONS OF STRUCTURES AND THE STRESSES THAT CAUSE THEM FOR THE PURPOSES OF WEIGHING AND CONTROLLING OVERLOAD AND FOR CONTROLLING

FORCES IN INDUSTRIAL PROCESSES, PRESSURE SENSORS TO MEASURE FLUID PRESSURE, IN CLASS 9 (U.S. CLS. 21, 23, 26, 36 AND 38).

OWNER OF INTERNATIONAL REGISTRATION
0505628 DATED 8-14-1986, EXPIRES 8-14-2016.

THE WORDING "SCAIME" HAS NO MEANING IN A FOREIGN LANGUAGE.

SER. NO. 79-040,893, FILED 5-18-2007.

JAMES STEIN, EXAMINING ATTORNEY

Int. Cls.: 3 and 5

Prior U.S. Cls.: 1, 4, 6, 18, 44, 46, 50, 51 and 52

United States Patent and Trademark Office

Reg. No. 3,576,328

Registered Feb. 17, 2009

**TRADEMARK
PRINCIPAL REGISTER**

WELLSKIN

PIERRE FABRE DERMO-COSMETIQUE
(FRANCE SOCIÉTÉ ANONYME)
45, PLACE ABEL GANCE
F-92100 BOULOGNE
FRANCE

FOR: COSMETICS, NAMELY, TOILET SOAPS, SKIN CREAMS, GELS, LOTIONS, MILKS AND EMULSIONS, SKIN BALM, LIP BALM, SHAVING BALM, SUN PRODUCTS FOR SKIN CARE, NAMELY, SKIN CREAMS, OILS, GELS, LOTIONS, MILKS AND EMULSIONS, SUN SCREEN PREPARATIONS AND SUN TANNING PREPARATIONS, IN CLASS 3 (U.S. CLS. 1, 4, 6, 50, 51 AND 52).

FOR: DERMATOLOGICALS; MEDICATED DERMOCOSMETIC PRODUCTS FOR SKIN CARE,

NAMELY SKIN CREAMS, GELS, MILKS, LOTIONS AND EMULSIONS, IN CLASS 5 (U.S. CLS. 6, 18, 44, 46, 51 AND 52).

THE MARK CONSISTS OF STANDARD CHARACTERS WITHOUT CLAIM TO ANY PARTICULAR FONT, STYLE, SIZE, OR COLOR.

OWNER OF INTERNATIONAL REGISTRATION
0802279 DATED 4-1-2003, EXPIRES 4-1-2013.

SER. NO. 79-040,939, FILED 12-15-2006.

KRISTINA MORRIS, EXAMINING ATTORNEY

Int. Cls.: 9 and 17

Prior U.S. Cls.: 1, 5, 12, 13, 21, 23, 26, 35, 36, 38 and 50

United States Patent and Trademark Office

Reg. No. 3,576,329

Registered Feb. 17, 2009

**TRADEMARK
PRINCIPAL REGISTER**

OPRISE

KEIWA KABUSHIKI KAISHA; (DOING BUSINESS AS KEIWA INC.) (JAPAN JOINT STOCK COMPANY)

2-5 KAMISHINJOU 1-CHOME
HIGASHIYODOGAWA-KU, OSAKA-SHI; OSAKA
533-0006
JAPAN

FOR: LIGHT DIFFUSION SHEETS SOLD AS AN INTEGRAL PART OF LIQUID CRYSTAL DISPLAYS FOR PROVIDING UNIFORM BRIGHTNESS OF LIQUID CRYSTAL DISPLAY BACKLIGHTS; ELECTRONIC MACHINES, APPARATUS AND THEIR PARTS, NAMELY, ELECTRONIC PLASMA DISPLAY PANELS AND COMPUTER PERIPHERAL DEVICES, IN CLASS 9 (U.S. CLS. 21, 23, 26, 36 AND 38).

FOR: SEMI-WORKED PLASTIC SHEETS FOR USE IN LIGHT DIFFUSION; SEMI-WORKED PLAS-

TICS IN THE FORM OF FILMS, SHEETS, TUBES AND BARS FOR USE IN MANUFACTURING, IN CLASS 17 (U.S. CLS. 1, 5, 12, 13, 35 AND 50).

THE MARK CONSISTS OF STANDARD CHARACTERS WITHOUT CLAIM TO ANY PARTICULAR FONT, STYLE, SIZE, OR COLOR.

PRIORITY DATE OF 2-27-2007 IS CLAIMED.

OWNER OF INTERNATIONAL REGISTRATION 0930710 DATED 3-30-2007, EXPIRES 3-30-2017.

SER. NO. 79-041,084, FILED 3-30-2007.

MARY MUNSON, EXAMINING ATTORNEY

Int. Cl.: 9

Prior U.S. Cls.: 21, 23, 26, 36 and 38

Reg. No. 3,576,330

United States Patent and Trademark Office

Registered Feb. 17, 2009

**TRADEMARK
PRINCIPAL REGISTER**

POWERPLEX

ELLENBERGER & POENSGEN GMBH (FED REP
GERMANY LIMITED LIABILITY COMPANY)
2-8, INDUSTRIESTRASSE
90518 ALTDORF
FED REP GERMANY

FOR: ON-BOARD COMPUTER NETWORK SYSTEMS CONTROLLED BY COMPUTER SUBSYSTEMS (BUS) THAT TRANSFER DATA BETWEEN COMPUTER COMPONENTS INSIDE COMPUTERS, FOR USE IN LAND, AIR AND WATER CRAFT, COMPRISED PRIMARILY OF ELECTRIC SAFETY SWITCHES, MONITORING APPARATUS, NAMELY, ANTENNAS, ELECTRONIC SENSORS FOR MEASURING WATER LEVEL, BATTERY POWER, WATER CURRENT, WAVE INCLINATION, WIND, TEMPERATURE, FORCE, SPEED, PRESSURE, HUMIDITY, GAS, ACCELERATION AND FLOW-RATE, ELECTRIC MICROCONTROLLERS AND INTEGRATED CIRCUIT MODULES FOR BUS-COUPLING, NAMELY, ELECTRIC COUPLINGS FOR BUS; ON-BOARD COMPUTER NETWORK SYSTEMS CONTROLLED BY COMPUTER SUBSYSTEMS (BUS) THAT TRANSFER DATA BETWEEN COMPUTERS, FOR USE IN LAND, AIR AND WATER CRAFT, COMPRISED PRIMARILY OF ELECTRIC SAFETY SWITCHES, MONITORING

APPARATUS, NAMELY, ANTENNAS, ELECTRONIC SENSORS FOR MEASURING WATER LEVEL, BATTERY POWER, WATER CURRENT, WAVE INCLINATION, WIND, TEMPERATURE, FORCE, SPEED, PRESSURE, HUMIDITY, GAS, ACCELERATION AND FLOW-RATE, ELECTRIC MICROCONTROLLERS AND INTEGRATED CIRCUIT MODULES FOR BUS-COUPLING, NAMELY, ELECTRIC COUPLINGS FOR BUS, IN CLASS 9 (U.S. CLS. 21, 23, 26, 36 AND 38).

THE MARK CONSISTS OF STANDARD CHARACTERS WITHOUT CLAIM TO ANY PARTICULAR FONT, STYLE, SIZE, OR COLOR.

PRIORITY DATE OF 9-22-2006 IS CLAIMED.

OWNER OF INTERNATIONAL REGISTRATION
0931091 DATED 3-22-2007, EXPIRES 3-22-2017.

SER. NO. 79-041,178, FILED 3-22-2007.

MARY MUNSON, EXAMINING ATTORNEY

Int. Cl.: 19

Prior U.S. Cls.: 1, 12, 33 and 50

United States Patent and Trademark Office

Reg. No. 3,576,331

Registered Feb. 17, 2009

**TRADEMARK
PRINCIPAL REGISTER**

TioCem

HEIDELBERGCEMENT AG (FED REP GERMA-
NY JOINT STOCK COMPANY)
BERLINER STR. 6
69120 HEIDELBERG
FED REP GERMANY

FOR: BUILDING MATERIAL NOT OF METAL,
NAMELY, PORTLAND CEMENT, HYDRAULIC CE-
MENTS, PORTLAND BLAST FURNACE SLAG CE-
MENT, SLAG-CEMENT, SLAG LIME CEMENT,
SLAG MODIFIED PORTLAND CEMENT, POZZO-
LANIC CEMENT, PORTLAND PUZZOLAN CE-
MENT, PUZZOLAN MODIFIED PORTLAND
CEMENT AND CEMENT MIXES, IN CLASS 19
(U.S. CLS. 1, 12, 33 AND 50).

THE MARK CONSISTS OF STANDARD CHAR-
ACTERS WITHOUT CLAIM TO ANY PARTICULAR
FONT, STYLE, SIZE, OR COLOR.

PRIORITY DATE OF 2-15-2007 IS CLAIMED.

OWNER OF INTERNATIONAL REGISTRATION
0931166 DATED 6-19-2007, EXPIRES 6-19-2017.

THE WORD "TIOCEM" HAS NO SIGNIFICANCE
IN THE RELEVANT TRADES OR INDUSTRIES,
ANY GEOGRAPHICAL SIGNIFICANCE, OR ANY
MEANING IN A FOREIGN LANGUAGE.

SER. NO. 79-041,200, FILED 6-19-2007.

WARREN L. OLANDRIA, EXAMINING ATTOR-
NEY

Int. Cls.: 35 and 36

Prior U.S. Cls.: 100, 101 and 102

United States Patent and Trademark Office

Reg. No. 3,576,332

Registered Feb. 17, 2009

**SERVICE MARK
PRINCIPAL REGISTER**

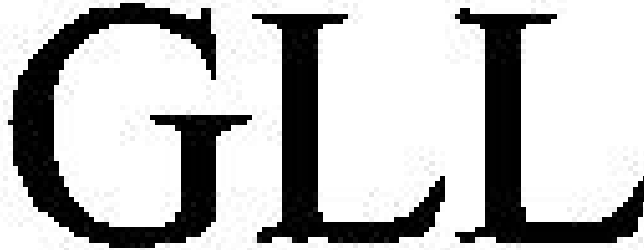

GLL REAL ESTATE PARTNERS GMBH (FED
REP GERMANY LIMITED LIABILITY COM-
PANY)

NYMPHENBURGER STRABE 136
80636 MÜNCHEN
FED REP GERMANY

FOR: BUSINESS MANAGEMENT; BUSINESS AD-
MINISTRATION; ARRANGING CONTRACTS CON-
CERNING THE CONSTRUCTION OF REAL
ESTATE FOR THIRD PARTIES; BUSINESS MAN-
AGEMENT CONSULTANCY RELATING TO REAL
ESTATE AFFAIRS; DEVELOPMENT OF ADVERTIS-
ING AND MARKETING CONCEPTS AS WELL AS
ADVERTISING AND MARKETING FOR REAL
ESTATE, IN CLASS 35 (U.S. CLS. 100, 101 AND 102).

FOR: FINANCIAL SERVICES, NAMELY, INVEST-
MENT SERVICES IN THE FIELD OF REAL ESTATE,
INVESTMENT SERVICES IN THE FIELD OF EQUI-
TIES, SECURITIES, STOCKS AND BONDS, MAN-
AGEMENT AND BROKERAGE IN THE FIELD OF
REAL ESTATE INVESTMENT, MANAGEMENT
AND BROKERAGE IN THE FIELD OF EQUITIES,
SECURITIES, STOCKS AND BONDS; REAL ESTATE
BROKERAGE, NAMELY, REAL ESTATE TRANS-
FER AND TRANSACTION SERVICES; INVEST-
MENT FUND TRANSFER AND TRANSACTION
SERVICES REGARDING EQUITIES, SECURITIES,
STOCKS AND BONDS; REAL ESTATE INVEST-
MENT SERVICES IN THE NATURE OF REAL
ESTATE FUND TRANSFER AND TRANSACTION
SERVICES; ORGANIZATION AND MANAGEMENT
OF REAL ESTATE FUNDS; FINANCIAL AND IN-
VESTMENT SERVICES, NAMELY, ORGANIZA-
TION AND MANAGEMENT OF EQUITY,
SECURITY, STOCK AND BOND FUNDS; REAL
ESTATE EQUITY-SHARING, NAMELY, MANA-
GING AND ARRANGING CO-OWNERSHIP OF
REAL ESTATE; FINANCIAL RISK MANAGEMENT,

NAMELY, COVERING AND HEDGING FINAN-
CIAL RISKS OF BANKS; FINANCIAL RISK MAN-
AGEMENT CONSULTATION RELATING TO THE
ORGANIZATION AND MANAGEMENT OF FUNDS
FOR COVERING AND HEDGING FINANCIAL
RISKS OF BANKS; FINANCIAL TRANSACTIONS,
NAMELY, INVESTMENT FUND TRANSACTION
SERVICES, INVESTMENT IN THE FIELD OF REAL
ESTATE, INVESTMENT IN EQUITIES, SECURITIES,
STOCKS AND BONDS; REAL ESTATE AFFAIRS,
NAMELY, REAL ESTATE APPRAISAL AND VA-
LUATION, REAL ESTATE MANAGEMENT; FI-
NANCIAL INVESTMENT SERVICES IN THE
FIELD OF REAL ESTATE, EQUITIES, SECURITIES,
STOCKS AND BONDS; REAL ESTATE MANE-
AGEMENT AS WELL AS PROCURING AND LEASING
REAL ESTATE FOR OTHERS; BROKERAGE OF
FUND ASSETS, NAMELY, MUTUAL FUND
BROKERAGE; INVESTMENT SERVICES, NAMELY,
ASSET MANAGEMENT; BROKERING CON-
TRACTS CONCERNING THE PURCHASE AND
SALE OF REAL ESTATE, IN CLASS 36 (U.S. CLS.
100, 101 AND 102).

THE MARK CONSISTS OF STANDARD CHAR-
ACTERS WITHOUT CLAIM TO ANY PARTICULAR
FONT, STYLE, SIZE, OR COLOR.

PRIORITY DATE OF 9-6-2006 IS CLAIMED.

OWNER OF INTERNATIONAL REGISTRATION
0931568 DATED 3-6-2007, EXPIRES 3-6-2017.

SER. NO. 79-041,365, FILED 3-6-2007.

CHARISMA HAMPTON, EXAMINING ATTORNEY

Int. Cls.: 9, 38, 41, 42 and 45

Prior U.S. Cls.: 21, 23, 26, 36, 38, 100, 101, 104 and 107

Reg. No. 3,576,333

United States Patent and Trademark Office

Registered Feb. 17, 2009

**TRADEMARK
SERVICE MARK
PRINCIPAL REGISTER**

AHeAD

TJARK AUERBACH (FED REP GERMANY INDIVIDUAL)
LINDAUER STRASSE 21
88069 TETTANANG
FED REP GERMANY

FOR: COMPUTER PROGRAMS, NAMELY, SUBPROGRAMS, PROGRAM MODULES, PROGRAM GENERATORS, SUPPORT SOFTWARE AND INTERFACES FOR COMPUTERS ALL FOR THE SECURITY OF COMPUTER SYSTEMS; DATA RECORDED ON DATA CARRIERS, NAMELY, PRE-RECORDED MAGNETIC DATA CARRIERS FEATURING DATA FOR DETECTION AND REMOVAL OF COMPUTER VIRUSES, NAMELY, SPYWARE, OTHER SOFTWARE WHICH CAUSES PROBLEMS WITH THE COMPUTER, AND SPYWARE; DATA FOR DETECTION AND REPAIR OF COMPUTER SOFTWARE AND COMPUTER HARDWARE PROBLEMS PRERECORDED ON MAGNETIC AND OPTICAL DATA CARRIERS, IN CLASS 9 (U.S. CLS. 21, 23, 26, 36 AND 38).

FOR: COLLECTION AND SUPPLY OF NEWS, NAMELY, TRANSMISSION OF NEWS; ELECTRONIC TRANSMISSION OF DATA; RUNNING OF AN ELECTRONIC INFORMATION AND COMMUNICATION SYSTEM, NAMELY, INFORMATION TRANSMISSION VIA COMMUNICATION NETWORKS; SERVICES IN CONNECTION WITH ONLINE SERVICES IN THE INTERNET, NAMELY, TRANSFER OF INFORMATION, NAMELY, PROVIDING MULTIPLE USE ACCESS TO GLOBAL COMPUTER INFORMATION NETWORKS FOR THE TRANSFER OF INFORMATION; PROVIDING AND RENTING OF ACCESS TIME TO A GLOBAL COMPUTER NETWORK FOR ACCESSING DATABASES, IN CLASS 38 (U.S. CLS. 100, 101 AND 104).

FOR: EDUCATION AND TRAINING SERVICES, NAMELY, CONDUCTING WORKSHOPS AND SEMINARS IN THE FIELD OF COMPUTER SECUR-

ITY SYSTEMS, CUSTOM WRITING, PUBLISHING AND EDITING OF PUBLICATIONS, NAMELY, WRITTEN TEXT EDITING AND PUBLISHING OF BOOKS, REVIEWS, MAGAZINES AND ELECTRONIC PUBLICATIONS, IN CLASS 41 (U.S. CLS. 100, 101 AND 107).

FOR: COMPUTER PROGRAMMING FOR DATA PROCESSING; TECHNICAL CONSULTATION REGARDING USE AND APPLICATION OF SOFTWARE; INSTALLATION AND MAINTENANCE OF COMPUTER SOFTWARE; SERVICES OF A SOFTWARE COMPANY, NAMELY, PLANNING, DESIGN, CREATION, PROGRAMMING, UPDATING, MAINTENANCE AND INSTALLATION OF SOFTWARE; TECHNOLOGICAL CONSULTATION SERVICES IN THE FIELD OF SUPPORT AND IMPLEMENTATION OF COMPUTER SYSTEMS IN ORDER TO FIX DATA STRUCTURES AND THEIR MODIFICATIONS; SERVICES IN CONNECTION WITH THE INTERNET, NAMELY, DESIGN AND MAINTENANCE OF COMPUTER PROGRAMS FOR THE SECURITY OF COMPUTER SYSTEMS AND CONSULTATION CONCERNING USE AND FURTHER DEVELOPMENT OF SUCH PROGRAMS, IN CLASS 42 (U.S. CLS. 100 AND 101).

FOR: SECURITY CONSULTANCY FOR THE PROTECTION OF REAL VALUE AND INDIVIDUALS, NAMELY, PERSONAL SECURITY CONSULTATION, IN CLASS 45 (U.S. CLS. 100 AND 101).

THE MARK CONSISTS OF STANDARD CHARACTERS WITHOUT CLAIM TO ANY PARTICULAR FONT, STYLE, SIZE, OR COLOR.

PRIORITY DATE OF 6-7-2006 IS CLAIMED.

OWNER OF INTERNATIONAL REGISTRATION 0931741 DATED 12-7-2006, EXPIRES 12-7-2016.

SER. NO. 79-041,443, FILED 12-7-2006.

MYRIAH HABEEB, EXAMINING ATTORNEY

Int. Cls.: 9 and 42

Prior U.S. Cls.: 21, 23, 26, 36, 38, 100 and 101

Reg. No. 3,576,334

United States Patent and Trademark Office

Registered Feb. 17, 2009

**TRADEMARK
SERVICE MARK
PRINCIPAL REGISTER**

AXSEM

AXSEM AG (SWITZERLAND AKTIENGESELLSCHAFT)
OSKAR-BIDER-STRASSE 1
CH-8600 DÜBENDORF
SWITZERLAND

FOR: INTEGRATED CIRCUITS; ELECTRONIC CHIPS FOR USE IN WIRELESS DATA COMMUNICATION, FOR USE IN ELECTRONIC DISPLAYS OR FOR USE IN DATA PROCESSING APPARATUS; COMPUTERS; COMPUTER PROGRAMS FOR USE WITH WIRELESS DATA COMMUNICATION PERIPHERALS OR FOR SETTING UP INTEGRATED CIRCUITS IN PERIPHERALS; COMPUTER SOFTWARE FOR USE WITH WIRELESS DATA COMMUNICATION PERIPHERALS OR FOR SETTING UP INTEGRATED CIRCUITS IN PERIPHERALS; COMPUTER OPERATING SYSTEMS; COMPUTER PERIPHERAL DEVICES; MAGNETIC DATA MEDIA, NAMELY, SOFTWARE RECORDED ON MAGNETIC DISCS FEATURING COMPUTER SOFTWARE FOR USE IN WIRELESS DATA COMMUNICATION APPLICATIONS AND CONTAINING COMPUTER SOFTWARE FOR SETTING UP ELECTRONIC CIRCUITS; OPTICAL DATA MEDIA, NAMELY, SOFTWARE RECORDED ON OPTICAL DISCS FEATURING COMPUTER SOFTWARE FOR USE IN WIRELESS DATA COMMUNICATION APPLICATIONS AND CONTAINING COMPUTER SOFTWARE FOR SETTING UP ELECTRONIC CIRCUITS; ELECTRONIC MEMORY CHIPS; DATA PROCESSING APPARATUS, NAMELY, CENTRAL PROCESSING UNITS, MICRO PROCESSORS, MICRO CONTROLLERS, COMPUTER HARDWARE AND COMPUTER PERIPHERALS; TRANSCEIVERS; CIRCUIT CARDS CONTAINING INTEGRATED CIRCUITS, NAMELY, ENCODED SMART CARDS CONTAINING PROGRAMMING USED TO GRANT PHYSICAL ACCESS TO CARD HOLDERS TO SECURE FACILITIES; SEMICONDUCTORS; HIGH-FREQUENCY APPARATUS, NAMELY, ELECTRONIC HIGH-FREQUENCY TRANSMIT-

TERS, ELECTRONIC HIGH-FREQUENCY RECEIVERS, ELECTRONIC HIGH-FREQUENCY SYNTHESIZERS, ELECTRONIC HIGH-FREQUENCY CONVERTERS AND HIGH-FREQUENCY MEASURING DEVICES; RADIO COMMUNICATION APPARATUS, NAMELY, RADIO TRANSMITTERS, RADIO RECEIVERS, RADIO TRANSCEIVERS, ELECTRICAL CABLES AND ANTENNAS, PRINTED CIRCUITS, COMPARATORS, AMPLIFIERS, ANALOGUE-TO-DIGITAL CONVERTERS, DIGITAL-TO-ANALOGUE CONVERTERS AND ELECTRONIC CIRCUITS FOR ERROR CORRECTION IN THE FORM OF PHASE LOCKED LOOPS, ELECTRONIC HIGH-FREQUENCY DIRECTIONAL COUPLERS FOR USE IN RADIO COMMUNICATION, MICROPROCESSORS, MICRO-CONTROLLERS; MODEMS; DISPLAY INTERFACES, NAMELY, FLAT PANEL DISPLAY SCREENS AND COMPUTER MONITORS. DISPLAY INTERFACES, NAMELY, FLAT PANEL DISPLAY SCREENS AND COMPUTER MONITORS; LAPTOP COMPUTERS; CALCULATING MACHINES, NAMELY, CALCULATORS AND CALCULATING SCALES; INTEGRATED SOLID STATE CIRCUIT MEMORY EXPANSION MODULES IN THE FORM OF ROM, RAM, SRAM, FRAM, MRAM, CBRAM, PRAM, PROM, EPROM AND E2PROM; SCANNER INTERFACES; SWITCHES, NAMELY, INTEGRATED RADIO AND HIGH FREQUENCY ANTENNA SWITCHES AND INTEGRATED DATA SWITCHES; ELECTRONIC SIGNAL TRANSCEIVERS; SILICON CHIPS; BOOSTING VOLTAGE STABILIZING POWER SUPPLIES; VOLTAGE REGULATORS; POCKET CALCULATORS; TELEPHONE SETS; FACSIMILE APPARATUS; AMPLIFIERS; VOLTMETERS; CONVERTERS; ELECTRIC RESISTANCES, NAMELY, PROGRAMMABLE INTEGRATED RESISTANCE ELEMENTS; CENTRAL DATA PROCESSING UNITS FOR PROCESSING INFORMATION, DATA, SOUND AND IMAGES; DATA PROCESSING INTERFACES, NAMELY, ELECTRONIC INTERFACE CARDS IN THE FORM OF PRINTED CIRCUIT BOARDS CONTAINING

INTEGRATED CIRCUITS; INTERFACES FOR TELECOMMUNICATIONS APPARATUS, NAMELY, PERIPHERAL COMPONENT INTERFACE HARDWARE; TRANSMITTERS, NAMELY, RADIO TRANSMITTERS, TELECOMMUNICATIONS TRANSMITTERS, IN CLASS 9 (U.S. CLS. 21, 23, 26, 36 AND 38).

FOR: DESIGN AND DEVELOPMENT OF COMPUTER PROGRAMS; COMPUTER PROGRAMMING; PROVIDING TECHNICAL ADVICE ABOUT COMPUTERS, NAMELY, PROVIDING TECHNICAL SUPPORT SERVICES FOR THE TROUBLESHOOTING OF COMPUTER HARDWARE, COMPUTER PROGRAMS AND INTEGRATED CIRCUIT PROBLEMS; CONSULTANCY SERVICES, NAMELY, PROVIDING TECHNICAL ADVICE REGARDING THE DESIGN OF INTEGRATED CIRCUITS; CREATION OF INTEGRATED CIRCUITS; DESIGNING OF CIRCUIT CARDS; CREATION OF CIRCUIT CARDS; RESEARCH IN THE FIELD OF ELECTRO-

NICS; PREPARING TECHNICAL EXPERT REPORTS REGARDING THE WORK OF ELECTRICAL ENGINEERS, QUALITY CONTROL, TECHNICAL PROJECT PLANNING, TECHNICAL SPECIFICATION OF TELECOMMUNICATIONS STANDARDS, IN CLASS 42 (U.S. CLS. 100 AND 101).

THE MARK CONSISTS OF STANDARD CHARACTERS WITHOUT CLAIM TO ANY PARTICULAR FONT, STYLE, SIZE, OR COLOR.

PRIORITY DATE OF 1-26-2007 IS CLAIMED.

OWNER OF INTERNATIONAL REGISTRATION 0932411 DATED 4-27-2007, EXPIRES 4-27-2017.

SER. NO. 79-041,768, FILED 4-27-2007.

AMY C. KEAN, EXAMINING ATTORNEY

Int. Cls.: 29 and 30

Prior U.S. Cl.: 46

United States Patent and Trademark Office

Reg. No. 3,576,335

Registered Feb. 17, 2009

TRADEMARK
PRINCIPAL REGISTER



VALUE CREATION BRANDS SÀRL (SWITZERLAND SÀRL)
CHEMIN DES COULEUVRES 8B
CH-1295 TANNAY
SWITZERLAND

FOR: PRESERVED, DRIED AND COOKED OR PREPARED FRUIT AND VEGETABLES; CROQUETTES; GRILLED, DRIED, PREPARED AND SEASONED WALNUTS; RAISINS, IN CLASS 29 (U.S. CL. 46).

FOR: CORN CHIPS; SNACKS, NAMELY, RICE-BASED SNACK FOODS, GRANOLA SNACKS, PRODUCTS FOR SNACKS MADE WITH CEREALS AND/OR RICE, NAMELY, CEREAL DERIVED FOOD BARS, COOKIES, CRACKERS; CORN FLOUR, POTATO FLOUR, FLOUR AND CONFECTIONERY PREPARATIONS BASED ON CEREALS OR MADE WITH CEREALS, NAMELY, CEREAL DERIVED FOOD BARS, COOKIES, CRACKERS; POPCORN; RICE AND RICE PREPARATIONS, NAMELY, RICE-BASED SNACK FOODS, GRANOLA SNACKS, IN CLASS 30 (U.S. CL. 46).

PRIORITY DATE OF 10-21-2006 IS CLAIMED.

OWNER OF INTERNATIONAL REGISTRATION
0932433 DATED 4-13-2007, EXPIRES 4-13-2017.

NO CLAIM IS MADE TO THE EXCLUSIVE RIGHT TO USE "ARARE", APART FROM THE MARK AS SHOWN.

THE FOREIGN WORDING, "ARARE", IN THE MARK TRANSLATES INTO ENGLISH AS BITE-SIZED "JAPANESE CRACKER" MADE FROM GLUTINOUS RICE AND FLAVORED WITH SOY SAUCE.

THE THREE NON-LATIN CHARACTERS IN THE MARK TRANSLITERATE TO THE FIVE LETTERS "A" "G" "I" "H" AND "O" WHICH HAS NO SIGNIFICANCE OTHER THAN TRADEMARK SIGNIFICANCE.

SER. NO. 79-041,778, FILED 4-13-2007.

CARYN GLASSER, EXAMINING ATTORNEY

Int. Cls.: 19 and 20

Prior U.S. Cls.: 1, 2, 12, 13, 22, 25, 32, 33 and 50

United States Patent and Trademark Office

Reg. No. 3,576,336

Registered Feb. 17, 2009

**TRADEMARK
PRINCIPAL REGISTER**

WASTOP

WAPRO AB (SWEDEN JOINT STOCK COMPAN-
NY)
BOX 197
SE-374 23 KARLSHAMN
SWEDEN

FOR: NON-METALLIC RIGID PIPES OF PLASTIC
OR RUBBER, NAMELY, NON-METAL SEWER
PIPES FOR BUILDING, IN CLASS 19 (U.S. CLS. 1,
12, 33 AND 50).

FOR: VALVES OF PLASTIC BEING OTHER THAN
MACHINE PARTS, NAMELY, NON-RETURN
VALVES AND FLAP VALVES OF PLASTIC FOR

WATER CONDUITS, VALVES IN THE NATURE OF
PLASTIC DRAIN TRAPS AND PLASTIC VALVES, IN
CLASS 20 (U.S. CLS. 2, 13, 22, 25, 32 AND 50).

OWNER OF INTERNATIONAL REGISTRATION
0932653 DATED 8-2-2007, EXPIRES 8-2-2017.

SER. NO. 79-041,866, FILED 8-2-2007.

KATHERINE E. HALMEN, EXAMINING ATTOR-
NEY

Int. Cls.: 29, 30 and 31

Prior U.S. Cls.: 1 and 46

United States Patent and Trademark Office

Reg. No. 3,576,337

Registered Feb. 17, 2009

**TRADEMARK
PRINCIPAL REGISTER**

oloves

BRAND STAND LTD. (SWITZERLAND CORPORATION)
NEUGASSE 3
ZUG, SWITZERLAND CH6300

FOR: MEAT, FISH, POULTRY AND GAME; MEAT EXTRACTS; PRESERVED, DRIED, COOKED AND FROZEN FRUITS AND VEGETABLES; JELLIES, JAMS, COMPOTES; EGGS, MILK AND MILK PRODUCTS EXCLUDING ICE CREAM, ICE MILK AND FROZEN YOGURT; EDIBLE OILS AND FATS, IN CLASS 29 (U.S. CL. 46).

FOR: COFFEE, TEA, COCOA, SUGAR, RICE, TAPIOCA, SAGO, ARTIFICIAL COFFEE; FLOURS AND PREPARATIONS MADE FROM CEREALS, NAMELY, CEREAL-BASED SNACK BARS, AND CEREAL-BASED ENERGY BARS NOT FOR USE AS A MEAL REPLACEMENT; BREAD; PASTRY; CONFECTIONERY, NAMELY, FROZEN CONFECTIONS, FREEZER POPS; ICES, NAMELY, EDIBLE FRUIT ICES, FRUIT ICE BARS, FLAVORED ICES; HONEY, TREACLE SYRUP; YEAST, BAKING-POWDER; SALT, MUSTARD; VINEGAR, SAUCES FOR USE AS CONDIMENTS; SPICES, ICE FOR REFRESHMENT, IN CLASS 30 (U.S. CL. 46).

FOR: AGRICULTURAL, HORTICULTURAL AND FORESTRY PRODUCTS AND GRAINS, NAMELY, UNPROCESSED GRAIN, SEEDS FOR FRUIT AND VEGETABLES, BIRD SEED, BULBS FOR HORTICULTURAL PURPOSES; LIVE ANIMALS; FRESH FRUITS AND VEGETABLES; NATURAL SEEDS, NAMELY, UNPROCESSED EDIBLE SEEDS, SEEDS FOR AGRICULTURAL PURPOSES, FLOWER SEEDS, WHEAT SEEDS, SOWING SEEDS; ANIMAL FOODSTUFFS; MALT FOR BREWING AND DISTILLING, IN CLASS 31 (U.S. CLS. 1 AND 46).

THE MARK CONSISTS OF STANDARD CHARACTERS WITHOUT CLAIM TO ANY PARTICULAR FONT, STYLE, SIZE, OR COLOR.

PRIORITY DATE OF 3-1-2007 IS CLAIMED.

OWNER OF INTERNATIONAL REGISTRATION 0932803 DATED 6-5-2007, EXPIRES 6-5-2017.

SER. NO. 79-041,911, FILED 6-5-2007.

ROBERT LAVACHE, EXAMINING ATTORNEY

Int. Cl.: 38

Prior U.S. Cls.: 100, 101 and 104

United States Patent and Trademark Office

Reg. No. 3,576,338

Registered Feb. 17, 2009

**SERVICE MARK
PRINCIPAL REGISTER**



IBER BAND EXCHANGE S.A. (SPAIN SOCIEDAD ANONIMA)
PASEO DE LA CASTELLANA, 21
E-28046 MADRID
SPAIN

FOR: TELECOMMUNICATIONS SERVICES, NAMELY, LOCAL AND LONG DISTANCE TRANSMISSION OF VOICE, DATA, GRAPHICS BY MEANS OF TELEPHONE, TELEGRAPHIC, CABLE, AND SATELLITE TRANSMISSIONS; WIRELESS ELECTRONIC DATA TRANSMISSION SERVICES FROM A ROAMING CENTER PROVIDING INTERCONNECTION BETWEEN WIRELESS OPERATORS AND MOBILE OPERATORS, IN CLASS 38 (U.S. CLS. 100, 101 AND 104).

PRIORITY DATE OF 10-2-2006 IS CLAIMED.

OWNER OF INTERNATIONAL REGISTRATION 0932827 DATED 10-23-2006, EXPIRES 10-23-2016.

THE COLOR(S) BLUE, WHITE, BLACK IS/ARE CLAIMED AS A FEATURE OF THE MARK.

THE COLOR BLUE APPEARS ON THE SHADED CIRCLE APPEARING BEHIND THE HAND, ON THE LINE SEPARATING THE DESIGN AND THE WORDING, ON THE LETTERS "GOEX" APPEARING IN THE WORD "GOWEX", AND ON THE BLUE SHADED CIRCLE APPEARING BEHIND THE LETTER "W" IN THE WORD "GOWEX"; THE COLOR BLACK APPEARS AS AN OUTLINE ON THE DESIGNS AND ON THE LETTERS, THE COLOR WHITE APPEARS ON THE HAND DESIGN ON THE LETTER "W" IN THE WORD "GOWEX", AND AS THE BACKGROUND COLOR FOR THE MARK.

SER. NO. 79-041,916, FILED 10-23-2006.

DEBRA LEE, EXAMINING ATTORNEY

Int. Cls.: 5 and 42

Prior U.S. Cls.: 6, 18, 44, 46, 51, 52, 100 and 101

United States Patent and Trademark Office

Reg. No. 3,576,339

Registered Feb. 17, 2009

**TRADEMARK
SERVICE MARK
PRINCIPAL REGISTER**

MablgX

KENTA BIOTECH AG (SWITZERLAND SOCIÉTÉ
ANONYME)
REHAGSTRASSE 79
CH-3018 BERN
SWITZERLAND

FOR: PHARMACEUTICAL PREPARATIONS FOR
THE PREVENTION AND TREATMENT OF CAN-
CER, INFLAMMATORY DISORDERS, AUTOIM-
MUNE DISORDERS, INFECTIOUS DISEASES,
NEURODEGENERATIVE DISORDERS AND RE-
SPIRATORY DISORDERS WHICH CAN BE TREA-
TED OR AMELIORATED BY ANTIBODIES
BINDING TO OR BLOCKING OF A TARGET ANTI-
GEN, IN CLASS 5 (U.S. CLS. 6, 18, 44, 46, 51 AND 52).

FOR: TECHNOLOGICAL SERVICES, NAMELY,
TECHNOLOGY RESEARCH IN THE FIELD OF
HUMAN MONOCLONAL ANTIBODIES; PHARMA-

CEUTICAL RESEARCH AND DEVELOPMENT IN
THE FIELD OF HUMAN MONOCLONAL ANTIBO-
DIES, IN CLASS 42 (U.S. CLS. 100 AND 101).

THE MARK CONSISTS OF STANDARD CHAR-
ACTERS WITHOUT CLAIM TO ANY PARTICULAR
FONT, STYLE, SIZE, OR COLOR.

PRIORITY DATE OF 2-21-2007 IS CLAIMED.

OWNER OF INTERNATIONAL REGISTRATION
0933103 DATED 7-9-2007, EXPIRES 7-9-2017.

SER. NO. 79-042,017, FILED 7-9-2007.

ROBIN MITTLER, EXAMINING ATTORNEY

Int. Cls.: 9, 41 and 42

Prior U.S. Cls.: 21, 23, 26, 36, 38, 100, 101 and 107

United States Patent and Trademark Office

Reg. No. 3,576,340

Registered Feb. 17, 2009

**TRADEMARK
SERVICE MARK
PRINCIPAL REGISTER**

CILAS Ecosizer

COMPAGNIE INDUSTRIELLE DES LASERS CILAS (FRANCE SOCIÉTÉ ANONYME)
8 AVENUE BUFFON -
BP 6319; Z.I. LA SOURCE; F-45100 ORLEANS
FRANCE

FOR: APPARATUS FOR LASER PARTICLE ANALYSIS, NAMELY, LASERS FOR MEASURING PURPOSES; LASER GRANULOMETERS; COMPUTER SOFTWARE FOR LASER PARTICLE ANALYSIS, IN CLASS 9 (U.S. CLS. 21, 23, 26, 36 AND 38).

FOR: ARRANGING AND CONDUCTING OF EDUCATIONAL COLLOQUIUMS, CONFERENCES, CONVENTIONS AND SEMINARS, SYMPOSIUMS REGARDING LASER PARTICLE ANALYSIS; PUBLICATION OF BOOKS AND REVIEWS CONCERNING LASER PARTICLE ANALYSIS, IN CLASS 41 (U.S. CLS. 100, 101 AND 107).

FOR: TECHNICAL RESEARCH FOR LASER PARTICLE ANALYSIS; ENGINEERING FOR LASER PARTICLE ANALYSIS; DESIGN FOR OTHERS IN THE FIELD OF APPARATUS FOR LASER PARTICLE ANALYSIS; EXPERTISE ACTIVITIES IN THE FIELD OF APPARATUS FOR LASER PARTICLE ANALYSIS, NAMELY, DRAWING UP OF EXPERT TECHNICAL OPINIONS IN THE FIELD OF OPTI-

CAL INSTRUMENTS AND APPARATUS FOR OTHERS, PROVIDING EXPERT CONSULTATION IN THE FIELD OF LASER PARTICLE ANALYSIS; DEVELOPMENT, DESIGN, INSTALLATION, UPDATING AND MAINTENANCE OF COMPUTER SOFTWARE FOR LASER PARTICLE ANALYSIS; COMPUTER PROGRAMMING FOR LASER PARTICLE ANALYSIS; DEVELOPMENT OF SOFTWARE IN CONNECTION WITH LASER PARTICLE ANALYSIS, IN CLASS 42 (U.S. CLS. 100 AND 101).

PRIORITY DATE OF 10-9-2006 IS CLAIMED.

OWNER OF INTERNATIONAL REGISTRATION 0933131 DATED 3-26-2007, EXPIRES 3-26-2017.

OWNER OF U.S. REG. NOS. 885,020, 1,828,079, AND 3,055,588.

THE WORDING "CILAS ECOSIZER" HAS NO MEANING IN A FOREIGN LANGUAGE

SER. NO. 79-042,029, FILED 3-26-2007.

WILLIAM ROSSMAN, EXAMINING ATTORNEY

Int. Cls.: 9, 12, 35, 38, 39 and 42

**Prior U.S. Cls.: 19, 21, 23, 26, 31, 35, 36, 38, 44, 100,
101, 102, 104 and 105**

Reg. No. 3,576,341

United States Patent and Trademark Office

Registered Feb. 17, 2009

**TRADEMARK
SERVICE MARK
PRINCIPAL REGISTER**

MITRAC

BOMBARDIER TRANSPORTATION GMBH (FED
REP GERMANY GMBH)
SCHÖNEBERGER UFER 1
10785 BERLIN
FED REP GERMANY

FOR: TELECOMMUNICATIONS APPARATUS, NAMELY, TRANSMITTERS AND RECEIVERS FOR SATELLITE POSITIONING, MOBILE TELEPHONE AND WIRELESS TRANSMITTERS APPARATUS FOR COMPUTER COMMUNICATION, NAMELY, MODEMS FOR WIRED AND WIRELESS INFORMATION TRANSMISSION; DATA PROCESSING EQUIPMENT, NAMELY, COMPUTERS; SOFTWARE PROGRAMS RECORDED ON DATA CARRIERS FOR DATA PROCESSING IN THE FIELD OF TRAIN COMMUNICATION, VEHICLE CONTROL, CONVERTER CONTROL, MONITORING AND DIAGNOSING FUNCTIONS AND DEVICES; ELECTRIC AND ELECTRONIC APPARATUS FOR THE MONITORING AND DISPLAY OF VEHICLE FUNCTIONS, NAMELY, POWER LINE CONDITIONS, ENGINE PARAMETERS, TEMPERATURES, BRAKE PRESSURES, TRACTION AND BRAKE MOMENTUM, PASSENGER COUNTING, VEHICLE WEIGHT, SUPPLY LEVELS, WASTE LEVELS, FILTER CONDITIONS, SPEED, ENERGY CONSUMPTION, ENERGY REGENERATION, DISPLAY AND ANALYSIS EQUIPMENT OF SAME; ELECTRIC AND ELECTRONIC APPARATUS FOR DIAGNOSING THE CONDITION OF A VEHICLE AND FOR ASCERTAINING MAINTENANCE INFORMATION, NAMELY, POWER LINE CONDITIONS, ENGINE PARAMETERS, TEMPERATURES, BRAKE PRESSURES, TRACTION AND BRAKE TORQUE, PASSENGER COUNTING, VEHICLE WEIGHT, SUPPLY LEVELS, WASTE LEVELS, FILTER CONDITIONS, SPEED, ENERGY CONSUMPTION, ENERGY REGENERATION, VIBRATIONS; ELECTRIC AND ELECTRONIC MEASURING, SIGNALING, INFORMATION PRO-

VIDING, MONITORING APPARATUS AND INSTRUMENTS, NAMELY, MODEMS, COMMUNICATION HARDWARE AND COMPUTERS FOR THE RECEIVING, PROCESSING AND DISPLAY OF INFORMATION CONCERNING PUBLIC TRANSPORTATION AND RAIL FREIGHT ROLLING STOCK; COMPUTER SYSTEMS, NAMELY, COMPUTER HARDWARE AND SOFTWARE FOR THE RECORDING AND TRANSMISSION OF OPERATIONAL PARAMETERS; RADIO-LOCATION EQUIPMENT FOR LOCATING VEHICLES, CARGOES AND FREIGHT, NAMELY, TRANSPONDERS, SATELLITE POSITIONING EQUIPMENT; MONITORING APPARATUS, NAMELY, COMPUTERS, ELECTRONIC DISPLAYS, COMMUNICATION EQUIPMENT, NAMELY, NETWORK COMPUTER AND TELECOMMUNICATIONS SWITCHES, GATEWAY ROUTERS IN THE NATURE OF COMPUTER CONTROL HARDWARE, RECEIVERS, TRANSMITTERS AND NETWORK DEVICES, NAMELY, TRAIN CONTROL UNITS FOR REGULATING ELECTRICAL MOTORS, CAMERAS, IMAGE STORAGE DEVICES, ALL FOR MONITORING AND DISPLAY OF PASSENGERS AND GOODS ON BOARD AND IN PROXIMITY OF PUBLIC TRANSPORTATION AND RAIL FREIGHT VEHICLE AREAS, IN CLASS 9 (U.S. CLS. 21, 23, 26, 36 AND 38).

FOR: ELECTRICAL PROPULSION AND CONTROL SYSTEM APPARATUS FOR LOCOMOTION BY LAND, NAMELY, GEAR-BOXES, TRACTION MOTORS, RAILWAY COUPLINGS AND TRACTION TORQUE CONVERTERS FOR ELECTRICAL MOTORS, IN CLASS 12 (U.S. CLS. 19, 21, 23, 31, 35 AND 44).

FOR: BUSINESS MANAGEMENT OF PUBLIC TRANSPORT AND RAIL FREIGHT OPERATING BUSINESSES, IN CLASS 35 (U.S. CLS. 100, 101 AND 102).

FOR: TELECOMMUNICATION SERVICES, NAMELY, WIRELESS TRANSMISSION, IN OR FROM RAILWAY VEHICLES, TROLLEBUSSES AND PEOPLE MOVERS, OF INFORMATION RELATING TO RAILWAY MATTERS; TELEVISION, RADIO OR ELECTRONIC TRANSMISSION FOR PASSENGERS IN RAILWAY VEHICLES, OF INFORMATION RELATING TO RAILWAY MATTERS, IN CLASS 38 (U.S. CLS. 100, 101 AND 104).

FOR: TRANSPORT OF GOODS; PUBLIC TRANSPORT OF PASSENGERS, IN CLASS 39 (U.S. CLS. 100 AND 105).

FOR: DATABASE DEVELOPMENT SERVICES; COMPUTER PROGRAMMING AND MAINTENANCE OF COMPUTER SOFTWARE, IN CLASS 42 (U.S. CLS. 100 AND 101).

PRIORITY DATE OF 5-21-2007 IS CLAIMED.

OWNER OF U.S. REG. NO. 2,835,747.
SER. NO. 79-042,263, FILED 5-23-2007.

OWNER OF INTERNATIONAL REGISTRATION 0933633 DATED 5-23-2007, EXPIRES 5-23-2017.

JASON TURNER, EXAMINING ATTORNEY

Int. Cls.: 14, 18, 25, 35 and 41

Prior U.S. Cls.: 1, 2, 3, 22, 27, 28, 39, 41, 50, 100, 101, 102 and 107

Reg. No. 3,576,342

United States Patent and Trademark Office

Registered Feb. 17, 2009

**TRADEMARK
SERVICE MARK
PRINCIPAL REGISTER**

Design 21

KABUSHIKI KAISHA FELISSIMO; (DOING BUSINESS AS FELISSIMO CORPORATION) (JAPAN CORPORATION)

59 NANIWA-MACHI, CHUO-KU

KOBE-SHI; HYOGO 650-0035

JAPAN

FOR: UNWROUGHT OR SEMI-WROUGHT PRECIOUS METALS; KEY RINGS AND TABLEWARE IN PRECIOUS METAL, NAMELY, BOWLS, DISHES, CUPS, DECANTER AND TEA POTS; CANDLE EXTINGUISHERS AND CANDLESTICKS OF PRECIOUS METAL; JEWEL CASES OF PRECIOUS METAL; FLOWER VASES AND BOWLS OF PRECIOUS METAL; TROPHIES, PLAQUE AND COMMEMORATIVE STATUARY CUPS MADE OF PRECIOUS METAL; PERSONAL ORNAMENTS OTHER THAN CUFF LINKS, NAMELY, JEWELRY AND/OR IMITATION JEWELRY; CUFF LINKS; PURSES AND WALLETS OF PRECIOUS METAL; SEMI-WROUGHT PRECIOUS STONES AND THEIR IMITATIONS; UNWROUGHT PRECIOUS STONES; POWDER COMPACTS OF PRECIOUS METAL; CLOCKS AND WATCHES; SMOKERS' ARTICLES OF PRECIOUS METAL, NAMELY, ASHTRAYS FOR SMOKERS MADE OF PRECIOUS METAL, CIGARETTE LIGHTERS OF PRECIOUS METAL, AND CIGAR AND CIGARETTE BOXES OF PRECIOUS METAL, IN CLASS 14 (U.S. CLS. 2, 27, 28 AND 50).

FOR: HANDBAG FRAMES, PURSE FRAMES; INDUSTRIAL PACKAGING CONTAINERS OF LEATHER; BAGS AND POUCHES, NAMELY, PURSES, WALLETS, SCHOOL BAGS, NAME CARD CASES, TRAVELING TRUNKS, BACKPACKS, RUCKSACKS, WHEELED SHOPPING BAGS, MESH SHOPPING BAGS, ATTACHÉ CASES, CARRY-ALL BAGS FOR CLIMBERS AND CAMPERS, HANDBAGS, BEACH BAGS, TRAVELING BAGS, LEATHER POU-

CHES, BRIEFCASES, LEATHER KEY CASES, STRING BAGS FOR SHOPPING, SUITCASES; VANITY CASES SOLD EMPTY; PARASOLS AND UMBRELLAS AND STRUCTURAL PARTS THEREFOR; WALKING STICKS, CANES, METAL PARTS OF CANES AND WALKING-STICKS AND HANDLES OF CANES AND WALKING-STICKS; SADDLERY; LEATHER STRAPS; RAWHIDES, RAW SKINS AND TANNED LEATHER; FUR, IN CLASS 18 (U.S. CLS. 1, 2, 3, 22 AND 41).

FOR: NON-JAPANESE STYLE OUTERCLOTHING, NAMELY, EVENING DRESSES, SCHOOL UNIFORMS, READY-MADE CLOTHING FOR MEN, WOMEN AND CHILDREN IN THE NATURE OF SHIRTS, SHORTS, TOPS, JACKETS, SWEATERS, COATS, OVERCOATS, PULLOVERS, AND PANTS; WORKING CLOTHING, IN THE NATURE OF SHIRTS, SHORTS, TOPS, JACKETS, SWEATERS, COATS, OVERCOATS, PULLOVERS AND PANTS; JACKETS; JOGGING PANTS; SWEAT PANTS; SUITS; SKIRTS; SKI JACKETS, SKI PANTS; TROUSERS; SMOCKS; FORMAL WEAR IN THE NATURE OF TUXEDOS, SUITS, SUIT COATS, TAIL COATS, WAIST COATS, DINNER JACKETS, TROUSERS, GOWNS, EVENING DRESSES, BALL GOWNS, MORNING DRESSES AND COCKTAIL DRESSES; COATS, OVERCOATS, TOPCOATS, MANTLES, RAINCOATS; CARDIGANS, SWEATERS; VESTS; WAIST COATS; SHIRTS, OPEN-NECKED SHIRTS, CUFFS, COLLARS; SPORT SHIRTS; BLOUSES; POLO SHIRTS; SHIRTS FOR SUITS; T-SHIRTS; NIGHTWEAR, NAMELY, NIGHT GOWNS, NEGLIGÉES, JAPANESE SLEEPING ROBES (NEMAKI), PAJAMAS AND BATH ROBES; UNDERWEAR; BATHING SUITS AND BATHING CAPS; JAPANESE TRADITIONAL CLOTHING, NAMELY, DETACHABLE NECKPIECES FOR KIMONOS (HANERI), FULL-LENGTH KIMONOS (NAGAGI), KIMONOS,

PLEATED SKIRTS FOR FORMAL KIMONOS (HAKAMA), SASH BANDS FOR KIMONO (OBI), SHORT OVERCOAT FOR KIMONO (HAORI), TIGHTENING-UP STRINGS FOR KIMONOS (DATEJIME), UNDERSHIRTS FOR KIMONOS (JUBAN), UNDERSHIRTS FOR KIMONOS (KOSHIMAKI), WAIST STRINGS FOR KIMONOS (KOSHIHIMO), WRAP BELTS FOR KIMONOS (DATEMAKI); HOODS, NIGHTCAPS, HELMETS FOR USE AS CLOTHING, CAPS AND HATS; GARTER BELTS, SOCK SUSPENDERS, SUSPENDERS, BELTS FOR CLOTHING; FOOTWEAR; MASQUERADE COSTUMES; CLOTHES FOR GYMNASTICS AND SPORTS, NAMELY, PARKAS, KARATE SUITS, SPORTS OVERUNIFORMS, KENDO OUTFITS, JUDO SUITS, SKI SUITS FOR COMPETITION, HEADBANDS, WIND-JACKETS, UNIFORMS AND STOCKINGS AND WRISTBANDS; SHOES AND BOOTS FOR GYMNASTICS AND SPORTS, IN CLASS 25 (U.S. CLS. 22 AND 39).

FOR: ADVERTISING AND PUBLICITY; ISSUANCE OF TRADING STAMPS, NAMELY, ON-LINE TRADING SERVICES IN WHICH SELLER POSTS PRODUCTS TO BE AUCTIONED AND BIDDING IS DONE VIA THE INTERNET; MARKETING RESEARCH, PROVIDING BUSINESS INFORMATION ON COMMODITY SALES; PROVIDING INFORMATION ON COMMODITY SALES THROUGH INTERNET WEBSITE; EMPLOYMENT AGENCIES FOR ARTISTS, SUCH AS PAINTERS, SCULPTORS AND PHOTOGRAPHERS; EMPLOYMENT AGENCIES FOR DESIGNERS, SUCH AS INTERIOR DESIGNERS, FASHION DESIGNERS AND INDUSTRIAL DESIGNERS, IN CLASS 35 (U.S. CLS. 100, 101 AND 102).

FOR: OPERATING LOTTERIES; EDUCATIONAL AND INSTRUCTION SERVICES, NAMELY, PROVIDING CLASSES, SEMINARS AND WORKSHOPS IN THE FIELD OF CRAFTS, SPORTS AND GENERAL KNOWLEDGE; ORGANIZING AND CONDUCTING SEMINARS AND WORKSHOPS IN THE FIELD OF CRAFTS, SPORTS, GENERAL KNOWLEDGE, DESIGN, ART, CULTURE, LITERATURE, MUSIC AND PLAY; ANIMAL TRAINING; PLANT EXHIBITIONS AND ANIMAL EXHIBITIONS; PROVIDING ELECTRONIC PUBLICATIONS, REFERENCE LIBRARIES OF LITERATURE AND DOCUMENTARY RECORDS, NAMELY, PUBLISHING OF ELECTRONIC PUBLICATIONS; ART EXHIBITIONS; CULTURAL EXHIBITIONS, NAMELY, GARDENS FOR PUBLIC ADMISSION AND CAVES FOR PUBLIC ADMISSION; PUBLICATION OF BOOKS; PLANNING ARRANGEMENT OF SHOWING MOVIES,

SHOWS, PLAYS OR MUSICAL PERFORMANCES; MOTION PICTURE THEATERS, MOTION PICTURE FILM PRODUCTION, AND MOVIE FILM DISTRIBUTION; PRESENTATION OF LIVE SHOW PERFORMANCES, DIRECTION OR PRESENTATION OF PLAYS, PRESENTATION OF MUSICAL PERFORMANCE; PRODUCTION OF RADIO OR TELEVISION PROGRAMS; PRODUCTION OF VIDEO TAPE FILMS IN THE FIELDS OF EDUCATION, CULTURE, ENTERTAINMENT AND SPORTS; DIRECTION OF MAKING RADIO OR TELEVISION PROGRAMS; OPERATION OF VIDEO EQUIPMENT OR AUDIO EQUIPMENT FOR PRODUCTION OF RADIO OR TELEVISION PROGRAMS; ARRANGING AND CONDUCTING SPORTS COMPETITIONS; ENTERTAINMENT IN THE NATURE OF FASHION SHOWS; ENTERTAINMENT IN THE NATURE OF HORSE RACES, BICYCLE RACES, BOAT RACES AND AUTOMOBILE RACES; PROVIDING AUDIO OR VIDEO STUDIOS; PROVIDING SPORTS FACILITIES, AMUSEMENT FACILITIES AND FACILITIES FOR MOVIES, SHOWS, PLAYS, MUSIC OR EDUCATIONAL TRAINING; BOOKING OF SEATS FOR SHOWS; RENTAL OF CINEMATOGRAPHIC MACHINES AND APPARATUS, CINEFILMS, MUSICAL INSTRUMENTS, GOLF AND SKI EQUIPMENT, TELEVISION SETS, RADIO SETS, BOOKS, RECORDS OR SOUND-RECORDED MAGNETIC TAPES, IMAGE-RECORDED MAGNETIC TAPES, FILMS, TOYS, AMUSEMENT MACHINES AND APPARATUS, GAME MACHINES AND APPARATUS, PAINTINGS AND CALLIGRAPHIC WORKS, CAMERAS AND PHOTOGRAPHIC EQUIPMENT; PHOTOGRAPHY; LANGUAGE INTERPRETATION AND TRANSLATION, IN CLASS 41 (U.S. CLS. 100, 101 AND 107).

THE MARK CONSISTS OF STANDARD CHARACTERS WITHOUT CLAIM TO ANY PARTICULAR FONT, STYLE, SIZE, OR COLOR.

PRIORITY DATE OF 9-28-2006 IS CLAIMED.

OWNER OF INTERNATIONAL REGISTRATION 0933692 DATED 10-10-2006, EXPIRES 10-10-2016.

NO CLAIM IS MADE TO THE EXCLUSIVE RIGHT TO USE DESIGN, APART FROM THE MARK AS SHOWN.

SER. NO. 79-042,289, FILED 10-10-2006.

ROBERT STRUCK, EXAMINING ATTORNEY

Int. Cls.: 10 and 41

Prior U.S. Cls.: 26, 39, 44, 100, 101 and 107

United States Patent and Trademark Office

Reg. No. 3,576,343

Registered Feb. 17, 2009

**TRADEMARK
SERVICE MARK
PRINCIPAL REGISTER**

LIFTS WITH CARE

LIKO AB (SWEDEN AKTIEBOLAG (AB))
NEDRE VÄGEN 100
SE-975 92 LULEÅ
SWEDEN

FOR: SPECIAL FURNITURE FOR MEDICAL USE, NAMELY, LEG SUPPORT EXTENDERS FOR ATTACHMENT TO FURNITURE, MOBILE AND STATIONARY INVALID LIFTS AND PATIENT STRETCHERS, ALL ADAPTED FOR MEDICAL PURPOSES; WALKING SUPPORTS FOR DISABLED, NAMELY, CRUTCHES, SUPPORTING CANES, WALKING FRAMES, IN CLASS 10 (U.S. CLS. 26, 39 AND 44).

FOR: EDUCATION SERVICES, NAMELY, PROVIDING TRAINING, SEMINARS AND PRACTICAL

TESTS IN THE FIELD OF INJURY PREVENTION RELATING TO MOVEMENT OF PERSONS AND OBJECTS IN ORDER TO PREVENT BACK INJURIES, IN CLASS 41 (U.S. CLS. 100, 101 AND 107).

THE MARK CONSISTS OF STANDARD CHARACTERS WITHOUT CLAIM TO ANY PARTICULAR FONT, STYLE, SIZE, OR COLOR.

OWNER OF INTERNATIONAL REGISTRATION
0933872 DATED 6-4-2007, EXPIRES 6-4-2017.

SER. NO. 79-042,371, FILED 6-4-2007.

MARILYN IZZI, EXAMINING ATTORNEY

Int. Cls.: 18, 24 and 25

Prior U.S. Cls.: 1, 2, 3, 22, 39, 41, 42 and 50

Reg. No. 3,576,344

United States Patent and Trademark Office

Registered Feb. 17, 2009

**TRADEMARK
PRINCIPAL REGISTER**



MILANI FLAVIO (ITALY INDIVIDUAL)
VIA GIOVANNI BOLZONI, 84
I-00124 ROMA
ITALY

FOR: LEATHER AND IMITATIONS OF LEATHER, AND GOODS MADE OF THESE MATERIALS, NAMELY, ALL PURPOSE SPORT BAGS, BEACH BAGS, BAGS FOR SPORTS, ALL-PURPOSE CARRYING BAGS, LEATHER BAGS, WALLETS, SUITCASES AND LEATHER AND IMITATION OF LEATHER KEY CHAINS; ANIMAL SKINS AND HIDES; TRUNKS AND TRAVELLING BAGS; UMBRELLAS, PARASOLS AND WALKING STICKS; WHIPS, HARNESSSES AND SADDLERY, IN CLASS 18 (U.S. CLS. 1, 2, 3, 22 AND 41).

FOR: TEXTILES AND TEXTILE GOODS, NAMELY, TEXTILE TABLECLOTHS; BED AND TABLE COVERS, NAMELY, TEXTILE BED BLANKETS,

TEXTILE BED SHEETS, TABLE LINEN AND TEXTILE TABLECLOTHS, IN CLASS 24 (U.S. CLS. 42 AND 50).

FOR: CLOTHING, NAMELY, T-SHIRTS, UNDERWEAR, STOCKINGS, SOCKS, TROUSERS, SHIRTS, SWEATERS, JACKETS, PADDED JACKETS, POLO SHIRTS, SWEATSHIRTS, SWIMMING COSTUMES AND DANCE COSTUMES; FOOTWEAR, NAMELY, SHOES, BOOTS AND SLIPPERS; HEADGEAR, NAMELY, HATS AND CAPS, IN CLASS 25 (U.S. CLS. 22 AND 39).

OWNER OF INTERNATIONAL REGISTRATION
0934598 DATED 7-4-2007, EXPIRES 7-4-2017.

SER. NO. 79-042,647, FILED 7-4-2007.

DAVID YONTEF, EXAMINING ATTORNEY

Int. Cls.: 7 and 12

Prior U.S. Cls.: 13, 19, 21, 23, 31, 34, 35 and 44

Reg. No. 3,576,345

United States Patent and Trademark Office

Registered Feb. 17, 2009

**TRADEMARK
PRINCIPAL REGISTER**

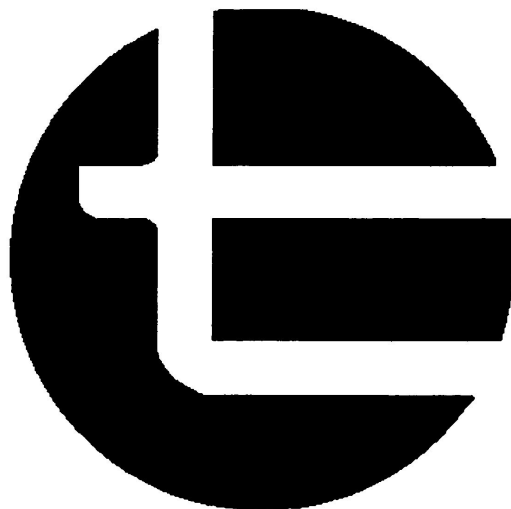

TOSEI CORPORATION (JAPAN CORPORATION)
429, KUSAJIMA, TOYAMA-SHI
TOYAMA 930-2201
JAPAN

FOR: MINING MACHINES AND APPARATUS, NAMELY, MINE BORERS, COAL CUTTING MACHINES, CUTTING MACHINES, CUTTING MACHINE PARTS, NAMELY, CUTTING BARS, ORE TREATING MACHINES, EXTRACTORS FOR MINES; MINEWORKING MACHINES, NAMELY, EXCAVATORS, CONVEYORS, GRADERS, CLASSIFIERS, COLLECTORS, SCREENERS, TUMBLERS, MILLS, AND WASHERS; CONSTRUCTION MACHINES AND APPARATUS, NAMELY, BULLDOZERS, CONCRETE CONSTRUCTION MACHINES, DRILLING BITS THAT ARE PARTS OF MACHINES, EARTH MOVING MACHINES, EXCAVATORS, MUD CATCHERS AND COLLECTORS, RAMS, ROAD MAKING MACHINES, SHREDDERS FOR INDUSTRIAL USE, ROAD SWEEPING MACHINES, ELECTRIC HAND DRILLS; LOADING-UNLOADING MACHINES AND APPARATUS, NAMELY, ROLLER BRIDGES, CRANES, CONVEYORS, ESCALATORS, HOISTS, HOPPERS FOR UNLOADING, LOADING APPARATUS, NAMELY, HYDRAULIC LIFT TABLES, LOADING RAMS, WINCHES; CHEMICAL PROCESSING MACHINES AND APPARATUS, NAMELY, PRESSES FOR CHEMICAL PROCESSING, AGITATORS FOR CHEMICAL PROCESSING, DRYING MACHINES FOR CHEMICAL PROCESSING, MIXING MACHINES FOR CHEMICAL PROCESSING, SINTERING MACHINES FOR

CHEMICAL PROCESSING, CALCINING MACHINES FOR CHEMICAL PROCESSING, SORTING MACHINES FOR CHEMICAL PROCESSING, GRANULATING MACHINES FOR CHEMICAL PROCESSING, EXTRACTING MACHINES FOR CHEMICAL PROCESSING, EMULSIFYING MACHINES FOR CHEMICAL PROCESSING, KNEADING MACHINES FOR CHEMICAL PROCESSING, DISINTEGRATORS FOR CHEMICAL PROCESSING, SEPARATING MACHINES FOR CHEMICAL PROCESSING, GRINDING MACHINES FOR CHEMICAL PROCESSING, FILTERING MACHINES FOR CHEMICAL PROCESSING, IN CLASS 7 (U.S. CLS. 13, 19, 21, 23, 31, 34 AND 35).

FOR: VESSELS AND THEIR PARTS AND FITTINGS, NAMELY, SAILING VESSELS, SCREW-PROPELLERS, STEERING GEARS AND RUDDERS FOR VESSELS, OARS, OARLOCKS, CANOE PADDLES, FENDERS FOR SHIPS, STRUCTURAL PARTS FOR BOATS, NAMELY, BOAT HOOKS, DAVITS FOR BOATS, PORTHOLES; AIR CRAFT AND THEIR PARTS AND FITTINGS, NAMELY, AIR CRAFT, FUSELAGES, LANDING GEARS, LANDING GEAR WHEELS, INNER TUBES FOR AIR CRAFT WHEEL TIRES, AIRPLANES; RAILWAY ROLLING STOCK AND THEIR PARTS AND FITTINGS, NAMELY, RAILWAY ROLLING STOCK, RAILWAY ROLLING STOCK WHEELS; AUTOMOBILES AND THEIR PARTS AND FITTING, NAMELY, AUTOMOBILES, AIR BAGS SAFETY DEVICES FOR AUTOMOBILES, WINDSCREENS, AIR PUMPS, AUTOMOBILE

CHAINS, REARVIEW MIRRORS, STRUCTURAL PARTS FOR AUTOMOBILES; TWO-WHEELED MOTOR VEHICLES AND THEIR PARTS AND FITTINGS AND BICYCLES AND THEIR PARTS AND FITTINGS, NAMELY, TWO-WHEELED MOTOR VEHICLES, BICYCLES, MUDGUARDS, TIRES OF TWO-WHEELED MOTOR VEHICLES AND BICYCLES, FRAMES FOR BICYCLES AND MOTORCYCLES, GEARS FOR BICYCLES AND MOTORCYCLES, GRIP TAPE FOR BICYCLES AND MOTORCYCLES, KICKSTANDS FOR BICYCLES AND MOTORCYCLES, CHAINS FOR BICYCLES AND MOTORCYCLES, BICYCLE BRAKES, HANDLE BARS FOR BICYCLES AND MOTORCYCLES, BELLS OF TWO-WHEELED MOTOR VEHICLES AND BICYCLES, SADDLES FOR BICYCLES AND MOTORCYCLES, RIMS FOR WHEEL OF

BICYCLES AND MOTORCYCLES; BABY CARRIAGES; WHEELCHAIRS; RICKSHAWS; SLEIGHS; WHEELBARROWS; CARTS; HORSE DRAWN CARRIAGES; BICYCLE TRAILERS, IN CLASS 12 (U.S. CLS. 19, 21, 23, 31, 35 AND 44).

OWNER OF INTERNATIONAL REGISTRATION 0934955 DATED 7-20-2007, EXPIRES 7-20-2017.

THE MARK CONSISTS OF A STYLIZED LETTER "T" IN A CIRCLE.

SER. NO. 79-042,739, FILED 7-20-2007.

KIM MONINGHOFF, EXAMINING ATTORNEY

Int. Cls.: 7, 9, 11, 38, 40 and 42

Prior U.S. Cls.: 13, 19, 21, 23, 26, 31, 34, 35, 36, 38, 100, 101, 103, 104 and 106

Reg. No. 3,576,346

United States Patent and Trademark Office

Registered Feb. 17, 2009

**TRADEMARK
SERVICE MARK
PRINCIPAL REGISTER**



WEBASTO AG (FED REP GERMANY JOINT STOCK COMPANY)
KRAILLINGER STRASSE 5
82131 GAUTING, FED REP GERMANY

FOR: ELECTRIC PUMPS FOR AIR-CONDITIONING UNITS; COMPONENTS FOR AIR CONDITIONING, HEATING, VENTILATING SYSTEMS FOR VEHICLES, NAMELY, PUMPS FOR HEATERS; AUXILIARY POWER UNITS APUS IN THE FORM OF ELECTRIC GENERATORS, AIR FILTERS FOR VEHICLE ENGINES, GAS FILTERS FOR ENGINES COMPONENTS, OIL FILTERS FOR VEHICLES, IN CLASS 7 (U.S. CLS. 13, 19, 21, 23, 31, 34 AND 35).

FOR: COMPUTER SOFTWARE FOR USE IN DATABASE MANAGEMENT, COMPUTER AIDED DESIGN (CAD), COMPUTER AIDED MANUFACTURING (CAM), COMPUTER ANIMATION, COMPUTER GRAPHICS, PRODUCT DATA MANAGEMENT (PDM), ALL OF USE IN THE AUTOMOTIVE INDUSTRY; REMOTE CONTROLS FOR LAND AND WATER VEHICLES COMPONENTS; RADIO, SATELLITE, INTERNET, AND WIRELESS TRANSMITTING AND RECEIVING DEVICES FOR REMOTE CONTROL OF VEHICLE COMPONENTS, NAMELY, REMOTE CONTROL TRANSMITTERS AND RECEIVERS; MEASURING, TESTING AND CONTROL DEVICES AND APPARATUS FOR USE IN THE FIELD OF AUTOMOTIVE INDUSTRY, NAMELY, THERMOMETERS, ALTIMETERS, NOISE METERS, SPEED CHECKING APPARATUS, NAMELY, SENSORS AND CHECKING DEVICES, HYGROMETERS, PRESSURE GAUGES, PRESSURE INDICATORS, PRESSURE MEASURING SENSORS, FLOW METERS, HUMIDITY CONTROL APPARATUS, AUTOMATIC COMBUSTION

CONTROL APPARATUS, VOLTAGE REGULATORS, ELECTRIC CURRENT SENSORS, ACCELERATION SENSORS, POSITION SENSORS, RPM SENSORS, TANK CAP SENSORS; ELECTRIC PLUG CONNECTIONS FOR ENABLING CONNECTION AND DISCONNECTION OF POWER AND/OR CONTROL CABLES; ELECTRICAL FUSES; ELECTRIC RELAYS; POWER SWITCHES; AUTOMATIC PRESSURE CONTROL MACHINES AND INSTRUMENTS; ELECTRIC CIRCUIT BREAKERS; THERMOSTATS; TEMPERATURE CONTROLLERS FOR WARMING AND COOLING VEHICLES, TEMPERATURE REGULATORS, SWITCHES AND CONTROLLERS; PRESSURE SENSORS; TEMPERATURE SENSORS; VOLTAGE REGULATORS AND ELECTRIC INTERFERENCE SUPPRESSOR SETS FOR AIR-CONDITIONING UNITS; FUEL CELLS AND FUEL REFORMERS; SOLAR EQUIPMENT, NAMELY, SOLAR BATTERIES FOR THE POWER SUPPLY OF LAND VEHICLES AND BOATS; ELECTRIC CONTROL DEVICES FOR USE IN THE FIELD OF AUTOMOTIVE INDUSTRY, NAMELY, ELECTRONIC APPARATUS FOR THE REMOTE CONTROL OF INDUSTRIAL OPERATIONS, ELECTRONIC CONTROL SYSTEMS FOR MACHINES, ELECTRONIC CONTROLS FOR MOTORS, ELECTRONIC CONTROLS FOR GASOLINE ENGINES FOR AUTOMOBILES, TRUCKS, RECREATIONAL VEHICLES, AND WATER VEHICLES; HEATER BATTERIES; PUMPS, NAMELY, METERED GASOLINE PUMPS; SOLAR ROOFS FOR THE GENERATION OF ELECTRICITY FOR LAND VEHICLES AND BOAT, IN CLASS 9 (U.S. CLS. 21, 23, 26, 36 AND 38).

FOR: AIR-CONDITIONING, COOLING, VENTILATING AND HEATING UNITS FOR LAND VEHICLES, AIR VEHICLES AND WATER VEHICLES;

WATER AND AIR HEATING UNITS FOR WATER VEHICLES; WINDOW DEFROSTING APPARATUS, ELECTRIC WATER HEATERS AND ENGINE PREHEATING UNITS FOR LAND VEHICLES, AIR VEHICLES AND WATER VEHICLES; ENGINE-INDEPENDENT AIR CONDITIONERS FOR LAND VEHICLES, AIR VEHICLES AND WATER VEHICLES; ELECTRIC HEATING UNITS FOR LAND VEHICLES, AIR VEHICLES AND WATER VEHICLES; AUXILIARY HEATING UNITS FOR LAND VEHICLES, AIR VEHICLES AND WATER VEHICLES; ROOF MOUNTED AIR CONDITIONERS AND HVAC UNITS CONSISTING OF HEATING, VENTILATION AND AIR-CONDITIONING UNITS FOR VEHICLES; LIGHTS FOR VEHICLES; EVAPORATORS; COOLANT DISTRIBUTORS AND COOLANT DRYERS FOR AIR-CONDITIONING EQUIPMENT IN VEHICLES, COOLANT COLLECTORS, COOLANT DISTRIBUTORS AND COOLANT DRYERS FOR AIR-CONDITIONING EQUIPMENT IN VEHICLES; HEAT EXCHANGERS; CONTINUOUS FLOW HEATERS; VALVES, NAMELY, VALVES FOR THERMOSTATS AND AIR-CONDITIONING UNITS; VENTILATORS, IN PARTICULAR FRESH AIR VENTILATORS FOR AIR-CONDITIONING UNITS; COOLING, VENTILATING AND HEATING UNITS FOR LAND VEHICLES, WATER VEHICLES AND AIR VEHICLES; COMPONENTS FOR AIR CONDITIONING, HEATING, VENTILATING SYSTEMS FOR VEHICLES, NAMELY, NOZZLES, FILTERS, VALVES, PULSE DAMPERS, FANS, VENTILATORS, EVAPORATORS; ENGINE-INDEPENDENT HEATING UNITS FOR VEHICLES; FLUID HEAT GENERATORS; DIESEL BURNERS FOR COMMERCIAL USE; AIR FILTERS FOR VEHICLE AIR CONDITIONING UNITS, IN CLASS 11 (U.S. CLS. 13, 21, 23, 31 AND 34).

FOR: PROVIDING TELECOMMUNICATIONS ACCESS TO GLOBAL COMPUTER NETWORKS FOR OBTAINING INFORMATION CONCERNING AUTOMOBILES, IN CLASS 38 (U.S. CLS. 100, 101 AND 104).

FOR: TECHNICAL CONSULTING IN THE FIELD OF PRODUCT MANUFACTURING IN THE AUTOMOTIVE INDUSTRY, IN CLASS 40 (U.S. CLS. 100, 103 AND 106).

FOR: TECHNICAL CONSULTING, NAMELY, PRODUCT RESEARCH AND DEVELOPMENT FOR THE AUTOMOTIVE INDUSTRY; COMPUTER PROGRAMMING FOR OTHERS; DESIGN OF COMPUTER SOFTWARE FOR OTHERS; INSTALLATION OF COMPUTER SOFTWARE FOR DIGITAL NETWORKS FOR OTHERS; COMPUTER PROGRAMMING FOR OTHERS FOR DATA PROCESSING, INSTALLATION OF COMPUTER SOFTWARE; DESIGNING, TESTING AND MAINTENANCE OF COMPUTER SOFTWARE, DESIGNING AND TESTING OF COMPUTER HARDWARE; MATERIAL TESTING WITH THE HELP OF COMPUTER HARDWARE AND COMPUTER SOFTWARE; TECHNICAL CONSULTING CONCERNING THE USE OF THE INTERNET; COMPUTER SOFTWARE DESIGN FOR OTHERS, NAMELY, DEVELOPMENT OF COMPUTER PROGRAMS RECORDED ON DATA MEDIA SOFTWARE, IN CLASS 42 (U.S. CLS. 100 AND 101).

OWNER OF INTERNATIONAL REGISTRATION 0934979 DATED 1-29-2007, EXPIRES 1-29-2017.

THE COLOR(S) RED AND WHITE IS/ARE CLAIMED AS A FEATURE OF THE MARK.

THE COLOR RED APPEARS IN THE INTERIOR OF THE WAVE DESIGN AND FADES TO THE COLOR WHITE IN THE CENTER OF THE DESIGN AND AT THE END OF THE LEFT SIDE OF THE MARK.

SER. NO. 79-042,749, FILED 1-29-2007.

JULIE GUTTADAURO, EXAMINING ATTORNEY

Int. Cls.: 11, 20 and 24

Prior U.S. Cls.: 2, 13, 21, 22, 23, 25, 31, 32, 34, 42 and 50

United States Patent and Trademark Office

Reg. No. 3,576,347

Registered Feb. 17, 2009

**TRADEMARK
PRINCIPAL REGISTER**

b O bles

**B O BLES V/ BOLETTE BLÆDEL (DENMARK CORPORATION)
SIAMVEJ 14
DK-2300 KØBENHAVN S
DENMARK**

FOR: APPARATUS FOR LIGHTING, NAMELY, LED LIGHT BULBS, LIGHT REFLECTORS, LIGHTING TUBES, IN CLASS 11 (U.S. CLS. 13, 21, 23, 31 AND 34).

FOR: FURNITURE, MIRRORS, PICTURE FRAMES, GOODS OF WOOD, CORK, REED, BONE AND SUBSTITUTES FOR THESE MATERIALS, AND MATERIALS, AND OF PLASTICS, NAMELY, STOOLS, CHAIRS, TABLES, BEDS, SHELVES, STORAGE BOX CARPET COASTERS FOR PROTECTING FURNITURE LEGS, FILING CABINETS, DRESSERS, DESK, AND TENTS, IN CLASS 20 (U.S. CLS. 2, 13, 22, 25, 32 AND 50).

FOR: TEXTILES AND TEXTILE GOODS, NAMELY, BEDCOVERS, BEDLINEN, PLASTIC TABLECOVERS, CURTAINS, FLOOR CUSHION, NAMELY, CUSHION COVERS , IN CLASS 24 (U.S. CLS. 42 AND 50).

PRIORITY DATE OF 8-3-2006 IS CLAIMED.

OWNER OF INTERNATIONAL REGISTRATION 0935066 DATED 2-2-2007, EXPIRES 2-2-2017.

SER. NO. 79-042,774, FILED 2-2-2007.

NAPOLEON SHARMA, EXAMINING ATTORNEY

Int. Cl.: 7

Prior U.S. Cls.: 13, 19, 21, 23, 31, 34 and 35

United States Patent and Trademark Office

Reg. No. 3,576,348

Registered Feb. 17, 2009

**TRADEMARK
PRINCIPAL REGISTER**



UCIMU - SISTEMI PER PRODURRE (ITALY ASSOCIATION)
128, VIALE FULVIO TESTI,
I-20092 CINISELLO BALSAMO
ITALY

FOR: MACHINE TOOLS FOR REMOVING METAL WASTE MATERIAL, MACHINE TOOLS FOR DEFORMATION WITHOUT MATERIAL REMOVAL IN THE NATURE OF METAL WASTE, AND FEED AND DRIVE DEVICES FOR METALWORKING MACHINES AND TOOLS, NAMELY, CONVEYORS, CONVEYOR BELTS AND ELECTRIC MOTORS FOR MACHINES, IN CLASS 7 (U.S. CLS. 13, 19, 21, 23, 31, 34 AND 35).

OWNER OF INTERNATIONAL REGISTRATION
0627378 DATED 11-21-1994, EXPIRES 11-21-2014.

"THE COLOR(S) WHITE AND RED IS/ARE CLAIMED AS A FEATURE OF THE MARK."

THE MARK CONSISTS OF THE WORD "UCIMU" IS WRITTEN IN WHITE WITHIN A RED LOZENGE.

SER. NO. 79-042,822, FILED 5-23-2007.

ROBERT STRUCK, EXAMINING ATTORNEY

Int. Cl.: 42

Prior U.S. Cls.: 100 and 101

United States Patent and Trademark Office

Reg. No. 3,576,349

Registered Feb. 17, 2009

SERVICE MARK
PRINCIPAL REGISTER

Relais de Venise

"SON ENTRECOTE"

MME HÉLÈNE, MARIE-LOUISE, CHRISTIANE.;
JEANNE GINESTE DE SAURS, ÉPOUSE DE;
M. THIERRY GODILLOT (FRANCE INDIVI-
DUAL)
5, AVENUE EMILE ACOLLAS
F-75007 PARIS
FRANCE

FOR: PROVIDING OF FOOD AND DRINK, IN
CLASS 42 (U.S. CLS. 100 AND 101).

OWNER OF INTERNATIONAL REGISTRATION
0681697 DATED 10-24-1997, EXPIRES 10-24-2017.

NO CLAIM IS MADE TO THE EXCLUSIVE
RIGHT TO USE "RELAIS" AND "ENTRECOTE",
APART FROM THE MARK AS SHOWN.

THE ENGLISH TRANSLATION OF "RELAIS DE
VENISE "SON ENTRECOTE" IS INN OF VENICE
"ITS RIBSTEAK".

SER. NO. 79-042,838, FILED 7-2-2007.

FRED CARL, EXAMINING ATTORNEY

Int. Cls.: 7, 9 and 42

**Prior U.S. Cls.: 13, 19, 21, 23, 26, 31, 34, 35, 36, 38, 100
and 101**

Reg. No. 3,576,350

United States Patent and Trademark Office

Registered Feb. 17, 2009

**TRADEMARK
SERVICE MARK
PRINCIPAL REGISTER**

Ratio-Test

HERBERT HÄNCHEN GMBH & CO. KG (FED
REP GERMANY LIMITED PARTNERSHIP)
BRUNNWIENSTRASSE 3
73760 OSTFILDERN
FED REP GERMANY

FOR: MACHINE PARTS, NAMELY, HYDRAULIC CYLINDERS, HYDRAULIC DRIVES, AND ELECTROHYDRAULIC DRIVES; MACHINE PARTS, NAMELY, HYDRAULIC VALVE ACTUATORS, LINEAR ACTUATORS, AND PNEUMATIC VALVE ACTUATORS; MACHINE PARTS, NAMELY, PNEUMATIC AND HYDRAULIC CONTROLS; MACHINE PARTS, NAMELY, MECHANICAL CONTROLS FOR HYDRAULIC CYLINDERS, IN CLASS 7 (U.S. CLS. 13, 19, 21, 23, 31, 34 AND 35).

FOR: MACHINES PARTS, NAMELY, ELECTRONIC CONTROLS FOR HYDRAULIC AND ELECTROHYDRAULIC DRIVES, IN CLASS 9 (U.S. CLS. 21, 23, 26, 36 AND 38).

FOR: COMPUTER PROGRAMMING OF HYDRAULIC AND ELECTROHYDRAULIC ACTUATOR AND SERVO COMPONENTS, IN CLASS 42 (U.S. CLS. 100 AND 101).

THE MARK CONSISTS OF STANDARD CHARACTERS WITHOUT CLAIM TO ANY PARTICULAR FONT, STYLE, SIZE, OR COLOR.

PRIORITY DATE OF 1-12-2007 IS CLAIMED.

OWNER OF INTERNATIONAL REGISTRATION 0935290 DATED 6-8-2007, EXPIRES 6-8-2017.

SER. NO. 79-042,938, FILED 6-8-2007.

DAVID TOOLEY, EXAMINING ATTORNEY

Int. Cl.: 33

Prior U.S. Cls.: 47 and 49

United States Patent and Trademark Office

Reg. No. 3,576,351

Registered Feb. 17, 2009

TRADEMARK
PRINCIPAL REGISTER

DOMAINE des FINES ROCHES



AMELIE BARROT (FRANCE INDIVIDUAL)

1, AVENUE DU BARON LEROY
F-84230 CHATEAUNEUF DU PAPE

FRANCE AND

GAELE BARROT EPOUSE MAILLET (FRANCE
INDIVIDUAL)

33, RUE JOSEPH DUCOS

F-84230 CHATEAUNEUF DU PAPE

FRANCE

FOR: WINES, IN CLASS 33 (U.S. CLS. 47 AND 49).

OWNER OF INTERNATIONAL REGISTRATION
0649935 DATED 1-26-1996, EXPIRES 1-26-2016.

NO CLAIM IS MADE TO THE EXCLUSIVE
RIGHT TO USE "DOMAINE", APART FROM THE
MARK AS SHOWN.

THE MARK CONSISTS OF A PICTURE OF A
CASTLE WITH A FIELD IN FRONT OF THE
CASTLE IN AN OVAL; ABOVE THE DESIGN IS
THE WORDING "DOMAINE DES FINES ROCHES".

THE FOREIGN WORDING IN THE MARK
TRANSLATES INTO ENGLISH AS VINEYARDS OF
THE FINE ROCKS.

SER. NO. 79-043,220, FILED 7-24-2007.

CHRISTOPHER BUONGIORNO, EXAMINING AT-
TORNEY

Int. Cl.: 41

Prior U.S. Cls.: 100, 101 and 107

United States Patent and Trademark Office

Reg. No. 3,576,352

Registered Feb. 17, 2009

SERVICE MARK
PRINCIPAL REGISTER



FÉDÉRATION INTERNATIONALE; DU SPORT
UNIVERSITAIRE.; EN ABRÉGÉ FISU AISBL
(BELGIUM AISBL)

CHÂTEAU DE LA SOLITUDE
AVENUE SCHALLER 54
B-1160 BRUXELLES, BELGIUM

FOR: EDUCATION IN THE FIELD OF UNIVERSITY SPORTS GAMES, NAMELY, ALPINE SKIING, ARCHERY, BADMINTON, BASEBALL, BEACH VOLLEYBALL, BIATHLON, BOXING, BRIDGE, CHESS, CROSS COUNTRY, CROSS COUNTRY SKIING, CURLING, CYCLING, EQUESTRIAN, FIELD HOCKEY, FIGURE SKATING, FLAT WATER CANOEING, FLOORBALL, FREESTYLE SKIING, FUTSAL, GOLF, HANDBALL, ICE HOCKEY, KARATE, MATCH RACING, NORDIC COMBINED, ORIENTEERING, ROWING, RUGBY 7, SHORT TRACK SPEED SKATING, SKIING, SKI JUMPING, SNOW BOARDING, SPEED SKATING, SPORT SHOOTING, SQUASH, TAEKWONDO, TRIATHLON, SAILING, WRESTLING, WOODBALL WILD WATER CANOEING, WATERSKIING, WEIGHTLIFTING RENDERED THROUGH PROVISION OF TRAINING CLASSES; ENTERTAINMENT IN THE NATURE OF UNIVERSITY SPORTS GAMES IN THE SPORT FIELDS PREVIOUSLY IDENTIFIED; ORGANIZATION OF EVENTS AND DEMONSTRATIONS FOR EDUCATIONAL AND SPORTING PURPOSES, NAMELY, SEMINARS, RESEARCH GROUPS AND CONVENTIONS IN THE FIELD OF UNIVERSITY SPORTS COMPETITIONS IN THE SPORT FIELDS PREVIOUSLY IDENTIFIED; ARRANGING AND CONDUCTING OF SPORTS COMPETITIONS; ORGANIZATION OF GAMES AND CONTESTS FOR LEISURE, EDUCATIONAL AND ENTERTAINMENT PURPOSES; ARRANGING AND CONDUCTING OF COLLOQUIUMS, CONFERENCES, CONGRESSES, SEMINARS, SYMPOSIUMS RELAT-

ING TO UNIVERSITY SPORTS; PUBLISHING, EDITING AND ON-LINE DISTRIBUTION OF NEWSPAPERS, BROCHURES, PERIODICALS AND OTHER PRINTED MATTER; MOTION PICTURE FILM PRODUCTION, IN CLASS 41 (U.S. CLS. 100, 101 AND 107).

PRIORITY DATE OF 12-21-2006 IS CLAIMED.

OWNER OF INTERNATIONAL REGISTRATION
0936257 DATED 5-25-2007, EXPIRES 5-25-2017.

NO CLAIM IS MADE TO THE EXCLUSIVE RIGHT TO USE "INTERNATIONAL UNIVERSITY SPORTS", APART FROM THE MARK AS SHOWN.

THE COLOR(S) BLACK, BLUE, YELLOW, GREEN AND RED IS/ARE CLAIMED AS A FEATURE OF THE MARK.

THE COLOR BLACK APPEARS IN THE WORDING "INTERNATIONAL UNIVERSITY SPORTS" AND IN THE STAR DESIGN IN THE CENTER OF THE MARK; THE COLOR BLUE APPEARS IN THE LEFTMOST STAR DESIGN; THE COLOR YELLOW APPEARS IN THE SECOND STAR DESIGN FROM THE LEFT; THE COLOR GREEN APPEARS IN THE FOURTH STAR DESIGN FROM THE LEFT; AND THE COLOR RED APPEARS IN THE RIGHTMOST STAR DESIGN IN THE MARK.

SER. NO. 79-043,334, FILED 5-25-2007.

GILBERT SWIFT, EXAMINING ATTORNEY

Int. Cls.: 9 and 42

Prior U.S. Cls.: 21, 23, 26, 36, 38, 100 and 101

Reg. No. 3,576,353

United States Patent and Trademark Office

Registered Feb. 17, 2009

**TRADEMARK
SERVICE MARK
PRINCIPAL REGISTER**

ezio

GEMALTO NV (NETHERLANDS SOCIÉTÉ DE
DROIT NÉERLANDAIS)
JOOP GEESINKWEG 541-542
NL-1096 AX AMSTERDAM
NETHERLANDS

FOR: DATA PROCESSORS; COMPUTERS, PERIPHERAL DEVICES FOR COMPUTERS, PERIPHERAL DEVICES WITH SECURE MICROPROCESSOR FOR COMPUTERS; ELECTRONIC COMPONENTS FOR COMPUTERS AND FOR ELECTRONIC SYSTEM COMPUTER HARDWARE, ELECTRONIC COMPONENTS FOR AN AUTONOMOUS COMPUTER AND FOR ELECTRONIC SYSTEM COMPUTER HARDWARE; ELECTRONIC COMPONENTS FOR PERIPHERAL COMPUTERS AND FOR ELECTRONIC SYSTEM COMPUTERS, ELECTRONIC COMPONENTS FOR CONTACTLESS COMPUTERS AND FOR ELECTRONIC SYSTEM CONTACTLESS COMPUTERS; SOFTWARE SOLD AS A COMPONENT IN COMPUTER CHIPS, INTEGRATED CIRCUITS AND INTEGRATED MICROCIRCUITS FOR USE IN MEMORY CARDS; COMPUTER COMMUNICATIONS SOFTWARE TO ALLOW CUSTOMERS TO ACCESS BANK ACCOUNT INFORMATION AND TRANSACT BANK BUSINESS; COMPUTER GAME SOFTWARE; COMPUTER SOFTWARE USED TO PRINT MOVIE TICKETS; COMPUTER SOFTWARE FOR COMMUNICATING WITH USERS OF HANDHELD COMPUTERS; COMPUTER SOFTWARE FOR USE IN CUSTOMER RELATIONSHIP MANAGEMENT (CRM) CHILDREN'S EDUCATIONAL COMPUTER SOFTWARE; COMPUTER SOFTWARE FOR CONTROLLING AND MANAGING ACCESS SERVER APPLICATIONS; COMPUTER SOFTWARE FOR PROCESSING PAYMENTS FOR PER VIEW TELEVISION VIEWING; COMPUTER SOFTWARE FOR USE IN THE SAFEGUARDING OF DIGITAL FILES, INCLUDING AUDIO, VIDEO, TEXT, BINARY, STILL IMAGES, GRAPHICS AND MULTIME-

DIA FILES IN THE HEALTH, MEDICINE AND TRANSPORT FIELDS; SOFTWARE FOR THE OPERATIONAL MANAGEMENT OF PORTABLE MAGNETIC AND ELECTRONIC CARDS; SOFTWARE FOR OPERATING SMART CARD READERS AND CHIP CARD READERS; COMPUTER SOFTWARE FOR WRITING PROGRAMS DESIGNED FOR ELECTRONIC CHIP CARDS, CARD READERS AND FOR APPARATUS AND EQUIPMENT USING CHIP CARDS; RECORDED OPERATING SYSTEM PROGRAMS; OPERATING SYSTEM PROGRAMS FOR CHIP CARD READERS; ELECTRONIC DEVICES FOR READING, ENCODING AND PROGRAMMING TRANSPONDER KEYS; MICROCHIPS; INTEGRATED CIRCUITS; PRINTED CIRCUITS, PRINTED CIRCUITS FOR MEMORY CARDS OR MICROPROCESSOR CARDS; MICROCIRCUITS; MICROPROCESSORS, SECURE MICROPROCESSORS; MEMORY OR MICROPROCESSOR CARDS; MAGNETIC CARDS; MAGNETIC IDENTIFICATION CARDS; BLANK ELECTRONIC CHIP CARDS; BLANK INTEGRATED CIRCUIT CARDS; BLANK MICROCIRCUIT CARDS; ENCODED ELECTRONIC CHIP CARDS CONTAINING PROGRAMMING USED FOR SECURING AND VERIFYING DIGITAL E-BANKING DATA; CONTACTLESS MAGNETIC CARDS; MAGNETIC CODED CARD READERS FOR DATA PROCESSING; READERS FOR SMART CARDS, CHIP CARDS, ELECTRONIC INTEGRATED CIRCUIT CARDS AND MICROCIRCUIT CARDS AND ELECTRONIC MEMORY AND MICROPROCESSOR CARDS; RADIO FREQUENCY IDENTIFICATION TAG READERS; LABELS, NAMELY, RADIO FREQUENCY IDENTIFICATION TAGS; CONTACTLESS ELECTRONIC LABELS, NAMELY, RADIO FREQUENCY IDENTIFICATION TAGS; SEMICONDUCTORS, SEMICONDUCTOR AND MICROPROCESSOR DEVICES; COMPUTER CHIPSET FOR USE IN TRANSMITTING DATA TO AND FROM A CENTRAL PROCESSING UNIT;

INTERFACE CARDS FOR DATA PROCESSING EQUIPMENT IN THE FORM OF PRINTED CIRCUITS; RADIO FREQUENCY IDENTIFICATION (RFID) CREDENTIALS, NAMELY, CARDS AND TAGS, AND READERS FOR RADIO FREQUENCY IDENTIFICATION CREDENTIALS; TRANSPONDERS; RADIOS; POINT OF SALE TERMINALS; PERIPHERAL DEVICES FOR RECEIPTS; FLASH CARD READERS AND ELECTRONIC BADGE READERS; VENDING MACHINES; MEMORY OR MICROPROCESSOR CARDS; CASH OR TICKET DISPENSERS; UPI (UNIVERSAL PERIPHERAL INTERFACE) HARDWARE AND SOFTWARE FOR MEMORY CARDS AND MICROPROCESSOR CARDS; BAR CODE READERS FOR USE WITH MEMORY AND MICROPROCESSOR CARDS; MICROPROCESSORS, ESPECIALLY SECURE MICROPROCESSORS; COIN-OPERATED GATES FOR CAR PARKS; SILICON WAFERS FOR INTEGRATED CIRCUITS; COIN-OPERATED PREPAYMENT MECHANISMS FOR CAR PARKS; DOWNLOADABLE COMPUTER SOFTWARE PROGRAMS AND COMPUTER PROGRAMS RECORDED ON DATA MEDIA, TO ALLOW CUSTOMERS TO ACCESS BANK ACCOUNT INFORMATION AND TRANSACT BANK BUSINESS; DOWNLOADABLE COMPUTER GAME SOFTWARE; DOWNLOADABLE COMPUTER SOFTWARE USED TO PRINT MOVIE TICKETS; DOWNLOADABLE COMPUTER SOFTWARE FOR COMMUNICATING WITH USERS OF HANDHELD COMPUTERS; DOWNLOADABLE COMPUTER SOFTWARE FOR USE IN CUSTOMER RELATIONSHIP MANAGEMENT (CRM) CHILDREN'S EDUCATIONAL COMPUTER SOFTWARE; DOWNLOADABLE COMPUTER SOFTWARE FOR CONTROLLING AND MANAGING ACCESS SERVER APPLICATIONS; DOWNLOADABLE COMPUTER SOFTWARE FOR PROCESSING PAYMENTS FOR PER VIEW TELEVISION VIEWING; DOWNLOADABLE COMPUTER SOFTWARE FOR USE IN THE SAFEGUARDING OF DIGITAL FILES, INCLUDING AUDIO, VIDEO, TEXT, BINARY, STILL IMAGES, GRAPHICS AND MULTIMEDIA FILES IN THE HEALTH, MEDICINE AND TRANSPORT FIELDS; DOWNLOADABLE SOFTWARE FOR THE OPERATIONAL MANAGEMENT OF PORTABLE MAGNETIC AND ELECTRONIC CARDS; DOWNLOADABLE SOFTWARE FOR OPERATING SMART CARD READERS AND CHIP CARD READERS; DOWNLOADABLE COMPUTER SOFTWARE FOR WRITING PROGRAMS DESIGNED FOR ELECTRONIC CHIP CARDS, CARD READERS AND FOR APPARATUS AND EQUIPMENT USING CHIP CARDS; RECORDED OPERATING SYSTEM PROGRAMS, IN CLASS 9 (U.S. CLS. 21, 23, 26, 36 AND 38).

FOR: DESIGN AND DEVELOPMENT OF COMPUTER SYSTEMS CONTAINING MEMORY CARDS, MICROPROCESSOR CARDS, AND OF

TELECOMMUNICATION SYSTEMS; COMPUTER CONSULTING; DUPLICATION OF COMPUTER PROGRAMS; COMPUTER PROGRAMMING; CONVERSION OF COMPUTER DATA AND PROGRAMS (NOT PHYSICAL CONVERSION); CONVERSION OF DOCUMENTS FROM A PHYSICAL TO AN ELECTRONIC MEDIUM; CONSULTING WITH REGARD TO MEMORY OR MICROPROCESSOR CARDS; ENGINEERING; CREATION, MAINTENANCE AND DESIGN OF WEB SITES FOR OTHERS; RESEARCH AND DEVELOPMENT OF NEW PRODUCTS FOR OTHERS; CUSTOM DESIGN AND ENGINEERING AND PROGRAMMING OF ELECTRONIC CHIP CARDS, INTEGRATED CIRCUIT CARDS, MICRO-CIRCUIT CARDS, MEMORY CARDS, MAGNETIC CARDS, ELECTRONIC CARDS, CONTACTLESS MEMORY CARDS; COMPUTER SERVICE, NAMELY, ACTING AS AN APPLICATION SERVICE PROVIDER IN THE FIELD OF KNOWLEDGE MANAGEMENT TO HOST COMPUTER APPLICATION SOFTWARE FOR THE COLLECTION, EDITING, ORGANIZING, MODIFYING, BOOK MARKING, TRANSMISSION, STORAGE AND SHARING OF DATA AND INFORMATION; DESIGN AND DEVELOPMENT OF COMPUTERS AND SOFTWARE, DEVELOPMENT AND DESIGN, INSTALLATION, MAINTENANCE, UPDATING AND RENTAL OF APPLICATION SOFTWARE, TECHNICAL SUPPORT SERVICES IN THE FIELD OF INFORMATION TECHNOLOGY AND TELECOMMUNICATIONS, NAMELY, DEVELOPMENT AND DESIGN, INSTALLATION, MAINTENANCE, SERVICING, UPDATING AND RENTAL OF APPLICATION SOFTWARE, SOFTWARE DEVELOPMENT, COMPUTER SOFTWARE DEVELOPMENT AND COMPUTER PROGRAMMING OF INTERACTIVE SERVICES ON MOBILE TERMINALS, WITH THE EXCEPTION OF LAPTOP COMPUTERS, TECHNICAL RESEARCH IN THE FIELD OF SOFTWARE DESIGN AND DEVELOPMENT, CUSTOM DESIGN AND ENGINEERING AND PROGRAMMING OF SOFTWARE, ALL BEING USED IN CONNECTION WITH DIGITAL SECURITY SOLUTIONS FOR E-BANKING SERVICES, IN CLASS 42 (U.S. CLS. 100 AND 101).

THE MARK CONSISTS OF STANDARD CHARACTERS WITHOUT CLAIM TO ANY PARTICULAR FONT, STYLE, SIZE, OR COLOR.

PRIORITY DATE OF 2-13-2007 IS CLAIMED.

OWNER OF INTERNATIONAL REGISTRATION 0938240 DATED 7-25-2007, EXPIRES 7-25-2017.

SER. NO. 79-044,118, FILED 7-25-2007.

KELLEY WELLS, EXAMINING ATTORNEY

Int. Cls.: 9, 35, 38, 41 and 42

**Prior U.S. Cls.: 21, 23, 26, 36, 38, 100, 101, 102, 104
and 107**

Reg. No. 3,576,354

United States Patent and Trademark Office

Registered Feb. 17, 2009

**TRADEMARK
SERVICE MARK
PRINCIPAL REGISTER**

M
MobiLead
MobileAD

TONNELIER LAURENT (FRANCE INDIVIDUAL)
57 RUE CLISSON
F-75013 PARIS
FRANCE

FOR: DATA PROCESSING EQUIPMENT, NAME-
LY, DATA PROCESSOR AND COMPUTERS; PER-
SONAL STEREO HEADSETS FOR USE WITH
COMPUTERS, TELEPHONES, RADIOS; NOTE-
BOOK COMPUTERS; MOBILE TELEPHONES; COM-
PUTER SOFTWARE FOR USE IN DATABASE
MANAGEMENT, USE AS A SPREADSHEET, FOR
WORD PROCESSING; GAMEWARE, NAMELY,-
COMPUTER GAME SOFTWARE; DOWNLOAD-
ABLE COMPUTER SOFTWARE FOR USE IN
DATABASE MANAGEMENT, USE AS A SPREAD-
SHEET, WORD PROCESSING; COMPUTER PRO-
GRAMS RECORDED ON DATA MEDIA FOR USE
IN DATABASE MANAGEMENT, USE AS A
SPREADSHEET, WORD PROCESSING; DOWN-
LOADABLE ELECTRONIC PUBLICATIONS,
NAMELY, BOOKS IN THE FIELD OF COMMUNI-
CATION AND TELECOMMUNICATION, MAGA-
ZINES IN THE FIELD OF COMMUNICATION
AND TELECOMMUNICATION, NEWSLETTERS IN
THE FIELD OF COMMUNICATION AND TELE-
COMMUNICATION; ANIMATED CARTOONS RE-
CORD ON COMPACT DISCS, VIDEO DISCS, AND
VIDEO TAPES, IN CLASS 9 (U.S. CLS. 21, 23, 26, 36
AND 38).

FOR: ADVERTISING; ADVERTISING AGEN-
CIES; DISSEMINATION OF ADVERTISING MAT-
TER; PUBLICATION OF ADVERTISING TEXTS;

ONLINE ADVERTISING ON A COMPUTER NET-
WORK; RENTAL OF ADVERTISING SPACE; COL-
LECTION OF DATA IN A CENTRAL FILE;
COMPUTERIZED FILE MANAGEMENT; DRAW-
ING-UP OF STATISTICS, NAMELY, COMPILATION
OF STATISTICS FOR BUSINESS PURPOSES; COM-
MERCIAL AND INDUSTRIAL MANAGEMENT AS-
SISTANCE; BUSINESS MANAGEMENT
CONSULTANCY; ADVISORY SERVICES FOR BUSI-
NESS MANAGEMENT, IN CLASS 35 (U.S. CLS. 100,
101 AND 102).

FOR: TELECOMMUNICATIONS SERVICES,
NAMELY, PROVIDING ACCESS TO TELECOMMU-
NICATIONS NETWORKS, RENTAL OF TELECOM-
MUNICATIONS EQUIPMENT; NEWS AGENCIES,
NAMELY, TRANSMISSION OF NEWS ITEMS TO
NEWS REPORTING ORGANIZATIONS; INFORMA-
TION ON TELECOMMUNICATIONS, NAMELY,
TRANSMISSION OF TELECOMMUNICATIONS IN-
FORMATION VIA OPTICAL TELECOMMUNICA-
TIONS NETWORKS; MESSAGE TRANSMISSION,
NAMELY, ELECTRONIC MESSAGE TRANSMIS-
SION, TRANSMISSION OF MESSAGES OVER ELE-
CTRONIC MEDIA; COMPUTER-ASSISTED
MESSAGE AND IMAGE TRANSMISSION; COMMU-
NICATIONS VIA COMPUTER TERMINALS; PRO-
VIDING CONNECTIONS BY
TELECOMMUNICATIONS TO A GLOBAL COMPU-
TER NETWORK; ELECTRONIC MAIL AND MES-
SAGING SERVICES; MOBILE RADIOTELEPHONY
SERVICES, IN CLASS 38 (U.S. CLS. 100, 101 AND 104).

FOR: EDUCATION SERVICES, NAMELY, PROVIDING CLASSES IN THE FIELD OF MATH; TRAINING SERVICES IN THE FIELD OF BUSINESS TRAINING; ENTERTAINMENT SERVICES, NAMELY, GOLF TOURNAMENTS, LIGHT SHOWS; ORGANIZING COMMUNITY SPORTING AND CULTURAL EVENTS; PROVIDING INFORMATION ON EDUCATIONAL AND ENTERTAINMENT EVENTS; DESKTOP PUBLISHING FOR OTHERS; ORGANIZATION OF EDUCATION AND ENTERTAINMENT COMPETITIONS; ARRANGING AND CONDUCTING COLLOQUIUMS, LECTURES AND SYMPOSIUMS IN THE FIELD OF MEDICAL SCIENCE; ORGANIZATION OF EXHIBITIONS FOR CULTURAL AND EDUCATIONAL PURPOSES; ELECTRONIC PUBLISHING OF ONLINE BOOKS AND PERIODICALS; BOOKING OF SEATS FOR SHOWS; PROVIDING GAMES VIA A COMPUTER NETWORK; GAMBLING SERVICES, IN CLASS 41 (U.S. CLS. 100, 101 AND 107).

FOR: CONDUCTING OF TECHNICAL PROJECT STUDIES INVOLVING THE MONITORING, TESTING, ANALYZING AND REPORTING ON THE INTERNET TRAFFIC CONTROL AND CONTENT OF WEBSITES OF OTHERS; RESEARCH AND DEVELOPMENT OF NEW PRODUCTS FOR THIRD PARTIES; COMPUTER SYSTEMS ANALYSIS; COM-

PUTER SOFTWARE CONSULTANCY; COMPUTER SYSTEMS DESIGN; DESIGN AND DEVELOPMENT OF COMPUTER HARDWARE AND SOFTWARE; DESIGN, DEVELOPMENT, INSTALLATION, MAINTENANCE, UPDATING AND RENTAL OF COMPUTER SOFTWARE FOR OTHERS; CREATION AND MAINTENANCE OF WEB SITES FOR OTHERS; HOSTING OF WEB SITES; DATA CONVERSION OF COMPUTER PROGRAMS AND DATA, NOT INCLUDING PHYSICAL CONVERSION; CONVERSION OF DOCUMENTS FROM A PHYSICAL TO AN ELECTRONIC MEDIUM, IN CLASS 42 (U.S. CLS. 100 AND 101).

PRIORITY DATE OF 10-4-2006 IS CLAIMED.

OWNER OF INTERNATIONAL REGISTRATION 0938816 DATED 3-29-2007, EXPIRES 3-29-2017.

NO CLAIM IS MADE TO THE EXCLUSIVE RIGHT TO USE "MOBILE" AND "AD", APART FROM THE MARK AS SHOWN.

SER. NO. 79-044,332, FILED 3-29-2007.

DAVID I, EXAMINING ATTORNEY

Int. Cls.: 16, 28, 38 and 41

**Prior U.S. Cls.: 2, 5, 22, 23, 29, 37, 38, 50, 100, 101, 104
and 107**

Reg. No. 3,576,355

United States Patent and Trademark Office

Registered Feb. 17, 2009

**TRADEMARK
SERVICE MARK
PRINCIPAL REGISTER**

DJECO

DJECO IMMOBILIER (FRANCE SOCIETE A RE-
SPONSABILITE LIMITEE)

3 RUE DES GRANDS AUGUSTINS

F-75006 PARIS

FRANCE

FOR: PAPER AND CARDBOARD; GOODS MADE FROM PAPER AND CARDBOARD, NAMELY, CARDBOARD BOXES; PRINTED MATTER, NAMELY, PRINTED FORMS, PRINTED CALENDARS, PRINTED INFORMATIONAL CARDS IN THE FIELD OF GAMES; PHOTOGRAPHS; STATIONERY; ADHESIVES FOR STATIONERY OR HOUSEHOLD PURPOSES; ARTIST'S MATERIALS, NAMELY, BRUSHES, PASTELS, PENCILS, PENS, CANVAS PANELS; PAINT BRUSHES; TYPEWRITERS; INSTRUCTIONAL AND TEACHING MATERIAL, NAMELY, MANUALS IN FIELD OF INSTRUCTIONAL GAMES, PRINTED INSTRUCTIONAL AND TEACHER MATERIALS IN THE FIELD OF INSTRUCTIONAL GAMES; PLASTIC MATERIALS FOR PACKAGING, NAMELY, PLASTIC BAGS, PLASTIC BUBBLE PACKS; PRINTERS' TYPE; PRINTING BLOCKS; COLORING AND PAINTING MATERIALS, NAMELY, COLOR PENCILS, LIQUID PAINT FELT TIP MARKING AND COLORING APPLICATORS; PRINTED PUBLICATIONS, NAMELY, LEAFLETS ABOUT GAMES, ADVERTISING POSTERS FOR OTHERS, PHOTOGRAPHS, MAGAZINES FEATURING GAMES, JOURNALS CONCERNING GAMES, PERIODICALS IN THE FIELD OF GAMES, CALENDARS; BOOKS IN THE FIELD OF GAMES, PICTURE BOOKS, NEWSPAPERS, MANUALS IN THE FIELD OF GAMES, PUBLICATIONS, NAMELY, BROCHURES IN THE FIELD OF GAMES; GRAPHIC PRINTS, PICTURES; PAPER MÂCHÉ AND CARDBOARD FIGURINES, IN CLASS 16 (U.S. CLS. 2, 5, 22, 23, 29, 37, 38 AND 50).

FOR: GAMES AND PLAYTHINGS MADE OF WOOD, NAMELY, DOLLS, KENDO SWORDS, TOY STATUETTES, FIGURINES, BACKGAMMON GAMES; PLAYING CARDS AND BOARD GAMES; MEMORY GAMES, CARD GAMES, AND PUZZLES; ARCADE TYPE ELECTRONIC GAME CONSOLES AND HAND-HELD UNITS FOR PLAYING ELECTRONIC GAMES; TOY BUILDING STRUCTURES, NAMELY, BLOCKS; DECORATIONS FOR CHRISTMAS TREES, IN CLASS 28 (U.S. CLS. 22, 23, 38 AND 50).

FOR: TELECOMMUNICATIONS IN THE NATURE OF RADIO COMMUNICATIONS SERVICES; MULTIMEDIA TELECOMMUNICATIONS SERVICES, NAMELY, TRANSMISSION OF SOUND AND VISION VIA INTERACTIVE MULTIMEDIA NETWORKS; TELECOMMUNICATIONS SERVICES PROVIDED VIA THE INTERNET, NAMELY, INTERNET TELEPHONE SERVICES; TELECOMMUNICATIONS SERVICES, NAMELY, BY DATA TRANSMISSION VIA RADIO, TELEGRAM AND TELEPHONE; TRANSMISSION OF FAXES AND MESSAGES VIA ELECTRONIC MEDIA, COMPUTER-AIDED TRANSMISSION OF DATA AND COMMUNICATION BETWEEN COMPUTER TERMINALS; ELECTRONIC MAIL SERVICES, ELECTRONIC MESSAGING IN THE NATURE OF ELECTRONIC QUEUING SERVICES, STORE-AND-FORWARD MESSAGING, OR THE RECORDING AND SUBSEQUENT TRANSMISSION OF VOICE MESSAGES BY TELEPHONE, AND TRANSMISSION OF INFORMATION BY ELECTRONIC MEANS; SECURE ELECTRONIC DATA TRANSMISSION SERVICES; COMPUTER-AIDED TRANSMISSION OF MESSAGES AND IMAGES BY SATELLITE; COMMUNICATIONS BY FIBRE OPTIC NETWORKS; ELECTRONIC MAIL SERVICES; COMPUTER-AIDED TRANSMISSION OF MESSAGES AND

IMAGES; ELECTRONIC TRANSMISSION OF INFORMATION CONTAINED IN DATA BANKS; ON-LINE MESSAGING SERVICES; COMMUNICATION SERVICES, NAMELY, ELECTRONIC TRANSMISSION OF DATA AND DOCUMENTS BY COMPUTERS; ELECTRONIC DATA INTERCHANGE SERVICES; ELECTRONIC TRANSMISSION OF INFORMATION BY ACCESS CODE TO COMPUTERIZED OR DATA COMMUNICATION DATABASES AND DATABASE SERVER CENTERS; COMMUNICATIONS SERVICES, NAMELY, TRANSMISSION OF INFORMATION BY COMPUTER TERMINALS ON NATIONAL, INTERNATIONAL AND WORLD-WIDE COMMUNICATION NETWORKS, BY CABLE, BY SATELLITE; TRANSMISSION OF INFORMATION BY MEANS OF ELECTRONIC CATALOGUES VIA THE INTERNET; COMPUTER-AIDED TRANSMISSION OF MESSAGES AND IMAGES; ALL OF THE ABOVE RELATING TO THE FIELD OF GAMES, IN CLASS 38 (U.S. CLS. 100, 101 AND 104).

FOR: EDUCATION, TRAINING AND ENTERTAINMENT SERVICES, NAMELY, A CONTINUING PROGRAM ABOUT GAMES ACCESSIBLE BY RADIO, TELEVISION, SATELLITE, AUDIO, VIDEO

AND COMPUTER NETWORKS, PROVIDING ADVICE AND INFORMATION FOR GAMES; ARRANGING AND CONDUCTING OF COLLOQUIUMS, CONFERENCES AND CONGRESSES IN THE FIELD OF GAME ENTERTAINMENT; PUBLICATION OF BOOKS AND JOURNALS; CULTURAL ACTIVITIES, NAMELY, ORGANIZATION OF EXHIBITIONS FOR CULTURAL PURPOSES; ARRANGING OF COMPETITIONS FOR EDUCATION OR ENTERTAINMENT, NAMELY, GAMES COMPETITIONS; ARRANGING AND CONDUCTING OF CONFERENCES, CONVENTIONS, EXHIBITIONS, SEMINARS AND MEETINGS IN THE FIELD OF GAME ENTERTAINMENT; ARRANGING THEATRE AND CONCERT TICKET RESERVATIONS FOR OTHERS, IN CLASS 41 (U.S. CLS. 100, 101 AND 107).

OWNER OF INTERNATIONAL REGISTRATION
0939120 DATED 5-28-2007, EXPIRES 5-28-2017.

SER. NO. 79-044,489, FILED 5-28-2007.

EUGENIA MARTIN, EXAMINING ATTORNEY

Int. Cls.: 35, 41 and 42

Prior U.S. Cls.: 100, 101, 102 and 107

United States Patent and Trademark Office

Reg. No. 3,576,356

Registered Feb. 17, 2009

**SERVICE MARK
PRINCIPAL REGISTER**

mayato

MAYATO GMBH
AM BORSIGTURM 9
13507 BERLIN
FED REP GERMANY

FOR: BUSINESS CONSULTANCY; BUSINESS ADMINISTRATION; BUSINESS MANAGEMENT CONSULTANCY; BUSINESS SURVEYS; MARKETING RESEARCH; MARKETING STUDIES; BUSINESS ANALYSIS OF FINANCIAL STATEMENTS , IN CLASS 35 (U.S. CLS. 100, 101 AND 102).

FOR: TRAINING IN THE USE OF BUSINESS INTELLIGENCE SOFTWARE TOOLS AND BEST PRACTICES, NAMELY, COMPUTER SOFTWARE DEVELOPMENT; ARRANGING AND CONDUCTING OF EDUCATIONAL CONFERENCES; ARRANGING AND CONDUCTING OF EDUCATION EVENTS, NAMELY, EDUCATIONAL AND CULTURAL EXHIBITIONS; EDUCATIONAL SERVICES, NAMELY, CONDUCTING WORKSHOPS, SEMINARS, INSTRUCTION AND EDUCATIONAL CONGRESSES IN THE FIELD OF BUSINESS INTELLIGENCE COMPUTER SOFTWARE TOOLS AND BEST PRACTICES, NAMELY, COMPUTER SOFTWARE DEVELOPMENT, IN CLASS 41 (U.S. CLS. 100, 101 AND 107).

FOR: COMPUTER SOFTWARE PROGRAMMING; TECHNICAL CONSULTANCY IN THE FIELD OF COMPUTER PROGRAMMING; TECHNICAL ANALYSIS AND SURVEYS, NAMELY, TECHNICAL SURVEYING; QUALITY CONTROL FOR OTHERS; COMPUTER PROJECT MANAGEMENT SERVICES, NAMELY, TECHNICAL PROJECT MANAGEMENT, NAMELY, FOR DESIGN AND IMPLEMENTATION OF BUSINESS INTELLIGENCE COMPUTER SOFTWARE AND COMPUTER PROCESSES, IN CLASS 42 (U.S. CLS. 100 AND 101).

THE MARK CONSISTS OF STANDARD CHARACTERS WITHOUT CLAIM TO ANY PARTICULAR FONT, STYLE, SIZE, OR COLOR.

OWNER OF INTERNATIONAL REGISTRATION 0940502 DATED 8-27-2007, EXPIRES 8-27-2017.

THE WORDING "MAYATO" HAS NO MEANING IN A FOREIGN LANGUAGE.

SER. NO. 79-045,033, FILED 8-27-2007.

DAYNA BROWNE, EXAMINING ATTORNEY

Int. Cls.: 5, 29 and 30

Prior U.S. Cls.: 6, 18, 44, 46, 51 and 52

United States Patent and Trademark Office

Reg. No. 3,576,357

Registered Feb. 17, 2009

**TRADEMARK
PRINCIPAL REGISTER**

RAUCH

RAUCH FRUCHTSÄFTE GMBH (AUSTRIA PRIVATE LIMITED COMPANY)

LANGGASSE 1

A-6830 RANKWEIL

AUSTRIA

FOR: DIETETIC FOOD ADAPTED FOR MEDICAL USE; FOOD FOR BABIES, IN CLASS 5 (U.S. CLS. 6, 18, 44, 46, 51 AND 52).

FOR: PRESERVED, DRIED, AND COOKED FRUITS AND VEGETABLES; JELLIES FOR FOOD; JAMS; MILK AND MILK PRODUCTS, NAMELY, MILK SHAKES, ICE CREAM, MILK COFFEE DRINKS, MILK-BASED BEVERAGES CONTAINING COFFEE, MILK DRINKS CONTAINING FRUITS, YOGURT; EDIBLE OILS AND FATS, IN CLASS 29 (U.S. CL. 46).

FOR: COFFEE; TEA; COCOA; ARTIFICIAL COFFEE; EDIBLE ICES; HONEY; TREACLE; VINEGAR; SAUCES; FRUIT SUGAR, IN CLASS 30 (U.S. CL. 46).

THE MARK CONSISTS OF STANDARD CHARACTERS WITHOUT CLAIM TO ANY PARTICULAR FONT, STYLE, SIZE, OR COLOR.

OWNER OF INTERNATIONAL REGISTRATION 0823647 DATED 1-19-2004, EXPIRES 1-19-2014.

OWNER OF U.S. REG. NOS. 2,872,961, 2,898,337 AND OTHERS.

SEC. 2(F).

SER. NO. 79-045,604, FILED 8-1-2007.

PATRICIA EVANKO, EXAMINING ATTORNEY

Int. Cl.: 30

Prior U.S. Cl.: 46

United States Patent and Trademark Office

Reg. No. 3,576,359

Registered Feb. 17, 2009

**TRADEMARK
PRINCIPAL REGISTER**

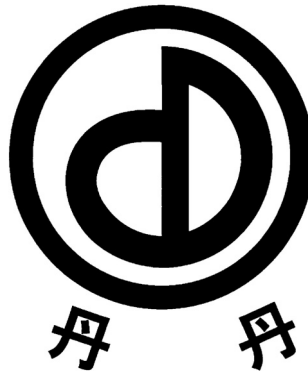

SICHUAN PROVINCE DANDAN CONDIMENT;
CO., LTD. (CHINA CORPORATION)
AN DE MEDIUM GARDEN
CHENGDU MODERN INDUSTRY HARBOR; PIX-
IAN COUNTY, CHENGDU CITY; SICHUAN PRO-
VINCE
CHINA

FOR: SEASONINGS; THICK BROAD BEAN
SAUCE AND DRESSINGS MADE OF BEANS AND
OTHER SPICES FOR COOKING AND FLAVORING,
IN CLASS 30 (U.S. CL. 46).

OWNER OF INTERNATIONAL REGISTRATION
0942589 DATED 10-24-2007, EXPIRES 10-24-2017.

THE MARK HAS NO SIGNIFICANT MEANING
OR RELEVANT ENGLISH TRANSLATION.

THE TRANSLITERATION OF THE NON-LATIN
CHARACTERS IN THE MARK IS: DAN DAN.

SER. NO. 79-045,831, FILED 10-24-2007.

ZACHARY BELLO, EXAMINING ATTORNEY

Int. Cls.: 21 and 33

Prior U.S. Cls.: 2, 13, 23, 29, 30, 33, 40, 47, 49 and 50

United States Patent and Trademark Office

Reg. No. 3,576,360

Registered Feb. 17, 2009

TRADEMARK
PRINCIPAL REGISTER



BELVEDERE (FRANCE SOCIÉTÉ ANONYME)
10 AVENUE CHARLES JAFFELIN,
F-21200 BEAUNE
FRANCE

FOR: BOTTLES, SOLD EMPTY, IN CLASS 21 (U.S. CLS. 2, 13, 23, 29, 30, 33, 40 AND 50).

FOR: ALCOHOLIC BEVERAGES EXCEPT BEERS, NAMELY, VODKA, LIQUEURS, EAUX-DE-VIE BRANDY, FRUIT-BASED ALCOHOLS, NAMELY, ALCOHOLIC BEVERAGES OF FRUIT, IN CLASS 33 (U.S. CLS. 47 AND 49).

PRIORITY DATE OF 4-13-2007 IS CLAIMED.

OWNER OF INTERNATIONAL REGISTRATION 0942840 DATED 10-11-2007, EXPIRES 10-11-2017.

OWNER OF U.S. REG. NOS. 2,378,523 AND 2,564,045.

NO CLAIM IS MADE TO THE EXCLUSIVE RIGHT TO USE THE DEPICTION OF THE CONFIGURATION OR SHAPE OF THE BOTTLE AND THE WORD "ESTATE", APART FROM THE MARK AS SHOWN.

THE COLOR(S) WHITE, BLACK, SILVERY GREY AND RED IS/ARE CLAIMED AS A FEATURE OF THE MARK.

THE COLOR WHITE APPEARS IN THE LETTER OF THE WORD "SOBIESKI", THE OUTER OUTLINE OF THE RECTANGULAR SHIELD BACKGROUND OF THE WORD "SOBIESKI", THE CLOUD IN THE BACKGROUND OF THE BOTTLE AND THE SHADOW OF THE BUILDING, THE COLOR SILVERY GREY OUTLINES THE LETTERS OF THE WORD "SOBIESKI," THE INNER OUTLINE OF THE RECTANGULAR SHIELD BACKGROUND OF THE WORD "SOBIESKI", AND APPEARS IN THE BACKGROUND OF THE BOTTLE AND THE SHADING OF THE DESIGN OF THE HOUSE AND SKY; THE COLOR BLACK APPEARS IN THE WINDOWS, DOORS AND OUTLINES OF DETAILS OF THE HOUSE, AND THE COLOR RED APPEARS IN THE RECTANGULAR SHIELD BACKGROUND OF THE WORD "SOBIESKI," IN THE LETTERS OF THE WORD "ESTATE" AND IN THE RECTANGULAR SHAPED BAR NEAR THE BOTTOM OF THE BOTTLE.

SER. NO. 79-045,974, FILED 10-11-2007.

CARYN GLASSER, EXAMINING ATTORNEY

Int. Cls.: 2, 19 and 27

Prior U.S. Cls.: 1, 6, 11, 12, 16, 19, 20, 33, 37, 42 and 50

United States Patent and Trademark Office

Reg. No. 3,576,361

Registered Feb. 17, 2009

TRADEMARK
PRINCIPAL REGISTER



GOBBETTO S.R.L. (ITALY LIMITED LIABILITY COMPANY)
VIA CARROCCIO, 16
I-20123 MILANO
ITALY

FOR: VARNISHES, PAINTS, LACQUERS; PRESERVATIVES FOR METALS AND ALLOYS THEREOF TO PREVENT RUSTING AND PRESERVATIVES TO PREVENT THE DETERIORATION OF WOOD; COLORANTS, MORDANTS FOR USE IN THE BUILDING INDUSTRY; RAW NATURAL RESINS, IN CLASS 2 (U.S. CLS. 6, 11 AND 16).

FOR: NON-METALLIC CONSTRUCTION MATERIALS, NAMELY, FLOORS NOT OF METAL; FLOOR TILES NOT OF METAL; ROAD BEDS, NAMELY, CONCRETE ROAD PAVEMENT BOARDS; NON-METALLIC CONSTRUCTION COVERINGS, NAMELY, NON-METAL ROOF COVERINGS; NON-METALLIC COVERINGS FOR WALLS, NAMELY, PLASTIC WALLBOARDS; NON-METALLIC PANELS FOR CONSTRUCTION, NAMELY, NONMETAL EXTERIOR PANELS; FACING PANELS, NAMELY, CERAMIC TILES FOR FACING;

ASPHALTS, PITCH AND BITUMEN, IN CLASS 19 (U.S. CLS. 1, 12, 33 AND 50).

FOR: FLOOR-COVERINGS; INSULATING FLOOR COVERINGS, NAMELY, INSULATING FLOOR COVERINGS IN VINYL, IN CLASS 27 (U.S. CLS. 19, 20, 37, 42 AND 50).

PRIORITY DATE OF 6-6-2007 IS CLAIMED.

OWNER OF INTERNATIONAL REGISTRATION 0942881 DATED 8-27-2007, EXPIRES 8-27-2017.

THE MARK CONSISTS OF A STYLIZED CUBE WITH THE WORDING "GOBBETTO".

THE MARK HAS NO MEANING IN A FOREIGN LANGUAGE.

SER. NO. 79-045,981, FILED 8-27-2007.

BERNICE MIDDLETON, EXAMINING ATTORNEY

Int. Cl.: 9

Prior U.S. Cls.: 21, 23, 26, 36 and 38

United States Patent and Trademark Office

Reg. No. 3,576,362

Registered Feb. 17, 2009

TRADEMARK
PRINCIPAL REGISTER



LYONEL RALLS (AUSTRALIA INDIVIDUAL)
49 EVANDALE STREET
FLOREAT WA 6014
AUSTRALIA

FOR: COMPUTER PROGRAMS FOR DATA PROCESSING; COMPUTER PROGRAMS FOR IMAGE PROCESSING; COMPUTER PROGRAMS FOR PRODUCING COMPUTER GRAPHICS; COMPUTER PROGRAMS FOR PROVIDING A GRAPHICAL PRESENTATION OF DATA; ELECTRONIC DATA PROCESSORS FOR THE STORAGE OF COMPUTER PROGRAMS; STORAGE APPARATUS, NAMELY, BLANK MAGNETIC DISKS FOR STORING COMPUTER PROGRAMS; DIGITAL IMAGE PROCESSORS FOR THE ANALYSIS OF TRANSPARENCIES; APPARATUS FOR REPRODUCTION OF IMAGES; APPARATUS FOR THE REPRODUCTION OF OPTICAL IMAGES; APPARATUS FOR TRANSMITTING FILM IMAGES ONTO TELEVISION SCREENS; APPARATUS FOR TRANSMITTING IMAGES; BLANK MAGNETIC CARRIERS FOR BEARING IMAGES; COMPUTER IMAGE PROJECTION APPARATUS, NAMELY, APPARATUS FOR TRANSMITTING AND REPRODUCING COLOR IMAGES; COMPUTER PROGRAMS RELATING TO THE CREATION OF GRAPHIC IMAGES; COMPUTER SCREENS; ELECTRIC OR ELECTRONIC CONTROL PANELS; PROJECTION SCREENS FOR MOVIE FILMS; FILTER SCREENS FOR COMPUTER SCREENS; FLAT PANEL DISPLAY SCREENS FOR ELECTRONIC DATA PROCESSING APPARATUS; PROJECTION SCREENS FOR MOVIE FILMS; SCREENS FOR USE WITH COMPUTERS, NAMELY, COMPUTER MONITORS; APPARATUS FOR ELECTRONIC IMAGE RECEPTION, NAMELY, VIDEO RECEIVERS; APPARATUS FOR ELECTRONIC IMAGE TRANSMISSION; PRE-RECORDED CINEMATOGRAPHIC FILMS FEATURING NATURAL WORLD WON-

TERS, CITY LANDSCAPES, FIREPLACES, WATER SCENERY, AND SCENIC VIEWS AROUND THE WORLD; COMPUTER GRAPHICS APPARATUS, NAMELY, COMPUTER GRAPHICS SOFTWARE AND COMPUTER GRAPHICS BOARDS; DATA PROCESSING SOFTWARE FOR GRAPHIC REPRESENTATIONS; COMPUTER SCREEN SAVER SOFTWARE; PHOTOGRAPHIC PRINTERS; APPARATUS FOR ELECTRONIC IMAGE RECEPTION, NAMELY, AUDIOVISUAL RECEIVERS; APPARATUS FOR ELECTRONIC IMAGE TRANSMISSION, IN CLASS 9 (U.S. CLS. 21, 23, 26, 36 AND 38).

PRIORITY DATE OF 3-1-2007 IS CLAIMED.

OWNER OF INTERNATIONAL REGISTRATION
0944201 DATED 8-23-2007, EXPIRES 8-23-2017.

THE COLOR(S) ORANGE AND GRAY IS/ARE
CLAIMED AS A FEATURE OF THE MARK.

THE MARK CONSISTS OF THE WORDING "SCREENPLACES" AND A DESIGN ELEMENT COMPRISING SEVEN SCATTERED DIAMONDS LOCATED TO THE LEFT OF THE LITERAL ELEMENT OF THE MARK AND ONE DIAMOND TO CROSS THE LETTER "A". THE COLOR ORANGE APPEARS IN THE DESIGN ELEMENT, INCLUDING THE DIAMOND THAT CROSSES THE LETTER "A", AND THE WORD "SCREEN". THE COLOR GRAY APPEARS IN THE WORD "PLACES".

SER. NO. 79-046,510, FILED 8-23-2007.

Laurie Kaufman, Examining Attorney

Int. Cl.: 1

Prior U.S. Cls.: 1, 5, 6, 10, 26 and 46

United States Patent and Trademark Office

Reg. No. 3,576,363

Registered Feb. 17, 2009

**TRADEMARK
PRINCIPAL REGISTER**

INVAZYME

HUNTSMAN ADVANCED MATERIALS (SWITZERLAND) GMBH (BELGIUM BESLOTEN VENNOOTSCHAP MET BEPERKTE AANSPRAKELIJKHEID (BVBA))

KLYBECKSTRASSE 200
CH-4057 BASEL
SWITZERLAND

FOR: CHEMICAL AUXILIARIES IN THE FORM OF LIQUIDS AND POWDERS FOR USE IN THE TEXTILE INDUSTRY; ENZYMES FOR USE IN THE TEXTILE INDUSTRY; CHEMICALS FOR USE IN THE TEXTILE INDUSTRY CONTAINING ENZYMES; PRETREATMENT AGENTS, NAMELY, CHEMICAL PRODUCTS FOR THE PRETREATMENT OF TEXTILES; SOFTENING AGENTS FOR USE IN THE MANUFACTURE OF TEXTILES; CHEMICAL AGENTS FOR THE DEFINED DEGRADATION OF FIBERS USING ENZYMES; CHEMICAL AGENTS FOR DECOMPOSING BLEACHING

AGENTS; SIZING AND DE-SIZING AGENTS FOR INDUSTRIAL USE, IN CLASS 1 (U.S. CLS. 1, 5, 6, 10, 26 AND 46).

THE MARK CONSISTS OF STANDARD CHARACTERS WITHOUT CLAIM TO ANY PARTICULAR FONT, STYLE, SIZE, OR COLOR.

PRIORITY DATE OF 2-26-2007 IS CLAIMED.

OWNER OF INTERNATIONAL REGISTRATION 0944437 DATED 8-3-2007, EXPIRES 8-3-2017.

SER. NO. 79-046,602, FILED 8-3-2007.

BRIAN NEVILLE, EXAMINING ATTORNEY

Int. Cl.: 5

Prior U.S. Cls.: 6, 18, 44, 46, 51 and 52

Reg. No. 3,576,364

United States Patent and Trademark Office

Registered Feb. 17, 2009

**TRADEMARK
PRINCIPAL REGISTER**

Z I R C O C E M

TOKUYAMA CORPORATION (JAPAN CORPORATION)
1-1, MIKAGE-CHO
SHUNAN-SHI; YAMAGUCHI 745-8648
JAPAN

FOR: DENTAL CEMENTS; DENTAL ETCHING AGENTS; ADHESIVES FOR DENTURES; DENTAL ADHESIVES; BONDING AND PRIMING MATERIALS FOR DENTAL PURPOSES; DENTAL ABRASIVES; DENTAL WAXES; MOLDING WAXES FOR DENTISTS; DENTAL IMPRESSION MATERIALS; ARTIFICIAL TOOTH MATERIALS; DENTAL GYPSUMS; DENTAL COMPOSITE RESINS; DENTAL INVESTMENT MATERIALS; DENTAL FILLINGS; TOOTH FILLING MATERIALS; DENTAL RELINING MATERIALS; DENTAL LINING MATERIALS; DENTAL TISSUE CONDITIONERS; OXY BARRIER AGENTS FOR DENTAL USE; SEPARATING AGENTS USED IN DENTISTRY IN THE MOLDING OF CROWN AND BRIDGE CASTINGS AND OF DENTURE BASES TO FACILITATE REMOVAL THEREOF FROM THE MOLD; MEDICINES FOR

DENTAL PURPOSES, NAMELY, MEDICINES FOR THE TREATMENT OF PERIODONTITIS AND TOOTHACHES, DESENSITIZING AGENTS FOR TOOTH HYPERSENSITIVITY, AND DIAGNOSTIC AGENTS FOR DENTAL USE, IN CLASS 5 (U.S. CLS. 6, 18, 44, 46, 51 AND 52).

THE MARK CONSISTS OF STANDARD CHARACTERS WITHOUT CLAIM TO ANY PARTICULAR FONT, STYLE, SIZE, OR COLOR.

OWNER OF INTERNATIONAL REGISTRATION 0944915 DATED 5-2-2007, EXPIRES 5-2-2017.

THE MARK "ZIRCOCEM" HAS NO MEANING IN A FOREIGN LANGUAGE.

SER. NO. 79-046,786, FILED 5-2-2007.

LINDA ESTRADA, EXAMINING ATTORNEY

Int. Cls.: 1, 3, 5 and 32

**Prior U.S. Cls.: 1, 4, 5, 6, 10, 18, 26, 44, 45, 46, 48, 50,
51 and 52**

Reg. No. 3,576,365

United States Patent and Trademark Office

Registered Feb. 17, 2009

**TRADEMARK
PRINCIPAL REGISTER**

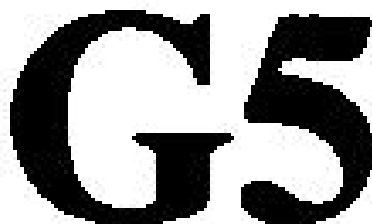

LLR-G5 LIMITED (IRELAND CORPORATION)
GOLDENMILE INDUSTRIAL ESTATE
BREAFFY ROAD, CASTLEBAR; COUNTY MAYO
IRELAND

FOR: ORGANIC SILICON FOR USE IN INDUS-
TRY, IN CLASS 1 (U.S. CLS. 1, 5, 6, 10, 26 AND 46).

FOR: TOILET PREPARATIONS, NAMELY, TOI-
LET SOAP AND TOOTHPASTE; CLEANING PRE-
PARATIONS; COSMETIC PREPARATIONS;
PREPARATIONS FOR THE CARE OF THE SKIN,
NAMELY, SKIN CREAMS; ANTI-AGING CREAMS;
PREPARATIONS CONTAINING ORGANIC SILI-
CON, NAMELY, CREAMS AND GEL FOR USE ON
THE BODY, ON THE SKIN AND ON THE HAIR, IN
CLASS 3 (U.S. CLS. 1, 4, 6, 50, 51 AND 52).

FOR: PHARMACEUTICAL PREPARATIONS FOR
THE TREATMENT OF ARTHRITIS AND SKIN
CONDITIONS; MEDICATED PREPARATIONS FOR
THE CARE OF THE SKIN AND HAIR; NUTRITION-
AL FOOD SUPPLEMENTS; FOOD SUPPLEMENTS
CONTAINING ORGANIC SILICON, IN CLASS 5
(U.S. CLS. 6, 18, 44, 46, 51 AND 52).

FOR: NON-ALCOHOLIC DRINKS AND PRE-
PARATIONS FOR MAKING SUCH DRINKS,

NAMELY, SOFT DRINKS AND SYRUPS AND POW-
DERS USED IN THE PREPARATION OF SOFT
DRINKS; SOFT DRINKS CONTAINING ORGANIC
SILICON; PREPARATIONS CONTAINING ORGAN-
IC SILICON FOR USE IN MAKING BEVERAGES,
NAMELY, NON-ALCOHOLIC FRUIT EXTRACTS
CONTAINING ORGANIC SILICON USED IN THE
PREPARATION OF BEVERAGES, IN CLASS 32 (U.S.
CLS. 45, 46 AND 48).

THE MARK CONSISTS OF STANDARD CHAR-
ACTERS WITHOUT CLAIM TO ANY PARTICULAR
FONT, STYLE, SIZE, OR COLOR.

PRIORITY DATE OF 4-3-2007 IS CLAIMED.

OWNER OF INTERNATIONAL REGISTRATION
0945330 DATED 10-3-2007, EXPIRES 10-3-2017.

THE WORD "G5" HAS NO MEANING IN A
FOREIGN LANGUAGE.

SER. NO. 79-046,932, FILED 10-3-2007.

ANDREW RHIM, EXAMINING ATTORNEY

Int. Cls.: 1, 3 and 4

Prior U.S. Cls.: 1, 4, 5, 6, 10, 15, 26, 46, 50, 51 and 52

United States Patent and Trademark Office

Reg. No. 3,576,366

Registered Feb. 17, 2009

**TRADEMARK
PRINCIPAL REGISTER**

MAXXUS

WIGET KG (FED REP GERMANY PARTNER-
SHIP LIMITED SHARES)
KIRCHHEIDER STRAÙE 139
32657 LEMGO
FED REP GERMANY

FOR: AUTOMOBILE ANTI-FREEZE, AUTOMO-
BILE RADIATOR PROTECTION PRODUCTS IN
THE NATURE OF FLUSHING AGENTS AND AD-
DITIVES TO PREVENT RUST, BRAKE FLUID, AND
CHEMICAL OIL ADDITIVES FOR AUTOMOBILE
OILS, IN CLASS 1 (U.S. CLS. 1, 5, 6, 10, 26 AND 46).

FOR: WINDOW AND GLASS PANE CLEANING
PREPARATIONS, AUTOMOTIVE VEHICLE CARE
PRODUCTS, NAMELY, CLEANING PREPARA-
TIONS, DETERGENTS, FRAGRANCES FOR AUTO-
MOBILES, POLYMER SEALANTS FOR CLEANING,
SHINING AND PROTECTING AUTOMOBILE EX-
TERIOR SURFACES, WINDSHIELD CLEANER
FLUIDS AND AUTOMOBILE WAX, IN CLASS 3
(U.S. CLS. 1, 4, 6, 50, 51 AND 52).

FOR: LUBRICANTS IN THE NATURE OF OIL
AND GREASE FOR USE IN AUTOMOBILE EN-
GINES AND GEARBOXES; AUTOMOTIVE HY-
DRAULIC OILS; AUTOMOTIVE GREASES; FLUID
AND GASEOUS FUELS FOR AUTOMOBILE EN-
GINES AS WELL AS COMPONENTS AND NON-
CHEMICAL ADDITIVES FOR SUCH FUELS, IN
CLASS 4 (U.S. CLS. 1, 6 AND 15).

THE MARK CONSISTS OF STANDARD CHAR-
ACTERS WITHOUT CLAIM TO ANY PARTICULAR
FONT, STYLE, SIZE, OR COLOR.

OWNER OF INTERNATIONAL REGISTRATION
0945831 DATED 11-3-2007, EXPIRES 11-3-2017.

SER. NO. 79-047,117, FILED 11-3-2007.

ELLEN BURNS, EXAMINING ATTORNEY

Int. Cls.: 1 and 17

Prior U.S. Cls.: 1, 5, 6, 10, 12, 13, 26, 35, 46 and 50

United States Patent and Trademark Office

Reg. No. 3,576,367

Registered Feb. 17, 2009

**TRADEMARK
PRINCIPAL REGISTER**

BORSOFT

BOREALIS AG (AUSTRIA AKTIENGESELL-
SCHAFT)
IZD TOWER, WAGRAMERSTR. 17-19
A-1220 VIENNA
AUSTRIA

FOR: UNPROCESSED PLASTICS; UNPROCESSED PLASTICS IN PELLET FORM; POLYETHYLENE RESINS; POLYPROPYLENE RESINS; POLYOLEFIN RESINS; UNPROCESSED ARTIFICIAL OR SYNTHETIC RESINS FOR USE IN THE MEDICAL, AUTOMOTIVE, AND ADVANCED PACKAGING MARKETS AND IN MAKING PLASTIC PIPES, WIRES, AND CABLES FOR THE THE INFRASTRUCTURE MARKET, AND NOT FOR USE IN THE MANUFACTURE OF PAPER, IN CLASS 1 (U.S. CLS. 1, 5, 6, 10, 26 AND 46).

FOR: SEMI-PROCESSED PLASTIC IN THE FORM OF FILMS, SHEETS, TUBES, BARS, RODS OR

FIBRES; PLASTICS IN EXTRUDED FORM USED IN PRODUCTION OF PLASTIC ARTICLES; SYNTHETIC RESINS IN EXTRUDED FORM, OR IN BARS, BLOCKS, PELLETS, RODS, SHEETS AND TUBES, ALL FOR GENERAL INDUSTRIAL USE; SEMI-FINISHED PRODUCTS, NAMELY SEMI-FINISHED ACRYLIC MOLDED PLASTIC SUBSTANCE, FOR USE IN PLASTICS INDUSTRY, IN CLASS 17 (U.S. CLS. 1, 5, 12, 13, 35 AND 50).

OWNER OF INTERNATIONAL REGISTRATION
0946222 DATED 11-22-2007, EXPIRES 11-22-2017.

SER. NO. 79-047,265, FILED 11-22-2007.

SARA THOMAS, EXAMINING ATTORNEY

Int. Cl.: 9

Prior U.S. Cls.: 21, 23, 26, 36 and 38

United States Patent and Trademark Office

Reg. No. 3,576,368

Registered Feb. 17, 2009

**TRADEMARK
PRINCIPAL REGISTER**

easyconfig

NATIONAL REJECTORS, INC. GMBH (FED REP
GERMANY LIMITED LIABILITY CORPOR-
ATION)

ZUM FRUCHTHOF, 6
21614 BUXTEHUDE
FED REP GERMANY

FOR: ELECTRONIC COIN AND BANKNOTE
TESTING APPARATUSES, APPARATUSES FOR
PROCESSING COINS AND BANKNOTES, NAME-
LY, AUTOMATIC VENDING MACHINES FOR
GOODS, GAMES, AND TICKETS, IN CLASS 9 (U.S.
CLS. 21, 23, 26, 36 AND 38).

THE MARK CONSISTS OF STANDARD CHAR-
ACTERS WITHOUT CLAIM TO ANY PARTICULAR
FONT, STYLE, SIZE, OR COLOR.

PRIORITY DATE OF 4-27-2007 IS CLAIMED.

OWNER OF INTERNATIONAL REGISTRATION
0946744 DATED 10-25-2007, EXPIRES 10-25-2017.

SER. NO. 79-047,464, FILED 10-25-2007.

COLLEEN DOMBROW, EXAMINING ATTORNEY

Int. Cls.: 9, 12 and 37

**Prior U.S. Cls.: 19, 21, 23, 26, 31, 35, 36, 38, 44, 100,
103 and 106**

Reg. No. 3,576,369

United States Patent and Trademark Office

Registered Feb. 17, 2009

**TRADEMARK
SERVICE MARK
PRINCIPAL REGISTER**

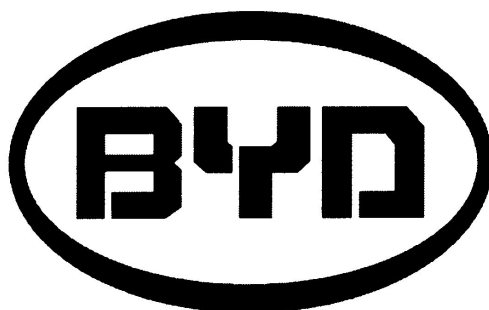

BYD COMPANY LIMITED (CHINA LIMITED LIABILITY COMPANY)
YAN AN ROAD, KUICHONG
LONGGANG DISTRICT, SHENZHEN CITY; 518119
GUANGDONG PROVINCE
SHENZHEN CITY, CHINA

FOR: COMPUTERS; COMPUTER SOFTWARE USED IN DATABASE MANAGEMENT; COMPUTER SOFTWARE USED FOR WORD PROCESSING; COMPUTER SOFTWARE FOR USE IN CUSTOMER RELATIONSHIP MANAGEMENT; COMPUTER SOFTWARE FOR THE FIELD OF WAREHOUSING AND DISTRIBUTION TO MANAGE TRANSACTIONAL DATA, PROVIDE STATISTICAL ANALYSIS, AND PRODUCE NOTIFICATIONS AND REPORTS; NAVIGATION APPARATUS FOR VEHICLES IN THE NATURE OF ON-BOARD COMPUTERS; PORTABLE TELEPHONES; INTEGRATED CIRCUITS; SEMI-CONDUCTORS; ELECTRIC ACCUMULATORS FOR VEHICLES; CHARGERS FOR ELECTRIC BATTERIES; GALVANIC BATTERIES; ELECTRIC ACCUMULATORS, IN CLASS 9 (U.S. CLS. 21, 23, 26, 36 AND 38).

FOR: LAND VEHICLES; AIRPLANES AND HELICOPTERS; SHIPS; RAIL VEHICLES, NAMELY, TRAINS; ELECTRIC VEHICLES, NAMELY, ELECTRIC CARS; AUTOMOBILES; MOTORS FOR LAND VEHICLES; ANTI-THEFT DEVICES FOR VEHICLES; MOTORCYCLES; BICYCLES; RAILWAY HAND-

CARS; TIRES FOR LAND VEHICLES; BOATS, IN CLASS 12 (U.S. CLS. 19, 21, 23, 31, 35 AND 44).

FOR: BUILDING CONSTRUCTION SUPERVISION; FACTORY CONSTRUCTION; MINING EXTRACTION; HEATING EQUIPMENT INSTALLATION AND REPAIR; ELECTRIC APPLIANCE INSTALLATION AND REPAIR; MOTOR VEHICLE MAINTENANCE AND REPAIR; VEHICLE SERVICE STATIONS; SHIPBUILDING; VEHICLE POLISHING; TIRE RETREADING, IN CLASS 37 (U.S. CLS. 100, 103 AND 106).

PRIORITY DATE OF 9-24-2007 IS CLAIMED.

OWNER OF INTERNATIONAL REGISTRATION 0946958 DATED 10-10-2007, EXPIRES 10-10-2017.

OWNER OF U.S. REG. NOS. 2,433,523 AND 3,340,327.

THE MARK "BYD" HAS NO MEANING IN A FOREIGN LANGUAGE.

SER. NO. 79-047,563, FILED 10-10-2007.

SCOTT BIBB, EXAMINING ATTORNEY

Int. Cls.: 17 and 19

Prior U.S. Cls.: 1, 5, 12, 13, 33, 35 and 50

United States Patent and Trademark Office

Reg. No. 3,576,370

Registered Feb. 17, 2009

**TRADEMARK
PRINCIPAL REGISTER**

UREFLUTE

GLOBAL POLYMER TECHNOLOGIES PTY LTD
(AUSTRALIA CORPORATION)

6 EASTLINK DRIVE
HALLAM VIC 3803
AUSTRALIA

FOR: EXTRUDED PLASTICS AND POLYMERS, NAMELY, EXTRUDED PLASTICS USED IN PRODUCTION; MATERIALS MADE FROM PLASTICS, POLYMERS AND RESINS FOR USE IN MANUFACTURE, NAMELY, EXTRUDED RESINS FOR GENERAL INDUSTRIAL USE; SHEETS AND PANELS MADE FROM POLYMERS AND RESINS FOR GENERAL INDUSTRIAL USE, IN CLASS 17 (U.S. CLS. 1, 5, 12, 13, 35 AND 50).

FOR: NON-METALLIC TRANSPORTABLE BUILDINGS; BUILDING MATERIALS, NAMELY, CEILING, FLOOR AND WALL PANELS AND SHEETS COMPRISING CORRUGATED AND GLUE-LAMINATED WOOD, CARDBOARD, PLASTIC AND RESIN, FOR USE IN BUILDING AND CONSTRUCTION; BUILDING CARDBOARD AND PLASTIC BOARD, NAMELY, CORRUGATED

POLYPROPYLENE BOARD USED AS A WOOD SUBSTITUTE INJECTED WITH LIQUID POLYURETHANE, CORRUGATED CARDBOARD USED AS A WOOD SUBSTITUTE INJECTED WITH POLYURETHANE FOAM, HARDBOARD, FIBERBOARD, CHIPBOARD, WALL BOARDS, FIBERGLASS BOARD, IN CLASS 19 (U.S. CLS. 1, 12, 33 AND 50).

THE MARK CONSISTS OF STANDARD CHARACTERS WITHOUT CLAIM TO ANY PARTICULAR FONT, STYLE, SIZE, OR COLOR.

PRIORITY DATE OF 5-23-2007 IS CLAIMED.

OWNER OF INTERNATIONAL REGISTRATION 0947562 DATED 10-31-2007, EXPIRES 10-31-2017.

SER. NO. 79-047,756, FILED 10-31-2007.

CARRIE GENOVESE, EXAMINING ATTORNEY

Int. Cl.: 9

Prior U.S. Cls.: 21, 23, 26, 36 and 38

Reg. No. 3,576,371

United States Patent and Trademark Office

Registered Feb. 17, 2009

**TRADEMARK
PRINCIPAL REGISTER**

INIM ELECTRONICS SRL (ITALY LIMITED LIABILITY COMPANY)
VIA FELICE CAVALLOTTI, 33
I-63017 PORTO SAN GIORGIO (AP)
ITALY

FOR: ELECTRICAL AND ELECTRONIC, ACTIVE AND PASSIVE SECURITY SYSTEMS, NAMELY, AGAINST INTRUSION SYSTEMS COMPRISED OF ANTI-INTRUSION ALARMS, ALARM CENTRAL UNITS, ELECTRICAL AND ELECTRONIC BURGLAR ALARMS; FIRE DETECTION SYSTEMS COMPRISED OF SECURITY AND FIRE ALARMS, FIRE AND SMOKE DETECTORS; FIRE SUPPRESSION SYSTEMS COMPRISED OF FIRE BLANKETS AND FIRE EXTINGUISHERS, FIRE EXTINGUISHING APPARATUS, FIRE EXTINGUISHING SYSTEMS; ACCESS AND PRESENCES CONTROL SYSTEMS COMPRISED OF VIDEO CAMERAS, ELECTRONIC CARD READERS, ACCESS CONTROL AND ALARM MONITORING SYSTEMS; POWER GENERATING AND MANAGING SYSTEMS COMPRISED OF ELECTRICAL POWER SUPPLIES, POWER SUPPLY CONNECTORS AND ADAPTORS FOR USE WITH PORTABLE ELECTRONIC DEVICES, POWER TRANSFORMERS FOR AMPLIFICATION, POWER-LINE TRANSMISSION MACHINES AND APPARATUS, RENEWABLE BATTERY SYSTEM TO PROVIDE BACKUP POWER, BATTERIES AND BATTERY CHARGERS; SURVEILLANCE AND VIDEO SURVEILLANCE SYSTEMS COMPRISED OF ELECTRIC AND ELECTRONIC VIDEO SURVEILLANCE INSTALLATIONS, AUDIO-VIDEO RECEIVERS, VIDEO CAMERAS, VIDEO RECORDERS, VIDEO MIXERS;

SYSTEMS FOR TRANSMISSION OF INFORMATION, DATA, VOICE, VIDEO, COMPRISED OF APPARATUS FOR RECORDING, TRANSMISSION, PROCESSING AND REPRODUCTION OF SOUND, IMAGES OR DATA, APPARATUS FOR TRANSMISSION OF COMMUNICATION, BUILDING SECURITY SYSTEMS COMPRISED SOFTWARE AND HARDWARE FOR PROVIDING PICTURE, VIDEO, ALARM STATUS, BUILDING PLANS, AND OTHER INFORMATION TO A REMOTE STATION; SYSTEMS FOR THE MANAGEMENT OF DATA AND INFORMATION, COMPRISED OF COMPUTER SOFTWARE FOR THE COLLECTION, EDITING, ORGANIZING, MODIFYING, BOOK MARKING, TRANSMISSION, STORAGE AND SHARING OF DATA AND INFORMATION; COMPUTER HARDWARE AND COMPUTER PERIPHERAL DEVICES, IN CLASS 9 (U.S. CLS. 21, 23, 26, 36 AND 38).

THE MARK CONSISTS OF STANDARD CHARACTERS WITHOUT CLAIM TO ANY PARTICULAR FONT, STYLE, SIZE, OR COLOR.

PRIORITY DATE OF 7-4-2007 IS CLAIMED.

OWNER OF INTERNATIONAL REGISTRATION
0948017 DATED 8-27-2007, EXPIRES 8-27-2017.

SER. NO. 79-047,948, FILED 8-27-2007.

SHANNON TWOHIG, EXAMINING ATTORNEY

Int. Cls.: 29, 30 and 31

Prior U.S. Cls.: 1 and 46

United States Patent and Trademark Office

Reg. No. 3,576,372

Registered Feb. 17, 2009

**TRADEMARK
PRINCIPAL REGISTER**

NUTRISWISS

NUTRISWISS AG (SWITZERLAND SOCIÉTÉ
ANONYME)
INDUSTRIERING 30
CH-3250 LYSS
SWITZERLAND

FOR: EDIBLE OILS AND FATS, ALL SAID PRO-
DUCTS OF SWISS ORIGIN, IN CLASS 29 (U.S. CL.
46).

FOR: COFFEE; TEA; COCOA; SUGAR; RICE;
TAPIOCA; SAGO; ARTIFICIAL COFFEE; FLOUR;
BREAD; PASTRY; EDIBLE ICES; HONEY; TREA-
CLE; YEAST; BAKING POWDER; SALT; MUSTARD;
VINEGAR; SPICES; ICE FOR REFRESHMENT, ALL
SAID PRODUCTS OF SWISS ORIGIN, IN CLASS 30
(U.S. CL. 46).

FOR: LIVE ANIMALS; FRESH FRUIT AND VE-
GETABLES; NATURAL PLANTS AND FLOWERS;
ANIMAL FEED, ALL SAID PRODUCTS OF SWISS
ORIGIN, IN CLASS 31 (U.S. CLS. 1 AND 46).

THE MARK CONSISTS OF STANDARD CHAR-
ACTERS WITHOUT CLAIM TO ANY PARTICULAR
FONT, STYLE, SIZE, OR COLOR.

OWNER OF INTERNATIONAL REGISTRATION
0685147 DATED 12-9-1997, EXPIRES 12-9-2017.

SER. NO. 79-048,044, FILED 12-11-2007.

TINA BROWN, EXAMINING ATTORNEY

Int. Cls.: 6, 7, 9, 12 and 17

Prior U.S. Cls.: 1, 2, 5, 12, 13, 14, 19, 21, 23, 25, 26, 31, 34, 35, 36, 38, 44 and 50

Reg. No. 3,576,373

United States Patent and Trademark Office

Registered Feb. 17, 2009

**TRADEMARK
PRINCIPAL REGISTER**

INA

SCHAEFFLER KG (FED REP GERMANY LIMITED PARTNERSHIP)
INDUSTRIESTRAÙE 1-3
91074 HERZOGENAURACH
FED REP GERMANY

FOR: PARTS OF BEARINGS, NAMELY, METAL ROLLERS, STEEL BALLS AND NEEDLES; METAL CURVED ROLLERS AND SUPPORT ROLLERS FOR USE IN MACHINE PARTS AND INDUSTRIAL MACHINERY; METAL SPLIT RINGS, IN CLASS 6 (U.S. CLS. 2, 12, 13, 14, 23, 25 AND 50).

FOR: BEARINGS, NAMELY, BALL BEARINGS, NEEDLE BEARINGS AND ROLLER BEARINGS FOR USE IN MACHINE PARTS AND INDUSTRIAL MACHINERY; PARTS OF BEARINGS FOR USE IN MACHINE PARTS AND INDUSTRIAL MACHINERY, NAMELY, BALL RINGS AND BALL CAGES; MACHINE PARTS, NAMELY, PLAIN BEARINGS, BALL JOINTS, JOINT HEADS WITH BARS AND THEIR COMPONENT PARTS; CARDAN JOINTS AND THEIR COMPONENT PARTS FOR USE IN MACHINE PARTS AND INDUSTRIAL MACHINERY; CLUTCHES FOR MACHINES AND THEIR COMPONENT PARTS; PRESSURE ROLLERS, BELT TENSIONERS, THREAD GUIDE ELEMENTS, ROTOR BEARINGS, TANGENTIAL PRESSURE ROLLER ASSEMBLIES, BOTTOM ROLLER BEARINGS, RADIAL BALL BEARINGS, AND SPINDLE BEARINGS FOR USE IN TEXTILE MACHINERY; TOP ROLLERS FOR DRAWING FRAMES AND THEIR LOADING ARMS, BEARINGS FOR BOTTOM ROLLERS, SPINNING SPINDLES AND TENSION ROLLERS, ALL FOR USE IN CONNECTION WITH INDUSTRIAL MACHINES; MACHINE TOOLS, NAMELY, FITTING DEVICES FOR FITTING GUIDEWAY COVERING STRIP FOR LINEAR GUI-

DANCE SYSTEMS, AND ADAPTERS FOR TIGHTENING LOCKNUTS, ALL FOR THE INSTALLATION OF AND MAINTENANCE OF MACHINES, BEARINGS, ROLLERS AND THE COMPONENT PARTS THEREOF, IN CLASS 7 (U.S. CLS. 13, 19, 21, 23, 31, 34 AND 35).

FOR: MEASURING APPARATUS AND INSTRUMENTS, NAMELY, DEVICES FOR MEASURING LENGTHS AND DIAMETERS, PARTICULARLY OF COMPONENTS OF ANTI-FRICTION BEARINGS, IN CLASS 9 (U.S. CLS. 21, 23, 26, 36 AND 38).

FOR: UNIVERSAL JOINTS FOR LAND VEHICLES, NAMELY, BALL JOINTS, JOINT HEADS WITH BARS AND THEIR COMPONENT PARTS, CARDAN JOINTS AND THEIR COMPONENT PARTS; SPARE PARTS FOR AUTOMOBILES, NAMELY, CARDAN SHAFTS, STEERING KNUCKLES, CONNECTING RODS AND VALVE TAPPETS; CLUTCHES FOR LAND VEHICLES AND THEIR COMPONENT PARTS, IN CLASS 12 (U.S. CLS. 19, 21, 23, 31, 35 AND 44).

FOR: WATER-TIGHT RINGS FOR PLUMBING PIPES, IN CLASS 17 (U.S. CLS. 1, 5, 12, 13, 35 AND 50).

OWNER OF INTERNATIONAL REGISTRATION 0310614 DATED 3-18-1966, EXPIRES 3-18-2016.

OWNER OF U.S. REG. NOS. 673,150, 828,795 AND OTHERS.

SER. NO. 79-048,333, FILED 5-30-2007.

DAVID HOFFMAN, EXAMINING ATTORNEY

Int. Cls.: 25 and 41

Prior U.S. Cls.: 22, 39, 100, 101 and 107

United States Patent and Trademark Office

Reg. No. 3,576,374

Registered Feb. 17, 2009

**TRADEMARK
SERVICE MARK
PRINCIPAL REGISTER**

GREEN JOURNEY

ADDAX (FRANCE SOCIÉTÉ PAR ACTIONS SIMPLIFIÉE)

138 RUE DU FAUBOURG SAINT-HONORÉ

F-75008 PARIS

FRANCE

FOR: SPORTS AND OUTER CLOTHING, NAME-
LY, ANORAKS, PARKAS, SPORTS SHOES, BEACH
SHOES, BEACH CLOTHING, NAMELY BEACH
COVER-UPS AND SWIMSUITS; BELTS, BERMUDA
SHORTS, GLOVES FOR CYCLING, BOOTS, ANKLE
BOOTS, BOXER SHORTS, CANVAS SHOES, CAPS,
SHORT-SLEEVED SHIRTS, COVERALLS, FOOT-
WEAR FOR CYCLING, CYCLISTS' JERSEYS, FOOT-
WEAR FOR DRIVING, PULLOVERS OF POLAR
FABRIC, WAISTCOATS OF POLAR FABRIC, MEN'S
AND WOMEN'S SHOES, SHORTS FOR GYMNAS-
TICS, JACKETS, JEANS, JOGGING SUITS, LIGHT
REFLECTIVE COATS, JACKETS REFLECTING THE
LIGHT, JACKETS, COATS, TROUSERS AND
WAISTCOATS FOR MEN AND WOMEN, SOCKS
FOR MEN, MITTENS, GLOVES FOR OUTDOOR
USE, OVERALLS, OVERCOATS, OVER-TROUSERS,
POLO SHIRTS, PULLOVERS, WATERPROOF
CLOTHING, NAMELY, JACKETS AND PANTS,
SHORT-SLEEVED SHIRTS, SHORTS, SHORT OR
LONG-SLEEVED T-SHIRTS, SKIRTS AND DRES-
SES, SHOES AND STOCKINGS, SPORTS COATS,
SPORTS SHIRTS, SPORTS BRAS, SPORTS-TYPE

JACKETS, SPORTS JERSEYS, TRACKSUITS,
FLEECE FABRIC PULLOVERS, BATHING SUITS,
IN CLASS 25 (U.S. CLS. 22 AND 39).

FOR: ORGANIZATION OF SPORTS COMPETI-
TIONS, NAMELY, ENTERTAINMENT IN THE
FIELD OF MOTOR CAR RACING , IN CLASS 41
(U.S. CLS. 100, 101 AND 107).

THE MARK CONSISTS OF STANDARD CHAR-
ACTERS WITHOUT CLAIM TO ANY PARTICULAR
FONT, STYLE, SIZE, OR COLOR.

PRIORITY DATE OF 4-13-2007 IS CLAIMED.

OWNER OF INTERNATIONAL REGISTRATION
0949246 DATED 10-11-2007, EXPIRES 10-11-2017.

NO CLAIM IS MADE TO THE EXCLUSIVE
RIGHT TO USE "GREEN", APART FROM THE
MARK AS SHOWN.

SER. NO. 79-048,401, FILED 10-11-2007.

JULIE VEPPUMTHARA, EXAMINING ATTORNEY

Int. Cl.: 5

Prior U.S. Cls.: 6, 18, 44, 46, 51 and 52

Reg. No. 3,576,375

United States Patent and Trademark Office

Registered Feb. 17, 2009

**TRADEMARK
PRINCIPAL REGISTER**



PRONOVA BIOPHARMA NORGE AS (NORWAY
LIMITED LIABILITY COMPANY)
VOLLSVEIEN 6
N-1366 LYSAKER, NORWAY

OWNER OF INTERNATIONAL REGISTRATION
0949733 DATED 10-30-2007, EXPIRES 10-30-2017.

FOR: PHARMACEUTICAL PREPARATIONS FOR
USE IN THE TREATMENT OF METABOLIC, IN-
FLAMMATORY AND CARDIOVASCULAR DISEA-
SES; LIPIDS FOR PHARMACEUTICAL PURPOSES
FOR USE IN THE TREATMENT OF METABOLIC,
INFLAMMATORY AND CARDIOVASCULAR DIS-
EASES; SUBSTANCES WITH MARINE ORIGIN,
NAMELY, OMEGA 3 LIPIDS FOR PHARMACEUTI-
CAL PURPOSES USED IN THE TREATMENT OF
METABOLIC, INFLAMMATORY AND CARDIO-
VASCULAR DISEASES, IN CLASS 5 (U.S. CLS. 6, 18,
44, 46, 51 AND 52).

NO CLAIM IS MADE TO THE EXCLUSIVE
RIGHT TO USE "BIOPHARMA" , APART FROM
THE MARK AS SHOWN.

THE MARK CONSISTS OF THE WORDS "PRO-
NOVA BIOPHARMA" IN A STYLIZED FORMAT
AND A CIRCULAR GLOBE ABOVE THE SECOND
"O" IN "PRONOVA".

SER. NO. 79-048,575, FILED 10-30-2007.

PRIORITY DATE OF 8-29-2007 IS CLAIMED.

DAVID TAYLOR, EXAMINING ATTORNEY

Int. Cl.: 9

Prior U.S. Cls.: 21, 23, 26, 36 and 38

Reg. No. 3,576,376

United States Patent and Trademark Office

Registered Feb. 17, 2009

TRADEMARK
PRINCIPAL REGISTER



DONGGUAN ALLLIKE ELECTRONICS CO. LTD.
(CHINA CORPORATION)
CHUANCHA DEVELOPMENT ZONE
MACHONG TOWN; DONGGUAN CITY; GUANG-
DONG
CHINA

FOR: CABINETS FOR LOUDSPEAKERS; LOUD-
SPEAKERS; LASER DISK PLAYERS; TELEPHONE
APPARATUS; LASER DISK PLAYERS FOR VEHI-
CLES; RADIOS FOR VEHICLES; CASSETTE PLAY-
ERS, IN CLASS 9 (U.S. CLS. 21, 23, 26, 36 AND 38).

OWNER OF INTERNATIONAL REGISTRATION
0949767 DATED 12-21-2007, EXPIRES 12-21-2017.

THE MARK CONSISTS OF THE WORDING "ALL-
LIKE" IN STYLIZED LETTERING ABOVE THREE
NON-LATIN CHARACTERS IN THE MARK.

THE NON-LATIN CHARACTERS IN THE MARK
TRANSLITERATE TO "AO LAI KE", WHICH HAS
NO MEANING IN ENGLISH.

SER. NO. 79-048,590, FILED 12-21-2007.

BERNICE MIDDLETON, EXAMINING ATTORNEY

Int. Cl.: 20

Prior U.S. Cls.: 2, 13, 22, 25, 32 and 50

United States Patent and Trademark Office

Reg. No. 3,576,377

Registered Feb. 17, 2009

**TRADEMARK
PRINCIPAL REGISTER**



TAKARA BELMONT CORPORATION (JAPAN
CORPORATION)
2-1-1, HIGASHI-SHINSAIBASHI
CHUO-KU
OSAKA-SHI, OSAKA 542-0083, JAPAN

THE ENGLISH TRANSLATION OF THE FOR-
EIGN WORDS IN THE MARK IS BEAUTIFUL
MOUNTAIN TREASURE.

FOR: BARBER'S CHAIRS, LADY'S HAIRDRES-
SER'S CHAIRS, IN CLASS 20 (U.S. CLS. 2, 13, 22, 25, 32
AND 50).

SER. NO. 79-048,628, FILED 12-17-2007.

OWNER OF INTERNATIONAL REGISTRATION
0949841 DATED 12-17-2007, EXPIRES 12-17-2017.

JESSICA A. POWERS, EXAMINING ATTORNEY

Int. Cl.: 11

Prior U.S. Cls.: 13, 21, 23, 31 and 34

United States Patent and Trademark Office

Reg. No. 3,576,378

Registered Feb. 17, 2009

**TRADEMARK
PRINCIPAL REGISTER**

**TAKARA
BELMONT**

TAKARA BELMONT CORPORATION (JAPAN
CORPORATION)
2-1-1, HIGASHI-SHINSAIBASHI
CHUO-KU., OSAKA-SHI, OSAKA 542-0083
JAPAN

FOR: MACHINES AND APPARATUS USED IN
BEAUTY SALONS OR BARBER'S SHOPS, NAMELY,
STATIONERY HAIR DRYERS WITH A HOOD FOR
COMMERCIAL USE, HAIR STEAMERS FOR HAIR-
DRESSING, TOWEL STEAMERS, AND SHAMPOO
BASINS, IN CLASS 11 (U.S. CLS. 13, 21, 23, 31 AND 34).

PRIORITY DATE OF 6-28-2007 IS CLAIMED.

OWNER OF INTERNATIONAL REGISTRATION
0949845 DATED 12-17-2007, EXPIRES 12-17-2017.

SER. NO. 79-048,630, FILED 12-17-2007.

JESSICA A. POWERS, EXAMINING ATTORNEY

Int. Cls.: 29, 30 and 32

Prior U.S. Cls.: 45, 46 and 48

United States Patent and Trademark Office

Reg. No. 3,576,379

Registered Feb. 17, 2009

TRADEMARK
PRINCIPAL REGISTER



BURG GROEP B.V. (NETHERLANDS BESLOTEN
VENNOTSCHAP)
EEUWIGELAAN 27
NL-1861 CL BERGEN
NETHERLANDS

MAKING BEVERAGES; PREPARATIONS FOR
MAKING BEVERAGES, NAMELY, LEMONADE,
SOFT DRINKS AND FRUIT DRINKS, IN CLASS 32
(U.S. CLS. 45, 46 AND 48).

FOR: EDIBLE OILS, IN CLASS 29 (U.S. CL. 46).

OWNER OF INTERNATIONAL REGISTRATION
0949858 DATED 12-18-2007, EXPIRES 12-18-2017.

FOR: VINEGAR, MUSTARD, IN CLASS 30 (U.S.
CL. 46).

SER. NO. 79-048,638, FILED 12-18-2007.

FOR: BEERS; MINERAL AND AERATED WA-
TER; NON-ALCOHOLIC APERITIFS, LEMONADE,
SOFT DRINKS, FRUIT DRINKS; SYRUPS FOR

GILBERT SWIFT, EXAMINING ATTORNEY

Int. Cl.: 5

Prior U.S. Cls.: 6, 18, 44, 46, 51 and 52

Reg. No. 3,576,380

United States Patent and Trademark Office

Registered Feb. 17, 2009

TRADEMARK
PRINCIPAL REGISTER

REMEMBER

TAURX THERAPEUTICS LTD (SINGAPORE A
PUBLIC COMPANY REGISTERED IN SINGA-
PORE)

51 AYER RAJAH CRESCENT
#07-01/02; SINGAPORE 139948
SINGAPORE

FOR: PHARMACEUTICAL PREPARATIONS FOR
THE TREATMENT OF DISEASES, ILLNESSES AND
AILMENTS IN HUMANS AND ANIMALS, NAME-
LY, INFECTIOUS AND PARASITIC DISEASES,
NEOPLASMS, BLOOD DISORDERS, MENTAL DIS-
ORDERS, DISORDERS OF THE NERVOUS SYSTEM
AND SENSORY, ORGANS, MUSCULOSKELETAL
SYSTEM DISORDERS, GENITOURINARY SYSTEM
DISORDERS, COMMUNICABLE DISEASES, NEU-
ROLOGICAL DISEASES, AND PSYCHOLOGICAL
CONDITIONS; CHEMICAL PREPARATIONS FOR
MEDICAL AND PHARMACEUTICAL PURPOSES,
NAMELY, FOR THE TREATMENT OF DISEASES,
ILLNESSES AND AILMENTS IN HUMANS AND
ANIMALS, NAMELY, INFECTIOUS AND PARASI-
TIC DISEASES, NEOPLASMS, BLOOD DISORDERS,
MENTAL DISORDERS, DISORDERS OF THE NER-
VOUS SYSTEM AND SENSORY, ORGANS, MUSCU-
LOSKELETAL SYSTEM DISORDERS, COM-
MUNICABLE DISEASES, NEUROLOGICAL DISEA-
SES, AND PSYCHOLOGICAL CONDITIONS, IN
CLASS 5 (U.S. CLS. 6, 18, 44, 46, 51 AND 52).

PRIORITY DATE OF 6-11-2007 IS CLAIMED.

OWNER OF INTERNATIONAL REGISTRATION
0949861 DATED 12-10-2007, EXPIRES 12-10-2017.

SER. NO. 79-048,639, FILED 12-10-2007.

BRIAN NEVILLE, EXAMINING ATTORNEY

Int. Cl.: 5

Prior U.S. Cls.: 6, 18, 44, 46, 51 and 52

Reg. No. 3,576,381

United States Patent and Trademark Office

Registered Feb. 17, 2009

TRADEMARK
PRINCIPAL REGISTER

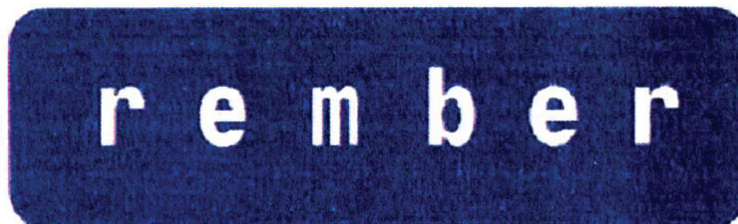

TAURX THERAPEUTICS LTD (SINGAPORE A
PUBLIC COMPANY REGISTERED IN SINGA-
PORE)

51 AYER RAJAH CRESCENT
#07-01/02; SINGAPORE 139948
SINGAPORE

FOR: PHARMACEUTICAL PREPARATIONS FOR THE TREATMENT OF DISEASES, ILLNESSES AND AILMENTS IN HUMANS AND ANIMALS, NAMELY, INFECTIOUS AND PARASITIC DISEASES, NEOPLASMS, BLOOD DISORDERS, MENTAL DISORDERS, DISORDERS OF THE NERVOUS SYSTEM AND SENSORY, ORGANS, MUSCULOSKELETAL SYSTEM DISORDERS, GENITOURINARY SYSTEM DISORDERS, COMMUNICABLE DISEASES, NEUROLOGICAL DISEASES, AND PSYCHOLOGICAL CONDITIONS; CHEMICAL PREPARATIONS FOR MEDICAL AND PHARMACEUTICAL PURPOSES, NAMELY, FOR THE TREATMENT OF DISEASES, ILLNESSES AND AILMENTS IN HUMANS AND ANIMALS, NAMELY, INFECTIOUS AND PARASITIC DISEASES, NEOPLASMS, BLOOD DISORDERS, MENTAL DISORDERS, DISORDERS OF THE NERVOUS SYSTEM AND SENSORY, ORGANS, MUSCULOSKELETAL SYSTEM DISORDERS, GENITOURINARY SYSTEM DISORDERS, COMMUNICABLE DISEASES, NEUROLOGICAL DISEASES, AND PSYCHOLOGICAL CONDITIONS; FIRST AID KITS AND DIAGNOSTIC KITS COMPRISED OF PHARMACEUTICAL AND CHEMICAL PRE-

PARATIONS FOR THE TREATMENT OF DISEASES, ILLNESSES, AND AILMENTS IN HUMANS AND ANIMALS, NAMELY, INFECTIOUS AND PARASITIC DISEASES, NEOPLASMS, BLOOD DISORDERS, MENTAL DISORDERS, DISORDERS OF THE NERVOUS SYSTEM AND SENSORY, ORGANS, MUSCULOSKELETAL SYSTEM DISORDERS, GENITOURINARY SYSTEM DISORDERS, COMMUNICABLE DISEASES, NEUROLOGICAL DISEASES, AND PSYCHOLOGICAL CONDITIONS, IN CLASS 5 (U.S. CLS. 6, 18, 44, 46, 51 AND 52).

PRIORITY DATE OF 6-13-2007 IS CLAIMED.

OWNER OF INTERNATIONAL REGISTRATION
0949862 DATED 12-12-2007, EXPIRES 12-12-2017.

THE COLOR(S) BLUE AND WHITE IS/ARE
CLAIMED AS A FEATURE OF THE MARK.

THE MARK CONSISTS OF WHITE LETTERS ON
A BLUE BACKGROUND.

SER. NO. 79-048,640, FILED 12-12-2007.

BRIAN NEVILLE, EXAMINING ATTORNEY

Int. Cl.: 36

Prior U.S. Cls.: 100, 101 and 102

United States Patent and Trademark Office

Reg. No. 3,576,382

Registered Feb. 17, 2009

**SERVICE MARK
PRINCIPAL REGISTER**

SKYSTREET

LEDA BETEILIGUNGS GMBH (AUSTRIA PRIVATE LIMITED COMPANY)
GAADNER STRASSE 80
A-2371 HINTERBRÜHL
AUSTRIA

FOR: FUND INVESTMENT SERVICES, IN CLASS 36 (U.S. CLS. 100, 101 AND 102).

THE MARK CONSISTS OF STANDARD CHARACTERS WITHOUT CLAIM TO ANY PARTICULAR FONT, STYLE, SIZE, OR COLOR.

PRIORITY DATE OF 7-5-2007 IS CLAIMED.

OWNER OF INTERNATIONAL REGISTRATION 0950054 DATED 8-14-2007, EXPIRES 8-14-2017.

SER. NO. 79-048,716, FILED 8-14-2007.

NAPOLEON SHARMA, EXAMINING ATTORNEY

Int. Cls.: 35, 41 and 44

Prior U.S. Cls.: 100, 101, 102 and 107

United States Patent and Trademark Office

Reg. No. 3,576,383

Registered Feb. 17, 2009

SERVICE MARK
PRINCIPAL REGISTER



KONINKLIJKE NEDERLANDSE; POLITIEHOND
VERENIGING (NETHERLANDS VERENI-
GING)
LIENDERTSEWEG 108
NL-3815 BJ AMERSFOORT
NETHERLANDS

FOR: MANAGEMENT OF COMMERCIAL BUSI-
NESS; OFFICE ADMINISTRATIVE SERVICES, PUB-
LICITY AND ADVERTISING SERVICES, IN CLASS
35 (U.S. CLS. 100, 101 AND 102).

FOR: ENTERTAINMENT, SPORTING AND CUL-
TURAL EVENTS, NAMELY, ORGANIZING SPORT-
ING EVENTS, ORGANIZING COMMUNITY
SPORTING AND CULTURAL EVENTS, ORGANIZ-
ING COMMUNITY FESTIVALS FEATURING
SPORTING EVENTS, TRAINING AND EDUCATION
OF DOGS; EDUCATIONAL EVENTS, NAMELY,
PROVIDING EDUCATION COURSES RELATED
TO DOG TRAINING; PROVIDING OF SEMINARS,
LECTURES, AND WORKSHOPS IN THE FIELD OF
DOG TRAINING; ONLINE ELECTRONIC PUBLISH-
ING AND PUBLICATION OF BOOKS, MAGAZINES
AND FOLDERS IN THE FIELD OF EDUCATION,

NAMELY, TRAINING AND TREATMENT OF
DOGS; ORGANIZATION OF COMPETITIONS IN
THE FIELD OF BEHAVIOR, OBEDIENCE AND
DEXTERITY OF DOGS, IN CLASS 41 (U.S. CLS.
100, 101 AND 107).

FOR: BREEDING OF DOGS, CARE AND TREAT-
MENT OF DOGS, NAMELY, KENNEL SERVICES,
DOG WALKING, DOG BATHING, NON-MEDICA-
TED PET GROOMING SERVICES, VETERINARY
SERVICES, NAMELY, PHYSICAL MEDICAL EX-
AMINATION OF DOGS, IN CLASS 44 (U.S. CLS. 100
AND 101).

PRIORITY DATE OF 9-24-2007 IS CLAIMED.

OWNER OF INTERNATIONAL REGISTRATION
0950264 DATED 10-3-2007, EXPIRES 10-3-2017.

SER. NO. 79-048,787, FILED 10-3-2007.

CARYN GLASSER, EXAMINING ATTORNEY

Int. Cl.: 43

Prior U.S. Cls.: 100 and 101

United States Patent and Trademark Office

Reg. No. 3,576,384

Registered Feb. 17, 2009

**SERVICE MARK
PRINCIPAL REGISTER**

DEBAILLEUL
LE TOUT EN SAVEUR

DEBAILLEUL PRODUCTS SOCIÉTÉ ANONYME
(BELGIUM ANONYMOUS COMPANY)
RUE DE GANSHOREN 27
B-1081 BRUSSELS
BELGIUM

FOR: SERVICES FOR PROVIDING FOOD AND
DRINK; TEA-ROOMS; CAFÉS, RESTAURANTS; CA-
TERING SERVICES, IN CLASS 43 (U.S. CLS. 100 AND
101).

PRIORITY DATE OF 6-19-2007 IS CLAIMED.

OWNER OF INTERNATIONAL REGISTRATION
0950283 DATED 12-17-2007, EXPIRES 12-17-2017.

OWNER OF U.S. REG. NO. 3,300,405.

THE ENGLISH TRANSLATION OF THE EXPRES-
SION "LE TOUT EN SAVEUR" IS AN EXPRESSION
MEANING "THE PINNACLE OF TASTE" OR "IT'S
ALL IN THE TASTE". THE APPLICANT ALSO
ADVISES THAT THE TERM "DEBAILLEUL" HAS
NO ENGLISH TRANSLATION.

SER. NO. 79-048,796, FILED 12-17-2007.

Laurie Mayes, Examining Attorney

Int. Cls.: 1, 9, 11, 37, 39, 40 and 42

**Prior U.S. Cls.: 1, 5, 6, 10, 13, 21, 23, 26, 31, 34, 36, 38,
46, 100, 101, 103, 105 and 106**

Reg. No. 3,576,385

United States Patent and Trademark Office

Registered Feb. 17, 2009

**TRADEMARK
SERVICE MARK
PRINCIPAL REGISTER**

COLIPLAGE

VEOLIA EAU -; COMPAGNIE GENERALE DES
EAUX (FRANCE SOCIÉTÉ ANONYME (SA))
52 RUE D'ANJOU
F-75008 PARIS
FRANCE

FOR: CHEMICAL REAGENTS FOR NON-MEDI-
CAL USE; CHEMICALS FOR WATER TREATMENT
FOR INDUSTRIAL AND DOMESTIC USE AND FOR
USE IN SWIMMING POOLS, IN CLASS 1 (U.S. CLS. 1,
5, 6, 10, 26 AND 46).

FOR: SCIENTIFIC, MEASURING APPARATUS
AND INSTRUMENTS, NAMELY, FLUID FLOW
MEASUREMENT APPARATUS AND INSTRU-
MENTS, AIR AND WATER PRESSURE MEASURE-
MENT APPARATUS AND INSTRUMENTS,
BACTERIAS FLUORESCENCE MEASUREMENT
APPARATUS AND INSTRUMENTS USED FOR
EVALUATING THE BACTERIOLOGICAL QUALI-
TY OF BATHING WATER; ENZYME ACTIVITY
MEASUREMENT APPARATUS AND INSTRU-
MENTS USED FOR EVALUATING THE BACTER-
IOLOGICAL QUALITY OF THE BATHING
WATERS, ELECTRONIC-BASED MEASURING AP-
PARATUS AND INSTRUMENTS FOR EVALUAT-
ING THE BACTERIOLOGICAL QUALITY OF THE
BATHING WATERS; APPARATUS AND INSTRU-
MENTS FOR CHEMICAL ANALYSIS FOR NON-
MEDICAL USE, NAMELY, DETECTION AND
IDENTIFICATION APPARATUS AND INSTRU-
MENTS USING UV RAYS FOR DETECTING AND
IDENTIFYING CHEMICAL AND BIOLOGICAL
SUBSTANCES IN BATHING WATERS, IN CLASS 9
(U.S. CLS. 21, 23, 26, 36 AND 38).

FOR: APPARATUS AND INSTRUMENTS FOR
WATER TREATMENT AND FOR PURIFYING WA-
TER, NAMELY, WATER FILTERING APPARATUS
AND INSTRUMENTS, WATER SOFTENING UNITS,
WATER PURIFYING APPARATUS AND INSTRU-
MENTS, AND WATER FILTERS FOR THE PUR-
POSE OF MEMBRANE FILTRATION, IN CLASS 11
(U.S. CLS. 13, 21, 23, 31 AND 34).

FOR: INSTALLATION AND REPAIR OF WATER
TREATMENT SYSTEMS AND OF IRRIGATION
DEVICES; DISINFECTING, IN CLASS 37 (U.S. CLS.
100, 103 AND 106).

FOR: WATER SUPPLYING, WATER DISTRI-
BUTION, IN CLASS 39 (U.S. CLS. 100 AND 105).

FOR: WATER TREATMENT SERVICES, IN
CLASS 40 (U.S. CLS. 100, 103 AND 106).

FOR: CHEMICAL ANALYSIS; CHEMICAL AND
BACTERIOLOGICAL RESEARCH, IN CLASS 42
(U.S. CLS. 100 AND 101).

OWNER OF INTERNATIONAL REGISTRATION
0950367 DATED 12-10-2007, EXPIRES 12-10-2017.

SER. NO. 79-048,833, FILED 12-10-2007.

ALLISON HOLTZ, EXAMINING ATTORNEY

Int. Cls.: 9, 10, 25, 28 and 35

Prior U.S. Cls.: 21, 22, 23, 26, 36, 38, 39, 44, 50, 100, 101 and 102

Reg. No. 3,576,386

United States Patent and Trademark Office

Registered Feb. 17, 2009

**TRADEMARK
SERVICE MARK
PRINCIPAL REGISTER**

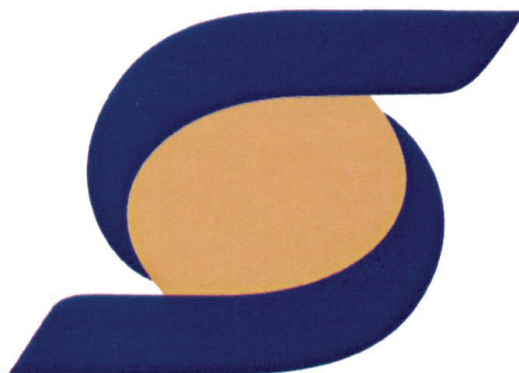

SPERIAN PROTECTION EUROPE (FRANCE SOCIÉTÉ PAR ACTIONS SIMPLIFIÉE)
IMMEUBLE EDISON,
Z.I. PARIS NORD II.; 33 RUE DES VANESSES; F-93420 VILLEPINTE
FRANCE

FOR: RESPIRATORS OTHER THAN FOR ARTIFICIAL RESPIRATION AND RESPIRATORY MASKS FOR NON-MEDICAL PURPOSES; RESPIRATORS FOR FILTERING AIR NOT FOR MEDICAL USE; FILTERS FOR NON-MEDICAL RESPIRATORY MASKS; OPTO-ELECTRONIC MASKS, NAMELY, PROTECTIVE MASKS NOT FOR MEDICAL PURPOSES; PROTECTIVE OPTICAL INSTRUMENTS, NAMELY, PROTECTIVE EYEWEAR; SPECTACLES, OPTICAL LENSES, NON-MEDICAL PROTECTIVE MASKS FOR EYES; FACE-PROTECTING WELDING SHIELDS; PROTECTIVE NON-MEDICAL SHIELDS, FILMS, FILTERS AND SHEETS FOR PROTECTING THE EYES FROM ULTRA-VIOLET LIGHT AND LASER RAYS; PROTECTIVE HELMETS; PROTECTIVE FACE AND EYE SHIELDS FOR WORKERS; EAR PROTECTION AND SOUNDPROOFING DEVICES, NAMELY, PROTECTIVE EARMUFFS, EARPLUGS AND HEADBANDS; AUTOMATIC DISTRIBUTION MACHINES FOR DEVICES FOR EAR PROTECTION NAMELY, DISPENSERS FOR EAR PROTECTION DEVICES; SAFETY AND PROTECTION EQUIPMENT FOR FALLS, NAMELY, HARNESSSES, LINES, FALL-ARREST LIFE LINES, LANYARDS, BARS, ANCHORS; SAFETY RESTRAINING DEVICES OTHER THAN FOR VEHICLE SEATS AND SPORTS EQUIPMENT;

SAFETY AND RETAINING BELTS NOT FOR VEHICLE SEATS OR SPORTS EQUIPMENT; LIFE LINES, SAFETY STRAPS NOT FOR VEHICLE SEATS OR SPORTS EQUIPMENT, LUMBAR SECURITY BELTS; SAFETY RESTRAINTS NOT FOR VEHICLE SEATS OR SPORTS EQUIPMENT; CLOTHING, HEADGEAR AND NON-ORTHOPEDIC FOOTWEAR FOR PROTECTION AGAINST ACCIDENTS, RADIATION AND FIRE; GLOVES FOR PROTECTION AGAINST ACCIDENTS, X-RAYS AND CHEMICAL AND BACTERIOLOGICAL RISKS; DEVICES AND INSTRUMENTS FOR EYE CLEANING, NAMELY, EYEWASH STATIONS CONSISTING OF EYE FLUSHING DEVICE, EYEWASH, AND EYE DECONTAMINATION SHOWERS; APPARATUS AND DEVICES FOR GAS TESTING AND TESTING EQUIPMENT FOR INDEPENDENT BREATHING ASSISTANCE APPARATUS, NAMELY, GAS DETECTORS; DEVICES FOR PERSONAL PROTECTION FOR USE IN ACCIDENT PREVENTION, NAMELY, PROTECTIVE CLOTHING, PROTECTIVE HEADGEAR, PROTECTIVE EAR COVERINGS, PROTECTIVE WORK GLOVES, PROTECTIVE FOOTWEAR, PROTECTIVE FOOTWEAR COVERINGS, NETS FOR PROTECTION AGAINST ACCIDENTS, PROTECTIVE HELMETS, CAPS, KNITTED CAPS AND HEADGEAR; OVERSHOES AND OVERBOOTS , IN CLASS 9 (U.S. CLS. 21, 23, 26, 36 AND 38).

FOR: HEARING PROTECTION DEVICES, NAMELY, HEADBANDS, EAR-PLUGS AND EAR-MUFFS USED FOR EAR PROTECTION FOR MEDICAL AND PROPHYLACTIC PURPOSES; PROTECTIVE MASKS, HEAD COVERINGS, GLOVES, SPECIAL

CLOTHING USED BY MEDICAL, SURGICAL AND DENTAL PERSONNEL, NAMELY, MEDICAL LUMBAR BELTS, SURGICAL SCRUBS, SURGICAL MASKS, SURGICAL CAPS, GLOVES FOR MEDICAL USE, SURGICAL GLOVES, SURGICAL SCRUB SUITS, OPERATING ROOM APPAREL, MEDICAL TREATMENT APPAREL; SURGICAL STERILE SHEETS, IN CLASS 10 (U.S. CLS. 26, 39 AND 44).

FOR: CLOTHING, NAMELY, PANTS, SHIRTS, COATS, APRONS, OVERALLS; GLOVES; FOOTWEAR; COVERINGS FOR SHOES AND BOOTS NOT FOR MEDICAL OR PROTECTIVE PURPOSES; NON-ORTHOPEDIC FOOTWEAR PARTS, NAMELY, HEELS, SHOE SOLES AND PROTECTIVE TOE CAPS, REMOVABLE OR NOT, MADE OF LEATHER, RUBBER, OR ANY OTHER MATERIAL; SOCKS, BOOT LINERS, SLIPPERS, BOOTS, HALF-BOOTS, CLOGS, NON-SLIP DEVICES FOR FOOTWEAR; HEADGEAR, NAMELY, HATS, CAPS; APRONS; BIBS NOT OF CLOTH OR PAPER; BIBS MADE OF PLASTIC AND OF NON-WOVEN FABRICS, IN CLASS 25 (U.S. CLS. 22 AND 39).

FOR: PROTECTIVE EQUIPMENT AGAINST FALLS IN SPORTS, NAMELY, HARNESES, BELTS, DESCENDERS, LIFELINES, LANYARDS, PITONS, CARABINERS, CLAMPING WEDGES; SAFETY DEVICES FOR SPORT, NAMELY, SAFETY HARNESES, SAFETY RESTRAINTS, HELMETS; CLIMBING

HARNESES; STRAPS FOR USE IN SPORTS, IN CLASS 28 (U.S. CLS. 22, 23, 38 AND 50).

FOR: WHOLESALE AND RETAIL STORE SERVICES FEATURING PROTECTIVE CLOTHING AND INDIVIDUAL PROTECTION DEVICES AGAINST ACCIDENTS, RADIATION, CHEMICAL AND BACTERIOLOGICAL CONTAMINATION, FIRE AND AGGRESSIVE NOISE, IN CLASS 35 (U.S. CLS. 100, 101 AND 102).

PRIORITY DATE OF 6-15-2007 IS CLAIMED.

OWNER OF INTERNATIONAL REGISTRATION 0950428 DATED 11-19-2007, EXPIRES 11-19-2017.

THE COLOR(S) BLUE AND ORANGE IS/ARE CLAIMED AS A FEATURE OF THE MARK.

THE MARK CONSISTS OF A STYLIZED LETTER "S" IN BLUE WRAPPED AROUND AN ORANGE OVAL.

SER. NO. 79-048,844, FILED 11-19-2007.

ALYSSA STEEL, EXAMINING ATTORNEY

Int. Cl.: 7

Prior U.S. Cls.: 13, 19, 21, 23, 31, 34 and 35

United States Patent and Trademark Office

Reg. No. 3,576,387

Registered Feb. 17, 2009

**TRADEMARK
PRINCIPAL REGISTER**



RIKEN KIKI CO., LTD. (JAPAN CORPORATION)
24-50, TAKANAWA 4-CHOME
MINATO-KU
TOKYO 108-0074, JAPAN

OWNER OF INTERNATIONAL REGISTRATION
0950516 DATED 11-29-2007, EXPIRES 11-29-2017.

THE COLOR(S) RED IS/ARE CLAIMED AS A
FEATURE OF THE MARK.

FOR: METALWORKING MACHINES AND ME-
TALWORKING MACHINE TOOLS, IN CLASS 7 (U.S.
CLS. 13, 19, 21, 23, 31, 34 AND 35).

THE COLOR RED APPEARS IN THE WORDING.

SER. NO. 79-048,875, FILED 11-29-2007.

PRIORITY DATE OF 10-5-2007 IS CLAIMED.

DAYNA BROWNE, EXAMINING ATTORNEY

Int. Cl.: 16

Prior U.S. Cls.: 2, 5, 22, 23, 29, 37, 38 and 50

Reg. No. 3,576,388

United States Patent and Trademark Office

Registered Feb. 17, 2009

**TRADEMARK
PRINCIPAL REGISTER**

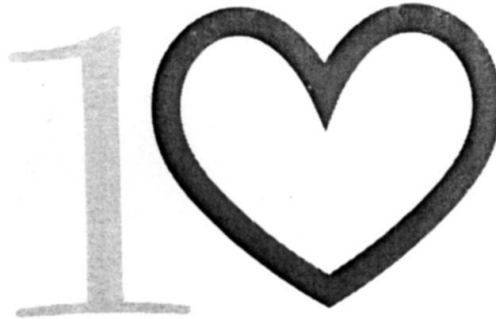

VIRCA S.P.A. (ITALY JOINT STOCK COMPANY)
VIA PER CASSANO, 120/V
I-21052 BUSTO ARSIZIO (VARESE)
ITALY

DECORATION, ADHESIVE TAPE FOR STATION-
ERY OR HOUSEHOLD PURPOSES, IN CLASS 16
(U.S. CLS. 2, 5, 22, 23, 29, 37, 38 AND 50).

PRIORITY DATE OF 3-8-2007 IS CLAIMED.

FOR: PAPER AND GOODS MADE FROM PAPER,
NAMELY, CALENDARS, DRAWING PAPER, EN-
VELOPES FOR LETTERS, WRITING PAPER, LET-
TER PAPER, CARDBOARD AND GOODS MADE IN
CARDBOARD, NAMELY, DIARIES, NOTEBOOKS,
COPYBOOKS, GREETINGS CARDS, BOOKS, PHO-
TOGRAPHS AND ALBUMS FOR PHOTOGRA-
PHIES; WRITING-MATERIALS, NAMELY, PENS,
BALLPOINT PENS AND PENCILS, STICKERS FOR

OWNER OF INTERNATIONAL REGISTRATION
0950608 DATED 8-27-2007, EXPIRES 8-27-2017.

SER. NO. 79-048,897, FILED 8-27-2007.

LINDA ESTRADA, EXAMINING ATTORNEY

Int. Cl.: 25

Prior U.S. Cls.: 22 and 39

United States Patent and Trademark Office

Reg. No. 3,576,389

Registered Feb. 17, 2009

**TRADEMARK
PRINCIPAL REGISTER**

SUAD

SUAD (FRANCE SARL)
670 CHEMIN DU CHARREL
F-13400 AUBAGNE
FRANCE

FOR: CLOTHING IN THE NATURE OF T-SHIRTS, SHIRTS, POLO SHIRTS, TROUSERS, JACKETS, SWEATERS, COATS, BELTS AND GLOVES; FUR COATS, HATS AND STOLE; FOOTWEAR; HEADGEAR IN THE NATURE OF HATS, CAPS, VISORS; LEATHER AND IMITATION LEATHER CLOTHING IN THE NATURE OF TROUSERS, JACKETS, SWEATERS; SCARVES; TIES; HOSIERY; SOCKS; FINISHED TEXTILE LINING FOR BOOTS; BEACH, SKI OR SPORTS FOOTWEAR; TEXTILE NAPPIES; UNDERWEAR, IN CLASS 25 (U.S. CLS. 22 AND 39).

THE MARK CONSISTS OF STANDARD CHARACTERS WITHOUT CLAIM TO ANY PARTICULAR FONT, STYLE, SIZE, OR COLOR.

PRIORITY DATE OF 6-14-2007 IS CLAIMED.

OWNER OF INTERNATIONAL REGISTRATION 0951298 DATED 12-13-2007, EXPIRES 12-13-2017.

SER. NO. 79-049,114, FILED 12-13-2007.

AMEETA JORDAN, EXAMINING ATTORNEY

Int. Cls.: 9, 16 and 28

Prior U.S. Cls.: 2, 5, 21, 22, 23, 26, 29, 36, 37, 38 and 50

Reg. No. 3,576,390

United States Patent and Trademark Office

Registered Feb. 17, 2009

**TRADEMARK
PRINCIPAL REGISTER**

UGENIA LAVENDER

GERALDINE HALLIWELL (UNITED KINGDOM INDIVIDUAL)
C/O LEE & THOMPSON,
GREEN GARDEN HOUSE, 15-22 ST.; CHRISTOPHER'S PLACE; LONDON W1M5HE
UNITED KINGDOM

FOR: AUDIO BOOKS IN THE FIELD OF CHILDREN'S FICTION RECORDED ON CD, MINI-DISC, RECORDS, CASSETTE OR DISC; ELECTRONIC PUBLICATIONS, NAMELY, TALKING BOOKS FEATURING CHILDREN'S FICTION OR CHARACTERS THEREFROM RECORDED ON CD, MINI-DISC, RECORDS, CASSETTE OR DISC; DOWNLOADABLE ELECTRONIC PUBLICATIONS, NAMELY, MAGAZINES, BOOKS AND COMICS, IN THE FIELD OF CHILDREN'S FICTION AND CHARACTERS THEREFROM PROVIDED FROM COMPUTER DATABASES OR THE INTERNET; DOWNLOADABLE ELECTRONIC PRINTED MATTER, NAMELY, MAGAZINES, BOOKS AND COMICS, IN THE FIELD OF CHILDREN'S FICTION AND CHARACTERS THEREFROM; ELECTRONIC BOOKS IN THE FIELD OF CHILDREN'S FICTION RECORDED ON CD, MINI-DISC, RECORDS, CASSETTE OR DISC, OR PROVIDED FROM COMPUTER DATABASES OR DOWNLOADABLE FROM THE INTERNET, IN CLASS 9 (U.S. CLS. 21, 23, 26, 36 AND 38).

FOR: PRINTED MATTER, NAMELY, EDUCATIONAL LEARNING CARDS, FLASH CARDS, ACTIVITY CARDS, WORKBOOKS, ALBUMS FOR STICKERS, TEXTBOOKS, ACTIVITY BOOKS, STORY BOOKS, PUZZLE BOOKS, PRINTED PUZZLES, TEACHER GUIDES, MANUALS, EDUCATIONAL CARD GAMES AND EDUCATIONAL BOOKLETS IN THE FIELD OF CHILDREN'S FICTION OR FEATURING CHARACTERS THEREFROM; PRINTED PUBLICATIONS, NAMELY, CHILDREN'S BOOKS, CHILDREN'S ACTIVITY BOOKS, CHILDREN'S INTERACTIVE EDUCATIONAL BOOKS, CHILDREN'S STORYBOOKS, COMIC BOOKS, PICTURE BOOKS, AND MAGAZINES IN THE FIELD OF CHILDREN'S FICTIONS OR FEATURING CHARACTERS THEREFROM; BOOKS IN THE FIELD OF CHILDREN'S FICTION OR FEATURING CHARACTERS THEREFROM;

MAGAZINES IN THE FIELD OF CHILDREN'S FICTION OR FEATURING CHARACTERS THEREFROM, AND BIRTHDAY BOOKS; POSTCARDS; PICTURES; POSTERS; DIARIES; GREETING CARDS; CALENDARS; PHOTOGRAPHS; NOTE PADS; NOTE BOOKS; STICKERS; DECALCOMANIAS; WRAPPING PAPER; PENS; BALLPOINT PENS; FOUNTAIN PENS; PENCILS; DRAWING RULERS; ERASERS; PENCIL SHARPENERS; PEN AND PENCIL CASES; PICTURE CARDS; CHILDREN'S PICTURE BOOKS; SONG BOOKS, IN CLASS 16 (U.S. CLS. 2, 5, 22, 23, 29, 37, 38 AND 50).

FOR: TOYS, NAMELY, BENDABLE TOYS, CHILDREN'S ART ACTIVITY TOYS, COLLECTABLE TOY FIGURES, INFANT TOYS, MUSICAL TOYS AND WATER SQUIRTING TOYS; DOLLS; GAMES AND PLAYTHINGS, NAMELY, BOARD GAMES, INTERACTIVE EDUCATIONAL BOARD GAMES, ROCKING HORSES, TOY MASKS, PLAY COSMETICS FOR CHILDREN, TOYS FOR PETS, TOY MOBILES, DOMINOES, CHESS AND CHECKERS GAMES, SKITTLES; PLUSH TOYS; RAG DOLLS; ACTION FIGURE DOLLS; ACTIVITY SETS COMPRISING TOY ACTION FIGURES AND ACCESSORIES THEREFOR; DOLLS; BABY SWINGS; BALLS FOR PLAYING GAMES AND SPORTS; BALLOONS; BATH TOYS; BEACH BALLS; TOY BUILDING BLOCKS, TOY BUILDING BRICKS AND TOY BUILDING GAMES; BOARD GAMES; CARD GAMES; PLAYING CARDS; TRADING CARD GAMES; CHILDREN'S BICYCLES; RIDE-ON TOYS, NAMELY, CHILDREN'S FOUR-WHEELED VEHICLES; CHILDREN'S PLAYHOUSES; CHILDREN'S RIDE-ON TOY VEHICLES; CHILDREN'S RIDING VEHICLES; COMPENDIUMS OF BOARD GAMES; TOY CONSTRUCTION SETS AND CONSTRUCTION TOYS; DICE; DICE GAMES; DOLLS' HOUSES, BEDS, CLOTHES, AND FURNITURE; FLYING DISCS; FOOTBALLS; ICE SKATES; IN-LINE ROLLER SKATES; INFANTS' SWINGS; INTERLOCKING TOY CONSTRUCTION PIECES; JIGSAW PUZZLES; JUMP ROPES PEDAL-PROPELLED WHEELED TOYS; PLAY SLIDES; PLAY STRUCTURES FOR CHILDREN; PUZZLES; RIDE-ON TOY VEHICLES; MOTORIZED RIDE-ON TOY VEHICLES; RIDE-ON TOYS; ROCKING TOYS; ROLLER SKATES; TOY

SCOOTERS; SKATEBOARDS; TOY FIGURES AND FIGURINES; TOY ACTION FIGURES AND ACCESSORIES THEREFOR; PLAY FIGURES; SCALE MODEL FIGURES; TOY AUTOMOBILES; TOY BICYCLES; TRAMPOLINES; TRICYCLES AND TRIKES; TOY VEHICLES FOR CHILDREN; WENDY HOUSES, NAMELY, A SMALL MODEL HOUSE THAT CHILDREN CAN ENTER AND PLAY IN; TRAMPOLINES IN THE NATURE OF BOUNCY CASTLES, IN CLASS 28 (U.S. CLS. 22, 23, 38 AND 50).

PRIORITY DATE OF 4-12-2007 IS CLAIMED.

OWNER OF INTERNATIONAL REGISTRATION 0951370 DATED 10-11-2007, EXPIRES 10-11-2017.

THE NAME(S), PORTRAIT(S), AND/OR SIGNATURE(S) SHOWN IN THE MARK DOES NOT IDENTIFY A PARTICULAR LIVING INDIVIDUAL.

SER. NO. 79-049,139, FILED 10-11-2007.

Laurie Kaufman, Examining Attorney

Int. Cl.: 9

Prior U.S. Cls.: 21, 23, 26, 36 and 38

Reg. No. 3,576,391

United States Patent and Trademark Office

Registered Feb. 17, 2009

TRADEMARK
PRINCIPAL REGISTER

MAYSER

MAYSER GMBH & CO. KG (FED REP GERMA-
NY GMBH)
ÖRLINGER STR. 1-3
89073 ULM
FED REP GERMANY

FOR: TACTILE SENSORS, IN PARTICULAR
ELECTRIC CONNECTION BLOCKS, SAFETY
SHUTDOWN MATS, BUFFERS AND ELECTRIC
SWITCHES ACTIVATED BY FOOT FOR SAFE-
GUARDING DANGEROUS MOTIONS OF MA-
CHINES AS WELL AS AUTOMATIC GATES,
INDUSTRIAL VEHICLES AND ROBOTS; TACTILE
SENSORS, ELECTRIC CONNECTION BLOCKS AND
SAFETY SHUTDOWN MATS FOR SECURITY SER-
VICES; SUPERSONIC EQUIPMENT, SUBSTANTIAL-
LY CONSISTING OF A SIGNAL TRANSDUCER/

RECEIVER AND A SIGNAL EVALUATION PRO-
CESSOR UNIT, FOR OBSTACLE DETECTION AS A
SAFEGUARD ON INDUSTRIAL TRUCKS AND
FOR MACHINE WORKPLACES, IN CLASS 9 (U.S.
CLS. 21, 23, 26, 36 AND 38).

OWNER OF INTERNATIONAL REGISTRATION
0951387 DATED 11-8-2007, EXPIRES 11-8-2017.

SEC. 2(F).

SER. NO. 79-049,147, FILED 11-8-2007.

LAURIE KAUFMAN, EXAMINING ATTORNEY

Int. Cl.: 16

Prior U.S. Cls.: 2, 5, 22, 23, 29, 37, 38 and 50

United States Patent and Trademark Office

Reg. No. 3,576,392

Registered Feb. 17, 2009

**TRADEMARK
PRINCIPAL REGISTER**

CHOPARD PASSIONS

CHOPARD INTERNATIONAL SA (SWITZER-
LAND SOCIÉTÉ ANONYME)
ROUTE DE PROMENTHOUX
CH-1197 PRANGINS
SWITZERLAND

FOR: PUBLICATIONS, NAMELY, PAMPHLETS,
CATALOGUES, NEWSPAPERS, MAGAZINES, PER-
IODICALS, PHOTOGRAPHS, PROSPECTUSES,
JOURNALS, IN THE FIELD OF WATCHES AND
JEWELLERY, IN CLASS 16 (U.S. CLS. 2, 5, 22, 23, 29,
37, 38 AND 50).

THE MARK CONSISTS OF STANDARD CHAR-
ACTERS WITHOUT CLAIM TO ANY PARTICULAR
FONT, STYLE, SIZE, OR COLOR.

PRIORITY DATE OF 6-15-2007 IS CLAIMED.

OWNER OF INTERNATIONAL REGISTRATION
0951401 DATED 12-14-2007, EXPIRES 12-14-2017.

OWNER OF U.S. REG. NOS. 2,755,042 AND
3,050,998.

SER. NO. 79-049,151, FILED 12-14-2007.

MARTHA FROMM, EXAMINING ATTORNEY

Int. Cl.: 12

Prior U.S. Cls.: 19, 21, 23, 31, 35 and 44

Reg. No. 3,576,393

United States Patent and Trademark Office

Registered Feb. 17, 2009

**TRADEMARK
PRINCIPAL REGISTER**

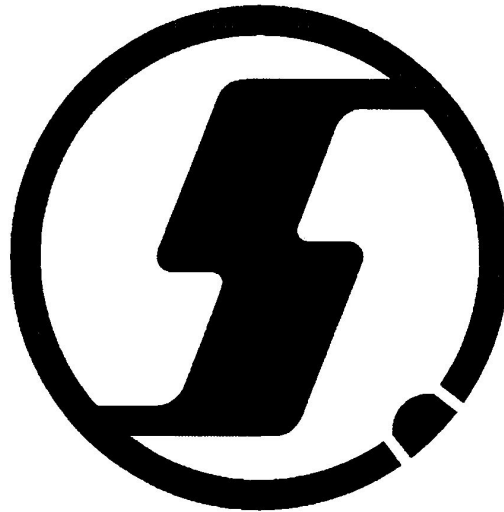

SHAANXI HEAVY-DUTY AUTOMOBILE CO.,
LTD. (CHINA CORPORATION)
JINGWEI INDUSTRIAL PARK
XI'AN ECONOMIC AND TECHNOLOGICAL DE-
VELOPMENT ZONE; XI'AN; 710200 SHAANXI
CHINA

FOR: SPORTS CARS; CROSS-COUNTRY VEHI-
CLES, NAMELY, ALL-TERRAIN VEHICLES, LAND
VEHICLES; WAGONS; VANS BEING VEHICLES;
AUTOMOBILES; AUTOMOBILE CHASSIS; BUS
CHASSIS; TRUCK CHASSIS; PARTS AND ACCES-

SORIES OF AUTOMOBILES, NAMELY, STRUC-
TURAL PARTS FOR AUTOMOBILES,
AUTOMOBILE CARGO RACKS, IN CLASS 12 (U.S.
CLS. 19, 21, 23, 31, 35 AND 44).

OWNER OF INTERNATIONAL REGISTRATION
0951587 DATED 1-10-2008, EXPIRES 1-10-2018.

SER. NO. 79-049,232, FILED 1-10-2008.

SAIMA MAKHDOOM, EXAMINING ATTORNEY

Int. Cl.: 29

Prior U.S. Cl.: 46

United States Patent and Trademark Office

Reg. No. 3,576,394

Registered Feb. 17, 2009

**TRADEMARK
PRINCIPAL REGISTER**

DELITUNAS

CONSERVAS SELECTAS MAR DE COUSO, S.A.
(SPAIN SOCIEDAD ANONIMA)
LUGAR DE COUSO, S/N
E-15965 AGUIÑO-RIVEIRA (A CORUÑA), SPAIN

FOR: MEAT, FISH, POULTRY AND GAME;
MEAT EXTRACTS; PRESERVED, FROZEN, DRIED
AND COOKED FRUITS AND VEGETABLES; JEL-
LIES, JAMS, COMPOTES; EGGS, MILK AND DAIRY
PRODUCTS EXCLUDING ICE CREAM, ICE MILK
AND FROZEN YOGURT; EDIBLE OILS AND FATS;
TINNED FISH, TINNED SEAFOOD, TINNED
SHELLFISH; FISH, NOT LIVE, FRESH AND FRO-
ZEN SEAFOOD AND MOLLUSCS, NAMELY, BABY
SCALLOPS, SCALLOPS, COCKLES, CLAMS, MUS-
SELS, NOT LIVE; PRECOOKED AND CONSERVE
MEALS CONSISTING PRIMARILY OF FISH, SEA-
FOOD AND MOLLUSCS; EDIBLE OILS AND FATS
MADE OF FISH, SEAFOOD AND MOLLUSCS;
SALTED PREPARATIONS OF FISH, SEAFOOD

AND MOLLUSCS, NAMELY, BABY SCALLOPS,
SCALLOPS, COCKLES, CLAMS, MUSSELS , IN
CLASS 29 (U.S. CL. 46).

THE MARK CONSISTS OF STANDARD CHAR-
ACTERS WITHOUT CLAIM TO ANY PARTICULAR
FONT, STYLE, SIZE, OR COLOR.

PRIORITY DATE OF 5-22-2007 IS CLAIMED.

OWNER OF INTERNATIONAL REGISTRATION
0951724 DATED 9-17-2007, EXPIRES 9-17-2017.

SER. NO. 79-049,285, FILED 9-17-2007.

THOMAS MANOR, EXAMINING ATTORNEY

Int. Cl.: 30

Prior U.S. Cl.: 46

United States Patent and Trademark Office

Reg. No. 3,576,395

Registered Feb. 17, 2009

TRADEMARK
PRINCIPAL REGISTER



CAFFÈ SPINNATO S.R.L. (ITALY LIMITED LIABILITY COMPANY)
VIA TOSCANA, 8
I-90100 PALERMO
ITALY

FOR: COFFEE, BAKERY PRODUCTS, PASTRY PRODUCTS, ICES, NAMELY, FRUIT ICES AND EDIBLE ICES, IN CLASS 30 (U.S. CL. 46).

PRIORITY DATE OF 11-27-2007 IS CLAIMED.

OWNER OF INTERNATIONAL REGISTRATION 0951821 DATED 12-14-2007, EXPIRES 12-14-2017.

NO CLAIM IS MADE TO THE EXCLUSIVE RIGHT TO USE "CAFFÈ", APART FROM THE MARK AS SHOWN.

THE ENGLISH TRANSLATION OF "CAFFÈ" IN THE MARK IS COFFEE.

SER. NO. 79-049,321, FILED 12-14-2007.

MATTHEW MCDOWELL, EXAMINING ATTORNEY

Int. Cl.: 4

Prior U.S. Cls.: 1, 6 and 15

United States Patent and Trademark Office

Reg. No. 3,576,396

Registered Feb. 17, 2009

**TRADEMARK
PRINCIPAL REGISTER**

lubrimed

BIEN-AIR HOLDING SA (SWITZERLAND SOCI-
ÉTÉ ANONYME)
LÄNGGASSE 60
CH-2504 BIEL/BIENNE
SWITZERLAND

FOR: LUBRICATING GREASES FOR MEDICAL
INSTRUMENTS; LUBRICATING OILS FOR MEDI-
CAL INSTRUMENTS, IN CLASS 4 (U.S. CLS. 1, 6
AND 15).

PRIORITY DATE OF 7-10-2007 IS CLAIMED.

OWNER OF INTERNATIONAL REGISTRATION
0951898 DATED 1-8-2008, EXPIRES 1-8-2018.

OWNER OF U.S. REG. NO. 3,256,648.

SER. NO. 79-049,357, FILED 1-8-2008.

MARK PILARO, EXAMINING ATTORNEY

Int. Cls.: 35 and 38

Prior U.S. Cls.: 100, 101, 102 and 104

United States Patent and Trademark Office

Reg. No. 3,576,397

Registered Feb. 17, 2009

**SERVICE MARK
PRINCIPAL REGISTER**

mailloc

BENEDIKT LEIBINGER (FED REP GERMANY
LIMITED LIABILITY COMPANY)
REUTESTRAÙE 3
79100 FREIBURG
FED REP GERMANY

FOR: BUSINESS INFORMATION SERVICES,
NAMELY, GATHERING AND REPORTING INFOR-
MATION REGARDING E-MAIL, IP AND ELECTRO-
NIC ADDRESSES OF OTHERS THAT ARE MADE
AVAILABLE TO OTHER COMPANIES FOR COM-
MERCIAL PURPOSES; SYSTEMATIZATION AND
COMPILATION OF DATA IN COMPUTER DATA-
BASES, NAMELY, MANAGEMENT AND COMPI-
LATION OF COMPUTERIZED DATABASES, IN
CLASS 35 (U.S. CLS. 100, 101 AND 102).

FOR: TELECOMMUNICATIONS SERVICES,
NAMELY, PROVIDING TELECOMMUNICATIONS
CONNECTIONS TO A GLOBAL COMPUTER NET-

WORK; PROVISION OF ACCESS TO AN ADDRESS
DATABASE ON THE INTERNET, IN CLASS 38 (U.S.
CLS. 100, 101 AND 104).

THE MARK CONSISTS OF STANDARD CHAR-
ACTERS WITHOUT CLAIM TO ANY PARTICULAR
FONT, STYLE, SIZE, OR COLOR.

PRIORITY DATE OF 6-22-2007 IS CLAIMED.

OWNER OF INTERNATIONAL REGISTRATION
0951908 DATED 12-14-2007, EXPIRES 12-14-2017.

SER. NO. 79-049,364, FILED 12-14-2007.

MATTHEW MCDOWELL, EXAMINING ATTOR-
NEY

Int. Cl.: 35

Prior U.S. Cls.: 100, 101 and 102

United States Patent and Trademark Office

Reg. No. 3,576,398

Registered Feb. 17, 2009

**SERVICE MARK
PRINCIPAL REGISTER**

JUST ADD KIDS

FUNTASTIC LIMITED (AUSTRALIA COMPANY)
635 WAVERLEY ROAD
GLEN WAVERLEY VIC 3150, AUSTRALIA

FOR: WHOLESALE DISTRIBUTORSHIP SERVICES IN THE FIELD OF CHILD CARE CENTER AND SCHOOL MATERIALS, SUPPLIES, FURNITURE, EQUIPMENT AND EDUCATIONAL/INSTRUCTIONAL RESOURCE MATERIALS; WHOLESALE DISTRIBUTORSHIP SERVICES IN THE FIELD OF EDUCATIONAL TOYS, GAMES, PUZZLES, ACTIVITY SETS, ART AND CRAFT SUPPLIES, MUSICAL INSTRUMENTS, EDUCATIONAL PUBLICATIONS, BOOKS AND REFERENCE MATERIALS IN PRINT AND/OR ELECTRONIC FORM, IN CLASS 35 (U.S. CLS. 100, 101 AND 102).

THE MARK CONSISTS OF STANDARD CHARACTERS WITHOUT CLAIM TO ANY PARTICULAR FONT, STYLE, SIZE, OR COLOR.

PRIORITY DATE OF 6-25-2007 IS CLAIMED.

OWNER OF INTERNATIONAL REGISTRATION
0952148 DATED 12-21-2007, EXPIRES 12-21-2017.

SER. NO. 79-049,408, FILED 12-21-2007.

KELLEY WELLS, EXAMINING ATTORNEY

Int. Cl.: 25

Prior U.S. Cls.: 22 and 39

United States Patent and Trademark Office

Reg. No. 3,576,399

Registered Feb. 17, 2009

**TRADEMARK
PRINCIPAL REGISTER**

PEU

CAMPER, S.L. (SPAIN SOCIEDAD LIMITADA)
POL. INDUSTRIAL S/N,
E-07300 INCA - BALEARES
SPAIN

FOR: CLOTHING, IN PARTICULAR, ANORAKS,
SWIMSUITS, BEACHWEAR, BELTS, BERMUDA
SHORTS, BIKINIS, JACKETS, BLOUSES, BOXER
SHORTS, CARDIGANS, JEANS, SPORTS COATS,
JUMPSUITS, GLOVES, GOLF SHIRTS, FUR JACK-
ETS, TIES, COATS, POLO-STYLE SHIRTS, JERSEYS,
SOCKS, SWEATSHIRTS, UNDERSHIRTS, SKIRTS,
TEE SHIRTS, TENNIS WEAR, UNDERWEAR; NON-
ORTHOPEDIC FOOTWEAR; HEADWEAR, IN
CLASS 25 (U.S. CLS. 22 AND 39).

THE MARK CONSISTS OF STANDARD CHAR-
ACTERS WITHOUT CLAIM TO ANY PARTICULAR
FONT, STYLE, SIZE, OR COLOR.

PRIORITY DATE OF 6-28-2007 IS CLAIMED.

OWNER OF INTERNATIONAL REGISTRATION
0952190 DATED 11-6-2007, EXPIRES 11-6-2017.

THE ENGLISH TRANSLATION OF THE WORD
"PEU" IN THE MARK IS "LITTLE".

SER. NO. 79-049,429, FILED 11-6-2007.

TINA BROWN, EXAMINING ATTORNEY

Int. Cl.: 9

Prior U.S. Cls.: 21, 23, 26, 36 and 38

United States Patent and Trademark Office

Reg. No. 3,576,400

Registered Feb. 17, 2009

**TRADEMARK
PRINCIPAL REGISTER**



JOHNSON ELECTRIC HOLDINGS LIMITED
(BERMUDA LIMITED COMPANY)

CEDAR HOUSE

41 CEDAR AVENUE; HAMILTON HM 12; BERMUDA

BERMUDA

FOR: ELECTRIC AND ELECTRONIC SOLENOIDS, SOLENOID SWITCHES AND SOLENOID VALVES; ELECTRIC AND ELECTRONIC SWITCHES; AND PARTS FOR ALL THE AFORESAID GOODS, IN CLASS 9 (U.S. CLS. 21, 23, 26, 36 AND 38).

PRIORITY DATE OF 3-17-2007 IS CLAIMED.

OWNER OF INTERNATIONAL REGISTRATION
0952199 DATED 9-12-2007, EXPIRES 9-12-2017.

THE COLOR(S) BLUE AND ORANGE IS/ARE
CLAIMED AS A FEATURE OF THE MARK.

THE COLOR BLUE APPEARS IN THE WORDING,
AND THE COLOR ORANGE APPEARS IN THE
TRIANGLE THAT IS LOCATED TO THE RIGHT OF
THE WORDING.

SER. NO. 79-049,431, FILED 9-12-2007.

ROBERT STRUCK, EXAMINING ATTORNEY

Int. Cl.: 9

Prior U.S. Cls.: 21, 23, 26, 36 and 38

Reg. No. 3,576,401

United States Patent and Trademark Office

Registered Feb. 17, 2009

**TRADEMARK
PRINCIPAL REGISTER**

OTEHALL

JOHNSON ELECTRIC HOLDINGS LIMITED
(BERMUDA LIMITED COMPANY)
CEDAR HOUSE
41 CEDAR AVENUE
HAMILTON HM 12, BERMUDA

THE COLOR(S) BLACK AND ORANGE IS/ARE CLAIMED AS A FEATURE OF THE MARK.

FOR: ELECTRIC AND ELECTRONIC SOLENOIDS, SOLENOID SWITCHES AND SOLENOID VALVES; ELECTRIC AND ELECTRONIC SWITCHES; AND PARTS FOR ALL THE AFORESAID GOODS, IN CLASS 9 (U.S. CLS. 21, 23, 26, 36 AND 38).

THE COLOR BLACK APPEARS IN THE WORDING, AND THE COLOR ORANGE APPEARS IN THE TRIANGLE THAT IS LOCATED INSIDE THE BLANK SPACE AT THE BOTTOM OF THE LETTER "A".

PRIORITY DATE OF 3-17-2007 IS CLAIMED.

SER. NO. 79-049,435, FILED 9-12-2007.

OWNER OF INTERNATIONAL REGISTRATION
0952203 DATED 9-12-2007, EXPIRES 9-12-2017.

ROBERT STRUCK, EXAMINING ATTORNEY

Int. Cl.: 6

Prior U.S. Cls.: 2, 12, 13, 14, 23, 25 and 50

Reg. No. 3,576,402

United States Patent and Trademark Office

Registered Feb. 17, 2009

**TRADEMARK
PRINCIPAL REGISTER**

KF Konrad Friedrichs

KONRAD FRIEDRICHS GMBH & CO. KG (FED
REP GERMANY GMBH & CO. KG)
VORWERKSTRASSE 20 95326
KULMBACH, FED REP GERMANY

PRIORITY DATE OF 4-5-2007 IS CLAIMED.

FOR: CERMETS, NAMELY, METAL-CERAMIC
COMPOSITES; RAW COBALT ORES; ALLOYS OF
COMMON METAL; COMMON METALS, UN-
WROUGHT AND SEMI-WORKED, FOR FURTHER
MANUFACTURE; TUNGSTEN; HARD METALS
FOR FURTHER MANUFACTURE, NAMELY, CE-
MENTED CARBIDES; HARD METAL SEMI-FIN-
ISHED PRODUCTS, NAMELY, CEMENTED
CARBIDE RODS FOR MAKING METAL-WORKING
TOOLS, IN CLASS 6 (U.S. CLS. 2, 12, 13, 14, 23, 25 AND
50).

OWNER OF INTERNATIONAL REGISTRATION
0952415 DATED 9-28-2007, EXPIRES 9-28-2017.

THE NAME(S), PORTRAIT(S), AND/OR SIGNA-
TURE(S) SHOWN IN THE MARK IDENTIFIES
"KONRAD FRIEDRICHS", WHOSE CONSENT(S)
TO REGISTER IS SUBMITTED.

THE MARK CONSISTS OF STANDARD CHAR-
ACTERS WITHOUT CLAIM TO ANY PARTICULAR
FONT, STYLE, SIZE, OR COLOR.

SER. NO. 79-049,523, FILED 9-28-2007.

GILBERT SWIFT, EXAMINING ATTORNEY

Int. Cl.: 18

Prior U.S. Cls.: 1, 2, 3, 22 and 41

United States Patent and Trademark Office

Reg. No. 3,576,403

Registered Feb. 17, 2009

**TRADEMARK
PRINCIPAL REGISTER**

KENJIKEDA
since 2003

IKEDA KENJI (JAPAN INDIVIDUAL)
2-18-5, HIGASHIKOHAMA, SUMIYOSHI-KU
OSAKA-SHI, OSAKA, JAPAN 5580051

OWNER OF INTERNATIONAL REGISTRATION
0952449 DATED 12-27-2007, EXPIRES 12-27-2017.

FOR: ALL-PURPOSE CARRYING BAGS; HAND-
BAGS; POUCHES AND THE LIKE, NAMELY,
DRAWSTRING POUCHES, FELT POUCHES AND
LEATHER POUCHES; HANDBAG FRAMES; PURSE
FRAMES; INDUSTRIAL PACKAGING CONTAIN-
ERS OF LEATHER, NAMELY, LEATHER BAGS
FOR MERCHANDISE PACKAGING; CLOTHING
FOR DOMESTIC PETS; VANITY CASES, SOLD
EMPTY; UMBRELLAS AND THEIR PARTS; WALK-
ING STICKS; CANES; METAL PARTS OF CANES
AND WALKING-STICKS; HANDLES OF CANES
AND WALKING-STICKS; SADDLERY; UN-
WORKED OR SEMI-WORKED LEATHER, IN
CLASS 18 (U.S. CLS. 1, 2, 3, 22 AND 41).

NO CLAIM IS MADE TO THE EXCLUSIVE
RIGHT TO USE "SINCE 2003", APART FROM THE
MARK AS SHOWN.

THE NAME(S), PORTRAIT(S), AND/OR SIGNA-
TURE(S) SHOWN IN THE MARK IDENTIFIES A
LIVING INDIVIDUAL, WHOSE CONSENT(S) TO
REGISTER IS SUBMITTED.

SER. NO. 79-049,539, FILED 12-27-2007.

WENDY GOODMAN, EXAMINING ATTORNEY

Int. Cl.: 18

Prior U.S. Cls.: 1, 2, 3, 22 and 41

United States Patent and Trademark Office

Reg. No. 3,576,404

Registered Feb. 17, 2009

TRADEMARK
PRINCIPAL REGISTER

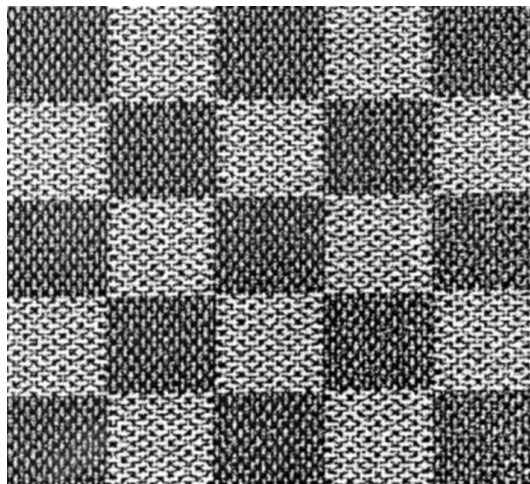

LOUIS VUITTON MALLETIER (FRANCE SOCI-
ÉTÉ ANONYME)
2 RUE DU PONT-NEUF
F-75001 PARIS
FRANCE

FOR: BOXES OF LEATHER OR IMITATION
LEATHER FOR PACKAGING AND CARRYING
GOODS, TRUNKS, SUITCASES, TRAVELING SETS
COMPRISED OF MATCHING LUGGAGE, TRAVEL-
ING BAGS, LUGGAGE, GARMENT BAGS FOR
TRAVEL, HATBOXES NOT OF PAPER OR CARD-
BOARD, VANITY CASES NOT FITTED, TOILETRY
CASES SOLD EMPTY, RUCKSACKS, SACHELS,
HANDBAGS, BEACH BAGS, LEATHER SHOPPING
BAGS, TEXTILE SHOPPING BAGS, SLING BAGS,
SUIT CARRIERS, SHOULDER BAGS, WAIST BAGS,
PURSES, TRAVEL CASES, BRIEFCASES, BRIEF-
CASE-TYPE PORTFOLIOS, LEATHER POUCHES,
WALLETS, CHANGE PURSES, KEY CASES, BUSI-
NESS CARD CASES, CALLING CARD CASES, UM-
BRELLAS, PARASOLS, ANIMAL CARRIER BAGS,
IN CLASS 18 (U.S. CLS. 1, 2, 3, 22 AND 41).

PRIORITY DATE OF 7-12-2007 IS CLAIMED.

OWNER OF INTERNATIONAL REGISTRATION
0952582 DATED 1-3-2008, EXPIRES 1-3-2018.

OWNER OF U.S. REG. NOS. 2,255,321 AND
2,421,618.

THE MARK CONSISTS OF SQUARES WITH A
CHECKERED PATTERN OF LIGHT AND DARK
WITH THE UNUSUAL CONTRAST OF WEFT AND
WARP. COLOR IS NOT CLAIMED AS A FEATURE
OF THE MARK. THE PATTERN APPEARS OVER
SUBSTANTIALLY THE ENTIRE SURFACE OF THE
GOODS. THE LINING CONSTITUTES A FEATURE
OF THE MARK AND, ITSELF, DOES NOT INDI-
CATE A SPECIFIC COLOR.

SEC. 2(F).

SER. NO. 79-049,581, FILED 1-3-2008.

FRED CARL, EXAMINING ATTORNEY

Int. Cl.: 5

Prior U.S. Cls.: 6, 18, 44, 46, 51 and 52

United States Patent and Trademark Office

Reg. No. 3,576,405

Registered Feb. 17, 2009

**TRADEMARK
PRINCIPAL REGISTER**



IPSEN PHARMA S.A.S.
65 QUAI GEORGES GORSE
F-92100 BOULOGNE BILLANCOURT
FRANCE

FOR: PHARMACEUTICAL PREPARATIONS FOR
USE IN THE TREATMENT OF GASTROINTESTIN-
AL DISEASES, IN CLASS 5 (U.S. CLS. 6, 18, 44, 46, 51
AND 52).

PRIORITY DATE OF 7-27-2007 IS CLAIMED.

OWNER OF INTERNATIONAL REGISTRATION
0952592 DATED 1-14-2008, EXPIRES 1-14-2018.

THE COLOR(S) DARK BLUE AND LIGHT BLUE
IS/ARE CLAIMED AS A FEATURE OF THE MARK.

THE MARK CONSISTS OF A BLUE RECTANGLE
WITH A WAVE SHAPE TOP. THE COLOR PATTERN
OF THE RECTANGLE FADES GRADUALLY FROM
DARK BLUE AT THE BOTTOM TO LIGHT BLUE AT
THE TOP.

SER. NO. 79-049,586, FILED 1-14-2008.

KATHERINE E. HALMEN, EXAMINING ATTOR-
NEY

Int. Cl.: 33

Prior U.S. Cls.: 47 and 49

United States Patent and Trademark Office

Reg. No. 3,576,406

Registered Feb. 17, 2009

TRADEMARK
PRINCIPAL REGISTER

*La Dame
de Montrose*



Saint-Estephe

FONCIERE DU CHATEAU MONTROSE
(FRANCE SOCIÉTÉ CIVILE D'EXPLOITATION
AGRICOLE)
CHÂTEAU MONTROSE
F-33180 SAINT-ESTEPHE, FRANCE

FOR: WINES OF GUARANTEED LABEL OF
ORIGIN, IN CLASS 33 (U.S. CLS. 47 AND 49).

PRIORITY DATE OF 7-26-2007 IS CLAIMED.

OWNER OF INTERNATIONAL REGISTRATION
0952669 DATED 1-8-2008, EXPIRES 1-8-2018.

NO CLAIM IS MADE TO THE EXCLUSIVE
RIGHT TO USE "SAINT-ESTEPHE", APART FROM
THE MARK AS SHOWN.

THE FOREIGN WORDING IN THE MARK
TRANSLATES INTO ENGLISH AS THE LADY OF.

SER. NO. 79-049,619, FILED 1-8-2008.

KATHERINE CHANG, EXAMINING ATTORNEY

Int. Cl.: 12

Prior U.S. Cls.: 19, 21, 23, 31, 35 and 44

United States Patent and Trademark Office

Reg. No. 3,576,407

Registered Feb. 17, 2009

**TRADEMARK
PRINCIPAL REGISTER**

Unifix

POMAGALSKI SA (FRANCE SOCIETE ANON-
YME)
11 RUE RENÉ CAMPHIN
F-38600 FONTAINE
FRANCE

OWNER OF INTERNATIONAL REGISTRATION
0952683 DATED 1-14-2008, EXPIRES 1-14-2018.

FOR: SKI LIFT INSTALLATIONS, NAMELY, SKI
LIFTS, IN CLASS 12 (U.S. CLS. 19, 21, 23, 31, 35 AND
44).

SER. NO. 79-049,624, FILED 1-14-2008.

PRIORITY DATE OF 8-10-2007 IS CLAIMED.

WILLIAM ROSSMAN, EXAMINING ATTORNEY

Int. Cl.: 9

Prior U.S. Cls.: 21, 23, 26, 36 and 38

Reg. No. 3,576,408

United States Patent and Trademark Office

Registered Feb. 17, 2009

**TRADEMARK
PRINCIPAL REGISTER**

ECOBUTTON

BRITE IDEAS GLOBAL LIMITED (UNITED
KINGDOM LIMITED LIABILITY COMPANY)
4 BANK COURT, WELDON ROAD
LEICESTERSHIRE
LOUGHBOROUGH, UNITED KINGDOM LE 11 5RF

FOR: COMPUTER HARDWARE; COMPUTER
SOFTWARE INSTALLED ON DESKTOP COMPU-
TERS FOR THE PURPOSE OF SWITCHING COMPU-
TERS INTO AN ENERGY SAVING MODE
WHILE NOT IN USE; COMPUTER PERIPHERALS;
USB HUBS, IN CLASS 9 (U.S. CLS. 21, 23, 26, 36 AND
38).

THE MARK CONSISTS OF STANDARD CHAR-
ACTERS WITHOUT CLAIM TO ANY PARTICULAR
FONT, STYLE, SIZE, OR COLOR.

OWNER OF INTERNATIONAL REGISTRATION
0952902 DATED 1-7-2008, EXPIRES 1-7-2018.

THE MARK "ECOBUTTON" HAS NO MEANING
IN A FOREIGN LANGUAGE.

SER. NO. 79-049,716, FILED 1-7-2008.

TEJBIR SINGH, EXAMINING ATTORNEY

Int. Cls.: 25, 30 and 41

Prior U.S. Cls.: 22, 39, 46, 100, 101 and 107

United States Patent and Trademark Office

Reg. No. 3,576,409

Registered Feb. 17, 2009

**TRADEMARK
SERVICE MARK
PRINCIPAL REGISTER**

TONY'S CHOCOLONELY

TONY'S FACTORY B.V. (NETHERLANDS BE-
SLOTEN VENNOOTSCHAP (B.V.))
ASTERWEG 20 S2HG
NL-1031 HN AMSTERDAM
NETHERLANDS

FOR: CLOTHING, NAMELY, T-SHIRTS; FOOT-
WEAR; HEADWEAR, NAMELY, HATS, CAPS, IN
CLASS 25 (U.S. CLS. 22 AND 39).

FOR: CHOCOLATE; CHOCOLATE PRODUCTS,
NAMELY, CHOCOLATE BARS, CHOCOLATE CAN-
DIES, CHOCOLATE PASTES, CHOCOLATE TOP-
PING, CHOCOLATE SPREAD, CHOCOLATE
SPRINKLES, CHOCOLATE BASED READY TO
EAT CANDIES AND SNACKS, CONFECTIONERY
CHIPS FOR BAKING, FROZEN CONFECTIONS,
PASTRY, ICE CREAM AND ICES, IN CLASS 30
(U.S. CL. 46).

FOR: PRODUCTION OF TELEVISION PRO-
GRAMS; EDUCATION SERVICES, NAMELY, PRO-
VIDING CLASSES AND SEMINARS IN THE FIELD

OF LABOR EXPLOITATION IN THE CHOCOLATE
INDUSTRY; PROVIDING OF ON-LINE TRAINING
IN THE FORM OF CLASSES AND SEMINARS IN
THE FIELD OF LABOR EXPLOITATION IN THE
CHOCOLATE INDUSTRY; ENTERTAINMENT SER-
VICES IN THE NATURE OF ON-GOING REALITY
BASED TELEVISION PROGRAMS; ORGANIZING
COMMUNITY SPORTING AND CULTURAL
EVENTS, IN CLASS 41 (U.S. CLS. 100, 101 AND 107).

THE MARK CONSISTS OF STANDARD CHAR-
ACTERS WITHOUT CLAIM TO ANY PARTICULAR
FONT, STYLE, SIZE, OR COLOR.

OWNER OF INTERNATIONAL REGISTRATION
0952903 DATED 12-14-2007, EXPIRES 12-14-2017.

SER. NO. 79-049,717, FILED 12-14-2007.

SKYE YOUNG, EXAMINING ATTORNEY

Int. Cl.: 33

Prior U.S. Cls.: 47 and 49

United States Patent and Trademark Office

Reg. No. 3,576,410

Registered Feb. 17, 2009

TRADEMARK
PRINCIPAL REGISTER

The logo for Mocavero features the word "MOCVERO" in a large, bold, sans-serif font. The letter "V" is stylized, with its left vertical stroke forming a curved shape that encloses a small, circular emblem containing a cross-like symbol.

AZIENDA VINICOLA MOCVERO; SAS DI
FRANCESCO MOCVERO & C. (ITALY LIM-
ITED PARTNERSHIP)

VIA MALLACCA ZUMMARI SN -
ARNESANO (LE), ITALY I73010

FOR: WINES, IN CLASS 33 (U.S. CLS. 47 AND 49).

PRIORITY DATE OF 7-12-2007 IS CLAIMED.

OWNER OF INTERNATIONAL REGISTRATION
0953235 DATED 1-8-2008, EXPIRES 1-8-2018.

THE WORDING "MOCVERO" IN THE MARK
DOES NOT HAVE ANY MEANING IN A FOREIGN
LANGUAGE.

SER. NO. 79-049,877, FILED 1-8-2008.

JANICE KIM, EXAMINING ATTORNEY

Int. Cl.: 25

Prior U.S. Cls.: 22 and 39

United States Patent and Trademark Office

Reg. No. 3,576,411

Registered Feb. 17, 2009

**TRADEMARK
PRINCIPAL REGISTER**

ANNIL CLUB

CAO ZHANG (CHINA CORPORATION)
20E 26 BUILDING, WEILAN COAST
DENGLIANG ROAD,; NANSHAN DISTRICT,;
SHENZHEN CITY; GUANGDONG PROVINCE
CHINA

SCARFS; LEATHER BELT; BATHING SUITS; LAY-
ETTES, IN CLASS 25 (U.S. CLS. 22 AND 39).

OWNER OF INTERNATIONAL REGISTRATION
0953301 DATED 2-14-2008, EXPIRES 2-14-2018.

FOR: CHILDREN'S CLOTHING, NAMELY, BIBS,
NOT OF PAPER; CLOTHING, NAMELY, BABIES'
PANTS; SHOES; HOSIERY; HATS; GLOVES;

SER. NO. 79-049,896, FILED 2-14-2008.

DANIEL CAPSHAW, EXAMINING ATTORNEY

Int. Cls.: 9 and 41

Prior U.S. Cls.: 21, 23, 26, 36, 38, 100, 101 and 107

United States Patent and Trademark Office

Reg. No. 3,576,412

Registered Feb. 17, 2009

**TRADEMARK
SERVICE MARK
PRINCIPAL REGISTER**

A New Visual Odyssey

KABUSHIKI KAISHA TOSHIBA (JAPAN CORPORATION)
1-1, SHIBAURA 1-CHOME
MINATO-KU; TOKYO 105-8001
JAPAN

FOR: TELEVISION RECEIVERS; REMOTE CONTROLS FOR TELEVISION RECEIVERS; VIDEOTAPE RECORDERS; VIDEOTAPE PLAYERS; DVD RECORDERS; DVD PLAYERS; HARD DISK DRIVE (HDD) VIDEO RECORDERS; VIDEO CAMERAS; DIGITAL AUDIO PLAYERS; DIGITAL AUDIO RECORDERS; LOUDSPEAKERS; MOBILE PHONES; LIQUID CRYSTAL DISPLAY PANELS FOR TELEVISIONS AND COMPUTER MONITORS; PERSONAL COMPUTERS; DOWNLOADABLE DIGITAL MUSIC FILES; OPTICAL DISC DRIVES, IN CLASS 9 (U.S. CLS. 21, 23, 26, 36 AND 38).

FOR: PROVIDING ON-LINE COMPUTER GAMES THROUGH COMMUNICATION NETWORKS OF

COMPUTERS AND MOBILE PHONES; PROVIDING INFORMATION RELATING TO COMPUTER GAMES THROUGH COMMUNICATION NETWORKS OF COMPUTERS AND MOBILE PHONES, IN CLASS 41 (U.S. CLS. 100, 101 AND 107).

THE MARK CONSISTS OF STANDARD CHARACTERS WITHOUT CLAIM TO ANY PARTICULAR FONT, STYLE, SIZE, OR COLOR.

PRIORITY DATE OF 6-18-2007 IS CLAIMED.

OWNER OF INTERNATIONAL REGISTRATION 0953309 DATED 10-25-2007, EXPIRES 10-25-2017.

SER. NO. 79-049,900, FILED 10-25-2007.

ELLEN PERKINS, EXAMINING ATTORNEY

Int. Cl.: 5

Prior U.S. Cls.: 6, 18, 44, 46, 51 and 52

United States Patent and Trademark Office

Reg. No. 3,576,413

Registered Feb. 17, 2009

**TRADEMARK
PRINCIPAL REGISTER**



IPSEN PHARMA S.A.S.
65 QUAI GEORGES GORSE
F-92100 BOULOGNE BILLANCOURT
FRANCE

FOR: PHARMACEUTICAL PREPARATIONS FOR
USE IN THE TREATMENT OF GASTROINTESTIN-
AL DISEASES, IN CLASS 5 (U.S. CLS. 6, 18, 44, 46, 51
AND 52).

PRIORITY DATE OF 7-27-2007 IS CLAIMED.

OWNER OF INTERNATIONAL REGISTRATION
0953450 DATED 1-14-2008, EXPIRES 1-14-2018.

THE COLOR(S) DARK BLUE, LIGHT BLUE AND
ORANGE IS/ARE CLAIMED AS A FEATURE OF
THE MARK.

THE MARK CONSISTS OF A BLUE RECTANGLE
WITH A WAVE SHAPE TOP. THE COLOR PATTERN
OF THE RECTANGLE FADES GRADUALLY FROM
DARK BLUE AT THE BOTTOM TO LIGHT BLUE AT
THE TOP. IN THE RECTANGLE, ON THE LEFT
SIDE, IS AN ORANGE HALF CIRCLE WITH LIGHT
BLUE SHADING.

SER. NO. 79-049,949, FILED 1-14-2008.

KATHERINE E. HALMEN, EXAMINING ATTOR-
NEY

Int. Cls.: 9, 38, 42 and 45

Prior U.S. Cls.: 21, 23, 26, 36, 38, 100, 101 and 104

United States Patent and Trademark Office

Reg. No. 3,576,414

Registered Feb. 17, 2009

**TRADEMARK
SERVICE MARK
PRINCIPAL REGISTER**



MOBOTIX AG (FED REP GERMANY AKTIEN-
GESELLSCHAFT)
LUXEMBURGER STRAÙE 6
67657 KAISERSLAUTERN
FED REP GERMANY

FOR: CAMERAS FOR SURVEILLANCE OF HOMES, BUSINESS AND PUBLIC PLACES, CONTROLLING THE ENTRANCES TO BUILDINGS AND VIDEO CONFERENCING; CONTROLS FOR CAMERAS FOR SURVEILLANCE OF HOMES, BUSINESS AND PUBLIC PLACES, CONTROLLING THE ENTRANCES TO BUILDINGS AND VIDEO CONFERENCING, AND ELECTRONIC IMAGE PROCESSORS FOR PROCESSING IMAGE DATA RECEIVED FROM SUCH CAMERAS; PRE-RECORDED DATA CARRIERS CONTAINING SOFTWARE FOR THE CONTROL OF CAMERAS FOR SURVEILLANCE OF HOMES, BUSINESS AND PUBLIC PLACES, CONTROLLING THE ENTRANCES TO BUILDINGS AND VIDEO CONFERENCING, AND SOFTWARE FOR THE PROCESSING OF IMAGE DATA RECEIVED FROM SUCH CAMERAS, IN CLASS 9 (U.S. CLS. 21, 23, 26, 36 AND 38).

FOR: LEASING OF TELECOMMUNICATION EQUIPMENT FOR THE TRANSMISSION OF IMAGE DATA RECEIVED FROM CAMERAS FOR SURVEILLANCE, CONTROLLING THE ENTRANCES TO BUILDINGS AND VIDEO CONFERENCING; LEASING OF TELECOMMUNICATION EQUIPMENT AND CONTROL CENTERS COMPRISED OF TELECOMMUNICATIONS EQUIPMENT FOR INSTALLATIONS RELATED TO CAMERAS FOR SURVEILLANCE, CONTROLLING THE ENTRANCES TO BUILDINGS AND VIDEO

CONFERENCING, IN CLASS 38 (U.S. CLS. 100, 101 AND 104).

FOR: SCIENTIFIC AND INDUSTRIAL RESEARCH IN THE FIELD OF CAMERAS FOR SURVEILLANCE, CONTROLLING THE ENTRANCES TO BUILDINGS AND VIDEO CONFERENCING AND THE TRANSMISSION OF IMAGE DATA FROM CAMERAS FOR SURVEILLANCE, CONTROLLING THE ENTRANCES TO BUILDINGS AND VIDEO CONFERENCING; COMPUTER PROGRAMMING FOR OTHERS IN THE FIELD OF TRANSMISSION OF LIVE IMAGES BY DATA CABLES AND/OR THE CONTROL OF ELECTRICAL APPARATUS, IN CLASS 42 (U.S. CLS. 100 AND 101).

FOR: CONSULTANCY IN THE FIELD OF SECURITY, IN CLASS 45 (U.S. CLS. 100 AND 101).

OWNER OF INTERNATIONAL REGISTRATION 0953505 DATED 8-6-2007, EXPIRES 8-6-2017.

THE COLOR(S) BLUE, GREY IS/ARE CLAIMED AS A FEATURE OF THE MARK.

THE COLOR BLUE APPEARS IN THE LETTER "M" AND THE COLOR GREY APPEARS IN THE LETTER "X".

SER. NO. 79-049,972, FILED 8-6-2007.

COLLEEN KEARNEY, EXAMINING ATTORNEY

Int. Cl.: 12

Prior U.S. Cls.: 19, 21, 23, 31, 35 and 44

United States Patent and Trademark Office

Reg. No. 3,576,415

Registered Feb. 17, 2009

**TRADEMARK
PRINCIPAL REGISTER**



BLUE DREAM S.P.A. (ITALY JOINT STOCK
COMPANY)
VIA PAOLO EMILIO BOTTA, 1
I-35138 PADOVA
ITALY

FOR: BOATS, MOTORBOATS, SPEEDBOATS,
SHIPS, YACHTS, FERRY BOATS, SAIL BOATS,
CANOES, HOUSE BOATS; PERSONAL WATER-
CRAFT, NAMELY, SMALL POWERBOATS, PERSONAL
JET BOATS; ALL-TERRAIN VEHICLES, ALSO
KNOWN AS ATV; SPORTS CARS, CARS, CABLE
CARS, AUTOMOBILES, CARTS, GO CARTS, PICK-
UP TRUCKS, BUSES, TRACTORS; AIRPLANES,
HELICOPTERS, HOVERCRAFTS, HYDROPLANES,
SEAPLANES, AMPHIBIOUS VEHICLES; MOTOR-
IZED SCOOTERS, WATER SCOOTERS; BICYCLES,
MOTORCYCLES; SKI LIFTS, SNOWMOBILES;
TRUCKS, LUGGAGE TRUCKS, TWO-WHEELED
TROLLEYS; TRAILERS; WAGONS; LUGGAGE
CARRIERS FOR VEHICLES; SKI-CARRIERS FOR

VEHICLES, LOCOMOTIVES; RECREATIONAL VE-
HICLES, NAMELY, CAMPERS; VANS, IN CLASS 12
(U.S. CLS. 19, 21, 23, 31, 35 AND 44).

PRIORITY DATE OF 7-2-2007 IS CLAIMED.

OWNER OF INTERNATIONAL REGISTRATION
0953527 DATED 10-11-2007, EXPIRES 10-11-2017.

THE MARK CONSISTS OF A SIGN DEPICTING
THE WORDING "BLUE DREAM," IN FANCY
CHARACTERS, ON THE LEFT OF WHICH A UN-
DULATING BAND IS POSITIONED COMPOSED OF
VARIOUS CIRCULAR SIGNS.

SER. NO. 79-049,980, FILED 10-11-2007.

ELI HELLMAN, EXAMINING ATTORNEY

Int. Cl.: 15

Prior U.S. Cls.: 2, 21 and 36

United States Patent and Trademark Office

Reg. No. 3,576,416

Registered Feb. 17, 2009

**TRADEMARK
PRINCIPAL REGISTER**



SANS LUTHIER DISTRIBUCIÓ S.L.U. (SPAIN
LIMITED LIABILITY CORPORATION OF A
SINGLE SHAREHOLDER)
SANTA MAGDALENA, 2
E-17854 (GIRONA)
SANT JAUME DE LLIERCA, SPAIN

OWNER OF INTERNATIONAL REGISTRATION
0953576 DATED 12-19-2007, EXPIRES 12-19-2017.

FOR: MUSICAL INSTRUMENTS, MOUTHPIECES
FOR MUSICAL INSTRUMENTS, VALVES FOR MU-
SICAL INSTRUMENTS, CASES FOR MUSICAL IN-
STRUMENTS, IN CLASS 15 (U.S. CLS. 2, 21 AND 36).

SER. NO. 79-050,003, FILED 12-19-2007.

JEAN IM, EXAMINING ATTORNEY

Int. Cls.: 29 and 31

Prior U.S. Cls.: 1 and 46

United States Patent and Trademark Office

Reg. No. 3,576,417

Registered Feb. 17, 2009

**TRADEMARK
PRINCIPAL REGISTER**



BACCINI ORTOFRUTTA S.R.L. (ITALY LIMITED LIABILITY COMPANY)
PIAZZA ARTOM, 12
I-50127 FIRENZE
ITALY

THE COLOR(S) BLUE, ORANGE, LIGHT ORANGE AND WHITE IS/ARE CLAIMED AS A FEATURE OF THE MARK.

FOR: PRESERVED, DRIED AND COOKED FRUITS AND VEGETABLES, IN CLASS 29 (U.S. CL. 46).

THE COLOR BLUE APPEARS IN THE BANNER HELD BY THE CHARACTER; THE COLOR ORANGE APPEARS IN THE INSIDE ENDS OF THE BANNER AND THE RIM AROUND THE SUN; THE COLOR LIGHT ORANGE APPEARS IN THE HAT OF THE CHARACTER, THE GLOVES AND THE INSIDE OF THE SUN AND THE COLOR WHITE APPEARS IN THE MUSTACHE OF THE CHARACTER AND EYEBALLS AND THE WORDING "MR. PICKER".

FOR: AGRICULTURAL SEEDS AND AGRICULTURAL GRAINS FOR PLANTING; FRESH FRUITS AND VEGETABLES, IN CLASS 31 (U.S. CLS. 1 AND 46).

OWNER OF INTERNATIONAL REGISTRATION 0953614 DATED 12-20-2007, EXPIRES 12-20-2017.

SER. NO. 79-050,022, FILED 12-20-2007.

THE NAME(S), PORTRAIT(S), AND/OR SIGNATURE(S) SHOWN IN THE MARK DOES NOT IDENTIFY A PARTICULAR LIVING INDIVIDUAL.

LESLEY LAMOTHE, EXAMINING ATTORNEY

Int. Cls.: 1 and 19

Prior U.S. Cls.: 1, 5, 6, 10, 12, 26, 33, 46 and 50

Reg. No. 3,576,418

United States Patent and Trademark Office

Registered Feb. 17, 2009

**TRADEMARK
PRINCIPAL REGISTER**

SECAR XENIOM

KERNEOS (FRANCE SOCIÉTÉ ANONYME)
8 RUE DES GRAVIERS
F-92200 NEUILLY-SUR-SEINE
FRANCE

FOR: CALCIUM ALUMINATES, NAMELY, CALCIUM ALUMINATE CHEMICAL PRODUCTS FOR USE IN THE BUILDING INDUSTRY AND CALCIUM ALUMINATE CHEMICAL PRODUCTS FOR USE IN THE REFRACTORY INDUSTRY; MINERAL AND CHEMICAL ADDITIVES AND ADMIXTURES FOR BUILDING MATERIALS, NAMELY, CONCRETE ADDITIVES, CONCRETE ADMIXTURES, CEMENT ADDITIVES, CEMENT ADMIXTURES, MORTAR ADDITIVES, AND MORTAR ADMIXTURES; CALCIUM ALUMINATE; ADDITIVES FOR CONCRETE; LIME CARBONATE, IN CLASS 1 (U.S. CLS. 1, 5, 6, 10, 26 AND 46).

FOR: CEMENTS, NAMELY, CEMENT MIXES; CEMENT MIXES MADE OF CALCIUM ALUMINATES, ALUMINOUS CEMENT MIXES, REFRACTORY CEMENT MIXES, AND HYDRAULIC BINDING AGENTS; CONCRETES, CONCRETES

MADE OF CALCIUM ALUMINATES, MORTARS, MORTARS MADE OF CALCIUM ALUMINATES; HARD AGGREGATE MATERIAL COMPOSED OF CEMENT AND MORTAR FOR HIGH PERFORMANCE CONCRETE; NON-METALLIC BUILDING MATERIALS WITH HIGH ALUMINA CONTENT, NAMELY, CEMENTS, CONCRETES, AND MORTARS, IN CLASS 19 (U.S. CLS. 1, 12, 33 AND 50).

THE MARK CONSISTS OF STANDARD CHARACTERS WITHOUT CLAIM TO ANY PARTICULAR FONT, STYLE, SIZE, OR COLOR.

PRIORITY DATE OF 7-19-2007 IS CLAIMED.

OWNER OF INTERNATIONAL REGISTRATION
0953630 DATED 1-15-2008, EXPIRES 1-15-2018.

SER. NO. 79-050,032, FILED 1-15-2008.

MICHAEL SOUDERS, EXAMINING ATTORNEY

Int. Cl.: 10

Prior U.S. Cls.: 26, 39 and 44

United States Patent and Trademark Office

Reg. No. 3,576,419

Registered Feb. 17, 2009

**TRADEMARK
PRINCIPAL REGISTER**

COCOON

CARE ESSENTIALS PTY LTD (AUSTRALIA
COMPANY)
PO BOX 808
MULGRAVE VIC 3170
AUSTRALIA

FOR: MEDICAL APPARATUS, EQUIPMENT OR
MACHINES TO KEEP PATIENTS WARM OR AT
SPECIFIC TEMPERATURES FOR PRE OR POST-
OPERATIVE CARE; PATIENT TEMPERATURE
MONITORS; MEDICAL BODY WARMERS; MEDI-
CAL ELECTRIC WARMING PADS, MEDICAL
BLANKETS FOR THE WARMING PATIENTS; MED-
ICAL WARMERS; MEDICAL WARMING APPARA-
TUS; MEDICAL THERMAL BLANKETS; MEDICAL
ELECTRIC BLANKETS; MEDICAL BLANKETS FOR

PRE AND POST OPERATIVE PATIENT CARE, IN
CLASS 10 (U.S. CLS. 26, 39 AND 44).

THE MARK CONSISTS OF STANDARD CHAR-
ACTERS WITHOUT CLAIM TO ANY PARTICULAR
FONT, STYLE, SIZE, OR COLOR.

OWNER OF INTERNATIONAL REGISTRATION
0953736 DATED 1-15-2008, EXPIRES 1-15-2018.

SER. NO. 79-050,064, FILED 1-15-2008.

RICHARD A. STRASER, EXAMINING ATTORNEY

Int. Cls.: 3, 4, 9, 14, 18, 20, 21, 24 and 25

Prior U.S. Cls.: 1, 2, 3, 4, 6, 13, 15, 21, 22, 23, 25, 26, 27, 28, 29, 30, 32, 33, 36, 38, 39, 40, 41, 42, 50, 51 and 52

Reg. No. 3,576,420

United States Patent and Trademark Office

Registered Feb. 17, 2009

**TRADEMARK
PRINCIPAL REGISTER**



CARMEN BUSQUETS (VENEZUELA INDIVIDUAL)
11 RUE BAYARD
F-75008 PARIS
FRANCE

FOR: SOAPS, PERFUMERY, COSMETICS, BODY OILS AND LOTIONS, AND PERFUMES, IN CLASS 3 (U.S. CLS. 1, 4, 6, 50, 51 AND 52).

FOR: CANDLES, IN CLASS 4 (U.S. CLS. 1, 6 AND 15).

FOR: OPTICAL INSTRUMENTS, NAMELY, SPECTACLES AND SUNGLASSES, IN CLASS 9 (U.S. CLS. 21, 23, 26, 36 AND 38).

FOR: PRECIOUS METALS AND THEIR ALLOYS, KEY RINGS OF PRECIOUS METAL, JEWELLERY, PRECIOUS STONES, NAMELY, PEARLS AND DIAMONDS, HOROLOGICAL AND CHRONOMETRIC INSTRUMENTS, AND ITEMS OF JEWELRY, NAMELY, EARRINGS, WATCH BANDS, BRACELETS, NECKLACES AND BROOCHES, IN CLASS 14 (U.S. CLS. 2, 27, 28 AND 50).

FOR: LEATHER AND IMITATION LEATHER, TRUNKS, CHESTS, SUITCASES, HANDBAGS, SHOPPING BAGS OF MESH AND TEXTILE, RUCKSACKS, TRAVELLING BAGS, SCHOOL BAGS, BEACH BAGS, BAGS FOR CAMPER AND CLIMBERS, NAMELY, HIKING BAGS AND BACKPACKS, SHOPPING BAGS WITH ATTACHED WHEELS, UMBRELLAS AND PARASOLS, AND

LEATHER ARTICLES, NAMELY, BAGS AND CASES, IN CLASS 18 (U.S. CLS. 1, 2, 3, 22 AND 41).

FOR: FURNITURE, MIRRORS, PICTURE FRAMES, WORKS OF ART MADE OF SHELL, OF CORAL, OF HORN, STUFFED ANIMALS, CUSHIONS, WOODEN OR PLASTIC BOXES, AND STOOLS, IN CLASS 20 (U.S. CLS. 2, 13, 22, 25, 32 AND 50).

FOR: TABLEWARE OF PRECIOUS METAL, NAMELY, PLATES, BOWLS, SAUCERS, CUPS, CANDLESTICKS, SERVING TRAYS, AND PITCHERS, IN CLASS 21 (U.S. CLS. 2, 13, 23, 29, 30, 33, 40 AND 50).

FOR: FABRICS FOR TEXTILE USE, HOUSEHOLD LINEN, TABLE LINEN, BATH LINEN, FACE TOWELS OF TEXTILE, HAND TOWELS OF TEXTILE, IN CLASS 24 (U.S. CLS. 42 AND 50).

FOR: CLOTHING FOR MEN, WOMEN, CHILDREN AND INFANTS, NAMELY, SHIRTS, BLOUSES, VESTS, CARDIGANS, HATS, T-SHIRTS, SWEATSHIRTS AND POLO SHIRTS; CASHMERE SCARVES, HATS, SWEATERS, PULLOVERS AND CARDIGANS; PANTS, JEANS AND CORDUROY PANTS; SKIRTS, SUITS, DRESSES, JACKETS, COATS AND CAPES; TUXEDOS AND EVENING GOWNS; INFANT AND TODDLER ONE-PIECE CLOTHING; FOOTWEAR, NAMELY, SHOES, BOOTS, SANDALS, MULES AND SLIPPERS; UNDERWEAR; AND GLOVES AND BELTS, IN CLASS 25 (U.S. CLS. 22 AND 39).

PRIORITY DATE OF 5-3-2007 IS CLAIMED.

THE MARK CONSISTS OF A STYLIZED LETTER
"C."

OWNER OF INTERNATIONAL REGISTRATION
0954090 DATED 11-2-2007, EXPIRES 11-2-2017.

SER. NO. 79-050,223, FILED 11-2-2007.

AISHA SALEM, EXAMINING ATTORNEY

Int. Cls.: 11, 20 and 21

Prior U.S. Cls.: 2, 13, 21, 22, 23, 25, 29, 30, 31, 32, 33, 34, 40 and 50

Reg. No. 3,576,421

United States Patent and Trademark Office

Registered Feb. 17, 2009

**TRADEMARK
PRINCIPAL REGISTER**

VASCO
HEATINGCONCEPTS

THE HEATING COMPANY BVBA (BELGIUM BVBA)
KRUISSHOEFSTRAAT 50
B-3650 DILSEN
BELGIUM

FOR: APPARATUS FOR LIGHTING, HEATING, STEAM GENERATING, COOKING, REFRIGERATING, DRYING, VENTILATING, WATER SUPPLY AND SANITARY PURPOSES, NAMELY, RADIATORS AND RADIATOR SEALS; INDIVIDUAL AND REPLACEMENT PARTS FOR ALL THE AFORESAID GOODS, IN CLASS 11 (U.S. CLS. 13, 21, 23, 31 AND 34).

FOR: FURNITURE AND FURNITURE PARTS AND PLASTIC PRODUCTS, NOT INCLUDED IN OTHER CLASSES, IN PARTICULAR, FURNITURE OF METAL, PLASTIC OR GLASS FOR EQUIPPING KITCHENS, BATHROOMS AND WASHROOMS; MIRRORS FOR INTERIOR FITTINGS; TOILET MIRRORS AND SHAVING MIRRORS; PARTS AND SPARE PARTS FOR ALL THE AFORESAID GOODS, IN CLASS 20 (U.S. CLS. 2, 13, 22, 25, 32 AND 50).

FOR: WASHROOM AND BATHROOM ACCESSORIES, NAMELY, TOWEL HOLDERS IN THE NATURE OF TOWEL BARS, RINGS AND RAILS, SOAP DISPENSERS, SOAP DISHES, SOAP HOLDERS, TOOTHBRUSH MUGS IN THE NATURE OF TOOTHBRUSH HOLDERS; UNITS FOR STORING TOILET UTENSILS, NAMELY, TOILET BRUSH HOLDER, TOILET PAPER HOLDER, TOILET BRUSHES, TOILET SPONGES; HOLDERS FOR TOILET ACCESSORIES, NAMELY, TOILET PAPER HOLDERS, TOILET TISSUE HOLDERS, TOILET ROLL HOLDERS, TOILET PAPER DISPENSERS; SMALL HOUSEHOLD APPARATUS AND PORTABLE CON-

TAINERS FOR HOUSEHOLD PURPOSES OF METAL, PLASTIC AND WOOD, NOT OF PRECIOUS METAL OR COATED THEREWITH, NAMELY, ALL PURPOSE PORTABLE HOUSEHOLD CONTAINERS, CONTAINERS FOR HOUSEHOLD OR KITCHEN USE, CONTAINERS FOR HOUSEHOLD USE, HOUSEHOLD CONTAINERS FOR FOOD, CONTAINERS FOR ICE, PORTABLE PLASTIC CONTAINERS FOR STORING HOUSEHOLD AND KITCHEN GOODS, PLASTIC STORAGE CONTAINERS FOR HOUSEHOLD USE, THERMAL INSULATED CONTAINERS FOR FOOD OR BEVERAGE, CONTAINERS FOR HOUSEHOLD USE, NAMELY, GLASS BULBS AND GLOBES, COLANDERS FOR HOUSEHOLD USE, GRATERS FOR HOUSEHOLD PURPOSES, HOLDERS FOR HOUSEHOLD IRONS, TRASH CONTAINERS FOR HOUSEHOLD USE, LAUNDRY BINS FOR HOUSEHOLD USE, SOAP CONTAINERS FOR HOUSEHOLD USE, HOUSEHOLD UTENSILS, NAMELY, GRATERS, SIEVES, SPATULAS, STRAINERS AND TURNERS; GLASSWARE, NAMELY, BEVERAGE GLASSWARE; PORCELAIN, NAMELY, PORCELAIN BUSTS, PORCELAIN SCULPTURES, STATUES AND STATUETTES, PORCELAIN KNOBS, PORCELAIN DOORKNOBS, PORCELAIN MUGS, PORCELAIN FIGURES AND FIGURINES, HOLIDAY ORNAMENTS OF PORCELAIN; ORNAMENTS OF PORCELAIN; EARTHENWARE, NAMELY EARTHENWARE BUSTS, EARTHENWARE SCULPTURES, STATUES AND STATUETTES, EARTHENWARE FIGURES AND FIGURINES, EARTHENWARE DOORKNOBS, EARTHENWARE DRAWER PULLS, EARTHENWARE MUGS; INDIVIDUAL AND REPLACEMENT PARTS FOR ALL THE AFORESAID GOODS, IN CLASS 21 (U.S. CLS. 2, 13, 23, 29, 30, 33, 40 AND 50).

PRIORITY DATE OF 7-16-2007 IS CLAIMED.

OWNER OF INTERNATIONAL REGISTRATION
0954130 DATED 11-22-2007, EXPIRES 11-22-2017.

OWNER OF U.S. REG. NO. 2,225,037.

THE COLOR(S) DARK GREY, RED IS/ARE
CLAIMED AS A FEATURE OF THE MARK.

THE MARK CONSISTS OF THE WORDING
"VASCO" IN DARK GRAY AND BENEATH THIS
WORDING "HEATINGCONCEPTS" IN RED.

THE FOREIGN WORDING IN THE MARK
TRANSLATES INTO ENGLISH AS BASQUE.

SER. NO. 79-050,238, FILED 11-22-2007.

NAKIA HENRY, EXAMINING ATTORNEY

Int. Cl.: 33

Prior U.S. Cls.: 47 and 49

United States Patent and Trademark Office

Reg. No. 3,576,422

Registered Feb. 17, 2009

TRADEMARK
PRINCIPAL REGISTER



CHATEAU LYNCH-BAGES (FRANCE SOCIETE
PAR ACTIONS SIMPLIFIEE)
CHATEAU LYNCH-BAGES
F-33250 PAUILLAC
FRANCE

FOR: WINES OF GUARANTEED LABEL OF
ORIGIN FROM THE ESTATE CALLED CHATEAU
LYNCH-BAGES, IN CLASS 33 (U.S. CLS. 47 AND 49).

PRIORITY DATE OF 10-12-2007 IS CLAIMED.

OWNER OF INTERNATIONAL REGISTRATION
0954614 DATED 12-26-2007, EXPIRES 12-26-2017.

OWNER OF U.S. REG. NO. 1,729,720.

NO CLAIM IS MADE TO THE EXCLUSIVE
RIGHT TO USE "CHATEAU", "GRAND CRU
CLASSE", "PAUILLAC", "2000", AND "PROPRIE-
TAIRE A PAUILLAC", APART FROM THE MARK
AS SHOWN.

THE COLOR(S) RED AND BLACK IS/ARE
CLAIMED AS A FEATURE OF THE MARK.

LABEL FRAMED IN RED, CONTAINING THE
DESIGN "CHATEAU LYNCH BAGES" AND TWO
SEALS IN RED AT THE BOTTOM ON EITHER SIDE
OF THE LABEL: "GRAND VIN" (IN RED); "CHA-
TEAU LYNCH BAGES" (IN BLACK), "GRAND CRU
CLASSE" (IN RED); "PAUILLAC" (IN BLACK); JM
CAZES PROPRIETAIRE A PAUILLAC" (IN RED).

THE WORDS "GRAND VIN GRAND CRU
CLASSE PROPRIETATRE" MAY BE TRANSLATED
INTO ENGLISH AS GREAT WINE FIRST VINTAGE
CLASS PROPRIETER.

SER. NO. 79-050,371, FILED 12-26-2007.

LESLEY LAMOTHE, EXAMINING ATTORNEY

Int. Cls.: 17 and 20

Prior U.S. Cls.: 1, 2, 5, 12, 13, 22, 25, 32, 35 and 50

United States Patent and Trademark Office

Reg. No. 3,576,423

Registered Feb. 17, 2009

**TRADEMARK
PRINCIPAL REGISTER**

XAPURA

LATEXCO, NAAMLOZE VENNOOTSCHAP (BELGIUM JOINT STOCK COMPANY)
SINT-AMANDSTRAAT 8 BIS
B-8700 TIELT
BELGIUM

FOR: RUBBER, GUTTA-PERCHA, GUM RESINS IN EXTRUDED FORM FOR GENERAL INDUSTRIAL USE AND GOODS MADE FROM THESE MATERIALS, NAMELY, LATEX MATTRESSES AND SEMI FINISHED RUBBER OR LATEX MOLDED SUBSTANCES FOR THE BEDDING INDUSTRY USED IN MATTRESSES; SEMI-FINISHED RUBBER OR LATEX MOLDED SUBSTANCES FOR THE MANUFACTURE OF MATTRESSES AND PILLOWS; LATEX RUBBER FOR USE IN THE MANUFACTURE OF MATTRESS CORES, IN CLASS 17 (U.S. CLS. 1, 5, 12, 13, 35 AND 50).

FOR: FURNITURE AND FURNITURE PARTS, MIRRORS, PICTURE FRAMES; CUSHIONS; BEDS AND SPRING MATTRESSES; MATTRESSES; BED-

DING, NAMELY, LATEX MATTRESSES, IN CLASS 20 (U.S. CLS. 2, 13, 22, 25, 32 AND 50).

THE MARK CONSISTS OF STANDARD CHARACTERS WITHOUT CLAIM TO ANY PARTICULAR FONT, STYLE, SIZE, OR COLOR.

PRIORITY DATE OF 7-24-2007 IS CLAIMED.

OWNER OF INTERNATIONAL REGISTRATION 0954816 DATED 1-24-2008, EXPIRES 1-24-2018.

THE MARK "XAPURA" HAS NO MEANING IN A FOREIGN LANGUAGE.

SER. NO. 79-050,418, FILED 1-24-2008.

JESSICA A. POWERS, EXAMINING ATTORNEY

Int. Cls.: 35 and 41

Prior U.S. Cls.: 100, 101, 102 and 107

United States Patent and Trademark Office

Reg. No. 3,576,424

Registered Feb. 17, 2009

**SERVICE MARK
PRINCIPAL REGISTER**

photokina

KOELNMESSE GMBH (FED REP GERMANY
GMBH (LIMITED LIABILITY COMPANY))
MESSEPLATZ 1
50679 KÖLN
FED REP GERMANY

FOR: ORGANIZATION OF EXHIBITIONS FOR
COMMERCIAL OR ADVERTISING PURPOSES;
CONSULTATION FOR EXHIBITORS IN BUSINESS
ORGANIZATION AND BUSINESS MANAGEMENT;
MARKETING, PUBLICITY, ADVERTISING SERVI-
CES; DISSEMINATION OF ADVERTISING MAT-
TER, IN CLASS 35 (U.S. CLS. 100, 101 AND 102).

FOR: ORGANIZATION OF FAIRS AND EXHIBI-
TIONS FOR CULTURAL OR EDUCATIONAL PUR-
POSES; ORGANIZATION OF EDUCATIONAL AND

CULTURAL CONGRESSES AND MEETINGS, IN
CLASS 41 (U.S. CLS. 100, 101 AND 107).

THE MARK CONSISTS OF STANDARD CHAR-
ACTERS WITHOUT CLAIM TO ANY PARTICULAR
FONT, STYLE, SIZE, OR COLOR.

OWNER OF INTERNATIONAL REGISTRATION
0687269 DATED 12-18-1997, EXPIRES 12-18-2017.

OWNER OF U.S. REG. NO. 835,272.

SER. NO. 79-050,427, FILED 12-19-2007.

Laurie Mayes, Examining Attorney

Int. Cls.: 17 and 19

Prior U.S. Cls.: 1, 5, 12, 13, 33, 35 and 50

United States Patent and Trademark Office

Reg. No. 3,576,425

Registered Feb. 17, 2009

**TRADEMARK
PRINCIPAL REGISTER**

VALPEX

HUANG XINPING (CHINA INDIVIDUAL)
NO. 209 TUJIA VILLAGE,
DIANKOU TOWN, ZHUJI CITY; ZHEJIANG PRO-
VINCE
CHINA

FOR: FLEXIBLE PLASTIC PIPE FOR PLUMBING;
JUNCTIONS NOT OF METAL FOR PLUMBING
PIPES; PIPE GASKETS; PIPE JACKETS, NOT OF
METAL FOR USE WITH PLUMBING PIPE; CYLIN-
DER JOININGS; SEMI-FINISHED PLASTIC IN THE
FORM OF STRIPS, IN CLASS 17 (U.S. CLS. 1, 5, 12, 13,
35 AND 50).

FOR: RIGID PIPES NOT OF METAL; WATER
PIPES NOT OF METAL; WATER PIPE VALVES, NOT
OF METAL OR PLASTIC; RIGID PIPES NOT OF
POLYPROPYLENE FOR THE SUPPLY OF DRINK-
ING WATER AND HEATING AND AIR CONDI-
TIONING SYSTEMS IN HOUSES, OFFICE
BUILDINGS AND INDUSTRIAL BUILDINGS;
DUCTS, NOT OF METAL, FOR VENTILATING

AND AIR-CONDITIONING INSTALLATIONS;
DRAIN PIPES, NOT OF METAL, MADE OF CON-
CRETE, CERAMIC, EARTHENWARE, SANDSTONE
AND WOOD; NON-METAL PENSTOCK PIPES
MADE OF CONCRETE, CERAMIC, EARTHEN-
WARE, SANDSTONE AND WOOD; PLASTIC-
BASED ALUMINUM-PLASTIC PIPES FOR DRAI-
NAGE AND WATER SUPPLY AND AIR CONDI-
TIONING SYSTEMS; PLASTIC BOARDS FOR
BUILDING USE, IN CLASS 19 (U.S. CLS. 1, 12, 33
AND 50).

OWNER OF INTERNATIONAL REGISTRATION
0954935 DATED 11-15-2007, EXPIRES 11-15-2017.

THE MARK CONSISTS OF THE WORD "VAL-
PEX".

SER. NO. 79-050,476, FILED 11-15-2007.

JULIE VEPPUMTHARA, EXAMINING ATTORNEY

Int. Cls.: 41 and 42

Prior U.S. Cls.: 100, 101 and 107

United States Patent and Trademark Office

Reg. No. 3,576,426

Registered Feb. 17, 2009

**SERVICE MARK
PRINCIPAL REGISTER**



IDEAL EDUCATION GROUP, S.L. (SPAIN S.L.)
ALBERTO AGUILERA, 26
E-28015 MADRID
SPAIN

FOR: EDUCATION SERVICES, NAMELY, PROVIDING CLASSES, SEMINARS AND WORKSHOPS IN THE FIELD OF LANGUAGE LEARNING; LANGUAGE SERVICES, NAMELY, LANGUAGE INSTRUCTION, LANGUAGE INTERPRETATION, LANGUAGE TRANSLATION, IN CLASS 41 (U.S. CLS. 100, 101 AND 107).

FOR: QUALITY CONTROL SERVICES FOR OTHERS, ACCREDITATION SERVICES, NAMELY, DEVELOPING AND PROVIDING STANDARDS FOR PREPARATION OF STANDARDS AND CERTIFICATION OF LANGUAGE LEARNING FOR THE PURPOSES OF ACCREDITATION AND CERTIFICATION, IN CLASS 42 (U.S. CLS. 100 AND 101).

PRIORITY DATE OF 7-5-2007 IS CLAIMED.

OWNER OF INTERNATIONAL REGISTRATION
0955001 DATED 12-14-2007, EXPIRES 12-14-2017.

NO CLAIM IS MADE TO THE EXCLUSIVE RIGHT TO USE "QUALITY CERTIFICATE", APART FROM THE MARK AS SHOWN.

THE COLOR(S) BLUE, RED AND GARNET IS/ ARE CLAIMED AS A FEATURE OF THE MARK.

THE MARK CONSISTS OF THE HIGHLY STYLIZED ACRONYM "IQ" THE LETTER "Q" APPEARS IN THE COLOR BLUE. THE BODY OF THE LETTER "I" IS FORMED BY THE LINE IN THE LETTER "Q" THE DOT OF THE LETTER "I" APPEARS IN THE CENTER OF THE LETTER "Q" IN THE COLOR RED. TO THE RIGHT OF THE "IQ" ACRONYM APPEARS THE WORDING "IDEAL QUALITY CERTIFICATE" THE WORDING "IDEAL QUALITY" APPEARS IN THE COLOR BLUE, AND THE TERM "CERTIFICATE" APPEARS IN THE COLOR GARNET.

SER. NO. 79-050,505, FILED 12-14-2007.

JEFFERY COWARD, EXAMINING ATTORNEY

Int. Cl.: 32

Prior U.S. Cls.: 45, 46 and 48

United States Patent and Trademark Office

Reg. No. 3,576,427

Registered Feb. 17, 2009

**TRADEMARK
PRINCIPAL REGISTER**

T.G.R. ENERGY DRINK

GELLWE SP. Z.O.O. (POLAND COMPANY)
UL. SPOKOJNA 4
ZABIERZOW, POLAND PL32080

FOR: ESSENCES FOR MAKING BEVERAGES, NAMELY, ESSENCES FOR MAKING SOFT DRINKS; LEMONADES, POWDERS USED IN THE PREPARATION OF SOFT DRINKS, NAMELY, LEMONADE POWDER, NON-ALCOHOLIC BEVERAGES, NAMELY, FRUIT JUICE BEVERAGES, EFFERVESCING BEVERAGES, NAMELY, SOFT DRINKS; FRUIT NECTARS, PREPARATIONS FOR MAKING SPARKLING WATER, POWDERED PREPARATIONS FOR MAKING SPORTS DRINKS AND ENERGY DRINKS, PREPARATIONS FOR MAKING MINERAL WATER, FRUIT JUICES, VEGETABLE JUICES, SORBETS IN THE FORM OF BEVERAGES,

SYRUPS FOR BEVERAGES, SPARKLING WATER, TABLE WATERS, MINERAL WATER, COOLING SPORTS AND ENERGY DRINKS, IN CLASS 32 (U.S. CLS. 45, 46 AND 48).

OWNER OF INTERNATIONAL REGISTRATION
0955130 DATED 1-17-2008, EXPIRES 1-17-2018.

NO CLAIM IS MADE TO THE EXCLUSIVE RIGHT TO USE "ENERGY DRINK", APART FROM THE MARK AS SHOWN.

SER. NO. 79-050,536, FILED 1-17-2008.

ANTHONY RINKER, EXAMINING ATTORNEY

Int. Cls.: 9 and 12

Prior U.S. Cls.: 19, 21, 23, 26, 31, 35, 36, 38 and 44

United States Patent and Trademark Office

Reg. No. 3,576,428

Registered Feb. 17, 2009

**TRADEMARK
PRINCIPAL REGISTER**



MCI (MIRROR CONTROLS INTERNATIONAL)
B.V. (NETHERLANDS BESLOTEN VENNOOTSCHAP)

WAARDEDIJK-OOST 9
NL-3417 XJ MONTFOORT
NETHERLANDS

FOR: ELECTRIC AND ELECTRONIC APPARATUS AND INSTRUMENTS, NAMELY, OPERATING SYSTEMS FOR CAR MIRRORS COMPOSED OF MICROPROCESSORS AND ELECTRONIC CONTROLS FOR CAR MIRRORS, IN CLASS 9 (U.S. CLS. 21, 23, 26, 36 AND 38).

FOR: PARTS OF VEHICLES, NAMELY, CAR MIRRORS AND STRUCTURAL PARTS THEREFOR, IN CLASS 12 (U.S. CLS. 19, 21, 23, 31, 35 AND 44).

PRIORITY DATE OF 7-30-2007 IS CLAIMED.

OWNER OF INTERNATIONAL REGISTRATION
0955203 DATED 1-10-2008, EXPIRES 1-10-2018.

THE COLOR(S) BLUE AND WHITE IS/ARE
CLAIMED AS A FEATURE OF THE MARK.

THE MARK CONSISTS OF THE COLORS BLUE AND WHITE, WITH THE COLOR BLUE APPEARING IN THE WORDING "MCI" AND IN THE THREE TRIANGLES TO THE LEFT OF THE WORDING "MCI" AND IN THE SHADING BEHIND THE WORDING "MCI", AND THE COLOR WHITE APPEARING IN THE TWO TRIANGLES TO THE LEFT OF THE WORDING "MCI" AND IN THE WHITE RECTANGLE BEHIND THE WORDING "MCI".

SER. NO. 79-050,555, FILED 1-10-2008.

APRIL ROACH, EXAMINING ATTORNEY

Int. Cls.: 9 and 12

Prior U.S. Cls.: 19, 21, 23, 26, 31, 35, 36, 38 and 44

United States Patent and Trademark Office

Reg. No. 3,576,429

Registered Feb. 17, 2009

**TRADEMARK
PRINCIPAL REGISTER**

Mci

MCI (MIRROR CONTROLS INTERNATIONAL)
B.V. (NETHERLANDS BESLOTEN VENNOOTSCHAP)
WAARDEDIJK-OOST 9
NL-3417 XJ MONTFOORT
NETHERLANDS

FOR: ELECTRIC AND ELECTRONIC APPARATUS AND INSTRUMENTS, NAMELY, OPERATING SYSTEMS FOR CAR MIRRORS COMPOSED OF MICROPROCESSORS AND ELECTRONIC CONTROLS FOR CAR MIRRORS, IN CLASS 9 (U.S. CLS. 21, 23, 26, 36 AND 38).

FOR: PARTS OF VEHICLES, NAMELY, CAR MIRRORS AND STRUCTURAL PARTS THEREFOR, IN CLASS 12 (U.S. CLS. 19, 21, 23, 31, 35 AND 44).

THE MARK CONSISTS OF STANDARD CHARACTERS WITHOUT CLAIM TO ANY PARTICULAR FONT, STYLE, SIZE, OR COLOR.

PRIORITY DATE OF 7-12-2007 IS CLAIMED.

OWNER OF INTERNATIONAL REGISTRATION
0955204 DATED 1-10-2008, EXPIRES 1-10-2018.

SER. NO. 79-050,556, FILED 1-10-2008.

APRIL ROACH, EXAMINING ATTORNEY

Int. Cl.: 7

Prior U.S. Cls.: 13, 19, 21, 23, 31, 34 and 35

United States Patent and Trademark Office

Reg. No. 3,576,430

Registered Feb. 17, 2009

**TRADEMARK
PRINCIPAL REGISTER**

ROTATEK

ROTATEK, S.A. (SPAIN SOCIEDAD ANÓNIMA)
AV. GRAELLS S/N
E-08190 SANT CUGAT DEL VALLES
(BARCELONA), SPAIN

HIGH QUALITY LABEL AND FLEXIBLE PACKAGING, LABEL INSPECTION SLITTER REWINDER, REEL COLLATOR FOR FORMS AND SNAP-OUT SETS, IN CLASS 7 (U.S. CLS. 13, 19, 21, 23, 31, 34 AND 35).

FOR: MACHINES FOR GRAPHIC ARTS, NAME-
LY, FLEXOGAPHIC ROTARY PRESS FOR LABEL
PRINTING AND PACKAGING, ROTARY OFFSET-
FLEXO PRESSES WITH VARIABLE FORMAT,
VARIABLE SIZE ROTARY FORMS PRESS, VARI-
ABLE FORMAT SEMI-ROTARY AND FULL RO-
TARY IN WET OFFSET, VARIABLE SLEEVE
OFFSET AND FLEXO PRINTING PRESS FOR THE

OWNER OF INTERNATIONAL REGISTRATION
0955206 DATED 6-21-2007, EXPIRES 6-21-2017.

SER. NO. 79-050,558, FILED 6-21-2007.

ELI HELLMAN, EXAMINING ATTORNEY

Int. Cls.: 9 and 21

**Prior U.S. Cls.: 2, 13, 21, 23, 26, 29, 30, 33, 36, 38, 40
and 50**

United States Patent and Trademark Office

Reg. No. 3,576,431

Registered Feb. 17, 2009

**TRADEMARK
PRINCIPAL REGISTER**

SCHOTT N-BK 7

SCHOTT AKTIENGESELLSCHAFT (FED REP
GERMANY AKTIENGESELLSCHAFT (JOINT
STOCK CORPORATION))
HATTENBERGSTRASSE 10
55122 MAINZ, FED REP GERMANY

FOR: OPTICAL GLASSES, IN CLASS 9 (U.S. CLS.
21, 23, 26, 36 AND 38).

FOR: UNWORKED OR SEMI-WORKED GLASS,
NOT GLASS USED IN BUILDING, IN CLASS 21 (U.S.
CLS. 2, 13, 23, 29, 30, 33, 40 AND 50).

THE MARK CONSISTS OF STANDARD CHAR-
ACTERS WITHOUT CLAIM TO ANY PARTICULAR
FONT, STYLE, SIZE, OR COLOR.

OWNER OF INTERNATIONAL REGISTRATION
0955367 DATED 1-30-2008, EXPIRES 1-30-2018.

SER. NO. 79-050,611, FILED 1-30-2008.

GILBERT SWIFT, EXAMINING ATTORNEY

Int. Cls.: 35 and 44

Prior U.S. Cls.: 100, 101 and 102

United States Patent and Trademark Office

Reg. No. 3,576,432

Registered Feb. 17, 2009

**SERVICE MARK
PRINCIPAL REGISTER**



dental line

CLINICAS DENTAL LINE, S.A. (SPAIN SOCIEDAD ANONIMA)
CAMINO DEL JAU, S/Nº
E-18320 SANTA FE (GRANADA)
SPAIN

FOR: ADVERTISING SERVICES; BUSINESS OPERATION AND MANAGEMENT CONSULTANCY FOR COMMERCIAL OR INDUSTRIAL COMPANIES; GOODS IMPORT-EXPORT AGENCIES; RETAIL STORES FEATURING DENTAL SUPPLIES, IN CLASS 35 (U.S. CLS. 100, 101 AND 102).

FOR: MEDICAL SERVICES; VETERINARY SERVICES; HYGIENIC AND BEAUTY CARE FOR HUMAN BEINGS OR ANIMALS, IN CLASS 44 (U.S. CLS. 100 AND 101).

OWNER OF INTERNATIONAL REGISTRATION 0955399 DATED 3-13-2007, EXPIRES 3-13-2017.

NO CLAIM IS MADE TO THE EXCLUSIVE RIGHT TO USE "DENTAL LINE", APART FROM THE MARK AS SHOWN.

THE TRADEMARK CONSISTS IN THE DENOMINATION "DENTAL LINE" CORRESPONDING TO THE COMMERCIAL NAME OF THE HOLDER WITH A SPECIAL SCRIPT AND UNDER TWO CURVED LINES JOINED AT THEIR ENDS IN A MOUTH FORM.

SER. NO. 79-050,624, FILED 3-13-2007.

ELI HELLMAN, EXAMINING ATTORNEY

Int. Cls.: 1, 5, 30, 31 and 32

Prior U.S. Cls.: 1, 5, 6, 10, 18, 26, 44, 45, 46, 48, 51 and 52

Reg. No. 3,576,433

United States Patent and Trademark Office

Registered Feb. 17, 2009

**TRADEMARK
PRINCIPAL REGISTER**

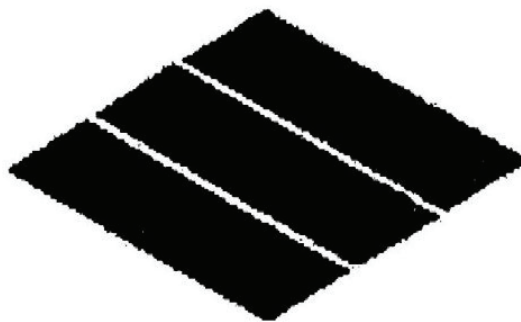

SANBISHI CO., LTD. (JAPAN CORPORATION)
123-1, MAMIZUKA-CHO
TOYOHASHI-SHI
AICHI-KEN 441-8007, JAPAN

FOR: ARTIFICIAL SWEETENERS, IN CLASS 1
(U.S. CLS. 1, 5, 6, 10, 26 AND 46).

FOR: POWDERED MILK FOR BABIES, IN CLASS
5 (U.S. CLS. 6, 18, 44, 46, 51 AND 52).

FOR: SOYA BEAN PASTE; WORCESTER SAUCE;
MEAT GRAVIES; KETCHUP; SOY SAUCE; VINE-
GAR; FLAVORED VINEGAR; SEASONING SOY
SAUCE; SALAD DRESSINGS; WHITE PASTA
SAUCE; MAYONNAISE; SAUCES FOR BARBE-
CUED MEAT; CUBE SUGAR; FRUCTOSE FLAVOR-
ING AND THICKENING SYRUP FOR USE IN THE
MANUFACTURE OF FOODS; CRYSTAL SUGAR;
SUGAR; MALTOSE; HONEY; GLUCOSE FOR
FOOD; POWDERED STARCH SYRUP; STARCH
SYRUP; TABLE SALT MIXED WITH SESAME

SEEDS; COOKING SALT; ROASTED AND GROUND
SESAME SEEDS; CELERY SALT; FOOD SEASON-
INGS, IN CLASS 30 (U.S. CL. 46).

FOR: RAW, FRESH AND UNPROCESSED HOPS,
IN CLASS 31 (U.S. CLS. 1 AND 46).

FOR: EXTRACTS OF HOPS FOR MAKING BEER,
IN CLASS 32 (U.S. CLS. 45, 46 AND 48).

OWNER OF INTERNATIONAL REGISTRATION
0955423 DATED 12-14-2007, EXPIRES 12-14-2017.

THE MARK CONSISTS OF A DIAMOND WITH
TWO INTERSECTING LINES GOING FROM LEFT
TO RIGHT IN A DOWNWARD DIRECTION.

SER. NO. 79-050,626, FILED 12-14-2007.

JENNIFER VASQUEZ, EXAMINING ATTORNEY

Int. Cls.: 3 and 5

Prior U.S. Cls.: 1, 4, 6, 18, 44, 46, 50, 51 and 52

United States Patent and Trademark Office

Reg. No. 3,576,434

Registered Feb. 17, 2009

**TRADEMARK
PRINCIPAL REGISTER**

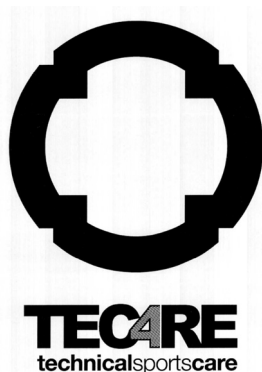

CHEMOUNI BLANDINE (FRANCE INDIVIDUAL)
27 RUE MELINGUE
F-75019 PARIS, FRANCE

FOR: LAUNDRY BLEACH, LAUNDRY DETERGENTS AND SOAPS; CLEANING POLISHING, SCOURING AND ABRASIVE PREPARATIONS; SOAPS; PERFUMES, ESSENTIAL OIL, COSMETICS, HAIR LOTIONS; DENTIFRICES; DEPILATORIES; MAKE-UP REMOVING PREPARATIONS; LIPSTICK; BEAUTY MASKS; SHAVING PREPARATIONS; LEATHER POLISHES; CREAMS FOR LEATHER; COSMETIC MASSAGE CREAMS AND OILS; COSMETIC SUNTAN AND SUN PROTECTING PREPARATIONS; COSMETICS WHICH MAY BE WORN WHILE PLAYING SPORTS, IN CLASS 3 (U.S. CLS. 1, 4, 6, 50, 51 AND 52).

FOR: PHARMACEUTICAL AND VETERINARY PREPARATIONS FOR MUSCULAR WARMING, HELPING MUSCLES RECOVER AFTER EXERCISE, HELPING MUSCLES RELAX AFTER EXERCISE AND FOR PUFFING MUSCLES IN CONDITION FOR PRACTICING SPORTS; SANITARY PREPARA-

TIONS FOR MEDICAL PURPOSES; DIETETIC FOODS ADAPTED FOR MEDICAL USE; FOOD FOR BABIES; MEDICAL PLASTERS; MEDICAL DRESSINGS; ALL PURPOSE DISINFECTANTS; PREPARATIONS FOR DESTROYING VERMIN; FUNGICIDES, HERBICIDES; MEDICATED BATH PREPARATIONS; SANITARY PADS, PANTS OR TOWELS; CHEMICAL REAGENTS FOR MEDICAL OR VETERINARY PURPOSES; MEDICINAL HERBS; HERBAL TEAS FOR MEDICINAL PURPOSES; PARASITICIDES; SUGAR FOR MEDICAL PURPOSES, IN CLASS 5 (U.S. CLS. 6, 18, 44, 46, 51 AND 52).

PRIORITY DATE OF 7-12-2007 IS CLAIMED.

OWNER OF INTERNATIONAL REGISTRATION
0955482 DATED 12-21-2007, EXPIRES 12-21-2017.

SER. NO. 79-050,638, FILED 12-21-2007.

DANIEL CAPSHAW, EXAMINING ATTORNEY

Int. Cls.: 3 and 44

Prior U.S. Cls.: 1, 4, 6, 50, 51, 52, 100 and 101

United States Patent and Trademark Office

Reg. No. 3,576,435

Registered Feb. 17, 2009

TRADEMARK
SERVICE MARK
PRINCIPAL REGISTER

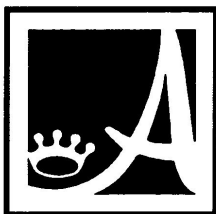

Alissi Brontë

ALISSI BRONTE, S.L. (SPAIN LIMITED LIABILITY COMPANY)
CAMINO DE LAS BRONTE, S/N
LA PALOMA; E-30120 EL PALMAR (MURCIA)
SPAIN

FOR: PERFUMERY AND COSMETICS, ESSENTIAL OILS FOR PERSONAL USE, SOAPS, SHAMPOOS AND DENTIFRICES, IN CLASS 3 (U.S. CLS. 1, 4, 6, 50, 51 AND 52).

FOR: MEDICAL SERVICES; SERVICES IN BEAUTY SALONS AND HAIRDRESSING SALONS, IN CLASS 44 (U.S. CLS. 100 AND 101).

OWNER OF INTERNATIONAL REGISTRATION 0955498 DATED 11-22-2007, EXPIRES 11-22-2017.

OWNER OF U.S. REG. NO. 3,127,193.

THE NAME "ALISSI BRONTË" DOES NOT IDENTIFY A LIVING INDIVIDUAL.

SER. NO. 79-050,646, FILED 11-22-2007.

SIMON TENG, EXAMINING ATTORNEY

Int. Cl.: 16

Prior U.S. Cls.: 2, 5, 22, 23, 29, 37, 38 and 50

Reg. No. 3,576,436

United States Patent and Trademark Office

Registered Feb. 17, 2009

**TRADEMARK
PRINCIPAL REGISTER**



DELUXE HOLDING AG (SWITZERLAND SOCI-
ETE ANONYME)
WALLSTRASSE 13,
POSTFACH 251; CH-4010 BASEL
SWITZERLAND

FOR: MAGAZINES FEATURING ART, FASHION
AND POPULAR CULTURE, IN CLASS 16 (U.S. CLS.
2, 5, 22, 23, 29, 37, 38 AND 50).

PRIORITY DATE OF 6-7-2007 IS CLAIMED.

OWNER OF INTERNATIONAL REGISTRATION
0955532 DATED 12-3-2007, EXPIRES 12-3-2017.

THE MARK CONSISTS OF THE WORDING
"RUGGED" IN STYLIZED FORM WITH A DESIGN
OF A STAR IN THE "R", A KNIFE DESIGN IN THE
"U", A GUN DESIGN IN EACH OF THE TWO "G"'S,
A BRASS KNUCKLE DESIGN IN THE "E" AND A
RAZOR BLADE DESIGN WITH THE WORDING
"STAINLESS" IN THE "D".

SER. NO. 79-050,656, FILED 12-3-2007.

DANIEL CAPSHAW, EXAMINING ATTORNEY

Int. Cl.: 33

Prior U.S. Cls.: 47 and 49

United States Patent and Trademark Office

Reg. No. 3,576,437

Registered Feb. 17, 2009

TRADEMARK
PRINCIPAL REGISTER

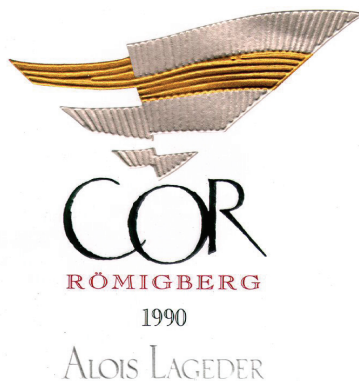

ALOIS LAGEDER SPA (ITALY SOCIÉTÉ PAR
ACTIONS)
VIA DEI CONTI 9,
SULLA STRADA DEL VINO; MAGRÉ (BZ)
ITALY

FOR: WINES, IN CLASS 33 (U.S. CLS. 47 AND 49).

OWNER OF INTERNATIONAL REGISTRATION
0652767 DATED 2-27-1996, EXPIRES 2-27-2016.

OWNER OF U.S. REG. NO. 1,421,370.

NO CLAIM IS MADE TO THE EXCLUSIVE
RIGHT TO USE "1990", APART FROM THE MARK
AS SHOWN.

THE COLOR(S) SILVER, GOLD, RED AND
BLACK IS/ARE CLAIMED AS A FEATURE OF
THE MARK.

THE MARK CONSISTS OF A GENERALLY TRI-
ANGULAR SHAPE COMPRISED OF ALTERNAT-
ING BARS OF SILVER AND GOLD, WITH
TEXTURED PATTERN OF HORIZONTAL AND
VERTICAL BARS WITHIN SEGMENTS OF THE
BARS OF THE TRIANGLE. BENEATH THE DESIGN
IS THE WORD "COR" IN BLACK; "ROMIOBERO" IN
RED, 1990 IN BLACK AND "ALOTS LAGEDER" IN
BLACK.

SER. NO. 79-050,685, FILED 12-20-2007.

EUGENIA MARTIN, EXAMINING ATTORNEY

Int. Cl.: 33

Prior U.S. Cls.: 47 and 49

United States Patent and Trademark Office

Reg. No. 3,576,438

Registered Feb. 17, 2009

**TRADEMARK
PRINCIPAL REGISTER**

CASA DE ILLANA

BODEGAS Y VIÑEDOS ILLANA, S.L. (SPAIN
SOCIEDAD LIMITADA)

FINCA BUENAVISTA

E-16708 POZOAMARGO (CUENCA), SPAIN

FOR: WINES, IN CLASS 33 (U.S. CLS. 47 AND 49).

THE MARK CONSISTS OF STANDARD CHAR-
ACTERS WITHOUT CLAIM TO ANY PARTICULAR
FONT, STYLE, SIZE, OR COLOR.

OWNER OF INTERNATIONAL REGISTRATION
0723062 DATED 10-6-1999, EXPIRES 10-6-2009.

THE FOREIGN WORDING IN THE MARK
TRANSLATES INTO ENGLISH AS HOUSE OF ILL-
ANA.

SER. NO. 79-050,692, FILED 7-25-2007.

ELI HELLMAN, EXAMINING ATTORNEY

Int. Cls.: 1, 4 and 7

**Prior U.S. Cls.: 1, 5, 6, 10, 13, 15, 19, 21, 23, 26, 31, 34,
35 and 46**

Reg. No. 3,576,439

United States Patent and Trademark Office

Registered Feb. 17, 2009

**TRADEMARK
PRINCIPAL REGISTER**

ARBAPELLETS

ARBAFLAME TECHNOLOGY AS (NORWAY
JOINT STOCK COMPANY)
GRASMO
N-2235 MATRAND
NORWAY

FOR: CHEMICALS FOR INDUSTRIAL USE; SYN-
THETIC RESINS, UNPROCESSED; FIRE EXTIN-
GUISHING COMPOSITIONS; ADHESIVES FOR
INDUSTRIAL PURPOSES , IN CLASS 1 (U.S. CLS. 1,
5, 6, 10, 26 AND 46).

FOR: FUELS, INCLUDING PELLETS, IN CLASS 4
(U.S. CLS. 1, 6 AND 15).

FOR: MACHINES AND MACHINE TOOLS FOR
PROCESSING PLANTS FOR PRODUCTION OF
FUEL PELLETS, IN CLASS 7 (U.S. CLS. 13, 19, 21,
23, 31, 34 AND 35).

THE MARK CONSISTS OF STANDARD CHAR-
ACTERS WITHOUT CLAIM TO ANY PARTICULAR
FONT, STYLE, SIZE, OR COLOR.

PRIORITY DATE OF 11-20-2007 IS CLAIMED.

OWNER OF INTERNATIONAL REGISTRATION
0955702 DATED 11-27-2007, EXPIRES 11-27-2017.

THE WORDING "ARBA" HAS NO MEANING IN
ENGLISH.

SER. NO. 79-050,748, FILED 11-27-2007.

KRISTINA MORRIS, EXAMINING ATTORNEY

Int. Cl.: 9

Prior U.S. Cls.: 21, 23, 26, 36 and 38

United States Patent and Trademark Office

Reg. No. 3,576,440

Registered Feb. 17, 2009

**TRADEMARK
PRINCIPAL REGISTER**



SAPHIRWERK INDUSTRIEPRODUKTE AG
(SWITZERLAND SOCIÉTÉ ANONYME)

ERLENSTRASSE 36
CH-2555 BRÜGG
SWITZERLAND

FOR: ACCESSORY FOR MEASURING INSTRUMENTS, NAMELY, STYLUS PROBE FOR TACTILE REGISTRATION OF SURFACES, IN CLASS 9 (U.S. CLS. 21, 23, 26, 36 AND 38).

PRIORITY DATE OF 6-13-2007 IS CLAIMED.

OWNER OF INTERNATIONAL REGISTRATION
0956066 DATED 12-13-2007, EXPIRES 12-13-2017.

THE COLOR(S) RED AND BLACK IS/ARE CLAIMED AS A FEATURE OF THE MARK.

THE MARK CONSISTS OF THE WORDING, "SCAN" AND THE SUPERSCRIP NUMBER "3" REPRESENTING THE CUBED FUNCTION, ALL IN THE COLOR RED WITH A THIN OUTLINE APPEARING IN THE COLOR BLACK AROUND THE WORDING "SCAN" AND THE SUPERSCRIP NUMBER "3" REPRESENTING THE CUBED FUNCTION.

THE MARK "SCAN³" HAS NO MEANING IN A FOREIGN LANGUAGE.

SER. NO. 79-050,863, FILED 12-13-2007.

CHARISMA HAMPTON, EXAMINING ATTORNEY

Int. Cl.: 20

Prior U.S. Cls.: 2, 13, 22, 25, 32 and 50

United States Patent and Trademark Office

Reg. No. 3,576,441

Registered Feb. 17, 2009

**TRADEMARK
PRINCIPAL REGISTER**

Datainer

BRIGITTE HELM-BÜRGERHOFF (FED REP
GERMANY INDIVIDUAL)
EPPENDORFER LANDSTRASSE 27
20249 HAMBURG
FED REP GERMANY

FOR: PACKAGING CONTAINERS OF PLASTIC,
NAMELY, CONTAINERS FOR DIGITAL DATA
CARRIERS AND COMPUTER HARD DISKS; REU-
SABLE PLASTIC CONTAINERS FOR TRANSPORT-
ING MERCHANDISE OR MATERIALS, NAMELY,
CONTAINERS FOR DIGITAL DATA CARRIERS
AND COMPUTER HARD DISKS; AND PLASTIC
STORAGE CONTAINERS FOR COMMERCIAL OR
INDUSTRIAL USE, NAMELY, CONTAINERS FOR
DIGITAL DATA CARRIERS AND COMPUTER

HARD DISKS, IN CLASS 20 (U.S. CLS. 2, 13, 22, 25,
32 AND 50).

THE MARK CONSISTS OF STANDARD CHAR-
ACTERS WITHOUT CLAIM TO ANY PARTICULAR
FONT, STYLE, SIZE, OR COLOR.

OWNER OF INTERNATIONAL REGISTRATION
0956072 DATED 1-21-2008, EXPIRES 1-21-2018.

SER. NO. 79-050,865, FILED 1-21-2008.

GILBERT SWIFT, EXAMINING ATTORNEY

Int. Cl.: 5

Prior U.S. Cls.: 6, 18, 44, 46, 51 and 52

United States Patent and Trademark Office

Reg. No. 3,576,442

Registered Feb. 17, 2009

TRADEMARK
PRINCIPAL REGISTER



NAKAMORI PHARMACEUTICAL CO., LTD (JAPAN CORPORATION)
C/O MIYAZAKI-TECHONO-RESEARCH-PARK,
17880-35, HIGASHI-KAMINAKA.; OAZA, SADO-
WARA-CHO.; MIYAZAKI-GUN; MIYAZAKI 880-
0303
JAPAN

FOR: PHARMACEUTICAL AGENTS FOR ANIMALS FOR TREATMENT OF DIGESTIVE ORGAN DISEASES, WEAKENING OF DIGESTIVE ORGANS, ANOREXIA, DIARRHEA, GASTRITIS, DIGESTIVE ORGAN ULCERS, CONSTIPATION, AND COLIC, IN CLASS 5 (U.S. CLS. 6, 18, 44, 46, 51 AND 52).

OWNER OF INTERNATIONAL REGISTRATION
0956120 DATED 1-9-2008, EXPIRES 1-9-2018.

NO CLAIM IS MADE TO THE EXCLUSIVE RIGHT TO USE "PET MEDICINE", "JUISAN", AND THE NON-LATIN CHARACTERS THAT MEAN "PET MEDICINE" AND "MEDICINE FOR PETS", APART FROM THE MARK AS SHOWN.

THE ENGLISH TRANSLATION OF "SHIN NAKAMORI JUISAN" IN THE MARK IS "VETERINARIAN NAKAMORI'S NEW PET MEDICINE."

THE NON-LATIN CHARACTERS IN THE MARK IN THE TOP LINE HAVE NO MEANING IN A FOREIGN LANGUAGE. THE NON-LATIN CHARACTERS IN THE MARK IN THE SECOND LINE FROM THE TOP TRANSLITERATE TO THE WORDING OF "SHIN NAKAMORI JUISAN", AND THE WORDING MEANS IN ENGLISH "VETERINARIAN NAKAMORI'S NEW PET MEDICINE." THE NON-LATIN CHARACTERS IN THE MARK IN THE BOTTOM LINE TRANSLITERATE TO THE WORDING OF "PETTO NO JOBI YAKU", AND THE WORDING MEANS IN ENGLISH "ALWAYS MUST-HAVE MEDICINE FOR PETS."

SER. NO. 79-050,888, FILED 1-9-2008.

TINA KUAN, EXAMINING ATTORNEY

Int. Cl.: 40

Prior U.S. Cls.: 100, 103 and 106

United States Patent and Trademark Office

Reg. No. 3,576,443

Registered Feb. 17, 2009

**SERVICE MARK
PRINCIPAL REGISTER**



CHIYODA INTEGRE CO., LTD. (JAPAN CORPORATION)
4-5, AKASHI-CHO, CHUO-KU
TOKYO 104-0044
JAPAN

FOR: PROCESSING OF RUBBER, NAMELY, DIE-CUTTING; PROCESSING OF PLASTICS, NAMELY, LAMINATING, DIE-CUTTING, GRAPHIC SCREEN PRINTING, CUTTING; MANUFACTURE OF RUBBER PARTS TO THE ORDER AND SPECIFICATION OF OTHERS, IN CLASS 40 (U.S. CLS. 100, 103 AND 106).

OWNER OF INTERNATIONAL REGISTRATION
0956206 DATED 2-25-2008, EXPIRES 2-25-2018.

THE COLOR(S) BLUE AND RED IS/ARE CLAIMED AS A FEATURE OF THE MARK.

THE MARK CONSISTS OF THE COLOR BLUE APPEARING ON THE LETTERS "C" AND "I" WITH THE COLOR RED APPEARING IN A DOT ABOVE THE LETTER "I".

SER. NO. 79-050,912, FILED 2-25-2008.

ELIZABETH KAJUBI, EXAMINING ATTORNEY

Int. Cl.: 40

Prior U.S. Cls.: 100, 103 and 106

United States Patent and Trademark Office

Reg. No. 3,576,444

Registered Feb. 17, 2009

**SERVICE MARK
PRINCIPAL REGISTER**



CHIYODA INTEGRE CO., LTD. (JAPAN CORPORATION)
4-5, AKASHI-CHO, CHUO-KU
TOKYO 104-0044
JAPAN

FOR: PROCESSING OF RUBBER, NAMELY, DIE-CUTTING; PROCESSING OF PLASTICS, NAMELY, LAMINATING, DIE-CUTTING, GRAPHIC SCREEN PRINTING, CUTTING; MANUFACTURE OF PLASTIC PARTS TO THE ORDER AND SPECIFICATION OF OTHERS, IN CLASS 40 (U.S. CLS. 100, 103 AND 106).

OWNER OF INTERNATIONAL REGISTRATION
0956207 DATED 2-25-2008, EXPIRES 2-25-2018.

NO CLAIM IS MADE TO THE EXCLUSIVE RIGHT TO USE "SOFT PRESS", APART FROM THE MARK AS SHOWN.

THE COLOR(S) YELLOW, RED, WHITE, BLUE AND LIGHT BLUE IS/ARE CLAIMED AS A FEATURE OF THE MARK.

THE MARK CONSISTS OF THE WORD "SOFT" APPEARING IN YELLOW WITH A BLUE BORDER, THE WORD "PRESS" APPEARING IN BLUE. BETWEEN THE WORDS "SOFT" AND "PRESS" APPEARS A RED TRIANGLE. THE LOWER LITERAL ELEMENT SHOWS THE WORDING IN WHITE WITH A LIGHT BLUE BACKGROUND.

SER. NO. 79-050,913, FILED 2-25-2008.

ELIZABETH KAJUBI, EXAMINING ATTORNEY

Int. Cl.: 25

Prior U.S. Cls.: 22 and 39

United States Patent and Trademark Office

Reg. No. 3,576,445

Registered Feb. 17, 2009

**TRADEMARK
PRINCIPAL REGISTER**

TONET

CARELLA S.R.L. (ITALY LIMITED LIABILITY
COMPANY)
VIA ROMA, 90
I-31050 MIANE (TV)
ITALY

FOR: CLOTHING FOR MEN, WOMEN, AND
CHILDREN, NAMELY, PULLOVERS, CARDIGANS,
SWEATERS, TROUSERS, SKIRTS, JACKETS, CAR-
DIGAN JACKETS, BLOUSES, SHIRTS, JEANS,
SWEATPANTS, SHORTS, SWEATSHIRTS, SUITS,
DRESSES, OVERCOATS, COATS, RAINCOATS,
BELTS, JERSEYS, NECKWEAR, SOCKS, STOCK-
INGS, HOSIERY, PANTYHOSE, UNDERWEAR,
VESTS, WAISTCOATS, JUMPERS, TRACKSUITS,
BLOUSONS, T-SHIRTS, ANORAKS, SUSPENDERS,
LOUNGEWEAR, OVERALLS, HATS, CAPS,
GLOVES, BATHING AND SHOWER CAPS, KER-
CHIEFS, SHOES, SHORT SHOES, SANDALS, BOOTS,

SKI BOOTS, SLIPPERS, PAJAMAS, POLO SHIRTS,
APRONS, MITTENS, NECKTIES, TIGHTS, LEG-
GINGS, IN CLASS 25 (U.S. CLS. 22 AND 39).

THE MARK CONSISTS OF STANDARD CHAR-
ACTERS WITHOUT CLAIM TO ANY PARTICULAR
FONT, STYLE, SIZE, OR COLOR.

PRIORITY DATE OF 7-27-2007 IS CLAIMED.

OWNER OF INTERNATIONAL REGISTRATION
0956303 DATED 1-10-2008, EXPIRES 1-10-2018.

SER. NO. 79-050,946, FILED 1-10-2008.

DANIEL BRODY, EXAMINING ATTORNEY

Int. Cl.: 9

Prior U.S. Cls.: 21, 23, 26, 36 and 38

Reg. No. 3,576,446

United States Patent and Trademark Office

Registered Feb. 17, 2009

**TRADEMARK
PRINCIPAL REGISTER**

A X R

YOKOGAWA ELECTRIC CORPORATION (JAPAN CORPORATION)
9-32, NAKACHO 2-CHOME
MUSASHINO-SHI; TOKYO 180-8750
JAPAN

IA; ELECTRODES, IN CLASS 9 (U.S. CLS. 21, 23, 26, 36 AND 38).

PRIORITY DATE OF 9-12-2007 IS CLAIMED.

FOR: FLOWMETERS; COMPUTER SOFTWARE FOR USE AS A SPREADSHEET USED IN THE FIELD OF FLOW RATE MEASUREMENT; COMPUTER SOFTWARE FOR USE AS A SPREADSHEET DOWNLOADABLE VIA COMPUTER NETWORK; ELECTRONIC PUBLICATIONS, NAMELY, BOOKS, MAGAZINES AND MANUALS FEATURING FLOWMETERS RECORDED ON COMPUTER MED-

OWNER OF INTERNATIONAL REGISTRATION 0956312 DATED 2-18-2008, EXPIRES 2-18-2018.

SER. NO. 79-050,951, FILED 2-18-2008.

TASNEEM HUSSAIN, EXAMINING ATTORNEY

Int. Cl.: 26

Prior U.S. Cls.: 37, 39, 40, 42 and 50

United States Patent and Trademark Office

Reg. No. 3,576,447

Registered Feb. 17, 2009

**TRADEMARK
PRINCIPAL REGISTER**

ez-TRAK

YKK CORPORATION (JAPAN CORPORATION)
1, KANDA IZUMI-CHO
CHIYODA-KU
TOKYO 101-8642, JAPAN

FOR: SLIDE FASTENERS; HOOK AND LOOP FASTENING TAPES; ADJUSTABLE FASTENERS FOR CLOTHING; RAIL FASTENERS; SNAP BUTTONS, BUTTONS; HOOK AND EYES; SNAP FASTENERS; EYELETS FOR CLOTHING; EYELETS FOR SHOES AND BOOTS; METAL FASTENERS FOR SHOES AND BOOTS; BUCKLES FOR CLOTHING; STRAP BUCKLES FOR BAGS; STRAP BUCKLES FOR BAGS FOR SPORTS; BUCKLES FOR SUSPENDERS; BUCKLES FOR BELTS; BUCKLES FOR SHOES AND BOOTS; SNAP HOOKS FOR

BACKPACKS; CORD STOPPERS; CORD END STOPPERS; ELASTIC RIBBONS; KNIT OR WOVEN TAPES FOR LUGGAGE AND APPAREL, IN CLASS 26 (U.S. CLS. 37, 39, 40, 42 AND 50).

PRIORITY DATE OF 1-17-2008 IS CLAIMED.

OWNER OF INTERNATIONAL REGISTRATION
0956315 DATED 2-13-2008, EXPIRES 2-13-2018.

SER. NO. 79-050,952, FILED 2-13-2008.

DAVID MILLER, EXAMINING ATTORNEY

Int. Cl.: 25

Prior U.S. Cls.: 22 and 39

United States Patent and Trademark Office

Reg. No. 3,576,448

Registered Feb. 17, 2009

**TRADEMARK
PRINCIPAL REGISTER**



DEHA

MEETING GROUP S.P.A. (ITALY JOINT STOCK
COMPANY)
VIA ROMA, 147 I-31050
VILLORBA (TREVISO), ITALY

FOR: TOPS, HIGH-NECK SHIRTS, HOODED
SWEATERS, PANTS, SHORT PANTS, MEDIUM-
LENGTH PANTS, LONG PANTS, PANTS FOR JAZZ
DANCE, T-SHIRTS, LONG-SLEEVED T-SHIRTS,
HOODED T-SHIRTS, SWEATSHIRTS WITH AND
WITHOUT ZIP, LONG-SLEEVED SWEATSHIRTS,
HOODED SWEATSHIRTS, CAT SUITS, JOGGING
SUITS, SHORTS, BERMUDA SHORTS, JACKETS,
CAPS, SLIPS, PANTIES, SOCKS, GLOVES, SWIM-
WEAR, SHIRTS, SPORT SHIRTS, POLO SHIRTS,
HATS, SKIRTS, SCARVES; OVERALLS, COATS,
DANCE DRESSES, DRESSES FOR BALLET, DANCE
SUITS, SUITS FOR BALLET, LEOTARDS, TUTUS,
BODY SUITS, TANK TOPS, UNITARDS, JUMPERS,
SWEATERS, CARDIGANS, PULLOVERS, JERSEYS
BEING CLOTHING, TROUSERS, LEGGINGS,
TRACK SUITS, JEANS, SWEAT PANTS, GYM SUITS,
KNICKERS, SUITS AND DRESSES, ANORAKS,

BELTS BEING CLOTHING, BATHROBES, LEG-
WARMERS, UNDERWEAR, FOOTWEAR, HEAD-
WEAR, NECKWEAR, STOCKINGS, PANTYHOSE,
TIGHTS, IN CLASS 25 (U.S. CLS. 22 AND 39).

OWNER OF INTERNATIONAL REGISTRATION
0907322 DATED 10-5-2005, EXPIRES 10-5-2015.

OWNER OF U.S. REG. NO. 3,233,678.

THE TRADEMARK CONSISTS IN A MARKING
DEPICTING THE STYLIZED WORD "DH" AND
THE WORD "DEHA" IN FANCY TYPE.

THE ENGLISH TRANSLATION OF THE FOR-
EIGN WORD IN THE MARK IS "BODY."

SER. NO. 79-050,988, FILED 9-17-2007.

DANIEL BRODY, EXAMINING ATTORNEY

Int. Cl.: 3

Prior U.S. Cls.: 1, 4, 6, 50, 51 and 52

United States Patent and Trademark Office

Reg. No. 3,576,449

Registered Feb. 17, 2009

**TRADEMARK
PRINCIPAL REGISTER**

DEPTA

HYPRED (FRANCE SOCIÉTÉ ANONYME)
55, BOULEVARD JULES VERGER
F-35800 DINARD
FRANCE

OWNER OF INTERNATIONAL REGISTRATION
0585597 DATED 5-18-1992, EXPIRES 5-18-2012.

FOR: BLEACHING PREPARATIONS FOR INDUSTRIAL USE; AND WASHING, CLEANING, AND SCOURING PREPARATIONS, IN CLASS 3 (U.S. CLS. 1, 4, 6, 50, 51 AND 52).

SER. NO. 79-051,150, FILED 1-18-2008.

PATRICIA EVANKO, EXAMINING ATTORNEY

Int. Cl.: 3

Prior U.S. Cls.: 1, 4, 6, 50, 51 and 52

United States Patent and Trademark Office

Reg. No. 3,576,450

Registered Feb. 17, 2009

**TRADEMARK
PRINCIPAL REGISTER**

DEPTACID

HYPRED (FRANCE SOCIÉTÉ ANONYME)
55, BOULEVARD JULES VERGER
F-35800 DINARD
FRANCE

OWNER OF INTERNATIONAL REGISTRATION
0585598 DATED 5-18-1992, EXPIRES 5-18-2012.

FOR: BLEACHING PREPARATIONS FOR INDUSTRIAL USE; AND WASHING, CLEANING, AND SCOURING PREPARATIONS, IN CLASS 3 (U.S. CLS. 1, 4, 6, 50, 51 AND 52).

SER. NO. 79-051,151, FILED 1-18-2008.

PATRICIA EVANKO, EXAMINING ATTORNEY

Int. Cls.: 19, 27 and 35

**Prior U.S. Cls.: 1, 12, 19, 20, 33, 37, 42, 50, 100, 101
and 102**

United States Patent and Trademark Office

Reg. No. 3,576,451

Registered Feb. 17, 2009

**TRADEMARK
SERVICE MARK
PRINCIPAL REGISTER**

ForbOnline

FORBO FINANCIAL SERVICES AG (SWITZER-
LAND CORPORATION)
LINDENSTRASSE 8
CH-6340 BAAR
SWITZERLAND

FOR: BUILDING MATERIALS, NAMELY, NON-
METAL FLOORS, CEILING PANELS, WALL PA-
NELS AND FRONTAGES, AS WELL AS PARQUET
AND VINYL SLABS, STRIPS, AND TILES, FOR
FLOORS, CEILINGS, WALLS AND FRONTAGES,
IN CLASS 19 (U.S. CLS. 1, 12, 33 AND 50).

FOR: FLOOR COVERINGS, FLOOR MATS, CAR-
PETS, LINOLEUM; WALL HANGINGS AND COV-
ERINGS, NAMELY, NON-TEXTILE WALL
HANGINGS, IN CLASS 27 (U.S. CLS. 19, 20, 37, 42
AND 50).

FOR: ONLINE RETAIL STORE SERVICES AND
WHOLESALE ORDERING SERVICES IN THE
FIELDS OF BUILDING MATERIALS, FLOORING

SYSTEMS, BONDING SYSTEMS AND MOVEMENT
SYSTEMS, IN CLASS 35 (U.S. CLS. 100, 101 AND 102).

THE MARK CONSISTS OF STANDARD CHAR-
ACTERS WITHOUT CLAIM TO ANY PARTICULAR
FONT, STYLE, SIZE, OR COLOR.

PRIORITY DATE OF 7-25-2007 IS CLAIMED.

OWNER OF INTERNATIONAL REGISTRATION
0956961 DATED 1-24-2008, EXPIRES 1-24-2018.

OWNER OF U.S. REG. NOS. 1,142,671, 2,791,372,
AND 2,804,830.

SER. NO. 79-051,222, FILED 1-24-2008.

JORDAN BAKER, EXAMINING ATTORNEY

Int. Cl.: 9

Prior U.S. Cls.: 21, 23, 26, 36 and 38

United States Patent and Trademark Office

Reg. No. 3,576,452

Registered Feb. 17, 2009

**TRADEMARK
PRINCIPAL REGISTER**



INOVA SEMICONDUCTORS GMBH (FED REP
GERMANY GMBH)
GRAFINGER STR. 26
81671 MÜNCHEN
FED REP GERMANY

FOR: SEMICONDUCTOR COMPONENTS,
NAMELY, SEMICONDUCTOR INTEGRATED CIR-
CUITS (ICS), IN CLASS 9 (U.S. CLS. 21, 23, 26, 36 AND
38).

OWNER OF INTERNATIONAL REGISTRATION
0957017 DATED 1-25-2008, EXPIRES 1-25-2018.

THE COLOR(S) GREY AND RED IS/ARE
CLAIMED AS A FEATURE OF THE MARK.

THE MARK CONSISTS OF THE COLORS GRAY
AND RED WITH THE WORDING "APIX" APPEAR-
ING IN THE COLOR GRAY; THE LETTER "I" IS
DOTTED WITH A 5 POINTED STAR APPEARING
IN THE COLOR RED.

SER. NO. 79-051,251, FILED 1-25-2008.

RICHARD WHITE, EXAMINING ATTORNEY

Int. Cl.: 9

Prior U.S. Cls.: 21, 23, 26, 36 and 38

United States Patent and Trademark Office

Reg. No. 3,576,453

Registered Feb. 17, 2009

TRADEMARK
PRINCIPAL REGISTER

KAMEMANNEN
カメマンネン

FUKUI KOKI CO., LTD. (JAPAN CORPORATION)

1-1-40, SANROKU-CHO

SABAE-SHI,; FUKUI 916-0021

JAPAN

FOR: GOGGLES FOR SPORTS, CONTACT LENSES, SUNGLASSES, PINCE-NEZ, EYEGLASSES, EYEGLASS CASES, EYEGLASS TEMPLES, CONTAINERS FOR CONTACT LENSES, PINCE-NEZ CASES, EYEGLASS CHAINS, EYEGLASS CORDS, EYEGLASS FRAMES, PINCE-NEZ CHAINS, PINCE-NEZ CORDS, PINCE-NEZ MOUNTINGS, DIVERS' MASKS, IN CLASS 9 (U.S. CLS. 21, 23, 26, 36 AND 38).

OWNER OF INTERNATIONAL REGISTRATION
0957051 DATED 2-25-2008, EXPIRES 2-25-2018.

THE WORD "KAMEMANNEN" HAS NO MEANING IN ENGLISH.

THE NON-LATIN CHARACTER(S) IN THE MARK TRANSLITERATES INTO "KAMEMANNEN".

SER. NO. 79-051,268, FILED 2-25-2008.

RONALD DELGIZZI, EXAMINING ATTORNEY

Int. Cls.: 3 and 44

Prior U.S. Cls.: 1, 4, 6, 50, 51, 52, 100 and 101

United States Patent and Trademark Office

Reg. No. 3,576,454

Registered Feb. 17, 2009

**TRADEMARK
SERVICE MARK
PRINCIPAL REGISTER**

L'ALCHIMIE BOTANIQUE DU FUTUR

COSTE SAVERIA (FRANCE LIMITED LIABILITY COMPANY)
16 RUE DU RANELAGH
F-75016 PARIS
FRANCE

FOR: BLEACHING PREPARATIONS FOR LAUNDRY USE; CLEANING, POLISHING, SCOURING AND ABRASIVE PREPARATIONS; SOAPS; ESSENTIAL OILS, DENTIFRICES, DEPILATORIES, MAKE-UP REMOVING PREPARATIONS, FACIAL MASKS; SHAVING PRODUCTS, NAMELY, SHAVING CREAM, SHAVING BALM, SHAVING LOTION; COSMETIC PRODUCTS FOR THE LIPS AND NAILS, NAMELY, NAIL POLISH, LIP GLOSS; MAKE-UP, DEODORANTS FOR PERSONAL USE, HAIR CARE PREPARATIONS; COSMETIC AND TOILETRY PRODUCTS FOR SKIN CARE AND CLEANSING, NAMELY, SKIN LOTION, SOAPS; PERFUMERY, IN CLASS 3 (U.S. CLS. 1, 4, 6, 50, 51 AND 52).

FOR: HYGIENIC AND BEAUTY CARE FOR HUMAN BEINGS OR ANIMALS, BEAUTY SALONS, SERVICES OF BEAUTY PARLOURS, HAIRDRES-

SING SALONS; PET CARE SERVICES, NAMELY, NON-MEDICATED PET GROOMING; LANDSCAPE GARDENING; AGRICULTURAL AND HORTICULTURAL SERVICES, NAMELY, AGRICULTURE ADVICE, KOI FARMING, CONTRACT FARMING FOR OTHERS, IN CLASS 44 (U.S. CLS. 100 AND 101).

THE MARK CONSISTS OF STANDARD CHARACTERS WITHOUT CLAIM TO ANY PARTICULAR FONT, STYLE, SIZE, OR COLOR.

OWNER OF INTERNATIONAL REGISTRATION 0957096 DATED 1-17-2008, EXPIRES 1-17-2018.

THE ENGLISH TRANSLATION OF THE FOREIGN WORD(S) IN THE MARK IS: THE BOTANICAL ALCHEMY OF THE FUTURE.

SER. NO. 79-051,286, FILED 1-17-2008.

CHRISTINE COOPER, EXAMINING ATTORNEY

Int. Cl.: 24

Prior U.S. Cls.: 42 and 50

United States Patent and Trademark Office

Reg. No. 3,576,455

Registered Feb. 17, 2009

**TRADEMARK
PRINCIPAL REGISTER**

BVLGARI

BULGARI S.P.A. (ITALY CORPORATION)
LUNGOTEVERE MARZIO, 11
I-00186 ROMA
ITALY

FOR: TEXTILES AND TEXTILE GOODS, NOT INCLUDED IN OTHER CLASSES, NAMELY, APPAREL FABRICS, FABRICS OF IMITATION ANIMAL SKINS, FABRICS FOR USE IN THE MANUFACTURE OF BAGS, OF CASES, OF PURSES, OF UMBRELLAS, AND OF WALLETS; FABRICS FOR SHAWLS AND SCARVES; BATH LINEN, FABRICS FOR TEXTILE USE; BED COVERS AND BED

LINEN; TABLE COVERS, NAMELY, TABLE LINEN, IN CLASS 24 (U.S. CLS. 42 AND 50).

OWNER OF INTERNATIONAL REGISTRATION 0957188 DATED 1-16-2008, EXPIRES 1-16-2018.

OWNER OF U.S. REG. NOS. 2,954,459, 3,348,876 AND OTHERS.

SER. NO. 79-051,324, FILED 1-16-2008.

JACLYN KIDWELL, EXAMINING ATTORNEY

Int. Cl.: 30

Prior U.S. Cl.: 46

United States Patent and Trademark Office

Reg. No. 3,576,456

Registered Feb. 17, 2009

**TRADEMARK
PRINCIPAL REGISTER**

Prosit

CREATIVE S.R.L. (ITALY LIMITED LIABILITY
COMPANY)
VIALE PRASSILLA, 41
I-00124 CASAL PALOCCO, ROMA
ITALY

FOR: PASTA; RICE, FLOUR, BUCKWHEAT
FLOUR, BARLEY FLOUR, CORN FLOUR, WHEAT
FLOUR, RICE FLOUR, TAPIOCA FLOUR, POTATO
STARCH; CEREAL PREPARATIONS, NAMELY,
CEREAL BASED SNACK FOOD, BREAKFAST CER-
EAL AND BISCUITS, BREAD, PASTA, CAKES
MADE WITH CEREALS; GLUTEN REDUCED
FLOUR AND BREAD; CRACKERS, BREADSTICK,
BISCUITS; PASTRY; POWDERS FOR ICE CREAMS;
EDIBLE ICES; CONES FOR ICE CREAM; YEAST;

YEAST POWDER; BAKING POWDER; SUGAR AND
SUGAR SUBSTITUTES, IN CLASS 30 (U.S. CL. 46).

PRIORITY DATE OF 7-2-2007 IS CLAIMED.

OWNER OF INTERNATIONAL REGISTRATION
0957273 DATED 12-21-2007, EXPIRES 12-21-2017.

THE TERM HAS NO MEANING IN A FOREIGN
LANGUAGE.

SER. NO. 79-051,350, FILED 12-21-2007.

MICHAEL TANNER, EXAMINING ATTORNEY

Int. Cl.: 30

Prior U.S. Cl.: 46

United States Patent and Trademark Office

Reg. No. 3,576,457

Registered Feb. 17, 2009

TRADEMARK
PRINCIPAL REGISTER



ZAKRYTOE AKTSIONERNOE OBSHCHESTVO;
"ESSEN PRODUCTION AG" (RUSSIAN FED.
CORPORATION)

D. 7, OKRUZHNOE SHOSSE

ELABUGA TOWN

RESPUBLIKA TATARSTAN, RUSSIAN FED. 423602

FOR: MAYONNAISE, KETCHUP, SALAD SAU-
CES, SAUCE MIXES, TOMATO SAUCE, IN CLASS 30
(U.S. CL. 46).

OWNER OF INTERNATIONAL REGISTRATION
0957302 DATED 6-29-2007, EXPIRES 6-29-2017.

THE NON-LATIN CHARACTER(S) IN THE
MARK TRANSLITERATE INTO "MAKHEEV",
AND THIS HAS NO MEANING IN ENGLISH.

SER. NO. 79-051,356, FILED 6-29-2007.

MARK RADEMACHER, EXAMINING ATTORNEY

Int. Cl.: 9

Prior U.S. Cls.: 21, 23, 26, 36 and 38

United States Patent and Trademark Office

Reg. No. 3,576,458

Registered Feb. 17, 2009

**TRADEMARK
PRINCIPAL REGISTER**

inspiro

SONOVA HOLDING AG (SWITZERLAND SOCI-
ÉTÉ ANONYME (SA))
LAUBISRÜTISTRASSE 28
CH-8712 STÄFA
SWITZERLAND

OWNER OF INTERNATIONAL REGISTRATION
0957678 DATED 3-7-2008, EXPIRES 3-7-2018.

FOR: WIRELESS RADIO TRANSMITTERS AND
RECEIVERS, IN CLASS 9 (U.S. CLS. 21, 23, 26, 36 AND
38).

THE ENGLISH TRANSLATION OF THE WORD
"INSPIRO" IN THE MARK IS INSPIRE.

THE MARK CONSISTS OF STANDARD CHAR-
ACTERS WITHOUT CLAIM TO ANY PARTICULAR
FONT, STYLE, SIZE, OR COLOR.

SER. NO. 79-051,481, FILED 3-7-2008.

PRIORITY DATE OF 11-14-2007 IS CLAIMED.

KELLY MCCOY, EXAMINING ATTORNEY

Int. Cl.: 14

Prior U.S. Cls.: 2, 27, 28 and 50

United States Patent and Trademark Office

Reg. No. 3,576,459

Registered Feb. 17, 2009

**TRADEMARK
PRINCIPAL REGISTER**

AKTEO

WINTIS, WORLD INVESTMENTS; TIMEPIECES
SA (SWITZERLAND SOCIÉTÉ ANONYME)

RUE DU RHONE 114

CASE POSTALE; CH-1211 GENÈVE 3

SWITZERLAND

FOR: WATCHES; CLOCK AND WATCH-MAK-
ING ARTICLES, NAMELY, DIALS FOR CLOCK
AND WATCH-MAKING; CHRONOMETRIC IN-
STRUMENTS; JEWELRY AND PRECIOUS STONES,
IN CLASS 14 (U.S. CLS. 2, 27, 28 AND 50).

OWNER OF INTERNATIONAL REGISTRATION
0637778 DATED 5-15-1995, EXPIRES 5-15-2015.

OWNER OF U.S. REG. NO. 2,785,241.

THE MARK HAS NO MEANING IN A FOREIGN
LANGUAGE.

SER. NO. 79-051,496, FILED 11-12-2007.

DAYNA BROWNE, EXAMINING ATTORNEY

Int. Cl.: 3

Prior U.S. Cls.: 1, 4, 6, 50, 51 and 52

United States Patent and Trademark Office

Reg. No. 3,576,460

Registered Feb. 17, 2009

**TRADEMARK
PRINCIPAL REGISTER**

PHYTOMER

SOCIETE DE COURTAGE ET DE DIFFUSION -;
CODIF INTERNATIONAL S.A.S. (FRANCE
SOCIÉTÉ PAR ACTIONS SIMPLIFIÉE)
61, RUE DU COMMANDANT L'HERMINIER
F-35400 SAINT-MALO
FRANCE

FOR: COSMETIC PRODUCTS FOR SKIN AND
BODY CARE, NAMELY, COSMETIC PREPARA-
TIONS FOR BODY CARE AND NON-MEDICATED
SKIN CARE PREPARATIONS; SOAPS, PERFUM-
ERY, ESSENTIAL OILS, HAIR LOTIONS, SHAM-
POOS, DENTIFRICES; COSMETIC PREPARATIONS
FOR BATHS; BATH SALTS, NOT FOR MEDICAL
PURPOSES; COSMETIC ANTI-AGING PREPARA-
TIONS, NAMELY, ANTI-AGING CREAMS, LO-
TIONS, MILKS, SPRAYS, STICKS, MASKS,
POWDERS AND GELS; MAKE-UP REMOVING
PREPARATIONS, CREAMS AND LOTIONS; DEPI-

LATORIES; DIPILATORY WAX AND DIPLIATORY
CREAM; GREASES FOR COSMETIC PURPOSES;
CLEANSING MILKS FOR TOILET PURPOSES; AL-
MOND OIL FOR COSMETIC PURPOSES; BEAUTY
MASKS; AND COSMETIC BEAUTY SERUMS, IN
CLASS 3 (U.S. CLS. 1, 4, 6, 50, 51 AND 52).

OWNER OF INTERNATIONAL REGISTRATION
0879461 DATED 2-6-2006, EXPIRES 2-6-2016.

OWNER OF U.S. REG. NOS. 2,861,997, 2,861,998,
AND 3,335,369.

SER. NO. 79-051,507, FILED 11-21-2007.

MICHAEL TANNER, EXAMINING ATTORNEY

Int. Cl.: 33

Prior U.S. Cls.: 47 and 49

United States Patent and Trademark Office

Reg. No. 3,576,461

Registered Feb. 17, 2009

**TRADEMARK
PRINCIPAL REGISTER**

PULLUS

PERUTNINA PTUJ, D.D. (SLOVENIA JOINT
STOCK COMPANY)
POTRCEVA CESTA 10
SI-2250 PTUJ
SLOVENIA

FOR: ALCOHOLIC BEVERAGES EXCEPT BEERS;
WINE, IN CLASS 33 (U.S. CLS. 47 AND 49).

THE MARK CONSISTS OF STANDARD CHAR-
ACTERS WITHOUT CLAIM TO ANY PARTICULAR
FONT, STYLE, SIZE, OR COLOR.

PRIORITY DATE OF 9-14-2007 IS CLAIMED.

OWNER OF INTERNATIONAL REGISTRATION
0958344 DATED 3-7-2008, EXPIRES 3-7-2018.

SER. NO. 79-051,752, FILED 3-7-2008.

JANICE KIM, EXAMINING ATTORNEY

Int. Cl.: 33

Prior U.S. Cls.: 47 and 49

United States Patent and Trademark Office

Reg. No. 3,576,462

Registered Feb. 17, 2009

TRADEMARK
PRINCIPAL REGISTER

The trademark 'Pellus' is rendered in a bold, black, handwritten-style font. The letters are thick and slightly irregular, with a cursive feel. The 'P' is particularly large and has a long, sweeping top bar that extends over the 'e'. The 'l' is tall and narrow, and the 'u' is rounded and connected to the 's'. The 's' has a long, thin tail that curves upwards.

PERUTNINA PTUJ, D.D. (SLOVENIA JOINT
STOCK COMPANY)
POTRCEVA CESTA 10
SI-2250 PTUJ
SLOVENIA

OWNER OF INTERNATIONAL REGISTRATION
0958346 DATED 3-10-2008, EXPIRES 3-10-2018.

FOR: ALCOHOLIC BEVERAGES EXCEPT BEERS;
WINE, IN CLASS 33 (U.S. CLS. 47 AND 49).

SER. NO. 79-051,754, FILED 3-10-2008.

PRIORITY DATE OF 9-14-2007 IS CLAIMED.

JANICE KIM, EXAMINING ATTORNEY

Int. Cl.: 11

Prior U.S. Cls.: 13, 21, 23, 31 and 34

United States Patent and Trademark Office

Reg. No. 3,576,463

Registered Feb. 17, 2009

**TRADEMARK
PRINCIPAL REGISTER**

Maia

HERBERT WALDMANN GMBH & CO. KG. (FED
REP GERMANY LIMITED COMPANY)
PETER-HENLEIN- STR. 5
78056 VILLINGEN-SCHWENNINGEN
FED REP GERMANY

FOR: LIGHTS, NAMELY, FREE-STANDING LU-
MINARIES, DESK-MOUNTED LUMINARIES,
SCREEN-MOUNTED LUMINARIES, ATTACHABLE
LUMINARIES, WALL-MOUNTED LUMINARIES,
SUSPENDED LUMINARIES, PENDANT LUMINAR-
IES FOR OFFICE AND DOMESTIC ROOMS; LAMPS,
IN CLASS 11 (U.S. CLS. 13, 21, 23, 31 AND 34).

THE MARK CONSISTS OF STANDARD CHAR-
ACTERS WITHOUT CLAIM TO ANY PARTICULAR
FONT, STYLE, SIZE, OR COLOR.

PRIORITY DATE OF 7-23-2007 IS CLAIMED.

OWNER OF INTERNATIONAL REGISTRATION
0958415 DATED 1-16-2008, EXPIRES 1-16-2018.

SER. NO. 79-051,779, FILED 1-16-2008.

NAKIA HENRY, EXAMINING ATTORNEY

Int. Cl.: 25

Prior U.S. Cls.: 22 and 39

United States Patent and Trademark Office

Reg. No. 3,576,464

Registered Feb. 17, 2009

TRADEMARK
PRINCIPAL REGISTER



NOVI FOOTWEAR LTD (SWITZERLAND SOCI-
ÉTÉ ANONYME)
MARTINSBRUGGSTRASSE 59
CH-9016 ST. GALLEN
SWITZERLAND

FOR: FOOTWEAR, IN CLASS 25 (U.S. CLS. 22 AND
39).

PRIORITY DATE OF 10-8-2007 IS CLAIMED.

OWNER OF INTERNATIONAL REGISTRATION
0958463 DATED 3-13-2008, EXPIRES 3-13-2018.

NO CLAIM IS MADE TO THE EXCLUSIVE
RIGHT TO USE "HEELS" AND "& CO", APART
FROM THE MARK AS SHOWN.

THE MARK CONSISTS OF THE WORDING
"HEELS & CO"; THE DESIGN OF A HIGH-HEELED
SHOE INTERRUPTS THE TERMS "HEELS" AND "&
CO"; AN INVERSE SHADOW DESIGN APPEARS
DIRECTLY AND EXCLUSIVELY BENEATH THE
HIGH-HEELED SHOE DESIGN.

SER. NO. 79-051,805, FILED 3-13-2008.

GILBERT SWIFT, EXAMINING ATTORNEY

Int. Cl.: 17

Prior U.S. Cls.: 1, 5, 12, 13, 35 and 50

United States Patent and Trademark Office

Reg. No. 3,576,465

Registered Feb. 17, 2009

**TRADEMARK
PRINCIPAL REGISTER**

龍 華

Longhua

MIANYANG LONGHUA FILM CO., LTD (CHINA
CORPORATION)
YONGXING INDUSTRIAL PARK
HI-TECH ZONE; MIANYANG, SICHUAN 621006
CHINA

FOR: POLYCARBONATE FILM FOR USE IN
INSULATION, PRESSWORK, FLAME BARRIER,
SCRAPE BARRIER. POLYPROPYLENE FILM FOR
USE IN INSULATION, FLAME BARRIER. POLYE-
STER FILM FOR USE IN BATTERY PRODUCT
PACKAGING, WHICH HAS THE CHARACTERIS-
TIC OF STRONG CONTRACTIBILITY, IN CLASS 17
(U.S. CLS. 1, 5, 12, 13, 35 AND 50).

OWNER OF INTERNATIONAL REGISTRATION
0958508 DATED 3-20-2008, EXPIRES 3-20-2018.

THE ENGLISH TRANSLATION OF THE FOR-
EIGN WORD(S) IN THE MARK IS: THE NON LATIN
CHARACTERS LONG MEANS DRAGON AND HUA
MEANS PROSPEROUS SPLENDID.

THE TRANSLITERATION OF THE NON-LATIN
CHARACTERS IN THE MARK IS: "LONG HUA".

SER. NO. 79-051,817, FILED 3-20-2008.

DORITT L. CARROLL, EXAMINING ATTORNEY

Int. Cl.: 14

Prior U.S. Cls.: 2, 27, 28 and 50

United States Patent and Trademark Office

Reg. No. 3,576,466

Registered Feb. 17, 2009

**TRADEMARK
PRINCIPAL REGISTER**

EASIUM

EASYL (FRANCE SOCIÉTÉ ANONYME)
13 RUE DE MONTRÉAL
F-74100 VILLE LA GRAND, FRANCE

PRIORITY DATE OF 8-29-2007 IS CLAIMED.

FOR: JEWELRY, PRECIOUS STONES, HOROLOGICAL AND CHRONOMETRIC INSTRUMENTS, PRECIOUS METALS AND THEIR ALLOYS; WORKS OF ART OF PRECIOUS METAL; JEWEL CASES, BOXES OF PRECIOUS METAL, WATCH CASES, WATCH STRAPS, WATCH CHAINS, WATCH SPRINGS AND WATCH GLASSES, FANCY KEY-RINGS, STATUES AND FIGURINES OF PRECIOUS METAL, CLOCK AND WATCH CASES AND JEWELRY CASKETS; MEDALS, IN CLASS 14 (U.S. CLS. 2, 27, 28 AND 50).

OWNER OF INTERNATIONAL REGISTRATION
0958544 DATED 2-28-2008, EXPIRES 2-28-2018.

OWNER OF U.S. REG. NO. 3,318,424.

SER. NO. 79-051,828, FILED 2-28-2008.

WILLIAM VERHOSEK, EXAMINING ATTORNEY

Int. Cls.: 9 and 42

Prior U.S. Cls.: 21, 23, 26, 36, 38, 100 and 101

United States Patent and Trademark Office

Reg. No. 3,576,467

Registered Feb. 17, 2009

**TRADEMARK
SERVICE MARK
PRINCIPAL REGISTER**

SeaBat

RESON A/S (DENMARK PUBLIC LIMITED COMPANY)
FABRIKSVANGEN 13
DK-3550 SLANGERUP
DENMARK

FOR: SCIENTIFIC, NAUTICAL, SURVEYING, PHOTOGRAPHIC, CINEMATOGRAPHIC, OPTICAL, WEIGHING, MEASURING, SIGNALING, AND CHECKING SUPERVISION APPARATUS AND INSTRUMENTS, NAMELY, UNDERWATER ACOUSTIC SYSTEMS COMPRISED OF MULTI-BEAM SONARS, ECHO SOUNDERS, SOUND VELOCITY PROBES, TRANSDUCERS, ACOUSTIC SENSORS, PROFILERS AND HYDRO PHONES, AND HYDROGRAPHIC EQUIPMENT, NAMELY, MULTI-BEAM SONARS, ECHO SOUNDERS, SOUND VELOCITY PROBES, TRANSDUCERS, ACOUSTIC SENSORS, PROFILERS AND HYDRO PHONES; APPARATUS FOR RECORDING, TRANSMISSION OR REPRODUCTION OF SOUND OR IMAGES; SCANNERS; COMPUTER SOFTWARE FOR USE IN THE FIELD OF UNDERWATER ACOUSTICS, NAMELY, FOR USE IN UNDERWATER SURVEYING AND MAPPING, SEA FLOOR SURVEYING AND MAPPING, AND DREDGE GUIDANCE; COMPUTER HARDWARE, IN CLASS 9 (U.S. CLS. 21, 23, 26, 36 AND 38).

FOR: SCIENTIFIC AND TECHNOLOGICAL SERVICES, NAMELY, SCIENTIFIC RESEARCH, DE-

SIGN FOR OTHERS IN THE FIELD OF MARINE SCIENCE AND TECHNOLOGY, DESIGN FOR OTHERS IN THE FIELD OF UNDERWATER ACOUSTIC SYSTEMS AND SONAR SYSTEMS, DESIGN OF GONDOLAS FOR SONAR INSTALLATION, SEA FLOOR AND HABITAT MAPPING AND SURVEYING, LEAK DETECTION IN RELATION TO UNDERWATER ACOUSTIC SYSTEMS AND SONAR SYSTEMS; INDUSTRIAL ANALYSIS AND RESEARCH SERVICES, NAMELY, RESEARCH AND DEVELOPMENT OF UNDERWATER ACOUSTIC EQUIPMENT AND MARINE TECHNOLOGICAL SOLUTIONS; DESIGN AND DEVELOPMENT OF COMPUTER HARDWARE AND SOFTWARE, AND COMPUTER CONSULTATION, IN CLASS 42 (U.S. CLS. 100 AND 101).

THE MARK CONSISTS OF STANDARD CHARACTERS WITHOUT CLAIM TO ANY PARTICULAR FONT, STYLE, SIZE, OR COLOR.

OWNER OF INTERNATIONAL REGISTRATION 0871750 DATED 11-23-2005, EXPIRES 11-23-2015.

SER. NO. 79-051,998, FILED 3-31-2008.

DORITT L. CARROLL, EXAMINING ATTORNEY

Int. Cls.: 9, 10, 11, 38 and 42

Prior U.S. Cls.: 13, 21, 23, 26, 31, 34, 36, 38, 39, 44,
100, 101 and 104

Reg. No. 3,576,468

United States Patent and Trademark Office

Registered Feb. 17, 2009

TRADEMARK
SERVICE MARK
PRINCIPAL REGISTER



BIOLOG (FRANCE SOCIÉTÉ À RESPONSABILITÉ LIMITÉE)
RUE LAVOISIER
F-37130 LANGEAIS
FRANCE

FOR: RADIO FREQUENCY ENABLED IDENTIFICATION AND TRACEABILITY SYSTEMS, DESIGNED TO PROVIDE ELECTRONIC IDENTIFICATION, MONITORING AND MANAGEMENT OF BLOOD BAGS, NAMELY, PORTABLE AND FIXED RFID DATA READERS, COMPUTER INPUTTING TERMINALS, INTEGRATED CIRCUITS, AND TELECOMMUNICATION EQUIPMENTS, NAMELY, ONBOARD COMPUTERS, DIGITAL MEDIAL SERVERS, COMPUTER SERVERS, INTERNET SERVERS, AND FIELDBUS, NAMELY, INDUSTRIAL NETWORK SYSTEM TO PROVIDE TWO-WAY COMMUNICATION WITH DATA READERS AND INPUT TERMINALS; COMPUTER SOFTWARE FOR OPERATING RADIO FREQUENCY ENABLED IDENTIFICATION AND TRACEABILITY SYSTEMS DESIGNED TO PROVIDE ELECTRONIC IDENTIFICATION, MONITORING AND MANAGEMENT OF BLOOD BAGS, IN CLASS 9 (U.S. CLS. 21, 23, 26, 36 AND 38).

FOR: MEDICAL BAGS, NAMELY, BLOOD BAGS CONTAINING ELECTRONIC CHIPS AND INTEGRATED CIRCUITS THAT PROVIDE ELECTRONIC IDENTIFICATION, MONITORING AND MANAGEMENT OF BLOOD BAGS, IN CLASS 10 (U.S. CLS. 26, 39 AND 44).

FOR: REFRIGERATORS SPECIALLY FITTED WITH RADIO FREQUENCY READERS DESIGNED TO PROVIDE STORAGE, ELECTRONIC IDENTIFI-

CATION, AND MONITORING AND MANAGEMENT OF BLOOD BAGS, IN CLASS 11 (U.S. CLS. 13, 21, 23, 31 AND 34).

FOR: COMMUNICATIONS BY COMPUTER TERMINALS, RADIO, AND INTERNET SERVERS, AS PART OF RADIO FREQUENCY ENABLED IDENTIFICATION AND TRACEABILITY SYSTEMS DESIGNED TO PROVIDE STORAGE, ELECTRONIC IDENTIFICATION, MONITORING AND MANAGEMENT OF BLOOD BAGS, IN CLASS 38 (U.S. CLS. 100, 101 AND 104).

FOR: DESIGN, DEVELOPMENT, MAINTENANCE AND UPDATING OF OPERATING SOFTWARE FOR RADIO FREQUENCY ENABLED IDENTIFICATION AND TRACEABILITY SYSTEMS, DESIGNED TO PROVIDE ELECTRONIC IDENTIFICATION, MONITORING AND CONDUCTING BLOOD BAGS, IN CLASS 42 (U.S. CLS. 100 AND 101).

OWNER OF INTERNATIONAL REGISTRATION
0946760 DATED 11-21-2007, EXPIRES 11-21-2017.

THE COLOR(S) BLUE AND RED IS/ARE CLAIMED AS A FEATURE OF THE MARK.

THE MARK CONSISTS OF THE WORDING "BIOLOG" IN THE COLORS BLUE. TO THE LEFT OF THE WORDING IS A SINGLE LINE CIRCLE IN THE COLOR BLUE. INSIDE THE CIRCLE IS A RED TRIANGLE WITH ONE CURVED SIDE, POINTING IN THE DIRECTION OF THE WORD "BIOLOG".

THE WORD "BIOLOG" HAS NO MEANING IN A
FOREIGN LANGUAGE.

SER. NO. 79-052,006, FILED 3-17-2008.

WENDY JUN, EXAMINING ATTORNEY

Int. Cl.: 21

Prior U.S. Cls.: 2, 13, 23, 29, 30, 33, 40 and 50

United States Patent and Trademark Office

Reg. No. 3,576,469

Registered Feb. 17, 2009

**TRADEMARK
PRINCIPAL REGISTER**

LITTLE BUBS

ROWENA WENCK (AUSTRALIA INDIVIDUAL)
100 RENTON AVENUE
MOOREBANK NSW 2170
AUSTRALIA

FOR: BRUSHES, NAMELY, BRUSHES FOR PERSONAL USE; BRUSHES FOR CLEANING, BRUSHES FOR PERSONAL HYGIENE, MAKE UP AND COSMETIC BRUSHES, SKIN CLEANSING BRUSHES; BATH BRUSHES AND BABIES' BRUSHES, NAMELY, BRUSHES FOR USE ON SKIN; APPLICATORS, NAMELY, APPLICATOR BRUSHES AND BRUSHES FOR THE APPLICATION OF SKIN CREAMS; CASES, CONTAINERS, HOLDERS AND DISPENSERS WITH OR WITHOUT LIDS THAT HAVE BEEN SPECIFICALLY ADAPTED FOR USE WITH BRUSHES FOR PERSONAL USE, BRUSHES FOR CLEANING, SKIN CLEANSING BRUSHES, MAKE-UP APPLICATORS, TOILET PAPER AND FOR HOUSEHOLD STORAGE PURPOSES; DISPENSING DEVICES, NAMELY, SKIN CREAM AND SKIN

LOTION DISPENSERS; STANDS SPECIFICALLY ADAPTED FOR USE WITH BRUSHES FOR PERSONAL USE, BRUSHES FOR CLEANING, SKIN CLEANSING BRUSHES, MAKE-UP APPLICATORS AND TOILET PAPER, IN CLASS 21 (U.S. CLS. 2, 13, 23, 29, 30, 33, 40 AND 50).

THE MARK CONSISTS OF STANDARD CHARACTERS WITHOUT CLAIM TO ANY PARTICULAR FONT, STYLE, SIZE, OR COLOR.

PRIORITY DATE OF 12-10-2007 IS CLAIMED.

OWNER OF INTERNATIONAL REGISTRATION 0959086 DATED 12-20-2007, EXPIRES 12-20-2017.

SER. NO. 79-052,029, FILED 12-20-2007.

PAULA MAHONEY, EXAMINING ATTORNEY

Int. Cl.: 9

Prior U.S. Cls.: 21, 23, 26, 36 and 38

United States Patent and Trademark Office

Reg. No. 3,576,470

Registered Feb. 17, 2009

**TRADEMARK
PRINCIPAL REGISTER**

GIO-GOI

GIO GOI BRANDS LIMITED
13 MELVILLE STREET
EDINBURGH EH3 7PE
UNITED KINGDOM

FOR: PHONOGRAPH RECORDS, COMPACT DISCS, AUDIO AND VIDEO TAPES, AUDIO AND VIDEO CASSETTES, AUDIO AND VIDEO CARTRIDGES, ALL BEARING SOUND RECORDINGS, VIDEO RECORDINGS, DATA, IMAGES, GAMES, GRAPHICS, TEXT, PROGRAMMES OR INFORMATION IN THE FIELDS OF FASHION, MUSIC, SPORT OR ENTERTAINMENT; DOWNLOADABLE ELECTRONIC PUBLICATIONS, NAMELY, NEWSLETTERS AND BROCHURES FEATURING FASHION, MUSIC, SPORT OR ENTERTAINMENT; MUSICAL SOUND AND VIDEO RECORDINGS; DIGITAL MUSIC DOWNLOADABLE FROM THE INTERNET; MOBILE PHONES; MOBILE PHONE COVERS; MOBILE PHONE ACCESSORIES, NAMELY, RINGTONES AND WALLPAPERS DOWNLOADABLE VIA GLOBAL COMPUTER NETWORKS AND

WIRELESS DEVICES; PHONE CARDS, NAMELY, PRE-PAID TELEPHONE CALLING CARDS, MAGNETICALLY ENCODED; CREDIT CARDS, NAMELY, MAGNETICALLY-ENCODED CREDIT CARDS; CONTACT LENSES, SPECTACLES AND SUNGLASSES; EYEGLOSS CASES; GOGGLES FOR SPORTS; PROTECTIVE HELMETS, PROTECTIVE HELMETS FOR SPORTS, IN CLASS 9 (U.S. CLS. 21, 23, 26, 36 AND 38).

THE MARK CONSISTS OF STANDARD CHARACTERS WITHOUT CLAIM TO ANY PARTICULAR FONT, STYLE, SIZE, OR COLOR.

OWNER OF INTERNATIONAL REGISTRATION
0959166 DATED 3-4-2008, EXPIRES 3-4-2018.

SER. NO. 79-052,057, FILED 3-4-2008.

AMEETA JORDAN, EXAMINING ATTORNEY

Int. Cls.: 12 and 39

Prior U.S. Cls.: 19, 21, 23, 31, 35, 44, 100 and 105

United States Patent and Trademark Office

Reg. No. 3,576,471

Registered Feb. 17, 2009

**TRADEMARK
SERVICE MARK
PRINCIPAL REGISTER**

ODYSTAR

ASTRIUM SAS (FRANCE SOCIÉTÉ PAR AC-
TIONS SIMPLIFIÉE)
6, RUE LAURENT PICHAT
F-75016 PARIS
FRANCE

FOR: SPACE VEHICLES AND VEHICLES FOR
SPACE TOURISM, NAMELY, SHUTTLES, ROCK-
ETS, IN CLASS 12 (U.S. CLS. 19, 21, 23, 31, 35 AND 44).

FOR: SPACE TRANSPORT SERVICES; ARRAN-
GING SPACE TRAVEL TOURS AND COORDINAT-
ING SPACE TRAVEL ARRANGEMENTS FOR
INDIVIDUALS AND FOR GROUPS; SPACE TRANSPOR-
T OF PASSENGERS; TRAVEL AGENCIES FOR
SPACE TRAVEL, NAMELY, MAKING RESERVA-
TIONS AND BOOKINGS FOR SPACE TRANSPOR-
TATION, IN CLASS 39 (U.S. CLS. 100 AND 105).

THE MARK CONSISTS OF STANDARD CHAR-
ACTERS WITHOUT CLAIM TO ANY PARTICULAR
FONT, STYLE, SIZE, OR COLOR.

PRIORITY DATE OF 9-28-2007 IS CLAIMED.

OWNER OF INTERNATIONAL REGISTRATION
0959489 DATED 3-12-2008, EXPIRES 3-12-2018.

SER. NO. 79-052,165, FILED 3-12-2008.

WARREN L. OLANDRIA, EXAMINING ATTOR-
NEY

Int. Cls.: 5, 16, 35, 41 and 44

Prior U.S. Cls.: 2, 5, 6, 18, 22, 23, 29, 37, 38, 44, 46, 50, 51, 52, 100, 101, 102 and 107

Reg. No. 3,576,472

United States Patent and Trademark Office

Registered Feb. 17, 2009

**TRADEMARK
SERVICE MARK
PRINCIPAL REGISTER**



ISTITUTO EUROPEO DI ONCOLOGIA S.R.L.
(ITALY SOCIÉTÉ À RESPONSABILITÉ LIMITÉE)
VIA FILODRAMMATICI, 10
I-20121 MILANO
ITALY

FOR: PHARMACEUTICAL PREPARATIONS FOR USE IN ONCOLOGY; DIETETIC FOODS FOR CHILDREN AND THE SICK ADAPTED FOR MEDICAL USE, IN CLASS 5 (U.S. CLS. 6, 18, 44, 46, 51 AND 52).

FOR: A SERIES OF BOOKS IN THE FIELD OF ONCOLOGY; COMPENDIUMS IN THE NATURE OF BOOKLETS AND RESEARCH REPORTS IN THE FIELD OF ONCOLOGY; NEWSPAPERS; SYNDICATED ARTICLES IN THE FORM OF REVIEWS IN THE FIELD OF ONCOLOGY; PRINTED PERIODICALS IN THE FIELD OF ONCOLOGY; LEAFLETS, PRINTED TEACHING MATERIALS, PRINTED REPORTS ALL ON THE SUBJECT OF ONCOLOGY; INDEX CARDS, IN CLASS 16 (U.S. CLS. 2, 5, 22, 23, 29, 37, 38 AND 50).

FOR: ENTERPRISE DEVELOPMENT SERVICES, NAMELY, DEVELOPING PROMOTIONAL CAMPAIGNS; BUSINESS MANAGEMENT SERVICES; BUSINESS PLANNING SERVICES; ECONOMIC ANALYSES IN THE MEDICAL AND HOSPITAL SECTOR; MARKET STUDIES, SURVEYS AND RESEARCH; BUSINESS MANAGEMENT AND ORGANIZATION CONSULTING; PERSONNEL MANAGEMENT AND CONSULTANCY; BUSINESS MANAGEMENT SERVICES, NAMELY, MANAGING COMPUTER DATA BANKS AND COMPUTER ARCHIVES FOR BUSINESS PURPOSES, IN CLASS 35 (U.S. CLS. 100, 101 AND 102).

FOR: EDUCATIONAL RESEARCH IN THE ONCOLOGY SECTOR; EDUCATIONAL SERVICES, NAMELY, ARRANGING AND CONDUCTING SPECIALIZATION COURSES FOR ONCOLOGISTS;

EDUCATIONAL SERVICES, NAMELY, ARRANGING CONFERENCES AND SEMINARS IN THE ONCOLOGY SECTOR AND THAT OF GENERAL MEDICINE; EDUCATIONAL SERVICES, NAMELY, ARRANGING COURSES TO PROMOTE PREVENTION AND TREATMENT IN THE FIGHT AGAINST TUMORS, IN CLASS 41 (U.S. CLS. 100, 101 AND 107).

FOR: MEDICAL AND SURGERY SERVICES, NAMELY, MEDICO-CHIRURGICAL ACTIVITY PERFORMED BY A HOSPITAL INSTITUTION; MEDICAL SERVICES, NAMELY, ACTIVITY PERFORMED BY A CLINICAL INSTITUTE SPECIALIZED IN THE PREVENTION AND EARLY DIAGNOSIS OF TUMORS; MEDICAL SERVICES, NAMELY, CLINIC SPECIALIZED IN THE TREATMENT OF TUMORS, IN CLASS 44 (U.S. CLS. 100 AND 101).

OWNER OF INTERNATIONAL REGISTRATION 0959546 DATED 1-18-2008, EXPIRES 1-18-2018.

NO CLAIM IS MADE TO THE EXCLUSIVE RIGHT TO USE "ISTITUTO EUROPEO DI ONCOLOGIA", APART FROM THE MARK AS SHOWN.

THE COLOR(S) BLACK, BLUE AND WHITE IS/ ARE CLAIMED AS A FEATURE OF THE MARK.

THE GRAPHIC ELEMENT OF THE MARK IS A BLUE CIRCLE OVER WHICH IS PARTIALLY SUPERIMPOSED BY A SERIES OF SMALL WHITE SQUARES OVER THE CIRCLE AND SMALL BLUE SQUARES TO THE LEFT OF THE CIRCLE, TOGETHER FORMING THE SHAPE OF A DIAMOND, WHICH AS A WHOLE FORM A WHITE AND BLUE LOZENGE, TO THE SIDE OF THE CIRCLE ARE THE LETTERS "IEO" IN BLACK AND BENEATH THEM THE WORDS "ISTITUTO EUROPEO DI ONCOLOGIA" IN BLUE.

THE ENGLISH TRANSLATION OF THE WORD
"ISTITUTO EUROPEO DI ONCOLOGIA" IN THE
MARK IS "EUROPEAN INSTITUTE OF ONCOLO-
GY".

SER. NO. 79-052,191, FILED 1-18-2008.

CHARLOTTE CORWIN, EXAMINING ATTORNEY

Int. Cls.: 35, 38, 41 and 42

Prior U.S. Cls.: 100, 101, 102, 104 and 107

Reg. No. 3,576,473

United States Patent and Trademark Office

Registered Feb. 17, 2009

**SERVICE MARK
PRINCIPAL REGISTER**

PeopleBrowsr

WWBAY PTY LIMITED (AUSTRALIA CORPORATION)
LEVEL 11
111 ELIZABETH STREET
SYDNEY NSW 2000, AUSTRALIA

FOR: ADVERTISING, IN CLASS 35 (U.S. CLS. 100, 101 AND 102).

FOR: ELECTRONIC EXCHANGE OF DATA STORED IN DATABASES ACCESSIBLE VIA TELECOMMUNICATION NETWORKS; COMMUNICATIONS VIA MULTINATIONAL TELECOMMUNICATION NETWORKS; COMMUNICATION SERVICES, NAMELY, TRANSMISSION OF VOICE, AUDIO, VISUAL IMAGES AND DATA BY TELECOMMUNICATIONS NETWORKS, WIRELESS COMMUNICATION NETWORKS, THE INTERNET, INFORMATION SERVICE NETWORKS AND DATA NETWORKS; DATA TRANSMISSION AND RECEPTION SERVICES VIA TELECOMMUNICATION MEANS; PROVIDING TELECOMMUNICATIONS CONNECTIONS TO THE INTERNET OR DATABASES, IN CLASS 38 (U.S. CLS. 100, 101 AND 104).

FOR: PROVISION OF ONLINE JOURNALS, NAMELY, BLOGS FEATURING EDUCATION OR ENTERTAINMENT, IN CLASS 41 (U.S. CLS. 100, 101 AND 107).

FOR: DESIGN OF COMPUTER SOFTWARE; DEVELOPMENT OF COMPUTER SOFTWARE, IN CLASS 42 (U.S. CLS. 100 AND 101).

THE MARK CONSISTS OF STANDARD CHARACTERS WITHOUT CLAIM TO ANY PARTICULAR FONT, STYLE, SIZE, OR COLOR.

OWNER OF INTERNATIONAL REGISTRATION 0959547 DATED 2-11-2008, EXPIRES 2-11-2018.

SER. NO. 79-052,192, FILED 2-11-2008.

ANTHONY RINKER, EXAMINING ATTORNEY

Int. Cl.: 9

Prior U.S. Cls.: 21, 23, 26, 36 and 38

United States Patent and Trademark Office

Reg. No. 3,576,474

Registered Feb. 17, 2009

**TRADEMARK
PRINCIPAL REGISTER**



STMICROELECTRONICS N.V. (NETHERLANDS
PUBLIC LIMITED LIABILITY COMPANY)
SCHIPHOL BOULEVARD 265,
A'DAM AIRP; NL-1118 BH LUCHTHAVEN SCHI-
PHOL
NETHERLANDS

FOR: INTEGRATED CIRCUITS, SEMICONDUCTORS,
MICROCONTROLLERS, MICROPROCESSORS,
EMBEDDED MICROPROCESSORS , IN
CLASS 9 (U.S. CLS. 21, 23, 26, 36 AND 38).

PRIORITY DATE OF 7-17-2007 IS CLAIMED.

OWNER OF INTERNATIONAL REGISTRATION
0959856 DATED 1-14-2008, EXPIRES 1-14-2018.

THE COLOR(S) BLUE IS/ARE CLAIMED AS A
FEATURE OF THE MARK.

THE MARK CONSISTS OF "STM" AND "32" AND
A BUTTERFLY, ALL APPEARING IN BLUE.

SER. NO. 79-052,283, FILED 1-14-2008.

DANNEAN HETZEL, EXAMINING ATTORNEY

Int. Cl.: 25

Prior U.S. Cls.: 22 and 39

United States Patent and Trademark Office

Reg. No. 3,576,475

Registered Feb. 17, 2009

TRADEMARK
PRINCIPAL REGISTER

流行传说
FASHION LEGEND

LIU XIAOQIAN (CHINA INDIVIDUAL)
SHANGNAN COMMUNITY,
XINHUA TOWN,; HUADU CITY; GUANGDONG
PROVINCE
CHINA

FOR: CLOTHING, NAMELY, SHIRTS, PANTS,
COATS FOR MEN AND WOMEN, SHIRTS; CLOTH-
ING FOR GYMNASTICS, NAMELY, GYM SUITS,
LEOTARDS; CAPS AND HATS; HOSIERY; GLOVES
FOR CLOTHING; NECKTIES; BELTS FOR CLOTH-
ING; WEDDING DRESSES, IN CLASS 25 (U.S. CLS.
22 AND 39).

OWNER OF INTERNATIONAL REGISTRATION
0959942 DATED 3-17-2008, EXPIRES 3-17-2018.

NO CLAIM IS MADE TO THE EXCLUSIVE
RIGHT TO USE "FASHION", APART FROM THE
MARK AS SHOWN.

THE MARK COMPOSED OF AN ENGLISH
PHRASE "FASHION LEGEND", AND ITS CHINESE
EQUIVALENT PRONOUNCED AS LIU XING
CHUAN SHUO.

THE ENGLISH TRANSLATION OF THE FOR-
EIGN WORD(S) IN THE MARK IS: "FASHION
LEGEND".

THE TRANSLITERATION OF THE NON-LATIN
CHARACTERS IN THE MARK IS: LIU XING
CHUAN SHUO.

SER. NO. 79-052,317, FILED 3-17-2008.

DEZMONA MIZELLE, EXAMINING ATTORNEY

Int. Cl.: 25

Prior U.S. Cls.: 22 and 39

United States Patent and Trademark Office

Reg. No. 3,576,476

Registered Feb. 17, 2009

TRADEMARK
PRINCIPAL REGISTER

TWNN
BLACK

ORKA TEKSTIL SANAYI VE TURIZM; TICARET ANONIM SIRKETI (TURKEY JOINT STOCK VENTURE)
OKMEYDANI, GÜRSEL MAHALLESİ,
YALIM SOKAK NO: 5; SISLI-ISTANBUL
TURKEY

FOR: CLOTHING, NAMELY, PULLOVERS; SKIRTS; DRESSES; BLOUSES; JEANS; TROUSERS; JACKETS; COATS, RAINCOATS, ANORAKS; SPORTSWEAR, NAMELY, SHIRTS, SHORTS, PANTS AND JACKETS; SHIRTS; T-SHIRTS; SWEAT-SHIRTS; BEACH CLOTHES, NAMELY, BATHING SUITS AND BEACH COVER-UPS; SHORTS; KNITWEAR, NAMELY, SHIRTS, SHORTS, SWEATERS AND SCARVES; OVERALLS; UNDERCLOTHING; BODICES; BRASSIERES; CAMISOLES; UNDERPANTS; DRESSING GOWNS; BATH ROBES; BATHING SUITS; PYJAMAS; GLOVES; SKI SUITS; HEADGEAR, NAMELY, HATS, CAPS, KNITTED CAPS, BERETS; FOOTWEAR, NAMELY, SHOES EXCLUDING ORTHOPAEDIC SHOES, SLIPPERS, BOOTS, SANDALS, BEACH SHOES, SPORTS SHOES,

LACE BOOTS; SHOE PARTS, NAMELY, HEELPIECES; HEELS; FOOTWEAR UPPERS; STOCKINGS; BELTS; TIES; NECKTIES; SHAWLS; SCARVES; MUFFLERS; NECK SCARVES; SARONGS; COLLARS FOR DRESSES; MANIPLES; MUFFS; SUSPENDERS; BRACES FOR CLOTHING; GARTERS; BANDANAS; HEADBANDS; CLOTHING FOR BABIES, NAMELY, BABIES' DIAPERS OF TEXTILE, IN CLASS 25 (U.S. CLS. 22 AND 39).

OWNER OF INTERNATIONAL REGISTRATION
0959959 DATED 2-26-2008, EXPIRES 2-26-2018.

NO CLAIM IS MADE TO THE EXCLUSIVE RIGHT TO USE "BLACK" , APART FROM THE MARK AS SHOWN.

SER. NO. 79-052,324, FILED 2-26-2008.

KRISTIN DAHLING, EXAMINING ATTORNEY

Int. Cls.: 16, 18, 25 and 28

Prior U.S. Cls.: 1, 2, 3, 5, 22, 23, 29, 37, 38, 39, 41 and 50

United States Patent and Trademark Office

Reg. No. 3,576,477

Registered Feb. 17, 2009

**TRADEMARK
PRINCIPAL REGISTER**



VISIODAN A/S (DENMARK PUBLIC LIMITED COMPANY (PLC))
STRANDVEJEN 171.1
DK-2900 HELLERUP
DENMARK

FOR: DRAWING RULERS, PENCILS, PENCIL SHARPENERS, ERASERS, PENS, PENCIL CASES, WRITING PAPER, FLAGS OF PAPER, IN CLASS 16 (U.S. CLS. 2, 5, 22, 23, 29, 37, 38 AND 50).

FOR: UMBRELLAS, ALL-PURPOSE CARRYING BAGS, SCHOOL BAGS, SPORT BAGS, TOILETRY BAGS SOLD EMPTY, WALLETS, IN CLASS 18 (U.S. CLS. 1, 2, 3, 22 AND 41).

FOR: CLOTHING FOR DRESS UP COSTUMES, NAMELY, CAPES, VESTS, SKIRTS, TOPS, BELTS, HATS, BANDANAS, WINGS, KNICKERS, CAPS, SUN HATS, T-SHIRTS, IN CLASS 25 (U.S. CLS. 22 AND 39).

FOR: TOYS MADE OF EVA FOAM FOR CHILDREN'S DRESS-UP ACCESSORIES, NAMELY,

SWORDS, SHIELDS, PISTOLS, RIFLES, SHERIFF BADGES, AXES, CROWNS, HAMMERS, SAWS, SPANNER, POWER DRILLS, HELMETS, STOP SIGNS, BATONS, HANDCUFFS, FEATHERS, KNIVES, SABRES, PIRATE HOOKS, MIRRORS, MASKS, TEDDY BEARS, PRINCESS WANDS, SWORD SHEATHS, TOY DIADEMS, PLAY TENTS, EYE PATCHES, IN CLASS 28 (U.S. CLS. 22, 23, 38 AND 50).

PRIORITY DATE OF 7-4-2007 IS CLAIMED.

OWNER OF INTERNATIONAL REGISTRATION 0960420 DATED 11-14-2007, EXPIRES 11-14-2017.

THE MARK CONSISTS OF THE FANCIFUL DESIGN OF A LION'S HEAD.

SER. NO. 79-052,453, FILED 11-14-2007.

HELENE LIWINSKI, EXAMINING ATTORNEY

Int. Cls.: 7, 31 and 42

Prior U.S. Cls.: 1, 13, 19, 21, 23, 31, 34, 35, 46, 100 and 101

United States Patent and Trademark Office

Reg. No. 3,576,478

Registered Feb. 17, 2009

**TRADEMARK
SERVICE MARK
PRINCIPAL REGISTER**

BOVITS

BÜHLER AG (SWITZERLAND SOCIÉTÉ ANON-
YME)
BAHNHOFSTRASSE
CH-9240 UZWIL
SWITZERLAND

FOR: MACHINES, NAMELY, MACHINES FOR
TREATING ANIMAL FOODSTUFFS AND CATTLE
FEED, IN CLASS 7 (U.S. CLS. 13, 19, 21, 23, 31, 34 AND
35).

FOR: AGRICULTURAL, HORTICULTURAL
AND FORESTRY PRODUCTS AND GRAINS,
NAMELY, AGRICULTURAL GRAINS FOR PLANT-
ING, AGRICULTURAL SEEDS; LIVE ANIMALS;
SEEDS, NAMELY, CROP SEEDS, GRASS SEEDS;
NATURAL PLANTS AND FLOWERS; ANIMAL
FOODSTUFFS, MALT FOR BREWING, DISTILLING
AND FEEDING, IN CLASS 31 (U.S. CLS. 1 AND 46).

FOR: SCIENTIFIC AND TECHNOLOGICAL SER-
VICES AND RESEARCH AND DESIGN SERVICES,
NAMELY, SCIENTIFIC RESEARCH AND DEVEL-
OPMENT IN THE NATURE OF GENETIC ENGI-
NEERING IN THE FIELD OF ANIMAL

FOODSTUFFS AND CATTLE FEED; INDUSTRIAL
ANALYSIS AND RESEARCH SERVICES IN THE
FIELD OF ANIMAL FOODSTUFFS AND CATTLE
FEED, IN CLASS 42 (U.S. CLS. 100 AND 101).

THE MARK CONSISTS OF STANDARD CHAR-
ACTERS WITHOUT CLAIM TO ANY PARTICULAR
FONT, STYLE, SIZE, OR COLOR.

PRIORITY DATE OF 12-5-2007 IS CLAIMED.

OWNER OF INTERNATIONAL REGISTRATION
0961108 DATED 4-16-2008, EXPIRES 4-16-2018.

THE MARK "BOVITIS" HAS NO SIGNIFICANCE
IN THE RELEVANT TRADE OR INDUSTRY, NEI-
THER A GEOGRAPHICAL SIGNIFICANCE NOR
ANY MEANING IN A FOREIGN LANGUAGE.

SER. NO. 79-052,688, FILED 4-16-2008.

RICHARD WHITE, EXAMINING ATTORNEY

Int. Cl.: 11

Prior U.S. Cls.: 13, 21, 23, 31 and 34

United States Patent and Trademark Office

Reg. No. 3,576,479

Registered Feb. 17, 2009

**TRADEMARK
PRINCIPAL REGISTER**

FIOCCHETTI

C.F. DI FIOCCHETTI CIRO & C. S.N.C. (ITALY
UNLIMITED PARTNERSHIP)

VIA LORENZINI, 53
I-42045 LUZZARA (RE)
ITALY

FOR: COLD STORES AND CELLS, NAMELY,
PORTABLE REFRIGERATED ROOMS, REFRIGER-
ATED SHIPPING CONTAINERS, REFRIGERATING
SHOWCASES, FREEZING SHOWCASES, REFRI-
GERATED MEDICAL CONTAINERS FOR STO-
RAGE, TRANSPORTATION AND COOLING OF
MEDICINES AND PHARMACEUTICALS; REFRIG-
ERATORS; GAS REFRIGERATORS; REFRIGER-
ATED COUNTERS, IN CLASS 11 (U.S. CLS. 13, 21,
23, 31 AND 34).

THE MARK CONSISTS OF STANDARD CHAR-
ACTERS WITHOUT CLAIM TO ANY PARTICULAR
FONT, STYLE, SIZE, OR COLOR.

PRIORITY DATE OF 1-31-2008 IS CLAIMED.

OWNER OF INTERNATIONAL REGISTRATION
0961155 DATED 2-19-2008, EXPIRES 2-19-2018.

THE WORD "FIOCCHETTI" HAS NO MEANING
IN A FOREIGN LANGUAGE.

SER. NO. 79-052,712, FILED 2-19-2008.

TINA BROWN, EXAMINING ATTORNEY

Int. Cls.: 32 and 33

Prior U.S. Cls.: 45, 46, 47, 48 and 49

United States Patent and Trademark Office

Reg. No. 3,576,480

Registered Feb. 17, 2009

**TRADEMARK
PRINCIPAL REGISTER**

WHALE'S CAROL

WEBER, JOHST (FED REP GERMANY INDIVIDUAL)
HUNSRÜCKSTR. 3
45133 ESSEN
FED REP GERMANY

FOR: NON-ALCOHOLIC DRINKS, NAMELY, MINERAL AND AERATED WATERS, IN CLASS 32 (U.S. CLS. 45, 46 AND 48).

FOR: ALCOHOLIC BEVERAGES, EXCEPT BEERS, NAMELY, WINES, IN CLASS 33 (U.S. CLS. 47 AND 49).

THE MARK CONSISTS OF STANDARD CHARACTERS WITHOUT CLAIM TO ANY PARTICULAR FONT, STYLE, SIZE, OR COLOR.

PRIORITY DATE OF 3-12-2008 IS CLAIMED.

OWNER OF INTERNATIONAL REGISTRATION 0962045 DATED 4-21-2008, EXPIRES 4-21-2018.

SER. NO. 79-053,038, FILED 4-21-2008.

KATINA MISTER, EXAMINING ATTORNEY

Int. Cls.: 1, 3 and 37

**Prior U.S. Cls.: 1, 4, 5, 6, 10, 26, 46, 50, 51, 52, 100, 103
and 106**

Reg. No. 3,576,481

United States Patent and Trademark Office

Registered Feb. 17, 2009

**TRADEMARK
SERVICE MARK
PRINCIPAL REGISTER**



CARE TEAM ITALIA S.R.L. UNIP. (ITALY LIMITED LIABILITY COMPANY)
VIA GASDOTTO, 8
I-36078 VALDAGNO (VICENZA)
ITALY

FOR: CHEMICALS USED IN INDUSTRY, SCIENCE AND PHOTOGRAPHY; TANNING SUBSTANCES, NAMELY, TANNING AGENTS FOR USE IN THE MANUFACTURE OF LEATHER; ADHESIVES USED IN INDUSTRY, IN CLASS 1 (U.S. CLS. 1, 5, 6, 10, 26 AND 46).

FOR: CLEANING, POLISHING, SCOURING AND ABRASIVE PREPARATIONS; SOAPS, IN CLASS 3 (U.S. CLS. 1, 4, 6, 50, 51 AND 52).

FOR: REPAIR SERVICES FOR FURNITURE AND AUTOMOBILE INTERIORS, IN CLASS 37 (U.S. CLS. 100, 103 AND 106).

PRIORITY DATE OF 12-6-2007 IS CLAIMED.

OWNER OF INTERNATIONAL REGISTRATION 0962202 DATED 3-19-2008, EXPIRES 3-19-2018.

THE MARK CONSISTS OF A STYLIZED HEART WITH A CROSS IN THE MIDDLE.

SER. NO. 79-053,081, FILED 3-19-2008.

AISHA SALEM, EXAMINING ATTORNEY

Int. Cls.: 6, 9 and 20

**Prior U.S. Cls.: 2, 12, 13, 14, 21, 22, 23, 25, 26, 32, 36,
38 and 50**

United States Patent and Trademark Office

Reg. No. 3,576,482

Registered Feb. 17, 2009

**TRADEMARK
PRINCIPAL REGISTER**

PHYSIX

VOGEL'S PRODUCTS B.V. (NETHERLANDS
CORPORATION)
HONDSRUGLAAN 93
NL-5628 DB EINDHOVEN
NETHERLANDS

FOR: TRANSPORTABLE BUILDINGS OF METAL; NON-ELECTRIC CABLES AND WIRES OF COMMON METAL; PIPES AND TUBES OF METAL; METAL SUPPORTS, FEET AND MOUNTING BRACKETS FOR LOUD SPEAKER BOXES, MONITORS, TELEVISION SETS AND KEYBOARDS, IN CLASS 6 (U.S. CLS. 2, 12, 13, 14, 23, 25 AND 50).

FOR: LUMINOUS SIGNS, IN CLASS 9 (U.S. CLS. 21, 23, 26, 36 AND 38).

FOR: FURNITURE FOR STORING AND PLACING AUDIO, VIDEO AND DATA PROCESSING EQUIPMENT; CABLE OR PIPE CLIPS OF PLASTIC;

PLASTIC SUPPORTS, FEET AND MOUNTING BRACKETS FOR LOUD SPEAKER BOXES, MONITORS, TELEVISION SETS AND KEYBOARDS, IN CLASS 20 (U.S. CLS. 2, 13, 22, 25, 32 AND 50).

THE MARK CONSISTS OF STANDARD CHARACTERS WITHOUT CLAIM TO ANY PARTICULAR FONT, STYLE, SIZE, OR COLOR.

PRIORITY DATE OF 10-4-2007 IS CLAIMED.

OWNER OF INTERNATIONAL REGISTRATION
0962255 DATED 4-3-2008, EXPIRES 4-3-2018.

SER. NO. 79-053,100, FILED 4-3-2008.

KRISTIN DAHLING, EXAMINING ATTORNEY

Int. Cl.: 9

Prior U.S. Cls.: 21, 23, 26, 36 and 38

United States Patent and Trademark Office

Reg. No. 3,576,483

Registered Feb. 17, 2009

**TRADEMARK
PRINCIPAL REGISTER**

LEKTOR

DALI A/S (DENMARK CORPORATION)
DALI ALLÉ 1
DK-9610 NØRAGER
DENMARK

FOR: LOUD SPEAKERS AND RELATED ARTICLES, NAMELY, LOUD SPEAKER CROSSOVERS, LOUD SPEAKER DRIVE UNITS, LOUD SPEAKER ENCLOSURES, CONNECTORS, TERMINALS, BASE REFLEX PORTS, SUBWOOFERS, MOUNTING BRACKETS AND SPIKES, IN CLASS 9 (U.S. CLS. 21, 23, 26, 36 AND 38).

THE MARK CONSISTS OF STANDARD CHARACTERS WITHOUT CLAIM TO ANY PARTICULAR FONT, STYLE, SIZE, OR COLOR.

PRIORITY DATE OF 1-17-2008 IS CLAIMED.

OWNER OF INTERNATIONAL REGISTRATION
0962378 DATED 4-25-2008, EXPIRES 4-25-2018.

THE ENGLISH TRANSLATION OF "LEKTOR" IS
LECTURER.

SER. NO. 79-053,144, FILED 4-25-2008.

SHANNON TWOHIG, EXAMINING ATTORNEY

Int. Cl.: 25

Prior U.S. Cls.: 22 and 39

United States Patent and Trademark Office

Reg. No. 3,576,484

Registered Feb. 17, 2009

**TRADEMARK
PRINCIPAL REGISTER**



FALC S.P.A. (ITALY JOINT-STOCK COMPANY)
CONTRADA SAN DOMENICO, 24
I-62012 CIVITANOVA MARCHE (MACERATA)
ITALY

OWNER OF INTERNATIONAL REGISTRATION
0962658 DATED 3-3-2008, EXPIRES 3-3-2018.

FOR: CLOTHING FOR ADULTS AND CHILDREN, NAMELY, HEAVY VESTS, JACKETS, COATS, PLUSH SHIRTS, OVERCOATS, DOWN COATS, MUFFLERS, GLOVES, TROUSERS, PANTS, DUNGAREES, SPORT JACKETS, POLO-NECK SWEATERS, T-SHIRTS, SHIRTS, BLOUSES, SOCKS, HEADWEAR, HATS, GYM-SUITS, FOOTWEAR, FOOTWEAR FOR CHILDREN, IN CLASS 25 (U.S. CLS. 22 AND 39).

THE MARK CONSISTS OF A STYLIZED REPRESENTATION OF A CAPITAL LETTER "N", PARTIALLY CONTAINED WITHIN A CIRCLE, WITH THE ENDS STICKING OUT.

SER. NO. 79-053,239, FILED 3-3-2008.

PRIORITY DATE OF 9-20-2007 IS CLAIMED.

G. MAYERSCHOFF, EXAMINING ATTORNEY

Int. Cl.: 9

Prior U.S. Cls.: 21, 23, 26, 36 and 38

Reg. No. 3,576,485

United States Patent and Trademark Office

Registered Feb. 17, 2009

**TRADEMARK
PRINCIPAL REGISTER**



BROADEX TECHNOLOGIES CO., LTD. (CHINA CORPORATION)
11 CONSTRUCTION ROAD
GUODIAN TOWNSHIP
HAINING; ZHEJIANG PROVINCE, CHINA

FOR: OPTICAL COMMUNICATION DEVICES, NAMELY, OPTICAL TRANSMITTERS, RECEIVERS, COUPLERS, SPLITTERS, FILTERS, ISOLATORS AND ATTENUATORS; NETWORK COMMUNICATION DEVICES, NAMELY, HUBS, SWITCHES AND ROUTERS; SET TOP BOX, ELECTRICAL TRANSFORMERS FOR TELECOMMUNICATIONS APPARATUS USED FOR TRANSFORMING DIGITAL VIDEO SIGNALS TO ANALOG VIDEO SIGNALS; MOBILE DATA TERMINAL (MDT), EQUIPMENTS USED FOR RECEIVING, DECODING, COMPRES-

SING AND TRANSMITTING DATA, NAMELY, DATA PROCESSORS; SONARS; TRANSMITTERS OF ELECTRONIC SIGNALS; TELECOMMUNICATION TRANSMITTERS; MODEMS; FIBER OPTIC CABLES; ANTI-INTERFERENCE WIRELESS DEVICES, NAMELY, FILTERS FOR RADIO INTERFERENCE SUPPRESSION, IN CLASS 9 (U.S. CLS. 21, 23, 26, 36 AND 38).

OWNER OF INTERNATIONAL REGISTRATION
0962870 DATED 3-20-2008, EXPIRES 3-20-2018.

SER. NO. 79-053,293, FILED 3-20-2008.

RONALD MCMORROW, EXAMINING ATTORNEY

Int. Cls.: 17, 22 and 24

Prior U.S. Cls.: 1, 2, 5, 7, 12, 13, 19, 22, 35, 42 and 50

United States Patent and Trademark Office

Reg. No. 3,576,486

Registered Feb. 17, 2009

**TRADEMARK
PRINCIPAL REGISTER**



O.R.V. OVATTIFICIO RESINATURA VALPADANA S.P.A. (ITALY JOINT STOCK COMPANY)
VIA REGINA ELENA, 39
I-35010 GRANTORTO (PADOVA)
ITALY

FOR: STUFFING OF RUBBER OR PLASTIC, IN CLASS 17 (U.S. CLS. 1, 5, 12, 13, 35 AND 50).

FOR: PADDING AND STUFFING MATERIALS NOT OF RUBBER, PAPER OR PLASTIC, IN CLASS 22 (U.S. CLS. 1, 2, 7, 19, 22, 42 AND 50).

FOR: TEXTILES AND TEXTILES NOT INCLUDED IN OTHER CLASSES, NAMELY, NON-WOVEN TEXTILE FABRICS, IN CLASS 24 (U.S. CLS. 42 AND 50).

PRIORITY DATE OF 2-28-2008 IS CLAIMED.

OWNER OF INTERNATIONAL REGISTRATION 0962951 DATED 3-19-2008, EXPIRES 3-19-2018.

THE COLOR(S) YELLOW, RED, WHITE AND BLACK IS/ARE CLAIMED AS A FEATURE OF THE MARK.

THE MARK CONSISTS OF THE COLORS YELLOW, RED, WHITE AND BLACK, WITH THE COLOR YELLOW APPEARING IN THE WORDING "VALTHERM", THE COLOR RED APPEARING IN THE HORIZONTAL LINE, THE COLOR WHITE APPEARING IN THE POLAR BEAR, AND THE COLOR BLACK APPEARING IN THE RECTANGLE AND THE POLAR BEAR.

SER. NO. 79-053,343, FILED 3-19-2008.

SHANNON TWOHIG, EXAMINING ATTORNEY

Int. Cls.: 9 and 42

Prior U.S. Cls.: 21, 23, 26, 36, 38, 100 and 101

United States Patent and Trademark Office

Reg. No. 3,576,487

Registered Feb. 17, 2009

**TRADEMARK
SERVICE MARK
PRINCIPAL REGISTER**



NEDERLANDSE ORGANISATIE VOOR TOEGEPAST-NATUURWETENSCHAPPELIJK ONDERZOEK (TNO) (NETHERLANDS CORPORATION)

SCHOEMAKERSTRAAT 97

NL-2628 VK DELFT

NETHERLANDS

FOR: COMPUTER SOFTWARE FOR TESTING INTELLIGENT SENSOR SYSTEMS; COMPUTER SOFTWARE FOR USE IN DEVELOPING INTELLIGENT SENSOR SYSTEMS; COMPUTER SOFTWARE FOR USE WITH SIMULATION MODELS FOR TESTING INTELLIGENT SENSOR SYSTEMS, COMPUTER SOFTWARE FOR USE WITH SIMULATION MODELS FOR DEVELOPING INTELLIGENT SENSOR SYSTEMS, COMPUTER SOFTWARE FOR USE IN THE OPERATION AND MAINTENANCE OF VEHICLES; COMPUTER SOFTWARE FOR USE IN TRAFFIC SAFETY; COMPUTER SOFTWARE FOR USE IN TRANSPORT AND TRANSPORTATION SYSTEMS; COMPUTER SOFTWARE FOR USE IN CONTROL ENGINEERING; COMPUTER SOFTWARE PLUG INS FOR TESTING INTELLIGENT SENSOR SYSTEMS; COMPUTER SOFTWARE PLUG INS FOR USE IN DEVELOPING INTELLIGENT SENSOR SYSTEMS; COMPUTER SOFTWARE PLUG INS FOR USE WITH SIMULATION MODELS FOR TESTING INTELLIGENT SENSOR SYSTEMS, COMPUTER SOFTWARE PLUG INS FOR USE WITH SIMULATION MODELS FOR DEVELOPING INTELLIGENT SENSOR SYSTEMS, COMPUTER SOFTWARE PLUG INS FOR USE IN THE OPERATION AND MAINTENANCE OF VEHICLES; COMPUTER SOFTWARE PLUG INS FOR USE IN TRAFFIC

SAFETY; COMPUTER SOFTWARE PLUG INS FOR USE IN TRANSPORT AND TRANSPORTATION SYSTEMS; COMPUTER SOFTWARE PLUG INS FOR USE IN CONTROL ENGINEERING, IN CLASS 9 (U.S. CLS. 21, 23, 26, 36 AND 38).

FOR: CUSTOM DESIGN OF SOFTWARE FOR TESTING INTELLIGENT SENSOR SYSTEMS; CUSTOM DESIGN OF SOFTWARE FOR DEVELOPING INTELLIGENT SENSOR SYSTEMS; CUSTOM DESIGN OF SOFTWARE FOR USE WITH SIMULATION MODELS FOR TESTING INTELLIGENT SENSOR SYSTEMS, CUSTOM DESIGN OF SOFTWARE FOR USE WITH SIMULATION MODELS FOR DEVELOPING INTELLIGENT SENSOR SYSTEMS, CUSTOM DESIGN OF SOFTWARE FOR USE IN VEHICLES; CUSTOM DESIGN OF SOFTWARE FOR TRAFFIC SAFETY; CUSTOM DESIGN OF SOFTWARE FOR USE IN TRANSPORT; CUSTOM DESIGN OF SOFTWARE FOR USE IN CONTROL ENGINEERING; CUSTOM DEVELOPMENT OF SOFTWARE FOR TESTING INTELLIGENT SENSOR SYSTEMS; CUSTOM DEVELOPMENT OF SOFTWARE FOR DEVELOPING INTELLIGENT SENSOR SYSTEMS; CUSTOM DEVELOPMENT OF SOFTWARE FOR USE WITH SIMULATION MODELS FOR TESTING INTELLIGENT SENSOR SYSTEMS, CUSTOM DEVELOPMENT OF SOFTWARE FOR USE WITH SIMULATION MODELS FOR DEVELOPING INTELLIGENT SENSOR SYSTEMS, CUSTOM DEVELOPMENT OF SOFTWARE FOR USE IN VEHICLES; CUSTOM DEVELOPMENT OF SOFTWARE FOR TRAFFIC SAFETY; CUSTOM DEVELOPMENT OF SOFTWARE FOR USE IN TRANSPORT; CUSTOM DEVELOPMENT OF SOFT-

WARE FOR USE IN CONTROL ENGINEERING; CUSTOM DESIGN OF SOFTWARE PLUG INS FOR TESTING INTELLIGENT SENSOR SYSTEMS; CUSTOM DEVELOPMENT OF INTELLIGENT SENSOR SYSTEMS FOR OTHERS; CUSTOM DESIGN OF SOFTWARE PLUG INS FOR USE WITH SIMULATION MODELS FOR TESTING INTELLIGENT SENSOR SYSTEMS; DESIGN OF SOFTWARE PLUG INS FOR USE WITH SIMULATION MODELS FOR DEVELOPING INTELLIGENT SENSOR SYSTEMS, CUSTOM DESIGN OF SOFTWARE PLUG INS FOR USE IN VEHICLES; CUSTOM DESIGN OF SOFTWARE PLUG INS FOR TRAFFIC SAFETY; CUSTOM DESIGN OF SOFTWARE PLUG INS FOR USE IN TRANSPORT; CUSTOM DESIGN OF SOFTWARE PLUG INS FOR USE IN CONTROL ENGINEERING CUSTOM DEVELOPMENT OF SOFTWARE PLUG INS FOR TESTING INTELLIGENT SENSOR SYSTEMS; CUSTOM DEVELOPMENT OF SOFTWARE PLUG INS FOR USE WITH SIMULATION MODELS FOR TESTING INTELLIGENT SENSOR SYSTEMS, CUSTOM DEVELOPMENT OF SOFTWARE PLUG INS FOR USE WITH SIMULATION MODELS FOR DEVELOPING INTELLIGENT SENSOR SYSTEMS, CUSTOM DEVELOPMENT OF SOFTWARE PLUG INS FOR USE IN VEHICLES; CUSTOM DEVELOPMENT OF SOFTWARE PLUG INS FOR TRAFFIC

SAFETY; CUSTOM DEVELOPMENT OF SOFTWARE PLUG INS FOR USE IN TRANSPORT; CUSTOM DEVELOPMENT OF SOFTWARE PLUG INS FOR USE IN CONTROL ENGINEERING, IN CLASS 42 (U.S. CLS. 100 AND 101).

PRIORITY DATE OF 7-2-2007 IS CLAIMED.

OWNER OF INTERNATIONAL REGISTRATION 0963023 DATED 12-31-2007, EXPIRES 12-31-2017.

NO CLAIM IS MADE TO THE EXCLUSIVE RIGHT TO USE "PRESCAN", APART FROM THE MARK AS SHOWN.

THE MARK CONSISTS OF THE STYLIZED WORDING "PRESCAN" AND THE LETTER "P" FORMED BY THE DESIGN OF A ROAD WITH DASHED LINES AND THREE ARCED SHAPES TO THE RIGHT OF THE ROAD DESIGN.

SER. NO. 79-053,379, FILED 12-31-2007.

JAY BESCH, EXAMINING ATTORNEY

Int. Cl.: 5

Prior U.S. Cls.: 6, 18, 44, 46, 51 and 52

United States Patent and Trademark Office

Reg. No. 3,576,488

Registered Feb. 17, 2009

**TRADEMARK
PRINCIPAL REGISTER**

CLUSTOid

ROXALL GMBH (FED REP GERMANY COMPAN-
NY WITH LIMITED LIABILITY)
CARL-PETERSEN-STRABE 4
20535 HAMBURG
FED REP GERMANY

FOR: PHARMACEUTICAL PREPARATIONS,
NAMELY, ALLERGY MEDICATIONS, IN CLASS 5
(U.S. CLS. 6, 18, 44, 46, 51 AND 52).

THE MARK CONSISTS OF STANDARD CHAR-
ACTERS WITHOUT CLAIM TO ANY PARTICULAR
FONT, STYLE, SIZE, OR COLOR.

OWNER OF INTERNATIONAL REGISTRATION
0963063 DATED 4-15-2008, EXPIRES 4-15-2018.

THE MARK HAS NO MEANING IN A FOREIGN
LANGUAGE.

SER. NO. 79-053,394, FILED 4-15-2008.

PATRICIA EVANKO, EXAMINING ATTORNEY

Int. Cl.: 1

Prior U.S. Cls.: 1, 5, 6, 10, 26 and 46

United States Patent and Trademark Office

Reg. No. 3,576,489

Registered Feb. 17, 2009

**TRADEMARK
PRINCIPAL REGISTER**

NAOLYS

NAOLYS, SARL (FRANCE SOCIÉTÉ À RESPONSABILITÉ LIMITÉE)

4 ALLÉE DU DOYEN GEORGES BRUS

F-33600 PESSAC

FRANCE

FOR: PLANT EXTRACTS, NAMELY, ELICITED DEDIFFERENTIATED PLANT CELLS, USED IN THE MANUFACTURE OF COSMETICS, IN CLASS 1 (U.S. CLS. 1, 5, 6, 10, 26 AND 46).

THE MARK CONSISTS OF STANDARD CHARACTERS WITHOUT CLAIM TO ANY PARTICULAR FONT, STYLE, SIZE, OR COLOR.

OWNER OF INTERNATIONAL REGISTRATION 0963111 DATED 3-25-2008, EXPIRES 3-25-2018.

SER. NO. 79-053,403, FILED 3-25-2008.

CARYN GLASSER, EXAMINING ATTORNEY

Int. Cl.: 5

Prior U.S. Cls.: 6, 18, 44, 46, 51 and 52

United States Patent and Trademark Office

Reg. No. 3,576,490

Registered Feb. 17, 2009

**TRADEMARK
PRINCIPAL REGISTER**

ROXOid

ROXALL GMBH (FED REP GERMANY COMPAN-
NY WITH LIMITED LIABILITY)
CARL-PETERSEN-STRABE 4
20535 HAMBURG
FED REP GERMANY

FOR: PHARMACEUTICAL PREPARATIONS,
NAMELY, ALLERGY MEDICATIONS, IN CLASS 5
(U.S. CLS. 6, 18, 44, 46, 51 AND 52).

THE MARK CONSISTS OF STANDARD CHAR-
ACTERS WITHOUT CLAIM TO ANY PARTICULAR
FONT, STYLE, SIZE, OR COLOR.

OWNER OF INTERNATIONAL REGISTRATION
0963249 DATED 4-15-2008, EXPIRES 4-15-2018.

THE MARK HAS NO MEANING IN A FOREIGN
LANGUAGE.

SER. NO. 79-053,444, FILED 4-15-2008.

PATRICIA EVANKO, EXAMINING ATTORNEY

Int. Cl.: 5

Prior U.S. Cls.: 6, 18, 44, 46, 51 and 52

United States Patent and Trademark Office

Reg. No. 3,576,491

Registered Feb. 17, 2009

**TRADEMARK
PRINCIPAL REGISTER**

HYMNOX

ROXALL GMBH (FED REP GERMANY COMP-
NY WITH LIMITED LIABILITY)
CARL-PETERSEN-STRABE 4
20535 HAMBURG
FED REP GERMANY

OWNER OF INTERNATIONAL REGISTRATION
0963251 DATED 4-15-2008, EXPIRES 4-15-2018.

FOR: PHARMACEUTICAL PREPARATIONS,
NAMELY, ALLERGY MEDICATIONS, IN CLASS 5
(U.S. CLS. 6, 18, 44, 46, 51 AND 52).

THE MARK HAS NO MEANING IN A FOREIGN
LANGUAGE.

THE MARK CONSISTS OF STANDARD CHAR-
ACTERS WITHOUT CLAIM TO ANY PARTICULAR
FONT, STYLE, SIZE, OR COLOR.

SER. NO. 79-053,446, FILED 4-15-2008.

PATRICIA EVANKO, EXAMINING ATTORNEY

Int. Cl.: 10

Prior U.S. Cls.: 26, 39 and 44

United States Patent and Trademark Office

Reg. No. 3,576,492

Registered Feb. 17, 2009

**TRADEMARK
PRINCIPAL REGISTER**

SEDATELEC

SEDATELEC (FRANCE SOCIÉTÉ ANONYME)

CHEMIN DES MÛRIERS

F-69540 IRIGNY, FRANCE

FOR: MEDICAL NEEDLES, ACUPUNCTURE NEEDLES, ELECTRODES FOR MEDICAL USE AND FOR ACUPUNCTURE; ELECTRONIC INSTRUMENTS AND APPARATUS INTENDED FOR THE MEDICAL FIELD, NAMELY, LASERS FOR MEDICAL USE, ELECTRONIC STIMULATORS FOR THE SKIN, NERVES AND MUSCLES, IN CLASS 10 (U.S. CLS. 26, 39 AND 44).

THE MARK CONSISTS OF STANDARD CHARACTERS WITHOUT CLAIM TO ANY PARTICULAR FONT, STYLE, SIZE, OR COLOR.

PRIORITY DATE OF 9-17-2007 IS CLAIMED.

OWNER OF INTERNATIONAL REGISTRATION 0963450 DATED 3-4-2008, EXPIRES 3-4-2018.

SER. NO. 79-053,534, FILED 3-4-2008.

LAURA HAMMEL, EXAMINING ATTORNEY

Int. Cl.: 33

Prior U.S. Cls.: 47 and 49

United States Patent and Trademark Office

Reg. No. 3,576,493

Registered Feb. 17, 2009

TRADEMARK
PRINCIPAL REGISTER

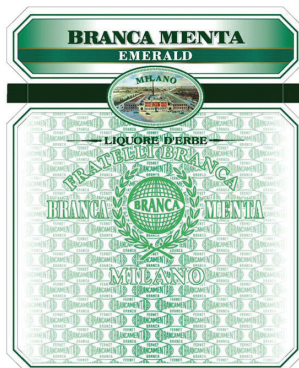

FRATELLI BRANCA DISTILLERIE S.R.L. (ITALLY LIMITED LIABILITY COMPANY)
VIA BROLETTO, 35 I-20121
MILANO, ITALY

FOR: HERB BASED LIQUEURS, IN CLASS 33 (U.S. CLS. 47 AND 49).

PRIORITY DATE OF 1-17-2008 IS CLAIMED.

OWNER OF INTERNATIONAL REGISTRATION 0963809 DATED 4-7-2008, EXPIRES 4-7-2018.

OWNER OF U.S. REG. NOS. 1,841,996, 3,282,440 AND OTHERS.

NO CLAIM IS MADE TO THE EXCLUSIVE RIGHT TO USE "LIQUORE D'ERBE", "MENTA", "FRATELLI" AND "MILANO", APART FROM THE MARK AS SHOWN.

THE COLOR(S) WHITE, BLACK, LIGHT GREEN, DARK GREEN, ORANGE, BROWN, SILVER, LIGHT BLUE AND GRAY IS/ARE CLAIMED AS A FEATURE OF THE MARK.

THE MARK CONSISTS OF TWO DIFFERENT SIZED RECTANGLES, BOTH OUTLINED IN DARK GREEN AND SILVER. THE SMALLER RECTANGLE IS ON TOP AND CONTAINS THE WORDING "BRANCA MENTA" APPEARING IN DARK GREEN, ABOVE A SOLID BAND APPEARING IN DARK GREEN WITH THE WORDING "EMERALD"

APPEARING IN WHITE - THE BAND IS OUTLINED ON THE TOP AND BOTTOM. THE RECTANGLE'S BACKGROUND APPEARS IN WHITE AND GREEN WITH WHITE APPEARING IN THE CENTER AND FADING TO DARK GREEN TOWARDS THE ENDS. THE BOTTOM RECTANGLE CONTAINS THE WORDING "LIQUORE D'ERBE" IN DARK GREEN, APPEARING ABOVE THE WORDING/DESIGN "FRATELLI BRANCA" WHICH APPEARS ON THE TOP OF A GLOBE DESIGN CONTAINING THE WORD "BRANCA" AND APPEARING BETWEEN TWO WHEAT BRANCHES. THE WORD "BRANCA" APPEARS TO THE LEFT OF THE GLOBE DESIGN AND THE WORD "MENTA" APPEARS TO THE RIGHT. THE WORD "MILANO" APPEARS BENEATH THE DESIGN. THE BACKGROUND OF THE BOTTOM RECTANGLE CONTAINS A REPEITIVE DESIGN CONSISTING OF LITTLE LIGHT GREEN AND WHITE OVALS WITH THE WORDING "FRATELLI BRANCA" APPEARING IN LIGHT GREEN. THE TWO RECTANGLES ARE SEPARATED BY A SOLID BAND, WHICH IS DIVIDED IN HALF BY AN OVAL CONTAINING A BUILDING DESIGN. THE OVAL IS OUTLINED IN DARK GREEN, LIGHT GREEN AND WHITE. AN ORANGE, BROWN AND DARK GREEN BUILDING IS ENCLOSED IN THE CIRCLE. A LIGHT BLUE AND WHITE SKY, GREEN GRASS AND BUSHES AND A GENERAL INDUSTRIAL BACKGROUND APPEAR AROUND AND BEHIND THE BUILDING. THE WORD "MILANO" APPEARS IN DARK GREEN AND RUNS ACROSS THE SKY ABOVE THE BUILDING.

THE FOREIGN WORDING IN THE MARK TRANSLATES INTO ENGLISH AS FOLLOWS: "LI-

QUORE D'ERBE" IN THE MARK IS "HERB LI-
QUOR"; "FRATELLI BRANCA" IN THE MARK IS
"BRANCA BROTHERS"; "BRANCA MENTA" IN
THE MARK IS "BRANCA MINT"; "MILANO" IN
THE MARK IS "MILAN".

SER. NO. 79-053,655, FILED 4-7-2008.

RON FAIRBANKS, EXAMINING ATTORNEY

Int. Cl.: 33

Prior U.S. Cls.: 47 and 49

United States Patent and Trademark Office

Reg. No. 3,576,494

Registered Feb. 17, 2009

TRADEMARK
PRINCIPAL REGISTER



FRATELLI BRANCA DISTILLERIE S.R.L. (ITALLY LIMITED LIABILITY COMPANY)
VIA BROLETTO, 35 I-20121
MILANO, ITALY

FOR: HERBS BASED LIQUOR, IN CLASS 33 (U.S. CLS. 47 AND 49).

PRIORITY DATE OF 1-17-2008 IS CLAIMED.

OWNER OF INTERNATIONAL REGISTRATION 0964221 DATED 4-7-2008, EXPIRES 4-7-2018.

OWNER OF U.S. REG. NOS. 1,841,996, 3,282,440 AND OTHERS.

NO CLAIM IS MADE TO THE EXCLUSIVE RIGHT TO USE "LIQUORE D'ERBE", "MENTA", "FRATELLI", "DISTILLERIE" AND "MILANO", APART FROM THE MARK AS SHOWN.

THE COLOR(S) WHITE, BLACK, LIGHT GREEN, DARK GREEN, ORANGE, BROWN, SILVER, LIGHT BLUE AND GRAY IS/ARE CLAIMED AS A FEATURE OF THE MARK.

THE MARK CONSISTS OF A BROWN EAGLE WITH BLACK AND GRAY WINGS HOLDING A BLACK, WHITE, ORANGE AND BROWN BOTTLE WITH A YELLOW LABEL IN ITS RIGHT CLAW AND THE EAGLE IS SITTING ON A TILTED BLUE GLOBE. ACROSS THE GLOBE IS A RED BAND WITH WORD "BRANCA" IN WHITE. THE WORD-

ING "FLLI. BRANCA MILANO" APPEARS BELOW THE BAND IN ORANGE CURSIVE. THE EAGLE AND GLOBE ARE ENCIRCLED BY A BLUE, WHITE, YELLOW AND ORANGE SKY AND ON THE BOTTOM OF THE CIRCLE APPEARS BLUE AND WHITE CLOUDS. BELOW THE CIRCLE AND BAND APPEARS A RECTANGLE WITH CUT CORNERS. THE RECTANGLE IS COMPRISED OF LITTLE GREEN AND WHITE OVALS WITH THE WORDING "FERNET BRANCAMENTA BRANCA". THE WORDING "BRANCA MENTA" APPEARS IN DARK GREEN, ABOVE A SOLID BAND APPEARING IN DARK GREEN WITH THE WORDING "EMERALD" APPEARING IN WHITE - THE BAND IS OUTLINED ON THE TOP AND BOTTOM. BENEATH THE WORD "EMERALD" APPEARS THE WORDING IN DARK GREEN: "FRATELLI BRANCA DISTILLERIE-MILANO - VIA BROLETTO - VICINO ALLA CHIESA DI S. TOMASO-DEL FAMOSO LIQUORE D'ERBE-BRANCA MENTA". THERE ARE THREE ADDITIONAL SENTENCES IN SMALLER FONTS APPEARING IN THE BACKGROUND - ONE APPEARING ABOVE "DEL FAMOSO LIQUORE D'ERBE" AND "BRANCA MENTA", AND THE OTHER TWO APPEARING BENEATH. THE BACKGROUND OF THE RECTANGLE CONTAINS A REPETITIVE DESIGN CONSISTING OF LITTLE LIGHT GREEN AND WHITE OVALS WITH THE WORDING "FERNET BRANCAMENTA BRANCA" APPEARING IN LIGHT GREEN. IN THE CENTER OF THIS REPETITIVE DESIGN IS A GLOBE WITH THE WORDING "BRANCA" APPEARING IN THE CENTER, THE GLOBE SITS BETWEEN TWO WHEAT BRANCHES.

THE FOREIGN WORDING IN THE MARK TRANSLATES INTO ENGLISH AS FOLLOWS: "BRANCA FLI. BRANCA MILANO" IS TRANSLATED AS "BRANCA BRANCA BROTHERS MILAN"; "BRANCA MENTA" IS TRANSLATED AS "BRANCA MINT"; "FRATELLI BRANCA DISTILLERIE" IS TRANSLATED AS "BRANCA BROTHERS DISTILLERIES"; "MILANO VIA BROLETTO VICINO ALLA CHIESA DI S. TOMASO" IS TRANSLATED AS "MILAN BROLETTO STREET NEAR SAINT TOMASO'S CHURCH"; "I FRATELLI BRANCA I SOLI CHE POSSEGGONO L'ORIGINALE FORMULA DI PRODUZIONE", "DEL FAMOSO LIQUORE D'ERBE BRANCAMENTA NE ASSICURANO L'ALTA QUALITA - E BONTA - GRAZIE AL PROCESSO DI

TRASFORMAZIONE CHE ESALTA LA GENUINITA - DEGLI INGREDIENTI NATURALI ED ESOTICI DAI SUPERBI AROMI MILANO" IS TRANSLATED AS "BRANCA BROTHERS THE ONES WHO HOLD THE ORIGINAL MANUFACTURING FORMULA, OF THE FAMOUS HERBS BASED LIQUOR BRANCAMENTA, ENSURING ITS HIGH QUALITY DUE TO THE TRANSFORMATION PROCESS WHICH EXALT THE TRUENESS, OF THE NATURAL AND EXOTIC INGREDIENTS HAVING SUPERB FLAVOUR"; "MILANO" IS "MILAN".

SER. NO. 79-053,806, FILED 4-7-2008.

RON FAIRBANKS, EXAMINING ATTORNEY

Int. Cls.: 1 and 11

Prior U.S. Cls.: 1, 5, 6, 10, 13, 21, 23, 26, 31, 34 and 46

United States Patent and Trademark Office

Reg. No. 3,576,495

Registered Feb. 17, 2009

**TRADEMARK
PRINCIPAL REGISTER**

Armal

DAIMONT S.P.A. (ITALY JOINT STOCK COMPANY)
VIA FIORENTINA, 109
I-50052 CERTALDO (FIRENZE)
ITALY

FOR: CHEMICALS FOR TREATING BIOLOGICAL WASTE IN SANITARY PLANTS AND CHEMICAL TOILETS, IN CLASS 1 (U.S. CLS. 1, 5, 6, 10, 26 AND 46).

FOR: SANITARY PLANTS AND APPLIANCES, NAMELY, CHEMICAL TOILETS AND TRANSPORTABLE MODULAR ENCLOSURES FOR CHEMICAL TOILETS, URINALS AND SINKS; TRANSPORTABLE WASTE WATER PURIFICATION UNITS, IN CLASS 11 (U.S. CLS. 13, 21, 23, 31 AND 34).

PRIORITY DATE OF 1-22-2008 IS CLAIMED.

OWNER OF INTERNATIONAL REGISTRATION 0964518 DATED 3-27-2008, EXPIRES 3-27-2018.

THE MARK CONSISTS OF THE WORD "ARMAL" IN FANCY CHARACTERS WITH A CAPITAL LETTER A.

SER. NO. 79-053,910, FILED 3-27-2008.

KIMBERLY PERRY, EXAMINING ATTORNEY

Int. Cls.: 16 and 40

Prior U.S. Cls.: 2, 5, 22, 23, 29, 37, 38, 50, 100, 103 and 106

Reg. No. 3,576,496

United States Patent and Trademark Office

Registered Feb. 17, 2009

**TRADEMARK
SERVICE MARK
PRINCIPAL REGISTER**



CEWE COLOR AG & CO. OHG (FED REP GER-
MANY GENERAL PARTNERSHIP)
MEERWEG 30-32
26133 OLDENBURG
FED REP GERMANY

THE COLOR(S) BLACK, RED, YELLOW AND
BLUE IS/ARE CLAIMED AS A FEATURE OF THE
MARK.

FOR: BOOKS, NAMELY, PHOTO BOOKS, IN
CLASS 16 (U.S. CLS. 2, 5, 22, 23, 29, 37, 38 AND 50).

THE MARK CONSISTS OF THREE TOUCHING
QUADRILATERALS OUTLINED IN THE COLOR
BLACK; FROM LEFT TO RIGHT THE QUADRI-
LATERALS ARE IN THE COLORS RED, YELLOW
AND BLUE.

FOR: SERVICES OF PHOTOGRAPH AND FILM
PROCESSING LABORATORY, NAMELY, PRINT-
ING OF PHOTO BOOKS AND PRINTING OF PHO-
TOGRAPHS, IN CLASS 40 (U.S. CLS. 100, 103 AND
106).

SER. NO. 79-053,944, FILED 1-3-2008.

OWNER OF INTERNATIONAL REGISTRATION
0704278 DATED 10-29-1998, EXPIRES 10-29-2018.

DOMINIC FATHY, EXAMINING ATTORNEY

Int. Cl.: 9

Prior U.S. Cls.: 21, 23, 26, 36 and 38

United States Patent and Trademark Office

Reg. No. 3,576,497

Registered Feb. 17, 2009

**TRADEMARK
PRINCIPAL REGISTER**

Ladbroke Finance Manager

ANGELO SIOKOS (AUSTRALIA INDIVIDUAL)
44/410 STANLEY STREET
SOUTH BRISBANE QLD 4101
AUSTRALIA

THE MARK CONSISTS OF STANDARD CHARACTERS WITHOUT CLAIM TO ANY PARTICULAR FONT, STYLE, SIZE, OR COLOR.

OWNER OF INTERNATIONAL REGISTRATION
0964750 DATED 5-14-2008, EXPIRES 5-14-2018.

FOR: COMPUTER PROGRAMS, NAMELY, COMPUTER SOFTWARE FOR USE IN DATABASE MANAGEMENT, FOR USE IN PRODUCING REQUIRED DOCUMENTATION, PROCESSING, TRACKING, UPDATING AND EDITING FINANCIAL DATA FOR USE BY FINANCE PROVIDERS AND IN THE FINANCIAL SERVICE INDUSTRY, IN CLASS 9 (U.S. CLS. 21, 23, 26, 36 AND 38).

NO CLAIM IS MADE TO THE EXCLUSIVE RIGHT TO USE "FINANCE MANAGER", APART FROM THE MARK AS SHOWN.

SER. NO. 79-054,009, FILED 5-14-2008.

MICHAEL TANNER, EXAMINING ATTORNEY

Int. Cls.: 9 and 42

Prior U.S. Cls.: 21, 23, 26, 36, 38, 100 and 101

United States Patent and Trademark Office

Reg. No. 3,576,498

Registered Feb. 17, 2009

**TRADEMARK
SERVICE MARK
PRINCIPAL REGISTER**

IceTea

INDUSTRIAL SOFTWARE TECHNOLOGY
(FRANCE SOCIÉTÉ ANONYME (S.A.))
1 RUE DE LA NOË
F-44321 NANTES CEDEX 3
FRANCE

FOR: COMPUTER SOFTWARE PROGRAMS FOR DEVELOPING OTHER COMPUTER SOFTWARE PROGRAMS; COMPILER SOFTWARE PROGRAMS, EDITOR SOFTWARE PROGRAMS, DEBUGGER SOFTWARE PROGRAMS AND UTILITY SOFTWARE PROGRAMS FOR DEVELOPING OTHER COMPUTER SOFTWARE PROGRAMS; COMPUTER SOFTWARE PROGRAMS FOR ASSISTING DEVELOPERS IN DEVELOPING SOFTWARE PROGRAM CODE FOR USE IN MULTIPLE APPLICATION SOFTWARE PROGRAMS; AND COMPUTER SOFTWARE PROGRAMS FOR RUNNING DEVELOPMENT SOFTWARE PROGRAMS AND APPLICATION SOFTWARE PROGRAMS, IN CLASS 9 (U.S. CLS. 21, 23, 26, 36 AND 38).

FOR: COMPUTER PROGRAMMING; COMPUTER SOFTWARE DESIGN; INSTALLATION, MAINTENANCE, DEVELOPING OF COMPUTER SOFTWARE PROGRAMS; CONSULTANCY IN THE FIELD OF COMPUTER SOFTWARE PROGRAMS, IN CLASS 42 (U.S. CLS. 100 AND 101).

THE MARK CONSISTS OF STANDARD CHARACTERS WITHOUT CLAIM TO ANY PARTICULAR FONT, STYLE, SIZE, OR COLOR.

OWNER OF INTERNATIONAL REGISTRATION
0964852 DATED 3-19-2008, EXPIRES 3-19-2018.

SER. NO. 79-054,039, FILED 3-19-2008.

GISELLE AGOSTO, EXAMINING ATTORNEY

Int. Cls.: 14, 16 and 18

**Prior U.S. Cls.: 1, 2, 3, 5, 22, 23, 27, 28, 29, 37, 38, 41
and 50**

Reg. No. 3,576,499

United States Patent and Trademark Office

Registered Feb. 17, 2009

**TRADEMARK
PRINCIPAL REGISTER**



PETER NIKOLAUS (FED REP GERMANY INDIVIDUAL)
AM WÄLDCHEN 29
66424 HOMBURG
FED REP GERMANY

FOR: WATCHES AND CHRONOMETRIC INSTRUMENTS, IN CLASS 14 (U.S. CLS. 2, 27, 28 AND 50).

FOR: WRITING IMPLEMENTS, WRITING SETS COMPRISED OF WRITING INSTRUMENTS AND CASES, IN CLASS 16 (U.S. CLS. 2, 5, 22, 23, 29, 37, 38 AND 50).

FOR: LEATHER AND IMITATIONS OF LEATHER; TRUNKS AND TRAVELING BAGS; BAGS AS FAR AS INCLUDED IN THIS CLASS, NAMELY, BRIEFCASES, DOCUMENT CASES, POCKET-WALLETS, HANDBAGS, PURSES, MAP CASES AND WHEELED SHOPPING BAGS, IN CLASS 18 (U.S. CLS. 1, 2, 3, 22 AND 41).

PRIORITY DATE OF 11-9-2007 IS CLAIMED.

OWNER OF INTERNATIONAL REGISTRATION 0964902 DATED 4-28-2008, EXPIRES 4-28-2018.

THE MARK CONSISTS OF THE DESIGN OF ONE SHADED IRREGULAR QUADRILATERAL AND TWO SHADED TRIANGLES. THE TRIANGLE ON THE RIGHT AND THE QUADRANGLE ON THE LEFT ARE INVERTED AND STAND ON ONE OF THEIR VERTEXES. BETWEEN THE POINTS OF THE QUADRANGLE AND THE INVERTED TRIANGLE IS ONE SMALLER TRIANGLE.

SER. NO. 79-054,059, FILED 4-28-2008.

MARILYN IZZI, EXAMINING ATTORNEY

Int. Cl.: 30

Prior U.S. Cl.: 46

United States Patent and Trademark Office

Reg. No. 3,576,500

Registered Feb. 17, 2009

**TRADEMARK
PRINCIPAL REGISTER**

ЭЛЕН

JOINT STOCK COMPANY; "YASNAYA POLYANA" (RUSSIAN FED. JOINT STOCK COMPANY)

83, ODOYEVSKOYE SHOSSE
RU-300036 G. TULA
RUSSIAN FED.

FOR: CONFECTIONERY, NAMELY, BONBONS, CANDY BARS, CHOCOLATE BARS, CHOCOLATE CANDIES, CHOCOLATE TRUFFLES, FILLED CHOCOLATE, MILK CHOCOLATE, TOFFEE COOKIES, SPICE-CAKES, RUSKS, HALVAH, FRUIT JELLIES, FONDANTS, PASTILLES, IN CLASS 30 (U.S. CL. 46).

OWNER OF INTERNATIONAL REGISTRATION
0965071 DATED 3-31-2008, EXPIRES 3-31-2018.

THE NON-LATIN WORDING IN MARK IS THE FEMALE NAME.

THE TRANSLITERATION OF THE NON-LATIN CHARACTERS IN THE MARK IS: ELEN.

SER. NO. 79-054,128, FILED 3-31-2008.

PATRICIA EVANKO, EXAMINING ATTORNEY

Int. Cl.: 7

Prior U.S. Cls.: 13, 19, 21, 23, 31, 34 and 35

United States Patent and Trademark Office

Reg. No. 3,576,501

Registered Feb. 17, 2009

**TRADEMARK
PRINCIPAL REGISTER**

PRATCO

R.M.D. PRESS CO PTY LTD (AUSTRALIA COMPANY)
C/- S3, REGENTS PARK ESTATE
391 PARK ROAD; REGENTS PARK NSW 2143
AUSTRALIA

FOR: MACHINE PARTS, NAMELY, ELECTRIC KNIVES AND BLADES FOR AGRICULTURAL MACHINES; MACHINE PARTS, NAMELY, GRASS CUTTING KNIVES AND BLADES, IN CLASS 7 (U.S. CLS. 13, 19, 21, 23, 31, 34 AND 35).

THE MARK CONSISTS OF STANDARD CHARACTERS WITHOUT CLAIM TO ANY PARTICULAR FONT, STYLE, SIZE, OR COLOR.

OWNER OF INTERNATIONAL REGISTRATION
0965119 DATED 3-13-2008, EXPIRES 3-13-2018.

SER. NO. 79-054,156, FILED 3-13-2008.

KEVIN DINALLO, EXAMINING ATTORNEY

Int. Cls.: 8, 14, 20, 21 and 26

**Prior U.S. Cls.: 2, 13, 22, 23, 25, 27, 28, 29, 30, 32, 33,
37, 39, 40, 42, 44 and 50**

Reg. No. 3,576,502

United States Patent and Trademark Office

Registered Feb. 17, 2009

**TRADEMARK
PRINCIPAL REGISTER**

BEATRICE ROSSI

BEATRICE ROSSI, SCHMUCK (SWITZERLAND
RAISON INDIVIDUELLE SELON LE DROIT
SUISSE (PRIVATE FIRM UNDER THE LAWS
OF SWITZERLAND.)

STORCHENGASSE 10
CH-8001 ZÜRICH
SWITZERLAND

FOR: CUTLERY, NAMELY, KNIVES, FORKS
AND SPOONS, IN CLASS 8 (U.S. CLS. 23, 28 AND 44).

FOR: PRECIOUS METALS AND THEIR ALLOYS;
PRECIOUS STONES, JEWELRY, INCLUDING PINS,
COSTUME JEWELRY, COSTUME JEWELRY MADE
OF WOOD, HORN, BONE, IVORY, WHALEBONE,
SHELL, AMBER, MOTHER-OF-PEARL AND MEER-
SCHAUM; HOROLOGICAL AND CHRONOMETRIC
INSTRUMENTS, IN CLASS 14 (U.S. CLS. 2, 27, 28
AND 50).

FOR: FURNITURE, MIRRORS, PICTURE
FRAMES, IN CLASS 20 (U.S. CLS. 2, 13, 22, 25, 32
AND 50).

FOR: HOUSEHOLD OR KITCHEN UTENSILS
AND CONTAINERS, NAMELY, MUGS, BOWLS,
DECANTERS, POTS, ICE BUCKETS, VASES, TRAYS;
COMBS; BRUSHES, NAMELY, HAIR BRUSHES,
MAKE-UP BRUSHES, SHOE BRUSHES; UN-
WORKED OR SEMI-WORKED GLASS NOT FOR

BUILDING, IN CLASS 21 (U.S. CLS. 2, 13, 23, 29, 30, 33,
40 AND 50).

FOR: HAIR BARRETTES, BUTTONS, CLOTHING
BUCKLES, MADE OF WOOD, HORN, BONE, IV-
ORY, WHALEBONE, SHELL, AMBER, MOTHER-
OF-PEARL AND MEERSCHAUM, IN CLASS 26 (U.S.
CLS. 37, 39, 40, 42 AND 50).

THE MARK CONSISTS OF STANDARD CHAR-
ACTERS WITHOUT CLAIM TO ANY PARTICULAR
FONT, STYLE, SIZE, OR COLOR.

PRIORITY DATE OF 12-6-2007 IS CLAIMED.

OWNER OF INTERNATIONAL REGISTRATION
0965194 DATED 4-15-2008, EXPIRES 4-15-2018.

THE NAME(S), PORTRAIT(S), AND/OR SIGNA-
TURE(S) SHOWN IN THE MARK IDENTIFIES
"BEATRICE ROSSI" , WHOSE CONSENT(S) TO
REGISTER IS SUBMITTED.

SER. NO. 79-054,200, FILED 4-15-2008.

PATRICIA EVANKO, EXAMINING ATTORNEY

Int. Cl.: 5

Prior U.S. Cls.: 6, 18, 44, 46, 51 and 52

United States Patent and Trademark Office

Reg. No. 3,576,503

Registered Feb. 17, 2009

**TRADEMARK
PRINCIPAL REGISTER**

FLAGIZA

NOVARTIS AG (SWITZERLAND CORPORATION)
CH-4002 BASEL
SWITZERLAND

FOR: PHARMACEUTICAL PREPARATIONS FOR THE PREVENTION OR TREATMENT OF DISEASES AND DISORDERS OF THE NERVOUS SYSTEM, THE IMMUNE SYSTEM, THE CARDIO-VASCULAR SYSTEM AND THE METABOLIC SYSTEM INCLUDING DIABETES, THE RESPIRATORY SYSTEM, THE GENITOURINARY SYSTEM, THE MUSCULO-SKELETAL SYSTEM, FOR THE TREATMENT OF INFLAMMATORY DISORDERS AND DISEASES, AND FOR USE IN DERMATOLOGY, ONCOLOGY, HEMATOLOGY, IN TISSUE AND ORGAN TRANSPLANTATION, IN OPHTHALMOLOGY; PHARMACEUTICAL PREPARATIONS FOR USE IN GASTROENTEROLOGY, FOR THE PREVENTION AND TREATMENT OF OCULAR DISORDERS OR DISEASES; ANTI-BACTERIAL, ANTI-INFECTIVE, ANTIBIOTIC, ANTIVIRAL AND ANTIFUN-

GAL PHARMACEUTICAL PREPARATIONS, IN CLASS 5 (U.S. CLS. 6, 18, 44, 46, 51 AND 52).

THE MARK CONSISTS OF STANDARD CHARACTERS WITHOUT CLAIM TO ANY PARTICULAR FONT, STYLE, SIZE, OR COLOR.

PRIORITY DATE OF 2-4-2008 IS CLAIMED.

OWNER OF INTERNATIONAL REGISTRATION 0965819 DATED 5-7-2008, EXPIRES 5-7-2018.

THE WORD "FLAGIZA" HAS NO MEANING IN ANY FOREIGN LANGUAGE.

SER. NO. 79-054,418, FILED 5-7-2008.

MARILYN IZZI, EXAMINING ATTORNEY

Int. Cl.: 5

Prior U.S. Cls.: 6, 18, 44, 46, 51 and 52

Reg. No. 3,576,504

United States Patent and Trademark Office

Registered Feb. 17, 2009

**TRADEMARK
PRINCIPAL REGISTER**

FULMAPA

NOVARTIS AG (SWITZERLAND CORPORATION)
BASEL, SWITZERLAND CH4002

ANTIBIOTIC, ANTIVIRAL AND ANTIFUNGAL PREPARATIONS, IN CLASS 5 (U.S. CLS. 6, 18, 44, 46, 51 AND 52).

FOR: PHARMACEUTICAL PREPARATIONS FOR THE PREVENTION OR TREATMENT OF DISEASES AND DISORDERS OF THE NERVOUS SYSTEM, THE IMMUNE SYSTEM, THE CARDIO-VASCULAR SYSTEM AND THE METABOLIC SYSTEM, DIABETES, THE RESPIRATORY SYSTEM, THE GENITOURINARY SYSTEM, THE MUSCULOSKELETAL SYSTEM, FOR THE TREATMENT OF INFLAMMATORY DISORDERS AND DISEASES, OR FOR USE IN DERMATOLOGY, ONCOLOGY, HEMATOLOGY, IN TISSUE AND ORGAN TRANSPLANTATION, IN OPHTHALMOLOGY; PHARMACEUTICAL PREPARATIONS FOR USE IN GASTROENTEROLOGY, FOR THE PREVENTION AND TREATMENT OF OCULAR DISORDERS OR DISEASES; ANTI-BACTERIAL, ANTI-INFECTIVE,

THE MARK CONSISTS OF STANDARD CHARACTERS WITHOUT CLAIM TO ANY PARTICULAR FONT, STYLE, SIZE, OR COLOR.

PRIORITY DATE OF 2-4-2008 IS CLAIMED.

OWNER OF INTERNATIONAL REGISTRATION 0965820 DATED 5-7-2008, EXPIRES 5-7-2018.

SER. NO. 79-054,419, FILED 5-7-2008.

BERNICE MIDDLETON, EXAMINING ATTORNEY

Int. Cls.: 9, 35, 37, 38 and 42

Prior U.S. Cls.: 21, 23, 26, 36, 38, 100, 101, 102, 103, 104 and 106

Reg. No. 3,576,505

United States Patent and Trademark Office

Registered Feb. 17, 2009

**TRADEMARK
SERVICE MARK
PRINCIPAL REGISTER**

btexx

BTEXX BUSINESS TECHNOLOGIES GMBH (FED
REP GERMANY GMBH)
RHEINSTRASSE 4N
55116 MAINZ
FED REP GERMANY

FOR: COMPUTER SOFTWARE USED TO CREATE SOFTWARE PLATFORMS, WEB-BASED BUSINESS APPLICATION, PORTALS AND DATA PLATFORMS FOR THE COMPILATION, ANALYSIS, VISUALIZATION, EXTRACTION, TRANSFORMATION AND CONFIGURATION OF BUSINESS DATA AND BUSINESS FIGURES AND FOR REPORTING AND CONTROLLING TECHNICAL FUNCTIONS FOR DATA MANAGEMENT, CREATION OF WEBSITES, DIALOGUE FUNCTIONS AND FOR DATABASE ACCESS; INTERNET BASED SOFTWARE APPLICATIONS TO SUPPORT OPERATIONAL AND ORGANIZATIONAL DATA HANDLING PROCESSES, NAMELY, USE IN DATABASE MANAGEMENT, USE AS A SPREADSHEET AND WORD PROCESSING FOR A VARIETY OF INDUSTRIES; DATA PROCESSING APPARATUS; ALL TYPES OF RECORDED DATA CARRIERS CONTAINING SOFTWARE FOR MANAGEMENT SYSTEMS, PORTAL MANAGEMENT, NAMELY, FOR CREATING AND MANAGING MODERN PORTAL PAGES, AND FOR IMPLEMENTING SOFTWARE TOOLS; BLANK DATA CARRIERS, NAMELY, BLANK CDS, FLOPPY DISKS, USB-STICKS AND MEMORY STICKS, IN CLASS 9 (U.S. CLS. 21, 23, 26, 36 AND 38).

FOR: MANAGEMENT CONSULTANCY; ORGANIZED PROJECT MANAGEMENT SERVICES FOR OTHERS IN THE FIELD OF DATA PROCESSING MANAGEMENT, IN CLASS 35 (U.S. CLS. 100, 101 AND 102).

FOR: INSTALLATION, MAINTENANCE AND REPAIRING OF COMPUTER SYSTEMS HARDWARE, COMPUTER NETWORK HARDWARE AND COMPUTER HARDWARE, IN CLASS 37 (U.S. CLS. 100, 103 AND 106).

FOR: PROVISION OF ACCESS TO THE INTERNET THROUGH SOFTWARE AND INTERNET BASED SOFTWARE APPLICATIONS IN DATA NETWORKS FOR THE SUPPORT OF OPERATIONAL AND ORGANIZATIONAL DATA HANDLING PROCESSES, IN CLASS 38 (U.S. CLS. 100, 101 AND 104).

FOR: INSTALLATION, IMPLEMENTATION, NAMELY, TECHNICAL ADJUSTMENT TO THE SPECIFIC REQUIREMENTS OF THE CONSUMER, CONFIGURATION, UPDATING, MAINTENANCE AND REPAIRING OF COMPUTER SOFTWARE, COMPUTER SYSTEMS SOFTWARE AND NETWORK SOFTWARE; DEVELOPMENT AND CREATION OF COMPUTER SOFTWARE, COMPUTER SYSTEMS SOFTWARE AND NETWORK SOFTWARE; CONFIGURATION OF COMPUTER NETWORKS WITH SOFTWARE, NAMELY, COMPUTER NETWORK DESIGN FOR OTHERS; DESIGN OF INTERNET AND INTRANET HOME PAGES; CONSULTANCY SERVICES IN THE FIELD OF COMPUTER SOFTWARE, COMPUTER SYSTEM ANALYSIS; COMPUTER TECHNICAL PROJECT MANAGEMENT SERVICES IN THE FIELD OF DATA PROCESSING, IN CLASS 42 (U.S. CLS. 100 AND 101).

THE MARK CONSISTS OF STANDARD CHARACTERS WITHOUT CLAIM TO ANY PARTICULAR FONT, STYLE, SIZE, OR COLOR.

PRIORITY DATE OF 6-6-2007 IS CLAIMED.

OWNER OF INTERNATIONAL REGISTRATION
0965821 DATED 12-5-2007, EXPIRES 12-5-2017.

SER. NO. 79-054,420, FILED 12-5-2007.

THE WORDING "BTEXX" HAS NO MEANING IN
A FOREIGN LANGUAGE

WILLIAM ROSSMAN, EXAMINING ATTORNEY

Int. Cl.: 7

Prior U.S. Cls.: 13, 19, 21, 23, 31, 34 and 35

United States Patent and Trademark Office

Reg. No. 3,576,506

Registered Feb. 17, 2009

**TRADEMARK
PRINCIPAL REGISTER**

DESIGNER DIAMOND

VSM GROUP AB (SWEDEN CORPORATION)
DROTTNINGGATAN 2
SE-561 84 HUSKVARNA
SWEDEN

FOR: SEWING MACHINES, IN CLASS 7 (U.S. CLS.
13, 19, 21, 23, 31, 34 AND 35).

PRIORITY DATE OF 11-29-2007 IS CLAIMED.

OWNER OF INTERNATIONAL REGISTRATION
0965867 DATED 1-22-2008, EXPIRES 1-22-2018.

OWNER OF U.S. REG. NO. 2,642,531.

SER. NO. 79-054,440, FILED 1-22-2008.

WILLIAM ROSSMAN, EXAMINING ATTORNEY

Int. Cl.: 34

Prior U.S. Cls.: 2, 8, 9 and 17

United States Patent and Trademark Office

Reg. No. 3,576,507

Registered Feb. 17, 2009

**TRADEMARK
PRINCIPAL REGISTER**

HOFNAR

J. VAN HORSSSEN B.V. (NETHERLANDS COR-
PORATION)
BAANHOEK 202
NL-3364 GN SLIEDRECHT
NETHERLANDS

THE ENGLISH TRANSLATION OF "HOFFNAR"
IS COURT JESTER.

FOR: CIGARS, CIGARETTES AND TOBACCO, IN
CLASS 34 (U.S. CLS. 2, 8, 9 AND 17).

SER. NO. 79-054,461, FILED 5-13-2008.

OWNER OF INTERNATIONAL REGISTRATION
0217186 DATED 2-11-1959, EXPIRES 2-11-2009.

DAVID HOFFMAN, EXAMINING ATTORNEY

Int. Cl.: 9

Prior U.S. Cls.: 21, 23, 26, 36 and 38

United States Patent and Trademark Office

Reg. No. 3,576,508

Registered Feb. 17, 2009

**TRADEMARK
PRINCIPAL REGISTER**

KEDACOM

KEDACOM INTERNATIONAL PTE. LTD. (SINGAPORE COMPANY)
101 CECIL STREET
#17-05 TONG ENG BUILDING; SINGAPORE 069533
SINGAPORE

FOR: WIRED AND WIRELESS VIDEO CONFERENCING SYSTEMS COMPRISED PRIMARILY OF VIDEO CAMERAS, VIDEO MONITORS, MICROPHONES, COMPUTER HARDWARE, AND COMMUNICATIONS SOFTWARE FOR CONNECTING COMPUTER NETWORK USERS; ELECTRONIC VIDEO SURVEILLANCE INSTALLATIONS; COMPUTER VIDEO SERVERS; TELEPHONE APPARATUS; RADIO TELEPHONE APPARATUS; APPARATUS FOR RECORDING, TRANSMISSION AND REPRODUCTION OF SOUND AND IMAGES; IMAGE RECOGNITION COMPUTER SOFTWARE FOR USE IN

TELECONFERENCING, IN CLASS 9 (U.S. CLS. 21, 23, 26, 36 AND 38).

OWNER OF INTERNATIONAL REGISTRATION 0965994 DATED 3-4-2008, EXPIRES 3-4-2018.

THE MARK CONSISTS OF THE STYLIZED WORD "KEDACOM".

THE WORDING "KEDACOM" HAS NO MEANING IN A FOREIGN LANGUAGE.

SER. NO. 79-054,494, FILED 3-4-2008.

DAVID TOOLEY, EXAMINING ATTORNEY

Int. Cls.: 3, 9, 14 and 18

Prior U.S. Cls.: 1, 2, 3, 4, 6, 21, 22, 23, 26, 27, 28, 36, 38, 41, 50, 51 and 52

Reg. No. 3,576,509

United States Patent and Trademark Office

Registered Feb. 17, 2009

**TRADEMARK
PRINCIPAL REGISTER**

pedro garcía

PEDRO GARCIA BRANDS, S.L. (SPAIN SOCIEDAD LIMITADA)
ITALIA, 46
PG. INDUSTRIAL DE CAMPO ALTO
E-03600 ELDA (ALICANTE), SPAIN

FOR: SOAPS, NAMELY, COSMETIC SOAPS; PERFUMERY, ESSENTIAL OILS, COSMETICS, HAIR LOTIONS, DENTIFRICES, IN CLASS 3 (U.S. CLS. 1, 4, 6, 50, 51 AND 52).

FOR: SPECTACLES, IN CLASS 9 (U.S. CLS. 21, 23, 26, 36 AND 38).

FOR: PRECIOUS METALS AND THEIR ALLOYS THEREOF; JEWELRY, PRECIOUS STONES; TIMEPIECES AND CHRONOMETRIC INSTRUMENTS, IN CLASS 14 (U.S. CLS. 2, 27, 28 AND 50).

FOR: LEATHER AND IMITATION LEATHER, GOODS MADE OF LEATHER AND IMITATION LEATHER, NAMELY, WALLETS, KEY HOLDERS,

BRIEFCASES, HANDBAGS; ANIMAL SKINS AND HIDES; TRUNKS AND SUITCASES; UMBRELLAS, PARASOLS AND WALKING STICKS; WHIPS AND SADDLERY, IN CLASS 18 (U.S. CLS. 1, 2, 3, 22 AND 41).

OWNER OF INTERNATIONAL REGISTRATION 0966007 DATED 3-14-2008, EXPIRES 3-14-2018.

THE NAME SHOWN IN THE MARK IDENTIFIES A LIVING INDIVIDUAL WHOSE CONSENT IS OF RECORD.

THE ENGLISH TRANSLATION OF THE FOREIGN WORD(S) IN THE MARK IS PETER GARCIA.

SER. NO. 79-054,499, FILED 3-14-2008.

SANJEEV VOHRA, EXAMINING ATTORNEY

Int. Cl.: 11

Prior U.S. Cls.: 13, 21, 23, 31 and 34

United States Patent and Trademark Office

Reg. No. 3,576,510

Registered Feb. 17, 2009

**TRADEMARK
PRINCIPAL REGISTER**

FRIALOC

FRIATEC AG (FED REP GERMANY JOINT
STOCK COMPANY)
STEINZEUGSTR. 50
68229 MANNHEIM
FED REP GERMANY

FOR: PLUMBING FITTINGS OF PLASTIC,
NAMELY, TAPS FOR INSTALLATION IN PIPE-
LINES FOR USE FOR LIQUID AND GASEOUS
MEDIA; PLUMBING FITTINGS OF PLASTIC,
NAMELY, VALVES, SLIDE VALVES, AND DRAIN
TAPS FOR INSTALLATION IN PIPELINES FOR USE
FOR LIQUID AND GASEOUS MEDIA, IN CLASS 11
(U.S. CLS. 13, 21, 23, 31 AND 34).

THE MARK CONSISTS OF STANDARD CHAR-
ACTERS WITHOUT CLAIM TO ANY PARTICULAR
FONT, STYLE, SIZE, OR COLOR.

PRIORITY DATE OF 10-18-2007 IS CLAIMED.

OWNER OF INTERNATIONAL REGISTRATION
0966474 DATED 2-12-2008, EXPIRES 2-12-2018.

SER. NO. 79-054,639, FILED 2-12-2008.

SANJEEV VOHRA, EXAMINING ATTORNEY

Int. Cls.: 3, 9, 14, 18 and 25

Prior U.S. Cls.: 1, 2, 3, 4, 6, 21, 22, 23, 26, 27, 28, 36, 38, 39, 41, 50, 51 and 52

Reg. No. 3,576,511

United States Patent and Trademark Office

Registered Feb. 17, 2009

**TRADEMARK
PRINCIPAL REGISTER**



TARKAN SALAR
IM KLOSTERGUT 20
31139 HILDESHEIM SORSUM
FED REP GERMANY

FOR: BODY AND BEAUTY CARE PRODUCTS, NAMELY, SOAPS, PERFUMES, SCENTED BODY WATER, EAU-DE-TOILETTE, PERSONAL DEODORANTS; ESSENTIAL OILS FOR PERSONAL USE; EYE SHADOWS, FOUNDATION, MAKE-UP CREAMS, MAKE-UP POWDER, LIPSTICKS, NAIL POLISH, CREAMS AND OILS FOR THE SKIN FOR COSMETIC PURPOSES; LOTIONS FOR COSMETIC PURPOSES, NAMELY, MOISTURIZING LOTIONS FOR THE SKIN; SHAVING PRODUCTS AND AFTERSHAVE CARE PRODUCTS, NAMELY, SHAVING BALMS, SHAVING LOTIONS; BATH PREPARATIONS FOR COSMETIC USE, NAMELY, OILS FOR USE IN THE SHOWER AND BATH, BATH SALTS, NOT FOR MEDICAL PURPOSES; MAKE-UP PREPARATIONS, IN CLASS 3 (U.S. CLS. 1, 4, 6, 50, 51 AND 52).

FOR: SPECTACLES, SUNGLASSES, SPECTACLE FRAMES, SPECTACLE LENSES, SPECTACLE CASES, IN CLASS 9 (U.S. CLS. 21, 23, 26, 36 AND 38).

FOR: PRECIOUS METALS AND THEIR ALLOYS AND PRODUCTS MADE FROM THESE MATERIALS OR COATED THEREWITH, NAMELY, BRACELETS, NECKLACES, EARRINGS, RINGS, KEY HOLDERS; HOROLOGICAL AND CHRONOMETRIC INSTRUMENTS, NAMELY, POCKET WATCHES, WRISTWATCHES, IN CLASS 14 (U.S. CLS. 2, 27, 28 AND 50).

FOR: LEATHER AND IMITATION LEATHER, PRODUCTS MADE OF THESE MATERIALS, NAMELY, HANDBAGS, SHOULDER BAGS, EVENING HANDBAGS, SHOPPING BAGS, WAIST BAGS, SCHOOL BAGS AND RUCKSACKS, BRIEF-CASES, SMALL SUITCASES, ALL-PURPOSE SPORTS BAGS, VALISES, TRAVELLING BAGS; SMALL LEATHER GOODS, NAMELY, PURSES, WALLETS, UNFITTED VANITY CASES, IN CLASS 18 (U.S. CLS. 1, 2, 3, 22 AND 41).

FOR: CLOTHING, NAMELY, TEE-SHIRTS, SHIRTS, SKIRTS, PULLOVERS, SWEATSHIRTS, BLOUSES, JEANS, TROUSERS, BERMUDA SHORTS, DRESSES, POLO SHIRTS, COATS, JACKETS, DENIM JACKETS, ANORAKS, WAISTCOATS, BLAZERS, SCARVES, COVERALLS, DUNGAREES, SOCKS, ANKLETS, STOCKINGS, TIGHTS, NIGHT-DRESSES, PYJAMAS; ALL THE ABOVE GOODS FOR WOMEN, MEN AND CHILDREN; UNDERGARMENTS, LINGERIE, KNITWEAR, NAMELY, KNIT SHIRTS AND KNIT PANTS; BELTS, GLOVES, NECKTIES, BRACES BEING SUSPENDERS, HEADBANDS; FASHION WEAR BATHING ITEMS FOR MEN AND WOMEN, NAMELY, BATHING SUITS, BATHING TRUNKS, BIKINIS, BEACH DRESSES; LEISURE AND TOWN FOOTWEAR FOR MEN AND WOMEN, SANDALS, CHILDREN'S FOOTWEAR; HEADWEAR, NAMELY, CAPS AND HOODS , IN CLASS 25 (U.S. CLS. 22 AND 39).

PRIORITY DATE OF 9-6-2007 IS CLAIMED.

OWNER OF INTERNATIONAL REGISTRATION
0966734 DATED 3-6-2008, EXPIRES 3-6-2018.

OWNER OF U.S. REG. NO. 3,212,362.

THE MARK CONSISTS OF A HIGHLY STYLIZED REPRESENTATION OF AN ELEPHANT WHEREIN THE MARK CONSISTS OF A SINGLE, UNBROKEN BRUSHSTROKE-TYPE LINE WHICH FORMS A HORIZONTAL LETTER "S", REPRESENTING THE

TRUNK AND HEAD OF THE ELEPHANT, AND THEN SWEEPS AROUND TO CREATE THE BODY AND TWO LEGS OF THE ELEPHANT.

SER. NO. 79-054,711, FILED 3-6-2008.

MYRIAH HABEEB, EXAMINING ATTORNEY

Int. Cl.: 11

Prior U.S. Cls.: 13, 21, 23, 31 and 34

United States Patent and Trademark Office

Reg. No. 3,576,512

Registered Feb. 17, 2009

**TRADEMARK
PRINCIPAL REGISTER**

ACONIT

NV BEKAERT SA (BELGIUM CORPORATION)

BEKAERTSTRAAT 2

B-8550 ZWEVEGEM, BELGIUM

FOR: GAS BURNERS; GAS BURNERS FOR GAS
INSTALLATIONS; BURNERS FOR INDUSTRIAL,
HEATING AND FURNACE BOILERS; GAS BUR-
NERS, NAMELY, PRE-MIX BURNERS, IN CLASS 11
(U.S. CLS. 13, 21, 23, 31 AND 34).

THE MARK CONSISTS OF STANDARD CHAR-
ACTERS WITHOUT CLAIM TO ANY PARTICULAR
FONT, STYLE, SIZE, OR COLOR.

OWNER OF INTERNATIONAL REGISTRATION
0966970 DATED 3-20-2008, EXPIRES 3-20-2018.

SER. NO. 79-054,785, FILED 3-20-2008.

CHRISTINE BLOMQUIST, EXAMINING ATTOR-
NEY

Int. Cl.: 5

Prior U.S. Cls.: 6, 18, 44, 46, 51 and 52

United States Patent and Trademark Office

Reg. No. 3,576,513

Registered Feb. 17, 2009

**TRADEMARK
PRINCIPAL REGISTER**

VRESKIZ

NOVARTIS AG (SWITZERLAND CORPORATION)
CH-4002 BASEL
SWITZERLAND

FOR: PHARMACEUTICAL PREPARATIONS FOR THE PREVENTION AND TREATMENT OF DISORDERS OF THE NERVOUS SYSTEM, THE IMMUNE SYSTEM, THE CARDIO-VASCULAR SYSTEM AND THE METABOLIC SYSTEM, THE RESPIRATORY SYSTEM, AND THE GENITOURINARY SYSTEM; PHARMACEUTICAL PREPARATIONS FOR THE TREATMENT OF DIABETES; PHARMACEUTICAL PREPARATIONS FOR THE TREATMENT OF MUSCULO-SKELETAL AND INFLAMMATORY DISORDERS; PHARMACEUTICAL PREPARATIONS FOR USE IN DERMATOLOGY, ONCOLOGY, HEMATOLOGY AND IN TISSUE AND ORGAN TRANSPLANTATION, IN OPHTHALMOLOGY; PHARMACEUTICAL PREPARATIONS FOR GASTROENTEROLOGICAL DISORDERS; PHARMACEUTICAL PREPARATIONS FOR THE PREVENTION AND TREATMENT OF OCULAR DISORDERS; PHARMACEUTICAL PREPARATIONS FOR THE TREATMENT OF BACTERIA-

BASED DISEASES; PHARMACEUTICAL PREPARATIONS, NAMELY, ANTI-INFECTIVE PREPARATIONS, ANTIVIRAL PREPARATIONS, ANTIBIOTICS, ANTIFUNGAL PREPARATIONS AND VACCINES, IN CLASS 5 (U.S. CLS. 6, 18, 44, 46, 51 AND 52).

THE MARK CONSISTS OF STANDARD CHARACTERS WITHOUT CLAIM TO ANY PARTICULAR FONT, STYLE, SIZE, OR COLOR.

PRIORITY DATE OF 4-7-2008 IS CLAIMED.

OWNER OF INTERNATIONAL REGISTRATION 0967175 DATED 6-3-2008, EXPIRES 6-3-2018.

THE TERM VRESKIZ HAS NO MEANING IN A FOREIGN LANGUAGE.

SER. NO. 79-054,846, FILED 6-3-2008.

KAREN SEVERSON, EXAMINING ATTORNEY

Int. Cl.: 25

Prior U.S. Cls.: 22 and 39

United States Patent and Trademark Office

Reg. No. 3,576,514

Registered Feb. 17, 2009

**TRADEMARK
PRINCIPAL REGISTER**

JANINE ROBIN

FRANCE LIGNE, SOCIÉTÉ ANONYME
(FRANCE SOCIÉTÉ ANONYME)
ZONE INDUSTRIELLE,
F-33210 LANGON
FRANCE

FOR: CLOTHING, NAMELY, DRESSES, PANTS,
PAJAMAS, DRESSING GOWNS, NIGHTIES;
SHIRTS, BRAS AND PANTIES; AND BEACH
CLOTHES, NAMELY, SWIMWEAR, PAREOS AND
DRESSES, IN CLASS 25 (U.S. CLS. 22 AND 39).

OWNER OF INTERNATIONAL REGISTRATION
0484903 DATED 5-14-1984, EXPIRES 5-14-2014.

"JANINE ROBIN" DOES NOT IDENTIFY A LIV-
ING INDIVIDUAL.

SER. NO. 79-054,957, FILED 4-17-2008.

RENEE SERVANCE, EXAMINING ATTORNEY

Int. Cl.: 33

Prior U.S. Cls.: 47 and 49

United States Patent and Trademark Office

Reg. No. 3,576,515

Registered Feb. 17, 2009

**TRADEMARK
PRINCIPAL REGISTER**

FLEURS DU MAL

DISTILLERIE GIRARD (FRANCE SOCIÉTÉ
ANONYME (SA))
ROUTE DE CARPENTRAS
F-84150 JONQUIERES
FRANCE

FOR: ALCOHOLIC BEVERAGES EXCEPT BEERS,
IN CLASS 33 (U.S. CLS. 47 AND 49).

THE MARK CONSISTS OF STANDARD CHAR-
ACTERS WITHOUT CLAIM TO ANY PARTICULAR
FONT, STYLE, SIZE, OR COLOR.

OWNER OF INTERNATIONAL REGISTRATION
0795702 DATED 12-13-2002, EXPIRES 12-13-2012.

THE FOREIGN WORDING IN THE MARK
TRANSLATES INTO ENGLISH AS "FLOWERS OF
EVIL."

SER. NO. 79-054,971, FILED 5-16-2008.

AMOS T. MATTHEWS, JR., EXAMINING ATTOR-
NEY

Int. Cl.: 33

Prior U.S. Cls.: 47 and 49

United States Patent and Trademark Office

Reg. No. 3,576,516

Registered Feb. 17, 2009

**TRADEMARK
PRINCIPAL REGISTER**

Anniversary Hill

SAM ATKINS (AUSTRALIA INDIVIDUAL)
69 BEULAH ROAD
NORWOOD SA 5067
AUSTRALIA

OWNER OF INTERNATIONAL REGISTRATION
0967927 DATED 6-10-2008, EXPIRES 6-10-2018.

FOR: WINE, IN CLASS 33 (U.S. CLS. 47 AND 49).

SER. NO. 79-055,156, FILED 6-10-2008.

THE MARK CONSISTS OF STANDARD CHAR-
ACTERS WITHOUT CLAIM TO ANY PARTICULAR
FONT, STYLE, SIZE, OR COLOR.

WARREN L. OLANDRIA, EXAMINING ATTOR-
NEY

Int. Cl.: 31

Prior U.S. Cls.: 1 and 46

United States Patent and Trademark Office

Reg. No. 3,576,517

Registered Feb. 17, 2009

**TRADEMARK
PRINCIPAL REGISTER**

SURWING

SUNTORY FLOWERS LIMITED (JAPAN CORPORATION)
2-13-12, HIRAKAWACHO
CHIYODA-KU
TOKYO 102-0093, JAPAN

FOR: SEEDLINGS, LIVE PLANTS AND FLOWERS, IN CLASS 31 (U.S. CLS. 1 AND 46).

THE MARK CONSISTS OF STANDARD CHARACTERS WITHOUT CLAIM TO ANY PARTICULAR FONT, STYLE, SIZE, OR COLOR.

PRIORITY DATE OF 5-14-2008 IS CLAIMED.

OWNER OF INTERNATIONAL REGISTRATION
0968050 DATED 6-4-2008, EXPIRES 6-4-2018.

SER. NO. 79-055,193, FILED 6-4-2008.

ELI HELLMAN, EXAMINING ATTORNEY

Int. Cls.: 18, 25 and 28

Prior U.S. Cls.: 1, 2, 3, 22, 23, 38, 39, 41 and 50

United States Patent and Trademark Office

Reg. No. 3,576,518

Registered Feb. 17, 2009

**TRADEMARK
PRINCIPAL REGISTER**

Core Racing USA

POWERSLIDE SPORTARTIKELVERTRIEBS
GMBH (FED REP GERMANY GMBH)
ESBACHGRABEN 3
95463 BINDLACH
FED REP GERMANY

FOR: SPORT BAGS, BACKPACKS, PURSES AND
CASES FOR TRANSPORTING AND STORAGE FOR
SKATES AND SPARE PARTS THEREOF; WALLETS,
IN CLASS 18 (U.S. CLS. 1, 2, 3, 22 AND 41).

FOR: CLOTHING, NAMELY, TOPS, BOTTOMS,
SHOES, AND HATS FOR SPORT AND FITNESS, IN
CLASS 25 (U.S. CLS. 22 AND 39).

FOR: IN-LINE, ROLLER, AND ICE SKATES;
PROTECTIVE GEAR CONSISTING OF KNEE PADS,
ELBOW PADS, WRISTGUARDS FOR IN-LINE,
ROLLER, AND ICE SKATING; FRAMES AND
CHASSIS FOR INLINE, ROLLER, AND ICE SKATES;

SPARE PARTS FOR THE ABOVE ITEMS, IN CLASS
28 (U.S. CLS. 22, 23, 38 AND 50).

THE MARK CONSISTS OF STANDARD CHAR-
ACTERS WITHOUT CLAIM TO ANY PARTICULAR
FONT, STYLE, SIZE, OR COLOR.

OWNER OF INTERNATIONAL REGISTRATION
0968104 DATED 6-15-2007, EXPIRES 6-15-2017.

NO CLAIM IS MADE TO THE EXCLUSIVE
RIGHT TO USE "RACING USA" IN INTERNATION-
AL CLASS 28 OR "USA" IN INTERNATIONAL
CLASSES 18 AND 25, APART FROM THE MARK
AS SHOWN.

SER. NO. 79-055,213, FILED 6-15-2007.

DAVID TOOLEY, EXAMINING ATTORNEY

Int. Cl.: 30

Prior U.S. Cl.: 46

United States Patent and Trademark Office

Reg. No. 3,576,519

Registered Feb. 17, 2009

TRADEMARK
PRINCIPAL REGISTER

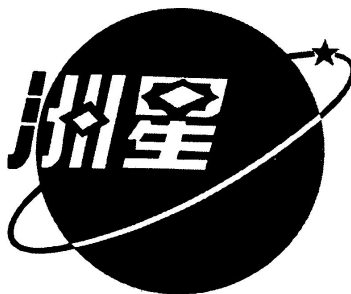

洲 星

GUANGZHOU ZHOUXING FOOD; PRODUCTS
CO., LTD. (CHINA LIMITED LIABILITY COM-
PANY)

SAN BU GANG, JIANGGAO TOWN
BAIYUN DISTRICT
GUANGZHOU CITY, CHINA 510450

FOR: BREAD; PASTRIES; PREPARATIONS
MADE FROM CEREALS, NAMELY, CORN
FLAKES, OATMEAL, CORN FLOUR AND WHEAT
FLOUR; WATER CHESTNUT STARCH; WATER
CHESTNUT CAKE; FLOUR-MILLING PRODUCTS,
NAMELY, NOODLES, RIBBON VERMICELLI, PAS-
TA, MACARONI AND INSTANT NOODLES; GLU-
TEN FOR FOOD; FOOD STARCH; PIES; STEAMED
BUNS STUFFED WITH MINCED MEAT, IN CLASS
30 (U.S. CL. 46).

OWNER OF INTERNATIONAL REGISTRATION
0968125 DATED 3-17-2008, EXPIRES 3-17-2018.

THE ENGLISH TRANSLATION OF THE FOR-
EIGN WORD(S) IN THE MARK IS: THE FIRST
CHINESE CHARACTER TRANSLATES AS CONTI-
NENT AND THE SECOND CHINESE CHARACTER
TRANSLATES AS STAR.

THE TRANSLITERATION OF THE NON-LATIN
CHARACTERS IN THE MARK IS: ZHOU XING.

SER. NO. 79-055,220, FILED 3-17-2008.

SUE LAWRENCE, EXAMINING ATTORNEY

Int. Cl.: 32

Prior U.S. Cls.: 45, 46 and 48

United States Patent and Trademark Office

Reg. No. 3,576,520

Registered Feb. 17, 2009

**TRADEMARK
PRINCIPAL REGISTER**



TIGER WOODS ENTERPRISES S.A. (SWITZERLAND SOCIÉTÉ ANONYME (SA))
C/O MEISSER & PARTNER, BAHNHOFSTRASSE 8
CH-7250 KLOSTERS
SWITZERLAND

FOR: ISOTONIC BEVERAGES, BOTTLED WATERS; FLAVOURED WATERS; FRUIT DRINKS AND FRUIT JUICES, IN CLASS 32 (U.S. CLS. 45, 46 AND 48).

PRIORITY DATE OF 3-17-2008 IS CLAIMED.

OWNER OF INTERNATIONAL REGISTRATION
0968346 DATED 6-18-2008, EXPIRES 6-18-2018.

THE NAME(S), PORTRAIT(S), AND/OR SIGNATURE(S) SHOWN IN THE MARK IDENTIFIES TIGER WOODS WHOSE CONSENT IS OF RECORD.

SER. NO. 79-055,290, FILED 6-18-2008.

SUE LAWRENCE, EXAMINING ATTORNEY

Int. Cl.: 24

Prior U.S. Cls.: 42 and 50

United States Patent and Trademark Office

Reg. No. 3,576,521

Registered Feb. 17, 2009

**TRADEMARK
PRINCIPAL REGISTER**



MARTINELLI GINETTO SPA; IN BREVE M.G.
SPA (C.F.01018510162) (ITALY JOINT STOCK
COMPANY)

VIA AGRO DEL CASTELLO, 38
I-24020 CASNIGO (BG)
ITALY

FOR: TEXTILES AND TEXTILE GOODS, NAME-
LY, TEXTILE FABRICS FOR THE MANUFACTURE
OF CLOTHING; TEXTILE USED AS FINISHINGS
FOR CLOTHING; BED AND TABLE LINEN, BED
BLANKETS, IN CLASS 24 (U.S. CLS. 42 AND 50).

OWNER OF INTERNATIONAL REGISTRATION
0849904 DATED 4-27-2005, EXPIRES 4-27-2015.

THE NAME "MARTINELLI GINETTO" DOES
NOT IDENTIFY A LIVING INDIVIDUAL.

THE TRADEMARK CONSISTS OF THE WORDS
"MARTINELLI GINETTO", ARRANGED IN TWO
LINES, THE INITIALS DEPICTED IN UPPERCASE
AND THE OTHER CHARACTERS IN FANCY LOW-
ERCASE TYPE; UNDER THE WORD "GINETTO" IS
A LARGE CAPITAL "M" CUTTING ACROSS THE
UPPER PART OF A LARGE "G"; THESE TWO
LETTERS ARE IN FANCY UPPERCASE TYPE; TO
THE RIGHT OF THE LETTER "G" IS A RECTAN-
GLE ABOVE WHICH THERE IS A FANCY DESIGN.

SER. NO. 79-055,328, FILED 12-15-2007.

JAMES A. RAUEN, EXAMINING ATTORNEY

Int. Cl.: 9

Prior U.S. Cls.: 21, 23, 26, 36 and 38

Reg. No. 3,576,522

United States Patent and Trademark Office

Registered Feb. 17, 2009

**TRADEMARK
PRINCIPAL REGISTER**



DAVITT KRANTZ & ASSOCIATES PTY LTD
(AUSTRALIA PROPRIETARY LIMITED COM-
PANY (P/L OR PTY. LTD.))
LEVEL 8,
350 COLLINS STREET; MELBOURNE VIC 3000
AUSTRALIA

OWNER OF INTERNATIONAL REGISTRATION
0968949 DATED 5-12-2008, EXPIRES 5-12-2018.

FOR: COMPUTER SOFTWARE, NAMELY, SOFT-
WARE FOR BUSINESS PROCESS MANAGEMENT,
IN CLASS 9 (U.S. CLS. 21, 23, 26, 36 AND 38).

SER. NO. 79-055,533, FILED 5-12-2008.

PRIORITY DATE OF 11-13-2007 IS CLAIMED.

ANDREA HACK, EXAMINING ATTORNEY

Int. Cls.: 1 and 3

Prior U.S. Cls.: 1, 4, 5, 6, 10, 26, 46, 50, 51 and 52

United States Patent and Trademark Office

Reg. No. 3,576,523

Registered Feb. 17, 2009

**TRADEMARK
PRINCIPAL REGISTER**

MYRRHONE

FIRMENICH SA (SWITZERLAND SOCIÉTÉ
ANONYME)
1 ROUTE DES JEUNES,
CASE POSTALE 239; CH-1211 GENÈVE 8
SWITZERLAND

FOR: CHEMICAL PRODUCTS, NAMELY, RAW
MATERIALS, INTENDED FOR USE IN THE FRA-
GRANCE INDUSTRY, IN CLASS 1 (U.S. CLS. 1, 5, 6,
10, 26 AND 46).

FOR: PERFUMES AND ESSENTIAL OILS INTEN-
DED TO PERFUME CONSUMER PRODUCTS, IN
CLASS 3 (U.S. CLS. 1, 4, 6, 50, 51 AND 52).

THE MARK CONSISTS OF STANDARD CHAR-
ACTERS WITHOUT CLAIM TO ANY PARTICULAR
FONT, STYLE, SIZE, OR COLOR.

PRIORITY DATE OF 1-29-2008 IS CLAIMED.

OWNER OF INTERNATIONAL REGISTRATION
0968975 DATED 6-13-2008, EXPIRES 6-13-2018.

SER. NO. 79-055,545, FILED 6-13-2008.

ANNE E. GUSTASON, EXAMINING ATTORNEY

Int. Cl.: 5

Prior U.S. Cls.: 6, 18, 44, 46, 51 and 52

Reg. No. 3,576,524

United States Patent and Trademark Office

Registered Feb. 17, 2009

**TRADEMARK
PRINCIPAL REGISTER**

SCAPHOZ

NOVARTIS AG (SWITZERLAND CORPORATION)
CH-4002 BASEL
SWITZERLAND

PARATIONS, ANTIBIOTICS, ANTIVIRAL PREPARATIONS, ANTIFUNGAL PREPARATIONS AND VACCINES, IN CLASS 5 (U.S. CLS. 6, 18, 44, 46, 51 AND 52).

FOR: PHARMACEUTICAL PREPARATIONS FOR THE PREVENTION AND TREATMENT OF DISORDERS OF THE NERVOUS SYSTEM, THE IMMUNE SYSTEM, THE CARDIO-VASCULAR AND METABOLIC SYSTEM INCLUDING DIABETES, THE RESPIRATORY SYSTEM, THE GENITOURINARY SYSTEM, MUSCULO-SKELETAL AND INFLAMMATORY DISORDERS, OR USED IN DERMATOLOGY, ONCOLOGY, HAEMATOLOGY, IN TISSUE AND ORGAN TRANSPLANTATION, OPHTHALMOLOGY; PHARMACEUTICAL PREPARATIONS FOR GASTROENTEROLOGICAL DISORDERS, FOR THE PREVENTION AND TREATMENT OF OCULAR DISORDERS OR DISEASES; ANTIBACTERIAL PREPARATIONS, ANTI-INFECTIVE PRE-

THE MARK CONSISTS OF STANDARD CHARACTERS WITHOUT CLAIM TO ANY PARTICULAR FONT, STYLE, SIZE, OR COLOR.

PRIORITY DATE OF 3-26-2008 IS CLAIMED.

OWNER OF INTERNATIONAL REGISTRATION 0969355 DATED 7-4-2008, EXPIRES 7-4-2018.

SER. NO. 79-055,723, FILED 7-4-2008.

SUSAN LESLIE DUBOIS, EXAMINING ATTORNEY

Int. Cl.: 31

Prior U.S. Cls.: 1 and 46

United States Patent and Trademark Office

Reg. No. 3,576,525

Registered Feb. 17, 2009

**TRADEMARK
PRINCIPAL REGISTER**

SURFUME

SUNTORY FLOWERS LIMITED (JAPAN CORPORATION)
2-13-12 HIRAKAWA-CHO
CHIYODA-KU; TOKYO 102-0093, JAPAN

FOR: SEEDLINGS, LIVE PLANTS AND FLOWERS, IN CLASS 31 (U.S. CLS. 1 AND 46).

THE MARK CONSISTS OF STANDARD CHARACTERS WITHOUT CLAIM TO ANY PARTICULAR FONT, STYLE, SIZE, OR COLOR.

PRIORITY DATE OF 6-3-2008 IS CLAIMED.

OWNER OF INTERNATIONAL REGISTRATION
0969396 DATED 6-30-2008, EXPIRES 6-30-2018.

SER. NO. 79-055,740, FILED 6-30-2008.

ELI HELLMAN, EXAMINING ATTORNEY

Int. Cl.: 24

Prior U.S. Cls.: 42 and 50

United States Patent and Trademark Office

Reg. No. 3,576,526

Registered Feb. 17, 2009

**TRADEMARK
PRINCIPAL REGISTER**

LANSIU

JIANGSU LANSIYU; HOME TEXTILE CO., LTD
(CHINA CORPORATION)
NO. 11, A SECTION,
ZHIHAO INDUSTRIAL PARK.; TONGZHOU CITY;-
JIANGSU
CHINA

FOR: FABRIC FOR TEXTILE USE; WALL HANG-
INGS OF TEXTILE; TOWELS OF TEXTILE; TOWEL
QUILT; BED SHEETS; COVERS FOR DUVETS;
QUILTS; BEDSPREADS AND BED COVERS; MOS-
QUITO NETS; BED BLANKETS; LOOSE FABRIC
COVERS FOR FURNITURE; CURTAINS OF TEX-
TILE OR PLASTIC; PLACE MATS NOT OF PAPER,
IN CLASS 24 (U.S. CLS. 42 AND 50).

THE MARK CONSISTS OF STANDARD CHAR-
ACTERS WITHOUT CLAIM TO ANY PARTICULAR
FONT, STYLE, SIZE, OR COLOR.

OWNER OF INTERNATIONAL REGISTRATION
0969674 DATED 3-8-2008, EXPIRES 3-8-2018.

"LANSIU" HAS NO GEOGRAPHICAL SIGNIFI-
CANCE AND CONSISTS OF A MADE-UP WORD
WHICH BEARS NO RELATION TO THE GOODS OF
INTEREST. IT HAS NO MEANING.

SER. NO. 79-055,833, FILED 3-8-2008.

AISHA SALEM, EXAMINING ATTORNEY

Int. Cl.: 25

Prior U.S. Cls.: 22 and 39

United States Patent and Trademark Office

Reg. No. 3,576,527

Registered Feb. 17, 2009

**TRADEMARK
PRINCIPAL REGISTER**

biom

**ECCO SKO A/S (DENMARK A CORPORATION
WITH LIMITED LIABILITY)
INDUSTRIVEJ 5
DK-6261 BREDEBRO
DENMARK**

**OWNER OF INTERNATIONAL REGISTRATION
0969825 DATED 7-4-2008, EXPIRES 7-4-2018.**

**FOR: FOOTWEAR, NAMELY, RUNNING SHOES
AND SHOES FOR EXERCISE, IN CLASS 25 (U.S.
CLS. 22 AND 39).**

SER. NO. 79-055,897, FILED 7-4-2008.

PRIORITY DATE OF 1-14-2008 IS CLAIMED.

MARILYN IZZI, EXAMINING ATTORNEY

Int. Cl.: 33

Prior U.S. Cls.: 47 and 49

United States Patent and Trademark Office

Reg. No. 3,576,528

Registered Feb. 17, 2009

**TRADEMARK
PRINCIPAL REGISTER**

LE POUSSIN

BORVIN (FRANCE SOCIÉTÉ À RESPONSABILITÉ LIMITÉE (SARL))
53, RUE DU DEHEZ
F-33290 BLANQUEFORT
FRANCE

FOR: WINE, IN CLASS 33 (U.S. CLS. 47 AND 49).

THE MARK CONSISTS OF STANDARD CHARACTERS WITHOUT CLAIM TO ANY PARTICULAR FONT, STYLE, SIZE, OR COLOR.

OWNER OF INTERNATIONAL REGISTRATION
0969919 DATED 5-15-2008, EXPIRES 5-15-2018.

THE ENGLISH TRANSLATION OF THE WORD
"LES POUSSIN" IN THE MARK IS "THE CHICK".

SER. NO. 79-055,931, FILED 5-15-2008.

KAREN K. BUSH, EXAMINING ATTORNEY

Int. Cls.: 30 and 43

Prior U.S. Cls.: 46, 100 and 101

United States Patent and Trademark Office

Reg. No. 3,576,529

Registered Feb. 17, 2009

**TRADEMARK
SERVICE MARK
PRINCIPAL REGISTER**

STAZIONI DEL GUSTO

ILLYCAFFÈ S.P.A.; CON UNICO SOCIO (ITALY
STOCK COMPANY WITH SOLE SHAREHOLD-
ER)

VIA FLAVIA, 110
I-34147 TRIESTE (TS)
ITALY

FOR: COFFEE, TEA, COCOA, SUGAR, ARTIFI-
CIAL COFFEE, COFFEE-BASED BEVERAGES,
CHOCOLATE-BASED BEVERAGES NOT BEING
DAIRY-BASED OR VEGETABLE-BASED, IN CLASS
30 (U.S. CL. 46).

FOR: SERVICES FOR PROVIDING FOOD AND
DRINKS, NAMELY, SERVING FOOD AND
DRINKS, CATERING OF FOOD AND DRINKS,
PROVIDING TEMPORARY ACCOMMODATION,
BAR SERVICES, COFFEE HOUSE AND RESTAU-
RANT SERVICES; PROVISION OF FOODSTUFFS
OR BEVERAGES BY AUTOMATIC VENDING MA-
CHINES, NAMELY, PROVIDING FOOD AND
DRINK; ADVICE WITH REGARD TO THE AFORE-
SAID SERVICES, NAMELY, PROVIDING ADVICE

TO TOURIST AND BUSINESS TRAVELERS ON
TEMPORARY ACCOMMODATIONS AND RES-
TAURANT DESTINATIONS, IN CLASS 43 (U.S.
CLS. 100 AND 101).

THE MARK CONSISTS OF STANDARD CHAR-
ACTERS WITHOUT CLAIM TO ANY PARTICULAR
FONT, STYLE, SIZE, OR COLOR.

PRIORITY DATE OF 4-16-2008 IS CLAIMED.

OWNER OF INTERNATIONAL REGISTRATION
0969941 DATED 5-21-2008, EXPIRES 5-21-2018.

THE ENGLISH TRANSLATION OF "STAZIONI
DEL GUSTO" IS TASTE STATION.

SER. NO. 79-055,940, FILED 5-21-2008.

JOHN DWYER, EXAMINING ATTORNEY

Int. Cl.: 14

Prior U.S. Cls.: 2, 27, 28 and 50

United States Patent and Trademark Office

Reg. No. 3,576,530

Registered Feb. 17, 2009

**TRADEMARK
PRINCIPAL REGISTER**

FENDISSIME

FENDI ADELE S.R.L. (ITALY LIMITED LIABILITY COMPANY)
VIA FLAMINIA, 968
I-00189 ROMA
ITALY

FOR: CLOCKS, WATCHES, CHRONOMETRIC INSTRUMENTS, IN CLASS 14 (U.S. CLS. 2, 27, 28 AND 50).

THE MARK CONSISTS OF STANDARD CHARACTERS WITHOUT CLAIM TO ANY PARTICULAR FONT, STYLE, SIZE, OR COLOR.

OWNER OF INTERNATIONAL REGISTRATION 0746131 DATED 10-11-2000, EXPIRES 10-11-2010.

OWNER OF U.S. REG. NOS. 1,569,570, 3,458,463 AND OTHERS.

SER. NO. 79-055,975, FILED 5-22-2008.

MICHAEL TANNER, EXAMINING ATTORNEY

Int. Cl.: 5

Prior U.S. Cls.: 6, 18, 44, 46, 51 and 52

United States Patent and Trademark Office

Reg. No. 3,576,531

Registered Feb. 17, 2009

**TRADEMARK
PRINCIPAL REGISTER**

RUSCADI

NOVARTIS AG (SWITZERLAND CORPORATION)
CH-4002 BASEL
SWITZERLAND

FOR: PHARMACEUTICAL PREPARATIONS FOR THE PREVENTION AND TREATMENT OF DISORDERS OF THE NERVOUS SYSTEM, THE IMMUNE SYSTEM, THE CARDIO-VASCULAR AND METABOLIC SYSTEM INCLUDING DIABETES, THE RESPIRATORY SYSTEM, THE GENITOURINARY SYSTEM, MUSCULO-SKELETAL AND INFLAMMATORY DISORDERS, OR USED IN DERMATOLOGY, ONCOLOGY, HAEMATOLOGY, IN TISSUE AND ORGAN TRANSPLANTATION, OPHTHALMOLOGY; PHARMACEUTICAL PREPARATIONS FOR GASTROENTEROLOGICAL DISORDERS, FOR THE PREVENTION AND TREATMENT OF OCULAR DISORDERS OR DISEASES; ANTIBACTERIAL PREPARATIONS, ANTI-INFECTIVE PRE-

PARATIONS, ANTIBIOTICS, ANTIVIRAL PREPARATIONS, ANTIFUNGAL PREPARATIONS AND VACCINES, IN CLASS 5 (U.S. CLS. 6, 18, 44, 46, 51 AND 52).

THE MARK CONSISTS OF STANDARD CHARACTERS WITHOUT CLAIM TO ANY PARTICULAR FONT, STYLE, SIZE, OR COLOR.

PRIORITY DATE OF 3-26-2008 IS CLAIMED.

OWNER OF INTERNATIONAL REGISTRATION 0970012 DATED 7-4-2008, EXPIRES 7-4-2018.

SER. NO. 79-055,995, FILED 7-4-2008.

SUSAN LESLIE DUBOIS, EXAMINING ATTORNEY

Int. Cl.: 10

Prior U.S. Cls.: 26, 39 and 44

United States Patent and Trademark Office

Reg. No. 3,576,532

Registered Feb. 17, 2009

**TRADEMARK
PRINCIPAL REGISTER**

IPP-ON

NEWDEAL (FRANCE SOCIÉTÉ PAR ACTIONS
SIMPLIFIÉE)
10 PLACE D'HELVÉTIE
F-69006 LYON
FRANCE

FOR: SURGICAL IMPLANTS COMPRISING ARTIFICIAL MATERIAL FOR IMMOBILISING THE PROXIMAL INTERPHALANGEAL JOINT OF THE FOOT; SURGICAL EQUIPMENT FOR ORTHOPAEDIC, OSTEOSYNTHETIC AND TRAUMATOLOGICAL APPLICATIONS, NAMELY, ARTIFICIAL SURGICAL IMPLANTS FOR THE TRAUMATOLOGICAL AND ORTHOPAEDIC OSTEOSYNTHESIS OF LIMBS AND THE TRUNKS; JOINT PROTHESES; GOODS OF METAL FOR MEDICAL USE, NAMELY, SURGICAL SCREWS, SURGICAL PINS; ARTHRODESIS NAILS, AND BOLTS; ANCILLARY EQUIPMENT, NAMELY, NEEDLE POSITIONING

GUIDES; SURGICAL INSTRUMENTS, NAMELY, IMPACTORS, IN CLASS 10 (U.S. CLS. 26, 39 AND 44).

THE MARK CONSISTS OF STANDARD CHARACTERS WITHOUT CLAIM TO ANY PARTICULAR FONT, STYLE, SIZE, OR COLOR.

PRIORITY DATE OF 6-25-2007 IS CLAIMED.

OWNER OF INTERNATIONAL REGISTRATION
0970544 DATED 12-13-2007, EXPIRES 12-13-2017.

SER. NO. 79-056,207, FILED 12-13-2007.

SCOTT BIBB, EXAMINING ATTORNEY

Int. Cl.: 5

Prior U.S. Cls.: 6, 18, 44, 46, 51 and 52

United States Patent and Trademark Office

Reg. No. 3,576,533

Registered Feb. 17, 2009

**TRADEMARK
PRINCIPAL REGISTER**

LIPDAY

BIOALLIANCE, PHARMA (FRANCE SOCIÉTÉ
ANONYME À DIRECTOIRE)
59 BOULEVARD DU GÉNÉRAL MARTIAL VALIN
F-75015 PARIS
FRANCE

FOR: PHARMACEUTICAL COMPOSITIONS FOR
THE TREATMENT OF HERPES, IN CLASS 5 (U.S.
CLS. 6, 18, 44, 46, 51 AND 52).

THE MARK CONSISTS OF STANDARD CHAR-
ACTERS WITHOUT CLAIM TO ANY PARTICULAR
FONT, STYLE, SIZE, OR COLOR.

PRIORITY DATE OF 1-24-2008 IS CLAIMED.

OWNER OF INTERNATIONAL REGISTRATION
0970780 DATED 7-2-2008, EXPIRES 7-2-2018.

SER. NO. 79-056,316, FILED 7-2-2008.

CHRISTINE BLOMQUIST, EXAMINING ATTOR-
NEY

Int. Cl.: 5

Prior U.S. Cls.: 6, 18, 44, 46, 51 and 52

United States Patent and Trademark Office

Reg. No. 3,576,534

Registered Feb. 17, 2009

**TRADEMARK
PRINCIPAL REGISTER**

LIVATAG

BIOALLIANCE, PHARMA (FRANCE SOCIÉTÉ
ANONYME À DIRECTOIRE)
59 BOULEVARD DU GÉNÉRAL MARTIAL VALIN
F-75015 PARIS
FRANCE

FOR: PHARMACEUTICAL PREPARATIONS IN
THE FORM OF NANOPARTICLES ADMINIS-
TERED INTRAVENOUSLY FOR THE TREATMENT
OF CANCER OF THE LIVER , IN CLASS 5 (U.S. CLS.
6, 18, 44, 46, 51 AND 52).

THE MARK CONSISTS OF STANDARD CHAR-
ACTERS WITHOUT CLAIM TO ANY PARTICULAR
FONT, STYLE, SIZE, OR COLOR.

PRIORITY DATE OF 1-14-2008 IS CLAIMED.

OWNER OF INTERNATIONAL REGISTRATION
0970781 DATED 7-2-2008, EXPIRES 7-2-2018.

SER. NO. 79-056,317, FILED 7-2-2008.

CHRISTINE BLOMQUIST, EXAMINING ATTOR-
NEY

Int. Cl.: 5

Prior U.S. Cls.: 6, 18, 44, 46, 51 and 52

United States Patent and Trademark Office

Reg. No. 3,576,535

Registered Feb. 17, 2009

**TRADEMARK
PRINCIPAL REGISTER**

NANOSTAM

BIOALLIANCE PHARMA (FRANCE SOCIÉTÉ
ANONYME À DIRECTOIRE)
59 BOULEVARD DU GÉNÉRAL MARTIAL VALIN
F-75015 PARIS
FRANCE

FOR: PHARMACEUTICAL PREPARATIONS IN
THE FORM OF NANOPARTICLES ADMINIS-
TERED INTRAVENOUSLY FOR THE TREATMENT
OF CANCER OF THE LIVER , IN CLASS 5 (U.S. CLS.
6, 18, 44, 46, 51 AND 52).

THE MARK CONSISTS OF STANDARD CHAR-
ACTERS WITHOUT CLAIM TO ANY PARTICULAR
FONT, STYLE, SIZE, OR COLOR.

PRIORITY DATE OF 1-14-2008 IS CLAIMED.

OWNER OF INTERNATIONAL REGISTRATION
0970782 DATED 7-2-2008, EXPIRES 7-2-2018.

SER. NO. 79-056,318, FILED 7-2-2008.

CHRISTINE BLOMQUIST, EXAMINING ATTOR-
NEY

Int. Cl.: 5

Prior U.S. Cls.: 6, 18, 44, 46, 51 and 52

United States Patent and Trademark Office

Reg. No. 3,576,536

Registered Feb. 17, 2009

**TRADEMARK
PRINCIPAL REGISTER**

CYDOXA

BIOALLIANCE PHARMA (FRANCE SOCIÉTÉ
ANONYME À DIRECTOIRE)
59 BOULEVARD DU GÉNÉRAL MARTIAL VALIN
F-75015 PARIS
FRANCE

FOR: PHARMACEUTICAL PREPARATIONS IN
THE FORM OF NANOPARTICLES ADMINIS-
TERED INTRAVENOUSLY FOR THE TREATMENT
OF CANCER OF THE LIVER , IN CLASS 5 (U.S. CLS.
6, 18, 44, 46, 51 AND 52).

THE MARK CONSISTS OF STANDARD CHAR-
ACTERS WITHOUT CLAIM TO ANY PARTICULAR
FONT, STYLE, SIZE, OR COLOR.

PRIORITY DATE OF 1-14-2008 IS CLAIMED.

OWNER OF INTERNATIONAL REGISTRATION
0970784 DATED 7-2-2008, EXPIRES 7-2-2018.

SER. NO. 79-056,320, FILED 7-2-2008.

CHRISTINE BLOMQUIST, EXAMINING ATTOR-
NEY

Int. Cl.: 9

Prior U.S. Cls.: 21, 23, 26, 36 and 38

United States Patent and Trademark Office

Reg. No. 3,576,537

Registered Feb. 17, 2009

TRADEMARK
PRINCIPAL REGISTER

TELIKOU

XU GANG (CHINA INDIVIDUAL)
ROOM 204, UNIT 5, BUILDING 37
NO. 13 STREET, JIANXI DISTRICT NORTH
LUOYANG CITY; HENAN PROVINCE
BEIJING, CHINA

FOR: ELECTRO-DYNAMIC APPARATUS FOR
THE REMOTE CONTROL OF SIGNALS, NAMELY,
TRANSMITTERS OF ELECTRONIC SIGNALS; IN-
TERCOMMUNICATION APPARATUS, NAMELY,
WIRELESS INTERCOM AND WIRED INTERCOM;
TELEPHONE RECEIVERS; RADIOTELEPHONY
SETS; PORTABLE TELEPHONES; MODEMS; ELEC-
TROACOUSTIC COMPOSITE MEMBER, NAME-
LY, ELECTROACOUSTIC TRANSDUCERS; TV

CAMERAS; LOUDSPEAKERS; BLANK MAGNETIC
SOUND RECORDING CARRIERS, IN CLASS 9 (U.S.
CLS. 21, 23, 26, 36 AND 38).

OWNER OF INTERNATIONAL REGISTRATION
0970858 DATED 5-27-2008, EXPIRES 5-27-2018.

THE ENGLISH WORD "TELIKOU" HAS NO
MEANING IN A FOREIGN LANGUAGE.

SER. NO. 79-056,346, FILED 5-27-2008.

BARBARA RUTLAND, EXAMINING ATTORNEY

Int. Cl.: 5

Prior U.S. Cls.: 6, 18, 44, 46, 51 and 52

United States Patent and Trademark Office

Reg. No. 3,576,538

Registered Feb. 17, 2009

**TRADEMARK
PRINCIPAL REGISTER**

TUVIGIN

NOVARTIS AG (SWITZERLAND CORPORATION)
CH-4002 BASEL
SWITZERLAND

OWNER OF INTERNATIONAL REGISTRATION
0971040 DATED 7-10-2008, EXPIRES 7-10-2018.

FOR: PHARMACEUTICAL PREPARATIONS FOR
USE IN ONCOLOGY, IN CLASS 5 (U.S. CLS. 6, 18, 44,
46, 51 AND 52).

OWNER OF U.S. REG. NO. 2,788,703.

THE MARK CONSISTS OF STANDARD CHAR-
ACTERS WITHOUT CLAIM TO ANY PARTICULAR
FONT, STYLE, SIZE, OR COLOR.

SER. NO. 79-056,392, FILED 7-10-2008.

SUSAN LESLIE DUBOIS, EXAMINING ATTORNEY

Int. Cl.: 3

Prior U.S. Cls.: 1, 4, 6, 50, 51 and 52

United States Patent and Trademark Office

Reg. No. 3,576,539

Registered Feb. 17, 2009

**TRADEMARK
PRINCIPAL REGISTER**

TSUMURA

TSUMURA & CO. (JAPAN COMPANY LIMITED
BY SHARES)
2-17-11, AKASAKA
MINATO-KU
TOKYO 107-8521, JAPAN

FOR: LAUNDRY BLEACH; LAUNDRY STARCH;
SHOE AND BOOT CREAM; POLISHING PREPARA-
TIONS; SHAMPOOS FOR PETS; CLEANING AND
SCOURING PREPARATIONS; TOILET SOAP;
SHAMPOOS; TOILET BOWL DETERGENTS; MEDI-
CATED SOAP; DENTIFRICES; COSMETICS; MAKE-
UP POWDER; TOILET WATER; LOTIONS FOR
COSMETIC PURPOSES; SKIN LOTIONS; COSMETIC
CREAM; SUNSCREEN CREAM; HAIR CARE PRE-
PARATIONS; HAIR SPRAY; HAIR TONICS; HAIR
RINSES; PERFUMES; BATH OILS; BATH SALTS
NOT FOR MEDICAL PURPOSES; PERFUMERY;

NATURAL PERFUMERY PREPARED FROM
PLANT EXTRACTS; NATURAL PERFUMERY PRE-
PARED FROM ANIMAL EXTRACTS; INCENSE;
FUMIGATION PREPARATIONS, NAMELY, FUMI-
GATING INCENSES (KUNKO), IN CLASS 3 (U.S.
CLS. 1, 4, 6, 50, 51 AND 52).

OWNER OF INTERNATIONAL REGISTRATION
0971450 DATED 10-1-2007, EXPIRES 10-1-2017.

OWNER OF U.S. REG. NOS. 1,974,735, 3,196,929
AND OTHERS.

SER. NO. 79-056,532, FILED 10-1-2007.

ROSELLE HERRERA, EXAMINING ATTORNEY

Int. Cl.: 1

Prior U.S. Cls.: 1, 5, 6, 10, 26 and 46

United States Patent and Trademark Office

Reg. No. 3,576,540

Registered Feb. 17, 2009

**TRADEMARK
PRINCIPAL REGISTER**

MAPRENAL

INEOS MELAMINES GMBH (FED REP GERMA-
NY CORPORATION)
ALT FECHENHEIM 34
60386 FRANKFURT
FED REP GERMANY

OWNER OF INTERNATIONAL REGISTRATION
0236135 DATED 10-1-1960, EXPIRES 10-1-2010.

FOR: SYNTHETIC AMINO RESINS IN THE
FORM OF POWDERS, GRANULES, EMULSIONS,
SUSPENSIONS, DISPERSIONS AND SOLUTIONS
FOR USE IN THERMOSETTING SURFACE COAT-
INGS , IN CLASS 1 (U.S. CLS. 1, 5, 6, 10, 26 AND 46).

SER. NO. 79-056,575, FILED 2-19-2008.

JACQUELINE A. LAVINE, EXAMINING ATTOR-
NEY

Int. Cl.: 9

Prior U.S. Cls.: 21, 23, 26, 36 and 38

United States Patent and Trademark Office

Reg. No. 3,576,541

Registered Feb. 17, 2009

**TRADEMARK
PRINCIPAL REGISTER**

DSPC

DATA BASE SOLUTIONS AG (SWITZERLAND
JOINT STOCK COMPANY)

NEUHOFSTRASSE 25

CH-6340 BAAR, SWITZERLAND

FOR: SOFTWARE, NAMELY, SOFTWARE FOR
ANALYZING PERFORMANCE ON A CENTRAL
MAINFRAME COMPUTER, IN CLASS 9 (U.S. CLS.
21, 23, 26, 36 AND 38).

THE MARK CONSISTS OF STANDARD CHAR-
ACTERS WITHOUT CLAIM TO ANY PARTICULAR
FONT, STYLE, SIZE, OR COLOR.

OWNER OF INTERNATIONAL REGISTRATION
0971575 DATED 7-11-2008, EXPIRES 7-11-2018.

SER. NO. 79-056,608, FILED 7-11-2008.

DOMINICK J. SALEMI, EXAMINING ATTORNEY

Int. Cl.: 37

Prior U.S. Cls.: 100, 103 and 106

United States Patent and Trademark Office

Reg. No. 3,576,542

Registered Feb. 17, 2009

**SERVICE MARK
PRINCIPAL REGISTER**

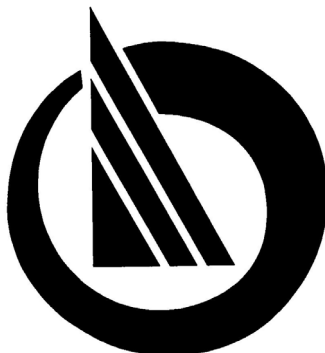

ZONGSHAN CITY SHENGXING; CURTAIN
WALL CO., LTD. (CHINA CORPORATION)
TANBEI INDUSTRIAL ZONE
DONGSHENG TOWN; ZHONGSHAN CITY;
GUANGDONG PROVINCE
CHINA

FOR: CONSTRUCTION CONSULTATION; CON-
STRUCTION AND REPAIR OF BUILDINGS; QUAR-
RY SERVICES; UPHOLSTERY REPAIR;
MACHINERY MAINTENANCE AND REPAIR; MA-
CHINERY INSTALLATION; PAINTING AND
VARNISHING; ELEVATOR INSTALLATION AND
REPAIR; CONSTRUCTION SERVICES, NAMELY,
PLANNING, LAYING OUT AND CUSTOM CON-
STRUCTION OF RESIDENTIAL AND COMMER-

CIAL COMMUNITIES; CONSTRUCTION
GRADING SERVICES, IN CLASS 37 (U.S. CLS. 100,
103 AND 106).

OWNER OF INTERNATIONAL REGISTRATION
0971603 DATED 6-24-2008, EXPIRES 6-24-2018.

THE MARK CONSISTS OF A SAIL SURROUND-
ED BY A CIRCLE.

SER. NO. 79-056,616, FILED 6-24-2008.

AISHA CLARKE, EXAMINING ATTORNEY

Int. Cl.: 34

Prior U.S. Cls.: 2, 8, 9 and 17

United States Patent and Trademark Office

Reg. No. 3,576,543

Registered Feb. 17, 2009

**TRADEMARK
PRINCIPAL REGISTER**

Platinum Pearl

ARDATH TOBACCO COMPANY LIMITED (UNITED KINGDOM APPLICANT IS A LIMITED LIABILITY COMPANY ORGANIZED UNDER THE LAWS OF THE ENGLAND AND WALES)
GLOBE HOUSE, 4 TEMPLE PLACE
LONDON WC2R 2PG
UNITED KINGDOM

FOR: CIGARETTES; TOBACCO; TOBACCO PRODUCTS, NAMELY, SMOKING TOBACCO, CUT TOBACCO, LEAF TOBACCO, CHEWING TOBACCO, SNUFF, IN CLASS 34 (U.S. CLS. 2, 8, 9 AND 17).

THE MARK CONSISTS OF STANDARD CHARACTERS WITHOUT CLAIM TO ANY PARTICULAR FONT, STYLE, SIZE, OR COLOR.

OWNER OF INTERNATIONAL REGISTRATION
0971606 DATED 6-18-2008, EXPIRES 6-18-2018.

SER. NO. 79-056,617, FILED 6-18-2008.

GILBERT SWIFT, EXAMINING ATTORNEY

Int. Cl.: 34

Prior U.S. Cls.: 2, 8, 9 and 17

United States Patent and Trademark Office

Reg. No. 3,576,544

Registered Feb. 17, 2009

**TRADEMARK
PRINCIPAL REGISTER**

Gold Pearl

ARDATH TOBACCO COMPANY LIMITED (UNITED KINGDOM APPLICANT IS A LIMITED LIABILITY COMPANY ORGANIZED UNDER THE LAWS OF THE ENGLAND AND WALES)
GLOBE HOUSE, 4 TEMPLE PLACE
LONDON WC2R 2PG
UNITED KINGDOM

FOR: CIGARETTES; TOBACCO; TOBACCO PRODUCTS, NAMELY, SMOKING TOBACCO, CUT TOBACCO, LEAF TOBACCO, CHEWING TOBACCO, SNUFF, IN CLASS 34 (U.S. CLS. 2, 8, 9 AND 17).

THE MARK CONSISTS OF STANDARD CHARACTERS WITHOUT CLAIM TO ANY PARTICULAR FONT, STYLE, SIZE, OR COLOR.

OWNER OF INTERNATIONAL REGISTRATION
0971607 DATED 6-18-2008, EXPIRES 6-18-2018.

SER. NO. 79-056,618, FILED 6-18-2008.

GILBERT SWIFT, EXAMINING ATTORNEY

Int. Cl.: 3

Prior U.S. Cls.: 1, 4, 6, 50, 51 and 52

United States Patent and Trademark Office

Reg. No. 3,576,545

Registered Feb. 17, 2009

**TRADEMARK
PRINCIPAL REGISTER**

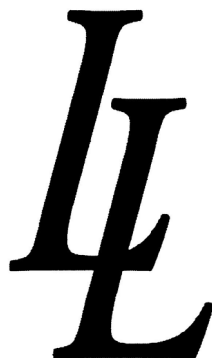

BÖRLIND GESELLSCHAFT FÜR KOSMETISCHE
ERZEUGNISSE MBH (FED REP GERMANY
LIMITED COMPANY)

LINDENSTRABE 15
75365 CALW
FED REP GERMANY

FOR: COSMETICS, NAMELY, FACIAL LOTIONS,
FACIAL CREAM, FACIAL CLEANSER, SKIN
CREAMS, FACIAL BEAUTY MASKS, SKIN LO-
TION, VANISHING CREAM, ANTI-WRINKLE
CREAM, SHOWER GEL, HAND CREAM, EYE
MAKE-UP REMOVER, SKIN FRESHENERS IN
THE NATURE OF BODY SPRAYS AND BODY
CARE FLUIDS, SKIN MILK, NAMELY, CLEANS-
ING MILK, BODY MILK, COSMETIC MILK, MOIST-
URIZING MILK, FACE MILK; SOAPS FOR

PERSONAL USE, IN CLASS 3 (U.S. CLS. 1, 4, 6, 50,
51 AND 52).

PRIORITY DATE OF 3-5-2008 IS CLAIMED.

OWNER OF INTERNATIONAL REGISTRATION
0971611 DATED 6-2-2008, EXPIRES 6-2-2018.

OWNER OF U.S. REG. NO. 3,181,115.

SER. NO. 79-056,621, FILED 6-2-2008.

CARYN GLASSER, EXAMINING ATTORNEY

Int. Cls.: 38, 41 and 42

Prior U.S. Cls.: 100, 101, 104 and 107

United States Patent and Trademark Office

Reg. No. 3,576,546

Registered Feb. 17, 2009

**SERVICE MARK
PRINCIPAL REGISTER**

RISSIP

AAATEACHDEAL (SWITZERLAND SOCIÉTÉ ANONYME)
BAARERSTRASSE 10
CH-6300 ZUG
SWITZERLAND

FOR: PROVISION OF TELECOMMUNICATION CHANNELS FOR ONLINE PURCHASING SERVICES; PROVISION OF REMOTE ACCESS TO DATA; SERVICES PROVIDING ACCESS TO ONLINE NETWORKS AND TO E-COMMERCE PLATFORMS, PROVIDING TELECOMMUNICATION ACCESS TO ELECTRONIC PLATFORMS FOR ONLINE TRAINING, IN CLASS 38 (U.S. CLS. 100, 101 AND 104).

FOR: PROVISION OF TRAINING AND FURTHER TRAINING IN THE FIELD OF COMPUTER, SECURITY, HEALTHCARE, BUSINESS, LAW, SCIENCES; PROVISION OF ELECTRONIC SPACE FOR TRAINING AND FURTHER TRAINING IN THE NATURE OF COURSES, STRUCTURED AND UNSTRUCTURED LEARNING, WORKSHOPS IN THE FIELD OF COMPUTER, SECURITY, HEALTHCARE, BUSINESS, LAW AND SCIENCE; PROVIDING EDUCATIONAL GUIDANCE AND ASSISTANCE IN TRAINING TO COMMUNITIES; PROVIDING COURSES AND WORKSHOPS THROUGH COMMUNICATION NETWORKS AND COMPUTERS AND E-COMMERCE PLATFORMS IN THE FIELD OF COMPUTER TECHNOLOGY, SECURITY, HEALTHCARE, BUSINESS, LAW AND SCIENCE; AGENCY SERVICES, NAMELY, PROVIDING TRAINING SERVICES IN THE FIELD OF COMPUTER AND INTERNET TECHNOLOGY, E-

LEARNING AND E-MARKETING, IN CLASS 41 (U.S. CLS. 100, 101 AND 107).

FOR: DESIGN AND DEVELOPMENT OF EQUIPMENT AND PROGRAMS FOR COMPUTING; RESEARCH AND DEVELOPMENT SERVICES IN SCIENCE AND TECHNOLOGY, AND RELATED RESEARCH AND DESIGN SERVICES; SCIENTIFIC AND TECHNOLOGICAL SERVICES THAT USE SPECIFIC FACILITIES IN THE FIELD OF INTERNET TECHNOLOGY; RENTAL AND MAINTENANCE OF MEMORY FOR USE BY THIRD PARTIES AS WEB SITES HOSTING, IN CLASS 42 (U.S. CLS. 100 AND 101).

THE MARK CONSISTS OF STANDARD CHARACTERS WITHOUT CLAIM TO ANY PARTICULAR FONT, STYLE, SIZE, OR COLOR.

PRIORITY DATE OF 4-17-2008 IS CLAIMED.

OWNER OF INTERNATIONAL REGISTRATION 0971714 DATED 5-21-2008, EXPIRES 5-21-2018.

THE WORDING "RISSIP" HAS NO MEANING IN A FOREIGN LANGUAGE

SER. NO. 79-056,667, FILED 5-21-2008.

ZACHARY BELLO, EXAMINING ATTORNEY

Int. Cls.: 7 and 9

Prior U.S. Cls.: 13, 19, 21, 23, 26, 31, 34, 35, 36 and 38

United States Patent and Trademark Office

Reg. No. 3,576,547

Registered Feb. 17, 2009

**TRADEMARK
PRINCIPAL REGISTER**

Beyeler Xpert

BYSTRONIC LASER AG (SWITZERLAND SOCI-
ÉTÉ ANONYME)
INDUSTRIESTRASSE 21
CH-3362 NIEDERÖNZ
SWITZERLAND

FOR: MECHANICAL AND HYDRAULIC
PRESSES FOR METALWORKING; TOOLS FOR
BENDING, NAMELY, BENDING MACHINES;
PUNCHING PRESSES IN THE NATURE OF BEND-
ING PUNCHES; DIES FOR USE WITH MACHINE
TOOLS IN THE NATURE OF BENDING DIES FOR
BENDING SHEET METAL; METAL WORKING
MACHINES IN THE NATURE OF MACHINES FOR
BENDING AND EDGING SHEET METAL, IN CLASS
7 (U.S. CLS. 13, 19, 21, 23, 31, 34 AND 35).

FOR: ELECTRICAL PROGRAMMABLE CON-
TROL DEVICES FOR MACHINES FOR BENDING

AND EDGING SHEET METAL, IN CLASS 9 (U.S.
CLS. 21, 23, 26, 36 AND 38).

THE MARK CONSISTS OF STANDARD CHAR-
ACTERS WITHOUT CLAIM TO ANY PARTICULAR
FONT, STYLE, SIZE, OR COLOR.

PRIORITY DATE OF 4-4-2008 IS CLAIMED.

OWNER OF INTERNATIONAL REGISTRATION
0971864 DATED 6-27-2008, EXPIRES 6-27-2018.

SER. NO. 79-056,720, FILED 6-27-2008.

CHRISTINE BLOMQUIST, EXAMINING ATTOR-
NEY

Int. Cl.: 10

Prior U.S. Cls.: 26, 39 and 44

United States Patent and Trademark Office

Reg. No. 3,576,548

Registered Feb. 17, 2009

**TRADEMARK
PRINCIPAL REGISTER**

ASPIREX

STRAUB MEDICAL AG (SWITZERLAND SOCI-
ÉTÉ ANONYME)
STRAUBSTRASSE
CH-7323 WANGS, SWITZERLAND

FOR: ROTATING CATHETERS FOR THE TREAT-
MENT OF ARTERIES AND VEINS BLOCKED BY
DEPOSITS, EMBOLISMS AND THROMBOSES, IN
CLASS 10 (U.S. CLS. 26, 39 AND 44).

THE MARK CONSISTS OF STANDARD CHAR-
ACTERS WITHOUT CLAIM TO ANY PARTICULAR
FONT, STYLE, SIZE, OR COLOR.

PRIORITY DATE OF 1-14-2008 IS CLAIMED.

OWNER OF INTERNATIONAL REGISTRATION
0971873 DATED 7-11-2008, EXPIRES 7-11-2018.

SER. NO. 79-056,726, FILED 7-11-2008.

DOMINICK J. SALEMI, EXAMINING ATTORNEY

Int. Cl.: 5

Prior U.S. Cls.: 6, 18, 44, 46, 51 and 52

United States Patent and Trademark Office

Reg. No. 3,576,549

Registered Feb. 17, 2009

**TRADEMARK
PRINCIPAL REGISTER**

SCAPHO

NOVARTIS AG (SWITZERLAND CORPORATION)
CH-4002 BASEL
SWITZERLAND

FOR: PHARMACEUTICAL PREPARATIONS FOR THE PREVENTION AND TREATMENT OF DISORDERS OF THE NERVOUS SYSTEM, THE IMMUNE SYSTEM, THE CARDIO-VASCULAR SYSTEM, THE METABOLIC SYSTEM, THE RESPIRATORY SYSTEM, THE MUSCULO-SKELETAL SYSTEM, THE GENITOURINARY SYSTEM; FOR THE TREATMENT OF INFLAMMATORY DISORDERS; FOR USE IN DERMATOLOGY, ONCOLOGY, HEMATOLOGY AND IN TISSUE AND ORGAN TRANSPLANTATION, IN OPHTHALMOLOGY, AND FOR GASTROENTEROLOGICAL DISORDERS; PHARMACEUTICAL PREPARATIONS FOR THE PREVENTION AND TREATMENT OF OCULAR DISORDERS OR DISEASES; FOR THE TREATMENT OF BACTERIA-BASED DISEASES; FOR

THE TREATMENT OF DIABETES, ANTI-INFECTIVE PREPARATIONS, ANTIVIRAL PREPARATIONS, ANTIBIOTICS, ANTIFUNGAL PREPARATIONS AND VACCINES, IN CLASS 5 (U.S. CLS. 6, 18, 44, 46, 51 AND 52).

THE MARK CONSISTS OF STANDARD CHARACTERS WITHOUT CLAIM TO ANY PARTICULAR FONT, STYLE, SIZE, OR COLOR.

PRIORITY DATE OF 3-26-2008 IS CLAIMED.

OWNER OF INTERNATIONAL REGISTRATION 0971896 DATED 7-4-2008, EXPIRES 7-4-2018.

SER. NO. 79-056,728, FILED 7-4-2008.

SUSAN LESLIE DUBOIS, EXAMINING ATTORNEY

Int. Cl.: 11

Prior U.S. Cls.: 13, 21, 23, 31 and 34

United States Patent and Trademark Office

Reg. No. 3,576,550

Registered Feb. 17, 2009

**TRADEMARK
PRINCIPAL REGISTER**

TIKKINA

BIG BANG (FRANCE SOCIÉTÉ PAR ACTIONS
SIMPLIFIÉE)
ZI DE CROLLES
F-38920 CROLLES, FRANCE

OWNER OF INTERNATIONAL REGISTRATION
0972005 DATED 7-8-2008, EXPIRES 7-8-2018.

FOR: ELECTRICAL LAMPS, HEADLAMPS, POR-
TABLE LAMPS, POCKET LAMPS, IN CLASS 11 (U.S.
CLS. 13, 21, 23, 31 AND 34).

SER. NO. 79-056,770, FILED 7-8-2008.

PRIORITY DATE OF 1-25-2008 IS CLAIMED.

JOHN DALIER, EXAMINING ATTORNEY

Int. Cl.: 34

Prior U.S. Cls.: 2, 8, 9 and 17

United States Patent and Trademark Office

Reg. No. 3,576,551

Registered Feb. 17, 2009

TRADEMARK
PRINCIPAL REGISTER

Brookfield

ALOIS PÖSCHL GMBH & CO. KG (FED REP
GERMANY LTD. CORPORATION)
DIESELSTRASSE 1
84144 GEISENHAUSEN
FED REP GERMANY

FOR: RAW TOBACCO IN LEAVES AND TOBACCO-BASED PRODUCTS MADE FROM TOBACCO ORIGINATING MOSTLY IN ENGLISH-SPEAKING COUNTRIES, NAMELY, CIGARETTES, CIGARS, CIGARILLOS; SMOKING TOBACCO; SMOKERS' ARTICLES, NAMELY, CIGARETTE PAPER, CIGARETTE HOLDERS, POCKET APPLIANCES FOR ROLLING ONE'S OWN CIGARETTES; TOBACCO

PIPES, PIPE POUCHES, LIGHTERS, PIPE TAMPERS; MATCHES, IN CLASS 34 (U.S. CLS. 2, 8, 9 AND 17).

OWNER OF INTERNATIONAL REGISTRATION
0516310 DATED 9-19-1987, EXPIRES 9-19-2017.

OWNER OF U.S. REG. NO. 2,502,673.

SER. NO. 79-056,844, FILED 3-10-2008.

LAURIE MAYES, EXAMINING ATTORNEY

Int. Cl.: 30

Prior U.S. Cl.: 46

United States Patent and Trademark Office

Reg. No. 3,576,552

Registered Feb. 17, 2009

TRADEMARK
PRINCIPAL REGISTER



BELCOLADE NV (BELGIUM LIMITED LIABILITY COMPANY)
INDUSTRIELAAN 16
INDUSTRIEZONE ZUID 111; B-9320 EREMBODENGEM
BELGIUM

FOR: COCOA; CHOCOLATE; COCOA PRODUCTS, NAMELY, COCOA POWDER, ROASTED COCOA, COCOA MIXES; BAKERY, PASTRY AND CONFECTIONERY PRODUCTS, NAMELY, BAKERY AND PASTRY DESSERTS, CHOCOLATE PASTE, CHOCOLATE POWDER, CHOCOLATE TOPPINGS, CHOCOLATE BASED FILLINGS FOR CAKES AND PIES, IN CLASS 30 (U.S. CL. 46).

OWNER OF INTERNATIONAL REGISTRATION
0972561 DATED 6-13-2008, EXPIRES 6-13-2018.

OWNER OF U.S. REG. NO. 1,553,928.

NO CLAIM IS MADE TO THE EXCLUSIVE RIGHT TO USE "REAL" AND "BELGIAN CHOCOLATE", APART FROM THE MARK AS SHOWN.

THE COLOR(S) BROWN, BEIGE AND WHITE IS/ARE CLAIMED AS A FEATURE OF THE MARK.

THE MARK CONSISTS OF THE COLORS BROWN, BEIGE AND WHITE, WITH THE COLOR BEIGE APPEARING IN THE WORDING "BELCOLADE" AND THE DESIGN OF THE BEAN, THE COLOR BROWN APPEARING IN THE BACKGROUND, AND THE COLOR WHITE APPEARING IN THE WORDING "THE REAL BELGIAN CHOCOLATE".

SER. NO. 79-056,998, FILED 6-13-2008.

SHANNON TWOHIG, EXAMINING ATTORNEY

Int. Cl.: 33

Prior U.S. Cls.: 47 and 49

United States Patent and Trademark Office

Reg. No. 3,576,553

Registered Feb. 17, 2009

**TRADEMARK
PRINCIPAL REGISTER**

Killerman's Run

KILIKANOON WINES PTY LTD (AUSTRALIA
PROPRIETARY LIMITED COMPANY (PTY
LTD))

PO BOX 396

CLARE SA 5453, AUSTRALIA

FOR: WINE, TABLE WINE, IN CLASS 33 (U.S. CLS.
47 AND 49).

THE MARK CONSISTS OF STANDARD CHAR-
ACTERS WITHOUT CLAIM TO ANY PARTICULAR
FONT, STYLE, SIZE, OR COLOR.

PRIORITY DATE OF 7-7-2008 IS CLAIMED.

OWNER OF INTERNATIONAL REGISTRATION
0972734 DATED 7-16-2008, EXPIRES 7-16-2018.

SER. NO. 79-057,061, FILED 7-16-2008.

JACLYN KIDWELL, EXAMINING ATTORNEY

Int. Cl.: 10

Prior U.S. Cls.: 26, 39 and 44

United States Patent and Trademark Office

Reg. No. 3,576,554

Registered Feb. 17, 2009

**TRADEMARK
PRINCIPAL REGISTER**

PowerHearing

SONOVA HOLDING AG (SWITZERLAND SOCI-
ÉTÉ ANONYME (SA))
LAUBISRÜTISTRASSE 28
CH-8712 STÄFA
SWITZERLAND

FOR: ACOUSTIC APPARATUS, NAMELY, HEAR-
ING AIDS AND PARTS THEREOF FOR THE HEAR-
ING IMPAIRED, IN CLASS 10 (U.S. CLS. 26, 39 AND
44).

THE MARK CONSISTS OF STANDARD CHAR-
ACTERS WITHOUT CLAIM TO ANY PARTICULAR
FONT, STYLE, SIZE, OR COLOR.

PRIORITY DATE OF 4-9-2008 IS CLAIMED.

OWNER OF INTERNATIONAL REGISTRATION
0972746 DATED 7-7-2008, EXPIRES 7-7-2018.

SER. NO. 79-057,066, FILED 7-7-2008.

CHRISTOPHER BUONGIORNO, EXAMINING AT-
TORNEY

Int. Cl.: 14

Prior U.S. Cls.: 2, 27, 28 and 50

United States Patent and Trademark Office

Reg. No. 3,576,555

Registered Feb. 17, 2009

**TRADEMARK
PRINCIPAL REGISTER**

ASSOLUTO

SALVATORE FERRAGAMO ITALIA S.P.A. (ITALY JOINT STOCK COMPANY)
VIA DEI TORNABUONI, 2
I-50123 FIRENZE (FI)
ITALY

FOR: CLOCKS, WATCHES, WRISTWATCHES, DIVING WATCHES, POCKET WATCHES, WATCH BANDS AND STRAPS, WATCH CHAINS, WATCH CASES, CHRONOGRAPHS FOR USE AS TIMEPIECES AND FOR USE AS WATCHES, CHRONOMETERS, IN CLASS 14 (U.S. CLS. 2, 27, 28 AND 50).

THE MARK CONSISTS OF STANDARD CHARACTERS WITHOUT CLAIM TO ANY PARTICULAR FONT, STYLE, SIZE, OR COLOR.

PRIORITY DATE OF 3-31-2008 IS CLAIMED.

OWNER OF INTERNATIONAL REGISTRATION 0973009 DATED 7-7-2008, EXPIRES 7-7-2018.

THE ENGLISH TRANSLATION OF THE WORD "ASSOLUTO" IN THE MARK IS ABSOLUTE.

SER. NO. 79-057,248, FILED 7-7-2008.

CHRISTOPHER BUONGIORNO, EXAMINING ATTORNEY

Int. Cl.: 14

Prior U.S. Cls.: 2, 27, 28 and 50

United States Patent and Trademark Office

Reg. No. 3,576,556

Registered Feb. 17, 2009

**TRADEMARK
PRINCIPAL REGISTER**

PALAGIO

SALVATORE FERRAGAMO ITALIA S.P.A. (ITALY JOINT STOCK COMPANY)
VIA DEI TORNABUONI, 2
I-50123 FIRENZE (FI)
ITALY

PRIORITY DATE OF 3-14-2008 IS CLAIMED.

FOR: CLOCKS, WATCHES, WRISTWATCHES, DIVING WATCHES, POCKET WATCHES, WATCH BANDS AND STRAPS, WATCH CHAINS, WATCH CASES, CHRONOGRAPHS FOR USE AS TIMEPIECES AND FOR USE AS WATCHES, CHRONOMETERS, IN CLASS 14 (U.S. CLS. 2, 27, 28 AND 50).

OWNER OF INTERNATIONAL REGISTRATION 0973010 DATED 7-7-2008, EXPIRES 7-7-2018.

SER. NO. 79-057,249, FILED 7-7-2008.

THE MARK CONSISTS OF STANDARD CHARACTERS WITHOUT CLAIM TO ANY PARTICULAR FONT, STYLE, SIZE, OR COLOR.

CHRISTOPHER BUONGIORNO, EXAMINING ATTORNEY

Int. Cl.: 33

Prior U.S. Cls.: 47 and 49

United States Patent and Trademark Office

Reg. No. 3,576,557

Registered Feb. 17, 2009

**TRADEMARK
PRINCIPAL REGISTER**

The Lackey

KILIKANOON WINES PTY LTD (AUSTRALIA
PROPRIETARY LIMITED COMPANY (PTY
LTD))
PO BOX 396
CLARE SA 5453, AUSTRALIA

FOR: WINE, TABLE WINE, IN CLASS 33 (U.S. CLS.
47 AND 49).

THE MARK CONSISTS OF STANDARD CHAR-
ACTERS WITHOUT CLAIM TO ANY PARTICULAR
FONT, STYLE, SIZE, OR COLOR.

PRIORITY DATE OF 7-7-2008 IS CLAIMED.

OWNER OF INTERNATIONAL REGISTRATION
0974055 DATED 7-16-2008, EXPIRES 7-16-2018.

SER. NO. 79-057,656, FILED 7-16-2008.

JACLYN KIDWELL, EXAMINING ATTORNEY

Int. Cl.: 33

Prior U.S. Cls.: 47 and 49

United States Patent and Trademark Office

Reg. No. 3,576,558

Registered Feb. 17, 2009

**TRADEMARK
PRINCIPAL REGISTER**

GO NATURAL

SKYY SPIRITS, LLC (CALIFORNIA LIMITED
LIABILITY COMPANY)
ONE BEACH STREET
SUITE 300
SAN FRANCISCO, CA 94133

PRIORITY DATE OF 5-5-2008 IS CLAIMED.

OWNER OF INTERNATIONAL REGISTRATION
0974081 DATED 7-8-2008, EXPIRES 7-8-2018.

FOR: ALCOHOLIC BEVERAGES EXCEPT BEERS,
IN CLASS 33 (U.S. CLS. 47 AND 49).

SER. NO. 79-057,664, FILED 7-8-2008.

THE MARK CONSISTS OF STANDARD CHAR-
ACTERS WITHOUT CLAIM TO ANY PARTICULAR
FONT, STYLE, SIZE, OR COLOR.

TRACY FLETCHER, EXAMINING ATTORNEY

Int. Cls.: 7 and 9

Prior U.S. Cls.: 13, 19, 21, 23, 26, 31, 34, 35, 36 and 38

United States Patent and Trademark Office

Reg. No. 3,576,559

Registered Feb. 17, 2009

**TRADEMARK
PRINCIPAL REGISTER**

AirGlide

MANROLAND AG (FED REP GERMANY STOCK CORPORATION)
MÜHLHEIMER STRASSE 341
63075 OFFENBACH / MAIN, FED REP GERMANY

FOR: PRINTING MACHINES FOR COMMERCIAL OR INDUSTRIAL USE AND COMPONENTS THEREFOR, NAMELY, SHEET-FED PRINTING PRESSES FOR LETTERPRESS PRINTING, FLAT PRINTING AND INTAGLIO PRINTING, MECHANICAL PRINT MATERIAL FEED AND DISCHARGE SYSTEMS AS PARTS OF PRINTING MACHINES, AND MECHANICAL PAPER DELIVERY SYSTEMS FOR SHEET-FED PRINTING MACHINES; MACHINES FOR COMMERCIAL USE IN THE PRINTING INDUSTRY, NAMELY, MACHINES FOR CUTTING, COATING, FOLDING, PERFORATING, SEWING, SORTING, COLLATING, INSERTING, ADDRESSING AND PACKAGING PRINTING PRODUCTS, IN CLASS 7 (U.S. CLS. 13, 19, 21, 23, 31, 34 AND 35).

FOR: ELECTRICAL CONTROL PANELS, ELECTRIC SWITCHES, VOLTAGE REGULATORS, ELECTRONIC MODULES FOR MONITORING

ELECTRIC CURRENT AND ELECTRICAL SIGNALS, VIDEO SCREENS, KEYBOARDS, AND COMPUTERS FOR USE AS INPUT AND OUTPUT DEVICES WITH COMMERCIAL PRINTING MACHINES; COMPUTER SOFTWARE FOR USE IN THE FIELD OF COMMERCIAL PRINTING RECORDED ON DATA CARRIERS, IN CLASS 9 (U.S. CLS. 21, 23, 26, 36 AND 38).

THE MARK CONSISTS OF STANDARD CHARACTERS WITHOUT CLAIM TO ANY PARTICULAR FONT, STYLE, SIZE, OR COLOR.

PRIORITY DATE OF 3-20-2008 IS CLAIMED.

OWNER OF INTERNATIONAL REGISTRATION 0974202 DATED 6-25-2008, EXPIRES 6-25-2018.

SER. NO. 79-057,700, FILED 6-25-2008.

KIM MONINGHOFF, EXAMINING ATTORNEY

Int. Cl.: 15

Prior U.S. Cls.: 2, 21 and 36

United States Patent and Trademark Office

Reg. No. 3,576,560

Registered Feb. 17, 2009

**TRADEMARK
PRINCIPAL REGISTER**

ZENZIAN

ZENZIAN PTY LTD (AUSTRALIA CORPORATION)
PO BOX 804
PADDINGTON QLD 4064, AUSTRALIA

FOR: BAGS ADAPTED FOR MUSICAL INSTRUMENTS; BRIDGES FOR MUSICAL INSTRUMENTS; COMPUTER CONTROLLED MUSICAL INSTRUMENTS; DRUM PEDALS; ELECTRIC MUSICAL INSTRUMENTS; ELECTRONIC MUSICAL INSTRUMENTS; MUSICAL INSTRUMENTS; PERCUSSION MUSICAL INSTRUMENTS; DRUMS; DRUMSTICKS; MUSIC STANDS ADAPTED FOR USE WITH MUSICAL INSTRUMENTS, IN CLASS 15 (U.S. CLS. 2, 21 AND 36).

THE MARK CONSISTS OF STANDARD CHARACTERS WITHOUT CLAIM TO ANY PARTICULAR FONT, STYLE, SIZE, OR COLOR.

PRIORITY DATE OF 1-15-2008 IS CLAIMED.

OWNER OF INTERNATIONAL REGISTRATION 0974776 DATED 7-12-2008, EXPIRES 7-12-2018.

SER. NO. 79-057,944, FILED 7-12-2008.

BRIDGETT SMITH, EXAMINING ATTORNEY

Int. Cl.: 20

Prior U.S. Cls.: 2, 13, 22, 25, 32 and 50

United States Patent and Trademark Office

Reg. No. 3,576,561

Registered Feb. 17, 2009

**TRADEMARK
PRINCIPAL REGISTER**

SOLEMATE

MURRAY NORMAN COOK (AUSTRALIA INDIVIDUAL)
52 TREAWE STREET
CLOVERDALE WA 6105
AUSTRALIA

FOR: DRAIN COVERS AND GRATES NOT OF METAL FOR SHOWER, BATH AND BATHROOM DRAINS, IN CLASS 20 (U.S. CLS. 2, 13, 22, 25, 32 AND 50).

THE MARK CONSISTS OF STANDARD CHARACTERS WITHOUT CLAIM TO ANY PARTICULAR FONT, STYLE, SIZE, OR COLOR.

OWNER OF INTERNATIONAL REGISTRATION 0975531 DATED 12-10-2007, EXPIRES 12-10-2017.

SER. NO. 79-058,146, FILED 12-10-2007.

MICHAEL LITZAU, EXAMINING ATTORNEY

Int. Cl.: 1

Prior U.S. Cls.: 1, 5, 6, 10, 26 and 46

United States Patent and Trademark Office

Reg. No. 3,576,562

Registered Feb. 17, 2009

**TRADEMARK
PRINCIPAL REGISTER**

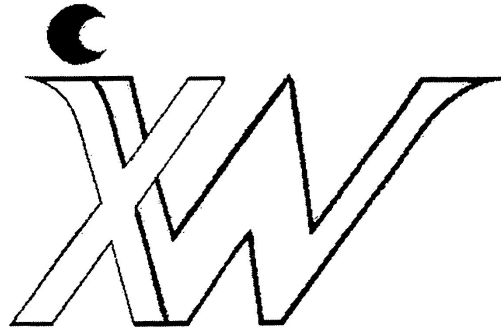

YIXING XINWEI LEESHING RARE; EARTH CO.,
LTD. (CHINA CORPORATION)

YANG'AN VILLAGE, DINGSHU TOWN

(FORMED DAPU TOWN)

YINXING CITY; JIANGSU, CHINA

FOR: RARE EARTH METALS; RARE EARTH
OXIDES; RARE EARTH COMPOUNDS; MIXED
RARE EARTH; PHOSPHOR POWDER , IN CLASS 1
(U.S. CLS. 1, 5, 6, 10, 26 AND 46).

OWNER OF INTERNATIONAL REGISTRATION
0975814 DATED 7-9-2008, EXPIRES 7-9-2018.

THE MARK CONSISTS OF THE STYLIZED LET-
TERS "XW" AND A DEVICE OF A CRESCENT OVER
THE LEFT SIDE OF THE LETTER "X".

SER. NO. 79-058,285, FILED 7-9-2008.

BERNICE MIDDLETON, EXAMINING ATTORNEY

Int. Cl.: 12

Prior U.S. Cls.: 19, 21, 23, 31, 35 and 44

United States Patent and Trademark Office

Reg. No. 3,576,563

Registered Feb. 17, 2009

**TRADEMARK
PRINCIPAL REGISTER**

755

BAYERISCHE MOTOREN WERKE AKTIENGE-
SELLSCHAFT (FED REP GERMANY AKTIEN-
GESELLSCHAFT (JOINT STOCK COMPANY))
PETUELRING 130
80809 MÜNCHEN
FED REP GERMANY

PRIORITY DATE OF 3-18-2008 IS CLAIMED.

OWNER OF INTERNATIONAL REGISTRATION
0975821 DATED 7-10-2008, EXPIRES 7-10-2018.

FOR: AUTOMOBILES, IN CLASS 12 (U.S. CLS. 19,
21, 23, 31, 35 AND 44).

SER. NO. 79-058,290, FILED 7-10-2008.

THE MARK CONSISTS OF STANDARD CHAR-
ACTERS WITHOUT CLAIM TO ANY PARTICULAR
FONT, STYLE, SIZE, OR COLOR.

KATHY DE JONGE, EXAMINING ATTORNEY

Int. Cl.: 33

Prior U.S. Cls.: 47 and 49

United States Patent and Trademark Office

Reg. No. 3,576,564

Registered Feb. 17, 2009

**TRADEMARK
PRINCIPAL REGISTER**

SOLOONIO

GENAGRICOLA S.P.A. (ITALY JOINT STOCK
COMPANY)
PIAZZA DUCA DEGLI ABRUZZI, 1
I-34132 TRIESTE (TS)
ITALY

PRIORITY DATE OF 6-5-2008 IS CLAIMED.

OWNER OF INTERNATIONAL REGISTRATION
0975932 DATED 7-22-2008, EXPIRES 7-22-2018.

FOR: WINE, GRAPPA, DISTILLED SPIRITS, IN
CLASS 33 (U.S. CLS. 47 AND 49).

SER. NO. 79-058,340, FILED 7-22-2008.

THE MARK CONSISTS OF STANDARD CHAR-
ACTERS WITHOUT CLAIM TO ANY PARTICULAR
FONT, STYLE, SIZE, OR COLOR.

CHRISTOPHER BUONGIORNO, EXAMINING AT-
TORNEY

Int. Cl.: 20

Prior U.S. Cls.: 2, 13, 22, 25, 32 and 50

United States Patent and Trademark Office

Reg. No. 3,576,565

Registered Feb. 17, 2009

TRADEMARK
PRINCIPAL REGISTER



NINGBO DASEN FURNITURE CO., LTD; (NING-BOSHI DASEN JIASI YOUXIAN GONGSI) (CHINA CORPORATION)
NO. 378, DONGQING ROAD,
TECHNOLOGICAL ZONE,; NINGBO; 315103 ZHE-
JIANG
CHINA

FOR: FURNITURE; FURNITURE FOR OFFICES;
FILING CABINETS; BEDS; FURNITURE FOR
SCHOOLS; FURNITURE OF METAL; SOFAS; MAT-
TRESSES; RACKS FOR TELEVISION SETS; TEA-
POYS, IN CLASS 20 (U.S. CLS. 2, 13, 22, 25, 32 AND 50).

OWNER OF INTERNATIONAL REGISTRATION
0976124 DATED 6-30-2008, EXPIRES 6-30-2018.

THE ENGLISH TRANSLATION OF THE FOR-
EIGN WORD(S) IN THE MARK IS: THE MEANING
OF THE FIRST CHARACTER IS "BIG" AND THE
MEANING OF THE SECOND IS "FOREST"; THE
COMBINATION IS MEANINGLESS, AND IT IS NOT
A GEOGRAPHY NAME, IT HAS NO SPECIAL
MEANING IN BUSINESS.

THE TRANSLITERATION OF THE NON-LATIN
CHARACTERS IN THE MARK IS: DASEN.

SER. NO. 79-058,408, FILED 6-30-2008.

SANJEEV VOHRA, EXAMINING ATTORNEY

Int. Cl.: 6

Prior U.S. Cls.: 2, 12, 13, 14, 23, 25 and 50

Reg. No. 3,576,566

United States Patent and Trademark Office

Registered Feb. 17, 2009

**TRADEMARK
PRINCIPAL REGISTER**



ZHEJIANG CATEL HARDWARE CO., LTD. (CHI-
NA CORPORATION)
SHACHENG SOUTHERN INDUSTRIAL ZONE,
LONGWAN; WENZHOU
CHINA

FOR: METAL HINGES; METAL KNOBS; FIXED
TOWEL DISPENSERS OF METAL; METAL LOCKS;
METAL SASH FASTENERS FOR WINDOWS; ME-
TAL WINDOW CASEMENTS; METAL WINDOW
FRAMES; METAL WINDOW PULLEYS; METAL
WINDOW SCREENS; METAL WINDOW SHUT-
TERS; METAL WINDOW SILLS; WINDOW CASE-
MENTS OF METAL; METAL HANDLES FOR
DOORS; METAL HARDWARE, NAMELY PULL-

EYS; METAL CASTERS; METAL RUNNERS FOR
SLIDING DOORS; METAL LATCHES; METAL
DOOR LATCHES; METAL LATCH BARS; METAL
CLOTHES HOOKS; METAL GARMENT HOOKS;
DOOR STOPS OF METAL, IN CLASS 6 (U.S. CLS. 2,
12, 13, 14, 23, 25 AND 50).

OWNER OF INTERNATIONAL REGISTRATION
0976231 DATED 3-31-2008, EXPIRES 3-31-2018.

SER. NO. 79-058,459, FILED 3-31-2008.

ALLISON SCHRODY, EXAMINING ATTORNEY

Int. Cl.: 9

Prior U.S. Cls.: 21, 23, 26, 36 and 38

United States Patent and Trademark Office

Reg. No. 3,576,567

Registered Feb. 17, 2009

**TRADEMARK
PRINCIPAL REGISTER**

Sundressed

MD GROUP B.V. (NETHERLANDS CORPORATION)
MATHENESSERLAAN 376
NL-3023 HB ROTTERDAM
NETHERLANDS

OWNER OF INTERNATIONAL REGISTRATION
0976454 DATED 6-25-2008, EXPIRES 6-25-2018.

FOR: SUNGLASSES; SPECTACLE CASES, IN
CLASS 9 (U.S. CLS. 21, 23, 26, 36 AND 38).

SER. NO. 79-058,549, FILED 6-25-2008.

THE MARK CONSISTS OF STANDARD CHARACTERS WITHOUT CLAIM TO ANY PARTICULAR FONT, STYLE, SIZE, OR COLOR.

CIMMERIAN COLEMAN, EXAMINING ATTORNEY

Int. Cl.: 8

Prior U.S. Cls.: 23, 28 and 44

United States Patent and Trademark Office

Reg. No. 3,576,568

Registered Feb. 17, 2009

**TRADEMARK
PRINCIPAL REGISTER**

Proman

HANGZHOU JILIN MACHINERY CO., LTD.
(CHINA CORPORATION)
445 KAIXUAN RD.,
HANGZHOU
CHINA

OWNER OF INTERNATIONAL REGISTRATION
0976942 DATED 7-9-2008, EXPIRES 7-9-2018.

FOR: SHOVELS; SPADES; LAWN AND GARDEN
TOOLS, NAMELY, CULTIVATORS; HAND TOOLS,
NAMELY, HAND JACKS; HAND TOOLS, NAMELY,
HAND-OPERATED PUMPS; HAMMERS, IN CLASS
8 (U.S. CLS. 23, 28 AND 44).

SER. NO. 79-058,732, FILED 7-9-2008.

APRIL ROACH, EXAMINING ATTORNEY

Int. Cl.: 10

Prior U.S. Cls.: 26, 39 and 44

United States Patent and Trademark Office

Reg. No. 3,576,569

Registered Feb. 17, 2009

**TRADEMARK
PRINCIPAL REGISTER**

RELAY

GN RESOUND A/S (DENMARK LIMITED LIABILITY COMPANY)
LAUTRUPBJERG 9
DK-2750 BALLERUP, DENMARK

FOR: HEARING AIDS, IN CLASS 10 (U.S. CLS. 26, 39 AND 44).

THE MARK CONSISTS OF STANDARD CHARACTERS WITHOUT CLAIM TO ANY PARTICULAR FONT, STYLE, SIZE, OR COLOR.

PRIORITY DATE OF 2-13-2008 IS CLAIMED.

OWNER OF INTERNATIONAL REGISTRATION 0977386 DATED 7-12-2008, EXPIRES 7-12-2018.

SER. NO. 79-058,913, FILED 7-12-2008.

BRIDGETT SMITH, EXAMINING ATTORNEY

Int. Cl.: 38

Prior U.S. Cls.: 100, 101, and 104

United States Patent and Trademark Office

Reg. No. 3,576,570

Registered Feb. 17, 2009

**SERVICE MARK
PRINCIPAL REGISTER**

MILLENNIUM RADIO

CANAL CONTINENTAL, SA DE CV (MEXICO
CORPORATION)
AV. MARIANO OTERO 3405
GUADALAJARA, JALISCO, MEXICO

OWNER OF U.S. REG. NO. 2,525,740.

FOR: RADIO BROADCASTING SERVICES, IN
CLASS 38 (U.S. CLS. 100, 101 AND 104).

NO CLAIM IS MADE TO THE EXCLUSIVE
RIGHT TO USE "RADIO", APART FROM THE
MARK AS SHOWN.

FIRST USE 2-12-2005; IN COMMERCE 2-12-2005.

SN 75-684,186, FILED 4-15-1999.

THE MARK CONSISTS OF STANDARD CHAR-
ACTERS WITHOUT CLAIM TO ANY PARTICULAR
FONT, STYLE, SIZE, OR COLOR.

ELLEN B. AWRICH, EXAMINING ATTORNEY

Int. Cl.: 12

Prior U.S. Cls.: 19, 21, 23, 31, 35, and 44

United States Patent and Trademark Office

Reg. No. 3,576,571

Registered Feb. 17, 2009

**TRADEMARK
PRINCIPAL REGISTER**

REV-LOC

DRUSSEL WILFLEY DESIGN, LLC (COLORADO
LIMITED LIABILITY COMPANY)
P.O. BOX 2330
DENVER, CO 80201

FIRST USE 8-30-2001; IN COMMERCE 8-30-2001.

SN 76-269,724, FILED 6-11-2001.

FOR: CLUTCHES FOR MOTORCYCLES, IN
CLASS 12 (U.S. CLS. 19, 21, 23, 31, 35 AND 44).

MARY BOAGNI, EXAMINING ATTORNEY

Int. Cl.: 9

Prior U.S. Cls.: 21, 23, 26, 36, and 38

United States Patent and Trademark Office

Reg. No. 3,576,572

Registered Feb. 17, 2009

**TRADEMARK
PRINCIPAL REGISTER**

SCREEN MASTER

COTCO INTERNATIONAL LIMITED (HONG
KONG CORPORATION)
UNIT 1-5, 13TH FLOOR
VANTA INDUSTRIAL CENTRE, 21 TAI LIN PAIR-
OADROAD
KWAI CHUNG, NEW TERRITORIES, HONG KONG

FOR: LED LAMPS, LED DISPLAYS, LED MOD-
ULES, IN CLASS 9 (U.S. CLS. 21, 23, 26, 36 AND 38).

FIRST USE 9-30-2002; IN COMMERCE 9-30-2002.

NO CLAIM IS MADE TO THE EXCLUSIVE
RIGHT TO USE "SCREEN", APART FROM THE
MARK AS SHOWN.

SN 76-418,969, FILED 6-7-2002.

MONIQUE MILLER, EXAMINING ATTORNEY

Int. Cls.: 3, 5, 9, 10, 16, 25, 28, 30, 41, and 44

Prior U.S. Cls.: 1, 2, 4, 5, 6, 18, 21, 22, 23, 26, 29, 36, 37, 38, 39, 44, 46, 50, 51, 52, 100, 101, and 107

Reg. No. 3,576,573

United States Patent and Trademark Office

Registered Feb. 17, 2009

**TRADEMARK
SERVICE MARK
PRINCIPAL REGISTER**

MEMORY MAKEOVER

AGEWELL, PC (INDIANA CORPORATION)
9292 N. MERIDIAN ST.
SUITE 107
INDIANAPOLIS, IN 46260

FOR: COSMETIC PREPARATIONS, NAMELY, SKIN AND NAIL CREAM, SKIN LOTIONS, SKIN SOAPS, SKIN CLEANSERS AND SHAMPOOS FOR THE BODY, IN CLASS 3 (U.S. CLS. 1, 4, 6, 50, 51 AND 52).

FIRST USE 11-28-2008; IN COMMERCE 11-28-2008.

FOR: THERAPEUTIC, HYGIENIC, AND PHARMACEUTICAL PREPARATIONS, NAMELY, CREAMS, GELS, EMOLLIENTS, LOTIONS, AND OINTMENTS FOR SKIN CONDITIONS INCLUDING AGE RELATED CHANGES SUCH AS DRY SKIN AND DECREASED ELASTICITY; VITAMINS, MINERALS, NUTRITIONAL AND DIETARY SUPPLEMENTS, IN CLASS 5 (U.S. CLS. 6, 18, 44, 46, 51 AND 52).

FIRST USE 11-26-2008; IN COMMERCE 11-26-2008.

FOR: PRERECORDED ELECTRONIC PUBLICATIONS, NAMELY, BOOKS, MANUALS, PAMPHLETS ON CD ROMS, COMPUTER FLOPPY DISKS, AND AUDIO COMPACT DISCS AND CASSETTES IN THE FIELD OF HEALTH INFORMATION RELATING TO PHYSICAL FITNESS INSTRUCTION AND HOLISTIC HEALTH AND WELL-BEING, INCLUDING, PSYCHOLOGICAL, PHYSICAL, SOCIAL AND SOCIAL-ENVIRONMENTAL INFORMATION, IN CLASS 9 (U.S. CLS. 21, 23, 26, 36 AND 38).

FIRST USE 11-29-2008; IN COMMERCE 11-29-2008.

FOR: SURGICAL AND MEDICAL APPARATUS AND INSTRUMENTS, NAMELY, MEDICATION DISPENSERS, IN CLASS 10 (U.S. CLS. 26, 39 AND 44).

FIRST USE 11-25-2008; IN COMMERCE 11-25-2008.

FOR: PRINTED MATERIALS, NAMELY, BOOKS AND JOURNALS IN FIELDS OF HEALTH INFORMATION, PHYSICAL FITNESS INSTRUCTION, FINANCIAL AND INVESTMENT MANAGEMENT, AND HOLISTIC HEALTH AND WELL BEING, NAMELY, PSYCHOLOGICAL, PHYSICAL, SOCIAL AND SOCIAL-ENVIRONMENTAL INFORMATION; PERSONAL ORGANIZERS, DATA BOOKS, AND STATIONERY, IN CLASS 16 (U.S. CLS. 2, 5, 22, 23, 29, 37, 38 AND 50).

FIRST USE 11-29-2008; IN COMMERCE 11-29-2008.

FOR: CLOTHING, NAMELY, HEADWEAR, IN CLASS 25 (U.S. CLS. 22 AND 39).

FIRST USE 11-26-2008; IN COMMERCE 11-26-2008.

FOR: SPORTING GOODS EQUIPMENT, NAMELY, EXERCISE BALLS, IN CLASS 28 (U.S. CLS. 22, 23, 38 AND 50).

FIRST USE 11-26-2008; IN COMMERCE 11-26-2008.

FOR: NUTRITIONAL FOODS, NAMELY, PROCESSED CEREAL BASED SNACK FOODS AND WHEAT BASED SNACK FOODS THAT ARE VITAMIN AND MINERAL FORTIFIED, IN CLASS 30 (U.S. CL. 46).

FIRST USE 11-26-2008; IN COMMERCE 11-26-2008.

FOR: EDUCATIONAL SERVICES, NAMELY, CONDUCTING CLASSES, SEMINARS AND WORKSHOPS IN THE FIELDS OF HOLISTIC HEALTH AND WELL BEING, INCLUDING, PSYCHOLOGICAL, PHYSICAL, SOCIAL AND SOCIAL-ENVIRONMENTAL INFORMATION, IN CLASS 41 (U.S. CLS. 100, 101 AND 107).

FIRST USE 11-26-2008; IN COMMERCE 11-26-2008.

FOR: PROVIDING HEALTH INFORMATION AND CONSULTATION SERVICES IN THE FIELDS OF HOLISTIC HEALTH AND WELL BEING, NAME- LY, PSYCHOLOGICAL, PHYSICAL, SOCIAL AND SOCIAL-ENVIRONMENTAL INFORMATION, IN CLASS 44 (U.S. CLS. 100 AND 101).

FIRST USE 11-26-2008; IN COMMERCE 11-26-2008.

NO CLAIM IS MADE TO THE EXCLUSIVE RIGHT TO USE "MEMORY", APART FROM THE MARK AS SHOWN.

SN 76-467,584, FILED 11-15-2002.

STEVEN R. FOSTER, EXAMINING ATTORNEY

Int. Cl.: 12

Prior U.S. Cls.: 19, 21, 23, 31, 35, and 44

United States Patent and Trademark Office

Reg. No. 3,576,574

Registered Feb. 17, 2009

**TRADEMARK
PRINCIPAL REGISTER**



SERRA SOLDADURA, S.A. (SPAIN CORPORATION)

P.I. ZONA FRANCA, SECTOR C

CALLE D, NO. 29, 08040 BARCELONA, SPAIN

FOR: VEHICLES, NAMELY, TRUCKS AND STRUCTURAL PARTS THEREFOR, NAMELY, AUTOMATICALLY GUIDED TRUCKS USED IN THE ASSEMBLY OF AIRCRAFT FOR THE TRANSPORTATION OF MATERIALS, IN CLASS 12 (U.S. CLS. 19, 21, 23, 31, 35 AND 44).

FIRST USE 7-15-2002; IN COMMERCE 5-6-2005.

OWNER OF SPAIN REG. NO. 2.514.995, DATED 11-27-2002, EXPIRES 11-27-2012.

NO CLAIM IS MADE TO THE EXCLUSIVE RIGHT TO USE "AERONAUTICS", APART FROM THE MARK AS SHOWN.

THE MARK CONSISTS OF THE WORD "SERRA" ON A RECTANGLE; THE WORD "AERONAUTICS"; A PARABOLA EMANATING FROM THE RIGHT OF THE RECTANGLE ABOVE THE WORD "AERONAUTICS", CURVING LEFT, AND ENDING AT A AIRPLANE ABOVE THE RECTANGLE.

THE ENGLISH TRANSLATION OF "SERRA" IS SIERRA OR GREENHOUSE.

SN 76-484,087, FILED 1-22-2003.

ALICE BENMAMAN, EXAMINING ATTORNEY

Int. Cl.: 9

Prior U.S. Cls.: 21, 23, 26, 36, and 38

United States Patent and Trademark Office

Reg. No. 3,576,575

Registered Feb. 17, 2009

**TRADEMARK
PRINCIPAL REGISTER**

ELITE

VECTOR PRODUCTS, INC. (FLORIDA CORPORATION)
4140 S.W. 28TH WAY
FT. LAUDERDALE, FL 33312

FIRST USE 3-5-2003; IN COMMERCE 3-5-2003.

SN 76-487,962, FILED 2-6-2003.

FOR: POWER INVERTERS, AUTOMOTIVE AND MARINE BATTERY JUMP STARTERS AND 12 VOLT PORTABLE POWER SUPPLY, IN CLASS 9 (U.S. CLS. 21, 23, 26, 36 AND 38).

ASMAT KHAN, EXAMINING ATTORNEY

Int. Cls.: 36, 37, 38, and 45

Prior U.S. Cls.: 100, 101, 102, 103, 104, and 106

United States Patent and Trademark Office

Reg. No. 3,576,576

Registered Feb. 17, 2009

**SERVICE MARK
PRINCIPAL REGISTER**

LANDIS + GYR

LANDIS+GYR AG (SWITZERLAND CORPORATION)
FELDSTRASSE 1
ZUG, SWITZERLAND 6300

FOR: PREPARATION OF LEASING AND FINANCE PROPOSALS FOR THIRD PARTIES; ENERGY METERING MANAGEMENT, SPECIFICALLY LEASING OF ENERGY AND WATER METERS; ISSUE OF PREPAID CARDS, IN CLASS 36 (U.S. CLS. 100, 101 AND 102).

FIRST USE 12-1-2002; IN COMMERCE 12-1-2002.

FOR: INSTALLATION OF METERING EQUIPMENT, TECHNICAL MANAGEMENT, NAMELY, ESTABLISHMENT AND MONITORING OF OPERATING PARAMETERS FOR THE SUPPLY AND DELIVERY OF FUELS, MAINTENANCE AND REPAIR OF PRODUCTS IN THE FIELDS OF ELECTRICAL ENGINEERING, ELECTRONICS, DATA PROCESSING, COMMUNICATIONS TECHNOLOGY, OPTICS AND MECHANICAL ENGINEERING, IN ADDITION TO DEVICES, APPARATUS AND INSTALLATIONS FOR THE MEASUREMENT AND CONTROL OF PRODUCTION, TRANSPORT AND CONSUMPTION OF ENERGY, ALSO OF DEVICES, APPARATUS AND INSTALLATIONS FOR BUILDING AUTOMATION AND OF HEATING, VENTILATION AND AIR CONDITIONING INSTALLATIONS AND DEVICES AND APPARATUS FOR THE CONTROL AND REGULATION OF SUCH INSTALLATIONS, ALSO OF DEVICES, APPARATUS AND INSTALLATIONS FOR TELECOMMUNICATIONS AND FOR THE REMOTE CONTROL, REMOTE MONITORING AND REMOTE MANAGEMENT OF TELECOMMUNICATIONS APPLIANCES, ALSO OF DEVICES, APPARATUS AND MERCHANDISE, AND ALSO OF MEANS OF IDENTIFICATION AUTHORIZATION AND CASH-FREE MEANS OF PAY-

MENT; INSTALLATION, MAINTENANCE AND REPAIR OF INSTALLATIONS, APPARATUS AND APPLIANCES IN THE FIELD OF ENERGY MANAGEMENT, ENERGY CUSTOMER MANAGEMENT, DETERMINATION OF ENERGY DATA AND CUSTOMER DATA, THE ENERGY MARKET AND THE ENERGY TRADE, ENERGY REPORTING, ENERGY BILLING AND ENERGY RATING, CALCULATION AND BILLING OF ENERGY COSTS, CALCULATION AND BILLING OF CHARGES AND THE ADMINISTRATION OF ENERGY CUSTOMER PROCESSES, IN CLASS 37 (U.S. CLS. 100, 103 AND 106).

FIRST USE 12-1-2002; IN COMMERCE 12-1-2002.

FOR: TELECOMMUNICATIONS SERVICES, NAMELY, ELECTRONIC TRANSMISSION OF DATA OF UTILITY METERS, IN CLASS 38 (U.S. CLS. 100, 101 AND 104).

FIRST USE 12-1-2002; IN COMMERCE 12-1-2002.

FOR: CONSULTING IN THE FIELD OF SECURITY, IN CLASS 45 (U.S. CLS. 100 AND 101).

FIRST USE 12-1-2002; IN COMMERCE 12-1-2002.

PRIORITY CLAIMED UNDER SEC. 44(D) ON SWITZERLAND APPLICATION NO. 07713/2002, FILED 10-10-2002, REG. NO. 503553, DATED 9-6-2002, EXPIRES 10-10-2012.

OWNER OF U.S. REG. NO. 2,437,910.

SN 76-488,547, FILED 2-4-2003.

SHAILA SETTLES, EXAMINING ATTORNEY

Int. Cl.: 31

Prior U.S. Cls.: 1 and 46

United States Patent and Trademark Office

Reg. No. 3,576,577

Registered Feb. 17, 2009

**TRADEMARK
PRINCIPAL REGISTER**

365 EVERYDAY VALUE

WHOLE FOODS MARKET IP, L.P. (DELAWARE
LIMITED PARTNERSHIP)
550 BOWIE STREET, 6TH FLOOR
AUSTIN, TX 78703

FIRST USE 12-31-1997; IN COMMERCE 12-31-1997.

SN 76-499,975, FILED 3-24-2003.

FOR: UNPROCESSED VEGETABLES, PET FOOD,
UNPROCESSED POPCORN, UNPROCESSED
FRUIT, UNPROCESSED BEANS AND RICE, IN
CLASS 31 (U.S. CLS. 1 AND 46).

CAROLINE WOOD, EXAMINING ATTORNEY

Int. Cl.: 30

Prior U.S. Cl.: 46

United States Patent and Trademark Office

Reg. No. 3,576,578

Registered Feb. 17, 2009

**TRADEMARK
PRINCIPAL REGISTER**

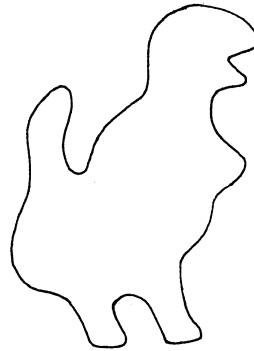

DINOSAUR-US F.E.C LICENSEE CORPORATION
(NEVADA CORPORATION)
3121 HILLSIDE DRIVE
WEST COVINA, CA 91791

FOR: PIZZA, PIZZA CRUST, PIZZA DOUGH,
CAKE, PIE, BREADS, PITA BREADS, BAGELS,
CRACKER, COOKIE, PROCESSED MEATS, PIZZA
SAUCE, CRACKER AND CHEESE COMBINATION,
HAMBURGER SANDWICHES, SANDWICHES, IN
CLASS 30 (U.S. CL. 46).

FIRST USE 3-5-1994; IN COMMERCE 3-8-2002.

THE MARK CONSISTS OF ADVERTISING IN-
SERT WITH THE COMPANY'S CONTACT INFOR-
MATION AND TRADEMARKED SLOGAN
DEPICTING THE DINOSAUR SHAPED IMAGE OF
THE MARK THAT GOES INTO THE CARDBOARD
PACKAGING OF THE DINOSAUR SHAPED PIZZA
PACKAGE.

SN 76-513,630, FILED 5-12-2003.

NAAKWAMA ANKRAH, EXAMINING ATTORNEY

Int. Cl.: 25

Prior U.S. Cls.: 22 and 39

United States Patent and Trademark Office

Reg. No. 3,576,579

Registered Feb. 17, 2009

**TRADEMARK
PRINCIPAL REGISTER**

GRAHA SHANTI

COSMIC MATTERS, LLC (FLORIDA LIMITED
LIABILITY COMPANY)
505 BEACHLAND BOULEVARD, #223
VERO BEACH, FL 32963

FOR: CLOTHING, NAMELY, TOPS, UNDER-
WEAR, SHIRTS, T-SHIRTS, IN CLASS 25 (U.S. CLS.
22 AND 39).

FIRST USE 10-4-2008; IN COMMERCE 10-4-2008.

THE MARK CONSISTS OF STANDARD CHAR-
ACTERS WITHOUT CLAIM TO ANY PARTICULAR
FONT, STYLE, SIZE, OR COLOR.

THE ENGLISH TRANSLATION OF "GRAHA
SHANTI" IS MAKING PEACE WITH THE PLANETS.

SN 76-556,543, FILED 11-4-2003.

GRETTA YAO, EXAMINING ATTORNEY

Int. Cl.: 9

Prior U.S. Cls.: 21, 23, 26, 36, and 38

Reg. No. 3,576,580

United States Patent and Trademark Office

Registered Feb. 17, 2009

**TRADEMARK
PRINCIPAL REGISTER**

TEAMLINK

WESTON SOLUTIONS (IPR), INC. (DELAWARE CORPORATION)
300 DELAWARE AVENUE, 9TH FLOOR
WILMINGTON, DE 19801

FOR: COMPUTER SOFTWARE FOR USE IN INFORMATION COLLECTION, UPDATING AND MANAGEMENT IN THE FIELD OF COLLABORATIVE SOFTWARE FOR ENVIRONMENTAL ENGINEERING AND ENVIRONMENTAL CONSULTING, IN CLASS 9 (U.S. CLS. 21, 23, 26, 36 AND 38).

FIRST USE 1-0-2000; IN COMMERCE 1-0-2000.

THE MARK CONSISTS OF STANDARD CHARACTERS WITHOUT CLAIM TO ANY PARTICULAR FONT, STYLE, SIZE, OR COLOR.

SN 76-563,156, FILED 11-20-2003.

MONIQUE MILLER, EXAMINING ATTORNEY

Int. Cl.: 9

Prior U.S. Cls.: 21, 23, 26, 36, and 38

Reg. No. 3,576,581

United States Patent and Trademark Office

Registered Feb. 17, 2009

**TRADEMARK
PRINCIPAL REGISTER**

SPAMAZING

SPAMAZING, INC. (DELAWARE CORPORATION)
9 BEACON STREET
SOMERVILLE, MA 02143

THE MARK CONSISTS OF STANDARD CHARACTERS WITHOUT CLAIM TO ANY PARTICULAR FONT, STYLE, SIZE, OR COLOR.

FOR: COMPUTER SOFTWARE, NAMELY, TELEPHONE AND EMAIL AUTHENTICATION SOFTWARE, IN CLASS 9 (U.S. CLS. 21, 23, 26, 36 AND 38).

SN 76-567,883, FILED 12-31-2003.

FIRST USE 2-1-2008; IN COMMERCE 2-1-2008.

DAVID MURRAY, EXAMINING ATTORNEY

Int. Cl.: 25

Prior U.S. Cls.: 22 and 39

United States Patent and Trademark Office

Reg. No. 3,576,582

Registered Feb. 17, 2009

**TRADEMARK
PRINCIPAL REGISTER**

**ENGINEERED FOR PERFORMANCE
BY TEFRON**

TEFRON LTD. (ISRAEL CORPORATION)
28 CHIDA STREET
BNEI-BRAK 51371, ISRAEL

FIRST USE 6-0-2004; IN COMMERCE 6-0-2004.

FOR: WOMEN'S AND GIRLS' ACTIVEWEAR,
NAMELY, PANTIES, BRAS, SPORTS BRAS, LEOTARDS,
BODY SUITS, SOCKS, KNEE-HIGHS, PANTYHOSE,
TIGHTS, LEGGINGS, T-SHIRTS, TANK TOPS,
SLIPS, CAMISOLES, TEDDIES, SHORTS, PANTS,
SHIRTS, JACKETS, SLEEPWEAR AND SWIMWEAR,
IN CLASS 25 (U.S. CLS. 22 AND 39).

THE MARK CONSISTS OF STANDARD CHARACTERS
WITHOUT CLAIM TO ANY PARTICULAR FONT,
STYLE, SIZE, OR COLOR.

SN 76-577,501, FILED 2-23-2004.

NANCY CLARKE, EXAMINING ATTORNEY

Int. Cl.: 35

Prior U.S. Cls.: 100, 101, and 102

United States Patent and Trademark Office

Reg. No. 3,576,583

Registered Feb. 17, 2009

**SERVICE MARK
PRINCIPAL REGISTER**

PERSONAL SHOPPER

PERSONAL SHOPPER, INC. (IDAHO CORPORATION)
9576 W. EMERALD STREET
JASON HAUGEN
BOISE, ID 83704

FIRST USE 4-18-2005; IN COMMERCE 4-18-2005.

THE MARK CONSISTS OF STANDARD CHARACTERS WITHOUT CLAIM TO ANY PARTICULAR FONT, STYLE, SIZE, OR COLOR.

FOR: COMPUTERIZED FACILITATING AND PROCESSING OF ORDERING AND PURCHASING FOR OTHERS OF CONSUMER GOODS AND SERVICES OF MANY BRANDS FROM MANY VENDORS FOR MEMBERS OF THE PUBLIC WITHOUT THE NEED FOR AN AGENT OR A SALES ASSOCIATE, IN CLASS 35 (U.S. CLS. 100, 101 AND 102).

SN 76-578,051, FILED 2-27-2004.

SOPHIA S. KIM, EXAMINING ATTORNEY

Int. Cl.: 41

Prior U.S. Cls.: 100, 101, and 107

United States Patent and Trademark Office

Reg. No. 3,576,584

Registered Feb. 17, 2009

**SERVICE MARK
PRINCIPAL REGISTER**

HUDDLE

USA FOOTBALL (VIRGINIA CORPORATION)
9300 BOONE BOULEVARD, SUITE 870
VIENNA, VA 22182

FOR: EDUCATIONAL SERVICES, NAMELY,
CONDUCTING PROGRAMS, CLASSES, SEMINARS,
CONFERENCES, WORKSHOPS AND EXHIBI-
TIONS, DISPLAYS, AND INTERACTIVE EXHIBITS
ON SPORTING AND OUTDOOR ATHLETIC ACTIV-
ITIES, IN CLASS 41 (U.S. CLS. 100, 101 AND 107).

FIRST USE 6-1-2004; IN COMMERCE 6-1-2004.

THE MARK CONSISTS OF STANDARD CHAR-
ACTERS WITHOUT CLAIM TO ANY PARTICULAR
FONT, STYLE, SIZE, OR COLOR.

SN 76-587,279, FILED 4-19-2004.

CHARLOTTE CORWIN, EXAMINING ATTORNEY

Int. Cl.: 18

Prior U.S. Cls.: 1, 2, 3, 22, and 41

United States Patent and Trademark Office

Reg. No. 3,576,585

Registered Feb. 17, 2009

**TRADEMARK
PRINCIPAL REGISTER**



DISNEY ENTERPRISES, INC. (DELAWARE CORPORATION)
500 SOUTH BUENA VISTA STREET
BURBANK, CA 91521

FOR: BEACH BAGS; BOOK BAGS; DIAPER BAGS;
DUFFEL BAGS; TOTE BAGS; HANDBAGS; BACK-
PACKS; PURSES; WALLETS, IN CLASS 18 (U.S. CLS.
1, 2, 3, 22 AND 41).

FIRST USE 4-1-2008; IN COMMERCE 4-1-2008.

OWNER OF U.S. REG. NO. 2,700,619.

SN 76-588,118, FILED 4-19-2004.

WILLIAM BRECKENFELD, EXAMINING ATTOR-
NEY

Int. Cl.: 29

Prior U.S. Cl.: 46

United States Patent and Trademark Office

Reg. No. 3,576,586

Registered Feb. 17, 2009

**TRADEMARK
PRINCIPAL REGISTER**

DESIGN · A · DOG

KENT QUALITY FOODS, INC. (MICHIGAN
CORPORATION)
703 LEONARD, N.W.
GRAND RAPIDS, MI 49548

THE MARK CONSISTS OF STANDARD CHAR-
ACTERS WITHOUT CLAIM TO ANY PARTICULAR
FONT, STYLE, SIZE, OR COLOR.

FOR: MEAT PRODUCTS, NAMELY, HOTDOGS,
IN CLASS 29 (U.S. CL. 46).

SN 76-590,566, FILED 5-5-2004.

FIRST USE 7-16-2008; IN COMMERCE 7-16-2008.

MARCIE MILONE, EXAMINING ATTORNEY

Int. Cl.: 25

Prior U.S. Cls.: 22 and 39

United States Patent and Trademark Office

Reg. No. 3,576,587

Registered Feb. 17, 2009

**TRADEMARK
PRINCIPAL REGISTER**



E. LAND WORLD LTD. (REPUBLIC OF KOREA
JOINT STOCK CORPORATION)
123 ELECTRONIC-TOWN 3 DONG
76-41 KOCHUCK-DONG
GURO-GU, SEOUL, REPUBLIC OF KOREA

FIRST USE 2-0-2005; IN COMMERCE 2-0-2005.

SN 76-595,661, FILED 6-4-2004.

FOR: CHILDREN'S CLOTHING; SHORTS, T-
SHIRT, HATS AND CAPS; BELTS FOR CLOTHING,
IN CLASS 25 (U.S. CLS. 22 AND 39).

MELVIN AXILBUND, EXAMINING ATTORNEY

Int. Cl.: 19

Prior U.S. Cls.: 1, 12, 33, and 50

United States Patent and Trademark Office

Reg. No. 3,576,588

Registered Feb. 17, 2009

**TRADEMARK
PRINCIPAL REGISTER**

COBRA CLIP

QUALITY EDGE, INC. (DELAWARE CORPORATION)

101 CLARK BOULEVARD
MIDDLETOWN, OH 45044

FOR: NON-METAL SUPPORTS FOR RAINWATER GUTTER GUARDS, IN CLASS 19 (U.S. CLS. 1, 12, 33 AND 50).

FIRST USE 11-0-2008; IN COMMERCE 11-0-2008.

THE MARK CONSISTS OF STANDARD CHARACTERS WITHOUT CLAIM TO ANY PARTICULAR FONT, STYLE, SIZE, OR COLOR.

NO CLAIM IS MADE TO THE EXCLUSIVE RIGHT TO USE "CLIP", APART FROM THE MARK AS SHOWN.

SN 76-598,623, FILED 6-22-2004.

INGRID C. EULIN, EXAMINING ATTORNEY

Int. Cl.: 20

Prior U.S. Cls.: 2, 13, 22, 25, 32, and 50

Reg. No. 3,576,589

United States Patent and Trademark Office

Registered Feb. 17, 2009

**TRADEMARK
PRINCIPAL REGISTER**

PETOOGLE

LEACHCO, INC. (OKLAHOMA CORPORATION)
130 E. 10TH STREET
ADA, OK 74820

THE MARK CONSISTS OF STANDARD CHARACTERS WITHOUT CLAIM TO ANY PARTICULAR FONT, STYLE, SIZE, OR COLOR.

FOR: PILLOWS FOR PETS, NAMELY, DOG AND CAT PILLOWS, IN CLASS 20 (U.S. CLS. 2, 13, 22, 25, 32 AND 50).

SN 76-617,322, FILED 10-20-2004.

FIRST USE 11-21-2008; IN COMMERCE 11-21-2008.

SAMUEL E. SHARPER JR., EXAMINING ATTORNEY

Int. Cl.: 16

Prior U.S. Cls.: 2, 5, 22, 23, 29, 37, 38, and 50

Reg. No. 3,576,590

United States Patent and Trademark Office

Registered Feb. 17, 2009

**TRADEMARK
PRINCIPAL REGISTER**

GRANDMA SUNDAY

SEASONS SHARED, LLC (UTAH LIMITED LIABILITY COMPANY)
271 INTERNATIONAL WAY
ALPINE, UT 84004

THE MARK CONSISTS OF STANDARD CHARACTERS WITHOUT CLAIM TO ANY PARTICULAR FONT, STYLE, SIZE, OR COLOR.

FOR: PRINTED PUBLICATIONS, NAMELY, ILLUSTRATED STORY BOOKS FOR CHILDREN AND YOUTHS; COOK BOOKS; PATTERNS DOLL CLOTHES, IN CLASS 16 (U.S. CLS. 2, 5, 22, 23, 29, 37, 38 AND 50).

SN 76-619,431, FILED 11-5-2004.

FIRST USE 11-28-2008; IN COMMERCE 11-28-2008.

JANICE L. MCMORROW, EXAMINING ATTORNEY

Int. Cls.: 3, 14, 25, 26, 28, and 35

Prior U.S. Cls.: 1, 2, 4, 6, 22, 23, 27, 28, 37, 38, 39, 40,
42, 50, 51, 52, 100, 101, and 102

Reg. No. 3,576,591

United States Patent and Trademark Office

Registered Feb. 17, 2009

TRADEMARK
SERVICE MARK
PRINCIPAL REGISTER

SMIFFY'S

R H SMITH & SON (WIGMAKERS) LIMITED
(UNITED KINGDOM CORPORATION)
PECKETT PLAZA
GAINSBOROUGH, LINCOLNSHIRE, DN21 1FJ,
UNITED KINGDOM

FOR: COSMETICS AND MAKEUP PREPARATIONS, NAMELY, FACE PAINT, GREASE PAINT, FACE PAINTING KITS CONSISTING OF SOLID AND LIQUID FACE PAINT, GLITTER GELS, BRUSHES, SPONGES AND FACE PAINTING GUIDES; GREASE PAINTING KITS CONSISTING OF GREASE PAINT, BRUSHES AND SPONGES; COSMETIC BODY GLITTER GEL AND DUST; COSMETICS, NAMELY, NOSE PUTTY, NAIL POLISH, ARTIFICIAL EYELASHES, LIPSTICK, FAKE BLOOD, FAKE BLOOD CAPSULES, FAKE SKIN COSMETICS, LIQUID LATEX, FAKE WOUNDS COSMETICS, TOOTH BLACKOUT; AND CLOWN ACCESSORIES IN THE NATURE OF CLOWN MAKE-UP AND CLOWN MAKE-UP KITS COMPRISED OF CLOWN MAKE-UP, IN CLASS 3 (U.S. CLS. 1, 4, 6, 50, 51 AND 52).

FIRST USE 1-31-2001; IN COMMERCE 1-31-2001.

FOR: THEATRICAL JEWELRY; TIARAS; JEWELRY, NAMELY, CROWNS; COSTUME JEWELRY, IN CLASS 14 (U.S. CLS. 2, 27, 28 AND 50).

FIRST USE 1-31-2001; IN COMMERCE 1-31-2001.

FOR: HATS, HEADDRESSES AND HEADGEAR IN THE NATURE OF HATS, HEADBANDS; THEATRICAL AND FANCY DRESS CLOTHING IN THE NATURE OF DRESSES, HATS, SHIRTS, PANTS AND FOOTWEAR; MASQUERADE AND HALLOW-

EEN COSTUMES, MASKS AND EYE MASKS SOLD IN CONNECTION THEREWITH AS A UNIT; AND CLOTHING ACCESSORIES, NAMELY, SCARVES, BOAS, BELTS, STOCKINGS, TIGHTS, GLOVES; CLOWN ACCESSORIES IN THE NATURE OF CLOWN APPAREL, NAMELY, TROUSERS, JACKETS, SHIRTS, OVERALLS, SOCKS, BOW-TIES, HATS, AND CLOWN FOOTWEAR, IN CLASS 25 (U.S. CLS. 22 AND 39).

FIRST USE 1-31-2001; IN COMMERCE 1-31-2001.

FOR: WIGS, FALSE BEARDS, FALSE SIDEBURNS, FALSE MOUSTACHES AND WIG ACCESSORIES IN THE NATURE OF WIG CAPS, WIG NETS, WIG PINS; AND CLOWN ACCESSORIES IN THE NATURE OF CLOWN WIGS, IN CLASS 26 (U.S. CLS. 37, 39, 40, 42 AND 50).

FIRST USE 1-31-2001; IN COMMERCE 1-31-2001.

FOR: TOYS, NAMELY, TOY WEAPONS AND TOY JEWELRY, THEATRICAL AND TOY MASKS, TOY EYE MASKS, TOY WIGS, TOY BEARDS, TOY SIDEBURNS, TOY MOUSTACHES, TOY TEETH, TOY NOSES, TOY EARS, TOY NAILS, TOY HORNS, TOY BODY PARTS; BOPPERS; PRACTICAL JOKE TOYS IN THE NATURE OF SQUIRT BOW-TIES, SQUIRT RINGS, SQUIRT COINS, SQUIRT CIGARETTES, SQUIRT LIGHTERS, SQUIRT GUM AND SQUIRT FLOWERS, FAKE CIGARETTES, FAKE CANDY, FAKE BULLET HOLES, FAKE CAR SCRATCHES, FAKE INSECTS, FAKE SUGAR, FAKE SMOKE, FAKE ICE CUBES, FAKE TURDS, FAKE FLATULENCE NOISEMAKERS AND SMELL, ITCHING POWDER, SNEEZING POWDER, EXPLODING CIGARETTES, EXPLODING BOTTLE OPENERS, EX-

PLODING PENS, EXPLODING GUM, EXPLODING LIGHTERS AND EXPLODING MATCHES, DISAPPEARING INK, AND HAND BUZZERS; PARTY ACCESSORIES, NAMELY, BALLOONS, PAPER STREAMERS, POPPERS, PARTY BLOWOUTS AND PARTY SQUEAKERS; ADULT TOYS AND NOVELTIES, NAMELY, JUMBO CONDOMS, NOVELTY INFLATABLE BREASTS, TIE-ON BREASTS, AND TIE-ON BUTTS, JUMBO KNICKERS, TOY SHACKLES, NOVELTY SEX ORGANS, NOVELTY WHIPS, AND NOVELTY INFLATABLE DOLLS AND ANIMALS; AND CLOWN ACCESSORIES IN THE NATURE OF CLOWN NOSES; ADULT NOVELTY FAKE SKIN AND FAKE WOUNDS, IN CLASS 28 (U.S. CLS. 22, 23, 38 AND 50).

FIRST USE 1-31-2001; IN COMMERCE 1-31-2001.

FOR: COMPUTERIZED ON-LINE RETAIL STORE AND MAIL ORDER CATALOG SERVICES IN THE FIELDS OF COSMETICS AND MAKEUP PREPARATIONS, NAMELY, FACE PAINT, GREASE PAINT, FACE PAINTING KITS, GREASE PAINTING KITS, GLITTER GEL, NOSE PUTTY, NAIL POLISH, ARTIFICIAL EYELASHES, LIPSTICK, FAKE BLOOD, FAKE BLOOD CAPSULES, FAKE SKIN, LIQUID LATEX, FAKE WOUNDS, CLOWN KITS AND TOOTH BLACKOUT, WIGS, FALSE HAIR, FALSE BEARDS, FALSE SIDEBURNS, FALSE MOUSTACHES, WIG CAPS, WIG NETS AND WIG PINS, FEATHERS FOR CLOTHES AND CLOTHING ACCESSORIES, KEY RINGS AND FOBS, THEATRICAL JEWELRY, NOVELTY ITEMS, NAMELY, CANDLES, PLAYING CARDS, PENS, WATER GUNS, PACIFIERS, STATUETTES, KEY CHAINS, STINK BOMBS, SPARKLERS, DECALS, STICKERS, PARTY HATS AND MASKS, DOOR HANGERS, MEN'S AND WOMEN'S CLOTHING, NAMELY, UNDERGAR-

MENTS, SHIRTS, PANTS, SHORT PANTS, ROBES, JACKETS, COATS, SUITS, HATS, WOMEN'S CLOTHING, NAMELY, LINGERIE, HOSIERY, SKIRTS, DRESSES, GOWNS, BODY SUITS, CAPES, VEILS, GLOVES, APRONS, EROTIC COSTUMES, MASQUERADE AND HALLOWEEN COSTUMES, NAMELY, HATS, HEADDRESSES, HEADGEAR, THEATRICAL AND FANCY DRESS CLOTHING, MASKS, AND CLOTHING ACCESSORIES, GLOVES, SCARVES, STOCKINGS, TIGHTS, BOAS, DEVICES AND MATERIALS FOR USE BY ADULT MEN AND WOMEN, NAMELY, BODY MASSAGE DEVICES, SEXUAL STIMULATION DEVICES, IMITATION SEXUAL ORGANS, INFLATABLE DOLLS AND ANIMALS, ADULT BODY RESTRAINTS AND SEX FETISH EQUIPMENT, NAMELY, CUFFS, MASKS, BLINDFOLDS, AND WHIPS, TOYS, NAMELY, TOY WEAPONS AND TOY JEWELRY, THEATRICAL AND TOY MASKS, TOY EYE MASKS, TOY WIGS, TOY BEARDS, TOY SIDEBURNS, TOY MOUSTACHES, PRACTICAL JOKE TOYS AND THEATRICAL NOVELTIES, BALLOONS, PARTY ACCESSORIES, ADULT TOYS, DEVICES AND NOVELTIES, NAMELY, SEX TOYS USED BY ADULTS IN SENSUAL PLAY, INFLATABLE DOLLS AND ANIMALS, AND NOVELTY SEX TOYS, IN CLASS 35 (U.S. CLS. 100, 101 AND 102).

FIRST USE 1-31-2001; IN COMMERCE 1-31-2001.

THE MARK CONSISTS OF STANDARD CHARACTERS WITHOUT CLAIM TO ANY PARTICULAR FONT, STYLE, SIZE, OR COLOR.

SN 76-623,324, FILED 12-6-2004.

FONG HSU, EXAMINING ATTORNEY

Int. Cls.: 35 and 41

Prior U.S. Cls.: 100, 101, 102, and 107

United States Patent and Trademark Office

Reg. No. 3,576,592

Registered Feb. 17, 2009

**SERVICE MARK
PRINCIPAL REGISTER**

SCHAZAM PRODUCTIONS

STRIKE KING LURE COMPANY (TENNESSEE CORPORATION)
466 WASHINGTON ST.
COLLIERVILLE, TN 380172918

FOR: PREPARING AUDIO-VISUAL PRESENTATIONS IN THE NATURE OF PROMOTIONAL VIDEOTAPES AND DVD VIDEOS FOR USE IN ADVERTISING OUTDOOR SPORTING ACTIVITIES AND RELATED PRODUCTS FOR USE DURING THESE ACTIVITIES; DISTRIBUTION OF COMMERCIALS AND ADVERTISEMENTS IN THE NATURE OF PROMOTIONAL VIDEOTAPES AND DVD VIDEOS FOR USE IN ADVERTISING OUTDOOR SPORTING ACTIVITIES AND RELATED PRODUCTS FOR USE DURING THESE ACTIVITIES; PRODUCTION AND DISTRIBUTION OF TELEVISION COMMERCIALS FEATURING OUTDOOR SPORTING ACTIVITIES AND RELATED PRODUCTS FOR USE DURING THESE ACTIVITIES, IN CLASS 35 (U.S. CLS. 100, 101 AND 102).

FIRST USE 7-20-2005; IN COMMERCE 7-20-2005.

FOR: ENTERTAINMENT SERVICES, NAMELY, SCRIPT WRITING, FILMING, FILM EDITING, FILM PRODUCTION AND DISTRIBUTION OF TELEVISION SHOWS IN THE FIELD OF OUTDOOR SPORTING ACTIVITIES AND EQUIPMENT FOR USE THEREWITH, IN CLASS 41 (U.S. CLS. 100, 101 AND 107).

FIRST USE 7-20-2005; IN COMMERCE 7-20-2005.

THE MARK CONSISTS OF STANDARD CHARACTERS WITHOUT CLAIM TO ANY PARTICULAR FONT, STYLE, SIZE, OR COLOR.

NO CLAIM IS MADE TO THE EXCLUSIVE RIGHT TO USE "PRODUCTIONS", APART FROM THE MARK AS SHOWN.

SN 76-629,794, FILED 1-24-2005.

TINA L. SNAPP, EXAMINING ATTORNEY

Int. Cl.: 42

Prior U.S. Cls.: 100 and 101

United States Patent and Trademark Office

Reg. No. 3,576,593

Registered Feb. 17, 2009

**SERVICE MARK
PRINCIPAL REGISTER**

N(i)2

NETWORK INFRASTRUCTURE INVENTORY
[N(i)2] INC. (CANADA CORPORATION)
4446, ST.LAURENT BLVD.
SUITE 300
MONTREAL, QUEBEC, CANADA H2W 1Z5

PRIORITY CLAIMED UNDER SEC. 44(D) ON
CANADA APPLICATION NO. 1250130, FILED 3-7-
2005, REG. NO. TMA664077, DATED 5-12-2006, EX-
PIRES 5-12-2021.

FOR: DEVELOPMENT OF COMPUTER SOFT-
WARE FOR MANAGING COMPUTER AND NET-
WORK RESOURCES OF BUSINESSES, IN CLASS 42
(U.S. CLS. 100 AND 101).

SN 76-634,715, FILED 3-31-2005.

FIRST USE 8-15-2006; IN COMMERCE 8-15-2006.

INGRID C. EULIN, EXAMINING ATTORNEY

Int. Cl.: 16

Prior U.S. Cls.: 2, 5, 22, 23, 29, 37, 38, and 50

Reg. No. 3,576,594

United States Patent and Trademark Office

Registered Feb. 17, 2009

TRADEMARK
PRINCIPAL REGISTER



CENTER ENTERPRISES, INC. (CONNECTICUT CORPORATION)
30 SHIELD STREET
WEST HARTFORD, CT 06110

FOR: RUBBER STAMPS, IN CLASS 16 (U.S. CLS. 2, 5, 22, 23, 29, 37, 38 AND 50).

FIRST USE 12-31-2005; IN COMMERCE 12-31-2005.

NO CLAIM IS MADE TO THE EXCLUSIVE RIGHT TO USE "ENTERPRISES", APART FROM THE MARK AS SHOWN.

THE MARK COMPRISES THE PHRASE "READY 2 LEARN" IN AN ARCUATE FORM, AND A SUPERPOSED CIRCULAR ELEMENT WITH A NOTCHED FLAG CONTAINING THE LETTERS "CE" AND THE WORDS "CENTER ENTERPRISES".

SN 76-636,462, FILED 4-20-2005.

WARREN L. OLANDRIA, EXAMINING ATTORNEY

Prior U.S. Cls.: A and B

United States Patent and Trademark Office

Reg. No. 3,576,595

Registered Feb. 17, 2009

**CERTIFICATION MARK
GOODS
SERVICES
PRINCIPAL REGISTER**

RDCPM

PLOTNICK, FREDRIC L. (UNITED STATES INDIVIDUAL)
BENSON MANOR #117
101 WASHINGTON LANE
JENKINTOWN, PA 19046

FOR: COMPUTER SOFTWARE FOR PLANNING, SCHEDULING AND SCHEDULE RISK ANALYSIS; PUBLICATIONS, NAMELY, TRAINING MANUALS, TEXTBOOKS, SOFTWARE MANUALS AND INSTRUCTION MANUALS; SCHEDULES, EVENT PLANS AND RESOURCE MANAGEMENT PLANS FOR PLANNING, SCHEDULING AND SCHEDULE RISK ANALYSIS, IN CLASS A (U.S. CL. A).

FIRST USE 6-24-2008; IN COMMERCE 6-24-2008.

FOR: TRAINING IN THE USE OF, TEACHING IN THE FIELD OF AND THE PROVISION OF PROJECT MANAGEMENT SERVICES UTILIZING THIS STANDARD IN AREAS SUCH AS ENGINEERING DESIGN AND IMPLEMENTATION, ARCHITECTURAL DESIGN AND IMPLEMENTATION, PRODUCT DEVELOPMENT, SOFTWARE DEVELOPMENT, ASSEMBLY AND MANUFACTURE, CONSTRUCTION AND ERECTION, MAINTENANCE, PROFESSIONAL SERVICES, AND ALL MANNER OF PROJECTS BOTH UNIQUE AND REPETITIVE, FOR PURPOSES INCLUDING THE PLANNING AND SCHEDULING OF EVENTS AND ACTIVITIES IN A LOGICAL ORDER, THE MANAGEMENT OF RESOURCES AND KNOWLEDGE AS APPLIED TO A PROJECT, GROUP OF PROJECTS, PROGRAM OF PROJECTS OR GROUP OF PROGRAMS, THE RECORDING OF A DESCRIPTION, RATIONALE OR SIGNIFICANCE OF THE LOGIC RELATIONSHIP BETWEEN EVENTS AND ACTIVITIES; THE ALLOCATION OF RESOURCES BASED UPON THE TYPE AND RECORDED RATIONALE FOR THE LOGIC RELATIONSHIP, THE

CALCULATION OF PROBABLE COMPLETION TIMES BASED UPON THE RELAXATION OF LOGIC RELATIONSHIPS OF VARYING TYPE AND RATIONALE, AND THE CALCULATION OF THE RISK OF TIMELY COMPLETION AND PROBABILITY OF VARIOUS TIMES OR DATES OF COMPLETION BASED UPON THE VALIDITY AND VARIABILITY OF ACTIVITY OF DURATION, SELECTION OF PREFERENCE AT LOGIC FORKS AND THE TYPE AND RECORDED RATIONALE FOR THE LOGIC RELATIONSHIP, IN CLASS B (U.S. CL. B).

FIRST USE 6-30-2008; IN COMMERCE 6-30-2008.

THE MARK CONSISTS OF STANDARD CHARACTERS WITHOUT CLAIM TO ANY PARTICULAR FONT, STYLE, SIZE, OR COLOR.

THE CERTIFICATION MARK, AS INTENDED TO BE USED BY AUTHORIZED PERSONS, IS INTENDED TO CERTIFY THAT ENTITIES THAT OFFER GOODS AND SERVICES HAVE ADHERED TO A SET OF DEVELOPED STANDARDS OF GOOD PRACTICES BY A THIRD PARTY BASED ON A VARIATION OF THE CRITICAL PATH METHOD OF SCHEDULING THAT WILL EXPAND AND FURTHER DEFINE THE TYPES OF LOGIC RELATIONSHIPS RECOGNIZED BETWEEN EVENTS AND ACTIVITIES AND THAT WILL RECORD THE RATIONALE AS WELL AS THE EXISTENCE OF SUCH LOGIC RELATIONSHIPS BETWEEN EVENTS AND ACTIVITIES. THE CERTIFICATION MARK MAY BE DESCRIBED IN PRINT AS THE RELATIONSHIP DIAGRAMMING VARIATION OF THE CRITICAL PATH METHOD OF SCHEDULE ANALYSIS.

SN 76-637,396, FILED 4-28-2005.

ANNE E. GUSTASON, EXAMINING ATTORNEY

Int. Cl.: 16

Prior U.S. Cls.: 2, 5, 22, 23, 29, 37, 38, and 50

United States Patent and Trademark Office

Reg. No. 3,576,596

Registered Feb. 17, 2009

**TRADEMARK
PRINCIPAL REGISTER**



Who Are The "African-Americans?"

LEE, LEON DARYL (UNITED STATES INDIVIDUAL)
P.O. BOX 9502
ROSEDALE, MD 21237

FOR: FRAMED ART PICTURES THAT FEATURES DRAWINGS, PHOTOGRAPHS, COINS, AND STAMPS, IN CLASS 16 (U.S. CLS. 2, 5, 22, 23, 29, 37, 38 AND 50).

FIRST USE 11-0-2007; IN COMMERCE 11-0-2007.

THE COLORS BLUE, BLACK, RED AND GREEN ARE CLAIMED AS A FEATURE OF THE MARK.

THE COLOR RED APPEARS AS THE COLOR OF THE OUTER VERTICAL LINES, THE COLOR BLUE APPEARS AS THE COLOR OF THE OUTER HORIZONTAL LINES, THE COLOR GREEN APPEARS AS THE COLOR OF THE INSIDE RECTANGLE, THE COLOR BLACK APPEARS AS THE COLOR OF ALL THE LETTERS AND ALL PUNCTUATION SYMBOLS AND THE COLOR OF THE BORDER ON THE INSIDE RECTANGLE.

SN 76-637,767, FILED 5-4-2005.

JEFF DEFORD, EXAMINING ATTORNEY

Int. Cl.: 5

Prior U.S. Cls.: 6, 18, 44, 46, 51, and 52

Reg. No. 3,576,597

United States Patent and Trademark Office

Registered Feb. 17, 2009

**TRADEMARK
PRINCIPAL REGISTER**

WIN OMEG3COMPLEX

WELLNESS INTERNATIONAL NETWORK, LTD.
(TEXAS LIMITED PARTNERSHIP)
5800 DEMOCRACY DRIVE
PLANO, TX 75024

OWNER OF U.S. REG. NOS. 1,790,083, 2,733,799,
AND OTHERS.

FOR: DIETARY AND NUTRITIONAL SUPPLE-
MENTS AND INSTRUCTIONAL MANUALS FOR
USE THEREWITH SOLD AS A UNIT, IN CLASS 5
(U.S. CLS. 6, 18, 44, 46, 51 AND 52).

NO CLAIM IS MADE TO THE EXCLUSIVE
RIGHT TO USE "OMEG3COMPLEX", APART FROM
THE MARK AS SHOWN.

FIRST USE 10-14-2005; IN COMMERCE 10-14-2005.

SN 76-639,925, FILED 6-2-2005.

THE MARK CONSISTS OF STANDARD CHAR-
ACTERS WITHOUT CLAIM TO ANY PARTICULAR
FONT, STYLE, SIZE, OR COLOR.

ELISSA GARBER KON, EXAMINING ATTORNEY

Int. Cl.: 35

Prior U.S. Cls.: 100, 101, and 102

United States Patent and Trademark Office

Reg. No. 3,576,598

Registered Feb. 17, 2009

**SERVICE MARK
PRINCIPAL REGISTER**

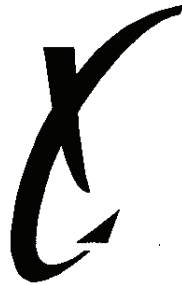

J.S. MUSIC CORPORATION (OHIO CORPORATION)
761-R BETA DRIVE
MAYFIELD VILLAGE, OH 44143

FIRST USE 7-0-2003; IN COMMERCE 7-0-2003.

FOR: RETAIL STORE SERVICES FEATURING
NEW AND USED MUSIC, MOVIES, VIDEO GAMES,
VIDEO GAME ACCESSORIES, AND ELECTRONICS,
IN CLASS 35 (U.S. CLS. 100, 101 AND 102).

SN 76-652,769, FILED 12-27-2005.

PATRICIA EVANKO, EXAMINING ATTORNEY

Int. Cl.: 11

Prior U.S. Cls.: 13, 21, 23, 31, and 34

United States Patent and Trademark Office

Reg. No. 3,576,599

Registered Feb. 17, 2009

**TRADEMARK
PRINCIPAL REGISTER**

BIOMAG

CAMBRIDGE WATER TECHNOLOGY, INC. (DE-
LAWARE CORPORATION)
35 NEW ENGLAND BUSINESS CENTER
SUITE 190
ANDOVER, MA 01810

FOR: WATER TREATMENT PLANT FOR BIO-
CHEMICAL PROCESSES FOR TREATMENT OF
WATER, IN CLASS 11 (U.S. CLS. 13, 21, 23, 31 AND
34).

FIRST USE 12-9-2008; IN COMMERCE 12-9-2008.

THE MARK CONSISTS OF STANDARD CHAR-
ACTERS WITHOUT CLAIM TO ANY PARTICULAR
FONT, STYLE, SIZE, OR COLOR.

SN 76-653,380, FILED 1-17-2006.

STEVEN JACKSON, EXAMINING ATTORNEY

Int. Cl.: 11

Prior U.S. Cls.: 13, 21, 23, 31, and 34

United States Patent and Trademark Office

Reg. No. 3,576,600

Registered Feb. 17, 2009

**TRADEMARK
PRINCIPAL REGISTER**

COMAG

CAMBRIDGE WATER TECHNOLOGY, INC. (DE-
LAWARE CORPORATION)
35 NEW ENGLAND BUSINESS CENTER
SUITE 190
ANDOVER, MA 01810

THE MARK CONSISTS OF STANDARD CHAR-
ACTERS WITHOUT CLAIM TO ANY PARTICULAR
FONT, STYLE, SIZE, OR COLOR.

FOR: WATER TREATMENT PLANT FOR TREAT-
MENT OF WATER, IN CLASS 11 (U.S. CLS. 13, 21, 23,
31 AND 34).

SN 76-653,384, FILED 1-17-2006.

FIRST USE 11-12-2008; IN COMMERCE 11-12-2008.

STEVEN JACKSON, EXAMINING ATTORNEY

Int. Cl.: 9

Prior U.S. Cls.: 21, 23, 26, 36, and 38

Reg. No. 3,576,601

United States Patent and Trademark Office

Registered Feb. 17, 2009

**TRADEMARK
PRINCIPAL REGISTER**

SMARTPROFILE

QUALITY VISION INTERNATIONAL, INC. (NEW
YORK CORPORATION)
850 HUDSON AVENUE
ROCHESTER, NY 14621

FIRST USE 11-10-2008; IN COMMERCE 11-10-2008.

THE MARK CONSISTS OF STANDARD CHAR-
ACTERS WITHOUT CLAIM TO ANY PARTICULAR
FONT, STYLE, SIZE, OR COLOR.

FOR: OPTICAL METROLOGY SOFTWARE FOR
DIMENSIONAL MEASUREMENT SYSTEMS
WHICH COMPARES A MEASURED PROFILE TO
THAT OF A DESIGN MASTER , IN CLASS 9 (U.S.
CLS. 21, 23, 26, 36 AND 38).

SN 76-655,237, FILED 2-17-2006.

ELLEN PERKINS, EXAMINING ATTORNEY

Int. Cl.: 3

Prior U.S. Cls.: 1, 4, 6, 50, 51, and 52

United States Patent and Trademark Office

Reg. No. 3,576,602

Registered Feb. 17, 2009

**TRADEMARK
PRINCIPAL REGISTER**

TRUE GREEN

NORDICO MARKET DEVELOPMENT, INC.
(NEW YORK CORPORATION)
226 EAST 54TH STREET, 7TH FLOOR
NEW YORK, NY 10022

FOR: CLEANING PREPARATIONS FOR HARD SURFACES AND SKIN, FOR SPOT CLEANING AND LAUNDERING FABRICS AND FOR REMOVING IMPURITIES FROM WATER AND AIR, IN CLASS 3 (U.S. CLS. 1, 4, 6, 50, 51 AND 52).

FIRST USE 2-7-2008; IN COMMERCE 2-7-2008.

THE MARK CONSISTS OF STANDARD CHARACTERS WITHOUT CLAIM TO ANY PARTICULAR FONT, STYLE, SIZE, OR COLOR.

SN 76-655,721, FILED 2-27-2006.

REBECCA POVARCHUK, EXAMINING ATTORNEY

Int. Cl.: 12

Prior U.S. Cls.: 19, 21, 23, 31, 35, and 44

United States Patent and Trademark Office

Reg. No. 3,576,603

Registered Feb. 17, 2009

**TRADEMARK
PRINCIPAL REGISTER**

SST

MITSUBISHI JIDOSHA KOGYO KABUSHIKI
KAISHA (JAPAN CORPORATION)
33-8, SHIBA 5-CHOME, MINATO-KU
TOKYO, JAPAN

THE MARK CONSISTS OF STANDARD CHAR-
ACTERS WITHOUT CLAIM TO ANY PARTICULAR
FONT, STYLE, SIZE, OR COLOR.

FOR: TRANSMISSION FOR AUTOMOBILES, IN
CLASS 12 (U.S. CLS. 19, 21, 23, 31, 35 AND 44).

SN 76-661,124, FILED 6-6-2006.

FIRST USE 12-20-2007; IN COMMERCE 6-0-2008.

DAVID HOFFMAN, EXAMINING ATTORNEY

Int. Cls.: 21 and 35

**Prior U.S. Cls.: 2, 13, 23, 29, 30, 33, 40, 50, 100, 101,
and 102**

United States Patent and Trademark Office

Reg. No. 3,576,604

Registered Feb. 17, 2009

**TRADEMARK
SERVICE MARK
PRINCIPAL REGISTER**

COOKIE QUENCHER QUENCH YOUR THIRST...AGAIN & AGAIN

CREST FOODS, INC. (TEXAS CORPORATION)
1900 PRESTON ROAD
SUITE 267-314
PLANO, TX 75093

FOR: PROMOTIONAL PLASTIC DRINKING
CUPS, IN CLASS 21 (U.S. CLS. 2, 13, 23, 29, 30, 33, 40
AND 50).

FIRST USE 6-30-2006; IN COMMERCE 6-30-2006.

FOR: PROMOTING THE SALE OF SOFT DRINKS,
SMOOTHIES, AND MILK SHAKES OF OTHERS

THROUGH THE DISTRIBUTION OF PROMOTION-
AL PLASTIC DRINKING CUPS, IN CLASS 35 (U.S.
CLS. 100, 101 AND 102).

FIRST USE 6-30-2006; IN COMMERCE 6-30-2006.

THE MARK CONSISTS OF STANDARD CHAR-
ACTERS WITHOUT CLAIM TO ANY PARTICULAR
FONT, STYLE, SIZE, OR COLOR.

SN 76-662,169, FILED 6-26-2006.

AISHA SALEM, EXAMINING ATTORNEY

Int. Cl.: 35

Prior U.S. Cls.: 100, 101, and 102

United States Patent and Trademark Office

Reg. No. 3,576,605

Registered Feb. 17, 2009

SERVICE MARK
PRINCIPAL REGISTER



ADVANCE MAGAZINE PUBLISHERS INC. (NEW
YORK CORPORATION)
FOUR TIMES SQUARE
NEW YORK, NY 10036

FOR: LIVE EVENTS IN THE NATURE OF EXHIBITIONS PROMOTING THE GOODS AND SERVICES OF OTHERS IN THE FIELDS OF SHOPPING FOR THE HOME, HOME GOODS AND LIFESTYLE PRODUCTS, IN CLASS 35 (U.S. CLS. 100, 101 AND 102).

FIRST USE 10-1-2006; IN COMMERCE 10-1-2006.

NO CLAIM IS MADE TO THE EXCLUSIVE RIGHT TO USE "BAZAAR", APART FROM THE MARK AS SHOWN.

THE MARK CONSISTS OF THE WORDS "THE DOMINO BAZAAR" AND AN ABSTRACT GEOMETRIC DESIGN.

SN 76-664,053, FILED 8-3-2006.

SUSAN RICHARDS, EXAMINING ATTORNEY

Int. Cl.: 5

Prior U.S. Cls.: 6, 18, 44, 46, 51, and 52

Reg. No. 3,576,606

United States Patent and Trademark Office

Registered Feb. 17, 2009

**TRADEMARK
PRINCIPAL REGISTER**

SYNOPLUS

NEWTON-EVERETT, LLC (ARIZONA LIMITED
LIABILITY COMPANY)
7420 E. PINNACLE PEAK ROAD, SUITE 126
SCOTTSDALE, AZ 85255

THE MARK CONSISTS OF STANDARD CHAR-
ACTERS WITHOUT CLAIM TO ANY PARTICULAR
FONT, STYLE, SIZE, OR COLOR.

FOR: VITAMINS AND FOOD SUPPLEMENTS
FOR JOINT CARE, IN CLASS 5 (U.S. CLS. 6, 18, 44,
46, 51 AND 52).

SN 76-666,008, FILED 9-14-2006.

FIRST USE 2-24-2005; IN COMMERCE 2-24-2005.

SETH A. RAPPAPORT, EXAMINING ATTORNEY

Int. Cl.: 5

Prior U.S. Cls.: 6, 18, 44, 46, 51, and 52

United States Patent and Trademark Office

Reg. No. 3,576,607

Registered Feb. 17, 2009

**TRADEMARK
PRINCIPAL REGISTER**

ADVANTRIM

NEWTON-EVERETT, LLC (ARIZONA LIMITED
LIABILITY COMPANY)
7420 E. PINNACLE PEAK ROAD, SUITE 126
SCOTTSDALE, AZ 85255

THE MARK CONSISTS OF STANDARD CHAR-
ACTERS WITHOUT CLAIM TO ANY PARTICULAR
FONT, STYLE, SIZE, OR COLOR.

FOR: DIETARY SUPPLEMENT TO AID IN
WEIGHT LOSS, IN CLASS 5 (U.S. CLS. 6, 18, 44, 46,
51 AND 52).

SN 76-666,065, FILED 9-14-2006.

FIRST USE 7-21-2006; IN COMMERCE 7-21-2006.

MARK SPARACINO, EXAMINING ATTORNEY

Int. Cl.: 30

Prior U.S. Cl.: 46

United States Patent and Trademark Office

Reg. No. 3,576,608

Registered Feb. 17, 2009

**TRADEMARK
PRINCIPAL REGISTER**

BAGEL-IT

THE DUKOFF TORO FOUNDATION, A NEW YORK TRUST, THE TRUSTEES COMPRISING OF AMY DUKOFF TORR AND MARILYN DUKOFF, BOTH U.S. CITIZEN (NEW YORK TRUST)

155 WEST 70TH STREET #7B
NEW YORK, NY 10023

FOR: TOASTED CONDIMENTS AND SEASONINGS, NAMELY, POPPY SEEDS, SESAME SEEDS, ONION, GARLIC AND SALT TO BE PLACED ON SALADS, BREADS AND OTHER FOODS, IN CLASS 30 (U.S. CL. 46).

FIRST USE 7-25-2008; IN COMMERCE 7-25-2008.

THE MARK CONSISTS OF STANDARD CHARACTERS WITHOUT CLAIM TO ANY PARTICULAR FONT, STYLE, SIZE, OR COLOR.

SN 76-667,462, FILED 10-10-2006.

ANDREA BUTLER, EXAMINING ATTORNEY

Int. Cl.: 3

Prior U.S. Cls.: 1, 4, 6, 50, 51, and 52

United States Patent and Trademark Office

Reg. No. 3,576,609

Registered Feb. 17, 2009

TRADEMARK
PRINCIPAL REGISTER

Lola

LOLA COSMETICS, LLC (CALIFORNIA LIMITED LIABILITY COMPANY)
9663 SANTA MONICA BLVD. SUITE 700
BEVERLY HILLS, CA 90210

FOR: SKIN AND BODY CARE PREPARATIONS, NAMELY, SKIN CLEANSERS, SKIN MOISTURIZERS, SKIN LOTIONS, SKIN SOAPS, SUN SCREEN PREPARATIONS, COSMETICS, NON-MEDICATED HAIR CARE PREPARATIONS, COLOGNES, PERFUMES, FRAGRANT OILS FOR PERSONAL USE, NON-MEDICATED BATH SALTS, INCENSE AND

TOOTH WHITENING PREPARATIONS, IN CLASS 3 (U.S. CLS. 1, 4, 6, 50, 51 AND 52).

FIRST USE 11-1-2001; IN COMMERCE 11-1-2001.

OWNER OF U.S. REG. NOS. 1,431,668, 2,667,128, AND 3,032,698.

SN 76-667,963, FILED 10-23-2006.

PAULA MAHONEY, EXAMINING ATTORNEY

Int. Cl.: 7

Prior U.S. Cls.: 13, 19, 21, 23, 31, 34, and 35

Reg. No. 3,576,610

United States Patent and Trademark Office

Registered Feb. 17, 2009

**TRADEMARK
PRINCIPAL REGISTER**

OMNIPURE OMNIVAC

SEVERN TRENT DE NORA, L.L.C. (DELAWARE
LIMITED LIABILITY COMPANY)
1110 INDUSTRIAL BLVD.
SUGAR LAND, TX 77478

THE MARK CONSISTS OF STANDARD CHAR-
ACTERS WITHOUT CLAIM TO ANY PARTICULAR
FONT, STYLE, SIZE, OR COLOR.

FOR: MARINE WASTEWATER TREATMENT
SYSTEM, NAMELY, A TANK AND VACUUM PUMP
SYSTEM FOR REMOVING WASTEWATER FROM
MARINE VESSELS, IN CLASS 7 (U.S. CLS. 13, 19, 21,
23, 31, 34 AND 35).

OWNER OF U.S. REG. NOS. 2,454,561, 3,136,284,
AND OTHERS.

SN 76-668,562, FILED 11-6-2006.

FIRST USE 11-6-2006; IN COMMERCE 11-6-2006.

DAVID ELTON, EXAMINING ATTORNEY

Int. Cl.: 44

Prior U.S. Cls.: 100 and 101

United States Patent and Trademark Office

Reg. No. 3,576,611

Registered Feb. 17, 2009

**SERVICE MARK
PRINCIPAL REGISTER**

21 DAY CLUB

E. ORIOLI'S ESSI SYSTEMS, INC. (CALIFORNIA CORPORATION)
70 OTIS STREET
SAN FRANCISCO, CA 94103

FOR: PROVIDING PSYCHOLOGICAL TESTING, ASSESSING, AND COUNSELING OVER THE INTERNET, NAMELY, MAPPING AND ASSESSING PERSONAL AND PROFESSIONAL BEHAVIOR, INCLUDING HEALTH, STRESS, RESILIENCY, CREATIVITY, LEADERSHIP, AND EMOTIONAL INTELLIGENCE; DETERMINING BEHAVIOR

CHANGE PLANS; AND MONITORING BEHAVIOR CHANGE, IN CLASS 44 (U.S. CLS. 100 AND 101).

FIRST USE 8-31-2004; IN COMMERCE 12-0-2007.

THE MARK CONSISTS OF STANDARD CHARACTERS WITHOUT CLAIM TO ANY PARTICULAR FONT, STYLE, SIZE, OR COLOR.

SN 76-669,168, FILED 11-17-2006.

JAMES A. RAUEN, EXAMINING ATTORNEY

Int. Cl.: 9

Prior U.S. Cls.: 21, 23, 26, 36, and 38

Reg. No. 3,576,612

United States Patent and Trademark Office

Registered Feb. 17, 2009

**TRADEMARK
PRINCIPAL REGISTER**

SPRING BREAK: CANCUN GOES WILD

GAMELOFT S.A. (FRANCE SOCIETE ANON-
YME)
14 RUE AUBER
75009 PARIS, FRANCE

FOR: COMPUTER SOFTWARE FOR ELECTRO-
NIC GAMES AND ENTERTAINMENT, NAMELY,
COMPUTER GAME SOFTWARE USED AND
PLAYED ON MOBILE AND CELLULAR TELE-
PHONES, HANDHELD COMPUTERS, PERSONAL
COMPUTERS AND PERSONAL DIGITAL ASSIS-
TANTS; DOWNLOADABLE ELECTRONIC GAME
PROGRAMS; DOWNLOADABLE RING TONES VIA
THE INTERNET AND WIRELESS DEVICES; DOWN-
LOADABLE VOICE RING TONES FOR MOBILE
TELECOMMUNICATIONS DEVICES; DOWNLOAD-
ABLE COMPUTER SOFTWARE FOR WALL PA-
PERS, NAMELY, STILL IMAGES FOR USE IN
BACKGROUNDS ON MOBILE PHONE SCREENS;
COMPUTER SCREEN SAVER SOFTWARE; COM-
PUTER SOFTWARE FOR PROCESSING ANIMA-
TED IMAGES FOR USE ON MOBILE PHONE

SCREENS; AND PROGRAMS FOR DOWNLOAD-
ING IMAGES TO MOBILE TELECOMMUNICA-
TION DEVICES, NAMELY, MOBILE AND
CELLULAR TELEPHONES, HANDHELD COMPU-
TERS, PERSONAL COMPUTERS AND PERSONAL
DIGITAL ASSISTANTS VIA THE GLOBAL COMPU-
TER NETWORK AND WIRELESS DEVICES; AND
COMPUTER SOFTWARE FOR USE IN THE DE-
SIGN, DEVELOPMENT AND EXECUTION OF
WIRELESS COMPUTER GAMES, IN CLASS 9 (U.S.
CLS. 21, 23, 26, 36 AND 38).

FIRST USE 1-1-2007; IN COMMERCE 1-1-2007.

THE MARK CONSISTS OF STANDARD CHAR-
ACTERS WITHOUT CLAIM TO ANY PARTICULAR
FONT, STYLE, SIZE, OR COLOR.

SN 76-671,409, FILED 1-16-2007.

LINDA M. KING, EXAMINING ATTORNEY

Int. Cls.: 16 and 44

Prior U.S. Cls.: 2, 5, 22, 23, 29, 37, 38, 50, 100, and 101

United States Patent and Trademark Office

Reg. No. 3,576,613

Registered Feb. 17, 2009

**TRADEMARK
SERVICE MARK
PRINCIPAL REGISTER**

SUNRISE SERIES

MENOPAUSERX, INC. (PENNSYLVANIA CORPORATION)
ONE ALTOONA PLACE
PITTSBURGH, PA 15228

FOR: PRINTED MATERIAL, NAMELY, PAMPHLETS AND NEWSLETTERS ON THE SUBJECT OF WOMEN'S HEALTH ISSUES AND RELATED TOPICS, IN CLASS 16 (U.S. CLS. 2, 5, 22, 23, 29, 37, 38 AND 50).

FIRST USE 10-0-2006; IN COMMERCE 10-0-2006.

FOR: PROVIDING ON-LINE WOMEN'S MEDICAL AND HEALTH INFORMATION, IN CLASS 44 (U.S. CLS. 100 AND 101).

FIRST USE 3-0-2007; IN COMMERCE 3-0-2007.

THE MARK CONSISTS OF STANDARD CHARACTERS WITHOUT CLAIM TO ANY PARTICULAR FONT, STYLE, SIZE, OR COLOR.

NO CLAIM IS MADE TO THE EXCLUSIVE RIGHT TO USE "SERIES", APART FROM THE MARK AS SHOWN.

SN 76-671,634, FILED 1-22-2007.

DAWN HAN, EXAMINING ATTORNEY

Int. Cl.: 38

Prior U.S. Cls.: 100, 101, and 104

United States Patent and Trademark Office

Reg. No. 3,576,614

Registered Feb. 17, 2009

**SERVICE MARK
PRINCIPAL REGISTER**



CALIFORNIA CATALOG & TECHNOLOGY (CALIFORNIA CORPORATION)
1106 E. TURNER RD., STE. A
LODI, CA 95240

FOR: TELECOMMUNICATIONS SERVICES INCLUDING VOICE, DATA AND INTERNET, NAMELY, TELEPHONE COMMUNICATIONS, CELLULAR PHONE SERVICES, CELLULAR TELEPHONE SERVICES, PAGING SERVICES, TELECOMMUNICATION CONNECTIONS TO A GLOBAL COMPUTER NETWORK, IN CLASS 38 (U.S. CLS. 100, 101 AND 104).

FIRST USE 12-1-2006; IN COMMERCE 12-1-2006.

NO CLAIM IS MADE TO THE EXCLUSIVE RIGHT TO USE "TELECOMM VOICE DATA INTERNET", APART FROM THE MARK AS SHOWN.

THE COLOR(S) DARK BLUE, LIGHT BLUE AND WHITE IS/ARE CLAIMED AS A FEATURE OF THE MARK.

THE DARK BLUE APPEARS IN THE UPPER BARS AND LOWER PART OF THE CIRCLE OF THE DESIGN AND IN THE LETTERING FOR "CCT" AND "VOICE DATA INTERNET", LIGHT BLUE IN THE LETTERING FOR "TELECOMM" AND THE LOWER BARS OF THE DESIGN AND WHITE IN THE MIDDLE PORTION OF THE DESIGN CIRCLE.

SN 76-671,734, FILED 1-24-2007.

BENJAMIN OKEKE, EXAMINING ATTORNEY

Int. Cl.: 39

Prior U.S. Cls.: 100 and 105

United States Patent and Trademark Office

Reg. No. 3,576,615

Registered Feb. 17, 2009

SERVICE MARK
PRINCIPAL REGISTER



SECUREDOCK, LLC (CALIFORNIA LIMITED
LIABILITY COMPANY)
5450 TRABUCO ROAD
IRVINE, CA 92620

FOR: INTERNET BASED ELECTRONIC DATA
STORAGE FOR SECURE DOCUMENT AND DATA
RETENTION BY USERS FOR ULTIMATE RETRIE-

VAL BY THE USER, IN CLASS 39 (U.S. CLS. 100 AND
105).

FIRST USE 11-1-2008; IN COMMERCE 11-1-2008.

SN 76-671,840, FILED 1-26-2007.

CHARLOTTE CORWIN, EXAMINING ATTORNEY

Int. Cl.: 25

Prior U.S. Cls.: 22 and 39

United States Patent and Trademark Office

Reg. No. 3,576,616

Registered Feb. 17, 2009

TRADEMARK
PRINCIPAL REGISTER



HARRELL, LYSA SERENITY (UNITED STATES
INDIVIDUAL)
2695 SW 183 AVENUE
MIRAMAR, FL 33029

FOR: CLOTHING, NAMELY, JERSEYS, UNIFORMS, ATHLETIC UNIFORMS, PANTS, CYCLE PANTS, TROUSERS, SLACKS, JEANS, DENIM JEANS, OVERALLS, COVERALLS, ROMPERS, JUMPERS, JUMP SUITS, SHORTS, BOXER SHORTS, SHIRTS, T-SHIRTS, UNDER SHIRTS, NIGHT SHIRTS, RUGBY SHIRTS, POLO SHIRTS, TOPS, CROP TOPS, TANK TOPS, HALTER TOPS, SWEAT SHIRTS, SWEAT SHORTS, SWEAT PANTS, WARM-UP SUITS, JOGGING SUITS, BLOUSES, SKIRTS, DRESSES, SWEATERS, VESTS, FLEECE VESTS, PULLOVERS, FLEECE PULLOVERS, SNOW SUITS, PARKAS, ANORAKS, PONCHOS, JACKETS, DINNER JACKETS, SPORTS JACKETS, GOLF AND SKI JACKETS, REVERSIBLE JACKETS, COATS, BLAZERS, SUITS, TURTLENECKS, SWIMWEAR, BEACHWEAR, CAPS, BERETS, HATS, HEADBANDS, WRIST BANDS, HEAD WEAR, EAR

MUFFS, APRONS, SCARVES, BANDANAS, BELTS, SUSPENDERS, NECKWEAR, NECKTIES, TIES, BOW TIES, CLOTH BIBS, NAMELY, SKI BIBS AND CLOTH BABY BIBS, CLOTH DIAPERS, BOOTIES, INFANTWEAR, UNDERWEAR, BRIEFS, TRUNKS, BRAS, SPORTS BRAS, SINGLETS, SOCKS, LOUNGEWEAR, ROBES, BATHROBES, PAJAMAS, SLEEPWEAR, NIGHT GOWNS, LINGERIE, CAMISOLES, SLIPS, STOCKINGS, BODY STOCKINGS, PANTYHOSE, HOSIERY, KNIT HOSIERY, LEG WARMERS, BODY SUITS, LEGGINGS, TIGHTS, LEOTARDS, UNITARDS, GLOVES, MITTENS, FOOTWEAR, SHOES, SNEAKERS, BOOTS, GALOSHES, SANDALS, ZORI, SLIPPERS, IN CLASS 25 (U.S. CLS. 22 AND 39).

FIRST USE 6-19-2007; IN COMMERCE 6-19-2007.

SN 76-672,583, FILED 2-12-2007.

BENJAMIN OKEKE, EXAMINING ATTORNEY

Int. Cls.: 9, 35, and 42

Prior U.S. Cls.: 21, 23, 26, 36, 38, 100, 101, and 102

United States Patent and Trademark Office

Reg. No. 3,576,617

Registered Feb. 17, 2009

**TRADEMARK
SERVICE MARK
PRINCIPAL REGISTER**

EQUATERRA

EQUATERRA, INC. (DELAWARE CORPORATION)
4800 WHITESBURG DR. #30, P.M.B. #342
HUNTSVILLE, AL 358021600

FOR: COMPUTER SOFTWARE FOR USE BY COMPANIES IN EVALUATING AND MANAGING INTERNAL SUPPORT FUNCTIONS AND OUTSOURCED SERVICES, NAMELY, IN THE AREAS OF FINANCIAL MANAGEMENT, FINANCIAL ACCOUNTING, ISSUE MANAGEMENT, CONTRACT MANAGEMENT, PERFORMANCE MANAGEMENT, COMPLIANCE MANAGEMENT, INFORMATION TECHNOLOGY, PROCUREMENT, ADMINISTRATIVE TASKS, HUMAN RESOURCES, AND RELATIONSHIP MANAGEMENT, IN CLASS 9 (U.S. CLS. 21, 23, 26, 36 AND 38).

FIRST USE 4-1-2000; IN COMMERCE 4-1-2000.

FOR: BUSINESS CONSULTATION IN THE FIELD OF STRATEGIC, CROSS ENTERPRISE OUTSOURCING, AND SHARED SERVICE ADVICE, IN CLASS 35 (U.S. CLS. 100, 101 AND 102).

FIRST USE 3-0-2003; IN COMMERCE 3-0-2003.

FOR: INFORMATION TECHNOLOGY CONSULTATION, COMPUTER SOFTWARE CONSULTATION; PROVIDING TEMPORARY USE OF ONLINE NON-DOWNLOADABLE COMPUTER SOFTWARE FOR USE BY COMPANIES IN EVALUATING AND MANAGING INTERNAL SUPPORT FUNCTIONS AND OUTSOURCED SERVICES, NAMELY, IN THE AREAS OF FINANCIAL MANAGEMENT, FINANCIAL ACCOUNTING, ISSUE MANAGEMENT, CONTRACT MANAGEMENT, PERFORMANCE MANAGEMENT, COMPLIANCE MANAGEMENT, INFORMATION TECHNOLOGY, PROCUREMENT, ADMINISTRATIVE TASKS, HUMAN RESOURCES, AND RELATIONSHIP MANAGEMENT, IN CLASS 42 (U.S. CLS. 100 AND 101).

FIRST USE 3-0-2003; IN COMMERCE 3-0-2003.

THE MARK CONSISTS OF STANDARD CHARACTERS WITHOUT CLAIM TO ANY PARTICULAR FONT, STYLE, SIZE, OR COLOR.

SN 76-672,729, FILED 2-15-2007.

ROSELLE HERRERA, EXAMINING ATTORNEY

Int. Cl.: 37

Prior U.S. Cls.: 100, 103, and 106

United States Patent and Trademark Office

Reg. No. 3,576,618

Registered Feb. 17, 2009

**SERVICE MARK
PRINCIPAL REGISTER**



CARRINGTON COMMUNITIES LC (VIRGINIA
LIMITED LIABILITY COMPANY)
8614 WESTWOOD CTR. DR.
SUITE 900
VIENNA, VA 22182

FOR: HOUSING SERVICES, NAMELY, RESIDEN-
TIAL BUILDING CONSTRUCTION TO DEVELOP

REAL PROPERTY, IN CLASS 37 (U.S. CLS. 100, 103
AND 106).

FIRST USE 6-3-2007; IN COMMERCE 6-3-2007.

SN 76-674,254, FILED 3-19-2007.

DAVID TAYLOR, EXAMINING ATTORNEY

Int. Cl.: 9

Prior U.S. Cls.: 21, 23, 26, 36, and 38

Reg. No. 3,576,619

United States Patent and Trademark Office

Registered Feb. 17, 2009

**TRADEMARK
PRINCIPAL REGISTER**

E-FORCE

MAGNETEK, INC. (DELAWARE CORPORATION)
N49 W13650 CAMPBELL DRIVE
MENOMONEE FALLS, WI 53051

THE MARK CONSISTS OF STANDARD CHARACTERS WITHOUT CLAIM TO ANY PARTICULAR FONT, STYLE, SIZE, OR COLOR.

FOR: POWER CONVERTERS AND INVERTERS,
IN CLASS 9 (U.S. CLS. 21, 23, 26, 36 AND 38).

SN 76-675,648, FILED 4-18-2007.

FIRST USE 9-25-2007; IN COMMERCE 9-25-2007.

TOBY BULLOFF, EXAMINING ATTORNEY

Int. Cl.: 7

Prior U.S. Cls.: 13, 19, 21, 23, 31, 34, and 35

Reg. No. 3,576,620

United States Patent and Trademark Office

Registered Feb. 17, 2009

**TRADEMARK
PRINCIPAL REGISTER**

L3510

NOVELLUS SYSTEMS, INC. (CALIFORNIA CORPORATION)
4000 NORTH FIRST STREET
SAN JOSE, CA 951341568

FOR: MACHINES FOR REMOVING LIGHT-SENSITIVE ORGANIC POLYMERS FROM SEMICONDUCTOR CHIPS DURING THE MANUFACTURE OF SAID CHIPS, AND PARTS FOR SUCH MACHINES, IN CLASS 7 (U.S. CLS. 13, 19, 21, 23, 31, 34 AND 35).

FIRST USE 0-0-1989; IN COMMERCE 0-0-1989.

THE MARK CONSISTS OF STANDARD CHARACTERS WITHOUT CLAIM TO ANY PARTICULAR FONT, STYLE, SIZE, OR COLOR.

SN 76-675,766, FILED 4-20-2007.

WILLIAM BRECKENFELD, EXAMINING ATTORNEY

Int. Cl.: 20

Prior U.S. Cls.: 2, 13, 22, 25, 32, and 50

United States Patent and Trademark Office

Reg. No. 3,576,621

Registered Feb. 17, 2009

**TRADEMARK
PRINCIPAL REGISTER**

FLAPMATE

WEATHERCHEM CORPORATION (OHIO CORPORATION)
2222 HIGHLAND ROAD
TWINSBURG, OH 44087

FOR: NON-METAL END CLOSURES FOR DISPENSING CONTAINERS, IN CLASS 20 (U.S. CLS. 2, 13, 22, 25, 32 AND 50).

FIRST USE 5-18-2007; IN COMMERCE 5-18-2007.

THE MARK CONSISTS OF STANDARD CHARACTERS WITHOUT CLAIM TO ANY PARTICULAR FONT, STYLE, SIZE, OR COLOR.

OWNER OF U.S. REG. NOS. 2,744,393 AND 3,009,299.

SN 76-676,254, FILED 4-30-2007.

ESTHER BELENKER, EXAMINING ATTORNEY

Int. Cl.: 36

Prior U.S. Cls.: 100, 101, and 102

United States Patent and Trademark Office

Reg. No. 3,576,622

Registered Feb. 17, 2009

**SERVICE MARK
PRINCIPAL REGISTER**

PLUS RELOCATION MORTGAGE

PLUS RELOCATION SERVICES, INC. (MINNE-
SOTA CORPORATION)
600 HWY 169 SOUTH, SUITE 550
MINNEAPOLIS, MN 55426

FOR: MORTGAGES SERVICES, NAMELY, LEND-
ING, BANKING AND BROKERAGE OF RESIDEN-
TIAL MORTGAGES ON BEHALF OF OTHERS AND
FOR RELOCATING BUSINESSES, EMPLOYERS,
EMPLOYEES AND INDIVIDUALS, IN CLASS 36
(U.S. CLS. 100, 101 AND 102).

FIRST USE 7-1-2008; IN COMMERCE 7-1-2008.

NO CLAIM IS MADE TO THE EXCLUSIVE
RIGHT TO USE "RELOCATION MORTGAGE",
APART FROM THE MARK AS SHOWN.

SN 76-676,585, FILED 5-9-2007.

RONALD AIKENS, EXAMINING ATTORNEY

Int. Cl.: 9

Prior U.S. Cls.: 21, 23, 26, 36, and 38

United States Patent and Trademark Office

Reg. No. 3,576,623

Registered Feb. 17, 2009

**TRADEMARK
PRINCIPAL REGISTER**



CETECH CO., LTD. (TAIWAN CORPORATION)
1F, NO. 313, DAYA ROAD, DAYA SHIANG
TAICHUNG COUNTY, TAIWAN 428

FOR: ELECTRODES; CARBON ELECTRODES;
FUEL CELLS; CARBON CLOTH AND CARBON
PAPER WITH GAS DIFFUSION LAYER FUNC-
TIONALITY FOR USE AS ELECTRODES AND IN
FUEL CELLS , IN CLASS 9 (U.S. CLS. 21, 23, 26, 36
AND 38).

FIRST USE 2-7-2007; IN COMMERCE 1-30-2008.

"CE" OR "CETECH" APPEARING IN THE MARK
HAS NO MEANING IN A FOREIGN LANGUAGE

SN 76-676,889, FILED 5-15-2007.

KALIE KUNG, EXAMINING ATTORNEY

Int. Cl.: 10

Prior U.S. Cls.: 26, 39, and 44

United States Patent and Trademark Office

Reg. No. 3,576,624

Registered Feb. 17, 2009

**TRADEMARK
PRINCIPAL REGISTER**

GRAFTMAKER

MUSCULOSKELETAL TRANSPLANT FOUNDATION (D.C. NON-PROFIT CORPORATION)
EDISON CORPORATE CENTER
SUITE 300, 125 MAY STREET
EDISON, NJ 08837

THE MARK CONSISTS OF STANDARD CHARACTERS WITHOUT CLAIM TO ANY PARTICULAR FONT, STYLE, SIZE, OR COLOR.

FOR: SURGICAL SAWS, NAMELY, CORE SAWS,
IN CLASS 10 (U.S. CLS. 26, 39 AND 44).

SN 76-677,107, FILED 5-18-2007.

FIRST USE 2-23-2007; IN COMMERCE 2-23-2007.

GINA HAYES, EXAMINING ATTORNEY

Int. Cl.: 11

Prior U.S. Cls.: 13, 21, 23, 31, and 34

United States Patent and Trademark Office

Reg. No. 3,576,625

Registered Feb. 17, 2009

**TRADEMARK
PRINCIPAL REGISTER**

RESPA

THE SY-KLONE COMPANY (FLORIDA CORPORATION)
6593 POWERS AVENUE, SUITE 17
JACKSONVILLE, FL 322172853

FOR: HEATING, VENTILATION AND AIR CONDITIONING (HVAC) AIR FILTRATION SYSTEMS WITH HIGH EFFICIENCY/HIGH CAPACITY AIR FILTRATION FOR OFF-HIGHWAY MACHINERY AND BUILDINGS, TEMPORARY AND PERMANENT, COMPRISED OF AIR FILTERS, BLOWERS, CONTROL MODULES, AIR PRECLEANERS, AND ASSOCIATED HOSES, FITTINGS, BRACKETS AND

MOUNTS, IN CLASS 11 (U.S. CLS. 13, 21, 23, 31 AND 34).

FIRST USE 4-0-2007; IN COMMERCE 4-0-2007.

THE MARK CONSISTS OF STANDARD CHARACTERS WITHOUT CLAIM TO ANY PARTICULAR FONT, STYLE, SIZE, OR COLOR.

SN 76-677,278, FILED 5-22-2007.

FLORENTINA BLANDU, EXAMINING ATTORNEY

Int. Cl.: 7

Prior U.S. Cls.: 13, 19, 21, 23, 31, 34, and 35

Reg. No. 3,576,626

United States Patent and Trademark Office

Registered Feb. 17, 2009

**TRADEMARK
PRINCIPAL REGISTER**

T-WREX

HAWK INDUSTRIES, INC. (CALIFORNIA CORPORATION)
1245 EAST 23RD STREET
SIGNAL HILL, CA 90755

FIRST USE 5-0-2007; IN COMMERCE 5-0-2007.

FOR: MAKE-UP BREAK-OUT SYSTEM, NAME-
LY, A POWER OPERATED HYDRAULIC PIPE
WRENCH AND SPINNER FOR TURNING OIL
WELL PIPE ABOUT ITS LONGITUDINAL AXIS
FOR MAKING AND BREAKING EXISTING JOINTS
IN SECTIONS OF THE PIPE, IN CLASS 7 (U.S. CLS.
13, 19, 21, 23, 31, 34 AND 35).

THE MARK CONSISTS OF STANDARD CHAR-
ACTERS WITHOUT CLAIM TO ANY PARTICULAR
FONT, STYLE, SIZE, OR COLOR.

SN 76-677,395, FILED 5-25-2007.

JESSICA A. POWERS, EXAMINING ATTORNEY

Int. Cl.: 43

Prior U.S. Cls.: 100 and 101

United States Patent and Trademark Office

Reg. No. 3,576,627

Registered Feb. 17, 2009

**SERVICE MARK
PRINCIPAL REGISTER**

L'YBANE

AL-RINEH, KAMAL (FRANCE INDIVIDUAL)
1 RUE DE LA LIBERTÉ
06000 NICE, FRANCE

THE MARK CONSISTS OF STANDARD CHAR-
ACTERS WITHOUT CLAIM TO ANY PARTICULAR
FONT, STYLE, SIZE, OR COLOR.

FOR: RESTAURANT AND BAR SERVICES;
TAKE-OUT RESTAURANT AND BAR SERVICES;
CATERING OF FOOD AND BEVERAGES, IN CLASS
43 (U.S. CLS. 100 AND 101).

SN 76-678,082, FILED 6-11-2007.

FIRST USE 6-1-2004; IN COMMERCE 10-1-2008.

SUSAN RICHARDS, EXAMINING ATTORNEY

Int. Cl.: 41

Prior U.S. Cls.: 100, 101, and 107

United States Patent and Trademark Office

Reg. No. 3,576,628

Registered Feb. 17, 2009

**SERVICE MARK
PRINCIPAL REGISTER**

BLACK FACES IN HIGH PLACES

RADIO ONE, INC. (DELAWARE CORPORATION)
5900 PRINCESS GARDEN PARKWAY - 7TH FLOOR
LANHAM, MD 20706

FOR: PRODUCTION AND DISTRIBUTION OF RADIO PROGRAMS; ORGANIZING AND CONDUCTING EDUCATIONAL EXHIBITIONS FEATURING PROMINENT AFRICAN AMERICANS; EDUCATIONAL AND ENTERTAINMENT SERVICES FEATURING MOTIVATIONAL AND EDUCATIONAL SPEAKERS, IN CLASS 41 (U.S. CLS. 100, 101 AND 107).

FIRST USE 12-0-2005; IN COMMERCE 12-0-2005.

THE MARK CONSISTS OF STANDARD CHARACTERS WITHOUT CLAIM TO ANY PARTICULAR FONT, STYLE, SIZE, OR COLOR.

SN 76-678,613, FILED 6-22-2007.

DAVID MURRAY, EXAMINING ATTORNEY

Int. Cl.: 43

Prior U.S. Cls.: 100 and 101

United States Patent and Trademark Office

Reg. No. 3,576,629

Registered Feb. 17, 2009

**SERVICE MARK
PRINCIPAL REGISTER**

CAFE VENTANA

NINKASI, LLC (MISSOURI LIMITED LIABILITY
COMPANY)
5203 CHIPPEWA, SUITE 301
ST. LOUIS, MO 63109

FOR: CAFÉ SERVICES FEATURING BEIGNETS
AND COFFEE, IN CLASS 43 (U.S. CLS. 100 AND 101).

FIRST USE 7-7-2005; IN COMMERCE 7-24-2008.

THE MARK CONSISTS OF STANDARD CHAR-
ACTERS WITHOUT CLAIM TO ANY PARTICULAR
FONT, STYLE, SIZE, OR COLOR.

NO CLAIM IS MADE TO THE EXCLUSIVE
RIGHT TO USE "CAFE", APART FROM THE MARK
AS SHOWN.

THE ENGLISH TRANSLATION OF THE WORD
"VENTANA" IN THE MARK IS WINDOW.

SN 76-678,838, FILED 6-28-2007.

DARRYL SPRUILL, EXAMINING ATTORNEY

Int. Cl.: 7

Prior U.S. Cls.: 13, 19, 21, 23, 31, 34, and 35

Reg. No. 3,576,630

United States Patent and Trademark Office

Registered Feb. 17, 2009

**TRADEMARK
PRINCIPAL REGISTER**

PAPERSHOOTER

STOROPACK, INC. (DELAWARE CORPORATION)
4758 DEVITT DRIVE
CINCINNATI, OH 45246

THE MARK CONSISTS OF STANDARD CHARACTERS WITHOUT CLAIM TO ANY PARTICULAR FONT, STYLE, SIZE, OR COLOR.

FOR: MACHINE FOR PRODUCING CRUMPLED PAPER FOR USE AS A PACKAGING MATERIAL, IN CLASS 7 (U.S. CLS. 13, 19, 21, 23, 31, 34 AND 35).

SN 76-679,077, FILED 7-5-2007.

FIRST USE 3-0-2007; IN COMMERCE 3-0-2007.

BENJAMIN OKEKE, EXAMINING ATTORNEY

Int. Cl.: 35

Prior U.S. Cls.: 100, 101, and 102

United States Patent and Trademark Office

Reg. No. 3,576,631

Registered Feb. 17, 2009

**SERVICE MARK
PRINCIPAL REGISTER**

ECOVATIVE

ECOVATIVE, LLC (CALIFORNIA LIMITED LIABILITY COMPANY)
2245 S. BEVERLY GLEN BOULEVARD, #306
LOS ANGELES, CA 90064

FOR: ONLINE RETAIL STORE SERVICES FEATURING CHILDREN'S TOYS, CHILDREN'S APPAREL, CHILDREN FASHION ACCESSORIES, PET TOYS, PET APPAREL, PET ACCESSORIES, PET SUPPLIES, BED AND BATH HOME FURNISHINGS, AND GREEN AND ECO-FRIENDLY PRODUCTS, IN CLASS 35 (U.S. CLS. 100, 101 AND 102).

FIRST USE 7-30-2007; IN COMMERCE 5-1-2008.

THE MARK CONSISTS OF STANDARD CHARACTERS WITHOUT CLAIM TO ANY PARTICULAR FONT, STYLE, SIZE, OR COLOR.

SN 76-679,421, FILED 7-12-2007.

KATHLEEN LORENZO, EXAMINING ATTORNEY

Int. Cl.: 25

Prior U.S. Cls.: 22 and 39

United States Patent and Trademark Office

Reg. No. 3,576,632

Registered Feb. 17, 2009

TRADEMARK
PRINCIPAL REGISTER



futur**g**eneration

LATTIMORE, KEVIN (UNITED STATES INDIVIDUAL)

702 GREENWILLOW PL

LANDOVER, MD 20785 AND

LATTIMORE, NIKKI (UNITED STATES INDIVIDUAL)

702 GREENWILLOW PL

LANDOVER, MD 20785

FOR: CLOTHING FOR KIDS AND ADULTS, NAMELY, PANTS, SHIRTS JACKETS AND HATS, IN CLASS 25 (U.S. CLS. 22 AND 39).

FIRST USE 11-6-2007; IN COMMERCE 11-6-2007.

THE COLOR(S) BLACK, WHITE AND RED IS/ARE CLAIMED AS A FEATURE OF THE MARK.

THE MARK CONSIST OF A CIRCLE WITH FG IN THE CENTER, WITH A WING DESIGN ON EACH SIDE OF THE CIRCLE AND A CROWN ON TOP OF THE CIRCLE WITH A DIAMOND DESIGN IN THE CENTER AND THE WORD FUTURE GENERATION WITH THE LETTER "E" AND "G" OVERLAPPING UNDERNEATH.

SN 76-679,619, FILED 7-18-2007.

STEPHANIE ALI, EXAMINING ATTORNEY

Int. Cl.: 16

Prior U.S. Cls.: 2, 5, 22, 23, 29, 37, 38, and 50

United States Patent and Trademark Office

Reg. No. 3,576,633

Registered Feb. 17, 2009

**TRADEMARK
PRINCIPAL REGISTER**

ROMANCE FOR GOOD

THOMAS NELSON, INC. (TENNESSEE CORPORATION)

P.O. BOX 141000

NASHVILLE, TN 372141000

FOR: A SERIES OF BOOKS FEATURING FICTION, IN CLASS 16 (U.S. CLS. 2, 5, 22, 23, 29, 37, 38 AND 50).

FIRST USE 11-1-2007; IN COMMERCE 11-1-2007.

THE MARK CONSISTS OF STANDARD CHARACTERS WITHOUT CLAIM TO ANY PARTICULAR FONT, STYLE, SIZE, OR COLOR.

NO CLAIM IS MADE TO THE EXCLUSIVE RIGHT TO USE "ROMANCE", APART FROM THE MARK AS SHOWN.

SN 76-680,594, FILED 8-13-2007.

TRACY WHITTAKER-BROWN, EXAMINING ATTORNEY

Int. Cl.: 7

Prior U.S. Cls.: 13, 19, 21, 23, 31, 34, and 35

United States Patent and Trademark Office

Reg. No. 3,576,634

Registered Feb. 17, 2009

**TRADEMARK
PRINCIPAL REGISTER**

ARCTICPRO

RTI TECHNOLOGIES, INC. (PENNSYLVANIA
CORPORATION)
10 INNOVATION DRIVE- BOX 3099
YORK, PA 17402

FOR: FLUID HANDLING MACHINES IN THE
NATURE OF AIR CONDITIONING SERVICING
EQUIPMENT USED TO RECOVER, RECYCLE
AND CHARGE REFRIGERANT , IN CLASS 7 (U.S.
CLS. 13, 19, 21, 23, 31, 34 AND 35).

FIRST USE 10-31-2007; IN COMMERCE 10-31-2007.

THE MARK CONSISTS OF STANDARD CHAR-
ACTERS WITHOUT CLAIM TO ANY PARTICULAR
FONT, STYLE, SIZE, OR COLOR.

SN 76-680,970, FILED 8-21-2007.

BONNIE LUKEN, EXAMINING ATTORNEY

Int. Cl.: 19

Prior U.S. Cls.: 1, 12, 33, and 50

United States Patent and Trademark Office

Reg. No. 3,576,635

Registered Feb. 17, 2009

**TRADEMARK
PRINCIPAL REGISTER**

CASITABLANCA

ANDERSON HARDWOOD FLOORS, INC.
(GEORGIA CORPORATION)
616 EAST WALNUT AVENUE, P.O. DRAWER 2128
DALTON, GA 307222128

FOR: WOOD FLOORING, IN CLASS 19 (U.S. CLS.
1, 12, 33 AND 50).

FIRST USE 9-14-2007; IN COMMERCE 9-14-2007.

THE MARK CONSISTS OF STANDARD CHAR-
ACTERS WITHOUT CLAIM TO ANY PARTICULAR
FONT, STYLE, SIZE, OR COLOR.

THE ENGLISH TRANSLATION OF "CASITA
BLANCA" IS SMALL WHITE HOUSE.

SN 76-680,996, FILED 8-22-2007.

LINDA LAVACHE, EXAMINING ATTORNEY

Int. Cl.: 9

Prior U.S. Cls.: 21, 23, 26, 36, and 38

United States Patent and Trademark Office

Reg. No. 3,576,636

Registered Feb. 17, 2009

**TRADEMARK
PRINCIPAL REGISTER**

NEXT GENERATION RANGEFINDER

SKYHAWKE TECHNOLOGIES, LLC (MISSISSIPPI LIMITED LIABILITY COMPANY)
274 COMMERCE PARK DRIVE, SUITE M
RIDGELAND, MS 39157

FOR: ELECTRONIC SATELLITE TRACKING AND INFORMATION SYSTEM COMPRISING COMPUTER HARDWARE AND COMPUTER SOFTWARE USED TO DETERMINE DISTANCES ON GOLF COURSES AND FOR ACCESSING RELEVANT DATA AND STATISTICS PERTINENT THERETO, IN CLASS 9 (U.S. CLS. 21, 23, 26, 36 AND 38).

FIRST USE 9-0-2007; IN COMMERCE 9-0-2007.

THE MARK CONSISTS OF STANDARD CHARACTERS WITHOUT CLAIM TO ANY PARTICULAR FONT, STYLE, SIZE, OR COLOR.

NO CLAIM IS MADE TO THE EXCLUSIVE RIGHT TO USE "RANGEFINDER", APART FROM THE MARK AS SHOWN.

SN 76-681,128, FILED 8-24-2007.

AMY C. KEAN, EXAMINING ATTORNEY

Int. Cls.: 18 and 25

Prior U.S. Cls.: 1, 2, 3, 22, 39, and 41

United States Patent and Trademark Office

Reg. No. 3,576,637

Registered Feb. 17, 2009

**TRADEMARK
PRINCIPAL REGISTER**



PACIFIC RESOURCES TRADING CO., LTD. (CALIFORNIA CORPORATION)
3033 WEST MISSION ROAD
ALHAMBRA, CA 91803

FOR: BAGS, NAMELY, ALL-PURPOSE CARRYING BAGS, IN CLASS 18 (U.S. CLS. 1, 2, 3, 22 AND 41).

FIRST USE 4-30-2008; IN COMMERCE 10-30-2008.

FOR: GARMENTS, NAMELY, T-SHIRTS, JACKETS, GLOVES, ATHLETIC CLOTHING, NAMELY, T-SHIRTS, PANTS, SHORTS, CAPS, VISORS, SOCKS,

SWEAT BANDS, SWEAT JACKETS, SWEAT PANTS, SWEAT SHIRTS, SWEAT SHORTS, SWEAT SUITS, AND HATS, IN CLASS 25 (U.S. CLS. 22 AND 39).

FIRST USE 4-30-2008; IN COMMERCE 10-30-2008.

THE MARK CONSISTS OF DRAWING OF A LADY DOING EXERCISE.

SN 76-681,326, FILED 8-30-2007.

BARBARA RUTLAND, EXAMINING ATTORNEY

Int. Cl.: 19

Prior U.S. Cls.: 1, 12, 33, and 50

United States Patent and Trademark Office

Reg. No. 3,576,638

Registered Feb. 17, 2009

**TRADEMARK
PRINCIPAL REGISTER**

ACOUSTIGREEN

INTEGRATED MOLECULAR MATERIAL SCI-
ENCE, LLC (MINNESOTA LIMITED LIABIL-
ITY COMPANY)
751 - 7TH STREET SO.
DELANO, MN 55328

FOR: NON-METAL ACOUSTICAL CEILING AND
WALL PANELS, IN CLASS 19 (U.S. CLS. 1, 12, 33 AND
50).

FIRST USE 5-8-2008; IN COMMERCE 5-8-2008.

THE MARK CONSISTS OF STANDARD CHAR-
ACTERS WITHOUT CLAIM TO ANY PARTICULAR
FONT, STYLE, SIZE, OR COLOR.

SN 76-681,393, FILED 8-31-2007.

DOMINIC J. FERRAIUOLO, EXAMINING ATTOR-
NEY

Int. Cl.: 19

Prior U.S. Cls.: 1, 12, 33, and 50

United States Patent and Trademark Office

Reg. No. 3,576,639

Registered Feb. 17, 2009

**TRADEMARK
PRINCIPAL REGISTER**

ORGANTEX

INTEGRATED MOLECULAR MATERIAL SCI-
ENCE, LLC (MINNESOTA LIMITED LIABIL-
ITY COMPANY)
751 - 7TH STREET SO.
DELANO, MN 55328

FOR: NON-METAL ACOUSTICAL CEILING AND
WALL PANELS, IN CLASS 19 (U.S. CLS. 1, 12, 33 AND
50).

FIRST USE 8-21-2008; IN COMMERCE 8-21-2008.

THE MARK CONSISTS OF STANDARD CHAR-
ACTERS WITHOUT CLAIM TO ANY PARTICULAR
FONT, STYLE, SIZE, OR COLOR.

SN 76-681,395, FILED 8-31-2007.

DOMINIC J. FERRAIUOLO, EXAMINING ATTOR-
NEY

Int. Cl.: 25

Prior U.S. Cls.: 22 and 39

United States Patent and Trademark Office

Reg. No. 3,576,640

Registered Feb. 17, 2009

**TRADEMARK
PRINCIPAL REGISTER**

DMIF

FLOOD, DENNIS M. (UNITED STATES INDIVIDUAL)
8 VAN CEDAR STREET
BRENTWOOD, NY 11717

FOR: PADDED HOCKEY PANTS, IN CLASS 25
(U.S. CLS. 22 AND 39).

FIRST USE 5-28-2008; IN COMMERCE 5-28-2008.

THE MARK CONSISTS OF STANDARD CHARACTERS WITHOUT CLAIM TO ANY PARTICULAR FONT, STYLE, SIZE, OR COLOR.

SN 76-681,596, FILED 9-7-2007.

CHRISTOPHER BUONGIORNO, EXAMINING ATTORNEY

Int. Cl.: 42

Prior U.S. Cls.: 100 and 101

United States Patent and Trademark Office

Reg. No. 3,576,641

Registered Feb. 17, 2009

**SERVICE MARK
PRINCIPAL REGISTER**

CELERITY

CELERITY IT (VIRGINIA LIMITED LIABILITY
COMPANY)
SUITE 500
8401 GREENSBORO DRIVE
MCLEAN, VA 22102

FOR: COMPUTER CONSULTING SERVICES IN
THE FIELD OF PROGRAMMING, ANALYSIS, DE-
SIGN AND IMPLEMENTATION; RESEARCH AND
DEVELOPMENT FOR NEW INFORMATION TECH-
NOLOGY PRODUCTS FOR OTHERS IN THE FIELD
OF INFORMATION TECHNOLOGY, IN CLASS 42
(U.S. CLS. 100 AND 101).

FIRST USE 3-15-2007; IN COMMERCE 3-15-2007.

THE MARK CONSISTS OF STANDARD CHAR-
ACTERS WITHOUT CLAIM TO ANY PARTICULAR
FONT, STYLE, SIZE, OR COLOR.

OWNER OF U.S. REG. NO. 2,977,596.

SN 76-681,975, FILED 9-17-2007.

KARANENDRA S. CHHINA, EXAMINING ATTOR-
NEY

Int. Cl.: 36

Prior U.S. Cls.: 100, 101, and 102

United States Patent and Trademark Office

Reg. No. 3,576,642

Registered Feb. 17, 2009

**SERVICE MARK
PRINCIPAL REGISTER**



GREAT EAST PROPERTIES HOLDINGS, LLC
(NEW HAMPSHIRE LIMITED LIABILITY
COMPANY)
69A ISLAND STREET, SUITE 3
KEENE, NH 03431

FOR: COMMERCIAL, INDUSTRIAL AND RESI-
DENTIAL REAL ESTATE BROKERAGE AND LIST-
ING SERVICE; REAL ESTATE LEASING; REAL
ESTATE AGENCY SERVICES FOR BUYERS AND

SELLERS; REAL ESTATE PROPERTY MANAGE-
MENT; INSURANCE BROKERAGE SERVICES, IN
CLASS 36 (U.S. CLS. 100, 101 AND 102).

FIRST USE 12-31-2007; IN COMMERCE 12-31-2007.

SN 76-682,768, FILED 10-10-2007.

BARBARA BROWN, EXAMINING ATTORNEY

Int. Cl.: 36

Prior U.S. Cls.: 100, 101, and 102

United States Patent and Trademark Office

Reg. No. 3,576,643

Registered Feb. 17, 2009

**SERVICE MARK
PRINCIPAL REGISTER**



THE MASIELLO GROUP

GREAT EAST PROPERTIES HOLDINGS, LLC
(NEW HAMPSHIRE LIMITED LIABILITY
COMPANY)
69A ISLAND STREET, SUITE 3
KEENE, NH 03431

FOR: COMMERCIAL, INDUSTRIAL AND RESI-
DENTIAL REAL ESTATE BROKERAGE AND LIST-
ING SERVICE; REAL ESTATE LEASING; REAL
ESTATE AGENCY SERVICES FOR BUYERS AND
SELLERS, IN CLASS 36 (U.S. CLS. 100, 101 AND 102).

FIRST USE 12-31-2007; IN COMMERCE 12-31-2007.

NO CLAIM IS MADE TO THE EXCLUSIVE
RIGHT TO USE "GROUP", APART FROM THE
MARK AS SHOWN.

SN 76-682,769, FILED 10-10-2007.

BARBARA BROWN, EXAMINING ATTORNEY

Int. Cl.: 36

Prior U.S. Cls.: 100, 101, and 102

United States Patent and Trademark Office

Reg. No. 3,576,644

Registered Feb. 17, 2009

**SERVICE MARK
PRINCIPAL REGISTER**

Funding For Life

ENTRE GLOBAL SERVICES, INC. (DELAWARE CORPORATION)
5 GREAT VALLEY PARKWAY, SUITE 318
MALVERN, PA 19355

FOR: LOAN AND FINANCIAL SERVICES, NAMELY, A BANK LOAN PROGRAM FOR OWNERS OF CERTAIN LIFE INSURANCE POLICIES, IN CLASS 36 (U.S. CLS. 100, 101 AND 102).

FIRST USE 6-4-2008; IN COMMERCE 6-4-2008.

THE MARK CONSISTS OF STANDARD CHARACTERS WITHOUT CLAIM TO ANY PARTICULAR FONT, STYLE, SIZE, OR COLOR.

NO CLAIM IS MADE TO THE EXCLUSIVE RIGHT TO USE "FUNDING", APART FROM THE MARK AS SHOWN.

SN 76-683,462, FILED 10-30-2007.

DAVID MURRAY, EXAMINING ATTORNEY

Int. Cl.: 35

Prior U.S. Cls.: 100, 101, and 102

United States Patent and Trademark Office

Reg. No. 3,576,645

Registered Feb. 17, 2009

**SERVICE MARK
PRINCIPAL REGISTER**

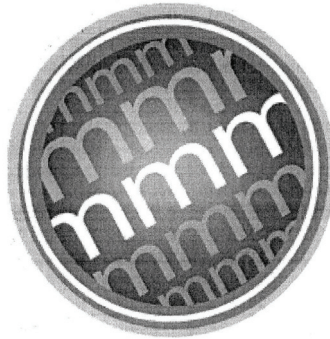

PLACE MINISTRIES (GEORGIA CORPORATION)
4125 OLD MILTON PARKWAY
ALPHARETTA, GA 30005

FIRST USE 5-15-2007; IN COMMERCE 5-15-2007.

SN 76-684,438, FILED 11-29-2007.

FOR: ONLINE SURVEYS FOR USE BY CHURCHES AND FOR SURVEYING CONGREGATIONS, IN CLASS 35 (U.S. CLS. 100, 101 AND 102).

KARANENDRA S. CHHINA, EXAMINING ATTORNEY

Int. Cl.: 3

Prior U.S. Cls.: 1, 4, 6, 50, 51, and 52

United States Patent and Trademark Office

Reg. No. 3,576,646

Registered Feb. 17, 2009

**TRADEMARK
PRINCIPAL REGISTER**

GENTLE FINISH MINERAL POWDER FOUNDATION

PRESTIGE COSMETICS (FLORIDA CORPORATION)
1601 GREEN ROAD
POMPANO BEACH, FL 33064

FOR: COSMETICS, NAMELY, FOUNDATION, POWDER, CONCEALER, IN CLASS 3 (U.S. CLS. 1, 4, 6, 50, 51 AND 52).

FIRST USE 1-1-2008; IN COMMERCE 1-1-2008.

THE MARK CONSISTS OF STANDARD CHARACTERS WITHOUT CLAIM TO ANY PARTICULAR FONT, STYLE, SIZE, OR COLOR.

NO CLAIM IS MADE TO THE EXCLUSIVE RIGHT TO USE "MINERAL POWDER FOUNDATION", APART FROM THE MARK AS SHOWN.

SN 76-684,682, FILED 12-6-2007.

MELISSA VALLILLO, EXAMINING ATTORNEY

Int. Cl.: 37

Prior U.S. Cls.: 100, 103, and 106

United States Patent and Trademark Office

Reg. No. 3,576,647

Registered Feb. 17, 2009

**SERVICE MARK
PRINCIPAL REGISTER**

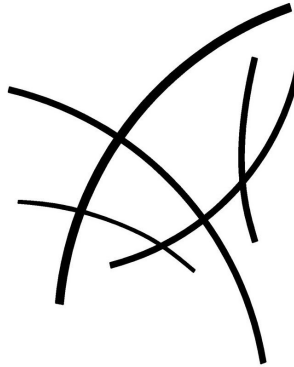

GRANITE SOURCE, INC. (VIRGINIA CORPORATION)
4155-F WESTFAX DRIVE
CHANTILLY, VA 20151

FOR: INSTALLATION OF NONSTRUCTURAL BUILDING MATERIALS, NAMELY, FINISHED STONE AND WOOD PRODUCTS FOR COUNTERTOPS, VANITY TOPS, FLOORS AND FIREPLACES, IN CLASS 37 (U.S. CLS. 100, 103 AND 106).

FIRST USE 2-1-2002; IN COMMERCE 2-1-2002.

THE MARK CONSISTS OF ARRANGEMENT OF FIVE SEMI-CIRCULAR LINES.

SN 76-684,806, FILED 12-10-2007.

SUSAN LESLIE DUBOIS, EXAMINING ATTORNEY

Int. Cls.: 16, 35, 36, and 42

Prior U.S. Cls.: 2, 5, 22, 23, 29, 37, 38, 50, 100, 101, and 102

Reg. No. 3,576,648

United States Patent and Trademark Office

Registered Feb. 17, 2009

**TRADEMARK
SERVICE MARK
PRINCIPAL REGISTER**



DATA MANAGEMENT PAYROLL SERVICES,
L.L.C. (MICHIGAN LIMITED LIABILITY
COMPANY)

755 W. BIG BEAVER ROAD
TROY, MI 48084

FOR: PRINTED MATTER, NAMELY, MANUALS
AND USER GUIDES IN THE FIELD OF EMPLOYER
PAYROLL AND BENEFITS ADMINISTRATION
MANAGEMENT; BULLETINS, CHECK LISTS, PER-
IODICALS AND NEWSLETTERS IN THE FIELD OF
PAYROLL ADMINISTRATION AND HUMAN RE-
SOURCE AND BENEFITS ADMINISTRATION, IN
CLASS 16 (U.S. CLS. 2, 5, 22, 23, 29, 37, 38 AND 50).

FIRST USE 11-15-2007; IN COMMERCE 11-15-2007.

FOR: PAYROLL PROCESSING SERVICES; PRO-
VIDING COMPUTING, DATA, AND PROFESSION-
AL SERVICES TO EMPLOYERS, NAMELY,
PAYROLL PROCESSING, TAX DEPOSIT FILING
AND REPORTING, HUMAN RESOURCES MAN-
AGEMENT, EMPLOYEE TIME AND ATTENDANCE
RECORD KEEPING, PENSION RECORD KEEPING,
EMPLOYEE LEASING, AND BUSINESS MANAGE-
MENT CONSULTING; BUSINESS MANAGEMENT
IN THE FIELD OF EMPLOYMENT COMPENSA-
TION, IN CLASS 35 (U.S. CLS. 100, 101 AND 102).

FIRST USE 11-15-2007; IN COMMERCE 11-15-2007.

FOR: PROVIDING PROFESSIONAL SERVICES
TO EMPLOYERS, NAMELY, PROCESSING, AD-
MINISTERING AND MANAGING EMPLOYEE
BENEFIT PLANS, ADMINISTRATION OF EMPLOY-

EE PENSION PLANS, IN CLASS 36 (U.S. CLS. 100, 101
AND 102).

FIRST USE 11-15-2007; IN COMMERCE 11-15-2007.

FOR: ONLINE SERVICES PROVIDED TO CLI-
ENTS VIA THE GLOBAL COMPUTER NETWORK
(INTERNET), NAMELY, PROVIDING ON-LINE
NON-DOWNLOADABLE SOFTWARE FOR PRO-
VIDING AN INTEGRATED PAYROLL/HUMAN RE-
SOURCE SERVICES FOR PROCESSING PAYROLLS,
EMPLOYEE EARNINGS RECORDS, PAYROLL
CHECKS AND CALCULATIONS, GENERAL LED-
GER REPORTS, WORKER'S COMPENSATION RE-
PORTS, AUDITS AND REPORTS, AND
PROCESSING PAYROLL TAX FILINGS FOR CLI-
ENTS INCLUDING COLLECTION OF FEDERAL
DEPOSITORY TAXES THROUGH AN ELECTRO-
NIC FUND TRANSFER SYSTEM WHICH GIVES
CLIENT'S THE ABILITY TO ACCESS INFORMA-
TION AND TO PRINT REPORTS, PAYROLL,
CHECKS, AND VOUCHERS, IN CLASS 42 (U.S.
CLS. 100 AND 101).

FIRST USE 11-15-2007; IN COMMERCE 11-15-2007.

OWNER OF U.S. REG. NOS. 1,847,846 AND
2,480,658.

NO CLAIM IS MADE TO THE EXCLUSIVE
RIGHT TO USE "DATA MANAGEMENT" AND
"PAYROLL SERVICES", APART FROM THE MARK
AS SHOWN.

SN 76-684,930, FILED 12-14-2007.

ANDREA BUTLER, EXAMINING ATTORNEY

Int. Cl.: 5

Prior U.S. Cls.: 6, 18, 44, 46, 51, and 52

United States Patent and Trademark Office

Reg. No. 3,576,649

Registered Feb. 17, 2009

**TRADEMARK
PRINCIPAL REGISTER**

GREAT MOODS

JEN USA, INC. (DELAWARE CORPORATION)
1280 JERSEY AVENUE
NORTH BRUNSWICK, NJ 08902

FOR: ROOM DIFFUSERS, NAMELY, ROOM
FRESHENERS, AND ALL PURPOSE DISINFEC-
TANTS, IN CLASS 5 (U.S. CLS. 6, 18, 44, 46, 51 AND
52).

FIRST USE 3-11-2006; IN COMMERCE 3-11-2006.

THE MARK CONSISTS OF STANDARD CHAR-
ACTERS WITHOUT CLAIM TO ANY PARTICULAR
FONT, STYLE, SIZE, OR COLOR.

OWNER OF U.S. REG. NOS. 3,273,316 AND
3,315,340.

SN 76-685,407, FILED 12-31-2007.

AMY ALFIERI, EXAMINING ATTORNEY

Int. Cls.: 9 and 41

Prior U.S. Cls.: 21, 23, 26, 36, 38, 100, 101, and 107

United States Patent and Trademark Office

Reg. No. 3,576,650

Registered Feb. 17, 2009

**TRADEMARK
SERVICE MARK
PRINCIPAL REGISTER**

LUNACRETE

J.J. VIDEO AND BOOK PRODUCTIONS, LLC
(FLORIDA LIMITED LIABILITY COMPANY)
P.O. BOX 250863
HOLLY HILL, FL 32125

FOR: VIDEO RECORDINGS FEATURING IN-
STRUCTION IN CONCRETE ART, DECORATION,
AND FINISHING, IN CLASS 9 (U.S. CLS. 21, 23, 26, 36
AND 38).

FIRST USE 8-7-2008; IN COMMERCE 8-7-2008.

FOR: EDUCATIONAL SERVICES, NAMELY, IN-
STRUCTION IN CONCRETE ART, DECORATION

AND FINISHING, IN CLASS 41 (U.S. CLS. 100, 101
AND 107).

FIRST USE 8-7-2008; IN COMMERCE 8-7-2008.

THE MARK CONSISTS OF STANDARD CHAR-
ACTERS WITHOUT CLAIM TO ANY PARTICULAR
FONT, STYLE, SIZE, OR COLOR.

SN 76-685,612, FILED 1-9-2008.

SHANNON TWOHIG, EXAMINING ATTORNEY

Int. Cl.: 21

Prior U.S. Cls.: 2, 13, 23, 29, 30, 33, 40, and 50

United States Patent and Trademark Office

Reg. No. 3,576,651

Registered Feb. 17, 2009

**TRADEMARK
PRINCIPAL REGISTER**

THE MONEY MANAGER

E&B GIFTWARE, LLC (DELAWARE LIMITED
LIABILITY COMPANY)

4 EXECUTIVE PLAZA

YONKERS, NY 10701

FOR: PLASTIC COIN BANK, IN CLASS 21 (U.S.
CLS. 2, 13, 23, 29, 30, 33, 40 AND 50).

FIRST USE 8-29-2008; IN COMMERCE 8-29-2008.

THE MARK CONSISTS OF STANDARD CHAR-
ACTERS WITHOUT CLAIM TO ANY PARTICULAR
FONT, STYLE, SIZE, OR COLOR.

NO CLAIM IS MADE TO THE EXCLUSIVE
RIGHT TO USE "MONEY", APART FROM THE
MARK AS SHOWN.

SN 76-686,695, FILED 2-11-2008.

ALICE BENMAMAN, EXAMINING ATTORNEY

Int. Cl.: 25

Prior U.S. Cls.: 22 and 39

United States Patent and Trademark Office

Reg. No. 3,576,652

Registered Feb. 17, 2009

TRADEMARK
PRINCIPAL REGISTER

du ♥ mi

TAYLOR, AMBER (UNITED STATES INDIVIDUAL)
60 W. 23RD STREET #932
NEW YORK, NY 10010

FOR: HOSIERY, LINGERIE, SHAPEWEAR, NAMELY, BRAS, BODY SCULPTING SHELF-BRA TANKTOPS, UNDERWEAR, TUMMY-CONTROL UNDERWEAR, BOY-SHORTS, FOUNDATION GARMENTS, SLEEPWEAR, SPORTSWEAR, NAMELY, BIKE-SHORTS, ACTIVEWEAR, NAMELY, SHORTS AND TOPS, WOMEN'S APPAREL, NAMELY, TANK-TOPS, CAMISOLES, IN CLASS 25 (U.S. CLS. 22 AND 39).

FIRST USE 8-3-2008; IN COMMERCE 8-3-2008.

THE COLOR(S) BLACK AND PINK IS/ARE CLAIMED AS A FEATURE OF THE MARK.

THE MARK CONSISTS OF THE TERM "DU" IN THE COLOR BLACK. TO THE RIGHT OF THE TERM "DU" APPEARS THE DESIGN OF A HEART IN THE COLOR PINK. TO THE RIGHT OF THE DESIGN OF THE HEART APPEARS THE TERM "MI" IN THE COLOR BLACK.

SN 76-686,981, FILED 2-21-2008.

MICHAEL WIENER, EXAMINING ATTORNEY

Int. Cl.: 41

Prior U.S. Cls.: 100, 101, and 107

Reg. No. 3,576,653

United States Patent and Trademark Office

Registered Feb. 17, 2009

**SERVICE MARK
PRINCIPAL REGISTER**

Centura Institute

YAGEN, GERALD W. (UNITED STATES INDIVIDUAL)
4455 SOUTH BOULEVARD
VIRGINIA BEACH, VA 23452

FOR: VOCATIONAL EDUCATION AND TRAINING IN THE FIELDS OF NURSING, DENTAL, MEDICAL, ELECTRONICS, BUSINESS, COMPUTERS, NETWORKING, PARALEGAL, MASSAGE, AND AVIATION MAINTENANCE, IN CLASS 41 (U.S. CLS. 100, 101 AND 107).

FIRST USE 3-10-2008; IN COMMERCE 3-10-2008.

THE MARK CONSISTS OF STANDARD CHARACTERS WITHOUT CLAIM TO ANY PARTICULAR FONT, STYLE, SIZE, OR COLOR.

NO CLAIM IS MADE TO THE EXCLUSIVE RIGHT TO USE "INSTITUTE", APART FROM THE MARK AS SHOWN.

SN 76-687,304, FILED 3-3-2008.

ERIN FALK, EXAMINING ATTORNEY

Int. Cls.: 6, 20, and 21

**Prior U.S. Cls.: 2, 12, 13, 14, 22, 23, 25, 29, 30, 32, 33,
40, and 50**

Reg. No. 3,576,654

United States Patent and Trademark Office

Registered Feb. 17, 2009

**TRADEMARK
PRINCIPAL REGISTER**

YORK

INTERDESIGN, INC. (OHIO CORPORATION)
30725 SOLON INDUSTRIAL PARKWAY
SOLON, OH 441394331

FOR: METAL GOODS, NAMELY, METAL BOTTLE CAPS, NON-PRECIOUS METAL SCULPTURES, METAL OVER THE DOOR RACKS, METAL PANEL PIN ON CLIPS, METAL HOUSE NUMBERS, METAL MAGNETIC SQUEEZE CLIP CLOSURES, MAGNETIC HOLDERS FOR METAL SQUEEZE CLIP CLOSURES, IN CLASS 6 (U.S. CLS. 2, 12, 13, 14, 23, 25 AND 50).

FIRST USE 1-5-2004; IN COMMERCE 1-5-2004.

FOR: METAL RACKS FOR CLOTHING, HATS, APRONS, COATS, JACKETS, SCARVES, BROOMS, MOPS, DUSTPANS, UMBRELLAS, BAGS, LADDERS, AND RAKES; NON-METAL HOUSEWARES, NAMELY, NON-METAL BOTTLE CAPS, NON-METAL BOTTLE CLOSURES, NON-METAL MAGNETIC SQUEEZE CLIP CLOSURES, PLASTIC BOXES, NON-METAL CLOSURES FOR BOTTLES AND CONTAINERS FOR PERSONAL HYGIENIC AND COSMETIC ARTICLES, PLASTIC CONTAINER CLOSURES, PICTURE FRAMES, FURNITURE MIRRORS, FOG FREE MIRRORS, NON-METAL PEGS, STORAGE RACKS FOR GLASSES, WOOD RACKS, GLASS RACKS, NON-METAL BOXES, PLASTIC BOX CONTAINING A MAGNET FOR STORAGE OF COUPONS, MAGNETIC PHOTO FRAMES, DRAWER ORGANIZER TRAYS, DRAWER ORGANIZER DIVIDERS, SINK MATS, SINK PROTECTION MATS, SINK GRID MATS, IN CLASS 20 (U.S. CLS. 2, 13, 22, 25, 32 AND 50).

FIRST USE 1-5-2004; IN COMMERCE 1-5-2004.

FOR: HOUSEHOLD ACCESSORIES, NAMELY, SQUEEGEES, SPONGE TRAYS, MAGNETIC BROOM HOLDERS, MAGNETIC CUPS, METAL

CUPS, PERFUME ATOMIZERS SOLD EMPTY; HOUSEWARES, NAMELY, BASKETS MADE OF PLASTIC, WASTE PAPER BASKETS, PLASTIC BATH RACKS, PLASTIC DRYING RACKS, BEVERAGEWARE, BOTTLES SOLD EMPTY, PLASTIC COASTERS, COASTERS NOT OF PAPER OR TABLE LINEN, BOWLS, SOAP BOXES, BOXES FOR DISPENSING PAPER TOWELS, CANDLE HOLDERS NOT OF PRECIOUS METAL, ALL PURPOSE PORTABLE CONTAINERS, SOAP CONTAINERS, CONTAINERS FOR FOOD OR BEVERAGE, CONTAINERS FOR HOUSEHOLD OR KITCHEN USE, CONTAINERS IN THE NATURE OF MAGNETIC CUPS AND HOLDERS FOR HOUSEHOLD OR KITCHEN USE, CUPS, PLASTIC CUPS, DRINKING VESSELS, GARBAGE CANS; HOUSEHOLD UTENSILS, NAMELY, DISH DRAINERS, NAMELY, PLASTIC RACKS FOR DRYING DISHES, DRAIN BOARD MATS, SINK SADDLES, SCRUBBER AND SPONGE HOLDERS, COMPOST CONTAINER FOR SINKS, SINK TRAYS, MUG RACKS, RECIPE BOXES, ARCH CLIPS, BROOM HOLDERS, MUGS, PAIL, SALAD BOWLS, CORNER SHELVES FOR SINKS, SOAP CRADLES, SPONGE CRADLES, SCRUB PAD HOLDERS, COMPOST CONTAINERS FOR COUNTERTOPS, DRAIN BOARD MATS, DISH DRAINERS, SINK TRAYS, HANGING BASKETS FOR STRADDLING A DOUBLE SINK, BASKETS SECURABLE TO SINKS FOR DRAINING SCRUBBERS AND TOWEL BARS; HOUSEHOLD ACCESSORIES, NAMELY, METAL RACKS FOR DRYING DISHES; HAND PUMPED FLAVOR SPRAYERS FOR FOOD; METAL TRIVETS; NON-PRECIOUS METAL CANDLE HOLDERS, IN CLASS 21 (U.S. CLS. 2, 13, 23, 29, 30, 33, 40 AND 50).

FIRST USE 1-5-2004; IN COMMERCE 1-5-2004.

SN 76-978,538, FILED 6-20-2002.

ALEX KEAM, EXAMINING ATTORNEY

Int. Cl.: 31

Prior U.S. Cls.: 1 and 46

United States Patent and Trademark Office

Reg. No. 3,576,655

Registered Feb. 17, 2009

TRADEMARK
PRINCIPAL REGISTER



MI PUEBLO SAN JOSE, INC. (CALIFORNIA CORPORATION)
1745 STORY ROAD
SAN JOSE, CA 95112

FOR: NATURAL AGRICULTURAL PRODUCTS, NAMELY, FRESH FRUITS AND VEGETABLES, AGRICULTURAL SEEDS, AGRICULTURAL GRAINS FOR PLANTING, LIVE PLANTS AND FLOWERS, AND FOODSTUFFS FOR ANIMALS , IN CLASS 31 (U.S. CLS. 1 AND 46).

FIRST USE 0-0-1994; IN COMMERCE 10-2-2008.

THE COLOR(S) RED, GREEN, WHITE AND YELLOW IS/ARE CLAIMED AS A FEATURE OF THE MARK.

THE COLORS RED, GREEN AND WHITE APPEAR IN THE WORDING, WHERE THE WORDS

"MI PUEBLO" HAVE A RED CENTER WITH A GREEN OUTLINE AND A NARROW WHITE SPACE BETWEEN THE RED CENTER AND GREEN OUTLINE; AN ARCHWAY WHICH IS PART OF THE LOGO EXTENDS INTO A WALL UPON WHICH THE WORDS "MI PUEBLO" APPEAR IS SHADED IN GREEN, WITH A FACIAL COLOR OF YELLOW, AND WITH TRIM IN THE FORM OF "MP" AND BRICKS IN RED. THE MOUNTAINS, BUILDINGS AND STREAM WHICH ARE VISIBLE THROUGH THE ARCHWAY ARE RED AND GREEN AGAINST A WHITE BACKGROUND.

THE ENGLISH TRANSLATION OF "MI PUEBLO" IS MY VILLAGE.

SN 76-978,829, FILED 7-16-2007.

RENEE MCCRAY, EXAMINING ATTORNEY

Int. Cl.: 28

Prior U.S. Cls.: 22, 23, 38, and 50

United States Patent and Trademark Office

Reg. No. 3,576,656

Registered Feb. 17, 2009

**TRADEMARK
PRINCIPAL REGISTER**

GAME N' COLOR

SPIN MASTER LTD. (CANADA CORPORATION)
450 FRONT STREET WEST
TORONTO, ONTARIO, CANADA M5V 1B6

THE MARK CONSISTS OF STANDARD CHAR-
ACTERS WITHOUT CLAIM TO ANY PARTICULAR
FONT, STYLE, SIZE, OR COLOR.

FOR: TOYS AND PRODUCTS HAVING SPECIAL
DRAWING SURFACES, NAMELY, CHILDREN'S
TOY ACTIVITY MATS, IN CLASS 28 (U.S. CLS. 22,
23, 38 AND 50).

SN 77-000,690, FILED 9-15-2006.

FIRST USE 11-14-2006; IN COMMERCE 11-14-2006.

BENJAMIN OKEKE, EXAMINING ATTORNEY

Int. Cl.: 41

Prior U.S. Cls.: 100, 101, and 107

United States Patent and Trademark Office

Reg. No. 3,576,657

Registered Feb. 17, 2009

**SERVICE MARK
PRINCIPAL REGISTER**

THE ROASTMASTER GENERAL

ENOUGH WITH THE BREAD ALREADY PRODUCTIONS, INC. (NEW YORK CORPORATION)
131 JERICHO TURNPIKE
JERICHO, NY 11753

FOR: ENTERTAINMENT SERVICES IN THE NATURE OF LIVE PERFORMANCES BY A COMEDIAN; PROVIDING RADIO AND TELEVISION PROGRAMMING IN THE FIELD OF COMEDY; PROVIDING ENTERTAINMENT IN THE NATURE OF THEATER PRODUCTIONS IN THE FIELD OF COMEDY; PROVIDING ENTERTAINMENT INFORMATION IN THE FIELD OF COMEDY VIA THE

INTERNET, IN CLASS 41 (U.S. CLS. 100, 101 AND 107).

FIRST USE 6-12-2008; IN COMMERCE 6-12-2008.

THE MARK CONSISTS OF STANDARD CHARACTERS WITHOUT CLAIM TO ANY PARTICULAR FONT, STYLE, SIZE, OR COLOR.

SN 77-000,818, FILED 9-15-2006.

YAT SYE, LEE, EXAMINING ATTORNEY

Int. Cl.: 25

Prior U.S. Cls.: 22 and 39

United States Patent and Trademark Office

Reg. No. 3,576,658

Registered Feb. 17, 2009

**TRADEMARK
PRINCIPAL REGISTER**

Flat Black Industries

OUTLAW VENTURES LLC (NEVADA LIMITED
LIABILITY COMPANY)
6679 TURINA ROAD
LAS VEGAS, NV 89146

FOR: BANDANAS; BEANIES; CAPS WITH VI-
SORS; HATS; SHIRTS; SHORT-SLEEVED SHIRTS;
SHORTS; SKULL CAPS; TANK TOPS; CAMISOLES;
SHORT-SLEEVED OR LONG-SLEEVED T-SHIRTS;
T-SHIRTS , IN CLASS 25 (U.S. CLS. 22 AND 39).

FIRST USE 9-17-2005; IN COMMERCE 5-19-2006.

THE MARK CONSISTS OF STANDARD CHAR-
ACTERS WITHOUT CLAIM TO ANY PARTICULAR
FONT, STYLE, SIZE, OR COLOR.

NO CLAIM IS MADE TO THE EXCLUSIVE
RIGHT TO USE "INDUSTRIES", APART FROM
THE MARK AS SHOWN.

SN 77-001,245, FILED 9-18-2006.

ESTHER A. BORSUK, EXAMINING ATTORNEY

Int. Cl.: 39

Prior U.S. Cls.: 100 and 105

United States Patent and Trademark Office

Reg. No. 3,576,659

Registered Feb. 17, 2009

**SERVICE MARK
PRINCIPAL REGISTER**

1-800-SKILIFT

BLACKSTONE, DAVID (CANADA INDIVIDUAL)
185 BROOKE AVENUE
TORONTO, CANADA M5M2K7

THE MARK CONSISTS OF STANDARD CHAR-
ACTERS WITHOUT CLAIM TO ANY PARTICULAR
FONT, STYLE, SIZE, OR COLOR.

FOR: PROVIDING TRAVEL INFORMATION
SERVICES IN THE FIELD OF SKI RESORTS, IN
CLASS 39 (U.S. CLS. 100 AND 105).

SN 77-001,251, FILED 9-18-2006.

FIRST USE 9-0-2008; IN COMMERCE 9-0-2008.

SHANNON TWOHIG, EXAMINING ATTORNEY

Int. Cl.: 9

Prior U.S. Cls.: 21, 23, 26, 36, and 38

United States Patent and Trademark Office

Reg. No. 3,576,660

Registered Feb. 17, 2009

TRADEMARK
PRINCIPAL REGISTER



ALWAYS "ON" UPS SYSTEMS INC. (CANADA CORPORATION)
#1-150 CAMPION RD.
KELOWNA, BRITISH COLUMBIA, CANADA
V1X7S8

FOR: ELECTRICAL POWER SUPPLIES EXCLUDING FUEL CELLS; INVERTERS; CONVERTERS; RECTIFIERS; BATTERY CHARGERS; POWER LINE NOISE FILTERS, IN CLASS 9 (U.S. CLS. 21, 23, 26, 36 AND 38).

FIRST USE 0-0-2004; IN COMMERCE 0-0-2005.

NO CLAIM IS MADE TO THE EXCLUSIVE RIGHT TO USE "UPS SYSTEMS INC.", APART FROM THE MARK AS SHOWN.

THE COLOR(S) BLACK, GREY, AND GREEN IS/ ARE CLAIMED AS A FEATURE OF THE MARK.

THE MARK CONSISTS OF THE STYLIZED WORDS "ALWAYS ON UPS SYSTEMS INC.". THE WORD "ALWAYS" AND THE LETTER "N" ARE IN BLACK. A POWER BUTTON SYMBOL IN PLACE OF THE LETTER "O" IN THE WORD "ON", APPEARS IN GREEN AND HAS A GREY SHADOW BENEATH IT. "UPS SYSTEMS INC." IS IN GREY.

SN 77-001,852, FILED 9-18-2006.

JESSICA A. POWERS, EXAMINING ATTORNEY

Int. Cl.: 9

Prior U.S. Cls.: 21, 23, 26, 36, and 38

United States Patent and Trademark Office

Reg. No. 3,576,661

Registered Feb. 17, 2009

**TRADEMARK
PRINCIPAL REGISTER**

CSRWARE

CSRWARE, INC. (CALIFORNIA CORPORATION)
220 SANSOME STREET, SUITE 800
SAN FRANCISCO, CA 94104

FIRST USE 7-2-2008; IN COMMERCE 7-2-2008.

FOR: COMPUTER SOFTWARE USED TO ASSIST BUSINESSES IN ACHIEVING CORPORATE SOCIAL RESPONSIBILITY BY MEASURING, TRACKING AND QUANTIFYING NATURAL RESOURCE CONSUMPTION, THE ENVIRONMENTAL FOOTPRINT AND THE SOCIAL COMPONENTS OF AN ECONOMICALLY SUCCESSFUL BUSINESS, IN CLASS 9 (U.S. CLS. 21, 23, 26, 36 AND 38).

THE MARK CONSISTS OF STANDARD CHARACTERS WITHOUT CLAIM TO ANY PARTICULAR FONT, STYLE, SIZE, OR COLOR.

SN 77-004,097, FILED 9-21-2006.

YAT SYE, LEE, EXAMINING ATTORNEY

Int. Cl.: 10

Prior U.S. Cls.: 26, 39, and 44

United States Patent and Trademark Office

Reg. No. 3,576,662

Registered Feb. 17, 2009

**TRADEMARK
PRINCIPAL REGISTER**

Needleator

JOHNSON, E. (UNITED STATES INDIVIDUAL),
AKA EVELYNE MINDES,
POST OFFICE BOX 24110
LOS ANGELES, CA 90024

THE MARK CONSISTS OF STANDARD CHAR-
ACTERS WITHOUT CLAIM TO ANY PARTICULAR
FONT, STYLE, SIZE, OR COLOR.

FOR: DEVICE FOR SEVERING AND CONTAIN-
ING SYRINGE NEEDLES FOR DISPOSAL, IN
CLASS 10 (U.S. CLS. 26, 39 AND 44).

SN 77-004,267, FILED 9-21-2006.

FIRST USE 12-1-2008; IN COMMERCE 12-1-2008.

ASMAT KHAN, EXAMINING ATTORNEY

Int. Cl.: 42

Prior U.S. Cls.: 100 and 101

United States Patent and Trademark Office

Reg. No. 3,576,663

Registered Feb. 17, 2009

**SERVICE MARK
PRINCIPAL REGISTER**

LUSKWOOD

LUSKWOOD, LLC (COLORADO LIMITED LIABILITY COMPANY)
PO BOX 170
IDLEDALE, CO 80453

THE MARK CONSISTS OF STANDARD CHARACTERS WITHOUT CLAIM TO ANY PARTICULAR FONT, STYLE, SIZE, OR COLOR.

FOR: GRAPHIC DESIGN; GRAPHIC DESIGN OF CHARACTERS; COMPUTER GRAPHIC DESIGN SERVICES, IN CLASS 42 (U.S. CLS. 100 AND 101).

SN 77-004,866, FILED 9-21-2006.

FIRST USE 9-13-2003; IN COMMERCE 9-18-2006.

COLLEEN DOMBROW, EXAMINING ATTORNEY

Int. Cl.: 33

Prior U.S. Cls.: 47 and 49

United States Patent and Trademark Office

Reg. No. 3,576,664

Registered Feb. 17, 2009

**TRADEMARK
PRINCIPAL REGISTER**

IL VINAIO CONSERVA

VINO FAVOLOSO IMPORTING AND DISTRI-
BUTING LLC (DELAWARE LIMITED LIABI-
LITY COMPANY)

19180 OLD WINERY ROAD

SONOMA, CA 95476

FOR: WINES, IN CLASS 33 (U.S. CLS. 47 AND 49).

FIRST USE 5-22-2008; IN COMMERCE 5-22-2008.

THE MARK CONSISTS OF STANDARD CHAR-
ACTERS WITHOUT CLAIM TO ANY PARTICULAR
FONT, STYLE, SIZE, OR COLOR.

THE FOREIGN WORDING IN THE MARK
TRANSLATES INTO ENGLISH AS "THE WINE
MAKER WHO CONSERVES".

SN 77-005,198, FILED 9-22-2006.

LYDIA BELZER, EXAMINING ATTORNEY

Int. Cl.: 41

Prior U.S. Cls.: 100, 101, and 107

United States Patent and Trademark Office

Reg. No. 3,576,665

Registered Feb. 17, 2009

**SERVICE MARK
PRINCIPAL REGISTER**

FUN SHUI

SCRIPPS NETWORKS, INC. (DELAWARE CORPORATION)
9721 SHERRILL BOULEVARD
KNOXVILLE, TN 37932

FOR: ENTERTAINMENT SERVICES, NAMELY, AN ON-GOING HOW-TO PROGRAM DISTRIBUTED OVER TELEVISION, SATELLITE, WIRELESS, AUDIO AND VIDEO MEDIA, FIBER OPTICS, CABLE, AND A GLOBAL COMPUTER NETWORK, IN THE FIELDS OF INTERIOR DESIGN AND DECORATING, IN CLASS 41 (U.S. CLS. 100, 101 AND 107).

FIRST USE 9-28-2007; IN COMMERCE 9-28-2007.

THE MARK CONSISTS OF STANDARD CHARACTERS WITHOUT CLAIM TO ANY PARTICULAR FONT, STYLE, SIZE, OR COLOR.

SN 77-005,522, FILED 9-22-2006.

KEVIN CORWIN, EXAMINING ATTORNEY

Int. Cls.: 35, 36, and 43

Prior U.S. Cls.: 100, 101, and 102

United States Patent and Trademark Office

Reg. No. 3,576,666

Registered Feb. 17, 2009

**SERVICE MARK
PRINCIPAL REGISTER**

FLG HOSPITALITY

FOCUS LODGING GROUP, LLC (OHIO LIMITED
LIABILITY COMPANY)
4887 SAWMILL ROAD
COLUMBUS, OH 43235

FOR: HOTEL AND RESORT MANAGEMENT
FOR OTHERS; BUSINESS MANAGEMENT SERVI-
CES FOR OTHERS IN THE FIELD OF HOTEL AND
RESORT OPERATION, ADMINISTRATION, AND
DEVELOPMENT; CONSULTING IN THE FIELD OF
HOTEL AND RESORT MARKETING, ACCOUNT-
ING, AND HUMAN RESOURCES, IN CLASS 35 (U.S.
CLS. 100, 101 AND 102).

FIRST USE 8-4-2004; IN COMMERCE 8-4-2004.

FOR: CONSULTING IN THE FIELD OF HOTEL
AND RESORT BROKERAGE; CONSULTING IN
THE FIELD OF HOTEL AND RESORT REAL ES-
TATE PURCHASING, IN CLASS 36 (U.S. CLS. 100, 101
AND 102).

FIRST USE 8-4-2004; IN COMMERCE 8-4-2004.

FOR: CONSULTING SERVICES IN THE FIELD
OF HOSPITALITY; CONSULTING IN THE FIELDS
OF HOTELS AND RESORT HOTEL SERVICES, IN
CLASS 43 (U.S. CLS. 100 AND 101).

FIRST USE 8-4-2004; IN COMMERCE 8-4-2004.

THE MARK CONSISTS OF STANDARD CHAR-
ACTERS WITHOUT CLAIM TO ANY PARTICULAR
FONT, STYLE, SIZE, OR COLOR.

NO CLAIM IS MADE TO THE EXCLUSIVE
RIGHT TO USE "HOSPITALITY", APART FROM
THE MARK AS SHOWN.

SN 77-007,358, FILED 9-26-2006.

CORY BOONE, EXAMINING ATTORNEY

Int. Cl.: 28

Prior U.S. Cls.: 22, 23, 38, and 50

United States Patent and Trademark Office

Reg. No. 3,576,667

Registered Feb. 17, 2009

**TRADEMARK
PRINCIPAL REGISTER**



F.C. ATLAS AC. (MEXICO CORPORATION)
AVENIDA PATRIA 2300
ZAPOPAN, MEXICO 45019

FOR: SOCCER BALL GOAL NETS; SOCCER BALL
KNEE PADS; SOCCER BALLS; SOCCER GOALS;
SPORT BALLS, IN CLASS 28 (U.S. CLS. 22, 23, 38 AND
50).

FIRST USE 2-9-2007; IN COMMERCE 2-9-2007.

THE COLOR(S) BLACK, RED AND WHITE IS/
ARE CLAIMED AS A FEATURE OF THE MARK.

THE MARK CONSISTS OF A SHIELD, HALF IN
RED AND THE OTHER HALF IN BLACK, THE
LETTER "A" APPEARING IN THE CENTER OF THE
SHIELD IS WHITE AND THE WORDING "ATLAS"
IS BLACK WITH RED UNDERLINE.

SN 77-007,894, FILED 9-26-2006.

JENNY PARK, EXAMINING ATTORNEY

Int. Cl.: 39

Prior U.S. Cls.: 100 and 105

United States Patent and Trademark Office

Reg. No. 3,576,668

Registered Feb. 17, 2009

**SERVICE MARK
PRINCIPAL REGISTER**

LYNX AVIATION

FRONTIER AIRLINES, INC. (COLORADO CORPORATION)
7001 TOWER ROAD
DENVER, CO 80249

FOR: AIR TRANSPORTATION SERVICES, NAMELY, THE TRANSPORTATION OF CARGO, FREIGHT AND PASSENGERS, IN CLASS 39 (U.S. CLS. 100 AND 105).

FIRST USE 10-31-2007; IN COMMERCE 10-31-2007.

THE MARK CONSISTS OF STANDARD CHARACTERS WITHOUT CLAIM TO ANY PARTICULAR FONT, STYLE, SIZE, OR COLOR.

NO CLAIM IS MADE TO THE EXCLUSIVE RIGHT TO USE "AVIATION", APART FROM THE MARK AS SHOWN.

SN 77-008,350, FILED 9-27-2006.

NELSON SNYDER, EXAMINING ATTORNEY

Int. Cl.: 9

Prior U.S. Cls.: 21, 23, 26, 36, and 38

United States Patent and Trademark Office

Reg. No. 3,576,669

Registered Feb. 17, 2009

**TRADEMARK
PRINCIPAL REGISTER**

FUSEAC

ELECTRONIC CONCEPTS, INC. (DELAWARE
CORPORATION)
526 INDUSTRIAL WAY WEST
EATONTOWN, NJ 07724

THE MARK CONSISTS OF STANDARD CHAR-
ACTERS WITHOUT CLAIM TO ANY PARTICULAR
FONT, STYLE, SIZE, OR COLOR.

FOR: ELECTRICAL CAPACITORS, IN CLASS 9
(U.S. CLS. 21, 23, 26, 36 AND 38).

SN 77-008,689, FILED 9-27-2006.

FIRST USE 10-8-2008; IN COMMERCE 10-8-2008.

KELLEY WELLS, EXAMINING ATTORNEY

Int. Cl.: 35

Prior U.S. Cls.: 100, 101, and 102

United States Patent and Trademark Office

Reg. No. 3,576,670

Registered Feb. 17, 2009

**SERVICE MARK
PRINCIPAL REGISTER**

DREAMENTIA

DREAMENTIA, INC. (CALIFORNIA CORPORATION)
453 S. SPRING STREET
SUITE 808
LOS ANGELES, CA 90013

FOR: ADVERTISING AGENCIES, NAMELY, PROMOTING THE GOODS AND SERVICES OF OTHERS; ADVERTISING SERVICES, NAMELY, CREATING CORPORATE AND BRAND IDENTITY FOR OTHERS; ADVERTISING, MARKETING AND PROMOTION SERVICES; POST-PRODUCTION EDITING SERVICES FOR VIDEO AND AUDIO COMMERCIALS; PREPARING AND PLACING OUTDOOR ADVERTISEMENTS FOR OTHERS; PRODUCTION OF TELEVISION COMMERCIALS;

PROVIDING TELEVISION ADVERTISING FOR OTHERS, ADVERTISING AND PROMOTING MOVIES AND MUSIC, IN CLASS 35 (U.S. CLS. 100, 101 AND 102).

FIRST USE 11-8-2006; IN COMMERCE 11-8-2006.

THE MARK CONSISTS OF STANDARD CHARACTERS WITHOUT CLAIM TO ANY PARTICULAR FONT, STYLE, SIZE, OR COLOR.

SN 77-009,567, FILED 9-28-2006.

CARYN GLASSER, EXAMINING ATTORNEY

Int. Cl.: 9

Prior U.S. Cls.: 21, 23, 26, 36, and 38

Reg. No. 3,576,671

United States Patent and Trademark Office

Registered Feb. 17, 2009

**TRADEMARK
PRINCIPAL REGISTER**

Form Medic

FABSOFT (NEW JERSEY CORPORATION)
25 CANFIELD ROAD
CEDAR GROVE, NJ 07006

THE MARK CONSISTS OF STANDARD CHARACTERS WITHOUT CLAIM TO ANY PARTICULAR FONT, STYLE, SIZE, OR COLOR.

FOR: COMPUTER SOFTWARE FOR ELECTRONIC FORM MANAGEMENT THAT STORES, RETRIEVES AND PRINTS DOCUMENTS AND ELECTRONICALLY DISTRIBUTES DOCUMENTS VIA FAX, E-MAIL, ARCHIVE AND PRINTERS , IN CLASS 9 (U.S. CLS. 21, 23, 26, 36 AND 38).

NO CLAIM IS MADE TO THE EXCLUSIVE RIGHT TO USE "FORM", APART FROM THE MARK AS SHOWN.

SN 77-010,614, FILED 9-29-2006.

FIRST USE 9-30-2006; IN COMMERCE 1-20-2007.

LAURA HAMMEL, EXAMINING ATTORNEY

Int. Cl.: 25

Prior U.S. Cls.: 22 and 39

United States Patent and Trademark Office

Reg. No. 3,576,672

Registered Feb. 17, 2009

**TRADEMARK
PRINCIPAL REGISTER**

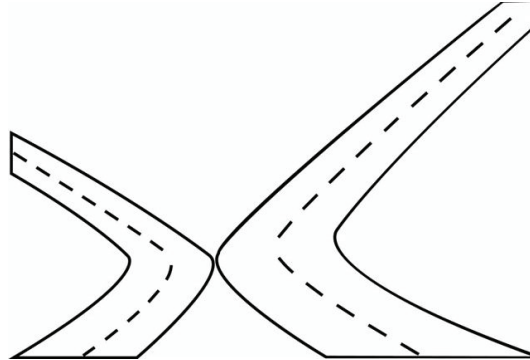

CODET INC. (CANADA CORPORATION)
C.P. 90
43/49 MAPLE
COATICOOK, CANADA J1A2S8

FOR: CAPS; JEANS; LEATHER SHOES; T-SHIRTS,
IN CLASS 25 (U.S. CLS. 22 AND 39).

FIRST USE 9-0-2008; IN COMMERCE 9-0-2008.

THE COLOR(S) BLACK AND WHITE IS/ARE
CLAIMED AS A FEATURE OF THE MARK.

THE MARK CONSISTS OF TWO WHITE CHEVRONS (ONE CHEVRON SMALLER THAN THE OTHER) TOUCHING IN THE CENTER FORMING AN X WITH A DOTTED LINE GOING THROUGH THE CENTER OF EACH CHEVRON. THE DOTTED LINES ARE BLACK, AND THE CHEVRONS ARE OUTLINED IN BLACK.

SN 77-011,713, FILED 10-2-2006.

ALICIA COLLINS, EXAMINING ATTORNEY

Int. Cl.: 6

Prior U.S. Cls.: 2, 12, 13, 14, 23, 25, and 50

Reg. No. 3,576,673

United States Patent and Trademark Office

Registered Feb. 17, 2009

**TRADEMARK
PRINCIPAL REGISTER**

NYTAB

NYLOK CORPORATION (MICHIGAN CORPORATION)
15260 HALLMARK DRIVE
MACOMB, MI 48042

THE MARK CONSISTS OF STANDARD CHARACTERS WITHOUT CLAIM TO ANY PARTICULAR FONT, STYLE, SIZE, OR COLOR.

FOR: METAL FASTENERS, NAMELY, NUTS, BOLTS AND SCREWS HAVING A PLASTIC OR RESIN RETENTION ELEMENT, IN CLASS 6 (U.S. CLS. 2, 12, 13, 14, 23, 25 AND 50).

SN 77-012,410, FILED 10-3-2006.

FIRST USE 8-17-2006; IN COMMERCE 8-17-2006.

TARAH HARDY, EXAMINING ATTORNEY

Int. Cls.: 7 and 9

Prior U.S. Cls.: 13, 19, 21, 23, 26, 31, 34, 35, 36, and 38

United States Patent and Trademark Office

Reg. No. 3,576,674

Registered Feb. 17, 2009

**TRADEMARK
PRINCIPAL REGISTER**

PNEU MASTER AIR

ARROW PNEUMATICS, INC. (ILLINOIS CORPORATION)
2111 WEST 21ST STREET
BROADVIEW, IL 60155

FOR: PNEUMATIC SYSTEMS WHICH POWER EQUIPMENT AND MACHINERY COMPRISING OF SINTERED BRONZE MUFFLERS, VENTS, IN-LINE FILTERS, VALVES, PRESSURE SNUBBERS, PARTICULATE FILTERS, COALESCING FILTERS, REGULATORS, IN-LINE LUBRICATION DISPENSERS, LUBRICATORS, IN-LINE DESICCANT DRYERS, DRAINS, Y-STRAINERS, COUPLERS, PANEL MOUNTED REGULATORS, MOUNTING BRACKETS, COIL HOSE, HOSE REELS, AND UNIT COMPONENTS COMPRISED OF A COMBINATION THEREOF, IN CLASS 7 (U.S. CLS. 13, 19, 21, 23, 31, 34 AND 35).

FIRST USE 11-4-2008; IN COMMERCE 11-4-2008.

FOR: PRESSURE SWITCHES, PRESSURE DIFFERENTIAL GAUGES, PRESSURE GAUGES, ELECTRIC PLUGS, AND ADAPTERS, ALL FOR USE WITH PNEUMATIC SYSTEMS THAT POWER EQUIPMENT AND MACHINERY, IN CLASS 9 (U.S. CLS. 21, 23, 26, 36 AND 38).

FIRST USE 11-4-2008; IN COMMERCE 11-4-2008.

THE MARK CONSISTS OF STANDARD CHARACTERS WITHOUT CLAIM TO ANY PARTICULAR FONT, STYLE, SIZE, OR COLOR.

NO CLAIM IS MADE TO THE EXCLUSIVE RIGHT TO USE "AIR", APART FROM THE MARK AS SHOWN.

SN 77-012,513, FILED 10-3-2006.

DANNEAN HETZEL, EXAMINING ATTORNEY

Int. Cl.: 1

Prior U.S. Cls.: 1, 5, 6, 10, 26, and 46

United States Patent and Trademark Office

Reg. No. 3,576,675

Registered Feb. 17, 2009

**TRADEMARK
PRINCIPAL REGISTER**

DUROX

BRUSH WELLMAN INC. (OHIO CORPORATION)
6070 PARKLAND BOULEVARD
MAYFIELD HEIGHTS, OH 44124

FOR: CERAMIC MATERIALS IN THE NATURE
OF SOLID SUBSTRATES OF BERYLLIUM OXIDE
AND LANTHANUM FOR USE IN CRUCIBLE AND
METAL DEPOSITION APPLICATIONS, IN CLASS 1
(U.S. CLS. 1, 5, 6, 10, 26 AND 46).

FIRST USE 1-22-2007; IN COMMERCE 1-22-2007.

THE MARK CONSISTS OF STANDARD CHAR-
ACTERS WITHOUT CLAIM TO ANY PARTICULAR
FONT, STYLE, SIZE, OR COLOR.

SN 77-012,847, FILED 10-3-2006.

DANIEL CAPSHAW, EXAMINING ATTORNEY

Int. Cls.: 9, 37, and 45

Prior U.S. Cls.: 21, 23, 26, 36, 38, 100, 101, 103, and 106

Reg. No. 3,576,676

United States Patent and Trademark Office

Registered Feb. 17, 2009

**TRADEMARK
SERVICE MARK
PRINCIPAL REGISTER**

VERISAFE

SECURE PACIFIC CORPORATION (WASHINGTON CORPORATION)
8220 NORTH INTERSTATE AVE.
PORTLAND, OR 97217

FOR: ELECTRONIC MONITORING SYSTEMS COMPRISED OF ANTI-INTRUSION ALARMS, ACCESS CONTROL SYSTEMS COMPRISED OF CARD READERS, NUMERIC KEYPADS, DOOR RELEASE BUTTONS AND WIRELESS KEYFOBS, CLOSED CIRCUIT TELEVISION SYSTEMS, ELECTRONIC HOLD-UP ALARMS AND DETECTORS AND FIRE AND EMERGENCY ALARM APPARATUS USING CENTRAL MONITORING STATIONS, IN CLASS 9 (U.S. CLS. 21, 23, 26, 36 AND 38).

FIRST USE 6-1-2007; IN COMMERCE 6-1-2007.

FOR: INSTALLATION AND SERVICING OF SECURITY AND SAFETY EQUIPMENT, NAMELY, INTRUSION, ACCESS CONTROL, CLOSED CIRCUIT TELEVISION, HOLD-UP, AND FIRE SUR-

VEILLANCE AND ALARM SYSTEMS , IN CLASS 37 (U.S. CLS. 100, 103 AND 106).

FIRST USE 6-1-2007; IN COMMERCE 6-1-2007.

FOR: CENTRAL STATION MONITORING OF SECURITY AND SAFETY EQUIPMENT, NAMELY, INTRUSION, ACCESS CONTROL, CLOSED CIRCUIT TELEVISION, HOLD-UP, AND FIRE SURVEILLANCE AND ALARM SYSTEMS, IN CLASS 45 (U.S. CLS. 100 AND 101).

FIRST USE 6-1-2007; IN COMMERCE 6-1-2007.

THE MARK CONSISTS OF STANDARD CHARACTERS WITHOUT CLAIM TO ANY PARTICULAR FONT, STYLE, SIZE, OR COLOR.

SN 77-012,894, FILED 10-3-2006.

ALICE BENMAMAN, EXAMINING ATTORNEY

Int. Cls.: 44 and 45

Prior U.S. Cls.: 100 and 101

United States Patent and Trademark Office

Reg. No. 3,576,677

Registered Feb. 17, 2009

**SERVICE MARK
PRINCIPAL REGISTER**



US INVESTIGATIONS SERVICES, LLC (DELA-
WARE LIMITED LIABILITY COMPANY)
7799 LEESBURG PIKE
SUITE 1100 NORTH
FALLS CHURCH, VA 22043

FOR: PROVIDING EMPLOYMENT AND PRE-
EMPLOYMENT DRUG AND ALCOHOL TESTING
OF CANDIDATES FOR VEHICLE DRIVER POSI-
TIONS, IN CLASS 44 (U.S. CLS. 100 AND 101).

FIRST USE 10-31-2006; IN COMMERCE 10-31-2006.

FOR: EMPLOYMENT AND PRE-EMPLOYMENT
BACKGROUND SCREENING SERVICES, NAME-
LY, PROVIDING CUSTOMIZED INFORMATION
WITH REGARD TO CANDIDATES FOR VEHICLE
DRIVER POSITIONS, IN CLASS 45 (U.S. CLS. 100
AND 101).

FIRST USE 10-31-2006; IN COMMERCE 10-31-2006.

OWNER OF U.S. REG. NOS. 1,443,502 AND
2,908,473.

THE COLOR(S) BLACK AND RED IS/ARE
CLAIMED AS A FEATURE OF THE MARK.

THE MARK CONSISTS OF THE WORDING
"DAC" IN BLACK, A CHECK MARK DESIGN IN
RED AND THE WORDING "THE DRIVING FORCE
BEHIND USIS" IN RED. THE MARK APPEARS ON
A TRANSPARENT BACKGROUND AND ANY COL-
OR APPEARING THEREIN IS NEITHER CLAIMED
AS, NOR IS A FEATURE OF THE MARK.

SN 77-014,922, FILED 10-5-2006.

BERNICE MIDDLETON, EXAMINING ATTORNEY

Int. Cl.: 25

Prior U.S. Cls.: 22 and 39

United States Patent and Trademark Office

Reg. No. 3,576,678

Registered Feb. 17, 2009

**TRADEMARK
PRINCIPAL REGISTER**

SL9

DEROCHE, JOSEPH E. (ILLINOIS LIMITED LIABILITY COMPANY)
833 WEST 15TH. PLACE, SUITE 808
CHICAGO, IL 60608

FOR: BIBS NOT OF CLOTH OR PAPER; CAPS; CHILDREN'S AND INFANTS' CLOTH BIBS; CHILDREN'S CLOTH EATING BIBS; CLOTH BIBS; CLOTH BIBS FOR ADULT DINERS; CLOTH BIBS FOR USE BY SENIOR CITIZENS OR PHYSICALLY-OR MENTALLY-CHALLENGED PERSONS; CLOTH DIAPERS; CLOTHING FOR WEAR IN JUDO PRACTICES; CLOTHING FOR WEAR IN WRESTLING GAMES; CLOTHING, NAMELY, ARM WARMERS; CLOTHING, NAMELY, FOLK COSTUMES; CLOTHING, NAMELY, KNEE WARMERS; CLOTHING, NAMELY, NECK TUBES; CLOTHING, NAMELY, WRAP-AROUNDS; CORSETS; DUSTERS; FOU-LARDS; HOODS; INFANT AND TODDLER ONE PIECE CLOTHING; INFANT CLOTH DIAPERS; JERSEYS; LEATHER BELTS; MANTLES; MUFFLERS; NON-DISPOSABLE CLOTH TRAINING

PANTS; PARTS OF CLOTHING, NAMELY, GUSSETS FOR TIGHTS, GUSSETS FOR STOCKINGS, GUSSETS FOR BATHING SUITS, GUSSETS FOR UNDERWEAR, GUSSETS FOR LEOTARDS AND GUSSETS FOR FOOTLETS; PERSPIRATION ABSORBENT UNDERWEAR CLOTHING; SHIFTS; SHORT SETS; SHOULDER PADS FOR CLOTHING; SHOULDER WRAPS; SWADDLING CLOTHES; TIES; TOPS; UNDERARM CLOTHING SHIELDS; WRAPS, IN CLASS 25 (U.S. CLS. 22 AND 39).

FIRST USE 9-15-2007; IN COMMERCE 2-10-2008.

THE MARK CONSISTS OF STANDARD CHARACTERS WITHOUT CLAIM TO ANY PARTICULAR FONT, STYLE, SIZE, OR COLOR.

SN 77-015,315, FILED 10-5-2006.

SUSAN STIGLITZ, EXAMINING ATTORNEY

Int. Cl.: 25

Prior U.S. Cls.: 22 and 39

United States Patent and Trademark Office

Reg. No. 3,576,679

Registered Feb. 17, 2009

**TRADEMARK
PRINCIPAL REGISTER**

MONTAUK TACKLE CO.

CESARK, RONALD (UNITED STATES INDIVIDUAL)

995 CLARK PLACE
WOODMERE, NY 11598

FOR: CLOTHING, NAMELY, SHIRTS, T-SHIRTS, SWEATSHIRTS AND HATS, IN CLASS 25 (U.S. CLS. 22 AND 39).

FIRST USE 9-1-2008; IN COMMERCE 9-1-2008.

THE MARK CONSISTS OF STANDARD CHARACTERS WITHOUT CLAIM TO ANY PARTICULAR FONT, STYLE, SIZE, OR COLOR.

NO CLAIM IS MADE TO THE EXCLUSIVE RIGHT TO USE "MONTAUK" AND "CO.", APART FROM THE MARK AS SHOWN.

SN 77-015,425, FILED 10-6-2006.

JOHN WILKE, EXAMINING ATTORNEY

Int. Cl.: 35

Prior U.S. Cls.: 100, 101, and 102

United States Patent and Trademark Office

Reg. No. 3,576,680

Registered Feb. 17, 2009

**SERVICE MARK
PRINCIPAL REGISTER**

Home of the Dream Maker

FELFEL, HELMI M. (UNITED STATES INDIVIDUAL)
425 BAY HARBOR RD.
MOORESVILLE, NC 28117

THE MARK CONSISTS OF STANDARD CHARACTERS WITHOUT CLAIM TO ANY PARTICULAR FONT, STYLE, SIZE, OR COLOR.

FOR: AUTOMOBILE DEALERSHIPS, IN CLASS 35 (U.S. CLS. 100, 101 AND 102).

SN 77-017,669, FILED 10-10-2006.

FIRST USE 6-1-2008; IN COMMERCE 6-1-2008.

DAVID TAYLOR, EXAMINING ATTORNEY

Int. Cl.: 41

Prior U.S. Cls.: 100, 101, and 107

United States Patent and Trademark Office

Reg. No. 3,576,681

Registered Feb. 17, 2009

**SERVICE MARK
PRINCIPAL REGISTER**

**MY MODEL LOOKS BETTER THAN
YOUR MODEL**

BLACK ENTERTAINMENT TELEVISION LLC
(D.C. LIMITED LIABILITY COMPANY)
ONE BET PLAZA, 1235 W STREET, N.E.
LEGAL AFFAIRS
WASHINGTON, DC 20018

FOR: ENTERTAINMENT IN THE NATURE OF
AN ON-GOING PROGRAM IN THE FIELD OF
FASHION DISTRIBUTED VIA THE INTERNET,
TELEVISION, CABLE AND WIRELESS, IN CLASS
41 (U.S. CLS. 100, 101 AND 107).

FIRST USE 11-1-2006; IN COMMERCE 11-1-2006.

THE MARK CONSISTS OF STANDARD CHAR-
ACTERS WITHOUT CLAIM TO ANY PARTICULAR
FONT, STYLE, SIZE, OR COLOR.

SN 77-017,710, FILED 10-10-2006.

TINA L. SNAPP, EXAMINING ATTORNEY

Int. Cl.: 3

Prior U.S. Cls.: 1, 4, 6, 50, 51, and 52

United States Patent and Trademark Office

Reg. No. 3,576,682

Registered Feb. 17, 2009

**TRADEMARK
PRINCIPAL REGISTER**

FOOTLOGIX PEDICEUTICALS

KVG GROUP INC. (CANADA CORPORATION)
1 WESTSIDE DRIVE, UNIT 12
TORONTO, ONTARIO, CANADA M9C 1B2

FOR: NON-MEDICATED FOOTCARE PRODUCTS, NAMELY, FOOT LOTIONS, FOOT DEODORANT SPRAYS, FOOT CREAMS, FOOT GELS AND FOOT POWDERS SOLD EXCLUSIVELY FOR THE SALON AND SPA MARKET, IN CLASS 3 (U.S. CLS. 1, 4, 6, 50, 51 AND 52).

FIRST USE 1-7-2007; IN COMMERCE 1-7-2007.

THE MARK CONSISTS OF STANDARD CHARACTERS WITHOUT CLAIM TO ANY PARTICULAR FONT, STYLE, SIZE, OR COLOR.

PRIORITY CLAIMED UNDER SEC. 44(D) ON CANADA APPLICATION NO. 1319998, FILED 10-12-2006.

SN 77-020,810, FILED 10-13-2006.

DAVID YONTEF, EXAMINING ATTORNEY

Int. Cls.: 9, 35, 37, and 42

**Prior U.S. Cls.: 21, 23, 26, 36, 38, 100, 101, 102, 103,
and 106**

Reg. No. 3,576,683

United States Patent and Trademark Office

Registered Feb. 17, 2009

**TRADEMARK
SERVICE MARK
PRINCIPAL REGISTER**

ZING

HONEYWELL INTERNATIONAL INC. (DELA-
WARE CORPORATION)
101 COLUMBIA ROAD
MORRISTOWN, NJ 07962

FOR: SOFTWARE AND HARDWARE TO PRO-
VIDE REMOTE BIDIRECTIONAL DATA ACCESS
TO VEHICLES FOR MONITORING AND MANA-
GING VEHICLE CREW, SECURITY, CONSUMA-
BLES, PERFORMANCE, CONFIGURATION,
MAINTENANCE AND SYSTEMS SUCH AS ENGINE
AND ELECTRONICS; SOFTWARE AND HARD-
WARE FOR USE IN PERFORMING REMOTE VE-
HICLE SYSTEM DIAGNOSTICS, PROGNOSTICS,
SOFTWARE UPDATES AND SOFTWARE REPAIRS;
SOFTWARE AND HARDWARE FOR USE IN PRO-
VIDING ALERTS AND RECOMMENDATIONS
BASED ON VEHICLE INFORMATION; ALL OF
THE AFOREMENTIONED GOODS TO BE USED IN
CONJUNCTION WITH TRANSPORTATION VEHI-
CLES EXCLUDING TAXIS AND LIVERY SERVI-
CES, IN CLASS 9 (U.S. CLS. 21, 23, 26, 36 AND 38).

FIRST USE 11-30-2006; IN COMMERCE 5-31-2007.

FOR: TRANSPORTATION LOGISTICS SERVICE
NETWORK UTILIZING SOFTWARE AND HARD-
WARE TO PROVIDE REMOTE BIDIRECTIONAL
DATA ACCESS TO VEHICLES FOR MONITORING
AND MANAGING VEHICLE CREW, SECURITY,
CONSUMABLES, PERFORMANCE, CONFIGURA-
TION, MAINTENANCE AND SYSTEMS SUCH AS
ENGINE AND ELECTRONICS, IN CLASS 35 (U.S.
CLS. 100, 101 AND 102).

FIRST USE 11-30-2006; IN COMMERCE 5-31-2007.

FOR: VEHICLE MAINTENANCE CONSULTA-
TION SERVICE UTILIZING SOFTWARE AND
HARDWARE TO PROVIDE REMOTE BIDIREC-
TIONAL DATA ACCESS TO VEHICLES FOR MON-
ITORING AND MANAGING VEHICLE CREW,
SECURITY, CONSUMABLES, PERFORMANCE,
CONFIGURATION, MAINTENANCE AND SYS-
TEMS SUCH AS ENGINE AND ELECTRONICS, IN
CLASS 37 (U.S. CLS. 100, 103 AND 106).

FIRST USE 11-30-2006; IN COMMERCE 5-31-2007.

FOR: PROVIDING REMOTE VEHICLE SYSTEM
DIAGNOSTICS, PROGNOSTICS, SOFTWARE UP-
DATES AND SOFTWARE REPAIRS; VEHICLE
MONITORING SERVICE WHICH TRACKS HARD-
WARE AND SOFTWARE PERFORMANCE AND
PROCESSES IN VEHICLE AND SENDS OUT
ALERTS AND RECOMMENDATIONS BASED ON
VEHICLE INFORMATION, IN CLASS 42 (U.S. CLS.
100 AND 101).

FIRST USE 11-30-2006; IN COMMERCE 5-31-2007.

THE MARK CONSISTS OF STANDARD CHAR-
ACTERS WITHOUT CLAIM TO ANY PARTICULAR
FONT, STYLE, SIZE, OR COLOR.

SN 77-021,671, FILED 10-16-2006.

MATTHEW MCDOWELL, EXAMINING ATTOR-
NEY

Int. Cls.: 9 and 16

Prior U.S. Cls.: 2, 5, 21, 22, 23, 26, 29, 36, 37, 38, and 50

Reg. No. 3,576,684

United States Patent and Trademark Office

Registered Feb. 17, 2009

**TRADEMARK
PRINCIPAL REGISTER**

CENTERSERVE

PROSCI, INC. (COLORADO CORPORATION)
1367 S. GARFIELD AVE.
LOVELAND, CO 80537

FOR: COMPUTER SOFTWARE FOR SCHEDULING CALL-CENTER PERSONNEL FOR OTHERS; DOWNLOADABLE ELECTRONIC PUBLICATIONS IN THE NATURE OF NEWSLETTERS, BOOKS, PAMPHLETS, USER MANUALS, AND MAGAZINES IN THE FIELD OF TELEPHONE CALL CENTERS AND OTHER SPECIALIZED TELECOMMUNICATIONS APPLICATIONS RECORDED ON COMPUTER MEDIA, NAMELY, THE MANAGEMENT OF TELEPHONE CALL CENTERS, IN CLASS 9 (U.S. CLS. 21, 23, 26, 36 AND 38).

FIRST USE 4-27-2007; IN COMMERCE 4-27-2007.

FOR: NEWSLETTERS AND A SERIES OF NON-FICTION BOOKS IN THE FIELD OF TELEPHONE CALL CENTERS AND OTHER SPECIALIZED TELECOMMUNICATIONS APPLICATIONS, NAMELY, THE MANAGEMENT OF TELEPHONE CALL CENTERS, IN CLASS 16 (U.S. CLS. 2, 5, 22, 23, 29, 37, 38 AND 50).

FIRST USE 4-27-2007; IN COMMERCE 4-27-2007.

THE MARK CONSISTS OF STANDARD CHARACTERS WITHOUT CLAIM TO ANY PARTICULAR FONT, STYLE, SIZE, OR COLOR.

SN 77-023,108, FILED 10-17-2006.

KAPIL BHANOT, EXAMINING ATTORNEY

Int. Cl.: 42

Prior U.S. Cls.: 100 and 101

United States Patent and Trademark Office

Reg. No. 3,576,685

Registered Feb. 17, 2009

**SERVICE MARK
PRINCIPAL REGISTER**



ACHIEVANCE, INC. (MINNESOTA CORPORATION)
11650 129TH AVENUE NORTH
DAYTON, MN 55327

FIRST USE 12-9-2008; IN COMMERCE 12-9-2008.

FOR: PROVIDING TEMPORARY USE OF NON-DOWNLOADABLE SOFTWARE, NAMELY, BEST-PRACTICE ON DEMAND HUMAN RESOURCE SOFTWARE FOR EVALUATING AND TRACKING EMPLOYEE AND COMPANY GOALS, EMPLOYEE PERFORMANCE, AND EMPLOYEE COMPENSATION, IN CLASS 42 (U.S. CLS. 100 AND 101).

THE MARK CONSISTS OF THE LETTER "A" WITH A PLUS SIGN ABOVE THE "A."

SN 77-024,104, FILED 10-18-2006.

LINDA POWELL, EXAMINING ATTORNEY

Int. Cl.: 2

Prior U.S. Cls.: 6, 11, and 16

United States Patent and Trademark Office

Reg. No. 3,576,686

Registered Feb. 17, 2009

TRADEMARK
PRINCIPAL REGISTER



*Colours with
infinite possibilities!*

LICHAO, ZHOU (CHINA INDIVIDUAL)
DONGXIN AVE, BINJIANG DISTRICT 15F-A
LANJIANG BUILDING, ZHIJIANG GONGYU
HANGZHOU, CHINA

FOR: CLEAR AND PIGMENTED COATINGS
USED IN THE NATURE OF PAINT; COLOR PIG-
MENTS; GOUACHES IN THE NATURE OF OPAQUE
COLOR PIGMENTS; INORGANIC PIGMENTS; OR-
GANIC PIGMENTS; PIGMENTS; PRINTING INKS,
COATINGS, PIGMENTS AND DISPERSIONS FOR
USE IN THE GRAPHIC ARTS INDUSTRY; TINTS
FOR ARCHITECTURAL PAINTS AND PIGMEN-

TED COATINGS FOR INTERIOR AND EXTERIOR
USE, IN CLASS 2 (U.S. CLS. 6, 11 AND 16).

FIRST USE 4-1-2008; IN COMMERCE 4-1-2008.

NO CLAIM IS MADE TO THE EXCLUSIVE
RIGHT TO USE "SYNTHETIC OXIDE PIGMENTS",
APART FROM THE MARK AS SHOWN.

SN 77-025,515, FILED 10-20-2006.

ROBIN CHOSID, EXAMINING ATTORNEY

Int. Cl.: 45

Prior U.S. Cls.: 100 and 101

United States Patent and Trademark Office

Reg. No. 3,576,687

Registered Feb. 17, 2009

**SERVICE MARK
PRINCIPAL REGISTER**

HONESTY IS THE BEST POLICY

TRUE NAME, INC. (CALIFORNIA CORPORATION)
3463 TANGLEWOOD LANE
ROLLING HILLS ESTATES, CA 90274

FIRST USE 11-4-2008; IN COMMERCE 11-4-2008.

FOR: BACKGROUND INVESTIGATION AND RESEARCH SERVICES; IDENTIFICATION VERIFICATION SERVICES, NAMELY, PROVIDING AUTHENTICATION OF PERSONAL IDENTIFICATION INFORMATION; ON-LINE IDENTITY RELIABILITY INVESTIGATION IN THE FIELD OF ON-LINE DATING AND CLAIMS MADE ABOUT AGE, GENDER, IN CLASS 45 (U.S. CLS. 100 AND 101).

THE MARK CONSISTS OF STANDARD CHARACTERS WITHOUT CLAIM TO ANY PARTICULAR FONT, STYLE, SIZE, OR COLOR.

SN 77-027,535, FILED 10-23-2006.

JAY BESCH, EXAMINING ATTORNEY

Int. Cl.: 16

Prior U.S. Cls.: 2, 5, 22, 23, 29, 37, 38, and 50

Reg. No. 3,576,688

United States Patent and Trademark Office

Registered Feb. 17, 2009

TRADEMARK
PRINCIPAL REGISTER

K² E² Y¹ B¹ O³ A⁴ R² D G² E¹ N¹ I² U¹ S³

LITTLEHALES, JANET M (AUSTRALIA INDIVIDUAL)
2 GILBERT PLACE
FRENCHS FOREST, NSW, AUSTRALIA 2086

FOR: STICKERS IN THE NATURE OF KEYBOARD TEMPLATES, IN CLASS 16 (U.S. CLS. 2, 5, 22, 23, 29, 37, 38 AND 50).

FIRST USE 12-1-2006; IN COMMERCE 12-1-2006.

NO CLAIM IS MADE TO THE EXCLUSIVE RIGHT TO USE "KEYBOARD", APART FROM THE MARK AS SHOWN.

THE MARK CONSISTS OF THE WORDS "KEYBOARD GENIUS" WHERE EACH INDIVIDUAL LETTER IS WITHIN A SQUARE OUTLINE AND NUMBERS "1", "2", "3", OR "4" APPEAR IN ONE CORNER OF EACH SQUARE.

SN 77-030,642, FILED 10-27-2006.

APRIL HESIK, EXAMINING ATTORNEY

Int. Cl.: 35

Prior U.S. Cls.: 100, 101, and 102

United States Patent and Trademark Office

Reg. No. 3,576,689

Registered Feb. 17, 2009

**SERVICE MARK
PRINCIPAL REGISTER**

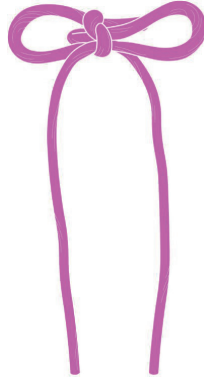

NATIONAL BREAST CANCER FOUNDATION,
INC. (TEXAS CORPORATION)
2600 NETWORK BOULEVARD, SUITE 300
FRISCO, TX 75034

FOR: PROMOTING PUBLIC AWARENESS OF
THE NEED FOR FUNDING TO FIGHT BREAST
CANCER AND TO AID IN SURVIVOR RECOVERY,
IN CLASS 35 (U.S. CLS. 100, 101 AND 102).

FIRST USE 5-0-2007; IN COMMERCE 5-0-2007.

THE COLOR(S) PINK IS/ARE CLAIMED AS A
FEATURE OF THE MARK.

THE MARK CONSISTS OF A STRING TIED IN A
KNOT. THE STRING IS PINK IN COLOR.

SN 77-032,812, FILED 10-31-2006.

RONALD AIKENS, EXAMINING ATTORNEY

Int. Cl.: 36

Prior U.S. Cls.: 100, 101, and 102

United States Patent and Trademark Office

Reg. No. 3,576,690

Registered Feb. 17, 2009

**SERVICE MARK
PRINCIPAL REGISTER**

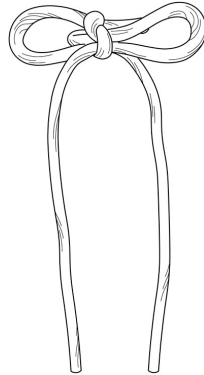

NATIONAL BREAST CANCER FOUNDATION,
INC. (TEXAS CORPORATION)
2600 NETWORK BOULEVARD, SUITE 300
FRISCO, TX 75034

FOR: CHARITABLE FUND-RAISING SERVICES,
NAMELY, RAISING MONEY FOR BREAST CAN-
CER PUBLIC AWARENESS PROGRAMS, BREAST
CANCER EDUCATION PROGRAMS, BREAST CAN-
CER DETECTION PROGRAMS, AND BREAST CAN-
CER RESEARCH PROGRAMS, AND FOR
SUBSIDIZING MAMMOGRAMS FOR UNDER-

SERVED WOMEN, IN CLASS 36 (U.S. CLS. 100, 101
AND 102).

FIRST USE 5-0-2007; IN COMMERCE 5-0-2007.

THE MARK CONSISTS OF A STRING TIED IN A
KNOT.

SN 77-034,797, FILED 11-1-2006.

RONALD AIKENS, EXAMINING ATTORNEY

Int. Cl.: 35

Prior U.S. Cls.: 100, 101, and 102

United States Patent and Trademark Office

Reg. No. 3,576,691

Registered Feb. 17, 2009

**SERVICE MARK
PRINCIPAL REGISTER**

STRING OF LIFE

NATIONAL BREAST CANCER FOUNDATION,
INC. (TEXAS CORPORATION)
2600 NETWORK BOULEVARD, SUITE 300
FRISCO, TX 75034

FOR: PROMOTING PUBLIC AWARENESS OF
THE NEED FOR FUNDING TO FIGHT BREAST
CANCER AND TO AID IN SURVIVOR RECOVERY,
IN CLASS 35 (U.S. CLS. 100, 101 AND 102).

FIRST USE 9-0-2007; IN COMMERCE 9-0-2007.

THE MARK CONSISTS OF STANDARD CHAR-
ACTERS WITHOUT CLAIM TO ANY PARTICULAR
FONT, STYLE, SIZE, OR COLOR.

SN 77-037,137, FILED 11-5-2006.

RONALD AIKENS, EXAMINING ATTORNEY

Int. Cl.: 42

Prior U.S. Cls.: 100 and 101

United States Patent and Trademark Office

Reg. No. 3,576,692

Registered Feb. 17, 2009

**SERVICE MARK
PRINCIPAL REGISTER**

SPEED STYLE

HILLS, KIMBA (UNITED STATES INDIVIDUAL)
1740 #C OCEAN PARK BOULEVARD
SANTA MONICA, CA 90405 AND
GORDON, JUDY (UNITED STATES INDIVIDUAL)
1740 #C OCEAN PARK BOULEVARD
SANTA MONICA, CA 90405

FOR: INTERIOR DECORATING, IN CLASS 42
(U.S. CLS. 100 AND 101).

FIRST USE 12-12-2008; IN COMMERCE 12-12-2008.

THE MARK CONSISTS OF STANDARD CHAR-
ACTERS WITHOUT CLAIM TO ANY PARTICULAR
FONT, STYLE, SIZE, OR COLOR.

NO CLAIM IS MADE TO THE EXCLUSIVE
RIGHT TO USE "STYLE", APART FROM THE
MARK AS SHOWN.

SN 77-037,957, FILED 11-6-2006.

KAPIL BHANOT, EXAMINING ATTORNEY

Int. Cl.: 35

Prior U.S. Cls.: 100, 101, and 102

United States Patent and Trademark Office

Reg. No. 3,576,693

Registered Feb. 17, 2009

**SERVICE MARK
PRINCIPAL REGISTER**

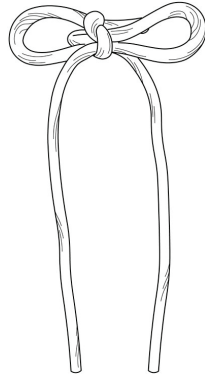

NATIONAL BREAST CANCER FOUNDATION,
INC. (TEXAS CORPORATION)
2600 NETWORK BOULEVARD, SUITE 300
FRISCO, TX 75034

FOR: PROMOTING PUBLIC AWARENESS OF
THE NEED FOR FUNDING TO FIGHT BREAST
CANCER AND TO AID IN SURVIVOR RECOVERY,
IN CLASS 35 (U.S. CLS. 100, 101 AND 102).

FIRST USE 5-0-2007; IN COMMERCE 5-0-2007.

THE MARK CONSISTS OF A STRING TIED IN A
KNOT.

SN 77-038,119, FILED 11-7-2006.

RONALD AIKENS, EXAMINING ATTORNEY

Int. Cl.: 16

Prior U.S. Cls.: 2, 5, 22, 23, 29, 37, 38, and 50

Reg. No. 3,576,694

United States Patent and Trademark Office

Registered Feb. 17, 2009

**TRADEMARK
PRINCIPAL REGISTER**

TruScent II

TORRELLAS & ROTHCHILD PRINTING AND
PACKAGING COMPANY, LLC (NEW YORK
LIMITED LIABILITY COMPANY)

10-11 148TH STREET
WHITESTONE, NY 11357

FOR: PAPER FOR USE IN THE GRAPHIC ARTS
INDUSTRY, IN CLASS 16 (U.S. CLS. 2, 5, 22, 23, 29, 37,
38 AND 50).

FIRST USE 6-1-2006; IN COMMERCE 6-1-2006.

THE MARK CONSISTS OF STANDARD CHAR-
ACTERS WITHOUT CLAIM TO ANY PARTICULAR
FONT, STYLE, SIZE, OR COLOR.

NO CLAIM IS MADE TO THE EXCLUSIVE
RIGHT TO USE "II", APART FROM THE MARK
AS SHOWN.

SN 77-038,456, FILED 11-7-2006.

LINDA ORNDORFF, EXAMINING ATTORNEY

Int. Cl.: 31

Prior U.S. Cls.: 1 and 46

United States Patent and Trademark Office

Reg. No. 3,576,695

Registered Feb. 17, 2009

**TRADEMARK
PRINCIPAL REGISTER**

PRIMATE CRUNCH

LAND O'LAKES PURINA FEED LLC (DELA-
WARE LIMITED LIABILITY COMPANY)

4001 LEXINGTON AVENUE NORTH

ARDEN HILLS, MN 55126

FOR: PRIMATE FEED SOLD TO ZOOS, IN CLASS
31 (U.S. CLS. 1 AND 46).

FIRST USE 4-21-2008; IN COMMERCE 4-21-2008.

THE MARK CONSISTS OF STANDARD CHAR-
ACTERS WITHOUT CLAIM TO ANY PARTICULAR
FONT, STYLE, SIZE, OR COLOR.

NO CLAIM IS MADE TO THE EXCLUSIVE
RIGHT TO USE "PRIMATE", APART FROM THE
MARK AS SHOWN.

SN 77-038,475, FILED 11-7-2006.

BARBARA GAYNOR, EXAMINING ATTORNEY

Int. Cls.: 7 and 17

Prior U.S. Cls.: 1, 5, 12, 13, 19, 21, 23, 31, 34, 35, and 50

Reg. No. 3,576,696

United States Patent and Trademark Office

Registered Feb. 17, 2009

**TRADEMARK
PRINCIPAL REGISTER**

SUPERTEX

UTEX INDUSTRIES, INC. (TEXAS CORPORATION)
SUITE 100
10810 OLD KATY ROAD
HOUSTON, TX 77043

FOR: MACHINE PARTS, NAMELY, BEARINGS AND LINEAR AND ROTATIONAL BEARINGS; STRUCTURAL AND REPLACEMENT PARTS FOR VALVES AND COMPRESSORS FOR MACHINES; MACHINE PARTS MADE OF THERMOPLASTIC AND THERMOSET MATERIALS FOR USE IN FLUID HANDLING EQUIPMENT, NAMELY, VALVES, WHEELS, COMPRESSOR PISTON RINGS, SPLINE ADAPTERS, AND COUPLINGS FOR DRIVE SHAFTS, IN CLASS 7 (U.S. CLS. 13, 19, 21, 23, 31, 34 AND 35).

FIRST USE 10-31-2008; IN COMMERCE 10-31-2008.

FOR: SEMI-PROCESSED PLASTIC IN THE FORM OF STOCK SHAPES AND NET SHAPES, NAMELY, ENGINEERING PLASTICS MADE OF THERMOPLASTIC AND THERMOSET MATERIALS FOR USE IN FLUID HANDLING EQUIPMENT; SEMI-PROCESSED PLASTIC MATERIALS FOR USE IN FURTHER MANUFACTURE, NAMELY, UNFINISHED THERMOPLASTIC AND THERMOSET MATERIALS USED IN THE MANUFACTURE OF MACHINE PARTS; SEMI-FINISHED PLASTIC GOODS, NAMELY, PLASTIC IN EXTRUDED OR MOLDED FORM FOR GENERAL INDUSTRIAL USE, NAMELY, THERMOPLASTIC AND THERMOSET MOLDED

OR EXTRUDED COMPONENTS; NON-METAL SEALING RINGS, GASKETS AND PACKINGS FOR FLUID HANDLING EQUIPMENT; PACKING MATERIALS FOR FORMING SEALS, NAMELY, PACKING RINGS FOR PUMP AND HYDRAULIC CYLINDER PACKINGS AND DIAPHRAGMS; SEMI-FINISHED PLASTIC GOODS, NAMELY, PLASTICS IN EXTRUDED FORM FOR INDUSTRIAL USE, NAMELY, PLASTICS MADE OF THERMOPLASTIC AND THERMOSET MATERIALS FOR USE IN FLUID HANDLING EQUIPMENT, AND EXTRUDED OR MOLDED FORM FOR USE IN THE MANUFACTURE OF FLUID SEALING DEVICES; FLEXIBLE POLYMERIC DAMPING DEVICES, NAMELY, SHOCK ABSORBING BUFFERS FOR INDUSTRIAL MACHINERY; ELECTRICAL INSULATORS, NAMELY, INSULATORS MADE OF THERMOPLASTIC AND THERMOSET COMPOUNDS; NON-METAL GASKETS, SEALS AND PACKINGS FOR USE IN FLUID HANDLING EQUIPMENT, IN CLASS 17 (U.S. CLS. 1, 5, 12, 13, 35 AND 50).

FIRST USE 10-31-2008; IN COMMERCE 10-31-2008.

THE MARK CONSISTS OF STANDARD CHARACTERS WITHOUT CLAIM TO ANY PARTICULAR FONT, STYLE, SIZE, OR COLOR.

SN 77-038,820, FILED 11-7-2006.

LINDSEY RUBIN, EXAMINING ATTORNEY

Int. Cl.: 36

Prior U.S. Cls.: 100, 101, and 102

United States Patent and Trademark Office

Reg. No. 3,576,697

Registered Feb. 17, 2009

**SERVICE MARK
PRINCIPAL REGISTER**

GOT BOOKS?

GOT BOOKS, INC. (MASSACHUSETTS CORPORATION)
25 SPRINGWELL ROAD
BILLERICA, MA 01821

FOR: CHARITABLE FUND RAISING SERVICES BY MEANS OF COLLECTING AND RESELLING NEW AND USED BOOKS, IN CLASS 36 (U.S. CLS. 100, 101 AND 102).

FIRST USE 12-9-2004; IN COMMERCE 12-9-2004.

THE MARK CONSISTS OF STANDARD CHARACTERS WITHOUT CLAIM TO ANY PARTICULAR FONT, STYLE, SIZE, OR COLOR.

NO CLAIM IS MADE TO THE EXCLUSIVE RIGHT TO USE "BOOKS", APART FROM THE MARK AS SHOWN.

SN 77-039,402, FILED 11-8-2006.

DAVID ELTON, EXAMINING ATTORNEY

Int. Cl.: 5

Prior U.S. Cls.: 6, 18, 44, 46, 51, and 52

United States Patent and Trademark Office

Reg. No. 3,576,698

Registered Feb. 17, 2009

**TRADEMARK
PRINCIPAL REGISTER**

Bromitize

SOLUTION BIOSCIENCES, INC. (NEW JERSEY
CORPORATION)
414 MAIN STREET
CHATHAM, NJ 07928

THE MARK CONSISTS OF STANDARD CHAR-
ACTERS WITHOUT CLAIM TO ANY PARTICULAR
FONT, STYLE, SIZE, OR COLOR.

FOR: BIOCIDES, IN CLASS 5 (U.S. CLS. 6, 18, 44, 46,
51 AND 52).

SN 77-040,645, FILED 11-9-2006.

FIRST USE 6-25-2006; IN COMMERCE 8-30-2007.

ANTHONY RINKER, EXAMINING ATTORNEY

Int. Cl.: 42

Prior U.S. Cls.: 100 and 101

United States Patent and Trademark Office

Reg. No. 3,576,699

Registered Feb. 17, 2009

**SERVICE MARK
PRINCIPAL REGISTER**

**THE ULTIMATE CERTIFIED
REAL CARD DEAL**

GIOIA SYSTEMS, LLC (COLORADO LIMITED
LIABILITY COMPANY)
SUITE 500
650 SOUTH CHERRY STREET
DENVER, CO 80246

FOR: COMPUTER SERVICES, NAMELY, ELECTRONICALLY GATHERING, ANALYZING AND FORMATTING DATA TO PROVIDE ELECTRONIC LISTINGS OF CARDS CORRESPONDING TO A READING OF PHYSICALLY SHUFFLED CARDS FOR USE IN ELECTRONIC OR COMPUTER CARD GAMES AND TO VERIFY THAT ELECTRONIC OR COMPUTER CARD GAMES ARE PLAYED AC-

CORDING TO THE ELECTRONIC LISTINGS OF CARDS, IN CLASS 42 (U.S. CLS. 100 AND 101).

FIRST USE 6-3-2008; IN COMMERCE 6-3-2008.

THE MARK CONSISTS OF STANDARD CHARACTERS WITHOUT CLAIM TO ANY PARTICULAR FONT, STYLE, SIZE, OR COLOR.

SN 77-041,035, FILED 11-9-2006.

DOMINIC FATHY, EXAMINING ATTORNEY

Int. Cl.: 42

Prior U.S. Cls.: 100 and 101

United States Patent and Trademark Office

Reg. No. 3,576,700

Registered Feb. 17, 2009

SERVICE MARK
PRINCIPAL REGISTER



CUT N' SHUFFLE

The ultimate certified real card deal.

GIOIA SYSTEMS, LLC (COLORADO LIMITED
LIABILITY COMPANY)
650 SOUTH CHERRY STREET
SUITE 500
DENVER, CO 80246

FOR: COMPUTER SERVICES, NAMELY, ELECTRONICALLY GATHERING, ANALYZING AND FORMATTING DATA TO PROVIDE ELECTRONIC LISTINGS OF CARDS CORRESPONDING TO A READING OF PHYSICALLY SHUFFLED CARDS FOR USE IN ELECTRONIC OR COMPUTER CARD

GAMES AND TO VERIFY THAT ELECTRONIC OR COMPUTER CARD GAMES ARE PLAYED ACCORDING TO THE ELECTRONIC LISTINGS OF CARDS, IN CLASS 42 (U.S. CLS. 100 AND 101).

FIRST USE 6-3-2008; IN COMMERCE 6-3-2008.

SN 77-041,047, FILED 11-9-2006.

DOMINIC FATHY, EXAMINING ATTORNEY

Int. Cl.: 28

Prior U.S. Cls.: 22, 23, 38, and 50

Reg. No. 3,576,701

United States Patent and Trademark Office

Registered Feb. 17, 2009

**TRADEMARK
PRINCIPAL REGISTER**

DRYLITE

MIZUNO USA, INC. (GEORGIA CORPORATION)
ONE JACK CURRAN WAY
4925 AVALON RIDGE PARKWAY
NORCROSS, GA 30071

FOR: BASEBALL BATS, BASEBALL BATTING GLOVES, BASEBALL GLOVES, CATCHERS' MASKS, ELBOW PADS FOR ATHLETIC USE, GOLF BALL RETRIEVERS, GOLF BAGS, GOLF GLOVES; GOLF CLUBS, GOLF CLUB COVERS, KNEE PADS FOR ATHLETIC USE, SHIN PADS FOR ATHLETIC USE, SOFTBALL GLOVES, SOFTBALL BATS, UMPIRE PROTECTION EQUIPMENT, BASEBALL

CHEST PROTECTORS NOT FOR USE FOR HUNTING OR FISHING, IN CLASS 28 (U.S. CLS. 22, 23, 38 AND 50).

FIRST USE 8-0-2007; IN COMMERCE 8-0-2007.

THE MARK CONSISTS OF STANDARD CHARACTERS WITHOUT CLAIM TO ANY PARTICULAR FONT, STYLE, SIZE, OR COLOR.

SN 77-046,011, FILED 11-16-2006.

JERI J. FICKES, EXAMINING ATTORNEY

Int. Cl.: 7

Prior U.S. Cls.: 13, 19, 21, 23, 31, 34, and 35

United States Patent and Trademark Office

Reg. No. 3,576,702

Registered Feb. 17, 2009

**TRADEMARK
PRINCIPAL REGISTER**

WILLITBLEND?

K-TEC, INC. (UTAH CORPORATION)
1206 SOUTH 1680 WEST
OREM, UT 84058

FOR: MIXERS AND ELECTRIC FOOD BLENDERS, IN CLASS 7 (U.S. CLS. 13, 19, 21, 23, 31, 34 AND 35).

FIRST USE 10-23-2006; IN COMMERCE 10-23-2006.

THE MARK CONSISTS OF STANDARD CHARACTERS WITHOUT CLAIM TO ANY PARTICULAR FONT, STYLE, SIZE, OR COLOR.

SN 77-046,021, FILED 11-16-2006.

NORA BUCHANAN WILL, EXAMINING ATTORNEY

Int. Cls.: 16 and 36

Prior U.S. Cls.: 2, 5, 22, 23, 29, 37, 38, 50, 100, 101, and 102

United States Patent and Trademark Office

Reg. No. 3,576,703

Registered Feb. 17, 2009

**TRADEMARK
SERVICE MARK
PRINCIPAL REGISTER**

INVESTRIGHT

WELLS FARGO & COMPANY (DELAWARE CORPORATION)
SIXTH AND MARQUETTE
1700 WELLS FARGO CENTER, MAC N9305-176
MINNEAPOLIS, MN 55479

FOR: PRINTED EDUCATIONAL MATERIALS IN THE FIELDS OF MONEY MANAGEMENT, INVESTING, INVESTMENTS AND FINANCIAL MATTERS, IN CLASS 16 (U.S. CLS. 2, 5, 22, 23, 29, 37, 38 AND 50).

FIRST USE 1-2-2007; IN COMMERCE 1-2-2007.

FOR: FINANCIAL INVESTMENT SERVICES IN THE FIELDS OF SECURITIES, MUTUAL FUNDS, AND PORTFOLIO MANAGEMENT; PROVIDING INFORMATION ABOUT MONEY MANAGEMENT,

INVESTING, INVESTMENTS AND FINANCIAL MATTERS; PROVIDING INFORMATION ABOUT MONEY MANAGEMENT, INVESTING, INVESTMENTS AND FINANCIAL MATTERS VIA THE INTERNET, IN CLASS 36 (U.S. CLS. 100, 101 AND 102).

FIRST USE 1-2-2007; IN COMMERCE 1-2-2007.

THE MARK CONSISTS OF STANDARD CHARACTERS WITHOUT CLAIM TO ANY PARTICULAR FONT, STYLE, SIZE, OR COLOR.

SN 77-046,114, FILED 11-16-2006.

MARY CRAWFORD, EXAMINING ATTORNEY

Int. Cl.: 9

Prior U.S. Cls.: 21, 23, 26, 36, and 38

Reg. No. 3,576,704

United States Patent and Trademark Office

Registered Feb. 17, 2009

**TRADEMARK
PRINCIPAL REGISTER**

The logo for MIPS, consisting of the letters M, I, P, and S in a bold, stylized, sans-serif font. The letters are closely spaced and have a slightly irregular, hand-drawn appearance.

MIPS TECHNOLOGIES, INC. (DELAWARE CORPORATION)
1225 CHARLESTON ROAD
MOUNTAIN VIEW, CA 94043

FOR: COMPUTER SOFTWARE AND CODE FOR USE IN, AND FOR USE IN THE DESIGN, DESCRIPTION, DEVELOPMENT, TESTING AND DEBUGGING OF, SEMICONDUCTORS, INTEGRATED CIRCUITS, COMPUTER HARDWARE, AND CODE; COMPUTER SOFTWARE FOR DESIGNING, DESCRIBING, TESTING, MODELING, SIMULATING, COMPILING, DEBUGGING, DEVELOPING, VERIFYING, INTERFACING, AND CONSTRUCTING SEMICONDUCTORS, INTEGRATED CIRCUITS, COMPUTER HARDWARE, COMPUTING DEVICES, AND CODE; MICROPROCESSOR AND MICROCONTROLLER CORES; INSTRUCTION SET ARCHITECTURES, EXTENSIONS TO INSTRUCTION SET ARCHITECTURES, AND PROCESSOR ARCHI-

TECTURES FOR MICROPROCESSORS AND MICROCONTROLLERS; ELECTRONIC PUBLICATIONS IN THE NATURE OF MANUALS, SPECIFICATIONS, GUIDES, AND DATASHEETS ALL IN THE FIELD OF COMPUTER TECHNOLOGY, COMPUTER CODE AND ELECTRONIC HARDWARE IN DOWNLOADABLE FORM OR RECORDED ON COMPUTER MEDIA, IN CLASS 9 (U.S. CLS. 21, 23, 26, 36 AND 38).

FIRST USE 1-16-2007; IN COMMERCE 5-13-2007.

OWNER OF U.S. REG. NO. 2,896,003.

SN 77-046,131, FILED 11-16-2006.

WILLIAM P. SHANAHAN, EXAMINING ATTORNEY

Int. Cl.: 35

Prior U.S. Cls.: 100, 101, and 102

United States Patent and Trademark Office

Reg. No. 3,576,705

Registered Feb. 17, 2009

**SERVICE MARK
PRINCIPAL REGISTER**



LO'S TRANSLATION LTD. (MACAO CORPORATION)
EDIFICIO KAM LOI, 2/F., FLAT K
AVENIDA DO INFANTE D. HENRIQUE, NO. 16
MACAU SAR, CHINA

FOR: PROMOTING PUBLIC AWARENESS OF THE INTEREST FOR THAI PRODUCTS IN THE FIELD OF BUSINESS MANAGEMENT, IN CLASS 35 (U.S. CLS. 100, 101 AND 102).

FIRST USE 4-21-2006; IN COMMERCE 4-1-2008.

NO CLAIM IS MADE TO THE EXCLUSIVE RIGHT TO USE "THAILAND", APART FROM THE MARK AS SHOWN.

THE COLOR(S) BLUE, GREEN, ORANGE, YELLOW AND WHITE IS/ARE CLAIMED AS A FEATURE OF THE MARK.

THE COLOR BLUE APPEARS ON THE EDGE OF THE ROOFS OF THE TEMPLE AND ON THE WORDS. THE COLOR GREEN APPEARS ON THE JADE AND THE COIN IN THE MIDDLE OF THE MARK. THE COLOR ORANGE APPEARS ON THE ROOFS OF THE TEMPLE. THE COLOR YELLOW APPEARS ON THE BEAMS OF THE TEMPLE. THE COLOR WHILE APPEARS ON THE WALLS OF THE TEMPLE.

THE NON-LATIN CHARACTERS IN THE MARK TRANSLITERATE TO "TAI GUO JIE" AND THIS MEANS "THAILAND STREET" IN ENGLISH.

SN 77-050,735, FILED 11-26-2006.

DAVID TAYLOR, EXAMINING ATTORNEY

Int. Cls.: 38 and 41

Prior U.S. Cls.: 100, 101, 104, and 107

United States Patent and Trademark Office

Reg. No. 3,576,706

Registered Feb. 17, 2009

**SERVICE MARK
PRINCIPAL REGISTER**



UREVIEWMOVIES.COM (CALIFORNIA PART-
NERSHIP)
20 64TH AVENUE
PLAYA DEL REY, CA 90293

FOR: PROVIDING ON-LINE CHAT ROOMS FOR
TRANSMISSION OF MESSAGES AMONG COMPU-
TER USERS CONCERNING ENTERTAINMENT
AND MOVIES; AND PROVIDING ON-LINE FOR-
UMS FOR TRANSMISSION OF MESSAGES AMONG
COMPUTER USERS CONCERNING ENTERTAIN-
MENT AND MOVIES, IN CLASS 38 (U.S. CLS. 100, 101
AND 104).

FIRST USE 8-25-2006; IN COMMERCE 9-1-2006.

FOR: ENTERTAINMENT SERVICES, NAMELY,
PROVIDING ON-LINE REVIEWS OF ENTERTAIN-
MENT AND MOVIES; AND PROVIDING A WEB
SITE WHERE USERS CAN POST RATINGS, RE-

VIEWS AND RECOMMENDATIONS ON EVENTS
AND ACTIVITIES IN THE FIELD OF ENTERTAIN-
MENT AND MUSIC, IN CLASS 41 (U.S. CLS. 100, 101
AND 107).

FIRST USE 8-25-2006; IN COMMERCE 9-1-2006.

NO CLAIM IS MADE TO THE EXCLUSIVE
RIGHT TO USE ".COM", APART FROM THE MARK
AS SHOWN.

THE MARK CONSISTS OF A REEL OF FILM AND
THE STYLIZED TEXT OF THE WORDING "URE-
VIEWMOVIES.COM".

SN 77-050,925, FILED 11-27-2006.

RONALD AIKENS, EXAMINING ATTORNEY

Int. Cl.: 41

Prior U.S. Cls.: 100, 101, and 107

United States Patent and Trademark Office

Reg. No. 3,576,707

Registered Feb. 17, 2009

**SERVICE MARK
PRINCIPAL REGISTER**

MAD MARINER

JUSTICE, GLEN (UNITED STATES INDIVIDUAL)
115 THIRD STREET, N.E.
WASHINGTON, DC 20002

FOR: ONLINE INTERACTIVE WEBSITE FEATURING NEWS AND INFORMATION, ARTICLES, REVIEWS, STATISTICS, AND INTERVIEWS REGARDING THE SPORT OF BOATING, IN CLASS 41 (U.S. CLS. 100, 101 AND 107).

FIRST USE 7-20-2007; IN COMMERCE 7-20-2007.

THE MARK CONSISTS OF STANDARD CHARACTERS WITHOUT CLAIM TO ANY PARTICULAR FONT, STYLE, SIZE, OR COLOR.

SN 77-051,424, FILED 11-27-2006.

NORA BUCHANAN WILL, EXAMINING ATTORNEY

Int. Cls.: 11, 20, and 21

**Prior U.S. Cls.: 2, 13, 21, 22, 23, 25, 29, 30, 31, 32, 33,
34, 40, and 50**

Reg. No. 3,576,708

United States Patent and Trademark Office

Registered Feb. 17, 2009

**TRADEMARK
PRINCIPAL REGISTER**

LIVING WITH NATURE

TROPICDANE CO., LTD. (HONG KONG LIMITED COMPANY)
904 KNUTSFORD COMMERCIAL BUILDING
4-5 KNUTSFORD TERRACE
TSHIMSHATSUI, KOWLOON, HONG KONG

FOR: SINK UNITS FOR INDOOR AND OUTDOOR USE, IN CLASS 11 (U.S. CLS. 13, 21, 23, 31 AND 34).

FIRST USE 3-0-2005; IN COMMERCE 5-1-2006.

FOR: FURNITURE, NAMELY, FURNITURE UNITS FOR KITCHENS, CHAIRS, TABLES, KITCHEN TABLES, COUNTERS, SHELVES, CUPBOARDS, CUPBOARDS FOR KITCHENS; PARTS FOR FURNITURE, NAMELY, COUNTER OR TABLE TOPS AND TABLE TOPS AND TABLETOP STANDS; SHOWROOM READY DISPLAY CASES ON PALLETS, MIRRORS AND PICTURE FRAMES, IN CLASS 20 (U.S. CLS. 2, 13, 22, 25, 32 AND 50).

FIRST USE 3-0-0200; IN COMMERCE 5-1-2006.

FOR: EARTHENWARE FLOWERPOTS AND FLOWER JARS, IN CLASS 21 (U.S. CLS. 2, 13, 23, 29, 30, 33, 40 AND 50).

FIRST USE 3-0-2005; IN COMMERCE 5-1-2006.

THE MARK CONSISTS OF STANDARD CHARACTERS WITHOUT CLAIM TO ANY PARTICULAR FONT, STYLE, SIZE, OR COLOR.

PRIORITY CLAIMED UNDER SEC. 44(D) ON ERPN CMNTY TM OFC APPLICATION NO. 005488903, FILED 11-22-2006.

SN 77-052,823, FILED 11-29-2006.

BENJAMIN OKEKE, EXAMINING ATTORNEY

Int. Cl.: 14

Prior U.S. Cls.: 2, 27, 28, and 50

United States Patent and Trademark Office

Reg. No. 3,576,709

Registered Feb. 17, 2009

**TRADEMARK
PRINCIPAL REGISTER**

SEA WIZARD

INVICTA WATCH COMPANY OF AMERICA,
INC. (FLORIDA CORPORATION)
3069 TAFT STREET
HOLLYWOOD, FL 33021

THE MARK CONSISTS OF STANDARD CHAR-
ACTERS WITHOUT CLAIM TO ANY PARTICULAR
FONT, STYLE, SIZE, OR COLOR.

FOR: WATCHES, IN CLASS 14 (U.S. CLS. 2, 27, 28
AND 50).

SN 77-053,762, FILED 11-30-2006.

FIRST USE 11-20-2008; IN COMMERCE 11-20-2008.

JENNIFER VASQUEZ, EXAMINING ATTORNEY

Int. Cl.: 36

Prior U.S. Cls.: 100, 101, and 102

United States Patent and Trademark Office

Reg. No. 3,576,710

Registered Feb. 17, 2009

**SERVICE MARK
PRINCIPAL REGISTER**

**WASATCH STRATEGIC INCOME
FUND**

WASATCH ADVISORS, INC. (UTAH CORPORATION)
150 SOCIAL HALL AVENUE, 4TH FLOOR
SALT LAKE CITY, UT 84111

FOR: FINANCIAL INVESTMENT ADVICE SERVICES, MUTUAL FUND INVESTMENT SERVICES, AND INVESTMENT MANAGEMENT SERVICES, NAMELY, INVESTMENT ASSET MANAGEMENT, IN CLASS 36 (U.S. CLS. 100, 101 AND 102).

FIRST USE 2-1-2006; IN COMMERCE 2-1-2006.

THE MARK CONSISTS OF STANDARD CHARACTERS WITHOUT CLAIM TO ANY PARTICULAR FONT, STYLE, SIZE, OR COLOR.

OWNER OF U.S. REG. NOS. 2,876,347, 2,878,518, AND OTHERS.

NO CLAIM IS MADE TO THE EXCLUSIVE RIGHT TO USE "STRATEGIC INCOME FUND", APART FROM THE MARK AS SHOWN.

SEC. 2(F) AS TO "WASATCH".

SN 77-055,789, FILED 12-1-2006.

LINDA ORNDORFF, EXAMINING ATTORNEY

Int. Cl.: 38

Prior U.S. Cls.: 100, 101, and 104

United States Patent and Trademark Office

Reg. No. 3,576,711

Registered Feb. 17, 2009

**SERVICE MARK
PRINCIPAL REGISTER**

Boomer Village

MW&C LTD. (NEVADA CORPORATION)
C/O LAW OFFICE OF JANET TROST
6881 W CHARLESTON BLVD # B
LAS VEGAS, NV 89117

FOR: COMMUNICATIONS SERVICES, NAMELY,
PROVIDING FORUMS AND PLATFORMS FOR
DEVELOPING AN ONLINE COMMUNITY BASED
ON SOCIAL, LIFESTYLE, ECONOMIC AND LEGAL
ISSUES PERTAINING TO THE BABY BOOMER
GENERATION, IN CLASS 38 (U.S. CLS. 100, 101
AND 104).

FIRST USE 12-8-2008; IN COMMERCE 12-8-2008.

THE MARK CONSISTS OF STANDARD CHAR-
ACTERS WITHOUT CLAIM TO ANY PARTICULAR
FONT, STYLE, SIZE, OR COLOR.

OWNER OF U.S. REG. NOS. 3,150,248 AND
3,189,180.

NO CLAIM IS MADE TO THE EXCLUSIVE
RIGHT TO USE "BOOMER", APART FROM THE
MARK AS SHOWN.

SN 77-056,042, FILED 12-3-2006.

LYDIA BELZER, EXAMINING ATTORNEY

Int. Cl.: 10

Prior U.S. Cls.: 26, 39, and 44

United States Patent and Trademark Office

Reg. No. 3,576,712

Registered Feb. 17, 2009

**TRADEMARK
PRINCIPAL REGISTER**

HEATSTREAM

IQ HONG KONG, LTD (HONG KONG COR-
PORATION)
1-6 MEI WAN STREET RM9
21F MEGA TRADE CENTRE
TSUEN WNA N.T., HONG KONG

THE MARK CONSISTS OF STANDARD CHAR-
ACTERS WITHOUT CLAIM TO ANY PARTICULAR
FONT, STYLE, SIZE, OR COLOR.

FOR: HEATING PADS AND HEATING BELTS
FOR MEDICAL USE, IN CLASS 10 (U.S. CLS. 26, 39
AND 44).

SN 77-056,415, FILED 12-4-2006.

FIRST USE 1-1-2008; IN COMMERCE 1-1-2008.

BENJAMIN OKEKE, EXAMINING ATTORNEY

Int. Cl.: 35

Prior U.S. Cls.: 100, 101, and 102

United States Patent and Trademark Office

Reg. No. 3,576,713

Registered Feb. 17, 2009

**SERVICE MARK
PRINCIPAL REGISTER**

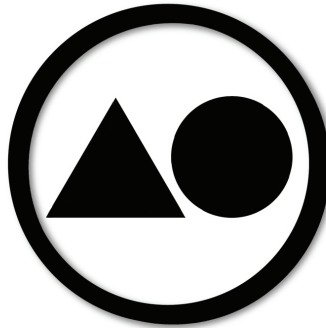

ANDREA OBSTON MARKETING COMMUNICA-
TIONS, LLC (CONNECTICUT LIMITED LIA-
BILITY COMPANY)
3 REGENCY DRIVE
BLOOMFIELD, CT 06002

FOR: ADVERTISING, MARKETING AND PUB-
LICITY SERVICES, NAMELY, STRATEGIC MAR-
KETING AUDITS, BRAND DEVELOPMENT AND
MARKETING, PUBLIC AND MEDIA RELATIONS,
BUSINESS CONSULTATION RELATING TO CRISIS
PLANNING AND MANAGEMENT, WEBSITES AND
INTERNET ADVERTISING AND RELATIONS

WITH MEDIA OUTLETS, IN CLASS 35 (U.S. CLS.
100, 101 AND 102).

FIRST USE 9-20-2006; IN COMMERCE 9-20-2006.

THE MARK CONSISTS OF A TRIANGLE AND A
CIRCLE WITHIN A LARGER CIRCLE.

SN 77-057,009, FILED 12-5-2006.

ARETHA SOMERVILLE, EXAMINING ATTORNEY

Int. Cl.: 18

Prior U.S. Cls.: 1, 2, 3, 22, and 41

United States Patent and Trademark Office

Reg. No. 3,576,714

Registered Feb. 17, 2009

**TRADEMARK
PRINCIPAL REGISTER**

Travel Outside the Box

CHERNOFF, DON (UNITED STATES INDIVIDUAL)
2226 CHESTERTOWN DRIVE
VIENNA, VA 22182

THE MARK CONSISTS OF STANDARD CHARACTERS WITHOUT CLAIM TO ANY PARTICULAR FONT, STYLE, SIZE, OR COLOR.

FOR: LUGGAGE, IN CLASS 18 (U.S. CLS. 1, 2, 3, 22 AND 41).

SN 77-058,600, FILED 12-6-2006.

FIRST USE 3-5-2007; IN COMMERCE 3-5-2007.

MAUREEN DALL, EXAMINING ATTORNEY

Int. Cl.: 9

Prior U.S. Cls.: 21, 23, 26, 36, and 38

United States Patent and Trademark Office

Reg. No. 3,576,715

Registered Feb. 17, 2009

**TRADEMARK
PRINCIPAL REGISTER**

Mystery P.I.

PLAYTIME MEDIA, INC. (CANADA CORPORATION)
SUITE 302
896 CAMBIE ST.
VANCOUVER, CANADA V6B296

FOR: ELECTRONIC GAME PROGRAMS; DOWNLOADABLE ELECTRONIC GAME PROGRAMS; ELECTRONIC GAME SOFTWARE; COMPUTER GAME PROGRAMS; DOWNLOADABLE COMPUTER GAME PROGRAMS; DOWNLOADABLE ELECTRONIC GAME ENTERTAINMENT, NAMELY, DOWNLOADABLE COMPUTER GAME SOFTWARE; INTERACTIVE VIDEO AND COMPUTER

GAME PROGRAMS; INTERACTIVE VIDEO GAME SOFTWARE; INTERACTIVE GAME SOFTWARE, IN CLASS 9 (U.S. CLS. 21, 23, 26, 36 AND 38).

FIRST USE 6-0-2007; IN COMMERCE 6-0-2007.

THE MARK CONSISTS OF STANDARD CHARACTERS WITHOUT CLAIM TO ANY PARTICULAR FONT, STYLE, SIZE, OR COLOR.

SN 77-059,509, FILED 12-7-2006.

SUZANNE BLANE, EXAMINING ATTORNEY

Int. Cl.: 12

Prior U.S. Cls.: 19, 21, 23, 31, 35, and 44

Reg. No. 3,576,716

United States Patent and Trademark Office

Registered Feb. 17, 2009

**TRADEMARK
PRINCIPAL REGISTER**

ONESOURCE

FEDERAL-MOGUL WORLD WIDE, INC. (MICHIGAN CORPORATION)
26555 NORTHWESTERN HIGHWAY
SOUTHFIELD, MI 48034

FOR: BRAKES, BRAKE PADS, BRAKE LININGS, BRAKE ROTORS FOR LAND VEHICLES; DRIVE-LINE PRODUCTS FOR LAND VEHICLES, NAME-
LY, UNIVERSAL JOINTS; CHASSIS PARTS FOR
LAND VEHICLES, NAMELY, BUSHINGS, BALL
JOINTS, BUMP STOPS, CENTER LINKS, CONTROL
ARMS, DRAG LINKS, STEERING STABILIZERS,
STRUT MOUNTS, SUSPENSION SPRINGS, SWAY
BARS, TIE RODS, TORSION ARMS; WHEEL HUB

ASSEMBLIES FOR LAND VEHICLES, IN CLASS 12
(U.S. CLS. 19, 21, 23, 31, 35 AND 44).

FIRST USE 6-24-2007; IN COMMERCE 6-24-2007.

THE MARK CONSISTS OF STANDARD CHAR-
ACTERS WITHOUT CLAIM TO ANY PARTICULAR
FONT, STYLE, SIZE, OR COLOR.

SN 77-063,666, FILED 12-13-2006.

FRANK LATTUCA, EXAMINING ATTORNEY

Int. Cl.: 30

Prior U.S. Cl.: 46

United States Patent and Trademark Office

Reg. No. 3,576,717

Registered Feb. 17, 2009

**TRADEMARK
PRINCIPAL REGISTER**



DESCAFEINADORES MEXICANOS S.A.DE C.V.
(MEXICO CORPORATION)
KM 341 CARRETERA MEXICO CORDOBA VERA-
CRUZ
CORDOBA, MEXICO

FOR: COFFEE BEANS, IN CLASS 30 (U.S. CL. 46).

FIRST USE 10-31-2007; IN COMMERCE 10-31-2007.

OWNER OF U.S. REG. NO. 3,062,375.

NO CLAIM IS MADE TO THE EXCLUSIVE
RIGHT TO USE "MOUNTAIN" AND "DECAF",
APART FROM THE MARK AS SHOWN.

THE MARK CONSISTS OF THE SILHOUETTE OF
A MOUNTAIN PEAK IN THE BACKGROUND,
SEPARATED FROM ONE-HALF OF A COFFEE
BEAN BY A STYLIZED FLOW OF WATER FROM
THE MOUNTAIN PEAK, WITH TWO STYLIZED
ARCS IN THE FOREGROUND.

SN 77-065,303, FILED 12-15-2006.

INGRID C. EULIN, EXAMINING ATTORNEY

Int. Cl.: 30

Prior U.S. Cl.: 46

United States Patent and Trademark Office

Reg. No. 3,576,718

Registered Feb. 17, 2009

**TRADEMARK
PRINCIPAL REGISTER**

SIMPLE SWEETS

SARA LEE BAKERY GROUP, INC. (DELAWARE
CORPORATION)
3500 LACEY ROAD
DOWNERS GROVE, IL 60515

NO CLAIM IS MADE TO THE EXCLUSIVE
RIGHT TO USE "SWEETS", APART FROM THE
MARK AS SHOWN.

FOR: BAKERY GOODS, IN CLASS 30 (U.S. CL. 46).

SN 77-066,174, FILED 12-18-2006.

FIRST USE 1-1-2007; IN COMMERCE 1-1-2007.

THE MARK CONSISTS OF STANDARD CHAR-
ACTERS WITHOUT CLAIM TO ANY PARTICULAR
FONT, STYLE, SIZE, OR COLOR.

KARANENDRA S. CHHINA, EXAMINING ATTOR-
NEY

Int. Cl.: 25

Prior U.S. Cls.: 22 and 39

United States Patent and Trademark Office

Reg. No. 3,576,719

Registered Feb. 17, 2009

TRADEMARK
PRINCIPAL REGISTER

GROOVE ROCK



WARNER, SATANA (UNITED STATES INDIVIDUAL)

#1

6900 COLDWATER CANYON AVE
NORTH HOLLYWOOD, CA 91605

FOR: CLOTHING, NAMELY, JEANS, SLACKS, PULLOVERS, SWEATERS, JACKETS, BLOUSES, SHIRTS, DRESSES, SWEATPANTS, SWEATSHIRTS, JERSEYS, SOCKS AND STOCKINGS, GYMSUITS, T-SHIRTS, SLEEPWEAR, HEADWEAR, HATS AND CAPS, IN CLASS 25 (U.S. CLS. 22 AND 39).

FIRST USE 5-1-2006; IN COMMERCE 5-1-2006.

THE COLOR(S) BLACK, WHITE, GRAY, AND PEACH IS/ARE CLAIMED AS A FEATURE OF THE MARK.

THE COLORS BLACK AND GRAY APPEAR IN THE WORDING "GROOVE ROCK" AND THE SPIKED WRIST BAND DESIGN; THE COLOR BLACK APPEARS IN THE OUTLINE OF THE HAND DESIGN AND THE FINGERNAILS SHOWN IN THE HAND DESIGN; THE COLOR PEACH APPEARS IN THE HAND DESIGN.

SN 77-066,830, FILED 12-18-2006.

JOHN DALIER, EXAMINING ATTORNEY

Int. Cl.: 11

Prior U.S. Cls.: 13, 21, 23, 31, and 34

Reg. No. 3,576,720

United States Patent and Trademark Office

Registered Feb. 17, 2009

**TRADEMARK
PRINCIPAL REGISTER**

NIXAN

CINDEX HOLDINGS LIMITED (HONG KONG
CORPORATION)
39 WANG CHIU ROAD
8/F, ENTERPRISE SQUARE 3
KOWLOON BAY, HONG KONG

FOR: LIGHTING FIXTURES; ELECTRIC HOLIDAY
CHRISTMAS LIGHTS; ELECTRIC LIGHTS
FOR CHRISTMAS TREES; ELECTRIC HOLIDAY
LIGHTS; PARTS AND FITTINGS FOR ALL THE
AFORESAID GOODS, IN CLASS 11 (U.S. CLS. 13, 21,
23, 31 AND 34).

FIRST USE 10-1-2001; IN COMMERCE 10-1-2001.

THE MARK CONSISTS OF STANDARD CHAR-
ACTERS WITHOUT CLAIM TO ANY PARTICULAR
FONT, STYLE, SIZE, OR COLOR.

SN 77-067,432, FILED 12-19-2006.

VIVIAN MICZNIK FIRST, EXAMINING ATTOR-
NEY

Int. Cls.: 35 and 45

Prior U.S. Cls.: 100, 101, and 102

United States Patent and Trademark Office

Reg. No. 3,576,721

Registered Feb. 17, 2009

**SERVICE MARK
PRINCIPAL REGISTER**



ZIRMED INC. (DELAWARE CORPORATION)
6TH FLOOR
626 WEST MAIN STREET
LOUISVILLE, KY 40202

FOR: BUSINESS SERVICES, NAMELY, PROVIDING CREDENTIALING AND HOSPITAL PRIVILEGING SERVICES FOR HEALTHCARE PROVIDERS AND LICENSED HEALTHCARE PERSONNEL, IN CLASS 35 (U.S. CLS. 100, 101 AND 102).

FIRST USE 11-28-2006; IN COMMERCE 11-28-2006.

FOR: IDENTIFICATION VERIFICATION SERVICES, NAMELY, PROVIDING AUTHENTICATION

OF PERSONAL IDENTIFICATION INFORMATION FOR HEALTHCARE PROVIDERS AND LICENSED HEALTHCARE PERSONNEL, IN CLASS 45 (U.S. CLS. 100 AND 101).

FIRST USE 11-28-2006; IN COMMERCE 11-28-2006.

NO CLAIM IS MADE TO THE EXCLUSIVE RIGHT TO USE "CREDENTIALING", APART FROM THE MARK AS SHOWN.

SN 77-068,038, FILED 12-20-2006.

SUSAN RICHARDS, EXAMINING ATTORNEY

Int. Cl.: 25

Prior U.S. Cls.: 22 and 39

United States Patent and Trademark Office

Reg. No. 3,576,722

Registered Feb. 17, 2009

**TRADEMARK
PRINCIPAL REGISTER**

**DR. SCHOLL'S ADVANTAGE
SPORT**

SCHERING-PLOUGH HEALTHCARE PRO-
DUCTS, INC. (DELAWARE CORPORATION)
3030 JACKSON AVENUE
MEMPHIS, TN 38151

FOR: FOOTWEAR, IN CLASS 25 (U.S. CLS. 22 AND
39).

FIRST USE 0-0-2003; IN COMMERCE 0-0-2003.

THE MARK CONSISTS OF STANDARD CHAR-
ACTERS WITHOUT CLAIM TO ANY PARTICULAR
FONT, STYLE, SIZE, OR COLOR.

OWNER OF U.S. REG. NOS. 191,089, 512,484, AND
OTHERS.

SN 77-068,492, FILED 12-20-2006.

CHERYL CLAYTON, EXAMINING ATTORNEY

Int. Cls.: 8 and 11

Prior U.S. Cls.: 13, 21, 23, 28, 31, 34, and 44

United States Patent and Trademark Office

Reg. No. 3,576,723

Registered Feb. 17, 2009

**TRADEMARK
PRINCIPAL REGISTER**

PLUMB4ORCE

EMBASSY GROUP LTD. (ILLINOIS CORPORATION)
P.O. BOX 843
ELGIN, IL 601210843

FOR: HAND TOOLS, NAMELY, WRENCHES, CHISELS, SCREW DRIVERS, NUT DRIVERS, AUGER BITS; MULTI-FUNCTION HAND TOOLS COMPRISED OF PLIERS; UTILITY KNIVES; SAWS; SHOVELS; HAMMERS; CAULKING GUNS, IN CLASS 8 (U.S. CLS. 23, 28 AND 44).

FIRST USE 10-31-2007; IN COMMERCE 10-31-2007.

FOR: FLASHLIGHTS; FAUCETS; TOILET BOWLS, TOILET SEATS, TOILET TANKS; LAVA-

TORY BOWLS, LAVATORY SEATS; SINKS; PLUMBING FITTINGS, NAMELY, DRAINS, TRAPS, VALVES, BIBBS; HOSEBIBBS; SILLCOCKS, IN CLASS 11 (U.S. CLS. 13, 21, 23, 31 AND 34).

FIRST USE 1-25-2008; IN COMMERCE 1-25-2008.

THE MARK CONSISTS OF STANDARD CHARACTERS WITHOUT CLAIM TO ANY PARTICULAR FONT, STYLE, SIZE, OR COLOR.

SN 77-068,617, FILED 12-20-2006.

MARK SPARACINO, EXAMINING ATTORNEY

Int. Cl.: 41

Prior U.S. Cls.: 100, 101, and 107

United States Patent and Trademark Office

Reg. No. 3,576,724

Registered Feb. 17, 2009

**SERVICE MARK
PRINCIPAL REGISTER**

FRESH AIR BOOKS

THE UPPER ROOM (TENNESSEE CORPORATION)
P.O. BOX 340004
1908 GRAND AVENUE
NASHVILLE, TN 372030004

FOR: PUBLICATION OF BOOKS, IN CLASS 41
(U.S. CLS. 100, 101 AND 107).

FIRST USE 11-4-2008; IN COMMERCE 11-4-2008.

THE MARK CONSISTS OF STANDARD CHARACTERS WITHOUT CLAIM TO ANY PARTICULAR FONT, STYLE, SIZE, OR COLOR.

NO CLAIM IS MADE TO THE EXCLUSIVE RIGHT TO USE "BOOKS", APART FROM THE MARK AS SHOWN.

SN 77-069,189, FILED 12-21-2006.

RAUL CORDOVA, EXAMINING ATTORNEY

Int. Cl.: 9

Prior U.S. Cls.: 21, 23, 26, 36, and 38

United States Patent and Trademark Office

Reg. No. 3,576,725

Registered Feb. 17, 2009

TRADEMARK
PRINCIPAL REGISTER

COUGAR CASH

SPIELO MANUFACTURING ULC (CANADA CORPORATION)
328 URQUHART AVENUE
MONCTON, NEW BRUNSWICK, CANADA E1H2R6

FOR: RECONFIGURABLE CASINO AND LOTTERY GAMING EQUIPMENT, NAMELY, SLOT MACHINES AND VIDEO LOTTERY TERMINALS AND OPERATIONAL COMPUTER GAME SOFTWARE THEREFOR, IN CLASS 9 (U.S. CLS. 21, 23, 26, 36 AND 38).

FIRST USE 2-25-2008; IN COMMERCE 2-25-2008.

THE MARK CONSISTS OF STANDARD CHARACTERS WITHOUT CLAIM TO ANY PARTICULAR FONT, STYLE, SIZE, OR COLOR.

NO CLAIM IS MADE TO THE EXCLUSIVE RIGHT TO USE "CASH", APART FROM THE MARK AS SHOWN.

SN 77-069,251, FILED 12-21-2006.

LEIGH LOWRY, EXAMINING ATTORNEY

Int. Cl.: 22

Prior U.S. Cls.: 1, 2, 7, 19, 22, 42, and 50

Reg. No. 3,576,726

United States Patent and Trademark Office

Registered Feb. 17, 2009

**TRADEMARK
PRINCIPAL REGISTER**

OVALMATIC

ENTERPRISES INTERNATIONAL, INC. (WA-
SHINGTON CORPORATION)
P.O. BOX 293
HOQUIAM, WA 985500359

FOR: NON-METAL STRAPPING AND TIE
DOWNS; NON-METAL MATERIAL FOR BANDING,
WRAPPING AND BALING, NAMELY, BANDS FOR
WRAPPING OR BINDING AND BAILING TWINE ,
IN CLASS 22 (U.S. CLS. 1, 2, 7, 19, 22, 42 AND 50).

FIRST USE 7-0-2004; IN COMMERCE 10-0-2005.

THE MARK CONSISTS OF STANDARD CHAR-
ACTERS WITHOUT CLAIM TO ANY PARTICULAR
FONT, STYLE, SIZE, OR COLOR.

OWNER OF U.S. REG. NOS. 629,374, 1,067,107,
AND 2,205,298.

SN 77-069,770, FILED 12-21-2006.

AMEETA JORDAN, EXAMINING ATTORNEY

Int. Cl.: 41

Prior U.S. Cls.: 100, 101, and 107

United States Patent and Trademark Office

Reg. No. 3,576,727

Registered Feb. 17, 2009

**SERVICE MARK
PRINCIPAL REGISTER**

THE TRACK LAB

THE TRACK LAB, LLC (MISSOURI LIMITED
LIABILITY COMPANY)
4408 SOUTHVIEW WAY DR.
ST. LOUIS, MO 63129

FOR: AUDIO, MUSIC, VIDEO, AND VOICE OVER
RECORDING AND PRODUCTION SERVICES, IN
CLASS 41 (U.S. CLS. 100, 101 AND 107).

FIRST USE 1-0-2008; IN COMMERCE 1-0-2008.

THE MARK CONSISTS OF STANDARD CHAR-
ACTERS WITHOUT CLAIM TO ANY PARTICULAR
FONT, STYLE, SIZE, OR COLOR.

NO CLAIM IS MADE TO THE EXCLUSIVE
RIGHT TO USE "TRACK", APART FROM THE
MARK AS SHOWN.

SN 77-071,806, FILED 12-27-2006.

LANA PHAM, EXAMINING ATTORNEY

Int. Cl.: 9

Prior U.S. Cls.: 21, 23, 26, 36, and 38

Reg. No. 3,576,728

United States Patent and Trademark Office

Registered Feb. 17, 2009

**TRADEMARK
PRINCIPAL REGISTER**

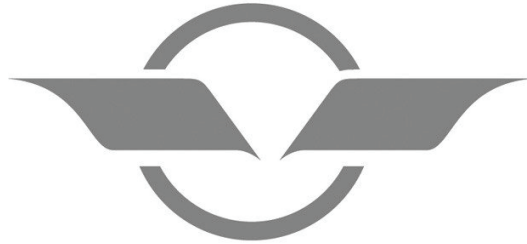

LIN, GUANG (UNITED STATES INDIVIDUAL)
5 CRAFTSMAN CT.
GREER, SC 29650

THE MARK CONSISTS OF A CIRCLE SPLIT IN
HALF HORIZONTALLY WITH 2 WING FEATURES
IN THE MIDDLE.

FOR: SUNGLASSES, IN CLASS 9 (U.S. CLS. 21, 23,
26, 36 AND 38).

SN 77-073,297, FILED 12-29-2006.

FIRST USE 8-1-2006; IN COMMERCE 8-1-2006.

TINA KUAN, EXAMINING ATTORNEY

Int. Cl.: 28

Prior U.S. Cls.: 22, 23, 38, and 50

United States Patent and Trademark Office

Reg. No. 3,576,729

Registered Feb. 17, 2009

**TRADEMARK
PRINCIPAL REGISTER**

SLITHERBITE

MATTEL, INC. (DELAWARE CORPORATION)
M1-1518
333 CONTINENTAL BLVD.
EL SEGUNDO, CA 902455012

THE MARK CONSISTS OF STANDARD CHAR-
ACTERS WITHOUT CLAIM TO ANY PARTICULAR
FONT, STYLE, SIZE, OR COLOR.

FOR: TOYS, GAMES AND PLAYTHINGS, NAME-
LY, TOY VEHICLES AND ACCESSORIES THERE-
FOR, IN CLASS 28 (U.S. CLS. 22, 23, 38 AND 50).

SN 77-075,468, FILED 1-3-2007.

FIRST USE 12-15-2008; IN COMMERCE 12-15-2008.

JOHN DWYER, EXAMINING ATTORNEY

Int. Cl.: 28

Prior U.S. Cls.: 22, 23, 38, and 50

United States Patent and Trademark Office

Reg. No. 3,576,730

Registered Feb. 17, 2009

**TRADEMARK
PRINCIPAL REGISTER**

RINGSLEY

MATTEL, INC. (DELAWARE CORPORATION)
M1-1518
333 CONTINENTAL BLVD.
EL SEGUNDO, CA 902455012

THE MARK CONSISTS OF STANDARD CHAR-
ACTERS WITHOUT CLAIM TO ANY PARTICULAR
FONT, STYLE, SIZE, OR COLOR.

FOR: TOYS, GAMES AND PLAYTHINGS, NAME-
LY, TOY VEHICLES AND ACCESSORIES THERE-
FOR, IN CLASS 28 (U.S. CLS. 22, 23, 38 AND 50).

SN 77-075,469, FILED 1-3-2007.

FIRST USE 12-15-2008; IN COMMERCE 12-15-2008.

JOHN DWYER, EXAMINING ATTORNEY

Int. Cl.: 30

Prior U.S. Cl.: 46

United States Patent and Trademark Office

Reg. No. 3,576,731

Registered Feb. 17, 2009

**TRADEMARK
PRINCIPAL REGISTER**

ARCTIC BERRY SORBETS

WM. WRIGLEY JR. COMPANY (DELAWARE
CORPORATION)
WRIGLEY BUILDING
410 NORTH MICHIGAN AVENUE
CHICAGO, IL 60611

FOR: CONFECTIONERY, NAMELY, CANDY
AND CANDY MINTS, IN CLASS 30 (U.S. CL. 46).

FIRST USE 12-1-2002; IN COMMERCE 12-1-2002.

THE MARK CONSISTS OF STANDARD CHAR-
ACTERS WITHOUT CLAIM TO ANY PARTICULAR
FONT, STYLE, SIZE, OR COLOR.

OWNER OF U.S. REG. NO. 2,988,138.

NO CLAIM IS MADE TO THE EXCLUSIVE
RIGHT TO USE "BERRY SORBETS", APART FROM
THE MARK AS SHOWN.

SN 77-076,072, FILED 1-4-2007.

ELLEN BURNS, EXAMINING ATTORNEY

Int. Cl.: 41

Prior U.S. Cls.: 100, 101, and 107

United States Patent and Trademark Office

Reg. No. 3,576,732

Registered Feb. 17, 2009

**SERVICE MARK
PRINCIPAL REGISTER**

THE FRIDGE

NATIONAL ENDOWMENT FOR FINANCIAL
EDUCATION (COLORADO NON-PROFIT
CORPORATION)
5299 DTC BOULEVARD, SUITE 1300
GREENWOOD VILLAGE, CO 80111

FOR: EDUCATIONAL SERVICES, NAMELY,
PROVIDING INFORMATION ON FINANCIAL
EDUCATION PROGRAMS IN THE FIELD OF PER-
SONAL MONEY MANAGEMENT, IN CLASS 41 (U.S.
CLS. 100, 101 AND 107).

FIRST USE 4-0-2007; IN COMMERCE 4-0-2007.

THE MARK CONSISTS OF STANDARD CHAR-
ACTERS WITHOUT CLAIM TO ANY PARTICULAR
FONT, STYLE, SIZE, OR COLOR.

SN 77-076,708, FILED 1-5-2007.

RUSS HERMAN, EXAMINING ATTORNEY

Int. Cl.: 36

Prior U.S. Cls.: 100, 101, and 102

United States Patent and Trademark Office

Reg. No. 3,576,733

Registered Feb. 17, 2009

**SERVICE MARK
PRINCIPAL REGISTER**

PAGOTRONIC

PANAFIN HOLDINGS LLC (FLORIDA LIMITED
LIABILITY COMPANY)
3034 NW 82ND AVENUE
MIAMI, FL 33122

FOR: CREDIT AND CASH CARD SERVICES;
CREDIT CARD TRANSACTION PROCESSING SER-
VICES; ELECTRONIC DEBIT TRANSACTIONS;
ELECTRONIC TRANSFERS OF MONEY, IN CLASS
36 (U.S. CLS. 100, 101 AND 102).

FIRST USE 2-0-2008; IN COMMERCE 2-0-2008.

THE MARK CONSISTS OF STANDARD CHAR-
ACTERS WITHOUT CLAIM TO ANY PARTICULAR
FONT, STYLE, SIZE, OR COLOR.

THE ENGLISH TRANSLATION OF THE WORD
"PAGO" IN THE MARK IS PAYMENT.

SN 77-077,039, FILED 1-5-2007.

MATTHEW EINSTEIN, EXAMINING ATTORNEY

Int. Cls.: 36 and 42

Prior U.S. Cls.: 100, 101, and 102

United States Patent and Trademark Office

Reg. No. 3,576,734

Registered Feb. 17, 2009

SERVICE MARK
PRINCIPAL REGISTER



Weichert *Valet*

WEICHERT CO. (NEW JERSEY CORPORATION)
1625 ROUTE 10
MORRIS PLAINS, NJ 07950

FOR: PROVIDING TO OTHERS ADVICE AND INFORMATION ABOUT THE PURCHASE AND SALE OF REAL ESTATE, IN CLASS 36 (U.S. CLS. 100, 101 AND 102).

FIRST USE 11-11-2008; IN COMMERCE 11-11-2008.

FOR: COMPUTER SERVICES, NAMELY, AT AN INTERNET USER'S REQUEST, PERFORMING CUSTOMIZED SEARCH SERVICES THAT PROVIDE SPECIFIC INFORMATION ABOUT REAL ESTATE PROPERTIES LISTED ON REGISTRANT'S WEB SITE, IN CLASS 42 (U.S. CLS. 100 AND 101).

FIRST USE 11-11-2008; IN COMMERCE 11-11-2008.

OWNER OF U.S. REG. NO. 1,454,583.

THE COLOR(S) YELLOW, WHITE, BLACK, CREAM AND GRAY IS/ARE CLAIMED AS A FEATURE OF THE MARK.

THE COLOR GRAY APPEARS IN THE WORD "VALET". THE COLOR GRAY IN THE PENGUIN'S SHADOW CONSTITUTES SHADING AND IS NOT PART OF THE MARK. THE COLOR CREAM APPEARS IN THE LOWER PART OF THE PENGUIN'S BODY AND FEET. THE COLOR BLACK APPEARS IN THE WORD "WEICHERT" AND IN THE TUXEDO JACKET WORN BY THE PENGUIN. THE PENGUIN IS HOLDING A WHITE NOTEPAD AND CARRYING A WHITE TOWEL OVER ITS WING. THE COLOR YELLOW APPEARS IN THE PENGUIN'S BEAK AND NECK.

SN 77-077,322, FILED 1-5-2007.

MICHAEL ENGEL, EXAMINING ATTORNEY

Int. Cl.: 9

Prior U.S. Cls.: 21, 23, 26, 36, and 38

United States Patent and Trademark Office

Reg. No. 3,576,735

Registered Feb. 17, 2009

**TRADEMARK
PRINCIPAL REGISTER**

XSPORTZ

CTS WHOLESALE, LLC (OREGON LIMITED
LIABILITY COMPANY)
SUITE 10
2791 PENCE LOOP SE
SALEM, OR 97302

THE MARK CONSISTS OF STANDARD CHAR-
ACTERS WITHOUT CLAIM TO ANY PARTICULAR
FONT, STYLE, SIZE, OR COLOR.

FOR: SUNGLASSES, IN CLASS 9 (U.S. CLS. 21, 23,
26, 36 AND 38).

SN 77-077,400, FILED 1-5-2007.

FIRST USE 3-15-2008; IN COMMERCE 3-15-2008.

JORDAN BAKER, EXAMINING ATTORNEY

Int. Cls.: 9 and 41

Prior U.S. Cls.: 21, 23, 26, 36, 38, 100, 101, and 107

United States Patent and Trademark Office

Reg. No. 3,576,736

Registered Feb. 17, 2009

**TRADEMARK
SERVICE MARK
PRINCIPAL REGISTER**

LOJ

NETWORK EDUTAINMENT GROUP, LLC (NEW YORK LIMITED LIABILITY COMPANY)
7211 AUSTIN STREET, #233
NEW YORK, NY 11375

FOR: MUSICAL SOUND AND VIDEO RECORDINGS; SOUND AND AUDIO VISUAL RECORDINGS FEATURING MUSICAL PERFORMANCES AND DRAMATIC WORKS; DOWNLOADABLE SOUND AND VIDEO RECORDS FEATURING MUSIC, MUSICAL PERFORMANCES AND DRAMATIC WORKS, IN CLASS 9 (U.S. CLS. 21, 23, 26, 36 AND 38).

FIRST USE 7-4-2007; IN COMMERCE 7-4-2007.

FOR: ENTERTAINMENT SERVICES IN THE NATURE OF LIVE MUSICAL PERFORMANCES, ENTERTAINMENT SERVICES IN THE NATURE OF LIVE MUSICAL PERFORMANCES PROVIDED BY

MEANS OF A GLOBAL COMPUTER NETWORK; PROVIDING INFORMATION ON A MUSICAL ARTIST AND SUCH ARTIST'S MUSIC, SOUND AND VIDEO RECORDINGS, PICTURES, NEWS, SPECIALS, PROJECT TOURS, PERSONAL APPEARANCES AND BIOGRAPHY VIA WEBSITE ON A GLOBAL COMPUTER NETWORK, IN CLASS 41 (U.S. CLS. 100, 101 AND 107).

FIRST USE 7-4-2007; IN COMMERCE 7-4-2007.

THE MARK CONSISTS OF STANDARD CHARACTERS WITHOUT CLAIM TO ANY PARTICULAR FONT, STYLE, SIZE, OR COLOR.

SN 77-077,725, FILED 1-8-2007.

ALICE BENMAMAN, EXAMINING ATTORNEY

Int. Cls.: 1 and 4

Prior U.S. Cls.: 1, 5, 6, 10, 15, 26, and 46

United States Patent and Trademark Office

Reg. No. 3,576,737

Registered Feb. 17, 2009

**TRADEMARK
PRINCIPAL REGISTER**

MPM

M.P.M. INTERNATIONAL OIL COMPANY B.V.
(NETHERLANDS LIMITED LIABILITY COMPANY)
ENERGIEWEG 79-81
ZOETERWOUDE, NETHERLANDS 2382NH

FOR: INDUSTRIAL CHEMICALS, NAMELY, CHEMICALS FOR INDUSTRIAL PURPOSES; ANTI-FREEZE; COOLANT, IN CLASS 1 (U.S. CLS. 1, 5, 6, 10, 26 AND 46).

FIRST USE 10-1-1993; IN COMMERCE 8-6-2007.

FOR: INDUSTRIAL OILS AND GREASES; LUBRICANTS, NAMELY, INDUSTRIAL LUBRICANTS; DUST ABSORBING, WETTING AND BINDING COMPOSITIONS, NAMELY, FLOOR ABSORBENTS IN THE NATURE OF GRANULAR ABSORBENT

OIL-BASED COMPOSITION FOR ABSORBING SPILLS FROM FLOORS; FUELS; FUELS, INCLUDING MOTOR SPIRIT AND ILLUMINANTS, IN CLASS 4 (U.S. CLS. 1, 6 AND 15).

FIRST USE 10-1-1993; IN COMMERCE 8-6-2007.

THE MARK CONSISTS OF STANDARD CHARACTERS WITHOUT CLAIM TO ANY PARTICULAR FONT, STYLE, SIZE, OR COLOR.

OWNER OF ERPN CMNTY TM OFC REG. NO. 003319928, DATED 3-3-2005, EXPIRES 8-20-2013.

SN 77-078,280, FILED 1-8-2007.

KIM SAITO, EXAMINING ATTORNEY

Int. Cl.: 36

Prior U.S. Cls.: 100, 101, and 102

United States Patent and Trademark Office

Reg. No. 3,576,738

Registered Feb. 17, 2009

**SERVICE MARK
PRINCIPAL REGISTER**



PANAFIN HOLDINGS LLC (FLORIDA LIMITED
LIABILITY COMPANY)
3034 NW 82ND AVENUE
MIAMI, FL 33122

FOR: CREDIT AND CASH CARD SERVICES;
CREDIT CARD TRANSACTION PROCESSING SER-
VICES; ELECTRONIC DEBIT TRANSACTIONS;
ELECTRONIC TRANSFERS OF MONEY, IN CLASS
36 (U.S. CLS. 100, 101 AND 102).

FIRST USE 2-0-2008; IN COMMERCE 2-0-2008.

THE COLOR(S) BLUE, ORANGE, AND GRAY IS/
ARE CLAIMED AS A FEATURE OF THE MARK.

THE MARK CONSISTS OF THE WORD "PAGO-
TRONIC" DIVIDED IN TWO PARTS. THE LETTERS
"PAGO" APPEAR IN BLUE ON TOP OF THE
LETTERS "TRONIC" IN ORANGE. GRAY BRACK-
ETS APPEAR AT EITHER END OF THE WORD.

THE ENGLISH TRANSLATION OF THE WORD
"PAGO" IN THE MARK IS PAYMENT.

SN 77-078,319, FILED 1-8-2007.

MATTHEW EINSTEIN, EXAMINING ATTORNEY

Int. Cls.: 1 and 4

Prior U.S. Cls.: 1, 5, 6, 10, 15, 26, and 46

United States Patent and Trademark Office

Reg. No. 3,576,739

Registered Feb. 17, 2009

**TRADEMARK
PRINCIPAL REGISTER**



M.P.M. INTERNATIONAL OIL COMPANY B.V.
(NETHERLANDS LIMITED LIABILITY COMPANY)
ENERGIEWEG 79-81
ZOETERWOUDE, NETHERLANDS 2382NH

FOR: INDUSTRIAL CHEMICALS, NAMELY, CHEMICALS FOR INDUSTRIAL PURPOSES; ANTI-FREEZE; COOLANT, IN CLASS 1 (U.S. CLS. 1, 5, 6, 10, 26 AND 46).

FIRST USE 10-1-1993; IN COMMERCE 8-6-2007.

FOR: INDUSTRIAL OILS AND GREASES; LUBRICANTS, NAMELY, INDUSTRIAL LUBRICANTS; DUST ABSORBING, WETTING AND BINDING COMPOSITIONS, NAMELY, FLOOR ABSORBENTS IN THE NATURE OF GRANULAR ABSORBENT OIL-BASED COMPOSITION FOR ABSORBING

SPILLS FROM FLOORS; FUELS; FUELS, INCLUDING MOTOR SPIRIT AND ILLUMINANTS, IN CLASS 4 (U.S. CLS. 1, 6 AND 15).

FIRST USE 10-1-1993; IN COMMERCE 8-6-2007.

PRIORITY CLAIMED UNDER SEC. 44(D) ON ERPN CMNTY TM OFC APPLICATION NO. 005596283, FILED 1-4-2007, REG. NO. 005596283, DATED 1-29-2008, EXPIRES 1-4-2017.

NO CLAIM IS MADE TO THE EXCLUSIVE RIGHT TO USE "INTERNATIONAL OIL COMPANY", APART FROM THE MARK AS SHOWN.

SN 77-078,326, FILED 1-8-2007.

KIM SAITO, EXAMINING ATTORNEY

Int. Cls.: 37 and 42

Prior U.S. Cls.: 100, 101, 103, and 106

United States Patent and Trademark Office

Reg. No. 3,576,740

Registered Feb. 17, 2009

SERVICE MARK
PRINCIPAL REGISTER

team
coach imaging

LETTRAPUB INC. (CANADA CORPORATION)
PARC INDUSTRIEL
1328, LÈRE RUE
SAINTE-MARIE, CANADA G6E1H4

FOR: MOUNTING AND INSTALLATION OF IMAGES, DRAWINGS AND GRAPHS ON ADHESIVE MATERIALS FOR THE PURPOSE OF IDENTIFICATION AND BILLPOSTING ON VARIOUS SURFACES, IN CLASS 37 (U.S. CLS. 100, 103 AND 106).

FIRST USE 1-0-2007; IN COMMERCE 12-0-2007.

FOR: DESIGN FOR OTHERS OF IMAGES, DRAWINGS AND GRAPHS ON ADHESIVE MATERIALS FOR THE PURPOSE OF IDENTIFICATION

AND BILLPOSTING ON VARIOUS SURFACES, IN CLASS 42 (U.S. CLS. 100 AND 101).

FIRST USE 1-0-2007; IN COMMERCE 12-0-2007.

PRIORITY CLAIMED UNDER SEC. 44(D) ON CANADA APPLICATION NO. 1321179, FILED 10-18-2006, REG. NO. TMA702,597, DATED 12-13-2007, EXPIRES 12-13-2022.

NO CLAIM IS MADE TO THE EXCLUSIVE RIGHT TO USE "COACH IMAGING", APART FROM THE MARK AS SHOWN.

SN 77-081,202, FILED 1-11-2007.

ALICIA COLLINS, EXAMINING ATTORNEY

Int. Cl.: 28

Prior U.S. Cls.: 22, 23, 38, and 50

United States Patent and Trademark Office

Reg. No. 3,576,741

Registered Feb. 17, 2009

**TRADEMARK
PRINCIPAL REGISTER**



GOLF GALAXY GOLFWORKS, INC. (OHIO CORPORATION)
4820 JACKSONTOWN ROAD
NEWARK, OH 43055

FOR: GOLF CLUB SHAFTS, IN CLASS 28 (U.S. CLS. 22, 23, 38 AND 50).

FIRST USE 1-1-2007; IN COMMERCE 1-1-2007.

OWNER OF U.S. REG. NO. 1,755,530.

NO CLAIM IS MADE TO THE EXCLUSIVE RIGHT TO USE "DISTANCE", APART FROM THE MARK AS SHOWN.

THE MARK CONSISTS OF THE TERMS "DM" AND "DISTANCE MASTER", WITH THE LETTERS "DM" DISPLAYED IN STYLIZED FORM AGAINST AN CONTRASTING OVAL GROUND, ENCIRCLED BY TWO CONTRASTING BANDS, AND WITH A PENNANT OR POINTER DESIGN WITHIN THE LETTER "D".

SN 77-081,871, FILED 1-12-2007.

ALEX KEAM, EXAMINING ATTORNEY

Int. Cl.: 45

Prior U.S. Cls.: 100 and 101

United States Patent and Trademark Office

Reg. No. 3,576,742

Registered Feb. 17, 2009

**SERVICE MARK
PRINCIPAL REGISTER**

**LIFE PURPOSE COACHING
CENTERS INTERNATIONAL**

BRAZELTON, KATHERINE F. (UNITED STATES
INDIVIDUAL)
5 EL VADO DRIVE
RANCHO SANTA MARGARITA, CA 92688

OWNER OF U.S. REG. NO. 3,134,226.

FOR: COUNSELING SERVICES IN THE FIELD
OF CHRISTIAN CONDUCT IN PERSONAL RELA-
TIONSIPS, IN CLASS 45 (U.S. CLS. 100 AND 101).

NO CLAIM IS MADE TO THE EXCLUSIVE
RIGHT TO USE "COACHING CENTERS INTERNA-
TIONAL", APART FROM THE MARK AS SHOWN.

FIRST USE 1-2-2007; IN COMMERCE 1-2-2007.

SN 77-082,195, FILED 1-12-2007.

THE MARK CONSISTS OF STANDARD CHAR-
ACTERS WITHOUT CLAIM TO ANY PARTICULAR
FONT, STYLE, SIZE, OR COLOR.

DAVID H. STINE, EXAMINING ATTORNEY

Int. Cl.: 20

Prior U.S. Cls.: 2, 13, 22, 25, 32, and 50

Reg. No. 3,576,743

United States Patent and Trademark Office

Registered Feb. 17, 2009

**TRADEMARK
PRINCIPAL REGISTER**

AUTOMATION IN A SHEET

EOS SURFACES, LLC (VIRGINIA LIMITED LIABILITY COMPANY)
1004 OBICI INDUSTRIAL BOULEVARD
SUFFOLK, VA 23434

THE MARK CONSISTS OF STANDARD CHARACTERS WITHOUT CLAIM TO ANY PARTICULAR FONT, STYLE, SIZE, OR COLOR.

FOR: FURNITURE PARTS, NAMELY, COUNTERTOPS, VANITY TOPS, AND WORK SURFACE COUNTERTOPS, IN CLASS 20 (U.S. CLS. 2, 13, 22, 25, 32 AND 50).

SN 77-082,201, FILED 1-12-2007.

FIRST USE 11-30-2006; IN COMMERCE 11-30-2006.

PAUL E. FAHRENKOPF, EXAMINING ATTORNEY

Int. Cl.: 9

Prior U.S. Cls.: 21, 23, 26, 36, and 38

Reg. No. 3,576,744

United States Patent and Trademark Office

Registered Feb. 17, 2009

**TRADEMARK
PRINCIPAL REGISTER**

SKYLARM

RD2TECH, LLC (NEW JERSEY LIMITED LIABILITY COMPANY)
6 SUNSET AVENUE
PRINCETON, NJ 085408528

AND VIDEO COMMUNICATIONS ACROSS MULTIPLE NETWORK INFRASTRUCTURES AND COMMUNICATIONS PROTOCOLS, IN CLASS 9 (U.S. CLS. 21, 23, 26, 36 AND 38).

FOR: COMPUTER NETWORK ADAPTERS; COMPUTER NETWORKING HARDWARE; MOBILE COMPUTING AND OPERATING PLATFORMS CONSISTING OF DATA TRANSCEIVERS, WIRELESS NETWORKS AND GATEWAYS FOR COLLECTION AND MANAGEMENT OF DATA; NETWORK ACCESS SERVER HARDWARE; NETWORK ACCESS SERVER OPERATING SOFTWARE; TELECOMMUNICATIONS AND DATA NETWORKING HARDWARE, NAMELY, DEVICES FOR TRANSPORTING AND AGGREGATING VOICE, DATA,

FIRST USE 10-26-2007; IN COMMERCE 12-25-2007.

THE MARK CONSISTS OF STANDARD CHARACTERS WITHOUT CLAIM TO ANY PARTICULAR FONT, STYLE, SIZE, OR COLOR.

SN 77-082,689, FILED 1-14-2007.

JOHN GARTNER, EXAMINING ATTORNEY

Int. Cl.: 19

Prior U.S. Cls.: 1, 12, 33, and 50

United States Patent and Trademark Office

Reg. No. 3,576,745

Registered Feb. 17, 2009

**TRADEMARK
PRINCIPAL REGISTER**

ENRAIL

ENDURIS, LLC (DELAWARE LIMITED LIABILITY COMPANY)
7167 OLD KINGS ROAD
JACKSONVILLE, FL 32219

FOR: FREESTANDING GUARD AND BARRIER ASSEMBLIES COMPRISED OF NON-METALLIC PLASTICS, IN CLASS 19 (U.S. CLS. 1, 12, 33 AND 50).

FIRST USE 1-29-2007; IN COMMERCE 1-29-2007.

THE MARK CONSISTS OF STANDARD CHARACTERS WITHOUT CLAIM TO ANY PARTICULAR FONT, STYLE, SIZE, OR COLOR.

SN 77-082,928, FILED 1-15-2007.

WILLIAM P. SHANAHAN, EXAMINING ATTORNEY

Int. Cl.: 35

Prior U.S. Cls.: 100, 101, and 102

United States Patent and Trademark Office

Reg. No. 3,576,746

Registered Feb. 17, 2009

**SERVICE MARK
PRINCIPAL REGISTER**

GROUP MW

LEES WABSCHALL, INC (ILLINOIS CORPORATION), DBA GROUP MW,
SUITE 100
1600 EISENHOWER LANE
LISLE, IL 60532

FOR: BUSINESS MANAGEMENT, CONSULTATION, AND SUPERVISION IN THE FIELD OF RETAIL AND WHOLESALE GOODS AND SERVICES; MARKETING SERVICES FOR OTHERS IN THE FIELD OF RETAIL AND WHOLESALE GOODS AND SERVICES; PRODUCT MERCHANDISING IN THE FIELD OF RETAIL AND WHOLESALE GOODS AND SERVICES, IN CLASS 35 (U.S. CLS. 100, 101 AND 102).

FIRST USE 6-4-2007; IN COMMERCE 6-4-2007.

THE MARK CONSISTS OF STANDARD CHARACTERS WITHOUT CLAIM TO ANY PARTICULAR FONT, STYLE, SIZE, OR COLOR.

NO CLAIM IS MADE TO THE EXCLUSIVE RIGHT TO USE "GROUP", APART FROM THE MARK AS SHOWN.

SN 77-083,733, FILED 1-16-2007.

ANGELA M. MICHELI, EXAMINING ATTORNEY

Int. Cl.: 11

Prior U.S. Cls.: 13, 21, 23, 31, and 34

United States Patent and Trademark Office

Reg. No. 3,576,747

Registered Feb. 17, 2009

**TRADEMARK
PRINCIPAL REGISTER**



ESQUIRE RADIO & ELECTRONICS INC. (DELA-
WARE CORPORATION)
4100 FIRST AVENUE
BROOKLYN, NY 11232

FOR: AIR PURIFICATION UNITS AND ELEC-
TRIC AIR SANITIZING UNITS, IN CLASS 11 (U.S.
CLS. 13, 21, 23, 31 AND 34).

FIRST USE 7-0-2008; IN COMMERCE 7-0-2008.

THE COLOR(S) BLUE IS/ARE CLAIMED AS A
FEATURE OF THE MARK.

THE COLOR BLUE APPEARS IN THE WORDING
"PAC".

SN 77-084,873, FILED 1-17-2007.

SOPHIA S. KIM, EXAMINING ATTORNEY

Int. Cl.: 19

Prior U.S. Cls.: 1, 12, 33, and 50

United States Patent and Trademark Office

Reg. No. 3,576,748

Registered Feb. 17, 2009

**TRADEMARK
PRINCIPAL REGISTER**

SOUND STEP

MP GLOBAL PRODUCTS, LLC (NEBRASKA
LIMITED LIABILITY COMPANY)
2500 OLD HADAR ROAD
NORFOLK, NE 68702

THE MARK CONSISTS OF STANDARD CHAR-
ACTERS WITHOUT CLAIM TO ANY PARTICULAR
FONT, STYLE, SIZE, OR COLOR.

FOR: FLOORING UNDERLAYMENTS, IN CLASS
19 (U.S. CLS. 1, 12, 33 AND 50).

SN 77-085,047, FILED 1-17-2007.

FIRST USE 10-25-2002; IN COMMERCE 10-25-2002.

BILL DAWE, EXAMINING ATTORNEY

Int. Cls.: 25 and 35

Prior U.S. Cls.: 22, 39, 100, 101, and 102

United States Patent and Trademark Office

Reg. No. 3,576,749

Registered Feb. 17, 2009

TRADEMARK
SERVICE MARK
PRINCIPAL REGISTER



HELIOS SPORT, INC. (CALIFORNIA CORPORATION)

3

9575 EASTER WAY
SAN DIEGO, CA 92121

FOR: ANKLE SOCKS; BICYCLE GLOVES; BICYCLING GLOVES; BODY SUITS; BOOTIES; BOTTOMS; CLOTHING, NAMELY, ARM WARMERS; CLOTHING, NAMELY, KNEE WARMERS; CYCLING SHOES; CYCLISTS' JERSEYS; GLOVES; GYM SHORTS; GYM SUITS; HATS; HEAD SWEATBANDS; HEAD WEAR; HEADBANDS; HEADBANDS AGAINST SWEATING; HEADGEAR, NAMELY, HATS, CAPS, HEAD COVERS; HEADWEAR; JERSEYS; JOGGING OUTFITS; JOGGING PANTS; JOGGING SUITS; KNITTED UNDERWEAR; LADIES' UNDERWEAR; LEG SHAPERS; LEG WARMERS; LEGGINGS; LEG-WARMERS; LEOTARDS; LEOTARDS AND TIGHTS FOR WOMEN, MEN AND CHILDREN OF NYLON, COTTON OR OTHER TEXTILE FIBERS; LIGHT-REFLECTING COATS; LIGHT-REFLECTING JACKETS; LOUNGEWEAR; MAILLOT; MEN'S SOCKS; MUSCLE TOPS; OVERSHOES; PANTIES, SHORTS AND BRIEFS; PERSPIRATION ABSORBENT UNDERWEAR CLOTHING; POLO SHIRTS; PULLOVERS; RAIN COATS; RAIN JACKETS; RAIN SUITS; RAIN TROUSERS; RAINCOATS; RAINPROOF JACKETS; RAINWEAR; RASH GUARDS; RIDING GLOVES; SHIRTS; SHORTS; SHORT-SLEEVED OR LONG-SLEEVED T-SHIRTS; SHORT-SLEEVED SHIRTS; SINGLET; SKIRTS; SKULL CAPS; SLEEVED OR SLEEVELESS JACKETS; SLEEVELESS JERSEYS; SMALL HATS; SNOWBOARD GLOVES; SOCKS; SOCKS AND

STOCKINGS; SPORTS BRA; SPORTS JACKETS; SPORTS JERSEYS; SPORTS JERSEYS AND BREECHES FOR SPORTS; SPORTS SHIRTS; SPORTS SHIRTS WITH SHORT SLEEVES; SPORTS OVERUNIFORMS; SPORTS SHIRTS; SPORTS SHIRTS WITH SHORT SLEEVES; SUN SLEEVES; SWEAT BANDS; SWEAT PANTS; SWEAT SHIRTS; SWEAT SHORTS; SWEAT SUITS; SWEATBANDS; SWEATSOCKS; TANK TOPS; THERMAL SOCKS; THERMAL UNDERWEAR; TRACK PANTS; TRACK SUITS; TRACKSUITS; TRAINING SUITS; TROUSERS; TROUSERS FOR SWEATING; UNDERCLOTHES; T-SHIRTS; UNDERGARMENTS; UNDERPANTS; UNDERSHIRTS; UNDERSKIRTS; UNDERWEAR; UNIFORMS; UNITARDS; VESTS; WARM UP SUITS; WATER SOCKS; WIND COATS; WIND RESISTANT JACKETS; WIND SHIRTS; WIND VESTS; WINDCHEATERS; WINDJAMMERS; WINDSHIRTS; WIND-JACKETS; WOMEN'S SOCKS; WOMEN'S UNDERWEAR; WOOLEN SOCKS; WOVEN OR KNITTED UNDERWEAR; WRIST BANDS; WRISTBANDS, IN CLASS 25 (U.S. CLS. 22 AND 39).

FIRST USE 11-13-2006; IN COMMERCE 11-24-2006.

FOR: WHOLESALE DISTRIBUTORSHIPS AND ONLINE RETAIL STORE FEATURING SOCKS, PRIVATE LABELING SOCKS, AND CUSTOM SOCKS FOR SPORTSWEAR, NAMELY, CYCLING SOCKS, RUNNING SOCKS, TRIATHLON SOCKS, WALKING SOCKS, GOLF SOCKS, TENNIS SOCKS, SOCCER SOCKS, BASKETBALL SOCKS, VOLLEYBALL SOCKS, BASEBALL SOCKS, FOOTBALL SOCKS, SKIING SOCKS, SNOWBOARDING SOCKS, EQUESTRIAN (HORSE BACK RIDING) SOCKS, RACE CAR

DRIVER SOCKS, MOTORCYCLING SOCKS, WORK AND STANDING SOCKS, SOCKS FOR OUTDOOR LABOR, ANTI-FRICTION SOCKS, NON-STATIC SOCKS, ANTI-STATIC SOCKS, MAGNETIC SOCKS, SOCKS FOR DIABETICS, THERAPEUTIC SOCKS, MEDICAL SOCKS, SOCKS FOR SURGEONS IN STATIC FREE ENVIRONMENTS, VARICOSE VEIN SOCKS, ORGANIC YARN SOCKS, ORGANIC SOCKS, ENVIRONMENTAL SOCKS, SOCKS MADE WITH RECYCLED MATERIALS, ORGANIC COTTON SOCKS, ORGANIC WOOL SOCKS, ORGANIC SILK SOCKS, AND ORGANIC WOOD YARN SOCKS, SPORTSWEAR AND ACTIVE WEAR IN GENERAL, NAMELY, WARM UP SUITS, PRE AND POST WORKOUT LEISURE WEAR, LOUNGEWEAR, ATHLETIC AND LEISURE SHOES, BICYCLE HELMETS, MOTORCYCLE HELMETS, CAR RACING HELMETS, HORSE BACK RIDING HELMETS, SKATEBOARD AND ROLLER SKATE HELMETS; RASH GUARDS, SHIN GUARDS, PROTECTIVE GEAR, RUNNING GLOVES AND MITTENS, CYCLING GLOVES AND MITTENS, HORSE BACK RIDING GLOVES AND MITTENS, SKIING GLOVES AND MITTENS, SNOWBOARDING GLOVES AND MITTENS, MOTORCYCLING GLOVES AND MITTENS, CAR DRIVING GLOVES AND MITTENS; SPORTS SHOES, CYCLING SHOES, RUNNING SHOES, TENNIS SHOES, GOLF SHOES, BEACH SHOES, BOAT SHOES, WALKING SHOES, AND LEISURE SHOES, SPORTS AND DRESS SOCKS, WRISTBANDS, HEAD BANDS, WINTER HEAD WEAR, HATS, VISORS, AND CAPS, UNDER SHIRTS, TANK TOPS, BASE LAYER SHIRTS, UNDERWEAR FOR RUNNING, CYCLING, TRIATHLON, SWIMMING, WATER SPORTS, SNORKELING, WATER SKIING, JET SKIING, SURFING, GOLF, TENNIS, WALKING, HIKING, SKIING, BASKETBALL, BASEBALL, SOCCER, FOOTBALL, RUGBY SNOWBOARDING, SNOWMOBILE, SNOW KAYAKING, WATER KAYAKING, GYM ACTIVITIES, AEROBICS, MARTIAL ARTS, YOGA, PILATES, DANCING, BALLET, ICE SKATING, HORSE BACK RIDING, EQUESTRIAN WEAR, MOTORCYCLE RACING, CAR RACING, AND GOKART RACING AND SPORTS ACTIVITIES SUCH AS RUNNING, CYCLING, SKIING, SNOWBOARD-

ING, AND WINTER AND SUMMER SPORTS, JOCK STRAPS, SPORTS BRAS, LINGERIE, THONGS, NIGHT GOWNS, PANTIES, LEG WARMERS, LEG TIGHTS, KNEE WARMERS, ARM WARMERS, CYCLING SHORTS, RUNNING SHORTS, TENNIS AND GOLF SHORTS, RUNNING SKIRTS, TENNIS SKIRTS, GOLF SKIRTS, VOLLEYBALL SKIRTS, BASKETBALL SKIRTS, SOCCER SKIRTS, ICE SKATING SKIRTS, ACTIVE WEAR SKIRTS, SWIMWEAR, SWIMSUITS, SWIMMING CAPS, BIKINIS, TOWELS, WET SUITS, SCUBA DIVING GEAR, SUN GLASSES AND EYEWEAR, RUNNING TANK TOPS, SINGLET, RUNNING SHIRTS, CYCLING SHIRTS AND JERSEYS, TRIATHLON SHIRTS AND JERSEYS, INCLUDING LONG SLEEVE, SHORT SLEEVE, AND NO SLEEVE JERSEYS, SKIN SUITS, TRACK PANTS, AND TRACK SUITS, WIND BREAKERS, SPORTS JACKETS; DENIM AND COTTON CLOTHES, POLO TYPE SHIRTS AND T-SHIRTS; VESTS, SWEATERS AND V-NECK SWEATERS, GOLF PANTS, GOLF SHIRTS, GOLF T-SHIRTS, GOLF SHORTS, MEN'S, WOMEN'S, YOUTH, AND CHILDREN'S ACTIVE WEAR AND LOUNGEWEAR, LEATHER JACKETS, LEATHER PANTS, AND LEATHER GLOVES SUCH AS THOSE FOR RIDING MOTORCYCLES, BICYCLES, BICYCLE PARTS, BICYCLE EQUIPMENT, BICYCLE WHEELS, BICYCLE SPARE PARTS, GYM EQUIPMENT, AND MECHANIC AND ELECTRONIC FITNESS GADGETS, NAMELY, STRETCHING BOARDS, INDOOR TRAINERS, INDOOR BICYCLE TRAINERS, TREADMILLS, WEIGHT AND RESISTANCE BEARING MECHANISMS, HEART RATE MONITORS, WATT POWER OUTPUT METERS, IN CLASS 35 (U.S. CLS. 100, 101 AND 102).

FIRST USE 11-13-2006; IN COMMERCE 11-24-2006.

NO CLAIM IS MADE TO THE EXCLUSIVE RIGHT TO USE "SPORT", APART FROM THE MARK AS SHOWN.

SN 77-085,167, FILED 1-17-2007.

KIMBERLY FRYE, EXAMINING ATTORNEY

Int. Cl.: 39

Prior U.S. Cls.: 100 and 105

United States Patent and Trademark Office

Reg. No. 3,576,750

Registered Feb. 17, 2009

**SERVICE MARK
PRINCIPAL REGISTER**

**DOING WHAT'S RIGHT WITH
WHAT'S LEFT**

ASSET NETWORK FOR EDUCATION WORLD-
WIDE, INC. (CALIFORNIA CORPORATION)
1396 LA LOMA RD., SUITE 100
PASADENA, CA 91105

FOR: COLLECTION, WAREHOUSING, DELIV-
ERY AND SETUP OF SURPLUS ASSETS IN THE
NATURE OF INTERIOR FURNISHINGS, CARPET,
LIGHT FIXTURES, FURNITURE, COMPUTER
EQUIPMENT, CLASSROOM SUPPLIES, MEDICAL
SUPPLIES AND OFFICE SUPPLIES, IN CLASS 39
(U.S. CLS. 100 AND 105).

FIRST USE 6-0-2006; IN COMMERCE 6-0-2006.

THE MARK CONSISTS OF STANDARD CHAR-
ACTERS WITHOUT CLAIM TO ANY PARTICULAR
FONT, STYLE, SIZE, OR COLOR.

SN 77-086,151, FILED 1-18-2007.

DEIRDRE ROBERTSON, EXAMINING ATTORNEY

Int. Cl.: 30

Prior U.S. Cl.: 46

United States Patent and Trademark Office

Reg. No. 3,576,751

Registered Feb. 17, 2009

**TRADEMARK
PRINCIPAL REGISTER**

NUTRI-BALLS

CEREAL INGREDIENTS, INC. (DELAWARE
CORPORATION)
4720 SOUTH 13TH STREET
LEAVENWORTH, KS 66048

FOR: CEREAL GRAIN-BASED NUTRITIONALLY
FORTIFIED FOOD PARTICLES USED AS AN IN-
GREDIENT FOR COMMERCIAL FOOD PRO-
DUCTS, IN CLASS 30 (U.S. CL. 46).

FIRST USE 12-15-2008; IN COMMERCE 12-15-2008.

THE MARK CONSISTS OF STANDARD CHAR-
ACTERS WITHOUT CLAIM TO ANY PARTICULAR
FONT, STYLE, SIZE, OR COLOR.

OWNER OF U.S. REG. NO. 3,104,646.

SN 77-087,791, FILED 1-22-2007.

SHARON MEIER, EXAMINING ATTORNEY

Int. Cl.: 41

Prior U.S. Cls.: 100, 101, and 107

United States Patent and Trademark Office

Reg. No. 3,576,752

Registered Feb. 17, 2009

**SERVICE MARK
PRINCIPAL REGISTER**

A WEB WIDE WORLD

HIVE7.COM, INC. (CALIFORNIA CORPORATION)
1020 POLK AVENUE
SUNNYVALE, CA 94085

FOR: ENTERTAINMENT SERVICES, NAMELY, PROVIDING AN ON-LINE GAME FEATURING A VIRTUAL ENVIRONMENT; AND PROVIDING AN ON-LINE COMPUTER GAME FEATURING GAMING, SKILL-BASED AND CHANCE-BASED GAMES, AND DATING GAMES, IN CLASS 41 (U.S. CLS. 100, 101 AND 107).

FIRST USE 0-0-2006; IN COMMERCE 0-0-2006.

THE MARK CONSISTS OF STANDARD CHARACTERS WITHOUT CLAIM TO ANY PARTICULAR FONT, STYLE, SIZE, OR COLOR.

SN 77-088,001, FILED 1-22-2007.

REBECCA GILBERT, EXAMINING ATTORNEY

Int. Cl.: 3

Prior U.S. Cls.: 1, 4, 6, 50, 51, and 52

United States Patent and Trademark Office

Reg. No. 3,576,753

Registered Feb. 17, 2009

**TRADEMARK
PRINCIPAL REGISTER**

EARTH BABY

OYE, INC. (CALIFORNIA CORPORATION)
20334 TRAILS END RD
WALNUT, CA 91789

FOR: BABY HAIR CONDITIONER; BABY LOTION; BABY OILS; BABY SHAMPOO, IN CLASS 3 (U.S. CLS. 1, 4, 6, 50, 51 AND 52).

FIRST USE 7-1-2008; IN COMMERCE 10-1-2008.

THE MARK CONSISTS OF STANDARD CHARACTERS WITHOUT CLAIM TO ANY PARTICULAR FONT, STYLE, SIZE, OR COLOR.

NO CLAIM IS MADE TO THE EXCLUSIVE RIGHT TO USE "BABY", APART FROM THE MARK AS SHOWN.

SN 77-088,336, FILED 1-22-2007.

JAY BESCH, EXAMINING ATTORNEY

Int. Cl.: 9

Prior U.S. Cls.: 21, 23, 26, 36, and 38

United States Patent and Trademark Office

Reg. No. 3,576,754

Registered Feb. 17, 2009

**TRADEMARK
PRINCIPAL REGISTER**

CORSTAR

A. L.LIGHTECH INC. (CALIFORNIA CORPORATION)
1525-B WEST ORANGE GROVE AVE.
ORANGE, CA 92868

THE MARK CONSISTS OF "CORSTAR", WHERE THE MARK IS INCORPORATED WITH STYLIZED WORDS "CORSTAR".

FOR: LIGHT EMITTING DIODES FOR USE IN LED LIGHT SOURCE SIGNAL LIGHTS, IN CLASS 9 (U.S. CLS. 21, 23, 26, 36 AND 38).

SN 77-088,990, FILED 1-23-2007.

FIRST USE 1-1-2007; IN COMMERCE 1-1-2008.

TIMOTHY FINNEGAN, EXAMINING ATTORNEY

Int. Cls.: 6 and 7

**Prior U.S. Cls.: 2, 12, 13, 14, 19, 21, 23, 25, 31, 34, 35,
and 50**

United States Patent and Trademark Office

Reg. No. 3,576,755

Registered Feb. 17, 2009

**TRADEMARK
PRINCIPAL REGISTER**

PRO PROVEN

HICKORY SPRINGS MANUFACTURING COM-
PANY (NORTH CAROLINA CORPORATION)
POST OFFICE BOX 128
HICKORY, NC 286030128

FOR: METAL FASTENERS, NAMELY, HAND
DRIVE NAILS SOLD IN BULK AND COLLATED
NAILS FOR USE IN NAILING GUNS; WIRE, NAME-
LY, TIE WIRE FOR TYING REINFORCING STEEL
BARS; METAL ANCHOR BOLTS; METAL BUILD-
ING SCREWS, IN CLASS 6 (U.S. CLS. 2, 12, 13, 14, 23,
25 AND 50).

FIRST USE 6-18-2008; IN COMMERCE 6-18-2008.

FOR: PNEUMATIC TOOLS, NAMELY, AIR COM-
PRESSORS, IN CLASS 7 (U.S. CLS. 13, 19, 21, 23, 31, 34
AND 35).

FIRST USE 9-25-2007; IN COMMERCE 9-25-2007.

THE MARK CONSISTS OF STANDARD CHAR-
ACTERS WITHOUT CLAIM TO ANY PARTICULAR
FONT, STYLE, SIZE, OR COLOR.

SN 77-089,095, FILED 1-23-2007.

SONYA STEPHENS, EXAMINING ATTORNEY

Int. Cls.: 6 and 7

**Prior U.S. Cls.: 2, 12, 13, 14, 19, 21, 23, 25, 31, 34, 35,
and 50**

Reg. No. 3,576,756

United States Patent and Trademark Office

Registered Feb. 17, 2009

**TRADEMARK
PRINCIPAL REGISTER**

DRIVEN QUALITY

HICKORY SPRINGS MANUFACTURING COM-
PANY (NORTH CAROLINA CORPORATION)
POST OFFICE BOX 128
HICKORY, NC 286030128

FOR: METAL FASTENERS, NAMELY, HAND
DRIVE NAILS SOLD IN BULK AND COLLATED
NAILS FOR USE IN NAILING GUNS; WIRE, NAME-
LY, TIE WIRE FOR TYING REINFORCING STEEL
BARS; METAL ANCHOR BOLTS; METAL BUILD-
ING SCREWS, IN CLASS 6 (U.S. CLS. 2, 12, 13, 14, 23,
25 AND 50).

FIRST USE 6-18-2008; IN COMMERCE 6-18-2008.

FOR: PNEUMATIC TOOLS, NAMELY, AIR COM-
PRESSORS, IN CLASS 7 (U.S. CLS. 13, 19, 21, 23, 31, 34
AND 35).

FIRST USE 9-25-2007; IN COMMERCE 9-25-2007.

THE MARK CONSISTS OF STANDARD CHAR-
ACTERS WITHOUT CLAIM TO ANY PARTICULAR
FONT, STYLE, SIZE, OR COLOR.

NO CLAIM IS MADE TO THE EXCLUSIVE
RIGHT TO USE "QUALITY", APART FROM THE
MARK AS SHOWN.

SN 77-089,102, FILED 1-23-2007.

SONYA STEPHENS, EXAMINING ATTORNEY

Int. Cl.: 25

Prior U.S. Cls.: 22 and 39

United States Patent and Trademark Office

Reg. No. 3,576,757

Registered Feb. 17, 2009

**TRADEMARK
PRINCIPAL REGISTER**

YUMS

ALREADY, LLC (TEXAS LIMITED LIABILITY
COMPANY)
2000 STAFFORD DRIVE
ARLINGTON, TX 76012

THE MARK CONSISTS OF STANDARD CHAR-
ACTERS WITHOUT CLAIM TO ANY PARTICULAR
FONT, STYLE, SIZE, OR COLOR.

FOR: ATHLETIC FOOTWEAR, BASEBALL CAPS;
CAPS; T-SHIRTS, IN CLASS 25 (U.S. CLS. 22 AND 39).

SN 77-089,254, FILED 1-23-2007.

FIRST USE 11-7-2007; IN COMMERCE 11-7-2007.

KIM SAITO, EXAMINING ATTORNEY

Int. Cl.: 41

Prior U.S. Cls.: 100, 101, and 107

United States Patent and Trademark Office

Reg. No. 3,576,758

Registered Feb. 17, 2009

**SERVICE MARK
PRINCIPAL REGISTER**

**SHAPING THE FUTURE ONE
ATHLETE AT A TIME**

NEWMAN HEALTH & FITNESS, INC. (FLORIDA
CORPORATION)
960 FERN DRIVE
DELRAY BEACH, FL 33483

FOR: PROVIDING FITNESS AND EXERCISE
FACILITIES; PHYSICAL FITNESS CONSULTA-
TION; PHYSICAL FITNESS INSTRUCTION; PHYSI-
CAL FITNESS CONDITIONING CLASSES; AND
HEALTH CLUB SERVICES, NAMELY, PROVIDING
INSTRUCTION AND EQUIPMENT IN THE FIELD
OF PHYSICAL EXERCISE, IN CLASS 41 (U.S. CLS.
100, 101 AND 107).

FIRST USE 7-31-2008; IN COMMERCE 7-31-2008.

THE MARK CONSISTS OF STANDARD CHAR-
ACTERS WITHOUT CLAIM TO ANY PARTICULAR
FONT, STYLE, SIZE, OR COLOR.

SN 77-090,323, FILED 1-24-2007.

BARBARA GAYNOR, EXAMINING ATTORNEY

Int. Cl.: 41

Prior U.S. Cls.: 100, 101, and 107

United States Patent and Trademark Office

Reg. No. 3,576,759

Registered Feb. 17, 2009

**SERVICE MARK
PRINCIPAL REGISTER**

THE UNSPOKEN RULES OF THE
GAME

SOFIELD, DEB (UNITED STATES INDIVIDUAL)
POST OFFICE BOX 5353
GREENVILLE, SC 29606

FIRST USE 12-31-2004; IN COMMERCE 12-31-2004.

FOR: TRAINING SERVICES IN THE FIELDS OF
PERSONAL SPEECH COACHING, PUBLIC SPEAK-
ING, PUBLIC PRESENTATION, AND PRESENTA-
TION SKILLS; CONSULTING RELATING TO THE
FOREGOING, IN CLASS 41 (U.S. CLS. 100, 101 AND
107).

THE MARK CONSISTS OF STANDARD CHAR-
ACTERS WITHOUT CLAIM TO ANY PARTICULAR
FONT, STYLE, SIZE, OR COLOR.

SN 77-090,400, FILED 1-24-2007.

KEVIN CORWIN, EXAMINING ATTORNEY

Int. Cl.: 3

Prior U.S. Cls.: 1, 4, 6, 50, 51, and 52

United States Patent and Trademark Office

Reg. No. 3,576,760

Registered Feb. 17, 2009

**TRADEMARK
PRINCIPAL REGISTER**

Baby Bee All Better Balm

BURT'S BEES, INC. (DELAWARE CORPORATION)
701 DISTRIBUTION DRIVE
DURHAM, NC 27709

OWNER OF U.S. REG. NOS. 2,169,521 AND
2,173,051.

FOR: NON-MEDICATED BALM FOR SOOTHING
ITCHING, SWELLING AND BRUISES ON BABIES,
IN CLASS 3 (U.S. CLS. 1, 4, 6, 50, 51 AND 52).

NO CLAIM IS MADE TO THE EXCLUSIVE
RIGHT TO USE "BALM", APART FROM THE
MARK AS SHOWN.

FIRST USE 6-30-2007; IN COMMERCE 6-30-2007.

SN 77-090,895, FILED 1-25-2007.

THE MARK CONSISTS OF STANDARD CHAR-
ACTERS WITHOUT CLAIM TO ANY PARTICULAR
FONT, STYLE, SIZE, OR COLOR.

LOURDES AYALA, EXAMINING ATTORNEY

Int. Cl.: 38

Prior U.S. Cls.: 100, 101, and 104

United States Patent and Trademark Office

Reg. No. 3,576,761

Registered Feb. 17, 2009

**SERVICE MARK
PRINCIPAL REGISTER**

STARFISH NETWORK

THE STARFISH TELEVISION NETWORK FOUNDATION (UTAH NON-PROFIT CORPORATION)
6952 HIGH TECH DRIVE
SALT LAKE CITY, UT 84047

FOR: INTERNET BROADCASTING SERVICES, TRANSMISSION OF INFORMATION VIA ELECTRONIC COMMUNICATIONS NETWORKS, CABLE AND SATELLITE TELEVISION BROADCASTING, VIDEO BROADCASTING, TRANSMISSION OF NEWS AND INFORMATION, TELEVISION BROADCASTING, AND TELEVISION TRANSMISSION SERVICES, IN CLASS 38 (U.S. CLS. 100, 101 AND 104).

FIRST USE 12-2-2008; IN COMMERCE 12-2-2008.

THE MARK CONSISTS OF STANDARD CHARACTERS WITHOUT CLAIM TO ANY PARTICULAR FONT, STYLE, SIZE, OR COLOR.

NO CLAIM IS MADE TO THE EXCLUSIVE RIGHT TO USE "NETWORK", APART FROM THE MARK AS SHOWN.

SN 77-091,109, FILED 1-25-2007.

LAURA HAMMEL, EXAMINING ATTORNEY

Int. Cls.: 9, 35, 36, 37, and 42

**Prior U.S. Cls.: 21, 23, 26, 36, 38, 100, 101, 102, 103,
and 106**

Reg. No. 3,576,762

United States Patent and Trademark Office

Registered Feb. 17, 2009

**TRADEMARK
SERVICE MARK
PRINCIPAL REGISTER**



DALLAS PROJECT HOLDINGS LIMITED (BARBADOS CORPORATION)
WHITE PARK ROAD
WHITEPARK HOUSE
BRIDGETOWN, BARBADOS

FOR: COMPUTER SOFTWARE FOR DESIGNING, INSTALLING AND EXECUTING MAINFRAME AND CLIENT/SERVER APPLICATION PROGRAMS; COMPUTER SOFTWARE FOR INTEGRATING THE FINANCIAL FUNCTIONS AND FUNCTIONS FOR PRODUCTION AND SALES FUNCTIONS OF A BUSINESS; COMPUTER SOFTWARE FOR THE MANAGEMENT OF SERVICES SUPPORTING A BUSINESS; COMPUTER SOFTWARE FOR CUSTOMER SERVICE; COMPUTER HARDWARE AND SOFTWARE FOR TESTING, MONITORING AND PROTECTING COMPUTER NETWORKS AND COMPUTER NETWORK EQUIPMENT, IN CLASS 9 (U.S. CLS. 21, 23, 26, 36 AND 38).

FIRST USE 12-1-2007; IN COMMERCE 12-1-2007.

FOR: BUSINESS MANAGEMENT, CONSULTATION AND PLANNING, AND PROVIDING INFORMATION RELATED TO BUSINESS MANAGEMENT, CONSULTATION AND PLANNING; BUSINESS MARKETING ADVICE; COMMERCIAL AND BUSINESS CONSULTING AND PROVIDING INFORMATION RELATED TO COMMERCIAL AND BUSINESS CONSULTING; BUSINESS CONSULTING REGARDING MERGERS AND ACQUISITIONS; BUSINESS ANALYSIS; MARKET ANALYSIS; BUSINESS EVALUATIONS; ASSIS-

TANCE TO MANAGEMENT OF COMMERCIAL ACTIVITIES AND MARKET RESEARCH SURVEYS; RESEARCH IN THE FIELD OF COMMERCIAL ACTIVITIES; ECONOMIC RESEARCH AND ANALYSIS; DRAFTING BUSINESS EXPERT REPORTS; ARRANGING AND CONDUCTING TRADE SHOWS AND CONFERENCES FOR COMMERCIAL OR ADVERTISING PURPOSES IN THE COMMERCIAL AND MANAGEMENT SECTOR; ADMINISTRATIVE MANAGEMENT OF PROJECTS IN THE FIELD OF DEVELOPING, SPECIFYING, INSTALLING AND IMPLEMENTING INFORMATION SYSTEMS; BUSINESS CONSULTING IN THE AREA OF TRADE IN TECHNOLOGICAL PRODUCTS; PROVIDING INFORMATION RELATED TO CONSULTING IN THE AREA OF ENTERPRISE ORGANIZATION; THE AFOREMENTIONED SERVICES RENDERED THROUGH A WORLDWIDE OFFICE NETWORK; MEDIATION OF TRADE BUSINESS FOR THIRD PARTIES IN THE NATURE OF BUSINESS MEDIATION FOR THE PROCUREMENT OF COMPUTER HARDWARE AND SOFTWARE FOR THIRD PARTIES, IN CLASS 35 (U.S. CLS. 100, 101 AND 102).

FIRST USE 4-1-2007; IN COMMERCE 4-1-2007.

FOR: FINANCIAL SERVICES, NAMELY, FINANCIAL ANALYSIS, ADVICE AND CONSULTATION, FINANCIAL CLEARING HOUSES, FINANCIAL EXCHANGE, FINANCIAL FORECASTING, FINANCIAL INFORMATION IN THE NATURE OF RATES OF EXCHANGE, FINANCIAL INFORMATION PROVIDED BY ELECTRONIC MEANS, FI-

NANCIAL INFORMATION PROCESSING, FINANCIAL MANAGEMENT, FINANCIAL PLANNING, FINANCIAL PORTFOLIO MANAGEMENT, FINANCIAL RESEARCH, FINANCIAL SERVICES IN THE NATURE OF AN INVESTMENT SECURITY, PROVIDING ON-LINE STORED VALUE ACCOUNTS IN AN ELECTRONIC ENVIRONMENT, INVESTMENT FUND TRANSFER AND TRANSACTION SERVICES AND FINANCIAL VALUATION OF PERSONAL PROPERTY AND REAL ESTATE; VENTURE CAPITAL FINANCING, NAMELY, PROVIDING FINANCING TO EMERGING AND START-UP COMPANIES, IN CLASS 36 (U.S. CLS. 100, 101 AND 102).

FIRST USE 4-1-2007; IN COMMERCE 4-1-2007.

FOR: INSTALLATION, IMPLEMENTATION, REPAIR AND MAINTENANCE OF COMPUTERS, COMPUTER SYSTEMS, COMPUTER NETWORKS, AND COMPUTER HARDWARE, IN CLASS 37 (U.S. CLS. 100, 103 AND 106).

FIRST USE 4-1-2007; IN COMMERCE 4-1-2007.

FOR: COMPUTER CONSULTATION SERVICES, NAMELY, PROVIDING INFORMATION IN THE AREAS OF INFORMATION TECHNOLOGY AND USE AND APPLICATION OF COMPUTERS AND COMPUTER SYSTEMS, COMPUTER HARDWARE DEVELOPMENT, COMPUTER NETWORK DESIGN FOR OTHERS, COMPUTER SERVICES, NAMELY, CREATING AND MAINTAINING WEB SITES FOR OTHERS, COMPUTER SOFTWARE DEVELOPMENT, COMPUTER CONSULTING SERVICES IN THE FIELD OF DESIGN, SELECTION, IMPLEMENTATION AND USE OF COMPUTER HARDWARE AND SOFTWARE SYSTEMS FOR OTHERS; INSTALLATION, MAINTENANCE AND UPDATING OF SOFTWARE; IMPLEMENTATION OF COMPUTER SYSTEMS AND COMPUTER NETWORKS; MANAGEMENT OF BACK-END SOFTWARE FUNCTIONS IN THE NATURE OF MAINTENANCE, UPDATING, UPGRADING, IMPLEMENTATION AND REPAIR OF COMPUTER SOFTWARE; RENDERING INFORMATION REGARDING INFORMATION TECHNOLOGY, NAMELY, PROVIDING A WEB SITE THAT FEATURES INFORMATION ON COMPUTER TECHNOLOGY AND USE AND APPLICATION OF COMPUTERS AND COMPUTER SYSTEMS; INFORMATION TECHNOLOGY CONSULTATION IN THE NATURE OF PROVIDING INFORMATION REGARDING CONSULTING WITH RESPECT TO INFORMATION TECHNOLOGY AND USE AND APPLICATION OF COMPUTERS AND COMPUTER SYSTEMS; ADVICE REGARDING USE AND APPLICATION OF COMPUTERS, COMPUTER SYSTEMS AND DEVELOPMENT OF COMPUTER SYSTEMS; DEVELOPMENT OF ON-LINE COMPUTER SOFTWARE SYSTEMS; ADVISING WITH RESPECT TO INFORMATION TECHNOLOGY IN THE NATURE OF INFORMATION TECHNOLOGY CONSULTATION; DEVELOPMENT OF COMPUTER SOFTWARE AND INTERNET WEB SITES; INSTALLATION, MAINTENANCE AND UPDATING OF COMPUTER SOFTWARE; TECHNICAL SUPPORT, NAMELY, COMPUTER NETWORK TESTING TO ENSURE NETWORK INTEGRITY AND MONITORING OF NETWORK SYSTEMS, IN CLASS 42 (U.S. CLS. 100 AND 101).

NANCE, UPDATING, UPGRADING, IMPLEMENTATION AND REPAIR OF COMPUTER SOFTWARE; RENDERING INFORMATION REGARDING INFORMATION TECHNOLOGY, NAMELY, PROVIDING A WEB SITE THAT FEATURES INFORMATION ON COMPUTER TECHNOLOGY AND USE AND APPLICATION OF COMPUTERS AND COMPUTER SYSTEMS; INFORMATION TECHNOLOGY CONSULTATION IN THE NATURE OF PROVIDING INFORMATION REGARDING CONSULTING WITH RESPECT TO INFORMATION TECHNOLOGY AND USE AND APPLICATION OF COMPUTERS AND COMPUTER SYSTEMS; ADVICE REGARDING USE AND APPLICATION OF COMPUTERS, COMPUTER SYSTEMS AND DEVELOPMENT OF COMPUTER SYSTEMS; DEVELOPMENT OF ON-LINE COMPUTER SOFTWARE SYSTEMS; ADVISING WITH RESPECT TO INFORMATION TECHNOLOGY IN THE NATURE OF INFORMATION TECHNOLOGY CONSULTATION; DEVELOPMENT OF COMPUTER SOFTWARE AND INTERNET WEB SITES; INSTALLATION, MAINTENANCE AND UPDATING OF COMPUTER SOFTWARE; TECHNICAL SUPPORT, NAMELY, COMPUTER NETWORK TESTING TO ENSURE NETWORK INTEGRITY AND MONITORING OF NETWORK SYSTEMS, IN CLASS 42 (U.S. CLS. 100 AND 101).

FIRST USE 4-1-2007; IN COMMERCE 4-1-2007.

OWNER OF U.S. REG. NOS. 2,869,154, 2,914,426, AND OTHERS.

THE MARK CONSISTS OF TWO ARCS OVER THE WORD "BEARINGPOINT" ENCLOSED IN A RECTANGLE.

SN 77-092,250, FILED 1-26-2007.

ANDREA K. NADELMAN, EXAMINING ATTORNEY

Int. Cls.: 9, 16, 35, 36, 38, 41, and 42

**Prior U.S. Cls.: 2, 5, 21, 22, 23, 26, 29, 36, 37, 38, 50,
100, 101, 102, 104, and 107**

Reg. No. 3,576,763

United States Patent and Trademark Office

Registered Feb. 17, 2009

**TRADEMARK
SERVICE MARK
PRINCIPAL REGISTER**

PARTICIPANT MEDIA

PARTICIPANT PRODUCTIONS, LLC (DELA-
WARE LIMITED LIABILITY COMPANY)
335 N. MAPLE DRIVE
BEVERLY HILLS, CA 90210

FOR: PRE-RECORDED AUDIO CASSETTES, AUDIO BOOKS AND COMPACT DISCS FEATURING MUSIC OR STORIES OR PUBLISHED BOOKS; PRE-RECORDED DIGITAL VIDEO DISCS, VIDEO CASSETTES AND DIGITAL VERSATILE DISCS FEATURING TV SHOWS, MOTION PICTURES AND PUBLIC SERVICE ANNOUNCEMENTS IN THE FIELD OF SOCIAL ACTION CAMPAIGNS; PRE-RECORDED CD-ROM DISCS FEATURING TV SHOWS, MOTION PICTURES AND PUBLIC SERVICE ANNOUNCEMENTS IN THE FIELD OF SOCIAL ACTION CAMPAIGNS, COMPUTER GAME PROGRAMS AND COMPUTER SOFTWARE FOR USE IN RECORDING, MANAGEMENT, DATA PROCESSING, MULTI-USER NETWORKING AND MULTI-USER CORRESPONDENCE AND DATA SHARING IN THE FIELDS OF SOCIAL ACTION CAMPAIGNS; DOWNLOADABLE MP3 FILES, MP3 RECORDINGS, ONLINE DISCUSSION BOARDS, WEB CASTS, POD CASTS FEATURING MUSIC, AUDIO BOOKS AND NEWS BROADCASTS; DOWNLOADABLE ELECTRONIC PUBLICATIONS IN THE NATURE OF BOOKS AND PERIODICALS IN THE FIELD OF SOCIAL ACTION AND SOCIAL RESPONSIBILITY FOCUSING ON ENVIRONMENTAL PROTECTION, CORPORATE SOCIAL RESPONSIBILITY, HEALTH, HUMAN RIGHTS AND TOLERANCE, PEACE AND SECURITY AND SOCIAL AND ECONOMIC EQUITY, IN CLASS 9 (U.S. CLS. 21, 23, 26, 36 AND 38).

FIRST USE 2-7-2008; IN COMMERCE 2-7-2008.

FOR: PRINTED EDUCATIONAL, INSTRUCTIONAL AND TEACHING MATERIALS, NAMELY,

BOOKS, PAMPHLETS AND PERIODICALS IN THE FIELDS OF SOCIAL ACTION AND SOCIAL RESPONSIBILITY FOCUSING ON ENVIRONMENTAL PROTECTION, CORPORATE SOCIAL RESPONSIBILITY, HEALTH, HUMAN RIGHTS AND TOLERANCE, PEACE AND SECURITY AND SOCIAL AND ECONOMIC EQUITY, IN CLASS 16 (U.S. CLS. 2, 5, 22, 23, 29, 37, 38 AND 50).

FIRST USE 2-7-2008; IN COMMERCE 2-7-2008.

FOR: SOCIAL ACTION CAMPAIGN SERVICES, NAMELY, ORGANIZING AND DEVELOPING PROMOTIONAL CAMPAIGNS TO EFFECTUATE SOCIAL CHANGE; PROMOTING PUBLIC AWARENESS OF SOCIAL ISSUES THROUGH SOCIAL ACTION CAMPAIGNS, MOTION PICTURE MEDIA, AND PRINT MEDIA; ARRANGING, HOSTING AND MARKETING PROMOTIONAL EVENTS FOR OTHERS, IN CLASS 35 (U.S. CLS. 100, 101 AND 102).

FIRST USE 2-7-2008; IN COMMERCE 2-7-2008.

FOR: CHARITABLE FUNDRAISING SERVICES, IN CLASS 36 (U.S. CLS. 100, 101 AND 102).

FIRST USE 2-7-2008; IN COMMERCE 2-7-2008.

FOR: TELEVISION BROADCASTING SERVICES; VIDEO BROADCASTING SERVICES OVER THE INTERNET OR OTHER COMMUNICATIONS NETWORK, AND ELECTRONICALLY TRANSMITTING VIDEO CLIPS AND PROVIDING TELECOMMUNICATIONS ACCESS TO VIDEO AND AUDIO CONTENT PROVIDED VIA A VIDEO-ON-DEMAND SERVICE VIA THE INTERNET; PROVIDING ONLINE CHAT ROOMS AND ELECTRONIC BULLETIN BOARDS FOR TRANSMISSION OF MESSAGES

AMONG COMPUTER USERS IN THE FIELD OF SOCIAL ACTION AND SOCIAL ADVOCACY RELATING TO ENVIRONMENTAL PROTECTION INITIATIVES, CORPORATE SOCIAL RESPONSIBILITY INITIATIVES, HEALTH INITIATIVES, HUMAN RIGHTS AND TOLERANCE INITIATIVES, PEACE AND SECURITY INITIATIVES AND SOCIAL AND ECONOMIC EQUITY INITIATIVES, IN CLASS 38 (U.S. CLS. 100, 101 AND 104).

FIRST USE 2-7-2008; IN COMMERCE 2-7-2008.

FOR: ARRANGING AND CONDUCTING EDUCATIONAL CONFERENCES; EDUCATIONAL SERVICES, NAMELY, PROVIDING EDUCATIONAL COURSES AT THE UNIVERSITY LEVEL AND SEMINARS IN THE FIELDS OF SOCIAL ACTION AND SOCIAL ADVOCACY, ENVIRONMENTAL PROTECTION, CORPORATE SOCIAL RESPONSIBILITY, HEALTH, HUMAN RIGHTS AND TOLERANCE, PEACE AND SECURITY AND SOCIAL AND ECONOMIC EQUITY, AND EDUCATIONAL MATERIALS ASSOCIATED THEREWITH; EDUCATIONAL SERVICES, NAMELY, ARRANGING AND CONDUCTING COLLOQUIUMS, CONVENTIONS, EXHIBITIONS, SEMINARS, CONFERENCES AND SYMPOSIUMS IN THE FIELD OF SOCIAL ACTION AND SOCIAL ADVOCACY RELATING TO ENVIRONMENTAL PROTECTION INITIATIVES, CORPORATE SOCIAL RESPONSIBILITY INITIATIVES, HEALTH INITIATIVES, HUMAN RIGHTS AND TOLERANCE INITIATIVES, PEACE AND SECURITY INITIATIVES AND SOCIAL AND ECONOMIC EQUITY INITIATIVES; PUBLISHING SERVICES, NAMELY, PUBLISHING OF BOOKS AND TEXTS OTHER THAN ADVERTISING TEXTS, INCLUDING PUBLISHING OF BOOKS AND NON-ADVERTISING TEXTS IN THE FIELDS OF SOCIAL ACTION INITIATIVES AND SOCIAL ADVOCACY, ENVIRONMENTAL PROTECTION, CORPORATE SOCIAL RESPONSIBILITY, HEALTH, HUMAN RIGHTS AND TOLERANCE, PEACE AND SECURITY AND SOCIAL AND ECONOMIC EQUITY; ELECTRONIC PUBLISHING SERVICES, NAMELY, THE PUBLICATION OF BOOKS AND PERIODICALS ONLINE THROUGH ELECTRONIC MEDIA FEATURING INFORMATION ON SOCIAL ACTION CAMPAIGNS, SOCIAL ADVOCACY, ENVIRONMENTAL PROTECTION, CORPORATE SOCIAL RESPONSIBILITY, HEALTH, HUMAN RIGHTS AND TOLERANCE, PEACE AND SECURITY AND SOCIAL AND ECONOMIC EQUITY; CONTINUING PUBLIC EDUCATIONAL SERVICE PROGRAMS IN THE FIELDS OF SOCIAL ACTION AND SOCIAL ADVOCACY, ENVIRONMENTAL PROTECTION, CORPORATE

SOCIAL RESPONSIBILITY, HEALTH, HUMAN RIGHTS AND TOLERANCE, PEACE AND SECURITY AND SOCIAL AND ECONOMIC EQUITY PRODUCED AND DISTRIBUTED OVER TELEVISION, SATELLITE, FILM, AUDIO, VIDEO, INTERNET, AND 3-D VIRTUAL REALITY MEDIA; ENTERTAINMENT SERVICES, NAMELY, PRODUCTION AND DISTRIBUTION OF MOTION PICTURES AND TELEVISION PROGRAMS; CONCERT ENTERTAINMENT, NAMELY, LIVE MUSIC AND LIVE MUSICAL PERFORMANCES BY BANDS AND INDIVIDUALS ARTISTS; PRODUCTION OF LIVE STAGE THEATER PRODUCTIONS; PROVIDING INTERACTIVE ONLINE ENTERTAINMENT INFORMATION IN THE FIELD OF MOTION PICTURES AND TELEVISION PROGRAMS; PROVIDING ONLINE INTERACTIVE EDUCATIONAL PROGRAMS AND EDUCATIONAL MATERIALS IN CONNECTION THEREWITH, IN THE FIELDS OF SOCIAL ACTION AND SOCIAL ADVOCACY, ENVIRONMENTAL PROTECTION, CORPORATE SOCIAL RESPONSIBILITY, HEALTH, HUMAN RIGHTS AND TOLERANCE, PEACE AND SECURITY AND SOCIAL AND ECONOMIC EQUITY, IN CLASS 41 (U.S. CLS. 100, 101 AND 107).

FIRST USE 2-7-2008; IN COMMERCE 2-7-2008.

FOR: COMPUTER SERVICES, NAMELY, HOSTING ONLINE WEB FACILITIES FOR OTHERS FOR ORGANIZING AND CONDUCTING ONLINE MEETINGS, GATHERINGS, AND INTERACTIVE DISCUSSIONS FOCUSED ON SOCIAL ACTION CAMPAIGNS AND SOCIAL ADVOCACY PROGRAMS; COMPUTER SERVICES, NAMELY, UPLOADING MUSIC TO THE INTERNET FOR OTHERS, IN CLASS 42 (U.S. CLS. 100 AND 101).

FIRST USE 2-7-2008; IN COMMERCE 2-7-2008.

THE MARK CONSISTS OF STANDARD CHARACTERS WITHOUT CLAIM TO ANY PARTICULAR FONT, STYLE, SIZE, OR COLOR.

OWNER OF U.S. REG. NOS. 3,042,629 AND 3,101,707.

NO CLAIM IS MADE TO THE EXCLUSIVE RIGHT TO USE "MEDIA", APART FROM THE MARK AS SHOWN.

SN 77-092,284, FILED 1-26-2007.

ZACHARY BELLO, EXAMINING ATTORNEY

Int. Cl.: 5

Prior U.S. Cls.: 6, 18, 44, 46, 51, and 52

United States Patent and Trademark Office

Reg. No. 3,576,764

Registered Feb. 17, 2009

**TRADEMARK
PRINCIPAL REGISTER**

REVUS TOP

SYNGENTA PARTICIPATIONS AG (SWITZER-
LAND CORPORATION)
SCHWARZWALDALLEE 215
BASEL, SWITZERLAND

THE MARK CONSISTS OF STANDARD CHAR-
ACTERS WITHOUT CLAIM TO ANY PARTICULAR
FONT, STYLE, SIZE, OR COLOR.

FOR: FUNGICIDES FOR AGRICULTURAL USE,
IN CLASS 5 (U.S. CLS. 6, 18, 44, 46, 51 AND 52).

SN 77-094,163, FILED 1-30-2007.

FIRST USE 5-2-2008; IN COMMERCE 5-2-2008.

ALICE BENMAMAN, EXAMINING ATTORNEY

Int. Cl.: 41

Prior U.S. Cls.: 100, 101, and 107

United States Patent and Trademark Office

Reg. No. 3,576,765

Registered Feb. 17, 2009

**SERVICE MARK
PRINCIPAL REGISTER**

SimpleScapes

EILERS, TAMBRA (UNITED STATES INDIVIDUAL)
2344 ROOKERY WAY
VIRGINIA BEACH, VA 23455

THE MARK CONSISTS OF STANDARD CHARACTERS WITHOUT CLAIM TO ANY PARTICULAR FONT, STYLE, SIZE, OR COLOR.

FOR: PROVIDE TRAINING AND INSTRUCTIONS FOR HORTICULTURE SERVICES, IN CLASS 41 (U.S. CLS. 100, 101 AND 107).

SN 77-094,605, FILED 1-30-2007.

FIRST USE 12-15-2007; IN COMMERCE 1-10-2008.

VERNA BETH RIRIE, EXAMINING ATTORNEY

Int. Cl.: 8

Prior U.S. Cls.: 23, 28, and 44

United States Patent and Trademark Office

Reg. No. 3,576,766

Registered Feb. 17, 2009

**TRADEMARK
PRINCIPAL REGISTER**

CURVATIONS

CONAIR CORPORATION (DELAWARE CORPORATION)
ONE CUMMINGS POINT ROAD
STAMFORD, CT 06902

FOR: ELECTRIC SHAVERS; NON-ELECTRIC
SHAVERS, IN CLASS 8 (U.S. CLS. 23, 28 AND 44).

FIRST USE 4-1-2007; IN COMMERCE 4-1-2007.

THE MARK CONSISTS OF STANDARD CHARACTERS WITHOUT CLAIM TO ANY PARTICULAR FONT, STYLE, SIZE, OR COLOR.

SN 77-094,631, FILED 1-30-2007.

ALICE BENMAMAN, EXAMINING ATTORNEY

Int. Cl.: 8

Prior U.S. Cls.: 23, 28, and 44

United States Patent and Trademark Office

Reg. No. 3,576,767

Registered Feb. 17, 2009

**TRADEMARK
PRINCIPAL REGISTER**

THE CHOPPER

CONAIR CORPORATION (DELAWARE CORPORATION)
ONE CUMMINGS POINT ROAD
STAMFORD, CT 06902

FOR: BLADES AND BRUSHES FOR ELECTRIC HAIR CLIPPERS AND TRIMMERS; ELECTRIC AND BATTERY-POWERED HAIR CLIPPERS; ELECTRIC AND BATTERY-POWERED HAIR TRIMMERS; ELECTRIC HAIR CLIPPERS; ELECTRIC HAIR TRIMMERS; ELECTRIC RAZORS AND ELECTRIC HAIR CLIPPERS; HAIR CLIPPERS; HAIR TRIMMERS; HAND-OPERATED HAIR CLIPPERS;

MUSTACHE AND BEARD TRIMMERS, IN CLASS 8 (U.S. CLS. 23, 28 AND 44).

FIRST USE 2-1-2007; IN COMMERCE 2-1-2007.

THE MARK CONSISTS OF STANDARD CHARACTERS WITHOUT CLAIM TO ANY PARTICULAR FONT, STYLE, SIZE, OR COLOR.

SN 77-094,654, FILED 1-30-2007.

ALICE BENMAMAN, EXAMINING ATTORNEY

Int. Cl.: 33

Prior U.S. Cls.: 47 and 49

United States Patent and Trademark Office

Reg. No. 3,576,768

Registered Feb. 17, 2009

**TRADEMARK
PRINCIPAL REGISTER**

CAROB TREE

VIÑAS ARGENTINAS, S.A. (ARGENTINA COR-
PORATION)
5513 COQUIMBITO, MAIPU
CARRIL RODRIGUEZ PEÑA, KM-7,5
MENDOZA, ARGENTINA

THE MARK CONSISTS OF STANDARD CHAR-
ACTERS WITHOUT CLAIM TO ANY PARTICULAR
FONT, STYLE, SIZE, OR COLOR.

FOR: WINES, IN CLASS 33 (U.S. CLS. 47 AND 49).

SN 77-095,582, FILED 1-31-2007.

FIRST USE 10-9-2008; IN COMMERCE 10-9-2008.

DAWN HAN, EXAMINING ATTORNEY

Int. Cl.: 35

Prior U.S. Cls.: 100, 101, and 102

United States Patent and Trademark Office

Reg. No. 3,576,769

Registered Feb. 17, 2009

**SERVICE MARK
PRINCIPAL REGISTER**

e-transitions

VISITING NURSE SERVICE OF NEW YORK,
INC. (NEW YORK CORPORATION)
107 EAST 70TH STREET
NEW YORK, NY 10021

THE MARK CONSISTS OF STANDARD CHAR-
ACTERS WITHOUT CLAIM TO ANY PARTICULAR
FONT, STYLE, SIZE, OR COLOR.

FOR: REFERRALS IN THE FIELD OF HOME
HEALTH CARE VIA THE INTERNET, IN CLASS 35
(U.S. CLS. 100, 101 AND 102).

SN 77-097,259, FILED 2-1-2007.

FIRST USE 1-11-2006; IN COMMERCE 1-11-2006.

CARRIE GENOVESE, EXAMINING ATTORNEY

Int. Cl.: 9

Prior U.S. Cls.: 21, 23, 26, 36, and 38

United States Patent and Trademark Office

Reg. No. 3,576,770

Registered Feb. 17, 2009

**TRADEMARK
PRINCIPAL REGISTER**

SPRING BREAK BEACH PARTY

GAMELOFT S.A. (FRANCE SOCIETE ANON-
YME)
14 RUE AUBER
PARIS, FRANCE 75009

FOR: COMPUTER SOFTWARE FOR ELECTRO-
NIC GAMES AND ENTERTAINMENT, NAMELY,
COMPUTER GAME SOFTWARE USED AND
PLAYED ON MOBILE AND CELLULAR TELE-
PHONES, HANDHELD COMPUTERS, PERSONAL
COMPUTERS AND PERSONAL DIGITAL ASSIS-
TANTS; DOWNLOADABLE ELECTRONIC GAME
PROGRAMS; DOWNLOADABLE RING TONES VIA
THE INTERNET AND WIRELESS DEVICES; DOWN-
LOADABLE VOICE RING TONES FOR MOBILE
TELECOMMUNICATIONS DEVICES; DOWNLOAD-
ABLE COMPUTER SOFTWARE FOR WALL PA-
PERS, NAMELY, STILL IMAGES FOR USE IN
BACKGROUNDS ON MOBILE PHONE SCREENS;
COMPUTER SCREEN SAVER SOFTWARE; COM-
PUTER SOFTWARE FOR PROCESSING ANIMA-
TED IMAGES FOR USE ON MOBILE PHONE

SCREENS; AND PROGRAMS FOR DOWNLOAD-
ING IMAGES TO MOBILE TELECOMMUNICA-
TION DEVICES, NAMELY, MOBILE AND
CELLULAR TELEPHONES, HANDHELD COMPU-
TERS, PERSONAL COMPUTERS AND PERSONAL
DIGITAL ASSISTANTS VIA THE GLOBAL COMPU-
TER NETWORK AND WIRELESS DEVICES; AND
COMPUTER SOFTWARE FOR USE IN THE DE-
SIGN, DEVELOPMENT AND EXECUTION OF
WIRELESS COMPUTER GAMES, IN CLASS 9 (U.S.
CLS. 21, 23, 26, 36 AND 38).

FIRST USE 2-1-2007; IN COMMERCE 2-1-2007.

THE MARK CONSISTS OF STANDARD CHAR-
ACTERS WITHOUT CLAIM TO ANY PARTICULAR
FONT, STYLE, SIZE, OR COLOR.

SN 77-099,317, FILED 2-5-2007.

LINDA M. KING, EXAMINING ATTORNEY

Int. Cl.: 9

Prior U.S. Cls.: 21, 23, 26, 36, and 38

United States Patent and Trademark Office

Reg. No. 3,576,771

Registered Feb. 17, 2009

**TRADEMARK
PRINCIPAL REGISTER**

NEXTREME

NEXTEP ENTERPRISES, INC. (MICHIGAN CORPORATION)
2075 W. BIG BEAVER RD., STE. 330
TROY, MI 48084

FOR: INDOOR AND OUTDOOR INTERACTIVE COMPUTER KIOSKS COMPRISING COMPUTERS, COMPUTER HARDWARE AND COMPUTER PERIPHERALS; SELF-SERVICE POINT-OF-SALE COMPUTER TERMINALS FOR ORDERING OF GOODS AND SERVICES; MICROPROCESSOR-BASED SELF-SERVICE POINT-OF-SALE COMPUTER TERMIN-

ALS UTILIZING A TOUCH SCREEN USER INTERFACE, IN CLASS 9 (U.S. CLS. 21, 23, 26, 36 AND 38).

FIRST USE 5-17-2007; IN COMMERCE 4-20-2007.

THE MARK CONSISTS OF STANDARD CHARACTERS WITHOUT CLAIM TO ANY PARTICULAR FONT, STYLE, SIZE, OR COLOR.

SN 77-099,662, FILED 2-5-2007.

SOPHIA S. KIM, EXAMINING ATTORNEY

Int. Cls.: 6, 9, and 11

Prior U.S. Cls.: 2, 12, 13, 14, 21, 23, 25, 26, 31, 34, 36,
38, and 50

Reg. No. 3,576,772

United States Patent and Trademark Office

Registered Feb. 17, 2009

TRADEMARK
PRINCIPAL REGISTER

MAXTHAL

SANDVIK INTELLECTUAL PROPERTY AB
(SWEDEN CORPORATION)
S-811
SANDVIKEN, SWEDEN 81

FOR: HEAT RESISTANT ALLOYS OF COMMON METALS, NAMELY, ALUMINUM, COPPER, LEAD, MAGNESIUM, NICKEL, TIN, TITANIUM, SILICON, NIOBIUM, AND ZINC, IN THE FORM OF WIRE, RIBBON, STRIP, FOIL, TUBING, CERMETS, AND WOVEN WIRE MESH FOR USE WITH CATALYZERS; BI-METALLIC STRIPS FOR CONVERTING TEMPERATURE CHANGES INTO MECHANICAL DISPLACEMENT; COMMON METALS AND ALLOYS FOR FURTHER MANUFACTURING, FOR EXAMPLE, AS HEATING ELEMENTS; NON-ELECTRIC CABLES; METAL WIRE; METAL FORGINGS; METAL TUBING; METAL POWDER; METAL RODS, METAL BARS, METAL CYLINDERS, METAL SHEETS, METAL PLATES, AND METAL BLOCKS, ALL FOR FURTHER MANUFACTURING; REFRACTORY BRICKS OF METAL, IN CLASS 6 (U.S. CLS. 2, 12, 13, 14, 23, 25 AND 50).

FIRST USE 1-1-2004; IN COMMERCE 1-1-2004.

FOR: ELECTRICAL RESISTANCE MATERIALS IN THE FORM OF WIRE, RIBBON, STRIP, FOIL, TUBING, CERMETS, AND WOVEN WIRE MESH FOR USE WITH CATALYZERS; CIRCUITS FOR HEATING; FOIL ELEMENTS, NAMELY, CIRCUITS FOR HEATING OR ELECTRICAL CONDUCTION; ELECTRIC AND ELECTRONIC APPARATUS AND

INSTRUMENTS FOR MEASURING, CONTROL AND SUPERVISION OF TOASTERS; ELECTRICAL CONTROLLERS FOR GAS AND OIL BURNERS; FURNACES FOR LABORATORY EXPERIMENTS, IN CLASS 9 (U.S. CLS. 21, 23, 26, 36 AND 38).

FIRST USE 1-1-2004; IN COMMERCE 1-1-2004.

FOR: HEATING ELEMENTS CONSISTING OF SINTERED METAL; APPARATUS FOR THE EXCHANGE OF SUBSTANCES AND HEAT FOR USE IN THE PRODUCTION OF HEAT AND STEAM, FOR USE IN COOKING, AND FOR USE IN REFRIGERATION, AND PARTS SPECIFICALLY FOR USE WITH THE FOREGOING APPARATUS; ELECTRICAL KITCHEN RANGES; SEPARATORS FOR THE CLEANING AND PURIFICATION OF GASES; FURNACES; KILN FURNITURE, IN CLASS 11 (U.S. CLS. 13, 21, 23, 31 AND 34).

FIRST USE 1-1-2004; IN COMMERCE 1-1-2004.

THE MARK CONSISTS OF STANDARD CHARACTERS WITHOUT CLAIM TO ANY PARTICULAR FONT, STYLE, SIZE, OR COLOR.

THE MARK "MAXTHAL" HAS NO MEANING IN A FOREIGN LANGUAGE.

SN 77-099,800, FILED 2-5-2007.

CORY BOONE, EXAMINING ATTORNEY

Int. Cl.: 5

Prior U.S. Cls.: 6, 18, 44, 46, 51, and 52

Reg. No. 3,576,773

United States Patent and Trademark Office

Registered Feb. 17, 2009

**TRADEMARK
PRINCIPAL REGISTER**

STRESSGUARDEQ

L.C.M. NUTRACEUTICALS, INC. (PENNSYLVANIA CORPORATION)
2783 SOUTH BRIDGE ROAD
WASHINGTON, PA 15301

THE MARK CONSISTS OF STANDARD CHARACTERS WITHOUT CLAIM TO ANY PARTICULAR FONT, STYLE, SIZE, OR COLOR.

FOR: NUTRACEUTICALS FOR THE TREATMENT OF EQUINE IMMUNITY, IN CLASS 5 (U.S. CLS. 6, 18, 44, 46, 51 AND 52).

SN 77-099,901, FILED 2-6-2007.

FIRST USE 4-22-2007; IN COMMERCE 4-22-2007.

ELIZABETH KAJUBI, EXAMINING ATTORNEY

Int. Cl.: 32

Prior U.S. Cls.: 45, 46, and 48

United States Patent and Trademark Office

Reg. No. 3,576,774

Registered Feb. 17, 2009

TRADEMARK
PRINCIPAL REGISTER



CERVECERIA MODELO, S.A. DE C.V. (MEXICO CORPORATION)
LAGO ALBERTO NO. 156, COLONIA ANAHUAC
11320 MEXICO D.F., MEXICO

FOR: ALCOHOLIC BEVERAGES, NAMELY BEER, IN CLASS 32 (U.S. CLS. 45, 46 AND 48).

FIRST USE 6-30-2006; IN COMMERCE 6-30-2006.

OWNER OF U.S. REG. NOS. 1,022,817, 1,217,760, AND OTHERS.

NO CLAIM IS MADE TO THE EXCLUSIVE RIGHT TO USE "ESPECIAL, CERVECERIA, SA. DE C.V." AND "MEXICO", APART FROM THE MARK AS SHOWN.

THE MARK CONSISTS OF THE STYLIZED LETTERING "MODELO ESPECIAL" APPEARING VER-

TICALLY AND SIDE BY SIDE WITH A LION/BANNER/CIRCULAR DESIGN BELOW WHICH CONTAINS THE STYLIZED LETTERING "CERVECERIA MODELO, S.A. DE C.V. MEXICO" AND TWO HORIZONTAL LINES APPEARING AT THE TOP AND TWO HORIZONTAL LINES APPEARING AT THE BOTTOM, THE DOTTED LINES ARE FOR PLACEMENT OF THE MARK ON THE GOODS ONLY AND ARE NOT PART OF THE MARK.

THE ENGLISH TRANSLATION OF THE TERMS "CERVECERIA" AND "MODELO ESPECIAL" APPEARING IN THE MARK IS "BREWERY" AND "SPECIAL MODEL".

SN 77-100,703, FILED 2-6-2007.

GENE MACIOL, EXAMINING ATTORNEY

Int. Cls.: 9, 38, 41, and 44

Prior U.S. Cls.: 21, 23, 26, 36, 38, 100, 101, 104, and 107

Reg. No. 3,576,775

United States Patent and Trademark Office

Registered Feb. 17, 2009

**TRADEMARK
SERVICE MARK
PRINCIPAL REGISTER**

STRUCTURE HOUSECALLS

STRUCTURE HOUSE ACQUISITION, LLC (DELAWARE LIMITED LIABILITY COMPANY)
20400 STEVENS CREEK ROAD, SUITE 600
CUPERTINO, CA 95014

FOR: ELECTRONIC COMMUNICATIONS EQUIPMENT, NAMELY, CELLULAR TELEPHONES FOR USE IN TRANSMITTING DATA FROM ELECTRONIC WEIGHT SCALES, IN CLASS 9 (U.S. CLS. 21, 23, 26, 36 AND 38).

FIRST USE 2-19-2007; IN COMMERCE 2-19-2007.

FOR: TELECOMMUNICATIONS SERVICES, NAMELY, TRANSMISSION OF DATA FROM ELECTRONIC WEIGHT SCALES VIA CELLULAR TELEPHONES, IN CLASS 38 (U.S. CLS. 100, 101 AND 104).

FIRST USE 2-19-2007; IN COMMERCE 2-19-2007.

FOR: INDIVIDUALIZED CONSULTATION AND INFORMATION RELATED TO PHYSICAL FITNESS, IN CLASS 41 (U.S. CLS. 100, 101 AND 107).

FIRST USE 2-19-2007; IN COMMERCE 2-19-2007.

FOR: PSYCHOTHERAPY AS IT RELATES TO NUTRITION AND WEIGHT LOSS; NUTRITION COUNSELING; CONSULTING TO INDIVIDUALS AND COMMUNITIES ENGAGED IN GROUP WEIGHT LOSS PROGRAMS; WEIGHT REDUCTION DIET PLANNING AND SUPERVISION, IN CLASS 44 (U.S. CLS. 100 AND 101).

FIRST USE 2-19-2007; IN COMMERCE 2-19-2007.

THE MARK CONSISTS OF STANDARD CHARACTERS WITHOUT CLAIM TO ANY PARTICULAR FONT, STYLE, SIZE, OR COLOR.

SN 77-101,560, FILED 2-7-2007.

MARCIE MILONE, EXAMINING ATTORNEY

Int. Cl.: 28

Prior U.S. Cls.: 22, 23, 38, and 50

United States Patent and Trademark Office

Reg. No. 3,576,776

Registered Feb. 17, 2009

**TRADEMARK
PRINCIPAL REGISTER**

WHAT'S YOUR IB?

BAILEY, AISHA (UNITED STATES INDIVIDUAL)
3 MAYFAIR LANE
WESTPORT, CT 06880

THE MARK CONSISTS OF STANDARD CHARACTERS WITHOUT CLAIM TO ANY PARTICULAR FONT, STYLE, SIZE, OR COLOR.

FOR: DOLLS; PLUSH TOYS, IN CLASS 28 (U.S. CLS. 22, 23, 38 AND 50).

SN 77-102,335, FILED 2-8-2007.

FIRST USE 2-1-2008; IN COMMERCE 2-1-2008.

DEIRDRE ROBERTSON, EXAMINING ATTORNEY

Int. Cl.: 28

Prior U.S. Cls.: 22, 23, 38, and 50

United States Patent and Trademark Office

Reg. No. 3,576,777

Registered Feb. 17, 2009

**TRADEMARK
PRINCIPAL REGISTER**

WHAT'S YOUR FLAVOR?

BAILEY, AISHA (UNITED STATES INDIVIDUAL)
3 MAYFAIR LANE
WESTPORT, CT 06880

THE MARK CONSISTS OF STANDARD CHARACTERS WITHOUT CLAIM TO ANY PARTICULAR FONT, STYLE, SIZE, OR COLOR.

FOR: DOLLS; PLUSH TOYS, IN CLASS 28 (U.S. CLS. 22, 23, 38 AND 50).

SN 77-102,348, FILED 2-8-2007.

FIRST USE 2-1-2008; IN COMMERCE 2-1-2008.

DEIRDRE ROBERTSON, EXAMINING ATTORNEY

Int. Cl.: 9

Prior U.S. Cls.: 21, 23, 26, 36, and 38

United States Patent and Trademark Office

Reg. No. 3,576,778

Registered Feb. 17, 2009

**TRADEMARK
PRINCIPAL REGISTER**

MINGLE

THOUGHTWORKS, INC. (DELAWARE CORPORATION)
200 E. RANDOLPH ST., 25TH FLOOR
CHICAGO, IL 60601

FOR: COMPUTER PROGRAMS FOR USE IN THE SOFTWARE BUILD PROCESS IN THE FIELD OF COMPUTER SOFTWARE DEVELOPMENT AND USER MANUALS AND DOCUMENTATION DISTRIBUTED THEREWITH; COMPUTER SOFTWARE DEVELOPMENT TOOLS, IN CLASS 9 (U.S. CLS. 21, 23, 26, 36 AND 38).

FIRST USE 12-1-2006; IN COMMERCE 7-31-2007.

THE MARK CONSISTS OF STANDARD CHARACTERS WITHOUT CLAIM TO ANY PARTICULAR FONT, STYLE, SIZE, OR COLOR.

SN 77-102,460, FILED 2-8-2007.

DAVID MURRAY, EXAMINING ATTORNEY

Int. Cl.: 9

Prior U.S. Cls.: 21, 23, 26, 36, and 38

United States Patent and Trademark Office

Reg. No. 3,576,779

Registered Feb. 17, 2009

**TRADEMARK
PRINCIPAL REGISTER**

MEANSTICK

SEAGRAVE FIRE APPARATUS, LLC (DELA-
WARE LIMITED LIABILITY COMPANY)
105 EAST 12TH STREET
CLINTONVILLE, WI 54929

THE MARK CONSISTS OF STANDARD CHAR-
ACTERS WITHOUT CLAIM TO ANY PARTICULAR
FONT, STYLE, SIZE, OR COLOR.

FOR: FIREFIGHTING TRUCKS, NAMELY, FIRE-
FIGHTING AERIAL TRUCKS AND LADDER
TRUCKS, IN CLASS 9 (U.S. CLS. 21, 23, 26, 36 AND
38).

SN 77-102,657, FILED 2-8-2007.

FIRST USE 10-31-2008; IN COMMERCE 10-31-2008.

SUSAN RICHARDS, EXAMINING ATTORNEY

Int. Cl.: 9

Prior U.S. Cls.: 21, 23, 26, 36, and 38

Reg. No. 3,576,780

United States Patent and Trademark Office

Registered Feb. 17, 2009

**TRADEMARK
PRINCIPAL REGISTER**

MARAUDER

SEAGRAVE FIRE APPARTUS, LLC (DELAWARE
LIMITED LIABILITY COMPANY)
105 EAST 12TH STREET
CLINTONVILLE, WI 54929

FOR: FIREFIGHTING EQUIPMENT, NAMELY,
FIRE ENGINES, FIRE TRUCKS, AERIAL TRUCKS,
RESCUE TRUCKS, BRUSH TRUCKS, TANKER
TRUCKS, PUMPER TRUCKS, AND CABS AND
CHASSIS THEREFOR, IN CLASS 9 (U.S. CLS. 21, 23,
26, 36 AND 38).

FIRST USE 10-28-2008; IN COMMERCE 10-28-2008.

THE MARK CONSISTS OF STANDARD CHAR-
ACTERS WITHOUT CLAIM TO ANY PARTICULAR
FONT, STYLE, SIZE, OR COLOR.

SN 77-102,664, FILED 2-8-2007.

ARETHA SOMERVILLE, EXAMINING ATTORNEY

Int. Cl.: 29

Prior U.S. Cl.: 46

United States Patent and Trademark Office

Reg. No. 3,576,781

Registered Feb. 17, 2009

TRADEMARK
PRINCIPAL REGISTER



HANWA AMERICAN CORP. (NEW YORK CORPORATION)
900 4TH AVENUE, SUITE 1640
SEATTLE, WA 98164

FOR: FROZEN FISH AND FROZEN SHELLFISH,
IN CLASS 29 (U.S. CL. 46).

FIRST USE 10-26-2006; IN COMMERCE 10-26-2006.

THE MARK CONSISTS OF STYLIZED VERSIONS
OF CHARACTERS FOR THE JAPANESE WORD
"KEN" WITH THE ENGLISH LETTERS "KEN" TO
THE RIGHT OF THE CHARACTERS.

THE FOREIGN WORDING IN THE MARK
TRANSLATES INTO ENGLISH AS SWORD.

THE NON-LATIN CHARACTER(S) IN THE
MARK TRANSLITERATE INTO "KEN", AND THIS
MEANS "SWORD" IN ENGLISH.

SN 77-103,650, FILED 2-9-2007.

GISELLE AGOSTO, EXAMINING ATTORNEY

Int. Cl.: 31

Prior U.S. Cls.: 1 and 46

United States Patent and Trademark Office

Reg. No. 3,576,782

Registered Feb. 17, 2009

**TRADEMARK
PRINCIPAL REGISTER**

STORYBOOK

AMERICAN DAYLILY & PERENNIALS, INC.
(MISSOURI CORPORATION)
31706 E. PINK HILL ROAD
GRAIN VALLEY, MO 64029

THE MARK CONSISTS OF STANDARD CHAR-
ACTERS WITHOUT CLAIM TO ANY PARTICULAR
FONT, STYLE, SIZE, OR COLOR.

FOR: LIVING PLANTS, IN CLASS 31 (U.S. CLS. 1
AND 46).

SN 77-104,061, FILED 2-9-2007.

FIRST USE 10-0-2006; IN COMMERCE 12-1-2006.

BENJAMIN ALLEN, EXAMINING ATTORNEY

Int. Cl.: 19

Prior U.S. Cls.: 1, 12, 33, and 50

United States Patent and Trademark Office

Reg. No. 3,576,783

Registered Feb. 17, 2009

TRADEMARK
PRINCIPAL REGISTER



PINEDA, MARTHA L. (UNITED STATES INDIVIDUAL)
7 MORNING BREEZE COURT
SILVER SPRING, MD 20904

FOR: NON-LUMINOUS, NON-MECHANICAL SIGNS NOT OF METAL, IN CLASS 19 (U.S. CLS. 1, 12, 33 AND 50).

FIRST USE 2-20-2008; IN COMMERCE 2-20-2008.

THE COLOR(S) NEON LIME GREEN AND BLACK IS/ARE CLAIMED AS A FEATURE OF THE MARK.

THE MARK CONSISTS OF "MARTISTRY UNLTD." IN BLACK LETTERS ON THE EDGE OF A HEART SHAPE COLORED NEON LIME GREEN IMAGE.

SEC. 2(F).

SN 77-104,594, FILED 2-11-2007.

DAWN FELDMAN, EXAMINING ATTORNEY

Int. Cl.: 35

Prior U.S. Cls.: 100, 101, and 102

United States Patent and Trademark Office

Reg. No. 3,576,784

Registered Feb. 17, 2009

**SERVICE MARK
PRINCIPAL REGISTER**

Ask.Share.Compare.

SHOPZOOM INC. (CANADA CORPORATION)
3440 AYLMER #37
MONTREAL, CANADA H2X2B7

FOR: PROMOTING THE GOODS AND SERVICES OF OTHERS VIA A GLOBAL COMPUTER NETWORK; PROVIDING A WEB SITE WHICH FEATURES ADVERTISEMENTS FOR THE GOODS AND SERVICES OF OTHERS ON A GLOBAL COMPUTER NETWORK, IN CLASS 35 (U.S. CLS. 100, 101 AND 102).

FIRST USE 4-25-2008; IN COMMERCE 4-25-2008.

THE MARK CONSISTS OF STANDARD CHARACTERS WITHOUT CLAIM TO ANY PARTICULAR FONT, STYLE, SIZE, OR COLOR.

SN 77-104,744, FILED 2-12-2007.

JOHN GARTNER, EXAMINING ATTORNEY

Int. Cl.: 35

Prior U.S. Cls.: 100, 101, and 102

United States Patent and Trademark Office

Reg. No. 3,576,785

Registered Feb. 17, 2009

**SERVICE MARK
PRINCIPAL REGISTER**

Movinmetal

ROBINSON, PETER (UNITED STATES INDIVIDUAL)
P.O. BOX 949
SAN MARCOS, CA 92079

THE MARK CONSISTS OF STANDARD CHARACTERS WITHOUT CLAIM TO ANY PARTICULAR FONT, STYLE, SIZE, OR COLOR.

FOR: DEALERSHIPS IN THE FIELD OF AUTOMOBILES, IN CLASS 35 (U.S. CLS. 100, 101 AND 102).

SN 77-105,484, FILED 2-12-2007.

FIRST USE 9-1-2007; IN COMMERCE 9-1-2007.

KRISTINA MORRIS, EXAMINING ATTORNEY

Int. Cl.: 28

Prior U.S. Cls.: 22, 23, 38, and 50

United States Patent and Trademark Office

Reg. No. 3,576,786

Registered Feb. 17, 2009

TRADEMARK
PRINCIPAL REGISTER



MEGA BRANDS INTERNATIONAL, LUXEMBOURG, ZUG BRANCH (LUXEMBOURG CORPORATION)

POSTSTRASSE 6

ZUG, SWITZERLAND CH-6300

FOR: HOBBY CRAFT KITS CONSISTING PRIMARILY OF BARRETTES, HEADBANDS, BANANA CLIP, ELASTIC HAIR TWISTERS, NETTING, COMBS, BRUSHES, HAIR AND BODY GLITTER, EMBROIDERY FLOSS, SHOE LACES, STRIPS OF RIBBON, CHILDREN'S PLAY COSMETICS, NAIL ART IN THE NATURE OF DECALS AND PLASTIC GEMS, BODY ART IN THE NATURE OF TEMPORARY TATTOOS FOR CHILDREN, NAIL FILES, PRESS-ON FASHION FALSE NAILS, NAIL POLISH, FOAM TOE SEPARATORS FOR USE IN PEDICURES, TOY JEWELRY, BEADS FOR USE IN THE CREATION OF JEWELRY, TOY METAL JEWELRY CHARMS, BEADING STRING, HAIR BOWS, BUTTONS FOR CLOTHING AND NOVELTY BUTTONS, CHENILLE STEMS, COLORED SAND, CONSTRUCTION PAPER, CORDS, CORKS, WOOD CRAFT STICKS, CRAYONS, FEATHERS FOR ORNAMENTATION, PICTURE FRAMES MADE OF FOAM RUBBER, FUNNEL, DECORATIVE GLITTER, GLITTER GLUE FOR STATIONERY OR HOUSEHOLD USE, GLUE FOR STATIONERY OR HOUSEHOLD USE, HOT MELT GLUE GUN, PLASTIC EYES, MAGNETS, MARKERS, PLASTIC TOY WEAVING LOOMS, MIRRORS, DRINKING STRAWS, ARTS AND CRAFT ACCESSORIES, NAMELY, POM-POMS, NOVELTY DECORATIVE PLASTIC WIGGLY EYES, ROUND PIECES OF WOOD FOR USE IN ARTS AND CRAFTS, PLASTIC FOAM BALLS FOR USE IN ARTS AND CRAFTS, RUBBER TUBES, MOLDED PLASTIC TOY FIGURE IN THE NATURE OF A BUTTERFLY, TOY ARTIFICIAL FLOWERS, TOY POCKETBOOK, TOY JEWELRY BOXES, MODELING CLAYS AND COMPOUNDS AND ACCESSORIES,

NAMELY, PLASTIC TOY EXTRUDERS, MOLDS FOR MODELING CLAYS, AND PLASTIC TOOLS FOR USE WITH MODELING COMPOUNDS, PIPE CLEANERS FOR ARTS AND CRAFTS, TOY PLASTIC TRAYS, FOAM MATS FOR USE ON PLAY AREA SURFACES, PREPRINTED DOLL HOUSE PARTS IN THE NATURE OF WALLS, RIBBONS, SAND, SAND TOYS, SAND SCOOPS, SEQUINS, STENCILS AND PATTERNS MADE OF PAPER AND PLASTIC, FOAM RUBBER SPONGES, THREAD, THREADING NEEDLES, TOY JEWELRY, YARN, ALL SOLD TOGETHER AS A UNIT; TOY SEWING CARDS FOR USE BY CHILDREN; JIGSAW PUZZLES; PUZZLES; HOBBY CRAFT KITS FOR MAKING JEWELRY OUT OF CANDY, MAKING CHOCOLATE, MAKING COTTON CANDY, DECORATING CLOTHING AND OTHER FABRICS, DECORATING CLOTHING AND HANDBAGS, CREATING JEWELRY, CREATING JEWELRY BOXES, CREATING TOY FURNITURE, DESIGNING LIPSTICKS AND GLOSSES, MAKING PERFUME, DECORATING FINGERNAILS AND TOENAILS; ROOM DÉCOR, NAMELY, NAMELY, TOY CLOCKS, TOY GLOBES AND TOY PINWHEELS; TOY FOR POLISHING ROCKS AND TOY JEWELRY; MECHANICAL DRAWING TOY; CHILDREN'S MULTIPLE ACTIVITY TOYS USED FOR DRAWING; ELECTRIC ACTION TOY WITH LIGHT CONDUCTING PEGS MOVABLY MOUNTED ON A BACKLIGHTED BOARD; HOBBY CRAFT KIT FOR MAKING TOY BIRDHOUSES; ENCAPSULATED INTERACTIVE ANIMATED TALKING, MUSICAL, AND ILLUMINATED TOY FIGURES, IN CLASS 28 (U.S. CLS. 22, 23, 38 AND 50).

FIRST USE 3-0-2007; IN COMMERCE 3-0-2007.

OWNER OF U.S. REG. NOS. 1,822,018 AND 3,159,675.

THE COLOR(S) BLUE, GREEN, YELLOW, ORANGE, PURPLE, BLACK AND WHITE IS/ARE CLAIMED AS A FEATURE OF THE MARK.

THE MARK CONSISTS OF THE WORDS "ROSE ART" ON AN OVAL WHITE BACKGROUND BORDERED BY A BLACK OVAL BAND, AND THEN A COLORED OVAL BAND WHICH, BEGINNING AT

THE TOP LEFT SIDE OF THE OVAL AND MOVING CLOCKWISE TO THE RIGHT, CONTAINS A SERIES OF COLOR GRADATIONS GOING FROM BLUE, TO GREEN, TO YELLOW, TO ORANGE, TO PURPLE, TO BLUE.

SN 77-105,790, FILED 2-13-2007.

SHARON MEIER, EXAMINING ATTORNEY

Int. Cl.: 16

Prior U.S. Cls.: 2, 5, 22, 23, 29, 37, 38, and 50

Reg. No. 3,576,787

United States Patent and Trademark Office

Registered Feb. 17, 2009

**TRADEMARK
PRINCIPAL REGISTER**

THE PEEL WHEEL

PHILOSOPHY, INC. (ARIZONA CORPORATION)
3809 EAST WATKINS STREET
PHOENIX, AZ 85034

THE MARK CONSISTS OF STANDARD CHARACTERS WITHOUT CLAIM TO ANY PARTICULAR FONT, STYLE, SIZE, OR COLOR.

FOR: PRINTED CHARTS, NAMELY, A PRINTED CIRCULAR ROTATING WHEEL THAT USES A QUESTION AND ANSWER FORMAT TO ASSIST A CONSUMER IN PURCHASING A PRODUCT, IN CLASS 16 (U.S. CLS. 2, 5, 22, 23, 29, 37, 38 AND 50).

NO CLAIM IS MADE TO THE EXCLUSIVE RIGHT TO USE "WHEEL", APART FROM THE MARK AS SHOWN.

SN 77-106,325, FILED 2-13-2007.

FIRST USE 3-0-2007; IN COMMERCE 3-0-2007.

ANTHONY RINKER, EXAMINING ATTORNEY

Int. Cl.: 12

Prior U.S. Cls.: 19, 21, 23, 31, 35, and 44

Reg. No. 3,576,788

United States Patent and Trademark Office

Registered Feb. 17, 2009

**TRADEMARK
PRINCIPAL REGISTER**

PIVIT

HARO BICYCLE CORPORATION (CALIFORNIA
CORPORATION)
1230 AVENIDA CHELSEA
VISTA, CA 92083

THE MARK CONSISTS OF STANDARD CHAR-
ACTERS WITHOUT CLAIM TO ANY PARTICULAR
FONT, STYLE, SIZE, OR COLOR.

FOR: COMPONENTS FOR MOUNTAIN BI-
CYCLES, NAMELY, SEATS, HANDLEBAR GRIPS,
PEDALS, IN CLASS 12 (U.S. CLS. 19, 21, 23, 31, 35 AND
44).

SN 77-106,644, FILED 2-13-2007.

FIRST USE 7-31-2004; IN COMMERCE 7-31-2004.

PAUL MORENO, EXAMINING ATTORNEY

Int. Cl.: 33

Prior U.S. Cls.: 47 and 49

United States Patent and Trademark Office

Reg. No. 3,576,789

Registered Feb. 17, 2009

**TRADEMARK
PRINCIPAL REGISTER**

HUIZACHE

LA TIZONA S.A. DE C.V. (MEXICO CORPORATION)
AV. SANTA FE 495, 4° PISO
COL. CRUZ MANCA, MEXICO 05349

FOR: TEQUILA, IN CLASS 33 (U.S. CLS. 47 AND 49).

FIRST USE 6-14-2006; IN COMMERCE 5-2-2008.

THE MARK CONSISTS OF STANDARD CHARACTERS WITHOUT CLAIM TO ANY PARTICULAR FONT, STYLE, SIZE, OR COLOR.

OWNER OF MEXICO REG. NO. 853962, DATED 8-17-2004, EXPIRES 8-17-2014.

SN 77-107,346, FILED 2-14-2007.

ALICE BENMAMAN, EXAMINING ATTORNEY

Int. Cls.: 16, 25, 28, and 41

**Prior U.S. Cls.: 2, 5, 22, 23, 29, 37, 38, 39, 50, 100, 101,
and 107**

Reg. No. 3,576,790

United States Patent and Trademark Office

Registered Feb. 17, 2009

**TRADEMARK
SERVICE MARK
PRINCIPAL REGISTER**

00

MICHAEL WALTRIP RACING HOLDINGS, LLC
(NORTH CAROLINA LIMITED LIABILITY
COMPANY)
20310 CHARTWELL CENTER DRIVE
CORNELIUS, NC 28031

FOR: PAPER GOODS AND PRINTED MATERIAL, NAMELY, BROCHURES, MAGAZINES, NEWSLETTERS, PAMPHLETS, SOUVENIR PROGRAMS, STATISTICAL RECORD SHEETS, AND BOOKS FEATURING SPORTS AND MUSIC; TRADING CARDS; COMMEMORATIVE STAMPS SHEETS; POSTCARDS; NOTE CARDS; POSTERS; STICKERS; BUMPER STICKERS; DECALS; STATIC DECALS; STATIC CLINGS MADE OF PAPER; CALENDARS; PAPER PLACE MATS; PAPER PENNANTS; PAPER BANNERS; UNMOUNTED AND MOUNTED PHOTOGRAPHS; ART PRINTS; PHOTOGRAPHIC PRINTS; LITHOGRAPHIC PRINTS; MEMO PADS; NOTE PADS; PENS; PENCILS; BINDERS; FOLDERS; BOOK COVERS; STATIONERY AND STATIONERY TYPE PORTFOLIOS; LIFE-SIZE STANDUP PHOTOGRAPHS; PAPER CAKE DECORATIONS, PHOTO ALBUMS; LOTTERY TICKETS, IN CLASS 16 (U.S. CLS. 2, 5, 22, 23, 29, 37, 38 AND 50).

FIRST USE 10-1-2006; IN COMMERCE 2-1-2007.

FOR: CLOTHING, NAMELY, SWEATSHIRTS, SWEAT PANTS, SWEAT SUITS, WARM-UP SUITS, SHIRTS, SPORT SHIRTS, GOLF SHIRTS, T-SHIRTS, TANK TOPS, SWEATERS, DRESSES, SKIRTS, JERSEYS, LONG PANTS, SPORT SHORTS, SHORTS, BATHING SUITS, PANTS, JACKETS, COATS, HATS, CAPS, BANDANAS, VISORS, BELTS, SUSPENDERS, HEAD BANDS, WRIST BANDS, SOCKS, HOSIERY, FOOTWEAR, GLOVES, SCARVES, NECKTIES, RAINCOATS, PONCHOS, PAJAMAS, NIGHT SHIRTS, NIGHT GOWNS AND ROBES; MASQUERADE COSTUMES, NAMELY, REPLICA DRIVER

SUITS, REPLICA DRIVER HELMETS AND BASEBALL UNIFORMS; INFANT WEAR; AND CLOTH BABY BIBS NOT OF PAPER; MEN'S AND WOMEN'S TWILL REPLICA DRIVER SUIT JACKETS; LEATHER JACKETS, IN CLASS 25 (U.S. CLS. 22 AND 39).

FIRST USE 10-1-2006; IN COMMERCE 2-1-2007.

FOR: TOYS AND SPORTING GOODS, NAMELY, MINIATURE REPLICA AUTOMOBILES, AUTOMOBILE HOODS, AIRPLANES, TRUCKS, BOATS, MOTORCYCLES AND ALL-TERRAIN VEHICLES; RADIO-CONTROLLED TOY CARS, AIRPLANES, TRUCKS, BOATS, MOTORCYCLES AND ALL-TERRAIN VEHICLES; TOY MODEL AUTOMOBILES, AIRPLANES, TRUCKS, BOATS, MOTORCYCLES AND ALL-TERRAIN VEHICLES; AUTOMOBILE, AIRPLANE, TRUCK, BOAT, MOTORCYCLE, AND ALL-TERRAIN VEHICLE TOY BANKS; TOY SLOT TRACK CARS AND TRUCKS; TOY PEDAL STOCK CARS AND TRUCKS; SPORTS BALLS, NAMELY, BASEBALLS, BASKETBALLS, FOOTBALLS, BEACH BALLS, TENNIS BALLS, VOLLEYBALLS, SOCCER BALLS AND GOLF BALLS; GOLF BAGS; BASEBALL TABLE TOP GAMES; SPORTS BOARD GAMES; DOLLS; STUFFED TOYS; STUFFED TOY ANIMALS; STUFFED TOY CARS AND TRUCKS; TOY ACTION FIGURES; CHRISTMAS TREE ORNAMENTS; BALLOONS; MINIATURE RACING HELMETS; AND YO-YOS; STAND ALONE AND HANDHELD VIDEO GAME MACHINES; PLAYING CARDS; BEAN BAGS; ELECTRONIC GAMES; SNOW GLOBES; RIDE-ON MINIATURE VEHICLES; STRATEGY CARD GAMES, IN CLASS 28 (U.S. CLS. 22, 23, 38 AND 50).

FIRST USE 10-1-2006; IN COMMERCE 2-1-2007.

FOR: ENTERTAINMENT SERVICES IN THE NATURE OF PARTICIPATING IN PROFESSIONAL AUTOMOBILE RACES AND AUTO RACING EXHIBITIONS, IN CLASS 41 (U.S. CLS. 100, 101 AND 107).

FIRST USE 10-1-2006; IN COMMERCE 2-1-2007.

THE MARK CONSISTS OF STANDARD CHARACTERS WITHOUT CLAIM TO ANY PARTICULAR FONT, STYLE, SIZE, OR COLOR.

SN 77-108,138, FILED 2-15-2007.

STEVEN JACKSON, EXAMINING ATTORNEY

Int. Cl.: 16

Prior U.S. Cls.: 2, 5, 22, 23, 29, 37, 38, and 50

United States Patent and Trademark Office

Reg. No. 3,576,791

Registered Feb. 17, 2009

**TRADEMARK
PRINCIPAL REGISTER**

ORGANIC RX

GREENE INK, INC. (CALIFORNIA CORPORATION)
9000 CROW CANYON ROAD, SUITE S220
DANVILLE, CA 94506

FOR: PUBLICATIONS, NAMELY, BROCHURES, BOOKLETS, VIDEOS AND TEACHING MATERIALS IN THE FIELD OF ORGANIC FOODS, IN CLASS 16 (U.S. CLS. 2, 5, 22, 23, 29, 37, 38 AND 50).

FIRST USE 3-31-2007; IN COMMERCE 3-31-2007.

THE MARK CONSISTS OF STANDARD CHARACTERS WITHOUT CLAIM TO ANY PARTICULAR FONT, STYLE, SIZE, OR COLOR.

NO CLAIM IS MADE TO THE EXCLUSIVE RIGHT TO USE "ORGANIC", APART FROM THE MARK AS SHOWN.

SN 77-109,376, FILED 2-16-2007.

ANGELA M. MICHELI, EXAMINING ATTORNEY

Int. Cl.: 28

Prior U.S. Cls.: 22, 23, 38, and 50

United States Patent and Trademark Office

Reg. No. 3,576,792

Registered Feb. 17, 2009

**TRADEMARK
PRINCIPAL REGISTER**

GLOBAL PLUSH

BUY-GLOBAL, INC. (NEW YORK CORPORATION)

530 EAGLE AVENUE

WEST HEMPSTEAD, NY 11552

FOR: PLUSH TOYS; STUFFED TOY ANIMALS, IN CLASS 28 (U.S. CLS. 22, 23, 38 AND 50).

FIRST USE 12-5-2008; IN COMMERCE 12-5-2008.

THE MARK CONSISTS OF STANDARD CHARACTERS WITHOUT CLAIM TO ANY PARTICULAR FONT, STYLE, SIZE, OR COLOR.

NO CLAIM IS MADE TO THE EXCLUSIVE RIGHT TO USE "PLUSH", APART FROM THE MARK AS SHOWN.

SN 77-109,578, FILED 2-16-2007.

MARK SPARACINO, EXAMINING ATTORNEY

Int. Cl.: 9

Prior U.S. Cls.: 21, 23, 26, 36, and 38

United States Patent and Trademark Office

Reg. No. 3,576,793

Registered Feb. 17, 2009

**TRADEMARK
PRINCIPAL REGISTER**

GO CHEMISTRY

CENGAGE LEARNING, INC. (DELAWARE CORPORATION)
200 FIRST STAMFORD PLACE
STAMFORD, CT 06902

FOR: EDUCATIONAL DOWNLOADABLE AUDIO FILES, MULTIMEDIA FILES, TEXT FILES, EMAILS, WRITTEN DOCUMENTS, AUDIO MATERIAL, VIDEO MATERIAL FEATURING INFORMATION IN THE FORM OF DOWNLOADABLE SHORT EDUCATIONAL/TRAINING COMMUNICATIONS IN THE FIELD OF CHEMISTRY VIA MOBILE DEVICES, IN CLASS 9 (U.S. CLS. 21, 23, 26, 36 AND 38).

FIRST USE 10-22-2008; IN COMMERCE 10-22-2008.

THE MARK CONSISTS OF STANDARD CHARACTERS WITHOUT CLAIM TO ANY PARTICULAR FONT, STYLE, SIZE, OR COLOR.

NO CLAIM IS MADE TO THE EXCLUSIVE RIGHT TO USE "CHEMISTRY", APART FROM THE MARK AS SHOWN.

SN 77-109,585, FILED 2-16-2007.

LOURDES AYALA, EXAMINING ATTORNEY

Int. Cl.: 45

Prior U.S. Cls.: 100 and 101

United States Patent and Trademark Office

Reg. No. 3,576,794

Registered Feb. 17, 2009

**SERVICE MARK
PRINCIPAL REGISTER**

Diamond Lounge

DIAMOND LOUNGE LIMITED (UNITED KING-
DOM CORPORATION)
C/O GALLAGHERS, PO BOX 698, 2ND FLOOR
TITCHFIELD HOUSE, 69-85 TABERNACLE ST
LONDON, UNITED KINGDOM EC2A 4RR

FOR: COMPUTER DATING SERVICES; DATING
SERVICES; INTERNET BASED SOCIAL NETWORK-
ING, INTRODUCTION, AND DATING SERVICES;
ONLINE SOCIAL NETWORKING SERVICES; SO-
CIAL INTRODUCTION AGENCIES; VIDEO DAT-
ING SERVICES; WEB SITE SERVICES FEATURING
ON-LINE DATING CLUB, IN CLASS 45 (U.S. CLS. 100
AND 101).

FIRST USE 1-1-2008; IN COMMERCE 1-1-2008.

THE MARK CONSISTS OF STANDARD CHAR-
ACTERS WITHOUT CLAIM TO ANY PARTICULAR
FONT, STYLE, SIZE, OR COLOR.

NO CLAIM IS MADE TO THE EXCLUSIVE
RIGHT TO USE "LOUNGE", APART FROM THE
MARK AS SHOWN.

SN 77-111,920, FILED 2-20-2007.

PAUL MORENO, EXAMINING ATTORNEY

Int. Cl.: 9

Prior U.S. Cls.: 21, 23, 26, 36, and 38

United States Patent and Trademark Office

Reg. No. 3,576,795

Registered Feb. 17, 2009

**TRADEMARK
PRINCIPAL REGISTER**

sofatronic Kaleidoscope

SOFATRONIC GMBH (FED REP GERMANY
CORPORATION)
STAHLTWIETE 23
HAMBURG, FED REP GERMANY 22761

FOR: COMPUTER GAME DEVELOPMENT PRO-
GRAMS; COMPUTER GAME DEVELOPMENT
SOFTWARE; COMPUTER PROGRAMS FOR EDIT-
ING IMAGES, SOUND AND VIDEO, IN CLASS 9
(U.S. CLS. 21, 23, 26, 36 AND 38).

FIRST USE 2-29-2008; IN COMMERCE 2-29-2008.

THE MARK CONSISTS OF STANDARD CHAR-
ACTERS WITHOUT CLAIM TO ANY PARTICULAR
FONT, STYLE, SIZE, OR COLOR.

SN 77-112,058, FILED 2-21-2007.

BONNIE LUKEN, EXAMINING ATTORNEY

Int. Cl.: 45

Prior U.S. Cls.: 100 and 101

United States Patent and Trademark Office

Reg. No. 3,576,796

Registered Feb. 17, 2009

**SERVICE MARK
PRINCIPAL REGISTER**

GOOD GUYS

LAWCO USA, P.L.L.C. (D.C. LIMITED LIABILITY
COMPANY)
SUITE 200
2273 RESEARCH BOULEVARD
ROCKVILLE, MD 20850

THE MARK CONSISTS OF STANDARD CHAR-
ACTERS WITHOUT CLAIM TO ANY PARTICULAR
FONT, STYLE, SIZE, OR COLOR.

FOR: LEGAL SERVICES, IN CLASS 45 (U.S. CLS.
100 AND 101).

SN 77-112,249, FILED 2-21-2007.

FIRST USE 9-19-2007; IN COMMERCE 9-19-2007.

MARY CRAWFORD, EXAMINING ATTORNEY

Int. Cl.: 33

Prior U.S. Cls.: 47 and 49

United States Patent and Trademark Office

Reg. No. 3,576,797

Registered Feb. 17, 2009

**TRADEMARK
PRINCIPAL REGISTER**

Protect Your Drink

GO IMPORTS, INC. (NEW YORK CORPORATION)
14 EAST 4TH STREET NO. 1119
NEW YORK, NY 10012

FOR: ALCOHOLIC BEVERAGES, NAMELY, DISTILLED SPIRITS, VODKA, RUM, GIN, WHISKEY, COGNAC; PREPARED ALCOHOLIC COCKTAIL, IN CLASS 33 (U.S. CLS. 47 AND 49).

FIRST USE 8-1-2008; IN COMMERCE 8-1-2008.

THE MARK CONSISTS OF STANDARD CHARACTERS WITHOUT CLAIM TO ANY PARTICULAR FONT, STYLE, SIZE, OR COLOR.

SN 77-112,792, FILED 2-21-2007.

DEIRDRE ROBERTSON, EXAMINING ATTORNEY

Int. Cls.: 35, 41, and 44

Prior U.S. Cls.: 100, 101, 102, and 107

United States Patent and Trademark Office

Reg. No. 3,576,798

Registered Feb. 17, 2009

**SERVICE MARK
PRINCIPAL REGISTER**

**BELIEVE...Choices For
Conscious Living**

SIMRAN PREET SINGH (UNITED STATES INDIVIDUAL)
128 RUSTIC MANOR COURT
LEXINGTON, SC 29072

FOR: RETAIL STORE SERVICES FEATURING MEDITATION AND SELF-HELP TAPES, WEAVERS, NAMELY, ETHERIC WEAVERS, MEDITATION PYRAMIDS, CHAIRS, INSTRUCTIONAL CDS, DVDS, AND BOOKS, IN CLASS 35 (U.S. CLS. 100, 101 AND 102).

FIRST USE 8-31-2007; IN COMMERCE 8-31-2007.

FOR: CONDUCTING WORKSHOPS AND SEMINARS IN SELF-AWARENESS, NAMELY, SPIRITUALITY, ALTERNATIVE HEALTH MODALITIES, META-PHYSICS, PHYSICAL TREATMENTS, PERSONAL GROWTH, EMPOWERMENT, AND MOTI-

VATION, AND CULTURAL TEACHINGS, IN CLASS 41 (U.S. CLS. 100, 101 AND 107).

FIRST USE 8-31-2007; IN COMMERCE 8-31-2007.

FOR: HEALTH SPA SERVICES FOR HEALTH AND WELLNESS OF BODY AND SPIRIT OFFERED AT A HEALTH RESORT; NUTRITION COUNSELING, IN CLASS 44 (U.S. CLS. 100 AND 101).

FIRST USE 8-31-2007; IN COMMERCE 8-31-2007.

THE MARK CONSISTS OF STANDARD CHARACTERS WITHOUT CLAIM TO ANY PARTICULAR FONT, STYLE, SIZE, OR COLOR.

SN 77-113,097, FILED 2-22-2007.

TIMOTHY FINNEGAN, EXAMINING ATTORNEY

Int. Cls.: 25 and 35

Prior U.S. Cls.: 22, 39, 100, 101, and 102

Reg. No. 3,576,799

United States Patent and Trademark Office

Registered Feb. 17, 2009

**TRADEMARK
SERVICE MARK
PRINCIPAL REGISTER**

CHEEKY DIVA

GETZ, JACQUELINE (UNITED STATES INDIVIDUAL)
434 WASHINGTON STREET
DEDHAM, MA 02026

FOR: CLOTHING, NAMELY, HATS, T-SHIRTS; JOGGING SUITS, SWEAT SHIRTS, SWEAT PANTS, IN CLASS 25 (U.S. CLS. 22 AND 39).

FIRST USE 6-30-2008; IN COMMERCE 8-29-2008.

FOR: RETAIL STORE SERVICES FEATURING HATS, T-SHIRTS, BELTS, JOGGING SUITS, SWEAT SHIRTS, SWEAT PANTS, SHORTS, SCARVES, GLOVES, JACKETS, PANTS, SKIRTS, JEANS, BLOUSES, DRESSES, SWEATERS, COATS, SLEEP WEAR, UNDERWEAR, SOCKS, SHOES, SNEAKERS, FLIP-FLOPS, BEACHWEAR, TOWELS, SOAP FOR PERSONAL USE, PAPER NAPKINS, DRINKING GLASSES, LIP BALM, CANDY MINTS, BUMPER STICKERS, BUTTONS, JEWELRY, MUGS, STATIONERY, KEY CHAINS, PLAYING CARDS, TOYS, SERVINGWARE FOR SERVING FOOD, GIFTS, HANDBAGS, MAKE-UP BAGS, LOTIONS, ASH TRAYS, PICTURE FRAMES NOT OF PRECIOUS METAL, CERAMIC GOODS, CLOCKS AND PLAQUES; ON-LINE RETAIL STORE SERVICES FEATURING

HATS, T-SHIRTS, BELTS, JOGGING SUITS, SWEAT SHIRTS, SWEAT PANTS, SHORTS, SCARVES, GLOVES, JACKETS, PANTS, SKIRTS, JEANS, BLOUSES, DRESSES, SWEATERS, COATS, SLEEP WEAR, UNDERWEAR, SOCKS, SHOES, SNEAKERS, FLIP-FLOPS, BEACHWEAR, TOWELS, SOAP FOR PERSONAL USE, NAPKINS, DRINKING GLASSES, LIP BALM, CANDY MINTS, BUMPER STICKERS, BUTTONS, JEWELRY, MUGS, CUPS, STATIONARY, KEY CHAINS, PLAYING CARDS, TOYS, SERVINGWARE FOR SERVING FOOD, GIFTS, HANDBAGS, MAKE-UP BAGS, LOTIONS, ASH TRAYS, PICTURE FRAMES NOT OF PRECIOUS METAL, CERAMIC GOODS, CLOCKS AND PLAQUES, IN CLASS 35 (U.S. CLS. 100, 101 AND 102).

FIRST USE 12-5-2005; IN COMMERCE 8-29-2008.

THE MARK CONSISTS OF STANDARD CHARACTERS WITHOUT CLAIM TO ANY PARTICULAR FONT, STYLE, SIZE, OR COLOR.

SN 77-113,311, FILED 2-22-2007.

ASMAT KHAN, EXAMINING ATTORNEY

Int. Cl.: 16

Prior U.S. Cls.: 2, 5, 22, 23, 29, 37, 38, and 50

United States Patent and Trademark Office

Reg. No. 3,576,800

Registered Feb. 17, 2009

**TRADEMARK
PRINCIPAL REGISTER**



ELIZABETH YOUMANS, ED.D. (UNITED STATES INDIVIDUAL)
2640 LOWER GREENS PLACE
SUITE 320 6445 S. CHICKASAW TRAIL
ORLANDO, FL 32829

THE MARK CONSISTS OF THE ENGLISH LETTERS "AMO" WITH THE "O" APPEARING AS A STYLIZED HEART.

FOR: PUBLICATIONS, NAMELY, BROCHURES, BOOKLETS, AND TEACHING MATERIALS FOR USE BY PASTORS AND EDUCATORS IN THE FIELD OF BIBLICAL PRINCIPLES AS APPLIED TO EDUCATION AND SELF-GOVERNMENT, IN CLASS 16 (U.S. CLS. 2, 5, 22, 23, 29, 37, 38 AND 50).

THE ENGLISH TRANSLATION OF THE WORD AMO IN THE MARK IS "NURTURE MY LAMBS".

SN 77-113,375, FILED 2-22-2007.

FIRST USE 6-1-2005; IN COMMERCE 4-1-2007.

CHARLOTTE CORWIN, EXAMINING ATTORNEY

Int. Cl.: 25

Prior U.S. Cls.: 22 and 39

United States Patent and Trademark Office

Reg. No. 3,576,801

Registered Feb. 17, 2009

**TRADEMARK
PRINCIPAL REGISTER**

ROCCO DELUCA

DELUCABIZ, LLC (CALIFORNIA LIMITED LIABILITY COMPANY)
3321 JOSIE AVENUE
LONG BEACH, CA 92614

FOR: CLOTHING, NAMELY, CAPS, T-SHIRTS, SWEAT SHIRTS, AND JACKETS, IN CLASS 25 (U.S. CLS. 22 AND 39).

FIRST USE 9-1-2006; IN COMMERCE 9-1-2006.

THE MARK CONSISTS OF STANDARD CHARACTERS WITHOUT CLAIM TO ANY PARTICULAR FONT, STYLE, SIZE, OR COLOR.

OWNER OF U.S. REG. NO. 3,447,561.

THE NAME(S), PORTRAIT(S), AND/OR SIGNATURE(S) SHOWN IN THE MARK IDENTIFIES ROCCO DELUCA, WHOSE CONSENT(S) TO REGISTER IS MADE OF RECORD.

SEC. 2(F).

SN 77-115,330, FILED 2-23-2007.

JEFF DEFORD, EXAMINING ATTORNEY

Int. Cl.: 30

Prior U.S. Cl.: 46

United States Patent and Trademark Office

Reg. No. 3,576,802

Registered Feb. 17, 2009

**TRADEMARK
PRINCIPAL REGISTER**

BUMBLE BLOSSOMS

CHUDLEIGH'S LTD. (CANADA CORPORATION)
8501 CHUDLEIGH WAY
MILTON, ONTARIO L9T 0L9

FOR: PASTRY, IN CLASS 30 (U.S. CL. 46).

FIRST USE 9-26-2008; IN COMMERCE 9-26-2008.

THE MARK CONSISTS OF STANDARD CHARACTERS WITHOUT CLAIM TO ANY PARTICULAR FONT, STYLE, SIZE, OR COLOR.

OWNER OF U.S. REG. NOS. 2,395,938 AND 2,397,934.

SN 77-115,781, FILED 2-26-2007.

MONIQUE MILLER, EXAMINING ATTORNEY

Int. Cl.: 9

Prior U.S. Cls.: 21, 23, 26, 36, and 38

Reg. No. 3,576,803

United States Patent and Trademark Office

Registered Feb. 17, 2009

**TRADEMARK
PRINCIPAL REGISTER**



SPEASTECH, INC. (ARKANSAS CORPORATION)
1527 BOWMAN ROAD, SUITE F
LITTLE ROCK, AR 72211

THE MARK CONSISTS OF A STYLIZED WAVING
LINE OVER WHICH THE WORDING "VENDWAVE
INDUSTRIAL VENDING SOLUTIONS" APPEARS.

FOR: VENDING MACHINES, IN CLASS 9 (U.S.
CLS. 21, 23, 26, 36 AND 38).

SN 77-116,133, FILED 2-26-2007.

FIRST USE 5-0-2007; IN COMMERCE 5-0-2007.

NO CLAIM IS MADE TO THE EXCLUSIVE
RIGHT TO USE "INDUSTRIAL VENDING SOLU-
TIONS", APART FROM THE MARK AS SHOWN.

KATHLEEN M. VANSTON, EXAMINING ATTOR-
NEY

Int. Cl.: 9

Prior U.S. Cls.: 21, 23, 26, 36, and 38

United States Patent and Trademark Office

Reg. No. 3,576,804

Registered Feb. 17, 2009

**TRADEMARK
PRINCIPAL REGISTER**

THE DRACULA X CHRONICLES

KONAMI DIGITAL ENTERTAINMENT CO.,
LTD. (JAPAN CORPORATION)
6-10-1, ROPPONGI, MINATO-KU
TOKYO, JAPAN

FOR: VIDEO GAME SOFTWARE; VIDEO GAME
PROGRAMS; COMPUTER GAME SOFTWARE;
COMPUTER GAME PROGRAMS; ELECTRONIC
GAME PROGRAMS, IN CLASS 9 (U.S. CLS. 21, 23,
26, 36 AND 38).

FIRST USE 10-23-2007; IN COMMERCE 10-23-2007.

THE MARK CONSISTS OF STANDARD CHAR-
ACTERS WITHOUT CLAIM TO ANY PARTICULAR
FONT, STYLE, SIZE, OR COLOR.

SN 77-116,287, FILED 2-26-2007.

ELIZABETH KAJUBI, EXAMINING ATTORNEY

Int. Cl.: 38

Prior U.S. Cls.: 100, 101, and 104

United States Patent and Trademark Office

Reg. No. 3,576,805

Registered Feb. 17, 2009

**SERVICE MARK
PRINCIPAL REGISTER**

CBS MOBILE

CBS BROADCASTING INC. (NEW YORK CORPORATION)
51 WEST 52ND STREET
NEW YORK, NY 10019

FOR: COMMUNICATION SERVICES, NAMELY, DIGITAL TRANSMISSION VIA THE INTERNET AND WIRELESS COMMUNICATION NETWORK, IN CLASS 38 (U.S. CLS. 100, 101 AND 104).

FIRST USE 2-7-2007; IN COMMERCE 2-7-2007.

THE MARK CONSISTS OF STANDARD CHARACTERS WITHOUT CLAIM TO ANY PARTICULAR FONT, STYLE, SIZE, OR COLOR.

NO CLAIM IS MADE TO THE EXCLUSIVE RIGHT TO USE "MOBILE", APART FROM THE MARK AS SHOWN.

SN 77-116,294, FILED 2-26-2007.

ROSELLE HERRERA, EXAMINING ATTORNEY

Int. Cl.: 41

Prior U.S. Cls.: 100, 101, and 107

United States Patent and Trademark Office

Reg. No. 3,576,806

Registered Feb. 17, 2009

**SERVICE MARK
PRINCIPAL REGISTER**

CBS MOBILE

CBS BROADCASTING INC. (NEW YORK CORPORATION)
51 WEST 52ND STREET
NEW YORK, NY 10019

FOR: ENTERTAINMENT SERVICES, IN THE NATURE OF PROGRAMS FEATURING ACTION, ADVENTURE, DRAMA, COMEDY, DOCUMENTARY, SPORTS, MUSIC, CULTURE, LIFESTYLE AND CHILDREN'S ENTERTAINMENT TRANSMITTED VIA THE INTERNET AND WIRELESS COMMUNICATION NETWORK, IN CLASS 41 (U.S. CLS. 100, 101 AND 107).

FIRST USE 2-7-2007; IN COMMERCE 2-7-2007.

THE MARK CONSISTS OF STANDARD CHARACTERS WITHOUT CLAIM TO ANY PARTICULAR FONT, STYLE, SIZE, OR COLOR.

NO CLAIM IS MADE TO THE EXCLUSIVE RIGHT TO USE "MOBILE", APART FROM THE MARK AS SHOWN.

SN 77-116,306, FILED 2-26-2007.

ROSELLE HERRERA, EXAMINING ATTORNEY

Int. Cl.: 35

Prior U.S. Cls.: 100, 101, and 102

United States Patent and Trademark Office

Reg. No. 3,576,807

Registered Feb. 17, 2009

**SERVICE MARK
PRINCIPAL REGISTER**

CRUSH THE BOX

MARTIN, HEATHER (UNITED STATES INDIVIDUAL)
21 HUDSON CT.
JERSEY CITY, NJ 07305

FOR: ADVERTISING AND ADVERTISEMENT SERVICES; ADVERTISING AND MARKETING; ADVERTISING SERVICES; ADVICE IN THE FIELD OF BUSINESS MANAGEMENT AND MARKETING; BUSINESS ADVICE AND INFORMATION; BUSINESS ADVICE, INQUIRIES OR INFORMATION; BUSINESS ADVISORY SERVICES, CONSULTANCY AND INFORMATION; BUSINESS CONSULTATION; BUSINESS CONSULTATION SERVICES; BUSINESS

CONSULTING AND INFORMATION SERVICES; BUSINESS CONSULTING, INQUIRIES OR INFORMATION, IN CLASS 35 (U.S. CLS. 100, 101 AND 102).

FIRST USE 8-0-2007; IN COMMERCE 1-29-2008.

THE MARK CONSISTS OF STANDARD CHARACTERS WITHOUT CLAIM TO ANY PARTICULAR FONT, STYLE, SIZE, OR COLOR.

SN 77-116,346, FILED 2-26-2007.

FRED CARL, EXAMINING ATTORNEY

Int. Cl.: 33

Prior U.S. Cls.: 47 and 49

United States Patent and Trademark Office

Reg. No. 3,576,808

Registered Feb. 17, 2009

**TRADEMARK
PRINCIPAL REGISTER**

THE MINERAL TOUCH

LA CHABLISIENNE (FRANCE COMPANY)
8 BOULEVARD PASTEUR
CHABLIS, FRANCE 89800

FOR: ALCOHOLIC BEVERAGES, NAMELY,
WINES, IN CLASS 33 (U.S. CLS. 47 AND 49).

FIRST USE 5-1-2008; IN COMMERCE 5-1-2008.

THE MARK CONSISTS OF STANDARD CHAR-
ACTERS WITHOUT CLAIM TO ANY PARTICULAR
FONT, STYLE, SIZE, OR COLOR.

NO CLAIM IS MADE TO THE EXCLUSIVE
RIGHT TO USE "MINERAL", APART FROM THE
MARK AS SHOWN.

THE WORDING "MINERAL" HAS NO MEANING
IN A FOREIGN LANGUAGE.

SN 77-116,943, FILED 2-27-2007.

STEVEN R. FINE, EXAMINING ATTORNEY

Int. Cls.: 12, 25, and 35

**Prior U.S. Cls.: 19, 21, 22, 23, 31, 35, 39, 44, 100, 101,
and 102**

Reg. No. 3,576,809

United States Patent and Trademark Office

Registered Feb. 17, 2009

**TRADEMARK
SERVICE MARK
PRINCIPAL REGISTER**



SLAVE, LLC (CALIFORNIA LIMITED LIABILITY
COMPANY)
20 HARMONY COURT
DANVILLE, CA 94526

FOR: (BASED ON USE) STRUCTURAL PARTS
FOR AUTOMOBILES AND MOTORCYCLES, IN
CLASS 12 (U.S. CLS. 19, 21, 23, 31, 35 AND 44).

FIRST USE 2-28-1999; IN COMMERCE 11-17-2006.

FOR: (BASED ON INTENT-TO-USE) HEAD
WEAR, FOOTWEAR AND CLOTHING, NAMELY
SHIRTS, PANTS, SWEATSHIRTS, SWEAT PANTS,
JACKETS, JACKET LINERS, WIND-RESISTANT
JACKETS, BELTS, BANDANNAS, KNIT HATS, SUS-
PENDERS, APRONS, GLOVES, SWEATERS, JER-
SEYS, VEHICLE-RIDING SUITS, VESTS, T-SHIRTS,
HATS, NECKTIES, COATS, BODY SUITS, WET
SUITS, BOOTS, IN CLASS 25 (U.S. CLS. 22 AND 39).

FIRST USE 12-4-2008; IN COMMERCE 12-4-2008.

FOR: (BASED ON INTENT-TO-USE) ON-LINE
RETAIL STORE SERVICES IN THE FIELD OF
AUTOMOBILE PARTS AND ACCESSORIES, IN
CLASS 35 (U.S. CLS. 100, 101 AND 102).

FIRST USE 12-4-2008; IN COMMERCE 12-4-2008.

THE MARK CONSISTS OF MARK SHOWS A
SCRIPTED LETTER "S" WITH WINGS ON EACH
SIDE OF THE LETTER AND A CROWN ON TOP OF
THE LETTER.

SN 77-117,149, FILED 2-27-2007.

WENDY JUN, EXAMINING ATTORNEY

Int. Cl.: 41

Prior U.S. Cls.: 100, 101, and 107

United States Patent and Trademark Office

Reg. No. 3,576,810

Registered Feb. 17, 2009

**SERVICE MARK
PRINCIPAL REGISTER**

Project Rejection

LIFE SKILLS AUTHORITIES LLC (ILLINOIS
LIMITED LIABILITY COMPANY)
330 W. GRAND AVE #2006
CHICAGO, IL 60610

FOR: PERSONAL COACHING SERVICES IN THE
FIELDS OF DATING, COMPATIBILITY, SOCIAL
RELATIONSHIPS, PERSONAL IMPROVEMENT,
SELF-DEVELOPMENT AND SELF AWARENESS;
EDUCATIONAL SERVICES, NAMELY, CONDUCT-
ING CLASSES, SEMINARS, CONFERENCES AND
WORKSHOPS IN THE FIELDS OF DATING, COM-
PATIBILITY, SOCIAL RELATIONSHIPS, AND EF-
FECTIVE COMMUNICATIONS; AND COURSE

MATERIALS DISTRIBUTED IN CONNECTION
WITH ALL OF THE FOREGOING SERVICES, IN
CLASS 41 (U.S. CLS. 100, 101 AND 107).

FIRST USE 9-1-2007; IN COMMERCE 9-1-2007.

THE MARK CONSISTS OF STANDARD CHAR-
ACTERS WITHOUT CLAIM TO ANY PARTICULAR
FONT, STYLE, SIZE, OR COLOR.

SN 77-117,202, FILED 2-27-2007.

JAY BESCH, EXAMINING ATTORNEY

Int. Cl.: 36

Prior U.S. Cls.: 100, 101, and 102

United States Patent and Trademark Office

Reg. No. 3,576,811

Registered Feb. 17, 2009

**SERVICE MARK
PRINCIPAL REGISTER**



MICROSOFT CORPORATION (WASHINGTON
CORPORATION)
ONE MICROSOFT WAY
REDMOND, WA 980526399

FIRST USE 3-13-2007; IN COMMERCE 3-13-2007.

SN 77-117,458, FILED 2-27-2007.

FOR: PHILANTHROPIC SERVICES CONCERN-
ING MONETARY DONATIONS MADE VIA THE
INTERNET AND WIRELESS NETWORKS, IN
CLASS 36 (U.S. CLS. 100, 101 AND 102).

MORGAN WYNNE, EXAMINING ATTORNEY

Int. Cl.: 9

Prior U.S. Cls.: 21, 23, 26, 36, and 38

United States Patent and Trademark Office

Reg. No. 3,576,812

Registered Feb. 17, 2009

**TRADEMARK
PRINCIPAL REGISTER**

TAPMATE

PARKER TECHNOLOGIES (CALIFORNIA PART-
NERSHIP)
19273 CANYON DRIVE
VILLA PARK, CA 92861

THE MARK CONSISTS OF STANDARD CHAR-
ACTERS WITHOUT CLAIM TO ANY PARTICULAR
FONT, STYLE, SIZE, OR COLOR.

FOR: FLOWMETERS, IN CLASS 9 (U.S. CLS. 21, 23,
26, 36 AND 38).

SN 77-118,036, FILED 2-28-2007.

FIRST USE 8-30-2007; IN COMMERCE 8-30-2007.

GIANCARLO CASTRO, EXAMINING ATTORNEY

Int. Cls.: 9 and 10

Prior U.S. Cls.: 21, 23, 26, 36, 38, 39, and 44

United States Patent and Trademark Office

Reg. No. 3,576,813

Registered Feb. 17, 2009

**TRADEMARK
PRINCIPAL REGISTER**

VELOCITY

SONIC INNOVATIONS, INC. (DELAWARE CORPORATION)
2795 EAST COTTONWOOD PARKWAY, SUITE 660
SALT LAKE CITY, UT 841217036

FOR: HEARING AID ACCESSORIES, NAMELY, COMPUTER SOFTWARE FOR PROGRAMMING HEARING AIDS AND BATTERIES, IN CLASS 9 (U.S. CLS. 21, 23, 26, 36 AND 38).

FIRST USE 6-30-2007; IN COMMERCE 6-30-2007.

FOR: HEARING AIDS; HEARING AID ACCESSORIES, NAMELY, CASES SPECIALLY ADAPTED

FOR HEARING AIDS, IN CLASS 10 (U.S. CLS. 26, 39 AND 44).

FIRST USE 6-30-2007; IN COMMERCE 6-30-2007.

THE MARK CONSISTS OF STANDARD CHARACTERS WITHOUT CLAIM TO ANY PARTICULAR FONT, STYLE, SIZE, OR COLOR.

SN 77-118,270, FILED 2-28-2007.

JAY BESCH, EXAMINING ATTORNEY

Int. Cl.: 35

Prior U.S. Cls.: 100, 101, and 102

United States Patent and Trademark Office

Reg. No. 3,576,814

Registered Feb. 17, 2009

**SERVICE MARK
PRINCIPAL REGISTER**

**IN GOD WE TRUST, ALL
OTHERS WE MONITOR**

NATIONAL TECHNICAL INVESTIGATORS AS-
SOCIATION (VIRGINIA NON-PROFIT COR-
PORATION)
114 ELLWOOD ST.
HAMILTON, NJ 22032

FOR: ASSOCIATION SERVICES, NAMELY, PRO-
MOTING THE INTERESTS OF LAW ENFORCE-
MENT, INTELLIGENCE PROFESSIONALS, AND
THOSE ENGAGED IN TECHNICAL SURVEIL-
LANCE, TACTICAL OPERATIONS, AND FORENSIC
ACTIVITIES, IN CLASS 35 (U.S. CLS. 100, 101 AND
102).

FIRST USE 1-0-2008; IN COMMERCE 1-0-2008.

THE MARK CONSISTS OF STANDARD CHAR-
ACTERS WITHOUT CLAIM TO ANY PARTICULAR
FONT, STYLE, SIZE, OR COLOR.

SN 77-118,661, FILED 2-28-2007.

SEAN CROWLEY, EXAMINING ATTORNEY

Int. Cls.: 41 and 44

Prior U.S. Cls.: 100, 101, and 107

United States Patent and Trademark Office

Reg. No. 3,576,815

Registered Feb. 17, 2009

**SERVICE MARK
PRINCIPAL REGISTER**

EEGYM

BROD, THOMAS M. (UNITED STATES INDIVIDUAL)
12304 SANTA MONICA BLVD
LOS ANGELES, CA 90025

FOR: EDUCATIONAL SERVICES, NAMELY, WORKSHOPS, CONFERENCES, SEMINARS AND CLASSES IN THE FIELD OF YOGA, MEDITATION, BREATHWORK, BODYWORK, RELAXATION, STRESS CONTROL, DEPRESSION, IMPROVING LEARNING SKILLS, LEARNING DISABILITY COGNITIVE SKILLS, SELF IMPROVEMENT AND BODY AND MENTAL HEALTH SELF REGULATION, IN CLASS 41 (U.S. CLS. 100, 101 AND 107).

FIRST USE 12-3-2008; IN COMMERCE 12-3-2008.

FOR: MEDICAL SERVICES, PSYCHOTHERAPY SERVICES, HYPNOSIS SERVICES, NUTRITION COUNSELING, CONSULTATION IN THE FIELD

OF BRAINWAVE BIOFEEDBACK, NEUROBIOFEEDBACK AND EEG BIOFEEDBACK; MUSIC THERAPY FOR PHYSICAL, PSYCHOLOGICAL AND COGNITIVE PURPOSES, BODYWORK THERAPY, PROVIDING INFORMATION RELATED TO HUMAN BRAIN FUNCTIONS; DIAGNOSTIC TESTING TO STIMULATE AND IMPROVE MENTAL PERFORMANCE, IN CLASS 44 (U.S. CLS. 100 AND 101).

FIRST USE 12-3-2008; IN COMMERCE 12-3-2008.

THE MARK CONSISTS OF STANDARD CHARACTERS WITHOUT CLAIM TO ANY PARTICULAR FONT, STYLE, SIZE, OR COLOR.

SN 77-118,773, FILED 2-28-2007.

LANA PHAM, EXAMINING ATTORNEY

Int. Cl.: 35

Prior U.S. Cls.: 100, 101, and 102

United States Patent and Trademark Office

Reg. No. 3,576,816

Registered Feb. 17, 2009

**SERVICE MARK
PRINCIPAL REGISTER**

The logo for "Amigos" features the word "Amigos" in a bold, sans-serif font. Above the letter "i" is a stylized cluster of five leaves, with one leaf pointing upwards and two on each side.

UNITED SUPERMARKETS, L.L.C. (TEXAS LIMITED LIABILITY COMPANY)
7830 ORLANDO AVENUE
LUBBOCK, TX 79423

FOR: RETAIL GROCERY STORES, IN CLASS 35 (U.S. CLS. 100, 101 AND 102).

FIRST USE 10-1-2007; IN COMMERCE 10-1-2007.

THE MARK CONSISTS OF THE WORD "AMIGOS" WITH A CLUSTER OF FIVE LEAVES AS THE TITLE OVER THE LETTER I IN THE WORD.

THE FOREIGN WORDING IN THE MARK TRANSLATES INTO ENGLISH AS FRIEND.

SN 77-119,533, FILED 3-1-2007.

ALYSSA STEEL, EXAMINING ATTORNEY

Int. Cl.: 35

Prior U.S. Cls.: 100, 101, and 102

United States Patent and Trademark Office

Reg. No. 3,576,817

Registered Feb. 17, 2009

**SERVICE MARK
PRINCIPAL REGISTER**

TAKE CONTROL OF YOUR SLEEP

SELECT COMFORT CORPORATION (MINNESOTA CORPORATION)
6105 TRENTON LANE NORTH
PLYMOUTH, MN 55442

FOR: RETAIL STORE SERVICES, ON-LINE RETAIL STORE SERVICES, MAIL ORDER SERVICES AND TELEPHONE SHOP AT HOME SERVICES, ALL FEATURING BEDS, MATTRESSES, BOX SPRINGS, BED FRAMES, HEADBOARDS, FOOTBOARDS, ADJUSTABLE FOUNDATIONS, ADJUSTABLE BEDS, SOFA BEDS, FURNITURE, PILLOWS, BED FITTINGS, AND BEDROOM ACCESSORIES, NAMELY, MATTRESS PADS, BED SHEETS, PILLOW CASES, BLANKETS, COMFORTERS, BEDSPREADS, COM-

FORTER COVERS, BED COVERS, PILLOW PROTECTORS, AND MATTRESS PROTECTORS, IN CLASS 35 (U.S. CLS. 100, 101 AND 102).

FIRST USE 7-0-2007; IN COMMERCE 7-0-2007.

THE MARK CONSISTS OF STANDARD CHARACTERS WITHOUT CLAIM TO ANY PARTICULAR FONT, STYLE, SIZE, OR COLOR.

SN 77-119,753, FILED 3-1-2007.

COLLEEN DOMBROW, EXAMINING ATTORNEY

Int. Cl.: 11

Prior U.S. Cls.: 13, 21, 23, 31, and 34

United States Patent and Trademark Office

Reg. No. 3,576,818

Registered Feb. 17, 2009

TRADEMARK
PRINCIPAL REGISTER

WESTPOINT
HOME

WP IP LLC (NEVADA LIMITED LIABILITY
COMPANY)
8TH FLOOR
28 EAST 28TH STREET
NEW YORK, NY 10016

NO CLAIM IS MADE TO THE EXCLUSIVE
RIGHT TO USE "HOME", APART FROM THE
MARK AS SHOWN.

FOR: AUTOMATIC ELECTRIC MATTRESS PADS
FOR WARMING, NOT FOR MEDICAL PURPOSES,
IN CLASS 11 (U.S. CLS. 13, 21, 23, 31 AND 34).

SN 77-119,816, FILED 3-1-2007.

FIRST USE 8-0-2005; IN COMMERCE 8-0-2005.

PAUL E. FAHRENKOPF, EXAMINING ATTORNEY

Int. Cl.: 20

Prior U.S. Cls.: 2, 13, 22, 25, 32, and 50

United States Patent and Trademark Office

Reg. No. 3,576,819

Registered Feb. 17, 2009

TRADEMARK
PRINCIPAL REGISTER

WESTPOINT
HOME

WP IP LLC (NEVADA LIMITED LIABILITY
COMPANY)
8TH FLOOR
28 EAST 28TH STREET
NEW YORK, NY 10016

FOR: PILLOWS, IN CLASS 20 (U.S. CLS. 2, 13, 22,
25, 32 AND 50).

FIRST USE 8-0-2005; IN COMMERCE 8-0-2005.

NO CLAIM IS MADE TO THE EXCLUSIVE
RIGHT TO USE "HOME", APART FROM THE
MARK AS SHOWN.

THE MARK CONSISTS OF A STYLIZED WRIT-
TEN FORM OF THE WORDS "WESTPOINT HOME".

SN 77-119,859, FILED 3-1-2007.

PAUL E. FAHRENKOPF, EXAMINING ATTORNEY

Int. Cl.: 7

Prior U.S. Cls.: 13, 19, 21, 23, 31, 34, and 35

Reg. No. 3,576,820

United States Patent and Trademark Office

Registered Feb. 17, 2009

**TRADEMARK
PRINCIPAL REGISTER**



ANDERSEN, KENNETH W. (UNITED STATES
INDIVIDUAL)
11328 ALDERIDGE CT
SAN DIEGO, CA 92131

FOR: MECHANICAL ENGINE PARTS FOR LAND
VEHICLES, IN CLASS 7 (U.S. CLS. 13, 19, 21, 23, 31, 34
AND 35).

FIRST USE 6-14-2006; IN COMMERCE 6-14-2006.

THE MARK CONSISTS OF A DESIGN CONSIST-
ING OF FOUR CONCENTRIC CONTRASTING CIR-
CLES, WITH THE UPPER HALF OF THE INNER

CIRCLE CONTAINING A STYLIZED LIGHTNING
BOLT DESIGN, AND WITH TWO RECTANGULAR
"EARS" ATTACHED TO THE RIGHT AND LEFT
QUADRANTS OF THE OUTSIDE CIRCLE, AND
WITH THE PHRASE "HARMAN & COLLINS" DIS-
PLAYED AGAINST A CONTRASTING RIBBON
SUPERIMPOSED OVER THE BOTTOM HALF OF
THE CIRCLES.

SN 77-120,409, FILED 3-1-2007.

ANDREA K. NADELMAN, EXAMINING ATTOR-
NEY

Int. Cl.: 32

Prior U.S. Cls.: 45, 46, and 48

United States Patent and Trademark Office

Reg. No. 3,576,821

Registered Feb. 17, 2009

**TRADEMARK
PRINCIPAL REGISTER**

RELAX RESPONSIBLY

CERVECERIA MODELO, S.A. DE C.V. (MEXICO
CORPORATION)
LAGO ALBERTO NO. 156, COLONIA ANAHUAC
11320 MEXICO D.F., MEXICO

FOR: BEER, IN CLASS 32 (U.S. CLS. 45, 46 AND 48).

FIRST USE 8-31-2007; IN COMMERCE 8-31-2007.

THE MARK CONSISTS OF STANDARD CHAR-
ACTERS WITHOUT CLAIM TO ANY PARTICULAR
FONT, STYLE, SIZE, OR COLOR.

SN 77-120,546, FILED 3-2-2007.

GENE MACIOL, EXAMINING ATTORNEY

Int. Cl.: 30

Prior U.S. Cl.: 46

United States Patent and Trademark Office

Reg. No. 3,576,822

Registered Feb. 17, 2009

**TRADEMARK
PRINCIPAL REGISTER**

CRUNCHALICIOUS

HEB GROCERY COMPANY, LP (TEXAS LIMITED PARTNERSHIP)
CORPORATE LAW DEPARTMENT
646 SOUTH MAIN
SAN ANTONIO, TX 78204

FOR: NACHO CHEESE CHIPS, NAMELY, CORN CHIPS WITH NACHO CHEESE FLAVORING AND TORTILLA CHIPS WITH NACHO CHEESE FLAVORING; NACHO CHEESE CHIPS, NAMELY, CORN CHIPS AND TORTILLA CHIPS FOR USE WITH NACHO CHEESE, IN CLASS 30 (U.S. CL. 46).

FIRST USE 4-0-2007; IN COMMERCE 4-0-2008.

THE MARK CONSISTS OF STANDARD CHARACTERS WITHOUT CLAIM TO ANY PARTICULAR FONT, STYLE, SIZE, OR COLOR.

SN 77-120,896, FILED 3-2-2007.

BRENDAN MCCAULEY, EXAMINING ATTORNEY

Int. Cl.: 44

Prior U.S. Cls.: 100 and 101

United States Patent and Trademark Office

Reg. No. 3,576,823

Registered Feb. 17, 2009

**SERVICE MARK
PRINCIPAL REGISTER**

**JK7 - THE SPA RETREAT FOR
THE SEVEN SENSES**

THE TRUSTEE OF JK INVESTMENT TRUST
(AUSTRALIA TRUST)
59/338 WILINAU RD.
HALEIWA, HI 96712

FOR: HEALTH SPA SERVICES FOR HEALTH AND WELLNESS OF THE BODY AND SPIRIT OFFERED AT A HEALTH RESORT; HEALTH SPA SERVICES FOR HEALTH AND WELLNESS OF THE MIND, BODY AND SPIRIT OFFERED IN OR FROM A REMOTE, MOBILE OR TEMPORARY ON-SITE LOCATION; HEALTH SPA SERVICES, NAMELY, COSMETIC BODY CARE SERVICES, IN CLASS 44 (U.S. CLS. 100 AND 101).

FIRST USE 5-1-2008; IN COMMERCE 5-1-2008.

THE MARK CONSISTS OF STANDARD CHARACTERS WITHOUT CLAIM TO ANY PARTICULAR FONT, STYLE, SIZE, OR COLOR.

NO CLAIM IS MADE TO THE EXCLUSIVE RIGHT TO USE "SPA RETREAT", APART FROM THE MARK AS SHOWN.

SN 77-121,118, FILED 3-2-2007.

DAVID TAYLOR, EXAMINING ATTORNEY

Int. Cl.: 20

Prior U.S. Cls.: 2, 13, 22, 25, 32, and 50

Reg. No. 3,576,824

United States Patent and Trademark Office

Registered Feb. 17, 2009

**TRADEMARK
PRINCIPAL REGISTER**

HIDEAWAY EASEL

WILTON INDUSTRIES, INC. (DELAWARE CORPORATION)

2240 WEST 75TH STREET

WOODRIDGE, IL 60517

FOR: PICTURE FRAMES, IN CLASS 20 (U.S. CLS. 2, 13, 22, 25, 32 AND 50).

FIRST USE 7-16-2006; IN COMMERCE 7-16-2006.

THE MARK CONSISTS OF STANDARD CHARACTERS WITHOUT CLAIM TO ANY PARTICULAR FONT, STYLE, SIZE, OR COLOR.

NO CLAIM IS MADE TO THE EXCLUSIVE RIGHT TO USE "EASEL", APART FROM THE MARK AS SHOWN.

SN 77-121,415, FILED 3-2-2007.

CURTIS FRENCH, EXAMINING ATTORNEY

Int. Cls.: 3, 30, and 35

Prior U.S. Cls.: 1, 4, 6, 46, 50, 51, 52, 100, 101, and 102

Reg. No. 3,576,825

United States Patent and Trademark Office

Registered Feb. 17, 2009

**TRADEMARK
SERVICE MARK
PRINCIPAL REGISTER**

WILLIAM & ALEXANDER

WINECOUNTRYGOURMET.COM LLC (CALI-
FORNIA LIMITED LIABILITY COMPANY)
PO BOX 4677
EL DORADO HILLS, CA 95762

FOR: GIFT BASKETS AND GIFT PACKAGES
CONTAINING SPA ITEMS, NAMELY, SOAP, BATH
SALTS, AND SKIN MOISTURIZERS, IN CLASS 3
(U.S. CLS. 1, 4, 6, 50, 51 AND 52).

FIRST USE 2-25-2007; IN COMMERCE 2-25-2007.

FOR: GIFT BASKETS AND GIFT PACKAGES
CONTAINING FOOD ITEMS, NAMELY, CANDIES,
COOKIES AND WHEAT-BASED SNACK FOODS, IN
CLASS 30 (U.S. CL. 46).

FIRST USE 2-25-2007; IN COMMERCE 2-25-2007.

FOR: ONLINE RETAIL STORE SERVICES FEATURING GIFT BASKETS AND GIFT PACKAGES, CONSISTING PRIMARILY OF FOOD ITEMS, CANDIES, COOKIES, WHEAT-BASED SNACK FOODS, COFFEES, PROCESSED FRUITS AND NUTS, SOAPS, BATH SALTS, SKIN MOISTURIZERS AND WINE, IN CLASS 35 (U.S. CLS. 100, 101 AND 102).

FIRST USE 11-15-2008; IN COMMERCE 11-15-2008.

THE MARK CONSISTS OF STANDARD CHARACTERS WITHOUT CLAIM TO ANY PARTICULAR FONT, STYLE, SIZE, OR COLOR.

SN 77-121,436, FILED 3-2-2007.

BERNICE MIDDLETON, EXAMINING ATTORNEY

Int. Cl.: 30

Prior U.S. Cl.: 46

United States Patent and Trademark Office

Reg. No. 3,576,826

Registered Feb. 17, 2009

**TRADEMARK
PRINCIPAL REGISTER**

BARELY LEGAL

COOPER, BARRY P.W. (UNITED STATES INDIVIDUAL)
408 SOUTH PIERCE AVE.
LOUISVILLE, CO 80027

THE MARK CONSISTS OF STANDARD CHARACTERS WITHOUT CLAIM TO ANY PARTICULAR FONT, STYLE, SIZE, OR COLOR.

FOR: BEVERAGES MADE OF TEA; TEA; ICED TEA; TEA-BASED BEVERAGES WITH HERBAL INGREDIENTS, IN CLASS 30 (U.S. CL. 46).

SN 77-121,482, FILED 3-2-2007.

FIRST USE 10-23-2008; IN COMMERCE 10-23-2008.

SUZANNE BLANE, EXAMINING ATTORNEY

Int. Cl.: 41

Prior U.S. Cls.: 100, 101, and 107

United States Patent and Trademark Office

Reg. No. 3,576,827

Registered Feb. 17, 2009

**SERVICE MARK
PRINCIPAL REGISTER**

WHERE KIDS COME TO LEARN

DREAMBOX LEARNING INC. (DELAWARE
CORPORATION)
SUITE 600
10900 NE 8TH STREET
BELLEVUE, WA 98004

FOR: ONLINE EDUCATIONAL SERVICES,
NAMELY, PROVIDING COURSES OF INSTRU-
CTION AT THE PRIMARY AND SECONDARY LE-
VELS, IN CLASS 41 (U.S. CLS. 100, 101 AND 107).

FIRST USE 2-20-2007; IN COMMERCE 2-20-2007.

THE MARK CONSISTS OF STANDARD CHAR-
ACTERS WITHOUT CLAIM TO ANY PARTICULAR
FONT, STYLE, SIZE, OR COLOR.

SN 77-121,606, FILED 3-2-2007.

KRISTINA MORRIS, EXAMINING ATTORNEY

Int. Cls.: 35, 39, 43, and 44

Prior U.S. Cls.: 100, 101, 102, and 105

United States Patent and Trademark Office

Reg. No. 3,576,828

Registered Feb. 17, 2009

**SERVICE MARK
PRINCIPAL REGISTER**

SPOILED WORLDWIDE

SPOILED WORLDWIDE, INC. (CALIFORNIA CORPORATION)
975 HANCOCK AVENUE, NO. 117
WEST HOLLYWOOD, CA 90069

FOR: PROVIDING ONLINE INFORMATION ABOUT SHOPPING, IN CLASS 35 (U.S. CLS. 100, 101 AND 102).

FIRST USE 12-2-2008; IN COMMERCE 12-2-2008.

FOR: PROVIDING ONLINE INFORMATION ABOUT TRAVELING, IN CLASS 39 (U.S. CLS. 100 AND 105).

FIRST USE 12-2-2008; IN COMMERCE 12-2-2008.

FOR: PROVIDING ONLINE INFORMATION ABOUT DINING, IN CLASS 43 (U.S. CLS. 100 AND 101).

FIRST USE 12-2-2008; IN COMMERCE 12-2-2008.

FOR: PROVIDING ONLINE INFORMATION ABOUT BEAUTY, IN CLASS 44 (U.S. CLS. 100 AND 101).

FIRST USE 12-2-2008; IN COMMERCE 12-2-2008.

THE MARK CONSISTS OF STANDARD CHARACTERS WITHOUT CLAIM TO ANY PARTICULAR FONT, STYLE, SIZE, OR COLOR.

SN 77-122,003, FILED 3-5-2007.

LEIGH CAROLINE CASE, EXAMINING ATTORNEY

Int. Cl.: 39

Prior U.S. Cls.: 100 and 105

United States Patent and Trademark Office

Reg. No. 3,576,829

Registered Feb. 17, 2009

**SERVICE MARK
PRINCIPAL REGISTER**

Stranded Towing

STRANDED TOWING (GEORGIA CORPORATION)
8050 BECKETT CENTER DR
WEST CHESTER, OH 45069

FOR: EMERGENCY AUTO OR TRUCK TOWING;
EMERGENCY AUTOMOBILE TOWING; VEHICLE
TOWING, IN CLASS 39 (U.S. CLS. 100 AND 105).

FIRST USE 0-0-1996; IN COMMERCE 0-0-1996.

THE MARK CONSISTS OF STANDARD CHARACTERS WITHOUT CLAIM TO ANY PARTICULAR FONT, STYLE, SIZE, OR COLOR.

NO CLAIM IS MADE TO THE EXCLUSIVE RIGHT TO USE "TOWING", APART FROM THE MARK AS SHOWN.

SN 77-122,185, FILED 3-5-2007.

JAMES LOVELACE, EXAMINING ATTORNEY

Int. Cl.: 5

Prior U.S. Cls.: 6, 18, 44, 46, 51, and 52

United States Patent and Trademark Office

Reg. No. 3,576,830

Registered Feb. 17, 2009

**TRADEMARK
PRINCIPAL REGISTER**

PLANT SPIRITS

TEXAS MEDICINALS, LLC (TEXAS LIMITED
LIABILITY COMPANY)
1203 EAST 7TH STREET
AUSTIN, TX 78702

FOR: MEDICINAL HERB EXTRACTS; PLANT
EXTRACTS FOR MEDICAL, VETERINARY AND
PHARMACEUTICAL PURPOSES, IN CLASS 5 (U.S.
CLS. 6, 18, 44, 46, 51 AND 52).

FIRST USE 2-1-2007; IN COMMERCE 6-27-2007.

THE MARK CONSISTS OF STANDARD CHAR-
ACTERS WITHOUT CLAIM TO ANY PARTICULAR
FONT, STYLE, SIZE, OR COLOR.

NO CLAIM IS MADE TO THE EXCLUSIVE
RIGHT TO USE "PLANT", APART FROM THE
MARK AS SHOWN.

SN 77-122,211, FILED 3-5-2007.

AMOS T. MATTHEWS, JR., EXAMINING ATTOR-
NEY

Int. Cl.: 35

Prior U.S. Cls.: 100, 101, and 102

United States Patent and Trademark Office

Reg. No. 3,576,831

Registered Feb. 17, 2009

**SERVICE MARK
PRINCIPAL REGISTER**

LANDWATCH.COM

SECONDSPACE, INC. (DELAWARE CORPORATION)
15375 SE 30TH PLACE, SUITE 130
BELLEVUE, WA 98007

FOR: ONLINE MARKETING SERVICES IN THE AREA OF MATCHING CONSUMERS WITH VACANT LAND, RECREATIONAL LAND, LAND LEASES, HOMESITES, DEVELOPMENT PROPERTIES, LAND AUCTIONS; MATCHING CONSUMERS WITH REAL ESTATE PROFESSIONALS IN THE FIELD OF REAL ESTATE SERVICES VIA AN ONLINE WEBSITE; ADVERTISING SERVICES; ONLINE BUSINESS DIRECTORIES FEATURING THIRD-PARTY LAND-RELATED SERVICES SUCH AS LAND CLEARING, WELL DRILLING, FORESTRY SERVICES AND OUTDOOR ACTIVITIES SUCH

AS HUNTING, FISHING, HIKING, EQUESTRIAN ACTIVITIES; ONLINE BUSINESS DIRECTORIES FEATURING OUTDOOR AND HUNTING-RELATED MERCHANDISE, IN CLASS 35 (U.S. CLS. 100, 101 AND 102).

FIRST USE 7-24-2004; IN COMMERCE 7-24-2004.

THE MARK CONSISTS OF STANDARD CHARACTERS WITHOUT CLAIM TO ANY PARTICULAR FONT, STYLE, SIZE, OR COLOR.

SN 77-123,826, FILED 3-6-2007.

GINA HAYES, EXAMINING ATTORNEY

Int. Cl.: 16

Prior U.S. Cls.: 2, 5, 22, 23, 29, 37, 38, and 50

Reg. No. 3,576,832

United States Patent and Trademark Office

Registered Feb. 17, 2009

**TRADEMARK
PRINCIPAL REGISTER**

SRX

MEGA BRANDS INTERNATIONAL, LUXEM-
BOURG, ZUG BRANCH (LUXEMBOURG
CORPORATION)
POSTSTRASSE 6
ZUG, SWITZERLAND CH-6300

THE MARK CONSISTS OF STANDARD CHAR-
ACTERS WITHOUT CLAIM TO ANY PARTICULAR
FONT, STYLE, SIZE, OR COLOR.

FOR: WRITING INSTRUMENTS, DRY ERASE
MARKERS, IN CLASS 16 (U.S. CLS. 2, 5, 22, 23, 29,
37, 38 AND 50).

SN 77-124,467, FILED 3-7-2007.

FIRST USE 4-0-2007; IN COMMERCE 4-0-2007.

SHARON MEIER, EXAMINING ATTORNEY

Int. Cls.: 10 and 25

Prior U.S. Cls.: 22, 26, 39, and 44

United States Patent and Trademark Office

Reg. No. 3,576,833

Registered Feb. 17, 2009

**TRADEMARK
PRINCIPAL REGISTER**

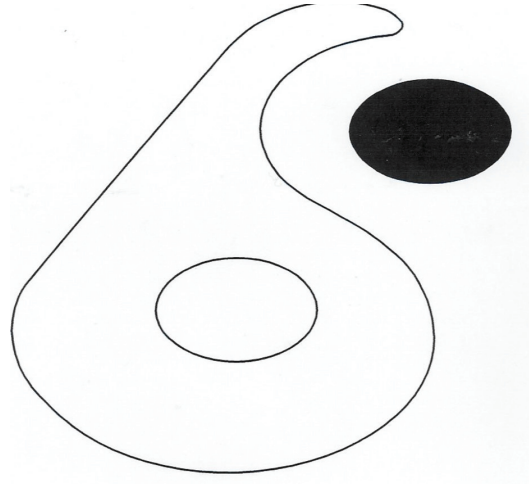

MILLIKEN & COMPANY (DELAWARE CORPORATION)
920 MILLIKEN ROAD
SPARTANBURG, SC 29303

FOR: CLOTHING, NAMELY, UNIFORMS, SPECIFICALLY, SURGICAL SCRUB SUITS, SURGICAL GOWNS, IN CLASS 10 (U.S. CLS. 26, 39 AND 44).

FIRST USE 10-4-2007; IN COMMERCE 10-4-2007.

FOR: CLOTHING, NAMELY, UNIFORMS, SPECIFICALLY, JACKETS, SKIRTS, PANTS, SCRUBS NOT FOR MEDICAL PURPOSES, SMOCKS, BUTCHER FROCKS, BUTCHER COATS, APRONS, IN CLASS 25 (U.S. CLS. 22 AND 39).

FIRST USE 10-4-2007; IN COMMERCE 10-4-2007.

SN 77-125,301, FILED 3-8-2007.

RONALD AIKENS, EXAMINING ATTORNEY

Int. Cl.: 10

Prior U.S. Cls.: 26, 39, and 44

United States Patent and Trademark Office

Reg. No. 3,576,834

Registered Feb. 17, 2009

**TRADEMARK
PRINCIPAL REGISTER**

TIMECHECK

REAY, GAVIN (UNITED KINGDOM INDIVIDUAL)
104 FELSHAM ROAD
LONDON, UNITED KINGDOM SW151DQ

FOR: DRUG DELIVERY SYSTEMS AND APPARATUS FOR MEDICAL USE, NAMELY, MEDICINE DOSAGE SPOONS AND DOSAGE ALERT SYSTEMS COMPRISED OF A MEDICINE DOSAGE SPOON WITH AN INDICATOR TO ALERT THE USER OF THE NEXT DOSING SCHEDULE, IN CLASS 10 (U.S. CLS. 26, 39 AND 44).

FIRST USE 6-22-2006; IN COMMERCE 3-31-2007.

THE MARK CONSISTS OF STANDARD CHARACTERS WITHOUT CLAIM TO ANY PARTICULAR FONT, STYLE, SIZE, OR COLOR.

SN 77-125,362, FILED 3-8-2007.

KIM SAITO, EXAMINING ATTORNEY

Int. Cl.: 14

Prior U.S. Cls.: 2, 27, 28, and 50

United States Patent and Trademark Office

Reg. No. 3,576,835

Registered Feb. 17, 2009

**TRADEMARK
PRINCIPAL REGISTER**

BUBBY'S

BUBBY'S LLC (GEORGIA LIMITED LIABILITY
COMPANY)
1050 PIEDMONT ROAD
MARIETTA, GA 30062

THE MARK CONSISTS OF STANDARD CHAR-
ACTERS WITHOUT CLAIM TO ANY PARTICULAR
FONT, STYLE, SIZE, OR COLOR.

FOR: MEN'S AND WOMEN'S ACCESSORIES,
NAMELY, JEWELRY, IN CLASS 14 (U.S. CLS. 2, 27,
28 AND 50).

SN 77-125,409, FILED 3-8-2007.

FIRST USE 11-30-2005; IN COMMERCE 11-30-2005.

HOWARD SMIGA, EXAMINING ATTORNEY

Int. Cl.: 9

Prior U.S. Cls.: 21, 23, 26, 36, and 38

Reg. No. 3,576,836

United States Patent and Trademark Office

Registered Feb. 17, 2009

**TRADEMARK
PRINCIPAL REGISTER**

MERCHANT

CRANE CO. (DELAWARE CORPORATION)
100 FIRST STAMFORD PLACE
STAMFORD, CT 06902

THE MARK CONSISTS OF STANDARD CHAR-
ACTERS WITHOUT CLAIM TO ANY PARTICULAR
FONT, STYLE, SIZE, OR COLOR.

FOR: VENDING MACHINES, AND PARTS AND
FITTINGS THEREFOR, IN CLASS 9 (U.S. CLS. 21, 23,
26, 36 AND 38).

SN 77-125,466, FILED 3-8-2007.

FIRST USE 2-27-2008; IN COMMERCE 3-11-2008.

BERNICE MIDDLETON, EXAMINING ATTORNEY

Int. Cls.: 41 and 43

Prior U.S. Cls.: 100, 101, and 107

United States Patent and Trademark Office

Reg. No. 3,576,837

Registered Feb. 17, 2009

**SERVICE MARK
PRINCIPAL REGISTER**



THE BRIDGE COMPANY OF FLORIDA, INC.
(DELAWARE CORPORATION)
3841 NE 2D AVE, STE 400
MIAMI, FL 33137

FOR: ENTERTAINMENT SERVICES IN THE NATURE OF WINE TASTING EVENTS, LIVE MUSIC CONCERTS, FASHION SHOWS, AND CONDUCTING PARTIES, IN CLASS 41 (U.S. CLS. 100, 101 AND 107).

FIRST USE 2-28-2008; IN COMMERCE 2-28-2008.

FOR: RESTAURANT, BAR AND CATERING SERVICES, IN CLASS 43 (U.S. CLS. 100 AND 101).

FIRST USE 12-6-2007; IN COMMERCE 12-6-2007.

THE COLOR(S) BLACK, WHITE, LIGHT BLUE, ORANGE, DARK BLUE, GREEN, GOLDEN YELLOW, AND BURGUNDY IS/ARE CLAIMED AS A FEATURE OF THE MARK.

THE MARK CONSISTS OF THE WORD "BROSIA" IN BLACK STYLIZED LOWERCASE LETTERING HORIZONTALLY BISECTING A RECTANGLE CONSISTING OF VERTICAL STRIPES OF COLOR IRREGULARLY INTERRUPTED BY WHITE SPACE. SOME VERTICAL STRIPES ARE THE SINGLE COLORS LIGHT BLUE, ORANGE, DARK BLUE, AND GREEN. OTHER VERTICAL STRIPES ARE TWO-TONED, NAMELY, GOLDEN YELLOW AND DARK BLUE, GREEN AND LIGHT BLUE, GOLDEN YELLOW AND BURGUNDY, LIGHT BLUE AND GOLDEN YELLOW, ORANGE AND GREEN, BLUE AND ORANGE, AND BURGUNDY AND ORANGE.

SN 77-126,139, FILED 3-8-2007.

AISHA SALEM, EXAMINING ATTORNEY

Int. Cls.: 16 and 41

Prior U.S. Cls.: 2, 5, 22, 23, 29, 37, 38, 50, 100, 101, and 107

Reg. No. 3,576,838

United States Patent and Trademark Office

Registered Feb. 17, 2009

**TRADEMARK
SERVICE MARK
PRINCIPAL REGISTER**

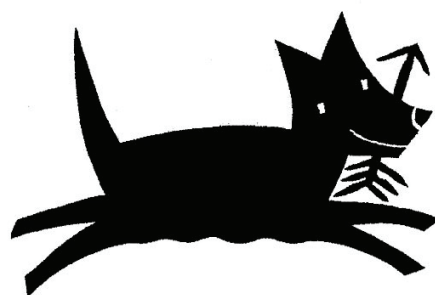

BLOOMSBURY PUBLISHING PLC (UNITED KINGDOM PUBLIC LIMITED COMPANY (PLC))
36 SOHO SQUARE
LONDON, UNITED KINGDOM W1D3QY

FOR: CATALOGS; PRINTED INSTRUCTIONAL, EDUCATIONAL, AND TEACHING MATERIALS ON A VARIETY OF TOPICS, IN CLASS 16 (U.S. CLS. 2, 5, 22, 23, 29, 37, 38 AND 50).

FIRST USE 12-0-2002; IN COMMERCE 12-0-2002.

FOR: MULTIMEDIA PUBLISHING OF BOOKS, MAGAZINES, JOURNALS, SOFTWARE, GAMES, MUSIC, AND ELECTRONIC PUBLICATIONS; PUBLISHING OF BOOKS, MAGAZINES, JOURNALS, REVIEWS AND ELECTRONIC PUBLICATIONS; LANGUAGE TEACHING; ENTERTAINMENT SER-

VICES NAMELY PROVIDING A WEB SITE FEATURING, PHOTOGRAPHIC, AUDIO, VIDEO AND PROSE PRESENTATIONS ON A VARIETY OF FICTION AND NON-FICTION TOPICS INCLUDING MUSIC, CONCERTS, FILM, VIDEOS, THEATRE, RADIO, TELEVISION, NEWS, SPORTS, GAMES AND CULTURAL EVENTS AND ENTERTAINMENT-RELATED PROGRAMS, IN CLASS 41 (U.S. CLS. 100, 101 AND 107).

FIRST USE 12-0-2002; IN COMMERCE 12-0-2002.

THE MARK CONSISTS OF A DOG WITH AN ARROW IN ITS MOUTH.

SN 77-126,539, FILED 3-9-2007.

JOHN HWANG, EXAMINING ATTORNEY

Int. Cl.: 35

Prior U.S. Cls.: 100, 101, and 102

United States Patent and Trademark Office

Reg. No. 3,576,839

Registered Feb. 17, 2009

**SERVICE MARK
PRINCIPAL REGISTER**

ALLIED PRN

PRN HEALTH SERVICES, INC. (WISCONSIN CORPORATION)
SUITE 200
4321 WEST COLLEGE AVENUE
APPLETON, WI 54914

FOR: EMPLOYMENT COUNSELING AND RECRUITING; EMPLOYMENT HIRING, RECRUITING, PLACEMENT, STAFFING AND CAREER NETWORKING SERVICES; TEMPORARY EMPLOYMENT AGENCIES, IN CLASS 35 (U.S. CLS. 100, 101 AND 102).

FIRST USE 2-28-2007; IN COMMERCE 2-28-2007.

THE MARK CONSISTS OF STANDARD CHARACTERS WITHOUT CLAIM TO ANY PARTICULAR FONT, STYLE, SIZE, OR COLOR.

OWNER OF U.S. REG. NOS. 1,242,392 AND 1,591,419.

SN 77-126,783, FILED 3-9-2007.

MONIQUE MILLER, EXAMINING ATTORNEY

Int. Cl.: 9

Prior U.S. Cls.: 21, 23, 26, 36, and 38

Reg. No. 3,576,840

United States Patent and Trademark Office

Registered Feb. 17, 2009

**TRADEMARK
PRINCIPAL REGISTER**

RECHARGEABLES REINVENTED

THE GILLETTE COMPANY (DELAWARE CORPORATION)

PRUDENTIAL TOWER BUILDING

BOSTON, MA 02199

FOR: BATTERIES, IN CLASS 9 (U.S. CLS. 21, 23, 26, 36 AND 38).

FIRST USE 10-31-2007; IN COMMERCE 10-31-2007.

THE MARK CONSISTS OF STANDARD CHARACTERS WITHOUT CLAIM TO ANY PARTICULAR FONT, STYLE, SIZE, OR COLOR.

NO CLAIM IS MADE TO THE EXCLUSIVE RIGHT TO USE "RECHARGEABLES", APART FROM THE MARK AS SHOWN.

SN 77-126,882, FILED 3-9-2007.

DAVID MILLER, EXAMINING ATTORNEY

Int. Cl.: 3

Prior U.S. Cls.: 1, 4, 6, 50, 51, and 52

United States Patent and Trademark Office

Reg. No. 3,576,841

Registered Feb. 17, 2009

**TRADEMARK
PRINCIPAL REGISTER**

STUNNING

AUSTRALIAN GOLD, INC. (INDIANA CORPORATION)
6270 CORPORATE DRIVE
INDIANAPOLIS, IN 46278

FOR: SKIN CARE PREPARATIONS, NAMELY, NON-MEDICATED INDOOR TANNING PREPARATIONS DISTRIBUTED AND MARKETED FOR SALE AND USE IN INDOOR TANNING SALONS, IN CLASS 3 (U.S. CLS. 1, 4, 6, 50, 51 AND 52).

FIRST USE 4-10-2007; IN COMMERCE 4-10-2007.

THE MARK CONSISTS OF STANDARD CHARACTERS WITHOUT CLAIM TO ANY PARTICULAR FONT, STYLE, SIZE, OR COLOR.

SN 77-127,201, FILED 3-9-2007.

THEODORE MCBRIDE, EXAMINING ATTORNEY

Int. Cl.: 43

Prior U.S. Cls.: 100 and 101

United States Patent and Trademark Office

Reg. No. 3,576,842

Registered Feb. 17, 2009

**SERVICE MARK
PRINCIPAL REGISTER**

LA MAR CEBICHERIA PERUANA

ZUPELY S.A. (URUGUAY CORPORATION)
AV. LUIS ALBERTO DE HERRERA 1248-TORRE B
PISO 17, MONTEVIDEO, URUGUAY

FOR: RESTAURANT SERVICES, IN CLASS 43
(U.S. CLS. 100 AND 101).

FIRST USE 4-27-2005; IN COMMERCE 9-0-2008.

THE MARK CONSISTS OF STANDARD CHAR-
ACTERS WITHOUT CLAIM TO ANY PARTICULAR
FONT, STYLE, SIZE, OR COLOR.

NO CLAIM IS MADE TO THE EXCLUSIVE
RIGHT TO USE "CEBICHERIA PERUANA", APART
FROM THE MARK AS SHOWN.

THE ENGLISH TRANSLATION OF "LA MAR
CEBICHERIA PERUANA" IS THE SEA PERUVIAN
CEBICHERIA. THE WORDING "CEBICHERIA" RE-
FERS TO A TRADITIONAL PERUVIAN DISH
MADE FROM FISH OR SEAFOOD.

SN 77-127,477, FILED 3-9-2007.

ALICIA COLLINS, EXAMINING ATTORNEY

Int. Cls.: 38 and 42

Prior U.S. Cls.: 100, 101, and 104

United States Patent and Trademark Office

Reg. No. 3,576,843

Registered Feb. 17, 2009

**SERVICE MARK
PRINCIPAL REGISTER**



MICROSOFT CORPORATION (WASHINGTON CORPORATION)
ONE MICROSOFT WAY
REDMOND, WA 980526399

FOR: TELECOMMUNICATIONS SERVICES, NAMELY, VOICE OVER IP SERVICES; INTERNET TELEPHONY SERVICES; PROVIDING TELECOMMUNICATIONS INFORMATION IN THE FIELDS OF VOICE OVER IP SERVICES AND AUTOMATED TELEPHONE ANSWERING AND MESSAGING, IN CLASS 38 (U.S. CLS. 100, 101 AND 104).

FIRST USE 3-0-2007; IN COMMERCE 3-0-2007.

FOR: TECHNICAL SUPPORT SERVICES, NAMELY, TROUBLESHOOTING OF COMPUTER HARD-

WARE AND SOFTWARE PROBLEMS AND MONITORING OF NETWORK SYSTEMS IN THE FIELDS OF TELECOMMUNICATIONS, VOICE OVER IP SERVICES AND AUTOMATED TELEPHONE ANSWERING AND MESSAGING; PROVIDING TECHNICAL INFORMATION IN THE FIELD OF COMPUTER SOFTWARE FOR USE WITH TELEPHONY, AUTOMATED TELEPHONE ANSWERING AND MESSAGING SERVICES, AND VOICE OVER IP, IN CLASS 42 (U.S. CLS. 100 AND 101).

FIRST USE 3-0-2007; IN COMMERCE 3-0-2007.

SN 77-127,512, FILED 3-9-2007.

MORGAN WYNNE, EXAMINING ATTORNEY

Int. Cl.: 25

Prior U.S. Cls.: 22 and 39

United States Patent and Trademark Office

Reg. No. 3,576,844

Registered Feb. 17, 2009

TRADEMARK
PRINCIPAL REGISTER

GET IT
2
GETHER
Images

MITCHELL, ROOSEVELT (UNITED STATES IN-
DIVIDUAL)
P.O. BOX 1206
BRANDON, MS 39043

FOR: SHIRTS; PANTS; FOOTWEAR; HEAD
SCARVES; SCARVES; SOCKS; JEANS; JACKETS;
SLACKS; WRISTBANDS; SHORT-SLEEVED OR
LONG-SLEEVED T-SHIRTS; T-SHIRTS; UNDER-
GARMENTS; THONGS; PANTIES; PANTIES,
SHORTS AND BRIEFS; BOXER BRIEFS; BOXER
SHORTS; NECKTIES; CAMP SHIRTS; DRESS
SHIRTS; GOLF SHIRTS; KNIT SHIRTS; NIGHT
SHIRTS; OPEN-NECKED SHIRTS; POLO SHIRTS;
RUGBY SHOES; RUGBY SHORTS; RUGBY TOPS;
SHIRTS FOR SUITS; SHORT-SLEEVED SHIRTS;

PAJAMAS; SLEEPWEAR; SNEAKERS; TENNIS
SHOES; WOMEN'S SHOES; RUNNING SHOES;
GYM SHORTS; SHORT SETS; SHORT TROUSERS,
IN CLASS 25 (U.S. CLS. 22 AND 39).

FIRST USE 5-1-2003; IN COMMERCE 5-25-2007.

THE MARK CONSISTS OF STANDARD CHAR-
ACTERS WITHOUT CLAIM TO ANY PARTICULAR
FONT, STYLE, SIZE, OR COLOR.

SN 77-127,633, FILED 3-9-2007.

ALICE BENMAMAN, EXAMINING ATTORNEY

Int. Cls.: 3 and 5

Prior U.S. Cls.: 1, 4, 6, 18, 44, 46, 50, 51, and 52

United States Patent and Trademark Office

Reg. No. 3,576,845

Registered Feb. 17, 2009

**TRADEMARK
PRINCIPAL REGISTER**



MAYORAL, FLOR (UNITED STATES INDIVIDUAL)
7300 SW 62ND PLACE, PH WEST
SOUTH MIAMI, FL 33143

FOR: LOTIONS FOR FACE AND BODY CARE; NON-MEDICATED SKIN CARE PREPARATIONS; NON-MEDICATED SKIN CREAMS; SKIN CLARIFIERS; SKIN CLEANSERS; SKIN CLEANSING LOTION; SKIN CREAMS; SKIN LOTIONS; SKIN MOISTURIZER; SKIN TONERS, IN CLASS 3 (U.S. CLS. 1, 4, 6, 50, 51 AND 52).

FIRST USE 11-19-2008; IN COMMERCE 11-19-2008.

FOR: MEDICATED LOTIONS FOR SKIN CLARIFICATION; MEDICATED SKIN CARE PREPARATIONS; MEDICATED SKIN PREPARATION FOR

USE IN TREATING SKIN DISCOLORATION AND HYPERPIGMENTATION; MEDICINAL CREAMS FOR SKIN CARE; PREPARATIONS FOR CLEANSING THE SKIN FOR MEDICAL USE; PRODUCTS AND PREPARATIONS FOR CLEANSING THE SKIN FOR MEDICAL USE, IN CLASS 5 (U.S. CLS. 6, 18, 44, 46, 51 AND 52).

FIRST USE 11-19-2008; IN COMMERCE 11-19-2008.

THE MARK CONSISTS OF STYLIZED LETTERS, SPECIFICALLY A STYLIZED "B".

SN 77-128,529, FILED 3-12-2007.

ANGELA M. MICHELI, EXAMINING ATTORNEY

Int. Cl.: 5

Prior U.S. Cls.: 6, 18, 44, 46, 51, and 52

Reg. No. 3,576,846

United States Patent and Trademark Office

Registered Feb. 17, 2009

**TRADEMARK
PRINCIPAL REGISTER**



ADNUTRIO INTERNATIONAL LIMITED (CANADA CORPORATION)
260 HEARST WAY, #512
KANATA, ONTARIO, CANADA K2L3H1

FOR: NATURAL DIET PRODUCTS FOR DIABETICS USED FOR WEIGHT LOSS, NAMELY, SHAKES, NUTRITIONAL BARS, ENERGETIC BARS, SOUPS, OATMEALS, CHILI, PUDDINGS, CAPPUCINO, CHAI LATTE, NON-ALCOHOLIC FRUIT DRINKS, HOT COCOA, ICED TEA, SALAD DRESSINGS, CRACKERS, INSTANT SOUPS, CHICKEN SALAD, GRILLED BEEF PATTIES, TUNA SALADS, NUTRI-

TIONAL BARS FOR DIABETICS, ENERGETIC BARS FOR DIABETICS, SHAKES FOR DIABETICS, BALANCED NUTRITION BARS, NON-ALCOHOLIC NUTRITIONAL SHAKES, NON-ALCOHOLIC NUTRITIONAL FRUIT JUICES, IN CLASS 5 (U.S. CLS. 6, 18, 44, 46, 51 AND 52).

FIRST USE 3-15-2007; IN COMMERCE 3-15-2007.

SN 77-129,109, FILED 3-13-2007.

MARY ROSSMAN, EXAMINING ATTORNEY

Int. Cl.: 11

Prior U.S. Cls.: 13, 21, 23, 31, and 34

Reg. No. 3,576,847

United States Patent and Trademark Office

Registered Feb. 17, 2009

**TRADEMARK
PRINCIPAL REGISTER**

VELO

THE MODERN FAN COMPANY (OREGON COR-
PORATION)
709 WASHINGTON ST.
ASHLAND, OR 97520

THE MARK CONSISTS OF STANDARD CHAR-
ACTERS WITHOUT CLAIM TO ANY PARTICULAR
FONT, STYLE, SIZE, OR COLOR.

FOR: CEILING FANS, IN CLASS 11 (U.S. CLS. 13,
21, 23, 31 AND 34).

SN 77-129,532, FILED 3-13-2007.

FIRST USE 9-15-2008; IN COMMERCE 9-15-2008.

ANNE E. GUSTASON, EXAMINING ATTORNEY

Int. Cl.: 9

Prior U.S. Cls.: 21, 23, 26, 36, and 38

United States Patent and Trademark Office

Reg. No. 3,576,848

Registered Feb. 17, 2009

**TRADEMARK
PRINCIPAL REGISTER**

GameDay Payoff

JAPPA, JASON M. (UNITED STATES INDIVIDUAL)
1400 PINE ROW COURT
ST. LOUIS, MO 63146

FOR: COMPUTER SOFTWARE USED TO RECORD, TRACK, AND EVALUATE SPORTS WAGERING AND TO ANALYZE SPORTS STATISTICS TO BETTER PREDICT THE OUTCOME OF GAMES, IN CLASS 9 (U.S. CLS. 21, 23, 26, 36 AND 38).

FIRST USE 9-8-2007; IN COMMERCE 9-8-2007.

THE MARK CONSISTS OF STANDARD CHARACTERS WITHOUT CLAIM TO ANY PARTICULAR FONT, STYLE, SIZE, OR COLOR.

SN 77-129,543, FILED 3-13-2007.

KEVIN CORWIN, EXAMINING ATTORNEY

Int. Cl.: 41

Prior U.S. Cls.: 100, 101, and 107

United States Patent and Trademark Office

Reg. No. 3,576,849

Registered Feb. 17, 2009

**SERVICE MARK
PRINCIPAL REGISTER**

CAMOUFLAGE

ALDRIDGE, CHESTER (UNITED STATES INDIVIDUAL)
336 BON AIR CENTER, #418
GREENBRAE, CA 94904

FOR: ENTERTAINMENT SERVICES, NAMELY, PROVIDING AN ON-LINE COMPUTER GAME, IN CLASS 41 (U.S. CLS. 100, 101 AND 107).

FIRST USE 12-3-2008; IN COMMERCE 12-3-2008.

THE MARK CONSISTS OF STANDARD CHARACTERS WITHOUT CLAIM TO ANY PARTICULAR FONT, STYLE, SIZE, OR COLOR.

SN 77-129,780, FILED 3-13-2007.

WILLIAM BRECKENFELD, EXAMINING ATTORNEY

Int. Cl.: 25

Prior U.S. Cls.: 22 and 39

United States Patent and Trademark Office

Reg. No. 3,576,850

Registered Feb. 17, 2009

**TRADEMARK
PRINCIPAL REGISTER**

CAPTAIN'S CURSE

LIVE NATION MOTOR SPORTS, INC. (TEXAS
CORPORATION)
4255 MERIDIAN PARKWAY
AURORA, IL 60504

OWNER OF U.S. REG. NOS. 3,473,161 AND
3,477,476.

FOR: CLOTHING, NAMELY, T-SHIRTS, JACK-
ETS AND HATS, IN CLASS 25 (U.S. CLS. 22 AND 39).

SEC. 2(F).

FIRST USE 3-24-2007; IN COMMERCE 3-24-2007.

SN 77-129,887, FILED 3-13-2007.

THE MARK CONSISTS OF STANDARD CHAR-
ACTERS WITHOUT CLAIM TO ANY PARTICULAR
FONT, STYLE, SIZE, OR COLOR.

ANNE E. GUSTASON, EXAMINING ATTORNEY

Int. Cl.: 28

Prior U.S. Cls.: 22, 23, 38, and 50

United States Patent and Trademark Office

Reg. No. 3,576,851

Registered Feb. 17, 2009

**TRADEMARK
PRINCIPAL REGISTER**

**SPECTRUM MORE THAN JUST
SUDOKU**

FRANKFORD GAMES, L.L.C. (PENNSYLVANIA
LIMITED LIABILITY COMPANY)
4435 PENN STREET
PHILADELPHIA, PA 19124

THE MARK CONSISTS OF STANDARD CHAR-
ACTERS WITHOUT CLAIM TO ANY PARTICULAR
FONT, STYLE, SIZE, OR COLOR.

FOR: BOARD GAMES, IN CLASS 28 (U.S. CLS. 22,
23, 38 AND 50).

SN 77-129,904, FILED 3-13-2007.

FIRST USE 2-11-2007; IN COMMERCE 2-11-2007.

MARGARET POWER, EXAMINING ATTORNEY

Int. Cl.: 25

Prior U.S. Cls.: 22 and 39

United States Patent and Trademark Office

Reg. No. 3,576,852

Registered Feb. 17, 2009

**TRADEMARK
PRINCIPAL REGISTER**

I'M JUST A REGULAR KID

FIBRE FOODS, LLC (MINNESOTA LIMITED
LIABILITY COMPANY)
4913 ROLLING GREEN PARKWAY
EDINA, MN 55436

FOR: SHORT-SLEEVED OR LONG-SLEEVED T-
SHIRTS; SWEAT SHIRTS, IN CLASS 25 (U.S. CLS. 22
AND 39).

FIRST USE 6-30-2008; IN COMMERCE 6-30-2008.

THE MARK CONSISTS OF STANDARD CHAR-
ACTERS WITHOUT CLAIM TO ANY PARTICULAR
FONT, STYLE, SIZE, OR COLOR.

SN 77-130,713, FILED 3-14-2007.

LEIGH CAROLINE CASE, EXAMINING ATTOR-
NEY

Int. Cls.: 30, 32, and 43

Prior U.S. Cls.: 45, 46, 48, 100, and 101

United States Patent and Trademark Office

Reg. No. 3,576,853

Registered Feb. 17, 2009

TRADEMARK
SERVICE MARK
PRINCIPAL REGISTER

ST-MARC CAFÉ
FRESH BAKED PASTRIES  ORGANIC COFFEE

SAINT MARC CAFE CO., LTD. (JAPAN CORPORATION)
173-104 HIRATA, OKAYAMA-SHI
OKAYAMA-KEN, JAPAN

FOR: CHOCOLATE-BASED BEVERAGES IN THE NATURE OF CHOCOLATE FOOD BEVERAGES NOT BEING DAIRY-BASED OR VEGETABLE BASED; BEVERAGES MADE OF COFFEE; BEVERAGES MADE OF TEA; BREAD; BREAD FILLED WITH CHOCOLATE; COFFEE; PIES; SANDWICHES; AND BREAD CONTAINING COOKED FOODS, IN CLASS 30 (U.S. CL. 46).

FIRST USE 3-8-1999; IN COMMERCE 7-18-2007.

FOR: NON-ALCOHOLIC BEVERAGES, NAMELY, FRUIT JUICES, NON-ALCOHOLIC BEVERAGES CONTAINING FRUIT JUICES, MINERAL WATER, SOFT DRINKS, IN CLASS 32 (U.S. CLS. 45, 46 AND 48).

FIRST USE 3-8-1999; IN COMMERCE 7-18-2007.

FOR: COFFEE SHOP SERVICES; CAFE RESTAURANT SERVICES; CAFE SERVICES; CAFETERIA SERVICES; CANTEEN SERVICES; SNACK-BAR SERVICES; RESTAURANT SERVICES; SELF-SERVICE RESTAURANT SERVICES; BAKERY RESTAURANT SERVICES, IN CLASS 43 (U.S. CLS. 100 AND 101).

FIRST USE 3-8-1999; IN COMMERCE 7-18-2007.

NO CLAIM IS MADE TO THE EXCLUSIVE RIGHT TO USE "CAFÉ," "FRESH BAKED PASTRY," AND "ORGANIC COFFEE", APART FROM THE MARK AS SHOWN.

THE MARK CONSISTS OF THE STYLIZED WORDS "ST-MARC CAFÉ FRESH BAKED PASTRY ORGANIC COFFEE". THE WORDS "FRESH BAKED PASTRY" AND "ORGANIC COFFEE" ARE SEPARATED BY A DEPICTION OF A CLOVER.

SN 77-130,935, FILED 3-14-2007.

LANA PHAM, EXAMINING ATTORNEY

Int. Cls.: 9, 16, and 41

**Prior U.S. Cls.: 2, 5, 21, 22, 23, 26, 29, 36, 37, 38, 50,
100, 101, and 107**

Reg. No. 3,576,854

United States Patent and Trademark Office

Registered Feb. 17, 2009

**TRADEMARK
SERVICE MARK
PRINCIPAL REGISTER**



GUIFX, LLC (FLORIDA LIMITED LIABILITY COMPANY)
2271 PALM BEACH LAKES BLVD
WEST PALM BEACH, FL 33409

FOR: COMPUTER SOFTWARE FOR TESTING AND EVALUATION OF ATHLETIC APTITUDE; DOWNLOADABLE SOFTWARE FOR TESTING AND EVALUATION OF ATHLETIC APTITUDE; EDUCATIONAL SOFTWARE FEATURING INSTRUCTION IN TESTING AND EVALUATION OF ATHLETIC APTITUDE, IN CLASS 9 (U.S. CLS. 21, 23, 26, 36 AND 38).

FIRST USE 1-1-2007; IN COMMERCE 6-1-2007.

FOR: EDUCATIONAL PUBLICATIONS, NAMELY, EDUCATIONAL LEARNING CARDS, FLASH CARDS, ACTIVITY CARDS, WORKBOOKS, TEXTBOOKS, ACTIVITY BOOKS, STORY BOOKS, PUZZLE BOOKS, PUZZLES, TEACHER GUIDES, MANUALS, POSTERS, EDUCATIONAL CARD GAMES AND EDUCATIONAL BOOKLETS IN THE FIELD OF SCORING AND EVALUATING ATHLETIC APTITUDE; PRINTED INSTRUCTIONAL, EDUCATIONAL, AND TEACHING MATERIALS IN THE FIELD OF SCORING AND EVALUATING ATHLETIC APTITUDE, IN CLASS 16 (U.S. CLS. 2, 5, 22, 23, 29, 37, 38 AND 50).

FIRST USE 1-1-2007; IN COMMERCE 6-1-2007.

FOR: EDUCATIONAL EXAMINATION SERVICES; EDUCATIONAL TESTING; PREPARING, ADMINISTERING, AND SCORING STANDARDIZED TESTS; EDUCATION SERVICES, NAMELY, PROVIDING TESTING AND EVALUATION IN THE FIELD OF ATHLETIC APTITUDE, IN CLASS 41 (U.S. CLS. 100, 101 AND 107).

FIRST USE 1-1-2007; IN COMMERCE 6-1-2007.

NO CLAIM IS MADE TO THE EXCLUSIVE RIGHT TO USE "SCORE", APART FROM THE MARK AS SHOWN.

THE COLOR(S) BLUE, WHITE AND GREEN IS/ ARE CLAIMED AS A FEATURE OF THE MARK.

THE MARK CONSISTS OF A SOCCER BALL-LIKE FIGURE OUTLINED IN BLUE WITH GREEN AND WHITE INTERIOR, THE WORD "CAP" IN BLUE LETTERS AND "SCORE" IN GREEN LETTERS.

SN 77-131,012, FILED 3-14-2007.

SANI KHOURI, EXAMINING ATTORNEY

Int. Cls.: 4, 6, and 20

Prior U.S. Cls.: 1, 2, 6, 12, 13, 14, 15, 22, 23, 25, 32, and 50

United States Patent and Trademark Office

Reg. No. 3,576,855

Registered Feb. 17, 2009

**TRADEMARK
PRINCIPAL REGISTER**

SERTIN

M G MARKLIN, LLC (NEW HAMPSHIRE LIMITED LIABILITY COMPANY)
112 RIVERSIDE DRIVE
CONTOOCOOK, NH 03229

FOR: CANDLES HAVING INSERTS TO PROMOTE STABILITY, IN CLASS 4 (U.S. CLS. 1, 6 AND 15).

FIRST USE 6-10-2008; IN COMMERCE 6-10-2008.

FOR: METAL SCREWS, IN CLASS 6 (U.S. CLS. 2, 12, 13, 14, 23, 25 AND 50).

FIRST USE 6-10-2008; IN COMMERCE 6-10-2008.

FOR: NON-METAL SCREWS, IN CLASS 20 (U.S. CLS. 2, 13, 22, 25, 32 AND 50).

FIRST USE 12-5-2008; IN COMMERCE 12-5-2008.

THE MARK CONSISTS OF STANDARD CHARACTERS WITHOUT CLAIM TO ANY PARTICULAR FONT, STYLE, SIZE, OR COLOR.

SN 77-131,060, FILED 3-14-2007.

MATTHEW MCDOWELL, EXAMINING ATTORNEY

Int. Cl.: 16

Prior U.S. Cls.: 2, 5, 22, 23, 29, 37, 38, and 50

Reg. No. 3,576,856

United States Patent and Trademark Office

Registered Feb. 17, 2009

**TRADEMARK
PRINCIPAL REGISTER**

EL CHALAN

TELMEX USA, L.L.C. (DELAWARE LIMITED
LIABILITY COMPANY)
3350 S.W. 148TH AVENUE
MIRAMAR, FL 33027

FOR: PRE-PAID TELEPHONE CALLING CARDS
NOT MAGNETICALLY ENCODED, IN CLASS 16
(U.S. CLS. 2, 5, 22, 23, 29, 37, 38 AND 50).

FIRST USE 8-13-2007; IN COMMERCE 8-13-2007.

THE MARK CONSISTS OF STANDARD CHAR-
ACTERS WITHOUT CLAIM TO ANY PARTICULAR
FONT, STYLE, SIZE, OR COLOR.

THE FOREIGN WORDING IN THE MARK
TRANSLATES INTO ENGLISH AS "PERUVIAN
COWBOY".

SN 77-131,352, FILED 3-14-2007.

JASON LOTT, EXAMINING ATTORNEY

Int. Cl.: 25

Prior U.S. Cls.: 22 and 39

United States Patent and Trademark Office

Reg. No. 3,576,857

Registered Feb. 17, 2009

**TRADEMARK
PRINCIPAL REGISTER**



ANIMAGE, LLC (FLORIDA LIMITED LIABILITY
COMPANY)

#1800

540 BRICKELL KEY DRIVE
MIAMI, FL 33131

FIRST USE 11-1-2008; IN COMMERCE 11-1-2008.

SN 77-131,538, FILED 3-15-2007.

FOR: CLOTHING, NAMELY, MEN'S, WOMEN'S
AND CHILDREN'S SHIRTS, IN CLASS 25 (U.S. CLS.
22 AND 39).

SAMUEL E. SHARPER JR., EXAMINING ATTOR-
NEY

Int. Cl.: 3

Prior U.S. Cls.: 1, 4, 6, 50, 51, and 52

Reg. No. 3,576,858

United States Patent and Trademark Office

Registered Feb. 17, 2009

**TRADEMARK
PRINCIPAL REGISTER**

O BOTICARIO MEN

BOTICA COMERCIAL FARMACEUTICA S.A.
(BRAZIL CORPORATION)
AV. RUI BARBOSA, 3450
AFONSO PENA
SAO JOSE DOS PINHAIS, PARANA, BRAZIL
83065260

FOR: SHAMPOOS FOR PERSONAL USE; LIQUID
AND BAR SOAPS FOR FACIAL AND BODY CARE,
MOISTURIZING CREAMS AND LOTIONS; PRE-
SHAVE AND AFTERSHAVE CREAMS, GELS,
FOAMS AND LOTIONS; COSMETICS FOR FACIAL
AND BODY CARE; DEODORANTS AND ANTI-
PERSPIRANTS; HAIR CARE PREPARATIONS, IN
CLASS 3 (U.S. CLS. 1, 4, 6, 50, 51 AND 52).

FIRST USE 7-28-2008; IN COMMERCE 7-28-2008.

THE MARK CONSISTS OF STANDARD CHAR-
ACTERS WITHOUT CLAIM TO ANY PARTICULAR
FONT, STYLE, SIZE, OR COLOR.

NO CLAIM IS MADE TO THE EXCLUSIVE
RIGHT TO USE "MEN", APART FROM THE MARK
AS SHOWN.

THE ENGLISH TRANSLATION OF THE WORD
"O BOTICARIO" IN THE MARK IS THE PHARMA-
CIST.

SN 77-131,703, FILED 3-15-2007.

MARGERY A. TIERNEY, EXAMINING ATTORNEY

Int. Cls.: 39 and 40

Prior U.S. Cls.: 100, 103, 105, and 106

United States Patent and Trademark Office

Reg. No. 3,576,859

Registered Feb. 17, 2009

**SERVICE MARK
PRINCIPAL REGISTER**

SIGNSHARE

SMITH, LUNDY (UNITED STATES INDIVIDUAL)
#2 322 CULVER BLVD.
PLAYA DEL REY, UNITED STATES 90293

FOR: DISTRIBUTION SERVICES, NAMELY, DELIVERY OF SIGNS, IN CLASS 39 (U.S. CLS. 100 AND 105).

FIRST USE 9-30-2007; IN COMMERCE 9-30-2007.

FOR: COMPUTERIZED SIGN MAKING SERVICES, NAMELY, SIGN PRINTING, IN CLASS 40 (U.S. CLS. 100, 103 AND 106).

FIRST USE 9-30-2007; IN COMMERCE 9-30-2007.

THE MARK CONSISTS OF STANDARD CHARACTERS WITHOUT CLAIM TO ANY PARTICULAR FONT, STYLE, SIZE, OR COLOR.

SN 77-131,938, FILED 3-15-2007.

MARLENE BELL, EXAMINING ATTORNEY

Int. Cl.: 6

Prior U.S. Cls.: 2, 12, 13, 14, 23, 25, and 50

Reg. No. 3,576,860

United States Patent and Trademark Office

Registered Feb. 17, 2009

**TRADEMARK
PRINCIPAL REGISTER**



A.M. CASTLE & CO. (DELAWARE CORPORATION)
3400 NORTH WOLF ROAD
FRANKLIN PARK, IL 60131

NO CLAIM IS MADE TO THE EXCLUSIVE
RIGHT TO USE "STEEL PLATE", APART FROM
THE MARK AS SHOWN.

FOR: CARBON STEEL PLATE, IN CLASS 6 (U.S.
CLS. 2, 12, 13, 14, 23, 25 AND 50).

SN 77-132,375, FILED 3-15-2007.

FIRST USE 12-31-1978; IN COMMERCE 12-31-1978.

PAUL CROWLEY, EXAMINING ATTORNEY

Int. Cl.: 37

Prior U.S. Cls.: 100, 103, and 106

United States Patent and Trademark Office

Reg. No. 3,576,861

Registered Feb. 17, 2009

**SERVICE MARK
PRINCIPAL REGISTER**

VULCAN TECHNOLOGIES

VULCAN TECHNOLOGIES, INC. (CALIFORNIA CORPORATION)
580 IRWIN STREET, SUITE #1
SAN RAFAEL, CA 94901

FOR: CONSULTING SERVICES IN THE AREA OF FIRE-SAFE CONSTRUCTION METHODS, FIRE-RETARDANT AND FIRE-RESISTANT CONSTRUCTION, IN CLASS 37 (U.S. CLS. 100, 103 AND 106).

FIRST USE 8-25-2008; IN COMMERCE 8-25-2008.

THE MARK CONSISTS OF STANDARD CHARACTERS WITHOUT CLAIM TO ANY PARTICULAR FONT, STYLE, SIZE, OR COLOR.

NO CLAIM IS MADE TO THE EXCLUSIVE RIGHT TO USE "TECHNOLOGIES", APART FROM THE MARK AS SHOWN.

SN 77-132,507, FILED 3-15-2007.

VIVIAN MICZNIK FIRST, EXAMINING ATTORNEY

Int. Cl.: 3

Prior U.S. Cls.: 1, 4, 6, 50, 51, and 52

United States Patent and Trademark Office

Reg. No. 3,576,862

Registered Feb. 17, 2009

**TRADEMARK
PRINCIPAL REGISTER**

GILLY HICKS SYDNEY

ABERCROMBIE & FITCH TRADING CO. (OHIO
CORPORATION)
6301 FITCH PATH
NEW ALBANY, OH 43054

FOR: COLOGNE; FRAGRANCES FOR PERSONAL USE; PERFUME; BEAUTY LOTIONS; BODY LOTIONS; HAND LOTIONS; BEAUTY CREAMS; BEAUTY CREAMS FOR BODY CARE; BODY AND BEAUTY CARE COSMETICS; MAKE-UP, IN CLASS 3 (U.S. CLS. 1, 4, 6, 50, 51 AND 52).

FIRST USE 1-21-2008; IN COMMERCE 1-21-2008.

THE MARK CONSISTS OF STANDARD CHARACTERS WITHOUT CLAIM TO ANY PARTICULAR FONT, STYLE, SIZE, OR COLOR.

THE NAME SHOWN IN THE MARK DOES NOT IDENTIFY A PARTICULAR LIVING INDIVIDUAL.

SN 77-132,778, FILED 3-16-2007.

MARGERY A. TIERNEY, EXAMINING ATTORNEY

Int. Cl.: 9

Prior U.S. Cls.: 21, 23, 26, 36, and 38

Reg. No. 3,576,863

United States Patent and Trademark Office

Registered Feb. 17, 2009

**TRADEMARK
PRINCIPAL REGISTER**

FRACTURE

LUCASFILM ENTERTAINMENT COMPANY
LTD. (CALIFORNIA CORPORATION)
P.O. BOX 29919
SAN FRANCISCO, CA 941290908

FOR: INTERACTIVE ENTERTAINMENT SOFTWARE AND ACCOMPANYING INSTRUCTION MANUALS SOLD AS A UNIT, NAMELY, COMPUTER GAME SOFTWARE AND MANUALS SOLD AS A UNIT, VIDEO GAME SOFTWARE AND MANUALS SOLD AS A UNIT, INTERACTIVE VIDEO GAME PROGRAMS, INTERACTIVE COMPUTER GAME PROGRAMS; AND PRE-RECORDED CD-ROMS AND DVDS FEATURING GAMES AND FILMS, COMPUTER GAME SOFTWARE, VIDEO GAME SOFTWARE, DOWNLOADABLE COMPUTER GAME SOFTWARE, DOWNLOADABLE IN-

TERACTIVE ENTERTAINMENT SOFTWARE FOR PLAYING COMPUTER GAMES, AND DOWNLOADABLE INTERACTIVE ENTERTAINMENT SOFTWARE FOR PLAYING COMPUTER GAMES AND VIDEO GAMES, IN CLASS 9 (U.S. CLS. 21, 23, 26, 36 AND 38).

FIRST USE 10-7-2008; IN COMMERCE 10-7-2008.

THE MARK CONSISTS OF STANDARD CHARACTERS WITHOUT CLAIM TO ANY PARTICULAR FONT, STYLE, SIZE, OR COLOR.

SN 77-133,073, FILED 3-16-2007.

DAVID I, EXAMINING ATTORNEY

Int. Cl.: 45

Prior U.S. Cls.: 100 and 101

United States Patent and Trademark Office

Reg. No. 3,576,864

Registered Feb. 17, 2009

**SERVICE MARK
PRINCIPAL REGISTER**

Teach The People

EDUCATIONAL COMMUNICATION LLC (DE-
LAWARE LIMITED LIABILITY COMPANY)
SUITE J
7150 COLUMBIA GATEWAY DRIVE
COLUMBIA, MD 21046

FOR: ONLINE SOCIAL NETWORKING SERVI-
CES, IN CLASS 45 (U.S. CLS. 100 AND 101).

FIRST USE 1-31-2007; IN COMMERCE 1-31-2007.

THE MARK CONSISTS OF STANDARD CHAR-
ACTERS WITHOUT CLAIM TO ANY PARTICULAR
FONT, STYLE, SIZE, OR COLOR.

SN 77-133,288, FILED 3-16-2007.

MICHAEL LITZAU, EXAMINING ATTORNEY

Int. Cl.: 33

Prior U.S. Cls.: 47 and 49

United States Patent and Trademark Office

Reg. No. 3,576,865

Registered Feb. 17, 2009

**TRADEMARK
PRINCIPAL REGISTER**

PROTEGE

ICARIA CREEK WINERY, INC. (CALIFORNIA
CORPORATION)
405 RIESLING STREET
CLOVERDALE, CA 95425

THE MARK CONSISTS OF STANDARD CHAR-
ACTERS WITHOUT CLAIM TO ANY PARTICULAR
FONT, STYLE, SIZE, OR COLOR.

FOR: WINES, IN CLASS 33 (U.S. CLS. 47 AND 49).

SN 77-133,612, FILED 3-16-2007.

FIRST USE 11-26-2008; IN COMMERCE 11-26-2008.

B. PARADEWELAI, EXAMINING ATTORNEY

Int. Cl.: 35

Prior U.S. Cls.: 100, 101, and 102

United States Patent and Trademark Office

Reg. No. 3,576,866

Registered Feb. 17, 2009

**SERVICE MARK
PRINCIPAL REGISTER**

BRANDS' CHOICE

ALLSTATE ENTERPRISES, LLC (DELAWARE
LIMITED LIABILITY COMPANY)
2775 SANDERS ROAD
NORTHBROOK, IL 60606

THE MARK CONSISTS OF STANDARD CHAR-
ACTERS WITHOUT CLAIM TO ANY PARTICULAR
FONT, STYLE, SIZE, OR COLOR.

FOR: MEMBERSHIP CLUB SERVICES PROVID-
ING DISCOUNTS AND PROCESSING REBATES
FOR THE SERVICES OF OTHERS, IN CLASS 35
(U.S. CLS. 100, 101 AND 102).

SN 77-134,004, FILED 3-19-2007.

FIRST USE 2-1-2007; IN COMMERCE 2-1-2007.

AMY C. KEAN, EXAMINING ATTORNEY

Int. Cl.: 13

Prior U.S. Cls.: 2 and 9

United States Patent and Trademark Office

Reg. No. 3,576,867

Registered Feb. 17, 2009

**TRADEMARK
PRINCIPAL REGISTER**

SABER

ASHBURY INTERNATIONAL GROUP INC. (VIR-
GINIA CORPORATION)
84 BUSINESS PARK CIRCLE
RUCKERSVILLE, VA 22968

THE MARK CONSISTS OF STANDARD CHAR-
ACTERS WITHOUT CLAIM TO ANY PARTICULAR
FONT, STYLE, SIZE, OR COLOR.

FOR: RIFLE STOCKS, IN CLASS 13 (U.S. CLS. 2
AND 9).

SN 77-134,134, FILED 3-19-2007.

FIRST USE 3-8-2007; IN COMMERCE 2-1-2008.

EMILY CARLSEN, EXAMINING ATTORNEY

Int. Cl.: 13

Prior U.S. Cls.: 2 and 9

United States Patent and Trademark Office

Reg. No. 3,576,868

Registered Feb. 17, 2009

**TRADEMARK
PRINCIPAL REGISTER**

FORSST

ASHBURY INTERNATIONAL GROUP INC. (VIR-
GINIA CORPORATION)
84 BUSINESS PARK CIRCLE
RUCKERSVILLE, VA 22968

THE MARK CONSISTS OF STANDARD CHAR-
ACTERS WITHOUT CLAIM TO ANY PARTICULAR
FONT, STYLE, SIZE, OR COLOR.

FOR: RIFLE STOCKS, IN CLASS 13 (U.S. CLS. 2
AND 9).

SN 77-134,147, FILED 3-19-2007.

FIRST USE 3-8-2007; IN COMMERCE 2-1-2008.

EMILY CARLSEN, EXAMINING ATTORNEY

Int. Cl.: 42

Prior U.S. Cls.: 100 and 101

United States Patent and Trademark Office

Reg. No. 3,576,869

Registered Feb. 17, 2009

**SERVICE MARK
PRINCIPAL REGISTER**

SELECT PRACTICE

CARESCIENCE, INC. (PENNSYLVANIA CORPORATION)
7TH FLOOR
3600 MARKET STREET
PHILADELPHIA, PA 19104

FOR: QUALITY CONTROL SERVICES FOR OTHERS IN THE NATURE OF COLLECTING, ANALYZING, SUMMARIZING, MANAGING AND REPORTING DATA AND INFORMATION FOR OTHERS IN THE FIELD OF HEALTH CARE QUALITY AND PERFORMANCE VIA LOCAL AND GLOBAL COMPUTER NETWORKS; DATABASE DEVELOPMENT FOR OTHERS IN THE FIELD OF

HEALTHCARE, IN CLASS 42 (U.S. CLS. 100 AND 101).

FIRST USE 8-15-2002; IN COMMERCE 8-15-2002.

THE MARK CONSISTS OF STANDARD CHARACTERS WITHOUT CLAIM TO ANY PARTICULAR FONT, STYLE, SIZE, OR COLOR.

SN 77-134,155, FILED 3-19-2007.

MARTHA SANTOMARTINO, EXAMINING ATTORNEY

Int. Cl.: 41

Prior U.S. Cls.: 100, 101, and 107

United States Patent and Trademark Office

Reg. No. 3,576,870

Registered Feb. 17, 2009

**SERVICE MARK
PRINCIPAL REGISTER**

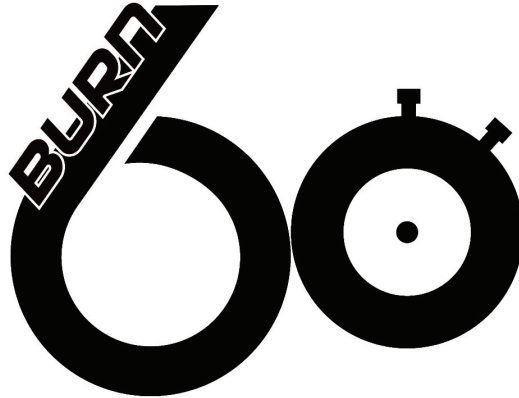

BURN 60, LLC (DELAWARE LIMITED LIABILITY COMPANY)
159 SOUTH BARRINGTON PLACE
LOS ANGELES, CA 90049

FOR: HEALTH AND FITNESS CENTERS, NAME-
LY, PROVIDING FITNESS AND EXERCISE FACIL-
ITIES; PHYSICAL FITNESS INSTRUCTION AND
PHYSICAL FITNESS CONSULTATION , IN CLASS
41 (U.S. CLS. 100, 101 AND 107).

FIRST USE 6-0-2007; IN COMMERCE 9-0-2008.

THE MARK CONSISTS OF A STYLIZED RENDI-
TION OF THE WORD "BURN" AND NUMBER "60".
"BURN" APPEARS DIAGONALLY ON TOP OF THE
NUMBER "6" AND THE NUMBER "0" IS REN-
DERED IN A STYLIZED FORM OF A STOP WATCH.

SN 77-134,438, FILED 3-19-2007.

JAMES MACFARLANE, EXAMINING ATTORNEY

Int. Cl.: 16

Prior U.S. Cls.: 2, 5, 22, 23, 29, 37, 38, and 50

Reg. No. 3,576,871

United States Patent and Trademark Office

Registered Feb. 17, 2009

**TRADEMARK
PRINCIPAL REGISTER**

Organized Health

SAWHNEY, AMRITA G. (UNITED STATES IN-
DIVIDUAL)
APT. 402
21 TRINITY PLACE
MONTCLAIR, NJ 07042

FOR: PERSONAL ORGANIZERS, IN CLASS 16
(U.S. CLS. 2, 5, 22, 23, 29, 37, 38 AND 50).

FIRST USE 7-28-2008; IN COMMERCE 9-10-2008.

THE MARK CONSISTS OF STANDARD CHAR-
ACTERS WITHOUT CLAIM TO ANY PARTICULAR
FONT, STYLE, SIZE, OR COLOR.

NO CLAIM IS MADE TO THE EXCLUSIVE
RIGHT TO USE "HEALTH", APART FROM THE
MARK AS SHOWN.

SN 77-134,441, FILED 3-19-2007.

MARK SPARACINO, EXAMINING ATTORNEY

Int. Cl.: 25

Prior U.S. Cls.: 22 and 39

United States Patent and Trademark Office

Reg. No. 3,576,872

Registered Feb. 17, 2009

**TRADEMARK
PRINCIPAL REGISTER**

PHALANX

UNG, TY (UNITED STATES INDIVIDUAL)
1118 #8 LAVETA TERRACE
LOS ANGELES, CA 90026

DERCLOTHES; UNDERGARMENTS; UNDER-
PANTS; UNDERSHIRTS, IN CLASS 25 (U.S. CLS. 22
AND 39).

FOR: BELTS; BRIEFS; CAPS; COATS; FLEECE
PULLOVERS; FOOTWEAR; GLOVES; HATS; HEAD
WEAR; HEADGEAR, NAMELY, HATS AND CAPS;
HEADWEAR; JACKETS; JERSEYS; NIGHTWEAR;
PAJAMAS; PANTS; SHOES; SHORTS; SLEEPWEAR;
SOCKS; SPORT COATS; SPORT SHIRTS; SPORTS
BRA; SPORTS JACKETS; SPORTS JERSEYS; SWEAT
PANTS; SWEAT SHIRTS; SWEAT SHORTS; SWIM
WEAR; T-SHIRTS; TOPS; UNDER GARMENTS; UN-

FIRST USE 12-11-2008; IN COMMERCE 12-11-2008.

THE MARK CONSISTS OF STANDARD CHAR-
ACTERS WITHOUT CLAIM TO ANY PARTICULAR
FONT, STYLE, SIZE, OR COLOR.

SN 77-134,974, FILED 3-20-2007.

THEODORE MCBRIDE, EXAMINING ATTORNEY

Int. Cl.: 9

Prior U.S. Cls.: 21, 23, 26, 36, and 38

United States Patent and Trademark Office

Reg. No. 3,576,873

Registered Feb. 17, 2009

**TRADEMARK
PRINCIPAL REGISTER**

PHALANX

UNG, TY (UNITED STATES INDIVIDUAL)
1118 #8 LAVETA TERRACE
LOS ANGELES, CA 90026

THE MARK CONSISTS OF STANDARD CHAR-
ACTERS WITHOUT CLAIM TO ANY PARTICULAR
FONT, STYLE, SIZE, OR COLOR.

FOR: SUNGLASSES, IN CLASS 9 (U.S. CLS. 21, 23,
26, 36 AND 38).

SN 77-134,976, FILED 3-20-2007.

FIRST USE 12-10-2008; IN COMMERCE 12-10-2008.

THEODORE MCBRIDE, EXAMINING ATTORNEY

Int. Cls.: 39, 41, and 43

Prior U.S. Cls.: 100, 101, 105, and 107

United States Patent and Trademark Office

Reg. No. 3,576,874

Registered Feb. 17, 2009

**SERVICE MARK
PRINCIPAL REGISTER**

HAMILTON HARBOR YACHT CLUB

HAMILTON HARBOR MARINA, INC. (FLORIDA CORPORATION)
SUITE 400
3003 TAMiami TRAIL NORTH
NAPLES, FL 34103

FOR: MARINA SERVICES; PROVIDING WET SLIP RENTAL AND DRY STORAGE OF YACHTS, IN CLASS 39 (U.S. CLS. 100 AND 105).

FIRST USE 10-7-2008; IN COMMERCE 10-7-2008.

FOR: YACHT CLUB SERVICES, IN CLASS 41 (U.S. CLS. 100, 101 AND 107).

FIRST USE 10-7-2008; IN COMMERCE 10-7-2008.

FOR: RESTAURANT, BAR AND COCKTAIL LOUNGE SERVICES; PROVISION OF FACILITIES FOR MEETINGS, CONFERENCES AND EXHIBI-

TIONS; PROVISION OF BANQUET AND SOCIAL FUNCTION FACILITIES FOR SPECIAL EVENTS; PROVIDING SPACE FOR MEETINGS, CONFERENCES AND SEMINARS, IN CLASS 43 (U.S. CLS. 100 AND 101).

FIRST USE 10-7-2008; IN COMMERCE 10-7-2008.

THE MARK CONSISTS OF STANDARD CHARACTERS WITHOUT CLAIM TO ANY PARTICULAR FONT, STYLE, SIZE, OR COLOR.

NO CLAIM IS MADE TO THE EXCLUSIVE RIGHT TO USE "HARBOR YACHT CLUB", APART FROM THE MARK AS SHOWN.

SN 77-135,019, FILED 3-20-2007.

JENNIFER VASQUEZ, EXAMINING ATTORNEY

Int. Cls.: 9 and 41

Prior U.S. Cls.: 21, 23, 26, 36, 38, 100, 101, and 107

United States Patent and Trademark Office

Reg. No. 3,576,875

Registered Feb. 17, 2009

**TRADEMARK
SERVICE MARK
PRINCIPAL REGISTER**

US@IT

SUN CHEMICAL CORPORATION (DELAWARE
CORPORATION)
35 WATERVIEW BLVD
LEGAL DEPT.-TRADEMARKS
PARSIPPANY, NJ 07054

FOR: PRINTING PRESS TRAINING SIMULATOR
SOFTWARE, IN CLASS 9 (U.S. CLS. 21, 23, 26, 36 AND
38).

FIRST USE 4-21-2007; IN COMMERCE 4-21-2007.

FOR: TRAINING IN LITHOGRAPHIC PRINCIPLES AND IN THE OPERATION OF PRINTING PRESSES AND PRINTING PRESS SIMULATORS, IN CLASS 41 (U.S. CLS. 100, 101 AND 107).

FIRST USE 4-3-2007; IN COMMERCE 4-3-2007.

SN 77-135,092, FILED 3-20-2007.

ROSELLE HERRERA, EXAMINING ATTORNEY

Int. Cl.: 41

Prior U.S. Cls.: 100, 101, and 107

United States Patent and Trademark Office

Reg. No. 3,576,876

Registered Feb. 17, 2009

**SERVICE MARK
PRINCIPAL REGISTER**

Integral Formation

NATIONAL CONSULTANTS FOR EDUCATION,
INC. (CONNECTICUT CORPORATION)
590 COLUMBUS AVENUE
THORNWOOD, NY 10594

FOR: EDUCATIONAL SERVICES, NAMELY,
CONDUCTING PROGRAMS IN THE FIELDS OF
PERSONAL ACADEMICS, HUMAN SPIRITUALITY,
AND APOSTOLIC ENHANCEMENT , IN CLASS 41
(U.S. CLS. 100, 101 AND 107).

FIRST USE 7-31-2007; IN COMMERCE 7-31-2007.

THE MARK CONSISTS OF STANDARD CHAR-
ACTERS WITHOUT CLAIM TO ANY PARTICULAR
FONT, STYLE, SIZE, OR COLOR.

SN 77-135,291, FILED 3-20-2007.

TINA L. SNAPP, EXAMINING ATTORNEY

Int. Cl.: 32

Prior U.S. Cls.: 45, 46, and 48

United States Patent and Trademark Office

Reg. No. 3,576,877

Registered Feb. 17, 2009

**TRADEMARK
PRINCIPAL REGISTER**

SPLASHDOWN

RETROFUTURE PRODUCTS LLC (NEW YORK
LIMITED LIABILITY COMPANY)
8 MAPLE STREET #5
PORT WASHINGTON, NY 11050

THE MARK CONSISTS OF STANDARD CHAR-
ACTERS WITHOUT CLAIM TO ANY PARTICULAR
FONT, STYLE, SIZE, OR COLOR.

FOR: POWDERS USED IN THE PREPARATION
OF SOFT DRINKS, IN CLASS 32 (U.S. CLS. 45, 46
AND 48).

SN 77-135,392, FILED 3-20-2007.

FIRST USE 4-0-2008; IN COMMERCE 4-0-2008.

LINDA M. KING, EXAMINING ATTORNEY

Int. Cl.: 3

Prior U.S. Cls.: 1, 4, 6, 50, 51, and 52

United States Patent and Trademark Office

Reg. No. 3,576,878

Registered Feb. 17, 2009

**TRADEMARK
PRINCIPAL REGISTER**

Color My Destiny

COLOR MY DESTINY LLC (NEW YORK LIMITED LIABILITY COMPANY)
SUITE 402
790 MADISON AVENUE
NEW YORK, NY 10021

FOR: COSMETICS; FACIAL CLEANSERS; SKIN MOISTURIZER; SKIN TONERS; FACIAL MASKS; FACIAL SCRUBS, IN CLASS 3 (U.S. CLS. 1, 4, 6, 50, 51 AND 52).

FIRST USE 1-1-2007; IN COMMERCE 8-1-2008.

THE MARK CONSISTS OF STANDARD CHARACTERS WITHOUT CLAIM TO ANY PARTICULAR FONT, STYLE, SIZE, OR COLOR.

SN 77-135,776, FILED 3-20-2007.

MARTHA SANTOMARTINO, EXAMINING ATTORNEY

Int. Cl.: 9

Prior U.S. Cls.: 21, 23, 26, 36, and 38

Reg. No. 3,576,879

United States Patent and Trademark Office

Registered Feb. 17, 2009

**TRADEMARK
PRINCIPAL REGISTER**

POWER PRO

TRANSAMERICAN AUTO PARTS COMPANY,
LLC (DELAWARE LIMITED LIABILITY COM-
PANY)
300 WEST ARTESIA BOULEVARD
COMPTON, CA 90220

THE MARK CONSISTS OF STANDARD CHAR-
ACTERS WITHOUT CLAIM TO ANY PARTICULAR
FONT, STYLE, SIZE, OR COLOR.

FOR: AN ELECTRONIC DEVICE TO TUNE LAND
VEHICLE ENGINE PERFORMANCE, IN CLASS 9
(U.S. CLS. 21, 23, 26, 36 AND 38).

SN 77-135,778, FILED 3-20-2007.

FIRST USE 2-0-2008; IN COMMERCE 2-0-2008.

MARTHA SANTOMARTINO, EXAMINING ATTOR-
NEY

Int. Cl.: 30

Prior U.S. Cl.: 46

United States Patent and Trademark Office

Reg. No. 3,576,880

Registered Feb. 17, 2009

**TRADEMARK
PRINCIPAL REGISTER**

EARTHGRAINS

SARA LEE BAKERY GROUP, INC. (DELAWARE
CORPORATION)
3500 LACEY ROAD
DOWNS GROVE, IL 60515

FOR: BAKERY PRODUCTS, NAMELY, BREAD,
BUNS AND ROLLS, IN CLASS 30 (U.S. CL. 46).

FIRST USE 1-23-1975; IN COMMERCE 1-23-1975.

THE MARK CONSISTS OF STANDARD CHAR-
ACTERS WITHOUT CLAIM TO ANY PARTICULAR
FONT, STYLE, SIZE, OR COLOR.

OWNER OF U.S. REG. NOS. 1,028,835, 1,110,637,
AND OTHERS.

SN 77-135,863, FILED 3-20-2007.

THEODORE MCBRIDE, EXAMINING ATTORNEY

Int. Cl.: 9

Prior U.S. Cls.: 21, 23, 26, 36, and 38

Reg. No. 3,576,881

United States Patent and Trademark Office

Registered Feb. 17, 2009

**TRADEMARK
PRINCIPAL REGISTER**

KEGWIZARD

NIAGARA DISPENSING TECHNOLOGIES, INC.
(DELAWARE CORPORATION)
170 NORTHPOINTE PKWY, SUITE 500
AMHERST, NY 14228

FOR: COMPUTER SOFTWARE FOR CONFIGURING, CONTROLLING AND OPERATING A HIGH-SPEED BEVERAGE DISPENSING SYSTEM, AND FOR DATA COLLECTION AND PROCESSING RELATED THERETO, IN CLASS 9 (U.S. CLS. 21, 23, 26, 36 AND 38).

FIRST USE 11-1-2007; IN COMMERCE 11-1-2007.

THE MARK CONSISTS OF STANDARD CHARACTERS WITHOUT CLAIM TO ANY PARTICULAR FONT, STYLE, SIZE, OR COLOR.

SN 77-136,523, FILED 3-21-2007.

MARY ROSSMAN, EXAMINING ATTORNEY

Int. Cl.: 41

Prior U.S. Cls.: 100, 101, and 107

United States Patent and Trademark Office

Reg. No. 3,576,882

Registered Feb. 17, 2009

**SERVICE MARK
PRINCIPAL REGISTER**

RATE MY SPACE

SCRIPPS NETWORKS, LLC. (DELAWARE LIMITED LIABILITY COMPANY)
9721 SHERRILL BOULEVARD
KNOXVILLE, TN 37932

FOR: ENTERTAINMENT SERVICES IN THE NATURE OF AN ON-GOING PROGRAM FEATURING HOME ENVIRONMENTS AND LIVING AREAS BROADCAST OVER TELEVISION, VIA SATELLITE, AND THROUGH OTHER AUDIOVISUAL MEDIA DISTRIBUTED OVER AUDIO AND VIDEO MEDIA, IN CLASS 41 (U.S. CLS. 100, 101 AND 107).

FIRST USE 6-15-2008; IN COMMERCE 6-15-2008.

THE MARK CONSISTS OF STANDARD CHARACTERS WITHOUT CLAIM TO ANY PARTICULAR FONT, STYLE, SIZE, OR COLOR.

SN 77-136,725, FILED 3-21-2007.

JAMES A. RAUEN, EXAMINING ATTORNEY

Int. Cl.: 25

Prior U.S. Cls.: 22 and 39

United States Patent and Trademark Office

Reg. No. 3,576,883

Registered Feb. 17, 2009

**TRADEMARK
PRINCIPAL REGISTER**

INDUSTRY 654

LINDSAY, JAMIE (UNITED STATES INDIVIDUAL)
P.O. BOX 881
LEWISTON, NY 14092

THE MARK CONSISTS OF STANDARD CHARACTERS WITHOUT CLAIM TO ANY PARTICULAR FONT, STYLE, SIZE, OR COLOR.

FOR: CLOTHING, NAMELY, SWEAT SHIRTS AND T-SHIRTS, IN CLASS 25 (U.S. CLS. 22 AND 39).

SN 77-136,911, FILED 3-21-2007.

FIRST USE 8-31-2008; IN COMMERCE 8-31-2008.

COLLEEN DOMBROW, EXAMINING ATTORNEY

Int. Cl.: 7

Prior U.S. Cls.: 13, 19, 21, 23, 31, 34, and 35

Reg. No. 3,576,884

United States Patent and Trademark Office

Registered Feb. 17, 2009

TRADEMARK
PRINCIPAL REGISTER



JOHNSON, GARRETT T. (UNITED STATES IN-
DIVIDUAL)
212 RUDEE AVENUE
VIRGINIA BEACH, VA 23451

FOR: MACHINES FOR PUMPING WATER AND
FOR CREATING ARTIFICIAL WATER WAVES
AND CURRENTS IN WATER PARKS AND WATER
SPORT FACILITIES UTILIZING WAVE ACTION,
AND PARTS THEREFOR, NAMELY, COMPRES-
SORS, TANKS, PUMPS, VALVES, PIPES AND SUP-
PORT FRAMES, IN CLASS 7 (U.S. CLS. 13, 19, 21, 23,
31, 34 AND 35).

FIRST USE 6-12-2007; IN COMMERCE 6-12-2007.

NO CLAIM IS MADE TO THE EXCLUSIVE
RIGHT TO USE "WAVE", APART FROM THE
MARK AS SHOWN.

THE MARK CONSISTS OF THE WORDS "WAVE
MASTER" ON WATER WITH A CRESTING WAVE
IN BETWEEN THE WORDS.

SN 77-137,181, FILED 3-21-2007.

LEIGH CAROLINE CASE, EXAMINING ATTOR-
NEY

Int. Cl.: 7

Prior U.S. Cls.: 13, 19, 21, 23, 31, 34, and 35

Reg. No. 3,576,885

United States Patent and Trademark Office

Registered Feb. 17, 2009

**TRADEMARK
PRINCIPAL REGISTER**



JOHNSON, GARRETT T. (UNITED STATES IN-
DIVIDUAL)
212 RUDEE AVENUE
VIRGINIA BEACH, VA 23451

NO CLAIM IS MADE TO THE EXCLUSIVE
RIGHT TO USE "WAVE", APART FROM THE
MARK AS SHOWN.

FOR: MACHINES FOR PUMPING WATER AND
FOR CREATING ARTIFICIAL WATER WAVES
AND CURRENTS IN WATER PARKS AND WATER
SPORT FACILITIES UTILIZING WAVE ACTION,
AND PARTS THEREFOR, NAMELY, COMPRES-
SORS, TANKS, PUMPS, VALVES, PIPES AND SUP-
PORT FRAMES, IN CLASS 7 (U.S. CLS. 13, 19, 21, 23,
31, 34 AND 35).

THE MARK CONSISTS OF THE WORDS "WAVE
CANNON" ON WATER WITH A CRESTING WAVE
IN BETWEEN THE WORDS.

SN 77-137,209, FILED 3-21-2007.

FIRST USE 6-12-2007; IN COMMERCE 6-12-2007.

LEIGH CAROLINE CASE, EXAMINING ATTOR-
NEY

Int. Cl.: 28

Prior U.S. Cls.: 22, 23, 38, and 50

United States Patent and Trademark Office

Reg. No. 3,576,886

Registered Feb. 17, 2009

**TRADEMARK
PRINCIPAL REGISTER**



JOHNSON, GARRETT T. (UNITED STATES IN-
DIVIDUAL)
212 RUDEE AVENUE
VIRGINIA BEACH, VA 23451

FOR: AMUSEMENT PARK RIDES, WATER PARK
RIDES AND OCEAN SIMULATORS FOR USE IN
WATER RIDES, IN CLASS 28 (U.S. CLS. 22, 23, 38
AND 50).

FIRST USE 6-30-2007; IN COMMERCE 6-30-2007.

THE MARK CONSISTS OF THE WORDS "WAVE
RACER" ON WATER WITH A CRESTING WAVE IN
BETWEEN THE WORDS.

SN 77-137,213, FILED 3-21-2007.

LEIGH CAROLINE CASE, EXAMINING ATTOR-
NEY

Int. Cl.: 4

Prior U.S. Cls.: 1, 6, and 15

United States Patent and Trademark Office

Reg. No. 3,576,887

Registered Feb. 17, 2009

**TRADEMARK
PRINCIPAL REGISTER**

Terasol

BHAN, SUNDEEP (UNITED STATES INDIVIDUAL)
15 BROAD STREET, #2110
NEW YORK, NY 10005 AND
YUVIENCO, MARIE (UNITED STATES INDIVIDUAL)
130 FULTON STREET, #4A
NEW YORK, NY 10038

FOR: BIOFUEL; BIOFUEL MADE FROM ANIMALS AND PLANT OILS, MATERIALS AND PRODUCTS; FEED STOCK BIOFUEL MADE FROM ANIMAL AND AGRICULTURAL OILS, MATERIALS AND PRODUCTS, IN CLASS 4 (U.S. CLS. 1, 6 AND 15).

FIRST USE 6-6-2008; IN COMMERCE 6-6-2008.

THE MARK CONSISTS OF STANDARD CHARACTERS WITHOUT CLAIM TO ANY PARTICULAR FONT, STYLE, SIZE, OR COLOR.

THE WORDING "TERASOL" HAS NO MEANING IN A FOREIGN LANGUAGE.

SN 77-137,215, FILED 3-21-2007.

JORDAN BAKER, EXAMINING ATTORNEY

Int. Cl.: 32

Prior U.S. Cls.: 45, 46, and 48

United States Patent and Trademark Office

Reg. No. 3,576,888

Registered Feb. 17, 2009

**TRADEMARK
PRINCIPAL REGISTER**

Artesian Falls

MOORE, MARTY T. (UNITED STATES INDIVIDUAL)
2552 STATE HIGHWAY 75 NORTH
HUNTSVILLE, TX 77320

FOR: BOTTLED ARTESIAN WATER; BOTTLED DRINKING WATER; BOTTLED WATER, IN CLASS 32 (U.S. CLS. 45, 46 AND 48).

FIRST USE 10-1-2008; IN COMMERCE 12-1-2008.

THE MARK CONSISTS OF STANDARD CHARACTERS WITHOUT CLAIM TO ANY PARTICULAR FONT, STYLE, SIZE, OR COLOR.

NO CLAIM IS MADE TO THE EXCLUSIVE RIGHT TO USE "ARTESIAN", APART FROM THE MARK AS SHOWN.

SN 77-137,782, FILED 3-22-2007.

CHERYL CLAYTON, EXAMINING ATTORNEY

Int. Cls.: 7 and 22

**Prior U.S. Cls.: 1, 2, 7, 13, 19, 21, 22, 23, 31, 34, 35, 42,
and 50**

United States Patent and Trademark Office

Reg. No. 3,576,889

Registered Feb. 17, 2009

**TRADEMARK
PRINCIPAL REGISTER**

CABLE TWIST

ZENOAH AMERICA INC. (GEORGIA CORPORATION)
4344 SHACKLEFORD ROAD
SUITE 500
NORCROSS, GA 30093

FOR: LAWN AND GARDEN STRING TRIMMER SPOOLS, IN CLASS 7 (U.S. CLS. 13, 19, 21, 23, 31, 34 AND 35).

FIRST USE 6-0-2007; IN COMMERCE 6-0-2007.

FOR: NYLON VEGETATION TRIMMER LINE, IN CLASS 22 (U.S. CLS. 1, 2, 7, 19, 22, 42 AND 50).

FIRST USE 6-0-2007; IN COMMERCE 6-0-2007.

THE MARK CONSISTS OF STANDARD CHARACTERS WITHOUT CLAIM TO ANY PARTICULAR FONT, STYLE, SIZE, OR COLOR.

SN 77-138,462, FILED 3-23-2007.

MARK SPARACINO, EXAMINING ATTORNEY

Int. Cl.: 25

Prior U.S. Cls.: 22 and 39

United States Patent and Trademark Office

Reg. No. 3,576,890

Registered Feb. 17, 2009

**TRADEMARK
PRINCIPAL REGISTER**

FIERY SPIRIT

HEISE, THERESE A. (UNITED STATES INDIVIDUAL)
4152 MINT ROAD
MARYVILLE, TN 378032208 AND
HEISE, BRIAN D. (UNITED STATES INDIVIDUAL)
4152 MINT ROAD
MARYVILLE, TN 378032208

FOR: BASEBALL CAPS; CROP TOPS; DENIM JACKETS; FLEECE PULLOVERS; JACKETS; JEANS; JERSEYS; KNIT SHIRTS; LOUNGE WEAR; OPEN-NECKED SHIRTS; PAJAMAS; PULLOVERS; SHIRTS; SHORTS; SHORT OR LONG SLEEVED T-SHIRTS; SHORT SLEEVED SHIRTS; SLEEPWEAR; SOCKS; SPORT SHIRTS; SPORTS BRA; SUN VISORS;

SWEAT SHIRTS; TANK TOPS; TOPS BEING CLOTHING; TURTLENECKS; T-SHIRTS; AND VESTS, IN CLASS 25 (U.S. CLS. 22 AND 39).

FIRST USE 9-5-2008; IN COMMERCE 9-5-2008.

THE MARK CONSISTS OF STANDARD CHARACTERS WITHOUT CLAIM TO ANY PARTICULAR FONT, STYLE, SIZE, OR COLOR.

SN 77-138,588, FILED 3-23-2007.

LYDIA BELZER, EXAMINING ATTORNEY

Int. Cl.: 29

Prior U.S. Cl.: 46

Reg. No. 3,576,891

United States Patent and Trademark Office

Registered Feb. 17, 2009

**TRADEMARK
PRINCIPAL REGISTER**

SASSY COW CREAMERY

JAMES BAERWOLF (UNITED STATES INDIVIDUAL)
N417 COUNTY HWY. N
COLUMBUS, WI 53925 AND
ROBERT BAERWOLF (UNITED STATES INDIVIDUAL)
2146 BRISTOL ROAD
SUN PRAIRIE, WI 53590

FOR: ORGANIC AND NON-ORGANIC BOTTLED MILK, IN CLASS 29 (U.S. CL. 46).

FIRST USE 5-1-2008; IN COMMERCE 5-1-2008.

THE MARK CONSISTS OF STANDARD CHARACTERS WITHOUT CLAIM TO ANY PARTICULAR FONT, STYLE, SIZE, OR COLOR.

NO CLAIM IS MADE TO THE EXCLUSIVE RIGHT TO USE "CREAMERY", APART FROM THE MARK AS SHOWN.

SN 77-138,882, FILED 3-23-2007.

RICHARD A. STRASER, EXAMINING ATTORNEY

Int. Cl.: 9

Prior U.S. Cls.: 21, 23, 26, 36, and 38

United States Patent and Trademark Office

Reg. No. 3,576,892

Registered Feb. 17, 2009

TRADEMARK
PRINCIPAL REGISTER



SIMPSON, SUZANNE M. (UNITED STATES INDIVIDUAL)

5580 LA JOLLA BOULEVARD, #82

LA JOLLA, CA 92037

FOR: AUDIO DISCS FEATURING SELF-HELP PROGRAM FOR CHILDREN, IN CLASS 9 (U.S. CLS. 21, 23, 26, 36 AND 38).

FIRST USE 3-0-2007; IN COMMERCE 3-0-2007.

NO CLAIM IS MADE TO THE EXCLUSIVE RIGHT TO USE "ESTEEM", APART FROM THE MARK AS SHOWN.

THE COLOR(S) WHITE, YELLOW, LIGHT BLUE, DARK BLUE AND BLACK IS/ARE CLAIMED AS A FEATURE OF THE MARK.

THE MARK CONSISTS OF THE LETTERS "E", "S", "T", "E", "E", "M", "D", "R", "E", "A", "M" AND "S" IN DARK BLUE AND BLACK WITH CIRCLE TO THE RIGHT OF LETTERS CONTAINING WHITE STARS, YELLOW HALF-MOON, LIGHT BLUE CLOUDS, DARK BLUE SKY, BLACK ACCENTS AND OUTLINED IN BLACK.

SN 77-139,634, FILED 3-24-2007.

REBECCA GILBERT, EXAMINING ATTORNEY

Int. Cl.: 35

Prior U.S. Cls.: 100, 101, and 102

United States Patent and Trademark Office

Reg. No. 3,576,893

Registered Feb. 17, 2009

**SERVICE MARK
PRINCIPAL REGISTER**

45FIX

45FIX, LLC (VIRGINIA LIMITED LIABILITY
COMPANY)
1928 ARLINGTON BLVD
CHARLOTTESVILLE, VA 22903

FOR: BUSINESS MANAGEMENT AND MAR-
KETING SERVICES, NAMELY, PROVIDING LEAD
GENERATION, SCHEDULING, PROPOSAL GEN-
ERATION, CUSTOMER SERVICES, AND COLLEC-
TIONS SERVICES TO CONTRACTS IN THE REAL
ESTATE IMPROVEMENT, HOME IMPROVEMENT,
CONSTRUCTION, HANDYMAN AND HOME
MAINTENANCE AND REPAIR INDUSTRIES; PRO-
VIDING CONSUMER INFORMATION SERVICES
AND PROVIDING REFERRALS IN THE FIELD OF

REAL ESTATE IMPROVEMENT, HOME IMPROVE-
MENT, CONSTRUCTION, HANDYMAN, REPAIR
AND HOME MAINTENANCE, IN CLASS 35 (U.S.
CLS. 100, 101 AND 102).

FIRST USE 9-30-2005; IN COMMERCE 9-30-2005.

THE MARK CONSISTS OF STANDARD CHAR-
ACTERS WITHOUT CLAIM TO ANY PARTICULAR
FONT, STYLE, SIZE, OR COLOR.

SN 77-141,303, FILED 3-27-2007.

DAVID H. STINE, EXAMINING ATTORNEY

Int. Cl.: 25

Prior U.S. Cls.: 22 and 39

United States Patent and Trademark Office

Reg. No. 3,576,894

Registered Feb. 17, 2009

**TRADEMARK
PRINCIPAL REGISTER**

THE LITTLE THONGS IN LIFE

GEORGEANN HUSZAR (UNITED STATES INDIVIDUAL)
2925 WEST 13 MILE ROAD, #107
ROYAL OAK, MI 48073

THE MARK CONSISTS OF STANDARD CHARACTERS WITHOUT CLAIM TO ANY PARTICULAR FONT, STYLE, SIZE, OR COLOR.

FOR: CLOTHING, NAMELY, UNDERWEAR, IN CLASS 25 (U.S. CLS. 22 AND 39).

SN 77-141,455, FILED 3-27-2007.

FIRST USE 12-10-2008; IN COMMERCE 12-10-2008.

KAPIL BHANOT, EXAMINING ATTORNEY

Int. Cl.: 41

Prior U.S. Cls.: 100, 101, and 107

United States Patent and Trademark Office

Reg. No. 3,576,895

Registered Feb. 17, 2009

**SERVICE MARK
PRINCIPAL REGISTER**

CANDICE MICHELLE

WORLD WRESTLING ENTERTAINMENT, INC.
(DELAWARE CORPORATION)
1241 EAST MAIN STREET
STAMFORD, CT 06902

FOR: ENTERTAINMENT SERVICES, NAMELY, WRESTLING EXHIBITIONS AND PERFORMANCES BY A PROFESSIONAL WRESTLER AND ENTERTAINER; PROVIDING WRESTLING NEWS AND INFORMATION VIA A GLOBAL COMPUTER NETWORK, IN CLASS 41 (U.S. CLS. 100, 101 AND 107).

FIRST USE 6-30-2005; IN COMMERCE 6-30-2005.

THE MARK CONSISTS OF STANDARD CHARACTERS WITHOUT CLAIM TO ANY PARTICULAR FONT, STYLE, SIZE, OR COLOR.

THE NAME(S), PORTRAIT(S), AND/OR SIGNATURE(S) SHOWN IN THE MARK DOES NOT IDENTIFY A PARTICULAR LIVING INDIVIDUAL.

SN 77-142,245, FILED 3-28-2007.

LEIGH CAROLINE CASE, EXAMINING ATTORNEY

Int. Cl.: 25

Prior U.S. Cls.: 22 and 39

United States Patent and Trademark Office

Reg. No. 3,576,896

Registered Feb. 17, 2009

**TRADEMARK
PRINCIPAL REGISTER**

GOT BEAUJOLAIS?

ROSS, HELENA (UNITED STATES INDIVIDUAL)
P.O. BOX 461
LOS OLIVOS, CA 93441

THE MARK CONSISTS OF STANDARD CHAR-
ACTERS WITHOUT CLAIM TO ANY PARTICULAR
FONT, STYLE, SIZE, OR COLOR.

FOR: CLOTHING, NAMELY, HATS, T-SHIRTS,
SHIRTS, SWEATSHIRTS AND JACKETS, IN CLASS
25 (U.S. CLS. 22 AND 39).

SN 77-142,424, FILED 3-28-2007.

FIRST USE 12-15-2008; IN COMMERCE 12-15-2008.

SHARON MEIER, EXAMINING ATTORNEY

Int. Cl.: 20

Prior U.S. Cls.: 2, 13, 22, 25, 32, and 50

United States Patent and Trademark Office

Reg. No. 3,576,897

Registered Feb. 17, 2009

**TRADEMARK
PRINCIPAL REGISTER**

VIDA

HARTSON-KENNEDY CABINET TOP CO. INC.
(INDIANA CORPORATION)
522 WEST 22ND STREET; P.O. BOX 3095
MARION, IN 46953

FOR: CUSTOM KITCHEN COUNTERTOPS AND
BAR COUNTERTOPS, IN CLASS 20 (U.S. CLS. 2, 13,
22, 25, 32 AND 50).

FIRST USE 3-24-2008; IN COMMERCE 3-24-2008.

THE MARK CONSISTS OF STANDARD CHAR-
ACTERS WITHOUT CLAIM TO ANY PARTICULAR
FONT, STYLE, SIZE, OR COLOR.

THE ENGLISH TRANSLATION OF THE SPANISH
WORD "VIDA" IS LIFE.

SN 77-143,826, FILED 3-29-2007.

BARBARA GAYNOR, EXAMINING ATTORNEY

Int. Cl.: 16

Prior U.S. Cls.: 2, 5, 22, 23, 29, 37, 38, and 50

United States Patent and Trademark Office

Reg. No. 3,576,898

Registered Feb. 17, 2009

**TRADEMARK
PRINCIPAL REGISTER**

THE BALTIMORE SUN

THE BALTIMORE SUN COMPANY (MARY-
LAND CORPORATION)

501 NORTH CALVERT STREET

BALTIMORE, MD 21278

FOR: DAILY NEWSPAPER, IN CLASS 16 (U.S.
CLS. 2, 5, 22, 23, 29, 37, 38 AND 50).

FIRST USE 8-24-2008; IN COMMERCE 8-24-2008.

THE MARK CONSISTS OF STANDARD CHAR-
ACTERS WITHOUT CLAIM TO ANY PARTICULAR
FONT, STYLE, SIZE, OR COLOR.

NO CLAIM IS MADE TO THE EXCLUSIVE
RIGHT TO USE "BALTIMORE", APART FROM
THE MARK AS SHOWN.

SN 77-144,023, FILED 3-29-2007.

RONALD AIKENS, EXAMINING ATTORNEY

Int. Cl.: 9

Prior U.S. Cls.: 21, 23, 26, 36, and 38

Reg. No. 3,576,899

United States Patent and Trademark Office

Registered Feb. 17, 2009

**TRADEMARK
PRINCIPAL REGISTER**

GEM

GENESISTP INC. (CANADA CORPORATION)
2430 MEADOWPINE BOULEVARD, SUITE 105
MISSISSAUGA, ONTARIO L5N6S2

FOR: SOFTWARE FOR DESIGN AND ENGINEERING OF BUILDING STRUCTURES; SOFTWARE FOR USE IN THE FIELD OF STEEL STRUCTURE MANUFACTURING AND CONSTRUCTION, NAMELY, SOFTWARE FOR TIME MANAGEMENT, PAYROLL, BUSINESS ANALYTICS, INSTALLATION MANAGEMENT, SHIPPING, WORKFORCE MANAGEMENT, INVENTORY MANAGEMENT, INVOICING, PURCHASING, AND CUSTOMER SUPPORT; SOFTWARE FOR THE DESIGN, PRICING, ENGINEERING, MANUFACTURE, AND CONSTRUCTION OF STEEL

STRUCTURES; SOFTWARE FOR AUTOMATION, MANAGEMENT, MEASURING, TRACKING, MONITORING, AND OPTIMIZATION OF MANUFACTURING PROCESSES AND EMPLOYEES, IN CLASS 9 (U.S. CLS. 21, 23, 26, 36 AND 38).

FIRST USE 8-27-2007; IN COMMERCE 8-27-2007.

THE MARK CONSISTS OF STANDARD CHARACTERS WITHOUT CLAIM TO ANY PARTICULAR FONT, STYLE, SIZE, OR COLOR.

SN 77-144,497, FILED 3-30-2007.

ZACHARY BELLO, EXAMINING ATTORNEY

Int. Cl.: 9

Prior U.S. Cls.: 21, 23, 26, 36, and 38

Reg. No. 3,576,900

United States Patent and Trademark Office

Registered Feb. 17, 2009

**TRADEMARK
PRINCIPAL REGISTER**

FRAMEBUILDER

GENESISTP INC. (CANADA CORPORATION)
2430 MEADOWPINE BOULEVARD, SUITE 105
MISSISSAUGA, ONTARIO L5N6S2

FOR: SOFTWARE FOR DESIGN AND ENGINEERING OF BUILDING STRUCTURES; SOFTWARE FOR USE IN THE FIELD OF STEEL STRUCTURE MANUFACTURING AND CONSTRUCTION, NAMELY, SOFTWARE FOR TIME MANAGEMENT, PAYROLL, BUSINESS ANALYTICS, INSTALLATION MANAGEMENT, SHIPPING, WORKFORCE MANAGEMENT, INVENTORY MANAGEMENT, INVOICING, PURCHASING, AND CUSTOMER SUPPORT; SOFTWARE FOR THE DESIGN, PRICING, ENGINEERING, MANUFACTURE, AND CONSTRUCTION OF STEEL

STRUCTURES; SOFTWARE FOR AUTOMATION, MANAGEMENT, MEASURING, TRACKING, MONITORING, AND OPTIMIZATION OF MANUFACTURING PROCESSES AND EMPLOYEES, IN CLASS 9 (U.S. CLS. 21, 23, 26, 36 AND 38).

FIRST USE 8-27-2007; IN COMMERCE 8-27-2007.

THE MARK CONSISTS OF STANDARD CHARACTERS WITHOUT CLAIM TO ANY PARTICULAR FONT, STYLE, SIZE, OR COLOR.

SN 77-144,501, FILED 3-30-2007.

ZACHARY BELLO, EXAMINING ATTORNEY

Int. Cl.: 35

Prior U.S. Cls.: 100, 101, and 102

United States Patent and Trademark Office

Reg. No. 3,576,901

Registered Feb. 17, 2009

**SERVICE MARK
PRINCIPAL REGISTER**

WOMAN WITHIN 365

REDCATS USA, L.P. (DELAWARE LIMITED
PARTNERSHIP)
2300 SOUTHEASTERN AVE.
INDIANAPOLIS, IN 46201

FOR: ON-LINE RETAIL STORE SERVICES FEATURING WOMEN'S CLOTHING, FOOTWEAR, AND CLOTHING ACCESSORIES, IN CLASS 35 (U.S. CLS. 100, 101 AND 102).

FIRST USE 8-8-2008; IN COMMERCE 8-8-2008.

THE MARK CONSISTS OF STANDARD CHARACTERS WITHOUT CLAIM TO ANY PARTICULAR FONT, STYLE, SIZE, OR COLOR.

OWNER OF U.S. REG. NOS. 1,617,731, 2,488,177, AND 3,220,573.

SN 77-144,636, FILED 3-30-2007.

THOMAS MANOR, EXAMINING ATTORNEY

Int. Cl.: 41

Prior U.S. Cls.: 100, 101, and 107

United States Patent and Trademark Office

Reg. No. 3,576,902

Registered Feb. 17, 2009

SERVICE MARK
PRINCIPAL REGISTER

BOLD

TME ACQUISITION HOLDINGS, LLC (DELA-
WARE LIMITED LIABILITY COMPANY)
150 MEADOWLANDS PARKWAY
SECAUCUS, NJ 07094

FOR: MEDICAL EDUCATION SERVICES, NAME-
LY, CONDUCTING SYMPOSIA AND SEMINARS
DIRECTED TO HEALTHCARE PROFESSIONALS
RELATING TO DISORDERS OF THE LOWER EX-
TREMITIES, AND DISTRIBUTING COURSE MATE-
RIALS IN CONNECTION THEREWITH, IN CLASS
41 (U.S. CLS. 100, 101 AND 107).

FIRST USE 8-31-2007; IN COMMERCE 8-31-2007.

THE MARK CONSISTS OF STANDARD CHAR-
ACTERS WITHOUT CLAIM TO ANY PARTICULAR
FONT, STYLE, SIZE, OR COLOR.

SN 77-146,109, FILED 4-2-2007.

MARY ROSSMAN, EXAMINING ATTORNEY

Int. Cl.: 9

Prior U.S. Cls.: 21, 23, 26, 36, and 38

United States Patent and Trademark Office

Reg. No. 3,576,903

Registered Feb. 17, 2009

**TRADEMARK
PRINCIPAL REGISTER**

WiseDoc

DAIHAN SCIENTIFIC CO., LTD. (REPUBLIC OF
KOREA CORPORATION)
24-4 SANGWOLGOK-DONG, SUNGBUK-GU
SEOUL 136-120, REPUBLIC OF KOREA

FOR: GEL IMAGE ANALYSIS SYSTEM CONSIST-
ING PRIMARILY OF COMPUTER HARDWARE
AND COMPARE SOFTWARE FOR PREPARING
GEL ANALYSIS REPORTS; GEL IMAGE CAPTURE
AND DNA ANALYSIS SYSTEM CONSISTING PRI-
MARILY OF COMPUTER HARDWARE AND COM-
PUTER SOFTWARE FOR IMAGE CAPTURE,

ANALYSIS, MANAGEMENT AND STORAGE OF
IMAGES, IN CLASS 9 (U.S. CLS. 21, 23, 26, 36 AND 38).

FIRST USE 6-3-2008; IN COMMERCE 6-3-2008.

THE MARK CONSISTS OF STANDARD CHAR-
ACTERS WITHOUT CLAIM TO ANY PARTICULAR
FONT, STYLE, SIZE, OR COLOR.

SN 77-146,419, FILED 4-2-2007.

SAIMA MAKHDOOM, EXAMINING ATTORNEY

Int. Cl.: 9

Prior U.S. Cls.: 21, 23, 26, 36, and 38

United States Patent and Trademark Office

Reg. No. 3,576,904

Registered Feb. 17, 2009

**TRADEMARK
PRINCIPAL REGISTER**

WiseMix

DAIHAN SCIENTIFIC CO., LTD. (REPUBLIC OF
KOREA CORPORATION)
24-4 SANGWOLGOK-DONG, SUNGBUK-GU
SEOUL 136-120, REPUBLIC OF KOREA

FOR: BALL MILL FOR LABORATORY USE;
MIXER FOR LABORATORY USE; BALL MILLS,
PROGRAMMABLE BALL MILLS, MIXERS, DIGI-
TAL ROCKERS FOR LABORATORY USE, IN CLASS
9 (U.S. CLS. 21, 23, 26, 36 AND 38).

FIRST USE 4-14-2008; IN COMMERCE 4-14-2008.

THE MARK CONSISTS OF STANDARD CHAR-
ACTERS WITHOUT CLAIM TO ANY PARTICULAR
FONT, STYLE, SIZE, OR COLOR.

SN 77-146,425, FILED 4-2-2007.

KATHERINE CONNOLLY, EXAMINING ATTOR-
NEY

Int. Cl.: 9

Prior U.S. Cls.: 21, 23, 26, 36, and 38

United States Patent and Trademark Office

Reg. No. 3,576,905

Registered Feb. 17, 2009

**TRADEMARK
PRINCIPAL REGISTER**

SHOP TALK

MEDIA CART HOLDINGS, INC. (DELAWARE CORPORATION)
1004 AVENUE N, SUITE 100
PLANO, TX 75074

FOR: COMPUTER SOFTWARE FOR TRACKING SHOPPING CART MOVEMENT IN STORES AND IDENTIFYING THE LOCATION OF SHOPPING CARTS THAT LEAVE STORE PREMISES, IDENTIFYING WHICH THIRD PARTY ADVERTISEMENTS APPEAR ON ELECTRONIC DISPLAYS AFFIXED TO THE SHOPPING CARTS, AND IDENTIFYING

PRODUCTS PURCHASED, IN CLASS 9 (U.S. CLS. 21, 23, 26, 36 AND 38).

FIRST USE 3-24-2007; IN COMMERCE 3-24-2007.

THE MARK CONSISTS OF STANDARD CHARACTERS WITHOUT CLAIM TO ANY PARTICULAR FONT, STYLE, SIZE, OR COLOR.

SN 77-146,499, FILED 4-2-2007.

B. PARADEWELAI, EXAMINING ATTORNEY

Int. Cl.: 9

Prior U.S. Cls.: 21, 23, 26, 36, and 38

Reg. No. 3,576,906

United States Patent and Trademark Office

Registered Feb. 17, 2009

**TRADEMARK
PRINCIPAL REGISTER**

LAKE EFFECT

GREAT LAKES CASE AND CABINET CO., INC.
(PENNSYLVANIA CORPORATION)
4193 ROUTE 6N-EAST
EDINBORO, PA 16412

FOR: AIR-COOLED MOUNTING RACKS, CON-
SOLES, AND ENCLOSURES FOR ELECTRICAL
COMPONENTS, NAMELY, COMPUTER HARD-
WARE AND TELECOMMUNICATIONS COMPU-
TER HARDWARE , IN CLASS 9 (U.S. CLS. 21, 23,
26, 36 AND 38).

FIRST USE 8-0-2006; IN COMMERCE 8-0-2006.

THE MARK CONSISTS OF STANDARD CHAR-
ACTERS WITHOUT CLAIM TO ANY PARTICULAR
FONT, STYLE, SIZE, OR COLOR.

SN 77-146,529, FILED 4-2-2007.

KAPIL BHANOT, EXAMINING ATTORNEY

Int. Cl.: 5

Prior U.S. Cls.: 6, 18, 44, 46, 51, and 52

United States Patent and Trademark Office

Reg. No. 3,576,907

Registered Feb. 17, 2009

**TRADEMARK
PRINCIPAL REGISTER**

Legendary Herbs

BRAND, CHARLES (UNITED STATES INDIVIDUAL)
1625 OAK AVENUE
BOULDER, CO 80304

FOR: DIETARY AND NUTRITIONAL SUPPLEMENTS, IN CLASS 5 (U.S. CLS. 6, 18, 44, 46, 51 AND 52).

FIRST USE 11-7-2008; IN COMMERCE 11-7-2008.

THE MARK CONSISTS OF STANDARD CHARACTERS WITHOUT CLAIM TO ANY PARTICULAR FONT, STYLE, SIZE, OR COLOR.

NO CLAIM IS MADE TO THE EXCLUSIVE RIGHT TO USE "HERBS", APART FROM THE MARK AS SHOWN.

SN 77-146,645, FILED 4-2-2007.

TEJBIR SINGH, EXAMINING ATTORNEY

Int. Cl.: 25

Prior U.S. Cls.: 22 and 39

United States Patent and Trademark Office

Reg. No. 3,576,908

Registered Feb. 17, 2009

TRADEMARK
PRINCIPAL REGISTER

GOOSEBUMPS

SCHOLASTIC INC. (NEW YORK CORPORATION)
557 BROADWAY
NEW YORK, NY 10012

FOR: CLOTHING AND WEARING APPAREL FOR CHILDREN, NAMELY, OUTERWEAR, NAMELY, JACKETS, SWEAT SHIRTS, SWEAT PANTS, WARM-UP SUITS; LEISURE WEAR, NAMELY, PANTS, JEANS, SHORT SETS, TANK TOPS; BEACHWEAR, NAMELY, SWIM SUITS, SWIM TRUNKS, BEACH SANDALS, WATER SOCKS; TEE-SHIRTS, SHORTS, UNDERWEAR, BOXER SHORTS, UNDER-SHIRTS, BRIEFS, DRESSES, JUMPERS, SKIRTS, SWEATERS, JACKETS, OVERALLS, TOPS, PANTS, JEANS, SHORT SETS, TANK TOPS, SCARVES, MITTENS, GLOVES, EAR MUFFS, TIES, BELTS, SLEEPWEAR, PAJAMAS, ROBES, NIGHT-SHIRTS, APRONS, RAIN JACKETS, RAINWEAR, CAPS

AND HATS, SOCKS AND TIGHTS, MASQUERADE COSTUMES AND MASKS SOLD IN CONNECTION THEREWITH; AND FOOTWEAR, IN CLASS 25 (U.S. CLS. 22 AND 39).

FIRST USE 9-1-2008; IN COMMERCE 9-1-2008.

THE MARK CONSISTS OF STANDARD CHARACTERS WITHOUT CLAIM TO ANY PARTICULAR FONT, STYLE, SIZE, OR COLOR.

OWNER OF U.S. REG. NOS. 1,871,292 AND 2,019,991.

SN 77-147,230, FILED 4-3-2007.

KATHLEEN M. VANSTON, EXAMINING ATTORNEY

Int. Cl.: 35

Prior U.S. Cls.: 100, 101, and 102

United States Patent and Trademark Office

Reg. No. 3,576,909

Registered Feb. 17, 2009

**SERVICE MARK
PRINCIPAL REGISTER**

**YOUR ULTIMATE PHYSIQUE &
PERFORMANCE GATEWAY**

BIO-ENGINEERED SUPPLEMENTS & NUTRI-
TION, INC. (DELAWARE CORPORATION)
5901 BROKEN SOUND PARKWAY NW
6TH FLOOR
BOCA RATON, FL 33487

FOR: ON-LINE RETAIL STORE SERVICES FEA-
TURING NUTRITIONAL SUPPLEMENTS, IN
CLASS 35 (U.S. CLS. 100, 101 AND 102).

FIRST USE 4-3-2007; IN COMMERCE 5-1-2008.

THE MARK CONSISTS OF STANDARD CHAR-
ACTERS WITHOUT CLAIM TO ANY PARTICULAR
FONT, STYLE, SIZE, OR COLOR.

SN 77-147,262, FILED 4-3-2007.

KELLEY WELLS, EXAMINING ATTORNEY

Int. Cl.: 5

Prior U.S. Cls.: 6, 18, 44, 46, 51, and 52

United States Patent and Trademark Office

Reg. No. 3,576,910

Registered Feb. 17, 2009

**TRADEMARK
PRINCIPAL REGISTER**



SCHERING-PLOUGH ANIMAL HEALTH CORPORATION (DELAWARE CORPORATION)
556 MORRIS AVENUE
SUMMIT, NJ 07901

FOR: A VETERINARY SYSTEMIC ANTI-INFECTIVE PREPARATION FOR THE TREATMENT OF POULTRY, SWINE AND BOVINE, IN CLASS 5 (U.S. CLS. 6, 18, 44, 46, 51 AND 52).

FIRST USE 10-13-2008; IN COMMERCE 10-13-2008.

OWNER OF U.S. REG. NO. 1,426,234.

THE COLOR(S) BLACK, WHITE, RED, AND YELLOW IS/ARE CLAIMED AS A FEATURE OF THE MARK.

THE MARK CONSISTS OF THE WORDING "NUFLOR GOLD" WITH AN ARC CIRCLING OVER THE WORDING AND A SPIKE ABOVE THE SECOND "O". THE COLOR BLACK APPEARS AS THE COLOR OF THE LETTERING "NUFLOR", AS THE OUTLINE OF THE LETTERING "GOLD", AND AS THE OUTLINE OF THE ARC. THE COLOR WHITE APPEARS IN THE ARC AS SHADING. THE COLOR RED APPEARS AS THE COLOR OF THE SPIKE. THE COLOR YELLOW APPEARS AS THE COLOR OF THE ARC AND IN THE LETTERING "GOLD".

SN 77-147,377, FILED 4-3-2007.

ANDREA HACK, EXAMINING ATTORNEY

Int. Cl.: 39

Prior U.S. Cls.: 100 and 105

United States Patent and Trademark Office

Reg. No. 3,576,911

Registered Feb. 17, 2009

**SERVICE MARK
PRINCIPAL REGISTER**



SCHERING-PLOUGH HOME AGAIN LLC (DE-
LAWARE LIMITED LIABILITY COMPANY)
2000 GALLOPING HILL ROAD
KENILWORTH, NJ 07033

FOR: PET RESCUE SERVICES, IN CLASS 39 (U.S.
CLS. 100 AND 105).

FIRST USE 10-31-2006; IN COMMERCE 10-31-2006.

OWNER OF U.S. REG. NOS. 2,019,751 AND
2,022,961.

NO CLAIM IS MADE TO THE EXCLUSIVE
RIGHT TO USE "PET RESCUERS", APART FROM
THE MARK AS SHOWN.

THE MARK CONSISTS OF A DESIGN OF HOUSE
WITH PAW IN LIEU OF A DOOR DEPICTED ON A
SHIELD WITH THE WORDS "HOMEAGAIN PET-
RESCUERS" UNDER THE DESIGN.

SN 77-147,480, FILED 4-3-2007.

KATHERINE CONNOLLY, EXAMINING ATTOR-
NEY

Int. Cl.: 5

Prior U.S. Cls.: 6, 18, 44, 46, 51, and 52

Reg. No. 3,576,912

United States Patent and Trademark Office

Registered Feb. 17, 2009

TRADEMARK
PRINCIPAL REGISTER



BATIZ, SERGIO J. (UNITED STATES INDIVIDUAL)
3401 ROBINSON AVENUE
AUSTIN, TX 78722

FOR: AIR FRESHENERS, IN CLASS 5 (U.S. CLS. 6, 18, 44, 46, 51 AND 52).

FIRST USE 2-1-2008; IN COMMERCE 2-1-2008.

THE MARK CONSISTS OF A WREATH WITH ANGELS IN IT, AND A LARGER ANGEL IN THE

MIDDLE SITTING ON A TOILET AND BLOWING A TRUMPET. ALONG THE TOP OF THE MARK IS A BANNER THAT READS, "POO-POURRI". A SECOND BANNER RUNS ALONG THE BOTTOM WITH THE WORDS "SPRITZ THE BOWL BEFORE YOU GO AND NO ONE ELSE WITH EVER KNOW".

SN 77-147,512, FILED 4-3-2007.

FRANK LATTUCA, EXAMINING ATTORNEY

Int. Cl.: 35

Prior U.S. Cls.: 100, 101, and 102

United States Patent and Trademark Office

Reg. No. 3,576,913

Registered Feb. 17, 2009

**SERVICE MARK
PRINCIPAL REGISTER**

FDM - THE SILENT MENTOR

CAP AVIATION CONSULTING GROUP, LLC
(FLORIDA LIMITED LIABILITY COMPANY)
STE 1606
4525 S ATLANTIC AVE
DAYTONA BEACH, FL 32127

FOR: BUSINESS CONSULTING SERVICES FOR
THE AIRLINE INDUSTRY, INCLUDING CORPO-
RATE AND GENERAL AVIATION, NAMELY,
MONITORING AND EVALUATING FLIGHT
QUALITY, CREW PERFORMANCE OPERATIONS,
IN CLASS 35 (U.S. CLS. 100, 101 AND 102).

FIRST USE 1-7-2007; IN COMMERCE 1-7-2007.

THE MARK CONSISTS OF STANDARD CHAR-
ACTERS WITHOUT CLAIM TO ANY PARTICULAR
FONT, STYLE, SIZE, OR COLOR.

NO CLAIM IS MADE TO THE EXCLUSIVE
RIGHT TO USE "FDM", APART FROM THE MARK
AS SHOWN.

SN 77-149,143, FILED 4-5-2007.

DAVID H. STINE, EXAMINING ATTORNEY

Int. Cl.: 10

Prior U.S. Cls.: 26, 39, and 44

United States Patent and Trademark Office

Reg. No. 3,576,914

Registered Feb. 17, 2009

**TRADEMARK
PRINCIPAL REGISTER**

The logo features the word "Disney" in its signature script font, with a large, stylized "D" that has a circular flourish. Below "Disney", the word "baby" is written in a simple, lowercase, sans-serif font.

DISNEY ENTERPRISES, INC. (DELAWARE CORPORATION)
500 SOUTH BUENA VISTA STREET
BURBANK, CA 91521

FOR: BABY BOTTLES; CUPS ADAPTED FOR FEEDING BABIES AND CHILDREN; BABY PACIFIERS; TEETHING RINGS, IN CLASS 10 (U.S. CLS. 26, 39 AND 44).

FIRST USE 5-29-2008; IN COMMERCE 5-29-2008.

OWNER OF U.S. REG. NOS. 3,045,495 AND 3,242,910.

NO CLAIM IS MADE TO THE EXCLUSIVE RIGHT TO USE "BABY", APART FROM THE MARK AS SHOWN.

SN 77-149,511, FILED 4-5-2007.

FONG HSU, EXAMINING ATTORNEY

Int. Cl.: 24

Prior U.S. Cls.: 42 and 50

United States Patent and Trademark Office

Reg. No. 3,576,915

Registered Feb. 17, 2009

**TRADEMARK
PRINCIPAL REGISTER**

The logo features the word "Disney" in its signature script font, with a large, stylized "D" that has a circular flourish. Below "Disney", the word "baby" is written in a lowercase, bold, sans-serif font.

DISNEY ENTERPRISES, INC. (DELAWARE CORPORATION)
500 SOUTH BUENA VISTA STREET
BURBANK, CA 91521

OWNER OF U.S. REG. NOS. 1,189,727, 2,372,024,
AND 2,412,749.

FOR: BATH LINEN; BATH TOWELS; BED BLANKETS; BED LINEN; BED SHEETS; BED SPREADS; BLANKET TROWS; CHILDREN'S BLANKETS; COMFORTERS; CRIB BUMPERS; CURTAINS; HOODED TOWELS; HOUSEHOLD LINEN; QUILTS; RECEIVING BLANKETS; TROWS; TOWELS; WASHCLOTHS, IN CLASS 24 (U.S. CLS. 42 AND 50).

NO CLAIM IS MADE TO THE EXCLUSIVE RIGHT TO USE "BABY", APART FROM THE MARK AS SHOWN.

SN 77-149,532, FILED 4-5-2007.

FIRST USE 4-18-2005; IN COMMERCE 4-18-2005.

FONG HSU, EXAMINING ATTORNEY

Int. Cl.: 24

Prior U.S. Cls.: 42 and 50

United States Patent and Trademark Office

Reg. No. 3,576,916

Registered Feb. 17, 2009

**TRADEMARK
PRINCIPAL REGISTER**

WHERE IMAGINATION BEGINS

DISNEY ENTERPRISES, INC. (DELAWARE CORPORATION)
500 SOUTH BUENA VISTA STREET
BURBANK, CA 91521

FOR: BATH LINEN; BED LINEN; BLANKET
THROWS; CHILDREN'S BLANKETS; HOODED TOWELS;
HOUSEHOLD LINEN; QUILTS; RECEIVING
BLANKETS; THROWS; TOWELS; WASHCLOTHS,
IN CLASS 24 (U.S. CLS. 42 AND 50).

FIRST USE 7-14-2007; IN COMMERCE 7-14-2007.

THE MARK CONSISTS OF STANDARD CHARACTERS
WITHOUT CLAIM TO ANY PARTICULAR FONT, STYLE,
SIZE, OR COLOR.

SN 77-149,918, FILED 4-5-2007.

FONG HSU, EXAMINING ATTORNEY

Int. Cl.: 20

Prior U.S. Cls.: 2, 13, 22, 25, 32, and 50

Reg. No. 3,576,917

United States Patent and Trademark Office

Registered Feb. 17, 2009

**TRADEMARK
PRINCIPAL REGISTER**

CHITTENDEN AND EASTMAN

MATTRESS DEVELOPMENT COMPANY OF DELAWARE, LLC (DELAWARE LIMITED LIABILITY COMPANY)

1375 JERSEY AVENUE
NORTH BRUNSWICK, NJ 08902

FOR: BEDDING, NAMELY, MATTRESSES AND BOX SPRINGS, IN CLASS 20 (U.S. CLS. 2, 13, 22, 25, 32 AND 50).

FIRST USE 2-1-2008; IN COMMERCE 2-1-2008.

THE MARK CONSISTS OF STANDARD CHARACTERS WITHOUT CLAIM TO ANY PARTICULAR FONT, STYLE, SIZE, OR COLOR.

THE NAME(S), PORTRAIT(S), AND/OR SIGNATURE(S) SHOWN IN THE MARK DOES NOT IDENTIFY A PARTICULAR LIVING INDIVIDUAL.

SN 77-150,421, FILED 4-6-2007.

EMILY CARLSEN, EXAMINING ATTORNEY

Int. Cl.: 25

Prior U.S. Cls.: 22 and 39

United States Patent and Trademark Office

Reg. No. 3,576,918

Registered Feb. 17, 2009

**TRADEMARK
PRINCIPAL REGISTER**

ROBERT BULLOCK

BULLOCK, ROBERT (UNITED STATES INDIVIDUAL)
49 SOUTH OXFORD STREET
BROOKLYN, NY 11217

THE MARK CONSISTS OF STANDARD CHARACTERS WITHOUT CLAIM TO ANY PARTICULAR FONT, STYLE, SIZE, OR COLOR.

FOR: CLOTHING, NAMELY, BRIDAL GOWNS; READY-TO-WEAR CLOTHING, NAMELY, BRIDAL GOWNS, IN CLASS 25 (U.S. CLS. 22 AND 39).

SN 77-150,816, FILED 4-6-2007.

FIRST USE 12-5-2007; IN COMMERCE 12-5-2007.

KATHERINE STOIDES, EXAMINING ATTORNEY

Int. Cls.: 41 and 45

Prior U.S. Cls.: 100, 101, and 107

United States Patent and Trademark Office

Reg. No. 3,576,919

Registered Feb. 17, 2009

**SERVICE MARK
PRINCIPAL REGISTER**

**WHEN GETTING IT RIGHT IS
THE ONLY OPTION, CHOOSE
JAMS**

JAMS/ENDISPUTE, LLC (DELAWARE LIMITED
LIABILITY COMPANY)
SUITE 300
1920 MAIN STREET
IRVINE, CA 92614

FOR: EDUCATIONAL SERVICES, NAMELY,
CONDUCTING SEMINARS PROVIDING INSTRU-
TION AND PRACTICAL APPLICATION IN THE
FIELD OF CONFLICT PREVENTION MANAGE-
MENT AND SETTLEMENT, AND MANUALS USED
IN CONNECTION THEREWITH, IN CLASS 41 (U.S.
CLS. 100, 101 AND 107).

FIRST USE 2-1-2007; IN COMMERCE 2-1-2007.

FOR: ALTERNATIVE DISPUTE RESOLUTION
SERVICES, NAMELY, CONFLICT PREVENTION,

MANAGEMENT AND SETTLEMENT SERVICES;
DESIGNING CONFLICT PREVENTION, MANAGE-
MENT AND SETTLEMENT METHODS, STRATE-
GIES AND PLANS FOR USE BY OTHERS AND
MANUALS DISTRIBUTED IN CONNECTION
THEREWITH, IN CLASS 45 (U.S. CLS. 100 AND 101).

FIRST USE 2-1-2007; IN COMMERCE 2-1-2007.

THE MARK CONSISTS OF STANDARD CHAR-
ACTERS WITHOUT CLAIM TO ANY PARTICULAR
FONT, STYLE, SIZE, OR COLOR.

SN 77-151,009, FILED 4-6-2007.

GIANCARLO CASTRO, EXAMINING ATTORNEY

Int. Cl.: 25

Prior U.S. Cls.: 22 and 39

United States Patent and Trademark Office

Reg. No. 3,576,920

Registered Feb. 17, 2009

TRADEMARK
PRINCIPAL REGISTER



LUXURY LANE (PENNSYLVANIA CORPORATION)
PO BOX 158
RIEGELSVILLE, PA 18077

FOR: CAMP SHIRTS; KNIT SHIRTS; POLO SHIRTS; BUTTON-FRONT ALOHA SHIRTS; SHORT-SLEEVED SHIRTS, IN CLASS 25 (U.S. CLS. 22 AND 39).

FIRST USE 1-0-2008; IN COMMERCE 1-0-2008.

THE COLOR(S) ORANGE, SKY BLUE, BLUE-GREEN, WHITE, AND PALE YELLOW IS/ARE CLAIMED AS A FEATURE OF THE MARK.

THE MARK CONSISTS OF "KOKOMO" TEXT IN STYLIZED FONT IN ORANGE COLOR, JUMPING DOLPHIN IN BLUE-GREEN COLOR WITH A WHITE UNDERSIDE, AND SKY BLUE WATER BELOW DOLPHIN, ALL BACKED BY PALE YELLOW BACKGROUND.

SN 77-151,161, FILED 4-6-2007.

ROBIN CHOSID, EXAMINING ATTORNEY

Int. Cl.: 31

Prior U.S. Cls.: 1 and 46

United States Patent and Trademark Office

Reg. No. 3,576,921

Registered Feb. 17, 2009

**TRADEMARK
PRINCIPAL REGISTER**

Healthy Tract

CARGILL, INCORPORATED (DELAWARE CORPORATION)

15407 MCGINTY ROAD WEST

WAYZATA, MN 55391

FOR: ANIMAL FEED, IN CLASS 31 (U.S. CLS. 1 AND 46).

FIRST USE 7-2-2008; IN COMMERCE 7-2-2008.

THE MARK CONSISTS OF STANDARD CHARACTERS WITHOUT CLAIM TO ANY PARTICULAR FONT, STYLE, SIZE, OR COLOR.

NO CLAIM IS MADE TO THE EXCLUSIVE RIGHT TO USE "HEALTHY", APART FROM THE MARK AS SHOWN.

SN 77-151,527, FILED 4-9-2007.

JANET LEE, EXAMINING ATTORNEY

Int. Cls.: 9, 35, 38, 39, 41, 42, and 45

Prior U.S. Cls.: 21, 23, 26, 36, 38, 100, 101, 102, 104, 105, and 107

Reg. No. 3,576,922

United States Patent and Trademark Office

Registered Feb. 17, 2009

**TRADEMARK
SERVICE MARK
PRINCIPAL REGISTER**



LATINO CELLULAR, LLC (FLORIDA LIMITED LIABILITY COMPANY)

SUITE 1180

550 BILTMORE WAY

CORAL GABLES, FL 33134

FOR: COMPUTER APPLICATION SOFTWARE FOR MOBILE PHONES; COMPUTER HARDWARE AND COMPUTER SOFTWARE PROGRAMS FOR THE INTEGRATION OF TEXT, AUDIO, GRAPHICS, STILL IMAGE AND MOVING PICTURES INTO AN INTERACTIVE DELIVERY FOR MULTIMEDIA APPLICATIONS; COMPUTER SOFTWARE FOR MANIPULATING DIGITAL AUDIO INFORMATION FOR USE IN AUDIO MEDIA APPLICATIONS; DIGITAL MATERIALS, NAMELY, DOWNLOADABLE FILES FEATURING MUSIC, FILMS, VIDEOS; DIGITAL MEDIA, NAMELY, DOWNLOADABLE FILES FEATURING AUDIO, VIDEO, MUSIC, FILM; DOWNLOADABLE MP3 FILES, MP3 RECORDINGS, ONLINE DISCUSSION BOARDS, WEB CASTS, POD CASTS FEATURING MUSIC, AUDIO BOOKS AND NEWS BROADCASTS; DOWNLOADABLE AUDIO FILES, MULTIMEDIA FILES, TEXT FILES, EMAILS, WRITTEN DOCUMENTS, AUDIO MATERIAL, VIDEO MATERIAL AND GAMES FEATURING INFORMATION IN THE FORM OF DOWNLOADABLE SHORT EDUCATIONAL/TRAINING COMMUNICATIONS IN THE FIELD OF HUMAN RESOURCE DEVELOPMENT FOR THE PROMOTION OF EMPLOYEE RETENTION, CAREER GROWTH AND INCREASED PRODUCTIVITY FOR EMPLOYEES AND EMPLOYERS; DOWNLOADABLE MULTIMEDIA FILE CONTAINING ARTWORK, TEXT, AUDIO, VIDEO, GAMES, AND INTERNET WEB LINKS RELATING TO ENTERTAINMENT; DOWNLOADABLE VIDEO RECORDINGS FEATURING MUSIC; ELECTRONIC

GAME SOFTWARE FOR CELLULAR TELEPHONES, IN CLASS 9 (U.S. CLS. 21, 23, 26, 36 AND 38).

FIRST USE 2-1-2007; IN COMMERCE 2-1-2007.

FOR: ON-LINE RETAIL STORE SERVICES FEATURING DOWNLOADABLE PRE-RECORDED MUSIC AND VIDEO, IN CLASS 35 (U.S. CLS. 100, 101 AND 102).

FIRST USE 2-1-2007; IN COMMERCE 2-1-2007.

FOR: COMMUNICATIONS SERVICES, NAMELY, TRANSMITTING STREAMED SOUND AND AUDIO-VISUAL RECORDINGS VIA THE INTERNET; MOBILE MEDIA SERVICES IN THE NATURE OF ELECTRONIC TRANSMISSION OF ENTERTAINMENT MEDIA CONTENT; STREAMING OF AUDIO MATERIAL ON THE INTERNET; STREAMING OF VIDEO MATERIAL ON THE INTERNET; WIRELESS COMMUNICATIONS SERVICES, NAMELY, TRANSMISSION OF GRAPHICS TO MOBILE TELEPHONES; WIRELESS DIGITAL MESSAGING SERVICES, IN CLASS 38 (U.S. CLS. 100, 101 AND 104).

FIRST USE 2-1-2007; IN COMMERCE 2-1-2007.

FOR: MOBILE MEDIA SERVICES IN THE NATURE OF STORAGE OF ENTERTAINMENT MEDIA CONTENT, IN CLASS 39 (U.S. CLS. 100 AND 105).

FIRST USE 2-1-2007; IN COMMERCE 2-1-2007.

FOR: ENTERTAINMENT SERVICES, NAMELY, NON-DOWNLOADABLE RINGTONES, PRE-RECORDED MUSIC, VIDEO AND GRAPHICS PRESENTED TO MOBILE COMMUNICATIONS

DEVICES VIA A GLOBAL COMPUTER NETWORK AND WIRELESS NETWORKS; ENTERTAINMENT SERVICES, NAMELY, PROVIDING A WEB SITE FEATURING MUSICAL PERFORMANCES, MUSICAL VIDEOS, RELATED FILM CLIPS, PHOTOGRAPHS, AND OTHER MULTIMEDIA MATERIALS; MOBILE MEDIA AND ENTERTAINMENT SERVICES IN THE NATURE OF CONTENT PREPARATION; MOBILE MEDIA AND ENTERTAINMENT SERVICES IN THE NATURE OF CONTENT PREPARATION, POST-PRODUCTION, IN CLASS 41 (U.S. CLS. 100, 101 AND 107).

FIRST USE 2-1-2007; IN COMMERCE 2-1-2007.

FOR: HOSTING OF DIGITAL CONTENT ON THE INTERNET, IN CLASS 42 (U.S. CLS. 100 AND 101).

FIRST USE 2-1-2007; IN COMMERCE 2-1-2007.

FOR: COMPUTER DATING SERVICES; DATING SERVICES; ONLINE SOCIAL NETWORKING SER-

VICES; PROVIDING AN INTERACTIVE WEBSITE FOR PERSONS TO LOCATE OTHER INDIVIDUALS WITH SIMILAR INTERESTS TO PARTICIPATE WITH THEM IN, OR ACCOMPANY THEM TO, EVENTS AND ACTIVITIES; WEB SITE SERVICES FEATURING ON-LINE DATING CLUB, IN CLASS 45 (U.S. CLS. 100 AND 101).

FIRST USE 2-1-2007; IN COMMERCE 2-1-2007.

THE MARK CONSISTS OF "LO2YO" IN BLOCK, GRAFFITI TYPE FONT.

THE FOREIGN WORDING IN THE MARK TRANSLATES INTO ENGLISH AS "YOUR THING, YOUR STUFF."

SN 77-151,691, FILED 4-9-2007.

MICHAEL KEATING, EXAMINING ATTORNEY

Int. Cl.: 7

Prior U.S. Cls.: 13, 19, 21, 23, 31, 34, and 35

Reg. No. 3,576,923

United States Patent and Trademark Office

Registered Feb. 17, 2009

**TRADEMARK
PRINCIPAL REGISTER**

ECO

FOUNTAIN INDUSTRIES COMPANY (MINNE-
SOTA CORPORATION)
922 EAST 14TH STREET
ALBERT LEA, MN 56007

FOR: TRASH COMPACTORS, IN CLASS 7 (U.S.
CLS. 13, 19, 21, 23, 31, 34 AND 35).

FIRST USE 11-27-2008; IN COMMERCE 11-27-2008.

THE MARK CONSISTS OF STANDARD CHAR-
ACTERS WITHOUT CLAIM TO ANY PARTICULAR
FONT, STYLE, SIZE, OR COLOR.

OWNER OF U.S. REG. NO. 3,183,799.

SN 77-151,815, FILED 4-9-2007.

TARAH HARDY, EXAMINING ATTORNEY

Int. Cls.: 7 and 11

Prior U.S. Cls.: 13, 19, 21, 23, 31, 34, and 35

United States Patent and Trademark Office

Reg. No. 3,576,924

Registered Feb. 17, 2009

**TRADEMARK
PRINCIPAL REGISTER**

Allergiene

LG ELECTRONICS INC. (REPUBLIC OF KOREA CORPORATION)
20, YOIDO-DONG, YONGDUNGPO-GU
SEOUL, REPUBLIC OF KOREA

FOR: WATER HEATERS AND STEAM GENERATORS DESIGNED TO REDUCE ALLERGENS AND KILL DUST MITES, SOLD AS AN INTEGRAL COMPONENT OF ELECTRIC CLOTHES WASHING MACHINES, ELECTRIC DISH WASHING MACHINES, STEAM LAUNDRY CLEANING MACHINES, STEAM DISH WASHING MACHINES, AND CLOTHES WASHING MACHINES THAT FEATURE A COMPONENT REMOTE MONITOR TO SENSE APPROPRIATE DETERGENT AND SUDS LEVELS, IN CLASS 7 (U.S. CLS. 13, 19, 21, 23, 31, 34 AND 35).

FIRST USE 6-0-2007; IN COMMERCE 6-0-2007.

FOR: WATER HEATERS AND STEAM GENERATORS DESIGNED TO REDUCE ALLERGENS AND KILL DUST MITES, SOLD AS AN INTEGRAL COMPONENT OF ELECTRIC LAUNDRY DRYERS AND GAS LAUNDRY DRYERS, IN CLASS 11 (U.S. CLS. 13, 21, 23, 31 AND 34).

FIRST USE 6-0-2007; IN COMMERCE 6-0-2007.

THE MARK CONSISTS OF STANDARD CHARACTERS WITHOUT CLAIM TO ANY PARTICULAR FONT, STYLE, SIZE, OR COLOR.

SN 77-151,856, FILED 4-9-2007.

JASON BLAIR, EXAMINING ATTORNEY

Int. Cl.: 11

Prior U.S. Cls.: 13, 21, 23, 31, and 34

United States Patent and Trademark Office

Reg. No. 3,576,925

Registered Feb. 17, 2009

**TRADEMARK
PRINCIPAL REGISTER**

Dream with the lights on

STUDIO ITALIA DESIGN USA, LLC (FLORIDA
LIMITED LIABILITY COMPANY)
1155 NW 159 TH DRIVE
MIAMI, FL 33169

FOR: ELECTRIC LIGHTING FIXTURES, NAME-
LY, SURFACE MOUNTED LIGHTING FIXTURES
IN THE NATURE OF WALL SCONCES, CEILING
MOUNTED OR SUSPENSION/PENDANTS AND
PORTABLE TABLE AND FLOOR LAMPS, IN CLASS
11 (U.S. CLS. 13, 21, 23, 31 AND 34).

FIRST USE 1-1-2004; IN COMMERCE 1-1-2004.

THE MARK CONSISTS OF STANDARD CHAR-
ACTERS WITHOUT CLAIM TO ANY PARTICULAR
FONT, STYLE, SIZE, OR COLOR.

SN 77-152,738, FILED 4-10-2007.

WILLIAM P. SHANAHAN, EXAMINING ATTOR-
NEY

Int. Cl.: 45

Prior U.S. Cls.: 100 and 101

United States Patent and Trademark Office

Reg. No. 3,576,926

Registered Feb. 17, 2009

**SERVICE MARK
PRINCIPAL REGISTER**

airlinefriends

DKAS LLC (PENNSYLVANIA LIMITED LIABILITY COMPANY)
P.O. BOX 5156
SPRINGFIELD, PA 19064

THE MARK CONSISTS OF STANDARD CHARACTERS WITHOUT CLAIM TO ANY PARTICULAR FONT, STYLE, SIZE, OR COLOR.

FOR: PROVIDING A WEBSITE FEATURING ON-LINE SOCIAL NETWORKING SERVICES FOR AIRLINE EMPLOYEES OF DIFFERENT AIRLINES, IN CLASS 45 (U.S. CLS. 100 AND 101).

SN 77-152,881, FILED 4-10-2007.

FIRST USE 9-1-2007; IN COMMERCE 12-14-2008.

CHRISTINA SOBRAL, EXAMINING ATTORNEY

Int. Cl.: 45

Prior U.S. Cls.: 100 and 101

United States Patent and Trademark Office

Reg. No. 3,576,927

Registered Feb. 17, 2009

**SERVICE MARK
PRINCIPAL REGISTER**

**MASTERCARD EXPERT
MONITORING SYSTEM**

MASTERCARD INTERNATIONAL INCORPORATED (DELAWARE CORPORATION)
LAW DEPARTMENT
2000 PURCHASE STREET
PURCHASE, NY 105772509

FOR: COMPUTERIZED FRAUD DETECTION AND EVALUATION SERVICES, INVOLVING THE PROVISION OF INFORMATION TO FINANCIAL INSTITUTIONS TO ACCESS DATA FROM PAYMENT CARD TRANSACTIONS FOR FRAUDULENT USES, IN CLASS 45 (U.S. CLS. 100 AND 101).

FIRST USE 1-0-2008; IN COMMERCE 1-0-2008.

THE MARK CONSISTS OF STANDARD CHARACTERS WITHOUT CLAIM TO ANY PARTICULAR FONT, STYLE, SIZE, OR COLOR.

OWNER OF U.S. REG. NOS. 2,856,769, 3,189,792, AND OTHERS.

NO CLAIM IS MADE TO THE EXCLUSIVE RIGHT TO USE "EXPERT MONITORING SYSTEM", APART FROM THE MARK AS SHOWN.

SN 77-153,167, FILED 4-10-2007.

STEPHEN AQUILA, EXAMINING ATTORNEY

Int. Cl.: 35

Prior U.S. Cls.: 100, 101, and 102

United States Patent and Trademark Office

Reg. No. 3,576,928

Registered Feb. 17, 2009

**SERVICE MARK
PRINCIPAL REGISTER**

COBRA LEGAL SOLUTIONS

COBRA LEGAL SOLUTIONS LLC (DELAWARE
LIMITED LIABILITY COMPANY)
C/O ALSTON & BIRD LLP
1201 W. PEACHTREE STREET
ATLANTA, GA 303093424

FOR: PROVIDING OFFICE SUPPORT STAFF
SERVICES, NAMELY, ADMINISTRATIVE AND
DOCUMENT REVIEW SERVICES TO CORPORATE
LAW DEPARTMENTS, LAW FIRMS, LAWYERS,
BUSINESS INSTITUTIONS, AND FINANCIAL IN-
STITUTIONS, IN CLASS 35 (U.S. CLS. 100, 101 AND
102).

FIRST USE 3-0-2007; IN COMMERCE 3-0-2007.

THE MARK CONSISTS OF STANDARD CHAR-
ACTERS WITHOUT CLAIM TO ANY PARTICULAR
FONT, STYLE, SIZE, OR COLOR.

NO CLAIM IS MADE TO THE EXCLUSIVE
RIGHT TO USE "LEGAL SOLUTIONS", APART
FROM THE MARK AS SHOWN.

SN 77-153,685, FILED 4-11-2007.

DANNEAN HETZEL, EXAMINING ATTORNEY

Int. Cl.: 41

Prior U.S. Cls.: 100, 101, and 107

United States Patent and Trademark Office

Reg. No. 3,576,929

Registered Feb. 17, 2009

**SERVICE MARK
PRINCIPAL REGISTER**

**IN THE NATION'S SERVICE
AND IN THE SERVICE OF ALL
NATIONS**

THE TRUSTEES OF PRINCETON UNIVERSITY
(NEW JERSEY NON-PROFIT CORPORATION)
4 NEW SOUTH BUILDING
PRINCETON, NJ 08544

FOR: EDUCATIONAL SERVICES, NAMELY,
PROVIDING INSTRUCTION AND TRAINING AT
THE UNDERGRADUATE, GRADUATE AND POST-
GRADUATE LEVELS; ENTERTAINMENT SERVI-
CES IN THE NATURE OF PRESENTATION OF A
VARIETY OF INTERCOLLEGIATE SPORTING
EVENTS, IN CLASS 41 (U.S. CLS. 100, 101 AND 107).

FIRST USE 12-10-2008; IN COMMERCE 12-10-2008.

THE MARK CONSISTS OF STANDARD CHAR-
ACTERS WITHOUT CLAIM TO ANY PARTICULAR
FONT, STYLE, SIZE, OR COLOR.

SN 77-154,258, FILED 4-11-2007.

DAVID MURRAY, EXAMINING ATTORNEY

Int. Cl.: 9

Prior U.S. Cls.: 21, 23, 26, 36, and 38

Reg. No. 3,576,930

United States Patent and Trademark Office

Registered Feb. 17, 2009

**TRADEMARK
PRINCIPAL REGISTER**



TIME MAP, LLC (NEW JERSEY LIMITED LIABILITY COMPANY)

25 MIDDLEBURY LANE, SUITE 9

WILLINGBORO, NJ 08046

FOR: AUTOMATED SYSTEMS CONSISTING OF COMPUTER SOFTWARE USED WITH WIRELESS COMMUNICATIONS DEVICES FOR PLANNING, SCHEDULING, CONTROLLING, MONITORING AND PROVIDING INFORMATION ON TRANSPORTATION ASSETS, IN CLASS 9 (U.S. CLS. 21, 23, 26, 36 AND 38).

FIRST USE 8-24-2008; IN COMMERCE 8-24-2008.

THE COLOR(S) BLACK, WHITE, GRAY AND RED IS/ARE CLAIMED AS A FEATURE OF THE MARK.

THE MARK CONSISTS OF A STOPWATCH OUTLINED IN BLACK WITH GRAY PUSH BUTTONS. THE FACE OF THE STOPWATCH IS BLACK AND OUTLINED WITH A WHITE CIRCLE. THE FACE CONTAINS A RED STAR OUTLINED IN WHITE WITH WHITE HOUR, MINUTE AND SECOND HANDS.

SN 77-154,924, FILED 4-12-2007.

MARIAM MAHMOUDI, EXAMINING ATTORNEY

Int. Cl.: 44

Prior U.S. Cls.: 100 and 101

United States Patent and Trademark Office

Reg. No. 3,576,931

Registered Feb. 17, 2009

**SERVICE MARK
PRINCIPAL REGISTER**

SMARTSCAPES

RIVERLAND PARTNERS, LLC (FLORIDA LIMITED LIABILITY COMPANY)
13005 PALM BEACH BOULEVARD
FT. MYERS, FL 33905

THE MARK CONSISTS OF STANDARD CHARACTERS WITHOUT CLAIM TO ANY PARTICULAR FONT, STYLE, SIZE, OR COLOR.

FOR: LANDSCAPE DESIGN AND GARDENING,
IN CLASS 44 (U.S. CLS. 100 AND 101).

SN 77-155,236, FILED 4-12-2007.

FIRST USE 6-6-2007; IN COMMERCE 7-13-2007.

COLLEEN DOMBROW, EXAMINING ATTORNEY

Int. Cl.: 11

Prior U.S. Cls.: 13, 21, 23, 31, and 34

United States Patent and Trademark Office

Reg. No. 3,576,932

Registered Feb. 17, 2009

**TRADEMARK
PRINCIPAL REGISTER**

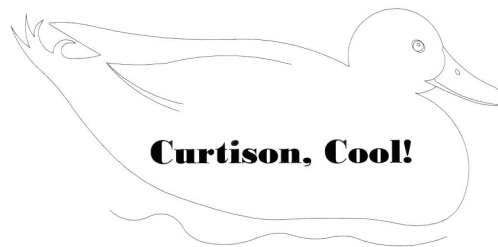

CURTISON INTERNATIONAL, INC. (TEXAS
CORPORATION)
3802 CANARY GRASS LN.
HOUSTON, TX 77059

FOR: CEILING FANS, ELECTRIC FANS, ELEC-
TRIC FANS FOR HOUSEHOLD PURPOSES, ELEC-
TRIC HEATING FANS, ELECTRIC WINDOW FANS,
PORTABLE ELECTRIC FANS, VENTILATING EX-
HAUST FANS, VENTILATING FANS FOR COM-

MERCIAL AND INDUSTRIAL USE, IN CLASS 11
(U.S. CLS. 13, 21, 23, 31 AND 34).

FIRST USE 5-5-2007; IN COMMERCE 4-0-2008.

SN 77-155,451, FILED 4-12-2007.

CHRISTINA SOBRAL, EXAMINING ATTORNEY

Int. Cls.: 25 and 45

Prior U.S. Cls.: 22, 39, 100, and 101

United States Patent and Trademark Office

Reg. No. 3,576,933

Registered Feb. 17, 2009

**TRADEMARK
SERVICE MARK
PRINCIPAL REGISTER**



DKAS LLC (PENNSYLVANIA LIMITED LIABILITY COMPANY)
P.O. BOX 5156
SPRINGFIELD, PA 19064

FOR: SHORT-SLEEVED T-SHIRTS, LONG-SLEEVED T-SHIRTS, AND BASEBALL CAPS, IN CLASS 25 (U.S. CLS. 22 AND 39).

FIRST USE 9-1-2007; IN COMMERCE 12-14-2008.

FOR: PROVIDING A WEBSITE FEATURING ONLINE SOCIAL NETWORKING SERVICES FOR AIRLINE EMPLOYEES OF DIFFERENT AIRLINES, IN CLASS 45 (U.S. CLS. 100 AND 101).

FIRST USE 9-1-2007; IN COMMERCE 12-14-2008.

THE COLOR(S) RED AND BLUE IS/ARE CLAIMED AS A FEATURE OF THE MARK.

THE MARK CONSISTS OF A STYLIZED LETTERING OF "AIRLINEFRIENDS.COM" AND A DIAGRAM OR A SKETCH OF AN AIRPLANE ON TOP OF THE LETTERING. THE WORD "AIRLINE" IS IN BLUE COLOR. THE TERM "FRIENDS.COM" IS IN RED COLOR. THE AIRPLANE IS ALSO IN BLUE COLOR.

SN 77-155,623, FILED 4-12-2007.

CHRISTINA SOBRAL, EXAMINING ATTORNEY

Int. Cl.: 42

Prior U.S. Cls.: 100 and 101

United States Patent and Trademark Office

Reg. No. 3,576,934

Registered Feb. 17, 2009

**SERVICE MARK
PRINCIPAL REGISTER**

DUARTE

DUARTE DESIGN, INC. (CALIFORNIA CORPORATION)
161 E. EVELYN AVE.
MOUNTAIN VIEW, CA 94041

FOR: COMPUTER-AIDED GRAPHIC ART DESIGN SERVICES, NAMELY, DESIGNING INTERACTIVE GRAPHIC ART AND MULTIMEDIA PRESENTATIONS FOR OTHERS, AND DESIGNING AND IMPLEMENTING NETWORK WEB PAGES FOR OTHERS, IN CLASS 42 (U.S. CLS. 100 AND 101).

FIRST USE 10-1-2007; IN COMMERCE 10-1-2007.

THE MARK CONSISTS OF STANDARD CHARACTERS WITHOUT CLAIM TO ANY PARTICULAR FONT, STYLE, SIZE, OR COLOR.

OWNER OF U.S. REG. NOS. 2,329,054 AND 2,613,648.

SEC. 2(F).

SN 77-155,654, FILED 4-12-2007.

ASMAT KHAN, EXAMINING ATTORNEY

Int. Cl.: 42

Prior U.S. Cls.: 100 and 101

United States Patent and Trademark Office

Reg. No. 3,576,935

Registered Feb. 17, 2009

**SERVICE MARK
PRINCIPAL REGISTER**



DUARTE DESIGN, INC. (CALIFORNIA CORPORATION)
161 E. EVELYN AVE.
MOUNTAIN VIEW, CA 94041

FOR: COMPUTER-AIDED GRAPHIC ART DESIGN SERVICES, NAMELY, DESIGNING INTERACTIVE GRAPHIC ART AND MULTIMEDIA PRESENTATIONS FOR OTHERS, AND DESIGNING AND IMPLEMENTING NETWORK WEB PAGES FOR OTHERS, IN CLASS 42 (U.S. CLS. 100 AND 101).

FIRST USE 10-1-2007; IN COMMERCE 10-1-2007.

OWNER OF U.S. REG. NOS. 2,329,054 AND 2,445,585.

THE MARK CONSISTS OF THE LETTER "D" APPEARING IN A CIRCLE IMAGE WITH A VERTICAL SLASH AND THE WORD "DUARTE" APPEARING TO ITS RIGHT.

SN 77-155,729, FILED 4-12-2007.

ASMAT KHAN, EXAMINING ATTORNEY

Int. Cl.: 28

Prior U.S. Cls.: 22, 23, 38, and 50

United States Patent and Trademark Office

Reg. No. 3,576,936

Registered Feb. 17, 2009

**TRADEMARK
PRINCIPAL REGISTER**

IMPACT WRAP

IMPACT GEL HOLDINGS (WISCONSIN LIMITED LIABILITY COMPANY)
204 N WASHINGTON
MELROSE, WI 54642

FOR: SPORTING GOODS, NAMELY, BASEBALL BATS, TENNIS RACQUETS, GOLF CLUBS, AND HOCKEY STICKS, IN CLASS 28 (U.S. CLS. 22, 23, 38 AND 50).

FIRST USE 5-30-2008; IN COMMERCE 5-30-2008.

THE MARK CONSISTS OF STANDARD CHARACTERS WITHOUT CLAIM TO ANY PARTICULAR FONT, STYLE, SIZE, OR COLOR.

NO CLAIM IS MADE TO THE EXCLUSIVE RIGHT TO USE "WRAP", APART FROM THE MARK AS SHOWN.

SN 77-155,857, FILED 4-13-2007.

ZACHARY BELLO, EXAMINING ATTORNEY

Int. Cl.: 16

Prior U.S. Cls.: 2, 5, 22, 23, 29, 37, 38, and 50

United States Patent and Trademark Office

Reg. No. 3,576,937

Registered Feb. 17, 2009

**TRADEMARK
PRINCIPAL REGISTER**

FLIP N' COLOR

RAPID DISPLAYS, INC. (ILLINOIS CORPORATION)
4300 WEST 47TH STREET
CHICAGO, IL 60632

FOR: ARTS AND CRAFT COLORING KIT COMPRISED OF SPIRAL BOUND NOTEBOOK CONTAINING LINE ART, PAPER WITH COLORANT, AND RUBBING STYLI, IN CLASS 16 (U.S. CLS. 2, 5, 22, 23, 29, 37, 38 AND 50).

FIRST USE 7-0-2007; IN COMMERCE 7-0-2007.

THE MARK CONSISTS OF STANDARD CHARACTERS WITHOUT CLAIM TO ANY PARTICULAR FONT, STYLE, SIZE, OR COLOR.

SN 77-155,874, FILED 4-13-2007.

RUSS HERMAN, EXAMINING ATTORNEY

Int. Cls.: 18, 24, and 25

Prior U.S. Cls.: 1, 2, 3, 22, 39, 41, 42, and 50

Reg. No. 3,576,938

United States Patent and Trademark Office

Registered Feb. 17, 2009

**TRADEMARK
PRINCIPAL REGISTER**

CELIA RACHEL

FAB INDUSTRIES CORP. (DELAWARE CORPORATION)
200 MADISON AVENUE
NEW YORK, NY 10016

FOR: BAGS, NAMELY, TOTE BAGS, TRAVEL BAGS, AND HAND BAGS, IN CLASS 18 (U.S. CLS. 1, 2, 3, 22 AND 41).

FIRST USE 7-19-2007; IN COMMERCE 7-19-2007.

FOR: BED SHEETS, COMFORTERS, BED BLANKETS, BABY AND CHILDREN'S BLANKETS, BABY AND CHILDREN'S SHEETS, DUST RUFFLES, PILLOW SHAMS, IN CLASS 24 (U.S. CLS. 42 AND 50).

FIRST USE 7-19-2007; IN COMMERCE 7-19-2007.

FOR: WOMEN'S APPAREL, NAMELY, TOPS, PANTS, CAPRIS, SKIRTS, DRESSES, SHRUGS, COVER-UPS, HOODIES, JACKETS, ATHLETIC SHORTS, ATHLETIC PANTS, ATHLETIC TOPS, T-SHIRTS, PAJAMA PANTS AND TOPS, NIGHTGOWNS, ROBES, CAMISOLES, TANK TOPS, PANTIES; MA-

TERNITY CLOTHES, NAMELY, TOPS, SKIRTS, PANTS, DRESSES, CAPRIS, PAJAMA PANTS AND TOPS, NIGHTGOWNS, ROBES; MEN'S APPAREL, NAMELY, ATHLETIC SHORTS, ATHLETIC PANTS, TOPS, T-SHIRTS; CHILDREN'S APPAREL, NAMELY, TOPS, PANTS, CAPRIS, SHORTS, SKIRTS, DRESSES, BASEBALL PANTS; HEADBANDS, SHAWLS, SCARVES; BABY BIBS NOT OF PAPER, IN CLASS 25 (U.S. CLS. 22 AND 39).

FIRST USE 7-19-2007; IN COMMERCE 7-19-2007.

THE MARK CONSISTS OF STANDARD CHARACTERS WITHOUT CLAIM TO ANY PARTICULAR FONT, STYLE, SIZE, OR COLOR.

THE NAME(S), PORTRAIT(S), AND/OR SIGNATURE(S) SHOWN IN THE MARK DOES NOT IDENTIFY A PARTICULAR LIVING INDIVIDUAL.

SN 77-155,923, FILED 4-13-2007.

RONALD DELGIZZI, EXAMINING ATTORNEY

Int. Cl.: 33

Prior U.S. Cls.: 47 and 49

United States Patent and Trademark Office

Reg. No. 3,576,939

Registered Feb. 17, 2009

**TRADEMARK
PRINCIPAL REGISTER**



CHATEAU LACAVE VINHOS FINOS LTDA.
(BRAZIL LIMITED LIABILITY COMPANY)
RIO GRANDE DO SUL
ESTRADA FEDERAL BR-116, S/Nº - KM 143
CAXIAS DO SUL, BRAZIL

FOR: WINES, IN CLASS 33 (U.S. CLS. 47 AND 49).

FIRST USE 8-31-2001; IN COMMERCE 1-31-2007.

NO CLAIM IS MADE TO THE EXCLUSIVE
RIGHT TO USE "CHATEAU LACAVE", APART
FROM THE MARK AS SHOWN.

THE ENGLISH TRANSLATION OF THE WORD-
ING "LA CAVE" IN THE MARK IS "THE CELLAR".

SN 77-155,980, FILED 4-13-2007.

CARRIE GENOVESE, EXAMINING ATTORNEY

Int. Cl.: 35

Prior U.S. Cls.: 100, 101, and 102

United States Patent and Trademark Office

Reg. No. 3,576,940

Registered Feb. 17, 2009

**SERVICE MARK
PRINCIPAL REGISTER**

Frumtha

HARLAN WHEELER (UNITED STATES INDIVIDUAL)
30802 MCCORMACK RIDGE ROAD
LAPWAI, ID 83540

THE MARK CONSISTS OF STANDARD CHARACTERS WITHOUT CLAIM TO ANY PARTICULAR FONT, STYLE, SIZE, OR COLOR.

FOR: RETAIL STORE AND ON-LINE RETAIL STORE SERVICES FEATURING CLOTHING, IN CLASS 35 (U.S. CLS. 100, 101 AND 102).

SN 77-157,231, FILED 4-16-2007.

FIRST USE 5-28-2007; IN COMMERCE 5-28-2007.

GEORGE LORENZO, EXAMINING ATTORNEY

Int. Cl.: 28

Prior U.S. Cls.: 22, 23, 38, and 50

United States Patent and Trademark Office

Reg. No. 3,576,941

Registered Feb. 17, 2009

**TRADEMARK
PRINCIPAL REGISTER**



RAVON INVEST, S.L. (SPAIN SOCIEDAD DE
RESPONSABILIDAD LIMITADA)
C/O JOSEP ENSELM CLAVE
91-93, 3^o, 2A
ESPLUGUES DE LIOBREGAT, SPAIN 08950

FOR: GYMNASTIC APPARATUS; ELLIPTICAL
EXERCISE MACHINES; MACHINES FOR PHYSI-
CAL EXERCISES; STATIONARY EXERCISE BI-
CYCLES; AND ROLLERS FOR STATIONARY
EXERCISE BICYCLES, IN CLASS 28 (U.S. CLS. 22,
23, 38 AND 50).

FIRST USE 4-7-2008; IN COMMERCE 4-7-2008.

NO CLAIM IS MADE TO THE EXCLUSIVE
RIGHT TO USE "INDOOR WALKING", APART
FROM THE MARK AS SHOWN.

THE COLOR(S) LIGHT BLUE AND DARK BLUE
IS/ARE CLAIMED AS A FEATURE OF THE MARK.

THE MARK CONSISTS OF THE WORDING "IN-
DOORWALKING" PLACED BELOW A STYLIZED
DEPICTION OF AN ELLIPTICAL EXERCISE APPA-
RATUS. THE COLOR DARK BLUE APPEARS IN
THE WORDING "INDOOR" AND IN THE DARKER
SHADED AREAS OF THE ELLIPTICAL MACHINE;
THE COLOR LIGHT BLUE APPEARS IN THE
WORDING "WALKING" AND THE LIGHTER SHA-
DED AREAS OF THE ELLIPTICAL MACHINE.

SN 77-157,253, FILED 4-16-2007.

MICHAEL GAAFAR, EXAMINING ATTORNEY

Int. Cls.: 35 and 41

Prior U.S. Cls.: 100, 101, 102, and 107

United States Patent and Trademark Office

Reg. No. 3,576,942

Registered Feb. 17, 2009

**SERVICE MARK
PRINCIPAL REGISTER**

LIVE MUSIC. HAND MADE.

ANSON VANCE LLC (DELAWARE LIMITED
LIABILITY COMPANY)
336 KING OF PRUSSIA ROAD
ST. DAVIDS, PA 19087

FOR: PROMOTING THE CONCERTS OF OTH-
ERS, IN CLASS 35 (U.S. CLS. 100, 101 AND 102).

FIRST USE 4-12-2007; IN COMMERCE 4-12-2007.

FOR: ENTERTAINMENT, NAMELY, LIVE MU-
SIC CONCERTS, IN CLASS 41 (U.S. CLS. 100, 101
AND 107).

FIRST USE 4-12-2007; IN COMMERCE 4-12-2007.

THE MARK CONSISTS OF STANDARD CHAR-
ACTERS WITHOUT CLAIM TO ANY PARTICULAR
FONT, STYLE, SIZE, OR COLOR.

NO CLAIM IS MADE TO THE EXCLUSIVE
RIGHT TO USE "LIVE MUSIC", APART FROM
THE MARK AS SHOWN.

SN 77-157,350, FILED 4-16-2007.

TRICIA SONNEBORN, EXAMINING ATTORNEY

Int. Cl.: 41

Prior U.S. Cls.: 100, 101, and 107

United States Patent and Trademark Office

Reg. No. 3,576,943

Registered Feb. 17, 2009

**SERVICE MARK
PRINCIPAL REGISTER**

DEFENDERS OF THE GAME

TAMPA BAY RAYS BASEBALL LTD. (FLORIDA
LIMITED PARTNERSHIP)
TROPICANA FIELD
TROPICANA DRIVE
ST. PETERSBURG, FL 33705

FOR: ENTERTAINMENT SERVICES IN THE
NATURE OF AN ONGOING ANIMATED SERIES
TO BE SHOWN IN A MAJOR LEAGUE BASEBALL
PARK, IN CLASS 41 (U.S. CLS. 100, 101 AND 107).

FIRST USE 5-20-2007; IN COMMERCE 5-20-2007.

THE MARK CONSISTS OF STANDARD CHAR-
ACTERS WITHOUT CLAIM TO ANY PARTICULAR
FONT, STYLE, SIZE, OR COLOR.

SN 77-157,623, FILED 4-16-2007.

LINDSEY RUBIN, EXAMINING ATTORNEY

Int. Cls.: 5, 9, 16, 21, and 24

Prior U.S. Cls.: 2, 5, 6, 13, 18, 21, 22, 23, 26, 29, 30, 33, 36, 37, 38, 40, 42, 44, 46, 50, 51, and 52

Reg. No. 3,576,944

United States Patent and Trademark Office

Registered Feb. 17, 2009

**TRADEMARK
PRINCIPAL REGISTER**

RAYSICS

W. R. RAYSON CO., INC. (NORTH CAROLINA CORPORATION)
720 S. DICKERSON ST.
BURGAW, NC 28425

FOR: ALL PURPOSE DISINFECTANT, IN CLASS 5 (U.S. CLS. 6, 18, 44, 46, 51 AND 52).

FIRST USE 7-1-2007; IN COMMERCE 7-1-2007.

FOR: PERSONAL PROTECTION KIT CONSISTING OF PROTECTIVE CLOTHING, NAMELY, COVERALLS AND BOOT COVERS, PROTECTIVE GLOVES FOR USE AT CRIME SCENES, SAFETY GOGGLES, PROTECTIVE ODOR AND DUST MASKS, POLYETHYLENE BIOHAZARD DISPOSAL BAGS TO STORE AND DISPOSE OF BIOHAZARD MATERIAL FOUND AT A CRIME SCENE, DISPOSABLE ANTI-MICROBIAL WIPES IMPREGNATED WITH CHEMICALS FOR USE AT A CRIME SCENE, SOLD AS A UNIT, IN CLASS 9 (U.S. CLS. 21, 23, 26, 36 AND 38).

FIRST USE 7-1-2007; IN COMMERCE 7-1-2007.

FOR: PAPER EVIDENCE BOXES, BARRIER PAPERS USED AS ENTRY INTO CRIME SCENES TO PREVENT CROSS CONTAMINATION, FINGERPRINT LIFT CARDS TO DOCUMENT FINGERPRINTS LIFTED AT A CRIME SCENE, EVIDENCE

MARKERS IN THE NATURE OF PAPER SIGNS TO MARK EVIDENCE AT A CRIME SCENE BEING PHOTOGRAPHED OR LOGGED, RULER PAPER TO ASSIST CRIME SCENE INVESTIGATORS WITH SCALE PHOTOGRAPHY DURING BLOOD SPLATTER RESTRICTIONS, IN CLASS 16 (U.S. CLS. 2, 5, 22, 23, 29, 37, 38 AND 50).

FIRST USE 7-1-2007; IN COMMERCE 7-1-2007.

FOR: DISPOSABLE LATEX AND NITRILE GLOVES FOR GENERAL USE, IN CLASS 21 (U.S. CLS. 2, 13, 23, 29, 30, 33, 40 AND 50).

FIRST USE 7-1-2007; IN COMMERCE 7-1-2007.

FOR: MYLAR BLANKETS, IN CLASS 24 (U.S. CLS. 42 AND 50).

FIRST USE 7-1-2007; IN COMMERCE 7-1-2007.

THE MARK CONSISTS OF STANDARD CHARACTERS WITHOUT CLAIM TO ANY PARTICULAR FONT, STYLE, SIZE, OR COLOR.

SN 77-158,476, FILED 4-17-2007.

DEZMONA MIZELLE, EXAMINING ATTORNEY

Int. Cl.: 35

Prior U.S. Cls.: 100, 101, and 102

United States Patent and Trademark Office

Reg. No. 3,576,945

Registered Feb. 17, 2009

**SERVICE MARK
PRINCIPAL REGISTER**

REWARD YOUR FASHION SENSE

LIMITED STORES LLC (DELAWARE LIMITED
LIABILITY COMPANY)
ATTN: SHENIA D. MIRACLE
THREE LIMITED PARKWAY
COLUMBUS, OH 43230

FOR: RETAIL STORE SERVICES FEATURING
CLOTHING; PROMOTING THE SALE OF CREDIT
CARD ACCOUNTS THROUGH THE ADMINISTRA-
TION OF INCENTIVE AWARD PROGRAMS AND
AWARDING PURCHASE POINTS FOR CREDIT
CARD USE, IN CLASS 35 (U.S. CLS. 100, 101 AND
102).

FIRST USE 7-31-2006; IN COMMERCE 7-31-2006.

THE MARK CONSISTS OF STANDARD CHAR-
ACTERS WITHOUT CLAIM TO ANY PARTICULAR
FONT, STYLE, SIZE, OR COLOR.

SN 77-159,196, FILED 4-18-2007.

JAY BESCH, EXAMINING ATTORNEY

Int. Cl.: 36

Prior U.S. Cls.: 100, 101, and 102

United States Patent and Trademark Office

Reg. No. 3,576,946

Registered Feb. 17, 2009

**SERVICE MARK
PRINCIPAL REGISTER**



WORLEY CLAIMS SERVICES, INC. (LOUISIANA
CORPORATION)
P.O. BOX 249
HAMMOND, LA 70404

FOR: PROPERTY AND CASUALTY CLAIMS AD-
JUSTING IN THE FIELD OF INSURANCE; INSUR-
ANCE CLAIMS ADMINISTRATION; INSURANCE
RISK MANAGEMENT, IN CLASS 36 (U.S. CLS. 100,
101 AND 102).

FIRST USE 6-1-1976; IN COMMERCE 6-1-1976.

OWNER OF U.S. REG. NOS. 2,260,589 AND
2,303,661.

SN 77-159,223, FILED 4-18-2007.

MICHELE SWAIN, EXAMINING ATTORNEY

Int. Cl.: 29

Prior U.S. Cl.: 46

United States Patent and Trademark Office

Reg. No. 3,576,947

Registered Feb. 17, 2009

**TRADEMARK
PRINCIPAL REGISTER**

NICO-NICO NORI

NICO-NICO NORI INC. (JAPAN CORPORATION)
NANIWA-KU 3-23, SHIKITSUHIGASHI 3-CHOME
OSAKA-SHI, OSAKA-FU, JAPAN

FOR: TOASTED LAVER, FLAVORED TOASTED
LAVER, IN CLASS 29 (U.S. CL. 46).

FIRST USE 7-1-2008; IN COMMERCE 7-0-2008.

THE MARK CONSISTS OF STANDARD CHAR-
ACTERS WITHOUT CLAIM TO ANY PARTICULAR
FONT, STYLE, SIZE, OR COLOR.

NO CLAIM IS MADE TO THE EXCLUSIVE
RIGHT TO USE "NORI", APART FROM THE MARK
AS SHOWN.

THE ENGLISH TRANSLATION OF THE WORD-
ING "NICO-NICO" IN THE MARK IS SMILE AND
HAPPY.

SN 77-159,827, FILED 4-18-2007.

KATHERINE CHANG, EXAMINING ATTORNEY

Int. Cl.: 30

Prior U.S. Cl.: 46

United States Patent and Trademark Office

Reg. No. 3,576,948

Registered Feb. 17, 2009

**TRADEMARK
PRINCIPAL REGISTER**



ANHING CORPORATION (CALIFORNIA COR-
PORATION)
418 NORTH AVENUE 19
LOS ANGELES, CA 90031

THE MARK CONSISTS OF A WINKING BOY IN
SHORTS.

FOR: RICE CRACKERS, IN CLASS 30 (U.S. CL. 46).

SN 77-159,971, FILED 4-18-2007.

FIRST USE 7-14-2008; IN COMMERCE 8-1-2008.

ROBERT C. CLARK JR., EXAMINING ATTORNEY

Int. Cl.: 35

Prior U.S. Cls.: 100, 101, and 102

United States Patent and Trademark Office

Reg. No. 3,576,949

Registered Feb. 17, 2009

**SERVICE MARK
PRINCIPAL REGISTER**



THE
LOLLIPOP TREE

THE LOLLIPOP TREE, INC. (COLORADO CORPORATION)
1600 LONG GROVE DRIVE, #124
MT. PLEASANT, SC 29464

PLANS, CHILDREN'S TOYS, SKIN CARE PRODUCTS, PET ACCESSORIES, STATIONARY ITEMS AND GARDEN ACCESSORIES, IN CLASS 35 (U.S. CLS. 100, 101 AND 102).

FOR: RETAIL AND ONLINE RETAIL STORE SERVICES FEATURING ARTWORK, ARCHITECTURAL ITEMS, CHILDREN'S FURNITURE AND ACCESSORIES, CHILDREN'S CLOTHING, CHILDREN'S PLAYHOUSES AND PLAYHOUSE DESIGN PLANS, DOG HOUSES AND DOG HOUSE DESIGN

FIRST USE 1-6-2009; IN COMMERCE 1-6-2009.

SN 77-160,181, FILED 4-18-2007.

LAURIE MAYES, EXAMINING ATTORNEY

Int. Cl.: 18

Prior U.S. Cls.: 1, 2, 3, 22, and 41

United States Patent and Trademark Office

Reg. No. 3,576,950

Registered Feb. 17, 2009

**TRADEMARK
PRINCIPAL REGISTER**



GKP GROUP LLC (NEW JERSEY LIMITED LIABILITY COMPANY)
6 VAN ALLEN PLACE
POMPTON PLAINS, NJ 07444

FOR: HANDBAGS, IN CLASS 18 (U.S. CLS. 1, 2, 3, 22 AND 41).

FIRST USE 5-1-2007; IN COMMERCE 5-1-2007.

NO CLAIM IS MADE TO THE EXCLUSIVE RIGHT TO USE "BAGS", APART FROM THE MARK AS SHOWN.

THE COLOR(S) BLACK AND TAN PANTONE NUMBER NO. 465U IS/ARE CLAIMED AS A FEATURE OF THE MARK.

THE MARK CONSISTS OF BLACK CAPITALIZED LETTERING WITH BOTTOM PART OF "S" WRAPPING AROUND NAME TO FORM A RECTANGULAR OUTLINE; BACKGROUND COLOR IS TAN PANTONE NUMBER NO. 465U.

SN 77-160,187, FILED 4-18-2007.

DORITT L. CARROLL, EXAMINING ATTORNEY

Int. Cl.: 12

Prior U.S. Cls.: 19, 21, 23, 31, 35, and 44

United States Patent and Trademark Office

Reg. No. 3,576,951

Registered Feb. 17, 2009

**TRADEMARK
PRINCIPAL REGISTER**

MADE IN AMERICANA

DESALVO, MICHAEL (UNITED STATES INDIVIDUAL)
UNIT C
2873 S. SHARI AVE
YUMA, AZ 85365

THE MARK CONSISTS OF STANDARD CHARACTERS WITHOUT CLAIM TO ANY PARTICULAR FONT, STYLE, SIZE, OR COLOR.

FOR: MOTORCYCLES, IN CLASS 12 (U.S. CLS. 19, 21, 23, 31, 35 AND 44).

SN 77-161,093, FILED 4-19-2007.

FIRST USE 8-3-2004; IN COMMERCE 2-20-2008.

JAY FLOWERS, EXAMINING ATTORNEY

Int. Cl.: 29

Prior U.S. Cl.: 46

United States Patent and Trademark Office

Reg. No. 3,576,952

Registered Feb. 17, 2009

**TRADEMARK
PRINCIPAL REGISTER**

CANYON CUT

THE INVENTURE GROUP, INC. (DELAWARE
CORPORATION)
3500 S. LA COMETA DRIVE
GOODYEAR, AZ 85338

THE MARK CONSISTS OF STANDARD CHAR-
ACTERS WITHOUT CLAIM TO ANY PARTICULAR
FONT, STYLE, SIZE, OR COLOR.

FOR: POTATO CHIPS, IN CLASS 29 (U.S. CL. 46).

SN 77-161,160, FILED 4-19-2007.

FIRST USE 6-1-2007; IN COMMERCE 6-1-2007.

BERYL GARDNER, EXAMINING ATTORNEY

Int. Cl.: 16

Prior U.S. Cls.: 2, 5, 22, 23, 29, 37, 38, and 50

Reg. No. 3,576,953

United States Patent and Trademark Office

Registered Feb. 17, 2009

**TRADEMARK
PRINCIPAL REGISTER**



FAMILY MANAGER, INC. (TENNESSEE CORPORATION)
4504 BRIAR OAKS CIRCLE
DALLAS, TX 75287

FOR: SERIES OF NON-FICTION BOOKS IN THE FIELD OF LIFESTYLE TOPICS; PROPERTY MANAGEMENT BOOKS; INTERIOR DESIGN BOOKS; BOOKS DIRECTED TO HOME MANAGEMENT; HOME REPAIR BOOKS; FINANCE AND BUDGET BOOKS; YARD CARE BOOKS; GARDENING BOOKS; BOOKS DIRECTED TO ENTERTAINMENT ACTIVITIES; TRAVEL BOOKS; DATE BOOKS; PARENTING AND CHILD RAISING BOOKS; MARRIAGE INFORMATION BOOKS; BOOKS IN THE FIELD OF COMMUNICATION SKILLS; MEDICAL REFERENCE BOOKS; NUTRITION BOOKS; BOOKS DIRECTED TO ETIQUETTE AND SOCIAL SKILLS; BOOKS DIRECTED TO SELF DEVELOPMENT; BOOKS DIRECTED TO WARDROBE MANAGE-

MENT; BOOKS DIRECTED TO BEAUTY ENHANCEMENT; BOOKS AND WORKBOOKS DIRECTED TO FITNESS; BOOKS AND WORKBOOKS DIRECTED TO DEVOTIONAL ISSUES; BOOKS AND WORKBOOKS DIRECTED TO TIME MANAGEMENT; FAMILY BUSINESS GUIDES; CALENDARS; HOME SCHOOL EDUCATION MANUALS; MANUALS IN THE FIELD OF PERSONAL EVALUATION AND GOAL SETTING; COOKBOOKS; MAGAZINES IN THE FIELD OF LIFESTYLE TOPICS; NEWSLETTERS IN THE FIELD OF LIFESTYLE TOPICS, IN CLASS 16 (U.S. CLS. 2, 5, 22, 23, 29, 37, 38 AND 50).

FIRST USE 6-30-2007; IN COMMERCE 6-30-2007.

SN 77-161,277, FILED 4-19-2007.

LINDA ORNDORFF, EXAMINING ATTORNEY

Int. Cl.: 44

Prior U.S. Cls.: 100 and 101

United States Patent and Trademark Office

Reg. No. 3,576,954

Registered Feb. 17, 2009

**SERVICE MARK
PRINCIPAL REGISTER**



UHS OF DELAWARE, INC. (DELAWARE CORPORATION)
367 SOUTH GULPH ROAD
KING OF PRUSSIA, PA 19406

FOR: MEDICAL IMAGING SERVICES, IN CLASS 44 (U.S. CLS. 100 AND 101).

FIRST USE 3-0-2007; IN COMMERCE 3-0-2007.

NO CLAIM IS MADE TO THE EXCLUSIVE RIGHT TO USE "WOMEN'S IMAGING CENTER" AND "HEALTHCARE SYSTEM", APART FROM THE MARK AS SHOWN.

THE MARK CONSISTS OF A BLACK BOX WITH AN OPEN END AND A LINE GOING TO THE CENTER OF THE BOX; A SWIRLING RIBBON WITH DOTS AT THE END OF THE RIBBON; ALL TO THE LEFT OF THE WORDS "THE WOMEN'S IMAGING CENTER AT NORTHWEST TEXAS HEALTHCARE SYSTEM".

SEC. 2(F) AS TO "NORTHWEST TEXAS".

SN 77-161,567, FILED 4-20-2007.

WILLIAM ROSSMAN, EXAMINING ATTORNEY

Int. Cl.: 4

Prior U.S. Cls.: 1, 6, and 15

United States Patent and Trademark Office

Reg. No. 3,576,955

Registered Feb. 17, 2009

**TRADEMARK
PRINCIPAL REGISTER**

PROPEL

PROPEL BIOFUELS, INC. (WASHINGTON CORPORATION)
4444 WOODLAND PARK AVE NORTH, SUITE 101
SEATTLE, WA 98103

THE MARK CONSISTS OF STANDARD CHARACTERS WITHOUT CLAIM TO ANY PARTICULAR FONT, STYLE, SIZE, OR COLOR.

FOR: FUEL FOR MOTOR VEHICLES, NAMELY, BIODIESEL; FUELS, IN CLASS 4 (U.S. CLS. 1, 6 AND 15).

SN 77-162,181, FILED 4-20-2007.

FIRST USE 10-10-2007; IN COMMERCE 12-1-2008.

JENNIFER VASQUEZ, EXAMINING ATTORNEY

Int. Cl.: 4

Prior U.S. Cls.: 1, 6, and 15

United States Patent and Trademark Office

Reg. No. 3,576,956

Registered Feb. 17, 2009

**TRADEMARK
PRINCIPAL REGISTER**

FUELING CHANGE

PROPEL BIOFUELS, INC. (WASHINGTON CORPORATION)
4444 WOODLAND PARK AVE NORTH, SUITE 101
SEATTLE, WA 98103

THE MARK CONSISTS OF STANDARD CHARACTERS WITHOUT CLAIM TO ANY PARTICULAR FONT, STYLE, SIZE, OR COLOR.

FOR: FUEL FOR MOTOR VEHICLES, NAMELY, BIODIESEL; FUELS, IN CLASS 4 (U.S. CLS. 1, 6 AND 15).

SN 77-162,259, FILED 4-20-2007.

FIRST USE 10-10-2007; IN COMMERCE 12-1-2008.

JENNIFER VASQUEZ, EXAMINING ATTORNEY

Int. Cls.: 18 and 21

Prior U.S. Cls.: 1, 2, 3, 13, 22, 23, 29, 30, 33, 40, 41, and 50

Reg. No. 3,576,957

United States Patent and Trademark Office

Registered Feb. 17, 2009

**TRADEMARK
PRINCIPAL REGISTER**



COLUMBIA SPORTSWEAR NORTH AMERICA,
INC. (OREGON CORPORATION)
14375 NW SCIENCE PARK DRIVE
PORTLAND, OR 97229

OWNER OF U.S. REG. NOS. 2,117,710, 3,095,747,
AND OTHERS.

FOR: CLOTHING FOR DOMESTIC PETS; ANI-
MAL LEASHES; COLLARS FOR PETS, IN CLASS 18
(U.S. CLS. 1, 2, 3, 22 AND 41).

NO CLAIM IS MADE TO THE EXCLUSIVE
RIGHT TO USE "SPORTSWEAR COMPANY",
APART FROM THE MARK AS SHOWN.

FIRST USE 2-0-2008; IN COMMERCE 2-0-2008.

THE MARK CONSISTS OF A WOVEN DIAMOND
DESIGN FOLLOWED BY THE WORDS "COLUM-
BIA" OVER "SPORTSWEAR COMPANY".

FOR: PET FEEDING DISHES, IN CLASS 21 (U.S.
CLS. 2, 13, 23, 29, 30, 33, 40 AND 50).

SN 77-163,007, FILED 4-23-2007.

FIRST USE 2-0-2008; IN COMMERCE 2-0-2008.

MICHAEL KEATING, EXAMINING ATTORNEY

Int. Cl.: 10

Prior U.S. Cls.: 26, 39, and 44

Reg. No. 3,576,958

United States Patent and Trademark Office

Registered Feb. 17, 2009

**TRADEMARK
PRINCIPAL REGISTER**

CHAMELEON

SPINEFRONTIER, INC. (DELAWARE CORPORATION)
100 CUMMINGS CENTER, SUITE 3500
BEVERLY, MA 01915

THE MARK CONSISTS OF STANDARD CHARACTERS WITHOUT CLAIM TO ANY PARTICULAR FONT, STYLE, SIZE, OR COLOR.

FOR: ORTHOPEDIC SPINAL IMPLANTS AND ORTHOPEDIC INSTRUMENTS TO FACILITATE THE IMPLANTATION OF ORTHOPEDIC SPINAL IMPLANTS, IN CLASS 10 (U.S. CLS. 26, 39 AND 44).

SN 77-163,937, FILED 4-24-2007.

FIRST USE 3-31-2008; IN COMMERCE 3-31-2008.

RENEE MCCRAY, EXAMINING ATTORNEY

Int. Cls.: 35 and 39

Prior U.S. Cls.: 100, 101, 102, and 105

United States Patent and Trademark Office

Reg. No. 3,576,959

Registered Feb. 17, 2009

**SERVICE MARK
PRINCIPAL REGISTER**

DPI SPECIALTY FOODS

DISTRIBUTION PLUS, INC. (DELAWARE CORPORATION)
SUITE 314
1007 CHURCH STREET
EVANSTON, IL 60201

FOR: WHOLESALE DISTRIBUTORSHIP SERVICES FEATURING SPECIALTY FOODS, DAIRY PRODUCTS AND DRY GOODS, IN CLASS 35 (U.S. CLS. 100, 101 AND 102).

FIRST USE 7-28-2008; IN COMMERCE 7-28-2008.

FOR: WAREHOUSE STORAGE SERVICES, IN CLASS 39 (U.S. CLS. 100 AND 105).

FIRST USE 7-28-2008; IN COMMERCE 7-28-2008.

THE MARK CONSISTS OF STANDARD CHARACTERS WITHOUT CLAIM TO ANY PARTICULAR FONT, STYLE, SIZE, OR COLOR.

OWNER OF U.S. REG. NO. 1,779,242.

NO CLAIM IS MADE TO THE EXCLUSIVE RIGHT TO USE "SPECIALTY FOODS", APART FROM THE MARK AS SHOWN.

SN 77-164,132, FILED 4-24-2007.

MELISSA VALLILLO, EXAMINING ATTORNEY

Int. Cls.: 16, 35, 40, and 45

Prior U.S. Cls.: 2, 5, 22, 23, 29, 37, 38, 50, 100, 101, 102, 103, and 106

Reg. No. 3,576,960

United States Patent and Trademark Office

Registered Feb. 17, 2009

**TRADEMARK
SERVICE MARK
PRINCIPAL REGISTER**

HARLAND CLARKE

HARLAND CLARKE CORP. (DELAWARE CORPORATION)
10931 LAUREATE DRIVE
SAN ANTONIO, TX 78249

FOR: BANK CHECKS; CHECKBOOK COVERS; ADDRESS LABELS; RUBBER STAMPS; CATALOGS FEATURING BANK CHECKS; PRINTED DEPOSIT ENVELOPES; PERSONAL ORGANIZERS; PRINTED DEPOSIT TICKETS AND SLIPS, IN CLASS 16 (U.S. CLS. 2, 5, 22, 23, 29, 37, 38 AND 50).

FIRST USE 5-10-2007; IN COMMERCE 5-10-2007.

FOR: WHOLESALE DISTRIBUTORSHIP AND RETAIL ORDERING SERVICES FEATURING CHECKS; COMPUTERIZED CHECK COSTS PRICING ANALYSIS SERVICES; AND DEMOGRAPHIC CONSULTATION SERVICES RENDERED TO FINANCIAL INSTITUTIONS; MAIL ORDER SERVICES IN THE FIELD OF BANK CHECKS, IN CLASS 35 (U.S. CLS. 100, 101 AND 102).

FIRST USE 5-10-2007; IN COMMERCE 5-10-2007.

FOR: CUSTOM IMPRINTING BANK CHECKS TO THE ORDER AND SPECIFICATIONS OF OTHERS IN THE FINANCIAL INSTITUTION TRADE; CUSTOM PRINTING SERVICES TO THE ORDER AND SPECIFICATION OF BANKS, CREDIT UNIONS

AND OTHER FINANCIAL INSTITUTIONS FEATURING A TEMPORARY SUPPLY OF CHECKS, DEPOSIT SLIPS, ATM CARD AND PIN MAILER, IN CLASS 40 (U.S. CLS. 100, 103 AND 106).

FIRST USE 5-10-2007; IN COMMERCE 5-10-2007.

FOR: SECURITY PRINTING SERVICES, NAMELY, CUSTOMIZING PRINTED MATERIALS BY INCORPORATING AND ENCODING ANTI-FRAUD, ANTI-COUNTERFEITING AND SECURITY FEATURES ONTO PRINTED MATERIALS SUCH AS CHECKS, FORMS, DOCUMENTS AND THE LIKE, IN CLASS 45 (U.S. CLS. 100 AND 101).

FIRST USE 5-10-2007; IN COMMERCE 5-10-2007.

THE MARK CONSISTS OF STANDARD CHARACTERS WITHOUT CLAIM TO ANY PARTICULAR FONT, STYLE, SIZE, OR COLOR.

THE NAME(S), PORTRAIT(S), AND/OR SIGNATURE(S) SHOWN IN THE MARK DOES NOT IDENTIFY A PARTICULAR LIVING INDIVIDUAL.

SN 77-164,469, FILED 4-24-2007.

ELISSA GARBER KON, EXAMINING ATTORNEY

Int. Cl.: 34

Prior U.S. Cls.: 2, 8, 9, and 17

United States Patent and Trademark Office

Reg. No. 3,576,961

Registered Feb. 17, 2009

**TRADEMARK
PRINCIPAL REGISTER**

REPOSADO 96

CIGARS INTERNATIONAL, INC. (DELAWARE
CORPORATION)
6771 CHRISPALT DRIVE
BATH, PA 18014

FOR: CIGARS, IN CLASS 34 (U.S. CLS. 2, 8, 9 AND
17).

FIRST USE 12-5-2008; IN COMMERCE 12-5-2008.

THE MARK CONSISTS OF STANDARD CHAR-
ACTERS WITHOUT CLAIM TO ANY PARTICULAR
FONT, STYLE, SIZE, OR COLOR.

THE FOREIGN WORDING IN THE MARK
TRANSLATES INTO ENGLISH AS RESTED.

SN 77-164,511, FILED 4-24-2007.

THEODORE MCBRIDE, EXAMINING ATTORNEY

Int. Cls.: 16 and 41

Prior U.S. Cls.: 2, 5, 22, 23, 29, 37, 38, 50, 100, 101, and 107

Reg. No. 3,576,962

United States Patent and Trademark Office

Registered Feb. 17, 2009

**TRADEMARK
SERVICE MARK
PRINCIPAL REGISTER**

CORR

THE ASSOCIATION OF BONE AND JOINT SUR-
GEONS (OKLAHOMA CORPORATION)
6300 NORTH RIVER ROAD, SUITE 727
ROSEMONT, IL 60018

FOR: PRINTED MATERIAL, NAMELY, JOUR-
NALS, ARTICLES, REPRINTS OF ARTICLES FEAT-
URING INFORMATION IN THE FIELD OF
ORTHOPAEDIC MEDICINE, IN CLASS 16 (U.S.
CLS. 2, 5, 22, 23, 29, 37, 38 AND 50).

FIRST USE 6-0-1999; IN COMMERCE 6-0-1999.

FOR: PROVIDING ONLINE PUBLICATIONS,
NAMELY, JOURNALS, ARTICLES AND REPRINTS

OF ARTICLES FEATURING INFORMATION IN
THE FIELD OF ORTHOPAEDIC MEDICINE, IN
CLASS 41 (U.S. CLS. 100, 101 AND 107).

FIRST USE 6-0-1999; IN COMMERCE 6-0-1999.

THE MARK CONSISTS OF STANDARD CHAR-
ACTERS WITHOUT CLAIM TO ANY PARTICULAR
FONT, STYLE, SIZE, OR COLOR.

SN 77-164,608, FILED 4-24-2007.

TRACY WHITTAKER-BROWN, EXAMINING AT-
TORNEY

Int. Cl.: 44

Prior U.S. Cls.: 100 and 101

United States Patent and Trademark Office

Reg. No. 3,576,963

Registered Feb. 17, 2009

**SERVICE MARK
PRINCIPAL REGISTER**

**The G-Lift by John R.
Gilmore M.D.**

GILMORE, JOHN R. (UNITED STATES INDIVIDUAL)
8230 WALNUT HILL LN. SUITE 308
DALLAS, TX 75220

FOR: SURGERY SERVICES, NAMELY, INVASIVE FACE LIFT SERVICES USING SUTURES IN THE SMAS (SUBMUSCULAR APONEUROTIC SYSTEM, CONNECTIVE TISSUE DEEP TO THE SKIN THAT SUPPORT THE STRUCTURES OF THE FACE) TO ACHIEVE THE DESIRED LIFTING EFFECT, IN CLASS 44 (U.S. CLS. 100 AND 101).

FIRST USE 8-1-2007; IN COMMERCE 8-1-2007.

THE MARK CONSISTS OF STANDARD CHARACTERS WITHOUT CLAIM TO ANY PARTICULAR FONT, STYLE, SIZE, OR COLOR.

SN 77-164,748, FILED 4-24-2007.

KIMBERLY PERRY, EXAMINING ATTORNEY

Int. Cl.: 5

Prior U.S. Cls.: 6, 18, 44, 46, 51, and 52

Reg. No. 3,576,964

United States Patent and Trademark Office

Registered Feb. 17, 2009

**TRADEMARK
PRINCIPAL REGISTER**

MUSCLE ASYLUM PROJECT

IML US TRADEMARK LTD. (CANADA CORPORATION)

5100 SPECTRUM WAY

MISSISSAUGA, ONTARIO, CANADA L4W5S2

FOR: DIETARY SUPPLEMENTS, IN CLASS 5 (U.S. CLS. 6, 18, 44, 46, 51 AND 52).

FIRST USE 8-0-2007; IN COMMERCE 8-0-2007.

THE MARK CONSISTS OF STANDARD CHARACTERS WITHOUT CLAIM TO ANY PARTICULAR FONT, STYLE, SIZE, OR COLOR.

NO CLAIM IS MADE TO THE EXCLUSIVE RIGHT TO USE "MUSCLE", APART FROM THE MARK AS SHOWN.

SN 77-165,002, FILED 4-25-2007.

MARK SPARACINO, EXAMINING ATTORNEY

Int. Cl.: 36

Prior U.S. Cls.: 100, 101, and 102

United States Patent and Trademark Office

Reg. No. 3,576,965

Registered Feb. 17, 2009

**SERVICE MARK
PRINCIPAL REGISTER**

TRUEBRIDGE CAPITAL PARTNERS

TRUEBRIDGE CAPITAL PARTNERS LLC (DE-
LAWARE LIMITED LIABILITY COMPANY)
2530 MERIDIAN PARKWAY
SUITE 200
DURHAM, NC 22713

FOR: FINANCIAL SERVICES IN THE FIELDS OF VENTURE CAPITAL FUNDS, GROWTH EQUITY FUNDS, AND PRIVATE EQUITY FUNDS; ASSET MANAGEMENT, NAMELY, INVESTMENT MANAGEMENT OF VENTURE CAPITAL, GROWTH EQUITY, BUYOUTS, HEDGE FUNDS, PUBLIC AND PRIVATE EQUITIES, REAL ESTATE, ENERGY AND REAL ASSETS INVESTMENTS, FIXED INCOME, AND CASH; INVESTMENT AND BROKERAGE SERVICES; FUND MANAGEMENT SERVICES, IN CLASS 36 (U.S. CLS. 100, 101 AND 102).

FIRST USE 5-0-2007; IN COMMERCE 5-0-2007.

THE MARK CONSISTS OF STANDARD CHARACTERS WITHOUT CLAIM TO ANY PARTICULAR FONT, STYLE, SIZE, OR COLOR.

NO CLAIM IS MADE TO THE EXCLUSIVE RIGHT TO USE "CAPITAL PARTNERS", APART FROM THE MARK AS SHOWN.

SN 77-165,116, FILED 4-25-2007.

RAUL CORDOVA, EXAMINING ATTORNEY

Int. Cl.: 5

Prior U.S. Cls.: 6, 18, 44, 46, 51, and 52

Reg. No. 3,576,966

United States Patent and Trademark Office

Registered Feb. 17, 2009

**TRADEMARK
PRINCIPAL REGISTER**

OsteoWrap

BACTERIN INTERNATIONAL, INC (NEVADA
CORPORATION)
600 CRUISER LANE
BELGRADE, MT 59714

THE MARK CONSISTS OF STANDARD CHAR-
ACTERS WITHOUT CLAIM TO ANY PARTICULAR
FONT, STYLE, SIZE, OR COLOR.

FOR: BIOLOGICAL DEMINERALIZED CORTI-
CAL BONE TISSUE INTENDED FOR SUBSEQUENT
IMPLANTATION; HUMAN ALLOGRAFT TISSUE,
IN CLASS 5 (U.S. CLS. 6, 18, 44, 46, 51 AND 52).

SN 77-165,553, FILED 4-25-2007.

FIRST USE 9-27-2005; IN COMMERCE 1-18-2006.

WENDY GOODMAN, EXAMINING ATTORNEY

Int. Cl.: 10

Prior U.S. Cls.: 26, 39, and 44

United States Patent and Trademark Office

Reg. No. 3,576,967

Registered Feb. 17, 2009

**TRADEMARK
PRINCIPAL REGISTER**

Elutia

BACTERIN INTERNATIONAL, INC. (NEVADA
CORPORATION)
600 CRUISER LANE
BELGRADE, MT 59714

THE MARK CONSISTS OF STANDARD CHAR-
ACTERS WITHOUT CLAIM TO ANY PARTICULAR
FONT, STYLE, SIZE, OR COLOR.

FOR: WOUND DRAINAGE APPARATUS; DRAI-
NAGE APPLIANCES FOR SURGICAL PROCE-
DURES; WOUND SUCTION APPARATUS, IN
CLASS 10 (U.S. CLS. 26, 39 AND 44).

SN 77-165,588, FILED 4-25-2007.

FIRST USE 3-0-2006; IN COMMERCE 6-30-2008.

WENDY GOODMAN, EXAMINING ATTORNEY

Int. Cl.: 25

Prior U.S. Cls.: 22 and 39

United States Patent and Trademark Office

Reg. No. 3,576,968

Registered Feb. 17, 2009

TRADEMARK
PRINCIPAL REGISTER



GAUDET, GINA LYNN (UNITED STATES INDIVIDUAL)
6 SOUTH HAMPTON ROAD
AMESBURY, MA 01913

FOR: CHILDREN'S CLOTHING FOR GIRLS, NAMELY, DRESSES, PANTS, T-SHIRTS, SHIRTS, SKIRTS, SHORTS, CAPRI PANTS, JACKETS, VESTS, TANK TOPS, CAMISOLES, TOPS, AND KERCHIEFS, IN CLASS 25 (U.S. CLS. 22 AND 39).

FIRST USE 7-31-2007; IN COMMERCE 7-31-2007.

THE NAME(S), PORTRAIT(S), AND/OR SIGNATURE(S) SHOWN IN THE MARK DOES NOT IDENTIFY A PARTICULAR LIVING INDIVIDUAL.

THE COLOR(S) RED AND WHITE IS/ARE CLAIMED AS A FEATURE OF THE MARK.

THE MARK CONSISTS OF THE WORD "JANE" IN LOWERCASE WHITE SCRIPT LETTERS, HAVING A WHITE FLOWER SHAPE IN PLACE OF THE DOT ON THE FIRST LETTER "J", ALL WITH A RED RECTANGULAR BACKGROUND.

SN 77-166,113, FILED 4-26-2007.

ARETHA SOMERVILLE, EXAMINING ATTORNEY

Int. Cl.: 1

Prior U.S. Cls.: 1, 5, 6, 10, 26, and 46

Reg. No. 3,576,969

United States Patent and Trademark Office

Registered Feb. 17, 2009

**TRADEMARK
PRINCIPAL REGISTER**

SET-XP

SIMPSON STRONG-TIE COMPANY, INC. (CALIFORNIA CORPORATION)
5956 W. LAS POSITAS BLVD.
PLEASANTON, CA 94588

FOR: EPOXY-BASED ADHESIVES FOR CONSTRUCTION, PARTICULARLY FOR USE WITH CONCRETE, IN CLASS 1 (U.S. CLS. 1, 5, 6, 10, 26 AND 46).

FIRST USE 6-23-2008; IN COMMERCE 6-23-2008.

THE MARK CONSISTS OF STANDARD CHARACTERS WITHOUT CLAIM TO ANY PARTICULAR FONT, STYLE, SIZE, OR COLOR.

THE WORDING "XP" HAS NO MEANING IN ENGLISH.

SN 77-166,273, FILED 4-26-2007.

ELI HELLMAN, EXAMINING ATTORNEY

Int. Cl.: 5

Prior U.S. Cls.: 6, 18, 44, 46, 51, and 52

Reg. No. 3,576,970

United States Patent and Trademark Office

Registered Feb. 17, 2009

**TRADEMARK
PRINCIPAL REGISTER**

Naturopathic Alternatives

NATUROPATHIC ALTERNATIVES LLC (NEVADA LIMITED LIABILITY COMPANY)
1722 N. COLLEGE, STE. C #122
FAYETTEVILLE, AR 72703

FOR: HOMEOPATHIC PHARMACEUTICALS FOR USE IN THE TREATMENT OF A WIDE VARIETY OF EVERYDAY AILMENTS, NAMELY, COLIC, COUGH, COLDS, DIARRHEA CONSTIPATION, GAS, ASTHMA, ECZEMA, EARACHE, TEE-THING, TOENAIL FUNGUS, ANXIETY, ATTENTION DEFICIT DISORDER, DEPRESSION, WEIGHT LOSS, MENOPAUSE, STRESS, INSOMNIA, CONJUNCTIVITIS, ALLERGIES, PAIN, ARTHRITIS, BACKACHE, FEVER, FATIGUE, HEADACHE, MIGRAINE, INDIGESTION, PREMENSTRUAL SYNDROME, RESTLESSNESS, SINUSITIS, SORE THROAT AND WATER RETENTION, IN INFANTS,

CHILDREN AND ADULTS; HOMEOPATHIC SUPPLEMENTS, IN CLASS 5 (U.S. CLS. 6, 18, 44, 46, 51 AND 52).

FIRST USE 11-1-2007; IN COMMERCE 11-1-2007.

THE MARK CONSISTS OF STANDARD CHARACTERS WITHOUT CLAIM TO ANY PARTICULAR FONT, STYLE, SIZE, OR COLOR.

NO CLAIM IS MADE TO THE EXCLUSIVE RIGHT TO USE "NATUROPATHIC", APART FROM THE MARK AS SHOWN.

SN 77-166,613, FILED 4-26-2007.

BRIAN CALLAGHAN, EXAMINING ATTORNEY

Int. Cl.: 35

Prior U.S. Cls.: 100, 101, and 102

United States Patent and Trademark Office

Reg. No. 3,576,971

Registered Feb. 17, 2009

**SERVICE MARK
PRINCIPAL REGISTER**

AUTOTARGET

ZANSHIN (CALIFORNIA CORPORATION), DBA
IPOST,
60 GALLI DRIVE, SUITE T
NOVATO, CA 94949

FOR: PROCESSING DATA FOR OTHERS; ANALYZING DATA FOR OTHERS; REPORTING OR DISPLAYING DATA ONLINE FOR OTHERS; PROVIDING A WEBSITE FOR ACCESSING DATA; PROVIDING A WEBSITE FOR INTERACTING WITH DATA; ALL OF THE FOREGOING SERVICES IN THE FIELD OF MARKETING ANALYTICS, IN CLASS 35 (U.S. CLS. 100, 101 AND 102).

FIRST USE 10-27-2006; IN COMMERCE 10-27-2006.

THE MARK CONSISTS OF STANDARD CHARACTERS WITHOUT CLAIM TO ANY PARTICULAR FONT, STYLE, SIZE, OR COLOR.

SN 77-167,558, FILED 4-27-2007.

MATTHEW PAPPAS, EXAMINING ATTORNEY

Int. Cls.: 36 and 41

Prior U.S. Cls.: 100, 101, 102, and 107

United States Patent and Trademark Office

Reg. No. 3,576,972

Registered Feb. 17, 2009

**SERVICE MARK
PRINCIPAL REGISTER**



MATHILE INSTITUTE FOR THE ADVANCE-
MENT OF HUMAN NUTRITION (OHIO
NON-PROFIT CORPORATION)
SUITE 200
6450 SAND LAKE ROAD
DAYTON, OH 45414

FOR: PHILANTHROPIC AND CHARITABLE SER-
VICES, NAMELY, FINANCIALLY SUPPORTING
NUTRITIONAL EDUCATION PROGRAMS, PRO-
DUCTS AND INFORMATION TO OVERCOME
MALNUTRITION OF THE WORLD'S CHILDREN
AND THEIR FAMILIES, IN CLASS 36 (U.S. CLS. 100,
101 AND 102).

FIRST USE 4-0-2007; IN COMMERCE 4-0-2007.

FOR: EDUCATIONAL SERVICES FOR PHILAN-
THROPIC AND CHARITABLE PURPOSES, NAME-

LY, DEVELOPING A CURRICULUM FOR OTHERS
IN THE FIELD OF NUTRITIONAL EDUCATION
PROGRAMS WITH A FOCUS ON OVERCOMING
MALNUTRITION OF THE WORLD'S CHILDREN
AND THEIR FAMILIES, IN CLASS 41 (U.S. CLS. 100,
101 AND 107).

FIRST USE 4-0-2007; IN COMMERCE 4-0-2007.

THE MARK CONSISTS OF A GEOMETRIC DE-
SIGN CONTAINING THE STYLIZED FIGURES OF
A MOTHER AND CHILDREN.

SN 77-167,696, FILED 4-27-2007.

LYDIA BELZER, EXAMINING ATTORNEY

Int. Cls.: 16 and 41

Prior U.S. Cls.: 2, 5, 22, 23, 29, 37, 38, 50, 100, 101, and 107

Reg. No. 3,576,973

United States Patent and Trademark Office

Registered Feb. 17, 2009

**TRADEMARK
SERVICE MARK
PRINCIPAL REGISTER**



WALSH, ROSEMARIE, A. (UNITED STATES INDIVIDUAL)

20 HAMILTON LANE

HUNTINGTON, NY 11743 AND

GINNETTY, CAROLE M. (UNITED STATES INDIVIDUAL)

9 MARK DRIVE

SMITHTOWN, NY 11787

FOR: A PORTABLE EIGHT-POCKET PAPER FOLDER FOR ORGANIZING COLLEGE APPLICATION PROCESS INFORMATION AND MATERIALS, IN CLASS 16 (U.S. CLS. 2, 5, 22, 23, 29, 37, 38 AND 50).

FIRST USE 11-29-2007; IN COMMERCE 11-29-2007.

FOR: PROVIDING INFORMATION AND GUIDANCE IN THE COLLEGE APPLICATION PROCESS, IN CLASS 41 (U.S. CLS. 100, 101 AND 107).

FIRST USE 12-10-2008; IN COMMERCE 12-10-2008.

NO CLAIM IS MADE TO THE EXCLUSIVE RIGHT TO USE "ORGANIZER", APART FROM THE MARK AS SHOWN.

THE MARK CONSISTS OF "C.A.P. ORGANIZER" IN A DIAMOND-SHAPED BOX WITH BORDER ON THE TWO RIGHT-HAND SIDES.

SN 77-167,847, FILED 4-27-2007.

ANTHONY RINKER, EXAMINING ATTORNEY

Int. Cls.: 16 and 41

Prior U.S. Cls.: 2, 5, 22, 23, 29, 37, 38, 50, 100, 101, and 107

Reg. No. 3,576,974

United States Patent and Trademark Office

Registered Feb. 17, 2009

**TRADEMARK
SERVICE MARK
PRINCIPAL REGISTER**

C.A.P. ORGANIZER

WALSH, ROSEMARIE A. (UNITED STATES INDIVIDUAL)

20 HAMILTON LANE

HUNTINGTON, NY 11743 AND

GINNETTY, CAROLE M. (UNITED STATES INDIVIDUAL)

9 MARK DRIVE

SMITHTOWN, NY 11787

FOR: A PORTABLE EIGHT-POCKET PAPER FOLDER FOR ORGANIZING COLLEGE APPLICATION PROCESS INFORMATION AND MATERIALS, IN CLASS 16 (U.S. CLS. 2, 5, 22, 23, 29, 37, 38 AND 50).

FIRST USE 11-29-2007; IN COMMERCE 11-29-2007.

FOR: PROVIDING INFORMATION AND GUIDANCE IN THE COLLEGE APPLICATION PROCESS, IN CLASS 41 (U.S. CLS. 100, 101 AND 107).

FIRST USE 12-10-2008; IN COMMERCE 12-10-2008.

THE MARK CONSISTS OF STANDARD CHARACTERS WITHOUT CLAIM TO ANY PARTICULAR FONT, STYLE, SIZE, OR COLOR.

NO CLAIM IS MADE TO THE EXCLUSIVE RIGHT TO USE "ORGANIZER", APART FROM THE MARK AS SHOWN.

SN 77-168,090, FILED 4-27-2007.

ANTHONY RINKER, EXAMINING ATTORNEY

Int. Cl.: 9

Prior U.S. Cls.: 21, 23, 26, 36, and 38

Reg. No. 3,576,975

United States Patent and Trademark Office

Registered Feb. 17, 2009

**TRADEMARK
PRINCIPAL REGISTER**

THE SINGING BEE

THE GURIN COMPANY (CALIFORNIA CORPORATION)
SUITE 303
11846 VENTURA BLVD
STUDIO CITY, CA 91604 AND
JUMA ENTERTAINMENT, LLC (PENNSYLVANIA LIMITED LIABILITY COMPANY)
SUITE 409
3800 BARHAM BOULEVARD
LOS ANGELES, CA 90068

FOR: VIDEO GAME DISCS, VIDEO GAME CARTRIDGES, VIDEO GAME SOFTWARE, PRERECORDED CDS, DVDS, VIDEO DISCS, AND AUDIO AND VIDEO CASSETTES FEATURING TELEVISION SHOWS, GAME SHOWS AND SINGING COMPETI-

TIONS; DOWNLOADABLE RING TONES, GRAPHICS AND MUSIC VIA THE INTERNET AND WIRELESS DEVICES; KARAOKE PLAYERS, IN CLASS 9 (U.S. CLS. 21, 23, 26, 36 AND 38).

FIRST USE 10-1-2007; IN COMMERCE 10-1-2007.

THE MARK CONSISTS OF STANDARD CHARACTERS WITHOUT CLAIM TO ANY PARTICULAR FONT, STYLE, SIZE, OR COLOR.

SN 77-168,161, FILED 4-27-2007.

THEODORE MCBRIDE, EXAMINING ATTORNEY

Int. Cl.: 28

Prior U.S. Cls.: 22, 23, 38, and 50

United States Patent and Trademark Office

Reg. No. 3,576,976

Registered Feb. 17, 2009

**TRADEMARK
PRINCIPAL REGISTER**

THE SINGING BEE

THE GURIN COMPANY (CALIFORNIA CORPORATION)
SUITE 303
11846 VENTURA BLVD
STUDIO CITY, CA 91604 AND
JUMA ENTERTAINMENT, LLC (PENNSYLVANIA LIMITED LIABILITY COMPANY)
SUITE 409
3800 BARHAM BOULEVARD
LOS ANGELES, CA 90068

FOR: TOYS, NAMELY, PLUSH TOYS, STUFFED TOY ANIMALS, MUSICAL TOYS, COLLECTABLE TOY FIGURES, BOARD GAMES, CARD GAMES, HAND-HELD UNITS FOR PLAYING VIDEO

GAMES, TABLETOP UNITS FOR PLAYING ELECTRONIC GAMES OTHER THAN IN CONJUNCTION WITH A TELEVISION OR COMPUTER, IN CLASS 28 (U.S. CLS. 22, 23, 38 AND 50).

FIRST USE 10-1-2007; IN COMMERCE 10-1-2007.

THE MARK CONSISTS OF STANDARD CHARACTERS WITHOUT CLAIM TO ANY PARTICULAR FONT, STYLE, SIZE, OR COLOR.

SN 77-168,168, FILED 4-27-2007.

THEODORE MCBRIDE, EXAMINING ATTORNEY

Int. Cl.: 38

Prior U.S. Cls.: 100, 101, and 104

United States Patent and Trademark Office

Reg. No. 3,576,977

Registered Feb. 17, 2009

**SERVICE MARK
PRINCIPAL REGISTER**

THE SINGING BEE

THE GURIN COMPANY (CALIFORNIA CORPORATION)
SUITE 303
11846 VENTURA BLVD
STUDIO CITY, CA 91604 AND
JUMA ENTERTAINMENT, LLC (PENNSYLVANIA LIMITED LIABILITY COMPANY)
SUITE 409
3800 BARHAM BOULEVARD
LOS ANGELES, CA 90068

FOR: STREAMING OF VIDEO AND AUDIO CONTENT ON THE INTERNET; MOBILE MEDIA SERVICES IN THE NATURE OF ELECTRONIC

TRANSMISSION OF ENTERTAINMENT MEDIA CONTENT, IN CLASS 38 (U.S. CLS. 100, 101 AND 104).

FIRST USE 7-10-2007; IN COMMERCE 7-10-2007.

THE MARK CONSISTS OF STANDARD CHARACTERS WITHOUT CLAIM TO ANY PARTICULAR FONT, STYLE, SIZE, OR COLOR.

SN 77-168,172, FILED 4-27-2007.

THEODORE MCBRIDE, EXAMINING ATTORNEY

Int. Cl.: 28

Prior U.S. Cls.: 22, 23, 38, and 50

United States Patent and Trademark Office

Reg. No. 3,576,978

Registered Feb. 17, 2009

**TRADEMARK
PRINCIPAL REGISTER**

MY LIL' VET

J.C. TOYS GROUP, INC. (FLORIDA CORPORATION)

9590 N.W. 40 STREET ROAD

MIAMI, FL 33178

FOR: DOLLS AND PLAYSETS THEREFOR, IN CLASS 28 (U.S. CLS. 22, 23, 38 AND 50).

FIRST USE 10-0-2007; IN COMMERCE 10-0-2007.

THE MARK CONSISTS OF STANDARD CHARACTERS WITHOUT CLAIM TO ANY PARTICULAR FONT, STYLE, SIZE, OR COLOR.

NO CLAIM IS MADE TO THE EXCLUSIVE RIGHT TO USE "VET", APART FROM THE MARK AS SHOWN.

SN 77-168,773, FILED 4-30-2007.

STEVEN R. FOSTER, EXAMINING ATTORNEY

Int. Cl.: 5

Prior U.S. Cls.: 6, 18, 44, 46, 51, and 52

Reg. No. 3,576,979

United States Patent and Trademark Office

Registered Feb. 17, 2009

**TRADEMARK
PRINCIPAL REGISTER**

TAM

MEDIQUEST THERAPEUTICS, INC. (WASHING-
TON CORPORATION)
22322 20TH AVENUE SE, SUITE 100
BOTHELL, WA 98021

FOR: DRUG DELIVERY AGENTS CONSISTING
OF MICROEMULSION FORMULATIONS THAT
FACILITATE THE DELIVERY OF PHARMACEUTI-
CAL AGENTS TO THE SKIN, NAILS, AND HAIR , IN
CLASS 5 (U.S. CLS. 6, 18, 44, 46, 51 AND 52).

FIRST USE 10-6-2008; IN COMMERCE 10-6-2008.

THE MARK CONSISTS OF STANDARD CHAR-
ACTERS WITHOUT CLAIM TO ANY PARTICULAR
FONT, STYLE, SIZE, OR COLOR.

SN 77-168,835, FILED 4-30-2007.

CHRISTINA SOBRAL, EXAMINING ATTORNEY

Int. Cl.: 10

Prior U.S. Cls.: 26, 39, and 44

United States Patent and Trademark Office

Reg. No. 3,576,980

Registered Feb. 17, 2009

**TRADEMARK
PRINCIPAL REGISTER**

CLINIC IN A CASE

MILOVICH, JOHN (UNITED STATES INDIVIDUAL)
73 BROADMOOR CIRCLE
ORMOND BEACH, FL 32174

FOR: HAND-HELD AND TABLE-TOP BATTERY POWERED THERAPY DEVICE CONSISTING OF PRE-GELLED TREATMENT PADS AND APPLICATION PROBE WITH COTTON SWAB ON END, FOR TREATING PAIN, PHYSICAL REHABILITATION AND ANTI-AGING TREATMENTS, IN CLASS 10 (U.S. CLS. 26, 39 AND 44).

FIRST USE 5-15-1997; IN COMMERCE 1-5-2007.

THE MARK CONSISTS OF STANDARD CHARACTERS WITHOUT CLAIM TO ANY PARTICULAR FONT, STYLE, SIZE, OR COLOR.

SN 77-168,982, FILED 4-30-2007.

VIVIAN MICZNIK FIRST, EXAMINING ATTORNEY

Int. Cl.: 9

Prior U.S. Cls.: 21, 23, 26, 36, and 38

United States Patent and Trademark Office

Reg. No. 3,576,981

Registered Feb. 17, 2009

**TRADEMARK
PRINCIPAL REGISTER**

ESSENTIALS BY A·B·S

AQUARIUS RAGS, LLC (CALIFORNIA LIMITED
LIABILITY COMPANY)
1231 LONG BEACH AVENUE
LOS ANGELES, CA 90021

FOR: EYEGLOSS FRAMES; SUNGLASSES, IN
CLASS 9 (U.S. CLS. 21, 23, 26, 36 AND 38).

FIRST USE 8-0-2007; IN COMMERCE 8-0-2007.

THE MARK CONSISTS OF STANDARD CHAR-
ACTERS WITHOUT CLAIM TO ANY PARTICULAR
FONT, STYLE, SIZE, OR COLOR.

OWNER OF U.S. REG. NOS. 2,228,025 AND
3,231,509.

SN 77-169,552, FILED 5-1-2007.

CHERYL CLAYTON, EXAMINING ATTORNEY

Int. Cl.: 4

Prior U.S. Cls.: 1, 6, and 15

United States Patent and Trademark Office

Reg. No. 3,576,982

Registered Feb. 17, 2009

**TRADEMARK
PRINCIPAL REGISTER**

VIESEL

COOKE'S ENVIRONMENTAL SERVICES, INC.
(FLORIDA CORPORATION)
3100 SE WAALER STREET
STUART, FL 34997

THE MARK CONSISTS OF STANDARD CHAR-
ACTERS WITHOUT CLAIM TO ANY PARTICULAR
FONT, STYLE, SIZE, OR COLOR.

FOR: ALTERNATIVE FUEL FOR MOTOR VEHI-
CLES, NAMELY, VEGETABLE BASED BIOFUELS,
IN CLASS 4 (U.S. CLS. 1, 6 AND 15).

SN 77-170,176, FILED 5-1-2007.

FIRST USE 5-1-2007; IN COMMERCE 11-1-2007.

KELLEY WELLS, EXAMINING ATTORNEY

Int. Cl.: 5

Prior U.S. Cls.: 6, 18, 44, 46, 51, and 52

United States Patent and Trademark Office

Reg. No. 3,576,983

Registered Feb. 17, 2009

**TRADEMARK
PRINCIPAL REGISTER**

CARB ONE

SAFE AT THE PLATE! LTD. (NEW YORK CORPORATION)
531 WAVERLY AVENUE
BROOKLYN, NY 11230

FOR: CAKES, CONFECTIONERY, AND PREPARED DIETARY ITEMS THAT ARE GLUTEN-FREE TO ACCOMMODATE SPECIAL MEDICAL AND HEALTH CONDITIONS; FOOD FOR DIABETICS, IN CLASS 5 (U.S. CLS. 6, 18, 44, 46, 51 AND 52).

FIRST USE 2-1-2008; IN COMMERCE 2-6-2008.

THE MARK CONSISTS OF STANDARD CHARACTERS WITHOUT CLAIM TO ANY PARTICULAR FONT, STYLE, SIZE, OR COLOR.

SN 77-170,727, FILED 5-2-2007.

KARANENDRA S. CHHINA, EXAMINING ATTORNEY

Int. Cl.: 9

Prior U.S. Cls.: 21, 23, 26, 36, and 38

Reg. No. 3,576,984

United States Patent and Trademark Office

Registered Feb. 17, 2009

**TRADEMARK
PRINCIPAL REGISTER**

SEG-MARK

OPTICTOOLS, LLC (UTAH LIMITED LIABILITY
COMPANY)
1476 W. 10400 S.
SOUTH JORDAN, UT 84095

THE MARK CONSISTS OF STANDARD CHAR-
ACTERS WITHOUT CLAIM TO ANY PARTICULAR
FONT, STYLE, SIZE, OR COLOR.

FOR: TEMPORARY, PLASTIC OPHTHALMIC
LENSES FOR USE IN CUSTOM FITTING OF SPEC-
TACLES AND SUNGLASSES, IN CLASS 9 (U.S. CLS.
21, 23, 26, 36 AND 38).

SN 77-171,003, FILED 5-2-2007.

FIRST USE 4-0-2008; IN COMMERCE 4-0-2008.

BERYL GARDNER, EXAMINING ATTORNEY

Int. Cl.: 44

Prior U.S. Cls.: 100 and 101

United States Patent and Trademark Office

Reg. No. 3,576,985

Registered Feb. 17, 2009

**SERVICE MARK
PRINCIPAL REGISTER**

HAELEN

HAELEN HYPERBARICS, LLC (SOUTH CAROLINA LIMITED LIABILITY COMPANY)
200 MERCHANT STREET
HILTON HEAD ISLAND, SC 29926

FOR: LEASING OF HYPERBARIC MEDICAL EQUIPMENT WITH ONGOING MAINTENANCE OF THE EQUIPMENT AND TRAINING PERSONNEL TO OPERATE THE EQUIPMENT, IN CLASS 44 (U.S. CLS. 100 AND 101).

FIRST USE 7-1-2008; IN COMMERCE 7-1-2008.

THE MARK CONSISTS OF STANDARD CHARACTERS WITHOUT CLAIM TO ANY PARTICULAR FONT, STYLE, SIZE, OR COLOR.

SN 77-171,028, FILED 5-2-2007.

ALICE SUE CARRUTHERS, EXAMINING ATTORNEY

Int. Cl.: 16

Prior U.S. Cls.: 2, 5, 22, 23, 29, 37, 38, and 50

United States Patent and Trademark Office

Reg. No. 3,576,986

Registered Feb. 17, 2009

TRADEMARK
PRINCIPAL REGISTER



CARDENAS, LUIS A (FLORIDA INDIVIDUAL)
4353 W. WATERS AVE.
TAMPA, FL 33614 AND
CARDENAS, ALEIDA (FLORIDA INDIVIDUAL)
4353 W. WATERS AVE.
TAMPA, FL 33614

FOR: MAGAZINE SERVING THE HISPANIC MARKET FEATURING INFORMATION REGARDING REAL ESTATE, SALES AND REPAIRS OF COMPUTERS AND AUTOMOBILES, COUPONS AND ADVERTISING, CONSUMER GOODS AND SERVICES, EMPLOYMENT OPPORTUNITIES, PERSONAL MESSAGES, ANNOUNCEMENTS OF MISSING PERSONS, IMMIGRATION INFORMATION AND SOCIAL EVENTS, IN CLASS 16 (U.S. CLS. 2, 5, 22, 23, 29, 37, 38 AND 50).

FIRST USE 6-1-2007; IN COMMERCE 6-1-2007.

NO CLAIM IS MADE TO THE EXCLUSIVE RIGHT TO USE "EL PARLANTE LATINO" AND "ELPARLANTE LATINO.COM" AND "MAGAZINE", APART FROM THE MARK AS SHOWN.

THE COLOR(S) BLACK, YELLOW, WHITE AND RED IS/ARE CLAIMED AS A FEATURE OF THE MARK.

THE MARK CONSISTS OF "EL PARLANTE LATINO MAGAZINE" IN BLACK, THE BACKGROUND IS YELLOW AND BLACK, THE BEE IS YELLOW AND BLACK WITH WHITE GLOVES AND SHOES AND THE WORDING "ALGUIEN BUSCA LO QUE USTED TIENE" IS IN YELLOW AND THE WORDING "...ALGUIEN TIENE LO QUE USTED BUSCA" AND "WWW.ELPARLANTELATINO.COM" IS IN BLACK. THE MAGAZINE PAGE IS WHITE WITH BLACK AND RED LETTERING.

THE FOREIGN WORDING IN THE MARK TRANSLATES INTO ENGLISH AS THE LATINO SPEAKER SOMEONE'S LOOKING FOR WHAT YOU HAVE... SOMEONE HAS WHAT YOU'RE LOOKING FOR.

SN 77-171,037, FILED 5-2-2007.

SCOTT BIBB, EXAMINING ATTORNEY

Int. Cl.: 44

Prior U.S. Cls.: 100 and 101

United States Patent and Trademark Office

Reg. No. 3,576,987

Registered Feb. 17, 2009

**SERVICE MARK
PRINCIPAL REGISTER**



HAELEN HYPERBARICS, LLC (SOUTH CAROLINA LIMITED LIABILITY COMPANY)
200 MERCHANT STREET
HILTON HEAD ISLAND, SC 29926

FOR: LEASING OF HYPERBARIC MEDICAL EQUIPMENT WITH ONGOING MAINTENANCE OF THE EQUIPMENT AND TRAINING PERSONNEL TO OPERATE THE EQUIPMENT, IN CLASS 44 (U.S. CLS. 100 AND 101).

FIRST USE 7-1-2008; IN COMMERCE 7-1-2008.

THE MARK CONSISTS OF TWO UPPER CASE LETTER "H'S", ONE OVER THE OTHER, SURROUNDED BY A REPRESENTATION OF A CIRCULAR CHAMBER AND NAUTICAL COMPASS DIRECTIONAL POINTS.

SN 77-171,048, FILED 5-2-2007.

ALICE SUE CARRUTHERS, EXAMINING ATTORNEY

Int. Cls.: 41 and 43

Prior U.S. Cls.: 100, 101, and 107

United States Patent and Trademark Office

Reg. No. 3,576,988

Registered Feb. 17, 2009

SERVICE MARK
PRINCIPAL REGISTER

The logo for MotorCity Casino Hotel features the word "MotorCity" in a stylized, cursive script. Below it, the words "CASINO HOTEL" are written in a smaller, all-caps, sans-serif font. The entire logo is underlined.

DETROIT ENTERTAINMENT, L.L.C. (MICHIGAN LIMITED LIABILITY COMPANY)
2901 GRAND RIVER
DETROIT, MI 48201

FOR: CASINO SERVICES; ENTERTAINMENT SERVICES, NAMELY LIVE PERFORMANCES FEATURING LIVE AND RECORDED MUSIC, PRERECORDED VIDEO, VARIETY SHOWS, SINGERS, DANCERS, MAGICIANS, ACTORS, ACROBATS, AND COMEDIANS, IN CLASS 41 (U.S. CLS. 100, 101 AND 107).

FIRST USE 7-31-2007; IN COMMERCE 7-31-2007.

FOR: RESTAURANT, BAR AND LOUNGE SERVICES, IN CLASS 43 (U.S. CLS. 100 AND 101).

FIRST USE 7-31-2007; IN COMMERCE 7-31-2007.

OWNER OF U.S. REG. NOS. 3,085,795, 3,190,362, AND OTHERS.

NO CLAIM IS MADE TO THE EXCLUSIVE RIGHT TO USE "CASINO HOTEL", APART FROM THE MARK AS SHOWN.

THE MARK CONSISTS OF THE STYLIZED WORDING "MOTORCITY" WITH THE WORDS "CASINO" AND "HOTEL" APPEARING BENEATH THE WORD "MOTOR".

SEC. 2(F) AS TO "MOTORCITY CASINO".

SN 77-171,181, FILED 5-2-2007.

KEVON CHISOLM, EXAMINING ATTORNEY

Int. Cl.: 43

Prior U.S. Cls.: 100 and 101

United States Patent and Trademark Office

Reg. No. 3,576,989

Registered Feb. 17, 2009

**SERVICE MARK
PRINCIPAL REGISTER**

Lucy's Asian Kitchen

OTG MANAGEMENT, INC. (PENNSYLVANIA
CORPORATION)
ONE INTERNATIONAL PLAZA, SUITE 130
PHILADELPHIA, PA 19113

FOR: RESTAURANT AND BAR SERVICES, IN
CLASS 43 (U.S. CLS. 100 AND 101).

FIRST USE 10-22-2008; IN COMMERCE 10-22-2008.

THE MARK CONSISTS OF STANDARD CHAR-
ACTERS WITHOUT CLAIM TO ANY PARTICULAR
FONT, STYLE, SIZE, OR COLOR.

NO CLAIM IS MADE TO THE EXCLUSIVE
RIGHT TO USE "ASIAN KITCHEN", APART FROM
THE MARK AS SHOWN.

SN 77-171,651, FILED 5-3-2007.

KARANENDRA S. CHHINA, EXAMINING ATTOR-
NEY

Int. Cls.: 9 and 42

Prior U.S. Cls.: 21, 23, 26, 36, 38, 100, and 101

United States Patent and Trademark Office

Reg. No. 3,576,990

Registered Feb. 17, 2009

**TRADEMARK
SERVICE MARK
PRINCIPAL REGISTER**



I-ENROLLER LLC (GEORGIA LIMITED LIABILITY COMPANY)
5 CONCOURSE PARKWAY
SUITE 2325
ATLANTA, GA 30328

FOR: DOWNLOADABLE COMPUTER SOFTWARE THAT FACILITATES ELECTRONIC SELECTION AND ENROLLMENT IN EMPLOYEE BENEFIT PLANS , IN CLASS 9 (U.S. CLS. 21, 23, 26, 36 AND 38).

FIRST USE 3-1-2005; IN COMMERCE 3-1-2005.

FOR: APPLICATION SERVICE PROVIDER (ASP) FEATURING SOFTWARE FOR USE IN SELECTING AND ENROLLING IN EMPLOYEE INSURANCE

BENEFIT PLANS, IN CLASS 42 (U.S. CLS. 100 AND 101).

FIRST USE 3-1-2005; IN COMMERCE 3-1-2005.

THE COLOR(S) BLUE AND GREEN IS/ARE CLAIMED AS A FEATURE OF THE MARK.

THE CIRCLE IN THE MARK IS GREEN, AND THE WORDING IS BLUE.

SN 77-172,018, FILED 5-3-2007.

ALICE SUE CARRUTHERS, EXAMINING ATTORNEY

Int. Cl.: 28

Prior U.S. Cls.: 22, 23, 38, and 50

United States Patent and Trademark Office

Reg. No. 3,576,991

Registered Feb. 17, 2009

**TRADEMARK
PRINCIPAL REGISTER**

FLUTTERFIELD

MATTEL, INC. (DELAWARE CORPORATION)
M1-1518
333 CONTINENTAL BLVD.
EL SEGUNDO, CA 90245

FOR: TOYS, GAMES AND PLAYTHINGS, NAME-
LY, DOLLS, DOLL CLOTHING AND DOLL ACCES-
SORIES, DOLL PLAYSETS, TOY FIGURES, AND
ACCESSORIES FOR ALL OF THE FOREGOING, IN
CLASS 28 (U.S. CLS. 22, 23, 38 AND 50).

FIRST USE 4-22-2008; IN COMMERCE 4-22-2008.

THE MARK CONSISTS OF STANDARD CHAR-
ACTERS WITHOUT CLAIM TO ANY PARTICULAR
FONT, STYLE, SIZE, OR COLOR.

SN 77-172,521, FILED 5-3-2007.

ODESSA BIBBINS, EXAMINING ATTORNEY

Int. Cl.: 28

Prior U.S. Cls.: 22, 23, 38, and 50

Reg. No. 3,576,992

United States Patent and Trademark Office

Registered Feb. 17, 2009

**TRADEMARK
PRINCIPAL REGISTER**

ZINZIE

MATTEL, INC. (DELAWARE CORPORATION)
M1-1518
333 CONTINENTAL BLVD.
EL SEGUNDO, CA 90245

FOR: TOYS, GAMES AND PLAYTHINGS, NAME-
LY, DOLLS, DOLL CLOTHING AND DOLL ACCES-
SORIES, TOY FIGURES, PLUSH TOYS, AND
ACCESSORIES FOR ALL OF THE FOREGOING, IN
CLASS 28 (U.S. CLS. 22, 23, 38 AND 50).

FIRST USE 4-9-2008; IN COMMERCE 4-9-2008.

THE MARK CONSISTS OF STANDARD CHAR-
ACTERS WITHOUT CLAIM TO ANY PARTICULAR
FONT, STYLE, SIZE, OR COLOR.

SN 77-172,526, FILED 5-3-2007.

ODESSA BIBBINS, EXAMINING ATTORNEY

Int. Cls.: 37 and 42

Prior U.S. Cls.: 100, 101, 103, and 106

United States Patent and Trademark Office

Reg. No. 3,576,993

Registered Feb. 17, 2009

**SERVICE MARK
PRINCIPAL REGISTER**

C-CAP

BE AEROSPACE, INC. (DELAWARE CORPORATION)
1400 CORPORATE CENTER WAY
WELLINGTON, FL 33414

FOR: REPAIR AND MAINTENANCE OF AIRCRAFT INTERIORS, IN CLASS 37 (U.S. CLS. 100, 103 AND 106).

FIRST USE 8-1-2007; IN COMMERCE 8-1-2007.

FOR: PRODUCT DEVELOPMENT FOR AIRCRAFT INTERIOR PRODUCTS, IN CLASS 42 (U.S. CLS. 100 AND 101).

FIRST USE 8-1-2007; IN COMMERCE 8-1-2007.

THE MARK CONSISTS OF STANDARD CHARACTERS WITHOUT CLAIM TO ANY PARTICULAR FONT, STYLE, SIZE, OR COLOR.

SN 77-172,693, FILED 5-4-2007.

TIMOTHY FINNEGAN, EXAMINING ATTORNEY

Int. Cl.: 10

Prior U.S. Cls.: 26, 39, and 44

Reg. No. 3,576,994

United States Patent and Trademark Office

Registered Feb. 17, 2009

**TRADEMARK
PRINCIPAL REGISTER**

SLEEP ON COMMAND

PAUL F. BECKER JR. (UNITED STATES INDIVIDUAL)
16 E. HIGHPOINT RD.
STUART, FL 34996

FOR: ELECTROMEDICAL REHABILITATIVE AND PAIN MANAGEMENT PRODUCTS FOR CLINICAL AND HOME USE, NAMELY, ELECTRICAL NERVE AND MUSCLE STIMULATORS, ULTRASONIC STIMULATORS, MAGNET THERAPY STIMULATORS AND LASER THERAPY STIMULATORS, IN CLASS 10 (U.S. CLS. 26, 39 AND 44).

FIRST USE 7-5-2007; IN COMMERCE 10-1-2007.

THE MARK CONSISTS OF STANDARD CHARACTERS WITHOUT CLAIM TO ANY PARTICULAR FONT, STYLE, SIZE, OR COLOR.

NO CLAIM IS MADE TO THE EXCLUSIVE RIGHT TO USE "SLEEP", APART FROM THE MARK AS SHOWN.

SN 77-172,714, FILED 5-4-2007.

SOPHIA S. KIM, EXAMINING ATTORNEY

Int. Cls.: 9 and 42

Prior U.S. Cls.: 21, 23, 26, 36, 38, 100, and 101

United States Patent and Trademark Office

Reg. No. 3,576,995

Registered Feb. 17, 2009

**TRADEMARK
SERVICE MARK
PRINCIPAL REGISTER**

**BUILDING TRUST THROUGH
INNOVATIVE VISUAL
COMMUNICATION**

XCPT COMMUNICATION TECHNOLOGIES, LLC
(DELAWARE LIMITED LIABILITY COMPAN-
NY)
530 US HIGHWAY 41 BYPASS S.
SUITE 9B
VENICE, FL 34285

FOR: COMPUTER SOFTWARE AND HARD-
WARE FOR MANAGING, CAPTURING, RENDER-
ING, INTERPRETING, ADJUSTING, ENHANCING
AND PROCESSING PICTURES, X-RAYS, IMAGES
AND DIGITAL CONTENT IN THE FIELD OF
DENTISTRY FOR DIAGNOSIS AND TREATMENT,
IN CLASS 9 (U.S. CLS. 21, 23, 26, 36 AND 38).

FIRST USE 1-0-2008; IN COMMERCE 1-0-2008.

FOR: DESIGN, DEVELOPMENT AND IMPLE-
MENTATION OF COMPUTER HARDWARE AND
SOFTWARE FOR OTHERS FOR USE IN THE FIELD
OF DENTISTRY, IN CLASS 42 (U.S. CLS. 100 AND
101).

FIRST USE 1-0-2008; IN COMMERCE 1-0-2008.

THE MARK CONSISTS OF STANDARD CHAR-
ACTERS WITHOUT CLAIM TO ANY PARTICULAR
FONT, STYLE, SIZE, OR COLOR.

SN 77-172,779, FILED 5-4-2007.

AMY C. KEAN, EXAMINING ATTORNEY

Int. Cl.: 9

Prior U.S. Cls.: 21, 23, 26, 36, and 38

United States Patent and Trademark Office

Reg. No. 3,576,996

Registered Feb. 17, 2009

**TRADEMARK
PRINCIPAL REGISTER**

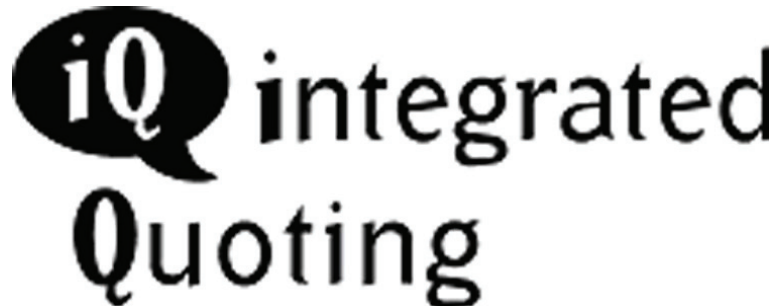

EPS SETTLEMENTS GROUP, INC. (CALIFORNIA CORPORATION)
SUITE 300
7100 EAST BELLEVIEW AVENUE
GREENWOOD VILLAGE, CO 80111

FOR: COMPUTER SOFTWARE FOR GENERATING EXPEDITED LIFE INSURANCE ANNUITY QUOTES, ACROSS LIFE INSURANCE CARRIERS FOR QUALIFIED AND NON-QUALIFIED STRUCTURED SETTLEMENTS AS PART OF PERSONAL PHYSICAL INJURY CLAIM RESOLUTION, ATTORNEY FEE COMPENSATION, AND OTHER INSTALLMENT RELATED COMMERCIAL SETTLEMENTS, IN CLASS 9 (U.S. CLS. 21, 23, 26, 36 AND 38).

FIRST USE 5-19-2008; IN COMMERCE 5-19-2008.

NO CLAIM IS MADE TO THE EXCLUSIVE RIGHT TO USE "INTEGRATED QUOTING", APART FROM THE MARK AS SHOWN.

THE MARK CONSISTS OF THE LETTERS "IQ" IN A SPEECH BUBBLE AND THE STYLIZED WORDS "INTEGRATED QUOTING".

SN 77-172,923, FILED 5-4-2007.

COLLEEN KEARNEY, EXAMINING ATTORNEY

Int. Cls.: 35, 36, and 44

Prior U.S. Cls.: 100, 101, and 102

United States Patent and Trademark Office

Reg. No. 3,576,997

Registered Feb. 17, 2009

**SERVICE MARK
PRINCIPAL REGISTER**



AMYOTROPHIC LATERAL SCLEROSIS ASSO-
CIATION (DELAWARE NOT-FOR-PROFIT
CORPORATION)
27001 AGOURA ROAD
SUITE 150
CALABASAS HILLS, CA 91301

FOR: ASSOCIATION SERVICES, NAMELY, PRO-
MOTING PUBLIC AWARENESS OF THE NEED
FOR RESEARCH AND FUNDING FOR AMYO-
TROPHIC LATERAL SCLEROSIS BY PROVIDING
INFORMATION IN THE FIELD OF AMYOTROPH-
IC LATERAL SCLEROSIS, IN CLASS 35 (U.S. CLS.
100, 101 AND 102).

FIRST USE 1-31-2007; IN COMMERCE 1-31-2007.

FOR: CHARITABLE FUND RAISING; CHARITA-
BLE FUND RAISING SERVICES FOR FUNDING
RESEARCH PROGRAMS, PATIENT SERVICES
PROGRAMS, CLINICAL CENTERS, AND RELATED
PROGRAMS AND ACTIVITIES RELATING TO THE
TREATMENT OF AND FINDING A CURE OF
AMYOTROPHIC LATERAL SCLEROSIS; FINAN-
CIAL SPONSORSHIP OF RESEARCH IN THE FIELD
OF AMYOTROPHIC LATERAL SCLEROSIS, IN
CLASS 36 (U.S. CLS. 100, 101 AND 102).

FIRST USE 1-31-2007; IN COMMERCE 1-31-2007.

FOR: PROVIDING INFORMATION IN THE
FIELD OF HEALTH CARE, IN CLASS 44 (U.S. CLS.
100 AND 101).

FIRST USE 1-31-2007; IN COMMERCE 1-31-2007.

OWNER OF U.S. REG. NO. 2,859,335.

NO CLAIM IS MADE TO THE EXCLUSIVE
RIGHT TO USE "ASSOCIATION", APART FROM
THE MARK AS SHOWN.

THE MARK CONSISTS OF THE LETTER "A"
BEHIND A HAND ABOVE THE WORDING "ALS
ASSOCIATION".

SEC. 2(F) AS TO "ALS ASSOCIATION".

SN 77-173,168, FILED 5-4-2007.

JOHN HWANG, EXAMINING ATTORNEY

Int. Cls.: 35 and 36

Prior U.S. Cls.: 100, 101, and 102

United States Patent and Trademark Office

Reg. No. 3,576,998

Registered Feb. 17, 2009

**SERVICE MARK
PRINCIPAL REGISTER**



AMYOTROPHIC LATERAL SCLEROSIS ASSO-
CIATION (DELAWARE NOT-FOR-PROFIT
CORPORATION)
27001 AGOURA ROAD
SUITE 150
CALABASAS HILLS, CA 91301

FOR: ASSOCIATION SERVICES, NAMELY, PRO-
MOTING PUBLIC AWARENESS OF THE NEED
FOR RESEARCH AND FUNDING FOR AMYO-
TROPHIC LATERAL SCLEROSIS BY PROVIDING
INFORMATION IN THE FIELD OF AMYOTROPH-
IC LATERAL SCLEROSIS, IN CLASS 35 (U.S. CLS.
100, 101 AND 102).

FIRST USE 1-31-2007; IN COMMERCE 1-31-2007.

FOR: CHARITABLE FUND RAISING; CHARITA-
BLE FUND RAISING SERVICES FOR FUNDING
RESEARCH PROGRAMS, PATIENT SERVICES
PROGRAMS, CLINICAL CENTERS, AND RELATED
PROGRAMS AND ACTIVITIES RELATING TO THE
TREATMENT OF AND FINDING A CURE OF
AMYOTROPHIC LATERAL SCLEROSIS; FINAN-

CIAL SPONSORSHIP OF RESEARCH IN THE FIELD
OF AMYOTROPHIC LATERAL SCLEROSIS, IN
CLASS 36 (U.S. CLS. 100, 101 AND 102).

FIRST USE 1-31-2007; IN COMMERCE 1-31-2007.

OWNER OF U.S. REG. NO. 2,859,335.

NO CLAIM IS MADE TO THE EXCLUSIVE
RIGHT TO USE "ASSOCIATION", APART FROM
THE MARK AS SHOWN.

THE MARK CONSISTS OF THE LETTER "A" IN
BEHIND A HAND ABOVE THE WORDING "ALS
ASSOCIATION FIGHTING LOU GEHRIG'S DIS-
EASE".

SEC. 2(F) AS TO "ALS ASSOCIATION".

SN 77-173,185, FILED 5-4-2007.

JOHN HWANG, EXAMINING ATTORNEY

Int. Cls.: 35 and 36

Prior U.S. Cls.: 100, 101, and 102

United States Patent and Trademark Office

Reg. No. 3,576,999

Registered Feb. 17, 2009

SERVICE MARK
PRINCIPAL REGISTER

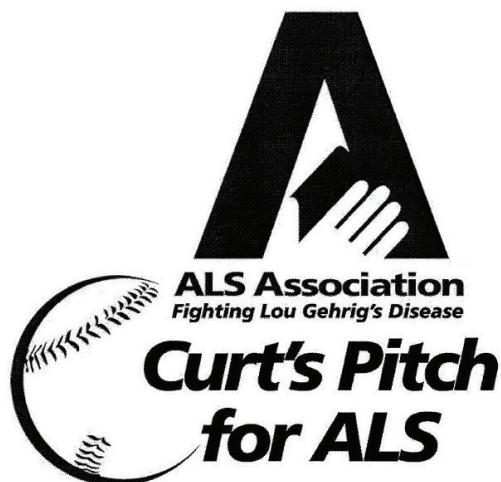

AMYOTROPHIC LATERAL SCLEROSIS ASSO-
CIATION (DELAWARE NOT-FOR-PROFIT
CORPORATION)
27001 AGOURA ROAD
SUITE 150
CALABASAS HILLS, CA 91301

FOR: ASSOCIATION SERVICES, NAMELY, PRO-
MOTING PUBLIC AWARENESS OF THE NEED
FOR RESEARCH AND FUNDING FOR AMYO-
TROPHIC LATERAL SCLEROSIS BY PROVIDING
INFORMATION IN THE FIELD OF AMYOTROPH-
IC LATERAL SCLEROSIS, IN CLASS 35 (U.S. CLS.
100, 101 AND 102).

FIRST USE 1-31-2007; IN COMMERCE 1-31-2007.

FOR: CHARITABLE FUND RAISING; CHARITA-
BLE FUND RAISING SERVICES FOR FUNDING
RESEARCH PROGRAMS, PATIENT SERVICES
PROGRAMS, CLINICAL CENTERS, AND RELATED
PROGRAMS AND ACTIVITIES RELATING TO THE
TREATMENT OF AND FINDING A CURE OF
AMYOTROPHIC LATERAL SCLEROSIS; FINAN-
CIAL SPONSORSHIP OF RESEARCH IN THE FIELD
OF AMYOTROPHIC LATERAL SCLEROSIS, IN
CLASS 36 (U.S. CLS. 100, 101 AND 102).

FIRST USE 1-31-2007; IN COMMERCE 1-31-2007.

OWNER OF U.S. REG. NO. 2,859,335.

NO CLAIM IS MADE TO THE EXCLUSIVE
RIGHT TO USE "ASSOCIATION", APART FROM
THE MARK AS SHOWN.

THE NAME "CURT" IN THE MARK IDENTIFIES
A LIVING INDIVIDUAL WHOSE CONSENT IS OF
RECORD.

THE MARK CONSISTS OF THE LETTER "A"
BEHIND A HAND ABOVE THE WORDING "ALS
ASSOCIATION FIGHTING LOU GEHRIG'S DIS-
EASE CURT'S PITCH FOR ALS", WHICH IS NEXT
TO THE OUTLINE OF A BASEBALL.

SEC. 2(F) AS TO "ALS ASSOCIATION".

SN 77-173,239, FILED 5-4-2007.

JOHN HWANG, EXAMINING ATTORNEY

Int. Cls.: 9, 16, and 41

**Prior U.S. Cls.: 2, 5, 21, 22, 23, 26, 29, 36, 37, 38, 50,
100, 101, and 107**

Reg. No. 3,577,000

United States Patent and Trademark Office

Registered Feb. 17, 2009

**TRADEMARK
SERVICE MARK
PRINCIPAL REGISTER**

MathForward

TEXAS INSTRUMENTS INCORPORATED (DE-
LAWARE CORPORATION)
MS3999
12500 TI BOULEVARD
DALLAS, TX 752434136

FOR: ELECTRONIC TEACHING MATERIALS,
NAMELY, ELECTRONIC MATHEMATICS WORK-
SHEETS FOR STUDENTS, BOTH DOWNLOAD-
ABLE AND PRE-RECORDED ON COMPUTER
MEDIA, IN CLASS 9 (U.S. CLS. 21, 23, 26, 36 AND 38).

FIRST USE 8-1-2008; IN COMMERCE 8-1-2008.

FOR: PRINTED PUBLICATIONS IN THE FIELD
OF MATHEMATICS, NAMELY, TEACHER MATE-
RIALS, NAMELY, GUIDEBOOKS, CURRICULUM
GUIDES, SUPPLEMENTAL RESOURCE GUIDES,
BROCHURES AND MANUALS, IN CLASS 16 (U.S.
CLS. 2, 5, 22, 23, 29, 37, 38 AND 50).

FIRST USE 8-1-2008; IN COMMERCE 8-1-2008.

FOR: EDUCATIONAL SERVICES, NAMELY, DE-
VELOPING AND ARRANGING EDUCATIONAL
PROGRAMS, MATERIALS, COURSES OF IN-
STRUCTION, AND CURRICULUM FOR OTHERS,
ALL OF THE FOREGOING IN THE FIELD OF
MATHEMATICS; CONSULTING SERVICES IN
THE FIELD OF MATHEMATICS, IN CLASS 41
(U.S. CLS. 100, 101 AND 107).

FIRST USE 8-1-2008; IN COMMERCE 8-1-2008.

THE MARK CONSISTS OF STANDARD CHAR-
ACTERS WITHOUT CLAIM TO ANY PARTICULAR
FONT, STYLE, SIZE, OR COLOR.

SN 77-173,323, FILED 5-4-2007.

KAREN SEVERSON, EXAMINING ATTORNEY

Int. Cl.: 31

Prior U.S. Cls.: 1 and 46

United States Patent and Trademark Office

Reg. No. 3,577,001

Registered Feb. 17, 2009

**TRADEMARK
PRINCIPAL REGISTER**



WILBUR-ELLIS COMPANY (CALIFORNIA CORPORATION)

345 CALIFORNIA STREET, 27TH FLOOR

SAN FRANCISCO, CA 94104

FOR: AGRICULTURAL SEEDS, CROP SEEDS, SEEDS FOR AGRICULTURAL PURPOSES, SOWING SEEDS, IN CLASS 31 (U.S. CLS. 1 AND 46).

FIRST USE 11-12-2007; IN COMMERCE 11-12-2007.

THE COLOR(S) YELLOW, BLUE, GREEN, RED, AND WHITE IS/ARE CLAIMED AS A FEATURE OF THE MARK.

THE MARK CONSISTS OF A CIRCLE OF YELLOW, BLUE, GREEN, AND RED QUADRANTS, WITH A DOMINANT LETTER "I" IN WHITE.

SN 77-173,357, FILED 5-4-2007.

ANNE MADDEN, EXAMINING ATTORNEY

Int. Cl.: 28

Prior U.S. Cls.: 22, 23, 38, and 50

United States Patent and Trademark Office

Reg. No. 3,577,002

Registered Feb. 17, 2009

**TRADEMARK
PRINCIPAL REGISTER**

PROTOTYPE H-24

MATTEL, INC. (DELAWARE CORPORATION)
M1-1518
333 CONTINENTAL BLVD.
EL SEGUNDO, CA 90245

THE MARK CONSISTS OF STANDARD CHAR-
ACTERS WITHOUT CLAIM TO ANY PARTICULAR
FONT, STYLE, SIZE, OR COLOR.

FOR: TOYS, GAMES AND PLAYTHINGS, NAME-
LY, TOY VEHICLES AND ACCESSORIES THERE-
FOR, IN CLASS 28 (U.S. CLS. 22, 23, 38 AND 50).

SN 77-174,312, FILED 5-7-2007.

FIRST USE 4-22-2008; IN COMMERCE 4-22-2008.

KAPIL BHANOT, EXAMINING ATTORNEY

Int. Cl.: 35

Prior U.S. Cls.: 100, 101, and 102

United States Patent and Trademark Office

Reg. No. 3,577,003

Registered Feb. 17, 2009

**SERVICE MARK
PRINCIPAL REGISTER**

SERVICE *Partner*

INTERNATIONAL TRUCK INTELLECTUAL
PROPERTY COMPANY, LLC (DELAWARE
LIMITED LIABILITY COMPANY)
LAW DEPARTMENT 2W
4201 WINFIELD ROAD
WARRENVILLE, IL 60555

FOR: PROMOTING THE GOODS AND SERVICES
OF OTHERS BY MEANS OF A PREFERRED CUS-
TOMER PROGRAM FEATURING EXPEDITED DI-
AGNOSTIC ANALYSIS AND CONSISTENT LABOR
RATES AND TIME SCHEDULES FOR COMMON

REPAIRS AND MAINTENANCE OPERATIONS FOR
FLEET VEHICLES AND INDIVIDUAL TRUCK
OWNER/OPERATORS, IN CLASS 35 (U.S. CLS. 100,
101 AND 102).

FIRST USE 1-1-2008; IN COMMERCE 1-1-2008.

SN 77-174,748, FILED 5-7-2007.

JOSETTE BEVERLY, EXAMINING ATTORNEY

Int. Cl.: 9

Prior U.S. Cls.: 21, 23, 26, 36, and 38

Reg. No. 3,577,004

United States Patent and Trademark Office

Registered Feb. 17, 2009

**TRADEMARK
PRINCIPAL REGISTER**

ALTUS

DAYMEN PHOTO MARKETING LP (CANADA
LIMITED PARTNERSHIP)
55 VALLEYWOOD DRIVE
MARKHAM, ONTARIO, CANADA L3R 5L9

FOR: BAGS, HARD AND SOFT COVERED CASES,
RUCKSACKS, HOLDALLS, BACKPACKS WITH
ROLLING WHEELS, BACKPACKS WITHOUT
ROLLING WHEELS, BELT PACKS, POCKETS, TOTE
BAGS, SHOULDER BAGS, MESSENGER BAGS AND
POUCHES, ALL DESIGNED FOR CARRYING PHOTOGRAPHIC,
CINEMATOGRAPHIC, VIDEOGRAPHIC, OPTICAL, AUDIO,
ELECTRONIC AND COMPUTER EQUIPMENT; FILM ORGANIZERS,
NAMELY, CASES FOR CARRYING EXPOSED AND UNEXPOSED
CAMERA FILM; CELL PHONE

POUCHES; WAIST HARNESES AND SHOULDER HARNESES
DESIGNED FOR USE WITH THE FOREGOING GOODS, IN CLASS 9
(U.S. CLS. 21, 23, 26, 36 AND 38).

FIRST USE 9-24-2007; IN COMMERCE 9-27-2007.

THE MARK CONSISTS OF STANDARD CHARACTERS WITHOUT
CLAIM TO ANY PARTICULAR FONT, STYLE, SIZE, OR COLOR.

SN 77-174,979, FILED 5-7-2007.

APRIL ROACH, EXAMINING ATTORNEY

Int. Cls.: 9 and 42

Prior U.S. Cls.: 21, 23, 26, 36, 38, 100, and 101

United States Patent and Trademark Office

Reg. No. 3,577,005

Registered Feb. 17, 2009

**TRADEMARK
SERVICE MARK
PRINCIPAL REGISTER**

**STUDENTMATE ADMINISTRATION
MODULE**

ALTA HEIGHTS TECHNOLOGY CORPORATION
(DELAWARE CORPORATION)
108 ALTA HEIGHTS CT.
LOS GATOS, CA 95030

FOR: DOWNLOADABLE COMPUTER SOFTWARE FOR USE IN CLASSROOMS THAT CREATES A WIRELESS CONNECTION BETWEEN COMPUTERS IN A NETWORK ENVIRONMENT FOR DEPLOYING AND RETRIEVING FILES, ENABLING MULTIPLE USES OF APPLICATIONS BY VARIOUS COMPUTERS ON A NETWORK, AND ENABLING REAL-TIME COMMUNICATION AMONG COMPUTERS ON A NETWORK, IN CLASS 9 (U.S. CLS. 21, 23, 26, 36 AND 38).

FIRST USE 4-4-2008; IN COMMERCE 4-4-2008.

FOR: PROVIDING TEMPORARY USE OF ONLINE NON-DOWNLOADABLE COMPUTER SOFTWARE FOR USE IN CLASSROOMS THAT CREATES A WIRELESS CONNECTION BETWEEN COMPUTERS

IN A NETWORK ENVIRONMENT FOR DEPLOYING AND RETRIEVING FILES, ENABLING MULTIPLE USES OF APPLICATIONS BY VARIOUS COMPUTERS ON A NETWORK, AND ENABLING REAL-TIME COMMUNICATION AMONG COMPUTERS ON A NETWORK, IN CLASS 42 (U.S. CLS. 100 AND 101).

FIRST USE 4-4-2008; IN COMMERCE 4-4-2008.

THE MARK CONSISTS OF STANDARD CHARACTERS WITHOUT CLAIM TO ANY PARTICULAR FONT, STYLE, SIZE, OR COLOR.

NO CLAIM IS MADE TO THE EXCLUSIVE RIGHT TO USE "ADMINISTRATION MODULE", APART FROM THE MARK AS SHOWN.

SN 77-175,107, FILED 5-8-2007.

AMY C. KEAN, EXAMINING ATTORNEY

Int. Cls.: 35, 36, and 42

Prior U.S. Cls.: 100, 101, and 102

United States Patent and Trademark Office

Reg. No. 3,577,006

Registered Feb. 17, 2009

**SERVICE MARK
PRINCIPAL REGISTER**

BEARVIEW

JPMORGAN CHASE & CO. (DELAWARE CORPORATION)
270 PARK AVENUE
NEW YORK, NY 10017

FOR: CUSTOMER RELATIONSHIP MANAGEMENT, IN CLASS 35 (U.S. CLS. 100, 101 AND 102).

FIRST USE 6-30-2007; IN COMMERCE 6-30-2007.

FOR: FINANCIAL SERVICES, NAMELY, PROVIDING FINANCIAL PLANNING, FINANCIAL ANALYSIS, RISK MANAGEMENT, RESEARCH, PROVIDING FINANCIAL TRADING TOOLS FOR OTHERS, FINANCIAL CLEARING HOUSES IN THE FIELD OF SECURITIES, COMMODITIES, FUTURES, AND DERIVATIVES, AND HEDGE FUND AND PRIVATE EQUITY INVESTMENTS, IN CLASS 36 (U.S. CLS. 100, 101 AND 102).

FIRST USE 6-30-2007; IN COMMERCE 6-30-2007.

FOR: PROVIDING TEMPORARY USE OF ON-LINE NON-DOWNLOADABLE SOFTWARE FOR

FINANCIAL PLANNING, ANALYSIS, RISK MANAGEMENT, RESEARCH, CLIENT RELATIONSHIP MANAGEMENT, TRADING, TRADE EXECUTION, OPERATIONAL WORK FLOW AND CLEARING IN THE FIELD OF SECURITIES, COMMODITIES, FUTURES, AND DERIVATIVES, AND HEDGE FUND AND PRIVATE EQUITY FUND INVESTMENTS, IN CLASS 42 (U.S. CLS. 100 AND 101).

FIRST USE 6-30-2007; IN COMMERCE 6-30-2007.

THE MARK CONSISTS OF STANDARD CHARACTERS WITHOUT CLAIM TO ANY PARTICULAR FONT, STYLE, SIZE, OR COLOR.

OWNER OF U.S. REG. NOS. 1,868,600, 3,212,317, AND OTHERS.

SN 77-175,177, FILED 5-8-2007.

LINDA M. KING, EXAMINING ATTORNEY

Int. Cls.: 14, 16, 24, and 27

**Prior U.S. Cls.: 2, 5, 19, 20, 22, 23, 27, 28, 29, 37, 38,
42, and 50**

Reg. No. 3,577,007

United States Patent and Trademark Office

Registered Feb. 17, 2009

**TRADEMARK
PRINCIPAL REGISTER**

CASA DE BANDINI

CALIFORNIA DEPARTMENT OF PARKS AND
RECREATION (CALIFORNIA STATE AGEN-
CY)

1416 9TH STREET, SUITE 1404-6
SACRAMENTO, CA 95814

FOR: JEWELRY, IN CLASS 14 (U.S. CLS. 2, 27, 28
AND 50).

FIRST USE 9-3-2008; IN COMMERCE 9-3-2008.

FOR: PRINTED ART REPRODUCTIONS, NAME-
LY, REPRODUCTIONS OF HISTORICAL PHOTO-
GRAPHS, COOKBOOKS, MAPS, BOOKS,
BROCHURES, AND POSTCARDS, IN CLASS 16
(U.S. CLS. 2, 5, 22, 23, 29, 37, 38 AND 50).

FIRST USE 9-12-2008; IN COMMERCE 9-12-2008.

FOR: DINING LINENS, BED LINENS, CUR-
TAINS, AND TOWELS, IN CLASS 24 (U.S. CLS. 42
AND 50).

FIRST USE 9-14-2008; IN COMMERCE 9-14-2008.

FOR: CARPETS, RUGS, FLOOR MATS AND
HISTORICAL REPRODUCTION WALLPAPER, IN
CLASS 27 (U.S. CLS. 19, 20, 37, 42 AND 50).

FIRST USE 10-11-2008; IN COMMERCE 11-9-2008.

THE MARK CONSISTS OF STANDARD CHAR-
ACTERS WITHOUT CLAIM TO ANY PARTICULAR
FONT, STYLE, SIZE, OR COLOR.

THE FOREIGN WORDING IN THE MARK
TRANSLATES INTO ENGLISH AS HOUSE OF.

SN 77-175,223, FILED 5-8-2007.

WON TEAK OH, EXAMINING ATTORNEY

Int. Cls.: 35 and 36

Prior U.S. Cls.: 100, 101, and 102

United States Patent and Trademark Office

Reg. No. 3,577,008

Registered Feb. 17, 2009

**SERVICE MARK
PRINCIPAL REGISTER**



AMYOTROPHIC LATERAL SCLEROSIS ASSO-
CIATION (DELAWARE NON-PROFIT COR-
PORATION)
27001 AGOURA ROAD
SUITE 150
CALABASAS HILLS, CA 91301

FOR: ASSOCIATION SERVICES, NAMELY, PRO-
MOTING PUBLIC AWARENESS OF THE NEED
FOR RESEARCH AND FUNDING FOR AMYO-
TROPHIC LATERAL SCLEROSIS BY PROVIDING
INFORMATION IN THE FIELD OF AMYOTROPH-
IC LATERAL SCLEROSIS, IN CLASS 35 (U.S. CLS.
100, 101 AND 102).

FIRST USE 1-31-2007; IN COMMERCE 1-31-2007.

FOR: CHARITABLE FUND RAISING; CHARITA-
BLE FUND RAISING SERVICES FOR FUNDING
RESEARCH PROGRAMS, PATIENT SERVICES
PROGRAMS, CLINICAL CENTERS, AND RELATED
PROGRAMS AND ACTIVITIES RELATING TO THE
TREATMENT OF AND FINDING A CURE OF
AMYOTROPHIC LATERAL SCLEROSIS; FINAN-
CIAL SPONSORSHIP OF RESEARCH IN THE FIELD

OF AMYOTROPHIC LATERAL SCLEROSIS, IN
CLASS 36 (U.S. CLS. 100, 101 AND 102).

FIRST USE 1-31-2007; IN COMMERCE 1-31-2007.

OWNER OF U.S. REG. NO. 2,859,335.

NO CLAIM IS MADE TO THE EXCLUSIVE
RIGHT TO USE "ASSOCIATION", APART FROM
THE MARK AS SHOWN.

THE MARK CONSISTS OF THE LETTER "A"
WITH A HAND INSIDE THE "A" AND ABOVE THE
WORDING "ALS ASSOCIATION", ALONG WITH A
SEMI-CIRCLE ON THE LEFT SIDE OF THE WORD-
ING "TREAT ALS TRANSLATIONAL RESEARCH
ADVANCING THERAPY FOR ALS".

SEC. 2(F) AS TO "ALS ASSOCIATION".

SN 77-175,275, FILED 5-8-2007.

JOHN HWANG, EXAMINING ATTORNEY

Int. Cls.: 35 and 36

Prior U.S. Cls.: 100, 101, and 102

United States Patent and Trademark Office

Reg. No. 3,577,009

Registered Feb. 17, 2009

SERVICE MARK
PRINCIPAL REGISTER



AMYOTROPHIC LATERAL SCLEROSIS ASSO-
CIATION (DELAWARE NON-PROFIT COR-
PORATION)
27001 AGOURA ROAD
SUITE 150
CALABASAS HILLS, CA 91301

FOR: PROMOTING THE INTERESTS OF AMYO-
TROPIC LATERAL SCLEROSIS SUFFERERS, RE-
SEARCHERS AND DOCTORS IN THE FIELDS OF
LEGISLATION, REGULATION AND POLITICS, IN
CLASS 35 (U.S. CLS. 100, 101 AND 102).

FIRST USE 1-31-2007; IN COMMERCE 1-31-2007.

FOR: CHARITABLE FUNDRAISING SERVICES
FOR PROMOTING RESEARCH, EDUCATION AND
PATIENT CARE RELATING TO AMYOTROPIC

LATERAL SCLEROSIS, IN CLASS 36 (U.S. CLS. 100,
101 AND 102).

FIRST USE 1-31-2007; IN COMMERCE 1-31-2007.

OWNER OF U.S. REG. NO. 2,859,335.

NO CLAIM IS MADE TO THE EXCLUSIVE
RIGHT TO USE "ASSOCIATION" AND "NATIONAL
ALS ADVOCACY DAY", APART FROM THE MARK
AS SHOWN.

SEC. 2(F) AS TO "ALS".

SN 77-175,279, FILED 5-8-2007.

JOHN HWANG, EXAMINING ATTORNEY

Int. Cl.: 25

Prior U.S. Cls.: 22 and 39

United States Patent and Trademark Office

Reg. No. 3,577,010

Registered Feb. 17, 2009

TRADEMARK
PRINCIPAL REGISTER



GRAY, MELANIE A. (UNITED STATES INDIVIDUAL)
P. O. BOX 1003
LATEXO, TX 75849

FOR: SWEAT SHIRTS; HATS; SHORT-SLEEVED OR LONG-SLEEVED T-SHIRTS; SWEAT PANTS, IN CLASS 25 (U.S. CLS. 22 AND 39).

FIRST USE 0-0-2007; IN COMMERCE 0-0-2007.

THE MARK CONSISTS OF A STYLIZED LETTER "Y" WITH A KNOT CENTERED ON THE "Y", ABOVE THE "V" OF THE LETTER "Y" ARE EYES, EYEBROWS AND A MOUTH, AND ABOVE THE EYES, EYEBROWS AND MOUTH IS THE PHRASE "Y KNOT" IN PARENTHESIS.

SN 77-175,305, FILED 5-8-2007.

CHRISTINA SOBRAL, EXAMINING ATTORNEY

Int. Cl.: 9

Prior U.S. Cls.: 21, 23, 26, 36, and 38

Reg. No. 3,577,011

United States Patent and Trademark Office

Registered Feb. 17, 2009

**TRADEMARK
PRINCIPAL REGISTER**

STRIDE

AUTOMATIONDIRECT.COM INC. (GEORGIA
CORPORATION)
3505 HUTCHINSON STREET
CUMMING, GA 30130

FIRST USE 12-12-2007; IN COMMERCE 12-12-2007.

FOR: INDUSTRIAL GRADE NETWORKING
PRODUCTS FOR COMPUTERS AND PROGRAM-
MABLE INDUSTRIAL CONTROLLERS, NAMELY,
ETHERNET SWITCHES, MODEMS, AND MEDIA
CONVERTERS, IN CLASS 9 (U.S. CLS. 21, 23, 26, 36
AND 38).

THE MARK CONSISTS OF STANDARD CHAR-
ACTERS WITHOUT CLAIM TO ANY PARTICULAR
FONT, STYLE, SIZE, OR COLOR.

SN 77-175,354, FILED 5-8-2007.

ERIN FALK, EXAMINING ATTORNEY

Int. Cl.: 11

Prior U.S. Cls.: 13, 21, 23, 31, and 34

United States Patent and Trademark Office

Reg. No. 3,577,012

Registered Feb. 17, 2009

**TRADEMARK
PRINCIPAL REGISTER**

Hubmar HomeTherapy

HUBMAR INTERNATIONAL INC. (CANADA
CORPORATION)

1170 BEAULAC

ST-LAURENT, QUEBEC, CANADA

FOR: ELECTRIC VAPORIZERS, IN CLASS 11 (U.S.
CLS. 13, 21, 23, 31 AND 34).

FIRST USE 3-1-2007; IN COMMERCE 3-1-2007.

THE MARK CONSISTS OF STANDARD CHAR-
ACTERS WITHOUT CLAIM TO ANY PARTICULAR
FONT, STYLE, SIZE, OR COLOR.

NO CLAIM IS MADE TO THE EXCLUSIVE
RIGHT TO USE "HOMETHERAPY", APART FROM
THE MARK AS SHOWN.

SN 77-175,755, FILED 5-8-2007.

KATHERINE CHANG, EXAMINING ATTORNEY

Int. Cl.: 6

Prior U.S. Cls.: 2, 12, 13, 14, 23, 25, and 50

Reg. No. 3,577,013

United States Patent and Trademark Office

Registered Feb. 17, 2009

**TRADEMARK
PRINCIPAL REGISTER**

KNUCKLEHEAD

TWECO PRODUCTS, INC. (DELAWARE CORPORATION)
16052 SWINGLEY RIDGE ROAD
SUITE 300
CHESTERFIELD, MO 63017

THE MARK CONSISTS OF STANDARD CHARACTERS WITHOUT CLAIM TO ANY PARTICULAR FONT, STYLE, SIZE, OR COLOR.

FOR: FLEXIBLE METAL CONDUCTOR TUBES
FOR USE IN ARC WELDING, IN CLASS 6 (U.S. CLS.
2, 12, 13, 14, 23, 25 AND 50).

SN 77-176,511, FILED 5-9-2007.

FIRST USE 9-30-2007; IN COMMERCE 9-30-2007.

RONALD AIKENS, EXAMINING ATTORNEY

Int. Cl.: 28

Prior U.S. Cls.: 22, 23, 38, and 50

United States Patent and Trademark Office

Reg. No. 3,577,014

Registered Feb. 17, 2009

**TRADEMARK
PRINCIPAL REGISTER**

ANGELWORKSART

ANGELWORKSART, LLC (MISSOURI LIMITED
LIABILITY COMPANY)
11325 WORNALL ROAD
KANSAS CITY, MO 64114

THE MARK CONSISTS OF STANDARD CHAR-
ACTERS WITHOUT CLAIM TO ANY PARTICULAR
FONT, STYLE, SIZE, OR COLOR.

FOR: CHRISTMAS TREE ORNAMENTS, IN
CLASS 28 (U.S. CLS. 22, 23, 38 AND 50).

SN 77-177,707, FILED 5-10-2007.

FIRST USE 7-15-2007; IN COMMERCE 7-15-2007.

ELLEN PERKINS, EXAMINING ATTORNEY

Int. Cl.: 30

Prior U.S. Cl.: 46

United States Patent and Trademark Office

Reg. No. 3,577,015

Registered Feb. 17, 2009

**TRADEMARK
PRINCIPAL REGISTER**

**DELICIOUS BREADS WHICH
COMPLIMENT A HEALTHY
LIFESTYLE**

RICH PRODUCTS CORPORATION (DELAWARE
CORPORATION)
ONE ROBERT RICH WAY
BUFFALO, NY 14213

THE MARK CONSISTS OF STANDARD CHAR-
ACTERS WITHOUT CLAIM TO ANY PARTICULAR
FONT, STYLE, SIZE, OR COLOR.

FOR: BREADS AND BAKERY PRODUCTS, IN
CLASS 30 (U.S. CL. 46).

SN 77-178,590, FILED 5-11-2007.

FIRST USE 9-15-2007; IN COMMERCE 9-15-2007.

THOMAS MANOR, EXAMINING ATTORNEY

Int. Cl.: 32

Prior U.S. Cls.: 45, 46, and 48

United States Patent and Trademark Office

Reg. No. 3,577,016

Registered Feb. 17, 2009

TRADEMARK
PRINCIPAL REGISTER

Cup-a-Water

NEW YORK SPRING WATER, INC. (NEW YORK CORPORATION)
517 WEST 36TH STREET
NEW YORK, NY 10018

FOR: SPRING WATER; MINERAL WATER; TABLE WATER; SODA WATER; CARBONATED WATER; NON-CARBONATED DRINKING WATER; AND DRINKING WATER, IN CLASS 32 (U.S. CLS. 45, 46 AND 48).

FIRST USE 6-11-2007; IN COMMERCE 6-11-2007.

THE MARK CONSISTS OF THE WORDING "CUP-A-WATER" WITH A STYLIZED TYPEFACE.

SN 77-179,172, FILED 5-11-2007.

ALEXANDER L. POWERS, EXAMINING ATTORNEY

Int. Cl.: 41

Prior U.S. Cls.: 100, 101, and 107

United States Patent and Trademark Office

Reg. No. 3,577,017

Registered Feb. 17, 2009

**SERVICE MARK
PRINCIPAL REGISTER**



TOPCODER, INC. (DELAWARE CORPORATION)
95 GLASTONBURY BLVD
GLASTONBURY, CT 06033

FOR: CONDUCTING PUZZLE-SOLVING AND
SCAVENGER HUNT CONTESTS OVER THE INTER-
NET, IN CLASS 41 (U.S. CLS. 100, 101 AND 107).

FIRST USE 5-7-2007; IN COMMERCE 5-7-2007.

THE MARK CONSISTS OF THE WORDS "THE
BALL" WITH A CIRCULAR COMPONENT SUR-
ROUNDED BY CIRCULAR RINGS.

SN 77-179,198, FILED 5-11-2007.

ROBERT STRUCK, EXAMINING ATTORNEY

Int. Cl.: 16

Prior U.S. Cls.: 2, 5, 22, 23, 29, 37, 38, and 50

Reg. No. 3,577,018

United States Patent and Trademark Office

Registered Feb. 17, 2009

**TRADEMARK
PRINCIPAL REGISTER**

ZIP CODE MAGAZINES

PINPOINT PUBLICATIONS, LLC (NEVADA LIMITED LIABILITY COMPANY)
SUITE E446
2505 ANTHEM VILLAGE DRIVE
HENDERSON, NV 89117

FOR: MAGAZINES FEATURING HOME, LIFESTYLE AND REGIONAL INFORMATION, IN CLASS 16 (U.S. CLS. 2, 5, 22, 23, 29, 37, 38 AND 50).

FIRST USE 1-0-2008; IN COMMERCE 1-0-2008.

THE MARK CONSISTS OF STANDARD CHARACTERS WITHOUT CLAIM TO ANY PARTICULAR FONT, STYLE, SIZE, OR COLOR.

NO CLAIM IS MADE TO THE EXCLUSIVE RIGHT TO USE "MAGAZINES", APART FROM THE MARK AS SHOWN.

SN 77-179,337, FILED 5-11-2007.

COLLEEN DOMBROW, EXAMINING ATTORNEY

Int. Cl.: 10

Prior U.S. Cls.: 26, 39, and 44

United States Patent and Trademark Office

Reg. No. 3,577,019

Registered Feb. 17, 2009

**TRADEMARK
PRINCIPAL REGISTER**

MDFLOW

BIOLASE TECHNOLOGY, INC. (DELAWARE
CORPORATION)
4 CROMWELL
IRVINE, CA 92618

FOR: ELECTROMAGNETIC ENERGY EMIT-
TING DEVICES FOR MEDICAL USE, NAMELY,
LASERS FOR MEDICAL USE, AND PARTS AND
COMPONENTS THEREFOR, IN CLASS 10 (U.S. CLS.
26, 39 AND 44).

FIRST USE 10-31-2004; IN COMMERCE 10-31-2004.

THE MARK CONSISTS OF STANDARD CHAR-
ACTERS WITHOUT CLAIM TO ANY PARTICULAR
FONT, STYLE, SIZE, OR COLOR.

SN 77-179,627, FILED 5-13-2007.

MARK PILARO, EXAMINING ATTORNEY

Int. Cl.: 12

Prior U.S. Cls.: 19, 21, 23, 31, 35, and 44

Reg. No. 3,577,020

United States Patent and Trademark Office

Registered Feb. 17, 2009

**TRADEMARK
PRINCIPAL REGISTER**

XL-27

SHADOW RODS, L.L.C. (MICHIGAN LIMITED
LIABILITY COMPANY)
5400 NORTH MICHIGAN
SAGINAW, MI 486049780

FIRST USE 11-10-2008; IN COMMERCE 11-10-2008.

FOR: AUTOMOBILE BODIES AND PARTS
THEREOF SUBSTANTIALLY CORRESPONDING
IN APPEARANCE TO ORIGINAL VINTAGE VEHI-
CLES BUT MODIFIED FROM THE ORIGINALS TO
PROVIDE GREATER COMFORT AND EASIER AC-
CESS FOR DRIVERS AND PASSENGERS, IN CLASS
12 (U.S. CLS. 19, 21, 23, 31, 35 AND 44).

THE MARK CONSISTS OF STANDARD CHAR-
ACTERS WITHOUT CLAIM TO ANY PARTICULAR
FONT, STYLE, SIZE, OR COLOR.

SN 77-179,849, FILED 5-14-2007.

STEVEN R. FINE, EXAMINING ATTORNEY

Int. Cl.: 28

Prior U.S. Cls.: 22, 23, 38, and 50

United States Patent and Trademark Office

Reg. No. 3,577,021

Registered Feb. 17, 2009

**TRADEMARK
PRINCIPAL REGISTER**

DIXIE CHALLENGER

MATTEL, INC. (DELAWARE CORPORATION)
M1-1518
333 CONTINENTAL BLVD.
EL SEGUNDO, CA 90245

THE MARK CONSISTS OF STANDARD CHAR-
ACTERS WITHOUT CLAIM TO ANY PARTICULAR
FONT, STYLE, SIZE, OR COLOR.

FOR: TOYS, GAMES AND PLAYTHINGS, NAME-
LY, TOY VEHICLES AND ACCESSORIES THERE-
FOR, IN CLASS 28 (U.S. CLS. 22, 23, 38 AND 50).

SN 77-179,869, FILED 5-14-2007.

FIRST USE 12-15-2008; IN COMMERCE 12-15-2008.

ALYSSA STEEL, EXAMINING ATTORNEY

Int. Cl.: 9

Prior U.S. Cls.: 21, 23, 26, 36, and 38

Reg. No. 3,577,022

United States Patent and Trademark Office

Registered Feb. 17, 2009

**TRADEMARK
PRINCIPAL REGISTER**

HIPCASE

NETALOG, INC. (NORTH CAROLINA CORPORATION)
100 CALHOUN STREET, SUITE 210
CHARLESTON, SC 29401

THE MARK CONSISTS OF STANDARD CHARACTERS WITHOUT CLAIM TO ANY PARTICULAR FONT, STYLE, SIZE, OR COLOR.

FOR: CASES FOR PORTABLE DIGITAL DEVICES, NAMELY, PORTABLE DIGITAL MEDIA PLAYERS AND PORTABLE PHONES, IN CLASS 9 (U.S. CLS. 21, 23, 26, 36 AND 38).

SN 77-180,545, FILED 5-14-2007.

FIRST USE 10-24-2007; IN COMMERCE 6-6-2008.

JAY BESCH, EXAMINING ATTORNEY

Int. Cl.: 12

Prior U.S. Cls.: 19, 21, 23, 31, 35, and 44

United States Patent and Trademark Office

Reg. No. 3,577,023

Registered Feb. 17, 2009

**TRADEMARK
PRINCIPAL REGISTER**

EASY FUEL

FORD MOTOR COMPANY (DELAWARE CORPORATION)
ONE AMERICAN ROAD
DEARBORN, MI 48126

FOR: CAPLESS FUEL FILL INLET SUPPLIED AS PART OF AN AUTOMOBILE, IN CLASS 12 (U.S. CLS. 19, 21, 23, 31, 35 AND 44).

FIRST USE 9-1-2007; IN COMMERCE 9-1-2007.

THE MARK CONSISTS OF STANDARD CHARACTERS WITHOUT CLAIM TO ANY PARTICULAR FONT, STYLE, SIZE, OR COLOR.

NO CLAIM IS MADE TO THE EXCLUSIVE RIGHT TO USE "FUEL", APART FROM THE MARK AS SHOWN.

SN 77-180,561, FILED 5-14-2007.

TEJBIR SINGH, EXAMINING ATTORNEY

Int. Cl.: 1

Prior U.S. Cls.: 1, 5, 6, 10, 26, and 46

United States Patent and Trademark Office

Reg. No. 3,577,024

Registered Feb. 17, 2009

**TRADEMARK
PRINCIPAL REGISTER**

Taimata

KABUSHIKIKAISHA KOJUNDOKAGAKU KEN-
KYUSHO (JAPAN CORPORATION)
5-1-28, CHIYODA
SAKADO-SHI, SAITAMA, JAPAN

FOR: CHEMICALS USED IN INDUSTRY AND
SCIENCE, IN CLASS 1 (U.S. CLS. 1, 5, 6, 10, 26 AND
46).

FIRST USE 7-11-2002; IN COMMERCE 12-14-2005.

THE MARK CONSISTS OF STANDARD CHAR-
ACTERS WITHOUT CLAIM TO ANY PARTICULAR
FONT, STYLE, SIZE, OR COLOR.

OWNER OF JAPAN REG. NO. 4596106, DATED 8-
16-2002, EXPIRES 8-16-2012.

SN 77-180,606, FILED 5-14-2007.

ALICIA COLLINS, EXAMINING ATTORNEY

Int. Cl.: 37

Prior U.S. Cls.: 100, 103, and 106

United States Patent and Trademark Office

Reg. No. 3,577,025

Registered Feb. 17, 2009

SERVICE MARK
PRINCIPAL REGISTER



NO-MO-SKEETAS, INC (DELAWARE CORPORATION)
F-190
13000 S. TRYON
CHARLOTTE, NC 28278

THE MARK CONSISTS OF A MOSQUITO WITH WINGS AND A SNOOT. A LINE RUNS THROUGH THE SNOOT TO FORM A "T" FOR THE "T" IN SKEETAS. IN QUOTATIONS UNDER THIS, "WINNING THE BACKYARD BATTLE".

FOR: PEST CONTROL, IN CLASS 37 (U.S. CLS. 100, 103 AND 106).

SN 77-180,806, FILED 5-14-2007.

FIRST USE 4-20-2007; IN COMMERCE 4-20-2007.

SOPHIA S. KIM, EXAMINING ATTORNEY

Int. Cl.: 24

Prior U.S. Cls.: 42 and 50

United States Patent and Trademark Office

Reg. No. 3,577,026

Registered Feb. 17, 2009

**TRADEMARK
PRINCIPAL REGISTER**

My Initials

HMS INTERNATIONAL FABRICS CORP. (NEW
YORK CORPORATION)
SUITE 503
730 FIFTH AVENUE
NEW YORK, NY 10019

THE MARK CONSISTS OF STANDARD CHAR-
ACTERS WITHOUT CLAIM TO ANY PARTICULAR
FONT, STYLE, SIZE, OR COLOR.

FOR: TEXTILE USED AS LINING FOR CLOTH-
ING, IN CLASS 24 (U.S. CLS. 42 AND 50).

SN 77-180,810, FILED 5-14-2007.

FIRST USE 8-15-2008; IN COMMERCE 8-15-2008.

SOPHIA S. KIM, EXAMINING ATTORNEY

Int. Cl.: 41

Prior U.S. Cls.: 100, 101, and 107

United States Patent and Trademark Office

Reg. No. 3,577,027

Registered Feb. 17, 2009

**SERVICE MARK
PRINCIPAL REGISTER**

PROPEL

IBIO INSTITUTE (ILLINOIS NON-PROFIT CORPORATION)
65 E. WACKER PLACE, SUITE 1600
CHICAGO, IL 60601

FOR: EDUCATIONAL SERVICES, NAMELY, CONDUCTING SEMINARS AND TRAINING FOR ENTREPRENEURS AND ENTREPRENEURIAL EXECUTIVES IN THE FIELDS OF BIOTECHNOLOGY AND LIFE SCIENCES AS WELL AS ASSOCIATED COMPUTER AND COMMUNICATIONS TECHNOLOGIES; EDUCATIONAL SERVICES, NAMELY, CONDUCTING SEMINARS AND TRAINING FOCUSING ON FINANCING, START-UP FUNDING, EMPLOYEE RECRUITMENT, HUMAN RESOURCES, PARTNERING, BUSINESS CREATION, CAPITAL FORMATION AND STRUCTURE, LEGAL ISSUES, INTELLECTUAL PROPERTY ISSUES, REGULATORY REQUIREMENTS AND PROCEDURES,

SALES AND MARKETING, MANAGEMENT ORGANIZATION, AND SUPPORT FOR COMPANIES IN THE BIOTECHNOLOGY INDUSTRY, INCLUDING BIOTECHNOLOGY AND LIFE SCIENCES AS WELL AS ASSOCIATED COMPUTER AND COMMUNICATIONS TECHNOLOGIES, IN CLASS 41 (U.S. CLS. 100, 101 AND 107).

FIRST USE 6-21-2007; IN COMMERCE 6-21-2007.

THE MARK CONSISTS OF STANDARD CHARACTERS WITHOUT CLAIM TO ANY PARTICULAR FONT, STYLE, SIZE, OR COLOR.

SN 77-181,085, FILED 5-15-2007.

ERIN FALK, EXAMINING ATTORNEY

Int. Cl.: 41

Prior U.S. Cls.: 100, 101, and 107

United States Patent and Trademark Office

Reg. No. 3,577,028

Registered Feb. 17, 2009

**SERVICE MARK
PRINCIPAL REGISTER**

SINGLED OUT

VIACOM INTERNATIONAL INC. (DELAWARE
CORPORATION)
1515 BROADWAY
NEW YORK, NY 10036

FOR: ENTERTAINMENT SERVICES IN THE
NATURE OF TELEVISION SERIES, FEATURING
LIVE ACTION, COMEDY AND DRAMA; PROVID-
ING ONLINE INFORMATION IN THE FIELD OF
ENTERTAINMENT CONCERNING TELEVISION
PROGRAMS, IN CLASS 41 (U.S. CLS. 100, 101 AND
107).

FIRST USE 6-5-1995; IN COMMERCE 6-5-1995.

THE MARK CONSISTS OF STANDARD CHAR-
ACTERS WITHOUT CLAIM TO ANY PARTICULAR
FONT, STYLE, SIZE, OR COLOR.

SN 77-181,136, FILED 5-15-2007.

TARAH HARDY, EXAMINING ATTORNEY

Int. Cls.: 36, 37, and 45

Prior U.S. Cls.: 100, 101, 102, 103, and 106

United States Patent and Trademark Office

Reg. No. 3,577,029

Registered Feb. 17, 2009

**SERVICE MARK
PRINCIPAL REGISTER**



PLATINUM REALTY, L.L.C. (IOWA LIMITED
LIABILITY COMPANY)
137 MAIN STREET
DUBUQUE, IA 52001

FOR: ASSESSMENT AND MANAGEMENT OF REAL ESTATE; LAND ACQUISITION, NAMELY, REAL ESTATE BROKERAGE; REAL ESTATE ACQUISITION SERVICES; REAL ESTATE AGENCIES; REAL ESTATE APPRAISAL; REAL ESTATE BROKERAGE; REAL ESTATE CONSULTANCY; REAL ESTATE CONSULTATION; REAL ESTATE EQUITY SHARING, NAMELY, MANAGING AND ARRANGING FOR CO-OWNERSHIP OF REAL ESTATE; REAL ESTATE ESCROW SERVICES; REAL ESTATE INVESTMENT; REAL ESTATE LENDING SERVICES; REAL ESTATE LISTING; REAL ESTATE MANAGEMENT; REAL ESTATE MANAGEMENT CONSULTATION; REAL ESTATE PROCUREMENT FOR OTHERS; APARTMENT HOUSE MANAGEMENT; BUILDING MANAGEMENT, IN CLASS 36 (U.S. CLS. 100, 101 AND 102).

FIRST USE 11-1-2008; IN COMMERCE 11-1-2008.

FOR: REAL ESTATE DEVELOPMENT; REAL ESTATE SITE SELECTION, IN CLASS 37 (U.S. CLS. 100, 103 AND 106).

FIRST USE 11-1-2008; IN COMMERCE 11-1-2008.

FOR: REAL ESTATE CLOSING SERVICES, IN CLASS 45 (U.S. CLS. 100 AND 101).

FIRST USE 11-1-2008; IN COMMERCE 11-1-2008.

NO CLAIM IS MADE TO THE EXCLUSIVE RIGHT TO USE "REALTY", APART FROM THE MARK AS SHOWN.

THE MARK CONSISTS OF THE WORDING "PLATINUM REALTY" AND A SQUARE WITH A CROSS HATCH PATTERN.

SN 77-181,570, FILED 5-15-2007.

KARANENDRA S. CHHINA, EXAMINING ATTORNEY

Int. Cl.: 36

Prior U.S. Cls.: 100, 101, and 102

United States Patent and Trademark Office

Reg. No. 3,577,030

Registered Feb. 17, 2009

**SERVICE MARK
PRINCIPAL REGISTER**

PLATINUM REALTY

PLATINUM REALTY, L.L.C. (IOWA LIMITED
LIABILITY COMPANY)
12737 MAIN STREET
DUBUQUE, IA 52001

FOR: ASSESSMENT AND MANAGEMENT OF
REAL ESTATE; LAND ACQUISITION, NAMELY,
REAL ESTATE BROKERAGE; REAL ESTATE AC-
QUISITION SERVICES; REAL ESTATE AGENCIES;
REAL ESTATE APPRAISAL; REAL ESTATE
BROKERAGE; REAL ESTATE CONSULTANCY;
REAL ESTATE CONSULTATION; REAL ESTATE
EQUITY SHARING, NAMELY, MANAGING AND
ARRANGING FOR CO-OWNERSHIP OF REAL ES-
TATE; REAL ESTATE ESCROW SERVICES; REAL
ESTATE INVESTMENT; REAL ESTATE LENDING
SERVICES; REAL ESTATE LISTING; REAL ESTATE
MANAGEMENT; REAL ESTATE MANAGEMENT
CONSULTATION; REAL ESTATE PROCUREMENT

FOR OTHERS, IN CLASS 36 (U.S. CLS. 100, 101 AND
102).

FIRST USE 11-1-2008; IN COMMERCE 11-1-2008.

THE MARK CONSISTS OF STANDARD CHAR-
ACTERS WITHOUT CLAIM TO ANY PARTICULAR
FONT, STYLE, SIZE, OR COLOR.

NO CLAIM IS MADE TO THE EXCLUSIVE
RIGHT TO USE "REALTY", APART FROM THE
MARK AS SHOWN.

SN 77-181,629, FILED 5-15-2007.

KARANENDRA S. CHHINA, EXAMINING ATTOR-
NEY

Int. Cl.: 42

Prior U.S. Cls.: 100 and 101

United States Patent and Trademark Office

Reg. No. 3,577,031

Registered Feb. 17, 2009

**SERVICE MARK
PRINCIPAL REGISTER**

LIFT THIS LOOK

SWATCHBOX TECHNOLOGIES, INC. (MASSACHUSETTS CORPORATION)
21 BRIGHAM STREET
WESTBOROUGH, MA 01581

FOR: INTERIOR DESIGN SERVICES AND PROVIDING A WEBSITE FEATURING INTERIOR DESIGN ADVICE AND SERVICES, IN CLASS 42 (U.S. CLS. 100 AND 101).

FIRST USE 9-0-2007; IN COMMERCE 9-0-2007.

THE MARK CONSISTS OF STANDARD CHARACTERS WITHOUT CLAIM TO ANY PARTICULAR FONT, STYLE, SIZE, OR COLOR.

SN 77-181,638, FILED 5-15-2007.

JANICE KIM, EXAMINING ATTORNEY

Int. Cl.: 41

Prior U.S. Cls.: 100, 101, and 107

United States Patent and Trademark Office

Reg. No. 3,577,032

Registered Feb. 17, 2009

**SERVICE MARK
PRINCIPAL REGISTER**

SACROLOGY

BALLIS, CINDY (UNITED STATES INDIVIDUAL)
956 SCHAUB AVE
MOBILE, AL 36609

FOR: TEACHING IN THE FIELD OF ACHIEVING BALANCE IN THE SACRUM AND THE SACROILIAC JOINT; EDUCATION SERVICES, NAMELY, PROVIDING CLASSES, SEMINARS, WORKSHOPS IN THE FIELD OF ACHIEVING BALANCE IN THE SACRUM AND THE SACROILIAC JOINT, IN CLASS 41 (U.S. CLS. 100, 101 AND 107).

FIRST USE 2-1-2008; IN COMMERCE 2-1-2008.

THE MARK CONSISTS OF STANDARD CHARACTERS WITHOUT CLAIM TO ANY PARTICULAR FONT, STYLE, SIZE, OR COLOR.

SN 77-181,954, FILED 5-15-2007.

HOWARD SMIGA, EXAMINING ATTORNEY

Int. Cl.: 9

Prior U.S. Cls.: 21, 23, 26, 36, and 38

United States Patent and Trademark Office

Reg. No. 3,577,033

Registered Feb. 17, 2009

**TRADEMARK
PRINCIPAL REGISTER**

Back Office Banker

DIGITAL EFT SOLUTIONS, LLC (VIRGINIA
LIMITED LIABILITY COMPANY)
10035 RED OAK LANE
SHIPPENSBURG, PA 17257

FOR: COMPUTER E-COMMERCE SOFTWARE
TO ALLOW USERS TO PERFORM ELECTRONIC
BUSINESS TRANSACTIONS VIA A GLOBAL COM-
PUTER NETWORK; COMPUTER SOFTWARE FOR
ELECTRONICALLY CAPTURING, IMAGING, PRO-
CESSING AND TRANSMITTING PAYMENT DATA
FOR DEPOSITING CHECKS, EXECUTING DEBIT
AND CREDIT CARD PAYMENTS, AND EQUIVA-
LENT E-COMMERCE TRANSACTIONSTHAT MAY
BE DOWNLOADED FROM A GLOBAL COMPUTER
NETWORK, IN CLASS 9 (U.S. CLS. 21, 23, 26, 36 AND
38).

FIRST USE 5-3-2007; IN COMMERCE 10-12-2007.

THE MARK CONSISTS OF STANDARD CHAR-
ACTERS WITHOUT CLAIM TO ANY PARTICULAR
FONT, STYLE, SIZE, OR COLOR.

NO CLAIM IS MADE TO THE EXCLUSIVE
RIGHT TO USE "BANKER" , APART FROM THE
MARK AS SHOWN.

SN 77-182,094, FILED 5-16-2007.

MICHAEL ENGEL, EXAMINING ATTORNEY

Int. Cls.: 7 and 12

Prior U.S. Cls.: 13, 19, 21, 23, 31, 34, 35, and 44

United States Patent and Trademark Office

Reg. No. 3,577,034

Registered Feb. 17, 2009

**TRADEMARK
PRINCIPAL REGISTER**

VORTEX

PERFORMANCE INDUSTRIES MANUFACTURING, INC. (FLORIDA CORPORATION)
11516 PERPETUAL DRIVE
ODESSA, FL 33556

FOR: MOTORCYCLE ENGINE PARTS, NAMELY, GUARDS, EXHAUST BRACKETS AND EXHAUST GUARDS, IN CLASS 7 (U.S. CLS. 13, 19, 21, 23, 31, 34 AND 35).

FIRST USE 7-1-1996; IN COMMERCE 7-1-1996.

FOR: STRUCTURAL PARTS FOR MOTORCYCLES; MOTORCYCLE PARTS, NAMELY, BRAKE PEDALS, CLUTCH LEVERS, SHIFT LEVERS, BREAK LEVERS, ADJUSTABLE LEVERS, FOOT CONTROLS, HAND CONTROLS, CLIP ON HANDLE BARS, HANDLE BAR CONTROL LEVERS, REAR SETS, NAMELY, FOOT CONTROLS, LOWERING LINKS, NAMELY, SUSPENSION

LINKS, SUSPENSION SPRINGS AND TENSION SPRINGS FOR MOTORCYCLES; MOTORCYCLE ENGINE COVERS; MOTORCYCLE ACCESSORIES, NAMELY, FRAME SLIDERS AND FRAME GUARDS, IN CLASS 12 (U.S. CLS. 19, 21, 23, 31, 35 AND 44).

FIRST USE 6-15-1997; IN COMMERCE 6-15-1997.

THE MARK CONSISTS OF STANDARD CHARACTERS WITHOUT CLAIM TO ANY PARTICULAR FONT, STYLE, SIZE, OR COLOR.

OWNER OF U.S. REG. NO. 2,475,676.

SN 77-182,315, FILED 5-16-2007.

DORITT L. CARROLL, EXAMINING ATTORNEY

Int. Cl.: 9

Prior U.S. Cls.: 21, 23, 26, 36, and 38

United States Patent and Trademark Office

Reg. No. 3,577,035

Registered Feb. 17, 2009

**TRADEMARK
PRINCIPAL REGISTER**



AIRTECH SOLUTIONS, INC (TEXAS CORPORATION)
P.O. BOX 261324
PLANO, TX 75026

FOR: A THREE PART ELECTRO-MECHANICAL DEVICE USED IN THE ADJUSTMENT OF DUCT MOUNTED AIR BALANCING DAMPERS IN AIR CONDITIONING SYSTEMS CONSISTING OF AN ELECTRIC ACTUATOR, AN ELECTRICAL CONNECTOR INTERFACE AND A REMOTE CONTROL MODULE WHICH ALLOWS ADJUSTMENT OF THE

ACTUATOR FROM A REMOTE LOCATION, IN CLASS 9 (U.S. CLS. 21, 23, 26, 36 AND 38).

FIRST USE 4-10-2008; IN COMMERCE 4-10-2008.

THE MARK CONSISTS OF "THE ZIPSET SYSTEM" WITH THE SWIRL OVER THE WORD "ZIPSET".

SN 77-182,365, FILED 5-16-2007.

ALICE BENMAMAN, EXAMINING ATTORNEY

Int. Cl.: 9

Prior U.S. Cls.: 21, 23, 26, 36, and 38

United States Patent and Trademark Office

Reg. No. 3,577,036

Registered Feb. 17, 2009

**TRADEMARK
PRINCIPAL REGISTER**

TERRAINONDEMAND

INTERMAP TECHNOLOGIES INC. (DELAWARE
CORPORATION)
SUITE 400
8310 SOUTH VALLEY HIGHWAY
ENGLEWOOD, CO 80112

FOR: SOFTWARE FOR THE EXTRACTION OF
DIGITAL TERRAIN ELEVATION DATA FROM A
DATA REPOSITORY, IN CLASS 9 (U.S. CLS. 21, 23,
26, 36 AND 38).

FIRST USE 12-31-2007; IN COMMERCE 12-31-2007.

THE MARK CONSISTS OF STANDARD CHAR-
ACTERS WITHOUT CLAIM TO ANY PARTICULAR
FONT, STYLE, SIZE, OR COLOR.

SN 77-182,860, FILED 5-16-2007.

ROBERT C. CLARK JR., EXAMINING ATTORNEY

Int. Cl.: 25

Prior U.S. Cls.: 22 and 39

United States Patent and Trademark Office

Reg. No. 3,577,037

Registered Feb. 17, 2009

TRADEMARK
PRINCIPAL REGISTER

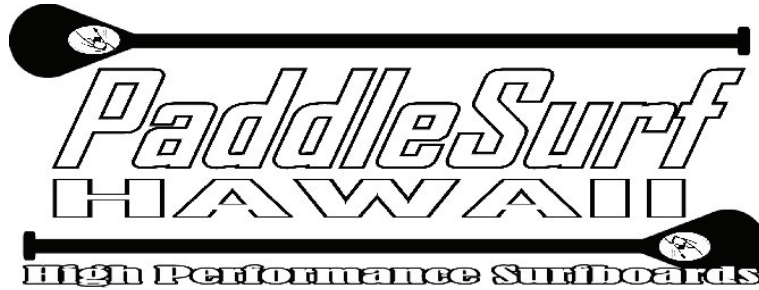

PADDLE SURF HAWAII, LLC (HAWAII LIMITED LIABILITY COMPANY)
98-030 HEKAHA STREET, SUITE 3
AIEA, HI 96701

FOR: CLOTHING, NAMELY, SHIRTS, SHORTS, T-SHIRTS, SWIM CAPS, SWIM TRUNKS, SWIM WEAR, WET SUITS, AND RASH GUARDS FOR MEN, WOMEN AND CHILDREN, IN CLASS 25 (U.S. CLS. 22 AND 39).

FIRST USE 1-1-2008; IN COMMERCE 10-15-2008.

OWNER OF U.S. REG. NO. 3,372,235.

NO CLAIM IS MADE TO THE EXCLUSIVE RIGHT TO USE "PADDLE SURF HAWAII", APART FROM THE MARK AS SHOWN.

THE MARK CONSISTS OF THE STYLIZED WORDS "PADDLE SURF HAWAII" CENTERED IN BETWEEN TWO HORIZONTAL PADDLES; EACH PADDLE CONTAINS AN OVAL ON EACH END AND INSIDE EACH OVAL THERE IS A HUMAN FIGURE HOLDING A PADDLE IN THE AIR, STANDING ON A BOARD AND CATCHING A WAVE; THE WORDS "HIGH PERFORMANCE SURFBOARDS" ARE CENTERED BELOW THE BOTTOM PADDLE.

SN 77-183,153, FILED 5-16-2007.

JAY FLOWERS, EXAMINING ATTORNEY

Int. Cl.: 16

Prior U.S. Cls.: 2, 5, 22, 23, 29, 37, 38, and 50

Reg. No. 3,577,038

United States Patent and Trademark Office

Registered Feb. 17, 2009

**TRADEMARK
PRINCIPAL REGISTER**

PENTECH VP

JAKKS PACIFIC, INC. (DELAWARE CORPORATION)
22619 PACIFIC COAST HIGHWAY
MALIBU, CA 90265

FOR: WRITING INSTRUMENTS, IN CLASS 16
(U.S. CLS. 2, 5, 22, 23, 29, 37, 38 AND 50).

FIRST USE 2-1-2008; IN COMMERCE 2-1-2008.

OWNER OF U.S. REG. NOS. 1,315,743 AND
2,451,714.

THE MARK CONSISTS OF THE WORD "PENTECH" WITH STYLIZED LETTER "E"S AND THE LETTERS "VP" IN STYLIZED FORM.

SN 77-183,677, FILED 5-17-2007.

ROBIN CHOSID, EXAMINING ATTORNEY

Int. Cl.: 45

Prior U.S. Cls.: 100 and 101

United States Patent and Trademark Office

Reg. No. 3,577,039

Registered Feb. 17, 2009

**SERVICE MARK
PRINCIPAL REGISTER**

BILLBOARD LATINO

AVOXAMERICA INC. (FLORIDA CORPORATION)

1000

8201 PETERS ROAD

PLANTATION, FL 33325

FOR: ONLINE SOCIAL NETWORKING SERVICES, IN CLASS 45 (U.S. CLS. 100 AND 101).

FIRST USE 6-24-2007; IN COMMERCE 6-24-2007.

THE MARK CONSISTS OF STANDARD CHARACTERS WITHOUT CLAIM TO ANY PARTICULAR FONT, STYLE, SIZE, OR COLOR.

NO CLAIM IS MADE TO THE EXCLUSIVE RIGHT TO USE "LATINO", APART FROM THE MARK AS SHOWN.

SN 77-183,818, FILED 5-17-2007.

WILLIAM P. SHANAHAN, EXAMINING ATTORNEY

Int. Cl.: 11

Prior U.S. Cls.: 13, 21, 23, 31, and 34

Reg. No. 3,577,040

United States Patent and Trademark Office

Registered Feb. 17, 2009

**TRADEMARK
PRINCIPAL REGISTER**

WONDER WINDERS

INNOVATIVE CONCEPTS CORPORATION (DE-
LAWARE CORPORATION)
83 PUTTER LANE
TORRINGTON, CT 06790

THE MARK CONSISTS OF STANDARD CHAR-
ACTERS WITHOUT CLAIM TO ANY PARTICULAR
FONT, STYLE, SIZE, OR COLOR.

FOR: FLASHLIGHTS; LED FLASHLIGHTS;
FLASHLIGHTS WITH INTERNAL GENERATORS
AND CRANKS FOR DRIVING THE GENERATORS
TO RECHARGE AN INTERNAL RECHARGEABLE
BATTERY; CRANK RECHARGEABLE FLASH-
LIGHTS, IN CLASS 11 (U.S. CLS. 13, 21, 23, 31 AND
34).

NO CLAIM IS MADE TO THE EXCLUSIVE
RIGHT TO USE "WINDERS", APART FROM THE
MARK AS SHOWN.

SN 77-184,703, FILED 5-18-2007.

FIRST USE 10-14-2007; IN COMMERCE 4-28-2008.

JAMES GRIFFIN, EXAMINING ATTORNEY

Int. Cls.: 9 and 41

Prior U.S. Cls.: 21, 23, 26, 36, 38, 100, 101, and 107

United States Patent and Trademark Office

Reg. No. 3,577,041

Registered Feb. 17, 2009

**TRADEMARK
SERVICE MARK
PRINCIPAL REGISTER**

MABINO GI

NEXON AMERICA INC. (DELAWARE CORPORATION)
7TH FLOOR
3460 WILSHIRE BOULEVARD
LOS ANGELES, CA 90010

FOR: VIDEO GAME SOFTWARE; VIDEO GAME PROGRAMS; VIDEO GAME CARTRIDGES; DISCS, JOYSTICKS, INTERACTIVE REMOTE CONTROL UNITS AND INTERACTIVE CONTROL FLOOR PADS OR MATS; COMPUTER PROGRAMS, NAME- LY, GAME SOFTWARE AND DOWNLOADABLE COMPUTER GAME PROGRAMS VIA THE INTER- NET AND WIRELESS DEVICES, IN CLASS 9 (U.S. CLS. 21, 23, 26, 36 AND 38).

FIRST USE 1-15-2008; IN COMMERCE 3-27-2008.

FOR: ENTERTAINMENT SERVICES, NAMELY, PROVIDING ONLINE INTERACTIVE COMPUTER GAME, IN CLASS 41 (U.S. CLS. 100, 101 AND 107).

FIRST USE 1-15-2008; IN COMMERCE 3-27-2008.

THE MARK CONSISTS OF STANDARD CHAR- ACTERS WITHOUT CLAIM TO ANY PARTICULAR FONT, STYLE, SIZE, OR COLOR.

THE NAME(S), PORTRAIT(S), AND/OR SIGNA- TURE(S) SHOWN IN THE MARK DOES NOT IDENTIFY A PARTICULAR LIVING INDIVIDUAL.

SN 77-185,504, FILED 5-20-2007.

SOPHIA S. KIM, EXAMINING ATTORNEY

Int. Cl.: 41

Prior U.S. Cls.: 100, 101, and 107

United States Patent and Trademark Office

Reg. No. 3,577,042

Registered Feb. 17, 2009

**SERVICE MARK
PRINCIPAL REGISTER**

Pale Blue Films

PATRICK G MCAVENA (UNITED STATES INDIVIDUAL)
6363 CLARK STATE RD.
GAHANNA, OH 43230

FOR: MOVIE STUDIOS; PRODUCTION AND DISTRIBUTION OF TELEVISION SHOWS AND MOVIES, IN CLASS 41 (U.S. CLS. 100, 101 AND 107).

FIRST USE 4-5-2008; IN COMMERCE 6-13-2008.

THE MARK CONSISTS OF STANDARD CHARACTERS WITHOUT CLAIM TO ANY PARTICULAR FONT, STYLE, SIZE, OR COLOR.

NO CLAIM IS MADE TO THE EXCLUSIVE RIGHT TO USE "FILMS", APART FROM THE MARK AS SHOWN.

SN 77-185,513, FILED 5-20-2007.

SOPHIA S. KIM, EXAMINING ATTORNEY

Int. Cl.: 23

Prior U.S. Cl.: 43

United States Patent and Trademark Office

Reg. No. 3,577,043

Registered Feb. 17, 2009

**TRADEMARK
PRINCIPAL REGISTER**

MIRASOL

KFI, INC. (NEW YORK CORPORATION), DBA
EURO YARNS,
315 BAYVIEW AVENUE
NEW YORK, NY 11701

THE MARK CONSISTS OF STANDARD CHAR-
ACTERS WITHOUT CLAIM TO ANY PARTICULAR
FONT, STYLE, SIZE, OR COLOR.

FOR: YARN, IN CLASS 23 (U.S. CL. 43).

SN 77-185,771, FILED 5-21-2007.

FIRST USE 4-1-2007; IN COMMERCE 4-1-2007.

YONG KIM, EXAMINING ATTORNEY

Int. Cl.: 16

Prior U.S. Cls.: 2, 5, 22, 23, 29, 37, 38, and 50

United States Patent and Trademark Office

Reg. No. 3,577,044

Registered Feb. 17, 2009

TRADEMARK
PRINCIPAL REGISTER



KRISTY VALSHAN, INC. (ILLINOIS CORPORATION)
447 HIGHLAND AVE.
ELMHURST, IL 60126

FOR: ADHESIVE NOTE PAPER; BOXES OF PAPER OR CARDBOARD; CARRYING CASES MADE OF PAPER; COASTERS MADE OF PAPER; GIFT WRAP PAPER; NOTE PAPERS; PAPER BAGS; PAPER BOXES FOR STORING GREETING CARDS; PAPER FOR USE IN THE MANUFACTURE OF WALLPAPER; PAPER GIFT BAGS; PAPER GIFT TAGS; PAPER HANG TAGS; PAPER STATIONERY; STATIONERY WRITING PAPER AND ENVELOPES; SCRAPBOOK ALBUMS; SCRAPBOOK PAGES; BRAG BOOKS; MEMORY BOOKS; BLANK JOUR-

NAL BOOKS, IN CLASS 16 (U.S. CLS. 2, 5, 22, 23, 29, 37, 38 AND 50).

FIRST USE 5-1-2007; IN COMMERCE 11-17-2007.

THE NAME SHOWN IN THE MARK DOES NOT IDENTIFY A PARTICULAR LIVING INDIVIDUAL.

THE MARK CONSISTS OF THE NAME "KRISTY VALSHAN" WITH LARGE LETTERS FOR THE "K" AND THE "V" WITH SCROLLED EMBELLISHMENTS.

SN 77-186,238, FILED 5-21-2007.

BARBARA RUTLAND, EXAMINING ATTORNEY

Int. Cl.: 9

Prior U.S. Cls.: 21, 23, 26, 36, and 38

United States Patent and Trademark Office

Reg. No. 3,577,045

Registered Feb. 17, 2009

**TRADEMARK
PRINCIPAL REGISTER**

VENDERIS

ITPARADE.COM, INC. (NORTH CAROLINA
CORPORATION)
124 QUADE DRIVE
CARY, NC 27513

FOR: INTEGRATED SUITE OF COMPUTER
SOFTWARE FOR THE AUTOMATION OF END-
OF-LIFE PROCESSES FOR COMPUTER HARD-
WARE ASSETS, NAMELY, SOFTWARE FOR USE
IN AUDITING COMPUTER HARDWARE CON-
TENT, FOR DIAGNOSTIC TESTING OF COMPU-
TER HARDWARE PERFORMANCE, FOR USE IN
SECURE DISK WIPING, AND FOR USE IN HARD-

WARE LICENSE RECOVERY, IN CLASS 9 (U.S. CLS.
21, 23, 26, 36 AND 38).

FIRST USE 2-8-2008; IN COMMERCE 2-8-2008.

THE MARK CONSISTS OF STANDARD CHAR-
ACTERS WITHOUT CLAIM TO ANY PARTICULAR
FONT, STYLE, SIZE, OR COLOR.

SN 77-186,272, FILED 5-21-2007.

LINDA ESTRADA, EXAMINING ATTORNEY

Int. Cl.: 9

Prior U.S. Cls.: 21, 23, 26, 36, and 38

Reg. No. 3,577,046

United States Patent and Trademark Office

Registered Feb. 17, 2009

**TRADEMARK
PRINCIPAL REGISTER**



SUSQUEHANNA FIRE EQUIPMENT COMPANY
(PENNSYLVANIA CORPORATION)
2122 MAIN STREET
DEWART, PA 17730

FOR: FIRE EXTINGUISHERS, IN CLASS 9 (U.S.
CLS. 21, 23, 26, 36 AND 38).

FIRST USE 9-4-2007; IN COMMERCE 9-4-2007.

NO CLAIM IS MADE TO THE EXCLUSIVE
RIGHT TO USE "SUSQUEHANNA SAFETY SOLU-
TIONS OF SUSQUEHANNA FIRE EQUIPMENT
CO.", APART FROM THE MARK AS SHOWN.

THE COLOR(S) RED AND BLACK IS/ARE
CLAIMED AS A FEATURE OF THE MARK.

THE MARK CONSISTS OF A BLACK OVAL, RED
TRIANGLE OUTLINED IN BLACK AND RED CA-
PITAL "S"S, THE REST OF THE LETTERING IS
BLACK. THE COLOR WHITE APPEARS IN THE
BACKGROUND AND IS NOT PART OF THE
MARK.

SN 77-186,774, FILED 5-22-2007.

MONIQUE MILLER, EXAMINING ATTORNEY

Int. Cls.: 9 and 35

Prior U.S. Cls.: 21, 23, 26, 36, 38, 100, 101, and 102

United States Patent and Trademark Office

Reg. No. 3,577,047

Registered Feb. 17, 2009

**TRADEMARK
SERVICE MARK
PRINCIPAL REGISTER**

CITY SHADES

MARSALLE, INC. (NEW YORK CORPORATION)
550 39TH STREET
BROOKLYN, NY 11232

FOR: PROTECTIVE EYEWEAR, NAMELY, SPECTACLES, NON-PRESCRIPTION AND PRESCRIPTION EYEWEAR, ANTI-GLARE AND MAGNIFYING GLASSES AND THEIR PARTS AND ACCESSORIES, NAMELY, REPLACEMENT LENSES, FRAMES, EARSTEMMING AND NASAL PIECES, CASES AND BOXES SPECIFICALLY ADAPTED FOR SPECTACLES, SUNGLASSES AND THEIR PARTS AND ACCESSORIES, IN CLASS 9 (U.S. CLS. 21, 23, 26, 36 AND 38).

FIRST USE 6-1-2008; IN COMMERCE 7-1-2008.

FOR: RETAIL STORE SERVICES FEATURING EYEGASSES, SUNGLASSES AND RELATED ACCESSORIES, IN CLASS 35 (U.S. CLS. 100, 101 AND 102).

FIRST USE 6-1-2008; IN COMMERCE 7-1-2008.

THE MARK CONSISTS OF STANDARD CHARACTERS WITHOUT CLAIM TO ANY PARTICULAR FONT, STYLE, SIZE, OR COLOR.

NO CLAIM IS MADE TO THE EXCLUSIVE RIGHT TO USE "SHADES", APART FROM THE MARK AS SHOWN.

SN 77-186,892, FILED 5-22-2007.

JULIE GUTTADAURO, EXAMINING ATTORNEY

Int. Cl.: 28

Prior U.S. Cls.: 22, 23, 38, and 50

Reg. No. 3,577,048

United States Patent and Trademark Office

Registered Feb. 17, 2009

**TRADEMARK
PRINCIPAL REGISTER**

STYLE YOUR OWN

MATTEL, INC. (DELAWARE CORPORATION)
M1-1518
333 CONTINENTAL BLVD.
EL SEGUNDO, CA 90245

FIRST USE 3-28-2008; IN COMMERCE 3-28-2008.

FOR: TOYS, GAMES AND PLAYTHINGS, NAME-
LY, TOY CELLPHONES, TOY MUSIC PLAYERS,
TOY PURSES, TOY CAMERAS, TOY LAPTOPS,
AND ACCESSORIES FOR ALL OF THE FOREGO-
ING, IN CLASS 28 (U.S. CLS. 22, 23, 38 AND 50).

THE MARK CONSISTS OF STANDARD CHAR-
ACTERS WITHOUT CLAIM TO ANY PARTICULAR
FONT, STYLE, SIZE, OR COLOR.

SN 77-188,215, FILED 5-23-2007.

GEOFFREY FOSDICK, EXAMINING ATTORNEY

Int. Cl.: 28

Prior U.S. Cls.: 22, 23, 38, and 50

United States Patent and Trademark Office

Reg. No. 3,577,049

Registered Feb. 17, 2009

**TRADEMARK
PRINCIPAL REGISTER**

SLEEPY DREAMS

MATTEL, INC. (DELAWARE CORPORATION)
M1-1518
333 CONTINENTAL BLVD.
EL SEGUNDO, CA 90245

FOR: TOYS, GAMES AND PLAYTHINGS, NAME-
LY, DOLLS, DOLL CLOTHING AND DOLL ACCES-
SORIES, TOY FIGURES AND ACCESSORIES
THEREFOR, IN CLASS 28 (U.S. CLS. 22, 23, 38 AND
50).

FIRST USE 4-22-2008; IN COMMERCE 4-22-2008.

THE MARK CONSISTS OF STANDARD CHAR-
ACTERS WITHOUT CLAIM TO ANY PARTICULAR
FONT, STYLE, SIZE, OR COLOR.

SN 77-188,216, FILED 5-23-2007.

GEOFFREY FOSDICK, EXAMINING ATTORNEY

Int. Cl.: 11

Prior U.S. Cls.: 13, 21, 23, 31, and 34

Reg. No. 3,577,050

United States Patent and Trademark Office

Registered Feb. 17, 2009

**TRADEMARK
PRINCIPAL REGISTER**

VORTEL

ADVANCED TECHNOLOGY ENVIRONMENTAL
CONTROL SYSTEMS, INC. (CALIFORNIA
CORPORATION)
601 UNIVERSITY AVE STE 278
SACRAMENTO, CA 95825

THE MARK CONSISTS OF STANDARD CHAR-
ACTERS WITHOUT CLAIM TO ANY PARTICULAR
FONT, STYLE, SIZE, OR COLOR.

FOR: DIFFUSERS FOR AIR CIRCULATION, IN
CLASS 11 (U.S. CLS. 13, 21, 23, 31 AND 34).

SN 77-188,290, FILED 5-23-2007.

FIRST USE 5-31-2007; IN COMMERCE 10-25-2007.

ERIN FALK, EXAMINING ATTORNEY

Int. Cl.: 16

Prior U.S. Cls.: 2, 5, 22, 23, 29, 37, 38, and 50

United States Patent and Trademark Office

Reg. No. 3,577,051

Registered Feb. 17, 2009

**TRADEMARK
PRINCIPAL REGISTER**

SMARTECH+

DAY-TIMERS, INC. (DELAWARE CORPORATION)
ONE WILLOW LANE
EAST TEXAS, PA 18046

FOR: HOME OFFICE PRODUCTS, NAMELY, LEATHER AND NON LEATHER PLANNER COVERS, DATED AND NON DATED PLANNER WORKBOOKS, AGENDAS, NOTEPADS, NOTEBOOKS, STATIONERY-TYPE PORTFOLIOS, STATIONERY, CALENDARS, ACRYLIC PLANNER ACCESSORIES, NAMELY, PAGE LOCATORS AND DOCUMENT

HOLDERS, IN CLASS 16 (U.S. CLS. 2, 5, 22, 23, 29, 37, 38 AND 50).

FIRST USE 5-1-2008; IN COMMERCE 5-1-2008.

THE MARK CONSISTS OF STANDARD CHARACTERS WITHOUT CLAIM TO ANY PARTICULAR FONT, STYLE, SIZE, OR COLOR.

SN 77-188,440, FILED 5-23-2007.

RONALD AIKENS, EXAMINING ATTORNEY

Int. Cl.: 9

Prior U.S. Cls.: 21, 23, 26, 36, and 38

United States Patent and Trademark Office

Reg. No. 3,577,052

Registered Feb. 17, 2009

TRADEMARK
PRINCIPAL REGISTER



THE GLIDDEN COMPANY (DELAWARE CORPORATION)
15885 WEST SPRAGUE ROAD
STRONGSVILLE, OH 44136

FOR: A COMPUTER PROGRAM OR SOFTWARE RECORDED ON MAGNETIC MEDIA OR DOWNLOADED FROM A REMOTE COMPUTER NETWORK FOR USE WHERE THE VIEWER MAY VISUALIZE AND CONCEPTUALIZE VARIABLE PAINT COLOR SCHEMES AND COMBINATIONS FOR EXTERIOR AND INTERIOR PAINTING OF COMMERCIAL, INDUSTRIAL AND RESIDENTIAL STRUCTURES, IN CLASS 9 (U.S. CLS. 21, 23, 26, 36 AND 38).

FIRST USE 5-30-2007; IN COMMERCE 5-30-2007.

NO CLAIM IS MADE TO THE EXCLUSIVE RIGHT TO USE "VIRTUAL PAINTER", APART FROM THE MARK AS SHOWN.

THE MARK CONSISTS OF AN IMAGE OF A COMPUTER, COMPUTER SCREEN, PAINT BRUSH AND THE WORDS "VITRUAL PAINTER" IN A CIRCLE.

SN 77-188,613, FILED 5-23-2007.

CORY BOONE, EXAMINING ATTORNEY

Int. Cl.: 25

Prior U.S. Cls.: 22 and 39

United States Patent and Trademark Office

Reg. No. 3,577,053

Registered Feb. 17, 2009

TRADEMARK
PRINCIPAL REGISTER



SEVEN WELLS, LLC (CALIFORNIA LIMITED
LIABILITY COMPANY)
1008 BRIOSO DRIVE
COSTA MESA, CA 92627

FOR: FOOTWEAR, IN CLASS 25 (U.S. CLS. 22 AND
39).

FIRST USE 3-31-2003; IN COMMERCE 3-31-2003.

OWNER OF U.S. REG. NOS. 2,099,036 AND
2,101,100.

NO CLAIM IS MADE TO THE EXCLUSIVE
RIGHT TO USE "INDUSTRIES", APART FROM
THE MARK AS SHOWN.

THE MARK CONSISTS OF A CARTOON DEPICTION
OF A DEVIL HOLDING A PITCHFORK,
WHERE THE PRONGS OF THE PITCHFORK FORM
THE "W" IN THE TERM "WORLD INDUSTRIES".

SN 77-188,924, FILED 5-23-2007.

TOBY BULLOFF, EXAMINING ATTORNEY

Int. Cl.: 25

Prior U.S. Cls.: 22 and 39

United States Patent and Trademark Office

Reg. No. 3,577,054

Registered Feb. 17, 2009

**TRADEMARK
PRINCIPAL REGISTER**

GIOVANNI Z

SUDINI IMPORTS LTD. INC (NEW JERSEY
CORPORATION)
69 ORCHARD STREET
RAMSEY, NJ 07446

THE MARK CONSISTS OF STANDARD CHAR-
ACTERS WITHOUT CLAIM TO ANY PARTICULAR
FONT, STYLE, SIZE, OR COLOR.

FOR: FOOTWEAR FOR WOMEN, IN CLASS 25
(U.S. CLS. 22 AND 39).

SN 77-189,400, FILED 5-24-2007.

FIRST USE 2-1-2007; IN COMMERCE 7-1-2007.

LINDA M. KING, EXAMINING ATTORNEY

Int. Cl.: 33

Prior U.S. Cls.: 47 and 49

United States Patent and Trademark Office

Reg. No. 3,577,055

Registered Feb. 17, 2009

**TRADEMARK
PRINCIPAL REGISTER**

COTEAUX SAUVAGES

MICHEL-SCHLUMBERGER PARTNERS, L.P.
(CALIFORNIA LIMITED PARTNERSHIP)

4155 WINE CREEK ROAD

HEALDSBURG, CA 95448

FOR: WINE, IN CLASS 33 (U.S. CLS. 47 AND 49).

FIRST USE 11-1-2008; IN COMMERCE 11-1-2008.

THE MARK CONSISTS OF STANDARD CHARACTERS WITHOUT CLAIM TO ANY PARTICULAR FONT, STYLE, SIZE, OR COLOR.

THE ENGLISH TRANSLATION OF "COTEAUX SAUVAGES" IN THE MARK IS WILD SLOPES.

SN 77-189,623, FILED 5-24-2007.

JENNIFER VASQUEZ, EXAMINING ATTORNEY

Int. Cl.: 9

Prior U.S. Cls.: 21, 23, 26, 36, and 38

Reg. No. 3,577,056

United States Patent and Trademark Office

Registered Feb. 17, 2009

**TRADEMARK
PRINCIPAL REGISTER**

VECTORJET

THE SABREEN GROUP, INC. (TEXAS CORPORATION)
5837 WAVETREE LANE
PLANO, TX 75093

FOR: NON-MEDICAL LASERS FOR MATERIAL PROCESSING AND MATERIAL MARKING FOR USE IN THE INDUSTRIAL, MICRO-INDUSTRIAL, MEDICAL, MANUFACTURING, PRODUCT SECURITY, AND IDENTIFICATION TRADES, ELECTRONIC CONTROLLERS FOR CONTROLLING LASER MARKING DEVICES, NAMELY, BEAM-STEERED GALVANOMETER SCAN HEADS, COMPONENT PARTS FOR THE AFOREMENTIONED GOODS, AND MANUALS THEREFOR SOLD AS A UNIT; APPLICATION AND OPERATING SOFTWARE FOR OPERATING AND CONTROLLING

NON-MEDICAL LASERS FOR MATERIAL PROCESSING AND MATERIAL MARKING AND FOR OPERATING ELECTRONIC CONTROLLERS FOR LASER MARKING, IN CLASS 9 (U.S. CLS. 21, 23, 26, 36 AND 38).

FIRST USE 10-27-2008; IN COMMERCE 10-27-2008.

THE MARK CONSISTS OF STANDARD CHARACTERS WITHOUT CLAIM TO ANY PARTICULAR FONT, STYLE, SIZE, OR COLOR.

SN 77-190,394, FILED 5-25-2007.

BONNIE LUKEN, EXAMINING ATTORNEY

Int. Cl.: 45

Prior U.S. Cls.: 100 and 101

United States Patent and Trademark Office

Reg. No. 3,577,057

Registered Feb. 17, 2009

**SERVICE MARK
PRINCIPAL REGISTER**

SIMPLE ENCOURAGEMENT

SIMPLE E CREATIONS, INC. (FLORIDA CORPORATION)

#214

35246 US HIGHWAY 19 NORTH
PALM HARBOR, FL 34684

FOR: PROVIDING A WEB SITE FEATURING INFORMATION IN THE FIELD OF PERSONAL RELATIONSHIPS, IN CLASS 45 (U.S. CLS. 100 AND 101).

FIRST USE 12-0-2006; IN COMMERCE 12-0-2006.

THE MARK CONSISTS OF STANDARD CHARACTERS WITHOUT CLAIM TO ANY PARTICULAR FONT, STYLE, SIZE, OR COLOR.

SN 77-190,526, FILED 5-25-2007.

STEVEN R. FINE, EXAMINING ATTORNEY

Int. Cls.: 16 and 44

Prior U.S. Cls.: 2, 5, 22, 23, 29, 37, 38, 50, 100, and 101

United States Patent and Trademark Office

Reg. No. 3,577,058

Registered Feb. 17, 2009

**TRADEMARK
SERVICE MARK
PRINCIPAL REGISTER**

PAMPERS VILLAGE

THE PROCTER & GAMBLE COMPANY (OHIO CORPORATION)
ONE PROCTER & GAMBLE PLAZA
CINCINNATI, OH 45202

FOR: DISPOSABLE DIAPERS; PRINTED PUBLICATIONS, NAMELY, BROCHURES, BOOKLETS, LEAFLETS AND PAMPHLETS DEALING WITH PREGNANCY, EXPECTANT MOTHER CARE, PARENTING AND BABY CARE, IN CLASS 16 (U.S. CLS. 2, 5, 22, 23, 29, 37, 38 AND 50).

FIRST USE 11-3-2008; IN COMMERCE 11-3-2008.

FOR: PROVIDING A WEBSITE ON GLOBAL COMPUTER NETWORKS FEATURING INFORMATION IN THE FIELD OF WELLNESS OF EXPEC-

TANT MOTHERS AND BABIES, IN CLASS 44 (U.S. CLS. 100 AND 101).

FIRST USE 11-3-2008; IN COMMERCE 11-3-2008.

THE MARK CONSISTS OF STANDARD CHARACTERS WITHOUT CLAIM TO ANY PARTICULAR FONT, STYLE, SIZE, OR COLOR.

OWNER OF U.S. REG. NOS. 745,513, 2,803,794, AND 3,146,704.

SN 77-190,769, FILED 5-25-2007.

KATHERINE STOIDES, EXAMINING ATTORNEY

Int. Cl.: 8

Prior U.S. Cls.: 23, 28, and 44

United States Patent and Trademark Office

Reg. No. 3,577,059

Registered Feb. 17, 2009

**TRADEMARK
PRINCIPAL REGISTER**

Shower Floors Done Right

SHOWER FLOORS DONE RIGHT, INC. (FLOR-
IDA CORPORATION)
P.O. BOX 270712
TAMPA, FL 33688

THE MARK CONSISTS OF STANDARD CHAR-
ACTERS WITHOUT CLAIM TO ANY PARTICULAR
FONT, STYLE, SIZE, OR COLOR.

FOR: MANUALLY OPERATED HAND TOOLS,
NAMELY, SCREEDS, IN CLASS 8 (U.S. CLS. 23, 28
AND 44).

SN 77-191,850, FILED 5-29-2007.

FIRST USE 12-10-2003; IN COMMERCE 3-25-2004.

ALICE BENMAMAN, EXAMINING ATTORNEY

Int. Cl.: 28

Prior U.S. Cls.: 22, 23, 38, and 50

United States Patent and Trademark Office

Reg. No. 3,577,060

Registered Feb. 17, 2009

**TRADEMARK
PRINCIPAL REGISTER**



DR. SEUSS ENTERPRISES, L.P. (CALIFORNIA
LIMITED PARTNERSHIP)
C/O KARL ZOBELL, ESQ. DLA PIPER US LLP
1200 PROSPECT STREET, SUITE 575
LA JOLLA, CA 920373610

FOR: CHRISTMAS TREE ORNAMENTS, IN
CLASS 28 (U.S. CLS. 22, 23, 38 AND 50).

FIRST USE 11-0-2007; IN COMMERCE 11-0-2007.

NO CLAIM IS MADE TO THE EXCLUSIVE
RIGHT TO USE THE REPRESENTATION OF THE

DESIGN OF CHRISTMAS ORNAMENTS, APART
FROM THE MARK AS SHOWN.

THE MARK CONSISTS OF A CHRISTMAS TREE
DECORATED WITH ORNAMENTS AND A STAR
ON TOP.

SN 77-192,215, FILED 5-29-2007.

BONNIE LUKEN, EXAMINING ATTORNEY

Int. Cl.: 41

Prior U.S. Cls.: 100, 101, and 107

United States Patent and Trademark Office

Reg. No. 3,577,061

Registered Feb. 17, 2009

**SERVICE MARK
PRINCIPAL REGISTER**

FLIGHT OF THE CONCHORDS

CLEMENT, JEMAIN (NEW ZEALAND INDIVIDUAL)
C/O JEFF ENDLICH OF BARNES MORRIS ET AL
LOS ANGELES, CA 90067 AND
MCKENZIE, BRET (NEW ZEALAND INDIVIDUAL)
C/O JEFF ENDLICH OF BARNES MORRIS ET AL
LOS ANGELES, CA 90067

FOR: ENTERTAINMENT SERVICES IN THE
NATURE OF AN ONGOING COMEDY TELEVISION
SERIES, IN CLASS 41 (U.S. CLS. 100, 101 AND 107).

FIRST USE 6-17-2007; IN COMMERCE 6-17-2007.

THE MARK CONSISTS OF STANDARD CHARACTERS WITHOUT CLAIM TO ANY PARTICULAR FONT, STYLE, SIZE, OR COLOR.

SN 77-192,267, FILED 5-29-2007.

MARK SPARACINO, EXAMINING ATTORNEY

Int. Cl.: 6

Prior U.S. Cls.: 2, 12, 13, 14, 23, 25, and 50

United States Patent and Trademark Office

Reg. No. 3,577,062

Registered Feb. 17, 2009

**TRADEMARK
PRINCIPAL REGISTER**



FORT WAYNE METALS RESEARCH PRODUCTS
CORP (INDIANA CORPORATION)
9609 ARDMORE AVENUE
FORT WAYNE, IN 46809

THE MARK CONSISTS OF THE LETTER "H"
WITH A DOUBLE, CIRCULAR PATTERN SUR-
ROUNDING IT.

FOR: WIRE, IN CLASS 6 (U.S. CLS. 2, 12, 13, 14, 23,
25 AND 50).

SN 77-192,335, FILED 5-29-2007.

FIRST USE 8-0-2008; IN COMMERCE 8-0-2008.

JESSICA A. POWERS, EXAMINING ATTORNEY

Int. Cl.: 33

Prior U.S. Cls.: 47 and 49

United States Patent and Trademark Office

Reg. No. 3,577,063

Registered Feb. 17, 2009

**TRADEMARK
PRINCIPAL REGISTER**



BODEGAS BARBADILLO, S.L. (SPAIN CORPORATION)
SANLÚCAR DE BARRAMEDA
C/LUIS DE EGUILAZ, 11
CÁDIZ, SPAIN 11540

FOR: ALCOHOLIC BEVERAGES (EXCEPT BEERS), NAMELY, WINE, CHAMOMILE, SHERRY, IN CLASS 33 (U.S. CLS. 47 AND 49).

FIRST USE 0-0-1920; IN COMMERCE 0-0-1999.

NO CLAIM IS MADE TO THE EXCLUSIVE RIGHT TO USE "ESTD." AND "1821", APART FROM THE MARK AS SHOWN.

THE MARK CONSISTS OF A SHIELD WITH THE WORDS "ESTD" ON ONE SIDE AND THE NUMBERS "1821" ON THE OTHER. A CROWN APPEARS ON THE TOP OF THE SHIELD. THE SHIELD IS DIVIDED INTO FOUR SECTIONS. THERE IS A CROSS ON THE TOP SECTION, A CASTLE IN THE LEFT SECTION, A LION IN THE RIGHT SECTION AND A FLEUR-DE-LIS IN THE LOWER SECTION. THE WORD "BARBADILLO" APPEARS BELOW THE SHIELD.

SN 77-193,113, FILED 5-30-2007.

RONALD AIKENS, EXAMINING ATTORNEY

Int. Cl.: 34

Prior U.S. Cls.: 2, 8, 9, and 17

United States Patent and Trademark Office

Reg. No. 3,577,064

Registered Feb. 17, 2009

**TRADEMARK
PRINCIPAL REGISTER**

Bodyshot

CHEYENNE INTERNATIONAL, LLC (NORTH
CAROLINA LIMITED LIABILITY COMPANY)
701 S. BATTLEGROUND AVENUE
GROVER, NC 28073

THE MARK CONSISTS OF STANDARD CHAR-
ACTERS WITHOUT CLAIM TO ANY PARTICULAR
FONT, STYLE, SIZE, OR COLOR.

FOR: CIGARETTES, CIGARS, CIGARILLOS,
SMOKELESS TOBACCO, CHEWING TOBACCO,
SNUFF, SMOKING TOBACCO AND CIGARETTE
PAPERS, IN CLASS 34 (U.S. CLS. 2, 8, 9 AND 17).

SN 77-193,169, FILED 5-30-2007.

FIRST USE 4-4-2008; IN COMMERCE 4-4-2008.

HOWARD FRIEDMAN, EXAMINING ATTORNEY

Int. Cl.: 25

Prior U.S. Cls.: 22 and 39

United States Patent and Trademark Office

Reg. No. 3,577,065

Registered Feb. 17, 2009

**TRADEMARK
PRINCIPAL REGISTER**

COMFORT BY DESIGN

WARNACO U.S., INC. (DELAWARE CORPORATION)
470 WHEELERS FARMS ROAD
MILFORD, CT 06460

FOR: INTIMATE APPAREL AND FIGURE ENHANCING GARMENTS, NAMELY, BRAS, PANTIES, UNDERWEAR, UNDERPANTS, UNDERGARMENTS, UNDERCLOTHES, LINGERIE, FOUNDATION GARMENTS AND CAMISOLES, IN CLASS 25 (U.S. CLS. 22 AND 39).

FIRST USE 3-15-2008; IN COMMERCE 3-15-2008.

THE MARK CONSISTS OF STANDARD CHARACTERS WITHOUT CLAIM TO ANY PARTICULAR FONT, STYLE, SIZE, OR COLOR.

OWNER OF U.S. REG. NOS. 1,146,658 AND 2,214,803.

SN 77-193,884, FILED 5-31-2007.

KARANENDRA S. CHHINA, EXAMINING ATTORNEY

Int. Cl.: 29

Prior U.S. Cl.: 46

United States Patent and Trademark Office

Reg. No. 3,577,066

Registered Feb. 17, 2009

**TRADEMARK
PRINCIPAL REGISTER**

ATHENOS NEO CLASSIC

CHURNY COMPANY, INC. (DELAWARE COR-
PORATION)

2211 SANDERS ROAD

NORTHBROOK, IL 60093

FOR: HUMMUS, IN CLASS 29 (U.S. CL. 46).

FIRST USE 8-15-2007; IN COMMERCE 8-15-2007.

THE MARK CONSISTS OF STANDARD CHAR-
ACTERS WITHOUT CLAIM TO ANY PARTICULAR
FONT, STYLE, SIZE, OR COLOR.

OWNER OF U.S. REG. NOS. 1,512,908, 2,821,307,
AND OTHERS.

SN 77-195,464, FILED 6-1-2007.

TRICIA SONNEBORN, EXAMINING ATTORNEY

Int. Cl.: 11

Prior U.S. Cls.: 13, 21, 23, 31, and 34

United States Patent and Trademark Office

Reg. No. 3,577,067

Registered Feb. 17, 2009

**TRADEMARK
PRINCIPAL REGISTER**



STUDIO ITALIA DESIGN USA, LLC (FLORIDA
LIMITED LIABILITY COMPANY)
1155 NW 159 TH DRIVE
MIAMI, FL 33169

FOR: PORTABLE, TABLE AND FLOOR LAMPS;
LIGHTING FIXTURES; ELECTRIC LIGHTING FIX-
TURES, NAMELY, SCONCES, IN CLASS 11 (U.S.
CLS. 13, 21, 23, 31 AND 34).

FIRST USE 1-1-2004; IN COMMERCE 1-1-2004.

NO CLAIM IS MADE TO THE EXCLUSIVE
RIGHT TO USE "ITALIA DESIGN", APART FROM
THE MARK AS SHOWN.

THE COLOR(S) RED AND WHITE IS/ARE
CLAIMED AS A FEATURE OF THE MARK.

THE MARK CONSISTS OF A RED SQUARE WITH
THE WORDS "STUDIO" "ITALIA" AND "DESIGN"
IN WHITE. THE WORDS "STUDIO" AND "ITALIA"
AND UNDERLINED BY A THIN WHITE LINE.

SN 77-195,471, FILED 6-1-2007.

WILLIAM P. SHANAHAN, EXAMINING ATTOR-
NEY

Int. Cl.: 42

Prior U.S. Cls.: 100 and 101

United States Patent and Trademark Office

Reg. No. 3,577,068

Registered Feb. 17, 2009

**SERVICE MARK
PRINCIPAL REGISTER**

CAM CONNECT

ROYAL BANK OF CANADA (CANADA CHAR-
TERED BANK)
4TH FLOOR - EAST WING
A/S RBC LAW GROUP, 1 PLACE VILLE MARIE
MONTREAL, CANADA H3C3A9

FOR: APPLICATION SERVICE PROVIDER (ASP),
UTILIZING A SECURE WEB PORTAL, FOR USE IN
COMMISSION MANAGEMENT FOR CLIENTS TO
EFFECTIVELY AND SECURELY MANAGE TRAD-
ING COMMISSION ALLOCATIONS AND OTHER
BROKER AND VENDOR DISBURSEMENTS AND

ACCOUNT ACTIVITY, IN CLASS 42 (U.S. CLS. 100
AND 101).

FIRST USE 5-0-2007; IN COMMERCE 5-0-2007.

THE MARK CONSISTS OF STANDARD CHAR-
ACTERS WITHOUT CLAIM TO ANY PARTICULAR
FONT, STYLE, SIZE, OR COLOR.

SN 77-196,069, FILED 6-1-2007.

ERIN FALK, EXAMINING ATTORNEY

Int. Cl.: 9

Prior U.S. Cls.: 21, 23, 26, 36, and 38

Reg. No. 3,577,069

United States Patent and Trademark Office

Registered Feb. 17, 2009

**TRADEMARK
PRINCIPAL REGISTER**

ZERIX

OPTIMUM SOURCE, INC. (PHILIPPINES CORPORATION)
2501 ORIENT SQUARE BLDG.
EMERALD AVENUE, ORTIGAS CENTER
PASIG CITY, PHILIPPINES

FOR: COMPUTER SOFTWARE THAT ALLOWS A PERSONAL COMPUTER OR LAPTOP TO SEND AND BROADCAST INFORMATION THROUGH SHORT MESSAGING SYSTEM (SMS) TO A MOBILE PHONE OR ANY DEVICE THAT USES SMS FROM A SPECIFIC DATABASE AND NOT DESIGNED FOR

EMERGENCY OR LAW ENFORCEMENT PURPOSES, IN CLASS 9 (U.S. CLS. 21, 23, 26, 36 AND 38).

FIRST USE 11-25-2008; IN COMMERCE 11-25-2008.

THE MARK CONSISTS OF STANDARD CHARACTERS WITHOUT CLAIM TO ANY PARTICULAR FONT, STYLE, SIZE, OR COLOR.

SN 77-197,449, FILED 6-5-2007.

HANNO RITTNER, EXAMINING ATTORNEY

Int. Cl.: 18

Prior U.S. Cls.: 1, 2, 3, 22, and 41

United States Patent and Trademark Office

Reg. No. 3,577,070

Registered Feb. 17, 2009

**TRADEMARK
PRINCIPAL REGISTER**

MAKTANK

TAIYO KOGYO CORPORATION (JAPAN CORPORATION)
4-8-4, KIKAWA-HIGASHI, YODOGAWA-KU
OSAKA-SHI, OSAKA, JAPAN 532-0012

FOR: BAGS AND POUCHES, NAMELY, ALL-PURPOSE CARRYING BAGS, CARRY-ALL BAGS, MESSENGER BAGS, SCHOOL BAGS, SLING BAGS, TOTE BAGS, TRAVEL BAGS, DRAWSTRING POUCHES, AND ZIPPERED POUCHES, IN CLASS 18 (U.S. CLS. 1, 2, 3, 22 AND 41).

FIRST USE 5-14-2007; IN COMMERCE 10-17-2008.

THE MARK CONSISTS OF STANDARD CHARACTERS WITHOUT CLAIM TO ANY PARTICULAR FONT, STYLE, SIZE, OR COLOR.

SN 77-197,631, FILED 6-5-2007.

ANNE FARRELL, EXAMINING ATTORNEY

Int. Cl.: 10

Prior U.S. Cls.: 26, 39, and 44

United States Patent and Trademark Office

Reg. No. 3,577,071

Registered Feb. 17, 2009

**TRADEMARK
PRINCIPAL REGISTER**

**MANATEE SOFT TISSUE
INSTRUMENT**

SIRENIA HOLDINGS, LLC (MISSOURI LIMITED
LIABILITY COMPANY)
1731 E. 20TH ST., SUITE B
JOPLIN, MO 64804

FOR: HAND-HELD MONOLITHIC TOOL MAR-
KETED TO HEALTH PROFESSIONALS THAT IN-
CLUDES MULTIPLE SURFACES FOR
THERAPEUTIC TREATMENT OF SOFT TISSUE
DISORDERS BY PRESSING ONE OF THE SURFA-
CES OF THE TOOL AGAINST SOFT TISSUE OF A
PATIENT, IN CLASS 10 (U.S. CLS. 26, 39 AND 44).

FIRST USE 12-2-2008; IN COMMERCE 12-2-2008.

THE MARK CONSISTS OF STANDARD CHAR-
ACTERS WITHOUT CLAIM TO ANY PARTICULAR
FONT, STYLE, SIZE, OR COLOR.

NO CLAIM IS MADE TO THE EXCLUSIVE
RIGHT TO USE "SOFT TISSUE INSTRUMENT",
APART FROM THE MARK AS SHOWN.

SN 77-198,710, FILED 6-6-2007.

COLLEEN KEARNEY, EXAMINING ATTORNEY

Int. Cl.: 7

Prior U.S. Cls.: 13, 19, 21, 23, 31, 34, and 35

Reg. No. 3,577,072

United States Patent and Trademark Office

Registered Feb. 17, 2009

**TRADEMARK
PRINCIPAL REGISTER**

BROOME ENGINEERING

UNIVERSAL INSTRUMENTS CORPORATION
(DELAWARE CORPORATION)
BOX 825
BINGHAMTON, NY 139020825

THE MARK CONSISTS OF STANDARD CHARACTERS WITHOUT CLAIM TO ANY PARTICULAR FONT, STYLE, SIZE, OR COLOR.

FOR: MACHINES FOR THE ASSEMBLY OF ELECTRONIC CIRCUIT BOARDS, NAMELY, MACHINES FOR MOUNTING AND BONDING ELECTRONIC COMPONENTS TO ELECTRONIC CIRCUIT BOARDS, IN CLASS 7 (U.S. CLS. 13, 19, 21, 23, 31, 34 AND 35).

NO CLAIM IS MADE TO THE EXCLUSIVE RIGHT TO USE "ENGINEERING", APART FROM THE MARK AS SHOWN.

SN 77-198,744, FILED 6-6-2007.

FIRST USE 6-0-2007; IN COMMERCE 6-0-2007.

DAWN FELDMAN, EXAMINING ATTORNEY

Int. Cl.: 37

Prior U.S. Cls.: 100, 103, and 106

United States Patent and Trademark Office

Reg. No. 3,577,073

Registered Feb. 17, 2009

**SERVICE MARK
PRINCIPAL REGISTER**



LEAK GEEKS (TEXAS CORPORATION)
10395 ALTA VISTA RD. #120
KELLER, TX 76248

FOR: REMODELING OF PLUMBING; MAINTENANCE AND/OR REPAIR OF PLUMBING, IN CLASS 37 (U.S. CLS. 100, 103 AND 106).

FIRST USE 6-1-2007; IN COMMERCE 7-20-2008.

THE MARK CONSISTS OF THE WORDS "LEAK GEEKS" IN A STYLIZED TEXT WITH A PLUMBER WITH OVERALLS, SHIRT, CAP AND GLASSES. TALL, SLENDER AND PLEASANT SMILE.

SN 77-198,912, FILED 6-6-2007.

GINA HAYES, EXAMINING ATTORNEY

Int. Cl.: 1

Prior U.S. Cls.: 1, 5, 6, 10, 26, and 46

United States Patent and Trademark Office

Reg. No. 3,577,074

Registered Feb. 17, 2009

**TRADEMARK
PRINCIPAL REGISTER**

PROSELECT

FERGUSON ENTERPRISES, INC. (VIRGINIA
CORPORATION)
12500 JEFFERSON AVENUE
NEWPORT NEWS, VA 236024314

FOR: GLYCOL, IN CLASS 1 (U.S. CLS. 1, 5, 6, 10, 26
AND 46).

FIRST USE 8-31-2007; IN COMMERCE 8-31-2007.

THE MARK CONSISTS OF STANDARD CHAR-
ACTERS WITHOUT CLAIM TO ANY PARTICULAR
FONT, STYLE, SIZE, OR COLOR.

OWNER OF U.S. REG. NO. 3,065,212.

SN 77-199,094, FILED 6-6-2007.

SUSAN RICHARDS, EXAMINING ATTORNEY

Int. Cl.: 43

Prior U.S. Cls.: 100 and 101

United States Patent and Trademark Office

Reg. No. 3,577,075

Registered Feb. 17, 2009

**SERVICE MARK
PRINCIPAL REGISTER**

È TUTTO QUA

CAMPO DEI FIORI, INC. (CALIFORNIA CORPORATION)

270 COLUMBUS AVENUE

SAN FRANCISCO, CA 94133

FOR: RESTAURANT SERVICES, IN CLASS 43
(U.S. CLS. 100 AND 101).

FIRST USE 6-16-2007; IN COMMERCE 10-26-2008.

THE MARK CONSISTS OF STANDARD CHARACTERS WITHOUT CLAIM TO ANY PARTICULAR FONT, STYLE, SIZE, OR COLOR.

THE FOREIGN WORDING IN THE MARK TRANSLATES INTO ENGLISH AS "EVERYTHING IS HERE".

SN 77-199,096, FILED 6-6-2007.

SUSAN RICHARDS, EXAMINING ATTORNEY

Int. Cl.: 9

Prior U.S. Cls.: 21, 23, 26, 36, and 38

Reg. No. 3,577,076

United States Patent and Trademark Office

Registered Feb. 17, 2009

**TRADEMARK
PRINCIPAL REGISTER**



ZHONGSHAN HUA FENG HARDWARE FAC-
TORY (CHINA CORPORATION)
FUYE ROAD, YONGNING, XIAOLAN
ZHONGSHAN CITY
GUANGDONG PROVINCE, CHINA

FOR: ELECTRIC LOCKS; MAGNIFYING PEEP-
HOLES FOR DOORS; ELECTRIC DOOR OPENERS;
SAFETY EQUIPMENT, NAMELY, FIRE ESCAPE
LADDERS; WEIGHING EQUIPMENT, NAMELY,
SCALES AND BALANCES, IN CLASS 9 (U.S. CLS.
21, 23, 26, 36 AND 38).

FIRST USE 6-22-1999; IN COMMERCE 12-25-2008.

THE MARK CONSISTS OF TWO CHINESE CHAR-
ACTERS, TWO INVENTED WORDS "HUA FENG"
AND A TRIANGULAR DEVICE.

THE NON-LATIN CHARACTERS IN THE MARK
TRANSLITERATE TO "HUA FENG", AND THESE
MEAN "FLOURISH EDGE" IN ENGLISH.

SN 77-199,796, FILED 6-6-2007.

BARBARA A. GOLD, EXAMINING ATTORNEY

Int. Cl.: 9

Prior U.S. Cls.: 21, 23, 26, 36, and 38

United States Patent and Trademark Office

Reg. No. 3,577,077

Registered Feb. 17, 2009

**TRADEMARK
PRINCIPAL REGISTER**

SWAY

SAMSUNG ELECTRONICS CO., LTD. (REPUBLIC OF KOREA CORPORATION)
416, MAETAN-DONG, YEONGTONG-GU, SUWON-SI
GYEONGGI-DO, REPUBLIC OF KOREA

FOR: MOBILE TELEPHONES; MOBILE TELEPHONES WITH MP3 PLAYER FUNCTIONS; MOBILE TELEPHONE ACCESSORIES, NAMELY, RECHARGEABLE BATTERIES, BATTERY CHARGERS, HEADSETS AND LEATHER CASES FOR MOBILE TELEPHONES, IN CLASS 9 (U.S. CLS. 21, 23, 26, 36 AND 38).

FIRST USE 10-3-2008; IN COMMERCE 10-3-2008.

THE MARK CONSISTS OF STANDARD CHARACTERS WITHOUT CLAIM TO ANY PARTICULAR FONT, STYLE, SIZE, OR COLOR.

SN 77-200,005, FILED 6-7-2007.

DORITT L. CARROLL, EXAMINING ATTORNEY

Int. Cl.: 10

Prior U.S. Cls.: 26, 39, and 44

United States Patent and Trademark Office

Reg. No. 3,577,078

Registered Feb. 17, 2009

**TRADEMARK
PRINCIPAL REGISTER**

The Vibe

RAFFEL SYSTEMS, LLC (WISCONSIN LIMITED
LIABILITY COMPANY)
N19W6723 COMMERCE COURT
CEDARBURG, WI 53012

THE MARK CONSISTS OF STANDARD CHAR-
ACTERS WITHOUT CLAIM TO ANY PARTICULAR
FONT, STYLE, SIZE, OR COLOR.

FOR: MASSAGE CHAIRS; MASSAGERS IN THE
NATURE OF ELECTROMECHANICAL MASSAGE
MECHANISM FOR CHAIRS, IN CLASS 10 (U.S. CLS.
26, 39 AND 44).

SN 77-200,015, FILED 6-7-2007.

FIRST USE 7-17-2008; IN COMMERCE 10-23-2008.

REBECCA EISINGER, EXAMINING ATTORNEY

Int. Cl.: 9

Prior U.S. Cls.: 21, 23, 26, 36, and 38

United States Patent and Trademark Office

Reg. No. 3,577,079

Registered Feb. 17, 2009

**TRADEMARK
PRINCIPAL REGISTER**



SIGNAL TECHNOLOGY CORPORATION (ARIZONA CORPORATION)
340 N. ROOSEVELT AVE
CHANDLER, AZ 85226

FOR: ELECTRIC OR ELECTRONIC SENSORS FOR DETECTING MOVEMENT OR MOTION FOR SITUATIONAL AWARENESS AND SECURITY PURPOSES, IN CLASS 9 (U.S. CLS. 21, 23, 26, 36 AND 38).

FIRST USE 11-18-2008; IN COMMERCE 11-18-2008.

THE COLOR(S) RED, GREY, BLUE, FUCHSIA, BLACK AND WHITE IS/ARE CLAIMED AS A FEATURE OF THE MARK.

THE MARK CONSISTS OF THE WORDING "MICROOBSERVER" IN THE COLOR BLACK WITH A TARGET DESIGN CONTAINING AN EYEBALL IN

THE CENTER OF THE TARGET. THE OUTSIDE RING OF THE TARGET IS IN THE COLOR RED AND OUTLINED IN BLACK. THE CROSS HAIRS INSIDE THE TARGET APPEAR IN THE COLOR GREY. THE EYEBALL INSIDE OF THE CROSS HAIRS HAS A BLACK RING ON THE OUTSIDE, FOLLOWED BY A HALF RED AND HALF FUCHSIA RING, AND FOLLOWED BY A BLUE RING. THE INNER EYEBALL IS COMPRISED OF A SPHERE IN THE COLOR BLACK THAT CONTAINS TWO WHITE DOTS. THE REMAINDER OF THE WHITE WITHIN THE OUTER CIRCLE OF THE TARGET AND WITHIN THE CROSS HAIRS REPRESENTS A TRANSPARENT BACKGROUND AND IS NOT IN COLOR.

SN 77-200,104, FILED 6-7-2007.

JEFFERY COWARD, EXAMINING ATTORNEY

Int. Cls.: 35 and 40

Prior U.S. Cls.: 100, 101, 102, 103, and 106

United States Patent and Trademark Office

Reg. No. 3,577,080

Registered Feb. 17, 2009

**SERVICE MARK
PRINCIPAL REGISTER**

SPORTS FUNATIC

FEY INDUSTRIES, INC. (MINNESOTA CORPORATION)
200 FOURTH AVE. N
EDGERTON, MN 55128

FOR: PREPARING PROMOTIONAL AND MERCHANDISING MATERIAL FOR OTHERS, IN CLASS 35 (U.S. CLS. 100, 101 AND 102).

FIRST USE 4-0-2007; IN COMMERCE 4-0-2007.

FOR: CUSTOMIZED PRINTING OF COMPANY NAMES AND LOGOS FOR PROMOTIONAL AND ADVERTISING PURPOSES ON A WIDE VARIETY OF GOODS FOR OTHERS, NAMELY, COASTERS, RING BINDERS, DESK FOLDERS, CHECKBOOK COVERS, AND PROTECTIVE CARRYING CASES FOR PORTABLE MUSIC PLAYERS, NAMELY, MP3 PLAYERS AND PORTABLE AND HANDHELD DIGITAL ELECTRONIC DEVICES FOR RECORDING,

ORGANIZING, TRANSMITTING, MANIPULATING AND REVIEWING AUDIO FILES AND ON VINYL MATERIALS BEARING A LOOK AND FEEL TO BASKETBALLS AND FOOTBALLS, IN CLASS 40 (U.S. CLS. 100, 103 AND 106).

FIRST USE 4-0-2007; IN COMMERCE 4-0-2007.

THE MARK CONSISTS OF STANDARD CHARACTERS WITHOUT CLAIM TO ANY PARTICULAR FONT, STYLE, SIZE, OR COLOR.

NO CLAIM IS MADE TO THE EXCLUSIVE RIGHT TO USE "SPORTS", APART FROM THE MARK AS SHOWN.

SN 77-200,354, FILED 6-7-2007.

JILL C. ALT, EXAMINING ATTORNEY

Int. Cls.: 9, 12, and 18

**Prior U.S. Cls.: 1, 2, 3, 19, 21, 22, 23, 26, 31, 35, 36, 38,
41, and 44**

Reg. No. 3,577,081

United States Patent and Trademark Office

Registered Feb. 17, 2009

**TRADEMARK
PRINCIPAL REGISTER**

AIRWALK

COLLECTIVE LICENSING INTERNATIONAL,
LLC (DELAWARE LIMITED LIABILITY COM-
PANY)
SUITE C200
800 ENGLEWOOD PARKWAY
ENGLEWOOD, CO 80110

FOR: SUNGLASSES FOR SPORTS, IN CLASS 9
(U.S. CLS. 21, 23, 26, 36 AND 38).

FIRST USE 7-1-2007; IN COMMERCE 7-1-2007.

FOR: BICYCLES; BICYCLE PARTS AND ACCES-
SORIES, NAMELY, FORKS, SEATS AND PEDALS,
IN CLASS 12 (U.S. CLS. 19, 21, 23, 31, 35 AND 44).

FIRST USE 7-1-2007; IN COMMERCE 7-1-2007.

FOR: ATHLETIC AND SPORTS BAGS, DUFFEL
BAGS, BACKPACKS, HANDBAGS, SCHOOL BAGS,

LUGGAGE, FANNY PACKS, HAND BAGS, TRAVEL
BAGS, GYM BAGS, SHOULDER BAGS, BOOK
BAGS, MESSENGER BAGS, SCHOOL BAGS AND
PURSES, IN CLASS 18 (U.S. CLS. 1, 2, 3, 22 AND 41).

FIRST USE 8-1-1998; IN COMMERCE 8-1-1998.

THE MARK CONSISTS OF STANDARD CHAR-
ACTERS WITHOUT CLAIM TO ANY PARTICULAR
FONT, STYLE, SIZE, OR COLOR.

OWNER OF U.S. REG. NOS. 1,511,840, 2,109,810,
AND OTHERS.

SN 77-200,504, FILED 6-7-2007.

JERI J. FICKES, EXAMINING ATTORNEY

Int. Cls.: 9 and 12

Prior U.S. Cls.: 19, 21, 23, 26, 31, 35, 36, 38, and 44

United States Patent and Trademark Office

Reg. No. 3,577,082

Registered Feb. 17, 2009

**TRADEMARK
PRINCIPAL REGISTER**

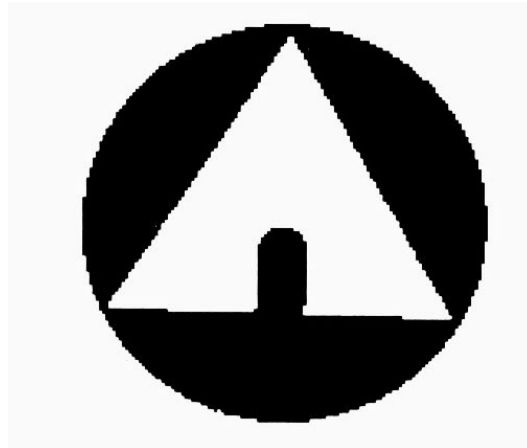

COLLECTIVE LICENSING INTERNATIONAL,
LLC (DELAWARE LIMITED LIABILITY COM-
PANY)
SUITE C200
800 ENGLEWOOD PARKWAY
ENGLEWOOD, CO 80110

FOR: SUNGLASSES FOR SPORTS, IN CLASS 9
(U.S. CLS. 21, 23, 26, 36 AND 38).

FIRST USE 7-1-2007; IN COMMERCE 7-1-2007.

FOR: BICYCLES; BICYCLE PARTS AND ACCES-
SORIES, NAMELY, FORKS, SEATS, AND PEDALS,
IN CLASS 12 (U.S. CLS. 19, 21, 23, 31, 35 AND 44).

FIRST USE 7-1-2007; IN COMMERCE 7-1-2007.

THE MARK CONSISTS OF THE LETTER "A" IN A
STYLIZED FORM INSIDE OF A BLACK CIRCLE.

SN 77-200,558, FILED 6-7-2007.

JERI J. FICKES, EXAMINING ATTORNEY

Int. Cl.: 25

Prior U.S. Cls.: 22 and 39

United States Patent and Trademark Office

Reg. No. 3,577,083

Registered Feb. 17, 2009

**TRADEMARK
PRINCIPAL REGISTER**



ANDERSON, JAMES (UNITED STATES INDIVIDUAL)
11614 VICTOR DRIVE
LONGMONT, CO 80504

FOR: SHORT-SLEEVED OR LONG-SLEEVED T-SHIRTS, IN CLASS 25 (U.S. CLS. 22 AND 39).

FIRST USE 9-1-1980; IN COMMERCE 9-15-1980.

THE COLOR(S) BLACK AND WHITE IS/ARE CLAIMED AS A FEATURE OF THE MARK.

THE MARK CONSISTS OF A BLACK AND WHITE MUSHROOM DESIGN HAVING A WHITE CAP WITH BLACK DOTS AND A BLACK BASE WITH A WHITE PATTERN. THE DESIGN INCLUDES WHITE GRASS AT THE BASE AND A BLACK BACKGROUND.

SN 77-200,980, FILED 6-8-2007.

CHRISTINA SOBRAL, EXAMINING ATTORNEY

Int. Cl.: 16

Prior U.S. Cls.: 2, 5, 22, 23, 29, 37, 38, and 50

Reg. No. 3,577,084

United States Patent and Trademark Office

Registered Feb. 17, 2009

**TRADEMARK
PRINCIPAL REGISTER**

FRUMART

KREINA CLEMENT (UNITED STATES INDIVIDUAL)
33301 1ST WAY SOUTH, #C-105
FEDERAL WAY, WA 98003

FOR: PAINTINGS; PAINTINGS AND CALLIGRAPHIC WORKS; PAINTINGS AND THEIR REPRODUCTIONS; PAINTINGS IN THE NATURE OF GOUACHES; WATERCOLOURS; DRAWINGS , IN CLASS 16 (U.S. CLS. 2, 5, 22, 23, 29, 37, 38 AND 50).

FIRST USE 11-9-2007; IN COMMERCE 12-13-2007.

THE MARK CONSISTS OF STANDARD CHARACTERS WITHOUT CLAIM TO ANY PARTICULAR FONT, STYLE, SIZE, OR COLOR.

THE ENGLISH TRANSLATION OF THE WORDING "FRUM" IS "OBSERVANT TO JEWISH LAW."

SN 77-202,006, FILED 6-8-2007.

DEIRDRE ROBERTSON, EXAMINING ATTORNEY

Int. Cl.: 33

Prior U.S. Cls.: 47 and 49

United States Patent and Trademark Office

Reg. No. 3,577,085

Registered Feb. 17, 2009

**TRADEMARK
PRINCIPAL REGISTER**

Majestic Oaks Cellars

SPANOSBERBERIAN WINERY LLC DBA BELL
WINE CELLARS (CALIFORNIA LIMITED LIABILITY COMPANY)

6200 WASHINGTON STREET
YOUNTVILLE, CA 94599

FOR: TABLE WINES, IN CLASS 33 (U.S. CLS. 47
AND 49).

FIRST USE 8-8-2007; IN COMMERCE 8-8-2007.

THE MARK CONSISTS OF STANDARD CHARACTERS WITHOUT CLAIM TO ANY PARTICULAR FONT, STYLE, SIZE, OR COLOR.

NO CLAIM IS MADE TO THE EXCLUSIVE RIGHT TO USE "CELLARS", APART FROM THE MARK AS SHOWN.

SN 77-202,225, FILED 6-10-2007.

SUSAN RICHARDS, EXAMINING ATTORNEY

Int. Cl.: 36

Prior U.S. Cls.: 100, 101, and 102

United States Patent and Trademark Office

Reg. No. 3,577,086

Registered Feb. 17, 2009

**SERVICE MARK
PRINCIPAL REGISTER**

IM

INTERNATIONAL INTELLECTUAL MANAGE-
MENT CORPORATION (CALIFORNIA COR-
PORATION)
3255 WILSHIRE BLVD., SUITE 1110
LOS ANGELES, CA 90010

FOR: INVESTMENT ADVICE AND CONSULTA-
TION; INVESTMENT MANAGEMENT; BUSINESS
BROKERAGE; BUSINESS FINANCE PROCURE-
MENT SERVICES; CAPITAL INVESTMENT CON-
SULTATION; CASH MANAGEMENT;
COMMERCIAL LENDING SERVICES; FINANCIAL
INVESTMENT IN THE FIELD OF REAL ESTATE,
SECURITIES, INTELLECTUAL PROPERTIES, AND
INVENTIONS; FINANCIAL MANAGEMENT; FI-
NANCIAL PORTFOLIO MANAGEMENT; FINAN-

CING SERVICES; PROVIDING WORKING
CAPITAL; AND VENTURE CAPITAL FUNDING
SERVICES, NAMELY, PROVIDING FINANCING
TO EMERGING AND START-UP COMPANIES, IN
CLASS 36 (U.S. CLS. 100, 101 AND 102).

FIRST USE 6-1-2006; IN COMMERCE 6-1-2006.

THE MARK CONSISTS OF STANDARD CHAR-
ACTERS WITHOUT CLAIM TO ANY PARTICULAR
FONT, STYLE, SIZE, OR COLOR.

SN 77-203,919, FILED 6-12-2007.

SUSAN RICHARDS, EXAMINING ATTORNEY

Int. Cl.: 25

Prior U.S. Cls.: 22 and 39

United States Patent and Trademark Office

Reg. No. 3,577,087

Registered Feb. 17, 2009

**TRADEMARK
PRINCIPAL REGISTER**



BACKERT, ELAINE (UNITED KINGDOM INDIVIDUAL)
80 RAMON DRIVE
GALT, CA 95632 AND
BACKERT, LAWRENCE (UNITED STATES INDIVIDUAL)
80 RAMON DRIVE
GALT, CA 95632

FOR: HATS; JACKETS; PANTS; PULLOVERS; SANDALS; SHIRTS; SHOES; SHORTS; SWIMSUITS, IN CLASS 25 (U.S. CLS. 22 AND 39).

FIRST USE 11-1-2008; IN COMMERCE 11-1-2008.

THE MARK CONSISTS OF THE LETTERS "FU" IN A STYLIZED TEXT. THEY ARE PLACED ON TOP OF A STAR. INSIDE THE STAR CONSISTS OF THE WORDS "FREAK UNIVERSE" IN A STYLIZED TEXT.

SN 77-204,485, FILED 6-12-2007.

JAMES MACFARLANE, EXAMINING ATTORNEY

Int. Cls.: 35 and 42

Prior U.S. Cls.: 100, 101, and 102

United States Patent and Trademark Office

Reg. No. 3,577,088

Registered Feb. 17, 2009

**SERVICE MARK
PRINCIPAL REGISTER**

VISIONAL COMMERCE

EYEONHOME CORP. (DELAWARE CORPORATION)
65 ENTERPRISE
ALISO, CA 92656

FOR: RETAIL STORE SERVICES AND ON-LINE RETAIL STORE SERVICES FEATURING A WIDE VARIETY OF CONSUMER GOODS OF OTHERS; OPERATING ON-LINE MARKETPLACES FOR SELLERS OF GOODS AND/OR SERVICES IN THE ON-LINE RETAIL SERVICES INDUSTRY, FEATURING ELECTRONIC COMMERCE SHOPPING GALLERIES DIRECTED TO THE CONSUMER; PROVIDING BUSINESS INFORMATION AND RELATED NEWS CONCERNING FINANCIAL MARKET DATA IN THE RETAIL FIELD; PROVIDING AN ON-LINE SEARCHABLE DATABASE FEATURING CLASSIFIED AD LISTINGS IN THE RETAIL FIELD; PROMOTING THE GOODS AND SERVICES OF OTHERS BY MEANS OF OPERATING AN ON-LINE SHOPPING MALL, WITH LINKS TO THE RETAIL WEB SITES OF OTHERS; PROVIDING A SEARCHABLE ON-LINE ADVERTISING GUIDE FEATURING THE GOODS AND SERVICES OF OTHER ON-LINE VENDORS ON THE INTERNET; PROVIDING STATISTICAL BUSINESS INFORMATION CONCERNING COMPUTER USAGE DATA OF NETWORKED BUSINESS COMPUTER INFORMATION SYSTEMS; BUSINESS SERVICES, NAMELY, REGISTERING, SCREENING, CREDENTIALING, AND ORGANIZING RETAIL VENDORS, SUPPLIERS, AND CONTRACTORS IN VARIOUS RETAIL FIELDS ON BEHALF OF OTHERS, IN CLASS 35 (U.S. CLS. 100, 101 AND 102).

FIRST USE 1-1-2008; IN COMMERCE 1-1-2008.

FOR: APPLICATION SERVICE PROVIDER FEATURING WEB-BASED SOFTWARE APPLICATIONS FOR USE IN THE RETAIL FIELD, NAMELY, FOR USE IN PROVIDING WEB ANALYTICS CONCERNING VISITATION TRAFFIC DATA, MANAGING AND VIEWING WEB-BASED ELECTRONIC SURVEILLANCE, MANAGING AND VIEWING VENDOR GALLERIES DISPLAYING PRODUCT IMAGES, INVENTORY TRACKING, AND MANAGING AND VIEWING VIDEO FEEDS; MONITORING NETWORKED INFORMATION COMPUTER SYSTEMS IN ORDER TO COLLECT, PROCESS AND REPORT ON INFORMATION ABOUT USAGE, IN CLASS 42 (U.S. CLS. 100 AND 101).

FIRST USE 1-1-2008; IN COMMERCE 1-1-2008.

THE MARK CONSISTS OF STANDARD CHARACTERS WITHOUT CLAIM TO ANY PARTICULAR FONT, STYLE, SIZE, OR COLOR.

NO CLAIM IS MADE TO THE EXCLUSIVE RIGHT TO USE "COMMERCE", APART FROM THE MARK AS SHOWN.

SN 77-205,188, FILED 6-13-2007.

ROBERT LAVACHE, EXAMINING ATTORNEY

Int. Cl.: 25

Prior U.S. Cls.: 22 and 39

United States Patent and Trademark Office

Reg. No. 3,577,089

Registered Feb. 17, 2009

**TRADEMARK
PRINCIPAL REGISTER**

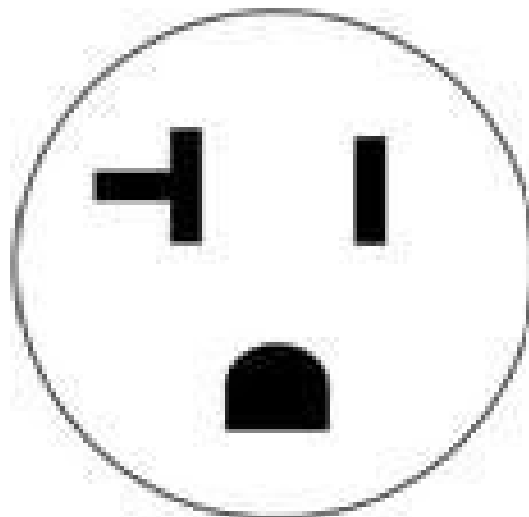

INTENTIONAL WORD, LLC (ILLINOIS LIMITED LIABILITY COMPANY)
4250 N. MARINE DRIVE #932
CHICAGO, IL 60613

FOR: CLOTHING, NAMELY, BUTTON DOWN SHIRT, T-SHIRT, JERSEYS, POLO SHIRTS, CREW NECK SHIRTS, TUBE TOP, HALTER TOP, WOMEN'S BLOUSE, VESTS, SWEATSHIRT, HOODED SWEATSHIRTS, SWEATER, JACKETS, SPORT COATS, BLAZERS JACKETS AND COATS, SWEAT PANTS, SWEAT SHORTS, PANTS, SHORTS, CAPRIS, BOARD SHORTS, CARGO PANTS, CROPPED PANTS, DENIM PANTS, DENIM SKIRTS, DENIM SHORTS, SKIRTS, SKORTS, DRESSES, SUITS, BRAS, PANTIES, THONGS, CAMISOLES, TANK TOPS,

SLIPS, STOCKINGS, TIGHTS AND HOSIERY, BOXER SHORTS, BOXER BRIEFS, BRIEFS, BIKINI UNDERWEAR, THONG UNDERWEAR, UNDERSHIRTS, SWIM TRUNKS, WOMEN'S SWIMWEAR, SOCKS, PAJAMAS, SLEEPWEAR, ROBES, LONG UNDERWEAR, HATS, CAPS, SKULL CAPS, BANDANAS, MITTENS, GLOVES, SCARVES, NECK TUBES, EAR MUFFS, EAR BANDS AND EAR WARMERS, IN CLASS 25 (U.S. CLS. 22 AND 39).

FIRST USE 12-17-2008; IN COMMERCE 12-17-2008.

SN 77-205,419, FILED 6-13-2007.

KELLEY WELLS, EXAMINING ATTORNEY

Int. Cl.: 9

Prior U.S. Cls.: 21, 23, 26, 36, and 38

United States Patent and Trademark Office

Reg. No. 3,577,090

Registered Feb. 17, 2009

**TRADEMARK
PRINCIPAL REGISTER**

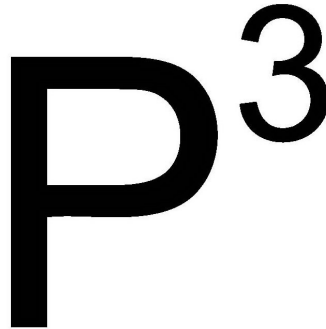
The trademark symbol consists of a large, bold, black capital letter 'P' followed by a smaller, bold, black number '3' positioned to the right and slightly above the top of the 'P'.

INDUCTOTHERM CORP. (NEW JERSEY CORPORATION)
10 INDEL AVENUE, P.O. BOX 157
RANCOCAS, NJ 08073

FOR: COMPUTER PROGRAM FOR CONTROL OF POURING OF MOLTEN METAL FROM A CONTAINER, IN CLASS 9 (U.S. CLS. 21, 23, 26, 36 AND 38).

FIRST USE 10-29-2008; IN COMMERCE 10-29-2008.

THE MARK CONSISTS OF THE WORD "P3" IN BLOCK CAPITAL LETTERS, THE NUMBER 3, IN A SMALLER SIZE, PLACED ON THE RIGHT TOP PART OF THE LETTER "P" TO INDICATE RAISED TO THE THIRD POWER.

SN 77-205,768, FILED 6-14-2007.

JANICE L. MCMORROW, EXAMINING ATTORNEY

Int. Cl.: 44

Prior U.S. Cls.: 100 and 101

United States Patent and Trademark Office

Reg. No. 3,577,091

Registered Feb. 17, 2009

**SERVICE MARK
PRINCIPAL REGISTER**

IVITAL

BRYANT, DAVID L., MR. (UNITED STATES
INDIVIDUAL)
4332 LIVINGSTON AVENUE
DALLAS, TX 75205

FOR: HEALTH CARE; WEIGHT LOSS SURGERY;
PROVIDING INFORMATION IN THE FIELD OF
HEALTH CARE AND WEIGHT MANAGEMENT;
COSMETIC TREATMENTS AND PROCEDURES,
NAMELY, NON-INVASIVE COSMETIC MEDICAL
PROCEDURES AND COSMETIC PLASTIC SUR-
GERY, IN CLASS 44 (U.S. CLS. 100 AND 101).

FIRST USE 1-15-2008; IN COMMERCE 1-15-2008.

THE MARK CONSISTS OF STANDARD CHAR-
ACTERS WITHOUT CLAIM TO ANY PARTICULAR
FONT, STYLE, SIZE, OR COLOR.

SN 77-206,421, FILED 6-14-2007.

SUSAN RICHARDS, EXAMINING ATTORNEY

Int. Cl.: 1

Prior U.S. Cls.: 1, 5, 6, 10, 26, and 46

United States Patent and Trademark Office

Reg. No. 3,577,092

Registered Feb. 17, 2009

**TRADEMARK
PRINCIPAL REGISTER**

AUTOMATIC

WILBUR-ELLIS COMPANY (CALIFORNIA CORPORATION)
345 CALIFORNIA STREET, 27TH FLOOR
SAN FRANCISCO, CA 94104

FOR: FOOD SUPPLEMENTS FOR AGRICULTURAL PRODUCTS AND OTHER PLANTS; PLANT FOOD; PREPARATIONS FOR FORTIFYING PLANTS; PLANT GROWTH REGULATORS FOR AGRICULTURAL USE; PLANT GROWTH REGULATING PREPARATIONS; PREPARATIONS FOR FORTIFYING PLANTS; SUBSTANCES FOR REGULATING PLANT GROWTH; MICRONUTRIENTS

FOR AGRICULTURAL USE, IN CLASS 1 (U.S. CLS. 1, 5, 6, 10, 26 AND 46).

FIRST USE 4-23-2008; IN COMMERCE 4-23-2008.

THE MARK CONSISTS OF STANDARD CHARACTERS WITHOUT CLAIM TO ANY PARTICULAR FONT, STYLE, SIZE, OR COLOR.

SN 77-206,422, FILED 6-14-2007.

ANNE MADDEN, EXAMINING ATTORNEY

Int. Cl.: 9

Prior U.S. Cls.: 21, 23, 26, 36, and 38

United States Patent and Trademark Office

Reg. No. 3,577,093

Registered Feb. 17, 2009

**TRADEMARK
PRINCIPAL REGISTER**

PINNACLE

TRU-TEST CORPORATION LIMITED (NEW
ZEALAND CORPORATION)
25 CARBINE ROAD, MT. WELLINGTON
AUCKLAND, NEW ZEALAND 1060

FOR: COMPUTER SOFTWARE, NAMELY, OPERATING SOFTWARE FOR USE IN OPERATING WEIGHING APPARATUS; SOFTWARE FOR USE IN CALIBRATING WEIGHING EQUIPMENT; DATA COLLECTION SOFTWARE AND USER INTERFACE SOFTWARE FOR USE WITH WEIGHING EQUIPMENT; SOFTWARE FOR USE IN PROGRAMMING WEIGHING EQUIPMENT; DATA INPUT

SOFTWARE FOR USE WITH WEIGHING EQUIPMENT, IN CLASS 9 (U.S. CLS. 21, 23, 26, 36 AND 38).

FIRST USE 8-31-2008; IN COMMERCE 8-31-2008.

THE MARK CONSISTS OF STANDARD CHARACTERS WITHOUT CLAIM TO ANY PARTICULAR FONT, STYLE, SIZE, OR COLOR.

SN 77-206,639, FILED 6-14-2007.

AISHA SALEM, EXAMINING ATTORNEY

Int. Cl.: 9

Prior U.S. Cls.: 21, 23, 26, 36, and 38

United States Patent and Trademark Office

Reg. No. 3,577,094

Registered Feb. 17, 2009

**TRADEMARK
PRINCIPAL REGISTER**

for your mobile lifestyle

DAVIS REUSS, INC. (CALIFORNIA CORPORATION)
22647 VENTURA BLVD.
WOODLAND HILLS, CA 91364

FOR: DOWNLOADABLE AUDIO AND VIDEO RECORDINGS FEATURING MUSIC, IMAGES, GRAPHICS, GAMES AND STATISTICAL DATA FOR CELL PHONES AND OTHER MOBILE DEVICES, IN CLASS 9 (U.S. CLS. 21, 23, 26, 36 AND 38).

FIRST USE 12-1-2007; IN COMMERCE 5-5-2008.

THE MARK CONSISTS OF STANDARD CHARACTERS WITHOUT CLAIM TO ANY PARTICULAR FONT, STYLE, SIZE, OR COLOR.

SN 77-206,715, FILED 6-14-2007.

KATHERINE CONNOLLY, EXAMINING ATTORNEY

Int. Cl.: 12

Prior U.S. Cls.: 19, 21, 23, 31, 35, and 44

Reg. No. 3,577,095

United States Patent and Trademark Office

Registered Feb. 17, 2009

**TRADEMARK
PRINCIPAL REGISTER**

HELICON

H-D MICHIGAN, INC. (MICHIGAN CORPORATION)
315 W. HURON, SUITE 400
ANN ARBOR, MI 48103

THE MARK CONSISTS OF STANDARD CHARACTERS WITHOUT CLAIM TO ANY PARTICULAR FONT, STYLE, SIZE, OR COLOR.

FOR: MOTORCYCLE ENGINES, IN CLASS 12
(U.S. CLS. 19, 21, 23, 31, 35 AND 44).

SN 77-206,816, FILED 6-15-2007.

FIRST USE 7-0-2007; IN COMMERCE 7-0-2007.

DAVID YONTEF, EXAMINING ATTORNEY

Int. Cl.: 30

Prior U.S. Cl.: 46

United States Patent and Trademark Office

Reg. No. 3,577,096

Registered Feb. 17, 2009

**TRADEMARK
PRINCIPAL REGISTER**

SUPER NAAN

SUPER BAKERY, INCORPORATED (PENNSYLVANIA CORPORATION)
SUITE 455
5700 CORPORATE DRIVE
PITTSBURGH, PA 15237

FOR: BAKERY PRODUCTS, NAMELY, INDIAN STYLE BREADS, IN CLASS 30 (U.S. CL. 46).

FIRST USE 8-31-2007; IN COMMERCE 8-31-2007.

THE MARK CONSISTS OF STANDARD CHARACTERS WITHOUT CLAIM TO ANY PARTICULAR FONT, STYLE, SIZE, OR COLOR.

OWNER OF U.S. REG. NOS. 1,767,566, 3,306,071, AND OTHERS.

NO CLAIM IS MADE TO THE EXCLUSIVE RIGHT TO USE "NAAN", APART FROM THE MARK AS SHOWN.

SEC. 2(F).

SN 77-206,839, FILED 6-15-2007.

SOPHIA S. KIM, EXAMINING ATTORNEY

Int. Cl.: 30

Prior U.S. Cl.: 46

United States Patent and Trademark Office

Reg. No. 3,577,097

Registered Feb. 17, 2009

**TRADEMARK
PRINCIPAL REGISTER**

SUPER ROTI

SUPER BAKERY, INCORPORATED (PENNSYLVANIA CORPORATION)
SUITE 455
5700 CORPORATE DRIVE
PITTSBURGH, PA 15237

FOR: BAKERY PRODUCTS, NAMELY, INDIAN STYLE BREADS, IN CLASS 30 (U.S. CL. 46).

FIRST USE 8-31-2007; IN COMMERCE 8-31-2007.

THE MARK CONSISTS OF STANDARD CHARACTERS WITHOUT CLAIM TO ANY PARTICULAR FONT, STYLE, SIZE, OR COLOR.

OWNER OF U.S. REG. NOS. 1,767,566, 3,306,071, AND OTHERS.

NO CLAIM IS MADE TO THE EXCLUSIVE RIGHT TO USE "ROTI", APART FROM THE MARK AS SHOWN.

SEC. 2(F).

SN 77-206,929, FILED 6-15-2007.

SOPHIA S. KIM, EXAMINING ATTORNEY

Int. Cl.: 9

Prior U.S. Cls.: 21, 23, 26, 36, and 38

United States Patent and Trademark Office

Reg. No. 3,577,098

Registered Feb. 17, 2009

**TRADEMARK
PRINCIPAL REGISTER**

VERSIMATION

XILAR CORP. (MICHIGAN CORPORATION)
890 W. GLASS
ORTONVILLE, MI 48462

FIRST USE 11-10-2008; IN COMMERCE 11-10-2008.

FOR: COMPUTER HARDWARE DEVICE USED
TO TRANSMIT TEXT MESSAGES AND GRAPHICS,
FOR USE IN CONNECTION WITH THE BROAD-
CASTING AND PRODUCTION OF PROGRAMS
AVAILABLE ON TELEVISION, CABLE NETWORKS,
AND GLOBAL COMPUTER NETWORKS, IN CLASS
9 (U.S. CLS. 21, 23, 26, 36 AND 38).

THE MARK CONSISTS OF STANDARD CHAR-
ACTERS WITHOUT CLAIM TO ANY PARTICULAR
FONT, STYLE, SIZE, OR COLOR.

SN 77-207,149, FILED 6-15-2007.

ALYSSA STEEL, EXAMINING ATTORNEY

Int. Cl.: 9

Prior U.S. Cls.: 21, 23, 26, 36, and 38

United States Patent and Trademark Office

Reg. No. 3,577,099

Registered Feb. 17, 2009

**TRADEMARK
PRINCIPAL REGISTER**

Azada

BIG FISH GAMES, INC. (WASHINGTON COR-
PORATION)
333 ELLIOTT AVENUE WEST
SUITE 200
SEATTLE, WA 98119

THE MARK CONSISTS OF STANDARD CHAR-
ACTERS WITHOUT CLAIM TO ANY PARTICULAR
FONT, STYLE, SIZE, OR COLOR.

FOR: ELECTRONIC GAME PROGRAMS, IN
CLASS 9 (U.S. CLS. 21, 23, 26, 36 AND 38).

SN 77-207,700, FILED 6-15-2007.

FIRST USE 1-19-2007; IN COMMERCE 1-19-2007.

LAURIE MAYES, EXAMINING ATTORNEY

Int. Cl.: 25

Prior U.S. Cls.: 22 and 39

United States Patent and Trademark Office

Reg. No. 3,577,100

Registered Feb. 17, 2009

TRADEMARK
PRINCIPAL REGISTER



DLCO APPAREL (CALIFORNIA SOLE PROPRIETORSHIP)
11305 SUMMERTIME LANE
CULVER CITY, CA 90230

FOR: PANTS; SHORT-SLEEVED OR LONG-SLEEVED T-SHIRTS; TOPS; DRESS SHIRTS; DRESSES; JACKETS; SCARVES; LEGGINGS; LEOTARDS AND TIGHTS FOR WOMEN OF NYLON, COTTON OR OTHER TEXTILE FIBERS; SKIRT SUITS; SKIRTS AND DRESSES; LEG-WARMERS; SHIRTS; SPORTS SHIRTS; SWIMWEAR; OVERALLS; JUMP-SUITS; TRACK PANTS, IN CLASS 25 (U.S. CLS. 22 AND 39).

FIRST USE 9-13-2008; IN COMMERCE 9-13-2008.

THE MARK CONSISTS OF A SPRAY-PAINTED STENCIL OF A 5-POINTED STAR SHAPE PLACED ON TWO WIDE, FEATHERED WINGS, THIRTY-ONE LINES APPEARING AS BEAMS OF LIGHT COMING OUT FROM BEHIND THE STAR SHAPE, AND THE TEXT "STARLYTE ETHOS" IN LOWER CASE LETTERS, INSIDE THE STAR SHAPE. THE ENTIRE MARK HAS A DISTRESSED EFFECT, THAT IS, IT APPEARS SLIGHTLY FADED AND DOTTED.

SN 77-207,785, FILED 6-15-2007.

WENDY GOODMAN, EXAMINING ATTORNEY

Int. Cl.: 1

Prior U.S. Cls.: 1, 5, 6, 10, 26, and 46

Reg. No. 3,577,101

United States Patent and Trademark Office

Registered Feb. 17, 2009

**TRADEMARK
PRINCIPAL REGISTER**

UCOE

MILLIPORE CORPORATION (MASSACHUSETTS
CORPORATION)
290 CONCORD ROAD
BILLERICA, MA 01803

FOR: GENE EXPRESSION TECHNOLOGY RE-
AGENTS, NAMELY, UBIQUITOUS CHROMATIN
OPENING ELEMENTS, FOR SCIENTIFIC OR RE-
SEARCH PURPOSES, IN CLASS 1 (U.S. CLS. 1, 5, 6, 10,
26 AND 46).

FIRST USE 12-31-2005; IN COMMERCE 12-31-2005.

THE MARK CONSISTS OF STANDARD CHAR-
ACTERS WITHOUT CLAIM TO ANY PARTICULAR
FONT, STYLE, SIZE, OR COLOR.

SN 77-208,294, FILED 6-18-2007.

STEVEN JACKSON, EXAMINING ATTORNEY

Int. Cl.: 29

Prior U.S. Cl.: 46

United States Patent and Trademark Office

Reg. No. 3,577,102

Registered Feb. 17, 2009

**TRADEMARK
PRINCIPAL REGISTER**

FRANCOFURTER

SUPER BAKERY, INCORPORATED (PENNSYLVANIA CORPORATION)
SUITE 455
5700 CORPORATE DRIVE
PITTSBURGH, PA 15237

FOR: COOKED AND SMOKED SAUSAGES MADE WITH BEEF AND/OR PORK, WITH OR WITHOUT CASING; HOT DOGS, WIENERS MADE WITH BEEF, PORK, TURKEY, CHICKEN, SOY AND/OR OTHER MEATLESS PRODUCTS, IN CLASS 29 (U.S. CL. 46).

FIRST USE 10-6-2008; IN COMMERCE 10-6-2008.

THE MARK CONSISTS OF STANDARD CHARACTERS WITHOUT CLAIM TO ANY PARTICULAR FONT, STYLE, SIZE, OR COLOR.

SN 77-208,702, FILED 6-18-2007.

SOPHIA S. KIM, EXAMINING ATTORNEY

Int. Cls.: 3 and 4

Prior U.S. Cls.: 1, 4, 6, 15, 50, 51, and 52

United States Patent and Trademark Office

Reg. No. 3,577,103

Registered Feb. 17, 2009

**TRADEMARK
PRINCIPAL REGISTER**

CURES BY AVANCE

DEPASQUALE, CARMEN (UNITED STATES INDIVIDUAL)
21-21 BROADWAY
FAIR LAWN, NJ 07410

FOR: HEALTH, BEAUTY, AND BODY PRODUCTS, NAMELY, NON-MEDICATED TOPICAL SKIN CARE AND SKIN CLEANSING PREPARATIONS, IN CLASS 3 (U.S. CLS. 1, 4, 6, 50, 51 AND 52).

FIRST USE 4-30-2008; IN COMMERCE 4-30-2008.

FOR: RITUAL CANDLES, IN CLASS 4 (U.S. CLS. 1, 6 AND 15).

FIRST USE 10-31-2008; IN COMMERCE 10-31-2008.

THE MARK CONSISTS OF STANDARD CHARACTERS WITHOUT CLAIM TO ANY PARTICULAR FONT, STYLE, SIZE, OR COLOR.

OWNER OF U.S. REG. NO. 2,005,468.

THE ENGLISH TRANSLATION OF THE FRENCH WORD "AVANCE" IN THE MARK IS ADVANCED.

SN 77-209,682, FILED 6-19-2007.

YONG KIM, EXAMINING ATTORNEY

Int. Cl.: 36

Prior U.S. Cls.: 100, 101, and 102

United States Patent and Trademark Office

Reg. No. 3,577,104

Registered Feb. 17, 2009

**SERVICE MARK
PRINCIPAL REGISTER**

WE NEVER STOP MOVING

CB TM LLC (CALIFORNIA LIMITED LIABILITY
COMPANY)
27271 LAS RAMBLAS, SUITE 132
MISSION VIEJO, CA 92691

THE MARK CONSISTS OF STANDARD CHAR-
ACTERS WITHOUT CLAIM TO ANY PARTICULAR
FONT, STYLE, SIZE, OR COLOR.

FOR: REAL ESTATE BROKERAGE SERVICES, IN
CLASS 36 (U.S. CLS. 100, 101 AND 102).

SN 77-210,512, FILED 6-20-2007.

FIRST USE 2-25-2008; IN COMMERCE 2-25-2008.

PAULA MAHONEY, EXAMINING ATTORNEY

Int. Cl.: 35

Prior U.S. Cls.: 100, 101, and 102

United States Patent and Trademark Office

Reg. No. 3,577,105

Registered Feb. 17, 2009

**SERVICE MARK
PRINCIPAL REGISTER**

livestores

LIVE STORES INC (CALIFORNIA CORPORATION)
5858 EDISON PLACE
CARLSBAD, CA 920086519

FOR: ON-LINE RETAIL STORE SERVICES FEATURING PERSONAL AND HOUSEHOLD GOODS, NAMELY, KITCHEN WARE, HOUSEHOLD CLEANING PRODUCTS, FURNITURE, BATH ACCESSORIES, AND APPLIANCES; ELECTRONIC COMMERCE SERVICES, NAMELY, PROVIDING INFORMATION ABOUT PRODUCTS VIA TELECOMMUNICATION NETWORKS FOR ADVERTISING AND SALES PURPOSES, IN CLASS 35 (U.S. CLS. 100, 101 AND 102).

FIRST USE 10-28-2008; IN COMMERCE 10-28-2008.

THE MARK CONSISTS OF STANDARD CHARACTERS WITHOUT CLAIM TO ANY PARTICULAR FONT, STYLE, SIZE, OR COLOR.

SEC. 2(F).

SN 77-210,965, FILED 6-20-2007.

RONALD AIKENS, EXAMINING ATTORNEY

Int. Cl.: 30

Prior U.S. Cl.: 46

United States Patent and Trademark Office

Reg. No. 3,577,106

Registered Feb. 17, 2009

TRADEMARK
PRINCIPAL REGISTER



CHYE CHOON FOODS PRIVATE LIMITED (SINGAPORE CORPORATION)
NO. 34 DEFU LANE 3
SINGAPORE, SINGAPORE 539451

FOR: FOOD STARCHES; FLOUR; RICE VERMICELLI; NOODLES; PASTA; INSTANT COOKING NOODLES AND RICE VERMICELLI, IN CLASS 30 (U.S. CL. 46).

FIRST USE 4-30-2004; IN COMMERCE 7-30-2006.

OWNER OF U.S. REG. NO. 3,210,373.

NO CLAIM IS MADE TO THE EXCLUSIVE RIGHT TO USE "BRAND", APART FROM THE MARK AS SHOWN.

THE MARK CONSISTS OF A PEACOCK DESIGN LOCATED IN AN OVAL SHAPE, THE STYLIZED WORDING "BRAND" LOCATED BELOW THE PEACOCK, AND THE STYLIZED WORDING "PEACOCK BIRD" LOCATED ABOVE THE PEACOCK.

SN 77-211,382, FILED 6-20-2007.

LAURIE MAYES, EXAMINING ATTORNEY

Int. Cl.: 29

Prior U.S. Cl.: 46

United States Patent and Trademark Office

Reg. No. 3,577,107

Registered Feb. 17, 2009

**TRADEMARK
PRINCIPAL REGISTER**

COCINA FINA

STAMPEDE MEAT, INC. (ILLINOIS CORPORATION)
7351 SOUTH 78TH AVENUE
BRIDGEVIEW, IL 60455

FOR: STEAK FAJITAS KIT COMPRISED PRIMARILY OF MEAT, IN CLASS 29 (U.S. CL. 46).

FIRST USE 12-20-2007; IN COMMERCE 12-20-2007.

THE MARK CONSISTS OF STANDARD CHARACTERS WITHOUT CLAIM TO ANY PARTICULAR FONT, STYLE, SIZE, OR COLOR.

THE FOREIGN WORDING IN THE MARK TRANSLATES INTO ENGLISH AS FINE KITCHEN.

SN 77-211,593, FILED 6-21-2007.

SARA THOMAS, EXAMINING ATTORNEY

Int. Cl.: 19

Prior U.S. Cls.: 1, 12, 33, and 50

United States Patent and Trademark Office

Reg. No. 3,577,108

Registered Feb. 17, 2009

**TRADEMARK
PRINCIPAL REGISTER**

FIN2000

FILTRONA EXTRUSION, INC. (VIRGINIA CORPORATION)
SUITE 472
2500 NORTHWINDS PARKWAY
ALPHARETTA, GA 30004

THE MARK CONSISTS OF STANDARD CHARACTERS WITHOUT CLAIM TO ANY PARTICULAR FONT, STYLE, SIZE, OR COLOR.

FOR: NON-METAL FENCE SLAT PANEL INSERT, IN CLASS 19 (U.S. CLS. 1, 12, 33 AND 50).

SN 77-211,798, FILED 6-21-2007.

FIRST USE 0-0-1997; IN COMMERCE 7-0-1998.

G. MAYERSCHOFF, EXAMINING ATTORNEY

Int. Cl.: 5

Prior U.S. Cls.: 6, 18, 44, 46, 51, and 52

United States Patent and Trademark Office

Reg. No. 3,577,109

Registered Feb. 17, 2009

**TRADEMARK
PRINCIPAL REGISTER**

ANIMAL TEST

UNIVERSAL PROTEIN SUPPLEMENTS COR-
PORATION (NEW JERSEY CORPORATION),
DBA UNIVERSAL NUTRITION,
3 TERMINAL ROAD
NEW BRUNSWICK, NJ 08901

FOR: DIETARY FOOD SUPPLEMENTS FOR HU-
MANS AND NOT FOR ANIMALS; NUTRITIONAL
SUPPLEMENTS FOR HUMANS AND NOT FOR
ANIMALS , IN CLASS 5 (U.S. CLS. 6, 18, 44, 46, 51
AND 52).

FIRST USE 9-0-2003; IN COMMERCE 10-0-2007.

THE MARK CONSISTS OF STANDARD CHAR-
ACTERS WITHOUT CLAIM TO ANY PARTICULAR
FONT, STYLE, SIZE, OR COLOR.

SN 77-213,112, FILED 6-22-2007.

SHAILA SETTLES, EXAMINING ATTORNEY

Int. Cl.: 16

Prior U.S. Cls.: 2, 5, 22, 23, 29, 37, 38, and 50

United States Patent and Trademark Office

Reg. No. 3,577,110

Registered Feb. 17, 2009

**TRADEMARK
PRINCIPAL REGISTER**

THE ME & YOU CREW

CRUMPTON, AMY (UNITED STATES INDIVIDUAL)
11782 PUMPKIN HOLLOW ROAD
BENTONVILLE, AR 72712

THE MARK CONSISTS OF STANDARD CHARACTERS WITHOUT CLAIM TO ANY PARTICULAR FONT, STYLE, SIZE, OR COLOR.

FOR: CHILDREN'S BOOKS, IN CLASS 16 (U.S. CLS. 2, 5, 22, 23, 29, 37, 38 AND 50).

SN 77-213,468, FILED 6-22-2007.

FIRST USE 6-22-2007; IN COMMERCE 11-21-2007.

MICHELLE DUBOIS, EXAMINING ATTORNEY

Int. Cl.: 9

Prior U.S. Cls.: 21, 23, 26, 36, and 38

United States Patent and Trademark Office

Reg. No. 3,577,111

Registered Feb. 17, 2009

**TRADEMARK
PRINCIPAL REGISTER**

TOMORROW IS RISING

KYOCERA WIRELESS CORP. (DELAWARE CORPORATION)
10300 CAMPUS POINT DRIVE
SAN DIEGO, CA 92121

FOR: TELECOMMUNICATIONS EQUIPMENT AND ACCESSORIES, NAMELY, TELEPHONES, MOBILE AND CELLULAR TELEPHONES, MOBILE AND CELLULAR TELEPHONES WITH CAMERAS, WIRELESS COMMUNICATION HANDSETS, MOBILE TELEPHONE BATTERIES, MOBILE TELEPHONE BATTERY CHARGERS, MOBILE TELEPHONE HEADSETS, MOBILE TELEPHONE

CAMERAS, IN CLASS 9 (U.S. CLS. 21, 23, 26, 36 AND 38).

FIRST USE 9-0-2007; IN COMMERCE 9-0-2007.

THE MARK CONSISTS OF STANDARD CHARACTERS WITHOUT CLAIM TO ANY PARTICULAR FONT, STYLE, SIZE, OR COLOR.

SN 77-213,535, FILED 6-22-2007.

DAVID I, EXAMINING ATTORNEY

Int. Cl.: 20

Prior U.S. Cls.: 2, 13, 22, 25, 32, and 50

United States Patent and Trademark Office

Reg. No. 3,577,112

Registered Feb. 17, 2009

**TRADEMARK
PRINCIPAL REGISTER**



SUSHI STYLE, INC. (GEORGIA CORPORATION)
790 NORTH AVENUE, #204
ATLANTA, GA 30306

FOR: FURNITURE, IN CLASS 20 (U.S. CLS. 2, 13,
22, 25, 32 AND 50).

FIRST USE 12-8-2008; IN COMMERCE 12-8-2008.

THE MARK CONSISTS OF THE WORD "SUSHIS-
TYLE" WITH FLOWER DESIGN CONSISTING OF 4
TEAR DROP PETALS WITH A SQUARE DESIGN IN
THE MIDDLE AND 4 INVERSE TEAR DROP PE-
TALS PROTRUDING FROM THE CENTER OF THE
DESIGN.

SN 77-213,828, FILED 6-23-2007.

TINA L. SNAPP, EXAMINING ATTORNEY

Int. Cls.: 35 and 36

Prior U.S. Cls.: 100, 101, and 102

United States Patent and Trademark Office

Reg. No. 3,577,113

Registered Feb. 17, 2009

**SERVICE MARK
PRINCIPAL REGISTER**



COLLABORATIVE MEDICAL RESEARCH, LLC
(OHIO LIMITED LIABILITY COMPANY)
6450 POE AVENUE, STE. 201
DAYTON, OH 454142645

FOR: PROMOTING PUBLIC AWARENESS OF
THE NEED FOR RESEARCH AND TREATMENT
OF BRAIN TUMORS, PARTICULARLY EPENDY-
MOMA, IN CLASS 35 (U.S. CLS. 100, 101 AND 102).

FIRST USE 5-0-2008; IN COMMERCE 5-0-2008.

FOR: PROVIDING FUNDS FOR THE RESEARCH
PROJECTS OF OTHERS IN THE TREATMENT OF
BRAIN TUMORS, PARTICULARLY EPENDYMOMA,
IN CLASS 36 (U.S. CLS. 100, 101 AND 102).

FIRST USE 5-0-2008; IN COMMERCE 5-0-2008.

NO CLAIM IS MADE TO THE EXCLUSIVE
RIGHT TO USE "COLLABORATIVE MEDICAL RE-
SEARCH", APART FROM THE MARK AS SHOWN.

THE MARK CONSISTS OF THE LETTERS "CMR",
THE WORDS "COLLABORATIVE MEDICAL RE-
SEARCH" AND THE DESIGN OF FOUR IRREGU-
LAR OVALS WITH ARROWS POINTING TO THE
CENTER.

SN 77-214,201, FILED 6-25-2007.

G. MAYERSCHOFF, EXAMINING ATTORNEY

Int. Cl.: 7

Prior U.S. Cls.: 13, 19, 21, 23, 31, 34, and 35

Reg. No. 3,577,114

United States Patent and Trademark Office

Registered Feb. 17, 2009

**TRADEMARK
PRINCIPAL REGISTER**



FLEX FUEL U.S., LLC (ILLINOIS LIMITED LIABILITY COMPANY)
5820 N. NORTHWEST HIGHWAY
CHICAGO, IL 60631

NO CLAIM IS MADE TO THE EXCLUSIVE RIGHT TO USE "E85 FLEX FUEL U.S.", APART FROM THE MARK AS SHOWN.

FOR: ENGINE PART IN THE NATURE OF A SUPPLEMENTAL FUEL SYSTEM COMPRISING AN APPARATUS WHICH ALLOWS A LAND VEHICLE TO BE OPERATED ON GASOLINE, ETHANOL OR ANY COMBINATION OF GASOLINE AND ETHANOL BY CONTINUOUSLY MONITORING ENGINE FUNCTIONS, THEN DELIVERING SUPPLEMENTARY FUEL INJECTION TO ALLOW A VEHICLE TO OPERATE AT OPTIMAL PERFORMANCE, IN CLASS 7 (U.S. CLS. 13, 19, 21, 23, 31, 34 AND 35).

THE MARK CONSISTS OF A DIAMOND SHAPE TO THE FAR LEFT WITH THE WORDS "E85" INSIDE OF THE DIAMOND. TO THE RIGHT OF THE DIAMOND ARE THE WORDS "FLEX FUEL U.S."

SN 77-214,274, FILED 6-25-2007.

FIRST USE 10-26-2006; IN COMMERCE 7-7-2007.

MICHELE SWAIN, EXAMINING ATTORNEY

Int. Cl.: 35

Prior U.S. Cls.: 100, 101, and 102

United States Patent and Trademark Office

Reg. No. 3,577,115

Registered Feb. 17, 2009

**SERVICE MARK
PRINCIPAL REGISTER**

THE SMALLEST SEED

SHANNON ASSOCIATES, LLC (CONNECTICUT
LIMITED LIABILITY COMPANY)
SUITE 810
333 WEST 57TH STREET
NEW YORK, NY 10019

FOR: BUSINESS DEVELOPMENT SERVICES,
NAMELY, PROVIDING START-UP SUPPORT FOR
BUSINESSES OF OTHERS, IN CLASS 35 (U.S. CLS.
100, 101 AND 102).

FIRST USE 12-1-2007; IN COMMERCE 12-1-2007.

THE MARK CONSISTS OF STANDARD CHAR-
ACTERS WITHOUT CLAIM TO ANY PARTICULAR
FONT, STYLE, SIZE, OR COLOR.

SN 77-214,429, FILED 6-25-2007.

HEATHER THOMPSON, EXAMINING ATTORNEY

Int. Cls.: 9, 35, and 36

Prior U.S. Cls.: 21, 23, 26, 36, 38, 100, 101, and 102

United States Patent and Trademark Office

Reg. No. 3,577,116

Registered Feb. 17, 2009

**TRADEMARK
SERVICE MARK
PRINCIPAL REGISTER**

NYSE MATCHPOINT

NYSE GROUP, INC. (DELAWARE CORPORATION)
11 WALL STREET
NEW YORK, NY 10005

FOR: COMPUTER HARDWARE AND SOFTWARE FOR PROVIDING A PROPRIETARY ELECTRONIC TRADE EXECUTION SYSTEM FOR THE ENTRY OF ORDERS FOR THE PURCHASE AND SALE OF SECURITIES BY OTHERS, FOR PROCESSING ORDERS FOR THE PURCHASE AND SALE OF SECURITIES BY OTHERS, AND FOR COMPILING, ORGANIZING AND DISSEMINATING TO OTHERS SECURITIES TRANSACTION DATA VIA A GLOBAL COMPUTER NETWORK, IN CLASS 9 (U.S. CLS. 21, 23, 26, 36 AND 38).

FIRST USE 4-25-2007; IN COMMERCE 4-25-2007.

FOR: INFORMATION MANAGEMENT SERVICES, NAMELY, PROVIDING A PROPRIETARY ELECTRONIC TRADE EXECUTION SYSTEM FOR THE ENTRY OF ORDERS FOR THE PURCHASE AND SALE OF SECURITIES BY OTHERS, AND FOR PROCESSING ORDERS FOR THE PURCHASE AND SALE OF SECURITIES BY OTHERS, IN CLASS 35 (U.S. CLS. 100, 101 AND 102).

FIRST USE 4-25-2007; IN COMMERCE 4-25-2007.

FOR: CONDUCTING A SECURITIES EXCHANGE AND RELATED SECURITIES EXCHANGE SERVI-

CES, NAMELY, PROVIDING A PROPRIETARY ELECTRONIC TRADE EXECUTION SYSTEM FOR THE ENTRY OF ORDERS FOR THE PURCHASE AND SALE OF SECURITIES BY OTHERS, FOR PROCESSING ORDERS FOR THE PURCHASE AND SALE OF SECURITIES BY OTHERS, AND FOR COMPILING, ORGANIZING AND DISSEMINATING TO OTHERS SECURITIES TRANSACTION DATA VIA A GLOBAL COMPUTER NETWORK; AND INFORMATION MANAGEMENT SERVICES, NAMELY, PROVIDING A PROPRIETARY ELECTRONIC TRADE EXECUTION SYSTEM FOR COMPILING, ORGANIZING, AND DISSEMINATING TO OTHERS SECURITIES TRANSACTIONS VIA A GLOBAL COMPUTER NETWORK, IN CLASS 36 (U.S. CLS. 100, 101 AND 102).

FIRST USE 4-25-2007; IN COMMERCE 4-25-2007.

THE MARK CONSISTS OF STANDARD CHARACTERS WITHOUT CLAIM TO ANY PARTICULAR FONT, STYLE, SIZE, OR COLOR.

OWNER OF U.S. REG. NOS. 909,350, 3,200,076, AND OTHERS.

SN 77-214,711, FILED 6-25-2007.

SUSAN RICHARDS, EXAMINING ATTORNEY

Int. Cls.: 14 and 40

Prior U.S. Cls.: 2, 27, 28, 50, 100, 103, and 106

United States Patent and Trademark Office

Reg. No. 3,577,117

Registered Feb. 17, 2009

**TRADEMARK
SERVICE MARK
PRINCIPAL REGISTER**

SUNCREST

US SYNTHETIC CORPORATION (DELAWARE CORPORATION)
1260 SOUTH 1600 WEST
OREM, UT 84058

FOR: MANUFACTURED JEWELS AND GEMS, NAMELY, DIAMONDS, IN CLASS 14 (U.S. CLS. 2, 27, 28 AND 50).

FIRST USE 7-1-2007; IN COMMERCE 7-1-2007.

FOR: CUSTOM MANUFACTURE OF JEWELS AND GEMS, NAMELY, DIAMONDS TO THE SPECIFICATIONS OF OTHERS; PROCESSING OF JEWELS AND GEMS, NAMELY, DIAMONDS BY APPLICATION OF ULTRA HIGH TEMPERATURE

AND ULTRA HIGH PRESSURE PRESSES TO IMPROVE THE QUALITY AND COLOR OF SUCH DIAMONDS, GEMS AND JEWELS, IN CLASS 40 (U.S. CLS. 100, 103 AND 106).

FIRST USE 8-8-2008; IN COMMERCE 8-8-2008.

THE MARK CONSISTS OF STANDARD CHARACTERS WITHOUT CLAIM TO ANY PARTICULAR FONT, STYLE, SIZE, OR COLOR.

SN 77-214,785, FILED 6-25-2007.

JANICE KIM, EXAMINING ATTORNEY

Int. Cl.: 9

Prior U.S. Cls.: 21, 23, 26, 36, and 38

Reg. No. 3,577,118

United States Patent and Trademark Office

Registered Feb. 17, 2009

**TRADEMARK
PRINCIPAL REGISTER**



DLJJ & ASSOCIATES, LLC (CALIFORNIA LIMITED LIABILITY COMPANY)
9601 WILSHIRE BLVD
SUITE 260
BEVERLY HILLS, CA 90210

SECURITY, IN CLASS 9 (U.S. CLS. 21, 23, 26, 36 AND 38).

FIRST USE 10-0-2006; IN COMMERCE 10-0-2006.

FOR: VIDEO RECORDINGS FEATURING INFORMATION IN THE FIELD OF COUNTER-TERRORISM AND HOMELAND SAFETY AND

SN 77-215,023, FILED 6-25-2007.

MICHAEL WEBSTER, EXAMINING ATTORNEY

Int. Cl.: 41

Prior U.S. Cls.: 100, 101, and 107

United States Patent and Trademark Office

Reg. No. 3,577,119

Registered Feb. 17, 2009

**SERVICE MARK
PRINCIPAL REGISTER**

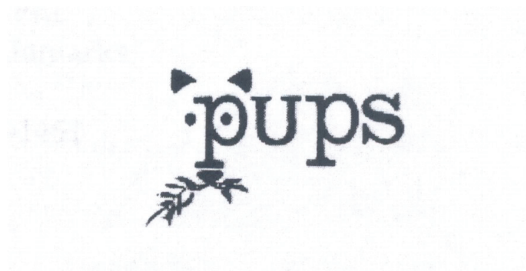

DLJJ & ASSOCIATES, LLC (CALIFORNIA LIMITED LIABILITY COMPANY)
9601 WILSHIRE BLVD
.SUITE 260
BEVERLY HILLS, CA 90210

FOR: EDUCATIONAL SERVICES, NAMELY, CONDUCTING EXHIBITIONS AND WORKSHOPS IN THE FIELD OF COUNTER-TERRORISM AND HOMELAND SAFETY AND SECURITY; EDUCATIONAL SERVICES, NAMELY, CONDUCTING EXHIBITIONS AND SEMINARS IN THE FIELD OF CANINE ASSISTANCE IN COUNTER-TERRORISM AND HOMELAND SAFETY AND SECURITY; DOG TRAINING SERVICES; EDUCATIONAL AND ENTERTAINMENT SERVICES, NAMELY, ARRAN-

GING MEETINGS AND PROVIDING MOTIVATIONAL AND EDUCATIONAL SPEAKERS, IN CLASS 41 (U.S. CLS. 100, 101 AND 107).

FIRST USE 10-0-2006; IN COMMERCE 10-0-2006.

THE MARK CONSISTS OF THE WORD "PUPS", WITH THE FIRST "P" FORMING THE NOSE OF AND A RING AROUND THE LEFT EYE OF A PUPPY, WHICH IS HOLDING A BRANCH OF LEAVES IN ITS MOUTH.

SN 77-215,044, FILED 6-25-2007.

ANTHONY RINKER, EXAMINING ATTORNEY

Int. Cl.: 33

Prior U.S. Cls.: 47 and 49

United States Patent and Trademark Office

Reg. No. 3,577,120

Registered Feb. 17, 2009

**TRADEMARK
PRINCIPAL REGISTER**

CALI 351

SIMMONS CANYON PARTNERS, LLC (DELA-
WARE LIMITED LIABILITY COMPANY)
16TH FLOOR
250 VESEY STREET
NEW YORK, NY 10080

THE MARK CONSISTS OF STANDARD CHAR-
ACTERS WITHOUT CLAIM TO ANY PARTICULAR
FONT, STYLE, SIZE, OR COLOR.

FOR: WINE, IN CLASS 33 (U.S. CLS. 47 AND 49).

SN 77-216,086, FILED 6-26-2007.

FIRST USE 5-24-2008; IN COMMERCE 5-24-2008.

TRICIA SONNEBORN, EXAMINING ATTORNEY

Int. Cl.: 3

Prior U.S. Cls.: 1, 4, 6, 50, 51, and 52

United States Patent and Trademark Office

Reg. No. 3,577,121

Registered Feb. 17, 2009

**TRADEMARK
PRINCIPAL REGISTER**

GAR-NOT

CALCIUM SILICATE CORP., INC. (TENNESSEE
CORPORATION)
601 WATSON FARM ROAD
LAKE HARBOR, FL 33459

FOR: ABRASIVES, NAMELY, ABRASIVES IN
PARTICULATE FORM FOR USE IN FLUID JET
CUTTING MACHINES, IN CLASS 3 (U.S. CLS. 1, 4, 6,
50, 51 AND 52).

FIRST USE 3-8-2008; IN COMMERCE 3-8-2008.

THE MARK CONSISTS OF STANDARD CHAR-
ACTERS WITHOUT CLAIM TO ANY PARTICULAR
FONT, STYLE, SIZE, OR COLOR.

SN 77-216,557, FILED 6-27-2007.

PATRICIA EVANKO, EXAMINING ATTORNEY

Int. Cl.: 5

Prior U.S. Cls.: 6, 18, 44, 46, 51, and 52

United States Patent and Trademark Office

Reg. No. 3,577,122

Registered Feb. 17, 2009

TRADEMARK
PRINCIPAL REGISTER

引藻

INTERNATIONAL CRYPTOMONADALES BIO-
TECHNOLOGY CO., LTD. (TAIWAN COR-
PORATION)

NO. 6, ALLEY 45, LANE 805, TSAO-ERH SEC.
ERH-HSI ROAD, CHIEN-PING, FANGYUAN
CHANGHUA, TAIWAN

FOR: NUTRITIONAL ADDITIVES FOR USE IN
FOODS AND DIETARY SUPPLEMENTS FOR HU-
MAN CONSUMPTION, DIETARY FIBER AS AN
ADDITIVE FOR FOOD PRODUCTS, DIETARY
FOOD SUPPLEMENTS, DIETARY FOODS ADAP-
TED FOR MEDICAL USE, IN CLASS 5 (U.S. CLS. 6,
18, 44, 46, 51 AND 52).

FIRST USE 7-1-1992; IN COMMERCE 5-15-2008.

NO CLAIM IS MADE TO THE EXCLUSIVE
RIGHT TO USE THE CHINESE CHARACTERS

WHICH TRANSLATE INTO "ALGA", APART FROM
THE MARK AS SHOWN.

THE MARK CONSISTS OF A CHINESE CHAR-
ACTER MARK.

THE FOREIGN WORDING IN THE MARK
TRANSLATES INTO ENGLISH AS "PULL, ALGA".

THE NON-LATIN CHARACTER(S) IN THE
MARK TRANSLITERATE INTO YIN, ZAO, AND
THIS MEANS "PULL, ALGA" IN ENGLISH.

SN 77-216,696, FILED 6-27-2007.

RICHARD A. STRASER, EXAMINING ATTORNEY

Int. Cls.: 25 and 32

Prior U.S. Cls.: 22, 39, 45, 46, and 48

United States Patent and Trademark Office

Reg. No. 3,577,123

Registered Feb. 17, 2009

**TRADEMARK
PRINCIPAL REGISTER**

1554 ENLIGHTENED BLACK ALE

NEW BELGIUM BREWING COMPANY, INC.
(COLORADO CORPORATION)
500 LINDEN STREET
FORT COLLINS, CO 80524

THE MARK CONSISTS OF STANDARD CHARACTERS WITHOUT CLAIM TO ANY PARTICULAR FONT, STYLE, SIZE, OR COLOR.

FOR: CLOTHING, NAMELY, SHIRTS, IN CLASS 25 (U.S. CLS. 22 AND 39).

NO CLAIM IS MADE TO THE EXCLUSIVE RIGHT TO USE "BLACK ALE", APART FROM THE MARK AS SHOWN.

FIRST USE 10-0-2007; IN COMMERCE 10-0-2007.

FOR: BEER AND ALE , IN CLASS 32 (U.S. CLS. 45, 46 AND 48).

SN 77-217,164, FILED 6-27-2007.

FIRST USE 8-0-2007; IN COMMERCE 8-0-2007.

TINA L. SNAPP, EXAMINING ATTORNEY

Int. Cl.: 27

Prior U.S. Cls.: 19, 20, 37, 42, and 50

United States Patent and Trademark Office

Reg. No. 3,577,124

Registered Feb. 17, 2009

**TRADEMARK
PRINCIPAL REGISTER**

RESISTA

CCA GLOBAL PARTNERS, INC. (DELAWARE
CORPORATION)
4301 EARTH CITY EXPRESSWAY
EARTH CITY, MO 63045

THE MARK CONSISTS OF STANDARD CHAR-
ACTERS WITHOUT CLAIM TO ANY PARTICULAR
FONT, STYLE, SIZE, OR COLOR.

FOR: FLOOR COVERINGS, NAMELY, CARPETS,
IN CLASS 27 (U.S. CLS. 19, 20, 37, 42 AND 50).

SN 77-217,656, FILED 6-28-2007.

FIRST USE 8-1-2005; IN COMMERCE 8-1-2005.

JUDITH HELFMAN, EXAMINING ATTORNEY

Int. Cl.: 27

Prior U.S. Cls.: 19, 20, 37, 42, and 50

United States Patent and Trademark Office

Reg. No. 3,577,125

Registered Feb. 17, 2009

TRADEMARK
PRINCIPAL REGISTER



CCA GLOBAL PARTNERS, INC. (DELAWARE
CORPORATION)
4301 EARTH CITY EXPRESSWAY
EARTH CITY, MO 63045

THE MARK CONSISTS OF DUCK WITH DRO-
PLET ON BACK ON TOP OR "RESISTA" WITH
LARGE "R" AND LARGE "A".

FOR: FLOOR COVERINGS, NAMELY, CARPETS,
IN CLASS 27 (U.S. CLS. 19, 20, 37, 42 AND 50).

SN 77-217,657, FILED 6-28-2007.

FIRST USE 8-1-2005; IN COMMERCE 8-1-2005.

JUDITH HELFMAN, EXAMINING ATTORNEY

Int. Cl.: 9

Prior U.S. Cls.: 21, 23, 26, 36, and 38

United States Patent and Trademark Office

Reg. No. 3,577,126

Registered Feb. 17, 2009

**TRADEMARK
PRINCIPAL REGISTER**

FORCEFIELD

ZONE LABS, L.L.C. (CALIFORNIA LIMITED
LIABILITY COMPANY)
800 BRIDGE PARKWAY
REDWOOD CITY, CA 94065

FOR: DOWNLOADABLE COMPUTER SOFTWARE FOR PROVIDING SECURITY FOR COMPUTERS CONNECTED TO THE INTERNET, SPECIFICALLY, CREATING A VIRTUAL BROWSER TO PREVENT THE DOWNLOAD OF MALWARE, VIRUSES AND KEY LOGGERS, IN CLASS 9 (U.S. CLS. 21, 23, 26, 36 AND 38).

FIRST USE 5-12-2008; IN COMMERCE 5-12-2008.

THE MARK CONSISTS OF STANDARD CHARACTERS WITHOUT CLAIM TO ANY PARTICULAR FONT, STYLE, SIZE, OR COLOR.

SN 77-219,042, FILED 6-29-2007.

RONALD AIKENS, EXAMINING ATTORNEY

Int. Cl.: 41

Prior U.S. Cls.: 100, 101, and 107

United States Patent and Trademark Office

Reg. No. 3,577,127

Registered Feb. 17, 2009

**SERVICE MARK
PRINCIPAL REGISTER**

Startalk

CURVED LIGHT PRODUCTIONS, LLC (NEW
YORK LIMITED LIABILITY COMPANY)
1359 BROADWAY
SUITE 600
NEW YORK, NY 10018

FOR: ENTERTAINMENT SERVICES, NAMELY, A
TALK RADIO SHOW ABOUT ASTRONOMY AND
ISSUES RELATED TO SPACE FEATURING SCI-
ENCE, COMEDY, DEBATE AND LIVE CALLS
FROM LISTENERS ACCESSIBLE BY RADIO, TELE-
VISION, SATELLITE, AUDIO, VIDEO AND COM-

PUTER NETWORKS, IN CLASS 41 (U.S. CLS. 100, 101
AND 107).

FIRST USE 12-1-2007; IN COMMERCE 12-1-2007.

THE MARK CONSISTS OF STANDARD CHAR-
ACTERS WITHOUT CLAIM TO ANY PARTICULAR
FONT, STYLE, SIZE, OR COLOR.

SN 77-220,691, FILED 7-2-2007.

G. MAYERSCHOFF, EXAMINING ATTORNEY

Int. Cl.: 8

Prior U.S. Cls.: 23, 28, and 44

United States Patent and Trademark Office

Reg. No. 3,577,128

Registered Feb. 17, 2009

**TRADEMARK
PRINCIPAL REGISTER**

UNIONTOOLS

AMES TRUE TEMPER PROPERTIES, INC. (MI-
CHIGAN CORPORATION)
300 DELAWARE AVENUE, SUITE 1704
WILMINGTON, DE 19801

FOR: MANUALLY OPERATED HAND TOOLS,
NAMELY, SOD LIFTERS, TRANSPLANTERS,
WEED CUTTERS, THATCHING RAKES, NUT
GATHERERS, BEAN HOOKS, GRASS WHIPS, SOIL
SCOOPS, DITCH BANK BLADES, GRASS HOOKS,
CORN KNIFES, FRUIT PICKERS AND GRASS
TRIMMERS, IN CLASS 8 (U.S. CLS. 23, 28 AND 44).

FIRST USE 0-0-1991; IN COMMERCE 0-0-1991.

THE MARK CONSISTS OF STANDARD CHAR-
ACTERS WITHOUT CLAIM TO ANY PARTICULAR
FONT, STYLE, SIZE, OR COLOR.

OWNER OF U.S. REG. NOS. 1,617,346, 1,619,472,
AND 3,012,013.

SN 77-222,171, FILED 7-5-2007.

MICHELE SWAIN, EXAMINING ATTORNEY

Int. Cl.: 43

Prior U.S. Cls.: 100 and 101

United States Patent and Trademark Office

Reg. No. 3,577,129

Registered Feb. 17, 2009

**SERVICE MARK
PRINCIPAL REGISTER**



PATRICIA RESORTS, LLC (SOUTH CAROLINA
LIMITED LIABILITY COMPANY)
601 19TH AVENUE NORTH
MYRTLE BEACH, SC 29577

NO CLAIM IS MADE TO THE EXCLUSIVE
RIGHT TO USE "RESORTS", APART FROM THE
MARK AS SHOWN.

FOR: HOTEL AND RESORT HOTEL SERVICES;
RESTAURANT AND CATERING SERVICES, PRO-
VIDING MEETING ROOM AND CONVENTION
FACILITIES, IN CLASS 43 (U.S. CLS. 100 AND 101).

SN 77-222,340, FILED 7-5-2007.

FIRST USE 9-30-2006; IN COMMERCE 9-30-2006.

MICHAEL WEBSTER, EXAMINING ATTORNEY

Int. Cl.: 8

Prior U.S. Cls.: 23, 28, and 44

United States Patent and Trademark Office

Reg. No. 3,577,130

Registered Feb. 17, 2009

**TRADEMARK
PRINCIPAL REGISTER**

UnionTools

AMES TRUE TEMPER PROPERTIES, INC. (MI-
CHIGAN CORPORATION)
300 DELAWARE AVENUE, SUITE 1704
WILMINGTON, DE 19801

FOR: MANUALLY OPERATED HAND TOOLS,
NAMELY, SOD LIFTERS, TRANSPLANTERS,
WEED CUTTERS, THATCHING RAKES, NUT
GATHERERS, BEAN HOOKS, GRASS WHIPS, SOIL
SCOOPS, DITCH BANK BLADES, GRASS HOOKS,
CORN KNIFES, FRUIT PICKERS AND GRASS
TRIMMERS, IN CLASS 8 (U.S. CLS. 23, 28 AND 44).

FIRST USE 0-0-1991; IN COMMERCE 0-0-1991.

OWNER OF U.S. REG. NOS. 1,617,346, 1,619,472,
AND 3,012,013.

SN 77-222,459, FILED 7-5-2007.

MICHELE SWAIN, EXAMINING ATTORNEY

Int. Cl.: 3

Prior U.S. Cls.: 1, 4, 6, 50, 51, and 52

United States Patent and Trademark Office

Reg. No. 3,577,131

Registered Feb. 17, 2009

**TRADEMARK
PRINCIPAL REGISTER**

DERMASILK MIRACLE CREAM

BIOTECH INTERNATIONAL CORPORATION
(CONNECTICUT CORPORATION)
107 OAKWOOD DRIVE
GLASTONBURY, CT 06033

FOR: BEAUTY CREAMS; BEAUTY LOTIONS;
BEAUTY SERUMS; HAND CREAMS; HAND LO-
TIONS; EYE CREAMS; EYE LOTIONS; SKIN
CREAMS; SKIN LOTIONS; BODY CREAMS; BODY
LOTIONS; FACE CREAMS; FACE AND BODY
CREAMS; FACE AND BODY LOTIONS; FACE
AND BODY BEAUTY CREAMS; SKIN CARE PRO-
DUCTS, NAMELY, NON-MEDICATED SKIN SER-
UM; LOTIONS FOR SKIN, FACE, AND BODY;
CREAMS FOR CELLULITE REDUCTION; LOTIONS
FOR CELLULITE REDUCTION; TONING LOTION,
FOR THE FACE, BODY AND HANDS; TOPICAL
NON-MEDICATED CREAMS, LOTIONS, OINT-

MENTS AND SERUMS FOR SKIN CARE, IN CLASS
3 (U.S. CLS. 1, 4, 6, 50, 51 AND 52).

FIRST USE 2-26-2008; IN COMMERCE 2-26-2008.

THE MARK CONSISTS OF STANDARD CHAR-
ACTERS WITHOUT CLAIM TO ANY PARTICULAR
FONT, STYLE, SIZE, OR COLOR.

OWNER OF U.S. REG. NO. 3,252,530.

NO CLAIM IS MADE TO THE EXCLUSIVE
RIGHT TO USE "CREAM", APART FROM THE
MARK AS SHOWN.

SN 77-223,288, FILED 7-6-2007.

SIMON TENG, EXAMINING ATTORNEY

Int. Cls.: 35 and 36

Prior U.S. Cls.: 100, 101, and 102

United States Patent and Trademark Office

Reg. No. 3,577,132

Registered Feb. 17, 2009

**SERVICE MARK
PRINCIPAL REGISTER**

Virtucard

SAFPAY, INC. (DELAWARE CORPORATION)
800 5TH AVE.
SUITE 4100
SEATTLE, WA 981043100

FOR: OPERATING ON-LINE MARKETPLACES FOR SELLERS OF GOODS AND/OR SERVICES; ADMINISTRATION, BILLING, AND RECONCILIATION OF ACCOUNTS ON BEHALF OF OTHERS, IN CLASS 35 (U.S. CLS. 100, 101 AND 102).

FIRST USE 10-9-2008; IN COMMERCE 10-9-2008.

FOR: ELECTRONIC COMMERCE PAYMENT SERVICES, NAMELY, ESTABLISHING ACCOUNTS USED TO PURCHASE GOODS AND SERVICES FROM SELECTED PROVIDERS ON THE INTER-

NET; ELECTRONIC FUNDS TRANSFER, NAMELY, ACCEPTING PAYMENTS ON BEHALF OF PROVIDERS OF GOODS AND SERVICES; ELECTRONIC PAYMENT, NAMELY, ELECTRONIC PROCESSING AND TRANSMISSION OF BILL PAYMENT DATA, IN CLASS 36 (U.S. CLS. 100, 101 AND 102).

FIRST USE 10-12-2008; IN COMMERCE 10-12-2008.

THE MARK CONSISTS OF STANDARD CHARACTERS WITHOUT CLAIM TO ANY PARTICULAR FONT, STYLE, SIZE, OR COLOR.

SN 77-223,947, FILED 7-6-2007.

MORGAN WYNNE, EXAMINING ATTORNEY

Int. Cls.: 3, 16, and 28

**Prior U.S. Cls.: 1, 2, 4, 5, 6, 22, 23, 29, 37, 38, 50, 51,
and 52**

Reg. No. 3,577,133

United States Patent and Trademark Office

Registered Feb. 17, 2009

**TRADEMARK
PRINCIPAL REGISTER**

MAKE & BELIEVE ME

HORIZON GROUP USA, INC. (NEW JERSEY CORPORATION)
76 STIRLING ROAD, SUITE 101
WARREN, NJ 07059

FOR: CHILDREN'S ACTIVITY KIT, NAMELY, A TRAVEL MAKE-UP SET COMPRISING COSMETIC BAGS, LIP GLOSS, NAIL POLISH, BODY GLITTER, EYE SHADOW, BODY JEWELS AND TEMPORARY TATTOOS, IN CLASS 3 (U.S. CLS. 1, 4, 6, 50, 51 AND 52).

FIRST USE 2-0-2008; IN COMMERCE 2-0-2008.

FOR: CHILDREN'S ACTIVITY KIT FOR WRITING AND ILLUSTRATING A STORY COMPRISING SCRAPBOOK, DIE CUT SHAPES, PERFORATED SHEET OF ICONS, RIBBON, GLUE, STICKERS, ACRYLIC STONES, MARKERS, PRINTED PAGES, SEQUINS, FOAM SQUARES, IN CLASS 16 (U.S. CLS. 2, 5, 22, 23, 29, 37, 38 AND 50).

FIRST USE 2-0-2008; IN COMMERCE 2-0-2008.

FOR: CHILDREN'S ACTIVITY KIT FOR CREATING AND DECORATING DRESS-UP COSTUMES FOR ROLE PLAY COMPRISING CLOTHING TO BE DECORATED, SATIN FLOWERS, SEQUIN TRIM, SATIN RIBBON, ACRYLIC STONES AND GLUE; CHILDREN'S ACTIVITY KIT FOR CREATING AND DECORATING ACCESSORIES FOR ROLE PLAY COMPRISING CHARMS, BEADS, ELASTIC CORD, ACRYLIC STONES, SEQUIN TRIM, GLUE, IN CLASS 28 (U.S. CLS. 22, 23, 38 AND 50).

FIRST USE 2-0-2008; IN COMMERCE 2-0-2008.

THE MARK CONSISTS OF STANDARD CHARACTERS WITHOUT CLAIM TO ANY PARTICULAR FONT, STYLE, SIZE, OR COLOR.

SN 77-224,520, FILED 7-9-2007.

SALLY SHIH, EXAMINING ATTORNEY

Int. Cl.: 33

Prior U.S. Cls.: 47 and 49

United States Patent and Trademark Office

Reg. No. 3,577,134

Registered Feb. 17, 2009

**TRADEMARK
PRINCIPAL REGISTER**

LIONSHARE

MEADOWOOD ASSOCIATES (CALIFORNIA
PARTNERSHIP)
900 MEADOWOOD LANE
ST. HELENA, CA 94574

THE MARK CONSISTS OF STANDARD CHAR-
ACTERS WITHOUT CLAIM TO ANY PARTICULAR
FONT, STYLE, SIZE, OR COLOR.

FOR: WINE, IN CLASS 33 (U.S. CLS. 47 AND 49).

SN 77-224,653, FILED 7-9-2007.

FIRST USE 5-5-2008; IN COMMERCE 5-5-2008.

KRISTIN DAHLING, EXAMINING ATTORNEY

Int. Cl.: 9

Prior U.S. Cls.: 21, 23, 26, 36, and 38

United States Patent and Trademark Office

Reg. No. 3,577,135

Registered Feb. 17, 2009

**TRADEMARK
PRINCIPAL REGISTER**

TOTAL NETWORK KNOWLEDGE

NETWITNESS CORPORATION (DELAWARE CORPORATION)
500 GROVE STREET SUITE 300
HERNDON, VA 20170

FOR: COMPUTER SOFTWARE FOR COLLECTION, ANALYSIS, AND MONITORING OF NETWORK TRAFFIC FOR MAINTENANCE OF NETWORK SECURITY, ENFORCEMENT OF BUSINESS POLICIES, RULES, AND PROCEDURES, AND PREVENTION OF INTELLECTUAL PROPERTY THEFT OR LOSS, COMPUTER-BASED FRAUD AND CRIME, AND OTHER INCIDENTS OF NETWORK INTRUSION AND MISUSE, IN CLASS 9 (U.S. CLS. 21, 23, 26, 36 AND 38).

FIRST USE 4-15-2008; IN COMMERCE 4-15-2008.

THE MARK CONSISTS OF STANDARD CHARACTERS WITHOUT CLAIM TO ANY PARTICULAR FONT, STYLE, SIZE, OR COLOR.

NO CLAIM IS MADE TO THE EXCLUSIVE RIGHT TO USE "NETWORK", APART FROM THE MARK AS SHOWN.

SN 77-224,962, FILED 7-9-2007.

MARILYN IZZI, EXAMINING ATTORNEY

Int. Cls.: 35 and 41

Prior U.S. Cls.: 100, 101, 102, and 107

United States Patent and Trademark Office

Reg. No. 3,577,136

Registered Feb. 17, 2009

**SERVICE MARK
PRINCIPAL REGISTER**

LIGHTWORKS PICTURES

LIGHTWORKS ENTERPRISES, INC. (NEW YORK CORPORATION)
74 TRINITY PLACE, SUITE 806
NEW YORK, NY 10006

FOR: ENTERTAINMENT MARKETING SERVICES, NAMELY, MARKETING, PROMOTION AND ADVERTISING OF MOTION PICTURES AND TELEVISION MOVIES, IN CLASS 35 (U.S. CLS. 100, 101 AND 102).

FIRST USE 12-3-2007; IN COMMERCE 12-3-2007.

FOR: PRODUCTION AND DISTRIBUTION OF MOTION PICTURES AND TELEVISION MOVIES, IN CLASS 41 (U.S. CLS. 100, 101 AND 107).

FIRST USE 12-8-2007; IN COMMERCE 12-8-2007.

THE MARK CONSISTS OF STANDARD CHARACTERS WITHOUT CLAIM TO ANY PARTICULAR FONT, STYLE, SIZE, OR COLOR.

OWNER OF U.S. REG. NOS. 3,210,395 AND 3,210,686.

NO CLAIM IS MADE TO THE EXCLUSIVE RIGHT TO USE "PICTURES", APART FROM THE MARK AS SHOWN.

SN 77-224,998, FILED 7-9-2007.

HENRY S. ZAK, EXAMINING ATTORNEY

Int. Cl.: 35

Prior U.S. Cls.: 100, 101, and 102

United States Patent and Trademark Office

Reg. No. 3,577,137

Registered Feb. 17, 2009

**SERVICE MARK
PRINCIPAL REGISTER**

GME

GREEN MEDIA ENTERPRISES, LLC (CALIFORNIA LIMITED LIABILITY COMPANY)
SUITE 265
11911 SAN VICENTE BOULEVARD
LOS ANGELES, CA 90049

FOR: ARRANGING AND CONDUCTING TRADE SHOWS FEATURING ENVIRONMENTALLY FRIENDLY PRODUCTS AND SERVICES, IN CLASS 35 (U.S. CLS. 100, 101 AND 102).

FIRST USE 5-0-2008; IN COMMERCE 5-0-2008.

THE MARK CONSISTS OF STANDARD CHARACTERS WITHOUT CLAIM TO ANY PARTICULAR FONT, STYLE, SIZE, OR COLOR.

SN 77-225,355, FILED 7-9-2007.

AISHA SALEM, EXAMINING ATTORNEY

Int. Cl.: 35

Prior U.S. Cls.: 100, 101, and 102

United States Patent and Trademark Office

Reg. No. 3,577,138

Registered Feb. 17, 2009

**SERVICE MARK
PRINCIPAL REGISTER**

FRANTASTIC

FRANCHISE CONSULTING, INC. (PENNSYLVANIA CORPORATION)
850 HULTON ROAD
OAKMONT, PA 15139

FOR: ASSISTANCE IN BUSINESS MANAGEMENT AND PRODUCT COMMERCIALIZATION, WITHIN THE FRAMEWORK OF A FRANCHISE CONTRACT; FRANCHISE SERVICES, NAMELY, OFFERING TECHNICAL AND BUSINESS MANAGEMENT ASSISTANCE IN THE ESTABLISHMENT AND OPERATION OF FRANCHISES OF

ALL TYPES, IN CLASS 35 (U.S. CLS. 100, 101 AND 102).

FIRST USE 12-9-2007; IN COMMERCE 12-9-2007.

THE MARK CONSISTS OF STANDARD CHARACTERS WITHOUT CLAIM TO ANY PARTICULAR FONT, STYLE, SIZE, OR COLOR.

SN 77-225,710, FILED 7-10-2007.

JAY BESCH, EXAMINING ATTORNEY

Int. Cls.: 35 and 36

Prior U.S. Cls.: 100, 101, and 102

United States Patent and Trademark Office

Reg. No. 3,577,139

Registered Feb. 17, 2009

**SERVICE MARK
PRINCIPAL REGISTER**

BIZUNITE

CCA GLOBAL PARTNERS, INC. (DELAWARE CORPORATION)
4301 EARTH CITY EXPRESSWAY
EARTH CITY, MO 63045

FOR: PROVIDING A SUITE OF VARIOUS BUSINESS SUPPORT SERVICES, SPECIFICALLY, PROVIDING OFFICE SUPPORT STAFF; HUMAN RESOURCE MANAGEMENT, CONSULTATION AND PERSONNEL SELECTION FOR OTHERS; ADVERTISING AND BUSINESS MANAGEMENT CONSULTANCY; ADVICE IN THE FIELDS OF BUSINESS MANAGEMENT AND MARKETING; ADVICE RELATING TO THE BUSINESS ORGANIZATION, OPERATIONS AND MANAGEMENT OF BUSINESS; ASSISTANCE, ADVISORY SERVICES AND CONSULTANCY WITH REGARD TO BUSINESS PLANNING, BUSINESS ANALYSIS, BUSINESS MANAGEMENT, AND BUSINESS ORGANIZATION; PROVIDING ADVICE AND ASSISTANCE IN OBTAINING THIRD PARTY CONTRACTS FOR OTHERS FOR THE PURCHASE AND SALE OF GOODS AND RETAIL SERVICES, AND

PROMOTING THE GOODS AND SERVICES OF OTHERS IN RELATION TO GENERAL BUSINESS NEEDS AND OPERATIONS, IN CLASS 35 (U.S. CLS. 100, 101 AND 102).

FIRST USE 1-0-2008; IN COMMERCE 1-0-2008.

FOR: PROVIDING ASSISTANCE AND ADVICE IN OBTAINING CREDIT CARD PROCESSING AND FINANCIAL PAYMENT FOR GOODS AND SERVICES, IN CLASS 36 (U.S. CLS. 100, 101 AND 102).

FIRST USE 1-0-2008; IN COMMERCE 1-0-2008.

THE MARK CONSISTS OF STANDARD CHARACTERS WITHOUT CLAIM TO ANY PARTICULAR FONT, STYLE, SIZE, OR COLOR.

SN 77-226,132, FILED 7-10-2007.

JUDITH HELFMAN, EXAMINING ATTORNEY

Int. Cl.: 35

Prior U.S. Cls.: 100, 101, and 102

United States Patent and Trademark Office

Reg. No. 3,577,140

Registered Feb. 17, 2009

**SERVICE MARK
PRINCIPAL REGISTER**

JOB1EXCHANGE

THE RUMPF CORPORATION (OHIO CORPORATION)
701 JEFFERSON AVENUE
TOLEDO, OH 436241917

FOR: EMPLOYMENT PLACEMENT SERVICES FOR EMPLOYERS AND PROSPECTIVE EMPLOYEES; TEMPORARY EMPLOYMENT PLACEMENT SERVICES FOR EMPLOYERS AND PROSPECTIVE EMPLOYEES; EMPLOYMENT COUNSELING AND RECRUITING; PERSONNEL MANAGEMENT AND PERSONNEL MANAGEMENT CONSULTATION SERVICES; EMPLOYEE LEASING SERVICES; EMPLOYMENT AGENCY SERVICES, NAMELY, RECRUITING, INTERVIEWING, PLACING,

COORDINATING AND SUPERVISING PERSONNEL BEING PROVIDED UNDER CONTRACT OR LONG TERM LEASE, IN CLASS 35 (U.S. CLS. 100, 101 AND 102).

FIRST USE 6-30-2008; IN COMMERCE 6-30-2008.

THE MARK CONSISTS OF STANDARD CHARACTERS WITHOUT CLAIM TO ANY PARTICULAR FONT, STYLE, SIZE, OR COLOR.

SN 77-226,546, FILED 7-11-2007.

RICHARD WHITE, EXAMINING ATTORNEY

Int. Cl.: 21

Prior U.S. Cls.: 2, 13, 23, 29, 30, 33, 40, and 50

United States Patent and Trademark Office

Reg. No. 3,577,141

Registered Feb. 17, 2009

**TRADEMARK
PRINCIPAL REGISTER**

Dog Bone Homes

EDDY, ROBERT H. (UNITED STATES INDIVIDUAL)
19 NEILLEHAVEN DRIVE
CAMDEN, ME 04843

FOR: NON-METAL STORAGE CONTAINERS FOR HOUSEHOLD USE AND COOKIE JARS BOTH IN THE SHAPE OF VARIOUS ARCHITECTURAL RESIDENTIAL STYLES, IN CLASS 21 (U.S. CLS. 2, 13, 23, 29, 30, 33, 40 AND 50).

FIRST USE 7-1-2008; IN COMMERCE 7-1-2008.

THE MARK CONSISTS OF STANDARD CHARACTERS WITHOUT CLAIM TO ANY PARTICULAR FONT, STYLE, SIZE, OR COLOR.

NO CLAIM IS MADE TO THE EXCLUSIVE RIGHT TO USE "DOG BONE", APART FROM THE MARK AS SHOWN.

SN 77-226,901, FILED 7-11-2007.

REBECCA SMITH, EXAMINING ATTORNEY

Int. Cl.: 3

Prior U.S. Cls.: 1, 4, 6, 50, 51, and 52

United States Patent and Trademark Office

Reg. No. 3,577,142

Registered Feb. 17, 2009

**TRADEMARK
PRINCIPAL REGISTER**

KIN COSMETICS

KIN COSMETICS, S.A. (SPAIN CORPORATION)
POL. IND. BUJONIS, PARCELAS 7-9
17220 SANT FELIU DE GUIXOLS
(GERONA), SPAIN

FOR: HAIR COLORANTS AND HAIR BLEACHING PREPARATIONS; HAIR LOTIONS, HAIR LACQUERS, HAIR SETTING PREPARATIONS, HAIR WAVING AND CURLING PREPARATIONS, HAIR CREAM, HAIR SHAMPOOS, PERFUMES AND PERFUMERY, TOILET SOAPS, AND SHOWER AND BATH GEL SOAPS, IN CLASS 3 (U.S. CLS. 1, 4, 6, 50, 51 AND 52).

FIRST USE 10-1-1944; IN COMMERCE 10-31-2007.

THE MARK CONSISTS OF STANDARD CHARACTERS WITHOUT CLAIM TO ANY PARTICULAR FONT, STYLE, SIZE, OR COLOR.

OWNER OF U.S. REG. NO. 3,063,835.

NO CLAIM IS MADE TO THE EXCLUSIVE RIGHT TO USE "COSMETICS", APART FROM THE MARK AS SHOWN.

SN 77-227,062, FILED 7-11-2007.

LANA PHAM, EXAMINING ATTORNEY

Int. Cl.: 3

Prior U.S. Cls.: 1, 4, 6, 50, 51, and 52

Reg. No. 3,577,143

United States Patent and Trademark Office

Registered Feb. 17, 2009

**TRADEMARK
PRINCIPAL REGISTER**

CERAKIN TECHNOLOGY

KIN COSMETICS, S.A. (SPAIN CORPORATION)
POL. IND. BUJONIS, PARCELAS 7-9
17220 SANT FELIU DE GUIXOLS
(GERONA), SPAIN

FOR: HAIR COLORANTS AND HAIR BLEACHING PREPARATIONS; HAIR LOTIONS, HAIR LACQUERS, HAIR SETTING PREPARATIONS, HAIR WAVING AND CURLING PREPARATIONS, HAIR CREAM, HAIR SHAMPOOS, PERFUMES AND PERFUMERY, TOILET SOAPS, AND SHOWER AND BATH GEL SOAPS, IN CLASS 3 (U.S. CLS. 1, 4, 6, 50, 51 AND 52).

FIRST USE 10-1-1935; IN COMMERCE 10-31-2007.

THE MARK CONSISTS OF STANDARD CHARACTERS WITHOUT CLAIM TO ANY PARTICULAR FONT, STYLE, SIZE, OR COLOR.

NO CLAIM IS MADE TO THE EXCLUSIVE RIGHT TO USE "TECHNOLOGY", APART FROM THE MARK AS SHOWN.

SN 77-227,074, FILED 7-11-2007.

LANA PHAM, EXAMINING ATTORNEY

Int. Cl.: 3

Prior U.S. Cls.: 1, 4, 6, 50, 51, and 52

United States Patent and Trademark Office

Reg. No. 3,577,144

Registered Feb. 17, 2009

**TRADEMARK
PRINCIPAL REGISTER**



KIN COSMETICS, S.A. (SPAIN CORPORATION)
POL. IND. BUJONIS, PARCELAS 7-9
17220 SANT FELIU DE GUIXOLS
(GERONA), SPAIN

FIRST USE 8-1-2007; IN COMMERCE 10-31-2007.

OWNER OF U.S. REG. NO. 3,063,835.

FOR: HAIR COLORANTS AND HAIR BLEACHING PREPARATIONS; HAIR LOTIONS, HAIR LACQUERS, HAIR SETTING PREPARATIONS, HAIR WAVING AND CURLING PREPARATIONS, HAIR CREAM, HAIR SHAMPOOS, PERFUMES AND PERFUMERY, TOILET SOAPS, AND SHOWER AND BATH GEL SOAPS, IN CLASS 3 (U.S. CLS. 1, 4, 6, 50, 51 AND 52).

THE MARK CONSISTS OF THE WORD "KIN" AND A DESIGN ELEMENT CONSISTING OF A WOMAN'S HEAD, FACE AND HAIR.

SN 77-227,088, FILED 7-11-2007.

LANA PHAM, EXAMINING ATTORNEY

Int. Cl.: 41

Prior U.S. Cls.: 100, 101, and 107

United States Patent and Trademark Office

Reg. No. 3,577,145

Registered Feb. 17, 2009

**SERVICE MARK
PRINCIPAL REGISTER**

Community Radar

EXCOGNITO, INC. (GEORGIA CORPORATION)
1955 FAIRWAY CIRCLE
ATLANTA, GA 30319

FOR: NEWS SYNDICATION REPORTING FOR
CIVIC AND COMMUNITY GROUPS; DIGITAL,
AUDIO, VIDEO, AND MULTI-MEDIA PUBLISHING
FOR CIVIC AND COMMUNITY GROUPS, IN CLASS
41 (U.S. CLS. 100, 101 AND 107).

FIRST USE 7-1-2007; IN COMMERCE 1-31-2008.

THE MARK CONSISTS OF STANDARD CHAR-
ACTERS WITHOUT CLAIM TO ANY PARTICULAR
FONT, STYLE, SIZE, OR COLOR.

NO CLAIM IS MADE TO THE EXCLUSIVE
RIGHT TO USE "COMMUNITY", APART FROM
THE MARK AS SHOWN.

SN 77-227,527, FILED 7-11-2007.

H. M. FISHER, EXAMINING ATTORNEY

Int. Cl.: 25

Prior U.S. Cls.: 22 and 39

United States Patent and Trademark Office

Reg. No. 3,577,146

Registered Feb. 17, 2009

**TRADEMARK
PRINCIPAL REGISTER**

Refuse2Compromise

REFUSE2COMPROMISE, LLC (SOUTH CAROLINA LIMITED LIABILITY COMPANY)
120 LOUDWATER DRIVE
ANDERSON, SC 29621

FOR: GOLF SHIRTS; SHIRTS; SHORT-SLEEVED OR LONG-SLEEVED T-SHIRTS; HEADGEAR, NAMELY, CAPS, IN CLASS 25 (U.S. CLS. 22 AND 39).

FIRST USE 12-1-2008; IN COMMERCE 12-1-2008.

THE MARK CONSISTS OF STANDARD CHARACTERS WITHOUT CLAIM TO ANY PARTICULAR FONT, STYLE, SIZE, OR COLOR.

SN 77-227,611, FILED 7-12-2007.

VIVIAN MICZNIK FIRST, EXAMINING ATTORNEY

Int. Cl.: 42

Prior U.S. Cls.: 100 and 101

United States Patent and Trademark Office

Reg. No. 3,577,147

Registered Feb. 17, 2009

**SERVICE MARK
PRINCIPAL REGISTER**

23ANDME

23ANDME, INC. (DELAWARE CORPORATION)
2606 BAYSHORE PARKWAY
MOUNTAIN VIEW, CA 94043

FOR: APPLICATION SERVICE PROVIDER (ASP) FEATURING SOFTWARE FOR PROVIDING ACCESS TO MULTIPLE DATABASES THAT CONTAIN AGGREGATED RESULTS OF GENOTYPING; APPLICATION SERVICE PROVIDER (ASP) FEATURING SOFTWARE FOR USE IN DATA MANAGEMENT, DATA STORAGE, DATA ANALYSIS, REPORT GENERATION, USER IDENTIFICATION, AND MEMBERSHIP IDENTIFICATION, ALL IN THE FIELDS OF GENETICS AND GENETIC TESTING; SCIENTIFIC RESEARCH IN THE FIELDS

OF GENETICS, GENETIC TESTING, GENETIC SCREENING, GENOTYPING, PHENOTYPING, MOLECULAR ANALYTICS, AND ANCESTRY, IN CLASS 42 (U.S. CLS. 100 AND 101).

FIRST USE 11-14-2007; IN COMMERCE 11-14-2007.

THE MARK CONSISTS OF STANDARD CHARACTERS WITHOUT CLAIM TO ANY PARTICULAR FONT, STYLE, SIZE, OR COLOR.

SN 77-228,004, FILED 7-12-2007.

SEAN CROWLEY, EXAMINING ATTORNEY

Int. Cl.: 5

Prior U.S. Cls.: 6, 18, 44, 46, 51, and 52

Reg. No. 3,577,148

United States Patent and Trademark Office

Registered Feb. 17, 2009

**TRADEMARK
PRINCIPAL REGISTER**

LIPO-SURE

IOMEDIX DEVELOPMENT INTERNATIONAL
SRL (BARBADOS CORPORATION)
THE GROVE, 21 PINE ROAD
BELLEVILLE ST. MICHAEL, BARBADOS BB11113

THE MARK CONSISTS OF STANDARD CHAR-
ACTERS WITHOUT CLAIM TO ANY PARTICULAR
FONT, STYLE, SIZE, OR COLOR.

FOR: DIETARY SUPPLEMENTS, IN CLASS 5 (U.S.
CLS. 6, 18, 44, 46, 51 AND 52).

SN 77-229,338, FILED 7-13-2007.

FIRST USE 9-0-2007; IN COMMERCE 9-0-2007.

PAUL E. FAHRENKOPF, EXAMINING ATTORNEY

Int. Cl.: 7

Prior U.S. Cls.: 13, 19, 21, 23, 31, 34, and 35

Reg. No. 3,577,149

United States Patent and Trademark Office

Registered Feb. 17, 2009

**TRADEMARK
PRINCIPAL REGISTER**

BrakeBoss

THE HILLIARD CORPORATION (NEW YORK
CORPORATION)
100 WEST FOURTH STREET
ELMIRA, NY 149021504

FOR: INDUSTRIAL BRAKE SYSTEM FOR CON-
TROLLING MOVEMENT OF MACHINERY
THROUGH HYDRAULIC OR PNEUMATIC BRAKE
SYSTEM CONTROLS, IN CLASS 7 (U.S. CLS. 13, 19,
21, 23, 31, 34 AND 35).

FIRST USE 7-31-2007; IN COMMERCE 7-31-2007.

THE MARK CONSISTS OF STANDARD CHAR-
ACTERS WITHOUT CLAIM TO ANY PARTICULAR
FONT, STYLE, SIZE, OR COLOR.

SN 77-229,390, FILED 7-13-2007.

STEPHEN AQUILA, EXAMINING ATTORNEY

Int. Cl.: 25

Prior U.S. Cls.: 22 and 39

United States Patent and Trademark Office

Reg. No. 3,577,150

Registered Feb. 17, 2009

**TRADEMARK
PRINCIPAL REGISTER**

**Make what's important,
important.**

REFUSE2COMPROMISE, LLC (SOUTH CAROLINA LIMITED LIABILITY COMPANY)
120 LOUDWATER DRIVE
ANDERSON, SC 29621

FOR: GOLF SHIRTS; SHORT-SLEEVED OR LONG-SLEEVED T-SHIRTS; HEADGEAR, NAME-
LY, CAPS, IN CLASS 25 (U.S. CLS. 22 AND 39).

FIRST USE 12-5-2008; IN COMMERCE 12-5-2008.

THE MARK CONSISTS OF STANDARD CHARACTERS WITHOUT CLAIM TO ANY PARTICULAR FONT, STYLE, SIZE, OR COLOR.

SN 77-229,766, FILED 7-13-2007.

VIVIAN MICZNIK FIRST, EXAMINING ATTORNEY

Int. Cl.: 35

Prior U.S. Cls.: 100, 101, and 102

United States Patent and Trademark Office

Reg. No. 3,577,151

Registered Feb. 17, 2009

**SERVICE MARK
PRINCIPAL REGISTER**

CRG

CRG PARTNERS GROUP LLC (DELAWARE
LIMITED LIABILITY COMPANY)
2 ATLANTIC AVENUE
BOSTON, MA 02110

FOR: CONSULTING SERVICES IN THE FIELD
OF BUSINESS TURNAROUND MANAGEMENT
AND BUSINESS PERFORMANCE IMPROVEMENT,
IN CLASS 35 (U.S. CLS. 100, 101 AND 102).

FIRST USE 11-25-2008; IN COMMERCE 11-25-2008.

THE MARK CONSISTS OF STANDARD CHAR-
ACTERS WITHOUT CLAIM TO ANY PARTICULAR
FONT, STYLE, SIZE, OR COLOR.

"CRG" HAS NO SIGNIFICANCE IN THE RELE-
VANT TRADE OR INDUSTRY OR AS APPLIED TO
THE SERVICES.

SN 77-230,186, FILED 7-16-2007.

MATTHEW PAPPAS, EXAMINING ATTORNEY

Int. Cl.: 12

Prior U.S. Cls.: 19, 21, 23, 31, 35, and 44

United States Patent and Trademark Office

Reg. No. 3,577,152

Registered Feb. 17, 2009

**TRADEMARK
PRINCIPAL REGISTER**



REC ENTERPRISES, LTD. (INDIANA CORPORATION), DBA CARICO SYSTEMS,
4211 CLUBVIEW DRIVE
FORT WAYNE, IN 46804

FOR: METAL NON-MOTORIZED CARTS FOR THE TRANSPORTATION OF GOODS, IN CLASS 12 (U.S. CLS. 19, 21, 23, 31, 35 AND 44).

FIRST USE 11-16-2007; IN COMMERCE 11-16-2007.

OWNER OF U.S. REG. NOS. 1,772,779 AND 1,807,027.

THE COLOR(S) RED, GREY, BLACK AND WHITE IS/ARE CLAIMED AS A FEATURE OF THE MARK.

THE MARK CONSISTS OF THE WORDS "FOLD RACK NROLL" IN RED LETTERS OUTLINED IN BLACK, WITH A TWO-LINE DESIGN UNDER THE LETTERS. THE LETTERS "O" ARE STYLIZED WHEELS IN THE COLORS BLACK AND GREY. THE LETTER "N" IS WHITE AND INCLUDES A GRID DESIGN. THE WORDS "BY CARICO SYSTEMS" APPEAR UNDER THE WORDS "FOLD RACK NROLL" IN BLACK. THE LETTER "C" IN "CARICO SYSTEMS" IS STYLIZED AND INCLUDES A RED BALL.

SN 77-230,213, FILED 7-16-2007.

WILLIAM ROSSMAN, EXAMINING ATTORNEY

Int. Cl.: 22

Prior U.S. Cls.: 1, 2, 7, 19, 22, 42, and 50

United States Patent and Trademark Office

Reg. No. 3,577,153

Registered Feb. 17, 2009

**TRADEMARK
PRINCIPAL REGISTER**



EZ ORGANIZER, INC. (CALIFORNIA CORPORATION)
SUITE 240
2171 CAMPUS DRIVE
IRVINE, CA 92612

FOR: FLEXIBLE STORAGE DEVICES, NAMELY, MESH NETTING MATERIAL WITH MEANS FOR ATTACHMENT TO WALLS, DOORS AND OTHER SURFACES, IN CLASS 22 (U.S. CLS. 1, 2, 7, 19, 22, 42 AND 50).

FIRST USE 2-0-2008; IN COMMERCE 2-0-2008.

NO CLAIM IS MADE TO THE EXCLUSIVE RIGHT TO USE "NET ORGANIZER", APART FROM THE MARK AS SHOWN.

THE MARK CONSISTS OF THE WORDS "EZ NET ORGANIZER" WITHIN A STYLIZED DESIGN..

SN 77-230,280, FILED 7-16-2007.

JAY FLOWERS, EXAMINING ATTORNEY

Int. Cl.: 35

Prior U.S. Cls.: 100, 101, and 102

United States Patent and Trademark Office

Reg. No. 3,577,154

Registered Feb. 17, 2009

**SERVICE MARK
PRINCIPAL REGISTER**

MY SHEETZ CARD

SHEETZ OF DELAWARE, INC. (DELAWARE CORPORATION)
501 SILVERSIDE DRIVE, SUITE 67
WILMINGTON, DE 19809

OWNER OF U.S. REG. NOS. 1,274,635, 2,650,622,
AND OTHERS.

FOR: CUSTOMER LOYALTY SERVICES AND CUSTOMER CLUB SERVICES, FOR COMMERCIAL, PROMOTIONAL AND/OR ADVERTISING PURPOSES, IN CLASS 35 (U.S. CLS. 100, 101 AND 102).

NO CLAIM IS MADE TO THE EXCLUSIVE RIGHT TO USE "CARD", APART FROM THE MARK AS SHOWN.

FIRST USE 12-1-2007; IN COMMERCE 12-1-2007.

SN 77-230,371, FILED 7-16-2007.

THE MARK CONSISTS OF STANDARD CHARACTERS WITHOUT CLAIM TO ANY PARTICULAR FONT, STYLE, SIZE, OR COLOR.

SCOTT BIBB, EXAMINING ATTORNEY

Int. Cl.: 5

Prior U.S. Cls.: 6, 18, 44, 46, 51, and 52

United States Patent and Trademark Office

Reg. No. 3,577,155

Registered Feb. 17, 2009

**TRADEMARK
PRINCIPAL REGISTER**

OXYTET

ALPHARMA INC. (DELAWARE CORPORATION)
440 ROUTE 22 EAST
BRIDGEWATER, NJ 08807

THE MARK CONSISTS OF STANDARD CHAR-
ACTERS WITHOUT CLAIM TO ANY PARTICULAR
FONT, STYLE, SIZE, OR COLOR.

FOR: VETERINARY PREPARATIONS AND
PHARMACEUTICALS, NAMELY, AN ANTIBIOTIC
FOR USE IN TREATING POULTRY AND SWINE, IN
CLASS 5 (U.S. CLS. 6, 18, 44, 46, 51 AND 52).

SN 77-231,184, FILED 7-17-2007.

FIRST USE 12-31-1985; IN COMMERCE 12-31-1985.

YAT SYE, LEE, EXAMINING ATTORNEY

Int. Cl.: 30

Prior U.S. Cl.: 46

United States Patent and Trademark Office

Reg. No. 3,577,156

Registered Feb. 17, 2009

**TRADEMARK
PRINCIPAL REGISTER**

AMANA

AMANA SOCIETY, INC. (IOWA CORPORATION)
506 39TH AVENUE
P.O. BOX 189
AMANA, IA 52203

OWNER OF U.S. REG. NOS. 754,769, 2,269,252,
AND OTHERS.

FOR: NOODLES, IN CLASS 30 (U.S. CL. 46).

SEC. 2(F).

FIRST USE 0-0-1997; IN COMMERCE 10-0-2007.

SN 77-231,214, FILED 7-17-2007.

THE MARK CONSISTS OF STANDARD CHAR-
ACTERS WITHOUT CLAIM TO ANY PARTICULAR
FONT, STYLE, SIZE, OR COLOR.

MARY MUNSON, EXAMINING ATTORNEY

Int. Cl.: 11

Prior U.S. Cls.: 13, 21, 23, 31, and 34

United States Patent and Trademark Office

Reg. No. 3,577,157

Registered Feb. 17, 2009

**TRADEMARK
PRINCIPAL REGISTER**

81

TRUCK-LITE CO., INC. (NEW YORK CORPORATION)
310 EAST ELMWOOD AVENUE
FALCONER, NY 14733

FOR: ELECTRIC LAMPS FOR COMMERCIAL VEHICLES, TRUCKS, BUSES, TRAILER BODIES, OFF-HIGHWAY VEHICLES, AND AGRICULTURAL VEHICLES, IN CLASS 11 (U.S. CLS. 13, 21, 23, 31 AND 34).

FIRST USE 6-30-2007; IN COMMERCE 6-30-2007.

THE MARK CONSISTS OF STANDARD CHARACTERS WITHOUT CLAIM TO ANY PARTICULAR FONT, STYLE, SIZE, OR COLOR.

SN 77-231,414, FILED 7-17-2007.

RICHARD A. STRASER, EXAMINING ATTORNEY

Int. Cl.: 41

Prior U.S. Cls.: 100, 101, and 107

United States Patent and Trademark Office

Reg. No. 3,577,158

Registered Feb. 17, 2009

SERVICE MARK
PRINCIPAL REGISTER



HANNA-BARBERA PRODUCTIONS, INC. (DE-
LAWARE CORPORATION)
4000 WARNER BLVD.
BURBANK, CA 91522

FOR: INTERNET SERVICES PROVIDING INFOR-
MATION VIA AN ELECTRONIC GLOBAL COMPU-
TER NETWORK IN THE FIELD OF
ENTERTAINMENT RELATING SPECIFICALLY TO
MOVIES, AND TELEVISION; AND PROVIDING
INFORMATION FOR AND ACTUAL ENTERTAIN-
MENT VIA AN ELECTRONIC GLOBAL COMMU-
NICATIONS NETWORK IN THE NATURE OF LIVE-
ACTION, COMEDY AND ANIMATED PROGRAMS

AND PRODUCTION OF LIVE-ACTION, COMEDY
AND ANIMATED MOTION PICTURE FILMS FOR
DISTRIBUTION VIA A GLOBAL COMPUTER NET-
WORK, IN CLASS 41 (U.S. CLS. 100, 101 AND 107).

FIRST USE 9-2-2008; IN COMMERCE 9-2-2008.

THE MARK CONSISTS OF "THE BANANA
SPLITS" IN STYLIZED LETTERING.

SN 77-231,959, FILED 7-17-2007.

KIMBERLY PERRY, EXAMINING ATTORNEY

Int. Cl.: 35

Prior U.S. Cls.: 100, 101, and 102

United States Patent and Trademark Office

Reg. No. 3,577,159

Registered Feb. 17, 2009

**SERVICE MARK
PRINCIPAL REGISTER**

**Memories Never Lost -
Archival Storage and
Transport System**

MEMORIES NEVER LOST (NEVADA LIMITED
LIABILITY COMPANY)
P.O. BOX 36272
LAS VEGAS, NV 89133

FOR: ON-LINE RETAIL STORE SERVICES FEATURING ARCHIVAL MATERIALS FOR THE SCRAPBOOKING, PHOTO ALBUM, PHOTO AND ARCHIVAL INDUSTRY, IN CLASS 35 (U.S. CLS. 100, 101 AND 102).

FIRST USE 7-1-2007; IN COMMERCE 7-1-2007.

THE MARK CONSISTS OF STANDARD CHARACTERS WITHOUT CLAIM TO ANY PARTICULAR FONT, STYLE, SIZE, OR COLOR.

NO CLAIM IS MADE TO THE EXCLUSIVE RIGHT TO USE "ARCHIVAL STORAGE AND TRANSPORT SYSTEM", APART FROM THE MARK AS SHOWN.

SN 77-233,495, FILED 7-19-2007.

ALICE BENMAMAN, EXAMINING ATTORNEY

Int. Cl.: 9

Prior U.S. Cls.: 21, 23, 26, 36, and 38

Reg. No. 3,577,160

United States Patent and Trademark Office

Registered Feb. 17, 2009

**TRADEMARK
PRINCIPAL REGISTER**

JUST PRINT IT

PROEXECUTE, LLC (LOUISIANA LIMITED LIABILITY COMPANY)
15961 AIRLINE HIGHWAY
BATON ROUGE, LA 70817

THE MARK CONSISTS OF STANDARD CHARACTERS WITHOUT CLAIM TO ANY PARTICULAR FONT, STYLE, SIZE, OR COLOR.

FOR: COMPUTER SOFTWARE FOR USE IN ALLOCATING PRINT JOBS TO PRINTERS AND PRINTER SYSTEMS, IN CLASS 9 (U.S. CLS. 21, 23, 26, 36 AND 38).

SN 77-235,780, FILED 7-23-2007.

FIRST USE 8-31-2007; IN COMMERCE 8-31-2007.

BENJAMIN OKEKE, EXAMINING ATTORNEY

Int. Cl.: 1

Prior U.S. Cls.: 1, 5, 6, 10, 26, and 46

Reg. No. 3,577,161

United States Patent and Trademark Office

Registered Feb. 17, 2009

**TRADEMARK
PRINCIPAL REGISTER**

WELLMUNE

BIOPOLYMER ENGINEERING, INC. (MINNESOTA CORPORATION), DBA BIOTHERA,
3388 MIKE COLLINS DRIVE
EAGAN, MN 55118

FOR: GLUCO POLYSACCHARIDE DERIVED FROM YEAST AND USED AS AN INGREDIENT IN THE MANUFACTURE OF FUNCTIONAL FOODS, BEVERAGES AND DIETARY SUPPLEMENTS, IN CLASS 1 (U.S. CLS. 1, 5, 6, 10, 26 AND 46).

FIRST USE 7-23-2007; IN COMMERCE 4-3-2008.

THE MARK CONSISTS OF STANDARD CHARACTERS WITHOUT CLAIM TO ANY PARTICULAR FONT, STYLE, SIZE, OR COLOR.

SN 77-235,945, FILED 7-23-2007.

FRED MANDIR, EXAMINING ATTORNEY

Int. Cl.: 3

Prior U.S. Cls.: 1, 4, 6, 50, 51, and 52

Reg. No. 3,577,162

United States Patent and Trademark Office

Registered Feb. 17, 2009

**TRADEMARK
PRINCIPAL REGISTER**

EVINO

PERFORMANCE BRANDS, INC. (FLORIDA
CORPORATION)
963 SHOTGUN ROAD
SUNRISE, FL 33326

FOR: BODY CREAMS; BODY LOTIONS; FACE
CREAMS; SKIN CREAMS; SKIN LOTIONS; SKIN
MOISTURIZER, IN CLASS 3 (U.S. CLS. 1, 4, 6, 50, 51
AND 52).

FIRST USE 7-31-2008; IN COMMERCE 7-31-2008.

THE MARK CONSISTS OF STANDARD CHAR-
ACTERS WITHOUT CLAIM TO ANY PARTICULAR
FONT, STYLE, SIZE, OR COLOR.

SN 77-235,950, FILED 7-23-2007.

JANICE L. MCMORROW, EXAMINING ATTOR-
NEY

Int. Cls.: 4 and 35

Prior U.S. Cls.: 1, 6, 15, 100, 101, and 102

United States Patent and Trademark Office

Reg. No. 3,577,163

Registered Feb. 17, 2009

**TRADEMARK
SERVICE MARK
PRINCIPAL REGISTER**

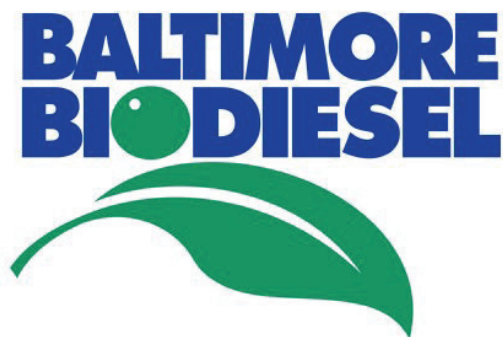

CHARM21, INC. (MARYLAND CORPORATION)
3401 UNIVERSITY PLACE
BALTIMORE, MD 21218

FOR: BIODIESEL FUEL; ALCOHOL AND MIXED
ALCOHOL FUEL; DIESEL FUEL; FUEL OIL; FUELS;
LIQUID FUELS, IN CLASS 4 (U.S. CLS. 1, 6 AND 15).

FIRST USE 5-11-2007; IN COMMERCE 5-11-2007.

FOR: RETAIL SHOPS FEATURING BIOFUELS,
BIODIESEL FUEL; DISTRIBUTORSHIPS IN THE
FIELD OF BIODIESEL FUELS, IN CLASS 35 (U.S.
CLS. 100, 101 AND 102).

FIRST USE 10-0-2006; IN COMMERCE 10-0-2006.

NO CLAIM IS MADE TO THE EXCLUSIVE
RIGHT TO USE "BALTIMORE BIODIESEL", APART
FROM THE MARK AS SHOWN.

THE COLOR(S) BLUE, GREEN AND WHITE IS/
ARE CLAIMED AS A FEATURE OF THE MARK.

THE MARK CONSISTS OF THE WORD "BALTI-
MORE" APPEARING IN BLUE, BELOW WHICH
THE WORD "BIODIESEL" APPEARS IN BLUE. THE
LETTER "O" IN BIODIESEL APPEARS AS A SOLID
GREEN BALL WITH A WHITE SPEC IN THE UPPER
LEFT HAND CORNER. A GREEN LEAF APPEARS
BELOW THE WORD "BIODIESEL" WITH A WHITE
STIPE IN THE MIDDLE OF THE LEAF.

SN 77-236,954, FILED 7-24-2007.

ESTHER A. BORSUK, EXAMINING ATTORNEY

Int. Cls.: 7 and 8

Prior U.S. Cls.: 13, 19, 21, 23, 28, 31, 34, 35, and 44

United States Patent and Trademark Office

Reg. No. 3,577,164

Registered Feb. 17, 2009

**TRADEMARK
PRINCIPAL REGISTER**

APPLE ARCHERY

APPLE ARCHERY PRODUCTS, LLC (PENNSYLVANIA LIMITED LIABILITY COMPANY)
245 BESHORE SCHOOL ROAD
MANCHESTER, PA 17345

FOR: POWER TOOLS USED FOR MAKING AND MAINTAINING ARCHERY EQUIPMENT, NAMELY, ARCHERY ARROW SAW; ARROW STOP FOR USE WITH ARCHERY ARROW SAW; AND ARCHERY ARROW BUILDING KIT PRIMARILY COMPRISED OF A POWER TOOL IN THE NATURE OF AN ARCHERY ARROW SAW, IN CLASS 7 (U.S. CLS. 13, 19, 21, 23, 31, 34 AND 35).

FIRST USE 11-19-2008; IN COMMERCE 11-19-2008.

FOR: HAND TOOLS USED FOR MAKING AND MAINTAINING ARCHERY EQUIPMENT, NAMELY, ARCHERY BOW PRESS; ADJUSTABLE STAND FOR ARCHERY BOW PRESS; PIVOTABLE BOW LIMB SUPPORT BAR FOR ARCHERY BOW PRESS; ARCHERY BOW COMPRESSION BAR FOR ARCHERY BOW PRESS; TOOL AND ACCESSORY TRAYS SPECIFICALLY FITTED FOR USE WITH ARCHERY

BOW PRESS; ARCHERY BOW PRESS ADAPTER FOR PARALLEL LIMB BOWS; ARCHERY ARROW STRAIGHTENER; ARCHERY BOW VISE; ARCHERY BOW VISE STAND; ARCHERY BOW STRING JIG; AND ARCHERY BOW STRING MAKING KIT PRIMARILY COMPRISED OF A HAND TOOL IN THE NATURE OF AN ARCHERY BOW STRING JIG, IN CLASS 8 (U.S. CLS. 23, 28 AND 44).

FIRST USE 11-19-2008; IN COMMERCE 11-19-2008.

THE MARK CONSISTS OF STANDARD CHARACTERS WITHOUT CLAIM TO ANY PARTICULAR FONT, STYLE, SIZE, OR COLOR.

NO CLAIM IS MADE TO THE EXCLUSIVE RIGHT TO USE "ARCHERY", APART FROM THE MARK AS SHOWN.

SN 77-237,123, FILED 7-24-2007.

ELLEN B. AWRICH, EXAMINING ATTORNEY

Int. Cl.: 39

Prior U.S. Cls.: 100 and 105

United States Patent and Trademark Office

Reg. No. 3,577,165

Registered Feb. 17, 2009

SERVICE MARK
PRINCIPAL REGISTER



The world in 24 hours

MCFADYEN, GRAHAM (UNITED KINGDOM
INDIVIDUAL)
95, MILNGAVIE ROAD
GLASGOW, UNITED KINGDOM G612EL

FOR: GLOBAL TRANSPORTATION OF FREIGHT
FOR OTHERS BY ALL AVAILABLE MEANS, IN
CLASS 39 (U.S. CLS. 100 AND 105).

FIRST USE 8-26-2004; IN COMMERCE 9-10-2008.

NO CLAIM IS MADE TO THE EXCLUSIVE
RIGHT TO USE "24 EXPRESS WORLD DELIVERY",
APART FROM THE MARK AS SHOWN.

THE COLOR(S) PURPLE, ORANGE AND GRAY
IS/ARE CLAIMED AS A FEATURE OF THE MARK.

THE MARK CONSISTS OF THE NUMBER "24" IN
PURPLE, ABOVE THE WORD "XPRESS" IN OR-
ANGE ABOVE THE WORDING "WORLD DELIV-
ERY" AND "THE WORLD IN 24 HOURS" ALL IN
GRAY.

SN 77-237,138, FILED 7-24-2007.

JAMES LOVELACE, EXAMINING ATTORNEY

Int. Cl.: 25

Prior U.S. Cls.: 22 and 39

United States Patent and Trademark Office

Reg. No. 3,577,166

Registered Feb. 17, 2009

**TRADEMARK
PRINCIPAL REGISTER**

The logo consists of the words "PIERANTONIO GASPARI" in a stylized, hand-drawn font. The letters are black and have a slightly irregular, artistic appearance. The "P" is particularly large and prominent. The words are written in all caps and are centered within a light gray rectangular background.

PIERANTONIO GASPARI SAS DI GASPARI
PIERANTONIO & C. (ITALY PARTNERSHIP)
VIA EINSTEIN, 18
47100 FORLI (FC), ITALY

FOR: CLOTHING, NAMELY, SWEATERS AND
PULLOVERS, SHIRTS, JACKETS, COATS, OVER-
COATS, TROUSERS, SKIRTS, SCARVES, HATS, IN
CLASS 25 (U.S. CLS. 22 AND 39).

FIRST USE 0-0-1990; IN COMMERCE 7-10-2008.

THE NAME PIERANTONIO GASPARI IDENTI-
FIES A LIVING INDIVIDUAL WHOSE CONSENT IS
OF RECORD.

THE MARK CONSISTS OF THE WORDS "PIER-
ANTONIO GASPARI" IN STYLIZED LETTERING.

SN 77-237,301, FILED 7-24-2007.

TARAH HARDY, EXAMINING ATTORNEY

Int. Cl.: 5

Prior U.S. Cls.: 6, 18, 44, 46, 51, and 52

United States Patent and Trademark Office

Reg. No. 3,577,167

Registered Feb. 17, 2009

**TRADEMARK
PRINCIPAL REGISTER**

initial

GC CORPORATION (JAPAN CORPORATION)
76-1, HASUNUMA-CHO, ITABASHI-KU,
TOKYO, JAPAN

FOR: DENTAL MATERIALS, NAMELY, DENTAL
PORCELAIN AND PORCELAIN LIQUIDS, AND
DENTAL BONDING AGENTS, IN CLASS 5 (U.S.
CLS. 6, 18, 44, 46, 51 AND 52).

FIRST USE 4-1-2003; IN COMMERCE 6-1-2004.

THE MARK CONSISTS OF STANDARD CHAR-
ACTERS WITHOUT CLAIM TO ANY PARTICULAR
FONT, STYLE, SIZE, OR COLOR.

SN 77-237,623, FILED 7-24-2007.

BARBARA RUTLAND, EXAMINING ATTORNEY

Int. Cl.: 30

Prior U.S. Cl.: 46

United States Patent and Trademark Office

Reg. No. 3,577,168

Registered Feb. 17, 2009

TRADEMARK
PRINCIPAL REGISTER



CFS HOLDINGS, INC. (DELAWARE CORPORATION)
2000 WEST BROAD STREET
RICHMOND, VA 23220

FOR: FLAVORINGS FOR BEVERAGES; FLAVORING ADDITIVES FOR NON-NUTRITIONAL PURPOSES; SPICES; MULLING SPICES, IN CLASS 30 (U.S. CL. 46).

FIRST USE 8-31-2007; IN COMMERCE 8-31-2007.

THE MARK CONSISTS OF A SILHOUETTE OF A WITCH ON A BROOMSTICK WITH THE WORDS "WITCH'S BREW" SUPERIMPOSED ON TOP OF THE IMAGE.

SN 77-238,059, FILED 7-25-2007.

JESSICA A. POWERS, EXAMINING ATTORNEY

Int. Cl.: 8

Prior U.S. Cls.: 23, 28, and 44

United States Patent and Trademark Office

Reg. No. 3,577,169

Registered Feb. 17, 2009

**TRADEMARK
PRINCIPAL REGISTER**

TRIM SILK

THE W.E. BASSETT COMPANY, INC. (CONNECTICUT CORPORATION)
100 TRAP FALLS ROAD EXTENSION
SHELTON, CT 06484

FOR: PERSONAL GROOMING IMPLEMENTS, NAMELY, CUTICLE TRIMMERS AND CUTICLE PUSHERS; NAIL AND CUTICLE SCISSORS; PERSONAL CARE SCISSORS; CUTICLE AND NAIL NIPPERS; TWEEZERS; FINGERNAIL AND TOE NAIL CLIPPERS; FOOT PADDLES/RASPS; CALLUS CUTTERS AND RASPS; NAIL FILES; NAIL BUFFERS;

NAIL CARE STICKS; AND FOOT FILES, IN CLASS 8 (U.S. CLS. 23, 28 AND 44).

FIRST USE 1-31-2008; IN COMMERCE 1-31-2008.

THE MARK CONSISTS OF STANDARD CHARACTERS WITHOUT CLAIM TO ANY PARTICULAR FONT, STYLE, SIZE, OR COLOR.

SN 77-238,425, FILED 7-25-2007.

ANGELA M. MICHELI, EXAMINING ATTORNEY

Int. Cls.: 9 and 41

Prior U.S. Cls.: 21, 23, 26, 36, 38, 100, 101, and 107

United States Patent and Trademark Office

Reg. No. 3,577,170

Registered Feb. 17, 2009

**TRADEMARK
SERVICE MARK
PRINCIPAL REGISTER**

PLAY-EM

PLAY-EM (CALIFORNIA CORPORATION)
STE. J #117
928 N. SAN FERNANDO BLVD.
BURBANK, CA 91504

FOR: GAME SOFTWARE, IN CLASS 9 (U.S. CLS.
21, 23, 26, 36 AND 38).

FIRST USE 2-28-2007; IN COMMERCE 9-7-2008.

FOR: ENTERTAINMENT SERVICES, NAMELY,
PROVIDING ON-LINE COMPUTER GAMES, IN
CLASS 41 (U.S. CLS. 100, 101 AND 107).

FIRST USE 2-28-2007; IN COMMERCE 9-7-2008.

THE MARK CONSISTS OF STANDARD CHAR-
ACTERS WITHOUT CLAIM TO ANY PARTICULAR
FONT, STYLE, SIZE, OR COLOR.

SN 77-238,973, FILED 7-26-2007.

G. MAYERSCHOFF, EXAMINING ATTORNEY

Int. Cls.: 38, 41, and 42

Prior U.S. Cls.: 100, 101, 104, and 107

United States Patent and Trademark Office

Reg. No. 3,577,171

Registered Feb. 17, 2009

**SERVICE MARK
PRINCIPAL REGISTER**

SPARKTEENS

SPARKPEOPLE, INC. (OHIO CORPORATION)
4392 MARBURG AVENUE
CINCINNATI, OH 45209

FOR: PROVIDING ON-LINE ELECTRONIC BULLETIN BOARDS FOR TRANSMISSION OF MESSAGES AMONG USERS ON MATTERS OF GENERAL INTEREST TO TEENS; INSTANT MESSAGING SERVICES; WEB MESSAGING SERVICES, IN CLASS 38 (U.S. CLS. 100, 101 AND 104).

FIRST USE 8-30-2007; IN COMMERCE 8-30-2007.

FOR: PROVIDING INFORMATION VIA A GLOBAL COMPUTER NETWORK IN THE FIELD OF PERSONAL AND PROFESSIONAL COACHING SERVICES ON THE SUBJECTS OF GOAL-SETTING AND ACHIEVEMENT RELATIVE TO FITNESS, EXERCISE, WEIGHT MANAGEMENT, NUTRITION, COOKING, GENERAL HEALTH, SLEEP, BREATHING, STRESS MANAGEMENT, PERSONAL LEADERSHIP, CREATIVITY, HOBBIES, GOAL SETTING AND TRACKING, CONSISTENCY, PURPOSE, VALUES AND BELIEFS, PUBLIC LEADERSHIP, MENTORING, AND COMMUNITY SERVICE FOR INDIVIDUALS AND GROUPS; PERSONAL AND PROFESSIONAL COACHING SERVICES VIA A GLOBAL COMPUTER NETWORK ON MATTERS OF GENERAL INTEREST TO TEENS IN THE FIELDS OF GOAL-SETTING AND ACHIEVEMENT RELATIVE TO FITNESS, EXERCISE, WEIGHT MANAGEMENT, NUTRITION, COOKING, GENERAL HEALTH, SLEEP, BREATHING, STRESS MANAGEMENT, PERSONAL LEADERSHIP, CREATIVITY, HOBBIES, GOAL SETTING AND TRACKING, CONSISTENCY, PURPOSE, VALUES AND BELIEFS, PUBLIC LEADERSHIP, MENTORING, AND COMMUNITY SERVICE FOR INDIVI-

DUALS AND GROUPS; AND PROVIDING EDUCATIONAL MENTORING SERVICES AND PROGRAMS VIA A GLOBAL COMPUTER NETWORK IN THE FIELDS OF GOAL-SETTING AND ACHIEVEMENT RELATIVE TO FITNESS, EXERCISE, WEIGHT MANAGEMENT, NUTRITION, COOKING, GENERAL HEALTH, SLEEP, BREATHING, STRESS MANAGEMENT, PERSONAL LEADERSHIP, CREATIVITY, HOBBIES, GOAL SETTING AND TRACKING, CONSISTENCY, PURPOSE, VALUES AND BELIEFS, PUBLIC LEADERSHIP, MENTORING, AND COMMUNITY SERVICE, IN CLASS 41 (U.S. CLS. 100, 101 AND 107).

FIRST USE 8-30-2007; IN COMMERCE 8-30-2007.

FOR: COMPUTER SERVICES, NAMELY, HOSTING ONLINE WEB FACILITIES FOR OTHERS FOR ORGANIZING AND CONDUCTING ONLINE MEETINGS, GATHERINGS, AND INTERACTIVE DISCUSSIONS; AND COMPUTER SERVICES IN THE NATURE OF CUSTOMIZED WEB PAGES FEATURING USER-DEFINED INFORMATION, PERSONAL PROFILES AND INFORMATION, IN CLASS 42 (U.S. CLS. 100 AND 101).

FIRST USE 8-30-2007; IN COMMERCE 8-30-2007.

THE MARK CONSISTS OF STANDARD CHARACTERS WITHOUT CLAIM TO ANY PARTICULAR FONT, STYLE, SIZE, OR COLOR.

OWNER OF U.S. REG. NOS. 2,723,758, 3,227,568, AND 3,273,112.

SN 77-240,219, FILED 7-27-2007.

ZHALEH DELANEY, EXAMINING ATTORNEY

Int. Cls.: 35 and 36

Prior U.S. Cls.: 100, 101, and 102

United States Patent and Trademark Office

Reg. No. 3,577,172

Registered Feb. 17, 2009

**SERVICE MARK
PRINCIPAL REGISTER**



INVESTORPLACE MEDIA, LLC (DELAWARE
LIMITED LIABILITY COMPANY)
9201 CORPORATE BOUELVARD
ROCKVILLE, MD 20850

FOR: PROVIDING INFORMATION RELATING
TO INVESTORS WHO QUALIFY TO PURCHASE
CERTAIN TYPES OF SECURITIES, IN CLASS 35
(U.S. CLS. 100, 101 AND 102).

FIRST USE 8-0-2007; IN COMMERCE 8-0-2007.

FOR: PROVIDING NEWS AND INFORMATION
RELATING TO THE FIELD OF FINANCE AND

FINANCIAL INVESTMENTS, IN CLASS 36 (U.S. CLS.
100, 101 AND 102).

FIRST USE 8-0-2007; IN COMMERCE 8-0-2007.

THE MARK CONSISTS OF THE DESIGN OF AN
INCOMPLETE CIRCLE COMPRISED OF THE RE-
PRESENTATION OF SMALL SQUARES.

SN 77-240,469, FILED 7-27-2007.

JAY BESCH, EXAMINING ATTORNEY

Int. Cls.: 35 and 43

Prior U.S. Cls.: 100, 101, and 102

United States Patent and Trademark Office

Reg. No. 3,577,173

Registered Feb. 17, 2009

**SERVICE MARK
PRINCIPAL REGISTER**

HAPPY CAMPER

TRAVEL RESORTS OF AMERICA, INC. (DELA-
WARE CORPORATION)
SUITE 20
340 COMMERCE AVENUE
SOUTHERN PINES, NC 28387

FOR: MANAGEMENT OF CAMPGROUND FA-
CILITIES; ADMINISTRATION OF A DISCOUNT
MEMBERSHIP PROGRAM TO ENABLE PARTICI-
PANTS TO OBTAIN DISCOUNTS ON SERVICES
THROUGH THE USE OF A DISCOUNT MEMBER-
SHIP, IN CLASS 35 (U.S. CLS. 100, 101 AND 102).

FIRST USE 12-0-1998; IN COMMERCE 12-0-1998.

FOR: PROVIDING CAMPGROUND FACILITIES;
BOOKING OF CAMPGROUND ACCOMMODA-
TIONS, IN CLASS 43 (U.S. CLS. 100 AND 101).

FIRST USE 12-0-1998; IN COMMERCE 12-0-1998.

THE MARK CONSISTS OF STANDARD CHAR-
ACTERS WITHOUT CLAIM TO ANY PARTICULAR
FONT, STYLE, SIZE, OR COLOR.

SN 77-240,923, FILED 7-27-2007.

DOMINIC FATHY, EXAMINING ATTORNEY

Int. Cl.: 30

Prior U.S. Cl.: 46

United States Patent and Trademark Office

Reg. No. 3,577,174

Registered Feb. 17, 2009

**TRADEMARK
PRINCIPAL REGISTER**

KARAMELADAS POP

GRUPO BIMBO, S.A. B. DE C.V. (MEXICO CORPORATION)
PROLONGACION PASEO DE LA REFORMA
NO. 1000, COL. PENA BLANCA SANTA FE
MEXICO CITY, MEXICO 01210

FOR: CARAMEL POPCORN, IN CLASS 30 (U.S. CL. 46).

FIRST USE 6-17-2008; IN COMMERCE 6-17-2008.

THE MARK CONSISTS OF STANDARD CHARACTERS WITHOUT CLAIM TO ANY PARTICULAR FONT, STYLE, SIZE, OR COLOR.

NO CLAIM IS MADE TO THE EXCLUSIVE RIGHT TO USE "KARAMELADAS", APART FROM THE MARK AS SHOWN.

THE WORD "KARAMELADAS" HAS NO ENGLISH TRANSLATION.

SN 77-241,021, FILED 7-27-2007.

WILLIAM VERHOSEK, EXAMINING ATTORNEY

Int. Cl.: 10

Prior U.S. Cls.: 26, 39, and 44

United States Patent and Trademark Office

Reg. No. 3,577,175

Registered Feb. 17, 2009

**TRADEMARK
PRINCIPAL REGISTER**

APLION

APLION MEDICAL, LLC (UTAH LIMITED LIABILITY COMPANY)
2425 SOUTH 900 WEST
SALT LAKE CITY, UT 84119

THE MARK CONSISTS OF STANDARD CHARACTERS WITHOUT CLAIM TO ANY PARTICULAR FONT, STYLE, SIZE, OR COLOR.

FOR: MEDICAL APPARATUS, NAMELY, INFUSION AND INJECTION PUMPS FOR ADMINISTERING BENEFICIAL AGENTS TO THE BODY, IN CLASS 10 (U.S. CLS. 26, 39 AND 44).

SN 77-241,142, FILED 7-27-2007.

FIRST USE 10-23-2008; IN COMMERCE 10-23-2008.

AMY C. KEAN, EXAMINING ATTORNEY

Int. Cl.: 16

Prior U.S. Cls.: 2, 5, 22, 23, 29, 37, 38, and 50

Reg. No. 3,577,176

United States Patent and Trademark Office

Registered Feb. 17, 2009

**TRADEMARK
PRINCIPAL REGISTER**

H5

IBASIS, INC. (DELAWARE CORPORATION)
20 SECOND AVENUE
BURLINGTON, MA 01803

FIRST USE 11-25-2008; IN COMMERCE 11-25-2008.

FOR: PRE-PAID TELEPHONE CALLING CARDS,
NOT MAGNETICALLY ENCODED; TELEPHONE
CALLING CARDS, NOT MAGNETICALLY ENCO-
DED, IN CLASS 16 (U.S. CLS. 2, 5, 22, 23, 29, 37, 38
AND 50).

THE MARK CONSISTS OF STANDARD CHAR-
ACTERS WITHOUT CLAIM TO ANY PARTICULAR
FONT, STYLE, SIZE, OR COLOR.

SN 77-241,500, FILED 7-29-2007.

SANI KHOURI, EXAMINING ATTORNEY

Int. Cl.: 16

Prior U.S. Cls.: 2, 5, 22, 23, 29, 37, 38, and 50

United States Patent and Trademark Office

Reg. No. 3,577,177

Registered Feb. 17, 2009

**TRADEMARK
PRINCIPAL REGISTER**

H3

IBASIS, INC. (DELAWARE CORPORATION)
20 SECOND AVENUE
BURLINGTON, MA 01803

FOR: PRE-PAID TELEPHONE CALLING CARDS,
NOT MAGNETICALLY ENCODED; TELEPHONE
CALLING CARDS, NOT MAGNETICALLY ENCO-
DED, IN CLASS 16 (U.S. CLS. 2, 5, 22, 23, 29, 37, 38
AND 50).

FIRST USE 11-25-2008; IN COMMERCE 11-25-2008.

THE MARK CONSISTS OF STANDARD CHAR-
ACTERS WITHOUT CLAIM TO ANY PARTICULAR
FONT, STYLE, SIZE, OR COLOR.

SN 77-241,538, FILED 7-29-2007.

SANI KHOURI, EXAMINING ATTORNEY

Int. Cl.: 16

Prior U.S. Cls.: 2, 5, 22, 23, 29, 37, 38, and 50

United States Patent and Trademark Office

Reg. No. 3,577,178

Registered Feb. 17, 2009

**TRADEMARK
PRINCIPAL REGISTER**

G5

IBASIS, INC. (DELAWARE CORPORATION)
20 SECOND AVENUE
BURLINGTON, MA 01803

FOR: PRE-PAID TELEPHONE CALLING CARDS,
NOT MAGNETICALLY ENCODED; TELEPHONE
CALLING CARDS, NOT MAGNETICALLY ENCO-
DED, IN CLASS 16 (U.S. CLS. 2, 5, 22, 23, 29, 37, 38
AND 50).

FIRST USE 11-25-2008; IN COMMERCE 11-25-2008.

THE MARK CONSISTS OF STANDARD CHAR-
ACTERS WITHOUT CLAIM TO ANY PARTICULAR
FONT, STYLE, SIZE, OR COLOR.

SN 77-241,557, FILED 7-29-2007.

SANI KHOURI, EXAMINING ATTORNEY

Int. Cl.: 35

Prior U.S. Cls.: 100, 101, and 102

United States Patent and Trademark Office

Reg. No. 3,577,179

Registered Feb. 17, 2009

**SERVICE MARK
PRINCIPAL REGISTER**

BLUELINK

BLUELINK, LLC (GEORGIA LIMITED LIABILITY COMPANY)
603 EAST PACES FERRY ROAD
ATLANTA, GA 30305

THE MARK CONSISTS OF STANDARD CHARACTERS WITHOUT CLAIM TO ANY PARTICULAR FONT, STYLE, SIZE, OR COLOR.

FOR: CONDUCTING BUSINESS RESEARCH AND SURVEYS; CONDUCTING SURVEYS OF HOMEOWNER SATISFACTION; ADVERTISING SERVICES, IN CLASS 35 (U.S. CLS. 100, 101 AND 102).

SN 77-241,648, FILED 7-30-2007.

FIRST USE 1-27-2008; IN COMMERCE 1-27-2008.

MICHAEL SOUDERS, EXAMINING ATTORNEY

Int. Cl.: 35

Prior U.S. Cls.: 100, 101, and 102

United States Patent and Trademark Office

Reg. No. 3,577,180

Registered Feb. 17, 2009

**SERVICE MARK
PRINCIPAL REGISTER**



BLUELINK, LLC (GEORGIA LIMITED LIABILITY COMPANY)
603 EAST PACES FERRY ROAD
ATLANTA, GA 30305

FIRST USE 1-27-2008; IN COMMERCE 1-27-2008.

SN 77-241,654, FILED 7-30-2007.

FOR: CONDUCTING BUSINESS RESEARCH AND SURVEYS; CONDUCTING SURVEYS OF HOMEOWNER SATISFACTION; ADVERTISING SERVICES, IN CLASS 35 (U.S. CLS. 100, 101 AND 102).

MICHAEL SOUDERS, EXAMINING ATTORNEY

Int. Cl.: 35

Prior U.S. Cls.: 100, 101, and 102

United States Patent and Trademark Office

Reg. No. 3,577,181

Registered Feb. 17, 2009

**SERVICE MARK
PRINCIPAL REGISTER**

INSPECT WHAT YOU EXPECT

BLUELINK, LLC (GEORGIA LIMITED LIABILITY COMPANY)
603 EAST PACES FERRY ROAD
ATLANTA, GA 30305

FOR: CONDUCTING BUSINESS RESEARCH AND SURVEYS; CONDUCTING SURVEYS OF HOMEOWNER SATISFACTION; HUMAN RESOURCES SERVICES, NAMELY, PERSONNEL SELECTION FOR OTHERS; ADVERTISING SERVICES, IN CLASS 35 (U.S. CLS. 100, 101 AND 102).

FIRST USE 10-28-2008; IN COMMERCE 10-28-2008.

THE MARK CONSISTS OF STANDARD CHARACTERS WITHOUT CLAIM TO ANY PARTICULAR FONT, STYLE, SIZE, OR COLOR.

SN 77-241,655, FILED 7-30-2007.

MICHAEL SOUDERS, EXAMINING ATTORNEY

Int. Cl.: 9

Prior U.S. Cls.: 21, 23, 26, 36, and 38

Reg. No. 3,577,182

United States Patent and Trademark Office

Registered Feb. 17, 2009

**TRADEMARK
PRINCIPAL REGISTER**

CONCEALFAB

CONCEALFAB CORPORATION (COLORADO
CORPORATION)
4355 NORTH PARK DRIVE
COLORADO SPRINGS, CO 80907

FIRST USE 10-17-2006; IN COMMERCE 10-17-2006.

FOR: ANTENNA CONCEALMENT DEVICES,
NAMELY, RADIO FREQUENCY TRANSPARENT
ENCLOSURES, STRUCTURES AND SCREEN
WALLS SPECIALLY ADAPTED TO HOLD AND
CONCEAL ANTENNAS , IN CLASS 9 (U.S. CLS. 21,
23, 26, 36 AND 38).

THE MARK CONSISTS OF STANDARD CHAR-
ACTERS WITHOUT CLAIM TO ANY PARTICULAR
FONT, STYLE, SIZE, OR COLOR.

SN 77-241,662, FILED 7-30-2007.

BRENDAN MCCAULEY, EXAMINING ATTORNEY

Int. Cls.: 35 and 41

Prior U.S. Cls.: 100, 101, 102, and 107

United States Patent and Trademark Office

Reg. No. 3,577,183

Registered Feb. 17, 2009

**SERVICE MARK
PRINCIPAL REGISTER**



INTERNATIONAL ADVERTISING ASSOCIATION (NEW YORK CORPORATION)
521 FIFTH AVENUE
NEW YORK, NY 10175

FOR: ASSOCIATION SERVICES PROMOTING THE INTERESTS OF MEMBERS OF THE GLOBAL ADVERTISING AND MARKETING COMMUNITY; ARRANGING, ORGANIZING AND CONDUCTING TRADE SHOWS AND TRADE FAIRS IN THE FIELD OF ADVERTISING AND MARKETING, IN CLASS 35 (U.S. CLS. 100, 101 AND 102).

FIRST USE 6-30-2007; IN COMMERCE 6-30-2007.

FOR: ARRANGING, ORGANIZING AND CONDUCTING EDUCATIONAL CONFERENCES, WORKSHOPS AND SEMINARS IN THE FIELD OF ADVERTISING AND MARKETING, IN CLASS 41 (U.S. CLS. 100, 101 AND 107).

FIRST USE 6-30-2007; IN COMMERCE 6-30-2007.

THE MARK CONSISTS OF THE STYLIZED DEPICTION OF THE LETTERS "IAA".

SN 77-242,003, FILED 7-30-2007.

DEIRDRE ROBERTSON, EXAMINING ATTORNEY

Int. Cl.: 33

Prior U.S. Cls.: 47 and 49

United States Patent and Trademark Office

Reg. No. 3,577,184

Registered Feb. 17, 2009

**TRADEMARK
PRINCIPAL REGISTER**

WHITEWASH

PARADOCX VINEYARD, LLC (PENNSYLVANIA
LIMITED LIABILITY COMPANY)
464 CHESTERVILLE ROAD
LANDENBERG, PA 19350

THE MARK CONSISTS OF STANDARD CHAR-
ACTERS WITHOUT CLAIM TO ANY PARTICULAR
FONT, STYLE, SIZE, OR COLOR.

FOR: WINE, IN CLASS 33 (U.S. CLS. 47 AND 49).

SN 77-242,038, FILED 7-30-2007.

FIRST USE 12-13-2007; IN COMMERCE 12-13-2007.

JASON BLAIR, EXAMINING ATTORNEY

Int. Cls.: 35 and 41

Prior U.S. Cls.: 100, 101, 102, and 107

United States Patent and Trademark Office

Reg. No. 3,577,185

Registered Feb. 17, 2009

**SERVICE MARK
PRINCIPAL REGISTER**

SMARTER CHOICES WELLNESS

FRENKEL & CO., INC. (NEW YORK CORPORATION)
350 HUDSON STREET, 4TH FLOOR
NEW YORK, NY 10014

FOR: ORGANIZING AND CONDUCTING HEALTH AND WELLNESS FAIRS, IN CLASS 35 (U.S. CLS. 100, 101 AND 102).

FIRST USE 5-4-2007; IN COMMERCE 5-4-2007.

FOR: EDUCATION SERVICES, NAMELY, HEALTH AND WELLNESS PROGRAMS, IN CLASS 41 (U.S. CLS. 100, 101 AND 107).

FIRST USE 4-23-2007; IN COMMERCE 4-23-2007.

THE MARK CONSISTS OF STANDARD CHARACTERS WITHOUT CLAIM TO ANY PARTICULAR FONT, STYLE, SIZE, OR COLOR.

NO CLAIM IS MADE TO THE EXCLUSIVE RIGHT TO USE "WELLNESS", APART FROM THE MARK AS SHOWN.

SN 77-242,215, FILED 7-30-2007.

KARANENDRA S. CHHINA, EXAMINING ATTORNEY

Int. Cl.: 2

Prior U.S. Cls.: 6, 11, and 16

United States Patent and Trademark Office

Reg. No. 3,577,186

Registered Feb. 17, 2009

**TRADEMARK
PRINCIPAL REGISTER**

SOFT TOUCH

SUN CHEMICAL CORPORATION (DELAWARE
CORPORATION)
LEGAL DEPT. - TRADEMARKS
35 WATERVIEW BLVD.
PARSIPPANY, NJ 07054

THE MARK CONSISTS OF STANDARD CHAR-
ACTERS WITHOUT CLAIM TO ANY PARTICULAR
FONT, STYLE, SIZE, OR COLOR.

FOR: COATINGS FOR USE IN THE GRAPHIC
ARTS INDUSTRY, IN CLASS 2 (U.S. CLS. 6, 11 AND
16).

SN 77-242,416, FILED 7-30-2007.

FIRST USE 12-0-2007; IN COMMERCE 12-0-2007.

DAVID MURRAY, EXAMINING ATTORNEY

Int. Cl.: 9

Prior U.S. Cls.: 21, 23, 26, 36, and 38

Reg. No. 3,577,187

United States Patent and Trademark Office

Registered Feb. 17, 2009

**TRADEMARK
PRINCIPAL REGISTER**

XICATO

XICATO, INC. (DELAWARE CORPORATION)
SUITE 204
4880 STEVENS CREEK
SAN JOSE, CA 95129

FIRST USE 11-27-2008; IN COMMERCE 11-27-2008.

THE MARK CONSISTS OF STANDARD CHARACTERS WITHOUT CLAIM TO ANY PARTICULAR FONT, STYLE, SIZE, OR COLOR.

FOR: SOLID-STATE LIGHTING SYSTEMS CONSISTING OF LIGHT EMITTING DIODES (LED), POLYCHLORINATED BIPHENYLS (PCB), INTERCONNECTS, HEAT SINKS, AND OPTICAL CAVITIES, IN CLASS 9 (U.S. CLS. 21, 23, 26, 36 AND 38).

SN 77-242,906, FILED 7-31-2007.

DAWN FELDMAN, EXAMINING ATTORNEY

Prior U.S. Cl.: B

United States Patent and Trademark Office

Reg. No. 3,577,188

Registered Feb. 17, 2009

CERTIFICATION MARK
SERVICES
PRINCIPAL REGISTER



ASSOCIATION OF BAY AREA GOVERNMENTS
(CALIFORNIA JOINT EXERCISE OF POWERS
ENTITY)
101 8TH STREET
OAKLAND, CA 94607

FOR: INTEGRATED PEST MANAGEMENT SER-
VICES, IN CLASS B (U.S. CL. B).

FIRST USE 6-21-2006; IN COMMERCE 9-1-2007.

NO CLAIM IS MADE TO THE EXCLUSIVE
RIGHT TO USE "CERTIFIED", APART FROM THE
MARK AS SHOWN.

THE COLOR(S) GREEN, LIGHT GREEN, BLUE
AND WHITE IS/ARE CLAIMED AS A FEATURE OF
THE MARK.

THE MARK CONSISTS OF A CIRCLE, THE OUT-
LINE 2/3 OF WHICH IS DESIGNATED BY SMALL
GREEN DOTS, THE REMAINING 1/3 LOWER POR-
TION OF OUTLINE IS THE WORD "CERTIFIED",
CENTERED IN LIGHT GREEN CAPITAL LETTERS.
INSIDE THE UPPER HALF OF CIRCLE IS A GREEN

DRAGONFLY. THE DRAGONFLY'S WINGS FLOW
HORIZONTALLY IN BOTH DIRECTIONS TO THE
EDGES OF CIRCLE, TIPS JUST BARELY PIERCE
THE OUTLINE OF GREEN DOTS. THE DRAGON-
FLY'S HEAD RESTS NEAR THE APEX OF CIRCLE
WHILE THE TAIL ALMOST DIVIDES THE CIRCLE
IN HALF IN A DOWNWARD MOTION. THE WORD
"ECOWISE" IN BLUE TRAVERSES CIRCLE JUST
BELOW THE MIDLINE. THE BACKGROUND IS
WHITE.

THE CERTIFICATION MARK, AS USED BY
PERSONS AUTHORIZED BY THE CERTIFIER,
CERTIFIES THAT THE SERVICES PROVIDED ARE
AN INTEGRATED PEST MANAGEMENT SERVICE
THAT PROVIDES LONG-TERM PEST CONTROL
WHILE EMPHASIZING PEST PREVENTION AND
NON-CHEMICAL PEST MANAGEMENT BY QUA-
LIFIED, LICENSED, STRUCTURAL PEST CON-
TROL PROFESSIONALS ACCORDING TO THE
CERTIFIER'S STANDARDS.

SN 77-243,098, FILED 7-31-2007.

JORDAN BAKER, EXAMINING ATTORNEY

Int. Cl.: 41

Prior U.S. Cls.: 100, 101, and 107

United States Patent and Trademark Office

Reg. No. 3,577,189

Registered Feb. 17, 2009

**SERVICE MARK
PRINCIPAL REGISTER**

24/24 RULE

COURTROOM TELEVISION NETWORK LLC
(NEW YORK LIMITED LIABILITY COMPA-
NY)

600 THIRD AVENUE
NEW YORK, NY 10016

FOR: ENTERTAINMENT SERVICES, NAMELY, A
CONTINUING TELEVISION PROGRAM SERIES
PROVIDED THROUGH CABLE TELEVISION,
BROADCAST TELEVISION, INTERNET, VIDEO-
ON-DEMAND, AND THROUGH OTHER DISTRI-
BUTION PLATFORMS IN THE FIELD OF COMEDY,

DRAMA, ACTION AND/OR ADVENTURE, IN
CLASS 41 (U.S. CLS. 100, 101 AND 107).

FIRST USE 12-28-2007; IN COMMERCE 12-28-2007.

THE MARK CONSISTS OF STANDARD CHAR-
ACTERS WITHOUT CLAIM TO ANY PARTICULAR
FONT, STYLE, SIZE, OR COLOR.

SN 77-243,250, FILED 7-31-2007.

MICHELLE DUBOIS, EXAMINING ATTORNEY

Int. Cl.: 5

Prior U.S. Cls.: 6, 18, 44, 46, 51, and 52

Reg. No. 3,577,190

United States Patent and Trademark Office

Registered Feb. 17, 2009

**TRADEMARK
PRINCIPAL REGISTER**

STAT CASSETTE

MICRO DISTRIBUTING II LTD. (TEXAS CORPORATION)
620 KENNEDY COURT
BELTON, TX 76513

FOR: DRUG TESTING KITS COMPRISED OF MEDICAL DIAGNOSTIC REAGENTS AND ASSAYS FOR TESTING BODY FLUIDS, IN CLASS 5 (U.S. CLS. 6, 18, 44, 46, 51 AND 52).

FIRST USE 4-15-2007; IN COMMERCE 12-1-2007.

THE MARK CONSISTS OF STANDARD CHARACTERS WITHOUT CLAIM TO ANY PARTICULAR FONT, STYLE, SIZE, OR COLOR.

NO CLAIM IS MADE TO THE EXCLUSIVE RIGHT TO USE "CASSETTE", APART FROM THE MARK AS SHOWN.

SN 77-243,797, FILED 7-31-2007.

CHARLOTTE CORWIN, EXAMINING ATTORNEY

Int. Cl.: 9

Prior U.S. Cls.: 21, 23, 26, 36, and 38

Reg. No. 3,577,191

United States Patent and Trademark Office

Registered Feb. 17, 2009

**TRADEMARK
PRINCIPAL REGISTER**



SONY CORPORATION (JAPAN CORPORATION)
1-7-1 KONAN, MINATO-KU
TOKYO, JAPAN

FOR: OPTICAL DISC PLAYERS AND RECORDERS FOR AUDIO, VIDEO AND COMPUTER DATA; TELEVISION SETS, IN CLASS 9 (U.S. CLS. 21, 23, 26, 36 AND 38).

FIRST USE 7-31-2007; IN COMMERCE 7-31-2007.

NO CLAIM IS MADE TO THE EXCLUSIVE RIGHT TO USE "24P TRUE CINEMA", APART FROM THE MARK AS SHOWN.

THE MARK CONSISTS OF THE WORDS "24P TRUE CINEMA" AGAINST A BACKGROUND THAT IS SUGGESTIVE OF MOTION PICTURE FILM.

SN 77-243,891, FILED 8-1-2007.

KAPIL BHANOT, EXAMINING ATTORNEY

Int. Cl.: 42

Prior U.S. Cls.: 100 and 101

United States Patent and Trademark Office

Reg. No. 3,577,192

Registered Feb. 17, 2009

SERVICE MARK
PRINCIPAL REGISTER



NORA JUNE CREASON (WASHINGTON LIMITED LIABILITY COMPANY)

11301 EXETER AV NE
SEATTLE, WA 981255909

FOR: TECHNICAL WRITING FOR OTHERS;
GRAPHIC ILLUSTRATION SERVICES FOR OTHERS, IN CLASS 42 (U.S. CLS. 100 AND 101).

FIRST USE 2-8-2008; IN COMMERCE 2-8-2008.

THE COLOR(S) RED, BLACK AND WHITE IS/
ARE CLAIMED AS A FEATURE OF THE MARK.

THE COLOR RED APPEARS IN THE DESIGN OF A CIRCLE BETWEEN THE TERMS "AERO" AND "DETA". THE COLOR BLACK APPEARS IN THE STYLIZED WORDING "AERO" AND "DETA", AND IN THE OUTLINE OF A PENCIL, HAND AND SLEEVE, AND IN FOUR HORIZONTAL LINES BELOW THE WORDING AND TO THE LEFT OF THE HAND AND SLEEVE DESIGN. THE COLOR WHITE APPEARS IN THE FILL OF THE PENCIL, HAND AND SLEEVE.

SN 77-244,847, FILED 8-1-2007.

JAY BESCH, EXAMINING ATTORNEY

Int. Cl.: 38

Prior U.S. Cls.: 100, 101, and 104

United States Patent and Trademark Office

Reg. No. 3,577,193

Registered Feb. 17, 2009

**SERVICE MARK
PRINCIPAL REGISTER**



RINGTONES FOR JESUS, INC. (WASHINGTON CORPORATION)
7250 REDMOND ROAD
REDMOND, WA 98052

FOR: ELECTRONIC TRANSMISSION VIA A GLOBAL COMPUTER NETWORK OF RINGTONES FOR CELLULAR AND MOBILE TELEPHONES; WIRELESS COMMUNICATION SERVICES, NAMELY, TRANSMISSION OF GRAPHICS AND MUSIC VIA THE INTERNET AND WIRELESS DEVICES, IN CLASS 38 (U.S. CLS. 100, 101 AND 104).

FIRST USE 4-29-2004; IN COMMERCE 9-15-2007.

NO CLAIM IS MADE TO THE EXCLUSIVE RIGHT TO USE "RINGTONES" AND THE PICTORIAL REPRESENTATION OF A CELLULAR PHONE, APART FROM THE MARK AS SHOWN.

SN 77-245,461, FILED 8-2-2007.

WENDY GOODMAN, EXAMINING ATTORNEY

Int. Cl.: 30

Prior U.S. Cl.: 46

United States Patent and Trademark Office

Reg. No. 3,577,194

Registered Feb. 17, 2009

**TRADEMARK
PRINCIPAL REGISTER**

Chicken Smooch

TUFFS, MICHELLE (UNITED STATES INDIVIDUAL)
3227 AVIARY COURT
ACWORTH, GA 30101

NO CLAIM IS MADE TO THE EXCLUSIVE RIGHT TO USE "CHICKEN", APART FROM THE MARK AS SHOWN.

FOR: SAUCES, IN CLASS 30 (U.S. CL. 46).

FIRST USE 1-1-2005; IN COMMERCE 4-21-2007.

SN 77-246,057, FILED 8-2-2007.

THE MARK CONSISTS OF STANDARD CHARACTERS WITHOUT CLAIM TO ANY PARTICULAR FONT, STYLE, SIZE, OR COLOR.

MICHELE SWAIN, EXAMINING ATTORNEY

Int. Cl.: 41

Prior U.S. Cls.: 100, 101, and 107

United States Patent and Trademark Office

Reg. No. 3,577,195

Registered Feb. 17, 2009

**SERVICE MARK
PRINCIPAL REGISTER**

**THE WORLD IS GOING GREEN.
YOU COMING?**

GREEN STREET FAIR, INC. (MICHIGAN CORPORATION)
410 S. MAIN STREET
SUITE 1
NORTHVILLE, MI 48167

FOR: EDUCATIONAL SERVICES, NAMELY, ORGANIZING AND CONDUCTING EDUCATIONAL FESTIVALS, EXHIBITIONS, SEMINARS, CONVENTIONS, AND CONFERENCES FEATURING ARTISANS, SPEAKERS, ENTERTAINERS, VENDORS AND EDUCATIONAL PRODUCT INFORMATION INFORMING THE PUBLIC ABOUT ECO-FRIENDLY PRODUCTS AND SERVICES AND EDUCATION-

AL ECOLOGICAL INFORMATION, IN CLASS 41 (U.S. CLS. 100, 101 AND 107).

FIRST USE 8-1-2008; IN COMMERCE 8-1-2008.

THE MARK CONSISTS OF STANDARD CHARACTERS WITHOUT CLAIM TO ANY PARTICULAR FONT, STYLE, SIZE, OR COLOR.

SN 77-246,273, FILED 8-3-2007.

CHERYL CLAYTON, EXAMINING ATTORNEY

Int. Cl.: 41

Prior U.S. Cls.: 100, 101, and 107

United States Patent and Trademark Office

Reg. No. 3,577,196

Registered Feb. 17, 2009

**SERVICE MARK
PRINCIPAL REGISTER**

SCRAMBLED EGGS

HIRSCH, ERIC H. (UNITED STATES INDIVIDUAL)
1315 BROADWAY, #B186
HEWLETT, NY 11557

THE MARK CONSISTS OF STANDARD CHARACTERS WITHOUT CLAIM TO ANY PARTICULAR FONT, STYLE, SIZE, OR COLOR.

FOR: ENTERTAINMENT IN THE NATURE OF A TELEVISION GAME SHOW, IN CLASS 41 (U.S. CLS. 100, 101 AND 107).

SN 77-246,372, FILED 8-3-2007.

FIRST USE 12-10-2008; IN COMMERCE 12-10-2008.

STEVEN JACKSON, EXAMINING ATTORNEY

Int. Cl.: 36

Prior U.S. Cls.: 100, 101, and 102

United States Patent and Trademark Office

Reg. No. 3,577,197

Registered Feb. 17, 2009

**SERVICE MARK
PRINCIPAL REGISTER**

CASTLE CREEK

CASTLE CREEK ADVISORS LLC (DELAWARE
LIMITED LIABILITY COMPANY)
P.O. BOX 1329
RANCHO SANTA FE, CA 920671329

FOR: FINANCIAL SERVICES, NAMELY, MAN-
AGEMENT OF INVESTMENTS, MANAGEMENT
OF CAPITAL INVESTMENT FUNDS, PRIVATE
EQUITY FUNDS, AND INVESTMENT BANKING
SERVICES; HEDGE FUND INVESTMENT SERVI-
CES; FINANCIAL MANAGEMENT SERVICES; FI-
NANCIAL ASSET MANAGEMENT SERVICES;
FINANCIAL AND INVESTMENT PORTFOLIO
MANAGEMENT SERVICES; PRIVATE EQUITY

FUND INVESTMENT SERVICES, IN CLASS 36
(U.S. CLS. 100, 101 AND 102).

FIRST USE 10-18-1995; IN COMMERCE 10-18-1995.

THE MARK CONSISTS OF STANDARD CHAR-
ACTERS WITHOUT CLAIM TO ANY PARTICULAR
FONT, STYLE, SIZE, OR COLOR.

SN 77-246,702, FILED 8-3-2007.

KRISTIN DAHLING, EXAMINING ATTORNEY

Int. Cl.: 7

Prior U.S. Cls.: 13, 19, 21, 23, 31, 34, and 35

United States Patent and Trademark Office

Reg. No. 3,577,198

Registered Feb. 17, 2009

TRADEMARK
PRINCIPAL REGISTER

FlexPLY

COMPOSIFLEX, INC. (PENNSYLVANIA CORPORATION)
8100 HAWTHORNE DRIVE
ERIE, PA 16509

FOR: MACHINE PARTS, NAMELY, COMPOSITE SPRINGS TO ACCOMMODATE VIBRATION, SHOCK, OR MOTION, IN CLASS 7 (U.S. CLS. 13, 19, 21, 23, 31, 34 AND 35).

FIRST USE 11-16-2007; IN COMMERCE 11-18-2008.

THE MARK CONSISTS OF THE WORD "FLEXPLY" WITH THE LETTER "L" DEPICTING A BENDING MOTION UTILIZING THREE OVERLAPPING "L" LETTERS THAT ARE BENT VARIOUS AMOUNTS AND SHADED DIFFERENTLY. THE LETTERS "PLY" ARE IN ITALIC FORMAT.

SN 77-247,635, FILED 8-6-2007.

LESLIE RICHARDS, EXAMINING ATTORNEY

Int. Cl.: 21

Prior U.S. Cls.: 2, 13, 23, 29, 30, 33, 40, and 50

Reg. No. 3,577,199

United States Patent and Trademark Office

Registered Feb. 17, 2009

**TRADEMARK
PRINCIPAL REGISTER**

TRANSFORMER

TABLECRAFT PRODUCTS COMPANY (ILLINOIS CORPORATION)
801 LAKESIDE DRIVE
GURNEE, IL 60031

FOR: WIRE BASKETS OF COMMON METALS FOR DISPLAYING AND/OR PRESENTING GOODS ON TABLES, COUNTERS, CARTS, AND OTHER HORIZONTAL SURFACES AND FOR COMMERCIAL USE IN FOOD SERVICE VENUES, IN CLASS 21 (U.S. CLS. 2, 13, 23, 29, 30, 33, 40 AND 50).

FIRST USE 1-31-2008; IN COMMERCE 2-29-2008.

THE MARK CONSISTS OF STANDARD CHARACTERS WITHOUT CLAIM TO ANY PARTICULAR FONT, STYLE, SIZE, OR COLOR.

SN 77-248,071, FILED 8-6-2007.

LAURIE MAYES, EXAMINING ATTORNEY

Int. Cl.: 38

Prior U.S. Cls.: 100, 101, and 104

United States Patent and Trademark Office

Reg. No. 3,577,200

Registered Feb. 17, 2009

**SERVICE MARK
PRINCIPAL REGISTER**



TRACFONE WIRELESS, INC. (FLORIDA CORPORATION)
9700 NW 112TH AVENUE
MIAMI, FL 33178

FOR: CELLULAR TELEPHONE TELECOMMUNICATIONS SERVICES PROVIDED VIA PREPAID AIR TIME CELLULAR TELEPHONES AND PREPAID AIR TIME CELLULAR TELEPHONE CALLING CARD SERVICES, IN CLASS 38 (U.S. CLS. 100, 101 AND 104).

FIRST USE 8-31-2007; IN COMMERCE 9-30-2007.

OWNER OF U.S. REG. NOS. 2,114,692, 2,761,017, AND OTHERS.

THE COLOR(S) BLUE AND WHITE IS/ARE CLAIMED AS A FEATURE OF THE MARK.

THE MARK CONSISTS OF THE WORD "TRACFONE" IN WHITE, WITH THE LETTER "O" IN STYLIZED FORM HAVING TWO CONCENTRIC CIRCLES WITHIN THE OUTER "O", SURROUNDED BY A BLUE BACKGROUND PORTION.

SN 77-248,824, FILED 8-7-2007.

SARA THOMAS, EXAMINING ATTORNEY

Int. Cls.: 39 and 42

Prior U.S. Cls.: 100, 101, and 105

United States Patent and Trademark Office

Reg. No. 3,577,201

Registered Feb. 17, 2009

**SERVICE MARK
PRINCIPAL REGISTER**

BELFOR ENVIRONMENTAL

BELFOR USA GROUP INC. (COLORADO CORPORATION)
185 OAKLAND AVE., SUITE 300
BIRMINGHAM, MI 48009

FOR: TRANSPORTATION OF MEDICAL WASTE AND SPECIAL WASTE; TRUCK TRANSPORT, IN CLASS 39 (U.S. CLS. 100 AND 105).

FIRST USE 5-18-2007; IN COMMERCE 12-2-2008.

FOR: CHEMICAL, BIOCHEMICAL, BIOLOGICAL AND BACTERIOLOGICAL RESEARCH AND ANALYSIS; ENVIRONMENTAL TESTING AND INSPECTION SERVICES; EVALUATION AND TESTING OF REAL ESTATE FOR THE PRESENCE OF HAZARDOUS MATERIAL, IN CLASS 42 (U.S. CLS. 100 AND 101).

FIRST USE 5-18-2007; IN COMMERCE 12-2-2008.

THE MARK CONSISTS OF STANDARD CHARACTERS WITHOUT CLAIM TO ANY PARTICULAR FONT, STYLE, SIZE, OR COLOR.

OWNER OF U.S. REG. NO. 2,559,315.

NO CLAIM IS MADE TO THE EXCLUSIVE RIGHT TO USE "ENVIRONMENTAL", APART FROM THE MARK AS SHOWN.

SEC. 2(F) AS TO "BELFOR".

SN 77-248,967, FILED 8-7-2007.

SUNG IN, EXAMINING ATTORNEY

Int. Cl.: 9

Prior U.S. Cls.: 21, 23, 26, 36, and 38

United States Patent and Trademark Office

Reg. No. 3,577,202

Registered Feb. 17, 2009

**TRADEMARK
PRINCIPAL REGISTER**

GATOR LINK

FIBER CONNECTIONS INC. (CANADA CORPORATION)
5878 HIGHWAY #9
SCHOMBERG, ONTARIO, CANADA L0G1T0

FOR: FIBER OPTIC CABLE MODULAR CONNECTORS INCORPORATING MEDIA CONVERTER TO ETHERNET AND ALSO INCORPORATING POE (POWER OVER ETHERNET) CAPABILITIES , IN CLASS 9 (U.S. CLS. 21, 23, 26, 36 AND 38).

FIRST USE 3-18-2008; IN COMMERCE 4-8-2008.

THE MARK CONSISTS OF STANDARD CHARACTERS WITHOUT CLAIM TO ANY PARTICULAR FONT, STYLE, SIZE, OR COLOR.

SN 77-250,277, FILED 8-8-2007.

BENJAMIN ALLEN, EXAMINING ATTORNEY

Int. Cl.: 44

Prior U.S. Cls.: 100 and 101

United States Patent and Trademark Office

Reg. No. 3,577,203

Registered Feb. 17, 2009

**SERVICE MARK
PRINCIPAL REGISTER**

MYSPA

SHR RETAIL, LLC (DELAWARE LIMITED LIABILITY COMPANY)
SUITE 1700
200 WEST MADISON STREET
CHICAGO, IL 60601

FOR: HEALTH AND BEAUTY SALON SERVICES; HEALTH SPA SERVICES, NAMELY, COSMETIC BODY CARE SERVICES; SPA SERVICES, NAMELY, HYDROTHERAPY, REFLEXOLOGY, DEPILATORY TREATMENTS, PROVISION OF FACIALS, MANICURES, AND PEDICURES, PHYSICAL THERAPY, COSMETICIAN SERVICES, NUTRITION CONSULTATION SERVICES, HAIR DRESSING, MASSAGE

AND AROMATHERAPY; OPERATION OF SAUNA FACILITIES AND STEAM ROOM FACILITIES, IN CLASS 44 (U.S. CLS. 100 AND 101).

FIRST USE 10-9-2008; IN COMMERCE 10-9-2008.

THE MARK CONSISTS OF STANDARD CHARACTERS WITHOUT CLAIM TO ANY PARTICULAR FONT, STYLE, SIZE, OR COLOR.

SN 77-251,158, FILED 8-9-2007.

GIANCARLO CASTRO, EXAMINING ATTORNEY

Int. Cl.: 25

Prior U.S. Cls.: 22 and 39

United States Patent and Trademark Office

Reg. No. 3,577,204

Registered Feb. 17, 2009

TRADEMARK
PRINCIPAL REGISTER



HORN, B.E. (UNITED STATES INDIVIDUAL)
C/O E.HANSCOM, 7395 PORTAGE WAY
CARLSBAD, CA 92011

FOR: SHIRTS; PANTS; HATS, IN CLASS 25 (U.S.
CLS. 22 AND 39).

FIRST USE 7-9-2007; IN COMMERCE 7-9-2007.

THE COLOR(S) RED AND BLACK IS/ARE
CLAIMED AS A FEATURE OF THE MARK.

THE MARK CONSISTS, IN PART, OF A STY-
LIZED DESIGN OF A SKATEBOARDING CAM-

LOCK IN THE COLORS RED AND BLACK. THE
WORD "REVENGE" APPEARS IN LARGE STY-
LIZED BLACK LETTERS TO THE RIGHT OF THE
CAMLOCK DESIGN OVERLAPPING THE RED
PORTION OF THE CAMLOCK DESIGN. THE
WORDS "TURN FOR A CHANGE" APPEAR IN
SMALL BLACK LETTERS TO THE RIGHT OF THE
CAMLOCK DESIGN AND ABOVE THE TERM
"REVENGE".

SN 77-251,273, FILED 8-9-2007.

ZHALEH DELANEY, EXAMINING ATTORNEY

Int. Cl.: 9

Prior U.S. Cls.: 21, 23, 26, 36, and 38

United States Patent and Trademark Office

Reg. No. 3,577,205

Registered Feb. 17, 2009

**TRADEMARK
PRINCIPAL REGISTER**

CENTRITEL

INFINITY PHOTO-OPTICAL CORPORATION
(COLORADO CORPORATION)
2530 FRONTIER AVE
BOULDER, CO 80301

THE MARK CONSISTS OF STANDARD CHARACTERS WITHOUT CLAIM TO ANY PARTICULAR FONT, STYLE, SIZE, OR COLOR.

FOR: MICROSCOPES; MICROSCOPES AND PARTS THEREOF; OPTICAL LENSES; TELESCOPES, IN CLASS 9 (U.S. CLS. 21, 23, 26, 36 AND 38).

SN 77-251,650, FILED 8-9-2007.

FIRST USE 11-6-2007; IN COMMERCE 11-6-2007.

BENJAMIN OKEKE, EXAMINING ATTORNEY

Int. Cls.: 11 and 20

Prior U.S. Cls.: 2, 13, 21, 22, 23, 25, 31, 32, 34, and 50

United States Patent and Trademark Office

Reg. No. 3,577,206

Registered Feb. 17, 2009

**TRADEMARK
PRINCIPAL REGISTER**

UTILIFIT

AMERICAN SHOWER & BATH CORPORATION
(MICHIGAN CORPORATION)

540 GLEN AVENUE

MOORESTOWN, NJ 08057

FOR: NON-METAL BATH TUBS, SINKS; PLUMBING FIXTURES, NAMELY, SINK TRAPS, SINK SPRAYERS AND FAUCETS, IN CLASS 11 (U.S. CLS. 13, 21, 23, 31 AND 34).

FIRST USE 10-30-2008; IN COMMERCE 10-30-2008.

FOR: STORAGE CABINETS, NON-METAL CHESTS, SHELVES AND DOORS, IN CLASS 20 (U.S. CLS. 2, 13, 22, 25, 32 AND 50).

FIRST USE 10-30-2008; IN COMMERCE 10-30-2008.

THE MARK CONSISTS OF STANDARD CHARACTERS WITHOUT CLAIM TO ANY PARTICULAR FONT, STYLE, SIZE, OR COLOR.

SN 77-252,108, FILED 8-10-2007.

JOHN DWYER, EXAMINING ATTORNEY

Int. Cl.: 38

Prior U.S. Cls.: 100, 101, and 104

United States Patent and Trademark Office

Reg. No. 3,577,207

Registered Feb. 17, 2009

**SERVICE MARK
PRINCIPAL REGISTER**

TELEVISIPHONERNETTING

COMCAST CORPORATION (PENNSYLVANIA CORPORATION)
1500 MARKET STREET
PHILADELPHIA, PA 19102

FOR: BROADBAND TELECOMMUNICATIONS SERVICES, NAMELY, LOCAL AND LONG DISTANCE TELEPHONE COMMUNICATION SERVICES; VOICE-OVER INTERNET PROTOCOL (VOIP) SERVICES; CABLE TELEVISION TRANSMISSION SERVICES; AND HIGH SPEED INTERNET SERVICES, NAMELY, PROVIDING HIGH SPEED ACCESS TO A GLOBAL COMPUTER INFORMATION NETWORK; COMMUNICATION SERVICES, NAMELY, PROVIDING MULTIPLE USER WIRELESS ACCESS

TO A GLOBAL COMMUNICATIONS NETWORK VIA PERSONAL COMPUTERS AND WIRELESS DEVICES, IN CLASS 38 (U.S. CLS. 100, 101 AND 104).

FIRST USE 8-20-2007; IN COMMERCE 8-20-2007.

THE MARK CONSISTS OF STANDARD CHARACTERS WITHOUT CLAIM TO ANY PARTICULAR FONT, STYLE, SIZE, OR COLOR.

SN 77-252,162, FILED 8-10-2007.

APRIL ROACH, EXAMINING ATTORNEY

Int. Cl.: 32

Prior U.S. Cls.: 45, 46, and 48

United States Patent and Trademark Office

Reg. No. 3,577,208

Registered Feb. 17, 2009

**TRADEMARK
PRINCIPAL REGISTER**

DAINZU

SABOR DE OAXACA S. A. DE C. V. (MEXICO
CORPORATION)

LT. A2

KM. 10 CARR. ATIZAPAN

PEDREGAL ATIZAPAN, MEXICO

THE MARK CONSISTS OF STANDARD CHAR-
ACTERS WITHOUT CLAIM TO ANY PARTICULAR
FONT, STYLE, SIZE, OR COLOR.

FOR: ALOE VERA DRINKS, IN CLASS 32 (U.S.
CLS. 45, 46 AND 48).

SN 77-252,383, FILED 8-10-2007.

FIRST USE 10-4-2004; IN COMMERCE 8-12-2008.

ESTHER A. BORSUK, EXAMINING ATTORNEY

Int. Cl.: 22

Prior U.S. Cls.: 1, 2, 7, 19, 22, 42, and 50

Reg. No. 3,577,209

United States Patent and Trademark Office

Registered Feb. 17, 2009

**TRADEMARK
PRINCIPAL REGISTER**

6IX AGAIN

SHAW INDUSTRIES GROUP, INC. (GEORGIA
CORPORATION)
616 EAST WALNUT AVENUE, P.O. DRAWER 2128
DALTON, GA 307222128

THE MARK CONSISTS OF STANDARD CHAR-
ACTERS WITHOUT CLAIM TO ANY PARTICULAR
FONT, STYLE, SIZE, OR COLOR.

FOR: SYNTHETIC FIBERS, IN CLASS 22 (U.S.
CLS. 1, 2, 7, 19, 22, 42 AND 50).

SN 77-252,496, FILED 8-10-2007.

FIRST USE 8-0-2007; IN COMMERCE 8-0-2007.

DAVID COLLIER, EXAMINING ATTORNEY

Int. Cl.: 32

Prior U.S. Cls.: 45, 46, and 48

United States Patent and Trademark Office

Reg. No. 3,577,210

Registered Feb. 17, 2009

**TRADEMARK
PRINCIPAL REGISTER**

DAINZU

SABOR DE OAXACA S. A. DE C. V. (MEXICO
CORPORATION)
LT. A2 KM. 10 CARR. ATIZAPAN
PEDREGAL ATIZAPAN, MEXICO

THE MARK CONSISTS OF STANDARD CHAR-
ACTERS WITHOUT CLAIM TO ANY PARTICULAR
FONT, STYLE, SIZE, OR COLOR.

FOR: NON-ALCOHOLIC COCKTAIL MIXES, IN
CLASS 32 (U.S. CLS. 45, 46 AND 48).

SN 77-252,501, FILED 8-10-2007.

FIRST USE 8-14-2008; IN COMMERCE 10-4-2008.

ESTHER A. BORSUK, EXAMINING ATTORNEY

Int. Cl.: 35

Prior U.S. Cls.: 100, 101, and 102

United States Patent and Trademark Office

Reg. No. 3,577,211

Registered Feb. 17, 2009

**SERVICE MARK
PRINCIPAL REGISTER**

CANDY CITY

PARTY CITY CORPORATION (DELAWARE
CORPORATION)
25 GREEN POND ROAD, SUITE 1
ROCKAWAY, NJ 07866

FOR: RETAIL STORE SERVICES AND ONLINE
RETAIL STORE SERVICES, FEATURING A WIDE
VARIETY OF CONSUMER GOODS OF OTHERS, IN
CLASS 35 (U.S. CLS. 100, 101 AND 102).

FIRST USE 12-31-2006; IN COMMERCE 12-31-2006.

THE MARK CONSISTS OF STANDARD CHAR-
ACTERS WITHOUT CLAIM TO ANY PARTICULAR
FONT, STYLE, SIZE, OR COLOR.

NO CLAIM IS MADE TO THE EXCLUSIVE
RIGHT TO USE "CANDY", APART FROM THE
MARK AS SHOWN.

SN 77-253,656, FILED 8-13-2007.

LAURA KOVALSKY, EXAMINING ATTORNEY

Int. Cls.: 41 and 42

Prior U.S. Cls.: 100, 101, and 107

United States Patent and Trademark Office

Reg. No. 3,577,212

Registered Feb. 17, 2009

**SERVICE MARK
PRINCIPAL REGISTER**

**SEE THE RACE BEFORE IT
HAPPENS**

MCKEEVER, SCOTT (UNITED STATES INDIVIDUAL)
1922 N. MAIN STREET
ORANGE, CA 92865

FOR: PROVIDING INFORMATION VIA A GLOBAL COMPUTER NETWORK RELATING TO HANDICAPPING OF RACES AND HORSE RACES, IN CLASS 41 (U.S. CLS. 100, 101 AND 107).

FIRST USE 9-20-2008; IN COMMERCE 9-20-2008.

FOR: APPLICATION SERVICE PROVIDER SERVICES, NAMELY, PROVIDING COMPUTER SOFT-

WARE APPLICATIONS FOR USE IN HANDICAPPING OF RACES AND HORSE RACES, IN CLASS 42 (U.S. CLS. 100 AND 101).

FIRST USE 9-20-2008; IN COMMERCE 9-20-2008.

THE MARK CONSISTS OF STANDARD CHARACTERS WITHOUT CLAIM TO ANY PARTICULAR FONT, STYLE, SIZE, OR COLOR.

SN 77-253,754, FILED 8-13-2007.

DAVID TOOLEY, EXAMINING ATTORNEY

Int. Cl.: 45

Prior U.S. Cls.: 100 and 101

United States Patent and Trademark Office

Reg. No. 3,577,213

Registered Feb. 17, 2009

**SERVICE MARK
PRINCIPAL REGISTER**

FleetingLook

FLEETINGLOOK, INC. (DELAWARE CORPORATION)
2009 37TH STREET, NW
WASHINGTON, DC 20007

FOR: PROVIDING A WEBSITE FEATURING INFORMATION AND CONTENT IN THE FIELDS OF PERSONAL RELATIONSHIPS, DATING AND FASHION, IN CLASS 45 (U.S. CLS. 100 AND 101).

FIRST USE 8-25-2008; IN COMMERCE 8-25-2008.

THE COLOR(S) PURPLE IS/ARE CLAIMED AS A FEATURE OF THE MARK.

THE MARK CONSISTS OF THE MARK "FLEETINGLOOK" IS ONE WORD WRITTEN IN ALL PURPLE COLOR AND THE TWO "O'S IN THE WORD HAVE TWO EYES LOOKING OUTWARD TO THE RIGHT.

SN 77-253,996, FILED S.R. 8-13-2007; AM. P.R. 12-28-2007.

DAVID I, EXAMINING ATTORNEY

Int. Cl.: 41

Prior U.S. Cls.: 100, 101, and 107

United States Patent and Trademark Office

Reg. No. 3,577,214

Registered Feb. 17, 2009

**SERVICE MARK
PRINCIPAL REGISTER**

EQUINALITY

SADOWSKI, JR., ROBERT J. (UNITED STATES
INDIVIDUAL)
71 PLEASANT STREET
PLAINFIELD, MA 01070

FOR: HORSE TRAINING AND EDUCATIONAL
SERVICES, NAMELY, PROVIDING CLASSES AND
WORKSHOPS IN THE FIELD OF HORSES, IN
CLASS 41 (U.S. CLS. 100, 101 AND 107).

FIRST USE 3-1-2008; IN COMMERCE 3-1-2008.

THE MARK CONSISTS OF STANDARD CHAR-
ACTERS WITHOUT CLAIM TO ANY PARTICULAR
FONT, STYLE, SIZE, OR COLOR.

THE WORDING "EQUINALITY" HAS NO MEAN-
ING IN A FOREIGN LANGUAGE.

SN 77-254,479, FILED 8-14-2007.

WON TEAK OH, EXAMINING ATTORNEY

Int. Cl.: 41

Prior U.S. Cls.: 100, 101, and 107

United States Patent and Trademark Office

Reg. No. 3,577,215

Registered Feb. 17, 2009

**SERVICE MARK
PRINCIPAL REGISTER**

HORSEMINDSHIP

SADOWSKI, JR., ROBERT J. (UNITED STATES
INDIVIDUAL)
71 PLEASANT STREET
PLAINFIELD, MA 01070

THE MARK CONSISTS OF STANDARD CHAR-
ACTERS WITHOUT CLAIM TO ANY PARTICULAR
FONT, STYLE, SIZE, OR COLOR.

FOR: HORSE TRAINING AND EDUCATIONAL
SERVICES, NAMELY, PROVIDING CLASSES AND
WORKSHOPS IN THE FIELD OF HORSES, IN
CLASS 41 (U.S. CLS. 100, 101 AND 107).

SN 77-254,484, FILED 8-14-2007.

FIRST USE 3-1-2008; IN COMMERCE 3-1-2008.

WON TEAK OH, EXAMINING ATTORNEY

Int. Cl.: 35

Prior U.S. Cls.: 100, 101, and 102

United States Patent and Trademark Office

Reg. No. 3,577,216

Registered Feb. 17, 2009

**SERVICE MARK
PRINCIPAL REGISTER**

B4 MARKETING SOLUTIONS

B4 MARKETING SOLUTIONS LLC (OHIO LIMITED LIABILITY COMPANY)
SUITE 104
24 NORTH HIGH STREET
AKRON, OH 44308

FOR: BUSINESS MARKETING SERVICES AND MARKETING SUPPORT SERVICES IN THE NATURE OF PROVIDING STRATEGIC PLANNING AND CREATING MARKETING MATERIALS , IN CLASS 35 (U.S. CLS. 100, 101 AND 102).

FIRST USE 10-3-2007; IN COMMERCE 10-3-2007.

THE MARK CONSISTS OF STANDARD CHARACTERS WITHOUT CLAIM TO ANY PARTICULAR FONT, STYLE, SIZE, OR COLOR.

NO CLAIM IS MADE TO THE EXCLUSIVE RIGHT TO USE "MARKETING SOLUTIONS", APART FROM THE MARK AS SHOWN.

SN 77-254,922, FILED 8-14-2007.

ANDREA BUTLER, EXAMINING ATTORNEY

Int. Cl.: 25

Prior U.S. Cls.: 22 and 39

United States Patent and Trademark Office

Reg. No. 3,577,217

Registered Feb. 17, 2009

**TRADEMARK
PRINCIPAL REGISTER**

AAR CUDA

ALL AMERICAN RACERS, INC. (CALIFORNIA
CORPORATION)
2334 SOUTH BROADWAY
SANTA ANA, CA 92707

NO CLAIM IS MADE TO THE EXCLUSIVE
RIGHT TO USE "CUDA", APART FROM THE
MARK AS SHOWN.

FOR: CLOTHING, NAMELY, T-SHIRTS AND
CAPS, IN CLASS 25 (U.S. CLS. 22 AND 39).

SEC. 2(F).

FIRST USE 5-22-2008; IN COMMERCE 5-22-2008.

SN 77-256,446, FILED 8-15-2007.

THE MARK CONSISTS OF STANDARD CHAR-
ACTERS WITHOUT CLAIM TO ANY PARTICULAR
FONT, STYLE, SIZE, OR COLOR.

LESLEY LAMOTHE, EXAMINING ATTORNEY

Int. Cl.: 7

Prior U.S. Cls.: 13, 19, 21, 23, 31, 34, and 35

United States Patent and Trademark Office

Reg. No. 3,577,218

Registered Feb. 17, 2009

TRADEMARK
PRINCIPAL REGISTER



HYDEN ENGINEERING PTY LIMITED (AUSTRALIA PRIVATE LIMITED COMPANY)

UNIT 1

48 RACECOURSE ROAD

RUTHERFORD, AUSTRALIA 2320

FIRST USE 5-7-1997; IN COMMERCE 11-30-2007.

SN 77-256,664, FILED 8-16-2007.

FOR: PUMPS, NAMELY, HYDRAULIC PUMPS,
IN CLASS 7 (U.S. CLS. 13, 19, 21, 23, 31, 34 AND 35).

JOHN WILKE, EXAMINING ATTORNEY

Int. Cl.: 25

Prior U.S. Cls.: 22 and 39

United States Patent and Trademark Office

Reg. No. 3,577,219

Registered Feb. 17, 2009

**TRADEMARK
PRINCIPAL REGISTER**



JACK BANAFSHEHA AND AMELIE MONGRAIN
(CALIFORNIA PARTNERSHIP)

11800 W. OLYMPIC BOULEVARD
LOS ANGELES, CA 90064

FOR: JACKETS, WATER RESISTANT JACKETS,
WIND RESISTANT JACKETS, PONCHOS, ANOR-
AKS, SMOCKS, RAINCOATS, TRENCH COATS,
BOOTS, PANTS, SHIRTS, T-SHIRTS, POLO SHIRTS,
SPORTS SHIRTS, SWEAT SHIRTS, JERSEYS AND
RUGBY SHIRTS, IN CLASS 25 (U.S. CLS. 22 AND 39).

FIRST USE 10-8-2008; IN COMMERCE 10-8-2008.

THE COLOR(S) RED, WHITE AND BLACK IS/
ARE CLAIMED AS A FEATURE OF THE MARK.

THE MARK CONSISTS OF THE COLOR RED
APPEARS IN THE SHAPE OF A RAIN DROP WITH
THE COLOR BLACK APPEARING IN THE BACK-
GROUND AND THE WORDING "HARD RAIN" IN
THE COLOR WHITE APPEARING ABOVE THE
RAIN DROP.

SN 77-257,397, FILED 8-16-2007.

WILLIAM ROSSMAN, EXAMINING ATTORNEY

Int. Cls.: 41 and 42

Prior U.S. Cls.: 100, 101, and 107

United States Patent and Trademark Office

Reg. No. 3,577,220

Registered Feb. 17, 2009

**SERVICE MARK
PRINCIPAL REGISTER**

Methuselah Foundation

METHUSELAH FOUNDATION (VIRGINIA CORPORATION)
8021 FLINT STREET
SPRINGFIELD, VA 22153

FOR: ARRANGING AND CONDUCTING EDUCATIONAL CONFERENCES; ARRANGING OF EXHIBITIONS, SEMINARS AND CONFERENCES; ARRANGING OF SEMINARS AND CONFERENCES; ON-LINE JOURNALS, NAMELY, BLOGS FEATURING ANTI-AGING MEDICINE; ON-LINE PUBLICATION OF ANTI-AGING MEDICINE; ORGANISATION OF CONFERENCES AND SYMPOSIA IN THE FIELD OF MEDICAL SCIENCE; ORGANIZATION OF SEMINARS, WORKING GROUPS, RESEARCH GROUPS AND CONVENTIONS, IN THE FIELD OF MEDICINE; PUBLICATION AND EDITING OF PRINTED MATTER; PUBLICATION OF BOOKS; PUBLICATION OF BOOKS, MAGAZINES, ALMANACS AND JOURNALS; PUBLICATION OF BOOKS, OF MAGAZINES, OF JOURNALS, OF NEWSPAPERS, OF PERIODICALS, OF CATALOGS, OF BROCHURES; PUBLICATION OF BROCHURES; PUBLICATION OF DOCUMENTS IN THE FIELD OF TRAINING, SCIENCE, PUBLIC LAW AND SOCIAL AFFAIRS; PUBLICATION OF ELECTRONIC MAGAZINES; PUBLICATION OF JOURNALS; PUBLICATION OF MAGAZINES; PUBLICATION OF MANUALS; PUBLICATION OF PERIODICALS; PUBLICATION OF PRINTED MATTER; PUBLICATION OF TEXTS, BOOKS, JOURNALS; PUBLICATION OF TEXTS, BOOKS, MAGAZINES AND OTHER PRINTED MATTER; PUBLICATION OF THE EDITORIAL CONTENT OF SITES ACCESSIBLE VIA A GLOBAL COMPUTER NETWORK; PUBLISHING OF ELECTRONIC PUBLICATIONS; ORGANIZING EXHIBITIONS FOR HEALTH, RESEARCH, GERONTOLOGICAL AND BIOMEDICAL EDUCATIONAL PURPOSES; CONTINUING PUBLIC SERVICE PROGRAMS IN THE FIELD OF ANTI-AGING

MEDICINE PRODUCED AND DISTRIBUTED OVER TELEVISION, SATELLITE, FILM, AUDIO, VIDEO, INTERNET, AND 3-D VIRTUAL REALITY MEDIA, IN CLASS 41 (U.S. CLS. 100, 101 AND 107).

FIRST USE 7-1-2008; IN COMMERCE 7-1-2008.

FOR: CHEMICAL, BIOCHEMICAL, BIOLOGICAL AND BACTERIOLOGICAL RESEARCH AND ANALYSIS; COMPILING DATA FOR RESEARCH PURPOSES IN THE FIELD OF MEDICAL SCIENCE AND MEDICAL CONSULTANCY; INFORMATION ON THE SUBJECT OF SCIENTIFIC RESEARCH IN THE FIELD OF BIOCHEMISTRY AND BIOTECHNOLOGY; LABORATORY RESEARCH IN THE FIELD OF BIOLOGY; MEDICAL AND SCIENTIFIC RESEARCH IN THE FIELD OF ANTI-AGING; MEDICAL AND SCIENTIFIC RESEARCH INFORMATION IN THE FIELD OF ANTI-AGING; MEDICAL RESEARCH; SCIENTIFIC RESEARCH; SCIENTIFIC RESEARCH AND DEVELOPMENT; SCIENTIFIC RESEARCH IN THE FIELD OF GENETICS AND GENETIC ENGINEERING, IN CLASS 42 (U.S. CLS. 100 AND 101).

FIRST USE 7-1-2008; IN COMMERCE 7-1-2008.

THE MARK CONSISTS OF STANDARD CHARACTERS WITHOUT CLAIM TO ANY PARTICULAR FONT, STYLE, SIZE, OR COLOR.

NO CLAIM IS MADE TO THE EXCLUSIVE RIGHT TO USE "FOUNDATION", APART FROM THE MARK AS SHOWN.

SN 77-257,879, FILED 8-17-2007.

CIMMERIAN COLEMAN, EXAMINING ATTORNEY

Int. Cl.: 17

Prior U.S. Cls.: 1, 5, 12, 13, 35, and 50

United States Patent and Trademark Office

Reg. No. 3,577,221

Registered Feb. 17, 2009

**TRADEMARK
PRINCIPAL REGISTER**

**A BETTER ENVIRONMENT
INSIDE AND OUT**

BEKAERT SPECIALTY FILMS, LLC (CALIFORNIA LIMITED LIABILITY COMPANY)
4540 VIEWRIDGE AVENUE
SAN DIEGO, CA 92123

FOR: PLASTIC FILM THAT IS TRANSPARENT, TINTED, LAMINATED OR REFLECTIVE FOR USE ON GLASS SURFACES, NAMELY, HOME, COMMERCIAL OR AUTO WINDOWS, IN CLASS 17 (U.S. CLS. 1, 5, 12, 13, 35 AND 50).

FIRST USE 12-20-2007; IN COMMERCE 1-21-2008.

THE MARK CONSISTS OF STANDARD CHARACTERS WITHOUT CLAIM TO ANY PARTICULAR FONT, STYLE, SIZE, OR COLOR.

SN 77-259,396, FILED 8-20-2007.

LINDA ORNDORFF, EXAMINING ATTORNEY

Int. Cl.: 40

Prior U.S. Cls.: 100, 103, and 106

United States Patent and Trademark Office

Reg. No. 3,577,222

Registered Feb. 17, 2009

**SERVICE MARK
PRINCIPAL REGISTER**

PFL

PRINTINGFORLESS.COM, INC. (DELAWARE
CORPORATION)
100 PFL WAY
LIVINGSTON, MT 59047

FOR: COMMERCIAL PRINTING; CUSTOM ON-
LINE PRINTING SERVICES; DESIGN PRINTING
FOR OTHERS, IN CLASS 40 (U.S. CLS. 100, 103 AND
106).

FIRST USE 12-8-2008; IN COMMERCE 12-8-2008.

THE MARK CONSISTS OF STANDARD CHAR-
ACTERS WITHOUT CLAIM TO ANY PARTICULAR
FONT, STYLE, SIZE, OR COLOR.

OWNER OF U.S. REG. NO. 3,189,427.

SN 77-259,609, FILED 8-20-2007.

JAY BESCH, EXAMINING ATTORNEY

Int. Cl.: 5

Prior U.S. Cls.: 6, 18, 44, 46, 51, and 52

United States Patent and Trademark Office

Reg. No. 3,577,223

Registered Feb. 17, 2009

**TRADEMARK
PRINCIPAL REGISTER**

FOUR SEASONS COURTYARD

TRUE VALUE COMPANY (DELAWARE COR-
PORATION)
8600 WEST BRYN MAWR AVENUE
CHICAGO, IL 606313505

FOR: INSECT REPELLENTS IN THE NATURE OF
CITRONELLA SOLD IN DECORATIVE CONTAIN-
ERS, LANTERNS AND TORCHES, IN CLASS 5 (U.S.
CLS. 6, 18, 44, 46, 51 AND 52).

FIRST USE 10-0-2007; IN COMMERCE 10-0-2007.

THE MARK CONSISTS OF STANDARD CHAR-
ACTERS WITHOUT CLAIM TO ANY PARTICULAR
FONT, STYLE, SIZE, OR COLOR.

SN 77-259,720, FILED 8-20-2007.

MELISSA VALLILLO, EXAMINING ATTORNEY

Int. Cl.: 32

Prior U.S. Cls.: 45, 46, and 48

United States Patent and Trademark Office

Reg. No. 3,577,224

Registered Feb. 17, 2009

**TRADEMARK
PRINCIPAL REGISTER**

COOL SENSATION

TOPCO HOLDINGS, INC. (WISCONSIN COR-
PORATION)
7711 GROSS POINT ROAD
SKOKIE, IL 60077

THE MARK CONSISTS OF STANDARD CHAR-
ACTERS WITHOUT CLAIM TO ANY PARTICULAR
FONT, STYLE, SIZE, OR COLOR.

FOR: BEVERAGES, NAMELY, FRUIT JUICES, IN
CLASS 32 (U.S. CLS. 45, 46 AND 48).

SN 77-259,768, FILED 8-20-2007.

FIRST USE 4-0-2008; IN COMMERCE 4-0-2008.

BENJAMIN ALLEN, EXAMINING ATTORNEY

Int. Cl.: 5

Prior U.S. Cls.: 6, 18, 44, 46, 51, and 52

United States Patent and Trademark Office

Reg. No. 3,577,225

Registered Feb. 17, 2009

**TRADEMARK
PRINCIPAL REGISTER**



TRUE VALUE COMPANY (DELAWARE COR-
PORATION)
8600 WEST BRYN MAWR AVENUE
CHICAGO, IL 606313505

FIRST USE 10-0-2007; IN COMMERCE 10-0-2007.

SN 77-259,837, FILED 8-20-2007.

FOR: INSECT REPELLENTS IN THE NATURE OF
CITRONELLA SOLD IN DECORATIVE CONTAIN-
ERS, LANTERNS AND TORCHES, IN CLASS 5 (U.S.
CLS. 6, 18, 44, 46, 51 AND 52).

AISHA SALEM, EXAMINING ATTORNEY

Int. Cl.: 19

Prior U.S. Cls.: 1, 12, 33, and 50

United States Patent and Trademark Office

Reg. No. 3,577,226

Registered Feb. 17, 2009

**TRADEMARK
PRINCIPAL REGISTER**

INLIGHTEN

W. L. GORE & ASSOCIATES, INC. (DELAWARE
CORPORATION)
555 PAPER MILL ROAD, P. O. BOX 9329
NEWARK, DE 19714

THE MARK CONSISTS OF STANDARD CHAR-
ACTERS WITHOUT CLAIM TO ANY PARTICULAR
FONT, STYLE, SIZE, OR COLOR.

FOR: INSECT SCREENS NOT OF METAL; NON-
METAL WINDOW SCREENS; NON-METAL DOORS,
IN CLASS 19 (U.S. CLS. 1, 12, 33 AND 50).

SN 77-260,203, FILED 8-21-2007.

FIRST USE 3-1-2007; IN COMMERCE 3-1-2007.

ALICE BENMAMAN, EXAMINING ATTORNEY

Int. Cl.: 28

Prior U.S. Cls.: 22, 23, 38, and 50

United States Patent and Trademark Office

Reg. No. 3,577,227

Registered Feb. 17, 2009

**TRADEMARK
PRINCIPAL REGISTER**

SPIRIT BUDDY

BARNARD, MARTIN (SOUTH AFRICA INDIVIDUAL)
9 SAUNDERS CLOSE
FISH HOEK 7975, SOUTH AFRICA

FOR: GAMES AND PLAYTHINGS FOR RELIGIOUS PURPOSES, NAMELY, BOARD GAMES AND EDUCATIONAL BOARD GAMES, IN CLASS 28 (U.S. CLS. 22, 23, 38 AND 50).

FIRST USE 8-0-2006; IN COMMERCE 8-0-2006.

THE MARK CONSISTS OF STANDARD CHARACTERS WITHOUT CLAIM TO ANY PARTICULAR FONT, STYLE, SIZE, OR COLOR.

SN 77-260,306, FILED 8-21-2007.

SETH A. RAPPAPORT, EXAMINING ATTORNEY

Int. Cls.: 9, 38, and 42

Prior U.S. Cls.: 21, 23, 26, 36, 38, 100, 101, and 104

United States Patent and Trademark Office

Reg. No. 3,577,228

Registered Feb. 17, 2009

**TRADEMARK
SERVICE MARK
PRINCIPAL REGISTER**

MEDIA FUSION

PACKETVIDEO CORPORATION (DELAWARE CORPORATION)
SUITE 210
10350 SCIENCE CENTER DR.
SAN DIEGO, CA 223131451

FOR: CONSUMER ELECTRONICS DEVICES FOR ORGANIZING, SERVING, RECEIVING, TRANSMITTING, MANIPULATING, AND REVIEWING TEXT, DATA, AND MEDIA FILES, NAMELY, MOBILE PHONES, COMPUTER HARDWARE IN THE NATURE OF MEDIA SERVERS, PERSONAL COMPUTERS AND MEDIA PLAYERS; COMPUTER SOFTWARE FOR USE IN ORGANIZING, SERVING, RECEIVING, TRANSMITTING, MANIPULATING, AND REVIEWING TEXT, DATA, AND MEDIA FILES ON CONSUMER ELECTRONIC DEVICES, IN CLASS 9 (U.S. CLS. 21, 23, 26, 36 AND 38).

FIRST USE 8-16-2007; IN COMMERCE 10-19-2007.

FOR: COMMUNICATION SERVICES IN THE NATURE OF ELECTRONIC TRANSMISSION OF TEXT, DATA AND AUDIOVISUAL CONTENT; TRANSMISSION OF AUDIO AND VIDEO MATERIAL ON THE INTERNET, IN CLASS 38 (U.S. CLS. 100, 101 AND 104).

FIRST USE 8-16-2007; IN COMMERCE 10-19-2007.

FOR: APPLICATION SERVICE PROVIDER, NAMELY, PROVIDING, HOSTING, MANAGING, DEVELOPING, AND MAINTAINING CONSUMER APPLICATIONS, SOFTWARE, WEBSITES AND GUIDES IN THE NATURE OF DATABASES IN THE FIELDS OF MEDIA, INFORMATION AND ENTERTAINMENT ACCESS ON CONSUMER ELECTRONICS DEVICES SUCH AS MOBILE PHONES, MEDIA SERVERS, PERSONAL COMPUTERS AND MEDIA PLAYERS, IN CLASS 42 (U.S. CLS. 100 AND 101).

FIRST USE 8-16-2007; IN COMMERCE 10-19-2007.

THE MARK CONSISTS OF STANDARD CHARACTERS WITHOUT CLAIM TO ANY PARTICULAR FONT, STYLE, SIZE, OR COLOR.

NO CLAIM IS MADE TO THE EXCLUSIVE RIGHT TO USE "MEDIA", APART FROM THE MARK AS SHOWN.

SN 77-260,691, FILED 8-21-2007.

RICHARD WHITE, EXAMINING ATTORNEY

Int. Cl.: 11

Prior U.S. Cls.: 13, 21, 23, 31, and 34

United States Patent and Trademark Office

Reg. No. 3,577,229

Registered Feb. 17, 2009

**TRADEMARK
PRINCIPAL REGISTER**

OILCARE

FRONTLINE INTERNATIONAL, INC. (NEVADA CORPORATION)
95 16TH STREET, S.W.
BARBERTON, OH 44203

FOR: WASTE AND FRESH COOKING OIL COLLECTION AND MAINTENANCE EQUIPMENT, NAMELY, CONTAINMENT TANKS AND FILTRATION UNITS AND PORTABLE PUMPING CADDIES, FOR FILTERING WASTE COOKING OIL, FOR COMMERCIAL KITCHEN ESTABLISHMENTS, IN CLASS 11 (U.S. CLS. 13, 21, 23, 31 AND 34).

FIRST USE 5-30-2008; IN COMMERCE 5-30-2008.

THE MARK CONSISTS OF STANDARD CHARACTERS WITHOUT CLAIM TO ANY PARTICULAR FONT, STYLE, SIZE, OR COLOR.

SN 77-260,715, FILED 8-21-2007.

DEIRDRE ROBERTSON, EXAMINING ATTORNEY

Int. Cl.: 21

Prior U.S. Cls.: 2, 13, 23, 29, 30, 33, 40, and 50

United States Patent and Trademark Office

Reg. No. 3,577,230

Registered Feb. 17, 2009

TRADEMARK
PRINCIPAL REGISTER



PIZZERIA UNO CORPORATION (DELAWARE CORPORATION)
1209 ORANGE STREET
WILMINGTON, DE 19801

FOR: PIZZA PANS AND HOUSEHOLD UTENSILS, NAMELY, SPATULAS, IN CLASS 21 (U.S. CLS. 2, 13, 23, 29, 30, 33, 40 AND 50).

FIRST USE 7-31-2008; IN COMMERCE 7-31-2008.

OWNER OF U.S. REG. NOS. 3,231,293, 3,263,050, AND OTHERS.

NO CLAIM IS MADE TO THE EXCLUSIVE RIGHT TO USE "CHICAGO GRILL" AND "EST. 1943", APART FROM THE MARK AS SHOWN.

THE COLOR(S) RED, YELLOW, BLACK, GRAY, AND WHITE IS/ARE CLAIMED AS A FEATURE OF THE MARK.

THE MARK CONSISTS OF THE WORD "UNO" IN RED, OUTLINED IN YELLOW, THEN WHITE, BLACK AND GRAY, AND IS LOCATED ABOVE THE WORDS "CHICAGO GRILL", WHICH ARE IN WHITE ON A BLACK BACKGROUND. THERE IS A HORIZONTAL WHITE LINE ABOVE AND BELOW THE WORDS "CHICAGO GRILL" AND A SERIES OF SHORT HORIZONTAL BARS ON EACH SIDE OF THE WORDS. PORTIONS OF THE WORDS "CHICAGO GRILL" AND OF THE HORIZONTAL LINES AND BARS HAVE GRAY SHADING. THE WORDS "EST. 1943" ARE IN BLACK.

THE ENGLISH TRANSLATION OF THE WORD "UNO" IN THE MARK IS ONE.

SN 77-261,363, FILED 8-22-2007.

COLLEEN DOMBROW, EXAMINING ATTORNEY

Int. Cl.: 37

Prior U.S. Cls.: 100, 103, and 106

United States Patent and Trademark Office

Reg. No. 3,577,231

Registered Feb. 17, 2009

**SERVICE MARK
PRINCIPAL REGISTER**

RAUL WALTERS COMPANIES

RAUL J. WALTERS REVOCABLE LIVING TRUST
(MISSOURI TRUST)
1021 ASHLAND ROAD, #601
COLUMBIA, MO 65203

FOR: REAL ESTATE DEVELOPMENT, IN CLASS
37 (U.S. CLS. 100, 103 AND 106).

FIRST USE 2-0-2008; IN COMMERCE 2-0-2008.

THE MARK CONSISTS OF STANDARD CHAR-
ACTERS WITHOUT CLAIM TO ANY PARTICULAR
FONT, STYLE, SIZE, OR COLOR.

NO CLAIM IS MADE TO THE EXCLUSIVE
RIGHT TO USE "COMPANIES", APART FROM
THE MARK AS SHOWN.

THE NAME "RAUL WALTERS" IDENTIFIES A
LIVING INDIVIDUAL WHOSE CONSENT IS OF
RECORD.

SN 77-261,409, FILED 8-22-2007.

BENJAMIN OKEKE, EXAMINING ATTORNEY

Int. Cl.: 31

Prior U.S. Cls.: 1 and 46

United States Patent and Trademark Office

Reg. No. 3,577,232

Registered Feb. 17, 2009

**TRADEMARK
PRINCIPAL REGISTER**

THE GREEN SOLUTION

DLF INTERNATIONAL SEEDS, INC. (OREGON
CORPORATION)
PO BOX 229
HALSEY, OR 97348

THE MARK CONSISTS OF STANDARD CHAR-
ACTERS WITHOUT CLAIM TO ANY PARTICULAR
FONT, STYLE, SIZE, OR COLOR.

FOR: GRASS SEED, IN CLASS 31 (U.S. CLS. 1 AND
46).

SN 77-261,558, FILED 8-22-2007.

FIRST USE 9-18-2008; IN COMMERCE 9-18-2008.

MATTHEW EINSTEIN, EXAMINING ATTORNEY

Int. Cl.: 25

Prior U.S. Cls.: 22 and 39

United States Patent and Trademark Office

Reg. No. 3,577,233

Registered Feb. 17, 2009

TRADEMARK
PRINCIPAL REGISTER



CPW SPORTSWEAR, INC. (NEW YORK CORPORATION)
234 WEST 39TH STREET, 9TH FLOOR
NEW YORK, NY 10018

FOR: WOMEN APPAREL, NAMELY, PANTS, JACKETS, SWEATERS, KNIT TOPS AND DRESSES, IN CLASS 25 (U.S. CLS. 22 AND 39).

FIRST USE 11-0-2006; IN COMMERCE 11-0-2006.

THE COLOR(S) GRAY AND BLACK IS/ARE CLAIMED AS A FEATURE OF THE MARK.

THE MARK CONSISTS OF A STYLIZED VERSION OF TREE BRANCHES WITH THE LETTERS "TWG" BELOW; THE COLOR GRAY APPEARS IN THE BRANCHES LOCATED IN THE BACKGROUND OF THE DESIGN; THE COLOR BLACK APPEARS IN THE BRANCHES LOCATED IN THE FORWARD PART OF THE DESIGN AND IN THE LETTERING "TWG".

SN 77-261,691, FILED 8-22-2007.

RAUL CORDOVA, EXAMINING ATTORNEY

Int. Cl.: 3

Prior U.S. Cls.: 1, 4, 6, 50, 51, and 52

United States Patent and Trademark Office

Reg. No. 3,577,234

Registered Feb. 17, 2009

**TRADEMARK
PRINCIPAL REGISTER**

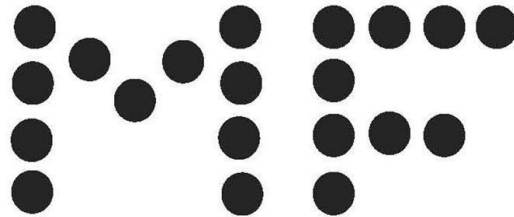

NOXELL CORPORATION (MARYLAND CORPORATION)
11050 YORK ROAD
HUNT VALLEY, MD 210302098

FOR: COSMETICS, IN CLASS 3 (U.S. CLS. 1, 4, 6, 50, 51 AND 52).

FIRST USE 6-9-2008; IN COMMERCE 6-9-2008.

OWNER OF U.S. REG. NOS. 1,373,314 AND 1,795,544.

THE MARK CONSISTS OF A STYLIZED VERSION OF THE LETTERS "M" AND "F".

SN 77-261,780, FILED 8-22-2007.

TIMOTHY FINNEGAN, EXAMINING ATTORNEY

Int. Cl.: 25

Prior U.S. Cls.: 22 and 39

United States Patent and Trademark Office

Reg. No. 3,577,235

Registered Feb. 17, 2009

**TRADEMARK
PRINCIPAL REGISTER**

Stay Sweet

SALAD BOWL LLC (COLORADO LIMITED LIABILITY COMPANY), DBA STAY SWEET,
11 VOYAGE STREET
MARINA DEL REY, CA 902927127

FOR: CAMP SHIRTS; DRESS SHIRTS; GOLF SHIRTS; KNIT SHIRTS; LONG-SLEEVED SHIRTS; NIGHT SHIRTS; OPEN-NECKED SHIRTS; PIQUE SHIRTS; POLO SHIRTS; SHIRT FRONTS; SHIRTS; SHORT-SLEEVED OR LONG-SLEEVED T-SHIRTS; SHORT-SLEEVED SHIRTS; SLEEP SHIRTS; SPORT SHIRTS; SPORTS SHIRTS; SPORTS SHIRTS WITH SHORT SLEEVES; SWEAT SHIRTS; T-SHIRTS; TEE

SHIRTS; YOGA SHIRTS, IN CLASS 25 (U.S. CLS. 22 AND 39).

FIRST USE 1-14-2008; IN COMMERCE 5-16-2008.

THE MARK CONSISTS OF STANDARD CHARACTERS WITHOUT CLAIM TO ANY PARTICULAR FONT, STYLE, SIZE, OR COLOR.

SN 77-261,957, FILED 8-22-2007.

MICHAEL GAAFAR, EXAMINING ATTORNEY

Int. Cls.: 9 and 45

Prior U.S. Cls.: 21, 23, 26, 36, 38, 100, and 101

United States Patent and Trademark Office

Reg. No. 3,577,236

Registered Feb. 17, 2009

**TRADEMARK
SERVICE MARK
PRINCIPAL REGISTER**

ASPEN

ASPEN TECHNOLOGY, INC. (DELAWARE CORPORATION)
200 WHEELER ROAD
BURLINGTON, MA 01803

FOR: HOUSE MARK FOR LINE OF COMPUTER SOFTWARE FOR PROCESS SIMULATION AND MODELING, ENGINEERING, MANUFACTURING AND SUPPLY CHAIN MANAGEMENT, IN CLASS 9 (U.S. CLS. 21, 23, 26, 36 AND 38).

FIRST USE 2-6-2000; IN COMMERCE 2-6-2000.

FOR: HOUSE MARK FOR SERVICES OF LICENSING OF COMPUTER SOFTWARE FOR PROCESS SIMULATION AND MODELING, ENGINEERING,

MANUFACTURING AND SUPPLY CHAIN MANAGEMENT, IN CLASS 45 (U.S. CLS. 100 AND 101).

FIRST USE 2-6-2000; IN COMMERCE 2-6-2000.

THE MARK CONSISTS OF STANDARD CHARACTERS WITHOUT CLAIM TO ANY PARTICULAR FONT, STYLE, SIZE, OR COLOR.

OWNER OF U.S. REG. NOS. 1,990,699, 2,190,267, AND 2,498,644.

SN 77-262,595, FILED 8-23-2007.

ROSELLE HERRERA, EXAMINING ATTORNEY

Int. Cls.: 30 and 43

Prior U.S. Cls.: 46, 100, and 101

United States Patent and Trademark Office

Reg. No. 3,577,237

Registered Feb. 17, 2009

**TRADEMARK
SERVICE MARK
PRINCIPAL REGISTER**

ART OF MUSTARD

SCHUSSLER CREATIVE, INC. (MINNESOTA CORPORATION)
858 DECATUR AVENUE NORTH
GOLDEN VALLEY, MN 55427

FOR: MUSTARDS AND DIPPING SAUCES, IN CLASS 30 (U.S. CL. 46).

FIRST USE 12-10-2008; IN COMMERCE 12-10-2008.

FOR: RESTAURANT SERVICES FOR CONSUMPTION ON THE PREMISES, IN CLASS 43 (U.S. CLS. 100 AND 101).

FIRST USE 8-13-2008; IN COMMERCE 8-13-2008.

THE MARK CONSISTS OF STANDARD CHARACTERS WITHOUT CLAIM TO ANY PARTICULAR FONT, STYLE, SIZE, OR COLOR.

NO CLAIM IS MADE TO THE EXCLUSIVE RIGHT TO USE "MUSTARD", APART FROM THE MARK AS SHOWN.

SN 77-262,782, FILED 8-23-2007.

SETH A. RAPPAPORT, EXAMINING ATTORNEY

Int. Cls.: 25 and 41

Prior U.S. Cls.: 22, 39, 100, 101, and 107

United States Patent and Trademark Office

Reg. No. 3,577,238

Registered Feb. 17, 2009

**TRADEMARK
SERVICE MARK
PRINCIPAL REGISTER**

CRUD

DOMBROSKI, MARK (UNITED STATES INDIVIDUAL)
21651 EDMUNTON
SAINT CLAIR SHORES, MI 48080

FOR: HATS; JACKETS; PANTS; SHORTS; T-SHIRTS, IN CLASS 25 (U.S. CLS. 22 AND 39).

FIRST USE 1-1-1999; IN COMMERCE 10-31-2008.

FOR: ENTERTAINMENT, NAMELY, LIVE PERFORMANCES BY A MUSICAL BAND, IN CLASS 41 (U.S. CLS. 100, 101 AND 107).

FIRST USE 3-1-2000; IN COMMERCE 3-1-2000.

THE MARK CONSISTS OF STANDARD CHARACTERS WITHOUT CLAIM TO ANY PARTICULAR FONT, STYLE, SIZE, OR COLOR.

SN 77-263,633, FILED 8-24-2007.

SALLY SHIH, EXAMINING ATTORNEY

Int. Cl.: 16

Prior U.S. Cls.: 2, 5, 22, 23, 29, 37, 38, and 50

Reg. No. 3,577,239

United States Patent and Trademark Office

Registered Feb. 17, 2009

**TRADEMARK
PRINCIPAL REGISTER**

Flor Blanca

WANIGU, LLC (TEXAS LIMITED LIABILITY COMPANY), DBA MARKET GROUP,
8506 DISCUS DRIVE
HUMBLE, TX 77346

THE MARK CONSISTS OF STANDARD CHARACTERS WITHOUT CLAIM TO ANY PARTICULAR FONT, STYLE, SIZE, OR COLOR.

FOR: TOILETTE PAPER; KITCHEN PAPER TOWEL; PAPER NAPKINS; PAPER TISSUES; FACIAL TISSUES; TOILETTE TISSUES; DISPOSABLE TOWELS COMPRISED PRIMARILY OF PAPER; DISPOSABLE DIAPERS, IN CLASS 16 (U.S. CLS. 2, 5, 22, 23, 29, 37, 38 AND 50).

THE FOREIGN WORDING IN THE MARK TRANSLATES INTO ENGLISH AS WHITE FLOWER.

SN 77-264,109, FILED 8-24-2007.

FIRST USE 4-30-2008; IN COMMERCE 4-30-2008.

JASON BLAIR, EXAMINING ATTORNEY

Int. Cl.: 36

Prior U.S. Cls.: 100, 101, and 102

United States Patent and Trademark Office

Reg. No. 3,577,240

Registered Feb. 17, 2009

**SERVICE MARK
PRINCIPAL REGISTER**

**NEW TRADITIONS NATIONAL
BANK**

NEW TRADITIONS NATIONAL BANK (UNITED
STATES INDIVIDUAL)
600 WILKINSON STREET
SUITE 100
ORLANDO, FL 32803

FOR: BANKING SERVICES, IN CLASS 36 (U.S.
CLS. 100, 101 AND 102).

FIRST USE 8-25-2008; IN COMMERCE 8-25-2008.

THE MARK CONSISTS OF STANDARD CHAR-
ACTERS WITHOUT CLAIM TO ANY PARTICULAR
FONT, STYLE, SIZE, OR COLOR.

NO CLAIM IS MADE TO THE EXCLUSIVE
RIGHT TO USE "NATIONAL BANK", APART
FROM THE MARK AS SHOWN.

SN 77-265,321, FILED 8-27-2007.

JULIE GUTTADAURO, EXAMINING ATTORNEY

Int. Cl.: 20

Prior U.S. Cls.: 2, 13, 22, 25, 32, and 50

United States Patent and Trademark Office

Reg. No. 3,577,241

Registered Feb. 17, 2009

**TRADEMARK
PRINCIPAL REGISTER**

RIBBON ROD

A TOUCH OF CLASS, LLC (ILLINOIS LIMITED
LIABILITY COMPANY)
401 MAIN STREET
CARTERVILLE, IL 62918

FOR: DRAPERY HARDWARE, NAMELY, VA-
LANCE RODS, CURTAIN RODS, CURTAIN ROD
HOOKS, CURTAIN ROD CONNECTORS, AND FI-
NIALS, IN CLASS 20 (U.S. CLS. 2, 13, 22, 25, 32 AND
50).

FIRST USE 7-3-2007; IN COMMERCE 7-3-2007.

THE MARK CONSISTS OF STANDARD CHAR-
ACTERS WITHOUT CLAIM TO ANY PARTICULAR
FONT, STYLE, SIZE, OR COLOR.

NO CLAIM IS MADE TO THE EXCLUSIVE
RIGHT TO USE "ROD", APART FROM THE MARK
AS SHOWN.

SN 77-265,462, FILED 8-27-2007.

DAVID MURRAY, EXAMINING ATTORNEY

Int. Cl.: 41

Prior U.S. Cls.: 100, 101, and 107

United States Patent and Trademark Office

Reg. No. 3,577,242

Registered Feb. 17, 2009

**SERVICE MARK
PRINCIPAL REGISTER**

**IF YOU THINK YOU'VE SEEN
IT ALL...THINK AGAIN**

VEST, HOLLIE D. (UNITED STATES INDIVIDUAL)
P. O. BOX 33219
LAS VEGAS, NV 89133

THE MARK CONSISTS OF STANDARD CHARACTERS WITHOUT CLAIM TO ANY PARTICULAR FONT, STYLE, SIZE, OR COLOR.

FOR: PRODUCING LIVE STAGE SHOWS FEATURING MUSIC, ILLUSIONS, AND COMEDY, IN CLASS 41 (U.S. CLS. 100, 101 AND 107).

SN 77-265,486, FILED 8-27-2007.

FIRST USE 9-13-2007; IN COMMERCE 9-13-2007.

AMY HELLA, EXAMINING ATTORNEY

Int. Cls.: 20 and 35

Prior U.S. Cls.: 2, 13, 22, 25, 32, 50, 100, 101, and 102

United States Patent and Trademark Office

Reg. No. 3,577,243

Registered Feb. 17, 2009

**TRADEMARK
SERVICE MARK
PRINCIPAL REGISTER**

Design Changes Everything

DMI MANAGEMENT, INC. (KENTUCKY CORPORATION)
9780 ORMSBY STATION ROAD
SUITE 200
LOUISVILLE, KY 40223

FOR: COMMERCIAL OFFICE FURNITURE AND RESIDENTIAL FURNITURE, IN CLASS 20 (U.S. CLS. 2, 13, 22, 25, 32 AND 50).

FIRST USE 12-1-2007; IN COMMERCE 12-1-2007.

FOR: RETAIL STORE SERVICES FEATURING COMMERCIAL OFFICE FURNITURE AND RESIDENTIAL FURNITURE; WHOLESALE STORE SERVICES FEATURING COMMERCIAL OFFICE

FURNITURE AND RESIDENTIAL FURNITURE; DISTRIBUTORSHIP SERVICES IN THE FIELD OF COMMERCIAL OFFICE FURNITURE AND RESIDENTIAL FURNITURE, IN CLASS 35 (U.S. CLS. 100, 101 AND 102).

FIRST USE 12-1-2007; IN COMMERCE 12-1-2007.

THE MARK CONSISTS OF STANDARD CHARACTERS WITHOUT CLAIM TO ANY PARTICULAR FONT, STYLE, SIZE, OR COLOR.

SN 77-266,264, FILED 8-28-2007.

ALICE BENMAMAN, EXAMINING ATTORNEY

Int. Cl.: 19

Prior U.S. Cls.: 1, 12, 33, and 50

United States Patent and Trademark Office

Reg. No. 3,577,244

Registered Feb. 17, 2009

**TRADEMARK
PRINCIPAL REGISTER**

CHESAPEAKE HUE

VINCI STONE, INC. (MARYLAND CORPORATION)
798 MARRIOTSVILLE ROAD
MARRIOTTSVILLE, MD 21104

FOR: NATURAL STONE VENEER FOR FACADES FOR BUILDINGS AND WALLS, BUILDING STONE, WALL STONE, TOMBSTONES MADE OF STONE, STONE FOR BUILDING AND CONSTRUCTION, MANTEL PIECES FOR FIREPLACES, MONUMENT STONE, PAVING STONE, BOULDERS, OUTDOOR DECORATIVE STONE, IN CLASS 19 (U.S. CLS. 1, 12, 33 AND 50).

FIRST USE 3-1-1950; IN COMMERCE 3-1-1950.

THE MARK CONSISTS OF STANDARD CHARACTERS WITHOUT CLAIM TO ANY PARTICULAR FONT, STYLE, SIZE, OR COLOR.

SN 77-266,268, FILED 8-28-2007.

STEVEN R. FINE, EXAMINING ATTORNEY

Int. Cl.: 35

Prior U.S. Cls.: 100, 101, and 102

United States Patent and Trademark Office

Reg. No. 3,577,245

Registered Feb. 17, 2009

**SERVICE MARK
PRINCIPAL REGISTER**

PERFECT DAY CLUB

PRATT, GRAHAM M. (UNITED STATES INDIVIDUAL)
101 MAPLE COURT
ATLANTIC BEACH, NC 28512

THE MARK CONSISTS OF STANDARD CHARACTERS WITHOUT CLAIM TO ANY PARTICULAR FONT, STYLE, SIZE, OR COLOR.

FOR: ON-LINE RETAIL STORE SERVICES FEATURING GIFT PACKAGES, IN CLASS 35 (U.S. CLS. 100, 101 AND 102).

SN 77-266,313, FILED 8-28-2007.

FIRST USE 11-5-2007; IN COMMERCE 11-5-2007.

RAUL CORDOVA, EXAMINING ATTORNEY

Int. Cl.: 3

Prior U.S. Cls.: 1, 4, 6, 50, 51, and 52

Reg. No. 3,577,246

United States Patent and Trademark Office

Registered Feb. 17, 2009

**TRADEMARK
PRINCIPAL REGISTER**

MY SECRET FORMULA

PHYSICIANS FORMULA, INC. (NEW YORK CORPORATION)
1055 WEST 8TH STREET
AZUSA, CA 91702

FOR: COSMETICS AND SKIN CARE PRODUCTS, NAMELY, CLEANSERS, MOISTURIZERS, CREAMS, LOTIONS AND MAKEUP REMOVERS, IN CLASS 3 (U.S. CLS. 1, 4, 6, 50, 51 AND 52).

FIRST USE 12-13-2007; IN COMMERCE 12-13-2007.

THE MARK CONSISTS OF STANDARD CHARACTERS WITHOUT CLAIM TO ANY PARTICULAR FONT, STYLE, SIZE, OR COLOR.

NO CLAIM IS MADE TO THE EXCLUSIVE RIGHT TO USE "SECRET FORMULA", APART FROM THE MARK AS SHOWN.

SN 77-266,593, FILED 8-28-2007.

KATHLEEN LORENZO, EXAMINING ATTORNEY

Int. Cl.: 20

Prior U.S. Cls.: 2, 13, 22, 25, 32, and 50

Reg. No. 3,577,247

United States Patent and Trademark Office

Registered Feb. 17, 2009

**TRADEMARK
PRINCIPAL REGISTER**

VISCO BABY

FACTORY DIRECT, INC., (OKLAHOMA CORPORATION)
219 S. PORTLAND
OKLAHOMA CITY, OK 73108

THE MARK CONSISTS OF STANDARD CHARACTERS WITHOUT CLAIM TO ANY PARTICULAR FONT, STYLE, SIZE, OR COLOR.

FOR: SLEEP PRODUCTS, NAMELY, MATTRESSES, SPRING MATTRESSES, BOX SPRINGS AND MATTRESS FOUNDATIONS, IN CLASS 20 (U.S. CLS. 2, 13, 22, 25, 32 AND 50).

SN 77-267,188, FILED 8-29-2007.

FIRST USE 1-20-2008; IN COMMERCE 1-20-2008.

CARYN GLASSER, EXAMINING ATTORNEY

Int. Cl.: 33

Prior U.S. Cls.: 47 and 49

United States Patent and Trademark Office

Reg. No. 3,577,248

Registered Feb. 17, 2009

**TRADEMARK
PRINCIPAL REGISTER**

TIZ RED

JACKSON FAMILY FARMS, LLC (CALIFORNIA
LIMITED LIABILITY COMPANY)
421 AVIATION BOULEVARD
SANTA ROSA, CA 95403

NO CLAIM IS MADE TO THE EXCLUSIVE
RIGHT TO USE "RED", APART FROM THE MARK
AS SHOWN.

FOR: WINE, IN CLASS 33 (U.S. CLS. 47 AND 49).

FIRST USE 11-1-2007; IN COMMERCE 11-1-2007.

SN 77-267,386, FILED 8-29-2007.

THE MARK CONSISTS OF STANDARD CHAR-
ACTERS WITHOUT CLAIM TO ANY PARTICULAR
FONT, STYLE, SIZE, OR COLOR.

NAPOLEON SHARMA, EXAMINING ATTORNEY

Int. Cl.: 41

Prior U.S. Cls.: 100, 101, and 107

United States Patent and Trademark Office

Reg. No. 3,577,249

Registered Feb. 17, 2009

**SERVICE MARK
PRINCIPAL REGISTER**

PHOTOCRYPTIC

GIFFORD, LEE STODDARD (UNITED STATES
INDIVIDUAL)
1020 ROCK ROSE LANE
LOMPOC, CA 93436

FOR: PHOTOGRAPHY SERVICES; PORTRAIT
PHOTOGRAPHY; ON-LINE LIBRARY SERVICES,
NAMELY, PROVIDING ELECTRONIC LIBRARY
SERVICES WHICH FEATURE NEWSPAPERS, MA-
GAZINES, PHOTOGRAPHS AND PICTURES VIA
AN ON-LINE COMPUTER NETWORK; PHOTO-
GRAPHIC AND VIDEO SERVICES, NAMELY, PHO-

TOGRAPHIC AND VIDEO CAPTURE, IN CLASS 41
(U.S. CLS. 100, 101 AND 107).

FIRST USE 6-10-2008; IN COMMERCE 6-10-2008.

THE MARK CONSISTS OF STANDARD CHAR-
ACTERS WITHOUT CLAIM TO ANY PARTICULAR
FONT, STYLE, SIZE, OR COLOR.

SN 77-267,674, FILED 8-29-2007.

RAMONA ORTIGA, EXAMINING ATTORNEY

Int. Cl.: 30

Prior U.S. Cl.: 46

United States Patent and Trademark Office

Reg. No. 3,577,250

Registered Feb. 17, 2009

**TRADEMARK
PRINCIPAL REGISTER**

DAIJYOBU

ANHING CORPORATION (CALIFORNIA CORPORATION)
418 NORTH AVENUE 19
LOS ANGELES, CA 90031

FOR: RICE CRACKERS; CANDY; SNACK FOODS, NAMELY, RICE-BASED SNACK FOODS, WHEAT-BASED SNACK FOODS, AND CORN-BASED SNACK FOODS, IN CLASS 30 (U.S. CL. 46).

FIRST USE 8-1-2008; IN COMMERCE 8-1-2008.

THE MARK CONSISTS OF STANDARD CHARACTERS WITHOUT CLAIM TO ANY PARTICULAR FONT, STYLE, SIZE, OR COLOR.

THE ENGLISH TRANSLATION OF THE WORD "DAIJYOBU" IN THE MARK IS SAFE; SECURE; FREE FROM DANGER.

SN 77-267,691, FILED 8-29-2007.

ZACHARY BELLO, EXAMINING ATTORNEY

Int. Cl.: 9

Prior U.S. Cls.: 21, 23, 26, 36, and 38

United States Patent and Trademark Office

Reg. No. 3,577,251

Registered Feb. 17, 2009

**TRADEMARK
PRINCIPAL REGISTER**

NEMESIS

EMERY, DAVID (UNITED STATES INDIVIDUAL)
424 CLEMENT AVENUE
CHARLOTTE, NC 282042328

THE MARK CONSISTS OF STANDARD CHARACTERS WITHOUT CLAIM TO ANY PARTICULAR FONT, STYLE, SIZE, OR COLOR.

FOR: ELECTRONIC METAL DETECTORS, IN CLASS 9 (U.S. CLS. 21, 23, 26, 36 AND 38).

SN 77-267,903, FILED 8-30-2007.

FIRST USE 11-13-2008; IN COMMERCE 11-13-2008.

ALLISON SCHRODY, EXAMINING ATTORNEY

Int. Cl.: 9

Prior U.S. Cls.: 21, 23, 26, 36, and 38

United States Patent and Trademark Office

Reg. No. 3,577,252

Registered Feb. 17, 2009

**TRADEMARK
PRINCIPAL REGISTER**

GOLD RIVER CANYON

VIDEO GAMING TECHNOLOGIES, INC. (TEN-
NESSEE CORPORATION)
155 FRANKLIN ROAD, SUITE 255
BRENTWOOD, TN 37027

FOR: COMPUTER SOFTWARE AND FIRMWARE
FOR GAMES OF CHANCE ON ANY COMPUTER-
IZED PLATFORM, INCLUDING DEDICATED
GAMING CONSOLES, VIDEO BASED SLOT MA-
CHINES, REEL BASED SLOT MACHINES, AND
VIDEO LOTTERY TERMINALS; GAMING DEVI-
CES, NAMELY, GAMING MACHINES, SLOT MA-
CHINES, BINGO MACHINES, WITH OR WITHOUT

VIDEO OUTPUT, IN CLASS 9 (U.S. CLS. 21, 23, 26, 36
AND 38).

FIRST USE 1-0-2008; IN COMMERCE 1-0-2008.

THE MARK CONSISTS OF STANDARD CHAR-
ACTERS WITHOUT CLAIM TO ANY PARTICULAR
FONT, STYLE, SIZE, OR COLOR.

SN 77-267,908, FILED 8-30-2007.

PAUL CROWLEY, EXAMINING ATTORNEY

Int. Cl.: 5

Prior U.S. Cls.: 6, 18, 44, 46, 51, and 52

United States Patent and Trademark Office

Reg. No. 3,577,253

Registered Feb. 17, 2009

**TRADEMARK
PRINCIPAL REGISTER**

NōzAmi

SAN FILIPPO, JOSEPH (UNITED STATES INDIVIDUAL)
708 FALCONGATE DR.
MONMOUTH JCT., NJ 08852

FOR: PHARMACEUTICAL PRODUCT IN THE FORM OF A NASAL SPRAY MADE FROM PLANT-DERIVED SESAME OIL, IN CLASS 5 (U.S. CLS. 6, 18, 44, 46, 51 AND 52).

FIRST USE 6-30-2008; IN COMMERCE 6-30-2008.

THE MARK CONSISTS OF STANDARD CHARACTERS WITHOUT CLAIM TO ANY PARTICULAR FONT, STYLE, SIZE, OR COLOR.

SN 77-268,553, FILED 8-30-2007.

KARANENDRA S. CHHINA, EXAMINING ATTORNEY

Int. Cl.: 30

Prior U.S. Cl.: 46

United States Patent and Trademark Office

Reg. No. 3,577,254

Registered Feb. 17, 2009

TRADEMARK
PRINCIPAL REGISTER



LENNY & LARRY'S, INC. (CALIFORNIA CORPORATION)
16157 MORRISON STREET
ENCINO, CA 91436

FOR: BAKERY GOODS, IN CLASS 30 (U.S. CL. 46).

FIRST USE 2-1-2007; IN COMMERCE 2-1-2007.

THE MARK CONSISTS OF THE BUSTS OF TWO MEN MAKING SILLY FACES WITH HAIR STANDING ON END AND THE WORDS "LENNY & LARRY'S" GOING THROUGH TOP OF HAIR.

SN 77-268,567, FILED 8-30-2007.

WILLIAM P. SHANAHAN, EXAMINING ATTORNEY

Int. Cl.: 33

Prior U.S. Cls.: 47 and 49

United States Patent and Trademark Office

Reg. No. 3,577,255

Registered Feb. 17, 2009

**TRADEMARK
PRINCIPAL REGISTER**

TRU

MODERN SPIRITS LLC (CALIFORNIA LIMITED
LIABILITY COMPANY)
168 W POMONA AVE
MONROVIA, CA 91016

THE MARK CONSISTS OF STANDARD CHAR-
ACTERS WITHOUT CLAIM TO ANY PARTICULAR
FONT, STYLE, SIZE, OR COLOR.

FOR: DISTILLED SPIRITS; DISTILLED SPIRITS
OF POTATO, IN CLASS 33 (U.S. CLS. 47 AND 49).

SN 77-269,140, FILED 8-31-2007.

FIRST USE 12-1-2007; IN COMMERCE 2-1-2008.

KATHERINE STOIDES, EXAMINING ATTORNEY

Int. Cl.: 37

Prior U.S. Cls.: 100, 103, and 106

United States Patent and Trademark Office

Reg. No. 3,577,256

Registered Feb. 17, 2009

**SERVICE MARK
PRINCIPAL REGISTER**

BROADWAY 3030

BROADWAY 3012 LLC (ILLINOIS LIMITED LIABILITY COMPANY)
2506 N. CLARK STREET, SUITE 288
CHICAGO, IL 60614

FOR: REAL ESTATE DEVELOPMENT OF RESIDENTIAL PROPERTY, IN CLASS 37 (U.S. CLS. 100, 103 AND 106).

FIRST USE 8-5-2008; IN COMMERCE 8-5-2008.

THE MARK CONSISTS OF STANDARD CHARACTERS WITHOUT CLAIM TO ANY PARTICULAR FONT, STYLE, SIZE, OR COLOR.

NO CLAIM IS MADE TO THE EXCLUSIVE RIGHT TO USE "BROADWAY", APART FROM THE MARK AS SHOWN.

SN 77-269,923, FILED 8-31-2007.

MARILYN IZZI, EXAMINING ATTORNEY

Int. Cl.: 3

Prior U.S. Cls.: 1, 4, 6, 50, 51, and 52

United States Patent and Trademark Office

Reg. No. 3,577,257

Registered Feb. 17, 2009

**TRADEMARK
PRINCIPAL REGISTER**

JOYBODY

GALLAGHER, JOSEPH (UNITED STATES INDIVIDUAL)
4324 HAWKSONG PLACE
CARY, NC 27518

THE MARK CONSISTS OF STANDARD CHARACTERS WITHOUT CLAIM TO ANY PARTICULAR FONT, STYLE, SIZE, OR COLOR.

FOR: SPA PRODUCTS, NAMELY, HAND-MILLED SOAPS AND BATH SALTS, IN CLASS 3 (U.S. CLS. 1, 4, 6, 50, 51 AND 52).

SN 77-270,453, FILED 9-3-2007.

FIRST USE 11-1-2008; IN COMMERCE 11-1-2008.

SOPHIA S. KIM, EXAMINING ATTORNEY

Int. Cl.: 39

Prior U.S. Cls.: 100 and 105

United States Patent and Trademark Office

Reg. No. 3,577,258

Registered Feb. 17, 2009

**SERVICE MARK
PRINCIPAL REGISTER**

MULTIWEIGHT

FEDERAL EXPRESS CORPORATION (DELA-
WARE CORPORATION)
3620 HACKS CROSS ROAD, BLDG B, 3RD FLOOR
MEMPHIS, TN 38125

FOR: SHIPPING AND DELIVERY SERVICES,
NAMELY, PICK-UP, TRANSPORTATION AND DE-
LIVERY OF PACKAGES AND LETTERS BY VAR-
IOUS MODES OF TRANSPORTATION , IN CLASS 39
(U.S. CLS. 100 AND 105).

FIRST USE 12-1-1989; IN COMMERCE 12-1-1989.

THE MARK CONSISTS OF STANDARD CHAR-
ACTERS WITHOUT CLAIM TO ANY PARTICULAR
FONT, STYLE, SIZE, OR COLOR.

OWNER OF U.S. REG. NO. 2,038,070.

SN 77-270,807, FILED 9-4-2007.

DAVID COLLIER, EXAMINING ATTORNEY

Int. Cl.: 39

Prior U.S. Cls.: 100 and 105

United States Patent and Trademark Office

Reg. No. 3,577,259

Registered Feb. 17, 2009

**SERVICE MARK
PRINCIPAL REGISTER**

MORE THAN OUR LOGO IS GREEN

ENTERPRISE RENT-A-CAR COMPANY (MISSOURI CORPORATION)
600 CORPORATE PARK DRIVE
ST. LOUIS, MO 63105

FOR: VEHICLE RENTAL AND LEASING SERVICES; AND RESERVATION SERVICES FOR THE RENTAL AND LEASING OF VEHICLES, NAMELY, RENTAL RESERVATIONS FOR AUTOMOBILES, TRUCKS, CARS, LAND VEHICLES, IN CLASS 39 (U.S. CLS. 100 AND 105).

FIRST USE 8-6-2007; IN COMMERCE 8-6-2007.

THE MARK CONSISTS OF STANDARD CHARACTERS WITHOUT CLAIM TO ANY PARTICULAR FONT, STYLE, SIZE, OR COLOR.

SN 77-271,014, FILED 9-4-2007.

THEODORE MCBRIDE, EXAMINING ATTORNEY

Int. Cl.: 33

Prior U.S. Cls.: 47 and 49

United States Patent and Trademark Office

Reg. No. 3,577,260

Registered Feb. 17, 2009

**TRADEMARK
PRINCIPAL REGISTER**

HARVEST GRAND

RYBEN SPIRITS, LLC (PENNSYLVANIA LIMITED LIABILITY COMPANY)
429 COVERED BRIDGE RD.
KING OF PRUSSIA, PA 19406

THE MARK CONSISTS OF STANDARD CHARACTERS WITHOUT CLAIM TO ANY PARTICULAR FONT, STYLE, SIZE, OR COLOR.

FOR: LIQUEURS, IN CLASS 33 (U.S. CLS. 47 AND 49).

SN 77-271,743, FILED 9-5-2007.

FIRST USE 8-25-2008; IN COMMERCE 9-9-2008.

DAVID COLLIER, EXAMINING ATTORNEY

Int. Cl.: 25

Prior U.S. Cls.: 22 and 39

United States Patent and Trademark Office

Reg. No. 3,577,261

Registered Feb. 17, 2009

**TRADEMARK
PRINCIPAL REGISTER**

COLOR AUTHORITY

M RUBIN & SONS, INC. (NEW YORK CORPORATION)
34-01 38TH AVENUE
LIC, NY 11101

FOR: HEADGEAR, NAMELY, HATS AND CAPS; OVERALLS, PANTS, SHIRTS, TOPS, SKIRTS, SHORTS, SWEATSHIRTS, JACKETS, UNDERWEAR, ROMPERS, SINGLETS, ROBES, COATS, GLOVES AND MITTENS, PAJAMAS, SLIPPERS, HEAD BANDS, SOCKS, SCARVES, FOOTWEAR, NECKWEAR, SLEEPWEAR AND SWIM WEAR, IN CLASS 25 (U.S. CLS. 22 AND 39).

FIRST USE 11-30-2008; IN COMMERCE 11-30-2008.

THE MARK CONSISTS OF STANDARD CHARACTERS WITHOUT CLAIM TO ANY PARTICULAR FONT, STYLE, SIZE, OR COLOR.

SN 77-271,835, FILED 9-5-2007.

GINA HAYES, EXAMINING ATTORNEY

Int. Cl.: 44

Prior U.S. Cls.: 100 and 101

United States Patent and Trademark Office

Reg. No. 3,577,262

Registered Feb. 17, 2009

SERVICE MARK
PRINCIPAL REGISTER

Urgent
CARE
at Heron Bay

Spalding Regional Medical Center

TENET HEALTHSYSTEM SPALDING, INC.
(GEORGIA CORPORATION)
13737 NOEL RD., STE. 100
DALLAS, TX 75240

FOR: HEALTH CARE, IN CLASS 44 (U.S. CLS. 100
AND 101).

FIRST USE 10-8-2007; IN COMMERCE 10-8-2007.

NO CLAIM IS MADE TO THE EXCLUSIVE
RIGHT TO USE "URGENT CARE AND SPALDING
REGIONAL MEDICAL CENTER", APART FROM
THE MARK AS SHOWN.

THE MARK CONSISTS OF THE WORDS "UR-
GENT CARE AT HERON BAY" WITH THE LETTER
"G" IN THE WORD "URGENT" AND THE LETTER
"R" IN THE WORD "CARE" CONNECTED ABOVE A
LINE AND DIRECTLY BELOW THE LINE THE
WORDS "SPALDING REGIONAL MEDICAL CEN-
TER".

SN 77-272,011, FILED 9-5-2007.

KAREN BRACEY, EXAMINING ATTORNEY

Int. Cl.: 44

Prior U.S. Cls.: 100 and 101

United States Patent and Trademark Office

Reg. No. 3,577,263

Registered Feb. 17, 2009

**SERVICE MARK
PRINCIPAL REGISTER**

BACK BAR

THERAPY SYSTEMS, INC. (TENNESSEE COR-
PORATION)
SUITE 202
4015 HILLSBORO PIKE
NASHVILLE, TN 37215

THE MARK CONSISTS OF STANDARD CHAR-
ACTERS WITHOUT CLAIM TO ANY PARTICULAR
FONT, STYLE, SIZE, OR COLOR.

FOR: HAIR SALON SERVICES, IN CLASS 44 (U.S.
CLS. 100 AND 101).

SN 77-272,174, FILED 9-5-2007.

FIRST USE 11-1-2007; IN COMMERCE 11-1-2007.

RONALD AIKENS, EXAMINING ATTORNEY

Int. Cl.: 6

Prior U.S. Cls.: 2, 12, 13, 14, 23, 25, and 50

Reg. No. 3,577,264

United States Patent and Trademark Office

Registered Feb. 17, 2009

**TRADEMARK
PRINCIPAL REGISTER**

COPPERPLUS

EMS ENGINEERED MATERIALS SOLUTIONS,
LLC (DELAWARE LIMITED LIABILITY COM-
PANY)
39 PERRY AVENUE
ATTLEBORO, MA 02703

FOR: COILS OF COPPER CLAD METAL FOR USE
IN MANUFACTURE OF FINISHED PRODUCTS;
SHEETS OF COPPER CLAD METAL FOR USE IN
MANUFACTURE OF FINISHED PRODUCTS, IN
CLASS 6 (U.S. CLS. 2, 12, 13, 14, 23, 25 AND 50).

FIRST USE 8-4-2008; IN COMMERCE 8-4-2008.

THE MARK CONSISTS OF STANDARD CHAR-
ACTERS WITHOUT CLAIM TO ANY PARTICULAR
FONT, STYLE, SIZE, OR COLOR.

SN 77-272,176, FILED 9-5-2007.

RONALD AIKENS, EXAMINING ATTORNEY

Int. Cl.: 45

Prior U.S. Cls.: 100 and 101

United States Patent and Trademark Office

Reg. No. 3,577,265

Registered Feb. 17, 2009

**SERVICE MARK
PRINCIPAL REGISTER**

NATIONAL HALL OF RECORDS

NATIONAL HALL OF RECORDS (OKLAHOMA
LIMITED LIABILITY COMPANY)
6737 SOUTH 85TH EAST AVENUE
TULSA, OK 74133

FOR: PROVIDING AN ON-LINE COMPUTER
DATABASE FEATURING DEATH NOTICES AND
OBITUARIES, IN CLASS 45 (U.S. CLS. 100 AND 101).

FIRST USE 10-18-2007; IN COMMERCE 10-18-2007.

THE MARK CONSISTS OF STANDARD CHAR-
ACTERS WITHOUT CLAIM TO ANY PARTICULAR
FONT, STYLE, SIZE, OR COLOR.

NO CLAIM IS MADE TO THE EXCLUSIVE
RIGHT TO USE "NATIONAL" AND "RECORDS",
APART FROM THE MARK AS SHOWN.

SN 77-272,196, FILED 9-5-2007.

NELSON SNYDER, EXAMINING ATTORNEY

Int. Cl.: 30

Prior U.S. Cl.: 46

United States Patent and Trademark Office

Reg. No. 3,577,266

Registered Feb. 17, 2009

**TRADEMARK
PRINCIPAL REGISTER**

FRESH BREATH TO GO

WEB CANDY, INC. (MINNESOTA CORPORATION)
15197 BOULDER AVENUE
ROSEMOUNT, MN 55068

FOR: BREATH FRESHENING CONFECTIONERY, NAMELY, BREATH MINTS, IN CLASS 30 (U.S. CL. 46).

FIRST USE 1-1-2008; IN COMMERCE 8-1-2008.

THE MARK CONSISTS OF STANDARD CHARACTERS WITHOUT CLAIM TO ANY PARTICULAR FONT, STYLE, SIZE, OR COLOR.

NO CLAIM IS MADE TO THE EXCLUSIVE RIGHT TO USE "FRESH BREATH", APART FROM THE MARK AS SHOWN.

SN 77-272,198, FILED 9-5-2007.

RONALD AIKENS, EXAMINING ATTORNEY

Int. Cl.: 3

Prior U.S. Cls.: 1, 4, 6, 50, 51, and 52

United States Patent and Trademark Office

Reg. No. 3,577,267

Registered Feb. 17, 2009

**TRADEMARK
PRINCIPAL REGISTER**

SIMPLY LEMON

THE CLOROX COMPANY (DELAWARE COR-
PORATION)

1221 BROADWAY

OAKLAND, CA 94612

FOR: DISHWASHING DETERGENTS, IN CLASS 3
(U.S. CLS. 1, 4, 6, 50, 51 AND 52).

FIRST USE 7-28-2008; IN COMMERCE 7-28-2008.

THE MARK CONSISTS OF STANDARD CHAR-
ACTERS WITHOUT CLAIM TO ANY PARTICULAR
FONT, STYLE, SIZE, OR COLOR.

NO CLAIM IS MADE TO THE EXCLUSIVE
RIGHT TO USE "LEMON", APART FROM THE
MARK AS SHOWN.

SN 77-272,508, FILED 9-5-2007.

SUSAN RICHARDS, EXAMINING ATTORNEY

Int. Cl.: 43

Prior U.S. Cls.: 100 and 101

United States Patent and Trademark Office

Reg. No. 3,577,268

Registered Feb. 17, 2009

**SERVICE MARK
PRINCIPAL REGISTER**

MOD PIZZA

MARKHAM, JAMES (UNITED STATES INDIVIDUAL)

2792 HIGHLAND DRIVE

CARLSBAD, CA 92008

FOR: BAR, RESTAURANT AND CATERING SERVICES, IN CLASS 43 (U.S. CLS. 100 AND 101).

FIRST USE 11-26-2008; IN COMMERCE 11-26-2008.

THE MARK CONSISTS OF STANDARD CHARACTERS WITHOUT CLAIM TO ANY PARTICULAR FONT, STYLE, SIZE, OR COLOR.

NO CLAIM IS MADE TO THE EXCLUSIVE RIGHT TO USE "PIZZA", APART FROM THE MARK AS SHOWN.

SN 77-272,959, FILED 9-6-2007.

WENDY GOODMAN, EXAMINING ATTORNEY

Int. Cl.: 29

Prior U.S. Cl.: 46

United States Patent and Trademark Office

Reg. No. 3,577,269

Registered Feb. 17, 2009

TRADEMARK
PRINCIPAL REGISTER



SEA PORT PRODUCTS CORPORATION (CALIFORNIA CORPORATION)
131 7TH AVENUE WEST
KIRKLAND, WA 98033

FOR: FROZEN SEAFOOD, IN CLASS 29 (U.S. CL. 46).

FIRST USE 1-0-2008; IN COMMERCE 1-0-2008.

THE COLOR(S) TEAL IS/ARE CLAIMED AS A FEATURE OF THE MARK.

THE MARK CONSISTS OF THE WORD "CNAMI", WITH LETTERING STYLIZED IN A WINDBLOWN LOOK, AND WITH THE "C" APPEARING AS AN OCEAN WAVE. THE COLOR TEAL APPEARS IN THE OUTLINE OF THE WORD "CNAMI". THE COLOR WHITE APPEARS ONLY AS BACKGROUND WITHIN THE OUTLINE OF THE LETTERS AND DESIGN IN THE TRADEMARK, AND WHITE IS NOT A PART OF THE TRADEMARK.

SN 77-272,960, FILED 9-6-2007.

WENDY GOODMAN, EXAMINING ATTORNEY

Int. Cl.: 9

Prior U.S. Cls.: 21, 23, 26, 36, and 38

United States Patent and Trademark Office

Reg. No. 3,577,270

Registered Feb. 17, 2009

**TRADEMARK
PRINCIPAL REGISTER**

NORSE WARRIOR

KONAMI AUSTRALIA PTY LTD (AUSTRALIA
AUSTRALIAN PRIVATE COMPANY)
28 LORD STREET
BOTANY, AUSTRALIA 2019

FOR: ELECTRONIC GAME PROGRAMS; GAMING EQUIPMENT, NAMELY, SLOT MACHINES WITH OR WITHOUT VIDEO OUTPUT; GAMING MACHINES; MACHINES FOR PLAYING GAMES OF CHANCE; SLOT MACHINES, IN CLASS 9 (U.S. CLS. 21, 23, 26, 36 AND 38).

FIRST USE 6-26-2007; IN COMMERCE 6-26-2007.

THE MARK CONSISTS OF STANDARD CHARACTERS WITHOUT CLAIM TO ANY PARTICULAR FONT, STYLE, SIZE, OR COLOR.

SN 77-273,736, FILED 9-7-2007.

JESSICA A. POWERS, EXAMINING ATTORNEY

Int. Cl.: 9

Prior U.S. Cls.: 21, 23, 26, 36, and 38

Reg. No. 3,577,271

United States Patent and Trademark Office

Registered Feb. 17, 2009

**TRADEMARK
PRINCIPAL REGISTER**

STAND & DELIVER

KONAMI AUSTRALIA PTY LTD (AUSTRALIA
AUSTRALIAN PRIVATE COMPANY)
28 LORD STREET
BOTANY, AUSTRALIA 2019

FOR: ELECTRONIC GAME PROGRAMS; GAMING EQUIPMENT, NAMELY, SLOT MACHINES WITH OR WITHOUT VIDEO OUTPUT; GAMING MACHINES; MACHINES FOR PLAYING GAMES OF CHANCE; SLOT MACHINES, IN CLASS 9 (U.S. CLS. 21, 23, 26, 36 AND 38).

FIRST USE 7-5-2007; IN COMMERCE 7-5-2007.

THE MARK CONSISTS OF STANDARD CHARACTERS WITHOUT CLAIM TO ANY PARTICULAR FONT, STYLE, SIZE, OR COLOR.

SN 77-273,738, FILED 9-7-2007.

JESSICA A. POWERS, EXAMINING ATTORNEY

Int. Cl.: 9

Prior U.S. Cls.: 21, 23, 26, 36, and 38

United States Patent and Trademark Office

Reg. No. 3,577,272

Registered Feb. 17, 2009

**TRADEMARK
PRINCIPAL REGISTER**

PIRATE'S ROSE

KONAMI AUSTRALIA PTY LTD (AUSTRALIA
AUSTRALIAN PRIVATE COMPANY)
28 LORD STREET
BOTANY, AUSTRALIA 2019

FOR: ELECTRONIC GAME PROGRAMS; GAMING EQUIPMENT, NAMELY, SLOT MACHINES WITH OR WITHOUT VIDEO OUTPUT; GAMING MACHINES; MACHINES FOR PLAYING GAMES OF CHANCE; SLOT MACHINES, IN CLASS 9 (U.S. CLS. 21, 23, 26, 36 AND 38).

FIRST USE 3-24-2008; IN COMMERCE 3-24-2008.

THE MARK CONSISTS OF STANDARD CHARACTERS WITHOUT CLAIM TO ANY PARTICULAR FONT, STYLE, SIZE, OR COLOR.

SN 77-273,739, FILED 9-7-2007.

JESSICA A. POWERS, EXAMINING ATTORNEY

Int. Cl.: 9

Prior U.S. Cls.: 21, 23, 26, 36, and 38

United States Patent and Trademark Office

Reg. No. 3,577,273

Registered Feb. 17, 2009

**TRADEMARK
PRINCIPAL REGISTER**

TIGER NIGHTS

KONAMI AUSTRALIA PTY LTD (AUSTRALIA
AUSTRALIAN PRIVATE COMPANY)
28 LORD STREET
BOTANY, AUSTRALIA 2019

FOR: ELECTRONIC GAME PROGRAMS; GAMING EQUIPMENT, NAMELY, SLOT MACHINES WITH OR WITHOUT VIDEO OUTPUT; GAMING MACHINES; MACHINES FOR PLAYING GAMES OF CHANCE; SLOT MACHINES, IN CLASS 9 (U.S. CLS. 21, 23, 26, 36 AND 38).

FIRST USE 7-25-2007; IN COMMERCE 7-25-2007.

THE MARK CONSISTS OF STANDARD CHARACTERS WITHOUT CLAIM TO ANY PARTICULAR FONT, STYLE, SIZE, OR COLOR.

SN 77-273,744, FILED 9-7-2007.

JESSICA A. POWERS, EXAMINING ATTORNEY

Int. Cl.: 25

Prior U.S. Cls.: 22 and 39

United States Patent and Trademark Office

Reg. No. 3,577,274

Registered Feb. 17, 2009

**TRADEMARK
PRINCIPAL REGISTER**

TUFF-GEAR

FAIRFIELD LINE, INC. (IOWA CORPORATION)
605 W. STONE STREET, P.O. BOX 500
FAIRFIELD, IA 52556

THE MARK CONSISTS OF STANDARD CHAR-
ACTERS WITHOUT CLAIM TO ANY PARTICULAR
FONT, STYLE, SIZE, OR COLOR.

FOR: GLOVES, IN CLASS 25 (U.S. CLS. 22 AND 39).

SN 77-273,831, FILED 9-7-2007.

FIRST USE 10-1-2007; IN COMMERCE 10-1-2007.

SOPHIA S. KIM, EXAMINING ATTORNEY

Int. Cl.: 36

Prior U.S. Cls.: 100, 101, and 102

United States Patent and Trademark Office

Reg. No. 3,577,275

Registered Feb. 17, 2009

**SERVICE MARK
PRINCIPAL REGISTER**

AMC PINNACLE

SUNTRUST BANKS, INC. (GEORGIA CORPORATION)
MC FL/ORL 2034
200 S. ORANGE AVENUE
ORLANDO, FL 32801

FOR: PERSONAL FINANCIAL SERVICES, NAMELY, A FEE-BASED INVESTMENT ACCOUNT, FINANCIAL CONSULTATION AND INVESTMENT ACCOUNT PLANNING, IN CLASS 36 (U.S. CLS. 100, 101 AND 102).

FIRST USE 9-1-2007; IN COMMERCE 9-1-2007.

THE MARK CONSISTS OF STANDARD CHARACTERS WITHOUT CLAIM TO ANY PARTICULAR FONT, STYLE, SIZE, OR COLOR.

OWNER OF U.S. REG. NOS. 2,873,252, 3,178,360, AND OTHERS.

SN 77-274,244, FILED 9-7-2007.

SAIMA MAKHDOOM, EXAMINING ATTORNEY

Int. Cl.: 30

Prior U.S. Cl.: 46

United States Patent and Trademark Office

Reg. No. 3,577,276

Registered Feb. 17, 2009

**TRADEMARK
PRINCIPAL REGISTER**

EXTREME SUPREME

U.S. RESTAURANTS CORPORATION (MINNE-
SOTA CORPORATION)
SUITE 215
3900 NORTHWOODS DRIVE
ARDEN HILLS, MN 55112

THE MARK CONSISTS OF STANDARD CHAR-
ACTERS WITHOUT CLAIM TO ANY PARTICULAR
FONT, STYLE, SIZE, OR COLOR.

SN 77-274,319, FILED 9-7-2007.

FOR: FROZEN PIZZA, IN CLASS 30 (U.S. CL. 46).

FIRST USE 8-0-2008; IN COMMERCE 8-0-2008.

KATHERINE STOIDES, EXAMINING ATTORNEY

Int. Cl.: 36

Prior U.S. Cls.: 100, 101, and 102

United States Patent and Trademark Office

Reg. No. 3,577,277

Registered Feb. 17, 2009

**SERVICE MARK
PRINCIPAL REGISTER**



THE PRESTON GROUP, LLC (TEXAS LIMITED
LIABILITY COMPANY)
2123 PALM CASTLE DRIVE
LEAGUE CITY, TX 775736696

FOR: BANKING CONSULTATION, IN CLASS 36
(U.S. CLS. 100, 101 AND 102).

FIRST USE 10-17-2007; IN COMMERCE 10-17-2007.

NO CLAIM IS MADE TO THE EXCLUSIVE
RIGHT TO USE "GROUP, LLC", APART FROM
THE MARK AS SHOWN.

THE MARK CONSISTS OF THREE STYLIZED
ARROWS TO THE LEFT OF THE LITERAL ELE-
MENT.

SN 77-275,077, FILED 9-9-2007.

KOURTNEE HODGES, EXAMINING ATTORNEY

Int. Cl.: 25

Prior U.S. Cls.: 22 and 39

United States Patent and Trademark Office

Reg. No. 3,577,278

Registered Feb. 17, 2009

**TRADEMARK
PRINCIPAL REGISTER**

RUB RELIEF

SCHERING-PLOUGH HEALTHCARE PRO-
DUCTS, INC. (DELAWARE CORPORATION)
3030 JACKSON AVENUE
MEMPHIS, TN 38151

FOR: NON-ORTHOPEDIC FOOTWEAR PADS TO
PREVENT BLISTERING AND IRRITATION WHEN
AFFIXED TO THE INSIDE OF SHOES, NAMELY,
STRIPS OF FOAM NOT SOLD AS COMPONENTS OF
SHOES, IN CLASS 25 (U.S. CLS. 22 AND 39).

FIRST USE 1-1-2008; IN COMMERCE 1-1-2008.

THE MARK CONSISTS OF STANDARD CHAR-
ACTERS WITHOUT CLAIM TO ANY PARTICULAR
FONT, STYLE, SIZE, OR COLOR.

NO CLAIM IS MADE TO THE EXCLUSIVE
RIGHT TO USE "RUB", APART FROM THE MARK
AS SHOWN.

SN 77-275,193, FILED 9-10-2007.

SIMON TENG, EXAMINING ATTORNEY

Int. Cl.: 9

Prior U.S. Cls.: 21, 23, 26, 36, and 38

Reg. No. 3,577,279

United States Patent and Trademark Office

Registered Feb. 17, 2009

**TRADEMARK
PRINCIPAL REGISTER**



T & D CORPORATION (CAYMAN ISLANDS
CORPORATION)
11 F, NO. 126
SEC. 4 NANKING EAST ROAD
TAIPEI, TAIWAN, CHINA

APPLICATIONS, DESKTOPS, AND FILES, IN CLASS
9 (U.S. CLS. 21, 23, 26, 36 AND 38).

FIRST USE 2-22-2008; IN COMMERCE 2-22-2008.

FOR: COMPUTER SOFTWARE FOR ONLINE
VOICE, DATA, AND MULTIMEDIA CONFEREN-
CING AND FOR ONLINE SHARING, COLLABORA-
TION ON, AND ACCESSING OF COMPUTER

SN 77-275,194, FILED 9-10-2007.

SHANNON TWOHIG, EXAMINING ATTORNEY

Int. Cls.: 35 and 41

Prior U.S. Cls.: 100, 101, 102, and 107

United States Patent and Trademark Office

Reg. No. 3,577,280

Registered Feb. 17, 2009

**SERVICE MARK
PRINCIPAL REGISTER**

Tech X.0

IDC RESEARCH, INC. (MASSACHUSETTS CORPORATION)
5 SPEEN STREET
FRAMINGHAM, MA 01701

FOR: ARRANGING AND CONDUCTING BUSINESS CONFERENCES, IN CLASS 35 (U.S. CLS. 100, 101 AND 102).

FIRST USE 1-8-2008; IN COMMERCE 1-8-2008.

FOR: ARRANGING OF EXHIBITIONS, SEMINARS AND CONFERENCES; ARRANGING OF SEMINARS AND CONFERENCES, IN CLASS 41 (U.S. CLS. 100, 101 AND 107).

FIRST USE 12-31-2007; IN COMMERCE 12-31-2007.

THE MARK CONSISTS OF STANDARD CHARACTERS WITHOUT CLAIM TO ANY PARTICULAR FONT, STYLE, SIZE, OR COLOR.

NO CLAIM IS MADE TO THE EXCLUSIVE RIGHT TO USE "TECH", APART FROM THE MARK AS SHOWN.

SN 77-275,398, FILED 9-10-2007.

MARLENE BELL, EXAMINING ATTORNEY

Int. Cl.: 25

Prior U.S. Cls.: 22 and 39

United States Patent and Trademark Office

Reg. No. 3,577,281

Registered Feb. 17, 2009

TRADEMARK
PRINCIPAL REGISTER



BALLET INTERNATIONAL LTD (UNITED
KINGDOM CORPORATION)
82 MEANWOOD ROAD
SANDHILL HOUSE
LEEDS, UNITED KINGDOM LS72RE

FOR: SPORTSWEAR, NAMELY, SWEATSHIRTS,
SWEATERS, SWEATPANTS, TRACK SUITS, PANTS,
VESTS, SHORTS, SHIRTS, T-SHIRTS, POLO SHIRTS,
DRESSES, SKIRTS AND PULLOVERS; NIGHT-
WEAR, NAMELY, PAJAMAS, NIGHT SHIRTS,
NIGHTGOWNS, NIGHTDRESSES, HOUSECOATS,
ROBES, NIGHTIES, NEGLIGEEES, BABY DOLL PA-
JAMAS, PEIGNOIRS AND JAPANESE SLEEPING
ROBES (NEMAKI); LOUNGEWEAR, NAMELY,

LOUNGING PANTS, SHIRTS AND TOPS, LOUNGE
JACKETS; BRIDAL WEAR, NAMELY, BRIDAL
GOWNS, PEIGNOIRS, BRIDESMAIDS' DRESSES,
FLOWER GIRL DRESSES, VEILS, BRIDAL GAR-
TERS, BRIDAL HEAD DRESSES AND GLOVES;
LINGERIE, SWIMWEAR AND HOSIERY, IN CLASS
25 (U.S. CLS. 22 AND 39).

FIRST USE 8-31-2007; IN COMMERCE 8-31-2007.

SN 77-275,623, FILED 9-10-2007.

RONALD MCMORROW, EXAMINING ATTORNEY

Int. Cl.: 35

Prior U.S. Cls.: 100, 101, and 102

United States Patent and Trademark Office

Reg. No. 3,577,282

Registered Feb. 17, 2009

**SERVICE MARK
PRINCIPAL REGISTER**

DAWDLE

THE CONO PROJECT, INC. (DELAWARE CORPORATION)
123 N. JEFFERSON ST., SUITE 4F
CHICAGO, IL 60661

FOR: ONLINE RETAIL CONSIGNMENT STORES
FEATURING NEW AND USED ELECTRONICS,
TOYS AND VIDEO GAMES, IN CLASS 35 (U.S.
CLS. 100, 101 AND 102).

FIRST USE 11-4-2007; IN COMMERCE 11-4-2007.

THE MARK CONSISTS OF STANDARD CHARACTERS WITHOUT CLAIM TO ANY PARTICULAR FONT, STYLE, SIZE, OR COLOR.

SN 77-275,662, FILED 9-10-2007.

RONALD AIKENS, EXAMINING ATTORNEY

Int. Cl.: 16

Prior U.S. Cls.: 2, 5, 22, 23, 29, 37, 38, and 50

United States Patent and Trademark Office

Reg. No. 3,577,283

Registered Feb. 17, 2009

**TRADEMARK
PRINCIPAL REGISTER**

QUICK RESPONSE

ERIC ARMIN INC. (NEW JERSEY CORPORATION), DBA EAI EDUCATION,
P.O. BOX 7046
118 BAUER DRIVE
OAKLAND, NJ 07436

FOR: CLEAR PLASTIC SLEEVE INTO WHICH LESSON MATERIALS AND BLANK PAPER CAN BE INSERTED FOR USE IN CLASSROOM INSTRUCTION, IN CLASS 16 (U.S. CLS. 2, 5, 22, 23, 29, 37, 38 AND 50).

FIRST USE 7-17-2007; IN COMMERCE 7-17-2007.

THE MARK CONSISTS OF STANDARD CHARACTERS WITHOUT CLAIM TO ANY PARTICULAR FONT, STYLE, SIZE, OR COLOR.

SN 77-275,664, FILED 9-10-2007.

RONALD AIKENS, EXAMINING ATTORNEY

Int. Cl.: 45

Prior U.S. Cls.: 100 and 101

United States Patent and Trademark Office

Reg. No. 3,577,284

Registered Feb. 17, 2009

**SERVICE MARK
PRINCIPAL REGISTER**

SAFETY SHERPA

BALDWIN AVIATION, INC. (SOUTH CAROLINA
CORPORATION)
1000 MAIN STREET, SUITE 200E
HILTON HEAD ISLAND, SC 29926

FOR: CONSULTING SERVICES AND ADVISORY
SERVICES IN THE FIELD OF SAFETY NEEDS OF
COMMERCIAL AND INDUSTRIAL AVIATION
COMPANIES; PROVIDING INFORMATION ON
THE FIELD OF AVIATION SAFETY, IN CLASS 45
(U.S. CLS. 100 AND 101).

FIRST USE 10-31-2007; IN COMMERCE 10-31-2007.

THE MARK CONSISTS OF STANDARD CHAR-
ACTERS WITHOUT CLAIM TO ANY PARTICULAR
FONT, STYLE, SIZE, OR COLOR.

SN 77-276,114, FILED 9-11-2007.

LOURDES AYALA, EXAMINING ATTORNEY

Int. Cl.: 5

Prior U.S. Cls.: 6, 18, 44, 46, 51, and 52

United States Patent and Trademark Office

Reg. No. 3,577,285

Registered Feb. 17, 2009

**TRADEMARK
PRINCIPAL REGISTER**

SA-TO-RI⁷

NUTRU, INC. (ILLINOIS CORPORATION)
2826 N. ORCHARD
CHICAGO, IL 60657

THE FOREIGN WORDING IN THE MARK
TRANSLATES INTO ENGLISH AS "ENLIGHTEN-
MENT".

FOR: DIETARY SUPPLEMENTS, IN CLASS 5 (U.S.
CLS. 6, 18, 44, 46, 51 AND 52).

SN 77-276,116, FILED 9-11-2007.

FIRST USE 7-1-2008; IN COMMERCE 7-1-2008.

THE MARK CONSISTS OF THE TERM "SA-TO-
RI⁷" WITH THE NUMBER "7" APPEARING IN
SUPERSCRIPT.

MATTHEW MCDOWELL, EXAMINING ATTOR-
NEY

Int. Cl.: 12

Prior U.S. Cls.: 19, 21, 23, 31, 35, and 44

United States Patent and Trademark Office

Reg. No. 3,577,286

Registered Feb. 17, 2009

**TRADEMARK
PRINCIPAL REGISTER**

BALL BUSTER

MIDWEST MOTORCYCLE SUPPLY DISTRIBUTORS CORP. (MISSOURI CORPORATION)
2100 STATE ROAD Z
PEVELY, MO 63070

THE MARK CONSISTS OF STANDARD CHARACTERS WITHOUT CLAIM TO ANY PARTICULAR FONT, STYLE, SIZE, OR COLOR.

FOR: MOTORCYCLES; MOTORCYCLE ENGINES; AND STRUCTURAL PARTS FOR MOTORCYCLES, IN CLASS 12 (U.S. CLS. 19, 21, 23, 31, 35 AND 44).

SN 77-276,604, FILED 9-11-2007.

FIRST USE 11-10-2007; IN COMMERCE 11-10-2007.

SANDRA MANIOS, EXAMINING ATTORNEY

Int. Cl.: 9

Prior U.S. Cls.: 21, 23, 26, 36, and 38

United States Patent and Trademark Office

Reg. No. 3,577,287

Registered Feb. 17, 2009

**TRADEMARK
PRINCIPAL REGISTER**

AQUACLEAR

VISION SOURCE L.P. (TEXAS LIMITED PART-
NERSHIP)
1849 KINGWOOD DRIVE, SUITE 101
KINGWOOD, TX 77339

THE MARK CONSISTS OF STANDARD CHAR-
ACTERS WITHOUT CLAIM TO ANY PARTICULAR
FONT, STYLE, SIZE, OR COLOR.

FOR: CONTACT LENSES, IN CLASS 9 (U.S. CLS.
21, 23, 26, 36 AND 38).

SN 77-276,983, FILED 9-11-2007.

FIRST USE 12-3-2008; IN COMMERCE 12-3-2008.

KEVIN CORWIN, EXAMINING ATTORNEY

Int. Cl.: 11

Prior U.S. Cls.: 13, 21, 23, 31, and 34

Reg. No. 3,577,288

United States Patent and Trademark Office

Registered Feb. 17, 2009

**TRADEMARK
PRINCIPAL REGISTER**

DecoFlex

SCRIPTO-TOKAI CORPORATION (DELAWARE
CORPORATION)
2055 S. HAVEN AVENUE
ONTARIO, CA 91761

THE MARK CONSISTS OF STANDARD CHAR-
ACTERS WITHOUT CLAIM TO ANY PARTICULAR
FONT, STYLE, SIZE, OR COLOR.

FOR: UTILITY LIGHTERS, NAMELY, LIGHTERS
PRIMARILY FOR LIGHTING GRILLS, FIREPLA-
CES, AND CANDLES, IN CLASS 11 (U.S. CLS. 13, 21,
23, 31 AND 34).

SN 77-277,118, FILED 9-11-2007.

FIRST USE 3-1-2008; IN COMMERCE 3-1-2008.

KEVIN CORWIN, EXAMINING ATTORNEY

Int. Cl.: 5

Prior U.S. Cls.: 6, 18, 44, 46, 51, and 52

Reg. No. 3,577,289

United States Patent and Trademark Office

Registered Feb. 17, 2009

**TRADEMARK
PRINCIPAL REGISTER**

FULL AND FRESH

CARGILL, INCORPORATED (DELAWARE CORPORATION)
15407 MCGINTY ROAD WEST
WAYZATA, MN 55391

THE MARK CONSISTS OF STANDARD CHARACTERS WITHOUT CLAIM TO ANY PARTICULAR FONT, STYLE, SIZE, OR COLOR.

FOR: ANIMAL FEED SUPPLEMENTS, IN CLASS 5 (U.S. CLS. 6, 18, 44, 46, 51 AND 52).

SN 77-277,261, FILED 9-12-2007.

FIRST USE 5-30-2008; IN COMMERCE 5-30-2008.

CYNTHIA SLOAN, EXAMINING ATTORNEY

Int. Cl.: 35

Prior U.S. Cls.: 100, 101, and 102

United States Patent and Trademark Office

Reg. No. 3,577,290

Registered Feb. 17, 2009

**SERVICE MARK
PRINCIPAL REGISTER**

1-on-1 Management

KR ENTERPRISES, INC. (OKLAHOMA CORPORATION)

104 N. 67TH STREET

BROKEN ARROW, OK 74014

FOR: BUSINESS CONSULTATION SERVICES, IN CLASS 35 (U.S. CLS. 100, 101 AND 102).

FIRST USE 1-1-2008; IN COMMERCE 1-1-2008.

THE MARK CONSISTS OF STANDARD CHARACTERS WITHOUT CLAIM TO ANY PARTICULAR FONT, STYLE, SIZE, OR COLOR.

NO CLAIM IS MADE TO THE EXCLUSIVE RIGHT TO USE "MANAGEMENT", APART FROM THE MARK AS SHOWN.

SN 77-277,435, FILED 9-12-2007.

JAY FLOWERS, EXAMINING ATTORNEY

Int. Cl.: 19

Prior U.S. Cls.: 1, 12, 33, and 50

United States Patent and Trademark Office

Reg. No. 3,577,291

Registered Feb. 17, 2009

**TRADEMARK
PRINCIPAL REGISTER**

TURBO GROUT HP

DAYTON SUPERIOR CORPORATION (DELA-
WARE CORPORATION)
SUITE 130
7777 WASHINGTON VILLAGE DRIVE
DAYTON, OH 45459

FOR: GROUT, IN CLASS 19 (U.S. CLS. 1, 12, 33
AND 50).

FIRST USE 5-5-2008; IN COMMERCE 5-5-2008.

THE MARK CONSISTS OF STANDARD CHAR-
ACTERS WITHOUT CLAIM TO ANY PARTICULAR
FONT, STYLE, SIZE, OR COLOR.

NO CLAIM IS MADE TO THE EXCLUSIVE
RIGHT TO USE "GROUT HP", APART FROM THE
MARK AS SHOWN.

SN 77-277,619, FILED 9-12-2007.

LOURDES AYALA, EXAMINING ATTORNEY

Int. Cl.: 3

Prior U.S. Cls.: 1, 4, 6, 50, 51, and 52

United States Patent and Trademark Office

Reg. No. 3,577,292

Registered Feb. 17, 2009

**TRADEMARK
PRINCIPAL REGISTER**



SEBASTIAN INTERNATIONAL, INC. (CALIFORNIA CORPORATION)
6109 DESOTO AVENUE
WOODLAND HILLS, CA 91367

FOR: HAIR CARE PREPARATIONS; HAIR STYLING PREPARATIONS, IN CLASS 3 (U.S. CLS. 1, 4, 6, 50, 51 AND 52).

FIRST USE 7-1-2008; IN COMMERCE 7-1-2008.

OWNER OF U.S. REG. NOS. 2,541,465, 3,121,957, AND OTHERS.

THE MARK CONSISTS OF A BLACK SQUARE WITH STYLIZED SCRIPT, ADJACENT AND TO THE LEFT OF THE SQUARE IS A WHITE RECTANGLE WITH A BLACK OUTLINE CONTAINING THE WORD "SEBASTIAN".

SN 77-278,240, FILED 9-12-2007.

JOHN HWANG, EXAMINING ATTORNEY

Int. Cls.: 30 and 32

Prior U.S. Cls.: 45, 46, and 48

United States Patent and Trademark Office

Reg. No. 3,577,293

Registered Feb. 17, 2009

**TRADEMARK
PRINCIPAL REGISTER**

CHROME

VULTAGGIO/NAPOLITAN BEVERAGE CO, LLC
(NEVADA LIMITED LIABILITY COMPANY)
SUITE G
5030 S. DECATUR BLVD.
LAS VEGAS, NV 89118

FOR: BEVERAGES MADE OF COFFEE; COFFEE;
PREPARED COFFEE AND COFFEE-BASED BEV-
ERAGES; COFFEE-BASED BEVERAGE CONTAIN-
ING MILK, IN CLASS 30 (U.S. CL. 46).

FIRST USE 10-15-2008; IN COMMERCE 10-15-2008.

FOR: BOTTLED DRINKING WATER; FLA-
VORED WATERS; MINERAL WATER; SPARKLING

WATER; COLAS; ENERGY DRINKS; FRUIT FLA-
VORED SOFT DRINKS; POP; SOFT DRINKS, IN
CLASS 32 (U.S. CLS. 45, 46 AND 48).

FIRST USE 9-15-2007; IN COMMERCE 5-8-2008.

THE MARK CONSISTS OF STANDARD CHAR-
ACTERS WITHOUT CLAIM TO ANY PARTICULAR
FONT, STYLE, SIZE, OR COLOR.

SN 77-278,247, FILED 9-12-2007.

JULIE GUTTADAURO, EXAMINING ATTORNEY

Int. Cls.: 41, 42, 44, and 45

Prior U.S. Cls.: 100, 101, and 107

United States Patent and Trademark Office

Reg. No. 3,577,294

Registered Feb. 17, 2009

**SERVICE MARK
PRINCIPAL REGISTER**

Organic Ergonomics

ORGANIC ERGONOMICS (D.C. LIMITED LIABILITY COMPANY)
P.O. BOX 2304
MERRIFIELD, VA 22082

FOR: TRAINING SERVICES IN THE FIELD OF SAFETY AND HEALTH, IN CLASS 41 (U.S. CLS. 100, 101 AND 107).

FIRST USE 5-16-2008; IN COMMERCE 5-19-2008.

FOR: CONSULTATION IN THE FIELD OF ERGONOMICS, NAMELY, DESIGNING WORKPLACE FACILITIES AND EQUIPMENT TO OPTIMIZE EFFICIENCY AND SAFETY, IN CLASS 42 (U.S. CLS. 100 AND 101).

FIRST USE 5-19-2008; IN COMMERCE 5-19-2008.

FOR: DIETARY AND NUTRITIONAL GUIDANCE, IN CLASS 44 (U.S. CLS. 100 AND 101).

FIRST USE 11-10-2008; IN COMMERCE 11-10-2008.

FOR: CONSULTING IN THE FIELD OF WORKPLACE SAFETY, IN CLASS 45 (U.S. CLS. 100 AND 101).

FIRST USE 5-16-2008; IN COMMERCE 5-19-2008.

THE MARK CONSISTS OF STANDARD CHARACTERS WITHOUT CLAIM TO ANY PARTICULAR FONT, STYLE, SIZE, OR COLOR.

NO CLAIM IS MADE TO THE EXCLUSIVE RIGHT TO USE "ERGONOMICS", APART FROM THE MARK AS SHOWN.

SN 77-278,397, FILED 9-12-2007.

LEIGH CAROLINE CASE, EXAMINING ATTORNEY

Int. Cl.: 36

Prior U.S. Cls.: 100, 101, and 102

United States Patent and Trademark Office

Reg. No. 3,577,295

Registered Feb. 17, 2009

**SERVICE MARK
PRINCIPAL REGISTER**

**Atlantic Public Adjusters
Inc.**

ATLANTIC PUBLIC ADJUSTERS INC. (FLORIDA
CORPORATION)
3180 N HAVERHILL ROAD A208
WEST PALM BEACH, FL 33417

FOR: APPRAISALS FOR INSURANCE CLAIMS
OF PERSONAL PROPERTY; APPRAISALS FOR IN-
SURANCE CLAIMS OF REAL ESTATE; CLAIMS
ADJUSTMENT IN THE FIELD OF INSURANCE;
INSURANCE CLAIMS PROCESSING; PROVIDING
INFORMATION IN INSURANCE MATTERS, IN
CLASS 36 (U.S. CLS. 100, 101 AND 102).

FIRST USE 7-9-2008; IN COMMERCE 7-9-2008.

THE MARK CONSISTS OF STANDARD CHAR-
ACTERS WITHOUT CLAIM TO ANY PARTICULAR
FONT, STYLE, SIZE, OR COLOR.

NO CLAIM IS MADE TO THE EXCLUSIVE
RIGHT TO USE "PUBLIC ADJUSTERS INC.",
APART FROM THE MARK AS SHOWN.

SN 77-279,295, FILED 9-13-2007.

TINA BROWN, EXAMINING ATTORNEY

Int. Cl.: 7

Prior U.S. Cls.: 13, 19, 21, 23, 31, 34, and 35

United States Patent and Trademark Office

Reg. No. 3,577,296

Registered Feb. 17, 2009

**TRADEMARK
PRINCIPAL REGISTER**

ENCORE

NORDSON CORPORATION (OHIO CORPORATION)
28601 CLEMENS ROAD
WESTLAKE, OH 44145

FOR: POWDER COATING EQUIPMENT, NAME-
LY, POWDER COATING SPRAY GUNS AND ELEC-
TRONIC CONTROLS THEREFORE SOLD AS AN
INTEGRAL COMPONENT PART THEREOF, IN
CLASS 7 (U.S. CLS. 13, 19, 21, 23, 31, 34 AND 35).

FIRST USE 11-20-2008; IN COMMERCE 11-20-2008.

THE MARK CONSISTS OF STANDARD CHAR-
ACTERS WITHOUT CLAIM TO ANY PARTICULAR
FONT, STYLE, SIZE, OR COLOR.

SN 77-279,395, FILED 9-14-2007.

ELI HELLMAN, EXAMINING ATTORNEY

Int. Cl.: 43

Prior U.S. Cls.: 100 and 101

United States Patent and Trademark Office

Reg. No. 3,577,297

Registered Feb. 17, 2009

SERVICE MARK
PRINCIPAL REGISTER



DAWALI INC. (ILLINOIS CORPORATION)
4833 WRIGHT TERRACE
SKOKIE, IL 60077

FOR: RESTAURANT SERVICES AND CATERING, IN CLASS 43 (U.S. CLS. 100 AND 101).

FIRST USE 11-1-2007; IN COMMERCE 5-15-2008.

NO CLAIM IS MADE TO THE EXCLUSIVE RIGHT TO USE "MEDITERRANEAN KITCHEN", APART FROM THE MARK AS SHOWN.

THE MARK CONSISTS OF A STYLIZED TEXT OF THE WORDS "DAWALI MEDITERRANEAN KITCHEN". THERE ARE VINE LEAFS AND GRAPES ON BOTH SIDES OF THE WORD DAWALI AND UNDERNEATH ARE THE WORDS MEDITERRANEAN KITCHEN.

THE ENGLISH TRANSLATION OF THE WORD "DAWALI" IN THE MARK IS GRAPEVINE.

SN 77-280,210, FILED 9-14-2007.

SARA THOMAS, EXAMINING ATTORNEY

Int. Cl.: 25

Prior U.S. Cls.: 22 and 39

United States Patent and Trademark Office

Reg. No. 3,577,298

Registered Feb. 17, 2009

TRADEMARK
PRINCIPAL REGISTER

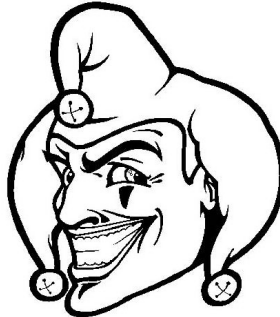

RUMMEL, JASON (UNITED STATES INDIVIDUAL)
1156 GRISWOLD ST
SHARON, PA 16146

FOR: CLOTHING, NAMELY, HOCKEY JERSEYS, BASEBALL JERSEYS, BASKETBALL JERSEYS, BOWLING JERSEYS, FOOTBALL JERSEYS, HOODED SWEATSHIRTS, HATS, BASEBALL CAPS AND VISORS, IN CLASS 25 (U.S. CLS. 22 AND 39).

FIRST USE 6-2-2008; IN COMMERCE 8-22-2008.

THE MARK CONSISTS OF A STYLIZED JOKER .

SN 77-280,280, FILED 9-14-2007.

GINA HAYES, EXAMINING ATTORNEY

Int. Cl.: 43

Prior U.S. Cls.: 100 and 101

United States Patent and Trademark Office

Reg. No. 3,577,299

Registered Feb. 17, 2009

**SERVICE MARK
PRINCIPAL REGISTER**

SHANABERRIES

VALERIA J BENTLEY (UNITED STATES INDIVIDUAL)
12116 STEWARTS-CROSSING DR
CHARLOTTE, NC 28215

FOR: CAFE-RESTAURANTS; CARRY-OUT RESTAURANTS; FAST-FOOD RESTAURANTS AND SNACKBARS; RESTAURANT AND BAR SERVICES; RESTAURANT SERVICES; RESTAURANT SERVICES FEATURING SANDWICHES; TAKE-OUT RESTAURANT SERVICES, IN CLASS 43 (U.S. CLS. 100 AND 101).

FIRST USE 6-1-2008; IN COMMERCE 6-1-2008.

THE MARK CONSISTS OF STANDARD CHARACTERS WITHOUT CLAIM TO ANY PARTICULAR FONT, STYLE, SIZE, OR COLOR.

SN 77-280,358, FILED 9-14-2007.

AISHA SALEM, EXAMINING ATTORNEY

Int. Cl.: 37

Prior U.S. Cls.: 100, 103, and 106

United States Patent and Trademark Office

Reg. No. 3,577,300

Registered Feb. 17, 2009

**SERVICE MARK
PRINCIPAL REGISTER**

POWERBLUE

POWERBLUE TECHNOLOGIES SERVICES, INC.
(NORTH CAROLINA CORPORATION)
206 HIGHLAND HILLS ROAD
RIVERDALE, GA 30296

FOR: GENERAL CONSTRUCTION CONTRACT-
ING; ELECTRICAL CONTRACTOR SERVICES; IN-
STALLATION, MAINTENANCE AND REPAIR OF
ELECTRIC AND ALTERNATIVE ENERGY SOUR-
CES, IN CLASS 37 (U.S. CLS. 100, 103 AND 106).

FIRST USE 8-0-2008; IN COMMERCE 8-0-2008.

THE MARK CONSISTS OF STANDARD CHAR-
ACTERS WITHOUT CLAIM TO ANY PARTICULAR
FONT, STYLE, SIZE, OR COLOR.

SN 77-280,613, FILED 9-16-2007.

ARETHA SOMERVILLE, EXAMINING ATTORNEY

Int. Cl.: 10

Prior U.S. Cls.: 26, 39, and 44

United States Patent and Trademark Office

Reg. No. 3,577,301

Registered Feb. 17, 2009

**TRADEMARK
PRINCIPAL REGISTER**

SMARTCODE

SUNRISE MEDICAL HHG INC. (CALIFORNIA CORPORATION)
7477 EAST DRY CREEK PARKWAY
LONGMONT, CO 80503

FOR: BREATHING APPARATUS FOR MEDICAL PURPOSES, NAMELY, A FEATURE FOR POSITIVE AIRWAY PRESSURE BREATHING APPARATUS FOR USE IN SLEEP THERAPY WHICH ALLOWS MEDICAL EQUIPMENT PROVIDERS TO OBTAIN PATIENT COMPLIANCE DATA FROM THE APPARATUS, IN CLASS 10 (U.S. CLS. 26, 39 AND 44).

FIRST USE 11-28-2008; IN COMMERCE 1-6-2009.

THE MARK CONSISTS OF STANDARD CHARACTERS WITHOUT CLAIM TO ANY PARTICULAR FONT, STYLE, SIZE, OR COLOR.

SN 77-281,091, FILED 9-17-2007.

MARIA-VICTORIA SUAREZ, EXAMINING ATTORNEY

Int. Cl.: 36

Prior U.S. Cls.: 100, 101, and 102

United States Patent and Trademark Office

Reg. No. 3,577,302

Registered Feb. 17, 2009

**SERVICE MARK
PRINCIPAL REGISTER**

COLOR OF COURAGE

CRAYOLA PROPERTIES, INC. (DELAWARE
CORPORATION)
2035 EDGEWOOD AVENUE
EASTON, PA 18042

THE MARK CONSISTS OF STANDARD CHAR-
ACTERS WITHOUT CLAIM TO ANY PARTICULAR
FONT, STYLE, SIZE, OR COLOR.

FOR: CHARITABLE FUND RAISING, IN CLASS
36 (U.S. CLS. 100, 101 AND 102).

SN 77-281,273, FILED 9-17-2007.

FIRST USE 11-1-2008; IN COMMERCE 11-1-2008.

WENDY GOODMAN, EXAMINING ATTORNEY

Int. Cl.: 16

Prior U.S. Cls.: 2, 5, 22, 23, 29, 37, 38, and 50

United States Patent and Trademark Office

Reg. No. 3,577,303

Registered Feb. 17, 2009

**TRADEMARK
PRINCIPAL REGISTER**

COURAGE

CRAYOLA PROPERTIES, INC. (DELAWARE
CORPORATION)
2035 EDGEWOOD AVENUE
EASTON, PA 18042

THE MARK CONSISTS OF STANDARD CHAR-
ACTERS WITHOUT CLAIM TO ANY PARTICULAR
FONT, STYLE, SIZE, OR COLOR.

FOR: CRAYONS; COLOR PENCILS; MARKERS,
IN CLASS 16 (U.S. CLS. 2, 5, 22, 23, 29, 37, 38 AND 50).

SN 77-281,289, FILED 9-17-2007.

FIRST USE 6-30-2008; IN COMMERCE 6-30-2008.

WENDY GOODMAN, EXAMINING ATTORNEY

Int. Cl.: 41

Prior U.S. Cls.: 100, 101, and 107

United States Patent and Trademark Office

Reg. No. 3,577,304

Registered Feb. 17, 2009

**SERVICE MARK
PRINCIPAL REGISTER**

RED ARROW

SHOTFISH PRODUCTIONS, INC. (VIRGINIA CORPORATION)
P.O. BOX 503
FORK UNION, VA 23055

FOR: ENTERTAINMENT SERVICES, NAMELY, PRODUCTION OF TELEVISION, CABLE, FILM, DVD AND VIDEO PROGRAMS ON THE TOPICS OF HUNTING, FISHING, AND WILDLIFE; PROVIDING AN ONGOING TELEVISION PROGRAM IN THE FIELD OF HUNTING, FISHING, AND WILDLIFE; ORGANIZING EXHIBITIONS ON THE TOPICS OF HUNTING, FISHING, CAMPING, HIKING, SPORTS AND WILDLIFE; LIVE PERFORMANCES IN THE NATURE OF OUTDOOR RECREATIONAL ACTIVITY DEMONSTRATIONS ON THE TOPICS OF HUNTING, FISHING, CAMPING, HIKING, SPORTS AND WILDLIFE; PROVIDING A WEBSITE VIA GLOBAL COMPUTER NETWORK FEATUR-

ING INFORMATION, ARTICLES, PHOTOS, IMAGES, AUDIO, VIDEO, WEB BLOGS, AND PODCASTS ON THE TOPICS OF RECREATION AND LEISURE ACTIVITIES, NAMELY, HUNTING, FISHING, AND WILDLIFE VIEWING; PROVIDING ON-LINE JOURNALS, NAMELY, BLOGS ON THE TOPICS OF HUNTING, FISHING, AND WILDLIFE, IN CLASS 41 (U.S. CLS. 100, 101 AND 107).

FIRST USE 7-20-2005; IN COMMERCE 7-20-2005.

THE MARK CONSISTS OF STANDARD CHARACTERS WITHOUT CLAIM TO ANY PARTICULAR FONT, STYLE, SIZE, OR COLOR.

SN 77-281,352, FILED 9-17-2007.

CHARLOTTE CORWIN, EXAMINING ATTORNEY

Int. Cl.: 9

Prior U.S. Cls.: 21, 23, 26, 36, and 38

Reg. No. 3,577,305

United States Patent and Trademark Office

Registered Feb. 17, 2009

**TRADEMARK
PRINCIPAL REGISTER**

Hot Coffee Cash

MULTIMEDIA GAMES, INC. (TEXAS CORPORATION)
206 WILD BASIN RD., BLDG B - 4TH FLR
AUSTIN, TX 78746

FOR: GAMING MACHINES, NAMELY, ELECTRONIC SLOT AND BINGO MACHINES; VIDEO LOTTERY TERMINALS, IN CLASS 9 (U.S. CLS. 21, 23, 26, 36 AND 38).

FIRST USE 11-13-2007; IN COMMERCE 11-13-2007.

THE MARK CONSISTS OF STANDARD CHARACTERS WITHOUT CLAIM TO ANY PARTICULAR FONT, STYLE, SIZE, OR COLOR.

NO CLAIM IS MADE TO THE EXCLUSIVE RIGHT TO USE "CASH", APART FROM THE MARK AS SHOWN.

SN 77-281,704, FILED 9-17-2007.

DAVID YONTEF, EXAMINING ATTORNEY

Int. Cl.: 16

Prior U.S. Cls.: 2, 5, 22, 23, 29, 37, 38, and 50

Reg. No. 3,577,306

United States Patent and Trademark Office

Registered Feb. 17, 2009

TRADEMARK
PRINCIPAL REGISTER

PowerHiking

POWER HIKING LTD. (CALIFORNIA CORPORATION)
P.O. BOX 788
TIBURON, CA 94920

NO CLAIM IS MADE TO THE EXCLUSIVE RIGHT TO USE "POWER HIKING", APART FROM THE MARK AS SHOWN.

FOR: SERIES OF BOOKS IN THE FIELDS OF WALKING, TOURING AND SIGHTSEEING, IN CLASS 16 (U.S. CLS. 2, 5, 22, 23, 29, 37, 38 AND 50).

SN 77-281,744, FILED 9-18-2007.

FIRST USE 12-0-2007; IN COMMERCE 12-0-2007.

TINA BROWN, EXAMINING ATTORNEY

Int. Cls.: 14, 18, and 45

Prior U.S. Cls.: 1, 2, 3, 22, 27, 28, 41, 50, 100, and 101

United States Patent and Trademark Office

Reg. No. 3,577,307

Registered Feb. 17, 2009

**TRADEMARK
SERVICE MARK
PRINCIPAL REGISTER**

RAVEN KAUFFMAN

KAUFFMAN, RAVEN (UNITED STATES INDIVIDUAL)
125 SOUTH DETROIT STREET
LOS ANGELES, CA 90036

FOR: JEWELRY, IN CLASS 14 (U.S. CLS. 2, 27, 28 AND 50).

FIRST USE 6-30-2006; IN COMMERCE 6-30-2006.

FOR: HANDBAGS; KEY CASES OF LEATHER AND SKINS; LEATHER BAGS, SUITCASES AND WALLETS; LEATHER CASES; LEATHER CASES FOR KEYS, IN CLASS 18 (U.S. CLS. 1, 2, 3, 22 AND 41).

FIRST USE 6-30-2006; IN COMMERCE 6-30-2006.

FOR: PERSONAL SHOPPING FOR OTHERS, IN CLASS 45 (U.S. CLS. 100 AND 101).

FIRST USE 6-30-2006; IN COMMERCE 6-30-2006.

THE MARK CONSISTS OF STANDARD CHARACTERS WITHOUT CLAIM TO ANY PARTICULAR FONT, STYLE, SIZE, OR COLOR.

THE NAME "RAVEN KAUFFMAN" IDENTIFIES A LIVING INDIVIDUAL WHOSE CONSENT IS OF RECORD.

SN 77-282,770, FILED 9-18-2007.

THEODORE MCBRIDE, EXAMINING ATTORNEY

Int. Cl.: 33

Prior U.S. Cls.: 47 and 49

United States Patent and Trademark Office

Reg. No. 3,577,308

Registered Feb. 17, 2009

**TRADEMARK
PRINCIPAL REGISTER**

MERLICIOUS

HERMAN EHLERS & SONS, INC. (CALIFORNIA
CORPORATION)
P.O. BOX 2239
LODI, CA 95241

THE MARK CONSISTS OF STANDARD CHAR-
ACTERS WITHOUT CLAIM TO ANY PARTICULAR
FONT, STYLE, SIZE, OR COLOR.

FOR: WINES, IN CLASS 33 (U.S. CLS. 47 AND 49).

SN 77-282,820, FILED 9-18-2007.

FIRST USE 2-19-2008; IN COMMERCE 2-20-2008.

GEORGE LORENZO, EXAMINING ATTORNEY

Int. Cl.: 22

Prior U.S. Cls.: 1, 2, 7, 19, 22, 42, and 50

Reg. No. 3,577,309

United States Patent and Trademark Office

Registered Feb. 17, 2009

**TRADEMARK
PRINCIPAL REGISTER**

ANCHORITE

PONCE, KAREN (UNITED STATES INDIVIDUAL)
1426 S. RITCHEY, STE. C
SANTA ANA, CA 92705

THE MARK CONSISTS OF STANDARD CHARACTERS WITHOUT CLAIM TO ANY PARTICULAR FONT, STYLE, SIZE, OR COLOR.

FOR: CABLE TIES AND STRAPS FOR FASTENING AND SECURING OBJECTS IN AN EARTHQUAKE, IN CLASS 22 (U.S. CLS. 1, 2, 7, 19, 22, 42 AND 50).

SN 77-283,079, FILED 9-19-2007.

FIRST USE 6-1-2007; IN COMMERCE 6-1-2007.

CHERYL CLAYTON, EXAMINING ATTORNEY

Int. Cl.: 3

Prior U.S. Cls.: 1, 4, 6, 50, 51, and 52

United States Patent and Trademark Office

Reg. No. 3,577,310

Registered Feb. 17, 2009

**TRADEMARK
PRINCIPAL REGISTER**



BEIERSDORF AG (FED REP GERMANY COR-
PORATION)
UNNASTRASSE 48
HAMBURG, FED REP GERMANY D-20253

FOR: SKIN CARE PREPARATIONS, IN CLASS 3
(U.S. CLS. 1, 4, 6, 50, 51 AND 52).

FIRST USE 6-0-2007; IN COMMERCE 6-0-2007.

OWNER OF U.S. REG. NOS. 93,627, 3,340,402, AND
OTHERS.

NO CLAIM IS MADE TO THE EXCLUSIVE
RIGHT TO USE "HAND", APART FROM THE
MARK AS SHOWN.

THE COLOR(S) BLUE, WHITE AND SILVER IS/
ARE CLAIMED AS A FEATURE OF THE MARK.

THE MARK CONSISTS OF THE DESIGNATION
"NIVEA" AND THE TERM "HAND" IN THE COLOR
WHITE DISPLAYED AGAINST A BLUE PANEL
WITH A SILVER BORDER. THE DESIGN OF TWO
HANDS IS DISPLAYED IN WHITE WITH A SILVER
BORDER.

SN 77-283,596, FILED 9-19-2007.

PAUL E. FAHRENKOPF, EXAMINING ATTORNEY

Int. Cl.: 16

Prior U.S. Cls.: 2, 5, 22, 23, 29, 37, 38, and 50

United States Patent and Trademark Office

Reg. No. 3,577,311

Registered Feb. 17, 2009

**TRADEMARK
PRINCIPAL REGISTER**

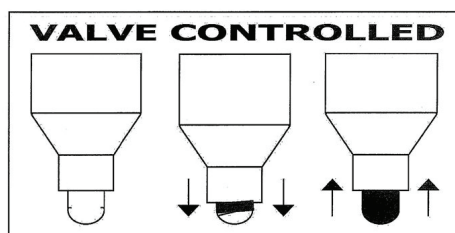

ARRO-MARK COMPANY, L.L.C. (NEW JERSEY
LIMITED LIABILITY COMPANY)
158 WEST FOREST AVENUE
ENGLEWOOD, NJ 07631

FOR: FELT TIP MARKING PENS, IN CLASS 16
(U.S. CLS. 2, 5, 22, 23, 29, 37, 38 AND 50).

FIRST USE 11-1-2008; IN COMMERCE 11-1-2008.

NO CLAIM IS MADE TO THE EXCLUSIVE
RIGHT TO USE "VALVE CONTROLLED", APART
FROM THE MARK AS SHOWN.

THE MARK CONSISTS OF THREE MARKER PEN
TIPS. THERE ARE TWO DOWNWARD ARROWS
SURROUNDING THE MIDDLE MARKER PEN TIP
AND TWO UPWARD ARROWS SURROUNDING
THE RIGHT MARKER PEN TIP. THE WORDS
"VALVE CONTROLLED" ARE ABOVE THE THREE
MARKER PEN TIPS. THE ENTIRE MARK IS CON-
TAINED WITHIN A RECTANGULAR BOX.

SN 77-284,839, FILED 9-20-2007.

MARY CRAWFORD, EXAMINING ATTORNEY

Int. Cl.: 25

Prior U.S. Cls.: 22 and 39

United States Patent and Trademark Office

Reg. No. 3,577,312

Registered Feb. 17, 2009

**TRADEMARK
PRINCIPAL REGISTER**

PIECE KEEPER

TAM, CHRISTOPHER (UNITED STATES INDIVIDUAL)
1255 ALDER CREEK CIRCLE
SAN LEANDRO, CA 94577

THE MARK CONSISTS OF STANDARD CHARACTERS WITHOUT CLAIM TO ANY PARTICULAR FONT, STYLE, SIZE, OR COLOR.

FOR: CLOTHING, NAMELY, TOPS, SHIRTS, T-SHIRTS, JACKETS, HATS, HEADWEAR AND FOOTWEAR, IN CLASS 25 (U.S. CLS. 22 AND 39).

SN 77-285,092, FILED 9-20-2007.

FIRST USE 11-15-2008; IN COMMERCE 11-15-2008.

RUDY R. SINGLETON, EXAMINING ATTORNEY

Int. Cl.: 44

Prior U.S. Cls.: 100 and 101

United States Patent and Trademark Office

Reg. No. 3,577,313

Registered Feb. 17, 2009

**SERVICE MARK
PRINCIPAL REGISTER**

BUCKEYECARE OPTOMETRISTS

WOODRUFF, ROBERT E. II (URUGUAY INDIVIDUAL)

412 CARLIN DR.

SAGAMORE HILLS, OH 44067

FOR: OPTOMETRY SERVICES, IN CLASS 44 (U.S. CLS. 100 AND 101).

FIRST USE 2-1-2005; IN COMMERCE 2-1-2005.

THE MARK CONSISTS OF STANDARD CHARACTERS WITHOUT CLAIM TO ANY PARTICULAR FONT, STYLE, SIZE, OR COLOR.

NO CLAIM IS MADE TO THE EXCLUSIVE RIGHT TO USE "OPTOMETRISTS", APART FROM THE MARK AS SHOWN.

SN 77-285,650, FILED 9-21-2007.

ARETHA SOMERVILLE, EXAMINING ATTORNEY

Int. Cl.: 28

Prior U.S. Cls.: 22, 23, 38, and 50

United States Patent and Trademark Office

Reg. No. 3,577,314

Registered Feb. 17, 2009

**TRADEMARK
PRINCIPAL REGISTER**



ECHECOPAR, CARLOS (PERU INDIVIDUAL)
JUAN FANNING 557, MIRAFLORES
LIMA, PERU

FOR: SURFBOARDS; BODY BOARDS; SAIL
BOARDS, IN CLASS 28 (U.S. CLS. 22, 23, 38 AND 50).

FIRST USE 8-21-2008; IN COMMERCE 8-21-2008.

THE MARK CONSISTS OF THE WORD "SUN-
TECH" WRITTEN IN THICKLY OUTLINED UPPER-
CASE LETTERS, WHERE THE LETTER "T" IS IN
ITALICIZED FORM AND THE LETTER "S" HAS A
CIRCULAR SHAPE WITH POINTED ENDS.

SN 77-285,723, FILED 9-21-2007.

RONALD AIKENS, EXAMINING ATTORNEY

Int. Cl.: 36

Prior U.S. Cls.: 100, 101, and 102

United States Patent and Trademark Office

Reg. No. 3,577,315

Registered Feb. 17, 2009

**SERVICE MARK
PRINCIPAL REGISTER**

ACCESS GRANTED

NYLX, INC. (NEW YORK CORPORATION)
SUITE 201
100 VALLEY RD
MT. ARLINGTON, NJ 07856

FOR: ON-LINE FINANCIAL EXCHANGE SERVICES FOR LOAN ORIGINATORS OF LOANS AND MORTGAGES, AND FOR MORTGAGE PRICING; FINANCIAL MANAGEMENT, NAMELY, ON-LINE MORTGAGE PRICING AND MANAGEMENT SERVICES FOR MORTGAGE BANKERS, MORTGAGE BROKERS, BANKS AND CREDIT UNIONS; PROVIDING MORTGAGE AND LOAN INFORMATION TO LOAN ORIGINATORS; FINANCIAL SERVICES,

NAMELY, MORTGAGE LENDING AND HOME EQUITY LOAN SERVICES AND MORTGAGE PROCUREMENT FOR OTHERS, IN CLASS 36 (U.S. CLS. 100, 101 AND 102).

FIRST USE 9-0-2007; IN COMMERCE 9-0-2007.

THE MARK CONSISTS OF STANDARD CHARACTERS WITHOUT CLAIM TO ANY PARTICULAR FONT, STYLE, SIZE, OR COLOR.

SN 77-285,744, FILED 9-21-2007.

EUGENIA MARTIN, EXAMINING ATTORNEY

Int. Cl.: 20

Prior U.S. Cls.: 2, 13, 22, 25, 32, and 50

United States Patent and Trademark Office

Reg. No. 3,577,316

Registered Feb. 17, 2009

**TRADEMARK
PRINCIPAL REGISTER**

QUICKBACK

EDWARD R GOLDEN (UNITED STATES INDIVIDUAL)
8386 IRONWOOD DRIVE
PINCKNEY, MI 48169

THE MARK CONSISTS OF STANDARD CHARACTERS WITHOUT CLAIM TO ANY PARTICULAR FONT, STYLE, SIZE, OR COLOR.

FOR: PICTURE FRAMES, IN CLASS 20 (U.S. CLS. 2, 13, 22, 25, 32 AND 50).

SN 77-285,940, FILED 9-21-2007.

FIRST USE 9-1-2008; IN COMMERCE 9-1-2008.

GEORGE LORENZO, EXAMINING ATTORNEY

Int. Cl.: 42

Prior U.S. Cls.: 100 and 101

United States Patent and Trademark Office

Reg. No. 3,577,317

Registered Feb. 17, 2009

**SERVICE MARK
PRINCIPAL REGISTER**

A2Z COMPTECH

A2Z COMPTECH, INC. (CALIFORNIA CORPORATION)
7221 GARDEN GROVE BLVD., SUITE C
GARDEN GROVE, CA 92841

FOR: CONSULTING SERVICES IN THE FIELD OF DESIGN, SELECTION, IMPLEMENTATION AND USE OF COMPUTER HARDWARE AND SOFTWARE SYSTEMS FOR OTHERS, IN CLASS 42 (U.S. CLS. 100 AND 101).

FIRST USE 5-31-2002; IN COMMERCE 5-31-2002.

THE MARK CONSISTS OF STANDARD CHARACTERS WITHOUT CLAIM TO ANY PARTICULAR FONT, STYLE, SIZE, OR COLOR.

SN 77-286,223, FILED 9-21-2007.

ROBIN CHOSID, EXAMINING ATTORNEY

Int. Cl.: 38

Prior U.S. Cls.: 100, 101, and 104

United States Patent and Trademark Office

Reg. No. 3,577,318

Registered Feb. 17, 2009

**SERVICE MARK
PRINCIPAL REGISTER**

THE OFFICIAL PHONE OF FUN

T-MOBILE USA, INC. (DELAWARE CORPORATION)
12920 S.E. 38TH STREET
BELLEVUE, WA 98006

FOR: TELECOMMUNICATIONS SERVICES, NAMELY, WIRELESS VOICE AND DATA TRANSMISSION, TWO WAY WIRELESS TRANSMISSION OF EMAIL AND TEXT BETWEEN WIRELESS TELECOMMUNICATIONS TERMINALS AND COMPUTERS, AND PROVIDING MULTIPLE-USER ACCESS TO A GLOBAL COMPUTER NETWORK, IN CLASS 38 (U.S. CLS. 100, 101 AND 104).

FIRST USE 10-31-2007; IN COMMERCE 10-31-2007.

THE MARK CONSISTS OF STANDARD CHARACTERS WITHOUT CLAIM TO ANY PARTICULAR FONT, STYLE, SIZE, OR COLOR.

SN 77-286,310, FILED 9-21-2007.

MARY CRAWFORD, EXAMINING ATTORNEY

Int. Cls.: 38 and 41

Prior U.S. Cls.: 100, 101, 104, and 107

United States Patent and Trademark Office

Reg. No. 3,577,319

Registered Feb. 17, 2009

**SERVICE MARK
PRINCIPAL REGISTER**

@asianave.com

COMMUNITY CONNECT INC. (DELAWARE CORPORATION)
205 HUDSON STREET
NEW YORK, NY 10013

FOR: ELECTRONIC MAIL SERVICES; PROVIDING ON-LINE CHAT ROOMS FOR TRANSMISSION OF MESSAGES AMONG COMPUTER USERS CONCERNING TOPICS OF GENERAL INTEREST TO INDIVIDUALS OF COMMON CULTURAL HERITAGE, IN CLASS 38 (U.S. CLS. 100, 101 AND 104).

FIRST USE 10-31-2005; IN COMMERCE 10-31-2005.

FOR: ENTERTAINMENT SERVICES, NAMELY, PROVIDING WEB SITES FEATURING MUSICAL

PERFORMANCES, FILM CLIPS, PHOTOGRAPHS, AND OTHER MULTIMEDIA MATERIALS; PROVIDING NEWS AND INFORMATION IN THE FIELDS OF ENTERTAINMENT AND CURRENT EVENTS OF INTEREST TO INDIVIDUALS OF COMMON CULTURAL HERITAGE VIA THE INTERNET, IN CLASS 41 (U.S. CLS. 100, 101 AND 107).

FIRST USE 10-31-2005; IN COMMERCE 10-31-2005.

SN 77-286,703, FILED 9-24-2007.

HEATHER SAPP, EXAMINING ATTORNEY

Int. Cl.: 33

Prior U.S. Cls.: 47 and 49

United States Patent and Trademark Office

Reg. No. 3,577,320

Registered Feb. 17, 2009

**TRADEMARK
PRINCIPAL REGISTER**



PARADOCX VINEYARD, LLC (PENNSYLVANIA
LIMITED LIABILITY COMPANY)
464 CHESTERVILLE ROAD
LANDENBERG, PA 19350

FIRST USE 12-13-2007; IN COMMERCE 12-13-2007.

SN 77-286,733, FILED 9-24-2007.

FOR: WINE, IN CLASS 33 (U.S. CLS. 47 AND 49).

JASON BLAIR, EXAMINING ATTORNEY

Int. Cl.: 28

Prior U.S. Cls.: 22, 23, 38, and 50

United States Patent and Trademark Office

Reg. No. 3,577,321

Registered Feb. 17, 2009

**TRADEMARK
PRINCIPAL REGISTER**

BLOODLINE

NOCONA LEATHER GOODS COMPANY, LTD.
(TEXAS CORPORATION)
208 WEST WALNUT STREET
NOCONA, TX 76255

FOR: SPORTING EQUIPMENT, NAMELY, BASEBALL BATS, SOFTBALL BATS, FIELDER'S GLOVES, BATTING GLOVES, CATCHER'S MASKS, CATCHER'S BODY PROTECTORS, AND BAGS SPECIALLY DESIGNED FOR BASEBALL TEAM EQUIPMENT, IN CLASS 28 (U.S. CLS. 22, 23, 38 AND 50).

FIRST USE 5-1-2008; IN COMMERCE 5-1-2008.

THE MARK CONSISTS OF STANDARD CHARACTERS WITHOUT CLAIM TO ANY PARTICULAR FONT, STYLE, SIZE, OR COLOR.

SN 77-286,770, FILED 9-24-2007.

THEODORE MCBRIDE, EXAMINING ATTORNEY

Int. Cl.: 9

Prior U.S. Cls.: 21, 23, 26, 36, and 38

United States Patent and Trademark Office

Reg. No. 3,577,322

Registered Feb. 17, 2009

TRADEMARK
PRINCIPAL REGISTER

3Q

QU, JINLIANG (CHINA INDIVIDUAL)
ROOM 302, GUDAI ROAD 1266-48
SHANGHAI, CHINA 201102

FOR: CONNECTORS FOR ELECTRONIC CIR-
CUITS; ELECTRIC AND ELECTRONIC CIRCUITS;
ELECTRIC CONNECTORS; ELECTRIC PLUGS;
ELECTRIC SOCKETS; ELECTRICAL CONNec-
TORS; ELECTRICAL PLUGS; ELECTRICAL SOCK-
ETS; ELECTRONIC COMPONENTS FOR
COMPUTERS; PLUG CONNECTORS; PLUG-IN

CONNECTORS, IN CLASS 9 (U.S. CLS. 21, 23, 26, 36
AND 38).

FIRST USE 6-6-2008; IN COMMERCE 6-6-2008.

THE MARK CONSISTS OF STANDARD CHAR-
ACTERS WITHOUT CLAIM TO ANY PARTICULAR
FONT, STYLE, SIZE, OR COLOR.

SN 77-286,788, FILED 9-24-2007.

DANNEAN HETZEL, EXAMINING ATTORNEY

Int. Cl.: 3

Prior U.S. Cls.: 1, 4, 6, 50, 51, and 52

United States Patent and Trademark Office

Reg. No. 3,577,323

Registered Feb. 17, 2009

**TRADEMARK
PRINCIPAL REGISTER**

FIRST SNOW

PHILOSOPHY, INC. (ARIZONA CORPORATION)
3809 EAST WATKINS STREET
PHOENIX, AZ 85034

THE MARK CONSISTS OF STANDARD CHAR-
ACTERS WITHOUT CLAIM TO ANY PARTICULAR
FONT, STYLE, SIZE, OR COLOR.

FOR: COSMETICS; NON-MEDICATED SKIN
CARE PREPARATIONS; SHOWER AND BATH
GEL, IN CLASS 3 (U.S. CLS. 1, 4, 6, 50, 51 AND 52).

SN 77-286,863, FILED 9-24-2007.

FIRST USE 10-2-2008; IN COMMERCE 10-2-2008.

DAWN HAN, EXAMINING ATTORNEY

Int. Cl.: 36

Prior U.S. Cls.: 100, 101, and 102

United States Patent and Trademark Office

Reg. No. 3,577,324

Registered Feb. 17, 2009

**SERVICE MARK
PRINCIPAL REGISTER**

USTED ES EL JEFE, NOSOTROS
SU BANCO

BANK OF AMERICA CORPORATION (DELA-
WARE CORPORATION)

100 NORTH TRYON STREET

CHARLOTTE, NC 28255

FOR: BANKING AND RELATED FINANCIAL
SERVICES, IN CLASS 36 (U.S. CLS. 100, 101 AND 102).

FIRST USE 11-0-2007; IN COMMERCE 11-0-2007.

THE MARK CONSISTS OF STANDARD CHAR-
ACTERS WITHOUT CLAIM TO ANY PARTICULAR
FONT, STYLE, SIZE, OR COLOR.

THE FOREIGN WORDING IN THE MARK
TRANSLATES INTO ENGLISH AS YOU ARE THE
BOSS, WE ARE YOUR BANK.

SN 77-287,083, FILED 9-24-2007.

STEVEN R. FINE, EXAMINING ATTORNEY

Int. Cl.: 30

Prior U.S. Cl.: 46

United States Patent and Trademark Office

Reg. No. 3,577,325

Registered Feb. 17, 2009

**TRADEMARK
PRINCIPAL REGISTER**

FRUIT SENSATIONS

WM. WRIGLEY JR. COMPANY (DELAWARE
CORPORATION)

410 NORTH MICHIGAN AVENUE

CHICAGO, IL 60611

FOR: BUBBLE GUM; CHEWING GUM, IN CLASS
30 (U.S. CL. 46).

FIRST USE 12-1-2007; IN COMMERCE 12-1-2007.

THE MARK CONSISTS OF STANDARD CHAR-
ACTERS WITHOUT CLAIM TO ANY PARTICULAR
FONT, STYLE, SIZE, OR COLOR.

NO CLAIM IS MADE TO THE EXCLUSIVE
RIGHT TO USE "FRUIT", APART FROM THE
MARK AS SHOWN.

SN 77-287,977, FILED 9-25-2007.

JAY FLOWERS, EXAMINING ATTORNEY

Int. Cl.: 21

Prior U.S. Cls.: 2, 13, 23, 29, 30, 33, 40, and 50

United States Patent and Trademark Office

Reg. No. 3,577,326

Registered Feb. 17, 2009

**TRADEMARK
PRINCIPAL REGISTER**

FLEXI GRIP

TEFAL S.A.S. (FRANCE CORPORATION)
Z.I. DES GRANGES, BP 89
RUMILLY, FRANCE 74150

FOR: NON-ELECTRIC KITCHEN COOKING
UTENSILS, NAMELY, FRYING PANS, STEW POTS,
PANCAKE GRIDDLES, COOKING POTS, SAUCE
PAN LIDS AND STEWPANS, IN CLASS 21 (U.S. CLS.
2, 13, 23, 29, 30, 33, 40 AND 50).

FIRST USE 1-31-2008; IN COMMERCE 1-31-2008.

THE MARK CONSISTS OF STANDARD CHAR-
ACTERS WITHOUT CLAIM TO ANY PARTICULAR
FONT, STYLE, SIZE, OR COLOR.

SN 77-288,287, FILED 9-25-2007.

ARETHA SOMERVILLE, EXAMINING ATTORNEY

Int. Cl.: 3

Prior U.S. Cls.: 1, 4, 6, 50, 51, and 52

United States Patent and Trademark Office

Reg. No. 3,577,327

Registered Feb. 17, 2009

**TRADEMARK
PRINCIPAL REGISTER**

BRIGHTFOAM

THE PROCTER & GAMBLE COMPANY (OHIO
CORPORATION)
ONE PROCTER & GAMBLE PLAZA
CINCINNATI, OH 45202

THE MARK CONSISTS OF STANDARD CHAR-
ACTERS WITHOUT CLAIM TO ANY PARTICULAR
FONT, STYLE, SIZE, OR COLOR.

FOR: HANDSOAP, BODY WASH AND HAIR
SHAMPOO, IN CLASS 3 (U.S. CLS. 1, 4, 6, 50, 51
AND 52).

SN 77-288,382, FILED 9-25-2007.

FIRST USE 2-28-2008; IN COMMERCE 2-28-2008.

BARBARA RUTLAND, EXAMINING ATTORNEY

Int. Cl.: 25

Prior U.S. Cls.: 22 and 39

United States Patent and Trademark Office

Reg. No. 3,577,328

Registered Feb. 17, 2009

**TRADEMARK
PRINCIPAL REGISTER**

ODOD

PATTERSON, RENARD (UNITED STATES INDIVIDUAL)
FLOOR 2
126 ADELPHI STREET
BROOKLYN, NY 11205

FOR: ATHLETIC FOOTWEAR; ATHLETIC SHOES; ATHLETIC UNIFORMS; BASEBALL CAPS; BATHING SUITS; BATHROBES; BEACH FOOTWEAR; BEACHWEAR; BELTS MADE OF LEATHER; BERMUDA SHORTS; BIKINIS; BLOUSES; BOOTS; BOXER SHORTS; CANVAS SHOES; COATS FOR MEN AND WOMEN; COVERALLS; CYCLING SHOES; DENIM JACKETS; DRESSES; FLEECE PULLOVERS; FOOTWEAR; GLOVES; GYM SHORTS; HEADWEAR; INFANT WEAR; JACKETS; JEANS; JERSEYS; JUMPSUITS; KNIT SHIRTS; LEATHER COATS; LEATHER JACKETS; LEATHER PANTS; MEN'S SOCKS; MEN'S SUITS, WOMEN'S SUITS; NECKERCHIEFS; NECKTIES; NIGHT-

WEAR; OVERCOATS; PAJAMAS; PANTIES, SHORTS AND BRIEFS; PANTS; POLO SHIRTS; PULLOVERS; RAINWEAR; RUNNING SHOES; SANDALS; SHIRTS; SHOES; SKIRTS; SLIPPERS; SNEAKERS; SUITS; SWEATERS; T-SHIRTS; TROUSERS; UNDERGARMENTS; WARM UP SUITS; WIND RESISTANT JACKETS, IN CLASS 25 (U.S. CLS. 22 AND 39).

FIRST USE 4-12-2008; IN COMMERCE 4-12-2008.

THE MARK CONSISTS OF STANDARD CHARACTERS WITHOUT CLAIM TO ANY PARTICULAR FONT, STYLE, SIZE, OR COLOR.

SN 77-288,482, FILED 9-25-2007.

PAUL E. FAHRENKOPF, EXAMINING ATTORNEY

Int. Cl.: 30

Prior U.S. Cl.: 46

United States Patent and Trademark Office

Reg. No. 3,577,329

Registered Feb. 17, 2009

**TRADEMARK
PRINCIPAL REGISTER**

E.A.T.

OAKFIELD FARMS, INC. (CALIFORNIA CORPORATION)
SUITE 203
22483 PACIFIC COAST HIGHWAY
MALIBU, CA 90265

FOR: MULTI COMPONENT FOOD PACKAGE COMBINATIONS IN THE NATURE OF PREPACKAGED SNACKS CONSISTING PRIMARILY OF COOKIES, CRACKERS, CANDY, CHEESE, NAMELY, PASTEURIZED PROCESS CHEESE FOOD, DRIED FOOD, NAMELY, CEREAL, NUTS, DRIED FRUIT AND CURED MEAT AND CHIPS, NAMELY,

POTATO CHIPS, PITA CHIPS AND CORN CHIPS, IN CLASS 30 (U.S. CL. 46).

FIRST USE 11-10-2007; IN COMMERCE 2-15-2008.

THE MARK CONSISTS OF STANDARD CHARACTERS WITHOUT CLAIM TO ANY PARTICULAR FONT, STYLE, SIZE, OR COLOR.

SN 77-288,804, FILED 9-25-2007.

DAVID TAYLOR, EXAMINING ATTORNEY

Int. Cl.: 35

Prior U.S. Cls.: 100, 101, and 102

United States Patent and Trademark Office

Reg. No. 3,577,330

Registered Feb. 17, 2009

**SERVICE MARK
PRINCIPAL REGISTER**



EXERCISE 2B FIT, LLC (NORTH CAROLINA
LIMITED LIABILITY COMPANY)
6050 FORDING CREEK LANE
KERNERSVILLE, NC 27284

THE MARK CONSISTS OF A STYLIZED LETTER
"X" WITH A CIRCLE OVER IT THAT IS SHADED.

FOR: ON-LINE RETAIL STORE SERVICES FEATURING CLOTHING AND RELATED ACCESSORIES, IN CLASS 35 (U.S. CLS. 100, 101 AND 102).

SN 77-288,919, FILED 9-26-2007.

FIRST USE 10-8-2007; IN COMMERCE 10-8-2007.

SUSAN RICHARDS, EXAMINING ATTORNEY

Int. Cl.: 36

Prior U.S. Cls.: 100, 101, and 102

United States Patent and Trademark Office

Reg. No. 3,577,331

Registered Feb. 17, 2009

**SERVICE MARK
PRINCIPAL REGISTER**

ALLSPORTSMARKET

CRYSTAL WORLD HOLDINGS, INC. (DELA-
WARE CORPORATION)
2053 N.W. 79TH AVENUE, #11928
DORAL, FL 331221614

FOR: FINANCIAL SERVICES, NAMELY, PRO-
VIDING EXCHANGE AND TRADING SERVICES
FOR SPORTS BASED FINANCIAL DERIVATIVES,
IN CLASS 36 (U.S. CLS. 100, 101 AND 102).

FIRST USE 9-30-2003; IN COMMERCE 9-30-2003.

THE MARK CONSISTS OF STANDARD CHAR-
ACTERS WITHOUT CLAIM TO ANY PARTICULAR
FONT, STYLE, SIZE, OR COLOR.

SN 77-289,006, FILED 9-26-2007.

CHERYL CLAYTON, EXAMINING ATTORNEY

Int. Cl.: 25

Prior U.S. Cls.: 22 and 39

United States Patent and Trademark Office

Reg. No. 3,577,332

Registered Feb. 17, 2009

**TRADEMARK
PRINCIPAL REGISTER**



EXERCISE 2B FIT, LLC (NORTH CAROLINA
LIMITED LIABILITY COMPANY)
6050 FORDING CREEK LANE
KERNERSVILLE, NC 27284

THE MARK CONSIST OF A STYLIZED LETTER
"X" WITH A CIRCLE OVER IT THAT IS SHADED.

FOR: CLOTHING; HEADWEAR, IN CLASS 25
(U.S. CLS. 22 AND 39).

SN 77-289,140, FILED 9-26-2007.

FIRST USE 10-8-2007; IN COMMERCE 10-8-2007.

SUSAN RICHARDS, EXAMINING ATTORNEY

Int. Cls.: 4 and 5

Prior U.S. Cls.: 1, 6, 15, 18, 44, 46, 51, and 52

United States Patent and Trademark Office

Reg. No. 3,577,333

Registered Feb. 17, 2009

**TRADEMARK
PRINCIPAL REGISTER**

WINDS & SPRINGTIME

THE PROCTER & GAMBLE COMPANY (OHIO
CORPORATION)
1 PROCTER & GAMBLE PLAZA
CINCINNATI, OH 45202

FOR: CANDLES, IN CLASS 4 (U.S. CLS. 1, 6 AND
15).

FIRST USE 1-31-2008; IN COMMERCE 1-31-2008.

FOR: AIR FRESHENERS AND ROOM DEODOR-
IZERS, IN CLASS 5 (U.S. CLS. 6, 18, 44, 46, 51 AND 52).

FIRST USE 1-31-2008; IN COMMERCE 1-31-2008.

THE MARK CONSISTS OF STANDARD CHAR-
ACTERS WITHOUT CLAIM TO ANY PARTICULAR
FONT, STYLE, SIZE, OR COLOR.

SN 77-289,456, FILED 9-26-2007.

BARBARA RUTLAND, EXAMINING ATTORNEY

Int. Cls.: 9, 16, and 41

**Prior U.S. Cls.: 2, 5, 21, 22, 23, 26, 29, 36, 37, 38, 50,
100, 101, and 107**

Reg. No. 3,577,334

United States Patent and Trademark Office

Registered Feb. 17, 2009

**TRADEMARK
SERVICE MARK
PRINCIPAL REGISTER**

1Sky

ISKY (D.C. NON-PROFIT CORPORATION)
1522 CERRO GORDO ROAD
SANTE FE, NM 87501

FOR: PRERECORDED CD-ROMS AND DVDS AND PRERECORDED DIGITAL VIDEO DISCS FEATURING THE GLOBAL WARMING PROBLEM AND THE NEEDED SOLUTIONS; DOWNLOADABLE ELECTRONIC PUBLICATIONS IN THE NATURE OF NEWSPAPERS, BOOKS, MAGAZINES IN THE FIELD OF THE GLOBAL WARMING PROBLEM AND THE NEEDED SOLUTIONS, IN CLASS 9 (U.S. CLS. 21, 23, 26, 36 AND 38).

FIRST USE 10-31-2008; IN COMMERCE 10-31-2008.

FOR: PUBLICATIONS, NAMELY, NEWSLETTERS, NEWSPAPERS, BROCHURES AND PAMPHLETS ON THE SUBJECTS OF ENERGY, ENERGY EFFICIENCY, GLOBAL WARMING IMPACTS AND SOLUTIONS, IN CLASS 16 (U.S. CLS. 2, 5, 22, 23, 29, 37, 38 AND 50).

FIRST USE 11-30-2007; IN COMMERCE 11-30-2007.

FOR: EDUCATIONAL SERVICES, NAMELY, ARRANGING AND CONDUCTING OF EDUCATIONAL CONGRESSES, SEMINARS, EDUCATIONAL PERFORMANCES IN THE NATURE OF EDUCATIONAL EXHIBITIONS ALL DEALING WITH THE ENVIRONMENT AND ENVIRONMENTAL ISSUES; NEWS REPORTING SERVICES, NAMELY, PROVIDING CURRENT NEWS CONTENT THROUGH PHOTOGRAPHIC, FILM AND VIDEO REPORTS, IN CLASS 41 (U.S. CLS. 100, 101 AND 107).

FIRST USE 10-31-2008; IN COMMERCE 10-31-2008.

THE MARK CONSISTS OF STANDARD CHARACTERS WITHOUT CLAIM TO ANY PARTICULAR FONT, STYLE, SIZE, OR COLOR.

SN 77-289,574, FILED 9-26-2007.

DARRYL SPRUILL, EXAMINING ATTORNEY

Int. Cl.: 5

Prior U.S. Cls.: 6, 18, 44, 46, 51, and 52

United States Patent and Trademark Office

Reg. No. 3,577,335

Registered Feb. 17, 2009

**TRADEMARK
PRINCIPAL REGISTER**

VI-DAB

MANCHESTER GROUP LLC (DELAWARE LIMITED LIABILITY COMPANY)
P.O. BOX 511
YARMOUTH, ME 04096

THE MARK CONSISTS OF STANDARD CHARACTERS WITHOUT CLAIM TO ANY PARTICULAR FONT, STYLE, SIZE, OR COLOR.

FOR: ANTIVIRAL AND ANTIMICROBIAL PREPARATIONS FOR TOPICAL USE, IN CLASS 5 (U.S. CLS. 6, 18, 44, 46, 51 AND 52).

SN 77-289,641, FILED 9-26-2007.

FIRST USE 12-20-2007; IN COMMERCE 12-20-2007.

GINA HAYES, EXAMINING ATTORNEY

Int. Cl.: 28

Prior U.S. Cls.: 22, 23, 38, and 50

United States Patent and Trademark Office

Reg. No. 3,577,336

Registered Feb. 17, 2009

**TRADEMARK
PRINCIPAL REGISTER**

DD

CLAWSON CUSTOM CUES, INC (FLORIDA CORPORATION)
5055-5 ST AUGUSTINE RD
JACKSONVILLE, FL 32207

THE MARK CONSISTS OF STANDARD CHARACTERS WITHOUT CLAIM TO ANY PARTICULAR FONT, STYLE, SIZE, OR COLOR.

FOR: BILLIARD CUES, IN CLASS 28 (U.S. CLS. 22, 23, 38 AND 50).

SN 77-289,678, FILED 9-26-2007.

FIRST USE 10-24-2007; IN COMMERCE 10-24-2007.

ANTHONY RINKER, EXAMINING ATTORNEY

Int. Cl.: 20

Prior U.S. Cls.: 2, 13, 22, 25, 32, and 50

United States Patent and Trademark Office

Reg. No. 3,577,337

Registered Feb. 17, 2009

**TRADEMARK
PRINCIPAL REGISTER**

Smart Box

SMART BOX LLC (FLORIDA LIMITED LIABILITY COMPANY)
7974 N.W. 14TH STREET
MIAMI, FL 33126

FOR: PACKAGING MATERIALS, NAMELY, PLASTIC SHIPPING AND STORAGE BOXES; CONTAINERS, NOT OF METAL FOR COMMERCIAL USE; PLASTIC STORAGE CONTAINERS FOR COMMERCIAL OR INDUSTRIAL USE, IN CLASS 20 (U.S. CLS. 2, 13, 22, 25, 32 AND 50).

FIRST USE 7-24-2007; IN COMMERCE 11-5-2007.

THE MARK CONSISTS OF STANDARD CHARACTERS WITHOUT CLAIM TO ANY PARTICULAR FONT, STYLE, SIZE, OR COLOR.

NO CLAIM IS MADE TO THE EXCLUSIVE RIGHT TO USE "BOX", APART FROM THE MARK AS SHOWN.

SN 77-289,680, FILED 9-26-2007.

RONALD AIKENS, EXAMINING ATTORNEY

Int. Cl.: 28

Prior U.S. Cls.: 22, 23, 38, and 50

Reg. No. 3,577,338

United States Patent and Trademark Office

Registered Feb. 17, 2009

**TRADEMARK
PRINCIPAL REGISTER**

VENOM

CLAWSON CUSTOM CUES, INC (FLORIDA
CORPORATION)
5055-5 ST AUGUSTINE RD
JACKSONVILLE, FL 32207

THE MARK CONSISTS OF STANDARD CHAR-
ACTERS WITHOUT CLAIM TO ANY PARTICULAR
FONT, STYLE, SIZE, OR COLOR.

FOR: BILLIARD CUES, IN CLASS 28 (U.S. CLS. 22,
23, 38 AND 50).

SN 77-289,738, FILED 9-26-2007.

FIRST USE 10-24-2007; IN COMMERCE 10-24-2007.

ANTHONY RINKER, EXAMINING ATTORNEY

Int. Cl.: 30

Prior U.S. Cl.: 46

United States Patent and Trademark Office

Reg. No. 3,577,339

Registered Feb. 17, 2009

TRADEMARK
PRINCIPAL REGISTER



M&S BBQ, INC. (ALABAMA CORPORATION),
DBA BIG DADDY'S REAL PIT BAR-B-QUE,
205 NORTH RAWLS STREET
ENTERPRISE, AL 36330

FOR: BARBEQUE SAUCE, IN CLASS 30 (U.S. CL.
46).

FIRST USE 8-18-2008; IN COMMERCE 8-18-2008.

NO CLAIM IS MADE TO THE EXCLUSIVE
RIGHT TO USE "REAL PIT BAR-B-QUE", APART
FROM THE MARK AS SHOWN.

THE MARK CONSISTS OF TWO CONCENTRIC
CIRCLES FOR WHICH THE INNER CIRCLE IS
WIDER THAN THE OUTER CIRCLE. THE WORD-
ING "BIG DADDY'S" IS WRITTEN WITHIN AN

UPPER-HALF OF THE INNER CIRCLE. A PIG
APPEARS AT THE CENTER OF THE CONCENTRIC
CIRCLES. THE PIG IS HOLDING A FORK AND
WEARING A NAPKIN THAT IS TIED AROUND
THE PIG'S NECK. THE PIG APPEARS TO BE
HOLDING A RECTANGULAR-SHAPED SIGN
THAT IS POSITIONED BELOW THE PIG AND OVER
A LOWER-HALF OF THE CONCENTRIC CIRCLES.
THE WORDING "REAL PIT BAR-B-QUE" APPEARS
WITHIN THE RECTANGULAR-SHAPED SIGN,
AND FLAMES APPEAR ALONG EDGES OF THE
WORDING "BAR-B-QUE" MAKING IT APPEAR AS
IF SUCH WORDING IS ON FIRE.

SN 77-289,873, FILED 9-26-2007.

GIANCARLO CASTRO, EXAMINING ATTORNEY

Int. Cl.: 29

Prior U.S. Cl.: 46

United States Patent and Trademark Office

Reg. No. 3,577,340

Registered Feb. 17, 2009

TRADEMARK
PRINCIPAL REGISTER



SF INVESTMENTS, INC. (DELAWARE CORPORATION)
103 BAYNARD BUILDING
3411 SILVERSIDE ROAD
WILMINGTON, DE 19810

FOR: MEAT, IN CLASS 29 (U.S. CL. 46).

FIRST USE 3-0-1999; IN COMMERCE 3-0-1999.

OWNER OF U.S. REG. NOS. 2,153,222 AND 3,113,606.

THE COLOR(S) RED, GOLD, BLACK, AND WHITE IS/ARE CLAIMED AS A FEATURE OF THE MARK.

THE MARK CONSISTS OF A RED BANNER, WHICH IS CURVED DOWN ON THE LEFT AND UP ON THE RIGHT AND IS OUTLINED IN GOLD WITH THE WORDS "TENDER 'N EASY" IN THE CENTER OF THE BANNER IN WHITE PRINT, OUTLINED IN BLACK.

SN 77-290,082, FILED 9-27-2007.

RONALD AIKENS, EXAMINING ATTORNEY

Int. Cl.: 3

Prior U.S. Cls.: 1, 4, 6, 50, 51, and 52

United States Patent and Trademark Office

Reg. No. 3,577,341

Registered Feb. 17, 2009

**TRADEMARK
PRINCIPAL REGISTER**

**THE COLOR THAT CHANGES
EVERYTHING**

THE PROCTER & GAMBLE COMPANY (OHIO
CORPORATION)
ONE PROCTER & GAMBLE PLAZA
CINCINNATI, OH 45202

THE MARK CONSISTS OF STANDARD CHAR-
ACTERS WITHOUT CLAIM TO ANY PARTICULAR
FONT, STYLE, SIZE, OR COLOR.

FOR: HAIR COLOR, IN CLASS 3 (U.S. CLS. 1, 4, 6,
50, 51 AND 52).

SN 77-290,378, FILED 9-27-2007.

FIRST USE 1-2-2008; IN COMMERCE 1-2-2008.

BARBARA RUTLAND, EXAMINING ATTORNEY

Int. Cl.: 42

Prior U.S. Cls.: 100 and 101

United States Patent and Trademark Office

Reg. No. 3,577,342

Registered Feb. 17, 2009

**SERVICE MARK
PRINCIPAL REGISTER**

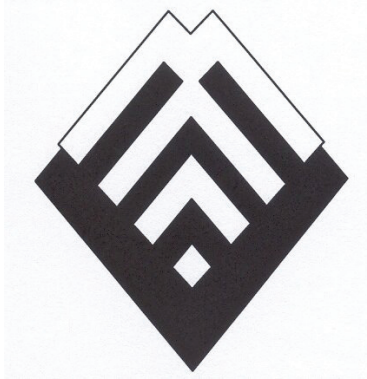

A2Z COMPTECH, INC. (CALIFORNIA CORPORATION)
7221 GARDEN GROVE BLVD., SUITE C
GARDEN GROVE, CA 92841

FOR: CONSULTING SERVICES IN THE FIELD OF DESIGN, SELECTION, IMPLEMENTATION AND USE OF COMPUTER HARDWARE AND SOFTWARE SYSTEMS FOR OTHERS, IN CLASS 42 (U.S. CLS. 100 AND 101).

FIRST USE 5-31-2002; IN COMMERCE 5-31-2002.

THE MARK CONSISTS OF DIAMOND WITH 3 CONCENTRIC HALF DIAMONDS ABOVE WHERE THE THIRD HALF DIAMOND HAS 2 PEAKS.

SN 77-290,495, FILED 9-27-2007.

ROBIN CHOSID, EXAMINING ATTORNEY

Int. Cl.: 5

Prior U.S. Cls.: 6, 18, 44, 46, 51, and 52

Reg. No. 3,577,343

United States Patent and Trademark Office

Registered Feb. 17, 2009

**TRADEMARK
PRINCIPAL REGISTER**

UNIQUAT

BRULIN & COMPANY, INC. (INDIANA CORPORATION)
P. O. BOX 270
INDIANAPOLIS, IN 462060270

FOR: GENERAL PURPOSE COMBINATION GERMICIDE, DETERGENT, DISINFECTANT, CLEANER, SANITIZER, FUNGICIDE, MILDEWSTAT, VIRUCIDE AND DEODORIZER FOR HOSPITAL, INSTITUTIONAL AND INDUSTRIAL USE, IN CLASS 5 (U.S. CLS. 6, 18, 44, 46, 51 AND 52).

FIRST USE 3-1-1995; IN COMMERCE 3-1-1995.

THE MARK CONSISTS OF STANDARD CHARACTERS WITHOUT CLAIM TO ANY PARTICULAR FONT, STYLE, SIZE, OR COLOR.

SN 77-290,497, FILED 9-27-2007.

MARTHA SANTOMARTINO, EXAMINING ATTORNEY

Int. Cl.: 42

Prior U.S. Cls.: 100 and 101

United States Patent and Trademark Office

Reg. No. 3,577,344

Registered Feb. 17, 2009

**SERVICE MARK
PRINCIPAL REGISTER**



A2Z COMPTECH, INC. (CALIFORNIA CORPORATION)
SUITE C
7221 GARDEN GROVE BLVD.
GARDEN GROVE, CA 92841

FOR: CONSULTING SERVICES IN THE FIELD OF DESIGN, SELECTION, IMPLEMENTATION AND USE OF COMPUTER HARDWARE AND SOFTWARE SYSTEMS FOR OTHERS , IN CLASS 42 (U.S. CLS. 100 AND 101).

FIRST USE 5-31-2002; IN COMMERCE 5-31-2002.

THE MARK CONSISTS OF DIAMOND WITH 3 CONCENTRIC HALF DIAMONDS ABOVE WHERE THE THIRD HALF DIAMOND HAS 2 PEAKS.

SN 77-290,522, FILED 9-27-2007.

ROBIN CHOSID, EXAMINING ATTORNEY

Int. Cl.: 35

Prior U.S. Cls.: 100, 101, and 102

United States Patent and Trademark Office

Reg. No. 3,577,345

Registered Feb. 17, 2009

**SERVICE MARK
PRINCIPAL REGISTER**

GREENZONE

MID-AMERICA EXPOSITIONS, INC. (MISSOURI CORPORATION)
SUITE 205
4049 PENNSYLVANIA
KANSAS CITY, MO 64111

FOR: ARRANGING AND CONDUCTING TRADE SHOWS IN THE FIELD OF ENVIRONMENTALLY FRIENDLY PRODUCTS AND SERVICES FOR HOME AND BUILDING REMODELERS AND HOME AND BUILDING OWNERS AND CONSUMERS.; PROMOTING AND CONDUCTING TRADE SHOWS IN THE FIELD OF ENVIRONMENTALLY FRIENDLY PRODUCTS AND SERVICES FOR

HOME AND BUILDING REMODELERS AND HOME AND BUILDING OWNERS AND CONSUMERS, IN CLASS 35 (U.S. CLS. 100, 101 AND 102).

FIRST USE 9-30-2008; IN COMMERCE 9-30-2008.

THE MARK CONSISTS OF STANDARD CHARACTERS WITHOUT CLAIM TO ANY PARTICULAR FONT, STYLE, SIZE, OR COLOR.

SN 77-290,561, FILED 9-27-2007.

DEZMONA MIZELLE, EXAMINING ATTORNEY

Int. Cl.: 26

Prior U.S. Cls.: 37, 39, 40, 42, and 50

United States Patent and Trademark Office

Reg. No. 3,577,346

Registered Feb. 17, 2009

**TRADEMARK
PRINCIPAL REGISTER**

Gimme Clips

DURHAM ENTERPRISES CORPORATION
(UTAH CORPORATION)
1837 S. 4130 W.
SUITE B
SALT LAKE CITY, UT 84104

FOR: HAIR CLIPS, IN CLASS 26 (U.S. CLS. 37, 39,
40, 42 AND 50).

FIRST USE 3-4-2008; IN COMMERCE 3-4-2008.

THE MARK CONSISTS OF STANDARD CHAR-
ACTERS WITHOUT CLAIM TO ANY PARTICULAR
FONT, STYLE, SIZE, OR COLOR.

NO CLAIM IS MADE TO THE EXCLUSIVE
RIGHT TO USE "CLIPS", APART FROM THE MARK
AS SHOWN.

SN 77-290,798, FILED 9-27-2007.

MAUREEN DALL, EXAMINING ATTORNEY

Int. Cl.: 9

Prior U.S. Cls.: 21, 23, 26, 36, and 38

Reg. No. 3,577,347

United States Patent and Trademark Office

Registered Feb. 17, 2009

**TRADEMARK
PRINCIPAL REGISTER**

eyekey

GEORGE, JONATHAN (UNITED STATES INDIVIDUAL)
1021 ARLINGTON BLVD APT 928
ARLINGTON, VA 22209

THE MARK CONSISTS OF STANDARD CHARACTERS WITHOUT CLAIM TO ANY PARTICULAR FONT, STYLE, SIZE, OR COLOR.

FOR: ACCESS CONTROL AND ALARM MONITORING SYSTEMS, IN CLASS 9 (U.S. CLS. 21, 23, 26, 36 AND 38).

SN 77-290,854, FILED 9-27-2007.

FIRST USE 10-20-2008; IN COMMERCE 11-29-2008.

WILLIAM BRECKENFELD, EXAMINING ATTORNEY

Int. Cl.: 18

Prior U.S. Cls.: 1, 2, 3, 22, and 41

United States Patent and Trademark Office

Reg. No. 3,577,348

Registered Feb. 17, 2009

**TRADEMARK
PRINCIPAL REGISTER**

CruiseDOG

CARNIVAL CORPORATION (PANAMA CORPORATION)
3655 N.W. 87TH AVENUE
MIAMI, FL 33178

FOR: DOG CLOTHING, IN CLASS 18 (U.S. CLS. 1, 2, 3, 22 AND 41).

FIRST USE 11-30-2007; IN COMMERCE 11-30-2007.

THE MARK CONSISTS OF THE WORDING "CRUISE DOG" WITH A PAW PRINT INSIDE THE LETTER "O" OF THE WORD "DOG".

SN 77-291,169, FILED 9-28-2007.

KATHERINE E. HALMEN, EXAMINING ATTORNEY

Int. Cl.: 12

Prior U.S. Cls.: 19, 21, 23, 31, 35, and 44

Reg. No. 3,577,349

United States Patent and Trademark Office

Registered Feb. 17, 2009

**TRADEMARK
PRINCIPAL REGISTER**

WHEEGO

RUFF & TUFF ELECTRIC VEHICLES, INC. (DE-
LAWARE CORPORATION)
1 RUFF & TUFF DRIVE
WINNSBORO, SC 29180

FOR: ELECTRIC AUTOMOBILES, IN CLASS 12
(U.S. CLS. 19, 21, 23, 31, 35 AND 44).

FIRST USE 9-22-2007; IN COMMERCE 5-7-2008.

THE MARK CONSISTS OF STANDARD CHAR-
ACTERS WITHOUT CLAIM TO ANY PARTICULAR
FONT, STYLE, SIZE, OR COLOR.

SN 77-291,186, FILED 9-28-2007.

ANDREA K. NADELMAN, EXAMINING ATTOR-
NEY

Int. Cl.: 30

Prior U.S. Cl.: 46

United States Patent and Trademark Office

Reg. No. 3,577,350

Registered Feb. 17, 2009

**TRADEMARK
PRINCIPAL REGISTER**

Easy to Eat

WILLIAMS, SAMUEL S. (UNITED STATES INDIVIDUAL)
10798 ZOELLER COURT
RENO, NV 89511

FOR: CANDY; CANDY BARS; CANDY WITH COCOA; CHOCOLATE CANDIES; CHOCOLATE BARS; CHOCOLATE COVERED NUTS; GRAIN-BASED FOOD BARS ALSO CONTAINING CHOCOLATE; CHOCOLATE-BASED READY-TO-EAT FOOD BARS, IN CLASS 30 (U.S. CL. 46).

FIRST USE 4-27-2008; IN COMMERCE 4-27-2008.

THE MARK CONSISTS OF STANDARD CHARACTERS WITHOUT CLAIM TO ANY PARTICULAR FONT, STYLE, SIZE, OR COLOR.

SN 77-291,351, FILED 9-28-2007.

SUSAN LESLIE DUBOIS, EXAMINING ATTORNEY

Int. Cl.: 25

Prior U.S. Cls.: 22 and 39

United States Patent and Trademark Office

Reg. No. 3,577,351

Registered Feb. 17, 2009

**TRADEMARK
PRINCIPAL REGISTER**

Java Rocks

WILLIAMS, SAMUEL S. (UNITED STATES INDIVIDUAL)
10798 ZOELLER COURT
RENO, NV 89511

THE MARK CONSISTS OF STANDARD CHARACTERS WITHOUT CLAIM TO ANY PARTICULAR FONT, STYLE, SIZE, OR COLOR.

FOR: T-SHIRTS; SWEAT SHIRTS; HATS; PANTS; JACKETS, IN CLASS 25 (U.S. CLS. 22 AND 39).

SN 77-291,354, FILED 9-28-2007.

FIRST USE 12-1-2008; IN COMMERCE 12-1-2008.

SUSAN LESLIE DUBOIS, EXAMINING ATTORNEY

Int. Cl.: 35

Prior U.S. Cls.: 100, 101, and 102

United States Patent and Trademark Office

Reg. No. 3,577,352

Registered Feb. 17, 2009

**SERVICE MARK
PRINCIPAL REGISTER**

Hiding In Plain Sight

WILLIAMS, SAMUEL S. (UNITED STATES INDIVIDUAL)
10798 ZOELLER COURT
RENO, NV 89511

FOR: PROMOTION OF BUSINESS OPPORTUNITIES; BUSINESS DEVELOPMENT SERVICES, NAMELY, PROVIDING START-UP SUPPORT FOR BUSINESSES OF OTHERS, IN CLASS 35 (U.S. CLS. 100, 101 AND 102).

FIRST USE 12-10-2008; IN COMMERCE 12-10-2008.

THE MARK CONSISTS OF STANDARD CHARACTERS WITHOUT CLAIM TO ANY PARTICULAR FONT, STYLE, SIZE, OR COLOR.

SN 77-291,358, FILED 9-28-2007.

SUSAN LESLIE DUBOIS, EXAMINING ATTORNEY

Int. Cl.: 35

Prior U.S. Cls.: 100, 101, and 102

United States Patent and Trademark Office

Reg. No. 3,577,353

Registered Feb. 17, 2009

**SERVICE MARK
PRINCIPAL REGISTER**

Occasion Creating

WILLIAMS, SAMUEL S. (UNITED STATES INDIVIDUAL)
10798 ZOELLER COURT
RENO, NE 89511

FOR: PROMOTION OF BUSINESS OPPORTUNITIES; BUSINESS DEVELOPMENT SERVICES, NAMELY, PROVIDING START-UP SUPPORT FOR BUSINESSES OF OTHERS, IN CLASS 35 (U.S. CLS. 100, 101 AND 102).

FIRST USE 4-27-2008; IN COMMERCE 4-27-2008.

THE MARK CONSISTS OF STANDARD CHARACTERS WITHOUT CLAIM TO ANY PARTICULAR FONT, STYLE, SIZE, OR COLOR.

SN 77-291,363, FILED 9-28-2007.

SUSAN LESLIE DUBOIS, EXAMINING ATTORNEY

Int. Cl.: 35

Prior U.S. Cls.: 100, 101, and 102

United States Patent and Trademark Office

Reg. No. 3,577,354

Registered Feb. 17, 2009

**SERVICE MARK
PRINCIPAL REGISTER**

Incuvation

WILLIAMS, SAMUEL S. (UNITED STATES INDIVIDUAL)
10798 ZOELLER COURT
RENO, NV 89511

FOR: PROMOTION OF BUSINESS OPPORTUNITIES; BUSINESS DEVELOPMENT SERVICES, NAMELY, PROVIDING START-UP SUPPORT FOR BUSINESSES OF OTHERS, IN CLASS 35 (U.S. CLS. 100, 101 AND 102).

FIRST USE 12-10-2008; IN COMMERCE 12-10-2008.

THE MARK CONSISTS OF STANDARD CHARACTERS WITHOUT CLAIM TO ANY PARTICULAR FONT, STYLE, SIZE, OR COLOR.

SN 77-291,376, FILED 9-28-2007.

SUSAN LESLIE DUBOIS, EXAMINING ATTORNEY

Int. Cls.: 6, 7, and 25

Prior U.S. Cls.: 2, 12, 13, 14, 19, 21, 22, 23, 25, 31, 34,
35, 39, and 50

Reg. No. 3,577,355

Registered Feb. 17, 2009

United States Patent and Trademark Office

**TRADEMARK
PRINCIPAL REGISTER**



METAL FABRICATING SOLUTIONS, L.L.C.
(UTAH LIMITED LIABILITY COMPANY)
1356 EAST 1630 SOUTH
SPANISH FORK, UT 84660

FOR: MULTI-PURPOSE METAL HOOKS FOR
USE IN HANGING HELMETS, CLOTHING, AND
RELATED EQUIPMENT FOR MOTORCYCLISTS,
ALL-TERRAIN VEHICLE USERS, SNOWMOBI-
LERS, AND WATERCRAFT USERS, IN CLASS 6
(U.S. CLS. 2, 12, 13, 14, 23, 25 AND 50).

FIRST USE 6-14-2005; IN COMMERCE 6-14-2005.

FOR: HIGH PERFORMANCE MOTOR VEHICLE
COMPONENTS AND ENGINE PARTS, NAMELY,
TURBO CHARGERS AND PARTS THEREOF, IN
CLASS 7 (U.S. CLS. 13, 19, 21, 23, 31, 34 AND 35).

FIRST USE 9-1-2007; IN COMMERCE 9-1-2007.

FOR: CLOTHING, NAMELY, SHIRTS, JACKETS,
AND HATS, IN CLASS 25 (U.S. CLS. 22 AND 39).

FIRST USE 7-1-2007; IN COMMERCE 10-1-2007.

NO CLAIM IS MADE TO THE EXCLUSIVE
RIGHT TO USE "RACING", APART FROM THE
MARK AS SHOWN.

THE MARK CONSISTS OF THE LETTERS AND
WORD "SPS RACING" ON TOP OF AN AMERICAN
FLAG AND A CHECKERED RACING FLAG WITH
THE WORDS "SECOND PLACE SUCKS" BELOW
THE FLAGS.

SN 77-291,622, FILED 9-28-2007.

ZACHARY BELLO, EXAMINING ATTORNEY

Int. Cl.: 14

Prior U.S. Cls.: 2, 27, 28, and 50

United States Patent and Trademark Office

Reg. No. 3,577,356

Registered Feb. 17, 2009

TRADEMARK
PRINCIPAL REGISTER

HENNESSEY_{TIME}

ACCUTIME WATCH CORP. (NEW YORK CORPORATION)
1001 AVENUE OF THE AMERICAS
NEW YORK, NY 10018

FOR: WATCHES, CLOCKS, WRIST WATCHES,
DIGITAL WATCHES, TIMEPIECES, IN CLASS 14
(U.S. CLS. 2, 27, 28 AND 50).

FIRST USE 3-1-2007; IN COMMERCE 3-1-2007.

NO CLAIM IS MADE TO THE EXCLUSIVE
RIGHT TO USE "TIME", APART FROM THE MARK
AS SHOWN.

THE MARK CONSISTS OF THE STYLIZED
WORD "HENNESSEY" HORIZONTALLY BE-
TWEEN TWO LINES, AND THE WORD "TIME"
PLACED VERTICALLY AT THE END OF THE
WORD "HENNESSEY".

SN 77-291,650, FILED 9-28-2007.

RONALD MCMORROW, EXAMINING ATTORNEY

Int. Cl.: 19

Prior U.S. Cls.: 1, 12, 33, and 50

United States Patent and Trademark Office

Reg. No. 3,577,357

Registered Feb. 17, 2009

**TRADEMARK
PRINCIPAL REGISTER**

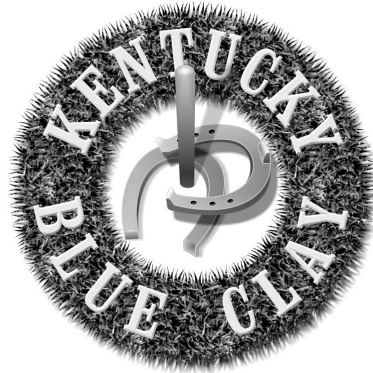

NORTHEAST SOLITE CORPORATION (VIRGINIA CORPORATION)
SUITE 105
4801 HERMITAGE ROAD
RICHMOND, VA 23227

FOR: KENTUCKY BLUE CLAY FOR HORSE-SHOE PITS, IN CLASS 19 (U.S. CLS. 1, 12, 33 AND 50).

FIRST USE 9-24-2007; IN COMMERCE 9-24-2007.

NO CLAIM IS MADE TO THE EXCLUSIVE RIGHT TO USE "KENTUCKY BLUE CLAY", APART FROM THE MARK AS SHOWN.

SN 77-292,171, FILED 9-28-2007.

BRIAN PINO, EXAMINING ATTORNEY

Int. Cl.: 18

Prior U.S. Cls.: 1, 2, 3, 22, and 41

United States Patent and Trademark Office

Reg. No. 3,577,358

Registered Feb. 17, 2009

**TRADEMARK
PRINCIPAL REGISTER**

TRAVEL CHIC

LUKA GLOBAL, INC. (MICHIGAN CORPORATION)
2732 TURTLE LAKE DRIVE
BLOOMFIELD HILLS, MI 48302

FOR: FASHION ACCESSORIES FOR TRAVEL,
NAMELY, HANDLE COVERS FOR LUGGAGE, IN
CLASS 18 (U.S. CLS. 1, 2, 3, 22 AND 41).

FIRST USE 11-1-2007; IN COMMERCE 11-8-2007.

THE MARK CONSISTS OF STANDARD CHARACTERS WITHOUT CLAIM TO ANY PARTICULAR FONT, STYLE, SIZE, OR COLOR.

NO CLAIM IS MADE TO THE EXCLUSIVE RIGHT TO USE "TRAVEL", APART FROM THE MARK AS SHOWN.

SN 77-292,998, FILED 10-1-2007.

JOHN GARTNER, EXAMINING ATTORNEY

Int. Cl.: 10

Prior U.S. Cls.: 26, 39, and 44

United States Patent and Trademark Office

Reg. No. 3,577,359

Registered Feb. 17, 2009

**TRADEMARK
PRINCIPAL REGISTER**

FREESTYLE FREEDOM LITE

ABBOTT DIABETES CARE INC. (DELAWARE
CORPORATION)
1420 HARBOR BAY PARKWAY
ALAMEDA, CA 94502

FOR: MEDICAL EQUIPMENT, NAMELY, INSTRUMENTS AND SENSORS FOR MEASURING BLOOD GLUCOSE LEVELS, INSTRUMENTS AND SENSORS FOR BIOTECHNOLOGY APPLICATIONS, NAMELY, FOR ANALYZING BLOOD AND BODILY FLUID CHEMISTRY, FOR MEASURING BLOOD GLUCOSE LEVELS, PROTEIN LEVELS AND HORMONE LEVELS; INSTRUMENTS AND SENSORS FOR DIABETES MONITORING, APPARATUS FOR MEASURING DOSAGES AND DELIVERING PHARMACEUTICALS, NAMELY, MEDICAL PUMPS, PENS, SYRINGES AND INFUSION SETS; AND APPARATUS FOR DRAWING OR

SAMPLING BLOOD OR OTHER BODILY FLUIDS, NAMELY, LANCES, LANCETS, LANCING DEVICES AND SENSORS, IN CLASS 10 (U.S. CLS. 26, 39 AND 44).

FIRST USE 2-22-2008; IN COMMERCE 2-22-2008.

THE MARK CONSISTS OF STANDARD CHARACTERS WITHOUT CLAIM TO ANY PARTICULAR FONT, STYLE, SIZE, OR COLOR.

OWNER OF U.S. REG. NO. 3,169,832.

SN 77-293,018, FILED 10-1-2007.

STEVEN R. FINE, EXAMINING ATTORNEY

Int. Cl.: 31

Prior U.S. Cls.: 1 and 46

United States Patent and Trademark Office

Reg. No. 3,577,360

Registered Feb. 17, 2009

**TRADEMARK
PRINCIPAL REGISTER**

**SHEPPARD & GREENE FOCUSED
ON FERRETS**

KAYTEE PRODUCTS INCORPORATED (WIS-
CONSIN CORPORATION)
P.O. BOX 230
CHILTON, WI 53014

FOR: PET FOOD, EDIBLE ANIMAL TREATS,
AND ACCESSORIES, NAMELY, ANIMAL LITTER,
IN CLASS 31 (U.S. CLS. 1 AND 46).

FIRST USE 12-1-2007; IN COMMERCE 12-1-2007.

THE MARK CONSISTS OF STANDARD CHAR-
ACTERS WITHOUT CLAIM TO ANY PARTICULAR
FONT, STYLE, SIZE, OR COLOR.

NO CLAIM IS MADE TO THE EXCLUSIVE
RIGHT TO USE "FERRETS", APART FROM THE
MARK AS SHOWN.

SN 77-293,101, FILED 10-1-2007.

TRICIA SONNEBORN, EXAMINING ATTORNEY

Int. Cl.: 43

Prior U.S. Cls.: 100 and 101

United States Patent and Trademark Office

Reg. No. 3,577,361

Registered Feb. 17, 2009

SERVICE MARK
PRINCIPAL REGISTER



ACORN ASSET MANAGEMENT, INC. (CALI-
FORNIA CORPORATION)
SUITE 175
2500 VENTURE OAKS WAY
SACRAMENTO, CA 95833

FOR: BAR SERVICES; CAFE-RESTAURANTS;
CAFES; COCKTAIL LOUNGE BUFFETS; COCK-
TAIL LOUNGES; COFFEE SHOPS; HOTEL, BAR
AND RESTAURANT SERVICES; PROVIDING BAN-
QUET AND SOCIAL FUNCTION FACILITIES FOR
SPECIAL OCCASIONS; PROVIDING OF FOOD AND
DRINK; PUBS; RESTAURANT AND BAR SERVI-
CES; RESTAURANT SERVICES; RESTAURANTS;

SERVING FOOD AND DRINKS; SERVING OF
FOOD AND DRINK/BEVERAGES; SNACK BARS;
TAVERN SERVICES, IN CLASS 43 (U.S. CLS. 100
AND 101).

FIRST USE 12-1-2007; IN COMMERCE 12-1-2007.

THE MARK CONSISTS OF A TREE LOGO WITH
THE WORDS "TEMPLE ORANGE" UNDERNEATH.

SN 77-293,120, FILED 10-1-2007.

CARYN GLASSER, EXAMINING ATTORNEY

Int. Cl.: 9

Prior U.S. Cls.: 21, 23, 26, 36, and 38

Reg. No. 3,577,362

United States Patent and Trademark Office

Registered Feb. 17, 2009

**TRADEMARK
PRINCIPAL REGISTER**



SPX CORPORATION (DELAWARE CORPORATION)
13515 BALLANTYNE CORPORATE PLACE
CHARLOTTE, NC 28277

FOR: VEHICLE EMISSION ANALYZERS, IN
CLASS 9 (U.S. CLS. 21, 23, 26, 36 AND 38).

FIRST USE 11-0-2008; IN COMMERCE 11-0-2008.

NO CLAIM IS MADE TO THE EXCLUSIVE
RIGHT TO USE "EMISSION INSPECTION SYSTEMS",
APART FROM THE MARK AS SHOWN.

THE MARK CONSISTS OF THE STYLIZED
WORDING "SMOGTAMER EMISSION INSPECTION
SYSTEMS" INCORPORATING A STYLIZED
LETTER "S" WITH SMOKE EMITTING THERE-
FROM.

SN 77-293,217, FILED 10-1-2007.

DAVID H. STINE, EXAMINING ATTORNEY

Int. Cl.: 37

Prior U.S. Cls.: 100, 103, and 106

United States Patent and Trademark Office

Reg. No. 3,577,363

Registered Feb. 17, 2009

**SERVICE MARK
PRINCIPAL REGISTER**

NBSCO

NEVADA BARRICADE & SIGN COMPANY, INC.
(NEVADA CORPORATION)
1300 MARIETTA WAY
SPARKS, NV 89431

THE MARK CONSISTS OF STANDARD CHAR-
ACTERS WITHOUT CLAIM TO ANY PARTICULAR
FONT, STYLE, SIZE, OR COLOR.

FOR: ROAD CONSTRUCTION; STREET CON-
STRUCTION; LEASING OF CONSTRUCTION
EQUIPMENT, IN CLASS 37 (U.S. CLS. 100, 103 AND
106).

SN 77-293,304, FILED 10-1-2007.

FIRST USE 10-1-2008; IN COMMERCE 10-1-2008.

JANET LEE, EXAMINING ATTORNEY

Int. Cls.: 16, 35, 41, 44, and 45

Prior U.S. Cls.: 2, 5, 22, 23, 29, 37, 38, 50, 100, 101, 102, and 107

Reg. No. 3,577,364

United States Patent and Trademark Office

Registered Feb. 17, 2009

**TRADEMARK
SERVICE MARK
PRINCIPAL REGISTER**

TRIOLITE

TRIOLITE, INC. (UTAH CORPORATION)
331 SOUTH 100 WEST
BRIGHAM CITY, UT 84302

FOR: PRINTED INSTRUCTIONAL, EDUCATIONAL, AND TEACHING MATERIALS IN THE FIELDS OF METAPHYSICS AND ALTERNATIVE HEALING, IN CLASS 16 (U.S. CLS. 2, 5, 22, 23, 29, 37, 38 AND 50).

FIRST USE 1-1-2005; IN COMMERCE 1-1-2005.

FOR: ON-LINE RETAIL STORE SERVICES FEATURING RITUAL OBJECTS, CANDLES, JEWELRY, INCENSE, OILS, INSTRUCTIONAL MANUALS, BOOKS, HOMEOPATHIC REMEDIES, IN CLASS 35 (U.S. CLS. 100, 101 AND 102).

FIRST USE 1-1-2005; IN COMMERCE 1-1-2005.

FOR: LIVE WORKSHOPS AND SEMINARS IN THE FIELDS OF METAPHYSICS AND ALTERNATIVE HEALING; PROVIDING ONLINE TRAINING IN THE FORM OF WEB-BASED SEMINARS AND WEB-BASED BROADCASTS IN THE FIELDS OF

METAPHYSICS AND ALTERNATIVE HEALING, IN CLASS 41 (U.S. CLS. 100, 101 AND 107).

FIRST USE 1-1-2005; IN COMMERCE 1-1-2005.

FOR: PROVIDING METAPHYSICAL AND ALTERNATIVE HEALING SERVICES, IN CLASS 44 (U.S. CLS. 100 AND 101).

FIRST USE 1-1-2005; IN COMMERCE 1-1-2005.

FOR: COUNSELING IN THE FIELDS OF METAPHYSICS AND ALTERNATIVE HEALING, IN CLASS 45 (U.S. CLS. 100 AND 101).

FIRST USE 1-1-2005; IN COMMERCE 1-1-2005.

THE MARK CONSISTS OF STANDARD CHARACTERS WITHOUT CLAIM TO ANY PARTICULAR FONT, STYLE, SIZE, OR COLOR.

SN 77-293,564, FILED 10-2-2007.

RICHARD A. STRASER, EXAMINING ATTORNEY

Int. Cl.: 1

Prior U.S. Cls.: 1, 5, 6, 10, 26, and 46

United States Patent and Trademark Office

Reg. No. 3,577,365

Registered Feb. 17, 2009

**TRADEMARK
PRINCIPAL REGISTER**

TrueORF

ORIGENE TECHNOLOGIES, INC. (DELAWARE
CORPORATION)
6 TAFT COURT
ROCKVILLE, MD 20850

THE MARK CONSISTS OF STANDARD CHAR-
ACTERS WITHOUT CLAIM TO ANY PARTICULAR
FONT, STYLE, SIZE, OR COLOR.

FOR: NUCLEIC ACID FOR LABORATORY USE,
IN CLASS 1 (U.S. CLS. 1, 5, 6, 10, 26 AND 46).

SN 77-293,853, FILED 10-2-2007.

FIRST USE 12-31-2007; IN COMMERCE 12-31-2007.

MELVIN AXILBUND, EXAMINING ATTORNEY

Int. Cl.: 8

Prior U.S. Cls.: 23, 28, and 44

United States Patent and Trademark Office

Reg. No. 3,577,366

Registered Feb. 17, 2009

**TRADEMARK
PRINCIPAL REGISTER**

BF

HIKARI CORPORATION (JAPAN CORPORATION)
32-16, KOMONE 1-CHOME, ITABASHI-KU
TOKYO, JAPAN

THE MARK CONSISTS OF STANDARD CHARACTERS WITHOUT CLAIM TO ANY PARTICULAR FONT, STYLE, SIZE, OR COLOR.

FOR: SCISSORS, IN CLASS 8 (U.S. CLS. 23, 28 AND 44).

SN 77-293,890, FILED 10-2-2007.

FIRST USE 1-27-2003; IN COMMERCE 4-6-2003.

LINDSEY RUBIN, EXAMINING ATTORNEY

Int. Cl.: 25

Prior U.S. Cls.: 22 and 39

United States Patent and Trademark Office

Reg. No. 3,577,367

Registered Feb. 17, 2009

TRADEMARK
PRINCIPAL REGISTER



ZENDOT, INC. (OHIO CORPORATION)
383 COLUMBIA ROAD
CLEVELAND, OH 44140

OWNER OF U.S. REG. NOS. 3,211,210 AND
3,334,780.

FOR: TOPS; PANTS; SWEATERS; SHIRTS; SWEAT
SHIRTS; SOCKS; CAPES; HATS; FOOTWEAR;
SWIMWEAR; HEADGEAR, NAMELY, BANDANAS,
VISORS, CAPS; RAINWEAR; UNDERWEAR;
SHORTS; APRONS , IN CLASS 25 (U.S. CLS. 22
AND 39).

THE MARK CONSISTS OF A MONKEY'S HEAD
AND NECK LOCATED WITHIN AN IMPERFECTLY
SQUARE BOX AND A DOT OR FILLED CIRCLE IN
ABOUT THE MIDDLE OF THE BOX.

SN 77-294,052, FILED 10-2-2007.

FIRST USE 11-0-2005; IN COMMERCE 11-0-2005.

BENJAMIN ALLEN, EXAMINING ATTORNEY

Int. Cl.: 5

Prior U.S. Cls.: 6, 18, 44, 46, 51, and 52

United States Patent and Trademark Office

Reg. No. 3,577,368

Registered Feb. 17, 2009

**TRADEMARK
PRINCIPAL REGISTER**

ALCODINE

4-H OF HOPE MINISTRIES, INC. (NORTH CAROLINA NON-PROFIT CORPORATION)
PO BOX 939
ROCKWELL, NC 28138

THE MARK CONSISTS OF STANDARD CHARACTERS WITHOUT CLAIM TO ANY PARTICULAR FONT, STYLE, SIZE, OR COLOR.

FOR: TOPICAL ANTISEPTIC MICROBIAL SOLUTION, IN CLASS 5 (U.S. CLS. 6, 18, 44, 46, 51 AND 52).

SN 77-294,061, FILED 10-2-2007.

FIRST USE 1-29-2008; IN COMMERCE 1-29-2008.

TARAH HARDY, EXAMINING ATTORNEY

Int. Cls.: 14 and 25

Prior U.S. Cls.: 2, 22, 27, 28, 39, and 50

United States Patent and Trademark Office

Reg. No. 3,577,369

Registered Feb. 17, 2009

TRADEMARK
PRINCIPAL REGISTER

Disaya

A-LIST CORPORATE LIMITED (THAILAND
LIMITED LIABILITY COMPANY)
KLONGTON SUB-DISTRICT KLONGTOEY DIS-
TRICT
NO. 40 SUKHUMVIT 34, SUKHUMVIT ROAD
BANGKOK METROPOLIS, THAILAND 10110

FOR: BRACELETS; EARRINGS, JEWELRY
BOXES OF PRECIOUS METAL, JEWELRY CHAINS;
KEY CHAINS OF PRECIOUS METAL; ORNA-
MENTS OF PRECIOUS METAL; RINGS BEING
JEWELRY, IN CLASS 14 (U.S. CLS. 2, 27, 28 AND 50).

FIRST USE 6-0-2007; IN COMMERCE 6-0-2007.

FOR: BELTS; CAPS; COATS; CROP TOPS; HATS;
JACKETS; JERSEYS; JUMPERS; KNIT SHIRTS; LEA-

TER COATS; OVER COATS; PANTS; SHIRTS;
SKIRTS; SWEATERS; T-SHIRTS; TANK TOPS;
TROUSERS; UNDERPANTS; UNDERWEAR, IN
CLASS 25 (U.S. CLS. 22 AND 39).

FIRST USE 6-0-2007; IN COMMERCE 6-0-2007.

THE MARK CONSISTS OF STYLIZED SPELLING
OF THE WORD "DISAYA".

THE WORDING IN THE MARK HAS NO FOR-
EIGN LANGUAGE MEANING.

SN 77-294,156, FILED 10-2-2007.

JESSICA A. POWERS, EXAMINING ATTORNEY

Int. Cl.: 9

Prior U.S. Cls.: 21, 23, 26, 36, and 38

United States Patent and Trademark Office

Reg. No. 3,577,370

Registered Feb. 17, 2009

**TRADEMARK
PRINCIPAL REGISTER**

SILVERBACK

WMS GAMING INC. (DELAWARE CORPORATION)
800 SOUTH NORTHPOINT BOULEVARD
WAUKEGAN, IL 60085

FOR: GAMING MACHINES THAT GENERATE OR DISPLAY WAGER OUTCOMES; GAMING SOFTWARE THAT GENERATES OR DISPLAYS WAGER OUTCOMES OF GAMING MACHINES, IN CLASS 9 (U.S. CLS. 21, 23, 26, 36 AND 38).

FIRST USE 8-22-2008; IN COMMERCE 8-22-2008.

THE MARK CONSISTS OF STANDARD CHARACTERS WITHOUT CLAIM TO ANY PARTICULAR FONT, STYLE, SIZE, OR COLOR.

SN 77-294,159, FILED 10-2-2007.

GEORGE LORENZO, EXAMINING ATTORNEY

Int. Cl.: 41

Prior U.S. Cls.: 100, 101, and 107

United States Patent and Trademark Office

Reg. No. 3,577,371

Registered Feb. 17, 2009

**SERVICE MARK
PRINCIPAL REGISTER**

FACE TOLERANCE

JENNIFER FORMAN WEINSTEIN (UNITED STATES INDIVIDUAL)
6531 EAST FANFOL DRIVE
PARADISE VALLEY, AZ 85253

THE MARK CONSISTS OF THE WORDS "FACE TOLERANCE" IN BLOCK LETTERING. THE LETTERS "C" AND "E" OF THE WORD "FACE" APPEAR IN BACKWARDS LETTERING.

FOR: EDUCATIONAL SERVICES, NAMELY, CONDUCTING COURSES OF INSTRUCTION ABOUT GLOBAL DIVERSITY AND DEMONSTRATING GLOBAL DIVERSITY THROUGH WORKS OF ART , IN CLASS 41 (U.S. CLS. 100, 101 AND 107).

SN 77-294,204, FILED 10-2-2007.

FIRST USE 5-3-2007; IN COMMERCE 10-31-2007.

DAWN FELDMAN, EXAMINING ATTORNEY

Int. Cl.: 29

Prior U.S. Cl.: 46

United States Patent and Trademark Office

Reg. No. 3,577,372

Registered Feb. 17, 2009

**TRADEMARK
PRINCIPAL REGISTER**

TOPS IT ALL

HEB GROCERY COMPANY, LP (TEXAS LIMITED PARTNERSHIP)
CORPORATE LAW DEPARTMENT
646 SOUTH MAIN
SAN ANTONIO, TX 78204

FOR: SNACK MIX CONSISTING PRIMARILY OF PROCESSED NUTS, PROCESSED FRUIT, CHOCOLATE CHIPS, WHITE CHOCOLATE DROPS, CHOCOLATE COOKIE DROPS, AND RAISINS , IN CLASS 29 (U.S. CL. 46).

FIRST USE 2-0-2008; IN COMMERCE 2-0-2008.

THE MARK CONSISTS OF STANDARD CHARACTERS WITHOUT CLAIM TO ANY PARTICULAR FONT, STYLE, SIZE, OR COLOR.

SN 77-294,234, FILED 10-2-2007.

G. MAYERSCHOFF, EXAMINING ATTORNEY

Int. Cl.: 30

Prior U.S. Cl.: 46

United States Patent and Trademark Office

Reg. No. 3,577,373

Registered Feb. 17, 2009

**TRADEMARK
PRINCIPAL REGISTER**

ESSENTIAL EATING

ESSENTIAL LIVING, LLC (PENNSYLVANIA
LIMITED LIABILITY COMPANY)
P.O. BOX 771
WAVERLY, PA 18471

FOR: BREAD; BREAD DOUGH; BREAD ROLLS;
BREAD STICKS; ROLLS; PRETZELS; CAKES; CUP
CAKES; TORTILLA SHELLS; TORTILLAS; BAGELS;
MUFFINS; PIZZA CRUST; PIZZA DOUGH; COOK-
IES; CRACKERS; DRIED PASTA; FRESH PASTA;
PASTA; FLOUR-BASED CHIPS, IN CLASS 30 (U.S.
CL. 46).

FIRST USE 10-21-2008; IN COMMERCE 10-21-2008.

THE MARK CONSISTS OF STANDARD CHAR-
ACTERS WITHOUT CLAIM TO ANY PARTICULAR
FONT, STYLE, SIZE, OR COLOR.

OWNER OF U.S. REG. NO. 3,247,669.

SN 77-294,240, FILED 10-2-2007.

CAROLINE WOOD, EXAMINING ATTORNEY

Int. Cl.: 29

Prior U.S. Cl.: 46

United States Patent and Trademark Office

Reg. No. 3,577,374

Registered Feb. 17, 2009

**TRADEMARK
PRINCIPAL REGISTER**

FAB FIVE

HEB GROCERY COMPANY, LP (TEXAS LIMITED PARTNERSHIP)
CORPORATE LAW DEPARTMENT
646 SOUTH MAIN
SAN ANTONIO, TX 78204

THE MARK CONSISTS OF STANDARD CHARACTERS WITHOUT CLAIM TO ANY PARTICULAR FONT, STYLE, SIZE, OR COLOR.

FOR: SNACK MIX CONSISTING PRIMARILY OF PROCESSED NUTS, PROCESSED FRUIT, AND CHOCOLATE RAISINS, IN CLASS 29 (U.S. CL. 46).

SN 77-294,249, FILED 10-2-2007.

FIRST USE 2-0-2008; IN COMMERCE 2-0-2008.

G. MAYERSCHOFF, EXAMINING ATTORNEY

Int. Cls.: 3 and 21

**Prior U.S. Cls.: 1, 2, 4, 6, 13, 23, 29, 30, 33, 40, 50, 51,
and 52**

United States Patent and Trademark Office

Reg. No. 3,577,375

Registered Feb. 17, 2009

**TRADEMARK
PRINCIPAL REGISTER**

THROW 'N GO

CROWN PRODUCTS, LLC (FLORIDA LIMITED
LIABILITY COMPANY)
2557 N.W. 52ND STREET
BOCA RATON, FL 33496

FIRST USE 3-1-2008; IN COMMERCE 3-1-2008.

FOR: DISPOSABLE WIPES IMPREGNATED
WITH CHEMICALS FOR PERSONAL HYGIENE,
IN CLASS 3 (U.S. CLS. 1, 4, 6, 50, 51 AND 52).

THE MARK CONSISTS OF STANDARD CHAR-
ACTERS WITHOUT CLAIM TO ANY PARTICULAR
FONT, STYLE, SIZE, OR COLOR.

FIRST USE 3-1-2008; IN COMMERCE 3-1-2008.

SN 77-294,422, FILED 10-2-2007.

FOR: DISPENSERS FOR DISPOSABLE WIPES;
WASTE RECEPTACLES FOR DISPOSABLE WIPES,
IN CLASS 21 (U.S. CLS. 2, 13, 23, 29, 30, 33, 40 AND 50).

JENNY PARK, EXAMINING ATTORNEY

Int. Cl.: 30

Prior U.S. Cl.: 46

United States Patent and Trademark Office

Reg. No. 3,577,376

Registered Feb. 17, 2009

**TRADEMARK
PRINCIPAL REGISTER**



KITTEN COFFEE LLC (NEW YORK LIMITED
LIABILITY COMPANY)
172 NORTH 11TH STREET
BROOKLYN, NY 11211

FOR: ROASTED COFFEE BEANS, IN CLASS 30
(U.S. CL. 46).

FIRST USE 10-1-2007; IN COMMERCE 10-1-2007.

THE COLOR(S) GREEN, BLACK IS/ARE
CLAIMED AS A FEATURE OF THE MARK.

THE MARK CONSISTS OF GREEN STYLISED
CAT AT CENTER ON BLACK CIRCULAR BACK-
GROUND SURROUNDED BY AND WITHIN
GREEN CIRCLE.

SN 77-294,965, FILED 10-3-2007.

VERNA BETH RIRIE, EXAMINING ATTORNEY

Int. Cl.: 25

Prior U.S. Cls.: 22 and 39

United States Patent and Trademark Office

Reg. No. 3,577,377

Registered Feb. 17, 2009

**TRADEMARK
PRINCIPAL REGISTER**

MILI

THE POPULAR STORE, INC. (FLORIDA CORPORATION)
1101 EAST HALLANDALE BEACH BOULEVARD
HALLANDALE BEACH, FL 33009

FOR: SHOES; ATHLETIC SHOES; GLOVES; HATS;
SANDALS; SCARVES; SOCKS; TIES, IN CLASS 25
(U.S. CLS. 22 AND 39).

FIRST USE 6-30-2007; IN COMMERCE 6-30-2007.

THE MARK CONSISTS OF STANDARD CHARACTERS WITHOUT CLAIM TO ANY PARTICULAR FONT, STYLE, SIZE, OR COLOR.

OWNER OF U.S. REG. NO. 3,370,796.

SN 77-294,974, FILED 10-3-2007.

ELLEN BURNS, EXAMINING ATTORNEY

Int. Cl.: 17

Prior U.S. Cls.: 1, 5, 12, 13, 35, and 50

United States Patent and Trademark Office

Reg. No. 3,577,378

Registered Feb. 17, 2009

**TRADEMARK
PRINCIPAL REGISTER**

**CORGON "WE GOT RID OF THE
CORE SO YOU WOULDN'T HAVE
TO"**

PREFERRED FILM CONVERTERS, INC. (OKLA-
HOMA CORPORATION)
6708 E. 13TH STREET
TULSA, OK 741125612

THE MARK CONSISTS OF STANDARD CHAR-
ACTERS WITHOUT CLAIM TO ANY PARTICULAR
FONT, STYLE, SIZE, OR COLOR.

FOR: CORELESS STRETCH FILM, NAMELY,
PLASTIC FILM USED FOR INDUSTRIAL OR COM-
MERCIAL PACKING, IN CLASS 17 (U.S. CLS. 1, 5, 12,
13, 35 AND 50).

SN 77-295,050, FILED 10-3-2007.

FIRST USE 12-4-2008; IN COMMERCE 12-4-2008.

JAMES MACFARLANE, EXAMINING ATTORNEY

Int. Cl.: 29

Prior U.S. Cl.: 46

United States Patent and Trademark Office

Reg. No. 3,577,379

Registered Feb. 17, 2009

**TRADEMARK
PRINCIPAL REGISTER**

CAVANAUGH CREATIONS

THE IBP FOODS CO. (DELAWARE CORPORATION)

2210 W. OAKLAWN DRIVE

SPRINGDALE, AR 72762

FOR: BEEF; CHICKEN, IN CLASS 29 (U.S. CL. 46).

FIRST USE 2-15-2008; IN COMMERCE 2-15-2008.

THE MARK CONSISTS OF STANDARD CHARACTERS WITHOUT CLAIM TO ANY PARTICULAR FONT, STYLE, SIZE, OR COLOR.

OWNER OF U.S. REG. NOS. 1,382,538 AND 2,174,068.

SN 77-295,201, FILED 10-3-2007.

SUSAN RICHARDS, EXAMINING ATTORNEY

Int. Cl.: 25

Prior U.S. Cls.: 22 and 39

United States Patent and Trademark Office

Reg. No. 3,577,380

Registered Feb. 17, 2009

**TRADEMARK
PRINCIPAL REGISTER**



THE APPAREL SOURCE (WASHINGTON CORPORATION), DBA THE SOURCE,
1020 SW 34TH ST.
RENTON, WA 98055

FOR: MEN'S, LADIES' AND CHILDREN'S CLOTHING, NAMELY, T-SHIRTS; KNIT TOPS, SHORTS AND PANTS; SWEATSHIRTS AND SWEATPANTS; WOVEN SHIRTS AND PANTS; INFANT AND TODDLER LAYETTES AND SETS; ROBES AND GOWNS; SLEEPWEAR; LINGERIE; CAPS AND HATS; SHOES; SOCKS; STOCKINGS; AND SLIPPERS, IN CLASS 25 (U.S. CLS. 22 AND 39).

FIRST USE 11-17-2008; IN COMMERCE 11-17-2008.

NO CLAIM IS MADE TO THE EXCLUSIVE RIGHT TO USE "ACTIVE", APART FROM THE MARK AS SHOWN.

THE COLOR(S) DARK GREEN, LIGHT GREEN AND WHITE IS/ARE CLAIMED AS A FEATURE OF THE MARK.

THE MARK CONSISTS OF THE LITERAL ELEMENTS "ECO ACTIVE" WITH THE WORD "ECO" IN DARK GREEN AND THE WORD "ACTIVE" IN LIGHT GREEN, STACKED TOP TO BOTTOM, TO THE LEFT OF A SQUARE COMPOSED OF LIGHT AND DARK GREEN SWATCHES SURROUNDING A FREE-FORM LEAF SHAPE ALSO IN DARK GREEN. THE COLOR WHITE APPEARS IN THE SQUARE AND LEAF DESIGN.

SN 77-295,256, FILED 10-3-2007.

DAVID MURRAY, EXAMINING ATTORNEY

Int. Cl.: 18

Prior U.S. Cls.: 1, 2, 3, 22, and 41

United States Patent and Trademark Office

Reg. No. 3,577,381

Registered Feb. 17, 2009

**TRADEMARK
PRINCIPAL REGISTER**

SAXSYSTUFF

SAXSYSTUFF LLC (COLORADO LIMITED LIABILITY COMPANY)
P.O. BOX 321
SNOWMASS, CO 81654

FOR: SHOPPING BAGS, NAMELY, CANVAS SHOPPING BAGS; BAGS MADE OF CLOTH, CANVAS AND NYLON, NAMELY, BAGS FOR SPORTS AND ATHLETIC BAGS, TOTE BAGS, SHOULDER BAGS, BEACH BAGS, SCHOOL BAGS, TRAVEL BAGS, STUFF BAGS, CAMPING BAGS, HANDBAGS, SATCHELS, CLUTCH BAGS, ALL PURPOSE ATHLETIC BAGS, ALL PURPOSES CARRYING BAGS, BOOK BAGS, CARRY-ALL BAGS, CARRY-

ON BAGS, OVERNIGHT BAGS, SHOULDER BAGS, IN CLASS 18 (U.S. CLS. 1, 2, 3, 22 AND 41).

FIRST USE 6-0-2008; IN COMMERCE 6-0-2008.

THE MARK CONSISTS OF STANDARD CHARACTERS WITHOUT CLAIM TO ANY PARTICULAR FONT, STYLE, SIZE, OR COLOR.

SN 77-295,526, FILED 10-3-2007.

BRENDAN MCCAULEY, EXAMINING ATTORNEY

Int. Cl.: 21

Prior U.S. Cls.: 2, 13, 23, 29, 30, 33, 40, and 50

United States Patent and Trademark Office

Reg. No. 3,577,382

Registered Feb. 17, 2009

**TRADEMARK
PRINCIPAL REGISTER**

BACON GENIE

EVRIHOLDER PRODUCTS, LLC (INDIANA LIMITED LIABILITY COMPANY)
1530 S. LEWIS STREET
ANAHEIM, CA 92805

FOR: NON-METAL COOKWARE FOR USE IN A MICROWAVE, NAMELY, COOKING RACK, IN CLASS 21 (U.S. CLS. 2, 13, 23, 29, 30, 33, 40 AND 50).

FIRST USE 6-12-2008; IN COMMERCE 6-12-2008.

THE MARK CONSISTS OF STANDARD CHARACTERS WITHOUT CLAIM TO ANY PARTICULAR FONT, STYLE, SIZE, OR COLOR.

NO CLAIM IS MADE TO THE EXCLUSIVE RIGHT TO USE "BACON", APART FROM THE MARK AS SHOWN.

SN 77-295,646, FILED 10-3-2007.

APRIL ROACH, EXAMINING ATTORNEY

Int. Cl.: 10

Prior U.S. Cls.: 26, 39, and 44

United States Patent and Trademark Office

Reg. No. 3,577,383

Registered Feb. 17, 2009

**TRADEMARK
PRINCIPAL REGISTER**

SANDMAN INFO

NELCOR PURITAN BENNETT LLC (DELA-
WARE LIMITED LIABILITY COMPANY)
6165 GUNBARREL AVENUE
BOULDER, CO 80301

FOR: MEDICAL APPARATUS FOR DIAGNOS-
ING AND TREATING RESPIRATORY-RELATED
SLEEP DISORDERS, NAMELY, CONTINUOUS PO-
SITIVE AIRWAY PRESSURE DEVICES AND PARTS
AND FITTINGS THEREFOR, IN CLASS 10 (U.S. CLS.
26, 39 AND 44).

FIRST USE 6-5-2008; IN COMMERCE 6-5-2008.

THE MARK CONSISTS OF STANDARD CHAR-
ACTERS WITHOUT CLAIM TO ANY PARTICULAR
FONT, STYLE, SIZE, OR COLOR.

OWNER OF U.S. REG. NOS. 2,293,035, 2,635,968,
AND 2,635,969.

SN 77-295,742, FILED 10-4-2007.

MARCIE MILONE, EXAMINING ATTORNEY

Int. Cl.: 9

Prior U.S. Cls.: 21, 23, 26, 36, and 38

Reg. No. 3,577,384

United States Patent and Trademark Office

Registered Feb. 17, 2009

**TRADEMARK
PRINCIPAL REGISTER**

AutoCAST

ES&S AUTOMARK, LLC (DELAWARE LIMITED
LIABILITY COMPANY)
11128 JOHN GALT BOULEVARD
SUITE 200
OMAHA, NE 68137

THE MARK CONSISTS OF STANDARD CHAR-
ACTERS WITHOUT CLAIM TO ANY PARTICULAR
FONT, STYLE, SIZE, OR COLOR.

FOR: ELECTRONIC VOTER ASSIST TERMINALS
FOR MARKING A BALLOT, IN CLASS 9 (U.S. CLS.
21, 23, 26, 36 AND 38).

SN 77-296,047, FILED 10-4-2007.

FIRST USE 9-9-2008; IN COMMERCE 9-9-2008.

EMILY CHUO, EXAMINING ATTORNEY

Int. Cl.: 30

Prior U.S. Cl.: 46

United States Patent and Trademark Office

Reg. No. 3,577,385

Registered Feb. 17, 2009

**TRADEMARK
PRINCIPAL REGISTER**

TINGLERZ

SOCIETE DES PRODUITS NESTLE S.A. (SWIT-
ZERLAND CORPORATION)
CASE POSTALE 353
1800 VEVEY, SWITZERLAND

FOR: CANDY, IN CLASS 30 (U.S. CL. 46).

FIRST USE 10-10-2008; IN COMMERCE 10-10-2008.

THE MARK CONSISTS OF STANDARD CHAR-
ACTERS WITHOUT CLAIM TO ANY PARTICULAR
FONT, STYLE, SIZE, OR COLOR.

SN 77-296,164, FILED 10-4-2007.

KATHERINE E. HALMEN, EXAMINING ATTOR-
NEY

Int. Cl.: 21

Prior U.S. Cls.: 2, 13, 23, 29, 30, 33, 40, and 50

United States Patent and Trademark Office

Reg. No. 3,577,386

Registered Feb. 17, 2009

**TRADEMARK
PRINCIPAL REGISTER**

CHOP N SCOOP

DEXAS INTERNATIONAL, LTD. (TEXAS LIMITED PARTNERSHIP)
585 SOUTH ROYAL LANE, SUITE 200
COPPELL, TX 75019

FOR: CUTTING BOARDS, IN CLASS 21 (U.S. CLS. 2, 13, 23, 29, 30, 33, 40 AND 50).

FIRST USE 12-11-2007; IN COMMERCE 12-11-2007.

THE MARK CONSISTS OF STANDARD CHARACTERS WITHOUT CLAIM TO ANY PARTICULAR FONT, STYLE, SIZE, OR COLOR.

OWNER OF U.S. REG. NO. 3,285,413.

NO CLAIM IS MADE TO THE EXCLUSIVE RIGHT TO USE "CHOP", APART FROM THE MARK AS SHOWN.

SN 77-296,270, FILED 10-4-2007.

ROBIN CHOSID, EXAMINING ATTORNEY

Int. Cl.: 35

Prior U.S. Cls.: 100, 101, and 102

United States Patent and Trademark Office

Reg. No. 3,577,387

Registered Feb. 17, 2009

SERVICE MARK
PRINCIPAL REGISTER



SHOEFITS, LLC (LOUISIANA LIMITED LIABILITY COMPANY)
SUITE 109
1437 ST. CHARLES STREET
HOUMA, LA 70360

FOR: RETAIL STORE SERVICES FEATURING
FOOTWEAR, HANDBAGS, AND ACCESSORIES;
ON-LINE RETAIL STORE SERVICES FEATURING

FOOTWEAR, HANDBAGS, AND ACCESSORIES, IN
CLASS 35 (U.S. CLS. 100, 101 AND 102).

FIRST USE 9-19-2004; IN COMMERCE 9-19-2004.

SN 77-296,384, FILED 10-4-2007.

LINDA M. KING, EXAMINING ATTORNEY

Int. Cl.: 25

Prior U.S. Cls.: 22 and 39

United States Patent and Trademark Office

Reg. No. 3,577,388

Registered Feb. 17, 2009

**TRADEMARK
PRINCIPAL REGISTER**

Take Life Slow

TAKE LIFE SLOW, LLC (MARYLAND LIMITED
LIABILITY COMPANY)
12417 DEOUDES ROAD
BOYDS, MD 208419022

THE MARK CONSISTS OF STANDARD CHAR-
ACTERS WITHOUT CLAIM TO ANY PARTICULAR
FONT, STYLE, SIZE, OR COLOR.

FOR: CLOTHING, NAMELY, SHIRTS, T-SHIRTS,
PANTS, SHORTS, SKIRTS, DRESSES, BELTS, HATS,
CAPS, TIES, SOCKS, SHOES, AND FLIP FLOPS, IN
CLASS 25 (U.S. CLS. 22 AND 39).

SN 77-296,734, FILED 10-4-2007.

FIRST USE 6-15-2008; IN COMMERCE 8-15-2008.

GEORGE LORENZO, EXAMINING ATTORNEY

Int. Cl.: 25

Prior U.S. Cls.: 22 and 39

United States Patent and Trademark Office

Reg. No. 3,577,389

Registered Feb. 17, 2009

**TRADEMARK
PRINCIPAL REGISTER**

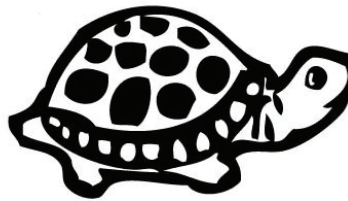

TAKE LIFE SLOW, LLC (MARYLAND LIMITED
LIABILITY COMPANY)
12417 DEOUDES ROAD
BOYDS, MD 208419022

FIRST USE 6-15-2008; IN COMMERCE 8-15-2008.

THE MARK CONSISTS OF A TURTLE.

FOR: CLOTHING, NAMELY, SHIRTS, T-SHIRTS,
PANTS, SHORTS, SKIRTS, DRESSES, BELTS, HATS,
CAPS, TIES, SOCKS, SHOES, AND FLIP FLOPS, IN
CLASS 25 (U.S. CLS. 22 AND 39).

SN 77-296,742, FILED 10-4-2007.

GEORGE LORENZO, EXAMINING ATTORNEY

Int. Cl.: 9

Prior U.S. Cls.: 21, 23, 26, 36, and 38

United States Patent and Trademark Office

Reg. No. 3,577,390

Registered Feb. 17, 2009

**TRADEMARK
PRINCIPAL REGISTER**

TPX

POLYCOM, INC. (DELAWARE CORPORATION)
4750 WILLOW ROAD
PLEASANTON, CA 94588

FOR: TELECOMMUNICATIONS AND DATA NETWORKING HARDWARE, NAMELY, DEVICES FOR TRANSPORTING AND AGGREGATING VOICE, DATA, AND VIDEO COMMUNICATIONS ACROSS MULTIPLE NETWORK INFRASTRUCTURES AND COMMUNICATIONS PROTOCOLS; VIDEO CONFERENCING SYSTEM COMPRISED OF VIDEO MONITORS, CAMERAS, CONFERENCING HARDWARE AND SOFTWARE, AND CON-

FERENCE ROOM FURNITURE, ALL SOLD AS A PACKAGE, IN CLASS 9 (U.S. CLS. 21, 23, 26, 36 AND 38).

FIRST USE 10-15-2007; IN COMMERCE 3-14-2008.

THE MARK CONSISTS OF STANDARD CHARACTERS WITHOUT CLAIM TO ANY PARTICULAR FONT, STYLE, SIZE, OR COLOR.

SN 77-297,055, FILED 10-5-2007.

AISHA SALEM, EXAMINING ATTORNEY

Int. Cl.: 14

Prior U.S. Cls.: 2, 27, 28, and 50

United States Patent and Trademark Office

Reg. No. 3,577,391

Registered Feb. 17, 2009

**TRADEMARK
PRINCIPAL REGISTER**

ALTIVO

ALTIVO TIMEPIECES INC. (CALIFORNIA CORPORATION)
7221 MELROSE AVE
LOS ANGELES, CA 90046

FOR: TIMEPIECES, IN CLASS 14 (U.S. CLS. 2, 27, 28 AND 50).

FIRST USE 11-6-2008; IN COMMERCE 11-6-2008.

THE MARK CONSISTS OF STANDARD CHARACTERS WITHOUT CLAIM TO ANY PARTICULAR FONT, STYLE, SIZE, OR COLOR.

THE ENGLISH TRANSLATION OF THE WORD "ALTIVO" IN THE MARK IS "HAUGHTY".

SN 77-297,087, FILED 10-5-2007.

DAVID MURRAY, EXAMINING ATTORNEY

Int. Cl.: 20

Prior U.S. Cls.: 2, 13, 22, 25, 32, and 50

United States Patent and Trademark Office

Reg. No. 3,577,392

Registered Feb. 17, 2009

**TRADEMARK
PRINCIPAL REGISTER**

CONSULT

KRUEGER INTERNATIONAL, INC. (WISCONSIN CORPORATION)
1330 BELLEVUE STREET
GREEN BAY, WI 54302

THE MARK CONSISTS OF STANDARD CHARACTERS WITHOUT CLAIM TO ANY PARTICULAR FONT, STYLE, SIZE, OR COLOR.

FOR: FURNITURE, IN CLASS 20 (U.S. CLS. 2, 13, 22, 25, 32 AND 50).

SN 77-297,389, FILED 10-5-2007.

FIRST USE 10-15-2008; IN COMMERCE 10-15-2008.

RONALD AIKENS, EXAMINING ATTORNEY

Int. Cl.: 35

Prior U.S. Cls.: 100, 101, and 102

United States Patent and Trademark Office

Reg. No. 3,577,393

Registered Feb. 17, 2009

**SERVICE MARK
PRINCIPAL REGISTER**

**Unleashing the Power of
Business Relationships**

S4 CONSULTING, INC. (OHIO CORPORATION)
580 NORTH FOURTH STREET, SUITE 600
COLUMBUS, OH 43215

BUSINESS RELATIONSHIP MANAGEMENT, IN
CLASS 35 (U.S. CLS. 100, 101 AND 102).

FIRST USE 2-1-2008; IN COMMERCE 2-1-2008.

FOR: BUSINESS MANAGEMENT CONSULTATION IN THE FIELD OF BUSINESS RELATIONSHIP MANAGEMENT; BUSINESS CONSULTATION IN THE FIELD OF BUSINESS RELATIONSHIP MANAGEMENT; BUSINESS MANAGEMENT CONSULTANCY AS WELL AS DEVELOPMENT OF PROCESSES FOR THE ANALYSIS AND THE IMPLEMENTATION OF STRATEGY PLANS AND MANAGEMENT PROJECTS IN THE FIELD OF

THE MARK CONSISTS OF STANDARD CHARACTERS WITHOUT CLAIM TO ANY PARTICULAR FONT, STYLE, SIZE, OR COLOR.

SN 77-297,484, FILED 10-5-2007.

DAWN HAN, EXAMINING ATTORNEY

Int. Cl.: 9

Prior U.S. Cls.: 21, 23, 26, 36, and 38

United States Patent and Trademark Office

Reg. No. 3,577,394

Registered Feb. 17, 2009

**TRADEMARK
PRINCIPAL REGISTER**

**POLYCOM TELEPRESENCE
EXPERIENCE**

POLYCOM, INC. (DELAWARE CORPORATION)
4750 WILLOW ROAD
PLEASANTON, CA 94588

FOR: TELECOMMUNICATIONS AND DATA NETWORKING HARDWARE, NAMELY, DEVICES FOR TRANSPORTING AND AGGREGATING VOICE, DATA, AND VIDEO COMMUNICATIONS ACROSS MULTIPLE NETWORK INFRASTRUCTURES AND COMMUNICATIONS PROTOCOLS; VIDEO CONFERENCING SYSTEM COMPRISED OF VIDEO MONITORS, CAMERAS, CONFERENCING HARDWARE AND SOFTWARE, AND CONFERENCE ROOM FURNITURE, ALL SOLD AS A PACKAGE, IN CLASS 9 (U.S. CLS. 21, 23, 26, 36 AND 38).

FIRST USE 10-15-2007; IN COMMERCE 3-14-2008.

THE MARK CONSISTS OF STANDARD CHARACTERS WITHOUT CLAIM TO ANY PARTICULAR FONT, STYLE, SIZE, OR COLOR.

OWNER OF U.S. REG. NOS. 1,783,295, 1,912,272, AND OTHERS.

NO CLAIM IS MADE TO THE EXCLUSIVE RIGHT TO USE "TELEPRESENCE", APART FROM THE MARK AS SHOWN.

SN 77-297,513, FILED 10-5-2007.

AISHA SALEM, EXAMINING ATTORNEY

Int. Cl.: 31

Prior U.S. Cls.: 1 and 46

United States Patent and Trademark Office

Reg. No. 3,577,395

Registered Feb. 17, 2009

**TRADEMARK
PRINCIPAL REGISTER**

COLORFUSION

W. ATLEE BURPEE COMPANY (DELAWARE
CORPORATION)
300 PARK AVENUE
WARMINSTER, PA 18974

FOR: FLOWER AND LIVING PLANT PLANTING
KIT COMPRISED OF SEEDS, BULBS AND PLANT-
ING PELLETS AND A CONTAINER FOR HOLDING
THE AFORESAID GOODS, SOLD AS A UNIT, IN
CLASS 31 (U.S. CLS. 1 AND 46).

FIRST USE 12-0-2007; IN COMMERCE 12-0-2007.

THE MARK CONSISTS OF STANDARD CHAR-
ACTERS WITHOUT CLAIM TO ANY PARTICULAR
FONT, STYLE, SIZE, OR COLOR.

SN 77-297,554, FILED 10-5-2007.

RUDY R. SINGLETON, EXAMINING ATTORNEY

Int. Cl.: 33

Prior U.S. Cls.: 47 and 49

United States Patent and Trademark Office

Reg. No. 3,577,396

Registered Feb. 17, 2009

**TRADEMARK
PRINCIPAL REGISTER**

KENZO

TSUJIMOTO, KENZO (JAPAN INDIVIDUAL)
2-15, EGANOSHO 5-CHOME, HABIKINO-SHI
OSAKA, JAPAN

FOR: WINE; ALCOHOLIC BEVERAGES OF
FRUIT; LIQUOR, IN CLASS 33 (U.S. CLS. 47 AND 49).

FIRST USE 6-4-2008; IN COMMERCE 6-25-2008.

THE MARK CONSISTS OF STANDARD CHAR-
ACTERS WITHOUT CLAIM TO ANY PARTICULAR
FONT, STYLE, SIZE, OR COLOR.

OWNER OF JAPAN REG. NO. 5098315, DATED 12-
14-2007, EXPIRES 12-14-2017.

SN 77-297,731, FILED 10-5-2007.

SAIMA MAKHDOOM, EXAMINING ATTORNEY

Int. Cl.: 2

Prior U.S. Cls.: 6, 11, and 16

United States Patent and Trademark Office

Reg. No. 3,577,397

Registered Feb. 17, 2009

**TRADEMARK
PRINCIPAL REGISTER**

I-STAT

ICS BUILDING TECHNOLOGIES (BR.VIRGIN
ISLANDS CORPORATION)
4500 WILLOW PARKWAY
CLEVELAND, OH 44125

THE MARK CONSISTS OF STANDARD CHAR-
ACTERS WITHOUT CLAIM TO ANY PARTICULAR
FONT, STYLE, SIZE, OR COLOR.

FOR: FLOOR COATINGS FOR INDUSTRIAL
AND COMMERCIAL ESTABLISHMENTS, IN CLASS
2 (U.S. CLS. 6, 11 AND 16).

SN 77-298,232, FILED 10-8-2007.

FIRST USE 1-1-2008; IN COMMERCE 1-1-2008.

KIMBERLY FRYE, EXAMINING ATTORNEY

Int. Cl.: 28

Prior U.S. Cls.: 22, 23, 38, and 50

United States Patent and Trademark Office

Reg. No. 3,577,398

Registered Feb. 17, 2009

**TRADEMARK
PRINCIPAL REGISTER**

TUBBY TUMMIES

THE HARTZ MOUNTAIN CORPORATION (NEW
JERSEY CORPORATION)
400 PLAZA DRIVE
SECAUCUS, NJ 07094

THE MARK CONSISTS OF STANDARD CHAR-
ACTERS WITHOUT CLAIM TO ANY PARTICULAR
FONT, STYLE, SIZE, OR COLOR.

FOR: PET TOYS, IN CLASS 28 (U.S. CLS. 22, 23, 38
AND 50).

SN 77-298,608, FILED 10-8-2007.

FIRST USE 12-1-2007; IN COMMERCE 12-1-2007.

CORY BOONE, EXAMINING ATTORNEY

Int. Cl.: 43

Prior U.S. Cls.: 100 and 101

United States Patent and Trademark Office

Reg. No. 3,577,399

Registered Feb. 17, 2009

**SERVICE MARK
PRINCIPAL REGISTER**

RUSTIC STEAK

TATO RESTAURANT HOLDINGS, INC. (FLOR-
IDA CORPORATION)

P.O. BOX 520085

LONGWOOD, FL 32752

FOR: RESTAURANT SERVICES, IN CLASS 43
(U.S. CLS. 100 AND 101).

FIRST USE 9-10-2008; IN COMMERCE 9-10-2008.

THE MARK CONSISTS OF STANDARD CHAR-
ACTERS WITHOUT CLAIM TO ANY PARTICULAR
FONT, STYLE, SIZE, OR COLOR.

NO CLAIM IS MADE TO THE EXCLUSIVE
RIGHT TO USE "STEAK", APART FROM THE
MARK AS SHOWN.

SN 77-299,321, FILED 10-9-2007.

KATHY DE JONGE, EXAMINING ATTORNEY

Int. Cl.: 11

Prior U.S. Cls.: 13, 21, 23, 31, and 34

United States Patent and Trademark Office

Reg. No. 3,577,400

Registered Feb. 17, 2009

**TRADEMARK
PRINCIPAL REGISTER**

**MINIMAL FIXTURES; MAXIMAL
IMPACT**

LUCIFER LIGHTING COMPANY (TEXAS COR-
PORATION)
3750 IH 35 NORTH
SAN ANTONIO, TX 78219

FOR: LIGHTS AND LIGHTING FIXTURES;
NAMELY, HIGH INTENSITY DISCHARGE (HID)
AND SOLID STATE; INCANDESCENT DOWN-
LIGHT AND UPLIGHT FIXTURES FOR INTERIOR
AND EXTERIOR LIGHTING , IN CLASS 11 (U.S.
CLS. 13, 21, 23, 31 AND 34).

FIRST USE 12-5-2008; IN COMMERCE 12-5-2008.

THE MARK CONSISTS OF STANDARD CHAR-
ACTERS WITHOUT CLAIM TO ANY PARTICULAR
FONT, STYLE, SIZE, OR COLOR.

SN 77-299,781, FILED 10-9-2007.

PAUL F. GAST, EXAMINING ATTORNEY

Int. Cl.: 41

Prior U.S. Cls.: 100, 101, and 107

United States Patent and Trademark Office

Reg. No. 3,577,401

Registered Feb. 17, 2009

**SERVICE MARK
PRINCIPAL REGISTER**

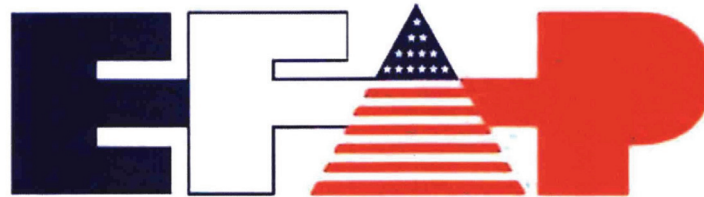

GRUPE EDH SARL (FRANCE LIMITED LIABILITY COMPANY)
61, RUE PIERRE CHARON
PARIS, FRANCE 75008

FOR: EDUCATIONAL SERVICES, NAMELY, PROVIDING COURSES OF INSTRUCTION AT THE COLLEGE LEVEL, IN CLASS 41 (U.S. CLS. 100, 101 AND 107).

FIRST USE 0-0-1991; IN COMMERCE 0-0-1991.

OWNER OF U.S. REG. NO. 1,448,420.

THE COLOR(S) BLUE, WHITE AND RED IS/ARE CLAIMED AS A FEATURE OF THE MARK.

THE MARK CONSISTS OF THE WORDING "EFAP" WHERE THE LETTER "E" IS IN BLUE, THE LETTER "F" IS IN WHITE OUTLINED IN BLUE, THE LETTER A IS A STYLIZED RENDITION OF THE FLAG OF THE UNITED STATES OF AMERICA IN RED, WHITE AND BLUE AND THE LETTER "P" IS IN RED.

SN 77-300,275, FILED 10-10-2007.

MARTHA FROMM, EXAMINING ATTORNEY

Int. Cl.: 30

Prior U.S. Cl.: 46

United States Patent and Trademark Office

Reg. No. 3,577,402

Registered Feb. 17, 2009

**TRADEMARK
PRINCIPAL REGISTER**

IYEMON CHA

KABUSHIKI KAISHA FUKUJUN (JAPAN
JOINT-STOCK COMPANY), DBA FUKUJUN
COMPANY LIMITED,
YAMASHIRO-CHO, KIZUGAWA-SHI
11, HIGASHI TSUKURIMICHI, KAMIKOMA
KYOTO-FU, JAPAN

FOR: TEA; GREEN TEA; ICED TEA, IN CLASS 30
(U.S. CL. 46).

FIRST USE 5-19-2008; IN COMMERCE 5-19-2008.

THE MARK CONSISTS OF STANDARD CHAR-
ACTERS WITHOUT CLAIM TO ANY PARTICULAR
FONT, STYLE, SIZE, OR COLOR.

OWNER OF U.S. REG. NO. 3,030,590.

NO CLAIM IS MADE TO THE EXCLUSIVE
RIGHT TO USE "CHA", APART FROM THE MARK
AS SHOWN.

THE ENGLISH TRANSLATION OF "CHA" IS
"TEA".

THE WORDING "IYEMON" HAS NO MEANING
IN A FOREIGN LANGUAGE.

SN 77-300,401, FILED 10-10-2007.

JOHN GARTNER, EXAMINING ATTORNEY

Int. Cl.: 10

Prior U.S. Cls.: 26, 39, and 44

United States Patent and Trademark Office

Reg. No. 3,577,403

Registered Feb. 17, 2009

**TRADEMARK
PRINCIPAL REGISTER**

HEARPAL

HEARPOD INC. (NEVADA CORPORATION)
5348 VEGAS DRIVE #908
LAS VEGAS, NV 89108

THE MARK CONSISTS OF STANDARD CHAR-
ACTERS WITHOUT CLAIM TO ANY PARTICULAR
FONT, STYLE, SIZE, OR COLOR.

FOR: HEARING AIDS, IN CLASS 10 (U.S. CLS. 26,
39 AND 44).

SN 77-300,489, FILED 10-10-2007.

FIRST USE 5-0-2008; IN COMMERCE 5-0-2008.

DAYNA BROWNE, EXAMINING ATTORNEY

Int. Cl.: 27

Prior U.S. Cls.: 19, 20, 37, 42, and 50

United States Patent and Trademark Office

Reg. No. 3,577,404

Registered Feb. 17, 2009

**TRADEMARK
PRINCIPAL REGISTER**

COURTEC

COURISTAN, INC. (NEW JERSEY CORPORATION)
TWO EXECUTIVE DRIVE
FORT LEE, NJ 07024

THE MARK CONSISTS OF STANDARD CHARACTERS WITHOUT CLAIM TO ANY PARTICULAR FONT, STYLE, SIZE, OR COLOR.

FOR: NYLON FIBER SOLD AS A COMPONENT OF CARPETING AND FLOOR COVERINGS, IN CLASS 27 (U.S. CLS. 19, 20, 37, 42 AND 50).

SN 77-300,597, FILED 10-10-2007.

FIRST USE 1-0-2007; IN COMMERCE 1-0-2007.

KEVIN DINALLO, EXAMINING ATTORNEY

Int. Cl.: 1

Prior U.S. Cls.: 1, 5, 6, 10, 26, and 46

Reg. No. 3,577,405

United States Patent and Trademark Office

Registered Feb. 17, 2009

**TRADEMARK
PRINCIPAL REGISTER**

NATURACELL

ROTUBA EXTRUDERS, INC. (NEW JERSEY
CORPORATION)
1401 PARK AVENUE SOUTH
LINDEN, NJ 07036

THE MARK CONSISTS OF STANDARD CHAR-
ACTERS WITHOUT CLAIM TO ANY PARTICULAR
FONT, STYLE, SIZE, OR COLOR.

FOR: POLYMER COMPOSITIONS FOR USE IN
THE MANUFACTURE OF PLASTIC PRODUCTS, IN
CLASS 1 (U.S. CLS. 1, 5, 6, 10, 26 AND 46).

SN 77-300,872, FILED 10-10-2007.

FIRST USE 1-7-2008; IN COMMERCE 2-4-2008.

ALICE BENMAMAN, EXAMINING ATTORNEY

Int. Cl.: 25

Prior U.S. Cls.: 22 and 39

United States Patent and Trademark Office

Reg. No. 3,577,406

Registered Feb. 17, 2009

**TRADEMARK
PRINCIPAL REGISTER**



NEW ORLEANS HORNETS NBA LIMITED
PARTNERSHIP (NORTH CAROLINA LIM-
ITED PARTNERSHIP)
1501 GIROD STREET
NEW ORLEANS, LA 70133

FOR: CLOTHING, NAMELY, HOSIERY, FOOT-
WEAR, BASKETBALL SHOES, BASKETBALL SNEA-
KERS, T-SHIRTS, SHIRTS, POLO SHIRTS,
SWEATSHIRTS, SWEATPANTS, PANTS, TANK
TOPS, JERSEYS, SHORTS, PAJAMAS, SPORT
SHIRTS, RUGBY SHIRTS, SWEATERS, BELTS, TIES,
NIGHTSHIRTS, HATS, CAPS, VISORS, WARM-UP
SUITS, WARM-UP PANTS, WARM-UP TOPS/
SHOOTING SHIRTS, JACKETS, WIND RESISTANT
JACKETS, PARKAS, COATS, BABY BIBS NOT OF
PAPER, HEAD BANDS, WRIST BANDS, APRONS,
UNDERGARMENTS, BOXER SHORTS, SLACKS,
EAR MUFFS, GLOVES, MITTENS, SCARVES, WO-
VEN AND KNIT SHIRTS, JERSEY DRESSES, DRES-
SES, CHEERLEADING DRESSES AND UNIFORMS,

SWIM WEAR, BATHING SUITS, SWIMSUITS, BIKI-
NIS, TANKINIS, SWIM TRUNKS, BATHING
TRUNKS, BOARD SHORTS, WET SUITS, BEACH
COVER-UPS, BATHING SUIT COVER-UPS, BATH-
ING SUIT WRAPS, SANDALS, BEACH SANDALS,
BEACH HATS, SUN VISORS, SWIM CAPS, BATH-
ING CAPS, NOVELTY HEADWEAR WITH AT-
TACHED WIGS, IN CLASS 25 (U.S. CLS. 22 AND 39).

FIRST USE 11-1-2008; IN COMMERCE 11-1-2008.

OWNER OF U.S. REG. NOS. 2,855,055, 2,957,883,
AND OTHERS.

THE MARK CONSISTS OF THE FLEUR-DE-LIS
WITH A HORNET HOLDING A BASKETBALL.

SN 77-300,903, FILED 10-10-2007.

ELLEN B. AWRICH, EXAMINING ATTORNEY

Int. Cl.: 41

Prior U.S. Cls.: 100, 101, and 107

United States Patent and Trademark Office

Reg. No. 3,577,407

Registered Feb. 17, 2009

**SERVICE MARK
PRINCIPAL REGISTER**



NEW ORLEANS HORNETS NBA LIMITED
PARTNERSHIP (NORTH CAROLINA LIM-
ITED PARTNERSHIP)
1501 GIROD STREET
NEW ORLEANS, LA 70133

FOR: ENTERTAINMENT AND EDUCATIONAL SERVICES IN THE NATURE OF ONGOING TELEVISION AND RADIO PROGRAMS IN THE FIELD OF BASKETBALL AND RENDERING LIVE BASKETBALL GAMES AND BASKETBALL EXHIBITIONS; PRODUCTION AND DISTRIBUTION OF RADIO PROGRAMS AND TELEVISION SHOWS FEATURING BROADCASTS OF BASKETBALL GAMES, BASKETBALL EVENTS AND PROGRAMS IN THE FIELD OF BASKETBALL; CONDUCTING AND ARRANGING BASKETBALL CLINICS AND CAMPS, COACHES CLINICS AND CAMPS, DANCE TEAM CLINICS AND CAMPS AND BASKETBALL EVENTS; ENTERTAINMENT SERVICES IN THE NATURE OF PERSONAL APPEARANCES BY A COSTUMED MASCOT AND/OR DANCE TEAM AT BASKETBALL GAMES AND EXHIBITIONS, CLINICS, CAMPS, PROMOTIONS, AND OTHER BASKETBALL-RELATED EVENTS, SPECIAL EVENTS AND PARTIES; FAN CLUB SERVICES; ENTERTAINMENT SERVICES, NAMELY, PROVIDING A WEBSITE FEATURING MULTIMEDIA MATERIAL IN THE NATURE OF TELEVISION HIGHLIGHTS, INTERACTIVE TELEVISION HIGHLIGHTS, VIDEO RECORDINGS, VIDEO STREAM RECORDINGS, INTERACTIVE VIDEO HIGHLIGHT SELECTIONS,

RADIO PROGRAMS, RADIO HIGHLIGHTS, AND AUDIO RECORDINGS IN THE FIELD OF BASKETBALL; PROVIDING BASKETBALL NEWS IN THE NATURE OF INFORMATION, STATISTICS, AND TRIVIA ABOUT BASKETBALL; PROVIDING ONLINE NON-DOWNLOADABLE GAMES, NAMELY, COMPUTER GAMES, VIDEO GAMES, INTERACTIVE VIDEO GAMES, ACTION SKILL GAMES, ARCADE GAMES, ADULTS' AND CHILDREN'S PARTY GAMES, SIMULATED BOARD GAMES, PUZZLES, AND TRIVIA GAMES; PROVIDING ONLINE NON-DOWNLOADABLE PUBLICATIONS IN THE NATURE OF MAGAZINES, GUIDES, NEWSLETTERS, COLORING BOOKS, GAME SCHEDULES IN THE FIELD OF BASKETBALL THAT CAN BE PRINTED OVER THE INTERNET; PROVIDING AN ONLINE COMPUTER DATABASE IN THE FIELD OF BASKETBALL, IN CLASS 41 (U.S. CLS. 100, 101 AND 107).

FIRST USE 10-1-2008; IN COMMERCE 10-1-2008.

OWNER OF U.S. REG. NOS. 2,855,055, 2,957,883, AND OTHERS.

THE MARK CONSISTS OF THE FLEUR-DE-LIS WITH A HORNET HOLDING A BASKETBALL.

SN 77-300,916, FILED 10-10-2007.

ELLEN B. AWRICH, EXAMINING ATTORNEY

Int. Cl.: 16

Prior U.S. Cls.: 2, 5, 22, 23, 29, 37, 38, and 50

Reg. No. 3,577,408

United States Patent and Trademark Office

Registered Feb. 17, 2009

**TRADEMARK
PRINCIPAL REGISTER**



NEW ORLEANS HORNETS NBA LIMITED
PARTNERSHIP (NORTH CAROLINA LIM-
ITED PARTNERSHIP)
1501 GIROD STREET
NEW ORLEANS, LA 70133

FOR: PUBLICATIONS AND PRINTED MATTER, NAMELY, BASKETBALL TRADING CARDS, TRADING CARDS, STICKERS, DECALS, COMMEMORATIVE BASKETBALL STAMPS, COLLECTIBLE CARDBOARD TRADING DISCS, MEMO BOARDS, CLIPBOARDS, PAPER COASTERS, POST CARDS, PLACE MATS OF PAPER, FACIAL TISSUES, NOTE CARDS, MEMO PADS, NOTE PADS, BALL POINT PENS, CRAYONS, MARKERS, RUBBER BANDS, PENCILS, PEN AND WRITING PAPER HOLDERS, DESKTOP DOCUMENT STANDS, SCRAP BOOKS, RUBBER STAMPS, RULERS, PAPER BANNERS AND FLAGS, 3-RING BINDERS, STATIONERY FOLDERS, WIREBOUND NOTEBOOKS, PORTFOLIO NOTEBOOKS, UNMOUNTED AND MOUNTED PHOTOGRAPHS, POSTERS, CALENDARS, BUMPER STICKERS, BOOK COVERS, BOOKMARKS, WRAPPING PAPER, CHILDREN'S ACTIVITY BOOKS, CHILDREN'S COLORING BOOKS, STATISTICAL BOOKS, GUIDE BOOKS, AND REFERENCE BOOKS IN THE FIELD OF BASKETBALL, MAGAZINES IN THE FIELD OF

BASKETBALL, CATALOGS FEATURING BASKETBALL, COMMEMORATIVE GAME AND SOUVENIR PROGRAMS RELATED TO BASKETBALL, PAPER PENNANTS, STATIONERY, STATIONERY-TYPE PORTFOLIOS, POST CARDS, INVITATION CARDS, PRINTED CERTIFICATES, GREETING CARDS, CHRISTMAS CARDS, HOLIDAY CARDS, STATISTICAL SHEETS FOR BASKETBALL TOPICS, NEWSLETTERS, BROCHURES, PAMPHLETS, AND GAME SCHEDULES IN THE FIELD OF BASKETBALL, BANK CHECKS, CHECK BOOK COVERS, CHECK BOOK HOLDERS, COMIC BOOKS; NON-MAGNETIC CREDIT CARDS AND TELEPHONE CALLING CARDS NOT MAGNETICALLY ENCODED, IN CLASS 16 (U.S. CLS. 2, 5, 22, 23, 29, 37, 38 AND 50).

FIRST USE 11-1-2008; IN COMMERCE 11-1-2008.

OWNER OF U.S. REG. NOS. 2,855,055, 2,957,883, AND OTHERS.

THE MARK CONSISTS OF THE FLEUR-DE-LIS WITH A HORNET HOLDING A BASKETBALL.

SN 77-300,920, FILED 10-10-2007.

ELLEN B. AWRICH, EXAMINING ATTORNEY

Int. Cl.: 44

Prior U.S. Cls.: 100 and 101

United States Patent and Trademark Office

Reg. No. 3,577,409

Registered Feb. 17, 2009

**SERVICE MARK
PRINCIPAL REGISTER**

SNORE RESCUE

BRIAN M. OLITSKY, D.M.D., P.A. (FLORIDA
CORPORATION)
24840 S TAMiami TR STE 3
BONITA SPRINGS, FL 34134

FOR: HEALTHCARE SERVICES, NAMELY,
TREATMENT OF PATIENTS WITH SNORING
AND SLEEP APNEA DISORDERS, IN CLASS 44
(U.S. CLS. 100 AND 101).

FIRST USE 10-0-2008; IN COMMERCE 10-0-2008.

THE MARK CONSISTS OF STANDARD CHAR-
ACTERS WITHOUT CLAIM TO ANY PARTICULAR
FONT, STYLE, SIZE, OR COLOR.

NO CLAIM IS MADE TO THE EXCLUSIVE
RIGHT TO USE "SNORE", APART FROM THE
MARK AS SHOWN.

SN 77-301,251, FILED 10-11-2007.

JERI J. FICKES, EXAMINING ATTORNEY

Int. Cl.: 36

Prior U.S. Cls.: 100, 101, and 102

United States Patent and Trademark Office

Reg. No. 3,577,410

Registered Feb. 17, 2009

**SERVICE MARK
PRINCIPAL REGISTER**

Get Well Adjusted.

ADMINISTRATIVE CLAIM SERVICE, INC. (MIN-
NESOTA CORPORATION)
SUITE 100
8970 W. 35W SERVICE DR. NE
MINNEAPOLIS, MN 55449

FOR: INSURANCE CLAIMS ADJUSTING AND
INSURANCE CLAIMS PROCESSING, IN CLASS 36
(U.S. CLS. 100, 101 AND 102).

FIRST USE 10-26-2007; IN COMMERCE 10-26-2007.

THE MARK CONSISTS OF STANDARD CHAR-
ACTERS WITHOUT CLAIM TO ANY PARTICULAR
FONT, STYLE, SIZE, OR COLOR.

SN 77-301,555, FILED 10-11-2007.

JOHN WILKE, EXAMINING ATTORNEY

Int. Cl.: 9

Prior U.S. Cls.: 21, 23, 26, 36, and 38

Reg. No. 3,577,411

United States Patent and Trademark Office

Registered Feb. 17, 2009

**TRADEMARK
PRINCIPAL REGISTER**



NEW ORLEANS HORNETS NBA LIMITED PARTNERSHIP (NORTH CAROLINA LIMITED PARTNERSHIP)
1501 GIROD STREET
NEW ORLEANS, LA 70133

FOR: AUDIO RECORDINGS AND VIDEO RECORDINGS IN THE FIELD OF BASKETBALL, AUDIO, VIDEO, COMPUTER AND LASER DISCS, PRE-RECORDED AUDIO AND VIDEO CASSETTES, PRE-RECORDED AUDIO AND VIDEO TAPES, PRE-RECORDED COMPACT DISCS, PRE-RECORDED COMPUTER DISCS, ALL RELATED TO BASKETBALL; COMPUTER ACCESSORIES, NAMELY, MOUSE PADS, MICE, DISC CASES, COMPUTER CARRY-ON CASES, KEYBOARD WRIST PADS, COMPUTER MONITOR CARDBOARD FRAMES, ALL RELATED TO BASKETBALL; COMPUTER PROGRAMS FOR VIEWING INFORMATION, STATISTICS OR TRIVIA ABOUT BASKETBALL; COMPUTER SOFTWARE, NAMELY, SCREEN SAVERS FEATURING BASKETBALL THEMES, COMPUTER SOFTWARE TO ACCESS AND VIEW COMPUTER WALLPAPER, COMPUTER BROWSERS, COMPUTER SKINS AND COMPUTER CURSORS; COMPUTER GAME SOFTWARE; VIDEO GAME SOFTWARE, VIDEO GAME CARTRIDGES, VIDEO GAME MACHINES FOR USE WITH TELEVISIONS, AND VIDEO GAME INTERACTIVE HAND HELD REMOTE CONTROLS FOR PLAYING ELECTRONIC GAMES; WIRELESS TELEPHONES; RADIOS, TELEPHONES, AND CELL PHONE ACCESSORIES, NAMELY, FACE PLATES AND CELL PHONE COV-

ERS; VIDEO MONITORS, COMPUTER MONITORS, BINOCULARS; SUNGLASSES; EYEGGLASS FRAMES; EYEWEAR STRAPS AND CHAINS; EYEGGLASS AND SUNGLASS CASES; MAGNETS; DISPOSABLE CAMERAS; CREDIT CARDS AND PREPAID TELEPHONE CALLING CARDS MAGNETICALLY ENCODED, DOWNLOADABLE VIDEO RECORDINGS, VIDEO STREAM RECORDINGS, AND AUDIO RECORDINGS IN THE FIELD OF BASKETBALL PROVIDED OVER THE INTERNET; DOWNLOADABLE COMPUTER SOFTWARE FOR VIEWING DATABASES OF INFORMATION, STATISTICAL INFORMATION, TRIVIA, POLLING INFORMATION, AND INTERACTIVE POLLING IN THE FIELD OF BASKETBALL PROVIDED OVER THE INTERNET; DOWNLOADABLE COMPUTER GAME SOFTWARE; DOWNLOADABLE VIDEO GAME PROGRAMS, INTERACTIVE VIDEO GAMES AND TRIVIA GAME SOFTWARE PROVIDED OVER THE INTERNET; DOWNLOADABLE COMPUTER SOFTWARE FOR USE AS SCREENSAVERS, WALLPAPER, BROWSERS, SKINS, AVATARS AND CURSORS OVER THE INTERNET; DOWNLOADABLE ELECTRONIC PUBLICATIONS IN THE NATURE OF MAGAZINES, NEWSLETTERS, COLORING BOOKS, GAME SCHEDULES ALL IN THE FIELD OF BASKETBALL PROVIDED OVER THE INTERNET; DOWNLOADABLE CATALOGS PROVIDED OVER THE INTERNET FEATURING AN ARRAY OF BASKETBALL-THEMED PRODUCTS; DOWNLOADABLE GREETING CARDS PROVIDED OVER

THE INTERNET, IN CLASS 9 (U.S. CLS. 21, 23, 26, 36 AND 38).

FIRST USE 11-1-2008; IN COMMERCE 11-1-2008.

OWNER OF U.S. REG. NOS. 2,855,055, 2,957,883, AND OTHERS.

THE MARK CONSISTS OF THE FLEUR-DE-LIS WITH A HORNET HOLDING A BASKETBALL.

SN 77-301,731, FILED 10-11-2007.

ELLEN B. AWRICH, EXAMINING ATTORNEY

Int. Cl.: 35

Prior U.S. Cls.: 100, 101, and 102

United States Patent and Trademark Office

Reg. No. 3,577,412

Registered Feb. 17, 2009

**SERVICE MARK
PRINCIPAL REGISTER**



NEW ORLEANS HORNETS NBA LIMITED
PARTNERSHIP (NORTH CAROLINA LIM-
ITED PARTNERSHIP)
1501 GIROD STREET
NEW ORLEANS, LA 70133

FOR: ONLINE RETAIL STORE SERVICES, ON-
LINE RETAIL ORDERING SERVICES, ELECTRO-
NIC RETAIL STORE SERVICES, ONLINE
CATALOG AND MAIL ORDER CATALOG SERVI-
CES, ALL FEATURING AN ARRAY OF BASKET-
BALL-THEMED MERCHANDISE; PROMOTING
THE GOODS AND SERVICES OF OTHERS BY
ALLOWING SPONSORS TO AFFILIATE THESE
GOODS AND SERVICES WITH A BASKETBALL
PROGRAM; PROMOTING THE SALE OF GOODS
AND SERVICES OF OTHERS THROUGH THE DIS-
TRIBUTION OF PROMOTIONAL CONTESTS PRO-

VIDED OVER THE INTERNET; CONDUCTING
PUBLIC OPINION POLL SURVEYS AND PUBLIC
OPINION POLL SURVEYS IN THE FIELD OF
BASKETBALL FOR NON-BUSINESS, NON-MAR-
KETING PURPOSES OVER THE INTERNET , IN
CLASS 35 (U.S. CLS. 100, 101 AND 102).

FIRST USE 11-1-2008; IN COMMERCE 11-1-2008.

OWNER OF U.S. REG. NOS. 2,855,055, 2,957,883,
AND OTHERS.

THE MARK CONSISTS OF THE FLEUR-DE-LIS
WITH A HORNET HOLDING A BASKETBALL.

SN 77-301,746, FILED 10-11-2007.

ELLEN B. AWRICH, EXAMINING ATTORNEY

Int. Cl.: 38

Prior U.S. Cls.: 100, 101, and 104

United States Patent and Trademark Office

Reg. No. 3,577,413

Registered Feb. 17, 2009

**SERVICE MARK
PRINCIPAL REGISTER**



NEW ORLEANS HORNETS NBA LIMITED
PARTNERSHIP (NORTH CAROLINA LIM-
ITED PARTNERSHIP)
1501 GIROD STREET
NEW ORLEANS, LA 70133

FOR: AUDIO BROADCASTING; CABLE TELEVI-
SION BROADCASTING; RADIO BROADCASTING;
SUBSCRIPTION TELEVISION BROADCASTING;
TELEVISION BROADCASTING; VIDEO BROAD-
CASTING; WEBCASTING SERVICES IN THE NAT-
URE OF PROVIDING ON-LINE CHAT ROOMS AND
ON-LINE INTERACTIVE CHAT ROOMS WITH
GUESTS FOR TRANSMISSION OF MESSAGES
AMONG COMPUTER USERS CONCERNING THE
FIELD OF BASKETBALL; BROADCASTING PRO-
GRAMS OVER THE INTERNET; PROVIDING ON-
LINE ELECTRONIC BULLETIN BOARDS FOR
TRANSMISSION OF MESSAGES AMONG COMPU-
TER USERS CONCERNING THE FIELD OF BAS-
KETBALL; PROVIDING MULTIPLE-USER ACCESS
TO A GLOBAL COMPUTER INFORMATION NET-

WORK FOR THE PURPOSE OF PARTICIPATING IN
INTERACTIVE POLLING IN THE FIELD OF BAS-
KETBALL; WIRELESS COMMUNICATIONS SERVI-
CES, NAMELY, TRANSMISSION OF GRAPHICS TO
MOBILE TELEPHONES; WIRELESS ELECTRONIC
TRANSMISSION OF VOICE SIGNALS, DATA, FAC-
SIMILES, IMAGES AND INFORMATION; WIRE-
LESS BROADBAND COMMUNICATIONS
SERVICES, IN CLASS 38 (U.S. CLS. 100, 101 AND 104).

FIRST USE 12-5-2007; IN COMMERCE 12-5-2007.

OWNER OF U.S. REG. NOS. 2,855,055, 2,957,883,
AND OTHERS.

THE MARK CONSISTS OF THE FLEUR-DE-LIS
WITH A HORNET HOLDING A BASKETBALL.

SN 77-301,751, FILED 10-11-2007.

ELLEN B. AWRICH, EXAMINING ATTORNEY

Int. Cl.: 35

Prior U.S. Cls.: 100, 101, and 102

United States Patent and Trademark Office

Reg. No. 3,577,414

Registered Feb. 17, 2009

**SERVICE MARK
PRINCIPAL REGISTER**

FloorSource SuperCenter

DIVERSIFIED SALES, INC. (ALABAMA CORPORATION)
1465 HIGHWAY 11
TRUSSVILLE, AL 35173

FOR: DISCOUNT STORES IN THE FIELD OF FLOORING, CARPETING, TILE, WOOD, AND OTHER FLOOR COVERINGS; RETAIL DISCOUNT STORE SERVICES IN THE FIELD OF FLOORING, CARPETING, TILE, WOOD AND OTHER FLOOR COVERINGS; RETAIL OUTLETS FEATURING FLOORING, CARPETING, TILE, WOOD AND OTHER FLOOR COVERINGS; RETAIL SHOPS FEATURING FLOORING, CARPETING, TILE, WOOD AND OTHER FLOOR COVERINGS; RETAIL STORE SERVICES FEATURING FLOORING, CARPETING, TILE, WOOD AND OTHER FLOOR COVERINGS; RETAIL STORES FEATURING FLOORING, CARPETING, TILE, WOOD AND OTHER FLOOR COVERINGS; RETAIL STORES FEATURING FLOORING, CARPETING, TILE, WOOD AND OTHER FLOOR COVERINGS; RETAIL FLOOR COVERING STORES;

WHOLESALE STORES FEATURING FLOORING, CARPETING, TILE, WOOD AND OTHER FLOOR COVERINGS, IN CLASS 35 (U.S. CLS. 100, 101 AND 102).

FIRST USE 1-25-2001; IN COMMERCE 1-25-2001.

THE MARK CONSISTS OF STANDARD CHARACTERS WITHOUT CLAIM TO ANY PARTICULAR FONT, STYLE, SIZE, OR COLOR.

NO CLAIM IS MADE TO THE EXCLUSIVE RIGHT TO USE "SUPER CENTER", APART FROM THE MARK AS SHOWN.

SN 77-301,933, FILED 10-11-2007.

JANICE L. MCMORROW, EXAMINING ATTORNEY

Int. Cl.: 11

Prior U.S. Cls.: 13, 21, 23, 31, and 34

United States Patent and Trademark Office

Reg. No. 3,577,415

Registered Feb. 17, 2009

**TRADEMARK
PRINCIPAL REGISTER**

FLEXX

TOWNSHEND, MARK E. (UNITED STATES IN-
DIVIDUAL)
5321 WEST CRENSHAW ST.
TAMPA, FL 33634

FOR: WATER FILTERING DEVICES, NAMELY,
WATER PURIFICATION INSTALLATIONS FOR
WASTE WATER AND SEWAGE CONSISTING OF
CURTAINS AND TEXTILE FABRICS; WATER FIL-
TERING UNITS FOR INDUSTRIAL USE; WATER
PURIFICATION TANKS; WATER PURIFICATION
UNITS; WATER PURIFIERS; WATER PURIFYING
APPARATUS; WATER SOFTENING UNITS; WATER
TREATMENT EQUIPMENT, NAMELY, CAR-
TRIDGE FILTRATION UNITS; WATER TREAT-
MENT EQUIPMENT, NAMELY, CHEMICAL

STERILIZATION UNITS; WATER TREATMENT
EQUIPMENT, NAMELY, REVERSE OSMOSIS FIL-
TRATION UNITS; WATER TREATMENT EQUIP-
MENT, NAMELY, ULTRAVIOLET STERILIZATION
UNITS, IN CLASS 11 (U.S. CLS. 13, 21, 23, 31 AND 34).

FIRST USE 7-15-2008; IN COMMERCE 7-15-2008.

THE MARK CONSISTS OF STANDARD CHAR-
ACTERS WITHOUT CLAIM TO ANY PARTICULAR
FONT, STYLE, SIZE, OR COLOR.

SN 77-302,269, FILED 10-11-2007.

DAYNA BROWNE, EXAMINING ATTORNEY

Int. Cl.: 9

Prior U.S. Cls.: 21, 23, 26, 36, and 38

Reg. No. 3,577,416

United States Patent and Trademark Office

Registered Feb. 17, 2009

**TRADEMARK
PRINCIPAL REGISTER**

EKO

CROSSBOW TECHNOLOGY, INC. (CALIFORNIA CORPORATION)
4145 N. FIRST STREET
SAN JOSE, CA 95134

FOR: COMPUTER HARDWARE USED TO MONITOR AND RECORD ENVIRONMENTAL CONDITIONS, NAMELY, SOIL, CROP, WEATHER, AND/OR POLLUTION CONDITIONS; ELECTRONIC WIRELESS SENSORS USED TO MONITOR AND RECORD ENVIRONMENTAL CONDITIONS, NAMELY, SOIL, CROP, WEATHER, AND/OR POLLUTION CONDITIONS; COMPUTER SOFTWARE FOR THE OPERATION OF ELECTRONIC WIRELESS SENSORS USED TO MONITOR AND RECORD ENVIRONMENTAL CONDITIONS, NAMELY, SOIL, CROP, WEATHER, AND/OR POLLUTION CONDITIONS; COMPUTER SOFTWARE FOR ADMINISTRATION OF COMPUTER NETWORKS FOR THE OPERATION OF ELECTRONIC WIRELESS SENSORS USED TO MONITOR AND RECORD ENVIR-

ONMENTAL CONDITIONS, NAMELY, SOIL, CROP, WEATHER, AND/OR POLLUTION CONDITIONS; COMPUTER SOFTWARE PLATFORMS FOR CONTROLLING ELECTRONIC WIRELESS SENSORS USED TO MONITOR AND RECORD ENVIRONMENTAL CONDITIONS, NAMELY, SOIL, CROP, WEATHER, AND/OR POLLUTION CONDITIONS; AND MANUALS SOLD AS A UNIT WITH THE FOREGOING, IN CLASS 9 (U.S. CLS. 21, 23, 26, 36 AND 38).

FIRST USE 4-11-2008; IN COMMERCE 4-11-2008.

THE MARK CONSISTS OF STANDARD CHARACTERS WITHOUT CLAIM TO ANY PARTICULAR FONT, STYLE, SIZE, OR COLOR.

SN 77-302,361, FILED 10-11-2007.

ZHALEH DELANEY, EXAMINING ATTORNEY

Int. Cl.: 37

Prior U.S. Cls.: 100, 103, and 106

United States Patent and Trademark Office

Reg. No. 3,577,417

Registered Feb. 17, 2009

**SERVICE MARK
PRINCIPAL REGISTER**

FISHERS RIDGE

ROWLEY 96 LLC (NEW YORK LIMITED LIABILITY COMPANY)
1950 BRIGHTON-HENRIETTA
TOWNLIN ROAD
ROCHESTER, NY 14623

FOR: REAL ESTATE DEVELOPMENT; LAND DEVELOPMENT SERVICES, NAMELY, PLANNING AND LAYING OUT OF RESIDENTIAL AND/OR COMMERCIAL COMMUNITIES, IN CLASS 37 (U.S. CLS. 100, 103 AND 106).

FIRST USE 11-9-2007; IN COMMERCE 11-9-2007.

THE MARK CONSISTS OF STANDARD CHARACTERS WITHOUT CLAIM TO ANY PARTICULAR FONT, STYLE, SIZE, OR COLOR.

THE WORDS "FISHERS RIDGE" HAS NO MEANING IN A FOREIGN LANGUAGE.

SN 77-302,896, FILED 10-12-2007.

AMEETA JORDAN, EXAMINING ATTORNEY

Int. Cl.: 9

Prior U.S. Cls.: 21, 23, 26, 36, and 38

United States Patent and Trademark Office

Reg. No. 3,577,418

Registered Feb. 17, 2009

**TRADEMARK
PRINCIPAL REGISTER**

PARATUNE

PARATEK MICROWAVE, INC. (MARYLAND CORPORATION)
9135 GUILFORD ROAD
COLUMBIA, MD 21046

FOR: ANTENNAE FILTERS; ANTENNAS; ANTENNAS FOR RADIO, FOR TELEVISION; ANTENNAS FOR WIRELESS COMMUNICATIONS APPARATUS; ELECTRONIC COMBINERS FOR CONNECTING ANTENNAS AND RECEIVERS; MICROWAVE ANTENNAE, IN CLASS 9 (U.S. CLS. 21, 23, 26, 36 AND 38).

FIRST USE 1-1-2008; IN COMMERCE 1-1-2008.

THE MARK CONSISTS OF STANDARD CHARACTERS WITHOUT CLAIM TO ANY PARTICULAR FONT, STYLE, SIZE, OR COLOR.

SN 77-302,935, FILED 10-12-2007.

KEVIN DINALLO, EXAMINING ATTORNEY

Int. Cl.: 25

Prior U.S. Cls.: 22 and 39

United States Patent and Trademark Office

Reg. No. 3,577,419

Registered Feb. 17, 2009

**TRADEMARK
PRINCIPAL REGISTER**

AZUMA

AZUMA USA, LLC (MARYLAND LIMITED LIABILITY COMPANY)

#B

1126 S. HANOVER ST.
BALTIMORE, MD 21230

FOR: CLOTHING, NAMELY, T-SHIRTS, SWEAT-SHIRTS, JACKETS, HATS, ATHLETIC UNIFORMS, SHORTS, PANTS, AND SOCKS; FOOTWEAR AND SHOES, NAMELY, ATHLETIC SHOES, IN CLASS 25 (U.S. CLS. 22 AND 39).

FIRST USE 1-1-2005; IN COMMERCE 7-1-2008.

THE MARK CONSISTS OF STANDARD CHARACTERS WITHOUT CLAIM TO ANY PARTICULAR FONT, STYLE, SIZE, OR COLOR.

SN 77-303,048, FILED 10-12-2007.

ZHALEH DELANEY, EXAMINING ATTORNEY

Int. Cl.: 41

Prior U.S. Cls.: 100, 101, and 107

United States Patent and Trademark Office

Reg. No. 3,577,420

Registered Feb. 17, 2009

**SERVICE MARK
PRINCIPAL REGISTER**



SHOWTIME NETWORKS INC. (DELAWARE CORPORATION)
1633 BROADWAY
NEW YORK, NY 10019

FOR: ENTERTAINMENT SERVICES, NAMELY, PRODUCTION AND DISTRIBUTION OF MOTION PICTURES, COMEDY, MUSICAL AND DRAMATIC TELEVISION SERIES, DOCUMENTARIES, TELEVISION SERIES FEATURING SPORTING EVENTS AND OTHER ATTRACTIONS RENDERED THROUGH THE MEDIA OF TELEVISION, CABLE, SATELLITE, RADIO, TELEPHONE AND BROADBAND SYSTEMS, AND VIA THE INTERNET, PORTABLE AND WIRELESS COMMUNICATION DEVICES, IN CLASS 41 (U.S. CLS. 100, 101 AND 107).

FIRST USE 1-31-2008; IN COMMERCE 1-31-2008.

OWNER OF U.S. REG. NOS. 2,496,206, 3,346,302, AND OTHERS.

THE MARK CONSISTS OF THE LETTERS "SHO" IN A CIRCLE FOLLOWED BY THE NUMERAL "2" SURROUNDED BY A CIRCLE.

SN 77-303,095, FILED 10-12-2007.

TAMARA FRAZIER, EXAMINING ATTORNEY

Int. Cl.: 38

Prior U.S. Cls.: 100, 101, and 104

United States Patent and Trademark Office

Reg. No. 3,577,421

Registered Feb. 17, 2009

**SERVICE MARK
PRINCIPAL REGISTER**



SHOWTIME NETWORKS INC. (DELAWARE CORPORATION)
1633 BROADWAY
NEW YORK, NY 10019

FOR: BROADCASTING SERVICES, NAMELY, TRANSMITTING, DOWNLOADING AND STREAMING DIGITAL AUDIO, VIDEO, GRAPHICS, TEXT AND DATA, RENDERED THROUGH THE MEDIA OF TELEVISION, CABLE, SATELLITE, RADIO, TELEPHONE AND BROADBAND SYSTEMS, AND VIA THE INTERNET, PORTABLE AND WIRELESS COMMUNICATIONS DEVICES; PROVIDING AN ONLINE COMMUNITY, DATABASE AND SERVICE ENABLING TRANSMISSION, DOWNLOADING AND STREAMING OF DIGITAL AUDIO, VIDEO, GRAPHICS, TEXT AND DATA; PEER TO PEER NETWORKING; PROVIDING ONLINE CHAT

ROOMS AND BULLETIN BOARDS FOR TRANSMISSION OF MESSAGES AMONG USERS IN THE FIELD OF GENERAL INTEREST, IN CLASS 38 (U.S. CLS. 100, 101 AND 104).

FIRST USE 1-31-2008; IN COMMERCE 1-31-2008.

OWNER OF U.S. REG. NOS. 2,496,206, 3,346,302, AND OTHERS.

THE MARK CONSISTS OF THE LETTERS "SHO" IN A CIRCLE FOLLOWED BY THE NUMERAL "2" SURROUNDED BY A CIRCLE.

SN 77-303,116, FILED 10-12-2007.

TAMARA FRAZIER, EXAMINING ATTORNEY

Int. Cl.: 41

Prior U.S. Cls.: 100, 101, and 107

United States Patent and Trademark Office

Reg. No. 3,577,422

Registered Feb. 17, 2009

**SERVICE MARK
PRINCIPAL REGISTER**



SHOWTIME NETWORKS INC. (DELAWARE CORPORATION)
1633 BROADWAY
NEW YORK, NY 10019

FOR: ENTERTAINMENT SERVICES, NAMELY, PRODUCTION AND DISTRIBUTION OF MOTION PICTURES, COMEDY, MUSICAL AND DRAMATIC TELEVISION SERIES, DOCUMENTARIES, TELEVISION SERIES FEATURING SPORTING EVENTS AND OTHER ATTRACTIONS RENDERED THROUGH THE MEDIA OF TELEVISION, CABLE, SATELLITE, RADIO, TELEPHONE AND BROADBAND SYSTEMS, AND VIA THE INTERNET, PORTABLE AND WIRELESS COMMUNICATION DEVICES, IN CLASS 41 (U.S. CLS. 100, 101 AND 107).

FIRST USE 1-31-2008; IN COMMERCE 1-31-2008.

OWNER OF U.S. REG. NOS. 2,180,434, 3,342,145, AND OTHERS.

THE MARK CONSISTS OF THE WORD "SHOW-TIME" WITH LETTERS "SHO" IN A CIRCLE FOLLOWED BY THE NUMERAL "2" SURROUNDED BY A CIRCLE.

SN 77-303,126, FILED 10-12-2007.

TAMARA FRAZIER, EXAMINING ATTORNEY

Int. Cl.: 38

Prior U.S. Cls.: 100, 101, and 104

United States Patent and Trademark Office

Reg. No. 3,577,423

Registered Feb. 17, 2009

SERVICE MARK
PRINCIPAL REGISTER



SHOWTIME NETWORKS INC. (DELAWARE CORPORATION)
1633 BROADWAY
NEW YORK, NY 10019

FOR: BROADCASTING SERVICES, NAMELY, TRANSMITTING, DOWNLOADING AND STREAMING DIGITAL AUDIO, VIDEO, GRAPHICS, TEXT AND DATA, RENDERED THROUGH THE MEDIA OF TELEVISION, CABLE, SATELLITE, RADIO, TELEPHONE AND BROADBAND SYSTEMS, AND VIA THE INTERNET, PORTABLE AND WIRELESS COMMUNICATIONS DEVICES; PROVIDING AN ONLINE COMMUNITY, DATABASE AND SERVICE ENABLING TRANSMISSION, DOWNLOADING AND STREAMING OF DIGITAL AUDIO, VIDEO, GRAPHICS, TEXT AND DATA; PEER TO PEER NETWORKING; PROVIDING ONLINE CHAT ROOMS AND BULLETIN BOARDS FOR TRANS-

MISSION OF MESSAGES AMONG USERS IN THE FIELD OF GENERAL INTEREST, IN CLASS 38 (U.S. CLS. 100, 101 AND 104).

FIRST USE 1-31-2008; IN COMMERCE 1-31-2008.

OWNER OF U.S. REG. NOS. 2,180,434, 3,342,145, AND OTHERS.

THE MARK CONSISTS OF THE WORD "SHOW-TIME" WITH LETTERS "SHO" IN A CIRCLE FOLLOWED BY THE NUMERAL "2" SURROUNDED BY A CIRCLE.

SN 77-303,134, FILED 10-12-2007.

TAMARA FRAZIER, EXAMINING ATTORNEY

Int. Cl.: 41

Prior U.S. Cls.: 100, 101, and 107

United States Patent and Trademark Office

Reg. No. 3,577,424

Registered Feb. 17, 2009

**SERVICE MARK
PRINCIPAL REGISTER**

SHOWTIME BOXING

SHOWTIME NETWORKS INC. (DELAWARE
CORPORATION)
1633 BROADWAY
NEW YORK, NY 10019

FOR: ENTERTAINMENT SERVICES, NAMELY,
CONTINUING TELEVISION SERIES FEATURING
BOXING AND INTERVIEWS RENDERED
THROUGH THE MEDIA OF TELEVISION, CABLE,
SATELLITE AND TELEPHONE SYSTEMS, WIRE-
LESS AND GLOBAL COMMUNICATIONS NET-
WORKS; PROVIDING INFORMATION IN THE
FIELD OF ENTERTAINMENT, NAMELY, PROVID-
ING INFORMATION ON BOXING EVENTS AND
BOXING INTERVIEWS VIA THE INTERNET, GLO-
BAL COMMUNICATION AND WIRELESS DEVI-
CES, IN CLASS 41 (U.S. CLS. 100, 101 AND 107).

FIRST USE 12-31-2007; IN COMMERCE 12-31-2007.

THE MARK CONSISTS OF STANDARD CHAR-
ACTERS WITHOUT CLAIM TO ANY PARTICULAR
FONT, STYLE, SIZE, OR COLOR.

OWNER OF U.S. REG. NOS. 2,180,434, 3,342,145,
AND OTHERS.

NO CLAIM IS MADE TO THE EXCLUSIVE
RIGHT TO USE "BOXING", APART FROM THE
MARK AS SHOWN.

SN 77-303,145, FILED 10-12-2007.

TAMARA FRAZIER, EXAMINING ATTORNEY

Int. Cl.: 16

Prior U.S. Cls.: 2, 5, 22, 23, 29, 37, 38, and 50

United States Patent and Trademark Office

Reg. No. 3,577,425

Registered Feb. 17, 2009

**TRADEMARK
PRINCIPAL REGISTER**



EDITORIAL TELEVISA INTERNATIONAL, S.A.
(MEXICO CORPORATION)
EDIFICIO E, PISO 2
AV. VASCO DE QUIROGA 2000
COL. ZEDEC SANTA FE, MEXICO 01210

FOR: SPANISH LANGUAGE MAGAZINE DEAL-
ING WITH CELEBRITIES, IN CLASS 16 (U.S. CLS. 2,
5, 22, 23, 29, 37, 38 AND 50).

FIRST USE 12-1-2002; IN COMMERCE 12-1-2008.

OWNER OF U.S. REG. NO. 3,182,172.

THE COLOR(S) WHITE AND RED IS/ARE
CLAIMED AS A FEATURE OF THE MARK.

THE MARK CONSISTS OF WHITE LETTERING
"CARAS" ON A RED BACKGROUND.

THE FOREIGN WORDING IN THE MARK
TRANSLATES INTO ENGLISH AS FACES.

SN 77-303,229, FILED 10-12-2007.

CHERYL CLAYTON, EXAMINING ATTORNEY

Int. Cl.: 14

Prior U.S. Cls.: 2, 27, 28, and 50

United States Patent and Trademark Office

Reg. No. 3,577,426

Registered Feb. 17, 2009

**TRADEMARK
PRINCIPAL REGISTER**

CAMP ROCK

DISNEY ENTERPRISES, INC. (DELAWARE COR-
PORATION)
500 SOUTH BUENA VISTA STREET
BURBANK, CA 91521

THE MARK CONSISTS OF STANDARD CHAR-
ACTERS WITHOUT CLAIM TO ANY PARTICULAR
FONT, STYLE, SIZE, OR COLOR.

FOR: JEWELRY, WATCHES AND CLOCKS, IN
CLASS 14 (U.S. CLS. 2, 27, 28 AND 50).

SN 77-303,262, FILED 10-12-2007.

FIRST USE 5-1-2008; IN COMMERCE 5-1-2008.

DARRYL SPRUILL, EXAMINING ATTORNEY

Int. Cl.: 35

Prior U.S. Cls.: 100, 101, and 102

United States Patent and Trademark Office

Reg. No. 3,577,427

Registered Feb. 17, 2009

**SERVICE MARK
PRINCIPAL REGISTER**

LA PEQUENA LATINO AMERICA

CLEAR CHANNEL BROADCASTING, INC. (NE-
VADA CORPORATION)
200 EAST BASSE ROAD
SAN ANTONIO, TX 78209

FOR: RETAIL GROCERY STORES, IN CLASS 35
(U.S. CLS. 100, 101 AND 102).

FIRST USE 1-31-2008; IN COMMERCE 1-31-2008.

THE MARK CONSISTS OF STANDARD CHAR-
ACTERS WITHOUT CLAIM TO ANY PARTICULAR
FONT, STYLE, SIZE, OR COLOR.

NO CLAIM IS MADE TO THE EXCLUSIVE
RIGHT TO USE "LATINO AMERICA", APART
FROM THE MARK AS SHOWN.

THE FOREIGN WORDING IN THE MARK
TRANSLATES INTO ENGLISH AS THE LITTLE
LATIN AMERICA.

SN 77-303,301, FILED 10-12-2007.

CIMMERIAN COLEMAN, EXAMINING ATTOR-
NEY

Int. Cl.: 16

Prior U.S. Cls.: 2, 5, 22, 23, 29, 37, 38, and 50

Reg. No. 3,577,428

United States Patent and Trademark Office

Registered Feb. 17, 2009

**TRADEMARK
PRINCIPAL REGISTER**

Naturally Wild Photography

VORTEX ENTERPRISES, INC. (IDAHO CORPORATION), DBA NATURALLY WILD PHOTOGRAPHY,

P.O. BOX 50345

IDAHO FALLS, ID 83405

FOR: PHOTOGRAPHS, IN CLASS 16 (U.S. CLS. 2, 5, 22, 23, 29, 37, 38 AND 50).

FIRST USE 7-2-2008; IN COMMERCE 7-21-2008.

THE MARK CONSISTS OF STANDARD CHARACTERS WITHOUT CLAIM TO ANY PARTICULAR FONT, STYLE, SIZE, OR COLOR.

NO CLAIM IS MADE TO THE EXCLUSIVE RIGHT TO USE "PHOTOGRAPHY", APART FROM THE MARK AS SHOWN.

SN 77-303,931, FILED 10-15-2007.

TOBY BULLOFF, EXAMINING ATTORNEY

Int. Cl.: 3

Prior U.S. Cls.: 1, 4, 6, 50, 51, and 52

United States Patent and Trademark Office

Reg. No. 3,577,429

Registered Feb. 17, 2009

**TRADEMARK
PRINCIPAL REGISTER**

THE SECRET OF SNOW CRYSTAL

AMOREPACIFIC CORPORATION (REPUBLIC OF
KOREA CORPORATION)
YONGSAN-KU
181, 2-KA, HANGANG-RO
SEOUL, REPUBLIC OF KOREA 140-777

FOR: COSMETICS; BODY AND BEAUTY CARE
COSMETICS; COSMETIC PREPARATIONS FOR
BODY AND SKIN CARE; COSMETICS FOR LIPS;
HAIR CARE, HAIR CLEANING, HAIR COLORING,
HAIR RELAXING AND HAIR STYLING PREPARA-
TIONS; COLORING PREPARATIONS FOR COS-
METIC PURPOSES; COSMETIC PENCILS; SKIN
LOTIONS; MAKEUP AND NAIL POLISH REMOV-
ERS; FACIAL AND SKIN MASKS; NAIL ENAMELS;
TOOTH AND DENTURE CLEANING AND
WHITENING PREPARATIONS; NON-MEDICATED

LIP CARE PREPARATIONS; MAKE-UP FOR THE
FACE AND BODY; MASCARA; FACE POWDERS;
FOUNDATIONS; CREAMY FOUNDATIONS; LIP-
STICKS; EYE LINER; BLUSHER, IN CLASS 3 (U.S.
CLS. 1, 4, 6, 50, 51 AND 52).

FIRST USE 5-0-2007; IN COMMERCE 7-0-2007.

THE MARK CONSISTS OF STANDARD CHAR-
ACTERS WITHOUT CLAIM TO ANY PARTICULAR
FONT, STYLE, SIZE, OR COLOR.

SN 77-303,958, FILED 10-15-2007.

GEOFFREY FOSDICK, EXAMINING ATTORNEY

Int. Cl.: 9

Prior U.S. Cls.: 21, 23, 26, 36, and 38

United States Patent and Trademark Office

Reg. No. 3,577,430

Registered Feb. 17, 2009

**TRADEMARK
PRINCIPAL REGISTER**

CHACK'N POP

KABUSHIKI KAISHA TAITO (JAPAN CORPORATION)
3-22-7 YOYOGI, SHIBUYA-KU
TOKYO 151-0053, JAPAN

FOR: DOWNLOADABLE SOFTWARE FOR USE AS GAME PROGRAMS ON MOBILE TELEPHONES; COMPUTER PROGRAMS FOR PLAYING GAMES RECORDED ON MOBILE TELEPHONES; COMPUTER GAME PROGRAMS PRE-RECORDED ON CARTRIDGES, DISCS, AND CARDS; DOWNLOADABLE SOFTWARE FOR USE AS COMPUTER GAME PROGRAMS; ELECTRONIC GAME PROGRAMS; INTERACTIVE MULTIMEDIA COMPUTER GAME PROGRAMS FEATURING DOWNLOADABLE SOUND AND DOWNLOADABLE DIGITAL MUSIC PROVIDED FROM THE INTERNET; DOWNLOADABLE SOFTWARE FOR USE AS SCREEN SAVERS FOR COMPUTERS OR MOBILE PHONES; DOWNLOADABLE SOFTWARE FOR USE AS RING TONES FOR MOBILE PHONES; PRE-RECORDED MAGNETIC DATA CARRIERS FEATURING GAMES;

PRE-RECORDED DIGITAL VIDEO DISCS FEATURING GAMES; DOWNLOADABLE ELECTRONIC PUBLICATIONS IN THE NATURE OF NEWSLETTER IN THE FIELD OF ANIMATION; AND ELECTRONIC PUBLICATIONS, NAMELY, JOURNALS AND NEWSLETTERS IN THE FIELD OF ENTERTAINMENT FEATURING COMPUTER GAMES, VIDEO GAMES, CARTOONS AND GENERAL ENTERTAINMENT RECORDED ON COMPUTER MEDIA, IN CLASS 9 (U.S. CLS. 21, 23, 26, 36 AND 38).

FIRST USE 0-0-1983; IN COMMERCE 0-0-1983.

THE MARK CONSISTS OF STANDARD CHARACTERS WITHOUT CLAIM TO ANY PARTICULAR FONT, STYLE, SIZE, OR COLOR.

SN 77-304,462, FILED 10-15-2007.

EDWARD NELSON, EXAMINING ATTORNEY

Int. Cl.: 41

Prior U.S. Cls.: 100, 101, and 107

United States Patent and Trademark Office

Reg. No. 3,577,431

Registered Feb. 17, 2009

**SERVICE MARK
PRINCIPAL REGISTER**

**LIFE PURPOSE COACHING
CENTERS INTERNATIONAL**

BRAZELTON, KATHERINE F. (UNITED STATES
INDIVIDUAL)

5 EL VADO DRIVE

RANCHO SANTA MARGARITA, CA 92688

FOR: TRAINING SERVICES, NAMELY, TRAIN-
ING INDIVIDUALS TO BE LIFE COACHES USING
CHRISTIAN-BASED GUIDANCE PRINCIPALS TO
ASSIST OTHERS IN THEIR PERSONAL LIVES , IN
CLASS 41 (U.S. CLS. 100, 101 AND 107).

FIRST USE 1-2-2007; IN COMMERCE 1-2-2007.

THE MARK CONSISTS OF STANDARD CHAR-
ACTERS WITHOUT CLAIM TO ANY PARTICULAR
FONT, STYLE, SIZE, OR COLOR.

OWNER OF U.S. REG. NO. 3,134,226.

NO CLAIM IS MADE TO THE EXCLUSIVE
RIGHT TO USE "LIFE" AND "COACHING CEN-
TERS INTERNATIONAL", APART FROM THE
MARK AS SHOWN.

SN 77-304,711, FILED 10-15-2007.

DAVID MURRAY, EXAMINING ATTORNEY

Int. Cl.: 45

Prior U.S. Cls.: 100 and 101

United States Patent and Trademark Office

Reg. No. 3,577,432

Registered Feb. 17, 2009

**SERVICE MARK
PRINCIPAL REGISTER**

**YOUR LIFE ON THE MOVIE
SCREEN**

BRAZELTON, KATHERINE F. (UNITED STATES
INDIVIDUAL)
5 EL VADO DRIVE
RANCHO SANTA MARGARITA, CA 92688

THE MARK CONSISTS OF STANDARD CHAR-
ACTERS WITHOUT CLAIM TO ANY PARTICULAR
FONT, STYLE, SIZE, OR COLOR.

FOR: COUNSELING SERVICES IN THE FIELD
OF CHRISTIAN CONDUCT IN PERSONAL RELA-
TIONSIPS, IN CLASS 45 (U.S. CLS. 100 AND 101).

SN 77-304,715, FILED 10-15-2007.

FIRST USE 3-15-2006; IN COMMERCE 3-15-2006.

DAVID MURRAY, EXAMINING ATTORNEY

Int. Cl.: 36

Prior U.S. Cls.: 100, 101, and 102

United States Patent and Trademark Office

Reg. No. 3,577,433

Registered Feb. 17, 2009

**SERVICE MARK
PRINCIPAL REGISTER**

**Your present. Your
future. We're here.**

CENTRAL FLORIDA EDUCATORS' FEDERAL
CREDIT UNION (FLORIDA NON-PROFIT OR-
GANIZATION)
1000 PRIMERA BLVD.
LAKE MARY, FL 32746

THE MARK CONSISTS OF STANDARD CHAR-
ACTERS WITHOUT CLAIM TO ANY PARTICULAR
FONT, STYLE, SIZE, OR COLOR.

FOR: CREDIT UNION SERVICES, IN CLASS 36
(U.S. CLS. 100, 101 AND 102).

SN 77-304,889, FILED 10-16-2007.

FIRST USE 10-15-2007; IN COMMERCE 10-15-2007.

MICHAEL WEBSTER, EXAMINING ATTORNEY

Int. Cl.: 25

Prior U.S. Cls.: 22 and 39

United States Patent and Trademark Office

Reg. No. 3,577,434

Registered Feb. 17, 2009

**TRADEMARK
PRINCIPAL REGISTER**

CARTILAGE

UNDER ARMOUR, INC. (MARYLAND CORPORATION)
1020 HULL STREET
BALTIMORE, MD 21230

THE MARK CONSISTS OF STANDARD CHARACTERS WITHOUT CLAIM TO ANY PARTICULAR FONT, STYLE, SIZE, OR COLOR.

FOR: FOOTWEAR, IN CLASS 25 (U.S. CLS. 22 AND 39).

SN 77-305,056, FILED 10-16-2007.

FIRST USE 1-5-2009; IN COMMERCE 1-5-2009.

ANDREA HACK, EXAMINING ATTORNEY

Int. Cls.: 16 and 25

Prior U.S. Cls.: 2, 5, 22, 23, 29, 37, 38, 39, and 50

United States Patent and Trademark Office

Reg. No. 3,577,435

Registered Feb. 17, 2009

TRADEMARK
PRINCIPAL REGISTER

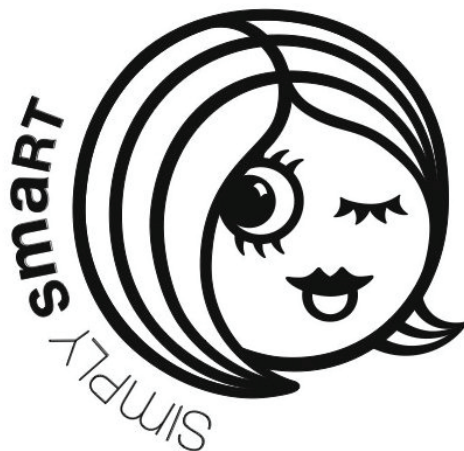

BRUGIONI, ANDRIA L. (UNITED STATES INDIVIDUAL)

96 VALLEY VIEW COURT

SAN MATEO, CA 94402

FOR: BLANK WRITING JOURNALS; BLANK NOTE CARDS; NOTE PADS; NOTEBOOKS; STATIONERY WRITING PAPER AND ENVELOPES; STICKERS, IN CLASS 16 (U.S. CLS. 2, 5, 22, 23, 29, 37, 38 AND 50).

FIRST USE 4-15-2008; IN COMMERCE 4-15-2008.

FOR: T-SHIRTS; SWEAT SHIRTS; PANTS; BASEBALL CAPS; PAJAMAS; SCARVES, IN CLASS 25 (U.S. CLS. 22 AND 39).

FIRST USE 4-15-2008; IN COMMERCE 4-15-2008.

THE MARK CONSISTS OF THE LITERAL ELEMENT OF "SIMPLY SMART" AND A STYLIZED WOMAN'S HEAD, SMILING WITH ONE EYE WINKING.

SN 77-305,124, FILED 10-16-2007.

IRA J. GOODSID, EXAMINING ATTORNEY

Int. Cls.: 38 and 42

Prior U.S. Cls.: 100, 101, and 104

United States Patent and Trademark Office

Reg. No. 3,577,436

Registered Feb. 17, 2009

**SERVICE MARK
PRINCIPAL REGISTER**



KADOO INC. (DELAWARE CORPORATION)
1300 EYE STREET, N.W., SUITE 1090
WASHINGTON, DC 20005

FOR: TELECOMMUNICATIONS SERVICES, NAMELY, COMMUNICATION SERVICES BY ELECTRONIC COMPUTER TERMINALS AND MOBILE PHONES; ELECTRONIC MAIL AND INSTANT MESSAGING SERVICES; ELECTRONIC TRANSMISSION OF DATA, SOUND, VIDEO, INFORMATION, MESSAGES, IMAGES, AND DOCUMENTS VIA COMPUTER TERMINALS AND MOBILE PHONES; PROVIDING ONLINE FORUMS FOR DISCUSSION AND ELECTRONIC BULLETIN/MESSAGE BOARDS FOR TRANSMISSION OF MESSAGES AMONG USERS IN THE FIELD OF GENERAL INTEREST; AUDIO AND VIDEO BROADCASTING SERVICES OVER THE INTERNET OR OTHER COMMUNICATIONS NETWORK, NAMELY, UPLOADING, POSTING, SHOWING, DISPLAYING, TAGGING AND ELECTRONICALLY TRANSMITTING INFORMATION, AUDIO, AND VIDEO CLIPS; AND STREAMING AUDIO AND VIDEO MATERIAL ON THE INTERNET, IN CLASS 38 (U.S. CLS. 100, 101 AND 104).

FIRST USE 9-0-2007; IN COMMERCE 9-0-2007.

FOR: COMPUTER SERVICES, NAMELY, COMPUTER SERVICES, NAMELY, HOSTING ONLINE WEB FACILITIES FOR OTHERS FOR ORGANIZING AND CONDUCTING ONLINE MEETINGS, GATHERINGS, AND INTERACTIVE DISCUSSIONS; WEB SITE HOSTING SERVICES; HOSTING OF DIGITAL CONTENT ON THE INTERNET; PROVIDING CUSTOMIZED ON-LINE WEB PAGES FEATURING USER-DEFINED INFORMATION, WHICH INCLUDES SEARCH ENGINES AND ON-LINE WEB LINKS TO OTHER WEB SITES; COMPUTER SERVICES, NAMELY, PROVIDING SEARCH ENGINES FOR OBTAINING DATA ON A GLOBAL COMPUTER NETWORK; APPLICATION SERVICE PROVIDER (ASP) FEATURING SOFTWARE TO ENABLE UPLOADING, POSTING, SHOWING, DISPLAYING, TAGGING, BLOGGING, SHARING OR OTHERWISE PROVIDING ELECTRONIC MEDIA OR INFORMATION OVER THE INTERNET OR OTHER COMMUNICATIONS NETWORK; PROVIDING TEMPORARY USE OF ON-LINE NON-DOWNLOADABLE SOFTWARE FOR CALENDAR MANAGEMENT, CONTACT MANAGEMENT, WEBPAGE CONTENT CREATION AND MANAGEMENT, SOCIAL NETWORK MANAGEMENT, FILE AND DOCUMENT SHARING, AND BLOG CREATION AND MANAGEMENT; PROVIDING TEMPORARY USE OF ON-LINE NON-DOWNLOADABLE SOFTWARE FOR THE COLLECTION, EDITING, ORGANIZING, MODIFYING, BOOK MARKING, TRANSMISSION, STORAGE AND SHARING OF DATA AND INFORMATION OVER COMPUTER NETWORKS; AND COMPUTER SERVICES, NAMELY, CREATING AN ONLINE COMMUNITY FOR REGISTERED USERS TO PARTICIPATE SHOWCASE INDIVIDUAL TALENTS, GET FEEDBACK FROM THEIR PEERS, FOR M VIRTUAL COMMUNITIES, AND ENGAGE IN SOCIAL NETWORKING, IN CLASS 42 (U.S. CLS. 100 AND 101).

TURING USER-DEFINED INFORMATION, WHICH INCLUDES SEARCH ENGINES AND ON-LINE WEB LINKS TO OTHER WEB SITES; COMPUTER SERVICES, NAMELY, PROVIDING SEARCH ENGINES FOR OBTAINING DATA ON A GLOBAL COMPUTER NETWORK; APPLICATION SERVICE PROVIDER (ASP) FEATURING SOFTWARE TO ENABLE UPLOADING, POSTING, SHOWING, DISPLAYING, TAGGING, BLOGGING, SHARING OR OTHERWISE PROVIDING ELECTRONIC MEDIA OR INFORMATION OVER THE INTERNET OR OTHER COMMUNICATIONS NETWORK; PROVIDING TEMPORARY USE OF ON-LINE NON-DOWNLOADABLE SOFTWARE FOR CALENDAR MANAGEMENT, CONTACT MANAGEMENT, WEBPAGE CONTENT CREATION AND MANAGEMENT, SOCIAL NETWORK MANAGEMENT, FILE AND DOCUMENT SHARING, AND BLOG CREATION AND MANAGEMENT; PROVIDING TEMPORARY USE OF ON-LINE NON-DOWNLOADABLE SOFTWARE FOR THE COLLECTION, EDITING, ORGANIZING, MODIFYING, BOOK MARKING, TRANSMISSION, STORAGE AND SHARING OF DATA AND INFORMATION OVER COMPUTER NETWORKS; AND COMPUTER SERVICES, NAMELY, CREATING AN ONLINE COMMUNITY FOR REGISTERED USERS TO PARTICIPATE SHOWCASE INDIVIDUAL TALENTS, GET FEEDBACK FROM THEIR PEERS, FOR M VIRTUAL COMMUNITIES, AND ENGAGE IN SOCIAL NETWORKING, IN CLASS 42 (U.S. CLS. 100 AND 101).

FIRST USE 9-0-2007; IN COMMERCE 9-0-2007.

THE COLOR(S) ORANGE AND RED IS/ARE CLAIMED AS A FEATURE OF THE MARK.

THE MARK CONSISTS OF A STYLIZED REPRESENTATION OF THE LETTER "K" IN WHICH THE COLOR ORANGE APPEARS ON THE LEFT SIDE OF

THE LETTER "K" AND THE COLOR RED APPEARS ON THE RIGHT SIDE OF THE LETTER "K".

SN 77-305,319, FILED 10-17-2007.

JOHN DALIER, EXAMINING ATTORNEY

Int. Cl.: 42

Prior U.S. Cls.: 100 and 101

United States Patent and Trademark Office

Reg. No. 3,577,437

Registered Feb. 17, 2009

SERVICE MARK
PRINCIPAL REGISTER



Protecting nature. Preserving life.

THE NATURE CONSERVANCY (D.C. NON-PROFIT CORPORATION)
SUITE 100
4245 NORTH FAIRFAX DRIVE
ARLINGTON, VA 22203

FOR: CONSULTING SERVICES CONCERNING CONSERVATION OF NATURAL RESOURCES AND PRESERVATION OF ENDANGERED SPECIES, IN CLASS 42 (U.S. CLS. 100 AND 101).

FIRST USE 6-1-2008; IN COMMERCE 6-1-2008.

OWNER OF U.S. REG. NOS. 1,486,182 AND 1,486,455.

THE COLOR(S) BLACK, WHITE AND GREEN IS/ARE CLAIMED AS A FEATURE OF THE MARK.

THE MARK CONSISTS OF THE WORDS "THE NATURE" SHOWN WITH THE WORD "CONSER-

VANCY" SHOWN UNDER THE WORDS "THE NATURE"; A GREEN SPHERE IS SHOWN TO THE RIGHT OF THE WORDS "THE NATURE CONSERVANCY"; THERE ARE THREE WHITE LEAVES SHOWN ON THE SPHERE. THE WORDS "PROTECTING NATURE. PRESERVING LIFE." ARE SHOWN UNDER THE WORDS "THE NATURE CONSERVANCY" AND THE SPHERE. THE COLOR BLACK APPEARS IN THE WORDING "THE NATURE CONSERVANCY PROTECTING NATURE. PRESERVING LIFE."

SEC. 2(F) AS TO "THE NATURE CONSERVANCY".

SN 77-305,358, FILED 10-16-2007.

ALICE BENMAMAN, EXAMINING ATTORNEY

Int. Cl.: 9

Prior U.S. Cls.: 21, 23, 26, 36, and 38

Reg. No. 3,577,438

United States Patent and Trademark Office

Registered Feb. 17, 2009

**TRADEMARK
PRINCIPAL REGISTER**



THOMAS, ALVIN (UNITED STATES INDIVIDUAL)
1048 RIVERSIDE DRIVE
WELCH, WV 24801

THE MARK CONSISTS OF STYLIZED WORDING OF "L.D.P. X CAMP".

FOR: MUSICAL SOUND RECORDINGS; MUSICAL VIDEO RECORDINGS, IN CLASS 9 (U.S. CLS. 21, 23, 26, 36 AND 38).

SN 77-305,379, FILED 10-16-2007.

FIRST USE 8-20-2006; IN COMMERCE 8-20-2006.

TINA KUAN, EXAMINING ATTORNEY

Int. Cl.: 41

Prior U.S. Cls.: 100, 101, and 107

United States Patent and Trademark Office

Reg. No. 3,577,439

Registered Feb. 17, 2009

**SERVICE MARK
PRINCIPAL REGISTER**



THOMAS, ALVIN (UNITED STATES INDIVIDUAL)
1048 RIVERSIDE DRIVE
WELCH, WV 24801

FOR: MUSIC PRODUCTION SERVICES; PRODUCTION OF SOUND AND MUSIC VIDEO RECORDINGS; RECORDING STUDIOS; COMPOSITION OF MUSIC FOR OTHERS, IN CLASS 41 (U.S. CLS. 100, 101 AND 107).

FIRST USE 8-20-2006; IN COMMERCE 8-20-2006.

THE MARK CONSISTS OF A STYLIZED DEPICTION OF THE WORDING "L.D.P. X CAMP".

SN 77-305,390, FILED 10-16-2007.

TINA KUAN, EXAMINING ATTORNEY

Int. Cl.: 43

Prior U.S. Cls.: 100 and 101

United States Patent and Trademark Office

Reg. No. 3,577,440

Registered Feb. 17, 2009

SERVICE MARK
PRINCIPAL REGISTER

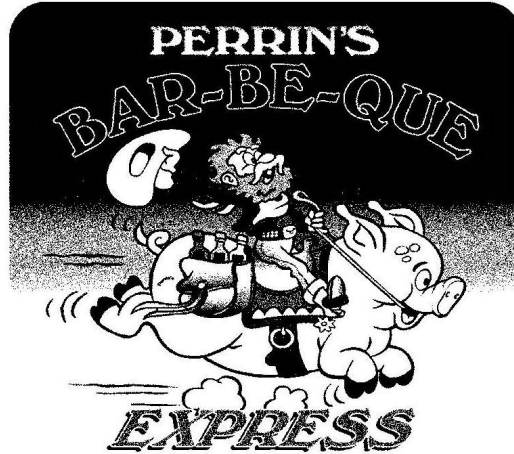

PERRIN'S BAR-BE-QUE EXPRESS, LLC (VIRGINIA LIMITED LIABILITY COMPANY)
3454-A ANDERSON HIGHWAY
POWHATAN, VA 23139

FOR: TAKE-OUT RESTAURANT SERVICES, IN CLASS 43 (U.S. CLS. 100 AND 101).

FIRST USE 2-18-2008; IN COMMERCE 2-18-2008.

NO CLAIM IS MADE TO THE EXCLUSIVE RIGHT TO USE "EXPRESS" AND "BAR-BE-QUE", APART FROM THE MARK AS SHOWN.

THE MARK CONSISTS OF CARTOON COWBOY WAIVING HAT AND RIDING ON A PIG WITH A SADDLE. AT THE TOP OF THE CARTOON ARE THE STYLIZED WORDS "PERRIN'S BAR-BE-QUE" AND UNDERNEATH THE CARTOON IS THE STYLIZED WORD "EXPRESS".

SN 77-305,428, FILED 10-16-2007.

LINDA E. BLOHM, EXAMINING ATTORNEY

Int. Cl.: 35

Prior U.S. Cls.: 100, 101, and 102

United States Patent and Trademark Office

Reg. No. 3,577,441

Registered Feb. 17, 2009

**SERVICE MARK
PRINCIPAL REGISTER**

MODO MODO

MODO MODO AGENCY LLC (GEORGIA LIMITED LIABILITY COMPANY)
185 DIXIE AVENUE
MARIETTA, GA 30008

FOR: BUSINESS MARKETING SERVICES; CONDUCTING MARKETING STUDIES; DIRECT MARKETING SERVICES; MARKET RESEARCH; MARKETING CONSULTING; MARKETING PLAN DEVELOPMENT; PROMOTION AND MARKETING SERVICES AND RELATED CONSULTING, IN CLASS 35 (U.S. CLS. 100, 101 AND 102).

FIRST USE 11-1-2007; IN COMMERCE 11-1-2007.

THE MARK CONSISTS OF STANDARD CHARACTERS WITHOUT CLAIM TO ANY PARTICULAR FONT, STYLE, SIZE, OR COLOR.

THE FOREIGN WORDING IN THE MARK TRANSLATES INTO ENGLISH AS WAY.

SN 77-305,639, FILED 10-16-2007.

ROSELLE HERRERA, EXAMINING ATTORNEY

Int. Cl.: 14

Prior U.S. Cls.: 2, 27, 28, and 50

United States Patent and Trademark Office

Reg. No. 3,577,442

Registered Feb. 17, 2009

**TRADEMARK
PRINCIPAL REGISTER**

HOME TEAM SPIRIT

HOME TEAM SPIRIT, LLC (COLORADO LIMITED LIABILITY COMPANY)
9461 LA COSTA LANE
LONE TREE, CO 80124

THE MARK CONSISTS OF STANDARD CHARACTERS WITHOUT CLAIM TO ANY PARTICULAR FONT, STYLE, SIZE, OR COLOR.

FOR: BRACELETS, IN CLASS 14 (U.S. CLS. 2, 27, 28 AND 50).

SN 77-305,655, FILED 10-16-2007.

FIRST USE 9-1-2007; IN COMMERCE 3-4-2008.

ANTHONY RINKER, EXAMINING ATTORNEY

Int. Cl.: 13

Prior U.S. Cls.: 2 and 9

United States Patent and Trademark Office

Reg. No. 3,577,443

Registered Feb. 17, 2009

**TRADEMARK
PRINCIPAL REGISTER**

GHILLIE

HOGUE GRIPS (CALIFORNIA PARTNERSHIP)
PO BOX 1138
PASO ROBLES, CA 93447

THE MARK CONSISTS OF STANDARD CHAR-
ACTERS WITHOUT CLAIM TO ANY PARTICULAR
FONT, STYLE, SIZE, OR COLOR.

FOR: GUN STOCKS; GRIPS FOR SMALL ARMS,
IN CLASS 13 (U.S. CLS. 2 AND 9).

SN 77-306,007, FILED 10-17-2007.

FIRST USE 7-0-2007; IN COMMERCE 7-0-2007.

SETH A. RAPPAPORT, EXAMINING ATTORNEY

Int. Cl.: 38

Prior U.S. Cls.: 100, 101, and 104

United States Patent and Trademark Office

Reg. No. 3,577,444

Registered Feb. 17, 2009

**SERVICE MARK
PRINCIPAL REGISTER**



COUNTY OF SAN DIEGO (CALIFORNIA POLITICAL SUBDIVISION)
5555 OVERLAND AVE, SUITE 1911
SAN DIEGO, CA 92123

FOR: OUTCALL NOTIFICATION SERVICES, IN CLASS 38 (U.S. CLS. 100, 101 AND 104).

FIRST USE 10-24-2007; IN COMMERCE 10-24-2007.

NO CLAIM IS MADE TO THE EXCLUSIVE RIGHT TO USE THE EXCLAMATION POINT WARNING SYMBOL AND "ALERT SAN DIEGO", APART FROM THE MARK AS SHOWN.

THE COLOR(S) YELLOW, TEAL, BLACK, WHITE, AND GREY IS/ARE CLAIMED AS A FEATURE OF THE MARK.

THE MARK CONSISTS OF A WHITE CELL PHONE WITH A GRAY STRIPE DOWN THE RIGHT SIDE OUTLINED IN GRAY. A WHITE TEXT BALLOON OUTLINED IN GRAY CONTAINS A YELLOW YIELD SIGN OUTLINED IN BLACK WITH A BLACK EXCLAMATION POINT. THE CELL PHONE IS ON TOP OF A TEAL AND WHITE CIRCLE WHICH SHOWS THROUGH THE SCREEN ON THE CELL PHONE. THE MARK ALSO CONSISTS OF THE TEXT "ALERTSANDIEGO" OUTLINED IN BLACK WITH "ALERT" IN YELLOW AND "SAN DIEGO" IN TEAL. UNDERNEATH "ALERTSANDIEGO" IS TEXT "GET SIGNED UP. GET NOTIFIED." IN GREY.

SN 77-306,195, FILED 10-17-2007.

MARY BOAGNI, EXAMINING ATTORNEY

Int. Cl.: 35

Prior U.S. Cls.: 100, 101, and 102

United States Patent and Trademark Office

Reg. No. 3,577,445

Registered Feb. 17, 2009

**SERVICE MARK
PRINCIPAL REGISTER**

SAYIDODIAMONDS.COM

FRED MEYER JEWELERS, INC. (CALIFORNIA
CORPORATION)
3800 S.E. 22ND AVE.
P.O. BOX 42121
PORTLAND, OR 97242

THE MARK CONSISTS OF STANDARD CHAR-
ACTERS WITHOUT CLAIM TO ANY PARTICULAR
FONT, STYLE, SIZE, OR COLOR.

FOR: ON-LINE RETAIL JEWELRY STORE SER-
VICES, IN CLASS 35 (U.S. CLS. 100, 101 AND 102).

SN 77-306,528, FILED 10-17-2007.

FIRST USE 11-0-2008; IN COMMERCE 11-0-2008.

IRA J. GOODSaid, EXAMINING ATTORNEY

Int. Cl.: 25

Prior U.S. Cls.: 22 and 39

United States Patent and Trademark Office

Reg. No. 3,577,446

Registered Feb. 17, 2009

**TRADEMARK
PRINCIPAL REGISTER**

ANNIE PINKY

PINKY FOOTWEAR, INC. (CALIFORNIA CORPORATION)

9803 RUSH STREET

S. EL MONTE, CA 91733

FOR: SHOES, IN CLASS 25 (U.S. CLS. 22 AND 39).

FIRST USE 1-1-2008; IN COMMERCE 1-1-2008.

THE MARK CONSISTS OF STANDARD CHARACTERS WITHOUT CLAIM TO ANY PARTICULAR FONT, STYLE, SIZE, OR COLOR.

THE NAME "ANNIE PINKY" DOES NOT IDENTIFY A LIVING INDIVIDUAL.

SN 77-306,686, FILED 10-17-2007.

KATHLEEN LORENZO, EXAMINING ATTORNEY

Int. Cl.: 30

Prior U.S. Cl.: 46

United States Patent and Trademark Office

Reg. No. 3,577,447

Registered Feb. 17, 2009

TRADEMARK
PRINCIPAL REGISTER

SLM MASALE

SLM MASALE LIMITED (INDIA CORPORATION)
19/5 IIIIRD FLOOR, SHAKTI NAGAR
DELHI, INDIA 110007

FOR: BAKING SPICES; CINNAMON POWDER; CLOVE POWDER; CURRY; CURRY POWDER; GINGER; HOT PEPPER POWDER; JAPANESE HORSE-RADISH POWDER SPICE (WASABI POWDER); JAPANESE PEPPER POWDER SPICE (SANSHO POWDER); MUSTARD POWDER; PEPPER; PEPPER POWDER; PROCESSED GINSENG USED AS AN HERB, SPICE OR FLAVORING; SPICE BLENDS; SPICE RUBS; SPICES; SPICES FOR THE FLAVORING OF PUMPKIN SEEDS, IN CLASS 30 (U.S. CL. 46).

FIRST USE 1-1-2008; IN COMMERCE 1-1-2008.

THE MARK CONSISTS OF STANDARD CHARACTERS WITHOUT CLAIM TO ANY PARTICULAR FONT, STYLE, SIZE, OR COLOR.

OWNER OF INDIA REG. NO. A-66411/2004, DATED 2-24-2004, EXPIRES 2-24-2014.

NO CLAIM IS MADE TO THE EXCLUSIVE RIGHT TO USE "MASALE" , APART FROM THE MARK AS SHOWN.

THE FOREIGN WORDING IN THE MARK TRANSLATES INTO ENGLISH AS SPICES.

SN 77-306,910, FILED 10-17-2007.

LINDA E. BLOHM, EXAMINING ATTORNEY

Int. Cl.: 42

Prior U.S. Cls.: 100 and 101

United States Patent and Trademark Office

Reg. No. 3,577,448

Registered Feb. 17, 2009

**SERVICE MARK
PRINCIPAL REGISTER**



LONG, THOMAS K W (UNITED STATES INDIVIDUAL)
6912 61ST STREET WEST
UNIVERSITY PLACE, WA 98467

FOR: GRAPHIC DESIGN OF IMAGES WHICH CAN BE IMPRINTED ON WEARABLE APPAREL AND STICKERS, IN CLASS 42 (U.S. CLS. 100 AND 101).

FIRST USE 10-27-2007; IN COMMERCE 9-13-2008.

THE MARK CONSISTS OF THE WORDING "ELECTRIC SEX" POSITIONED ABOVE CLOUDS AND THE LETTERS "E S" WHICH ARE IN THE SHAPE OF A LIGHTNING BOLT.

SN 77-306,933, FILED 10-18-2007.

KEVIN DINALLO, EXAMINING ATTORNEY

Int. Cls.: 9, 16, and 41

Prior U.S. Cls.: 2, 5, 21, 22, 23, 26, 29, 36, 37, 38, 50, 100, 101, and 107

Reg. No. 3,577,449

United States Patent and Trademark Office

Registered Feb. 17, 2009

**TRADEMARK
SERVICE MARK
PRINCIPAL REGISTER**



ISKY (D.C. NON-PROFIT CORPORATION)
1522 CERRO GORDO ROAD
SANTA FE, NM 87501

FOR: PRERECORDED CD-ROMS AND DVDS AND PRERECORDED DIGITAL VIDEO DISCS FEATURING THE GLOBAL WARMING PROBLEM AND THE NEEDED SOLUTIONS; DOWNLOADABLE ELECTRONIC PUBLICATIONS IN THE NATURE OF NEWSPAPERS, BOOKS, MAGAZINES IN THE FIELD OF THE GLOBAL WARMING PROBLEM AND THE NEEDED SOLUTIONS, IN CLASS 9 (U.S. CLS. 21, 23, 26, 36 AND 38).

FIRST USE 10-31-2008; IN COMMERCE 10-31-2008.

FOR: PUBLICATIONS, NAMELY, NEWSLETTERS, NEWSPAPERS, BROCHURES AND PAMPHLETS ON THE SUBJECTS OF ENERGY, ENERGY EFFICIENCY, GLOBAL WARMING IMPACTS AND SOLUTIONS, IN CLASS 16 (U.S. CLS. 2, 5, 22, 23, 29, 37, 38 AND 50).

FIRST USE 11-30-2007; IN COMMERCE 11-30-2007.

FOR: EDUCATIONAL SERVICES, NAMELY, ARRANGING AND CONDUCTING OF EDUCATIONAL CONGRESSES, SEMINARS, EDUCATIONAL PERFORMANCES IN THE NATURE EDUCATIONAL EXHIBITIONS ALL DEALING WITH THE ENVIRONMENT AND ENVIRONMENTAL ISSUES; NEWS REPORTING SERVICES, NAMELY, PROVIDING CURRENT NEWS CONTENT THROUGH PHOTOGRAPHIC, FILM AND VIDEO REPORTS, IN CLASS 41 (U.S. CLS. 100, 101 AND 107).

FIRST USE 10-31-2008; IN COMMERCE 10-31-2008.

THE MARK CONSISTS OF TWO SQUARES; ONE CONTAINING THE NUMBER "1" AND THE OTHER CONTAINING THE WORD "SKY" AGAINST A BACKGROUND OF CLOUDS.

SN 77-307,043, FILED 10-18-2007.

DARRYL SPRUILL, EXAMINING ATTORNEY

Int. Cl.: 7

Prior U.S. Cls.: 13, 19, 21, 23, 31, 34, and 35

Reg. No. 3,577,450

United States Patent and Trademark Office

Registered Feb. 17, 2009

**TRADEMARK
PRINCIPAL REGISTER**

IDEAL

NATIONAL OILWELL VARCO, L.P. (DELAWARE
LIMITED PARTNERSHIP)
7909 PARKWOOD CIRCLE DRIVE
HOUSTON, TX 77036

FOR: MACHINES, FABRICATED STRUCTURES,
TOOLS AND REPLACEMENT PARTS THEREFOR
FOR USE IN THE PRODUCTION OF OIL AND GAS
FROM WELLS AND FOR THE DRILLING OF OIL
AND GAS WELLS, NAMELY, DRILLING MASTS,
SUBSTRUCTURES; CROWN BLOCKS; DEADLINE-
WIRELINE ANCHORS; DRAW-WORKS AND
BRAKES THEREFOR; POWER SWIVELS; ROTARY
TABLE; SHEAVES; TRAVELING BLOCKS; WIN-
CHES; WINDLASSES; MACHINES USED TO MAKE

AND BREAK THREADED CONNECTIONS OF TUB-
ULAR MEMBERS, IN CLASS 7 (U.S. CLS. 13, 19, 21,
23, 31, 34 AND 35).

FIRST USE 4-24-2003; IN COMMERCE 4-24-2003.

THE MARK CONSISTS OF STANDARD CHAR-
ACTERS WITHOUT CLAIM TO ANY PARTICULAR
FONT, STYLE, SIZE, OR COLOR.

SN 77-307,156, FILED 10-18-2007.

BARBARA GAYNOR, EXAMINING ATTORNEY

Int. Cl.: 28

Prior U.S. Cls.: 22, 23, 38, and 50

United States Patent and Trademark Office

Reg. No. 3,577,451

Registered Feb. 17, 2009

**TRADEMARK
PRINCIPAL REGISTER**

CRAZY TYPHOON

NAMCO BANDAI GAMES INC. (JAPAN CORPORATION)
4-5-15 HIGASHI SHINAGAWA, SHINAGAWA-KU
TOKYO, JAPAN 1408590

THE MARK CONSISTS OF STANDARD CHARACTERS WITHOUT CLAIM TO ANY PARTICULAR FONT, STYLE, SIZE, OR COLOR.

FOR: COIN-OPERATED AMUSEMENT GAME MACHINES, IN CLASS 28 (U.S. CLS. 22, 23, 38 AND 50).

SN 77-307,202, FILED 10-18-2007.

FIRST USE 6-11-2008; IN COMMERCE 6-11-2008.

ELISSA GARBER KON, EXAMINING ATTORNEY

Int. Cl.: 22

Prior U.S. Cls.: 1, 2, 7, 19, 22, 42, and 50

United States Patent and Trademark Office

Reg. No. 3,577,452

Registered Feb. 17, 2009

**TRADEMARK
PRINCIPAL REGISTER**

PAINTING JUST GOT EASIER!

BERCOM INTERNATIONAL, LLC (MINNESOTA
LIMITED LIABILITY COMPANY)
1709 LAKE DRIVE WEST
CHANHASSEN, MN 55317

FOR: BUNGEE CORDS, IN CLASS 22 (U.S. CLS. 1,
2, 7, 19, 22, 42 AND 50).

FIRST USE 12-31-2007; IN COMMERCE 12-31-2007.

THE MARK CONSISTS OF STANDARD CHAR-
ACTERS WITHOUT CLAIM TO ANY PARTICULAR
FONT, STYLE, SIZE, OR COLOR.

OWNER OF U.S. REG. NO. 2,825,119.

SN 77-307,296, FILED 10-18-2007.

G. MAYERSCHOFF, EXAMINING ATTORNEY

Int. Cl.: 31

Prior U.S. Cls.: 1 and 46

United States Patent and Trademark Office

Reg. No. 3,577,453

Registered Feb. 17, 2009

**TRADEMARK
PRINCIPAL REGISTER**

HEALTHY MOUTH

DOG ESSENTIAL, LLC (NEW JERSEY LIMITED
LIABILITY COMPANY)
8 LA BARRE AVENUE
TRENTON, NJ 08618

THE MARK CONSISTS OF STANDARD CHAR-
ACTERS WITHOUT CLAIM TO ANY PARTICULAR
FONT, STYLE, SIZE, OR COLOR.

FOR: BEVERAGES FOR ANIMALS, IN CLASS 31
(U.S. CLS. 1 AND 46).

SN 77-307,553, FILED 10-18-2007.

FIRST USE 1-31-2008; IN COMMERCE 1-31-2008.

SETH A. RAPPAPORT, EXAMINING ATTORNEY

Int. Cl.: 5

Prior U.S. Cls.: 6, 18, 44, 46, 51, and 52

United States Patent and Trademark Office

Reg. No. 3,577,454

Registered Feb. 17, 2009

**TRADEMARK
PRINCIPAL REGISTER**

NutriVantage

KENT FEEDS, INC. (IOWA CORPORATION)
1600 OREGON STREET
MUSCATINE, IA 52761

FOR: ANIMAL FEED SUPPLEMENTS, IN CLASS
5 (U.S. CLS. 6, 18, 44, 46, 51 AND 52).

FIRST USE 12-1-2007; IN COMMERCE 12-1-2007.

THE MARK CONSISTS OF STANDARD CHAR-
ACTERS WITHOUT CLAIM TO ANY PARTICULAR
FONT, STYLE, SIZE, OR COLOR.

SN 77-307,576, FILED 10-18-2007.

WILLIAM BRECKENFELD, EXAMINING ATTOR-
NEY

Int. Cl.: 31

Prior U.S. Cls.: 1 and 46

United States Patent and Trademark Office

Reg. No. 3,577,455

Registered Feb. 17, 2009

**TRADEMARK
PRINCIPAL REGISTER**

Dental Care That Dogs Drink

DOG ESSENTIAL, LLC (NEW JERSEY LIMITED
LIABILITY COMPANY)
8 LA BARRE AVENUE
TRENTON, NJ 08618

THE MARK CONSISTS OF STANDARD CHAR-
ACTERS WITHOUT CLAIM TO ANY PARTICULAR
FONT, STYLE, SIZE, OR COLOR.

FOR: DRINKING WATER FOR DOGS, IN CLASS
31 (U.S. CLS. 1 AND 46).

SN 77-307,585, FILED 10-18-2007.

FIRST USE 1-31-2008; IN COMMERCE 1-31-2008.

SETH A. RAPPAPORT, EXAMINING ATTORNEY

Int. Cl.: 3

Prior U.S. Cls.: 1, 4, 6, 50, 51, and 52

United States Patent and Trademark Office

Reg. No. 3,577,456

Registered Feb. 17, 2009

**TRADEMARK
PRINCIPAL REGISTER**

HULA-LA

YUSEF MANUFACTURING LABORATORIES,
LLC (UTAH LIMITED LIABILITY COMPANY),
DBA LIME LITE MARKETING,
PO BOX 160347
FREEPORT WEST, F-4, #3
CLEARFIELD, UT 840160347

FIRST USE 9-11-2008; IN COMMERCE 9-11-2008.

THE MARK CONSISTS OF STANDARD CHAR-
ACTERS WITHOUT CLAIM TO ANY PARTICULAR
FONT, STYLE, SIZE, OR COLOR.

FOR: BODY AND BEAUTY CARE COSMETICS;
COSMETIC SUN-PROTECTING PREPARATIONS;
COSMETIC SUN-TANNING PREPARATIONS, IN
CLASS 3 (U.S. CLS. 1, 4, 6, 50, 51 AND 52).

SN 77-307,686, FILED 10-18-2007.

STEVEN JACKSON, EXAMINING ATTORNEY

Int. Cls.: 16 and 18

Prior U.S. Cls.: 1, 2, 3, 5, 22, 23, 29, 37, 38, 41, and 50

United States Patent and Trademark Office

Reg. No. 3,577,457

Registered Feb. 17, 2009

**TRADEMARK
PRINCIPAL REGISTER**

RESORT

SAMSONITE CORPORATION (DELAWARE CORPORATION)
575 WEST STREET, SUITE 110
MANSFIELD, MA 02048

FOR: COIN HOLDERS; DOCUMENT HOLDERS; NOTEBOOKS, IN CLASS 16 (U.S. CLS. 2, 5, 22, 23, 29, 37, 38 AND 50).

FIRST USE 11-1-2007; IN COMMERCE 11-1-2007.

FOR: LUGGAGE; MESSENGER BAGS; BOSTON BAGS; GARMENT BAGS FOR TRAVEL; BILL-FOLDS; WALLETS; TRAVELING BAGS; COIN PURSES; HANDBAGS; PURSES; JEWELRY

ORGANIZERS FOR TRAVEL; COSMETIC BAGS SOLD EMPTY; TOILETRY CASES SOLD EMPTY, IN CLASS 18 (U.S. CLS. 1, 2, 3, 22 AND 41).

FIRST USE 11-1-2007; IN COMMERCE 11-1-2007.

THE MARK CONSISTS OF STANDARD CHARACTERS WITHOUT CLAIM TO ANY PARTICULAR FONT, STYLE, SIZE, OR COLOR.

SN 77-308,095, FILED 10-19-2007.

THOMAS MANOR, EXAMINING ATTORNEY

Int. Cl.: 5

Prior U.S. Cls.: 6, 18, 44, 46, 51, and 52

United States Patent and Trademark Office

Reg. No. 3,577,458

Registered Feb. 17, 2009

**TRADEMARK
PRINCIPAL REGISTER**

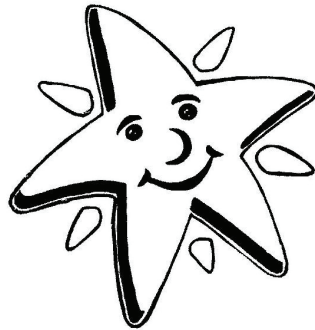

FIRST QUALITY PRODUCTS, INC. (NEW YORK CORPORATION)
80 CUTTERMILL ROAD, SUITE 500
GREAT NECK, NY 11021

THE MARK CONSISTS OF A STAR WITH A FACE.

FOR: DISPOSABLE INCONTINENCE BRIEFS, IN CLASS 5 (U.S. CLS. 6, 18, 44, 46, 51 AND 52).

SN 77-308,234, FILED 10-19-2007.

FIRST USE 5-29-2008; IN COMMERCE 5-29-2008.

MARY ROSSMAN, EXAMINING ATTORNEY

Int. Cl.: 1

Prior U.S. Cls.: 1, 5, 6, 10, 26, and 46

United States Patent and Trademark Office

Reg. No. 3,577,459

Registered Feb. 17, 2009

**TRADEMARK
PRINCIPAL REGISTER**

BIO-RELEASE EF

DAYTON SUPERIOR CORPORATION (DELA-
WARE CORPORATION)
SUITE 130
7777 WASHINGTON VILLAGE DRIVE
DAYTON, OH 45459

FOR: CONCRETE FORM AND MOLD RELEASE
COMPOUNDS FOR USE IN CONCRETE FABRICA-
TION; CHEMICAL PREPARATIONS FOR CURING,
HARDENING AND BOND BREAKING FOR USE IN
CONCRETE FORMULATIONS, IN CLASS 1 (U.S.
CLS. 1, 5, 6, 10, 26 AND 46).

FIRST USE 4-0-2007; IN COMMERCE 4-0-2007.

THE MARK CONSISTS OF STANDARD CHAR-
ACTERS WITHOUT CLAIM TO ANY PARTICULAR
FONT, STYLE, SIZE, OR COLOR.

NO CLAIM IS MADE TO THE EXCLUSIVE
RIGHT TO USE "EF", APART FROM THE MARK
AS SHOWN.

SN 77-308,510, FILED 10-19-2007.

LOURDES AYALA, EXAMINING ATTORNEY

Int. Cl.: 33

Prior U.S. Cls.: 47 and 49

United States Patent and Trademark Office

Reg. No. 3,577,460

Registered Feb. 17, 2009

**TRADEMARK
PRINCIPAL REGISTER**

INAMBÚ

TWO PINES GROUP, LLC (OHIO LIMITED LIABILITY COMPANY)
SUITE 210
200 MARKET AVE. N
CANTON, OH 44702

THE MARK CONSISTS OF STANDARD CHARACTERS WITHOUT CLAIM TO ANY PARTICULAR FONT, STYLE, SIZE, OR COLOR.

FOR: WINE, IN CLASS 33 (U.S. CLS. 47 AND 49).

SN 77-308,884, FILED 10-19-2007.

FIRST USE 1-15-2008; IN COMMERCE 1-15-2008.

KAPIL BHANOT, EXAMINING ATTORNEY

Int. Cls.: 35 and 36

Prior U.S. Cls.: 100, 101, and 102

United States Patent and Trademark Office

Reg. No. 3,577,461

Registered Feb. 17, 2009

**SERVICE MARK
PRINCIPAL REGISTER**



Nigerian-American Center for Peace and Development

OPERATION PEACE OF MIND-OPM (NIGERIAN-AMERICAN CENTER FOR PEACE AND DEVELOPMENT) (TEXAS CORPORATION)

SUITE 105

705 SOUTH MILL STREET

LEWISVILLE, TX 75057

FOR: PROMOTING PUBLIC AWARENESS OF THE NEED FOR RECONCILIATION, TOLERANCE, DEMOCRACY, PEACE, HOPE AND DEVELOPMENT AS THEY RELATE TO NIGERIA AND THE WORLD; PROMOTING PUBLIC AWARENESS FOR THE NEED FOR VIABLE CRIME FIGHTING INITIATIVES; PROMOTING PUBLIC AWARENESS OF THE NEED FOR FACILITATING THE COLLATION, ASSEMBLAGE AND ACCESSIBILITY OF EXPERTISE OF INDIGENOUS NIGERIANS AND SUPPORT FOR NIGERIA'S TECHNOLOGICAL ADVANCEMENT; PROMOTING PUBLIC AWARENESS OF THE WELFARE OF NIGERIANS; PROMOTING PUBLIC AWARENESS OF THE NEED FOR ETHICAL BUSINESS STANDARDS AND PRACTICES THAT FACILITATE ECONOMIC DEVELOPMENT AND INVESTMENT; PROMOTING PUBLIC AWARENESS AND CONCERN FOR HEALTHCARE, EDUCATION, AGRICULTURE, TECHNOLOGY AND SOCIAL DEVELOPMENT; PROMOTING PUBLIC AWARENESS OF DEMOCRATIC VALUES FOR NIGERIA, PATRIOTISM AND VOLUNTEERISM, YOUTH GROUPS, GOODS, TOURISM AND CULTURAL EXCHANGES OF NIGERIA AND THE WORLD; BUSINESS CONSULTATION REGARD-

ING ACTION-ORIENTED PROGRAMS AND COORDINATING WITH NON-PROFIT ORGANIZATIONS IN ADVANCING NIGERIAN CAUSES, IN CLASS 35 (U.S. CLS. 100, 101 AND 102).

FIRST USE 9-12-2002; IN COMMERCE 9-12-2002.

FOR: CHARITABLE FUNDRAISING FOR CAUSES TO ADVANCE THE DEVELOPMENT OF NIGERIA AND THE WORLD, IN CLASS 36 (U.S. CLS. 100, 101 AND 102).

FIRST USE 9-12-2002; IN COMMERCE 9-12-2002.

NO CLAIM IS MADE TO THE EXCLUSIVE RIGHT TO USE "NIGERIAN-AMERICAN" OR "CENTER FOR PEACE AND DEVELOPMENT", APART FROM THE MARK AS SHOWN.

THE MARK CONSISTS OF THE WORDS "OPM OPERATION PEACE OF MIND NIGERIAN-AMERICAN CENTER FOR PEACE AND DEVELOPMENT" UNDER THE IMAGE OF A BIRD OR DOVE CARRYING A LEAFED BRANCH IN ITS MOUTH, WITH THE BODY OF THE BIRD BEING COMPOSED OF AN AMERICAN-FLAG LIKENESS AND THE WINGS OF THE BIRD BEING COMPOSED OF A NIGERIAN-FLAG LIKENESS.

SN 77-308,942, FILED 10-19-2007.

ANDREW RHIM, EXAMINING ATTORNEY

Int. Cl.: 31

Prior U.S. Cls.: 1 and 46

United States Patent and Trademark Office

Reg. No. 3,577,462

Registered Feb. 17, 2009

TRADEMARK
PRINCIPAL REGISTER

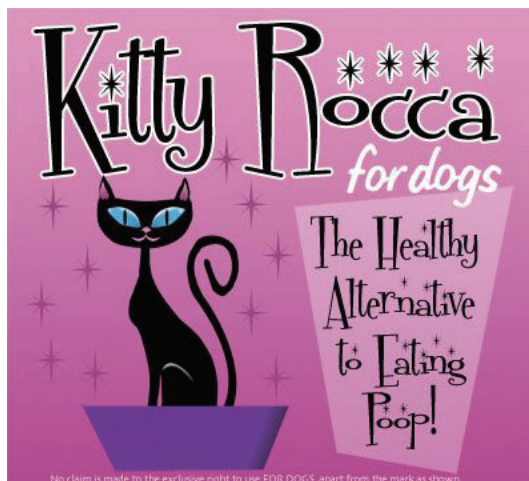

SMITH, GEORGE W. (UNITED STATES INDIVIDUAL)
2525 33RD AVE.
SACRAMENTO, CA 95822

FOR: DOG TREATS, IN CLASS 31 (U.S. CLS. 1 AND 46).

FIRST USE 6-20-2008; IN COMMERCE 11-1-2008.

NO CLAIM IS MADE TO THE EXCLUSIVE RIGHT TO USE "FOR DOGS", APART FROM THE MARK AS SHOWN.

THE MARK DOES NOT IDENTIFY A LIVING PERSON.

THE COLOR(S) BLACK, PINK, WHITE, PURPLE AND BLUE ARE CLAIMED AS A FEATURE OF THE MARK. IS/ARE CLAIMED AS A FEATURE OF THE MARK.

THE MARK CONSISTS OF STYLIZED BLACK CAT IN A PURPLE CAT BOX, WITH A GRADUATED PINK TONE IN THE BACKGROUND WITH SCATTERED DARK PINK STARS. THE WORDS "KITTY ROCCA" APPEAR IN BLACK LETTERS WITH A WHITE OUTLINE, WITH BLACK AND WHITE STARS OVER THE LETTERING. THE WORDS "FOR DOGS" APPEAR IN WHITE BENEATH IT. TO THE RIGHT OF THE CAT DESIGN IS A LIGHT PINK BOX WITH THE PHRASE "THE HEALTHY ALTERNATIVE TO EATING POOP!" IN BLACK LETTERS WITH SCATTERED BLACK STARS IN THE BACKGROUND.

SN 77-309,435, FILED 10-21-2007.

SUSAN LESLIE DUBOIS, EXAMINING ATTORNEY

Int. Cl.: 16

Prior U.S. Cls.: 2, 5, 22, 23, 29, 37, 38, and 50

United States Patent and Trademark Office

Reg. No. 3,577,463

Registered Feb. 17, 2009

**TRADEMARK
PRINCIPAL REGISTER**

Biopackit

TETRA INTERNATIONAL PUERTO RICO CORP
(PUERTO RICO CORPORATION)
PMB 151, 1750 CALLE LOIZA
SAN JUAN, PUERTO RICO 00911

FOR: PACKAGING AND CONTAINERS COM-
PRISED OF STARCH-BASED MATERIALS IN THE
NATURE OF A PAPER SUBSTITUTE FOR FOOD,
BEVERAGES AND CONSUMER PRODUCTS, IN
CLASS 16 (U.S. CLS. 2, 5, 22, 23, 29, 37, 38 AND 50).

FIRST USE 10-9-2008; IN COMMERCE 10-10-2008.

THE MARK CONSISTS OF STANDARD CHAR-
ACTERS WITHOUT CLAIM TO ANY PARTICULAR
FONT, STYLE, SIZE, OR COLOR.

SN 77-309,498, FILED 10-22-2007.

GINA HAYES, EXAMINING ATTORNEY

Int. Cl.: 28

Prior U.S. Cls.: 22, 23, 38, and 50

United States Patent and Trademark Office

Reg. No. 3,577,464

Registered Feb. 17, 2009

**TRADEMARK
PRINCIPAL REGISTER**

FED UP FOWLS

THE HARTZ MOUNTAIN CORPORATION (NEW
JERSEY CORPORATION)
400 PLAZA DRIVE
SECAUCUS, NJ 07094

THE MARK CONSISTS OF STANDARD CHAR-
ACTERS WITHOUT CLAIM TO ANY PARTICULAR
FONT, STYLE, SIZE, OR COLOR.

FOR: PET TOYS, IN CLASS 28 (U.S. CLS. 22, 23, 38
AND 50).

SN 77-310,346, FILED 10-22-2007.

FIRST USE 1-1-2008; IN COMMERCE 1-1-2008.

CORY BOONE, EXAMINING ATTORNEY

Int. Cl.: 9

Prior U.S. Cls.: 21, 23, 26, 36, and 38

United States Patent and Trademark Office

Reg. No. 3,577,465

Registered Feb. 17, 2009

**TRADEMARK
PRINCIPAL REGISTER**

**MYSTERY CASE FILES: MADAME
FATE**

BIG FISH GAMES, INC. (WASHINGTON COR-
PORATION)
333 ELLIOTT AVENUE WEST
SUITE 200
SEATTLE, WA 98119

THE MARK CONSISTS OF STANDARD CHAR-
ACTERS WITHOUT CLAIM TO ANY PARTICULAR
FONT, STYLE, SIZE, OR COLOR.

FOR: ELECTRONIC GAME PROGRAMS, IN
CLASS 9 (U.S. CLS. 21, 23, 26, 36 AND 38).

SN 77-310,442, FILED 10-22-2007.

FIRST USE 11-8-2007; IN COMMERCE 11-8-2007.

CHERYL CLAYTON, EXAMINING ATTORNEY

Int. Cl.: 3

Prior U.S. Cls.: 1, 4, 6, 50, 51, and 52

United States Patent and Trademark Office

Reg. No. 3,577,466

Registered Feb. 17, 2009

TRADEMARK
PRINCIPAL REGISTER

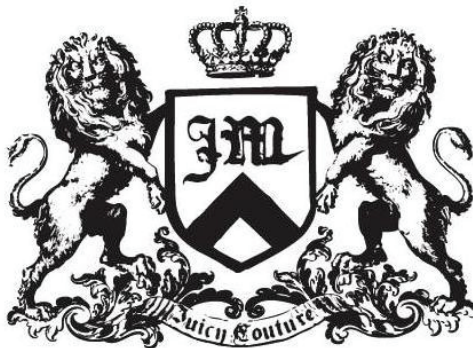

L.C. LICENSING, INC. (DELAWARE CORPORATION)
1441 BROADWAY
NEW YORK, NY 10018

FOR: AFTER-SHAVE BALMS; AFTER-SHAVE GEL; AFTER-SHAVE LOTIONS; BODY WASHES; COLOGNE; EAU DE COLOGNE; EAU DE PERFUME; EAU DE TOILETTE; PERFUME; PERSONAL DEODORANTS; SHOWER AND BATH GEL; SKIN LOTION, IN CLASS 3 (U.S. CLS. 1, 4, 6, 50, 51 AND 52).

FIRST USE 3-25-2008; IN COMMERCE 3-25-2008.

OWNER OF U.S. REG. NOS. 2,978,046, 3,194,741, AND OTHERS.

NO CLAIM IS MADE TO THE EXCLUSIVE RIGHT TO USE "COUTURE", APART FROM THE MARK AS SHOWN.

THE MARK CONSISTS OF TWO HERALDIC LIONS HOLDING A SHIELD WITH "JM" AND A BAR DESIGN. ABOVE THE SHIELD IS A CROWN. BELOW THE SHIELD IS A BANNER AND PLANT DESIGN.

SN 77-310,768, FILED 10-23-2007.

JESSICA A. POWERS, EXAMINING ATTORNEY

Int. Cl.: 21

Prior U.S. Cls.: 2, 13, 23, 29, 30, 33, 40, and 50

Reg. No. 3,577,467

United States Patent and Trademark Office

Registered Feb. 17, 2009

**TRADEMARK
PRINCIPAL REGISTER**

GREENGOURMET

CONAIR CORPORATION (DELAWARE CORPORATION)
ONE CUMMINGS POINT ROAD
STAMFORD, CT 06902

FOR: COOKWARE, NAMELY, POTS AND PANS; COOKWARE, NAMELY, STEAMERS; COOKWARE, NAMELY, POTS, PANS, SAUCEPOTS, STOCKPOTS, DOUBLE BOILERS, SAUTÉ PANS, SKILLETTS, POT COVERS, SKILLET COVERS, IN CLASS 21 (U.S. CLS. 2, 13, 23, 29, 30, 33, 40 AND 50).

FIRST USE 1-31-2008; IN COMMERCE 1-31-2008.

THE MARK CONSISTS OF STANDARD CHARACTERS WITHOUT CLAIM TO ANY PARTICULAR FONT, STYLE, SIZE, OR COLOR.

SN 77-310,848, FILED 10-23-2007.

AISHA SALEM, EXAMINING ATTORNEY

Int. Cl.: 9

Prior U.S. Cls.: 21, 23, 26, 36, and 38

United States Patent and Trademark Office

Reg. No. 3,577,468

Registered Feb. 17, 2009

**TRADEMARK
PRINCIPAL REGISTER**

**STYLE TO CONTENT LEARNING
PREFERENCES INVENTORY**

DEZMON EDUCATIONAL STRATEGIES, LLC
(MARYLAND LIMITED LIABILITY COMPAN-
NY)
9445 ASHLYN CIRCLE
OWINGS MILLS, MD 21117

FOR: COMPUTER SOFTWARE AND DOWN-
LOADABLE COMPUTER SOFTWARE FOR ASSESS-
MENT AND INVENTORY OF STUDENT
LEARNING PREFERENCES, BEHAVIORS AND
DIFFICULTIES FOR ASSISTING EDUCATORS
AND EDUCATION ADMINISTRATORS IN THE
FIELD OF EDUCATION, IN CLASS 9 (U.S. CLS. 21,
23, 26, 36 AND 38).

FIRST USE 12-5-2008; IN COMMERCE 12-5-2008.

THE MARK CONSISTS OF STANDARD CHAR-
ACTERS WITHOUT CLAIM TO ANY PARTICULAR
FONT, STYLE, SIZE, OR COLOR.

NO CLAIM IS MADE TO THE EXCLUSIVE
RIGHT TO USE "LEARNING PREFERENCES IN-
VENTORY", APART FROM THE MARK AS
SHOWN.

THE WORDING "STYLE TO CONTENT" HAS NO
MEANING IN A FOREIGN LANGUAGE.

SN 77-311,822, FILED 10-24-2007.

PAUL E. FAHRENKOPF, EXAMINING ATTORNEY

Int. Cl.: 30

Prior U.S. Cl.: 46

United States Patent and Trademark Office

Reg. No. 3,577,469

Registered Feb. 17, 2009

**TRADEMARK
PRINCIPAL REGISTER**

SHAPE

SYSCO CORPORATION (DELAWARE COR-
PORATION)
1390 ENCLAVE PARKWAY
HOUSTON, TX 770771390

THE MARK CONSISTS OF STANDARD CHAR-
ACTERS WITHOUT CLAIM TO ANY PARTICULAR
FONT, STYLE, SIZE, OR COLOR.

FOR: SUGAR SUBSTITUTES, IN CLASS 30 (U.S.
CL. 46).

SN 77-312,278, FILED 10-24-2007.

FIRST USE 9-28-2007; IN COMMERCE 9-28-2007.

THEODORE MCBRIDE, EXAMINING ATTORNEY

Int. Cl.: 28

Prior U.S. Cls.: 22, 23, 38, and 50

United States Patent and Trademark Office

Reg. No. 3,577,470

Registered Feb. 17, 2009

**TRADEMARK
PRINCIPAL REGISTER**



PROFESSIONAL GOLF BALL SERVICES, LTD.
(TEXAS LIMITED PARTNERSHIP)
12505 REED ROAD, SUITE 200
SUGAR LAND, TX 77478

FOR: GOLF GLOVES, IN CLASS 28 (U.S. CLS. 22,
23, 38 AND 50).

FIRST USE 7-15-2008; IN COMMERCE 11-1-2008.

NO CLAIM IS MADE TO THE EXCLUSIVE
RIGHT TO USE "ONE SIZE FITS ALL", APART
FROM THE MARK AS SHOWN.

THE MARK CONSISTS OF THE STYLIZED TEXT
"ONESIZE", "FITSALL" AND A STYLIZED GLOVE.

SN 77-312,515, FILED 10-24-2007.

KEVIN DINALLO, EXAMINING ATTORNEY

Int. Cl.: 37

Prior U.S. Cls.: 100, 103, and 106

United States Patent and Trademark Office

Reg. No. 3,577,471

Registered Feb. 17, 2009

**SERVICE MARK
PRINCIPAL REGISTER**

**CONNECTING PEOPLE WITH
NATURE**

EVERGREEN LAND CO., L.P. (TEXAS LIMITED
PARTNERSHIP)
100 CRESCENT COURT
SUITE 1150
DALLAS, TX 75201

THE MARK CONSISTS OF STANDARD CHAR-
ACTERS WITHOUT CLAIM TO ANY PARTICULAR
FONT, STYLE, SIZE, OR COLOR.

FOR: REAL ESTATE DEVELOPMENT, IN CLASS
37 (U.S. CLS. 100, 103 AND 106).

SN 77-312,731, FILED 10-24-2007.

FIRST USE 12-4-2008; IN COMMERCE 12-4-2008.

TARAH HARDY, EXAMINING ATTORNEY

Int. Cl.: 5

Prior U.S. Cls.: 6, 18, 44, 46, 51, and 52

United States Patent and Trademark Office

Reg. No. 3,577,472

Registered Feb. 17, 2009

**TRADEMARK
PRINCIPAL REGISTER**

IMIGOLD

UNITED PHOSPHORUS, INC. (DELAWARE COR-
PORATION)
630 FREEDOM BUSINESS CENTER, STE. 402
KING OF PRUSSIA, PA 19406

THE MARK CONSISTS OF STANDARD CHAR-
ACTERS WITHOUT CLAIM TO ANY PARTICULAR
FONT, STYLE, SIZE, OR COLOR.

FOR: AGRICULTURAL INSECTICIDE, IN CLASS
5 (U.S. CLS. 6, 18, 44, 46, 51 AND 52).

SN 77-313,360, FILED 10-25-2007.

FIRST USE 12-9-2008; IN COMMERCE 12-9-2008.

DARRYL SPRUILL, EXAMINING ATTORNEY

Int. Cl.: 41

Prior U.S. Cls.: 100, 101, and 107

United States Patent and Trademark Office

Reg. No. 3,577,473

Registered Feb. 17, 2009

**SERVICE MARK
PRINCIPAL REGISTER**

COOKOLOGY

KOPSIDAS, MARIA (UNITED STATES INDIVIDUAL)
2806 SPENCER ROAD
CHEVY CHASE, MD 20815

FOR: EDUCATION SERVICES, NAMELY, PROVIDING INSTRUCTION, WORKSHOPS, CLASSES, SEMINARS, TUTORING AND MENTORING IN THE FIELD OF CULINARY ARTS, IN CLASS 41 (U.S. CLS. 100, 101 AND 107).

FIRST USE 8-1-2007; IN COMMERCE 8-1-2007.

THE MARK CONSISTS OF STANDARD CHARACTERS WITHOUT CLAIM TO ANY PARTICULAR FONT, STYLE, SIZE, OR COLOR.

SN 77-313,416, FILED 10-25-2007.

JACLYN KIDWELL, EXAMINING ATTORNEY

Int. Cl.: 9

Prior U.S. Cls.: 21, 23, 26, 36, and 38

United States Patent and Trademark Office

Reg. No. 3,577,474

Registered Feb. 17, 2009

**TRADEMARK
PRINCIPAL REGISTER**

POWERMAG+

OPTELEC U.S., INC. (MASSACHUSETTS CORPORATION)
321 BILLERICA ROAD
CHELMSFORD, MA 08124

THE MARK CONSISTS OF STANDARD CHARACTERS WITHOUT CLAIM TO ANY PARTICULAR FONT, STYLE, SIZE, OR COLOR.

FOR: OPTICAL MAGNIFICATION PRODUCTS, NAMELY, MONOCULAR AND BINOCULAR MAGNIFYING GLASSES, IN CLASS 9 (U.S. CLS. 21, 23, 26, 36 AND 38).

SN 77-313,656, FILED 10-25-2007.

FIRST USE 1-0-2008; IN COMMERCE 1-0-2008.

RONALD DELGIZZI, EXAMINING ATTORNEY

Int. Cl.: 39

Prior U.S. Cls.: 100 and 105

United States Patent and Trademark Office

Reg. No. 3,577,475

Registered Feb. 17, 2009

**SERVICE MARK
PRINCIPAL REGISTER**

ALLIANCE SEATING & MOBILITY

THE SCOOTER STORE, LTD. (TEXAS LIMITED
PARTNERSHIP)
1650 INDEPENDENCE
NEW BRAUNFELS, TX 78132

FOR: DELIVERY OF WHEELCHAIRS, POWER
CHAIRS, LIFT CHAIRS, AND MOTORIZED SCOO-
TERS, IN CLASS 39 (U.S. CLS. 100 AND 105).

FIRST USE 2-1-2008; IN COMMERCE 2-1-2008.

THE MARK CONSISTS OF STANDARD CHAR-
ACTERS WITHOUT CLAIM TO ANY PARTICULAR
FONT, STYLE, SIZE, OR COLOR.

NO CLAIM IS MADE TO THE EXCLUSIVE
RIGHT TO USE "SEATING & MOBILITY", APART
FROM THE MARK AS SHOWN.

SN 77-313,689, FILED 10-25-2007.

TOBY BULLOFF, EXAMINING ATTORNEY

Int. Cl.: 43

Prior U.S. Cls.: 100 and 101

United States Patent and Trademark Office

Reg. No. 3,577,476

Registered Feb. 17, 2009

**SERVICE MARK
PRINCIPAL REGISTER**

**THE LEGACY HOTEL AND
MEETING CENTRE**

CONGRESSIONAL HOTEL CORPORATION
(MARYLAND CORPORATION)
SUITE 200
2701 TOWER OAKS BLVD.
ROCKVILLE, MD 20852

FOR: HOTEL SERVICES; RESTAURANT SERVICES; PROVISION OF CONFERENCE, EXHIBITION AND MEETING FACILITIES, IN CLASS 43 (U.S. CLS. 100 AND 101).

FIRST USE 2-1-2008; IN COMMERCE 2-1-2008.

THE MARK CONSISTS OF STANDARD CHARACTERS WITHOUT CLAIM TO ANY PARTICULAR FONT, STYLE, SIZE, OR COLOR.

NO CLAIM IS MADE TO THE EXCLUSIVE RIGHT TO USE "HOTEL AND MEETING CENTRE", APART FROM THE MARK AS SHOWN.

SN 77-314,241, FILED 10-26-2007.

REBECCA SMITH, EXAMINING ATTORNEY

Int. Cl.: 35

Prior U.S. Cls.: 100, 101, and 102

United States Patent and Trademark Office

Reg. No. 3,577,477

Registered Feb. 17, 2009

**SERVICE MARK
PRINCIPAL REGISTER**

ONESOURCE

MEDICAL STAFFING NETWORK, INC. (DELA-
WARE CORPORATION)
SUITE 110
901 YAMATO ROAD
BOCA RATON, FL 33431

FOR: NURSING AND ALLIED HEALTHCARE
STAFFING VENDOR MANAGEMENT SERVICES
FOR HOSPITALS AND HEALTHCARE FACILITIES,
IN CLASS 35 (U.S. CLS. 100, 101 AND 102).

FIRST USE 4-15-2008; IN COMMERCE 4-15-2008.

THE MARK CONSISTS OF STANDARD CHAR-
ACTERS WITHOUT CLAIM TO ANY PARTICULAR
FONT, STYLE, SIZE, OR COLOR.

SN 77-314,552, FILED 10-26-2007.

TARAH HARDY, EXAMINING ATTORNEY

Int. Cl.: 16

Prior U.S. Cls.: 2, 5, 22, 23, 29, 37, 38, and 50

United States Patent and Trademark Office

Reg. No. 3,577,478

Registered Feb. 17, 2009

**TRADEMARK
PRINCIPAL REGISTER**

Detective Thumbkins

HILL, TRACEY (UNITED STATES INDIVIDUAL)
50-52 WEST LINDSELY
CEDAR GROVE, NJ 07009

FOR: FINGERPRINT KITS, IN CLASS 16 (U.S.
CLS. 2, 5, 22, 23, 29, 37, 38 AND 50).

FIRST USE 9-1-2007; IN COMMERCE 9-1-2007.

THE MARK CONSISTS OF STANDARD CHAR-
ACTERS WITHOUT CLAIM TO ANY PARTICULAR
FONT, STYLE, SIZE, OR COLOR.

SN 77-315,199, FILED 10-27-2007.

MARIA-VICTORIA SUAREZ, EXAMINING ATTOR-
NEY

Int. Cl.: 32

Prior U.S. Cls.: 45, 46, and 48

United States Patent and Trademark Office

Reg. No. 3,577,479

Registered Feb. 17, 2009

**TRADEMARK
PRINCIPAL REGISTER**

HYPER SHOT

GIRAFFE BEVERAGES, INC. (CANADA CORPORATION)
7 SELBY ROAD
BRAMPTON, CANADA L6W1K5

FOR: NON-ALCOHOLIC BEVERAGES, NAMELY, SPORTS DRINKS AND ENERGY DRINKS, IN CLASS 32 (U.S. CLS. 45, 46 AND 48).

FIRST USE 4-28-2008; IN COMMERCE 4-28-2008.

THE MARK CONSISTS OF STANDARD CHARACTERS WITHOUT CLAIM TO ANY PARTICULAR FONT, STYLE, SIZE, OR COLOR.

PRIORITY CLAIMED UNDER SEC. 44(D) ON CANADA APPLICATION NO. 1367601, FILED 10-15-2007.

SN 77-315,684, FILED 10-29-2007.

JAMES A. RAUEN, EXAMINING ATTORNEY

Int. Cl.: 1

Prior U.S. Cls.: 1, 5, 6, 10, 26, and 46

Reg. No. 3,577,480

United States Patent and Trademark Office

Registered Feb. 17, 2009

**TRADEMARK
PRINCIPAL REGISTER**

OOZE

CENTRAL PURCHASING, LLC (CALIFORNIA
LIMITED LIABILITY COMPANY)
3491 MISSION OAKS BOULEVARD
CAMARILLO, CA 93011

THE MARK CONSISTS OF STANDARD CHAR-
ACTERS WITHOUT CLAIM TO ANY PARTICULAR
FONT, STYLE, SIZE, OR COLOR.

FOR: TIRE SEALANTS, NAMELY, SEALANTS TO
REPAIR OR PREVENT PUNCTURES, IN CLASS 1
(U.S. CLS. 1, 5, 6, 10, 26 AND 46).

SN 77-316,053, FILED 10-29-2007.

FIRST USE 2-11-2008; IN COMMERCE 2-11-2008.

JAMES LOVELACE, EXAMINING ATTORNEY

Int. Cl.: 38

Prior U.S. Cls.: 100, 101, and 104

United States Patent and Trademark Office

Reg. No. 3,577,481

Registered Feb. 17, 2009

**SERVICE MARK
PRINCIPAL REGISTER**

ULISTEN

PROCTOR FINANCIAL, INC. (MICHIGAN CORPORATION)
200 KIRTS BLVD.
TROY, MI 48084

FOR: CUSTOMER SERVICE PROGRAM IN THE INSURANCE FIELD, NAMELY, PROVIDING ONLINE ACCESS TO DATABASES FEATURING INFORMATION IN THE NATURE OF RECORDINGS OF TELEPHONE CALLS MADE TO INSURANCE CALL CENTERS, IN CLASS 38 (U.S. CLS. 100, 101 AND 104).

FIRST USE 11-0-2007; IN COMMERCE 11-0-2007.

THE MARK CONSISTS OF STANDARD CHARACTERS WITHOUT CLAIM TO ANY PARTICULAR FONT, STYLE, SIZE, OR COLOR.

SN 77-316,160, FILED 10-29-2007.

JAMES LOVELACE, EXAMINING ATTORNEY

Int. Cl.: 7

Prior U.S. Cls.: 13, 19, 21, 23, 31, 34, and 35

United States Patent and Trademark Office

Reg. No. 3,577,482

Registered Feb. 17, 2009

**TRADEMARK
PRINCIPAL REGISTER**

SUPER COACHVAC

PROTEAM, INC. (IDAHO CORPORATION)
5118 N. SAWYER AVE.
BOISE, ID 83714

FOR: BRUSHES FOR VACUUM CLEANERS;
HOSES FOR VACUUM CLEANERS; SUCTION NOZ-
ZLES FOR VACUUM CLEANERS; VACUUM CLEA-
NER BAGS; VACUUM CLEANER HOSES; VACUUM
CLEANERS; VACUUM CLEANERS FOR INDUS-
TRIAL PURPOSES; FILTERS FOR VACUUM CLEA-
NER MACHINES, IN CLASS 7 (U.S. CLS. 13, 19, 21, 23,
31, 34 AND 35).

FIRST USE 7-14-1993; IN COMMERCE 7-14-1993.

THE MARK CONSISTS OF STANDARD CHAR-
ACTERS WITHOUT CLAIM TO ANY PARTICULAR
FONT, STYLE, SIZE, OR COLOR.

OWNER OF U.S. REG. NO. 2,312,862.

NO CLAIM IS MADE TO THE EXCLUSIVE
RIGHT TO USE "SUPER", APART FROM THE
MARK AS SHOWN.

SN 77-316,278, FILED 10-29-2007.

MARIA-VICTORIA SUAREZ, EXAMINING ATTOR-
NEY

Int. Cl.: 35

Prior U.S. Cls.: 100, 101, and 102

United States Patent and Trademark Office

Reg. No. 3,577,483

Registered Feb. 17, 2009

**SERVICE MARK
PRINCIPAL REGISTER**

Gigi's CupCakes

BUTLER, GINA (UNITED STATES INDIVIDUAL)
5152 VILLAGE TRACE DRIVE
NASHVILLE, TN 37211

FOR: RETAIL BAKERY SHOPS, IN CLASS 35 (U.S.
CLS. 100, 101 AND 102).

FIRST USE 9-0-2007; IN COMMERCE 9-0-2007.

THE MARK CONSISTS OF STANDARD CHAR-
ACTERS WITHOUT CLAIM TO ANY PARTICULAR
FONT, STYLE, SIZE, OR COLOR.

NO CLAIM IS MADE TO THE EXCLUSIVE
RIGHT TO USE "CUPCAKES", APART FROM THE
MARK AS SHOWN.

SN 77-316,340, FILED 10-29-2007.

KATHRYN COWARD, EXAMINING ATTORNEY

Int. Cl.: 25

Prior U.S. Cls.: 22 and 39

United States Patent and Trademark Office

Reg. No. 3,577,484

Registered Feb. 17, 2009

TRADEMARK
PRINCIPAL REGISTER



IDENTITY 11 (NEW JERSEY SOLE PROPRIETORSHIP)
PO BOX 11
PARAMUS, NJ 076530011

FOR: HOODS; MUSCLE TOPS; SHIRTS; SHORT-SLEEVED OR LONG-SLEEVED T-SHIRTS; SHORT-SLEEVED SHIRTS; T-SHIRTS; TANK TOPS; TANK-TOPS; TEE SHIRTS; TOPS; BOTTOMS; CAPS; CAPS WITH VISORS; DRESSES; HATS; JACKETS; NECKWEAR; SCARVES; SKULL CAPS; SKULLIES; SLEEVED OR SLEEVELESS JACKETS; SWEAT SHIRTS, IN CLASS 25 (U.S. CLS. 22 AND 39).

FIRST USE 6-21-2007; IN COMMERCE 6-21-2007.

THE MARK CONSISTS OF A BAT-LIKE ANGEL WITH THE WORD "IDENTITY" ABOVE AND THE NUMBER "11" WITHIN THE CENTER.

SN 77-316,507, FILED 10-30-2007.

DOMINIC FATHY, EXAMINING ATTORNEY

Int. Cl.: 11

Prior U.S. Cls.: 13, 21, 23, 31, and 34

United States Patent and Trademark Office

Reg. No. 3,577,485

Registered Feb. 17, 2009

**TRADEMARK
PRINCIPAL REGISTER**

MEADOW

HUNTER FAN COMPANY (DELAWARE COR-
PORATION)
2500 FRISCO AVENUE
MEMPHIS, TN 38114

THE MARK CONSISTS OF STANDARD CHAR-
ACTERS WITHOUT CLAIM TO ANY PARTICULAR
FONT, STYLE, SIZE, OR COLOR.

FOR: CEILING FANS, IN CLASS 11 (U.S. CLS. 13,
21, 23, 31 AND 34).

SN 77-317,073, FILED 10-30-2007.

FIRST USE 5-8-2008; IN COMMERCE 5-8-2008.

KATHERINE CHANG, EXAMINING ATTORNEY

Int. Cl.: 7

Prior U.S. Cls.: 13, 19, 21, 23, 31, 34, and 35

Reg. No. 3,577,486

United States Patent and Trademark Office

Registered Feb. 17, 2009

**TRADEMARK
PRINCIPAL REGISTER**

T6

MORIDGE MANUFACTURING, INC. (KANSAS
CORPORATION)
P.O. BOX 810
MOUNDRIDGE, KS 67107

THE MARK CONSISTS OF STANDARD CHAR-
ACTERS WITHOUT CLAIM TO ANY PARTICULAR
FONT, STYLE, SIZE, OR COLOR.

FOR: HYDROSTATIC TRANSMISSIONS FOR
RIDING LAWN MOWERS, IN CLASS 7 (U.S. CLS.
13, 19, 21, 23, 31, 34 AND 35).

SN 77-317,276, FILED 10-30-2007.

FIRST USE 6-13-2007; IN COMMERCE 11-27-2007.

DOMINIC FATHY, EXAMINING ATTORNEY

Int. Cl.: 10

Prior U.S. Cls.: 26, 39, and 44

United States Patent and Trademark Office

Reg. No. 3,577,487

Registered Feb. 17, 2009

**TRADEMARK
PRINCIPAL REGISTER**

BEAM

OREGON AESTHETIC TECHNOLOGIES, INC.
(OREGON CORPORATION)
2439 NW THURMAN
PORTLAND, OR 97210

THE MARK CONSISTS OF STANDARD CHAR-
ACTERS WITHOUT CLAIM TO ANY PARTICULAR
FONT, STYLE, SIZE, OR COLOR.

FOR: INSTRUMENTS, NAMELY, LAMPS AND
LED DEVICES FOR TREATMENT OF A VARIETY
OF SKIN CONDITIONS AND FOR ANTI-AGING
THERAPY, IN CLASS 10 (U.S. CLS. 26, 39 AND 44).

SN 77-317,413, FILED 10-30-2007.

FIRST USE 6-28-2008; IN COMMERCE 6-28-2008.

MELISSA VALLILLO, EXAMINING ATTORNEY

Int. Cl.: 9

Prior U.S. Cls.: 21, 23, 26, 36, and 38

United States Patent and Trademark Office

Reg. No. 3,577,488

Registered Feb. 17, 2009

**TRADEMARK
PRINCIPAL REGISTER**

HOODIEZ

JAY-Y ENTERPRISE CO., INC. (CALIFORNIA
CORPORATION)
632 NEW YORK DRIVE
POMONA, CA 91768

FOR: SUNGLASSES, IN CLASS 9 (U.S. CLS. 21, 23,
26, 36 AND 38).

FIRST USE 1-31-2008; IN COMMERCE 1-31-2008.

THE MARK CONSISTS OF STANDARD CHAR-
ACTERS WITHOUT CLAIM TO ANY PARTICULAR
FONT, STYLE, SIZE, OR COLOR.

SN 77-317,467, FILED 10-30-2007.

MATTHEW MCDOWELL, EXAMINING ATTOR-
NEY

Int. Cl.: 44

Prior U.S. Cls.: 100 and 101

United States Patent and Trademark Office

Reg. No. 3,577,489

Registered Feb. 17, 2009

**SERVICE MARK
PRINCIPAL REGISTER**

SharedHealth
ePrescribe

SHARED HEALTH, INC. (TENNESSEE COR-
PORATION)
SUITE 410
401 CHESTNUT STREET
CHATTANOOGA, TN 37402

FOR: PROVIDING ELECTRONIC MEDICAL IN-
FORMATION BETWEEN INSURANCE COMPANY,
PROVIDERS AND SUBSCRIBERS, IN CLASS 44 (U.S.
CLS. 100 AND 101).

FIRST USE 11-17-2008; IN COMMERCE 11-17-2008.

OWNER OF U.S. REG. NOS. 3,121,840, 3,283,597,
AND OTHERS.

NO CLAIM IS MADE TO THE EXCLUSIVE
RIGHT TO USE "EPREScribe", APART FROM
THE MARK AS SHOWN.

SN 77-317,564, FILED 10-31-2007.

KATHERINE E. HALMEN, EXAMINING ATTOR-
NEY

Int. Cl.: 29

Prior U.S. Cl.: 46

United States Patent and Trademark Office

Reg. No. 3,577,490

Registered Feb. 17, 2009

**TRADEMARK
PRINCIPAL REGISTER**

OLIVAROMA

B.C.S. INTERNATIONAL CORPORATION (NEW
YORK CORPORATION)
47-15 33RD STREET
LONG ISLAND CITY, NY 11101

FOR: OLIVE OIL, IN CLASS 29 (U.S. CL. 46).

FIRST USE 10-0-2006; IN COMMERCE 10-0-2006.

THE MARK CONSISTS OF STANDARD CHAR-
ACTERS WITHOUT CLAIM TO ANY PARTICULAR
FONT, STYLE, SIZE, OR COLOR.

SN 77-317,641, FILED 10-31-2007.

KATHERINE CHANG, EXAMINING ATTORNEY

Int. Cl.: 9

Prior U.S. Cls.: 21, 23, 26, 36, and 38

United States Patent and Trademark Office

Reg. No. 3,577,491

Registered Feb. 17, 2009

**TRADEMARK
PRINCIPAL REGISTER**

K2 SPORTS

K-2 CORPORATION (INDIANA CORPORATION)
4201 6TH AVE S
SEATTLE, WA 98108

FOR: HELMETS FOR SPORTS, IN CLASS 9 (U.S.
CLS. 21, 23, 26, 36 AND 38).

FIRST USE 1-0-2008; IN COMMERCE 8-0-2008.

THE MARK CONSISTS OF STANDARD CHAR-
ACTERS WITHOUT CLAIM TO ANY PARTICULAR
FONT, STYLE, SIZE, OR COLOR.

NO CLAIM IS MADE TO THE EXCLUSIVE
RIGHT TO USE "SPORTS", APART FROM THE
MARK AS SHOWN.

SN 77-317,822, FILED 10-31-2007.

PATRICIA EVANKO, EXAMINING ATTORNEY

Int. Cl.: 11

Prior U.S. Cls.: 13, 21, 23, 31, and 34

United States Patent and Trademark Office

Reg. No. 3,577,492

Registered Feb. 17, 2009

**TRADEMARK
PRINCIPAL REGISTER**



TRINA SOLAR LIMITED (CAYMAN ISLANDS
LIMITED LIABILITY COMPANY)
CRICKET SQUARE, HUTCHINS DRIVE
P.O. BOX 2681
GRAND CAYMAN KY1-1111, CAYMAN ISLANDS

FOR: SOLAR LIGHT FIXTURES, NAMELY, IN-
DOOR AND OUTDOOR SOLAR POWERED LIGHT-
ING UNITS AND FIXTURES; SOLAR WATER
HEATERS; SUN LAMPS; STREET LAMPS; SOLAR
COLLECTORS; SOLAR THERMAL INSTALLA-
TIONS, NAMELY, SOLAR THERMAL MODULES;
AIR CLEANING UNITS CONTAINING AN AIR
FILTER, ULTRAVIOLET LIGHTS AND A PHOTO-
CATALYTIC FILTER; ENERGY STORAGE
PLANTS; POWER PLANTS; LIGHT PANELS FOR
VEHICLES, NAMELY, LAND VEHICLES; SOLAR

HEAT COLLECTION PANELS, IN CLASS 11 (U.S.
CLS. 13, 21, 23, 31 AND 34).

FIRST USE 7-31-2006; IN COMMERCE 3-31-2008.

THE COLOR(S) BLUE AND RED IS/ARE
CLAIMED AS A FEATURE OF THE MARK.

THE MARK CONSISTS OF THE WORD "TRINA"
IN THE COLOR BLUE AND THE DOT ON THE
UPPER PART OF THE "I" IN THE COLOR RED.

SN 77-318,688, FILED 11-1-2007.

BRENDAN REGAN, EXAMINING ATTORNEY

Int. Cl.: 19

Prior U.S. Cls.: 1, 12, 33, and 50

United States Patent and Trademark Office

Reg. No. 3,577,493

Registered Feb. 17, 2009

**TRADEMARK
PRINCIPAL REGISTER**



TRINA SOLAR LIMITED (CAYMAN ISLANDS
LIMITED LIABILITY COMPANY)
CRICKET SQUARE, HUTCHINS DRIVE
P.O. BOX 2681
GRAND CAYMAN KY1-1111, CAYMAN ISLANDS

FOR: ROOFING, NOT OF METAL, INCORPORATING SOLAR CELLS; NON-METAL TILES; LUMBER; NON-METAL POLES FOR ELECTRIC POWER LINES; NON-METAL CEILING PANELS; WOOD PANELING; PARQUET WOOD FLOORING; STONE ROOFING TILES; ROOFING MEMBRANES; NON-METAL DOOR PANELS, IN CLASS 19 (U.S. CLS. 1, 12, 33 AND 50).

FIRST USE 7-31-2006; IN COMMERCE 3-31-2008.

THE COLOR(S) BLUE AND RED IS/ARE CLAIMED AS A FEATURE OF THE MARK.

THE MARK CONSISTS OF THE WORD "TRINA" IN THE COLOR BLUE AND THE DOT ON THE UPPER PART OF THE "I" IN THE COLOR RED.

SN 77-318,689, FILED 11-1-2007.

BRENDAN REGAN, EXAMINING ATTORNEY

Int. Cl.: 41

Prior U.S. Cls.: 100, 101, and 107

United States Patent and Trademark Office

Reg. No. 3,577,494

Registered Feb. 17, 2009

**SERVICE MARK
PRINCIPAL REGISTER**

Luv Ur Body

ASPEN ATHLETIC CLUBS, L.L.C. (IOWA LIMITED LIABILITY COMPANY)
10930 HICKMAN ROAD
DES MOINES, IA 50325

FOR: HEALTH CLUB SERVICES, NAMELY, PROVIDING INSTRUCTION AND EQUIPMENT IN THE FIELD OF PHYSICAL EXERCISE, IN CLASS 41 (U.S. CLS. 100, 101 AND 107).

FIRST USE 4-1-2008; IN COMMERCE 4-1-2008.

THE MARK CONSISTS OF STANDARD CHARACTERS WITHOUT CLAIM TO ANY PARTICULAR FONT, STYLE, SIZE, OR COLOR.

NO CLAIM IS MADE TO THE EXCLUSIVE RIGHT TO USE "BODY", APART FROM THE MARK AS SHOWN.

SN 77-319,161, FILED 11-1-2007.

BRENDAN REGAN, EXAMINING ATTORNEY

Int. Cl.: 28

Prior U.S. Cls.: 22, 23, 38, and 50

United States Patent and Trademark Office

Reg. No. 3,577,495

Registered Feb. 17, 2009

**TRADEMARK
PRINCIPAL REGISTER**

NRG BUILDERS

PLAYPOWER LT FARMINGTON, INC. (MISSOURI CORPORATION)
ONE IRON MOUNTAIN DRIVE
FARMINGTON, MO 63640

FOR: PLAYGROUND EQUIPMENT, NAMELY, PLAY SYSTEMS COMPRISED OF ANY COMBINATION OF SLIDES, CLIMBERS, LADDERS, BRIDGES, RAMPS, DECKS, STAIRS AND ROOFS, IN CLASS 28 (U.S. CLS. 22, 23, 38 AND 50).

FIRST USE 11-0-2007; IN COMMERCE 11-0-2007.

THE MARK CONSISTS OF STANDARD CHARACTERS WITHOUT CLAIM TO ANY PARTICULAR FONT, STYLE, SIZE, OR COLOR.

OWNER OF U.S. REG. NOS. 2,471,640, 3,085,411, AND 3,192,177.

SN 77-319,252, FILED 11-1-2007.

LOURDES AYALA, EXAMINING ATTORNEY

Int. Cl.: 9

Prior U.S. Cls.: 21, 23, 26, 36, and 38

United States Patent and Trademark Office

Reg. No. 3,577,496

Registered Feb. 17, 2009

**TRADEMARK
PRINCIPAL REGISTER**

PHARAOH'S PYRAMID

WMS GAMING INC. (DELAWARE CORPORATION)
800 SOUTH NORTHPOINT BOULEVARD
WAUKEGAN, IL 60085

FOR: GAMING MACHINES THAT GENERATE OR DISPLAY WAGER OUTCOMES; GAMING SOFTWARE THAT GENERATES OR DISPLAYS WAGER OUTCOMES OF GAMING MACHINES, IN CLASS 9 (U.S. CLS. 21, 23, 26, 36 AND 38).

FIRST USE 11-18-2008; IN COMMERCE 11-18-2008.

THE MARK CONSISTS OF STANDARD CHARACTERS WITHOUT CLAIM TO ANY PARTICULAR FONT, STYLE, SIZE, OR COLOR.

SN 77-319,748, FILED 11-2-2007.

GEORGE LORENZO, EXAMINING ATTORNEY

Int. Cl.: 36

Prior U.S. Cls.: 100, 101, and 102

United States Patent and Trademark Office

Reg. No. 3,577,497

Registered Feb. 17, 2009

**SERVICE MARK
PRINCIPAL REGISTER**

THE WORST BRINGS OUT OUR
BEST

WEST BEND MUTUAL INSURANCE COMPANY
(WISCONSIN CORPORATION)
1900 SOUTH 18TH AVENUE
WEST BEND, WI 53095

THE MARK CONSISTS OF STANDARD CHAR-
ACTERS WITHOUT CLAIM TO ANY PARTICULAR
FONT, STYLE, SIZE, OR COLOR.

FOR: INSURANCE SERVICES, NAMELY, WRIT-
ING PROPERTY AND CASUALTY INSURANCE, IN
CLASS 36 (U.S. CLS. 100, 101 AND 102).

SN 77-320,153, FILED 11-2-2007.

FIRST USE 1-20-2008; IN COMMERCE 1-20-2008.

ELLEN BURNS, EXAMINING ATTORNEY

Int. Cl.: 36

Prior U.S. Cls.: 100, 101, and 102

United States Patent and Trademark Office

Reg. No. 3,577,498

Registered Feb. 17, 2009

**SERVICE MARK
PRINCIPAL REGISTER**

THE SILVER LINING

WEST BEND MUTUAL INSURANCE COMPANY
(WISCONSIN CORPORATION)
1900 SOUTH 18TH AVENUE
WEST BEND, WI 53095

THE MARK CONSISTS OF STANDARD CHAR-
ACTERS WITHOUT CLAIM TO ANY PARTICULAR
FONT, STYLE, SIZE, OR COLOR.

FOR: INSURANCE SERVICES, NAMELY, WRIT-
ING PROPERTY AND CASUALTY INSURANCE, IN
CLASS 36 (U.S. CLS. 100, 101 AND 102).

SN 77-320,167, FILED 11-2-2007.

FIRST USE 1-20-2008; IN COMMERCE 1-20-2008.

ELLEN BURNS, EXAMINING ATTORNEY

Int. Cl.: 14

Prior U.S. Cls.: 2, 27, 28, and 50

United States Patent and Trademark Office

Reg. No. 3,577,499

Registered Feb. 17, 2009

**TRADEMARK
PRINCIPAL REGISTER**

ODELIA

A.V. JEWELRY EXPORT-IMPORT, LTD. (NEW
YORK CORPORATION)
62 WEST 47TH STREET
SUITE 603
NEW YORK, NY 10036

THE MARK CONSISTS OF STANDARD CHAR-
ACTERS WITHOUT CLAIM TO ANY PARTICULAR
FONT, STYLE, SIZE, OR COLOR.

FOR: JEWELRY AND WATCHES, IN CLASS 14
(U.S. CLS. 2, 27, 28 AND 50).

SN 77-320,344, FILED 11-2-2007.

FIRST USE 2-10-2008; IN COMMERCE 2-10-2008.

GEOFFREY FOSDICK, EXAMINING ATTORNEY

Int. Cl.: 42

Prior U.S. Cls.: 100 and 101

United States Patent and Trademark Office

Reg. No. 3,577,500

Registered Feb. 17, 2009

**SERVICE MARK
PRINCIPAL REGISTER**

**WE EXIST TO RESTORE AND
IMPROVE HUMAN LIFE!**

STEGENGA + PARTNERS, PC (GEORGIA COR-
PORATION)
3625 BROOKSIDE PARKWAY
SUITE 380
ALPHARETTA, GA 30022

FOR: ARCHITECTURAL DESIGN SERVICES, IN
CLASS 42 (U.S. CLS. 100 AND 101).

FIRST USE 6-1-2008; IN COMMERCE 6-1-2008.

THE MARK CONSISTS OF STANDARD CHAR-
ACTERS WITHOUT CLAIM TO ANY PARTICULAR
FONT, STYLE, SIZE, OR COLOR.

SN 77-321,140, FILED 11-5-2007.

DEIRDRE ROBERTSON, EXAMINING ATTORNEY

Int. Cl.: 12

Prior U.S. Cls.: 19, 21, 23, 31, 35, and 44

United States Patent and Trademark Office

Reg. No. 3,577,501

Registered Feb. 17, 2009

**TRADEMARK
PRINCIPAL REGISTER**

POWRGUARD

A. STUCKI CO. (DELAWARE CORPORATION)
2600 NEVILLE ROAD
PITTSBURGH, PA 15225

THE MARK CONSISTS OF STANDARD CHAR-
ACTERS WITHOUT CLAIM TO ANY PARTICULAR
FONT, STYLE, SIZE, OR COLOR.

FOR: FRICTION DRAFT GEAR FOR RAILWAY
VEHICLES, IN CLASS 12 (U.S. CLS. 19, 21, 23, 31, 35
AND 44).

SN 77-321,391, FILED 11-5-2007.

FIRST USE 8-0-2008; IN COMMERCE 8-0-2008.

KIMBERLY PERRY, EXAMINING ATTORNEY

Int. Cl.: 12

Prior U.S. Cls.: 19, 21, 23, 31, 35, and 44

Reg. No. 3,577,502

United States Patent and Trademark Office

Registered Feb. 17, 2009

**TRADEMARK
PRINCIPAL REGISTER**

RETROXT

A. STUCKI CO. (DELAWARE CORPORATION)
2600 NEVILLE ROAD
PITTSBURGH, PA 15225

THE MARK CONSISTS OF STANDARD CHAR-
ACTERS WITHOUT CLAIM TO ANY PARTICULAR
FONT, STYLE, SIZE, OR COLOR.

FOR: CONSTANT CONTACT SIDE BEARINGS
FOR RAILWAY VEHICLES, IN CLASS 12 (U.S. CLS.
19, 21, 23, 31, 35 AND 44).

SN 77-321,402, FILED 11-5-2007.

FIRST USE 9-0-2004; IN COMMERCE 9-0-2004.

KIMBERLY PERRY, EXAMINING ATTORNEY

Int. Cl.: 9

Prior U.S. Cls.: 21, 23, 26, 36, and 38

United States Patent and Trademark Office

Reg. No. 3,577,503

Registered Feb. 17, 2009

**TRADEMARK
PRINCIPAL REGISTER**

SUGARSYNC

SHARPCAST, INC. (CALIFORNIA CORPORATION)
250 CAMBRIDGE AVENUE, SUITE 101
PALO ALTO, CA 94306

FOR: DOWNLOADABLE COMPUTER SOFTWARE FOR BACKING UP, STORING, DESKTOP ORGANIZING, SYNCHRONIZING, SHARING, COLLABORATING, RECOVERING, MIGRATING AND REPLICATING USER'S ELECTRONIC AND DIGITAL FILES, DATA AND APPLICATIONS AMONG A USER'S COMPUTERS, HANDHELD DEVICES, CELL PHONES, PERSONAL DIGITAL ASSISTANT, INTERNET-ENABLED DEVICES, AND WIRELESS DEVICES; DOWNLOADABLE

COMPUTER SOFTWARE FOR SHARING, EDITING, PRINTING, SYNCHRONIZING, STORING AND BACKING UP PHOTO FILES, IN CLASS 9 (U.S. CLS. 21, 23, 26, 36 AND 38).

FIRST USE 3-20-2008; IN COMMERCE 3-20-2008.

THE MARK CONSISTS OF STANDARD CHARACTERS WITHOUT CLAIM TO ANY PARTICULAR FONT, STYLE, SIZE, OR COLOR.

SN 77-321,588, FILED 11-5-2007.

WENDY JUN, EXAMINING ATTORNEY

Int. Cl.: 35

Prior U.S. Cls.: 100, 101, and 102

United States Patent and Trademark Office

Reg. No. 3,577,504

Registered Feb. 17, 2009

**SERVICE MARK
PRINCIPAL REGISTER**

**BOOMER INSIGHTS
GENERATION GROUP**

EDELMAN, INC. (DELAWARE CORPORATION)
63RD FLOOR
200 EAST RANDOLPH STREET
CHICAGO, IL 60601

FOR: PUBLIC RELATIONS, IN CLASS 35 (U.S.
CLS. 100, 101 AND 102).

FIRST USE 2-8-2008; IN COMMERCE 2-8-2008.

THE MARK CONSISTS OF STANDARD CHAR-
ACTERS WITHOUT CLAIM TO ANY PARTICULAR
FONT, STYLE, SIZE, OR COLOR.

NO CLAIM IS MADE TO THE EXCLUSIVE
RIGHT TO USE "GROUP", APART FROM THE
MARK AS SHOWN.

SN 77-322,518, FILED 11-6-2007.

IRA J. GOODSaid, EXAMINING ATTORNEY

Int. Cl.: 35

Prior U.S. Cls.: 100, 101, and 102

United States Patent and Trademark Office

Reg. No. 3,577,505

Registered Feb. 17, 2009

**SERVICE MARK
PRINCIPAL REGISTER**

MÁS DE LO QUE ESPERAS

KOHL'S ILLINOIS, INC. (NEVADA CORPORATION)
NEW YORK SQUARE
4340 FOX VALLEY CENTER DRIVE
AURORA, IL 60504

FOR: RETAIL DEPARTMENT STORE SERVICES,
IN CLASS 35 (U.S. CLS. 100, 101 AND 102).

FIRST USE 9-0-2007; IN COMMERCE 9-0-2007.

THE MARK CONSISTS OF STANDARD CHARACTERS WITHOUT CLAIM TO ANY PARTICULAR FONT, STYLE, SIZE, OR COLOR.

OWNER OF U.S. REG. NO. 3,086,610.

THE FOREIGN WORDING IN THE MARK TRANSLATES INTO ENGLISH AS MORE THAN YOU EXPECT.

SN 77-322,607, FILED 11-6-2007.

JOHN HWANG, EXAMINING ATTORNEY

Int. Cl.: 12

Prior U.S. Cls.: 19, 21, 23, 31, 35, and 44

United States Patent and Trademark Office

Reg. No. 3,577,506

Registered Feb. 17, 2009

**TRADEMARK
PRINCIPAL REGISTER**

ARMOR MAX

THE GOODYEAR TIRE & RUBBER COMPANY
(OHIO CORPORATION)
DEPT. 823
1144 EAST MARKET STREET
AKRON, OH 443160001

THE MARK CONSISTS OF STANDARD CHAR-
ACTERS WITHOUT CLAIM TO ANY PARTICULAR
FONT, STYLE, SIZE, OR COLOR.

FOR: TIRES, IN CLASS 12 (U.S. CLS. 19, 21, 23, 31,
35 AND 44).

SN 77-322,739, FILED 11-6-2007.

FIRST USE 10-19-2007; IN COMMERCE 10-19-2007.

RONALD AIKENS, EXAMINING ATTORNEY

Int. Cl.: 12

Prior U.S. Cls.: 19, 21, 23, 31, 35, and 44

United States Patent and Trademark Office

Reg. No. 3,577,507

Registered Feb. 17, 2009

**TRADEMARK
PRINCIPAL REGISTER**

G150 HSA

THE GOODYEAR TIRE & RUBBER COMPANY
(OHIO CORPORATION)
IP LAW DEPARTMENT
1144 EAST MARKET STREET
AKRON, OH 443160001

THE MARK CONSISTS OF STANDARD CHAR-
ACTERS WITHOUT CLAIM TO ANY PARTICULAR
FONT, STYLE, SIZE, OR COLOR.

FOR: TIRES, IN CLASS 12 (U.S. CLS. 19, 21, 23, 31,
35 AND 44).

SN 77-322,756, FILED 11-6-2007.

FIRST USE 2-12-2008; IN COMMERCE 2-12-2008.

RONALD AIKENS, EXAMINING ATTORNEY

Int. Cl.: 5

Prior U.S. Cls.: 6, 18, 44, 46, 51, and 52

Reg. No. 3,577,508

United States Patent and Trademark Office

Registered Feb. 17, 2009

**TRADEMARK
PRINCIPAL REGISTER**

KIXOR

BASF SE (EUROPEAN COMMUNITY SOCIETAS
EUROPAEA)
CARL-BOSCH-STRASSE 38
LUDWIGSHAFEN AM RHEIN, FED REP GERMA-
NY

FOR: PESTICIDES, NAMELY, HERBICIDES, IN
CLASS 5 (U.S. CLS. 6, 18, 44, 46, 51 AND 52).

FIRST USE 2-0-2008; IN COMMERCE 2-0-2008.

THE MARK CONSISTS OF STANDARD CHAR-
ACTERS WITHOUT CLAIM TO ANY PARTICULAR
FONT, STYLE, SIZE, OR COLOR.

SN 77-323,526, FILED 11-7-2007.

MATTHEW MCDOWELL, EXAMINING ATTOR-
NEY

Int. Cl.: 42

Prior U.S. Cls.: 100 and 101

United States Patent and Trademark Office

Reg. No. 3,577,509

Registered Feb. 17, 2009

**SERVICE MARK
PRINCIPAL REGISTER**



FOURTHLINK, INC. (DELAWARE CORPORATION)
29 CRAFTS STREET
SUITE 550
NEWTON, MA 02458

FOR: APPLICATION SERVICE PROVIDER (ASP)
FEATURING SOFTWARE FOR USE IN PROJECT
MANAGEMENT, SCHEDULING AND RESOURCE
MANAGEMENT, IN CLASS 42 (U.S. CLS. 100 AND
101).

FIRST USE 2-1-2008; IN COMMERCE 2-1-2008.

THE MARK CONSISTS OF THE WORDS
"FOURTH" AND "LINK" SEPARATED BY THE
NUMBER "4" WITHIN A SMALL CIRCLE, WITH A
SMALLER BLACK OVAL BENEATH THE NUMBER
"4", WITH A CURVED LINE CONNECTING THE
LETTER "H" AT THE END OF THE WORD
"FOURTH" WITH THE LETTER "L" AT THE BE-
GINNING OF THE WORD "LINK".

SN 77-323,715, FILED 11-7-2007.

KIMBERLY PERRY, EXAMINING ATTORNEY

Int. Cl.: 9

Prior U.S. Cls.: 21, 23, 26, 36, and 38

United States Patent and Trademark Office

Reg. No. 3,577,510

Registered Feb. 17, 2009

**TRADEMARK
PRINCIPAL REGISTER**

HOG WILD

WMS GAMING INC. (DELAWARE CORPORATION)
800 SOUTH NORTHPOINT BOULEVARD
WAUKEGAN, IL 60085

FOR: GAMING MACHINES THAT GENERATE OR DISPLAY WAGER OUTCOMES; GAMING SOFTWARE THAT GENERATES OR DISPLAYS WAGER OUTCOMES OF GAMING MACHINES, IN CLASS 9 (U.S. CLS. 21, 23, 26, 36 AND 38).

FIRST USE 11-18-2008; IN COMMERCE 11-18-2008.

THE MARK CONSISTS OF STANDARD CHARACTERS WITHOUT CLAIM TO ANY PARTICULAR FONT, STYLE, SIZE, OR COLOR.

SN 77-323,972, FILED 11-7-2007.

GEORGE LORENZO, EXAMINING ATTORNEY

Int. Cl.: 10

Prior U.S. Cls.: 26, 39, and 44

United States Patent and Trademark Office

Reg. No. 3,577,511

Registered Feb. 17, 2009

**TRADEMARK
PRINCIPAL REGISTER**

V-RASER

HOYA PHOTONICS, INC. (CALIFORNIA CORPORATION)
47733 FREMONT BOULEVARD
FREMONT, CA 94538

THE MARK CONSISTS OF STANDARD CHARACTERS WITHOUT CLAIM TO ANY PARTICULAR FONT, STYLE, SIZE, OR COLOR.

FOR: LASERS FOR SURGICAL AND MEDICAL USE AND INSTRUCTION MANUALS SOLD AS A UNIT THEREWITH, IN CLASS 10 (U.S. CLS. 26, 39 AND 44).

SN 77-324,018, FILED 11-7-2007.

FIRST USE 4-0-2008; IN COMMERCE 11-0-2008.

RUSS HERMAN, EXAMINING ATTORNEY

Int. Cl.: 12

Prior U.S. Cls.: 19, 21, 23, 31, 35, and 44

United States Patent and Trademark Office

Reg. No. 3,577,512

Registered Feb. 17, 2009

TRADEMARK
PRINCIPAL REGISTER



VT SPECIALIZED VEHICLES CORPORATION
(DELAWARE CORPORATION)
P.O. BOX 880
911 WEST 5TH STREET
WASHINGTON, NC 27889

FOR: TRUCK BODIES, IN CLASS 12 (U.S. CLS. 19,
21, 23, 31, 35 AND 44).

FIRST USE 11-23-2006; IN COMMERCE 11-23-2006.

THE MARK CONSISTS OF THE WORD "PACK-
STAR" PRESENTED IN A STYLIZED FORM AND
HAVING FIVE STARS IN AN ARC-SHAPED PAT-
TERN IMMEDIATELY BELOW AND TO THE
RIGHT OF THE "STAR" PORTION OF THE MARK.

SN 77-324,365, FILED 11-8-2007.

LINDA POWELL, EXAMINING ATTORNEY

Int. Cl.: 37

Prior U.S. Cls.: 100, 103, and 106

United States Patent and Trademark Office

Reg. No. 3,577,513

Registered Feb. 17, 2009

**SERVICE MARK
PRINCIPAL REGISTER**

PURITY MOBILE SANITIZING

PURITY MOBILE SANITIZING, INC. (NORTH
CAROLINA CORPORATION)
1801 SPRING DRIVE
GARNER, NC 27529

FOR: PEST CONTROL AND EXTERMINATION
OTHER THAN FOR AGRICULTURAL PURPOSES;
CLEANING OF MATTRESSES, IN CLASS 37 (U.S.
CLS. 100, 103 AND 106).

FIRST USE 12-0-1991; IN COMMERCE 12-0-1991.

THE MARK CONSISTS OF STANDARD CHAR-
ACTERS WITHOUT CLAIM TO ANY PARTICULAR
FONT, STYLE, SIZE, OR COLOR.

NO CLAIM IS MADE TO THE EXCLUSIVE
RIGHT TO USE "MOBILE SANITIZING", APART
FROM THE MARK AS SHOWN.

SN 77-324,476, FILED 11-8-2007.

MARK PILARO, EXAMINING ATTORNEY

Int. Cls.: 36 and 42

Prior U.S. Cls.: 100, 101, and 102

United States Patent and Trademark Office

Reg. No. 3,577,514

Registered Feb. 17, 2009

**SERVICE MARK
PRINCIPAL REGISTER**

DEPOSZIP

EASTERN CORPORATE FEDERAL CREDIT UNION (MASSACHUSETTS FEDERALLY CHARTERED CREDIT UNION)

35 CORPORATE DRIVE
SUITE 300
BURLINGTON, MA 01803

FOR: FINANCIAL SERVICES, NAMELY, ELECTRONIC REMOTE CHECK DEPOSIT SERVICES, IN CLASS 36 (U.S. CLS. 100, 101 AND 102).

FIRST USE 9-30-2007; IN COMMERCE 9-30-2007.

FOR: PROVIDING TEMPORARY USE OF ON-LINE NON-DOWNLOADABLE SOFTWARE FOR

ELECTRONIC REMOTE CHECK DEPOSIT SERVICES, IN CLASS 42 (U.S. CLS. 100 AND 101).

FIRST USE 9-30-2007; IN COMMERCE 9-30-2007.

THE MARK CONSISTS OF STANDARD CHARACTERS WITHOUT CLAIM TO ANY PARTICULAR FONT, STYLE, SIZE, OR COLOR.

SN 77-325,099, FILED 11-8-2007.

LINDA ORNDORFF, EXAMINING ATTORNEY

Int. Cl.: 35

Prior U.S. Cls.: 100, 101, and 102

United States Patent and Trademark Office

Reg. No. 3,577,515

Registered Feb. 17, 2009

**SERVICE MARK
PRINCIPAL REGISTER**



FLY CREATIVE SOLUTIONS, LLC (KENTUCKY
LIMITED LIABILITY COMPANY)
2824 MAJESTIC VIEW WALK
LEXINGTON, KY 40511

FOR: ADVERTISING SERVICES, NAMELY,
CREATING CORPORATE LOGOS FOR OTHERS,
IN CLASS 35 (U.S. CLS. 100, 101 AND 102).

FIRST USE 8-3-2008; IN COMMERCE 8-3-2008.

THE MARK CONSISTS OF A STYLIZED INSECT
WITH A TEAR- OR DROPLET-SHAPED BODY AND
WINGS, A VECTOR LINE HANDLE ATTACHED TO
THE LEFT WING, AND THE DESIGNATION "LO-
GOFLY.NET".

SN 77-325,490, FILED 11-9-2007.

DAVID C. REIHNER, EXAMINING ATTORNEY

Int. Cl.: 25

Prior U.S. Cls.: 22 and 39

United States Patent and Trademark Office

Reg. No. 3,577,516

Registered Feb. 17, 2009

**TRADEMARK
PRINCIPAL REGISTER**

BECAUSE WE ALL LIVE HERE.

E.S. ORIGINALS, INC. (NEW YORK CORPORATION)
450 WEST 33RD STREET
NEW YORK, NY 10001

THE MARK CONSISTS OF STANDARD CHARACTERS WITHOUT CLAIM TO ANY PARTICULAR FONT, STYLE, SIZE, OR COLOR.

FOR: FOOTWEAR, IN CLASS 25 (U.S. CLS. 22 AND 39).

SN 77-325,511, FILED 11-9-2007.

FIRST USE 6-15-2008; IN COMMERCE 6-15-2008.

SONYA STEPHENS, EXAMINING ATTORNEY

Int. Cl.: 11

Prior U.S. Cls.: 13, 21, 23, 31, and 34

United States Patent and Trademark Office

Reg. No. 3,577,517

Registered Feb. 17, 2009

**TRADEMARK
PRINCIPAL REGISTER**

Song

SONG BATH LLC (CONNECTICUT LIMITED
LIABILITY COMPANY)
146 OLD KINGS HIGHWAY
NEW CANAAN, CT 06840

THE MARK CONSISTS OF STANDARD CHAR-
ACTERS WITHOUT CLAIM TO ANY PARTICULAR
FONT, STYLE, SIZE, OR COLOR.

FOR: BATHTUBS, SINKS, BATHTUB LEGS, AND
BATHTUB DRAIN ASSEMBLIES, IN CLASS 11 (U.S.
CLS. 13, 21, 23, 31 AND 34).

SN 77-326,855, FILED 11-12-2007.

FIRST USE 7-7-2006; IN COMMERCE 7-7-2006.

JENNIFER MARTIN, EXAMINING ATTORNEY

Int. Cl.: 33

Prior U.S. Cls.: 47 and 49

United States Patent and Trademark Office

Reg. No. 3,577,518

Registered Feb. 17, 2009

TRADEMARK
PRINCIPAL REGISTER

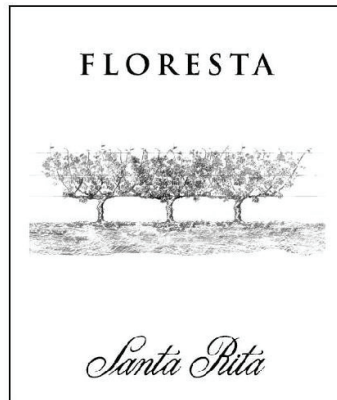

SOCIEDAD ANÓNIMA VIÑA SANTA RITA
(CHILE CORPORATION)
LAS CONDES
APOQUINDO 3669, PISO 6°
SANTIAGO, CHILE

OWNER OF U.S. REG. NOS. 2,275,710, 2,782,373,
AND OTHERS.

THE ENGLISH TRANSLATION OF "SANTA
RITA" AND "FLORESTA" IS "SAINT RITA" AND
"FOREST".

FOR: WINES, IN CLASS 33 (U.S. CLS. 47 AND 49).

SN 77-326,991, FILED 11-12-2007.

FIRST USE 6-3-2007; IN COMMERCE 6-3-2007.

REBECCA EISINGER, EXAMINING ATTORNEY

Int. Cl.: 35

Prior U.S. Cls.: 100, 101, and 102

United States Patent and Trademark Office

Reg. No. 3,577,519

Registered Feb. 17, 2009

**SERVICE MARK
PRINCIPAL REGISTER**

Mountain Chandelier

WILLIAM PETERSON & ASSOCIATES, LLC
(FLORIDA LIMITED LIABILITY COMPANY),
DBA MOUNTAIN CHANDELIER,
4 ALEXANDER COURT
ORMOND BEACH, FL 32174

FOR: COMMERCIAL AND RESIDENTIAL
LIGHTING FIXTURE STORE SERVICES, IN CLASS
35 (U.S. CLS. 100, 101 AND 102).

FIRST USE 12-9-2008; IN COMMERCE 12-9-2008.

THE MARK CONSISTS OF STANDARD CHAR-
ACTERS WITHOUT CLAIM TO ANY PARTICULAR
FONT, STYLE, SIZE, OR COLOR.

NO CLAIM IS MADE TO THE EXCLUSIVE
RIGHT TO USE "CHANDELIER", APART FROM
THE MARK AS SHOWN.

SN 77-327,292, FILED 11-12-2007.

LEIGH CAROLINE CASE, EXAMINING ATTOR-
NEY

Int. Cl.: 33

Prior U.S. Cls.: 47 and 49

United States Patent and Trademark Office

Reg. No. 3,577,520

Registered Feb. 17, 2009

TRADEMARK
PRINCIPAL REGISTER

LONKO

VIÑEDOS DE LA PATAGONIA S.R.L. (ARGENTINA CORPORATION)

MENDOZA 69

NEUQUÉN, ARGENTINA Q8300BOA

FOR: WINES, IN CLASS 33 (U.S. CLS. 47 AND 49).

FIRST USE 9-30-2007; IN COMMERCE 6-30-2008.

THE MARK CONSISTS OF STANDARD CHARACTERS WITHOUT CLAIM TO ANY PARTICULAR FONT, STYLE, SIZE, OR COLOR.

THE TERM "LONKO" HAS NO MEANING IN A FOREIGN LANGUAGE.

SN 77-327,689, FILED 11-12-2007.

KAREN SEVERSON, EXAMINING ATTORNEY

Int. Cl.: 11

Prior U.S. Cls.: 13, 21, 23, 31, and 34

United States Patent and Trademark Office

Reg. No. 3,577,521

Registered Feb. 17, 2009

**TRADEMARK
PRINCIPAL REGISTER**

SLIPPIN

CUNNINGHAM, BARBARA (UNITED STATES
INDIVIDUAL)
44 MAPLE ROAD
BRIARCLIFF MANOR, NY 10510

THE MARK CONSISTS OF STANDARD CHAR-
ACTERS WITHOUT CLAIM TO ANY PARTICULAR
FONT, STYLE, SIZE, OR COLOR.

FOR: POUCH TO HOLD CHEMICALLY ACTIVA-
TED HAND WARMERS, IN CLASS 11 (U.S. CLS. 13,
21, 23, 31 AND 34).

SN 77-327,804, FILED 11-13-2007.

FIRST USE 11-8-2008; IN COMMERCE 11-8-2008.

DAVID C. REIHNER, EXAMINING ATTORNEY

Int. Cl.: 29

Prior U.S. Cl.: 46

United States Patent and Trademark Office

Reg. No. 3,577,522

Registered Feb. 17, 2009

**TRADEMARK
PRINCIPAL REGISTER**

RENAISSANCE

DAVIS, BRIAN K. (UNITED STATES INDIVIDUAL)
21877 AVENUE 5
MADERA, CA 93637

THE MARK CONSISTS OF STANDARD CHARACTERS WITHOUT CLAIM TO ANY PARTICULAR FONT, STYLE, SIZE, OR COLOR.

FOR: PROCESSED NUTS; ROASTED NUTS; SHELLED NUTS; PROCESSED ALMONDS, IN CLASS 29 (U.S. CL. 46).

SN 77-328,180, FILED 11-13-2007.

FIRST USE 8-1-2008; IN COMMERCE 8-1-2008.

BRENDAN MCCAULEY, EXAMINING ATTORNEY

Int. Cl.: 9

Prior U.S. Cls.: 21, 23, 26, 36, and 38

United States Patent and Trademark Office

Reg. No. 3,577,523

Registered Feb. 17, 2009

**TRADEMARK
PRINCIPAL REGISTER**

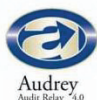

M2NS CORPORATION (OHIO CORPORATION)
SUITE 103
6037 FRANTZ ROAD
DUBLIN, OH 43017

FOR: COMPUTER SOFTWARE FOR HANDLING
OFF-LINE COMPLETION OF AUDITS, IN CLASS 9
(U.S. CLS. 21, 23, 26, 36 AND 38).

FIRST USE 11-3-2008; IN COMMERCE 11-3-2008.

NO CLAIM IS MADE TO THE EXCLUSIVE
RIGHT TO USE "AUDIT RELAY", APART FROM
THE MARK AS SHOWN.

THE COLOR(S) BLUE, TAN AND BLACK IS/ARE
CLAIMED AS A FEATURE OF THE MARK.

THE MARK CONSISTS OF THE COLOR BLUE
APPEARS IN THE ARROW DESIGN, BACK-
GROUND OF THE INNER CIRCLE AND THE
INTERIOR OF THE OUTER CIRCLE, THE COLOR
TAN APPEARS IN THE LETTER "A" DESIGN AND
OUTLINE OF THE EXTERIOR CIRCLE, THE COL-
OR BLACK APPEARS IN THE WORDING "AU-
DREY AUDIT RELAY 4.0" APPEARING BELOW
THE DESIGN AND THE COLOR WHITE APPEAR-
ING AS THE INTERIOR BORDER OF THE OUT-
SIDE CIRCLE IS INTENDED TO INDICATE
BACKGROUND OR TRANSPARENT AREAS AND
IS NOT PART OF THE MARK.

SN 77-328,448, FILED 11-13-2007.

GENE MACIOL, EXAMINING ATTORNEY

Int. Cls.: 9 and 10

Prior U.S. Cls.: 21, 23, 26, 36, 38, 39, and 44

United States Patent and Trademark Office

Reg. No. 3,577,524

Registered Feb. 17, 2009

**TRADEMARK
PRINCIPAL REGISTER**



WAVETEC VISION SYSTEMS, INC. (DELAWARE CORPORATION)

SUITE 170
66 ARGONAUT
ALISO VIEJO, CA 92656

FOR: COMPUTER SOFTWARE AND HARDWARE FOR USE IN TAKING, PROCESSING, RECORDING, STORING AND TRANSMITTING OPTICAL MEASUREMENTS; COMPUTER SOFTWARE AND HARDWARE FOR PERFORMING OPTICAL DIAGNOSTICS, IN CLASS 9 (U.S. CLS. 21, 23, 26, 36 AND 38).

FIRST USE 6-25-2008; IN COMMERCE 6-25-2008.

FOR: OPHTHALMIC AND OPTOMETRIC INSTRUMENTS FOR TAKING, PROCESSING, RECORDING, STORING AND TRANSMITTING OPTICAL MEASUREMENTS AND PERFORMING DIAGNOSTIC TESTS; LASERS FOR OPHTHALMIC AND OPTOMETRIC USE, IN CLASS 10 (U.S. CLS. 26, 39 AND 44).

FIRST USE 6-25-2008; IN COMMERCE 6-25-2008.

THE MARK CONSISTS OF A CIRCLE COMPOSED OF VARYING SIZED DOTS.

SN 77-328,682, FILED 11-13-2007.

ALICE BENMAMAN, EXAMINING ATTORNEY

Int. Cl.: 41

Prior U.S. Cls.: 100, 101, and 107

United States Patent and Trademark Office

Reg. No. 3,577,525

Registered Feb. 17, 2009

**SERVICE MARK
PRINCIPAL REGISTER**

VIRTUAL VANTAGE POINTS

APCO WORLDWIDE, INC. (DELAWARE CORPORATION)
700 12TH STREET, SUITE 800
WASHINGTON, DC 20005

FOR: ON-LINE JOURNALS, NAMELY, BLOGS FEATURING CURRENT EVENTS, COMMUNICATIONS INDUSTRY ISSUES, INTERNATIONAL RELATIONS AND POLITICS, IN CLASS 41 (U.S. CLS. 100, 101 AND 107).

FIRST USE 11-13-2007; IN COMMERCE 11-13-2007.

THE MARK CONSISTS OF STANDARD CHARACTERS WITHOUT CLAIM TO ANY PARTICULAR FONT, STYLE, SIZE, OR COLOR.

NO CLAIM IS MADE TO THE EXCLUSIVE RIGHT TO USE "VIRTUAL", APART FROM THE MARK AS SHOWN.

SN 77-329,033, FILED 11-14-2007.

CHRISTINA SOBRAL, EXAMINING ATTORNEY

Int. Cl.: 41

Prior U.S. Cls.: 100, 101, and 107

United States Patent and Trademark Office

Reg. No. 3,577,526

Registered Feb. 17, 2009

**SERVICE MARK
PRINCIPAL REGISTER**

RAVEL VIRTUAL STUDIOS

RAVEL VIRTUAL STUDIOS, LLC (NEW YORK
LIMITED LIABILITY COMPANY)

5 BRISTOL DRIVE

MANHASSET, NY 11030

FOR: MUSIC PRODUCTION SERVICES, IN
CLASS 41 (U.S. CLS. 100, 101 AND 107).

FIRST USE 6-0-2008; IN COMMERCE 6-0-2008.

THE MARK CONSISTS OF STANDARD CHAR-
ACTERS WITHOUT CLAIM TO ANY PARTICULAR
FONT, STYLE, SIZE, OR COLOR.

NO CLAIM IS MADE TO THE EXCLUSIVE
RIGHT TO USE "VIRTUAL STUDIOS", APART
FROM THE MARK AS SHOWN.

SN 77-329,202, FILED 11-14-2007.

CHRISTINA SOBRAL, EXAMINING ATTORNEY

Int. Cl.: 9

Prior U.S. Cls.: 21, 23, 26, 36, and 38

United States Patent and Trademark Office

Reg. No. 3,577,527

Registered Feb. 17, 2009

**TRADEMARK
PRINCIPAL REGISTER**

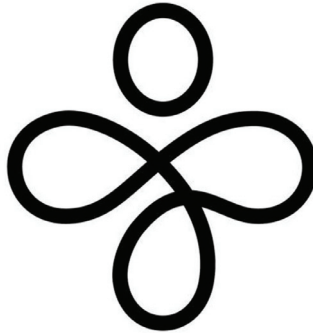

MICROSOFT CORPORATION (WASHINGTON CORPORATION)
ONE MICROSOFT WAY
REDMOND, WA 980526399

FOR: COMPUTER HARDWARE; COMPUTER DISPLAY AND INPUT SYSTEM COMPRISED OF A PROJECTOR, CAMERA AND COMPUTER SOFTWARE FOR DISPLAYING IMAGES AND DETECTING OBJECTS, USER GESTURES AND COMMANDS, IN CLASS 9 (U.S. CLS. 21, 23, 26, 36 AND 38).

FIRST USE 4-17-2008; IN COMMERCE 4-17-2008.

PRIORITY CLAIMED UNDER SEC. 44(D) ON FED REP GERMANY APPLICATION NO. 30731878.8, FILED 5-14-2007.

THE MARK CONSISTS OF AN OVAL POSITIONED ABOVE A FANCIFUL LOOP DESIGN.

SN 77-329,410, FILED 11-14-2007.

AMEETA JORDAN, EXAMINING ATTORNEY

Int. Cls.: 25 and 41

Prior U.S. Cls.: 22, 39, 100, 101, and 107

United States Patent and Trademark Office

Reg. No. 3,577,528

Registered Feb. 17, 2009

**TRADEMARK
SERVICE MARK
PRINCIPAL REGISTER**

We Got Big Game

ALASKA'S REMOTE ADVENTURES LLC (ALASKA LIMITED LIABILITY COMPANY)
P.O. BOX 230082
ANCHORAGE, AK 99523

FOR: CAMP SHIRTS; SHORT-SLEEVED OR LONG-SLEEVED T-SHIRTS; KNIT SHIRTS; LONG-SLEEVED SHIRTS; OPEN-NECKED SHIRTS; POLO SHIRTS; RUGBY SHIRTS; SHORT-SLEEVED SHIRTS; SPORT SHIRTS; SPORTS SHIRTS; SWEAT SHIRTS; FLEECE VESTS; BASEBALL CAPS; DENIM JACKETS; FISHERMEN'S JACKETS; HEAVY JACKETS; JACKETS; RAINPROOF JACKETS; MEN AND WOMEN JACKETS, COATS, TROUSERS, VESTS; RAIN JACKETS; SHELL JACKETS; SLEEVED OR SLEEVELESS JACKETS; SPORTS JACKETS; WATERPROOF JACKETS AND PANTS; WIND RESIS-

TANT JACKETS; WIND-JACKETS, IN CLASS 25 (U.S. CLS. 22 AND 39).

FIRST USE 6-10-2008; IN COMMERCE 7-1-2008.

FOR: HUNTING GUIDE SERVICES, IN CLASS 41 (U.S. CLS. 100, 101 AND 107).

FIRST USE 0-0-2006; IN COMMERCE 0-0-2006.

THE MARK CONSISTS OF STANDARD CHARACTERS WITHOUT CLAIM TO ANY PARTICULAR FONT, STYLE, SIZE, OR COLOR.

SN 77-330,001, FILED 11-15-2007.

RONALD AIKENS, EXAMINING ATTORNEY

Int. Cl.: 3

Prior U.S. Cls.: 1, 4, 6, 50, 51, and 52

Reg. No. 3,577,529

United States Patent and Trademark Office

Registered Feb. 17, 2009

**TRADEMARK
PRINCIPAL REGISTER**

EASEAMINE

CARMEL LABORATORIES, LLC (MASSACHU-
SETTS LIMITED LIABILITY COMPANY)
P.O. BOX 826
WORCESTER, MA 01613

THE MARK CONSISTS OF STANDARD CHAR-
ACTERS WITHOUT CLAIM TO ANY PARTICULAR
FONT, STYLE, SIZE, OR COLOR.

FOR: ANTI-WRINKLE CREAM, IN CLASS 3 (U.S.
CLS. 1, 4, 6, 50, 51 AND 52).

SN 77-330,237, FILED 11-15-2007.

FIRST USE 6-9-2008; IN COMMERCE 6-9-2008.

ALICIA COLLINS, EXAMINING ATTORNEY

Int. Cl.: 37

Prior U.S. Cls.: 100, 103, and 106

United States Patent and Trademark Office

Reg. No. 3,577,530

Registered Feb. 17, 2009

SERVICE MARK
PRINCIPAL REGISTER



RUSSELL REID WASTE HAULING AND DISPOSAL SERVICE CO, INC. (NEW JERSEY CORPORATION)
200 SMITH STREET
KEASBEY, NJ 08832

FOR: SEPTIC TANK AND CESSPOOL CLEANING, SEWAGE SLUDGE DISPOSAL FOR OTHERS, IN CLASS 37 (U.S. CLS. 100, 103 AND 106).

FIRST USE 1-1-2007; IN COMMERCE 1-1-2007.

OWNER OF U.S. REG. NOS. 1,861,206, 2,245,855, AND OTHERS.

THE NAME "MR. JOHN" "RUSSELL REID" DOES NOT IDENTIFY A LIVING INDIVIDUAL.

THE COLOR(S) BLUE, GREEN, WHITE, RED AND GRAY IS/ARE CLAIMED AS A FEATURE OF THE MARK.

THE MARK CONSISTS OF THE BACKGROUND IS WHITE. THERE IS A GRAY CIRCLE. INSIDE THE GRAY CIRCLE IS A SOLID BLUE BACKWARDS LETTER "R" BACK-TO-BACK WITH A FORWARD FACING SOLID GREEN LETTER "R". UNDERNEATH THE TWO LETTER "R"S, THERE IS SOLID BLUE WRITING STATING "RUSSELL REID". TO THE RIGHT IS A RED LOGO OF A BOX WITH TWO TRIANGLES ON TOP AND TWO PARALLEL LINES IN AN UP-DOWN DIRECTION. THERE IS RED WRITING UNDERNEATH THIS BOX STATING "MR. JOHN".

SN 77-330,288, FILED 11-15-2007.

SETH A. RAPPAPORT, EXAMINING ATTORNEY

Int. Cl.: 41

Prior U.S. Cls.: 100, 101, and 107

United States Patent and Trademark Office

Reg. No. 3,577,531

Registered Feb. 17, 2009

**SERVICE MARK
PRINCIPAL REGISTER**



VIBRANT BRAINS LLC (CALIFORNIA LIMITED
LIABILITY COMPANY)
2609 CALIFORNIA ST.
SAN FRANCISCO, CA 94115

FOR: PROVIDING FACILITIES WHERE CLIENTS
WILL BE TRAINED TO USE LICENSED SOFTWARE
PRODUCTS THAT IMPROVE COGNITIVE FUNC-
TION; PROVIDING TRAINING FOR USE OF LI-
CENSED SOFTWARE PRODUCTS THAT IMPROVE
COGNITIVE FUNCTION, IN CLASS 41 (U.S. CLS.
100, 101 AND 107).

FIRST USE 12-1-2007; IN COMMERCE 12-8-2007.

THE COLOR(S) LIGHT GREEN AND MAGENTA
IS/ARE CLAIMED AS A FEATURE OF THE MARK.

THE MARK CONSISTS OF A STYLIZED
"THOUGHT BUBBLE" IN LIGHT GREEN WITH A
MULTIPOINTED PORTION OF THE SURFACE
AREA OF THE "THOUGHT BUBBLE" DISPLACED
AND COLORED IN MAGENTA.

SN 77-330,548, FILED 11-15-2007.

LINDSEY RUBIN, EXAMINING ATTORNEY

Int. Cls.: 35 and 36

Prior U.S. Cls.: 100, 101, and 102

United States Patent and Trademark Office

Reg. No. 3,577,532

Registered Feb. 17, 2009

**SERVICE MARK
PRINCIPAL REGISTER**

Condo Authority

JACKSON HOLDINGS, LLC. (VIRGINIA LIMITED LIABILITY COMPANY)
625 N. WASHINGTON ST., SUITE 304
ALEXANDRIA, VA 22314

FOR: REAL ESTATE MARKETING SERVICES IN THE FIELD OF CONDOMINIUMS, IN CLASS 35 (U.S. CLS. 100, 101 AND 102).

FIRST USE 4-18-2008; IN COMMERCE 4-18-2008.

FOR: PROVIDING REAL ESTATE LISTINGS AND REAL ESTATE INFORMATION VIA THE INTERNET, IN CLASS 36 (U.S. CLS. 100, 101 AND 102).

FIRST USE 4-18-2008; IN COMMERCE 4-18-2008.

THE MARK CONSISTS OF STANDARD CHARACTERS WITHOUT CLAIM TO ANY PARTICULAR FONT, STYLE, SIZE, OR COLOR.

NO CLAIM IS MADE TO THE EXCLUSIVE RIGHT TO USE "CONDO", APART FROM THE MARK AS SHOWN.

SN 77-330,700, FILED 11-15-2007.

ASMAT KHAN, EXAMINING ATTORNEY

Int. Cl.: 29

Prior U.S. Cl.: 46

United States Patent and Trademark Office

Reg. No. 3,577,533

Registered Feb. 17, 2009

**TRADEMARK
PRINCIPAL REGISTER**



COUNTRY CREEK FARMS, LLC (TENNESSEE
LIMITED LIABILITY COMPANY)

5509 WALSH LANE

ROGERS, AR 72758

FOR: EGGS, IN CLASS 29 (U.S. CL. 46).

FIRST USE 8-0-2005; IN COMMERCE 8-0-2005.

NO CLAIM IS MADE TO THE EXCLUSIVE
RIGHT TO USE "NATURALS", APART FROM THE
MARK AS SHOWN.

THE MARK COMPRISES A FARMYARD SCENE
WITH A RISING SUN IN THE BACKGROUND.

SN 77-331,325, FILED 11-16-2007.

CYNTHIA SLOAN, EXAMINING ATTORNEY

Int. Cl.: 43

Prior U.S. Cls.: 100 and 101

United States Patent and Trademark Office

Reg. No. 3,577,534

Registered Feb. 17, 2009

SERVICE MARK
PRINCIPAL REGISTER



J&J SNACK FOODS CORP. (NEW JERSEY CORPORATION)
6000 CENTRAL HIGHWAY
PENNSAUKEN, NJ 08109

FOR: CONTRACT FOOD SERVICES FOR EDUCATIONAL INSTITUTIONS, IN CLASS 43 (U.S. CLS. 100 AND 101).

FIRST USE 3-0-2006; IN COMMERCE 3-0-2006.

OWNER OF U.S. REG. NOS. 2,851,297 AND 3,137,114.

NO CLAIM IS MADE TO THE EXCLUSIVE RIGHT TO USE "SNACK FOODS SCHOOL FOOD

SERVICE PROGRAM", APART FROM THE MARK AS SHOWN.

THE MARK CONSISTS OF A BANNER WITH THE STYLIZED WORDING "J&J SNACK FOODS" ON IT, AND A HOUSE UNDERNEATH AND TO THE LEFT OF THE BANNER, FOLLOWED BY THE STYLIZED WORDING "SCHOOL FOODSERVICE PROGRAM A LA CARTE SMART" WITHIN A SHADED RECTANGLE WITH CURVED EDGES.

SN 77-331,458, FILED 11-16-2007.

JAY BESCH, EXAMINING ATTORNEY

Int. Cl.: 28

Prior U.S. Cls.: 22, 23, 38, and 50

United States Patent and Trademark Office

Reg. No. 3,577,535

Registered Feb. 17, 2009

**TRADEMARK
PRINCIPAL REGISTER**

DUZ-IT-ALL

ROD-N-BOBB'S INC. (WISCONSIN CORPORATION)
630 LAMPLIGHTER CT.
EAU CLAIRE, WI 54073

THE MARK CONSISTS OF STANDARD CHARACTERS WITHOUT CLAIM TO ANY PARTICULAR FONT, STYLE, SIZE, OR COLOR.

FOR: FISHING BOBBERS, IN CLASS 28 (U.S. CLS. 22, 23, 38 AND 50).

SN 77-331,864, FILED 11-16-2007.

FIRST USE 1-31-2008; IN COMMERCE 1-31-2008.

MARCIE MILONE, EXAMINING ATTORNEY

Int. Cl.: 36

Prior U.S. Cls.: 100, 101, and 102

United States Patent and Trademark Office

Reg. No. 3,577,536

Registered Feb. 17, 2009

**SERVICE MARK
PRINCIPAL REGISTER**

**PEOPLE AND IDEAS THAT
CHANGE THE GAME**

FBR CAPITAL MARKETS CORPORATION (VIRGINIA CORPORATION)
1001 NINETEENTH STREET NORTH
ARLINGTON, VA 22209

FOR: FINANCIAL SERVICES, NAMELY, INVESTMENT BANKING, STOCK TRADING, BROKERAGE IN THE FIELD OF STOCKS, INVESTMENT MANAGEMENT AND ASSET MANAGEMENT, IN CLASS 36 (U.S. CLS. 100, 101 AND 102).

FIRST USE 6-1-2008; IN COMMERCE 6-1-2008.

THE MARK CONSISTS OF STANDARD CHARACTERS WITHOUT CLAIM TO ANY PARTICULAR FONT, STYLE, SIZE, OR COLOR.

SN 77-332,047, FILED 11-16-2007.

SHAUNIA CARLYLE, EXAMINING ATTORNEY

Int. Cl.: 42

Prior U.S. Cls.: 100 and 101

United States Patent and Trademark Office

Reg. No. 3,577,537

Registered Feb. 17, 2009

**SERVICE MARK
PRINCIPAL REGISTER**

Storecheck

STORECHECK, SA DE CV (MEXICO SOCIEDAD ANONIMA (SA DE CV))
PAQUE IND ALAMOS
AV MANUFACTURA NO 8 BIX LOCAL 17
QUERETARO, MEXICO 76160

FOR: TECHNICAL CONSULTATION IN THE FIELD OF AUTOMATING BUSINESS DATA COLLECTION, FOR THE COMPILATION AND INTERPRETATION OF DATA IN THE FIELD OF POINT OF SALE PERFORMANCE INFORMATION, IN CLASS 42 (U.S. CLS. 100 AND 101).

FIRST USE 11-19-2008; IN COMMERCE 11-19-2008.

THE MARK CONSISTS OF STANDARD CHARACTERS WITHOUT CLAIM TO ANY PARTICULAR FONT, STYLE, SIZE, OR COLOR.

SN 77-332,721, FILED 11-19-2007.

VIVIAN MICZNIK FIRST, EXAMINING ATTORNEY

Int. Cl.: 5

Prior U.S. Cls.: 6, 18, 44, 46, 51, and 52

United States Patent and Trademark Office

Reg. No. 3,577,538

Registered Feb. 17, 2009

**TRADEMARK
PRINCIPAL REGISTER**

BRIGADIER

FMC CORPORATION (DELAWARE CORPORATION)
1735 MARKET STREET
PHILADELPHIA, PA 19103

THE MARK CONSISTS OF STANDARD CHARACTERS WITHOUT CLAIM TO ANY PARTICULAR FONT, STYLE, SIZE, OR COLOR.

FOR: PREPARATIONS FOR THE DESTRUCTION OF VERMIN; PESTICIDES, IN CLASS 5 (U.S. CLS. 6, 18, 44, 46, 51 AND 52).

SN 77-332,894, FILED 11-19-2007.

FIRST USE 6-16-2008; IN COMMERCE 6-16-2008.

ALYSSA STEEL, EXAMINING ATTORNEY

Int. Cl.: 5

Prior U.S. Cls.: 6, 18, 44, 46, 51, and 52

Reg. No. 3,577,539

United States Patent and Trademark Office

Registered Feb. 17, 2009

**TRADEMARK
PRINCIPAL REGISTER**

GENTIANPURE

NATUREX, INC. (DELAWARE CORPORATION)
375 HUYLER STREET
SOUTH HACKENSACK, NJ 07606

THE MARK CONSISTS OF STANDARD CHAR-
ACTERS WITHOUT CLAIM TO ANY PARTICULAR
FONT, STYLE, SIZE, OR COLOR.

FOR: DIETETIC SUBSTANCES ADAPTED FOR
MEDICAL USE; FOOD SUPPLEMENTS FOR MED-
ICAL USE; MINERAL FOOD SUPPLEMENTS, IN
CLASS 5 (U.S. CLS. 6, 18, 44, 46, 51 AND 52).

SN 77-332,951, FILED 11-19-2007.

FIRST USE 11-7-2007; IN COMMERCE 11-7-2007.

BRENDAN REGAN, EXAMINING ATTORNEY

Int. Cl.: 42

Prior U.S. Cls.: 100 and 101

United States Patent and Trademark Office

Reg. No. 3,577,540

Registered Feb. 17, 2009

**SERVICE MARK
PRINCIPAL REGISTER**



STORECHECK, SA DE CV (MEXICO SOCIEDAD ANONIMA (SA DE CV))
PAQUE IND ALAMOS
AV MANUFACTURA NO 8 BIS LOCAL 17
QUERETARO, MEXICO 76160

FOR: TECHNICAL CONSULTATION IN THE FIELD OF AUTOMATING BUSINESS DATA COLLECTION, FOR THE COMPILATION AND INTERPRETATION OF DATA IN THE FIELD OF POINT OF SALE PERFORMANCE INFORMATION, IN CLASS 42 (U.S. CLS. 100 AND 101).

FIRST USE 11-19-2008; IN COMMERCE 11-19-2008.

THE COLOR(S) RED, GRAY IS/ARE CLAIMED AS A FEATURE OF THE MARK.

THE MARK CONSISTS OF THE COLOR RED APPEARING IN THE WORD "STORECHECK" AND THE COLOR GRAY APPEARING IN THE DESIGN.

SN 77-333,126, FILED 11-19-2007.

VIVIAN MICZNIK FIRST, EXAMINING ATTORNEY

Int. Cl.: 28

Prior U.S. Cls.: 22, 23, 38, and 50

United States Patent and Trademark Office

Reg. No. 3,577,541

Registered Feb. 17, 2009

TRADEMARK
PRINCIPAL REGISTER



BYRDIES, INC. (CALIFORNIA CORPORATION)
PO BOX 556
KENWOOD, CA 95452

FOR: GOLF CLUBS; GOLF IRONS; GOLF CLUB
GRIPS; GOLF CLUB HEADS; GOLF CLUB INSERTS;
GOLF CLUB SHAFTS, IN CLASS 28 (U.S. CLS. 22, 23,
38 AND 50).

FIRST USE 2-1-2008; IN COMMERCE 6-20-2008.

THE MARK CONSISTS OF THE WORD "TRIO"
WITH THE DESIGN OF A BIRD WING.

SN 77-333,291, FILED 11-19-2007.

GRETTA YAO, EXAMINING ATTORNEY

Int. Cl.: 42

Prior U.S. Cls.: 100 and 101

United States Patent and Trademark Office

Reg. No. 3,577,542

Registered Feb. 17, 2009

**SERVICE MARK
PRINCIPAL REGISTER**

PLANET TEACH TEACH YOUR
PASSION, LEARN YOUR DREAM

PLANET TEACH CORPORATION (TEXAS COR-
PORATION)
APT. 2004
9757 PINE LAKE DRIVE
HOUSTON, TX 77055

FOR: PROVIDING CUSTOMIZED ON-LINE WEB
PAGES FEATURING USER-DEFINED INFORMA-
TION, WHICH FEATURES CONTENT THAT IS
UPLOADED FOR THE PURPOSE OF TEACHING
ANOTHER VIEWER OF THAT CONTENT HOW TO
ACCOMPLISH A SPECIFIC TASK WHILE ORGA-
NIZING ALL CONTENT BY THE AUTHOR OF
THAT CONTENT AND RATING EACH CONTENT
AUTHOR BY THE VALUE THE VIEWING USERS
GIVE THAT CONTENT AUTHOR, IN CLASS 42 (U.S.
CLS. 100 AND 101).

FIRST USE 5-1-2008; IN COMMERCE 5-1-2008.

THE MARK CONSISTS OF STANDARD CHAR-
ACTERS WITHOUT CLAIM TO ANY PARTICULAR
FONT, STYLE, SIZE, OR COLOR.

NO CLAIM IS MADE TO THE EXCLUSIVE
RIGHT TO USE "TEACH", APART FROM THE
MARK AS SHOWN.

SN 77-333,939, FILED 11-20-2007.

KAPIL BHANOT, EXAMINING ATTORNEY

Int. Cls.: 14, 40, and 42

Prior U.S. Cls.: 2, 27, 28, 50, 100, 101, 103, and 106

United States Patent and Trademark Office

Reg. No. 3,577,543

Registered Feb. 17, 2009

TRADEMARK
SERVICE MARK
PRINCIPAL REGISTER



UNITED PRECIOUS METAL REFINING, INC.
(NEW YORK CORPORATION)
2781 TOWNLINE ROAD
ALDEN, NY 14004

FOR: PRECIOUS METALS AND ALLOYS THERE-
OF, IN CLASS 14 (U.S. CLS. 2, 27, 28 AND 50).

FIRST USE 11-20-2007; IN COMMERCE 12-1-2007.

FOR: PRECIOUS METAL REFINING AND RE-
CYCLING SERVICES, IN CLASS 40 (U.S. CLS. 100,
103 AND 106).

FIRST USE 11-20-2007; IN COMMERCE 12-1-2007.

FOR: ASSAY SERVICES FOR PRECIOUS METALS
AND ALLOYS, IN CLASS 42 (U.S. CLS. 100 AND 101).

FIRST USE 11-20-2007; IN COMMERCE 12-1-2007.

OWNER OF U.S. REG. NOS. 1,547,283 AND
1,916,366.

NO CLAIM IS MADE TO THE EXCLUSIVE
RIGHT TO USE "ENVIRONMENTALLY RESPONSIB-
LE" FOR THE SERVICES LISTED IN INTERNA-
TIONAL CLASSES 40 AND 42. , APART FROM THE
MARK AS SHOWN.

THE MARK CONSISTS OF THE WORD "UNI-
TED" IS PLACED ABOVE THE WORD "RE-DE-

FINED" WHICH IS ABOVE THE WORD
"ENVIRONMENTALLY" WHICH IS ABOVE THE
WORD "RESPONSIBLE." THE "U" OF "UNITED" IS
TREATED IN THE DESIGN AS A BEAKER FILLED
TO THE TOP WITH A LIQUID. THE BEAKER IS
TILTED TO THE LEFT SO THAT SOME OF THE
LIQUID IS EFFECTIVELY BEING Poured OUT OF
THE BEAKER. THE LIQUID PASSES THROUGH
THE FIRST UPPER-CASE "E" OF THE WORD "RE-
DEFINED." JUST BENEATH THE SAME FIRST "E"
OF "RE-DEFINED" THE LIQUID SOLIDIFIES INTO
A BAR OF METAL (AN INGOT) WITH THE LET-
TERS "UNITED" PRINTED ON THE FACE OF THE
BAR. JUST TO THE RIGHT OF THE RIGHT END OF
THE BAR, IS THE WORD "ENVIRONMENTALLY",
AS MENTIONED ABOVE. THE "E-D" SECTION OF
THE WORD "RE-DEFINED", AS MENTIONED
ABOVE, IS PRINTED ON A SPHERE DESIGN,
WHICH DESIGN IS DESCRIBED AS A MOSTLY
SOLID SPHERE EXCEPT FOR TWO CUT-OUTS
FROM THE TOP RIGHT AND LEFT PORTIONS
OF THE SPHERE. IN ADDITION, THERE IS AN
ARC, FORMED WITH A ONE-SIDED ARROW-
HEADED TIP, WHICH IS INDEPENDENTLY LOCA-
TED ABOVE THE TOP RIGHT PORTION OF THE
SPHERE.

SN 77-334,019, FILED 11-20-2007.

DAVID MURRAY, EXAMINING ATTORNEY

Int. Cl.: 29

Prior U.S. Cl.: 46

United States Patent and Trademark Office

Reg. No. 3,577,544

Registered Feb. 17, 2009

**TRADEMARK
PRINCIPAL REGISTER**

DEATH VALLEY CHIPOTLE

KETTLE FOODS, INC. (OREGON CORPORATION)
3125 KETTLE CT. SE
SALEM, OR 973015572

NO CLAIM IS MADE TO THE EXCLUSIVE
RIGHT TO USE "CHIPOTLE", APART FROM THE
MARK AS SHOWN.

FOR: POTATO CHIPS, IN CLASS 29 (U.S. CL. 46).

FIRST USE 4-1-2008; IN COMMERCE 4-1-2008.

SN 77-335,712, FILED 11-21-2007.

THE MARK CONSISTS OF STANDARD CHARACTERS WITHOUT CLAIM TO ANY PARTICULAR FONT, STYLE, SIZE, OR COLOR.

CARYN GLASSER, EXAMINING ATTORNEY

Int. Cl.: 42

Prior U.S. Cls.: 100 and 101

United States Patent and Trademark Office

Reg. No. 3,577,545

Registered Feb. 17, 2009

**SERVICE MARK
PRINCIPAL REGISTER**

itQMS

IT QUALITY MANAGEMENT SOLUTIONS (PRIVATE) LIMITED (SRI LANKA LIMITED LIABILITY COMPANY)
25/35 KALINGA MAWATHA
COLOMBO 5, SRI LANKA

FOR: CONSULTING IN THE FIELD OF INFORMATION TECHNOLOGY, IN CLASS 42 (U.S. CLS. 100 AND 101).

FIRST USE 4-15-2007; IN COMMERCE 4-15-2007.

THE COLOR(S) DARK BLUE IS/ARE CLAIMED AS A FEATURE OF THE MARK.

THE MARK CONSISTS OF THE STYLIZED DARK BLUE WORDING "ITQMS".

SN 77-335,792, FILED 11-22-2007.

CHRISTINA SOBRAL, EXAMINING ATTORNEY

Int. Cl.: 9

Prior U.S. Cls.: 21, 23, 26, 36, and 38

Reg. No. 3,577,546

United States Patent and Trademark Office

Registered Feb. 17, 2009

**TRADEMARK
PRINCIPAL REGISTER**

VENUS

EPISTAR CORPORATION (TAIWAN CORPORATION)
SCIENCE-BASED INDUSTRIAL PARK
NO. 5, LI HSIN 5TH ROAD
HSINCHU, TAIWAN

THE MARK CONSISTS OF STANDARD CHARACTERS WITHOUT CLAIM TO ANY PARTICULAR FONT, STYLE, SIZE, OR COLOR.

FOR: LIGHT DIODES, LIGHT EMITTING DIODE (LED) DISPLAYS AND LIGHT EMITTING DIODES, IN CLASS 9 (U.S. CLS. 21, 23, 26, 36 AND 38).

SN 77-336,187, FILED 11-24-2007.

FIRST USE 5-31-2008; IN COMMERCE 5-31-2008.

JESSICA A. POWERS, EXAMINING ATTORNEY

Int. Cl.: 16

Prior U.S. Cls.: 2, 5, 22, 23, 29, 37, 38, and 50

United States Patent and Trademark Office

Reg. No. 3,577,547

Registered Feb. 17, 2009

**TRADEMARK
PRINCIPAL REGISTER**

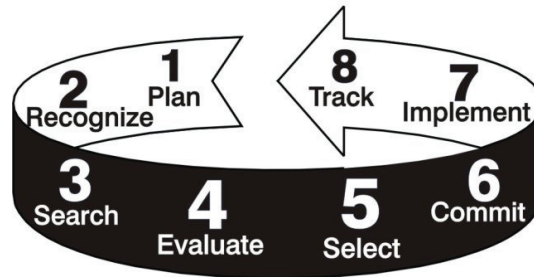

ACCLIVUS CORPORATION (TEXAS CORPORATION)
14500 MIDWAY ROAD
DALLAS, TX 75244

FOR: PRINTED MATERIALS, NAMELY, WORKBOOKS, WALL CHARTS, AND SKILL GUIDES FOR USE IN WORKSHOPS, LECTURES, COURSE SYMPOSIA AND CONFERENCES IN THE FIELD OF BUSINESS MANAGEMENT, SALES COMMUNICATION AND BUILDING RELATIONSHIPS WITH CUSTOMERS, IN CLASS 16 (U.S. CLS. 2, 5, 22, 23, 29, 37, 38 AND 50).

FIRST USE 5-31-2000; IN COMMERCE 5-31-2000.

THE MARK CONSISTS OF CIRCULAR ARROW RIBBON LOOP WITH THE WORDS "1 PLAN" "2 RECOGNIZE" "3 SEARCH" "4 EVALUATE" "5 SELECT" "6 COMMIT" "7 IMPLEMENT" "8 TRACK".

SN 77-336,292, FILED 11-25-2007.

CIMMERIAN COLEMAN, EXAMINING ATTORNEY

Int. Cls.: 9 and 16

Prior U.S. Cls.: 2, 5, 21, 22, 23, 26, 29, 36, 37, 38, and 50

Reg. No. 3,577,548

United States Patent and Trademark Office

Registered Feb. 17, 2009

**TRADEMARK
PRINCIPAL REGISTER**

GTD WEEKLY REVIEW

DAVID ALLEN & CO. (CALIFORNIA CORPORATION)
407-F BRYANT CIRCLE
OJAI, CA 93023

FOR: DVDS, CDS, AND SOFTWARE FEATURING INFORMATION AND INSTRUCTION ON THE DEVELOPMENT OF MANAGEMENT AND BUSINESS SKILLS, EFFICIENT WORK HABITS, PLANNING AND ORGANIZATIONAL TECHNIQUES, AND PERSONAL PRODUCTIVITY GROWTH; AND PRE-RECORDED VIDEO AND AUDIO CASSETTE TAPES FEATURING INFORMATION AND INSTRUCTION ON THE DEVELOPMENT OF MANAGEMENT AND BUSINESS SKILLS, EFFICIENT WORK HABITS, PLANNING AND ORGANIZATIONAL TECHNIQUES, AND PERSONAL PRODUCTIVITY AND GROWTH, IN CLASS 9 (U.S. CLS. 21, 23, 26, 36 AND 38).

FIRST USE 6-15-1996; IN COMMERCE 6-15-1996.

FOR: PUBLICATIONS, NAMELY, BOOKS, BROCHURES, PAMPHLETS AND PRINTED SEMINAR COURSE MATERIALS ALL FEATURING THE DEVELOPMENT OF MANAGEMENT AND BUSINESS SKILLS, EFFICIENT WORK HABITS, PLANNING AND ORGANIZATIONAL TECHNIQUES, AND PERSONAL PRODUCTIVITY AND GROWTH;

DESKTOP PLANNERS; MARKING TEMPLATES; WRITING PENS AND PENCILS; NOTEBOOKS AND MEMO PADS; AND EDUCATIONAL, COACHING AND TRAINING PUBLICATIONS, NAMELY, BOOKS, BROCHURES, PAMPHLETS AND PRINTED SEMINAR COURSE MATERIALS IN THE FIELDS OF INDIVIDUAL AND BUSINESS PRODUCTIVITY, SELF IMPROVEMENT AND TIME MANAGEMENT DISTRIBUTED TO SUBSCRIBER MEMBERS, IN CLASS 16 (U.S. CLS. 2, 5, 22, 23, 29, 37, 38 AND 50).

FIRST USE 6-15-1996; IN COMMERCE 6-15-1996.

THE MARK CONSISTS OF STANDARD CHARACTERS WITHOUT CLAIM TO ANY PARTICULAR FONT, STYLE, SIZE, OR COLOR.

OWNER OF U.S. REG. NO. 3,022,705.

NO CLAIM IS MADE TO THE EXCLUSIVE RIGHT TO USE "WEEKLY REVIEW", APART FROM THE MARK AS SHOWN.

SN 77-336,572, FILED 11-26-2007.

KATHRYN COWARD, EXAMINING ATTORNEY

Int. Cl.: 35

Prior U.S. Cls.: 100, 101, and 102

United States Patent and Trademark Office

Reg. No. 3,577,549

Registered Feb. 17, 2009

**SERVICE MARK
PRINCIPAL REGISTER**

**ONE GREAT THING LEADS TO
ANOTHER**

KOHL'S ILLINOIS, INC. (NEVADA CORPORATION)
NEW YORK SQUARE
4340 FOX VALLEY CENTER
AURORA, IL 60504

THE MARK CONSISTS OF STANDARD CHARACTERS WITHOUT CLAIM TO ANY PARTICULAR FONT, STYLE, SIZE, OR COLOR.

FOR: RETAIL DEPARTMENT STORE SERVICES,
IN CLASS 35 (U.S. CLS. 100, 101 AND 102).

SN 77-336,874, FILED 11-26-2007.

FIRST USE 3-0-2008; IN COMMERCE 3-0-2008.

JOHN HWANG, EXAMINING ATTORNEY

Int. Cl.: 16

Prior U.S. Cls.: 2, 5, 22, 23, 29, 37, 38, and 50

United States Patent and Trademark Office

Reg. No. 3,577,550

Registered Feb. 17, 2009

**TRADEMARK
PRINCIPAL REGISTER**

FOSTERING CREATIVITY

KAREN FOSTER DESIGN, INC. (UTAH CORPORATION)
623 NORTH 1250 WEST
CENTERVILLE, UT 84014

FOR: PAPER; PRINTED PAPER SHEETS; CARD-STOCK, DECORATIVE PAPER FOR SCRAPBOOKING; RUBBER STAMPS, INK STAMPS; PAPER BOXES; PHOTO STORAGE BOXES; SCRAPBOOKS; SCRAPBOOK ALBUMS; SCRAPBOOK PAGES; TRANSFERS; BOOKS ON SCRAPBOOKING; MEMORY PLANNERS; PAPER LABELS; FLOSS FOR USE IN SCRAPBOOKING; PAPER TAGS; CORK SHEETS FOR USE IN SCRAPBOOKING; HAND TOOLS FOR DECORATIVE HOLE PUNCHING, EMBOSsing, FASTENING AND SETTING EYELETS FOR USE IN SCRAPBOOKING; DECORATIVE PAPER LABELS, SIGNS, BRADS, CHARMS, PINCH TABS,

TRANSFER, RUB-ONS, AND PATCHES ALL FOR USE IN SCRAPBOOK; AND SCRAPBOOK KITS CONSISTING PRIMARILY OF PAPER SHEETS AND STICKERS, IN CLASS 16 (U.S. CLS. 2, 5, 22, 23, 29, 37, 38 AND 50).

FIRST USE 12-1-2007; IN COMMERCE 12-1-2007.

THE MARK CONSISTS OF STANDARD CHARACTERS WITHOUT CLAIM TO ANY PARTICULAR FONT, STYLE, SIZE, OR COLOR.

OWNER OF U.S. REG. NO. 3,379,347.

SN 77-336,989, FILED 11-26-2007.

ANDREA SAUNDERS, EXAMINING ATTORNEY

Int. Cl.: 9

Prior U.S. Cls.: 21, 23, 26, 36, and 38

United States Patent and Trademark Office

Reg. No. 3,577,551

Registered Feb. 17, 2009

**TRADEMARK
PRINCIPAL REGISTER**

MYSTERY IN LONDON

BIG FISH GAMES, INC. (WASHINGTON COR-
PORATION)
SUITE 200
333 ELLIOTT AVENUE WEST
SEATTLE, WA 98119

FOR: ELECTRONIC GAME PROGRAMS, IN
CLASS 9 (U.S. CLS. 21, 23, 26, 36 AND 38).

FIRST USE 2-14-2007; IN COMMERCE 2-14-2007.

THE MARK CONSISTS OF STANDARD CHAR-
ACTERS WITHOUT CLAIM TO ANY PARTICULAR
FONT, STYLE, SIZE, OR COLOR.

SN 77-337,168, FILED 11-26-2007.

CHERYL CLAYTON, EXAMINING ATTORNEY

Int. Cl.: 25

Prior U.S. Cls.: 22 and 39

United States Patent and Trademark Office

Reg. No. 3,577,552

Registered Feb. 17, 2009

**TRADEMARK
PRINCIPAL REGISTER**

BLISSITUDE

SURYA, INC. (CALIFORNIA CORPORATION)
6205 EL CAMINO REAL
CARLSBAD, CA 92009

THE MARK CONSISTS OF STANDARD CHAR-
ACTERS WITHOUT CLAIM TO ANY PARTICULAR
FONT, STYLE, SIZE, OR COLOR.

FOR: BOTTOMS; JACKETS; LADIES' SUITS;
PANTS; SHIRTS; SKIRTS AND DRESSES; TANK
TOPS; TOPS, IN CLASS 25 (U.S. CLS. 22 AND 39).

SN 77-337,213, FILED 11-26-2007.

FIRST USE 2-29-2008; IN COMMERCE 2-29-2008.

DEIRDRE ROBERTSON, EXAMINING ATTORNEY

Int. Cl.: 45

Prior U.S. Cls.: 100 and 101

United States Patent and Trademark Office

Reg. No. 3,577,553

Registered Feb. 17, 2009

**SERVICE MARK
PRINCIPAL REGISTER**

ActiKare

ACTIKARE, INC. (FLORIDA CORPORATION)
SUITE 185
15310 AMBERLY DRIVE
TAMPA, FL 33647

FOR: PROVIDING PERSONAL ASSISTANT SUPPORT SERVICES, NAMELY, COMPANIONSHIP, HOUSEKEEPING ASSISTANCE, MEAL PLANNING AND PREPARATION ASSISTANCE, PROVIDING INCIDENTAL TRANSPORTATION TO SHOPPING ERRANDS, PLACES OF WORSHIP, LEISURE ACTIVITIES, APPOINTMENTS AND PHARMACIES, DRY CLEANING ASSISTANCE, ASSISTANCE IN SORTING AND ORGANIZATION OF MAIL, MANAGING NEWSPAPER AND MAGAZINE SUBSCRIPTIONS, MANAGING APPOINTMENT CALENDAR,

PET CARE, AND PERSONAL CARE ASSISTANCE IN ACTIVITIES OF DAILY LIVING SUCH AS BATHING, GROOMING AND PERSONAL MOBILITY FOR ELDERLY PEOPLE, IN CLASS 45 (U.S. CLS. 100 AND 101).

FIRST USE 9-5-2008; IN COMMERCE 9-5-2008.

THE MARK CONSISTS OF STANDARD CHARACTERS WITHOUT CLAIM TO ANY PARTICULAR FONT, STYLE, SIZE, OR COLOR.

SN 77-337,611, FILED 11-27-2007.

LOURDES AYALA, EXAMINING ATTORNEY

Int. Cl.: 29

Prior U.S. Cl.: 46

United States Patent and Trademark Office

Reg. No. 3,577,554

Registered Feb. 17, 2009

**TRADEMARK
PRINCIPAL REGISTER**

FRESH TONIGHT

J&B WHOLESALE DISTRIBUTING, INC. (MINNESOTA CORPORATION)
P.O. BOX 212
13200 43RD STREET
ST. MICHAEL, MN 55376

FOR: FRESH AND FROZEN ENTREES CONSISTING OF SEASONED, MARINATED, BREADED, WRAPPED OR STUFFED MEAT, POULTRY, FISH OR SEAFOOD, IN CLASS 29 (U.S. CL. 46).

FIRST USE 12-3-2008; IN COMMERCE 12-3-2008.

THE MARK CONSISTS OF STANDARD CHARACTERS WITHOUT CLAIM TO ANY PARTICULAR FONT, STYLE, SIZE, OR COLOR.

SN 77-338,007, FILED 11-27-2007.

MARTHA SANTOMARTINO, EXAMINING ATTORNEY

Int. Cl.: 9

Prior U.S. Cls.: 21, 23, 26, 36, and 38

United States Patent and Trademark Office

Reg. No. 3,577,555

Registered Feb. 17, 2009

**TRADEMARK
PRINCIPAL REGISTER**



GYBE ENGINEERING B.V. (NETHERLANDS CORPORATION)
GROOTE KREEK 6
AMERSFOORT, NETHERLANDS 3823JB

FOR: BATTERIES, IN CLASS 9 (U.S. CLS. 21, 23, 26, 36 AND 38).

FIRST USE 11-0-2007; IN COMMERCE 11-0-2007.

THE COLOR(S) ORANGE, BLACK AND WHITE IS/ARE CLAIMED AS A FEATURE OF THE MARK.

THE MARK CONSISTS OF THE STYLIZED WORDING "SUPER" IN ORANGE LETTERS WITH BLACK OUTLINE; A WAVY LINE IN BLACK ABOVE THE WORDING "SUPER"; A SUBSTANTIALLY SEMI-CIRCULAR DESIGN IN ORANGE AND BLACK WAVY LINES TO THE RIGHT OF THE WORDING "SUPER"; A STYLIZED LETTER "B" IN WHITE IN THE FOREGROUND OF THE SEMI-CIRCULAR DESIGN.

SN 77-338,329, FILED 11-27-2007.

ROBIN CHOSID, EXAMINING ATTORNEY

Int. Cl.: 9

Prior U.S. Cls.: 21, 23, 26, 36, and 38

United States Patent and Trademark Office

Reg. No. 3,577,556

Registered Feb. 17, 2009

**TRADEMARK
PRINCIPAL REGISTER**



PRATT, DOROTHY JEAN (UNITED STATES INDIVIDUAL)
8031 E. TUCKEY LANE
SCOTTSDALE, AZ 85250

FOR: AUDIO RECORDINGS FEATURING MUSIC, IN CLASS 9 (U.S. CLS. 21, 23, 26, 36 AND 38).

FIRST USE 10-1-2008; IN COMMERCE 11-16-2008.

NO CLAIM IS MADE TO THE EXCLUSIVE RIGHT TO USE "RECORDS", APART FROM THE MARK AS SHOWN.

THE COLOR(S) TURQUOISE, DARK LAVENDER, LIGHT GRAY, WHITE, AQUA BLUE IS/ARE CLAIMED AS A FEATURE OF THE MARK.

THE MARK CONSISTS OF A DARK LAVENDER BACKGROUND IN THE SQUARE, TURQUOISE IN THE OUTER AREAS OF THE DISC ITSELF, BLUE AQUA AS THE TEXT FOR "TURQUOISE RECORDS", LIGHT GRAY FOR THE NEXT SHADE OF THE SMALLER CIRCLE OF THE DISC, AND WHITE FOR THE VERY CENTER OF THE DISC WHICH IS ALSO A CIRCLE. THE COMPLETE DISC REPRESENTS A CD.

SN 77-338,407, FILED 11-28-2007.

KARANENDRA S. CHHINA, EXAMINING ATTORNEY

Int. Cl.: 39

Prior U.S. Cls.: 100 and 105

United States Patent and Trademark Office

Reg. No. 3,577,557

Registered Feb. 17, 2009

**SERVICE MARK
PRINCIPAL REGISTER**

365 SELF STORAGE

CHAI INVESTMENT GROUP LLC (ARIZONA
LIMITED LIABILITY COMPANY)
10930 NORTH TATUM BLVD.
SUITE 101
PHOENIX, AZ 85028

FOR: RENTAL OF STORAGE SPACES, IN CLASS
39 (U.S. CLS. 100 AND 105).

FIRST USE 1-31-2008; IN COMMERCE 1-31-2008.

THE MARK CONSISTS OF STANDARD CHAR-
ACTERS WITHOUT CLAIM TO ANY PARTICULAR
FONT, STYLE, SIZE, OR COLOR.

NO CLAIM IS MADE TO THE EXCLUSIVE
RIGHT TO USE "SELF STORAGE", APART FROM
THE MARK AS SHOWN.

SN 77-339,532, FILED 11-28-2007.

MICHELE SWAIN, EXAMINING ATTORNEY

Int. Cl.: 39

Prior U.S. Cls.: 100 and 105

United States Patent and Trademark Office

Reg. No. 3,577,558

Registered Feb. 17, 2009

**SERVICE MARK
PRINCIPAL REGISTER**



CHAI INVESTMENT GROUP LLC (ARIZONA
LIMITED LIABILITY COMPANY)

10930 NORTH TATUM BLVD.

SUITE 101

PHOENIX, AZ 85028

FOR: RENTAL OF STORAGE SPACES, IN CLASS
39 (U.S. CLS. 100 AND 105).

FIRST USE 1-31-2008; IN COMMERCE 1-31-2008.

NO CLAIM IS MADE TO THE EXCLUSIVE
RIGHT TO USE "SELF STORAGE", APART FROM
THE MARK AS SHOWN.

THE MARK CONSISTS OF THE WORDS "365
SELF STORAGE" SUPERIMPOSED OVER THE STY-
LIZED REPRESENTATION OF TWO ARROWS
FORMING A CIRCLE.

SN 77-339,537, FILED 11-29-2007.

MICHELE SWAIN, EXAMINING ATTORNEY

Int. Cls.: 36, 37, and 40

Prior U.S. Cls.: 100, 101, 102, 103, and 106

United States Patent and Trademark Office

Reg. No. 3,577,559

Registered Feb. 17, 2009

**SERVICE MARK
PRINCIPAL REGISTER**

Sundurance

KURT CONTI (UNITED STATES INDIVIDUAL)
1 CRAGWOOD ROAD
C/O CONTI ENTERPRISES
PLAINFIELD, NJ 07080

FOR: CONSULTANCY CONCERNING FINANCING OF ENERGY PROJECTS, IN CLASS 36 (U.S. CLS. 100, 101 AND 102).

FIRST USE 1-15-2008; IN COMMERCE 1-15-2008.

FOR: INSTALLATION OF RENEWABLE ENERGY SYSTEMS FOR SOLAR ENERGY COLLECTION AND DISPERSON, IN CLASS 37 (U.S. CLS. 100, 103 AND 106).

FIRST USE 1-15-2008; IN COMMERCE 1-15-2008.

FOR: GENERATION OF ENERGY; PRODUCTION OF ENERGY, IN CLASS 40 (U.S. CLS. 100, 103 AND 106).

FIRST USE 1-15-2008; IN COMMERCE 1-15-2008.

THE MARK CONSISTS OF STANDARD CHARACTERS WITHOUT CLAIM TO ANY PARTICULAR FONT, STYLE, SIZE, OR COLOR.

SN 77-339,927, FILED 11-29-2007.

JEFF DEFORD, EXAMINING ATTORNEY

Int. Cl.: 25

Prior U.S. Cls.: 22 and 39

United States Patent and Trademark Office

Reg. No. 3,577,560

Registered Feb. 17, 2009

**TRADEMARK
PRINCIPAL REGISTER**

THE DARK DEFENDER

SHOWTIME NETWORKS INC. (DELAWARE
CORPORATION)
1633 BROADWAY
NEW YORK, NY 10019

THE MARK CONSISTS OF STANDARD CHAR-
ACTERS WITHOUT CLAIM TO ANY PARTICULAR
FONT, STYLE, SIZE, OR COLOR.

FOR: CLOTHING, NAMELY, HEADWEAR,
FOOTWEAR, T-SHIRTS, TANK TOPS, SWEAT-
SHIRTS, IN CLASS 25 (U.S. CLS. 22 AND 39).

SN 77-340,343, FILED 11-29-2007.

FIRST USE 10-31-2007; IN COMMERCE 10-31-2007.

TAMARA FRAZIER, EXAMINING ATTORNEY

Int. Cl.: 41

Prior U.S. Cls.: 100, 101, and 107

United States Patent and Trademark Office

Reg. No. 3,577,561

Registered Feb. 17, 2009

**SERVICE MARK
PRINCIPAL REGISTER**

**TELEVISION WITH A
CONSCIENCE**

ACADEMY OF TELEVISION ARTS & SCIENCES
(CALIFORNIA UNINCORPORATED ASSO-
CIATION)
5220 LANKERSHIM BOULEVARD
NORTH HOLLYWOOD, CA 91601

FOR: PROVIDING RECOGNITION BY THE WAY
OF A SERIES OF AWARDS TO DEMONSTRATE
EXCELLENCE IN THE FIELD OF TELEVISION, IN
CLASS 41 (U.S. CLS. 100, 101 AND 107).

FIRST USE 12-13-2007; IN COMMERCE 12-13-2007.

THE MARK CONSISTS OF STANDARD CHAR-
ACTERS WITHOUT CLAIM TO ANY PARTICULAR
FONT, STYLE, SIZE, OR COLOR.

SN 77-340,415, FILED 11-29-2007.

CIMMERIAN COLEMAN, EXAMINING ATTOR-
NEY

Int. Cl.: 16

Prior U.S. Cls.: 2, 5, 22, 23, 29, 37, 38, and 50

Reg. No. 3,577,562

United States Patent and Trademark Office

Registered Feb. 17, 2009

**TRADEMARK
PRINCIPAL REGISTER**

NO MORE FLIPPIN' PAGES

INKTREE, INC. (VIRGINIA CORPORATION)
204 RIDGE STREET, SUITE 100
CHARLOTTESVILLE, VA 22903

FOR: PRESENTATION BOARDS; PRESENTATION FOLDERS; DRY ERASE WRITING BOARDS AND WRITING SURFACES; FOLDERS; FOLDABLE POSTER BOARDS FOR DISPLAY OF PRINTED INSTRUCTIONAL, EDUCATIONAL, AND TEACHING MATERIALS; PRINTED PRODUCTS, NAMELY, INSTRUCTIONAL, EDUCATIONAL, AND TEACHING MATERIALS IN THE FIELDS OF MUSIC, COOKING, EXERCISE, AUTO-MECHANIC, HOME-REPAIR, HOME IMPROVEMENT, SMALL CRAFT PROJECTS, SMALL HOME AND OFFICE PROJECTS, CONSUMER ELECTRONICS ASSEMBLY AND INSTALLATION, FURNITURE ASSEMBLY, CORPORATE AND EMPLOYEE TRAINING MATERIAL, MARKETING COLLATERAL SUCH AS TRADE SHOW DISPLAY OR GENERAL COLLATERAL, QUICK REFERENCE GUIDE, COMPUTER SOFTWARE QUICK REFERENCE GUIDE, VIDEO GAME QUICK REFERENCE GUIDE, CALL CENTER EMPLOYEE QUICK REFERENCE GUIDE, TEACHING MATERIALS IN THE FIELDS OF TEXTBOOK SUPPLEMENT ON THE SUBJECTS OF MATH, SCIENCE, LITERACY, SOCIAL STUDIES, LAW, MEDICINE, ECONOMICS, HOME ECONOMICS, HISTORY, RELIGION, ENGINEERING, ART, MUSIC, COMPUTERS AND COMPUTER SCIENCE,

ARCHITECTURE, CULTURE, FINANCE, ACCOUNTING, POLITICS, BUSINESS, MARKETING, ADVERTISING, AND ELECTRONICS, MAPS, GEOGRAPHICAL MAPS, TOPOGRAPHICAL MAPS, KEY CONCEPTS IN TEACHING CURRICULUMS, HOBBY MODELING, COURTROOM EVIDENCE AND VISUAL AID PRESENTATION, COACHING AID, ANY HOBBY GAME AND ACTIVITY, PRESENTED ON FOLDABLE DISPLAY BOARDS; PRINTED PRODUCTS, NAMELY, INSTRUCTIONAL, EDUCATIONAL, AND TEACHING MATERIALS IN THE FIELDS OF PRE-KINDERGARTEN, PRIMARY, SECONDARY, COLLEGE, GRADUATE, PROFESSIONAL AND TRADE SCHOOL TEXTBOOK SUPPLEMENTS, PRESENTED ON FOLDABLE DISPLAY BOARDS; PRINTED PRODUCTS, NAMELY, INSTRUCTION SHEETS, PRINTED CHARTS, AND STUDY GUIDES PRESENTED ON FOLDABLE DISPLAY BOARDS, IN CLASS 16 (U.S. CLS. 2, 5, 22, 23, 29, 37, 38 AND 50).

FIRST USE 9-15-2008; IN COMMERCE 9-15-2008.

THE MARK CONSISTS OF STANDARD CHARACTERS WITHOUT CLAIM TO ANY PARTICULAR FONT, STYLE, SIZE, OR COLOR.

SN 77-341,031, FILED 11-30-2007.

RAMONA ORTIGA, EXAMINING ATTORNEY

Int. Cl.: 45

Prior U.S. Cls.: 100 and 101

United States Patent and Trademark Office

Reg. No. 3,577,563

Registered Feb. 17, 2009

**SERVICE MARK
PRINCIPAL REGISTER**

THE BEST OR IT'S FREE

OUTLOOK AMUSEMENTS, INC. (CALIFORNIA
CORPORATION)
SUITE 500
6725 SUNSET BOULEVARD
LOS ANGELES, CA 90028

THE MARK CONSISTS OF STANDARD CHAR-
ACTERS WITHOUT CLAIM TO ANY PARTICULAR
FONT, STYLE, SIZE, OR COLOR.

FOR: PSYCHIC AND ASTROLOGICAL READING
SERVICES, IN CLASS 45 (U.S. CLS. 100 AND 101).

SN 77-341,045, FILED 11-30-2007.

FIRST USE 7-12-2007; IN COMMERCE 7-12-2007.

RICHARD A. STRASER, EXAMINING ATTORNEY

Int. Cl.: 9

Prior U.S. Cls.: 21, 23, 26, 36, and 38

United States Patent and Trademark Office

Reg. No. 3,577,564

Registered Feb. 17, 2009

**TRADEMARK
PRINCIPAL REGISTER**

Q RATE

SAMTEC, INC. (INDIANA CORPORATION)
P.O. BOX 1147
520 PARK EAST BLVD.
NEW ALBANY, IN 47150

FOR: HIGH SPEED ELECTRICAL CONNECTORS
AND HIGH SPEED INTERFACES FOR COMPUTERS
AND PERIPHERALS, TELECOMMUNICATIONS,
DATACOM, INDUSTRIAL, AND TEST AND
DIAGNOSTIC APPLICATIONS, IN CLASS 9
(U.S. CLS. 21, 23, 26, 36 AND 38).

FIRST USE 3-0-2008; IN COMMERCE 3-0-2008.

THE MARK CONSISTS OF STANDARD CHARACTERS
WITHOUT CLAIM TO ANY PARTICULAR FONT,
STYLE, SIZE, OR COLOR.

SN 77-341,382, FILED 11-30-2007.

SOPHIA S. KIM, EXAMINING ATTORNEY

Int. Cls.: 35 and 37

Prior U.S. Cls.: 100, 101, 102, 103, and 106

United States Patent and Trademark Office

Reg. No. 3,577,565

Registered Feb. 17, 2009

**SERVICE MARK
PRINCIPAL REGISTER**

AVCOM TECHNIK

AVCOM AVIONICS & INSTRUMENTS INC.
(FLORIDA CORPORATION)
3008 N.W. 82 AVENUE
MIAMI, FL 33122

FOR: RETAIL STORE SERVICES FEATURING
AIRPLANE PARTS, IN CLASS 35 (U.S. CLS. 100, 101
AND 102).

FIRST USE 6-27-2008; IN COMMERCE 6-27-2008.

FOR: AIRCRAFT REPAIR AND MAINTENANCE
AND REPAIR OF AERIAL NAVIGATION EQUIP-
MENT, IN CLASS 37 (U.S. CLS. 100, 103 AND 106).

FIRST USE 6-27-2008; IN COMMERCE 6-27-2008.

THE MARK CONSISTS OF STANDARD CHAR-
ACTERS WITHOUT CLAIM TO ANY PARTICULAR
FONT, STYLE, SIZE, OR COLOR.

OWNER OF U.S. REG. NO. 2,278,966.

NO CLAIM IS MADE TO THE EXCLUSIVE
RIGHT TO USE "TECHNIK", APART FROM THE
MARK AS SHOWN.

THE FOREIGN WORDING IN THE MARK
TRANSLATES INTO ENGLISH AS TECHNOLOGY.

SN 77-341,391, FILED 11-30-2007.

SOPHIA S. KIM, EXAMINING ATTORNEY

Int. Cl.: 36

Prior U.S. Cls.: 100, 101, and 102

United States Patent and Trademark Office

Reg. No. 3,577,566

Registered Feb. 17, 2009

**SERVICE MARK
PRINCIPAL REGISTER**

**INVEST SMART. LIVE
HAPPILY EVER AFTER.**

CLAREMONT INVESTMENT PARTNERS LLC
(DELAWARE LIMITED LIABILITY COMPAN-
NY)
104 SUMMIT AVENUE
SUMMIT, NJ 07902

FOR: FINANCIAL SERVICES, NAMELY, INVEST-
MENT ADVICE, FINANCIAL CONSULTATION
AND FINANCIAL INVESTMENT IN THE FIELD
OF MUTUAL FUNDS , IN CLASS 36 (U.S. CLS. 100,
101 AND 102).

FIRST USE 11-8-2008; IN COMMERCE 11-8-2008.

THE MARK CONSISTS OF STANDARD CHAR-
ACTERS WITHOUT CLAIM TO ANY PARTICULAR
FONT, STYLE, SIZE, OR COLOR.

SN 77-341,445, FILED 11-30-2007.

ERIN FALK, EXAMINING ATTORNEY

Int. Cl.: 36

Prior U.S. Cls.: 100, 101, and 102

United States Patent and Trademark Office

Reg. No. 3,577,567

Registered Feb. 17, 2009

**SERVICE MARK
PRINCIPAL REGISTER**

MORGANDIRECT

JPMORGAN CHASE & CO. (DELAWARE CORPORATION)
270 PARK AVENUE
NEW YORK, NY 10017

FOR: FINANCIAL SERVICES, NAMELY, ONLINE PRE-TRADE AND EXECUTION SERVICES, IN CLASS 36 (U.S. CLS. 100, 101 AND 102).

FIRST USE 9-25-2008; IN COMMERCE 9-25-2008.

THE MARK CONSISTS OF STANDARD CHARACTERS WITHOUT CLAIM TO ANY PARTICULAR FONT, STYLE, SIZE, OR COLOR.

OWNER OF U.S. REG. NOS. 2,648,769, 3,335,070, AND OTHERS.

SN 77-341,517, FILED 11-30-2007.

SHANNON TWOHIG, EXAMINING ATTORNEY

Int. Cl.: 43

Prior U.S. Cls.: 100 and 101

United States Patent and Trademark Office

Reg. No. 3,577,568

Registered Feb. 17, 2009

**SERVICE MARK
PRINCIPAL REGISTER**

GET YOUR GAME ON

STATION CASINOS, INC. (NEVADA CORPORATION)
1505 S. PAVILION CENTER DRIVE
LAS VEGAS, NV 89135

FOR: RESORT HOTELS; HOTEL, RESTAURANT AND BAR SERVICES; COCKTAIL LOUNGES; PROVIDING CONVENTION FACILITIES; PROVIDING FACILITIES FOR EXHIBITIONS; ARENA SERVICES, NAMELY, PROVIDING FACILITIES FOR SPORTS, CONCERTS, CONVENTIONS AND EXHIBITIONS; CAFETERIAS; SNACK BARS; CATERING; PROVIDING BANQUET AND SOCIAL FUNCTION

FACILITIES FOR SPECIAL OCCASIONS, IN CLASS 43 (U.S. CLS. 100 AND 101).

FIRST USE 2-1-2008; IN COMMERCE 2-1-2008.

THE MARK CONSISTS OF STANDARD CHARACTERS WITHOUT CLAIM TO ANY PARTICULAR FONT, STYLE, SIZE, OR COLOR.

SN 77-341,795, FILED 12-1-2007.

MICHAEL SOUDERS, EXAMINING ATTORNEY

Int. Cl.: 35

Prior U.S. Cls.: 100, 101, and 102

United States Patent and Trademark Office

Reg. No. 3,577,569

Registered Feb. 17, 2009

**SERVICE MARK
PRINCIPAL REGISTER**

TIN CAN COMMUNICATIONS

PARANDIAN, CHRISTOPHER R. (UNITED STATES INDIVIDUAL)
1934 CALVERT STREET, NW #4
WASHINGTON, DC 20009

FOR: PUBLIC RELATIONS; PUBLIC RELATIONS CONSULTATION IN THE FIELD OF PUBLIC AFFAIRS; ADVERTISING AND MARKETING CONSULTATION CONCERNING THE USE OF NEW MEDIA TO ASSIST BUSINESSES AND OTHER ENTITIES; ADVERTISING AND MARKETING CONSULTATION IN THE FIELDS OF PARTICIPATION MARKETING AND INTERACTIVE MEDIA, IN CLASS 35 (U.S. CLS. 100, 101 AND 102).

FIRST USE 1-0-2008; IN COMMERCE 1-0-2008.

THE MARK CONSISTS OF STANDARD CHARACTERS WITHOUT CLAIM TO ANY PARTICULAR FONT, STYLE, SIZE, OR COLOR.

NO CLAIM IS MADE TO THE EXCLUSIVE RIGHT TO USE "COMMUNICATIONS", APART FROM THE MARK AS SHOWN.

SN 77-342,071, FILED 12-2-2007.

ROBERT LAVACHE, EXAMINING ATTORNEY

Int. Cl.: 35

Prior U.S. Cls.: 100, 101, and 102

United States Patent and Trademark Office

Reg. No. 3,577,570

Registered Feb. 17, 2009

**SERVICE MARK
PRINCIPAL REGISTER**



MIEDEMA AUCTIONEERING AND APPRAISALS, INC. (MICHIGAN CORPORATION)
601 GORDON INDUSTRIAL COURT
BYRON CENTER, MI 49315

THE MARK CONSISTS OF THE WORD "ORBIT-BID.COM".

FOR: ONLINE AUCTION SERVICES, IN CLASS 35
(U.S. CLS. 100, 101 AND 102).

SN 77-342,138, FILED 12-3-2007.

FIRST USE 12-1-2008; IN COMMERCE 12-1-2008.

HEATHER THOMPSON, EXAMINING ATTORNEY

Int. Cl.: 41

Prior U.S. Cls.: 100, 101, and 107

United States Patent and Trademark Office

Reg. No. 3,577,571

Registered Feb. 17, 2009

**SERVICE MARK
PRINCIPAL REGISTER**

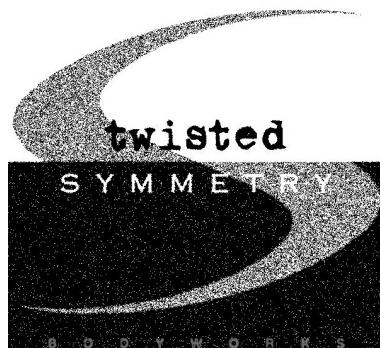

MILLER, K.W. (UNITED STATES INDIVIDUAL)
13638 BASSETT STREET
VALLEY GLEN, CA 91405

FOR: PROVIDING ASSISTANCE, PERSONAL TRAINING AND PHYSICAL FITNESS CONSULTATION TO INDIVIDUALS TO HELP THEM MAKE PHYSICAL FITNESS, STRENGTH, CONDITIONING, AND EXERCISE IMPROVEMENT IN THEIR DAILY LIVING, IN CLASS 41 (U.S. CLS. 100, 101 AND 107).

FIRST USE 12-28-2007; IN COMMERCE 12-28-2007.

NO CLAIM IS MADE TO THE EXCLUSIVE RIGHT TO USE "BODYWORKS", APART FROM THE MARK AS SHOWN.

THE STIPPLING IS FOR SHADING PURPOSES ONLY.

THE MARK CONSISTS OF AN S-LIKE MARK THAT IS CUT IN TWO WITH EACH HALF SLIGHTLY MOVED HORIZONTALLY AWAY FROM EACH OTHER AND IT OVERLAYS A TWO-TONE BOX. THE STYLIZED WORD "TWISTED" IS OVERLAID THE TOP PART OF THE BOX. THE STYLIZED WORD "SYMMETRY" IS OVERLAID THE BOTTOM HALF OF THE BOX. THE STYLIZED WORD "BODYWORKS" IS STRETCHING ACROSS THE BOTTOM OF THE LOWER HALF OF THE BOX.

SN 77-342,405, FILED 12-3-2007.

RONALD AIKENS, EXAMINING ATTORNEY

Int. Cl.: 32

Prior U.S. Cls.: 45, 46, and 48

Reg. No. 3,577,572

United States Patent and Trademark Office

Registered Feb. 17, 2009

**TRADEMARK
PRINCIPAL REGISTER**

LIPS OF FAITH

NEW BELGIUM BREWING COMPANY, INC.
(COLORADO CORPORATION)
500 LINDEN STREET
FORT COLLINS, CO 80524

THE MARK CONSISTS OF STANDARD CHARACTERS WITHOUT CLAIM TO ANY PARTICULAR FONT, STYLE, SIZE, OR COLOR.

FOR: BEER AND ALE, IN CLASS 32 (U.S. CLS. 45, 46 AND 48).

SN 77-342,464, FILED 12-3-2007.

FIRST USE 12-0-2005; IN COMMERCE 4-0-2008.

AMOS T. MATTHEWS, JR., EXAMINING ATTORNEY

Int. Cl.: 19

Prior U.S. Cls.: 1, 12, 33, and 50

United States Patent and Trademark Office

Reg. No. 3,577,573

Registered Feb. 17, 2009

**TRADEMARK
PRINCIPAL REGISTER**

COVENTRY BY ALSIDE

ASSOCIATED MATERIALS, LLC (DELAWARE
LIMITED LIABILITY COMPANY), DBA AL-
SIDE,
3773 STATE RD
CUYAHOGA FALLS, OH 44223

FOR: VINYL SIDING, IN CLASS 19 (U.S. CLS. 1, 12,
33 AND 50).

FIRST USE 12-0-2007; IN COMMERCE 12-0-2007.

THE MARK CONSISTS OF STANDARD CHAR-
ACTERS WITHOUT CLAIM TO ANY PARTICULAR
FONT, STYLE, SIZE, OR COLOR.

OWNER OF U.S. REG. NOS. 507,692, 889,603, AND
1,326,987.

SN 77-342,506, FILED 12-3-2007.

RAUL CORDOVA, EXAMINING ATTORNEY

Int. Cls.: 1 and 5

Prior U.S. Cls.: 1, 5, 6, 10, 18, 26, 44, 46, 51, and 52

United States Patent and Trademark Office

Reg. No. 3,577,574

Registered Feb. 17, 2009

**TRADEMARK
PRINCIPAL REGISTER**

CELASE

CYTHORI THERAPEUTICS, INC. (DELAWARE
CORPORATION)
3020 CALLAN ROAD
SAN DIEGO, CA 92121

FOR: REAGENTS FOR SCIENTIFIC, LABORATORY,
CLINICAL AND MEDICAL RESEARCH
USE, IN CLASS 1 (U.S. CLS. 1, 5, 6, 10, 26 AND 46).

FIRST USE 11-17-2006; IN COMMERCE 11-17-2006.

FOR: REAGENTS FOR MEDICAL USE, IN CLASS
5 (U.S. CLS. 6, 18, 44, 46, 51 AND 52).

FIRST USE 11-17-2006; IN COMMERCE 11-17-2006.

THE MARK CONSISTS OF STANDARD CHARACTERS
WITHOUT CLAIM TO ANY PARTICULAR
FONT, STYLE, SIZE, OR COLOR.

SN 77-343,271, FILED 12-4-2007.

SARA THOMAS, EXAMINING ATTORNEY

Int. Cl.: 41

Prior U.S. Cls.: 100, 101, and 107

United States Patent and Trademark Office

Reg. No. 3,577,575

Registered Feb. 17, 2009

**SERVICE MARK
PRINCIPAL REGISTER**

CASE FILE FRIDAYS

COURTROOM TELEVISION NETWORK LLC
(NEW YORK LIMITED LIABILITY COMPA-
NY)
600 THIRD AVENUE
NEW YORK, NY 10016

FOR: ENTERTAINMENT IN THE NATURE OF
ON-GOING TELEVISION PROGRAMS, ON-GOING
TELEVISION SERIES AND ON-GOING INTERSTI-
TIAL TELEVISION PROGRAM SEGMENTS FEAT-
URING TELEVISION PROGRAMMING IN THE
FIELD OF COMEDY, DRAMA, ACTION, OR AD-
VENTURE PROVIDED THROUGH CABLE TELEVI-
SION, BROADCAST TELEVISION, VIDEO ON

DEMAND AND VIA GLOBAL COMPUTER NET-
WORKS, IN CLASS 41 (U.S. CLS. 100, 101 AND 107).

FIRST USE 1-14-2008; IN COMMERCE 1-14-2008.

THE MARK CONSISTS OF STANDARD CHAR-
ACTERS WITHOUT CLAIM TO ANY PARTICULAR
FONT, STYLE, SIZE, OR COLOR.

SN 77-343,298, FILED 12-4-2007.

TRICIA SONNEBORN, EXAMINING ATTORNEY

Int. Cls.: 11 and 35

Prior U.S. Cls.: 13, 21, 23, 31, 34, 100, 101, and 102

United States Patent and Trademark Office

Reg. No. 3,577,576

Registered Feb. 17, 2009

**TRADEMARK
SERVICE MARK
PRINCIPAL REGISTER**

SOLAR SANTA

MR. LIGHT, INC. (PENNSYLVANIA CORPORATION)
1843 FAIRVIEW AVENUE
WILLOW GROVE, PA 19090

FOR: SOLAR LIGHT FIXTURES, NAMELY, INDOOR AND OUTDOOR SOLAR POWERED LIGHTING UNITS AND FIXTURES, IN CLASS 11 (U.S. CLS. 13, 21, 23, 31 AND 34).

FIRST USE 8-4-2008; IN COMMERCE 8-4-2008.

FOR: ON-LINE ORDERING SERVICES FEATURING SOLAR LIGHTING PRODUCTS, IN CLASS 35 (U.S. CLS. 100, 101 AND 102).

FIRST USE 4-0-2006; IN COMMERCE 4-0-2006.

THE MARK CONSISTS OF STANDARD CHARACTERS WITHOUT CLAIM TO ANY PARTICULAR FONT, STYLE, SIZE, OR COLOR.

NO CLAIM IS MADE TO THE EXCLUSIVE RIGHT TO USE "SOLAR", APART FROM THE MARK AS SHOWN.

SN 77-344,452, FILED 12-5-2007.

HOWARD SMIGA, EXAMINING ATTORNEY

Int. Cl.: 9

Prior U.S. Cls.: 21, 23, 26, 36, and 38

United States Patent and Trademark Office

Reg. No. 3,577,577

Registered Feb. 17, 2009

**TRADEMARK
PRINCIPAL REGISTER**

CLAIMBOT

LUCID PATENT, LLC (MINNESOTA LIMITED
LIABILITY COMPANY)
1600 TCF TOWER, 121 S. EIGHTH STREET
MINNEAPOLIS, MN 55402

FOR: COMPUTER SOFTWARE AND INSTRU-
TION MANUALS SOLD AS A UNIT FOR USE IN
PERFORMING LEGAL AND BUSINESS RE-
SEARCH, IN CLASS 9 (U.S. CLS. 21, 23, 26, 36 AND
38).

FIRST USE 8-9-2007; IN COMMERCE 3-21-2008.

THE MARK CONSISTS OF STANDARD CHAR-
ACTERS WITHOUT CLAIM TO ANY PARTICULAR
FONT, STYLE, SIZE, OR COLOR.

SN 77-344,712, FILED 12-5-2007.

SARA THOMAS, EXAMINING ATTORNEY

Int. Cl.: 11

Prior U.S. Cls.: 13, 21, 23, 31, and 34

United States Patent and Trademark Office

Reg. No. 3,577,578

Registered Feb. 17, 2009

**TRADEMARK
PRINCIPAL REGISTER**

R-SERIES

ACCOR TECHNOLOGY, INC. (WASHINGTON
CORPORATION)
SUITE 100
1400 112TH AVENUE SE
BELLEVUE, WA 98004

FOR: PLUMBING FITTINGS AND PARTS,
NAMELY, VALVES, COUPLERS AND FLEXIBLE
COUPLERS, IN CLASS 11 (U.S. CLS. 13, 21, 23, 31
AND 34).

FIRST USE 10-1-2007; IN COMMERCE 10-1-2007.

THE MARK CONSISTS OF STANDARD CHAR-
ACTERS WITHOUT CLAIM TO ANY PARTICULAR
FONT, STYLE, SIZE, OR COLOR.

SN 77-345,087, FILED 12-5-2007.

BERNICE MIDDLETON, EXAMINING ATTORNEY

Int. Cls.: 7, 16, and 20

**Prior U.S. Cls.: 2, 5, 13, 19, 21, 22, 23, 25, 29, 31, 32,
34, 35, 37, 38, and 50**

Reg. No. 3,577,579

United States Patent and Trademark Office

Registered Feb. 17, 2009

**TRADEMARK
PRINCIPAL REGISTER**

HURST INTERNATIONAL

HURST INTERNATIONAL, LLC (CALIFORNIA
LIMITED LIABILITY COMPANY)
20747 DEARBORN STREET
CHATSWORTH, CA 91311

FOR: AUTOMATIC INDUSTRIAL LABELING
MACHINES FOR APPLYING LABELS, SEMI-AUTO-
MATIC INDUSTRIAL LABELING MACHINES FOR
APPLYING LABELS, IN CLASS 7 (U.S. CLS. 13, 19, 21,
23, 31, 34 AND 35).

FIRST USE 10-31-2008; IN COMMERCE 10-31-2008.

FOR: ADHESIVE LABELS; AND PAPER LABELS,
IN CLASS 16 (U.S. CLS. 2, 5, 22, 23, 29, 37, 38 AND 50).

FIRST USE 11-17-2008; IN COMMERCE 11-17-2008.

FOR: PLASTIC LABELS, IN CLASS 20 (U.S. CLS. 2,
13, 22, 25, 32 AND 50).

FIRST USE 11-17-2008; IN COMMERCE 11-17-2008.

THE MARK CONSISTS OF STANDARD CHAR-
ACTERS WITHOUT CLAIM TO ANY PARTICULAR
FONT, STYLE, SIZE, OR COLOR.

NO CLAIM IS MADE TO THE EXCLUSIVE
RIGHT TO USE "INTERNATIONAL", APART
FROM THE MARK AS SHOWN.

SN 77-345,206, FILED 12-5-2007.

CARRIE GENOVESE, EXAMINING ATTORNEY

Int. Cl.: 20

Prior U.S. Cls.: 2, 13, 22, 25, 32, and 50

Reg. No. 3,577,580

United States Patent and Trademark Office

Registered Feb. 17, 2009

**TRADEMARK
PRINCIPAL REGISTER**

ASCENTIA

MASCO RETAIL CABINET GROUP, LLC (OHIO
LIMITED LIABILITY COMPANY)
15535 SOUTH STATE AVENUE
MIDDLEFIELD, OH 44062

THE MARK CONSISTS OF STANDARD CHAR-
ACTERS WITHOUT CLAIM TO ANY PARTICULAR
FONT, STYLE, SIZE, OR COLOR.

FOR: CABINetry, IN CLASS 20 (U.S. CLS. 2, 13,
22, 25, 32 AND 50).

SN 77-345,312, FILED 12-6-2007.

FIRST USE 10-0-2007; IN COMMERCE 10-0-2007.

JORDAN BAKER, EXAMINING ATTORNEY

Int. Cl.: 3

Prior U.S. Cls.: 1, 4, 6, 50, 51, and 52

United States Patent and Trademark Office

Reg. No. 3,577,581

Registered Feb. 17, 2009

**TRADEMARK
PRINCIPAL REGISTER**

MICHAEL KORS VERY PRETTY

MICHAEL KORS, LLC (DELAWARE LIMITED
LIABILITY COMPANY)
11 WEST 42ND STREET
NEW YORK, NY 10036

OWNER OF U.S. REG. NOS. 2,476,689, 2,810,931,
AND OTHERS.

FOR: FRAGRANCES FOR PERSONAL USE, IN
CLASS 3 (U.S. CLS. 1, 4, 6, 50, 51 AND 52).

THE NAME "MICHAEL KORS" IDENTIFIES A
LIVING INDIVIDUAL WHOSE CONSENT IS OF
RECORD.

FIRST USE 9-1-2008; IN COMMERCE 9-1-2008.

SN 77-345,394, FILED 12-6-2007.

THE MARK CONSISTS OF STANDARD CHAR-
ACTERS WITHOUT CLAIM TO ANY PARTICULAR
FONT, STYLE, SIZE, OR COLOR.

LINDA LAVACHE, EXAMINING ATTORNEY

Int. Cl.: 37

Prior U.S. Cls.: 100, 103, and 106

United States Patent and Trademark Office

Reg. No. 3,577,582

Registered Feb. 17, 2009

**SERVICE MARK
PRINCIPAL REGISTER**

SERVICE IQ

SMITH & NEPHEW, INC. (DELAWARE CORPORATION)

1450 BROOKS ROAD

MEMPHIS, TN 38116

FOR: MAINTENANCE AND REPAIR OF MEDICAL INSTRUMENTS AND APPARATUS, IN CLASS 37 (U.S. CLS. 100, 103 AND 106).

FIRST USE 1-24-2008; IN COMMERCE 1-24-2008.

THE MARK CONSISTS OF STANDARD CHARACTERS WITHOUT CLAIM TO ANY PARTICULAR FONT, STYLE, SIZE, OR COLOR.

NO CLAIM IS MADE TO THE EXCLUSIVE RIGHT TO USE "SERVICE", APART FROM THE MARK AS SHOWN.

SN 77-345,505, FILED 12-6-2007.

JANICE L. MCMORROW, EXAMINING ATTORNEY

Int. Cl.: 25

Prior U.S. Cls.: 22 and 39

United States Patent and Trademark Office

Reg. No. 3,577,583

Registered Feb. 17, 2009

**TRADEMARK
PRINCIPAL REGISTER**



JONES INVESTMENT CO. INC. (DELAWARE
CORPORATION)
SUITE 225
1007 ORANGE STREET
WILMINGTON, DE 19801

THE MARK CONSISTS OF THE LETTERS "A"
FORMED TO RESEMBLE A CELTIC DESIGN.

FOR: BOTTOMS; TOPS, IN CLASS 25 (U.S. CLS. 22
AND 39).

SN 77-345,700, FILED 12-6-2007.

FIRST USE 7-31-2008; IN COMMERCE 7-31-2008.

LANA PHAM, EXAMINING ATTORNEY

Int. Cl.: 18

Prior U.S. Cls.: 1, 2, 3, 22, and 41

United States Patent and Trademark Office

Reg. No. 3,577,584

Registered Feb. 17, 2009

**TRADEMARK
PRINCIPAL REGISTER**

THE DARK DEFENDER

SHOWTIME NETWORKS INC. (DELAWARE
CORPORATION)
1633 BROADWAY
NEW YORK, NY 10019

THE MARK CONSISTS OF STANDARD CHAR-
ACTERS WITHOUT CLAIM TO ANY PARTICULAR
FONT, STYLE, SIZE, OR COLOR.

FOR: UMBRELLAS, LUGGAGE, LUGGAGE
TAGS, TOTE BAG AND BACKPACKS, IN CLASS 18
(U.S. CLS. 1, 2, 3, 22 AND 41).

SN 77-347,066, FILED 12-7-2007.

FIRST USE 10-31-2007; IN COMMERCE 10-31-2007.

TAMARA FRAZIER, EXAMINING ATTORNEY

Int. Cl.: 3

Prior U.S. Cls.: 1, 4, 6, 50, 51, and 52

Reg. No. 3,577,585

United States Patent and Trademark Office

Registered Feb. 17, 2009

**TRADEMARK
PRINCIPAL REGISTER**

ADOVIA

KEYAN, ALEXANDER O. (UNITED STATES INDIVIDUAL)
9831 INDEPENDENCE AVENUE
CHATSWORTH, CA 91311

FOR: BODY AND BEAUTY CARE COSMETICS; BEAUTY CARE PREPARATIONS; BODY CREAM SOAP; BODY CREAMS; BODY EMULSIONS; BODY LOTIONS; BODY MILKS; BODY OILS; BODY POWDER; BODY SPRAYS; COSMETIC CREAMS FOR SKIN CARE; COSMETIC PREPARATIONS FOR BODY CARE; COSMETIC PREPARATIONS FOR SKIN RENEWAL; COSMETICS; FACE AND BODY BEAUTY CREAMS; FACE AND BODY CREAMS; FACE AND BODY LOTIONS; FACE AND BODY MILK; LOTIONS FOR BODY, FACE, AND SKIN; MAKE-UP PRODUCTS FOR THE FACE AND BODY; NON-MEDICATED SKIN CARE PREPARATIONS; NON-MEDICATED SKIN CREAMS; NON-MEDICATED STIMULATING LOTIONS FOR THE SKIN; SKIN CARE PRODUCTS, NAMELY, NON-MEDICATED SKIN SERUM; SKIN CLARIFIERS; SKIN CLEANSERS; SKIN CLEANSING CREAM; SKIN CLEANSING LOTION; SKIN CONDITIONERS;

SKIN CREAMS; SKIN CREAMS IN LIQUID AND IN SOLID FORM; SKIN EMOLLIENTS; SKIN GELS FOR ACCELERATING, ENHANCING OR EXTENDING TANS; SKIN LIGHTENERS; SKIN LIGHTENING CREAMS; SKIN LOTIONS; SKIN MASKS; SKIN MOISTURIZER; SKIN MOISTURIZER MASKS; ARAI-NUKA, NAMELY, SKIN POLISHING RICE BRAN; SKIN SOAP; SKIN TEXTURIZERS; SKIN TONERS; SKIN WHITENING CREAMS; SOAPS FOR BODY CARE; WRINKLE REMOVING SKIN CARE PREPARATIONS, IN CLASS 3 (U.S. CLS. 1, 4, 6, 50, 51 AND 52).

FIRST USE 9-1-2008; IN COMMERCE 11-14-2008.

THE MARK CONSISTS OF STANDARD CHARACTERS WITHOUT CLAIM TO ANY PARTICULAR FONT, STYLE, SIZE, OR COLOR.

SN 77-347,215, FILED 12-7-2007.

WILLIAM VERHOSEK, EXAMINING ATTORNEY

Int. Cl.: 28

Prior U.S. Cls.: 22, 23, 38, and 50

United States Patent and Trademark Office

Reg. No. 3,577,586

Registered Feb. 17, 2009

**TRADEMARK
PRINCIPAL REGISTER**



CA SPORTS (PAKISTAN PARTNERSHIP)
DASKA ROAD
BOGRA SIALKOT, PAKISTAN 51310

FOR: SPORTING ARTICLES, NAMELY, CRICKET BATS, CRICKET BALLS, CRICKET PADS FOR PROTECTING THE LEGS, CRICKET GLOVES, AND BAGS SPECIFICALLY ADAPTED FOR CRICKET

EQUIPMENT , IN CLASS 28 (U.S. CLS. 22, 23, 38 AND 50).

FIRST USE 0-0-1998; IN COMMERCE 0-0-1998.

SN 77-347,786, FILED 12-10-2007.

H. M. FISHER, EXAMINING ATTORNEY

Int. Cl.: 38

Prior U.S. Cls.: 100, 101, and 104

United States Patent and Trademark Office

Reg. No. 3,577,587

Registered Feb. 17, 2009

**SERVICE MARK
PRINCIPAL REGISTER**

PALLADIA

VIACOM INTERNATIONAL INC. (DELAWARE
CORPORATION)
1515 BROADWAY
NEW YORK, NY 10036

FOR: HIGH DEFINITION TELEVISION BROADCASTING SERVICES VIA CABLE, SATELLITE AND OTHER MEANS; CABLE RADIO BROADCASTING AND TRANSMISSION; MOBILE RADIO COMMUNICATION; RADIO BROADCASTING; RADIO COMMUNICATION, IN CLASS 38 (U.S. CLS. 100, 101 AND 104).

FIRST USE 9-1-2008; IN COMMERCE 9-1-2008.

THE MARK CONSISTS OF STANDARD CHARACTERS WITHOUT CLAIM TO ANY PARTICULAR FONT, STYLE, SIZE, OR COLOR.

SN 77-348,219, FILED 12-10-2007.

KATINA MISTER, EXAMINING ATTORNEY

Int. Cl.: 41

Prior U.S. Cls.: 100, 101, and 107

United States Patent and Trademark Office

Reg. No. 3,577,588

Registered Feb. 17, 2009

**SERVICE MARK
PRINCIPAL REGISTER**

PALLADIA

VIACOM INTERNATIONAL INC. (DELAWARE
CORPORATION)
1515 BROADWAY
NEW YORK, NY 10036

FOR: ENTERTAINMENT SERVICES, NAMELY,
HIGH DEFINITION TELEVISION PROGRAMS FEATURING
MUSIC, LIVE ACTION, DRAMA, COMEDY,
ANIMATION, NEWS, AND GENERAL ENTERTAINMENT,
IN CLASS 41 (U.S. CLS. 100, 101 AND 107).

FIRST USE 9-1-2008; IN COMMERCE 9-1-2008.

THE MARK CONSISTS OF STANDARD CHARACTERS
WITHOUT CLAIM TO ANY PARTICULAR FONT,
STYLE, SIZE, OR COLOR.

SN 77-348,221, FILED 12-10-2007.

KATINA MISTER, EXAMINING ATTORNEY

Int. Cl.: 3

Prior U.S. Cls.: 1, 4, 6, 50, 51, and 52

United States Patent and Trademark Office

Reg. No. 3,577,589

Registered Feb. 17, 2009

**TRADEMARK
PRINCIPAL REGISTER**

NATURAL FIX

NATURAL FIX (CONNECTICUT LIMITED LIABILITY COMPANY)
847 FARMINGTON AVENUE
WEST HARTFORD, CT 06119

FOR: COSMETICS, IN CLASS 3 (U.S. CLS. 1, 4, 6, 50, 51 AND 52).

FIRST USE 12-1-2008; IN COMMERCE 12-2-2008.

THE MARK CONSISTS OF STANDARD CHARACTERS WITHOUT CLAIM TO ANY PARTICULAR FONT, STYLE, SIZE, OR COLOR.

NO CLAIM IS MADE TO THE EXCLUSIVE RIGHT TO USE "NATURAL", APART FROM THE MARK AS SHOWN.

SN 77-349,911, FILED 12-12-2007.

AMOS T. MATTHEWS, JR., EXAMINING ATTORNEY

Int. Cl.: 29

Prior U.S. Cl.: 46

United States Patent and Trademark Office

Reg. No. 3,577,590

Registered Feb. 17, 2009

**TRADEMARK
PRINCIPAL REGISTER**

MONTEVECCHIO

INVERSIONES MONTE LOS OLIVOS S.A (CHILE
CORPORATION)
APOQUINDO 4499, PISO 19, LAS CONDES
SANTIAGO, CHILE

THE FOREIGN WORDING IN THE MARK
TRANSLATES INTO ENGLISH AS "OLD MOUN-
TAIN".

FOR: OLIVE OIL AND EDIBLE OILS, IN CLASS 29
(U.S. CL. 46).

SN 77-350,044, FILED 12-12-2007.

FIRST USE 7-25-2008; IN COMMERCE 7-25-2008.

THE MARK CONSISTS OF STANDARD CHAR-
ACTERS WITHOUT CLAIM TO ANY PARTICULAR
FONT, STYLE, SIZE, OR COLOR.

KATHERINE CONNOLLY, EXAMINING ATTOR-
NEY

Int. Cl.: 36

Prior U.S. Cls.: 100, 101, and 102

United States Patent and Trademark Office

Reg. No. 3,577,591

Registered Feb. 17, 2009

**SERVICE MARK
PRINCIPAL REGISTER**

DTN Marketplace

DTN, INC. (DELAWARE CORPORATION)
9110 W. DODGE ROAD
OMAHA, NE 68114

OWNER OF U.S. REG. NOS. 1,515,187, 1,659,521,
AND OTHERS.

FOR: ONLINE BROKERAGE IN THE FIELD OF
AGRICULTURAL GOODS AND COMMODITIES, IN
CLASS 36 (U.S. CLS. 100, 101 AND 102).

NO CLAIM IS MADE TO THE EXCLUSIVE
RIGHT TO USE "MARKETSPACE", APART FROM
THE MARK AS SHOWN.

FIRST USE 7-9-2008; IN COMMERCE 7-9-2008.

SN 77-350,445, FILED 12-12-2007.

THE MARK CONSISTS OF STANDARD CHAR-
ACTERS WITHOUT CLAIM TO ANY PARTICULAR
FONT, STYLE, SIZE, OR COLOR.

JESSICA A. POWERS, EXAMINING ATTORNEY

Int. Cl.: 28

Prior U.S. Cls.: 22, 23, 38, and 50

United States Patent and Trademark Office

Reg. No. 3,577,592

Registered Feb. 17, 2009

**TRADEMARK
PRINCIPAL REGISTER**

AUDRINA

JAKKS PACIFIC, INC. (DELAWARE CORPORATION)
22619 PACIFIC COAST HIGHWAY
MALIBU, CA 90265

THE MARK CONSISTS OF STANDARD CHARACTERS WITHOUT CLAIM TO ANY PARTICULAR FONT, STYLE, SIZE, OR COLOR.

FOR: DOLL HOUSES; DOLLS; DOLLS AND ACCESSORIES THEREFOR; DOLLS AND DOLLS' CLOTHING; DOLLS AND PLAYSETS THEREFOR, IN CLASS 28 (U.S. CLS. 22, 23, 38 AND 50).

SN 77-350,563, FILED 12-12-2007.

FIRST USE 6-30-2008; IN COMMERCE 6-30-2008.

MAUREEN DALL, EXAMINING ATTORNEY

Int. Cl.: 28

Prior U.S. Cls.: 22, 23, 38, and 50

United States Patent and Trademark Office

Reg. No. 3,577,593

Registered Feb. 17, 2009

**TRADEMARK
PRINCIPAL REGISTER**

JUN

JAKKS PACIFIC, INC. (DELAWARE CORPORATION)
22619 PACIFIC COAST HIGHWAY
MALIBU, CA 90265

THE MARK CONSISTS OF STANDARD CHARACTERS WITHOUT CLAIM TO ANY PARTICULAR FONT, STYLE, SIZE, OR COLOR.

FOR: DOLL HOUSES; DOLLS; DOLLS AND ACCESSORIES THEREFOR; DOLLS AND DOLLS' CLOTHING; DOLLS AND PLAYSETS THEREFOR, IN CLASS 28 (U.S. CLS. 22, 23, 38 AND 50).

SN 77-350,586, FILED 12-12-2007.

FIRST USE 6-30-2008; IN COMMERCE 6-30-2008.

MAUREEN DALL, EXAMINING ATTORNEY

Int. Cls.: 25 and 28

Prior U.S. Cls.: 22, 23, 38, 39, and 50

United States Patent and Trademark Office

Reg. No. 3,577,594

Registered Feb. 17, 2009

**TRADEMARK
PRINCIPAL REGISTER**

GOLF YOUR BALL

WATSON JR., JAMES H. (UNITED STATES INDIVIDUAL)
1869 WEST LITTLETON BLVD.
LITTLETON, CO 80120

FOR: SHIRTS; POLO SHIRTS; SWEAT SHIRTS; T-SHIRTS; WIND SHIRTS; JERSEYS; TANK TOPS; SHORTS; JACKETS; COATS; BELTS; CAPS; HATS; VISORS; BEANIES; FLEECE PULLOVERS; SWEATERS; JEANS; PANTS; OVERALLS; BATHING SUITS; SWIM TRUNKS; BANDANAS; SHOES; SANDALS; SOCKS; PAJAMAS; SWEAT PANTS; UNDERWEAR; BRIEFS; THERMAL UNDERWEAR, IN CLASS 25 (U.S. CLS. 22 AND 39).

FIRST USE 3-27-2008; IN COMMERCE 3-27-2008.

FOR: GOLF BAGS; GOLF BALLS; HEAD COVERS FOR GOLF CLUBS, IN CLASS 28 (U.S. CLS. 22, 23, 38 AND 50).

FIRST USE 3-27-2008; IN COMMERCE 11-11-2008.

THE MARK CONSISTS OF STANDARD CHARACTERS WITHOUT CLAIM TO ANY PARTICULAR FONT, STYLE, SIZE, OR COLOR.

SN 77-350,819, FILED 12-13-2007.

AISHA SALEM, EXAMINING ATTORNEY

Int. Cl.: 25

Prior U.S. Cls.: 22 and 39

United States Patent and Trademark Office

Reg. No. 3,577,595

Registered Feb. 17, 2009

**TRADEMARK
PRINCIPAL REGISTER**

ESSENTIALS BY ENCHANTED

C.S.F. CORP. (DELAWARE CORPORATION)
1105 N. MARKET STREET, SUITE 607
WILMINGTON, DE 19801

FOR: INTIMATE APPAREL, NAMELY, BRAS,
PANTIES, UNDERWEAR, UNDERPANTS, UNDER-
GARMENTS, UNDERCLOTHES, SLIPS, LINGERIE,
FOUNDATION GARMENTS, SLEEPWEAR AND
NIGHTGOWNS, IN CLASS 25 (U.S. CLS. 22 AND 39).

FIRST USE 8-4-2008; IN COMMERCE 8-4-2008.

THE MARK CONSISTS OF STANDARD CHAR-
ACTERS WITHOUT CLAIM TO ANY PARTICULAR
FONT, STYLE, SIZE, OR COLOR.

OWNER OF U.S. REG. NO. 3,133,572.

SN 77-351,393, FILED 12-13-2007.

WENDY GOODMAN, EXAMINING ATTORNEY

Int. Cl.: 38

Prior U.S. Cls.: 100, 101, and 104

United States Patent and Trademark Office

Reg. No. 3,577,596

Registered Feb. 17, 2009

**SERVICE MARK
PRINCIPAL REGISTER**

BEARMAIL

BUILD-A-BEAR RETAIL MANAGEMENT, INC.
(DELAWARE CORPORATION)
1954 INNERBELT BUSINESS CENTER DRIVE
ST. LOUIS, MO 631145760

THE MARK CONSISTS OF STANDARD CHAR-
ACTERS WITHOUT CLAIM TO ANY PARTICULAR
FONT, STYLE, SIZE, OR COLOR.

FOR: ELECTRONIC MESSAGE AND DATA
TRANSMISSION AND ELECTRONIC MAIL MESSA-
GING SERVICES, IN CLASS 38 (U.S. CLS. 100, 101
AND 104).

SN 77-351,430, FILED 12-13-2007.

FIRST USE 10-1-2008; IN COMMERCE 10-1-2008.

SUSAN RICHARDS, EXAMINING ATTORNEY

Int. Cl.: 44

Prior U.S. Cls.: 100 and 101

United States Patent and Trademark Office

Reg. No. 3,577,597

Registered Feb. 17, 2009

**SERVICE MARK
PRINCIPAL REGISTER**

MEDAISLE

MEDAISLEEXPRESS, LLC (NEVADA LIMITED
LIABILITY COMPANY)
82 E. GLENDALE AVE.
SPARKS, NV 89431

THE MARK CONSISTS OF STANDARD CHAR-
ACTERS WITHOUT CLAIM TO ANY PARTICULAR
FONT, STYLE, SIZE, OR COLOR.

FOR: URGENT MEDICAL CARE CENTERS, IN
CLASS 44 (U.S. CLS. 100 AND 101).

SN 77-351,634, FILED 12-13-2007.

FIRST USE 3-15-2008; IN COMMERCE 3-15-2008.

ARETHA SOMERVILLE, EXAMINING ATTORNEY

Int. Cl.: 41

Prior U.S. Cls.: 100, 101, and 107

United States Patent and Trademark Office

Reg. No. 3,577,598

Registered Feb. 17, 2009

**SERVICE MARK
PRINCIPAL REGISTER**

GET RANKING

TWENTIETH CENTURY FOX FILM CORPORATION (DELAWARE CORPORATION)
10201 WEST PICO BOULEVARD
LOS ANGELES, CA 90035

THE MARK CONSISTS OF STANDARD CHARACTERS WITHOUT CLAIM TO ANY PARTICULAR FONT, STYLE, SIZE, OR COLOR.

FOR: ENTERTAINMENT SERVICES IN THE NATURE OF TELEVISION SEGMENTS IN THE REALITY GENRE, IN CLASS 41 (U.S. CLS. 100, 101 AND 107).

SN 77-351,730, FILED 12-13-2007.

FIRST USE 1-19-2008; IN COMMERCE 1-19-2008.

ALLISON SCHRODY, EXAMINING ATTORNEY

Int. Cl.: 9

Prior U.S. Cls.: 21, 23, 26, 36, and 38

United States Patent and Trademark Office

Reg. No. 3,577,599

Registered Feb. 17, 2009

**TRADEMARK
PRINCIPAL REGISTER**

VISUAL XPRESS

OMEGA LEGAL SYSTEMS, INC. (ARIZONA CORPORATION)
SUITE 200
3875 N. 44TH STREET
PHOENIX, AZ 85018

FOR: COMPUTER SOFTWARE FOR USE IN THE LEGAL FIELD, NAMELY, SOFTWARE USED TO EXPLORE, DISPLAY, ANALYZE AND SHARE FINANCIAL INFORMATION, CLIENT/MATTER INFORMATION AND ATTORNEY PRODUCTIVITY INFORMATION WITHIN A LAW FIRM, IN CLASS 9 (U.S. CLS. 21, 23, 26, 36 AND 38).

FIRST USE 6-0-2008; IN COMMERCE 6-0-2008.

THE MARK CONSISTS OF STANDARD CHARACTERS WITHOUT CLAIM TO ANY PARTICULAR FONT, STYLE, SIZE, OR COLOR.

SN 77-352,050, FILED 12-14-2007.

SHANNON TWOHIG, EXAMINING ATTORNEY

Int. Cl.: 12

Prior U.S. Cls.: 19, 21, 23, 31, 35, and 44

United States Patent and Trademark Office

Reg. No. 3,577,600

Registered Feb. 17, 2009

**TRADEMARK
PRINCIPAL REGISTER**

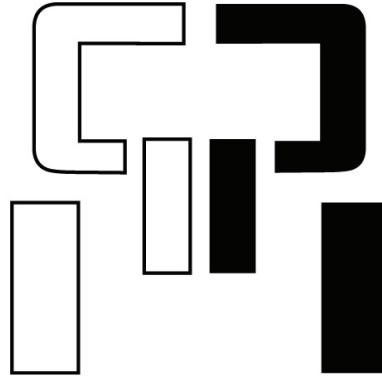

CRAWLER READY (UNITED STATES SOLE
PROPRIETORSHIP)
1770 TEAKWOOD DR.
SANDY, UT 84092

FOR: LAND VEHICLE SUSPENSION PARTS,
NAMELY, EQUALIZERS; LAND VEHICLE SUSPEN-
SION PARTS, NAMELY, COIL SPRINGS; LAND
VEHICLE SUSPENSION PARTS, NAMELY, LEAF
SPRINGS; LAND VEHICLE SUSPENSION PARTS,
NAMELY, TORSION/SWAY BARS; SUSPENSION
SPRINGS FOR MOTOR CARS; VEHICLE PARTS,

NAMELY, SUSPENSION STRUTS, IN CLASS 12 (U.S.
CLS. 19, 21, 23, 31, 35 AND 44).

FIRST USE 1-1-2008; IN COMMERCE 1-1-2008.

THE MARK CONSISTS OF TWO LETTER "R'S"
THAT ARE BACK-TO-BACK THAT ALSO CREATES
THE DESIGN OF AN OFF-ROAD VEHICLE.

SN 77-352,258, FILED 12-14-2007.

JULIE WATSON, EXAMINING ATTORNEY

Int. Cls.: 35 and 43

Prior U.S. Cls.: 100, 101, and 102

United States Patent and Trademark Office

Reg. No. 3,577,601

Registered Feb. 17, 2009

**SERVICE MARK
PRINCIPAL REGISTER**

**MAKING THE TRAVELER'S DAY
BETTER**

HMSHOST CORPORATION (DELAWARE CORPORATION)
6905 ROCKLEDGE DRIVE, MS 7-1
BETHESDA, MD 20817

FOR: RETAIL NEWSSTAND, BOOKSTORE, AND GIFT STORE MANAGEMENT AND BUSINESS DEVELOPMENT SERVICES, NAMELY, BUSINESS CONSULTATION IN THE FIELDS OF TARGETED COMMUNICATIONS AND MARKET RESEARCH, STRATEGIC ALLIANCES, FINANCES, BUSINESS PROCESSES, BRAND MANAGEMENT, MARKET ACCESS, AND FRANCHISING; RETAIL NEWSSTANDS, BOOKSTORES, AND GIFT STORE SERVICES; RETAIL STORE SERVICES FEATURING CONVENIENCE STORE ITEMS; RETAIL CONVENIENCE STORES; RETAIL STORE SERVICES FEATURING A WIDE VARIETY OF CONSUMER GOODS OF OTHERS; CONSULTATION IN THE FIELD OF TARGETED COMMUNICATIONS IN THE NATURE OF DIRECT MARKETING, MARKET RESEARCH, AND STRATEGIC PLANNING IN THE FIELD OF RESTAURANTS AND CONCESSION STANDS; CONSULTATION IN THE FIELD OF

BUSINESS PROCESSES, BRAND MANAGEMENT, MARKET ACCESS, AND FRANCHISING IN THE FIELD OF RESTAURANTS AND CONCESSION STANDS; CONCESSION STANDS FEATURING FOOD AND BEVERAGES; AND RESTAURANT AND CONCESSION MANAGEMENT AND BUSINESS DEVELOPMENT SERVICES, IN CLASS 35 (U.S. CLS. 100, 101 AND 102).

FIRST USE 1-1-2006; IN COMMERCE 1-1-2006.

FOR: RESTAURANT AND BAR SERVICES, IN CLASS 43 (U.S. CLS. 100 AND 101).

FIRST USE 1-1-2006; IN COMMERCE 1-1-2006.

THE MARK CONSISTS OF STANDARD CHARACTERS WITHOUT CLAIM TO ANY PARTICULAR FONT, STYLE, SIZE, OR COLOR.

SN 77-352,832, FILED 12-14-2007.

SUSAN RICHARDS, EXAMINING ATTORNEY

Int. Cl.: 9

Prior U.S. Cls.: 21, 23, 26, 36, and 38

United States Patent and Trademark Office

Reg. No. 3,577,602

Registered Feb. 17, 2009

TRADEMARK
PRINCIPAL REGISTER



DEFYNE ENTERTAINMENT (FLORIDA CORPORATION)
PO BOX 771134
CORAL SPRINGS, FL 33077

FOR: PRERECORDED AUDIO TAPES FEATURING MUSICAL SOUND RECORDINGS, AND PRERECORDED COMPACT DISCS FEATURING MUSICAL SOUND RECORDINGS, IN CLASS 9 (U.S. CLS. 21, 23, 26, 36 AND 38).

FIRST USE 6-14-2008; IN COMMERCE 6-14-2008.

NO CLAIM IS MADE TO THE EXCLUSIVE RIGHT TO USE "ENTERTAINMENT", APART FROM THE MARK AS SHOWN.

THE COLOR(S) PURPLE, GRAY, BLACK AND WHITE IS/ARE CLAIMED AS A FEATURE OF THE MARK.

THE MARK CONSISTS OF TWO FEMALE SILHOUETTES IN GRAY, WITH A BLACK RECORD IN THE CENTER WITH PURPLE LETTERS "D" AND "E" IN THE CENTER OF RECORD ON A WHITE BACKGROUND. THE BANNER IS IN PURPLE WITH NAME "DEFYNE ENTERTAINMENT" IN WHITE LETTERS. BACKGROUND HAS PURPLE DESIGNS AND STARS.

SN 77-352,866, FILED 12-14-2007.

JULIE VEPPUMTHARA, EXAMINING ATTORNEY

Int. Cl.: 43

Prior U.S. Cls.: 100 and 101

United States Patent and Trademark Office

Reg. No. 3,577,603

Registered Feb. 17, 2009

**SERVICE MARK
PRINCIPAL REGISTER**

ASCEND COLLECTION

CHOICE HOTELS INTERNATIONAL, INC. (DE-
LAWARE CORPORATION)
10750 COLUMBIA PIKE
SILVER SPRING, MD 20901

FOR: HOTEL AND MOTEL SERVICES, HOTEL
AND MOTEL RESERVATION SERVICES FOR OTH-
ERS, AND ONLINE HOTEL AND MOTEL RESER-
VATION SERVICES FOR OTHERS, IN CLASS 43
(U.S. CLS. 100 AND 101).

FIRST USE 10-24-2008; IN COMMERCE 10-24-2008.

THE MARK CONSISTS OF STANDARD CHAR-
ACTERS WITHOUT CLAIM TO ANY PARTICULAR
FONT, STYLE, SIZE, OR COLOR.

NO CLAIM IS MADE TO THE EXCLUSIVE
RIGHT TO USE "COLLECTION", APART FROM
THE MARK AS SHOWN.

SN 77-353,800, FILED 12-17-2007.

BRENDAN MCCAULEY, EXAMINING ATTORNEY

Int. Cl.: 9

Prior U.S. Cls.: 21, 23, 26, 36, and 38

United States Patent and Trademark Office

Reg. No. 3,577,604

Registered Feb. 17, 2009

**TRADEMARK
PRINCIPAL REGISTER**

WHAT CAN BE NOW

WHAT CAN BE NOW INC (COLORADO CORPORATION)
P.O. BOX 2940
GRAND JUNCTION, CO 81505

FOR: PRERECORDED COMPACT DISCS AND DVDS, AND DOWNLOADABLE AUDIO MULTIMEDIA, AND TEXT FILES, ALL FEATURING INFORMATION IN THE FIELD OF PERSONAL AND BUSINESS GROWTH COACHING , IN CLASS 9 (U.S. CLS. 21, 23, 26, 36 AND 38).

FIRST USE 8-1-2008; IN COMMERCE 11-5-2008.

THE MARK CONSISTS OF STANDARD CHARACTERS WITHOUT CLAIM TO ANY PARTICULAR FONT, STYLE, SIZE, OR COLOR.

SN 77-354,586, FILED 12-18-2007.

MELVIN AXILBUND, EXAMINING ATTORNEY

Int. Cl.: 9

Prior U.S. Cls.: 21, 23, 26, 36, and 38

Reg. No. 3,577,605

United States Patent and Trademark Office

Registered Feb. 17, 2009

**TRADEMARK
PRINCIPAL REGISTER**

ARTISAN

EPSON AMERICA, INC. (CALIFORNIA CORPORATION)
3840 KILROY AIRPORT WAY
LONG BEACH, CA 90806

THE MARK CONSISTS OF STANDARD CHARACTERS WITHOUT CLAIM TO ANY PARTICULAR FONT, STYLE, SIZE, OR COLOR.

FOR: PRINTERS, IN CLASS 9 (U.S. CLS. 21, 23, 26, 36 AND 38).

SN 77-354,866, FILED 12-18-2007.

FIRST USE 8-31-2008; IN COMMERCE 8-31-2008.

JASON BLAIR, EXAMINING ATTORNEY

Int. Cl.: 23

Prior U.S. Cl.: 43

United States Patent and Trademark Office

Reg. No. 3,577,606

Registered Feb. 17, 2009

**TRADEMARK
PRINCIPAL REGISTER**

SILENZIO

J. & P. COATS, LIMITED (SCOTLAND CORPORATION)

155 ST. VINCENT STREET

GLASGOW G2 5PA, SCOTLAND

FOR: HANDKNITTING YARNS, IN CLASS 23 (U.S. CL. 43).

FIRST USE 5-20-2008; IN COMMERCE 5-20-2008.

THE MARK CONSISTS OF STANDARD CHARACTERS WITHOUT CLAIM TO ANY PARTICULAR FONT, STYLE, SIZE, OR COLOR.

THE FOREIGN WORDING IN THE MARK TRANSLATES INTO ENGLISH AS SILENCE.

SN 77-355,331, FILED 12-19-2007.

CIMMERIAN COLEMAN, EXAMINING ATTORNEY

Int. Cl.: 9

Prior U.S. Cls.: 21, 23, 26, 36, and 38

United States Patent and Trademark Office

Reg. No. 3,577,607

Registered Feb. 17, 2009

**TRADEMARK
PRINCIPAL REGISTER**

SCRAYER

21ST CENTURY SYSTEMS, INC. (NEW YORK
CORPORATION)
6825 PINE STREET
OMAHA, NE 68106

FOR: INTERACTIVE COMPUTER KIOSKS COM-
PRISING COMPUTERS, COMPUTER HARDWARE,
COMPUTER PERIPHERALS, AND COMPUTER OP-
ERATING SOFTWARE, FOR USE IN PROVIDING
DIRECTORY ASSISTANCE WITHIN BUILDINGS
AND CAMPUSES, IN CLASS 9 (U.S. CLS. 21, 23, 26,
36 AND 38).

FIRST USE 12-10-2007; IN COMMERCE 1-30-2008.

THE MARK CONSISTS OF STANDARD CHAR-
ACTERS WITHOUT CLAIM TO ANY PARTICULAR
FONT, STYLE, SIZE, OR COLOR.

SN 77-357,066, FILED 12-20-2007.

SEAN CROWLEY, EXAMINING ATTORNEY

Int. Cl.: 30

Prior U.S. Cl.: 46

United States Patent and Trademark Office

Reg. No. 3,577,608

Registered Feb. 17, 2009

**TRADEMARK
PRINCIPAL REGISTER**

EVERLASTING VANILLA

CHINABERRY, INC. (CALIFORNIA CORPORATION)
SUITE B
2780 VIA ORANGE WAY
SPRING VALLEY, CA 91978

FOR: VANILLA BEANS AND A BOTTLE SOLD AS
A UNIT FOR THE PURPOSE OF MAKING VANILLA
EXTRACT, IN CLASS 30 (U.S. CL. 46).

FIRST USE 9-0-2008; IN COMMERCE 9-0-2008.

THE MARK CONSISTS OF STANDARD CHARACTERS WITHOUT CLAIM TO ANY PARTICULAR FONT, STYLE, SIZE, OR COLOR.

NO CLAIM IS MADE TO THE EXCLUSIVE RIGHT TO USE "VANILLA", APART FROM THE MARK AS SHOWN.

SN 77-357,243, FILED 12-20-2007.

MARTHA SANTOMARTINO, EXAMINING ATTORNEY

Int. Cls.: 35, 36, and 41

Prior U.S. Cls.: 100, 101, 102, and 107

United States Patent and Trademark Office

Reg. No. 3,577,609

Registered Feb. 17, 2009

**SERVICE MARK
PRINCIPAL REGISTER**

**EASY TO GET TO. HARD TO
LEAVE.**

VIEJAS BAND OF KUMEYAAY INDIANS CAPITAN GRANDE BAND OF DIEGUENO MISSION INDIANS OF CALIFORNIA: VIEJAS (BARON LONG) GROUP OF CAPITAN GRANDE BAND OF MISSION INDIANS OF THE VIEJAS RESERVATION, ALSO KNOWN AS VIEJAS BAND OF KUMEYAAY INDIANS, THE MEMBERS OF WHICH ARE UNITED STATES CITIZENS (UNITED STATES FEDERALLY-RECOGNIZED INDIAN TRIBE)

5000 WILLOWS ROAD
ALPINE, CA 91901

FOR: PROMOTING LIVE ENTERTAINMENT EVENTS OF OTHERS, NAMELY, LIVE CONCERTS, THEATRICAL SHOWS, MUSICAL TOURS AND MUSICAL FESTIVALS; PROMOTING THE LIVE ENTERTAINMENT VENUES OF OTHERS; PROMOTING MUSICAL ARTISTS; PROMOTING MUSICAL ENTERTAINMENT EVENTS AND MUSICAL ACTS OF OTHERS THROUGH THE DISSEMINATION OF PRINTED PROMOTIONAL MATERIALS AND VIA THE INTERNET; DISTRIBUTORSHIPS IN THE FIELD OF AUDIO AND VIDEO RECORDINGS OF RECORDED LIVE ENTERTAINMENT, IN CLASS 35 (U.S. CLS. 100, 101 AND 102).

FIRST USE 2-1-2007; IN COMMERCE 2-1-2007.

FOR: SHOPPING CENTER SERVICES, NAMELY, RENTAL OF SHOPPING CENTER SPACE; REAL ESTATE INVESTMENT AND REAL ESTATE MANAGEMENT, IN CLASS 36 (U.S. CLS. 100, 101 AND 102).

FIRST USE 2-1-2007; IN COMMERCE 2-1-2007.

FOR: CASINO AND GAMING SERVICES; OPERATING VENUES FOR HOSTING LIVE ENTERTAINMENT, NAMELY, THEATERS, AMPHITHEATERS, ARENAS AND CONCERT HALLS; NIGHTCLUB SERVICES FEATURING LIVE AND RECORDED MUSICAL ENTERTAINMENT; PRODUCTION OF LIVE CONCERTS; PRODUCTION OF AUDIO AND VIDEO RECORDINGS OF RECORDED LIVE ENTERTAINMENT; PROVIDING FACILITIES FOR THE PRESENTATIONS OF LIVE MUSICAL ENTERTAINMENT; PROVIDING ONLINE ENTERTAINMENT INFORMATION ABOUT MUSICAL ARTISTS VIA THE GLOBAL COMPUTER NETWORK; ENTERTAINMENT IN THE NATURE OF LIVE MUSICAL PERFORMANCES, MAGIC SHOWS, LIGHT AND LASER SHOWS, WATER FOUNTAIN PERFORMANCES, DANCE, FIREWORKS DISPLAYS, AND PERSONAL APPEARANCES BY CELEBRITY MOVIE STARS, COMEDIANS, SPORTS CELEBRITIES, AND ENTERTAINMENT CELEBRITY PERFORMANCES; TICKET AGENCY SERVICES FOR CONCERTS, THEATRICAL PRESENTATIONS, AND OTHER ENTERTAINMENT EVENTS RENDERED ONLINE, THROUGH PHONE ORDERS AND THROUGH TICKET OUTLETS, IN CLASS 41 (U.S. CLS. 100, 101 AND 107).

FIRST USE 2-1-2007; IN COMMERCE 2-1-2007.

THE MARK CONSISTS OF STANDARD CHARACTERS WITHOUT CLAIM TO ANY PARTICULAR FONT, STYLE, SIZE, OR COLOR.

SN 77-357,429, FILED 12-20-2007.

KATHY DE JONGE, EXAMINING ATTORNEY

Int. Cl.: 3

Prior U.S. Cls.: 1, 4, 6, 50, 51, and 52

United States Patent and Trademark Office

Reg. No. 3,577,610

Registered Feb. 17, 2009

**TRADEMARK
PRINCIPAL REGISTER**

POWER PLAY

MBL/TIGI PRODUCTS , LP (TEXAS LIMITED
PARTNERSHIP)
2311 MIDWAY ROAD
CARROLLTON, TX 75006

THE MARK CONSISTS OF STANDARD CHAR-
ACTERS WITHOUT CLAIM TO ANY PARTICULAR
FONT, STYLE, SIZE, OR COLOR.

FOR: HAIR CARE PRODUCTS, NAMELY, HAIR
GELS AND HAIR CARE PREPARATIONS, IN
CLASS 3 (U.S. CLS. 1, 4, 6, 50, 51 AND 52).

SN 77-358,329, FILED 12-21-2007.

FIRST USE 6-1-2008; IN COMMERCE 6-1-2008.

LAURIE MAYES, EXAMINING ATTORNEY

Int. Cl.: 32

Prior U.S. Cls.: 45, 46, and 48

United States Patent and Trademark Office

Reg. No. 3,577,611

Registered Feb. 17, 2009

**TRADEMARK
PRINCIPAL REGISTER**

SUNSWEEP BOOSTERS

SUNSWEEP GROWERS INC. (CALIFORNIA
CORPORATION)

901 NORTH WALTON AVENUE

YUBA CITY, CA 95993

FOR: FRUIT JUICES AND FRUIT DRINKS, IN
CLASS 32 (U.S. CLS. 45, 46 AND 48).

FIRST USE 9-15-2008; IN COMMERCE 9-15-2008.

THE MARK CONSISTS OF STANDARD CHAR-
ACTERS WITHOUT CLAIM TO ANY PARTICULAR
FONT, STYLE, SIZE, OR COLOR.

OWNER OF U.S. REG. NOS. 307,699, 2,495,957,
AND OTHERS.

SN 77-358,540, FILED 12-21-2007.

MATTHEW MCDOWELL, EXAMINING ATTOR-
NEY

Int. Cls.: 9 and 16

Prior U.S. Cls.: 2, 5, 21, 22, 23, 26, 29, 36, 37, 38, and 50

Reg. No. 3,577,612

United States Patent and Trademark Office

Registered Feb. 17, 2009

**TRADEMARK
PRINCIPAL REGISTER**



CARDIAC SELF ASSESSMENT (WASHINGTON
SOLE PROPRIETORSHIP)
1605 S. CLINTON RD.
SPOKANE, WA 99216

FOR: PRE-RECORDED INTERACTIVE CDS FEATURING MEDICAL LECTURES, AND QUESTIONS AND ANSWERS, IN CLASS 9 (U.S. CLS. 21, 23, 26, 36 AND 38).

FIRST USE 9-1-2008; IN COMMERCE 9-1-2008.

FOR: A SERIES OF BOOKS AND WRITTEN ARTICLES IN THE FIELD OF CARDIOVASCULAR MEDICINE, IN CLASS 16 (U.S. CLS. 2, 5, 22, 23, 29, 37, 38 AND 50).

FIRST USE 9-1-2008; IN COMMERCE 9-1-2008.

NO CLAIM IS MADE TO THE EXCLUSIVE RIGHT TO USE "CARDIO-VASCULAR" & "REVIEW", APART FROM THE MARK AS SHOWN.

THE MARK CONSISTS OF "TODD'S" TEXT IS ABOVE HEART IMAGE. HEART IMAGE CONTAINS CURVED TEXT "CARDIOVASCULAR". BELOW HEART IMAGE IS "REVIEW" TEXT.

SN 77-358,739, FILED 12-21-2007.

KARANENDRA S. CHHINA, EXAMINING ATTORNEY

Int. Cl.: 1

Prior U.S. Cls.: 1, 5, 6, 10, 26, and 46

United States Patent and Trademark Office

Reg. No. 3,577,613

Registered Feb. 17, 2009

**TRADEMARK
PRINCIPAL REGISTER**

LazyMan Liquid Gold

OUTSIDEPRIDE.COM, INC. (OREGON CORPORATION)
915 NORTH MAIN STREET
INDEPENDENCE, OR 97351

FOR: HORTICULTURAL PRODUCTS, NAMELY, SOIL AMENDMENTS THAT ARE INCORPORATED INTO OR ONTO A TURF, LAWN OR SOIL PROFILE FOR CREATING A HEALTH MEDIUM FOR INCREASED ROOT GROWTH AND/OR A SMOOTHER TURF OR LAWN SURFACE CUT OR APPEARANCE, IN CLASS 1 (U.S. CLS. 1, 5, 6, 10, 26 AND 46).

FIRST USE 2-1-2008; IN COMMERCE 2-1-2008.

THE MARK CONSISTS OF STANDARD CHARACTERS WITHOUT CLAIM TO ANY PARTICULAR FONT, STYLE, SIZE, OR COLOR.

OWNER OF U.S. REG. NO. 3,093,135.

SN 77-358,946, FILED 12-23-2007.

LESLEY LAMOTHE, EXAMINING ATTORNEY

Int. Cl.: 9

Prior U.S. Cls.: 21, 23, 26, 36, and 38

United States Patent and Trademark Office

Reg. No. 3,577,614

Registered Feb. 17, 2009

**TRADEMARK
PRINCIPAL REGISTER**

ARCADIA

ARCADIA ENTERTAINMENT, INC. (DELA-
WARE CORPORATION)
900 ISLAND DRIVE, SUITE 203
REDWOOD CITY, CA 94065

FOR: COMPUTER SOFTWARE, NAMELY, SOFTWARE FOR PROVIDING MULTI-USER CONCURRENT ACCESS TO A PERSISTENT 3D VIRTUAL WORLD WITH USER-TAILORED 3D AVATARS AND FOR CREATING A PERSISTENT 3D VIRTUAL WORLD WITH USER-TAILORED 3D AVATARS, IN CLASS 9 (U.S. CLS. 21, 23, 26, 36 AND 38).

FIRST USE 12-8-2008; IN COMMERCE 12-8-2008.

THE MARK CONSISTS OF STANDARD CHARACTERS WITHOUT CLAIM TO ANY PARTICULAR FONT, STYLE, SIZE, OR COLOR.

SN 77-359,101, FILED 12-24-2007.

RENEE MCCRAY, EXAMINING ATTORNEY

Int. Cl.: 35

Prior U.S. Cls.: 100, 101, and 102

United States Patent and Trademark Office

Reg. No. 3,577,615

Registered Feb. 17, 2009

**SERVICE MARK
PRINCIPAL REGISTER**

FOREVER SUMMER

ORANGE COUNTY TOURISM COUNCIL (CALI-
FORNIA CORPORATION)
P.O. BOX 6850
FULLERTON, CA 928346850

FOR: ADVERTISING, MARKETING AND PRO-
MOTING THE ECONOMIC DEVELOPMENT OF
ORANGE COUNTY, CALIFORNIA, IN CLASS 35
(U.S. CLS. 100, 101 AND 102).

FIRST USE 2-15-2008; IN COMMERCE 2-15-2008.

THE MARK CONSISTS OF STANDARD CHAR-
ACTERS WITHOUT CLAIM TO ANY PARTICULAR
FONT, STYLE, SIZE, OR COLOR.

SN 77-359,179, FILED 12-25-2007.

RUDY R. SINGLETON, EXAMINING ATTORNEY

Int. Cl.: 16

Prior U.S. Cls.: 2, 5, 22, 23, 29, 37, 38, and 50

United States Patent and Trademark Office

Reg. No. 3,577,616

Registered Feb. 17, 2009

**TRADEMARK
PRINCIPAL REGISTER**

FOREVER SUMMER

ORANGE COUNTY TOURISM COUNCIL (CALI-
FORNIA CORPORATION)
P.O. BOX 6850
FULLERTON, CA 928346850

FOR: PRINTED MATERIALS, NAMELY, NEWS-
LETTERS AND PAMPHLETS IN THE FIELD OF
TRAVEL AND TOURISM; AND INFORMATIONAL
FLYERS FEATURING TRAVEL AND TOURISM;
AND BROCHURES ABOUT TRAVEL AND TOUR-
ISM, IN CLASS 16 (U.S. CLS. 2, 5, 22, 23, 29, 37, 38 AND
50).

FIRST USE 2-15-2008; IN COMMERCE 2-15-2008.

THE MARK CONSISTS OF STANDARD CHAR-
ACTERS WITHOUT CLAIM TO ANY PARTICULAR
FONT, STYLE, SIZE, OR COLOR.

SN 77-359,180, FILED 12-25-2007.

RUDY R. SINGLETON, EXAMINING ATTORNEY

Int. Cl.: 35

Prior U.S. Cls.: 100, 101, and 102

United States Patent and Trademark Office

Reg. No. 3,577,617

Registered Feb. 17, 2009

**SERVICE MARK
PRINCIPAL REGISTER**



ORANGE COUNTY TOURISM COUNCIL (CALI-
FORNIA CORPORATION)
P.O. BOX 6850
FULLERTON, CA 928346850

FOR: ADVERTISING, MARKETING AND PRO-
MOTING THE ECONOMIC DEVELOPMENT OF
ORANGE COUNTY, CALIFORNIA, IN CLASS 35
(U.S. CLS. 100, 101 AND 102).

FIRST USE 2-15-2008; IN COMMERCE 2-15-2008.

THE MARK CONSISTS OF THE LETTERS "OC"
FLOATING ON A WAVE WITH THE WORD "THE"
WITHIN THE LETTER "O".

SN 77-359,183, FILED 12-25-2007.

RUDY R. SINGLETON, EXAMINING ATTORNEY

Int. Cl.: 35

Prior U.S. Cls.: 100, 101, and 102

United States Patent and Trademark Office

Reg. No. 3,577,618

Registered Feb. 17, 2009

**SERVICE MARK
PRINCIPAL REGISTER**



ORANGE COUNTY TOURISM COUNCIL (CALIFORNIA CORPORATION)
P.O. BOX 6850
FULLERTON, CA 928346850

FOR: ADVERTISING, MARKETING AND PROMOTING THE ECONOMIC DEVELOPMENT OF ORANGE COUNTY, CALIFORNIA, IN CLASS 35 (U.S. CLS. 100, 101 AND 102).

FIRST USE 2-15-2008; IN COMMERCE 2-15-2008.

THE MARK CONSISTS OF THE LETTERS "OC" FLOATING ON A WAVE WITH THE WORD "THE" WITHIN THE LETTER "O", THE WORDS "FOREVER SUMMER" UNDER THE WAVE.

SN 77-359,184, FILED 12-25-2007.

RUDY R. SINGLETON, EXAMINING ATTORNEY

Int. Cl.: 16

Prior U.S. Cls.: 2, 5, 22, 23, 29, 37, 38, and 50

United States Patent and Trademark Office

Reg. No. 3,577,619

Registered Feb. 17, 2009

**TRADEMARK
PRINCIPAL REGISTER**



ORANGE COUNTY TOURISM COUNCIL (CALIFORNIA CORPORATION)
P.O. BOX 6850
FULLERTON, CA 928346850

FOR: PRINTED MATERIALS, NAMELY, NEWSLETTERS AND PAMPHLETS IN THE FIELD OF TRAVEL AND TOURISM; AND INFORMATIONAL FLYERS FEATURING TRAVEL AND TOURISM; AND BROCHURES ABOUT TRAVEL AND TOURISM, IN CLASS 16 (U.S. CLS. 2, 5, 22, 23, 29, 37, 38 AND 50).

FIRST USE 2-15-2008; IN COMMERCE 2-15-2008.

THE MARK CONSISTS OF THE LETTERS "OC" FLOATING ON A WAVE WITH THE WORD "THE" WITHIN THE LETTER "O", THE WORDS "FOREVER SUMMER" UNDER THE WAVE.

SN 77-359,197, FILED 12-25-2007.

RUDY R. SINGLETON, EXAMINING ATTORNEY

Int. Cl.: 42

Prior U.S. Cls.: 100 and 101

United States Patent and Trademark Office

Reg. No. 3,577,620

Registered Feb. 17, 2009

**SERVICE MARK
PRINCIPAL REGISTER**

ITERASI

ITERASI, INC. (DELAWARE CORPORATION)
1525 NE MARINE DRIVE
PORTLAND, OR 97211

FOR: PROVIDING ON-LINE NON-DOWNLOAD-
ABLE COMPUTER SOFTWARE FOR CREATING
ARCHIVES OF A COMPUTER USER'S ELECTRO-
NIC TRANSACTIONS AND CORRESPONDENCE,
IN CLASS 42 (U.S. CLS. 100 AND 101).

FIRST USE 11-9-2008; IN COMMERCE 11-9-2008.

THE MARK CONSISTS OF STANDARD CHAR-
ACTERS WITHOUT CLAIM TO ANY PARTICULAR
FONT, STYLE, SIZE, OR COLOR.

SN 77-359,794, FILED 12-26-2007.

KIMBERLY FRYE, EXAMINING ATTORNEY

Int. Cl.: 3

Prior U.S. Cls.: 1, 4, 6, 50, 51, and 52

United States Patent and Trademark Office

Reg. No. 3,577,621

Registered Feb. 17, 2009

**TRADEMARK
PRINCIPAL REGISTER**

ELECTRO WIZARD

THE SHERWIN-WILLIAMS COMPANY (OHIO
CORPORATION)
101 PROSPECT AVENUE NW
CLEVELAND, OH 441151075

FOR: CLEANER FOR USE ON ELECTRONIC
DEVICES AND EQUIPMENT, IN CLASS 3 (U.S.
CLS. 1, 4, 6, 50, 51 AND 52).

FIRST USE 8-8-2008; IN COMMERCE 8-8-2008.

THE MARK CONSISTS OF STANDARD CHAR-
ACTERS WITHOUT CLAIM TO ANY PARTICULAR
FONT, STYLE, SIZE, OR COLOR.

SN 77-359,867, FILED 12-27-2007.

WILLIAM BRECKENFELD, EXAMINING ATTOR-
NEY

Int. Cl.: 41

Prior U.S. Cls.: 100, 101, and 107

United States Patent and Trademark Office

Reg. No. 3,577,622

Registered Feb. 17, 2009

**SERVICE MARK
PRINCIPAL REGISTER**

SpenceTF Productions

FOLMAR, SPENCER (UNITED STATES INDIVIDUAL)
264 ODYSSEY LANE
MORRISDALE, PA 16858

FOR: FILM EDITING; FILM PRODUCTION, IN CLASS 41 (U.S. CLS. 100, 101 AND 107).

FIRST USE 4-27-2007; IN COMMERCE 8-29-2008.

THE MARK CONSISTS OF STANDARD CHARACTERS WITHOUT CLAIM TO ANY PARTICULAR FONT, STYLE, SIZE, OR COLOR.

NO CLAIM IS MADE TO THE EXCLUSIVE RIGHT TO USE "PRODUCTIONS", APART FROM THE MARK AS SHOWN.

SN 77-361,229, FILED 12-28-2007.

MARTHA SANTOMARTINO, EXAMINING ATTORNEY

Int. Cls.: 44 and 45

Prior U.S. Cls.: 100 and 101

United States Patent and Trademark Office

Reg. No. 3,577,623

Registered Feb. 17, 2009

**SERVICE MARK
PRINCIPAL REGISTER**

PatientsLikeMe

PATIENTSLIKEME INC. (DELAWARE CORPORATION)
222 THIRD STREET, SUITE 0234
CAMBRIDGE, MA 02142

FOR: COMPUTER SERVICES IN THE NATURE OF PROVIDING CUSTOMIZED WEB PAGES FEATURING HEALTH AND MEDICAL INFORMATION, INCLUDING USER-DEFINED HEALTH AND MEDICAL INFORMATION AND PERSONAL HEALTH PROFILES; PROVIDING HEALTH AND MEDICAL INFORMATION, IN CLASS 44 (U.S. CLS. 100 AND 101).

FIRST USE 3-14-2006; IN COMMERCE 3-14-2006.

FOR: PROVIDING AN ONLINE SOCIAL NETWORKING WEBSITE FOR REGISTERED USERS FOR SHARING HEALTH AND MEDICAL INFORMATION AND ENGAGING IN RELATED NETWORKING, IN CLASS 45 (U.S. CLS. 100 AND 101).

FIRST USE 3-14-2006; IN COMMERCE 3-14-2006.

THE MARK CONSISTS OF STANDARD CHARACTERS WITHOUT CLAIM TO ANY PARTICULAR FONT, STYLE, SIZE, OR COLOR.

SN 77-361,688, FILED 12-31-2007.

JOHN KELLY, EXAMINING ATTORNEY

Int. Cl.: 25

Prior U.S. Cls.: 22 and 39

United States Patent and Trademark Office

Reg. No. 3,577,624

Registered Feb. 17, 2009

**TRADEMARK
PRINCIPAL REGISTER**

Southern Drawls

SOUTHERN PROPER, LLC (GEORGIA LIMITED
LIABILITY COMPANY)
1872 HICKORY ROAD
CHAMBLEE, GA 30341

THE MARK CONSISTS OF STANDARD CHAR-
ACTERS WITHOUT CLAIM TO ANY PARTICULAR
FONT, STYLE, SIZE, OR COLOR.

FOR: BOXER BRIEFS; BOXER SHORTS; SHORTS;
LOUNGE PANTS, IN CLASS 25 (U.S. CLS. 22 AND
39).

SN 77-362,230, FILED 1-1-2008.

FIRST USE 4-1-2008; IN COMMERCE 4-1-2008.

JANET LEE, EXAMINING ATTORNEY

Int. Cl.: 25

Prior U.S. Cls.: 22 and 39

United States Patent and Trademark Office

Reg. No. 3,577,625

Registered Feb. 17, 2009

**TRADEMARK
PRINCIPAL REGISTER**

LIFE IS ETERNAL

CARSWELL, BUCKY F. (UNITED STATES INDIVIDUAL)
104 SKILTON DRIVE
TRAVELERS REST, SC 29690

FOR: CLOTHING, NAMELY, T-SHIRTS, HATS, LONG SLEEVE SHIRTS, IN CLASS 25 (U.S. CLS. 22 AND 39).

FIRST USE 11-18-2008; IN COMMERCE 11-18-2008.

THE MARK CONSISTS OF STANDARD CHARACTERS WITHOUT CLAIM TO ANY PARTICULAR FONT, STYLE, SIZE, OR COLOR.

SN 77-362,285, FILED 1-2-2008.

TRACY WHITTAKER-BROWN, EXAMINING ATTORNEY

Int. Cl.: 41

Prior U.S. Cls.: 100, 101, and 107

United States Patent and Trademark Office

Reg. No. 3,577,626

Registered Feb. 17, 2009

**SERVICE MARK
PRINCIPAL REGISTER**

A TIME 2 DANCE

ROLAND'S DANCE STUDIO, INC. (NORTH
CAROLINA CORPORATION)
310 HOPE MILLS ROAD
FAYETTEVILLE, NC 28304

THE MARK CONSISTS OF STANDARD CHAR-
ACTERS WITHOUT CLAIM TO ANY PARTICULAR
FONT, STYLE, SIZE, OR COLOR.

FOR: DANCE INSTRUCTION, IN CLASS 41 (U.S.
CLS. 100, 101 AND 107).

SN 77-362,422, FILED 1-2-2008.

FIRST USE 7-1-2008; IN COMMERCE 8-15-2008.

NATALIE POLZER, EXAMINING ATTORNEY

Int. Cl.: 25

Prior U.S. Cls.: 22 and 39

United States Patent and Trademark Office

Reg. No. 3,577,627

Registered Feb. 17, 2009

TRADEMARK
PRINCIPAL REGISTER



BIZZ R ENTERPRISES (MARYLAND LIMITED
LIABILITY COMPANY)
1300 RITCHIE ROAD SUITE J
FORESTVILLE, MD 20747

FOR: PANTS, HATS, JACKETS, DRESS SHIRTS,
SHORT-SLEEVED OR LONG-SLEEVED T-SHIRTS,
POLO SHIRTS, SPORTS SNEAKERS, UNDERWEAR,
SOCKS, SPORT COATS, SUITS, JERSEYS, BASE-
BALL CAPS, SLIPPERS, ROBES, IN CLASS 25 (U.S.
CLS. 22 AND 39).

FIRST USE 5-15-2008; IN COMMERCE 5-15-2008.

THE MARK CONSISTS OF THE WORDING
"CUM-LAUDE" IN A BANNER ABOVE A STYLIZED
CREST WHICH CONTAINS A LARGE LETTER "C"
WITH THE LETTERS "LE" WITHIN THE LETTER
"C", AND A BANNER BELOW THE CREST CON-
TAINING THE WORD "EDITIONS".

SN 77-362,913, FILED 1-2-2008.

ANDREA K. NADELMAN, EXAMINING ATTOR-
NEY

Int. Cls.: 41, 42, and 44

Prior U.S. Cls.: 100, 101, 107, and 200

Reg. No. 3,577,628

United States Patent and Trademark Office

Registered Feb. 17, 2009

**SERVICE MARK
COLLECTIVE MEMBERSHIP
PRINCIPAL REGISTER**

TACF

THE AMERICAN CHESTNUT FOUNDATION
(VIRGINIA CORPORATION)
469 MAIN STREET
BENNINGTON, VT 05201

FOR: EDUCATIONAL SERVICES, NAMELY, THE DEVELOPMENT AND DISSEMINATION OF EDUCATION MATERIALS OF OTHERS ABOUT THE AMERICAN CHESTNUT TREE, THE AMERICAN CHESTNUT TREE BLIGHT, AND EFFORTS TO DEVELOP A BLIGHT-RESISTANT AMERICAN CHESTNUT TREE, IN CLASS 41 (U.S. CLS. 100, 101 AND 107).

FIRST USE 0-0-1997; IN COMMERCE 0-0-1997.

FOR: SCIENTIFIC RESEARCH IN THE FIELD OF DEVELOPING A BLIGHT-RESISTANT AMERICAN CHESTNUT TREE; PROVIDING AN ONLINE WEBSITE CONTAINING SCIENTIFIC RESEARCH MATERIALS RELATED TO THE AMERICAN CHESTNUT TREE, THE AMERICAN CHESTNUT TREE BLIGHT, AND EFFORTS TO DEVELOP A BLIGHT-RESISTANT AMERICAN CHESTNUT TREE, IN CLASS 42 (U.S. CLS. 100 AND 101).

FIRST USE 0-0-1997; IN COMMERCE 0-0-1997.

FOR: PROVIDING AN ONLINE WEBSITE CONTAINING BOTANICAL INFORMATION RELATED TO THE AMERICAN CHESTNUT TREE, THE AMERICAN CHESTNUT TREE BLIGHT, AND PLANT BREEDING EFFORTS TO DEVELOP A BLIGHT-RESISTANT AMERICAN CHESTNUT TREE; PLANT BREEDING SERVICES, IN CLASS 44 (U.S. CLS. 100 AND 101).

FIRST USE 0-0-2001; IN COMMERCE 0-0-2001.

FOR: INDICATING MEMBERSHIP IN AN ORGANIZATION SEEKING TO RESTORE THE AMERICAN CHESTNUT TREE TO ITS NATIVE FORESTS THROUGH A SCIENTIFIC RESEARCH AND BREEDING PROGRAM, IN CLASS 200 (U.S. CL. 200).

FIRST USE 10-31-2008; IN COMMERCE 10-31-2008.

THE MARK CONSISTS OF STANDARD CHARACTERS WITHOUT CLAIM TO ANY PARTICULAR FONT, STYLE, SIZE, OR COLOR.

SN 77-363,196, FILED 1-3-2008.

ANDREA K. NADELMAN, EXAMINING ATTORNEY

Int. Cl.: 11

Prior U.S. Cls.: 13, 21, 23, 31, and 34

United States Patent and Trademark Office

Reg. No. 3,577,629

Registered Feb. 17, 2009

**TRADEMARK
PRINCIPAL REGISTER**

EVENSEAR

DIMPLEX NORTH AMERICA LIMITED (CANADA CORPORATION)

1367 INDUSTRIAL ROAD

CAMBRIDGE, ONTARIO, CANADA N1R7G8

FOR: ELECTRIC GRILLS, IN CLASS 11 (U.S. CLS. 13, 21, 23, 31 AND 34).

FIRST USE 4-0-2008; IN COMMERCE 4-0-2008.

THE MARK CONSISTS OF STANDARD CHARACTERS WITHOUT CLAIM TO ANY PARTICULAR FONT, STYLE, SIZE, OR COLOR.

PRIORITY CLAIMED UNDER SEC. 44(D) ON CANADA APPLICATION NO. 1373557, FILED 11-27-2007.

SN 77-363,601, FILED 1-3-2008.

JIM RINGLE, EXAMINING ATTORNEY

Int. Cl.: 36

Prior U.S. Cls.: 100, 101, and 102

United States Patent and Trademark Office

Reg. No. 3,577,630

Registered Feb. 17, 2009

**SERVICE MARK
PRINCIPAL REGISTER**



AUCTOS CAPITAL MANAGEMENT LLC (DELA-
WARE LIMITED LIABILITY COMPANY)
899 SOUTH PLYMOUTH COURT, #2303
CHICAGO, IL 60605

FIRST USE 11-0-2007; IN COMMERCE 11-0-2007.

FOR: FINANCIAL SERVICES, NAMELY, OPERA-
TION AND MANAGEMENT OF HEDGE FUNDS,
COMMODITY POOLS AND OTHER COLLECTIVE
INVESTMENT VEHICLES, AND TRADING FOR
OTHERS OF SECURITIES, OPTIONS, FUTURES,
DERIVATIVES, DEBT INSTRUMENTS AND COM-
MODITIES, IN CLASS 36 (U.S. CLS. 100, 101 AND
102).

NO CLAIM IS MADE TO THE EXCLUSIVE
RIGHT TO USE "CAPITAL MANAGEMENT",
APART FROM THE MARK AS SHOWN.

SN 77-363,606, FILED 1-3-2008.

MELISSA VALLILLO, EXAMINING ATTORNEY

Int. Cl.: 31

Prior U.S. Cls.: 1 and 46

United States Patent and Trademark Office

Reg. No. 3,577,631

Registered Feb. 17, 2009

**TRADEMARK
PRINCIPAL REGISTER**



HBH ENTERPRISES (UTAH CORPORATION)
1060 N SPRING CREEK PLACE
SPRINGVILLE, UT 84663

THE STIPPLING IS A FEATURE OF THE MARK
AND DOES NOT INDICATE COLOR.

FOR: DOG TREATS, IN CLASS 31 (U.S. CLS. 1
AND 46).

SN 77-363,653, FILED 1-3-2008.

FIRST USE 2-12-2008; IN COMMERCE 2-12-2008.

RONALD MCMORROW, EXAMINING ATTORNEY

Int. Cl.: 41

Prior U.S. Cls.: 100, 101, and 107

United States Patent and Trademark Office

Reg. No. 3,577,632

Registered Feb. 17, 2009

SERVICE MARK
PRINCIPAL REGISTER

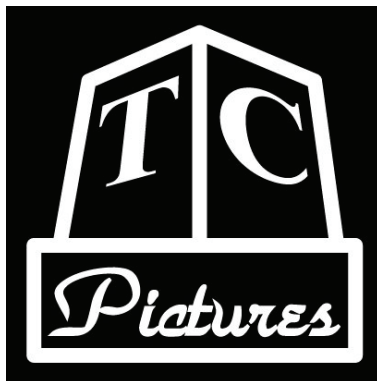

CLARK, THOMAS C (UNITED STATES INDIVIDUAL)
307 COCHECO COURT
DOVER, NH 03820

FOR: PRODUCTION AND DISTRIBUTION OF MOTION PICTURES, IN CLASS 41 (U.S. CLS. 100, 101 AND 107).

FIRST USE 1-24-2008; IN COMMERCE 2-12-2008.

NO CLAIM IS MADE TO THE EXCLUSIVE RIGHT TO USE "PICTURES", APART FROM THE MARK AS SHOWN.

THE MARK CONSISTS OF TWO GEOMETRICAL TRAPEZIA ARE PLACED SIDE-BY-SIDE TO SHARE A COMMON EDGE. THE LETTERS "T" AND "C" ARE PLACED IN THE TOP HALF OF THEM, ONE LETTER FOR EACH SHAPE. THE LETTERS ARE THEN SKEWED TO APPEAR TO RUN PARALLEL TO THE TRAPEZIUM'S EDGES. A WIDE RECTANGLE IS THEN PLACED OVER THE BOTTOM PORTION AND CONTAINS THE TEXT "PICTURES".

SN 77-363,818, FILED 1-3-2008.

FRANK LATTUCA, EXAMINING ATTORNEY

Int. Cl.: 9

Prior U.S. Cls.: 21, 23, 26, 36, and 38

Reg. No. 3,577,633

United States Patent and Trademark Office

Registered Feb. 17, 2009

**TRADEMARK
PRINCIPAL REGISTER**

RUBY COUTURE

THE FIND, AGAIN LLC (MINNESOTA LIMITED
LIABILITY COMPANY)
7820 EDEN PRAIRIE ROAD
EDEN PRAIRIE, MN 55347

THE MARK CONSISTS OF STANDARD CHAR-
ACTERS WITHOUT CLAIM TO ANY PARTICULAR
FONT, STYLE, SIZE, OR COLOR.

FOR: MP3 PLAYER CASES, CAMERA BAGS,
COMPUTER BAGS, DVD PLAYER BAGS, MOBILE
PHONE CASES, PDA CASES, IN CLASS 9 (U.S. CLS.
21, 23, 26, 36 AND 38).

SN 77-364,201, FILED 1-4-2008.

FIRST USE 8-31-2008; IN COMMERCE 8-31-2008.

KEVIN DINALLO, EXAMINING ATTORNEY

Int. Cl.: 5

Prior U.S. Cls.: 6, 18, 44, 46, 51, and 52

United States Patent and Trademark Office

Reg. No. 3,577,634

Registered Feb. 17, 2009

**TRADEMARK
PRINCIPAL REGISTER**

TRILLIUM

REGAL CHEMICAL COMPANY (GEORGIA CORPORATION)
P.O. BOX 900
ALPHARETTA, GA 30329

THE MARK CONSISTS OF STANDARD CHARACTERS WITHOUT CLAIM TO ANY PARTICULAR FONT, STYLE, SIZE, OR COLOR.

FOR: HERBICIDES FOR AGRICULTURAL, COMMERCIAL AND DOMESTIC USE, IN CLASS 5 (U.S. CLS. 6, 18, 44, 46, 51 AND 52).

SN 77-365,816, FILED 1-7-2008.

FIRST USE 1-22-2008; IN COMMERCE 1-22-2008.

DANIEL BRODY, EXAMINING ATTORNEY

Int. Cl.: 25

Prior U.S. Cls.: 22 and 39

United States Patent and Trademark Office

Reg. No. 3,577,635

Registered Feb. 17, 2009

TRADEMARK
PRINCIPAL REGISTER



GUYANA FOOTBALL FEDERATION (GUYANA CORPORATION)
16294 S.W. 76TH STREET
MIAMI, FL 33193

FOR: CAPS; POLO SHIRTS; SHIRTS, IN CLASS 25 (U.S. CLS. 22 AND 39).

FIRST USE 1-19-2008; IN COMMERCE 10-4-2008.

NO CLAIM IS MADE TO THE EXCLUSIVE RIGHT TO USE "GUYANA NATIONAL FOOTBALL TEAM", APART FROM THE MARK AS SHOWN.

THE STIPPLING IS FOR SHADING PURPOSES.

THE MARK CONSISTS OF A GRAPHIC OF A JAGUAR WITH ITS MOUTH OPEN. ON THE TOP OF THE JAGUARS HEAD IS A SOCCER BALL. ON TOP OF THE SOCCER BALL ARE THE STYLIZED WORDS "GOLDEN JAGUARS" AND BELOW THE JAGUAR ARE THE STYLIZED WORDS "GUYANA NATIONAL FOOTBALL TEAM". THERE ARE WAVY VERTICAL LINES ON EITHER SIDE OF THE JAGUAR'S HEAD.

SN 77-365,876, FILED 1-7-2008.

ALYSSA STEEL, EXAMINING ATTORNEY

Int. Cl.: 9

Prior U.S. Cls.: 21, 23, 26, 36, and 38

Reg. No. 3,577,636

United States Patent and Trademark Office

Registered Feb. 17, 2009

**TRADEMARK
PRINCIPAL REGISTER**

AXICHROM

GE HEALTHCARE BIO-SCIENCES AB (SWEDEN
PRIVATE LIMITED LIABILITY COMPANY)
30 BJORKGATAN
UPPSALA, SWEDEN SE-75184

FOR: SCIENTIFIC APPARATUS AND INSTRUMENTS, NAMELY, CHROMATOGRAPHY COLUMNS FOR USE IN PURIFICATION IN THE LABORATORY AND PARTS AND FITTINGS THEREFOR, IN CLASS 9 (U.S. CLS. 21, 23, 26, 36 AND 38).

FIRST USE 12-0-2007; IN COMMERCE 12-0-2007.

THE MARK CONSISTS OF STANDARD CHARACTERS WITHOUT CLAIM TO ANY PARTICULAR FONT, STYLE, SIZE, OR COLOR.

SN 77-366,193, FILED 1-8-2008.

SAIMA MAKHDOOM, EXAMINING ATTORNEY

Int. Cl.: 36

Prior U.S. Cls.: 100, 101, and 102

United States Patent and Trademark Office

Reg. No. 3,577,637

Registered Feb. 17, 2009

**SERVICE MARK
PRINCIPAL REGISTER**

THE EMBER FOUNDATION

THE EMBER FOUNDATION (ILLINOIS NON-
PROFIT CORPORATION)
SUITE 208
3553 W. PETERSON AVENUE
CHICAGO, IL 60659

FOR: ELEEMOSYNARY SERVICES IN THE
FIELD OF MONETARY DONATIONS FOR JEWISH
RELIGIOUS EDUCATION, IN CLASS 36 (U.S. CLS.
100, 101 AND 102).

FIRST USE 8-0-2007; IN COMMERCE 8-0-2007.

THE MARK CONSISTS OF STANDARD CHAR-
ACTERS WITHOUT CLAIM TO ANY PARTICULAR
FONT, STYLE, SIZE, OR COLOR.

NO CLAIM IS MADE TO THE EXCLUSIVE
RIGHT TO USE "FOUNDATION", APART FROM
THE MARK AS SHOWN.

SN 77-366,596, FILED 1-8-2008.

VIVIAN MICZNIK FIRST, EXAMINING ATTOR-
NEY

Int. Cl.: 43

Prior U.S. Cls.: 100 and 101

United States Patent and Trademark Office

Reg. No. 3,577,638

Registered Feb. 17, 2009

**SERVICE MARK
PRINCIPAL REGISTER**



GUSTO GRILLED ORGANICS, INC. (NEW YORK
CORPORATION)
CHACABUCO 96, 20. PISO
BUENOS AIRES, ARGENTINA

FIRST USE 1-31-2008; IN COMMERCE 1-31-2008.

SN 77-367,153, FILED 1-9-2008.

FOR: FAST FOOD RESTAURANTS FEATURING
ORGANIC FOODS, IN CLASS 43 (U.S. CLS. 100 AND
101).

ANTHONY RINKER, EXAMINING ATTORNEY

Int. Cl.: 11

Prior U.S. Cls.: 13, 21, 23, 31, and 34

United States Patent and Trademark Office

Reg. No. 3,577,639

Registered Feb. 17, 2009

**TRADEMARK
PRINCIPAL REGISTER**



SURVEX CORPORATION (TAIWAN CORPORATION)
IF, NO. 19, LANE 91 JUNGWU ROAD
EAST DISTRICT
TAICHUNG CITY 401, TAIWAN

FOR: PEDESTALS, NAMELY SINK PEDESTALS AND LAVATORY PEDESTALS; SHOWERS AND SHOWER INSTALLATIONS; SHOWER HEADS; BATH SPOUTS; HYDRANTS; FAUCETS; MIXER FAUCETS FOR WATER PIPES; WATER FAUCET SPOUTS; TOUCHLESS FLUSHING APPARATUS, NAMELY, TOUCHLESS WATER CONTROL VALVES; PLUMBING FITTINGS, NAMELY, VALVES, FAUCET FILTERS, COCKS; PLUMBING FIXTURES, NAMELY, SHOWER SPRAYERS,

SHOWER MIXERS, SINK SPRAYERS, IN CLASS 11 (U.S. CLS. 13, 21, 23, 31 AND 34).

FIRST USE 8-0-2008; IN COMMERCE 10-0-2008.

THE COLOR(S) RED, BLUE AND BLACK IS/ARE CLAIMED AS A FEATURE OF THE MARK.

THE MARK CONSISTS OF A RED "S" INTERSECTED BY A BLUE "V". BOTH LETTERS ARE PARTIALLY OUTLINED IN BLACK.

SN 77-367,568, FILED 1-9-2008.

JULIE WATSON, EXAMINING ATTORNEY

Int. Cl.: 43

Prior U.S. Cls.: 100 and 101

United States Patent and Trademark Office

Reg. No. 3,577,640

Registered Feb. 17, 2009

**SERVICE MARK
PRINCIPAL REGISTER**

HAPPY KIDS HAPPY MOMS

MCDONALD'S CORPORATION (DELAWARE
CORPORATION)
ONE MCDONALD'S PLAZA
OAK BROOK, IL 60523

THE MARK CONSISTS OF STANDARD CHAR-
ACTERS WITHOUT CLAIM TO ANY PARTICULAR
FONT, STYLE, SIZE, OR COLOR.

FOR: PREPARATION OF FOOD AND BEVERA-
GES, RESTAURANT SERVICES, IN CLASS 43 (U.S.
CLS. 100 AND 101).

SN 77-367,655, FILED 1-9-2008.

FIRST USE 6-30-2007; IN COMMERCE 6-30-2007.

HOWARD SMIGA, EXAMINING ATTORNEY

Int. Cls.: 1 and 5

Prior U.S. Cls.: 1, 5, 6, 10, 18, 26, 44, 46, 51, and 52

United States Patent and Trademark Office

Reg. No. 3,577,641

Registered Feb. 17, 2009

**TRADEMARK
PRINCIPAL REGISTER**

SANBIO

TEDESCHI, BRUCE J (UNITED STATES INDIVIDUAL)
787 VERDEMONT CIRCLE
SIMI VALLEY, CA 93065

FOR: BIOLOGICAL TISSUE, NAMELY, BLOOD, STEM CELLS, UMBILICAL CORDS AND PLACENTAS FOR SCIENTIFIC AND MEDICAL RESEARCH USE, IN CLASS 1 (U.S. CLS. 1, 5, 6, 10, 26 AND 46).

FIRST USE 11-5-1998; IN COMMERCE 11-5-1998.

FOR: DIAGNOSTIC KITS CONSISTING PRIMARILY OF MONOCLONAL ANTIBODIES, BUFFERS,

AND REAGENTS FOR USE IN DISEASE TESTING; STEM CELLS FOR MEDICAL OR VETERINARY USE, IN CLASS 5 (U.S. CLS. 6, 18, 44, 46, 51 AND 52).

FIRST USE 11-5-1998; IN COMMERCE 11-5-2008.

THE MARK CONSISTS OF STANDARD CHARACTERS WITHOUT CLAIM TO ANY PARTICULAR FONT, STYLE, SIZE, OR COLOR.

SN 77-368,476, FILED 1-10-2008.

MARC LEIPZIG, EXAMINING ATTORNEY

Int. Cls.: 39 and 43

Prior U.S. Cls.: 100, 101, and 105

United States Patent and Trademark Office

Reg. No. 3,577,642

Registered Feb. 17, 2009

**SERVICE MARK
PRINCIPAL REGISTER**



THE CORYN GROUP LLC II (DELAWARE LIMITED LIABILITY COMPANY)
7 CAMPUS BOULEVARD
NO. 100
NEWTOWN SQUARE, PA 190733295

FOR: ARRANGING AND PROVIDING TRAVEL VACATION PACKAGES, NAMELY, MAKING RESERVATIONS AND BOOKINGS FOR TRANSPORTATION, IN CLASS 39 (U.S. CLS. 100 AND 105).

FIRST USE 12-14-2007; IN COMMERCE 12-14-2007.

FOR: ARRANGING AND PROVIDING TRAVEL VACATION PACKAGES, NAMELY, MAKING RESERVATIONS AND BOOKINGS FOR TEMPORARY LODGING, IN CLASS 43 (U.S. CLS. 100 AND 101).

FIRST USE 12-14-2007; IN COMMERCE 12-14-2007.

OWNER OF U.S. REG. NOS. 1,462,268, 2,666,330, AND OTHERS.

NO CLAIM IS MADE TO THE EXCLUSIVE RIGHT TO USE "LEISURE GROUP", APART FROM THE MARK AS SHOWN.

THE COLOR(S) RED, YELLOW, WHITE, AND DARK BLUE IS/ARE CLAIMED AS A FEATURE OF THE MARK.

THE MARK CONSISTS OF A DESIGN OF AN APPLE, WITH THE BODY OF THE APPLE IN RED, A REFLECTION MARK ON THE BODY OF THE APPLE IN WHITE AND THE STEM IN YELLOW, WITH THE WORDS "APPLE LEISURE GROUP" IN DARK BLUE.

SN 77-368,525, FILED 1-10-2008.

COURTNEY MCCORMICK, EXAMINING ATTORNEY

Int. Cl.: 5

Prior U.S. Cls.: 6, 18, 44, 46, 51, and 52

United States Patent and Trademark Office

Reg. No. 3,577,643

Registered Feb. 17, 2009

**TRADEMARK
PRINCIPAL REGISTER**

Buona Vita

FARO, ANTHONY E. (FLORIDA CORPORATION), DBA FLORIDA PROFESSIONAL CHIROPRACTIC,
SUITE 105
100 S. SCENIC HWY
LAKE WALES, FL 33853

FOR: DIETARY AND NUTRITIONAL SUPPLEMENTS; HERBAL SUPPLEMENTS; HOMEOPATHIC SUPPLEMENTS; MINERAL NUTRITIONAL SUPPLEMENTS; NUTRACEUTICALS FOR USE AS A DIETARY SUPPLEMENT; NUTRITIONAL SUPPLEMENTS; NUTRITIONAL SUPPLEMENTS IN LOTION FORM SOLD AS A COMPONENT OF NUTRITIONAL SKIN CARE PRODUCTS; POWDERED NUTRITIONAL SUPPLEMENT DRINK

MIX; VITAMIN AND MINERAL SUPPLEMENTS, IN CLASS 5 (U.S. CLS. 6, 18, 44, 46, 51 AND 52).

FIRST USE 9-1-2008; IN COMMERCE 9-1-2008.

THE MARK CONSISTS OF STANDARD CHARACTERS WITHOUT CLAIM TO ANY PARTICULAR FONT, STYLE, SIZE, OR COLOR.

THE ENGLISH TRANSLATION OF THE WORD "BUONA VITA" IN THE MARK IS GOOD LIFE.

SN 77-368,992, FILED 1-10-2008.

GINA HAYES, EXAMINING ATTORNEY

Int. Cls.: 25 and 41

Prior U.S. Cls.: 22, 39, 100, 101, and 107

United States Patent and Trademark Office

Reg. No. 3,577,644

Registered Feb. 17, 2009

**TRADEMARK
SERVICE MARK
PRINCIPAL REGISTER**

NICO STAI

NICOLAS GARCIA-ARANDA STAI (SPAIN INDIVIDUAL)

1504 MCCOLLUM STREET
LOS ANGELES, CA 90026

FOR: CLOTHING, NAMELY, CAPS, HOODS, HATS, TOPS, SHIRTS, T-SHIRTS, PANTS, SWEAT-PANTS, SHORTS, SWEATSHIRTS, DRESSES, SKIRTS, JACKETS, JERSEYS, BELTS, ARM WARMERS, LEG WARMERS, HAND WARMERS, SCARVES, NECK TUBES, BATHROBES, INFANT AND TODDLER ONE PIECE CLOTHING, INFANT CLOTHING, NAMELY, T-SHIRTS, PANTS, SWEATERS AND CAPS, MANTLES, MUFFLERS, WRAPS, TIES, GLOVES, SOCKS, IN CLASS 25 (U.S. CLS. 22 AND 39).

FIRST USE 3-1-2000; IN COMMERCE 3-1-2005.

FOR: ENTERTAINMENT SERVICES, NAMELY, LIVE PERFORMANCES BY A MUSICAL BAND OR ROCK GROUP, IN CLASS 41 (U.S. CLS. 100, 101 AND 107).

FIRST USE 3-1-2000; IN COMMERCE 3-1-2005.

THE MARK CONSISTS OF STANDARD CHARACTERS WITHOUT CLAIM TO ANY PARTICULAR FONT, STYLE, SIZE, OR COLOR.

THE NAME(S), PORTRAIT(S), AND/OR SIGNATURE(S) SHOWN IN THE MARK IDENTIFIES A PARTICULAR LIVING INDIVIDUAL, WHOSE CONSENT(S) TO REGISTER IS SUBMITTED.

SN 77-369,108, FILED 1-11-2008.

KATHY DE JONGE, EXAMINING ATTORNEY

Int. Cl.: 35

Prior U.S. Cls.: 100, 101, and 102

United States Patent and Trademark Office

Reg. No. 3,577,645

Registered Feb. 17, 2009

**SERVICE MARK
PRINCIPAL REGISTER**

FIT STARTS HERE

LANE BRYANT PURCHASING CORP. (OHIO
CORPORATION)
3344 MORSE CROSSING ROAD
COLUMBUS, OH 43219

FOR: RETAIL STORE SERVICES FEATURING
WOMEN'S WEARING APPAREL AND ACCESSOR-
IES; COMPUTERIZED ON-LINE RETAIL STORE
SERVICES FEATURING WOMEN'S WEARING AP-
PAREL AND ACCESSORIES; MAIL ORDER CATA-
LOG SERVICES FEATURING WOMEN'S WEARING
APPAREL AND ACCESSORIES, IN CLASS 35 (U.S.
CLS. 100, 101 AND 102).

FIRST USE 2-20-2008; IN COMMERCE 2-20-2008.

THE MARK CONSISTS OF STANDARD CHAR-
ACTERS WITHOUT CLAIM TO ANY PARTICULAR
FONT, STYLE, SIZE, OR COLOR.

SN 77-369,854, FILED 1-11-2008.

KRISTIN DAHLING, EXAMINING ATTORNEY

Int. Cl.: 40

Prior U.S. Cls.: 100, 103, and 106

United States Patent and Trademark Office

Reg. No. 3,577,646

Registered Feb. 17, 2009

**SERVICE MARK
PRINCIPAL REGISTER**

Proud to be

KENOYER, LARA MALINN (UNITED STATES
INDIVIDUAL)
3501 BRIDGE ST
MONITOR, WA 98836

THE MARK CONSISTS OF STANDARD CHAR-
ACTERS WITHOUT CLAIM TO ANY PARTICULAR
FONT, STYLE, SIZE, OR COLOR.

FOR: IMPRINTING MESSAGES ON T-SHIRTS, IN
CLASS 40 (U.S. CLS. 100, 103 AND 106).

SN 77-370,389, FILED 1-13-2008.

FIRST USE 7-11-2008; IN COMMERCE 12-7-2008.

DAVID MURRAY, EXAMINING ATTORNEY

Int. Cl.: 5

Prior U.S. Cls.: 6, 18, 44, 46, 51, and 52

United States Patent and Trademark Office

Reg. No. 3,577,647

Registered Feb. 17, 2009

**TRADEMARK
PRINCIPAL REGISTER**

OPTIBALANCE

ADM ALLIANCE NUTRITION, INC. (ILLINOIS
CORPORATION)
4666 FARIES PARKWAY
DECATUR, IL 62526

THE MARK CONSISTS OF STANDARD CHAR-
ACTERS WITHOUT CLAIM TO ANY PARTICULAR
FONT, STYLE, SIZE, OR COLOR.

FOR: NUTRITIONAL FEED SUPPLEMENTS FOR
LIVESTOCK, IN CLASS 5 (U.S. CLS. 6, 18, 44, 46, 51
AND 52).

SN 77-370,689, FILED 1-14-2008.

FIRST USE 4-1-2008; IN COMMERCE 4-22-2008.

WON TEAK OH, EXAMINING ATTORNEY

Int. Cl.: 10

Prior U.S. Cls.: 26, 39, and 44

United States Patent and Trademark Office

Reg. No. 3,577,648

Registered Feb. 17, 2009

**TRADEMARK
PRINCIPAL REGISTER**

Halo

NUVASIVE, INC. (DELAWARE CORPORATION)
7475 LUSK BOULEVARD
SAN DIEGO, CA 92121

FOR: MEDICAL DEVICES FOR USE IN SURGERY, NAMELY, ORTHOPEDIC IMPLANTS, FIXATION PLATES, SCREWS, TARGETING SYSTEMS FOR SCREW PLACEMENT, INSTRUMENTS FOR ACCESSING A SURGICAL TARGET SITE, INSTRUMENTS FOR THE PREPARATION, DISTRACTION, AND SIZING A SURGICAL TARGET SITE, INSTRUMENTS FOR INSERTION OF IMPLANTS INTO A SURGICAL TARGET SITE, INSTRUMENTS FOR SECURING THE IMPLANTS TO BONE STRUCTURES WITHIN A SURGICAL TARGET SITE,

AND CONTAINERS FOR HOLDING, TRANSPORTING, AND STERILIZING SUCH IMPLANTS, PLATES, SCREWS, AND INSTRUMENTS, IN CLASS 10 (U.S. CLS. 26, 39 AND 44).

FIRST USE 12-31-2007; IN COMMERCE 12-31-2007.

THE MARK CONSISTS OF STANDARD CHARACTERS WITHOUT CLAIM TO ANY PARTICULAR FONT, STYLE, SIZE, OR COLOR.

SN 77-371,096, FILED 1-14-2008.

JOHN WILKE, EXAMINING ATTORNEY

Int. Cl.: 41

Prior U.S. Cls.: 100, 101, and 107

United States Patent and Trademark Office

Reg. No. 3,577,649

Registered Feb. 17, 2009

**SERVICE MARK
PRINCIPAL REGISTER**

HEARTS AROUND THE WORLD

STARDUST CHILDRENS FOUNDATION INC.
(MASSACHUSETTS CORPORATION)
6 LODGE LANE
NATICK, MA 01760

FOR: EDUCATION SERVICES, NAMELY, PROVIDING LIVE AND ON-LINE CLASSES, SEMINARS, WORKSHOPS IN PERSON, OVER THE PHONE, VIA THE INTERNET OR OTHER MEDIA IN THE FIELD OF EMPOWERING INDIVIDUALS AND GROUPS, IN CLASS 41 (U.S. CLS. 100, 101 AND 107).

FIRST USE 8-26-2008; IN COMMERCE 8-26-2008.

THE MARK CONSISTS OF STANDARD CHARACTERS WITHOUT CLAIM TO ANY PARTICULAR FONT, STYLE, SIZE, OR COLOR.

SN 77-372,495, FILED 1-15-2008.

KOURTNEE HODGES, EXAMINING ATTORNEY

Prior U.S. Cl.: B

United States Patent and Trademark Office

Reg. No. 3,577,650

Registered Feb. 17, 2009

CERTIFICATION MARK
SERVICES
PRINCIPAL REGISTER



INTERNATIONAL ASSOCIATION FOR CONTINUING EDUCATION AND TRAINING (NORTH CAROLINA NON-PROFIT ASSOCIATION)

1760 OLD MEADOW ROAD
SUITE 500
MCLEAN, VA 22102

FOR: CONTINUING EDUCATION AND TRAINING PROGRAMS FOR ORGANIZATIONS OF ALL SIZES ACROSS A BROAD RANGE OF INDUSTRIAL AND PROFESSIONAL FIELDS, IN CLASS B (U.S. CL. B).

FIRST USE 1-25-2008, THE MARK WAS FIRST USED ANYWHERE IN A DIFFERENT FORM OTHER THAN THAT SOUGHT TO BE REGISTERED ON 02/00/1998.; IN COMMERCE 1-25-2008, THE MARK WAS FIRST USED IN COMMERCE IN A DIFFERENT FORM OTHER THAN THAT SOUGHT TO BE REGISTERED ON 02/00/1998..

OWNER OF U.S. REG. NO. 2,643,244.

THE MARK CONSISTS OF THE WORDS "AUTHORIZED IACET PROVIDER" WITHIN A RECTANGULAR BORDER, CONTAINING HORIZONTAL BANDS NEAR TOP AND BOTTOM, AND A STYLIZED GLOBE DESIGN WITHIN THE LETTER "C" OF "IACET".

THE CERTIFICATION MARK, AS INTENDED TO BE USED BY AUTHORIZED PERSONS, IS INTENDED TO CERTIFY THAT THE SERVICES OF THAT PROVIDER ARE OFFERED AND DELIVERED WITH QUALITY AND CONSISTENCY AND IN ACCORDANCE WITH THE GUIDELINES, CRITERIA, STANDARDS AND PROCEDURES WHICH ARE DEVELOPED, IMPLEMENTED AND EVALUATED BY THE CERTIFIER.

SEC. 2(F) AS TO "AUTHORIZED IACET PROVIDER".

SN 77-372,506, FILED 1-15-2008.

ARETHA SOMERVILLE, EXAMINING ATTORNEY

Int. Cl.: 20

Prior U.S. Cls.: 2, 13, 22, 25, 32, and 50

Reg. No. 3,577,651

United States Patent and Trademark Office

Registered Feb. 17, 2009

**TRADEMARK
PRINCIPAL REGISTER**

BANANAGIRL

OSPREY PRODUCT DEVELOPMENT (COLORADO LIMITED LIABILITY COMPANY)
SUITE 119
405 MASON COURT
FORT COLLINS, CO 80524

FOR: PORTABLE PLASTIC CONTAINERS IN VARIOUS CONFIGURATIONS AND COLORS WHICH PROTECT ANY FRUIT OR VEGETABLE, IN CLASS 20 (U.S. CLS. 2, 13, 22, 25, 32 AND 50).

FIRST USE 11-25-2008; IN COMMERCE 11-25-2008.

THE MARK CONSISTS OF STANDARD CHARACTERS WITHOUT CLAIM TO ANY PARTICULAR FONT, STYLE, SIZE, OR COLOR.

SN 77-372,592, FILED 1-15-2008.

GIANCARLO CASTRO, EXAMINING ATTORNEY

Int. Cl.: 16

Prior U.S. Cls.: 2, 5, 22, 23, 29, 37, 38, and 50

Reg. No. 3,577,652

United States Patent and Trademark Office

Registered Feb. 17, 2009

**TRADEMARK
PRINCIPAL REGISTER**

EMERGEN SEAT

BYERS, FREDRICK RANDOLPH II (UNITED STATES INDIVIDUAL)

457 NARROW SHORE ROAD

AYDLETT, NC 27916

FOR: TOILET SEAT COVER PAPER, IN CLASS 16 (U.S. CLS. 2, 5, 22, 23, 29, 37, 38 AND 50).

FIRST USE 2-1-2008; IN COMMERCE 2-1-2008.

THE MARK CONSISTS OF STANDARD CHARACTERS WITHOUT CLAIM TO ANY PARTICULAR FONT, STYLE, SIZE, OR COLOR.

NO CLAIM IS MADE TO THE EXCLUSIVE RIGHT TO USE "SEAT", APART FROM THE MARK AS SHOWN.

SN 77-373,273, FILED 1-16-2008.

ANTHONY RINKER, EXAMINING ATTORNEY

Int. Cl.: 10

Prior U.S. Cls.: 26, 39, and 44

United States Patent and Trademark Office

Reg. No. 3,577,653

Registered Feb. 17, 2009

**TRADEMARK
PRINCIPAL REGISTER**

CREATURE COMFORT

HELEN OF TROY LIMITED (BARBADOS CORPORATION)
P.O. BOX 836E
13 8TH AVENUE, BELLEVILLE
ST. MICHAEL, BARBADOS

FOR: ELECTRIC FOOT SPA MASSAGERS; MASSAGE APPARATUS, IN CLASS 10 (U.S. CLS. 26, 39 AND 44).

FIRST USE 10-1-2008; IN COMMERCE 10-1-2008.

THE MARK CONSISTS OF STANDARD CHARACTERS WITHOUT CLAIM TO ANY PARTICULAR FONT, STYLE, SIZE, OR COLOR.

SN 77-373,681, FILED 1-16-2008.

TRACY WHITTAKER-BROWN, EXAMINING ATTORNEY

Int. Cl.: 33

Prior U.S. Cls.: 47 and 49

United States Patent and Trademark Office

Reg. No. 3,577,654

Registered Feb. 17, 2009

**TRADEMARK
PRINCIPAL REGISTER**

Barbarians Wealth

USB CORPORATION (ILLINOIS CORPORATION)
2251 WESTVIEW DRIVE
DES PLAINES, IL 60018

THE MARK CONSISTS OF STANDARD CHAR-
ACTERS WITHOUT CLAIM TO ANY PARTICULAR
FONT, STYLE, SIZE, OR COLOR.

FOR: GRAPE WINE, IN CLASS 33 (U.S. CLS. 47
AND 49).

SN 77-374,940, FILED 1-18-2008.

FIRST USE 11-1-2008; IN COMMERCE 11-1-2008.

GINA HAYES, EXAMINING ATTORNEY

Int. Cl.: 33

Prior U.S. Cls.: 47 and 49

United States Patent and Trademark Office

Reg. No. 3,577,655

Registered Feb. 17, 2009

**TRADEMARK
PRINCIPAL REGISTER**

go to heaven

USB CORPORATION (ILLINOIS CORPORATION)
2251 WESTVIEW DRIVE
DES PLAINES, IL 60018

THE MARK CONSISTS OF STANDARD CHAR-
ACTERS WITHOUT CLAIM TO ANY PARTICULAR
FONT, STYLE, SIZE, OR COLOR.

FOR: BRANDY, IN CLASS 33 (U.S. CLS. 47 AND
49).

SN 77-374,978, FILED 1-18-2008.

FIRST USE 11-1-2008; IN COMMERCE 11-1-2008.

GINA HAYES, EXAMINING ATTORNEY

Int. Cl.: 35

Prior U.S. Cls.: 100, 101, and 102

United States Patent and Trademark Office

Reg. No. 3,577,656

Registered Feb. 17, 2009

**SERVICE MARK
PRINCIPAL REGISTER**



PORTAL ASSOCIATES LLC (NEW YORK LIMITED LIABILITY COMPANY), DBA RESU-PIC.COM,
P.O. BOX 471728
BROOKLYN, NY 11216

FOR: PROVIDING AN INTERACTIVE WEB SITE THAT FACILITATES THE PREPARATION OF RESUMES, IN CLASS 35 (U.S. CLS. 100, 101 AND 102).

FIRST USE 6-20-2007; IN COMMERCE 8-20-2007.

THE COLOR(S) BLUE, BLACK, WHITE AND RED IS/ARE CLAIMED AS A FEATURE OF THE MARK.

THE MARK CONSISTS OF A BLUE GLOBE REPRESENTING BODIES OF WATER AS WELL AS OUTLINING THE CONTINENTS OF THE WORLD AND THE SILHOUETTE OF A MAN CARRYING A BRIEFCASE IN BLACK. THE WORDING "RESU" APPEARS IN RED, "PIC.COM" IN BLUE AND "DON'T JUST POST YOUR RESUME, POST YOURSELF!!" IN BLACK. WHITE IS IN THE BACKGROUND.

SN 77-375,046, FILED 1-18-2008.

RENEE MCCRAY, EXAMINING ATTORNEY

Int. Cl.: 41

Prior U.S. Cls.: 100, 101, and 107

United States Patent and Trademark Office

Reg. No. 3,577,657

Registered Feb. 17, 2009

**SERVICE MARK
PRINCIPAL REGISTER**

FOND FAREWELL

FINAL FAREWELL, INC. (ARIZONA CORPORATION)
12262 N. 56TH STREET
GLENDALE, AZ 85304

FOR: END-OF-LIFE CONSULTING SERVICES,
NAMELY, VIDEOTAPE PRODUCTION AND
AUDIO RECORDING AND PRODUCTION IN RE-
FERENCE TO MESSAGES TO LOVED ONES, IN
CLASS 41 (U.S. CLS. 100, 101 AND 107).

FIRST USE 5-0-2008; IN COMMERCE 5-0-2008.

THE MARK CONSISTS OF STANDARD CHAR-
ACTERS WITHOUT CLAIM TO ANY PARTICULAR
FONT, STYLE, SIZE, OR COLOR.

SN 77-376,316, FILED 1-21-2008.

JANICE L. MCMORROW, EXAMINING ATTOR-
NEY

Int. Cl.: 43

Prior U.S. Cls.: 100 and 101

United States Patent and Trademark Office

Reg. No. 3,577,658

Registered Feb. 17, 2009

**SERVICE MARK
PRINCIPAL REGISTER**

CAFE RACER

H-D MICHIGAN, INC. (MICHIGAN CORPORATION)

315 W. HURON, SUITE 400

ANN ARBOR, MI 48103

FOR: CAFE AND RESTAURANT SERVICES, IN CLASS 43 (U.S. CLS. 100 AND 101).

FIRST USE 7-0-2008; IN COMMERCE 7-0-2008.

THE MARK CONSISTS OF STANDARD CHARACTERS WITHOUT CLAIM TO ANY PARTICULAR FONT, STYLE, SIZE, OR COLOR.

NO CLAIM IS MADE TO THE EXCLUSIVE RIGHT TO USE "CAFE", APART FROM THE MARK AS SHOWN.

SN 77-378,075, FILED 1-23-2008.

AISHA SALEM, EXAMINING ATTORNEY

Int. Cl.: 3

Prior U.S. Cls.: 1, 4, 6, 50, 51, and 52

United States Patent and Trademark Office

Reg. No. 3,577,659

Registered Feb. 17, 2009

TRADEMARK
PRINCIPAL REGISTER

DeLaine
by
Michelle Douglas

MICHELLE DOUGLAS INTERNATIONAL, INC.
(INDIANA CORPORATION)
8865 WEST 400 NORTH
SUITE 120
MICHIGAN CITY, IN 46360

FIRST USE 8-1-2008; IN COMMERCE 9-15-2008.

"MICHELLE DOUGLAS" DOES NOT IDENTIFY
A PARTICULAR LIVING INDIVIDUAL.

FOR: BEAUTY CREAMS AND BEAUTY LO-
TIONS; BODY AND BEAUTY CARE COSMETICS;
FACE AND BODY CREAMS; FACE AND BODY
LOTIONS, IN CLASS 3 (U.S. CLS. 1, 4, 6, 50, 51 AND
52).

SN 77-378,086, FILED 1-23-2008.

GRETTA YAO, EXAMINING ATTORNEY

Int. Cl.: 9

Prior U.S. Cls.: 21, 23, 26, 36, and 38

United States Patent and Trademark Office

Reg. No. 3,577,660

Registered Feb. 17, 2009

**TRADEMARK
PRINCIPAL REGISTER**

HF-mLVDS

SILICONWORKS CO., LTD. (REPUBLIC OF KOREA CORPORATION)
104-13, MUNJI-DONG, YUSEONG-GU
DAEJEON-SI, REPUBLIC OF KOREA

FOR: SEMICONDUCTOR CHIPS, INTEGRATED CIRCUITS, SILICON WAFERS, MICROPROCESSORS, COMPUTER CHIPS, LIQUID CRYSTAL DISPLAY MONITORS, APPLICATION SPECIFIC STANDARD PRINTED CIRCUIT BOARDS, IN CLASS 9 (U.S. CLS. 21, 23, 26, 36 AND 38).

FIRST USE 4-10-2008; IN COMMERCE 4-10-2008.

THE MARK CONSISTS OF STANDARD CHARACTERS WITHOUT CLAIM TO ANY PARTICULAR FONT, STYLE, SIZE, OR COLOR.

SN 77-378,151, FILED 1-23-2008.

CHARLES L. JENKINS, EXAMINING ATTORNEY

Int. Cls.: 44 and 45

Prior U.S. Cls.: 100 and 101

United States Patent and Trademark Office

Reg. No. 3,577,661

Registered Feb. 17, 2009

**SERVICE MARK
PRINCIPAL REGISTER**

RHEMA

SANTOS, REYNALDO (UNITED STATES INDIVIDUAL)

SUITE 338

3605 LONG BEACH BLVD.

LONG BEACH, CA 90807 AND

VIGILIA, HELEN (UNITED STATES INDIVIDUAL)

SUITE 338

3605 LONG BEACH BLVD.

LONG BEACH, CA 90807

FOR: HOME HEALTH CARE SERVICES; HOME NURSING AID SERVICES; NURSING CARE; NURSING SERVICES; SPEECH AND HEARING THERAPY; PHYSICAL THERAPY; HEALTH CARE; MANAGED HEALTH CARE SERVICES, IN CLASS 44 (U.S. CLS. 100 AND 101).

FIRST USE 10-1-2007; IN COMMERCE 1-1-2008.

FOR: PERSONAL CARE ASSISTANCE OF ACTIVITIES OF DAILY LIVING, SUCH AS BATHING, GROOMING AND PERSONAL MOBILITY FOR MENTALLY OR PHYSICALLY CHALLENGED PEOPLE; PERSONAL CHEF SERVICES, IN CLASS 45 (U.S. CLS. 100 AND 101).

FIRST USE 10-1-2007; IN COMMERCE 1-1-2008.

THE MARK CONSISTS OF STANDARD CHARACTERS WITHOUT CLAIM TO ANY PARTICULAR FONT, STYLE, SIZE, OR COLOR.

THE FOREIGN WORDING IN THE MARK TRANSLATES INTO ENGLISH AS WORD.

SN 77-378,968, FILED 1-23-2008.

BARBARA GAYNOR, EXAMINING ATTORNEY

Int. Cl.: 41

Prior U.S. Cls.: 100, 101, and 107

United States Patent and Trademark Office

Reg. No. 3,577,662

Registered Feb. 17, 2009

**SERVICE MARK
PRINCIPAL REGISTER**

EXTREME JUSTICE

EXTREME JUSTICE, LLC (VIRGINIA LIMITED
LIABILITY COMPANY)
7611 YELLOW LILY DRIVE, #204
MANASSAS, VA 20109

FOR: ENTERTAINMENT, NAMELY, PRODUCTION OF FILMS, TELEVISION SHOWS, VIDEO GAME SOFTWARE, ANIMATED FILMS AND ANIMATED TELEVISION SHOWS , IN CLASS 41 (U.S. CLS. 100, 101 AND 107).

FIRST USE 9-19-2008; IN COMMERCE 9-19-2008.

THE MARK CONSISTS OF STANDARD CHARACTERS WITHOUT CLAIM TO ANY PARTICULAR FONT, STYLE, SIZE, OR COLOR.

SN 77-379,103, FILED 1-23-2008.

ROBERT LAVACHE, EXAMINING ATTORNEY

Int. Cl.: 25

Prior U.S. Cls.: 22 and 39

United States Patent and Trademark Office

Reg. No. 3,577,663

Registered Feb. 17, 2009

**TRADEMARK
PRINCIPAL REGISTER**

MARTINI SOL

PHANTOM INDUSTRIES INC. (CANADA CORPORATION)
207 WESTON ROAD
TORONTO, ONTARIO, CANADA M6N4Z3

FOR: SWIMWEAR, IN CLASS 25 (U.S. CLS. 22 AND 39).

FIRST USE 12-19-2006; IN COMMERCE 12-19-2006.

THE MARK CONSISTS OF STANDARD CHARACTERS WITHOUT CLAIM TO ANY PARTICULAR FONT, STYLE, SIZE, OR COLOR.

THE ENGLISH TRANSLATION OF THE WORD "SOL" IN THE MARK IS SUN.

SN 77-379,517, FILED 1-24-2008.

BARNEY CHARLON, EXAMINING ATTORNEY

Int. Cls.: 16 and 41

Prior U.S. Cls.: 2, 5, 22, 23, 29, 37, 38, 50, 100, 101, and 107

Reg. No. 3,577,664

United States Patent and Trademark Office

Registered Feb. 17, 2009

**TRADEMARK
SERVICE MARK
PRINCIPAL REGISTER**

EM Electronic Musician

PENTON BUSINESS MEDIA, INC. (DELAWARE CORPORATION)
4TH FLOOR
249 WEST 17TH STREET
NEW YORK, NY 10011

FOR: MAGAZINES FEATURING INFORMATION IN THE FIELD OF MUSIC PRODUCTION AND MUSIC PRODUCTION TECHNOLOGY, IN CLASS 16 (U.S. CLS. 2, 5, 22, 23, 29, 37, 38 AND 50).

FIRST USE 2-0-2008; IN COMMERCE 2-0-2008.

FOR: PROVIDING ON-LINE PUBLICATIONS IN THE NATURE OF MAGAZINES, GUIDES AND NEWSLETTERS IN THE FIELD OF MUSIC PRODUCTION AND MUSIC PRODUCTION TECHNOLOGY; ON-LINE JOURNALS, NAMELY, BLOGS FEATURING INFORMATION IN THE FIELD OF MUSIC PRODUCTION AND MUSIC PRODUCTION TECHNOLOGY; ENTERTAINMENT SERVICES, NAMELY, PROVIDING WEBCASTS IN THE FIELD OF MUSIC PRODUCTION AND MUSIC PRODUC-

TION TECHNOLOGY; ENTERTAINMENT SERVICES, NAMELY, PROVIDING PODCASTS IN THE FIELD OF MUSIC PRODUCTION AND MUSIC PRODUCTION TECHNOLOGY, IN CLASS 41 (U.S. CLS. 100, 101 AND 107).

FIRST USE 1-15-2008; IN COMMERCE 1-15-2008.

THE MARK CONSISTS OF STANDARD CHARACTERS WITHOUT CLAIM TO ANY PARTICULAR FONT, STYLE, SIZE, OR COLOR.

OWNER OF U.S. REG. NOS. 1,496,331 AND 2,152,104.

SEC. 2(F) AS TO "ELECTRONIC MUSICIAN".

SN 77-379,913, FILED 1-24-2008.

MICHAEL ENGEL, EXAMINING ATTORNEY

Int. Cls.: 35 and 43

Prior U.S. Cls.: 100, 101, and 102

United States Patent and Trademark Office

Reg. No. 3,577,665

Registered Feb. 17, 2009

**SERVICE MARK
PRINCIPAL REGISTER**

COCOA LATTE

LAS VEGAS SANDS CORP. (NEVADA CORPORATION)
3355 LAS VEGAS BOULEVARD SOUTH
LAS VEGAS, NV 89109

FOR: RETAIL CANDY STORES; RETAIL STORE SERVICES IN THE FIELD OF BEVERAGES, BAKERY, ICE CREAMS, GELATOS AND OTHER CONFECTIONERY ITEMS, NAMELY, CANDIES, CHOCOLATE ARTICLES, CHOCOLATE SAUCES, SUGAR CONFECTIONERY, TRUFFLES, CARAMELS, TOFFEE, BRITTLES, WAFERS, NUTS, HOT AND COLD BEVERAGES, PIES, CAKES, COOKIES AND BROWNIES; RETAIL BAKERY SHOPS; TAKE-OUT BAKERY SERVICES, IN CLASS 35 (U.S. CLS. 100, 101 AND 102).

FIRST USE 6-20-2008; IN COMMERCE 6-20-2008.

FOR: CAFE AND RESTAURANT SERVICES; PREPARATION OF FOOD AND BEVERAGES; SERVING FOOD AND DRINKS, IN CLASS 43 (U.S. CLS. 100 AND 101).

FIRST USE 6-20-2008; IN COMMERCE 6-20-2008.

THE MARK CONSISTS OF STANDARD CHARACTERS WITHOUT CLAIM TO ANY PARTICULAR FONT, STYLE, SIZE, OR COLOR.

NO CLAIM IS MADE TO THE EXCLUSIVE RIGHT TO USE "COCOA", APART FROM THE MARK AS SHOWN.

SN 77-380,259, FILED 1-25-2008.

RAUL CORDOVA, EXAMINING ATTORNEY

Int. Cl.: 16

Prior U.S. Cls.: 2, 5, 22, 23, 29, 37, 38, and 50

United States Patent and Trademark Office

Reg. No. 3,577,666

Registered Feb. 17, 2009

**TRADEMARK
PRINCIPAL REGISTER**

CREATIVE IDEAS

EZEKIEL, MICHAEL (UNITED STATES INDIVIDUAL)
1235 SEAGULL TERRACE
HOLLYWOOD, FL 33019

FOR: HIGHLIGHTING MARKERS; HIGHLIGHTER PENS; COLOURED PENS; MARKING PENS; BALL POINT PENS, IN CLASS 16 (U.S. CLS. 2, 5, 22, 23, 29, 37, 38 AND 50).

FIRST USE 6-0-2008; IN COMMERCE 6-0-2008.

THE MARK CONSISTS OF STANDARD CHARACTERS WITHOUT CLAIM TO ANY PARTICULAR FONT, STYLE, SIZE, OR COLOR.

SN 77-380,903, FILED 1-25-2008.

MARY MUNSON, EXAMINING ATTORNEY

Int. Cl.: 37

Prior U.S. Cls.: 100, 103, and 106

United States Patent and Trademark Office

Reg. No. 3,577,667

Registered Feb. 17, 2009

**SERVICE MARK
PRINCIPAL REGISTER**



WHITTEN JR., JAMES A. (UNITED STATES INDIVIDUAL)
3130 SILVERMILL LOOP
LAND O LAKES, FL 34638

FOR: INSTALLATION, MAINTENANCE AND REPAIR OF COMPUTER HARDWARE; INSTALLATION, MAINTENANCE AND REPAIR OF ETHERNET AND WIRELESS NETWORKS; INSTALLATION AND REPAIR OF COMPUTER HARDWARE; COMPUTER INSTALLATION AND REPAIR; INSTALLATION OF COMPUTER NETWORKS; INSTALLATION OF COMPUTER SYSTEMS; MAINTENANCE AND REPAIR OF COMPUTER HARDWARE; MAINTENANCE AND REPAIR OF COMPUTER NETWORKS; MAINTENANCE OF COMPUTER HARDWARE; MAINTENANCE OF COMPUTER HARDWARE SYSTEMS; REPAIR OF COMPUTER HARDWARE; REPAIR OF DAMAGED COMPUTERS; UPDATING OF COMPUTER HARDWARE; UPGRADING OF COMPUTER HARDWARE; REPAIR OR MAINTENANCE OF COMPUTERS, IN CLASS 37 (U.S. CLS. 100, 103 AND 106).

FIRST USE 2-1-2008; IN COMMERCE 2-1-2008.

THE COLOR(S) TEAL, ORANGE, AND GRAY IS/ARE CLAIMED AS A FEATURE OF THE MARK.

THE MARK CONSISTS OF THE WORD "GEEKS" ALL LOWERCASE IN THE COLOR TEAL WITH AN ORANGE CIRCLE AROUND THE LOOPED PORTION OF BOTH "E"S. THE WORD "GEEKS" IS FOLLOWED BY A GRAY HYPHEN ("-"). THE HYPHEN ("-") IS FOLLOWED BY THE WORD "IN" ALL LOWERCASE, IN THE COLOR ORANGE, WHICH IS FOLLOWED BY A GRAY HYPHEN ("-"). THE GRAY HYPHEN ("-") IS FOLLOWED BY THE WORD "ROUTE" ALL LOWERCASE, IN THE COLOR GRAY. THE WORDS "GEEKS-IN-ROUTE" ARE PARTIALLY MIRRORED UPSIDE DOWN BELOW THEMSELVES IN EACH OF THEIR CORRESPONDING COLORS.

SN 77-381,419, FILED 1-26-2008.

LEIGH CAROLINE CASE, EXAMINING ATTORNEY

Int. Cl.: 5

Prior U.S. Cls.: 6, 18, 44, 46, 51, and 52

United States Patent and Trademark Office

Reg. No. 3,577,668

Registered Feb. 17, 2009

**TRADEMARK
PRINCIPAL REGISTER**

**Turn any drink into a
Sport drink!**

X23 HOLDINGS (UTAH LIMITED LIABILITY
COMPANY)
356 N. 750 W. D-9 SUITE 112
AMERICAN FORK, UT 84003

THE MARK CONSISTS OF STANDARD CHAR-
ACTERS WITHOUT CLAIM TO ANY PARTICULAR
FONT, STYLE, SIZE, OR COLOR.

FOR: ELECTROLYTE REPLACEMENT SOLU-
TIONS, IN CLASS 5 (U.S. CLS. 6, 18, 44, 46, 51 AND 52).

SN 77-382,495, FILED 1-28-2008.

FIRST USE 5-22-2008; IN COMMERCE 5-22-2008.

MATTHEW EINSTEIN, EXAMINING ATTORNEY

Int. Cl.: 41

Prior U.S. Cls.: 100, 101, and 107

United States Patent and Trademark Office

Reg. No. 3,577,669

Registered Feb. 17, 2009

**SERVICE MARK
PRINCIPAL REGISTER**

SNPwatch

23ANDME, INC. (DELAWARE CORPORATION)
2606 BAYSHORE PARKWAY
MOUNTAIN VIEW, CA 94043

THE MARK CONSISTS OF STANDARD CHAR-
ACTERS WITHOUT CLAIM TO ANY PARTICULAR
FONT, STYLE, SIZE, OR COLOR.

FOR: ON-LINE JOURNALS, NAMELY, BLOGS IN
THE FIELD OF MOLECULAR BIOLOGY, IN CLASS
41 (U.S. CLS. 100, 101 AND 107).

SN 77-382,873, FILED 1-29-2008.

FIRST USE 1-17-2008; IN COMMERCE 1-17-2008.

LINDSEY RUBIN, EXAMINING ATTORNEY

Int. Cl.: 25

Prior U.S. Cls.: 22 and 39

United States Patent and Trademark Office

Reg. No. 3,577,670

Registered Feb. 17, 2009

**TRADEMARK
PRINCIPAL REGISTER**

eco ike

MOSER, FAITH C. (UNITED STATES INDIVIDUAL)
215 FARMINGTON ROAD
PITTSBURGH, PA 15215

FOR: SHIRTS, IN CLASS 25 (U.S. CLS. 22 AND 39).

FIRST USE 3-7-2008; IN COMMERCE 3-7-2008.

THE MARK CONSISTS OF STANDARD CHARACTERS WITHOUT CLAIM TO ANY PARTICULAR FONT, STYLE, SIZE, OR COLOR.

THE NAME(S), PORTRAIT(S), AND/OR SIGNATURE(S) SHOWN IN THE MARK IDENTIFIES THE NICKNAME OF APPLICANT'S MINOR SON, WHOSE CONSENT(S) TO REGISTER IS SUBMITTED.

SN 77-384,093, FILED 1-30-2008.

DAVID C. REIHNER, EXAMINING ATTORNEY

Int. Cl.: 9

Prior U.S. Cls.: 21, 23, 26, 36, and 38

Reg. No. 3,577,671

United States Patent and Trademark Office

Registered Feb. 17, 2009

TRADEMARK
PRINCIPAL REGISTER



ZHANG, DANPENG (CHINA INDIVIDUAL)
APT. # A
39A ST. ANDREWS BLVD
CLIFTON, NJ 07012

FOR: ELECTRONIC SENSORS; ELECTRONIC MEASUREMENT AND INSPECTION INSTRUMENTS, NAMELY, PHOTOELECTRIC ENCODERS; ELECTRONIC PROXIMITY SWITCHES FOR DETECTING METAL TARGETS IN INDUSTRIAL POSITION SENSING APPLICATIONS AND FOR DETECTING METAL OR NON-METALLIC TARGETS IN INDUSTRIAL POSITION SENSING APPLICATIONS; PHOTOELECTRIC SENSORS; FLOW SWITCHES FOR MONITORING LIQUID OR GAS FLOW RATE IN PIPES; FLOW METERS FOR MEASURING LIQUID OR GAS FLOW RATE IN PIPES; FLOW SENSORS FOR CONVERTING LIQUID OR GAS FLOW RATE IN PIPES INTO STANDARD INDUSTRIAL ELECTRONIC SIGNAL; PRESSURE SWITCHES FOR MONITORING LIQUID OR GAS PRESSURE IN PIPES OR VESSELS; PRESSURE

TRANSMITTERS; PRESSURE METERS FOR MEASURING LIQUID OR GAS PRESSURE VALUE IN PIPES OR VESSELS; LEVEL SWITCHES FOR MONITORING LIQUID OR POWDER LEVEL IN VESSELS; LEVEL TRANSMITTERS FOR CONVERTING LIQUID OR POWDER LEVEL VALUE IN VESSELS INTO STANDARD INDUSTRIAL ELECTRONIC SIGNAL; LEVEL METERS FOR MEASURING LIQUID OR POWDER LEVEL IN VESSELS; TEMPERATURE SWITCHES; TEMPERATURE TRANSMITTERS; TEMPERATURE METERS, IN CLASS 9 (U.S. CLS. 21, 23, 26, 36 AND 38).

FIRST USE 9-1-2000; IN COMMERCE 9-1-2000.

THE MARK CONSISTS OF THE TERM "BANNA" IN BOLD BLOCK LETTERS, WITH THE "B" APPEARING INSIDE OF A CIRCLE.

SN 77-384,279, FILED 1-30-2008.

ESTHER BELENKER, EXAMINING ATTORNEY

Int. Cl.: 41

Prior U.S. Cls.: 100, 101, and 107

United States Patent and Trademark Office

Reg. No. 3,577,672

Registered Feb. 17, 2009

SERVICE MARK
PRINCIPAL REGISTER



INTERNATIONAL LEADERSHIP WORKSHOP
LLC (WASHINGTON LIMITED LIABILITY
COMPANY)
18105 NE 31ST ST
REDMOND, WA 98052

FOR: EDUCATION SERVICES, NAMELY, PROVIDING LIVE AND ON-LINE SEMINARS, WORKSHOPS, AND CLASSES IN THE FIELD OF INTERNATIONAL LEADERSHIP AND DEVELOPMENT; EDUCATIONAL SERVICES, NAMELY, CONDUCTING PROGRAMS IN THE FIELD OF INTERNATIONAL LEADERSHIP; EDUCATIONAL SERVICES, NAMELY, DEVELOPING CURRICULUM FOR OTHERS IN THE FIELD OF INTERNATIONAL LEADERSHIP; PROVIDING EDUCATIONAL MENTORING SERVICES AND PROGRAMS IN THE FIELD OF INTERNATIONAL LEADERSHIP, IN CLASS 41 (U.S. CLS. 100, 101 AND 107).

FIRST USE 3-25-2008; IN COMMERCE 3-25-2008.

NO CLAIM IS MADE TO THE EXCLUSIVE RIGHT TO USE "INTERNATIONAL LEADERSHIP

WORKSHOP", APART FROM THE MARK AS SHOWN.

THE COLOR(S) BLUE, GREEN, LIGHT GREEN, AND LIGHT GRAY IS/ARE CLAIMED AS A FEATURE OF THE MARK.

THE MARK CONSISTS OF THE ABBREVIATION "INTLWO", IN BLUE LETTERING, ABOVE STYLIZED CONCENTRIC CONCAVE LINES, IN BOTH LIGHT GREEN AND LIGHT GRAY, IN THE MIDDLE OF WHICH STAND TWO GREEN STYLIZED MALE SILHOUETTES LOOKING AT A BLUE STYLIZED GLOBE WITH A STAND WITH THE WORDS "INTERNATIONAL LEADERSHIP WORKSHOP" IN BLUE APPEARING AT THE BOTTOM OF THE MARK.

SN 77-386,533, FILED 2-1-2008.

MARLENE BELL, EXAMINING ATTORNEY

Int. Cl.: 36

Prior U.S. Cls.: 100, 101, and 102

United States Patent and Trademark Office

Reg. No. 3,577,673

Registered Feb. 17, 2009

**SERVICE MARK
PRINCIPAL REGISTER**

RESPUESTA INMEDIATA

PROGRESSIVE CASUALTY INSURANCE COM-
PANY (OHIO CORPORATION)
6300 WILSON MILLS ROAD
MAYFIELD VILLAGE, OH 44143

FOR: PROPERTY AND CASUALTY INSURANCE
CLAIMS PROCESSING, ADJUSTMENT, SETTLE-
MENT AND ADMINISTRATION SERVICES, IN
CLASS 36 (U.S. CLS. 100, 101 AND 102).

FIRST USE 4-30-2008; IN COMMERCE 4-30-2008.

THE MARK CONSISTS OF STANDARD CHAR-
ACTERS WITHOUT CLAIM TO ANY PARTICULAR
FONT, STYLE, SIZE, OR COLOR.

THE FOREIGN WORDING IN THE MARK
TRANSLATES INTO ENGLISH AS IMMEDIATE
RESPONSE.

SEC. 2(F).

SN 77-387,489, FILED 2-4-2008.

LESLEY LAMOTHE, EXAMINING ATTORNEY

Int. Cl.: 20

Prior U.S. Cls.: 2, 13, 22, 25, 32, and 50

United States Patent and Trademark Office

Reg. No. 3,577,674

Registered Feb. 17, 2009

**TRADEMARK
PRINCIPAL REGISTER**



SLEEP HEALTHCENTERS LLC (MASSACHU-
SETTS LIMITED LIABILITY COMPANY)
1505 COMMONWEALTH AVE.
BRIGHTON, MA 021353605

THE MARK CONSISTS OF A FANCIFUL REPRE-
SENTATION OF A CLOSED EYE.

FOR: MATTRESS TOPPERS, IN CLASS 20 (U.S.
CLS. 2, 13, 22, 25, 32 AND 50).

SN 77-388,379, FILED 2-4-2008.

FIRST USE 11-25-2008; IN COMMERCE 11-25-2008.

HOWARD B. LEVINE, EXAMINING ATTORNEY

Int. Cl.: 31

Prior U.S. Cls.: 1 and 46

United States Patent and Trademark Office

Reg. No. 3,577,675

Registered Feb. 17, 2009

**TRADEMARK
PRINCIPAL REGISTER**

ELANOS

ELSNER PAC JUNGPFANZEN GBR (FED REP
GERMANY GESELLSCHAFT BURGERLI-
CHEN RECHTS (GBR))
KIPSDORFER STR. 146
01279 DRESDEN, FED REP GERMANY

THE MARK CONSISTS OF STANDARD CHAR-
ACTERS WITHOUT CLAIM TO ANY PARTICULAR
FONT, STYLE, SIZE, OR COLOR.

FOR: LIVE PLANTS AND NATURAL FLOWERS
THEREOF, IN CLASS 31 (U.S. CLS. 1 AND 46).

SN 77-388,610, FILED 2-5-2008.

FIRST USE 4-1-2008; IN COMMERCE 4-1-2008.

KATHERINE STOIDES, EXAMINING ATTORNEY

Int. Cl.: 40

Prior U.S. Cls.: 100, 103, and 106

United States Patent and Trademark Office

Reg. No. 3,577,676

Registered Feb. 17, 2009

**SERVICE MARK
PRINCIPAL REGISTER**

STORMRAX

PLASTIC SOLUTIONS, INC. (VIRGINIA CORPORATION)
P.O. BOX 4386
WINCHESTER, VA 22604

FOR: CUSTOM MANUFACTURE OF MOLDS FOR USE IN INDUSTRY; CUSTOM MANUFACTURE OF GRATINGS AND SCREENS TO BE PLACED OVER WATER INLETS FOR FILTERING DEBRIS, IN CLASS 40 (U.S. CLS. 100, 103 AND 106).

FIRST USE 2-29-2008; IN COMMERCE 2-29-2008.

THE MARK CONSISTS OF STANDARD CHARACTERS WITHOUT CLAIM TO ANY PARTICULAR FONT, STYLE, SIZE, OR COLOR.

SN 77-388,651, FILED 2-5-2008.

COURTNEY MCCORMICK, EXAMINING ATTORNEY

Int. Cl.: 31

Prior U.S. Cls.: 1 and 46

United States Patent and Trademark Office

Reg. No. 3,577,677

Registered Feb. 17, 2009

**TRADEMARK
PRINCIPAL REGISTER**

SHIVA

ELSNER PAC JUNGPFANZEN GBR (FED REP
GERMANY GESELLSCHAFT BURGERLI-
CHEN RECHTS (GBR))
KIPSDORFER STR. 146
01279 DRESDEN, FED REP GERMANY

THE MARK CONSISTS OF STANDARD CHAR-
ACTERS WITHOUT CLAIM TO ANY PARTICULAR
FONT, STYLE, SIZE, OR COLOR.

FOR: LIVE PLANTS AND NATURAL FLOWERS
THEREOF, IN CLASS 31 (U.S. CLS. 1 AND 46).

SN 77-388,685, FILED 2-5-2008.

FIRST USE 4-1-2008; IN COMMERCE 4-1-2008.

KATHERINE STOIDES, EXAMINING ATTORNEY

Int. Cl.: 3

Prior U.S. Cls.: 1, 4, 6, 50, 51, and 52

United States Patent and Trademark Office

Reg. No. 3,577,678

Registered Feb. 17, 2009

**TRADEMARK
PRINCIPAL REGISTER**

ROOT AWAKENING

KAO KABUSHIKI KAISHA (JAPAN CORPORATION), DBA KAO CORPORATION,
14-10, NIHONBASHI KAYABACHO 1-CHOME
CHUO-KU, TOKYO, JAPAN 103-8210

THE MARK CONSISTS OF STANDARD CHARACTERS WITHOUT CLAIM TO ANY PARTICULAR FONT, STYLE, SIZE, OR COLOR.

FOR: HAIR CARE PREPARATIONS, IN CLASS 3
(U.S. CLS. 1, 4, 6, 50, 51 AND 52).

SN 77-388,891, FILED 2-5-2008.

FIRST USE 12-5-2008; IN COMMERCE 12-5-2008.

DEIRDRE ROBERTSON, EXAMINING ATTORNEY

Int. Cl.: 37

Prior U.S. Cls.: 100, 103, and 106

United States Patent and Trademark Office

Reg. No. 3,577,679

Registered Feb. 17, 2009

**SERVICE MARK
PRINCIPAL REGISTER**

**SAVING THE ENVIRONMENT ONE
SLAB AT A TIME**

SLABJACK NW, LLC (WASHINGTON LIMITED
LIABILITY COMPANY)
975 1ST AVENUE NE
ISSAQUAH, WA 98027

FOR: MAINTENANCE AND/OR REPAIR OF
CONCRETE SLABS AND FOUNDATIONS ON
HOMES, PORCHES, DRIVEWAYS AND BUILD-
INGS; CONCRETE LEVELLING AND REPAIR SER-
VICES FOR OTHERS, IN CLASS 37 (U.S. CLS. 100, 103
AND 106).

FIRST USE 11-21-2008; IN COMMERCE 11-21-2008.

THE MARK CONSISTS OF STANDARD CHAR-
ACTERS WITHOUT CLAIM TO ANY PARTICULAR
FONT, STYLE, SIZE, OR COLOR.

SN 77-389,041, FILED 2-5-2008.

WENDY GOODMAN, EXAMINING ATTORNEY

Int. Cl.: 11

Prior U.S. Cls.: 13, 21, 23, 31, and 34

United States Patent and Trademark Office

Reg. No. 3,577,680

Registered Feb. 17, 2009

**TRADEMARK
PRINCIPAL REGISTER**

ILLUMINATED IMPRESSIONS

RACOOSIN, ERIC (UNITED STATES INDIVIDUAL)
25341 PIEDRA BLANCA
LAGUNA NIGUEL, CA 92677 AND
TIMPER, JEFF (UNITED STATES INDIVIDUAL)
410 CALLE NINA
SAN CLEMENTE, CA 92672

FOR: ILLUMINATION DEVICE FOR ILLUMINATING A GUEST CHECK PRESENTER, IN CLASS 11 (U.S. CLS. 13, 21, 23, 31 AND 34).

FIRST USE 12-12-2008; IN COMMERCE 12-12-2008.

THE MARK CONSISTS OF STANDARD CHARACTERS WITHOUT CLAIM TO ANY PARTICULAR FONT, STYLE, SIZE, OR COLOR.

NO CLAIM IS MADE TO THE EXCLUSIVE RIGHT TO USE "ILLUMINATED", APART FROM THE MARK AS SHOWN.

SN 77-389,150, FILED 2-5-2008.

CHRISTINE BLOMQUIST, EXAMINING ATTORNEY

Int. Cl.: 36

Prior U.S. Cls.: 100, 101, and 102

United States Patent and Trademark Office

Reg. No. 3,577,681

Registered Feb. 17, 2009

**SERVICE MARK
PRINCIPAL REGISTER**

EMMA

MUNICIPAL SECURITIES RULEMAKING
BOARD (VIRGINIA NON-PROFIT, NON-
STOCK CORPORATION)
1900 DUKE STREET
SUITE 600
ALEXANDRIA, VA 22314

FOR: PROVIDING FINANCIAL, TRADING, RE-
GISTRATION AND DISCLOSURE INFORMATION
BY ELECTRONIC MEANS, NAMELY, THE RE-
CEIPT, ACCEPTANCE, COMPILATION, AND DIS-
SEMINATION OF INFORMATION IN THE FIELD
OF MUNICIPAL BONDS, MUNICIPAL NOTES AND
OTHER MUNICIPAL SECURITIES; PROVIDING
ON-LINE AND ELECTRONIC COMPUTER DATA-

BASES FEATURING FINANCIAL INFORMATION
IN THE FIELD OF MUNICIPAL BONDS, MUNICI-
PAL NOTES AND OTHER MUNICIPAL SECURI-
TIES, IN CLASS 36 (U.S. CLS. 100, 101 AND 102).

FIRST USE 3-31-2008; IN COMMERCE 3-31-2008.

THE MARK CONSISTS OF STANDARD CHAR-
ACTERS WITHOUT CLAIM TO ANY PARTICULAR
FONT, STYLE, SIZE, OR COLOR.

SN 77-389,319, FILED 2-5-2008.

KIMBERLY FRYE, EXAMINING ATTORNEY

Int. Cl.: 9

Prior U.S. Cls.: 21, 23, 26, 36, and 38

Reg. No. 3,577,682

United States Patent and Trademark Office

Registered Feb. 17, 2009

**TRADEMARK
PRINCIPAL REGISTER**

ADA CONVERTERS

IZ TECHNOLOGY CORPORATION (CANADA
CORPORATION)
UNIT 240
109 BRAID STREET
NEW WESTMINSTER, BRITISH COLUMBIA, CA-
NADA V3L5H4

FOR: DIGITAL SIGNAL PROCESSORS AND
CONVERTERS, NAMELY, ANALOG AUDIO TO
DIGITAL AUDIO AND DIGITAL AUDIO TO ANA-
LOG AUDIO PROCESSORS AND CONVERTERS, IN
CLASS 9 (U.S. CLS. 21, 23, 26, 36 AND 38).

FIRST USE 4-18-2008; IN COMMERCE 4-18-2008.

THE MARK CONSISTS OF STANDARD CHAR-
ACTERS WITHOUT CLAIM TO ANY PARTICULAR
FONT, STYLE, SIZE, OR COLOR.

NO CLAIM IS MADE TO THE EXCLUSIVE
RIGHT TO USE "CONVERTERS", APART FROM
THE MARK AS SHOWN.

SN 77-389,345, FILED 2-5-2008.

PATRICIA EVANKO, EXAMINING ATTORNEY

Int. Cl.: 10

Prior U.S. Cls.: 26, 39, and 44

United States Patent and Trademark Office

Reg. No. 3,577,683

Registered Feb. 17, 2009

**TRADEMARK
PRINCIPAL REGISTER**

**SAFE & IMMEDIATE SINUS
RELIEF NATURALLY**

MED-SYSTEMS, INC. (WISCONSIN CORPORATION)
P.O. BOX 45634
MADISON, WI 53774

THE MARK CONSISTS OF STANDARD CHARACTERS WITHOUT CLAIM TO ANY PARTICULAR FONT, STYLE, SIZE, OR COLOR.

FOR: MEDICAL DEVICE USED TO OPEN AND IRRIGATE NASAL PASSAGES, IN CLASS 10 (U.S. CLS. 26, 39 AND 44).

SN 77-390,027, FILED 2-6-2008.

FIRST USE 3-0-2008; IN COMMERCE 6-0-2008.

MICHAEL WIENER, EXAMINING ATTORNEY

Int. Cl.: 11

Prior U.S. Cls.: 13, 21, 23, 31, and 34

United States Patent and Trademark Office

Reg. No. 3,577,684

Registered Feb. 17, 2009

**TRADEMARK
PRINCIPAL REGISTER**

MAGICSTREAM

PENTAIR WATER POOL AND SPA, INC. (DELA-
WARE CORPORATION)
1620 HAWKINS AVENUE
SANFORD, NC 27330

FOR: WATER DELIVERY SYSTEM COMPRISED
OF WATER NOZZLES TO PRODUCE WATER FEA-
TURES USED IN SWIMMING POOLS, SPAS, FOUN-
TAINS, AND PONDS, NAMELY, STREAMS, FALLS,
SHOWERS, DROPS, FOAMS, AERATIONS, SHEETS
AND JETS OF WATER, IN CLASS 11 (U.S. CLS. 13, 21,
23, 31 AND 34).

FIRST USE 4-7-2008; IN COMMERCE 4-7-2008.

THE MARK CONSISTS OF STANDARD CHAR-
ACTERS WITHOUT CLAIM TO ANY PARTICULAR
FONT, STYLE, SIZE, OR COLOR.

SN 77-390,806, FILED 2-7-2008.

ANTHONY RINKER, EXAMINING ATTORNEY

Int. Cl.: 11

Prior U.S. Cls.: 13, 21, 23, 31, and 34

United States Patent and Trademark Office

Reg. No. 3,577,685

Registered Feb. 17, 2009

**TRADEMARK
PRINCIPAL REGISTER**

WALLSPRING

PENTAIR WATER POOL AND SPA, INC. (DELA-
WARE CORPORATION)
1620 HAWKINS AVENUE
SANFORD, NC 27330

FOR: DECORATIVE WATER FOUNTAINS USED
IN SWIMMING POOLS, SPAS, FOUNTAINS AND
PONDS THAT INCORPORATES A WATER NOZZLE
TO PRODUCE WATER FEATURES AND WATER
EFFECTS, NAMELY, STREAMS, FALLS, SHOWERS,
DROPS, FOAMS, AERATIONS, SHEETS AND JETS
OF WATER, IN CLASS 11 (U.S. CLS. 13, 21, 23, 31 AND
34).

FIRST USE 3-13-2008; IN COMMERCE 3-13-2008.

THE MARK CONSISTS OF STANDARD CHAR-
ACTERS WITHOUT CLAIM TO ANY PARTICULAR
FONT, STYLE, SIZE, OR COLOR.

SN 77-390,818, FILED 2-7-2008.

ANTHONY RINKER, EXAMINING ATTORNEY

Int. Cl.: 33

Prior U.S. Cls.: 47 and 49

United States Patent and Trademark Office

Reg. No. 3,577,686

Registered Feb. 17, 2009

**TRADEMARK
PRINCIPAL REGISTER**

RANGE 30 WEST

FOXEN VINEYARD, INC. (CALIFORNIA CORPORATION)
SUITE A
920 GARDEN STREET
SANTA BARBARA, CA 93101

FOR: RED WINE; TABLE WINES; WINE; WINES,
IN CLASS 33 (U.S. CLS. 47 AND 49).

FIRST USE 8-8-2006; IN COMMERCE 8-8-2006.

THE MARK CONSISTS OF STANDARD CHARACTERS WITHOUT CLAIM TO ANY PARTICULAR FONT, STYLE, SIZE, OR COLOR.

SN 77-391,302, FILED 2-7-2008.

AMY HELLA, EXAMINING ATTORNEY

Int. Cl.: 28

Prior U.S. Cls.: 22, 23, 38, and 50

United States Patent and Trademark Office

Reg. No. 3,577,687

Registered Feb. 17, 2009

**TRADEMARK
PRINCIPAL REGISTER**

HEARTREVEL

DAIWA SEIKO, INC. (JAPAN CORPORATION)
14-16
MAESAWA 3-CHOME, HIGASHIKURUME-CITY
TOKYO, JAPAN

THE MARK CONSISTS OF STANDARD CHAR-
ACTERS WITHOUT CLAIM TO ANY PARTICULAR
FONT, STYLE, SIZE, OR COLOR.

FOR: GOLF CLUBS, GOLF CLUB SHAFTS, GOLF
BAGS, GOLF GLOVES AND GOLF BALLS, IN
CLASS 28 (U.S. CLS. 22, 23, 38 AND 50).

SN 77-392,113, FILED 2-8-2008.

FIRST USE 10-25-2008; IN COMMERCE 10-25-2008.

JULIE GUTTADAURO, EXAMINING ATTORNEY

Int. Cl.: 11

Prior U.S. Cls.: 13, 21, 23, 31, and 34

United States Patent and Trademark Office

Reg. No. 3,577,688

Registered Feb. 17, 2009

**TRADEMARK
PRINCIPAL REGISTER**

MAGICFALLS

PENTAIR WATER POOL AND SPA, INC. (DELA-
WARE CORPORATION)
1620 HAWKINS AVENUE
SANFORD, NC 27330

FOR: A WATERFALL DELIVERY SYSTEM FOR
SWIMMING POOLS, SPAS, FOUNTAINS, AND
PONDS, COMPRISED OF WATER NOZZLES TO
PRODUCE WATER FEATURES AND WATER EF-
FECTS, NAMELY, STREAMS, FALLS, SHOWERS,
DROPS, FOAMS, AERATIONS, SHEETS AND JETS
OF WATER, IN CLASS 11 (U.S. CLS. 13, 21, 23, 31 AND
34).

FIRST USE 3-13-2008; IN COMMERCE 3-13-2008.

THE MARK CONSISTS OF STANDARD CHAR-
ACTERS WITHOUT CLAIM TO ANY PARTICULAR
FONT, STYLE, SIZE, OR COLOR.

SN 77-392,582, FILED 2-8-2008.

ANTHONY RINKER, EXAMINING ATTORNEY

Int. Cl.: 41

Prior U.S. Cls.: 100, 101, and 107

United States Patent and Trademark Office

Reg. No. 3,577,689

Registered Feb. 17, 2009

**SERVICE MARK
PRINCIPAL REGISTER**

Conceptual Linking

CYBERCROCODILE (VIRGINIA LIMITED LIABILITY COMPANY)
1285 CARL D SILVER PKWY #337
FREDERICKSBURG, VA 22401

FOR: EDUCATIONAL SERVICES, NAMELY, TRAINING EMPLOYEES ON THE SKILLS OF DATA AGGREGATION, ASSIMILATION, AND RECOLLECTION IN THE FIELD OF INFORMATION SECURITY, IN CLASS 41 (U.S. CLS. 100, 101 AND 107).

FIRST USE 5-14-2007; IN COMMERCE 3-10-2008.

THE MARK CONSISTS OF STANDARD CHARACTERS WITHOUT CLAIM TO ANY PARTICULAR FONT, STYLE, SIZE, OR COLOR.

SN 77-392,976, FILED 2-8-2008.

SUSAN LESLIE DUBOIS, EXAMINING ATTORNEY

Int. Cl.: 10

Prior U.S. Cls.: 26, 39, and 44

United States Patent and Trademark Office

Reg. No. 3,577,690

Registered Feb. 17, 2009

**TRADEMARK
PRINCIPAL REGISTER**

Alure Refine

ALURE MEDICAL, INC (DELAWARE CORPORATION)
2445 IMPALA DRIVE
CARLSBAD, CA 92010

FOR: MEDICAL INSTRUMENTS FOR USE IN COSMETIC AND PLASTIC SURGERY; SURGICAL AND MEDICAL APPARATUS AND INSTRUMENTS FOR USE IN GENERAL SURGERY; SURGICAL INSTRUMENTS FOR USE IN COSMETIC AND PLASTIC SURGERY, IN CLASS 10 (U.S. CLS. 26, 39 AND 44).

FIRST USE 1-22-2008; IN COMMERCE 1-22-2008.

THE MARK CONSISTS OF STANDARD CHARACTERS WITHOUT CLAIM TO ANY PARTICULAR FONT, STYLE, SIZE, OR COLOR.

SN 77-393,299, FILED 2-10-2008.

GINA HAYES, EXAMINING ATTORNEY

Int. Cl.: 44

Prior U.S. Cls.: 100 and 101

United States Patent and Trademark Office

Reg. No. 3,577,691

Registered Feb. 17, 2009

**SERVICE MARK
PRINCIPAL REGISTER**

QUALMED EVALUATIONS

QUALMED EVALUATIONS, LLC (NEW JERSEY
LIMITED LIABILITY COMPANY)
SUITE 275
523 FELLOWSHIP ROAD
MOUNT LAUREL, NJ 08054

FOR: MEDICAL SERVICES, NAMELY, FOR THE
MANAGEMENT OF INDEPENDENT MEDICAL
EVALUATIONS PROVIDED BY PHYSICIANS, IN
CLASS 44 (U.S. CLS. 100 AND 101).

FIRST USE 4-0-2008; IN COMMERCE 4-0-2008.

THE MARK CONSISTS OF STANDARD CHAR-
ACTERS WITHOUT CLAIM TO ANY PARTICULAR
FONT, STYLE, SIZE, OR COLOR.

NO CLAIM IS MADE TO THE EXCLUSIVE
RIGHT TO USE "EVALUATIONS", APART FROM
THE MARK AS SHOWN.

SN 77-393,615, FILED 2-11-2008.

MICHAEL WIENER, EXAMINING ATTORNEY

Int. Cl.: 20

Prior U.S. Cls.: 2, 13, 22, 25, 32, and 50

United States Patent and Trademark Office

Reg. No. 3,577,692

Registered Feb. 17, 2009

**TRADEMARK
PRINCIPAL REGISTER**

COMFORT SUPPORT RATING

SEALY TECHNOLOGY LLC (NORTH CAROLINA LIMITED LIABILITY COMPANY)

ONE OFFICE PARKWAY

TRINITY, NC 27370

FOR: MATTRESSES; BOX SPRINGS, IN CLASS 20 (U.S. CLS. 2, 13, 22, 25, 32 AND 50).

FIRST USE 1-0-2008; IN COMMERCE 1-0-2008.

THE MARK CONSISTS OF STANDARD CHARACTERS WITHOUT CLAIM TO ANY PARTICULAR FONT, STYLE, SIZE, OR COLOR.

NO CLAIM IS MADE TO THE EXCLUSIVE RIGHT TO USE "SUPPORT", APART FROM THE MARK AS SHOWN.

SN 77-395,520, FILED 2-13-2008.

DAVID I, EXAMINING ATTORNEY

Int. Cl.: 30

Prior U.S. Cl.: 46

United States Patent and Trademark Office

Reg. No. 3,577,693

Registered Feb. 17, 2009

**TRADEMARK
PRINCIPAL REGISTER**

ENERGY GO BITES

RUDOLPH FOODS COMPANY, INC. (OHIO CORPORATION)

P.O. BOX 509

LIMA, OH 45802

FOR: SNACK FOOD MADE OF WHEAT, CORN AND/OR RICE, IN CLASS 30 (U.S. CL. 46).

FIRST USE 7-1-2008; IN COMMERCE 7-1-2008.

THE MARK CONSISTS OF STANDARD CHARACTERS WITHOUT CLAIM TO ANY PARTICULAR FONT, STYLE, SIZE, OR COLOR.

NO CLAIM IS MADE TO THE EXCLUSIVE RIGHT TO USE "ENERGY" AND "BITES", APART FROM THE MARK AS SHOWN.

SN 77-396,838, FILED 2-14-2008.

STEVEN JACKSON, EXAMINING ATTORNEY

Int. Cl.: 1

Prior U.S. Cls.: 1, 5, 6, 10, 26, and 46

Reg. No. 3,577,694

United States Patent and Trademark Office

Registered Feb. 17, 2009

**TRADEMARK
PRINCIPAL REGISTER**

GBS

OCEAN ORGANICS, INC. (MICHIGAN CORPORATION)
2153 NEWPORT ROAD
ANN ARBOR, MI 48103

FIRST USE 5-21-2008; IN COMMERCE 5-21-2008.

FOR: FERTILIZERS AND SOIL CONDITIONERS FOR AGRICULTURAL AND DOMESTIC USE, NAMELY, FOR GOLF COURSE, ATHLETIC FIELDS, HOME GARDENS, SOD FARMS, PROFESSIONAL AND GENERAL LANDSCAPE AND TURF USE, IN CLASS 1 (U.S. CLS. 1, 5, 6, 10, 26 AND 46).

THE MARK CONSISTS OF STANDARD CHARACTERS WITHOUT CLAIM TO ANY PARTICULAR FONT, STYLE, SIZE, OR COLOR.

SN 77-396,962, FILED 2-14-2008.

SUSAN RICHARDS, EXAMINING ATTORNEY

Int. Cl.: 7

Prior U.S. Cls.: 13, 19, 21, 23, 31, 34, and 35

Reg. No. 3,577,695

United States Patent and Trademark Office

Registered Feb. 17, 2009

**TRADEMARK
PRINCIPAL REGISTER**

PERSONNA ARMOREDGE

AMERICAN SAFETY RAZOR COMPANY (DELA-
WARE CORPORATION)
SUITE 401 240 CEDAR KNOLLS ROAD
CEDAR KNOLLS, NJ 07927

FOR: MACHINE PARTS, NAMELY, BLADES FOR
INCORPORATION IN CARPET AND FABRIC PRO-
CESSING DEVICES AND EQUIPMENT, IN CLASS 7
(U.S. CLS. 13, 19, 21, 23, 31, 34 AND 35).

FIRST USE 5-13-2008; IN COMMERCE 6-5-2008.

THE MARK CONSISTS OF STANDARD CHAR-
ACTERS WITHOUT CLAIM TO ANY PARTICULAR
FONT, STYLE, SIZE, OR COLOR.

OWNER OF U.S. REG. NOS. 1,421,801, 1,537,220,
AND OTHERS.

SN 77-397,184, FILED 2-14-2008.

MELISSA VALLILLO, EXAMINING ATTORNEY

Int. Cl.: 33

Prior U.S. Cls.: 47 and 49

United States Patent and Trademark Office

Reg. No. 3,577,696

Registered Feb. 17, 2009

**TRADEMARK
PRINCIPAL REGISTER**

Live Wire

ROANOKE VALLEY WINE COMPANY (VIRGINIA CORPORATION)
P.O. BOX 93
DALEVILLE, VA 24083

THE MARK CONSISTS OF STANDARD CHARACTERS WITHOUT CLAIM TO ANY PARTICULAR FONT, STYLE, SIZE, OR COLOR.

FOR: WINES, IN CLASS 33 (U.S. CLS. 47 AND 49).

SN 77-397,568, FILED 2-14-2008.

FIRST USE 11-13-2008; IN COMMERCE 11-13-2008.

ALICE BENMAMAN, EXAMINING ATTORNEY

Int. Cls.: 16 and 28

Prior U.S. Cls.: 2, 5, 22, 23, 29, 37, 38, and 50

United States Patent and Trademark Office

Reg. No. 3,577,697

Registered Feb. 17, 2009

**TRADEMARK
PRINCIPAL REGISTER**

MOONMAN

EE PUBLISHING & PRODUCTIONS, LLC (VIRGINIA LIMITED LIABILITY COMPANY)
P.O. BOX 7006
FAIRFAX STATION, VA 22039

FOR: CHILDREN'S BOOKS, IN CLASS 16 (U.S. CLS. 2, 5, 22, 23, 29, 37, 38 AND 50).

FIRST USE 3-0-2008; IN COMMERCE 3-0-2008.

FOR: TOYS, NAMELY, DOLLS, IN CLASS 28 (U.S. CLS. 22, 23, 38 AND 50).

FIRST USE 8-0-2008; IN COMMERCE 8-0-2008.

THE MARK CONSISTS OF STANDARD CHARACTERS WITHOUT CLAIM TO ANY PARTICULAR FONT, STYLE, SIZE, OR COLOR.

SN 77-398,103, FILED 2-15-2008.

KATINA MISTER, EXAMINING ATTORNEY

Int. Cl.: 28

Prior U.S. Cls.: 22, 23, 38, and 50

United States Patent and Trademark Office

Reg. No. 3,577,698

Registered Feb. 17, 2009

**TRADEMARK
PRINCIPAL REGISTER**

4CHESS

SAUVE, RAYMOND (CANADA INDIVIDUAL)
275 ELM
CHATEAUGUAY, CANADA J675N7

THE MARK CONSISTS OF STANDARD CHAR-
ACTERS WITHOUT CLAIM TO ANY PARTICULAR
FONT, STYLE, SIZE, OR COLOR.

FOR: CHESS GAMES, IN CLASS 28 (U.S. CLS. 22,
23, 38 AND 50).

SN 77-398,625, FILED 2-15-2008.

FIRST USE 11-1-2006; IN COMMERCE 2-25-2008.

MELISSA VALLILLO, EXAMINING ATTORNEY

Int. Cl.: 42

Prior U.S. Cls.: 100 and 101

United States Patent and Trademark Office

Reg. No. 3,577,699

Registered Feb. 17, 2009

**SERVICE MARK
PRINCIPAL REGISTER**

greenbelly

JACOBS, TRICIA (UNITED STATES INDIVIDUAL), DBA GREENBELLY,
15 WEST VAN SCOTER
HORNELL, NY 14843

THE MARK CONSISTS OF STANDARD CHARACTERS WITHOUT CLAIM TO ANY PARTICULAR FONT, STYLE, SIZE, OR COLOR.

FOR: COMMERCIAL ART DESIGN, IN CLASS 42 (U.S. CLS. 100 AND 101).

SN 77-399,387, FILED 2-18-2008.

FIRST USE 5-1-2008; IN COMMERCE 5-1-2008.

MIDGE BUTLER, EXAMINING ATTORNEY

Int. Cl.: 35

Prior U.S. Cls.: 100, 101, and 102

United States Patent and Trademark Office

Reg. No. 3,577,700

Registered Feb. 17, 2009

**SERVICE MARK
PRINCIPAL REGISTER**



DECERCHIO, LOUIS (UNITED STATES INDIVIDUAL)
UNIT C
539 FORD STREET
WEST CONSHOHOCKEN, PA 19428

FOR: AUTOMOBILE DEALERSHIPS, IN CLASS 35
(U.S. CLS. 100, 101 AND 102).

FIRST USE 11-1-2007; IN COMMERCE 11-1-2007.

NO CLAIM IS MADE TO THE EXCLUSIVE RIGHT TO USE "VETTES", APART FROM THE MARK AS SHOWN.

THE MARK CONSISTS OF THE INTERROGATORY PHRASE "GOT VETTES?" ON A SHADED RECTANGULAR BACKGROUND.

SN 77-399,450, FILED 2-18-2008.

ALICIA COLLINS, EXAMINING ATTORNEY

Int. Cl.: 11

Prior U.S. Cls.: 13, 21, 23, 31, and 34

United States Patent and Trademark Office

Reg. No. 3,577,701

Registered Feb. 17, 2009

**TRADEMARK
PRINCIPAL REGISTER**

SANDS

LAS VEGAS SANDS CORP. (NEVADA CORPORATION)
3355 LAS VEGAS BOULEVARD SOUTH
LAS VEGAS, NV 89109

FOR: FLASHLIGHTS, IN CLASS 11 (U.S. CLS. 13, 21, 23, 31 AND 34).

FIRST USE 6-7-2007; IN COMMERCE 6-7-2007.

THE MARK CONSISTS OF STANDARD CHARACTERS WITHOUT CLAIM TO ANY PARTICULAR FONT, STYLE, SIZE, OR COLOR.

OWNER OF U.S. REG. NO. 1,209,102.

SN 77-401,810, FILED 2-20-2008.

RAUL CORDOVA, EXAMINING ATTORNEY

Int. Cl.: 37

Prior U.S. Cls.: 100, 103, and 106

United States Patent and Trademark Office

Reg. No. 3,577,702

Registered Feb. 17, 2009

**SERVICE MARK
PRINCIPAL REGISTER**

SANDS

LAS VEGAS SANDS CORP. (NEVADA CORPORATION)
3355 LAS VEGAS BOULEVARD SOUTH
LAS VEGAS, NV 89109

THE MARK CONSISTS OF STANDARD CHARACTERS WITHOUT CLAIM TO ANY PARTICULAR FONT, STYLE, SIZE, OR COLOR.

FOR: JANITORIAL SERVICES; ELECTRICAL CONTRACTOR SERVICES; REPAIR OR MAINTENANCE OF ELECTRIC LIGHTING APPARATUS; PLUMBING SERVICES, IN CLASS 37 (U.S. CLS. 100, 103 AND 106).

OWNER OF U.S. REG. NO. 1,209,102.

SN 77-401,883, FILED 2-20-2008.

FIRST USE 8-24-2007; IN COMMERCE 8-24-2007.

RAUL CORDOVA, EXAMINING ATTORNEY

Int. Cl.: 38

Prior U.S. Cls.: 100, 101, and 104

United States Patent and Trademark Office

Reg. No. 3,577,703

Registered Feb. 17, 2009

**SERVICE MARK
PRINCIPAL REGISTER**

SANDS

LAS VEGAS SANDS CORP. (NEVADA CORPORATION)
3355 LAS VEGAS BOULEVARD SOUTH
LAS VEGAS, NV 89109

FOR: INFORMATION TRANSMISSION SERVICES VIA DIGITAL NETWORKS; PROVIDING ACCESS TO TELECOMMUNICATION NETWORKS; COMMUNICATION SERVICES, NAMELY, ELECTRONIC TRANSMISSION OF DATA AND DOCUMENTS AMONG USERS OF COMPUTERS; TELECOMMUNICATION CONSULTATION IN THE NATURE OF TECHNICAL CONSULTING IN THE FIELD OF AUDIO, TEXT AND VISUAL DATA TRANSMISSION AND COMMUNICATION; LOCAL AND LONG DISTANCE TELEPHONE SERVICES; PROVIDING TELEPHONE CONFERENCING SERVICES; TELEPHONE VOICE MESSAGING SERVICES; FACSIMILE TRANSMISSION AND RETRIEVAL SERVICES; PROVIDING E-MAIL FAX SERVICES; WIRELESS BROADBAND COMMUNICATION SERVICES; RENTAL OF EQUIPMENT FOR

TELECOMMUNICATIONS; TELECOMMUNICATION SERVICES, NAMELY, LOCAL AND LONG DISTANCE TRANSMISSION OF VOICE, DATA, GRAPHICS BY MEANS OF TELEPHONE, TELEGRAPHIC, CABLE, AND SATELLITE TRANSMISSIONS; VOICE MAIL SERVICES; TELECOMMUNICATIONS SERVICES, NAMELY, ISDN SERVICES, IN CLASS 38 (U.S. CLS. 100, 101 AND 104).

FIRST USE 8-24-2007; IN COMMERCE 8-24-2007.

THE MARK CONSISTS OF STANDARD CHARACTERS WITHOUT CLAIM TO ANY PARTICULAR FONT, STYLE, SIZE, OR COLOR.

OWNER OF U.S. REG. NO. 1,209,102.

SN 77-401,890, FILED 2-20-2008.

RAUL CORDOVA, EXAMINING ATTORNEY

Int. Cl.: 42

Prior U.S. Cls.: 100 and 101

United States Patent and Trademark Office

Reg. No. 3,577,704

Registered Feb. 17, 2009

**SERVICE MARK
PRINCIPAL REGISTER**

SANDS

LAS VEGAS SANDS CORP. (NEVADA CORPORATION)
3355 LAS VEGAS BOULEVARD SOUTH
LAS VEGAS, NV 89109

FOR: RENTAL OF COMPUTERS AND SOFTWARE; DECORATION SERVICES FOR TRADE SHOW BOOTHS AND EXHIBITIONS, NAMELY, PROVIDING INTERIOR DECORATING OF TRADE SHOW BOOTHS AND EXHIBITION SPACES; FLORAL DECORATION SERVICES AND FLORAL DESIGN SERVICES FOR WEDDINGS AND SPECIAL EVENTS, IN CLASS 42 (U.S. CLS. 100 AND 101).

FIRST USE 8-24-2007; IN COMMERCE 8-24-2007.

THE MARK CONSISTS OF STANDARD CHARACTERS WITHOUT CLAIM TO ANY PARTICULAR FONT, STYLE, SIZE, OR COLOR.

OWNER OF U.S. REG. NO. 1,209,102.

SN 77-401,909, FILED 2-20-2008.

RAUL CORDOVA, EXAMINING ATTORNEY

Int. Cl.: 36

Prior U.S. Cls.: 100, 101, and 102

United States Patent and Trademark Office

Reg. No. 3,577,705

Registered Feb. 17, 2009

**SERVICE MARK
PRINCIPAL REGISTER**



UMB FINANCIAL CORPORATION (MISSOURI
CORPORATION)
1010 GRAND AVENUE
KANSAS CITY, MO 64105

THE MARK CONSISTS OF A RUDIMENTARY
LINE DRAWING OF A PERSON.

FOR: FINANCIAL SERVICES, NAMELY, BANK-
ING SERVICES, IN CLASS 36 (U.S. CLS. 100, 101 AND
102).

SN 77-402,802, FILED 2-21-2008.

FIRST USE 2-26-2008; IN COMMERCE 2-26-2008.

RUSS HERMAN, EXAMINING ATTORNEY

Int. Cl.: 36

Prior U.S. Cls.: 100, 101, and 102

United States Patent and Trademark Office

Reg. No. 3,577,706

Registered Feb. 17, 2009

**SERVICE MARK
PRINCIPAL REGISTER**

MOODY'S CREDITVALUES

MIS QUALITY MANAGEMENT CORP. (DELA-
WARE CORPORATION)
501 SILVERSIDE ROAD; SUITE 20
WILMINGTON, DE 19809

FOR: FINANCIAL SERVICES, NAMELY, PRO-
VIDING PRICING, VALUATION, AND ANALYTI-
CAL SERVICES WITH RESPECT TO STRUCTURED
FINANCE TRANSACTIONS, IN CLASS 36 (U.S. CLS.
100, 101 AND 102).

FIRST USE 1-28-2008; IN COMMERCE 1-28-2008.

THE MARK CONSISTS OF STANDARD CHAR-
ACTERS WITHOUT CLAIM TO ANY PARTICULAR
FONT, STYLE, SIZE, OR COLOR.

OWNER OF U.S. REG. NOS. 871,342, 3,190,114,
AND OTHERS.

THE NAME "MOODY" DOES NOT IDENTIFY A
LIVING INDIVIDUAL.

SN 77-403,005, FILED 2-21-2008.

MARK PILARO, EXAMINING ATTORNEY

Int. Cl.: 41

Prior U.S. Cls.: 100, 101, and 107

United States Patent and Trademark Office

Reg. No. 3,577,707

Registered Feb. 17, 2009

**SERVICE MARK
PRINCIPAL REGISTER**

evalimi

BILLS, CHAD (UNITED STATES INDIVIDUAL)
6574 TURNSTONE WAY
ROCKLIN, CA 95765 AND
BILLS, KIM (UNITED STATES INDIVIDUAL)
6574 TURNSTONE WAY
ROCKLIN, CA 95765

FIRST USE 1-29-2008; IN COMMERCE 3-28-2008.

THE MARK CONSISTS OF STANDARD CHARACTERS WITHOUT CLAIM TO ANY PARTICULAR FONT, STYLE, SIZE, OR COLOR.

FOR: PHOTOGRAPHY; PHOTOGRAPHY SERVICES; PORTRAIT PHOTOGRAPHY; PROVIDING FACILITIES FOR PRODUCING VIDEO, CINEMA AND PHOTOGRAPHY PRODUCTIONS, IN CLASS 41 (U.S. CLS. 100, 101 AND 107).

SN 77-404,374, FILED 2-22-2008.

ALICIA COLLINS, EXAMINING ATTORNEY

Int. Cl.: 35

Prior U.S. Cls.: 100, 101, and 102

United States Patent and Trademark Office

Reg. No. 3,577,708

Registered Feb. 17, 2009

**SERVICE MARK
PRINCIPAL REGISTER**

INTEGRASTAT

WORKPLACE HEARING, INC. (NORTH CAROLINA CORPORATION)
420-B GALLIMORE DAIRY ROAD
GREENSBORO, NC 27409

FOR: PROVIDING WEB ENABLED DATA MANAGEMENT SERVICES FOR OCCUPATIONAL HEALTH SCREENING AND PROGRAM MANAGEMENT, NAMELY, AN OCCUPATIONAL HEALTH DATA MANAGEMENT AND REPORTING SYSTEM PROVIDING SECURE HIPPA COMPLIANT DATA CONTROL AND MANAGEMENT TO EMPLOYERS, IN CLASS 35 (U.S. CLS. 100, 101 AND 102).

FIRST USE 9-23-2008; IN COMMERCE 9-23-2008.

THE MARK CONSISTS OF STANDARD CHARACTERS WITHOUT CLAIM TO ANY PARTICULAR FONT, STYLE, SIZE, OR COLOR.

SN 77-404,771, FILED 2-25-2008.

WILLIAM P. SHANAHAN, EXAMINING ATTORNEY

Int. Cl.: 35

Prior U.S. Cls.: 100, 101, and 102

United States Patent and Trademark Office

Reg. No. 3,577,709

Registered Feb. 17, 2009

**SERVICE MARK
PRINCIPAL REGISTER**



ECSTASIS, LLC (CALIFORNIA LIMITED LIABILITY COMPANY)
SUITE A252
31441 SANTA MARGARITA PARKWAY
RANCHO SANTA MARGARITA, CA 92688

FOR: BUSINESS MANAGEMENT CONSULTATION IN THE FIELD OF EXECUTIVE AND LEADERSHIP DEVELOPMENT, IN CLASS 35 (U.S. CLS. 100, 101 AND 102).

FIRST USE 2-1-2008; IN COMMERCE 2-1-2008.

NO CLAIM IS MADE TO THE EXCLUSIVE RIGHT TO USE "CONSULTING LLC", APART FROM THE MARK AS SHOWN.

THE COLOR(S) LIGHT GOLD, MEDIUM GOLD, LIGHT BROWN AND LIGHT GRAY IS/ARE CLAIMED AS A FEATURE OF THE MARK.

THE MARK CONSISTS THE WORDING "ECSTASIS" IN THE COLOR LIGHT BROWN, THE WORDING "CONSULTING" IN LIGHT GRAY, THE LETTERING "LLC" IN MEDIUM GOLD, AND A DESIGN CONSISTING OF THREE LETTERS "U" IN A TRIANGULAR FORM IN THE COLORS MEDIUM GOLD, LIGHT GOLD AND LIGHT GRAY.

SN 77-405,060, FILED 2-25-2008.

VERNA BETH RIRIE, EXAMINING ATTORNEY

Int. Cl.: 33

Prior U.S. Cls.: 47 and 49

United States Patent and Trademark Office

Reg. No. 3,577,710

Registered Feb. 17, 2009

**TRADEMARK
PRINCIPAL REGISTER**

Ocean Trust

MELANIE J MARKS (UNITED STATES INDIVIDUAL)
2307 FENTON PARKWAY, SUITE 107-33
SAN DIEGO, CA 92108

THE MARK CONSISTS OF STANDARD CHARACTERS WITHOUT CLAIM TO ANY PARTICULAR FONT, STYLE, SIZE, OR COLOR.

FOR: WINE, IN CLASS 33 (U.S. CLS. 47 AND 49).

SN 77-405,067, FILED 2-25-2008.

FIRST USE 9-1-2006; IN COMMERCE 7-1-2007.

ROBERT STRUCK, EXAMINING ATTORNEY

Int. Cl.: 36

Prior U.S. Cls.: 100, 101, and 102

United States Patent and Trademark Office

Reg. No. 3,577,711

Registered Feb. 17, 2009

**SERVICE MARK
PRINCIPAL REGISTER**

WOMEN WITH BALLS

NATIONAL BREAST CANCER COALITION
FUND (PENNSYLVANIA NON-PROFIT COR-
PORATION)
1101 17TH ST NW, SUITE 1300
WASHINGTON, DC 20036

FOR: ORGANIZING AND CONDUCTING FUN-
DRAISING EVENTS, NAMELY, CHARITY SPORT-
ING EVENTS, IN CLASS 36 (U.S. CLS. 100, 101 AND
102).

FIRST USE 3-0-2008; IN COMMERCE 3-0-2008.

THE MARK CONSISTS OF STANDARD CHAR-
ACTERS WITHOUT CLAIM TO ANY PARTICULAR
FONT, STYLE, SIZE, OR COLOR.

SN 77-406,199, FILED 2-26-2008.

C. DIONNE CLYBURN, EXAMINING ATTORNEY

Int. Cl.: 30

Prior U.S. Cl.: 46

United States Patent and Trademark Office

Reg. No. 3,577,712

Registered Feb. 17, 2009

**TRADEMARK
PRINCIPAL REGISTER**

WAZOO

THE TOPPS COMPANY, INC. (DELAWARE COR-
PORATION)
ONE WHITEHALL STREET
NEW YORK, NY 10004

THE MARK CONSISTS OF STANDARD CHAR-
ACTERS WITHOUT CLAIM TO ANY PARTICULAR
FONT, STYLE, SIZE, OR COLOR.

FOR: CANDY, IN CLASS 30 (U.S. CL. 46).

SN 77-406,308, FILED 2-26-2008.

FIRST USE 12-12-2008; IN COMMERCE 12-12-2008.

MARY ROSSMAN, EXAMINING ATTORNEY

Int. Cl.: 14

Prior U.S. Cls.: 2, 27, 28, and 50

United States Patent and Trademark Office

Reg. No. 3,577,713

Registered Feb. 17, 2009

**TRADEMARK
PRINCIPAL REGISTER**

GIRLTOPIA

GIRL SCOUTS OF THE UNITED STATES OF
AMERICA (NEW YORK CORPORATION)
420 5TH AVENUE
NEW YORK, NY 100182798

THE MARK CONSISTS OF STANDARD CHAR-
ACTERS WITHOUT CLAIM TO ANY PARTICULAR
FONT, STYLE, SIZE, OR COLOR.

FOR: PRECIOUS METALS; JEWELRY, IN CLASS
14 (U.S. CLS. 2, 27, 28 AND 50).

SN 77-406,582, FILED 2-26-2008.

FIRST USE 6-30-2008; IN COMMERCE 6-30-2008.

WENDY GOODMAN, EXAMINING ATTORNEY

Int. Cl.: 25

Prior U.S. Cls.: 22 and 39

United States Patent and Trademark Office

Reg. No. 3,577,714

Registered Feb. 17, 2009

**TRADEMARK
PRINCIPAL REGISTER**

GIRLTOPIA

GIRL SCOUTS OF THE UNITED STATES OF
AMERICA (NEW YORK CORPORATION)
420 5TH AVENUE
NEW YORK, NY 100182798

FOR: CLOTHING, NAMELY, T-SHIRTS, SWEAT-
SHIRTS, POLOS, JACKETS, SWEATERS, SHIRTS,
BLOUSES, TIES, JUMPERS, SHORTS, SLACKS,
NIGHTSHIRTS, TIGHTS, SOCKS, SWEATPANTS,
SCARVES, AND PONCHOS; HEADWEAR, NAME-
LY, HATS, HEADBANDS, SWEATBANDS AND VI-
SORS; FOOTWEAR, IN CLASS 25 (U.S. CLS. 22 AND
39).

FIRST USE 6-30-2008; IN COMMERCE 6-30-2008.

THE MARK CONSISTS OF STANDARD CHAR-
ACTERS WITHOUT CLAIM TO ANY PARTICULAR
FONT, STYLE, SIZE, OR COLOR.

SN 77-406,720, FILED 2-26-2008.

WENDY GOODMAN, EXAMINING ATTORNEY

Int. Cl.: 16

Prior U.S. Cls.: 2, 5, 22, 23, 29, 37, 38, and 50

United States Patent and Trademark Office

Reg. No. 3,577,715

Registered Feb. 17, 2009

**TRADEMARK
PRINCIPAL REGISTER**

GIRLTOPIA

GIRL SCOUTS OF THE UNITED STATES OF
AMERICA (NEW YORK CORPORATION)
420 5TH AVENUE
NEW YORK, NY 100182798

FOR: PRINTED AWARD CERTIFICATES, STICKERS, BANNERS MADE OF PAPER, FLAGS MADE OF PAPER, EDUCATIONAL PUBLICATIONS, NAMELY, TRAINING MANUALS IN THE FIELD OF CONDUCTING PROGRAMS AND ACTIVITIES FOR GIRLS AND YOUNG WOMEN TO PROMOTE SOCIAL, PHYSICAL AND INTELLECTUAL GROWTH AND DEVELOPMENT; WRITING IN-

STRUMENTS; STATIONERY, IN CLASS 16 (U.S. CLS. 2, 5, 22, 23, 29, 37, 38 AND 50).

FIRST USE 6-30-2008; IN COMMERCE 6-30-2008.

THE MARK CONSISTS OF STANDARD CHARACTERS WITHOUT CLAIM TO ANY PARTICULAR FONT, STYLE, SIZE, OR COLOR.

SN 77-406,731, FILED 2-26-2008.

WENDY GOODMAN, EXAMINING ATTORNEY

Int. Cl.: 9

Prior U.S. Cls.: 21, 23, 26, 36, and 38

United States Patent and Trademark Office

Reg. No. 3,577,716

Registered Feb. 17, 2009

**TRADEMARK
PRINCIPAL REGISTER**

SENTRY

US AUTOMATIC, LTD. (TEXAS LIMITED PART-
NERSHIP)
118 HILLSIDE DRIVE
LEWISVILLE, TX 75057

THE MARK CONSISTS OF STANDARD CHAR-
ACTERS WITHOUT CLAIM TO ANY PARTICULAR
FONT, STYLE, SIZE, OR COLOR.

FOR: GATE OPERATORS POWERED BY BAT-
TERY, ELECTRICITY OR SOLAR POWER, IN
CLASS 9 (U.S. CLS. 21, 23, 26, 36 AND 38).

SN 77-407,501, FILED 2-27-2008.

FIRST USE 7-0-2008; IN COMMERCE 8-0-2008.

RUDY R. SINGLETON, EXAMINING ATTORNEY

Int. Cl.: 45

Prior U.S. Cls.: 100 and 101

United States Patent and Trademark Office

Reg. No. 3,577,717

Registered Feb. 17, 2009

**SERVICE MARK
PRINCIPAL REGISTER**

MORE TOGETHER

FAEGRE & BENSON LLP (MINNESOTA LIMITED LIABILITY PARTNERSHIP)
2200 WELLS FARGO CENTER
90 SOUTH SEVENTH STREET
MINNEAPOLIS, MN 554023901

FOR: LEGAL SERVICES; PROVIDING INFORMATION ON LEGAL-RELATED MATTERS VIA THE INTERNET, IN CLASS 45 (U.S. CLS. 100 AND 101).

FIRST USE 5-22-2008; IN COMMERCE 5-22-2008.

THE MARK CONSISTS OF STANDARD CHARACTERS WITHOUT CLAIM TO ANY PARTICULAR FONT, STYLE, SIZE, OR COLOR.

SN 77-407,691, FILED 2-27-2008.

RUSS HERMAN, EXAMINING ATTORNEY

Int. Cl.: 8

Prior U.S. Cls.: 23, 28, and 44

United States Patent and Trademark Office

Reg. No. 3,577,718

Registered Feb. 17, 2009

**TRADEMARK
PRINCIPAL REGISTER**

EASY CLIP

ANDIS COMPANY (WISCONSIN CORPORATION)

1800 RENAISSANCE BLVD.

STURTEVANT, WI 53177

FOR: ELECTRIC ANIMAL HAIR CLIPPERS, IN CLASS 8 (U.S. CLS. 23, 28 AND 44).

FIRST USE 6-27-2008; IN COMMERCE 6-27-2008.

THE MARK CONSISTS OF STANDARD CHARACTERS WITHOUT CLAIM TO ANY PARTICULAR FONT, STYLE, SIZE, OR COLOR.

NO CLAIM IS MADE TO THE EXCLUSIVE RIGHT TO USE "CLIP", APART FROM THE MARK AS SHOWN.

SN 77-407,816, FILED 2-27-2008.

KAELIE KUNG, EXAMINING ATTORNEY

Int. Cl.: 16

Prior U.S. Cls.: 2, 5, 22, 23, 29, 37, 38, and 50

United States Patent and Trademark Office

Reg. No. 3,577,719

Registered Feb. 17, 2009

**TRADEMARK
PRINCIPAL REGISTER**

Econo-Cut

CONVERT-ALL, INC. (WISCONSIN CORPORATION)
P O BOX 39
523 W WALL STREET
DARIEN, WI 53114

FOR: SYNTHETIC PAPER, NAMELY, PRINTING
SUBSTRATE FOR PRODUCING TAGS, LABELS,
SIGNS, BANNERS, BUSINESS FORMS, IN CLASS
16 (U.S. CLS. 2, 5, 22, 23, 29, 37, 38 AND 50).

FIRST USE 12-18-2008; IN COMMERCE 12-18-2008.

THE MARK CONSISTS OF STANDARD CHARACTERS WITHOUT CLAIM TO ANY PARTICULAR FONT, STYLE, SIZE, OR COLOR.

SN 77-407,818, FILED 2-27-2008.

KAELIE KUNG, EXAMINING ATTORNEY

Int. Cl.: 3

Prior U.S. Cls.: 1, 4, 6, 50, 51, and 52

United States Patent and Trademark Office

Reg. No. 3,577,720

Registered Feb. 17, 2009

**TRADEMARK
PRINCIPAL REGISTER**

ELNETT SATIN

L'OREAL (FRANCE SOCIÉTÉ ANONYME (SA))
14 RUE ROYALE
PARIS, FRANCE 75008

THE MARK CONSISTS OF STANDARD CHAR-
ACTERS WITHOUT CLAIM TO ANY PARTICULAR
FONT, STYLE, SIZE, OR COLOR.

FOR: HAIR SPRAY, IN CLASS 3 (U.S. CLS. 1, 4, 6,
50, 51 AND 52).

SN 77-408,625, FILED 2-28-2008.

FIRST USE 10-11-2008; IN COMMERCE 10-11-2008.

TINA L. SNAPP, EXAMINING ATTORNEY

Int. Cls.: 38 and 41

Prior U.S. Cls.: 100, 101, 104, and 107

United States Patent and Trademark Office

Reg. No. 3,577,721

Registered Feb. 17, 2009

**SERVICE MARK
PRINCIPAL REGISTER**

**THE COUNTRY WITH A
CONSCIENCE**

U.S. COUNTRY RADIO, LLC (FLORIDA LIMITED LIABILITY COMPANY)

#413

1172 SOUTH DIXIE HIGHWAY
CORAL GABLES, FL 331462918

FOR: RADIO BROADCASTING SERVICES, IN CLASS 38 (U.S. CLS. 100, 101 AND 104).

FIRST USE 4-10-2008; IN COMMERCE 4-10-2008.

FOR: ENTERTAINMENT SERVICES, NAMELY, RADIO ENTERTAINMENT PRODUCTION AND

RADIO PROGRAMMING, IN CLASS 41 (U.S. CLS. 100, 101 AND 107).

FIRST USE 4-10-2008; IN COMMERCE 4-10-2008.

THE MARK CONSISTS OF STANDARD CHARACTERS WITHOUT CLAIM TO ANY PARTICULAR FONT, STYLE, SIZE, OR COLOR.

SN 77-409,376, FILED 2-29-2008.

ALICIA COLLINS, EXAMINING ATTORNEY

Int. Cl.: 36

Prior U.S. Cls.: 100, 101, and 102

United States Patent and Trademark Office

Reg. No. 3,577,722

Registered Feb. 17, 2009

SERVICE MARK
PRINCIPAL REGISTER

TranLogix

TRANLOGIX (DELAWARE CORPORATION)
12TH FLOOR
488 MADISON AVENUE
NEW YORK, NY 10022

FOR: PROVIDING ELECTRONIC PROCESSING
OF ACH AND CREDIT CARD TRANSACTIONS
AND ELECTRONIC PAYMENTS VIA A GLOBAL
COMPUTER NETWORK, IN CLASS 36 (U.S. CLS. 100,
101 AND 102).

FIRST USE 2-15-2008; IN COMMERCE 2-15-2008.

THE STIPPLING IS FOR SHADING PURPOSES
ONLY.

THE MARK CONSISTS OF THE TEXT "TRANLO-
GIX" IN THE TYPEFACE MYRIAD PRO ITALICS.
THE "TRAN" IS BOLD, THE "LOGI" IS NOT BOLD,
THE "X" IS BOLD AND CUSTOM STYLED WITH
THE BOTTOM LEFT LEG EXTENDED TO THE
BASELINE OF THE "G".

SN 77-412,333, FILED 3-4-2008.

JOHN GARTNER, EXAMINING ATTORNEY

Int. Cl.: 16

Prior U.S. Cls.: 2, 5, 22, 23, 29, 37, 38, and 50

Reg. No. 3,577,723

United States Patent and Trademark Office

Registered Feb. 17, 2009

**TRADEMARK
PRINCIPAL REGISTER**

ROYAL RESOURCE

WAUSAU PAPER PRINTING & WRITING, LLC
(WISCONSIN LIMITED LIABILITY COMPAN-
NY)
100 PAPER PLACE
MOSINEE, WI 54455

FOR: PRINTING, WRITING, IMAGING AND
COVER PAPERS, IN CLASS 16 (U.S. CLS. 2, 5, 22, 23,
29, 37, 38 AND 50).

FIRST USE 9-0-2008; IN COMMERCE 9-11-2008.

THE MARK CONSISTS OF STANDARD CHAR-
ACTERS WITHOUT CLAIM TO ANY PARTICULAR
FONT, STYLE, SIZE, OR COLOR.

OWNER OF U.S. REG. NOS. 1,718,073, 3,121,174,
AND OTHERS.

SN 77-412,378, FILED 3-4-2008.

ESTHER BELENKER, EXAMINING ATTORNEY

Int. Cl.: 5

Prior U.S. Cls.: 6, 18, 44, 46, 51, and 52

United States Patent and Trademark Office

Reg. No. 3,577,724

Registered Feb. 17, 2009

**TRADEMARK
PRINCIPAL REGISTER**

VIRAPHYTE

BLAIR, FRED (UNITED STATES INDIVIDUAL)
542 EAST 14TH STREET, #22
NEW YORK, NY 10009 AND
KUEBEL, MARK (UNITED STATES INDIVIDUAL)
402 WEST 148TH STREET, #42
NEW YORK, NY 10031

FOR: MEDICINAL HERB EXTRACTS, IN CLASS 5
(U.S. CLS. 6, 18, 44, 46, 51 AND 52).

FIRST USE 3-25-2008; IN COMMERCE 3-25-2008.

THE MARK CONSISTS OF STANDARD CHAR-
ACTERS WITHOUT CLAIM TO ANY PARTICULAR
FONT, STYLE, SIZE, OR COLOR.

SN 77-412,860, FILED 3-4-2008.

DANNEAN HETZEL, EXAMINING ATTORNEY

Int. Cls.: 35 and 41

Prior U.S. Cls.: 100, 101, 102, and 107

United States Patent and Trademark Office

Reg. No. 3,577,725

Registered Feb. 17, 2009

**SERVICE MARK
PRINCIPAL REGISTER**



CRICKET COUNCIL USA INC. (FLORIDA CORPORATION)
6221 W ATLANTIC BLVD.
6221 W ATLANTIC BLVD. MARGATE, FL 33063
MARGATE, FL 33063

FOR: ADVERTISING, INCLUDING PROMOTION OF PRODUCTS AND SERVICES OF THIRD PARTIES THROUGH SPONSORING ARRANGEMENTS AND LICENCE AGREEMENTS RELATING TO INTERNATIONAL SPORTS' EVENTS; PRODUCT MERCHANDISING, IN CLASS 35 (U.S. CLS. 100, 101 AND 102).

FIRST USE 2-1-2008; IN COMMERCE 2-1-2008.

FOR: ENTERTAINMENT SERVICES, NAMELY, AN ON-GOING SERIES FEATURING CRICKET TOURNAMENTS AND GAMES PROVIDED THROUGH RADIO, TELEVISION, INTERNET, IN CLASS 41 (U.S. CLS. 100, 101 AND 107).

FIRST USE 2-1-2008; IN COMMERCE 2-1-2008.

THE COLOR(S) RED, GREEN, BLUE, YELLOW, BLACK IS/ARE CLAIMED AS A FEATURE OF THE MARK.

THE MARK CONSISTS OF A CRICKET PLAYER WEARING A HAT WITH A BLUE TOP OUTLINE, A GREEN RIM, A RED CHIN STRAP, HIS ARMS ARE OUTLINED IN BLUE, HIS HANDS ARE OUTLINED IN YELLOW, HE IS HOLDING A RED CRICKET BAT, THE RIGHT TORSO IS OUTLINED IN RED EXTENDING DOWN THE TOP OF HIS LEG AND THE LEFT TORSO IS OUTLINED IN GREEN EXTENDING DOWN TO THE INSIDE OF HIS CALF, THE OUTSIDE OF HIS KNEE TO HIS LOWER SHIN IS OUTLINED IN YELLOW, THE LOGO IS IN BLACK.

SN 77-413,280, FILED 3-5-2008.

CIMMERIAN COLEMAN, EXAMINING ATTORNEY

Int. Cls.: 37 and 42

Prior U.S. Cls.: 100, 101, 103, and 106

United States Patent and Trademark Office

Reg. No. 3,577,726

Registered Feb. 17, 2009

**SERVICE MARK
PRINCIPAL REGISTER**

BUILD THE BEST, BE THE BEST

FLATIRON CONSTRUCTION CORP (DELA-
WARE CORPORATION)
10090 I-25 FRONTAGE ROAD
LONGMONT, CO 80504

FOR: CONSTRUCTION OF ROADS, COMMERCIAL BUILDINGS, POWER PLANTS, PIPELINES, TUNNELS, BRIDGES, AIRPORTS, RAIL LINES, TRANSIT LINES, MARINE STRUCTURES, POWER GENERATING STRUCTURES AND POWER TRANSMITTING STRUCTURES, IN CLASS 37 (U.S. CLS. 100, 103 AND 106).

FIRST USE 4-1-2008; IN COMMERCE 4-1-2008.

FOR: INDUSTRIAL DESIGN SERVICES, IN CLASS 42 (U.S. CLS. 100 AND 101).

FIRST USE 4-1-2008; IN COMMERCE 4-1-2008.

THE MARK CONSISTS OF STANDARD CHARACTERS WITHOUT CLAIM TO ANY PARTICULAR FONT, STYLE, SIZE, OR COLOR.

SN 77-413,300, FILED 3-5-2008.

ARETHA SOMERVILLE, EXAMINING ATTORNEY

Int. Cl.: 9

Prior U.S. Cls.: 21, 23, 26, 36, and 38

United States Patent and Trademark Office

Reg. No. 3,577,727

Registered Feb. 17, 2009

**TRADEMARK
PRINCIPAL REGISTER**

Ingio

VINBALANCE, LLC (WASHINGTON LIMITED
LIABILITY COMPANY)
6 E. ALDER, STE. 224
WALLA WALLA, WA 99362

FOR: COMPUTER SOFTWARE AND HARD-
WARE FOR WINERY PRODUCTION, SUPPLIES
INVENTORY, FINISHED GOOD INVENTORY,
SALES, WINE TAX REPORTING, WINE SUBSCRIP-
TION CLUB, POINT OF SALE, COST TRACKING,
DISTRIBUTOR MANAGEMENT AND ACCOUNT-
ING, IN CLASS 9 (U.S. CLS. 21, 23, 26, 36 AND 38).

FIRST USE 10-15-2008; IN COMMERCE 10-15-2008.

THE MARK CONSISTS OF STANDARD CHAR-
ACTERS WITHOUT CLAIM TO ANY PARTICULAR
FONT, STYLE, SIZE, OR COLOR.

SN 77-413,378, FILED 3-5-2008.

ARETHA SOMERVILLE, EXAMINING ATTORNEY

Int. Cl.: 42

Prior U.S. Cls.: 100 and 101

United States Patent and Trademark Office

Reg. No. 3,577,728

Registered Feb. 17, 2009

**SERVICE MARK
PRINCIPAL REGISTER**

MY FRIDGE

YADAHOME.COM LLC (DELAWARE LIMITED
LIABILITY COMPANY)
UNIT 628
1000 FELL STREET
BALTIMORE, MD 21231

FOR: COMPUTER SERVICES IN THE NATURE
OF CUSTOMIZED WEB PAGES FEATURING USER-
DEFINED INFORMATION, PERSONAL PROFILES
AND INFORMATION , IN CLASS 42 (U.S. CLS. 100
AND 101).

FIRST USE 5-12-2008; IN COMMERCE 5-12-2008.

THE MARK CONSISTS OF STANDARD CHAR-
ACTERS WITHOUT CLAIM TO ANY PARTICULAR
FONT, STYLE, SIZE, OR COLOR.

SN 77-413,386, FILED 3-5-2008.

FLORENTINA BLANDU, EXAMINING ATTORNEY

Int. Cl.: 5

Prior U.S. Cls.: 6, 18, 44, 46, 51, and 52

Reg. No. 3,577,729

United States Patent and Trademark Office

Registered Feb. 17, 2009

**TRADEMARK
PRINCIPAL REGISTER**

SILVER MATRIX

BRENNEN MEDICAL, LLC (MINNESOTA LIMITED LIABILITY COMPANY)
1290 HAMMOND RD.
ST. PAUL, MN 55110

THE MARK CONSISTS OF STANDARD CHARACTERS WITHOUT CLAIM TO ANY PARTICULAR FONT, STYLE, SIZE, OR COLOR.

FOR: ANTIMICROBIAL WOUND DRESSING, IN CLASS 5 (U.S. CLS. 6, 18, 44, 46, 51 AND 52).

SN 77-413,438, FILED 3-5-2008.

FIRST USE 6-4-2008; IN COMMERCE 6-4-2008.

TIMOTHY FINNEGAN, EXAMINING ATTORNEY

Int. Cl.: 17

Prior U.S. Cls.: 1, 5, 12, 13, 35, and 50

United States Patent and Trademark Office

Reg. No. 3,577,730

Registered Feb. 17, 2009

**TRADEMARK
PRINCIPAL REGISTER**

E-FILL SIPHON

AERO DESIGN AND MANUFACTURING COM-
PANY, INC. (MINNESOTA CORPORATION)
8 SOUTH 18TH AVENUE WEST
DULUTH, MN 55806

FOR: FUEL-TRANSFER SIPHONING DEVICE,
NAMELY, NON-METAL PETROLEUM HOSES, IN
CLASS 17 (U.S. CLS. 1, 5, 12, 13, 35 AND 50).

FIRST USE 4-0-2008; IN COMMERCE 4-0-2008.

THE MARK CONSISTS OF STANDARD CHAR-
ACTERS WITHOUT CLAIM TO ANY PARTICULAR
FONT, STYLE, SIZE, OR COLOR.

NO CLAIM IS MADE TO THE EXCLUSIVE
RIGHT TO USE "SIPHON", APART FROM THE
MARK AS SHOWN.

SN 77-414,471, FILED 3-6-2008.

TAMARA FRAZIER, EXAMINING ATTORNEY

Int. Cls.: 4, 7, 9, 12, 35, 37, and 45

Prior U.S. Cls.: 1, 6, 13, 15, 19, 21, 23, 26, 31, 34, 35, 36, 38, 44, 100, 101, 102, 103, and 106

Reg. No. 3,577,731

United States Patent and Trademark Office

Registered Feb. 17, 2009

**TRADEMARK
SERVICE MARK
PRINCIPAL REGISTER**

GREASECAR

GREASECAR VEGETABLE FUEL SYSTEMS, LLC
(MASSACHUSETTS LIMITED LIABILITY
COMPANY)

933 MAIN STREET
HOLYOKE, MA 01040

FOR: FUELS; RENEWABLE FUELS , IN CLASS 4
(U.S. CLS. 1, 6 AND 15).

FIRST USE 7-1-2008; IN COMMERCE 7-1-2008.

FOR: FILTERS FOR ALTERNATIVE FUEL POWERED MACHINES; FUEL FILTERS; FUEL INJECTOR PARTS FOR LAND AND WATER VEHICLE ENGINES; HEAT EXCHANGERS BEING PARTS OF MACHINES; INTERNAL COMBUSTION ENGINES FOR MACHINE OPERATION AND REPLACEMENT PARTS THEREFOR; OIL FILTERS; OIL FILTERS FOR MOTORS AND ENGINES; VALVES BEING PARTS OF MACHINES; VALVES BEING PARTS OF ALTERNATIVE FUEL SYSTEMS FOR MACHINES; VEHICLE ENGINE PARTS, NAMELY, OIL TANKS, IN CLASS 7 (U.S. CLS. 13, 19, 21, 23, 31, 34 AND 35).

FIRST USE 11-0-2000; IN COMMERCE 11-0-2000.

FOR: ELECTRICAL CONTROLLERS; ELECTRICAL CONTROLLING DEVICES; DOWNLOADABLE ELECTRONIC NEWSLETTERS IN THE FIELD OF VEHICLES AND VEHICLE PARTS, IN CLASS 9 (U.S. CLS. 21, 23, 26, 36 AND 38).

FIRST USE 3-1-2008; IN COMMERCE 3-1-2008.

FOR: AUTOMOBILE ENGINES; ENGINES FOR LAND VEHICLES; FUEL LINES FOR VEHICLES; GAS TANKS FOR LAND VEHICLES; GAS TANKS FOR ALTERNATIVE FUEL VEHICLES; INTERNAL COMBUSTION ENGINES FOR LAND VEHICLES;

STRUCTURAL PARTS FOR AUTOMOBILES; STRUCTURAL PARTS FOR BOATS; STRUCTURAL PARTS FOR BUSES; STRUCTURAL PARTS FOR TRUCKS; STRUCTURAL PARTS FOR VANS; BACK-UP WARNING ALARMS FOR VEHICLES, IN CLASS 12 (U.S. CLS. 19, 21, 23, 31, 35 AND 44).

FIRST USE 11-0-2000; IN COMMERCE 11-0-2000.

FOR: COMPUTERIZED ON-LINE ORDERING SERVICES IN THE FIELD OF AUTOMOTIVE ACCESSORY PARTS AND PARTS RELATING TO AUTOMOTIVE ALTERNATIVE FUEL UTILIZATION; ON-LINE ORDERING SERVICES FEATURING AUTOMOTIVE ACCESSORY PARTS AND PARTS RELATING TO AUTOMOTIVE ALTERNATIVE FUEL UTILIZATION; PROVIDING A WEB SITE THAT ENABLES USERS TO POST ITEMS FOR SALE THROUGH ON-LINE CLASSIFIED ADVERTISEMENTS; PROVIDING AN ON-LINE SEARCHABLE DATABASE FEATURING CLASSIFIED AD LISTINGS AND EMPLOYMENT OPPORTUNITIES, IN CLASS 35 (U.S. CLS. 100, 101 AND 102).

FIRST USE 11-0-2000; IN COMMERCE 11-0-2000.

FOR: AUTOMOTIVE CONVERSION SERVICES, NAMELY, INSTALLING SPECIALTY AUTOMOTIVE EQUIPMENT; INSTALLATION OF AUTOMOTIVE PARTS FOR ALTERNATIVE FUEL UTILIZATION; INSTALLATION, MAINTENANCE AND REPAIR OF AUTOMOBILES; MACHINERY INSTALLATION; AUTOMOBILE CUSTOMIZATION SERVICES; AUTOMOBILE SERVICE STATION SERVICES, IN CLASS 37 (U.S. CLS. 100, 103 AND 106).

FIRST USE 1-0-2001; IN COMMERCE 1-0-2001.

FOR: ORGANIZING AND CONDUCTING SUPPORT GROUPS IN THE FIELD OF ALTERNATIVE FUEL UTILIZATION; PERSONAL LIFESTYLE CONSULTING SERVICES, IN CLASS 45 (U.S. CLS. 100 AND 101).

FIRST USE 11-0-2000; IN COMMERCE 11-0-2000.

THE MARK CONSISTS OF STANDARD CHARACTERS WITHOUT CLAIM TO ANY PARTICULAR FONT, STYLE, SIZE, OR COLOR.

SN 77-414,809, FILED 3-6-2008.

JAY BESCH, EXAMINING ATTORNEY

Int. Cls.: 9, 16, and 41

**Prior U.S. Cls.: 2, 5, 21, 22, 23, 26, 29, 36, 37, 38, 50,
100, 101, and 107**

Reg. No. 3,577,732

United States Patent and Trademark Office

Registered Feb. 17, 2009

**TRADEMARK
SERVICE MARK
PRINCIPAL REGISTER**



WESTON DISTANCE LEARNING, INC. (COLOR-
ADO CORPORATION)
2001 LOWE ST.
FT. COLLINS, CO 80525

FOR: INFORMATION STORAGE DEVICES,
NAMELY, COMPACT DISCS (CD'S), AND DIGITAL
VIDEO DISCS (DVD'S), FEATURING INSTRUC-
TIONAL, TEACHING AND TRAINING MATERI-
ALS IN THE FIELDS OF BUSINESS,
MANAGEMENT, COMPUTERS, ACCOUNTING,
ECONOMICS, MATHEMATICS, SCIENCE, GENER-
AL EDUCATION AND HEALTH, IN CLASS 9 (U.S.
CLS. 21, 23, 26, 36 AND 38).

FIRST USE 3-0-2008; IN COMMERCE 3-0-2008.

FOR: BOOKS, BROCHURES AND PERIODICALS
FEATURING INSTRUCTIONAL, TEACHING AND
TRAINING MATERIALS IN THE FIELDS OF BUSI-
NESS, MANAGEMENT, COMPUTERS, ACCOUNT-
ING, ECONOMICS, MATHEMATICS, SCIENCE,
GENERAL EDUCATION AND HEALTH, IN CLASS
16 (U.S. CLS. 2, 5, 22, 23, 29, 37, 38 AND 50).

FIRST USE 3-0-2008; IN COMMERCE 3-0-2008.

FOR: PROVIDING AN INTERACTIVE WEB SITE
FEATURING INSTRUCTIONAL, TEACHING AND
TRAINING COURSES IN THE FIELDS OF BUSI-
NESS, MANAGEMENT, COMPUTERS, ACCOUNT-
ING, ECONOMICS, MATHEMATICS, SCIENCE,
GENERAL EDUCATION AND HEALTH, IN CLASS
41 (U.S. CLS. 100, 101 AND 107).

FIRST USE 3-4-2008; IN COMMERCE 3-4-2008.

OWNER OF U.S. REG. NOS. 3,093,727 AND
3,204,316.

NO CLAIM IS MADE TO THE EXCLUSIVE
RIGHT TO USE "COLLEGE", APART FROM THE
MARK AS SHOWN.

THE MARK CONSISTS OF THE WORDS AND
LETTERS "MCKINLEY MC COLLEGE" POSI-
TIONED IN A RECTANGLE.

SN 77-415,426, FILED 3-6-2008.

JASON BLAIR, EXAMINING ATTORNEY

Int. Cl.: 25

Prior U.S. Cls.: 22 and 39

United States Patent and Trademark Office

Reg. No. 3,577,733

Registered Feb. 17, 2009

**TRADEMARK
PRINCIPAL REGISTER**

IDRY

DYNASTY FOOTWEAR, LTD. (CALIFORNIA
CORPORATION)
800 NORTH SEPULVEDA BOULEVARD
EL SEGUNDO, CA 90245

THE MARK CONSISTS OF STANDARD CHAR-
ACTERS WITHOUT CLAIM TO ANY PARTICULAR
FONT, STYLE, SIZE, OR COLOR.

FOR: CLOTHING, NAMELY, T-SHIRTS AND
CAPS; FOOTWEAR, IN CLASS 25 (U.S. CLS. 22
AND 39).

SN 77-415,500, FILED 3-6-2008.

FIRST USE 4-0-2008; IN COMMERCE 5-0-2008.

BENJAMIN OKEKE, EXAMINING ATTORNEY

Int. Cl.: 25

Prior U.S. Cls.: 22 and 39

United States Patent and Trademark Office

Reg. No. 3,577,734

Registered Feb. 17, 2009

**TRADEMARK
PRINCIPAL REGISTER**

TRUE ENVY

JIANGSU GLOBAL DEVELOPMENT, INC. (NEW
YORK CORPORATION)
246 WEST 38TH STREET, SUITE 5B
NEW YORK, NY 10018

FOR: LADIES SPORTSWEAR, NAMELY, JACK-
ETS, PANTS, SKIRTS, BLOUSES, SHIRTS, SHORTS,
DRESSES, SWEATERS, T-SHIRTS, IN CLASS 25 (U.S.
CLS. 22 AND 39).

FIRST USE 5-8-2008; IN COMMERCE 5-8-2008.

THE MARK CONSISTS OF STANDARD CHAR-
ACTERS WITHOUT CLAIM TO ANY PARTICULAR
FONT, STYLE, SIZE, OR COLOR.

SN 77-416,416, FILED 3-7-2008.

STEVEN JACKSON, EXAMINING ATTORNEY

Int. Cl.: 9

Prior U.S. Cls.: 21, 23, 26, 36, and 38

United States Patent and Trademark Office

Reg. No. 3,577,735

Registered Feb. 17, 2009

**TRADEMARK
PRINCIPAL REGISTER**

A Kingdom for Keflings

WAHOO STUDIOS, INC. (UTAH CORPORATION)
1806 SANDHILL ROAD
OREM, UT 84058

FOR: COMPUTER GAME PROGRAMS; COMPUTER GAME PROGRAMS, CARTRIDGES, AND CASSETTES; COMPUTER GAME SOFTWARE; COMPUTER PROGRAMS FOR VIDEO AND COMPUTER GAMES; ELECTRONIC GAME PROGRAMS; ELECTRONIC GAME SOFTWARE; ELECTRONIC GAME SOFTWARE FOR CELLULAR TELEPHONES; ELECTRONIC GAME SOFTWARE FOR HANDHELD ELECTRONIC DEVICES; ELECTRONIC GAME SOFTWARE FOR WIRELESS DEVICES; ELECTRONIC INTERACTIVE BOARD GAMES FOR USE WITH EXTERNAL MONITOR; GAME SOFT-

WARE; INTERACTIVE MULTIMEDIA COMPUTER GAME PROGRAM; INTERACTIVE VIDEO GAME PROGRAMS; VIDEO AND COMPUTER GAME PROGRAMS; VIDEO GAME SOFTWARE; VIRTUAL REALITY GAME SOFTWARE, IN CLASS 9 (U.S. CLS. 21, 23, 26, 36 AND 38).

FIRST USE 7-15-2008; IN COMMERCE 11-19-2008.

THE MARK CONSISTS OF STANDARD CHARACTERS WITHOUT CLAIM TO ANY PARTICULAR FONT, STYLE, SIZE, OR COLOR.

SN 77-416,443, FILED 3-7-2008.

NELSON SNYDER, EXAMINING ATTORNEY

Int. Cl.: 5

Prior U.S. Cls.: 6, 18, 44, 46, 51, and 52

United States Patent and Trademark Office

Reg. No. 3,577,736

Registered Feb. 17, 2009

**TRADEMARK
PRINCIPAL REGISTER**

**DERMATELLIGENCE
DERMATELLIGENT**

ENNIS CHRISTIENA W (AUSTRALIA INDIVIDUAL)
884 HANCOCK WAY
KARRATHA, AUSTRALIA 6714 AND
ENNIS PETER J (AUSTRALIA INDIVIDUAL)
884 HANCOCK WAY
KARRATHA, AUSTRALIA 6714

FOR: MEDICATED LOTIONS FOR SKIN; MEDICATED SKIN CARE PREPARATIONS; MEDICATED SKIN CARE PREPARATIONS, NAMELY, CREAMS, LOTIONS, GELS, TONERS, CLEANERS

AND PEELS; MEDICINAL CREAMS FOR SKIN CARE, IN CLASS 5 (U.S. CLS. 6, 18, 44, 46, 51 AND 52).

FIRST USE 3-17-2008; IN COMMERCE 3-17-2008.

THE MARK CONSISTS OF STANDARD CHARACTERS WITHOUT CLAIM TO ANY PARTICULAR FONT, STYLE, SIZE, OR COLOR.

SN 77-416,703, FILED 3-7-2008.

FRED MANDIR, EXAMINING ATTORNEY

Int. Cl.: 42

Prior U.S. Cls.: 100 and 101

United States Patent and Trademark Office

Reg. No. 3,577,737

Registered Feb. 17, 2009

**SERVICE MARK
PRINCIPAL REGISTER**

POOLED IN

POOLED IN, INC (DELAWARE CORPORATION)
206 CORAL CREEK LN.
MORRISVILLE, NC 27560

THE MARK CONSISTS OF STANDARD CHAR-
ACTERS WITHOUT CLAIM TO ANY PARTICULAR
FONT, STYLE, SIZE, OR COLOR.

FOR: NONDOWNLOADABLE SOFTWARE FOR
SCHEDULE AND TASK MANAGEMENT ACCES-
SED VIA THE WORLDWIDE WEB, IN CLASS 42 (U.S.
CLS. 100 AND 101).

SN 77-418,385, FILED 3-11-2008.

FIRST USE 3-1-2008; IN COMMERCE 10-6-2008.

MATTHEW PAPPAS, EXAMINING ATTORNEY

Int. Cl.: 42

Prior U.S. Cls.: 100 and 101

United States Patent and Trademark Office

Reg. No. 3,577,738

Registered Feb. 17, 2009

**SERVICE MARK
PRINCIPAL REGISTER**

program4food

RAI, MANTRAVADI (UNITED STATES INDIVIDUAL)
1545 TAINAN DRIVE
SAN JOSE, CA 95131

FOR: COMPUTER PROGRAMMING SERVICES; COMPUTER SERVICES, NAMELY, RENDERING INFORMATION TECHNOLOGY CONSULTING; COMPUTER SOFTWARE APPLICATION DEVELOPMENT, IN CLASS 42 (U.S. CLS. 100 AND 101).

FIRST USE 12-1-2008; IN COMMERCE 12-1-2008.

THE MARK CONSISTS OF STANDARD CHARACTERS WITHOUT CLAIM TO ANY PARTICULAR FONT, STYLE, SIZE, OR COLOR.

SN 77-418,410, FILED 3-11-2008.

KOURTNEE HODGES, EXAMINING ATTORNEY

Int. Cl.: 9

Prior U.S. Cls.: 21, 23, 26, 36, and 38

Reg. No. 3,577,739

United States Patent and Trademark Office

Registered Feb. 17, 2009

**TRADEMARK
PRINCIPAL REGISTER**

EZ TRAK

UNITEC ELECTRONICS, INC. (MARYLAND CORPORATION), DBA UNITEC ELECTRONICS,
7125 TROY HILL DRIVE
ELKRIDGE, MD 21075

FOR: COMPUTER HARDWARE AND SOFTWARE FOR CONDUCTING TRANSACTIONS INVOLVING PROCUREMENT, PURCHASING, PAYMENT, AND IDENTIFYING USERS THROUGH ELECTRONIC MEANS; COMPUTER HARDWARE AND SOFTWARE FOR FACILITATING PAYMENT TRANSACTIONS BY ELECTRONIC MEANS, IN CLASS 9 (U.S. CLS. 21, 23, 26, 36 AND 38).

FIRST USE 3-24-2008; IN COMMERCE 3-24-2008.

THE MARK CONSISTS OF STANDARD CHARACTERS WITHOUT CLAIM TO ANY PARTICULAR FONT, STYLE, SIZE, OR COLOR.

NO CLAIM IS MADE TO THE EXCLUSIVE RIGHT TO USE "TRACK", APART FROM THE MARK AS SHOWN.

SN 77-419,786, FILED 3-12-2008.

MARLENE BELL, EXAMINING ATTORNEY

Int. Cl.: 16

Prior U.S. Cls.: 2, 5, 22, 23, 29, 37, 38, and 50

Reg. No. 3,577,740

United States Patent and Trademark Office

Registered Feb. 17, 2009

**TRADEMARK
PRINCIPAL REGISTER**

UEXCEL

EXCELSIOR COLLEGE (NEW YORK CORPORATION)
7 COLUMBIA CIRCLE
ALBANY, NY 12203

FOR: PRINTED TESTS, TEST BOOKLETS, BOOKS AND BROCHURES PROVIDING INFORMATION AND GUIDANCE FOR SCHOOLS, UNIVERSITIES, TEACHERS AND STUDENTS REGARDING COLLEGE LEVEL CREDIT EXAMINATIONS; TEST PREPARATION GUIDES IN THE FIELD OF COLLEGE LEVEL COURSE CREDIT EXAMINATIONS; PRINTED INSTRUCTIONAL EDUCATIONAL AND TEACHING MATERIALS IN THE FIELD OF COLLEGE LEVEL COURSE PREPARATION AND EX-

AMINATIONS, IN CLASS 16 (U.S. CLS. 2, 5, 22, 23, 29, 37, 38 AND 50).

FIRST USE 7-28-2008; IN COMMERCE 7-28-2008.

THE MARK CONSISTS OF STANDARD CHARACTERS WITHOUT CLAIM TO ANY PARTICULAR FONT, STYLE, SIZE, OR COLOR.

OWNER OF U.S. REG. NOS. 2,500,388, 2,661,665, AND OTHERS.

SN 77-420,681, FILED 3-13-2008.

DAYNA BROWNE, EXAMINING ATTORNEY

Int. Cl.: 41

Prior U.S. Cls.: 100, 101, and 107

United States Patent and Trademark Office

Reg. No. 3,577,741

Registered Feb. 17, 2009

**SERVICE MARK
PRINCIPAL REGISTER**

UEXCEL

EXCELSIOR COLLEGE (NEW YORK CORPORATION)
7 COLUMBIA CIRCLE
ALBANY, NY 12203

FOR: COLLEGE LEVEL TESTING SERVICES, NAMELY, PREPARING AND ADMINISTERING EXAMINATIONS DESIGNED TO PROVIDE A MEASURE OF COLLEGE LEVEL COURSE ACHIEVEMENT ON WHICH COLLEGE CREDIT MAY BE AWARDED; SCORING OF COLLEGE LEVEL EXAMINATIONS; PROVIDING TRANSCRIPTS FOR THE PURPOSE OF AWARDED COLLEGE LEVEL CREDIT, IN CLASS 41 (U.S. CLS. 100, 101 AND 107).

FIRST USE 7-28-2008; IN COMMERCE 7-28-2008.

THE MARK CONSISTS OF STANDARD CHARACTERS WITHOUT CLAIM TO ANY PARTICULAR FONT, STYLE, SIZE, OR COLOR.

OWNER OF U.S. REG. NOS. 2,500,388, 2,661,665, AND OTHERS.

SN 77-420,691, FILED 3-13-2008.

DAYNA BROWNE, EXAMINING ATTORNEY

Int. Cl.: 32

Prior U.S. Cls.: 45, 46, and 48

United States Patent and Trademark Office

Reg. No. 3,577,742

Registered Feb. 17, 2009

**TRADEMARK
PRINCIPAL REGISTER**

ABU ABED

CALIFORNIA GARDEN PRODUCTS, INC. (CALIFORNIA CORPORATION)
14 RANCHO CIRCLE
LAKE FOREST, CA 92630

THE MARK CONSISTS OF STANDARD CHARACTERS WITHOUT CLAIM TO ANY PARTICULAR FONT, STYLE, SIZE, OR COLOR.

FOR: ENERGY DRINKS, FRUIT DRINKS AND FRUIT JUICES, FLAVORED WATER AND ISOTONIC DRINKS, IN CLASS 32 (U.S. CLS. 45, 46 AND 48).

SN 77-422,723, FILED 3-14-2008.

FIRST USE 5-26-2008; IN COMMERCE 5-26-2008.

TINA L. SNAPP, EXAMINING ATTORNEY

Int. Cl.: 32

Prior U.S. Cls.: 45, 46, and 48

Reg. No. 3,577,743

United States Patent and Trademark Office

Registered Feb. 17, 2009

TRADEMARK
PRINCIPAL REGISTER



CALIFORNIA GARDEN PRODUCTS, INC. (CALIFORNIA CORPORATION)
14 RANCHO CIRCLE
LAKE FOREST, CA 92630

FOR: ENERGY DRINKS, FRUIT DRINKS AND FRUIT JUICES, FLAVORED WATER AND ISOTONIC DRINKS, IN CLASS 32 (U.S. CLS. 45, 46 AND 48).

FIRST USE 5-26-2008; IN COMMERCE 5-26-2008.

THE MARK CONSISTS OF STYLIZED ARABIC WRITING THAT TRANSLATES TO "ABU ABED" AND THE DEPICTION OF THE HEAD AND SHOULDERS OF A MUSTACHIOED MAN WEARING A FEZ.

SN 77-422,736, FILED 3-14-2008.

TINA L. SNAPP, EXAMINING ATTORNEY

Int. Cls.: 9, 16, and 41

**Prior U.S. Cls.: 2, 5, 21, 22, 23, 26, 29, 36, 37, 38, 50,
100, 101, and 107**

Reg. No. 3,577,744

United States Patent and Trademark Office

Registered Feb. 17, 2009

**TRADEMARK
SERVICE MARK
PRINCIPAL REGISTER**



WESTON DISTANCE LEARNING, INC. (COLOR-
ADO CORPORATION)
2001 LOWE ST.
FT. COLLINS, CO 80525

FOR: INFORMATION STORAGE DEVICES,
NAMELY, COMPACT DISCS (CD'S), AND DIGITAL
VIDEO DISCS (DVD'S), FEATURING INSTRUC-
TIONAL, TEACHING AND TRAINING MATERI-
ALS IN THE FIELDS OF BUSINESS,
MANAGEMENT, COMPUTERS, ACCOUNTING,
ECONOMICS, MATHEMATICS, SCIENCE, GENER-
AL EDUCATION AND HEALTH, IN CLASS 9 (U.S.
CLS. 21, 23, 26, 36 AND 38).

FIRST USE 3-0-2008; IN COMMERCE 3-0-2008.

FOR: BOOKS, BROCHURES AND PERIODICALS
FEATURING INSTRUCTIONAL, TEACHING AND
TRAINING MATERIALS IN THE FIELDS OF BUSI-
NESS, MANAGEMENT, COMPUTERS, ACCOUNT-
ING, ECONOMICS, MATHEMATICS, SCIENCE,
GENERAL EDUCATION AND HEALTH, IN CLASS
16 (U.S. CLS. 2, 5, 22, 23, 29, 37, 38 AND 50).

FIRST USE 3-0-2008; IN COMMERCE 3-0-2008.

FOR: PROVIDING AN INTERACTIVE WEB SITE
FEATURING INSTRUCTIONAL, TEACHING AND
TRAINING COURSES IN THE FIELDS OF BUSI-
NESS, MANAGEMENT, COMPUTERS, ACCOUNT-
ING, ECONOMICS, MATHEMATICS, SCIENCE,
GENERAL EDUCATION AND HEALTH, IN CLASS
41 (U.S. CLS. 100, 101 AND 107).

FIRST USE 3-4-2008; IN COMMERCE 3-4-2008.

OWNER OF U.S. REG. NOS. 3,093,727 AND
3,204,316.

NO CLAIM IS MADE TO THE EXCLUSIVE
RIGHT TO USE "COLLEGE", APART FROM THE
MARK AS SHOWN.

THE MARK CONSISTS OF THE WORDS AND
LETTERS "MC MCKINLEY COLLEGE" POSI-
TIONED IN A RECTANGLE.

SN 77-422,739, FILED 3-14-2008.

JASON BLAIR, EXAMINING ATTORNEY

Int. Cl.: 44

Prior U.S. Cls.: 100 and 101

United States Patent and Trademark Office

Reg. No. 3,577,745

Registered Feb. 17, 2009

**SERVICE MARK
PRINCIPAL REGISTER**

TREEFACTS

HORTICULTURAL ASSET MANAGEMENT, INC.
(DELAWARE CORPORATION)
107 EDINBURGH SOUTH, SUITE 205
CARY, NC 27511

THE MARK CONSISTS OF STANDARD CHAR-
ACTERS WITHOUT CLAIM TO ANY PARTICULAR
FONT, STYLE, SIZE, OR COLOR.

FOR: HORTICULTURAL SERVICES, IN CLASS 44
(U.S. CLS. 100 AND 101).

SN 77-423,923, FILED 3-17-2008.

FIRST USE 3-0-2008; IN COMMERCE 3-0-2008.

TINA L. SNAPP, EXAMINING ATTORNEY

Int. Cl.: 35

Prior U.S. Cls.: 100, 101, and 102

United States Patent and Trademark Office

Reg. No. 3,577,746

Registered Feb. 17, 2009

**SERVICE MARK
PRINCIPAL REGISTER**



HARRAH'S LICENSE COMPANY, LLC (NEVADA
LIMITED LIABILITY COMPANY)
ONE CAESARS PALACE DRIVE
LAS VEGAS, NV 89109

THE MARK CONSISTS OF THE LETTERS "ETC"
WITH A "STAR" DESIGN FOLLOWING THE LET-
TER "C".

FOR: RETAIL GIFT SHOPS, IN CLASS 35 (U.S.
CLS. 100, 101 AND 102).

SN 77-424,067, FILED 3-17-2008.

FIRST USE 5-23-2008; IN COMMERCE 5-23-2008.

JANICE KIM, EXAMINING ATTORNEY

Int. Cl.: 25

Prior U.S. Cls.: 22 and 39

United States Patent and Trademark Office

Reg. No. 3,577,747

Registered Feb. 17, 2009

**TRADEMARK
PRINCIPAL REGISTER**



**The Marine
Mammal Center**

THE MARINE MAMMAL CENTER (CALIFORNIA NON-PROFIT CORPORATION)
MARIN HEADLANDS, 1065 FORT CRONKHITE
SAUSALITO, CA 949652697

FOR: HATS, SHIRTS, SWEATSHIRTS, TOPS,
PANTS, APRONS, JACKETS, AND COATS, IN
CLASS 25 (U.S. CLS. 22 AND 39).

FIRST USE 9-1-2008; IN COMMERCE 9-1-2008.

OWNER OF U.S. REG. NOS. 1,722,622, 2,723,948,
AND 2,799,855.

THE MARK CONSISTS OF DESIGN OF SEAL IN
THE SHAPE OF A TEARDROP, ALONG WITH THE
WORDING "THE MARINE MAMMAL CENTER".

SN 77-424,338, FILED 3-17-2008.

MARTHA SANTOMARTINO, EXAMINING ATTOR-
NEY

Int. Cl.: 25

Prior U.S. Cls.: 22 and 39

United States Patent and Trademark Office

Reg. No. 3,577,748

Registered Feb. 17, 2009

**TRADEMARK
PRINCIPAL REGISTER**



**The Marine
Mammal Center**

THE MARINE MAMMAL CENTER (CALIFORNIA NON-PROFIT CORPORATION)
MARIN HEADLANDS, 1065 FORT CRONKHITE
SAUSALITO, CA 949652697

FOR: HATS, SHIRTS, SWEATSHIRTS, TOPS,
PANTS, APRONS, JACKETS, AND COATS, IN
CLASS 25 (U.S. CLS. 22 AND 39).

FIRST USE 9-1-2008; IN COMMERCE 9-1-2008.

OWNER OF U.S. REG. NOS. 1,722,622, 2,723,948,
AND 2,799,855.

THE MARK CONSISTS OF DESIGN OF SEAL IN
THE SHAPE OF A TEARDROP, ALONG WITH THE
WORDING "THE MARINE MAMMAL CENTER".

SN 77-424,347, FILED 3-17-2008.

MARTHA SANTOMARTINO, EXAMINING ATTORNEY

Int. Cl.: 1

Prior U.S. Cls.: 1, 5, 6, 10, 26, and 46

United States Patent and Trademark Office

Reg. No. 3,577,749

Registered Feb. 17, 2009

**TRADEMARK
PRINCIPAL REGISTER**

STYROSAFE

HAWKEYE INDUSTRIES, INC. (GEORGIA CORPORATION)
3050 BROOKVIEW DRIVE
MARIETTA, GA 30068

THE MARK CONSISTS OF STANDARD CHARACTERS WITHOUT CLAIM TO ANY PARTICULAR FONT, STYLE, SIZE, OR COLOR.

FOR: UNSATURATED POLYESTER RESIN, IN CLASS 1 (U.S. CLS. 1, 5, 6, 10, 26 AND 46).

SN 77-424,679, FILED 3-18-2008.

FIRST USE 1-1-2008; IN COMMERCE 1-1-2008.

DEZMONA MIZELLE, EXAMINING ATTORNEY

Int. Cl.: 16

Prior U.S. Cls.: 2, 5, 22, 23, 29, 37, 38, and 50

United States Patent and Trademark Office

Reg. No. 3,577,750

Registered Feb. 17, 2009

**TRADEMARK
PRINCIPAL REGISTER**

**"Foreverwhite" Glass
Whiteboard**

AMERICAN GLASS TOP COMPANY (ILLINOIS
CORPORATION)

1200 W. IRVING PARK ROAD

BENSENVILLE, IL 60106

FOR: DRY ERASE WHITEBOARD MADE OF
STEEL BACKED WHITE TEMPERED GLASS, IN
CLASS 16 (U.S. CLS. 2, 5, 22, 23, 29, 37, 38 AND 50).

FIRST USE 6-25-2008; IN COMMERCE 6-25-2008.

THE MARK CONSISTS OF STANDARD CHAR-
ACTERS WITHOUT CLAIM TO ANY PARTICULAR
FONT, STYLE, SIZE, OR COLOR.

NO CLAIM IS MADE TO THE EXCLUSIVE
RIGHT TO USE "GLASS WHITEBOARD", APART
FROM THE MARK AS SHOWN.

SN 77-424,862, FILED 3-18-2008.

KATHERINE CONNOLLY, EXAMINING ATTOR-
NEY

Int. Cl.: 35

Prior U.S. Cls.: 100, 101, and 102

United States Patent and Trademark Office

Reg. No. 3,577,751

Registered Feb. 17, 2009

SERVICE MARK
PRINCIPAL REGISTER



L.O.F.T. SPORTS, LLC (CONNECTICUT LIMITED
LIABILITY COMPANY)
79 PIERCE ROAD
SOUTH WINDSOR, CT 06074

FOR: ONLINE RETAIL CONSIGNMENT STORES
FEATURING GOLF APPAREL, NOVELTY AND
GIFT ITEMS, IN CLASS 35 (U.S. CLS. 100, 101 AND
102).

FIRST USE 6-1-2008; IN COMMERCE 6-1-2008.

NO CLAIM IS MADE TO THE EXCLUSIVE
RIGHT TO USE "GOLF", APART FROM THE MARK
AS SHOWN.

THE MARK CONSISTS OF THE STYLIZED
WORDS "L.O.F.T. GOLF". IMAGE OF A STICK
FIGURE SWINGING A GOLF CLUB WITH THE
GOLF BALL BOUNCING ON THE FLOOR.

SN 77-425,255, FILED 3-18-2008.

NAAKWAMA ANKRAH, EXAMINING ATTORNEY

Int. Cls.: 6 and 21

Prior U.S. Cls.: 2, 12, 13, 14, 23, 25, 29, 30, 33, 40, and 50

Reg. No. 3,577,752

United States Patent and Trademark Office

Registered Feb. 17, 2009

**TRADEMARK
PRINCIPAL REGISTER**



THE BLESSING BANK, INC. (TEXAS CORPORATION)
1700 PACIFIC AVE SUITE 4450
DALLAS, TX 75201

NO CLAIM IS MADE TO THE EXCLUSIVE RIGHT TO USE "BANK", APART FROM THE MARK AS SHOWN.

FOR: METAL COIN BANKS, IN CLASS 6 (U.S. CLS. 2, 12, 13, 14, 23, 25 AND 50).

THE MARK CONSISTS OF THE OUTLINE OF A HEART WITH THE WORDS "BLESSING BANK" TO THE RIGHT OF THE HEART.

FIRST USE 7-31-2008; IN COMMERCE 10-9-2008.

FOR: NON-METAL COIN BANKS, IN CLASS 21 (U.S. CLS. 2, 13, 23, 29, 30, 33, 40 AND 50).

SN 77-426,232, FILED 3-19-2008.

FIRST USE 7-31-2008; IN COMMERCE 10-9-2008.

RONALD AIKENS, EXAMINING ATTORNEY

Int. Cl.: 43

Prior U.S. Cls.: 100 and 101

United States Patent and Trademark Office

Reg. No. 3,577,753

Registered Feb. 17, 2009

**SERVICE MARK
PRINCIPAL REGISTER**

The Armchair Oenophile

HEAD, ANTHONY C (UNITED STATES INDIVIDUAL)
701-A ALPINE TRAIL
SAN MARCOS, TX 78666

FOR: PROVIDING INFORMATION ABOUT WINE CHARACTERISTICS; PROVIDING INFORMATION, NEWS AND COMMENTARY IN THE FIELD OF DINING; SOMMELIER SERVICES, NAMELY, PROVIDING ADVICE ON WINE AND WINE AND FOOD PAIRING, IN CLASS 43 (U.S. CLS. 100 AND 101).

FIRST USE 2-1-2006; IN COMMERCE 2-1-2006.

THE MARK CONSISTS OF STANDARD CHARACTERS WITHOUT CLAIM TO ANY PARTICULAR FONT, STYLE, SIZE, OR COLOR.

NO CLAIM IS MADE TO THE EXCLUSIVE RIGHT TO USE "OENOPHILE", APART FROM THE MARK AS SHOWN.

SN 77-428,033, FILED 3-21-2008.

CHARLES L. JENKINS, EXAMINING ATTORNEY

Int. Cl.: 16

Prior U.S. Cls.: 2, 5, 22, 23, 29, 37, 38, and 50

Reg. No. 3,577,754

United States Patent and Trademark Office

Registered Feb. 17, 2009

**TRADEMARK
PRINCIPAL REGISTER**

WAO JOURNAL

WORLD ALLERGY ORGANIZATION, INC. (WIS-
CONSIN NON-STOCK CORPORATION)
SUITE 1100
555 EAST WELLS STREET
MILWAUKEE, WI 53202

FOR: JOURNALS CONCERNING ISSUES OF
CLINICAL CARE, EDUCATION, RESEARCH,
TRAINING, AND ADVANCEMENT OF UNDER-
STANDING IN THE FIELD OF ALLERGY AND
CLINICAL IMMUNOLOGY, IN CLASS 16 (U.S. CLS.
2, 5, 22, 23, 29, 37, 38 AND 50).

FIRST USE 1-1-2008; IN COMMERCE 1-1-2008.

THE MARK CONSISTS OF STANDARD CHAR-
ACTERS WITHOUT CLAIM TO ANY PARTICULAR
FONT, STYLE, SIZE, OR COLOR.

OWNER OF U.S. REG. NOS. 2,518,111, 2,525,189,
AND 2,565,668.

NO CLAIM IS MADE TO THE EXCLUSIVE
RIGHT TO USE "JOURNAL", APART FROM THE
MARK AS SHOWN.

SN 77-428,240, FILED 3-21-2008.

ARETHA SOMERVILLE, EXAMINING ATTORNEY

Int. Cl.: 2

Prior U.S. Cls.: 6, 11, and 16

United States Patent and Trademark Office

Reg. No. 3,577,755

Registered Feb. 17, 2009

**TRADEMARK
PRINCIPAL REGISTER**

**Safety Should Be Seen, Not
Kept in the Dark**

PERFORMANCE INDICATOR, LLC (DELAWARE
LIMITED LIABILITY COMPANY)
116 JOHN STREET, SOUTH MILL
LOWELL, MA 01852

FOR: CAMOUFLAGE PAINTS FOR MILITARY
EQUIPMENT; COATING COMPOSITIONS IN THE
NATURE OF PAINT FOR INDUSTRIAL APPLICA-
TIONS; COLORANTS, PAINTS AND DYES FOR
GENERAL INDUSTRIAL USE; EXTERIOR PAINT;
FABRIC PAINTS; FLUORESCENT PAINTS; PAINT
FOR CONCRETE FLOORS; PAINT FOR INDUS-
TRIAL EQUIPMENT AND MACHINERY; PAINTS;
PAINTS FOR SAFETY MARKING; PAVEMENT

MARKING PAINT; PAVEMENT STRIPING PAINT,
IN CLASS 2 (U.S. CLS. 6, 11 AND 16).

FIRST USE 4-28-2008; IN COMMERCE 4-28-2008.

THE MARK CONSISTS OF STANDARD CHAR-
ACTERS WITHOUT CLAIM TO ANY PARTICULAR
FONT, STYLE, SIZE, OR COLOR.

SN 77-428,298, FILED 3-21-2008.

MARC LEIPZIG, EXAMINING ATTORNEY

Int. Cl.: 31

Prior U.S. Cls.: 1 and 46

United States Patent and Trademark Office

Reg. No. 3,577,756

Registered Feb. 17, 2009

**TRADEMARK
PRINCIPAL REGISTER**

PAWSITIVELY GOURMET

BOW WOW GIFTS, LLC (OHIO LIMITED LIABILITY COMPANY)

3599 WINCHELL ROAD

MANTUA, OH 44255

FOR: PET TREATS, IN CLASS 31 (U.S. CLS. 1 AND 46).

FIRST USE 6-1-2008; IN COMMERCE 6-1-2008.

THE MARK CONSISTS OF STANDARD CHARACTERS WITHOUT CLAIM TO ANY PARTICULAR FONT, STYLE, SIZE, OR COLOR.

NO CLAIM IS MADE TO THE EXCLUSIVE RIGHT TO USE "GOURMET", APART FROM THE MARK AS SHOWN.

SN 77-428,518, FILED 3-21-2008.

RUDY R. SINGLETON, EXAMINING ATTORNEY

Int. Cl.: 30

Prior U.S. Cl.: 46

United States Patent and Trademark Office

Reg. No. 3,577,757

Registered Feb. 17, 2009

**TRADEMARK
PRINCIPAL REGISTER**

CEYLON SUN

SOUTHERN SUN TEAS (PRIVATE) LIMITED
(SRI LANKA CORPORATION)

49/21, FIFE ROAD, COLOMBO 5

COLOMBO, SRI LANKA 50000

FOR: COFFEE AND TEA, IN CLASS 30 (U.S. CL.
46).

FIRST USE 10-15-2008; IN COMMERCE 10-15-2008.

THE MARK CONSISTS OF STANDARD CHAR-
ACTERS WITHOUT CLAIM TO ANY PARTICULAR
FONT, STYLE, SIZE, OR COLOR.

NO CLAIM IS MADE TO THE EXCLUSIVE
RIGHT TO USE "CEYLON", APART FROM THE
MARK AS SHOWN.

SN 77-429,580, FILED 3-24-2008.

YAT SYE, LEE, EXAMINING ATTORNEY

Int. Cl.: 1

Prior U.S. Cls.: 1, 5, 6, 10, 26, and 46

United States Patent and Trademark Office

Reg. No. 3,577,758

Registered Feb. 17, 2009

**TRADEMARK
PRINCIPAL REGISTER**

TURF GRIP

ILLINOIS TOOL WORKS INC. (DELAWARE
CORPORATION)
3600 WEST LAKE AVENUE
GLENVIEW, IL 600261215

FOR: CONSTRUCTION INDUSTRY ADHESIVES
AND INDUSTRIAL ADHESIVES, IN CLASS 1 (U.S.
CLS. 1, 5, 6, 10, 26 AND 46).

FIRST USE 5-1-2008; IN COMMERCE 5-1-2008.

THE MARK CONSISTS OF STANDARD CHAR-
ACTERS WITHOUT CLAIM TO ANY PARTICULAR
FONT, STYLE, SIZE, OR COLOR.

NO CLAIM IS MADE TO THE EXCLUSIVE
RIGHT TO USE "TURF", APART FROM THE MARK
AS SHOWN.

SN 77-429,691, FILED 3-24-2008.

MARLENE BELL, EXAMINING ATTORNEY

Int. Cl.: 33

Prior U.S. Cls.: 47 and 49

United States Patent and Trademark Office

Reg. No. 3,577,759

Registered Feb. 17, 2009

**TRADEMARK
PRINCIPAL REGISTER**

Claude Thomas

STANDLEY, CLAUDE THOMAS (UNITED STATES INDIVIDUAL)
7171 DRY CREEK ROAD
HEALDSBURG, CA 95448

THE MARK CONSISTS OF STANDARD CHARACTERS WITHOUT CLAIM TO ANY PARTICULAR FONT, STYLE, SIZE, OR COLOR.

FOR: WINE, IN CLASS 33 (U.S. CLS. 47 AND 49).

SN 77-431,845, FILED 3-26-2008.

FIRST USE 8-21-2008; IN COMMERCE 8-21-2008.

YONG KIM, EXAMINING ATTORNEY

Int. Cl.: 31

Prior U.S. Cls.: 1 and 46

United States Patent and Trademark Office

Reg. No. 3,577,760

Registered Feb. 17, 2009

**TRADEMARK
PRINCIPAL REGISTER**

PURE DELIGHTS

OLD MOTHER HUBBARD, INC. (DELAWARE
CORPORATION)
200 AMES POND DRIVE
TEWKSBURY, MA 01876

THE MARK CONSISTS OF STANDARD CHAR-
ACTERS WITHOUT CLAIM TO ANY PARTICULAR
FONT, STYLE, SIZE, OR COLOR.

FOR: PET FOOD AND PET TREATS, IN CLASS 31
(U.S. CLS. 1 AND 46).

SN 77-432,876, FILED 3-27-2008.

FIRST USE 1-30-2008; IN COMMERCE 7-1-2008.

JESSICA A. POWERS, EXAMINING ATTORNEY

Int. Cl.: 35

Prior U.S. Cls.: 100, 101, and 102

United States Patent and Trademark Office

Reg. No. 3,577,761

Registered Feb. 17, 2009

**SERVICE MARK
PRINCIPAL REGISTER**

DOWNTOWN

INFLUENCE INTERNATIONAL, INC. (UTAH
CORPORATION)
SUITE 2
746 EAST 1910 SOUTH
PROVO, UT 84606

THE MARK CONSISTS OF STANDARD CHAR-
ACTERS WITHOUT CLAIM TO ANY PARTICULAR
FONT, STYLE, SIZE, OR COLOR.

FOR: BUSINESS NETWORKING; ONLINE BUSI-
NESS NETWORKING SERVICES, IN CLASS 35 (U.S.
CLS. 100, 101 AND 102).

SN 77-434,193, FILED 3-28-2008.

FIRST USE 4-1-2008; IN COMMERCE 4-1-2008.

JAMES STEIN, EXAMINING ATTORNEY

Int. Cl.: 16

Prior U.S. Cls.: 2, 5, 22, 23, 29, 37, 38, and 50

United States Patent and Trademark Office

Reg. No. 3,577,762

Registered Feb. 17, 2009

**TRADEMARK
PRINCIPAL REGISTER**

STEALTH CORE

SPC RESOURCES, INC. (DELAWARE CORPORATION)
MAIL DROP Y11
125 W. HOME AVENUE
HARTSVILLE, SC 29550

FOR: PAPER PRODUCTS, NAMELY, PAPER TUBES AND PAPER CORES, IN CLASS 16 (U.S. CLS. 2, 5, 22, 23, 29, 37, 38 AND 50).

FIRST USE 5-2-2008; IN COMMERCE 5-2-2008.

THE MARK CONSISTS OF STANDARD CHARACTERS WITHOUT CLAIM TO ANY PARTICULAR FONT, STYLE, SIZE, OR COLOR.

NO CLAIM IS MADE TO THE EXCLUSIVE RIGHT TO USE "CORE", APART FROM THE MARK AS SHOWN.

SN 77-434,268, FILED 3-28-2008.

GRETTA YAO, EXAMINING ATTORNEY

Int. Cl.: 41

Prior U.S. Cls.: 100, 101, and 107

United States Patent and Trademark Office

Reg. No. 3,577,763

Registered Feb. 17, 2009

**SERVICE MARK
PRINCIPAL REGISTER**

Your Life, Your Way

KITE, DEVAUN MARIE (UNITED STATES INDIVIDUAL), DBA DEE KITE,
150 PARK HILL DR.
SAN ANTONIO, TX 78212

THE MARK CONSISTS OF STANDARD CHARACTERS WITHOUT CLAIM TO ANY PARTICULAR FONT, STYLE, SIZE, OR COLOR.

FOR: LIFE COACHING SERVICES IN THE FIELD OF PERSONAL GROWTH AND DEVELOPMENT, IN CLASS 41 (U.S. CLS. 100, 101 AND 107).

SN 77-436,255, FILED 3-31-2008.

FIRST USE 12-4-2008; IN COMMERCE 12-4-2008.

RICHARD A. STRASER, EXAMINING ATTORNEY

Int. Cl.: 3

Prior U.S. Cls.: 1, 4, 6, 50, 51, and 52

United States Patent and Trademark Office

Reg. No. 3,577,764

Registered Feb. 17, 2009

**TRADEMARK
PRINCIPAL REGISTER**

ESSENTIAL GOLD

ESSENTIAL PROCESS INC. (INDIANA CORPORATION)
903 SOUTH PRAIRIE STREET
BROOKSTON, IN 47923

FOR: NATURAL SOAP FOR BODY CARE AND HOUSEHOLD USE, IN CLASS 3 (U.S. CLS. 1, 4, 6, 50, 51 AND 52).

FIRST USE 10-1-2008; IN COMMERCE 10-1-2008.

THE MARK CONSISTS OF STANDARD CHARACTERS WITHOUT CLAIM TO ANY PARTICULAR FONT, STYLE, SIZE, OR COLOR.

NO CLAIM IS MADE TO THE EXCLUSIVE RIGHT TO USE "GOLD", APART FROM THE MARK AS SHOWN.

SN 77-437,268, FILED 4-1-2008.

TOBY BULLOFF, EXAMINING ATTORNEY

Int. Cl.: 25

Prior U.S. Cls.: 22 and 39

United States Patent and Trademark Office

Reg. No. 3,577,765

Registered Feb. 17, 2009

**TRADEMARK
PRINCIPAL REGISTER**

IT'S IN OUR DNA

CPR BRANDS, L.L.C. (CALIFORNIA LIMITED LIABILITY COMPANY), DBA CPR GEAR,
6320 DREXEL AVENUE
LOS ANGELES, CA 90048

FOR: BASEBALL CAPS; BOXER SHORTS; CHILDREN'S AND INFANTS' CLOTH BIBS; CHILDREN'S CLOTH EATING BIBS; CHILDREN'S HEADWEAR; COATS; COATS FOR MEN AND WOMEN; COATS MADE OF COTTON; EAR MUFFS; FLEECE PULLOVERS; GLOVES; GOLF CAPS; GYM SHORTS; GYM SUITS; HATS; HEAD SCARVES; HEAD SWEATBANDS; HEAD WEAR; HEADBANDS; HOODED PULLOVERS; HOODED SWEAT SHIRTS; INFANT SLEEPERS; INFANT WEAR; INFANT AND TODDLER ONE PIECE CLOTHING; JOGGING OUTFITS; JOGGING PANTS; JOGGING SUITS; JUMPERS; JUMPSUITS; KNITTED CAPS; LONG JACKETS; DOWN JACKETS; MEN AND WOMEN JACKETS, COATS, TROUSERS, VESTS; NIGHT SHIRTS; NIGHTGOWNS; PAJAMA BOTTOMS; PAJAMAS; PARKAS; POLO SHIRTS; PULLOVERS; RAIN COATS; RAIN JACKETS; RUGBY

SHIRTS; RUGBY TOPS; SHIRTS; SHORTS; SKULL CAPS; SLEEPWEAR; SPORTS JACKETS; SPORTS JERSEYS; SPORTS JERSEYS AND BREECHES FOR SPORTS; SPORTS OVERUNIFORMS; SPORTS SHIRTS; SPORTS SHIRTS WITH SHORT SLEEVES; SWEAT BANDS; SWEAT PANTS; SWEAT SHIRTS; SWEAT SHORTS; SWEAT SUITS; SWEATBANDS; SWEATERS; T-SHIRTS; TANK TOPS; TANK-TOPS; TRACK PANTS; TRACK SUITS; TRACKSUITS; TURTLENECKS; WIND-JACKETS; WOMEN'S UNDERWEAR, IN CLASS 25 (U.S. CLS. 22 AND 39).

FIRST USE 11-16-2008; IN COMMERCE 11-16-2008.

THE MARK CONSISTS OF STANDARD CHARACTERS WITHOUT CLAIM TO ANY PARTICULAR FONT, STYLE, SIZE, OR COLOR.

SN 77-437,835, FILED 4-2-2008.

JAMES LOVELACE, EXAMINING ATTORNEY

Int. Cl.: 28

Prior U.S. Cls.: 22, 23, 38, and 50

United States Patent and Trademark Office

Reg. No. 3,577,766

Registered Feb. 17, 2009

**TRADEMARK
PRINCIPAL REGISTER**

ELMO LIVE

SESAME WORKSHOP (NEW YORK NON-PROFIT CORPORATION)
ONE LINCOLN PLAZA
NEW YORK, NY 10023

FOR: PLUSH TOYS, IN CLASS 28 (U.S. CLS. 22, 23, 38 AND 50).

FIRST USE 10-14-2008; IN COMMERCE 10-14-2008.

THE MARK CONSISTS OF STANDARD CHARACTERS WITHOUT CLAIM TO ANY PARTICULAR FONT, STYLE, SIZE, OR COLOR.

OWNER OF U.S. REG. NOS. 2,458,022 AND 2,646,137.

SN 77-437,935, FILED 4-2-2008.

JAMES LOVELACE, EXAMINING ATTORNEY

Int. Cl.: 43

Prior U.S. Cls.: 100 and 101

United States Patent and Trademark Office

Reg. No. 3,577,767

Registered Feb. 17, 2009

**SERVICE MARK
PRINCIPAL REGISTER**

DOG WATCH

CLAVE HOLDINGS LLC (CONNECTICUT LIMITED LIABILITY COMPANY)
P.O. BOX 323
STONINGTON, CT 06378

FOR: RESTAURANT AND BAR SERVICES, IN CLASS 43 (U.S. CLS. 100 AND 101).

FIRST USE 5-19-2008; IN COMMERCE 5-19-2008.

THE MARK CONSISTS OF STANDARD CHARACTERS WITHOUT CLAIM TO ANY PARTICULAR FONT, STYLE, SIZE, OR COLOR.

SN 77-438,848, FILED 4-3-2008.

WILLIAM P. SHANAHAN, EXAMINING ATTORNEY

Int. Cl.: 42

Prior U.S. Cls.: 100 and 101

United States Patent and Trademark Office

Reg. No. 3,577,768

Registered Feb. 17, 2009

**SERVICE MARK
PRINCIPAL REGISTER**

TrueCustom

THE DESIGN PEOPLE, INC. (CALIFORNIA CORPORATION)
SUITE 450
1700 EAST WALNUT AVENUE
EL SEGUNDO, CA 90292

FOR: CREATING, DESIGNING AND MAINTAINING WEB SITES; DESIGN, CREATION, HOSTING, MAINTENANCE OF WEB SITES FOR OTHERS; WEB SITE DESIGN; WEB SITE HOSTING SERVICES , IN CLASS 42 (U.S. CLS. 100 AND 101).

FIRST USE 12-1-2003; IN COMMERCE 12-1-2003.

THE MARK CONSISTS OF STANDARD CHARACTERS WITHOUT CLAIM TO ANY PARTICULAR FONT, STYLE, SIZE, OR COLOR.

SN 77-439,189, FILED 4-3-2008.

ALEXANDER L. POWERS, EXAMINING ATTORNEY

Int. Cl.: 42

Prior U.S. Cls.: 100 and 101

United States Patent and Trademark Office

Reg. No. 3,577,769

Registered Feb. 17, 2009

**SERVICE MARK
PRINCIPAL REGISTER**

OB//Session

OUTWARD BOUND, INC. (NEW YORK INCORPORATED ASSOCIATION)
100 MYSTERY POINT ROAD
GARRISON, NY 105249767

FOR: COMPUTER SERVICES, NAMELY, HOSTING AND MAINTAINING AN ONLINE WEB SITE FOR OTHERS TO UPLOAD INFORMATION AND CONTENT SUCH AS PHOTOS VIDEOS AND TESTIMONIALS; COMPUTER SERVICES, NAMELY, INTERACTIVE HOSTING SERVICES WHICH ALLOW THE USER TO PUBLISH AND SHARE THEIR OWN

CONTENT AND IMAGES ONLINE, IN CLASS 42 (U.S. CLS. 100 AND 101).

FIRST USE 4-1-2008; IN COMMERCE 10-28-2008.

THE MARK CONSISTS OF STANDARD CHARACTERS WITHOUT CLAIM TO ANY PARTICULAR FONT, STYLE, SIZE, OR COLOR.

SN 77-439,578, FILED 4-3-2008.

MICHAEL SOUDERS, EXAMINING ATTORNEY

Int. Cls.: 35 and 45

Prior U.S. Cls.: 100, 101, and 102

United States Patent and Trademark Office

Reg. No. 3,577,770

Registered Feb. 17, 2009

**SERVICE MARK
PRINCIPAL REGISTER**

TWINE

RADAR NETWORKS, INC. (DELAWARE CORPORATION)
410 TOWNSEND STREET
SAN FRANCISCO, CA 94107

FOR: ADVERTISING THE GOODS AND SERVICES OF OTHERS VIA THE INTERNET, IN CLASS 35 (U.S. CLS. 100, 101 AND 102).

FIRST USE 9-1-2008; IN COMMERCE 9-1-2008.

FOR: ONLINE SOCIAL NETWORKING SERVICES, IN CLASS 45 (U.S. CLS. 100 AND 101).

FIRST USE 10-3-2007; IN COMMERCE 10-3-2007.

THE MARK CONSISTS OF STANDARD CHARACTERS WITHOUT CLAIM TO ANY PARTICULAR FONT, STYLE, SIZE, OR COLOR.

SN 77-439,619, FILED 4-3-2008.

PAUL E. FAHRENKOPF, EXAMINING ATTORNEY

Int. Cl.: 41

Prior U.S. Cls.: 100, 101, and 107

United States Patent and Trademark Office

Reg. No. 3,577,771

Registered Feb. 17, 2009

**SERVICE MARK
PRINCIPAL REGISTER**

**REVOLUTION FROM THE HEART
OF NATURE**

COLLECTIVE HERITAGE INSTITUTE (NEW
MEXICO CORPORATION)
OLD LAMY SCHOOLHOUSE 6 CERRO CIRCLE
LAMY, NM 87540

FOR: EDUCATIONAL AND ENTERTAINMENT SERVICES, NAMELY, A CONTINUING PROGRAM ABOUT CONSERVATION, ECOLOGY, INDIGENOUS PEOPLE ISSUES, NUTRITION, ORGANIC, BIODYNAMIC, SUSTAINABLE AND RESTORATIVE FARMING AND HORTICULTURE, AND SUSTAINABLE ECONOMICS ACCESSIBLE BY RADIO, TELEVISION, SATELLITE, AUDIO, VIDEO AND COMPUTER NETWORKS; EDUCATIONAL SERVICES, NAMELY, CONDUCTING CONFERENCES ACCESSIBLE BY RADIO, TELEVISION, SATELLITE, AUDIO, VIDEO AND COMPUTER NETWORKS IN THE FIELD OF CONSERVATION, ECOLOGY, INDIGENOUS PEOPLE ISSUES, NUTRITION, ORGANIC, BIODYNAMIC, SUSTAINABLE AND

RESTORATIVE FARMING AND HORTICULTURE, AND SUSTAINABLE ECONOMICS; EDUCATIONAL RESEARCH; PROVIDING NEWSLETTERS IN THE FIELD OF CONSERVATION, ECOLOGY, INDIGENOUS PEOPLE ISSUES, NUTRITION, ORGANIC, BIODYNAMIC, SUSTAINABLE AND RESTORATIVE FARMING AND HORTICULTURE, AND SUSTAINABLE ECONOMICS VIA E-MAIL, IN CLASS 41 (U.S. CLS. 100, 101 AND 107).

FIRST USE 10-17-2008; IN COMMERCE 10-17-2008.

THE MARK CONSISTS OF STANDARD CHARACTERS WITHOUT CLAIM TO ANY PARTICULAR FONT, STYLE, SIZE, OR COLOR.

SN 77-440,648, FILED 4-4-2008.

JULIE WATSON, EXAMINING ATTORNEY

Int. Cl.: 25

Prior U.S. Cls.: 22 and 39

United States Patent and Trademark Office

Reg. No. 3,577,772

Registered Feb. 17, 2009

**TRADEMARK
PRINCIPAL REGISTER**

FROM WOMB TO TOMB

CPR BRANDS, L.L.C. (CALIFORNIA LIMITED LIABILITY COMPANY), DBA CPR GEAR,
6320 DREXEL AVENUE
LOS ANGELES, CA 90048

FOR: BASEBALL CAPS; BOXER SHORTS; CHILDREN'S AND INFANTS' CLOTH BIBS; CHILDREN'S CLOTH EATING BIBS; CHILDREN'S HEADWEAR; COATS; COATS FOR MEN AND WOMEN; COATS MADE OF COTTON; EAR MUFFS; FLEECE PULLOVERS; GLOVES; GOLF CAPS; GYM SHORTS; GYM SUITS; HATS; HEAD SCARVES; HEAD SWEATBANDS; HEAD WEAR; HEADBANDS; HOODED PULLOVERS; HOODED SWEAT SHIRTS; INFANT SLEEPERS; INFANT WEAR; INFANT AND TODDLER ONE PIECE CLOTHING; JOGGING OUTFITS; JOGGING PANTS; JOGGING SUITS; JUMPERS; JUMPSUITS; KNITTED CAPS; LONG JACKETS; DOWN JACKETS; MEN AND WOMEN JACKETS, COATS, TROUSERS, VESTS; NIGHT SHIRTS; NIGHTGOWNS; PAJAMA BOTTOMS; PAJAMAS; PARKAS; POLO SHIRTS; PULLOVERS; RAIN COATS; RAIN JACKETS; RUGBY

SHIRTS; RUGBY TOPS; SHIRTS; SHORTS; SKULL CAPS; SLEEPWEAR; SPORTS JACKETS; SPORTS JERSEYS; SPORTS JERSEYS AND BREECHES FOR SPORTS; SPORTS OVERUNIFORMS; SPORTS SHIRTS; SPORTS SHIRTS WITH SHORT SLEEVES; SWEAT BANDS; SWEAT PANTS; SWEAT SHIRTS; SWEAT SHORTS; SWEAT SUITS; SWEATBANDS; SWEATERS; T-SHIRTS; TANK TOPS; TANK-TOPS; TRACK PANTS; TRACK SUITS; TRACKSUITS; TURTLENECKS; WIND-JACKETS; WOMEN'S UNDERWEAR, IN CLASS 25 (U.S. CLS. 22 AND 39).

FIRST USE 10-5-2008; IN COMMERCE 10-5-2008.

THE MARK CONSISTS OF STANDARD CHARACTERS WITHOUT CLAIM TO ANY PARTICULAR FONT, STYLE, SIZE, OR COLOR.

SN 77-440,764, FILED 4-4-2008.

RONALD MCMORROW, EXAMINING ATTORNEY

Int. Cl.: 35

Prior U.S. Cls.: 100, 101, and 102

United States Patent and Trademark Office

Reg. No. 3,577,773

Registered Feb. 17, 2009

**SERVICE MARK
PRINCIPAL REGISTER**



ZAPPOLD ADVISORS LLC (MARYLAND LIMITED LIABILITY COMPANY)
554 NORTH FREDERICK AVENUE, SUITE 238
GAITHERSBURG, MD 208772504

FOR: BUSINESS MANAGEMENT CONSULTING AND ADVISORY SERVICES, IN CLASS 35 (U.S. CLS. 100, 101 AND 102).

FIRST USE 4-1-2008; IN COMMERCE 4-1-2008.

NO CLAIM IS MADE TO THE EXCLUSIVE RIGHT TO USE "ADVISORS LLC", APART FROM THE MARK AS SHOWN.

THE COLOR(S) BURGUNDY, BLACK, AND WHITE IS/ARE CLAIMED AS A FEATURE OF THE MARK.

THE MARK CONSISTS OF A BURGUNDY AND WHITE COLORED CIRCULAR SWOOP WITH THE WORDS "ZAPPOLD ADVISORS LLC" IN BLACK AND WHITE, "ZAPPOLD" IS WITHIN THE CIRCULAR SWOOP.

SN 77-441,168, FILED 4-7-2008.

ANTHONY RINKER, EXAMINING ATTORNEY

Int. Cl.: 42

Prior U.S. Cls.: 100 and 101

United States Patent and Trademark Office

Reg. No. 3,577,774

Registered Feb. 17, 2009

**SERVICE MARK
PRINCIPAL REGISTER**

ON THE HUNT

OLB MEDIA LLC (MASSACHUSETTS LIMITED
LIABILITY COMPANY)
215 FIRST STREET, SUITE 500
CAMBRIDGE, MA 02142

THE MARK CONSISTS OF STANDARD CHAR-
ACTERS WITHOUT CLAIM TO ANY PARTICULAR
FONT, STYLE, SIZE, OR COLOR.

FOR: PROVIDING A WEB SITE TO ALLOW
USERS TO SUBMIT AND VIEW ADULT VIDEOS,
IN CLASS 42 (U.S. CLS. 100 AND 101).

SN 77-441,662, FILED 4-7-2008.

FIRST USE 2-20-2008; IN COMMERCE 2-20-2008.

CHRIS WELLS, EXAMINING ATTORNEY

Int. Cl.: 33

Prior U.S. Cls.: 47 and 49

United States Patent and Trademark Office

Reg. No. 3,577,775

Registered Feb. 17, 2009

**TRADEMARK
PRINCIPAL REGISTER**

LUMINESCE

LOWDEN SCHOOLHOUSE CORPORATION (WA-
SHINGTON CORPORATION)
41 LOWDEN SCHOOL ROAD
LOWDEN, WA 99360

THE MARK CONSISTS OF STANDARD CHAR-
ACTERS WITHOUT CLAIM TO ANY PARTICULAR
FONT, STYLE, SIZE, OR COLOR.

FOR: WINE, IN CLASS 33 (U.S. CLS. 47 AND 49).

SN 77-441,726, FILED 4-7-2008.

FIRST USE 9-30-2008; IN COMMERCE 9-30-2008.

SHANNON TWOHIG, EXAMINING ATTORNEY

Int. Cl.: 33

Prior U.S. Cls.: 47 and 49

United States Patent and Trademark Office

Reg. No. 3,577,776

Registered Feb. 17, 2009

**TRADEMARK
PRINCIPAL REGISTER**

UV CHERRY

PHILLIPS PRODUCTS COMPANY LLC (MINNESOTA LIMITED LIABILITY COMPANY)
1607 SOUTH 12TH STREET
PRINCETON, MN 55371

FOR: VODKA, IN CLASS 33 (U.S. CLS. 47 AND 49).

FIRST USE 5-31-2006; IN COMMERCE 5-31-2006.

THE MARK CONSISTS OF STANDARD CHARACTERS WITHOUT CLAIM TO ANY PARTICULAR FONT, STYLE, SIZE, OR COLOR.

OWNER OF U.S. REG. NOS. 3,281,759, 3,381,671, AND OTHERS.

NO CLAIM IS MADE TO THE EXCLUSIVE RIGHT TO USE "CHERRY", APART FROM THE MARK AS SHOWN.

SN 77-441,733, FILED 4-7-2008.

GIANCARLO CASTRO, EXAMINING ATTORNEY

Int. Cl.: 33

Prior U.S. Cls.: 47 and 49

United States Patent and Trademark Office

Reg. No. 3,577,777

Registered Feb. 17, 2009

**TRADEMARK
PRINCIPAL REGISTER**

UV VANILLA

PHILLIPS PRODUCTS COMPANY LLC (MINNESOTA LIMITED LIABILITY COMPANY)
1607 SOUTH 12TH STREET
PRINCETON, MN 55371

FOR: VODKA, IN CLASS 33 (U.S. CLS. 47 AND 49).

FIRST USE 5-31-2006; IN COMMERCE 5-31-2006.

THE MARK CONSISTS OF STANDARD CHARACTERS WITHOUT CLAIM TO ANY PARTICULAR FONT, STYLE, SIZE, OR COLOR.

OWNER OF U.S. REG. NOS. 3,281,759, 3,381,671, AND OTHERS.

NO CLAIM IS MADE TO THE EXCLUSIVE RIGHT TO USE "VANILLA", APART FROM THE MARK AS SHOWN.

SN 77-441,778, FILED 4-7-2008.

GIANCARLO CASTRO, EXAMINING ATTORNEY

Int. Cl.: 5

Prior U.S. Cls.: 6, 18, 44, 46, 51, and 52

United States Patent and Trademark Office

Reg. No. 3,577,778

Registered Feb. 17, 2009

**TRADEMARK
PRINCIPAL REGISTER**

VOLUMAIZE

BIO-ENGINEERED SUPPLEMENTS & NUTRI-
TION, INC. (DELAWARE CORPORATION)
5901 BROKEN SOUND PARKWAY NW, 6TH FLOOR
BOCA RATON, FL 33487

THE MARK CONSISTS OF STANDARD CHAR-
ACTERS WITHOUT CLAIM TO ANY PARTICULAR
FONT, STYLE, SIZE, OR COLOR.

FOR: DIETARY SUPPLEMENTS, IN CLASS 5 (U.S.
CLS. 6, 18, 44, 46, 51 AND 52).

SN 77-442,083, FILED 4-7-2008.

FIRST USE 8-25-2008; IN COMMERCE 8-25-2008.

ELLEN PERKINS, EXAMINING ATTORNEY

Int. Cl.: 9

Prior U.S. Cls.: 21, 23, 26, 36, and 38

United States Patent and Trademark Office

Reg. No. 3,577,779

Registered Feb. 17, 2009

**TRADEMARK
PRINCIPAL REGISTER**

DECKADANCE

IMAGE LINE BVBA (BELGIUM LIMITED LIABILITY COMPANY)
KORTRIJKSESTEENWEG 281
SINT-MARTENS-LATEM, BELGIUM B-9830

FOR: COMPUTER SOFTWARE FOR DISC JOCKEYS, CONSISTING OF A DIGITAL MIXING CONSOLE ALLOWING THE MANIPULATION OF AUDIO SIGNALS, IN CLASS 9 (U.S. CLS. 21, 23, 26, 36 AND 38).

FIRST USE 1-14-2007; IN COMMERCE 5-1-2007.

THE MARK CONSISTS OF STANDARD CHARACTERS WITHOUT CLAIM TO ANY PARTICULAR FONT, STYLE, SIZE, OR COLOR.

SN 77-442,328, FILED 4-8-2008.

FRANK LATTUCA, EXAMINING ATTORNEY

Int. Cl.: 42

Prior U.S. Cls.: 100 and 101

United States Patent and Trademark Office

Reg. No. 3,577,780

Registered Feb. 17, 2009

**SERVICE MARK
PRINCIPAL REGISTER**

SupportSync

KOLYER, JEFF (UNITED STATES INDIVIDUAL)
80 YAMPA WAY
FREMONT, CA 94539

FOR: PROVIDING TEMPORARY USE OF ON-LINE NON-DOWNLOADABLE SOFTWARE TO STORE, MANAGE, TRACK, ANALYZE, AND REPORT DATA IN THE FIELD OF CUSTOMER SERVICE AND TECHNICAL SUPPORT; PROVIDING TEMPORARY USE OF ON-LINE NON-DOWNLOADABLE SOFTWARE TO FACILITATE COM-

MUNICATING AMONG PEER PROFESSIONALS AND CUSTOMERS IN THE CUSTOMER SERVICE AND TECHNICAL SUPPORT FIELDS, IN CLASS 42 (U.S. CLS. 100 AND 101).

FIRST USE 4-4-2008; IN COMMERCE 4-4-2008.

SN 77-443,361, FILED 4-8-2008.

BARNEY CHARLON, EXAMINING ATTORNEY

Int. Cl.: 3

Prior U.S. Cls.: 1, 4, 6, 50, 51, and 52

United States Patent and Trademark Office

Reg. No. 3,577,781

Registered Feb. 17, 2009

**TRADEMARK
PRINCIPAL REGISTER**

NAUTICA OCEANS

NAUTICA APPAREL, INC. (DELAWARE CORPORATION)
40 WEST 57TH STREET
NEW YORK, NY 10019

OWNER OF U.S. REG. NOS. 1,464,663, 3,170,094,
AND OTHERS.

FOR: FRAGRANCES FOR PERSONAL USE, IN
CLASS 3 (U.S. CLS. 1, 4, 6, 50, 51 AND 52).

THE FOREIGN WORDING IN THE MARK
TRANSLATES INTO ENGLISH AS "NAUTICAL".

FIRST USE 12-8-2008; IN COMMERCE 12-8-2008.

SN 77-444,022, FILED 4-9-2008.

THE MARK CONSISTS OF STANDARD CHARACTERS WITHOUT CLAIM TO ANY PARTICULAR FONT, STYLE, SIZE, OR COLOR.

ERIN FALK, EXAMINING ATTORNEY

Int. Cl.: 35

Prior U.S. Cls.: 100, 101, and 102

United States Patent and Trademark Office

Reg. No. 3,577,782

Registered Feb. 17, 2009

**SERVICE MARK
PRINCIPAL REGISTER**

Z'S PLEASE

URNER'S INC. (CALIFORNIA CORPORATION)
P.O. BOX 41240
BAKERSFIELD, CA 93384

FOR: RETAIL STORE SERVICES FEATURING
MATTRESSES, BEDS, HEADBOARDS, FOOT-
BOARDS, ADJUSTABLE FOUNDATIONS AND
BOX SPRINGS, IN CLASS 35 (U.S. CLS. 100, 101
AND 102).

FIRST USE 5-31-2008; IN COMMERCE 5-31-2008.

THE MARK CONSISTS OF STANDARD CHAR-
ACTERS WITHOUT CLAIM TO ANY PARTICULAR
FONT, STYLE, SIZE, OR COLOR.

SN 77-444,047, FILED 4-9-2008.

MARY CRAWFORD, EXAMINING ATTORNEY

Int. Cl.: 39

Prior U.S. Cls.: 100 and 105

United States Patent and Trademark Office

Reg. No. 3,577,783

Registered Feb. 17, 2009

**SERVICE MARK
PRINCIPAL REGISTER**

More Than Just Pizza

SCHAEFER, DENITA L. (INDIANA CORPORATION), DBA JUST PIZZA,
2140 N MITTHOEFFER RD.
INDIANAPOLIS, IN 46229

THE MARK CONSISTS OF STANDARD CHARACTERS WITHOUT CLAIM TO ANY PARTICULAR FONT, STYLE, SIZE, OR COLOR.

FOR: DELIVERY OF FOOD BY RESTAURANTS,
IN CLASS 39 (U.S. CLS. 100 AND 105).

SN 77-444,093, FILED 4-9-2008.

FIRST USE 3-1-2008; IN COMMERCE 3-1-2008.

DAVID MURRAY, EXAMINING ATTORNEY

Int. Cl.: 8

Prior U.S. Cls.: 23, 28, and 44

United States Patent and Trademark Office

Reg. No. 3,577,784

Registered Feb. 17, 2009

**TRADEMARK
PRINCIPAL REGISTER**

CLEAR-MARK

JSD TOOL (ARIZONA LIMITED LIABILITY
COMPANY)
1658 E. DEL RIO DR.
TEMPE, AZ 85282

FOR: MULTI-FUNCTION HAND TOOLS COM-
PRISED OF SCRAPERS, BLADES AND BRUSHES
FOR ATTACHMENT TO A WRITING INSTRU-
MENT, IN CLASS 8 (U.S. CLS. 23, 28 AND 44).

FIRST USE 8-20-2008; IN COMMERCE 9-8-2008.

THE MARK CONSISTS OF STANDARD CHAR-
ACTERS WITHOUT CLAIM TO ANY PARTICULAR
FONT, STYLE, SIZE, OR COLOR.

SN 77-444,366, FILED 4-9-2008.

COURTNEY MCCORMICK, EXAMINING ATTOR-
NEY

Int. Cl.: 3

Prior U.S. Cls.: 1, 4, 6, 50, 51, and 52

United States Patent and Trademark Office

Reg. No. 3,577,785

Registered Feb. 17, 2009

**TRADEMARK
PRINCIPAL REGISTER**

DREAMBOAT

CALIFORNIA TAN, LLC (INDIANA LIMITED
LIABILITY COMPANY)
6270 CORPORATE DRIVE
INDIANAPOLIS, IN 46278

THE MARK CONSISTS OF STANDARD CHAR-
ACTERS WITHOUT CLAIM TO ANY PARTICULAR
FONT, STYLE, SIZE, OR COLOR.

FOR: INDOOR SKIN TANNING LOTIONS, IN
CLASS 3 (U.S. CLS. 1, 4, 6, 50, 51 AND 52).

SN 77-445,708, FILED 4-11-2008.

FIRST USE 11-1-2008; IN COMMERCE 11-1-2008.

JAMES LOVELACE, EXAMINING ATTORNEY

Int. Cl.: 1

Prior U.S. Cls.: 1, 5, 6, 10, 26, and 46

United States Patent and Trademark Office

Reg. No. 3,577,786

Registered Feb. 17, 2009

**TRADEMARK
PRINCIPAL REGISTER**

CLONEstable

BIOMATRICA. INC. (CALIFORNIA CORPORATION)
5627 OBERLIN DR. #124
SAN DIEGO, CA 92121

THE MARK CONSISTS OF STANDARD CHARACTERS WITHOUT CLAIM TO ANY PARTICULAR FONT, STYLE, SIZE, OR COLOR.

FOR: REAGENTS USED FOR SCIENTIFIC AND RESEARCH USE, IN CLASS 1 (U.S. CLS. 1, 5, 6, 10, 26 AND 46).

SN 77-446,049, FILED 4-11-2008.

FIRST USE 10-1-2008; IN COMMERCE 10-1-2008.

AMEETA JORDAN, EXAMINING ATTORNEY

Int. Cl.: 5

Prior U.S. Cls.: 6, 18, 44, 46, 51, and 52

United States Patent and Trademark Office

Reg. No. 3,577,787

Registered Feb. 17, 2009

**TRADEMARK
PRINCIPAL REGISTER**



ALCON, INC. (SWITZERLAND CORPORATION)
BOSCH 69
CH-6331 HUENENBERG, SWITZERLAND

FOR: OPHTHALMIC PREPARATIONS, IN CLASS
5 (U.S. CLS. 6, 18, 44, 46, 51 AND 52).

FIRST USE 6-26-2008; IN COMMERCE 6-26-2008.

THE MARK CONSISTS OF A CRESCENT MOON
WITH THREE STARS ABOVE IT AND TWO STARS
BELOW IT.

SN 77-447,711, FILED 4-14-2008.

SAMUEL E. SHARPER JR., EXAMINING ATTOR-
NEY

Int. Cl.: 9

Prior U.S. Cls.: 21, 23, 26, 36, and 38

Reg. No. 3,577,788

United States Patent and Trademark Office

Registered Feb. 17, 2009

**TRADEMARK
PRINCIPAL REGISTER**

BOOST

IRIS INTERNATIONAL, INC. (DELAWARE CORPORATION)
9172 EATON AVENUE
CHATSWORTH, CA 91311

THE MARK CONSISTS OF STANDARD CHARACTERS WITHOUT CLAIM TO ANY PARTICULAR FONT, STYLE, SIZE, OR COLOR.

FOR: SWITCH BOX TO BE USED WITH A URINE CHEMISTRY SYSTEM, IN CLASS 9 (U.S. CLS. 21, 23, 26, 36 AND 38).

SN 77-447,740, FILED 4-14-2008.

FIRST USE 9-19-2008; IN COMMERCE 9-19-2008.

SANI KHOURI, EXAMINING ATTORNEY

Int. Cls.: 20 and 24

Prior U.S. Cls.: 2, 13, 22, 25, 32, 42, and 50

United States Patent and Trademark Office

Reg. No. 3,577,789

Registered Feb. 17, 2009

**TRADEMARK
PRINCIPAL REGISTER**

Softrest

L&S LINENS CO. LTD. (HONG KONG CORPORATION)
ROOM 1101A, 11TH FLOOR, 1-5 SUGAR STREET
HONG KONG, CHINA

FOR: MATTRESSES AND PILLOWS, IN CLASS 20
(U.S. CLS. 2, 13, 22, 25, 32 AND 50).

FIRST USE 10-1-2008; IN COMMERCE 10-1-2008.

FOR: COMFORTERS; MATTRESS COVERS;
MATTRESS PADS; BED SHEETS, IN CLASS 24 (U.S.
CLS. 42 AND 50).

FIRST USE 10-1-2008; IN COMMERCE 10-1-2008.

THE MARK CONSISTS OF STANDARD CHARACTERS WITHOUT CLAIM TO ANY PARTICULAR FONT, STYLE, SIZE, OR COLOR.

SN 77-448,405, FILED 4-15-2008.

RAUL CORDOVA, EXAMINING ATTORNEY

Int. Cl.: 21

Prior U.S. Cls.: 2, 13, 23, 29, 30, 33, 40, and 50

United States Patent and Trademark Office

Reg. No. 3,577,790

Registered Feb. 17, 2009

**TRADEMARK
PRINCIPAL REGISTER**

EXPRESS ION ROUND

JOHN PAUL MITCHELL SYSTEMS (CALIFORNIA CORPORATION)

20705 CENTRE POINTE PARKWAY

SANTA CLARITA, CA 91350

FOR: HAIR BRUSHES, IN CLASS 21 (U.S. CLS. 2, 13, 23, 29, 30, 33, 40 AND 50).

FIRST USE 7-15-2008; IN COMMERCE 7-15-2008.

THE MARK CONSISTS OF STANDARD CHARACTERS WITHOUT CLAIM TO ANY PARTICULAR FONT, STYLE, SIZE, OR COLOR.

NO CLAIM IS MADE TO THE EXCLUSIVE RIGHT TO USE "ION ROUND", APART FROM THE MARK AS SHOWN.

SN 77-448,510, FILED 4-15-2008.

ROBIN MITTLER, EXAMINING ATTORNEY

Int. Cl.: 11

Prior U.S. Cls.: 13, 21, 23, 31, and 34

United States Patent and Trademark Office

Reg. No. 3,577,791

Registered Feb. 17, 2009

**TRADEMARK
PRINCIPAL REGISTER**

XTHERM

RAYPAK, INC. (CALIFORNIA CORPORATION)
2151 EASTMAN AVENUE
OXNARD, CA 93030

THE MARK CONSISTS OF STANDARD CHAR-
ACTERS WITHOUT CLAIM TO ANY PARTICULAR
FONT, STYLE, SIZE, OR COLOR.

FOR: HEATING EQUIPMENT, NAMELY, GAS-
FIRED BOILERS AND WATER HEATERS, IN
CLASS 11 (U.S. CLS. 13, 21, 23, 31 AND 34).

SN 77-448,735, FILED 4-15-2008.

FIRST USE 11-21-2008; IN COMMERCE 11-21-2008.

ALICE BENMAMAN, EXAMINING ATTORNEY

Int. Cl.: 28

Prior U.S. Cls.: 22, 23, 38, and 50

United States Patent and Trademark Office

Reg. No. 3,577,792

Registered Feb. 17, 2009

**TRADEMARK
PRINCIPAL REGISTER**

MY NEW ARRIVAL

HONG KONG CITY TOYS FACTORY LIMITED
(BR. VIRGIN ISLANDS CORPORATION)
ROOM 701
5 SILVERCORD TOWER 1 30 CANTON ROAD
KOWLOON, HONG KONG

THE MARK CONSISTS OF STANDARD CHARACTERS WITHOUT CLAIM TO ANY PARTICULAR FONT, STYLE, SIZE, OR COLOR.

FOR: DOLLS, DOLL CLOTHING, DOLL PLAYSETS AND DOLL ACCESSORIES, IN CLASS 28 (U.S. CLS. 22, 23, 38 AND 50).

SN 77-449,768, FILED 4-16-2008.

FIRST USE 12-10-2008; IN COMMERCE 12-10-2008.

LINDA ORNDORFF, EXAMINING ATTORNEY

Int. Cl.: 28

Prior U.S. Cls.: 22, 23, 38, and 50

United States Patent and Trademark Office

Reg. No. 3,577,793

Registered Feb. 17, 2009

**TRADEMARK
PRINCIPAL REGISTER**

HELLO DOLLY

HONG KONG CITY TOYS FACTORY LIMITED
(BR. VIRGIN ISLANDS CORPORATION)
ROOM 701
5 SILVERCORD TOWER 1 30 CANTON ROAD
KOWLOON, HONG KONG

THE MARK CONSISTS OF STANDARD CHAR-
ACTERS WITHOUT CLAIM TO ANY PARTICULAR
FONT, STYLE, SIZE, OR COLOR.

FOR: DOLLS, DOLL CLOTHING, DOLL PLAY-
SETS AND DOLL ACCESSORIES, IN CLASS 28 (U.S.
CLS. 22, 23, 38 AND 50).

SN 77-449,775, FILED 4-16-2008.

FIRST USE 12-10-2008; IN COMMERCE 12-10-2008.

LINDA ORNDORFF, EXAMINING ATTORNEY

Int. Cl.: 8

Prior U.S. Cls.: 23, 28, and 44

United States Patent and Trademark Office

Reg. No. 3,577,794

Registered Feb. 17, 2009

**TRADEMARK
PRINCIPAL REGISTER**

5 IN 1 CHAMPION

WAHL CLIPPER CORPORATION (ILLINOIS
CORPORATION)

P.O. BOX 578

STERLING, IL 610810578

FOR: ELECTRIC HAIR CLIPPER BLADES, IN
CLASS 8 (U.S. CLS. 23, 28 AND 44).

FIRST USE 2-0-2008; IN COMMERCE 2-0-2008.

THE MARK CONSISTS OF STANDARD CHAR-
ACTERS WITHOUT CLAIM TO ANY PARTICULAR
FONT, STYLE, SIZE, OR COLOR.

NO CLAIM IS MADE TO THE EXCLUSIVE
RIGHT TO USE "5 IN 1", APART FROM THE MARK
AS SHOWN.

SN 77-449,880, FILED 4-16-2008.

APRIL HESIK, EXAMINING ATTORNEY

Int. Cl.: 36

Prior U.S. Cls.: 100, 101, and 102

United States Patent and Trademark Office

Reg. No. 3,577,795

Registered Feb. 17, 2009

**SERVICE MARK
PRINCIPAL REGISTER**

**Nagel & Associates, LLC
We Manage Wealth. You
Manage Life.**

NAGEL & ASSOCIATES, LLC (WISCONSIN LIMITED LIABILITY COMPANY)
2111 NORTH GATE ROAD
GREEN BAY, WI 54313

FOR: INVESTMENT MANAGEMENT; BANKING CONSULTATION; INSURANCE CONSULTATION; FINANCIAL PLANNING FOR RETIREMENT, IN CLASS 36 (U.S. CLS. 100, 101 AND 102).

FIRST USE 6-1-2008; IN COMMERCE 6-1-2008.

THE MARK CONSISTS OF STANDARD CHARACTERS WITHOUT CLAIM TO ANY PARTICULAR FONT, STYLE, SIZE, OR COLOR.

NO CLAIM IS MADE TO THE EXCLUSIVE RIGHT TO USE "ASSOCIATES, LLC WE MANAGE WEALTH", APART FROM THE MARK AS SHOWN.

SN 77-450,002, FILED 4-16-2008.

MAYUR VAGHANI, EXAMINING ATTORNEY

Int. Cl.: 42

Prior U.S. Cls.: 100 and 101

United States Patent and Trademark Office

Reg. No. 3,577,796

Registered Feb. 17, 2009

**SERVICE MARK
PRINCIPAL REGISTER**



Abbu Incorporated

ABBU INCORPORATED (NEW YORK CORPORATION)

86-16 56TH AVENUE; APARTMENT 2A
ELMHURST, NY 11373

FOR: DESIGNING OF CLOTHING, HEAD-GEAR
AND FOOT-GEAR, IN CLASS 42 (U.S. CLS. 100 AND
101).

FIRST USE 8-1-2007; IN COMMERCE 12-17-2007.

NO CLAIM IS MADE TO THE EXCLUSIVE
RIGHT TO USE "INCORPORATED", APART FROM
THE MARK AS SHOWN.

THE STIPLING IS A FEATURE OF THE MARK
AND DOES NOT INDICATE COLOR.

THE COLOR(S) YELLOW, BLACK, WHITE IS/
ARE CLAIMED AS A FEATURE OF THE MARK.

THE MARK CONSISTS OF A YELLOW, DIAGONAL
OVAL BENT TO THE RIGHT CONTAINING
WITHIN THE CENTER OF THE OVAL THE WORD
"ABBU" IN LOWER CASE, BOLD, BLACK LETTERS.
BELOW THE YELLOW OVAL IS A BLACK REC-
TANGLE, ALIGNED HORIZONTALLY WITH THE
YELLOW OVAL CONTAINING WITHIN IT THE
WORDS "ABBU INCORPORATED" IN WHITE LET-
TERS THAT HAVE BEEN CENTERED WITHIN THE
RECTANGLE. .

SN 77-450,277, FILED 4-16-2008.

JOHN WILKE, EXAMINING ATTORNEY

Int. Cl.: 25

Prior U.S. Cls.: 22 and 39

United States Patent and Trademark Office

Reg. No. 3,577,797

Registered Feb. 17, 2009

TRADEMARK
PRINCIPAL REGISTER



ABBU INCORPORATED (NEW YORK CORPORATION)
86-16 56TH AVENUE; APRATMENT 2A
ELMHURST, NY 11373

FOR: BABY BODYSUITS; BABY BOTTOMS; BABY BUNTING; BABY TOPS; BELTS; CAPRI PANTS; CAPS; CARGO PANTS; CHILDREN'S AND INFANTS' CLOTH BIBS; CHILDREN'S CLOTH EATING BIBS; CLOTH BIBS; CLOTH DIAPERS; CLOTHING, NAMELY, KNEE WARMERS; CLOTHING, NAMELY, NECK TUBES; CLOTHING, NAMELY, THOBES; CLOTHING, NAMELY, WRAP-AROUNDS; CREWNECK SWEATERS; DENIMS; DUSTERS; FUR HATS; HAT BANDS; HATS; HOODS; INFANT AND TODDLER ONE PIECE CLOTHING; INFANT CLOTH DIAPERS; JERSEYS; JOGGING PANTS; JUMPERS; LEATHER BELTS; LEATHER PANTS; LOUNGE PANTS; MANTLES; MOCK TURTLE-NECK SWEATERS; MUFFLERS; NON-DISPOSABLE CLOTH TRAINING PANTS; PANTS; PAPER HATS FOR USE AS CLOTHING ITEMS; PARTS OF CLOTHING, NAMELY, GUSSETS FOR TIGHTS, GUSSETS FOR STOCKINGS, GUSSETS FOR BATHING SUITS, GUSSETS FOR UNDERWEAR, GUSSETS FOR LEOTARDS AND GUSSETS FOR FOOTLETS; PERSPIRATION ABSORBENT UNDERWEAR CLOTHING; PETTI-PANTS; PLASTIC BABY BIBS; SEDGE HATS (SUGE-GASA); SHIFTS; SHORT SETS; SHORT-SLEEVED OR LONG-SLEEVED T-SHIRTS; SHOULDER WRAPS; SKI PANTS; SMALL HATS; SNOW PANTS; SNOWBOARD PANTS; STRETCH PANTS; SWADDLING CLOTHES; SWEAT PANTS; SWEATERS; T-SHIRTS; TAP PANTS; TIES; TOBOGGAN HATS, PANTS AND CAPS; TOPS; TRACK

PANTS; TRIATHLON CLOTHING, NAMELY, TRIATHLON TIGHTS, TRIATHLON SHORTS, TRIATHLON SINGLETS, TRIATHLON SHIRTS, TRIATHLON SUITS; TURTLENECK SWEATERS; UNDERARM CLOTHING SHIELDS; V-NECK SWEATERS; WATERPROOF JACKETS AND PANTS; WIND PANTS; WOOLLY HATS; WRAPS; YOGA PANTS, IN CLASS 25 (U.S. CLS. 22 AND 39).

FIRST USE 12-1-2007; IN COMMERCE 12-1-2008.

THE COLOR(S) LIME GREEN, BLACK, WHITE IS/ARE CLAIMED AS A FEATURE OF THE MARK.

THE MARK CONSISTS OF THE STYLIZED LETTERS "GOLKIDS" WHICH IS IN BOLD, LIME GREEN COLOR. THE "O" IN "GOLKIDS" IS REPLACED BY A SOCCER BALL DRAWING WITH A ZIGZAG LINE ON THE LEFT SIDE OF SOCCER BALL SIMULATING IMPACT WITH THE LETTER "G" WHICH IS ROTATED SLIGHTLY TO THE LEFT AS IF STRUCK. THE "I" IS LOWER CASE. THERE IS A BLACK DRAWING OF A STYLIZED MALE CHILD SILHOUETTED OVER THE "K" PERFORMING AN OVERHEAD KICK. ABOVE THE "L" AND "K" IS A BLACK CURVED LINE BETWEEN THE CHILD'S RAISED FOOT AND SOCCER BALL.

THE FOREIGN WORDING IN THE MARK TRANSLATES INTO ENGLISH AS GOALKID S.

SN 77-450,344, FILED 4-16-2008.

JOHN WILKE, EXAMINING ATTORNEY

Int. Cl.: 15

Prior U.S. Cls.: 2, 21, and 36

United States Patent and Trademark Office

Reg. No. 3,577,798

Registered Feb. 17, 2009

**TRADEMARK
PRINCIPAL REGISTER**

**PANHANDLER STEEL DRUM
PRODUCTS**

HOPETOWN MUSIC INC. (CALIFORNIA CORPORATION)
1508 E. 33RD. STREET
SIGNAL HILL, CA 90755

FOR: MUSICAL INSTRUMENTS, NAMELY, STEEL PAN MUSIC INSTRUMENTS AND STEEL PAN PLAYING MALLETS; STANDS FOR MUSICAL INSTRUMENTS, IN CLASS 15 (U.S. CLS. 2, 21 AND 36).

FIRST USE 9-1-2008; IN COMMERCE 10-1-2008.

THE MARK CONSISTS OF STANDARD CHARACTERS WITHOUT CLAIM TO ANY PARTICULAR FONT, STYLE, SIZE, OR COLOR.

NO CLAIM IS MADE TO THE EXCLUSIVE RIGHT TO USE "STEEL DRUM PRODUCTS", APART FROM THE MARK AS SHOWN.

SN 77-450,738, FILED 4-17-2008.

APRIL ROACH, EXAMINING ATTORNEY

Int. Cl.: 36

Prior U.S. Cls.: 100, 101, and 102

United States Patent and Trademark Office

Reg. No. 3,577,799

Registered Feb. 17, 2009

**SERVICE MARK
PRINCIPAL REGISTER**

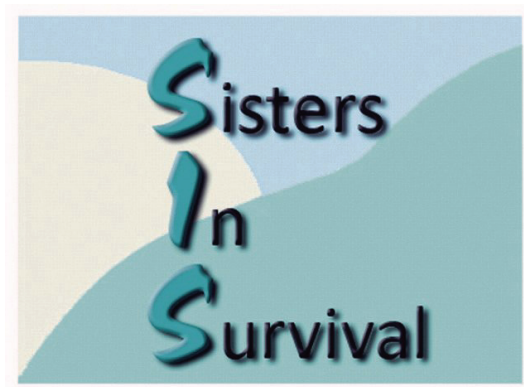

SISTERS IN SURVIVAL (ARIZONA CORPORATION)
10751 N. FRANK LLOYD WRIGHT, SUITE 104
SCOTTSDALE, AZ 85259

FOR: CHARITABLE FUNDRAISING SERVICES,
IN CLASS 36 (U.S. CLS. 100, 101 AND 102).

FIRST USE 9-26-2008; IN COMMERCE 9-26-2008.

THE COLOR(S) TEAL, BLACK, GREEN, YELLOW, AND BLUE IS/ARE CLAIMED AS A FEATURE OF THE MARK.

THE MARK CONSISTS OF THE WORDS "SISTERS IN SURVIVAL" IN THE FOREGROUND. THE FIRST LETTERS OF "SISTERS", "IN" AND "SURVI-

VAL" ARE TEAL, SHADOWED IN BLACK AND CAPITALIZED. THE REMAINING LETTERS ARE IN LOWERCASE BLACK. ALL LETTERS ARE STYLIZED WITH A DROP SHADOW, INNER SHADOW, BEVELED AND EMBOSSED. IN THE BACKGROUND, A GREEN HILL BEGINS IN THE LOWER LEFT CORNER AND EXTENDS TO THE UPPER RIGHT. ON THE LEFT SIDE, A LARGE PALE YELLOW SUN EXTENDS UPWARD TO THE SKY AND MID-WAY TO THE HILL. A LIGHT BLUE SKY EXTENDS FROM SIDE-TO-SIDE IN THE UPPER PORTION OF THE BACKGROUND, AND FORMS A "V" SHAPE WITH THE HILL AND SUN.

SN 77-452,788, FILED 4-19-2008.

KIM SAITO, EXAMINING ATTORNEY

Int. Cl.: 31

Prior U.S. Cls.: 1 and 46

United States Patent and Trademark Office

Reg. No. 3,577,800

Registered Feb. 17, 2009

**TRADEMARK
PRINCIPAL REGISTER**

IN A CLASS BY ITSELF

LB BRANDS, LLC (MAINE LIMITED LIABILITY
COMPANY)
PO BOX 239
PORT CLYDE, ME 04855

THE MARK CONSISTS OF STANDARD CHAR-
ACTERS WITHOUT CLAIM TO ANY PARTICULAR
FONT, STYLE, SIZE, OR COLOR.

FOR: LIVE LOBSTER, IN CLASS 31 (U.S. CLS. 1
AND 46).

SN 77-452,897, FILED 4-20-2008.

FIRST USE 10-31-2008; IN COMMERCE 10-31-2008.

TIMOTHY FINNEGAN, EXAMINING ATTORNEY

Int. Cl.: 35

Prior U.S. Cls.: 100, 101, and 102

United States Patent and Trademark Office

Reg. No. 3,577,801

Registered Feb. 17, 2009

**SERVICE MARK
PRINCIPAL REGISTER**

enviromodal

MOFFET, ERIC (UNITED STATES INDIVIDUAL)
58 SCNTIC RD
EAST WINDSOR, CT 06088

THE MARK CONSISTS OF STANDARD CHAR-
ACTERS WITHOUT CLAIM TO ANY PARTICULAR
FONT, STYLE, SIZE, OR COLOR.

FOR: TRANSPORTATION LOGISTICS SERVICES,
NAMELY, ARRANGING THE TRANSPORTATION
OF GOODS FOR OTHERS, IN CLASS 35 (U.S. CLS.
100, 101 AND 102).

SN 77-454,565, FILED 4-22-2008.

FIRST USE 10-1-2008; IN COMMERCE 10-15-2008.

SIMON TENG, EXAMINING ATTORNEY

Int. Cl.: 5

Prior U.S. Cls.: 6, 18, 44, 46, 51, and 52

Reg. No. 3,577,802

United States Patent and Trademark Office

Registered Feb. 17, 2009

**TRADEMARK
PRINCIPAL REGISTER**

PreSurge

ATHLETIC EDGE NUTRITION INC (NEVADA
CORPORATION)
3109 GRAND AVE 280
MIAMI, FL 33133

FIRST USE 11-1-2008; IN COMMERCE 11-1-2008.

FOR: AMINO ACIDS FOR NUTRITIONAL PURPOSES; DIETARY AND NUTRITIONAL SUPPLEMENTS; DIETARY SUPPLEMENTAL DRINKS; DIETARY SUPPLEMENTS; DIETARY SUPPLEMENTS FOR HUMAN CONSUMPTION , IN CLASS 5 (U.S. CLS. 6, 18, 44, 46, 51 AND 52).

THE MARK CONSISTS OF STANDARD CHARACTERS WITHOUT CLAIM TO ANY PARTICULAR FONT, STYLE, SIZE, OR COLOR.

SN 77-454,986, FILED 4-22-2008.

DORITT L. CARROLL, EXAMINING ATTORNEY

Int. Cl.: 30

Prior U.S. Cl.: 46

United States Patent and Trademark Office

Reg. No. 3,577,803

Registered Feb. 17, 2009

**TRADEMARK
PRINCIPAL REGISTER**

VITATOPS

VITALICIOUS, INC. (NEW YORK CORPORATION)

11 BROADWAY, SUITE 1155

NEW YORK, NY 10004

FOR: MUFFIN TOPS, IN CLASS 30 (U.S. CL. 46).

FIRST USE 1-1-2003; IN COMMERCE 1-1-2003.

THE MARK CONSISTS OF STANDARD CHARACTERS WITHOUT CLAIM TO ANY PARTICULAR FONT, STYLE, SIZE, OR COLOR.

OWNER OF U.S. REG. NOS. 2,292,363 AND 3,243,451.

SN 77-457,267, FILED 4-24-2008.

TRACY FLETCHER, EXAMINING ATTORNEY

Int. Cl.: 42

Prior U.S. Cls.: 100 and 101

United States Patent and Trademark Office

Reg. No. 3,577,804

Registered Feb. 17, 2009

**SERVICE MARK
PRINCIPAL REGISTER**

ITARIN

KOLYER, JEFF (UNITED STATES INDIVIDUAL)
80 YAMPA WAY
FREMONT, CA 94539

FOR: COMPUTER HARDWARE AND SOFTWARE CONSULTING SERVICES; PROVIDING TEMPORARY USE OF ON-LINE NONDOWNLOADABLE SOFTWARE DEVELOPMENT TOOLS FOR TECH SUPPORT TEAMS TO TRACK CUSTOMERS,

CASES AND RETURNS , IN CLASS 42 (U.S. CLS. 100 AND 101).

FIRST USE 8-6-2008; IN COMMERCE 8-6-2008.

SN 77-460,211, FILED 4-29-2008.

BARNEY CHARLON, EXAMINING ATTORNEY

Int. Cls.: 9 and 25

Prior U.S. Cls.: 21, 22, 23, 26, 36, 38, and 39

United States Patent and Trademark Office

Reg. No. 3,577,805

Registered Feb. 17, 2009

**TRADEMARK
PRINCIPAL REGISTER**



ATHLETIC KINETICS CORPORATION (MARY-
LAND CORPORATION)
3521 SANGUINE DRIVE
NEW WINDSOR, MD 21776

FOR: EYEWEAR; EYEWEAR ACCESSORIES,
NAMELY, STRAPS, NECK CORDS AND HEAD
STRAPS WHICH RESTRAIN EYEWEAR FROM
MOVEMENT ON A WEARER; EYEWEAR CASES;
PROTECTIVE EYEWEAR; PROTECTIVE EYEWEAR
AND COMPONENT PARTS THEREOF; SPECTA-
CLES AND SUNGLASSES; SPECTACLES, FRAMES
AND CASES; SPORTS' GLASSES; SUNGLASS LEN-
SES; SUNGLASSES; SUNGLASSES AND SPECTA-
CLES, IN CLASS 9 (U.S. CLS. 21, 23, 26, 36 AND 38).

FIRST USE 5-2-2008; IN COMMERCE 9-1-2008.

FOR: T-SHIRTS; SKULL CAPS; SHIRTS; SHORT-
SLEEVED OR LONG-SLEEVED T-SHIRTS; SHORTS;
SPORTS JERSEYS; SPORTS SHIRTS; SPORTS
SHIRTS WITH SHORT SLEEVES; SWEAT PANTS;
SWEAT SHIRTS; TURTLENECKS; VISORS; WARM
UP OUTFITS; WARM UP SUITS; WIND-JACKETS;

WRISTBANDS; JACKETS; HEAD SWEATBANDS;
HEADGEAR, NAMELY, HATS, BEANIES, VISORS;
HEADWEAR; HOODED PULLOVERS; HOODED
SWEAT SHIRTS; GLOVES; GLOVES INCLUDING
THOSE MADE OF SKIN, HIDE OR FUR; BEACH-
WEAR; POLO SHIRTS, IN CLASS 25 (U.S. CLS. 22
AND 39).

FIRST USE 5-2-2008; IN COMMERCE 9-1-2008.

NO CLAIM IS MADE TO THE EXCLUSIVE
RIGHT TO USE "AK", APART FROM THE MARK
AS SHOWN.

THE MARK CONSISTS OF A STYLIZED DEPI-
TION OF THE LETTERS "A" AND "K" CONNec-
TED.

SN 77-460,620, FILED 4-29-2008.

WILLIAM P. SHANAHAN, EXAMINING ATTOR-
NEY

Int. Cl.: 16

Prior U.S. Cls.: 2, 5, 22, 23, 29, 37, 38, and 50

Reg. No. 3,577,806

United States Patent and Trademark Office

Registered Feb. 17, 2009

**TRADEMARK
PRINCIPAL REGISTER**

IDEA BUILDER

MEADWESTVACO CORPORATION (DELAWARE
CORPORATION)
MEADWESTVACO CORPORATE CENTER
11013 WEST BROAD STREET
GLEN ALLEN, VA 23060

FOR: CHILDREN'S ACTIVITY BOOKS, EDUCA-
TIONAL WRITING AND DRAWING TABLETS AND
PADS, IN CLASS 16 (U.S. CLS. 2, 5, 22, 23, 29, 37, 38
AND 50).

FIRST USE 9-21-2008; IN COMMERCE 9-21-2008.

THE MARK CONSISTS OF STANDARD CHAR-
ACTERS WITHOUT CLAIM TO ANY PARTICULAR
FONT, STYLE, SIZE, OR COLOR.

SN 77-460,666, FILED 4-29-2008.

ZACHARY BELLO, EXAMINING ATTORNEY

Int. Cls.: 41 and 43

Prior U.S. Cls.: 100, 101, and 107

United States Patent and Trademark Office

Reg. No. 3,577,807

Registered Feb. 17, 2009

**SERVICE MARK
PRINCIPAL REGISTER**

Everyone Plays a Part

HARRAH'S LICENSE COMPANY, LLC (NEVADA
LIMITED LIABILITY COMPANY)
ONE CAESARS PALACE DRIVE
LAS VEGAS, NV 89109

FOR: PROVIDING ENTERTAINMENT SERVICES
IN THE NATURE OF CASINO AND GAMING
ACTIVITIES; CASINO SERVICES; CONDUCTING
AND PROVIDING FACILITIES FOR SPECIAL
EVENTS FEATURING CASINO AND GAMING
CONTESTS, IN CLASS 41 (U.S. CLS. 100, 101 AND
107).

FIRST USE 5-27-2008; IN COMMERCE 6-25-2008.

FOR: HOTEL SERVICES; BAR AND RESTAU-
RANT SERVICES; PROVISION OF CONFERENCE,
EXHIBITION AND MEETING FACILITIES, IN
CLASS 43 (U.S. CLS. 100 AND 101).

FIRST USE 5-27-2008; IN COMMERCE 6-25-2008.

THE MARK CONSISTS OF STANDARD CHAR-
ACTERS WITHOUT CLAIM TO ANY PARTICULAR
FONT, STYLE, SIZE, OR COLOR.

SN 77-461,080, FILED 4-29-2008.

KEVIN DINALLO, EXAMINING ATTORNEY

Int. Cl.: 9

Prior U.S. Cls.: 21, 23, 26, 36, and 38

United States Patent and Trademark Office

Reg. No. 3,577,808

Registered Feb. 17, 2009

**TRADEMARK
PRINCIPAL REGISTER**

Tradewinds Caravans

SANDLOT GAMES CORPORATION (WASHINGTON CORPORATION)
SUITE 101
22030 20TH AVENUE SE
BOTHELL, WA 98021

FOR: COMPUTER GAME PROGRAMS; COMPUTER GAME SOFTWARE; COMPUTER PROGRAMS FOR VIDEO AND COMPUTER GAMES; DOWNLOADABLE MULTIMEDIA GAME PROGRAMS VIA THE INTERNET AND WIRELESS DEVICES; GAME SOFTWARE; INTERACTIVE VIDEO GAME PROGRAMS; ELECTRONIC GAME PROGRAMS; ELECTRONIC GAME SOFTWARE, IN CLASS 9 (U.S. CLS. 21, 23, 26, 36 AND 38).

FIRST USE 5-30-2008; IN COMMERCE 5-30-2008.

THE MARK CONSISTS OF STANDARD CHARACTERS WITHOUT CLAIM TO ANY PARTICULAR FONT, STYLE, SIZE, OR COLOR.

OWNER OF U.S. REG. NO. 3,101,783.

SN 77-466,180, FILED 5-5-2008.

DAVID YONTEF, EXAMINING ATTORNEY

Int. Cl.: 9

Prior U.S. Cls.: 21, 23, 26, 36, and 38

Reg. No. 3,577,809

United States Patent and Trademark Office

Registered Feb. 17, 2009

**TRADEMARK
PRINCIPAL REGISTER**

MAGNIM

PANNAWAY TECHNOLOGIES, INC. (NEW
HAMPSHIRE CORPORATION)
215 COMMERCE WAY
PORTSMOUTH, NH 03801

FIRST USE 6-26-2008; IN COMMERCE 6-26-2008.

FOR: TELECOMMUNICATIONS AND DATA
NETWORKING HARDWARE, NAMELY, DEVICES
FOR TRANSPORTING AND AGGREGATING
VOICE, DATA, AND VIDEO COMMUNICATIONS
ACROSS MULTIPLE NETWORK INFRASTRUC-
TURES AND COMMUNICATIONS PROTOCOLS,
IN CLASS 9 (U.S. CLS. 21, 23, 26, 36 AND 38).

THE MARK CONSISTS OF STANDARD CHAR-
ACTERS WITHOUT CLAIM TO ANY PARTICULAR
FONT, STYLE, SIZE, OR COLOR.

SN 77-472,212, FILED 5-12-2008.

JAY BESCH, EXAMINING ATTORNEY

Int. Cl.: 5

Prior U.S. Cls.: 6, 18, 44, 46, 51, and 52

Reg. No. 3,577,810

United States Patent and Trademark Office

Registered Feb. 17, 2009

**TRADEMARK
PRINCIPAL REGISTER**

MULTI-KILL

WOODSTREAM CORPORATION (PENNSYLVANIA CORPORATION)
69 NORTH LOCUST STREET
LITITZ, PA 17543

THE MARK CONSISTS OF STANDARD CHARACTERS WITHOUT CLAIM TO ANY PARTICULAR FONT, STYLE, SIZE, OR COLOR.

FOR: RODENTICIDES, IN CLASS 5 (U.S. CLS. 6, 18, 44, 46, 51 AND 52).

SN 77-476,575, FILED 5-16-2008.

FIRST USE 10-9-2008; IN COMMERCE 10-9-2008.

GINA HAYES, EXAMINING ATTORNEY

Int. Cl.: 16

Prior U.S. Cls.: 2, 5, 22, 23, 29, 37, 38, and 50

United States Patent and Trademark Office

Reg. No. 3,577,811

Registered Feb. 17, 2009

**TRADEMARK
PRINCIPAL REGISTER**

**The first revolution in
painting since the roller.**

WHOLEY, MARK (UNITED STATES INDIVIDUAL)
31 BAKER ST 2W
WARREN, RI 02885

THE MARK CONSISTS OF STANDARD CHARACTERS WITHOUT CLAIM TO ANY PARTICULAR FONT, STYLE, SIZE, OR COLOR.

FOR: PAINT BRUSHES, IN CLASS 16 (U.S. CLS. 2, 5, 22, 23, 29, 37, 38 AND 50).

SN 77-477,011, FILED 5-16-2008.

FIRST USE 0-0-2005; IN COMMERCE 0-0-2007.

TINA BROWN, EXAMINING ATTORNEY

Int. Cl.: 25

Prior U.S. Cls.: 22 and 39

United States Patent and Trademark Office

Reg. No. 3,577,812

Registered Feb. 17, 2009

**TRADEMARK
PRINCIPAL REGISTER**

WHEN YOU WANT WATER, MAKE
IT WHET. GET WHET NOW. BE
WHETTED.

ENTREPRENEURIAL VENTURES CAPITAL CO
LLC (PENNSYLVANIA LIMITED LIABILITY
COMPANY)
429 FORBES AVENUE
PITTSBURGH, PA 15219

FOR: FABRIC SOLD AS AN INTEGRAL COMPO-
NENT OF FINISHED CLOTHING ITEMS, NAMELY,
CAPS, HATS; HEADWEAR, UNDERWEAR, TEE
SHIRTS, SHORTS , IN CLASS 25 (U.S. CLS. 22 AND
39).

FIRST USE 8-18-2008; IN COMMERCE 8-18-2008.

THE MARK CONSISTS OF STANDARD CHAR-
ACTERS WITHOUT CLAIM TO ANY PARTICULAR
FONT, STYLE, SIZE, OR COLOR.

SN 77-490,287, FILED 6-4-2008.

KATINA MISTER, EXAMINING ATTORNEY

Int. Cl.: 42

Prior U.S. Cls.: 100 and 101

United States Patent and Trademark Office

Reg. No. 3,577,813

Registered Feb. 17, 2009

**SERVICE MARK
PRINCIPAL REGISTER**

WHEN "WHERE" MATTERS

GEOMAS (INTERNATIONAL) LIMITED (UNI-
TED KINGDOM PRIVATE LIMITED COMPA-
NY)
WORD TRADE CENTRE, VIA LUGANO 11
6982 LUGANO-AGNO, SWITZERLAND

FOR: PROVIDING SPECIFIC INFORMATION AS
REQUESTED BY CUSTOMERS VIA ELECTRONIC
COMMUNICATION DEVICES AND THE INTER-
NET, IN CLASS 42 (U.S. CLS. 100 AND 101).

FIRST USE 4-2-2007; IN COMMERCE 4-2-2007.

THE MARK CONSISTS OF STANDARD CHAR-
ACTERS WITHOUT CLAIM TO ANY PARTICULAR
FONT, STYLE, SIZE, OR COLOR.

SN 77-975,038, FILED 4-4-2007.

ALLISON HOLTZ, EXAMINING ATTORNEY

Int. Cl.: 25

Prior U.S. Cls.: 22 and 39

United States Patent and Trademark Office

Reg. No. 3,577,814

Registered Feb. 17, 2009

**TRADEMARK
PRINCIPAL REGISTER**

R-925

ABERCROMBIE & FITCH TRADING CO. (OHIO
CORPORATION)
6301 FITCH PATH
NEW ALBANY, OH 43054

FOR: SHOES; BELTS, IN CLASS 25 (U.S. CLS. 22
AND 39).

FIRST USE 9-0-2004; IN COMMERCE 9-0-2004.

THE MARK CONSISTS OF STANDARD CHAR-
ACTERS WITHOUT CLAIM TO ANY PARTICULAR
FONT, STYLE, SIZE, OR COLOR.

OWNER OF U.S. REG. NO. 3,030,750.

SN 77-975,940, FILED 8-14-2007.

KATHERINE STOIDES, EXAMINING ATTORNEY

Int. Cls.: 28, 35, 40, and 42

Prior U.S. Cls.: 22, 23, 38, 50, 100, 101, 102, 103, and 106

United States Patent and Trademark Office

Reg. No. 3,577,815

Registered Feb. 17, 2009

**TRADEMARK
SERVICE MARK
PRINCIPAL REGISTER**



GREEN TOYS INCORPORATED (CALIFORNIA CORPORATION)
SUITE 283
912 COLE STREET
SAN FRANCISCO, CA 94117

FOR: TOYS, NAMELY, TOY TEA SETS, TOY BAKEWARE AND COOKWARE, TOY SAND BUCKETS, TOY SAND SHOVELS, TOY SAND RAKES, SAND CASTLE MOLDS, TOY GARDENING SETS COMPRISING PLANTER TRAYS, PLANTER POTS, TROWELS, SOIL AND FLOWER AND PLANT SEEDS, ALL SOLD TOGETHER AS A UNIT, IN CLASS 28 (U.S. CLS. 22, 23, 38 AND 50).

FIRST USE 3-11-2008; IN COMMERCE 3-11-2008.

FOR: DISTRIBUTORSHIP SERVICES, WHOLESALE DISTRIBUTORSHIPS, WHOLESALE ORDERING, WHOLESALE STORE SERVICES, ALL IN THE FIELD OF TOYS, GAMES, AND A WIDE RANGE OF CHILDREN'S PRODUCTS, IN CLASS 35 (U.S. CLS. 100, 101 AND 102).

FIRST USE 3-11-2008; IN COMMERCE 3-11-2008.

FOR: MANUFACTURING SERVICES FOR OTHERS IN THE FIELD OF TOYS, GAMES, AND A WIDE RANGE OF CHILDREN'S PRODUCTS, IN CLASS 40 (U.S. CLS. 100, 103 AND 106).

FIRST USE 3-11-2008; IN COMMERCE 3-11-2008.

FOR: DESIGN AND TESTING FOR NEW PRODUCT DEVELOPMENT; DESIGN OF PACKAGING MATERIALS; PACKAGING DESIGN FOR OTHERS; RESEARCH AND DEVELOPMENT OF NEW TOYS, GAMES, AND A WIDE RANGE OF CHILDREN'S PRODUCTS, IN CLASS 42 (U.S. CLS. 100 AND 101).

FIRST USE 3-11-2008; IN COMMERCE 3-11-2008.

NO CLAIM IS MADE TO THE EXCLUSIVE RIGHT TO USE "GREEN TOYS", APART FROM THE MARK AS SHOWN.

SN 77-976,097, FILED 5-23-2007.

ALICE SUE CARRUTHERS, EXAMINING ATTORNEY

Int. Cl.: 3

Prior U.S. Cls.: 1, 4, 6, 50, 51, and 52

United States Patent and Trademark Office

Reg. No. 3,577,816

Registered Feb. 17, 2009

**TRADEMARK
PRINCIPAL REGISTER**

Save Your Lips

SAVE YOUR WORLD, L.L.C. (NEW JERSEY
LIMITED LIABILITY COMPANY)
P.O. BOX 745
SHORT HILLS, NJ 07078

THE MARK CONSISTS OF STANDARD CHAR-
ACTERS WITHOUT CLAIM TO ANY PARTICULAR
FONT, STYLE, SIZE, OR COLOR.

FOR: COSMETICS, NAMELY, LIP BALM; LIP
BALM; NON-MEDICATED LIP CARE PREPARA-
TIONS; NON-MEDICATED LIP PROTECTOR, IN
CLASS 3 (U.S. CLS. 1, 4, 6, 50, 51 AND 52).

SN 77-976,153, FILED 7-26-2007.

FIRST USE 3-15-2008; IN COMMERCE 3-15-2008.

SUZANNE BLANE, EXAMINING ATTORNEY

Int. Cl.: 25

Prior U.S. Cls.: 22 and 39

United States Patent and Trademark Office

Reg. No. 3,577,817

Registered Feb. 17, 2009

**TRADEMARK
PRINCIPAL REGISTER**



CLAUDIO BUONO (UNITED STATES INDIVIDUAL)
3640 MIDDLE ROAD
WINCHESTER, VA 22602

FOR: CLOTHING, NAMELY, T-SHIRTS, SWEATSHIRTS, SWEATPANTS, JACKETS, TANK TOPS, SHIRTS, PANTS, AND SHORTS, IN CLASS 25 (U.S. CLS. 22 AND 39).

FIRST USE 11-12-2008; IN COMMERCE 11-12-2008.

NO CLAIM IS MADE TO THE EXCLUSIVE RIGHT TO USE "WEAR", APART FROM THE MARK AS SHOWN.

THE MARK CONSISTS OF STYLIZED LETTERS "G" AND "D" WITH THE WORD "WEAR" INSIDE THE "D"; THE WORDS "NO OFFSEASON" UNDER THE "G" AND "D".

SN 77-976,255, FILED 1-10-2008.

KATINA MISTER, EXAMINING ATTORNEY

Int. Cls.: 16 and 25

Prior U.S. Cls.: 2, 5, 22, 23, 29, 37, 38, 39, and 50

United States Patent and Trademark Office

Reg. No. 3,577,818

Registered Feb. 17, 2009

**TRADEMARK
PRINCIPAL REGISTER**

FLEUR DE TIGRÉ

STACEY UFFMAN BLANCHARD (UNITED STATES INDIVIDUAL)
17611 SILVERFOX COURT
BATON ROUGE, LA 70810

THE MARK CONSISTS OF STANDARD CHARACTERS WITHOUT CLAIM TO ANY PARTICULAR FONT, STYLE, SIZE, OR COLOR.

FOR: DECALS, IN CLASS 16 (U.S. CLS. 2, 5, 22, 23, 29, 37, 38 AND 50).

THE FOREIGN WORDING IN THE MARK TRANSLATES INTO ENGLISH AS FLOWER OF THE TIGER.

FIRST USE 8-21-2007; IN COMMERCE 8-15-2008.

FOR: HATS; SHIRTS; BOXER SHORTS; VISORS; BLOUSES, IN CLASS 25 (U.S. CLS. 22 AND 39).

SN 77-976,306, FILED 9-12-2007.

FIRST USE 7-2-2007; IN COMMERCE 8-15-2007.

SHAUNIA CARLYLE, EXAMINING ATTORNEY

Int. Cl.: 41

Prior U.S. Cls.: 100, 101, and 107

United States Patent and Trademark Office

Reg. No. 3,577,819

Registered Feb. 17, 2009

**SERVICE MARK
PRINCIPAL REGISTER**

PERPETUAL MOJO

PERPETUAL MOJO INCORPORATED (OHIO CORPORATION)
5 BEECHPOINT DRIVE
OXFORD, OH 45056

FOR: EDUCATIONAL SERVICES, NAMELY, TRAINING AND PROVIDING COURSES OF INSTRUCTION IN THE FIELDS OF PHYSICAL CONDITIONING, PHYSICAL REHABILITATION, ATHLETIC CONDITIONING AND ERGONOMICS AND DISTRIBUTION OF COURSE MATERIAL IN CONNECTION THEREWITH; PHYSICAL EDUCATION SERVICES; PHYSICAL FITNESS CONDITIONING CLASSES; PHYSICAL FITNESS INSTRUCTION; CONSULTATION AND PROVIDING INFORMA-

TION IN THE FIELDS OF PHYSICAL FITNESS, PHYSICAL CONDITIONING, AND ATHLETIC CONDITIONING, IN CLASS 41 (U.S. CLS. 100, 101 AND 107).

FIRST USE 7-16-2008; IN COMMERCE 9-28-2008.

THE MARK CONSISTS OF STANDARD CHARACTERS WITHOUT CLAIM TO ANY PARTICULAR FONT, STYLE, SIZE, OR COLOR.

SN 77-976,342, FILED 3-5-2007.

CHARLES L. JENKINS, EXAMINING ATTORNEY

Int. Cl.: 3

Prior U.S. Cls.: 1, 4, 6, 50, 51, and 52

Reg. No. 3,577,820

United States Patent and Trademark Office

Registered Feb. 17, 2009

**TRADEMARK
PRINCIPAL REGISTER**

GWEN STEFANI

LAMB-GRS (CALIFORNIA LIMITED LIABILITY
COMPANY)
C/O GOLDRING, HERTZ & LICHTENSTEIN, LLP
450 N. ROXBURY DRIVE, 8TH FLOOR
BEVERLY HILLS, CA 90210

FOR: BODY LOTION, SHOWER GEL, PERSONAL
FRAGRANCES, IN CLASS 3 (U.S. CLS. 1, 4, 6, 50, 51
AND 52).

FIRST USE 7-1-2007; IN COMMERCE 7-1-2007.

THE MARK CONSISTS OF STANDARD CHAR-
ACTERS WITHOUT CLAIM TO ANY PARTICULAR
FONT, STYLE, SIZE, OR COLOR.

THE NAME "GWEN STEFANI" IDENTIFIES A
LIVING INDIVIDUAL WHOSE CONSENT IS OF
RECORD.

SN 77-976,358, FILED 4-24-2007.

AMY HELLA, EXAMINING ATTORNEY

Int. Cl.: 35

Prior U.S. Cls.: 100, 101, and 102

United States Patent and Trademark Office

Reg. No. 3,577,821

Registered Feb. 17, 2009

**SERVICE MARK
PRINCIPAL REGISTER**

Just Say the Word

OUTSKIRTS, INC. (CALIFORNIA CORPORATION)
1750 14TH STREET, SUITE A
SANTA MONICA, CA 90404

FOR: MEDICAL TRANSCRIPTION SERVICES; MESSAGE TRANSCRIPTION; SERVICES COMPRISING THE RECORDING, TRANSCRIPTION, COMPOSITION, COMPILATION AND SYSTEMATIZATION OF WRITTEN COMMUNICATIONS AND RECORDINGS, AS WELL AS THE COMPILATION OF MATHEMATICAL OR STATISTICAL DATA; SERVICES CONSISTING OF THE REGISTRATION, COLLECTION, TRANSCRIPTION, COMPILATION AND SYSTEMIZATION OF WRITTEN COMMUNICATIONS AND DATA; SERVICES

COMPRISED OF RECORDING, TRANSCRIPTION, TRANSFORMATION, COMPOSITION, COMPILATION AND SYSTEMIZATION OF INFORMATION USED IN ELECTRONIC TRANSMISSIONS, IN CLASS 35 (U.S. CLS. 100, 101 AND 102).

FIRST USE 11-5-2008; IN COMMERCE 11-5-2008.

THE MARK CONSISTS OF STANDARD CHARACTERS WITHOUT CLAIM TO ANY PARTICULAR FONT, STYLE, SIZE, OR COLOR.

SN 77-976,409, FILED 6-13-2007.

KAREN SEVERSON, EXAMINING ATTORNEY

Int. Cl.: 3

Prior U.S. Cls.: 1, 4, 6, 50, 51, and 52

United States Patent and Trademark Office

Reg. No. 3,577,822

Registered Feb. 17, 2009

**TRADEMARK
PRINCIPAL REGISTER**

XANGO

DBC, LLC (UTAH CORPORATION)
2889 ASHTON BOULEVARD
LEHI, UT 84043

FIRST USE 10-24-2008; IN COMMERCE 10-24-2008.

SN 78-172,743, FILED 10-9-2002.

FOR: SKIN CARE PREPARATIONS AND HAIR
CARE PREPARATIONS, IN CLASS 3 (U.S. CLS. 1, 4, 6,
50, 51 AND 52).

HEATHER THOMPSON, EXAMINING ATTORNEY

Int. Cls.: 2, 11, 19, 37, and 40

**Prior U.S. Cls.: 1, 6, 11, 12, 13, 16, 21, 23, 31, 33, 34,
50, 100, 103, and 106**

Reg. No. 3,577,823

United States Patent and Trademark Office

Registered Feb. 17, 2009

**TRADEMARK
SERVICE MARK
PRINCIPAL REGISTER**

STELLAC

STELLAC OY (FINLAND CORPORATION)
HALLITUSKATU 3 B
50100 MIKKELI, FINLAND

FOR: PRESERVATIVES AGAINST DETERIORATION OF WOOD; WOOD SURFACE TREATMENT MATERIALS, NAMELY, PAINTS, COATINGS, LACQUERS, AND PIGMENTS, IN CLASS 2 (U.S. CLS. 6, 11 AND 16).

FIRST USE 4-5-2000; IN COMMERCE 8-23-2006.

FOR: WOOD DRYERS; WOOD HEAT TREATMENT EQUIPMENT, NAMELY, KILNS, OVENS AND PARTS AND FITTINGS THEREFOR, IN CLASS 11 (U.S. CLS. 13, 21, 23, 31 AND 34).

FIRST USE 4-5-2000; IN COMMERCE 8-23-2006.

FOR: TIMBER JOISTS, TIMBER PLANKS, TIMBER BEAMS; DRIED AND HEAT TREATED SAWN TIMBER, DRIED AND HEAT TREATED DRESSED

TIMBER, DRIED AND HEAT TREATED PLANED TIMBER; PAINTED, COATED AND SURFACE TREATED TIMBER, IN CLASS 19 (U.S. CLS. 1, 12, 33 AND 50).

FIRST USE 4-5-2000; IN COMMERCE 8-23-2006.

FOR: BUILDING CONSTRUCTION; INSTALLATION AND REPAIR OF WOOD DRYERS AND WOOD HEAT TREATMENT APPARATUS, IN CLASS 37 (U.S. CLS. 100, 103 AND 106).

FIRST USE 4-5-2000; IN COMMERCE 8-23-2006.

FOR: TREATING OF WOOD AND TIMBER, IN CLASS 40 (U.S. CLS. 100, 103 AND 106).

FIRST USE 4-5-2000; IN COMMERCE 8-23-2006.

SN 78-200,628, FILED 1-7-2003.

AMY C. KEAN, EXAMINING ATTORNEY

Int. Cl.: 11

Prior U.S. Cls.: 13, 21, 23, 31, and 34

United States Patent and Trademark Office

Reg. No. 3,577,824

Registered Feb. 17, 2009

**TRADEMARK
PRINCIPAL REGISTER**

COMFORT PLUS

EMERSON ELECTRIC CO. (MISSOURI CORPORATION)
8000 WEST FLORISSANT AVENUE
ST. LOUIS, MO 63136

FIRST USE 2-28-2002; IN COMMERCE 2-28-2002.

SN 78-235,518, FILED 4-9-2003.

FOR: HUMIDIFIERS AND INDOOR AIR CLEANERS, IN CLASS 11 (U.S. CLS. 13, 21, 23, 31 AND 34).

JEFFERY COWARD, EXAMINING ATTORNEY

Int. Cls.: 35 and 36

Prior U.S. Cls.: 100, 101, and 102

United States Patent and Trademark Office

Reg. No. 3,577,825

Registered Feb. 17, 2009

**SERVICE MARK
PRINCIPAL REGISTER**

**SENIORITY LIFE ACHIEVEMENT
REWARDS**

SENIORITY HOLDINGS LLC (DELAWARE LIMITED LIABILITY COMPANY)
C/O 10 OLD JACKSON AVENUE, NO. 1
HASTINGS-ON-HUDSON, NY 10706

FOR: REFERRALS IN THE FIELDS OF FINANCIAL PLANNING, IN CLASS 35 (U.S. CLS. 100, 101 AND 102).

FIRST USE 10-17-2008; IN COMMERCE 10-17-2008.

FOR: PROVIDING INFORMATION ON NO-FEE CREDIT CARD SERVICES AND PROGRAMS; ON-LINE BANKING SERVICES FEATURING SPECIAL ACCOUNT STATUS; PROVIDING INFORMATION, ADVICE AND CONSULTATION SERVICES, NAME-
LY, THOSE IN THE FIELDS OF LOANS, EMPLOY-
MENT OPPORTUNITIES, MONEY MANAGEMENT,

INVESTMENT, FINANCE, AND PREDATORY LENDING, IN CLASS 36 (U.S. CLS. 100, 101 AND 102).

FIRST USE 10-17-2008; IN COMMERCE 10-17-2008.

THE MARK CONSISTS OF STANDARD CHARACTERS WITHOUT CLAIM TO ANY PARTICULAR FONT, STYLE, SIZE, OR COLOR.

NO CLAIM IS MADE TO THE EXCLUSIVE RIGHT TO USE "REWARDS", APART FROM THE MARK AS SHOWN.

SN 78-277,909, FILED 7-23-2003.

CYNTHIA SLOAN, EXAMINING ATTORNEY

Int. Cl.: 30

Prior U.S. Cl.: 46

United States Patent and Trademark Office

Reg. No. 3,577,826

Registered Feb. 17, 2009

**TRADEMARK
PRINCIPAL REGISTER**

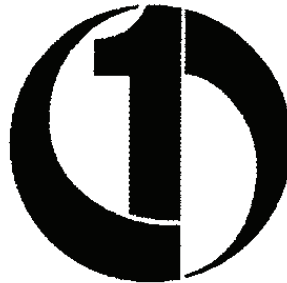

JAVA TRADING CO., LLC (DELAWARE LIMITED LIABILITY COMPANY)
801 HOUSER WAY N.
RENTON, WA 98055

FIRST USE 4-0-2004; IN COMMERCE 7-0-2004.

SN 78-310,310, FILED 10-7-2003.

FOR: COFFEE, TEA, AND PRE-PACKAGED COFFEE PODS, AND TEA PODS, IN CLASS 30 (U.S. CL. 46).

JANICE L. MCMORROW, EXAMINING ATTORNEY

Int. Cl.: 7

Prior U.S. Cls.: 13, 19, 21, 23, 31, 34, and 35

United States Patent and Trademark Office

Reg. No. 3,577,827

Registered Feb. 17, 2009

**TRADEMARK
PRINCIPAL REGISTER**

MERIDIAN

BRUNO INDEPENDENT LIVING AIDS, INC.
(WISCONSIN CORPORATION)
1780 EXECUTIVE DRIVE
OCONOMOWOC, WI 53066

FIRST USE 4-1-2005; IN COMMERCE 4-1-2005.

SN 78-320,503, FILED 10-29-2003.

FOR: VEHICLE-MOUNTED HOISTS, IN CLASS 7
(U.S. CLS. 13, 19, 21, 23, 31, 34 AND 35).

RONALD AIKENS, EXAMINING ATTORNEY

Int. Cls.: 7 and 37

Prior U.S. Cls.: 13, 19, 21, 23, 31, 34, 35, 100, 103, and 106

Reg. No. 3,577,828

United States Patent and Trademark Office

Registered Feb. 17, 2009

**TRADEMARK
SERVICE MARK
PRINCIPAL REGISTER**

**NOTHING MUCH GETS
PAST OUR SEALS**

STEIN SEAL COMPANY (DELAWARE CORPORATION)
P.O. BOX 316
1500 INDUSTRIAL PARK BOULEVARD
KULPSVILLE, PA 19443

FOR: SEALS USED IN TURBOMACHINERY, FOR LIMITING AND CONTROLLING FLUID TRANSPORT BETWEEN AND AMONG REGIONS OF DIFFERING PRESSURE, IN CLASS 7 (U.S. CLS. 13, 19, 21, 23, 31, 34 AND 35).

FIRST USE 12-29-2008; IN COMMERCE 12-29-2008.

FOR: REPAIR AND MAINTENANCE OF SEALS AND SEALING ASSEMBLIES USED IN TURBOMA-

CHINERY FOR LIMITING AND CONTROLLING FLUID TRANSPORT BETWEEN AND AMONG REGIONS OF DIFFERING PRESSURE, IN CLASS 37 (U.S. CLS. 100, 103 AND 106).

FIRST USE 9-26-2008; IN COMMERCE 9-26-2008.

THE MARK CONSISTS OF STANDARD CHARACTERS WITHOUT CLAIM TO ANY PARTICULAR FONT, STYLE, SIZE, OR COLOR.

SN 78-324,648, FILED 11-7-2003.

ANN E. SAPPENFIELD, EXAMINING ATTORNEY

Int. Cl.: 25

Prior U.S. Cls.: 22 and 39

United States Patent and Trademark Office

Reg. No. 3,577,829

Registered Feb. 17, 2009

TRADEMARK
PRINCIPAL REGISTER



For Our People

HARDEMAN, ALONZO R. (UNITED STATES INDIVIDUAL)
220 WOODCHASE
VICTORIA, TX 77904 AND
GANT, RONALD E. (UNITED STATES INDIVIDUAL)
220 WOODCHASE
VICTORIA, TX 77904 AND
LOVE, SHAWN (UNITED STATES INDIVIDUAL)
220 WOODCHASE
VICTORIA, TX 77904

FOR: MOST COMMON WEARING APPAREL, NAMELY, T-SHIRTS, KNIT-SHIRTS, POLO-STYLE SHIRTS, JERSEYS, PANTS, SHORTS, SOCKS, UNDER-GARMENTS, AND BASEBALL-STYLE CAPS, IN CLASS 25 (U.S. CLS. 22 AND 39).

FIRST USE 4-3-2008; IN COMMERCE 4-3-2008.

THE COLORS RED, YELLOW AND GREEN ARE CLAIMED AS A FEATURE OF THE MARK.

THE COLOR RED APPEARS IN A DIAMOND AS A VERTICAL TRIANGULAR-SHAPED BAR IN THE LEFT THIRD OF THE DIAMOND AND IN THE SCRIPT "FOR OUR PEOPLE" BELOW THE DIAMOND, THE COLOR YELLOW APPEARS IN A DIAMOND AS A VERTICAL BAR IN THE CENTER THIRD OF THE DIAMOND, IN THE BORDER AROUND THE DIAMOND AND ON THE TOP OF THE DIAMOND, AND THE COLOR GREEN APPEARS IN A DIAMOND AS A VERTICAL TRIANGULAR-SHAPED BAR IN THE RIGHT THIRD OF THE DIAMOND.

THE MARK CONSISTS OF A VERTICALLY DRAWN ACRONYM IN A STYLIZED FORMAT THAT MAKES THE THREE LETTERS "FOP" APPEAR TO FUSE DISTINCTIVELY.

SN 78-339,423, FILED 12-11-2003.

PATRICIA EVANKO, EXAMINING ATTORNEY

Int. Cl.: 11

Prior U.S. Cls.: 13, 21, 23, 31, and 34

United States Patent and Trademark Office

Reg. No. 3,577,830

Registered Feb. 17, 2009

**TRADEMARK
PRINCIPAL REGISTER**

Shower to Flower

SOUTHWEST WATER SOLUTIONS, L.L.C. (DE-
LAWARE LIMITED LIABILITY COMPANY)
SUITE 208
5520 RUFFIN ROAD
SAN DIEGO, CA 92123

FOR: GRAY WATER RECLAMATION SYSTEM
COMPRISING COLLECTION VALVE, WATER
PUMP, FILTER, AND STORAGE TANK, AND IRRI-
GATION FIXTURES SOLD IN CONNECTION
THEREWITH, IN CLASS 11 (U.S. CLS. 13, 21, 23, 31
AND 34).

FIRST USE 12-11-2008; IN COMMERCE 12-11-2008.

THE MARK CONSISTS OF STANDARD CHAR-
ACTERS WITHOUT CLAIM TO ANY PARTICULAR
FONT, STYLE, SIZE, OR COLOR.

SN 78-354,981, FILED 1-21-2004.

STEVEN JACKSON, EXAMINING ATTORNEY

Int. Cl.: 43

Prior U.S. Cls.: 100 and 101

United States Patent and Trademark Office

Reg. No. 3,577,831

Registered Feb. 17, 2009

**SERVICE MARK
PRINCIPAL REGISTER**

**GENARES WORLDWIDE
RESERVATION
SERVICES**

LEXINGTON MANAGEMENT CORPORATION
(TEXAS CORPORATION)
2555 SW GRAPEVINE PARKWAY #200
GRAPEVINE, TX 76051

FOR: MAKING HOTEL RESERVATIONS FOR
OTHERS AND RESERVATION OF CONVENTION
SPACE FOR OTHERS, IN CLASS 43 (U.S. CLS. 100
AND 101).

FIRST USE 2-28-2005; IN COMMERCE 2-28-2005.

THE MARK CONSISTS OF STANDARD CHAR-
ACTERS WITHOUT CLAIM TO ANY PARTICULAR
FONT, STYLE, SIZE, OR COLOR.

NO CLAIM IS MADE TO THE EXCLUSIVE
RIGHT TO USE "WORLDWIDE RESERVATION
SERVICES", APART FROM THE MARK AS SHOWN.

SN 78-355,227, FILED 1-21-2004.

ELLEN PERKINS, EXAMINING ATTORNEY

Int. Cl.: 5

Prior U.S. Cls.: 6, 18, 44, 46, 51, and 52

United States Patent and Trademark Office

Reg. No. 3,577,832

Registered Feb. 17, 2009

**TRADEMARK
PRINCIPAL REGISTER**

CREA-CELL

CELL US TRADEMARK LTD. (CANADA CORPORATION)
5100 SPECTRUM WAY
MISSISSAUGA, ONTARIO, CANADA L4W 5S2

FOR: INGREDIENT SOLD AS AN INTEGRAL COMPONENT OF FOOD AND SPORT NUTRITIONAL SUPPLEMENTS FOR STRENGTH AND PERFORMANCE ENHANCEMENT, POWDERED NUTRITIONAL SUPPLEMENT DRINK MIXES, MEAL REPLACEMENT SNACK BARS, IN CLASS 5 (U.S. CLS. 6, 18, 44, 46, 51 AND 52).

FIRST USE 4-0-2004; IN COMMERCE 4-0-2004.

THE MARK CONSISTS OF STANDARD CHARACTERS WITHOUT CLAIM TO ANY PARTICULAR FONT, STYLE, SIZE, OR COLOR.

SN 78-363,216, FILED 2-5-2004.

RON FAIRBANKS, EXAMINING ATTORNEY

Int. Cl.: 9

Prior U.S. Cls.: 21, 23, 26, 36, and 38

United States Patent and Trademark Office

Reg. No. 3,577,833

Registered Feb. 17, 2009

**TRADEMARK
PRINCIPAL REGISTER**

A-CPFM

MITSUBISHI HEAVY INDUSTRIES, LTD. (JAPAN CORPORATION)
16-5, KONAN 2-CHOME
MINATO-KU, TOKYO, JAPAN

FOR: APPARATUS FOR SURVEILLANCE OF CONTROLLING TURBINES, NAMELY, VIBRATION INTERFACE MODULES WHICH ANALYZE COMBUSTION PRESSURE FLUCTUATION, COMPUTERS AND COMPUTER SOFTWARE WHICH ANALYZES PRESSURE FLUCTUATION CHARACTERISTICS AND CALCULATES TURBINE CONTROL PARAMETERS; AND INSTRUMENTS FOR MEASURING TURBINE VIBRATION, NAMELY, ELECTRONIC SENSORS FOR MEASURING TUR-

BINE FLUCTUATION AND PRESSURE TRANSDUCERS FOR MEASURING INTERNAL PRESSURE FLUCTUATION, IN CLASS 9 (U.S. CLS. 21, 23, 26, 36 AND 38).

FIRST USE 6-18-2008; IN COMMERCE 10-17-2008.

THE MARK CONSISTS OF STANDARD CHARACTERS WITHOUT CLAIM TO ANY PARTICULAR FONT, STYLE, SIZE, OR COLOR.

SN 78-393,004, FILED 3-30-2004.

ELLEN PERKINS, EXAMINING ATTORNEY

Int. Cl.: 25

Prior U.S. Cls.: 22 and 39

United States Patent and Trademark Office

Reg. No. 3,577,834

Registered Feb. 17, 2009

**TRADEMARK
PRINCIPAL REGISTER**

DOLOMITE

TECNICA S.P.A. (ITALY CORPORATION)
VIA FANTE D'ITALIA, 56
GIAVERA DEL MONTELLO (TREVISO), ITALY
31040

FOR: CLOTHING, NAMELY, SHIRTS, T-SHIRTS,
SKIRTS, POLO SHIRTS, SHORTS, PANTS, SNOW
PANTS, SCARVES, PULLOVERS, TROUSERS, PAR-
KAS, SWEATERS, MITTENS, TANK TOPS, JUM-
PERS, GLOVES, COATS, JACKETS AND WIND-
RESISTANT JACKETS; FOOTWEAR; HEADGEAR,

NAMELY, HATS, CAPS, IN CLASS 25 (U.S. CLS. 22
AND 39).

FIRST USE 12-31-2005; IN COMMERCE 12-31-2005.

OWNER OF U.S. REG. NOS. 1,194,373 AND
1,953,780.

SN 78-399,421, FILED 4-9-2004.

DAVID MURRAY, EXAMINING ATTORNEY

Int. Cl.: 37

Prior U.S. Cls.: 100, 103, and 106

United States Patent and Trademark Office

Reg. No. 3,577,835

Registered Feb. 17, 2009

**SERVICE MARK
PRINCIPAL REGISTER**

Q-SHIELD

AMERICAN DIESEL & GAS, INC. (FLORIDA CORPORATION)
4800 NORTH FEDERAL HIGHWAY, SUITE 104D
BOCA RATON, FL 33431

FOR: INSTALLATION OF HEAT REFLECTIVE AND INSULATING MATERIALS, NAMELY, WRAPS, COVERS AND BLANKETS, IN THE FORM OF PRE-CUT PIECES, PRE-CUT AND ASSEMBLED PIECES OR IN SHEET METAL FORM, FOR USE ON ENGINE COMPONENTS, ENGINE COMPARTMENT WALLS AND ACCESS HOODS, IN CLASS 37 (U.S. CLS. 100, 103 AND 106).

FIRST USE 4-15-2004; IN COMMERCE 4-15-2004.

THE MARK CONSISTS OF STANDARD CHARACTERS WITHOUT CLAIM TO ANY PARTICULAR FONT, STYLE, SIZE, OR COLOR.

SN 78-419,849, FILED 5-17-2004.

ASMAT KHAN, EXAMINING ATTORNEY

Int. Cl.: 42

Prior U.S. Cls.: 100 and 101

United States Patent and Trademark Office

Reg. No. 3,577,836

Registered Feb. 17, 2009

**SERVICE MARK
PRINCIPAL REGISTER**

SEAIPOS

MULTI SERVICE CORPORATION (MISSOURI
CORPORATION)
8650 COLLEGE BLVD.
OVERLAND PARK, KS 66210

FOR: APPLICATION SERVICE PROVIDER,
NAMELY, HOSTING COMPUTER SOFTWARE AP-
PLICATIONS OF OTHERS IN THE FIELD OF
POINT-OF-SALE CREDIT CARD TRANSACTIONS,
IN CLASS 42 (U.S. CLS. 100 AND 101).

FIRST USE 11-30-2004; IN COMMERCE 11-30-2004.

THE MARK CONSISTS OF STANDARD CHAR-
ACTERS WITHOUT CLAIM TO ANY PARTICULAR
FONT, STYLE, SIZE, OR COLOR.

SN 78-420,038, FILED 5-17-2004.

STEVEN R. FOSTER, EXAMINING ATTORNEY

Int. Cl.: 40

Prior U.S. Cls.: 100, 103, and 106

United States Patent and Trademark Office

Reg. No. 3,577,837

Registered Feb. 17, 2009

**SERVICE MARK
PRINCIPAL REGISTER**

EARTHRENEW

EARTHRENEW, INC. (CALIFORNIA CORPORATION)
504 AVENUE ALHAMBRA #203
HALF MOON BAY, CA 940193148

THE MARK CONSISTS OF STANDARD CHARACTERS WITHOUT CLAIM TO ANY PARTICULAR FONT, STYLE, SIZE, OR COLOR.

FOR: CONSULTATION WITH REGARD TO TREATMENT OF WASTE MATERIALS AND WITH REGARD TO USE OF FERTILIZERS, IN CLASS 40 (U.S. CLS. 100, 103 AND 106).

SN 78-426,789, FILED 5-28-2004.

FIRST USE 12-16-2008; IN COMMERCE 12-16-2008.

CAROLINE WOOD, EXAMINING ATTORNEY

Int. Cl.: 25

Prior U.S. Cls.: 22 and 39

United States Patent and Trademark Office

Reg. No. 3,577,838

Registered Feb. 17, 2009

**TRADEMARK
PRINCIPAL REGISTER**

VIRGO II

BEN ELIAS INDUSTRIES CORP. (NEW YORK CORPORATION)
1400 BROADWAY
NEW YORK, NY 100185300

THE MARK CONSISTS OF STANDARD CHARACTERS WITHOUT CLAIM TO ANY PARTICULAR FONT, STYLE, SIZE, OR COLOR.

FOR: PLUS SIZE CLOTHING, NAMELY, DRESSES, SUITS; OUTERWEAR, NAMELY, JACKETS, IN CLASS 25 (U.S. CLS. 22 AND 39).

SN 78-428,473, FILED 6-2-2004.

FIRST USE 11-7-2005; IN COMMERCE 11-7-2005.

ALYSSA STEEL, EXAMINING ATTORNEY

Int. Cls.: 18 and 24

Prior U.S. Cls.: 1, 2, 3, 22, 41, 42, and 50

United States Patent and Trademark Office

Reg. No. 3,577,839

Registered Feb. 17, 2009

**TRADEMARK
PRINCIPAL REGISTER**

SMILEY

SMILEY COMPANY SPRL, THE (BELGIUM LIMITED LIABILITY COMPANY)
16 RUE DES TROIS ARBRES
BRUSSELS, BELGIUM 1180

FOR: TRAVELING BAGS, SCHOOL SATCHELS, SUITCASES, AND TRAVELING LEATHER SETS CONSISTING OF TRAVELING BAGS, IN CLASS 18 (U.S. CLS. 1, 2, 3, 22 AND 41).

FIRST USE 12-4-2008; IN COMMERCE 12-4-2008.

FOR: BATH LINEN, BED LINEN, HOUSEHOLD LINEN, TABLE LINEN, UNFITTED FABRIC FURNITURE COVERS, CURTAINS OF TEXTILE OR

PLASTIC, AND TABLE MATS, NOT OF PAPER, IN CLASS 24 (U.S. CLS. 42 AND 50).

FIRST USE 12-4-2008; IN COMMERCE 12-4-2008.

THE MARK CONSISTS OF STANDARD CHARACTERS WITHOUT CLAIM TO ANY PARTICULAR FONT, STYLE, SIZE, OR COLOR.

OWNER OF U.S. REG. NOS. 2,566,529, 2,801,529, AND OTHERS.

SN 78-433,858, FILED 6-11-2004.

DAVID MURRAY, EXAMINING ATTORNEY

Int. Cls.: 41, 42, and 44

Prior U.S. Cls.: 100, 101, and 107

United States Patent and Trademark Office

Reg. No. 3,577,840

Registered Feb. 17, 2009

**SERVICE MARK
PRINCIPAL REGISTER**

**BEAUMONT
PHYSICIANS**

WILLIAM BEAUMONT HOSPITAL (MICHIGAN CORPORATION)
3601 WEST 13 MILE ROAD
ROYAL OAK, MI 48072

FOR: EDUCATIONAL SERVICES, NAMELY, CONDUCTING CLASSES, SEMINARS, CONFERENCES AND WORKSHOPS IN THE FIELD OF HEALTH CARE, IN CLASS 41 (U.S. CLS. 100, 101 AND 107).

FIRST USE 12-12-2008; IN COMMERCE 12-12-2008.

FOR: RESEARCH SERVICES IN THE FIELD OF HEALTH CARE, IN CLASS 42 (U.S. CLS. 100 AND 101).

FIRST USE 12-12-2008; IN COMMERCE 12-12-2008.

FOR: HEALTH CARE SERVICES, IN CLASS 44 (U.S. CLS. 100 AND 101).

FIRST USE 12-12-2008; IN COMMERCE 12-12-2008.

THE MARK CONSISTS OF STANDARD CHARACTERS WITHOUT CLAIM TO ANY PARTICULAR FONT, STYLE, SIZE, OR COLOR.

OWNER OF U.S. REG. NOS. 1,382,845, 2,917,267, AND OTHERS.

NO CLAIM IS MADE TO THE EXCLUSIVE RIGHT TO USE "PHYSICIANS", APART FROM THE MARK AS SHOWN.

SN 78-437,042, FILED 6-17-2004.

MICHAEL SOUDERS, EXAMINING ATTORNEY

Int. Cls.: 41, 42, and 44

Prior U.S. Cls.: 100, 101, and 107

United States Patent and Trademark Office

Reg. No. 3,577,841

Registered Feb. 17, 2009

**SERVICE MARK
PRINCIPAL REGISTER**

BEAUMONT DOCTORS

WILLIAM BEAUMONT HOSPITAL (MICHIGAN CORPORATION)
3601 WEST 13 MILE ROAD
ROYAL OAK, MI 48072

FOR: EDUCATIONAL SERVICES, NAMELY, CONDUCTING CLASSES, SEMINARS, CONFERENCES AND WORKSHOPS IN THE FIELD OF HEALTH CARE, IN CLASS 41 (U.S. CLS. 100, 101 AND 107).

FIRST USE 12-12-2008; IN COMMERCE 12-12-2008.

FOR: RESEARCH SERVICES IN THE FIELD OF HEALTH CARE, IN CLASS 42 (U.S. CLS. 100 AND 101).

FIRST USE 12-12-2008; IN COMMERCE 12-12-2008.

FOR: HEALTH CARE SERVICES, IN CLASS 44 (U.S. CLS. 100 AND 101).

FIRST USE 12-12-2008; IN COMMERCE 12-12-2008.

THE MARK CONSISTS OF STANDARD CHARACTERS WITHOUT CLAIM TO ANY PARTICULAR FONT, STYLE, SIZE, OR COLOR.

OWNER OF U.S. REG. NOS. 1,382,845, 2,917,267, AND OTHERS.

NO CLAIM IS MADE TO THE EXCLUSIVE RIGHT TO USE "DOCTORS", APART FROM THE MARK AS SHOWN.

SN 78-437,049, FILED 6-17-2004.

MICHAEL SOUDERS, EXAMINING ATTORNEY

Int. Cls.: 9 and 35

Prior U.S. Cls.: 21, 23, 26, 36, 38, 100, 101, and 102

United States Patent and Trademark Office

Reg. No. 3,577,842

Registered Feb. 17, 2009

**TRADEMARK
SERVICE MARK
PRINCIPAL REGISTER**

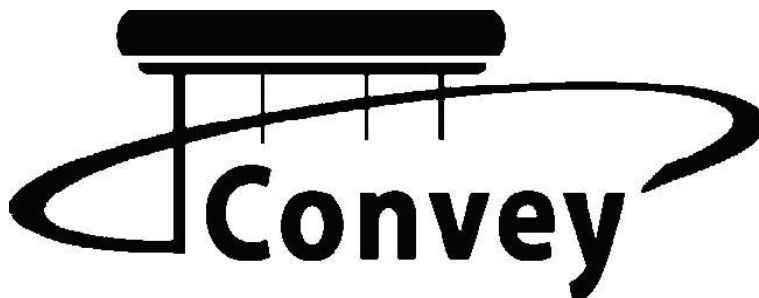

CONVEY COMPLIANCE SYSTEMS, INC. (MINNESOTA CORPORATION)
3650 ANNAPOLIS LANE, SUITE 190
PLYMOUTH, MN 55447

FOR: COMPUTER SOFTWARE FOR CALCULATING, REVIEWING AND REPORTING EMPLOYEE WAGES AND TAXES, IN CLASS 9 (U.S. CLS. 21, 23, 26, 36 AND 38).

FIRST USE 10-0-2003; IN COMMERCE 10-0-2003.

FOR: COMPUTING, DATA, AND PROFESSIONAL SERVICES FOR EMPLOYERS, NAMELY, PAY-

ROLL PROCESSING IN THE NATURE OF ADMINISTRATION OF BUSINESS PAYROLL FOR OTHERS, TAX FILING SERVICES, AND TAX REPORTING SERVICES, NAMELY, TAX DECLARATION PROCEDURE SERVICES, IN CLASS 35 (U.S. CLS. 100, 101 AND 102).

FIRST USE 10-0-2003; IN COMMERCE 10-0-2003.

SN 78-442,371, FILED 6-28-2004.

MARCIE MILONE, EXAMINING ATTORNEY

Int. Cls.: 29 and 30

Prior U.S. Cl.: 46

United States Patent and Trademark Office

Reg. No. 3,577,843

Registered Feb. 17, 2009

**TRADEMARK
PRINCIPAL REGISTER**

HEALTHY JOE

TO-JO FOOD PRODUCTS, INC. (PENNSYLVANIA CORPORATION)
974 PENN GREEN ROAD
AVONDALE, PA 19311

FOR: SANDWICH FILLINGS, NAMELY, MEATLESS FILLINGS CONTAINING PROCESSED MUSHROOMS AS THE PRIMARY FOOD FILLING; SANDWICH TOPPINGS, NAMELY, READY TO USE SAUTÉED MUSHROOM TOPPINGS AND FLAVORED MUSHROOM TOPPINGS; MEATLESS SIDE DISHES CONSISTING MAINLY OF PROCESSED MUSHROOMS; DIPS EXCLUDING SALSA AND OTHER SAUCES USED AS DIPS, CONTAINING MUSHROOMS AND AT LEAST ONE OTHER VEGETABLE, IN CLASS 29 (U.S. CL. 46).

FIRST USE 11-0-2006; IN COMMERCE 12-8-2008.

FOR: MUSHROOM FLAVORED SAUCES, IN CLASS 30 (U.S. CL. 46).

FIRST USE 11-0-2006; IN COMMERCE 12-8-2008.

THE MARK CONSISTS OF STANDARD CHARACTERS WITHOUT CLAIM TO ANY PARTICULAR FONT, STYLE, SIZE, OR COLOR.

NO CLAIM IS MADE TO THE EXCLUSIVE RIGHT TO USE "HEALTHY", APART FROM THE MARK AS SHOWN.

SN 78-458,860, FILED 7-29-2004.

JENNIFER DIXON, EXAMINING ATTORNEY

Int. Cl.: 36

Prior U.S. Cls.: 100, 101, and 102

United States Patent and Trademark Office

Reg. No. 3,577,844

Registered Feb. 17, 2009

**SERVICE MARK
PRINCIPAL REGISTER**

**STERLING THE REAL
ESTATE BANK**

STERLING BANK & TRUST FSB (UNITED STATES FEDERALLY CHARTERED SAVINGS BANK)
ONE TOWNE SQUARE, 17TH FLOOR
SOUTHFIELD, MI 48076

FOR: BANKING SERVICES; INVESTMENT BROKERAGE SERVICES; PROVIDING SAFE DEPOSIT BOXES; ISSUING OFFICIAL CHECKS; CURRENCY EXCHANGE SERVICES; CURRENCY EXCHANGE INFORMATION SERVICES; MORTGAGE ORIGINATION AND SERVICING; LENDING SERVICES, NAMELY, COMMERCIAL LENDING SERVICES, CONSUMER LENDING SERVICES, MORTGAGE LENDING SERVICES; LOAN APPLICATION PROCESSING SERVICES; ISSUING LETTERS OF CREDIT; ELECTRONIC FUNDS TRANSFER SERVICES; PROVIDING ON-LINE FINANCIAL INFORMATION; CREDIT CARD SERVICES; CREDIT REPORTING SERVICES; FINANCIAL PLANNING SERVICES; INVESTMENT OF FUNDS FOR OTHERS; INVESTMENT CONSULTATION AND MANAGEMENT IN THE FIELDS OF SECURITIES, FUNDS, MUTUAL FUNDS, COMMODITIES AND CAPITAL; FINANCIAL INVESTMENT IN THE

FIELD OF REAL ESTATE, REAL ESTATE ESCROW SERVICES; REAL ESTATE VALUATION SERVICES; REAL ESTATE APPRAISAL SERVICES, REAL ESTATE ACQUISITION SERVICES, REAL ESTATE CONSULTATION SERVICES; REAL ESTATE TRUSTEE SERVICES; REAL ESTATE INVESTMENT SERVICES, IN CLASS 36 (U.S. CLS. 100, 101 AND 102).

FIRST USE 1-1-2002; IN COMMERCE 1-1-2002.

THE MARK CONSISTS OF STANDARD CHARACTERS WITHOUT CLAIM TO ANY PARTICULAR FONT, STYLE, SIZE, OR COLOR.

OWNER OF U.S. REG. NOS. 1,530,060, 2,101,979, AND OTHERS.

NO CLAIM IS MADE TO THE EXCLUSIVE RIGHT TO USE "THE REAL ESTATE BANK", APART FROM THE MARK AS SHOWN.

SN 78-460,756, FILED 8-2-2004.

DAVID MURRAY, EXAMINING ATTORNEY

Int. Cl.: 41

Prior U.S. Cls.: 100, 101, and 107

United States Patent and Trademark Office

Reg. No. 3,577,845

Registered Feb. 17, 2009

**SERVICE MARK
PRINCIPAL REGISTER**

THE SCIENCE OF FUN

GAMELOGIC INC. (DELAWARE CORPORATION)
411 WAVERLY OAKS ROAD, SUITE 312
WALTHAM, MA 02452

FOR: ENTERTAINMENT SERVICES, NAMELY,
PROVIDING AN ONLINE COMPUTER GAME;
ELECTRONIC CASINO GAMING SERVICES, IN
CLASS 41 (U.S. CLS. 100, 101 AND 107).

FIRST USE 4-10-2008; IN COMMERCE 4-10-2008.

THE MARK CONSISTS OF STANDARD CHARACTERS WITHOUT CLAIM TO ANY PARTICULAR FONT, STYLE, SIZE, OR COLOR.

SN 78-467,185, FILED 8-13-2004.

KIMBERLY FRYE, EXAMINING ATTORNEY

Int. Cls.: 7 and 9

Prior U.S. Cls.: 13, 19, 21, 23, 26, 31, 34, 35, 36, and 38

United States Patent and Trademark Office

Reg. No. 3,577,846

Registered Feb. 17, 2009

**TRADEMARK
PRINCIPAL REGISTER**

SMARTLINE

PRINTRONIX, INC. (CALIFORNIA CORPORATION)
14600 MYFORD ROAD
IRVINE, CA 926061005

FOR: INDUSTRIAL MACHINES FOR PRINTING AND FOR ENCODING BY PRINTING A BAR CODE OR NUMBER ON RADIO FREQUENCY IDENTIFICATION TAGS , IN CLASS 7 (U.S. CLS. 13, 19, 21, 23, 31, 34 AND 35).

FIRST USE 11-21-2003; IN COMMERCE 11-21-2003.

FOR: INDUSTRIAL MACHINES FOR READING AND MAGNETIC ENCODING OF RADIO FRE-

QUENCY IDENTIFICATION TAGS, IN CLASS 9 (U.S. CLS. 21, 23, 26, 36 AND 38).

FIRST USE 11-21-2003; IN COMMERCE 11-21-2003.

THE MARK CONSISTS OF STANDARD CHARACTERS WITHOUT CLAIM TO ANY PARTICULAR FONT, STYLE, SIZE, OR COLOR.

SN 78-469,093, FILED 8-17-2004.

ASMAT KHAN, EXAMINING ATTORNEY

Int. Cl.: 3

Prior U.S. Cls.: 1, 4, 6, 50, 51, and 52

Reg. No. 3,577,847

United States Patent and Trademark Office

Registered Feb. 17, 2009

**TRADEMARK
PRINCIPAL REGISTER**

**TESTED ONLY ON
PARTY ANIMALS**

JACKSON GROUP OF COMPANIES PTY LTD
(AUSTRALIA CORPORATION)
126 LINKS AVENUE SOUTH, EAGLE FARM
BRISBANE, QUEENSLAND, AUSTRALIA 4006

FOR: HAIR CARE PRODUCTS, NAMELY, SHAM-
POOS AND CONDITIONERS; HAIR STYLING PRO-
DUCTS, NAMELY, MOUSSES, STYLING GELS,
HAIR SPRAYS, SPRAY ON SHINE, VOLUMISING
SPRAY, FIZZ SPRAY, BLOW DRY LOTION; HAIR
COLOURING PREPARATIONS; NON-MEDICATED
HAIR TREATMENT PREPARATIONS; PERMA-

NENT WAVE SOLUTIONS, IN CLASS 3 (U.S. CLS.
1, 4, 6, 50, 51 AND 52).

FIRST USE 7-25-2004; IN COMMERCE 7-25-2004.

THE MARK CONSISTS OF STANDARD CHAR-
ACTERS WITHOUT CLAIM TO ANY PARTICULAR
FONT, STYLE, SIZE, OR COLOR.

SN 78-485,968, FILED 9-20-2004.

TAMARA FRAZIER, EXAMINING ATTORNEY

Int. Cl.: 35

Prior U.S. Cls.: 100, 101, and 102

United States Patent and Trademark Office

Reg. No. 3,577,848

Registered Feb. 17, 2009

**SERVICE MARK
PRINCIPAL REGISTER**

DNA JENES

GOLDSTEIN, MARK R. (UNITED STATES INDIVIDUAL)
3775 WHIDBEY WAY
NAPLES, PA 34119

FOR: WHOLESALE AND RETAIL STORE SERVICES FEATURING POCKETBOOKS, LUNCH BAGS, BACKPACKS, DIARIES, PHOTO ALBUMS, HAIR CLIPS, COMBS, MIRRORS, STATIONERY, PENS, ENVELOPES AND ADDRESS BOOKS, IN CLASS 35 (U.S. CLS. 100, 101 AND 102).

FIRST USE 9-1-2004; IN COMMERCE 11-15-2008.

THE MARK CONSISTS OF STANDARD CHARACTERS WITHOUT CLAIM TO ANY PARTICULAR FONT, STYLE, SIZE, OR COLOR.

OWNER OF U.S. REG. NO. 2,700,606.

NO CLAIM IS MADE TO THE EXCLUSIVE RIGHT TO USE "JEANS", APART FROM THE MARK AS SHOWN.

SN 78-487,513, FILED 9-22-2004.

ESTHER A. BORSUK, EXAMINING ATTORNEY

Int. Cl.: 22

Prior U.S. Cls.: 1, 2, 7, 19, 22, 42, and 50

United States Patent and Trademark Office

Reg. No. 3,577,849

Registered Feb. 17, 2009

**TRADEMARK
PRINCIPAL REGISTER**

WOOLITE

RECKITT BENCKISER INC. (DELAWARE CORPORATION)
399 INTERPACE PARKWAY
PARSIPPANY, NJ 07054

FOR: MESH BAGS FOR WASHING LINGERIE, MESH BAGS FOR WASHING UNDERGARMENTS; SHOE BAGS FOR STORAGE; GARMENT BAGS FOR STORAGE; CANVAS, MESH, AND CLOTH BAGS FOR STORING SHOES AND CLOTHING, IN CLASS 22 (U.S. CLS. 1, 2, 7, 19, 22, 42 AND 50).

FIRST USE 5-6-2006; IN COMMERCE 5-6-2006.

THE MARK CONSISTS OF STANDARD CHARACTERS WITHOUT CLAIM TO ANY PARTICULAR FONT, STYLE, SIZE, OR COLOR.

OWNER OF U.S. REG. NOS. 1,008,288, 1,948,852, AND 2,522,302.

SN 78-491,389, FILED 9-29-2004.

JASON TURNER, EXAMINING ATTORNEY

Int. Cl.: 28

Prior U.S. Cls.: 22, 23, 38, and 50

United States Patent and Trademark Office

Reg. No. 3,577,850

Registered Feb. 17, 2009

**TRADEMARK
PRINCIPAL REGISTER**

SUBSURFER

FIELDING, JERRY J. JR. (UNITED STATES IN-
DIVIDUAL)
11325 GUYN DRIVE
BRIGHTON, MI 48114

THE MARK CONSISTS OF STANDARD CHAR-
ACTERS WITHOUT CLAIM TO ANY PARTICULAR
FONT, STYLE, SIZE, OR COLOR.

FOR: WATER TOYS, IN CLASS 28 (U.S. CLS. 22, 23,
38 AND 50).

SN 78-491,579, FILED 9-29-2004.

FIRST USE 3-25-2008; IN COMMERCE 3-25-2008.

FRED MANDIR, EXAMINING ATTORNEY

Int. Cl.: 43

Prior U.S. Cls.: 100 and 101

United States Patent and Trademark Office

Reg. No. 3,577,851

Registered Feb. 17, 2009

**SERVICE MARK
PRINCIPAL REGISTER**

SOUTHERN MADE

LOWRANCE, ROBERT (UNITED STATES INDIVIDUAL)
4601 ENNIS PARKWAY
ENNIS, TX 75119

THE MARK CONSISTS OF STANDARD CHARACTERS WITHOUT CLAIM TO ANY PARTICULAR FONT, STYLE, SIZE, OR COLOR.

FOR: BAR AND RESTAURANT SERVICES, IN CLASS 43 (U.S. CLS. 100 AND 101).

SN 78-491,654, FILED 9-29-2004.

FIRST USE 12-4-2008; IN COMMERCE 12-4-2008.

DARRYL SPRUILL, EXAMINING ATTORNEY

Int. Cl.: 41

Prior U.S. Cls.: 100, 101, and 107

United States Patent and Trademark Office

Reg. No. 3,577,852

Registered Feb. 17, 2009

**SERVICE MARK
PRINCIPAL REGISTER**

Humoroid

STRAMLER, JAMES H. (UNITED STATES INDIVIDUAL)
P. O. BOX 58264
HOUSTON, TX 77258

THE MARK CONSISTS OF STANDARD CHARACTERS WITHOUT CLAIM TO ANY PARTICULAR FONT, STYLE, SIZE, OR COLOR.

FOR: COMEDY WRITING SERVICES; PRESENTATION OF LIVE COMEDY SHOW PERFORMANCES, IN CLASS 41 (U.S. CLS. 100, 101 AND 107).

SN 78-491,890, FILED 9-29-2004.

FIRST USE 5-28-2006; IN COMMERCE 5-28-2006.

IRA J. GOODSaid, EXAMINING ATTORNEY

Int. Cl.: 16

Prior U.S. Cls.: 2, 5, 22, 23, 29, 37, 38, and 50

Reg. No. 3,577,853

United States Patent and Trademark Office

Registered Feb. 17, 2009

**TRADEMARK
PRINCIPAL REGISTER**

CASA

NATIONAL CASA ASSOCIATION (WASHINGTON PUBLIC BENEFIT CORPORATION)
NORTH TOWER SUITE 500
100 WEST HARRISON
SEATTLE, WA 98119

FOR: PRINTED MATERIALS, NAMELY, BOOKS, BROCHURES, HANDBOOKS, MAGAZINES, MANUALS AND NEWSLETTERS RELATING TO CHILD WELFARE, CHILDREN INVOLVED IN LEGAL ACTIONS AND VOLUNTEERS ACTING ON BEHALF OF CHILDREN; EDUCATIONAL PUBLICATIONS, NAMELY, TRAINING MANUALS, BOOKS, BROCHURES, HANDBOOKS, MAGAZINES, AND NEWSLETTERS RELATING TO CHILD WELFARE, CHILDREN INVOLVED IN LEGAL ACTIONS AND VOLUNTEERS ACTING ON BEHALF OF CHILDREN; POSTERS, PENS, NOTE CARDS, NOTE

PADS, STATIONERY, STICKERS, AND PAPER SHOPPING BAGS, ALL SOLD EXCLUSIVELY AS PROMOTIONAL ITEMS AT RETAIL OR ONLINE RETAIL STORES BY REGISTRANT, IN CLASS 16 (U.S. CLS. 2, 5, 22, 23, 29, 37, 38 AND 50).

FIRST USE 5-1-1985; IN COMMERCE 0-0-2004.

THE MARK CONSISTS OF STANDARD CHARACTERS WITHOUT CLAIM TO ANY PARTICULAR FONT, STYLE, SIZE, OR COLOR.

OWNER OF U.S. REG. NO. 1,839,711.

SN 78-495,039, FILED 10-5-2004.

KIM SAITO, EXAMINING ATTORNEY

Int. Cl.: 18

Prior U.S. Cls.: 1, 2, 3, 22, and 41

United States Patent and Trademark Office

Reg. No. 3,577,854

Registered Feb. 17, 2009

**TRADEMARK
PRINCIPAL REGISTER**

BARKENDER

RADIO SYSTEMS CORPORATION (DELAWARE
CORPORATION)
10427 ELECTRIC AVENUE
KNOXVILLE, TN 37932

THE MARK CONSISTS OF STANDARD CHAR-
ACTERS WITHOUT CLAIM TO ANY PARTICULAR
FONT, STYLE, SIZE, OR COLOR.

FOR: TRAINING COLLAR FOR DOGS, IN CLASS
18 (U.S. CLS. 1, 2, 3, 22 AND 41).

SN 78-496,794, FILED 10-8-2004.

FIRST USE 11-0-2008; IN COMMERCE 11-0-2008.

JOHN LINCOSKI, EXAMINING ATTORNEY

Int. Cls.: 9, 16, 35, and 41

**Prior U.S. Cls.: 2, 5, 21, 22, 23, 26, 29, 36, 37, 38, 50,
100, 101, 102, and 107**

Reg. No. 3,577,855

United States Patent and Trademark Office

Registered Feb. 17, 2009

**TRADEMARK
SERVICE MARK
PRINCIPAL REGISTER**

FOLLOW THAT DREAM!

LEV AVIV, TSUFIT (CANADA INDIVIDUAL),
DBA TSUFIT,
8171 YONGE ST., SUITE 148
THORNHILL, ONTARIO, CANADA L3T 2C6

FOR: PRERECORDED COMPACT DISCS (CD'S), AUDIO TAPES AND CASSETTES AND VIDEO TAPES AND CASSETTES AND DIGITAL VIDEO DISCS (DVD'S) FOR HOME, BUSINESS AND EDUCATIONAL USES AND FOR CORPORATE AND ORGANIZATIONAL TRAINING, FEATURING SPEECHES, SEMINARS, EDUCATION, INFORMATION, COACHING AND GUIDANCE ON THE SUBJECTS OF BUSINESS, MARKETING, HOW TO ATTRACT PUBLICITY FOR THEIR BUSINESS OR FOR THEMSELVES, PUBLIC RELATIONS, CREATING A SUCCESSFUL BUSINESS MODEL, IMPROVING THE PROFITABILITY OF THEIR BUSINESS SINGING, ACTING, COMEDIC PERFORMANCE, ADDING HUMOR TO THEIR SPEECHES AND SEMINARS, PUBLIC SPEAKING, BUSINESS NETWORKING, CAREER CHOICE, CAREER CHANGE, STARTING A BUSINESS, BOOK WRITING, AND ENTREPRENEURSHIP; ELECTRONIC PUBLICATIONS, NEWSLETTERS, NEWSPAPER AND MAGAZINE COLUMNS ON THE SUBJECTS OF BUSINESS, MARKETING, HOW TO ATTRACT PUBLICITY FOR THEIR BUSINESS OR FOR THEMSELVES, PUBLIC RELATIONS, CREATING A SUCCESSFUL BUSINESS MODEL, IMPROVING THE PROFITABILITY OF THEIR BUSINESS, SINGING, ACTING, COMEDIC PERFORMANCE, ADDING HUMOR TO THEIR SPEECHES AND SEMINARS, PUBLIC SPEAKING, BUSINESS NETWORKING, CAREER CHOICE, CAREER CHANGE, STARTING A BUSINESS, BOOK WRITING, AND ENTREPRENEURSHIP; PRE-RECORDED AUDIO AND VIDEO CASSETTES, PRE-RECORDED COMPACT DISCS (CDS), AND PRE-RECORDED DIGITAL VIDEO

DISCS (DVDS), ALL CONTAINING ENTERTAINMENT RELATING TO BUSINESS, ENTREPRENEURSHIP, MARKETING, PERFORMANCE, CAREER CHOICE, MUSIC OR COMEDY; SOUND RECORDINGS FEATURING MUSIC, COMEDY, SPEECHES AND SEMINARS, IN CLASS 9 (U.S. CLS. 21, 23, 26, 36 AND 38).

FIRST USE 7-2-2002; IN COMMERCE 7-2-2002.

FOR: PRINTED PUBLICATIONS AND PRINTED MATERIALS IN THE FIELDS OF BUSINESS, MARKETING, ENTREPRENEURSHIP, CAREER CHOICE, PUBLIC SPEAKING AND CAREER CHANGE, NAMELY, BOOKS, DIARIES, WORKBOOKS, GUIDES, BOOKLETS, BROCHURES, PAMPHLETS, NEWSLETTERS, NEWSPAPERS, MAGAZINES, PLANNERS, ORGANIZERS, DAYBOOKS, BLANK BOOKS, JOURNALS, CALENDARS, NEWSPAPER AND MAGAZINE COLUMNS, POSTCARDS, PRINTED MATTER IN THE FIELDS OF BUSINESS, MARKETING, ENTREPRENEURSHIP, PUBLIC SPEAKING, CAREER CHOICE AND CAREER CHANGE, NAMELY, FORMS, ASSESSMENT SHEETS, WORKSHEETS, NOTEBOOKS, CHECKLISTS, TO DO LISTS, POSTERS, EXECUTIVE AND PERSONAL COACHING MATERIALS AND QUIZZES, STICKERS, SCRAPBOOKS, BOOK PLATES, NAME TAGS, IN CLASS 16 (U.S. CLS. 2, 5, 22, 23, 29, 37, 38 AND 50).

FIRST USE 7-2-2002; IN COMMERCE 7-2-2002.

FOR: BUSINESS ADVICE AND INFORMATION AND CONSULTATION PROVIDED VIA KEYNOTE SPEAKING SERVICES AND SPEECHES AND FEATURED SPEAKING SERVICES AND SPEECHES, WORKSHOPS AND SEMINARS IN THE FIELDS OF MARKETING, PUBLIC SPEAKING, BUSINESS

NETWORKING, CREATING BUSINESS NETWORKING INTRODUCTIONS AND INFOMERCIALS, STARTING A BUSINESS, PUBLICITY, AND PROMOTION AND ENTREPRENEURSHIP; BUSINESS ADVICE AND INFORMATION PROVIDED VIA COACHING AND CONSULTING, WORKSHOPS AND SEMINARS, IN THE FIELDS OF MARKETING AND PROMOTION, PUBLICITY, INFOMERCIALS, STARTING A BUSINESS, AND ENTREPRENEURSHIP, IN CLASS 35 (U.S. CLS. 100, 101 AND 102).

FIRST USE 7-2-2002; IN COMMERCE 7-2-2002.

FOR: CONDUCTING AND PROVIDING PERSONAL COACHING SERVICES, SEMINARS, SPEECHES, LECTURES, PUBLIC ADDRESSES AND WORKSHOPS, CONDUCTED LIVE OR ON THE TELEPHONE OFFERED TO 1) ENTREPRENEURS, BUSINESS OWNERS, CORPORATE EMPLOYEES WHO WANT TO FURTHER THEIR CAREER AND IMPROVE THEIR SKILLS AND TO 2) INDIVIDUALS CONSIDERING STARTING A BUSINESS OR MAKING A CAREER CHANGE AND TO 3) ACTORS, SINGERS, COMEDIANS AND PROFESSIONAL SPEAKERS WHO WANT TO FURTHER THEIR CAREER OR IMPROVE THEIR SKILLS IN THE FIELDS OF MARKETING, HOW TO ATTRACT PUBLICITY FOR THEIR BUSINESS OR FOR THEMSELVES, PUBLIC RELATIONS, CREATING A SUCCESSFUL BUSINESS MODEL, IMPROVING THE PROFITABILITY OF THEIR BUSINESS SINGING, ACTING, COMEDIC PERFORMANCE, ADDING HUMOR TO THEIR SPEECHES AND SEMINARS, PUBLIC SPEAKING, BUSINESS NETWORKING, CAREER CHOICE, STARTING A BUSINESS, BOOK WRITING, AND ENTREPRENEURSHIP; AND PRINTED MATERIALS DISTRIBUTED IN CONNECTION THEREWITH; BOTH FOR INDIVIDUALS, ONE ON ONE, AND FOR GROUPS AND IN SEMINARS, SPEECHES, LECTURES, PUBLIC ADDRESSES AND WORKSHOPS, CONDUCTED LIVE OR ON THE TELEPHONE; EDUCATIONAL SERVICES OFFERED TO 1) ENTREPRENEURS, BUSINESS OWNERS, CORPORATE EMPLOYEES WHO WANT TO FURTHER THEIR CAREER AND IMPROVE THEIR SKILLS AND TO 2) INDIVIDUALS CONSIDERING STARTING A BUSINESS OR MAKING A CAREER CHANGE AND TO 3) ACTORS, SINGERS, COMEDIANS AND PROFESSIONAL SPEAKERS WHO WANT TO FURTHER THEIR CAREER OR IMPROVE THEIR SKILLS,

NAMELY, CONDUCTING AND PRESENTING SPEECHES, SEMINARS, TRAINING PROGRAMS, WORKSHOPS, EDUCATIONAL RETREATS, LECTURES AND PUBLIC ADDRESSES IN THE FIELDS LISTED ABOVE; AND PRINTED MATERIALS DISTRIBUTED IN CONNECTION THEREWITH; ENTERTAINMENT SERVICES, NAMELY, THE CREATION AND PRODUCTION OF RADIO TALK SHOWS ON THE SUBJECTS OF ENTREPRENEURSHIP, CAREER CHANGE AND CAREER CHOICE, STARTING AND RUNNING A SUCCESSFUL BUSINESS, PUBLIC SPEAKING, PUBLIC RELATIONS AND MARKETING; OPERATION OF AN EDUCATIONAL LIBRARY; EDUCATIONAL CONFERENCES, EDUCATIONAL CAMPS AND EDUCATIONAL RETREATS OFFERED TO 1) ENTREPRENEURS, BUSINESS OWNERS AND CORPORATE EMPLOYEES WHO WANT TO FURTHER THEIR CAREER OR IMPROVE THEIR SKILLS IN THE FIELDS LISTED ABOVE AND TO 2) INDIVIDUALS CONSIDERING STARTING A BUSINESS OR MAKING A CAREER CHANGE AND TO 3) ACTORS, SINGERS, COMEDIANS AND PROFESSIONAL SPEAKERS WHO WANT TO FURTHER THEIR CAREER OR IMPROVE THEIR SKILLS IN THE FIELDS LISTED ABOVE; AND PRINTED MATERIALS DISTRIBUTED IN CONNECTION THEREWITH; ARRANGING AND CONDUCTING NON-BUSINESS CONFERENCES; SONG WRITING SERVICES FOR OTHERS, ENTERTAINMENT SERVICES, NAMELY, CREATION AND PRODUCTION OF RADIO PROGRAMS; PROVIDING A WEBSITE CONTAINING ENTERTAINMENT INFORMATION ABOUT ONGOING COMEDY, MUSIC, CONCERTS AND TALK SHOW TELEVISION AND RADIO PROGRAMS, IN CLASS 41 (U.S. CLS. 100, 101 AND 107).

FIRST USE 7-2-2002; IN COMMERCE 7-2-2002.

THE MARK CONSISTS OF STANDARD CHARACTERS WITHOUT CLAIM TO ANY PARTICULAR FONT, STYLE, SIZE, OR COLOR.

PRIORITY CLAIMED UNDER SEC. 44(D) ON CANADA APPLICATION NO. 1214828, FILED 4-20-2004, REG. NO. TMA700,149, DATED 11-5-2007, EXPIRES 11-5-2022.

SN 78-498,564, FILED 10-12-2004.

KIMBERLY FRYE, EXAMINING ATTORNEY

Int. Cl.: 33

Prior U.S. Cls.: 47 and 49

United States Patent and Trademark Office

Reg. No. 3,577,856

Registered Feb. 17, 2009

**TRADEMARK
PRINCIPAL REGISTER**

CLEARLY SMIRNOFF

DIAGEO NORTH AMERICA, INC. (CONNECTI-
CUT CORPORATION)
801 MAIN AVE
NORWALK, CT 06851

THE MARK CONSISTS OF STANDARD CHAR-
ACTERS WITHOUT CLAIM TO ANY PARTICULAR
FONT, STYLE, SIZE, OR COLOR.

FOR: ALCOHOLIC BEVERAGES, NAMELY, SPIR-
ITS, IN CLASS 33 (U.S. CLS. 47 AND 49).

SN 78-503,029, FILED 10-20-2004.

FIRST USE 11-15-2008; IN COMMERCE 11-15-2008.

ANNE E. GUSTASON, EXAMINING ATTORNEY

Prior U.S. Cl.: A

United States Patent and Trademark Office

Reg. No. 3,577,857

Registered Feb. 17, 2009

CERTIFICATION MARK
GOODS
PRINCIPAL REGISTER



THE QUEEN SIRIKIT INSTITUTE OF SERICULTURE, OFFICE OF THE PERMANENT SECRETARY, MINISTRY OF AGRICULTURE AND COOPERATIVES (THAILAND GOVERNMENT OF THAILAND)

50 PHAHOLYOTHIN ROAD
CHATUCHAK, BANGKOK, THAILAND 10900

FOR: FABRICS, NAMELY, SILK, IN CLASS A (U.S. CL. A).

FIRST USE 11-14-2007; IN COMMERCE 11-14-2007.

NO CLAIM IS MADE TO THE EXCLUSIVE RIGHT TO USE "SILK", APART FROM THE MARK AS SHOWN.

THE COLOR(S) DARK BLUE IS/ARE CLAIMED AS A FEATURE OF THE MARK.

THE COLOR DARK BLUE APPEARS IN THE PEACOCK, THE TWO CONCENTRIC CIRCLES, AND THE WORDING OF THE MARK.

THE MARK CONSISTS OF THE IMAGE OF A PEACOCK INSIDE TWO CONCENTRIC CIRCLES WITH THE WORDS "THAI SILK" UNDERNEATH THE CIRCLES. THE DESIGN AND WORDS ARE IN DARK BLUE.

THE CERTIFICATION MARK, AS INTENDED TO BE USED BY AUTHORIZED PERSONS, IS INTENDED TO CERTIFY THAT THE PRODUCT IS MADE OF PURE SILK THREADS AND MANUFACTURED IN THAILAND.

SN 78-508,448, FILED 10-29-2004.

BENJAMIN OKEKE, EXAMINING ATTORNEY

Prior U.S. Cl.: A

United States Patent and Trademark Office

Reg. No. 3,577,858

Registered Feb. 17, 2009

CERTIFICATION MARK
GOODS
PRINCIPAL REGISTER



THE QUEEN SIRIKIT INSTITUTE OF SERICULTURE, OFFICE OF THE PERMANENT SECRETARY, MINISTRY OF AGRICULTURE AND COOPERATIVES (THAILAND GOVERNMENT OF THAILAND)

50 PHAHOLYOTHIN ROAD
CHATUCHAK, BANGKOK, THAILAND 10900

FOR: FABRICS, NAMELY, SILK, IN CLASS A (U.S. CL. A).

FIRST USE 11-14-2007; IN COMMERCE 11-14-2007.

NO CLAIM IS MADE TO THE EXCLUSIVE RIGHT TO USE "SILK", APART FROM THE MARK AS SHOWN.

THE COLOR(S) LIGHT BLUE IS/ARE CLAIMED AS A FEATURE OF THE MARK.

THE MARK CONSISTS OF THE IMAGE OF A PEACOCK INSIDE TWO CONCENTRIC CIRCLES WITH THE WORDS "CLASSIC THAI SILK" UNDERNEATH THE CIRCLES. THE DESIGN AND WORDS ARE IN LIGHT BLUE.

THE CERTIFICATION MARKS, AS INTENDED TO BE USED BY AUTHORIZED PERSONS, IS INTENDED TO CERTIFY THAT THE PRODUCT IS MADE OF PURE SILK THREADS AND MANUFACTURED IN THAILAND.

SN 78-508,484, FILED 10-29-2004.

BENJAMIN OKEKE, EXAMINING ATTORNEY

Int. Cl.: 36

Prior U.S. Cls.: 100, 101, and 102

United States Patent and Trademark Office

Reg. No. 3,577,859

Registered Feb. 17, 2009

**SERVICE MARK
PRINCIPAL REGISTER**



ICICI BANK LIMITED (INDIA CORPORATION)
LANDMARK
RACE COURSE CIRCLE
VADODARA, INDIA 390 007

FOR: SERVICES RELATING TO FINANCE AFFAIRS, MONETARY AFFAIRS AND REAL ESTATE AFFAIRS, NAMELY, EQUITY CAPITAL INVESTMENTS; MONETARY EXCHANGE, BANKING SERVICES, MERCHANT BANKING, CONSULTANCY SERVICES IN THE FIELD OF BANKING, FINANCIAL PLANNING, FINANCIAL MANAGEMENT AND PAYMENT SERVICES; PROVISION OF FINANCIAL INFORMATION VIA COMPUTER SYSTEMS, PROVIDING INFORMATION IN THE FIELD OF FINANCE AND BANKING SERVICES VIA THE INTERNET; PROVIDING ONLINE STORED VALUE ACCOUNTS IN AN ELECTRONIC ENVIRONMENT; ELECTRONIC BANKING SERVICES AND INTERACTIVE ELECTRONIC PROVISION OF FINANCIAL AND BANKING SERVICES VIA GLOBAL COMPUTER NETWORKS, NAMELY, FINANCIAL ANALYSIS AND CONSULTATION AND ONLINE BANKING; STOCK EXCHANGE SYSTEMS, NAMELY, AGENCIES FOR BROKERAGE OF SECURITIES TRADING IN OVERSEAS SECURITIES MARKETS AND OF TRANSACTIONS ON COMMISSION OF OVERSEAS MARKET SECURITIES FUTURES; FINANCIAL STATEMENT PREPARATION AND ANALYSIS FOR BUSINESSES; FINANCIAL EVALUATION FOR INSURANCE PURPOSES; FINANCIAL PORTFOLIO MANAGEMENT; FUND

INVESTMENT; CREDIT CARD SERVICES; DEBIT CARD SERVICES, DEBIT ACCOUNT SERVICES VIA A COMPUTER READABLE CARD; SAFE DEPOSIT BOX SERVICES; LENDING, NAMELY, MORTGAGE LENDING; SECURITY SERVICES, NAMELY, GUARANTEEING LOANS; FINANCIAL CLEARING HOUSES; FINANCIAL SERVICES, NAMELY, ASSISTING OTHERS WITH THE COMPLETION OF FINANCIAL TRANSACTIONS FOR SECURITIES, CASH MANAGEMENT, ORGANIZATION OF STOCK EXCHANGES FOR THE BENEFIT OF THE TRADE OF STOCKS AND OTHER FINANCIAL VALUES; FINANCIAL RESEARCH IN THE FIELDS OF FIXED INCOMES, TRADING OF EQUITIES, EQUITY DERIVATIVES, SWAPS AND OPTIONS; ELECTRONIC PAYMENT, NAMELY, ELECTRONIC PROCESSING AND TRANSMISSION OF BILL PAYMENT DATA; ISSUE OF TRAVELER'S CHECKS; FINANCIAL SPONSORSHIP IN THE FIELD OF CULTURAL AND SPORTS EVENTS; REAL ESTATE APPRAISAL; FINANCIAL VALUATION OF REAL ESTATE; REAL ESTATE BROKERAGE AND AGENCY SERVICES; LEASING OF REAL ESTATE AND REAL ESTATE CONSULTANCY SERVICES, IN CLASS 36 (U.S. CLS. 100, 101 AND 102).

FIRST USE 1-5-1955; IN COMMERCE 11-1-2004.

SN 78-508,488, FILED 10-29-2004.

RAUL CORDOVA, EXAMINING ATTORNEY

Int. Cl.: 24

Prior U.S. Cls.: 42 and 50

United States Patent and Trademark Office

Reg. No. 3,577,860

Registered Feb. 17, 2009

**TRADEMARK
PRINCIPAL REGISTER**

T400

INVISTA NORTH AMERICA S.A.R.L. (LUXEM-
BOURG CORPORATION)
THREE LITTLE FALLS CENTRE
2801 CENTERVILLE ROAD
WILMINGTON, DE 19808

FOR: SYNTHETIC FIBER FABRIC, IN CLASS 24
(U.S. CLS. 42 AND 50).

FIRST USE 6-30-2008; IN COMMERCE 6-30-2008.

THE MARK CONSISTS OF STANDARD CHAR-
ACTERS WITHOUT CLAIM TO ANY PARTICULAR
FONT, STYLE, SIZE, OR COLOR.

SN 78-515,274, FILED 11-11-2004.

ANNE MADDEN, EXAMINING ATTORNEY

Int. Cl.: 38

Prior U.S. Cls.: 100, 101, and 104

United States Patent and Trademark Office

Reg. No. 3,577,861

Registered Feb. 17, 2009

**SERVICE MARK
PRINCIPAL REGISTER**

VIDEOPRESENCE

VIDEOPRESENCE, INC. (WASHINGTON COR-
PORATION)
P.O. BOX 821625
VANCOUVER, WA 986820037

FOR: NETWORK CONFERENCING SERVICES,
IN CLASS 38 (U.S. CLS. 100, 101 AND 104).

FIRST USE 8-1-2004; IN COMMERCE 8-1-2004.

THE MARK CONSISTS OF STANDARD CHAR-
ACTERS WITHOUT CLAIM TO ANY PARTICULAR
FONT, STYLE, SIZE, OR COLOR.

SN 78-517,216, FILED 11-15-2004.

VIVIAN MICZNIK FIRST, EXAMINING ATTOR-
NEY

Int. Cl.: 16

Prior U.S. Cls.: 2, 5, 22, 23, 29, 37, 38, and 50

Reg. No. 3,577,862

United States Patent and Trademark Office

Registered Feb. 17, 2009

**TRADEMARK
PRINCIPAL REGISTER**

WACKY PACK

THE TOPPS COMPANY, INC. (DELAWARE CORPORATION)
ONE WHITEHALL STREET
NEW YORK, NY 10004

OWNER OF U.S. REG. NOS. 852,416 AND 1,276,119.

FOR: STICKERS HAVING HUMOROUS CONTENT AND ALBUMS THEREFOR, IN CLASS 16 (U.S. CLS. 2, 5, 22, 23, 29, 37, 38 AND 50).

NO CLAIM IS MADE TO THE EXCLUSIVE RIGHT TO USE "PACK", APART FROM THE MARK AS SHOWN.

FIRST USE 1-0-2008; IN COMMERCE 1-0-2008.

SN 78-519,233, FILED 11-18-2004.

THE MARK CONSISTS OF STANDARD CHARACTERS WITHOUT CLAIM TO ANY PARTICULAR FONT, STYLE, SIZE, OR COLOR.

KATHY DE JONGE, EXAMINING ATTORNEY

Int. Cl.: 7

Prior U.S. Cls.: 13, 19, 21, 23, 31, 34, and 35

United States Patent and Trademark Office

Reg. No. 3,577,863

Registered Feb. 17, 2009

**TRADEMARK
PRINCIPAL REGISTER**

NHTC

NGK SPARK PLUG CO., LTD. (JAPAN CORPORATION)

14-18, TAKATSUJI-CHO, MIZUHO-KU
NAGOYA CITY, JAPAN

FOR: IGNITION APPARATUS AND THEIR ACCESSORIES BEING PARTS OF INTERNAL COMBUSTION ENGINES OF ALL KINDS, NAMELY, SPARK PLUGS AND THEIR CAPS, CABLES AND IGNITION COILS; GLOW PLUGS; AIR HEATERS FOR HEATING UP AIR GIVING TO INTERNAL

COMBUSTION ENGINES, IN CLASS 7 (U.S. CLS. 13, 19, 21, 23, 31, 34 AND 35).

FIRST USE 6-21-2001; IN COMMERCE 2-14-2003.

THE MARK CONSISTS OF STANDARD CHARACTERS WITHOUT CLAIM TO ANY PARTICULAR FONT, STYLE, SIZE, OR COLOR.

SN 78-520,263, FILED 11-19-2004.

HENRY S. ZAK, EXAMINING ATTORNEY

Int. Cl.: 5

Prior U.S. Cls.: 6, 18, 44, 46, 51, and 52

United States Patent and Trademark Office

Reg. No. 3,577,864

Registered Feb. 17, 2009

**TRADEMARK
PRINCIPAL REGISTER**

RESEARCH TO RAPIDS

QUIDEL CORPORATION (DELAWARE CORPORATION)
10165 MCKELLAR COURT
SAN DIEGO, CA 92121

FOR: IN VITRO MEDICAL TEST KITS CONSISTING OF REAGENTS AND ONE OR MORE OF THE FOLLOWING, NAMELY, PIPETTES, TEST CASSETTES CONTAINING TEST STRIPS, COLLECTION VESSELS, EXTRACTION BOTTLES, PROCEDURE CARDS, TEST STRIPS, AND COTTON SWABS FOR DETECTION AND DIAGNOSIS OF OSTEOPOROSIS, CANCER, AND INFLAMMATORY AND AUTOIM-

MUNE DISEASES, IN CLASS 5 (U.S. CLS. 6, 18, 44, 46, 51 AND 52).

FIRST USE 8-0-2005; IN COMMERCE 8-0-2005.

THE MARK CONSISTS OF STANDARD CHARACTERS WITHOUT CLAIM TO ANY PARTICULAR FONT, STYLE, SIZE, OR COLOR.

SN 78-521,973, FILED 11-23-2004.

G. MAYERSCHOFF, EXAMINING ATTORNEY

Int. Cl.: 9

Prior U.S. Cls.: 21, 23, 26, 36, and 38

United States Patent and Trademark Office

Reg. No. 3,577,865

Registered Feb. 17, 2009

**TRADEMARK
PRINCIPAL REGISTER**

FRESHTIME

INFRATAB, INC. (CALIFORNIA CORPORATION)
4347 RAYTHEON ROAD
OXNARD, CA 93033

FOR: ELECTRONIC SENSORS, COMPUTER HARDWARE, AND COMPUTER SOFTWARE USED TO ANALYZE AND DISPLAY PRODUCT CHARACTERISTICS AND ENVIRONMENTAL FACTORS IN THE NATURE OF PRODUCTION INFORMATION, MATERIALS, SHELF LIFE, PERISHABILITY, PULL DATES, TEXTURE, TASTE, VISCOSITY SEPARATIONS OVER TIME, ODOR, AND GENERAL SIGNS OF FRESHNESS OR USABILITY, IN THE FIELDS OF PERISHABLE GOODS MANAGEMENT,

SUPPLY CHAIN MANAGEMENT AND LOGISTICS MANAGEMENT, IN CLASS 9 (U.S. CLS. 21, 23, 26, 36 AND 38).

FIRST USE 9-10-2008; IN COMMERCE 9-10-2008.

THE MARK CONSISTS OF STANDARD CHARACTERS WITHOUT CLAIM TO ANY PARTICULAR FONT, STYLE, SIZE, OR COLOR.

SN 78-524,793, FILED 11-30-2004.

ALLISON HOLTZ, EXAMINING ATTORNEY

Int. Cl.: 30

Prior U.S. Cl.: 46

United States Patent and Trademark Office

Reg. No. 3,577,866

Registered Feb. 17, 2009

**TRADEMARK
PRINCIPAL REGISTER**

ORIENT EXPRESS

VAN HOUTTE INC. (CANADA CORPORATION)
8300 19E AVENUE
MONTREAL, QUEBEC, CANADA H1Z 4J8

THE MARK CONSISTS OF STANDARD CHAR-
ACTERS WITHOUT CLAIM TO ANY PARTICULAR
FONT, STYLE, SIZE, OR COLOR.

FOR: COFFEE, IN CLASS 30 (U.S. CL. 46).

SN 78-525,209, FILED 12-1-2004.

FIRST USE 0-0-1980; IN COMMERCE 12-0-2004.

INGRID C. EULIN, EXAMINING ATTORNEY

Int. Cl.: 7

Prior U.S. Cls.: 13, 19, 21, 23, 31, 34, and 35

Reg. No. 3,577,867

United States Patent and Trademark Office

Registered Feb. 17, 2009

**TRADEMARK
PRINCIPAL REGISTER**

SIGNET

THYSSENKRUPP ACCESS CORPORATION (DE-
LAWARE CORPORATION)
4001 E. 138TH STREET
GRANDVIEW, MO 64030

THE MARK CONSISTS OF STANDARD CHAR-
ACTERS WITHOUT CLAIM TO ANY PARTICULAR
FONT, STYLE, SIZE, OR COLOR.

FOR: ELEVATORS, IN CLASS 7 (U.S. CLS. 13, 19,
21, 23, 31, 34 AND 35).

SN 78-532,021, FILED 12-14-2004.

FIRST USE 1-0-2005; IN COMMERCE 1-0-2005.

CAROLINE WOOD, EXAMINING ATTORNEY

Int. Cls.: 36 and 44

Prior U.S. Cls.: 100, 101, and 102

United States Patent and Trademark Office

Reg. No. 3,577,868

Registered Feb. 17, 2009

**SERVICE MARK
PRINCIPAL REGISTER**

Passport Dental

DELTA DENTAL PLAN OF MICHIGAN, INC.
(MICHIGAN NON-PROFIT CORPORATION)
4100 OKEMOS RD.
OKEMOS, MI 48864

FOR: DENTAL HEALTH INSURANCE ADMINISTRATION, NAMELY, THE PROCESSING OF DENTAL BENEFITS AND PROCESSING OF DENTAL CLAIMS ON THE INTERNET , IN CLASS 36 (U.S. CLS. 100, 101 AND 102).

FIRST USE 1-1-2004; IN COMMERCE 4-1-2007.

FOR: DENTIST SERVICES, IN CLASS 44 (U.S. CLS. 100 AND 101).

FIRST USE 1-1-2004; IN COMMERCE 4-1-2007.

THE MARK CONSISTS OF STANDARD CHARACTERS WITHOUT CLAIM TO ANY PARTICULAR FONT, STYLE, SIZE, OR COLOR.

NO CLAIM IS MADE TO THE EXCLUSIVE RIGHT TO USE "DENTAL", APART FROM THE MARK AS SHOWN.

SN 78-536,228, FILED 12-21-2004.

LYDIA BELZER, EXAMINING ATTORNEY

Int. Cls.: 9, 14, 16, 21, 25, and 41

Prior U.S. Cls.: 2, 5, 13, 21, 22, 23, 26, 27, 28, 29, 30, 33, 36, 37, 38, 39, 40, 50, 100, 101, and 107

Reg. No. 3,577,869

United States Patent and Trademark Office

Registered Feb. 17, 2009

**TRADEMARK
SERVICE MARK
PRINCIPAL REGISTER**

**CORTEO CIRQUE DU
SOLEIL**

DREAM MERCHANT COMPANY KFT., THE
(HUNGARY CORPORATION)
DOHANY UTCA 12, 2ND FLOOR
BUDAPEST, HUNGARY 1074

FOR: PRE-RECORDED MEDIA FOR THE STORAGE AND REPRODUCTION OF SOUND AND/OR VIDEO, FEATURING MUSIC AND/OR THEATRICAL OR DRAMATIC PERFORMANCES, NAMELY, COMPACT DISCS; DECORATIVE MAGNETS, IN CLASS 9 (U.S. CLS. 21, 23, 26, 36 AND 38).

FIRST USE 9-23-2005; IN COMMERCE 9-23-2005.

FOR: KEY CHAINS NOT OF PRECIOUS METAL, IN CLASS 14 (U.S. CLS. 2, 27, 28 AND 50).

FIRST USE 9-23-2005; IN COMMERCE 9-23-2005.

FOR: PAPER GOODS, NAMELY, SOUVENIR PROGRAMS AND POSTERS, IN CLASS 16 (U.S. CLS. 2, 5, 22, 23, 29, 37, 38 AND 50).

FIRST USE 5-18-2005; IN COMMERCE 5-18-2005.

FOR: HOUSEHOLD AND NOVELTY ITEMS, NAMELY, MUGS, IN CLASS 21 (U.S. CLS. 2, 13, 23, 29, 30, 33, 40 AND 50).

FIRST USE 6-6-2005; IN COMMERCE 6-6-2005.

FOR: CLOTHING AND WEARING APPAREL, NAMELY, T-SHIRTS, IN CLASS 25 (U.S. CLS. 22 AND 39).

FIRST USE 9-23-2005; IN COMMERCE 9-23-2005.

FOR: ENTERTAINMENT SERVICES, NAMELY, PRESENTATION OF THEATRICAL PERFORMANCES FEATURING ARTISTIC ACTS, COMICAL ACTS, CHOREOGRAPHY AND/OR DANCE, SET TO MUSIC AND/OR SONG, IN CLASS 41 (U.S. CLS. 100, 101 AND 107).

FIRST USE 9-23-2005; IN COMMERCE 9-23-2005.

THE MARK CONSISTS OF STANDARD CHARACTERS WITHOUT CLAIM TO ANY PARTICULAR FONT, STYLE, SIZE, OR COLOR.

OWNER OF U.S. REG. NOS. 1,887,078, 1,947,481, AND OTHERS.

THE ENGLISH TRANSLATION OF "CORTEO" IS "PROCESSION" OR "CORTEGE". THE ENGLISH TRANSLATION OF "CIRQUE DU SOLEIL" IS "CIRCUS OF THE SUN".

SN 78-549,310, FILED 1-18-2005.

WILLIAM BRECKENFELD, EXAMINING ATTORNEY

Int. Cl.: 6

Prior U.S. Cls.: 2, 12, 13, 14, 23, 25, and 50

United States Patent and Trademark Office

Reg. No. 3,577,870

Registered Feb. 17, 2009

**TRADEMARK
PRINCIPAL REGISTER**

GS 125

GREER INDUSTRIES, INC. (WEST VIRGINIA
CORPORATION)
P.O. BOX 1900
MORGANTOWN, WV 265071900

THE MARK CONSISTS OF STANDARD CHAR-
ACTERS WITHOUT CLAIM TO ANY PARTICULAR
FONT, STYLE, SIZE, OR COLOR.

FOR: COLD ROLLED STEEL, IN CLASS 6 (U.S.
CLS. 2, 12, 13, 14, 23, 25 AND 50).

SN 78-554,338, FILED 1-26-2005.

FIRST USE 8-17-2005; IN COMMERCE 8-17-2005.

APRIL HESIK, EXAMINING ATTORNEY

Int. Cl.: 35

Prior U.S. Cls.: 100, 101, and 102

United States Patent and Trademark Office

Reg. No. 3,577,871

Registered Feb. 17, 2009

**SERVICE MARK
PRINCIPAL REGISTER**

**ZOO PALS MAKE
EATING FUN**

PACTIV CORPORATION (DELAWARE CORPORATION)
1900 WEST FIELD COURT
LAKE FOREST, IL 60045

FOR: DISTRIBUTORSHIP SERVICES IN THE FIELD OF DISPOSABLE DINNERWARE AND PLASTIC FOOD STORAGE BAGS; PROVIDING BUSINESS INFORMATION IN THE NATURE OF MARKETING DATA AND MERCHANDISE INFORMATION IN THE FIELD OF DISPOSABLE DINNERWARE AND PLASTIC FOOD STORAGE BAGS, IN CLASS 35 (U.S. CLS. 100, 101 AND 102).

FIRST USE 3-0-2007; IN COMMERCE 3-0-2007.

THE MARK CONSISTS OF STANDARD CHARACTERS WITHOUT CLAIM TO ANY PARTICULAR FONT, STYLE, SIZE, OR COLOR.

OWNER OF U.S. REG. NOS. 2,613,492, 2,728,839, AND 2,811,800.

SN 78-562,458, FILED 2-8-2005.

ASMAT KHAN, EXAMINING ATTORNEY

Int. Cl.: 28

Prior U.S. Cls.: 22, 23, 38, and 50

United States Patent and Trademark Office

Reg. No. 3,577,872

Registered Feb. 17, 2009

**TRADEMARK
PRINCIPAL REGISTER**

HookRod

BARRETT, ALAN J. (UNITED STATES INDIVIDUAL)
8822 CHARBANE
WHITE LAKE, MI 48386

THE MARK CONSISTS OF STANDARD CHARACTERS WITHOUT CLAIM TO ANY PARTICULAR FONT, STYLE, SIZE, OR COLOR.

FOR: FISHING RODS, IN CLASS 28 (U.S. CLS. 22, 23, 38 AND 50).

SN 78-566,543, FILED 2-14-2005.

FIRST USE 6-6-2006; IN COMMERCE 5-10-2007.

LYDIA BELZER, EXAMINING ATTORNEY

Int. Cl.: 25

Prior U.S. Cls.: 22 and 39

United States Patent and Trademark Office

Reg. No. 3,577,873

Registered Feb. 17, 2009

**TRADEMARK
PRINCIPAL REGISTER**

CRAZY KIDS

ONLY THE BEST, INC. (HAWAII CORPORATION)
99-969 IWAENA STREET
AIEA, HI 96701

FOR: YOUTH'S, CHILDREN'S AND INFANT'S
APPAREL, NAMELY, T-SHIRTS, SHIRTS, TOPS,
JACKETS, SHORTS, SWEATSHIRTS, SWIMSUITS,
IN CLASS 25 (U.S. CLS. 22 AND 39).

FIRST USE 4-15-2008; IN COMMERCE 4-15-2008.

THE MARK CONSISTS OF STANDARD CHAR-
ACTERS WITHOUT CLAIM TO ANY PARTICULAR
FONT, STYLE, SIZE, OR COLOR.

SN 78-567,200, FILED 2-14-2005.

FONG HSU, EXAMINING ATTORNEY

Int. Cl.: 25

Prior U.S. Cls.: 22 and 39

United States Patent and Trademark Office

Reg. No. 3,577,874

Registered Feb. 17, 2009

**TRADEMARK
PRINCIPAL REGISTER**

TOOL TIME

TOWN & COUNTRY APPAREL, INC. (FLORIDA
CORPORATION)
C/O JEROME V. LAVIN
1241 GULF OF MEXICO DRIVE, #703
LONGBOAT KEY, FL 34228

THE MARK CONSISTS OF STANDARD CHAR-
ACTERS WITHOUT CLAIM TO ANY PARTICULAR
FONT, STYLE, SIZE, OR COLOR.

FOR: COATS, JACKETS, SHIRTS, SWEATERS,
BELTS, SUSPENDERS, HEADWEAR, FOOTWEAR,
IN CLASS 25 (U.S. CLS. 22 AND 39).

SN 78-570,469, FILED 2-18-2005.

FIRST USE 7-31-2008; IN COMMERCE 7-31-2008.

ANNE E. GUSTASON, EXAMINING ATTORNEY

Int. Cls.: 21 and 31

Prior U.S. Cls.: 1, 2, 13, 23, 29, 30, 33, 40, 46, and 50

United States Patent and Trademark Office

Reg. No. 3,577,875

Registered Feb. 17, 2009

**TRADEMARK
PRINCIPAL REGISTER**

LUCKY LITTER

LUCKY LITTER, LLC (DELAWARE LIMITED
LIABILITY COMPANY)
1730 NORTH CLARK STREET
SUITE 2506
CHICAGO, IL 60614

FOR: CAT LITTER BOXES, IN CLASS 21 (U.S. CLS.
2, 13, 23, 29, 30, 33, 40 AND 50).

FIRST USE 7-26-2005; IN COMMERCE 10-0-2005.

FOR: CAT LITTER; CARTRIDGES CONTAINING
LITTER FOR CAT LITTER BOXES, IN CLASS 31
(U.S. CLS. 1 AND 46).

FIRST USE 7-26-2005; IN COMMERCE 10-0-2005.

THE MARK CONSISTS OF STANDARD CHAR-
ACTERS WITHOUT CLAIM TO ANY PARTICULAR
FONT, STYLE, SIZE, OR COLOR.

NO CLAIM IS MADE TO THE EXCLUSIVE
RIGHT TO USE "LITTER", APART FROM THE
MARK AS SHOWN.

SN 78-576,140, FILED 2-28-2005.

JEFFERY COWARD, EXAMINING ATTORNEY

Int. Cls.: 35, 36, and 45

Prior U.S. Cls.: 100, 101, and 102

United States Patent and Trademark Office

Reg. No. 3,577,876

Registered Feb. 17, 2009

**SERVICE MARK
PRINCIPAL REGISTER**



IDODOLOGY GROUP, L.L.C. (FLORIDA LIMITED LIABILITY COMPANY)
2335 HANSEN COURT, STE. C
TALLAHASSEE, FL 32301

FOR: CREDENTIAL INFRASTRUCTURE AND MANAGEMENT PRODUCTS AND SERVICES, NAMELY, BUSINESS MANAGEMENT CONSULTING AND INTERNET TRANSACTION PROCESSING, RESULTING IN BIOGRAPHIC IDENTITY AUTHENTICATION OF INDIVIDUALS AND BUSINESSES; BUSINESS CONSULTING IN THE FIELD OF CONSUMER AND BUSINESS PROFILING, BUSINESS INFORMATION MANAGEMENT ALL DESIGNED TO ASSIST BUSINESS AND OTHER ORGANIZATIONS IN THE PURCHASE OF GOODS AND THE SALE OF SERVICES AT THE SALES COUNTER, IN PERSON, BY TELECOMMUNICATION DEVICES, BY WEB ENABLED SYSTEMS OR ANOTHER SALES MODE, IN CLASS 35 (U.S. CLS. 100, 101 AND 102).

FIRST USE 10-1-2005; IN COMMERCE 10-1-2005.

FOR: FINANCIAL CREDENTIAL INFRASTRUCTURE AND MANAGEMENT PRODUCTS AND SERVICES, NAMELY, CHECK VERIFICATION; CREDIT CARD VERIFICATION AND INTERNET TRANSACTION VERIFICATION RESULTING IN BIOGRAPHIC IDENTITY AUTHENTICATION OF INDIVIDUALS AND BUSINESSES, IN CLASS 36 (U.S. CLS. 100, 101 AND 102).

FIRST USE 10-1-2005; IN COMMERCE 10-1-2005.

FOR: IDENTIFICATION VERIFICATION SERVICES, NAMELY, PROVIDING AUTHENTICATION

OF PERSONAL IDENTIFICATION INFORMATION VIA SECURE STORAGE AND TRANSMITTING SUCH INFORMATION VIA THE INTERNET; ALSO, PROVIDING AUTHENTICATION OF PERSONAL IDENTIFICATION INFORMATION AND VERIFICATION OF AGE, IN CLASS 45 (U.S. CLS. 100 AND 101).

FIRST USE 10-1-2005; IN COMMERCE 10-1-2005.

NO CLAIM IS MADE TO THE EXCLUSIVE RIGHT TO USE "ID ONLINE", APART FROM THE MARK AS SHOWN.

"THE COLOR(S) WHITE, BLUE AND BLACK IS/ARE CLAIMED AS A FEATURE OF THE MARK."

THE COLOR BLUE APPEARS IN THE LETTERS "ID" AND THE HUMAN FORM. THE COLOR BLACK APPEARS IN THE WORD "WE" AND THE LETTERS "ONLINE". THE COLOR WHITE APPEARS IN THE CHECK MARK.

THE MARK CONSISTS OF THE COLOR BLUE APPEARS IN THE WORD "ID" AND THE DEPICTION OF A HUMAN. THE COLOR WHITE IS IN THE CHECKMARK THAT IS IN THE MIDDLE OF THE HUMAN'S BODY. THE COLOR BLACK IS FOUND IN THE WORDING "WE" AND "ONLINE".

SN 78-585,357, FILED 3-11-2005.

SUSAN HAYASH, EXAMINING ATTORNEY

Int. Cl.: 9

Prior U.S. Cls.: 21, 23, 26, 36, and 38

United States Patent and Trademark Office

Reg. No. 3,577,877

Registered Feb. 17, 2009

**TRADEMARK
PRINCIPAL REGISTER**

CLEAREDGE

ALLIANCE DATA FHC, INC (DELAWARE CORPORATION)
17655 WATERVIEW PARKWAY
DALLAS, TX 77070

FOR: CUSTOMIZED MARKETING DATABASES FOR USE IN MONITORING, TRACKING CUSTOMER INFORMATION, ANALYZATION OF CUSTOMER DATA, PLANNING COORDINATING, AND MANAGING MARKET CAMPAIGNS RECORDED ON SOFTWARE, IN CLASS 9 (U.S. CLS. 21, 23, 26, 36 AND 38).

FIRST USE 5-5-2004; IN COMMERCE 5-5-2004.

THE MARK CONSISTS OF STANDARD CHARACTERS WITHOUT CLAIM TO ANY PARTICULAR FONT, STYLE, SIZE, OR COLOR.

SN 78-600,215, FILED 4-1-2005.

BENJAMIN OKEKE, EXAMINING ATTORNEY

Int. Cl.: 35

Prior U.S. Cls.: 100, 101, and 102

United States Patent and Trademark Office

Reg. No. 3,577,878

Registered Feb. 17, 2009

**SERVICE MARK
PRINCIPAL REGISTER**

LYHOO

ZHENG, ZHILIANG (CHINA INDIVIDUAL)
19925 STEVENS CREEK BLVD.
CUPERTINO, CA 95014

THE MARK CONSISTS OF STANDARD CHAR-
ACTERS WITHOUT CLAIM TO ANY PARTICULAR
FONT, STYLE, SIZE, OR COLOR.

FOR: ADVERTISING SERVICES, IN CLASS 35
(U.S. CLS. 100, 101 AND 102).

SN 78-603,744, FILED 4-7-2005.

FIRST USE 6-1-2008; IN COMMERCE 6-1-2008.

ANNE E. GUSTASON, EXAMINING ATTORNEY

Int. Cl.: 36

Prior U.S. Cls.: 100, 101, and 102

United States Patent and Trademark Office

Reg. No. 3,577,879

Registered Feb. 17, 2009

**SERVICE MARK
PRINCIPAL REGISTER**

HERITAGE PROTECTOR PLUS

PREMERA BLUE CROSS (WASHINGTON CORPORATION)
P.O. BOX 327, MAIL STOP 316
SEATTLE, WA 981110327

FOR: HEALTH, MEDICAL, HOSPITAL, PHARMACEUTICAL AND PRESCRIPTION DRUG INSURANCE UNDERWRITING; ADMINISTRATION AND ORGANIZING OF PREPAID AND PREFERRED PROVIDER HEALTH, MEDICAL, HOSPITAL, PHARMACEUTICAL, PRESCRIPTION DRUG PLANS AND HEALTH SAVINGS ACCOUNTS AND SIMILAR ACCOUNTS AND RELATED HEALTH CARE PLANS AND NETWORKS; INSURANCE CLAIMS ADMINISTRATION AND PROCESSING; PROVIDING ELIGIBILITY AND BENEFIT INFORMATION IN INSURANCE MATTERS; INSURANCE CONSULTATION IN THE NATURE OF CLAIMS REMITTANCE ADVISING; PROVIDING INFORMATION, DATA, REPORTS AND ANALYSIS PERTAINING TO THE UNDERWRITING OF HEALTH, MEDICAL, HOSPITAL, PHARMACEUTICAL AND PRESCRIPTION DRUG INSURANCE AND PERTAINING TO THE ADMINISTRATION AND ORGANIZING OF PREPAID AND PREFERRED PROVIDER HEALTH, MEDICAL, HOSPITAL,

PHARMACEUTICAL, PRESCRIPTION DRUG PLANS AND HEALTH SAVINGS ACCOUNTS AND SIMILAR ACCOUNTS AND RELATED HEALTH CARE PLANS AND NETWORKS; ADMINISTERING, ORGANIZING AND UNDERWRITING HEALTH CARE COVERAGE THROUGH CONTRACTED RELATIONSHIPS WITH SUBSCRIBERS AND PROFESSIONAL CLINICAL, HOSPITAL, NURSING HOME AND OTHER HEALTH CARE PROVIDERS, IN CLASS 36 (U.S. CLS. 100, 101 AND 102).

FIRST USE 5-0-2005; IN COMMERCE 5-0-2005.

THE MARK CONSISTS OF STANDARD CHARACTERS WITHOUT CLAIM TO ANY PARTICULAR FONT, STYLE, SIZE, OR COLOR.

NO CLAIM IS MADE TO THE EXCLUSIVE RIGHT TO USE "PROTECTOR", APART FROM THE MARK AS SHOWN.

SN 78-609,163, FILED 4-14-2005.

SUZANNE BLANE, EXAMINING ATTORNEY

Int. Cl.: 36

Prior U.S. Cls.: 100, 101, and 102

United States Patent and Trademark Office

Reg. No. 3,577,880

Registered Feb. 17, 2009

**SERVICE MARK
PRINCIPAL REGISTER**

HERITAGE VALUE PLUS

PREMERA BLUE CROSS (WASHINGTON CORPORATION)
P.O. BOX 327, MAIL STOP 316
SEATTLE, WA 981110327

FOR: HEALTH, MEDICAL, HOSPITAL, PHARMACEUTICAL AND PRESCRIPTION DRUG INSURANCE UNDERWRITING; ADMINISTRATION AND ORGANIZING OF PREPAID AND PREFERRED PROVIDER HEALTH, MEDICAL, HOSPITAL, PHARMACEUTICAL, PRESCRIPTION DRUG PLANS AND HEALTH SAVINGS ACCOUNTS AND SIMILAR ACCOUNTS AND RELATED HEALTH CARE PLANS AND NETWORKS; INSURANCE CLAIMS ADMINISTRATION AND PROCESSING; PROVIDING ELIGIBILITY AND BENEFIT INFORMATION IN INSURANCE MATTERS; INSURANCE CONSULTATION IN THE NATURE OF CLAIMS REMITTANCE ADVISING; PROVIDING INFORMATION, DATA, REPORTS AND ANALYSIS PERTAINING TO THE UNDERWRITING OF HEALTH, MEDICAL, HOSPITAL, PHARMACEUTICAL AND PRESCRIPTION DRUG INSURANCE AND PERTAINING TO THE ADMINISTRATION AND ORGA-

NIZING OF PREPAID AND PREFERRED PROVIDER HEALTH, MEDICAL, HOSPITAL, PHARMACEUTICAL, PRESCRIPTION DRUG PLANS AND HEALTH SAVINGS ACCOUNTS AND SIMILAR ACCOUNTS AND RELATED HEALTH CARE PLANS AND NETWORKS; ADMINISTERING, ORGANIZING AND UNDERWRITING HEALTH CARE COVERAGE THROUGH CONTRACTED RELATIONSHIPS WITH SUBSCRIBERS AND PROFESSIONAL CLINICAL, HOSPITAL, NURSING HOME AND OTHER HEALTH CARE PROVIDERS, IN CLASS 36 (U.S. CLS. 100, 101 AND 102).

FIRST USE 5-0-2005; IN COMMERCE 5-0-2005.

THE MARK CONSISTS OF STANDARD CHARACTERS WITHOUT CLAIM TO ANY PARTICULAR FONT, STYLE, SIZE, OR COLOR.

SN 78-609,167, FILED 4-14-2005.

SUZANNE BLANE, EXAMINING ATTORNEY

Int. Cl.: 9

Prior U.S. Cls.: 21, 23, 26, 36, and 38

United States Patent and Trademark Office

Reg. No. 3,577,881

Registered Feb. 17, 2009

**TRADEMARK
PRINCIPAL REGISTER**

Virtual Heroes

VIRTUAL HEROES, INC. (NORTH CAROLINA CORPORATION)
4601 CREEKSTONE DR.
SUITE 160
DURHAM, NC 27703

FOR: INTERACTIVE COMPUTER SOFTWARE AND PROGRAMS FOR TRAINING AND EDUCATIONAL PURPOSES IN THE FIELDS OF HEALTHCARE, FIRST RESPONDER AND HOMELAND SECURITY, CORPORATE WORKFORCE, DEPARTMENT OF DEFENSE AND OTHER GOVERNMENTAL AGENCIES, AND GRADE SCHOOL EDUCATION, IN CLASS 9 (U.S. CLS. 21, 23, 26, 36 AND 38).

FIRST USE 6-1-2005; IN COMMERCE 6-1-2005.

THE MARK CONSISTS OF STANDARD CHARACTERS WITHOUT CLAIM TO ANY PARTICULAR FONT, STYLE, SIZE, OR COLOR.

NO CLAIM IS MADE TO THE EXCLUSIVE RIGHT TO USE "VIRTUAL", APART FROM THE MARK AS SHOWN.

SN 78-609,990, FILED 4-15-2005.

DAVID MURRAY, EXAMINING ATTORNEY

Int. Cl.: 17

Prior U.S. Cls.: 1, 5, 12, 13, 35, and 50

United States Patent and Trademark Office

Reg. No. 3,577,882

Registered Feb. 17, 2009

**TRADEMARK
PRINCIPAL REGISTER**



HENKEL AG & CO. KGAA (FED REP GERMANY
PARTNERSHIP LIMITED BY SHARES)
HENKELSTRASSE 67
DUESSELDORF, FED REP GERMANY 40589

FOR: HOUSE MARK FOR A LINE OF ADHESIVES AND SEALANTS FOR GENERAL USE; HOME INSULATING MATERIALS, NAMELY, FOAM TAPES, ADHESIVE-BACKED FOAM INSULATION, FOAM SEALANT KITS FOR ELECTRICAL OUTLETS, ROPE CAULK, SEALING KITS FOR AIR CONDITIONERS AND TURBINES, ADHESIVE-BACKED SEALING TAPES, FOAM PIPE COVERS, FOAM FAUCET COVERS, DOOR SWEEPS, WINDOW INSULATING KITS CONSISTING OF CLEAR PLASTIC FILM AND ADHESIVE TAPE, IN CLASS 17 (U.S. CLS. 1, 5, 12, 13, 35 AND 50).

FIRST USE 6-1-2002; IN COMMERCE 6-1-2002.

OWNER OF U.S. REG. NOS. 981,467 AND 2,674,230.

THE COLOR(S) RED AND WHITE IS/ARE CLAIMED AS A FEATURE OF THE MARK.

THE COLOR RED IS USED FOR THE WORD "HENKEL" AND FOR THE OVAL SURROUNDING THE WORD. THE COLOR WHITE APPEARS INSIDE THE OVAL, AND AS BACKGROUND FOR THE WORDING.

SEC. 2(F).

SN 78-610,098, FILED 4-15-2005.

JANICE L. MCMORROW, EXAMINING ATTORNEY

Int. Cl.: 44

Prior U.S. Cls.: 100 and 101

United States Patent and Trademark Office

Reg. No. 3,577,883

Registered Feb. 17, 2009

**SERVICE MARK
PRINCIPAL REGISTER**

WAVE MOBILIZATION

HENDRICKSON METHOD INSTITUTE, INC.
(CALIFORNIA CORPORATION)
388 COLUSA AVE.
KENSINGTON, CA 94707

FOR: PHYSICAL THERAPY; ORTHOPEDIC THERAPY; CLINICAL MASSAGE; ORTHOPEDIC MASSAGE; MANUAL THERAPY; EXERCISE AND REHABILITATION THERAPY BY MEANS OF SPECIAL MASSAGE TECHNIQUES, IN CLASS 44 (U.S. CLS. 100 AND 101).

FIRST USE 12-0-2005; IN COMMERCE 9-24-2006.

THE MARK CONSISTS OF STANDARD CHARACTERS WITHOUT CLAIM TO ANY PARTICULAR FONT, STYLE, SIZE, OR COLOR.

NO CLAIM IS MADE TO THE EXCLUSIVE RIGHT TO USE "MOBILIZATION", APART FROM THE MARK AS SHOWN.

SN 78-612,404, FILED 4-19-2005.

LESLEY LAMOTHE, EXAMINING ATTORNEY

Int. Cl.: 35

Prior U.S. Cls.: 100, 101, and 102

United States Patent and Trademark Office

Reg. No. 3,577,884

Registered Feb. 17, 2009

**SERVICE MARK
PRINCIPAL REGISTER**

PUMPS-TO-PARKS

ROCKEFELLER, ALLISON WHIPPLE (UNITED STATES INDIVIDUAL)
117A E. 65TH STREET
NEW YORK, NY 10065

FOR: PROMOTING PUBLIC AWARENESS OF THE NEED FOR PARKS, PUBLIC SPACES, AND ENVIRONMENTAL REMEDIATION; PROMOTING ECONOMIC AND CULTURAL DEVELOPMENT OF COMMUNITIES , IN CLASS 35 (U.S. CLS. 100, 101 AND 102).

FIRST USE 6-30-2005; IN COMMERCE 7-31-2008.

THE MARK CONSISTS OF STANDARD CHARACTERS WITHOUT CLAIM TO ANY PARTICULAR FONT, STYLE, SIZE, OR COLOR.

SN 78-613,013, FILED 4-20-2005.

SUZANNE BLANE, EXAMINING ATTORNEY

Int. Cl.: 12

Prior U.S. Cls.: 19, 21, 23, 31, 35, and 44

United States Patent and Trademark Office

Reg. No. 3,577,885

Registered Feb. 17, 2009

**TRADEMARK
PRINCIPAL REGISTER**

THROTTLE

DYNACRAFT BSC, INC. (MASSACHUSETTS
CORPORATION)
89 S. KELLY ROAD
AMERICAN CANYON, CA 94503

THE MARK CONSISTS OF STANDARD CHAR-
ACTERS WITHOUT CLAIM TO ANY PARTICULAR
FONT, STYLE, SIZE, OR COLOR.

FOR: BICYCLES, IN CLASS 12 (U.S. CLS. 19, 21, 23,
31, 35 AND 44).

SN 78-617,343, FILED 4-26-2005.

FIRST USE 2-22-2008; IN COMMERCE 2-22-2008.

ROBERT LAVACHE, EXAMINING ATTORNEY

Int. Cl.: 40

Prior U.S. Cls.: 100, 103, and 106

United States Patent and Trademark Office

Reg. No. 3,577,886

Registered Feb. 17, 2009

**SERVICE MARK
PRINCIPAL REGISTER**

ROC

CARGILL, INCORPORATED (DELAWARE CORPORATION)
15407 MCGINTY ROAD WEST
WAYZATA, MN 55391

THE MARK CONSISTS OF STANDARD CHARACTERS WITHOUT CLAIM TO ANY PARTICULAR FONT, STYLE, SIZE, OR COLOR.

FOR: CUSTOM MANUFACTURING OF PELLETED FEEDLOT SUPPLEMENTS FOR ANIMAL STOCK, IN CLASS 40 (U.S. CLS. 100, 103 AND 106).

SN 78-618,593, FILED 4-28-2005.

FIRST USE 4-25-2005; IN COMMERCE 4-25-2005.

LINDA POWELL, EXAMINING ATTORNEY

Int. Cl.: 9

Prior U.S. Cls.: 21, 23, 26, 36, and 38

United States Patent and Trademark Office

Reg. No. 3,577,887

Registered Feb. 17, 2009

**TRADEMARK
PRINCIPAL REGISTER**

10GF

SUPERIOR ESSEX COMMUNICATIONS LP (DE-
LAWARE LIMITED PARTNERSHIP)
SUITE 150
6120 POWERS FERRY ROAD
ATLANTA, GA 30339

FOR: HIGH SPEED FIBER DATA COMMUNICA-
TIONS CABLES AND HIGH SPEED FIBER DATA
CABLE CONNECTORS FOR USE IN A LOCAL
AREA NETWORK "LAN" DATA AND TELECOM-

MUNICATIONS WIRING SYSTEM, IN CLASS 9 (U.S.
CLS. 21, 23, 26, 36 AND 38).

FIRST USE 1-0-2006; IN COMMERCE 1-0-2006.

SN 78-620,113, FILED 4-29-2005.

DAVID MURRAY, EXAMINING ATTORNEY

Int. Cls.: 9, 25, and 28

Prior U.S. Cls.: 21, 22, 23, 26, 36, 38, 39, and 50

Reg. No. 3,577,888

United States Patent and Trademark Office

Registered Feb. 17, 2009

**TRADEMARK
PRINCIPAL REGISTER**

HIP HOP HARRY

TAKE THAT PRODUCTIONS, INC (CALIFORNIA CORPORATION), DBA HIP HOP HARRY PRODUCTIONS,
8306 WILSHIRE BLVD
SUITE 353
BEVERLY HILLS, CA 90211

FOR: CHILDREN'S VIDEO TAPES, MUSICAL SOUND RECORDINGS, IN CLASS 9 (U.S. CLS. 21, 23, 26, 36 AND 38).

FIRST USE 1-1-2006; IN COMMERCE 1-1-2006.

FOR: CHILDREN'S APPAREL, NAMELY, BATHROBES, SLEEPWEAR, UNDERWEAR, SOCKS, LEGGINGS, ONE PIECE BODY SUITS, LONG AND SHORT SLEEVE TOPS, DRESS SHIRTS, JACKETS, SWEATERS, SWEAT SUITS, PANTS, SHORTS, JEANS, SKIRTS, DRESSES, SWEATBANDS, HATS, GLOVES, SHOES, BELTS, SUSPENDERS, SWIMWEAR, CLOTH BIBS, ALL THE FOREGOING RELATING TO CHILDREN'S VIDEO TAPES AND MUSICAL SOUND RECORDINGS, IN CLASS 25 (U.S. CLS. 22 AND 39).

FIRST USE 1-1-2007; IN COMMERCE 1-1-2007.

FOR: CHILDREN'S TOYS, NAMELY, BOARD GAMES, HAND-HELD UNIT FOR PLAYING VIDEO GAMES, PLUSH TOYS, DOLLS, ACTION FIGURES, PLAYSETS FOR DOLLS AND ACTION FIGURES, ELECTRONIC EDUCATIONAL GAME MACHINES, TOY CARS, TOY TRAINS, ALPHABET BLOCKS, TOY BUILDING SETS, BUILDING BLOCKS, PUZZLES, MAGIC TRICKS, ALL THE FOREGOING RELATING TO CHILDREN'S VIDEO TAPES AND MUSICAL SOUND RECORDINGS, IN CLASS 28 (U.S. CLS. 22, 23, 38 AND 50).

FIRST USE 6-1-2007; IN COMMERCE 6-1-2007.

THE MARK CONSISTS OF STANDARD CHARACTERS WITHOUT CLAIM TO ANY PARTICULAR FONT, STYLE, SIZE, OR COLOR.

NO CLAIM IS MADE TO THE EXCLUSIVE RIGHT TO USE "HIP HOP", APART FROM THE MARK AS SHOWN.

SN 78-628,931, FILED 5-12-2005.

ELLEN BURNS, EXAMINING ATTORNEY

Int. Cls.: 35, 39, and 44

Prior U.S. Cls.: 100, 101, 102, and 105

United States Patent and Trademark Office

Reg. No. 3,577,889

Registered Feb. 17, 2009

**SERVICE MARK
PRINCIPAL REGISTER**

HELP WIN THE RACE FOR LIFE

CORD:USE CORD BLOOD BANK, INC. (FLOR-
IDA CORPORATION)
SUITE 300
1800 PEMBROOK DRIVE
ORLANDO, FL 32810

FOR: RETAIL DISTRIBUTORSHIP SERVICES IN
THE FIELD OF BLOOD AND BLOOD BY-PRO-
DUCTS, IN CLASS 35 (U.S. CLS. 100, 101 AND 102).

FIRST USE 8-17-2006; IN COMMERCE 8-17-2006.

FOR: STORAGE OF HUMAN UMBILICAL CORD
BLOOD STEM CELLS FOR MEDICAL USE, IN
CLASS 39 (U.S. CLS. 100 AND 105).

FIRST USE 8-17-2006; IN COMMERCE 8-17-2006.

FOR: BLOOD BANK SERVICES, NAMELY, COL-
LECTION AND PRESERVATION OF HUMAN UM-
BILICAL CORD BLOOD STEM CELLS, IN CLASS 44
(U.S. CLS. 100 AND 101).

FIRST USE 8-17-2006; IN COMMERCE 8-17-2006.

THE MARK CONSISTS OF STANDARD CHAR-
ACTERS WITHOUT CLAIM TO ANY PARTICULAR
FONT, STYLE, SIZE, OR COLOR.

SN 78-629,637, FILED 5-13-2005.

ZACHARY BELLO, EXAMINING ATTORNEY

Int. Cl.: 28

Prior U.S. Cls.: 22, 23, 38, and 50

United States Patent and Trademark Office

Reg. No. 3,577,890

Registered Feb. 17, 2009

**TRADEMARK
PRINCIPAL REGISTER**

GOLFSPHERE

FLANAGAN, GAIL L. (UNITED STATES INDIVIDUAL)
38 BILTMORE AVENUE
RYE, NY 10580

FOR: EXERCISE EQUIPMENT, NAMELY, MEDICINE BALLS, SWISS BALLS, BALANCE BOARDS, EXERCISE MATS, YOGA MATS, FREE WEIGHTS, DUMBBELLS, WEIGHT TRAINING MACHINES, TREADMILLS, ABDOMINAL BOARDS, RESISTANCE CABLES, WRIST AND ANKLE WEIGHTS FOR EXERCISE, STATIONARY BICYCLES, ELLIPTICAL AEROBIC TRAINING MACHINES FOR GENERAL FITNESS TRAINING, STRENGTH

TRAINING, FLEXIBILITY TRAINING, ENDURANCE TRAINING AND GOLF TRAINING, IN CLASS 28 (U.S. CLS. 22, 23, 38 AND 50).

FIRST USE 4-1-2005; IN COMMERCE 11-10-2007.

THE MARK CONSISTS OF STANDARD CHARACTERS WITHOUT CLAIM TO ANY PARTICULAR FONT, STYLE, SIZE, OR COLOR.

SN 78-632,969, FILED 5-19-2005.

MICHELE SWAIN, EXAMINING ATTORNEY

Int. Cl.: 41

Prior U.S. Cls.: 100, 101, and 107

United States Patent and Trademark Office

Reg. No. 3,577,891

Registered Feb. 17, 2009

**SERVICE MARK
PRINCIPAL REGISTER**

GOLFSPHERE FITNESS SYSTEM

FLANAGAN, GAIL L. (UNITED STATES INDIVIDUAL)
38 BILTMORE AVENUE
RYE, NY 10580

FOR: PROVIDING INFORMATION REGARDING GENERAL FITNESS TRAINING, STRENGTH TRAINING, FLEXIBILITY TRAINING, ENDURANCE TRAINING AND GOLF TRAINING, IN CLASS 41 (U.S. CLS. 100, 101 AND 107).

FIRST USE 4-1-2005; IN COMMERCE 11-10-2007.

THE MARK CONSISTS OF STANDARD CHARACTERS WITHOUT CLAIM TO ANY PARTICULAR FONT, STYLE, SIZE, OR COLOR.

NO CLAIM IS MADE TO THE EXCLUSIVE RIGHT TO USE "FITNESS SYSTEM", APART FROM THE MARK AS SHOWN.

SN 78-634,438, FILED 5-22-2005.

CHRISTINE COOPER, EXAMINING ATTORNEY

Int. Cl.: 33

Prior U.S. Cls.: 47 and 49

United States Patent and Trademark Office

Reg. No. 3,577,892

Registered Feb. 17, 2009

**TRADEMARK
PRINCIPAL REGISTER**

PEMBROOKE

ROUND HILL CELLARS (CALIFORNIA CORPORATION), DBA RUTHERFORD WINE COMPANY,
1680 SILVERADO TRAIL
ST. HELENA, CA 94574

THE MARK CONSISTS OF STANDARD CHARACTERS WITHOUT CLAIM TO ANY PARTICULAR FONT, STYLE, SIZE, OR COLOR.

FOR: WINES, IN CLASS 33 (U.S. CLS. 47 AND 49).

SN 78-640,100, FILED 5-31-2005.

FIRST USE 11-14-2007; IN COMMERCE 11-14-2007.

HEATHER SAPP, EXAMINING ATTORNEY

Int. Cls.: 9, 16, 18, 25, 28, and 41

Prior U.S. Cls.: 1, 2, 3, 5, 21, 22, 23, 26, 29, 36, 37, 38, 39, 41, 50, 100, 101, and 107

Reg. No. 3,577,893

United States Patent and Trademark Office

Registered Feb. 17, 2009

**TRADEMARK
SERVICE MARK
PRINCIPAL REGISTER**

YU-GI-OH! GX

KABUSHIKI KAISHA SHUEISHA, TA SHUEISHA
INC. (JAPAN CORPORATION)
5-10 HITOTSUBASHI 2-CHOME CHIYODA-KU
TOKYO, JAPAN

FOR: DVDS FEATURING CHILDREN'S STORIES,
MOTION PICTURE EXCERPTS, AND MOTION PIC-
TURE SOUNDTRACKS, IN CLASS 9 (U.S. CLS. 21, 23,
26, 36 AND 38).

FIRST USE 2-13-2007; IN COMMERCE 2-13-2007.

FOR: STORY BOOKS, CHILDREN'S BOOKS,
TRADING CARDS, POSTERS, CALENDARS,
STICKERS, PRINTED PAPER INVITATIONS, IN
CLASS 16 (U.S. CLS. 2, 5, 22, 23, 29, 37, 38 AND 50).

FIRST USE 1-15-2006; IN COMMERCE 1-15-2006.

FOR: BACK PACKS, WALLETS, IN CLASS 18 (U.S.
CLS. 1, 2, 3, 22 AND 41).

FIRST USE 5-1-2006; IN COMMERCE 5-1-2006.

FOR: WEARING APPAREL, NAMELY, T-SHIRTS,
PANTS, SHORTS, FOOTWEAR AND HEADWEAR,
IN CLASS 25 (U.S. CLS. 22 AND 39).

FIRST USE 9-0-2005; IN COMMERCE 9-0-2005.

FOR: TOYS, NAMELY, ACTION FIGURES, TOY
BALLS, PLAYING CARDS, IN CLASS 28 (U.S. CLS.
22, 23, 38 AND 50).

FIRST USE 10-0-2005; IN COMMERCE 10-0-2005.

FOR: ENTERTAINMENT SERVICES, NAMELY,
PRODUCTION OF TELEVISION PROGRAMS, IN
CLASS 41 (U.S. CLS. 100, 101 AND 107).

FIRST USE 9-1-2007; IN COMMERCE 9-1-2007.

THE MARK CONSISTS OF STANDARD CHAR-
ACTERS WITHOUT CLAIM TO ANY PARTICULAR
FONT, STYLE, SIZE, OR COLOR.

THE FOREIGN WORDING IN THE MARK
TRANSLATES INTO ENGLISH AS KING OF THE
GAMES.

SN 78-641,263, FILED 6-1-2005.

WENDY JUN, EXAMINING ATTORNEY

Int. Cl.: 36

Prior U.S. Cls.: 100, 101, and 102

United States Patent and Trademark Office

Reg. No. 3,577,894

Registered Feb. 17, 2009

**SERVICE MARK
PRINCIPAL REGISTER**

WHOLE PLANET FOUNDATION

WHOLE FOODS MARKET IP, L.P. (DELAWARE
LIMITED PARTNERSHIP)
6TH FLOOR
550 BOWIE STREET
AUSTIN, TX 78703

FOR: CHARITABLE FUNDRAISING; ACCEPTING AND ADMINISTERING MONETARY CHARITABLE CONTRIBUTIONS; PHILANTHROPIC AND ELEEMOSYNARY SERVICES CONCERNING MONETARY DONATIONS, GRANTS AND FINANCIAL SUPPORT FOR ECONOMIC DEVELOPMENT PROJECTS IN DEVELOPING COUNTRIES; FINANCIAL SPONSORSHIP OF ORGANIZATIONS THAT PROVIDE LOAN FINANCING IN DEVELOPING COUNTRIES; FINANCIAL SPONSORSHIP OF ORGANIZATIONS THAT PROVIDE AND PROMOTE ECONOMIC DEVELOPMENT IN DEVELOPING COUNTRIES; AWARDING GRANTS TO ORGANIZATIONS THAT PROVIDE AND PROMOTE ECONOMIC DEVELOPMENT IN DEVELOPING COUNTRIES; PHILANTHROPIC SERVICES CON-

CERNING THE MONETARY SUPPORT AND FACILITATION OF VOLUNTEERISM; PROVIDING ON-LINE INFORMATION AND INTERACTIVE DATA BASES IN THE FIELD OF MICRO CREDIT LENDING IN DEVELOPING COUNTRIES, IN CLASS 36 (U.S. CLS. 100, 101 AND 102).

FIRST USE 4-0-2005; IN COMMERCE 4-0-2005.

THE MARK CONSISTS OF STANDARD CHARACTERS WITHOUT CLAIM TO ANY PARTICULAR FONT, STYLE, SIZE, OR COLOR.

NO CLAIM IS MADE TO THE EXCLUSIVE RIGHT TO USE "FOUNDATION", APART FROM THE MARK AS SHOWN.

SN 78-645,112, FILED 6-7-2005.

KATHY DE JONGE, EXAMINING ATTORNEY

Int. Cl.: 3

Prior U.S. Cls.: 1, 4, 6, 50, 51, and 52

United States Patent and Trademark Office

Reg. No. 3,577,895

Registered Feb. 17, 2009

**TRADEMARK
PRINCIPAL REGISTER**

ECONET

ECONET, INC. (DELAWARE CORPORATION)
2660 WILLAMETTE DR., N.E.
LACEY, WA 98516

FIRST USE 10-15-2008; IN COMMERCE 10-15-2008.

FOR: COSMETICS, NAMELY, MAKE-UP, PERFUME AND COLOGNE; SKIN LIGHTENER; SUNSCREEN; NON-MEDICATED SKIN REPAIR PREPARATIONS; NON-MEDICATED POWDERS, CREAMS, OILS AND LOTIONS FOR AFTER SUN EXPOSURE; HAIR LOTIONS; AND HAIR CARE PREPARATIONS, IN CLASS 3 (U.S. CLS. 1, 4, 6, 50, 51 AND 52).

THE MARK CONSISTS OF STANDARD CHARACTERS WITHOUT CLAIM TO ANY PARTICULAR FONT, STYLE, SIZE, OR COLOR.

SN 78-647,637, FILED 6-9-2005.

WILLIAM P. SHANAHAN, EXAMINING ATTORNEY

Int. Cl.: 16

Prior U.S. Cls.: 2, 5, 22, 23, 29, 37, 38, and 50

United States Patent and Trademark Office

Reg. No. 3,577,896

Registered Feb. 17, 2009

**TRADEMARK
PRINCIPAL REGISTER**

A FLAIR FOR LIVING

TCJC HOLDINGS LLC (DELAWARE LIMITED
LIABILITY COMPANY)
20 EAST 63RD STREET
NEW YORK, NY 10021

FOR: PRINTED MATTER, NAMELY, BOOKS
REGARDING LIFESTYLES, HOUSEKEEPING,
HOME CARE, HOME MAKING, COOKING, EN-
TERTAINMENT, CRAFTS, GARDENING, DEC-
ORATING, HOME INTERIORS, INTERIOR
DECORATING, STATIONERY, GIFT-WRAPPING
PAPER, GIFT CARDS, IN CLASS 16 (U.S. CLS. 2, 5,
22, 23, 29, 37, 38 AND 50).

FIRST USE 5-0-2008; IN COMMERCE 5-0-2008.

THE MARK CONSISTS OF STANDARD CHAR-
ACTERS WITHOUT CLAIM TO ANY PARTICULAR
FONT, STYLE, SIZE, OR COLOR.

SN 78-651,369, FILED 6-15-2005.

JOHN GARTNER, EXAMINING ATTORNEY

Int. Cl.: 9

Prior U.S. Cls.: 21, 23, 26, 36, and 38

United States Patent and Trademark Office

Reg. No. 3,577,897

Registered Feb. 17, 2009

**TRADEMARK
PRINCIPAL REGISTER**

HOME

HILLCREST LABORATORIES, INC. (DELAWARE CORPORATION)
15245 SHADY GROVE ROAD
ROCKVILLE, MD 20850

FOR: COMPUTER HARDWARE AND COMPUTER SOFTWARE FOR PROGRAMMING, SEARCHING, RECORDING, PLAYING, TRANSMITTING AND DOWNLOADING ENTERTAINMENT MEDIA FOR PERSONALIZED, INTERACTIVE ENTERTAINMENT PROGRAMMING, AND ACCOMPANYING MANUALS SOLD AS A UNIT; COMPUTER SOFTWARE FOR ORGANIZING DATA AND INFORMATION IN THE FORM OF ELECTRONIC CALENDARS AND ORGANIZERS; COMPUTER SOFTWARE AND COMPUTER PERIPHERALS FOR PERSONALIZED, INTERACTIVE ENTERTAINMENT PROGRAMMING PROMOTING THE SALE OF GOODS AND SERVICES OF OTHERS;

COMPUTER SOFTWARE FOR VIEWING AN ONLINE NETWORK GUIDE TO PERSONALIZED AND INTERACTIVE ENTERTAINMENT PROGRAMMING; COMPUTER SOFTWARE FOR PROVIDING ON SCREEN, INTERACTIVE GUIDE FOR SELECTING, ADMINISTERING AND MAINTAINING PERSONALIZED ENTERTAINMENT PROGRAMMING, IN CLASS 9 (U.S. CLS. 21, 23, 26, 36 AND 38).

FIRST USE 7-1-2008; IN COMMERCE 7-1-2008.

THE MARK CONSISTS OF STANDARD CHARACTERS WITHOUT CLAIM TO ANY PARTICULAR FONT, STYLE, SIZE, OR COLOR.

SN 78-653,387, FILED 6-17-2005.

STEPHEN AQUILA, EXAMINING ATTORNEY

Int. Cl.: 9

Prior U.S. Cls.: 21, 23, 26, 36, and 38

United States Patent and Trademark Office

Reg. No. 3,577,898

Registered Feb. 17, 2009

**TRADEMARK
PRINCIPAL REGISTER**

TERRASIGHT

SARNOFF CORPORATION (NEW JERSEY CORPORATION)
201 WASHINGTON ROAD
PRINCETON, NJ 08540

FOR: COMPUTER SYSTEMS, NAMELY, COMPUTER HARDWARE AND SOFTWARE USED TO CAPTURE, STORE, RETRIEVE, EDIT, COMPRESS, DECOMPRESS, TRANSMIT, MARK UP, VISUALIZE AND DISPLAY VIDEO DATA AND ASSOCIATED METADATA, IN CLASS 9 (U.S. CLS. 21, 23, 26, 36 AND 38).

FIRST USE 1-1-2008; IN COMMERCE 1-1-2008.

THE MARK CONSISTS OF STANDARD CHARACTERS WITHOUT CLAIM TO ANY PARTICULAR FONT, STYLE, SIZE, OR COLOR.

SN 78-654,839, FILED 6-21-2005.

MICHELLE DUBOIS, EXAMINING ATTORNEY

Int. Cls.: 35 and 43

Prior U.S. Cls.: 100, 101, and 102

United States Patent and Trademark Office

Reg. No. 3,577,899

Registered Feb. 17, 2009

**SERVICE MARK
PRINCIPAL REGISTER**



SHELLS & FISH IMPORT AND EXPORT CO.
(FLORIDA CORPORATION)
3403 NW 82ND AVENUE
MIAMI, FL 33122

FOR: IMPORT AND EXPORT OF SHRIMP AND
FISH, IN CLASS 35 (U.S. CLS. 100, 101 AND 102).

FIRST USE 11-1-2003; IN COMMERCE 11-1-2003.

FOR: SEAFOOD RESTAURANTS, IN CLASS 43
(U.S. CLS. 100 AND 101).

FIRST USE 11-1-2003; IN COMMERCE 11-1-2003.

THE COLORS LIGHT BLUE, DARK BLUE AND
ORANGE ARE CLAIMED AS A FEATURE OF THE
MARK

THE COLOR LIGHT BLUE APPEARS IN ALL
LETTERING, THE AMPERSAND IS DARK BLUE
AND THE SHRIMP AND "FISH" DESIGNS ARE
ORANGE.

THE MARK CONSISTS OF CAPITAL S, LOWER
CASE HLLS, CAPITAL F, LOWER CASE SH IN
PANTONE AZUL 300; SHRIMP AND "FISH" SYM-
BOLS IN ORANGE 021; AMPERSAND IN PANTONE
REFLEX BLUE.

SN 78-655,909, FILED 6-22-2005.

SHAUNIA CARLYLE, EXAMINING ATTORNEY

Int. Cls.: 6, 20, and 21

**Prior U.S. Cls.: 2, 12, 13, 14, 22, 23, 25, 29, 30, 32, 33,
40, and 50**

Reg. No. 3,577,900

United States Patent and Trademark Office

Registered Feb. 17, 2009

**TRADEMARK
PRINCIPAL REGISTER**

The logo features the word "allison" in a lowercase, cursive-style font. The letters are bold and black. The word is enclosed within a thin, black, rounded rectangular border. The 'l' is notably tall and thin, extending above the rest of the word.

NEWELL OPERATING COMPANY (DELAWARE
CORPORATION)
THREE GLENLAKE PKWY.
ATLANTA, GA 30328

FOR: CABINET AND DRAWER PULLS, KNOBS,
BACKPLATES, HINGES, DOOR STOPS, HOOKS,
LATCHES, AND SAFETY LATCHES, ALL MADE
WHOLLY OR IN PRIMARY PART OF METAL, IN
CLASS 6 (U.S. CLS. 2, 12, 13, 14, 23, 25 AND 50).

FIRST USE 6-23-2005; IN COMMERCE 6-23-2005.

FOR: CABINET AND DRAWER PULLS, KNOBS,
AND BACKPLATES, ALL MADE WHOLLY OR IN
PRIMARY PART OF WOOD, IN CLASS 20 (U.S. CLS.
2, 13, 22, 25, 32 AND 50).

FIRST USE 6-23-2005; IN COMMERCE 6-23-2005.

FOR: CABINET AND DRAWER PULLS, KNOBS,
BACKPLATES, AND HOOKS, ALL MADE WHOLLY
OR IN PRIMARY PART OF CERAMIC, IN CLASS 21
(U.S. CLS. 2, 13, 23, 29, 30, 33, 40 AND 50).

FIRST USE 6-23-2005; IN COMMERCE 6-23-2005.

OWNER OF U.S. REG. NO. 2,126,739.

SN 78-656,940, FILED 6-23-2005.

VERNA BETH RIRIE, EXAMINING ATTORNEY

Int. Cl.: 44

Prior U.S. Cls.: 100 and 101

United States Patent and Trademark Office

Reg. No. 3,577,901

Registered Feb. 17, 2009

**SERVICE MARK
PRINCIPAL REGISTER**

ISLAND DENTAL

CHESLEY R. HOUSKE, JR., DDS, INC. (CALI-
FORNIA CORPORATION)
920 GARDEN STREET, SUITE A
C/O KOENIG & ASSOCIATES
SANTA BARBARA, CA 93101

FOR: DENTAL HYGIENIST SERVICES, DENTIST
SERVICES, DENTISTRY, IN CLASS 44 (U.S. CLS. 100
AND 101).

FIRST USE 4-30-2005; IN COMMERCE 4-30-2005.

THE MARK CONSISTS OF STANDARD CHAR-
ACTERS WITHOUT CLAIM TO ANY PARTICULAR
FONT, STYLE, SIZE, OR COLOR.

NO CLAIM IS MADE TO THE EXCLUSIVE
RIGHT TO USE "DENTAL", APART FROM THE
MARK AS SHOWN.

SN 78-664,974, FILED 7-6-2005.

JOHN HWANG, EXAMINING ATTORNEY

Int. Cls.: 9 and 35

Prior U.S. Cls.: 21, 23, 26, 36, 38, 100, 101, and 102

United States Patent and Trademark Office

Reg. No. 3,577,902

Registered Feb. 17, 2009

**TRADEMARK
SERVICE MARK
PRINCIPAL REGISTER**

CHAMELEON

KETELSEN, RICHARD (UNITED STATES INDIVIDUAL)

14080 74TH PLACE

MAPLE GROVE, MN 55311

FOR: SOFTWARE FOR PERSONAL DIGITAL ASSISTANTS, PERSONAL COMPUTERS, AND CELLULAR PHONES, WHICH ALLOWS THE USER TO CUSTOMIZE ICONS, AVATARS, BACKGROUNDS, WALLPAPERS AND ELECTRONIC THEMES, IN CLASS 9 (U.S. CLS. 21, 23, 26, 36 AND 38).

FIRST USE 7-1-2005; IN COMMERCE 7-1-2005.

FOR: RETAIL STORE SERVICES IN THE FIELD OF HANDHELD SOFTWARE AND PERSONAL DIGITAL ASSISTANT (PDA) RELATED PRODUCTS, IN CLASS 35 (U.S. CLS. 100, 101 AND 102).

FIRST USE 7-1-2005; IN COMMERCE 7-1-2005.

THE MARK CONSISTS OF STANDARD CHARACTERS WITHOUT CLAIM TO ANY PARTICULAR FONT, STYLE, SIZE, OR COLOR.

SN 78-666,422, FILED 7-8-2005.

LESLEY LAMOTHE, EXAMINING ATTORNEY

Int. Cl.: 3

Prior U.S. Cls.: 1, 4, 6, 50, 51, and 52

United States Patent and Trademark Office

Reg. No. 3,577,903

Registered Feb. 17, 2009

**TRADEMARK
PRINCIPAL REGISTER**

LUCKY TIGER BEAN BLOCK

AT LAST NATURALS, INC. (NEW YORK CORPORATION)
401 COLUMBUS AVENUE
VALHALLA, NY 10595

OWNER OF U.S. REG. NOS. 321,154, 2,978,120,
AND OTHERS.

FOR: SUN BLOCK PREPARATIONS, SUNSCREENS,
AND SUNTAN LOTIONS, IN CLASS 3 (U.S. CLS. 1, 4, 6, 50, 51 AND 52).

NO CLAIM IS MADE TO THE EXCLUSIVE
RIGHT TO USE "BLOCK", APART FROM THE
MARK AS SHOWN.

FIRST USE 12-9-2008; IN COMMERCE 12-9-2008.

SN 78-667,551, FILED 7-11-2005.

THE MARK CONSISTS OF STANDARD CHARACTERS
WITHOUT CLAIM TO ANY PARTICULAR
FONT, STYLE, SIZE, OR COLOR.

ESTHER A. BORSUK, EXAMINING ATTORNEY

Int. Cl.: 41

Prior U.S. Cls.: 100, 101, and 107

United States Patent and Trademark Office

Reg. No. 3,577,904

Registered Feb. 17, 2009

**SERVICE MARK
PRINCIPAL REGISTER**

BROADWAY REFRAMED

SHORENSTEIN HAYS-NEDERLANDER THEATERS LLC (DELAWARE LIMITED LIABILITY COMPANY)
1182 MARKET STREET, SUITE 200
SAN FRANCISCO, CA 94102

FOR: PRESENTATION OF LIVE ENTERTAINMENT PERFORMANCES, IN THE NATURE OF MUSICAL PERFORMANCES, MUSICALS, VARIETY SHOWS, DRAMATIC PERFORMANCES, PLAYS, COMEDY SHOWS, MUSICAL SHOWS AND LIVE GROUP MUSICAL PERFORMANCES, CONCERTS AND SHOWS; PROVIDING FACILITIES FOR MOVIES, SHOWS, PLAYS, MUSIC OR EDUCATIONAL TRAINING, IN CLASS 41 (U.S. CLS. 100, 101 AND 107).

FIRST USE 9-1-2005; IN COMMERCE 9-1-2005.

THE MARK CONSISTS OF STANDARD CHARACTERS WITHOUT CLAIM TO ANY PARTICULAR FONT, STYLE, SIZE, OR COLOR.

NO CLAIM IS MADE TO THE EXCLUSIVE RIGHT TO USE "BROADWAY", APART FROM THE MARK AS SHOWN.

SN 78-671,011, FILED 7-14-2005.

KAREN M. STRZYZ, EXAMINING ATTORNEY

Int. Cl.: 30

Prior U.S. Cl.: 46

United States Patent and Trademark Office

Reg. No. 3,577,905

Registered Feb. 17, 2009

**TRADEMARK
PRINCIPAL REGISTER**

TEA LOVER'S CHOCOLATE

BRIDGE BRANDS (CALIFORNIA CORPORATION)
286 FOLSOM ST.
SAN FRANCISCO, CA 94103

FOR: CHOCOLATE, IN CLASS 30 (U.S. CL. 46).

FIRST USE 12-11-2006; IN COMMERCE 1-30-2007.

THE MARK CONSISTS OF STANDARD CHARACTERS WITHOUT CLAIM TO ANY PARTICULAR FONT, STYLE, SIZE, OR COLOR.

OWNER OF U.S. REG. NOS. 2,959,278 AND 2,959,279.

NO CLAIM IS MADE TO THE EXCLUSIVE RIGHT TO USE "CHOCOLATE", APART FROM THE MARK AS SHOWN.

SN 78-671,378, FILED 7-15-2005.

TINA BROWN, EXAMINING ATTORNEY

Int. Cl.: 25

Prior U.S. Cls.: 22 and 39

United States Patent and Trademark Office

Reg. No. 3,577,906

Registered Feb. 17, 2009

**TRADEMARK
PRINCIPAL REGISTER**

YOUR LIFE, YOUR BOOTS.

COLUMBIA INSURANCE COMPANY (NEBRASKA CORPORATION)

3024 HARNEY STREET

OMAHA, NE 68131

FOR: FOOTWEAR, IN CLASS 25 (U.S. CLS. 22 AND 39).

FIRST USE 0-0-2006; IN COMMERCE 0-0-2006.

THE MARK CONSISTS OF STANDARD CHARACTERS WITHOUT CLAIM TO ANY PARTICULAR FONT, STYLE, SIZE, OR COLOR.

NO CLAIM IS MADE TO THE EXCLUSIVE RIGHT TO USE "BOOTS", APART FROM THE MARK AS SHOWN.

SN 78-671,479, FILED 7-15-2005.

SIMON TENG, EXAMINING ATTORNEY

Int. Cl.: 20

Prior U.S. Cls.: 2, 13, 22, 25, 32, and 50

Reg. No. 3,577,907

United States Patent and Trademark Office

Registered Feb. 17, 2009

**TRADEMARK
PRINCIPAL REGISTER**

ROUND & ROUND

ROUND AND ROUND, LLC (TEXAS LIMITED
LIABILITY COMPANY)
1200 VALWOOD PARKWAY
CARROLLTON, TX 75006

THE MARK CONSISTS OF STANDARD CHAR-
ACTERS WITHOUT CLAIM TO ANY PARTICULAR
FONT, STYLE, SIZE, OR COLOR.

FOR: FURNITURE, IN CLASS 20 (U.S. CLS. 2, 13,
22, 25, 32 AND 50).

SN 78-673,310, FILED 7-19-2005.

FIRST USE 3-1-2007; IN COMMERCE 3-1-2007.

LINDA ORNDORFF, EXAMINING ATTORNEY

Int. Cl.: 36

Prior U.S. Cls.: 100, 101, and 102

United States Patent and Trademark Office

Reg. No. 3,577,908

Registered Feb. 17, 2009

**SERVICE MARK
PRINCIPAL REGISTER**

PEACHTREE HILLS PLACE

ISAKSON/BARNHART RETIREMENT DEVELOPMENT CO., LLC (GEORGIA LIMITED LIABILITY COMPANY)
25 TECHNOLOGY PARKWAY SOUTH, SUITE 201
NORCROSS, GA 30092

FOR: CONTINUING CARE RETIREMENT COMMUNITY SERVICES OFFERING INDEPENDENT LIVING, NAMELY, LEASING OF REAL PROPERTY IN THE NATURE OF PROVIDING NINETY PERCENT REFUNDABLE LIFETIME LEASES OF SINGLE-FAMILY HOMES AND APARTMENTS, IN CLASS 36 (U.S. CLS. 100, 101 AND 102).

FIRST USE 3-6-2006; IN COMMERCE 3-15-2006.

THE MARK CONSISTS OF STANDARD CHARACTERS WITHOUT CLAIM TO ANY PARTICULAR FONT, STYLE, SIZE, OR COLOR.

NO CLAIM IS MADE TO THE EXCLUSIVE RIGHT TO USE "PEACHTREE HILLS", APART FROM THE MARK AS SHOWN.

SN 78-673,430, FILED 7-19-2005.

ANDREW RHIM, EXAMINING ATTORNEY

Int. Cl.: 10

Prior U.S. Cls.: 26, 39, and 44

United States Patent and Trademark Office

Reg. No. 3,577,909

Registered Feb. 17, 2009

**TRADEMARK
PRINCIPAL REGISTER**



PARADIGM SPINE, LLC (DELAWARE LIMITED
LIABILITY COMPANY)
14TH FLOOR
505 PARK AVENUE
NEW YORK, NY 10022

FIRST USE 5-23-2008; IN COMMERCE 5-23-2008.

NO CLAIM IS MADE TO THE EXCLUSIVE
RIGHT TO USE "SPINE", APART FROM THE MARK
AS SHOWN.

FOR: MEDICAL PRODUCTS, NAMELY, SURGI-
CALLY IMPLANTABLE SPINAL STABILIZATION
DEVICES FOR TREATING SPINAL DISEASE OR
INSTABILITY IN THE NATURE OF IMPLANTS
CONSISTING OF ARTIFICIAL MATERIALS, IN
CLASS 10 (U.S. CLS. 26, 39 AND 44).

SN 78-674,106, FILED 7-20-2005.

SARA THOMAS, EXAMINING ATTORNEY

Int. Cl.: 25

Prior U.S. Cls.: 22 and 39

United States Patent and Trademark Office

Reg. No. 3,577,910

Registered Feb. 17, 2009

**TRADEMARK
PRINCIPAL REGISTER**

Pimparella

HOLLAHOOD ENTERTAINMENT CORP. (NEW
YORK CORPORATION)
130 CHURCH STREET
#169
NEW YORK, NY 10007

FOR: CLOTHING, NAMELY, T-SHIRTS, JACKETS, SWEATERS, TANK TOPS, JEANS, PANTS, HATS, HEAD GEAR, NAMELY, HATS AND CAPS, SHIRTS, SKIRTS, DRESSES, COATS, UNDERWEAR, WRIST BANDS, SWEAT SHIRTS, SUITS, SHOES, AND BATHING SUITS, IN CLASS 25 (U.S. CLS. 22 AND 39).

FIRST USE 6-1-2005; IN COMMERCE 6-1-2005.

THE MARK CONSISTS OF STANDARD CHARACTERS WITHOUT CLAIM TO ANY PARTICULAR FONT, STYLE, SIZE, OR COLOR.

SN 78-675,712, FILED 7-21-2005.

KRISTINA MORRIS, EXAMINING ATTORNEY

Int. Cl.: 9

Prior U.S. Cls.: 21, 23, 26, 36, and 38

United States Patent and Trademark Office

Reg. No. 3,577,911

Registered Feb. 17, 2009

**TRADEMARK
PRINCIPAL REGISTER**

ACCOUNTATRON

RCD HOLDINGS, INC. (MICHIGAN CORPORATION)
300 RIVER PLACE
DETROIT, MI 48207

FOR: SOFTWARE, NAMELY, POINT-OF-SALE SOFTWARE FOR TABLE MANAGEMENT AND MANAGEMENT OF RESERVATIONS AND RECEIPTS, AND ACCOUNTING SOFTWARE FOR MANAGEMENT OF ACCOUNTS PAYABLE, INVENTORY, PAYROLL, GENERAL LEDGER AND RESERVATIONS, USED IN THE RESTAURANT AND HOSPITALITY FIELDS AND USER MANUALS

SOLD AS A UNIT, IN CLASS 9 (U.S. CLS. 21, 23, 26, 36 AND 38).

FIRST USE 8-1-2006; IN COMMERCE 8-1-2006.

THE MARK CONSISTS OF STANDARD CHARACTERS WITHOUT CLAIM TO ANY PARTICULAR FONT, STYLE, SIZE, OR COLOR.

SN 78-678,452, FILED 7-26-2005.

NAKIA HENRY, EXAMINING ATTORNEY

Int. Cl.: 45

Prior U.S. Cls.: 100 and 101

United States Patent and Trademark Office

Reg. No. 3,577,912

Registered Feb. 17, 2009

**SERVICE MARK
PRINCIPAL REGISTER**

USIS Guardian

US INVESTIGATIONS SERVICES, LLC (DELA-
WARE LIMITED LIABILITY COMPANY)
SUITE 1100 NORTH
7799 LEESBURG PIKE
FALLS CHURCH, VA 22043

FOR: INVESTIGATIVE SERVICES, NAMELY,
CONDUCTING CRIMINAL BACKGROUND
CHECKS OF PUBLIC RECORDS; PROVIDING IN-
FORMATION FROM AN ONLINE DATABASE OF
PUBLIC RECORDS TO CONDUCT CRIMINAL
BACKGROUND INVESTIGATIONS, IN CLASS 45
(U.S. CLS. 100 AND 101).

FIRST USE 11-30-2005; IN COMMERCE 11-30-2005.

THE MARK CONSISTS OF STANDARD CHAR-
ACTERS WITHOUT CLAIM TO ANY PARTICULAR
FONT, STYLE, SIZE, OR COLOR.

OWNER OF U.S. REG. NOS. 2,108,939, 2,177,426,
AND OTHERS.

SN 78-679,177, FILED 7-27-2005.

STEVEN R. FOSTER, EXAMINING ATTORNEY

Int. Cl.: 42

Prior U.S. Cls.: 100 and 101

United States Patent and Trademark Office

Reg. No. 3,577,913

Registered Feb. 17, 2009

**SERVICE MARK
PRINCIPAL REGISTER**

MICROFAST

ANALYTICAL SPECIALISTS INC. (LOUISIANA
CORPORATION)
5536 RIVERBEND BOULEVARD
BATON ROUGE, LA 70820

FOR: ANALYSIS OF THE CHEMICAL COMPOSITION OR CHARACTERISTICS OF MATERIALS, IN CLASS 42 (U.S. CLS. 100 AND 101).

FIRST USE 1-1-2008; IN COMMERCE 1-1-2008.

THE MARK CONSISTS OF STANDARD CHARACTERS WITHOUT CLAIM TO ANY PARTICULAR FONT, STYLE, SIZE, OR COLOR.

SN 78-679,991, FILED 7-27-2005.

ALEXANDER L. POWERS, EXAMINING ATTORNEY

Int. Cl.: 32

Prior U.S. Cls.: 45, 46, and 48

United States Patent and Trademark Office

Reg. No. 3,577,914

Registered Feb. 17, 2009

**TRADEMARK
PRINCIPAL REGISTER**

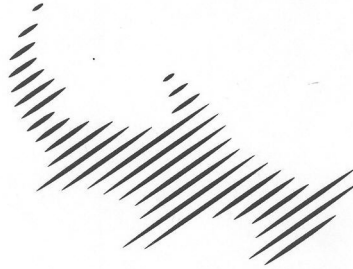

NEW ACE US TRADEMARK LTD. (CANADA
CORPORATION)
5100 SPECTRUM
MISSISSAUGA, ONTARIO, CANADA L4W 5S2

FOR: ENERGY DRINKS FEATURING ADDED
NUTRIENTS, IN CLASS 32 (U.S. CLS. 45, 46 AND 48).

FIRST USE 1-0-2007; IN COMMERCE 1-0-2007.

THE MARK CONSISTS OF A STYLIZED SHARK.

SN 78-681,663, FILED 7-29-2005.

BARBARA RUTLAND, EXAMINING ATTORNEY

Int. Cl.: 10

Prior U.S. Cls.: 26, 39, and 44

United States Patent and Trademark Office

Reg. No. 3,577,915

Registered Feb. 17, 2009

TRADEMARK
PRINCIPAL REGISTER

CLIMAX

VAST RESOURCES, INC. (CALIFORNIA CORPORATION), DBA TOPCO SALES,
9401 DE SOTO AVENUE
CHATSWORTH, CA 91311

FOR: ADULT SEXUAL AIDS, NAMELY, ELECTRIC AND NON-ELECTRIC MASSAGE DEVICES AND ACCESSORIES FOR MASSAGING OR VIBRATING PORTIONS OF THE FACE AND BODY; IMITATION SEXUAL ORGANS, NAMELY, DILDOES, STIMULATION DEVICES FOR AIDING IN SEXUAL AROUSAL AND PERFORMANCE; VIBRATORS AND VIBRATOR SLEEVES; AND VACUUM PUMPS AND VACUUM PUMP ACCESSORIES, NAMELY, A CYLINDER SLEEVE, CUSHION INSERTS, CONSTRICTION RINGS AND CONSTRICTION RING LOADERS FOR USE TO MAINTAIN

PENILE RIGIDITY, IN CLASS 10 (U.S. CLS. 26, 39 AND 44).

FIRST USE 4-0-2007; IN COMMERCE 4-0-2007.

THE MARK CONSISTS OF STANDARD CHARACTERS WITHOUT CLAIM TO ANY PARTICULAR FONT, STYLE, SIZE, OR COLOR.

OWNER OF U.S. REG. NOS. 2,532,215 AND 2,580,611.

SN 78-692,514, FILED 8-15-2005.

COLLEEN KEARNEY, EXAMINING ATTORNEY

Int. Cl.: 36

Prior U.S. Cls.: 100, 101, and 102

United States Patent and Trademark Office

Reg. No. 3,577,916

Registered Feb. 17, 2009

**SERVICE MARK
PRINCIPAL REGISTER**



MERCURY INVESTMENT PROPERTIES, LP (DELAWARE LIMITED PARTNERSHIP)
2100 ONE COMMERCE SQUARE
MEMPHIS, TN 38103

FOR: FINANCIAL INVESTMENT IN THE FIELD OF COMMERCIAL REAL ESTATE, IN CLASS 36 (U.S. CLS. 100, 101 AND 102).

FIRST USE 9-1-2005; IN COMMERCE 1-1-2006.

NO CLAIM IS MADE TO THE EXCLUSIVE RIGHT TO USE "INVESTMENT PROPERTIES", APART FROM THE MARK AS SHOWN.

THE GRAY TONES IN THE DRAWING ARE NOT INTENDED TO INDICATE THE COLOR GRAY, RATHER ARE ONLY USED FOR SHADING PURPOSES.

THE MARK CONSISTS OF A LIKENESS OF THE ROMAN GOD OF COMMERCE, "MERCURY", WEARING A WINGED HAT KNOWN AS A PETASUS.

SN 78-695,249, FILED 8-18-2005.

BARBARA RUTLAND, EXAMINING ATTORNEY

Int. Cls.: 9 and 42

Prior U.S. Cls.: 21, 23, 26, 36, 38, 100, and 101

United States Patent and Trademark Office

Reg. No. 3,577,917

Registered Feb. 17, 2009

**TRADEMARK
SERVICE MARK
PRINCIPAL REGISTER**

JetPak

JETARK HOLDINGS, INC. (DELAWARE CORPORATION)
475 GATE FIVE ROAD, SUITE 320
SAUSALITO, CA 94965

FOR: COMPUTER SOFTWARE FOR CREATING, COLLECTING, STORING, RETRIEVING AND PROVIDING SEARCHABLE AND/OR SHAREABLE LINKS, TEXTS, IMAGES, WEB DOCUMENTS, AUDIO/VIDEO FILES, OTHER ELECTRONIC FILES, RESOURCES AND/OR OTHER INFORMATION THAT CAN BE INDEPENDENTLY OR COLLABORATIVELY REVIEWED, SEARCHED, COMPILED, REFINED, INDEXED, ORGANIZED, CREATED, EXCHANGED AND/OR SHARED ON COMPUTER NETWORKS, IN CLASS 9 (U.S. CLS. 21, 23, 26, 36 AND 38).

FIRST USE 12-31-2005; IN COMMERCE 12-31-2005.

FOR: COMPUTER SERVICES AND ONLINE COMPUTER SERVICES, NAMELY, HOSTING WEBSITES FOR OTHERS THAT ALLOW CREATING, COLLECTING, STORING, RETRIEVING AND ACT-

ING AS AN APPLICATION SERVICE PROVIDER IN THE FIELD OF KNOWLEDGE MANAGEMENT TO HOST COMPUTER APPLICATION SOFTWARE FOR CREATING SEARCHABLE DATABASES OF INFORMATION, SHAREABLE LINKS, TEXTS, IMAGES, WEB DOCUMENTS, AUDIO/VIDEO FILES, OTHER ELECTRONIC FILES, RESOURCES AND/OR OTHER INFORMATION THAT CAN BE INDEPENDENTLY OR COLLABORATIVELY REVIEWED, SEARCHED, COMPILED, REFINED, INDEXED, ORGANIZED, CREATED, EXCHANGED AND/OR SHARED ON COMPUTER NETWORKS, IN CLASS 42 (U.S. CLS. 100 AND 101).

FIRST USE 9-1-2005; IN COMMERCE 9-1-2005.

THE MARK CONSISTS OF STANDARD CHARACTERS WITHOUT CLAIM TO ANY PARTICULAR FONT, STYLE, SIZE, OR COLOR.

SN 78-698,916, FILED 8-23-2005.

FONG HSU, EXAMINING ATTORNEY

Int. Cl.: 1

Prior U.S. Cls.: 1, 5, 6, 10, 26, and 46

United States Patent and Trademark Office

Reg. No. 3,577,918

Registered Feb. 17, 2009

**TRADEMARK
PRINCIPAL REGISTER**

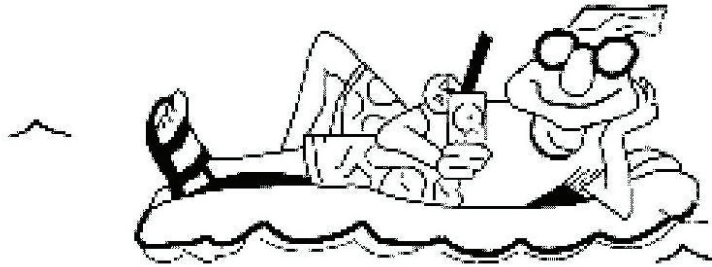

PPG INDUSTRIES OHIO, INC. (DELAWARE
CORPORATION)
3800 WEST 143RD STREET
CLEVELAND, OH 44111

FOR: WASTE WATER TREATMENT CHEMI-
CALS FOR INDUSTRIAL USE; WATER PURIFYING
CHEMICALS FOR SWIMMING POOLS; WATER
TREATMENT CHEMICALS FOR USE IN SWIM-
MING POOLS AND SPAS, IN CLASS 1 (U.S. CLS. 1, 5,
6, 10, 26 AND 46).

FIRST USE 12-31-1987; IN COMMERCE 12-31-1987.

THE MARK CONSISTS OF A CARICATURE OF
MAN WEARING SWIMMING ATTIRE LYING ON A
POOL FLOAT HOLDING A GLASS.

SN 78-707,149, FILED 9-6-2005.

JENNIFER VASQUEZ, EXAMINING ATTORNEY

Int. Cl.: 35

Prior U.S. Cls.: 100, 101, and 102

United States Patent and Trademark Office

Reg. No. 3,577,919

Registered Feb. 17, 2009

**SERVICE MARK
PRINCIPAL REGISTER**



CHRISTINA GUZMAN (NORTH CAROLINA
SOLE PROPRIETORSHIP)
1235 E EAST BLVD., #103
CHARLOTTE, NC 28203

THE MARK CONSISTS OF A SHEPERD HOLD-
ING A STAFF.

FOR: RETAIL APPAREL STORES, IN CLASS 35
(U.S. CLS. 100, 101 AND 102).

SN 78-707,723, FILED 9-6-2005.

FIRST USE 1-1-2005; IN COMMERCE 6-1-2005.

CHARLOTTE CORWIN, EXAMINING ATTORNEY

Int. Cl.: 5

Prior U.S. Cls.: 6, 18, 44, 46, 51, and 52

United States Patent and Trademark Office

Reg. No. 3,577,920

Registered Feb. 17, 2009

**TRADEMARK
PRINCIPAL REGISTER**

VITACEBROL

LABORATORIOS LOPEZ, S.A. DE C.V. (EL SAL-
VADOR CORPORATION)
KM 5.5 BLVD DE EJERCITO NACIONAL
SOYAPANGO
SAN SALVADOR, EL SALVADOR

FOR: PHARMACEUTICAL PRODUCTS, NAME-
LY, FOOD SUPPLEMENTS, IN CLASS 5 (U.S. CLS. 6,
18, 44, 46, 51 AND 52).

FIRST USE 5-0-1970; IN COMMERCE 8-0-2008.

OWNER OF EL SALVADOR REG. NO. 13663,
DATED 6-10-1966, EXPIRES 6-10-2016.

SN 78-708,970, FILED 9-8-2005.

BARNEY CHARLON, EXAMINING ATTORNEY

Int. Cl.: 9

Prior U.S. Cls.: 21, 23, 26, 36, and 38

United States Patent and Trademark Office

Reg. No. 3,577,921

Registered Feb. 17, 2009

**TRADEMARK
PRINCIPAL REGISTER**

CU HUB

EPL, INC. (ALABAMA CORPORATION)
SUITE 400
22 INVERNESS CENTER
BIRMINGHAM, AL 35242

FOR: COMPUTER SOFTWARE FOR INTEGRATING AND INTERFACING ONE OR MORE DISPARATE DATA PROCESSING APPLICATIONS SUCH THAT THE CORE PROCESSOR FOR ONE RUNNING APPLICATION MAY BE SWITCHED OUT AND REPLACED WITHOUT THE NEED TO SWITCH OUT ALL OTHER RUNNING APPLICATIONS, IN CLASS 9 (U.S. CLS. 21, 23, 26, 36 AND 38).

FIRST USE 4-17-2008; IN COMMERCE 4-17-2008.

THE MARK CONSISTS OF STANDARD CHARACTERS WITHOUT CLAIM TO ANY PARTICULAR FONT, STYLE, SIZE, OR COLOR.

NO CLAIM IS MADE TO THE EXCLUSIVE RIGHT TO USE "CU", APART FROM THE MARK AS SHOWN.

SN 78-710,673, FILED 9-11-2005.

KATHRYN COWARD, EXAMINING ATTORNEY

Int. Cls.: 17 and 19

Prior U.S. Cls.: 1, 5, 12, 13, 33, 35, and 50

United States Patent and Trademark Office

Reg. No. 3,577,922

Registered Feb. 17, 2009

**TRADEMARK
PRINCIPAL REGISTER**

LRM INDUSTRIES, LLC

LRM INDUSTRIES, LLC (DELAWARE LIMITED
LIABILITY COMPANY)
135 GUS HIPP BLVD.
ROCKLEDGE, FL 329552660

FOR: FINISHED AND SEMI-FINISHED PLASTIC
PRODUCTS AND COMPONENT PARTS THEREOF,
NAMELY, PLASTICS IN THE FORM OF SHEETS
AND TUBES FOR USE IN MANUFACTURING;
MOLDED PLASTIC IN THE FORM OF SHEETS
AND TUBES FOR USE IN MANUFACTURING, IN
CLASS 17 (U.S. CLS. 1, 5, 12, 13, 35 AND 50).

FIRST USE 3-21-2007; IN COMMERCE 3-21-2007.

FOR: BUILDING MATERIALS, PRINCIPALLY
OF PLASTIC, NAMELY, DECKING AND COMPO-
SITE FLOOR BUILDING PANELS, OUTSIDE AND
INSIDE FLOOR COVERING PANELS FOR CON-

STRUCTION, RIGID PIPES MADE OF PLASTIC,
ESPECIALLY MADE OF GLASS FIBER REIN-
FORCED PLASTIC, FOR GENERAL INDUSTRIAL
USE, IN CLASS 19 (U.S. CLS. 1, 12, 33 AND 50).

FIRST USE 3-21-2007; IN COMMERCE 3-21-2007.

THE MARK CONSISTS OF STANDARD CHAR-
ACTERS WITHOUT CLAIM TO ANY PARTICULAR
FONT, STYLE, SIZE, OR COLOR.

NO CLAIM IS MADE TO THE EXCLUSIVE
RIGHT TO USE "INDUSTRIES, LLC", APART FROM
THE MARK AS SHOWN.

SN 78-713,291, FILED 9-15-2005.

ALICIA COLLINS, EXAMINING ATTORNEY

Int. Cl.: 36

Prior U.S. Cls.: 100, 101, and 102

United States Patent and Trademark Office

Reg. No. 3,577,923

Registered Feb. 17, 2009

**SERVICE MARK
PRINCIPAL REGISTER**

BLUE HEALTHCARE BANK

BLUE CROSS AND BLUE SHIELD ASSOCIATION
(ILLINOIS NON-PROFIT CORPORATION)
6TH FLOOR
225 NORTH MICHIGAN AVENUE
CHICAGO, IL 60601

FOR: ADMINISTRATION, FINANCIAL MANAGEMENT AND MAINTENANCE OF HEALTH SAVINGS ACCOUNTS, MEDICAL SAVINGS ACCOUNTS, HEALTH REIMBURSEMENT ARRANGEMENTS AND FLEXIBLE SPENDING ACCOUNTS; OFFERING CONSUMER-DRIVEN HEALTH CARE PLAN, NAMELY, UNDERWRITING, ADMINISTRATION, FINANCING, AND MAINTENANCE OF CONSUMER-DRIVEN HEALTH CARE PLANS AND DEFINED CONTRIBUTION HEALTH CARE PLANS; DEBIT CARD SERVICES, CHECK CASHING AND CHECK ISSUANCE, ELECTRONIC DEBIT TRANSACTIONS AND ELECTRONIC CHECK PROCESSING TRANSACTIONS AND PROVIDING FINANCIAL INFORMATION BY ELECTRONIC MEANS VIA A GLOBAL COMPUTER NETWORK, ALL OF WHICH ARE PROVIDED IN CONNECTION WITH HEALTH CARE COVERAGE PLANS; BANKING AND FINANCIAL SERVICES, NAMELY, CHECKING AND SAVINGS ACCOUNT SERVICES, ELECTRONIC FUNDS TRANSFER, CASH MANAGEMENT AND DISBURSEMENT SERVICES, LENDING SERVICES, ACCEPTANCE OF DEPOSITS AND LOAN PAYMENTS, CHECK CASHING AND CHECK ISSUANCE, ELECTRONIC PAYMENT SER-

VICES, PROVIDING FINANCIAL INFORMATION BY ELECTRONIC MEANS, PROVIDING SECURE FINANCIAL TRANSACTIONS IN THE NATURE OF ELECTRONIC CASH TRANSACTIONS, ELECTRONIC CHECK PROCESSING TRANSACTIONS, TRUSTEE SERVICES, SECURITY SERVICES, CERTIFICATES OF DEPOSITS, ASSET MANAGEMENT SERVICES, STORED-VALUE CARD SERVICES, SMART CARD SERVICES, CREDIT CARD SERVICES, ALL OF WHICH ARE PROVIDED IN CONNECTION WITH HEALTH CARE COVERAGE PLANS, IN CLASS 36 (U.S. CLS. 100, 101 AND 102).

FIRST USE 5-26-2006; IN COMMERCE 2-13-2007.

THE MARK CONSISTS OF STANDARD CHARACTERS WITHOUT CLAIM TO ANY PARTICULAR FONT, STYLE, SIZE, OR COLOR.

OWNER OF U.S. REG. NOS. 557,037, 2,146,352, AND OTHERS.

NO CLAIM IS MADE TO THE EXCLUSIVE RIGHT TO USE "HEALTHCARE BANK", APART FROM THE MARK AS SHOWN.

SN 78-714,913, FILED 9-16-2005.

JENNIFER DIXON, EXAMINING ATTORNEY

Int. Cl.: 36

Prior U.S. Cls.: 100, 101, and 102

United States Patent and Trademark Office

Reg. No. 3,577,924

Registered Feb. 17, 2009

**SERVICE MARK
PRINCIPAL REGISTER**

CONSUMER SMARTFUNDS

MID-WEST NATIONAL LIFE INSURANCE COMPANY OF TENNESSEE (TEXAS CORPORATION)
9151 GRAPEVINE HIGHWAY
NORTH RICHLAND HILLS, TX 76180

FOR: HEALTH INSURANCE SERVICES, NAME-
LY, PROCESSING OF INSURANCE CLAIMS AND
PAYMENT DATA, IN CLASS 36 (U.S. CLS. 100, 101
AND 102).

FIRST USE 8-1-2006; IN COMMERCE 8-1-2006.

THE MARK CONSISTS OF STANDARD CHAR-
ACTERS WITHOUT CLAIM TO ANY PARTICULAR
FONT, STYLE, SIZE, OR COLOR.

NO CLAIM IS MADE TO THE EXCLUSIVE
RIGHT TO USE "CONSUMER", APART FROM
THE MARK AS SHOWN.

SN 78-725,526, FILED 10-3-2005.

DAVID YONTEF, EXAMINING ATTORNEY

Int. Cl.: 10

Prior U.S. Cls.: 26, 39, and 44

United States Patent and Trademark Office

Reg. No. 3,577,925

Registered Feb. 17, 2009

**TRADEMARK
PRINCIPAL REGISTER**

Magellan

COVIDIEN AG (SWITZERLAND CORPORATION)
VICTOR VON BRUNS-STRASSE 19
NEUHAUSEN AM RHEINFALL, SWITZERLAND
8212

FOR: SURGICAL, MEDICAL AND VETERINARY APPARATUS AND INSTRUMENTS, NAMELY INJECTION DEVICES AND THEIR COMPONENTS FOR ALL MANNER OF INJECTION COLLECTION AND TRANSFER OF TISSUES AND FLUIDS, IN CLASS 10 (U.S. CLS. 26, 39 AND 44).

FIRST USE 5-1-2008; IN COMMERCE 5-1-2008.

THE MARK CONSISTS OF STANDARD CHARACTERS WITHOUT CLAIM TO ANY PARTICULAR FONT, STYLE, SIZE, OR COLOR.

OWNER OF U.S. REG. NO. 2,774,118.

SN 78-727,541, FILED 10-6-2005.

DAVID HOFFMAN, EXAMINING ATTORNEY

Int. Cl.: 41

Prior U.S. Cls.: 100, 101, and 107

United States Patent and Trademark Office

Reg. No. 3,577,926

Registered Feb. 17, 2009

**SERVICE MARK
PRINCIPAL REGISTER**

SOULa
OF NOBLE CHARACTER

TARVER, TARYN (UNITED STATES INDIVIDUAL)
929 E. 2ND STREET, SUITE 205
LOS ANGELES, CA 90012

FIRST USE 9-16-2006; IN COMMERCE 1-3-2008.

SN 78-732,157, FILED 10-12-2005.

FOR: PUBLISHING OF BOOKS AND MAGAZINES, IN CLASS 41 (U.S. CLS. 100, 101 AND 107).

AMY ALFIERI, EXAMINING ATTORNEY

Int. Cl.: 19

Prior U.S. Cls.: 1, 12, 33, and 50

United States Patent and Trademark Office

Reg. No. 3,577,927

Registered Feb. 17, 2009

**TRADEMARK
PRINCIPAL REGISTER**

TEMPOHOUSING

TEMPOHOUSING BV (UNITED KINGDOM PRIVATE LIMITED COMPANY)
WENCKEBACHWEG 3010
AMSTERDAM, NETHERLANDS 1096 DP

THE MARK CONSISTS OF STANDARD CHARACTERS WITHOUT CLAIM TO ANY PARTICULAR FONT, STYLE, SIZE, OR COLOR.

FOR: MANUFACTURED HOUSING IN THE NATURE OF HOMES CONSTRUCTED FROM SHIPPING CONTAINERS FOR HOUSING SOLUTIONS, IN CLASS 19 (U.S. CLS. 1, 12, 33 AND 50).

SN 78-733,084, FILED 10-14-2005.

FIRST USE 12-1-2005; IN COMMERCE 1-1-2006.

DEIRDRE ROBERTSON, EXAMINING ATTORNEY

Int. Cl.: 25

Prior U.S. Cls.: 22 and 39

United States Patent and Trademark Office

Reg. No. 3,577,928

Registered Feb. 17, 2009

**TRADEMARK
PRINCIPAL REGISTER**

BROOKLYN ATHLETIC 1906

BROOKLYN OVERALL LICENSING CORP.
(NEW YORK CORPORATION)
42 WOODS DRIVE
EAST HILL, NY 11576

FOR: A FULL LINE OF CLOTHING, IN CLASS 25
(U.S. CLS. 22 AND 39).

FIRST USE 7-0-2006; IN COMMERCE 7-0-2006.

THE MARK CONSISTS OF STANDARD CHAR-
ACTERS WITHOUT CLAIM TO ANY PARTICULAR
FONT, STYLE, SIZE, OR COLOR.

OWNER OF U.S. REG. NO. 3,245,607.

NO CLAIM IS MADE TO THE EXCLUSIVE
RIGHT TO USE "BROOKLYN ATHLETIC", APART
FROM THE MARK AS SHOWN.

SN 78-737,737, FILED 10-21-2005.

ALICE BENMAMAN, EXAMINING ATTORNEY

Int. Cl.: 41

Prior U.S. Cls.: 100, 101, and 107

United States Patent and Trademark Office

Reg. No. 3,577,929

Registered Feb. 17, 2009

SERVICE MARK
PRINCIPAL REGISTER



GRANT, RON (UNITED STATES INDIVIDUAL)
1119 WELLESLEY
LOS ANGELES, CA 90049 AND
LESKO, MICHAEL (UNITED STATES INDIVIDUAL)
11680 COLUMBIANA-CANFIELD RD.
COLUMBIANA, OH 44408 AND
OVADIA, RON (UNITED STATES INDIVIDUAL)
54 TIDEWIND
IRVINE, CA 92603

THE MARK CONSISTS OF THE WORDING "ASTROTOTS" WHEREIN THE SECOND LETTER "T" IS REPRESENTED BY A CHILD'S TOY, THE SECOND "O" IS REPRESENTED BY A BEACH BALL, THE THIRD LETTER "T" IS REPRESENTED BY AN AIRPLANE AND THE LAST LETTER "S" IS REPRESENTED BY A CRAYON. "ASTROTOTS" IS WITHIN AN OBLONG WHICH FEATURES VARIOUS ROUND CELESTIAL BODIES.

FOR: CHILDREN'S TV SHOW FEATURING ORIGINAL ANIMATION WITH STORIES, MUSIC, AND SONGS ABOUT SPACE EXPLORATION, IN CLASS 41 (U.S. CLS. 100, 101 AND 107).

SN 78-738,530, FILED 10-21-2005.

FIRST USE 6-15-2007; IN COMMERCE 10-17-2007.

MELISSA VALLILLO, EXAMINING ATTORNEY

Int. Cl.: 35

Prior U.S. Cls.: 100, 101, and 102

United States Patent and Trademark Office

Reg. No. 3,577,930

Registered Feb. 17, 2009

**SERVICE MARK
PRINCIPAL REGISTER**

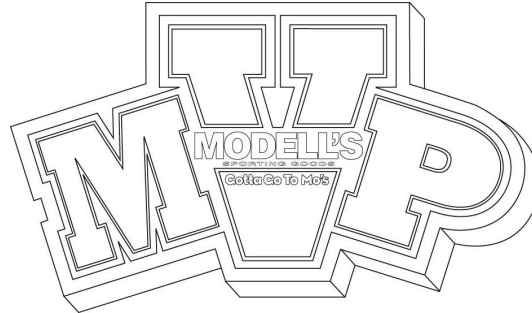

MODELL'S II, INC. (DELAWARE CORPORATION)

498 SEVENTH AVENUE
NEW YORK, NY 10018

FOR: RETAIL STORE SERVICES IN THE FIELDS OF MEN'S, WOMEN'S AND CHILDREN'S SPORTING GOODS, FOOTWEAR AND APPAREL FEATURING A FREQUENT BUYER PLAN FOR INCENTIVE AWARDS, IN CLASS 35 (U.S. CLS. 100, 101 AND 102).

FIRST USE 5-1-2006; IN COMMERCE 5-1-2006.

OWNER OF U.S. REG. NOS. 2,176,220, 2,292,322, AND OTHERS.

NO CLAIM IS MADE TO THE EXCLUSIVE RIGHT TO USE "SPORTING GOODS", APART FROM THE MARK AS SHOWN.

THE MARK CONSISTS OF THE LETTERS "MVP" AND THE WORDS "MODELL'S SPORTING GOODS GOTTA GO TO MO'S".

SN 78-741,064, FILED 10-26-2005.

AMY ALFIERI, EXAMINING ATTORNEY

Int. Cl.: 35

Prior U.S. Cls.: 100, 101, and 102

United States Patent and Trademark Office

Reg. No. 3,577,931

Registered Feb. 17, 2009

**SERVICE MARK
PRINCIPAL REGISTER**

SPRUNG IDEAS

SPRUNG IDEAS, INC. (GEORGIA CORPORATION)
1869 MACFARLAND ROAD
ALPHARETTA, GA 30005

FOR: BUSINESS CONSULTATION AND MANAGEMENT REGARDING MARKETING ACTIVITIES AND LAUNCHING OF NEW PRODUCTS; BUSINESS CONSULTATION SERVICES; PROMOTION AND MARKETING SERVICES AND RELATED CONSULTING, IN CLASS 35 (U.S. CLS. 100, 101 AND 102).

FIRST USE 12-5-2008; IN COMMERCE 12-5-2008.

THE MARK CONSISTS OF STANDARD CHARACTERS WITHOUT CLAIM TO ANY PARTICULAR FONT, STYLE, SIZE, OR COLOR.

NO CLAIM IS MADE TO THE EXCLUSIVE RIGHT TO USE "IDEAS", APART FROM THE MARK AS SHOWN.

SN 78-741,213, FILED 10-26-2005.

SANI KHOURI, EXAMINING ATTORNEY

Int. Cl.: 35

Prior U.S. Cls.: 100, 101, and 102

United States Patent and Trademark Office

Reg. No. 3,577,932

Registered Feb. 17, 2009

**SERVICE MARK
PRINCIPAL REGISTER**

AD-WATER

HOPKINS OUTDOOR ADVERTISING (TEXAS
SOLE PROPRIETORSHIP)
P.O. BOX 25261
DALLAS, TX 75225

FOR: PROMOTING THE GOODS AND SERVICES
OF OTHERS BY PROVIDING SPECIALLY LA-
BELED BOTTLES OF WATER WHICH FEATURE
THE ADVERTISEMENTS AND PROMOTIONS OF
OTHERS, IN CLASS 35 (U.S. CLS. 100, 101 AND 102).

FIRST USE 1-1-2008; IN COMMERCE 7-4-2008.

THE MARK CONSISTS OF STANDARD CHAR-
ACTERS WITHOUT CLAIM TO ANY PARTICULAR
FONT, STYLE, SIZE, OR COLOR.

SN 78-743,720, FILED 10-31-2005.

DAVID C. REIHNER, EXAMINING ATTORNEY

Int. Cl.: 9

Prior U.S. Cls.: 21, 23, 26, 36, and 38

United States Patent and Trademark Office

Reg. No. 3,577,933

Registered Feb. 17, 2009

**TRADEMARK
PRINCIPAL REGISTER**

DISNEY PRINCESS

DISNEY ENTERPRISES, INC. (DELAWARE CORPORATION)
500 SOUTH BUENA VISTA STREET
BURBANK, CA 91521

FOR: AUDIO SPEAKERS; CALCULATORS; CAMCORDERS; FACE PLATES FOR CELLULAR TELEPHONES NOT MADE OF PAPER; CELLULAR TELEPHONE APPARATUSES; COMPUTER KEYBOARDS; COMPUTER MONITORS; COMPUTER MOUSE; PRE-RECORDED DIGITAL VERSATILE DISCS AND DIGITAL VIDEO DISCS FEATURING LIVE ACTION ENTERTAINMENT FOR CHILDREN AND MOTION PICTURE FILMS; ELECTRONIC PERSONAL ORGANIZERS; EYEGLOSS CASES; EYEGASSES; KARAOKE MACHINES; LOUD-SPEAKERS; MOTION PICTURE FILMS IN THE FIELD OF LIVE ACTION AND ANIMATED ENTERTAINMENT FOR CHILDREN; PERSONAL STEREOS; PERSONAL DIGITAL ASSISTANTS;

PRINTERS; RADIOS; TELEPHONE SETS; VIDEO CAMERAS; PRE-RECORDED VIDEO CASSETTES AND PRE-RECORDED VIDEO DISCS, IN THE FILED OF LIVE ACTION VIDEO DISK PLAYERS; WRIST RESTS FOR USE WITH COMPUTERS, IN CLASS 9 (U.S. CLS. 21, 23, 26, 36 AND 38).

FIRST USE 11-18-2008; IN COMMERCE 11-18-2008.

THE MARK CONSISTS OF STANDARD CHARACTERS WITHOUT CLAIM TO ANY PARTICULAR FONT, STYLE, SIZE, OR COLOR.

OWNER OF U.S. REG. NOS. 2,363,784, 3,018,432, AND OTHERS.

SN 78-743,826, FILED 10-31-2005.

FONG HSU, EXAMINING ATTORNEY

Int. Cl.: 9

Prior U.S. Cls.: 21, 23, 26, 36, and 38

United States Patent and Trademark Office

Reg. No. 3,577,934

Registered Feb. 17, 2009

**TRADEMARK
PRINCIPAL REGISTER**

MSTATION ORB

MSTATION CORPORATION (CALIFORNIA CORPORATION)

#123

9040 TELSTAR AVENUE
EL MONTE, CA 91731

FOR: AUDIO SPEAKERS; LOUD SPEAKERS; STEREO SYSTEMS COMPRISED OF AUDIO SPEAKERS, STEREO DRIVERS, SUBWOOFER DRIVERS, STEREO AMPLIFIERS, AND SUBWOOFER AMPLIFIERS INCORPORATING DOCKING STATIONS OR INTERFACES FOR USE WITH AUDIO DEVICES, INCLUDING, PORTABLE AUDIO DEVICES, PERSONAL AUDIO DEVICES ; HOME ENTERTAINMENT SYSTEMS COMPRISED OF AUDIO SPEAKERS INCORPORATING DOCKING STATIONS OR INTERFACES FOR USE WITH AUDIO DEVICES, INCLUDING, PORTABLE AUDIO DEVI-

CES, PERSONAL AUDIO DEVICES, IN CLASS 9 (U.S. CLS. 21, 23, 26, 36 AND 38).

FIRST USE 10-1-2005; IN COMMERCE 10-1-2005.

THE MARK CONSISTS OF STANDARD CHARACTERS WITHOUT CLAIM TO ANY PARTICULAR FONT, STYLE, SIZE, OR COLOR.

NO CLAIM IS MADE TO THE EXCLUSIVE RIGHT TO USE "ORB", APART FROM THE MARK AS SHOWN.

SN 78-747,782, FILED 11-4-2005.

TINA BROWN, EXAMINING ATTORNEY

Int. Cl.: 6

Prior U.S. Cls.: 2, 12, 13, 14, 23, 25, and 50

Reg. No. 3,577,935

United States Patent and Trademark Office

Registered Feb. 17, 2009

**TRADEMARK
PRINCIPAL REGISTER**



STUDCO BUILDING SYSTEMS US, LLC (NEW YORK LIMITED LIABILITY COMPANY)
545 BASKET ROAD
WEBSTER, NY 14580

FOR: DOOR JAMBS OF METAL, IN CLASS 6 (U.S. CLS. 2, 12, 13, 14, 23, 25 AND 50).

FIRST USE 12-31-1998; IN COMMERCE 4-2-2006.

NO CLAIM IS MADE TO THE EXCLUSIVE RIGHT TO USE "JAMB", APART FROM THE MARK AS SHOWN.

THE MARK CONSISTS OF A RECTANGULAR BORDER WITH THE WORDS "EZY JAMB" SET IN THE MIDDLE OF THE BORDER WITH A SIDEWAYS "L" DESIGN THAT IS DIRECTLY UNDER THE WORD "JAMB".

SN 78-748,644, FILED 11-7-2005.

DEIRDRE ROBERTSON, EXAMINING ATTORNEY

Int. Cl.: 16

Prior U.S. Cls.: 2, 5, 22, 23, 29, 37, 38, and 50

United States Patent and Trademark Office

Reg. No. 3,577,936

Registered Feb. 17, 2009

TRADEMARK
PRINCIPAL REGISTER

Speckled Pup



FISH, DEBORAH I (UNITED STATES INDIVIDUAL)
19752 250TH ST. SE
BROOKS, MN 56715

FOR: GREETING CARDS, STATIONERY, IN CLASS 16 (U.S. CLS. 2, 5, 22, 23, 29, 37, 38 AND 50).

FIRST USE 1-1-2007; IN COMMERCE 1-1-2007.

THE COLORS BLACK, DARK RED, WHITE, SIENNA BROWN, PINK, AND OCHRE IS ARE CLAIMED AS A FEATURE OF THE MARK.

THE COLORS WHITE WITH SIENNA BROWN AND BLACK SPLOTCHES APPEAR IN THE BODY, LEGS AND HEAD OF THE DOG. THE TONGUE OF THE DOG IS PINK AND WHITE. THE EYES OF THE DOG ARE OCHRE. ALL LETTERS IN THE WORDS "SPECKLED PUP" HAVE A BLACK OUTLINE OVER A DARK RED FILL.

SN 78-748,958, FILED 11-8-2005.

PRISCILLA MILTON, EXAMINING ATTORNEY

Int. Cl.: 9

Prior U.S. Cls.: 21, 23, 26, 36, and 38

United States Patent and Trademark Office

Reg. No. 3,577,937

Registered Feb. 17, 2009

**TRADEMARK
PRINCIPAL REGISTER**

Dino Bucks

GLOBAL GAMING GROUP, INC. (NEVADA
CORPORATION)
SUITE 14
3035 E. PATRICK LANE
LAS VEGAS, NV 89120

FOR: GAMBLING MACHINES; GAMING EQUIP-
MENT, NAMELY, SLOT MACHINES WITH OR
WITHOUT VIDEO OUTPUT; GAMING MACHINES;
MACHINES FOR PLAYING GAMES OF CHANCE;
SLOT MACHINES, IN CLASS 9 (U.S. CLS. 21, 23, 26, 36
AND 38).

FIRST USE 2-19-2008; IN COMMERCE 2-19-2008.

THE MARK CONSISTS OF STANDARD CHAR-
ACTERS WITHOUT CLAIM TO ANY PARTICULAR
FONT, STYLE, SIZE, OR COLOR.

NO CLAIM IS MADE TO THE EXCLUSIVE
RIGHT TO USE "BUCKS", APART FROM THE
MARK AS SHOWN.

SN 78-749,705, FILED 11-8-2005.

SIMON TENG, EXAMINING ATTORNEY

Int. Cl.: 33

Prior U.S. Cls.: 47 and 49

United States Patent and Trademark Office

Reg. No. 3,577,938

Registered Feb. 17, 2009

**TRADEMARK
PRINCIPAL REGISTER**

РУССКОЕ ЗОЛОТО

"WHITE GOLD" LLC (RUSSIAN FED. OPEN
JOINT-STOCK COMPANY)
KORP. 21A, D. 34, KUTUZOVSKY PROSPEKT
MOSCOW, RUSSIAN FED. 121170

FOR: VODKA OF RUSSIAN ORIGIN, IN CLASS 33
(U.S. CLS. 47 AND 49).

FIRST USE 11-17-2008; IN COMMERCE 11-17-2008.

OWNER OF U.S. REG. NO. 2,801,797.

NO CLAIM IS MADE TO THE EXCLUSIVE
RIGHT TO USE THE NON-LATIN CHARACTERS
THAT MEAN "RUSSIAN", APART FROM THE
MARK AS SHOWN.

THE NON-LATIN CHARACTER(S) IN THE
MARK TRANSLATES INTO "RUSSIAN GOLD".

THE NON-LATIN CHARACTER(S) IN THE
MARK TRANSLITERATES INTO "RUSSKOE ZO-
LOTO".

SN 78-751,313, FILED 11-10-2005.

AMOS T. MATTHEWS, JR., EXAMINING ATTOR-
NEY

Int. Cl.: 40

Prior U.S. Cls.: 100, 103, and 106

United States Patent and Trademark Office

Reg. No. 3,577,939

Registered Feb. 17, 2009

**SERVICE MARK
PRINCIPAL REGISTER**



ALEXANDER, CARLINE M (UNITED STATES INDIVIDUAL)
4125 TIFFIN ST
HOUSTON, TX 77026 AND
MERRITTE, DIANA (UNITED STATES INDIVIDUAL)
1806 HALSTEAD
MISSOURI CITY, TX 77489

FOR: IMPRINTING MESSAGES ON T-SHIRTS, IN CLASS 40 (U.S. CLS. 100, 103 AND 106).

FIRST USE 3-25-2007; IN COMMERCE 3-25-2007.

NO CLAIM IS MADE TO THE EXCLUSIVE RIGHT TO USE THE PICTORIAL REPRESENTATION OF THE UNITED STATES, APART FROM THE MARK AS SHOWN.

THE COLOR(S) GREEN, BLACK, RED, YELLOW AND GRAY ARE IS/ARE CLAIMED AS A FEATURE OF THE MARK.

THE MARK CONSISTS OF THE COLOR GREEN APPEARS ON THE LEFT SIDE OF THE MAP. THE COLOR BLACK APPEARS IN THE CENTER OF THE MAP AND THE COLOR RED APPEARS ON THE RIGHT SIDE OF THE MAP. THE LETTERS COMPRISING THE TERM "WEEZ FREE" APPEAR IN YELLOW WITH A RED OUTLINE. EACH OF THE LETTERS SEPARATELY CAST ITSELF AS A GRAY BACKGROUND SHADOW.

SN 78-751,786, FILED 11-10-2005.

RUSS HERMAN, EXAMINING ATTORNEY

Int. Cl.: 35

Prior U.S. Cls.: 100, 101, and 102

United States Patent and Trademark Office

Reg. No. 3,577,940

Registered Feb. 17, 2009

SERVICE MARK
PRINCIPAL REGISTER



NBA PROPERTIES, INC. (NEW YORK CORPORATION)
OLYMPIC TOWER-645 FIFTH AVENUE
NEW YORK, NY 10022

FOR: RETAIL STORE SERVICES, COMPUTERIZED ON-LINE RETAIL STORE SERVICES, ONLINE ORDERING SERVICES, ELECTRONIC RETAILING SERVICES VIA COMPUTER, ELECTRONIC MAIL ORDER CATALOG SERVICES ALL FEATURING AN ARRAY OF BASKETBALL-THEMED MERCHANDISE; PROMOTING THE GOODS AND SERVICES OF OTHERS BY ALLOWING SPONSORS TO AFFILIATE THESE GOODS AND SERVICES WITH A BASKETBALL PROGRAM; PROMOTING THE SALE OF GOODS AND SERVICES OF OTHERS THROUGH THE DISTRIBUTION OF PROMOTIONAL CONTESTS PROVIDED OVER THE INTERNET; CONDUCTING PUBLIC OPINION POLL SURVEYS AND PUBLIC OPINION POLL SURVEYS IN THE FIELD OF BASKETBALL FOR NON-BUSINESS, NON-MARKETING PURPOSES OVER THE INTER-

NET; CHARITABLE SERVICES, NAMELY, ORGANIZING AND CONDUCTING VOLUNTEER PROGRAMS AND COMMUNITY SERVICE PROJECTS; PROMOTING PUBLIC AWARENESS OF THE NEED FOR EDUCATION, CHARITABLE GIVING, AND COMMUNITY SERVICE, IN CLASS 35 (U.S. CLS. 100, 101 AND 102).

FIRST USE 1-31-2006; IN COMMERCE 1-31-2006.

OWNER OF U.S. REG. NOS. 1,703,656 AND 2,239,294.

THE MARK CONSISTS OF A REPRESENTATION OF A GLOBE AND A BASKETBALL WITH A HEART ALONG SIDE THE "NBA" LOGO CONSISTING OF A BASKETBALL PLAYER SILHOUETTE.

SN 78-752,123, FILED 11-11-2005.

ALICIA COLLINS, EXAMINING ATTORNEY

Int. Cl.: 12

Prior U.S. Cls.: 19, 21, 23, 31, 35, and 44

Reg. No. 3,577,941

United States Patent and Trademark Office

Registered Feb. 17, 2009

**TRADEMARK
PRINCIPAL REGISTER**

RACEWRAP

GOODYEAR TIRE & RUBBER COMPANY, THE
(OHIO CORPORATION)
IP LAW DEPARTMENT
1144 EAST MARKET STREET
AKRON, OH 443160001

THE MARK CONSISTS OF STANDARD CHAR-
ACTERS WITHOUT CLAIM TO ANY PARTICULAR
FONT, STYLE, SIZE, OR COLOR.

FOR: PLY SOLD AS AN INTEGRAL COMPO-
NENT OF TIRES, IN CLASS 12 (U.S. CLS. 19, 21, 23, 31,
35 AND 44).

SN 78-754,473, FILED 11-15-2005.

FIRST USE 6-10-2003; IN COMMERCE 6-10-2003.

ASMAT KHAN, EXAMINING ATTORNEY

Int. Cl.: 9

Prior U.S. Cls.: 21, 23, 26, 36, and 38

United States Patent and Trademark Office

Reg. No. 3,577,942

Registered Feb. 17, 2009

**TRADEMARK
PRINCIPAL REGISTER**

CYBERWORKBENCH

NIPPON DENKI KABUSHIKI KAISHA (JAPAN CORPORATION), DBA NEC CORPORATION, 7-1, SHIBA 5-CHOME MINATO-KU TOKYO, JAPAN

FOR: COMPUTER AIDED DESIGN (CAD) SOFTWARE FOR DESIGNING INTEGRATED CIRCUITS; COMPUTER SOFTWARE FOR MODELING AND IMPLEMENTING HARDWARE AND SOFTWARE COMPONENTS IN THE FIELD OF ELECTRONIC ENGINEERING, ELECTRONIC DESIGN AUTOMATION, AND INTEGRATED CIRCUIT DESIGN, IN CLASS 9 (U.S. CLS. 21, 23, 26, 36 AND 38).

FIRST USE 6-8-2008; IN COMMERCE 6-8-2008.

THE MARK CONSISTS OF STANDARD CHARACTERS WITHOUT CLAIM TO ANY PARTICULAR FONT, STYLE, SIZE, OR COLOR.

SN 78-754,888, FILED 11-16-2005.

CURTIS FRENCH, EXAMINING ATTORNEY

Int. Cl.: 25

Prior U.S. Cls.: 22 and 39

United States Patent and Trademark Office

Reg. No. 3,577,943

Registered Feb. 17, 2009

**TRADEMARK
PRINCIPAL REGISTER**

Foxy Boxy

ST.CLAIR, WILLIAM BEAR (UNITED STATES
INDIVIDUAL)
738 W 17TH ST. SUITE F
COSTA MEASA, CA 926274340

THE MARK CONSISTS OF STANDARD CHAR-
ACTERS WITHOUT CLAIM TO ANY PARTICULAR
FONT, STYLE, SIZE, OR COLOR.

FOR: SHIRTS, IN CLASS 25 (U.S. CLS. 22 AND 39).

SN 78-756,903, FILED 11-18-2005.

FIRST USE 7-0-2004; IN COMMERCE 7-0-2004.

JILL C. ALT, EXAMINING ATTORNEY

Int. Cl.: 36

Prior U.S. Cls.: 100, 101, and 102

United States Patent and Trademark Office

Reg. No. 3,577,944

Registered Feb. 17, 2009

**SERVICE MARK
PRINCIPAL REGISTER**

Animal Real Estate Services

PACIFIC LIBERTY ENTERPRISES, LLC (CALIFORNIA CORPORATION)
C/O MICHAEL FANNING
4047 CANFIELD ROAD
SEBASOPOL, CA 95472

FOR: APPRAISAL OF REAL ESTATE; ASSESSMENT AND MANAGEMENT OF REAL ESTATE; FINANCIAL INVESTMENT IN THE FIELD OF COMMERCIAL AND RESIDENTIAL REAL ESTATE; LAND ACQUISITION, NAMELY, REAL ESTATE BROKERAGE; LEASING OF REAL ESTATE; OPERATING MARKETPLACES FOR SELLERS OF GOODS AND/OR SERVICES ; PROVIDING INFORMATION IN THE FIELD OF REAL ESTATE BY MEANS OF LINKING THE WEB SITE TO OTHER WEB SITES FEATURING REAL ESTATE INFORMATION; REAL ESTATE ACQUISITION SERVICES; REAL ESTATE APPRAISAL; REAL ESTATE BROKERAGE; REAL ESTATE CONSULTATION; REAL ESTATE EQUITY SHARING, NAMELY, MANAGING AND ARRANGING FOR CO-OWNERSHIP OF REAL ESTATE; REAL ESTATE ESCROW

SERVICES; REAL ESTATE INVESTMENT; REAL ESTATE LISTING; REAL ESTATE MANAGEMENT; REAL ESTATE MANAGEMENT CONSULTATION; REAL ESTATE PROCUREMENT FOR OTHERS; REAL ESTATE TRUSTEE SERVICES; REAL ESTATE VALUATION SERVICES; REAL ESTATE VALUATIONS, IN CLASS 36 (U.S. CLS. 100, 101 AND 102).

FIRST USE 11-24-2008; IN COMMERCE 11-24-2008.

THE MARK CONSISTS OF STANDARD CHARACTERS WITHOUT CLAIM TO ANY PARTICULAR FONT, STYLE, SIZE, OR COLOR.

NO CLAIM IS MADE TO THE EXCLUSIVE RIGHT TO USE "REAL ESTATE SERVICES", APART FROM THE MARK AS SHOWN.

SN 78-757,506, FILED 11-18-2005.

SOPHIA S. KIM, EXAMINING ATTORNEY

Int. Cls.: 1, 29, 30, and 31

Prior U.S. Cls.: 1, 5, 6, 10, 26, and 46

United States Patent and Trademark Office

Reg. No. 3,577,945

Registered Feb. 17, 2009

**TRADEMARK
PRINCIPAL REGISTER**

SUNOPTA

SUNOPTA, INC. (CANADA CORPORATION)
2838 BOVAIRD DRIVE WEST
NORVAL, ONTARIO, CANADA L7A 0H2

FOR: STABILIZERS FOR FOOD COMPRISED OF
FOOD STARCHES, EDIBLE GUMS AND HYDRO-
COLLOIDS, IN CLASS 1 (U.S. CLS. 1, 5, 6, 10, 26 AND
46).

FIRST USE 11-26-2008; IN COMMERCE 11-26-2008.

FOR: NATURAL, ORGANIC, KOSHER, SPECIAL-
TY AND CONVENTIONAL FOOD PRODUCTS AND
INGREDIENTS, NAMELY, FROZEN FRUITS,
NAMELY, FROZEN STRAWBERRIES AND FRO-
ZEN BLUEBERRIES; FRUIT BASED ORGANIC
FOOD BARS; ORGANIC FRUITS, NAMELY, FRO-
ZEN BLUEBERRIES; PROCESSED PACKAGED
EDAMAME; PROCESSED NATURAL AND OR-
GANIC SOY FIBERS AND OKRA FIBERS USED

AS AN INGREDIENT FOR MAKING OTHER
FOODS, IN CLASS 29 (U.S. CL. 46).

FIRST USE 4-30-2006; IN COMMERCE 4-30-2006.

FOR: DRY HONEY, IN CLASS 30 (U.S. CL. 46).

FIRST USE 5-31-2007; IN COMMERCE 5-31-2007.

FOR: UNPROCESSED GRAINS, IN CLASS 31 (U.S.
CLS. 1 AND 46).

FIRST USE 11-30-2004; IN COMMERCE 11-30-2004.

THE MARK CONSISTS OF STANDARD CHAR-
ACTERS WITHOUT CLAIM TO ANY PARTICULAR
FONT, STYLE, SIZE, OR COLOR.

SN 78-761,608, FILED 11-28-2005.

JOHN GARTNER, EXAMINING ATTORNEY

Int. Cls.: 4, 7, 11, and 40

Prior U.S. Cls.: 1, 6, 13, 15, 19, 21, 23, 31, 34, 35, 100, 103, and 106

Reg. No. 3,577,946

United States Patent and Trademark Office

Registered Feb. 17, 2009

**TRADEMARK
SERVICE MARK
PRINCIPAL REGISTER**

VIRENT

VIRENT ENERGY SYSTEMS, INC. (DELAWARE CORPORATION)
3571 ANDERSON STREET
MADISON, WI 53704

FOR: FUELS, IN CLASS 4 (U.S. CLS. 1, 6 AND 15).

FIRST USE 12-22-2004; IN COMMERCE 12-22-2004.

FOR: AUXILIARY POWER UNITS FOR SUPPLYING ELECTRICAL POWER TO HEAT AND POWER GENERATORS; POWER UNITS FOR SUPPLYING ELECTRICAL POWER, NAMELY, INTERNAL COMBUSTION ENGINES FOR POWER GENERATION, IN CLASS 7 (U.S. CLS. 13, 19, 21, 23, 31, 34 AND 35).

FIRST USE 12-22-2004; IN COMMERCE 12-22-2004.

FOR: HYDROGEN GENERATORS, IN CLASS 11 (U.S. CLS. 13, 21, 23, 31 AND 34).

FIRST USE 12-22-2004; IN COMMERCE 12-22-2004.

FOR: GENERATION OF POWER; PRODUCTION OF ENERGY; AND GAS PRODUCTION SERVICES, IN CLASS 40 (U.S. CLS. 100, 103 AND 106).

FIRST USE 12-21-2005; IN COMMERCE 12-21-2005.

THE MARK CONSISTS OF STANDARD CHARACTERS WITHOUT CLAIM TO ANY PARTICULAR FONT, STYLE, SIZE, OR COLOR.

THE WORDING "VIRENT" HAS NO MEANING IN A FOREIGN LANGUAGE.

SN 78-762,189, FILED 11-29-2005.

MAUREEN DALL, EXAMINING ATTORNEY

Int. Cls.: 16, 18, 25, 26, 35, and 41

Prior U.S. Cls.: 1, 2, 3, 5, 22, 23, 29, 37, 38, 39, 40, 41, 42, 50, 100, 101, 102, and 107

Reg. No. 3,577,947

United States Patent and Trademark Office

Registered Feb. 17, 2009

**TRADEMARK
SERVICE MARK
PRINCIPAL REGISTER**

**ASAE & THE CENTER FOR
ASSOCIATION LEADERSHIP**

AMERICAN SOCIETY OF ASSOCIATION EXECUTIVES (D.C. CORPORATION)
1575 EYE STREET, N.W., SUITE 1200
WASHINGTON, DC 20005 AND
THE CENTER FOR ASSOCIATION LEADERSHIP
(D.C. NON-PROFIT CORPORATION)
1300 PENNSYLVANIA AVE., N.W.
RONALD REAGAN BUILDING & INTERNATIONAL TRADE CENTER
WASHINGTON, DC 20004

FOR: PRINTED MATERIALS, NAMELY, NEWSLETTERS, MAGAZINES, BROCHURES, AND FLYERS FEATURING INFORMATION FOR ASSOCIATION EXECUTIVES; SERIES OF NON-FICTION BOOKS FEATURING INFORMATION FOR ASSOCIATION EXECUTIVES; PENS; PENCILS; HIGHLIGHTERS; BUSINESS CARDS; BINDERS; FOLDERS; STATIONERY; NOTEBOOKS; NOTE PADS; AND DAILY PLANNERS, IN CLASS 16 (U.S. CLS. 2, 5, 22, 23, 29, 37, 38 AND 50).

FIRST USE 8-14-2005; IN COMMERCE 8-14-2005.

FOR: UMBRELLAS, IN CLASS 18 (U.S. CLS. 1, 2, 3, 22 AND 41).

FIRST USE 8-14-2005; IN COMMERCE 8-14-2005.

FOR: CLOTHING, NAMELY, SHIRTS, T-SHIRTS, BLOUSES, SWEATERS, JACKETS, HATS, VISORS, AND SWEATSHIRTS, IN CLASS 25 (U.S. CLS. 22 AND 39).

FIRST USE 8-14-2005; IN COMMERCE 8-14-2005.

FOR: NOVELTY BUTTONS, IN CLASS 26 (U.S. CLS. 37, 39, 40, 42 AND 50).

FIRST USE 8-14-2005; IN COMMERCE 8-14-2005.

FOR: PROVIDING BUSINESS INFORMATION TO ASSOCIATION EXECUTIVES BY MEANS OF A WEB SITE; ASSOCIATION SERVICES, NAMELY, PROMOTING THE INTERESTS OF ASSOCIATION EXECUTIVES, IN CLASS 35 (U.S. CLS. 100, 101 AND 102).

FIRST USE 8-14-2005; IN COMMERCE 8-14-2005.

FOR: EDUCATION SERVICES, NAMELY, PROVIDING IN-PERSON AND ONLINE CLASSES, SEMINARS, AND LECTURES FOR ASSOCIATION EXECUTIVES AND DISTRIBUTING COURSE MATERIALS IN CONNECTION THEREWITH, IN CLASS 41 (U.S. CLS. 100, 101 AND 107).

FIRST USE 8-14-2005; IN COMMERCE 8-14-2005.

THE MARK CONSISTS OF STANDARD CHARACTERS WITHOUT CLAIM TO ANY PARTICULAR FONT, STYLE, SIZE, OR COLOR.

NO CLAIM IS MADE TO THE EXCLUSIVE RIGHT TO USE "ASSOCIATION LEADERSHIP" AS TO THE GOODS IN CLASS 16 AND "THE CENTER FOR ASSOCIATION LEADERSHIP" AS TO THE SERVICES IN CLASSES 35 AND 41, APART FROM THE MARK AS SHOWN.

SN 78-762,744, FILED 11-29-2005.

YONG KIM, EXAMINING ATTORNEY

Int. Cl.: 41

Prior U.S. Cls.: 100, 101, and 107

United States Patent and Trademark Office

Reg. No. 3,577,948

Registered Feb. 17, 2009

**SERVICE MARK
PRINCIPAL REGISTER**

COMEDY CENTRAL MOTHERLOAD

COMEDY PARTNERS (NEW YORK PARTNER-
SHIP)
1515 BROADWAY
NEW YORK, NY 10036

FOR: ENTERTAINMENT SERVICES, NAMELY,
PROVIDING VIDEO AND AUDIO CONTENT AND
TELEVISION PROGRAMS IN THE FIELD OF NEWS,
COMEDY AND DRAMA; LIVE MUSICAL CON-
CERTS; TELEVISION NEWS SHOWS; PROVIDING
INFORMATION IN THE FIELD OF TELEVISION
PROGRAMS; DANCE SHOWS, MUSIC SHOWS AND
VIDEO AWARD SHOWS; COMEDY SHOWS, GAME
SHOWS BEFORE LIVE AUDIENCES WHICH ARE
BROADCAST LIVE OR TAPED FOR LATER
BROADCAST; LIVE MUSICAL CONCERTS AND
TELEVISION NEWS SHOWS VIA A GLOBAL COM-
PUTER NETWORK, IN CLASS 41 (U.S. CLS. 100, 101
AND 107).

FIRST USE 10-25-2005; IN COMMERCE 10-25-2005.

THE MARK CONSISTS OF STANDARD CHAR-
ACTERS WITHOUT CLAIM TO ANY PARTICULAR
FONT, STYLE, SIZE, OR COLOR.

OWNER OF U.S. REG. NOS. 1,741,737, 2,136,025,
AND OTHERS.

NO CLAIM IS MADE TO THE EXCLUSIVE
RIGHT TO USE "COMEDY", APART FROM THE
MARK AS SHOWN.

SN 78-767,734, FILED 12-6-2005.

VIVIAN MICZNIK FIRST, EXAMINING ATTOR-
NEY

Int. Cl.: 33

Prior U.S. Cls.: 47 and 49

United States Patent and Trademark Office

Reg. No. 3,577,949

Registered Feb. 17, 2009

TRADEMARK
PRINCIPAL REGISTER



TEQUILA GALINDO, S.A. DE C.V. (MEXICO CORPORATION)
PRESA DEBARAJAS 4D ARANDAS KM 1 CRUCERO
ARANDAS-ATOTONILCO;
ARANDAS, MEXICO 47180

FOR: ALCOHOLIC BEVERAGES, NAMELY, TEQUILA, IN CLASS 33 (U.S. CLS. 47 AND 49).

FIRST USE 12-13-2005; IN COMMERCE 12-13-2005.

THE COLOR(S) BROWN, ORANGE, WHITE, BLACK, AND GREEN OLIVE IS/ARE CLAIMED AS A FEATURE OF THE MARK.

"THE MARK CONSISTS OF AN OVAL WITH A HORSESHOE SHAPE WITH THE OUTLINE IN

ORANGE, AND IN THE INSIDE IS SHADOWED WITH BROWN, BLACK AND GREEN OLIVE COLORS. INSIDE THE HORSESHOE SHAPE OR OVAL, IN THE SUPERIOR PART, THERE IS A SHIELD WITH THE SURROUNDING IN ORANGE COLOR, AND IN THE CENTER YOU CAN SEE AN AGAVE PLANT IN ORANGE COLOR TOO. OVER THE AGAVE PLANT, THERE IS A SIGN WITH RIBBON SHAPE IN ORANGE COLOR. IN THE MIDDLE OF THE OVAL, IT IS WRITTEN THE WORD "GALINDO" IN BLACK WITH OUTLINE IN BROWN AND GREEN OLIVE. IN THE LOWER PART OF THE OVAL, THERE ARE SIX CURVED LINES IN GREEN OLIVE COLOR."

SN 78-768,379, FILED 12-7-2005.

PRISCILLA MILTON, EXAMINING ATTORNEY

Int. Cl.: 3

Prior U.S. Cls.: 1, 4, 6, 50, 51, and 52

United States Patent and Trademark Office

Reg. No. 3,577,950

Registered Feb. 17, 2009

**TRADEMARK
PRINCIPAL REGISTER**

PINALEN BY PINOL

INDUSTRIAS ALEN, S.A. DE C.V. (MEXICO
CORPORATION)
BLVD. DIAZ ORDAZ NO. 1000
COL. LOS TREVINO
SANTA CATARINA, N.L., MEXICO CP 66350

FOR: LIQUID CLEANING PREPARATIONS FOR
HOUSEHOLD USE, IN CLASS 3 (U.S. CLS. 1, 4, 6, 50,
51 AND 52).

FIRST USE 3-24-2008; IN COMMERCE 3-24-2008.

THE MARK CONSISTS OF STANDARD CHAR-
ACTERS WITHOUT CLAIM TO ANY PARTICULAR
FONT, STYLE, SIZE, OR COLOR.

OWNER OF U.S. REG. NO. 1,506,745.

SN 78-771,013, FILED 12-12-2005.

ODESSA BIBBINS, EXAMINING ATTORNEY

Int. Cl.: 22

Prior U.S. Cls.: 1, 2, 7, 19, 22, 42, and 50

Reg. No. 3,577,951

United States Patent and Trademark Office

Registered Feb. 17, 2009

**TRADEMARK
PRINCIPAL REGISTER**

EZCARRY

FLOPPY PRODUCTS, INC. (ARIZONA CORPORATION)
7440 S PRIEST DRIVE
TEMPE, AZ 85283

THE MARK CONSISTS OF STANDARD CHARACTERS WITHOUT CLAIM TO ANY PARTICULAR FONT, STYLE, SIZE, OR COLOR.

FOR: UNFITTED SHOPPING CART COVERS TO PREVENT CHILDREN FROM CONTACTING SHOPPING CART SURFACES, IN CLASS 22 (U.S. CLS. 1, 2, 7, 19, 22, 42 AND 50).

SN 78-771,501, FILED 12-12-2005.

FIRST USE 6-1-2008; IN COMMERCE 6-1-2008.

JASON LOTT, EXAMINING ATTORNEY

Int. Cl.: 9

Prior U.S. Cls.: 21, 23, 26, 36, and 38

Reg. No. 3,577,952

United States Patent and Trademark Office

Registered Feb. 17, 2009

**TRADEMARK
PRINCIPAL REGISTER**

ZAKLAND

ZAK MORGAN ENTERTAINMENT GROUP, LLC
(CALIFORNIA CORPORATION)
10752 ACAMA STREET
NORTH HOLLYWOOD, CA 91602

THE MARK CONSISTS OF STANDARD CHARACTERS WITHOUT CLAIM TO ANY PARTICULAR FONT, STYLE, SIZE, OR COLOR.

FOR: PRERECORDED DVDS AND PRERECORDED CDS, ALL FEATURING MUSIC, IN CLASS 9 (U.S. CLS. 21, 23, 26, 36 AND 38).

SN 78-773,745, FILED 12-14-2005.

FIRST USE 7-0-2007; IN COMMERCE 5-22-2008.

RUDY R. SINGLETON, EXAMINING ATTORNEY

Int. Cl.: 41

Prior U.S. Cls.: 100, 101, and 107

United States Patent and Trademark Office

Reg. No. 3,577,953

Registered Feb. 17, 2009

**SERVICE MARK
PRINCIPAL REGISTER**

GARMENTO

FRANKEL, HEYWOOD (UNITED STATES INDIVIDUAL)
2185 LEMOINE AVE
NYHEYLA@AOL.COM
FORT LEE, NJ 07024

THE MARK CONSISTS OF STANDARD CHARACTERS WITHOUT CLAIM TO ANY PARTICULAR FONT, STYLE, SIZE, OR COLOR.

FOR: PUBLICATION OF TRADE MAGAZINES, JOURNALS, IN THE FIELD OF FASHION, IN CLASS 41 (U.S. CLS. 100, 101 AND 107).

SN 78-774,384, FILED 12-15-2005.

FIRST USE 9-15-2007; IN COMMERCE 10-28-2008.

JEFFREY LOOK, EXAMINING ATTORNEY

Int. Cl.: 3

Prior U.S. Cls.: 1, 4, 6, 50, 51, and 52

United States Patent and Trademark Office

Reg. No. 3,577,954

Registered Feb. 17, 2009

TRADEMARK
PRINCIPAL REGISTER

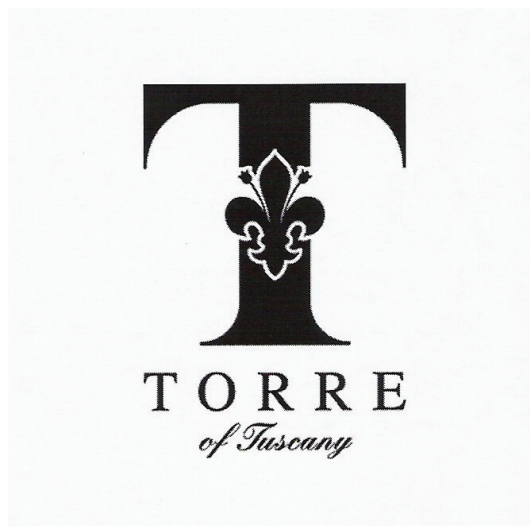

VINCENZO TORRE (ITALY INDIVIDUAL)
VIA LUCCA 13
RONCHI, ITALY I-54039

FIRST USE 12-0-2005; IN COMMERCE 7-0-2008.

FOR: SKIN SOAPS; PERFUMERY; ESSENTIAL OILS; COSMETICS, NAMELY, LIPSTICKS, LIP GLOSSES, MAKEUP POWDER, SKIN CREAMS, SKIN LOTIONS, BLUSHERS, MASCARA, EYELINER, EYE SHADOW, EYE PENCILS, SKIN MOISTURIZING CREAMS, NON-MEDICATED SKIN CLEANSING PREPARATIONS, NAIL POLISH, NAIL VARNISH, BATH SALTS, DEODORANTS FOR PERSONAL USE AND ANTIPERSPIRANTS, HAIR LOTIONS; DENTRIFICES, IN CLASS 3 (U.S. CLS. 1, 4, 6, 50, 51 AND 52).

NO CLAIM IS MADE TO THE EXCLUSIVE RIGHT TO USE "OF TUSCANY", APART FROM THE MARK AS SHOWN.

THE FOREIGN WORDING IN THE MARK TRANSLATES INTO ENGLISH AS TOWER.

SN 78-775,863, FILED 12-19-2005.

MARY BOAGNI, EXAMINING ATTORNEY

Int. Cl.: 3

Prior U.S. Cls.: 1, 4, 6, 50, 51, and 52

Reg. No. 3,577,955

United States Patent and Trademark Office

Registered Feb. 17, 2009

**TRADEMARK
PRINCIPAL REGISTER**

GLOVON

GLANBIA PLC (IRELAND PUBLIC LIMITED
COMPANY)
GLANBIA HOUSE
KILKENNY, IRELAND

FOR: PERSONAL HYGIENE AND BODY CARE
PRODUCTS, NAMELY, BODY WASHES, SHOWER
AND BATH GELS, SHAMPOOS, SOAPS FOR PER-
SONAL USE, HAIR CONDITIONERS, SKIN
CLEANSERS, SKIN TONERS, SKIN MOISTURI-
ZERS; ORAL HYGIENE PRODUCTS IN THE NAT-
URE OF DENTIFRICES, DENTIFRICES IN THE
FORM OF GUMS, NON-MEDICATED MOUTH WA-
SHES AND TOOTHPASTES, IN CLASS 3 (U.S. CLS. 1,
4, 6, 50, 51 AND 52).

FIRST USE 4-30-2008; IN COMMERCE 4-30-2008.

THE MARK CONSISTS OF STANDARD CHAR-
ACTERS WITHOUT CLAIM TO ANY PARTICULAR
FONT, STYLE, SIZE, OR COLOR.

PRIORITY CLAIMED UNDER SEC. 44(D) ON
ERPNTY TM OFC APPLICATION NO.
004791943, FILED 12-19-2005, REG. NO. 004791943,
DATED 1-29-2007, EXPIRES 12-19-2015.

THE MARK "GLOVON" HAS NO MEANING IN A
FOREIGN LANGUAGE.

SN 78-779,218, FILED 12-22-2005.

SUSAN RICHARDS, EXAMINING ATTORNEY

Int. Cl.: 16

Prior U.S. Cls.: 2, 5, 22, 23, 29, 37, 38, and 50

Reg. No. 3,577,956

United States Patent and Trademark Office

Registered Feb. 17, 2009

TRADEMARK
PRINCIPAL REGISTER



LAS VEGAS SANDS CORP. (NEVADA CORPORATION)
3355 LAS VEGAS BLVD, SOUTH
LAS VEGAS, NV 89109

FOR: PUBLICATIONS, NAMELY, BROCHURES AND BOOKLETS IN THE FIELD OF HOTEL AND CASINO ACCOMMODATIONS, STATIONERY, PRINTED VISUALS IN THE NATURE OF PROMOTIONAL MATERIALS, PENS, PAPER NAPKINS, NOTE PAPER, , LOOSE LEAF PAPER, LOOSE LEAF PADS, IN CLASS 16 (U.S. CLS. 2, 5, 22, 23, 29, 37, 38 AND 50).

FIRST USE 1-11-2008; IN COMMERCE 1-11-2008.

OWNER OF U.S. REG. NOS. 2,999,279 AND 2,999,280.

THE MARK CONSISTS OF CHINESE CHARACTERS IN A VERTICAL STYLIZED OVAL DESIGN, WHICH IS ON TOP OF THE STYLIZED LITERAL ELEMENT "PAIZA".

THE NON-LATIN CHARACTERS IN THE MARK TRANSLATE TO "U BEEN" IN CANTONESE AND "UR BEN" IN MANDARIN. THIS MEANS "ROYAL PLAQUE" IN ENGLISH.

SN 78-783,222, FILED 12-30-2005.

BILL DAWE, EXAMINING ATTORNEY

Int. Cl.: 36

Prior U.S. Cls.: 100, 101, and 102

United States Patent and Trademark Office

Reg. No. 3,577,957

Registered Feb. 17, 2009

**SERVICE MARK
PRINCIPAL REGISTER**

CREEKSIDE MORTGAGE

PREMIER MORTGAGE FUNDING, INC. (OHIO CORPORATION), DBA CREEKSIDE MORTGAGE,
725 BOARDMAN-CANFIELD ROAD
SUITE 2 BUILDING L
BOARDMAN, OH 44512

FOR: MORTGAGE BROKERAGE AND REAL ESTATE BROKERAGE, IN CLASS 36 (U.S. CLS. 100, 101 AND 102).

FIRST USE 12-5-2006; IN COMMERCE 12-5-2006.

THE MARK CONSISTS OF STANDARD CHARACTERS WITHOUT CLAIM TO ANY PARTICULAR FONT, STYLE, SIZE, OR COLOR.

NO CLAIM IS MADE TO THE EXCLUSIVE RIGHT TO USE "MORTGAGE", APART FROM THE MARK AS SHOWN.

SN 78-784,691, FILED 1-4-2006.

MICHAEL WEBSTER, EXAMINING ATTORNEY

Int. Cls.: 9 and 42

Prior U.S. Cls.: 21, 23, 26, 36, 38, 100, and 101

United States Patent and Trademark Office

Reg. No. 3,577,958

Registered Feb. 17, 2009

**TRADEMARK
SERVICE MARK
PRINCIPAL REGISTER**

PORTAONE

PORTAONE, INC. (CANADA CORPORATION)
SUITE 400, 2963 GLEN DRIVE
WESTWOOD CORPORATE CENTRE
COQUITLAM, CANADA V3B 2P7

FOR: COMPUTER SOFTWARE FOR USE IN COMMUNICATIONS NETWORKS FOR MANAGING VOICE, DATA AND FAX TRAFFIC; COMPUTER SOFTWARE FOR SUBSCRIBER MANAGEMENT IN COMMUNICATIONS NETWORKS; COMPUTER SOFTWARE FOR PROVIDING TELEPHONY SERVICES ON BROADBAND INFRASTRUCTURES; COMPUTER SOFTWARE FOR USE IN COMMUNICATIONS NETWORKS FOR CALL CONTROL, NAMELY, PROVIDING CALL ROUTING TO SMALL AND LARGE PACKET VOICE NETWORKS; COMPUTER SOFTWARE FOR PROVIDING VOICE SERVICES FOR BROADBAND INFRASTRUCTURES; COMPUTER SOFTWARE FOR BUILDING VOIP NETWORKS; COMPUTER SOFTWARE FOR USE IN COMMUNICATIONS NETWORKS FOR CUSTOMER MANAGEMENT AND BILLING PLATFORMS FOR IMMEDIATE LAUNCHING, PRICING AND PROVISIONING OF PREPAID, POSTPAID AND WHOLESALE VOIP SERVICES, IN CLASS 9 (U.S. CLS. 21, 23, 26, 36 AND 38).

FIRST USE 4-30-2002; IN COMMERCE 4-30-2002.

FOR: COMPUTER SERVICES IN THE FIELD OF COMMUNICATIONS, NAMELY, CONSULTING SERVICES IN THE FIELD OF DESIGN, SELECTION,

IMPLEMENTATION AND USE OF COMPUTER HARDWARE AND SOFTWARE, COMPUTER PROGRAMMING FOR OTHERS, OPERATION AND MANAGEMENT OF COMPUTER RESOURCES FOR OTHERS, NAMELY, REMOTE MANAGEMENT OF MULTIMEDIA COMMUNICATION SYSTEMS AND APPLICATIONS FOR OTHERS, AND SOFTWARE DESIGN FOR OTHERS, ACTING AS AN APPLICATION SERVICES PROVIDER IN THE FIELD OF KNOWLEDGE MANAGEMENT TO HOST COMPUTER APPLICATION SOFTWARE FOR MANAGING VOICE, DATA AND FAX TRAFFIC, FOR CUSTOMER MANAGEMENT AND BILLING PLATFORMS FOR LAUNCHING, PRICING AND PROVISIONING OF PREPAID, POSTPAID AND WHOLESALE VOIP SERVICES; AND FOR CALL CONTROL VIA LOCAL, WIDE AREA AND GLOBAL COMMUNICATIONS NETWORKS, IN CLASS 42 (U.S. CLS. 100 AND 101).

FIRST USE 4-30-2002; IN COMMERCE 4-30-2002.

THE MARK CONSISTS OF STANDARD CHARACTERS WITHOUT CLAIM TO ANY PARTICULAR FONT, STYLE, SIZE, OR COLOR.

PRIORITY CLAIMED UNDER SEC. 44(D) ON CANADA APPLICATION NO. 1267533, FILED 8-5-2005.

SN 78-787,863, FILED 1-9-2006.

SUSAN RICHARDS, EXAMINING ATTORNEY

Int. Cl.: 20

Prior U.S. Cls.: 2, 13, 22, 25, 32, and 50

Reg. No. 3,577,959

United States Patent and Trademark Office

Registered Feb. 17, 2009

**TRADEMARK
PRINCIPAL REGISTER**

DA VINCI

KRUEGER INTERNATIONAL, INC. (WISCONSIN CORPORATION)
1330 BELLEVUE STREET
GREEN BAY, WI 54302

FOR: OFFICE AND INSTITUTIONAL FURNITURE, NAMELY, DESKS, TABLES, MODESTY PANELS, WORK SURFACES, TRANSACTION SURFACES, CREDENZAS, HUTCHES, SHELVING AND STORAGE UNITS, BOOKCASES, WARDROBES, PEDESTALS, AND LATERAL FILES, IN CLASS 20 (U.S. CLS. 2, 13, 22, 25, 32 AND 50).

FIRST USE 5-15-2006; IN COMMERCE 5-15-2006.

THE MARK CONSISTS OF STANDARD CHARACTERS WITHOUT CLAIM TO ANY PARTICULAR FONT, STYLE, SIZE, OR COLOR.

SN 78-790,528, FILED 1-12-2006.

MICHAEL ENGEL, EXAMINING ATTORNEY

Int. Cl.: 41

Prior U.S. Cls.: 100, 101, and 107

United States Patent and Trademark Office

Reg. No. 3,577,960

Registered Feb. 17, 2009

**SERVICE MARK
PRINCIPAL REGISTER**

**Heroes: Ordinary People
Doing Extraordinary Things**

EDISON NATION HOLDINGS, LLC (NORTH
CAROLINA LIMITED LIABILITY COMPANY)
520 ELLIOT STREET
CHARLOTTE, NC 28202

FOR: ENTERTAINMENT IN THE NATURE OF A
TELEVISION NEWS PROGRAM ABOUT PEOPLE
DOING CHARITY AND VOLUNTEER WORK MAK-
ING A DIFFERENCE IN THEIR COMMUNITY;
AND PROVIDING AN ON-LINE PUBLICATION IN
THE NATURE OF A NEWSLETTER ABOUT PEOP-
LE DOING CHARITY AND/OR VOLUNTEER

WORK MAKING A DIFFERENCE IN THEIR COM-
MUNITY, IN CLASS 41 (U.S. CLS. 100, 101 AND 107).

FIRST USE 10-28-2005; IN COMMERCE 10-28-2005.

THE MARK CONSISTS OF STANDARD CHAR-
ACTERS WITHOUT CLAIM TO ANY PARTICULAR
FONT, STYLE, SIZE, OR COLOR.

SN 78-792,188, FILED 1-16-2006.

JEFFREY LOOK, EXAMINING ATTORNEY

Int. Cl.: 36

Prior U.S. Cls.: 100, 101, and 102

United States Patent and Trademark Office

Reg. No. 3,577,961

Registered Feb. 17, 2009

SERVICE MARK
PRINCIPAL REGISTER



PERSONAL SHOPPER, INC. (IDAHO CORPORATION)
9576 W. EMERALD STREET
BOISE, ID 83704

FOR: BROKERAGE OF CONSUMER GOODS
AND SERVICES FOR COMPUTER USERS, IN
CLASS 36 (U.S. CLS. 100, 101 AND 102).

FIRST USE 4-30-2005; IN COMMERCE 4-30-2005.

OWNER OF U.S. REG. NOS. 2,613,366 AND
2,805,258.

NO CLAIM IS MADE TO THE EXCLUSIVE
RIGHT TO USE "PERSONAL", APART FROM THE
MARK AS SHOWN.

SN 78-792,190, FILED 1-16-2006.

DAWN HAN, EXAMINING ATTORNEY

Int. Cl.: 25

Prior U.S. Cls.: 22 and 39

United States Patent and Trademark Office

Reg. No. 3,577,962

Registered Feb. 17, 2009

**TRADEMARK
PRINCIPAL REGISTER**



NEUVILLE INDUSTRIES, INC. (NORTH CAROLINA CORPORATION)
1500 13TH STREET S.W.
HICKORY, NC 28602

FIRST USE 8-31-2007; IN COMMERCE 8-31-2007.

SN 78-792,787, FILED 1-17-2006.

FOR: MEN'S, WOMEN'S, AND CHILDREN'S SOCKS AND HOSIERY, IN CLASS 25 (U.S. CLS. 22 AND 39).

CAROLINE WOOD, EXAMINING ATTORNEY

Int. Cl.: 25

Prior U.S. Cls.: 22 and 39

United States Patent and Trademark Office

Reg. No. 3,577,963

Registered Feb. 17, 2009

**TRADEMARK
PRINCIPAL REGISTER**

XMA

XMA, L.L.C. (OKLAHOMA LIMITED LIABILITY
COMPANY)
1000 CENTURY BLVD.
MIDWEST CITY, OK 73110

FOR: CLOTHING, NAMELY, SHIRTS, TRACK
SUITS, BEANIES AND HEADWEAR, IN CLASS 25
(U.S. CLS. 22 AND 39).

FIRST USE 7-1-2003; IN COMMERCE 7-1-2003.

THE MARK CONSISTS OF STANDARD CHAR-
ACTERS WITHOUT CLAIM TO ANY PARTICULAR
FONT, STYLE, SIZE, OR COLOR.

OWNER OF U.S. REG. NO. 3,151,235.

SN 78-795,276, FILED 1-19-2006.

TIMOTHY FINNEGAN, EXAMINING ATTORNEY

Int. Cl.: 19

Prior U.S. Cls.: 1, 12, 33, and 50

United States Patent and Trademark Office

Reg. No. 3,577,964

Registered Feb. 17, 2009

**TRADEMARK
PRINCIPAL REGISTER**

Castello Stoneline

KRONOSPAN TECHNICAL COMPANY LTD.
(CYPRUS CORPORATION)
2 ANDREA ZAKKOU STREET, OFFICE 102
ENGOMI, CYPRUS CY-2404

FOR: HIGH PRESSURE LAMINATES FOR
FLOOR COVERINGS, IN CLASS 19 (U.S. CLS. 1, 12,
33 AND 50).

FIRST USE 9-0-2006; IN COMMERCE 9-0-2006.

THE MARK CONSISTS OF STANDARD CHAR-
ACTERS WITHOUT CLAIM TO ANY PARTICULAR
FONT, STYLE, SIZE, OR COLOR.

THE MARK WORD IN ITALIAN IS "CASTELLO"
AND MEANS "CASTLE" IN ENGLISH.

SN 78-798,659, FILED 1-25-2006.

DANIEL CAPSHAW, EXAMINING ATTORNEY

Int. Cl.: 25

Prior U.S. Cls.: 22 and 39

United States Patent and Trademark Office

Reg. No. 3,577,965

Registered Feb. 17, 2009

TRADEMARK
PRINCIPAL REGISTER

LOGAN MILAN

MILLICAN, SANDRA F. (UNITED STATES IN-
DIVIDUAL)
P.O. BOX 5116
LA QUINTA, CA 92248

FOR: CLOTHING FOR WOMEN, AND CHILDREN, NAMELY, POLO SHIRTS, COATS, SHIRTS, TOPS, BLOUSES, T-SHIRTS, SWEATERS, DRESSES, SKIRTS, SUITS, TANK TOPS, JEANS, TENNIS WEAR, NAMELY, TENNIS SHIRTS, TENNIS TOPS, TENNIS SKIRTS, AND TENNIS DRESSES; GOLF WEAR, NAMELY, GOLF SHIRTS AND GOLF POLOS; SKI WEAR, NAMELY, SKI SHIRTS INCLUDING THERMAL SHIRTS; TRACK WEAR, NAMELY, TRACK SHIRTS, SWEATSHIRTS HOODED AND UNHOODED; BEACH WEAR, NAMELY, BIKINI TOPS, BIKINI BOTTOMS, AND HALTER TOPS; EVENING WEAR, NAMELY, GOWNS, TUXEDOS, DINNER COATS; UNDERWEAR, BOXER BRIEFS AND BOXER SHORTS, UNDERSHIRTS, SOCKS,

HOSIERY, PAJAMAS, ROBES, LOUNGEWEAR, SCARF'S, SHAWLS, HEADWEAR, HATS, CAPS, VISORS, BANDANAS, BELTS, AND GLOVES, IN CLASS 25 (U.S. CLS. 22 AND 39).

FIRST USE 5-19-2006; IN COMMERCE 5-19-2006.

THE MARK CONSISTS OF STANDARD CHARACTERS WITHOUT CLAIM TO ANY PARTICULAR FONT, STYLE, SIZE, OR COLOR.

THE NAME "LOGAN MILAN" IDENTIFIES A LIVING INDIVIDUAL WHOSE CONSENT IS OF RECORD.

SN 78-799,670, FILED 1-26-2006.

KATHERINE STOIDES, EXAMINING ATTORNEY

Int. Cl.: 36

Prior U.S. Cls.: 100, 101, and 102

United States Patent and Trademark Office

Reg. No. 3,577,966

Registered Feb. 17, 2009

**SERVICE MARK
PRINCIPAL REGISTER**

4 YOUR CHOICE

PAVEZ, JORGE F. (UNITED STATES INDIVIDUAL)
SUITE 101
2275 S. MAIN STREET
CORONA, CA 92882

THE MARK CONSISTS OF STANDARD CHARACTERS WITHOUT CLAIM TO ANY PARTICULAR FONT, STYLE, SIZE, OR COLOR.

FOR: INSURANCE AGENCY AND BROKERAGE,
IN CLASS 36 (U.S. CLS. 100, 101 AND 102).

SN 78-803,190, FILED 1-31-2006.

FIRST USE 6-1-2007; IN COMMERCE 6-1-2007.

JILL PRATER, EXAMINING ATTORNEY

Int. Cl.: 1

Prior U.S. Cls.: 1, 5, 6, 10, 26, and 46

United States Patent and Trademark Office

Reg. No. 3,577,967

Registered Feb. 17, 2009

**TRADEMARK
PRINCIPAL REGISTER**

ChiroSolv

VAIDYA, NITEEN A. (UNITED STATES INDIVIDUAL)
616 STENDHAL LN.
CUPERTINO, CA 95014

FOR: CHEMICAL TEST KITS FOR SCREENING RESOLVING AGENTS AND SOLVENTS DURING CHIRAL RESOLUTION FOR LABORATORY OR RESEARCH USE, IN CLASS 1 (U.S. CLS. 1, 5, 6, 10, 26 AND 46).

FIRST USE 2-3-2006; IN COMMERCE 3-1-2006.

THE MARK CONSISTS OF STANDARD CHARACTERS WITHOUT CLAIM TO ANY PARTICULAR FONT, STYLE, SIZE, OR COLOR.

OWNER OF U.S. REG. NO. 2,703,889.

SN 78-804,917, FILED 2-1-2006.

LESLEY LAMOTHE, EXAMINING ATTORNEY

Int. Cls.: 24 and 25

Prior U.S. Cls.: 22, 39, 42, and 50

United States Patent and Trademark Office

Reg. No. 3,577,968

Registered Feb. 17, 2009

**TRADEMARK
PRINCIPAL REGISTER**

HARDFLEECE

ARC'TERYX EQUIPMENT INC. (CANADA CORPORATION)
100-2155 DOLLARTON HWY.
NORTH VANCOUVER, B.C., CANADA V7H 3B2

FOR: LAMINATED TEXTILE FABRICS EACH HAVING AN OUTER SURFACES CONSISTING OF STRETCH WOVEN MATERIAL AND AN INNER LAYER CONSISTING OF A MANMADE FLEECE FOR USE IN OUTDOOR WINTER SPORTS CLOTHING, NAMELY, SHIRTS, COATS, JACKETS, ANORAKS, JERSEYS, OVERALLS, OVERCOATS, PANTS, PULLOVERS, SWEATERS, T-SHIRTS, SOCKS, GLOVES, HATS AND HEADBANDS, UNDERWEAR AND UNDERSHIRTS, IN CLASS 24 (U.S. CLS. 42 AND 50).

FIRST USE 3-10-2008; IN COMMERCE 4-4-2008.

FOR: CLOTHING, NAMELY OUTDOOR WINTER SPORTS CLOTHING MADE IN WHOLE OR IN

PART OF LAMINATED TEXTILE FABRICS EACH HAVING AN OUTER SURFACE CONSISTING OF A STRETCH WOVEN MATERIAL AND AN INNER LAYER OF MANMADE FLEECE , NAMELY, SHIRTS, COATS, JACKETS, ANORAKS, JERSEYS, OVERALLS, OVERCOATS, PANTS PULLOVERS, SWEATERS, T-SHIRTS, SOCKS, GLOVES, HATS AND HEADBANDS, UNDERWEAR AND UNDERSHIRTS, IN CLASS 25 (U.S. CLS. 22 AND 39).

FIRST USE 6-10-2008; IN COMMERCE 7-5-2008.

THE MARK CONSISTS OF STANDARD CHARACTERS WITHOUT CLAIM TO ANY PARTICULAR FONT, STYLE, SIZE, OR COLOR.

SN 78-807,588, FILED 2-6-2006.

SUSAN RICHARDS, EXAMINING ATTORNEY

Int. Cls.: 35, 39, and 43

Prior U.S. Cls.: 100, 101, 102, and 105

United States Patent and Trademark Office

Reg. No. 3,577,969

Registered Feb. 17, 2009

**SERVICE MARK
PRINCIPAL REGISTER**

KNOW WHEN TO BUY

FARECAST, INC. (WASHINGTON CORPORATION)
200 WEST THOMAS STREET, SUITE 300
SEATTLE, WA 98119

FOR: BUSINESS SERVICES, NAMELY, PROVIDING COMPUTER DATABASES REGARDING THE PURCHASE AND SALE OF SERVICES OF OTHERS, NAMELY, AIRLINE TICKETING AND HOTEL AND MOTEL RESERVATION SERVICES VIA AN ON-LINE COMPUTER NETWORK; ANALYZING, FORECASTING AND PREDICTING PRICING OF SERVICES, NAMELY, AIRLINE TICKETING AND HOTEL AND MOTEL RESERVATION SERVICES VIA AN ON-LINE COMPUTER NETWORK AND PROVIDING INFORMATION TO USERS REGARDING THE SAME, IN CLASS 35 (U.S. CLS. 100, 101 AND 102).

FIRST USE 6-27-2006; IN COMMERCE 6-27-2006.

FOR: PROVIDING INFORMATION CONCERNING TRAVEL, IN CLASS 39 (U.S. CLS. 100 AND 105).

FIRST USE 6-27-2006; IN COMMERCE 6-27-2006.

FOR: PROVIDING INFORMATION REGARDING LODGING, IN CLASS 43 (U.S. CLS. 100 AND 101).

FIRST USE 6-27-2006; IN COMMERCE 6-27-2006.

THE MARK CONSISTS OF STANDARD CHARACTERS WITHOUT CLAIM TO ANY PARTICULAR FONT, STYLE, SIZE, OR COLOR.

SN 78-808,417, FILED 2-6-2006.

JULIE WATSON, EXAMINING ATTORNEY

Int. Cl.: 28

Prior U.S. Cls.: 22, 23, 38, and 50

United States Patent and Trademark Office

Reg. No. 3,577,970

Registered Feb. 17, 2009

**TRADEMARK
PRINCIPAL REGISTER**

SECRET ID

MATTEL, INC. (DELAWARE CORPORATION)
M1-1518
333 CONTINENTAL BLVD.
EL SEGUNDO, CA 902455012

FOR: TOYS, GAMES AND PLAYTHINGS, NAME-
LY, TOY ACTION FIGURES, TOY FIGURES, AND
ACCESSORIES FOR ALL OF THE FOREGOING, IN
CLASS 28 (U.S. CLS. 22, 23, 38 AND 50).

FIRST USE 12-9-2008; IN COMMERCE 12-9-2008.

THE MARK CONSISTS OF STANDARD CHAR-
ACTERS WITHOUT CLAIM TO ANY PARTICULAR
FONT, STYLE, SIZE, OR COLOR.

SN 78-808,445, FILED 2-6-2006.

JEFF DEFORD, EXAMINING ATTORNEY

Int. Cl.: 3

Prior U.S. Cls.: 1, 4, 6, 50, 51, and 52

United States Patent and Trademark Office

Reg. No. 3,577,971

Registered Feb. 17, 2009

**TRADEMARK
PRINCIPAL REGISTER**

**SILVER SERVICE TREATMENT
FOR THE FACE**

COR LLC (MASSACHUSETTS LIMITED LIABILITY COMPANY)
1313 WASHINGTON STREET
SUITE 230
BOSTON, MA 02118

FOR: FACE AND BODY LOTIONS; FACIAL CLEANSERS, IN CLASS 3 (U.S. CLS. 1, 4, 6, 50, 51 AND 52).

FIRST USE 2-1-2006; IN COMMERCE 2-1-2006.

THE MARK CONSISTS OF STANDARD CHARACTERS WITHOUT CLAIM TO ANY PARTICULAR FONT, STYLE, SIZE, OR COLOR.

NO CLAIM IS MADE TO THE EXCLUSIVE RIGHT TO USE "FOR THE FACE", APART FROM THE MARK AS SHOWN.

SN 78-808,854, FILED 2-7-2006.

ELLEN PERKINS, EXAMINING ATTORNEY

Int. Cl.: 29

Prior U.S. Cl.: 46

United States Patent and Trademark Office

Reg. No. 3,577,972

Registered Feb. 17, 2009

**TRADEMARK
PRINCIPAL REGISTER**

**MARTINIS KALAMATA EXTRA
VIRGIN OLIVE OIL**

KALAMATA FOOD PURVEYORS, INC. (CALI-
FORNIA CORPORATION)
SUITE 500
4061 EAST CASTRO VALLEY BLVD.
CASTRO VALLEY, CA 94552

NO CLAIM IS MADE TO THE EXCLUSIVE
RIGHT TO USE "KALAMATA EXTRA VIRGIN
OLIVE OIL", APART FROM THE MARK AS
SHOWN.

FOR: OLIVE OIL, IN CLASS 29 (U.S. CL. 46).

FIRST USE 11-4-2008; IN COMMERCE 11-4-2008.

SN 78-812,434, FILED 2-10-2006.

THE MARK CONSISTS OF STANDARD CHAR-
ACTERS WITHOUT CLAIM TO ANY PARTICULAR
FONT, STYLE, SIZE, OR COLOR.

KIM SAITO, EXAMINING ATTORNEY

Int. Cl.: 35

Prior U.S. Cls.: 100, 101, and 102

United States Patent and Trademark Office

Reg. No. 3,577,973

Registered Feb. 17, 2009

**SERVICE MARK
PRINCIPAL REGISTER**

INDIESCOVERY

HEAR IT FIRST, LLC (DELAWARE LIMITED
LIABILITY COMPANY)
1305 16TH AVENUE SOUTH
2ND FLOOR
NASHVILLE, TN 37212

FOR: ONLINE RETAIL STORE SERVICES OF
MUSICAL SOUND RECORDINGS, AUDIO VISUAL
RECORDINGS FEATURING MUSIC AND MER-
CHANDISE OF MUSICAL GROUPS AND MUSICAL
PERFORMERS, IN CLASS 35 (U.S. CLS. 100, 101 AND
102).

FIRST USE 12-0-2005; IN COMMERCE 12-0-2005.

THE MARK CONSISTS OF STANDARD CHAR-
ACTERS WITHOUT CLAIM TO ANY PARTICULAR
FONT, STYLE, SIZE, OR COLOR.

SN 78-812,460, FILED 2-10-2006.

JOHN LINCOSKI, EXAMINING ATTORNEY

Int. Cl.: 9

Prior U.S. Cls.: 21, 23, 26, 36, and 38

Reg. No. 3,577,974

United States Patent and Trademark Office

Registered Feb. 17, 2009

**TRADEMARK
PRINCIPAL REGISTER**

The logo for PixelAlive features the word "Pixel" in blue and "Alive" in orange. The letter "x" in "Pixel" is stylized as a 3x3 grid of colored squares: the top row has a green square, a red square, and a blue square; the middle row has a red square, a blue square, and a green square; the bottom row has a blue square, a green square, and a red square.

SUNPLUS TECHNOLOGY CO., LTD. (TAIWAN
COMPANY LIMITED BY SHARES)
SCIENCE-BASED INDUSTRIAL PARK
19, INNOVATION ROAD 1
HSIN-CHU, TAIWAN

FOR: INTEGRATED CIRCUIT; COMPLEMEN-
TARY METAL OXIDE SEMICONDUCTOR IMAGE
SENSORS FOR DIGITAL CAMERAS OR VIDEO
CAMERAS , IN CLASS 9 (U.S. CLS. 21, 23, 26, 36
AND 38).

FIRST USE 3-5-2007; IN COMMERCE 4-8-2007.

THE COLOR(S) BLUE, GREEN, ORANGE AND
RED IS/ARE CLAIMED AS A FEATURE OF THE
MARK.

THE MARK IS COMPRISED OF THE WORD
"PIXELALIVE". THE LETTERS "P", "I", "E" AND
"L" ARE IN THE COLOR BLUE AND THE LETTER
"X" IS IN THE COLORS, BLUE, RED AND GREEN.
THE WORD "ALIVE" IS IN THE COLOR ORANGE.

SN 78-813,474, FILED 2-13-2006.

MARK SPARACINO, EXAMINING ATTORNEY

Int. Cl.: 42

Prior U.S. Cls.: 100 and 101

United States Patent and Trademark Office

Reg. No. 3,577,975

Registered Feb. 17, 2009

**SERVICE MARK
PRINCIPAL REGISTER**

FLATWORLD

AMBIR TECHNOLOGY GROUP (CANADA COMPANY)
21 CANTERBURY STREET
SAINT JOHN, NEW BRUNSWICK, CANADA E2L 2C3

FOR: INFORMATION TECHNOLOGY CONSULTING SERVICES, NAMELY, SYSTEM AND INFRASTRUCTURE ANALYSIS, DESIGN, DEVELOPMENT, INTEGRATION, IMPLEMENTATION, TESTING AND ROLL-OUT , IN CLASS 42 (U.S. CLS. 100 AND 101).

FIRST USE 3-24-2006; IN COMMERCE 3-24-2006.

THE MARK CONSISTS OF STANDARD CHARACTERS WITHOUT CLAIM TO ANY PARTICULAR FONT, STYLE, SIZE, OR COLOR.

SN 78-817,317, FILED 2-17-2006.

LAURIE MAYES, EXAMINING ATTORNEY

Int. Cl.: 25

Prior U.S. Cls.: 22 and 39

United States Patent and Trademark Office

Reg. No. 3,577,976

Registered Feb. 17, 2009

TRADEMARK
PRINCIPAL REGISTER



CITY OF NEW YORK, BY AND THROUGH THE
NEW YORK CITY TAXI AND LIMOUSINE
COMMISSION (NEW YORK MUNICIPAL
CORPORATION)
40 RECTOR STREET
NEW YORK, NY 10006

NO CLAIM IS MADE TO THE EXCLUSIVE
RIGHT TO USE "NEW YORK CITY", APART FROM
THE MARK AS SHOWN.

FOR: BASEBALL CAPS; SWEAT SHIRTS; T-
SHIRTS, IN CLASS 25 (U.S. CLS. 22 AND 39).

SN 78-817,483, FILED 2-17-2006.

FIRST USE 4-19-2006; IN COMMERCE 4-19-2006.

TRACY FLETCHER, EXAMINING ATTORNEY

Int. Cl.: 17

Prior U.S. Cls.: 1, 5, 12, 13, 35, and 50

United States Patent and Trademark Office

Reg. No. 3,577,977

Registered Feb. 17, 2009

**TRADEMARK
PRINCIPAL REGISTER**



TIRE CURING BLADDERS, LP. (ARKANSAS
LIMITED PARTNERSHIP)
5701 MURRAY STREET
LITTLE ROCK, AR 72209

FOR: LATEX RUBBER FOR USE IN THE MAN-
UFACTURE OF TIRES, IN CLASS 17 (U.S. CLS. 1, 5,
12, 13, 35 AND 50).

FIRST USE 6-1-2005; IN COMMERCE 6-1-2005.

NO CLAIM IS MADE TO THE EXCLUSIVE
RIGHT TO USE "TIRE CURING BLADDERS",
APART FROM THE MARK AS SHOWN.

THE COLOR(S) ORANGE, GRAY, WHITE AND
DARK BLUE IS/ARE CLAIMED AS A FEATURE OF
THE MARK.

THE MARK COMPRISES A DARK BLUE TIRE
WITH WHITE WALLS AND THE WORDING "TIRE
CURING BLADDERS" WRITTEN IN DARK BLUE
WITHIN THE WHITE WALL PORTION. A TIRE
BLADDER IS PRESENTED INSIDE THE TIRE. THE
BLADDER IS DARK BLUE ON THE OUTSIDE AND
WHITE ON THE INSIDE. THE LETTERS "TCB"
APPEAR IN GRAY TO THE LEFT OF THE TIRE.
THE WHOLE MARK APPEARS WITHIN A WHITE
RECTANGLE BOARDED IN ORANGE.

SN 78-819,392, FILED 2-21-2006.

GEOFFREY FOSDICK, EXAMINING ATTORNEY

Int. Cls.: 16, 25, 28, 35, and 36

**Prior U.S. Cls.: 2, 5, 22, 23, 29, 37, 38, 39, 50, 100, 101,
and 102**

Reg. No. 3,577,978

United States Patent and Trademark Office

Registered Feb. 17, 2009

**TRADEMARK
SERVICE MARK
PRINCIPAL REGISTER**

Karito

KIDSGIVE, LLC (CALIFORNIA LIMITED LIABILITY COMPANY)
815 17TH STREET
MANHATTAN BEACH, CA 90266

FOR: CHILDREN'S BOOKS; SERIES OF FICTION BOOKS, IN CLASS 16 (U.S. CLS. 2, 5, 22, 23, 29, 37, 38 AND 50).

FIRST USE 6-0-2007; IN COMMERCE 6-0-2007.

FOR: T-SHIRTS; TOPS, IN CLASS 25 (U.S. CLS. 22 AND 39).

FIRST USE 11-3-2008; IN COMMERCE 11-5-2008.

FOR: DOLL ACCESSORIES; DOLL CLOTHING; DOLL COSTUMES; DOLLS; DOLLS AND ACCESSORIES THEREFOR; DOLLS AND PLAYSETS THEREFOR; DOLLS FOR PLAYING; HEADGEAR FOR DOLLS; PLAYSETS FOR DOLLS; PLUSH TOYS; SHOES FOR DOLLS; STUFFED TOY ANIMALS; TOY FIGURES, IN CLASS 28 (U.S. CLS. 22, 23, 38 AND 50).

FIRST USE 6-0-2007; IN COMMERCE 6-0-2007.

FOR: ELECTRONIC CATALOG SERVICES AND MAIL ORDER CATALOG SERVICES FEATURING

MULTICULTURAL ITEMS, NAMELY, BOOKS, GAMES, TOYS, DOLLS, DOLL ACCESSORIES, DOLL APPAREL, APPAREL, PERSONAL ACCESSORIES, JEWELRY AND PRE-RECORDED MEDIA, IN CLASS 35 (U.S. CLS. 100, 101 AND 102).

FIRST USE 7-0-2007; IN COMMERCE 7-0-2007.

FOR: ACCEPTING AND ADMINISTERING MONETARY CHARITABLE CONTRIBUTIONS TO DESIGNATED NAMED RECIPIENTS, IN CLASS 36 (U.S. CLS. 100, 101 AND 102).

FIRST USE 7-0-2007; IN COMMERCE 7-0-2007.

THE MARK CONSISTS OF STANDARD CHARACTERS WITHOUT CLAIM TO ANY PARTICULAR FONT, STYLE, SIZE, OR COLOR.

THE FOREIGN WORDING IN THE MARK TRANSLATES INTO ENGLISH AS "CHARITY AND LOVE OF ONE'S NEIGHBOR".

SN 78-822,764, FILED 2-24-2006.

LYDIA BELZER, EXAMINING ATTORNEY

Int. Cl.: 2

Prior U.S. Cls.: 6, 11, and 16

United States Patent and Trademark Office

Reg. No. 3,577,979

Registered Feb. 17, 2009

**TRADEMARK
PRINCIPAL REGISTER**

PLASTI-KOTE STONE TOUCH

THE VALSPAR CORPORATION (MINNESOTA
CORPORATION)
1101 SOUTH THIRD STREET
MINNEAPOLIS, MN 55415

OWNER OF U.S. REG. NOS. 2,476,515 AND
2,815,800.

FOR: DECORATIVE AND PROTECTIVE PAINT,
NAMELY, DECORATIVE SPRAY ENAMELS AND
TEXTURE FINISHES FOR DOMESTIC USE, IN
CLASS 2 (U.S. CLS. 6, 11 AND 16).

NO CLAIM IS MADE TO THE EXCLUSIVE
RIGHT TO USE "STONE", APART FROM THE
MARK AS SHOWN.

FIRST USE 5-31-2006; IN COMMERCE 5-31-2006.

SN 78-826,085, FILED 3-1-2006.

THE MARK CONSISTS OF STANDARD CHAR-
ACTERS WITHOUT CLAIM TO ANY PARTICULAR
FONT, STYLE, SIZE, OR COLOR.

JASON TURNER, EXAMINING ATTORNEY

Int. Cl.: 36

Prior U.S. Cls.: 100, 101, and 102

United States Patent and Trademark Office

Reg. No. 3,577,980

Registered Feb. 17, 2009

**SERVICE MARK
PRINCIPAL REGISTER**

IntuitiveCompliance

TORRENT TECHNOLOGIES, INC. (DELAWARE
CORPORATION)
1935 THIRD AVE EAST
SUITE 100
KALISPELL, MT 59901

THE MARK CONSISTS OF STANDARD CHAR-
ACTERS WITHOUT CLAIM TO ANY PARTICULAR
FONT, STYLE, SIZE, OR COLOR.

FOR: ELECTRONIC PROCESSING OF INSUR-
ANCE CLAIMS AND PAYMENT DATA, IN CLASS
36 (U.S. CLS. 100, 101 AND 102).

SN 78-826,326, FILED 3-1-2006.

FIRST USE 3-0-2005; IN COMMERCE 5-0-2005.

KELLY BOULTON, EXAMINING ATTORNEY

Int. Cl.: 29

Prior U.S. Cl.: 46

United States Patent and Trademark Office

Reg. No. 3,577,981

Registered Feb. 17, 2009

**TRADEMARK
PRINCIPAL REGISTER**

PARTY ON THE GO

ADVANCE BRANDS, L.L.C. (DELAWARE LIMITED LIABILITY COMPANY)
3540 S. BOULEVARD STREET, SUITE 225
EDMOND, OK 73013

THE MARK CONSISTS OF STANDARD CHARACTERS WITHOUT CLAIM TO ANY PARTICULAR FONT, STYLE, SIZE, OR COLOR.

FOR: FROZEN BEEF AND POULTRY APPETIZERS, IN CLASS 29 (U.S. CL. 46).

SN 78-827,522, FILED 3-2-2006.

FIRST USE 8-31-2006; IN COMMERCE 8-31-2006.

COLLEEN KEARNEY, EXAMINING ATTORNEY

Int. Cl.: 9

Prior U.S. Cls.: 21, 23, 26, 36, and 38

United States Patent and Trademark Office

Reg. No. 3,577,982

Registered Feb. 17, 2009

TRADEMARK
PRINCIPAL REGISTER

MAXAZRIA

MLA MULTIBRAND HOLDINGS, INC. (DELA-
WARE CORPORATION)
2761 FRUITLAND AVENUE
VERNON, CA 90058

OWNER OF U.S. REG. NOS. 2,160,919, 2,581,590,
AND OTHERS.

FOR: EYE GLASSES, CASES FOR EYE GLASSES,
FRAMES FOR EYE GLASSES, SUN GLASSES,
CASES FOR SUN GLASSES, FRAMES FOR SUN
GLASSES, IN CLASS 9 (U.S. CLS. 21, 23, 26, 36 AND
38).

THE NAME(S), PORTRAIT(S), AND/OR SIGNA-
TURE(S) SHOWN IN THE MARK IDENTIFIES
"MAX AZRIA", WHOSE CONSENT(S) TO REGISTER
IS SUBMITTED.

FIRST USE 1-1-2004; IN COMMERCE 10-31-2004.

SN 78-827,937, FILED 3-2-2006.

THE MARK CONSISTS OF STANDARD CHAR-
ACTERS WITHOUT CLAIM TO ANY PARTICULAR
FONT, STYLE, SIZE, OR COLOR.

KRISTINA MORRIS, EXAMINING ATTORNEY

Int. Cl.: 16

Prior U.S. Cls.: 2, 5, 22, 23, 29, 37, 38, and 50

United States Patent and Trademark Office

Reg. No. 3,577,983

Registered Feb. 17, 2009

**TRADEMARK
PRINCIPAL REGISTER**

DELMARKO

DELL MARKING SYSTEMS, INC. (MICHIGAN
CORPORATION)
721 WANDA
FERNDALE, MI 48220

THE MARK CONSISTS OF STANDARD CHAR-
ACTERS WITHOUT CLAIM TO ANY PARTICULAR
FONT, STYLE, SIZE, OR COLOR.

FOR: INDUSTRIAL MARKING DEVICES, NAME-
LY, INDUSTRIAL MARKING PENS, IN CLASS 16
(U.S. CLS. 2, 5, 22, 23, 29, 37, 38 AND 50).

SN 78-828,290, FILED 3-3-2006.

FIRST USE 1-31-2007; IN COMMERCE 1-31-2007.

VERNA BETH RIRIE, EXAMINING ATTORNEY

Int. Cls.: 39 and 42

Prior U.S. Cls.: 100, 101, and 105

United States Patent and Trademark Office

Reg. No. 3,577,984

Registered Feb. 17, 2009

**SERVICE MARK
PRINCIPAL REGISTER**

**STREETWEAR MADE FOR
MOTION**

STREETWEAR BRANDS, LLC (DELAWARE LIMITED LIABILITY COMPANY)
40 KENWOOD CIRCLE
FRANKLIN, MA 02038

FOR: DISTRIBUTION SERVICES, NAMELY, DELIVERY OF ATHLETIC APPAREL TO OTHERS, IN CLASS 39 (U.S. CLS. 100 AND 105).

FIRST USE 5-1-2007; IN COMMERCE 5-1-2007.

FOR: DESIGN FOR OTHERS IN THE FIELD OF ATHLETIC APPAREL, IN CLASS 42 (U.S. CLS. 100 AND 101).

FIRST USE 5-1-2007; IN COMMERCE 5-1-2007.

THE MARK CONSISTS OF STANDARD CHARACTERS WITHOUT CLAIM TO ANY PARTICULAR FONT, STYLE, SIZE, OR COLOR.

NO CLAIM IS MADE TO THE EXCLUSIVE RIGHT TO USE "STREETWEAR", APART FROM THE MARK AS SHOWN.

SN 78-828,827, FILED 3-3-2006.

ALYSSA STEEL, EXAMINING ATTORNEY

Int. Cl.: 36

Prior U.S. Cls.: 100, 101, and 102

United States Patent and Trademark Office

Reg. No. 3,577,985

Registered Feb. 17, 2009

**SERVICE MARK
PRINCIPAL REGISTER**

ADVANTAGE

NORTH AMERICAN COMPANY FOR LIFE AND
HEALTH INSURANCE (IOWA CORPORATION)
525 WEST VAN BUREN
CHICAGO, IL 60607

THE MARK CONSISTS OF STANDARD CHAR-
ACTERS WITHOUT CLAIM TO ANY PARTICULAR
FONT, STYLE, SIZE, OR COLOR.

FOR: LIFE INSURANCE UNDERWRITING, IN
CLASS 36 (U.S. CLS. 100, 101 AND 102).

SN 78-831,223, FILED 3-7-2006.

FIRST USE 4-15-2006; IN COMMERCE 4-15-2006.

DEZMONA MIZELLE, EXAMINING ATTORNEY

Int. Cl.: 28

Prior U.S. Cls.: 22, 23, 38, and 50

United States Patent and Trademark Office

Reg. No. 3,577,986

Registered Feb. 17, 2009

TRADEMARK
PRINCIPAL REGISTER



SHERRY, KELLY D (UNITED STATES INDIVIDUAL)
12207 DECOOK
STERLING HEIGHTS, MI 48313

FOR: DOLLS AND PLUSH TOYS, IN CLASS 28
(U.S. CLS. 22, 23, 38 AND 50).

FIRST USE 9-25-2008; IN COMMERCE 9-25-2008.

THE COLORS YELLOW, GREEN, PURPLE, PINK, TAN, BLACK AND WHITE ARE CLAIMED AS A FEATURE OF THE MARK.

THE COLOR YELLOW APPEARS AS THE 3-DIMENSIONAL BORDER WITHIN WHICH IS CONTAINED A GREEN BACKGROUND, UPON WHICH

THE COLORS BLACK AND WHITE APPEAR AS THE SHOES AND SOCKS OF A LITTLE GIRL, THE COLORS BLACK AND TAN APPEARS THE LEGS OF A LITTLE GIRL, THE COLORS PURPLE, PINK AND BLACK APPEAR AS THE DRESS AND SHIRT OF A LITTLE GIRL AND THE COLOR BLACK APPEARS AS THE TEXT AND THE "MOTION" LINES AROUND THE KNEES OF A LITTLE GIRLS.

THE MARK CONSISTS OF CHILD WITH LITTLE KNOBBY KNEES.

SN 78-836,414, FILED 3-14-2006.

RONALD AIKENS, EXAMINING ATTORNEY

Int. Cl.: 35

Prior U.S. Cls.: 100, 101, and 102

United States Patent and Trademark Office

Reg. No. 3,577,987

Registered Feb. 17, 2009

**SERVICE MARK
PRINCIPAL REGISTER**

BRIDGE HOMECARE PARTNERS

BRIDGE HOMECARE PARTNERS LLC (OHIO
LIMITED LIABILITY COMPANY)
2700 KETTERING TOWER, 40 N. MAIN ST.
DAYTON, OH 454232700

FOR: MANAGING AND OPERATING HOME
HEALTH CARE SERVICE BUSINESSES ON BE-
HALF OF HOSPITALS, NURSING HOMES AND
OTHER HEALTH CARE PROVIDERS , IN CLASS 35
(U.S. CLS. 100, 101 AND 102).

FIRST USE 1-1-2006; IN COMMERCE 1-1-2006.

THE MARK CONSISTS OF STANDARD CHAR-
ACTERS WITHOUT CLAIM TO ANY PARTICULAR
FONT, STYLE, SIZE, OR COLOR.

NO CLAIM IS MADE TO THE EXCLUSIVE
RIGHT TO USE "HOMECARE PARTNERS", APART
FROM THE MARK AS SHOWN.

SN 78-839,298, FILED 3-16-2006.

SEAN CROWLEY, EXAMINING ATTORNEY

Int. Cl.: 25

Prior U.S. Cls.: 22 and 39

United States Patent and Trademark Office

Reg. No. 3,577,988

Registered Feb. 17, 2009

**TRADEMARK
PRINCIPAL REGISTER**

KICKBALL SUPERSTAR

WAKA, LLC (VIRGINIA LIMITED LIABILITY
COMPANY)
3717 COLUMBIA PIKE
ARLINGTON, VA 22204

FOR: CLOTHING FOR ADULTS, NAMELY,
CAPS, GOLF SHIRTS, HOODS, JERSEYS, MAN-
TLES, MUFFLERS, PERSPIRATION ABSORBENT
UNDERWEAR CLOTHING, POLO SHIRTS, SHIRTS,
SHIRTS, SHORT SETS, SHOULDER PADS FOR
CLOTHING, SPORT SHIRTS, T-SHIRTS, TOPS, UN-
DERARM CLOTHING SHIELDS, IN CLASS 25 (U.S.
CLS. 22 AND 39).

FIRST USE 5-1-2006; IN COMMERCE 5-1-2006.

THE MARK CONSISTS OF STANDARD CHAR-
ACTERS WITHOUT CLAIM TO ANY PARTICULAR
FONT, STYLE, SIZE, OR COLOR.

NO CLAIM IS MADE TO THE EXCLUSIVE
RIGHT TO USE "KICKBALL", APART FROM THE
MARK AS SHOWN.

SN 78-841,930, FILED 3-21-2006.

BONNIE LUKEN, EXAMINING ATTORNEY

Int. Cls.: 6, 17, and 42

**Prior U.S. Cls.: 1, 2, 5, 12, 13, 14, 23, 25, 35, 50, 100,
and 101**

Reg. No. 3,577,989

United States Patent and Trademark Office

Registered Feb. 17, 2009

**TRADEMARK
SERVICE MARK
PRINCIPAL REGISTER**



SHELL TRADEMARK MANAGEMENT B.V.
(NETHERLANDS CORPORATION)
CAREL VAN BYLANDTLAAN 30, 2596 HR
THE HAGUE, NETHERLANDS

FOR: METAL PIPES WITH RUBBER CLADDING,
IN CLASS 6 (U.S. CLS. 2, 12, 13, 14, 23, 25 AND 50).

FIRST USE 9-1-2006; IN COMMERCE 9-1-2006.

FOR: RUBBER PRODUCTS FOR USE IN OIL AND
GAS WELLS, NAMELY, RUBBER SEALS, BEADS
AND RUBBER PIPELINE COATING TO FORM
ZONAL ISOLATION BARRIERS OF NON-METAL
ATTACHED TO WIRE WRAP SAND SCREENS AND
INFLATABLE RUBBER PACKING TO ISOLATE
AND DIRECT FLOW IN PRODUCTION WELLS
AND RUBBER SEALS FOR WELL COMPLETION
EQUIPMENT IN OIL AND GAS WELLS, IN CLASS
17 (U.S. CLS. 1, 5, 12, 13, 35 AND 50).

FIRST USE 9-1-2006; IN COMMERCE 9-1-2006.

FOR: RESEARCH AND ENGINEERING SERVI-
CES RELATING TO RUBBER PRODUCTS FOR USE
IN OIL AND GAS WELLS, IN CLASS 42 (U.S. CLS. 100
AND 101).

FIRST USE 9-1-2006; IN COMMERCE 9-1-2006.

THE COLOR(S) RED AND BLUE IS/ARE
CLAIMED AS A FEATURE OF THE MARK.

THE MARK CONSISTS OF THREE CONCENTRIC
SWIRLS. THE TWO OUTER SWIRLS ARE BLUE,
ENCIRCLING A RED SWIRL.

SN 78-844,652, FILED 3-23-2006.

LINDA MICKLEBURGH, EXAMINING ATTORNEY

Int. Cls.: 29 and 30

Prior U.S. Cl.: 46

United States Patent and Trademark Office

Reg. No. 3,577,990

Registered Feb. 17, 2009

**TRADEMARK
PRINCIPAL REGISTER**

BALAJI

PATEL, SUSHMA M (UNITED STATES INDIVIDUAL)
5 SONOMA COURT
OLD BRIDGE, NJ 08857

FOR: PROCESSED BEANS; PROCESSED NUTS; EDIBLE OILS; BUTTER; FRUIT-BASED, VEGETABLE-BASED, AND POTATO-BASED SNACK FOODS; PICKLES; FROZEN FRUIT AND VEGETABLES; FRUIT PULP; FRUIT PUREE; FROZEN AND PREPARED MEALS CONSISTING PRIMARILY OF MEAT, FISH, POULTRY OR VEGETABLES, IN CLASS 29 (U.S. CL. 46).

FIRST USE 6-0-2008; IN COMMERCE 6-0-2008.

FOR: PROCESSED GRAINS; PROCESSED WHEAT; BAKERY DESSERTS; FLOUR; SAUCES; CHUTNEY; RICE; BAKERY GOODS; BISCUITS; COOKIES; SPICES; BREAD; FROZEN AND PREPARED MEALS CONSISTING PRIMARILY OF PASTA AND RICE, IN CLASS 30 (U.S. CL. 46).

FIRST USE 6-0-2008; IN COMMERCE 6-0-2008.

THE MARK CONSISTS OF STANDARD CHARACTERS WITHOUT CLAIM TO ANY PARTICULAR FONT, STYLE, SIZE, OR COLOR.

SN 78-848,870, FILED 3-29-2006.

HENRY S. ZAK, EXAMINING ATTORNEY

Int. Cl.: 35

Prior U.S. Cls.: 100, 101, and 102

United States Patent and Trademark Office

Reg. No. 3,577,991

Registered Feb. 17, 2009

**SERVICE MARK
PRINCIPAL REGISTER**

mystore

MEAGHER, TODD (UNITED STATES INDIVIDUAL)
2101 LEGACY COURT
KELLER, TX 76248

FOR: ADVERTISING AND INFORMATION DISTRIBUTION SERVICES, NAMELY, PROVIDING CLASSIFIED ADVERTISING SPACE VIA A GLOBAL COMPUTER NETWORK; PROMOTING THE GOODS AND SERVICES OF OTHERS OVER THE INTERNET; PROVIDING ON-LINE COMPUTER DATABASES AND ON-LINE SEARCHABLE DATABASES FEATURING CLASSIFIED LISTINGS AND

WANT ADS, IN CLASS 35 (U.S. CLS. 100, 101 AND 102).

FIRST USE 11-1-2005; IN COMMERCE 11-1-2005.

THE MARK CONSISTS OF STANDARD CHARACTERS WITHOUT CLAIM TO ANY PARTICULAR FONT, STYLE, SIZE, OR COLOR.

SN 78-853,849, FILED 4-4-2006.

TINA L. SNAPP, EXAMINING ATTORNEY

Int. Cl.: 35

Prior U.S. Cls.: 100, 101, and 102

United States Patent and Trademark Office

Reg. No. 3,577,992

Registered Feb. 17, 2009

**SERVICE MARK
PRINCIPAL REGISTER**

mystore.com

MEAGHER, TODD (UNITED STATES INDIVIDUAL)
2101 LEGACY COURT
KELLER, TX 76248

FOR: ADVERTISING AND INFORMATION DISTRIBUTION SERVICES, NAMELY, PROVIDING CLASSIFIED ADVERTISING SPACE VIA A GLOBAL COMPUTER NETWORK; PROMOTING THE GOODS AND SERVICES OF OTHERS OVER THE INTERNET; PROVIDING ON-LINE COMPUTER DATABASES AND ON-LINE SEARCHABLE DATABASES FEATURING CLASSIFIED LISTINGS AND

WANT ADS, IN CLASS 35 (U.S. CLS. 100, 101 AND 102).

FIRST USE 11-1-2005; IN COMMERCE 11-1-2005.

THE MARK CONSISTS OF STANDARD CHARACTERS WITHOUT CLAIM TO ANY PARTICULAR FONT, STYLE, SIZE, OR COLOR.

SN 78-853,866, FILED 4-4-2006.

TINA L. SNAPP, EXAMINING ATTORNEY

Int. Cl.: 26

Prior U.S. Cls.: 37, 39, 40, 42, and 50

United States Patent and Trademark Office

Reg. No. 3,577,993

Registered Feb. 17, 2009

TRADEMARK
PRINCIPAL REGISTER



DAVID FITZPATRICK (MASSACHUSETTS SOLE
PROPRIETORSHIP)
48 SILK STREET
ARLINGTON, MA 02474

FOR: HAIR ACCESSORIES, NAMELY, CLAW
CLIPS AND SNAP CLIPS; HAIR ORNAMENTS;
HAIR CLIPS; BARRETTES; PONYTAIL HOLDERS,
IN CLASS 26 (U.S. CLS. 37, 39, 40, 42 AND 50).

FIRST USE 12-1-2008; IN COMMERCE 12-1-2008.

THE COLOR(S) BROWN, BLUE AND LIGHT
BLUE IS/ARE CLAIMED AS A FEATURE OF THE
MARK.

THE COLOR BROWN APPEARS IN THE WORD-
ING "BIRTH OF BEAUTY". THE COLOR BLUE
APPEARS IN THE BUTTERFLY DESIGN ON THE
RIGHT AND THE COLOR LIGHT BLUE APPEARS
IN THE BUTTERFLY DESIGN ON THE LEFT.

SN 78-854,213, FILED 4-5-2006.

COLLEEN KEARNEY, EXAMINING ATTORNEY

Int. Cl.: 9

Prior U.S. Cls.: 21, 23, 26, 36, and 38

United States Patent and Trademark Office

Reg. No. 3,577,994

Registered Feb. 17, 2009

**TRADEMARK
PRINCIPAL REGISTER**

TEACHER TALK

HANEN EARLY LANGUAGE PROGRAM (CANADA CORPORATION)
1075 BAY STREET, SUITE 515
TORONTO, ONTARIO, CANADA M5S 2B1

FOR: PRE-RECORDED VIDEOTAPES, CD-ROMS AND DVDS, ALL RELATED TO METHODS, TECHNIQUES AND APPROACHES TO ASSIST AND FACILITATE LANGUAGE AND COMMUNICATION DEVELOPMENT IN LANGUAGE-DELAYED CHILDREN; DOWNLOADABLE PUBLICATIONS, NAMELY, BOOKS, BOOKLETS, TEACHING GUIDES, BROCHURES, NEWSLETTERS, ALL RELATED TO METHODS, TECHNIQUES AND APPROACHES TO ASSIST AND FACILITATE LANGUAGE AND COMMUNICATION DEVELOPMENT IN LANGUAGE-DELAYED CHILDREN; ELECTRONIC PUBLICATIONS RECORDED ON READABLE MEDIA, NAMELY, CD'S AND DVDS,

NAMELY, BOOKS, BOOKLETS, TEACHING GUIDES, BROCHURES, NEWSLETTERS, ALL RELATED TO METHODS, TECHNIQUES AND APPROACHES TO ASSIST AND FACILITATE LANGUAGE AND COMMUNICATION DEVELOPMENT IN LANGUAGE-DELAYED CHILDREN, IN CLASS 9 (U.S. CLS. 21, 23, 26, 36 AND 38).

FIRST USE 10-22-2004; IN COMMERCE 10-0-2004.

THE MARK CONSISTS OF STANDARD CHARACTERS WITHOUT CLAIM TO ANY PARTICULAR FONT, STYLE, SIZE, OR COLOR.

SN 78-854,765, FILED 4-5-2006.

RONALD AIKENS, EXAMINING ATTORNEY

Int. Cl.: 38

Prior U.S. Cls.: 100, 101, and 104

United States Patent and Trademark Office

Reg. No. 3,577,995

Registered Feb. 17, 2009

**SERVICE MARK
PRINCIPAL REGISTER**

XM RADIO

XM SATELLITE RADIO INC. (DELAWARE CORPORATION)
1500 ECKINGTON PLACE, NE
WASHINGTON, DC 20002

OWNER OF U.S. REG. NOS. 2,547,677, 2,666,915,
AND OTHERS.

FOR: SATELLITE RADIO BROADCASTING SERVICES; WEBCASTING SERVICES, IN CLASS 38 (U.S. CLS. 100, 101 AND 104).

NO CLAIM IS MADE TO THE EXCLUSIVE RIGHT TO USE "RADIO", APART FROM THE MARK AS SHOWN.

FIRST USE 9-25-2001; IN COMMERCE 9-25-2001.

SN 78-855,286, FILED 4-6-2006.

THE MARK CONSISTS OF STANDARD CHARACTERS WITHOUT CLAIM TO ANY PARTICULAR FONT, STYLE, SIZE, OR COLOR.

TRACY WHITTAKER-BROWN, EXAMINING ATTORNEY

Int. Cl.: 28

Prior U.S. Cls.: 22, 23, 38, and 50

United States Patent and Trademark Office

Reg. No. 3,577,996

Registered Feb. 17, 2009

**TRADEMARK
PRINCIPAL REGISTER**

KIDHOUSES

ARCHITECTURE KIDS, L.L.C. (ARIZONA LIMITED LIABILITY COMPANY)
204 SOUTH FARMER AVENUE
TEMPE, AZ 85281

FOR: PLAY HOUSES AND JUNGLE GYMS; EDUCATIONAL TOYS, NAMELY, KITS FOR BUILDING OUTDOOR PLAY EQUIPMENT, JUNGLE GYMS, PLAY EQUIPMENT, PLAY HOUSES, PLAY TENTS, TOY HOUSES, PLAYSET BUILDINGS, AND PLAY TUNNELS, IN CLASS 28 (U.S. CLS. 22, 23, 38 AND 50).

FIRST USE 10-22-2006; IN COMMERCE 10-22-2006.

THE MARK CONSISTS OF STANDARD CHARACTERS WITHOUT CLAIM TO ANY PARTICULAR FONT, STYLE, SIZE, OR COLOR.

SN 78-855,646, FILED 4-6-2006.

TINA BROWN, EXAMINING ATTORNEY

Int. Cls.: 9 and 10

Prior U.S. Cls.: 21, 23, 26, 36, 38, 39, and 44

United States Patent and Trademark Office

Reg. No. 3,577,997

Registered Feb. 17, 2009

**TRADEMARK
PRINCIPAL REGISTER**

FRALEX

FRALEX THERAPEUTICS INC. (CANADA CORPORATION)
SUITE 580
190 ATTWELL DRIVE
TORONTO, CANADA M9W 6H8

FOR: COMPUTER SOFTWARE FOR USE WITH APPARATUSES FOR GENERATING MAGNETIC FIELDS TO TREAT PHYSIOLOGICAL, NEUROLOGICAL AND/OR BEHAVIORAL DISORDERS, IN CLASS 9 (U.S. CLS. 21, 23, 26, 36 AND 38).

FIRST USE 11-1-2006; IN COMMERCE 12-1-2007.

FOR: APPARATUSES FOR GENERATING MAGNETIC FIELDS TO TREAT PHYSIOLOGICAL, NEUROLOGICAL AND/OR BEHAVIORAL DISORDERS, IN CLASS 10 (U.S. CLS. 26, 39 AND 44).

FIRST USE 11-1-2006; IN COMMERCE 12-1-2007.

THE MARK CONSISTS OF STANDARD CHARACTERS WITHOUT CLAIM TO ANY PARTICULAR FONT, STYLE, SIZE, OR COLOR.

PRIORITY CLAIMED UNDER SEC. 44(D) ON CANADA APPLICATION NO. 1296021, FILED 3-31-2006, REG. NO. TMA709766, DATED 3-18-2008, EXPIRES 3-18-2023.

SN 78-857,860, FILED 4-10-2006.

ROBIN CHOSID, EXAMINING ATTORNEY

Int. Cls.: 16 and 43

Prior U.S. Cls.: 2, 5, 22, 23, 29, 37, 38, 50, 100, and 101

Reg. No. 3,577,998

United States Patent and Trademark Office

Registered Feb. 17, 2009

**TRADEMARK
SERVICE MARK
PRINCIPAL REGISTER**

DR. DRINX

MCGILL, JERRELL D. (UNITED STATES INDIVIDUAL)

15615 BARBAROSSA DRIVE

HOUSTON, TX 77083

FOR: PRINTED MATTER, NAMELY, BROCHURES, NEWSLETTERS, NEWSPAPERS, MAGAZINES, INSTRUCTIONAL MANUALS, BOOKS, AND RECIPE BOOKS, ALL IN THE FIELD OF THE WHOLESALE ALCOHOLIC BEVERAGES INDUSTRY, IN CLASS 16 (U.S. CLS. 2, 5, 22, 23, 29, 37, 38 AND 50).

FIRST USE 11-18-2008; IN COMMERCE 11-18-2008.

FOR: CONSULTING SERVICES IN THE FIELD OF ALCOHOLIC BEVERAGE AND COCKTAIL PREPARATION FOR THE WHOLESALE ALCOHOLIC BEVERAGES INDUSTRY, IN CLASS 43 (U.S. CLS. 100 AND 101).

FIRST USE 11-18-2008; IN COMMERCE 11-18-2008.

THE MARK CONSISTS OF STANDARD CHARACTERS WITHOUT CLAIM TO ANY PARTICULAR FONT, STYLE, SIZE, OR COLOR.

SN 78-858,274, FILED 4-10-2006.

JESSICA A. POWERS, EXAMINING ATTORNEY

Int. Cl.: 5

Prior U.S. Cls.: 6, 18, 44, 46, 51, and 52

Reg. No. 3,577,999

United States Patent and Trademark Office

Registered Feb. 17, 2009

**TRADEMARK
PRINCIPAL REGISTER**

CYLARIS

DIET US TRADEMARK LTD. (CANADA COR-
PORATION)
5100 SPECTRUM WAY
MISSISSAUGA, CANADA L4W 5S2

THE MARK CONSISTS OF STANDARD CHAR-
ACTERS WITHOUT CLAIM TO ANY PARTICULAR
FONT, STYLE, SIZE, OR COLOR.

FOR: DIETARY SUPPLEMENTS, IN CLASS 5 (U.S.
CLS. 6, 18, 44, 46, 51 AND 52).

SN 78-858,739, FILED 4-11-2006.

FIRST USE 1-0-2007; IN COMMERCE 1-0-2007.

MARILYN IZZI, EXAMINING ATTORNEY

Int. Cl.: 9

Prior U.S. Cls.: 21, 23, 26, 36, and 38

United States Patent and Trademark Office

Reg. No. 3,578,000

Registered Feb. 17, 2009

**TRADEMARK
PRINCIPAL REGISTER**

MESSENGER PLUS! LIVE

YUNA SOFTWARE LTD. (UNITED KINGDOM
COMPANY)

P.O. BOX 540

NO. 1 WESLEY STREET, ST. HELIER

JERSEY, UNITED KINGDOM JE45UU

FOR: COMPUTER SOFTWARE FOR INSTANT
MESSAGING SERVICES, IN CLASS 9 (U.S. CLS. 21,
23, 26, 36 AND 38).

FIRST USE 12-16-2005; IN COMMERCE 12-16-2005.

THE MARK CONSISTS OF STANDARD CHAR-
ACTERS WITHOUT CLAIM TO ANY PARTICULAR
FONT, STYLE, SIZE, OR COLOR.

OWNER OF U.S. REG. NO. 2,901,587.

NO CLAIM IS MADE TO THE EXCLUSIVE
RIGHT TO USE "LIVE", APART FROM THE MARK
AS SHOWN.

SN 78-862,478, FILED 4-17-2006.

DAWN FELDMAN, EXAMINING ATTORNEY

Int. Cl.: 9

Prior U.S. Cls.: 21, 23, 26, 36, and 38

Reg. No. 3,578,001

United States Patent and Trademark Office

Registered Feb. 17, 2009

**TRADEMARK
PRINCIPAL REGISTER**

NeuralOS

NEURALIQ, INC. (DELAWARE CORPORATION)
SUITE. 119
1639 11TH STREET
SANTA MONICA, CA 90404

ACCESS BY COMPUTER USERS, IN CLASS 9 (U.S. CLS. 21, 23, 26, 36 AND 38).

FIRST USE 6-24-2008; IN COMMERCE 6-24-2008.

FOR: COMPUTER SOFTWARE FOR USE IN SECURITY, PROTECTION AND IDENTIFICATION OF COMPUTER USERS; NETWORK ACCESS SERVER OPERATING SOFTWARE FOR SECURING NETWORKS AND DETECTING, IDENTIFYING, DIVERTING AND PREVENTING UNAUTHORIZED

THE MARK CONSISTS OF STANDARD CHARACTERS WITHOUT CLAIM TO ANY PARTICULAR FONT, STYLE, SIZE, OR COLOR.

SN 78-862,584, FILED 4-17-2006.

KEVIN CORWIN, EXAMINING ATTORNEY

Int. Cl.: 5

Prior U.S. Cls.: 6, 18, 44, 46, 51, and 52

United States Patent and Trademark Office

Reg. No. 3,578,002

Registered Feb. 17, 2009

TRADEMARK
PRINCIPAL REGISTER

其實男人更需要補

CEREBOS PACIFIC LIMITED (SINGAPORE CORPORATION)
400 ORCHARD ROAD #11-12, ORCHARD TOWERS
SINGAPORE 238875, SINGAPORE

FOR: DIETARY FOOD SUPPLEMENTS; DIETARY FOOD SUPPLEMENTS COMPRISING OR CONTAINING ESSENCE OF CHICKEN; CHICKEN EXTRACTS USED AS NUTRITIONAL HEALTH FOOD SUPPLEMENTS; CHINESE MEDICINAL AND OTHER TONIC PREPARATIONS, CONSISTING OF HERBS, VITAMINS, AND MINERALS FOR IMPROVING OR STRENGTHENING HEALTH, NAMELY, HERBAL SUPPLEMENTS, IN CLASS 5 (U.S. CLS. 6, 18, 44, 46, 51 AND 52).

FIRST USE 3-0-1998; IN COMMERCE 3-0-1998.

THE FOREIGN WORDING IN THE MARK TRANSLATES INTO ENGLISH AS ACTUALLY MEN NEED NOURISHMENT ALL THE MORE.

THE NON-LATIN CHARACTERS IN THE MARK TRANSLITERATE TO "QI SHI NAN REN GENG XU YAO BU" AND THIS MEANS ACTUALLY MEN NEED NOURISHMENT ALL THE MORE IN ENGLISH.

SN 78-863,545, FILED 4-18-2006.

LEIGH LOWRY, EXAMINING ATTORNEY

Int. Cls.: 9 and 16

Prior U.S. Cls.: 2, 5, 21, 22, 23, 26, 29, 36, 37, 38, and 50

Reg. No. 3,578,003

United States Patent and Trademark Office

Registered Feb. 17, 2009

**TRADEMARK
PRINCIPAL REGISTER**

WORD WARM-UPS

READ NATURALLY, INC. (MINNESOTA CORPORATION)
750 S. PLAZA DRIVE, #100
MENDOTA HEIGHTS, MN 55120

FOR: EDUCATIONAL MATERIALS, NAMELY, GUIDED READING EXERCISES, PRE-RECORDED ON MACHINE-READABLE COMPUTER MEDIA FOR USE BY TEACHERS AND STUDENTS IN THE FIELD OF LANGUAGE EDUCATION, IN CLASS 9 (U.S. CLS. 21, 23, 26, 36 AND 38).

FIRST USE 3-23-2006; IN COMMERCE 3-23-2006.

FOR: PAPER AND CARDBOARD GOODS, NAMELY, BOOKS IN THE FIELD OF LANGUAGE EDUCATION, POSTERS, WORKSHEETS, USER'S

MANUALS, AND KITS COMPOSED OF BOOKS, POSTERS, WORKSHEETS AND USERS MANUALS, FOR USE BY TEACHERS AND STUDENTS IN THE FIELD OF LANGUAGE EDUCATION, IN CLASS 16 (U.S. CLS. 2, 5, 22, 23, 29, 37, 38 AND 50).

FIRST USE 3-23-2006; IN COMMERCE 3-23-2006.

THE MARK CONSISTS OF STANDARD CHARACTERS WITHOUT CLAIM TO ANY PARTICULAR FONT, STYLE, SIZE, OR COLOR.

SN 78-863,865, FILED 4-18-2006.

LINDA ESTRADA, EXAMINING ATTORNEY

Int. Cls.: 20 and 25

Prior U.S. Cls.: 2, 13, 22, 25, 32, 39, and 50

United States Patent and Trademark Office

Reg. No. 3,578,004

Registered Feb. 17, 2009

TRADEMARK
PRINCIPAL REGISTER



STAEHLER, TROY (UNITED STATES INDIVIDUAL)

681 BARBRE CIRCLE
CORONA, CA 92879 AND

STAEHLER, NICOLE (UNITED STATES INDIVIDUAL)

681 BARBRE CIRCLE
CORONA, CA 92879

FOR: CAR PARTS AND CAR ACCESSORIES, NAMELY, CAR PLAQUES, IN CLASS 20 (U.S. CLS. 2, 13, 22, 25, 32 AND 50).

FIRST USE 6-0-1986; IN COMMERCE 6-0-1988.

FOR: CLOTHING, NAMELY, SHIRTS, JACKETS, PANTS, SHOES, HEADWEAR, HATS AND BEANIES, IN CLASS 25 (U.S. CLS. 22 AND 39).

FIRST USE 6-0-1986; IN COMMERCE 6-0-1988.

SN 78-864,262, FILED 4-18-2006.

SAMUEL E. SHARPER JR., EXAMINING ATTORNEY

Int. Cls.: 20 and 25

Prior U.S. Cls.: 2, 13, 22, 25, 32, 39, and 50

United States Patent and Trademark Office

Reg. No. 3,578,005

Registered Feb. 17, 2009

**TRADEMARK
PRINCIPAL REGISTER**

ROLLERZ ONLY

STAEHLER, TROY (UNITED STATES INDIVIDUAL)
681 BARBRE CIRCLE
CORONA, CA 92879 AND
STAEHLER, NICOLE (UNITED STATES INDIVIDUAL)
681 BARBRE CIRCLE
CORONA, CA 92879

FOR: CAR PARTS AND CAR ACCESSORIES, NAMELY, CAR PLAQUES, IN CLASS 20 (U.S. CLS. 2, 13, 22, 25, 32 AND 50).

FIRST USE 6-0-1986; IN COMMERCE 6-0-1988.

FOR: CLOTHING, NAMELY, SHIRTS, JACKETS, PANTS, SHOES, HEADWEAR, HATS AND BEANIES, IN CLASS 25 (U.S. CLS. 22 AND 39).

FIRST USE 6-0-1986; IN COMMERCE 6-0-1988.

THE MARK CONSISTS OF STANDARD CHARACTERS WITHOUT CLAIM TO ANY PARTICULAR FONT, STYLE, SIZE, OR COLOR.

SN 78-864,264, FILED 4-18-2006.

SAMUEL E. SHARPER JR., EXAMINING ATTORNEY

Int. Cl.: 16

Prior U.S. Cls.: 2, 5, 22, 23, 29, 37, 38, and 50

United States Patent and Trademark Office

Reg. No. 3,578,006

Registered Feb. 17, 2009

**TRADEMARK
PRINCIPAL REGISTER**

COMSTOCK

PAUL L. COMSTOCK (UNITED STATES INDIVIDUAL)
2600 SOUTH GESSNER, SUITE 411
HOUSTON, TX 77063

FOR: PRINTED MATTER, NAMELY, BROCHURES AND PAMPHLETS IN THE FIELD OF STRATEGIC ESTATE SUCCESSORSHIP AND INVESTMENT PLANNING, IN CLASS 16 (U.S. CLS. 2, 5, 22, 23, 29, 37, 38 AND 50).

FIRST USE 8-26-2006; IN COMMERCE 8-26-2006.

THE MARK CONSISTS OF STANDARD CHARACTERS WITHOUT CLAIM TO ANY PARTICULAR FONT, STYLE, SIZE, OR COLOR.

OWNER OF U.S. REG. NO. 3,321,389.

SEC. 2(F).

SN 78-865,294, FILED 4-19-2006.

ERNEST SHOSHO, EXAMINING ATTORNEY

Int. Cl.: 41

Prior U.S. Cls.: 100, 101, and 107

United States Patent and Trademark Office

Reg. No. 3,578,007

Registered Feb. 17, 2009

**SERVICE MARK
PRINCIPAL REGISTER**

COMSTOCK

PAUL L. COMSTOCK (UNITED STATES INDIVIDUAL)
TWO RIVERWAY, SUITE 1000
HOUSTON, TX 77056

FOR: EDUCATIONAL SERVICES, NAMELY, SEMINARS, CLASSES, AND WORKSHOPS IN THE FIELD OF STRATEGIC ESTATE SUCCESSORSHIP AND INVESTMENT PLANNING, IN CLASS 41 (U.S. CLS. 100, 101 AND 107).

FIRST USE 8-26-2008; IN COMMERCE 8-26-2008.

THE MARK CONSISTS OF STANDARD CHARACTERS WITHOUT CLAIM TO ANY PARTICULAR FONT, STYLE, SIZE, OR COLOR.

OWNER OF U.S. REG. NO. 3,321,389.

SEC. 2(F).

SN 78-865,306, FILED 4-19-2006.

ERNEST SHOSHO, EXAMINING ATTORNEY

Int. Cl.: 45

Prior U.S. Cls.: 100 and 101

United States Patent and Trademark Office

Reg. No. 3,578,008

Registered Feb. 17, 2009

**SERVICE MARK
PRINCIPAL REGISTER**

atneed.com

JACKMAN FINANCIAL CORP. (ILLINOIS CORPORATION)
5118 S. BLACKSTONE AVE.
CHICAGO, IL 60615

THE MARK CONSISTS OF STANDARD CHARACTERS WITHOUT CLAIM TO ANY PARTICULAR FONT, STYLE, SIZE, OR COLOR.

FOR: FUNERAL SERVICE UNDERTAKING, IN CLASS 45 (U.S. CLS. 100 AND 101).

SN 78-865,920, FILED 4-20-2006.

FIRST USE 8-25-2008; IN COMMERCE 8-25-2008.

JEFF DEFORD, EXAMINING ATTORNEY

Int. Cl.: 1

Prior U.S. Cls.: 1, 5, 6, 10, 26, and 46

United States Patent and Trademark Office

Reg. No. 3,578,009

Registered Feb. 17, 2009

**TRADEMARK
PRINCIPAL REGISTER**

Cell Saver

ARCH CHEMICALS, INC. (VIRGINIA CORPORATION)
501 MERRITT 7
P.O. BOX 5204
NORWALK, CT 068565204

FOR: CHEMICAL FOR USE IN SWIMMING POOLS AND SPAS, OR IN CHLORINE GENERATING APPARATUS THEREOF, TO REDUCE SCALE FORMATION, IN CLASS 1 (U.S. CLS. 1, 5, 6, 10, 26 AND 46).

FIRST USE 9-15-2006; IN COMMERCE 9-15-2006.

THE MARK CONSISTS OF STANDARD CHARACTERS WITHOUT CLAIM TO ANY PARTICULAR FONT, STYLE, SIZE, OR COLOR.

NO CLAIM IS MADE TO THE EXCLUSIVE RIGHT TO USE "CELL", APART FROM THE MARK AS SHOWN.

SN 78-866,164, FILED 4-20-2006.

CIMMERIAN COLEMAN, EXAMINING ATTORNEY

Int. Cls.: 25, 38, and 41

Prior U.S. Cls.: 22, 39, 100, 101, 104, and 107

United States Patent and Trademark Office

Reg. No. 3,578,010

Registered Feb. 17, 2009

**TRADEMARK
SERVICE MARK
PRINCIPAL REGISTER**

SPREAD RADIO LIVE

SPREAD RADIO, INC. (CALIFORNIA CORPORATION)
1900 AVENUE OF THE STARS
25TH FLOOR
LOS ANGELES, CA 90067

FOR: CLOTHING, NAMELY, T-SHIRTS, SWEAT-SHIRTS, CAMISOLES, IN CLASS 25 (U.S. CLS. 22 AND 39).

FIRST USE 11-0-2005; IN COMMERCE 5-0-2006.

FOR: RADIO WEBCASTS AND PROVIDING ON-LINE CHAT ROOMS FOR TRANSMISSION OF MESSAGES AMONG COMPUTER USERS CONCERNING MUSIC, MUSICAL ARTISTS, AND NEWS IN THE FIELD OF MUSIC, IN CLASS 38 (U.S. CLS. 100, 101 AND 104).

FIRST USE 11-15-2005; IN COMMERCE 11-15-2005.

FOR: ENTERTAINMENT SERVICES, NAMELY, PRODUCING RADIO PROGRAMS FEATURING

MUSIC, INTERVIEWS AND INFORMATION IN THE MUSIC INDUSTRY; PROVIDING A WEBSITE WITH INFORMATION ON RADIO PROGRAMS, MUSICAL ARTISTS, PHOTOGRAPHS, MUSIC NEWS, RECORDING ARTISTS, AND LINKS TO WEBSITES OF OTHERS FEATURING INFORMATION ON MUSIC AND MUSICAL ARTISTS, IN CLASS 41 (U.S. CLS. 100, 101 AND 107).

FIRST USE 11-15-2005; IN COMMERCE 11-15-2005.

THE MARK CONSISTS OF STANDARD CHARACTERS WITHOUT CLAIM TO ANY PARTICULAR FONT, STYLE, SIZE, OR COLOR.

NO CLAIM IS MADE TO THE EXCLUSIVE RIGHT TO USE "RADIO LIVE" AS TO CLASS 38 AND 41, APART FROM THE MARK AS SHOWN.

SN 78-866,228, FILED 4-20-2006.

ANDREW LEASER, EXAMINING ATTORNEY

Int. Cls.: 16, 35, 40, and 41

**Prior U.S. Cls.: 2, 5, 22, 23, 29, 37, 38, 50, 100, 101,
102, 103, 106, and 107**

Reg. No. 3,578,011

United States Patent and Trademark Office

Registered Feb. 17, 2009

**TRADEMARK
SERVICE MARK
PRINCIPAL REGISTER**

BIGSHOTS

CONSUMER PROGRAMS INCORPORATED
(MISSOURI CORPORATION)
1706 WASHINGTON AVENUE
ST. LOUIS, MO 63103

FOR: PHOTOGRAPHIC PRINTS, PHOTO-
GRAPHS, PORTRAITS, POSTERS, PHOTOGRAPHIC
ALBUMS, STATIONERY, CALENDARS, IN CLASS
16 (U.S. CLS. 2, 5, 22, 23, 29, 37, 38 AND 50).

FIRST USE 5-14-2007; IN COMMERCE 5-14-2007.

FOR: RETAIL STORE SERVICES AND ON-LINE
RETAIL STORE SERVICES FEATURING PHOTO-
GRAPHY, PORTRAIT PHOTOGRAPHY, AND
PRINT PROCESSING, DEVELOPING, AND RE-
TOUCHING, IN CLASS 35 (U.S. CLS. 100, 101 AND
102).

FIRST USE 5-14-2007; IN COMMERCE 5-14-2007.

FOR: PHOTOGRAPHIC PRINT PROCESSING,
RETOUCHING, PORTRAIT PRINTING, DEVELOP-
ING, IN CLASS 40 (U.S. CLS. 100, 103 AND 106).

FIRST USE 5-14-2007; IN COMMERCE 5-14-2007.

FOR: PORTRAIT PHOTOGRAPHY, PHOTO-
GRAPHIC SERVICES, NAMELY, PHOTOGRAPHIC
CAPTURE, IN CLASS 41 (U.S. CLS. 100, 101 AND 107).

FIRST USE 5-14-2007; IN COMMERCE 5-14-2007.

THE MARK CONSISTS OF STANDARD CHAR-
ACTERS WITHOUT CLAIM TO ANY PARTICULAR
FONT, STYLE, SIZE, OR COLOR.

SN 78-868,342, FILED 4-24-2006.

JASON TURNER, EXAMINING ATTORNEY

Int. Cls.: 35, 39, and 42

Prior U.S. Cls.: 100, 101, 102, and 105

United States Patent and Trademark Office

Reg. No. 3,578,012

Registered Feb. 17, 2009

**SERVICE MARK
PRINCIPAL REGISTER**

ACTIVEAUDIENCE

IGUIDE, INC. (DELAWARE CORPORATION)
230 THIRD AVENUE
WALTHAM, MA 02451

FOR: DISSEMINATION OF ADVERTISING FOR OTHERS ON A GLOBAL COMPUTER NETWORK; ADVERTISING BY TRANSMISSION OF ONLINE PUBLICITY FOR THIRD PARTIES THROUGH ELECTRONIC COMMUNICATIONS NETWORKS; PROVIDING ADVERTISING SPACE ON THE INTERNET, IN CLASS 35 (U.S. CLS. 100, 101 AND 102).

FIRST USE 5-31-2006; IN COMMERCE 5-21-2006.

FOR: PARKING DOMAIN NAMES FOR OTHERS, NAMELY, PROVIDING COMPUTER SERVERS FOR FACILITATION OF THE STORAGE OF DOMAIN

NAME ADDRESS, IN CLASS 39 (U.S. CLS. 100 AND 105).

FIRST USE 5-31-2006; IN COMMERCE 5-31-2006.

FOR: COMPUTER SERVICES, NAMELY, HOSTING THE WEB SITES OF OTHERS, IN CLASS 42 (U.S. CLS. 100 AND 101).

FIRST USE 5-31-2006; IN COMMERCE 5-31-2006.

THE MARK CONSISTS OF STANDARD CHARACTERS WITHOUT CLAIM TO ANY PARTICULAR FONT, STYLE, SIZE, OR COLOR.

SN 78-868,724, FILED 4-25-2006.

SUSAN RICHARDS, EXAMINING ATTORNEY

Int. Cl.: 39

Prior U.S. Cls.: 100 and 105

United States Patent and Trademark Office

Reg. No. 3,578,013

Registered Feb. 17, 2009

**SERVICE MARK
PRINCIPAL REGISTER**

ACTIVEAUDIENCE.COM

IGUIDE, INC. (DELAWARE CORPORATION)
230 THIRD AVENUE
WALTHAM, MA 02451

FOR: PARKING DOMAIN NAMES FOR OTHERS,
NAMELY, PROVIDING COMPUTER SERVERS FOR
FACILITATION OF THE STORAGE OF DOMAIN
NAME ADDRESS, IN CLASS 39 (U.S. CLS. 100 AND
105).

FIRST USE 4-30-2006; IN COMMERCE 4-30-2006.

THE MARK CONSISTS OF STANDARD CHAR-
ACTERS WITHOUT CLAIM TO ANY PARTICULAR
FONT, STYLE, SIZE, OR COLOR.

SN 78-868,744, FILED 4-25-2006.

GINA HAYES, EXAMINING ATTORNEY

Int. Cl.: 38

Prior U.S. Cls.: 100, 101, and 104

United States Patent and Trademark Office

Reg. No. 3,578,014

Registered Feb. 17, 2009

**SERVICE MARK
PRINCIPAL REGISTER**

WII

NINTENDO OF AMERICA INC. (WASHINGTON
CORPORATION)
4820 150TH AVENUE NE
REDMOND, WA 98052

THE MARK CONSISTS OF STANDARD CHAR-
ACTERS WITHOUT CLAIM TO ANY PARTICULAR
FONT, STYLE, SIZE, OR COLOR.

FOR: WIRELESS ELECTRONIC TRANSMISSION
OF VOICE SIGNALS, WIRELESS VOICE MAIL
SERVICES, IN CLASS 38 (U.S. CLS. 100, 101 AND 104).

SN 78-870,871, FILED 4-27-2006.

FIRST USE 11-16-2008; IN COMMERCE 11-16-2008.

KRISTINA MORRIS, EXAMINING ATTORNEY

Int. Cl.: 25

Prior U.S. Cls.: 22 and 39

United States Patent and Trademark Office

Reg. No. 3,578,015

Registered Feb. 17, 2009

TRADEMARK
PRINCIPAL REGISTER

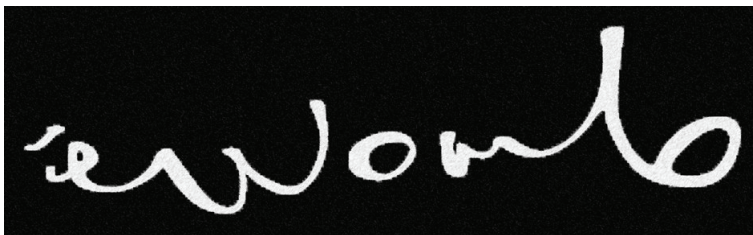

NG AI TENG (SINGAPORE SOLE PROPRIETORSHIP), TA WOMB WARDROBE,
1003 BUKIT MERAH CENTRAL #07-09
SINGAPORE, SINGAPORE 159836

FOR: CLOTHING, NAMELY, JEANS, PAJAMAS; COATS; DRESSING GOWNS; JACKETS; KNITWEAR, NAMELY, SWEATERS, JERSEYS AND PULLOVERS; PANTS; SCARVES; SHAWLS; SHIRTS; SUITS; TEE-SHIRTS; VESTS; TROUSERS; WAISTCOATS; BLOUSES; SKIRTS; DRESSES; EVENING DRESSES; GLOVES; JERSEYS; TOPS; WRAPS; BELTS; ARTICLES OF CLOTHING FOR MEN AND WOMEN, NAMELY, THREE-PIECE SUITS, JUMP SUITS; ARTICLES OF CLOTHING FOR CHILDREN, NAMELY, DRESSES, FROCKS, COATS, OVERALLS,

PAJAMAS, SMOCKS; SHOES; SPORT SHOES; HATS; BOAS; BODICES; CAMISOLES; CORSETS; FUR STOLE; OVERCOATS; SLIPS; TOGAS; VEILS AND PARKAS; FOOTWEAR; HEADGEAR, NAMELY, HATS AND CAPS, IN CLASS 25 (U.S. CLS. 22 AND 39).

FIRST USE 12-30-2005; IN COMMERCE 12-30-2006.

THE MARK CONSISTS OF STYLIZED WORDING FOR "EWOMB" ON A RECTANGLE.

SN 78-871,635, FILED 4-27-2006.

SUSAN RICHARDS, EXAMINING ATTORNEY

Int. Cl.: 24

Prior U.S. Cls.: 42 and 50

United States Patent and Trademark Office

Reg. No. 3,578,016

Registered Feb. 17, 2009

**TRADEMARK
PRINCIPAL REGISTER**

LIVING IN STYLE

MARAN, INC. (DELAWARE CORPORATION)
4301-4315 TONNELLE AVENUE
NORTH BERGEN, NJ 07047

FIRST USE 10-0-2006; IN COMMERCE 10-0-2006.

FOR: BED LINEN, COMFORTERS; PILLOW SHAMS; BED SKIRTS; SHEETS; PILLOW CASES; DUVETS; FABRIC WINDOW COVERINGS AND TREATMENTS, NAMELY, CURTAINS, DRAPERIES, SHEERS AND VALANCES, IN CLASS 24 (U.S. CLS. 42 AND 50).

THE MARK CONSISTS OF STANDARD CHARACTERS WITHOUT CLAIM TO ANY PARTICULAR FONT, STYLE, SIZE, OR COLOR.

SN 78-872,133, FILED 4-28-2006.

SUSAN RICHARDS, EXAMINING ATTORNEY

Int. Cl.: 26

Prior U.S. Cls.: 37, 39, 40, 42, and 50

United States Patent and Trademark Office

Reg. No. 3,578,017

Registered Feb. 17, 2009

**TRADEMARK
PRINCIPAL REGISTER**

Baby's First Bows

NO SLIPPY HAIR CLIPPY, INC. (CALIFORNIA CORPORATION)
801 ALAMO DR.
VACAVILLE, CA 95688

FOR: HAIR ACCESSORIES, NAMELY, BARR-ETTES, IN CLASS 26 (U.S. CLS. 37, 39, 40, 42 AND 50).

FIRST USE 8-1-2007; IN COMMERCE 8-1-2007.

THE MARK CONSISTS OF STANDARD CHARACTERS WITHOUT CLAIM TO ANY PARTICULAR FONT, STYLE, SIZE, OR COLOR.

NO CLAIM IS MADE TO THE EXCLUSIVE RIGHT TO USE "BABY'S" AND "BOWS", APART FROM THE MARK AS SHOWN.

SN 78-872,880, FILED 4-29-2006.

TRACY WHITTAKER-BROWN, EXAMINING ATTORNEY

Int. Cl.: 29

Prior U.S. Cl.: 46

United States Patent and Trademark Office

Reg. No. 3,578,018

Registered Feb. 17, 2009

TRADEMARK
PRINCIPAL REGISTER



DR. CHUNG'S FOOD CO., LTD. (REPUBLIC OF KOREA CORPORATION)
1-25 SONGJEONG-DONG, HEUNGDEOK-GU
CHEONGJU-SI, CHUNGCHEONGBUK-DO, REPUBLIC OF KOREA

FOR: KIDNEY BEANS PRESERVED; MUNG BEANS PRESERVED; PROCESSED PEANUTS; PROCESSED FRUITS; PEAS PRESERVED; BROAD BEANS PRESERVED; BEANS PRESERVED; RED BEANS PRESERVED; THICK TOFU; TOFU; SOYA BEAN MILK; FERMENTED MILK; BUTTER; BUTTER CREAM; POWDERED MILK FOR FOOD PURPOSES, EXCEPT FOR INFANTS; SOUR MILK PRODUCTS, NAMELY, SOUR CREAM; GOAT'S MILK; SHEEP MILK; CONDENSED MILK SWEETENED OR UNSWEETENED, FAT REMOVED OR NON-FAT REMOVED; YOGURT; MILK; LACTIC ACID BACTERIA DRINKS; LACTIC ACID DRINKS; WHEY; CHEESE; KEFIR MILK BEVERAGE; CONDENSED MILK; KOUMISS MILK BEVERAGES;

WHIPPED CREAM; FRUIT POWDERS FOR USE AS A FOOD ADDITIVE, IN CLASS 29 (U.S. CL. 46).

FIRST USE 9-6-1985; IN COMMERCE 12-26-1999.

THE COLOR(S) ORANGE, GREEN AND WHITE IS/ARE CLAIMED AS A FEATURE OF THE MARK.

THE MARK CONSISTS OF A GREEN CIRCLE WITH KOREAN CHARACTERS IN WHITE. THE GREEN CIRCLE IS SURROUNDED BY SMALLER ORANGE CIRCLES. THE BACKGROUND OF THE MARK IS WHITE.

THE TRANSLITERATION OF THE NON-LATIN CHARACTERS IN THE MARK IS VEGEMIL.

SN 78-873,349, FILED 5-1-2006.

PAULA MAHONEY, EXAMINING ATTORNEY

Int. Cl.: 5

Prior U.S. Cls.: 6, 18, 44, 46, 51, and 52

Reg. No. 3,578,019

United States Patent and Trademark Office

Registered Feb. 17, 2009

**TRADEMARK
PRINCIPAL REGISTER**



ORCHID CHEMICALS & PHARMACEUTICALS
LIMITED (INDIA COMPANY)
ORCHID TOWERS, 313 VALLUVAR KOTTOM
HIGH
NUNGAMBAKKAM, CHENNAI, INDIA 600034

FOR: BULK DRUG SUBSTANCES IN THE NAT-
URE OF PHARMACEUTICAL PREPARATIONS
FOR USE IN THE TREATMENT OF INFECTIONS,
ALLERGIES, AND ILLNESSES RELATING TO THE
CARDIO VASCULAR SYSTEM, THE CENTRAL
NERVOUS SYSTEM, THE GASTROINTESTINAL
SYSTEM, THE GENITOURINARY TRACT, AND

THE ENDOCRINE SYSTEM, IN CLASS 5 (U.S. CLS.
6, 18, 44, 46, 51 AND 52).

FIRST USE 6-7-2005; IN COMMERCE 6-7-2005.

NO CLAIM IS MADE TO THE EXCLUSIVE
RIGHT TO USE "HEALTHCARE", APART FROM
THE MARK AS SHOWN.

SN 78-874,182, FILED 5-2-2006.

MARY MUNSON, EXAMINING ATTORNEY

Int. Cl.: 3

Prior U.S. Cls.: 1, 4, 6, 50, 51, and 52

Reg. No. 3,578,020

United States Patent and Trademark Office

Registered Feb. 17, 2009

**TRADEMARK
PRINCIPAL REGISTER**



SO COZY, LLC (NEW YORK LIMITED LIABILITY COMPANY)
448 AMSTERDAM AVENUE
NEW YORK, NY 10024

FOR: HAIR CARE PREPARATIONS; SHAMPOOS,
IN CLASS 3 (U.S. CLS. 1, 4, 6, 50, 51 AND 52).

FIRST USE 5-18-2006; IN COMMERCE 5-18-2006.

NO CLAIM IS MADE TO THE EXCLUSIVE
RIGHT TO USE "SHAMPOO", APART FROM THE
MARK AS SHOWN.

THE MARK CONSISTS OF THE WORD "BOO"
AND EXCLAMATION POINT. BOTH LETTER "OS"
APPEARING IN THE MARK ARE REPRESENTATIVE
OF TWO EYES, WHILE THE EXCLAMATION
POINT IS FIGURATIVE OF A GHOST.

SN 78-875,093, FILED 5-3-2006.

WILLIAM VERHOSEK, EXAMINING ATTORNEY

Int. Cl.: 9

Prior U.S. Cls.: 21, 23, 26, 36, and 38

Reg. No. 3,578,021

United States Patent and Trademark Office

Registered Feb. 17, 2009

**TRADEMARK
PRINCIPAL REGISTER**

MICROMATE

SANDISK CORPORATION (DELAWARE CORPORATION)
601 MCCARTHY BOULEVARD
MILPITAS, CA 95035

THE MARK CONSISTS OF STANDARD CHARACTERS WITHOUT CLAIM TO ANY PARTICULAR FONT, STYLE, SIZE, OR COLOR.

FOR: FLASH MEMORY CARD READERS AND WRITERS, IN CLASS 9 (U.S. CLS. 21, 23, 26, 36 AND 38).

SN 78-878,104, FILED 5-5-2006.

FIRST USE 8-30-2006; IN COMMERCE 8-30-2006.

SUZANNE BLANE, EXAMINING ATTORNEY

Int. Cl.: 9

Prior U.S. Cls.: 21, 23, 26, 36, and 38

United States Patent and Trademark Office

Reg. No. 3,578,022

Registered Feb. 17, 2009

**TRADEMARK
PRINCIPAL REGISTER**

HASP SRM

ALADDIN KNOWLEDGE SYSTEMS LTD. (IS-
RAEL CORPORATION)
PO BOX 3968
35 EFAL ST . KIRYAT ARYE
PETACH TIKVA, ISRAEL 49511

FOR: COMPUTER SOFTWARE FOR CLIENT
SERVER APPLICATIONS, NAMELY, A DIGITAL
RIGHTS MANAGEMENT SYSTEM FOR SOFT-
WARE LICENSORS AND LICENSEES , IN CLASS 9
(U.S. CLS. 21, 23, 26, 36 AND 38).

FIRST USE 3-27-2007; IN COMMERCE 3-27-2007.

THE MARK CONSISTS OF STANDARD CHAR-
ACTERS WITHOUT CLAIM TO ANY PARTICULAR
FONT, STYLE, SIZE, OR COLOR.

OWNER OF U.S. REG. NOS. 1,673,252, 1,976,311,
AND 2,009,567.

NO CLAIM IS MADE TO THE EXCLUSIVE
RIGHT TO USE "SRM", APART FROM THE MARK
AS SHOWN.

SN 78-879,343, FILED 5-9-2006.

CARYN GLASSER, EXAMINING ATTORNEY

Int. Cls.: 5 and 29

Prior U.S. Cls.: 6, 18, 44, 46, 51, and 52

United States Patent and Trademark Office

Reg. No. 3,578,023

Registered Feb. 17, 2009

**TRADEMARK
PRINCIPAL REGISTER**

MUSCLE FOODS

MUSCLE FOODS, LLC (FLORIDA LIMITED LIABILITY COMPANY)
13217 ROYAL GEORGE AVENUE
ODESSA, FL 13217

FOR: FOOD SUPPLEMENTS FOR BODY BUILDING, FOOD AND SPORT NUTRITIONAL SUPPLEMENTS FOR STRENGTH AND PERFORMANCE ENHANCEMENT; SNACK FOODS, NAMELY, MEAL REPLACEMENT BARS, CHIPS, AND PUFFS, IN CLASS 5 (U.S. CLS. 6, 18, 44, 46, 51 AND 52).

FIRST USE 2-0-2007; IN COMMERCE 2-0-2007.

FOR: PROTEIN ADDED, NUTRIENT-DENSE SNACK FOODS, NAMELY, BARS, CHIPS, AND PUFFS, IN CLASS 29 (U.S. CL. 46).

FIRST USE 2-0-2007; IN COMMERCE 2-0-2007.

THE MARK CONSISTS OF STANDARD CHARACTERS WITHOUT CLAIM TO ANY PARTICULAR FONT, STYLE, SIZE, OR COLOR.

NO CLAIM IS MADE TO THE EXCLUSIVE RIGHT TO USE "FOODS", APART FROM THE MARK AS SHOWN.

SN 78-880,421, FILED 5-10-2006.

SUSAN RICHARDS, EXAMINING ATTORNEY

Int. Cl.: 9

Prior U.S. Cls.: 21, 23, 26, 36, and 38

United States Patent and Trademark Office

Reg. No. 3,578,024

Registered Feb. 17, 2009

**TRADEMARK
PRINCIPAL REGISTER**



WISCONSIN CROP IMPROVEMENT ASSOCIATION (WISCONSIN CORPORATION)
1575 LINDEN DRIVE
MADISON, WI 53706

FOR: SEED GERMINATION TESTING SYSTEMS CONSISTING PRIMARILY OF INTERCHANGEABLE TRAYS WITH SIZED APERTURES TO ACCOMMODATE DIFFERENT SIZE SEEDS AND A FRAME FOR THE TRAYS WITH CORRESPONDING APERTURES; MACHINES FOR SEED GERMINATION TESTING, IN CLASS 9 (U.S. CLS. 21, 23, 26, 36 AND 38).

FIRST USE 6-0-2006; IN COMMERCE 6-0-2006.

NO CLAIM IS MADE TO THE EXCLUSIVE RIGHT TO USE "PREP BOARD PLANTING SYSTEM", APART FROM THE MARK AS SHOWN.

THE MARK CONSISTS OF A TEST TUBE WITH A SECTION OF "DNA" IN THE TUBE WITH A LEAF AND PLANT STEM REPRESENTATION ABOVE THE TUBE.

SN 78-880,735, FILED 5-10-2006.

ALICIA COLLINS, EXAMINING ATTORNEY

Int. Cl.: 42

Prior U.S. Cls.: 100 and 101

United States Patent and Trademark Office

Reg. No. 3,578,025

Registered Feb. 17, 2009

**SERVICE MARK
PRINCIPAL REGISTER**

Dasko Communications

DASKO COMMUNICATIONS (CALIFORNIA CORPORATION)
14012 RUE SAN REMO
DEL MAR, CA 92014

FOR: PROVIDING TEMPORARY USE OF ON-LINE, NON-DOWNLOADABLE SOFTWARE USED FOR TRANSMISSION, STORAGE AND SHARING OF DATA AND INFORMATION IN THE FIELDS OF SALES COACHING, ROLE PLAYING, PRODUCT KNOWLEDGE VERIFICATION AND VIDEO FEED-BACK DIRECTED TO COMPANIES FOR THE IMPROVEMENT OF SALES ORGANIZATION SKILLS, IN CLASS 42 (U.S. CLS. 100 AND 101).

FIRST USE 1-2-2007; IN COMMERCE 1-2-2007.

THE MARK CONSISTS OF STANDARD CHARACTERS WITHOUT CLAIM TO ANY PARTICULAR FONT, STYLE, SIZE, OR COLOR.

NO CLAIM IS MADE TO THE EXCLUSIVE RIGHT TO USE "COMMUNICATIONS", APART FROM THE MARK AS SHOWN.

SN 78-881,998, FILED 5-11-2006.

AMY HELLA, EXAMINING ATTORNEY

Int. Cls.: 25 and 28

Prior U.S. Cls.: 22, 23, 38, 39, and 50

United States Patent and Trademark Office

Reg. No. 3,578,026

Registered Feb. 17, 2009

TRADEMARK
PRINCIPAL REGISTER



SERVANTHOOD, INC. (NEW YORK CORPORATION)
P.O. BOX 916
WHEATLEY HEIGHTS, NY 11798

FOR: CLOTHING FOR MEN, WOMEN AND CHILDREN, NAMELY, PANTS, SHIRTS, SWEATERS, T-SHIRTS, VESTS, SWEAT SHIRTS, SWEAT PANTS, SWEAT JACKETS, SWEAT SHORTS, POLO SHIRTS, TANK TOPS, BATHING SUITS, CAPS, HATS, BASEBALL CAPS, GLOVES, GOLF TROUSERS, SNOW SUITS, PARKAS, PONCHOS, JEANS, DENIM JACKETS, DENIM SHIRTS, DENIM SHORTS, FOOTBALL JERSEYS, SPORTS COATS, SUIT COATS, SUITS, FUR COATS, RAINCOATS, DRESSES, EVENING DRESSES, SILK SCARVES, SILK TIES, SHOES, SANDALS, SNEAKERS, SNOW BOOTS, RAINBOOTS, GOLF SHOES, FOOTBALL SHOES, BASEBALL SHOES, BOWLING SHOES, SOCKS, UNDERWEAR, AND UNIFORMS FOR PLAYING SPORTS, IN CLASS 25 (U.S. CLS. 22 AND 39).

FIRST USE 12-1-2006; IN COMMERCE 12-1-2006.

FOR: SPORTING GOODS, NAMELY, BALLS FOR PLAYING SPORTS; BAR-BELLS, FREE WEIGHTS, BASEBALL BATS; BASEBALL BATTING GLOVES;

BASEBALL GLOVES; BASEBALL CATCHERS' MASKS, BASEBALLS; BASKETBALLS; BASKETBALL BASKETS; BASKETBALL HOOPS; SOCCER BALLS; TWIRLING BATONS; STATIONARY EXERCISE BICYCLES; BOWLING BALLS; FOOTBALLS; FOOTBALL KNEE PADS; FENCING ARTICLES, NAMELY, FENCING MASKS, AND EPEES; FENCING FOILS; FENCING GAUNTLETS; HOCKEY STICKS; HOCKEY SKATES; HOCKEY GOALIE EQUIPMENT, NAMELY, GOALIE PADS; HOCKEY GLOVES; FIGURE SKATES; GYMNASTICS EQUIPMENT, NAMELY, PARALLEL BARS, BALANCE BEAMS, AND MATS; YOGA EQUIPMENT, NAMELY, BALLS AND MATS; TOYS AND GAMES, NAMELY, BOARD GAMES, ACTION FIGURE DOLLS, ACTION TOYS, TOY GUNS AND SWORDS, ARCADE GAMES, ELECTRONIC HANDHELD GAME UNITS, IN CLASS 28 (U.S. CLS. 22, 23, 38 AND 50).

FIRST USE 12-1-2006; IN COMMERCE 12-1-2006.

SN 78-885,241, FILED 5-17-2006.

WILLIAM P. SHANAHAN, EXAMINING ATTORNEY

Int. Cls.: 9 and 42

Prior U.S. Cls.: 21, 23, 26, 36, 38, 100, and 101

United States Patent and Trademark Office

Reg. No. 3,578,027

Registered Feb. 17, 2009

**TRADEMARK
SERVICE MARK
PRINCIPAL REGISTER**



SWIFT SOFTWARE, INC. (MARYLAND CORPORATION)
SUITE 302
5301 BUCKEYSTOWN PIKE
FREDERICK, MD 21704

FOR: COMPUTER SOFTWARE FOR AUTOMATING BUSINESS PROCESSES, TASKS, WORKFLOW, AND ELECTRONIC RESOURCES IN THE FIELDS OF BUSINESS PROCESS MANAGEMENT, TASK MANAGEMENT, AND COLLABORATIVE PROJECT MANAGEMENT, IN CLASS 9 (U.S. CLS. 21, 23, 26, 36 AND 38).

FIRST USE 6-0-2006; IN COMMERCE 6-0-2006.

FOR: TECHNICAL SUPPORT SERVICES, NAMELY, TROUBLESHOOTING COMPUTER SOFTWARE PROBLEMS, IN CLASS 42 (U.S. CLS. 100 AND 101).

FIRST USE 6-0-2006; IN COMMERCE 6-0-2006.

THE COLOR(S) RED, BLUE, GREEN, YELLOW, WHITE AND BLACK IS/ARE CLAIMED AS A FEATURE OF THE MARK.

THE COLOR RED APPEARS IN THE BOTTOM SQUARE IN THE MARK, THE COLOR BLUE APPEARS IN THE TOP SQUARE AND "JOBTRAQ" LETTERING IN THE MARK, THE COLOR GREEN APPEARS IN THE RIGHT SQUARE IN THE MARK, THE COLOR YELLOW APPEARS IN THE LEFT SQUARE IN THE MARK, THE COLOR WHITE APPEARS IN THE HIGHLIGHTING OF THE SQUARES AND THE ARROW CROSSING THE SQUARES IN THE MARK, AND THE COLOR BLACK APPEARS IN THE SHADOWS BEHIND THE SQUARES IN THE MARK. THE MARK APPEARS ON A TRANSPARENT BACKGROUND AND NO OTHER COLORS ARE CLAIMED.

SN 78-885,462, FILED 5-17-2006.

JASON LOTT, EXAMINING ATTORNEY

Int. Cls.: 9, 16, 35, 38, and 41

**Prior U.S. Cls.: 2, 5, 21, 22, 23, 26, 29, 36, 37, 38, 50,
100, 101, 102, 104, and 107**

Reg. No. 3,578,028

United States Patent and Trademark Office

Registered Feb. 17, 2009

**TRADEMARK
SERVICE MARK
PRINCIPAL REGISTER**

**LEADING REMARKABLE WOMEN
TO UNCOMMON SUCCESS**

JANE POLLAK, INC. (CONNECTICUT CORPORATION)
P.O. BOX 2605
WESTPORT, CT 06880

FOR: PRE-RECORDED ELECTRONIC MEDIA, NAMELY, AUDIO/VIDEO DISCS AND TAPES, DIGITAL RECORDING DISCS AND TAPES, SERIES OF PRE-RECORDED COMPACT SOUND RECORDING DISCS, VIDEO DISCS AND VIDEOTAPES FEATURING INSTRUCTION IN THE FIELD OF BUSINESS, COMMUNICATIONS, WORKPLACE STRATEGIES, INSPIRATION, SPIRITUALITY, PERSONAL DEVELOPMENT, SELF-ESTEEM, SELF-FULFILLMENT, SELF-ANALYSIS AND IDENTITY; MUSIC, SOUND EFFECTS AND SPEECHES, IN CLASS 9 (U.S. CLS. 21, 23, 26, 36 AND 38).

FIRST USE 6-6-2006; IN COMMERCE 6-6-2006.

FOR: PAPER AND PRINTED MATTER, NAMELY, SYNDICATED COLUMNS FOR PUBLICATION IN BOOKLETS, BROCHURES, CATALOGS, DIRECTORIES ON THE SUBJECT OF BUSINESS, COMMUNICATIONS, WORKPLACE STRATEGIES, INSPIRATION, SPIRITUALITY, PERSONAL DEVELOPMENT, SELF-ESTEEM, SELF-FULFILLMENT, SELF-ANALYSIS AND IDENTITY; MAGAZINES, MANUALS, NEWSLETTERS, NEWSPAPERS, PAMPHLETS AND PERIODICALS ALL IN THE FIELD OF BUSINESS, COMMUNICATIONS, WORKPLACE STRATEGIES, INSPIRATION, SPIRITUALITY, PERSONAL DEVELOPMENT, SELF-ESTEEM, SELF-FULFILLMENT, SELF-ANALYSIS AND IDENTITY; AGENDAS, EVENT, PHOTOGRAPH AND SCRAPBOOK ALBUMS, BUSINESS CARDS, BOOKMARKS, CALENDARS, DESK DIARIES; PHOTOGRAPHS AND PHOTOGRAPH STANDS; PRINTED GREETING CARDS; PRINTED EDUCATIONAL, INSTRUCTIONAL AND TEACH-

ING MATERIALS IN THE FIELD OF BUSINESS, COMMUNICATIONS, WORKPLACE STRATEGIES, INSPIRATION, SPIRITUALITY, PERSONAL DEVELOPMENT, SELF-ESTEEM, SELF-FULFILLMENT, SELF-ANALYSIS AND IDENTITY; PROMOTIONAL POSTCARDS AND POSTERS, SERIES OF NON-FICTION BOOKS IN THE FIELD OF BUSINESS, COMMUNICATIONS, WORKPLACE STRATEGIES, INSPIRATION, SPIRITUALITY, PERSONAL DEVELOPMENT, SELF-ESTEEM, SELF-FULFILLMENT, SELF-ANALYSIS AND IDENTITY; WORKBOOKS IN THE FIELD OF BUSINESS, COMMUNICATIONS, WORKPLACE STRATEGIES, INSPIRATION, SPIRITUALITY, PERSONAL DEVELOPMENT, SELF-ESTEEM, SELF-FULFILLMENT, SELF-ANALYSIS AND IDENTITY; STATIONERY, NAMELY, LETTERHEAD AND ENVELOPES, PADS, STATIONERY COVERS, NAMELY, DOCUMENT COVERS, FOLDERS AND STICKERS; PENS AND PENCILS, IN CLASS 16 (U.S. CLS. 2, 5, 22, 23, 29, 37, 38 AND 50).

FIRST USE 6-6-2006; IN COMMERCE 6-6-2006.

FOR: BUSINESS MARKETING AND MANAGEMENT CONSULTING SERVICES; PROVIDING INFORMATION SERVICES IN THE FIELD OF BUSINESS; ON-LINE RETAIL STORE SERVICES FEATURING CD'S, DVD'S AND BOOKS IN THE FIELD OF BUSINESS, COMMUNICATIONS, WORKPLACE STRATEGIES, INSPIRATION, SPIRITUALITY, PERSONAL DEVELOPMENT, SELF-ESTEEM, SELF-FULFILLMENT, SELF-ANALYSIS AND IDENTITY, IN CLASS 35 (U.S. CLS. 100, 101 AND 102).

FIRST USE 6-6-2006; IN COMMERCE 6-6-2006.

FOR: PROVIDING INFORMATION SERVICES IN THE FIELD OF COMMUNICATIONS; TELECOM-

MUNICATIONS SERVICES, NAMELY, BROADCASTING RADIO AND TELEVISION PROGRAMS AND FILMS VIA A GLOBAL COMPUTER NETWORK; COMMUNICATIONS BY TELEPHONE AND FACSIMILE TRANSMISSION; ELECTRONIC, ELECTRIC, AND DIGITAL TRANSMISSION OF VOICE, DATA, IMAGES, SOUND, SIGNAL AND MESSAGES; ELECTRONIC TRANSMISSION OF BOOKS, E-ZINES AND NEWSLETTERS VIA A GLOBAL COMPUTER NETWORK; ELECTRONIC TRANSMISSION OF GREETING CARDS AND MAILERS VIA A GLOBAL COMPUTER NETWORK; TRANSMISSION OF DATA, DOCUMENTS AND INFORMATION BY ELECTRONIC MEDIA, IN CLASS 38 (U.S. CLS. 100, 101 AND 104).

FIRST USE 6-6-2006; IN COMMERCE 6-6-2006.

FOR: EDUCATIONAL AND INSTRUCTIONAL SERVICES, NAMELY, ARRANGING AND CONDUCTING CONFERENCES, SEMINARS, AND WORKSHOPS IN THE FIELD OF BUSINESS, COMMUNICATIONS, WORKPLACE STRATEGIES, INSPIRATION, SPIRITUALITY, PERSONAL DEVELOPMENT, SELF-ESTEEM, SELF-FULFILLMENT, SELF-ANALYSIS AND IDENTITY; ENTERTAINMENT SERVICES, NAMELY, LIVE SPEAKING PERFORMANCES AND SPEAKING ENGAGEMENTS IN THE FIELD OF BUSINESS, COMMUNICATIONS, WORKPLACE STRATEGIES, INSPIRATION, SPIRITUALITY, PERSONAL DEVELOPMENT, SELF-ESTEEM, SELF-FULFILL-

MENT, SELF-ANALYSIS AND IDENTITY; PRODUCTION OF RADIO AND TELEVISION AND FILM PROGRAMS FOR TRANSMISSION VIA BROADCAST, CABLE, DIGITAL AND GLOBAL COMPUTER NETWORK AND PUBLICATION OF ACCOMPANYING MATERIALS IN THE FORM OF BOOKS, MAGAZINES AND NEWSLETTERS; ELECTRONIC PUBLISHING, NAMELY, PUBLICATION OF TEXT AND GRAPHIC WORKS OF OTHERS ON CD AND DVD FEATURING FICTION AND NON-FICTION IN THE FIELD OF PROVIDING INFORMATION SERVICES IN THE FIELD OF BUSINESS, COMMUNICATIONS, WORKPLACE STRATEGIES, INSPIRATION, SPIRITUALITY, PERSONAL DEVELOPMENT, SELF-ESTEEM, SELF-FULFILLMENT, SELF-ANALYSIS AND IDENTITY; PUBLICATION SERVICES FOR OTHERS, NAMELY, BOOKS, MAGAZINES, NEWSLETTERS, SCREENPLAYS AND MEDIA RECORDINGS, NAMELY, MUSICAL TEXTS, IN CLASS 41 (U.S. CLS. 100, 101 AND 107).

FIRST USE 6-6-2006; IN COMMERCE 6-6-2006.

THE MARK CONSISTS OF STANDARD CHARACTERS WITHOUT CLAIM TO ANY PARTICULAR FONT, STYLE, SIZE, OR COLOR.

SN 78-892,785, FILED 5-25-2006.

ROBERT STRUCK, EXAMINING ATTORNEY

Int. Cl.: 20

Prior U.S. Cls.: 2, 13, 22, 25, 32, and 50

Reg. No. 3,578,029

United States Patent and Trademark Office

Registered Feb. 17, 2009

**TRADEMARK
PRINCIPAL REGISTER**

DISNEY PARKS

DISNEY ENTERPRISES, INC. (DELAWARE CORPORATION)
500 SOUTH BUENA VISTA STREET
BURBANK, CA 91521

FOR: JEWELRY BOXES NOT MADE OF PRECIOUS METALS; PICTURE FRAMES; PILLOWS, IN CLASS 20 (U.S. CLS. 2, 13, 22, 25, 32 AND 50).

FIRST USE 3-0-2008; IN COMMERCE 3-0-2008.

THE MARK CONSISTS OF STANDARD CHARACTERS WITHOUT CLAIM TO ANY PARTICULAR FONT, STYLE, SIZE, OR COLOR.

OWNER OF U.S. REG. NOS. 2,412,749 AND 3,066,604.

SN 78-893,335, FILED 5-25-2006.

FONG HSU, EXAMINING ATTORNEY

Int. Cls.: 21 and 25

Prior U.S. Cls.: 2, 13, 22, 23, 29, 30, 33, 39, 40, and 50

United States Patent and Trademark Office

Reg. No. 3,578,030

Registered Feb. 17, 2009

**TRADEMARK
PRINCIPAL REGISTER**



BOK FINANCIAL CORPORATION (OKLAHOMA CORPORATION)
P.O. BOX 2300
TULSA, OK 74192

FOR: MUGS, IN CLASS 21 (U.S. CLS. 2, 13, 23, 29, 30, 33, 40 AND 50).

FIRST USE 3-31-2008; IN COMMERCE 3-31-2008.

FOR: POLO SHIRTS, SHIRTS , IN CLASS 25 (U.S. CLS. 22 AND 39).

FIRST USE 3-31-2008; IN COMMERCE 3-31-2008.

OWNER OF U.S. REG. NO. 1,056,277.

NO CLAIM IS MADE TO THE EXCLUSIVE RIGHT TO USE "CENTER", APART FROM THE MARK AS SHOWN.

THE MARK CONSISTS OF AN EIGHT-SIDED POLYGON DESIGN WITH THE WORDS "BOK CENTER" TO THE RIGHT OF THE POLYGON.

SN 78-893,770, FILED 5-26-2006.

LEIGH CAROLINE CASE, EXAMINING ATTORNEY

Int. Cl.: 25

Prior U.S. Cls.: 22 and 39

United States Patent and Trademark Office

Reg. No. 3,578,031

Registered Feb. 17, 2009

**TRADEMARK
PRINCIPAL REGISTER**

RHODE RAG

RHODES, STEVEN L. (UNITED STATES INDIVIDUAL)
926 SOUTH 2ND ST.
JACKSONVILLE BEACH, FL 32250

THE MARK CONSISTS OF STANDARD CHARACTERS WITHOUT CLAIM TO ANY PARTICULAR FONT, STYLE, SIZE, OR COLOR.

FOR: BANDANAS, IN CLASS 25 (U.S. CLS. 22 AND 39).

SN 78-894,369, FILED 5-26-2006.

FIRST USE 4-28-2007; IN COMMERCE 4-28-2007.

RONALD AIKENS, EXAMINING ATTORNEY

Int. Cls.: 35, 36, 37, 41, and 43

Prior U.S. Cls.: 100, 101, 102, 103, 106, and 107

United States Patent and Trademark Office

Reg. No. 3,578,032

Registered Feb. 17, 2009

**SERVICE MARK
PRINCIPAL REGISTER**

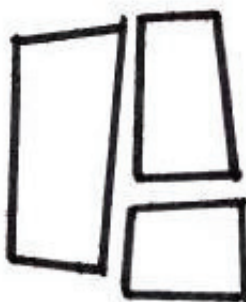

LNR SOUTH SHORE, LLC (DELAWARE LIMITED LIABILITY COMPANY)
1900 CROWN COLONY DRIVE
QUINCY, MA 02169

FOR: RETAIL STORE SERVICES FEATURING GOLF EQUIPMENT; REAL ESTATE SALES MANAGEMENT FOR RESIDENTIAL, COMMERCIAL, OFFICE, RETAIL, AND RECREATIONAL FACILITIES AND PROPERTIES, IN CLASS 35 (U.S. CLS. 100, 101 AND 102).

FIRST USE 11-1-2006; IN COMMERCE 11-1-2006.

FOR: BUILDING MANAGEMENT; REAL ESTATE BROKERAGE; LEASING OF REAL ESTATE, NAMELY, RESIDENTIAL COMMERCIAL, OFFICE, RETAIL, AND RECREATIONAL FACILITIES AND PROPERTIES, IN CLASS 36 (U.S. CLS. 100, 101 AND 102).

FIRST USE 11-1-2006; IN COMMERCE 11-1-2006.

FOR: LAND DEVELOPMENT SERVICES, NAMELY, PLANNING, LAYING OUT, AND CONSTRUCTING RESIDENTIAL, COMMERCIAL, OFFICE, RETAIL, AND RECREATIONAL FACILITIES AND PROPERTIES; COMMUNITY DEVELOPMENT, NAMELY, PLANNING, LAYING OUT, AND CONSTRUCTING A MASTER PLANNED COMMUNITY HAVING RESIDENTIAL, COMMERCIAL, OFFICE,

RETAIL, AND RECREATIONAL PROPERTIES, IN CLASS 37 (U.S. CLS. 100, 103 AND 106).

FIRST USE 11-1-2006; IN COMMERCE 11-1-2006.

FOR: GOLF COURSE; GOLF CLUB SERVICES; PROVIDING GOLF FACILITIES, NAMELY, DRIVING RANGES AND PRACTICE AREAS; RENTAL OF GOLF EQUIPMENT; GOLF INSTRUCTION SERVICES; ENTERTAINMENT SERVICES, NAMELY, ORGANIZING AND CONDUCTING GOLF TOURNAMENTS; RECREATIONAL SERVICES IN THE NATURE OF PROVIDING FACILITIES FOR RECREATION ACTIVITIES, NAMELY, GOLF, TRACK, HIKING, TENNIS, SOCCER, BASEBALL, AND FOOTBALL; RECREATIONAL SERVICES IN THE NATURE OF PROVIDING GYMNASIUMS, IN CLASS 41 (U.S. CLS. 100, 101 AND 107).

FIRST USE 11-1-2006; IN COMMERCE 11-1-2006.

FOR: RESTAURANT, CATERING, AND BAR SERVICES; PROVIDING BANQUET AND SOCIAL FUNCTION FACILITIES FOR SPECIAL OCCASIONS, IN CLASS 43 (U.S. CLS. 100 AND 101).

FIRST USE 11-1-2006; IN COMMERCE 11-1-2006.

SN 78-895,605, FILED 5-30-2006.

KEVIN CORWIN, EXAMINING ATTORNEY

Int. Cl.: 35

Prior U.S. Cls.: 100, 101, and 102

United States Patent and Trademark Office

Reg. No. 3,578,033

Registered Feb. 17, 2009

**SERVICE MARK
PRINCIPAL REGISTER**



GROWTH MANAGEMENT SOLUTIONS, INC.
(OHIO CORPORATION)

330 W. SPRING STREET, SUITE 205
COLUMBUS, OH 43215

FOR: ACCOUNTING SERVICES; FINANCIAL
STATEMENT PREPARATION AND ANALYSIS
FOR BUSINESSES, IN CLASS 35 (U.S. CLS. 100, 101
AND 102).

FIRST USE 6-1-2006; IN COMMERCE 6-1-2006.

NO CLAIM IS MADE TO THE EXCLUSIVE
RIGHT TO USE "CFO" AND "GROUP", APART
FROM THE MARK AS SHOWN.

THE COLOR(S) GREEN IS/ARE CLAIMED AS A
FEATURE OF THE MARK.

THE MARK CONSISTS OF THE WORD ELE-
MENTS "BEANSTALK CFO GROUP" PLACED
AROUND AN IMAGE OF A LEAF IN A BOX. THE
"BEANSTALK CFO GROUP" ELEMENTS ARE STY-
LIZED AND INCORPORATES THE STALK RUN-
NING THROUGH THE LETTER "S" TO CONNOTE
A DOLLAR SIGN, WITH THE ENTIRE MARK
APPEARING IN THE COLOR GREEN.

SN 78-896,160, FILED 5-30-2006.

JEFF DEFORD, EXAMINING ATTORNEY

Int. Cl.: 9

Prior U.S. Cls.: 21, 23, 26, 36, and 38

United States Patent and Trademark Office

Reg. No. 3,578,034

Registered Feb. 17, 2009

**TRADEMARK
PRINCIPAL REGISTER**

Taglocity

TERAZEN TECHNOLOGY INC. (CANADA CORPORATION)
189 DAVIE STREET
SUITE 606
VANCOUVER, BC, CANADA V6Z 2X9

FOR: COMPUTER SOFTWARE FOR THE COLLECTION, EDITING, ORGANIZING, MODIFYING, BOOK MARKING, TRANSMISSION, STORAGE AND SHARING OF DATA AND INFORMATION , IN CLASS 9 (U.S. CLS. 21, 23, 26, 36 AND 38).

FIRST USE 0-0-2007; IN COMMERCE 0-0-2007.

THE MARK CONSISTS OF STANDARD CHARACTERS WITHOUT CLAIM TO ANY PARTICULAR FONT, STYLE, SIZE, OR COLOR.

SN 78-896,338, FILED 5-30-2006.

LESLEY LAMOTHE, EXAMINING ATTORNEY

Int. Cl.: 11

Prior U.S. Cls.: 13, 21, 23, 31, and 34

Reg. No. 3,578,035

United States Patent and Trademark Office

Registered Feb. 17, 2009

**TRADEMARK
PRINCIPAL REGISTER**

MIA

CRAFTMADE INTERNATIONAL INC. (DELA-
WARE CORPORATION)
650 S. ROYAL LANE
COPPELL, TX 75019

THE MARK CONSISTS OF STANDARD CHAR-
ACTERS WITHOUT CLAIM TO ANY PARTICULAR
FONT, STYLE, SIZE, OR COLOR.

FOR: CEILING FANS, IN CLASS 11 (U.S. CLS. 13,
21, 23, 31 AND 34).

SN 78-900,260, FILED 6-5-2006.

FIRST USE 6-1-2006; IN COMMERCE 1-1-2007.

LINDA LAVACHE, EXAMINING ATTORNEY

Int. Cl.: 11

Prior U.S. Cls.: 13, 21, 23, 31, and 34

Reg. No. 3,578,036

United States Patent and Trademark Office

Registered Feb. 17, 2009

**TRADEMARK
PRINCIPAL REGISTER**

TRELLIS

CRAFTMADE INTERNATIONAL INC. (DELA-
WARE CORPORATION)
650 S. ROYAL LANE
COPPELL, TX 75019

THE MARK CONSISTS OF STANDARD CHAR-
ACTERS WITHOUT CLAIM TO ANY PARTICULAR
FONT, STYLE, SIZE, OR COLOR.

FOR: CEILING FANS, IN CLASS 11 (U.S. CLS. 13,
21, 23, 31 AND 34).

SN 78-900,282, FILED 6-5-2006.

FIRST USE 6-1-2006; IN COMMERCE 1-1-2007.

LINDA LAVACHE, EXAMINING ATTORNEY

Int. Cl.: 41

Prior U.S. Cls.: 100, 101, and 107

United States Patent and Trademark Office

Reg. No. 3,578,037

Registered Feb. 17, 2009

**SERVICE MARK
PRINCIPAL REGISTER**

SECRETS NO ONE EVER TOLD
YOU

BALKIND, HARRIETT LEVIN (UNITED STATES
INDIVIDUAL)
325 WEST END AVENUE, PHA
NEW YORK, NY 10023

FOR: ENTERTAINMENT AND EDUCATIONAL
SERVICES IN THE NATURE OF PROVIDING IN-
TERNET CONTENT FEATURING PERSONAL DE-
VELOPMENT, SELF-HELP, AND ADVICE
CONCERNING LIFE EXPERIENCES, IN CLASS 41
(U.S. CLS. 100, 101 AND 107).

FIRST USE 10-21-2007; IN COMMERCE 10-21-2007.

THE MARK CONSISTS OF STANDARD CHAR-
ACTERS WITHOUT CLAIM TO ANY PARTICULAR
FONT, STYLE, SIZE, OR COLOR.

SN 78-905,051, FILED 6-9-2006.

RONALD AIKENS, EXAMINING ATTORNEY

Int. Cls.: 1, 3, 5, 29, and 31

Prior U.S. Cls.: 1, 4, 5, 6, 10, 18, 26, 44, 46, 50, 51, and 52

Reg. No. 3,578,038

United States Patent and Trademark Office

Registered Feb. 17, 2009

**TRADEMARK
PRINCIPAL REGISTER**

NATURAL OCEAN

EUROCAN BIO-MARINE INC. (CANADA CORPORATION)
5537 HENNESSEY PLACE
HALIFAX, CANADA B3K 2A7

FOR: MARINE PLANT BASED PRODUCTS, NAMELY, PLANT AND CROP GROWTH REGULATORS, FERTILIZERS, AND PLANT FOOD FOR GROWTH STIMULATION, ALL FOR AGRICULTURAL, HORTICULTURAL AND DOMESTIC USE, IN CLASS 1 (U.S. CLS. 1, 5, 6, 10, 26 AND 46).

FIRST USE 2-4-2006; IN COMMERCE 6-30-2008.

FOR: MARINE PLANT BASED COSMETICS FOR HUMAN AND ANIMAL USE, IN CLASS 3 (U.S. CLS. 1, 4, 6, 50, 51 AND 52).

FIRST USE 2-4-2006; IN COMMERCE 6-30-2008.

FOR: MARINE PLANT BASED DIETARY AND NUTRITIONAL SUPPLEMENTS FOR HUMAN AND ANIMAL CONSUMPTION, IN CLASS 5 (U.S. CLS. 6, 18, 44, 46, 51 AND 52).

FIRST USE 2-4-2006; IN COMMERCE 6-30-2008.

FOR: MARINE PLANT BASED PROCESSED EDIBLE SEAWEED, IN CLASS 29 (U.S. CL. 46).

FIRST USE 2-4-2006; IN COMMERCE 6-30-2008.

FOR: MARINE PLANT BASED PET FOOD; MARINE PLANT BASED ANIMAL FEED; MARINE PLANT BASED LIVESTOCK FEED, IN CLASS 31 (U.S. CLS. 1 AND 46).

FIRST USE 2-4-2006; IN COMMERCE 6-30-2008.

THE MARK CONSISTS OF STANDARD CHARACTERS WITHOUT CLAIM TO ANY PARTICULAR FONT, STYLE, SIZE, OR COLOR.

NO CLAIM IS MADE TO THE EXCLUSIVE RIGHT TO USE "NATURAL", APART FROM THE MARK AS SHOWN.

SN 78-905,531, FILED 6-11-2006.

FRED MANDIR, EXAMINING ATTORNEY

Int. Cls.: 6, 7, and 12

**Prior U.S. Cls.: 2, 12, 13, 14, 19, 21, 23, 25, 31, 34, 35,
44, and 50**

Reg. No. 3,578,039

United States Patent and Trademark Office

Registered Feb. 17, 2009

**TRADEMARK
PRINCIPAL REGISTER**

MOBILE SOLUTIONS

SUNEX INTERNATIONAL INC. (SOUTH CAROLINA CORPORATION)
P.O. BOX 1233
TRAVELERS REST, SC 29690

FOR: METAL ENGINE STANDS, IN CLASS 6 (U.S. CLS. 2, 12, 13, 14, 23, 25 AND 50).

FIRST USE 11-26-2008; IN COMMERCE 11-26-2008.

FOR: HYDRAULIC JACKS, HYDRAULIC JACK STANDS, AIR POWER JACKS, SERVICE ELEVATORS, POWER TRANSMISSION JACKS, ENGINE CRANES, IN CLASS 7 (U.S. CLS. 13, 19, 21, 23, 31, 34 AND 35).

FIRST USE 11-26-2008; IN COMMERCE 11-26-2008.

FOR: WHEELED DOLLIES, TOOL SERVICE CARTS, MECHANICS' CREEPERS, AND MECHANICS' CREEPER SEATS, IN CLASS 12 (U.S. CLS. 19, 21, 23, 31, 35 AND 44).

FIRST USE 11-26-2008; IN COMMERCE 11-26-0208.

THE MARK CONSISTS OF STANDARD CHARACTERS WITHOUT CLAIM TO ANY PARTICULAR FONT, STYLE, SIZE, OR COLOR.

NO CLAIM IS MADE TO THE EXCLUSIVE RIGHT TO USE "MOBILE", APART FROM THE MARK AS SHOWN.

SN 78-906,606, FILED 6-13-2006.

DAWN HAN, EXAMINING ATTORNEY

Int. Cl.: 36

Prior U.S. Cls.: 100, 101, and 102

United States Patent and Trademark Office

Reg. No. 3,578,040

Registered Feb. 17, 2009

**SERVICE MARK
PRINCIPAL REGISTER**

THE CHARITY STRIPE

FREE THROWS FOR FUNDRAISING, INC. (IL-
LINOIS CORPORATION)
305 LEE ROAD
NORTHBROOK, IL 60062

THE MARK CONSISTS OF STANDARD CHAR-
ACTERS WITHOUT CLAIM TO ANY PARTICULAR
FONT, STYLE, SIZE, OR COLOR.

FOR: CHARITABLE FUND RAISING, IN CLASS
36 (U.S. CLS. 100, 101 AND 102).

SN 78-907,279, FILED 6-13-2006.

FIRST USE 11-7-2007; IN COMMERCE 11-7-2007.

KYLE PEETE, EXAMINING ATTORNEY

Int. Cl.: 21

Prior U.S. Cls.: 2, 13, 23, 29, 30, 33, 40, and 50

United States Patent and Trademark Office

Reg. No. 3,578,041

Registered Feb. 17, 2009

**TRADEMARK
PRINCIPAL REGISTER**

YOU'RE INVITED!

CRYSTAL CLEAR INDUSTRIES, INC. (NEW
JERSEY CORPORATION)
2 BERGEN TURNPIKE
RIDGEFIELD PARK, NJ 07660

FOR: PORCELAINWARE AND STONWARE,
BOWLS, DISHES, PLATES, SERVING TRAYS AND
DISHES, PLATTERS, OIL AND VINEGAR SETS,
CUPS AND SAUCERS, TEAPOTS, BEVERAGE
GLASSWARE, IN CLASS 21 (U.S. CLS. 2, 13, 23, 29,
30, 33, 40 AND 50).

FIRST USE 0-0-2006; IN COMMERCE 0-0-2006.

THE MARK CONSISTS OF STANDARD CHAR-
ACTERS WITHOUT CLAIM TO ANY PARTICULAR
FONT, STYLE, SIZE, OR COLOR.

SN 78-908,856, FILED 6-15-2006.

PRISCILLA MILTON, EXAMINING ATTORNEY

Int. Cl.: 5

Prior U.S. Cls.: 6, 18, 44, 46, 51, and 52

United States Patent and Trademark Office

Reg. No. 3,578,042

Registered Feb. 17, 2009

**TRADEMARK
PRINCIPAL REGISTER**

360 DEGREE PROTECTION

PLAYTEX PRODUCTS, INC. (DELAWARE CORPORATION)
300 NYALA FARMS ROAD
WESTPORT, CT 06880

FOR: TAMPONS, IN CLASS 5 (U.S. CLS. 6, 18, 44, 46, 51 AND 52).

FIRST USE 9-0-2006; IN COMMERCE 9-0-2006.

THE MARK CONSISTS OF STANDARD CHARACTERS WITHOUT CLAIM TO ANY PARTICULAR FONT, STYLE, SIZE, OR COLOR.

NO CLAIM IS MADE TO THE EXCLUSIVE RIGHT TO USE "PROTECTION", APART FROM THE MARK AS SHOWN.

SN 78-908,942, FILED 6-15-2006.

ALICE SUE CARRUTHERS, EXAMINING ATTORNEY

Int. Cls.: 6, 7, and 9

**Prior U.S. Cls.: 2, 12, 13, 14, 19, 21, 23, 25, 26, 31, 34,
35, 36, 38, and 50**

Reg. No. 3,578,043

United States Patent and Trademark Office

Registered Feb. 17, 2009

**TRADEMARK
PRINCIPAL REGISTER**

PHILIPP SPRING

QRG LTD. (UNITED KINGDOM A PRIVATE LIMITED COMPANY), DBA QUANTUM RESEARCH GROUP, LTD.,
10 ROMSEY ROAD
EASTLEIGH, HAMPSHIRE, UNITED KINGDOM
SO50 9AL

FOR: METAL HARDWARE, NAMELY, SPRINGS USED FOR TOUCH KEYS, TOUCH SENSOR CONTROLS, AND SWITCHES, IN CLASS 6 (U.S. CLS. 2, 12, 13, 14, 23, 25 AND 50).

FIRST USE 0-0-2005; IN COMMERCE 0-0-2005.

FOR: PARTS OF MACHINES, NAMELY, SPRINGS USED FOR TOUCH KEYS, TOUCH SENSOR CONTROLS, AND SWITCHES, IN CLASS 7 (U.S. CLS. 13, 19, 21, 23, 31, 34 AND 35).

FIRST USE 0-0-2005; IN COMMERCE 0-0-2005.

FOR: ELECTRICALLY CONDUCTIVE SPRINGS AND ELECTRICALLY CONDUCTIVE MECHANICAL

COMPONENTS, IN THE NATURE OF BIASING COMPRESSIBLE COMPONENTS, NAMELY, SPRINGS, WHICH TRANSFER ELECTRICAL SIGNALS FROM THE TOUCH PANEL, USED FOR TOUCH KEYS, TOUCH SENSOR CONTROLS, AND SWITCHES, IN CLASS 9 (U.S. CLS. 21, 23, 26, 36 AND 38).

FIRST USE 0-0-2005; IN COMMERCE 0-0-2005.

THE MARK CONSISTS OF STANDARD CHARACTERS WITHOUT CLAIM TO ANY PARTICULAR FONT, STYLE, SIZE, OR COLOR.

NO CLAIM IS MADE TO THE EXCLUSIVE RIGHT TO USE "SPRING", APART FROM THE MARK AS SHOWN.

SN 78-909,659, FILED 6-15-2006.

KAREN SEVERSON, EXAMINING ATTORNEY

Int. Cls.: 35 and 37

Prior U.S. Cls.: 100, 101, 102, 103, and 106

United States Patent and Trademark Office

Reg. No. 3,578,044

Registered Feb. 17, 2009

**SERVICE MARK
PRINCIPAL REGISTER**

CM NEUTRAL

GIARAMITA, MICHAEL J. (UNITED STATES
INDIVIDUAL)
10 HILLSIDE AVENUE
PORT WASHINGTON, NY 11050

FOR: CONSULTING SERVICES IN THE FIELD
OF PROJECT, PROGRAM AND CONSTRUCTION
MANAGEMENT; CONSTRUCTION ESTIMATING
SERVICES, NAMELY, ESTIMATING CONTRACT-
ING WORK, IN CLASS 35 (U.S. CLS. 100, 101 AND
102).

FIRST USE 5-0-2008; IN COMMERCE 5-0-2008.

FOR: CONSTRUCTION CONSULTING SERVI-
CES; CONSULTING SERVICES IN THE FIELD OF
CONSTRUCTION MANAGEMENT, CONSTRU-
TION PLANNING SERVICES, CONSTRUCTION SU-
PERVISION, CONSTRUCTION PROGRAM

MANAGEMENT, CONSTRUCTION SCHEDULING,
CONSTRUCTION PROJECT AND QUALITY CON-
TROL PLAN DEVELOPMENT SERVICES, IN CLASS
37 (U.S. CLS. 100, 103 AND 106).

FIRST USE 5-0-2008; IN COMMERCE 5-0-2008.

THE MARK CONSISTS OF STANDARD CHAR-
ACTERS WITHOUT CLAIM TO ANY PARTICULAR
FONT, STYLE, SIZE, OR COLOR.

NO CLAIM IS MADE TO THE EXCLUSIVE
RIGHT TO USE "CM", APART FROM THE MARK
AS SHOWN.

SN 78-911,173, FILED 6-19-2006.

SOPHIA S. KIM, EXAMINING ATTORNEY

Int. Cls.: 35 and 42

Prior U.S. Cls.: 100, 101, and 102

United States Patent and Trademark Office

Reg. No. 3,578,045

Registered Feb. 17, 2009

**SERVICE MARK
PRINCIPAL REGISTER**

RB-IDEALINK

RECKITT BENCKISER S.AR.L (LUXEMBOURG CORPORATION)
39 BOULEVARD JOSEPH LL
G.D. DE LUXEMBOURG, LUXEMBOURG L-1840

FOR: ADVERTISING SERVICES; BUSINESS APPRAISALS; BUSINESS INQUIRIES; MARKET RESEARCH SERVICES; BUSINESS PROCESS MANAGEMENT; BUSINESS RESEARCH; BUSINESS INFORMATION SERVICES; PREPARING BUSINESS REPORTS; ARRANGING AND CONDUCTING TRADE SHOWS OR CONFERENCES IN THE FIELD OF BUSINESS AND MANAGEMENT; INFORMATION SERVICES RELATING TO ALL THE AFORESAID SERVICES INCLUDING SUCH SERVICES PROVIDED ON-LINE OR VIA THE INTERNET, IN CLASS 35 (U.S. CLS. 100, 101 AND 102).

FIRST USE 7-14-2006; IN COMMERCE 7-14-2006.

FOR: SCIENTIFIC RESEARCH INTO THE DEVELOPMENT OF NEW PRODUCTS FOR OTHERS; LICENSING OF INTELLECTUAL PROPERTY; INTELLECTUAL PROPERTY CONSULTANCY; INFORMATION TECHNOLOGY CONSULTING, IN CLASS 42 (U.S. CLS. 100 AND 101).

FIRST USE 7-14-2006; IN COMMERCE 7-14-2006.

THE MARK CONSISTS OF STANDARD CHARACTERS WITHOUT CLAIM TO ANY PARTICULAR FONT, STYLE, SIZE, OR COLOR.

SN 78-911,890, FILED 6-20-2006.

MARILYN IZZI, EXAMINING ATTORNEY

Int. Cl.: 36

Prior U.S. Cls.: 100, 101, and 102

United States Patent and Trademark Office

Reg. No. 3,578,046

Registered Feb. 17, 2009

**SERVICE MARK
PRINCIPAL REGISTER**

GARNET GROUP

KUTLER, VEENA (UNITED STATES INDIVIDUAL)

6701 DEMOCRACY BOULEVARD, SUITE 505
BETHESDA, MD 20817 AND

SIMON, ANNETTE (UNITED STATES INDIVIDUAL)

6701 DEMOCRACY BOULEVARD, SUITE 505
BETHESDA, MD 20817 AND

RAPACZ, TANYA (UNITED STATES INDIVIDUAL)

6701 DEMOCRACY BOULEVARD, SUITE 505
BETHESDA, MD 20817 AND

SMITH, LISETTE (UNITED STATES INDIVIDUAL)

6701 DEMOCRACY BOULEVARD, SUITE 505
BETHESDA, MD 20817

FOR: FINANCIAL AND INVESTMENT PLANNING, FINANCIAL AND INVESTMENT MANAGEMENT, FINANCIAL ANALYSIS AND CONSULTATION, INVESTMENT ADVISORY AND CONSULTATION, NOT INCLUDING SERVICES AS-

SOCIATED WITH THE CREATION, PROVISION AND/OR ADMINISTRATION OF INVESTMENT PRODUCTS, INCLUDING HEDGE FUNDS, IN CLASS 36 (U.S. CLS. 100, 101 AND 102).

FIRST USE 7-14-2006; IN COMMERCE 7-14-2006.

THE MARK CONSISTS OF STANDARD CHARACTERS WITHOUT CLAIM TO ANY PARTICULAR FONT, STYLE, SIZE, OR COLOR.

NO CLAIM IS MADE TO THE EXCLUSIVE RIGHT TO USE "GROUP", APART FROM THE MARK AS SHOWN.

SN 78-916,264, FILED 6-24-2006.

LOURDES AYALA, EXAMINING ATTORNEY

Int. Cl.: 36

Prior U.S. Cls.: 100, 101, and 102

United States Patent and Trademark Office

Reg. No. 3,578,047

Registered Feb. 17, 2009

SERVICE MARK
PRINCIPAL REGISTER



WEISSENMAYER, ROSEMARY T. (UNITED STATES INDIVIDUAL)
10 SPINNAKER COURT
DURHAM, NC 27703

FOR: ART BROKERAGE, IN CLASS 36 (U.S. CLS. 100, 101 AND 102).

FIRST USE 1-5-2007; IN COMMERCE 1-5-2007.

THE COLOR(S) DARK PINK IS/ARE CLAIMED AS A FEATURE OF THE MARK.

THE ENTIRE MARK IS IN THE COLOR DARK PINK.

SN 78-916,266, FILED 6-25-2006.

CHARLOTTE CORWIN, EXAMINING ATTORNEY

Int. Cls.: 3 and 21

**Prior U.S. Cls.: 1, 2, 4, 6, 13, 23, 29, 30, 33, 40, 50, 51,
and 52**

United States Patent and Trademark Office

Reg. No. 3,578,048

Registered Feb. 17, 2009

**TRADEMARK
PRINCIPAL REGISTER**

SUPREME CLEAN

TOPCO ASSOCIATES, LLC (DELAWARE LTD
LIAB CO)
7711 GROSS POINT ROAD
SKOKIE, IL 60077

FOR: ALL-PURPOSE HOUSEHOLD CLEANING
PREPARATION; DISPOSABLE WIPES IMPREGNA-
TED WITH CLEANING SOLUTION FOR CLEAN-
ING HARD SURFACES FOR HOUSEHOLD
PURPOSES, IN CLASS 3 (U.S. CLS. 1, 4, 6, 50, 51
AND 52).

FIRST USE 1-0-2007; IN COMMERCE 1-0-2007.

FOR: PRE-MOISTENED CLEANING CLOTHS IM-
PREGNATED WITH CLEANING SOLUTION FOR
CLEANING HARD SURFACES, IN CLASS 21 (U.S.
CLS. 2, 13, 23, 29, 30, 33, 40 AND 50).

FIRST USE 1-0-2007; IN COMMERCE 1-0-2007.

THE MARK CONSISTS OF STANDARD CHAR-
ACTERS WITHOUT CLAIM TO ANY PARTICULAR
FONT, STYLE, SIZE, OR COLOR.

OWNER OF U.S. REG. NO. 2,988,206.

NO CLAIM IS MADE TO THE EXCLUSIVE
RIGHT TO USE "CLEAN", APART FROM THE
MARK AS SHOWN.

SN 78-916,555, FILED 6-26-2006.

SOPHIA S. KIM, EXAMINING ATTORNEY

Int. Cl.: 43

Prior U.S. Cls.: 100 and 101

United States Patent and Trademark Office

Reg. No. 3,578,049

Registered Feb. 17, 2009

**SERVICE MARK
PRINCIPAL REGISTER**

BALI HAI

NEVADA LINKS, INC. (NEVADA CORPORATION)
5500 EAST FLAMINGO
LAS VEGAS, NV 89122

FOR: HOTEL AND RESORT HOTEL SERVICES,
IN CLASS 43 (U.S. CLS. 100 AND 101).

FIRST USE 9-0-2001; IN COMMERCE 9-0-2001.

THE MARK CONSISTS OF STANDARD CHARACTERS WITHOUT CLAIM TO ANY PARTICULAR FONT, STYLE, SIZE, OR COLOR.

OWNER OF U.S. REG. NO. 2,478,614.

SN 78-916,680, FILED 6-26-2006.

SANDRA MANIOS, EXAMINING ATTORNEY

Int. Cl.: 29

Prior U.S. Cl.: 46

United States Patent and Trademark Office

Reg. No. 3,578,050

Registered Feb. 17, 2009

**TRADEMARK
PRINCIPAL REGISTER**

REGALO

OMAGGIO, INC. (CALIFORNIA CORPORATION)
283 CARNE ROAD
OJAI, CA 93023

FOR: EDIBLE OIL; OLIVE OIL, IN CLASS 29 (U.S.
CL. 46).

FIRST USE 12-12-2007; IN COMMERCE 12-12-2007.

THE MARK CONSISTS OF STANDARD CHAR-
ACTERS WITHOUT CLAIM TO ANY PARTICULAR
FONT, STYLE, SIZE, OR COLOR.

THE FOREIGN WORDING IN THE MARK
TRANSLATES INTO ENGLISH AS GIFT.

SN 78-919,816, FILED 6-29-2006.

JEFFERY COWARD, EXAMINING ATTORNEY

Int. Cl.: 25

Prior U.S. Cls.: 22 and 39

United States Patent and Trademark Office

Reg. No. 3,578,051

Registered Feb. 17, 2009

**TRADEMARK
PRINCIPAL REGISTER**

the child that rocks

SWOPE, TAYLOR H (UNITED STATES INDIVIDUAL)
107 W. 68TH ST #4F
NEW YORK, NY 10023

FOR: BIBS NOT OF CLOTH OR PAPER; CHILDREN'S AND INFANTS' CLOTH BIBS; CHILDREN'S CLOTH EATING BIBS; CLOTH BIBS; DRESSES; INFANT AND TODDLER ONE PIECE CLOTHING; ONE PIECE GARMENT FOR INFANTS AND TODDLERS; PANTS; ROMPERS; SHORT-SLEEVED OR LONG-SLEEVED T-SHIRTS; SHORT-SLEEVED SHIRTS; SHORTS; SKIRTS AND DRESSES; SWEAT SHIRTS; T-SHIRTS; TOPS, IN CLASS 25 (U.S. CLS. 22 AND 39).

FIRST USE 5-22-2006; IN COMMERCE 6-15-2006.

THE MARK CONSISTS OF STANDARD CHARACTERS WITHOUT CLAIM TO ANY PARTICULAR FONT, STYLE, SIZE, OR COLOR.

OWNER OF U.S. REG. NO. 7,820,159.

SN 78-919,876, FILED 6-29-2006.

LINDSEY RUBIN, EXAMINING ATTORNEY

Int. Cl.: 9

Prior U.S. Cls.: 21, 23, 26, 36, and 38

United States Patent and Trademark Office

Reg. No. 3,578,052

Registered Feb. 17, 2009

**TRADEMARK
PRINCIPAL REGISTER**

ANDOVER INFINET

TOUR ANDOVER CONTROLS, INC. (DELA-
WARE CORPORATION)
ONE HIGH STREET
NORTH ANDOVER, MA 01845

FOR: COMPUTER SOFTWARE PROGRAMS FOR
USE IN DESIGNING, IMPLEMENTING, MANA-
GING AND CONTROLLING BUILDING AUTOMA-
TION SYSTEMS, IN CLASS 9 (U.S. CLS. 21, 23, 26, 36
AND 38).

FIRST USE 9-0-2005; IN COMMERCE 9-0-2005.

THE MARK CONSISTS OF STANDARD CHAR-
ACTERS WITHOUT CLAIM TO ANY PARTICULAR
FONT, STYLE, SIZE, OR COLOR.

OWNER OF U.S. REG. NOS. 2,818,968 AND
2,868,449.

SEC. 2(F) AS TO "ANDOVER".

SN 78-919,969, FILED 6-29-2006.

SUSAN RICHARDS, EXAMINING ATTORNEY

Int. Cl.: 9

Prior U.S. Cls.: 21, 23, 26, 36, and 38

United States Patent and Trademark Office

Reg. No. 3,578,053

Registered Feb. 17, 2009

**TRADEMARK
PRINCIPAL REGISTER**

ANDOVER PLAIN ENGLISH

TOUR ANDOVER CONTROLS, INC. (DELA-
WARE CORPORATION)
ONE HIGH STREET
NORTH ANDOVER, MA 01845

FOR: COMPUTER SOFTWARE PROGRAMS FOR
USE IN DESIGNING, IMPLEMENTING, MANA-
GING AND CONTROLLING BUILDING AUTOMA-
TION SYSTEMS AND INSTRUCTION AND
DOCUMENTATION MANUALS FOR USERS AND
PROGRAMMERS, ALL SOLD AS A UNIT, IN CLASS
9 (U.S. CLS. 21, 23, 26, 36 AND 38).

FIRST USE 9-0-2005; IN COMMERCE 9-0-2005.

THE MARK CONSISTS OF STANDARD CHAR-
ACTERS WITHOUT CLAIM TO ANY PARTICULAR
FONT, STYLE, SIZE, OR COLOR.

OWNER OF U.S. REG. NOS. 2,818,968 AND
2,868,449.

SEC. 2(F) AS TO "ANDOVER".

SN 78-919,977, FILED 6-29-2006.

SUSAN RICHARDS, EXAMINING ATTORNEY

Int. Cl.: 43

Prior U.S. Cls.: 100 and 101

United States Patent and Trademark Office

Reg. No. 3,578,054

Registered Feb. 17, 2009

**SERVICE MARK
PRINCIPAL REGISTER**



STONEYS SEAFOOD HOUSE, INC. (MARY-
LAND CORPORATION)
P.O. BOX 241
DOWELL, MD 20629

FOR: RESTAURANT SERVICES, NAMELY, PRO-
VIDING FOOD AND DRINK FOR CONSUMPTION
BY PATRONS, IN CLASS 43 (U.S. CLS. 100 AND 101).

FIRST USE 6-0-1988; IN COMMERCE 6-0-1988.

THE COLORS YELLOW, ORANGE AND BLACK
ARE CLAIMED AS A FEATURE OF THE MARK.

THE COLORS YELLOW AND ORANGE APPEAR
IN THE WORDING "STONEYS"; THE COLOR
BLACK APPEARS ON THE DEPICTION OF SHAD-
ING OF THE WORD "STONEYS".

SN 78-920,782, FILED 6-30-2006.

MORGAN WYNNE, EXAMINING ATTORNEY

Int. Cl.: 43

Prior U.S. Cls.: 100 and 101

United States Patent and Trademark Office

Reg. No. 3,578,055

Registered Feb. 17, 2009

SERVICE MARK
PRINCIPAL REGISTER

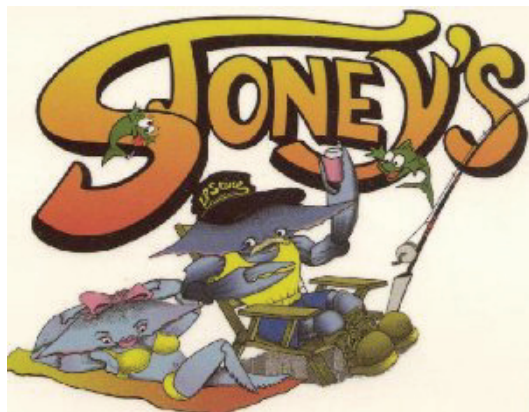

STONEYS SEAFOOD HOUSE, INC. (MARY-
LAND CORPORATION)
P.O.BOX 241
DOWELL, MD 20629

FOR: RESTAURANT SERVICES, NAMELY, PRO-
VIDING FOOD AND DRINK FOR CONSUMPTION
BY PATRONS, IN CLASS 43 (U.S. CLS. 100 AND 101).

FIRST USE 4-0-1991; IN COMMERCE 4-0-1991.

THE COLORS BLUE, ORANGE, YELLOW,
GREEN, PINK, RED, BLACK, GRAY AND WHITE
ARE CLAIMED AS A FEATURE OF THE MARK.

THE MARK CONSISTS OF A FEMALE BLUE
CRAB WITH PINK LIPS AND WHITE EYES WITH
BLACK PUPILS WEARING A YELLOW BIKINI
AND A PINK BOW LYING ON AN ORANGE AND

YELLOW BLANKET NEXT TO A MALE BLUE AND
GRAY CRAB WITH WHITE EYES AND BLACK
PUPILS WEARING A YELLOW SHIRT, BLUE
SHORTS, GREEN BOOTS, A YELLOW MUSTACHE,
BLACK HAT WITH THE WORDS "L P STONE"
WRITTEN IN YELLOW, SITTING IN A GREEN
CHAIR HOLDING A PINK DRINK. UNDER THE
CHAIR IS GRAY SHADING. NEXT TO THE CHAIR
IS A BLACK FISHING POLE WITH A GRAY HAN-
DLE AND REEL. THERE ARE TWO GREEN FISH
FEATURING WHITE EYES WITH BLACK PUPILS
AND RED TONGUES IN THE WORD "STONEYS".
THE WORD "STONEYS" APPEARS IN YELLOW
AND ORANGE SURROUNDED BY BLACK SHAD-
ING AND IS LOCATED OVER THE CRABS.

SN 78-920,811, FILED 6-30-2006.

MORGAN WYNNE, EXAMINING ATTORNEY

Int. Cl.: 38

Prior U.S. Cls.: 100, 101, and 104

United States Patent and Trademark Office

Reg. No. 3,578,056

Registered Feb. 17, 2009

**SERVICE MARK
PRINCIPAL REGISTER**

LOCAL WITH MORE

COMCAST CORPORATION (PENNSYLVANIA
CORPORATION)
1500 MARKET STREET
PHILADELPHIA, PA 19102

THE MARK CONSISTS OF STANDARD CHAR-
ACTERS WITHOUT CLAIM TO ANY PARTICULAR
FONT, STYLE, SIZE, OR COLOR.

FOR: VOICE-OVER INTERNET PROTOCOL
(VOIP) TELEPHONE SERVICES, IN CLASS 38 (U.S.
CLS. 100, 101 AND 104).

SN 78-920,994, FILED 6-30-2006.

FIRST USE 10-15-2007; IN COMMERCE 10-15-2007.

ALICE BENMAMAN, EXAMINING ATTORNEY

Int. Cl.: 36

Prior U.S. Cls.: 100, 101, and 102

United States Patent and Trademark Office

Reg. No. 3,578,057

Registered Feb. 17, 2009

**SERVICE MARK
PRINCIPAL REGISTER**

ANYTIME ADVANCE

AARC, INC. (DELAWARE CORPORATION)
P.O. BOX 3058
SPARTANBURG, SC 293043058

FOR: FINANCIAL SERVICES IN THE NATURE
OF CHECK CASHING, DEFERRED DEPOSITS, FI-
NANCIAL OVERDRAFT PROTECTION, PAYDAY
ADVANCES AND SHORT-TERM CONSUMER
LOANS, IN CLASS 36 (U.S. CLS. 100, 101 AND 102).

FIRST USE 12-1-2008; IN COMMERCE 12-1-2008.

THE MARK CONSISTS OF STANDARD CHAR-
ACTERS WITHOUT CLAIM TO ANY PARTICULAR
FONT, STYLE, SIZE, OR COLOR.

NO CLAIM IS MADE TO THE EXCLUSIVE
RIGHT TO USE "ADVANCE", APART FROM THE
MARK AS SHOWN.

SN 78-923,315, FILED 7-6-2006.

FRANK LATTUCA, EXAMINING ATTORNEY

Int. Cl.: 12

Prior U.S. Cls.: 19, 21, 23, 31, 35, and 44

United States Patent and Trademark Office

Reg. No. 3,578,058

Registered Feb. 17, 2009

**TRADEMARK
PRINCIPAL REGISTER**

WARNER GEAR

BORGWARNER INC. (DELAWARE CORPORATION)

3850 HAMLIN ROAD

AUBURN HILLS, MI 48326

FOR: LAND VEHICLE PARTS, NAMELY, TRANSMISSIONS, TRANSFER CASES, TRACTION CONTROL ASSEMBLIES COMPRISED OF CLUTCHES, SENSORS, AND CONTROLLERS, FOR REGULATING THE TRANSFER OF TORQUE IN A VEHICLE DRIVELINE FOR LAND VEHICLES, TRANSMISSION SYNCHRONIZERS, AND AXLE ASSEMBLIES, IN CLASS 12 (U.S. CLS. 19, 21, 23, 31, 35 AND 44).

FIRST USE 12-5-2008; IN COMMERCE 12-5-2008.

THE MARK CONSISTS OF STANDARD CHARACTERS WITHOUT CLAIM TO ANY PARTICULAR FONT, STYLE, SIZE, OR COLOR.

OWNER OF U.S. REG. NOS. 787,366, 1,412,240, AND 1,414,891.

NO CLAIM IS MADE TO THE EXCLUSIVE RIGHT TO USE "GEAR", APART FROM THE MARK AS SHOWN.

SEC. 2(F) AS TO "WARNER" .

SN 78-923,542, FILED 7-6-2006.

MARY MUNSON, EXAMINING ATTORNEY

Int. Cls.: 21 and 24

Prior U.S. Cls.: 2, 13, 23, 29, 30, 33, 40, 42, and 50

Reg. No. 3,578,059

United States Patent and Trademark Office

Registered Feb. 17, 2009

**TRADEMARK
PRINCIPAL REGISTER**

HOGSWIPE

VENTURE 4 PARTNERS LLC (FLORIDA LIMITED LIABILITY COMPANY)

6663 C BOCA PINES TRAIL

BOCA RATON, FL 33433

FOR: CLEANING CLOTHS FOR AUTOMOTIVE VEHICLES IN THE NATURE OF A TOWEL-LIKE CLOTH FOR WIPING AND CLEANING SURFACES, IN CLASS 21 (U.S. CLS. 2, 13, 23, 29, 30, 33, 40 AND 50).

FIRST USE 11-1-2008; IN COMMERCE 11-1-2008.

FOR: TOWELS INCORPORATING CARABINERS FOR ATTACHING TO A BELT OR BELT LOOP, IN CLASS 24 (U.S. CLS. 42 AND 50).

FIRST USE 11-1-2008; IN COMMERCE 11-1-2008.

THE MARK CONSISTS OF STANDARD CHARACTERS WITHOUT CLAIM TO ANY PARTICULAR FONT, STYLE, SIZE, OR COLOR.

SN 78-924,748, FILED 7-7-2006.

LYDIA BELZER, EXAMINING ATTORNEY

Int. Cls.: 25 and 28

Prior U.S. Cls.: 22, 23, 38, 39, and 50

Reg. No. 3,578,060

United States Patent and Trademark Office

Registered Feb. 17, 2009

**TRADEMARK
PRINCIPAL REGISTER**

GAARA

KABUSHIKI KAISHA SHUEISHA A/T/A
SHUEISHA INC. (JAPAN CORPORATION)
5-10 HITOTSUBASHI 2-CHOME, CHIYODA-KU
TOKYO, JAPAN

FOR: MEN'S, WOMEN'S, CHILDREN'S AND IN-
FANT'S CLOTHING, NAMELY, SHIRTS, T-SHIRT-
S, AND SWEATSHIRTS, IN CLASS 25 (U.S. CLS. 22
AND 39).

FIRST USE 7-20-2006; IN COMMERCE 7-20-2006.

FOR: TOYS AND SPORTING GOODS, NAMELY,
PLAY FIGURES AND ACCESSORIES THEREFOR,
TOY ACTION FIGURES AND ACCESSORIES
THEREFOR, TOY FIGURES, TOY STATUETTES
AND TOY FIGURINES MADE OF MOLDED PLAS-
TIC, MECHANICAL ACTION TOYS, DOLLS AND
ACCESSORIES THEREFOR, DOLL PLAY SETS,

PLAY SETS FOR ACTION FIGURES, CARD
GAMES, COLLECTABLE CARD GAMES, PLAYING
CARDS, SKATEBOARDS, AND COLLECTABLE
GAME CARDS AND TRADING CARDS, IN CLASS
28 (U.S. CLS. 22, 23, 38 AND 50).

FIRST USE 7-12-2006; IN COMMERCE 7-12-2006.

THE MARK CONSISTS OF STANDARD CHAR-
ACTERS WITHOUT CLAIM TO ANY PARTICULAR
FONT, STYLE, SIZE, OR COLOR.

THE WORDING "GAARA" IN THE MARK HAS
NO MEANING IN A FOREIGN LANGUAGE.

SN 78-926,166, FILED 7-10-2006.

LINDA ESTRADA, EXAMINING ATTORNEY

Int. Cl.: 9

Prior U.S. Cls.: 21, 23, 26, 36, and 38

United States Patent and Trademark Office

Reg. No. 3,578,061

Registered Feb. 17, 2009

**TRADEMARK
PRINCIPAL REGISTER**



NORD, BRETT A. (UNITED STATES INDIVIDUAL)
1369 ANNIE LACE WAY
DRAPER, UT 84020

FOR: COMPUTER SOFTWARE FOR USE IN CREATING AND CUSTOMIZING THREE DIMENSIONAL CHARACTER AND AVATAR APPLICATIONS THAT CAN BE DOWNLOADED TO PERSONAL COMPUTERS, DIGITAL PERSONAL ASSISTANTS AND MOBILE DEVICES, IN CLASS 9 (U.S. CLS. 21, 23, 26, 36 AND 38).

FIRST USE 10-2-2008; IN COMMERCE 10-2-2008.

NO CLAIM IS MADE TO THE EXCLUSIVE RIGHT TO USE "MOBILE", APART FROM THE MARK AS SHOWN.

THE COLOR(S) BLUE AND BLACK IS/ARE CLAIMED AS A FEATURE OF THE MARK.

THE MARK CONSISTS OF THE COLOR BLACK APPEARS IN THE WORDING "GO FIGURE" AND "MOBILE PERSONALITIES" AND THE COLOR BLUE APPEARS IN THE EXCLAMATION POINT AND THE HORIZONTAL LINE.

SN 78-926,617, FILED 7-11-2006.

SUSAN RICHARDS, EXAMINING ATTORNEY

Int. Cl.: 9

Prior U.S. Cls.: 21, 23, 26, 36, and 38

United States Patent and Trademark Office

Reg. No. 3,578,062

Registered Feb. 17, 2009

**TRADEMARK
PRINCIPAL REGISTER**

PAT SAJAK'S TRIVIA GEMS

PAT SAJAK GAMES, LLC (CALIFORNIA LIMITED LIABILITY COMPANY)
10202 WEST WASHINGTON BOULEVARD
CULVER CITY, CA 90232

FOR: COMPUTER GAME SOFTWARE; ELECTRONIC GAME SOFTWARE FOR CELLULAR TELEPHONES AND WIRELESS DEVICES; VIRTUAL REALITY GAME SOFTWARE; ELECTRONIC GAME SOFTWARE FOR HANDHELD ELECTRONIC DEVICES; INTERACTIVE MULTIMEDIA COMPUTER GAME PROGRAMS; AND MOUSE PADS, IN CLASS 9 (U.S. CLS. 21, 23, 26, 36 AND 38).

FIRST USE 10-5-2006; IN COMMERCE 10-5-2006.

THE MARK CONSISTS OF STANDARD CHARACTERS WITHOUT CLAIM TO ANY PARTICULAR FONT, STYLE, SIZE, OR COLOR.

NO CLAIM IS MADE TO THE EXCLUSIVE RIGHT TO USE "TRIVIA", APART FROM THE MARK AS SHOWN.

THE NAME "PAT SAJAK" IDENTIFIES A LIVING INDIVIDUAL WHOSE CONSENT IS OF RECORD.

SN 78-927,138, FILED 7-11-2006.

ARETHA SOMERVILLE, EXAMINING ATTORNEY

Int. Cl.: 41

Prior U.S. Cls.: 100, 101, and 107

United States Patent and Trademark Office

Reg. No. 3,578,063

Registered Feb. 17, 2009

**SERVICE MARK
PRINCIPAL REGISTER**

SIMPLY DELICIOSO

CHICA WORLDWIDE, LLC (DELAWARE LIMITED LIABILITY COMPANY)
SUITE 400
2711 CENTERVILLE ROAD
WILMINGTON, DE 19808

FOR: AN ONGOING TELEVISION SERIES IN THE FIELDS OF CUISINE, COOKING, DATING, DECORATING, SHOPPING, BEAUTY, HEALTH AND LIFESTYLE; PROVIDING A WEBSITE WITH INFORMATION ON A TELEVISION SERIES IN THE FIELDS OF CUISINE, COOKING, DATING, DECORATING, SHOPPING, BEAUTY, HEALTH AND LIFESTYLE, IN CLASS 41 (U.S. CLS. 100, 101 AND 107).

FIRST USE 7-14-2007; IN COMMERCE 7-14-2007.

THE MARK CONSISTS OF STANDARD CHARACTERS WITHOUT CLAIM TO ANY PARTICULAR FONT, STYLE, SIZE, OR COLOR.

THE FOREIGN WORDING IN THE MARK TRANSLATES INTO ENGLISH AS "DELICIOUS".

SN 78-927,778, FILED 7-12-2006.

HEATHER SAPP, EXAMINING ATTORNEY

Int. Cl.: 16

Prior U.S. Cls.: 2, 5, 22, 23, 29, 37, 38, and 50

Reg. No. 3,578,064

United States Patent and Trademark Office

Registered Feb. 17, 2009

**TRADEMARK
PRINCIPAL REGISTER**

**THE EXCEPTIONAL READING
COMPREHENSION SERIES**

THE EXCEPTIONAL COMPANY, LLC (TENNESSEE LIMITED LIABILITY COMPANY)
SUITE 308
3401 WEST END AVENUE
NASHVILLE, TN 37203

FOR: PRINTED INSTRUCTIONAL, EDUCATION AND TEACHING MATERIALS IN THE FIELD OF READING; INSTRUCTIONAL TEACHING GUIDES AND WORKBOOK MANUALS SOLD AS A UNIT FOR EDUCATIONAL APPLICATIONS, IN CLASS 16 (U.S. CLS. 2, 5, 22, 23, 29, 37, 38 AND 50).

FIRST USE 8-0-2006; IN COMMERCE 8-0-2006.

THE MARK CONSISTS OF STANDARD CHARACTERS WITHOUT CLAIM TO ANY PARTICULAR FONT, STYLE, SIZE, OR COLOR.

NO CLAIM IS MADE TO THE EXCLUSIVE RIGHT TO USE "READING COMPREHENSION SERIES", APART FROM THE MARK AS SHOWN.

SN 78-928,227, FILED 7-12-2006.

JORDAN BAKER, EXAMINING ATTORNEY

Int. Cl.: 28

Prior U.S. Cls.: 22, 23, 38, and 50

United States Patent and Trademark Office

Reg. No. 3,578,065

Registered Feb. 17, 2009

**TRADEMARK
PRINCIPAL REGISTER**

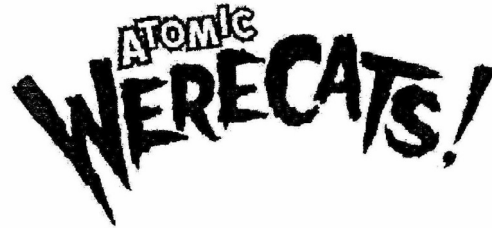

OWERKA-MOORE, ALYASHA (UNITED STATES
INDIVIDUAL)
UNIT B
731 9TH AVENUE
SAN DIEGO, CA 92101

NO CLAIM IS MADE TO THE EXCLUSIVE
RIGHT TO USE "WERECATS", APART FROM THE
MARK AS SHOWN.

FOR: FANTASY CHARACTER DOLLS; PLUSH
DOLLS, IN CLASS 28 (U.S. CLS. 22, 23, 38 AND 50).

SN 78-928,661, FILED 7-13-2006.

FIRST USE 8-1-2006; IN COMMERCE 8-1-2006.

KIMBERLY FRYE, EXAMINING ATTORNEY

Int. Cl.: 36

Prior U.S. Cls.: 100, 101, and 102

United States Patent and Trademark Office

Reg. No. 3,578,066

Registered Feb. 17, 2009

**SERVICE MARK
PRINCIPAL REGISTER**

VALUE TO MOMENTUM

BLADEROCK CAPITAL, LLC (DELAWARE LIMITED LIABILITY COMPANY)
121 MOUNT VERNON STREET
BOSTON, MA 02108

FOR: FINANCIAL SERVICES, NAMELY, MAKING INVESTMENTS IN COMPANIES AND ALL TYPES OF SECURITIES, PUBLIC AND PRIVATE, PROVIDING FINANCING AND FINANCIAL ADVISORY SERVICES TO COMPANIES IN ALL STAGES, FORMING CAPITAL INVESTMENT FUNDS TO INVEST IN SUCH ENTERPRISES, MANAGING CA-

PITAL INVESTMENT FUNDS, IN CLASS 36 (U.S. CLS. 100, 101 AND 102).

FIRST USE 7-13-2006; IN COMMERCE 9-26-2008.

THE MARK CONSISTS OF STANDARD CHARACTERS WITHOUT CLAIM TO ANY PARTICULAR FONT, STYLE, SIZE, OR COLOR.

SN 78-928,854, FILED 7-13-2006.

ANNE E. GUSTASON, EXAMINING ATTORNEY

Int. Cl.: 35

Prior U.S. Cls.: 100, 101, and 102

United States Patent and Trademark Office

Reg. No. 3,578,067

Registered Feb. 17, 2009

**SERVICE MARK
PRINCIPAL REGISTER**

HEALTH POWER FOR MINORITIES

GOODWIN, DR. NORMA J. (UNITED STATES
INDIVIDUAL)
747 EAST 37TH STREET
BROOKLYN, NY 11210

FOR: PROMOTING PUBLIC AWARENESS OF
MINORITY GROUP HEALTH CARE ISSUES, IN
CLASS 35 (U.S. CLS. 100, 101 AND 102).

FIRST USE 6-30-2007; IN COMMERCE 6-30-2007.

THE MARK CONSISTS OF STANDARD CHAR-
ACTERS WITHOUT CLAIM TO ANY PARTICULAR
FONT, STYLE, SIZE, OR COLOR.

OWNER OF U.S. REG. NOS. 3,047,351 AND
3,047,352.

SN 78-928,917, FILED 7-13-2006.

KAREN SEVERSON, EXAMINING ATTORNEY

Int. Cl.: 25

Prior U.S. Cls.: 22 and 39

United States Patent and Trademark Office

Reg. No. 3,578,068

Registered Feb. 17, 2009

**TRADEMARK
PRINCIPAL REGISTER**

KONGO - IT'S AN ATTITUDE

H & R VENTURES, LLC (CALIFORNIA LIMITED
LIABILITY COMPANY)
5724 VISTA SAN JUANICO
SAN DIEGO, CA 92154

THE MARK CONSISTS OF STANDARD CHAR-
ACTERS WITHOUT CLAIM TO ANY PARTICULAR
FONT, STYLE, SIZE, OR COLOR.

FOR: CLOTHING, NAMELY, SHIRTS, SHORTS,
HATS, PANTS, SWEAT SHIRTS, SWEAT PANTS,
CAPS, IN CLASS 25 (U.S. CLS. 22 AND 39).

SN 78-928,942, FILED 7-13-2006.

FIRST USE 3-1-2006; IN COMMERCE 3-1-2006.

PAUL E. FAHRENKOPF, EXAMINING ATTORNEY

Int. Cl.: 3

Prior U.S. Cls.: 1, 4, 6, 50, 51, and 52

Reg. No. 3,578,069

United States Patent and Trademark Office

Registered Feb. 17, 2009

**TRADEMARK
PRINCIPAL REGISTER**

DOLCE VANITA

THE PARADIGM GROUP, INC. (CALIFORNIA CORPORATION)
1149 HILLTOP DRIVE
REDDING, CA 96003

FOR: COSMETICS, NAMELY, BATH GELS, BODY CREAMS, COSMETIC PENCILS, HAND CREAMS, NIGHT CREAMS, SKIN CLEANSING CREAMS, SKIN CREAMS, VANISHING CREAMS, EYE CREAMS, SKIN LOTIONS, FACIAL LOTIONS, BODY LOTIONS, SKIN MOISTURIZERS, SHOWER GELS, SKIN CLARIFIERS, SKIN SOAPS; MAKE-UP PRODUCTS, NAMELY, EYE MAKEUP, EYE MAKE-UP REMOVER, EYE PENCILS, EYE SHADOW, EYEBROW PENCILS, EYELINER, FACE POWDER, LIPSTICK, MAKEUP MASCARA AND ROUGE; COSMETIC FACE POWDERS FOR THE SKIN AND

MINERAL MAKEUP, IN CLASS 3 (U.S. CLS. 1, 4, 6, 50, 51 AND 52).

FIRST USE 9-25-2007; IN COMMERCE 9-25-2007.

THE MARK CONSISTS OF STANDARD CHARACTERS WITHOUT CLAIM TO ANY PARTICULAR FONT, STYLE, SIZE, OR COLOR.

THE ENGLISH TRANSLATION OF THE WORD "DOLCE VANITA" IN THE MARK IS "SWEET VANITY".

SN 78-929,594, FILED 7-14-2006.

ARETHA SOMERVILLE, EXAMINING ATTORNEY

Int. Cl.: 5

Prior U.S. Cls.: 6, 18, 44, 46, 51, and 52

United States Patent and Trademark Office

Reg. No. 3,578,070

Registered Feb. 17, 2009

**TRADEMARK
PRINCIPAL REGISTER**

RENUAC

PFIZER INC. (DELAWARE CORPORATION)
235 EAST 42ND STREET
NEW YORK, NY 10017

THE MARK CONSISTS OF STANDARD CHAR-
ACTERS WITHOUT CLAIM TO ANY PARTICULAR
FONT, STYLE, SIZE, OR COLOR.

FOR: PHARMACEUTICAL PREPARATIONS FOR
THE TREATMENT OF UROLOGICAL DISEASES
AND DISORDERS, IN CLASS 5 (U.S. CLS. 6, 18, 44, 46,
51 AND 52).

SN 78-929,648, FILED 7-14-2006.

FIRST USE 11-26-2008; IN COMMERCE 11-26-2008.

JOHN HWANG, EXAMINING ATTORNEY

Int. Cls.: 25, 28, and 35

Prior U.S. Cls.: 22, 23, 38, 39, 50, 100, 101, and 102

United States Patent and Trademark Office

Reg. No. 3,578,071

Registered Feb. 17, 2009

TRADEMARK
SERVICE MARK
PRINCIPAL REGISTER



SILVA HOLDINGS, LLC (FLORIDA LIMITED LIABILITY COMPANY)
11440 SW 21 STREET
MIRAMAR, FL 33025

THE COLOR(S) RED, YELLOW AND BLUE IS/ ARE CLAIMED AS A FEATURE OF THE MARK.

FOR: T-SHIRTS, IN CLASS 25 (U.S. CLS. 22 AND 39).

FIRST USE 5-22-2006; IN COMMERCE 5-22-2006.

FOR: PLUSH TOYS, IN CLASS 28 (U.S. CLS. 22, 23, 38 AND 50).

FIRST USE 9-6-2006; IN COMMERCE 9-6-2006.

FOR: PROMOTING, ADVERTISING AND MARKETING OF THE ON-LINE WEBSITES OF OTHERS; PROMOTION, ADVERTISING AND MARKETING OF ON-LINE WEBSITES, IN CLASS 35 (U.S. CLS. 100, 101 AND 102).

FIRST USE 1-31-2007; IN COMMERCE 1-31-2007.

NO CLAIM IS MADE TO THE EXCLUSIVE RIGHT TO USE "COLOR", APART FROM THE MARK AS SHOWN.

THE MARK CONSISTS OF THE WORD "COLOR" IS IN YELLOW WITH A RED OUTLINE AND SLIGHTLY AT AN ANGLE. UNDER THE WORD "COLOR" IS THE WORD "WITH" WHICH IS IN YELLOW WITHIN A BLUE ECLIPSE WITH A RED OUTLINE. NEXT TO THE WORD "WITH" IS A RED BRUSH WITH YELLOW PAINT ON THE TIP OF ITS BLUE BRISTLES. UNDER THE WORD "WITH" AND THE PAINT BRUSH IS THE WORD "LEO" WHICH IS IN BLUE, OUTLINED IN YELLOW AND RED. THERE ARE ALSO YELLOW PAINT DROPS BETWEEN THE WORDS "COLOR" AND "LEO".

SN 78-929,731, FILED 7-14-2006.

ANN E. SAPPENFIELD, EXAMINING ATTORNEY

Int. Cl.: 9

Prior U.S. Cls.: 21, 23, 26, 36, and 38

United States Patent and Trademark Office

Reg. No. 3,578,072

Registered Feb. 17, 2009

**TRADEMARK
PRINCIPAL REGISTER**

ScholarMan

SCHMIDT, CAMERON (UNITED STATES INDIVIDUAL)

#381

3540 CRAIN HWY
BOWIE, MD 20716

FOR: AUDIO RECORDINGS FEATURING MUSIC; PRE-RECORDED CD'S, VIDEO TAPES, LASER DISKS AND DVD'S FEATURING MUSIC, IN CLASS 9 (U.S. CLS. 21, 23, 26, 36 AND 38).

FIRST USE 1-1-2007; IN COMMERCE 1-1-2007.

THE MARK CONSISTS OF STANDARD CHARACTERS WITHOUT CLAIM TO ANY PARTICULAR FONT, STYLE, SIZE, OR COLOR.

SN 78-930,860, FILED 7-17-2006.

DEIRDRE ROBERTSON, EXAMINING ATTORNEY

Int. Cl.: 18

Prior U.S. Cls.: 1, 2, 3, 22, and 41

United States Patent and Trademark Office

Reg. No. 3,578,073

Registered Feb. 17, 2009

**TRADEMARK
PRINCIPAL REGISTER**

HOMANZ

TSANG, HO MAN SHIRLEY (HONG KONG IN-
DIVIDUAL)
27-31 AU PUI WAN STREET
UNIT A & B, 8/F UNISON INDUSTRIAL CENTRE
FOTAN, SHATIN, HONG KONG

FOR: BAGS OF LEATHER AND IMITATION
LEAHER; HANDBAGS; SHOULDER BAGS; TOTE
BAGS; HOBO BAGS; CLUTCH BAGS; EVENING
HANDBAGS; SACHELS; BACKPACKS; COIN PUR-
SES; PURSES; WALLETS; DRAWSTRING POU-
CHES; LEATHER CASES; KEY CASES; NAME
CARD CASES; CREDIT CARD CASES; COSMETICS

BAGS SOLD EMPTY, IN CLASS 18 (U.S. CLS. 1, 2, 3,
22 AND 41).

FIRST USE 9-20-2006; IN COMMERCE 6-18-2008.

THE MARK CONSISTS OF STANDARD CHAR-
ACTERS WITHOUT CLAIM TO ANY PARTICULAR
FONT, STYLE, SIZE, OR COLOR.

SN 78-931,126, FILED 7-17-2006.

ASMAT KHAN, EXAMINING ATTORNEY

Int. Cl.: 35

Prior U.S. Cls.: 100, 101, and 102

United States Patent and Trademark Office

Reg. No. 3,578,074

Registered Feb. 17, 2009

**SERVICE MARK
PRINCIPAL REGISTER**

vision
155

DILLARD'S INC. (DELAWARE CORPORATION)
P.O. BOX 486
1600 CANTRELL ROAD
LITTLE ROCK, AR 72203

FIRST USE 1-1-2007; IN COMMERCE 1-1-2007.

SN 78-931,728, FILED 7-18-2006.

FOR: RETAIL STORE SERVICES, NAMELY,
CLOTHING SECTION OF DEPARTMENT STORE,
IN CLASS 35 (U.S. CLS. 100, 101 AND 102).

SUSAN RICHARDS, EXAMINING ATTORNEY

Int. Cl.: 7

Prior U.S. Cls.: 13, 19, 21, 23, 31, 34, and 35

United States Patent and Trademark Office

Reg. No. 3,578,075

Registered Feb. 17, 2009

**TRADEMARK
PRINCIPAL REGISTER**



**KSIN LUXEMBOURG III, S.AR.L. (LUXEM-
BOURG CORPORATION)
1, RUE DES GLACIS
L-1628, LUXEMBOURG**

**OWNER OF U.S. REG. NOS. 118,709, 787,684, AND
OTHERS.**

**FOR: SEWING MACHINES, IN CLASS 7 (U.S. CLS.
13, 19, 21, 23, 31, 34 AND 35).**

SN 78-932,085, FILED 7-18-2006.

FIRST USE 12-31-2006; IN COMMERCE 12-31-2006.

SUSAN RICHARDS, EXAMINING ATTORNEY

Int. Cls.: 7 and 26

**Prior U.S. Cls.: 13, 19, 21, 23, 31, 34, 35, 37, 39, 40, 42,
and 50**

Reg. No. 3,578,076

United States Patent and Trademark Office

Registered Feb. 17, 2009

**TRADEMARK
PRINCIPAL REGISTER**



KSIN LUXEMBOURG III, S.AR.L. (LUXEM-
BOURG CORPORATION)
1, RUE DES GLACIS
L-1628, LUXEMBOURG

FOR: SEWING MACHINES, IN CLASS 7 (U.S. CLS.
13, 19, 21, 23, 31, 34 AND 35).

FIRST USE 12-31-2006; IN COMMERCE 12-31-2006.

FOR: SEWING MACHINE NEEDLES, IN CLASS 26
(U.S. CLS. 37, 39, 40, 42 AND 50).

FIRST USE 12-31-2006; IN COMMERCE 12-31-2006.

OWNER OF U.S. REG. NOS. 118,709, 787,684, AND
OTHERS.

SN 78-932,246, FILED 7-18-2006.

SUSAN RICHARDS, EXAMINING ATTORNEY

Int. Cl.: 9

Prior U.S. Cls.: 21, 23, 26, 36, and 38

Reg. No. 3,578,077

United States Patent and Trademark Office

Registered Feb. 17, 2009

**TRADEMARK
PRINCIPAL REGISTER**

ILOOP MOBILE

ILOOP MOBILE, INC. (DELAWARE CORPORATION)
55 SOUTH MARKET ST., SUITE 1560
SAN JOSE, CA 95113

FOR: COMPUTER HARDWARE AND COMPUTER SOFTWARE PROGRAMS FOR THE INTEGRATION OF TEXT, AUDIO, GRAPHICS, STILL IMAGES AND MOVING PICTURES INTO AN INTERACTIVE DELIVERY PLATFORM FOR WIRELESS CONTENT, IN CLASS 9 (U.S. CLS. 21, 23, 26, 36 AND 38).

FIRST USE 1-6-2007; IN COMMERCE 1-6-2007.

THE MARK CONSISTS OF STANDARD CHARACTERS WITHOUT CLAIM TO ANY PARTICULAR FONT, STYLE, SIZE, OR COLOR.

NO CLAIM IS MADE TO THE EXCLUSIVE RIGHT TO USE "MOBILE", APART FROM THE MARK AS SHOWN.

SN 78-932,298, FILED 7-18-2006.

MORGAN WYNNE, EXAMINING ATTORNEY

Int. Cl.: 41

Prior U.S. Cls.: 100, 101, and 107

United States Patent and Trademark Office

Reg. No. 3,578,078

Registered Feb. 17, 2009

**SERVICE MARK
PRINCIPAL REGISTER**

RANDOM! CARTOONS

VIACOM INTERNATIONAL INC. (DELAWARE
CORPORATION)
34TH FLOOR
1515 BROADWAY
NEW YORK, NY 10036

FOR: ENTERTAINMENT SERVICES IN THE
NATURE OF TELEVISION SERIES, FEATURING
ANIMATION, COMEDY AND DRAMA; PROVID-
ING ONLINE INFORMATION IN THE FIELD OF
ENTERTAINMENT CONCERNING TELEVISION
PROGRAMS, IN CLASS 41 (U.S. CLS. 100, 101 AND
107).

FIRST USE 12-6-2008; IN COMMERCE 12-6-2008.

THE MARK CONSISTS OF STANDARD CHAR-
ACTERS WITHOUT CLAIM TO ANY PARTICULAR
FONT, STYLE, SIZE, OR COLOR.

OWNER OF U.S. REG. NO. 2,839,175.

NO CLAIM IS MADE TO THE EXCLUSIVE
RIGHT TO USE "CARTOONS", APART FROM THE
MARK AS SHOWN.

SN 78-932,517, FILED 7-19-2006.

SUSAN RICHARDS, EXAMINING ATTORNEY

Int. Cl.: 35

Prior U.S. Cls.: 100, 101, and 102

United States Patent and Trademark Office

Reg. No. 3,578,079

Registered Feb. 17, 2009

**SERVICE MARK
PRINCIPAL REGISTER**

BuyRiteBlinds.com

CUSTOM WHOLESALE BLINDS, INC. (FLORIDA
CORPORATION)
5350 N.W. 165TH STREET
MIAMI, FL 33014

FOR: ON-LINE RETAIL STORE SERVICES FEATURING WINDOW TREATMENTS, NAMELY, BLINDS, SHADES AND DRAPERIES, IN CLASS 35 (U.S. CLS. 100, 101 AND 102).

FIRST USE 8-7-2006; IN COMMERCE 8-7-2006.

THE MARK CONSISTS OF STANDARD CHARACTERS WITHOUT CLAIM TO ANY PARTICULAR FONT, STYLE, SIZE, OR COLOR.

SN 78-932,571, FILED 7-19-2006.

CIMMERIAN COLEMAN, EXAMINING ATTORNEY

Int. Cl.: 34

Prior U.S. Cls.: 2, 8, 9, and 17

United States Patent and Trademark Office

Reg. No. 3,578,080

Registered Feb. 17, 2009

**TRADEMARK
PRINCIPAL REGISTER**

BENJAMINS

CEZANNE FRANKLIN, INC. (NEVADA CORPORATION)
848 RAINBOW BLVD.
LAS VEGAS, NV 89107

THE MARK CONSISTS OF STANDARD CHARACTERS WITHOUT CLAIM TO ANY PARTICULAR FONT, STYLE, SIZE, OR COLOR.

FOR: CIGARETTES; TOBACCO, IN CLASS 34 (U.S. CLS. 2, 8, 9 AND 17).

SN 78-933,757, FILED 7-20-2006.

FIRST USE 9-4-2008; IN COMMERCE 9-4-2008.

ASMAT KHAN, EXAMINING ATTORNEY

Int. Cl.: 9

Prior U.S. Cls.: 21, 23, 26, 36, and 38

United States Patent and Trademark Office

Reg. No. 3,578,081

Registered Feb. 17, 2009

**TRADEMARK
PRINCIPAL REGISTER**

ONE NETWORK. ONE PLAN.

VPI SYSTEMS, INC. (DELAWARE CORPORATION)
CRUZ PLAZA
943 HOLMDEL ROAD
HOLMDEL, NJ 07733

FOR: COMPUTER SOFTWARE FOR USE BY COMMUNICATIONS SERVICE PROVIDERS FOR DESIGNING, INTEGRATING AND MANAGING TELECOMMUNICATIONS NETWORKS, IN CLASS 9 (U.S. CLS. 21, 23, 26, 36 AND 38).

FIRST USE 6-19-2006; IN COMMERCE 6-19-2006.

THE MARK CONSISTS OF STANDARD CHARACTERS WITHOUT CLAIM TO ANY PARTICULAR FONT, STYLE, SIZE, OR COLOR.

NO CLAIM IS MADE TO THE EXCLUSIVE RIGHT TO USE "NETWORK", APART FROM THE MARK AS SHOWN.

SN 78-934,797, FILED 7-21-2006.

WILLIAM BRECKENFELD, EXAMINING ATTORNEY

Int. Cl.: 41

Prior U.S. Cls.: 100, 101, and 107

United States Patent and Trademark Office

Reg. No. 3,578,082

Registered Feb. 17, 2009

**SERVICE MARK
PRINCIPAL REGISTER**

33 MILES

THOMAS VASQUEZ ENTERTAINMENT, LLC
(TENNESSEE LIMITED LIABILITY COMPAN-
NY)
SUITE 103-A
106 MISSION COURT
FRANKLIN, TN 37067

FOR: ENTERTAINMENT, NAMELY, LIVE PER-
FORMANCES BY A MUSICAL BAND, IN CLASS 41
(U.S. CLS. 100, 101 AND 107).

FIRST USE 1-0-2006; IN COMMERCE 1-0-2006.

THE MARK CONSISTS OF STANDARD CHAR-
ACTERS WITHOUT CLAIM TO ANY PARTICULAR
FONT, STYLE, SIZE, OR COLOR.

SN 78-935,742, FILED 7-24-2006.

DAVID MILLER, EXAMINING ATTORNEY

Int. Cls.: 37 and 42

Prior U.S. Cls.: 100, 101, 103, and 106

United States Patent and Trademark Office

Reg. No. 3,578,083

Registered Feb. 17, 2009

**SERVICE MARK
PRINCIPAL REGISTER**

SmartStart

ROSEMOUNT INC. (MINNESOTA CORPORATION)
12001 TECHNOLOGY DRIVE
EDEN PRAIRIE, MN 55344

FOR: INSTALLATION OF WIRELESS INDUSTRIAL PROCESS CONTROL SYSTEMS, IN CLASS 37 (U.S. CLS. 100, 103 AND 106).

FIRST USE 1-2-2007; IN COMMERCE 1-2-2007.

FOR: TECHNICAL SUPPORT SERVICES, NAMELY, TROUBLESHOOTING OF INDUSTRIAL PROCESS CONTROL COMPUTER SOFTWARE PROBLEMS; INSTALLATION OF COMPUTER

SOFTWARE FOR WIRELESS INDUSTRIAL PROCESS CONTROL SYSTEMS, IN CLASS 42 (U.S. CLS. 100 AND 101).

FIRST USE 1-2-2007; IN COMMERCE 1-2-2007.

THE MARK CONSISTS OF STANDARD CHARACTERS WITHOUT CLAIM TO ANY PARTICULAR FONT, STYLE, SIZE, OR COLOR.

SN 78-935,906, FILED 7-24-2006.

MICHAEL SOUDERS, EXAMINING ATTORNEY

Int. Cl.: 35

Prior U.S. Cls.: 100, 101, and 102

United States Patent and Trademark Office

Reg. No. 3,578,084

Registered Feb. 17, 2009

**SERVICE MARK
PRINCIPAL REGISTER**



SMARTREVENUE.COM (CONNECTICUT CORPORATION)
19 PEACEABLE STREET
RIDGFIELD, CT 06877

FOR: CONDUCTING BUSINESS AND MARKET RESEARCH SURVEYS, IN CLASS 35 (U.S. CLS. 100, 101 AND 102).

FIRST USE 11-1-2006; IN COMMERCE 11-1-2006.

THE MARK CONSISTS OF THE WORD "OSIRIS" PRECEDED BY A SIMPLE LINE-DRAWING CONSISTING OF A SQUARE CONTAINING, IN CLOCKWISE ORDER, AN ABSTRACT OUTLINE OF A WOMAN, AN EYE AND A STAIR-LIKE GEOMETRIC DESIGN.

SN 78-936,042, FILED 7-24-2006.

MICHAEL GAAFAR, EXAMINING ATTORNEY

Int. Cls.: 19 and 20

Prior U.S. Cls.: 1, 2, 12, 13, 22, 25, 32, 33, and 50

United States Patent and Trademark Office

Reg. No. 3,578,085

Registered Feb. 17, 2009

**TRADEMARK
PRINCIPAL REGISTER**



GRANT FOREST PRODUCTS INC. (CANADA CORPORATION)
SUITE 1520
181 BAY STREET
TORONTO, CANADA M5J 2T3

FOR: WOOD FLOOR BOARDS; STRUCTURAL AND ARCHITECTURAL MEMBERS FORMED OF PRESSED WOOD FIBERS, IN CLASS 19 (U.S. CLS. 1, 12, 33 AND 50).

FIRST USE 2-28-2007; IN COMMERCE 2-28-2007.

FOR: WOOD PRODUCTS, NAMELY, COMPOSITE PANELS, PARTICLEBOARD AND FIBERBOARD FOR USE IN FURTHER MANUFACTURING OF SIGNS, CONCRETE FORMS, TRANSPORT VEHICLE INTERIOR LINERS, AND UNDERLAYMENT

SUBFLOORING, IN CLASS 20 (U.S. CLS. 2, 13, 22, 25, 32 AND 50).

FIRST USE 2-28-2007; IN COMMERCE 2-28-2007.

PRIORITY CLAIMED UNDER SEC. 44(D) ON CANADA APPLICATION NO. 1303308, FILED 5-16-2006, REG. NO. TMA691,608, DATED 7-6-2007, EXPIRES 7-6-2022.

NO CLAIM IS MADE TO THE EXCLUSIVE RIGHT TO USE "COAT", APART FROM THE MARK AS SHOWN.

SN 78-936,371, FILED 7-24-2006.

JIM RINGLE, EXAMINING ATTORNEY

Int. Cl.: 16

Prior U.S. Cls.: 2, 5, 22, 23, 29, 37, 38, and 50

United States Patent and Trademark Office

Reg. No. 3,578,086

Registered Feb. 17, 2009

**TRADEMARK
PRINCIPAL REGISTER**

SlickPins

CASALE, JOSEPH N. (UNITED STATES INDIVIDUAL)
111 CHARIOT COURT
CARY, NC 27519

THE MARK CONSISTS OF STANDARD CHARACTERS WITHOUT CLAIM TO ANY PARTICULAR FONT, STYLE, SIZE, OR COLOR.

FOR: CORKBOARD PINS; PUSH PINS, IN CLASS 16 (U.S. CLS. 2, 5, 22, 23, 29, 37, 38 AND 50).

SN 78-936,513, FILED 7-24-2006.

FIRST USE 1-1-2007; IN COMMERCE 1-1-2007.

JEFF DEFORD, EXAMINING ATTORNEY

Int. Cls.: 6 and 19

Prior U.S. Cls.: 1, 2, 12, 13, 14, 23, 25, 33, and 50

United States Patent and Trademark Office

Reg. No. 3,578,087

Registered Feb. 17, 2009

**TRADEMARK
PRINCIPAL REGISTER**



CHESHIRE MOULDINGS & WOODTURNINGS
LTD. (ENGLAND LIMITED LIABILITY COM-
PANY)
STOCKTON HEALTH WARRINGTON
15 LONDON ROAD
CHESHIRE, UNITED KINGDOM WA4 6SG

FOR: BUILDING MATERIALS AND BUILDING
ELEMENTS OF METAL, NAMELY, METALLIC
PARTS AND FITTINGS FOR STAIRCASES, STAIR-
CASES MADE OF METAL, SPINDLES, NEWELS,
NEWEL CAPS, HAND RAILS, BASE RAILS, NEWEL
POSTS, HAND RAIL FITTINGS MADE OF METAL,
METAL BALUSTRADES, REPLACEMENT PARTS
AND FITTINGS FOR THE AFORESAID GOODS, IN
CLASS 6 (U.S. CLS. 2, 12, 13, 14, 23, 25 AND 50).

FIRST USE 4-30-2007; IN COMMERCE 7-31-2007.

FOR: NON-METAL BUILDING MATERIALS,
NAMELY, WOOD STAIRCASES FOR INDOOR DO-
MESTIC USE, HAND RAIL FITTINGS, BEADING,
NEWELS, NEWEL CAPS, SURFACES FOR STAIR-
CASES, DOWELS AND DOWELLING, SPINDLES,
WALL MOUNTED HAND RAIL SYSTEMS, DECK-
ING BALUSTERS, HAND RAIL FITTINGS MADE
OF WOOD, MOULDINGS MADE OF PLASTIC,
BALUSTRADES, REPLACEMENT PARTS AND FIT-
TINGS FOR ALL THE AFORESAID, IN CLASS 19
(U.S. CLS. 1, 12, 33 AND 50).

FIRST USE 4-30-2007; IN COMMERCE 7-31-2007.

SN 78-936,829, FILED 7-25-2006.

ELLEN BURNS, EXAMINING ATTORNEY

Int. Cl.: 38

Prior U.S. Cls.: 100, 101, and 104

United States Patent and Trademark Office

Reg. No. 3,578,088

Registered Feb. 17, 2009

**SERVICE MARK
PRINCIPAL REGISTER**

RISER

GETTY IMAGES (US), INC. (NEW YORK CORPORATION)
601 NORTH 34TH STREET
SEATTLE, WA 98103

FOR: ELECTRONIC DELIVERY OF IMAGES, PHOTOGRAPHS, STOCK PHOTOGRAPHS, ARCHIVAL PHOTOGRAPHS, GRAPHIC DESIGNS, CLIP ART, NEWS IMAGES, AND ILLUSTRATIONS VIA A GLOBAL COMPUTER NETWORK AND OTHER COMPUTER NETWORKS, IN CLASS 38 (U.S. CLS. 100, 101 AND 104).

FIRST USE 8-29-2006; IN COMMERCE 8-29-2006.

THE MARK CONSISTS OF STANDARD CHARACTERS WITHOUT CLAIM TO ANY PARTICULAR FONT, STYLE, SIZE, OR COLOR.

SN 78-937,180, FILED 7-25-2006.

INGRID C. EULIN, EXAMINING ATTORNEY

Int. Cl.: 25

Prior U.S. Cls.: 22 and 39

United States Patent and Trademark Office

Reg. No. 3,578,089

Registered Feb. 17, 2009

**TRADEMARK
PRINCIPAL REGISTER**

GORE BIKE WEAR

W. L. GORE & ASSOCIATES, INC. (DELAWARE CORPORATION)

555 PAPER MILL ROAD, P. O. BOX 9329

NEWARK, DE 19714

FOR: JERSEYS, JACKETS, PANTS, VESTS, SING-LETS, SHORTS, LEG WARMERS, KNEE WAR-MERS, GLOVES, FOOTWEAR, HEADGEAR, NAMELY, HATS, CAPS, NECK GAITERS, HEAD-BANDS, IN CLASS 25 (U.S. CLS. 22 AND 39).

FIRST USE 10-31-2005; IN COMMERCE 10-31-2005.

THE MARK CONSISTS OF STANDARD CHAR-ACTERS WITHOUT CLAIM TO ANY PARTICULAR FONT, STYLE, SIZE, OR COLOR.

OWNER OF U.S. REG. NOS. 1,670,825, 1,804,547, AND 1,983,461.

NO CLAIM IS MADE TO THE EXCLUSIVE RIGHT TO USE "BIKE WEAR", APART FROM THE MARK AS SHOWN.

SN 78-937,998, FILED 7-26-2006.

MARY MUNSON, EXAMINING ATTORNEY

Int. Cls.: 35 and 42

Prior U.S. Cls.: 100, 101, and 102

United States Patent and Trademark Office

Reg. No. 3,578,090

Registered Feb. 17, 2009

**SERVICE MARK
PRINCIPAL REGISTER**

SERVERTASTIC

AGUK SOLUTIONS LIMITED (UNITED KINGDOM CORPORATION)
FIRST FLOOR, ALMA HOUSE, 8 ALMA SQUARE
SCARBOROUGH, UNITED KINGDOM YO11 1JR

FOR: (BASED ON USE IN COMMERCE SECTION 1(A) AND SECTION 44(E)) COMPUTERIZED ONLINE RETAIL STORE SERVICES FROM A SECURE WEBSITE VIA A GLOBAL COMPUTER NETWORK FEATURING COMPUTER SOFTWARE, COMPUTER PROGRAMS, AND COMPUTER HARDWARE; PROVIDING CONSUMER INFORMATION IN THE FIELD OF COMPUTER SOFTWARE AND HARDWARE GOODS FOR OTHERS, IN CLASS 35 (U.S. CLS. 100, 101 AND 102).

FIRST USE 12-1-2004; IN COMMERCE 12-1-2004.

FOR: (BASED ON SECTION 44(E)) COMPUTER SOFTWARE DESIGN, DEVELOPMENT AND CONSULTATION SERVICES FOR OTHERS; TECHNICAL SUPPORT SERVICES, NAMELY, TROUBLESHOOTING OF COMPUTER HARDWARE AND SOFTWARE PROBLEMS; CONSULT-

ING SERVICES IN THE FIELD OF DESIGN, SELECTION, IMPLEMENTATION AND USE OF COMPUTER HARDWARE AND SOFTWARE SYSTEMS FOR OTHERS; RENTAL OF COMPUTER HARDWARE; RENTAL OF COMPUTER SOFTWARE; PROVIDING A WEBSITE THAT FEATURES INFORMATION ON COMPUTER TECHNOLOGY AND PROGRAMMING, IN CLASS 42 (U.S. CLS. 100 AND 101).

THE MARK CONSISTS OF STANDARD CHARACTERS WITHOUT CLAIM TO ANY PARTICULAR FONT, STYLE, SIZE, OR COLOR.

PRIORITY CLAIMED UNDER SEC. 44(D) ON ERPN CMNTY TM OFC APPLICATION NO. 005091053, FILED 5-23-2006, REG. NO. 005091053, DATED 4-25-2007, EXPIRES 5-23-2016.

SN 78-939,812, FILED 7-28-2006.

ZHALEH DELANEY, EXAMINING ATTORNEY

Int. Cl.: 3

Prior U.S. Cls.: 1, 4, 6, 50, 51, and 52

United States Patent and Trademark Office

Reg. No. 3,578,091

Registered Feb. 17, 2009

**TRADEMARK
PRINCIPAL REGISTER**

LASZLO FOR MEN

ERNO LASZLO, INC. (DELAWARE CORPORATION)

519 BROOME STREET, 2ND FLOOR

NEW YORK, NY 10013

FOR: SHAVING PREPARATIONS, NAMELY, SHAVING CREAMS AND SHAVING LOTIONS; SKIN MOISTURIZERS; EYE GELS, IN CLASS 3 (U.S. CLS. 1, 4, 6, 50, 51 AND 52).

FIRST USE 9-30-2008; IN COMMERCE 9-30-2008.

THE MARK CONSISTS OF STANDARD CHARACTERS WITHOUT CLAIM TO ANY PARTICULAR FONT, STYLE, SIZE, OR COLOR.

OWNER OF U.S. REG. NO. 843,809.

NO CLAIM IS MADE TO THE EXCLUSIVE RIGHT TO USE "FOR MEN", APART FROM THE MARK AS SHOWN.

SN 78-940,126, FILED 7-28-2006.

GIANCARLO CASTRO, EXAMINING ATTORNEY

Int. Cl.: 5

Prior U.S. Cls.: 6, 18, 44, 46, 51, and 52

United States Patent and Trademark Office

Reg. No. 3,578,092

Registered Feb. 17, 2009

**TRADEMARK
PRINCIPAL REGISTER**

FENSTOP

BAYER AKTIENGESELLSCHAFT (FED REP
GERMANY JOINT STOCK COMPANY)
D-51368
LEVERKUSEN-BAYERWERK, FED REP GERMA-
NY

THE MARK CONSISTS OF STANDARD CHAR-
ACTERS WITHOUT CLAIM TO ANY PARTICULAR
FONT, STYLE, SIZE, OR COLOR.

FOR: FUNGICIDES, IN CLASS 5 (U.S. CLS. 6, 18,
44, 46, 51 AND 52).

SN 78-940,817, FILED 7-31-2006.

FIRST USE 3-31-2007; IN COMMERCE 3-31-2007.

SAIMA MAKHDOOM, EXAMINING ATTORNEY

Int. Cls.: 41, 43, and 44

Prior U.S. Cls.: 100, 101, and 107

United States Patent and Trademark Office

Reg. No. 3,578,093

Registered Feb. 17, 2009

**SERVICE MARK
PRINCIPAL REGISTER**



EMERITUS CORPORATION (WASHINGTON CORPORATION)
3131 ELLIOTT AVENUE
SUITE 500
SEATTLE, WA 98121

FOR: EDUCATIONAL SERVICES, NAMELY, PROVIDING COURSES OF INSTRUCTION ABOUT ALZHEIMER'S DISEASE AND CARING FOR PERSONS SUFFERING FROM ALZHEIMER'S DISEASE, IN CLASS 41 (U.S. CLS. 100, 101 AND 107).

FIRST USE 8-31-2006; IN COMMERCE 8-31-2006.

FOR: PROVIDING ASSISTED LIVING AND RETIREMENT HOUSING; AND PROVIDING ELDER CARE SERVICES, IN CLASS 43 (U.S. CLS. 100 AND 101).

FIRST USE 8-31-2006; IN COMMERCE 8-31-2006.

FOR: PROVIDING HEALTH CARE FOR THE ELDERLY, DISABLED AND RETIRED PERSONS; NURSING HOME SERVICES; AND HOME HEALTH CARE SERVICES; PROVIDING INFORMATION IN THE FIELDS OF HEALTH AND MEDICINE, IN CLASS 44 (U.S. CLS. 100 AND 101).

FIRST USE 8-31-2006; IN COMMERCE 8-31-2006.

NO CLAIM IS MADE TO THE EXCLUSIVE RIGHT TO USE "MENTAL PHYSICAL SOCIAL SPIRITUAL NUTRITIONAL", APART FROM THE MARK AS SHOWN.

SN 78-942,542, FILED 8-1-2006.

FONG HSU, EXAMINING ATTORNEY

Int. Cl.: 45

Prior U.S. Cls.: 100 and 101

United States Patent and Trademark Office

Reg. No. 3,578,094

Registered Feb. 17, 2009

**SERVICE MARK
PRINCIPAL REGISTER**

PROMAPALOOZA

GURL2GURL PRODUCTIONS, INC. (D.C. CORPORATION)
101 W. 55TH STREET SUITE 15W.
NEW YORK, NY 10019

THE MARK CONSISTS OF STANDARD CHARACTERS WITHOUT CLAIM TO ANY PARTICULAR FONT, STYLE, SIZE, OR COLOR.

FOR: ONLINE SOCIAL NETWORKING SERVICES, IN CLASS 45 (U.S. CLS. 100 AND 101).

SN 78-942,617, FILED 8-1-2006.

FIRST USE 6-13-2008; IN COMMERCE 6-13-2008.

ROBIN MITTLER, EXAMINING ATTORNEY

Int. Cl.: 14

Prior U.S. Cls.: 2, 27, 28, and 50

United States Patent and Trademark Office

Reg. No. 3,578,095

Registered Feb. 17, 2009

**TRADEMARK
PRINCIPAL REGISTER**

Masquerade
Experience the Frenzy!

KREYLING, DOUGLAS (UNITED STATES INDIVIDUAL)
547 DESOTO DRIVE
DESOTO, TX 75115

FIRST USE 4-5-2007; IN COMMERCE 4-5-2007.

SN 78-943,269, FILED 8-2-2006.

FOR: JEWELRY, RINGS BEING JEWELRY, JEWELRY CHAINS, EARRINGS, BRACELETS, NECKLACES, PENDANTS, AND BROOCHES, IN CLASS 14 (U.S. CLS. 2, 27, 28 AND 50).

JIM RINGLE, EXAMINING ATTORNEY

Int. Cl.: 14

Prior U.S. Cls.: 2, 27, 28, and 50

United States Patent and Trademark Office

Reg. No. 3,578,096

Registered Feb. 17, 2009

**TRADEMARK
PRINCIPAL REGISTER**

MASQUERADE

KREYLING, DOUGLAS (UNITED STATES INDIVIDUAL)
547 DESOTO DRIVE
DESOTO, TX 75115

FOR: JEWELRY, RINGS BEING JEWELRY, JEWELRY CHAINS, EARRINGS, BRACELETS, NECKLACES, PENDANTS, AND BROOCHES, IN CLASS 14 (U.S. CLS. 2, 27, 28 AND 50).

FIRST USE 7-28-2006; IN COMMERCE 7-28-2006.

THE MARK CONSISTS OF STANDARD CHARACTERS WITHOUT CLAIM TO ANY PARTICULAR FONT, STYLE, SIZE, OR COLOR.

SN 78-943,277, FILED 8-2-2006.

JIM RINGLE, EXAMINING ATTORNEY

Int. Cl.: 1

Prior U.S. Cls.: 1, 5, 6, 10, 26, and 46

Reg. No. 3,578,097

United States Patent and Trademark Office

Registered Feb. 17, 2009

**TRADEMARK
PRINCIPAL REGISTER**



NEWLIGHT TECHNOLOGIES, LLC (CALIFORNIA CORPORATION)
6285 E. SPRING STREET, #303N
LONG BEACH, CA 92808

FIRST USE 9-1-2006; IN COMMERCE 3-1-2008.

FOR: BIODEGRADABLE THERMOPLASTIC FOR USE IN MANUFACTURING NOT USED IN ANTI-FOULING COATINGS, NAMELY, UNPROCESSED PLASTICS IN ALL FORMS, POLYMER BEADS AND POLYMER COMPOSITIONS FOR USE IN MANUFACTURING OF COMMERCIAL AND INDUSTRIAL GOODS, IN CLASS 1 (U.S. CLS. 1, 5, 6, 10, 26 AND 46).

NO CLAIM IS MADE TO THE EXCLUSIVE RIGHT TO USE "BIO" AND THE DESIGN OF THE RECYCLING SYMBOL, APART FROM THE MARK AS SHOWN.

SN 78-943,341, FILED 8-2-2006.

KELLY CHOE, EXAMINING ATTORNEY

Int. Cls.: 38 and 42

Prior U.S. Cls.: 100, 101, and 104

United States Patent and Trademark Office

Reg. No. 3,578,098

Registered Feb. 17, 2009

**SERVICE MARK
PRINCIPAL REGISTER**

VERIZON BUSINESS

VERIZON TRADEMARK SERVICES LLC (DELAWARE LIMITED LIABILITY COMPANY)
1320 NORTH COURT HOUSE ROAD
ARLINGTON, VA 22201

FOR: CONSULTING IN THE FIELD OF TELECOMMUNICATIONS AND COMPUTERIZED COMMUNICATIONS, IN CLASS 38 (U.S. CLS. 100, 101 AND 104).

FIRST USE 1-23-2006; IN COMMERCE 1-23-2006.

FOR: WEB PAGE HOSTING SERVICES, OPERATING ELECTRONIC INFORMATION NETWORKS; DESIGN IN THE FIELD OF TELECOMMUNICATIONS AND COMPUTERIZED COMMUNICATIONS; CONSULTING AND DESIGN SERVICES IN THE FIELD OF INFORMATION TECHNOLOGY, COMPUTER PROGRAMMING, DATA CENTER MANAGEMENT SERVICES AND GLOBAL COMPUTER NETWORKS; PROVIDING DATA CENTER SERVICE, NAMELY, THE CENTRALIZED INSTALLATION AND MANAGEMENT FOR OTHERS OF STORAGE USED BY AN APPLICATION SERVICE PROVIDER TO MAINTAIN DATABASE INFORMATION OF OTHERS; COLOCATION SERVICES, NAMELY, THE PROVISION OF A SECURE ENVIRONMENTALLY-CONTROLLED FACILITY AND TECHNICAL MONITORING FOR THE TELECOMMUNICATIONS EQUIPMENT OF OTHERS; HOSTING THE WEB SITES OF OTHERS ON A COMPUTER SERVER ON A GLOBAL COMPUTER

NETWORK, HOSTING OF DIGITAL CONTENT ON THE INTERNET, MAINTENANCE OF WEBSITES FOR OTHERS; APPLICATION SERVICE PROVIDER (ASP) SERVICES, NAMELY, HOSTING COMPUTER SOFTWARE APPLICATIONS OF OTHERS; AUTHENTICATION SERVICES IN THE FIELDS OF TELECOMMUNICATIONS AND NETWORK SERVICES; PROVIDING TEMPORARY USE OF NON-DOWNLOADABLE NETWORK AUDITING SOFTWARE IN THE FIELDS OF SECURE COMMUNICATIONS AND DATA NETWORKS; DESIGN FOR OTHERS IN THE FIELD OF COMPUTERIZED COMMUNICATIONS AND DATA NETWORKS, IN CLASS 42 (U.S. CLS. 100 AND 101).

FIRST USE 1-23-2006; IN COMMERCE 1-23-2006.

THE MARK CONSISTS OF STANDARD CHARACTERS WITHOUT CLAIM TO ANY PARTICULAR FONT, STYLE, SIZE, OR COLOR.

OWNER OF U.S. REG. NOS. 2,879,802, 3,085,712, AND OTHERS.

NO CLAIM IS MADE TO THE EXCLUSIVE RIGHT TO USE "BUSINESS", APART FROM THE MARK AS SHOWN.

SN 78-943,614, FILED 8-2-2006.

PATRICIA EVANKO, EXAMINING ATTORNEY

Int. Cl.: 25

Prior U.S. Cls.: 22 and 39

United States Patent and Trademark Office

Reg. No. 3,578,099

Registered Feb. 17, 2009

TRADEMARK
PRINCIPAL REGISTER

HANES*brands*INC

HANESBRANDS INC. (MARYLAND CORPORATION)
1000 EAST HANES MILL ROAD
WINSTON SALEM, NC 27105

FOR: BRAS; HOSIERY; JACKETS; PANTS; SHAPWEAR, NAMELY, BODYSUITS, THIGH SHAPERS AND GIRDLES; SHIRTS; SHORTS; SKIRTS; SLEEPWEAR; SOCKS; SWEAT PANTS; SWEAT SHIRTS; T-SHIRTS; THERMAL UNDERWEAR; UNDERWEAR, IN CLASS 25 (U.S. CLS. 22 AND 39).

THE MARK CONSISTS OF THREE WORDS THE FIRST BEING "HANES" IN ALL CAPS, THE SECOND WORD FOLLOWING THE FIRST WORD WITH NO SPACE BEING "BRANDS" IN LOWER CASE AND ITALICS AND THE THIRD WORD FOLLOWING THE SECOND WORD WITH NO SPACE BEING "INC" IN ALL CAPS.

SN 78-944,177, FILED 8-3-2006.

FIRST USE 9-6-2006; IN COMMERCE 9-6-2006.

KEVIN DINALLO, EXAMINING ATTORNEY

Int. Cl.: 25

Prior U.S. Cls.: 22 and 39

United States Patent and Trademark Office

Reg. No. 3,578,100

Registered Feb. 17, 2009

TRADEMARK
PRINCIPAL REGISTER

H*b*I

HANESBRANDS INC. (MARYLAND CORPORATION)
1000 EAST HANES MILL ROAD
WINSTON SALEM, NC 27105

FOR: BRAS; HOSIERY; JACKETS; PANTS; SHAPESWEAR, NAMELY, BODYSUITS, THIGH SHAPERS AND GIRDLES; SHIRTS; SHORTS; SKIRTS; SLEEPWEAR; SOCKS; SWEAT PANTS; SWEAT

SHIRTS; T-SHIRTS; THERMAL UNDERWEAR; UNDERWEAR, IN CLASS 25 (U.S. CLS. 22 AND 39).

FIRST USE 9-6-2006; IN COMMERCE 9-6-2006.

SN 78-944,260, FILED 8-3-2006.

DAWN HAN, EXAMINING ATTORNEY

Int. Cl.: 25

Prior U.S. Cls.: 22 and 39

United States Patent and Trademark Office

Reg. No. 3,578,101

Registered Feb. 17, 2009

**TRADEMARK
PRINCIPAL REGISTER**

ALMIGHTY HEROES

ALMIGHTY HEROES MEDIA GROUP, LLC (DE-
LAWARE LIMITED LIABILITY COMPANY)
826 HAHN DRIVE
SHAKOPEE, MN 55379

FOR: CLOTHING, NAMELY, CHILDREN'S BIB-
LICAL COSTUMES, WRISTBANDS, T-SHIRTS, AND
CAPS, IN CLASS 25 (U.S. CLS. 22 AND 39).

FIRST USE 7-2-2007; IN COMMERCE 7-2-2007.

THE MARK CONSISTS OF STANDARD CHAR-
ACTERS WITHOUT CLAIM TO ANY PARTICULAR
FONT, STYLE, SIZE, OR COLOR.

OWNER OF U.S. REG. NO. 2,809,252.

SN 78-944,818, FILED 8-4-2006.

ARETHA SOMERVILLE, EXAMINING ATTORNEY

Int. Cl.: 3

Prior U.S. Cls.: 1, 4, 6, 50, 51, and 52

United States Patent and Trademark Office

Reg. No. 3,578,102

Registered Feb. 17, 2009

**TRADEMARK
PRINCIPAL REGISTER**

**trick and treatment
concealer**

SOAP & GLORY LIMITED (UNITED KINGDOM
LIMITED LIABILITY JOINT STOCK COMPA-
NY)

ORCHARD HOUSE, FIRST FLOOR
167-169 KENSINGTON HIGH STREET
LONDON, UNITED KINGDOM W8 6SH

FOR: COSMETICS, NAMELY, CONCEALERS
AND SKIN CAMOUFLAGING PIGMENTS,
CREAMS AND POWDERS, IN CLASS 3 (U.S. CLS.
1, 4, 6, 50, 51 AND 52).

FIRST USE 2-15-2008; IN COMMERCE 2-15-2008.

THE MARK CONSISTS OF STANDARD CHAR-
ACTERS WITHOUT CLAIM TO ANY PARTICULAR
FONT, STYLE, SIZE, OR COLOR.

NO CLAIM IS MADE TO THE EXCLUSIVE
RIGHT TO USE "CONCEALER", APART FROM
THE MARK AS SHOWN.

SN 78-946,143, FILED 8-7-2006.

DARRYL SPRUILL, EXAMINING ATTORNEY

Int. Cl.: 41

Prior U.S. Cls.: 100, 101, and 107

United States Patent and Trademark Office

Reg. No. 3,578,103

Registered Feb. 17, 2009

**SERVICE MARK
PRINCIPAL REGISTER**

KINGSISLE

KINGSISLE ENTERTAINMENT, INC. (TEXAS
CORPORATION)
2745 N. DALLAS PARKWAY
SUITE 75254
PLANO, TX 75093

THE MARK CONSISTS OF STANDARD CHAR-
ACTERS WITHOUT CLAIM TO ANY PARTICULAR
FONT, STYLE, SIZE, OR COLOR.

FOR: ENTERTAINMENT SERVICES, NAMELY,
PROVIDING ON-LINE COMPUTER GAMES, IN
CLASS 41 (U.S. CLS. 100, 101 AND 107).

SN 78-947,004, FILED 8-8-2006.

FIRST USE 8-1-2005; IN COMMERCE 8-1-2005.

THOMAS MANOR, EXAMINING ATTORNEY

Int. Cl.: 41

Prior U.S. Cls.: 100, 101, and 107

United States Patent and Trademark Office

Reg. No. 3,578,104

Registered Feb. 17, 2009

**SERVICE MARK
PRINCIPAL REGISTER**

WIZARD 101

KINGSISLE ENTERTAINMENT, INC. (TEXAS
CORPORATION)
2745 N. DALLAS PARKWAY
SUITE 620
PLANO, TX 75093

THE MARK CONSISTS OF STANDARD CHAR-
ACTERS WITHOUT CLAIM TO ANY PARTICULAR
FONT, STYLE, SIZE, OR COLOR.

FOR: ENTERTAINMENT SERVICES, NAMELY,
PROVIDING ON-LINE COMPUTER GAMES, IN
CLASS 41 (U.S. CLS. 100, 101 AND 107).

SN 78-947,016, FILED 8-8-2006.

FIRST USE 5-21-2008; IN COMMERCE 5-21-2008.

THOMAS MANOR, EXAMINING ATTORNEY

Int. Cl.: 36

Prior U.S. Cls.: 100, 101, and 102

United States Patent and Trademark Office

Reg. No. 3,578,105

Registered Feb. 17, 2009

**SERVICE MARK
PRINCIPAL REGISTER**

FREEDOM DIRECT

IFREEDOM DIRECT CORPORATION (UTAH CORPORATION)
2363 SOUTH FOOTHILL DRIVE
SALT LAKE CITY, UT 84102

FOR: BANKING; MORTGAGE BANKING; MORTGAGE BROKERAGE; MORTGAGE LENDING; MORTGAGE BANKING SERVICES, NAMELY, ORIGINATION, ACQUISITION, SERVICING, SECURITIZATION AND BROKERAGE OF MORTGAGE LOANS; MORTGAGE SERVICES, NAMELY, BUYER PRE-QUALIFICATION OF MORTGAGES FOR MORTGAGE BROKERS AND BANKS; CONSUMER LENDING SERVICES; AND FINANCING SERVICES, IN CLASS 36 (U.S. CLS. 100, 101 AND 102).

FIRST USE 12-17-2008; IN COMMERCE 12-17-2008.

THE MARK CONSISTS OF STANDARD CHARACTERS WITHOUT CLAIM TO ANY PARTICULAR FONT, STYLE, SIZE, OR COLOR.

NO CLAIM IS MADE TO THE EXCLUSIVE RIGHT TO USE "DIRECT", APART FROM THE MARK AS SHOWN.

SN 78-947,725, FILED 8-8-2006.

MELVIN AXILBUND, EXAMINING ATTORNEY

Int. Cls.: 41 and 44

Prior U.S. Cls.: 100, 101, and 107

United States Patent and Trademark Office

Reg. No. 3,578,106

Registered Feb. 17, 2009

**SERVICE MARK
PRINCIPAL REGISTER**

Swede Equine

SWEDE EQUINE, LLC (WYOMING LIMITED
LIABILITY COMPANY)
144 10TH STREET
DEL MAR, CA 92014

FOR: HORSE TRAINING, IN CLASS 41 (U.S. CLS.
100, 101 AND 107).

FIRST USE 1-0-2007; IN COMMERCE 1-0-2007.

FOR: HORSE FARMS, IN CLASS 44 (U.S. CLS. 100
AND 101).

FIRST USE 12-27-2008; IN COMMERCE 12-27-2008.

THE MARK CONSISTS OF STANDARD CHAR-
ACTERS WITHOUT CLAIM TO ANY PARTICULAR
FONT, STYLE, SIZE, OR COLOR.

NO CLAIM IS MADE TO THE EXCLUSIVE
RIGHT TO USE "EQUINE", APART FROM THE
MARK AS SHOWN.

SN 78-947,864, FILED 8-8-2006.

MELVIN AXILBUND, EXAMINING ATTORNEY

Int. Cl.: 1

Prior U.S. Cls.: 1, 5, 6, 10, 26, and 46

Reg. No. 3,578,107

United States Patent and Trademark Office

Registered Feb. 17, 2009

**TRADEMARK
PRINCIPAL REGISTER**

FORTEFIBER

THE DOW CHEMICAL COMPANY (DELAWARE
CORPORATION)
TRADEMARK & COPYRIGHT PRACTICE GROUP
2030 DOW CENTER
MIDLAND, MI 48674

THE MARK CONSISTS OF STANDARD CHAR-
ACTERS WITHOUT CLAIM TO ANY PARTICULAR
FONT, STYLE, SIZE, OR COLOR.

FOR: METHYCELLULOSE FIBER ADDITIVE
FOR USE IN THE MANUFACTURE OF FOOD, IN
CLASS 1 (U.S. CLS. 1, 5, 6, 10, 26 AND 46).

SN 78-948,390, FILED 8-9-2006.

FIRST USE 6-27-2008; IN COMMERCE 6-27-2008.

BERNICE MIDDLETON, EXAMINING ATTORNEY

Int. Cl.: 9

Prior U.S. Cls.: 21, 23, 26, 36, and 38

Reg. No. 3,578,108

United States Patent and Trademark Office

Registered Feb. 17, 2009

**TRADEMARK
PRINCIPAL REGISTER**

G-PROCESSOR

SONY KABUSHIKI KAISHA (JAPAN CORPORATION), TA SONY CORPORATION,
1-7-1 KONAN, MINATO-KU
TOKYO, JAPAN

THE MARK CONSISTS OF STANDARD CHARACTERS WITHOUT CLAIM TO ANY PARTICULAR FONT, STYLE, SIZE, OR COLOR.

FOR: AUDIO DISC PLAYERS; VIDEO DISC PLAYERS; MULTI-DISC PLAYERS, NAMELY, AUDIO AND VIDEO DISK PLAYERS, IN CLASS 9 (U.S. CLS. 21, 23, 26, 36 AND 38).

SN 78-948,770, FILED 8-9-2006.

FIRST USE 10-31-2007; IN COMMERCE 10-31-2007.

THOMAS MANOR, EXAMINING ATTORNEY

Int. Cl.: 5

Prior U.S. Cls.: 6, 18, 44, 46, 51, and 52

Reg. No. 3,578,109

United States Patent and Trademark Office

Registered Feb. 17, 2009

**TRADEMARK
PRINCIPAL REGISTER**

FastZinc

APPLIED MEDICAL RESEARCH (TEXAS CORPORATION)
3413 SPANISH OAK DR.
AUSTIN, TX 78731

FOR: PHARMACEUTICAL COMPOSITIONS CONTAINING ZINC SALTS FOR THE PREVENTION AND TREATMENT OF COLD AND FLU SYMPTOMS, IN CLASS 5 (U.S. CLS. 6, 18, 44, 46, 51 AND 52).

FIRST USE 8-5-2008; IN COMMERCE 8-5-2008.

THE MARK CONSISTS OF STANDARD CHARACTERS WITHOUT CLAIM TO ANY PARTICULAR FONT, STYLE, SIZE, OR COLOR.

SN 78-949,561, FILED 8-10-2006.

DANIEL CAPSHAW, EXAMINING ATTORNEY

Int. Cls.: 35 and 36

Prior U.S. Cls.: 100, 101, and 102

United States Patent and Trademark Office

Reg. No. 3,578,110

Registered Feb. 17, 2009

**SERVICE MARK
PRINCIPAL REGISTER**

JACKSON

JACKSON NATIONAL LIFE INSURANCE COMPANY (MICHIGAN CORPORATION)
1 CORPORATE WAY
LANSING, MI 48951

FOR: INSURANCE MARKETING CONSULTING SERVICES FOR AGENTS AND BROKERS, IN CLASS 35 (U.S. CLS. 100, 101 AND 102).

FIRST USE 8-0-2006; IN COMMERCE 8-0-2006.

FOR: LIFE INSURANCE AND ANNUITY UNDERWRITING SERVICES, IN CLASS 36 (U.S. CLS. 100, 101 AND 102).

FIRST USE 8-0-2008; IN COMMERCE 8-0-2008.

THE MARK CONSISTS OF STANDARD CHARACTERS WITHOUT CLAIM TO ANY PARTICULAR FONT, STYLE, SIZE, OR COLOR.

OWNER OF U.S. REG. NOS. 1,489,625, 2,338,319, AND OTHERS.

THE NAME(S), PORTRAIT(S), AND/OR SIGNATURE(S) SHOWN IN THE MARK DOES NOT IDENTIFY A PARTICULAR LIVING INDIVIDUAL.

SN 78-949,574, FILED 8-10-2006.

MATTHEW MCDOWELL, EXAMINING ATTORNEY

Int. Cls.: 35 and 36

Prior U.S. Cls.: 100, 101, and 102

United States Patent and Trademark Office

Reg. No. 3,578,111

Registered Feb. 17, 2009

**SERVICE MARK
PRINCIPAL REGISTER**

JACKSON 

JACKSON NATIONAL LIFE INSURANCE COM-
PANY (MICHIGAN CORPORATION)
1 CORPORATE WAY
LANSING, MI 48951

FOR: INSURANCE MARKETING CONSULTING
SERVICES FOR AGENTS AND BROKERS, IN
CLASS 35 (U.S. CLS. 100, 101 AND 102).

FIRST USE 6-0-2006; IN COMMERCE 6-0-2006.

FOR: LIFE INSURANCE AND ANNUITY UN-
DERWRITING SERVICES, IN CLASS 36 (U.S. CLS.
100, 101 AND 102).

FIRST USE 6-0-2006; IN COMMERCE 6-0-2006.

OWNER OF U.S. REG. NOS. 1,489,625, 2,338,319,
AND OTHERS.

THE NAME(S), PORTRAIT(S), AND/OR SIGNA-
TURE(S) SHOWN IN THE MARK DOES NOT IDEN-
TIFY A PARTICULAR LIVING INDIVIDUAL.

THE MARK CONSISTS OF THE LITERAL ELE-
MENT "JACKSON" WHEREIN THE "O" IN "JACK-
SON" IS STYLIZED AND INTENDED TO FORM
THE HEAD OF A HORSE.

SN 78-949,936, FILED 8-11-2006.

MATTHEW MCDOWELL, EXAMINING ATTOR-
NEY

Int. Cl.: 35

Prior U.S. Cls.: 100, 101, and 102

United States Patent and Trademark Office

Reg. No. 3,578,112

Registered Feb. 17, 2009

**SERVICE MARK
PRINCIPAL REGISTER**

WelcomeToAggieland

MCMICHEN, ROBERT MICHAEL (UNITED STATES INDIVIDUAL)
1405 BAYOU WOODS DR
COLLEGE STATION, TX 77840

FOR: ADVERTISING AND PUBLICITY SERVICES, NAMELY, PROMOTING THE GOODS, SERVICES, BRAND IDENTITY AND COMMERCIAL INFORMATION AND NEWS OF THIRD PARTIES THROUGH PRINT, AUDIO, VIDEO, DIGITAL AND ON-LINE MEDIUM, IN CLASS 35 (U.S. CLS. 100, 101 AND 102).

FIRST USE 9-23-2008; IN COMMERCE 9-23-2008.

THE MARK CONSISTS OF STANDARD CHARACTERS WITHOUT CLAIM TO ANY PARTICULAR FONT, STYLE, SIZE, OR COLOR.

SN 78-951,222, FILED 8-14-2006.

REBECCA GILBERT, EXAMINING ATTORNEY

Int. Cl.: 34

Prior U.S. Cls.: 2, 8, 9, and 17

United States Patent and Trademark Office

Reg. No. 3,578,113

Registered Feb. 17, 2009

**TRADEMARK
PRINCIPAL REGISTER**

XEREZ

CUBAN IMPORTS (FLORIDA CORPORATION)
15476 NW 77TH STREET
MIAMI LAKES, FL 33016

FOR: CIGARS, IN CLASS 34 (U.S. CLS. 2, 8, 9 AND 17).

FIRST USE 10-31-2008; IN COMMERCE 10-31-2008.

THE MARK CONSISTS OF STANDARD CHARACTERS WITHOUT CLAIM TO ANY PARTICULAR FONT, STYLE, SIZE, OR COLOR.

THE NAME(S), PORTRAIT(S), AND/OR SIGNATURE(S) SHOWN IN THE MARK DOES NOT IDENTIFY A PARTICULAR LIVING INDIVIDUAL.

SN 78-951,585, FILED 8-14-2006.

LOURDES AYALA, EXAMINING ATTORNEY

Int. Cl.: 9

Prior U.S. Cls.: 21, 23, 26, 36, and 38

Reg. No. 3,578,114

United States Patent and Trademark Office

Registered Feb. 17, 2009

**TRADEMARK
PRINCIPAL REGISTER**

SwapNeat

SWAPNEAT INC. (CANADA CORPORATION)
1001-77 CARLTON ST.
TORONTO, ONTARIO, CANADA M5B2J7

FOR: COMPUTER SOFTWARE FOR CREATING SEARCHABLE DATABASES OF INFORMATION AND DATA; COMPUTER SOFTWARE FOR ORGANIZING AND VIEWING DIGITAL IMAGES AND PHOTOGRAPHS; COMPUTER SOFTWARE FOR PROVIDING AN ONLINE DATABASE IN THE FIELD OF TRANSACTION PROCESSING TO UPLOAD TRANSACTIONAL DATA, PROVIDE STATISTICAL ANALYSIS, AND PRODUCE NOTIFICATIONS AND REPORTS; COMPUTER SOFTWARE FOR THE COLLECTION, EDITING, ORGANIZING, MODIFYING, BOOK MARKING, TRANSMISSION, STORAGE AND SHARING OF DATA AND INFORMATION; COMPUTER SOFT-

WARE FOR USE IN THE SAFEGUARDING OF DIGITAL FILES, INCLUDING AUDIO, VIDEO, TEXT, BINARY, STILL IMAGES, GRAPHICS AND MULTIMEDIA FILES; DOWNLOADABLE SOFTWARE FOR ASSIGNING METADATA TO DIGITAL MEDIA ASSETS; SOFTWARE FOR PROCESSING IMAGES, GRAPHICS AND TEXT, IN CLASS 9 (U.S. CLS. 21, 23, 26, 36 AND 38).

FIRST USE 11-10-2006; IN COMMERCE 7-30-2008.

THE MARK CONSISTS OF STANDARD CHARACTERS WITHOUT CLAIM TO ANY PARTICULAR FONT, STYLE, SIZE, OR COLOR.

SN 78-951,893, FILED 8-14-2006.

DAVID H. STINE, EXAMINING ATTORNEY

Int. Cl.: 37

Prior U.S. Cls.: 100, 103, and 106

United States Patent and Trademark Office

Reg. No. 3,578,115

Registered Feb. 17, 2009

**SERVICE MARK
PRINCIPAL REGISTER**



VERIZON TRADEMARK SERVICES LLC (DELA-
WARE LIMITED LIABILITY COMPANY)
1320 NORTH COURT HOUSE ROAD
ARLINGTON, VA 22201

FOR: INSTALLATION, MAINTENANCE AND
REPAIR OF TELECOMMUNICATIONS EQUIP-
MENT, COMPUTER HARDWARE, AUDIO AND
VIDEO EQUIPMENT, COMPUTER SYSTEMS AND
COMMUNICATION NETWORKS, IN CLASS 37 (U.S.
CLS. 100, 103 AND 106).

FIRST USE 1-23-2006; IN COMMERCE 1-23-2006.

OWNER OF U.S. REG. NOS. 2,879,802, 3,085,712,
AND OTHERS.

NO CLAIM IS MADE TO THE EXCLUSIVE
RIGHT TO USE "BUSINESS", APART FROM THE
MARK AS SHOWN.

THE MARK CONSISTS OF "VERIZON BUSINESS"
AND STACKED V DESIGN.

SN 78-952,062, FILED 8-15-2006.

PATRICIA EVANKO, EXAMINING ATTORNEY

Int. Cl.: 35

Prior U.S. Cls.: 100, 101, and 102

United States Patent and Trademark Office

Reg. No. 3,578,116

Registered Feb. 17, 2009

**SERVICE MARK
PRINCIPAL REGISTER**

ARCADIAN NETWORKS

ARCADIAN NETWORKS, INC. (DELAWARE
CORPORATION)
400 COLUMBUS AVE.
VALHALLA, NY 10595

FOR: OPERATION AND ADMINISTRATION OF
TELECOMMUNICATION SYSTEMS AND NET-
WORKS FOR OTHERS, IN CLASS 35 (U.S. CLS. 100,
101 AND 102).

FIRST USE 4-6-2006; IN COMMERCE 4-6-2006.

THE MARK CONSISTS OF STANDARD CHAR-
ACTERS WITHOUT CLAIM TO ANY PARTICULAR
FONT, STYLE, SIZE, OR COLOR.

NO CLAIM IS MADE TO THE EXCLUSIVE
RIGHT TO USE "NETWORKS", APART FROM
THE MARK AS SHOWN.

SN 78-954,189, FILED 8-17-2006.

RICHARD A. STRASER, EXAMINING ATTORNEY

Int. Cl.: 38

Prior U.S. Cls.: 100, 101, and 104

United States Patent and Trademark Office

Reg. No. 3,578,117

Registered Feb. 17, 2009

**SERVICE MARK
PRINCIPAL REGISTER**

ARCADIAN NETWORKS

ARCADIAN NETWORKS, INC. (DELAWARE CORPORATION)
400 COLUMBUS AVE.
VALHALLA, NY 10595

FOR: TELECOMMUNICATION SERVICES, NAMELY, TRANSMISSION OF VOICE, DATA AND DOCUMENTS IN THE FIELDS OF GOVERNMENTAL, UTILITIES, MINING AND ENVIRONMENTAL MANAGEMENT OPERATIONS; LEASING OF TELECOMMUNICATION EQUIPMENT; PROVIDING THIRD PARTY USERS WITH ACCESS TO TELECOMMUNICATION INFRASTRUCTURE; TELECOMMUNICATIONS SERVICES, NAMELY, PROVIDING ACCESS TO WIRELESS NETWORKS; PROVIDING ACCESS TO TELECOMMUNICATION NETWORKS; PROVIDING PRIVATE AND SECURE REAL TIME ELECTRONIC COMMUNICATION OVER A COMPUTER

NETWORK; AND PROVIDING ACCESS TO LOCAL AREA NETWORKS, IN CLASS 38 (U.S. CLS. 100, 101 AND 104).

FIRST USE 4-6-2006; IN COMMERCE 4-6-2006.

THE MARK CONSISTS OF STANDARD CHARACTERS WITHOUT CLAIM TO ANY PARTICULAR FONT, STYLE, SIZE, OR COLOR.

NO CLAIM IS MADE TO THE EXCLUSIVE RIGHT TO USE "NETWORKS", APART FROM THE MARK AS SHOWN.

SN 78-954,206, FILED 8-17-2006.

RICHARD A. STRASER, EXAMINING ATTORNEY

Int. Cls.: 35 and 43

Prior U.S. Cls.: 100, 101, and 102

United States Patent and Trademark Office

Reg. No. 3,578,118

Registered Feb. 17, 2009

**SERVICE MARK
PRINCIPAL REGISTER**

BIG TOSS

LEVY PREMIUM FOODSERVICE LIMITED
PARTNERSHIP (ILLINOIS LIMITED PART-
NERSHIP)

980 NORTH MICHIGAN AVENUE, SUITE 400
CHICAGO, IL 60611

FOR: CONCESSION STANDS FEATURING FOOD
AND BEVERAGES, IN CLASS 35 (U.S. CLS. 100, 101
AND 102).

FIRST USE 3-0-2006; IN COMMERCE 3-0-2006.

FOR: CONTRACT FOOD SERVICES; RESTAU-
RANT SERVICES; SERVING FOOD AND DRINKS,
IN CLASS 43 (U.S. CLS. 100 AND 101).

FIRST USE 3-0-2006; IN COMMERCE 3-0-2006.

THE MARK CONSISTS OF STANDARD CHAR-
ACTERS WITHOUT CLAIM TO ANY PARTICULAR
FONT, STYLE, SIZE, OR COLOR.

SN 78-955,052, FILED 8-18-2006.

COLLEEN KEARNEY, EXAMINING ATTORNEY

Int. Cl.: 16

Prior U.S. Cls.: 2, 5, 22, 23, 29, 37, 38, and 50

Reg. No. 3,578,119

United States Patent and Trademark Office

Registered Feb. 17, 2009

**TRADEMARK
PRINCIPAL REGISTER**

EFFORTLESS SUCCESS

SELF ESTEEM SEMINARS, INC. (CALIFORNIA CORPORATION)
929 VIA FRUTERIA
SANTA BARBARA, CA 93110

FIRST USE 12-21-2007; IN COMMERCE 12-21-2007.

FOR: PAPER GOODS AND PRINTED MATTER, NAMELY, NON-FICTION BOOKS, NEWSLETTERS, WORKBOOKS, TEACHING MATERIALS AND MAGAZINES IN THE FIELD OF INSPIRATION, SELF-ESTEEM AND PERSONAL DEVELOPMENT, IN CLASS 16 (U.S. CLS. 2, 5, 22, 23, 29, 37, 38 AND 50).

THE MARK CONSISTS OF STANDARD CHARACTERS WITHOUT CLAIM TO ANY PARTICULAR FONT, STYLE, SIZE, OR COLOR.

SN 78-955,225, FILED 8-18-2006.

KEVIN CORWIN, EXAMINING ATTORNEY

Int. Cl.: 42

Prior U.S. Cls.: 100 and 101

United States Patent and Trademark Office

Reg. No. 3,578,120

Registered Feb. 17, 2009

**SERVICE MARK
PRINCIPAL REGISTER**

TOYTIMETOYS

TOY TIME TOYS, CO. (ARIZONA CORPORATION)
4110 GOLDWATER BLVD. SUITE 200
SCOTTSDALE, AZ 85251

THE MARK CONSISTS OF STANDARD CHARACTERS WITHOUT CLAIM TO ANY PARTICULAR FONT, STYLE, SIZE, OR COLOR.

FOR: DESIGN OF TOYS AND SPORTING GOODS FOR OTHERS, AND CONSULTING IN THE FIELD OF TOY AND SPORTING GOOD DESIGN, IN CLASS 42 (U.S. CLS. 100 AND 101).

SN 78-955,756, FILED 8-18-2006.

FIRST USE 10-16-1996; IN COMMERCE 11-9-1996.

MARGARET POWER, EXAMINING ATTORNEY

Int. Cl.: 30

Prior U.S. Cl.: 46

United States Patent and Trademark Office

Reg. No. 3,578,121

Registered Feb. 17, 2009

**TRADEMARK
PRINCIPAL REGISTER**

SHAKTEA

WHELAN, KRISTINE (UNITED STATES INDIVIDUAL)
9 AVONDALE ROAD
WESTERLY, RI 02891

FOR: TEA, IN CLASS 30 (U.S. CL. 46).

FIRST USE 10-21-2008; IN COMMERCE 10-21-2008.

THE MARK CONSISTS OF STANDARD CHARACTERS WITHOUT CLAIM TO ANY PARTICULAR FONT, STYLE, SIZE, OR COLOR.

SN 78-956,682, FILED 8-21-2006.

WILLIAM BRECKENFELD, EXAMINING ATTORNEY

Int. Cl.: 36

Prior U.S. Cls.: 100, 101, and 102

United States Patent and Trademark Office

Reg. No. 3,578,122

Registered Feb. 17, 2009

**SERVICE MARK
PRINCIPAL REGISTER**

AUTONOMIC ALLOCATION

INVESCO POWERSHARES CAPITAL MANAGE-
MENT LLC (DELAWARE LIMITED LIABILI-
TY COMPANY)
301 WEST ROOSEVELT ROAD
WHEATON, IL 60187

FOR: FINANCIAL SERVICES, NAMELY, INVEST-
MENT FUND MANAGEMENT FEATURING SECU-
RITIES ALLOCATION AND SELECTION SERVICES;
INVESTMENT ASSET MANAGEMENT ADVISORY
SERVICE, IN CLASS 36 (U.S. CLS. 100, 101 AND 102).

FIRST USE 8-31-2008; IN COMMERCE 8-31-2008.

THE MARK CONSISTS OF STANDARD CHAR-
ACTERS WITHOUT CLAIM TO ANY PARTICULAR
FONT, STYLE, SIZE, OR COLOR.

NO CLAIM IS MADE TO THE EXCLUSIVE
RIGHT TO USE "ALLOCATION", APART FROM
THE MARK AS SHOWN.

SN 78-956,870, FILED 8-21-2006.

ELI HELLMAN, EXAMINING ATTORNEY

Int. Cl.: 25

Prior U.S. Cls.: 22 and 39

United States Patent and Trademark Office

Reg. No. 3,578,123

Registered Feb. 17, 2009

**TRADEMARK
PRINCIPAL REGISTER**

ON THE EDGE

GALLAGHER, SHANE P. (UNITED STATES IN-
DIVIDUAL)
304 PLAYA BOULEVARD
#1
LA SELVA BEACH, CA 95076

THE MARK CONSISTS OF STANDARD CHAR-
ACTERS WITHOUT CLAIM TO ANY PARTICULAR
FONT, STYLE, SIZE, OR COLOR.

FOR: CLOTHING, NAMELY, T-SHIRTS, IN
CLASS 25 (U.S. CLS. 22 AND 39).

SN 78-957,970, FILED 8-22-2006.

FIRST USE 9-0-2008; IN COMMERCE 9-0-2008.

JERI J. FICKES, EXAMINING ATTORNEY

Int. Cl.: 16

Prior U.S. Cls.: 2, 5, 22, 23, 29, 37, 38, and 50

Reg. No. 3,578,124

United States Patent and Trademark Office

Registered Feb. 17, 2009

**TRADEMARK
PRINCIPAL REGISTER**

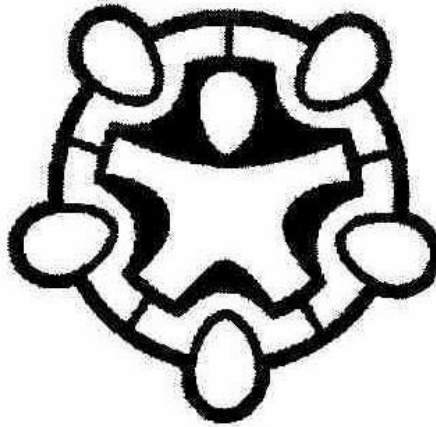

FUTURE LEADERS INSTITUTE, THE (CALIFORNIA CORPORATION)
1201 MARTIN LUTHER KING JR. WAY
SUITE 104
OAKLAND, CA 94612

FOR: PRINTED EDUCATIONAL MATERIALS, NAMELY, BOOKS AND PAMPHLETS IN THE FIELDS OF LEADERSHIP, COMMUNITY AWARE-

NESS, CIVICS, AND CHARITY, IN CLASS 16 (U.S. CLS. 2, 5, 22, 23, 29, 37, 38 AND 50).

FIRST USE 11-0-2004; IN COMMERCE 11-0-2004.

SN 78-958,029, FILED 8-22-2006.

JORDAN BAKER, EXAMINING ATTORNEY

Int. Cl.: 10

Prior U.S. Cls.: 26, 39, and 44

United States Patent and Trademark Office

Reg. No. 3,578,125

Registered Feb. 17, 2009

**TRADEMARK
PRINCIPAL REGISTER**

SPOT-ON PAIN RELIEVER

FEEL BETTER FOREVER LLC (CALIFORNIA
LIMITED LIABILITY COMPANY)
1532 ELENA CT.
SOLANA BEACH, CA 92075

FOR: THERAPEUTIC DEVICES, NAMELY, COM-
BINATION BALL/STRAP DEVICES THAT PROVIDE
MASSAGING ACTION TO RELIEVE PAIN, IN
CLASS 10 (U.S. CLS. 26, 39 AND 44).

FIRST USE 12-5-2008; IN COMMERCE 12-5-2008.

THE MARK CONSISTS OF STANDARD CHAR-
ACTERS WITHOUT CLAIM TO ANY PARTICULAR
FONT, STYLE, SIZE, OR COLOR.

NO CLAIM IS MADE TO THE EXCLUSIVE
RIGHT TO USE "PAIN RELIEVER", APART FROM
THE MARK AS SHOWN.

SN 78-959,061, FILED 8-23-2006.

STEPHEN AQUILA, EXAMINING ATTORNEY

Int. Cl.: 9

Prior U.S. Cls.: 21, 23, 26, 36, and 38

United States Patent and Trademark Office

Reg. No. 3,578,126

Registered Feb. 17, 2009

TRADEMARK
PRINCIPAL REGISTER

RadFlash

ANTANOUSKI, ALIAKSANDR A. (BELARUS INDIVIDUAL)
SCORINY AVENUE, 69-11
MINSK, BELARUS 220013

FOR: SCIENTIFIC APPARATUS FOR SIGNALING, CONTROLLING AND TESTING HAZARDOUS GASES IN THE AIR; TECHNICAL APPARATUS FOR MONITORING AND CHECKING FOR TOXIC GASES IN THE AIR; GAS SENSORS FOR MEASURING GAS CONCENTRATION; ELECTRONIC OXYGEN MONITORS FOR ENVIRONMENTAL USE; SELF-RESCUE APPARATUS, NAMELY, RESPIRATORY GAS CONTAINERS; GAS METERS; GAS DETECTORS FOR DETECTING THE PRESENCE OF GAS; GAS CHROMATOGRAPHY APPARATUS; METAL DETECTORS; ALTIMETERS; BAROMETERS; GASOMETERS; OXYGEN REGULATORS;

DOSIMETERS; INTERCOMMUNICATION APPARATUS, NAMELY, CELLULAR PHONES AND WALKIE-TALKIES; PRECISION THEODOLITES FOR ACCURATE MEASURING; SPEEDOMETERS; LASER SPEED DETECTORS; TIME CLOCKS FOR RECORDING TIME, IN CLASS 9 (U.S. CLS. 21, 23, 26, 36 AND 38).

FIRST USE 9-15-2006; IN COMMERCE 9-15-2006.

THE MARK CONSISTS OF STANDARD CHARACTERS WITHOUT CLAIM TO ANY PARTICULAR FONT, STYLE, SIZE, OR COLOR.

SN 78-959,246, FILED 8-24-2006.

BERYL GARDNER, EXAMINING ATTORNEY

Int. Cl.: 43

Prior U.S. Cls.: 100 and 101

United States Patent and Trademark Office

Reg. No. 3,578,127

Registered Feb. 17, 2009

**SERVICE MARK
PRINCIPAL REGISTER**

RYO

SAJI, MONIR (UNITED STATES INDIVIDUAL)
4 SHEA CIRCLE
BURLINGTON, MA 01803

THE MARK CONSISTS OF STANDARD CHAR-
ACTERS WITHOUT CLAIM TO ANY PARTICULAR
FONT, STYLE, SIZE, OR COLOR.

FOR: RESTAURANT, IN CLASS 43 (U.S. CLS. 100
AND 101).

SN 78-959,731, FILED 8-24-2006.

FIRST USE 12-3-2007; IN COMMERCE 12-3-2007.

KHANH LE, EXAMINING ATTORNEY

Int. Cl.: 28

Prior U.S. Cls.: 22, 23, 38, and 50

United States Patent and Trademark Office

Reg. No. 3,578,128

Registered Feb. 17, 2009

**TRADEMARK
PRINCIPAL REGISTER**

NEON NIGHTS CHALLENGE

MATTEL, INC. (DELAWARE CORPORATION)
MAIL STOP M1-1518
333 CONTINENTAL BOULEVARD
EL SEGUNDO, CA 90245

FOR: TOYS, GAMES AND PLAYTHINGS, NAME-
LY, TOY VEHICLE TRACK SETS AND ACCESSOR-
IES THEREFOR, IN CLASS 28 (U.S. CLS. 22, 23, 38
AND 50).

FIRST USE 12-15-2008; IN COMMERCE 12-15-2008.

THE MARK CONSISTS OF STANDARD CHAR-
ACTERS WITHOUT CLAIM TO ANY PARTICULAR
FONT, STYLE, SIZE, OR COLOR.

SN 78-960,539, FILED 8-25-2006.

TIMOTHY FINNEGAN, EXAMINING ATTORNEY

Int. Cl.: 36

Prior U.S. Cls.: 100, 101, and 102

United States Patent and Trademark Office

Reg. No. 3,578,129

Registered Feb. 17, 2009

**SERVICE MARK
PRINCIPAL REGISTER**

EASTERN FLEX EQUITY

EASTERN BANK (MASSACHUSETTS CORPORATION)
265 FRANKLIN STREET
BOSTON, MA 02110

FOR: BANKING; MONEY LENDING; HOME EQUITY LOANS; MORTGAGE BANKING SERVICES, NAMELY, SERVICING OF MORTGAGE LOANS; ON-LINE BANKING SERVICES; REVOLVING LOANS; TEMPORARY LOANS, IN CLASS 36 (U.S. CLS. 100, 101 AND 102).

FIRST USE 11-0-2006; IN COMMERCE 11-0-2006.

THE MARK CONSISTS OF STANDARD CHARACTERS WITHOUT CLAIM TO ANY PARTICULAR FONT, STYLE, SIZE, OR COLOR.

NO CLAIM IS MADE TO THE EXCLUSIVE RIGHT TO USE "EQUITY", APART FROM THE MARK AS SHOWN.

SN 78-960,580, FILED 8-25-2006.

SARA THOMAS, EXAMINING ATTORNEY

Int. Cl.: 19

Prior U.S. Cls.: 1, 12, 33, and 50

United States Patent and Trademark Office

Reg. No. 3,578,130

Registered Feb. 17, 2009

**TRADEMARK
PRINCIPAL REGISTER**

Granite Solutions

STONE INTERIORS, LLC (ALABAMA LIMITED
LIABILITY COMPANY)

PO BOX 693

30281 COUNTY ROAD 49

LOXLEY, AL 36551

FOR: GRANITE; MARBLE, IN CLASS 19 (U.S. CLS.
1, 12, 33 AND 50).

FIRST USE 2-1-2006; IN COMMERCE 2-1-2006.

THE MARK CONSISTS OF STANDARD CHAR-
ACTERS WITHOUT CLAIM TO ANY PARTICULAR
FONT, STYLE, SIZE, OR COLOR.

NO CLAIM IS MADE TO THE EXCLUSIVE
RIGHT TO USE "GRANITE", APART FROM THE
MARK AS SHOWN.

SN 78-961,359, FILED 8-27-2006.

DAVID COLLIER, EXAMINING ATTORNEY

Int. Cl.: 25

Prior U.S. Cls.: 22 and 39

United States Patent and Trademark Office

Reg. No. 3,578,131

Registered Feb. 17, 2009

**TRADEMARK
PRINCIPAL REGISTER**

La Cosa Nuestra

BLANCO LABEL, LLC (CALIFORNIA LIMITED
LIABILITY COMPANY)
9328 TELSTAR AVE
EL MONTE, CA 91731

FOR: BALLOON PANTS; BELTS; CAMP SHIRTS;
CAPRI PANTS; CAPS; CLOTHING, NAMELY, FOLK
COSTUMES; CLOTHING, NAMELY, NECK TUBES;
CLOTHING, NAMELY, WRAP-AROUNDS; DENIM
JACKETS; DENIMS; DOWN JACKETS; DRESS
SHIRTS; DUSTERS; GOLF SHIRTS; HEAVY JACK-
ETS; HOODS; INFANT AND TODDLER ONE PIECE
CLOTHING; JACKETS; JEANS; JERSEYS; JOGGING
PANTS; KNIT SHIRTS; LEATHER BELTS; LONG
JACKETS; MUFFLERS; NIGHT SHIRTS; OPEN-
NECKED SHIRTS; PARTS OF CLOTHING, NAME-
LY, GUSSETS FOR TIGHTS, GUSSETS FOR STOCK-
INGS, GUSSETS FOR BATHING SUITS, GUSSETS
FOR UNDERWEAR, GUSSETS FOR LEOTARDS
AND GUSSETS FOR FOOTLETS; PERSPIRATION
ABSORBENT UNDERWEAR CLOTHING; ROBES;
SANDALS; SHIRTS FOR SUITS; SHORT-SLEEVED
OR LONG-SLEEVED T-SHIRTS; SHORT-SLEEVED

SHIRTS; SHORTS; SHOULDER WRAPS; SKI PANTS;
SLEEP SHIRTS; SPORTS SHIRTS; SPORTS SHIRTS
WITH SHORT SLEEVES; SWEAT PANTS; SWEAT
SHIRTS; T-SHIRTS; TIES; TOBOGGAN HATS,
PANTS AND CAPS; TOPS; WATERPROOF JACKETS
AND PANTS; WIND SHIRTS; WRAPS, IN CLASS 25
(U.S. CLS. 22 AND 39).

FIRST USE 3-15-2007; IN COMMERCE 9-1-2007.

THE MARK CONSISTS OF STANDARD CHAR-
ACTERS WITHOUT CLAIM TO ANY PARTICULAR
FONT, STYLE, SIZE, OR COLOR.

THE ENGLISH TRANSLATION OF THE WORD
"LA COSA NUESTRA" IN THE MARK IS "THE
THING OF OURS".

SN 78-961,556, FILED 8-28-2006.

G. MAYERSCHOFF, EXAMINING ATTORNEY

Int. Cl.: 5

Prior U.S. Cls.: 6, 18, 44, 46, 51, and 52

Reg. No. 3,578,132

United States Patent and Trademark Office

Registered Feb. 17, 2009

**TRADEMARK
PRINCIPAL REGISTER**

DR. MOREPEN

QUGEN, INC. (NEW JERSEY CORPORATION)
SUITE 300
FORRESTAL VILLAGE
PRINCETON, NJ 08540

FIRST USE 12-1-2006; IN COMMERCE 12-1-2006.

THE MARK CONSISTS OF STANDARD CHARACTERS WITHOUT CLAIM TO ANY PARTICULAR FONT, STYLE, SIZE, OR COLOR.

FOR: NON-PRESCRIPTION, OVER-THE-COUNTER MEDICATION, NAMELY, PAIN RELIEF, FEVER RELIEF, ACIDITY, GAS, AND MOTION SICKNESS RELIEF, IN CLASS 5 (U.S. CLS. 6, 18, 44, 46, 51 AND 52).

SN 78-962,227, FILED 8-28-2006.

ZACHARY BELLO, EXAMINING ATTORNEY

Int. Cl.: 16

Prior U.S. Cls.: 2, 5, 22, 23, 29, 37, 38, and 50

United States Patent and Trademark Office

Reg. No. 3,578,133

Registered Feb. 17, 2009

**TRADEMARK
PRINCIPAL REGISTER**

LOOK & LOOK AGAIN!

KIDSBOOKS LLC (ILLINOIS LIMITED LIABILITY COMPANY)
3535 W PETERSON AVE
CHICAGO, IL 60659

THE MARK CONSISTS OF STANDARD CHARACTERS WITHOUT CLAIM TO ANY PARTICULAR FONT, STYLE, SIZE, OR COLOR.

FOR: CHILDREN'S BOOKS, IN CLASS 16 (U.S. CLS. 2, 5, 22, 23, 29, 37, 38 AND 50).

SN 78-963,537, FILED 8-30-2006.

FIRST USE 6-24-2008; IN COMMERCE 6-24-2008.

JOHN E. MICHOS, EXAMINING ATTORNEY

Int. Cl.: 36

Prior U.S. Cls.: 100, 101, and 102

United States Patent and Trademark Office

Reg. No. 3,578,134

Registered Feb. 17, 2009

**SERVICE MARK
PRINCIPAL REGISTER**

Are you evolving?

EVOLUTION FINANCE, INC. (DELAWARE CORPORATION)
1530 KEY BOULEVARD, #1530
ARLINGTON, VA 22209

THE MARK CONSISTS OF STANDARD CHARACTERS WITHOUT CLAIM TO ANY PARTICULAR FONT, STYLE, SIZE, OR COLOR.

FOR: CREDIT CARD SERVICES, IN CLASS 36 (U.S. CLS. 100, 101 AND 102).

SN 78-963,538, FILED 8-30-2006.

FIRST USE 6-15-2008; IN COMMERCE 6-15-2008.

ALICIA COLLINS, EXAMINING ATTORNEY

Int. Cl.: 10

Prior U.S. Cls.: 26, 39, and 44

United States Patent and Trademark Office

Reg. No. 3,578,135

Registered Feb. 17, 2009

**TRADEMARK
PRINCIPAL REGISTER**

SPIROS

ICU MEDICAL, INC. (DELAWARE CORPORATION)
951 CALLE AMANECER
SAN CLEMENTE, CA 92673

THE MARK CONSISTS OF STANDARD CHARACTERS WITHOUT CLAIM TO ANY PARTICULAR FONT, STYLE, SIZE, OR COLOR.

FOR: MEDICAL DEVICES, NAMELY, MEDICAL INTRAVENOUS CONNECTORS, IN CLASS 10 (U.S. CLS. 26, 39 AND 44).

SN 78-965,434, FILED 8-31-2006.

FIRST USE 4-25-2007; IN COMMERCE 4-25-2007.

ELLEN B. AWRICH, EXAMINING ATTORNEY

Int. Cl.: 43

Prior U.S. Cls.: 100 and 101

United States Patent and Trademark Office

Reg. No. 3,578,136

Registered Feb. 17, 2009

**SERVICE MARK
PRINCIPAL REGISTER**

STRIPBURGER

LETTUCE ENTERTAIN YOU ENTERPRISES (IL-
LINOIS CORPORATION)
5419 NORTH SHERIDAN ROAD
CHICAGO, IL 60640

THE MARK CONSISTS OF STANDARD CHAR-
ACTERS WITHOUT CLAIM TO ANY PARTICULAR
FONT, STYLE, SIZE, OR COLOR.

FOR: RESTAURANT SERVICES, IN CLASS 43
(U.S. CLS. 100 AND 101).

SN 78-971,220, FILED 9-11-2006.

FIRST USE 6-22-2007; IN COMMERCE 6-22-2007.

JOHN E. MICHOS, EXAMINING ATTORNEY

Int. Cl.: 45

Prior U.S. Cls.: 100 and 101

United States Patent and Trademark Office

Reg. No. 3,578,137

Registered Feb. 17, 2009

**SERVICE MARK
PRINCIPAL REGISTER**

MIXALCO

TERRABON, LLC (TEXAS LIMITED LIABILITY
COMPANY)
4400 EAST HWY. 21
BRYAN, TX 77806

THE MARK CONSISTS OF STANDARD CHAR-
ACTERS WITHOUT CLAIM TO ANY PARTICULAR
FONT, STYLE, SIZE, OR COLOR.

FOR: LICENSING OF PROCESSES FOR CONVER-
SION OF BIOMASS INTO FUELS, ALCOHOLS,
CHEMICALS AND HYDROGEN, IN CLASS 45 (U.S.
CLS. 100 AND 101).

SN 78-972,540, FILED 9-12-2006.

FIRST USE 8-24-2007; IN COMMERCE 8-24-2007.

ANTHONY RINKER, EXAMINING ATTORNEY

Int. Cls.: 9 and 41

Prior U.S. Cls.: 21, 23, 26, 36, 38, 100, 101, and 107

United States Patent and Trademark Office

Reg. No. 3,578,138

Registered Feb. 17, 2009

**TRADEMARK
SERVICE MARK
PRINCIPAL REGISTER**

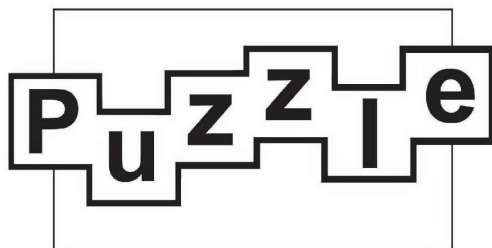

ASIA ANIMATION LIMITED (HONG KONG CORPORATION)
67 MODY ROAD, TSIMSHATSUI EAST
UNITS 816, 8TH FLOOR, PENINSULA CENTRE
KOWLOON, HONG KONG

FOR: VIDEO TAPES WITH ANIMATED CARTOONS; COMPUTER GAME SOFTWARE; VIDEO GAME SOFTWARE; SERIES OF PRE-RECORDED VIDEO AND AUDIO CASSETTES FEATURING CARTOONS; SERIES OF PRE-RECORDED COMPACT DISCS AND DIGITAL VIDEO DISCS FEATURING CARTOONS; ELECTRONIC PUBLICATIONS, NAMELY, MAGAZINES, BOOKS AND MANUALS IN THE FIELD OF VIDEO GAMES, COMPUTER GAMES AND CARTOONS, IN CLASS 9 (U.S. CLS. 21, 23, 26, 36 AND 38).

FIRST USE 3-0-2007; IN COMMERCE 3-0-2007.

FOR: PRODUCTION AND DISTRIBUTION OF ANIMATED AND MOTION PICTURE FILMS VIA TELEVISION, INTERNET, SATELLITE BROADCAST; PUBLICATION OF BOOKS, MAGAZINES, COMIC BOOKS; PRODUCTION AND DISTRIBUTION OF MOVIES AND ANIMATED CARTOON PICTURES, IN CLASS 41 (U.S. CLS. 100, 101 AND 107).

FIRST USE 3-0-2007; IN COMMERCE 3-0-2007.

THE MARK CONSISTS OF THE WORD "PUZZLE" WITH THE LETTERS OUTLINED, THEN SURROUNDED BY A RECTANGLE.

SN 78-973,016, FILED 9-13-2006.

JIM RINGLE, EXAMINING ATTORNEY

Int. Cl.: 3

Prior U.S. Cls.: 1, 4, 6, 50, 51, and 52

United States Patent and Trademark Office

Reg. No. 3,578,139

Registered Feb. 17, 2009

**TRADEMARK
PRINCIPAL REGISTER**

SUSAN BROWN'S BABY

FLORATECH BOTANICALS, INC. (ARIZONA CORPORATION)
291 E. EL PRADO CT .
CHANDLER, AZ 85225

FOR: PERSONAL SKIN CARE COSMETIC PRODUCTS, NAMELY, SHAMPOOS, CONDITIONERS, SKIN LOTIONS, CLEANSERS, FACIAL MASKS, SCRUBS, EXFOLIANTS, TONERS, ASTRINGENTS, COSMETIC MILKS, SHOWER GELS, SKIN GELS, LIP BALMS, LIP GLOSS, SOAPS, MOISTURIZERS, BODY OILS AND CREAMS, IN CLASS 3 (U.S. CLS. 1, 4, 6, 50, 51 AND 52).

FIRST USE 9-13-2006; IN COMMERCE 9-13-2006.

THE MARK CONSISTS OF STANDARD CHARACTERS WITHOUT CLAIM TO ANY PARTICULAR FONT, STYLE, SIZE, OR COLOR.

NO CLAIM IS MADE TO THE EXCLUSIVE RIGHT TO USE "BABY", APART FROM THE MARK AS SHOWN.

THE NAME(S), PORTRAIT(S), AND/OR SIGNATURE(S) SHOWN IN THE MARK IDENTIFIES "SUSAN BROWN", WHOSE CONSENT(S) TO REGISTER IS SUBMITTED.

SN 78-973,463, FILED 9-13-2006.

ASMAT KHAN, EXAMINING ATTORNEY

Int. Cl.: 36

Prior U.S. Cls.: 100, 101, and 102

United States Patent and Trademark Office

Reg. No. 3,578,140

Registered Feb. 17, 2009

**SERVICE MARK
PRINCIPAL REGISTER**

AUTO INSURANCE BUY THE MILE

MILEMETER, INC. (DELAWARE CORPORATION)
1700 PACIFIC AVENUE, SUITE 2400
DALLAS, TX 75201

FOR: INSURANCE UNDERWRITING AND BROKERAGE IN THE FIELD OF ACCIDENT INSURANCE FOR VEHICLES; DIRECT SALES INSURANCE UNDERWRITING AND BROKERAGE IN THE FIELD OF ACCIDENT INSURANCE FOR VEHICLES, IN CLASS 36 (U.S. CLS. 100, 101 AND 102).

FIRST USE 10-31-2008; IN COMMERCE 10-31-2008.

THE MARK CONSISTS OF STANDARD CHARACTERS WITHOUT CLAIM TO ANY PARTICULAR FONT, STYLE, SIZE, OR COLOR.

NO CLAIM IS MADE TO THE EXCLUSIVE RIGHT TO USE "AUTO INSURANCE", APART FROM THE MARK AS SHOWN.

SN 78-973,803, FILED 9-13-2006.

BENJAMIN OKEKE, EXAMINING ATTORNEY

Int. Cl.: 28

Prior U.S. Cls.: 22, 23, 38, and 50

Reg. No. 3,578,141

United States Patent and Trademark Office

Registered Feb. 17, 2009

**TRADEMARK
PRINCIPAL REGISTER**

SHOXX

MATTEL, INC. (DELAWARE CORPORATION)
MAIL STOP M1-1518
333 CONTINENTAL BOULEVARD
EL SEGUNDO, CA 90245

THE MARK CONSISTS OF STANDARD CHAR-
ACTERS WITHOUT CLAIM TO ANY PARTICULAR
FONT, STYLE, SIZE, OR COLOR.

FOR: TOYS, GAMES AND PLAYTHINGS, NAME-
LY, TOY VEHICLES AND ACCESSORIES THERE-
FOR, IN CLASS 28 (U.S. CLS. 22, 23, 38 AND 50).

SN 78-974,334, FILED 9-14-2006.

FIRST USE 12-15-2008; IN COMMERCE 12-15-2008.

FRED MANDIR, EXAMINING ATTORNEY

Int. Cl.: 41

Prior U.S. Cls.: 100, 101, and 107

United States Patent and Trademark Office

Reg. No. 3,578,142

Registered Feb. 17, 2009

**SERVICE MARK
PRINCIPAL REGISTER**

GOLD RUSH

JMBP, INC. (CALIFORNIA CORPORATION)
640 N. SEPULVEDA BOULEVARD
LOS ANGELES, CA 90049

FOR: ENTERTAINMENT IN THE NATURE OF
ON-GOING TELEVISION PROGRAMS AND TELE-
VISION SPECIALS IN THE FIELD OF REALITY
TELEVISION, IN CLASS 41 (U.S. CLS. 100, 101 AND
107).

FIRST USE 9-13-2006; IN COMMERCE 9-13-2006.

THE MARK CONSISTS OF STANDARD CHAR-
ACTERS WITHOUT CLAIM TO ANY PARTICULAR
FONT, STYLE, SIZE, OR COLOR.

SN 78-977,716, FILED 1-27-2006.

JAMES LOVELACE, EXAMINING ATTORNEY

Int. Cls.: 41 and 43

Prior U.S. Cls.: 100, 101, and 107

United States Patent and Trademark Office

Reg. No. 3,578,143

Registered Feb. 17, 2009

**SERVICE MARK
PRINCIPAL REGISTER**

FAT BLACK PUSSY CAT

FAT BPC, INC. (FLORIDA CORPORATION)
355 ALHAMBRA CIRCLE, SUITE 1100
CORAL GABLES, FL 33134

FIRST USE 8-0-2005; IN COMMERCE 8-0-2005.

FOR: NIGHT CLUB SERVICES, IN CLASS 41 (U.S.
CLS. 100, 101 AND 107).

THE MARK CONSISTS OF STANDARD CHAR-
ACTERS WITHOUT CLAIM TO ANY PARTICULAR
FONT, STYLE, SIZE, OR COLOR.

FIRST USE 8-0-2005; IN COMMERCE 8-0-2005.

SN 78-980,431, FILED 3-22-2006.

FOR: RESTAURANT AND BAR SERVICES , IN
CLASS 43 (U.S. CLS. 100 AND 101).

REBECCA POVARCHUK, EXAMINING ATTOR-
NEY

Int. Cl.: 5

Prior U.S. Cls.: 6, 18, 44, 46, 51, and 52

United States Patent and Trademark Office

Reg. No. 3,578,144

Registered Feb. 17, 2009

**TRADEMARK
PRINCIPAL REGISTER**

MARILEX

PHARMA MEDICO INTERNATIONAL APS
(DENMARK CORPORATION)
P.O. BOX 5181, GRAVEN 25B
AARHUS C, DENMARK 8000

FOR: PHARMACEUTICAL PREPARATIONS
AND SUBSTANCES IN THE NATURE OF SKIN
LOTION, HAIR SHAMPOO AND FOR THE TREAT-
MENT OF HAIR LOSS; MEDICATED SUN PROTEC-
TION CREAMS AND LOTIONS; MEDICATED
ANTI-WRINKLE AND ANTI-CELLULITE CREAMS
AND LOTIONS; ANTI-ITCH OINTMENTS; MULTI-
PURPOSE MEDICATED ANALGESIC BALM AND
MENTHOLATED SALVES; PHARMACEUTICAL
AND DIETETIC NUTRITIONAL SUPPLEMENTS;

FOOD SUPPLEMENTS AND VITAMIN FORTIFIED
BEVERAGES, IN CLASS 5 (U.S. CLS. 6, 18, 44, 46, 51
AND 52).

FIRST USE 7-1-2007; IN COMMERCE 7-1-2007.

THE MARK CONSISTS OF STANDARD CHAR-
ACTERS WITHOUT CLAIM TO ANY PARTICULAR
FONT, STYLE, SIZE, OR COLOR.

SN 78-980,559, FILED 6-23-2006.

RONALD AIKENS, EXAMINING ATTORNEY

Int. Cls.: 21, 24, 25, 36, and 37

**Prior U.S. Cls.: 2, 13, 22, 23, 29, 30, 33, 39, 40, 42, 50,
100, 101, 102, 103, and 106**

Reg. No. 3,578,145

United States Patent and Trademark Office

Registered Feb. 17, 2009

**TRADEMARK
SERVICE MARK
PRINCIPAL REGISTER**

ALBANY

PARK RIDGE SECURITIES CORP. (BAHAMAS CORPORATION)
P.O. BOX N7776, CAY HOUSE, LYFORD CAY
NEW PROVIDENCE, BAHAMAS

FOR: BEVERAGE GLASSWARE; PLASTIC CUPS AND MUGS; ORNAMENTAL DECORATIVE TABLE ACCESSORIES, NAMELY, BOWLS WITH AND WITHOUT LIDS, DISHES, FIGURINES AND SCULPTURES, MADE OF GLASS, CRYSTAL AND CHINA, IN CLASS 21 (U.S. CLS. 2, 13, 23, 29, 30, 33, 40 AND 50).

FIRST USE 3-15-2005; IN COMMERCE 3-15-2005.

FOR: BATH AND BEACH TOWELS, IN CLASS 24 (U.S. CLS. 42 AND 50).

FIRST USE 3-15-2005; IN COMMERCE 3-15-2005.

FOR: CLOTHING, NAMELY, HATS, JACKETS, SWEATERS, T-SHIRTS, IN CLASS 25 (U.S. CLS. 22 AND 39).

FIRST USE 3-15-2005; IN COMMERCE 3-15-2005.

FOR: REAL ESTATE BROKERAGE SERVICES, IN CLASS 36 (U.S. CLS. 100, 101 AND 102).

FIRST USE 3-15-2005; IN COMMERCE 3-15-2005.

FOR: PLANNING AND LAYING OUT OF RESIDENTIAL COMMUNITIES, IN CLASS 37 (U.S. CLS. 100, 103 AND 106).

FIRST USE 3-15-2005; IN COMMERCE 3-15-2005.

THE MARK CONSISTS OF STANDARD CHARACTERS WITHOUT CLAIM TO ANY PARTICULAR FONT, STYLE, SIZE, OR COLOR.

SN 78-980,772, FILED 3-21-2005.

MARTHA FROMM, EXAMINING ATTORNEY

Int. Cl.: 25

Prior U.S. Cls.: 22 and 39

United States Patent and Trademark Office

Reg. No. 3,578,146

Registered Feb. 17, 2009

**TRADEMARK
PRINCIPAL REGISTER**

RISER GOODWYN

ROSETTA CLOTHING, LLC (CALIFORNIA LIMITED LIABILITY COMPANY)
SUITE 2575
101 HUNTINGTON AVE
BOSTON, MA 021997669

FOR: CLOTHING, NAMELY, DRESSES, SKIRTS, TOPS, BLOUSES, SHORTS, JACKETS, PANTS, SHIRTS, SWEATERS, COATS, SCARVES, IN CLASS 25 (U.S. CLS. 22 AND 39).

FIRST USE 5-5-2006; IN COMMERCE 5-5-2006.

THE MARK CONSISTS OF STANDARD CHARACTERS WITHOUT CLAIM TO ANY PARTICULAR FONT, STYLE, SIZE, OR COLOR.

THE NAME SHOWN IN THE MARK DOES NOT IDENTIFY A PARTICULAR LIVING INDIVIDUAL.

SN 78-980,783, FILED 8-4-2006.

INGRID C. EULIN, EXAMINING ATTORNEY

Int. Cls.: 17, 19, and 22

Prior U.S. Cls.: 1, 2, 5, 7, 12, 13, 19, 22, 33, 35, 42, and 50

United States Patent and Trademark Office

Reg. No. 3,578,147

Registered Feb. 17, 2009

**TRADEMARK
PRINCIPAL REGISTER**

Performance  Fibers

PERFORMANCE FIBERS, INC. (DELAWARE CORPORATION)
707 EAST MAIN STREET, SUITE 1800
RICHMOND, VA 23219

FOR: POLYESTER AND SYNTHETIC FIBERS FOR USE IN THE MANUFACTURE OF TIRE CORD, IN CLASS 17 (U.S. CLS. 1, 5, 12, 13, 35 AND 50).

FIRST USE 8-27-2008; IN COMMERCE 8-27-2008.

FOR: POLYESTER AND SYNTHETIC FIBERS SOLD AS AN INTEGRAL COMPONENT OF NON-METAL ROOFING MATERIALS, IN CLASS 19 (U.S. CLS. 1, 12, 33 AND 50).

FIRST USE 3-30-2008; IN COMMERCE 3-30-2008.

FOR: POLYESTER AND SYNTHETIC FIBERS SOLD AS AN INTEGRAL COMPONENT OF ROPES, CORDAGE, TWINES, MOORING LINES MADE OF CORDAGE FOR TYING BOATS TO A DOCK, IN CLASS 22 (U.S. CLS. 1, 2, 7, 19, 22, 42 AND 50).

FIRST USE 6-16-2007; IN COMMERCE 6-16-2007.

NO CLAIM IS MADE TO THE EXCLUSIVE RIGHT TO USE "PERFORMANCE FIBERS", APART FROM THE MARK AS SHOWN.

SN 78-980,811, FILED 12-17-2004.

JEFF DEFORD, EXAMINING ATTORNEY

Int. Cls.: 1 and 5

Prior U.S. Cls.: 1, 5, 6, 10, 18, 26, 44, 46, 51, and 52

United States Patent and Trademark Office

Reg. No. 3,578,148

Registered Feb. 17, 2009

**TRADEMARK
PRINCIPAL REGISTER**

PHARMA GABA

PHARMA FOODS INTERNATIONAL CO., LTD
(JAPAN CORPORATION)
1-49, GORYO OHARA, NISHIKYO-KU
KYOTO-SHI, JAPAN 615-8245

FOR: GAMMA-AMINOBUTYRIC ACID (GABA)
FOR USE AS A FOOD ADDITIVE; FERMENTATION
EXTRACT, NAMELY, GAMMA-AMINOBUTYRIC
ACID (GABA) BY LACTIC ACID BACTERIA FOR
USE AS A FOOD ADDITIVE, IN CLASS 1 (U.S. CLS. 1,
5, 6, 10, 26 AND 46).

FIRST USE 10-20-2006; IN COMMERCE 10-20-2006.

FOR: DIETARY AND NUTRITIONAL SUPPLE-
MENTS, ALL CONSISTING MAINLY OF AMINO
ACID IN TABLET, CAPSULE, GRANULAR, POW-

DER, LIQUID, AND GELLED FORM, IN CLASS 5
(U.S. CLS. 6, 18, 44, 46, 51 AND 52).

FIRST USE 4-1-2007; IN COMMERCE 4-1-2007.

THE MARK CONSISTS OF STANDARD CHAR-
ACTERS WITHOUT CLAIM TO ANY PARTICULAR
FONT, STYLE, SIZE, OR COLOR.

NO CLAIM IS MADE TO THE EXCLUSIVE
RIGHT TO USE "GABA", APART FROM THE
MARK AS SHOWN.

SN 78-980,813, FILED 5-31-2006.

KEVON CHISOLM, EXAMINING ATTORNEY

Int. Cl.: 25

Prior U.S. Cls.: 22 and 39

United States Patent and Trademark Office

Reg. No. 3,578,149

Registered Feb. 17, 2009

**TRADEMARK
PRINCIPAL REGISTER**

PHINEAS AND FERB

DISNEY ENTERPRISES, INC. (DELAWARE CORPORATION)
500 SOUTH BUENA VISTA STREET
BURBANK, CA 91521

THE MARK CONSISTS OF STANDARD CHARACTERS WITHOUT CLAIM TO ANY PARTICULAR FONT, STYLE, SIZE, OR COLOR.

FOR: SHIRTS; T-SHIRTS, IN CLASS 25 (U.S. CLS. 22 AND 39).

SN 78-980,853, FILED 2-6-2006.

FIRST USE 5-0-2008; IN COMMERCE 5-0-2008.

MARK SPARACINO, EXAMINING ATTORNEY

Int. Cl.: 44

Prior U.S. Cls.: 100 and 101

United States Patent and Trademark Office

Reg. No. 3,578,150

Registered Feb. 17, 2009

**SERVICE MARK
SUPPLEMENTAL REGISTER**

GRANDIFLORA

SAN FELASCO NURSERIES, INC. (FLORIDA
CORPORATION)
7315 NW 126 STREET
GAINESVILLE, FL 32653

THE MARK CONSISTS OF STANDARD CHAR-
ACTERS WITHOUT CLAIM TO ANY PARTICULAR
FONT, STYLE, SIZE, OR COLOR.

FOR: PLANT NURSERIES, IN CLASS 44 (U.S. CLS.
100 AND 101).

SER. NO. 76-607,172, FILED P.R. 8-16-2004; AM. S.R.
1-13-2009.

FIRST USE 7-1-2004; IN COMMERCE 7-1-2004.

NELSON SNYDER, EXAMINING ATTORNEY

Int. Cl.: 12

Prior U.S. Cls.: 19, 21, 23, 31, 35, and 44

United States Patent and Trademark Office

Reg. No. 3,578,151

Registered Feb. 17, 2009

**TRADEMARK
SUPPLEMENTAL REGISTER**

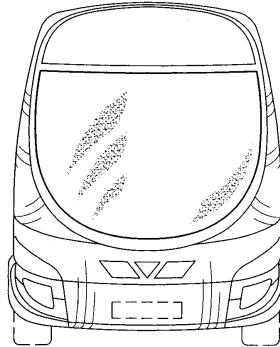

WRIGHTS GROUP LIMITED (NORTHERN IRELAND LIMITED LIABILITY COMPANY)
GALGORM INDUSTRIAL ESTATE
FENAGHY ROAD
GALGORM, BALLYMENA, CO. ANTRIM, NORTHERN IRELAND BT42 1PY

FOR: LAND VEHICLES, NAMELY, BUSES, STREETCARS, AND TRAMS AND STRUCTURAL PARTS FOR BUSES, STREETCARS AND TRAMS, IN CLASS 12 (U.S. CLS. 19, 21, 23, 31, 35 AND 44).

FIRST USE 10-6-2008; IN COMMERCE 10-6-2008.

OWNER OF U.S. REG. NO. 2,737,273.

THE STIPPLING IS FOR SHADING PURPOSES.

SER. NO. 76-667,029, FILED P.R. 10-5-2006; AM. S.R. 12-23-2008.

SETH A. RAPPAPORT, EXAMINING ATTORNEY

Int. Cl.: 44

Prior U.S. Cls.: 100 and 101

United States Patent and Trademark Office

Reg. No. 3,578,152

Registered Feb. 17, 2009

**SERVICE MARK
SUPPLEMENTAL REGISTER**

**FIRST LUXURY FAMILY
WELLNESS RESORT**

THE CLIFFS COMMUNITIES, INC. (SOUTH
CAROLINA CORPORATION)

301 BEAVER DAM ROAD

TRAVELERS REST, SC 29690

FOR: HEALTH CARE SERVICES FOR HEALTH,
FITNESS AND WELLNESS OF THE BODY AND
THE SPIRIT, IN CLASS 44 (U.S. CLS. 100 AND 101).

FIRST USE 10-31-2006; IN COMMERCE 10-31-2006.

THE MARK CONSISTS OF STANDARD CHAR-
ACTERS WITHOUT CLAIM TO ANY PARTICULAR
FONT, STYLE, SIZE, OR COLOR.

NO CLAIM IS MADE TO THE EXCLUSIVE
RIGHT TO USE "WELLNESS RESORT", APART
FROM THE MARK AS SHOWN.

SER. NO. 76-672,526, FILED P.R. 2-12-2007; AM. S.R.
8-4-2008.

ALLISON SCHRODY, EXAMINING ATTORNEY

Int. Cl.: 43

Prior U.S. Cls.: 100 and 101

United States Patent and Trademark Office

Reg. No. 3,578,153

Registered Feb. 17, 2009

**SERVICE MARK
SUPPLEMENTAL REGISTER**

PITTSBURGH CHOP HOUSE

THE TRUSTEE OF DANIEL R. FLECK IRA, THE
TRUSTEE COMPRISING OF EQUITY TRUST
COMPANY, A SOUTH DAKOTA CORPORA-
TION (OHIO TRUST)

225 BURNS ROAD
ELYRIA, OH 44035

FOR: RESTAURANT, IN CLASS 43 (U.S. CLS. 100
AND 101).

FIRST USE 8-1-2007; IN COMMERCE 11-1-2007.

THE MARK CONSISTS OF STANDARD CHAR-
ACTERS WITHOUT CLAIM TO ANY PARTICULAR
FONT, STYLE, SIZE, OR COLOR.

NO CLAIM IS MADE TO THE EXCLUSIVE
RIGHT TO USE "CHOP HOUSE", APART FROM
THE MARK AS SHOWN.

SER. NO. 76-680,639, FILED P.R. 8-13-2007; AM. S.R.
12-19-2008.

BARBARA RUTLAND, EXAMINING ATTORNEY

Int. Cl.: 9

Prior U.S. Cls.: 21, 23, 26, 36, and 38

United States Patent and Trademark Office

Reg. No. 3,578,154

Registered Feb. 17, 2009

**TRADEMARK
SUPPLEMENTAL REGISTER**

#1 RANGEFINDER IN GOLF

SKYHAWKE TECHNOLOGIES, LLC (MISSISSIPPI LIMITED LIABILITY COMPANY)
274 COMMERCE PARK DRIVE, SUITE M
RIDGELAND, MS 39157

FOR: ELECTRONIC SATELLITE TRACKING AND INFORMATION SYSTEM COMPRISING COMPUTER HARDWARE AND COMPUTER SOFTWARE USED TO DETERMINE DISTANCES ON GOLF COURSES AND FOR ACCESSING RELEVANT DATA AND STATISTICS PERTINENT THERETO, IN CLASS 9 (U.S. CLS. 21, 23, 26, 36 AND 38).

FIRST USE 9-0-2007; IN COMMERCE 9-0-2007.

THE MARK CONSISTS OF STANDARD CHARACTERS WITHOUT CLAIM TO ANY PARTICULAR FONT, STYLE, SIZE, OR COLOR.

SER. NO. 76-681,130, FILED P.R. 8-24-2007; AM. S.R. 6-10-2008.

AMY C. KEAN, EXAMINING ATTORNEY

Int. Cl.: 36

Prior U.S. Cls.: 100, 101, and 102

United States Patent and Trademark Office

Reg. No. 3,578,155

Registered Feb. 17, 2009

**SERVICE MARK
SUPPLEMENTAL REGISTER**

TANGLEWOOD WEALTH MANAGEMENT

TANGLEWOOD CAPITAL MANAGEMENT, INC.
(TEXAS CORPORATION)
1400 POST OAK BLVD., SUITE 550
HOUSTON, TX 77056

FOR: FINANCIAL INVESTMENT SERVICES IN THE FIELD OF BOTH U.S. AND INTERNATIONAL STOCKS, BONDS, EQUITIES, SECURITIES, MUTUAL FUNDS, REAL ESTATE PORTFOLIOS, EXCHANGE TRADED FUNDS (ETFs), AND COMMODITIES, IN CLASS 36 (U.S. CLS. 100, 101 AND 102).

FIRST USE 5-1-2008; IN COMMERCE 5-1-2008.

THE MARK CONSISTS OF STANDARD CHARACTERS WITHOUT CLAIM TO ANY PARTICULAR FONT, STYLE, SIZE, OR COLOR.

NO CLAIM IS MADE TO THE EXCLUSIVE RIGHT TO USE "WEALTH MANAGEMENT", APART FROM THE MARK AS SHOWN.

SER. NO. 76-681,143, FILED P.R. 8-24-2007; AM. S.R. 5-29-2008.

ELI HELLMAN, EXAMINING ATTORNEY

Int. Cl.: 25

Prior U.S. Cls.: 22 and 39

United States Patent and Trademark Office

Reg. No. 3,578,156

Registered Feb. 17, 2009

**TRADEMARK
SUPPLEMENTAL REGISTER**

ARMSTON

PROSPEROUS INTERNATIONAL, INC. (NEW
YORK CORPORATION)
53B OTIS STREET
W. BABYLON, NY 11704

FOR: GLOVES, IN CLASS 25 (U.S. CLS. 22 AND 39).

FIRST USE 1-2-2008; IN COMMERCE 1-2-2008.

THE MARK CONSISTS OF STANDARD CHAR-
ACTERS WITHOUT CLAIM TO ANY PARTICULAR
FONT, STYLE, SIZE, OR COLOR.

SER. NO. 76-686,742, FILED P.R. 2-11-2008; AM. S.R.
12-3-2008.

REGINA DRUMMOND, EXAMINING ATTORNEY

Int. Cl.: 37

Prior U.S. Cls.: 100, 103, and 106

United States Patent and Trademark Office

Reg. No. 3,578,157

Registered Feb. 17, 2009

**SERVICE MARK
SUPPLEMENTAL REGISTER**

ENVIRONMENTAL PUMP SERVICES

CRISTANDO, BLAINE (UNITED STATES INDIVIDUAL)
319 FUCHSIA WAY
HEALDSBURG, CA 95448 AND
HAWLEY, ERIC (UNITED STATES INDIVIDUAL)
319 FUCHSIA WAY
HEALDSBURG, CA 95448

FOR: ENVIRONMENTAL REMEDIATION SERVICES, NAMELY, LIQUID WASTE REMOVAL, SEPTIC WASTE REMOVAL, AND WINERY WASTE REMOVAL, IN CLASS 37 (U.S. CLS. 100, 103 AND 106).

FIRST USE 12-17-2007; IN COMMERCE 1-19-2008.

THE MARK CONSISTS OF STANDARD CHARACTERS WITHOUT CLAIM TO ANY PARTICULAR FONT, STYLE, SIZE, OR COLOR.

NO CLAIM IS MADE TO THE EXCLUSIVE RIGHT TO USE "PUMP SERVICES", APART FROM THE MARK AS SHOWN.

SER. NO. 76-686,903, FILED P.R. 2-19-2008; AM. S.R. 1-9-2009.

BARBARA BROWN, EXAMINING ATTORNEY

Int. Cl.: 29

Prior U.S. Cl.: 46

United States Patent and Trademark Office

Reg. No. 3,578,158

Registered Feb. 17, 2009

**TRADEMARK
SUPPLEMENTAL REGISTER**

O'Connell's Corned Beef

L&P PROVISIONS, INC. (ILLINOIS CORPORATION)
1301 WEST LAKE STREET
CHICAGO, IL 60607

FOR: CORNED BEEF, IN CLASS 29 (U.S. CL. 46).

FIRST USE 10-2-2006; IN COMMERCE 10-4-2006.

NO CLAIM IS MADE TO THE EXCLUSIVE RIGHT TO USE "CORNED BEEF", APART FROM THE MARK AS SHOWN.

SER. NO. 76-692,945, FILED P.R. 9-18-2008; AM. S.R. 12-27-2008.

JENNIFER HETU, EXAMINING ATTORNEY

Int. Cl.: 33

Prior U.S. Cls.: 47 and 49

United States Patent and Trademark Office

Reg. No. 3,578,159

Registered Feb. 17, 2009

**TRADEMARK
SUPPLEMENTAL REGISTER**

DUARTE FAMILY VINEYARDS

DUARTE, MICHAEL (UNITED STATES INDIVIDUAL)

5860 LAIRD ROAD

LOOMIS, CA 95650

FOR: STILL WINE, IN CLASS 33 (U.S. CLS. 47 AND 49).

FIRST USE 12-8-2008; IN COMMERCE 12-8-2008.

THE MARK CONSISTS OF STANDARD CHARACTERS WITHOUT CLAIM TO ANY PARTICULAR FONT, STYLE, SIZE, OR COLOR.

NO CLAIM IS MADE TO THE EXCLUSIVE RIGHT TO USE "FAMILY VINEYARDS", APART FROM THE MARK AS SHOWN.

SER. NO. 76-692,961, FILED P.R. 9-18-2008; AM. S.R. 12-29-2008.

CARYN GLASSER, EXAMINING ATTORNEY

Int. Cl.: 25

Prior U.S. Cls.: 22 and 39

United States Patent and Trademark Office

Reg. No. 3,578,160

Registered Feb. 17, 2009

**TRADEMARK
SUPPLEMENTAL REGISTER**

random.things

KRUEGER, THERESA (UNITED STATES INDIVIDUAL)
5320 VIA SEVILLA
YORBA LINDA, CA 92887

FOR: SHORT-SLEEVED OR LONG-SLEEVED T-SHIRTS, IN CLASS 25 (U.S. CLS. 22 AND 39).

FIRST USE 12-15-2007; IN COMMERCE 12-15-2007.

THE MARK CONSISTS OF STANDARD CHARACTERS WITHOUT CLAIM TO ANY PARTICULAR FONT, STYLE, SIZE, OR COLOR.

SER. NO. 77-011,693, FILED P.R. 10-2-2006; AM. S.R. 1-12-2009.

LINDSEY RUBIN, EXAMINING ATTORNEY

Int. Cl.: 39

Prior U.S. Cls.: 100 and 105

United States Patent and Trademark Office

Reg. No. 3,578,161

Registered Feb. 17, 2009

**SERVICE MARK
SUPPLEMENTAL REGISTER**

FANTASY SPORTS MANAGER

FSDASHBOARD, INC. (DELAWARE CORPORATION)
SUITE 1800
3340 PEACHTREE ROAD NE
ATLANTA, GA 30326

FOR: PROVIDING A WEBSITE FEATURING AN ON-LINE DATABASE FOR ELECTRONIC STORAGE OF FANTASY SPORTS INFORMATION, IN CLASS 39 (U.S. CLS. 100 AND 105).

FIRST USE 7-24-2007; IN COMMERCE 7-24-2007.

THE MARK CONSISTS OF STANDARD CHARACTERS WITHOUT CLAIM TO ANY PARTICULAR FONT, STYLE, SIZE, OR COLOR.

NO CLAIM IS MADE TO THE EXCLUSIVE RIGHT TO USE "FANTASY SPORTS", APART FROM THE MARK AS SHOWN.

SER. NO. 77-018,700, FILED P.R. 10-11-2006; AM. S.R. 10-12-2007.

SIMON TENG, EXAMINING ATTORNEY

Int. Cl.: 41

Prior U.S. Cls.: 100, 101, and 107

United States Patent and Trademark Office

Reg. No. 3,578,162

Registered Feb. 17, 2009

**SERVICE MARK
SUPPLEMENTAL REGISTER**

BROADWAY NEWS BUREAU

THE BROADWAY LEAGUE INC. (NEW YORK
NON-PROFIT CORPORATION)

226 WEST 47TH STREET

NEW YORK, NY 10036

FOR: PROVIDING INFORMATION IN THE
FIELD OF THEATRE, IN CLASS 41 (U.S. CLS. 100,
101 AND 107).

FIRST USE 6-0-2007; IN COMMERCE 6-0-2007.

THE MARK CONSISTS OF STANDARD CHAR-
ACTERS WITHOUT CLAIM TO ANY PARTICULAR
FONT, STYLE, SIZE, OR COLOR.

NO CLAIM IS MADE TO THE EXCLUSIVE
RIGHT TO USE "NEWS BUREAU", APART FROM
THE MARK AS SHOWN.

SER. NO. 77-025,216, FILED P.R. 10-19-2006; AM.
S.R. 11-18-2008.

ELLEN PERKINS, EXAMINING ATTORNEY

Int. Cl.: 41

Prior U.S. Cls.: 100, 101, and 107

United States Patent and Trademark Office

Reg. No. 3,578,163

Registered Feb. 17, 2009

**SERVICE MARK
SUPPLEMENTAL REGISTER**

**American Taekwondo
Federation**

MELATTI, ALLAN S. (UNITED STATES INDIVIDUAL)
5485 N. SIMMONS STREET, SUITE 1
NORTH LAS VEGAS, NV 89031

FOR: MARTIAL ARTS INSTRUCTION AND EDUCATIONAL SERVICES, NAMELY, CONDUCTING CLASSES FOR CHILDREN AND ADULTS, SEMINARS, WORKSHOPS, AND CONFERENCES IN THE FIELD OF MARTIAL ARTS AND SELF DEFENSE, IN CLASS 41 (U.S. CLS. 100, 101 AND 107).

FIRST USE 3-1-2004; IN COMMERCE 3-1-2004.

THE MARK CONSISTS OF STANDARD CHARACTERS WITHOUT CLAIM TO ANY PARTICULAR FONT, STYLE, SIZE, OR COLOR.

NO CLAIM IS MADE TO THE EXCLUSIVE RIGHT TO USE "FEDERATION", APART FROM THE MARK AS SHOWN.

SER. NO. 77-033,163, FILED P.R. 10-31-2006; AM. S.R. 1-8-2009.

SAMUEL E. SHARPER JR., EXAMINING ATTORNEY

Int. Cl.: 30

Prior U.S. Cl.: 46

United States Patent and Trademark Office

Reg. No. 3,578,164

Registered Feb. 17, 2009

**TRADEMARK
SUPPLEMENTAL REGISTER**

GOOD HEALTHY FOODS

SKP AND ASSOCIATES, INC. (OREGON CORPORATION)
16140 TRAIL DRIVE
OREGON CITY, OR 97045

FOR: SAUCES, SPICE BLENDS, DRY RUBS FOR MEATS AND FISH, MARINADES, DIPPING SAUCES, AND GLAZES FOR MEATS AND FISH, IN CLASS 30 (U.S. CL. 46).

FIRST USE 5-1-2007; IN COMMERCE 5-1-2007.

THE MARK CONSISTS OF STANDARD CHARACTERS WITHOUT CLAIM TO ANY PARTICULAR FONT, STYLE, SIZE, OR COLOR.

NO CLAIM IS MADE TO THE EXCLUSIVE RIGHT TO USE "FOODS", APART FROM THE MARK AS SHOWN.

SER. NO. 77-040,529, FILED P.R. 11-9-2006; AM. S.R. 10-1-2007.

YONG KIM, EXAMINING ATTORNEY

Int. Cl.: 38

Prior U.S. Cls.: 100, 101, and 104

United States Patent and Trademark Office

Reg. No. 3,578,165

Registered Feb. 17, 2009

**SERVICE MARK
SUPPLEMENTAL REGISTER**

CAROLINA HOMES ON DEMAND

TIME WARNER CABLE INC. (DELAWARE CORPORATION)
290 HARBOR DRIVE
STAMFORD, CT 06902

FOR: VIDEO-ON-DEMAND CABLE TELEVISION TRANSMISSION SERVICES, IN CLASS 38 (U.S. CLS. 100, 101 AND 104).

FIRST USE 12-1-2007; IN COMMERCE 12-1-2007.

THE MARK CONSISTS OF STANDARD CHARACTERS WITHOUT CLAIM TO ANY PARTICULAR FONT, STYLE, SIZE, OR COLOR.

OWNER OF U.S. REG. NOS. 3,203,124 AND 3,203,139.

NO CLAIM IS MADE TO THE EXCLUSIVE RIGHT TO USE "ON DEMAND", APART FROM THE MARK AS SHOWN.

SER. NO. 77-047,006, FILED P.R. 11-17-2006; AM. S.R. 12-5-2008.

ANNE FARRELL, EXAMINING ATTORNEY

Int. Cl.: 20

Prior U.S. Cls.: 2, 13, 22, 25, 32, and 50

Reg. No. 3,578,166

United States Patent and Trademark Office

Registered Feb. 17, 2009

**TRADEMARK
SUPPLEMENTAL REGISTER**

FLAMELESS

MULTI-COLOR CORPORATION (OHIO CORPORATION)
SUITE 1300
425 WALNUT STREET
CINCINNATI, OH 45202

FOR: PLASTIC AND THERMOPLASTIC LABELS, NAMELY, BLANK, PARTIALLY PRINTED, OR FULLY PRINTED WAX-BASED LABELS AND ADHESIVE LABELS, IN CLASS 20 (U.S. CLS. 2, 13, 22, 25, 32 AND 50).

FIRST USE 7-0-2005; IN COMMERCE 7-0-2005.

THE MARK CONSISTS OF STANDARD CHARACTERS WITHOUT CLAIM TO ANY PARTICULAR FONT, STYLE, SIZE, OR COLOR.

SER. NO. 77-060,196, FILED P.R. 12-8-2006; AM. S.R. 5-7-2008.

ANGELA M. MICHELI, EXAMINING ATTORNEY

Int. Cl.: 41

Prior U.S. Cls.: 100, 101, and 107

United States Patent and Trademark Office

Reg. No. 3,578,167

Registered Feb. 17, 2009

**SERVICE MARK
SUPPLEMENTAL REGISTER**

WHITE ELK

SAKURA PROPERTIES, LLC (UTAH LIMITED
LIABILITY COMPANY)
185 EAST 200 NORTH
SALEM, UT 84653

FOR: PROVIDING HUNTING PRESERVES,
HUNTING GUIDE SERVICES, AND ANIMAL EX-
HIBITION SERVICES, IN CLASS 41 (U.S. CLS. 100, 101
AND 107).

FIRST USE 9-26-2008; IN COMMERCE 9-26-2008.

THE MARK CONSISTS OF STANDARD CHAR-
ACTERS WITHOUT CLAIM TO ANY PARTICULAR
FONT, STYLE, SIZE, OR COLOR.

SER. NO. 77-065,219, FILED P.R. 12-15-2006; AM.
S.R. 11-3-2008.

DAVID TOOLEY, EXAMINING ATTORNEY

Int. Cls.: 8 and 9

Prior U.S. Cls.: 21, 23, 26, 28, 36, 38, and 44

United States Patent and Trademark Office

Reg. No. 3,578,168

Registered Feb. 17, 2009

**TRADEMARK
SUPPLEMENTAL REGISTER**

Microtorque

ATLAS COPCO TOOLS AB (SWEDEN CORPORATION)
SICKLA INDUSTRIVÄG 15
NACKA, STOCKHOLM, SWEDEN SE-10523

FOR: MANUALLY OPERATED HAND TOOLS, NAMELY, HAND-HELD SCREWDRIVER, PUSH-START CONFIGURABLE SCREWDRIVER, AND FIXTURE SCREWDRIVER, IN CLASS 8 (U.S. CLS. 23, 28 AND 44).

FIRST USE 1-0-2007; IN COMMERCE 1-0-2007.

FOR: TORQUE MEASUREMENT EQUIPMENT, NAMELY, SENSOR-CONTROLLED MEASURE-

MENT INSTRUMENT FOR USE WITH ASSEMBLY OF CONSUMER GOODS AND ELECTRONICS, IN CLASS 9 (U.S. CLS. 21, 23, 26, 36 AND 38).

FIRST USE 1-0-2007; IN COMMERCE 1-0-2007.

THE MARK CONSISTS OF STANDARD CHARACTERS WITHOUT CLAIM TO ANY PARTICULAR FONT, STYLE, SIZE, OR COLOR.

SER. NO. 77-083,415, FILED P.R. 1-16-2007; AM. S.R. 9-19-2008.

REGINA DRUMMOND, EXAMINING ATTORNEY

Int. Cls.: 22 and 26

Prior U.S. Cls.: 1, 2, 7, 19, 22, 37, 39, 40, 42, and 50

United States Patent and Trademark Office

Reg. No. 3,578,169

Registered Feb. 17, 2009

**TRADEMARK
SUPPLEMENTAL REGISTER**

HOT WATER SET

KANEKA CORPORATION (JAPAN CORPORATION)
2-4, NAKANOSHIMA 3-CHOME
KITA-KU, OSAKA, JAPAN

FOR: ARTIFICIAL FIBERS USED IN MANUFACTURE OF WIGS AND HAIRPIECES, IN CLASS 22 (U.S. CLS. 1, 2, 7, 19, 22, 42 AND 50).

FIRST USE 9-4-2007; IN COMMERCE 9-30-2008.

FOR: WIGS AND HAIRPIECES, IN CLASS 26 (U.S. CLS. 37, 39, 40, 42 AND 50).

FIRST USE 9-4-2007; IN COMMERCE 9-30-2008.

THE MARK CONSISTS OF STANDARD CHARACTERS WITHOUT CLAIM TO ANY PARTICULAR FONT, STYLE, SIZE, OR COLOR.

SER. NO. 77-086,333, FILED P.R. 1-19-2007; AM. S.R. 1-6-2009.

CURTIS FRENCH, EXAMINING ATTORNEY

Int. Cl.: 9

Prior U.S. Cls.: 21, 23, 26, 36, and 38

United States Patent and Trademark Office

Reg. No. 3,578,170

Registered Feb. 17, 2009

**TRADEMARK
SUPPLEMENTAL REGISTER**

**DATABASE DRIVEN RELATIONAL
OBJECT MODEL**

SHIPCONSTRUCTOR SOFTWARE INC. (CANADA CORPORATION)
304 - 3960 QUADRA STREET
VICTORIA, CANADA V8X4A3

FOR: COMPUTER SOFTWARE FOR USE IN DESIGNING, MODELING AND BUILDING MARINE VESSELS, IN CLASS 9 (U.S. CLS. 21, 23, 26, 36 AND 38).

THE MARK CONSISTS OF STANDARD CHARACTERS WITHOUT CLAIM TO ANY PARTICULAR FONT, STYLE, SIZE, OR COLOR.

PRIORITY CLAIMED UNDER SEC. 44(D) ON CANADA APPLICATION NO. 1311423, FILED 8-1-2006, REG. NO. TMA713940, DATED 5-8-2008, EXPIRES 5-8-2023.

SER. NO. 77-096,649, FILED P.R. 2-1-2007; AM. S.R. 12-23-2008.

HEATHER THOMPSON, EXAMINING ATTORNEY

Int. Cl.: 25

Prior U.S. Cls.: 22 and 39

United States Patent and Trademark Office

Reg. No. 3,578,171

Registered Feb. 17, 2009

**TRADEMARK
SUPPLEMENTAL REGISTER**



JOHN DEBUF (UNITED STATES INDIVIDUAL)
3040 CENTRAL AVE., #C108
BILLINGS, MT 59102

THE MARK CONSISTS OF A LITTLE BOY WEAR-
ING A DIAPER WITH GOGGLES ON HIS HEAD.

FOR: T-SHIRTS, HATS, CAPS, SHORTS, COATS,
JACKETS, SWEATSHIRTS, AND TOPS, IN CLASS 25
(U.S. CLS. 22 AND 39).

SER. NO. 77-099,686, FILED P.R. 2-5-2007; AM. S.R.
4-18-2008.

FIRST USE 5-31-2007; IN COMMERCE 5-31-2007.

SOPHIA S. KIM, EXAMINING ATTORNEY

Int. Cl.: 43

Prior U.S. Cls.: 100 and 101

United States Patent and Trademark Office

Reg. No. 3,578,172

Registered Feb. 17, 2009

**SERVICE MARK
SUPPLEMENTAL REGISTER**

The Koop

SENDER, SHANE (UNITED STATES INDIVIDUAL)
9514 E. HAVASUPAI DRIVE
SCOTTSDALE, AZ 85255

FOR: RESTAURANTS, IN CLASS 43 (U.S. CLS. 100 AND 101).

FIRST USE 4-26-2007; IN COMMERCE 4-10-2008.

THE MARK CONSISTS OF STANDARD CHARACTERS WITHOUT CLAIM TO ANY PARTICULAR FONT, STYLE, SIZE, OR COLOR.

SER. NO. 77-166,312, FILED P.R. 4-26-2007; AM. S.R. 1-7-2009.

SIMON TENG, EXAMINING ATTORNEY

Int. Cl.: 31

Prior U.S. Cls.: 1 and 46

United States Patent and Trademark Office

Reg. No. 3,578,173

Registered Feb. 17, 2009

**TRADEMARK
SUPPLEMENTAL REGISTER**

WESTERN REGIONAL BLEND

WAGNER'S, LLC (DELAWARE LIMITED LIABILITY COMPANY)

SUITE 300

366 N. BROADWAY

JERICHO, NY 11753

FOR: BIRD SEED, IN CLASS 31 (U.S. CLS. 1 AND 46).

FIRST USE 10-0-2006; IN COMMERCE 10-0-2006.

THE MARK CONSISTS OF STANDARD CHARACTERS WITHOUT CLAIM TO ANY PARTICULAR FONT, STYLE, SIZE, OR COLOR.

NO CLAIM IS MADE TO THE EXCLUSIVE RIGHT TO USE "BLEND", APART FROM THE MARK AS SHOWN.

SER. NO. 77-172,793, FILED P.R. 5-4-2007; AM. S.R. 1-9-2009.

MARTHA FROMM, EXAMINING ATTORNEY

Int. Cl.: 31

Prior U.S. Cls.: 1 and 46

United States Patent and Trademark Office

Reg. No. 3,578,174

Registered Feb. 17, 2009

**TRADEMARK
SUPPLEMENTAL REGISTER**

EASTERN REGIONAL BLEND

WAGNER'S, LLC (DELAWARE LIMITED LIABILITY COMPANY)

SUITE 300

366 N. BROADWAY

JERICO, NY 11753

FOR: BIRD SEED, IN CLASS 31 (U.S. CLS. 1 AND 46).

FIRST USE 6-0-2006; IN COMMERCE 6-0-2006.

THE MARK CONSISTS OF STANDARD CHARACTERS WITHOUT CLAIM TO ANY PARTICULAR FONT, STYLE, SIZE, OR COLOR.

NO CLAIM IS MADE TO THE EXCLUSIVE RIGHT TO USE "BLEND", APART FROM THE MARK AS SHOWN.

SER. NO. 77-172,797, FILED P.R. 5-4-2007; AM. S.R. 1-9-2009.

MARTHA FROMM, EXAMINING ATTORNEY

Int. Cl.: 9

Prior U.S. Cls.: 21, 23, 26, 36, and 38

United States Patent and Trademark Office

Reg. No. 3,578,175

Registered Feb. 17, 2009

**TRADEMARK
SUPPLEMENTAL REGISTER**

CurrentPath

SUMMIT MICROELECTRONICS, INC. (CALI-
FORNIA CORPORATION)
757 N. MARY AVENUE
SUNNYVALE, CA 94085

FOR: SEMICONDUCTOR INTEGRATED CIR-
CUITS, IN CLASS 9 (U.S. CLS. 21, 23, 26, 36 AND 38).

FIRST USE 10-31-2007; IN COMMERCE 10-31-2007.

THE MARK CONSISTS OF STANDARD CHAR-
ACTERS WITHOUT CLAIM TO ANY PARTICULAR
FONT, STYLE, SIZE, OR COLOR.

SER. NO. 77-174,406, FILED P.R. 5-7-2007; AM. S.R.
9-2-2008.

APRIL ROACH, EXAMINING ATTORNEY

Int. Cl.: 35

Prior U.S. Cls.: 100, 101, and 102

United States Patent and Trademark Office

Reg. No. 3,578,176

Registered Feb. 17, 2009

**SERVICE MARK
SUPPLEMENTAL REGISTER**

ON-DEMAND IDENTIFICATION

TARGUS INFORMATION CORPORATION (DE-
LAWARE CORPORATION)
8010 TOWERS CRESCENT DRIVE, FIFTH FLOOR
VIENNA, VA 22182

FOR: INFORMATION SERVICES, NAMELY,
PROVIDING CLIENT ORGANIZATIONS WITH
CONSUMER LEAD INFORMATION RELEVANT
TO CONSUMER RELATIONSHIP MANAGEMENT
AND MARKETING, IN CLASS 35 (U.S. CLS. 100, 101
AND 102).

FIRST USE 12-12-2006; IN COMMERCE 12-12-2006.

THE MARK CONSISTS OF STANDARD CHAR-
ACTERS WITHOUT CLAIM TO ANY PARTICULAR
FONT, STYLE, SIZE, OR COLOR.

NO CLAIM IS MADE TO THE EXCLUSIVE
RIGHT TO USE "IDENTIFICATION", APART FROM
THE MARK AS SHOWN.

SER. NO. 77-203,812, FILED P.R. 6-12-2007; AM. S.R.
12-4-2008.

LINDA ESTRADA, EXAMINING ATTORNEY

Int. Cls.: 35 and 45

Prior U.S. Cls.: 100, 101, and 102

United States Patent and Trademark Office

Reg. No. 3,578,177

Registered Feb. 17, 2009

**SERVICE MARK
SUPPLEMENTAL REGISTER**

ON-DEMAND VERIFICATION

TARGUS INFORMATION CORPORATION (DE-
LAWARE CORPORATION)
8010 TOWERS CRESCENT DRIVE, FIFTH FLOOR
VIENNA, VA 22182

FOR: INFORMATION SERVICES, NAMELY,
PROVIDING CLIENT ORGANIZATIONS WITH
BUSINESS INFORMATION ABOUT THE QUALITY
OF CONSUMER LEAD DATA , IN CLASS 35 (U.S.
CLS. 100, 101 AND 102).

FIRST USE 12-12-2006; IN COMMERCE 12-12-2006.

FOR: INFORMATION SERVICES IN THE FIELD
OF IDENTIFICATION VERIFICATION, NAMELY,
PROVIDING AUTHENTICATION OF PERSONAL
IDENTIFICATION INFORMATION FOR CON-
FIRMING THE IDENTITY OF PROSPECTS AND
PERSONS SUBMITTING INFORMATION FOR ON-

LINE TRANSACTIONS AND PROGRAM ENROLL-
MENT REQUESTS, IN CLASS 45 (U.S. CLS. 100 AND
101).

FIRST USE 12-12-2006; IN COMMERCE 12-12-2006.

THE MARK CONSISTS OF STANDARD CHAR-
ACTERS WITHOUT CLAIM TO ANY PARTICULAR
FONT, STYLE, SIZE, OR COLOR.

NO CLAIM IS MADE TO THE EXCLUSIVE
RIGHT TO USE "VERIFICATION", APART FROM
THE MARK AS SHOWN.

SER. NO. 77-203,824, FILED P.R. 6-12-2007; AM. S.R.
12-4-2008.

LINDA ESTRADA, EXAMINING ATTORNEY

Int. Cl.: 25

Prior U.S. Cls.: 22 and 39

United States Patent and Trademark Office

Reg. No. 3,578,178

Registered Feb. 17, 2009

**TRADEMARK
SUPPLEMENTAL REGISTER**

**I LIKE TO PLAY.....AND
I'M GOOD AT IT!**

DEBUF, JOHN (UNITED STATES INDIVIDUAL)
5408 SPRINGSTONE AVE.
BILLINGS, MT 59106

FOR: T-SHIRTS, HATS, CAPS, SHORTS, COATS,
JACKETS, SWEATSHIRTS, TOPS AND UNDER-
WEAR, IN CLASS 25 (U.S. CLS. 22 AND 39).

FIRST USE 5-31-2007; IN COMMERCE 5-31-2007.

THE MARK CONSISTS OF STANDARD CHAR-
ACTERS WITHOUT CLAIM TO ANY PARTICULAR
FONT, STYLE, SIZE, OR COLOR.

SER. NO. 77-205,411, FILED P.R. 6-13-2007; AM. S.R.
1-13-2009.

JOHN GARTNER, EXAMINING ATTORNEY

Int. Cl.: 25

Prior U.S. Cls.: 22 and 39

United States Patent and Trademark Office

Reg. No. 3,578,179

Registered Feb. 17, 2009

**TRADEMARK
SUPPLEMENTAL REGISTER**

SOHO LADY

CALWELL CORPORATION (CALIFORNIA CORPORATION)
4621 LITTLEJOHN STREET
BALDWIN PARK, CA 91706

FOR: BATHING SUITS, BATHROBES, BLOUSES, BODY SUITS, BRA, DRESSES, DRESSING GOWNS, EVENING GOWNS, FOOTWEAR, FUR COATS AND JACKETS, GLOVES, GYM SUITS, HAND-KNITTED SWEATERS, HEAD BAND, HEAD WEAR, JACKETS, JEANS, JOGGING SUITS, LINGERIE, NIGHT GOWNS, NIGHT SHIRTS, PAJAMAS, PANTS, RAIN COATS, SCARVES, SHIRTS, SHORTS, SKIRTS, SLACKS, SOCKS, SUITS, SPORTSWEAR, NAMELY, TOPS, SHORTS, AND PANTS; SWEATERS, SWEAT

PANTS, SWEAT SUITS, TIES, T-SHIRTS, UNDERWEAR AND WAIST BELTS, IN CLASS 25 (U.S. CLS. 22 AND 39).

FIRST USE 4-27-2006; IN COMMERCE 4-27-2006.

THE MARK CONSISTS OF STANDARD CHARACTERS WITHOUT CLAIM TO ANY PARTICULAR FONT, STYLE, SIZE, OR COLOR.

SER. NO. 77-215,192, FILED P.R. 6-26-2007; AM. S.R. 12-1-2008.

JANICE KIM, EXAMINING ATTORNEY

Int. Cl.: 37

Prior U.S. Cls.: 100, 103, and 106

United States Patent and Trademark Office

Reg. No. 3,578,180

Registered Feb. 17, 2009

**SERVICE MARK
SUPPLEMENTAL REGISTER**

Ragged Mountain

RMR EQUIPMENT HOLDING, LLC (NEW
HAMPSHIRE LIMITED LIABILITY COMPA-
NY)
STE 100
2150 SOUTH 1300 EAST
SALT LAKE CITY, UT 84106

FOR: REAL ESTATE DEVELOPMENT, IN CLASS
37 (U.S. CLS. 100, 103 AND 106).

FIRST USE 3-31-2008; IN COMMERCE 3-31-2008.

THE MARK CONSISTS OF STANDARD CHAR-
ACTERS WITHOUT CLAIM TO ANY PARTICULAR
FONT, STYLE, SIZE, OR COLOR.

SER. NO. 77-224,405, FILED P.R. 7-9-2007; AM. S.R.
12-30-2008.

MATTHEW PAPPAS, EXAMINING ATTORNEY

Int. Cl.: 41

Prior U.S. Cls.: 100, 101, and 107

United States Patent and Trademark Office

Reg. No. 3,578,181

Registered Feb. 17, 2009

**SERVICE MARK
SUPPLEMENTAL REGISTER**

MP3 SHOWDOWN!

LIMEGREEN PRODUCTIONS, LLC (ILLINOIS
LIMITED LIABILITY COMPANY)
344 N. OGDEN AVENUE, 3RD FLOOR
CHICAGO, IL 60607

FOR: HOLDING DEEJAY COMPETITIONS, IN
CLASS 41 (U.S. CLS. 100, 101 AND 107).

FIRST USE 4-23-2007; IN COMMERCE 5-10-2007.

THE MARK CONSISTS OF STANDARD CHAR-
ACTERS WITHOUT CLAIM TO ANY PARTICULAR
FONT, STYLE, SIZE, OR COLOR.

SER. NO. 77-227,743, FILED P.R. 7-12-2007; AM. S.R.
4-18-2008.

DAVID YONTEF, EXAMINING ATTORNEY

Int. Cl.: 9

Prior U.S. Cls.: 21, 23, 26, 36, and 38

United States Patent and Trademark Office

Reg. No. 3,578,182

Registered Feb. 17, 2009

**TRADEMARK
SUPPLEMENTAL REGISTER**

SCIENCE ELEMENTS

AMERICAN CHEMICAL SOCIETY (D.C. CORPORATION)
1155 SIXTEENTH ST., NW
WASHINGTON, DC 20036

FOR: DOWNLOADABLE PODCASTS IN THE FIELD OF SCIENCE, IN CLASS 9 (U.S. CLS. 21, 23, 26, 36 AND 38).

FIRST USE 5-2-2007; IN COMMERCE 5-2-2007.

THE MARK CONSISTS OF STANDARD CHARACTERS WITHOUT CLAIM TO ANY PARTICULAR FONT, STYLE, SIZE, OR COLOR.

OWNER OF U.S. REG. NO. 3,398,265.

NO CLAIM IS MADE TO THE EXCLUSIVE RIGHT TO USE "SCIENCE", APART FROM THE MARK AS SHOWN.

SER. NO. 77-238,499, FILED P.R. 7-25-2007; AM. S.R. 12-16-2008.

TIMOTHY FINNEGAN, EXAMINING ATTORNEY

Int. Cls.: 3, 9, 16, 21, 24, 29, 30, 32, and 38

Prior U.S. Cls.: 1, 2, 4, 5, 6, 13, 21, 22, 23, 26, 29, 30, 33, 36, 37, 38, 40, 42, 45, 46, 48, 50, 51, 52, 100, 101, and 104

Reg. No. 3,578,183

United States Patent and Trademark Office

Registered Feb. 17, 2009

**TRADEMARK
SERVICE MARK
SUPPLEMENTAL REGISTER**

MRS BEETON'S

WARD LOCK LTD. (UNITED KINGDOM LIMITED LIABILITY COMPANY)

UPPER SAINT MARTINS LANE

ORION HOUSE 5

LONDON, WC2H 9EA, UNITED KINGDOM

FOR: DETERGENTS AND SOAPS, CLEANING, POLISHING, SCOURING AND ABRASIVE PREPARATIONS; PREPARATIONS FOR LAUNDRY USE; FABRIC CONDITIONERS AND BLEACH; DISHWASHING DETERGENTS; DISINFECTANTS AND BACTERICIDAL SOAPS; HAIR RINSES, NON-MEDICAL DENTAL RINSES, BATH FOAMS AND SHOWER GELS; SHAMPOOS AND HAIR CONDITIONING PREPARATIONS; DENTIFRICES, IN CLASS 3 (U.S. CLS. 1, 4, 6, 50, 51 AND 52).

FOR: PRERECORDED AUDIO AND VIDEO TAPES, VIDEO CASSETTES, CD-ROMS, PHONOGRAPH RECORDS, AUDIO CASSETTES AND COMPACT DISKS ALL ON THE SUBJECT OF COOKERY AND HOUSEHOLD MANAGEMENT; PHOTOGRAPHIC FILM AND SLIDE TRANSPARENCIES ON THE SUBJECT OF COOKERY AND HOUSEHOLD MANAGEMENT; VIDEO GAME MACHINES USED WITH TELEVISION RECEIVERS; ELECTRONIC GAME SOFTWARE AND COMPUTER GAME SOFTWARE; APPARATUS FOR THE RECORDING, TRANSMISSION AND REPRODUCTION OF SOUND OR IMAGE; RADIOS; ENCODED MAGNETIC CARDS, MAGNETIC IDENTIFYING CARDS, MAGNETICALLY ENCODED CREDIT CARDS, DEBIT CARDS; SPECTACLES, SPECTACLE CASES, SUNGLASSES, FRAMES AND CASES FOR SPECTACLES AND SUNGLASSES; BEAKERS; LIGHT SWITCHES, IN CLASS 9 (U.S. CLS. 21, 23, 26, 36 AND 38).

FOR: PAPER AND PRINTED MATTER, NAMELY, LABELS, CARDBOARD; PLACE MATS; NEWSPAPERS, GENERAL INTEREST MAGAZINES, SERIES OF FICTION BOOKS, BROCHURES AND MANUALS ALL IN THE FIELD OF COOKERY AND HOUSEHOLD MANAGEMENT; PHOTOGRAPHS; PICTURES, PRINTS; POSTERS; GREETING CARDS; POSTCARDS; NOTEPADS; ADDRESS BOOKS; SCRAPBOOKS; FOLDERS; CATALOGUES IN THE FIELD OF COOKERY AND HOUSEHOLD MANAGEMENT; CALENDARS; FOLDERS; PHOTOGRAPHIC ALBUMS; DIARIES; BOOKLETS; POSTAGE STAMPS; COVERS FOR POSTAGE STAMPS; STAMP ALBUMS; STICKERS; CAR STICKERS; DECALCOMANIA; MODELLING COMPOUNDS; STATIONERY, PENS, PENCILS, PENCIL SHARPENERS, PENCIL CASES, DRAWING RULERS, ERASERS; BOXES FOR PENS, BOOK MARKERS; DRAWING MATERIALS FOR BLACKBOARDS, ARTISTS' MATERIALS, NAMELY, BRUSHES, PASTELS, PENCILS AND PENS; INSTRUCTIONAL AND TEACHING MATERIALS, NAMELY, BOOKS, MANUALS AND PAMPHLETS IN THE FIELD OF COOKERY AND HOUSEHOLD MANAGEMENT; PAPER NAPKINS, PAPER HANDKERCHIEFS; PAPER FOR WRAPPING AND PACKAGING; GIFT BAGS, SHOPPING BAGS; ENVELOPES; PAINT BRUSHES AND PAINT BOXES; PRINTERS TYPE, PRINTING BLOCKS, IN CLASS 16 (U.S. CLS. 2, 5, 22, 23, 29, 37, 38 AND 50).

FOR: HOUSEHOLD AND KITCHEN UTENSILS AND CONTAINERS, NAMELY, DUSTERS, OIL AND VINEGAR CRUETS; BEVERAGE GLASSWARE, EARTHENWARE, PORCELAIN AND CHINA MUGS AND FIGURINES; COASTERS NOT OF PAPER OR TABLE LINEN LUNCH BOXES, PORTABLE COOLERS AND FITTED PICNIC BASKETS;

COMBS AND CLEANING SPONGES; COOKIE JARS AND BREAD BOXES; CUPS, SAUCERS, BOWLS; VASES; JUGS AND DECANTERS; CORK SCREWS; ICE BUCKETS AND COCKTAIL SHAKERS; SALT AND PEPPER MILLS; BOTTLE OPENERS; KITCHEN AND BARBECUE UTENSILS, NAMELY, FORKS, TONGS AND SPATULAS; COOKWARE, NAMELY, POTS AND PANS; MUGS; CANDLESTICKS; KETTLES, TEAPOTS; TOWEL RACKS; TOILET BRUSHES; LAUNDRY BINS FOR DOMESTIC USE, GLASS STORAGE JARS; CARAFES; NON-ELECTRIC FRUIT JUICERS; GRATERS FOR DOMESTIC USE; FRUIT BOWLS; TOOTHBRUSHES, TOOTHBRUSH HOLDERS; SOAP DISHES; PLANTERS FOR FLOWERS AND PLANTS; CHOPPING BOARDS FOR KITCHEN USE; FLASKS, IN CLASS 21 (U.S. CLS. 2, 13, 23, 29, 30, 33, 40 AND 50).

FOR: TOWELS, TEA TOWELS, DISH CLOTHS, PLACE MATS NOT OF PAPER, OVEN CLOTHS, POT HOLDERS AND OVEN MITS, IN CLASS 24 (U.S. CLS. 42 AND 50).

FOR: MEAT; FISH; POULTRY; PRESERVED, DRIED AND COOKED FRUITS AND VEGETABLES; DAIRY BASED SNACK FOODS, FRUIT BASED SNACK FOODS, MEAT BASED SNACK FOODS; FROZEN PREPARED MEALS CONSISTING PRIMARILY OF MEAT, DAIRY AND VEGETARIAN ENTREES; JELLIES; JAMS; DAIRY PRODUCTS EXCLUDING ICE CREAM, ICE MILK AND FROZEN YOGHURT; EGGS; MILK AND FRUIT FLAVORED MILK BASED DRINKS; BUTTER; CHEESE; YOGHURT; CREAM; PROCESSED NUTS AND POTATO CHIPS; SOUPS; MEAT AND VEGETABLE SPREADS AND PATE; SALADS EXCEPT MACARONI, RICE AND PASTA; EDIBLE OILS, PICKLES AND FRUIT PRESERVES, IN CLASS 29 (U.S. CL. 46).

FOR: COFFEE, MIXTURES OF COFFEE AND CHICORY; CHOCOLATE FOOD BEVERAGES NOT BEING DAIRY BASED OR VEGETABLE BASED;

COCOA-BASED BEVERAGES; TEA AND HERBAL TEA; SUGAR; RICE; FLOUR; BREAD; CEREAL BASED SNACK FOODS, PASTRIES AND CAKES; PASTA; BISCUITS; CHOCOLATE BARS AND CANDIES ICE CREAMS AND SORBETS; SAUCES AND SPICES; SALAD DRESSINGS AND MAYONNAISE; FROZEN PREPARED MEALS CONSISTING PRIMARILY OF PASTA OR RICE, IN CLASS 30 (U.S. CL. 46).

FOR: NON-ALCOHOLIC FRUIT BEVERAGES AND DRINKS; NON-ALCOHOLIC FRUIT EXTRACTS USED IN THE PREPARATION OF NON-ALCOHOLIC BEVERAGES AND DRINKS, SOFT DRINKS AND FLAVORED WATERS, IN CLASS 32 (U.S. CLS. 45, 46 AND 48).

FOR: NEWS AGENCY SERVICES, NAMELY, TRANSMISSION OF NEWS TO NEWS REPORTING ORGANIZATIONS; BROADCASTING OF RADIO AND TELEVISION PROGRAMS, BY MEANS OF WIRE, CABLE, SATELLITE TRANSMISSION ; PROVIDING ACCESS TO TELECOMMUNICATIONS NETWORKS, IN CLASS 38 (U.S. CLS. 100, 101 AND 104).

THE MARK CONSISTS OF STANDARD CHARACTERS WITHOUT CLAIM TO ANY PARTICULAR FONT, STYLE, SIZE, OR COLOR.

PRIORITY CLAIMED UNDER SEC. 44(D) ON ERPN CMNTY TM OFC APPLICATION NO. 5920541, FILED 5-21-2007, REG. NO. 5920541, DATED 3-7-2008, EXPIRES 5-25-2017.

OWNER OF U.S. REG. NO. 1,453,337.

SER. NO. 77-240,886, FILED P.R. 7-27-2007; AM. S.R. 12-17-2008.

H. M. FISHER, EXAMINING ATTORNEY

Int. Cls.: 35 and 36

Prior U.S. Cls.: 100, 101, and 102

United States Patent and Trademark Office

Reg. No. 3,578,184

Registered Feb. 17, 2009

**SERVICE MARK
SUPPLEMENTAL REGISTER**

**VOLUNTEER FLORIDA
FOUNDATION**

THE FLORIDA COMMISSION ON COMMUNITY SERVICES (FLORIDA COMMISSION ON THE EXECUTIVE BRANCH OF FLORIDA GOVERNMENT), DBA THE GOVERNOR'S COMMISSION ON VOLUNTEERISM AND COMMUNITY SERVICE, VOLUNTEER FLORIDA,

401 SOUTH MONROE STREET
TALLAHASSEE, FL 32301

FOR: ELEEMOSYNARY SERVICES, NAMELY, ORGANIZING AND CONDUCTING VOLUNTEER PROGRAMS AND COMMUNITY SERVICE PROJECTS IN FURTHERANCE OF THE FLORIDA VOLUNTEER AND COMMUNITY SERVICE ACT OF 2001, IN CLASS 35 (U.S. CLS. 100, 101 AND 102).

FIRST USE 7-1-2004; IN COMMERCE 7-1-2004.

FOR: ELEEMOSYNARY SERVICES, NAMELY, CHARITABLE FUNDRAISING SERVICES, NAME-

LY, SEEKING MONETARY DONATIONS FROM PRIVATE AND CORPORATE DONORS IN FURTHERANCE OF THE FLORIDA VOLUNTEER AND COMMUNITY SERVICE ACT OF 2001, IN CLASS 36 (U.S. CLS. 100, 101 AND 102).

FIRST USE 7-1-2004; IN COMMERCE 7-1-2004.

THE MARK CONSISTS OF STANDARD CHARACTERS WITHOUT CLAIM TO ANY PARTICULAR FONT, STYLE, SIZE, OR COLOR.

NO CLAIM IS MADE TO THE EXCLUSIVE RIGHT TO USE "VOLUNTEER" AND "FOUNDATION", APART FROM THE MARK AS SHOWN.

SER. NO. 77-241,611, FILED P.R. 7-30-2007; AM. S.R. 4-18-2008.

BILL DAWE, EXAMINING ATTORNEY

Int. Cl.: 41

Prior U.S. Cls.: 100, 101, and 107

United States Patent and Trademark Office

Reg. No. 3,578,185

Registered Feb. 17, 2009

**SERVICE MARK
SUPPLEMENTAL REGISTER**

SEGMENTO DE SALUD

MBC AND ASSOCIATES, INC. (TENNESSEE
CORPORATION)
911 HAWKINS STREET
NASHVILLE, TN 37203

FOR: EDUCATION AND ENTERTAINMENT
SERVICES, NAMELY, AN ON-GOING SERIES OF
TELEVISION PROGRAMS ON HEALTH RELATED
ISSUES, IN CLASS 41 (U.S. CLS. 100, 101 AND 107).

FIRST USE 9-3-2008; IN COMMERCE 9-3-2008.

THE MARK CONSISTS OF STANDARD CHAR-
ACTERS WITHOUT CLAIM TO ANY PARTICULAR
FONT, STYLE, SIZE, OR COLOR.

OWNER OF U.S. REG. NOS. 1,838,863 AND
1,844,651.

THE FOREIGN WORDING IN THE MARK
TRANSLATES INTO ENGLISH AS "HEALTH SEG-
MENT".

SER. NO. 77-244,066, FILED P.R. 8-1-2007; AM. S.R.
12-5-2008.

RUDY R. SINGLETON, EXAMINING ATTORNEY

Int. Cl.: 37

Prior U.S. Cls.: 100, 103, and 106

United States Patent and Trademark Office

Reg. No. 3,578,186

Registered Feb. 17, 2009

**SERVICE MARK
SUPPLEMENTAL REGISTER**

MODULAR QUIK-CONNECT

ZEPHYR GAS SERVICES, LP (TEXAS LIMITED
PARTNERSHIP)
11433 BRITTMOORE PARK DRIVE
HOUSTON, TX 77041

FOR: RENTAL SERVICES OF CONSTRUCTION
AND BUILDING EQUIPMENT; INSTALLATION
SERVICES, NAMELY, OF CONSTRUCTION,
BUILDING AND COOLING EQUIPMENT FOR
THE GAS INDUSTRY, IN CLASS 37 (U.S. CLS. 100,
103 AND 106).

FIRST USE 1-0-2007; IN COMMERCE 1-0-2007.

THE MARK CONSISTS OF STANDARD CHAR-
ACTERS WITHOUT CLAIM TO ANY PARTICULAR
FONT, STYLE, SIZE, OR COLOR.

SER. NO. 77-246,007, FILED P.R. 8-2-2007; AM. S.R.
1-7-2009.

JASON LOTT, EXAMINING ATTORNEY

Int. Cl.: 9

Prior U.S. Cls.: 21, 23, 26, 36, and 38

United States Patent and Trademark Office

Reg. No. 3,578,187

Registered Feb. 17, 2009

**TRADEMARK
SUPPLEMENTAL REGISTER**

MatterTrack

WONG, LUELLA (UNITED STATES INDIVIDUAL)
3405 HASTINGS CIRCLE
LOUISVILLE, KY 40241

FOR: COMPUTER SOFTWARE FOR MANAGEMENT OF OUTSIDE LEGAL COUNSEL FOR CORPORATIONS, IN CLASS 9 (U.S. CLS. 21, 23, 26, 36 AND 38).

FIRST USE 4-1-2005; IN COMMERCE 4-1-2005.

THE MARK CONSISTS OF STANDARD CHARACTERS WITHOUT CLAIM TO ANY PARTICULAR FONT, STYLE, SIZE, OR COLOR.

SER. NO. 77-248,296, FILED P.R. 8-6-2007; AM. S.R. 12-19-2008.

JENNIFER VASQUEZ, EXAMINING ATTORNEY

Int. Cl.: 39

Prior U.S. Cls.: 100 and 105

United States Patent and Trademark Office

Reg. No. 3,578,188

Registered Feb. 17, 2009

**SERVICE MARK
SUPPLEMENTAL REGISTER**

HOME EXCHANGE

HOMEEEXCHANGE.COM INC. (CALIFORNIA
CORPORATION)
45 16TH STREET
HERMOSA BEACH, CA 90254

FOR: MEMBERSHIP SERVICES, PROVIDED PRIMARILY VIA THE INTERNET THAT LISTS MEMBERS' RESIDENCES, INCLUDING BUT NOT LIMITED TO A HOUSE, HOUSEBOAT, SAILBOAT, MOTOR BOAT, OR RV FOR TEMPORARY USE, IN CLASS 39 (U.S. CLS. 100 AND 105).

FIRST USE 1-1-1998; IN COMMERCE 1-1-1998.

THE MARK CONSISTS OF STANDARD CHARACTERS WITHOUT CLAIM TO ANY PARTICULAR FONT, STYLE, SIZE, OR COLOR.

SER. NO. 77-252,211, FILED P.R. 8-10-2007; AM. S.R. 12-10-2008.

GINA HAYES, EXAMINING ATTORNEY

Int. Cl.: 9

Prior U.S. Cls.: 21, 23, 26, 36, and 38

United States Patent and Trademark Office

Reg. No. 3,578,189

Registered Feb. 17, 2009

**TRADEMARK
SUPPLEMENTAL REGISTER**

CEL-FI

NEXTIVITY INC. (DELAWARE CORPORATION)
12230 WORLD TRADE DRIVE, SUITE 250
SAN DIEGO, CA 92128

FOR: CELLULAR REPEATERS, IN CLASS 9 (U.S.
CLS. 21, 23, 26, 36 AND 38).

FIRST USE 12-6-2007; IN COMMERCE 12-6-2007.

THE MARK CONSISTS OF STANDARD CHAR-
ACTERS WITHOUT CLAIM TO ANY PARTICULAR
FONT, STYLE, SIZE, OR COLOR.

SER. NO. 77-253,936, FILED P.R. 8-13-2007; AM. S.R.
1-13-2009.

ELISSA GARBER KON, EXAMINING ATTORNEY

Int. Cls.: 25, 41, and 43

Prior U.S. Cls.: 22, 39, 100, 101, and 107

Reg. No. 3,578,190

United States Patent and Trademark Office

Registered Feb. 17, 2009

**TRADEMARK
SERVICE MARK
SUPPLEMENTAL REGISTER**

MUSIC INC

CONSOLIDATED DEVELOPMENTS LIMITED
(UNITED KINGDOM CORPORATION)
171 WARDOUR STREET
LONDON, UNITED KINGDOM W1V3TA

FOR: (BASED ON 44(E)) ARTICLES OF CLOTHING, NAMELY, SHIRTS, PANTS, HATS, SWEATSHIRTS, JACKETS, COATS, SHOES, SOCKS AND UNDERWEAR, IN CLASS 25 (U.S. CLS. 22 AND 39).

FOR: (BASED ON 44(D) PRIORITY APPLICATION) (BASED ON 44(E)) ENTERTAINMENT SERVICES, NAMELY, CONDUCTING PARTIES, PROVIDING ONLINE REVIEWS OF MOVIES AND MUSIC; LEISURE SERVICES, NAMELY, GOLF COURSES, AMUSEMENT PARKS, BOWLING ALLEYS; ORGANIZATION OF ENTERTAINMENT AND LEISURE SERVICES, NAMELY, ORGANIZING COMMUNITY SPORTING AND CULTURAL EVENTS, ORGANIZING OF DANCING EVENTS; NIGHT CLUBS; DISCOTHEQUES; DANCE CLUBS; ENTERTAINMENT CLUB SERVICES, NAMELY, YACHT CLUBS, POLO CLUB SERVICES; PROVISION OF LEISURE FACILITIES, NAMELY, PROVIDING GOLF FACILITIES, PROVIDING FACILITIES FOR RECREATIONAL ACTIVITIES; PROVISION OF ENTERTAINMENT, NAMELY, PROVIDING ON-LINE COMPUTER GAMES, PROVIDING PODCASTS IN THE FIELD OF MUSIC; PRODUCTION OF SHOWS, NAMELY, TELEVISION CHAT SHOW PRODUCTION, PRODUCTION OF GAME SHOWS; MUSICAL ENTERTAINMENT SERVICES, NAMELY, PROVIDING A WEB SITE FEATURING MUSICAL PERFORMANCES, MUSICAL VIDEOS, RELATED FILM CLIPS, PHOTOGRAPHS, AND OTHER MULTIMEDIA MATERIALS; LIVE ENTERTAINMENT, NAMELY, LIVE MUSIC CONCERTS; LIVE PERFORMANCES, NAMELY, LIVE PERFORMANCES BY A MUSICAL BAND; SOCIAL CLUB SERVICES, NAMELY, ARRANGING, PLANNING, ORGANIZING, AND CONDUCTING SO-

CIAL EVENTS, GET-TOGETHERS, AND PARTIES FOR CLUB MEMBERS; RENTAL AND PRODUCTION OF SOUND RECORDINGS; ARRANGING, ORGANIZING, AND CONDUCTING SPORTS COMPETITIONS; ORGANIZATION OF GAMES; ARRANGING AND CONDUCTING ENTERTAINMENT EXHIBITIONS IN THE NATURE OF QUIZ SHOWS, AND KNOWLEDGE COMPETITIONS; CASINO SERVICES, NAMELY, CASINOS, AND PROVIDING CASINO FACILITIES; ORGANIZING COMMUNITY SPORTING AND CULTURAL EVENTS; INFORMATION, ADVISORY AND CONSULTANCY SERVICES RELATING TO ALL OF THE AFOREMENTIONED SERVICES, IN CLASS 41 (U.S. CLS. 100, 101 AND 107).

FOR: (BASED ON 44(D) PRIORITY APPLICATION) (BASED ON 44(E)) SERVICES FOR PROVIDING FOOD AND DRINK; CATERING; RESTAURANT SERVICES; BRASSERIE, NAMELY, PROVIDING FOOD AND DRINK; CAFES; SNACK BARS; TEA ROOMS; COFFEE BAR SERVICES; FOOD COOKING SERVICES, NAMELY, FOOD PREPARATION SERVICES; SERVING ALCOHOLIC AND NON-ALCOHOLIC BEVERAGES; PROVIDING SOCIAL FUNCTION FACILITIES, NAMELY, PROVISION OF FACILITIES FOR THE CONSUMPTION OF ALCOHOLIC AND NON-ALCOHOLIC BEVERAGES; BAR AND LOUNGE BAR SERVICES; PUBLIC HOUSE SERVICES, NAMELY, INNS; COCKTAIL LOUNGES; SANDWICH BAR SERVICES AND TAKEAWAY RESTAURANT SERVICES; HOSPITALITY SERVICES, NAMELY, CATERING, HOTEL SERVICES, MOTELS; HOTEL SERVICES; PROVIDING TEMPORARY ACCOMMODATIONS; RENTAL OF ROOMS; PROVISION OF MEETING, EXHIBITION, SOCIAL FUNCTIONS AND CONFERENCE FACILITIES; INFORMATION, ADVISORY AND CONSULTANCY SERVICES RELATING TO ALL OF THE AFOREMENTIONED SERVICES, IN CLASS 43 (U.S. CLS. 100 AND 101).

THE MARK CONSISTS OF STANDARD CHARACTERS WITHOUT CLAIM TO ANY PARTICULAR FONT, STYLE, SIZE, OR COLOR.

PRIORITY CLAIMED UNDER SEC. 44(D) ON ERPN CMNTY TM OFC APPLICATION NO. 005760971, FILED 3-15-2007, REG. NO. 005760971, DATED 2-19-2008, EXPIRES 3-15-2017.

OWNER OF ERPN CMNTY TM OFC REG. NO. 000571661, DATED 3-10-2000, EXPIRES 7-16-2017.

OWNER OF U.S. REG. NO. 2,436,082.

NO CLAIM IS MADE TO THE EXCLUSIVE RIGHT TO USE "INC", APART FROM THE MARK AS SHOWN.

SER. NO. 77-255,391, FILED P.R. 8-14-2007; AM. S.R. 12-15-2008.

JAY BESCH, EXAMINING ATTORNEY

Int. Cl.: 15

Prior U.S. Cls.: 2, 21, and 36

United States Patent and Trademark Office

Reg. No. 3,578,191

Registered Feb. 17, 2009

TRADEMARK
SUPPLEMENTAL REGISTER

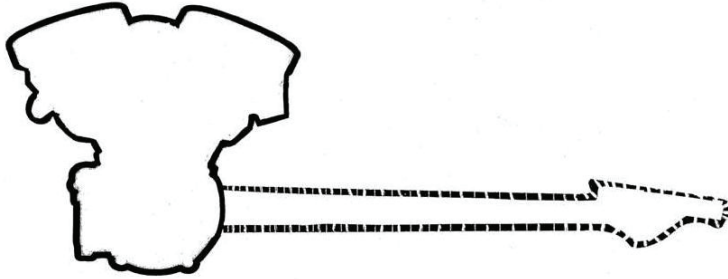

MEEKER, BILL (UNITED STATES INDIVIDUAL)
930 MAIN STREET
BAYVILLE, NJ 08721

FOR: ELECTRIC GUITARS, IN CLASS 15 (U.S.
CLS. 2, 21 AND 36).

FIRST USE 11-0-2008; IN COMMERCE 11-0-2008.

THE MARK CONSISTS OF A TWO DIMENSION-
AL CONFIGURATION OF A GUITAR BODY, THE

SHAPE OF WHICH IS IN SOLID LINES. THE
GUITAR BODY CONSISTS OF A DESIGN OF A
MOTORCYCLE ENGINE. THE NECK AND HEAD-
STOCK OF THE GUITAR ARE SHOWN IN DOTTED
LINES AND ARE NOT CLAIMED AS A FEATURE
OF THE MARK.

SER. NO. 77-258,143, FILED P.R. 8-17-2007; AM. S.R.
12-30-2008.

DANNEAN HETZEL, EXAMINING ATTORNEY

Int. Cl.: 9

Prior U.S. Cls.: 21, 23, 26, 36, and 38

United States Patent and Trademark Office

Reg. No. 3,578,192

Registered Feb. 17, 2009

**TRADEMARK
SUPPLEMENTAL REGISTER**

SIDEMOUNT

TRAUTMAN, TOM (UNITED STATES INDIVIDUAL)
7415 WEST WALKER DRIVE
LITTLETON, CO 80123

FOR: ELECTRIC DOOR OPENERS, IN CLASS 9
(U.S. CLS. 21, 23, 26, 36 AND 38).

FIRST USE 12-14-1994; IN COMMERCE 12-14-1994.

THE MARK CONSISTS OF STANDARD CHARACTERS WITHOUT CLAIM TO ANY PARTICULAR FONT, STYLE, SIZE, OR COLOR.

OWNER OF U.S. REG. NO. 2,644,699.

SER. NO. 77-259,805, FILED P.R. 8-20-2007; AM. S.R. 12-17-2008.

EVELYN BRADLEY, EXAMINING ATTORNEY

Int. Cl.: 8

Prior U.S. Cls.: 23, 28, and 44

United States Patent and Trademark Office

Reg. No. 3,578,193

Registered Feb. 17, 2009

**TRADEMARK
SUPPLEMENTAL REGISTER**

TRIM A WICK

BOWERS, CHRISTOPHER (UNITED STATES IN-
DIVIDUAL)
772 EAST PROVIDENCE ROAD
ALDAN, PA 19018

FOR: CANDLE WICK TRIMMERS, IN CLASS 8
(U.S. CLS. 23, 28 AND 44).

FIRST USE 10-9-2008; IN COMMERCE 10-11-2008.

THE MARK CONSISTS OF STANDARD CHAR-
ACTERS WITHOUT CLAIM TO ANY PARTICULAR
FONT, STYLE, SIZE, OR COLOR.

SER. NO. 77-263,006, FILED P.R. 8-23-2007; AM. S.R.
12-29-2008.

TRICIA SONNEBORN, EXAMINING ATTORNEY

Int. Cl.: 3

Prior U.S. Cls.: 1, 4, 6, 50, 51, and 52

United States Patent and Trademark Office

Reg. No. 3,578,194

Registered Feb. 17, 2009

**TRADEMARK
SUPPLEMENTAL REGISTER**

WHITE WILLOW

ABERCROMBIE & FITCH TRADING CO. (OHIO
CORPORATION)
6301 FITCH PATH
NEW ALBANY, OH 43054

FOR: FRAGRANCES FOR PERSONAL USE;
BEAUTY LOTIONS; BODY LOTIONS; HAND LO-
TIONS; BEAUTY CREAMS; BEAUTY CREAMS FOR
BODY CARE, IN CLASS 3 (U.S. CLS. 1, 4, 6, 50, 51
AND 52).

FIRST USE 1-21-2008; IN COMMERCE 1-21-2008.

THE MARK CONSISTS OF STANDARD CHAR-
ACTERS WITHOUT CLAIM TO ANY PARTICULAR
FONT, STYLE, SIZE, OR COLOR.

SER. NO. 77-264,624, FILED P.R. 8-27-2007; AM. S.R.
2-21-2008.

KATHERINE STOIDES, EXAMINING ATTORNEY

Int. Cl.: 42

Prior U.S. Cls.: 100 and 101

United States Patent and Trademark Office

Reg. No. 3,578,195

Registered Feb. 17, 2009

**SERVICE MARK
SUPPLEMENTAL REGISTER**

BADDAY.TV

XYZ MEDIA CORP (NEVADA CORPORATION)
8305 MOUNT LOGAN COURT
LAS VEGAS, NV 89131

THE MARK CONSISTS OF STANDARD CHAR-
ACTERS WITHOUT CLAIM TO ANY PARTICULAR
FONT, STYLE, SIZE, OR COLOR.

FOR: PROVIDING A WEBSITE THAT GIVES
COMPUTER USERS THE ABILITY TO UPLOAD,
EXCHANGE AND SHARE PHOTOS, VIDEOS AND
VIDEO LOGS, IN CLASS 42 (U.S. CLS. 100 AND 101).

SER. NO. 77-266,764, FILED P.R. 8-28-2007; AM. S.R.
1-9-2009.

FIRST USE 7-0-2007; IN COMMERCE 7-0-2007.

BRIAN PINO, EXAMINING ATTORNEY

Int. Cl.: 9

Prior U.S. Cls.: 21, 23, 26, 36, and 38

United States Patent and Trademark Office

Reg. No. 3,578,196

Registered Feb. 17, 2009

**TRADEMARK
SUPPLEMENTAL REGISTER**

YELLOW MASK

CAPITAL VISION, INC. (PENNSYLVANIA CORPORATION)
917 SR 92 N
TUNKHANNOCK, PA 18657

FOR: EMERGENCY PROTECTIVE BREATHING HOOD, IN CLASS 9 (U.S. CLS. 21, 23, 26, 36 AND 38).

FIRST USE 11-0-2008; IN COMMERCE 11-0-2008.

THE MARK CONSISTS OF STANDARD CHARACTERS WITHOUT CLAIM TO ANY PARTICULAR FONT, STYLE, SIZE, OR COLOR.

SER. NO. 77-267,017, FILED P.R. 8-29-2007; AM. S.R. 12-26-2008.

DANIEL CAPSHAW, EXAMINING ATTORNEY

Int. Cl.: 25

Prior U.S. Cls.: 22 and 39

United States Patent and Trademark Office

Reg. No. 3,578,197

Registered Feb. 17, 2009

**TRADEMARK
SUPPLEMENTAL REGISTER**

**THE AFTER CESAREAN
UNDERWEAR**

BROOKS, CATHERINE (UNITED STATES INDIVIDUAL)
P.O. BOX 236
SOLANA BEACH, CA 92075

FOR: CLOTHING FOR WOMEN, NAMELY, PANTIES, UNDERWEAR, BIKINIS, THONGS, BELTS, AND UNDERGARMENTS OR UNDERPANTS, ALL WITH A THERAPEUTIC COMPRESSION PANEL ON THE CLOTHING , IN CLASS 25 (U.S. CLS. 22 AND 39).

FIRST USE 10-11-2006; IN COMMERCE 9-13-2007.

THE MARK CONSISTS OF STANDARD CHARACTERS WITHOUT CLAIM TO ANY PARTICULAR FONT, STYLE, SIZE, OR COLOR.

SER. NO. 77-287,717, FILED P.R. 9-24-2007; AM. S.R. 12-30-2008.

TEJBIR SINGH, EXAMINING ATTORNEY

Int. Cls.: 5, 10, and 44

Prior U.S. Cls.: 6, 18, 26, 39, 44, 46, 51, 52, 100, and 101

United States Patent and Trademark Office

Reg. No. 3,578,198

Registered Feb. 17, 2009

**TRADEMARK
SERVICE MARK
SUPPLEMENTAL REGISTER**

Otsuka

OTSUKA PHARMACEUTICAL CO., LTD. (JAPAN CORPORATION)
2-9, KANDA-TSUKASAMACHI, CHIYODA-KU
TOKYO, JAPAN

FOR: PHARMACEUTICAL PREPARATIONS FOR THE TREATMENT OF DISORDERS ON CENTRAL NERVOUS SYSTEM, IN CLASS 5 (U.S. CLS. 6, 18, 44, 46, 51 AND 52).

FIRST USE 2-0-2008; IN COMMERCE 9-0-2008.

FOR: MEDICAL EQUIPMENT FOR MEASURING GAS CONTENT IN EXPIRED BREATH TO DETERMINE THE EXISTENCE OF MICRO-ORGANISM IN HUMAN DIGESTIVE ORGANS, IN CLASS 10 (U.S. CLS. 26, 39 AND 44).

FIRST USE 4-0-2008; IN COMMERCE 7-0-2008.

FOR: MEDICAL SERVICES; PROVIDING MEDICAL INFORMATION, IN CLASS 44 (U.S. CLS. 100 AND 101).

FIRST USE 1-0-2008; IN COMMERCE 4-0-2008.

OWNER OF U.S. REG. NO. 1,834,298.

SER. NO. 77-300,289, FILED P.R. 10-10-2007; AM. S.R. 12-12-2008.

JORDAN BAKER, EXAMINING ATTORNEY

Int. Cl.: 44

Prior U.S. Cls.: 100 and 101

United States Patent and Trademark Office

Reg. No. 3,578,199

Registered Feb. 17, 2009

**SERVICE MARK
SUPPLEMENTAL REGISTER**

STOP SMOKING FOR GOOD

REDICLINIC LLC (DELAWARE LIMITED LIABILITY COMPANY)
9 GREENWAY PLAZA
HOUSTON, TX 77046

FOR: MEDICAL CLINIC SERVICES; MEDICAL TESTING; HEALTH SCREENING, HEALTH MAINTENANCE AND HEALTH IMPROVEMENT PROGRESS, AND HEALTH RISK APPRAISAL, NAMELY, HEALTH CARE, IN CLASS 44 (U.S. CLS. 100 AND 101).

FIRST USE 6-0-2007; IN COMMERCE 6-0-2007.

THE MARK CONSISTS OF STANDARD CHARACTERS WITHOUT CLAIM TO ANY PARTICULAR FONT, STYLE, SIZE, OR COLOR.

SER. NO. 77-301,986, FILED P.R. 10-11-2007; AM. S.R. 12-11-2008.

MARK RADEMACHER, EXAMINING ATTORNEY

Int. Cl.: 9

Prior U.S. Cls.: 21, 23, 26, 36, and 38

United States Patent and Trademark Office

Reg. No. 3,578,200

Registered Feb. 17, 2009

**TRADEMARK
SUPPLEMENTAL REGISTER**

Talking Navigator

RL & ASSOCIATES, INC. (CALIFORNIA CORPORATION)
P.O. BOX 14633
SAN FRANCISCO, CA 94114

FOR: COMPUTER APPLICATION SOFTWARE AND HARDWARE FOR MOBILE COMPUTERS, MOBILE PHONES, GLOBAL POSITIONING SYSTEMS, AND OTHER COMMUNICATIONS DEVICES ENABLING BLIND OR VISION IMPAIRED USERS TO AUDIBLY RECEIVE DIRECTIONS FOR NAVIGATION IN SPECIFIED OR GENERAL GEOGRAPHICAL AREAS, EMPLOYING USER SPECIFIED ROUTES OR INTERACTIVE LOCATION BASED DIRECTIONS, IN CLASS 9 (U.S. CLS. 21, 23, 26, 36 AND 38).

FIRST USE 3-21-2007; IN COMMERCE 3-21-2007.

THE MARK CONSISTS OF STANDARD CHARACTERS WITHOUT CLAIM TO ANY PARTICULAR FONT, STYLE, SIZE, OR COLOR.

NO CLAIM IS MADE TO THE EXCLUSIVE RIGHT TO USE "NAVIGATOR", APART FROM THE MARK AS SHOWN.

SER. NO. 77-320,251, FILED P.R. 11-2-2007; AM. S.R. 1-9-2009.

ROBERT LAVACHE, EXAMINING ATTORNEY

Int. Cl.: 39

Prior U.S. Cls.: 100 and 105

United States Patent and Trademark Office

Reg. No. 3,578,201

Registered Feb. 17, 2009

**SERVICE MARK
SUPPLEMENTAL REGISTER**

TRAVEL + LEISURE CHECK IN

AMERICAN EXPRESS MARKETING & DEVELOPMENT CORP. (DELAWARE CORPORATION)
200 VESEY STREET
NEW YORK, NY 10285

FOR: A SECTION OF A WEBSITE CONTAINING INFORMATION IN THE FIELD OF TRAVEL, IN CLASS 39 (U.S. CLS. 100 AND 105).

FIRST USE 3-25-2008; IN COMMERCE 3-25-2008.

THE MARK CONSISTS OF STANDARD CHARACTERS WITHOUT CLAIM TO ANY PARTICULAR FONT, STYLE, SIZE, OR COLOR.

OWNER OF U.S. REG. NOS. 935,732, 3,070,070, AND 3,286,129.

SER. NO. 77-321,450, FILED P.R. 11-5-2007; AM. S.R. 1-12-2009.

LOURDES AYALA, EXAMINING ATTORNEY

Int. Cl.: 7

Prior U.S. Cls.: 13, 19, 21, 23, 31, 34, and 35

United States Patent and Trademark Office

Reg. No. 3,578,202

Registered Feb. 17, 2009

**TRADEMARK
SUPPLEMENTAL REGISTER**



SANCHEZ MONTIEL, LUIS ROBERTO (MEXICO
INDIVIDUAL)
COL. SN. MATEO TECOLOAPAN
CARRETERA LAGO DE GUADALUPE #6
ATIZAPAN DE ZARAGOZA, MEXICO 52920

FOR: BEARINGS BEING MACHINE PARTS,
NAMELY, BALL BEARINGS, ROLLER BEARINGS,
SELF-LUBRICATING BEARINGS, RADIAL BEAR-
INGS, LINEAR BEARINGS, THREE-POINT CON-
TACT BEARINGS, FOUR-POINT CONTACT
BEARINGS, ANGULAR BEARINGS, SELF-ALIGN-
ING BEARINGS, BEARINGS FOR SHAFTS, BEAR-
INGS FOR OSCILLATING MASSES,
BIOCOMPATIBLE BEARINGS, BEARINGS FOR MI-
CRO MOTORS, BEARINGS FOR HARD DISKS;
MACHINES, NAMELY, DRILLING MACHINES
AND METALWORKING MACHINES; MACHINE

TOOLS, NAMELY, ROUTERS AND METALWORK-
ING MACHINE TOOLS, IN CLASS 7 (U.S. CLS. 13, 19,
21, 23, 31, 34 AND 35).

FIRST USE 11-0-2008; IN COMMERCE 12-10-2008.

THE COLOR(S) YELLOW AND BLUE IS/ARE
CLAIMED AS A FEATURE OF THE MARK.

THE MARK CONSISTS OF THE WORD "SAM-
PER" IN ALL CAPS AND IN THE COLOR YELLOW
WITH A BLUE BACKGROUND.

SER. NO. 77-326,911, FILED P.R. 11-12-2007; AM.
S.R. 12-18-2008.

MARY ROSSMAN, EXAMINING ATTORNEY

Int. Cl.: 25

Prior U.S. Cls.: 22 and 39

United States Patent and Trademark Office

Reg. No. 3,578,203

Registered Feb. 17, 2009

**TRADEMARK
SUPPLEMENTAL REGISTER**

OKAJI

HIDEKI OKAJIMA, C/O PETER GREENBERG &
ASSOCIATES (JAPAN INDIVIDUAL)

200 MADISON AVENUE, SUITE 2225

NEW YORK, NY 10016

FOR: CLOTHING, NAMELY, TEE-SHIRTS, IN
CLASS 25 (U.S. CLS. 22 AND 39).

FIRST USE 10-26-2007; IN COMMERCE 10-26-2007.

THE MARK CONSISTS OF STANDARD CHAR-
ACTERS WITHOUT CLAIM TO ANY PARTICULAR
FONT, STYLE, SIZE, OR COLOR.

THE NAME "OKAJI" IDENTIFIES A LIVING
INDIVIDUAL WHOSE CONSENT IS OF RECORD.

SER. NO. 77-330,499, FILED P.R. 11-15-2007; AM.
S.R. 1-8-2009.

DAVID COLLIER, EXAMINING ATTORNEY

Int. Cl.: 21

Prior U.S. Cls.: 2, 13, 23, 29, 30, 33, 40, and 50

United States Patent and Trademark Office

Reg. No. 3,578,204

Registered Feb. 17, 2009

**TRADEMARK
SUPPLEMENTAL REGISTER**

3 D BRISTLE PATTERN

1682796 ONTARIO INC. (CANADA CORPORATION)
2409 YONGE STREET
TORONTO, CANADA M4F2E7

THE MARK CONSISTS OF STANDARD CHARACTERS WITHOUT CLAIM TO ANY PARTICULAR FONT, STYLE, SIZE, OR COLOR.

FOR: HAIR BRUSHES, IN CLASS 21 (U.S. CLS. 2, 13, 23, 29, 30, 33, 40 AND 50).

SER. NO. 77-332,801, FILED P.R. 11-19-2007; AM. S.R. 9-1-2008.

FIRST USE 11-1-2005; IN COMMERCE 11-1-2005.

KATHRYN COWARD, EXAMINING ATTORNEY

Int. Cl.: 16

Prior U.S. Cls.: 2, 5, 22, 23, 29, 37, 38, and 50

United States Patent and Trademark Office

Reg. No. 3,578,205

Registered Feb. 17, 2009

**TRADEMARK
SUPPLEMENTAL REGISTER**

**SOCCER ILLUSTRATED FUTBOL
ILUSTRADO CALCIO ILLUSTRATO**

HUTCHINSON, LORRAINE M. (UNITED STATES
INDIVIDUAL)
P. O. BOX 243
BRONX, NY 10462

FOR: PUBLICATIONS, NAMELY, BOOKS, MA-
GAZINES, NEWSPAPERS, CATALOGS, BRO-
CHURES AND PERIODICALS IN THE FIELD OF
NATIONAL AND INTERNATIONAL SOCCER , IN
CLASS 16 (U.S. CLS. 2, 5, 22, 23, 29, 37, 38 AND 50).

FIRST USE 11-1-2000; IN COMMERCE 11-1-2000.

THE MARK CONSISTS OF STANDARD CHAR-
ACTERS WITHOUT CLAIM TO ANY PARTICULAR
FONT, STYLE, SIZE, OR COLOR.

THE FOREIGN WORDING IN THE MARK
TRANSLATES INTO ENGLISH AS SOCCER ILLU-
STRATED AND SOCCER ILLUSTRATED.

SER. NO. 77-336,095, FILED 11-23-2007.

KIMBERLY KREHELY, EXAMINING ATTORNEY

Int. Cls.: 35 and 41

Prior U.S. Cls.: 100, 101, 102, and 107

United States Patent and Trademark Office

Reg. No. 3,578,206

Registered Feb. 17, 2009

**SERVICE MARK
SUPPLEMENTAL REGISTER**

Tailored Care

THE BOARD OF REGENTS OF THE UNIVERSITY OF WISCONSIN SYSTEM (WISCONSIN CORPORATION)
1860 VAN HISE HALL
1220 LINDEN DRIVE
MADISON, WI 53706

FOR: REFERRALS IN THE FIELD OF HUMAN SERVICES, NAMELY, SOCIOLOGY, PSYCHOLOGY, SOCIAL WORK, MENTAL HEALTH, GERONTOLOGY, AND NURSING, IN CLASS 35 (U.S. CLS. 100, 101 AND 102).

FIRST USE 12-21-2007; IN COMMERCE 12-27-2008.

FOR: EDUCATIONAL ASSESSMENT; EDUCATIONAL TRAINING PROGRAMS TO ASSIST FAMILY CAREGIVERS IDENTIFY AND LOCATE

RESOURCES AND SERVICES IN THE FIELD OF HUMAN SERVICES, NAMELY, SOCIOLOGY, PSYCHOLOGY, SOCIAL WORK, MENTAL HEALTH, GERONTOLOGY, AND NURSING, IN CLASS 41 (U.S. CLS. 100, 101 AND 107).

FIRST USE 12-21-2007; IN COMMERCE 2-27-2008.

THE MARK CONSISTS OF STANDARD CHARACTERS WITHOUT CLAIM TO ANY PARTICULAR FONT, STYLE, SIZE, OR COLOR.

SER. NO. 77-355,561, FILED P.R. 12-19-2007; AM. S.R. 8-18-2008.

WENDY GOODMAN, EXAMINING ATTORNEY

Int. Cls.: 35 and 41

Prior U.S. Cls.: 100, 101, 102, and 107

United States Patent and Trademark Office

Reg. No. 3,578,207

Registered Feb. 17, 2009

**SERVICE MARK
SUPPLEMENTAL REGISTER**

**Tailored Caregiver
Assessment and Referral**

THE BOARD OF REGENTS OF THE UNIVERSITY OF WISCONSIN SYSTEM (WISCONSIN CORPORATION)
1860 VAN HISE HALL
1220 LINDEN DRIVE
MADISON, WI 53706

FOR: REFERRALS IN THE FIELD OF HUMAN SERVICES, NAMELY, SOCIOLOGY, PSYCHOLOGY, SOCIAL WORK, MENTAL HEALTH, GERONTOLOGY, AND NURSING, IN CLASS 35 (U.S. CLS. 100, 101 AND 102).

FIRST USE 12-21-2007; IN COMMERCE 12-27-2008.

FOR: EDUCATIONAL ASSESSMENT; EDUCATIONAL TRAINING PROGRAMS TO ASSIST FAMILY CAREGIVERS IDENTIFY AND LOCATE RESOURCES AND SERVICES IN THE FIELD OF HUMAN SERVICES, NAMELY, SOCIOLOGY, PSY-

CHOLOGY, SOCIAL WORK, MENTAL HEALTH, GERONTOLOGY, AND NURSING, IN CLASS 41 (U.S. CLS. 100, 101 AND 107).

FIRST USE 12-21-2007; IN COMMERCE 2-26-2008.

THE MARK CONSISTS OF STANDARD CHARACTERS WITHOUT CLAIM TO ANY PARTICULAR FONT, STYLE, SIZE, OR COLOR.

NO CLAIM IS MADE TO THE EXCLUSIVE RIGHT TO USE "ASSESSMENT AND REFERRAL", APART FROM THE MARK AS SHOWN.

SER. NO. 77-355,586, FILED P.R. 12-19-2007; AM. S.R. 8-18-2008.

WENDY GOODMAN, EXAMINING ATTORNEY

Int. Cls.: 6, 9, and 11

**Prior U.S. Cls.: 2, 12, 13, 14, 21, 23, 25, 26, 31, 34, 36,
38, and 50**

Reg. No. 3,578,208

United States Patent and Trademark Office

Registered Feb. 17, 2009

**TRADEMARK
SUPPLEMENTAL REGISTER**

FRESE

FRESE A/S (DENMARK LIMITED COMPANY)
SOROVEJ 8
SLAGELSE, DENMARK DK-4200

FOR: VALVES OF METAL, NOT PARTS OF MACHINES, NAMELY, DRAIN VALVES, SAFETY VALVES, REGULATING VALVES, CIRCULATING VALVES; CONNECTING PIPES AND CARTRIDGES OF METAL FOR PIPELINES; PIPE COUPLINGS AND JUNCTIONS OF METAL; METAL DRAIN PIPES AND METAL DRAIN TRAPS, IN CLASS 6 (U.S. CLS. 2, 12, 13, 14, 23, 25 AND 50).

FOR: HIGH PRESSURE MANOMETERS, IN CLASS 9 (U.S. CLS. 21, 23, 26, 36 AND 38).

FOR: VALVES AS PARTS FOR DISTRICT HEATING AND DOMESTIC HEATING SYSTEMS; VALVES, FITTINGS AND MOUNTINGS AS PARTS FOR HEATING, COOLING AND AIR-CONDITIONING INSTALLATIONS, NAMELY, FLOW CONTROL

CARTRIDGES AND PLUMBING DRAINS; FITTINGS AND MOUNTINGS AS PARTS FOR WATER DISTRIBUTION SYSTEMS AND INSTALLATIONS, NAMELY, FLOW CONTROL CARTRIDGES AND PLUMBING DRAINS; THERMOSTATIC VALVES, IN CLASS 11 (U.S. CLS. 13, 21, 23, 31 AND 34).

THE MARK CONSISTS OF STANDARD CHARACTERS WITHOUT CLAIM TO ANY PARTICULAR FONT, STYLE, SIZE, OR COLOR.

OWNER OF DENMARK REG. NO. VR200503301, DATED 8-30-2005, EXPIRES 8-30-2015.

THE WORDING "FRESE" HAS NO MEANING IN A FOREIGN LANGUAGE.

SER. NO. 77-355,797, FILED P.R. 12-19-2007; AM. S.R. 1-5-2009.

AISHA CLARKE, EXAMINING ATTORNEY

Int. Cl.: 10

Prior U.S. Cls.: 26, 39, and 44

United States Patent and Trademark Office

Reg. No. 3,578,209

Registered Feb. 17, 2009

**TRADEMARK
SUPPLEMENTAL REGISTER**

TRAVEL ROLLER

WOOD, ADAM (CANADA INDIVIDUAL)
1611 - 43 STREET S.W.
CALGARY, CANADA T3C2A5

THE MARK CONSISTS OF STANDARD CHAR-
ACTERS WITHOUT CLAIM TO ANY PARTICULAR
FONT, STYLE, SIZE, OR COLOR.

FOR: THERAPEUTIC DEVICE IN THE SHAPE OF
A CYLINDER DESIGN TO AID IN RELAXING AND
STRETCHING MUSCLES, IN CLASS 10 (U.S. CLS. 26,
39 AND 44).

SER. NO. 77-356,885, FILED P.R. 12-20-2007; AM.
S.R. 11-24-2008.

FIRST USE 10-13-2007; IN COMMERCE 11-11-2007.

TINA L. SNAPP, EXAMINING ATTORNEY

Int. Cl.: 8

Prior U.S. Cls.: 23, 28, and 44

United States Patent and Trademark Office

Reg. No. 3,578,210

Registered Feb. 17, 2009

**TRADEMARK
SUPPLEMENTAL REGISTER**

CUSTOM CUT

CONAIR CORPORATION (DELAWARE CORPORATION)
ONE CUMMINGS POINT ROAD
STAMFORD, CT 06902

FOR: ELECTRIC AND BATTERY-POWERED HAIR CLIPPERS; ELECTRIC HAIR CLIPPERS; ELECTRIC AND BATTERY-POWERED HAIR TRIMMERS; ELECTRIC HAIR TRIMMERS; MUSTACHE AND BEARD TRIMMERS, IN CLASS 8 (U.S. CLS. 23, 28 AND 44).

FIRST USE 3-31-2008; IN COMMERCE 3-31-2008.

THE MARK CONSISTS OF STANDARD CHARACTERS WITHOUT CLAIM TO ANY PARTICULAR FONT, STYLE, SIZE, OR COLOR.

SER. NO. 77-366,804, FILED P.R. 1-8-2008; AM. S.R. 8-20-2008.

SUSAN RICHARDS, EXAMINING ATTORNEY

Int. Cls.: 35 and 41

Prior U.S. Cls.: 100, 101, 102, and 107

United States Patent and Trademark Office

Reg. No. 3,578,211

Registered Feb. 17, 2009

SERVICE MARK
SUPPLEMENTAL REGISTER



THE BOARD OF REGENTS OF THE UNIVERSITY OF WISCONSIN SYSTEM (WISCONSIN CORPORATION)
1860 VAN HISE HALL
1220 LINDEN DRIVE
MADISON, WI 53706

FOR: REFERRALS IN THE FIELD OF HUMAN SERVICES, NAMELY, SOCIOLOGY, PSYCHOLOGY, SOCIAL WORK, MENTAL HEALTH, GERONTOLOGY, AND NURSING, IN CLASS 35 (U.S. CLS. 100, 101 AND 102).

FIRST USE 12-21-2007; IN COMMERCE 2-26-2008.

FOR: EDUCATIONAL ASSESSMENT; EDUCATIONAL TRAINING PROGRAMS TO ASSIST FAMILY CAREGIVERS IDENTIFY AND LOCATE RESOURCES AND SERVICES, IN THE FIELD OF HUMAN SERVICES, NAMELY, SOCIOLOGY, PSYCHOLOGY, SOCIAL WORK, MENTAL HEALTH, GERONTOLOGY, AND NURSING, IN CLASS 41 (U.S. CLS. 100, 101 AND 107).

FIRST USE 12-21-2007; IN COMMERCE 2-26-2008.

THE COLOR(S) LIGHT BLUE, DARK BLUE, LIGHT GREEN, LIGHT ORANGE, TAN AND BLUE-GRAY IS/ARE CLAIMED AS A FEATURE OF THE MARK.

THE MARK CONSISTS OF THE WORDING "TAILORED CARE" INSIDE A RECTANGULAR BORDER AGAINST A BLUE-GRAY BACKGROUND. THE WORD "TAILORED" IS DARK BLUE IN EDWARDIAN SCRIPT ITC FONT, AND BEGINS WITH A LARGE STYLIZED LETTER "T" AND THE REMAINING LETTERS, "AILORED", APPEAR ABOVE THE WORD "CARE". THE WORD "CARE" IS IN CAPITAL LETTERS IN BANGLE FONT. THE LETTERS OF THE WORD "CARE" ARE, RESPECTIVELY, LIGHT GREEN, LIGHT BLUE, LIGHT ORANGE AND TAN.

SER. NO. 77-369,953, FILED P.R. 1-11-2008; AM. S.R. 8-18-2008.

WENDY GOODMAN, EXAMINING ATTORNEY

Int. Cl.: 32

Prior U.S. Cls.: 45, 46, and 48

United States Patent and Trademark Office

Reg. No. 3,578,212

Registered Feb. 17, 2009

**TRADEMARK
SUPPLEMENTAL REGISTER**

Infant Water

DEVONE LAWSON, INC. (CALIFORNIA CORPORATION)
13428 MAXELLA AVENUE 507
MARINA DEL REY, CA 90292

FOR: BOTTLED DRINKING WATER; BOTTLED WATER; DRINKING WATER; FLAVORED BOTTLED WATER; FLAVORED WATERS; FLAVOURED WATERS, IN CLASS 32 (U.S. CLS. 45, 46 AND 48).

FIRST USE 1-8-2008; IN COMMERCE 1-8-2008.

THE MARK CONSISTS OF STANDARD CHARACTERS WITHOUT CLAIM TO ANY PARTICULAR FONT, STYLE, SIZE, OR COLOR.

NO CLAIM IS MADE TO THE EXCLUSIVE RIGHT TO USE "WATER", APART FROM THE MARK AS SHOWN.

SER. NO. 77-370,391, FILED P.R. 1-13-2008; AM. S.R. 9-16-2008.

JEAN IM, EXAMINING ATTORNEY

Int. Cl.: 32

Prior U.S. Cls.: 45, 46, and 48

United States Patent and Trademark Office

Reg. No. 3,578,213

Registered Feb. 17, 2009

**TRADEMARK
SUPPLEMENTAL REGISTER**

Infant Juice

DEVONE LAWSON, INC. (CALIFORNIA CORPORATION)

13428 MAXELLA AVENUE 507

MARINA DEL REY, CA 90292

FOR: FRUIT DRINKS AND JUICES; FRUIT JUICES AND FRUIT DRINKS, IN CLASS 32 (U.S. CLS. 45, 46 AND 48).

FIRST USE 1-8-2008; IN COMMERCE 1-8-2008.

THE MARK CONSISTS OF STANDARD CHARACTERS WITHOUT CLAIM TO ANY PARTICULAR FONT, STYLE, SIZE, OR COLOR.

NO CLAIM IS MADE TO THE EXCLUSIVE RIGHT TO USE "JUICE", APART FROM THE MARK AS SHOWN.

SER. NO. 77-370,396, FILED P.R. 1-13-2008; AM. S.R. 9-16-2008.

JEAN IM, EXAMINING ATTORNEY

Int. Cl.: 32

Prior U.S. Cls.: 45, 46, and 48

United States Patent and Trademark Office

Reg. No. 3,578,214

Registered Feb. 17, 2009

**TRADEMARK
SUPPLEMENTAL REGISTER**

Pediatric Juice

DEVONE LAWSON, INC. (CALIFORNIA CORPORATION)
13428 MAXELLA AVENUE 507
MARINA DEL REY, CA 90292

FOR: FRUIT JUICES; FRUIT JUICES AND FRUIT DRINKS; NON-ALCOHOLIC BEVERAGES CONTAINING FRUIT JUICES; NON-ALCOHOLIC FRUIT JUICE BEVERAGES, IN CLASS 32 (U.S. CLS. 45, 46 AND 48).

FIRST USE 1-8-2008; IN COMMERCE 1-8-2008.

THE MARK CONSISTS OF STANDARD CHARACTERS WITHOUT CLAIM TO ANY PARTICULAR FONT, STYLE, SIZE, OR COLOR.

NO CLAIM IS MADE TO THE EXCLUSIVE RIGHT TO USE "JUICE", APART FROM THE MARK AS SHOWN.

SER. NO. 77-370,405, FILED P.R. 1-13-2008; AM. S.R. 9-16-2008.

JEAN IM, EXAMINING ATTORNEY

Int. Cls.: 35 and 41

Prior U.S. Cls.: 100, 101, 102, and 107

United States Patent and Trademark Office

Reg. No. 3,578,215

Registered Feb. 17, 2009

**SERVICE MARK
SUPPLEMENTAL REGISTER**

THE BROADWAY LEAGUE

THE BROADWAY LEAGUE INC. (NEW YORK
NON-PROFIT CORPORATION)

226 WEST 47TH STREET

NEW YORK, NY 10036

FOR: PROMOTING THE LIVE THEATRICAL
SHOWS OF OTHERS; TRADE ASSOCIATION SER-
VICES, NAMELY, PROMOTING THE INTERESTS
OF LIVE THEATRE AND PROFESSIONALS WHO
WORK IN LIVE THEATRE; ARRANGING PERSONAL
APPEARANCES BY PERSONS WORKING IN
THE FIELD OF LIVE THEATRE, IN CLASS 35 (U.S.
CLS. 100, 101 AND 102).

FIRST USE 12-19-2007; IN COMMERCE 12-19-2007.

FOR: PROVIDING INFORMATION CONCERN-
ING LIVE THEATRE PRODUCTIONS, IN CLASS 41
(U.S. CLS. 100, 101 AND 107).

FIRST USE 12-19-2007; IN COMMERCE 12-19-2007.

THE MARK CONSISTS OF STANDARD CHAR-
ACTERS WITHOUT CLAIM TO ANY PARTICULAR
FONT, STYLE, SIZE, OR COLOR.

NO CLAIM IS MADE TO THE EXCLUSIVE
RIGHT TO USE "LEAGUE", APART FROM THE
MARK AS SHOWN.

SER. NO. 77-379,551, FILED P.R. 1-24-2008; AM. S.R.
1-6-2009.

GEOFFREY FOSDICK, EXAMINING ATTORNEY

Int. Cl.: 41

Prior U.S. Cls.: 100, 101, and 107

United States Patent and Trademark Office

Reg. No. 3,578,216

Registered Feb. 17, 2009

**SERVICE MARK
SUPPLEMENTAL REGISTER**

VIRGINIA TRIATHLON SERIES

SET-UP, INC. (NORTH CAROLINA CORPORATION)

P. O. BOX 15144

WILMINGTON, NC 28408

FOR: ENTERTAINMENT SERVICES, NAMELY, ORGANIZING AND CONDUCTING TRIATHLON AND DUATHLON ATHLETIC EVENTS, IN CLASS 41 (U.S. CLS. 100, 101 AND 107).

FIRST USE 1-1-2007; IN COMMERCE 1-1-2007.

THE MARK CONSISTS OF STANDARD CHARACTERS WITHOUT CLAIM TO ANY PARTICULAR FONT, STYLE, SIZE, OR COLOR.

OWNER OF U.S. REG. NO. 3,134,669.

NO CLAIM IS MADE TO THE EXCLUSIVE RIGHT TO USE "TRIATHLON SERIES", APART FROM THE MARK AS SHOWN.

SER. NO. 77-379,714, FILED P.R. 1-24-2008; AM. S.R. 10-27-2008.

JULIE WATSON, EXAMINING ATTORNEY

Int. Cl.: 9

Prior U.S. Cls.: 21, 23, 26, 36, and 38

United States Patent and Trademark Office

Reg. No. 3,578,217

Registered Feb. 17, 2009

**TRADEMARK
SUPPLEMENTAL REGISTER**

TRANSMIT

PANIC INC (OREGON CORPORATION)
425 NW 10TH AVE STE 301
PORTLAND, OR 97209

FOR: DOWNLOADABLE SOFTWARE FOR
SENDING, RECEIVING, AND MANAGING FILES
AND DATA ACROSS GLOBAL COMMUNICATION
NETWORKS, IN CLASS 9 (U.S. CLS. 21, 23, 26, 36
AND 38).

FIRST USE 1-20-1999; IN COMMERCE 1-20-1999.

THE MARK CONSISTS OF STANDARD CHAR-
ACTERS WITHOUT CLAIM TO ANY PARTICULAR
FONT, STYLE, SIZE, OR COLOR.

SER. NO. 77-381,192, FILED 1-25-2008.

EVELYN BRADLEY, EXAMINING ATTORNEY

Int. Cl.: 3

Prior U.S. Cls.: 1, 4, 6, 50, 51, and 52

United States Patent and Trademark Office

Reg. No. 3,578,218

Registered Feb. 17, 2009

**TRADEMARK
SUPPLEMENTAL REGISTER**

pHacial

NATURE'S TOPICALS, INC. (MONTANA CORPORATION)
9 MUELLER COURT
HELENA, MT 59601

FOR: BOTANICALLY-BASED COSMETICS FOR TOPICAL USE ON HUMAN HAIR, SKIN, AND NAILS, AS GELS, LOTIONS, SCRUBS, CREAMS, OILS, SERUMS AND OTHER LIQUIDS, IN CLASS 3 (U.S. CLS. 1, 4, 6, 50, 51 AND 52).

FIRST USE 1-20-2008; IN COMMERCE 1-20-2008.

THE MARK CONSISTS OF STANDARD CHARACTERS WITHOUT CLAIM TO ANY PARTICULAR FONT, STYLE, SIZE, OR COLOR.

SER. NO. 77-385,762, FILED P.R. 1-31-2008; AM. S.R. 11-12-2008.

ERNEST SHOSHO, EXAMINING ATTORNEY

Int. Cls.: 10 and 44

Prior U.S. Cls.: 26, 39, 44, 100, and 101

United States Patent and Trademark Office

Reg. No. 3,578,219

Registered Feb. 17, 2009

**TRADEMARK
SERVICE MARK
SUPPLEMENTAL REGISTER**

Digital Meridian Imaging

MIRIDIA TECHNOLOGY, INC (IDAHO CORPORATION)
940 EAST CAROL STREET
MERIDIAN, ID 83646

FOR: ACUPUNCTURE EQUIPMENT; ACUPUNCTURE INSTRUMENTS, IN CLASS 10 (U.S. CLS. 26, 39 AND 44).

FIRST USE 7-12-2004; IN COMMERCE 7-12-2004.

FOR: ACUPUNCTURE; ACUPUNCTURE SERVICES, IN CLASS 44 (U.S. CLS. 100 AND 101).

FIRST USE 7-12-2004; IN COMMERCE 7-12-2004.

THE MARK CONSISTS OF STANDARD CHARACTERS WITHOUT CLAIM TO ANY PARTICULAR FONT, STYLE, SIZE, OR COLOR.

SER. NO. 77-386,472, FILED P.R. 2-1-2008; AM. S.R. 11-17-2008.

SAIMA MAKHDOOM, EXAMINING ATTORNEY

Int. Cl.: 9

Prior U.S. Cls.: 21, 23, 26, 36, and 38

Reg. No. 3,578,220

United States Patent and Trademark Office

Registered Feb. 17, 2009

TRADEMARK
SUPPLEMENTAL REGISTER

BENTLEY

AUCERA SA (SWITZERLAND CORPORATION)
RUE DE LA GARE 20 2525
LANDERON, SWITZERLAND

FOR: COMPUTERS; COMPUTER PERIPHERAL DEVICES; BLANK OPTICAL DISCS; COMPUTER MOUSE; SCANNERS; ELECTRONIC POCKET TRANSLATORS; NOTEBOOK COMPUTERS; POCKET CALCULATORS; ELECTRONIC PUBLICATIONS, NAMELY, BOOKS, MAGAZINES AND MANUALS FEATURING INSTRUCTION AND EDUCATION RECORDED ON COMPUTER MEDIA; PHOTOCOPIERS; ELECTRIC NAVIGATIONAL INSTRUMENTS; ELECTRONIC NAVIGATIONAL AND POSITIONING APPARATUS AND INSTRUMENTS; RADIO TELEPHONY SETS; TELEPHONE APPARATUS; TELEPHONE TRANSMITTERS; ANSWERING MACHINES; VIDEO TELEPHONES; NAVIGATION APPARATUS FOR VEHICLES IN THE NATURE OF ON-BOARD COMPUTER; PORTABLE TELEPHONES; SATELLITE NAVIGATIONAL SYSTEM, NAMELY, A GLOBAL POSITIONING SYSTEM (GPS); WALKIE-TALKIES; BEEP-PAGE SET; TELEPHONE SET SHEATH; HANDS FREE KITS FOR PHONES; THERMIONIC VALVES USED IN ELECTRON TUBES; TAPE RECORDERS; RADIOS; MICROPHONES; RADIO FOR VEHICLES; TELEVISION APPARATUS; BLANK VIDEOTAPES; VIDEO RECORDERS; HORNS FOR LOUDSPEAKERS; CAMCORDERS; VIDEO GAME CARTRIDGES; ACTINOMETERS; CINEMATOGRAPHIC CAMERAS; CAMERAS; CAMERA FILTERS; DIAPHRAGMS FOR CAMERA LENS; FILTERS FOR ULTRAVIOLET RAYS, FOR PHOTOGRAPHY; PHOTOGRAPH APPARATUS BAG; PRESSURE GAUGES FOR VEHICLE TIRES; AUTOMATIC PRESSURE INDICATORS USED IN VEHICLES; SPEEDOMETER; AUTOMOTIVE MEASURING INSTRUMENTS, NAMELY, PETROL AND GAS GAUGES; SPEED INDICATORS; TEMPERATURE INDICA-

TORS; ODOMETER; OIL METER; MICROSCOPES; MAGNIFYING GLASSES; TELESCOPE; BINOCULARS; ELECTRIC CABLES; COAXIAL CABLES; SILICON WAFER; SILICON CARBIDE DIODES; SEMICONDUCTOR APPARATUS; CAPACITORS; ELECTRIC CONDUCTORS; CELL SWITCHES; ELECTRIC RESISTANCES; ELECTRICITY TRANSFORMERS; ELECTRIC RELAYS; ELECTRICAL ARMATURES; ELECTRIC AUTOMATIC TIME SWITCHES; ELECTRIC CONTACTS; ELECTRIC PLUGS; ELECTRIC SOCKETS; ELECTROMAGNETIC INTERFERENCE SHIELDS FOR USE IN CONNECTION WITH TELECOMMUNICATION EQUIPMENT; PROTECTIVE SUITS FOR AVIATORS; PROTECTIVE HELMETS; ANTI-GLARE SPECTACLES; LIFE JACKETS; LIFE JACKETS FOR SWIMMING; SWIMMING OR SCUBA DIVING MASKS; BURGLAR ALARMS; ANTI-THEFT ALARMS; ELECTRIC BATTERIES FOR VEHICLES; ELECTRIC ACCUMULATORS FOR VEHICLES; ACCUMULATOR JARS; BATTERY JARS; ANODE BATTERIES; HIGH TENSION BATTERIES; BATTERY CHARGERS; GALVANIC CELLS; BATTERIES; BATTERIES FOR POCKET LAMPS; SOLAR BATTERIES; PHOTOGRAPHIC TRANSPARENCIES; ELECTRIC IRONS; CIGAR LIGHTERS FOR AUTOMOBILES, IN CLASS 9 (U.S. CLS. 21, 23, 26, 36 AND 38).

FIRST USE 4-23-1996; IN COMMERCE 9-9-2003.

THE MARK CONSISTS OF STANDARD CHARACTERS WITHOUT CLAIM TO ANY PARTICULAR FONT, STYLE, SIZE, OR COLOR.

SER. NO. 77-387,984, FILED P.R. 2-4-2008; AM. S.R. 11-17-2008.

ANGELA M. MICHELI, EXAMINING ATTORNEY

Int. Cl.: 10

Prior U.S. Cls.: 26, 39, and 44

United States Patent and Trademark Office

Reg. No. 3,578,221

Registered Feb. 17, 2009

**TRADEMARK
SUPPLEMENTAL REGISTER**

CLEAR-PAK

CHARTER MEDICAL, LTD. (DELAWARE CORPORATION)
CHQ LEGAL DEPT.
3948-A WESTPOINT BLVD.
WINSTON-SALEM, NC 27103

FOR: CONTAINERS ESPECIALLY MADE FOR BIOLOGICAL AND PHARMACEUTICAL MATERIALS, NAMELY, SINGLE USE DISPOSABLE CONTAINERS SPECIALLY DESIGNED FOR PRODUCING, TRANSPORTING AND HOLDING BIOPROCESSING MATERIALS, IN CLASS 10 (U.S. CLS. 26, 39 AND 44).

FIRST USE 9-23-2008; IN COMMERCE 9-23-2008.

THE MARK CONSISTS OF STANDARD CHARACTERS WITHOUT CLAIM TO ANY PARTICULAR FONT, STYLE, SIZE, OR COLOR.

SER. NO. 77-389,707, FILED P.R. 2-6-2008; AM. S.R. 11-12-2008.

ROBIN MITTLER, EXAMINING ATTORNEY

Int. Cl.: 16

Prior U.S. Cls.: 2, 5, 22, 23, 29, 37, 38, and 50

United States Patent and Trademark Office

Reg. No. 3,578,222

Registered Feb. 17, 2009

**TRADEMARK
SUPPLEMENTAL REGISTER**

ProAudio Review

The Review Resource for Sound Professionals

NEWBAY MEDIA LLC (DELAWARE LIMITED
LIABILITY COMPANY)

810 SEVENTH AVENUE
NEW YORK, NY 10019

FOR: MAGAZINES AND NEWSLETTERS IN THE
FIELD OF PROFESSIONAL AUDIO EQUIPMENT,
IN CLASS 16 (U.S. CLS. 2, 5, 22, 23, 29, 37, 38 AND 50).

FIRST USE 9-19-2006; IN COMMERCE 9-19-2006.

OWNER OF U.S. REG. NO. 2,143,845.

NO CLAIM IS MADE TO THE EXCLUSIVE
RIGHT TO USE "REVIEW", APART FROM THE
MARK AS SHOWN.

THE MARK CONSISTS OF THE WORDS "PRO
AUDIO REVIEW" TOGETHER ON ONE LINE WITH
"AUDIO" IN ITALICS AND THE OTHERS WORDS
TOGETHER ON THE LINE BELOW BEGINNING
UNDER THE "I" IN AUDIO.

SER. NO. 77-392,390, FILED P.R. 2-8-2008; AM. S.R.
2-8-2008.

AMEETA JORDAN, EXAMINING ATTORNEY

Int. Cl.: 35

Prior U.S. Cls.: 100, 101, and 102

United States Patent and Trademark Office

Reg. No. 3,578,223

Registered Feb. 17, 2009

**SERVICE MARK
SUPPLEMENTAL REGISTER**

Elite Target Systems

ELITE TARGET SYSTEMS (COLORADO CORPORATION)
SUITE B5, #70
135 COUNTRY CENTER DRIVE
PAGOSA SPRINGS, CO 81147

FOR: MANUFACTURER OF TARGET SYSTEMS USED BY LAW ENFORCEMENT AND THE MILITARY FOR THE PURPOSE OF PRESENTING AND HIDING TARGETS TO THE FIRING LINE FOR TRAINING AND PRACTICE WITH VARIOUS FIREARMS, IN CLASS 35 (U.S. CLS. 100, 101 AND 102).

FIRST USE 3-15-2004; IN COMMERCE 9-0-2004.

THE MARK CONSISTS OF STANDARD CHARACTERS WITHOUT CLAIM TO ANY PARTICULAR FONT, STYLE, SIZE, OR COLOR.

NO CLAIM IS MADE TO THE EXCLUSIVE RIGHT TO USE "TARGET SYSTEMS", APART FROM THE MARK AS SHOWN.

SER. NO. 77-393,713, FILED P.R. 2-11-2008; AM. S.R. 1-13-2009.

RICHARD WHITE, EXAMINING ATTORNEY

Int. Cl.: 35

Prior U.S. Cls.: 100, 101, and 102

United States Patent and Trademark Office

Reg. No. 3,578,224

Registered Feb. 17, 2009

**SERVICE MARK
SUPPLEMENTAL REGISTER**

Rewards for Engagement

E-MILES, LLC (DELAWARE LIMITED LIABILITY COMPANY)
8401 N. CENTRAL EXPRESSWAY STE.1000 LB37
DALLAS, TX 75225

FOR: PROMOTING THE GOODS AND SERVICES OF OTHERS THROUGH A CONSUMER LOYALTY MARKETING PROGRAM OFFERING REWARDS, NAMELY, FREQUENT TRAVELER PROGRAM MILES AS AN INCENTIVE FOR CONSUMERS SUPPLYING RESEARCH INFORMATION IN PERSON THROUGH INTERACTIVE MEDIA, IN CLASS 35 (U.S. CLS. 100, 101 AND 102).

FIRST USE 11-25-2008; IN COMMERCE 11-25-2008.

THE MARK CONSISTS OF STANDARD CHARACTERS WITHOUT CLAIM TO ANY PARTICULAR FONT, STYLE, SIZE, OR COLOR.

NO CLAIM IS MADE TO THE EXCLUSIVE RIGHT TO USE "REWARDS", APART FROM THE MARK AS SHOWN.

SER. NO. 77-396,222, FILED P.R. 2-13-2008; AM. S.R. 11-25-2008.

MYRIAH HABEEB, EXAMINING ATTORNEY

Int. Cl.: 35

Prior U.S. Cls.: 100, 101, and 102

United States Patent and Trademark Office

Reg. No. 3,578,225

Registered Feb. 17, 2009

**SERVICE MARK
SUPPLEMENTAL REGISTER**

Engagement Rewards

E-MILES, LLC (DELAWARE LIMITED LIABILITY COMPANY)
8401 N. CENTRAL EXPRESSWAY STE. 1000
DALLAS, TX 75225

FOR: PROMOTING THE GOODS AND SERVICES OF OTHERS THROUGH A CONSUMER LOYALTY MARKETING PROGRAM OFFERING REWARDS, NAMELY, FREQUENT TRAVELER PROGRAM MILES AS AN INCENTIVE FOR CONSUMERS SUPPLYING RESEARCH INFORMATION IN PERSON THROUGH INTERACTIVE MEDIA, IN CLASS 35 (U.S. CLS. 100, 101 AND 102).

FIRST USE 11-25-2008; IN COMMERCE 11-25-2008.

THE MARK CONSISTS OF STANDARD CHARACTERS WITHOUT CLAIM TO ANY PARTICULAR FONT, STYLE, SIZE, OR COLOR.

NO CLAIM IS MADE TO THE EXCLUSIVE RIGHT TO USE "REWARDS", APART FROM THE MARK AS SHOWN.

SER. NO. 77-396,245, FILED P.R. 2-13-2008; AM. S.R. 11-25-2008.

MYRIAH HABEEB, EXAMINING ATTORNEY

Int. Cl.: 36

Prior U.S. Cls.: 100, 101, and 102

United States Patent and Trademark Office

Reg. No. 3,578,226

Registered Feb. 17, 2009

**SERVICE MARK
SUPPLEMENTAL REGISTER**

**THE GATE CITY'S COMMUNITY
BANK**

GCCB, LLC (NORTH CAROLINA LIMITED LIABILITY COMPANY)

SUITE G 101

1515 WEST CORNWALLIS DRIVE

GREENSBORO, NC 27408

FOR: BANKING SERVICES, IN CLASS 36 (U.S. CLS. 100, 101 AND 102).

FIRST USE 2-29-2008; IN COMMERCE 2-29-2008.

THE MARK CONSISTS OF STANDARD CHARACTERS WITHOUT CLAIM TO ANY PARTICULAR FONT, STYLE, SIZE, OR COLOR.

NO CLAIM IS MADE TO THE EXCLUSIVE RIGHT TO USE "COMMUNITY BANK", APART FROM THE MARK AS SHOWN.

SER. NO. 77-399,543, FILED P.R. 2-18-2008; AM. S.R. 12-18-2008.

RONALD DELGIZZI, EXAMINING ATTORNEY

Int. Cl.: 41

Prior U.S. Cls.: 100, 101, and 107

United States Patent and Trademark Office

Reg. No. 3,578,227

Registered Feb. 17, 2009

**SERVICE MARK
SUPPLEMENTAL REGISTER**

ROCK AND ROLL ACADEMY

ROCK AND ROLL ACADEMY, LLC (COLOR-
ADO LIMITED LIABILITY COMPANY)
172 ALEXANDER OVERLOOK
TELLURIDE, CO 81435

FOR: EDUCATION SERVICES, NAMELY, PROVIDING INSTRUCTION IN THE FIELDS OF MUSIC AND MUSICAL GROUPS; EDUCATION SERVICES, NAMELY, PROVIDING INSTRUCTION IN THE FIELD OF CREATION OF AUDIO VISUAL PRESENTATIONS; DEVELOPING EDUCATIONAL MANUALS FOR OTHERS IN THE FIELD OF MUSIC AND MUSICAL GROUPS; EDUCATIONAL SERVICES IN THE NATURE OF MUSIC AND MUSICAL GROUP SCHOOLS; EDUCATIONAL SERVICES, NAMELY, CONDUCTING PROGRAMS IN THE FIELD OF MUSIC AND MUSICAL GROUP PERFORMANCE SKILLS; EDUCATIONAL SERVICES, NAMELY, PROVIDING INSTRUCTION AND TRAINING FOR ENTERTAINMENT BY LIVE MU-

SICAL GROUPS, IN CLASS 41 (U.S. CLS. 100, 101 AND 107).

FIRST USE 2-28-2004; IN COMMERCE 2-28-2004.

THE MARK CONSISTS OF STANDARD CHARACTERS WITHOUT CLAIM TO ANY PARTICULAR FONT, STYLE, SIZE, OR COLOR.

OWNER OF U.S. REG. NO. 3,278,125.

NO CLAIM IS MADE TO THE EXCLUSIVE RIGHT TO USE "ACADEMY", APART FROM THE MARK AS SHOWN.

SER. NO. 77-401,681, FILED 2-20-2008.

BENJAMIN OKEKE, EXAMINING ATTORNEY

Int. Cl.: 9

Prior U.S. Cls.: 21, 23, 26, 36, and 38

United States Patent and Trademark Office

Reg. No. 3,578,228

Registered Feb. 17, 2009

**TRADEMARK
SUPPLEMENTAL REGISTER**

INTEGRATION DESIGNER

REMOTE TECHNOLOGIES INCORPORATED
(MINNESOTA CORPORATION)
SUITE 180, 5775 12TH AVENUE EAST
SHAKOPEE, MN 55379

FOR: COMPUTER SOFTWARE, NAMELY, SOFTWARE TO ALLOW FOR THE CONFIGURATION, SETUP, AND PROGRAMMING, INCLUDING THE ABILITY TO CONFIGURE DISPLAY SCREENS, OF WIRELESS REMOTE CONTROLS, WIRED REMOTE CONTROLS, AND CONTROL SYSTEMS FOR COORDINATING OPERATION OF RELATED COMPONENTS, IN CLASS 9 (U.S. CLS. 21, 23, 26, 36 AND 38).

FIRST USE 2-7-2008; IN COMMERCE 2-7-2008.

THE MARK CONSISTS OF STANDARD CHARACTERS WITHOUT CLAIM TO ANY PARTICULAR FONT, STYLE, SIZE, OR COLOR.

SER. NO. 77-402,619, FILED P.R. 2-21-2008; AM. S.R. 12-30-2008.

RUDY R. SINGLETON, EXAMINING ATTORNEY

Int. Cl.: 36

Prior U.S. Cls.: 100, 101, and 102

United States Patent and Trademark Office

Reg. No. 3,578,229

Registered Feb. 17, 2009

**SERVICE MARK
SUPPLEMENTAL REGISTER**

The Wisconsin Foundation

TERRENCE R. WALL REVOCABLE TRUST U/A/
D 10/27/92 (WISCONSIN TRUST)

8401 GREENWAY BLVD., SUITE 800

MIDDLETON, WI 53562

FOR: CHARITABLE FUND RAISING, IN CLASS
36 (U.S. CLS. 100, 101 AND 102).

FIRST USE 7-10-2008; IN COMMERCE 7-10-2008.

THE MARK CONSISTS OF STANDARD CHAR-
ACTERS WITHOUT CLAIM TO ANY PARTICULAR
FONT, STYLE, SIZE, OR COLOR.

NO CLAIM IS MADE TO THE EXCLUSIVE
RIGHT TO USE "FOUNDATION", APART FROM
THE MARK AS SHOWN.

SER. NO. 77-402,666, FILED P.R. 2-21-2008; AM. S.R.
12-11-2008.

LINDA ORNDORFF, EXAMINING ATTORNEY

Int. Cl.: 21

Prior U.S. Cls.: 2, 13, 23, 29, 30, 33, 40, and 50

United States Patent and Trademark Office

Reg. No. 3,578,230

Registered Feb. 17, 2009

**TRADEMARK
SUPPLEMENTAL REGISTER**

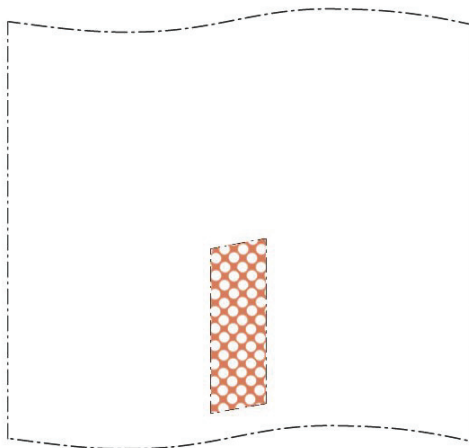

THE LIBMAN COMPANY (ILLINOIS CORPORATION)

220 N. SHELDON

ARCOLA, IL 61910

FOR: CLEANING CLOTHS; CLEANING, DUSTING AND POLISHING CLOTHS, IN CLASS 21 (U.S. CLS. 2, 13, 23, 29, 30, 33, 40 AND 50).

FIRST USE 9-29-2006; IN COMMERCE 9-29-2006.

THE COLOR(S) RED AND WHITE IS/ARE CLAIMED AS A FEATURE OF THE MARK.

THE MARK CONSISTS OF A CLOTH IN WHICH WHITE POLKA DOTS ON A RED BACKGROUND ARE FEATURED ON THE CLOTH. THE OUTLINE OF THE CLOTH IS SHOWN IN DOTTED LINES TO INDICATE A REPRESENTATIVE PLACEMENT OF THE MARK ON THE CLOTH, AND THE OUTLINE OF THE MARK ITSELF ON THE CLOTH IS SHOWN IN DOTTED LINES TO INDICATE THAT THE MARK EXTENDS TO COVER THE ENTIRE SURFACE OF THE CLOTH IRRESPECTIVE OF THE SHAPE OF THE CLOTH.

SER. NO. 77-403,140, FILED P.R. 2-21-2008; AM. S.R. 12-9-2008.

AMY HELLA, EXAMINING ATTORNEY

Int. Cls.: 35 and 42

Prior U.S. Cls.: 100, 101, and 102

United States Patent and Trademark Office

Reg. No. 3,578,231

Registered Feb. 17, 2009

SERVICE MARK
SUPPLEMENTAL REGISTER

demographix

DEMOGRAPHIX LIMITED (ENGLAND LIMITED
LIABILITY COMPANY)
57 CHESTNUT ROAD
LONDON, UNITED KINGDOM SE279EZ

FOR: CONDUCTING BUSINESS AND MARKET RESEARCH SURVEYS; BUSINESS APPRAISALS; BUSINESS CONSULTANCY; BUSINESS INFORMATION; BUSINESS INQUIRIES; BUSINESS INVESTIGATIONS AND BUSINESS RESEARCH; MARKETING, NAMELY, MARKET RESEARCH AND CONDUCTING MARKETING STUDIES; MARKET SURVEY ANALYSIS; CONDUCTING OF PUBLIC OPINION POLLS AND PUBLIC OPINION POLLING; PROCESSING OF BUSINESS AND/OR MARKET SURVEY RESULTS, NAMELY, COMPILATION OF THE RESULTS; COLLECTION OF INFORMATION RELATING TO MARKET STUDIES, BUSINESS STUDIES AND/OR OPINION POLLS; MARKET RESEARCH DATA COLLECTION SERVICES; COMPILATION OF BUSINESS DATA; BUSINESS DATA ANALYSIS; DATABASE MANAGEMENT; BUSINESS DATA COLLECTION, COMPILATION AND/OR MANAGEMENT; BUSINESS DATA ADVICE AND/OR CONSULTANCY; CONDUCTING SOCIAL AND POLITICAL PUBLIC OPINION POLLS AND PUBLIC OPINION POLLING; PROVIDING INFORMATION REGARDING POLITICAL ISSUES; SOCIAL RESEARCH AND STUDIES, NAMELY, CONDUCTING DEMOGRAPHIC STUDIES; POLITICAL RESEARCH AND STUDIES,

NAMELY, CONDUCTING PUBLIC OPINION POLLS; SOCIAL AND POLITICAL INQUIRIES, NAMELY, CONDUCTING PUBLIC OPINION POLLS REGARDING SOCIAL AND POLITICAL ISSUES; COMPILATION AND SYSTEMIZATION OF INFORMATION INTO COMPUTER DATABASES; COMPUTERISED ANALYSIS OF DATA, NAMELY, BUSINESS DATA, DATA RELATING TO SOCIAL AND POLITICAL ISSUES, AND DEMOGRAPHIC DATA, IN CLASS 35 (U.S. CLS. 100, 101 AND 102).

FOR: COMPUTER PROGRAMMING SERVICES; UPGRADING OF COMPUTER SOFTWARE; INSTALLATION AND MAINTENANCE OF COMPUTER SOFTWARE; SOFTWARE DESIGN, CONSULTANCY AND/OR ADVISORY SERVICES; DESIGN OF SURVEYS; DEVELOPMENT OF DATA-PROCESSING SOFTWARE PROGRAMS, IN CLASS 42 (U.S. CLS. 100 AND 101).

OWNER OF UNITED KINGDOM REG. NO. 2403666, DATED 10-11-2005, EXPIRES 10-11-2015.

THE MARK CONSISTS OF THE LETTERS "DEMOGRAPHIX" FEATURING A STYLIZED "X".

SER. NO. 77-403,847, FILED P.R. 2-22-2008; AM. S.R. 12-7-2008.

SUE LAWRENCE, EXAMINING ATTORNEY

Int. Cl.: 5

Prior U.S. Cls.: 6, 18, 44, 46, 51, and 52

United States Patent and Trademark Office

Reg. No. 3,578,232

Registered Feb. 17, 2009

**TRADEMARK
SUPPLEMENTAL REGISTER**

Fertile Foods

SIMMONS, KATHRYN (CANADA INDIVIDUAL),
DBA FERTILE FOODS LLC,

9906 LAKE WASHINGTON BLVD

BELLEVUE, WA 98004

FOR: FERTILITY ENHANCEMENT PREPARA-
TIONS, IN CLASS 5 (U.S. CLS. 6, 18, 44, 46, 51 AND 52).

FIRST USE 8-3-2007; IN COMMERCE 8-3-2007.

THE MARK CONSISTS OF STANDARD CHAR-
ACTERS WITHOUT CLAIM TO ANY PARTICULAR
FONT, STYLE, SIZE, OR COLOR.

NO CLAIM IS MADE TO THE EXCLUSIVE
RIGHT TO USE "FOODS", APART FROM THE
MARK AS SHOWN.

SER. NO. 77-404,254, FILED P.R. 2-22-2008; AM. S.R.
12-8-2008.

KOURTNEE HODGES, EXAMINING ATTORNEY

Int. Cl.: 35

Prior U.S. Cls.: 100, 101, and 102

United States Patent and Trademark Office

Reg. No. 3,578,233

Registered Feb. 17, 2009

**SERVICE MARK
SUPPLEMENTAL REGISTER**

Government Print Management

E-LYNXX CORPORATION (PENNSYLVANIA CORPORATION)
P. O. BOX W
1051 SHEFFLER DRIVE
CHAMBERSBURG, PA 17201

FOR: PROVIDING INFORMATION ABOUT GOVERNMENT PRINTING SALES; BUSINESS CONSULTATION FOR PRINT SUPPLIERS IN THE FIELD OF FEDERAL, STATE, AND LOCAL GOVERNMENT CONTRACTING OPPORTUNITIES, IN CLASS 35 (U.S. CLS. 100, 101 AND 102).

FIRST USE 4-9-2008; IN COMMERCE 4-9-2008.

THE MARK CONSISTS OF STANDARD CHARACTERS WITHOUT CLAIM TO ANY PARTICULAR FONT, STYLE, SIZE, OR COLOR.

NO CLAIM IS MADE TO THE EXCLUSIVE RIGHT TO USE "PRINT MANAGEMENT", APART FROM THE MARK AS SHOWN.

SER. NO. 77-406,550, FILED P.R. 2-26-2008; AM. S.R. 12-4-2008.

MARK PILARO, EXAMINING ATTORNEY

Int. Cl.: 35

Prior U.S. Cls.: 100, 101, and 102

United States Patent and Trademark Office

Reg. No. 3,578,234

Registered Feb. 17, 2009

**SERVICE MARK
SUPPLEMENTAL REGISTER**

SALES PROCESS MANAGEMENT

PREFERRED HOME BUYERS NETWORK, INC.
(MINNESOTA CORPORATION)

28215 BOULDER CIRCLE

EXCELSIOR, MN 55331

FOR: BUSINESS MARKETING SERVICES; BUSINESS MANAGEMENT CONSULTING AND ADVISORY SERVICES, IN CLASS 35 (U.S. CLS. 100, 101 AND 102).

FIRST USE 10-4-2006; IN COMMERCE 10-4-2006.

THE MARK CONSISTS OF STANDARD CHARACTERS WITHOUT CLAIM TO ANY PARTICULAR FONT, STYLE, SIZE, OR COLOR.

NO CLAIM IS MADE TO THE EXCLUSIVE RIGHT TO USE "MANAGEMENT", APART FROM THE MARK AS SHOWN.

SER. NO. 77-406,568, FILED P.R. 2-26-2008; AM. S.R. 2-26-2008.

MATTHEW MCDOWELL, EXAMINING ATTORNEY

Int. Cl.: 6

Prior U.S. Cls.: 2, 12, 13, 14, 23, 25, and 50

United States Patent and Trademark Office

Reg. No. 3,578,235

Registered Feb. 17, 2009

TRADEMARK
SUPPLEMENTAL REGISTER

The Perfect Pet Gate

KING RACK INDUSTRIAL CO., LTD. (TAIWAN CORPORATION)

NO. 152, SHUNFAN RD., DAJIA TOWN

TAICHUNG COUNTY, TAIWAN

FOR: METAL DOG BARRIERS FOR CONTAINING DOGS IN A PARTICULAR AREA OF A VEHICLE AND A PARTICULAR AREA OF AN EDIFICE; METAL PET BARRIERS FOR CONTAINING PETS IN A PARTICULAR AREA OF A VEHICLE AND A PARTICULAR AREA OF AN EDIFICE, IN CLASS 6 (U.S. CLS. 2, 12, 13, 14, 23, 25 AND 50).

FIRST USE 12-11-2007; IN COMMERCE 12-11-2007.

NO CLAIM IS MADE TO THE EXCLUSIVE RIGHT TO USE "GATE", APART FROM THE MARK AS SHOWN.

THE COLOR(S) BLUE IS/ARE CLAIMED AS A FEATURE OF THE MARK.

THE MARK CONSISTS OF THE STYLIZED WORDS "THE PERFECT PET GATE" WITH THE WORD LETTERS IN DARK BLUE AND HAVING A LIGHT BLUE BORDER.

SER. NO. 77-410,520, FILED P.R. 3-1-2008; AM. S.R. 12-5-2008.

ALICE BENMAMAN, EXAMINING ATTORNEY

Int. Cl.: 6

Prior U.S. Cls.: 2, 12, 13, 14, 23, 25, and 50

United States Patent and Trademark Office

Reg. No. 3,578,236

Registered Feb. 17, 2009

TRADEMARK
SUPPLEMENTAL REGISTER

Doggie Blockers

KING RACK INDUSTRIAL CO., LTD. (TAIWAN CORPORATION)
NO. 152, SHUNFAN RD., DAJIA TOWN
TAICHUNG COUNTY, TAIWAN

FOR: METAL DOG BARRIERS FOR CONTAINING DOGS IN A PARTICULAR AREA OF A VEHICLE AND A PARTICULAR AREA OF AN EDIFICE; METAL PET BARRIERS FOR CONTAINING PETS IN A PARTICULAR AREA OF A VEHICLE AND A PARTICULAR AREA OF AN EDIFICE, IN CLASS 6 (U.S. CLS. 2, 12, 13, 14, 23, 25 AND 50).

FIRST USE 2-20-2008; IN COMMERCE 2-20-2008.

THE COLOR(S) BLUE IS/ARE CLAIMED AS A FEATURE OF THE MARK.

THE MARK CONSISTS OF THE STYLIZED WORDS "DOGGIE BLOCKERS" WITH THE WORD LETTERS IN DARK BLUE AND HAVING A LIGHT BLUE BORDER.

SER. NO. 77-410,526, FILED P.R. 3-1-2008; AM. S.R. 12-5-2008.

ALICE BENMAMAN, EXAMINING ATTORNEY

Int. Cl.: 35

Prior U.S. Cls.: 100, 101, and 102

United States Patent and Trademark Office

Reg. No. 3,578,237

Registered Feb. 17, 2009

**SERVICE MARK
SUPPLEMENTAL REGISTER**

CAREGIVERLIST

CAREGIVERLIST, INC. (ILLINOIS CORPORATION)
650 W. GRACE STREET, SUITE 2
CHICAGO, IL 60613

FOR: PROVIDING A WEBSITE FEATURING RATINGS AND REVIEWS RELATING TO SENIOR CARE SERVICE PROVIDERS AND EDUCATORS AS WELL AS PRODUCTS FOR SENIOR CARE NEEDS, IN CLASS 35 (U.S. CLS. 100, 101 AND 102).

FIRST USE 11-30-2006; IN COMMERCE 11-30-2006.

THE MARK CONSISTS OF STANDARD CHARACTERS WITHOUT CLAIM TO ANY PARTICULAR FONT, STYLE, SIZE, OR COLOR.

SER. NO. 77-410,808, FILED P.R. 3-2-2008; AM. S.R. 12-10-2008.

JULIE WATSON, EXAMINING ATTORNEY

Int. Cl.: 9

Prior U.S. Cls.: 21, 23, 26, 36, and 38

United States Patent and Trademark Office

Reg. No. 3,578,238

Registered Feb. 17, 2009

**TRADEMARK
SUPPLEMENTAL REGISTER**

**ELECTRONIC MEDICAL RECORD
& SURVEILLANCE SYSTEM**

IBANEZ, RUTH C. (PHILIPPINES INDIVIDUAL)
4709 65TH STREET
NEW YORK, NY 11377

FOR: COMPUTER SOFTWARE SYSTEM DESIGNED TO FACILITATE TELEMEDICINE BY PROVIDING REMOTE ACCESS TO A PATIENT'S MEDICAL RECORDS AND FACILITATING THE PROVISION OF MEDICAL SERVICES BY ENABLING MEDICAL PROFESSIONALS TO COMMUNICATE WITH PATIENTS AND OTHER MEDICAL PROFESSIONALS, IN CLASS 9 (U.S. CLS. 21, 23, 26, 36 AND 38).

FIRST USE 4-0-2007; IN COMMERCE 4-0-2007.

THE MARK CONSISTS OF STANDARD CHARACTERS WITHOUT CLAIM TO ANY PARTICULAR FONT, STYLE, SIZE, OR COLOR.

NO CLAIM IS MADE TO THE EXCLUSIVE RIGHT TO USE "SYSTEM", APART FROM THE MARK AS SHOWN.

SER. NO. 77-411,284, FILED P.R. 3-3-2008; AM. S.R. 11-13-2008.

ALLISON HOLTZ, EXAMINING ATTORNEY

Int. Cl.: 10

Prior U.S. Cls.: 26, 39, and 44

United States Patent and Trademark Office

Reg. No. 3,578,239

Registered Feb. 17, 2009

**TRADEMARK
SUPPLEMENTAL REGISTER**

SKID SEAT

CAREGIVERS AIDE, LLC (PENNSYLVANIA
LIMITED LIABILITY COMPANY)
1035 INDIAN DRIVE
AUBURN, PA 17922

FOR: CUSTOM MAT MADE OF VINYL OR
SUEDE TO ASSIST IN THE REPOSITIONING OF
PATIENTS FOR MEDICAL USE, IN CLASS 10 (U.S.
CLS. 26, 39 AND 44).

FIRST USE 5-1-2008; IN COMMERCE 5-1-2008.

THE MARK CONSISTS OF STANDARD CHAR-
ACTERS WITHOUT CLAIM TO ANY PARTICULAR
FONT, STYLE, SIZE, OR COLOR.

SER. NO. 77-412,063, FILED P.R. 3-4-2008; AM. S.R.
10-16-2008.

DEZMONA MIZELLE, EXAMINING ATTORNEY

Int. Cl.: 36

Prior U.S. Cls.: 100, 101, and 102

United States Patent and Trademark Office

Reg. No. 3,578,240

Registered Feb. 17, 2009

SERVICE MARK
SUPPLEMENTAL REGISTER

بنك قطر الوطني

QATAR NATIONAL BANK (QATAR CORPORATION)
P.O. BOX 1000
DOHA, QATAR

FOR: FINANCIAL AFFAIRS, NAMELY, BANKING SERVICES AND MONETARY EXCHANGE, IN CLASS 36 (U.S. CLS. 100, 101 AND 102).

OWNER OF QATAR REG. NO. 49808, DATED 10-12-2008, EXPIRES 10-12-2018.

NO CLAIM IS MADE TO THE EXCLUSIVE RIGHT TO USE THE ARABIC CHARACTERS THAT MEAN NATIONAL BANK, APART FROM THE MARK AS SHOWN.

THE MARK CONSISTS OF THE WORDS QATAR NATIONAL BANK IN ARABIC SCRIPT.

SER. NO. 77-414,080, FILED P.R. 3-5-2008; AM. S.R. 12-18-2008.

JOHN DWYER, EXAMINING ATTORNEY

Int. Cl.: 36

Prior U.S. Cls.: 100, 101, and 102

United States Patent and Trademark Office

Reg. No. 3,578,241

Registered Feb. 17, 2009

**SERVICE MARK
SUPPLEMENTAL REGISTER**

QATAR NATIONAL BANK

QATAR NATIONAL BANK (QATAR CORPORATION)
P.O. BOX 1000
DOHA, QATAR

FOR: FINANCIAL AFFAIRS, NAMELY, BANKING SERVICES AND MONETARY EXCHANGE, IN CLASS 36 (U.S. CLS. 100, 101 AND 102).

THE MARK CONSISTS OF STANDARD CHARACTERS WITHOUT CLAIM TO ANY PARTICULAR FONT, STYLE, SIZE, OR COLOR.

OWNER OF QATAR REG. NO. 49807, DATED 10-12-2008, EXPIRES 3-13-2018.

NO CLAIM IS MADE TO THE EXCLUSIVE RIGHT TO USE "NATIONAL BANK", APART FROM THE MARK AS SHOWN.

SER. NO. 77-414,131, FILED P.R. 3-5-2008; AM. S.R. 12-18-2008.

JOHN DWYER, EXAMINING ATTORNEY

Int. Cl.: 10

Prior U.S. Cls.: 26, 39, and 44

United States Patent and Trademark Office

Reg. No. 3,578,242

Registered Feb. 17, 2009

**TRADEMARK
SUPPLEMENTAL REGISTER**

WELBY

ALDI INC. (ILLINOIS CORPORATION)
1200 N. KIRK ROAD
BATAVIA, IL 60510

FOR: BLOOD PRESSURE MONITORS, THERMO-
METERS FOR MEDICAL PURPOSES, IN CLASS 10
(U.S. CLS. 26, 39 AND 44).

FIRST USE 10-13-2007; IN COMMERCE 10-13-2007.

THE MARK CONSISTS OF STANDARD CHAR-
ACTERS WITHOUT CLAIM TO ANY PARTICULAR
FONT, STYLE, SIZE, OR COLOR.

OWNER OF U.S. REG. NOS. 1,987,776, 2,721,801,
AND OTHERS.

SER. NO. 77-414,964, FILED P.R. 3-6-2008; AM. S.R.
11-26-2008.

MAYUR VAGHANI, EXAMINING ATTORNEY

Int. Cl.: 37

Prior U.S. Cls.: 100, 103, and 106

United States Patent and Trademark Office

Reg. No. 3,578,243

Registered Feb. 17, 2009

**SERVICE MARK
SUPPLEMENTAL REGISTER**

ROOF SHADE

ROOF SHADE, INC. (UTAH CORPORATION)
12 ROLLINGWOOD LANE
SANDY, UT 84092

FOR: INSTALLATION OF BUILDING EXTERIOR
INSULATION SYSTEMS, IN CLASS 37 (U.S. CLS. 100,
103 AND 106).

FIRST USE 7-5-2007; IN COMMERCE 7-5-2007.

THE MARK CONSISTS OF STANDARD CHAR-
ACTERS WITHOUT CLAIM TO ANY PARTICULAR
FONT, STYLE, SIZE, OR COLOR.

SER. NO. 77-416,561, FILED P.R. 3-7-2008; AM. S.R.
12-18-2008.

DARRYL SPRUILL, EXAMINING ATTORNEY

Int. Cl.: 18

Prior U.S. Cls.: 1, 2, 3, 22, and 41

United States Patent and Trademark Office

Reg. No. 3,578,244

Registered Feb. 17, 2009

**TRADEMARK
SUPPLEMENTAL REGISTER**

THE ULTIMATE NURSING BAG

COLUMBIA INSURANCE COMPANY (DELA-
WARE CORPORATION)
3024 HARNEY STREET
OMAHA, NE 68131

FOR: ALL-PURPOSE CARRYING BAGS SPECIFI-
CALLY FOR NURSES AND PERSONS WORKING
IN THE MEDICAL FIELD, SOLD VIA RETAIL UNI-
FORM STORES, UNIFORM CATALOGS, AND PRO-
PRIETARY WEBSITES , IN CLASS 18 (U.S. CLS. 1, 2,
3, 22 AND 41).

FIRST USE 10-24-2007; IN COMMERCE 10-24-2007.

THE MARK CONSISTS OF STANDARD CHAR-
ACTERS WITHOUT CLAIM TO ANY PARTICULAR
FONT, STYLE, SIZE, OR COLOR.

SER. NO. 77-417,657, FILED P.R. 3-10-2008; AM. S.R.
1-12-2009.

JEAN IM, EXAMINING ATTORNEY

Int. Cl.: 9

Prior U.S. Cls.: 21, 23, 26, 36, and 38

United States Patent and Trademark Office

Reg. No. 3,578,245

Registered Feb. 17, 2009

**TRADEMARK
SUPPLEMENTAL REGISTER**

METASDRAM

METARAM, INC. (DELAWARE CORPORATION)
SUITE 400
181 METRO DRIVE
SAN JOSE, CA 95110

THE MARK CONSISTS OF STANDARD CHAR-
ACTERS WITHOUT CLAIM TO ANY PARTICULAR
FONT, STYLE, SIZE, OR COLOR.

FOR: INTEGRATED CIRCUITS FOR USE IN BIT
STORAGE IN A PC OR EMBEDDED SYSTEM EN-
VIRONMENT, IN CLASS 9 (U.S. CLS. 21, 23, 26, 36
AND 38).

SER. NO. 77-418,742, FILED P.R. 3-11-2008; AM. S.R.
12-15-2008.

FIRST USE 1-0-2008; IN COMMERCE 2-0-2008.

SUZANNE BLANE, EXAMINING ATTORNEY

Int. Cl.: 8

Prior U.S. Cls.: 23, 28, and 44

Reg. No. 3,578,246

United States Patent and Trademark Office

Registered Feb. 17, 2009

**TRADEMARK
SUPPLEMENTAL REGISTER**

ROLSON AMERICA

FRIEDER ENTERPRISES, INC. (OHIO CORPORATION)
30901 CARTER STREET, UNIT B
SOLON, OH 44139

FOR: DRILL BITS FOR HAND DRILLS; HAMMERS; HAND TOOLS, NAMELY, CLAMPS; HAND TOOLS, NAMELY, DRILLS; HAND TOOLS, NAMELY, PAINT SCRAPERS; HAND TOOLS, NAMELY, RATCHET WRENCHES; HAND TOOLS, NAMELY, SAWS; HAND TOOLS, NAMELY, SCREWDRIVERS; HAND TOOLS, NAMELY, SOCKET SETS; HAND TOOLS, NAMELY, WRENCHES; PLIERS, IN CLASS 8 (U.S. CLS. 23, 28 AND 44).

FIRST USE 9-23-2008; IN COMMERCE 9-23-2008.

THE MARK CONSISTS OF STANDARD CHARACTERS WITHOUT CLAIM TO ANY PARTICULAR FONT, STYLE, SIZE, OR COLOR.

NO CLAIM IS MADE TO THE EXCLUSIVE RIGHT TO USE "AMERICA", APART FROM THE MARK AS SHOWN.

SER. NO. 77-421,108, FILED P.R. 3-13-2008; AM. S.R. 10-17-2008.

REGINA DRUMMOND, EXAMINING ATTORNEY

Int. Cl.: 42

Prior U.S. Cls.: 100 and 101

United States Patent and Trademark Office

Reg. No. 3,578,247

Registered Feb. 17, 2009

**SERVICE MARK
SUPPLEMENTAL REGISTER**

TRAFFIC QUALITY MANAGEMENT

CLICK FORENSICS, INC. (DELAWARE CORPORATION)
BUILDING A, SUITE 301
4301 WESTBANK DR.
AUSTIN, TX 78746

FOR: COMPUTER SERVICES, NAMELY, MONITORING, TESTING, ANALYZING, AND REPORTING ON INTERNET TRAFFIC AND CONTENT OF THE WEB SITES OF OTHERS , IN CLASS 42 (U.S. CLS. 100 AND 101).

FIRST USE 8-0-2008; IN COMMERCE 8-0-2008.

THE MARK CONSISTS OF STANDARD CHARACTERS WITHOUT CLAIM TO ANY PARTICULAR FONT, STYLE, SIZE, OR COLOR.

SER. NO. 77-422,063, FILED P.R. 3-14-2008; AM. S.R. 12-22-2008.

MONIQUE MILLER, EXAMINING ATTORNEY

Int. Cl.: 29

Prior U.S. Cl.: 46

United States Patent and Trademark Office

Reg. No. 3,578,248

Registered Feb. 17, 2009

**TRADEMARK
SUPPLEMENTAL REGISTER**

TOLMAN

PALACE INDUSTRIES, LLC (OREGON LIMITED
LIABILITY COMPANY)
311 NORTH FRONT STREET
CENTRAL POINT, OR 97502

FOR: CHEESE, IN CLASS 29 (U.S. CL. 46).

FIRST USE 12-1-2008; IN COMMERCE 12-1-2008.

THE MARK CONSISTS OF STANDARD CHAR-
ACTERS WITHOUT CLAIM TO ANY PARTICULAR
FONT, STYLE, SIZE, OR COLOR.

SER. NO. 77-422,413, FILED P.R. 3-14-2008; AM. S.R.
12-16-2008.

JANET LEE, EXAMINING ATTORNEY

Int. Cl.: 41

Prior U.S. Cls.: 100, 101, and 107

United States Patent and Trademark Office

Reg. No. 3,578,249

Registered Feb. 17, 2009

SERVICE MARK
SUPPLEMENTAL REGISTER

WOMEN
IN UTILITIES

CIS CONFERENCE, INC. (TEXAS CORPORATION)
4817 HWY 1417 NORTH
SHERMAN, TX 75092

FOR: EDUCATIONAL SERVICES, NAMELY, CONDUCTING CONFERENCES FOR UTILITY PERSONNEL IN THE FIELDS OF ELECTRICAL, TELEPHONE, TELEPHONY, GAS, WATER AND SEWER UTILITIES THAT WORK IN COOPERATIVES AND MUNICIPALITIES THROUGHOUT THE UNITED STATES AND FOREIGN COUNTRIES, IN CLASS 41 (U.S. CLS. 100, 101 AND 107).

FIRST USE 12-1-2007; IN COMMERCE 12-1-2007.

NO CLAIM IS MADE TO THE EXCLUSIVE RIGHT TO USE "WOMEN" OR "UTILITIES", APART FROM THE MARK AS SHOWN.

THE MARK CONSISTS OF A STYLIZED "W" IN THE WORD "WOMEN" IN ALL CAPITALIZED LETTERS LOCATED OVER "IN UTILITIES" IN ALL CAPITALIZED LETTERS.

SER. NO. 77-423,164, FILED P.R. 3-16-2008; AM. S.R. 12-22-2008.

PAM WILLIS, EXAMINING ATTORNEY

Int. Cl.: 9

Prior U.S. Cls.: 21, 23, 26, 36, and 38

United States Patent and Trademark Office

Reg. No. 3,578,250

Registered Feb. 17, 2009

**TRADEMARK
SUPPLEMENTAL REGISTER**

TREEFACTS

HORTICULTURAL ASSET MANAGEMENT, INC.
(DELAWARE CORPORATION)
107 EDINBURGH SOUTH, SUITE 205
CARY, NC 27511

FOR: COMPUTER SOFTWARE FOR THE
HEALTH RATING, RISK RATING AND VALUA-
TION OF TREES, SHRUBS AND OTHER PLANT
MATERIAL ON RESIDENTIAL, COMMERCIAL,
PUBLIC AND GOVERNMENT OWNED PROPER-
TIES, IN CLASS 9 (U.S. CLS. 21, 23, 26, 36 AND 38).

FIRST USE 12-22-2008; IN COMMERCE 12-22-2008.

THE MARK CONSISTS OF STANDARD CHAR-
ACTERS WITHOUT CLAIM TO ANY PARTICULAR
FONT, STYLE, SIZE, OR COLOR.

SER. NO. 77-423,946, FILED P.R. 3-17-2008; AM. S.R.
12-22-2008.

TINA L. SNAPP, EXAMINING ATTORNEY

Int. Cl.: 35

Prior U.S. Cls.: 100, 101, and 102

United States Patent and Trademark Office

Reg. No. 3,578,251

Registered Feb. 17, 2009

**SERVICE MARK
SUPPLEMENTAL REGISTER**

RENTDENVERONLINE.COM

RENTDENVERONLINE.COM, LLC (COLORADO
LIMITED LIABILITY COMPANY)
SUITE 206
45 OGDEN ST.
DENVER, CO 80218

FOR: ON-LINE ADVERTISING AND MARKET-
ING SERVICES; PROVISION OF ADVERTISING
SPACE BY ELECTRONIC MEANS AND GLOBAL
INFORMATION NETWORKS; ON-LINE ADVER-
TISING ON COMPUTER COMMUNICATION NET-
WORKS; DISSEMINATION OF ADVERTISING FOR
OTHERS VIA AN ON-LINE COMMUNICATIONS
NETWORK ON THE INTERNET; ADVERTISING
SERVICES, NAMELY, PROVIDING INFORMATION
AS TO THE AVAILABILITY OF ROOMS, APART-

MENTS, CONDOMINIUMS, LOFTS AND TEMPOR-
ARY AND PERMANENT HOUSING FOR RENT OR
PURCHASE, IN CLASS 35 (U.S. CLS. 100, 101 AND
102).

FIRST USE 9-1-2008; IN COMMERCE 9-1-2008.

THE MARK CONSISTS OF STANDARD CHAR-
ACTERS WITHOUT CLAIM TO ANY PARTICULAR
FONT, STYLE, SIZE, OR COLOR.

SER. NO. 77-424,119, FILED P.R. 3-17-2008; AM. S.R.
12-26-2008.

CHRISTINE BLOMQUIST, EXAMINING ATTOR-
NEY

Int. Cl.: 35

Prior U.S. Cls.: 100, 101, and 102

United States Patent and Trademark Office

Reg. No. 3,578,252

Registered Feb. 17, 2009

**SERVICE MARK
SUPPLEMENTAL REGISTER**

VENDORRATE

VENDORRATE, INC. (DELAWARE CORPORATION)
15559 UNION AVENUE, #108
LOS GATOS, CA 95032

FOR: PROVIDING BUSINESS AND MARKETING INFORMATION IN THE FIELD OF INFORMATION TECHNOLOGY, ALL VIA ELECTRONIC COMMUNICATIONS NETWORKS, IN CLASS 35 (U.S. CLS. 100, 101 AND 102).

FIRST USE 2-15-2008; IN COMMERCE 2-15-2008.

THE MARK CONSISTS OF STANDARD CHARACTERS WITHOUT CLAIM TO ANY PARTICULAR FONT, STYLE, SIZE, OR COLOR.

SER. NO. 77-424,124, FILED P.R. 3-17-2008; AM. S.R. 12-24-2008.

ROBERT LAVACHE, EXAMINING ATTORNEY

Int. Cl.: 9

Prior U.S. Cls.: 21, 23, 26, 36, and 38

United States Patent and Trademark Office

Reg. No. 3,578,253

Registered Feb. 17, 2009

**TRADEMARK
SUPPLEMENTAL REGISTER**

SCHROEDER CABINETS

SCHROEDER CABINET CORPORATION (CALIFORNIA CORPORATION)

15146 WALBROOK DR.

HACIENDA HEIGHTS, CA 91745

FOR: AUDIO SPEAKER ENCLOSURES; CABINETS FOR LOUDSPEAKERS; CONSUMER ELECTRONIC PRODUCTS, NAMELY, AUDIO AMPLIFIERS, AUDIO SPEAKERS, AUDIO RECEIVERS, ELECTRICAL AUDIO AND SPEAKER CABLES AND CONNECTORS, HOME THEATER SYSTEMS, AUDIO DECODERS, VIDEO DECODERS, SPEAKERS, POWER CONVERSION DEVICES, POWER CONVERTERS, AND POWER INVERTERS; LOUD SPEAKER SYSTEMS; LOUD SPEAKERS; LOUDSPEAKER CABINETS; SPEAKER ENCLOSURES; AUDIO SPEAKERS, IN CLASS 9 (U.S. CLS. 21, 23, 26, 36 AND 38).

SURES; AUDIO SPEAKERS, IN CLASS 9 (U.S. CLS. 21, 23, 26, 36 AND 38).

FIRST USE 7-31-2004; IN COMMERCE 7-31-2004.

THE MARK CONSISTS OF STANDARD CHARACTERS WITHOUT CLAIM TO ANY PARTICULAR FONT, STYLE, SIZE, OR COLOR.

NO CLAIM IS MADE TO THE EXCLUSIVE RIGHT TO USE "CABINETS", APART FROM THE MARK AS SHOWN.

SER. NO. 77-426,117, FILED P.R. 3-19-2008; AM. S.R. 12-23-2008.

RONALD MCMORROW, EXAMINING ATTORNEY

Int. Cl.: 9

Prior U.S. Cls.: 21, 23, 26, 36, and 38

United States Patent and Trademark Office

Reg. No. 3,578,254

Registered Feb. 17, 2009

**TRADEMARK
SUPPLEMENTAL REGISTER**



SCHROEDER CABINETS CORPORATION (CALIFORNIA CORPORATION)
15146 WALBROOK DRIVE
HACIENDA HEIGHTS, CA 91745

FOR: AUDIO SPEAKER ENCLOSURES; AUDIO SPEAKERS; CABINETS FOR LOUDSPEAKERS; LOUD SPEAKER SYSTEMS; LOUDSPEAKER CABINETS; SPEAKER ENCLOSURES, IN CLASS 9 (U.S. CLS. 21, 23, 26, 36 AND 38).

FIRST USE 7-31-2004; IN COMMERCE 7-31-2004.

THE COLOR(S) YELLOW, BLACK IS/ARE CLAIMED AS A FEATURE OF THE MARK.

THE MARK CONSISTS OF THE NAME "SCHROEDER" IN YELLOW LETTERS ON A BLACK BACKGROUND.

SER. NO. 77-426,199, FILED P.R. 3-19-2008; AM. S.R. 12-23-2008.

STEPHANIE ALI, EXAMINING ATTORNEY

Int. Cl.: 11

Prior U.S. Cls.: 13, 21, 23, 31, and 34

United States Patent and Trademark Office

Reg. No. 3,578,255

Registered Feb. 17, 2009

**TRADEMARK
SUPPLEMENTAL REGISTER**

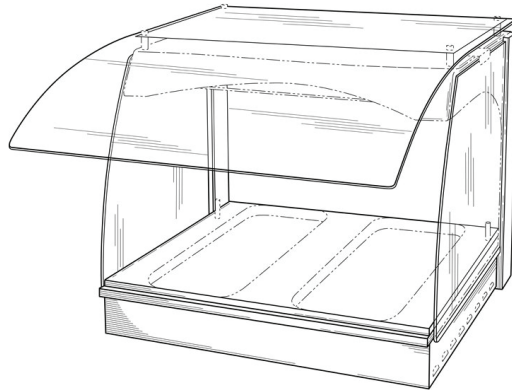

HATCO CORPORATION (WISCONSIN CORPORATION)

635 S. 28TH STREET
MILWAUKEE, WI 53215

FOR: ELECTRIC MERCHANDIZING FOOD WARMER, IN CLASS 11 (U.S. CLS. 13, 21, 23, 31 AND 34).

FIRST USE 7-10-2007; IN COMMERCE 7-10-2007.

THE MARK CONSISTS OF A CONFIGURATION OF THE GOODS, INCLUDING THE FEATURES OF A CURVED SIDE PANEL PROFILE AND CURVED SNEEZE GUARD. BROKEN LINES INDICATE MATTER NOT CLAIMED AS PART OF THE MARK, AND SERVE ONLY TO SHOW PLACEMENT OF THE MARK.

SER. NO. 77-429,692, FILED P.R. 3-24-2008; AM. S.R. 12-24-2008.

PATRICIA EVANKO, EXAMINING ATTORNEY

Int. Cl.: 11

Prior U.S. Cls.: 13, 21, 23, 31, and 34

United States Patent and Trademark Office

Reg. No. 3,578,256

Registered Feb. 17, 2009

**TRADEMARK
SUPPLEMENTAL REGISTER**

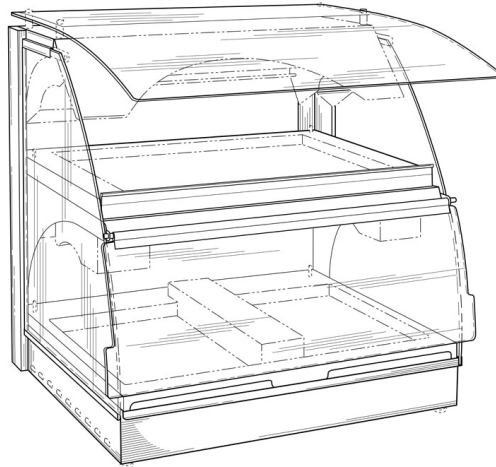

HATCO CORPORATION (WISCONSIN CORPORATION)

**635 S. 28TH STREET
MILWAUKEE, WI 53215**

**FOR: ELECTRIC MERCHANDIZING FOOD
WARMER, IN CLASS 11 (U.S. CLS. 13, 21, 23, 31
AND 34).**

FIRST USE 5-4-2007; IN COMMERCE 5-4-2007.

**THE MARK CONSISTS OF A CONFIGURATION
OF THE GOODS, INCLUDING THE FEATURES OF
A CURVED SIDE PANEL PROFILE AND CURVED
SNEEZE GUARD. BROKEN LINES INDICATE
MATTER NOT CLAIMED AS PART OF THE MARK
AND SERVE ONLY TO SHOW PLACEMENT OF
THE MARK.**

**SER. NO. 77-429,708, FILED P.R. 3-24-2008; AM. S.R.
12-24-2008.**

PATRICIA EVANKO, EXAMINING ATTORNEY

Int. Cl.: 41

Prior U.S. Cls.: 100, 101, and 107

United States Patent and Trademark Office

Reg. No. 3,578,257

Registered Feb. 17, 2009

**SERVICE MARK
SUPPLEMENTAL REGISTER**

CHAMPIONSHIP COMEDY

CHIZMAR, TIMOTHY C. (UNITED STATES IN-
DIVIDUAL)
14500 ALDER DR
CORONA, CA 92880

FOR: ENTERTAINMENT SERVICES IN THE
NATURE OF COMEDY SHOWS; PRESENTATION
OF LIVE COMEDY SHOWS, IN CLASS 41 (U.S. CLS.
100, 101 AND 107).

FIRST USE 8-0-2007; IN COMMERCE 8-0-2007.

THE MARK CONSISTS OF STANDARD CHAR-
ACTERS WITHOUT CLAIM TO ANY PARTICULAR
FONT, STYLE, SIZE, OR COLOR.

NO CLAIM IS MADE TO THE EXCLUSIVE
RIGHT TO USE "COMEDY", APART FROM THE
MARK AS SHOWN.

SER. NO. 77-433,885, FILED P.R. 3-27-2008; AM. S.R.
12-22-2008.

GRETTA YAO, EXAMINING ATTORNEY

Int. Cl.: 37

Prior U.S. Cls.: 100, 103, and 106

United States Patent and Trademark Office

Reg. No. 3,578,258

Registered Feb. 17, 2009

**SERVICE MARK
SUPPLEMENTAL REGISTER**

AMERICAN SECURITY TRAQ

AMERICAN BIOMEDICAL GROUP INC. (OKLAHOMA CORPORATION)

6220 N. CLASSEN BLVD.

OKLAHOMA CITY, OK 73118

FOR: SECURITY SERVICES, NAMELY, INSTALLATION OF SECURITY SYSTEMS, IN CLASS 37 (U.S. CLS. 100, 103 AND 106).

FIRST USE 4-5-2008; IN COMMERCE 4-5-2008.

THE MARK CONSISTS OF STANDARD CHARACTERS WITHOUT CLAIM TO ANY PARTICULAR FONT, STYLE, SIZE, OR COLOR.

NO CLAIM IS MADE TO THE EXCLUSIVE RIGHT TO USE "SECURITY", APART FROM THE MARK AS SHOWN.

SER. NO. 77-434,255, FILED P.R. 3-28-2008; AM. S.R. 1-8-2009.

MELISSA VALLILLO, EXAMINING ATTORNEY

Int. Cl.: 29

Prior U.S. Cl.: 46

United States Patent and Trademark Office

Reg. No. 3,578,259

Registered Feb. 17, 2009

**TRADEMARK
SUPPLEMENTAL REGISTER**

**Cherry
Cherry
Cherry**

SENECA FOODS CORPORATION (NEW YORK
CORPORATION)
3736 SOUTH MAIN STREET
MARION, NY 14505

FOR: CANNED FRUITS, IN CLASS 29 (U.S. CL.
46).

FIRST USE 7-31-2008; IN COMMERCE 7-31-2008.

THE MARK CONSISTS OF THE WORD "CHERRY" THREE TIMES, STACKED ON TOP OF EACH OTHER.

SER. NO. 77-437,906, FILED P.R. 4-2-2008; AM. S.R. 11-24-2008.

LINDA ESTRADA, EXAMINING ATTORNEY

Int. Cl.: 35

Prior U.S. Cls.: 100, 101, and 102

United States Patent and Trademark Office

Reg. No. 3,578,260

Registered Feb. 17, 2009

**SERVICE MARK
SUPPLEMENTAL REGISTER**

**NATIONAL ALLIANCE OF
FOREST OWNERS**

NATIONAL ALLIANCE OF FOREST OWNERS
(D.C. NON-PROFIT CORPORATION)
C/O SMITH BUCKLIN
2025 M STREET, NW
WASHINGTON, DC 20036

FOR: LOBBYING SERVICES, NAMELY, PROMOTING THE INTERESTS OF FOREST OWNERS IN THE FIELDS OF POLITICS, LEGISLATION, AND REGULATION, IN CLASS 35 (U.S. CLS. 100, 101 AND 102).

FIRST USE 4-1-2008; IN COMMERCE 5-1-2008.

THE MARK CONSISTS OF STANDARD CHARACTERS WITHOUT CLAIM TO ANY PARTICULAR FONT, STYLE, SIZE, OR COLOR.

SER. NO. 77-447,105, FILED P.R. 4-14-2008; AM. S.R. 1-5-2009.

DAVID C. REIHNER, EXAMINING ATTORNEY

Int. Cls.: 16 and 25

Prior U.S. Cls.: 2, 5, 22, 23, 29, 37, 38, 39, and 50

United States Patent and Trademark Office

Reg. No. 3,578,261

Registered Feb. 17, 2009

**TRADEMARK
SUPPLEMENTAL REGISTER**

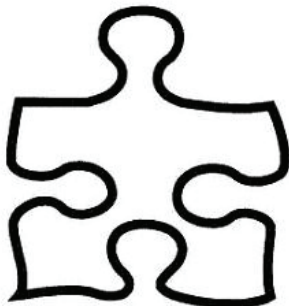

CLAFFEY, DANIEL F. (UNITED STATES INDIVIDUAL)
25444 HARDY PLACE
STEVENSON RANCH, CA 91381

FOR: ART MOUNTS; ART PADS; ART PAPER; ART PICTURES; ART PRINTS; ART PRINTS ON CANVAS; GRAPHIC ART REPRODUCTIONS; LITHOGRAPHIC WORKS OF ART; PHOTOGRAPHIC OR ART MOUNTS; PRINTED ART REPRODUCTIONS; COLOR PRINTS; GICLEE PRINTS; GRAPHIC PRINTS AND REPRESENTATIONS; LITHOGRAPHIC PRINTS; PHOTOGRAPHIC PRINTS; PICTORIAL PRINTS; PRINTS; LITHOGRAPHS; GREETING CARDS; GIFT CARDS; NOTE CARDS; PLACE CARDS; STATIONERY; PENS; PENCILS; LUNCH BAGS; PAPER GIFT BAGS, IN CLASS 16 (U.S. CLS. 2, 5, 22, 23, 29, 37, 38 AND 50).

FIRST USE 3-1-2008; IN COMMERCE 3-1-2008.

FOR: BATHING SUITS; BELTS; BLOUSES; BOOTS; CAPS; COATS; COATS OF DENIM; DENIM JACKETS; DENIMS; DRESSES; GLOVES; HATS;

INFANT AND TODDLER ONE PIECE CLOTHING; INFANT WEAR; JACKETS; JEANS; LINGERIE; MEN'S SUITS, WOMEN'S SUITS; NIGHTWEAR; RAIN COATS; PAJAMAS; PANTS; SANDALS; SCARVES; SHIRTS; SHOES; SHORTS; SKIRT SUITS; SKIRTS; SLACKS; SLIPPERS; SOCKS; SPORT COATS; SPORT SHIRTS; SPORTS JACKETS; SPORTS JERSEYS; SPORTS SHIRTS; STOCKINGS; SWEAT JACKETS; SWEAT PANTS; SWEAT SHIRTS; SWEAT SHORTS; SWEAT SUITS; SWEATERS; T-SHIRTS; TENNIS SHOES; THONGS; TIES; TANK-TOPS; TOPS; UNDERWEAR; VESTS , IN CLASS 25 (U.S. CLS. 22 AND 39).

FIRST USE 3-1-2008; IN COMMERCE 3-1-2008.

THE MARK CONSISTS OF AN OUTLINE OF A PUZZLE PIECE.

SER. NO. 77-447,622, FILED P.R. 4-14-2008; AM. S.R. 12-23-2008.

KATINA MISTER, EXAMINING ATTORNEY

Int. Cl.: 16

Prior U.S. Cls.: 2, 5, 22, 23, 29, 37, 38, and 50

Reg. No. 3,578,262

United States Patent and Trademark Office

Registered Feb. 17, 2009

**TRADEMARK
SUPPLEMENTAL REGISTER**

Long Island Trends

ALL ISLAND MEDIA, INC. (NEW YORK CORPORATION)
2950 VETERANS HWY
BOHEMIA, NY 11788

THE MARK CONSISTS OF STANDARD CHARACTERS WITHOUT CLAIM TO ANY PARTICULAR FONT, STYLE, SIZE, OR COLOR.

FOR: PUBLICATIONS, NAMELY, WEEKLY SHOPPER NEWSPAPER IN THE FIELDS OF RETAIL, IN CLASS 16 (U.S. CLS. 2, 5, 22, 23, 29, 37, 38 AND 50).

SER. NO. 77-448,223, FILED P.R. 4-15-2008; AM. S.R. 12-15-2008.

FIRST USE 3-13-2008; IN COMMERCE 3-13-2008.

KELLY CHOE, EXAMINING ATTORNEY

Int. Cl.: 42

Prior U.S. Cls.: 100 and 101

United States Patent and Trademark Office

Reg. No. 3,578,263

Registered Feb. 17, 2009

**SERVICE MARK
SUPPLEMENTAL REGISTER**

The IV&V Group

THE IV & V GROUP, INC. (VIRGINIA CORPORATION)
2801 TOWNEY VIEW COURT
VIENNA, VA 221807022

FOR: COMPUTER SERVICES, NAMELY, CONDUCTING INDEPENDENT VERIFICATION AND VALIDATION SERVICES ON SOFTWARE INTENSIVE SYSTEMS, IN CLASS 42 (U.S. CLS. 100 AND 101).

FIRST USE 4-20-2005; IN COMMERCE 4-20-2005.

THE MARK CONSISTS OF STANDARD CHARACTERS WITHOUT CLAIM TO ANY PARTICULAR FONT, STYLE, SIZE, OR COLOR.

SER. NO. 77-454,506, FILED P.R. 4-22-2008; AM. S.R. 11-20-2008.

STEVEN R. FINE, EXAMINING ATTORNEY

Int. Cl.: 42

Prior U.S. Cls.: 100 and 101

United States Patent and Trademark Office

Reg. No. 3,578,264

Registered Feb. 17, 2009

**SERVICE MARK
SUPPLEMENTAL REGISTER**



THE IV & V GROUP, INC. (VIRGINIA CORPORATION)
2801 TOWNEY VIEW COURT
VIENNA, VA 221807022

FOR: COMPUTER SERVICES, NAMELY, CONDUCTING INDEPENDENT VERIFICATION AND VALIDATION SERVICES ON SOFTWARE INTENSIVE SYSTEMS, IN CLASS 42 (U.S. CLS. 100 AND 101).

FIRST USE 4-20-2005; IN COMMERCE 4-20-2005.

NO CLAIM IS MADE TO THE EXCLUSIVE RIGHT TO USE "INDEPENDENT VERIFICATION & VALIDATION", APART FROM THE MARK AS SHOWN.

THE COLOR(S) BLUE AND WHITE IS/ARE CLAIMED AS A FEATURE OF THE MARK.

THE MARK CONSISTS OF A BLUE RECTANGLE WITH THE LETTERS "I", "V", "V" AND THE WORDS "THE" AND "GROUP" IN WHITE AND THE SYMBOL & IN PALER SHADE OF BLUE. BELOW THE LETTERS, THE WORDS "INDEPENDENT VERIFICATION AND VALIDATION" APPEAR IN WHITE. BENEATH THE BLUE RECTANGLE IS A BLUE LINE.

SER. NO. 77-454,514, FILED P.R. 4-22-2008; AM. S.R. 11-20-2008.

STEVEN R. FINE, EXAMINING ATTORNEY

Int. Cl.: 9

Prior U.S. Cls.: 21, 23, 26, 36, and 38

Reg. No. 3,578,265

United States Patent and Trademark Office

Registered Feb. 17, 2009

**TRADEMARK
SUPPLEMENTAL REGISTER**

Premier Literacy

PREMIER ASSISTIVE TECHNOLOGY, INC. (MI-
CHIGAN CORPORATION), DBA PREMIER
LITERACY,
1309 N. WILLIAM ST.
SUITE 205
JOLIET, IL 60435

FOR: COMPUTER SOFTWARE AND HARD-
WARE FOR USE IN LITERACY INSTRUCTION
AND ANALYSIS, IN CLASS 9 (U.S. CLS. 21, 23, 26,
36 AND 38).

FIRST USE 3-1-2008; IN COMMERCE 3-1-2008.

THE MARK CONSISTS OF STANDARD CHAR-
ACTERS WITHOUT CLAIM TO ANY PARTICULAR
FONT, STYLE, SIZE, OR COLOR.

SER. NO. 77-457,326, FILED P.R. 4-24-2008; AM. S.R.
1-2-2009.

JAY BESCH, EXAMINING ATTORNEY

Int. Cl.: 35

Prior U.S. Cls.: 100, 101, and 102

United States Patent and Trademark Office

Reg. No. 3,578,266

Registered Feb. 17, 2009

**SERVICE MARK
SUPPLEMENTAL REGISTER**

KOSHER VINTNERS ASSOCIATION

ROYAL WINE CORPORATION (NEW YORK
CORPORATION)

63 NORTH HOOK ROAD

BAYONNE, NJ 07002

FOR: PROVIDING CONSUMER INFORMATION
AND RELATED NEWS IN THE FIELD OF KOSHER
WINES, IN CLASS 35 (U.S. CLS. 100, 101 AND 102).

FIRST USE 4-30-2008; IN COMMERCE 4-30-2008.

THE MARK CONSISTS OF STANDARD CHAR-
ACTERS WITHOUT CLAIM TO ANY PARTICULAR
FONT, STYLE, SIZE, OR COLOR.

NO CLAIM IS MADE TO THE EXCLUSIVE
RIGHT TO USE "VINTNERS ASSOCIATION",
APART FROM THE MARK AS SHOWN.

SER. NO. 77-464,427, FILED P.R. 5-2-2008; AM. S.R.
12-30-2008.

GINA FINK, EXAMINING ATTORNEY

Int. Cl.: 44

Prior U.S. Cls.: 100 and 101

United States Patent and Trademark Office

Reg. No. 3,578,267

Registered Feb. 17, 2009

**SERVICE MARK
SUPPLEMENTAL REGISTER**

PHYSIOCARE

BETHESDA PHYSIOCARE (MARYLAND CORPORATION)

C-15

7830 OLD GEORGETOWN ROAD

BETHESDA, MD 208142440

FOR: PHYSICAL THERAPY; TREATMENT OF PAIN AND BODY MOVEMENT DYSFUNCTION THROUGH PHYSICAL THERAPY, IN CLASS 44 (U.S. CLS. 100 AND 101).

FIRST USE 10-1-2006; IN COMMERCE 10-1-2006.

THE MARK CONSISTS OF STANDARD CHARACTERS WITHOUT CLAIM TO ANY PARTICULAR FONT, STYLE, SIZE, OR COLOR.

SER. NO. 77-474,508, FILED P.R. 5-14-2008; AM. S.R. 12-23-2008.

LINDA LAVACHE, EXAMINING ATTORNEY

Int. Cl.: 18

Prior U.S. Cls.: 1, 2, 3, 22, and 41

United States Patent and Trademark Office

Reg. No. 3,578,268

Registered Feb. 17, 2009

**TRADEMARK
SUPPLEMENTAL REGISTER**

HEALTH CHEW

DEL MONTE CORPORATION (DELAWARE
CORPORATION)

ONE MARKET STREET

SAN FRANCISCO, CA 94105

FOR: RAWHIDE CHEWS FOR DOGS, IN CLASS
18 (U.S. CLS. 1, 2, 3, 22 AND 41).

FIRST USE 10-5-2008; IN COMMERCE 10-5-2008.

THE MARK CONSISTS OF STANDARD CHAR-
ACTERS WITHOUT CLAIM TO ANY PARTICULAR
FONT, STYLE, SIZE, OR COLOR.

NO CLAIM IS MADE TO THE EXCLUSIVE
RIGHT TO USE "CHEW", APART FROM THE
MARK AS SHOWN.

SER. NO. 77-475,620, FILED P.R. 5-15-2008; AM. S.R.
12-15-2008.

COLLEEN KEARNEY, EXAMINING ATTORNEY

Int. Cl.: 19

Prior U.S. Cls.: 1, 12, 33, and 50

United States Patent and Trademark Office

Reg. No. 3,578,269

Registered Feb. 17, 2009

**TRADEMARK
SUPPLEMENTAL REGISTER**



BOSTON CEDAR, INC. (MASSACHUSETTS CORPORATION)
54 HIGH STREET
HOLBROOK, MA 02343

FOR: WHITE COATED EXTERIOR WOOD TRIM,
IN CLASS 19 (U.S. CLS. 1, 12, 33 AND 50).

FIRST USE 2-28-2006; IN COMMERCE 2-28-2006.

OWNER OF U.S. REG. NOS. 3,368,947 AND
3,377,642.

THE COLOR(S) RED, WHITE, BLACK AND GREY
IS/ARE CLAIMED AS A FEATURE OF THE MARK.

THE MARK CONSISTS OF "TIO2" IN A RED BOX
WITH "TITANIUM" AND THE DOT OVER THE "I"
IN GREY, "O2" AND WHITE IN BLACK AND "TI"
IN WHITE.

SER. NO. 77-482,306, FILED P.R. 5-23-2008; AM. S.R.
12-8-2008.

ANN E. SAPPENFIELD, EXAMINING ATTORNEY

Int. Cl.: 10

Prior U.S. Cls.: 26, 39, and 44

United States Patent and Trademark Office

Reg. No. 3,578,270

Registered Feb. 17, 2009

**TRADEMARK
SUPPLEMENTAL REGISTER**

HANDY HOLDER

JEANETTE CAMERON (UNITED STATES INDIVIDUAL)
1924 N. HADLEY RD
LAPEER, MI 48446

FOR: SUPPORTERS FOR MEDICAL PURPOSES; SUPPORTS FOR GENERAL MEDICAL USE; SUPPORTS FOR HANDS FOR MEDICAL USE; SUPPORTS FOR ARMS FOR MEDICAL USE, IN CLASS 10 (U.S. CLS. 26, 39 AND 44).

FIRST USE 4-0-2008; IN COMMERCE 5-15-2008.

THE MARK CONSISTS OF STANDARD CHARACTERS WITHOUT CLAIM TO ANY PARTICULAR FONT, STYLE, SIZE, OR COLOR.

NO CLAIM IS MADE TO THE EXCLUSIVE RIGHT TO USE "HOLDER", APART FROM THE MARK AS SHOWN.

SER. NO. 77-487,583, FILED P.R. 5-30-2008; AM. S.R. 12-19-2008.

BILL DAWE, EXAMINING ATTORNEY

Int. Cl.: 25

Prior U.S. Cls.: 22 and 39

United States Patent and Trademark Office

Reg. No. 3,578,271

Registered Feb. 17, 2009

TRADEMARK
SUPPLEMENTAL REGISTER



RILEY, BETH AILEEN (UNITED STATES INDIVIDUAL), DBA SO-CAL TACTICAL, 12508 RIDGETON DRIVE LAKESIDE, CA 92040

FOR: BABY BODYSUITS, IN CLASS 25 (U.S. CLS. 22 AND 39).

FIRST USE 6-1-2008; IN COMMERCE 6-1-2008.

NO CLAIM IS MADE TO THE EXCLUSIVE RIGHT TO USE "BABY" , APART FROM THE MARK AS SHOWN.

THE COLOR(S) BLACK, WHITE, YELLOW AND PINK IS/ARE CLAIMED AS A FEATURE OF THE MARK.

THE MARK CONSISTS OF A WHITE BACKGROUND WITH BLACK LETTERING OUTLINED IN PINK FORMING THE WORD, "TACTICAL" ON TOP OF YELLOW HANDCUFFS OUTLINED IN PINK WITH THE WORD "BABY" IN BLACK LETTERING OUTLINED IN PINK TO THE RIGHT OF THE HANDCUFFS.

SER. NO. 77-488,171, FILED P.R. 6-1-2008; AM. S.R. 6-1-2008.

MATTHEW MCDOWELL, EXAMINING ATTORNEY

Int. Cl.: 3

Prior U.S. Cls.: 1, 4, 6, 50, 51, and 52

United States Patent and Trademark Office

Reg. No. 3,578,272

Registered Feb. 17, 2009

**TRADEMARK
SUPPLEMENTAL REGISTER**

ACNE.ORG

DAN KERN, INC. (CALIFORNIA CORPORATION)
1026 CASTRO STREET
SAN FRANCISCO, CA 94114

FOR: SKIN AND BODY CARE PREPARATIONS,
NAMELY, SKIN CLEANSERS, MOISTURIZERS
AND LOTIONS, IN CLASS 3 (U.S. CLS. 1, 4, 6, 50, 51
AND 52).

FIRST USE 2-1-2008; IN COMMERCE 2-1-2008.

THE MARK CONSISTS OF STANDARD CHARACTERS WITHOUT CLAIM TO ANY PARTICULAR FONT, STYLE, SIZE, OR COLOR.

SER. NO. 77-489,552, FILED P.R. 6-3-2008; AM. S.R. 12-8-2008.

DARRYL SPRUILL, EXAMINING ATTORNEY

Int. Cl.: 5

Prior U.S. Cls.: 6, 18, 44, 46, 51, and 52

United States Patent and Trademark Office

Reg. No. 3,578,273

Registered Feb. 17, 2009

**TRADEMARK
SUPPLEMENTAL REGISTER**

ACNE.ORG

DAN KERN, INC. (CALIFORNIA CORPORATION)
1026 CASTRO STREET
SAN FRANCISCO, CA 94114

FOR: ACNE TREATMENT PREPARATIONS, IN CLASS 5 (U.S. CLS. 6, 18, 44, 46, 51 AND 52).

FIRST USE 2-1-2008; IN COMMERCE 2-1-2008.

THE MARK CONSISTS OF STANDARD CHARACTERS WITHOUT CLAIM TO ANY PARTICULAR FONT, STYLE, SIZE, OR COLOR.

SER. NO. 77-489,566, FILED P.R. 6-3-2008; AM. S.R. 12-8-2008.

DARRYL SPRUILL, EXAMINING ATTORNEY

Int. Cl.: 41

Prior U.S. Cls.: 100, 101, and 107

United States Patent and Trademark Office

Reg. No. 3,578,274

Registered Feb. 17, 2009

**SERVICE MARK
SUPPLEMENTAL REGISTER**

**The George Washington
Foundation**

GEORGE WASHINGTON'S FREDERICKSBURG
FOUNDATION (VIRGINIA CORPORATION)
1201 WASHINGTON AVENUE
FREDERICKSBURG, VA 22401

FOR: MUSEUMS, IN CLASS 41 (U.S. CLS. 100, 101
AND 107).

FIRST USE 7-21-2008; IN COMMERCE 7-21-2008.

THE MARK CONSISTS OF STANDARD CHAR-
ACTERS WITHOUT CLAIM TO ANY PARTICULAR
FONT, STYLE, SIZE, OR COLOR.

NO CLAIM IS MADE TO THE EXCLUSIVE
RIGHT TO USE "FOUNDATION", APART FROM
THE MARK AS SHOWN.

SER. NO. 77-491,894, FILED P.R. 6-5-2008; AM. S.R.
9-18-2008.

COURTNEY MCCORMICK, EXAMINING ATTOR-
NEY

Int. Cl.: 42

Prior U.S. Cls.: 100 and 101

United States Patent and Trademark Office

Reg. No. 3,578,275

Registered Feb. 17, 2009

**SERVICE MARK
SUPPLEMENTAL REGISTER**

**NATIONAL CENTER ON SERVICE
OBLIGATION**

OPTIMAL SOLUTIONS GROUP, LLC (D.C. LIMITED LIABILITY COMPANY)
8100 PROFESSIONAL PLACE, SUITE 312
HYATTSVILLE, MD 20785

FOR: PROVIDING A WEBSITE FEATURING TEMPORARY USE OF NON-DOWNLOADABLE COMPUTER SOFTWARE ACCESSED VIA GLOBAL COMPUTER NETWORK USED TO TRACK REQUIRED WORK SERVICE FULFILLMENT OF RECIPIENTS OF FINANCIAL SCHOLARSHIP AWARDS, IN CLASS 42 (U.S. CLS. 100 AND 101).

FIRST USE 2-29-2008; IN COMMERCE 2-29-2008.

THE MARK CONSISTS OF STANDARD CHARACTERS WITHOUT CLAIM TO ANY PARTICULAR FONT, STYLE, SIZE, OR COLOR.

SER. NO. 77-508,167, FILED P.R. 6-25-2008; AM. S.R. 12-29-2008.

JEAN IM, EXAMINING ATTORNEY

Int. Cl.: 26

Prior U.S. Cls.: 37, 39, 40, 42, and 50

United States Patent and Trademark Office

Reg. No. 3,578,276

Registered Feb. 17, 2009

**TRADEMARK
SUPPLEMENTAL REGISTER**

DIMANNO DESIGNS

DIMANNO, STEFANY (UNITED STATES INDIVIDUAL)

SUITE 609

208 W. 23RD STREET

NEW YORK, NY 10011

FOR: PONYTAIL HOLDERS, IN CLASS 26 (U.S. CLS. 37, 39, 40, 42 AND 50).

FIRST USE 11-17-2008; IN COMMERCE 11-17-2008.

THE MARK CONSISTS OF STANDARD CHARACTERS WITHOUT CLAIM TO ANY PARTICULAR FONT, STYLE, SIZE, OR COLOR.

NO CLAIM IS MADE TO THE EXCLUSIVE RIGHT TO USE "DESIGNS", APART FROM THE MARK AS SHOWN.

SER. NO. 77-508,824, FILED P.R. 6-26-2008; AM. S.R. 12-8-2008.

MATTHEW MCDOWELL, EXAMINING ATTORNEY

Int. Cl.: 41

Prior U.S. Cls.: 100, 101, and 107

United States Patent and Trademark Office

Reg. No. 3,578,277

Registered Feb. 17, 2009

**SERVICE MARK
SUPPLEMENTAL REGISTER**

MEDTECH COLLEGE

MED TECH COLLEGE, LLC (INDIANA LIMITED
LIABILITY COMPANY)

6602 EAST 75TH STREET, SUITE 200

INDIANAPOLIS, IN 46250

FOR: EDUCATION SERVICES IN THE NATURE
OF COURSES AT THE UNIVERSITY LEVEL, IN
CLASS 41 (U.S. CLS. 100, 101 AND 107).

FIRST USE 3-0-2004; IN COMMERCE 4-0-2004.

THE MARK CONSISTS OF STANDARD CHAR-
ACTERS WITHOUT CLAIM TO ANY PARTICULAR
FONT, STYLE, SIZE, OR COLOR.

NO CLAIM IS MADE TO THE EXCLUSIVE
RIGHT TO USE "COLLEGE", APART FROM THE
MARK AS SHOWN.

SER. NO. 77-511,235, FILED P.R. 6-30-2008; AM. S.R.
1-8-2009.

MELVIN AXILBUND, EXAMINING ATTORNEY

Int. Cl.: 16

Prior U.S. Cls.: 2, 5, 22, 23, 29, 37, 38, and 50

United States Patent and Trademark Office

Reg. No. 3,578,278

Registered Feb. 17, 2009

**TRADEMARK
SUPPLEMENTAL REGISTER**

GRATITUDE BEADS 101

FRANK SMITH (UNITED STATES INDIVIDUAL)
NO. 163
4888 DAVIS BOULEVARD
NAPLES, FL 34104

FOR: ROSARIES, IN CLASS 16 (U.S. CLS. 2, 5, 22,
23, 29, 37, 38 AND 50).

FIRST USE 5-3-2008; IN COMMERCE 5-3-2008.

THE MARK CONSISTS OF STANDARD CHAR-
ACTERS WITHOUT CLAIM TO ANY PARTICULAR
FONT, STYLE, SIZE, OR COLOR.

NO CLAIM IS MADE TO THE EXCLUSIVE
RIGHT TO USE "GRATITUDE BEADS", APART
FROM THE MARK AS SHOWN.

SER. NO. 77-516,082, FILED P.R. 7-7-2008; AM. S.R.
11-24-2008.

ODESSA BIBBINS, EXAMINING ATTORNEY

Int. Cl.: 35

Prior U.S. Cls.: 100, 101, and 102

United States Patent and Trademark Office

Reg. No. 3,578,279

Registered Feb. 17, 2009

**SERVICE MARK
SUPPLEMENTAL REGISTER**

DEMOGRAPHER

BUCK CONSULTANTS, LLC (DELAWARE LIMITED LIABILITY COMPANY)
ONE PENNSYLVANIA PLAZA
NEW YORK, NY 10119

FOR: CONSULTING SERVICES IN THE FIELD OF HUMAN RESOURCES, NAMELY, WORK-FORCE ANALYSIS FOR USE IN CONNECTION WITH ADMINISTRATION AND MANAGEMENT OF CORPORATE AND GOVERNMENTAL EMPLOYEES, IN CLASS 35 (U.S. CLS. 100, 101 AND 102).

FIRST USE 11-3-2003; IN COMMERCE 11-3-2003.

THE MARK CONSISTS OF STANDARD CHARACTERS WITHOUT CLAIM TO ANY PARTICULAR FONT, STYLE, SIZE, OR COLOR.

SER. NO. 77-516,697, FILED 7-8-2008.

LOURDES AYALA, EXAMINING ATTORNEY

Int. Cl.: 2

Prior U.S. Cls.: 6, 11, and 16

United States Patent and Trademark Office

Reg. No. 3,578,280

Registered Feb. 17, 2009

**TRADEMARK
SUPPLEMENTAL REGISTER**

SINGLESTEP

BOYER INDUSTRIES CORPORATION (KANSAS
CORPORATION)
3741 GREENWAY CIRCLE
LAWRENCE, KS 66046

FOR: COATING COMPOSITIONS IN THE NAT-
URE OF SLIP-RESISTANT SEALANTS FOR CON-
CRETE SURFACES, IN CLASS 2 (U.S. CLS. 6, 11 AND
16).

FIRST USE 1-31-2008; IN COMMERCE 1-31-2008.

THE MARK CONSISTS OF STANDARD CHAR-
ACTERS WITHOUT CLAIM TO ANY PARTICULAR
FONT, STYLE, SIZE, OR COLOR.

SER. NO. 77-521,983, FILED P.R. 7-14-2008; AM. S.R.
1-9-2008.

SARA THOMAS, EXAMINING ATTORNEY

Int. Cl.: 42

Prior U.S. Cls.: 100 and 101

United States Patent and Trademark Office

Reg. No. 3,578,281

Registered Feb. 17, 2009

**SERVICE MARK
SUPPLEMENTAL REGISTER**

OnTheNetOFFICE

SACA TECHNOLOGIES, INC. (CALIFORNIA CORPORATION)
1260 N. HANCOCK ST. SUITE 102
ANAHEIM HILLS, CA 92807

FOR: APPLICATION SERVICE PROVIDER (ASP),
NAMELY, HOSTING COMPUTER SOFTWARE AP-
PLICATIONS OF OTHERS; CONSULTING IN THE
FIELD OF INFORMATION TECHNOLOGY , IN
CLASS 42 (U.S. CLS. 100 AND 101).

FIRST USE 11-3-2007; IN COMMERCE 11-3-2007.

THE MARK CONSISTS OF STANDARD CHAR-
ACTERS WITHOUT CLAIM TO ANY PARTICULAR
FONT, STYLE, SIZE, OR COLOR.

SER. NO. 77-522,083, FILED P.R. 7-15-2008; AM. S.R.
11-30-2008.

ROBERT C. CLARK JR., EXAMINING ATTORNEY

Int. Cl.: 44

Prior U.S. Cls.: 100 and 101

United States Patent and Trademark Office

Reg. No. 3,578,282

Registered Feb. 17, 2009

**SERVICE MARK
SUPPLEMENTAL REGISTER**

**TOTAL WELLNESS
PROFESSIONALS**

TOTAL WELLNESS PROFESSIONALS OF CALIFORNIA, LLC (CALIFORNIA LIMITED LIABILITY COMPANY)

712 E MCNAB ROAD

POMPANO BEACH, FL 33060

FOR: MASSAGE, IN CLASS 44 (U.S. CLS. 100 AND 101).

FIRST USE 6-1-2006; IN COMMERCE 6-1-2006.

THE MARK CONSISTS OF STANDARD CHARACTERS WITHOUT CLAIM TO ANY PARTICULAR FONT, STYLE, SIZE, OR COLOR.

NO CLAIM IS MADE TO THE EXCLUSIVE RIGHT TO USE "PROFESSIONALS", APART FROM THE MARK AS SHOWN.

SER. NO. 77-522,775, FILED P.R. 7-15-2008; AM. S.R. 10-30-2008.

ELIZABETH KAJUBI, EXAMINING ATTORNEY

Int. Cl.: 25

Prior U.S. Cls.: 22 and 39

United States Patent and Trademark Office

Reg. No. 3,578,283

Registered Feb. 17, 2009

**TRADEMARK
SUPPLEMENTAL REGISTER**

BRAVEHEART

DENIS, SEJDIEVSKI (UNITED STATES INDIVIDUAL)
96 PONDELLA RD
NORTH FORT MYERS, FL 33903

FOR: COATS; FOOTWEAR; GLOVES; HEADBANDS; HEADGEAR, NAMELY, HATS, CAPS; HOODED SWEAT SHIRTS; JACKETS; JOGGING SUITS; KNIT SHIRTS; PANTS; POLO SHIRTS; SHIRTS; SHORT-SLEEVED OR LONG-SLEEVED T-SHIRTS; SHORTS; SOCKS; SWEAT PANTS; SWEAT SHIRTS; SWEATERS; T-SHIRTS; TANK TOPS; UNDERWEAR; WEARABLE GARMENTS AND

CLOTHING, NAMELY, SHIRTS, IN CLASS 25 (U.S. CLS. 22 AND 39).

FIRST USE 11-4-2008; IN COMMERCE 11-4-2008.

THE MARK CONSISTS OF STANDARD CHARACTERS WITHOUT CLAIM TO ANY PARTICULAR FONT, STYLE, SIZE, OR COLOR.

SER. NO. 77-526,512, FILED P.R. 7-18-2008; AM. S.R. 1-8-2009.

SAIMA MAKHDOOM, EXAMINING ATTORNEY

Int. Cl.: 8

Prior U.S. Cls.: 23, 28, and 44

Reg. No. 3,578,284

United States Patent and Trademark Office

Registered Feb. 17, 2009

**TRADEMARK
SUPPLEMENTAL REGISTER**

THUMBSWITCH

GUARDAIR CORPORATION (MASSACHUSETTS
CORPORATION)
54 SECOND AVENUE
CHICOPEE, MA 01020

FOR: PNEUMATIC HAND-OPERATED TOOLS
FOR INDUSTRIAL AND CONSTRUCTION USE,
NAMELY, HAND-HELD SAFETY AIR GUNS USED
FOR CLEANING AND MAINTENANCE, IN CLASS 8
(U.S. CLS. 23, 28 AND 44).

FIRST USE 4-15-2008; IN COMMERCE 4-15-2008.

THE MARK CONSISTS OF STANDARD CHAR-
ACTERS WITHOUT CLAIM TO ANY PARTICULAR
FONT, STYLE, SIZE, OR COLOR.

SER. NO. 77-535,527, FILED P.R. 7-31-2008; AM. S.R.
12-1-2008.

APRIL ROACH, EXAMINING ATTORNEY

Int. Cl.: 45

Prior U.S. Cls.: 100 and 101

United States Patent and Trademark Office

Reg. No. 3,578,285

Registered Feb. 17, 2009

**SERVICE MARK
SUPPLEMENTAL REGISTER**

LOST PET U.S.A.

LOST PET CORPORATION (ILLINOIS COR-
PORATION)
1253 RICHMOND LANE
WILMETTE, IL 60091

FOR: ASSISTING IN LOCATING LOST PETS, IN
CLASS 45 (U.S. CLS. 100 AND 101).

FIRST USE 10-10-2008; IN COMMERCE 10-10-2008.

THE MARK CONSISTS OF STANDARD CHAR-
ACTERS WITHOUT CLAIM TO ANY PARTICULAR
FONT, STYLE, SIZE, OR COLOR.

SER. NO. 77-537,402, FILED P.R. 8-1-2008; AM. S.R.
12-15-2008.

KIMBERLY FRYE, EXAMINING ATTORNEY

Int. Cls.: 35, 41, and 42

Prior U.S. Cls.: 100, 101, 102, and 107

United States Patent and Trademark Office

Reg. No. 3,578,286

Registered Feb. 17, 2009

**SERVICE MARK
SUPPLEMENTAL REGISTER**

Papercheck

PAPER-CHECK.COM, LLC. (FLORIDA LIMITED LIABILITY COMPANY), DBA PAPERCHECK, 71 STEVENSON STREET SUITE 446 SAN FRANCISCO, CA 94105

FOR: PROJECT MANAGEMENT SERVICES FOR OTHERS IN THE FIELDS OF LANGUAGE TRANSLATION, CUSTOM WRITING, TEXT ADAPTATION, INTERPRETING AND PROOFREADING, IN CLASS 35 (U.S. CLS. 100, 101 AND 102).

FIRST USE 1-1-2005; IN COMMERCE 1-1-2005.

FOR: PUBLICATION AND EDITING OF PRINTED MATTER; WRITTEN TEXT EDITING, IN CLASS 41 (U.S. CLS. 100, 101 AND 107).

FIRST USE 1-1-2005; IN COMMERCE 1-1-2005.

FOR: PROVIDING A WEB SITE THAT GIVES COMPUTER USERS THE ABILITY TO UPLOAD AND SHARE USER-GENERATED VIDEOS, ESSAYS AND ARTICLES ON A WIDE VARIETY OF TOPICS AND SUBJECTS , IN CLASS 42 (U.S. CLS. 100 AND 101).

FIRST USE 1-1-2005; IN COMMERCE 1-1-2005.

THE MARK CONSISTS OF STANDARD CHARACTERS WITHOUT CLAIM TO ANY PARTICULAR FONT, STYLE, SIZE, OR COLOR.

SER. NO. 77-540,718, FILED 8-6-2008.

VERNA BETH RIRIE, EXAMINING ATTORNEY

Int. Cl.: 42

Prior U.S. Cls.: 100 and 101

United States Patent and Trademark Office

Reg. No. 3,578,287

Registered Feb. 17, 2009

**SERVICE MARK
SUPPLEMENTAL REGISTER**

US RADON MANAGEMENT

US RADON MANAGEMENT, INC. (CONNECTI-
CUT CORPORATION)
87 TAYLOR REED PLACE
STAMFORD, CT 06906

FOR: RADON DETECTION AND REDUCTION,
IN CLASS 42 (U.S. CLS. 100 AND 101).

FIRST USE 1-1-2006; IN COMMERCE 1-1-2006.

THE MARK CONSISTS OF STANDARD CHAR-
ACTERS WITHOUT CLAIM TO ANY PARTICULAR
FONT, STYLE, SIZE, OR COLOR.

OWNER OF U.S. REG. NO. 2,670,648.

NO CLAIM IS MADE TO THE EXCLUSIVE
RIGHT TO USE "RADON MANAGEMENT", APART
FROM THE MARK AS SHOWN.

SER. NO. 77-542,795, FILED P.R. 8-8-2008; AM. S.R.
12-5-2008.

SHAILA SETTLES, EXAMINING ATTORNEY

Int. Cl.: 42

Prior U.S. Cls.: 100 and 101

United States Patent and Trademark Office

Reg. No. 3,578,288

Registered Feb. 17, 2009

**SERVICE MARK
SUPPLEMENTAL REGISTER**

OralDNA

ORALDNA LABS, INC. (DELAWARE CORPORATION)
214 OVERLOOK CIRCLE, SUITE 120
BRENTWOOD, TN 37027

FOR: DIAGNOSTIC LABORATORY SERVICES FOR DENTAL PROFESSIONALS AND OTHER HEALTHCARE PROVIDERS, NAMELY, MOLECULAR TESTING FOR BACTERIA AND GENETIC TESTING FOR GENETIC POLYMORPHISMS, IN CLASS 42 (U.S. CLS. 100 AND 101).

FIRST USE 3-3-2008; IN COMMERCE 8-25-2008.

THE MARK CONSISTS OF STANDARD CHARACTERS WITHOUT CLAIM TO ANY PARTICULAR FONT, STYLE, SIZE, OR COLOR.

SER. NO. 77-557,645, FILED P.R. 8-28-2008; AM. S.R. 1-7-2009.

VERNA BETH RIRIE, EXAMINING ATTORNEY

Int. Cl.: 37

Prior U.S. Cls.: 100, 103, and 106

United States Patent and Trademark Office

Reg. No. 3,578,289

Registered Feb. 17, 2009

**SERVICE MARK
SUPPLEMENTAL REGISTER**

New England Roof Cleaners

CARPENTERS LLC (MASSACHUSETTS LIMITED
LIABILITY COMPANY), DBA NEW ENG-
LAND ROOF CLEANERS,

25 VERNON ST

NEW BEDFORD, MA 02745

FOR: ROOFING SERVICES, IN CLASS 37 (U.S.
CLS. 100, 103 AND 106).

FIRST USE 6-1-2004; IN COMMERCE 0-0-2005.

THE MARK CONSISTS OF STANDARD CHAR-
ACTERS WITHOUT CLAIM TO ANY PARTICULAR
FONT, STYLE, SIZE, OR COLOR.

NO CLAIM IS MADE TO THE EXCLUSIVE
RIGHT TO USE "ROOF CLEANERS", APART FROM
THE MARK AS SHOWN.

SER. NO. 77-560,224, FILED 9-2-2008.

MARK RADEMACHER, EXAMINING ATTORNEY

Int. Cl.: 44

Prior U.S. Cls.: 100 and 101

United States Patent and Trademark Office

Reg. No. 3,578,290

Registered Feb. 17, 2009

**SERVICE MARK
SUPPLEMENTAL REGISTER**

**Cheyenne Oncology &
Hematology Associates**

MEMORIAL HOSPITAL OF LARAMIE COUNTY
(WYOMING MUNICIPAL CORPORATION)
214 EAST 23RD STREET
CHEYENNE, WY 82001

FOR: MEDICAL CLINICS; MEDICAL SERVICES;
MEDICAL SERVICES, NAMELY, ONCOLOGY;
MEDICAL TESTING; PHYSICIAN SERVICES; TIS-
SUE TYPING SERVICES, IN CLASS 44 (U.S. CLS. 100
AND 101).

FIRST USE 8-1-2007; IN COMMERCE 8-1-2007.

THE MARK CONSISTS OF STANDARD CHAR-
ACTERS WITHOUT CLAIM TO ANY PARTICULAR
FONT, STYLE, SIZE, OR COLOR.

NO CLAIM IS MADE TO THE EXCLUSIVE
RIGHT TO USE "ONCOLOGY & HEMATOLOGY
ASSOCIATES", APART FROM THE MARK AS
SHOWN.

SER. NO. 77-569,653, FILED P.R. 9-15-2008; AM. S.R.
12-29-2008.

DAVID TAYLOR, EXAMINING ATTORNEY

Int. Cl.: 9

Prior U.S. Cls.: 21, 23, 26, 36, and 38

United States Patent and Trademark Office

Reg. No. 3,578,291

Registered Feb. 17, 2009

**TRADEMARK
SUPPLEMENTAL REGISTER**

iSpreadsheet

SAVY SODA PTY LTD (AUSTRALIA LIMITED
LIABILITY COMPANY)
1 / 21 LEGON RD
OAKLEIGH SOUTH, AUSTRALIA 3167

FOR: COMPUTER SOFTWARE FOR COMMUNICATING WITH USERS OF HAND-HELD COMPUTERS; COMPUTER SOFTWARE FOR PROVIDING AN ON-LINE DATABASE IN THE FIELD OF TRANSACTION PROCESSING TO UPLOAD TRANSACTIONAL DATA, PROVIDE STATISTICAL ANALYSIS, AND PRODUCE NOTIFICATIONS AND REPORTS; COMPUTER SOFTWARE FOR THE COLLECTION, EDITING, ORGANIZING, MODIFYING, BOOK MARKING, TRANSMISSION, STORAGE AND SHARING OF DATA AND INFORMATION; COMPUTER SOFTWARE FOR WIRELESS CON-

TENT DELIVERY; COMPUTER SOFTWARE FOR SPREADSHEET; COMPUTER SOFTWARE FOR SPREADSHEET THAT MAY BE DOWNLOADED FROM A GLOBAL COMPUTER NETWORK, IN CLASS 9 (U.S. CLS. 21, 23, 26, 36 AND 38).

FIRST USE 9-24-2008; IN COMMERCE 9-24-2008.

THE MARK CONSISTS OF STANDARD CHARACTERS WITHOUT CLAIM TO ANY PARTICULAR FONT, STYLE, SIZE, OR COLOR.

SER. NO. 77-570,569, FILED P.R. 9-16-2008; AM. S.R. 12-24-2008.

RICHARD A. STRASER, EXAMINING ATTORNEY

Int. Cls.: 16, 25, and 41

**Prior U.S. Cls.: 2, 5, 22, 23, 29, 37, 38, 39, 50, 100, 101,
and 107**

Reg. No. 3,578,292

United States Patent and Trademark Office

Registered Feb. 17, 2009

**TRADEMARK
SERVICE MARK
SUPPLEMENTAL REGISTER**

MILE HIGH MUSIC FESTIVAL

AEG LIVE-ROCKY MOUNTAINS, LLC (DELA-
WARE LIMITED LIABILITY COMPANY)
1100 SOUTH FLOWER
LOS ANGELES, CA 90015

FOR: POSTERS; EVENT PROGRAMS, IN CLASS
16 (U.S. CLS. 2, 5, 22, 23, 29, 37, 38 AND 50).

FIRST USE 7-19-2008; IN COMMERCE 7-19-2008.

FOR: CLOTHING, NAMELY, SWEATSHIRTS
AND T-SHIRTS, IN CLASS 25 (U.S. CLS. 22 AND 39).

FIRST USE 7-19-2008; IN COMMERCE 7-19-2008.

FOR: ENTERTAINMENT SERVICES, NAMELY,
ORGANIZING AND PRODUCING MUSICAL FES-
TIVALS, IN CLASS 41 (U.S. CLS. 100, 101 AND 107).

FIRST USE 7-19-2008; IN COMMERCE 7-19-2008.

THE MARK CONSISTS OF STANDARD CHAR-
ACTERS WITHOUT CLAIM TO ANY PARTICULAR
FONT, STYLE, SIZE, OR COLOR.

NO CLAIM IS MADE TO THE EXCLUSIVE
RIGHT TO USE "MUSIC FESTIVAL", APART FROM
THE MARK AS SHOWN.

SER. NO. 77-572,717, FILED P.R. 9-17-2008; AM. S.R.
1-9-2009.

MICHAEL LITZAU, EXAMINING ATTORNEY

Int. Cl.: 43

Prior U.S. Cls.: 100 and 101

United States Patent and Trademark Office

Reg. No. 3,578,293

Registered Feb. 17, 2009

**SERVICE MARK
SUPPLEMENTAL REGISTER**

**South Florida's Most Highly
Recommended Caterer**

EXECUTIVE ONE CATERING, INC. (FLORIDA
CORPORATION)
10814 CANYON BAY LANE
BOYNTON BEACH, FL 33473

FOR: CATERING, IN CLASS 43 (U.S. CLS. 100
AND 101).

FIRST USE 2-1-2007; IN COMMERCE 2-1-2007.

THE MARK CONSISTS OF STANDARD CHAR-
ACTERS WITHOUT CLAIM TO ANY PARTICULAR
FONT, STYLE, SIZE, OR COLOR.

SER. NO. 77-580,871, FILED P.R. 9-29-2008; AM. S.R.
12-30-2008.

BARBARA RUTLAND, EXAMINING ATTORNEY

Int. Cl.: 18

Prior U.S. Cls.: 1, 2, 3, 22, and 41

United States Patent and Trademark Office

Reg. No. 3,578,294

Registered Feb. 17, 2009

**TRADEMARK
SUPPLEMENTAL REGISTER**

ARMPOCKET

MORGAN, MARK (UNITED STATES INDIVIDUAL)
3624 ALCANTARA AVE
DORAL, FL 33178 AND
NIELSEN, JYTTE (UNITED STATES INDIVIDUAL)
3624 ALCANTARA AVE
DORAL, FL 33178

FOR: MULTI-PURPOSE PURSES; PURSES; PURSES AND WALLETS; SMALL PURSES; WRIST MOUNTED PURSES, IN CLASS 18 (U.S. CLS. 1, 2, 3, 22 AND 41).

FIRST USE 1-1-2006; IN COMMERCE 1-1-2006.

THE MARK CONSISTS OF STANDARD CHARACTERS WITHOUT CLAIM TO ANY PARTICULAR FONT, STYLE, SIZE, OR COLOR.

SER. NO. 77-588,114, FILED 10-8-2008.

SANJEEV VOHRA, EXAMINING ATTORNEY

Int. Cl.: 25

Prior U.S. Cls.: 22 and 39

United States Patent and Trademark Office

Reg. No. 3,578,295

Registered Feb. 17, 2009

**TRADEMARK
SUPPLEMENTAL REGISTER**

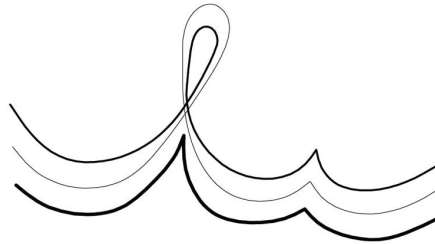

SWAT.FAME, INC. (CALIFORNIA CORPORATION)
16425 EAST GALE AVENUE
CITY OF INDUSTRY, CA 91745

FIRST USE 5-0-2006; IN COMMERCE 5-0-2006.

SER. NO. 77-975,738, FILED 12-11-2006.

FOR: JEANS, PANTS, CAPRIS, BOTTOMS,
SHORTS, BERMUDA SHORTS, SKIRTS, IN CLASS
25 (U.S. CLS. 22 AND 39).

KATHERINE CHANG, EXAMINING ATTORNEY

Int. Cls.: 3, 9, 16, 18, 25, and 34

Prior U.S. Cls.: 1, 2, 3, 4, 5, 6, 8, 9, 17, 21, 22, 23, 26, 29, 36, 37, 38, 39, 41, 50, 51, and 52

Reg. No. 3,578,296

United States Patent and Trademark Office

Registered Feb. 17, 2009

**TRADEMARK
SUPPLEMENTAL REGISTER**

A. LANGE & SOHNE

LANGE UHREN GMBH (FED REP GERMANY
LIMITED LIABILITY COMPANY)
ALTENBERGER STRASSE 15
01768 GLASHUTTE, FED REP GERMANY

FOR: SOAPS; PERFUMERY; ESSENTIAL OILS;
HAIR LOTIONS; COSMETICS, IN CLASS 3 (U.S. CLS.
1, 4, 6, 50, 51 AND 52).

FOR: EYEGLASSES; SUNGLASSES; EYEGLASS
FRAMES AND PARTS AND FITTINGS THERE-
FORE; EYEGLASS CASES AND HOLDERS; ELEC-
TRONIC AGENDAS; AND CALCULATORS, IN
CLASS 9 (U.S. CLS. 21, 23, 26, 36 AND 38).

FOR: WRITING INSTRUMENTS, FOUNTAIN
PENS, BALL-POINT PENS, PENCILS, FELT-TIP
PENS, ROLLER BALL PENS, AND PARTS AND
FITTINGS FOR THE AFOREMENTIONED GOODS,
DOCUMENT MARKERS, POUCHES FOR WRITING
INSTRUMENTS; GIFT CASES FOR WRITING IN-
STRUMENTS, PEN INK CARTRIDGES AND PEN
INK REFILLS, NOTE PAPER, DIARIES, ORGANI-
ZERS, PAPERWEIGHTS, PEN AND PENCIL HOLD-
ERS, STATIONERY; DESK SETS, AND STANDS
FOR WRITING INSTRUMENTS, CHECKBOOK
HOLDERS, AGENDAS AND DESKPADS, IN CLASS
16 (U.S. CLS. 2, 5, 22, 23, 29, 37, 38 AND 50).

FOR: GOODS MADE OF LEATHER AND/OR
IMITATION OF LEATHER, NAMELY, WALLETS,
NAME CARD CASES PASSPORT CASES, PURSES,
KEY CASES; HANDBAGS; LEATHER MERCHAN-
DISE BAGS FOR PACKAGING; BRIEFCASES, VA-
NITY CASES SOLD EMPTY; SUITCASES;
BACKPACKS; TRAVELING BAGS; TRAVELING
TRUNKS; SCHOOL BAGS; ATTACHE-CASES,

STRAPS FOR HANDBAGS; SHOULDER STRAPS
FOR TRAVELING BAGS; WALKING STICKS AND
UMBRELLAS; LEATHER KEY FOBS, IN CLASS 18
(U.S. CLS. 1, 2, 3, 22 AND 41).

FOR: CLOTHING, NAMELY, TROUSERS, T-
SHIRTS, TIES, SCARVES, BELTS, SHOES AND
HATS, IN CLASS 25 (U.S. CLS. 22 AND 39).

FOR: CIGARETTE LIGHTERS NOT OF PRE-
CIOUS METAL, ASHTRAYS NOT OF PRECIOUS
METAL, CIGAR CUTTERS, CIGARETTE AND CI-
GAR HOLDERS NOT OF PRECIOUS METAL, CI-
GARETTE FILTERS, CIGARETTE PAPER,
HUMIDORS, MATCHBOXES NOT OF PRECIOUS
METAL, PIPE CLEANERS, PIPE RACKS, TOBACCO
POUCHES, IN CLASS 34 (U.S. CLS. 2, 8, 9 AND 17).

THE MARK CONSISTS OF STANDARD CHAR-
ACTERS WITHOUT CLAIM TO ANY PARTICULAR
FONT, STYLE, SIZE, OR COLOR.

PRIORITY CLAIMED UNDER SEC. 44(D) ON FED
REP GERMANY APPLICATION NO. 30543773.9,
FILED 7-21-2005, REG. NO. 30543773.9, DATED 7-21-
2005, EXPIRES 7-21-2015.

OWNER OF U.S. REG. NO. 2,430,848.

THE FOREIGN WORDING IN THE MARK
TRANSLATES INTO ENGLISH AS SONS.

SER. NO. 78-677,486, FILED P.R. 7-25-2005; AM. S.R.
12-31-2008.

CAROLINE WOOD, EXAMINING ATTORNEY

Int. Cls.: 7 and 9

Prior U.S. Cls.: 13, 19, 21, 23, 26, 31, 34, 35, 36, and 38

United States Patent and Trademark Office

Reg. No. 3,578,297

Registered Feb. 17, 2009

**TRADEMARK
SUPPLEMENTAL REGISTER**

LI-POWER

METABOWERKE GMBH (FED REP GERMANY
CORPORATION)
METABO-ALLEE 1
NÜRTINGEN, FED REP GERMANY 72622

FOR: POWER TOOLS, NAMELY, SCREWDRI-
VERS, DRILLS, DRILL HAMMERS, SAWS, JIG
SAWS, ANGLE GRINDERS, SANDERS, ROUTERS,
HEDGE TRIMMERS, IN CLASS 7 (U.S. CLS. 13, 19,
21, 23, 31, 34 AND 35).

FIRST USE 1-0-2006; IN COMMERCE 1-0-2006.

FOR: BATTERY PACKS FOR ELECTRIC HAND
TOOLS AND CHARGING DEVICES FOR THOSE
BATTERIES, IN CLASS 9 (U.S. CLS. 21, 23, 26, 36 AND
38).

FIRST USE 1-0-2006; IN COMMERCE 1-0-2006.

THE MARK CONSISTS OF STANDARD CHAR-
ACTERS WITHOUT CLAIM TO ANY PARTICULAR
FONT, STYLE, SIZE, OR COLOR.

PRIORITY CLAIMED UNDER SEC. 44(D) ON
ERPN CMNTY TM OFC APPLICATION NO. 72622,
FILED 2-2-2005.

SER. NO. 78-677,502, FILED P.R. 7-25-2005; AM. S.R.
12-8-2008.

DORITT L. CARROLL, EXAMINING ATTORNEY

Int. Cl.: 25

Prior U.S. Cls.: 22 and 39

United States Patent and Trademark Office

Reg. No. 3,578,298

Registered Feb. 17, 2009

**TRADEMARK
SUPPLEMENTAL REGISTER**

**THE ORIGINAL THE
REVOLUTION THE REAL**

NBA PROPERTIES, INC. (NEW YORK CORPORATION)
OLYMPIC TOWER-645 FIFTH AVENUE
NEW YORK, NY 10022

FOR: CLOTHING, NAMELY, HOSIERY, FOOTWEAR, BASKETBALL SHOES, BASKETBALL SNEAKERS, T-SHIRTS, SHIRTS, POLO SHIRTS, SWEATSHIRTS, SWEATPANTS, PANTS, TANK TOPS, JERSEYS, SHORTS, PAJAMAS, SPORT SHIRTS, RUGBY SHIRTS, SWEATERS, BELTS, TIES, NIGHTSHIRTS, HATS, CAPS, VISORS, WARM-UP SUITS, WARM-UP PANTS, WARM-UP TOPS/SHOOTING SHIRTS, JACKETS, WIND RESISTANT JACKETS, PARKAS, COATS, BABY BIBS NOT OF PAPER, HEAD BANDS, WRIST BANDS, APRONS, UNDERGARMENTS, BOXER SHORTS, SLACKS, EAR MUFFS, GLOVES, MITTENS, SCARVES, WOVEN AND KNIT SHIRTS, JERSEY DRESSES, DRESSES, CHEERLEADING DRESSES AND UNIFORMS,

SWIM WEAR, BATHING SUITS, SWIMSUITS, BIKINIS, TANKINIS, SWIM TRUNKS, BATHING TRUNKS, BOARD SHORTS, WET SUITS, BEACH COVER-UPS, BATHING SUIT COVER-UPS, BATHING SUIT WRAPS, SANDALS, BEACH SANDALS, BEACH HATS, SUN VISORS, SWIM CAPS, BATHING CAPS, NOVELTY HEADWEAR WITH ATTACHED WIGS, IN CLASS 25 (U.S. CLS. 22 AND 39).

FIRST USE 5-31-2005; IN COMMERCE 5-31-2005.

THE MARK CONSISTS OF STANDARD CHARACTERS WITHOUT CLAIM TO ANY PARTICULAR FONT, STYLE, SIZE, OR COLOR.

SER. NO. 78-794,943, FILED P.R. 1-19-2006; AM. S.R. 3-12-2007.

MARY ROSSMAN, EXAMINING ATTORNEY

Int. Cl.: 24

Prior U.S. Cls.: 42 and 50

United States Patent and Trademark Office

Reg. No. 3,578,299

Registered Feb. 17, 2009

TRADEMARK
SUPPLEMENTAL REGISTER



BOISE STATE UNIVERSITY (IDAHO STATE
AGENCY)
C/O TLG - 2215 W. STATE STREET
BOISE, ID 83702

FOR: MULTIPURPOSE TEXTILE TOWELS FOR
USE AT SPORTING EVENTS, IN CLASS 24 (U.S. CLS.
42 AND 50).

FIRST USE 7-0-2006; IN COMMERCE 7-0-2006.

NO CLAIM IS MADE TO THE EXCLUSIVE
RIGHT TO USE "BOISE'S WORLD FAMOUS BLUE"
AND "TOWEL", APART FROM THE MARK AS
SHOWN.

THE COLOR(S) BLUE AND WHITE IS/ARE
CLAIMED AS A FEATURE OF THE MARK.

THE MARK CONSISTS OF THE WORDS "BOISE'S
WORLD FAMOUS BLUE TURF TOWEL
WWW.BLUETURFTOWEL.COM" SHOWN IN BLUE
AND WHITE ON A BLUE AND WHITE FOOTBALL
FIELD.

SER. NO. 78-848,672, FILED P.R. 3-29-2006; AM. S.R.
12-12-2008.

DAVID YONTEF, EXAMINING ATTORNEY

Int. Cl.: 9

Prior U.S. Cls.: 21, 23, 26, 36, and 38

United States Patent and Trademark Office

Reg. No. 3,578,300

Registered Feb. 17, 2009

**TRADEMARK
SUPPLEMENTAL REGISTER**

SMART CONTROL PANEL

THE CHAMBERLAIN GROUP, INC. (CONNECTI-
CUT CORPORATION)

845 LARCH AVENUE

ELMHURST, IL 601261196

FOR: KEYPADS; ELECTRONIC SECURITY DE-
VICES, NAMELY, ELECTRONIC CONTROLS FOR
GRANTING ACCESS AND EGRESS THROUGH
DOORS, IN CLASS 9 (U.S. CLS. 21, 23, 26, 36 AND 38).

FIRST USE 2-1-2007; IN COMMERCE 2-1-2007.

THE MARK CONSISTS OF STANDARD CHAR-
ACTERS WITHOUT CLAIM TO ANY PARTICULAR
FONT, STYLE, SIZE, OR COLOR.

OWNER OF U.S. REG. NO. 2,374,138.

NO CLAIM IS MADE TO THE EXCLUSIVE
RIGHT TO USE "CONTROL PANEL", APART FROM
THE MARK AS SHOWN.

SER. NO. 78-933,638, FILED P.R. 7-20-2006; AM. S.R.
12-8-2008.

RONALD AIKENS, EXAMINING ATTORNEY

Int. Cls.: 9 and 16

Prior U.S. Cls.: 2, 5, 21, 22, 23, 26, 29, 36, 37, 38, and 50

United States Patent and Trademark Office

Reg. No. 3,578,301

Registered Feb. 17, 2009

**TRADEMARK
SUPPLEMENTAL REGISTER**

POST FALL INDEX

DR. DEANNA L. GRAY-MICELI (UNITED STATES INDIVIDUAL)
P.O. BOX 2032
HADDONFIELD, NJ 08033

FOR: COMPUTER SOFTWARE FOR USE IN RESEARCH IN ASSESSING HUMAN FALLS FOR USE IN THE HEALTH CARE INDUSTRY, IN CLASS 9 (U.S. CLS. 21, 23, 26, 36 AND 38).

FIRST USE 6-1-2005; IN COMMERCE 6-1-2005.

FOR: PRINTED GUIDES FOR ASSESSING HUMAN FALLS FOR USE IN THE HEALTH CARE INDUSTRY, IN CLASS 16 (U.S. CLS. 2, 5, 22, 23, 29, 37, 38 AND 50).

FIRST USE 6-1-2005; IN COMMERCE 6-1-2005.

THE MARK CONSISTS OF STANDARD CHARACTERS WITHOUT CLAIM TO ANY PARTICULAR FONT, STYLE, SIZE, OR COLOR.

NO CLAIM IS MADE TO THE EXCLUSIVE RIGHT TO USE "INDEX", APART FROM THE MARK AS SHOWN.

SER. NO. 78-940,245, FILED P.R. 7-28-2006; AM. S.R. 7-3-2008.

LINDSEY RUBIN, EXAMINING ATTORNEY