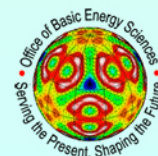


---

# Basic Research Needs for Electrical Energy Storage

---

Report of the Basic Energy  
Sciences Workshop on  
Electrical Energy Storage  
April 2-4, 2007



**On the cover:**

The cover depicts the structure of a monolayer of water molecules on the (110) surface of RuO<sub>2</sub>. This dense water monolayer structure is one of several interfacial water/RuO<sub>2</sub> phases that occurs as a function of chemical potential. The physical and chemical phenomena that occur at such interfaces are important for gaining a fundamental understanding of what occurs at electrodes in electrochemical capacitors and, ultimately, the improvement of their performance. The structure in the figure was obtained from in situ X-ray studies\* along with density functional calculations† to help define the hydrogen positions.

The graphic shows the water oxygen atoms in yellow, hydrogen in green, and the RuO<sub>2</sub> surface in light gray.

---

\*Y. S. Chu, T. E. Lister, W. G. Cullen, H. You, and Z. Nagy, "Commensurate water monolayer at the RuO<sub>2</sub>(110)/water interface," *Physical Review Letters* **86**, 3364 (2001).

†P. Zapol and L. A. Curtiss, unpublished.

# BASIC RESEARCH NEEDS FOR ELECTRICAL ENERGY STORAGE

## Report of the Basic Energy Sciences Workshop for Electrical Energy Storage

**Chair:** John B. Goodenough, University of Texas, Austin  
**Co-chairs:** Héctor D. Abruña, Cornell University  
Michelle V. Buchanan, Oak Ridge National Laboratory

**Panel Leads:** *Chemical Storage Science*  
Steven Visco, Lawrence Berkeley National Laboratory  
M. Stanley Whittingham, Binghamton University

*Capacitive Storage Science*  
Bruce Dunn, University of California, Los Angeles  
Yury Gogotsi, Drexel University

*Cross-Cutting Science*  
Andrew Gewirth, University of Illinois  
Daniel Nocera, Massachusetts Institute of Technology

**Basic Energy Sciences Leads:**  
Richard (Dick) Kelley, Office of Science, Department of Energy  
John S. Vetrano, Office of Science, Department of Energy

**Administrative:** Christie L. Ashton, Basic Energy Sciences, Department of Energy  
Karen Chitwood, Oak Ridge Institute for Science and Education  
Sophia Kitts, Oak Ridge Institute for Science and Education

**Communications/Web/Publications:**  
Brenda Campbell, Oak Ridge National Laboratory  
Deborah Counce, Oak Ridge National Laboratory  
Jeanne Dole, Oak Ridge National Laboratory  
Greg Gruzalski, Oak Ridge National Laboratory  
Sandi Lyttle, Oak Ridge National Laboratory  
Virgie Jo Sapp, Oak Ridge National Laboratory  
Brenda Smith, Oak Ridge National Laboratory  
Debbie Stevens, Oak Ridge National Laboratory

*This report is available on the web at [http://www.sc.doe.gov/bes/reports/files/EES\\_rpt.pdf](http://www.sc.doe.gov/bes/reports/files/EES_rpt.pdf)*

Office of Basic Energy Sciences  
Department of Energy  
July 2007





# CONTENTS

	<b>Page</b>
Figures.....	v
Abbreviations, Acronyms, and Initialisms.....	vii
Executive Summary of the DOE Basic Energy Sciences Workshop .....	ix
Introduction.....	1
Basic Research Needs for Electrical Energy Storage .....	7
Chemical Energy Storage .....	9
Capacitive Energy Storage.....	16
Priority Research Directions.....	23
Novel Designs and Strategies for Chemical Energy Storage.....	25
Solid-Electrolyte Interfaces and Interphases in Chemical Energy Storage .....	31
Capacitive Energy Storage Materials by Design .....	37
Electrolyte Interactions in Capacitive Energy Storage .....	41
Multifunctional Materials for Pseudocapacitors and Hybrid Devices .....	47
Rational Materials Design Through Theory and Modeling.....	53
Cross-cutting Science for Electrical Energy Storage.....	65
Advances in Characterization .....	67
Nanostructured Materials.....	69
Innovation in Electrolytes.....	72
Theory, Modeling, and Simulation.....	74
Conclusion .....	77
Appendix A: Technology and Applied R&D Needs for Electrical Energy Storage.....	A-1
Appendix B: Probing Electrical Energy Storage Chemistry and Physics Over Broad Time and Length Scales .....	B-1
Appendix C: Workshop on Basic Research Needs Electrical Energy Storage.....	C-1



## FIGURES

Figure	Page
1. A battery system involves interactions among various states of matter.....	12
2. The large concentrations of dislocations in commercial LiCoO <sub>2</sub> , as revealed by transmission electron microscopy raise fundamental questions with direct bearing on battery function.....	12
3. Power density as a function of energy density for various energy storage devices .....	18
4. Schematic illustration of the cation arrangement in a layered, composite xLi <sub>2</sub> MnO <sub>3</sub> •(1-x)LiMn <sub>0.5</sub> Ni <sub>0.5</sub> O <sub>2</sub> electrode structure in which LiMn <sub>6</sub> units, characteristic of the Li <sub>2</sub> MnO <sub>3</sub> component (and disordered LiMn <sub>5</sub> Ni units), are embedded as stabilizers in the residual LiMn <sub>0.5</sub> Ni <sub>0.5</sub> O <sub>2</sub> component.....	26
5. Three-dimensional nanostructure demonstrating the intergrowth of the anode, cathode, and electrolyte .....	28
6. Operation principle, interphase formation, intra-electrode and intra-cell interfaces in lithium-ion cells .....	31
7. A proposed model of the electrode near a complex SEI .....	32
8. SEI stability and growth during continuous lithium uptake and removal for different anodes: graphite, lithium storage metals, and metallic lithium.....	33
9. LiODFOB: a hybrid electrolyte salt material formed from LiBF <sub>4</sub> and LiBOB .....	34
10. Schematic of an activated carbon-based EDLC illustrating the heterogeneity of particle size, pore size, and pore structure of the electrode that ultimately leads to performance limitations .....	37
11. Cagey structures .....	39
12. Ions in the ionic liquids (a) <i>N</i> -methyl- <i>N</i> -propylpyrrolidinium bis(trifluoromethanesulfonyl)-imide (PYR <sub>13</sub> TFSI) and (b) 1-ethyl-3-methylimidazolium tetrafluoroborate (EMIBF <sub>4</sub> ) .....	43
13. Schematic of how ion solvation may change in pores of different sizes during electric double layer charging (electrode material, black; solvent, blue; cation, orange, anion, red) .....	43

14. Calculated and scaled Raman spectra for (a) $\text{Et}_4\text{N}^+$ $D_{2d}$ (solid line) and $S_4$ (dotted line), (b) TFSI transoid $C_2$ (solid line) and cisoid $C_1$ (dotted line) compared with (c) experimental Raman spectrum of $\text{Et}_4\text{NTFSI}$ recorded at 296 K .....	44
15. Transmission electron micrograph of nanocomposite of $\text{RuO}_2$ and the conducting polymer, PAPPA.....	51
16. (Left) Sketch of a single electrode layer of a carbon-based EC illustrating the hierarchical pore structure with macropores between carbon agglomerates and micro-to-nanopores inside agglomerates.....	55
17. Breakdown of circuit models in nonlinear charging dynamics .....	59
18. (Left) Atomic configuration of propylene carbonate in a carbon slit obtained by reverse Monte Carlo simulations from X-ray diffraction measurements on Maxsorb92-16 porous carbon with a surface area of $2440 \text{ m}^2/\text{g}$ and a pore size of 1 nm .....	60
19. Molecular-dynamics simulations of an EC consisting of a periodic carbon nanotube forest in a common organic electrolyte (1 M TEA + $\text{BF}_4^-$ in propylene carbonate) .....	61
B.1. Normalized Mn(a), Ni(b), and Co(c) K-edges XANES of $\text{Li}_{1-x}\text{Co}_{1/3}\text{Ni}_{1/3}\text{Mn}_{1/3}\text{O}_2$ as a function of the amount of lithium in the lattice.....	B-6
B.2. Imaging lithium in a block copolymer electrolyte .....	B-7
B.3. A multifunctional imaging nanoprobe.....	B-8

## ABBREVIATIONS, ACRONYMS, AND INITIALISMS

ASAXS	“anomalous” small-angle X-ray scattering
CDC	carbide-derived carbon
DFT	density functional theory
DL	double layer
EC	electrochemical capacitor
EDLC	electrical (or electrochemical) double layer capacitor
EES	electrical energy storage
ESR	equivalent series resistance
EXAFS	extended X-ray absorption fine structure
HRTEM	high-resolution transmission electron microscopy
IL	ionic liquid
Li-ion	lithium-ion
MD	molecular dynamics
MOF	metal-organic-frameworks
NMR	nuclear magnetic resonance
NSOM	near-field scanning optical microscopy
PDF	pair distribution function (analysis)
PRD	priority research direction
QABOB	quaternary ammonium bis(oxalato)borate
RSOXS	resonant soft X-ray scattering
SAXS	small-angle X-ray scattering

SEI	solid electrolyte interphase
ShARE	Shared Research Equipment User Facility
SNS	Spallation Neutron Source
SPM	spanning probe microscopy
SSA	specific surface area
TFSI	trifluoromethanesulfonylimide
XANES	X-ray absorption near edge structure
XAS	X-ray absorption spectroscopy
XPS	X-ray photoelectron (or photoemission) spectroscopy

# **EXECUTIVE SUMMARY OF THE DOE BASIC ENERGY SCIENCES WORKSHOP BASIC RESEARCH NEEDS FOR ELECTRICAL ENERGY STORAGE**

The projected doubling of world energy consumption within the next 50 years, coupled with the growing demand for low- or even zero-emission sources of energy, has brought increasing awareness of the need for efficient, clean, and renewable energy sources. Energy based on electricity that can be generated from renewable sources, such as solar or wind, offers enormous potential for meeting future energy demands. However, the use of electricity generated from these intermittent, renewable sources requires efficient electrical energy storage (EES). For commercial and residential grid applications, electricity must be reliably available 24 hours a day; even second-to-second fluctuations cause major disruptions with costs estimated to be tens of billions of dollars annually. Thus, for large-scale solar- or wind-based electrical generation to be practical, the development of new EES systems will be critical to meeting continuous energy demands and effectively leveling the cyclic nature of these energy sources. In addition, greatly improved EES systems are needed to progress from today's hybrid electric vehicles to plug-in hybrids or all-electric vehicles. Improvements in EES reliability and safety are also needed to prevent premature, and sometimes catastrophic, device failure. Chemical energy storage devices (batteries) and electrochemical capacitors (ECs) are among the leading EES technologies today. Both are based on electrochemistry, and the fundamental difference between them is that batteries store energy in chemical reactants capable of generating charge, whereas electrochemical capacitors store energy directly as charge.

The performance of current EES technologies falls well short of requirements for using electrical energy efficiently in transportation, commercial, and residential applications. For example, EES devices with substantially higher energy and power densities and faster recharge times are needed if all-electric/plug-in hybrid vehicles are to be deployed broadly as replacements for gasoline-powered vehicles. Although EES devices have been available for many decades, there are many fundamental gaps in understanding the atomic- and molecular-level processes that govern their operation, performance limitations, and failure. Fundamental research is critically needed to uncover the underlying principles that govern these complex and interrelated processes. With a full understanding of these processes, new concepts can be formulated for addressing present EES technology gaps and meeting future energy storage requirements. The Office of Basic Energy Sciences (BES) within the Department of Energy (DOE) Office of Science convened a workshop April 2–4, 2007, charged with identifying basic research needs and opportunities underlying batteries, capacitors, and related EES technologies, with a focus on new or emerging science challenges with potential for significant long-term impact on the efficient storage and release of electrical energy.

Prior to the workshop, BES worked closely with the DOE Office of Energy Efficiency and Renewable Energy and the DOE Office of Electricity Delivery and Energy Reliability to clearly define future requirements for EES from the perspective of applications relevant to

transportation and electricity distribution, respectively, and to identify critical technology gaps. In addition, leaders in EES industrial and applied research laboratories were recruited to prepare a technology resource document, *Technology and Applied R&D Needs for Electrical Energy Storage*, which provided the groundwork for and served as a basis to inform the deliberation of basic research discussions for the workshop attendees. The invited workshop attendees, numbering more than 130, included representatives from universities, national laboratories, and industry, including a significant number of scientists from Japan and Europe. A plenary session at the beginning of the workshop captured the present state of the art in research and development and technology needs required for EES for the future. The workshop participants were asked to identify key priority research directions that hold particular promise for providing needed advances that will, in turn, revolutionize the performance of EES. Participants were divided between two panels focusing on the major types of EES, chemical energy storage and capacitive energy storage. A third panel focused on cross-cutting research that will be critical to achieving the technical breakthroughs required to meet future EES needs. A closing plenary session summarized the most urgent research needs that were identified for both chemical and capacitive energy storage. The research directions identified by the panelists are presented in this report in three sections corresponding to the findings of the three workshop panels.

The panel on chemical energy storage acknowledged that progressing to the higher energy and power densities required for future batteries will push materials to the edge of stability; yet these devices must be safe and reliable through thousands of rapid charge-discharge cycles. A major challenge for chemical energy storage is developing the ability to store more energy while maintaining stable electrode-electrolyte interfaces. The need to mitigate the volume and structural changes to the active electrode sites accompanying the charge-discharge cycle encourages exploration of nanoscale structures. Recent developments in nanostructured and multifunctional materials were singled out as having the potential to dramatically increase energy capacity and power densities. However, an understanding of nanoscale phenomena is needed to take full advantage of the unique chemistry and physics that can occur at the nanoscale. Further, there is an urgent need to develop a fundamental understanding of the interdependence of the electrolyte and electrode materials, especially with respect to controlling charge transfer from the electrode to the electrolyte. Combining the power of new computational capabilities and in situ analytical tools could open up entirely new avenues for designing novel multifunctional nanomaterials with the desired physical and chemical properties, leading to greatly enhanced performance.

The panel on capacitive storage recognized that, in general, ECs have higher power densities than batteries, as well as sub-second response times. However, energy storage densities are currently lower than they are for batteries and are insufficient for many applications. As with batteries, the need for higher energy densities requires new materials. Similarly, advances in electrolytes are needed to increase voltage and conductivity while ensuring stability. Understanding how materials store and transport charge at electrode-electrolyte interfaces is critically important and will require a fundamental understanding of charge transfer and transport mechanisms. The capability to synthesize nanostructured electrodes with tailored, high-surface-area architectures offers the potential for storing multiple charges at a single site, increasing charge density. The addition of surface functionalities could also contribute to



high and reproducible charge storage capabilities, as well as rapid charge-discharge functions. The design of new materials with tailored architectures optimized for effective capacitive charge storage will be catalyzed by new computational and analytical tools that can provide the needed foundation for the rational design of these multifunctional materials. These tools will also provide the molecular-level insights required to establish the physical and chemical criteria for attaining higher voltages, higher ionic conductivity, and wide electrochemical and thermal stability in electrolytes.

The third panel identified four cross-cutting research directions that were considered to be critical for meeting future technology needs in EES:

1. Advances in Characterization
2. Nanostructured Materials
3. Innovations in Electrolytes
4. Theory, Modeling, and Simulation

Exceptional insight into the physical and chemical phenomena that underlie the operation of energy storage devices can be afforded by a new generation of analytical tools. This information will catalyze the development of new materials and processes required for future EES systems. New in situ photon- and particle-based microscopic, spectroscopic, and scattering techniques with time resolution down to the femtosecond range and spatial resolution spanning the atomic and mesoscopic scales are needed to meet the challenge of developing future EES systems. These measurements are critical to achieving the ability to design EES systems rationally, including materials and novel architectures that exhibit optimal performance. This information will help identify the underlying reasons behind failure modes and afford directions for mitigating them.

The performance of energy storage systems is limited by the performance of the constituent materials—including active materials, conductors, and inert additives. Recent research suggests that synthetic control of material architectures (including pore size, structure, and composition; particle size and composition; and electrode structure down to nanoscale dimensions) could lead to transformational breakthroughs in key energy storage parameters such as capacity, power, charge-discharge rates, and lifetimes. Investigation of model systems of irreducible complexity will require the close coupling of theory and experiment in conjunction with well-defined structures to elucidate fundamental materials properties. Novel approaches are needed to develop multifunctional materials that are self-healing, self-regulating, failure-tolerant, impurity-sequestering, and sustainable. Advances in nanoscience offer particularly exciting possibilities for the development of revolutionary three-dimensional architectures that simultaneously optimize ion and electron transport and capacity.

The design of EES systems with long cycle lifetimes and high energy-storage capacities will require a fundamental understanding of charge transfer and transport processes. The interfaces of electrodes with electrolytes are astonishingly complex and dynamic. The dynamic structures of interfaces need to be characterized so that the paths of electrons and attendant trafficking of ions may be directed with exquisite fidelity. New capabilities are needed to “observe” the dynamic composition and structure at an electrode surface, in real

time, during charge transport and transfer processes. With this underpinning knowledge, wholly new concepts in materials design can be developed for producing materials that are capable of storing higher energy densities and have long cycle lifetimes.

A characteristic common to chemical and capacitive energy storage devices is that the electrolyte transfers ions/charge between electrodes during charge and discharge cycles. An ideal electrolyte provides high conductivity over a broad temperature range, is chemically and electrochemically inert at the electrode, and is inherently safe. Too often the electrolyte is the weak link in the energy storage system, limiting both performance and reliability of EES. At present, the myriad interactions that occur in electrolyte systems—ion-ion, ion-solvent, and ion-electrode—are poorly understood. Fundamental research will provide the knowledge that will permit the formulation of novel designed electrolytes, such as ionic liquids and nanocomposite polymer electrolytes, that will enhance the performance and lifetimes of electrolytes.

Advances in fundamental theoretical methodologies and computer technologies provide an unparalleled opportunity for understanding the complexities of processes and materials needed to make the groundbreaking discoveries that will lead to the next generation of EES. Theory, modeling, and simulation can effectively complement experimental efforts and can provide insight into mechanisms, predict trends, identify new materials, and guide experiments. Large multiscale computations that integrate methods at different time and length scales have the potential to provide a fundamental understanding of processes such as phase transitions in electrode materials, ion transport in electrolytes, charge transfer at interfaces, and electronic transport in electrodes.

Revolutionary breakthroughs in EES have been singled out as perhaps the most crucial need for this nation's secure energy future. The BES Workshop on Basic Research Needs for Electrical Energy Storage concluded that the breakthroughs required for tomorrow's energy storage needs will not be realized with incremental evolutionary improvements in existing technologies. Rather, they will be realized only with fundamental research to understand the underlying processes involved in EES, which will in turn enable the development of novel EES concepts that incorporate revolutionary new materials and chemical processes. Recent advances have provided the ability to synthesize novel nanoscale materials with architectures tailored for specific performance; to characterize materials and dynamic chemical processes at the atomic and molecular level; and to simulate and predict structural and functional relationships using modern computational tools. Together, these new capabilities provide unprecedented potential for addressing technology and performance gaps in EES devices.

## **INTRODUCTION**



## INTRODUCTION

A modern economy depends on the ready availability of cheap energy. Today, the world's energy supply is primarily centered on fossil fuels. The energy dilemma facing the United States is twofold: global warming from CO<sub>2</sub> emissions, an international problem; and our vulnerability from a dependence on foreign oil. A major component of this dilemma is distributed CO<sub>2</sub> emissions. The internal combustion engine is a major source of distributed CO<sub>2</sub> emissions caused by combustion of gasoline derived largely from foreign oil. Another major source of CO<sub>2</sub> is the combustion of fossil fuels to produce electricity. New technologies for generating electricity from sources that do not generate CO<sub>2</sub>, such as solar, wind, and nuclear, together with the advent of plug-in hybrid electric vehicles (PHEV) and even all-electric vehicles (EVs), offer the potential of alleviating our present dilemma.

The major challenge in realizing this vision, however, is the development of effective electrical energy storage (EES) systems. Today's EES devices, typically chemical storage (batteries) or electrochemical capacitors (ECs), are not capable of meeting tomorrow's energy storage requirements. Portable EES in the form of rechargeable batteries powers the wireless revolution in cellular telephones and laptop computers and now enables the hybrid electric vehicle (HEV). These developments have stimulated an international race to achieve the PHEV, which would allow commuters to drive to work under total electric power stored from the grid during off-peak hours. However, current battery technology provides only limited vehicle performance and driving range—fewer than 50 miles between charging cycles. Enhanced EES devices will be needed to make PHEVs practical for efficient and reliable transportation.

EES will also be critical for effective around-the-clock delivery of electricity generated from solar, wind, or nuclear sources. For example, EES devices will be required to store electricity generated from solar sources for use at night. Because energy use peaks during the day, electricity generated during low-demand periods at night needs to be stored efficiently for use during peak demand. EES devices are also needed to mitigate short-term fluctuations in power, which represent a major problem in the current electrical supply grid. Current EES systems fall far short of meeting these future electrical energy supply needs. Without these advanced EES systems, the vision of transitioning to emerging technologies for alternative (non-CO<sub>2</sub> generating) electricity generation will not be realized.

Because the efficient generation and use of clean electricity is critical for this nation's future, EES is viewed as a critical technology need. Unfortunately, battery technology has not changed substantially in nearly 200 years. Electrochemical capacitive storage is a newer technology, but it has many features in common with batteries. In both systems, many complex and interrelated chemical and physical processes occur; however, our knowledge of these processes is quite limited at present. Understanding these processes is critically important for breaking through existing technology barriers and providing new concepts for future EES systems.

The workshop “Basic Research Needs for Electrical Energy Storage Systems” was charged with identifying fundamental research needs and opportunities that would provide the underpinning science that is needed to guide significant technical improvements in EES systems. Prior to the workshop, the Department of Energy (DOE) Office of Basic Energy Sciences (BES) worked closely with the DOE Office of Energy Efficiency and Renewable Energy (EERE) and the DOE Office of Electricity Delivery and Energy Reliability (OE) to clearly define future requirements for EES from the perspective of applications relevant to transportation and electricity distribution, respectively, and to identify critical technology gaps. In addition, leaders in the EES industry and applied research laboratories were recruited to prepare a technology resource document, *Technology and Applied R&D Needs for Electrical Energy Storage* (Appendix A of this report), which provided the foundation on which the workshop participants initiated discussion at the workshop. At the workshop, additional insight into EES technology needs were provided by representatives from DOE EERE and DOE OE, and plenary talks were given by experts on the current state of Li-ion batteries and ECs, as well as a review of capacitors and hybrid energy sources in Japan. Based on this background information, the workshop participants evaluated technology bottlenecks in EES systems, which currently limit the full realization of EVs and renewable sources of electrical energy, and identified high-priority fundamental research directions that are needed to address these technology challenges.

Separate panels were formed to assess the two dominant types of EES systems, chemical storage and capacitive storage, and this report is similarly divided. Both of these system types are based on electrochemistry; but batteries store energy in the form of chemical reactants capable of generating charge, whereas electrochemical capacitors store energy directly as charge. Priority Research Directions (PRDs) were formulated for both of these areas. However, the workshop attendees recognized that there was significant overlap in the key fundamental research needs for both areas. A third panel was convened to define the highest-priority cross-cutting research directions that could provide significant breakthroughs to meet future technology needs in EES.

The workshop panelists noted that recent advances in nanoscale science; novel analysis techniques; and advanced computational capabilities for theory, modeling, and simulation provide an unprecedented opportunity for developing tailored, multifunctional materials and associated chemical processes that are required for future EES systems. Armed with these capabilities, a new paradigm of designing EES systems holistically may be achievable. The result will be the design of multifunctional, self-repairing, and self-regulating systems that have higher energy and power densities, faster recharge times, and longer lifetimes than today’s technologies.

It was strongly recognized that significant progress toward meeting future EES needs cannot be made by incremental evolutionary changes in existing technologies. Only through fundamental research can key insight into the physical and chemical processes that occur in EES be obtained. The knowledge that will result is critically needed for breakthroughs required for the development of new materials and electrolytes. These breakthroughs are the only path forward for realizing practical transportation by EVs and efficient distribution of solar- and wind-generated electrical power. Further, the panels noted that recent

developments have stimulated interdisciplinary collaborations that bring physics, chemistry, materials science, and computational science to the electrochemical arena. These collaborations promise to move profoundly the underpinning science of devices that store chemical and physical energy in electrochemical cells. These efforts can be expected to enable a paradigm shift in our generation and use of energy, a shift essential to extricating the world from its impending energy dilemma.





# **BASIC RESEARCH NEEDS FOR ELECTRICAL ENERGY STORAGE**

Chemical Energy Storage.....	9
Capacitive Energy Storage.....	16



## CHEMICAL ENERGY STORAGE

### *Abstract*

Battery performance involves complex, interrelated physical and chemical processes between electrode materials and electrolytes. Although some recent improvements have made rechargeable batteries ubiquitous in today's portable electronic devices, the design of batteries has not changed substantially since their invention 200 years ago. Transformational changes in battery technologies are critically needed to enable the effective use of alternative energy sources such as solar and wind, to allow the expansion of hybrid electric vehicles (HEVs) to plug-in HEVs and all-electric vehicles (EVs), and to assist in utility load-leveling. For these applications, batteries must store more energy per unit volume and weight, and they must be capable of undergoing many thousands of charge-discharge cycles. Future requirements for batteries demand innovative concepts for charge storage at the interface of the electrode and electrolyte. These concepts will be realized only by gaining a fundamental understanding of the chemical and physical processes that occur at this complex interface. These studies will require close coupling of new analytical and computational tools to understand these processes at the atomic and molecular level. The knowledge gained from these studies will catalyze the design of new multifunctional materials that are tailored to provide the optimal performance required for future electrical energy storage applications.

### **Introduction**

The future use of electrical energy depends on the development of the next generation of batteries.<sup>1,2</sup> Batteries are ubiquitous—virtually all portable electronic devices rely on energy stored chemically in them. The advent of Li-ion rechargeable batteries ushered in the wireless revolution and has stimulated a quest for batteries to power HEVs—powered by a combination of gasoline and batteries that are recharged during braking—and EVs. Batteries are also needed to realize the full potential of renewable energy sources as part of the electric distribution grid. Descriptions of these and other projected technology needs for batteries are described in the Factual Document in Appendix A of this document.

Existing battery technologies have serious cost and performance limitations that hinder the rapid transition to EVs and efficient use of renewable energy sources. Other technical bottlenecks include the limited energy storage capacity of individual battery cells and the lack of fast recharge cycles with long cell lifetimes. To increase the energy storage capacity of each cell significantly, increases in cell voltage and/or in the amount of charge stored reversibly per unit weight and volume are needed. Increasing the cell voltage requires the development of new electrolytes for thermodynamic stability or of surface passivation layers that adjust rapidly to changes in electrode morphology during a fast charge and discharge. Increasing the amount of charge stored reversibly may require identification of redox centers in the host electrode materials that accept more than one electron over a small voltage window. The need to mitigate the volume and structural changes of the active electrode sites in a charge-discharge cycle calls for the exploration of new materials that have nanoscale features that could enhance reversible charge storage. Especially exciting is the potential for designing novel multifunctional materials that, for example, would increase the level of energy storage per unit volume and decrease dead weight.

To achieve the goals of using electrical energy in transportation and electricity grid applications, a major step change in battery technology is needed—a step that can be taken only by obtaining a fundamental understanding of the physical and chemical processes that occur in these complex systems to enable breakthroughs in batteries, including electrode materials and electrolyte chemistries.

## **Fundamental Challenges**

Batteries are inherently complex and virtually living systems—their electrochemistry, phase transformations, and transport processes vary not only during cycling but often also throughout their lifetime. Although they are often viewed as simple for consumers to use, their successful operation relies on a series of complex, interrelated mechanisms involving thermodynamic instability in many parts of the charge-discharge cycle and the formation of metastable phases. The requirements for long-term stability are extremely stringent and necessitate control of the chemical and physical processes over a wide variety of temporal and structural length scales.

A battery system involves interactions among various states of matter—crystalline and amorphous solids, polymers, and organic liquids, among others (see sidebar “What Is a Battery?”). Some components, such as the electrodes and electrolytes, are considered electrochemically active; others, such as the conductive additives, binders, current collectors and separators, are used mainly to maintain the electrode’s electronic and mechanical integrity. Yet all of these components contribute to battery function and interact with one another, contributing to a convoluted system of interrelated reactions and physico-chemical processes that can manifest themselves indirectly via a large variety of symptoms and phenomena.

To provide the major breakthroughs needed to address future technology requirements, a fundamental understanding of the chemical and physical processes that occur in these complex systems must be obtained. New analytical and computational methods and experimental strategies are required to study the properties of the individual components and their interfaces. An interdisciplinary effort is required that brings together chemists, materials scientists, and physicists. This is particularly important for a fundamental understanding of processes at the electrode-electrolyte interface.

The largest and most critical knowledge gaps exist in the basic understanding of the mechanisms and kinetics of the elementary steps that occur during battery operation. These processes—which include charge transfer phenomena, charge carrier and mass transport in the bulk of the materials and across interfaces, and structural changes and phase transitions—determine the main parameters of the entire EES system: energy density, charge-discharge rate, lifetime, and safety. For example, understanding structure and reactivity at hidden or buried interfaces is particularly important for understanding battery performance and failure modes. These interfaces may include a reaction front moving through a particle in a two-phase reaction (Figure 1, ii); an interface between the conducting matrix (e.g., carbon), the binder, or the solid electrolyte interphase (SEI) (see PRD “Rational Design of Interfaces and Interphases”) and the electrode material (Figure 1, i and iv); or a dislocation originally present in the material or caused by electrochemical cycling (Figure 2). New analytical tools

## What Is a Battery?

A battery contains one or more electrochemical cells; these may be connected in series or parallel to provide the desired voltage and power.

The anode is the electropositive electrode from which electrons are generated to do external work. In a lithium cell, the anode contains lithium, commonly held within graphite in the well-known lithium-ion batteries.

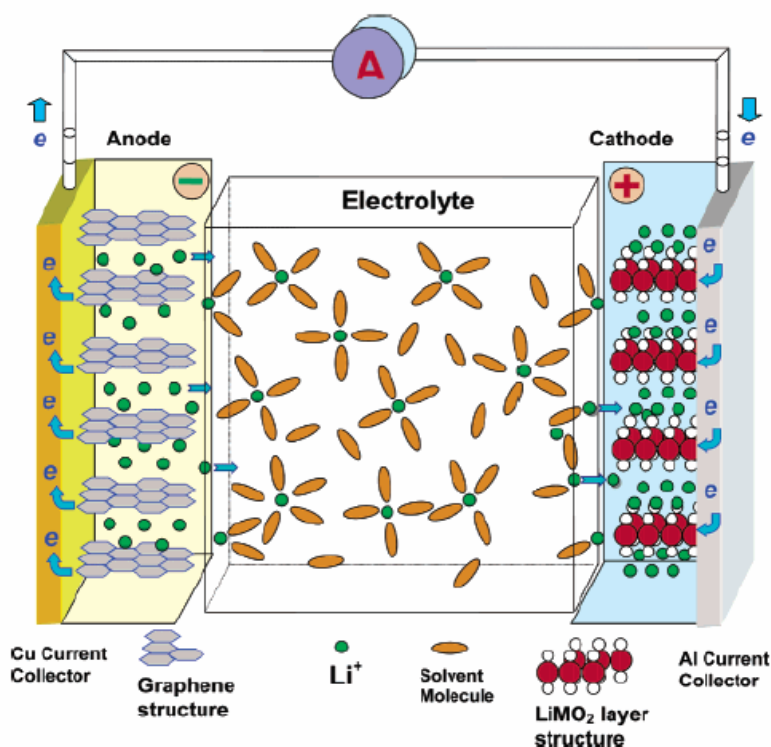
The cathode is the electronegative electrode to which positive ions migrate inside the cell and electrons migrate through the external electrical circuit.

The electrolyte allows the flow of positive ions, for example lithium ions, from one electrode to another. It allows the flow only of ions and not of electrons. The electrolyte is commonly a liquid solution containing a salt dissolved in a solvent. The electrolyte must be stable in the presence of both electrodes.

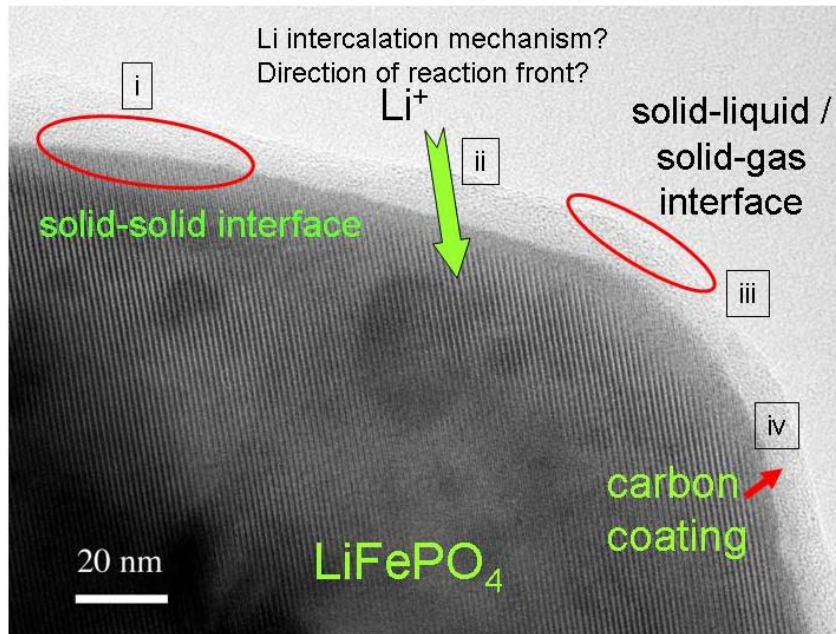
The current collectors allow the transport of electrons to and from the electrodes. They are typically metals and must not react with the electrode materials. Typically, copper is used for the anode and aluminum for the cathode (the lighter-weight aluminum reacts with lithium and therefore cannot be used for lithium-based anodes).

The cell voltage is determined by the energy of the chemical reaction occurring in the cell.

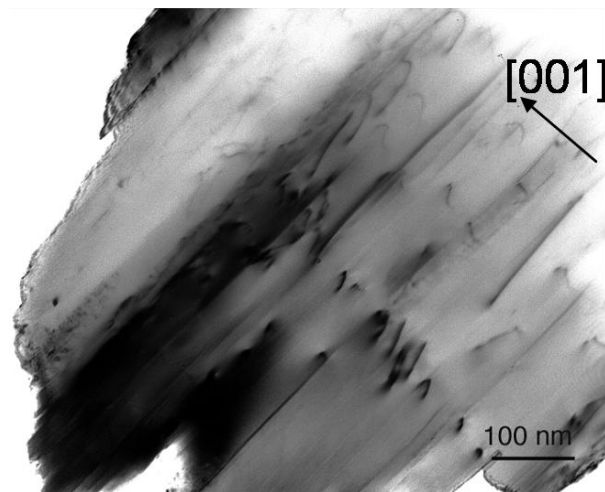
The anode and cathode are, in practice, complex composites. They contain, besides the active material, polymeric binders to hold the powder structure together and conductive diluents such as carbon black to give the whole structure electronic conductivity so that electrons can be transported to the active material. In addition these components are combined so as to leave sufficient porosity to allow the liquid electrolyte to penetrate the powder structure and the ions to reach the reacting sites.



are needed to allow monitoring of a reaction front moving through a particle in a two-phase reaction (Figure 1, ii) in real time, and to image concentration gradients and heterogeneity in these complex systems. A detailed, molecular-level understanding is needed of the mechanism by which an ion intercalates or reacts at the liquid-solid interface (Figure 1, iii) or at the gas-solid interface, depending on the type of battery being studied.



**Figure 1. A battery system involves interactions among various states of matter.** Transmission electron microscopy data courtesy of H. Gabsrisch.



**Figure 2. The large concentrations of dislocations in commercial  $\text{LiCoO}_2$ , as revealed by transmission electron microscopy, raise fundamental questions with direct bearing on battery function.** For example, what role do dislocations play in cycling performance? How do the dislocations change during cycling? What is their relationship to fracture formation/prevention?<sup>3</sup>

Further, an understanding is needed of how these mechanisms vary with surface and bulk structure, particle morphology, and electronic properties of the solid for both intercalation and conversion reactions. Also important is the ability to correlate the structure of the interface with its reactivity, to bridge the gap between localized ultrafast phenomena that occur at the Å–micron length scale and the macroscopic long-term behavior of the battery system. Gaining insight into the nature of these processes is key to designing novel materials and chemistries for the next generation of chemical EES devices.

Recent advances in nanoscience, analytical techniques, and computational modeling present unprecedented opportunities to solve technical bottlenecks. New synthetic approaches can allow the design of materials with exquisite control of chemical and physical processes at the atomic and molecular levels. Development of in situ methods and even multi-technique probes that push the limits of both spatial and temporal resolution can provide detailed insight into these processes and relate them to electrode structure. New computational tools, which can be employed to model complex battery systems and can couple with experimental techniques both to feed data into modeling and to use modeling/theory to help interpret experimental data, are critically important.

### **The Potential of Nanoscience**

The discovery of new nanostructured materials has opened opportunities to develop novel tailored chemical EES systems. In particular, recent developments in the area of chemical EES have clearly demonstrated a series of phenomena that are unique to materials with length scales at the nano-regime.<sup>3–8</sup> These phenomena range from high-rate performance, including enhancement of ionic conductivity in electrolyte nanocomposites, to the development of new electrochemical processes (e.g., involving conversion reactions that can dramatically increase the capacity that can be extracted from the system). The ability to control the structure of materials at the nanoscale adds size as a functional variable, in addition to composition and structure. However, the lack of a fundamental understanding of how thermodynamic properties, such as phase co-existence, change at the nanoscale is in stark contrast to the wealth of information available on the novel electronic, optical, and magnetic properties of nanomaterials. While the latter properties typically arise from the interaction of the electronic structure with the boundary conditions (e.g., electron confinement and/or localization), purely energetic properties and thermodynamic behavior change in a less transparent way at the nanoscale.

Many fundamental questions remain to be answered. For example, are the differences in the electrochemical properties of bulk and nanosize electrode materials simply due to the higher concentrations of different surfaces available for intercalation, or are the electronic properties of the nanomaterials significantly different? Are surface structures at the nanoscale significantly different from those in the bulk or are the improved properties simply a transport effect? At the nanoscale, can we conceptually separate pseudocapacitive from storage reactions? Can we develop general rules and, if so, how widely do we expect them to apply? How are ionic and electronic transport processes coupled in complex heterogeneous nanostructured materials? The ability to modify the properties of materials by treating size and shape as new variables presents great opportunities for designing new classes of materials for EES.

It is imperative to explore how the different properties of nanoparticles and their composites can be used to increase the power and energy efficiency of battery systems. A tremendous opportunity exists to exploit nanoscale phenomena to design new chemistries and even whole new electrode and electrolyte architectures—from nanoporous mesoscopic structures to three-dimensional electrodes with active and passive multifunctional components interconnected within architectures that offer superior energy storage capacity, fast kinetics and enhanced mass transport, and mechanical integrity. To do so, we need to be able to control chemistries and assembly processes. Furthermore, low-cost, high-volume synthesis and fabrication techniques and nanocomposites with improved safety characteristics must be designed, to satisfy requirements for large-scale manufacturing of nanostructure materials and for their use in practical battery systems.

### **New Capabilities in Computation and Analysis**

Although clever engineering can address some inherent problems with a particular battery chemistry, dramatic improvements in performance will ultimately come from the development of different electrode and electrolyte materials. New computational and analysis tools are needed to realize significant breakthroughs in these areas. For example, new analytical tools will provide an understanding of how the phase behavior and electrochemical properties of materials are modified at the atomic level. With this information, computational tools will expedite the design of materials with structures and architectures tailored for specific performance characteristics. It is now possible to predict many properties of materials before attempting to synthesize and test them (see Appendix B, “Probing Electrical Energy Storage Chemistry And Physics Over Broad Time And Length Scales,” for further details), and expanded computational capabilities specific to chemical energy storage are a critical need. New capabilities in modeling and simulation could help unravel the complex processes involved in charge transport across the electrode-electrolyte interface and identify underlying reactions that cause capacity degradation.

Tremendous opportunities exist to develop and apply novel experimental methodologies with increased spatial, energy, and temporal resolution. These could answer a wide range of fundamental questions in chemical electrical storage, identifying and providing ways to overcome some of the barriers in this field. In particular, techniques that combine higher-resolution imaging, fast spectroscopic tools, and improved electrochemical probes will enable researchers to unravel the complex processes that occur at electrodes, electrolytes, and interfaces. For further information on opportunities for advances in characterization tools needed for chemical EES, see Appendix B.

### **Priority Research Directions**

Future advances in chemical electrical storage technologies are critically linked to a significantly improved fundamental understanding of the complex physical and chemical phenomena that occur in these systems. This understanding will lead to the development of radically new materials with novel electrochemical processes and storage mechanisms, which, in turn, will lead to batteries with much higher performance.

Given these imperatives, the two priority research directions (PRDs) outlined below were developed for chemical energy storage science. As noted earlier, new capabilities in



computation and analysis will be needed to achieve the goals of these two PRDs. Because characterization and computational tools are critical to progress in all aspects of EES, research needs for these two areas are summarized in the “Cross-cutting” section of this report.

**Novel designs and strategies for electrochemical systems.** This PRD seeks to understand the processes involved in charge and mass transfer/transport, including changes that occur within the electrode during the charge-discharge cycle and at the interface. With this knowledge, it may be possible to design multifunctional nanomaterials, including those that self-assemble, to increase charge storage and minimize problems due to charge-discharge cycles. This PRD also addresses the possibility of increasing charge density by developing redox couples that can accept more than one electron within a small voltage window. An elucidation of the physical and chemical processes that occur in these electrochemical systems is required before novel materials and chemical processes can be designed to produce batteries for future applications. Acquiring this understanding will require the development and optimization of new characterization tools that utilize recent advances in spectroscopic, imaging, and scattering methods.

**Rational design of interfaces and interphases in chemical energy storage cells.** Interfaces play key roles in chemical energy storage cells, and understanding the physical and chemical processes that occur at these interfaces is key to the design of new materials and chemistries needed for future chemical energy storage cells. Understanding interface/interphase dependence on electrode materials and electrolyte components and additives (intra-cell and intra-electrode) and designing desirable interfaces/interphase are major scientific challenges that must be met to achieve revolutionary breakthroughs in future chemical energy storage devices.

## References

1. M. S. Whittingham, R. F. Savinelli, and T. Zawodzinski, ed., “Batteries and Fuel Cells,” *Chemical Reviews* **104**, 4243–4886 (2004).
2. J. M. Tarascon and M. Armand, *Nature* **414**, 359 (2001).
3. H. Gabrisch, R. Yazami, and B. Fultz, *Electrochem. Solid St. Lett.* **5**(6), A111–A114 (2002).
4. P. Poizot, S. Laruelle, S. Grugeon, L. Dupont, and J. M. Tarascon, *Nature* **407**, 496 (2000).
5. Q. Fan and M. S. Whittingham, *Electrochem. Solid-State Lett.* **10**, A48 (2007).
6. <http://www.sony.net/SonyInfo/News/Press/200502/05-006E/>
7. J. R. Dahn, R. E. Mar, and A. Abouzeid, *J. Electrochem. Soc.* **153**, A361 (2006).
8. Q. Fan and M. S. Whittingham, *Mater. Res. Soc. Proc.* **972**, AA07-03 (2006).

## CAPACITIVE ENERGY STORAGE

### *Abstract*

To realize the full potential of electrochemical capacitors (ECs) as electrical energy storage (EES) devices, new materials and chemical processes are needed to improve their charge storage capabilities by increasing both their energy and their power densities. Incremental changes in existing technologies will not produce the breakthroughs needed to realize these improvements. Rather, a fundamental understanding of the physical and chemical processes that take place in the EC—including the electrodes, the electrolytes, and especially their interfaces—is needed to design revolutionary concepts. For example, new strategies in which EC materials simultaneously exploit multiple charge storage mechanisms need to be identified. Charge storage mechanisms need to be understood to enable the design of new materials for pseudocapacitors and hybrid devices. There is a need for new electrolytes that have high ionic conductivity in combination with wide electrochemical, chemical, and thermal stability; are non-toxic, biodegradable, and/or renewable; can be immobilized; and can be produced from sustainable sources. New continuum, atomistic, and quantum mechanical models are needed to understand solvents and ions in pores, predict new material chemistries and architectures, and discover new physical phenomena at the electrochemical interfaces. From fundamental science, novel energy storage mechanisms can be designed into new materials. With these breakthroughs, ECs have the potential to emerge as an important energy storage technology in the future.

### **Introduction**

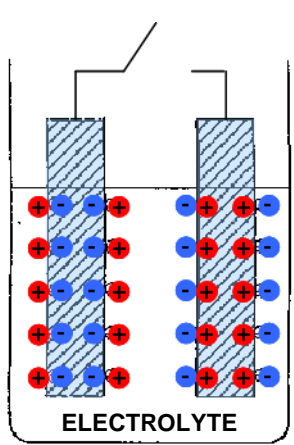
ECs include two general types, electric double layer capacitors (EDLCs, also known as supercapacitors or ultracapacitors) and pseudocapacitors. ECs differ from conventional dielectric and electrolytic capacitors in that they store far more energy. As EES devices, ECs have a number of potentially high-impact characteristics, such as fast charging (within seconds), reliability, large number of charge-discharge cycles (hundreds of thousands), and wide operating temperatures. Because of their very fast charging rate, ECs may be able to recover the energy from many repetitive processes (e.g., braking in cars or descending elevators) that is currently being wasted. Large-scale ECs can perform functions of a different kind, such as power quality regulation of the electrical grid, which can avoid the costly shutdown of industrial operations as a result of intermittent outages and power fluctuations.

While ECs are related to batteries, they use a different energy storage mechanism. Batteries move charged chemical species (ions) from one electrode via an electrolyte to the second electrode, where they interact chemically. Thus batteries store chemical energy (see Chemical energy storage panel report). EDLCs store electrical charge physically, without chemical reactions taking place. Because the charge is stored physically, with no chemical or phase changes taking place, the process is highly reversible and the discharge-charge cycle can be repeated virtually without limit. Typically, an EDLC stores electrical charge in an electrical double layer in an electrode-electrolyte interface of high surface area (see sidebar “Electrochemical Capacitor”). Because of the high surface area and the extremely low thickness of the double layer, these devices can have extraordinarily high specific and volumetric capacitances. A striking dissimilarity between batteries and ECs is the number of

charge-discharge cycles each can undergo before failure. The dimensional and phase changes occurring in battery electrodes represent one of the key limitations in attaining longer charge-discharge cycling. In contrast, no inherent physical or chemical changes occur in EC electrodes during cycling because the charge is stored electrostatically. As a result, ECs exhibit cycle lifetimes ranging from a few hundred thousand to over one million cycles. Most notably, however, ECs have the ability to deliver an order of magnitude more power than batteries. However, at present, their energy densities are generally lower than those of batteries. As the energy densities of ECs have increased, applications using ECs as EES devices—from vehicles, cell phones, and photocopiers to larger industrial drive systems—have increased<sup>1</sup> and in some cases have displaced batteries.

**Electrochemical Capacitor**

A simple EC can be constructed by inserting two conductors (electrodes) in a beaker containing an electrolyte, for example, two carbon rods in salt water, and connecting them to a power source. Initially there is no measurable voltage between the two electrodes; but when the switch is closed and current flows from one electrode to the other, from the power source, charge separation is naturally created at each liquid-solid interface. This effectively creates two capacitors that are series-connected by the electrolyte. Voltage persists after the switch is opened, and energy is stored. In this state, solvated ions in the electrolyte are attracted to the electrode surface by an equal but opposite charge in the electrode. These two parallel regions of charge form the source of the term “double layer.”



**+** positive charge  
**-** negative charge

Charged double layer persists after power source is removed, providing a source of stored electric energy.

A convenient way to compare the operational characteristics for batteries and ECs is to plot the power density as a function of energy density, as shown in Figure 3. The “capacitors” shown on the low-energy-density end refer to the dielectric and electrolytic types widely used in power and consumer electronic circuits. These types of capacitors have very high power, very fast response time, almost unlimited cycle life, and zero maintenance. However, their energy density is very low (less than 0.1 Wh/kg in most cases). Hence they store very small amounts of energy and are not useful for applications in which significant energy storage is needed. On the other hand, ECs can operate over a fairly broad range of energy and power densities. This versatility is a key feature for adapting EC systems for energy storage, energy harvesting, and energy regeneration applications. EDLCs with specific capacitances in excess of 200 F/g, cycle life well above  $1 \times 10^6$  cycles, and pseudocapacitances in excess of 750 F/g are especially noteworthy. Moreover, the high discharge/charge rates of ECs have

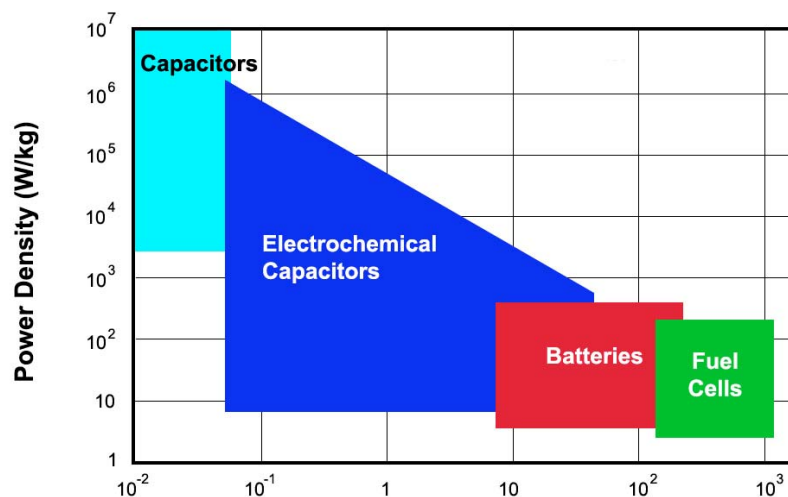


Figure 3. Power density as a function of energy density for various energy storage devices.<sup>2,1</sup>

led to their use in a variety of applications based on supplying high power. However, certain performance limitations persist, and these limitations have prevented more widespread applications for ECs. They include relatively low energy density (<10 Wh/kg), low cell voltage (<1 V for aqueous and ~3 V for organic electrolytes), and sensitivity to impurities.

EC technology has been influenced strongly by both the battery field and traditional electrochemistry. This is evident by the fact that carbon electrodes are widely used for EC devices with electrolytes containing sulfuric acid or acetonitrile.<sup>3,4</sup> The battery influence is further apparent from the continuing studies of the transition-metal oxide cathodes commonly used in Li-ion batteries and the use of propylene carbonate as an electrolyte. Except for these derivative studies, little effort has been focused on designing either electrode materials or electrolytes that are specific for ECs. Moreover, there have been only a few limited modeling studies applied to ECs. In some respects, ECs can be considered to have been overlooked scientifically. A fundamental understanding is lacking for such basic processes as charging, charge storage, and pseudocapacitance.<sup>5</sup> If we are to take full advantage of ECs, especially their extraordinarily high discharge rate properties and cyclability, we need an infusion of basic science to provide the vital background for the materials and mechanisms that are at its core.

## Fundamental Challenges

Dramatic advances in capacitor storage science can be made by achieving a fundamental understanding of the interrelated physical and chemical phenomena involved in EC energy storage, such as electrode structures, interfacial relationships, electrolyte properties, and charge storage/discharge processes. Understanding the atomic- and molecular-level interactions among EC components will allow the development of the next generation of high-performance ECs. For example, future ECs may include novel electrode materials that reach unprecedented levels of power and energy density by combining double layer and pseudocapacitive processes. This could be achieved through a variety of strategies such as self-assembly of thin films, use of multiphase materials, and incorporation of three-

dimensional architectures. By designing electrolytes for optimum performance in capacitive modalities, the critical need for high-voltage operation may be achieved without compromising conductivity and stability. Once the fundamental underpinnings of ECs are understood, the principles for designing novel materials and energy storage mechanisms will be revealed, positioning ECs for enormous opportunities available in energy storage, and regeneration.

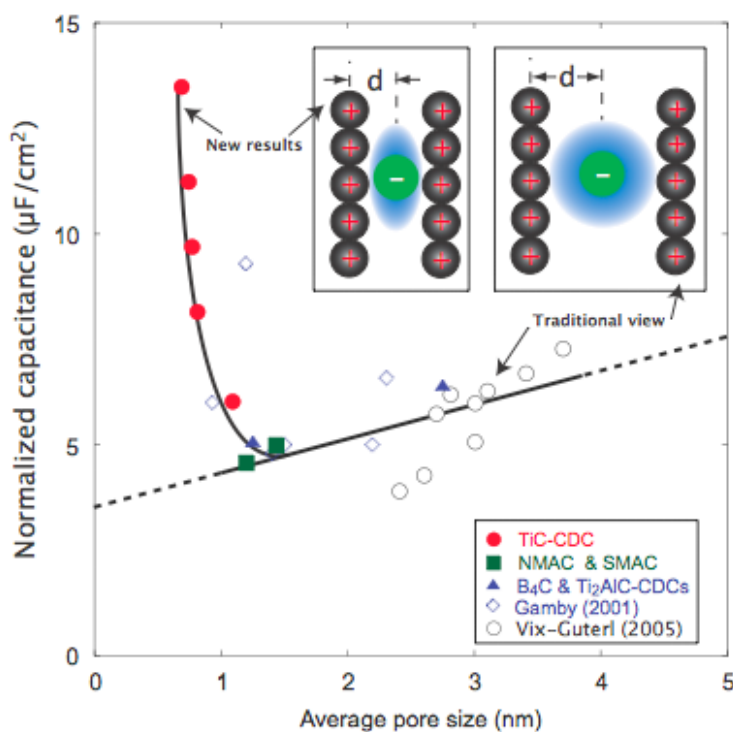
Recent advances in nanoscience, computational capabilities, and analytical tools have the potential to provide unprecedented breakthroughs for ECs. ECs are intrinsically nanoscale systems in which ions fit into pores of, typically, 0.5–3 nm in size. However, little is known about the physico-chemical consequences of nanoscale dimensions (see sidebar “Correlation Between Pore Size, Ion Size, and Specific Capacitance”). Further, it is necessary to understand how various factors—such as pore size, surface area, and surface chemistry—affect the performance of ECs. This knowledge can be used to design nanostructured materials with optimized architectures that could yield dramatic improvements in current capabilities in energy and power. Novel electrolyte systems that operate at higher voltages and have higher room-temperature conductivity are critically needed for the next generation of ECs. Fundamentals of solvation dynamics, molecular interactions at interfaces, and ion transport must be better understood to tailor electrolytes for optimal performance. Exciting opportunities exist for creating multifunctional electrolytes that scavenge impurities and exhibit self-healing. A potential bridge between ECs and batteries is combining a battery-type electrode with a capacitor-type electrode in so-called hybrid or asymmetric ECs.<sup>6</sup> This approach needs to be better understood at the fundamental level so that it enables the tailoring of energy density without compromising power density. In situ characterization of the electrolyte/electrode interface during charging/discharging at molecular and atomic levels is critical to understanding the fundamental processes in capacitive energy storage. This will require the development of new experimental techniques that combine measurement and imaging, including so-called chemical imaging, where chemical information can be obtained at high spatial resolution. In addition, new computational capabilities can allow modeling of active materials, electrolytes, and electrochemical processes at the nanoscale and across broad length and time scales. These models will assist in the discovery of new materials and the performance evaluation of new system designs.

To achieve these goals, three PRDs were identified for developing key breakthroughs needed for future ECs.

**Charge storage materials by design.** The interaction of electrodes and electrolytes at the electrical double layer can be improved enormously by integrating multiple chemical and physical functionalities so that the material can simultaneously exploit more than one mechanism of charge storage. Materials with narrow pore size distributions able to store desolvated ions may provide an avenue for enhancing both energy and power density. New capabilities for designing materials at the nanoscale show exceptional promise for tailoring of electrode architectures to realize higher EC performance.

### Correlation Between Pore Size, Ion Size, and Specific Capacitance

The electrolyte environment is very complex at the nanoscale. Surrounding each electrolyte ion is a layer of solvent molecules that is attracted to the charged ions. It was long thought that this so-called solvation layer was tightly bound to its ion nucleus, and therefore pores would need to be larger than the diameter of both the solvent layer and the ion. Therefore, scientists were interested in increasing the pore size as much as possible without significantly compromising the surface area. Recent work on carbon derived from metal carbide precursors has elucidated the mechanism governing this capacitance increase with increasing pore size. However, these studies have also shown that the capacitance increases anomalously if the pore size is decreased below the size of the solvation shell. This approach leads to an increase in capacitance of almost 50% compared with the best-performing commercially available activated carbons. Additional studies are needed to fully understand these complex relationships.



Dependence of material capacitance normalized by surface area on pore size. The results show that increasing the pore size above  $\sim 1$  nm marginally increases the normalized capacitance. Decreasing the pore size below  $\sim 1$  nm sharply increases the normalized capacitance due to constriction of the ion solvation shell (inset). Phenomena of this kind must be understood, described theoretically, and used in designing new material/solvent systems for capacitive energy storage.

**Multifunctional materials for pseudocapacitors and hybrid devices.** There are extraordinary opportunities for taking advantage of materials that exhibit pseudocapacitance to produce high-performance ECs. Improved understanding of charge-transfer processes in pseudocapacitance is a critical step that will lead to the design of new materials and multifunctional architectures offering substantially higher levels of energy and power density.

**Electrolytes for capacitive energy storage.** At present, there is a lack of understanding of the influence of electrolyte components on molecular interactions, physical properties, and EC performance. Fundamental understanding of molecular interactions in the bulk solution and at interfaces will be a key consideration in identifying the next generation of electrolyte

systems that offer high conductivity and wider electrochemical windows, allowing higher operating voltages to be realized.

As was noted in the Chemical Energy Storage panel report, theory, modeling, and simulation tools are also needed for ECs. These needs are described in PRD 6, “Rational Materials Design through Theory and Modeling.” New computational tools can guide experiments that test our fundamental understanding of the various processes involved in capacitive storage science. To date, relatively few models have been applied to ECs, although various modeling approaches are available and seem appropriate. Numerous topics of central importance to capacitive energy storage processes in such areas as dynamics, charge transfer, and interfacial properties need to be explored to identify new directions in both materials and electrode architectures.

The potential impact of developing new generations of ECs is significant.<sup>7</sup> There are many opportunities for storing energy and recovering waste energy for which batteries are either not appropriate or are far from optimal because of their limited power capability in charge or discharge modes and/or their limited cycle life for deep discharge. These applications include energy storage and load leveling in solar, wind, and other energy sources and for power quality regulation on the electrical grid. ECs have particular promise for energy recovery from regenerative braking in vehicles and/or stop-start in industrial equipment, reducing energy requirements. Further applications in which energy can be recovered from intermittent light, vibration, and motion sources (e.g., walking) may also be possible with new EC technologies. The current lack of fundamental knowledge of how these devices work at the atomic and molecular level is a major impediment to needed advances in this field. Basic research is needed to obtain this knowledge and provide breakthroughs that are needed in the design of electrodes and electrolytes for future EC devices.

## References

1. R. Kotz and M. Carlen, “Principles and Applications of Electrochemical Capacitors,” *Electrochimica Acta* **45**, 2483–2498 (2000).
2. M. S. Halper and J. C. Ellenbogen, MITRE Nanosystems Group, 2006.
3. F. Beguin and E. Frackowiak, “Nanotextured Carbons for Electrochemical Energy Storage,” *Nanomaterials Handbook*, CRC Press/Taylor and Francis, pp. 713–737, Ed. Y. Gogotsi, 2006.
4. A. G. Pandolfo and A. F. Hollenkamp, “Carbon Properties and Their Role in Supercapacitors,” *J. of Power Sources* **157**, 11–27 (2006).
5. J. Chmiola and Y. Gogotsi, “Supercapacitors as Advanced Energy Storage Devices,” *Nanotechnology Law and Business* **4**(1), 577–584 (2007).
6. W. G. Pell and B. E. Conway, “Peculiarities and requirements of asymmetric capacitor devices based on combination of capacitor and battery-type electrodes,” *J. of Power Sources* **136**, 334–345 (2004).
7. R. F. Service, “New ‘Supercapacitor’ Promises to Pack More Electrical Punch,” *Science* **313**, 902–905 (2006).





## PRIORITY RESEARCH DIRECTIONS

Novel Designs and Strategies for Chemical Energy Storage .....	25
Solid-Electrolyte Interfaces and Interphases in Chemical Energy Storage .....	31
Capacitive Energy Storage Materials by Design .....	37
Electrolyte Interactions in Capacitive Energy Storage .....	41
Multifunctional Materials for Pseudocapacitors and Hybrid Devices .....	47
Rational Materials Design Through Theory and Modeling.....	53



## NOVEL DESIGNS AND STRATEGIES FOR CHEMICAL ENERGY STORAGE

*New electrochemical cell chemistries and designs that consider all of the interacting chemical and physical processes occurring in the system as a whole are needed to enhance significantly the performance of today's chemical energy storage systems. Access to redox centers that can accept more than one electron without a step change in cell voltage, elimination of dead weight by the introduction of multifunctional materials, and design of radical new cell architectures inspired by nature are some of the fundamental research opportunities to enhance greatly the energy density of today's batteries. A new paradigm is required to design new anode and cathode materials, along with novel chemistries in which redox couples exchange multiple electrons in a narrow potential range to provide electrochemical cells with high voltage, high energy, high power, and long lifetime.*

### Background and Motivation

A chemical energy storage system (battery) is inherently complex, consisting of a cathode, an electrolyte, and an anode (see sidebar “What is a Battery?” on page 11). Any future system must be designed to include a number of essential characteristics, including

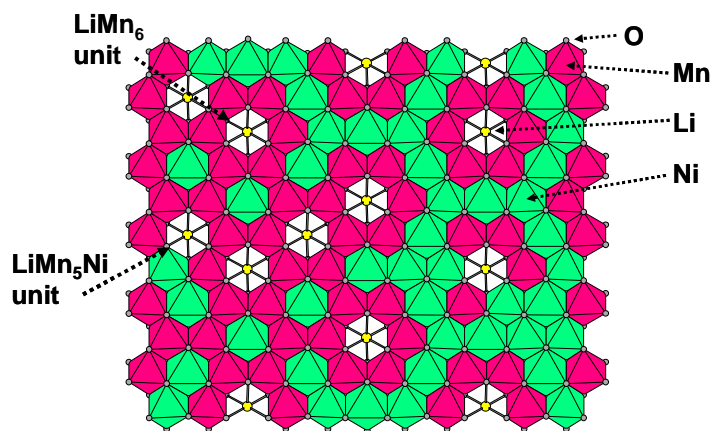
- high energy density;
- sufficient power achieved through holistic design of the storage materials, supporting components, and device construction;
- electrochemical and materials stability to ensure long lifetimes;
- practical materials synthesis and device fabrication approaches;
- reasonable cost; and
- optimized safe operation and manageable toxicity and environmental effects.

Future chemical energy storage applications, ranging from portable consumer products to hybrid and plug-in electric vehicles to electrical distribution load-leveling, require years to decades of deep discharge with subsequent recharging (charge-discharge cycles). This level of use must occur with minimal loss of performance so that the same capacity is available on every discharge (i.e., with minimal capacity fade). The necessity of ensuring stable cycle-life response has restricted the number of electrons that can be transferred in any given discharge or charge reaction, thereby limiting the utilization of the electrodes and the amount of energy that could be available from the batteries.

This restriction in battery operation is driven by the fact that deep, but thermodynamically allowable, discharge reactions usually drive the electrodes toward physical and chemical conditions that cannot be fully reversed upon charging. The extent to which the physical and chemical properties of electrode materials change during electrochemical cycling is dependent on the battery's chemistry. For example, during charge-discharge, the electrode materials can undergo damaging structural changes. They can fracture, resulting in the loss of electronic contact, and they can dissolve in the electrolyte, thereby lowering the cycling efficiency and delivered energy of the batteries.

Recent research has shown that the electron/redox center count in nanoscale forms of charge storing materials can be significantly superior to their crystalline counterparts for reasons that are still unclear. For instance, amorphous  $V_2O_5$  prepared with a nanoporous, sol-gel-derived

architecture can accept and release four electrons reversibly<sup>1,2</sup> whereas crystalline  $V_2O_5$ , on reaction with lithium, transforms to  $Li_3V_2O_5$  that cycles only 1–2 electrons per  $V_2O_5$  unit.<sup>3</sup> Even more intriguing is that nanoscale forms of the well known rutile,  $TiO_2$ , structure that had been previously shown to be relatively inert to lithium uptake in its crystalline bulk form (<0.1 Li per  $TiO_2$  unit) can be an effective lithium-ion insertion electrode.<sup>4</sup> Furthermore,  $LiFePO_4$  [Ref. 5], which has traditionally been regarded as having intrinsically low electronic and lithium-ion conductivities, has now been deployed in nanophase form in commercial, high-rate lithium-ion batteries with excellent stability and safety attributes.<sup>5</sup> In a more recent advance, the concept of stabilizing layered  $LiMO_2$  and spinel  $LiM_2O_4$  ( $M = Mn, Ni, Co$ ) electrode structures by introducing nanodomains of  $Li_2MnO_3$  that are structurally compatible with the host electrode (Figure 4) is quite promising.<sup>6,7</sup> These successful examples of improved performance gained with nanoscale materials holds exciting potential for future chemical energy storage strategies. Further, with recent developments in the ability to tailor materials at the atomic level, completely new electrode materials for reversible charge storage may be discovered.



**Figure 4. Schematic illustration of the cation arrangement in a layered, composite  $xLi_2MnO_3 \bullet (1-x)LiMn_{0.5}Ni_{0.5}O_2$  electrode structure in which  $LiMn_6$  units, characteristic of the  $Li_2MnO_3$  component (and disordered  $LiMn_5Ni$  units), are embedded as stabilizers in the residual  $LiMn_{0.5}Ni_{0.5}O_2$  component.<sup>8</sup>**

Designing new chemical energy storage materials will require strategies to create new anode and cathode materials that provide a stable electrode-electrolyte interface at all states of charge and discharge to achieve long cycle life. These strategies are especially important when the energy delivered by the cell is enhanced by increasing the number of electrons cycled at designed-in voltages above 4 V. For example, high-voltage batteries, notably those with lithium-based chemistries, are usually unsafe for today's technologies. Increases in the releasable energy of any future battery must be balanced by new design strategies that limit catastrophic failure, including structural/functional components that provide self-healing checks on thermal runaway.

The large increase in specific surface area (from  $\leq 1\text{m}^2/\text{g}$  to  $\geq 10^2\text{m}^2/\text{g}$ ) upon switching to nanoscale materials for battery electrodes requires a fundamental understanding of electrode-electrolyte interfaces. This knowledge will allow these critical interfaces to be designed to ensure that they are chemically and morphologically robust. This scientific challenge can also be addressed by shifting current concepts of electrochemical storage devices from the predominance of inorganic solid-state cathode materials to new systems based on organic systems such as organosulfur compounds, liquids, or molten salts (e.g., organic catholytes and redox flow batteries) as well as gases (e.g., metal-air electrochemical couples). New developments in nanoscience are poised to accelerate this shift by incorporating

nanostructured, high-surface-area electrode scaffolds that host the fluid electrolyte and provide current collection while also providing dispersed catalysts to promote redox reactions at the electrode. For example, sodium batteries may deserve renewed attention, particularly if suitable room-temperature molten salts can be identified, whereas a reversible Li/Li<sub>2</sub>O<sub>2</sub> (Li-air) system<sup>9,10</sup> with an ultraporous catalyzed nanoarchitecture for the air cathode offers promise for significantly increasing the energy density of state-of-the-art batteries.

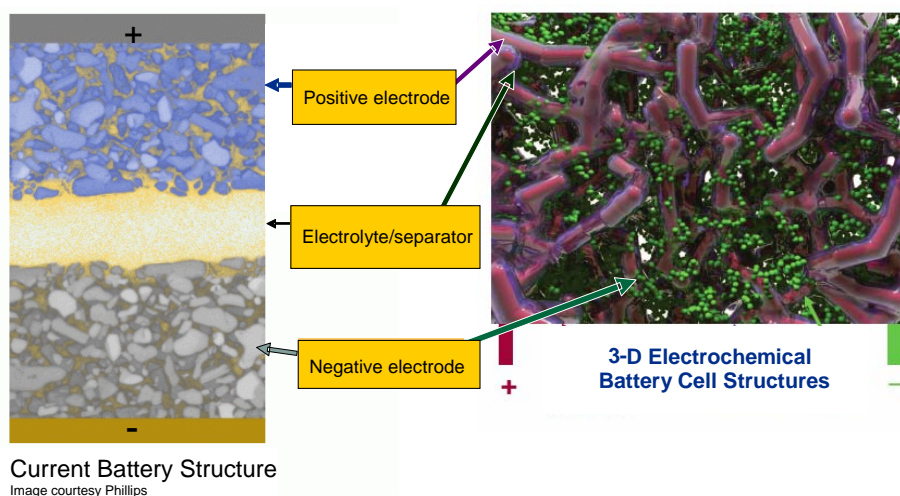
Currently, no batteries can meet the criteria that are required for tomorrow's energy storage needs (see Factual Document, Appendix A). While battery technologies have been optimized to some extent, they have remained essentially the same for many decades. For example, the laminated cell design used commercially today is strikingly similar to the original design of Volta, now more than 200 years old. Changes have been evolutionary to meet changing performance criteria, but radical, revolutionary approaches that consider the entire system are required to provide batteries that meet these criteria. Fundamental research is needed to identify broad areas in materials and chemical sciences where advances can have dramatic societal impact.

## Research Directions

New materials and chemistries are required for the radical improvements in energy and power densities of chemical energy storage systems for transportation and electrical grid applications. Basic research efforts will require interdisciplinary teams of materials and chemical scientists to elucidate the fundamental processes that occur in chemical energy storage systems, including (1) understanding the basis for the design and synthesis of new anode and cathode materials and cell chemistries; (2) establishing the principles controlling electrode surfaces and electrode-electrolyte interfaces; (3) characterizing physical, chemical, and dynamic electrochemical properties; and (4) theoretical modeling of electrode structure and design and electrochemical phenomena. Specific aspects that should be included in new research are discussed in the following sections.

**Tailored nanostructured electrode materials.** Stable, high-potential materials (>4 V) may be achieved through tailored introduction of anions, structural modifications, and defects/disorder. These nanostructured materials could be designed to create stable multifunctional surface layers to access and increase capacity and power and maintain electronic conductivity at all times during electrochemical cycling. For example, porous nanostructured materials could be embedded with catalysts to increase capacity and reaction rates with gaseous electrodes. Multifunctional materials can be envisioned for use in electrodes that will optimize the ionic transport, electronic conductivity, and stability of the operating voltage of the cells. For example, battery electrodes are commonly made of composites containing carbon to interconnect the active electrode particles electronically with one another and with the current collector; Teflon, to bind the mass together; and pores filled with electrolyte to provide a large-area electrode-electrolyte interface. Novel electrochemically active, electronically conductive polymers are candidates for replacing these components with tailored architectures that integrate the components, increasing the charge storage capacity per electrode mass.

New approaches to materials synthesis have already produced examples of three-dimensional interpenetrating-electrode cell designs<sup>11</sup> (Figure 5). These designs have the potential for higher performance by separating the length scales for electronic and ionic transport, thereby accessing previously unachievable regimes in the plot of energy vs. power. These new structures have the potential to decrease the ionic transport distance between positive and negative electrodes while maintaining a matching electronic transport to the current collectors.



**Figure 5. Three-dimensional nanostructure demonstrating the intergrowth of the anode, cathode, and electrolyte.<sup>11</sup>**

In addition, new nanoscale materials could be produced by self-assembly.<sup>12</sup> Nature uses self-assembly to produce materials with specific functionality.<sup>13</sup> These bio-inspired concepts have potential for the development of novel nanomaterials and architectures to enhance the development of chemical energy storage systems. The ability to apply these techniques to the fabrication of battery electrodes could be revolutionary. Also, nature often relies on two-electron redox centers (typically coupled with two protons) as in quinones and disulfides; as described below, this has the potential of increasing charge density.

**Designed materials that offer more than two electrons per redox center.** A redox couple that could accept more than one electron, without a large change in cell voltage as the additional electrons are added, has the potential to increase significantly the energy density of a cell. For example, such a redox couple might be designed as a structure into which either two single-electron transfer species (e.g.,  $\text{Li}^+$  or  $\text{Na}^+$ ) or multivalent electron-transfer systems, such as alkaline earths (e.g.,  $\text{Mg}^{2+}$  or  $\text{Al}^{3+}$ ), can be inserted per redox center. Materials with these features could improve energy and power densities in electrochemical storage devices. In addition, conversion/displacement reactions of organic/organometallic redox couples with high electrochemical and chemical reversibility and polymers that have pendant redox moieties are interesting families of materials to be explored.

**Developing a unified model of mixed ionic and electronic conductivity in electrodes.** The electrochemically active materials that store the chemical energy of a battery are mixed ionic

and electronic conductors. For example, composite electrodes contain (in addition to electrochemically active particles) an electrolyte for transporting ions, carbon as an electronic conductor, and a polymer as a binding agent to hold the electrode together. We do not yet have a detailed understanding of the processes involved in charge and mass transfer and transport within the active particles and across the particle-electrolyte interface (including across any interface phases that may be present) or the electronic pathways between the particles and the current collector. This understanding is needed to guide the design of new cell architectures as well as to identify possible multielectron redox centers and their accessibility. Moreover, the understanding of multifunctional electrodes could lead, for example, to the design of an electronic conductor that could also participate as a binding agent (such as a conducting polymer) or an over-discharge protection agent (such as  $\text{TiS}_2$ ). New characterization tools (see the Cross-cutting section and Appendix B) will be needed to provide real-time, in situ data that can elucidate these transport processes.

**Minimizing physical changes in electrode materials during charge-discharge cycles.** The insertion/extraction of charge and mass into/from an active particle in a rechargeable battery is accompanied by a volume change and, where a constant output voltage is achieved, by a displacive phase change. Volume changes are associated with a solid solution of host (active particle) and guest (working ion); a constant voltage is associated with a two-phase segregation rather than a solid solution. If reversible insertion/extraction of the guest ion is to be fast, any phase segregation must not involve atomic diffusion, only small atomic displacements. Clearly, this translates into fast charge-discharge cycles. We need to understand the kinetics of the transport of phase boundaries where displacive phase changes occur and the effect of particle size on the structural integrity of a particle that undergoes these changes over many charge-discharge cycles. These processes are critical to power capability and to cycle life.

In all of these studies, in situ measurements will allow understanding of dynamic phenomena and processes at the electrode-electrolyte interface and within the cathode/anode materials during charge-discharge cycles. New tools could also be devised to permit the functional state of the cell to be determined during operation. Further, new computational tools are required for modeling structures of anode/cathode materials during charge-discharge, ion transport phenomena, and electrode design (see Cross-cutting section).

### **Potential Impact**

The research areas outlined above have the potential to make a significant impact on a broad range of other fields as well as on chemical energy storage. For example, several other energy-related fields, such as organic photovoltaics, electrochromics, hydrogen storage, catalysis, supercapacitors, and fuel cells, also depend on complex charge and/or mass transport. Through real-time and in situ studies of charge transport in novel electrically conducting materials used in chemical energy storage systems, we could gain a fundamental understanding that would impact these other energy-related technologies. The development of novel nanoscale multifunctional materials, including the ability to synthesize these materials via self-assembly, may inspire consideration of this strategy in other fields.

## References

1. S. Passerini, D. B. Le, W. H. Smyrl, M. Berrettoni, R. Tossici, R. Marassi, and M. Giorgetti, "XAS and electrochemical characterization of lithiated high surface area  $V_2O_5$  aerogels," *Solid State Ionics* **104**, 195–204, 1997.
2. D. R. Rolison and B. Dunn, "Electrically conductive oxide aerogels: New materials in electrochemistry," *Journal of Materials Chemistry* **11**, 963–981, 2001.
3. C. Delmas, H. Cognacauradou, J. M. Cocciantelli, M. Menetrier, and J. P. Doumerc, "The  $Li_xV_2O_5$  system—An overview of the structure modifications induced by the lithium intercalation," *Solid State Ionics* **69**, 257–264, 1994.
4. E. Baudrin, S. Cassaignon, M. Koesch, J.-P. Jolivet, L. Dupont, and J.M. Tarascon, "Structural evolution during the reaction of Li with nano-sized rutile type  $TiO_2$  at room temperature," *Electrochemistry Communications* **9**, 337–342, 2007.
5. A. K. Padhi, K. S. Nanjundaswamy, and J. B. Goodenough, "Phospho-olivines as positive-electrode materials for rechargeable lithium batteries" *Journal of the Electrochemical Society* **144**, 1188–1194, 1997.
6. M. M. Thackeray, C. S. Johnson, J. T. Vaughey, N. Li, and S. A. Hackney, "Advances in manganese-oxide 'composite' electrodes for lithium-ion batteries," *Journal of Materials Chemistry* **15**, 2257–2267, 2005.
7. "Higher capacity lithium-ion batteries—new cathode materials boost performance," *Chemical and Engineering News* **15**, 13, 2007.
8. M. M. Thackeray, S.-H. Kang, C. S. Johnson, J. T. Vaughey, R. Benedek, and S. A. Hackney, " $Li_2MO_3$ -stabilized  $LiMO_2$  electrodes for lithium-ion batteries," *Journal of Materials Chemistry* DOI: 10.1039/b702425h, 2007.
9. K. M. Abraham and Z. Jiang, "A polymer electrolyte-based rechargeable lithium/oxygen battery," *Journal of the Electrochemical Society* **143**, 1–5, 1996.
10. T. Ogasawara, A. Debart, M. Holzapfel, P. Novak, and P. G. Bruce, "Rechargeable  $Li_2O_2$  electrode for lithium batteries," *Journal of the American Chemical Society* **128**, 1390–1393, 2006.
11. J. W. Long, B. Dunn, D. R. Rolison, and H. S. White, "Three-dimensional battery architectures," *Chem. Rev* **104**, 4463–4492, 2004.
12. D. Golodnitsky, V. Yufit, M. Nathan, I. Shechtman, T. Ripenbein, E. Strauss, S. Menkin, and E. Peled, "Advanced materials for the 3D microbattery," *J. Power Sources* **153**, 281–287, 2006.
13. K. T. Nam, D. W. Kim, P. J. Yoo, C.-Y. Chiang, N. Meethong, P. T. Hammond, Y.-M. Chiang, and A. M. Belcher, "Virus-enabled synthesis and assembly of nanowires for lithium ion battery electrodes," *Science* **312**, 885–888, 2006.

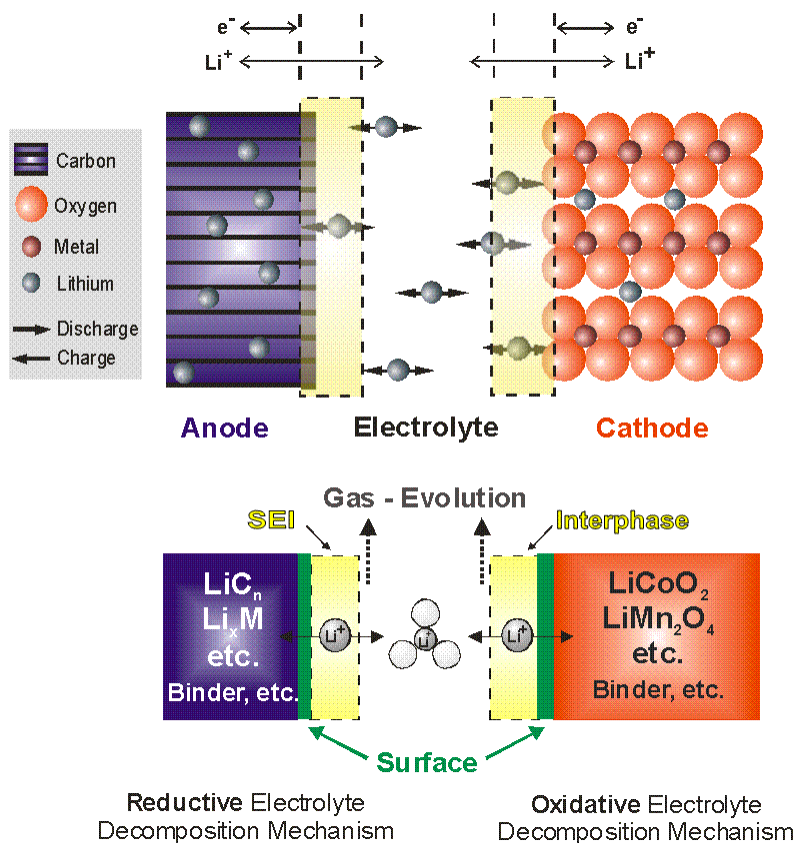


## SOLID-ELECTROLYTE INTERFACES AND INTERPHASES IN CHEMICAL ENERGY STORAGE

*Interfaces play important roles in chemical energy storage cells. These include intra-electrode interfaces within (composite) electrodes as well as intra-cell interfaces; the most important being the latter—those between the electrodes and electrolytes. Almost all electrode couples in chemical energy storage cells operate beyond the thermodynamic stability limits of the electrolytes. These cells operate in many cases only because electrode-electrolyte reactions result in the formation of new phases (or interphases) at the electrode-electrolyte interfaces. A molecular-level understanding of the full range of interfaces in chemical energy storage systems is needed. This knowledge would enable a systems approach for designing tailored interfaces/interphases for future high-energy chemical energy storage systems with longer lifetimes and safer performance.*

### Background and Motivation

A successful example of a well functioning chemical energy storage system that relies on the formation of effective interphases is the lithium-ion cell (Figure 6). Lithium-ion cells exhibit cell voltages of up to 4.5 V and, therefore, operate far beyond the thermodynamic stability window of the organic electrolytes they use, causing electrolyte decomposition.

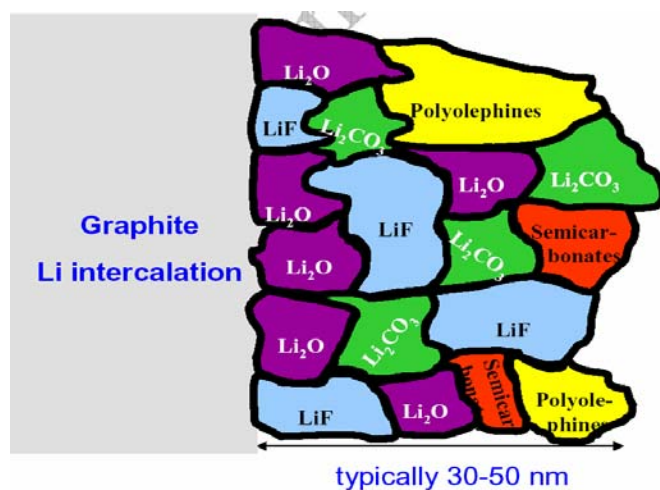


**Figure 6. Operation principle, interphase formation, intra-electrode and intra-cell interfaces in lithium-ion cells.**

Fortunately, during the charging process these electrolyte reduction products form protective films at the negative electrode. In the ideal (but not fully realized) case, these films are electronically insulating. These films, known as the solid electrolyte interphase (SEI), can hinder further electrolyte reduction while still acting as a membrane for the active charge carrier (e.g., the lithium cation in a lithium battery). Because SEI formation is associated with the irreversible consumption of both the charge carrier and the electrolyte, this process is detrimental to the specific energy of the cell. Moreover, it requires an increased use of costly positive electrode material, which increases the cost of the cell. To a first approximation, the SEI and the associated irreversible capacity losses depend on the composition of the electrolyte and on the properties of the anode material. The anode surface is of paramount importance in the formation of the SEI and can be affected by a range of parameters, such as surface area, surface morphology, and surface chemical composition.

While the overall concept is generally accepted, little is actually understood about the SEI, and many fundamental questions remain unanswered. How is the SEI formed and what is its chemical composition? How does the SEI change during operation of the cell and with changes in temperature, voltage, and charge-discharge rates? What are the electrical transport properties of the SEI, and how are they related to SEI compositions? What is the nature of the ideal SEI, and can it be tailored (using both electrolyte and anode materials) to optimize a specific system? How can the impact of the SEI be separated from the cell behavior? What is the role of interfaces and the SEI in governing charge-transfer in solid electrode/solid electrolyte and solid electrode/liquid electrolyte systems? In all of these questions, new in situ analytical tools are needed to monitor the SEI both qualitatively and quantitatively.

These questions about the SEI also apply to interfaces and interphases in chemical energy storage cells as a whole. Understanding the interface/interphase dependence on electrode materials, electrolyte components and additives (intra-cell and intra-electrode), and designing desirable interfaces/interphases are major scientific challenges that must be met to achieve truly innovative breakthroughs in future chemical energy storage devices (Figure 7).



**Figure 7. A proposed model of the electrode near a complex SEI.** Even the SEI has intra-component interfaces.

## Research Directions

### Strategies for electrode-electrolyte synergy to enable the design of novel cathodes

The interface/interphase behavior of electrode and electrolyte components must be carefully considered in electrode and electrolyte development, and synergetic electrode-electrolyte research is required for achieving breakthroughs in battery technologies. An example is the advancement of lithium metal anode batteries compared with graphite anode-based lithium ion batteries. The first attempts to take advantage of graphite as an anode material in the mid-1970s failed because the electrolyte was compatible with metallic lithium, but not with graphite. Only a complete change of the electrolyte chemistry enabled the successful operation of graphitic anodes in lithium-ion cells in 1990. With the potential of developing novel, high-capacity anodes and cathodes based on tailored nanoscale materials, new electrolytes are needed that are specifically designed for use with these new nanomaterials. Further, high-voltage cathodes (which operate above 4 V, for example) need electrolytes that are stable at these potentials and/or form an interphase sufficiently stable to enable operation at these potential voltages. Beyond today's graphitic anodes, new interphases are needed for the next-generation anode materials, which in turn, require new electrolyte chemistries.

Another issue to be considered is that high-capacity anode and cathode materials usually can establish the large storage capacities only through substantial changes in structure and bulk. This occurs when the lithium or other active ion is taken up into an electrode in a lithium battery, for instance. This uptake results in a highly dynamic electrode surface that becomes an active interface to the electrolyte during cycling. These changes vary depending upon the composition of the electrode. For example, graphite shows only small volume changes during charge-discharge cycling; thus, there is only a small impact on the mechanical stability of the SEI on graphite (Figure 8). In contrast, lithium storage metals and alloys show much larger

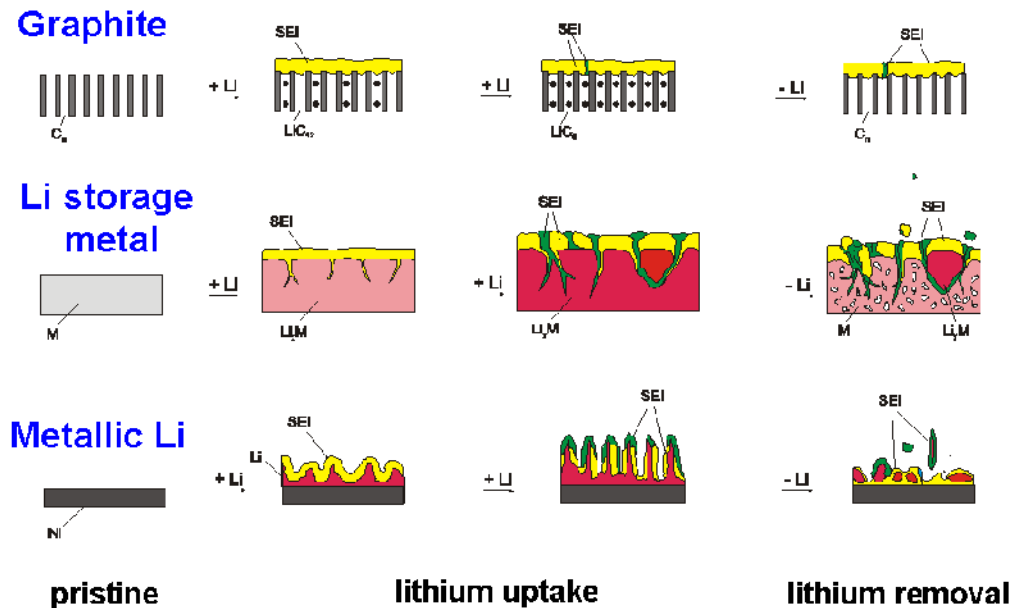


Figure 8. SEI stability and growth during continuous lithium uptake and removal for different anodes: graphite, lithium storage metals, and metallic lithium.

volume changes. Any cracks caused by an increase in volume of the electrode materials must be accommodated with the SEI; however, the SEI itself may break down during cycling. As a consequence, irreversible capacity losses are not limited to the first few cycles, but may continue to deteriorate cell performance and life. Accordingly, both electrodes and electrolytes have to be designed to take this into account, and systems that use novel nanoscale materials and appropriate electrolytes could be designed to minimize these changes.

### Design of new electrolytes and anodes for multifunctionality

Despite the success of lithium-ion systems in research and industrial applications, the advent of new applications has revealed the limitations of state-of-the-art electrode and electrolyte materials in these systems with regard to performance, cell life, safety, and cost. To meet future chemical energy storage system needs, new electrolytes are critically needed. For instance, the most common electrolyte salt, lithium hexafluorophosphate ( $\text{LiPF}_6$ ), is unstable at elevated temperatures and against even minimum moisture levels. Ester-based solvents (such as propylene carbonate) employed as part of the electrolyte have limited oxidation stability and low-temperature performance. Further, the presently used liquid organic electrolyte systems are flammable and tend to leak. Finally, the new materials used as replacements for traditional graphitic anodes contain surface impurities and/or suffer from significant surface dynamics during cycling that render them unstable.

**Electrolyte chemistries.** The beneficial effect of new electrolyte chemistries on cell performance can be illustrated by the following example. The advantages of the two electrolyte salts, lithium bi-oxalato borate ( $\text{LiBOB}$ ) and lithium tetrafluoroborate ( $\text{LiBF}_4$ ), can be combined into one salt, lithium oxalyldifluoroborate ( $\text{LiODFB}$ ), that is a hybrid possessing the structural features of both salts (Figure 9). The disadvantages of both components are eliminated (i.e., the lower conductivity of  $\text{LiBF}_4$  in carbonate solvents and the higher resistivity of the SEI formed in  $\text{LiBOB}$ ).

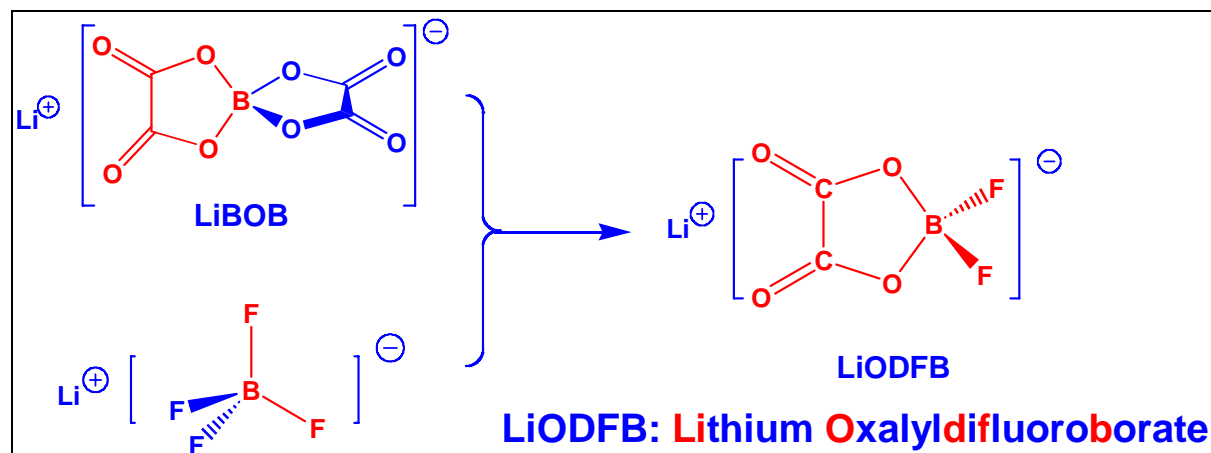


Figure 9. LiODFOB: a hybrid electrolyte salt material formed from  $\text{LiBF}_4$  and  $\text{LiBOB}$ .

Many opportunities exist for designing electrolytes for optimum cell performance. One approach would be to add materials to the electrolyte to tailor the formation of the SEI. Such electrolyte additives have been shown to be helpful in maintaining high-temperature stability and sometimes improving kinetics at low temperature. In addition, several additives have been demonstrated to overcome the problems of overcharge reactions in lithium-ion cells. Another approach would be the development of completely new electrolyte chemistries based on ionic liquids, ceramics, polymers, and hybrids or composites of these materials. Regardless of the approach, interface/interphase issues and physical electrolyte properties and their influence on thermodynamics and kinetics must be considered. However, our present understanding of these important issues is quite limited. Further, the design of the optimal electrode will require a fundamental understanding of these issues as a system, taking into account the interplay of all of the physical and chemical parameters that affect cell performance. For example, we must understand the physical interactions (ion-ion, ion-solvent, etc.) of the electrolyte components with each other. We must also understand how cell performance is affected by the viscosity, wettability, and conductivity of the electrolyte system. Moreover, it is critical to understand the impact of individual electrolyte components on SEI formation and stabilization in conjunction with various anode and cathode chemistries that need to be addressed. New computational tools will make it possible to model these processes so that optimal electrolytes can be designed.

**Anode materials.** For future chemical energy storage systems, a major target is attaining a higher redox potential than that afforded by today's lithium/graphite system without the cell voltage (and capacity) penalty suffered by use of the high rate/zero strain oxide  $\text{Li}_4\text{Ti}_5\text{O}_{12}$ . This target poses a particular challenge, because large volumetric changes have to be compensated in any high-capacity anode material. Nanocomposite materials may provide these needed technology breakthroughs. Fundamental research is needed to uncover the characteristics that lead to optimal properties, including understanding solid-solution behavior when two-phase behavior would otherwise dominate in bulk materials, and controlling the complex nature of the interfaces in composites. Another promising approach is developing novel chemical energy storage systems that operate by displacement reactions (rather than intercalation chemistry) based on low-potential oxides, sulfides, phosphides, and their composites. These materials would require the design of new electrolyte/SEI combinations to optimize the overall system. Lowering the overall voltage of the displacement reaction and tailoring it by choice of chemistries is a highly desirable goal if these materials are to see acceptance in cell systems. New probes must be developed to gain a full understanding of the large voltage hysteresis displayed by these systems (generally, a consequence of mass transfer energetics) and to allow it to be minimized through careful control of nanostructured approaches. Finally, new analytical and computational tools are needed to monitor and model experiments. These tools will allow us to understand the effect of electrolyte components within the complex electrolyte/electrode cell system and the interdependence of these components. These components and the resulting electrolyte systems are critical for extending the temperature- and voltage-window operations that are required for future chemical energy storage systems.

## **Potential Impact on Electrical Energy Storage and Beyond**

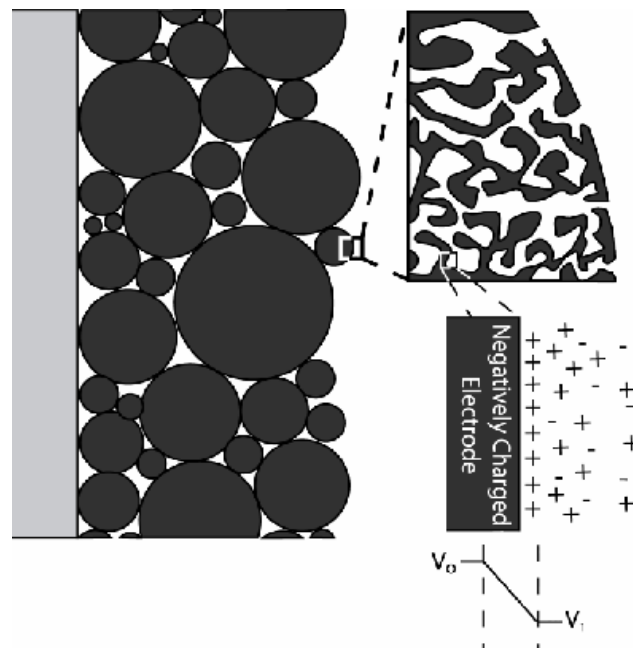
The interface of the electrolyte and the interphases formed from electrolyte decomposition are critically important to chemical-based electrical energy storage systems. The research directions described above seek a systems-based understanding of interfaces and would result in a holistic and synergetic approach for designing tailored interfaces/interphases for future high-energy storage systems with longer life and safer performance. This understanding will also further advances in other fields involving charge-transfer interfaces and chemically formed interphases, such as those in fuel cells, capacitors, electrocatalysts, bio-inspired separation membranes, and other applications of importance to energy production, storage, and use.

## CAPACITIVE ENERGY STORAGE MATERIALS BY DESIGN

*Achieving a significant increase in the energy density of electrical double layer capacitor (EDLC) energy storage devices while retaining their characteristic advantages of high power and extraordinary cyclability will open up great possibilities for the use of capacitor-based storage across the entire energy sector. Currently there is a lack of fundamental understanding of charge storage on the nanoscale, which has led to an Edisonian approach to improvements in these systems. Furthermore, this lack of understanding continues to hamper the design and development of alternative electrochemical capacitor (EC) storage materials with energy densities that could approach those of lead-acid batteries. A systematic, highly coordinated research effort in which synthesis is strongly coordinated with modeling and the characterization of novel materials with controlled and optimized pore structures, tailored surface functionality, and nanostructured architectures is critically needed to elucidate these fundamental atomic- and molecular-level issues.*

### Background and Motivation

Although the energy density of ECs is currently lower than that of batteries, they can deliver this energy at very high rates (power) for over a million charge-discharge cycles. Activated carbon, the most widely used electrode material in commercial devices, benefits from its ready availability and low cost despite (1) an ill-defined and/or unoptimized pore structure that ultimately limits its capacitance, (2) a variable surface functionality that leads to long-term degradation, (3) high self-discharge that limits shelf-life of the charged device, and (4) low (<10 Wh/kg) energy density. ECs using activated carbons primarily store charge in the electrochemical double layer, wherein electrolyte ions are closely associated with the electrode surface (Figure 10). This *physical* mechanism of charge storage distinguishes



**Figure 10. Schematic of an activated carbon-based EDLC illustrating the heterogeneity of particle size, pore size, and pore structure of the electrode that ultimately leads to performance limitations.**

EDLCs (and ECs in general) from *chemical* energy storage systems (batteries) and leads to their distinct advantages of high power and extremely high cyclability. Finding ways to increase the energy density of EDLCs significantly while retaining these advantages will open up great possibilities for their use across the entire energy sector.

Because the double layer capacitance of an EDLC depends, in part, on the specific surface area (SSA) of the electrodes, numerous efforts have been made to increase the SSA of activated carbons. Current materials approach a few thousand square meters per gram, and it is expected that further increases in SSA alone will lead only to incremental improvements in performance. Thus, significant advancement in the field will require the discovery of innovative charge storage concepts and materials. Currently, there is a lack of fundamental understanding of the charge storage phenomena on the nanoscale, which to date has led to a trial-and-error approach to its optimization. Moreover, this lack of understanding continues to hamper the design and development of alternative, potentially high-energy-density, capacitive charge storage materials.

### **Science Questions and Opportunities**

The physics and chemistry involved in charge storage of EDLCs have not been well studied, and elucidating these processes is necessary if a basis for understanding how to increase the energy density of these charge storage materials is to be gained. Either single or multiple charge storage mechanisms can be considered. For example, improvement in charge storage for “pure” double layer carbon EDLCs could potentially lead to materials having surface areas  $>3500 \text{ m}^2/\text{g}$ , pore volumes of  $>3 \text{ cm}^3/\text{g}$ , and pore sizes in the range of 1–2 nm. The challenge is the synthesis of tailored materials with these characteristics in a highly controlled and reproducible manner. The roles of pore structure and pore size for materials utilizing only double layer charging is another key fundamental question. The recent report of an anomalous increase in capacitance of carbide-derived carbon materials with pore sizes below 1 nm may necessitate a rethinking of traditionally held views on effective ion size and solvation.<sup>1</sup> Can systems with a controlled pore size and structure be used as models to elucidate these interactions? Uncontrolled surface functionality is known to be a cause of premature EDLC failure. However, could redox couples be rationally incorporated to enhance capacitance while maintaining long-term cyclability? Can the unprecedented control over structure and properties that the recent nanotechnology revolution provides be applied to the synthesis of new capacitive energy storage materials and to the architectures of electrodes made from them to achieve energy densities far greater than are currently available?

### **Research Directions**

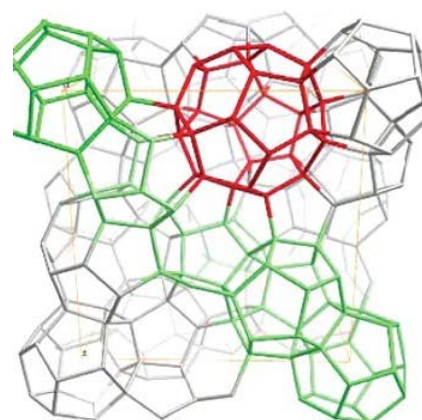
**Materials utilizing only double layer charge storage.** Recent discoveries of dramatic capacitance enhancement in nanoporous carbons underscores the need to move beyond today’s standard activated carbons with their poorly controlled pore size distribution and to identify the phenomena responsible for the dramatic increase of both the gravimetric and volumetric capacitance. One fundamental question that must be answered is, what is the best pore size for an EDLC material that leads to the highest capacitance in a defined electrolyte? The answer will require a reexamination of our current limited understanding of the double layer charging mechanism as applied to the subnanoscale level. The underlying cause of the impressive capacitance enhancement observed for pores smaller than 1 nm is not completely



understood at present, nor are the limits of how far this phenomenon can be extended. The current double layer charging theories are inadequate to explain subnanoscale effects that could be operating in these materials, including the thermodynamics of ion solvation-desolvation and possible surface electronic density redistribution. The experimental results must be closely coupled with new modeling approaches that specifically consider those features unique to EDLCs rather than simply applying existing models based on batteries.

Tailored materials with mono-dispersed pore size distribution have the potential to provide optimum charge storage. Unfortunately, the availability of such materials is currently limited. Today, high-surface-area activated carbons are prepared with a top-down approach employing chemical or physical activation, but this leads to random pore sizes and broad distributions. Recent advances in nanoscience provide the opportunity to design structures with tailored pore sizes from a variety of material families.

An example of materials with a controllable, well-defined pore structure is zeolites (Figure 11), which are, unfortunately, electrically insulating. Synthesis of electrically conducting analogs using other (transition) metal derivatives would greatly extend the range of materials with well-defined pore structures. Recent reports of semiconducting crystalline microporous materials with band gaps as low as 0.25 eV would open these and related materials to exploration in charge storage applications. Similarly, a new family of materials called metal-organic-frameworks has recently been reported, with some members possessing well-defined pore structures and surface areas in excess of 3000 m<sup>2</sup>/g. Again, these materials are insulating, so syntheses must be devised to extend these strategies to conducting materials appropriate to EDLCs.



**Figure 11. Cagey structures.** Zeolite architecture of MIL-101 showing mesoporous cages with diameters of 29 Å (green) and 34 Å (red) featuring 12 Å pentagonal and 15 Å hexagonal openings.<sup>3</sup>

**Multifunctional charge storage concepts.** Although incremental capacitance and energy increases are expected from using nanoporous EC materials, truly revolutionary increases can be achieved by creating multifunctional materials that allow charge storage via multiple mechanisms. For example, unlike the random and ill-defined functionalities present in activated carbons, which often impair long-term cycle stability, reversibly stable redox groups could be *intentionally introduced* so that their pseudocapacitance can significantly enhance the double layer capacitance of the high SSA substrate. Alternatively, conformal dielectric or conducting materials could be used to modify the surfaces of ordered high-surface-area materials. Incorporating a dielectric material onto high SSA conducting substrates will enable large voltage increases, while conductive coatings of materials with pseudocapacitive behavior, such as conducting polymers, will dramatically increase the electrode's capacitance. High reversibility and thinness are needed for conductive coatings to ensure long-term cycle stability and favorable power, respectively.

**Materials utilizing designed architectures.** While novel nanostructured materials lead to very high surface areas, the ion paths into the materials are often tortuous. The opportunity to explore designed structures whose porosity might exceed that of today's activated-carbon-based EDLCs can be pursued. One possible structure is envisioned as an array of vertically aligned nanotubes made from carbon and other materials, where the spacing between the tubes is matched to the diameters of the solvated ions. This arrangement has the potential to provide high-porosity (>80%), straight paths for efficient ion diffusion. Research into these and other types of tailored architectures has great potential to improve EDLC performance significantly.

Further improvements in performance could potentially be achieved by integrating the porous material and the current collector. This integration could lead to a decrease in the equivalent series resistance (ESR), which limits the overall power in charge storage devices. Today's technology uses aluminum current collectors, which suffer from passivating layers that must first be removed, and their corrosion over time causes an increase in ESR. This, in turn, leads to a decrease in the capacitance over time. Although small changes in assembly can decrease the resistance, they cannot provide a fundamental decrease in ESR values. Future electrodes may consist of carbon current collectors (e.g., graphene sheets or carbon nanotubes with metallic conductivity) that are lightweight, electrically conductive, and not subjected to any chemical reactions under the operation conditions. The nanostructured porous materials would be assembled directly onto the carbon current collectors.

## Technology Impact

EDLCs constitute the most widely known class of ECs and serve as the basis for numerous applications. It is readily apparent that increasing the energy density of EDLCs to the level of lead-acid batteries will have an enormous impact, as it will enable entirely new approaches to EC-based energy storage technology and energy regeneration systems to be realized. Some of the directions described in this section, involving the design of materials and architectures, may provide the basis for the next generation of high-performance EDLCs. To achieve such advances, it is essential that we place considerable emphasis on improving our understanding of charge storage processes, especially at the nanoscale.

## References

1. J. Chmiola, G. Yushin, Y. Gogotsi, C. Portet, P. Simon, and P. L. Taberna, "Anomalous increase in carbon capacitance at pore sizes less than 1 nanometer," *Science* **313**, 1760–63 (2006).
2. R. K. Dash, "Nanoporous Carbons Derived from Binary Carbides and Their Optimization for Hydrogen Storage," Ph.D. Thesis, Drexel University, 2006.
3. G. Férey, F. Millange, J. Dutour, S. Surblé, and I. Margiolaki, "A chromium terephthalate-based solid with unusually large pore volumes and surface area," *Science* **309**(5743), 2040–2042.

## ELECTROLYTE INTERACTIONS IN CAPACITIVE ENERGY STORAGE

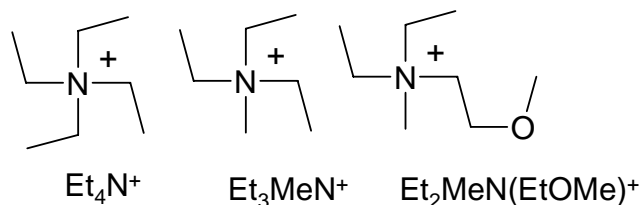
*To design the ideal electrolyte for an electrochemical capacitor (EC) requires a fundamental understanding of the molecular interactions in both the bulk electrolyte and electrode-electrolyte interface. At present there is a general lack of understanding regarding the influence of electrolyte components (salts, solvents, additives) on molecular interactions and physical properties (ionic conductivity, viscosity, volatility) and how electrolyte properties influence device performance. Understanding these fundamental properties and interactions will enable design of new electrolytes that are tuned for specific electrode-electrolyte systems and diverse applications in regeneration and storage of energy.*

### Background and Motivation

The performance of ECs can be limited significantly by the electrolyte properties. The ideal electrolyte will have the following features:

- high ionic conductivity and/or mobility for a very fast charge-discharge rate ( $<1$  s),
- high chemical and electrochemical stability resulting in a high capacitance and long device lifetime,
- excellent temperature stability to deliver high power and energy at both low ( $< -30^{\circ}\text{C}$ ) and high ( $>100^{\circ}\text{C}$ ) temperatures, and
- low volatility and low flammability for high safety.

Additional desired features for future EC electrolytes include “immobilized” electrolytes for simplification of capacitor configuration and electrolytes produced from sustainable materials, which are inexpensive, nontoxic, biodegradable, and/or renewable. Both aqueous and nonaqueous EC electrolytes are commercially used. Aqueous electrolytes with KOH or  $\text{H}_2\text{SO}_4$  yield much higher conductivities and thus lower device impedance and faster response times. However, organic electrolytes permit wider operating voltages, which is beneficial as the energy of a capacitor scales with the square of the voltage. Organic electrolytes used in commercial ECs generally consist of 1 M acetonitrile or propylene carbonate solutions with tetraethylammonium tetrafluoroborate ( $\text{Et}_4\text{NBF}_4$ ) (m.p.  $>300^{\circ}\text{C}$ ) or  $\text{Et}_3\text{MeNBF}_4$ . The structurally similar ionic liquid (IL)  $\text{Et}_2\text{MeN}(\text{EtOMe})\text{BF}_4$  (m.p.  $9^{\circ}\text{C}$ ) is now also commercially used in ECs.<sup>1</sup> The structures of these cations are shown below.



The advantages of this IL include a higher solubility than  $\text{Et}_4\text{NBF}_4$  in carbonate solvents, enabling the use of concentrated solutions and thus providing higher capacitance and higher conductivity at low temperature.

At present, EC electrolytes such as those noted are selected by optimizing the bulk properties thought to be critical for EC performance, such as high ionic conductivity, large

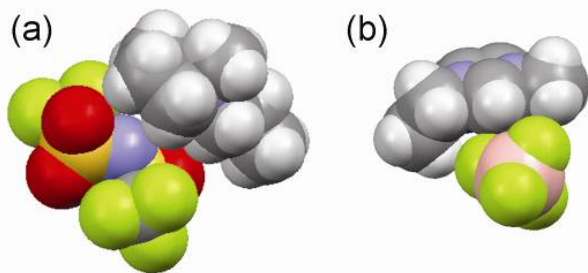
electrochemical stability window, and low viscosity. Overall EC performance, however, is determined largely by the electrolyte behavior at the electrode-electrolyte interfaces under charged condition, which may differ significantly from the bulk, especially for the highly porous materials used for EC electrodes. There is an important interrelationship between bulk and interfacial properties and device performance—including charge-discharge behavior, energy density, and lifetime—that is currently not understood. This knowledge will permit the tailoring of electrolytes for diverse, demanding EC applications and provide the fundamental background to take ECs to the next step.

## Research Directions

The electrolyte must be considered in the context of two regimes—in bulk solution and at the interface with the EC electrode. We do not presently have the fundamental knowledge to determine whether bulk electrolyte properties are the most suitable criteria for the selection of electrolyte components in ECs. For example, the wettability and conductivities of 1 M quaternary ammonium bis(oxalato)borates (QABOBs)/propylene carbonate solutions are lower than those of 1 M  $\text{Et}_4\text{NBF}_4$ /propylene carbonate. Yet, the charge-discharge characteristics of the QABOB solutions are comparable to or better than those of the commercial 1 M  $\text{Et}_4\text{NBF}_4$ /propylene carbonate solution.<sup>2</sup> Such examples challenge the conventional wisdom and require further examination of EC electrode charging-discharging mechanisms with electrolytes. The following section outlines key issues that must be addressed to enable the design and control of the chemical and physical parameters that control charge storage in ECs.

**Fundamental understanding of the relationships among solvent/salt structure, solution concentration, temperature, and electrolyte physical properties to design improved electrolytes.** Although a bulk solution consisting of a single solvent and single salt (e.g., 1 M  $\text{Et}_4\text{NBF}_4$  in propylene carbonate) may appear to be a relatively simple system, complex solvent-ion and ion-ion interactions may result in the formation of a variety of solvates, including contact ion pairs and aggregates. These complex interactions dictate the macroscopic properties of bulk electrolytes such as ion conductivity, viscosity, and volatility. We need to understand these connections to design new electrolytes. New tools are needed that can provide insight into the physical and chemical aspects of the bulk solution, including combined techniques that can provide multiple dimensions of information such as structural and dynamic changes as a function of temperature. For example, neutron scattering, combined with deuterium labeling, may provide insight into ion solvation. Complementing analytical tools, the development of new computational tools will also be critical for modeling the molecular interactions in the bulk solution. This detailed molecular information can then be used to correlate and explain the link between electrolyte bulk physical properties such as viscosity, conductivity, volatility, and solvent/salt structure. This type of information is particularly important for ILs.

ILs (Figure 12) represent a particularly interesting type of electrolyte because many ILs are nonvolatile at atmospheric pressure and have low flammability. The benefits of using ILs, therefore, include improved safety from reducing or eliminating the volatile, highly flammable organic solvents and improved high- and low-temperature operation.<sup>1,3</sup> Because no additional solvent molecules are present, no concentration gradients occur in the bulk, and



**Figure 12.** Ions in the ionic liquids (a) *N*-methyl-*N*-propylpyrrolidinium bis(trifluoromethane-sulfonyl)imide (PYR<sub>13</sub>TFSI) and (b) 1-ethyl-3-methylimidazolium tetrafluoroborate (EMIBF<sub>4</sub>).

understanding of these “simple” bulk solutions would allow more complicated mixed solvents and/or mixed salts to be studied. Their potential benefits are exemplified by the mixed solvent electrolytes used in commercial lithium-ion batteries and possible eutectics that may exist for ILs. This understanding would also help elucidate the mechanism for electrolyte degradation, which shortens the lifetime of an EC. This understanding could provide insights that could lead to the development of impurity scavenging or even self-healing reactions that could be designed into the chemistry of the electrolyte solution and extend its lifetime.

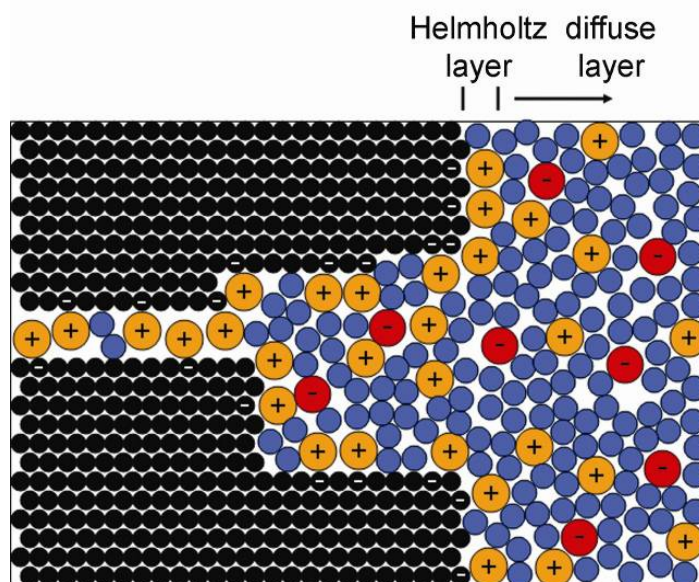
**Control of physical and chemical processes at the electrolyte/ electrode surface to provide enhanced energy and power density.**

The solvent-ion and ion-ion interactions in the bulk phase are governed by electrostatic, steric, and other forces. Near a charged electrode interface, however, the balance of these forces results in the formation of an electric double layer (DL) (Figure 13). Thus, in addition to understanding the molecular-level behavior of electrolytes in the bulk phase, we need to understand their behavior at the electrode interface. Understanding the number of ions participating in the charge storage process for different electrolyte systems and different electrode/solution materials is clearly of fundamental importance. Understanding the structure of the electrical DL is even more critical since the total capacitance ( $C_{TOT}$ ) is determined by both the capacitance due to the Helmholtz layer ( $C_{Helm}$ ) and the diffuse layer ( $C_{Diff}$ ):<sup>4</sup>

$$1/C_{TOT} = 1/C_{Helm} + 1/C_{Diff} .$$

cation and anion structure and size may be readily controlled. The ambient-temperature viscosity of ILs is typically one order of magnitude or more higher than that of a 1 M Et<sub>3</sub>MeNBF<sub>4</sub>/propylene carbonate solution. Nevertheless, the conductivity can be comparable or even higher, and the underlying principles for these behaviors are poorly understood.

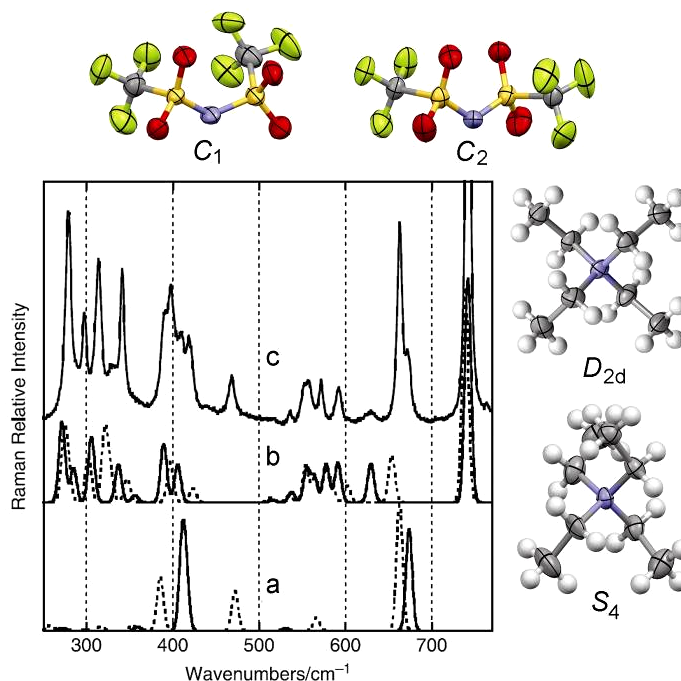
Obtaining a molecular level



**Figure 13.** Schematic of how ion solvation may change in pores of different sizes during electric double layer charging (electrode material, black; solvent, blue; cation, orange, anion, red).

In the extreme case of interfaces within confined pores, especially those in which the pore size approaches the ion dimensions, radical differences in the DL structure are expected. It was previously believed that some or all of the pores were not used for DL charging if their dimensions were too small. However, highly anomalous increases in capacitance have been observed to occur when a significant fraction of micropores (with diameters  $< 2$  nm in size, according to IUPAC classification) are present.<sup>5</sup> Differences in the size and charge of the ion can also impact the interaction with the electrode. For example, it has been found that while the capacitance of ECs with activated carbon and 1 M propylene carbonate solutions of various salts is strongly dependent on the anion, it is essentially independent of the nature of the cation.<sup>1</sup> Clearly, the choice of electrolyte will have a significant impact on micropore utilization, and further work is needed to understand the relationship among ions, solvents, and electrode pore size as well as their integrated impact on DL capacitance and charging/discharging. Little is known about the interaction of these unconventional electrolytes with electrode surfaces and within pores, and conventional DL models may be further challenged with these novel materials.

The experimental characterization of the molecular structure at interfaces is extraordinarily challenging and requires the development of new analytical techniques capable of elucidating dynamic processes at high spatial and temporal resolution. For example, considerable insight into the conformations and interactions of the  $\text{Et}_4\text{N}^+$  and trifluoromethanesulfonylimide (TFSI) ions in  $\text{Et}_4\text{NTFSI}$  is possible in bulk solution with vibrational spectroscopy (Figure 14).<sup>6</sup> However, new tools or combinations of tools are needed to examine these



**Figure 14.** Calculated and scaled Raman spectra for (a)  $\text{Et}_4\text{N}^+$   $D_{2d}$  (solid line) and  $S_4$  (dotted line), (b) TFSI transoid  $C_2$  (solid line) and cisoid  $C_1$  (dotted line) compared with (c) experimental Raman spectrum of  $\text{Et}_4\text{NTFSI}$  recorded at 296 K.<sup>6</sup>



species dynamically at the interface and in pores associated with EC electrodes. For example, sum frequency generation vibrational spectroscopy and electrochemical impedance spectroscopy have indicated that the DL of an IL-platinum interface consists only of a single layer of ions (a Helmholtz layer without the diffuse layer).<sup>7</sup> Other novel tools, such as in situ X-ray and neutron scattering, have great potential for studying electrode-electrolyte interfaces. These experimental measurements should be coupled with molecular modeling/simulations to explain how the bulk molecular interactions change at interfaces and in confined pores under the influence of an electric field. New computational tools will allow the complex set of physical and chemical phenomena that occur at the electrode-electrolyte interface to be modeled and provide insight for the tailored design of electrolytes.

**Electrolytes to enhance Faradaic pseudocapacitance.** Faradaic pseudocapacitance can generate and store 10 to 100 times as much energy as nonfaradaic EDL capacitance. Like battery electrodes (see Chemical Energy Storage Panel Report), pseudocapacitance involves charge transfer redox reactions. Unlike those in battery electrodes, however, the reactions exhibit fast and reversible charge-discharge responses. Electrolytes will, therefore, need to be tailored to promote fast ionic transfer and redox reactions in both aqueous and nonaqueous systems. To achieve this, many issues need to be understood. What is the function of ions in a pseudocapacitive reaction? Is the degree of hydration at the surface of the electrode critical for high energy density in metal oxides or nonoxides? How can the electrochemical operational window be expanded from 1 V to >2 V? Is it possible to use ILs for pseudocapacitance with metal oxides or nonoxides? The use of ILs with electrically conducting polymers has already been demonstrated but is far from fully understood and optimized. Are immobilized electrolytes suitable for pseudocapacitance, especially with respect to ECs with microporous electrodes? Immobilized liquid electrolytes are of high interest because the immobilized matrices will enable novel bipolar layered structures, moving us away from metal-can cell configuration and opening up new opportunities for increasing the specific energy and power density.

## Impact

Basic research is critical for elucidating the rules for designing novel electrolyte material systems. The insight from studies of bulk and interfacial properties of electrolytes will inspire innovative approaches to overcome current technology “show stoppers” such as limited electrochemical operational windows, poor electrode wettability by the electrolyte (which inhibits full electrode utilization), and long-term stability issues due to impurities or electrolyte degradation. The success of this research will lead us closer to achieving ideal electrolytes for ECs. New materials with high ionic conductivity and wider electrochemical operation windows will facilitate high-energy density and high-rate devices. Further, electrolytes with high chemical and thermal stability combined with low or negligible volatility will ensure long-term performance, reliability, and safety. Designs that immobilize the electrolyte have the potential to increase energy and power density and simplify the design, fabrication, and packaging of ECs. Technical breakthroughs gained by fundamental research will lead to new concepts for high-power energy storage systems that have high performance, high efficiency, and a flexible form factor. This could open the door to a range of innovative EC designs—not just a battery-like can, but also conformal, flexible, and fiber-

like wearable ECs that can be incorporated into virtually any device to provide power for portable electronics and other applications.

## References

1. K. Yuyama, G. Masuda, H. Yoshida, and T. Sato, "Ionic liquids containing the tetrafluoroborate anion have the best performance and stability for electric double layer capacitor applications," *Journal of Power Sources* **162**, 1401 (2006).
2. N. Nanbu, T. Ebina, H. Uno, S. Ishizawa, and Y. Sasaki, "Physical and electrochemical properties of quaternary ammonium bis(oxalato)borates and their application to electric double layer capacitors," *Electrochimica Acta* **52**, 1763 (2006).
3. A. Balducci, R. Dugas, P. L. Taberna, P. Simon, D. Plée, M. Mastragostino, and S. Passerini, "High temperature carbon-carbon supercapacitor using ionic liquid as electrolyte," *J. Power Sources* **165**, 922 (2007).
4. B. E. Conway, *Electrochemical Supercapacitors: Scientific Fundamentals and Technological Applications*, Kluwer Academic/Plenum Publishers, New York, 1999.
5. J. Chmiola, G. Yushin, Y. Gogotsi, C. Portet, P. Simon, and P. L. Taberna. "Anomalous increase in carbon capacitance at pore sizes less than 1 nanometer," *Science* **313**, 1760 (2006).
6. M. Herstedt, W. A. Henderson, M. Smirnov, L. Ducasse, L. Servant, D. Talaga, and J. C. Lassègues, "Conformational isomerism and phase transitions in tetraethylammonium bis(trifluoromethanesulfonyl) imide Et<sub>4</sub>N<sup>+</sup>TFSI<sup>-</sup>," *Journal of Molecular Structure* **783**, 145 (2006).
7. S. Baldelli, "Probing electric fields at the ionic liquid-electrode interface using sum frequency generation spectroscopy and electrochemistry," *Journal of Physical Chemistry* **109**, 13049 (2005).



## MULTIFUNCTIONAL MATERIALS FOR PSEUDOCAPACITORS AND HYBRID DEVICES

*Pseudocapacitors exhibit characteristics of both electrochemical double layer capacitors (EDLCs) and batteries. They thus offer the potential to address critical performance gaps that exist between those two classes of energy storage devices. Materials that exhibit pseudocapacitance range from conducting and redox polymers to a variety of transition metal oxides. To further advance this broad class of energy storage materials, future fundamental research should focus on the design and discovery of new materials and architectures. In particular, composite architectures comprising multiple components (e.g., combinations of polymers, oxides, and/or carbon) will be required to achieve optimized energy and power density. A fundamental understanding of interfacial phenomena, including charge storage processes, will also be critical to achieve stability and high performance for pseudocapacitor materials.*

### Background and Motivation

The term “pseudocapacitance” broadly describes rapid and reversible Faradaic reactions whose discharge profiles mimic those of EDLCs.<sup>1,2</sup> The classes of materials being investigated for their promising pseudocapacitance include transition metal oxides, conductive nitrides, and conducting polymers. Because pseudocapacitive mechanisms involve electron-transfer reactions and may include both bulk and interfacial processes, materials that exhibit pseudocapacitance often provide higher energy densities than materials that store charge via double layer capacitance (e.g., high-surface-area carbons). Thus, devices that incorporate pseudocapacitance charge storage functionality will bridge the performance gap that currently exists between batteries and EDLCs in terms of achieving both high energy and high power density.<sup>3</sup> In addition, materials that exhibit pseudocapacitance may be combined with traditional chemical energy storage (battery) *or* EDLC materials to produce hybrid asymmetric devices that further expand the possible energy/power performance range beyond any metrics that are achievable today. Electrical energy storage (EES) devices based on pseudocapacitance may ultimately replace conventional systems that require discrete battery and capacitor components to address the usually divergent requirements for power vs. energy density.

### Science Questions and Opportunities

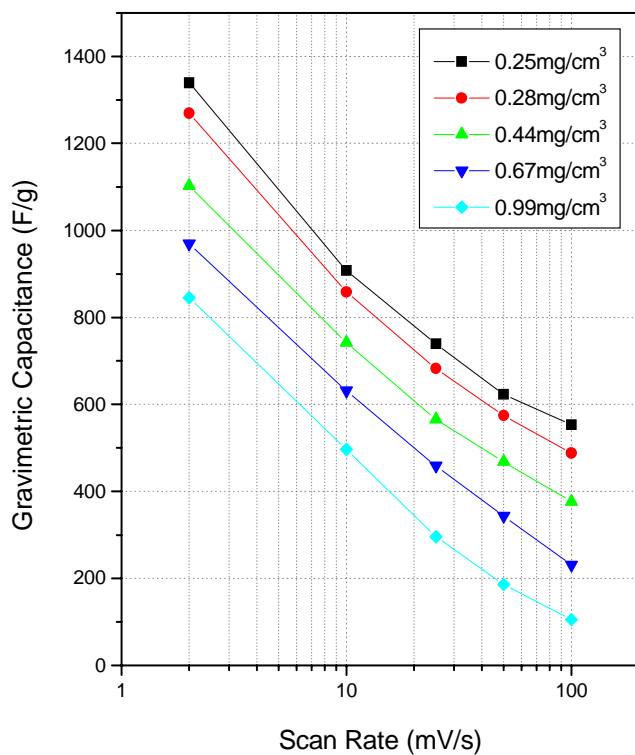
Hydrous forms of ruthenium dioxide ( $\text{RuO}_2$ ) currently represent the state of the art in pseudocapacitor materials exhibiting specific capacitances in excess of  $700 \text{ F/g}^{-1}$  (Ref. 4). However, the high cost of ruthenium (a platinum group metal) is prohibitive for any large-scale application to EES. Thus, alternative materials are presently being explored, including lower-cost transition metal oxides (e.g.,  $\text{MnO}_2$  and  $\text{MnFe}_2\text{O}_4$ ) as well as a broad class of conducting and redox polymers. However, simply exploring possible new materials without understanding the fundamental issues that result in optimum performance will not result in the technology breakthroughs that are needed for future EES devices. Although the redox-based charge storage mechanisms of pseudocapacitor materials are related to those of conventional battery materials, the pseudocapacitance phenomenon is not well understood. Because pseudocapacitance is exhibited by a broad class of materials, the operational mechanisms of particular materials, often based on highly complex and specific redox reactions, cannot be generalized to new pseudocapacitor materials as they are discovered.

Charge storage mechanisms may also be affected by the introduction of advanced electrolyte compositions. It is clear that the design of new, high-performance pseudocapacitor materials will require fundamental investigations of charge storage mechanisms.

The components of pseudocapacitors must serve a variety of distinct and often divergent functions: (1) electron conduction, (2) ion conduction, (3) charge storage, and (4) providing the physical structure of the electrode itself. Few individual materials exhibit all of these properties. Thus, there is great promise in developing new composite materials and architectures in which selected components are assembled into multifunctional structures using recent advances in nanoscience. Porosity (i.e., void space) is also an important component in electrode structures that are designed for high-power performance, as it facilitates the rapid transport of ions to electroactive interfaces. Therefore, advanced pseudocapacitors must ultimately be designed as composite architectures that include all of

### ***Unconventional Materials for Electrochemical Pseudocapacitance***

Transition metal nitrides and carbides are well known for their refractory characteristics and excellent corrosion resistance to acids and bases. At the same time, transition metal nonoxides exhibit metallic characteristics with electronic conductivities as high as  $2 \times 10^6$  S/m. These characteristics make them attractive candidates for capacitor applications as a potential replacement for costly ruthenium oxide. In addition, the ability of some of the transition metals such as vanadium to access multiple oxidation states, similar to that of ruthenium, renders them as candidate EC materials. For example, nanocrystalline VN (~5 nm) particles recently synthesized at temperatures as low as 400°C exhibit an impressive specific capacitance of 1340 F/g at a scan rate of 2 mV/s and a specific capacitance of 550 F/g at 100 mV/s and 190 F/g at a scan rate of 2 V/s (see figure).<sup>5</sup> XPS and HRTEM analysis indicate the reversible oxidation and reduction of vanadium (II–IV) arises from a monolayer surface film of an amorphous oxide/oxynitride. The exact mechanism, interaction with the aqueous KOH electrolyte, and the electrochemical stability are still unknown. These and other novel pseudocapacitance materials hold exciting promise for future generations of EES devices.



the functionalities described. New approaches to synthesis and fabrication will be required to achieve multifunctional architectures, particularly where the individual components are spatially distributed on the nanoscale. The progress in achieving such complex composites is also currently limited by the lack of specific modeling efforts that could provide predictive direction to the synthesis of these tailored structures.

## Research Directions

Fundamental understanding of pseudocapacitance mechanisms. Ultimately, revolutionary advances in energy and power storage densities in pseudocapacitors will emerge from a stronger fundamental understanding of the charge storage mechanisms that support pseudocapacitor function. Because most pseudocapacitor materials are prepared and studied in high-surface-area forms, contributions from double layer capacitance may also be important. Further effort will be required to differentiate between the double layer and reduction-oxidation (redox) processes that are inherent to the various classes of pseudocapacitor materials. Classical approaches such as impedance spectroscopy, studies of ion/electron transport kinetics, adsorption/desorption thermodynamics, and response-time distribution can shed light on the problem. However, it should be noted that nonclassical phenomena, such as quantum size effects, that are inherent to nanoscale materials may further complicate the analysis of such materials. Established spectroscopic methods (e.g., X-ray-based methods) that are compatible with in situ investigations should also be exploited to further characterize the pseudocapacitance process. Dimensional control of material architectures and use of nanofabrication should enable systematic experimental studies of ion transport in well-defined one-, two-, and three-dimensional structures. Such studies should be strongly coupled to theoretical modeling. Integrated studies—including theoretical modeling of both ion and charge transport in conducting polymers, mixed oxides, and other pseudocapacitive materials—should be undertaken, especially in well-defined material systems. High-resolution near-field optical and spatially resolved scanning probe techniques may be promising tools to probe ion and electron transport in charge storage materials that are inhomogeneous, particularly multifunctional composites.

**Design of new pseudocapacitor materials and architectures.** Once the underpinning mechanisms for pseudocapacitance are understood, this knowledge will provide a basis for designing new materials. Because a pseudocapacitor stores energy on the surface or subsurface, the capacity or specific energy may be enhanced by increasing the surface area of the electrode materials. Nanoscience offers new routes to the synthesis of high-surface-area materials, such as nanotubes, nanowires, and nanohorns. These and other nanomaterials offer a great potential to enhance the energy density for pseudocapacitors. New classes of pseudocapacitor materials may include nanostructures made from metal oxides, metal nonoxides (e.g., sulfides, nitrides, carbides, borides), and new conducting and redox-active polymers. Further, block copolymers can be used as templates for designing tailored architectures. Hierarchical assembly of multicomponent nanoscale materials may also be achieved with self-assembly or biomimetic approaches using DNA or proteins.

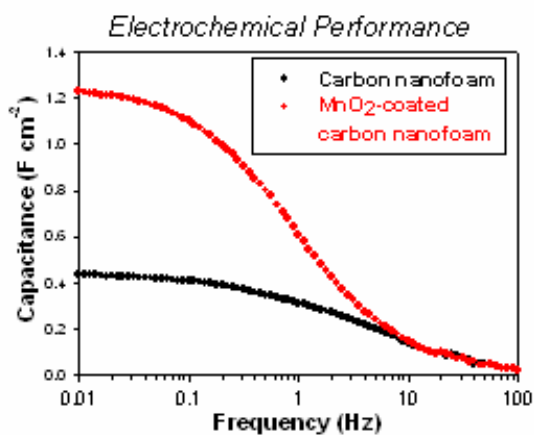
It may also be possible to tune the performance of the material by selective modifications. For example, for conducting polymers, substantial improvement in redox stability, especially of n-dopable conducting polymers, could result from quantum chemical-aided design of

molecular building blocks that facilitate shifting of the highest occupied molecular orbital and lowest unoccupied molecular orbital levels. Conducting block copolymers could facilitate the integration of both high electronic conductivity and excellent ion transport or the fusion of p-doped and n-doped blocks in a material.

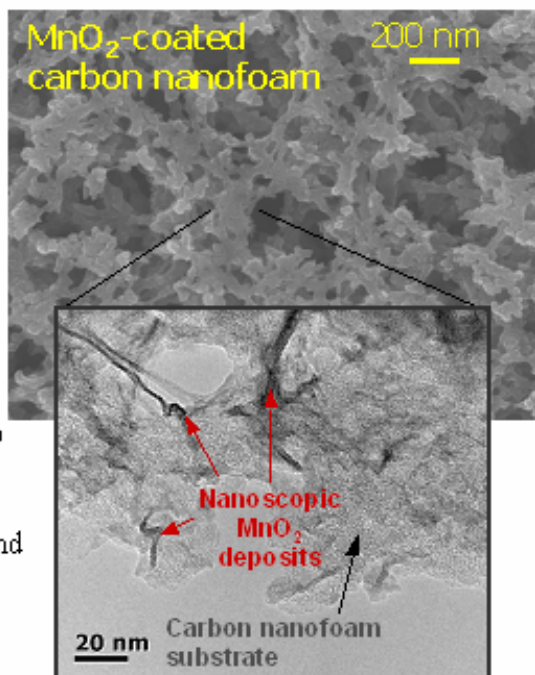
Complex composite materials and structures that maintain the desirable properties of the individual components while also exploiting both anticipated and unanticipated synergistic effects may be possible in future pseudocapacitance materials. Nanoscale electrode structures based on conductive, porous, three-dimensional frameworks could provide critical breakthroughs for the design of future multifunctional pseudocapacitor architectures. Such composite architectures will necessitate rethinking how multiple nanoscale components are integrated into high-performance materials for energy storage.<sup>6</sup> New synthesis and fabrication strategies will be required to incorporate pseudocapacitor materials with such

### **Multifunctional Nanoarchitectures for Electrochemical Capacitors**

Advanced electrode designs for ECs will be based on multifunctional nanoarchitectures in which pathways for electronic and ionic conductivity are balanced and optimized, permeation of electrolyte is facile, and charge storage functionality is incorporated. Ultraporous nanoscale architectures may provide novel platforms for such a design. For example, an approach to decorate the surface of carbon nanofoams with ultrathin (10–20 nm) electroactive  $\text{MnO}_2$  coatings was recently reported.<sup>7</sup> The resulting hybrid nanoarchitecture enables the rapid and reversible charge-discharge of the  $\text{MnO}_2$  coating, which significantly enhances the charge storage capacity of the hybrid electrode, even at high rates and frequencies. This and other approaches based on tailored nanostructured materials have the potential to produce revolutionary enhancements in energy and power density.

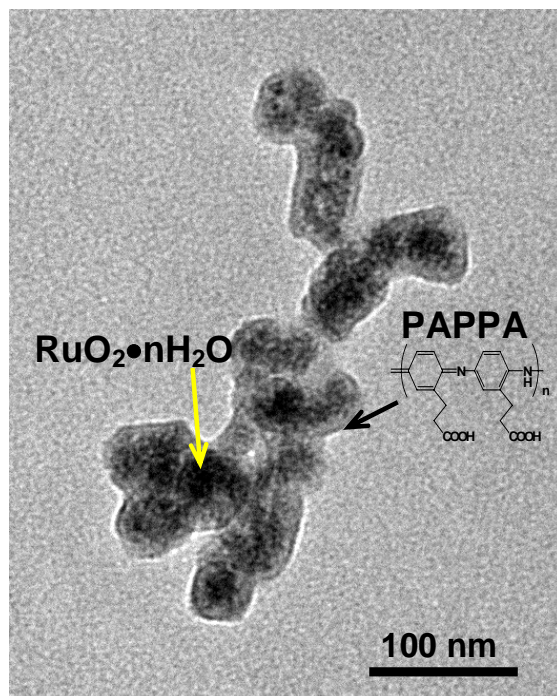


Fischer, Pettigrew, Rolison, Stroud, and Long, *Nano Letters* 7, 281 (2007).



conductive architectures.<sup>7</sup> Templating strategies with multifunctional composites are another potential route to high-performance, ultraporous electrode structures, as recently demonstrated by Min et al. for RuO<sub>2</sub>/carbon composites.<sup>8</sup>

The properties of all electrochemical systems strongly depend on interfacial phenomena, and pseudocapacitor materials and structures are no exception. A fundamental understanding is needed of the interactions that occur at the interfaces between the active pseudocapacitor material and contacting electrolyte, as well as interfaces between components in multifunctional architectures. The findings of such studies should be used to design materials that exhibit more robust and functional interfaces. For example, Machida et al. recently demonstrated that thin conducting polymer coatings could enhance the proton-electron exchange at the surfaces of RuO<sub>2</sub> nanoparticles (Figure 15), resulting in an enhancement of 5 orders of magnitude in the electrochemical cycle lifetime.<sup>9</sup> Related approaches should be explored to enhance the performance and stability of other pseudocapacitor materials. Surface and interface design strategies should also be directed at surface modifications that promote self-healing or self-regulation of the redox potential.



**Figure 15. Transmission electron micrograph of nanocomposite of RuO<sub>2</sub> and the conducting polymer, PAPP.<sup>9</sup>**

## Potential Impact

Fundamental understanding of the principles involved in pseudocapacitance will provide the underpinning knowledge needed to design the next generation of materials needed for EES systems. This set of design rules is needed to enable the rational design of new materials and composite architectures. New synthesis approaches, especially those that produce tailored multifunctional nanoscale architectures, have the potential to produce EES devices that exhibit far greater power and energy densities than are achievable with present technologies. Such rationally designed and produced devices also promise to exhibit significantly improved stability and lifetime relative to the pseudocapacitors of today.

## References

1. B. E. Conway, *Electrochemical Supercapacitors, Scientific Fundamentals and Technological Applications*, Kluwer Academic/Plenum, New York, 1999.
2. B. E. Conway and W. G. Pell, "Double layer and pseudocapacitance types of electrochemical capacitors and their applications to the development of hybrid devices," *Journal of Solid State Electrochemistry* **7**, 637 (2003).

3. A. Burke, "Ultracapacitors: why, how, and where is the technology," *Journal of Power Sources* **91**, 37 (2000).
4. J. P. Zheng, C. J. Cygan, and T. R. Jow, "Hydrous ruthenium oxide as an electrode material for electrochemical capacitors," *Journal of the Electrochemical Society* **142**, 2699 (1995).
5. D. Choi, G. E. Blomgren, and P. N. Kumta, "Fast and reversible surface redox reaction in nanocrystalline vanadium nitride supercapacitors," *Advanced Materials* **18**, 1178 (2006).
6. J. W. Long, D. R. Rolison, H. S. White, and B. Dunn, "Three-dimensional battery architectures," *Chemical Reviews* **104**, 4463 (2004).
7. A. E. Fischer, K. A. Pettigrew, D. R. Rolison, R. M. Stroud, and J. W. Long, "Incorporation of homogeneous, nanoscale MnO<sub>2</sub> within ultraporous carbon structures via self-limiting electroless deposition: implications for electrochemical capacitors," *Nano Letters* **7**, 281 (2007).
8. M. Min, K. Machida, J. H. Jang, and K. Naoi, "Hydrous RuO<sub>2</sub>/carbon black nanocomposites with 3D porous structure by novel incipient wetness method for supercapacitors," *Journal of the Electrochemical Society* **153**, A334 (2006).
9. K. Machida, K. Furuuchi, M. Min, and K. Naoi, "Mixed proton-electron conducting nanocomposite based on hydrous RuO<sub>2</sub> and polyaniline derivatives for supercapacitors," *Electrochemistry*, **72**, 404 (2004).

## RATIONAL MATERIALS DESIGN THROUGH THEORY AND MODELING

*The rational design of novel electrical energy storage (EES) systems with high energy and power density will require the development of a full suite of computational techniques to calculate all the properties of electroactive materials and the microstructures in which they are embedded. A revolutionary advance, for example, would be the ability to design stable materials that can exchange multiple electrons per redox couple and to predict their structural stability during charge-discharge cycling. Compared with related areas of electrochemistry (including batteries), the theory of electrochemical capacitors (ECs) is largely undeveloped. Many opportunities exist to develop and apply new continuum, statistical-mechanical, atomistic, and quantum-mechanical models. Although this effort can benefit from progress in related fields, ECs present many unique modeling challenges, such as ultra-fast, nonlinear, and nonuniform double layer charging; anomalous transport, molecular structure, and wetting characteristics in nanopores; new nonpolar electrode materials and nonaqueous electrolytes; pseudocapacitance combining redox reactions with charge screening; and widely disparate length and time scales. To achieve the ideal of rational design of EES materials, microstructures, and systems, it will be necessary to develop fundamentally new theories and modeling tools that can also have broader impacts in physics, chemistry, biology, and applied mathematics.*

### Background

Advances in theory and modeling capabilities will be critical for obtaining atomic- and molecular-level insight into the myriad processes that occur in EES and for modeling new materials and architectures needed for future technology breakthroughs. Although chemical energy storage (batteries) and ECs share common components such as electrodes and electrolytes, the physical and chemical processes in these two systems are quite distinct. Therefore the research directions for each are presented separately.

### Chemical Energy Storage

Storage of electrical charge through electrochemical means requires the reversible conversion and transport of ions, such as  $H^+$ ,  $Li^+$ ,  $Na^+$ ,  $Mg^{2+}$ ,  $OH^-$ , and  $O^{2-}$ , across large potential differences. These ions are shuttled from one electrode material through a composite electrode structure into the electrolyte and ultimately are stored in the other electrode. The design of EES systems with high energy and power and long lifetimes requires accommodating a large number of ions, and their charge-compensating electrons, at either electrode without inducing irreversible changes in the structure of the active material, the electrode-electrolyte interfaces, or the electrode microstructure. The rational design of electrodes requires the parallel development of computational techniques, from ab initio to the mesoscale and continuum scale, and a strategy to integrate them into a predictive tool. Specific examples include both bottom-up and top-down modeling. For example, high-throughput atomistic simulations can be scaled up to select real, often composite materials to produce novel electrochemistries, and scaled down from the device level to predict possible damage from structural loads to battery constituents.

Distinct mechanisms exist to accommodate ions on an electrode. Ions can be stored in interstitial sites of intercalation compounds while their charge-compensating electrons reduce



transition metal cations. Increasing energy density for such intercalation electrodes requires breaking through the one-electron-per-metal barrier and finding crystal (or noncrystalline) structures that can remain stable under a multivalence change of the redox center and a large concentration change of exchangeable cations. In conversion reactions, a compound chemically reacts or alloys with the incoming ions from the electrolyte and completely converts to other phases (e.g.,  $\text{BiF}_3 + 3\text{Li} \rightarrow \text{Bi} + 3\text{LiF}$ ).<sup>1</sup> Since such conversion reactions use all valence states of an ion up to the metallic state, they have the potential to radically increase the energy density of batteries. Whether ions are stored in intercalation compounds or through alloying reactions, the extreme degree of reversibility needed in applications (>1000 cycles) requires a fundamental understanding of what controls the kinetics of phase changes, interface creation and migration, and microstructure evolution. Finally, as active materials are typically embedded in complex multiphase, multicomponent microstructures, modeling at the mesoscale is needed to understand transport, deformation, and evolution of such microstructures.<sup>2</sup>

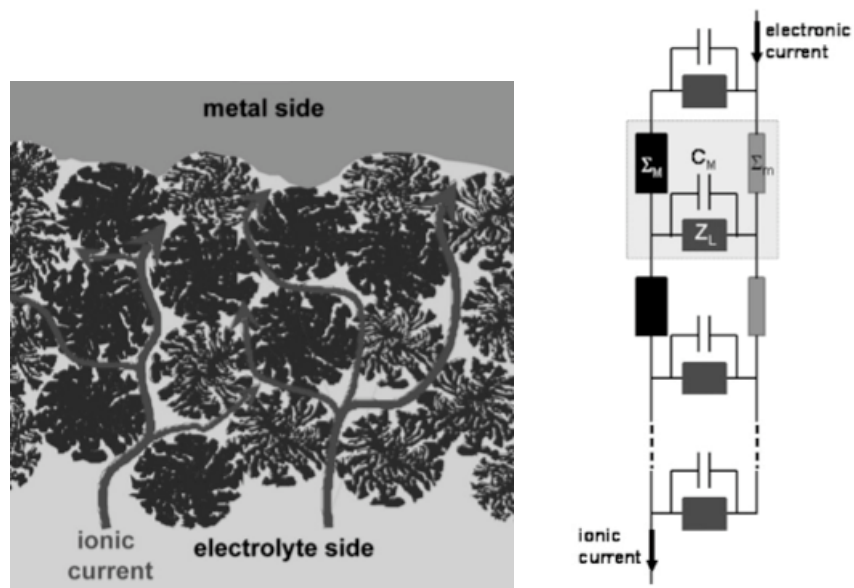
Enormous progress has already been made in the computational prediction of several important properties of electrochemical materials, including redox potential<sup>3</sup> and ion mobility. Mesoscale modeling has been advanced by simultaneous progress in applied mathematics and mechanics to allow simulation of transport and mechanics in complex architectures of packed agglomerates,<sup>4</sup> but a full predictive theory of chemical energy storage systems requires fundamental research and methodological developments in several areas listed below. Progress in these areas will enable computational modeling of performance, lifetime, and safety; drastically accelerate innovation in new materials; and catalyze new designs for higher energy and power at lower cost.

### **Capacitive Energy Storage**

Capacitive energy storage has received less attention from theorists than has chemical energy storage. The modeling of ECs is still in its infancy, so major technological advances may be expected from a long-term investment in fundamental research. The standard model consists of transmission-line equivalent circuits for the charging of cylindrical pores or networks of pores (Figure 16).<sup>5</sup> Although clearly oversimplified, such models provide useful analytical formulae to interpret experimental impedance spectra, for example, separating purely capacitive response (double layer charging) from pseudocapacitive response (simultaneous surface redox reactions).<sup>6</sup> By considering more complicated equivalent circuits of nested transmission lines, first attempts have also been made to understand and optimize the effect of microstructure on capacitive charging.<sup>7</sup> As simple as this approach may seem, it already suggests the possibility of radically improving power density and energy density through advanced structural design.

There are important distinctions between ECs and batteries that merit separate and focused research programs, in spite of some cross-cutting themes. Batteries use Faradaic reactions and bulk-phase transformations to achieve high energy density and high voltage at the expense of slow transport and limited cycle life. ECs use much faster interfacial transport in the electrolyte phase to achieve high power density and much longer cycle life, at the expense of lower energy density due to interfacial, rather than bulk, energy storage. The obvious route to increasing energy density is to increase the surface-to-volume ratio of the





**Figure 16. (Left) Sketch of a single electrode layer of a carbon-based EC illustrating the hierarchical pore structure with macropores between carbon agglomerates and micro-to-nanopores inside agglomerates. (Right) Transmission line model for the charging dynamics of the EC electrode, consisting of repeated blocks of resistors for bulk ionic current in the pores and electronic current in the carbon phase, connected by parallel impedance/capacitance elements to model double layer charging.<sup>7</sup>**

electrode, but this raises fundamental scientific questions about potentially new physics and chemistry in nanostructured materials. There is little existing theory to predict, for example, the behavior of ions and solvents confined in nanopores or the nonlinear dynamics of charging in a complex electrified microstructure with vastly disparate length and time scales.

Unlike batteries, ECs also share some features with biological ion channels, but again, there are important differences and unique challenges. Biological ion channels exhibit highly selective, single-file diffusion of ions through protein pores in cell membranes that has been the subject of intense study in recent years.<sup>8,9</sup> Developing theoretical models based on continuum, statistical, and atomistic descriptions has been crucial to understanding size selectivity.<sup>10</sup>

Recent molecular dynamics (MD) simulations<sup>11</sup> and experiments<sup>12</sup> on nanoporous carbon, however, suggest that the structure of water and the solvation of ions are fundamentally different in nanopores from in the bulk. There is also tantalizing evidence that sub-nanometer carbon nanopores have a dramatic and anomalous increase in specific capacitance compared with larger nanopores and micropores.<sup>13</sup> The common wisdom is just the opposite—that pores smaller than the bulk solvation shell cannot contribute to charge storage. Clearly, there is a pressing need for better theories and MD simulations to explain and predict such anomalous behavior at the nanoscale, which could be exploited to boost dramatically the energy and power density of ECs.

## Research Directions

### Chemical Energy Storage

**Predictive kinetics of phase changes.** Electrode materials with high energy density undergo large chemical, dimensional, and morphological changes during charge and discharge. If these changes are irreversible, they can cause capacity degradation with repeated charge-discharge cycles. Although ab initio methods can accurately screen compounds for their energy density and redox potential, no quantitative predictions can be made for stability, a key requirement for electrode materials. For intercalation compounds, predictive modeling of the kinetics of phase transformations is needed to design compounds that can tolerate large changes in ion and electron concentration. To rationally design conversion electrodes, coarse-graining approaches are needed to predict which phases form upon alloying and dealloying of the active ions from the electrode and to understand the cause of hysteresis, as it significantly decreases the energy storage efficiency of these reactions.

**Rational design and performance evaluation of electrode microstructures.** Currently, macroscopic models that allow the prediction of battery behavior from fundamental materials properties incorporate a limited amount of microscopic detail. A classic example is the incorporation of intercalation processes in battery electrodes via the use of a pseudo-two-dimensional architecture. Here, the composite electrode is coarse grained across the spatial dimension, while the intercalation inside the particle is incorporated by coarse graining across a particle. The two scales are then combined to form the electrode model. While powerful, this coarse graining across the particle dimension eliminates detailed description of many of the complexities that are known to be important in batteries, especially the structural details of the various battery materials. A grand challenge in performance and lifetime modeling is being able to accurately incorporate the actual structural information in macroscopic models to provide an effective means of correlating material-specific information to performance. This would enable the prediction of electrode behavior in both spatial and temporal dimensions during high charge rates and the tracking of microstructure and materials evolution during cycling.

**Formation, structure, and charge transfer across reaction interfaces.** The phase that forms as a reaction layer between the electrode and electrolyte (the solid electrolyte interphase, or SEI) is critical to the performance, life, and safety of batteries. This complex interface is very poorly understood and even more poorly described in mathematical models for performance. The picture is complicated by the changes that the SEI undergoes during cycling, including cracking, spalling, and reformation. As new materials that perform at higher voltages are developed, and new additives identified, the interface will become more complex, necessitating methods to describe the formation and growth of these layers. The grand challenge lies in predicting the structure of the electrochemically formed reaction layers between the electrode and electrolyte under large variations in potentials and then quantifying electron and/or ion transport through them. MD methods that can include electric field effects and chemical reactivity may be particularly well suited to addressing this problem. Efforts to model the SEI layer must rely heavily on results from novel in situ characterization tools to establish their accuracy and relevance. When integrated with the mechanical modeling of electrode structures, SEI models are expected to result in a very detailed description of interfacial processes and to connect changes at the interface to

changes in performance through the life of an electrochemical cell. The result will be an ability to rapidly evaluate new combinations of materials and electrolytes and gauge their usefulness.

**Modeling the electrochemistry of nanoscale materials and surfaces.** Nanoscale materials offer great opportunity for energy storage. Chemistry and structure have been the dominant domains across which materials optimization has been performed. Reducing the particle size to the scale where the kinetics and thermodynamics become significantly different from those of the bulk can bring an extra dimension to this design space and generate materials that are fundamentally different from their bulk equivalents.

Modeling should address to what extent the thermodynamics and kinetics of ion reactions with nanomaterials are different from those with bulk materials and characterize the effects of surfaces on the intrinsic electrochemical properties and performance. Ab initio methods are good at modeling very small particles ( $< 2$  nm) and infinite systems (with periodic boundary conditions); however, novel ideas are needed to deal with nanomaterials at the technologically relevant length scale from 10 to 150 nm.

**Transport modeling.** Charge transport (ionic and electronic) is particularly important for chemical energy storage. While many materials and systems can, in principle, be used to exchange charge, many of them do not have the proper rate capability to function in storage devices at room temperature. To ultimately predict the rate at which chemical systems can charge and discharge, the development of models at multiple length scales, from crystal structures to microstructures, is required. Models need to be significantly complex to capture ion and electron transport in multicomponent electrolytes and complex multiphase microstructures. As many active materials are strongly anisotropic in their transport properties, mesoscale models of composite electrodes may need to take that into account. For nanosystems in which sizes approach the screening lengths and for high rate potential changes, models may have to remove the common constraint of local electroneutrality.<sup>14</sup> Poor electron conductors may be of particular interest as electrode materials because they are often strongly bonded, giving them good stability and safety characteristics. Methods to model mixed conduction in these systems need to go beyond mean field theory to explain the effect of the strong coupling between localized polarons and ions on the overall transport characteristics. Such transport models will need to be informed by electronic structure methods beyond common density functional theory (DFT) to properly capture electron localization.<sup>15</sup>

**Inverse and high-throughput materials design.** Materials for EES are likely to see the first benefits of large-scale computational materials science, which can be applied to calculating many of the required properties. One question is whether high-throughput search methods can be implemented with predictive modeling tools to scan large numbers of compositions, structures, particle sizes, etc., to find new electrode materials. New computational tools and analysis methods need to be developed to enable such large computational searches. In “inverse design,” one tries to invert this problem and, rather than calculate properties for a well-defined composition or structure, to design materials or microstructures that have very

specific properties. Mathematical techniques that enable such inverse design, starting either from key physical insights or from large amounts of data, are particularly needed.

### **Capacitive Energy Storage**

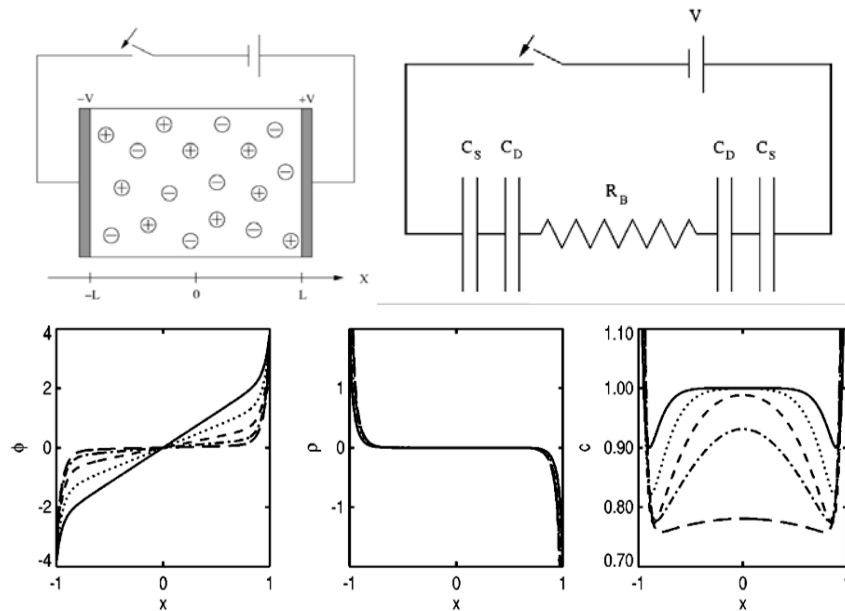
New predictive models for capacitive energy storage systems need to be developed at all length and time scales, ranging from quantum (<nanometer, <picosecond) to atomistic (<10 nm, <1 ns), to micro-continuum (>nanometer, >nanosecond), to macro-continuum (>millimeter, >microsecond) for relevant materials and geometries. Such models could enable rational selection of electrolyte and electrode materials, design and optimization of electrode architectures, and discovery of new physical or chemical phenomena. To achieve these goals, fundamental new understanding is needed through close interplay among theory, computation, and experiment based on simple model systems.

Can we systematically predict the nonlinear charging dynamics and energy density of an EC from first principles given only the chemical species and electrode microstructure? This vision would require accurate models to be developed at each scale and new methods to derive effective parameters at the next higher scale from analytical or simulation results at a smaller scale. For example, classical continuum models of ion transport (Poisson-Nernst-Planck, or PNP, equations) could be analyzed in suddenly electrified pore geometries to derive equivalent circuit models for linear and nonlinear responses. The continuum equations could then be modified to account for discrete effects coming from atomistic simulations, such as steric constraints, chemical potentials, and electrostatic correlations. Going down in scale, interatomic potentials for familiar materials (such as certain aqueous electrolytes and carbon) may need to be adjusted for new settings, and potentials will also need to be developed and validated for many new materials (such as complex organic solvents). In each of these cases, new models must be validated and calibrated using simple experiments to ensure their predictive power.

There are many open questions regarding the anomalous behavior of solvents and ions in nanostructures that must be answered for a fundamental understanding of ECs, especially as the surface-to-volume ratio increases to improve energy density. How and under what conditions will an electrolyte enter and wet a pore? What is the equilibrium structure of ions and solvents in a particular confined geometry? What are the effects of surface functional groups or bulk impurities? Do ions lose solvation under the influence of large fields and/or confined spaces? Do different ions in multicomponent electrolytes segregate upon insertion into a complex nanostructure? Is there any significant hydrodynamic slip or electro-osmotic flow? How does ion transport in a nanopore fundamentally differ from tangential “surface conduction” in a flat double layer? To answer such questions, the challenge will be to develop new and more accurate atomistic and quantum-mechanical modeling tools tailored for unique EC materials. Below, several different types of modeling tools are discussed in the context of EC systems.

**Continuum modeling.** A natural direction at the level of continuum modeling would be to go beyond equivalent-circuit models that, by design, can only describe the linear response of the system to a small applied voltage, such as the impedance. Although impedance spectroscopy is a key tool for characterization, nonlinear dynamics at large applied voltages

is often more relevant for the practical operation of ECs. One goal, therefore, would be to systematically derive nonlinear generalizations of circuit models starting from the underlying transport equations. This derivation has been done recently for thin double layers by using mathematical methods of matched asymptotic expansions applied to the classical PNP equations. In the simplest case of a parallel-plate cell of blocking electrodes subjected to a sudden large voltage (Figure 17), the analysis shows that the classical RC circuit model breaks down as a result of adsorption of neutral salt in the double layer.<sup>16</sup> The latter depletes the bulk solution and triggers slow diffusive relaxation, which invalidates the assumption of Ohm's law in the bulk. Such effects have also been calculated recently for nonlinear charging of metal spheres and cylinders,<sup>17</sup> but the nonlinear propagation of charge through long nanopores or complex microstructures in ECs is an important open problem.

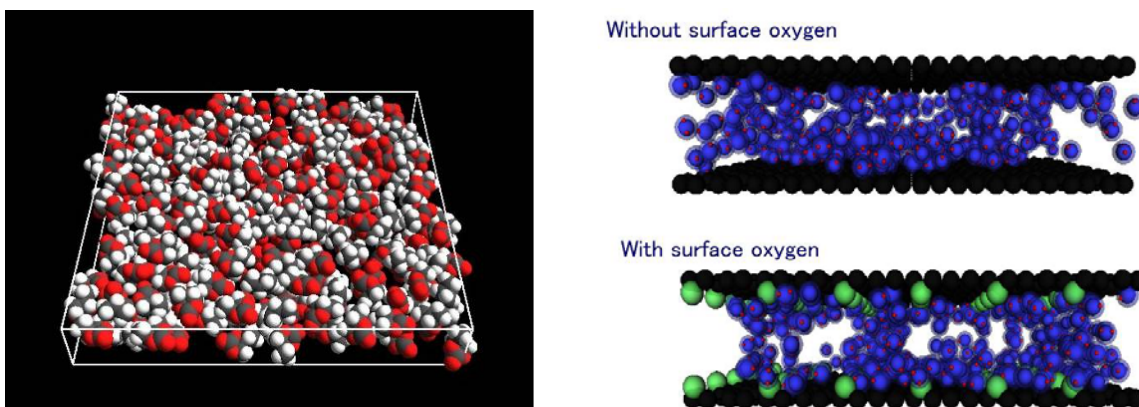


**Figure 17. Breakdown of circuit models in nonlinear charging dynamics.** (Top left) A suddenly applied large voltage across blocking electrodes. (Top right) Equivalent RC circuit. (Bottom) Solution to the Poisson-Nernst-Planck equations for the potential, charge density, and salt concentration profiles, from left to right, which shows that the double layers adsorb neutral salt upon charging, depleting the bulk electrolyte and leading to slow diffusive relaxation after the initial “RC” charging.<sup>16</sup>

The small dimensions of nanopores in ECs, as well as the large applied voltages, also call into question the validity of the classical PNP equations, including the Gouy-Chapman solution for a flat double layer in a binary electrolyte. There have been many attempts to derive “modified” Poisson-Boltzmann equations accounting for steric effects of finite ion size and electrostatic correlations in thermal equilibrium by applying statistical mechanical methods to the primitive model of a charged hard-sphere fluid. Recently this work has begun to be extended to charging dynamics via modified PNP equations with a simple description of steric effects.<sup>18</sup> It would be a great advance to derive and validate modified PNP equations for EC materials that can approximately describe the charging of nanopore arrays, including entrance effects from micropores.

Better continuum models can yield crucial analytical insights and efficient computational tools provided they can be validated against reliable atomistic simulations and experimental model systems. They also provide the ability to incorporate multiple physical processes occurring at the electrode or device scales. For example, the sudden insertion of ions into a nanoporous structure can cause it to swell, so it will be important to develop models coupling charge transport to the mechanical response of the composite material. Joule heating during EC charging can also be a serious concern, so the coupling of charging dynamics with heat transfer and energy dissipation will be another important long-term goal in continuum modeling of ECs.

**Atomistic modeling.** The simplest form of atomistic modeling involves statistical sampling of model discrete systems, such as the primitive model and its variants or Lennard-Jones potentials, via Monte Carlo simulations. This approach has been used extensively to understand equilibrium double layers in modified Poisson-Boltzmann theories<sup>18</sup> and applied to transport in biological ion channels.<sup>9,10</sup> In the setting of ECs, reverse Monte Carlo simulations have been used to reconstruct the typical atomic structure of solvent and ions that best fits experimental X-ray diffraction structure factors (Figure 18). Grand canonical Monte Carlo simulations have also been used to study the structure of water in nanopores and the effect of introducing functional groups on the walls.<sup>19</sup> Although Monte Carlo methods are not as effective in describing dynamical phenomena, they can efficiently reveal statistical structure with reasonable computational expense.



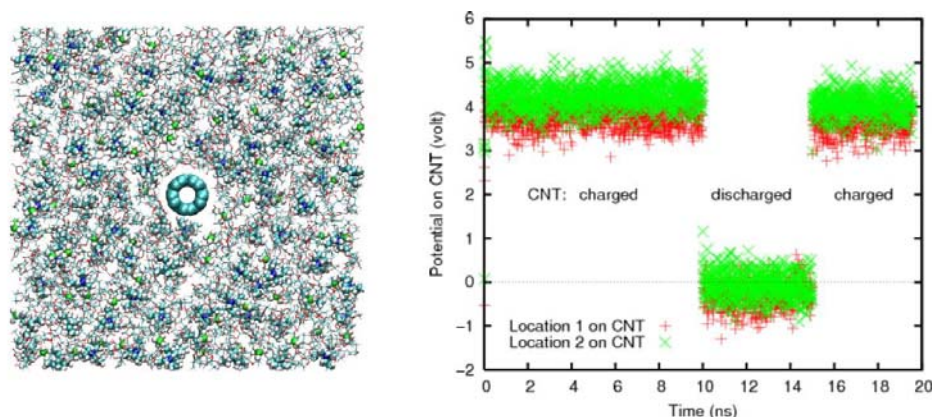
**Figure 18.** (Left) Atomic configuration of propylene carbonate in a carbon slit obtained by reverse Monte Carlo simulations from X-ray diffraction measurements on Maxsorb92-16 porous carbon with a surface area of 2440 m<sup>2</sup>/g and a pore size of 1 nm (provided by K. Kaneka, unpublished, 2007). (Right) Grand canonical Monte Carlo simulations of water (TIP5 potential) confined in a flat slit of structureless carbon (10-4-3 potentials). The effect of surface oxygen is simulated by artificial functional groups described by a Lennard-Jones potential.<sup>20</sup>

**Molecular dynamics simulations.** MD simulations often provide the best balance between computational expense and accuracy in capturing atomic interactions. The method consists of integrating Newton's law for atoms described by point masses interacting through effective interatomic potentials (like balls and springs). It has been widely developed in many other fields, such as semiconductors and biophysics, but the greatest challenge for performing meaningful MD simulations is to derive accurate and reliable interatomic potentials,



validated against quantum-mechanical simulations (see below) or experiments, where possible. These validations must be done in the atomic environments of interest, such as the interior of a nanotube in contact with a particular organic solvent, because a potential often cannot be trusted to be transferable to a new set of configurations far from the domain where it was fitted.

To date, there have been no MD simulations of actual ECs, but some recent studies have begun to address fundamental issues arising from confinement in nanopores. For example, MD simulations have predicted anomalous solvation of ions and surprising water structures (such as hydrogen “wires”) in carbon nanotubes.<sup>11</sup> A full-scale model of a carbon nanotube forest in an organic electrolyte has recently been studied to understand better new EC designs, including charging dynamics (Figure 19). Such simulations can provide crucial aid in the rational design of electrode and electrolyte materials for desired properties in ECs.



**Figure 19. Molecular-dynamics simulations of an EC consisting of a periodic carbon nanotube forest in a common organic electrolyte (1 M TEA + BF<sub>4</sub><sup>-</sup> in propylene carbonate).** (Left) Initial molecular configuration. (Right) Time series of the carbon nanotube potential in response to a sudden change in surface charge, showing picosecond response. (Provided by L. Yang, B. Fishbine, and L. R. Pratt, unpublished, 2007.)

Finally, it will also be essential to develop ab initio quantum-mechanical simulations for ECs, since classical potentials cannot be expected to reliably predict interfacial forces, charge transfer (for pseudocapacitance), activation energy barriers for transport, desolvation or adsorption, etc. The challenge for ECs is in some ways much greater than for batteries, where ab initio methods based on DFT have had a major impact in predicting new lithium intercalation materials and bulk diffusion coefficients. The reason is that battery intercalation compounds, although complicated, have a regular bulk crystal structure that can be treated with periodic boundary conditions and a small number of atoms (<100). In contrast, disordered organic solvent molecules and ions in confined nanostructures require many more atoms and time dependence to evolve configurations for a proper description. Predictive quantum-mechanical simulations of such situations clearly present a long-term grand challenge for research. Perhaps the largest impact in the short term would be predicting the bulk properties of new candidate electrolytes to aid in their selection for use in ECs.

## Modeling of Spectroscopic Methods

Novel characterization techniques can create complex signal outputs whose relation to the underlying structure or physical phenomena can benefit significantly from computational modeling. Electronic structure modeling has, for example, been particularly useful for interpreting nuclear magnetic resonance, infrared, Raman, or X-ray photoelectron spectroscopy spectra. It is expected that the novel spectroscopic methods that will be developed to characterize chemical systems with spatial and temporal resolution will push theoretical approaches to the limit and require the further development of more advanced approaches that treat more accurately the dynamical interaction between electrons (e.g., quantum Monte Carlo and other methods beyond DFT, such as the GW method, the Bethe-Salpeter equation, or dynamical mean field theory), and between the electrons and rapidly varying external potentials (e.g., time-dependent DFT).

## Impact

Revolutionary advances in EES, which are needed to address future needs in energy storage, utilization, and regeneration, are not likely to occur without an aggressive investment in developing fundamental scientific understanding of the myriad processes that occur in these devices. There are tremendous opportunities for significant impact on this field from harnessing the powerful capabilities in modeling and theory. For example, with more accurate models, improved electrode nanostructures may be designed for attaining higher energy density without sacrificing power density. Fundamental new understanding at the atomistic level for highly charged double layers and transport in nanopores will also provide clues to improving the energy density or safety of EES by different (and sometimes unexpected) choices of electrode and electrolyte materials, as well as different choices of microstructured and nanostructured electrode architectures.

Many of the goals outlined are ambitious and will require sustained efforts in basic research to address. The stakes are high, however, because breakthroughs in the theoretical understanding of nanoscale phenomena and charging dynamics in EES systems can have an immediate and lasting impact, not only on EES technology through rational design and interpretation of experiments but also on the basic science of electrochemical systems and nanostructures. A century after the Gouy-Chapman-Stern model of the double layer was proposed, it is still by far the most widespread theoretical picture of the diffuse electrochemical double layer. If new research can develop more accurate, but still tractable, continuum models for nonlinear dynamics of double layer charging in the context of ECs, for example—taking into account steric, solvation, or correlation effects in confined spaces—then they would surely enter the base of knowledge in electrochemistry and permanently alter how the scientific community treats double layers and pores. Similarly, accurate atomistic models for MD of important new electrolytes or electrode materials would have lasting use. The same holds for quantum-mechanical methods, which may become more tractable and thus more widely applicable with advanced computers of the future.



## References

1. M. Bervas et al., "Investigation of the lithiation and delithiation conversion mechanisms of bismuth fluoride nanocomposites," *Journal of the Electrochemical Society* **153**, A799–A808 (2006).
2. K. A. Striebel et al., "The effect of compression on natural graphite anode performance and matrix conductivity," *Journal of Power Sources* **134**(2), 241–251 (2004).
3. F. Zhou et al., "First-principles prediction of redox potentials in transition-metal compounds with LDA + U.," *Physical Review B* **70**, 235121 (2004).
4. C.-W. Wang, K. A. Cook, and A. M. Sastry, "Conduction in multiphase particulate fibrous networks simulations and experiments on Li-ion anodes," *Journal of the Electrochemical Society* **150**(3), A385–A397 (2003).
5. R. Kotz and M. Carlen, "Principles and applications of electrochemical capacitors," *Electrochimica Acta* **45**, 2483 (2000).
6. J. H. Jang, et al., "Complex capacitance analysis on leakage current appearing in electric double layer capacitor carbon electrode," *Journal of the Electrochemical Society* **152**, A1418 (2005).
7. M. Eikerling, A. A. Kornyshev, and E. Lust, "Optimized structure of nanoporous carbon-based double layer capacitors," *Journal of the Electrochemical Society* **152**, E24 (2005).
8. L. R. Pratt and A. Pohorille, "Modeling of aqueous solution interfaces in biophysics," *Chemical Reviews* (2002).
9. B. Nadler et al., "Diffusion through protein channels: From molecular description to continuum equations," *Nanotechnology* **3**, 439 (2003).
10. D. Gillespie and R. Roth, "Physics of size selectivity," *Physical Review Letters* **95**, 247801 (2005).
11. L. Yang, and G. Shekhar, "Modeling the selective partitioning of cations into negatively charged nanopores in water," *Journal of Chemical Physics* **126**, 084706 (2007).
12. C.-H. Yang, et al., "Nanowindow-regulated specific conductance of supercapacitor electrodes of single-wall carbon nanohorns," *Journal of the American Chemical Society Communications* **129**, 20 (2007).
13. J. Chmiola, et al., "Anomalous increase in carbon capacitance at pore sizes less than 1 nanometer," *Science* **313**, 1760 (2006).
14. K. T. Chu and M. Z. Bazant, "Electrochemical thin films at and above the classical limiting current," *Siam Journal on Applied Mathematics* **65**, 1485–1505 (2005).
15. T. Maxisch, F. Zhou, and G. Ceder, "Ab initio study of the migration of small polarons in olivine  $\text{Li}_x\text{FePO}_4$  and their association with lithium ions and vacancies," *Physical Review B* **73** (2006).
16. M. Z. Bazant, K. Thornton, and A. Ajdari, "Diffuse-charge dynamics in electrochemical systems," *Physical Review E* **70**, 021506 (2004).
17. K. T. Chu and M. Z. Bazant, "Nonlinear electrochemical relaxation around conductors," *Physical Review E* **74**, 011501 (2006).
18. M. S. Kilic, M. Z. Bazant, and A. Ajdari, "Steric effects on the dynamics of electrolytes at large applied voltages: I. Double layer capacitance," *Physical Review E* **75**, 021502 (2007).
19. T. Ohba, H. Kanoh, and K. Kaneko, "Structures and stability of water nanoclusters in hydrophobic nanospaces," *Nano Letters* **5**, 227–230 (2005).
20. T. Ohba and K. Kaneka, *Journal of Chemical Physics*, in press, 2007.



# **CROSS-CUTTING SCIENCE FOR ELECTRICAL ENERGY STORAGE**

Advances in Characterization .....	67
Nanostructured Materials .....	69
Innovation in Electrolytes.....	72
Theory, Modeling, and Simulation .....	74



## **CROSS-CUTTING SCIENCE FOR ELECTRICAL ENERGY STORAGE**

A broad range of basic research needs common to electrical energy storage (EES), both chemical energy storage devices (batteries) and electrochemical capacitors (ECs), emerged during the workshop. These “cross-cutting issues” spanned broad areas of science on new frontiers. An overarching theme throughout the workshop was the need to reveal the processes that underpin energy storage at the atomic level so that novel EES materials, including electrodes, electrolytes and structures with tailored architectures and targeted properties, may be designed. Such insight will require the close coupling of new capabilities in nanoscale synthesis techniques, computational simulation, modeling and theory, and analysis tools. Researchers will push the frontiers of science to develop new approaches for studying complex physical and chemical events that span broad spatial scales (from nanometers to centimeters) and temporal scales (down to femtoseconds). The cross-cutting themes are broadly focused into four different areas:

1. Advances in Characterization
2. Nanostructured Materials
3. Innovations in Electrolytes
4. Theory, Modeling, and Simulation

While these cross-cutting themes are described individually in this section, they are actually interdependent in many cases. For example, the combination of new characterization tools with theory, modeling, and simulation can be applied to achieve an understanding, at the molecular level, of chemical events and processes that occur at the surface of an electrode. These advances might then produce new design rules directed at the synthesis of new multifunctional nanostructured materials for EES.

### **ADVANCES IN CHARACTERIZATION**

#### **Overview**

The ability to answer fundamental questions required to create advanced EES devices relies critically on the development and application of novel characterization tools with increased spatial, energy, and temporal resolution. The development of tools that have high sensitivity and cover the wide time scales of processes associated with EES (femtoseconds–days) has the potential to revolutionize the field and was a common theme in all the priority research directions (PRDs). Information obtained from these tools will provide fundamental understanding of EES systems, including electron and charge transfer processes and mechanisms by which ions interact with electrode materials. In particular, approaches that combine two or more techniques to provide so-called multi-dimensional analysis will allow the complex, interdependent processes that occur at electrodes, electrolytes, and the interfaces to be revealed. The increased neutron and X-ray fluxes and optimized beamline optics at Department of Energy and other national facilities, combined with specialized instrumentation, are particularly exciting because these facilities provide opportunities for the design of an entirely new set of experiments to follow electrochemical processes in real time.

## Research Directions

The development of new materials and chemical processes that will lead to future generations of EES systems is critically dependent on identifying, understanding, and assessing the relative importance of the myriad processes that are relevant to the function and failure of these systems. The design of batteries and ECs with long cycle lifetimes and high energy-storage capabilities will require a fundamental understanding of charge transfer and transport. At the atomic level, the direct coupling of electron and nuclear motions needs to be understood so that predictive theories that define how the electron couples to ions during transport may be developed. In this way, defect sites may be identified, allowing the design of self-healing materials for the electrolyte and electrode interface. The dynamic structure of interfaces needs to be characterized so that the paths of electrons and attendant trafficking of ions may be directed with exquisite fidelity. To accomplish this, the potential landscape of the electrode interface needs to be defined precisely; this calls for the development of new combined electrochemical and structural techniques that probe the interface on molecular length scales, preferably in situ and under operating conditions. With this ability to “observe” the dynamic composition and structure at an electrode surface during charge transport and transfer processes, electron and ion flows may be understood. This crucial information will allow the design of the highest energy storing materials with long cycle lifetimes. Further, the relationship of the atomic- and molecular-level structure of electrode materials to functionality must be understood.

Fundamental challenges abound in confronting the task of building a foundation for the comprehensive description of charge transfer and transport at electrodes and their interfaces. To meet these challenges, a new set of analysis tools is needed that are capable of selectively characterizing the processes at unprecedented levels of spatial and temporal resolution. Novel strategies are required to

- characterize local processes on timescales that are relevant to the electrochemical process (femtoseconds–days);
- determine the structural changes induced in active and passive battery components during electrochemical cycling, both in- and ex-situ, over nanometer to macroscopic length scales;
- probe structure and reactivity at all the relevant interfaces in batteries and ECs; and
- image structural, electrochemical, and physical/electronic properties simultaneously to correlate atomic and electronic structure with reactivity.

The transport of electroactive materials and associated species to an electrochemical interface involves several complex and interrelated mechanisms—diffusion, migration, spontaneous or induced convective movements—that prevail over distances from nanometers to hundreds of micrometers from the electrode surface. Despite their crucial importance, little is known about these mechanisms because of the lack of experimental methods and instrumentation that are required for these in situ measurements. New techniques that combine several analytical probes of these important processes are critically needed to understand ion and electron transport at interfaces. To this end, these so-called multi-dimensional experiments could reveal both the transport of the electroactive species and the inert ions needed to maintain macroscopic electroneutrality. In addition, a strong coupling of these measurements

with theory, modeling, and simulation is needed to provide a complete understanding of these critical charge transfer and transport processes.

Ultra-fast (megavolt per second) voltammetric techniques have the potential to directly monitor electron transfer down to the nanosecond range. These techniques can provide information about critical steps involved in charge transfer and transport, including molecular reorganization and displacement of electroactive species over nanometer distances. High spatial resolution in electrochemical measurements may be possible with the development of new electrodes with nanoscale dimensions. These electrodes could provide precise and direct local measurements of dynamic concentrations near active electrode surfaces.

Spectroscopic methods can be used to provide additional information to these electrochemical measurements. New spectroscopic tools are needed that have the nanoscale resolution necessary to map the region at electrode interfaces and yet not be vulnerable to high optical index gradients arising from high concentration gradients. Ideally, these measurements could be conducted rapidly across entire electrochemical diffusion layers.

Recent advances have been made in characterization techniques that have not been fully exploited for the study of EES systems. Some examples of these capabilities are summarized in Appendix B, “Probing Electrical Energy Storage Chemistry and Physics Over Broad Time and Length Scales.” For example, exciting new capabilities for studying both structure and dynamics are possible at synchrotron and neutron sources. Hybrid microscopic techniques that combine the ultrafast time resolution of lasers with the nanometer spatial resolution of electron imaging could provide multi-dimensional imaging of interfacial dynamics. The combination of atomic-scale probes, such as scanning tunneling microscopy, with femtosecond laser modulation of the tunneling current could offer the ultimate resolution of dynamical processes at electrochemical interfaces. New approaches to conducting these crucial measurements are needed to obtain a more complete understanding of charge transfer and transport at interfaces.

## **Impact**

New analysis techniques and methodologies will provide unique insights into the critical structural, chemical, and physical materials properties that will allow a rational design of EES materials with vastly improved performance. Progress in this area is a prerequisite condition for the development of novel and/or enhanced energy storage and conversion systems for future applications in portable electronics, transportation, and stationary applications. Specifically, results are expected to lead to an increased ability to design materials and processes that ultimately will revolutionize the performance of EES devices. The capabilities developed as part of this research will impact many scientific areas in energy research and many other fields based on interfacial processes.

## **NANOSTRUCTURED MATERIALS**

### **Overview**

Today’s batteries and ECs depend on porous composite electrodes that generally consist of a random mixture of active material, a conductive additive, and a binder. There is no doubt that

the performance of EES devices is limited by the performance and interplay of these three constituent materials. New materials with structures and architectures designed for improved functionality are critically needed to address this major technical bottleneck for both chemical and capacitive energy storage devices. Advances in nanoscience have opened the potential for providing synthetic control of materials architectures, including pore size, structure, composition, particle size, and even three-dimensional electrode structure down to nanoscale dimensions. These designed structures could lead to transformational enhancements in key energy storage parameters such as capacity, power, charge-discharge rates, and lifetimes. For example, it may be possible to achieve greatly enhanced double layer capacitance materials using nanocrystalline materials and porous materials with nanometer-sized pores. Further, modification of these nanomaterials may even permit specific features, such as capacitances, to be selectively tuned. Nanoscience also offers the potential for designing multifunctional materials that contain self healing or self-regulating components that hold promise for substantially increasing device lifetimes and enhancing safety. Novel three-dimensional electrode structures and architectures may lead to significantly decreased transport impedances.

The key issue related to the development of new materials with tailored architectures to transform EES is embodied in the question, “What are the fundamental relationships between structure and energy storage properties?” Unfortunately, the required fundamental understanding to answer the question does not yet exist. However, this question embodies both the challenges and opportunities associated with this cross-cutting research direction. A fundamental understanding of the relationships between structure and function for EES materials will enable the prediction of structures with vastly improved capabilities for EES applications and generate new methods for synthesizing, characterizing (under operating conditions), and optimizing energy storage materials.

## **Research Directions**

Nanostructured materials can be as simple as nanoparticles on a support or highly complex, such as three-dimensional, multifunctional structures. Little is known about the behavior of even simple nanoparticles under chemical or capacitive energy storage conditions. We need to understand how the electrochemistry of nanoparticles varies with size and whether these effects are purely kinetic or also thermodynamic in nature (a shift in  $E^\circ$ , akin to bandgap variations in semiconductor nanoparticles). The influence of inter-particle distance on the electrochemical response also needs to be investigated. In cases where a reaction results in a volume change (e.g., lithium ion intercalation within a battery electrode), the resulting strain in the nanoparticle needs to be understood as a function of loading. For example, is this strain elastically accommodated, or are defects formed in nanoparticles? Information is also needed to understand how particles fail—by particle fracture, the formation of a surface layer, sintering, or other identifiable physico-chemical changes in the bulk chemical composition and structure of the particle.

Tailored materials can be imagined that will enhance charge transport and increase charge density in EES. For example, two-dimensional arrays of nanoparticles may be made with precisely defined size, shape, and inter-particle distances. Innovative, non-lithographic methods for preparing nearly size-monodisperse metal nanoparticle arrays may provide a



path for the preparation of metal oxide particles having a composition relevant to chemical and capacitive energy storage devices. Similarly, well-defined pore arrays and single pores with the ability to control pore attributes, such as diameter, inter-pore spacing, and pore surface composition, represent another approach to tailoring materials for EES. These pore arrays may be made from inorganic or polymeric materials. It may be possible to modulate pore function by attaching chemical functionalities to pore openings and channels. Changes in pore size and pore modifications may have dramatic effects on ion mobility, ion solvation, ion pairing, and other key factors that impact EES. Once these relationships are understood, materials could be tailored to create pores with appropriate shapes, sizes, compositions, modifications, and densities to optimize performance.

Moving from two to three dimensions holds particular promise for greatly improving the performance of energy storage materials. Currently, among the most efficient materials in this regard are carbon aerogels, which possess enormous surface areas of up to 1000 m<sup>2</sup>/g. However, the pores within these materials are highly tortuous with a broad diameter and shape distribution. This random pore structure is not optimized for ion transport; in addition, carbon aerogels are electronically resistive materials. Can new materials be designed that simultaneously optimize ion and electron transport rates by tailoring pore structure? Can the performance of these materials be further enhanced with selective modification of the pore walls to provide specific, multiple functionalities? Fundamental questions of ion and electron transport in these materials must be answered in order to design materials with optimized performance.

It may also be possible to achieve revolutionary breakthroughs in device performance by tailoring specific structures in materials to enhance functionality. This tailoring might include functions such as the ability to repair or heal defects, self-regulate, self-clean, sequester impurities, and tolerate abuse. Other types of multifunctionality to improve electrochemical and capacitive energy storage may be achievable once the fundamental basis of the relationship of structure and function, as well as failure modes, is understood. Complex materials can provide a means of *reversibly* bridging high-temperature runaway conditions. Current technology involves an *irreversible* phase change in a low-melting-point separator material. It may be possible to design the architecture of the separator to contain a phase change material and allow reversible current limitation during temperature excursions.

## **Impact**

A fundamental understanding of the relationships between the structure and function of energy storage materials, and the development of new synthetic methods for precise control of device architectures, can move capacity, power, and lifetime improvements to EES devices beyond the incremental to the transformational—a result with the potential to dramatically change the energy landscape of the United States. Advances in materials architectures in other contexts could give rise to opportunities to create multifunctional materials for energy storage devices that might eliminate the significant dead weight in current devices and provide the framework for high energy and power densities, fast charge-discharge rates, long lifetimes, and self-regulating, safe operation. Finally, research on nanostructured materials will have a broad impact on the energy landscape beyond the focus

on EES. Similar materials issues are critically important to fuel cells, solar cells, solid-state lighting, and hydrogen storage materials.

## **INNOVATION IN ELECTROLYTES**

### **Overview**

The fundamental purpose of the electrolyte in any EES device is to transfer ions between electrodes during charge and discharge cycles with minimal transport impedances. An ideal electrolyte provides high ionic conductivity over a broad temperature range, is chemically and electrochemically inert at the electrode, and is inherently safe. Too often, the electrolyte is the weak link in the energy storage system.

Research in electrolytes for batteries and ECs needs to move away from current inadequate concepts and toward redefining a new generation of electrolytes. This goal will be achieved only by understanding the many physical and chemical phenomena that govern electrolyte performance. Atomic- and molecular-level understanding of ion-ion, ion-solvent, and ion-electrode interactions is needed and will be enabled by new capabilities in synthesis, characterization (electrochemical, spectroscopic and imaging), and computation. This key information could produce wholly new concepts in tailored electrolyte ions and in ionic and nanocomposite polymer electrolytes, for example, that could revolutionize EES performance

### **Research Directions**

Understanding electrolyte interactions and processes at the atomic and molecular levels is critical for establishing a framework of rules that govern specific parameters essential to optimal EES performance. Our knowledge of these physical and chemical parameters in EES is quite limited and represents a major bottleneck for the development of future EES devices. These parameters include high ionic conductivity, low or high fluidity, wide electrochemical potential window (in both the thermodynamic and kinetic senses), low volatility, broad temperature range, and stability tolerance. Further, understanding of the behavior of ions and solvents in bulk and at electrode interfaces, of their dynamics on solvation timescales, and of structures at atomic length scales must be gained. The importance of ion-ion and ion-solvent interactions in avoiding ion-pairing in the bulk phase and in the electrode interphase is not understood. The dynamic aspects of ion polarizability that enter into ion association, mobility, and interfacial interactions also need to be determined. The experimental results from these and other studies would be complemented and strengthened by computational investigation and new analytical tools that can be employed in the relevant spatio-temporal scales.

Comprehensive understanding of the electrical double layer—its structure, dimensions, ion and solvent content, electrical field distribution and relaxation dynamics—is a critically important research goal. It is well known that high concentrations of salts seriously alter the electrical double layer from classical models, through specific ion-electrode interactions, ion desolvation, and changes in the distribution of electrical gradients that drive electrode reactions. Our understanding of such effects in the context of solid, often structurally heterogeneous electrodes used in modern battery and capacitor systems, and in concentrated salts like ionic liquids (ILs), is quite inadequate at present. New characterization tools for

studying double layer capacity and dimensions, and how composition and structure vary spatially and temporally in an electrochemical context, are critically needed, and would represent valuable adjuncts to other aspects of electrolyte design as well as to studies of new electrode materials themselves.

ILs based on ions such as imidazolium, phosphonium, and quaternary ammonium are of increasing electrochemical interest. Their attractive virtues of high ion concentrations, low volatility, good temperature tolerance, and potentially wide operating voltage windows make this class of materials particularly interesting as electrolytes for EES. There is a large, unexplored structural diversity in ILs, and the design rules of these materials as useful electrolytes remain at a primitive state.

New battery electrolyte concepts are needed that go beyond today's polymer electrolytes. Immobile materials like inorganic compounds, polymer electrolytes, and polymer hosts offer another significant advantage over mobile materials. Once they form a stable passivating (non-electronically but ionically conducting) layer at an operating electrode interface, their lack of continued access to the electrode surface renders them kinetically inert. Designing polymers with tailored architectures could allow higher ion mobilities. The surfaces of pores could be modified to permit ions (rather than an ion pair or ion clusters) to diffuse through a weakly interacting medium. Novel systems with tailored structures—such as ion-conducting glasses and metal oxides, in which ion mobility is facilitated by vacancies, defects, or well-defined channels—may provide alternative approaches. Inspiration for these enhanced ion transport systems may be gained by studying membranes and pores in biological systems. Drawing on analogies to biological structures responsible for intercellular ion transport, pore-like structures might be assembled in block copolymers that exhibit weak coupling to ions. Polymeric analogs of ILs, where the cationic component, such as an imidazole derivative, is incorporated into a polymer, are areas that could benefit from an understanding of the relationships of the structure and ion transport in these systems.

Another promising area ripe for exploration is nanoparticle composites. The interstitial space in ensembles of high-surface-area nanoparticles should provide conductive channels for ion transport, somewhat analogous to models for proton conduction in Nafion™. Clearly, the nanoparticle concentration in the ensemble must be beyond the percolation threshold, and the particles may need surface treatments to achieve reasonable conductivities. Sintered nanoparticle composites could provide free-standing monoliths that combine high conductivity, excellent mechanical properties, and the potential for simple processing. The synthetic chemistry of nanoparticles and their surfaces, and simulations of particle self-assembly and ion transport in such materials, could be key elements in the design of critically needed materials

Batteries, ECs, and other EES devices do fail; and smart materials that are designed to respond to deviations in device performance could dramatically improve device reliability, safety, and lifetime. Recent progress in designing responsive polymers has provided materials whose properties reversibly change in response to temperature, pressure, and other external stimuli. It might be possible to design materials that moderate temperature

excursions within batteries, and polymer layers that selectively remove dendrites or restore conductive pathways in composite electrode structures.

## **Impact**

The ideal electrolyte for a battery or an EC is one that imposes no limitations on the intrinsic voltages of the electrochemical reaction couples or the charge state of the double layer and that is indefinitely stable, is very temperature tolerant, poses no safety hazard or environmental disposal issues, is lightweight, and can be deployed at low cost. The current understanding of the many complex and interdependent processes that govern electrolyte performance in EES is extremely limited. With fundamental understanding of electrolyte processes at the atomic and molecular levels, new insights into the design of novel electrolytes will dramatically increase the performance of EES devices. These improvements will have relevance to fuel cells, electrolytic hydrogen production, and other technologies involving charge/ion transport.

## **THEORY, MODELING, AND SIMULATION**

### **Overview**

Advances in algorithms for theory, modeling and simulations, and computer technologies provide unparalleled opportunities for understanding the complexities of chemical processes and materials needed for the next generation of EES systems. One of the Priority Research Directions (PRDs) is “Rational Materials Design through Theory and Modeling.” However, advances in theory, modeling, and simulation were noted as a critical need in all of the other PRDs, and are therefore included in this cross-cutting summary. Theory, modeling, and simulation can effectively complement experimental efforts in fundamental scientific research on EES and can provide insight into novel charge storage mechanisms, predict trends, and provide design criteria for new materials and guide experiments. In the future, large multiscale computations that integrate methods at different time and length scales will be able to provide a fundamental understanding of processes such as phase transitions in electrode materials, ion transport in electrolytes, charge transfer at interfaces, and electronic transport in electrodes. A more demanding goal for theory is the design, from first principles, of new materials with better performance for batteries and ECs.

### **Research Directions**

Multiscale modeling is a cross-cutting research topic that is critical to all aspects of basic research on batteries and ECs. It can be used to explore physical and chemical processes in energy storage systems occurring over the full range of length scales—from the atomic to the macroscopic, and time scales—from femtosec to seconds, thus providing an understanding of complex phenomena, molecules, and materials and their interplay with the architecture of the material. For example, extremely short timescales (femto- to nanoseconds) characterize simulations and experiments on kinetics and phase formation. Longer timescales are needed for issues of lifetime, based on mechanisms of degradation. To this end, theory can guide and provide a framework in which to interpret experiment and assist in the design of molecules, materials, and systems. In electrode materials, for example, theory will be particularly important in uncovering the nature of the phase transitions and providing knowledge of diffusion properties, intercalation mechanisms, and electrochemical and transport properties.

An even more demanding goal is to use multiscale simulations to help design electrode materials with properties desired by users, such as porous carbon materials with desired morphologies.

Computer simulations can make important contributions to investigation of the structure and dynamics of electrolytes to provide an understanding of factors contributing to ion transport mechanisms and ionic conductivity. They will play a key role in the design of new electrolytes with appropriate stability and conductivity properties and in the exploration of high-risk areas such as finding solid polymer electrolytes with high room temperature conductivities and understanding the effect of pore size on the electrolyte structure of ECs. Finally, in the research on electrode–electrolyte interfaces, new or expanded theory is essential to gaining a comprehensive understanding of the nature of the interface, of which little is known but which nevertheless is the subject of much speculation. Such theory will be especially important for exploring phenomena occurring at the interface that are crucial for energy storage systems, including the charge transfer processes at the interface, structure of the double layer at the interface, and desired coatings.

Multiscale modeling represents a new opportunity for the design of novel materials for batteries and ECs with defined properties. The ultimate realization of such a virtual design capability would mean that a user need only specify a desired set of properties, along with system or environmental constraints. The computational approach would provide materials or devices, with suitable and optimal approaches for their synthesis. For example, with the help of theoretical and methodological advances and high-performance parallel computing, it will be possible to carry out reliable, first-principles-based simulations of new electrolytes with new components for the formation of protective coatings or nanocarbon materials for ECs with desired pore size and morphology. Also, it will be possible to design composite electrodes and cells that consist of several different materials with specially designed features, such as expansion and contraction. In addition, high-throughput virtual screening of many candidate materials may use calculations at one or more length scales to screen many possibilities and will be a useful computational tool where experimental testing takes a long time and is expensive.

To take advantage of these opportunities for multiscale modeling in EES systems, close collaboration among experimental and computational researchers is necessary. Validation of new theoretical methods with experiments on model systems is essential to ensure reliability of computational simulations, especially in collaboration with characterization scientists using neutron, X-ray, electron, electrochemical, and spectroscopic techniques. Finally, access to best-in-class high-performance computing resources at national facilities, as well as local computer clusters, is essential for realizing the potential of theory, modeling, and simulation to contribute to major breakthroughs in EES.

## **Impact**

New computational methods for theory, modeling, and simulation will play a crucial role in the future development of a fundamental understanding of chemical and physical processes needed for designing and synthesizing new materials for batteries and ECs. Coupled with new characterization techniques and synthesis, computational methods will enable the design

of materials at the nanoscale, expediting new discoveries critical for energy storage systems. These computational methods will have broad applicability to many other areas central to many diverse energy technologies that require the development of new tailored materials and chemical processes.

## **CONCLUSION**





## CONCLUSION

Generation of electricity from renewable resources, such as solar and wind, and the use of electricity in transportation offer great potential to reduce our dependence on foreign oil and reduce global warming caused by CO<sub>2</sub>. However, widespread implementation of these and other sources of electrical energy will be possible only if there are effective systems of electrical energy storage (EES) for portable electric power on the one hand and stationary electric power on the other hand. Current EES technologies, based on chemical energy storage (batteries) and electrochemical capacitive (EC) energy storage, fall far short of meeting these future needs. Rechargeable batteries are ubiquitous in today's mobile society. But these devices, which power mobile phones, MP3 players, and laptop computers, have limited energy storage capacity and slow recharge cycles that restrict their use in either transportation or electrical grid applications. Batteries also have limited lifetimes because of degradation of their electrode materials during charge/recharge cycles. Restrictions in operating temperatures, especially below 0°C, also impact their widespread use.

ECs are related to batteries, but ECs store energy directly as charge whereas batteries store energy in chemical reactants capable of generating charge. ECs have higher discharge rates, and thus high power performance, than batteries because their charge is not limited by kinetics and mass transport, as is the case with batteries. Because ECs store charge physically rather than chemically, these devices have longer lifetimes than batteries, which suffer from degradation of electrode materials during charge-discharge cycling. The highly reversible charge storage process in ECs results in device lifetimes in excess of hundreds of thousands of charge-discharge cycles. However, ECs have lower energy densities than batteries and are limited to operation below about 3 V, which restricts their current applications.

Advances in EES technologies to date have generally been based on empirical approaches to the identification of electrode materials and electrolytes; traditional system architectures easily fabricated with techniques that are available to modern industrial laboratories are commonly used. Although EES systems have been used for nearly two centuries, our knowledge of the chemical and physical processes that occur in batteries or ECs is surprisingly very limited. To make the revolutionary breakthroughs needed to meet future energy application requirements, it is critical to understand the myriad, interconnected processes involved in the operation of these devices. Ultimately these processes affect such key performance issues as charge-discharge behavior, system failure, and device safety. For example, batteries, to the end user, appear to be simple; however they are dynamic systems that change with every charge-discharge cycle over their lifetime. What would appear to be a simple interface between the battery electrodes and electrolyte is in fact a complex set of phases that change with time—some of these phases can be advantageous to the operation of a battery, while others degrade its lifetime. If we could understand the formation and changes of these phases, it may be possible to design materials that take advantage of processes and optimize battery performance. The knowledge needed to elucidate these and other phenomena that occur in EES systems can be obtained only through fundamental research. This research will lay the foundation needed for realizing revolutionary technology breakthroughs needed for future EES applications.

This Report outlines substantial technical challenges required for advances in EES and presents priority research directions that offer promise for addressing these challenges. In particular, emerging capabilities in nanoscience offer unprecedented opportunities to enable the development of new EES concepts that could transcend today's technologies. These include the ability to design nanoscale materials with specific functionalities, to characterize materials structures at the nanoscale and observe chemical processes from femtosecond to second timescales, and to model and predict new structures and functionalities computationally. Many of the central challenges in EES—electron and ion transport, interfacial processes, and multifunctional nanomaterials, for example—are also of importance in other energy-related areas, such as fuel cells, hydrogen production, photocells, and others. Thus the knowledge gained in basic research in ESS will have broad impact in other areas related to long-term energy needs.

The Report stresses that to achieve the ambitious performance goals required in future EES systems, fundamental knowledge of the physical and chemical processes that occur in these systems is required. A major cross-cutting theme in the report is the need for new characterization tools that will provide an atomic- and molecular-level understanding of these key processes. These needs include the development of electrochemical and spectroscopic methods that can provide insight into charge and mass transfer within electroactive particles and electrolytes as well as across electrode-electrolyte interfaces. The required information includes high-resolution structural information, as well as the ability to examine dynamic processes that occur across the range of femtosecond to second timescales. Imaging techniques, especially those that can provide chemical information, could examine displacive phase changes within electrodes. Combined characterization techniques could provide critical information on the formation and permeation of protective electrode-electrolyte interface phases, and on the effect of nanoscale dimensions on electroactive particles and on electrolytes in organized porous structures. New capabilities in high-flux photon and neutron sources and specialty instrumentation at these facilities offer new capabilities for studying both structure and dynamics.

A second cross-cutting theme in the Report is the need for developing novel materials tailored for optimal EES performance. In chemical energy storage, nanoscale materials with tailored architectures hold exceptional promise for decreasing the ionic transport distance between positive and negative electrodes while maintaining a matching electronic transport to the current collectors. Strategies are also needed to create new anode and cathode materials that provide a stable electrode-electrolyte interface at all states of charge and discharge to achieve long cycle life. This is critically important, for example, if the driving ranges of plug-in hybrid electric vehicles are to become practical for more than just short commutes. Developing these new strategies will require in-depth understanding of the interfaces and interphases between the electrodes and electrolytes. From this knowledge, electrode materials and electrolytes could be designed as a system to optimize battery performance. For example, new materials that store ions by displacement reactions rather than intercalation could provide less disruption of the interface and lead to longer battery life. New concepts are also needed to deliver higher energy capacities by increasing the number of electrons accepted per redox center.

Many of the materials used in today's ECs have been adapted from batteries, although the process of charge storage in the two systems is quite different. New materials specifically designed for ECs are critically needed for achieving a step change in EC performance. As was the case for chemical energy storage materials, before new materials can be designed, the fundamental principles that govern capacitive charge storage must be understood. With this information, tailored nanomaterials with well-defined pore structures could be designed to yield vast improvements in EC performance. Further, the introduction of multiple functionalities into these pores could allow charge storage by multiple mechanisms. These modifications could allow capacitances to be tuned selectively or to provide self-healing properties to extend device lifetimes. Using the principles of nature, self-assembly offers a completely new approach for developing novel nanomaterials and architectures. Self-assembly could also provide less costly routes for manufacturing both ECs and batteries.

A third cross-cutting theme in the Report is the need for innovations in electrolytes. Electrolytes are key components of EES, providing the means of transferring charge/ions to electrodes. Comprehensive understanding of the electrical double layer is a critical need; once gained, it would provide valuable information on the governing principles of EES operation. These principles would allow new electrolytes to be designed to provide higher operating voltages, higher conductivity, and wider electrochemical windows. Special emphasis was given to the passivation layer that forms at the electrode-electrolyte interface where the interface is not thermodynamically stable. The solid electrolyte interphase (SEI) not only must provide kinetic stability to the interface but also must be permeable to the working ion. Insertion/extraction of the working ion into/from an electrode particle in a charge-discharge cycle in a battery causes the electrode particles to change dimensions and thus the interface. At high rates of charge-discharge, i.e. at high power, the SEI must reform rapidly compared with unwanted chemical reactions at the unprotected interface.

Increasing the stable voltage across the electrolyte of an EC was also emphasized as a key to higher energy density of the device. The interaction of electrolytes with pores in ECs may have vastly different capacitive performance as a function of pore size. Thus it may be possible to design electrolytes for specific electrode materials. Conversely, materials could be designed to control ion mobility, ion pairs or ion clusters. Understanding the effects of electrolyte degradation and impurities may reveal routes to designing "smart," self-repairing electrolyte solutions for EES systems that could lead to greatly improved lifetimes.

The fourth cross-cutting theme that arose from all sections of the Report is the need for advances in theory, modeling, and simulation. Fundamental advances in computational algorithms and computer technologies were recognized as providing an unparalleled opportunity for providing the new insights into the complexities of processes and materials needed to make the groundbreaking discoveries that will lead to the next generation of electrical storage systems. Theory, modeling, and simulation can effectively complement experimental efforts on EES systems and can reveal mechanisms, predict trends, identify new materials, and guide experiments. In the future, large multiscale computations that integrate methods at different time and length scales will be able to provide a fundamental understanding of processes such as phase transitions in electrode materials, ion transport in electrolytes, charge transfer at interfaces, and electronic transport in electrodes. A more

demanding goal for theory is the design, from first principles, of new materials with better performance for batteries and ECs. Because batteries and ECs operate under very different conditions, it was recognized that very different computational challenges exist for these EES systems.

At the heart of these research activities, the materials science community will be called upon to design new materials and to devise synthetic routes to nanomaterials of a given morphology. These will be designed so as to allow optimum transfer of ions within and between electrodes, as well as of electrons between the operative redox couples and the current collectors that contact the external electric circuit. These materials must be abundant and non-toxic; the mass and charge transfers must occur with minimal energy loss over a charge-discharge cycle; and within a cell, a large portion of the theoretically available electrical energy at high power must be available over many cycles. The chemistry community will identify redox couples capable of receiving more than one electron at a fixed voltage, or the electrolyte that will give thermodynamic stability with electrodes that give a high cell output voltage. However, both materials scientists and chemists must be guided by an intuition educated by a deeper understanding of the complex processes operative in an electrochemical cell. This understanding will be made possible only by advanced physical and electrochemical measurements and computational tools. The design of optimal cell architectures, whether inspired by self-organized natural system or by the theoretical modeler, must eventually be realized by the engineer who fabricates the end product. Clearly, an interdisciplinary collaborative research effort is essential for the breakthroughs the targeted goals demand.

At the close of the workshop, the panelists were very enthusiastic about the potential of EES. They concluded that the identified targets for portable and stationary EES could indeed be met with a sustained commitment to interdisciplinary basic research. This research would focus on the fundamentals involved in the charge and mass transfer processes of electrochemical cells; the structural changes associated with chemical energy storage; the tailoring of accessible redox couples; the development of thermodynamically stable cells of high energy density; the ability to control, synthetically, the assembly of nanoparticles with tailored morphology into designed architectures; and the electrochemical characterization of both components and the end product. The advances in nanoscience, computation, and characterization offer unprecedented potential for achieving these goals. The workshop concluded that now is a propitious moment for a major commitment to a sustained research effort into EES, an effort that addresses an urgent need to achieve a secure energy future for our nation.

**APPENDIX A: TECHNOLOGY AND APPLIED R&D NEEDS  
FOR ELECTRICAL ENERGY STORAGE**

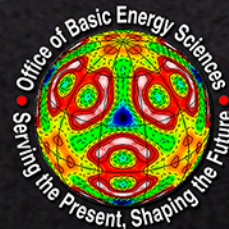




# Technology and Applied R&D Needs for Electrical Energy Storage

Resource Document for the Workshop on Basic Research Needs  
for Electrical Energy Storage

*March 2007*







# TECHNOLOGY AND APPLIED R&D NEEDS FOR ELECTRICAL ENERGY STORAGE

## Resource Document for the Workshop on Basic Research Needs for Electrical Energy Storage

March 2007

### Contributors

Fred Baker, Oak Ridge National Laboratory  
(ORNL)

Greg Gruzalski, ORNL

Ralph Brodd, Broddarp of Nevada

Robert Hamlen, Communications–Electronics  
Command (CECOM) (retired)

Gil Brown, ORNL

Haresh Kamath, EPRI

M. V. Buchanan, ORNL

Gordon Michaels, ORNL

Brenda Campbell, ORNL

John M. Miller, Maxwell Technologies

Deborah Counce, ORNL

John R. Miller, JME, Inc.

Tina Curry, ORNL

Patrick Moseley, Advanced Lead–Acid Battery  
Consortium

Sheng Dai, ORNL

Chaitanya Narula, ORNL

David DePaoli, ORNL

C. Patrissi, Naval Undersea Water Center

Dan Doughty, Sion Power

Brenda Phillips, ORNL

Nancy Dudney, ORNL

Carlos Ponce de Leon,  
University of Southampton

Ron Gordon, University of Utah

Michael Thackeray, Argonne National Laboratory

Allison Gray, ORNL

F. C. Walsh, University of Southampton



## CONTENTS

Acronyms .....	v
1. Introduction.....	1
2. Electric Energy Storage Applications.....	3
2.1 Transportation.....	3
2.2 Stationary Electrical Energy Storage: Transmission and Distribution Grid, Renewable Energy, and Distributed Generation.....	9
2.3 Portable Power.....	16
3. Rechargeable Batteries for Energy Storage Applications.....	19
3.1 Overview.....	19
3.2 Lead–acid Batteries.....	20
3.3 Nickel Batteries.....	22
3.4 High-temperature Sodium Beta Batteries.....	27
3.5 Lithium Batteries.....	30
3.6 Metal Air Batteries.....	34
3.7 Redox Flow Cells.....	37
3.8 Conclusions.....	42
4. Advanced Electrochemical (Super) Capacitors.....	45
4.1 Overview.....	45
4.2 State of the Art of Electrochemical Capacitors.....	45
4.3 Applications of Electrochemical Capacitors.....	53
4.4 Technological Challenges for Enhancing the Performance of Electrochemical Capacitors.....	56
4.5 Additional Reading.....	58



## ABBREVIATIONS, ACRONYMS, AND INITIALISMS

A/V	active electrochemical area to volume
ASR	area-specific resistance
BASE	$\beta''$ -Al <sub>2</sub> O <sub>3</sub> solid electrolyte
CD	charge depleting
CS	charge sustaining
DG	distributed generation
DOE	U.S. Department of Energy
EC	electrochemical capacitor
eCVT	electronic continuously variable transmission
ESR	equivalent series resistance
EV	electric vehicle
FCHV	fuel cell hybrid vehicle
GM	General Motors
HEV	hybrid electric vehicle
HRPSOC	high-rate partial-state-of-charge
IC	internal combustion
LL	load leveling energy storage systems
Ni-Cd	nickel cadmium
Ni-Fe	nickel-iron
NiMH	nickel metal hydride
Ni-Zn	nickel-zinc
OCV	open circuit voltage
PHEV	plug-in hybrid electric vehicle
R&D	research and development
SEI	solid-electrolyte-interphase
SLI	starting, lighting, and ignition (automotive)
SOC	state of charge
TD	transmission and distribution
USABC	U.S. Advanced Battery Consortium
VRLA	valve regulated lead–acid battery
ZEBRA	Na/S or Na/Ni/Cl <sub>2</sub> cells



## 1. INTRODUCTION

The projected doubling of world energy consumption within the next 50 years, coupled with the growing demand for low- or even zero-emission sources of energy, has brought increasing awareness of the need for efficient, clean, and renewable energy sources. Of particular interest are energy sources based on electricity that can be generated from renewable sources, such as solar energy. Indeed, advances in solar photovoltaic cells, thermoelectrics, and other electrical energy technologies offer enormous potential for meeting future energy demands. However, the efficient utilization of electricity generated from these and other renewable sources requires some form of electrical energy storage, such as batteries or electrochemical capacitors (often referred to as ultracapacitors or supercapacitors). Both of these storage devices are based on electrochemistry, and the fundamental difference between batteries and electrochemical capacitors is that the former store energy in chemical reactants capable of generating charge, whereas the latter store energy directly as charge.

Today's energy storage technologies fall far short of the requirements for efficiently using electrical energy efficiently in transportation vehicles, commercial and residential applications, and even consumer devices. For example, electrical storage devices with high energy and power densities are needed to power electric vehicles with performance comparable to that of today's petroleum-fueled internal combustion (IC) vehicles. In addition, both recharge time and overall lifetimes of storage devices are important considerations if electrically powered vehicles are to become practical. For commercial and residential applications, electricity must be reliably available 24 hours a day. Even minute-to-minute fluctuations in electrical power can cause major costly disruptions. Thus for large-scale solar- or wind-based electrical generation to be practical, electrical storage devices are critical to meeting off-cycle demands, effectively leveling the phased nature of these energy sources. Because of these technology gaps, energy storage has been singled out as a critical need for a secure energy future.<sup>1</sup>

This document was produced in preparation for a Department of Energy (DOE) Office of Basic Energy Sciences Workshop titled "Basic Research Needs for Energy Storage." This workshop will identify key basic research directions that could provide revolutionary breakthroughs needed for meeting future requirements for electrical energy storage. This document was intended to provide a high-level assessment of current technologies used for electrical storage—focusing specifically on batteries and electrochemical capacitors—and to define requirements that are foreseen for the future application of these technologies in transportation vehicles, commercial and residential uses, and portable devices. Thus it provides a common background for the workshop participants and sets the technological basis for the workshop. The document was prepared by Oak Ridge National Laboratory in consultation with subject matter experts from other national laboratories, universities, and industry.

---

<sup>1</sup> Basic Energy Sciences Advisory Committee, *Basic Research Needs to Assure a Secure Energy Future*, Proceedings of Basic Research Needs to Assure a Secure Energy Future, John Stringer, chair, Gaithersburg, MD, February 2003.





## 2. ELECTRIC ENERGY STORAGE APPLICATIONS

### 2.1 TRANSPORTATION

#### Overview

The development of transportation vehicle technology is being pursued by DOE and the automotive industry with several overarching goals in mind:

- increasing transportation vehicle energy efficiency
- promoting fuel switching away from petroleum-derived fuels and increasing reliance on electricity, hydrogen, biofuels, and/or liquid fuels from unconventional resources
- decreasing vehicle emissions and adverse environmental impacts
- improving safety and vehicular performance

Electrical energy storage technology is an important component of all major approaches for advanced vehicle technology (see Table 1).

**Table 1. The functional role of electricity storage in transportation vehicles**

Vehicle technology	Functional role of energy storage	Distinguishing top-level requirements
Conventional IC engine	Startup and ancillary services	Cost and cycle life
Mild hybrid electric vehicle (HEV)	Power during stop-and-go	Operate at 45 to 75% charge, very long cycle life, V = 45 to 145 V
Strong HEV	Stop-and-go power plus propulsion assist	Operate at 45 to 75% charge, very long cycle life, V = 200 to 290 V
Plug-in HEV	Propulsion over 40- to 60-mile range	High specific power and energy, deep discharge, long cycle life
All-electric vehicle (EV)	Propulsion (no IC engine)	High specific power and energy, deep discharge, long cycle life
Fuel cell hydrogen vehicle (FCHV)	Transient power for acceleration and maneuvering Power for fuel cell compressor and traction power during startup and transients	High specific power, moderate specific energy, long cycle life
HEVs, EVs, FCHVs	Regenerative brake energy recovery	High charge rate

#### 2.1.1 Advanced Engine Technology

Gasoline IC engines form the standard against which other engine technologies are judged. Gasoline IC engines can achieve power densities of 50 to 70 kW/L, whereas diesel-fueled engines have somewhat lower power density. However, the peak power of a vehicle engine is needed only infrequently, and automotive passenger car and light truck engines are designed for nearly a 10:1 ratio of peak to average power output. The specific cost of IC engines is now in the range of \$30–\$35/kW, which sets the benchmark for fuel cell systems and electrical-power systems for automotive applications.

**Advanced IC engines.** Desired functionality for IC engines is high specific output, reliable and low emissions output over 7,500 hours in operation, pumping losses as low as possible, and wide brake-specific fuel consumption plateaus permitting efficient operation at lower speeds and lower torque. Research and development (R&D) goals are to increase the overall efficiency of IC engine systems from 35 to 45% and to extend fuel options to biofuels, liquid fuels from unconventional sources, and hydrogen.

The sole role for electrical storage in an advanced IC engine is to provide startup power and ancillary power for services when the engine is shut down.

**Hybrid electric vehicles.** Hybrid electric vehicles (HEVs) are based upon combining an IC engine, an electric motor, and an electrical storage system in a flexible architecture: the drive train operates either with electrical power from the battery or with power from the IC engine. HEVs achieve higher fuel efficiency by

- use of battery power to allow the IC engine to avoid operating conditions and transients in which the IC engine operation is inefficient (idling, acceleration, deceleration)
- recuperating braking energy to replenish the energy storage system

The IC engine sustains the charge level of the battery. During periods when combustion engine operation is inherently inefficient and the vehicle operates on battery power—idling at stop lights, low-speed operation—the engine is turned off. The key HEV systems include very efficient electric motors and energy storage systems with high turnaround (charge–discharge) efficiency capable of very long cycle life in a charge-sustaining mode—a mode in which the state-of charge does not undergo large swings very often because the IC engine power is used to recharge it.

Two major subcategories of HEVs have emerged over the past 10 years. Toyota presently owns 65% of the HEV market with its **strong hybrid** designs based on Toyota's proprietary electronic transmission system: the single-mode power-split electronic continuously variable transmission (eCVT). These systems operate at 30 kW or more and are designed for higher voltages in order to reduce thermal burden, size, and cost. Honda is the preeminent manufacturer of **mild hybrids** with its integrated motor-assist crankshaft-mounted starter/alternator unit. The Honda Accord HEV operates at 12–14 KW or less, and mild hybrids are currently designed for lower voltages.

Both Honda and Toyota specify nickel metal hydride batteries for their HEV products in order to provide an 8-year, 80,000-mile to 10-year, 100,000-mile warranty on their hybrid components. This warranty interval reflects the charge-sustaining (CS) mode of operation that imposes many shallow cycles on the energy storage components. Desired functionality for CS-mode hybrid vehicles is an energy throughput of >20-MWh cycles, which implies typical values of >300,000 cycles at shallow discharge. Energy storage batteries in CS-mode hybrids nominally operate at 60% of their total charge with a total working range of 45 to 75% (a 30% swing in the state of charge).

At present there is no standard system voltage for either mild or strong hybrids. Toyota's HEV systems are designed for battery potentials of 201 to 288 V and use multistep power electronics to achieve output potentials of 500 to 650 V for the eCVT systems. Mild hybrids operate at lower voltages and do not require power electronics to boost the voltage. Honda vehicles require battery potentials of 144 V, and systems offered by General Motors (GM) and others require battery potentials of 42 V.

In city driving, about 30% of a typical vehicle's engine output is lost to braking. One of the efficiency advantages of an HEV over a conventional vehicle is its use of regenerative braking. An HEV is

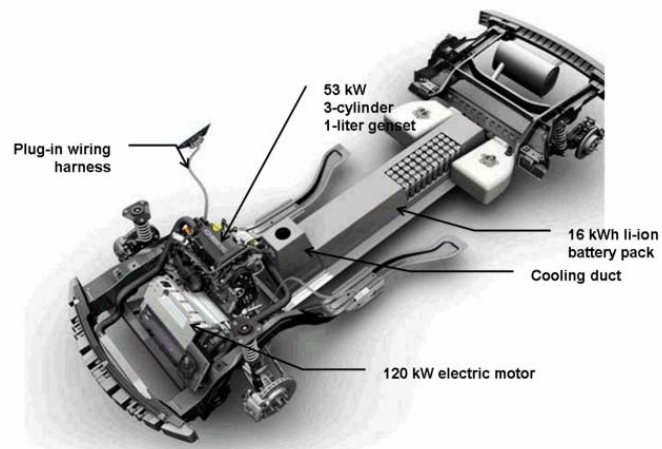
designed with electronically controlled brakes and maintains traditional friction brakes as a backup. Low-end HEVs employ electronically controlled braking as parallel regenerative braking systems, an incremental upgrade of conventional antilock brakes. High-end, more fuel-efficient HEVs implement series regenerative braking systems that recuperate the largest percentage of the available braking energy. The HEV decelerates, the direction of the torque in the vehicle motor reverses, and it operates as an electric generator, converting the change in the vehicle's momentum into electricity (with about 30–35% conversion efficiency) and storing it in the battery. Thus HEVs require that the energy storage system have a high enough charge rate to accept the regenerated energy during braking.

**All-electric vehicles.** Development of battery electric vehicles (EVs) started in the early 1970s and had diversified into several system architectures by the early 1990s. Propulsion components ranged from 75 kW (Ford–DOE ETX program) to 120 kW (GM EV1 program) and primarily used lead–acid batteries for energy storage. Storage levels for EVs are nominally 30 kWh because of weight considerations and technology limitations in the past. A range of 60 miles to over 100 miles, depending on driving conditions and ancillary loading, was typical for all-EVs. Future EVs planned by Mitsubishi will have four wheel motors (~48 kW each) and a 300-mile range.

The desired functionality of EVs must include single-speed propulsion components so that no shifting is required. This in turn places a high burden on the electric machine's constant power speed ratio. EVs require high-specific-energy batteries and perhaps ultracapacitor energy storage components for long cycle life in a charge-depleting (CD) mode of operation with superimposed CS mode dynamics. The combined influence of CD and CS modes on lithium battery cycle life is unknown at this time.

All-EVs benefit from higher-voltage operation, nominally in the range of 900 V.

**Plug-in hybrid electric vehicles.** Plug-in HEVs (PHEVs) function in a manner similar to EVs except that the IC engine acts as range extender for the battery. Plug-in HEVs have the additional requirements for IC engine management and electric generator operation. The PHEV usually departs architecturally from the HEV in having a series hybrid propulsion system, like the EV (Fig. 1). In series hybrids, the drive train is powered by the electric battery (or storage system), and the role of the IC engine is simply to recharge the battery.



**Fig. 1. Phantom view of the recently announced GM Volt PHEV.** It shows the packaging of a small 3-cylinder engine and 53-kW engine-generator along with a 120-kW (EV1) traction drive and 16-kWh lithium-ion battery pack sourced from Cobasys-A123 Systems and Johnson Controls-Saft Advanced Power Solutions, LLC.

The transmission in a PHEV has the same challenges as in an EV in terms of single-speed no shifting, torque for grade holding, acceleration performance, and cruise capability. High power is demanded from the energy storage system during acceleration, passing maneuvers, and braking. High energy is demanded from the energy storage system to maximize the all-electric range of the vehicle.

In general, expansion of the usable state-of-charge window for electricity storage operation, along with long electricity storage system life over many deep discharge cycles, are critical requirements for reducing the incremental costs of PHEVs.<sup>2</sup>

**Fuel cell hydrogen vehicles.** Several manufacturers have developed near-commercial hydrogen fuel cell power plants in road-ready vehicles. Among them are Toyota, Honda, BMW, GM, and Ford. The functionalities are similar to those of PHEVs from the vehicle level because the system is series hybrid with all-electric drive. Fuel cell hybrid vehicles (FCHVs) depart from conventional HEVs in that fuel cell plants permit component packaging in and beneath the vehicle floor pan and better packaging flexibility for the traction motor(s) (either an axle motor with half-shaft links to wheels or in-wheel motors). Currently, the driving range of an FCHV is limited by its inability to store more than approximately 2 kg of hydrogen per high-pressure cylinder (composite tanks at 350 bar/ ~5,000 psi).

Today's fuel cells are inherently slower in response than IC engines. When rapid power changes are required (e.g., acceleration), IC engines can change speeds on the order of 100,000 rpm per second. Current fuel cells have a significant lag due to gas flow rates and typically require several seconds to respond to a demand for power that traverses a 10 to 90% sweep of total power. Thus in FCHVs, the high power for acceleration, maneuvering, and braking support must be delivered by the energy storage systems. FCHVs also require moderate energy density storage for startup in cold climates, powering the air compressor, powering ancillaries, and recuperating energy.

### 2.1.2 Energy Storage Technology Requirements

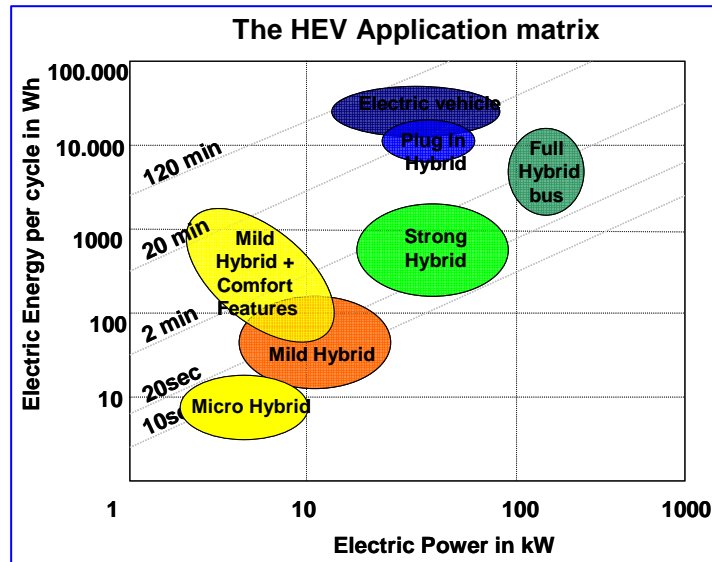
Energy storage technologies and their respective applications are summarized in Fig. 2. The vertical axis corresponds to the energy discharged in a cycle. HEVs are shallow discharge systems and thus lie beneath PHEVs and EVs on the chart. The U.S. Advanced Battery Consortium (USABC) has consolidated the requirements for energy storage systems for HEVs into a compact table of requirements (Table 2). In Table 2,

- “Energy efficiency” refers to the round-trip efficiency involved in a discharge and recharge event. The high efficiency values given are problematic for batteries but are achievable with ultracapacitors under most conditions.
- “Cycle life” implies operation for over 7,500 hours in service (not calendar hours), during which time the component will be at high electrical stress levels and in harsh environmental conditions.
- “Self-discharge” is the natural decay of charge from the storage device. For ultracapacitors, the present USABC requirement on self-discharge is ambiguous and under review. If cell capacitance is 3000 F and the test time is 72 hours, then for 4% voltage loss over those stand time hours, the internal self-discharge equivalent resistance must be greater than 27  $\Omega$ . If the capacity of the cell is lower, 650 F for example, then it can have a much higher self-discharge resistance of 123  $\Omega$ . Manufacturers typically specify self-discharge as an equivalent current, such as 5.2 mA of leakage.

In all cases, the desire to minimize resistive losses and associated thermal loads, and to reduce the size and weight of the equipment, are the technological drivers toward higher system voltages (and hence lower electrical currents). Over the long term, energy storage potentials are expected to converge to 240 V for strong HEVs, and associated electromechanical system equipment voltages will remain in the 650-V to perhaps 800-V range. Because of the relatively higher power requirements for

---

<sup>2</sup> T. Markel and A. Simpson, *Plug-in Hybrid electric Vehicle Energy Storage Design*, NREL/CP-540-39614, National Renewable Energy Laboratory, May 2006.



**Fig 2. The total power and discharge power requirements for HEVs, including PHEVs and EVs.** The deep discharge cycles required for PHEVs and EVs, combined with the requirements for long battery life, are not attainable with current technology.

**Table 2. Electricity storage requirements, as published by the U.S. American Battery Consortium, for three different HEV architectures<sup>3</sup>**

System attributes	12 V start-stop	42 V start-stop	42 V transient power assist
Discharge pulse	4.2 kW, 2 s	6 kW, 2 s	13 kW, 2 s
Regenerative pulse	—	—	8 kW, 2 s
Cold cranking pulse @ 130°C	4.2 kW, 7 V min	8 kW, 21 V min	8 kW, 21 V min
Available energy (CP @ 1kW)	15 Wh	30 Wh	60 Wh
Recharge rate (kW)	0.4 kW	2.4 kW	2.6 kW
Cycle life/equiv. road miles	750 km/150,000 miles	750 km/150,000 miles	750 km/150,000 miles
Cycle life and efficiency load profile	UC 10	UC 10	UC 10
Calendar life (years)	15	15	15
Energy efficiency on UC10 load profile (%)	95	95%	95%
Self-discharge (72 h from max. V)	<4%	<4%	<4%
Maximum operating voltage (Vdc)	17	48	48
Minimum operating voltage (Vdc)	9	27	27
Operating temperature range (°C)	-30 to +52	-30 to +52	-30 to +52
Survival temperature range (°C)	-46 to +66	-46 to +66	-46 to +66
Maximum system weight (kg)	5	10	20
Maximum system volume (L)	4	8	16
Selling price (\$/system @100 K/year)	40	80	130

<sup>3</sup> C. Ashtiani et al., "Ultracapacitors for Automotive Applications," *Journal of Power Sources* **154**, 561–566 (2006).

heavy vehicles such as buses, the electricity storage and electromechanical systems in HEV and EV buses would have much to gain by raising their system voltages to 1500 V.

### 2.1.3 Major Unmet Technology Goals for On-vehicle Electrical Energy Storage

**Specific energy and power.** The leading electrical energy storage technologies today are electrochemical cells and ultracapacitors. Electrochemical cells are capable of very high specific energy; e.g., lithium-ion batteries, which are considered the standard advanced battery, currently offer about 200 Wh/kg with a maximum theoretical capability of 385 Wh/kg. As can be seen in Fig. 2, the energy and discharge power requirements for PHEVs and EVs are in the range of 10,000 to 20,000 Wh and are about an order of magnitude higher than for HEVs. Further, these combined requirements imply weights and volumes for electricity storage that are unattractively high. These requirements will not be met by incremental advances in current electrical energy storage technologies. Fundamental breakthroughs in materials and chemical processes in electric storage technology are needed to achieve the values of energy density while meeting requirements of weight and cost that will make widespread use of PHEVs and EVs attractive.

**Very long cycle life, no wear mechanisms.** A major drawback of all electrochemical cells is the limited serviceable life due to electrode wear mechanisms, associated with mass transport of the electrode constituents.

**Recharge rates.** Lithium-ion technology has a very high discharge rate capability, but its recharge rate is far more limited. Thus matching lithium-ion systems to the requirements of regenerative braking energy systems is a concern.

**Temperature range of operation.** Transportation vehicles must operate in a wide temperature range; current specifications are  $-30$  to  $52^{\circ}\text{C}$ . Both the charge and recharge rates at cold temperatures are low for lithium-ion systems, and at  $-40^{\circ}\text{C}$ , they are typically 20 to 30% of room temperature charge rates. By contrast, ultracapacitors do not lose the capability for high power delivery at cold temperatures and are capable of functioning well at  $-40^{\circ}\text{C}$ . Because of these synergistic attributes, the combination of ultracapacitors with lithium cells is being actively explored by industry.

A variety of performance-degrading effects can be found in batteries at the upper end of the range of vehicular operating temperatures. As an example, nickel metal hydride (NiMH) batteries are known to experience reversible side reactions that lower efficiency at  $45^{\circ}\text{C}$  and above, as well as other side effects at  $50^{\circ}\text{C}$  and above that can shorten their life or reduce their charging capacity.

Operation at high temperature can also lead to thermal runaway of batteries—self-discharge of current, which leads to more heat generation, thereby increasing the temperature and the levels of self-discharge further. Lithium-based systems can generate internal heat at  $60$ – $80^{\circ}\text{C}$  and may require active cooling for vehicular applications. Thermal runaway can occur, but at much higher temperatures. Reducing exothermic and gas-producing reactions in battery systems would both extend the life and expand the range of safe operation.

**Reliability.** Attaining high reliability in energy storage system operation will require that latent flaws in electricity storage systems be diagnosable; the alternative is that the flaws will result in failures that will show up only after months to years in service. Industry experience has shown that undiagnosable latent flaws, such as electrolyte impurities or incompletely mixed phases, are definitely a concern for the lithium-ion system.

**Capacitor range and self-discharge.** Ultracapacitor technology shortfalls are relatively high levels of self discharge (i.e., leakage.) and the limitation to cell potentials below 3 V.

**Abuse tolerance.** Any high-energy storage system has the potential for safety problems. Batteries have the fuel (anode) and oxidizer (cathode) packaged together, and unintended release of the energy can have serious consequences. Abuse tolerance in battery systems depends on the choice of materials used in electrode structure and other components, as well as design choices by the manufacturer (e.g., the use of shutdown separators, over-voltage cutoff devices, vents in the cells to release pressure and electrolyte). Safety becomes more critical as the energy and power density of batteries approach those of high explosives. Safe operation and resistance to abuse without catastrophic results are key elements in developing new high-energy power sources for transportation vehicles.

Ultracapacitors are far more tolerant of abuse than lithium systems and can tolerate over-voltage and over-temperature conditions for more than 2 hours with benign failure. (In this instance, benign failure refers to controlled venting of evolved gasses via an engineered vent aperture or through a container breach.)

**Cost:** The challenge currently facing lithium-ion cell manufacturers is improving the manufacturing process to result in lower costs.

## **2.2 STATIONARY ELECTRICAL ENERGY STORAGE: TRANSMISSION AND DISTRIBUTION GRID, RENEWABLE ENERGY, AND DISTRIBUTED GENERATION**

Electrical energy storage is required for efficient use of renewable energy sources (both local and distributed applications) and for efficient and reliable transmission and distribution (TD) of electrical energy (i.e., grid applications). Because these storage devices are stationary, the technology drivers are quite different from those for transportation vehicles or portable power. Enhanced electricity storage capabilities for renewable energy and electric grid applications have the potential for the following top-level benefits:

- Providing responsive power to meet the minute-to-minute fluctuations in electricity demand and increase operational margins against grid system upsets.
- Improving the reliability and stability of the grid in situations where conventional solutions are becoming increasingly problematic.
- Improving the efficiency of off-grid solar and wind power and enabling the integration onto the grid of large-scale solar or wind energy plants
- Providing capability to “peak shave” or “load shift,” thus enabling peak loads to be met during periods when new generation or TD assets cannot yet be brought on-line

### **2.2.1 Transmission and Distribution Grid Applications**

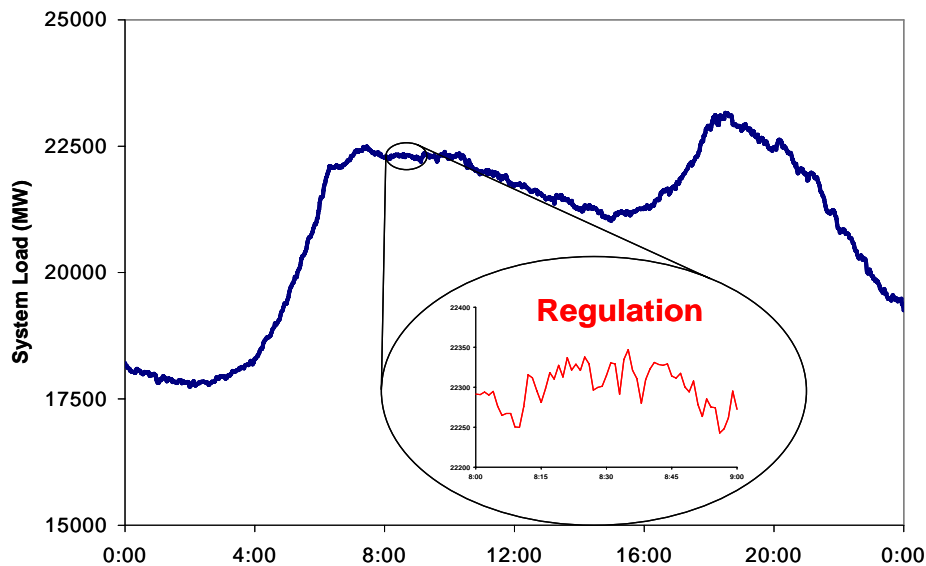
With large-scale energy storage systems unavailable, the electricity network system has evolved in such a way that there are built-in inefficiencies within the TD system, and conditions in which the required reliability and stability of the grid are not achieved. Application of advanced energy storage technologies could make the grid more reliable and stable while improving the energy efficiency of grid operations.

To date, large-scale applications of energy storage for TD have not been extensive. Currently, roughly 2.5% of the total electric power delivered in the United States passes through energy storage. That amount is primarily limited to applications associated with pumped hydroelectric storage. The percentages are somewhat larger in Europe and Japan, at 10% and 15%, respectively, in large part

because of favorable economics in those areas.<sup>4</sup> Using advanced electrical storage technologies could have a significant impact on grid reliability and stability.

**Grid reliability and regulation.** Individual consumers perpetually make independent choices “to turn on or turn off the electricity”—whether appliances, electric lights, or industrial equipment. Even in large regional grid systems where the high number of these decisions causes the individual effects to largely cancel out, the aggregated demand for electricity has small, rapid fluctuations (on the order of seconds to a minute) in the level of electricity demand, or load. The generation of electrical power cannot be exactly matched to these small, rapid fluctuations in load.

Figure 3 shows an actual variation of power load for a winter day on a segment of the U.S. grid. The large-scale features of the variation in power load (demand) are relatively easy for power systems operators to anticipate and match by increasing or decreasing the level of electricity generation on the grid. However, as Fig. 3 illustrates, the demand for electric power will fluctuate on a time scale of seconds or minutes.



**Fig. 3. An electric power demand load on the ERCOT, Texas, segment over 24 hours on a winter day.<sup>5</sup>**

The term “regulation” refers to minute-to-minute balancing of the power system. Why is matching the generation to power load so important to power system operators? When the instantaneous electricity generation level is mismatched to the instantaneous load, it is manifested as a shift in the ac frequency at which the power grid operates. The frequency of ac power in the United States is designed to be 60 Hz, but it will dip to, say, 59.5 Hz when the demand for electrical power exceeds the generated level by 1 part in 120. Not only does the customer receive power at a slightly shifted ac frequency when that happens, but also the rotating generator equipment at power generation plants is constrained to rotate at the slightly shifted frequency.

<sup>4</sup> *Handbook of Energy Storage for Transmission and Distribution Applications*, Electric Power Research Institute, Palo Alto, CA, and the Department of Energy, Washington, D.C., 2003.

<sup>5</sup> Electric Reliability Council of Texas, *1999 FERC 714 Data*, February 2002.



Figure 4 shows the effects of and operator responses to variations in grid power frequency. Large excursions in frequency of 3% or more are likely to cause damage to the generator turbine equipment; therefore, the power generator systems will be automatically shut down if the frequency variations exceed  $\pm 1.5\%$ —leading to outages and undesired effects on other generator systems. Of course, other operator responses are performed at smaller levels of frequency variation to avoid tripping a generator.

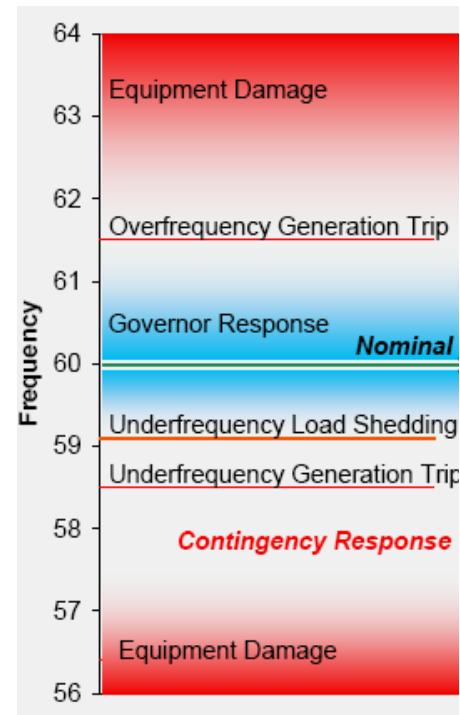
In normal operating scenarios, the frequency is closely monitored and the variations are controlled to within  $\pm 0.01\%$ . But randomness and the occasional outage of a generator system can pose challenges for system operators. Operators currently rely on activating additional electrical generation resources or cutting off service (shedding load) to certain designated customers. Electricity storage systems could be designed to have ideal characteristics to assist with power regulation, namely quick response time and an inherent ability to efficiently follow load; i.e., they would discharge power at a rate that matches demand. Thus as new breakthroughs in electrical energy storage increase the effectiveness and decrease cost, the regulation of generated power would be an important application for advanced energy storage.

#### Grid Stability Applications—Reserve Power

The electricity network operates as a just-in-time delivery system: power is generated, transmitted, and consumed nearly immediately, without the need for storage. This feat is accomplished through massive aggregation of loads and generation, which reduces the effects on the grid from fluctuations of individual loads and even individual generation units. Large shifts in load tend to occur over periods of minutes or hours, giving operators time to respond by increasing or decreasing generation. The effects of outages of individual generator units on grid operations are also reduced, thus increasing system reliability.

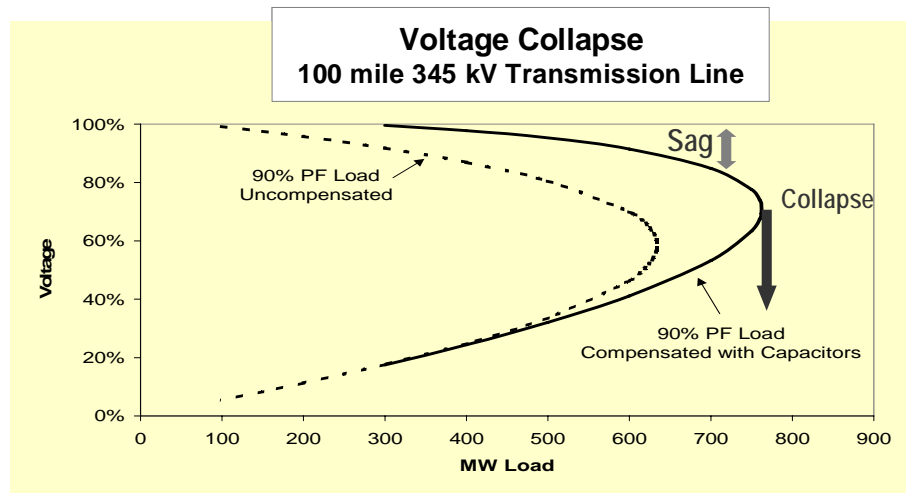
The phenomenon of grid instability is a growing concern. When ac power cables are operated at very high currents, the dynamic effects of inductance cause the voltage in the line to drop—a phenomenon known as voltage sag (see Fig. 5). With increasingly high values of ac electric power flow, a point is reached at which no value of voltage is sustainable; this condition is called voltage collapse. The grid control response to voltage collapse will involve shutting down affected generator units and transmission cables, which will inevitably shift power load to other lines and generator systems, placing them in operational jeopardy. The result can be a widespread cascading outage, such as the one that occurred on August 11, 2003.

The larger the power network, the more stable it is. A very large network, such as the Eastern Interconnect in the United States, is a relatively stable and reliable system. But in some situations the power network is not as stable and reliable as desired:



**Fig. 4. The ac frequency range of a typical electric power system, showing operator-controlled and automatic control responses.<sup>6</sup>**

<sup>6</sup> B. J. Kirby, J. Dyer, C. Martinez, R. A. Shoureshi, R. Guttromson, and J. Dagle, *Frequency Control Concerns in The North American Electric Power System*, ORNL/TM-2003/41, Oak Ridge National Laboratory, December 2002.



**Fig. 5. The stable values of ac voltage when high levels of power are present in a 100-mile-long transmission line.** Note that as power flow reaches about 760 MW, a voltage collapse instability is encountered even with capacitor compensation. “PF” refers to the product of ac power and ac frequency and has units of joules.<sup>7</sup>

1. In some areas, such as the Hawaiian Islands, the power system is too small to have sufficient aggregated load and generation to smooth out fluctuations.
2. Existing TD systems (power lines and substations) might be insufficient to deliver the power required by loads at the time it is needed, leading to grid congestion and poor power reliability and quality. This condition might occur at the edges of the distribution system for loads, or when load has grown beyond the capabilities of the existing TD infrastructure. Connecticut, Long Island, NY, and Southern California are examples of areas affected by grid congestion.<sup>8</sup>
3. The mix of generation facilities poses practical limitations on the ability of the operator to change the generation level. This might be an issue on networks that have a high reliance on generation with fixed output, such as nuclear power, or a large percentage of intermittent renewable generation such as wind or solar power.

In cases in which stability, reliability, and /or power quality issues exist, electric power utilities must find other ways to make the grid performance acceptable. Conventional solutions include

1. Enlarging the network by building additional TD power lines and substations. However, the siting and land acquisition process for establishing new “rights-of-way” for TD corridors now requires more than 15 years! The cost per mile for new TD power corridors, also a consideration, ranges from \$1.2 million to \$6 million.
2. Building small generator systems and locating them strategically within the congested area to provide reserve power. In addition to cost and schedule considerations this alternative poses, the sites of grid congestion are usually densely populated so that atmospheric emissions from fossil-fueled generators may exceed air quality standards.

Thus traditional solutions are not always acceptable or reliable. Large-scale electricity storage plants, preferably located near areas where demand is high, would represent an important resource for managing the grid during upset conditions such as voltage sag.

<sup>7</sup> B. Kirby, *The Role of Demand Resources In Regional Transmission Expansion Planning and Reliable Operations*, ORNL/TM 2006/512, Oak Ridge National Laboratory, July 2006.

<sup>8</sup> *National Electric Transmission Congestion Study*, U.S. Department of Energy, August 2006 (available at [222.oe.energy.gov/docs/reports\\_studies.htm](http://222.oe.energy.gov/docs/reports_studies.htm)).

The following applications are ways energy storage can be used to improve the reliability, stability, and cost-effectiveness of the electricity grid and its power generation system.

**Peak-shaving** is a high-value variant of load shifting (discussed below) in which a relatively small amount of energy is added to the power system at peak demand times to reduce the magnitude of the peak. An electricity customer can use peak shaving to minimize demand charges. A TD utility can use peak shaving to defer the upgrade of assets or to manage peak loads during the lengthy period sometimes required for construction of new assets.

**Load shifting.** Load shifting involves storing energy at one time and releasing it at another. It has always been the most tantalizing grid-related application for energy storage, in part because its technical and economic benefits are easy to understand: store energy when excess is being generated and release it at times of greater demand. Load leveling or energy arbitrage is one flavor of load-shifting in which energy is stored when it can be produced cheaply (at off-peak times, for example) and released at peak times when it is more valuable. But load leveling is also the hardest application to implement because the technical requirements are quite demanding, the size of deployed storage systems is quite large, and the economic value is relatively small. Even though the economic value is significant, energy storage technologies are not available at a low enough cost to justify their application.

## 2.2.2 Electricity Storage for Renewable Energy Systems,

Solar and wind energy are the largest and fastest-growing renewable energy resources and have the potential to be a major source of electrical energy in the future. However, the large-scale use of these energy sources poses special challenges in dispatching their electricity. Solar or wind power systems convert natural sources of energy (sunlight and wind kinetic energy) into electricity, with the result that the instantaneous level of energy resource, and thus electricity generation, is relatively uncontrolled and variable. In a power system where both the *generation* of electricity and the *demand* for electricity are not controllable, it becomes problematic for an operator to provide electricity at levels that match the load. (See the discussion in Sect. 2.1 about the importance of matching generation and demand.)

Energy storage eases this problem by absorbing energy when the generated power exceeds the need and covering the shortfall when the generated power is less than is needed. Development of low-cost electricity storage systems with appropriate performance characteristics will be a key to large-scale deployment of wind and solar power systems.

**Load shifting.** Because wind and solar system operators have limited control over the amount of power generated, the rate of renewable power generation will rarely match the load requirement. Therefore, during periods of low demand, wind power generation must be curtailed. Energy storage can be used to store energy generated during periods of low demand and deliver it during periods of high demand. When applied to wind generation, this application is sometimes called “firming and shaping” because it changes the power profile of the wind to allow greater control over dispatch.

The wind energy resource is often greatest during the night hours when the demand for electricity is low; thus wind generation would benefit from load shifting. A similar problem affects owners of small renewable sources that operate “off-grid,” such as residential solar photovoltaic systems. The peak solar generation period will often not coincide with the peak power consumption period (e.g., during the winter). In such situations, cost-effective energy storage systems are desirable to store generated power during the peak generation period for later use at the peak consumption period.

**Power regulation.** In an area with a great deal of wind or solar energy generation, sudden shifts in wind patterns or sunlight intensity can lead to significant minute-to-minute imbalances between generation and load. For reasons described in the previous section, imbalances lead to changes in system frequency. The power industry seeks to match the electricity generation level to the fluctuating demand for electricity within a tolerance of about 0.1%, and imbalances greater than 2.5% (1.5 Hz out of 60 Hz) are an automatic trigger for emergency shutdown of equipment.

The extent to which solar or wind electric power assets can be tied into a larger power system grid will be governed by the extent to which the short fluctuations in their aggregated power generation levels can be safely accommodated by the larger power system. Energy storage systems are required to smooth out the short-time-frame variability in solar or wind-based electricity generation.

This same issue applies to off-grid usage of wind and solar power, or to micro-grid systems that rely mainly on these renewable sources. Variability and intermittency in power generation will lead, at best, to inefficient usage of the renewable resource. Electricity storage is critical to the widespread use of renewable energy to allow leveling of rapid fluctuations in power generation (seconds to minutes) and to provide bridging power for short periods of reduced power generation.

### 2.2.3 Applications to Distributed Energy Resources

Distributed generation (DG) systems have several important roles in grid applications. First, distributed generators can provide backup power when outages occur. They can serve as uninterruptible power systems for critical industrial operations and be used as reserve power when the demand for electricity exceeds the baseload generation capacity. Additionally, DG systems can be operated in areas where fully loaded or congested distribution systems lack adequate capacity to meet peak electricity demand.

Energy storage is commonly used with DG devices such as fuel cells, microturbines, and even conventional diesel generators (Fig. 6). This storage is used for a number of purposes, including black start, bridging power, and load smoothing.



**Fig. 6. 100-kW diesel generator.**

**Black start.** The first role, black start, is the same as that provided by the starting battery in an automobile—to provide the initial energy required to start the generator from a stopped state. This application typically requires the injection of a large amount of power for a short period of time—a matter of seconds.

**Bridging power.** Energy storage is also used to provide bridging power to loads while a backup generator is started. Distributed generators are often used as backups to the grid, but they often require time to start up. Energy storage can be used to bridge the gap between grid power and the backup generator so that loads see uninterrupted power. Bridging power is typically required for from a few seconds to a few minutes.

**Load smoothing.** Load smoothing allows distributed generators to act as if they are part of a larger and more robust electrical grid. Many DG systems, such as reformer-fed fuel cells and microturbine generators, are sometimes insufficiently responsive to quickly changing loads. The peaks and valleys in the typical load profile make it difficult to optimize such generators: they must be significantly

oversized, and load fluctuations—such as those associated with the startup of large motors—may not be fully supported. In addition, because generators are not perfectly reliable, it may be necessary to provide additional generating units, or reserve capacity, ready to respond immediately in case of failure. In such cases, energy storage can be used to decouple generation from load. Energy storage provides power when the load increases faster than the generator can compensate, and it absorbs power in the opposite situation. The effect is that the generator sees a smoother load, and the load sees a firmer, more robust source.

These three basic purposes also make energy storage a very important component for almost all off-grid distributed energy systems, including those operating in a microgrid environment.

#### **2.2.4 Technology Requirements: Energy Storage for the TD Grid, Renewable Energy, and Distributed Generation**

The functional requirements for electrical storage systems supporting wind and solar energy, distributed energy systems, or grid operations are very different from the requirements for those supporting transportation vehicles. Electricity storage systems in electric power applications will be stationary and ground-based; therefore, the weight, volume, and energy density of electricity storage is not as important for them as for mobile vehicle applications. Individual batteries or capacitors can be connected into “banks” so that the individual current and voltage capacity of a unit is not a concern.

Why is energy storage for electricity production not more widespread? The fundamental issue with energy storage is cost, expressed both in terms of the unit cost of power (megawatts) and in terms of the unit cost of capacity (duration of storage). Although different applications have different cost tolerances, in general the cost of electricity storage needs to be comparable to or less than the cost of generating electricity.

The technology requirements are summarized for the main applications in Table 3.

**Power quality/frequency regulation.** Energy storage used for frequency regulation need not have a great deal of capacity—15 to 30 minutes is sufficient—but must have very good cycle life, as the system is likely to encounter several discharge events a day. High discharge rates are important, although the state-of-charge of the storage system will not typically move over a wide range.

**Load shifting.** Technologies providing reserve electricity for load shifting require large-scale systems involving a large amount of stored energy. Long cycle life, high round-trip energy efficiency, and low operation and maintenance costs are principal drivers. Because the quantities of stored energy are high, the safety and abuse tolerance concerns are enhanced for these types of systems.

#### **2.2.5 Technology Challenges**

**Cost.** The primary outstanding technology challenge is low cost. In most cases there are specific embodiments of storage technology that can meet the listed specifications for the various applications, with the singular exception of the cost requirement. In most electricity storage technologies, lower-cost materials synthesis methods are needed for electrodes and electrolytes, as well as strategies for increasing the energy and power capacity of storage hardware. Methods to increase the inherent safety and abuse tolerance of electricity storage systems would reduce the engineered packaging requirements of these systems and hence reduce their cost. Of course, specific cost reduction strategies will be different for different electricity storage systems; thus they are discussed in greater length in Chapters 3 and 4.

**Table 3. Top-level energy storage requirements for grid applications<sup>9</sup>**

Storage technology parameter	Customer (load) applications		Power system operator applications		
	Power quality	Backup power for outages	Regulation	Reserve power for grid stability and reliability	Load shifting and load leveling
Capital cost (1) (\$/kW)	400		700	300–1000	300 (load leveling) 400–1000 (peak shaving and load shifting) 650 (renewables)
Total U.S. market potential (GW)			30–40	70–100	80 (cost sensitive)
Storage system power level	Up to 100 kW	1 to 50 MW	Up to 200 MW	10 MW to 1	1 MW to 1 GW
Discharge time at rated power	0 to 5 s	Minutes to days	Seconds	0.2 to 2 h	1– 8 hours
Capacity (storage time)	Up to 1 min	Months to years	Seconds	~ 2 weeks	Hours to days
Lifetime (years)	5	20	20	40	7–10
Other			Long cycle length		

**Safety and abuse tolerance.** Another technology challenge is safety and abuse tolerance. Current electrochemical systems for electric energy storage have the potential of rapidly releasing their energy if certain temperature limits are exceeded. Depending upon the energy density and electrochemistry of the system and the specific initiating event, the uncontrolled energy release can range from a thermal runaway event that simply drains the storage system of its energy to an explosive discharge of energy. Engineered barriers against these hazards are the standard path to minimizing the risks. However, there would be great interest in electrochemical system technology that involved inherent safeguards against rapid, explosive releases of energy.

### 2.3 PORTABLE POWER

The rate at which the portability and mobility of electrical devices can advance hinges significantly on electrical energy storage. So important is this energy source that engineers design handheld devices around the storage device, rather than the other way around. The use of primary (non-rechargeable) and secondary (rechargeable) batteries is ubiquitous throughout society because of the proliferation of portable electronic devices. Batteries are an ideal energy storage system because they are simple (no moving parts, no noise), reliable (–20 to >100°C, shelf life of many years), have a wide range of energy and power densities, and have the ability to load-follow.

Rechargeable battery technology has long been a bottleneck in the development of improved portable electronic products. Consumers require smaller, lighter, and longer-operating electronic devices, which require increased energy content; and high current pulses for communication devices demand

<sup>9</sup> A. Nourai, “Comparison of the Costs of Energy Storage Technologies for T&D Applications,” *American Electric Power*, July 2004 (available at [www.ElectricityStorage.org](http://www.ElectricityStorage.org)); P. C. Butler, J. Iannucci, and J. Eyer, *Innovative Business Cases for Energy Storage in a Restructured Electricity Marketplace*, SAND2003-0362, Sandia National Laboratories, Albuquerque, NM, February 2003.



batteries with higher discharge rates. These requirements strain the ability of current battery technology.

### 2.3.1 Description of Portable Power Applications

Batteries make up a major section of the energy storage and conversion systems market and are among the most diverse of electronic components. Individual battery types differ in the electrochemical couples employed, capacity, physical size, weight, shape, drain rate capability, thermal performance, cycle life, shelf life, and cost. Because the products in which batteries are used are the drivers for current and future battery needs and their specifications, one way to analyze the portable power battery market is by the power and duty cycle of the products themselves.

For example, in micropower applications such as backup power, self-discharge of the energy source may be a critical parameter. In contrast, for cellular phones, maximizing energy density and life cycle is critical. Applications requiring exposure to environmental extremes require good battery performance at high (>50°C) and low (< -20°C) temperatures.

Table 4 shows a market segmentation scheme for portable electronics products in which applications are plotted against nominal active power on the X-axis and duty cycle on the Y-axis. Nominal active power is defined as the approximate average dc power during active usage. It is divided into five basic categories: (1) micropower (<1 mW), (2) low power (1 mW to 1 W), (3) medium power (1 to 10 W), (4) high power (10 to 100 W), and (5) very high power (>100 W).

**Table 4. Power and duty cycle of major portable power applications; HEVs and EVs are also shown for comparison.** High-volume, high-value consumer applications are shaded in green

Power / Duty Cycle	Micro Power (<1mW)	Low Rate (1mW to 1W)	Medium Rate (1W to 10W)	High Rate (10 -100W)	Very High Rate (>100W)
<b>Low (&lt;1%)</b>	Appliance RTC Backup	Pager "Bridge" Battery Camera PCS Comm	Flashlights ARDIS Radio	Portable Appliances Camcorder w/Lights	
<b>Medium (1 to 33%)</b>	"Smart" Cards MEMS	Portable Games Consumer Audio Cordless Phone Handheld Comp/PDA	Cellular Phone Camcorder GPS Portable Computer	Power Tools	EV Hybrid EV
<b>High (&gt;33%)</b>	Computer RTC Pacemaker	Sensors	Portable POS Terminal "Augmented Reality" Device		

Duty cycle is defined as the approximate percentage of active usage versus "suspend" or off time. It is divided into three categories: (1) low (<1%), (2) medium (1 to 33%), and (3) high (>33%). It can also be thought of as the cumulative energy needs (cumulative Wh) of the device over time.

Primary batteries occupy the quadrants requiring low-duty-cycle/micro- to mid-power and high-duty-cycle/micropower. Rechargeable batteries occupy quadrants with medium duty cycles and high power demands. This segmentation is driven mainly by the fact that rechargeable batteries offer low operating costs because their energy is renewable through low-cost ac charging (e.g., it typically costs less than \$0.01 to recharge a cell phone battery). Low-duty-cycle products or micropower/high-duty-cycle products usually need the higher energy density, low self-discharge, and lower initial cost of

primary batteries. The low duty cycle accommodates another attractive feature of primary batteries—consumers do not have to think about or manage battery charging.

Medium-power/medium-duty-cycle applications include cellular phones and computers that are served by lithium-ion and NiMH batteries. The edges of the segmentation graph are typically served by specialty, primary lithium batteries or Ni-Cd batteries, which are the power source of choice for use in power tools.

### 2.3.2 Technology Challenges

There are several technology challenges that, if explored, could provide opportunities to enhance the energy, power, shelf life, cycle life, and reliability of battery systems.

**Understanding of performance degradation and failure mechanisms.** Batteries are complex architectures composed of many different materials. Thermodynamic stability of these materials is seldom achieved and as a result, parasitic reactions on the surfaces of the electrodes shorten life and compromise performance

**Higher power density and longer life.** Although many battery chemistries and particle morphologies have been developed and demonstrated, the fundamental architecture of all commercial batteries remains the same: thin layers of electrolytes sandwiched between an anode and a cathode. Novel architectures (e.g., 3-dimensional) and improved use of materials may have the potential to increase the power density and alter degradation and failure mechanisms.

**Enhanced energy density.** Battery size is becoming a major driver for the size of hand-held and portable devices. To further miniaturize the battery in order to further reduce the size of portable devices, higher-energy-density materials and systems are desired.

**New electrolytes for high-efficiency and high-current operation.** State-of-the-art liquid electrolytes are composed of a complex mixture of organic solvents and dissolved salts to optimize ionic conductivity over a wide variety of temperatures and voltages; this operational flexibility is critical for many portable electronic applications. Ions physically (and rapidly) move from anode to cathode through an inert matrix (the separator) during battery use. The separator both contains the ionic liquid and permits the anode and cathode to be in close proximity without shorting. Because of the changing volume of the anode and cathode during use (or during a charging cycle), the separator must be able to absorb significant stress while maintaining the integrity of the cell. Battery technology would benefit significantly from the development of separators and electrolytes with improved stability and conductivity.

**Safety and abuse tolerance.** Electrochemical systems for electricity storage have the property of rapidly releasing energy if certain temperature limits are exceeded. Depending upon the energy density and electrochemistry of the system and the specific initiating event, the uncontrolled energy release can range from a thermal

*...the theoretical specific energy of a lithium thionyl chloride battery is 1420 Wh/L, comparable to the theoretical specific energy of TNT at 1920 Wh/L.*

runaway event that simply drains the storage system of its energy to an explosive discharge of energy. For example, the theoretical specific energy of a lithium thionyl chloride battery is on the order of 1420 Wh/L, which is comparable to the theoretical specific energy of TNT at 1922 Wh/L. Developing new materials with high energy density but lower heat and gas generation during off-normal conditions could provide substantial benefits.



### 3. RECHARGEABLE BATTERIES FOR ENERGY STORAGE APPLICATIONS

#### 3.1 OVERVIEW

Electrochemical cells store energy as chemical reactants, generating a cell voltage near that calculated using the Nernst equation and values for free energies of the chemical reactions:

$$E = -\Delta G^\circ / nF - (RT/nF) \ln(a_{\text{products}}/a_{\text{reactants}})$$

Upon discharge, the flow of electrons allows the reactions to proceed at the electrode surfaces—oxidation at the anode and reduction at the cathode. The chemical reactants are generally formed and stored at the electrodes upon charge of the cell, but they also can be stored in the electrolyte. The electrolyte, which can be a solid, liquid, or gel, serves as the reservoir for ions participating in the reactions and serves as a barrier to electron transport that would short-circuit the cell. The term “separator” usually refers to a porous membrane used along with the electrolyte to ensure that the anode and cathode do not come in contact. A “cell” is the basic electrochemical unit, whereas a “battery” contains one or more electrochemical cells and ancillary components.

Although thermodynamics fixes the theoretical potential of an electrochemical cell, the realized potential, discharge current, and capacity utilization are determined by the ion and electron transport, activation barriers, and impedance of the interfaces. To maximize the power delivered by a battery, distances across the electrolyte as well as from the current collector to the electrode-electrolyte interface are kept small.

Chapter 3 is grouped by different families of batteries, including those shown in Fig. 7. The discussion includes batteries available commercially, batteries used in power distribution systems either widely or as demonstration facilities, and batteries under development. Some battery couples are well over 100 years old, whereas others are based on newly developed materials. Many batteries are fabricated as stacked plates; others are based on tubular or spiral-wound architectures. Significant effort has been dedicated to the development of new battery architectures and new reactive materials, electrolytes, packaging, current collectors, and separators. However, the requirements of many future energy applications for effective electrical energy storage will not be met with currently available batteries. The technology improvements required for the next generation of batteries are also discussed.

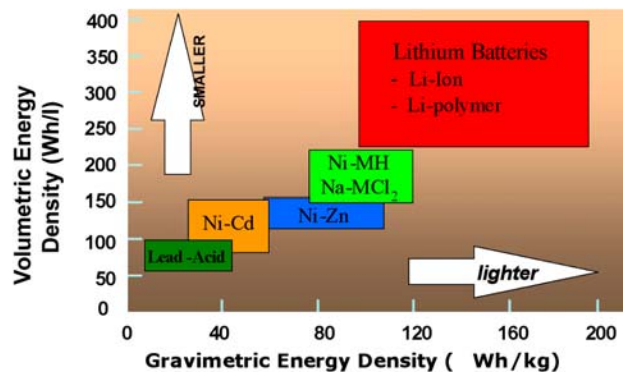
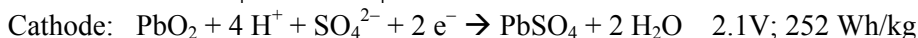
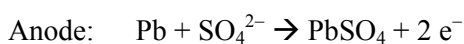


Fig. 7. Performance of several classes of batteries.

## 3.2 LEAD-ACID BATTERIES

### 3.2.1 Introduction

Lead-acid batteries (~2 V per cell) are based on the reversible electrochemical conversion of lead to lead sulfate (anode) and quadrivalent lead oxide to lead sulfate (cathode) in a concentrated sulfuric acid electrolyte. The electrodes are generally formed by a detailed process to give a thick coating (~1 mm) of lead compounds and additives on current collectors (grids) of lead, alloys, or carbons. For good cycling, the active electrode materials must remain connected electrically to the current collectors and wetted by the electrolyte. The many morphologies that can form upon cycling complicate the reactions at the electrodes. Most common lead-acid batteries are formed as stacked electrode plates, whereas some advanced designs are spiral-wound. The half-cell reactions for the cell discharge, the open circuit potential for a charged cell, and the theoretical energy density based on the cell reactions and mass of active material are shown in the following formulas. The reactions are reversed upon charge of the cell.



### 3.2.2 State of the Art

The suitability of a rechargeable battery for any particular application is judged by reference to a set of its characteristic attributes, including cost, energy storage capacity, power, weight, volume, and useful life. The relative importance of these attributes varies greatly from one application to another. Lead-acid batteries tend to be stereotyped as a result of their complete acceptance (in one form) for automobile starting, lighting, and ignition (SLI) tasks for which low cost has been the most compelling factor.

As the automotive world has looked beyond the conventional vehicle configuration, in which motive power is provided solely by an IC engine, the relative importance of the characteristic attributes of the battery required has shifted. Simultaneously, the appreciation of what is achievable with lead-acid chemistry has advanced. In this section, the match of appropriate forms of lead-acid-based batteries against conventional and newly-emergent automotive requirements is reviewed.

Batteries for SLI applications in IC engine vehicles operate from a state-of-charge of about 90% and are required to provide power for engine cranking of up to 10 kW. This translates to a specific power of up to 600 W kg<sup>-1</sup>, normally sustained for less than 1 second.<sup>10</sup> SLI batteries can provide a cumulative energy throughput of about 100 times the nominal capacity, and an end-of-life condition is reached after 5,000 to 10,000 cranking events (4–6 years in temperate climates). Lead-acid batteries reliably meet the requirements for SLI applications. The end-of-life failure is due to either corrosion of the grid or shedding of the active material from the positive plate. This limited lifetime is tolerated because of the low cost of the replacement batteries. The poor specific energy of the lead-acid battery is not sufficient to offset the cost advantage for the SLI applications.

**Electric vehicles.** Batteries for EVs must be capable of being discharged to a rather low state of charge and then being fully recharged. For lead-acid batteries, cycling over a wide range of state of charge maximizes the volume change of the active material and exacerbates the tendency for active material to be shed from the plates. Full cycle duty can also lead to corrosion of the positive grid.

---

<sup>10</sup> *Valve-regulated Lead-acid Batteries*, eds. D. A. J. Rand, P. T. Moseley, J. Garche and C. D. Parker, Elsevier, Amsterdam, New York, Oxford, 2004.

Such failure mechanisms can be held at bay in valve-regulated lead–acid (VRLA) batteries by the use of high levels of compression to the plate stack and by the use of corrosion-resistant alloys in the manufacture of the grids. Deep cycle lives of up to 1000 cranking events have been achieved by using these methods. The specific energy of lead–acid batteries is limited to around 35 Wh kg<sup>-1</sup>, however, so if the weight of batteries is to be held within reasonable bounds, it is unlikely that the range of an EV with lead–acid batteries could exceed 100 miles. This was the maximum range achieved by the lower-cost version of the GM EV1.

Neither conventional 12-V SLI batteries nor present-generation deep-cycle batteries can provide the performance required by the new high-power HEV systems for an acceptable life. Batteries for these high-power systems will operate from a partial-state-of-charge baseline and will be discharged, and particularly recharged, at extraordinarily high rates (albeit within a small range of state-of-charge). Under such conditions, the life-limiting mechanism appears to involve the progressive accumulation of lead sulfate on the negative plate. This failure mode appears as a result of the very high rates of recharge and persists because the battery is not routinely returned to a full state of charge in the required duty cycle.

To offer an acceptable life in such applications, conventional designs of VRLA batteries must be revised. The battery must be able to sustain the negative plate charge reaction at very high rates, overcoming diffusion limitations (leading to reduced lead sulfate solubility, etc.) that would otherwise lead to the onset of secondary reactions, such as hydrogen evolution, and charge inefficiency.

Two straightforward design modifications offer the potential to redeem this situation and to allow the lead–acid battery to perform successfully in the high-rate partial-state-of-charge (HRPSOC) routine demanded in HEVs. Providing an appropriate grid design allows the plates in the battery to accept the high charge rates required; and incorporating elevated concentrations of carbon (a few wt % instead of the traditional 0.2 wt %) alleviates the tendency for sulfate to accumulate and appears to offer the route to a long operating life in the HRPSOC regime.

Batteries assembled with these relatively straightforward design elements are generally able to match the DOE FreedomCAR peak power goals<sup>11</sup> for minimum power assist (625 W kg<sup>-1</sup>) and, in some cases, to approach the peak power goals for maximum power assist (1000 W kg<sup>-1</sup>). Such batteries are also able to perform 300,000 simulated HEV cycles without failing, thus achieving the FreedomCAR lifetime goal.<sup>11</sup>

Batteries rated at 144 V of all three types shown in Table 5 have been running successfully in Honda Insight HEVs from which the original NiMH batteries have been removed.<sup>12</sup> In the medium hybrid application (offering regenerative braking and power assist but little or no all-electric range), the specific energy of the battery is less important than its ability to provide adequate power for an acceptable life.

A frequent mistake is to point to the SLI battery as evidence that lead–acid batteries are unable to satisfy the performance requirements of other, quite different, applications. In fact, when designed specifically for that purpose, batteries that make use of the lead–acid chemistry are capable of providing useful service in deep discharge and particularly in HRPSOC regimens.

---

<sup>11</sup> *FreedomCAR Energy Storage System Performance Goals for Power-assisted Hybrid Electric Vehicles*, November 2002.

<sup>12</sup> Internal reports, Advanced Lead–Acid Battery Consortium

**Table 5. Batteries specifically designed for high-rate partial-state-of-charge operation  
—as in power-assist HEVs**

<b>Battery type, manufacturer</b>	<b>Design elements</b>
“RHOLAB” (8 Ah), Enersys Bipolar (7 Ah), Effpower Ultra (7 Ah), Furukawa/CSIRO	Twin-tab to boost power, spiral wound Bipolar plate of porous ceramic impregnated with lead Additional carbon capacitive element in common with negative plate

Application of lead–acid batteries for distributed energy or the electrical transmission grid is less important than automotive applications. Although large-scale stationary application of lead–acid cells has been considered for a long time, apart from a few demonstrations, there has been little growth in this application. The largest demonstration of lead–acid batteries for electric utility applications in the United States is a 20-MW/18-MWh plant in San Juan, Puerto Rico. Similarly, in remote area power supply situations, there is a demonstration operating in a village in the Amazon region of Peru.

### 3.2.3 Technical and Cost Barriers

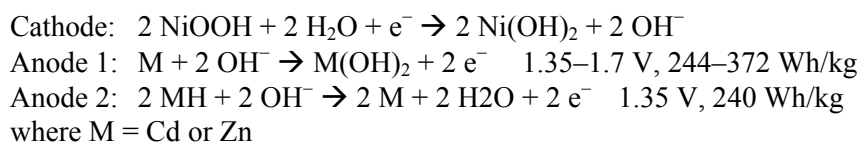
Although a list of critical technological barriers will differ for different applications, the following are the main issues limiting development and expanded use of lead–acid batteries.

<b>Technical barriers and needs</b>	<b>Component(s)</b>
<ul style="list-style-type: none"> <li>• Low specific capacity and energy</li> </ul>	<ul style="list-style-type: none"> <li>• Active materials and grids</li> </ul>
<ul style="list-style-type: none"> <li>• Progressive buildup of a resistive lead sulfate layer with cycling</li> </ul>	<ul style="list-style-type: none"> <li>• Negative electrode</li> </ul>
<ul style="list-style-type: none"> <li>• Corrosion of current collector with cycling</li> </ul>	<ul style="list-style-type: none"> <li>• Positive electrode</li> </ul>
<ul style="list-style-type: none"> <li>• Loss of active material due to shedding as the result of volume changes for the active materials</li> </ul>	<ul style="list-style-type: none"> <li>• Active materials</li> </ul>
<ul style="list-style-type: none"> <li>• Need for lightweight grids that can operate at extremely high rates</li> </ul>	<ul style="list-style-type: none"> <li>• Grids</li> </ul>
<ul style="list-style-type: none"> <li>• Need for a way in which elevated levels of carbon (graphite) in the negative plate can dramatically improve the performance of VRLA batteries in the high-rate partial-state-of-charge duty required by HEVs</li> </ul>	<ul style="list-style-type: none"> <li>• Negative electrode</li> </ul>

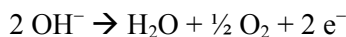
## 3.3 NICKEL BATTERIES

### 3.3.1 Introduction

Nickel batteries of approximately 1 V all share the same cathode, which is nickel oxyhydroxide in the charged state. In an aqueous KOH electrolyte, the cathode discharges to form nickel hydroxide. The anodes are either metals that oxidize to form a hydroxide, or metal hydrides that lose hydrogen when discharged. In the following general half-cell reactions, *M* indicates the metal or alloy at the anode. The theoretical specific energy is also listed.



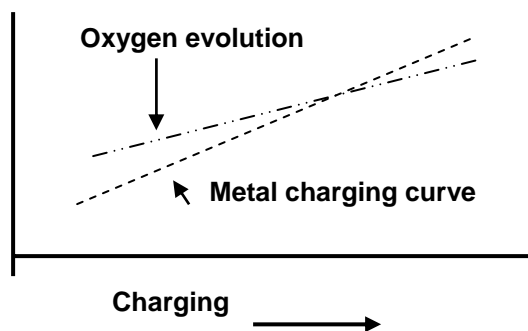
The open circuit voltage (OCV) and other specifications for this family of batteries are listed in Table 6. A complication with this cell chemistry arises from the formation of oxygen gas at the cathode upon recharge of the cell. After ~80% charge, oxygen is generated via this formula (Fig. 8):



**Table 6. Overview of the performance characteristics of nickel battery systems**

System	Ni-Cd (pocket)	Ni-Cd (sealed)	NiMH	Ni-Zn	Ni-Fe (pocket)	Ni-H <sub>2</sub>
OCV	1.2	1.2	1.2	1.6	1.4	1.2
Wh/l	40	100	75	60	55	105
Wh/kg	20	35	240	120	30	64
Power	Low	High	High	High	Low	Med
Discharge	Flat	Flat	Flat	Flat	Flat	Flat
Cycle life	2000	700	600	500	4000	6000

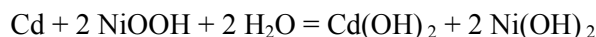
In a sealed cell, with a minimum amount of electrolyte, this oxygen can diffuse back to the anode, where it reacts to generate water and prevents any buildup of gas pressure. In a vented cell, also known as a pocket cell, the cell is flooded with excess electrolyte and includes a gas barrier to prevent this occurrence. This arrangement is described in more detail in the following section. The capacities of the anode versus cathode are adjusted to control reactions. All systems in Table 6 have a flat discharge voltage characteristic and must use electronic controls for state of charge determination.



**Fig. 8. Oxygen forms at the cathode after 80% cell recharge.**

### 3.3.2 State of the Art

#### Nickel Cadmium (Ni-Cd)



Ni-Cd batteries have two incarnations. One is the Edison construction with nickel or nickel-plated-steel pocket plates to hold the active mass, or reactants with conductive KOH media. This was the basis for the original Edison cell that has excellent low-rate performance with extremely long cycle life and a calendar life of 30 or more years. It is used today mainly in railroad cars in Europe and was incorporated in a recent utility energy storage demonstration in Alaska. The initial cost is significantly more than for lead-acid batteries, but the overall cost is lower when increased reliability, maintenance, and length of service are considered.

The second incarnation was a sealed cell developed for jet planes in Germany during WWII. The active mass was vacuum-impregnated into original sintered carbonyl-powdered nickel to form the electrode structure. Cells are flat plate or spiral wrap construction. Today, high-performance electrodes use an open nickel fiber or nickel foam structure impregnated with high-density spherical Ni(OH)<sub>2</sub>. For portable power applications, Ni-Cd was the original mobile phone and notebook battery

but lost out to Li-ion with its lighter weight and higher energy storage capability. Currently, it is the battery of choice for power tools and low-end electronics. It is characterized by an excellent high-rate and low-temperature capability, as well as resistance to abuse and overcharge. For full charge, the nickel electrode operates above the oxygen potential; and for full charge, oxygen is liberated. Oxygen then diffuses through the porous separator structure and recombines on the cadmium electrode. The high-surface-area nickel provides a good reaction surface to recombine oxygen formed during charge and on overcharge. It can be overdischarged without damage. Ni-Cd batteries are used universally for starting and emergency power on jet aircraft because of their reliability and wide temperature operating range.

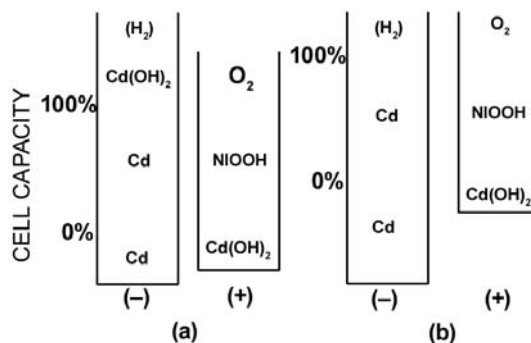
The depiction of the overcharge mechanism is shown in Fig. 9. For sealed Ni-Cd, a simple charger can be used, and charge can be terminated by temperature or voltage measurement. Cadmium is toxic and because of environmental issues is banned in several countries in Europe. Recycling processes are in place but do not recover the materials for reuse in the Ni-Cd cell assembly.

### Nickel Metal Hydride (NiMH)

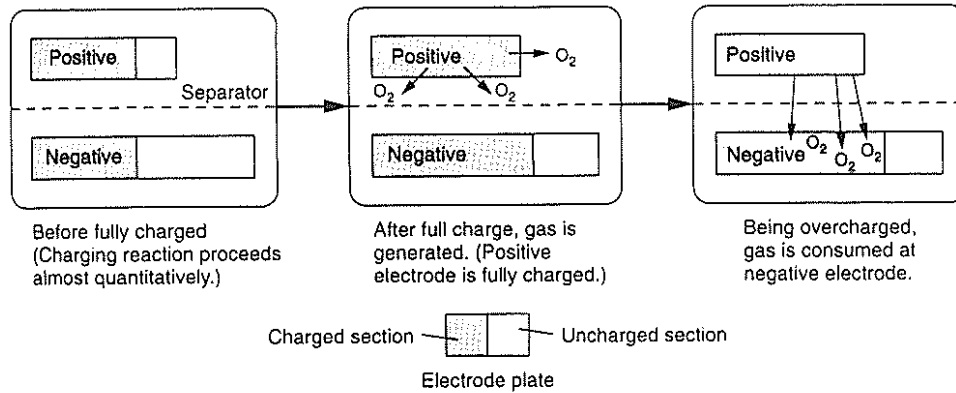


The NiMH cell was first proposed at COMSAT and Bell Laboratories as a substitute for Ni-Cd in satellite applications. It does not have the same environmental restrictions as Ni-Cd. NiMH is used in all HEVs on the market today. Basically, NiMH has the Ni-Cd cell construction and replaces the cadmium electrode with an AB<sub>5</sub> hydride storage electrode composition where A is Ni and B is lanthanum (or another rare earth element). The AB<sub>2</sub> alloy with a different structure has found acceptance for its higher hydrogen storage capability. Most commercial systems use the AB<sub>5</sub> alloy, as it has better high rate and longer cycle life. Recently, a new alloy, A<sub>2</sub>B<sub>7</sub>, based on a combination of structures, has been developed that has greater performance. The change also allows a rebalancing of the capacities of the anode and cathode to deliver a higher-performing system. The composition of the hydride electrode is a complex mixture, with additives to prolong cell life, reduce self discharge, etc. The composition has been referred to as a “kitchen sink” alloy because of its many components.

The flat discharge characteristic, excellent high rate, long cycle life, and abuse tolerance has made NiMH the first choice for use in HEVs. The flat discharge makes determination of the state of charge more difficult. Performance falls off quickly below 0°C and becomes rate-sensitive because of the hydride electrode. The NiMH system has a self discharge rate of about 15–30% per month, depending on the hydride alloy composition. The NiMH has the same ability to withstand overcharge and overdischarge as does the Ni-Cd system, along with a significant increase in energy storage capability. As a result, the NiMH is a high-performance system that is very robust and can tolerate abuse without damage. The charge process for NiMH is depicted in Fig. 10. Significant research activity on alloy compositions and new higher-performance spherical nickel hydroxides has improved performance considerably.

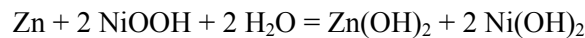


**Fig. 9. Cell balance for (a) sealed and (b) vented Ni-Cd cells.** In sealed cells it is essential to prevent H<sub>2</sub> evolution on charge and essential that only O<sub>2</sub> be evolved. The oxygen evolved from the nickel electrode diffused to the Cd electrode, where it reacts to form cadmium metal.



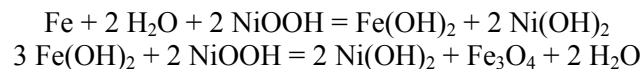
**Figure 10. Charge and overcharge processes for a sealed NiMH cell.** The different cell balance for NiMH results in a higher capacity for NiMH over Ni-Cd for the same size cell.

### Nickel Zinc (Ni-Zn)



The Ni-Zn battery has a spiral wrap construction similar to that of the sealed Ni-Cd, but the cadmium electrode is replaced by a zinc electrode. The result is a higher-voltage unit cell than in either the Ni-Cd or NiMH, coupled with the excellent high-rate capability of the zinc electrode. Zinc has faster kinetics than cadmium for better high-rate performance. Past issues with Ni-Zn center around the tendency of zinc electrodes to undergo shape change (densification), passivation, and dendrite formation. At one time, GM had a sizable Ni-Zn battery development effort aimed at use in EV and SLI applications. Recently, PowerGenix has addressed these issues and has developed new electrolyte compositions that prolong the integrity of the zinc electrode to increase cycle life and minimize passivation, dendrite formation, and shape change. The high-rate capability of the zinc electrode leads to excellent power capability for Ni-Zn. There are no resource limitations on zinc, and it can be lower in cost than the Ni-Cd or NiMH.

### Nickel Iron (Ni-Fe)



The Ni-Fe battery has a two plateau discharge characteristic. This system is not in general usage except in the former Soviet Union. The batteries use the pocket plate construction, which has an extremely long service life and is virtually indestructible. Their main use has been for lighting on railroad cars. The cells must be vented, as hydrogen is evolved on recharge as a result of the low hydrogen overvoltage on the negative electrode. Since the iron electrode operates near the hydrogen potential, it also releases hydrogen on storage, creating potentially hazardous conditions. Although the Ni-Fe battery was initially viewed as a less expensive substitute for Ni-Cd, the hydrogen gassing problems limited its use. The cost lies between those of lead-acid and Ni-Cd batteries.

### Nickel Hydrogen (Ni-H<sub>2</sub>)



The Ni-H<sub>2</sub> system was developed for space power. It couples a hydrogen fuel cell anode with an NiOOH cathode. It has good high-rate capability, extremely long cycle life, and resistance to abuse but is an expensive construction with a titanium pressure vessel containment. For long life, the nickel positive electrode is fabricated by using an electrochemical impregnation process. The hydrogen negative electrode uses a platinum catalyst on a nickel substrate hydrogen electrode construction. The cells have extremely long life but are expensive. The H<sub>2</sub> pressure provides an accurate state of charge determination. The cell can tolerate overcharge and overdischarge without damage.

### 3.3.3 Technical and Cost Barriers

In general, nickel battery technology would benefit from a better understanding of the mechanisms associated with the operation of the porous electrode. This should be feasible, as electrochemical modeling of the electrode operation is now becoming fairly sophisticated. The most urgent issue requiring attention is the low-temperature performance of the hydride anode. Here, a better understanding of hydrogen in the alloys, including the diffusion and bonding, might identify new alloy compositions. For zinc electrodes, the technical concern is the tendency to form dendritic and mossy deposits and also passivation in certain electrolyte compositions. Identifying new electrolytes or additives might provide a way to avoid this process during cycling. Finally, the energy efficiency and stability of nickel cathodes should be improved. Nanostructured materials or additives may improve the rate capability, while electrolyte additives may be used to raise the oxygen overvoltage.

Technical barriers and needs	Component(s)
• Poor rate performance at temperatures below 0°C; new alloys needed for -30°C operation with good efficiency (no. 1 need)	• Hydride anode
• Need for higher storage capacity	• Hydride anode
• Need for increased stability and corrosion resistance	• Hydride anode
• Tendency to form dendritic, mossy, and passivating deposits at zinc surface	• Zinc anode, electrolyte
• Energy efficiency of nickel oxide cathodes needs to be improved, particularly against oxygen generation during the last 20% of the charge	• Ni oxide cathode, electrolyte
• Need to improve stability of crystalline structure	• Ni oxide cathode
• Need to improve high rate capability	• Ni oxide cathode

### 3.3.4 Additional Reading

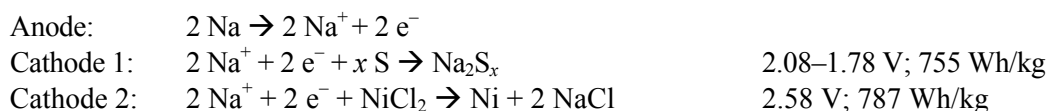
1. D. Linden and T. Reddy, *Handbook of Batteries*, 3rd ed., McGraw Hill, , New York, 2002
2. R. Brodd, *Batteries for Cordless Appliances*, Research Studies Press, Lechworth, 1987
3. J. Dunlop, W. Earl, and G. Van Ommering, U.S. Patent 3,850,694, November 26, 1974.
4. D. Feder and D. Mauer, U.S. Patent 3,980,501, September 14, 1976.
5. [www.powergenix.com](http://www.powergenix.com) (web site for PowerGenix, maker of nickel-zinc rechargeable battery)
6. M. Fetcenko, presentation at the 23rd International Battery Seminar, Ft. Lauderdale, FL, March 15, 2006.



## 3.4 HIGH-TEMPERATURE SODIUM BETA BATTERIES

### 3.4.1 Introduction

Beta batteries employing Na/S or Na/NiCl<sub>2</sub> (ZEBRA) unit cells are rechargeable energy storage systems utilizing sodium-ion conducting, polycrystalline β"-Al<sub>2</sub>O<sub>3</sub> solid electrolytes (BASE) stabilized with either Li<sub>2</sub>O or MgO.<sup>13</sup> These batteries operate at moderate temperatures (i.e., ~270–350°C) using liquid sodium as anodes. Cathodes are either molten S/Na<sub>2</sub>S<sub>x</sub> in porous graphite felts or, in the case of ZEBRA cells, molten NaAlCl<sub>4</sub> impregnated in porous Ni/NiCl<sub>2</sub> structures. Impervious BASE membranes separate molten electrodes and provide a transport medium for Na<sup>+</sup> ions. During discharge, sodium ions migrate through BASE ceramic membranes from anodes to cathodes, where they react with sulfur to form sodium polysulfide (see cathode 1), or alternatively, reduce NiCl<sub>2</sub> to Ni via migration of sodium ions in NaAlCl<sub>4</sub> (see cathode 2).



### 3.4.2 State of the Art

#### Tubular Design

BASE membranes are manufactured in cost-effective processing operations from spray-dried powders formed into tubular shapes by automatic isostatic pressing and sintered/annealed in gas-fired furnaces. Fully dense with diametral strengths of ~320 MPa and sodium-ion resistivities ≈3 Ωcm @ 300°C, BASE ceramics exhibit long-term durability in operating cells and batteries. Structural components in tubular Na/S cells with central-sodium configurations include (1) cylindrical thin-walled BASE tubes, closed at one end, encapsulating liquid sodium; (2) dense α-Al<sub>2</sub>O<sub>3</sub> ceramic headers glass-sealed to open ends of BASE tubes, providing electrical insulation between anode and cathode compartments; and (3) tubular cathode containers fabricated from corrosion-protected metals or alloys, closed at one end, serving as current collectors for sulfur electrodes. Because sulfur and sodium polysulfide are electronic insulators, molten cathodes are encapsulated in porous graphite felts serving as electronic shunts.

Unit cells in ZEBRA batteries are similar to Na/S cells in that they include liquid sodium anodes, central impervious BASE tubes, and electrically-insulating ceramic seal headers. However, the porous, central Ni/NiCl<sub>2</sub> cores impregnated with molten NaAlCl<sub>4</sub> auxiliary electrolytes are placed inside BASE tubular membranes. Liquid sodium metal anodes are located outside tubular BASE ceramics (not inside, as in Na/S cells) with clover-leaf cross sections (required to improve power densities in unit cells) in mild steel containers with rectangular or square cross sections. Inverted tubular-cell designs effectively eliminate corrosion of cathode containers by molten cathode reactants, a significant problem that gradually degrades performance and limits effective lifetimes of Na/S cells. In ZEBRA cells, auxiliary liquid electrolytes, sodium tetrachloroaluminate (NaAlCl<sub>4</sub>) melting at 154°C, are required, which permit sodium ions passing through BASE membranes to reach various reaction sites in porous nickel chloride structures. Formation of metallic nickel during discharge of

---

<sup>13</sup> J. L. Sudworth and A.R. Tilley, *The Sodium Sulfur Battery*, Chapman and Hall, London, 1985; J. L. Sudworth, "High Temperature Cells," pp. 243–274 in *Modern Batteries: An Introduction to Electrochemical Power Sources*, eds. Colin A. Vincent and Bruno Scrosati, Chapter 8, Arnold (Hodder Headline Group), London, and John Wiley and Sons, New York, 1997; C.-H. Dustmann, *J. Power Sources*, **127**, 85 (2004); R. S. Gordon, W. Fischer, and A. V. Virkar, *Century of Progress in Electrochemical Ceramics Technology: Energy Storage, Power Generation, Chemical Processing and Sensing*, in preparation, 2007.

ZEBRA cells provides effective electronic shunts between central metallic cores and BASE ceramic membranes.

Significant numbers of batteries have been manufactured and tested successfully in EVs and load-leveling (LL) energy storage systems. Several million thin-walled (1–3 mm) BASE tubular membranes of various sizes—i.e. diameters of between 25 mm (for EV cells) and 60 mm (for LL cells) and lengths of up to ~ 500 mm—have been fabricated in pilot-scale operations in North America, Europe, and Asia. A variety of large-scale Na/S LL battery systems varying in size between 400 kWh (50 kW) and 64 MWh (8 MW) with cumulative energy-storage capacity of several hundred MWh have been manufactured and placed into operation in Japan by NGK Insulators. Manufacturing operations capable of fabricating ~ 400,000 632-Ah LL Na/S cells and ~400,000 30-Ah EV ZEBRA cells per year have been installed by NGK Insulators in Japan and MES-DEA in Switzerland, respectively.

### Electric Vehicle Batteries

Since they can store significant quantities of energy and generate relatively high peak powers per unit of battery weight and volume, beta batteries are attractive energy storage systems for power sources in EVs. State-of-the-art EV batteries up to 130 kWh in size with required endurance characteristics have been successfully demonstrated in ~1000 road tests with EVs in North America and Europe. Calendar lifetimes of ~11 years have been demonstrated in ZEBRA batteries. Cycle lives equivalent to ~3500 complete discharge/charge cycles have been achieved in EV battery modules, and more than 1450 cycles have been achieved in full-scale EV batteries. Vehicle performance parameters—i.e., acceleration capabilities and driving ranges between charging cycles, which are characteristic of EVs propelled by beta batteries—are substandard compared with motor vehicles powered by conventional IC engines. However, state-of-the-art performance characteristics of unit cells and batteries summarized in Table 7, which meet mid-term requirements of the USABC, should be acceptable for many urban applications. For beta batteries in EVs to be fully competitive, substantially improved cell designs are required. They will involve planar or multi-tube unit cells with significantly higher ratios of the active electrochemical area to cell volume (A/V) and consequently a lower area-specific resistance (ASR). Redesigned unit cells are projected to have stored energy ratios of over 300 Wh/l and 200 Wh/kg and peak power ratios over 600 W/l and 400 W/kg.

**Table 7. Optimum performance of beta cells and batteries with tubular cell designs**

	EV cells (30–40 Ah)		EV batteries (25–40 kWh) ~ 360 cells per EV battery	
<b>Stored energy ratios</b>				
	<b>Wh/l</b>	<b>Wh/kg</b>	<b>Wh/l</b>	<b>Wh/kg</b>
Na/S <sup>a</sup>	360	180	151	105
Na/NiCl <sub>2</sub> <sup>b</sup>	340	145	183	118
<b>Peak power ratios</b>				
	<b>W/l</b>	<b>W/kg</b>	<b>W/l</b>	<b>W/kg</b>
Na/S	727	390, 0% DOD 337, 80% DOD	234	210, 0% DOD 181, 80% DOD
ZEBRA Na/NiCl <sub>2</sub>	613	271, 0% DOD 146, 80% DOD	276	185, 0% DOD 170, 80% DOD

<sup>a</sup>ASEA-BBC (Germany)

<sup>b</sup>MES-DEA (Switzerland)

## Batteries for Load Leveling

Beta batteries, because of their high volumetric energy density and small footprints, can also be used effectively in stationary LL energy storage systems in electric utilities and at industrial facilities in urban/suburban locations. A variety of LL energy storage battery systems up to 64 MWh in size (i.e., 8 MW delivered over 8-hour discharge cycles) have been demonstrated successfully with acceptable degradation in performance in field tests lasting several years. LL Na/S modules and batteries have been produced that satisfy all performance, lifetime, endurance, and safety requirements. These batteries have been constructed from self-contained battery modules 400 kWh (50 kW) in size. These 400-kWh modules have specific energies of  $\sim 120$  Wh/kg, energy densities of  $\sim 160$  Wh/l ( $\sim 370$  Wh/l at the unit cell level), and very small footprints,  $\sim 100$  kWh/m<sup>2</sup>. Energy efficiencies are  $\sim 87\%$  initially, declining to  $\sim 81\%$  after  $\sim 2500$  cycles. Very large LL battery systems have been operated continuously for periods of more than 8 years, compiling more than 1800 discharge and charging cycles. Individual LL unit cells have demonstrated lifetimes of  $>4500$  cycles with  $\sim 10\%$  reduction in capacity. Since LL Na/S batteries can be discharged rapidly at five times base-load rates for short periods of up to 10 seconds, they can also be employed in power quality applications.

## Advanced Cell Designs in R&D

High-performance, durable unit cells with planar/bipolar designs are projected to have (1) relatively high open-circuit voltages ( $\geq 2$  V); (2) lower ASRs; (3) failure modes with low electrical resistance; (4) increased depths of discharge compared with Na/S cells; (5) liquid-phase cathodes, which are mixed ionic and electronic conductors and chemically compatible with iron-based metal alloys; and (6) operating temperatures consistent with metallic components employed in cell interconnections and flexible seals, all self-contained in stainless steel enclosures.<sup>14</sup>

A vapor-phase process has been developed for fabricating strong ( $\sim 900$  MPa), fine-grained (several microns), thin-walled (150–300 microns) and flat plates of BASE membranes suitable for planar/bipolar beta cells with high power and energy densities.<sup>15</sup> Electrolytes are formed by reaction of Na<sub>2</sub>O vapor with impervious, cast sheets of  $\alpha$ -Al<sub>2</sub>O<sub>3</sub>/zirconia composite precursors. Reasonably rapid and direct conversion to conductive  $\beta''$ -Al<sub>2</sub>O<sub>3</sub> phases at 1450°C occurs without loss of Na<sub>2</sub>O. BASE membranes formed by this potentially economical process are very resistant to attack by moisture. Another advantage of vapor-phase processing is formation of substantial crystallographic texture, wherein conduction-planes in  $\beta''$ -Al<sub>2</sub>O<sub>3</sub> align themselves perpendicular to walls of flat BASE membranes. Planar BASE electrolytes—which have been produced previously by tape casting followed by sintering and annealing in conventional processing operations—are relatively weak mechanically and possess undesirable conduction anisotropy.<sup>16</sup>

### 3.4.3 Technical and Cost Barriers

Commercial state-of-the-art beta batteries have a variety of limitations, which are summarized in the list below. In view of problems related to containment of cathode reactants, corrosion of metallic containers, brittle glass seals, and failure of cells in modes with high electrical resistance, development of Na/S batteries with planar/bipolar and other advanced cell designs will be very challenging. Evolving designs for beta cells with higher A/V ratios, lower ASRs, and higher-capacity

<sup>14</sup> R. S. Gordon, W. Fischer, and A. V. Virkar, *Century of Progress in Electrochemical Ceramics Technology: Energy Storage, Power Generation, Chemical Processing and Sensing*, in preparation, 2007.

<sup>15</sup> A. V. Virkar, T. J. Armstrong, N. Weber, K-Z. Fung, and J-F Jue, "Role of Coupled Transport in the Fabrication of sodium  $\beta''$ -Alumina-Containing Ceramics by a Vapor Phase Process," p. 200 in *Proceeding—High Temperature Materials: A Symposium in Honor of the 65<sup>th</sup> Birthday of Professor Wayne L. Worrell*, ed. S.C. Singhal, Electrochemical Proceedings, Vol. 2002–2005, Pennington, NJ, 2002.

cathodes will eventually replace unit cells with tubular designs. Advanced cathodes will be improved alternatives to sulfur and  $\text{NiCl}_2$  and will be more compatible chemically with iron-based metals used in cell construction. Advanced vapor-phase processing will produce flat BASE membranes, which are strong, fine-grained, and tolerant to water exposure and have high sodium-ion conductivities in preferred directions.

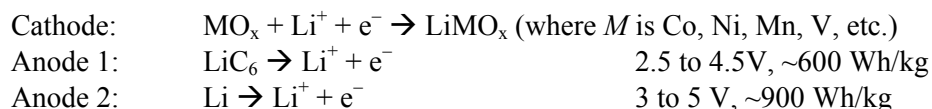
Technical barriers and needs	Component(s)
<ul style="list-style-type: none"> <li>Relatively high ASR and low A/V of tubular unit cell, which severely limits EV battery performance</li> </ul>	<ul style="list-style-type: none"> <li>Unit cell</li> </ul>
<ul style="list-style-type: none"> <li>Restricted energy storage capacity and limited energy densities</li> </ul>	<ul style="list-style-type: none"> <li>Na/S unit cells</li> </ul>
<ul style="list-style-type: none"> <li>Long-term corrosion of metallic cathode containers</li> </ul>	<ul style="list-style-type: none"> <li><math>\text{Na}_2\text{S}_x</math> containers</li> </ul>
<ul style="list-style-type: none"> <li>Failure of Na/S cells with high electrical resistance in relatively small EV batteries (ZEBRA cells do not have this problem)</li> </ul>	<ul style="list-style-type: none"> <li>Unit cells in EV batteries</li> </ul>
<ul style="list-style-type: none"> <li>Need for cost-effective techniques are needed for manufacturing thin (150–300 <math>\mu\text{m}</math>), flat BASE membranes with optimum mechanical and electrical properties</li> </ul>	<ul style="list-style-type: none"> <li>Planar BASE membranes</li> </ul>
<ul style="list-style-type: none"> <li>Expensive carbon felts in cathode structures of Na/S cells</li> </ul>	<ul style="list-style-type: none"> <li>Cathode structure</li> </ul>
<ul style="list-style-type: none"> <li>Expensive encapsulation devices to prevent loss of <math>\text{Na}_2\text{O}</math> during sintering of BASE membranes at 1585°C</li> </ul>	<ul style="list-style-type: none"> <li>BASE fabrication</li> </ul>
<ul style="list-style-type: none"> <li>Water sensitivity of polycrystalline BASE membranes fabricated by conventional liquid-phase sintering</li> </ul>	<ul style="list-style-type: none"> <li>BASE storage</li> </ul>
<ul style="list-style-type: none"> <li>Brittle glass seals</li> </ul>	<ul style="list-style-type: none"> <li>Seals</li> </ul>
<ul style="list-style-type: none"> <li>Corrosion in ZEBRA cells between <math>\text{NiCl}_2</math> and mild steel cell components (avoided in tubular cells with central cathode designs)</li> </ul>	<ul style="list-style-type: none"> <li>Mild steel cell components</li> </ul>

### 3.5 LITHIUM BATTERIES

#### 3.5.1 Introduction

Non-aqueous lithium batteries employ a wide range of electrode and electrolyte materials, providing a diverse number of electrochemical couples compared with other battery systems. Several systems are used in today's commercial batteries, but many materials are still in the R&D phase. Typical primary (nonrechargeable) lithium batteries with liquid electrolytes couple a metallic lithium or a lithium-metal-alloy anode with either a solid metal oxide/sulfide cathode or a soluble cathode. Secondary (rechargeable), liquid electrolyte lithium-ion batteries use intercalation (insertion) electrode materials that can store and release a large amount of lithium in a reversible manner without damaging the structures of the host electrodes. The most common anode and cathode materials in current lithium-ion cells are graphite ( $\text{Li}_x\text{C}_6$ ) and  $\text{Li}_{1-x}\text{CoO}_2$  ( $1 \leq x \leq 0$ ), respectively. Rechargeable lithium batteries with lithium metal anodes have also been commercialized, but these systems comprise only a small sector of the lithium battery market; they make use of both liquid and solid electrolytes, such as lithium-conducting ceramics, glasses, or polymers. The choice of the anode and cathode determines the voltage of each lithium cell. The type of reaction that takes place at the electrodes, either single-phase (insertion) or multi-phase (which may accompany an insertion process), defines the shape of the voltage profile of the cells during discharge. Because metallic lithium,  $\text{Li}_x\text{C}_6$ , and lithium-metal-alloy anodes provide a high reduction potential, and most lithium battery cathodes provide a high oxidation potential, many lithium cells provide an OCV of 3 V or more during charge and discharge. The high reactivity between the electrodes and nonaqueous electrolytes at these high cell voltages is suppressed and countered by the formation of a stabilizing solid-electrolyte-interphase (SEI) layer

that protects from further reactions while enabling lithium-ion transport from the electrode into the electrolyte and vice versa. Typical half cell reactions are



### 3.5.2 State of the Art

The introduction of primary (nonrechargeable), non-aqueous lithium batteries in the 1970s and subsequently secondary (rechargeable) lithium-ion systems in the 1990s to power portable electronic devices, such as cellular phones and laptop computers, sparked a revolution in battery technology and a marked swing away from the relatively low-voltage, aqueous systems, such as Ni-Cd and NiMH batteries, and high-temperature systems. Lithium batteries are now being developed for a myriad of devices both large and small, such as uninterrupted power supply units for the telecommunications industry and rechargeable power sources for consumer electronics, medical, aerospace, defense and transportation sectors.

This section focuses on the state of the art of rechargeable lithium batteries, notably for high-energy and high-power applications. Primary lithium batteries, such as Li/FeS<sub>2</sub>, Li/SO<sub>2</sub>, and Li/SOCl<sub>2</sub>, that are used predominantly for defense-related applications; Li/MnO<sub>2</sub> for cameras and memory backup in computers; and Li/Ag<sub>2</sub>V<sub>4</sub>O<sub>11</sub> for cardiac defibrillators in the medical industry, are not considered.

#### Lithium Batteries with Metallic Lithium Anodes

Lithium batteries with metallic lithium negative electrodes (anodes) offer the highest theoretical capacity of all conventional battery types (i.e., excluding metal-fuel systems, such as Al/air) and in principle should provide the greatest energy of all lithium batteries. However, when liquid electrolytes are used, the rechargeability of each lithium cell is severely compromised by reactions that can occur between the nonaqueous, flammable electrolytes and the cycled lithium electrode, which becomes moss-like with extremely high surface area. Overcoming this hurdle presents an enormous challenge to the lithium battery industry. Despite this obstacle, some efforts are still being conducted to capitalize on and exploit the advantages of metallic lithium systems, for example, lithium-sulfur batteries.

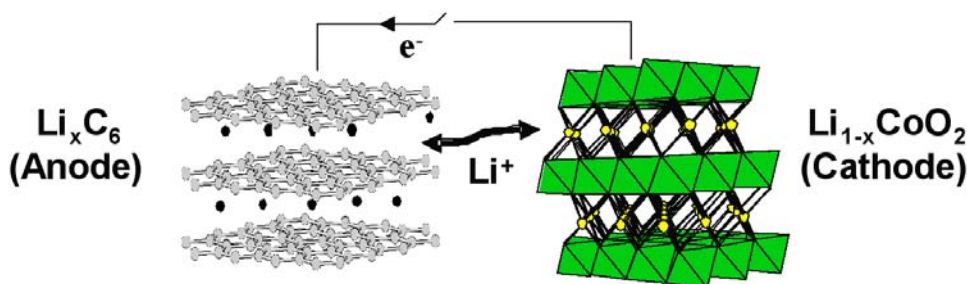
**Lithium-sulfur batteries** can, in principle, provide a very high energy density. Based on the mass of the light, electrochemically active elements alone, an Li/S cell offers a theoretical capacity of 1680 Ah/kg that translates to an energy density of 2300 Wh/kg for an average discharge voltage of 2 V. Reduction of elemental sulfur leads to the formation of soluble sulfur species (e.g., Li<sub>2</sub>S<sub>8</sub>) that dissolve into the electrolyte, where they undergo solution phase reduction at the carbon surface of the positive electrode until they eventually precipitate as a discharge product, presumably Li<sub>2</sub>S. In contrast to the more conventional Li metal/intercalation cathode rechargeable battery chemistries, Li dendrite formation is mitigated in Li/S cells as a result of its solution phase redox chemistry. This chemistry also provides inherent chemical overcharge protection, enhancing safety, particularly for high-capacity multi-cell battery packs. The electrolyte can be a solid polymer (e.g., polyethylene oxide), a gelled-polymer electrolyte, or a liquid electrolyte. Li/S batteries are still in the development stage but remain attractive for the longer term because of their inherently high energy content, high power capability, and potential for low cost.

**Solid state lithium-polymer batteries** with lithium-ion conducting polymer electrolytes provide one possible solution to overcome the safety barriers of metallic lithium/liquid electrolyte battery systems. In this respect, an all solid state Li/lithium salt–polyethylene oxide electrolyte/LiV<sub>3</sub>O<sub>8</sub> battery has

been manufactured for the telecommunications industry for uninterrupted power supply applications. The lithium-ion conductivity of the polymer electrolyte is too low to allow high-rate cycling at room temperature, so it functions typically at about 60°C or higher. On long-term cycling, lithium dendrite formation and internal shorts are possible, thus compromising the life of the cells.

### Lithium-ion Batteries

A lithium-ion battery configuration improves the safety of lithium batteries because lithium is contained within a host structure, both at the negative electrode and at the positive electrode (cathode). During charge and discharge, lithium is simply transferred between one host structure and the other, with concomitant oxidation and reduction processes occurring at the two electrodes. Conventional lithium-ion cells used for portable power and commercial cells are based on a  $\text{Li}_x\text{C}_6/\text{Li}_{1-x}\text{CoO}_2$  electrochemical couple (see Fig. 11); they operate at ~4 V and can provide a practical ~150 Wh/kg (energy) and ~1000 W/kg (power). However, in their charged state, the cells are inherently unsafe. The lithiated-graphite electrode is strongly reducing, as it operates close to the potential of metallic lithium, whereas a delithiated  $\text{Li}_{1-x}\text{CoO}_2$  electrode is an extremely strong oxidant; in the presence of flammable organic electrolyte solvents, there is a risk of heat generation, thermal runaway, cell venting, fire, and rapid disassembly. Therefore, every  $\text{Li}_x\text{C}_6/\text{Li}_{1-x}\text{CoO}_2$  cell in a battery pack needs to be protected by sophisticated electronic circuitry to prevent overcharge.



**Fig. 11. A schematic illustration of a  $\text{Li}_x\text{C}_6/\text{Li}_{1-x}\text{CoO}_2$  lithium-ion cell.** During discharge,  $\text{Li}^+$  ions migrate through the electrolyte and electrons flow through the external circuit, both moving from the anode (–electrode) to the cathode (+ electrode).

The recent recall of millions of lithium-ion cells for laptop computers by battery manufacturers because of a few fire-related incidents emphasizes the urgent necessity for alternative host electrode materials, electrolyte salts and solvents, separators, and beneficial additives such as electrode passivating agents and redox shuttles and the need to model, understand, and design electrode systems and electrode/electrolyte interfaces in the quest for safer batteries.

An advantage of lithium-ion technology is its versatility, which stems from the ability to tailor the voltage of cells using the wide range of redox potentials available from lithium insertion compounds. Although lithiated graphite ( $\text{LiC}_6$ ) remains the material of choice for the negative electrode, considerable progress is being made toward designing amorphous metal alloy or intermetallic electrodes that can store greater amounts of lithium. However, these electrodes, which operate a few hundred millivolts above the potential of metallic lithium, are compromised by large volumetric changes during lithium insertion/extraction that limit the cycle life of cells. Metal oxides, notably the lithium titanate spinel  $\text{Li}_4\text{Ti}_5\text{O}_{12}$  that operates at 1.55 V vs.  $\text{Li}^0$ , are extremely safe alternatives to graphite. In this case, safety is obtained at the expense of cell capacity and voltage and therefore energy. With respect to positive electrodes,  $\text{LiMn}_2\text{O}_4$  (spinel) and its substituted derivatives and

LiFePO<sub>4</sub> (olivine) have been used as alternatives to LiCoO<sub>2</sub> in commercial portable lithium-ion cells. All three cathode materials deliver a relatively low electrochemical capacity (~100–150 mAh/g compared with the theoretical capacity of LiCoO<sub>2</sub> (274 mAh/g), thereby limiting the available energy. In recent years, layered Li<sub>1+x</sub>M<sub>1-x</sub>O<sub>2</sub> compounds (M=Co, Ni, Mn), in which *M* is predominantly manganese and nickel, have shown promise for increasing the capacity and energy of lithium cells and batteries. Performance specifications reported for various lithium-ion battery products with layered LiCoO<sub>2</sub>, spinel LiMn<sub>2</sub>O<sub>4</sub> and olivine LiFePO<sub>4</sub> electrodes are shown in Table 8.

**Table 8. Performance specifications reported for various lithium-ion battery products**

	<b>Li-ion (LiCoO<sub>2</sub>) (MoliCel, model ICR-18650J)</b>	<b>Li-ion (LiMn<sub>2</sub>O<sub>4</sub>) (MoliCel, model IMR26700)</b>	<b>Li-ion (LiFePO<sub>4</sub>) (A123 Systems, ANR26650M1)</b>
Nominal voltage	3.75 V	4.2–2.5 V	3.3 V
Nominal capacity	2.4 Ah	3.0 Ah	2.3 Ah
Energy density	188 Wh/kg; 520 Wh/l	285 Wh/l	
Power density		1500 W/kg at 20s	
Discharge current	4.0 A max		70–120 A (pulse)
Charge current	2.4 A max		10 A
Internal impedance			(1 kHz ac) 8 mΩ
Dimensions (mm, diam × length)	18.24×65 mm	26.4×70 mm	26×65 mm
Weight	47 g	47 g	70 g
Cycle life at 10°C, 100% DOD			> 1000 cycles
Operating temperature: discharge	–20 to 60°C		
charge	0 to 45°C		

Despite their huge energy advantages, safety limitations pose the greatest threat to the future of lithium-ion batteries, particularly if they are used with current cell chemistries in large, heavy-duty devices such as all-EVs and HEVs that require high energy and power from the battery for range and acceleration, respectively. New, high-capacity anode and cathode materials that are stable at high cell voltages are required. More robust passivating films at electrode/electrolyte interfaces in fully charged cells are required, as they are critical to both battery safety and life. Improved separators are required to shut down cells at the onset of thermal runaway. Nonflammable electrolyte solvents are needed to replace commonly used flammable organic carbonates, such as dimethyl carbonate and ethylene carbonate, particularly those that provide improved low-temperature performance (–30 °C). Alternative electrolyte salts to the popular but corrosive LiPF<sub>6</sub> salt are required because, in the presence of trace amounts of water in the electrolyte, HF is generated that can dissolve metal oxide electrodes, notably LiMn<sub>2</sub>O<sub>4</sub>, thereby damaging cycle life.

The tremendous versatility of lithium battery materials technology provides further opportunities and the incentive to overcome those barriers still restricting the performance of today’s commercial systems, by either the discovery of new materials or the manipulation and improvement of existing ones.

### 3.5.3 Technical and Cost Barriers

<p><b>Technical Barriers and needs</b></p> <p><b>Anodes</b></p> <ul style="list-style-type: none"> <li>• Alternative anodes (e.g., intermetallics, oxides) to improve safety and performance</li> <li>• Enhanced specific and volumetric capacity and rate capability</li> </ul>
--

- Reduced first-cycle capacity loss and volumetric expansion of intermetallic electrodes
- Enhanced stability and robustness of SEI layers
- Elimination of lithium dendrites (lithium metal anode)
- Prevention of mossy lithium formation (lithium metal anode)

#### **Cathodes**

- Enhanced specific capacity, rate capability, stability over a wide composition range
- Enhanced stability/robustness of high-potential electrode surfaces (>4.2 V vs. Li<sup>0</sup>)
- Reduced solubility of transition metal ions
- Low cost materials, for example, manganese- or iron-based systems

#### **Electrolytes and separators**

- Nonflammable liquid electrolytes with adequate Li<sup>+</sup>-ion conductivity
- Expanded electrochemical stability window, to 5 V
- Low-cost, non-toxic salts
- Improved low-temperature performance
- Effective redox shuttles for overcharge protection
- Electrolyte additives for effective SEI layer formation
- Stable ionic liquids and solid polymer electrolytes with acceptable conductivity
- Lower cost and improved shutdown properties of separators

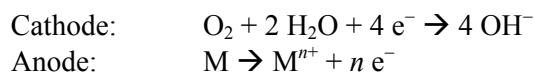
### **3.5.4 Additional Reading**

1. D. Linden and T. B. Reddy, eds., *Handbook of Batteries*, 3<sup>rd</sup> ed., McGraw Hill, New York, 2002.
2. M. Winter, J. O. Besenhard, M. E. Spahr, and P. Novak, "Insertion Electrode Materials for Rechargeable Lithium Batteries," *Adv. Mater.* **10**(10), 725–763 (1998).
3. J.-M. Tarascon and M. Armand, "Issues and Challenges Facing Rechargeable Lithium Batteries," *Nature* **414**, 359–367 (2001).
4. M. S. Whittingham, R. F. Savinell, and T. Zawodzinski, eds., "Batteries and Fuel Cells," *Chemical Reviews* **104**(10), 4243–4886 (2004).

## **3.6 METAL-AIR BATTERIES**

### **3.6.1 Introduction**

Because of their potential for very high energy densities, metal-air batteries based on zinc, aluminum, magnesium, and lithium have received much attention over the past several decades. Their obvious key advantage is that there is essentially no weight related to the cathode reactant, other than the air electrode, since the cathode reactant is oxygen from the air. The various potential candidates for use as anodes in metal air batteries depend on the equivalent weight of the metal, its electrochemical potential, and the extent to which the inherent activity of the more active metals can be controlled and taken advantage of. A summary of the various candidates and their characteristics is given in Table 9.



The discharge reaction at the anode proceeds to form and precipitate hydroxides, oxides, or hydrated species.



**Table 9. Theoretical characteristics of metal-air cells**

<b>Metal anode</b>	<b>Electrochemical equivalent of metal Ah/g</b>	<b>Theoretical cell voltage vs oxygen</b>	<b>Valence change</b>	<b>Theoretical specific energy of metal (kWh/kg)</b>	<b>Practical operating voltage (V)</b>
Li	3.86	3.4	1	13	2.4–3.1
Ca	1.34	3.4	2	4.6	2
Mg	2.2	3.1	2	6.8	1.2–1.4
Al	2.98	2.7	3	8.1	1.1–1.4
Zn	0.82	1.6	2	1.3	1.0–1.2
Fe	0.96	1.3	2	1.2	1

In similar metal-water batteries, the potential energy available is related to the reaction between the metal and water, involving the evolution of hydrogen from the counter electrode. Essentially, this means that the potential voltage of the reaction is 1.23 V lower than the voltage for the reaction with oxygen. Because of the inherent loss of energy that would occur as a result of this reaction, batteries of this type are unlikely to be used in larger applications, such as in EVs.

### 3.6.2 State of the Art

Much attention has been paid to metal-air batteries in relation to small and large applications.<sup>16,17</sup> In general, metal-air batteries are most useful in applications where there are no temperature extremes and where the capacity is used within a reasonable time of initial activation. The current state of the art for the various existing or potential systems is described in the following paragraphs. The sequence is based approximately on the amount of past effort invested in each system. The most recent efforts in the area of metal-air batteries have involved the lithium-air system, in smaller size ranges, which has the potential to achieve an energy density approaching that of diesel fuel.

In the larger battery range, there have been significant programs aimed at rechargeable zinc-air and aluminum-air batteries involving both static and circulating electrolytes. Both zinc-air and aluminum-air batteries have been candidates for EV batteries. Zinc-air batteries are potentially electrically rechargeable; and in aluminum-air batteries, the aluminum could be recharged in a central recharging station. The case could be made that when fossil fuels run short, aluminum will be the fuel of the future, being recharged using nuclear power and reacted electrochemically in vehicles to provide propulsion power.

#### Zinc-air Batteries

Since zinc is only about 0.4 V below the reversible hydrogen potential, and since it has a high overpotential for hydrogen evolution, it can be used in electrically rechargeable systems. Rechargeable zinc batteries with silver oxide and manganese dioxide cathodes have been used in various applications, including as large batteries for the propulsion of torpedoes. Various approaches

<sup>16</sup> A. J. Appleby and M. Jacquier, "The CGE Circulating Zinc-Air Battery—A Practical Vehicle Power Source," *J. Power Sources* **1**, 17–34, July (1976).

<sup>17</sup> D. A. J. Rand, "Battery Systems for Electric Vehicles, State of Art Review," *J. Power Sources* **4**, 101 (1979).

have been investigated related to the recharging of the zinc electrode, including work by the General Atomics Division of General Dynamics in 1967. That effort involved the use of flat plates and a circulating electrolyte. Subsequently, in 1976, CGE in France<sup>18</sup> investigated an alternative approach to a circulating zinc-air battery, in which particulate zinc was circulated through cylindrical tubes of air cathodes and the zinc was then recharged into particulate zinc by being deposited at high current densities on pointed deposition electrodes.

Various other approaches to both mechanically and electrically rechargeable zinc-air batteries have been investigated,<sup>18</sup> but none of them has resulted in a viable rechargeable zinc-air system. The Arotech Electric Vehicle Division announced in 2004 that a bus using its zinc-air battery had achieved a range of 133 miles using zinc electrodes that are recharged outside the bus.

Zinc-air primary batteries that are on the market have energy densities of up to about 300 Wh/kg. They do not operate over a wide range of temperatures, but where they operate near ambient temperatures, they represent a low-cost, high-energy-density power source. For example, they have taken over most of the market for hearing aid batteries, where the operating temperature range is limited. In addition, for many years zinc-air primary batteries were used to power railroad signaling devices. Recently, a large zinc-air primary battery with a capacity of about 800 Wh and an energy density of about 300 Wh/kg was introduced for military applications.<sup>18</sup> This portable primary power source is inherently safer than lithium primary batteries, since it contains no flammable electrolytes and no lithium. There are the limitations that it does not operate well at low temperatures, and that it must be used within several days of the time that it is opened. For larger batteries, the internal heating may be used to warm the system to a desirable operating temperature.

### **Aluminum-air Batteries**

There have been extensive programs aimed at developing aluminum-air batteries for EVs. These involved, in the 1980s, the Lawrence Livermore Laboratory,<sup>19</sup> Eltech Systems, and Alcan Aluminum Corp.

There are two major means of operation of aluminum-air batteries, which can be used in either saline or caustic solutions. In caustic systems, with the appropriate alloy, the efficiency is low at low current densities and high at high current densities; however, care must be taken to maintain stability at open-circuit conditions. In neutral or saline systems, the efficiency is relatively high under all circumstances, in the range of 75%, but attainable current densities are not very high because of the relatively low conductivity of the saline solution. The essential difference is that in a caustic system, the amount of water required is about 1.5 cc/Wh, whereas in a saline system it is on the order of 2.5 cc/Wh. This means that although a saline system is inherently safer, it will require a larger volume and will operate at a lower current density. Another difference is that saline alloys generally require the use of a very high-purity aluminum alloy starting material and the use of gallium as one of the alloying components. For a caustic system, the alloy may contain more iron as an impurity, but a key alloying agent is likely to be indium. Although neither metal is desirable from an environmental viewpoint, indium is generally considered to be more toxic. These batteries were investigated in the 1980s as possible electrical storage devices for EVs.

---

<sup>18</sup> Battery model BA-8180, Electric Fuel Batteries.

<sup>19</sup> R. P. Hamlen and T. B. Atwater, "Metal-Air Batteries," p.28.1 in *Handbook of Batteries*, 3rd ed., D. Linden and T. B. Reddy, eds., 2002; J. F. Cooper, "Estimates of the Cost and Energy Consumption of Aluminum-Air Electric Vehicles," in *Proceedings of the ECS Fall Meeting*, Hollywood, FL, October 1980, UCRL 84445, rev.1, 1981.

## Lithium-air Batteries

There have been recent significant advances in lithium-air batteries, involving the use of a protected conductive glass layer between the lithium and the air cathode. Although this system is not at a point where it is useful for large systems, it has achieved a high efficiency for small systems at the relatively high cell voltage of close to 3 V. This system represents a battery that could approach the energy density of diesel fuel, in the range of 8,000–13,000 Wh/kg. Although in the near term there do not appear to be feasible approaches to larger batteries, the system probably represents one of the few viable approaches toward reaching the energy density of a liquid hydrocarbon fuel.

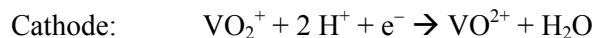
### 3.6.3 Technical Barriers

Technical barriers and needs	Component(s)
<ul style="list-style-type: none"> <li>• Dependence on environmental conditions, maintaining access to air while minimizing evaporation of water</li> <li>• Limited operating temperature</li> <li>• Necessity to remove CO<sub>2</sub> from the air to prevent carbonation of electrolyte</li> <li>• Potential for formation of shorting dendrites when charged</li> </ul>	<ul style="list-style-type: none"> <li>• Cathode and separator</li> <li>• Electrolyte</li> <li>• Electrolyte</li> <li>• Zinc anode, separator</li> </ul>
<ul style="list-style-type: none"> <li>• Non-uniform distribution of anode material develops as a result of solution and precipitation of reaction products</li> <li>• Limited power output</li> <li>• Low current densities resulting from resistive electrolyte</li> </ul>	<ul style="list-style-type: none"> <li>• Anode, electrolyte</li> <li>• All</li> <li>• Solid electrolyte for lithium-air</li> </ul>
<ul style="list-style-type: none"> <li>• Poor cycle life times</li> </ul>	

## 3.7 REDOX FLOW CELLS

### 3.7.1 Introduction

Typically, a redox flow cell consists of two parallel electrodes separated by an ion exchange membrane, forming two electrolyte flow compartments. A separate electrolyte solution, containing soluble redox couples, circulates through each compartment from an independent electrolytic circuit (see Fig. 12). The energy in redox flow batteries is stored in the electrolyte, which is charged or discharged by either applying or withdrawing current, respectively, across the electrodes. The charge/discharge cycles involve electrochemical reactions at the electrodes. For example, in the all-vanadium redox flow battery, the V(II)/V(III) redox couple circulates through the negative electrolyte compartment and the redox couple V(IV)/V(V) through the positive compartment. The reactions on discharge are



Cell voltage: 1.26 V; gravimetric energy density: 29 Wh kg<sup>-1</sup>

Figure 12 shows the redox flow cell with the charge and discharge reactions for a unit cell. It is common to form stacks of 10 to 200 units to achieve the energy level desired. The electrodes act as bipolar electrodes. The capacity can also be modified by increasing the electrode size (single electrode areas of 0.020 to 1 m<sup>2</sup>) and by using a series of stacks in parallel or series configuration. Figure 13 shows a four-stack cell connected in electrical series.

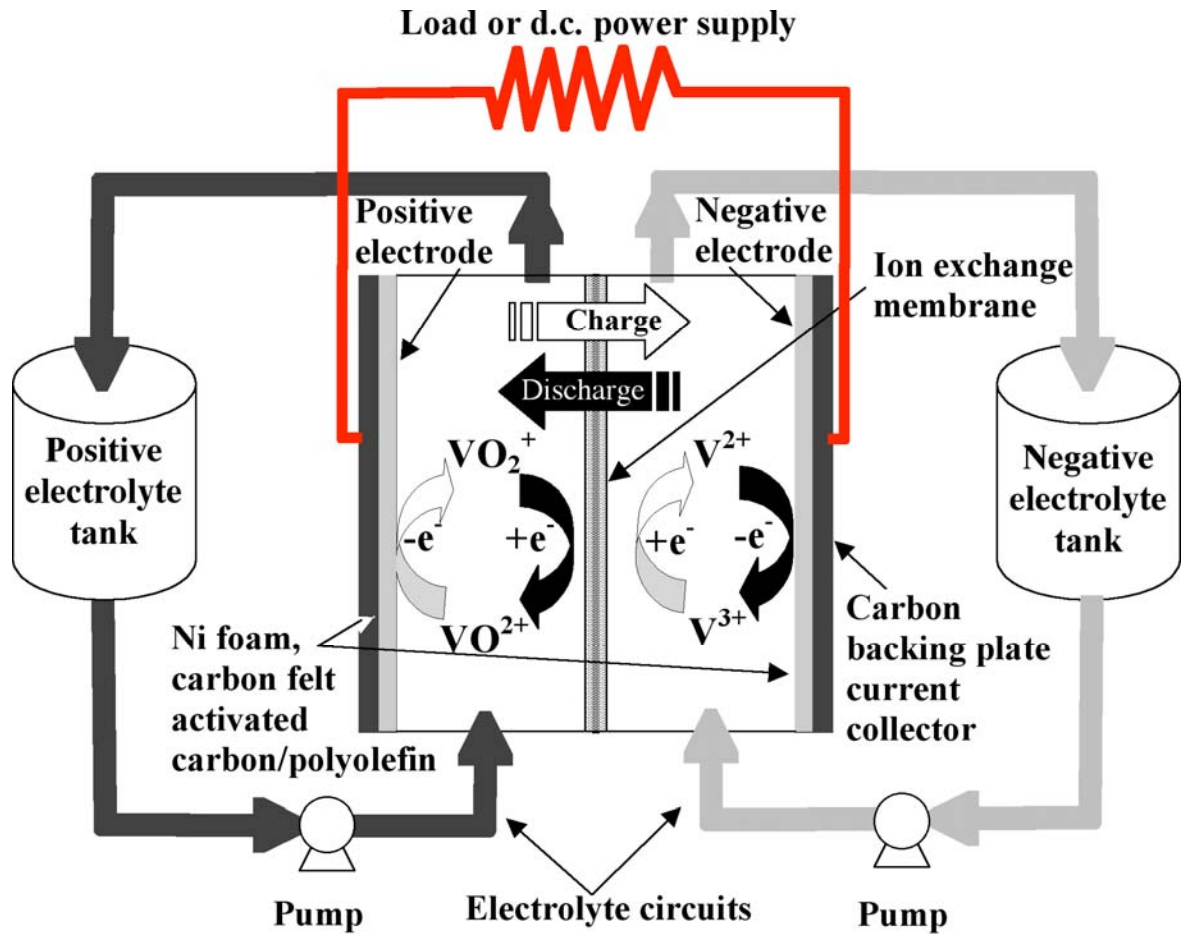
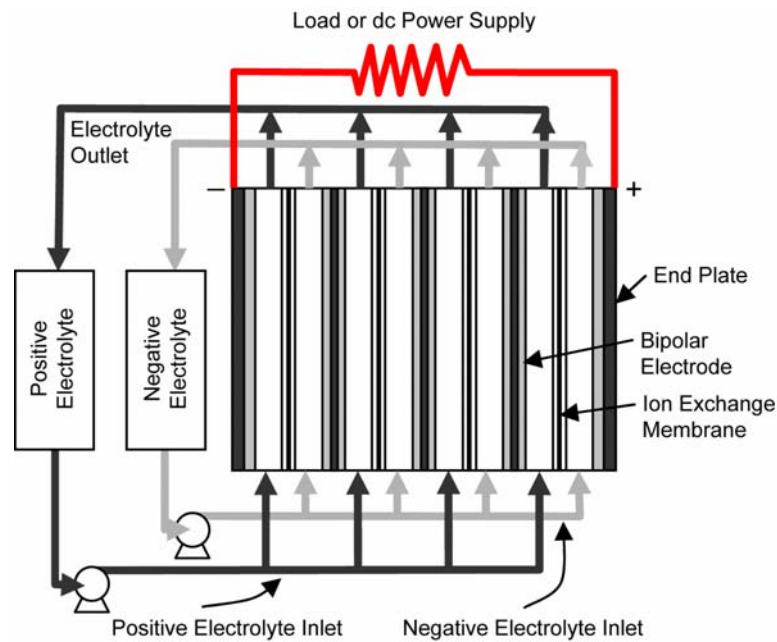


Fig. 12. Schematic diagram of a typical redox flow cell, the all-vanadium redox flow battery.

A distinction from other storage batteries and fuel cells is that the redox flow cells store energy in the reduced and oxidized species that recirculate through the cell, whereas in lead–acid batteries, the energy is within the electrode structure, and fuel cells store the energy chemically in external reactants.

### 3.7.2 State of the Art

The use of energy redox flow cells for electric power transmission applications provides effective use of existing plant investment, flexibility in operation, and better response to price changes. Stored electricity can be made readily available to meet immediate changes in demand, allowing effective operation of base load units at high and essentially constant levels of power. Redox flow cells use off-peak power for pumping and/or charging. This stabilizes operations and provides flexibility for buying or selling electricity during on-peak or off-peak periods. Modular construction technologies allow high power rating, long energy storage time, and excellent response time; full power can be delivered in few seconds. Such characteristics are important in the competitive electricity market. At the generation level, energy storage can be used to increase the load factor, helping utilities cope with load increases and covering operating and contingency reserves. Thus there is a significant potential market for energy storage products.



**Fig. 13. A stack of four redox flow cells using bipolar electrodes in a filter-press arrangement.**

The following redox flow cell systems have been intensively studied:

- all-vanadium
- bromine-polysulphide
- vanadium-bromine
- iron-chromium
- zinc-bromine
- zinc-cerium
- soluble lead–acid redox flow batteries

Other, less common redox flow cells use sodium or potassium sulphide-polysulfide species in the anodic reaction and iodide-polyiodide or chloride-chlorine in the cathodic reaction.

Table 10 lists a number of redox flow cells compared with the conventional lead–acid battery. From this table, the following features can be highlighted:

- Cells have generally operated at a small scale, with the exceptions of the vanadium redox flow battery and the bromine-polysulfide system using Regenesys Technologies cells. The installed power is in the range of several tens of kilowatts for most systems and 100s of kilowatts for bromine-polysulfide (Regenesys).
- The systems use a cationic membrane to separate the two electrode reactions, except the soluble lead–acid battery system.

**Table 10. Comparison of different redox flow cell systems<sup>a</sup>**

System	Electrodes	Membrane	E <sub>cell</sub> (V)	Current (A/m <sup>2</sup> )	Area (m <sup>2</sup> )	R <sub>A</sub> (ohm m <sup>2</sup> )	Efficiency (%) voltage, current, energy	Power, energy (installed)	T (°C)
Fe/Cr	Fe: carbon felt	Cationic membrane Nafion™ 117	1.03	9	0.04	0.11	81.6 81.2 66.3	10 W 80 Wh	30–55
	Cr: carbon felt + catalyst	Anionic membrane	0.77	64.5	0.31	0.012	73 99 72	1 kW 10 kWh	NG
Bromine-polysulfide	Carbon polymer composite	Cationic membrane	1.54	600	0.67	0.002	75 90 67	1–15 MW 120 MWh	35
Vanadium-vanadium	Graphite felt	Selemon CMV	1.70	800	0.15	0.002	73.2 98.2 71.9	1.3 kW 0.7 kWh	35
Soluble lead–acid	Carbon composite	None	1.78	100– 600	0.0002	NG	82 85 65	NG	24–32
Lead–acid <sup>a</sup>	Lead dioxide and lead	Micro- porous separator	2.04	NG	NG	NG	NG 80–90 70–75	NG 6 kWh– 24 MWh	35

<sup>a</sup>Lead–acid is provided for comparison.<sup>20</sup>

- The electrode material is often carbon or carbon composites; 3-dimensional and carbon felt electrodes are commonly used.
- Efficiencies are dependent on the state of charge and process. Voltage, current, and energy efficiencies are typically 73–82%, 80–98% and 66–75%, respectively.

Further developments in redox flow cells require improved reactor characterization, better catalysis by composite electrodes, enhanced membrane performance, and longer-term electrolyte management. It is also necessary to consider the large-scale engineering of redox flow cell systems and their integration with other energy systems, together with the evaluation of time-dependence performance of cell components. Current improvements in redox flow cell technology are the development of modular reactors and stack design, electrode structures, improved electrocatalysis of electrode surfaces, tailoring of the reaction environment in filter-press cells, and intelligent control systems to maximize voltage power efficiency.

The specific energy density of redox flow cells typically varies from 18 to 28 kW h ton<sup>-1</sup> and the volumetric energy density from 21 to 35 kW h m<sup>-3</sup>. Comparisons with other storage technologies place the energy density of redox flow cells below that of batteries such as metal-air, lithium-ion, NaS, Ni-Cd, and lead–acid, making them generally unsuitable for portable applications. However, redox flow batteries are competitive for energy storage, along with Ni-Cd batteries, electrochemical capacitors, flywheels, and lead–acid batteries.

The cyclic nature of wind, tidal, and photovoltaic systems makes these renewable energy sources potentially suitable for redox flow batteries. Redox flow batteries can be used to store energy during periods when conditions favor production; and in periods of low production, the stored electricity in

<sup>20</sup> C. Ponce de León, A. Frías-Ferrer, J. González-García, D. A. Szánto, and F. C. Walsh, “Redox Flow Cells for Energy Conversion,” *Journal of Power Sources* **160**, 716 (2006).

the redox flow cells can be dispatched. This capability increases the value of renewable energy sources and would provide an efficient energy supply in remote power applications.

On a large scale, redox flow cells are used for load leveling and grid support. They offer the capability to prevent service interruptions in the event of failure and to prevent voltage spikes, voltage sags, and power outages that last for periods from a few cycles (less than a second) to minutes, protecting production and data for customers. For electric power transmission systems, redox flow batteries can provide the following advantages:

- effective use of existing plant investment
- flexibility of operation and better response to price changes
- stored electricity that can be readily available to meet immediate changes in demand
- constant levels of power in a power plant generator
- use of off-peak power for pumping and/or charging, stabilizing operations and providing the flexibility to buy or sell electricity during on-peak or off-peak periods
- transportability, modularity
- high energy (charging) efficiency
- flexible operation
- low cost

Some disadvantages of redox flow cells are

- The technology is relatively new and unfamiliar.
- Maintenance is difficult because the corrosive and toxic electrolyte necessitates thermal management, electrolyte management, and careful storage and transport.
- Failures in the membrane could result in mixing of the electrolytes; vanadium cells will lose power in those cases, but a hazardous situation might be created in other systems where the electrolytes are incompatible.

### 3.7.3 Technical Barriers

A significant potential market for energy storage products, unsatisfied by existing technology, exists within the range from several hundred megawatts and several hours of storage to the multi-megawatt level. The future market for electricity storage systems is in conjunction with renewable energy sources, such as photovoltaic generation and wind power energy systems.

Technical barriers and needs	Component(s)
<ul style="list-style-type: none"> <li>• Improved electrode catalysts are needed</li> <li>• Membrane failures lead to loss of power and health and safety issues</li> </ul>	<ul style="list-style-type: none"> <li>• Electrodes</li> <li>• Electrolyte membrane</li> </ul>
<ul style="list-style-type: none"> <li>• Low energy density</li> <li>• Complex maintenance and system management</li> <li>• Corrosion and toxicity</li> </ul>	<ul style="list-style-type: none"> <li>• All</li> <li>• All</li> <li>• All active components</li> </ul>

### 3.7.4 Additional Reading

1. M. Bartolozzi, "Development of Redox Flow Batteries: A Historical Bibliography," *J. Power Sources* **27**, 219 (1989).
2. M. Skyllas-Kazacos and F. Grossmith, "Efficient Vanadium Redox Flow Cell," *Journal of the Electrochemical Society* **134**, 2950 (1987).
3. D. Pletcher and R. Wills, "A Novel Flow Battery: A Lead Acid Battery Based on an Electrolyte Soluble Lead (II): Parts I and II, Preliminary and Flow Cell Studies," *Physical Chemistry Chemical Physics* **6**, 1779 (2004).
4. A. Hazza, D. Pletcher, R. Wills. *Physical Chemistry Chemical Physics*, **6**, 1773 (2004).

## 3.8 CONCLUSIONS

Energy, power, cost, lifetime, and safety are key performance criteria for electrical energy storage with batteries. This overview has highlighted a number of engineering and scientific challenges, the successful resolution of which would lead to breakthroughs in electrochemical energy storage.

Every battery developer seeks to pack more energy into a smaller and lighter package. Across the board, batteries have specific energies of only from 1/10 to ¼ of the theoretical capacity based on the reactants. Discovering advanced active materials and reactions with higher energy densities is important but is only part of the answer. Battery architectures are also needed that efficiently use 100% of these active materials. Advanced architectures and assembly techniques should look beyond the stacks, tubes, and spiral designs. Breakthroughs will also come from devising ways to reduce the mass, volume, and expense of all the inactive battery components, including the packaging, current collectors, separators, and additives. New materials that are lighter, stronger, corrosion-resistant, and conductive should be researched for battery applications.

Increasing the power delivered by a battery and reducing its recharge time hinge on reducing internal resistances due to electronic and mass transport and the reaction rates at the interface. Using nanoparticles of the active materials may greatly boost the power delivered by reducing diffusion distances within and between the active materials and by increasing interface areas of the active materials. This is particularly important for low-temperature performance. However, nanomaterials may also lead to greater problems with poor lifetime and stability because the larger interface areas contribute to deleterious side reactions, enhanced dissolution, and the introduction of impurities. Because of this real or perceived tradeoff, the unique properties of nanomaterials for battery applications have not been fully explored. Unique behaviors might include altered phase transition mechanisms, wider composition ranges, and greater mechanical stability toward volume changes.

Life-limiting corrosion is a problem identified for each of the battery systems described in this section. Corrosion affects the seals, containers, current collectors, and contacts, particularly in designs with corrosive liquid electrolytes or liquid electrodes. All solid state batteries are less prone to corrosion problems, but solid electrolytes with sufficient ionic conductivity are few, even as very thin films. Other degradation processes are associated with charge/discharge cycling and the large, repeated removal and deposition of materials. Over a 10-year lifetime, even for a small rechargeable battery, the amount of mass transformed by the battery reactions is huge. For metal electrodes, this stripping and plating often leads to dendrites, roughened or mossy surfaces. For compounds, the precipitation, crystallization, and grain growth mechanisms also result in undesirable morphologies that lead to polarization and capacity losses. A better understanding of these mechanisms and of how the structures slowly evolve over the course of thousands of cycles is critical to predicting and extending lifetimes. New tools for studying how to extend cycling behavior are needed, including in-situ probes, model simulations, and rational methods for accelerated testing. Relating short-term



laboratory studies and observations to the reality of materials cycled for a decade at different rates, temperatures, and depths of discharge is an important challenge for the scientific community.

Finally, the importance of safety for the consumer, for transportation, for manufacturing, and for the environment cannot be overemphasized. To a large degree, safeguards can be engineered, but engineering solutions add cost and weight to the battery. Fundamental research will lead to breakthroughs in alternative materials and chemical reactions, such as nonflammable electrolytes with a large electrochemical window for high-voltage cells, active materials that remain stable if overcharged or overdischarged, and entirely new classes of reversible electrochemical reactions.



## 4. ADVANCED ELECTROCHEMICAL (SUPER) CAPACITORS

### 4.1 OVERVIEW

Electrochemical capacitors (ECs), variously referred to by manufacturers in promotional literature as “supercapacitors” or “ultracapacitors,” store electrical charge in a double layer at the interface between a carbon electrode and an electrolyte. Consequently, they are also quite properly referred to as “electric double layer capacitors.” Since “super” and “ultra” are promotional rather than scientifically descriptive terms, this section will refer to all such devices as ECs.

Because of the high internal surface area of the nanoporous carbon electrode material and the nanosize thickness of the double layer, ECs possess very high specific and volumetric capacitances that are several orders of magnitude greater than those of electrolytic and electrostatic capacitors. This is an enabling technology by which previously unattainable capacitance density is coupled with essentially unlimited charge/discharge cycle life. ECs possess high power density but low energy density relative to batteries; therefore, they serve a functional purpose between conventional capacitors and batteries.

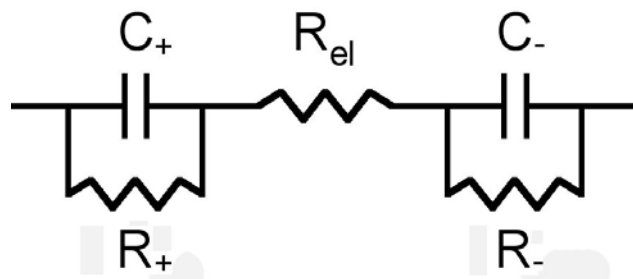
The EC was invented in 1957 by H. I. Becker of General Electric (U.S. Patent 2,800,616). Unfortunately, Becker’s device was not very practical in that both of the electrodes needed to be immersed in a container of electrolyte, similar to a flooded battery; therefore, it was never commercialized. However, Becker did appreciate the large capacitance values subsequently achieved by Robert A. Rightmire, an electrochemist at the Standard Oil Company of Ohio (SOHIO), to whom can be attributed the invention of the device in the format now commonly used. Following the commercial introduction of NEC’s SuperCapacitor™ in 1978, ECs have evolved through several generations of design. Initially, they were used as backup power devices for volatile clock chips and CMOS computer memories; but many other applications have emerged during the past 25 years, including portable wireless communication, enhanced power quality for distributed power systems, and high-efficiency energy storage for EVs and HEVs. Overall, the unique attributes of ECs complement the weaknesses of other power sources, such as batteries and fuel cells.

### 4.2 STATE OF THE ART OF ELECTROCHEMICAL CAPACITORS

#### 4.2.1 Basic Principles of Electrochemical Capacitors

Capacitors in general physically store electrical energy as equal quantities of positive and negative charge on opposite sides of an insulating material. When the two sides are connected by a conducting path, current flows until complete charge balance is achieved. The capacitor is returned to its charged state by applying a voltage across the electrodes. Because no chemical or phase changes take place, the process is highly reversible and the charge-discharge cycle can be repeated virtually without limit. In construction and operation, an EC differs markedly from an electrostatic capacitor in that the latter is a single capacitor comprising two conductors separated by an insulator. ECs, like electrolytic capacitors, comprise two capacitors in series. ECs resemble batteries in that each of the two electrodes is immersed in an electrolyte and they are separated by an ion-permeable membrane. Each electrode-electrolyte interface represents a capacitor; therefore, the complete cell comprises two capacitors in series, for which the equivalent circuit diagram is shown in Fig. 14.  $R_+$  and  $R_-$  represent leakage resistances; and in the limit where they are large (i.e., almost always), the total capacitance ( $C_t$ ) is given by Eq. (1), where  $C_+$  and  $C_-$  are the respective capacities of each half of the cell.

$$\frac{1}{C_t} = \frac{1}{C_+} + \frac{1}{C_-} \quad (1)$$



**Fig. 14. Equivalent circuit diagram.**

The double layer capacitance ( $C_{dl}$ ) at each electrode interface is given by Eq. (2), where  $\epsilon$  is the dielectric constant of the electrical double layer region of thickness  $t$ ,  $\epsilon_0 = 8.9 \cdot 10^{-12} \text{ Fm}^{-1}$ , and  $A$  is the surface area of the electrode material.

$$C_{dl} = \frac{\epsilon_0 \epsilon A}{t} \quad (2)$$

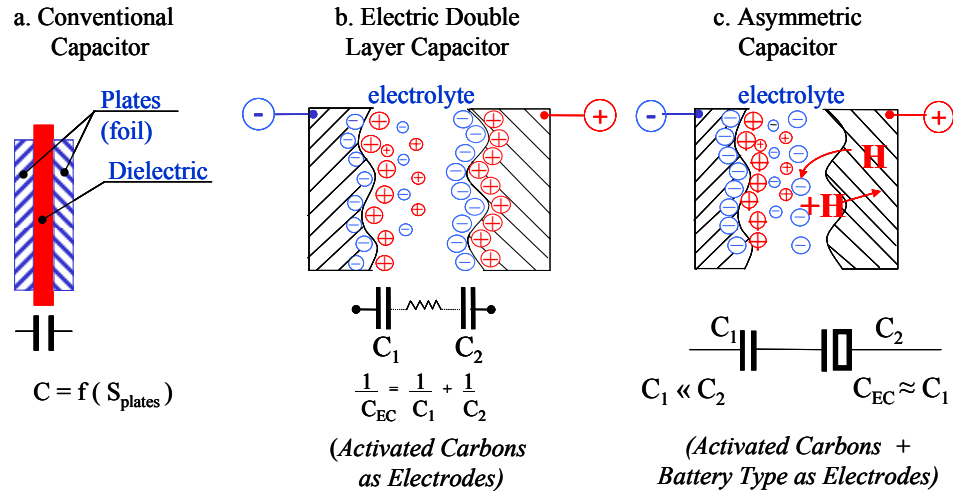
The stored energy ( $E$ ) and the maximum peak power ( $P$ ) of an EC are given by Eqs. (3) and (4), respectively, where  $C$  is the capacitance in Farads (F),  $V$  is the nominal voltage in volts, and  $R$  is the equivalent series resistance in ohms. Maximum peak power is achieved with a matched load.

$$E = \frac{CV^2}{2} \quad (3)$$

$$P = \frac{V^2}{4R} \quad (4)$$

Models for the main types of ECs are shown in Fig. 15, in which 15b and c represent symmetric and asymmetric devices, respectively, in the charged state. Solvated ions in the layer are attracted to the electrode surface by an equal but opposite charge in the solid. These two parallel regions of charge are described as a “double layer,” in which charge separation is measured in molecular dimensions, i.e., <1 nanometer (nm).

To a large extent, the capacitance of an EC is dependent on the characteristics of the electrode material, which is usually nanoporous (activated) carbon for symmetric ECs. The surface area of activated carbon typically used is  $>1000 \text{ m}^2/\text{g}$  ( $>10^6 \text{ m}^2/\text{kg}$ ), which results in specific capacitance values  $>10^5 \text{ F/kg}$  and the ability to produce individual devices rated at many thousands of Farads. Cell voltage is also a very important operating parameter that influences energy storage, which is apparent from Eqs. (3) and (4), in which both the energy and power of an EC are proportional to the square of the operating voltage. The operating voltage of the cell is dependent on electrolyte stability. Aqueous electrolytes, such as sulfuric acid ( $\text{H}_2\text{SO}_4$ ) and potassium hydroxide (KOH), offer the advantage of high ionic conductivity but suffer a low breakdown potential of about 1.2 V. On the other hand, organic electrolytes—such as propylene carbonate and acetonitrile ( $\text{CH}_3\text{CN}$ ) containing dissolved quaternary ammonium salts—permit operating voltages of near 3 V without breakdown, but their electrical resistance is at least an order of magnitude greater than that of aqueous electrolytes. Providing the applied voltage to the cell does not exceed the electrolyte breakdown potential; no



**Fig. 15. Types of electrochemical capacitors in the charged state.** (Drawing courtesy of ELIT Company)

significant chemical reactions will occur,<sup>21</sup> at least in the absence of functional groups on the surface of the electrode material (that are susceptible to reactions at these voltages).

As with other types of energy storage devices, high internal resistance limits the power capability of ECs. This resistance is properly termed “equivalent series resistance” (ESR), the precisely defined technical term for the resistance of the device when it has a 0° phase angle between current and voltage for an applied ac signal and therefore appears exactly like a resistor. The frequency of the ac signal at these conditions is referred to technically as the “self-resonant frequency.” The EC in this situation is measured at a frequency where (in this technology) it is dominated by the ionic resistance of the separator. Factors that can contribute in varying degrees to the ESR of an EC include

- Ionic resistance of the electrolyte in the separator, which is controlled by the thickness and openness of the separator and the electrolyte conductivity
- Electronic resistance of the electrode materials (generally very small by design)
- Resistance of the interface between electrodes and current collectors (a factor now virtually negligible in commercial products, having been eliminated by modern design)

The discussion thus far pertains to ECs in which electrical energy is stored through formation of a double layer at the interface between a carbon material and an electrolyte. However, there is a class of energy storage materials that undergo electron transfer reactions yet behave in a capacitive manner. Materials that exhibit behavior of this nature are called “pseudocapacitors” because they store electrical energy via mechanisms other than formation of an electric double layer but otherwise behave electrically like capacitors. For example, symmetrical devices have been produced with ruthenium oxide (RuO<sub>2</sub>) or iridium oxide (IrO<sub>2</sub>) as the electrode material and H<sub>2</sub>SO<sub>4</sub> as the electrolyte, which operate like a conventional double-layer capacitor with respect to charge and discharge. Such devices possess specific capacities upward of about 800 F/g, very high volumetric and power

<sup>21</sup> B. E. Conway, *Electrochemical Supercapacitors: Scientific Fundamentals and Technological Applications*, Kluwer Academic, New York, 1999.

densities, and excellent cycle life. On the downside, RuO<sub>2</sub> and IrO<sub>2</sub> are rare, noble metal oxides and as such are far too expensive for commercial applications, except those requiring the smallest of EC devices. Besides the mixed metal oxides, several classes of polymers show pseudocapacitive charge storage, including polythiophenes; these materials have been investigated in symmetric and asymmetric designs.

### Comparison of Capacitor Types

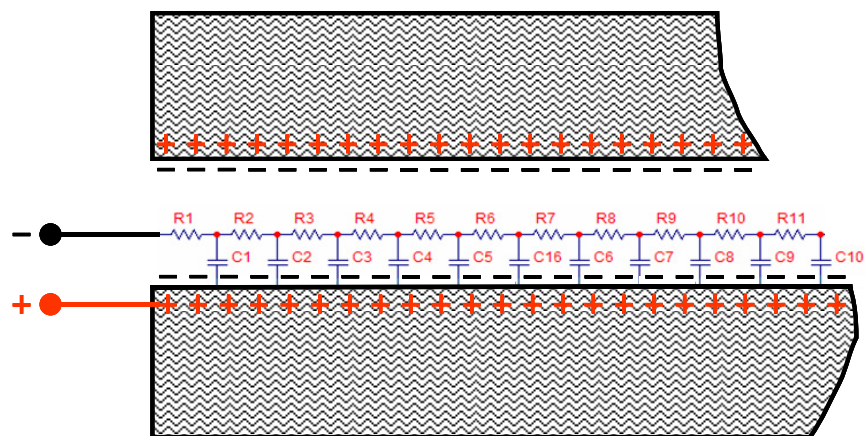
To place into perspective key advantages of ECs, the three main types of capacitor systems are compared in Table 11 for the mass, volume, cost, and response time of each capacitor system possessing an energy storage value of 1 MJ (0.28 kWh). The largest-size component of each type was linearly scaled in mass, size, and cost to make the comparison.

**Table 11. Comparison of key parameters of each type of capacitor with 1 MJ of energy storage**

Capacitor type	Mass (kg)	Volume (m <sup>3</sup> )	Cost (\$)	Response time (seconds)
Electrostatic	200,000	140	700,000	10 <sup>-9</sup>
Electrolytic	10,000	2.2	300,000	10 <sup>-4</sup>
Electrochemical	100	0.1	15,000	1

It is apparent from this comparison for a 1-MJ energy storage system that ECs are substantially lower in mass, volume, and cost than electrostatic and electrolytic capacitors. However, it is equally apparent that they have much slower response times. This precludes their use in ac filtering applications; in essence, they essentially are dc devices. Thus while ECs can readily be used in those applications served by electrolytic or electrostatic capacitors where pulse power is the objective, such is not the case where high-frequency response above 1 Hz is required. On the other hand, response times of ECs are extremely fast compared with those of batteries, for which a 1-s discharge time is equivalent to a 3600-C discharge rate. Some specialized capacitor systems fall outside the parameter values listed in Table 11. Examples are very large kV-rated pulse electrostatic capacitors with higher energy densities but substantially reduced cycle life; electrolytic capacitors developed for implantable defibrillator applications (limited operating time); and pulsed ECs with very fast response time (10<sup>-3</sup> s) but also greatly reduced energy density.

The very feature of an EC that makes such high capacitances possible, namely the highly porous electrodes, is also the reason for the relatively slow response times of the devices. To illustrate why, Fig. 16 is an idealistic representation of a cross section of a pore in a nanoporous carbon material, where it is shown as a cylinder filled with electrolyte in which an electric double layer covers the interior wall surface of the pore. Electrical connections to the stored charge are made through the solid carbon surrounding the pore and through the electrolyte from the mouth of the pore. Charge stored near the pore mouth is accessible through a short path with small electrolyte resistance. In contrast, charge stored deeper within the pore must traverse a longer electrolyte path with a significantly higher series resistance. Thus this distributed charge storage creates a complicated electrical response with no single characteristic time. In essence, the overall response time for a single pore is represented by a multiple-time-constant equivalent circuit model (superimposed on the representation of a pore in Fig. 16).



**Fig. 16. Idealistic representation of a nanopore in a carbon electrode of an electrochemical capacitor.**

#### 4.2.2 Comparison of Electrochemical Capacitors and Batteries

The operating voltage of an EC is limited by the breakdown potential of the electrolyte (typically 1 to 3 V per cell) and is generally much lower than that of either electrostatic or electrolytic capacitors. In many practical applications, therefore, EC cells must be series-connected, similar to batteries, to meet operating voltage requirements. To illustrate the major differences between secondary (rechargeable) batteries and ECs, important fundamental properties of each are compared in Table 12.

**Table 12. Comparison of properties of secondary batteries and electrochemical capacitors**

Property	Battery	Electrochemical capacitor
Storage mechanism	Chemical	Physical
Power limitation	Reaction kinetics, mass transport	Separator ionic conductivity
Energy limitation	Electrode mass	Electrode surface area
Output voltage	Constant value	Changing value—state of charge known precisely
Charge rate	Reaction kinetics, mass transport	Very high, same as discharge rate
Cycle life limitations	Physical stability, chemical reversibility	Side reactions
Life limitation	Thermodynamic stability	Side reactions

As mentioned earlier, the fundamental difference between batteries and ECs is that the former store energy in chemical reactants capable of generating charge, whereas the latter store energy directly as charge. Thus battery discharge rate, and therefore power performance, is limited by the reaction kinetics of the battery electrodes and the mass transport of the reactants, which means that charge and discharge rates are often different. The thermodynamics of the battery reactants dictate that the

system operating voltage is relatively constant and, to the first order, independent of the state of charge (SOC) of the battery. Consequently, it is often difficult to measure the SOC of a battery precisely.

In contrast, symmetric ECs have no reaction kinetics to limit charge and discharge rates and thus have exceptionally high power capability for both discharge and charge cycles. During charge or discharge, capacitor voltage is not constant but increases linearly (at constant charge current); thus the SOC of an EC is much more easily determined than that of a battery. Furthermore, because ECs store charge physically rather than chemically, they experience no volume or phase changes during charge/discharge cycling. In short, the highly reversible charge storage in an EC results in a cycle life measuring from hundreds of thousands to many millions of full charge/discharge cycles. In marked contrast, because chemical reactions in a battery are not fully reversible, the number of charge/discharge cycles is limited to a few thousand at most.

Another major difference between batteries and ECs is energy density. Chemical reactions in the battery allow high energy density, whereas physical charge storage in a capacitor does not. To illustrate this energy storage difference, an AAA-size alkaline cell under low-rate discharge is comparable to a 10,000-F EC discharged from 1.5 to 0.9 V. The reason for this major energy difference is that most of the material in a battery electrode can contribute to energy storage, but only the specific surface area of the carbon electrode material in an EC does so. For example, batteries have specific energy densities from ~25 Wh/kg (~90 kJ/kg) to more than 150 Wh/kg (540 kJ/kg); in marked contrast, large ECs have specific energy values in the range of only 1–10 Wh/kg (3.6 to 36 kJ/kg). Regardless, both batteries and ECs have relatively low operating voltages, necessitating the use of strings of cells in series to meet the requirements of high-voltage applications.

ECs have evolved to truly high power-density devices, with matched load pulse power levels greater than 10 kW/kg and specific energies of more than 10 Wh/kg. In contrast, a state-of-the-art lithium-ion battery, optimized for power density, has a specific power on discharge of 3 to 5 kW/kg and a specific energy of 65 Wh/kg. ECs have ten times the power and one tenth to one twentieth the energy of an energy-optimized lithium-ion battery, and extremely long cycle life compared with any battery. The performance attributes of ECs produced by different manufacturers are highlighted in Table 13.

ECs and batteries are conveniently compared by plotting specific power (P) and specific energy (E) on a Ragone chart. This is a log-log plot of P versus E with a parameter of time (note that  $E/P = \text{time}$ ) shown as sloping curves on the chart. Since the relationship between P and E is linear ( $E = \gamma P + E_0$ ), the Ragone plots will show up as negative sloped lines that roll into a knee as the parameter P approaches its matched-load value. The intersection of the Ragone plot with a vertical line at the matched load specific power, PML, is not a characteristic response time of the cell but rather a response time at its maximum power point. The response time of a cell is generally much different from (much longer than) that given by the point of intersection of the Ragone plot. Ragone plots always terminate at the PML value because that is the highest power that can be delivered or absorbed by the cell.

One task facing EC manufacturers today is to increase the operating voltage of the cell. The state of development of symmetric EC technology today is cell operating voltages limited to 2.7 V for organic electrolytes, with capacitances of 5000 F or more. More to the point, the key to future improvements is the ability of manufacturers to raise cell operating voltages to well above 3.0 V.



**Table 13. Performance of large commercial electrochemical capacitor products**

Manufacturer	Electrolyte	Rated voltage (V)	Capacity (F)	Series resistance (mΩ)	Mass (kg)	Specific energy (Wh/kg)	Response time <sup>a</sup> (seconds)
ECOND (module)	Aqueous	270	2.33	300	48.0	0.5	0.7
ELIT (module)	Aqueous	14.5	423	1.0	15.7	0.8	0.4
ESMA (module)	Aqueous	1.5	10,000	0.28	1.1	2.7	3.0
LS Cable (cell)	PC	2.8	3,200	0.50	0.63	5.2	1.5
Maxwell Technologies (cell)	AN	2.7	3,000	0.37	0.55	5.5	0.9
NessCap (cell)	PC	2.7	3,600	0.50	0.67	5.3	1.8
Nippon Chemi-Con (cell)	PC	2.5	2,400	0.7	0.5	4.2	1.7

AN = acetonitrile liquid; PC = propylene carbonate liquid; aqueous: KOH in water

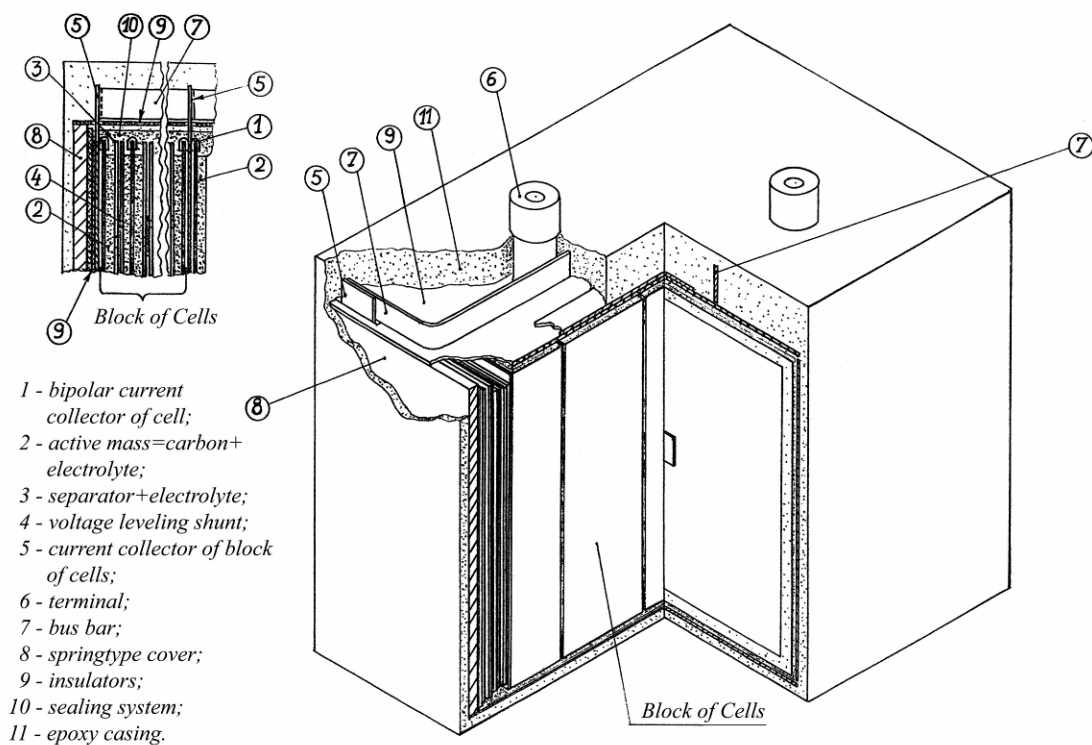
<sup>a</sup>Typical response time (approximate) is calculated as the product of the series resistance and the capacitance.

Overall, ECs have low specific energy, very high charge/discharge rates, a sloping discharge curve that directly provides SOC, essentially unlimited cycle life, and maintenance-free operation. In contrast, batteries have high specific energy, limited charge/discharge rates, relatively flat discharge curves, and limited cycle life and require periodic maintenance.

### Evolution of Design and Construction of Electrochemical Capacitors

The earliest ECs introduced 25 years ago were symmetric designs, using the same carbon material for both the positive and negative electrodes, each of which had similar mass and capacitance values. These early symmetric devices used aqueous electrolyte, H<sub>2</sub>SO<sub>4</sub> or KOH, which limited operating cell voltage to ~1.2 V/cell and nominal cell rating to ~0.9 V. A cutaway drawing of an ELIT module, a bipolar symmetric device using KOH electrolyte, is shown in Fig. 17.

In the second generation of ECs, aqueous electrolytes were replaced by organic electrolytes as a means of increasing cell operating voltage. The organic electrolyte is typically an ammonium salt dissolved in an organic solvent, such as propylene carbonate or acetonitrile. This change increased the rated cell voltage from about 0.9 to 2.3–2.7 V/cell. Spiral-wound (Fig. 18) or prismatic plate construction ECs using an organic electrolyte are the most popular type. However, organic electrolytes do have disadvantages, including the fact that the dielectric constant of the organic solvents used is less than that of water. Furthermore, the double layer thickness is greater because of the larger-size solvent molecules, and the effective surface area of the electrode material is diminished to some extent because the larger solvated ions cannot penetrate all the pores in the electrodes; this reduces specific capacitance, i.e., per unit mass of electrode material. The ionic conductivity of organic electrolytes is also much less than that of aqueous electrolytes, particularly at low temperatures, another factor reducing power density. It should also be noted that stable, long-term operation at high voltages requires extremely pure materials. Trace quantities of water in the electrolyte can create problems; therefore, the EC device must be very tightly packaged to avoid



**Fig. 17. Cutaway drawing of a bipolar symmetric electrochemical capacitor module.** (Drawing courtesy of ELIT Company)

penetration by water. Nevertheless, despite these caveats, the substantial increase in energy density is a net advantage of organic electrolytes.

The most recent EC designs are asymmetric and comprise two capacitors in series, one capacitor-like and the other battery-like, with varying electrode capacitance ratios depending on the application. The capacitor electrode is identical to those used in symmetric ECs, consisting of a high-surface-area nanoporous carbon electrode with double layer charge storage. In contrast, the battery-like electrode relies on an electron charge transfer reaction at the electrode–electrolyte interface to store energy, exactly like an electrode in a rechargeable battery. In this design, the capacity of the battery-like electrode is generally many times greater than the capacity of the porous carbon electrode. The depth of discharge of the battery-like electrode is very small during operation, resulting in much higher cycle life than is normally possible for rechargeable batteries. Reaction kinetics generally does not limit charge or discharge rates of asymmetric designs because the battery-like electrode is usually oversized and therefore operates at substantially lower current density than normal in a battery.

Several novel asymmetric EC designs are under development. One such design mates a nanoporous carbon electrode with a lithium ion intercalation electrode using an organic electrolyte to achieve a high operating voltage. In addition, an asymmetric system being developed by ESMA combines a nanoporous carbon electrode with a lead dioxide battery-like electrode using  $H_2SO_4$  as the electrolyte.

The carbon electrodes in both symmetric and asymmetric ECs comprise high-surface-area nanoporous carbon in particulate, bonded, or cloth form; the carbons are produced from both natural and synthetic precursor materials. Carbon properties of importance include

- High surface area range (1000 to 2500 m<sup>2</sup>g<sup>-1</sup>)
- Tailored pore structure and high pore volume
- Good electrical conductivity
- High purity
- Good corrosion resistance
- Relatively low cost, i.e., costs in line with those of specialized industrial materials, not pharmaceutical materials
- Appropriate surface conditioning
- Optimum structure; edge rather than basal planes

The first four of these properties are particularly important with respect to the performance of EC electrodes. Although high surface area is the key to achieving a high electrolyte interfacial area, it is also important that the surface area be located within pores accessible to the solvated electrolyte ions. This means that the pores must typically be within the small mesopore range, e.g., about 2–5 nm in width. In addition to the properties listed, in many cases high-temperature stability and adaptability to composite materials are important criteria for suitable carbon materials. Currently, for commercial viability in many applications, the cost of carbon materials as measured in terms of \$/Wh, \$/kW, and/or \$/kg is a key limiting factor. A common target for automotive applications is on the order of \$10/kg.

The outer physical surface of each electrode is in close contact with a current collector, and an ion-conducting but electrically-insulating material is used as a separator between the electrodes to prevent short circuiting between them. The “jelly roll” configuration uses particulate carbon pasted onto an aluminum foil current collector with a separator, which is spirally wound. A different design uses similarly sequentially stacked layers of current collector, electrode, separator, electrode, collector, etc., but assembled in a prismatic configuration. Each collector in the prismatic design is tabbed, and alternating tabs are electrically connected to the device terminals. This arrangement reduces series resistance in the device. Asymmetric EC cells using aqueous electrolytes are currently constructed in much the same way as Ni-Cd rechargeable batteries used in aircraft applications. Photographs shown in Fig. 19 are of representative, large size ECs manufactured by ELIT, ECOND, NESS, Maxwell Technologies, Nippon Chemi-Con, Power Systems, LS Cable, and ESMA, respectively. The smallest device shown (Maxwell Technologies) stores about 1 kJ of energy, whereas the largest device shown (ESMA) stores about 180 kJ of energy.

### 4.3 APPLICATIONS OF ELECTROCHEMICAL CAPACITORS

Following the initial commercialization of ECs for computer memory backup power, use of these devices has broadened to many diverse applications in different industries, including transportation, energy conservation, power quality, and, notably, portable electronics. In many applications, ECs are paired with batteries to improve the power performance of the system as a whole; in some cases, they replace batteries altogether. Often, ECs are used to meet peak power demands that are well above



**Fig. 18. Cutaway drawing of a spiral-wound electrochemical capacitor module.** (Photo courtesy of Nippon Chemi-Con)



**Fig. 19. Commercial large-format electrochemical capacitors.**

steady state values, thereby extending battery runtime and life. Similarly, ECs furnish the power required for instant restarts of equipment, e.g., heating the fusing roll of a photocopier machine or powering up a computer CPU from energy-saving sleep mode to full operation. The use of ECs for much larger-scale applications has been demonstrated, but high cost has discouraged their widespread acceptance to date. As a result, manufacturers have redoubled their efforts to reduce product costs, but at the same time they have increasingly emphasized in their marketing efforts the reduced life-cycle costs of ECs compared with batteries. The potential benefits of ECs in several large-scale applications are discussed in the following paragraphs.

In the early 1990s, ECs were proposed as a load-leveling technology for battery-powered EVs. The addition of ECs provided greater power for acceleration, higher energy capture efficiency during braking, and longer battery operational life. Plug-in hybrid vehicles will similarly benefit by including ECs in the battery energy storage system. ECs are also being used on demonstration vehicles in which they are the only electrical energy source. For example, the all-electric bus shown in Fig. 20 uses an ESMA EC system for drive power and has no IC engine or batteries. The bus is part of a fleet of vehicles that operate on an approximately 10-km (6.2-mile) loop route in a Moscow park area. The bus uses an asymmetric EC system that is rated at 190 V and stores 30 MJ of energy; it is recharged in 15 minutes between each circuit of the route. This bus is perhaps the largest EC-powered EV constructed.

The advantages of ECs could also be exploited in HEVs. Some HEVs on the market use batteries only, but their performance could be enhanced with ECs. For example, the batteries in a Toyota Prius recapture <50% of the braking energy, whereas ECs could recapture >90%. The hybrid gasoline/electric bus shown in Fig. 21 has only EC energy storage—no batteries. The bus has a Maxwell Technologies 1.5-MJ EC system rated at 400 V. Many hundreds of these buses are in city transit service in southern California.

HEVs offer higher gas mileage and reduced air emissions. DOE is funding development of a heavy hybrid vehicle power system for use in refuse trucks, which typically incur 800–1000 start-stop cycles each day. Similarly, the U.S. military has demonstration units of hybrid 5- and 7-ton trucks. For these



**Fig. 20. Electric bus powered solely by an asymmetric electrochemical capacitor system.**  
(Photo courtesy of ESMA Joint Stock Company)



**Fig. 21. Gasoline/electric hybrid bus with an electrochemical capacitor energy storage system.**  
(Photo courtesy of ISE Corporation)

and other HEVs, use of advanced ECs offers both performance and life cycle advantages over conventional battery storage systems alone.

Other transport applications for ECs include “minimal hybrid” and fuel-cell-powered vehicles. The minimal hybrid has no electric drive, but the gasoline engine stops when the vehicle stops; as in an engine-powered golf cart, the engine restarts to move the vehicle on. This is an ideal application for ECs in which their high cycle life can be exploited. Fuel-cell-powered vehicles also benefit from the addition of ECs to the electric power train system to compensate for the typically slow response of fuel cells to load power changes; i.e., by optimizing energy and power requirements for the entire system. Without an EC, a fuel cell must be oversized to provide responsive acceleration of the vehicle. The benefits of fuel cell/electrochemical capacitor systems are being demonstrated in electric forklifts, in which the capacitor meets peaks in power demand and is used for regenerative braking energy capture. On a larger scale, commercial crane systems have been developed that incorporate ECs for regenerative energy capture; e.g., energy savings of ~40% have been reported for a Japanese container-ship crane. Similarly, ECs are being introduced into light rail systems to capture braking energy; the capacitor system is located either on the train or at a station where the reclaimed energy is used to accelerate the same or another train near the station.

ECs have been evaluated for power supply applications unrelated to the drive train in vehicles. These include electric power steering, preheating of catalytic converters, active suspension systems, electrically operated air-conditioners, and electromagnetic valve actuation—all of which improve vehicle gas mileage, reduce emissions, and/or improve performance. From a technical standpoint, these applications of ECs in vehicles have been well demonstrated, but their widespread use is dependent on the introduction of a cost-competitive capacitor system to supply the power for such additional electric loads.

ECs are being test-marketed to the trucking industry for diesel engine starting. New ancillary electrical equipment such as computer systems and comfort/convenience options for drivers drain truck batteries during extended key-off stops, sometimes to the point that they fail to provide sufficient power to restart the truck engine, especially during cold weather. The addition of an EC to batteries improves starting reliability and increases the lifetime of the starting system itself. Often, the “dead” battery will not start the diesel engine but still contains sufficient energy to charge an EC,



typically in 1 minute or less, which can then be used to restart the engine because of its much greater power performance. An example of an EC used to jumpstart diesel engines, often at low temperatures, is shown in Fig. 22.

A related application is engine starting for stationary motor generator systems used in commercial and public buildings to cover the loss of grid power. Currently, large Ni-Cd or lead–acid batteries are typically used for these stationary generators, but an EC system would be more reliable, provide greater power density for rapid starting, require no maintenance, and ultimately be more environmentally friendly. In addition, an EC storage system could be used to provide the 10 to 15 seconds of electrical energy needed until the stationary generator set is fully operational and able to meet the required power demand. Furthermore, ECs recharge much more quickly than batteries and do not require the special precautions needed to vent flammable gases during the recharging of large battery systems. A 2.1-MW EC energy storage system with a design life of 15 years is shown in Fig. 23. The system was assembled using more than 7000 EC cells and is located in a semiconductor production facility in Japan; it delivers its rated power for 1 second, greatly improving overall power quality.



**Fig. 22. Portable electrochemical capacitor device for jumpstarting large diesel engines.**  
(Photo courtesy of ELIT Company)



**Fig. 23. Large electrochemical capacitor storage system that provides short-time uninterruptible power.** (Photo courtesy of Nippon Chemi-Con)

#### **4.4 TECHNOLOGICAL CHALLENGES FOR ENHANCING THE PERFORMANCE OF ELECTROCHEMICAL CAPACITORS**

- **Increase the operating voltage to well above 3 V.** This is a top priority goal for the future development of symmetric ECs. The capacitor characteristic time response must still be <1 second.
- **Increase the energy density at least two-fold.** This may be achievable through the use of advanced materials tailored for optimal performance. The first order of materials cost is, of course, dependent on the mass. Thus costs on an energy basis will be halved with this action. Again, capacitor characteristic time response must still be <1 second.

- **Exploit innovative designs.** There are great untapped possibilities in the wide variety of designs that have emerged in recent work, particularly for aqueous electrolyte asymmetric capacitors. A great boost in capacitance has been achieved by operating at high potentials at which the carbon is actually pushed to very negative potentials that are well below their normal hydrogen evolution potential. The boost in potential may increase energy storage by a factor of 5; in addition, a further increase in energy storage, by a factor of 2, results from the asymmetric design compared with the symmetric. Furthermore, cell voltage at zero charge state is not zero; this condition augments device operating voltage and further increases the value of the stored energy. Collectively, these factors result in a much higher probability of producing a much higher energy density product while maintaining a very high cycle life, simply by adopting an asymmetric instead of symmetric design of capacitor.

Although these substantial benefits of asymmetric capacitors have been demonstrated, the mechanisms by which they are achieved are not understood. Thus there is an urgent need to develop a sound fundamental understanding of the mechanisms responsible for this enhanced capacitance of carbon at very low negative potentials. An understanding of the fundamental phenomena involved could undoubtedly be exploited to obtain further, substantial increases in the performance of asymmetric ECs.

- **Develop a new generation of electrolytes.** In any new electrolyte system, there must be a concentration of ions sufficient to accommodate the increased charge storage that results from higher operating voltage. Thus electrolyte concentration will have to be much higher than that typically used today; i.e., about 1.8 M.

Asymmetric capacitors using organic electrolytes clearly pose an almost immediate solution to the problem of how to break through the 3-V operating voltage barrier (simply through design change). This solution has already been demonstrated by the Fuji Heavy Industries lithium capacitor, which uses double layer charge storage for the capacitor electrode and a graphitic carbon intercalation electrode for the battery electrode. This mating of different electrode materials has provided reported operating voltages above 3 V with good stability. However, since the electrolyte is organic, it will suffer some of the manufacturing challenges inherent in symmetric organic electrolyte devices, such as energy-intensive drying techniques, a requirement for sophisticated packaging to prevent either water entering or the electrolyte evaporating, and so forth. Nevertheless, this would be a premier performance product with an energy density significantly above that of competing designs. Once again, this asymmetric organic electrolyte design will require electrolytes that are stable at high voltages and have a higher ion concentration than is possible with the present materials.

- **Improve electrode materials.** The main challenge in this effort is to increase the density of electronic states in the carbon (or in other electrode materials used in pseudo-capacitance-type devices) to levels higher than in present materials. In turn, this increase may necessitate minimum web thicknesses or layers in the highly porous materials so that solid state charge of ions on the electrolyte side can be balanced. The charge in the solid is dependent on the density of states in the electrode material.
- **Enhance the purity of materials.** Impurities in electrode materials that are soluble in the electrolyte result in gas generation and increased leakage current (self-discharge of the device). Insoluble impurities are relatively inert, but they nevertheless decrease volumetric capacity simply by occupying space in the device. Removing such impurities is a tedious and expensive process that contributes significantly to capacitor cost, particularly if the goal is to operate the device at much higher voltages. Therefore, more effective and less costly procedures for

removing impurities from the carbon electrode materials, or indeed an alternative approach of “neutralizing” the effects of impurities is needed, e.g., through the use of chelating agents or other additives in the electrolyte.

#### 4.5 ADDITIONAL READING

1. B. M. Barnett, E. Dowgiallo, G. Halpert, Y. Matsuda, Y., and Z-i. Takehara, eds., *Proceedings of the Symposium on New Sealed Rechargeable Batteries and Supercapacitors*, 93-23, The Electrochemical Society, Pennington, NJ, 1993.
2. R. J. Brodd, D. H. Doughty, J. H. Kim, M. Morita, K. Naoi, G. Nagasubramanian, and C. Nanjundiah, eds., *Proceedings of the International Symposium of Electrochemical Capacitor and Hybrid Power Sources*, 2002-7, The Electrochemical Society, Pennington, NJ, 2002.
3. R. De Levie, “On Porous Electrodes in Electrolyte Solutions,” *Electrochimica Acta* **8**, 751–780 (1963).
4. F. M. Delnick and M. Tomkiewicz, eds., *Proceedings of the Symposium on Electrochemical Capacitors*, 95-29, The Electrochemical Society, Pennington, NJ, 1996.
5. F. M. Delnick, D. Ingersoll, X. Andrieu, and K. Naoi, eds., *Proceedings of the Symposium on Electrochemical Capacitors II*, 96-25, The Electrochemical Society, Pennington, NJ, 1997.
6. H. Kamath and J. R. Miller, “Electrochemical Capacitor Energy Storage,” in *Handbook of Energy Storage for Transmission or Distribution Applications*, 1st ed., Electric Power Research Institute, Palo Alto, CA, 2002.
7. K. Kinoshita, *Carbon: Electrochemical and Physicochemical Properties*, John Wiley and Sons, New York, 1998.
8. C. Korzeniewski and B. E. Conway, eds., *Proceedings of the Symposium on the Electrochemical Double Layer*, 97-17, The Electrochemical Society, Pennington, NJ, 1997.
9. *Proceedings of International Seminar on Double Layer Capacitors and Hybrid Energy Storage Devices*, N. Marincic, organizer, 3 vols., Redox Engineering, Bonita Springs, FL, 2003–2005.
10. *Proceedings of Advanced Capacitor World Summit*, J. R. Miller, chair, 4 vols., Intertech, Portland, Maine, 2003–2006.
11. G. A. Nazri, E. Takeuchi, R. Koetz, and B. Scrosati, eds., *Proceedings of the International Symposium on Batteries and Supercapacitors*, 2001-21, The Electrochemical Society, Pennington, NJ, 2003.
12. I. D. Raistrick, “Electrochemical Capacitors,” in *Electrochemistry of Semiconductors and Electronics: Processes and Devices*, J. McHardy and F. Ludwig, eds., Noyes Publications, Park Ridge, NJ, 1992, pp. 297–355.
13. *Proceedings of the 2003 International Conference on Advanced Capacitors*, Y. Sato, chair, Kyoto, Japan, Electrochemical Society of Japan, 2003.
14. *Proceedings of International Seminar on Double Layer Capacitors and Related Devices*, S. Wolsky and N. Marincic, organizers, 12 vols., Florida Educational Seminars, Boca Raton, FL, 1991–2002.



**APPENDIX B: PROBING ELECTRICAL ENERGY STORAGE  
CHEMISTRY AND PHYSICS OVER BROAD TIME  
AND LENGTH SCALES**



# PROBING ELECTRICAL ENERGY STORAGE CHEMISTRY AND PHYSICS OVER BROAD TIME AND LENGTH SCALES

Progress in microscopy, scattering, and spectroscopy has advanced our understanding of chemical and interfacial processes. Revolutionary insights into the physico-chemical phenomena that underlie the operation of energy storage devices require further optimization of current methodologies and the development of new in situ photon- and particle-based microscopic, spectroscopic, and scattering techniques with time resolution down to the femtosecond range and spatial resolution spanning the atomic and mesoscopic scales. Information derived from these measurements will lead to the rational design of batteries and electrochemical capacitors (ECs), including materials and novel architectures that exhibit optimal performance in terms of charge-discharge characteristics and capacities approaching theoretical values. In addition, this information will help identify the underlying reasons behind failure modes and afford directions for mitigating them. Examples are provided of emerging techniques that illustrate potential research approaches toward meeting the challenges in the area of in situ characterization.

## INTRODUCTION

Electrical energy storage (EES) devices are complex multicomponent systems that incorporate widely dissimilar phases in physical and electrical contact. The operation of batteries and double layer capacitors relies critically on electron and ionic transfer across solid-solid and solid-liquid interfaces and within each of the constituent phases. A microscopic understanding of each of these elementary events could lead to dramatic improvements in performance. The continuous charge and discharge of EES devices invariably leads to performance degradation brought about by irreversible changes in the structure, morphology, and composition of the materials, the nature and mechanism of which has not yet been fully identified. Examples include the slow side reactions at highly polarized electrodes, particularly anodes, that consume solvent and anions, forming films such as those that occur at the solid electrolyte interphase (SEI) on lithium and Li-ion electrode surfaces.

Crucial to gaining a fundamental understanding of chemical energy storage phenomena is the development and implementation of in situ photon- and particle-based (e.g., neutron) spectroscopic, microscopic, and scattering techniques capable of the highest sensitivity and structural and elemental specificity. These techniques would allow the monitoring of events with time resolution down to femtoseconds and spatial resolution down to the mesoscopic and atomic length scales. Novel multi-technique and in situ strategies are required that would allow simultaneous imaging of structural, electrochemical, and physical/electronic properties simultaneously to correlate atomic and electronic structure with reactivity. These novel techniques would also allow researchers to exploit the inherent time dependence of the electrochemistry experiment (e.g., the ability to pulse) that is sensitive to surfaces and interfaces. The increased use of nanomaterials or nanocomposites in this field introduces new challenges for characterization. A complementary approach that will assist in the elucidation of the physico-chemical principles underlying the wide variety of involved phenomena relies on the design of appropriate model systems more amenable to joint theoretical-experimental analysis.

## SCIENCE OPPORTUNITIES

Electronic and ionic transport across interfaces and within phases is crucial to the operation of EES devices. Key elementary processes include (1) concerted electron and ion transport at the interface between an electrolyte and an ion intercalation electrode and (2) the spatial and temporal evolution of phase boundaries in single particles of charge storage materials. A better understanding of the underlying principles that govern these phenomena is inextricably linked to our ability to monitor in situ charge flow in real time and with high spatial resolution. At present, a temporal gap exists between the time scales accessible to electrochemical methods and those available to other characterization techniques, especially structural.

Scanning probe microscopies make it possible to image surfaces with unprecedented resolution, both in vacuum and in electrochemical environments. Extending these microscopic techniques to the nano- and femtosecond time scales represents a tremendous challenge with extraordinary repercussions in energy storage, catalysis, and other interfacial disciplines. Scattering techniques that rely on long-range order face similar challenges (such as diffraction) for monitoring nanometer-scale materials embedded in a host phase (such as a particle of a Li-ion intercalation material incorporated in a composite electrode material). New-generation synchrotron light sources and neutron reactors now under construction in the United States, including the Spallation Neutron Source (SNS) at Oak Ridge National Laboratory and NSLS-II at Brookhaven National Laboratory, will open new venues for meeting these challenges. Surprisingly, little progress has been made toward the development of electrochemical techniques with response times of less than 100 ns. This constraint is due partly to the physical size of electrodes, because the time constant of the cell correlates linearly with the radius size of the electrode-electrolyte interface. Another constraint is the current lack of special electronic circuit designs to avoid undesirable induction and ground loops.

## POTENTIAL RESEARCH APPROACHES

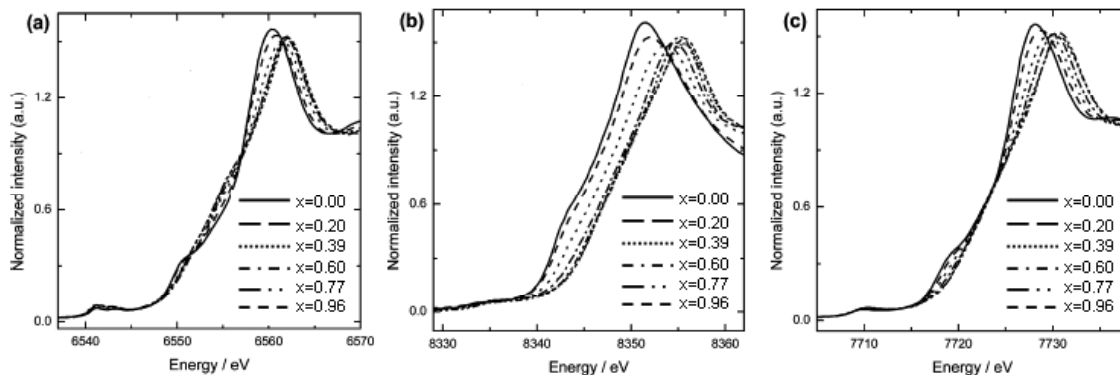
Advances in experimental scattering, microscopy, and spectroscopy are required to meet the desired spatial and temporal response characterization goals. Research that leverages advances in each of these areas to fully exploit their potential for EES characterization should be strongly encouraged. Additionally, the development of combinations of in situ high-spatial-resolution and high-temporal-resolution techniques should serve as a prolegomenon for future progress. Use of new characterization instrumentation will require the design, engineering, and optimization of novel electrochemical cells with components that are compatible with specific characterization techniques. The following subsection presents selected examples that illustrate some of the research opportunities offered by emerging instrumentation and methods.

**Neutron-based techniques**—Neutrons are ideally suited for high-specificity monitoring of lithium, one of the most important components of a Li-ion battery. In particular, the coherent neutron scattering lengths of  $^7\text{Li}$  and  $^6\text{Li}$  are negative and positive, respectively. Therefore, the scattering contrast between a lithiated compound of interest and the background can be eliminated by the appropriate choice of a  $^6\text{Li}$  and  $^7\text{Li}$  ratio (making the lithium essentially “invisible”). It is then possible to focus on other components such as carbon or the organic

electrolytes, as demonstrated for  $^1\text{H}$  and  $^2\text{H}$ , and for  $^{62}\text{Ni}$  and natural abundance Ni in a Li-ion battery material.<sup>1</sup> The high flux and pulsed source of the SNS will allow smaller in situ neutron diffraction cells to be developed so that smaller samples (or even single crystals) can be studied under increasingly realistic timescales. New classes of experiments can now be applied to battery materials. One-dimensional (area-averaged) compositional structures of buried interfaces can be measured by neutron reflectometry through a chosen electrode under in situ operating conditions. Neutron reflectometry allows direct observation of electrochemically driven transformations, intercalation propagation fronts, kinetics, and interface reconstruction/coarsening. Submicron lateral morphology changes can also be observed simultaneously through grazing angle diffraction. At the SNS, single-cycle and multicycle stroboscopic measurements will achieve subminute and subsecond temporal resolution, respectively, providing new opportunities for monitoring the kinetics of a number of processes. Three-dimensional architectures and self-assembled nano- and mesostructures can be investigated using small-angle neutron scattering.

**X-ray scattering**—The development of improved beam optics with more focused beams, (e.g., as proposed for development at NSLS-II) will allow spatially resolved experiments. For example, the use of X-ray absorption spectroscopy (XAS) with significantly improved spatial resolution (1–10 nm) will allow researchers to better understand batteries. While resonant hard X-ray scattering (and reflectivity) are routinely used to locate the presence of heavy metals such as iron and manganese, the emergence of resonant soft X-ray scattering (RSOXS) experiments at a variety of synchrotron sources (e.g., the Advanced Light Source) provides avenues for determining the specific locations of light elements such as carbon and lithium. The extended X-ray absorption fine structure (EXAFS) method, which is sensitive to short-range physical structure, will continue to play an important role in the in situ characterization of local structure, particularly in disordered materials. The X-ray absorption near edge structure (XANES) portion of XAFS reveals electronic properties and change in the oxidation state. For example, Figure B.1 shows the iron, nickel, and cobalt K-edge XANES obtained in situ for  $\text{Li}_{1-x}\text{Co}_{1/3}\text{Ni}_{1/3}\text{Mn}_{1/3}\text{O}_2$  as a function of the extent of Li-ion intercalation during charging, illustrating the high element specificity of the technique. With appropriate hardware and optics, it is possible to acquire spectra in a matter of seconds (quick XAFS), facilitating the study of kinetic phenomena important in battery processes. Diffraction anomalous fine structure is a promising development in XAS, offering the capability to probe site-selective local structures for systems with chemically identical atoms. Although it is difficult to apply to dilute systems, the higher brightness of third- and fourth-generation synchrotron sources will make measurements, even in situ, feasible.

The higher-intensity synchrotron fluxes already available at the Advanced Photon Source will continue to drive technique development. One such method—in situ pair distribution function (PDF) analysis—should play a role in following conversion reactions of nanoparticles. Diffraction measurements on single crystals will provide detailed mechanistic information. These measurements are increasingly more feasible on smaller and smaller crystallites because of current developments in synchrotron sources. The challenge of characterizing the disorder inherent to many EES systems will continue to drive methods and software development in this field. Results from techniques such as PDF analysis require input from other structural local and long-range probes because the data become increasingly

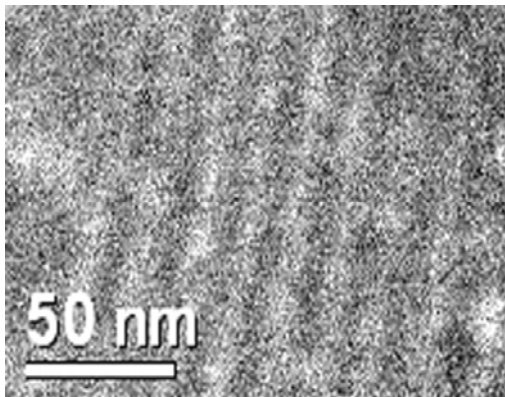


**Figure B.1. Normalized Mn(a), Ni(b), and Co(c) K-edges XANES of  $\text{Li}_{1-x}\text{Co}_{1/3}\text{Ni}_{1/3}\text{Mn}_{1/3}\text{O}_2$  as a function of the amount of lithium in the lattice.<sup>2</sup>**

more difficult to interpret as the systems become more complex and heterogeneous. These methods require further development.

Microbeam small angle X-ray scattering (SAXS) in scanning probe mode is particularly useful for investigating composite materials. In third- or fourth-generation synchrotrons, the probe size can be brought below 1 micron to provide local information about solid-solid and solid-liquid interfaces with time resolution that can reach microseconds. By acquiring SAXS data above and below the absorption edge of a particular element in a so called “anomalous” SAXS (ASAXS), scattering from that element can be isolated, allowing the direct location of a particular element within the structure from the electron density (index) profile. For example, in situ ASAXS measurements could be used to determine the size distribution of metal/metal-oxide particles distributed in a porous carbon binder and possible changes in that distribution as a function of the state of charge and cycle history. Resonant and nonresonant X-ray Raman scattering can provide the same information as vacuum ultraviolet absorption, determining the electronic structure by providing shallow core-level absorption spectroscopy information, particularly the K-edge of oxygen and carbon and the L-edges of three-dimensional transition metals, using hard X-rays, with the concomitant advantages of sensitivity to small samples and in situ measurement.<sup>3</sup>

**Electron microscopy**—Electron microscopies have already made outstanding contributions to the microstructural characterization of EES materials. Major goals in this field include the development of aberration-free imaging methods in the nanometer range that can be used to investigate battery materials, and the use of (elastic and inelastic) scattered electrons for the structural and chemical analysis of materials at very high spatial resolution. The combination of high local structural resolution with high local spectroscopic resolution in energy (e.g., EELS  $<0.2$  eV resolution,  $<20$  nm spot size) can allow different valence states in fully and partially intercalated host materials to be distinguished and can allow impurity states and bonding at interfaces at atomic dimensions to be characterized. High-resolution energy filtered electron microscopy can be used to locate elements spatially, as illustrated for an organic microphase separated block copolymer in Figure B.2. The instrumentation to perform such measurement is available at several Department of Energy user facilities, such as the National Center for Electron Microscopy and the Shared Research Equipment User Facility (ShARE).



**Figure B.2. Imaging lithium in a block copolymer electrolyte.** Energy-filtered electron micrograph. Bright regions show the lithium-rich domains, confined to 20 nm lamellae. (Pending patent application PCT/US2007/0, “High Elastic Modulus Polymer Electrolytes,” filed by the Regents of the University of California, 4/3/2007.)

A new generation of dedicated aberration-corrected transmission electron microscopes—optimized for in situ experiments where the effects of radiation damage, induced by the high-energy electron beam, are minimized or eliminated—is expected to provide a marked improvement in all types of electron microscopy techniques. The projected technical progress in in situ high-resolution transmission electron microscopy instrumentation, environmental chambers, and improved accessories and the development of advanced specimen preparation methodologies will create new and unique possibilities for dynamic studies of electrode materials in the sub-nanometer range. In situ, energy-filtered imaging of specimens with well-defined geometries will allow diffusion paths to be followed (e.g., lithium ions in the crystalline

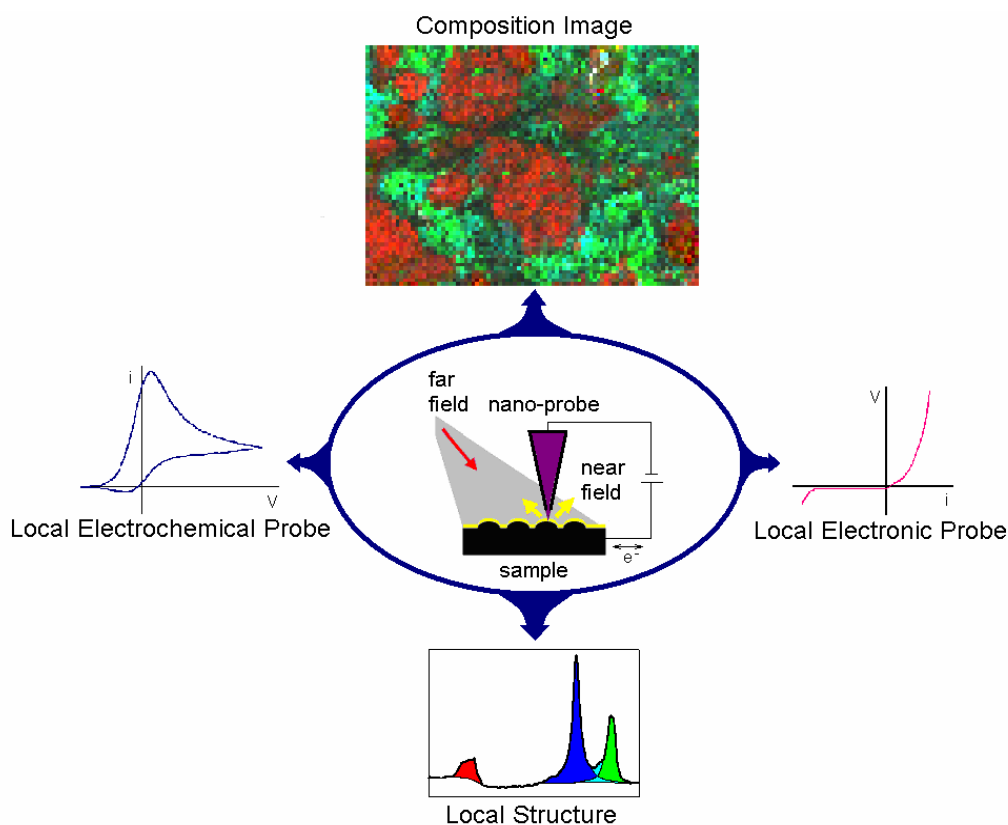
lattice). In situ, real-time imaging of dynamic processes induced by a local perturbation (e.g., a charge or mass transfer, mechanical stress) represents the longer-term goal for electron microscopy, which requires new advanced experimental strategies. Recent advances in the development of ultrafast electron microscopy and diffraction analysis with short pulses of electrons (femto- and picoseconds) will further reduce the risk of damage to sensitive specimens by the electron beam without compromising the quality of structural and chemical characterization.

**Nuclear magnetic resonance (NMR)**—NMR, an element-specific probe of local structure, is positioned to play an increasingly important role in characterizing both structure and dynamics in the electrodes, electrolyte, and interfaces. The chemical, hyperfine, and Knight shifts provide considerable detail concerning both the local structure and the electronic environment in diamagnetic, paramagnetic, and metallic materials, respectively.<sup>4,5</sup> The application of in situ NMR methods to this field is still in its infancy, although in situ static NMR has been used to study functioning battery cells,<sup>6</sup> and in situ NMR cells for use in electrocatalysis<sup>7,8</sup> have been built. Similar NMR cells to study electrode-electrolyte interfaces can be envisaged, which may allow researchers to unravel the dynamics of the interface processes. Incorporating magic angle spinning into the design of an in situ cell will be a challenge, but techniques developed in other fields could be adapted to this problem.

**Nonlinear laser-based techniques**—Simultaneous acquisition of topography and spectroscopy images, from which local electrochemical current-voltage characteristics for a fixed probe position can be determined, represents one future target for the development of new concepts and dedicated surface analytical techniques. The objective is to combine the high spatial resolution and versatility of scanning probe microscopy (SPM) with electrochemical and/or spectroscopic local sensing ability. Multifunctional SPM probes

enable the direct correlation of structural information with chemical surface activity and topography.

The combination of SPM and near-field scanning optical microscopy (NSOM) offers significantly increased spatial resolution below the diffraction limit (20–100 nm), single-photon sensitivity, simultaneous topographic characterization, and compatibility with optical spectroscopies (Figure B.3). Individual nanostructures, which are too small for optical imaging, can be characterized by inducing local excitations at a precise distance from the nanostructure. Nano-Raman, surface-enhanced Raman, tip-enhanced resonant Raman, infrared, second harmonic, photoluminescence, and fluorescence spectroscopies are suitable for in situ local characterization of chemical and physical surface properties of EES electrodes and surface layers at a subwavelength resolution and coverages down to pmol/cm.<sup>2,9</sup>



**Figure B.3. A multifunctional imaging nanoprobe.**

Femtosecond laser pulse confocal microscopy or NSOM can be used to probe and monitor order-disorder phase transition and relaxation processes in active materials via nonlinear optical properties (e.g., through second harmonic generation at surfaces). Fast single-pulse (instead of scanning methods) Raman mapping and imaging in the mid- and far-infrared range represent a new class of tools with excellent high resolution (<100 nm) for in situ study of the structure of porous materials, composites, and nanostructures used in chemical energy storage systems.



Since most chemical reactions involve nuclear motions at a time scale of  $>10$  fs, the ultrafast spectroscopy/imaging techniques are required to resolve and follow the pathways of complex reactions at the electrode-electrolyte interface. In situ infrared visible sum frequency generation spectroscopy can probe solvent structure above a battery or capacitor electrode and resolve the solvent molecules in environments associated with both the electrode surface and the diffuse double layer.<sup>10</sup>

## POTENTIAL IMPACT

Structural and spectroscopic techniques in the static and slow dynamics modes have reached a high level of maturity because of the advent of high-intensity lasers and synchrotron sources and linear and nonlinear optical techniques. It is now possible to determine a great deal about the structure of the electrodes and electrolyte in EES devices at various states of charge and discharge, cycle life, and other factors.

## WORKS CONSULTED

1. J. Bréger, N. Dupré, P. J. Chupas, P. L. Lee, T. Proffen, J. B. Parise, and C. P. Grey, "Short and long range order in the positive electrode material  $\text{Li}(\text{NiMn})_{0.5}\text{O}_2$ : A joint X-ray and neutron diffraction, pair distribution function analysis and NMR study," *J. Am. Chem. Soc.* **127** (20), 7529–7537 (2005).
2. W. S. Yoon, M. Balasubramanian, K. Y. Chung, X. Q. Yang, J. McBreen, C. P. Grey, and D.A. Fischer, "Investigation of the charge compensation mechanism on the electrochemically Li-ion deintercalated  $\text{Li}_{1-x}\text{Co}_{1/3}\text{Ni}_{1/3}\text{Mn}_{1/3}\text{O}_2$  electrode system by combination of soft and hard X-ray absorption spectroscopy." *J. Am. Chem. Soc.* **127**, 17479–17487 (2005).
3. H. Hayashi, Y. Udagawa, J. Gillet, W. Caliebe, and C. Kao, "Chemical applications of inelastic X-ray scattering," in *Chemical Application of Synchrotron Radiation*, T.-K. Sham, ed., World Scientific: Singapore, Vol. 12, p. 850, 2002.
4. C. P. Slichter, *Principles of Magnetic Resonance*. 3rd ed.; Springer-Verlag: Berlin, p. 655, 1990.
5. C. P. Grey and N. Dupre, "NMR studies of cathode materials for lithium-ion rechargeable batteries," *Chem. Rev.* **104**, 4493–4512 (2004).
6. F. Chevallier, C. Clinard, E. Frackowiak, J. N. Rouzaud, F. Beguin, M. Morcrette, and J. M. Tarascon, "The first in situ Li-7 nuclear magnetic resonance study of lithium insertion in hard-carbon anode materials for Li-ion batteries," *J. Chem. Phys.* **118**, 6038–6045 (2003).
7. Y. Y. Tong, A. Wieckowski, and E. Oldfield, "NMR of electrocatalysts," *J. Phys. Chem. B* **106**, 2434–2446 (2002).
8. B. M. Rush, J. A. Reimer, and E. J. Cairns, "Nuclear magnetic resonance and voltammetry studies of carbon monoxide adsorption and oxidation on a carbon-supported platinum fuel cell electrocatalyst," *J. Electrochem. Soc.* **148**, A137–A148 (2001).
9. K. F. Domke, D. Zhang, and B. Pettinger, "Toward Raman fingerprints of single dye molecules at atomically smooth Au(111)," *J. Am. Chem. Soc.* **128**, 14721–14727 (2006).
10. Z. D. Schultz, S. K. Shaw, and A. A. Gewirth, "Potential dependent organization of water at the electrified metal-liquid interface," *J. Am. Chem. Soc.* **127**, 15916–15922 (2005).



**APPENDIX C: WORKSHOP ON BASIC RESEARCH NEEDS  
ELECTRICAL ENERGY STORAGE**



## **Workshop on Basic Research Needs Electrical Energy Storage**

**April 2-4, 2007**

Bethesda North Marriott 5701 Marinelli Road, Bethesda, Maryland 20852

<http://marriott.com/property/propertypage/WASBN>

### **Agendas for Plenary Sessions**

<b>Plenary Opening Session --- Monday, April 2, 2007</b>		
Moderator: John Goodenough – University of Texas-Austin		
7:30 am - 8:30 am	Registration and Continental Breakfast	
8:30 am - 8:40 am	Welcome and Workshop Charter BES Energy Security Plan	Pat Dehmer, Director, Office of Basic Energy Sciences
8:40 am - 8:50 am	Introduction of Workshop Leadership	John Goodenough, Workshop Chair, University of Texas - Austin
8:50 am - 9:15 am	Research Needs: A Transportation Perspective	Tien Duong, Office of FreedomCAR and Vehicle Technologies, DOE-EERE
9:15 am - 9:40 am	Electrical Energy Storage—Technology and Applications	Imre Gyuk, Program Manager Energy Storage Research, DOE-OE
9:40 am - 10:10 am	Break	
10:10 am - 10:50 am	The Li-ion Battery Technology: What are the Present Issues and Future Challenges	Jean-Marie Tarascon, Universite' de Picardie Jules Verne
10:50 am - 11:30 am	Electrochemical Capacitors: Technology, Applications, Promises, and Needs	John R. Miller, JME, Inc.
11:30 am - 12:10 pm	Recent Advances in Capacitors and Hybrid Energy Sources in Japan	Katsuhiko Naoi, Tokyo University of Agriculture & Technology
12:10-1:10	Lunch	
12:45-1:00	Workshop Format and Goals	John Goodenough, University of Texas-Austin, Workshop Chair; Hector Abruna, Cornell University and Michelle Buchanan, ORNL, Workshop co-Chairs
1:00-1:45	Introduction of Panel Topics	Panel Leads: Stan Whittingham, Binghamton University; Steve Visco, LBNL; Yury Gogotsi, Drexel University; Bruce Dunn, UCLA; Andrew Gewirth, UIUC; Dan Nocera, MIT

### **Workshop Breakout Sessions**

**Monday, April 2, 2007, 1:45 PM through Wednesday, April 4, 2007, 1:00 PM**

(Detailed breakout sessions agenda and meeting room assignments will be provided separately)

### **Plenary Closing Session --- Wednesday, April 4, 2007**

Moderator: Michelle Buchanan, Oak Ridge National Laboratory

1:00 pm - 1:30 pm	Grand Challenges	John Goodenough, University of Texas-Austin, Workshop Chair; Hector Abruna, Cornell University and Michelle Buchanan, ORNL, Workshop co-Chairs
1:30 pm – 2:30 pm	Chemical Storage Science Panel Survey and Priority Research Directions	Panel 1
2:30 pm – 3:30 pm	Capacitive Storage Science Panel Survey and Priority Research Directions	Panel 2
3:30 pm – 4:30 pm	Cross-Cutting Panel Survey and Priority Research Directions	Panel 3
4:30 pm – 4:45 pm	Workshop Concluding Remarks	John Goodenough, University of Texas-Austin, Workshop Chair; Hector Abruna, Cornell University and Michelle Buchanan, ORNL, Workshop co-Chairs
4:45 pm – 5:00 pm	Final Closing Remarks	Pat Dehmer, Director, Office of Basic Energy Sciences
5:00 pm	Workshop Adjourns	

### **Workshop Report Writing Session**

**Wednesday, April 4, 2007, 7:00 PM - Thursday, April 5, 4:00 PM**

(Workshop Chair, co-Chairs, Panel Leads and Core Writing Groups only)

**Breakout Sessions—Chemical Storage Science  
Monday, April 2, 2007—Forest Glen**

**Panel Co-Leads: Steven Visco (LBNL) and  
Stanley Whittingham (Binghamton University)**

2:00 – 2:15 p.m.	Panel Leads: Introduction
2:15 – 2:35 p.m.	Glen Amatucci: Systems
2:35 – 2:55 p.m.	Mike Thackeray: Cathodes
2:55 – 3:15 p.m.	Martin Winter: Anodes and Electrolytes
3:15 – 3:30 p.m.	Gerbrand Ceder: Theory and Modeling
3:30 – 3:50 p.m.	Clare Grey: Characterization
3:50 – 4:10 p.m.	BREAK
4:10 – 5:30 p.m.	Discuss PRDs
5:30 – 7:00 p.m.	Working Dinner (Salon F&G)
7:00 – 9:00 p.m.	Discuss PRDs

**Breakout Sessions—Capacitive Storage Science  
Monday, April 2, 2007—Brookside**

**Panel Co-Leads: Bruce Dunn (University of California) and  
Yury Gogotsi (Drexel University)**

2:00 – 2:15 p.m.	Panel Leads: Introduction
2:15 – 2:35 p.m.	Andy Burke: Capacitive Devices and Systems
2:35 – 2:55 p.m.	Patrice Simon: Materials for EDLCs
2:55 – 3:15 p.m.	Sam Jenekhe: Pseudocapacitor Materials
3:15 – 3:30 p.m.	BREAK
3:30 – 3:50 p.m.	Michel Armand: Electrolytes
3:50 – 4:10 p.m.	Katsumi Kaneko: Theory and Modeling
4:10 – 5:30 p.m.	Discuss PRDs
5:30 – 7:00 p.m.	Working Dinner (Salon F&G)
7:00 – 9:00 p.m.	Discuss PRDs





## WORKSHOP PARTICIPANTS

### Workshop Chair

John B. Goodenough, University of Texas, Austin

### Workshop Co-chairs

Héctor D. Abruña, Cornell University

Michelle V. Buchanan, Oak Ridge National Laboratory

### Panel Leads

Bruce Dunn, University of California, Los Angeles

Andrew Gewirth, University of Illinois

Yury Gogotsi, Drexel University

Daniel Nocera, Massachusetts Institute of Technology

Steven Visco, Lawrence Berkeley National Laboratory

M. Stanley Whittingham, Binghamton University

### Plenary Speakers

Tien Duong, Energy Efficiency and Renewable energy, U.S. Department of Energy

Imre Gyuk, Electricity Delivery and Energy Reliability, U.S. Department of Energy

John R. Miller, JME, Inc.

Katsuhiko Naoi, Tokyo University of Agriculture and Technology

Jean-Marie Tarascon, Université de Picardie Jules Verne

### Panel 1: Chemical Storage Sciences

Glenn Amatucci, Rutgers, The State University of New Jersey

Khalil Amine, Argonne National Laboratory

C. Austen Angell, Arizona State University

Gerbrand Ceder, Massachusetts Institute of Technology

Yet-Ming Chiang, Massachusetts Institute of Technology

Heike Gabrisch, University of New Orleans

Clare Grey, State University of New York at Stony Brook

T. Richard Jow, U.S. Army Research Laboratory

Robert Kostecki, Lawrence Berkeley Laboratory

Linda Nazar, University of Waterloo

Rosa Palacin, Campus de la Universitat Autònoma de Barcelona

Debra Rolison, U.S. Naval Research Laboratory

Ann Marie Sastry, University of Michigan

Venkat Srinivasan, Lawrence Berkeley National Laboratory

Michael Thackeray, Argonne National Laboratory

Martin Winter, Graz University of Technology

Atsuo Yamada, Tokyo Institute of Technology

### Panel 2: Capacitive Storage Sciences

Michel Armand, Université de Picardie Jules Verne

Martin Z. Bazant, Massachusetts Institute of Technology

Ralph Brodd, Broddarp

Andrew Burke, University of California–Davis

Ranjan Dash, Maxwell Technologies

John Ferraris, University of Texas  
Wesley Henderson, U.S. Naval Academy  
Samson Jenekhe, University of Washington  
Katsumi Kaneko, Chiba University  
Prashant Kumta, Carnegie Mellon University  
Keryn Lian, University of Toronto  
Jeffrey Long, U.S. Naval Research Laboratory  
Joel Schindall, Massachusetts Institute of Technology  
Bruno Scrosati, Universti di Roma  
Patrice Simon, Universite Paul Sabatier  
Henry White, University of Utah

### **Panel 3: Crosscutting Sciences**

Christian Amatore, UMR 8640 “Pasteur”  
Greg Baker, Michigan State University  
Larry Curtiss, Argonne National Laboratory  
Marten denBoer, Queens College of City University of New York  
John Harb, Brigham Young University  
Royce Murray, University of North Carolina  
Reginald Penner, University of California, Irvine  
Hrvoje Petek, University of Pittsburgh  
Daniel Scherson, Case Western Reserve University  
Ralph White, University of South Carolina

### **Office of Basic Energy Sciences**

Kristin Bennett  
Linda Blevins  
Patricia Dehmer  
Patrick Dobson  
James Horwitz  
Richard Kelley  
Aravinda Kini  
Harriet Kung  
Paul Maupin  
John Miller  
Eric Rohlfig  
Mark Spitler  
John Vetrano  
Jane Zhu

### **Observers**

Julie Carruthers, Office of Science (DOE-SC)  
Adam Cohen, Office of Science (DOE-SC)  
Kohl Gill, Office of Science (DOE-SC)  
Ahsan Khan, Office of Science (DOE-SC)  
Uday Varadarajan, Office of Science (DOE-SC)  
Michelle Anderson, Office of Naval Research  
Terry Aselage, Sandia National Laboratories  
Cyrus Ashtiani, DaimlerChrysler Corporation

Frederick Baker, Oak Ridge National Laboratory  
Nitash Balsara, Lawrence Berkeley National Laboratory  
Jim Beckwith, Central Intelligence Agency  
John Boyes, Sandia National Laboratories  
Gilbert Brown, Oak Ridge National Laboratory  
Albarran Carlos Ponce de Leon, University of Southampton  
Frank Delnick, Sandia National Laboratories  
Dan Doughty, SION Power Corporation  
Nancy Dudley, Oak Ridge National Laboratory  
Kimberly Duncan, American Physical Society  
James Eberhardt, Office of FreedomCAR and Vehicle Technologies  
Joe Farmer, Lawrence Livermore National Laboratory  
Peter Fedkiw, North Carolina State University  
Fernando Garzon, Los Alamos National Laboratory  
Kevin Gering, Idaho National Laboratory  
Doon Gibbs, Brookhaven National Laboratory  
Ron Gordon, University of Utah  
Ahsan Habib, GM Research and Development Center  
Robert Hamlen, Consultant  
Mason Harrup, Idaho National Laboratory  
David Hobbs, Savannah River National Laboratory  
Jason Hodges, Oak Ridge National Laboratory  
David Howell, Energy Efficiency and Renewable energy, U.S. Department of Energy  
Bob Hwang, Sandia National Laboratories  
David Ingersoll, Sandia National Laboratories  
Haresh Kamath, EPRI  
Peter Kofinas, University of Maryland  
Jun Liu, Pacific Northwest National Laboratory  
Cynthia Lundgren, Army Research Laboratory  
Robert Mantz, U.S. Army  
Michelle Manzo, National Aeronautics and Space Administration  
Steve Martin, Ames Laboratory  
Jim Miller, Argonne National Laboratory  
Jim Misewich, Brookhaven National Laboratory  
Patrick Moseley, Journal of Power Sources  
Ted Motyka, Savannah River National Laboratory  
Sekazi Mtingwa, Massachusetts Institute of Technology  
John Newman, Lawrence Berkeley National Laboratory  
Mike Pellin, Argonne National Laboratory  
Lawrence Pratt, Los Alamos National Laboratory  
Kendra Rand, Materials Research Society Bulletin  
Paul Scott, ISE Corporation  
Ed Shaffer, Army Research Laboratory  
Paul Trulove, U.S. Naval Academy  
John Turner, National Renewable Energy Laboratory  
Jud Virden, Pacific Northwest National Laboratory  
Andrew Williamson, Lawrence Livermore National Laboratory  
Phyllis Yoshida, Energy Efficiency and Renewable energy, U.S. Department of Energy  
Kevin Zavadil, Sandia National Laboratories



**DISCLAIMER**

This report was prepared as an account of work sponsored by an agency of the United States Government. Neither the United States government nor any agency thereof, nor any of their employees, makes any warranty, express or implied, or assumes any legal liability or responsibility for the accuracy, completeness, or usefulness of any information, apparatus, product, or process disclosed, or represents that its use would not infringe privately owned rights. Reference herein to any specific commercial product, process, or service by trade name, trademark, manufacturer, or otherwise, does not necessarily constitute or imply its endorsement, recommendation, or favoring by the United States Government or any agency thereof. The views and opinions of authors expressed herein do not necessarily state or reflect those of the United States Government or any agency thereof.

