



Hybrid Hydraulic System Development for Commercial Vehicles

Presented at the SCAQMD Hydraulic Hybrid Forum
November 15, 2007

Brad Bohlmann
Business Development Manager, Advanced Technology

Eaton: A Leader in Commercial Hybrids



- Eaton is the only hybrid system supplier developing both hybrid electric and hybrid hydraulic solutions for commercial vehicles.
- Eaton is in the unique position of being able to offer our customers the best possible solution, not just the one we have.

Eaton Hybrid Programs



Electric Hybrids

- Eaton has focused on building parallel hybrid electric systems, as they provide the best balance between costs and benefits.
- FedEx Express, UPS, and a number of utilities have incorporated the Eaton hybrid electric system into their fleets. We are also working with Coca Cola and a number of others.



Hydraulic Hybrids

- Eaton has active programs on both parallel and series hybrid hydraulic systems. The target applications range from light to heavy duty commercial vehicles.
- The first Eaton parallel hybrid hydraulic system will be commercialized for refuse trucks in 2008.



Hybrid Electric and Hybrid Hydraulic Comparison



- The value proposition for all hybrids is duty cycle dependent.
- Hybrid electric systems have much higher energy storage capacity, and generally have low to moderate power capabilities.
- In addition, hybrid electric systems can more easily provide an auxiliary electric power source.

Hybrid Electric and Hybrid Hydraulic Comparison



- Hybrid hydraulic systems have much higher power capabilities, for a shorter length of time.
- In addition, they typically regenerate much more braking energy than hybrid electric systems.
- Eaton has studied both technologies in a wide variety of applications. We believe that there are significant opportunities for both technologies. In some cases the choice of technology is clear; in others it is less so. The market is still evaluating both technologies in many cases.



Why Hydraulics?

- High power density
- High energy transfer rate
- Leverages proven technologies
- Packaging (size, flexibility)



Why Now?

- Significant improvements have been made by Eaton recently in a number of areas including:
 - ◆ External leakage
 - ◆ Noise (NVH)
 - ◆ Efficiency
 - ◆ Electrohydraulic controls
 - ◆ Material science for reduced weight
- Market drivers including demand for improved operating costs and lower exhaust emissions.



Why Eaton?

- Global Leader in fluid power design and manufacture of products and systems.
- Currently produces over 500,000 pump/motors per year with very high reliability in the field.
- Strong knowledge of associated technologies:
 - Pumps and motors
 - Valves
 - Electronic controls
 - Accumulators
 - Fluids



Why Eaton?

- World-class expertise in noise, vibration, and harshness (NVH) reduction for on- and off-highway applications.
- Tier 1 supplier to the truck and automotive industries.
- Unique portfolio of complimentary products and technologies.

Eaton's Hybrid Hydraulic Development Roadmap



Fuel Economy Improvement

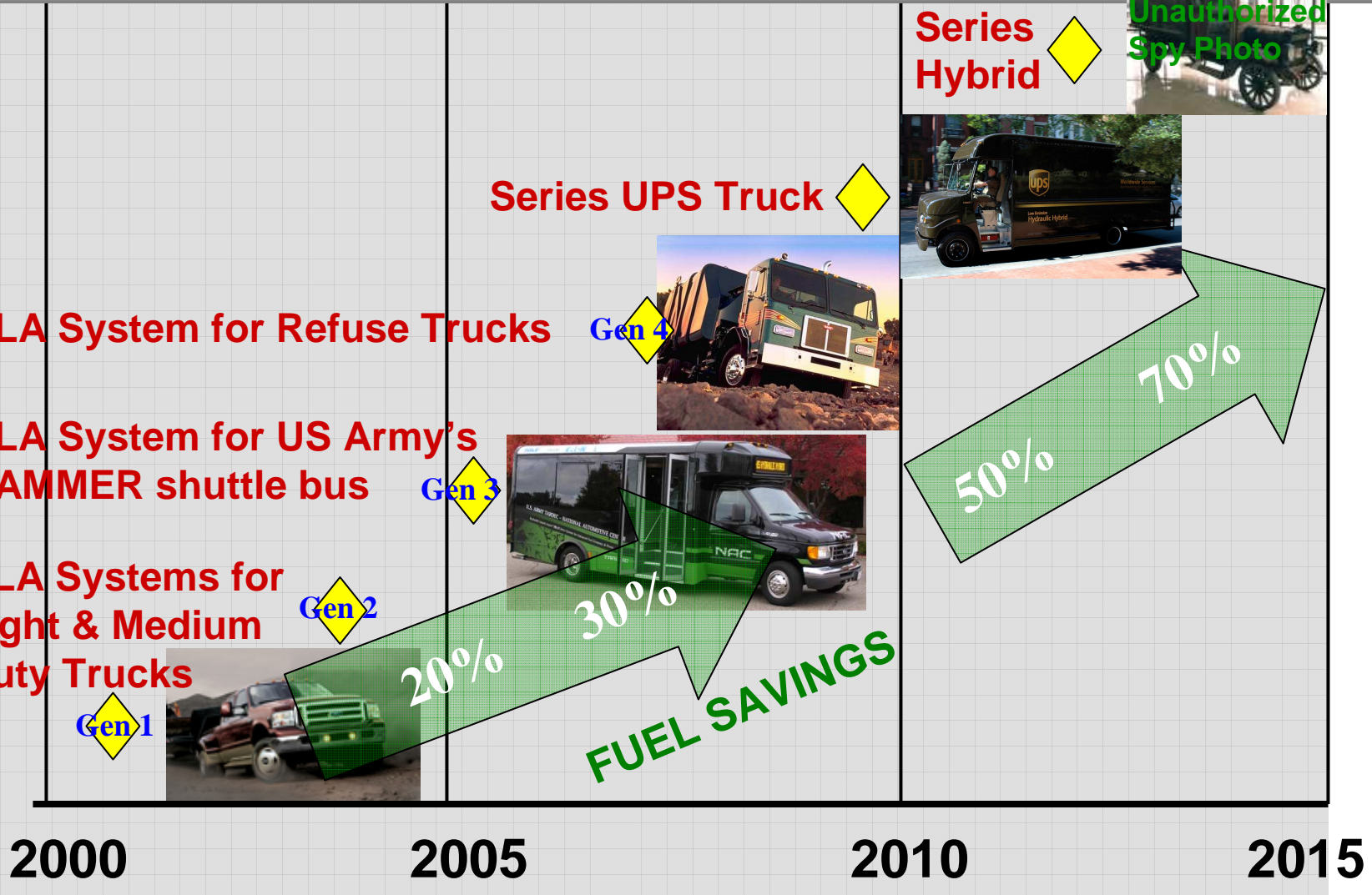

Parallel Hybrid Hydraulic Architecture

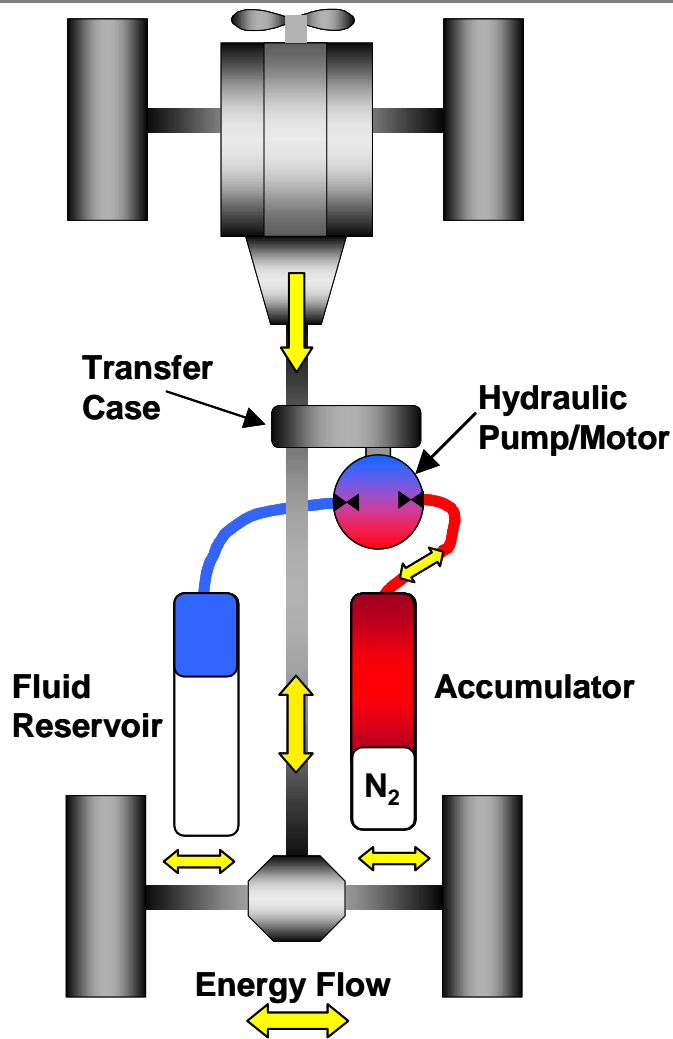

Eaton HLA[®] System for Heavy Duty Trucks

- In a parallel hybrid hydraulic system, the hybrid system is **attached** to the conventional vehicle driveline.
- A parallel system is best suited for vehicles that operate in stop and go duty cycles. Examples include refuse trucks and buses.
- The value proposition is provided through:
 - Improved fuel economy achieved through regeneration of braking energy
 - Lower maintenance costs. Brake life is increased 2-4 times.
 - Improved productivity (e.g., more refuse pickups per day) due to the extra power the HLA system provides.
- Fuel economy and emissions reductions of 20-30+% range and paybacks in 2-3 years are possible in vehicles making frequent stops.

What is the Eaton HLA[®] System?



- The Eaton HLA system is a parallel hybrid hydraulic regenerative braking system.
- The HLA system recovers the majority of the energy normally wasted as heat during braking and uses it to supplement the engine's power during acceleration.
- The HLA system provides the greatest benefit when the vehicle's driving cycle involves stop and go driving.

How does the HLA System work?

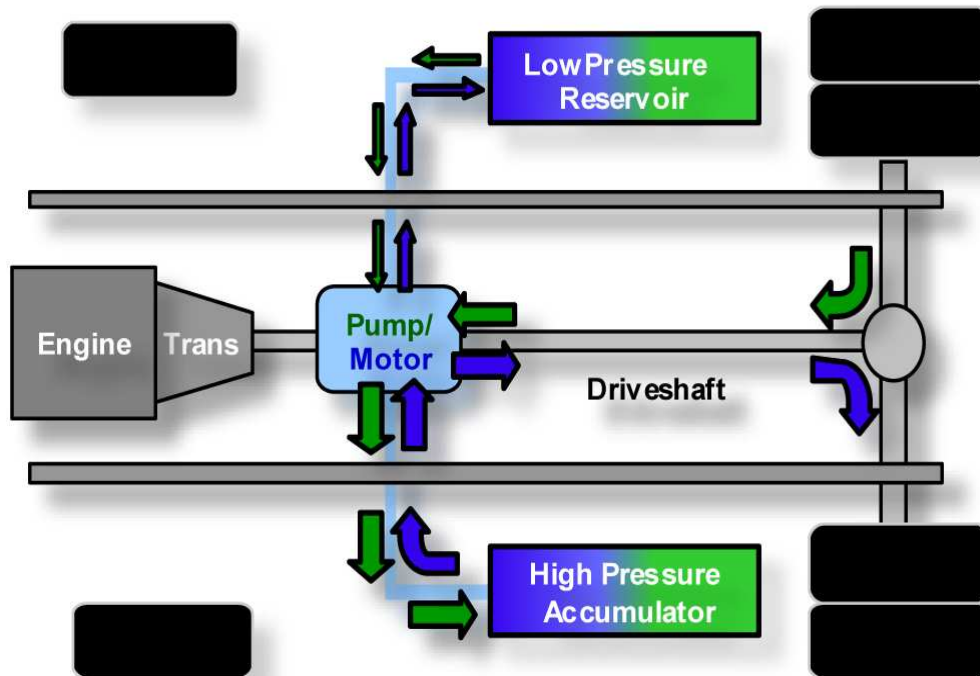

Regeneration Mode

During braking, the vehicle's kinetic energy drives the pump/motor as a pump, transferring hydraulic fluid from the low pressure reservoir to the high pressure accumulator. The fluid compresses nitrogen gas in the accumulator and pressurizes the system.

Launch Assist Mode

During acceleration, fluid in the high pressure accumulator is metered out to drive the pump/motor as a motor. The system propels the vehicle by transmitting torque to the driveshaft.

Current Status: HLA System for Light & Medium Duty



- A diesel hybrid hydraulic shuttle bus on a Ford E450 chassis was delivered to the US Army in May 2006.
- The vehicle met or exceeded all of the program goals including demonstrating >25% fuel economy improvement on the EPA city driving cycle and reducing in-cab noise during acceleration by more than 6 dBA.



Current Status: HLA System for Refuse



- Heavy duty HLA system development is focusing initially on solid waste compaction (refuse) trucks.
- Eaton plans to begin fielding a fleet of 12 refuse trucks with pre-production HLA systems in late 2007.
- Eaton plans to commercialize the HLA system for refuse applications in 2008.

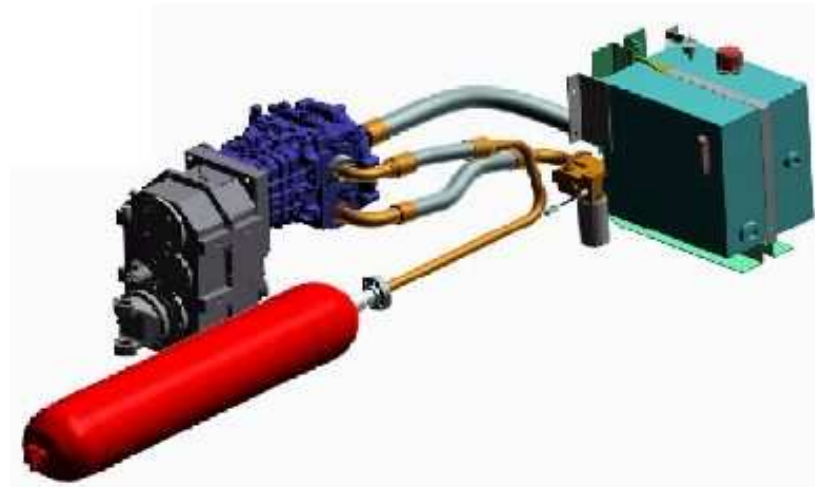

Class 8 Refuse Truck Test Data



	Economy Mode	Productivity Mode
Fuel Economy Improvement ¹	28%	17%
Vehicle Acceleration	+2%	+26%
Productivity (Cycle Time Improvement)	N/A	11.5%
Brake Life	>2x	>2x

¹ During waste pickup

Vehicle Configuration: Peterbilt 320 chassis @ 63,000lb GVW
CAT C-10 315 hp engine
Allison 4560 5-speed automatic transmission
100 feet between stops

Series Hybrid Hydraulic Architecture

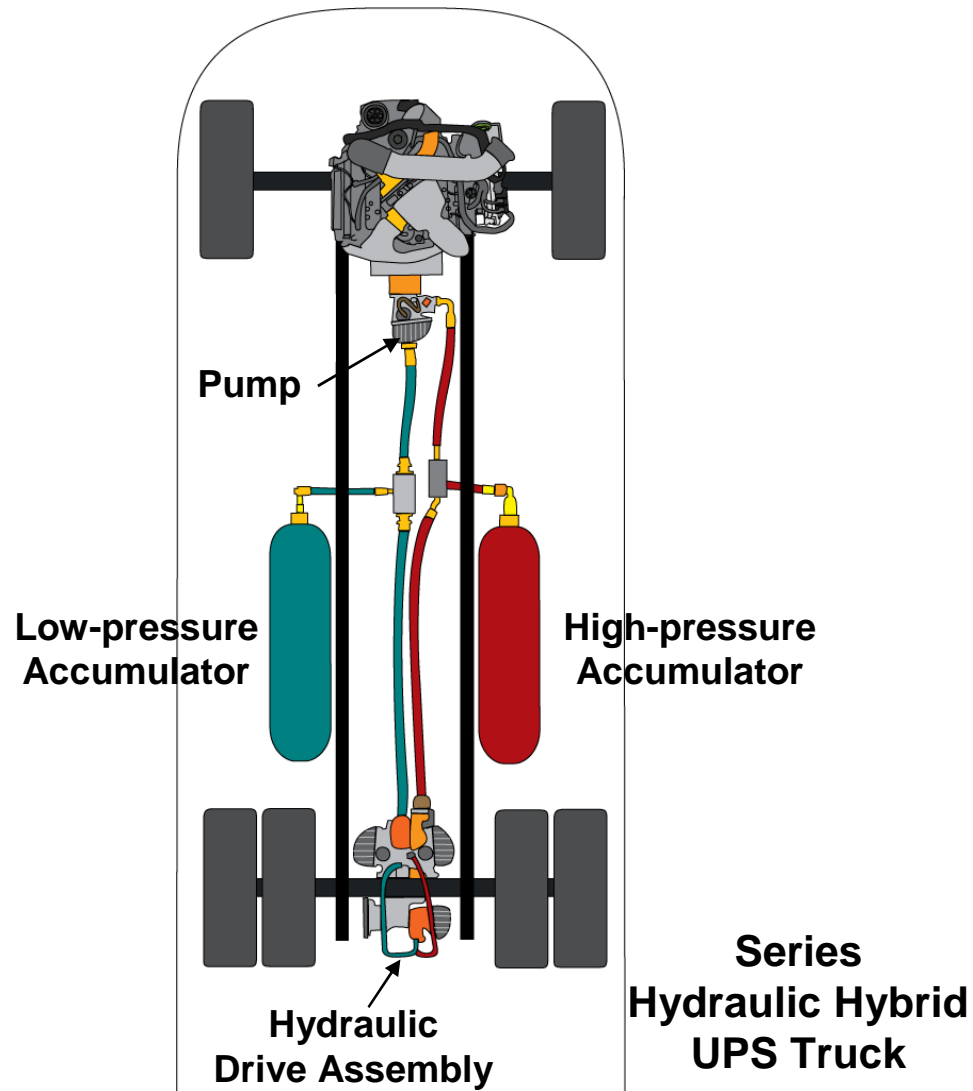

- In a series hybrid hydraulic, the conventional vehicle driveline is **replaced** by the hybrid system. The transmission and driveline are removed and energy is transferred from the engine to the drive wheels through fluid power.
- The technology is suited to a broader range of applications than parallel hybrid hydraulic systems, though benefits will be greatest in vehicles in stop and go duty cycles.
- The value proposition is provided by:
 - operating the engine at a “sweet spot” of best fuel consumption facilitated by the IVT functionality of the series hybrid system
 - regeneration of braking energy
 - shutting the engine off when not needed

Current Status: Series Hybrid Hydraulic Drivetrain



- In 2001, Eaton signed a Cooperative Research and Development Agreement with the US EPA to develop hydraulic hybrid components and systems.
- The EPA, Eaton, International Truck and Engine, UPS, and the US Army partnered to build the world's first hydraulic hybrid parcel delivery truck. This vehicle was first shown publicly in June 2006.

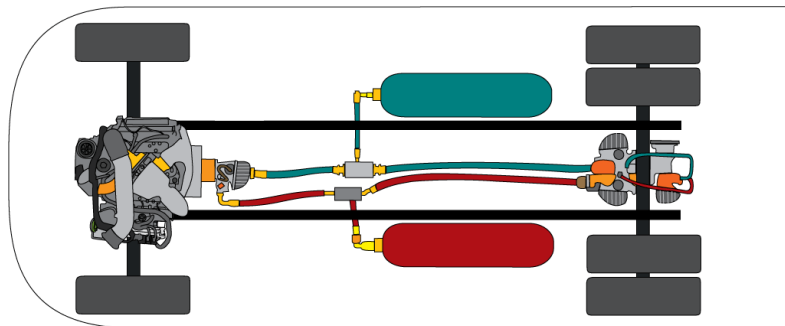

Current Status: Series Hybrid Hydraulic Drivetrain



- The series hybrid hydraulic UPS truck demonstrated 50-70% better fuel economy than a standard truck in chassis dynamometer testing over the EPA City Cycle with no degradation in performance.
- This vehicle was put into parcel delivery service in the Detroit area and achieved 45-50% better fuel economy in “real world” use.



Current Status: Series Hybrid Hydraulic Drivetrain



- Eaton is working on “advanced series” hybrid hydraulic technologies that show promise of even greater benefits.
- The advanced series hybrid systems provide the potential for better performance, higher efficiency, lower operating costs, lower emissions, and safer vehicle operation.



In Summary



- Eaton has made a substantial commitment to develop technologies that will simultaneously reduce energy consumption and exhaust emissions.
- Eaton is developing a portfolio of hybrid electric and hybrid hydraulic products that will provide solutions in a wide variety of on- and off-highway vehicles.
- Eaton is currently offering hybrid electric products for commercial vehicle applications. Our hybrid hydraulic products will enter the market in 2008.

The Power of One Eaton

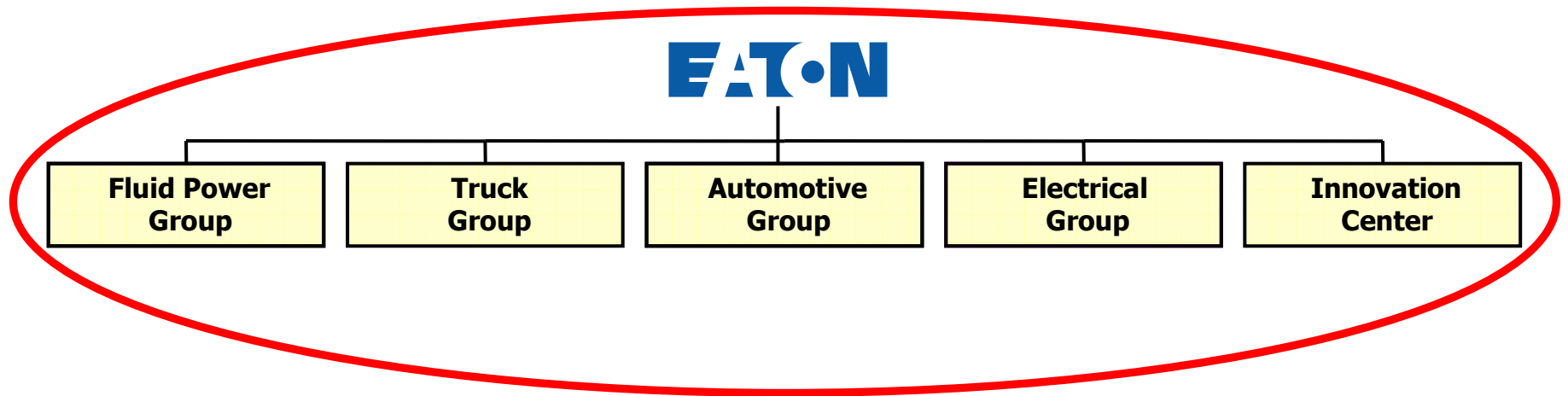

Eaton is uniquely positioned with world-class engineering expertise and manufacturing capabilities in the Fluid Power, Truck, Automotive, and Electrical markets.

Eaton Corporation
2006 Sales \$12.4B
63,000 employees
Sells products to customers in more than 140 countries

Thank you!



For additional information, please contact:

Brad Bohlmann

(952) 937-7137

BradleyFBohlmann@Eaton.com

