

# **Forensic Casework Applications of mtDNA**

Suni M. Edson

Armed Forces DNA Identification  
Laboratory (AFDIL)

# Outline

- Mitochondrial DNA as a Means of Identification
- Laboratory Design
- Degraded Skeletal Remains
  - Sample Selection
  - Contamination Control
  - Extraction Methods
  - Amplification and Sequencing Strategies
- Acquisition of Appropriate Reference Materials
- Validation

# Armed Forces DNA Identification Laboratory

- Established in 1990
  - With the primary purpose of identifying the remains of missing US servicemembers.
- Part of the Armed Forces Institute of Pathology (AFIP) and the American Registry of Pathology (ARP)



# AFDIL

- Part of the Armed Forces Medical Examiner System (AFMES)
  - Current military death cases
- Partner with Joint POW/MIA Accounting Command – Central Identification Laboratory
  - Missing military personnel from past US conflicts



# AFDIL Organization

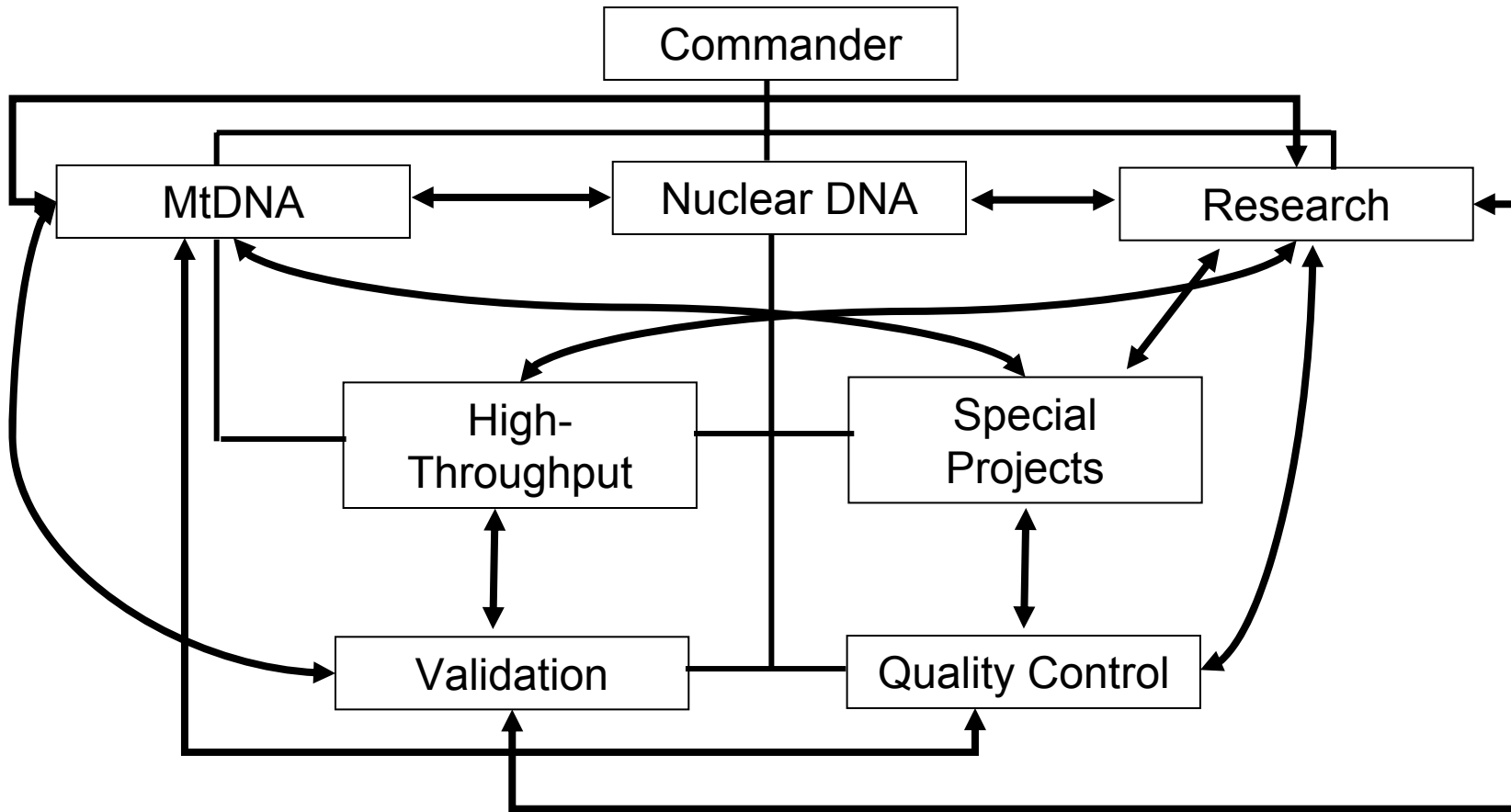

# **Mitochondrial DNA as a Means of Identification**

When do you need it and why?

# Why go to mtDNA?

- Disadvantages
  - mtDNA is not a positive form of identification

# Not a means of positive ID

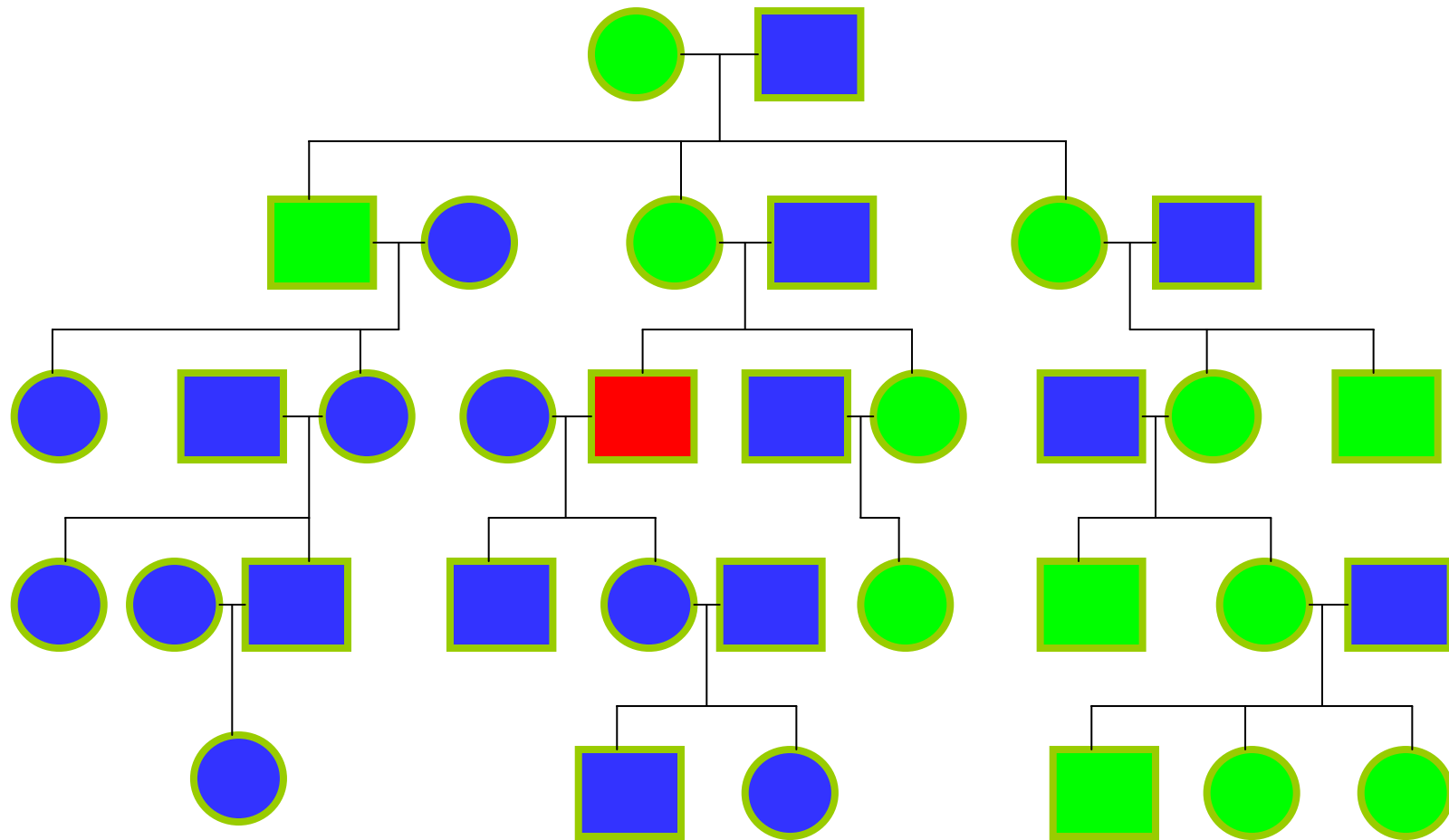



# Why go to mtDNA?

- Disadvantages
  - mtDNA is not a positive form of identification
    - 7% of US Caucasians have the most common type
    - Most common type in US African Americans is shared by ~2.25%.
    - Additional information is required for identification.

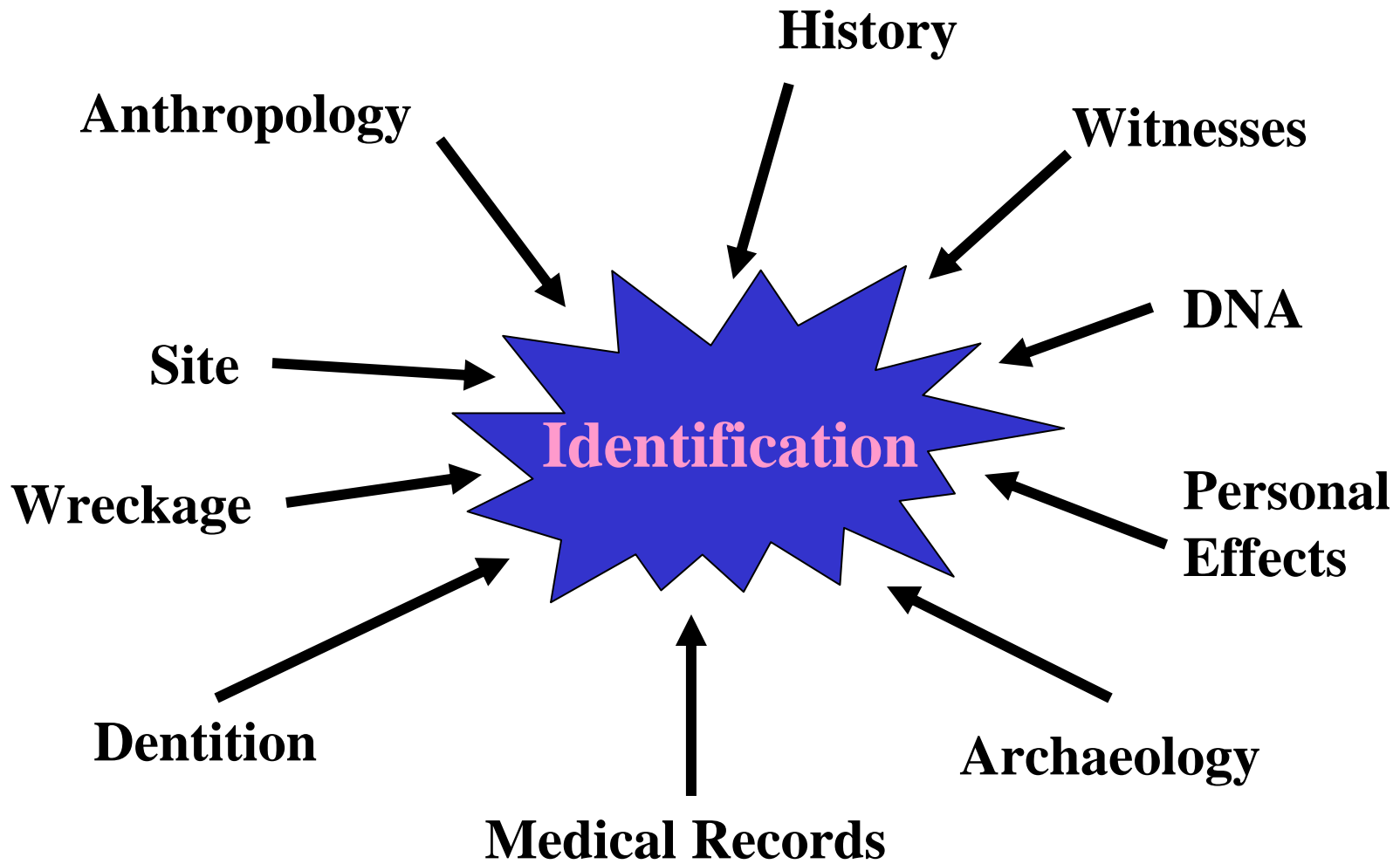

# Why go to mtDNA?

- Disadvantages
  - mtDNA is not a positive form of identification
    - 7% of US Caucasians have the most common type
    - Most common type in US African Americans is shared by ~2.25%.
    - Additional information is required for identification.
  - Easily contaminated with modern DNA

# Contamination

- Modern DNA can easily be introduced and overwhelm target DNA from the sample.
  - Due to the sensitivity of the reaction
    - Increased cycle number
    - Increased Taq
- Appropriate controls must be implemented to assure that the mtDNA sequence being reported is authentic.
- Laboratories need to be designed to lessen the chances of contamination.

# Why go to mtDNA?

- Disadvantages
  - mtDNA is not a positive form of identification
    - 7% of US Caucasians have the most common type
    - Most common type in US African Americans is shared by ~2.25%.
    - Additional information is required for identification.
  - Easily contaminated with modern DNA
  - Time-consuming and costly

# Nuclear DNA Analysis

Sample Collection



Laboratory



- 24-36 hours
- ~\$100 per sample
- Use commercially available kits for processing

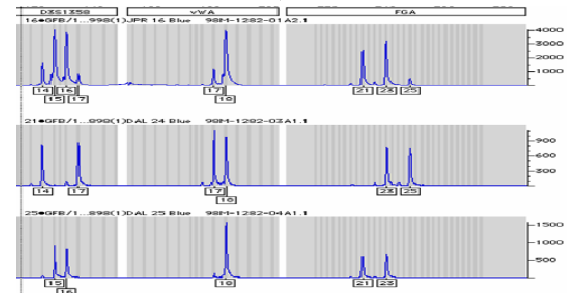

Profile generation

# MtDNA Analysis

Sample Collection



Laboratory



- 1-6 weeks post-submission to the laboratory
- ~\$1,000 per sample
- Custom designed primers

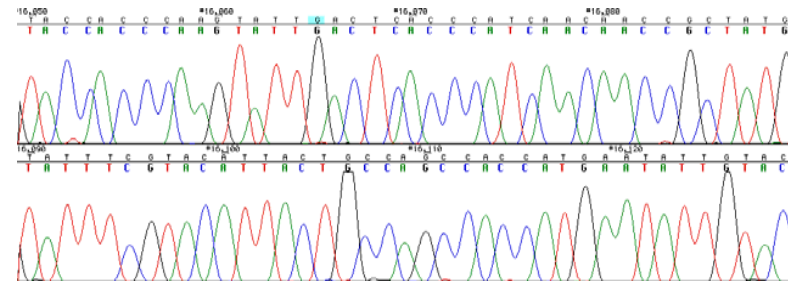

Profile generation

# Why go to mtDNA?

- Advantages
  - Maternally inherited
    - The pool of potential references is greatly increased.



# Limited references available for nuclear DNA matches

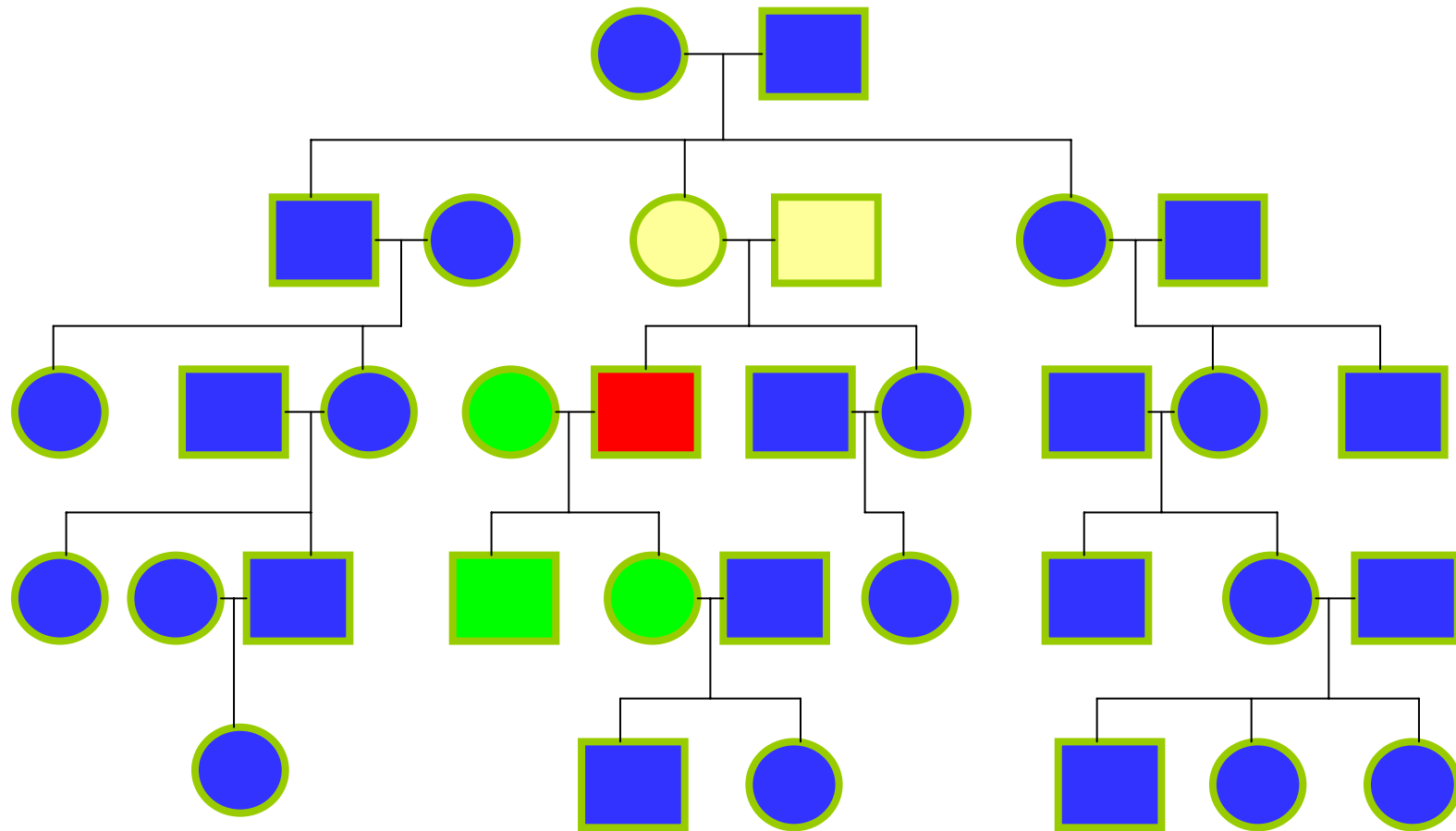

# Maternal inheritance

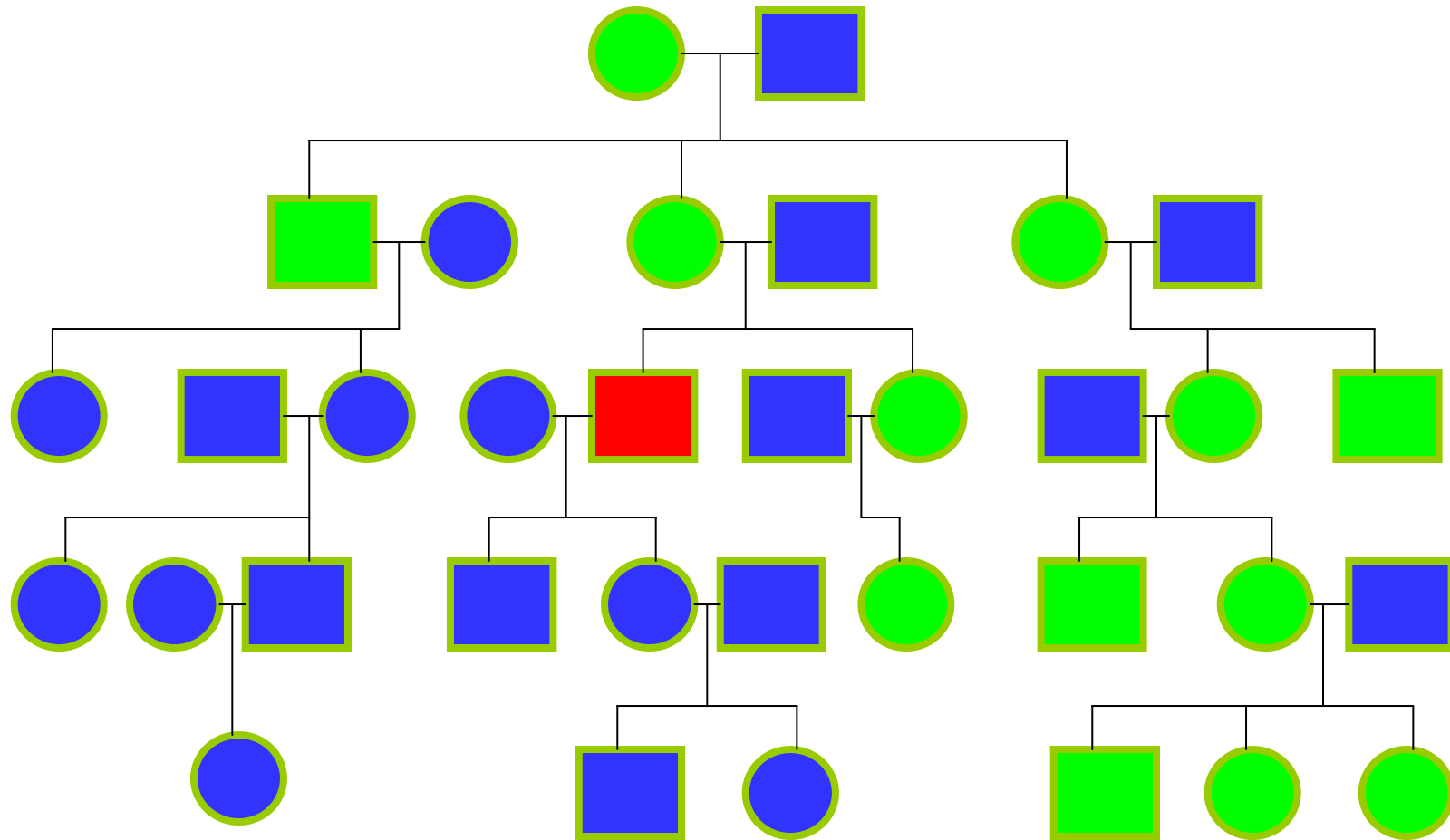

# Why go to mtDNA?

- Advantages
  - Maternally inherited
    - The pool of potential references is greatly increased.
  - Numerous copies of the mitochondrial DNA genome in each cell.

# Multiple copies per Cell

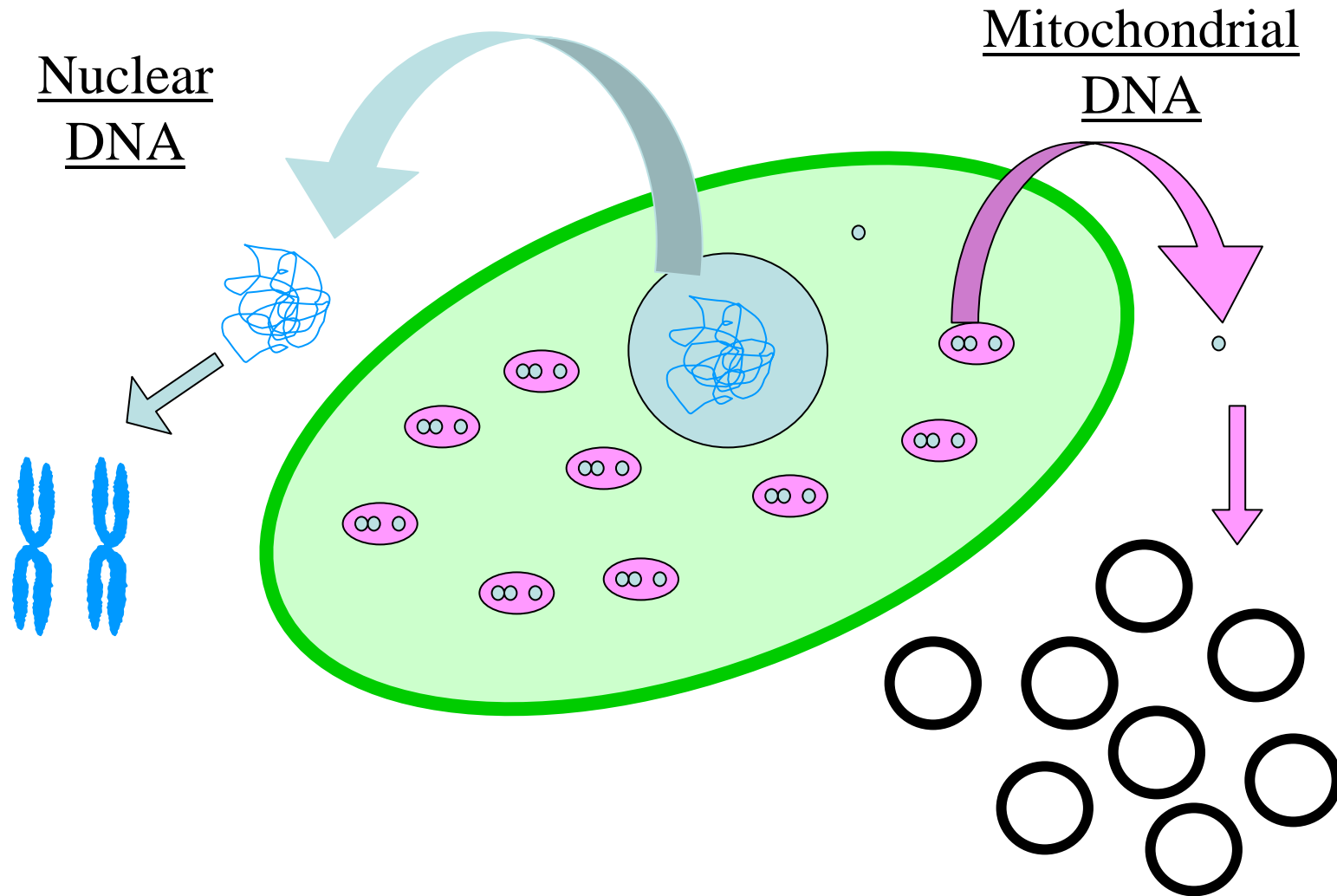

# Why go to mtDNA?

- Advantages
  - Maternally inherited
    - The pool of potential references is greatly increased.
  - Numerous copies of the mitochondrial DNA genome in each cell.
  - Small genome size and multiple copies increase chances of recovering DNA from degraded samples.

# Increased chances of recovering usable DNA

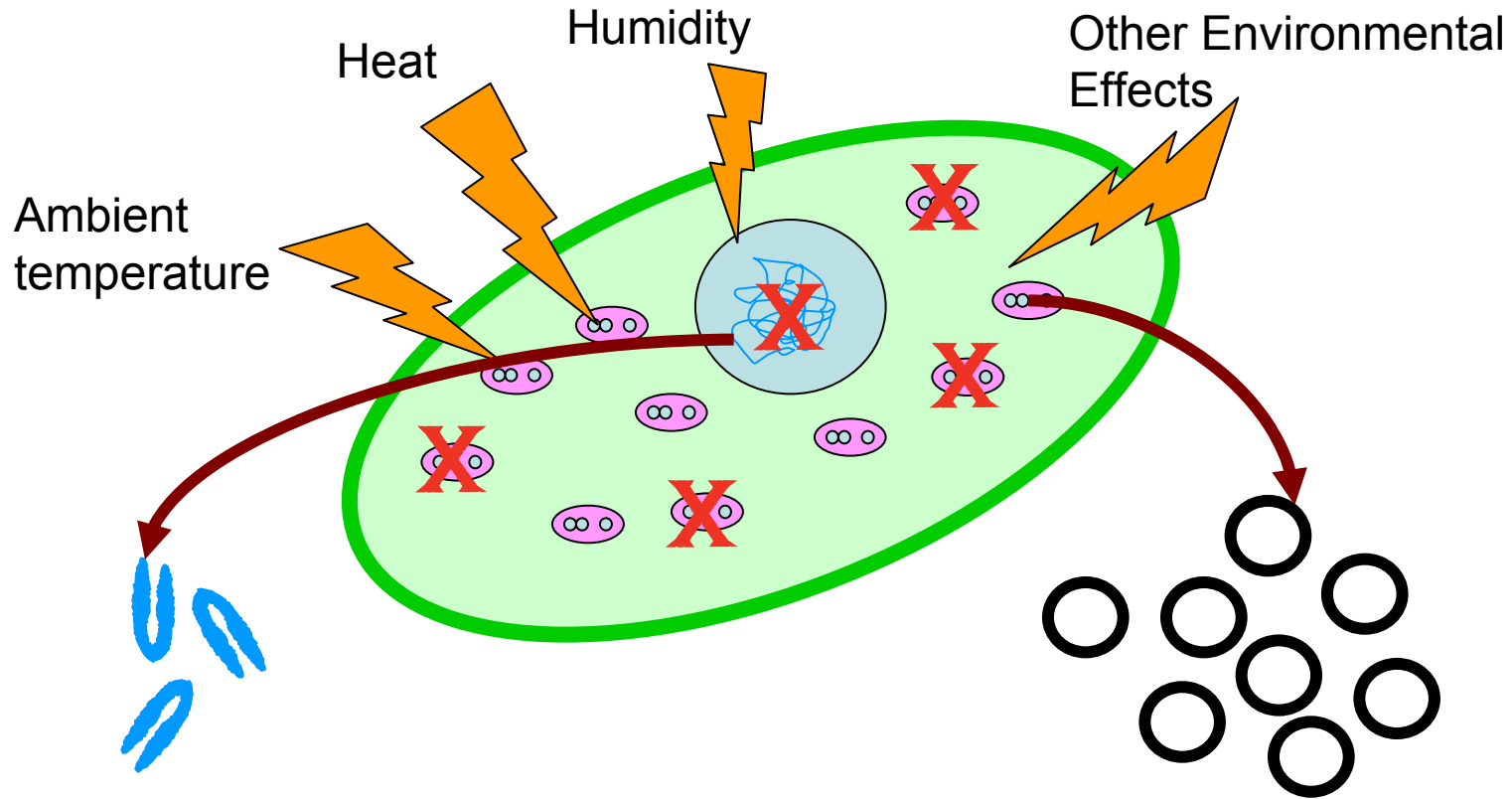

# What type of samples would require mitochondrial DNA?

- Degraded samples
  - Hair with no root
  - Skeletonized remains
  - Teeth
  - Any other type of biological material that has been environmentally damaged and fails to produce a nuclear DNA profile
- Samples where no direct or immediate family reference is available.

# **Laboratory Design**

Organizing Your Space, People,  
and Samples



# Laboratory Design

- All laboratories should be designed to be separated by use.
- At AFDIL, pre-PCR labs are physically separated from post-PCR by magnetically sealed doors and airlocks



# Pre- and post-PCR Separation

- Separation of pre- and post-PCR areas prevents contamination.
  - Amplified product needs to be kept away from low quantity DNA areas.
  - Personnel flow from pre- and post-PCR areas needs to be controlled.



# Pre- and post-PCR Separation

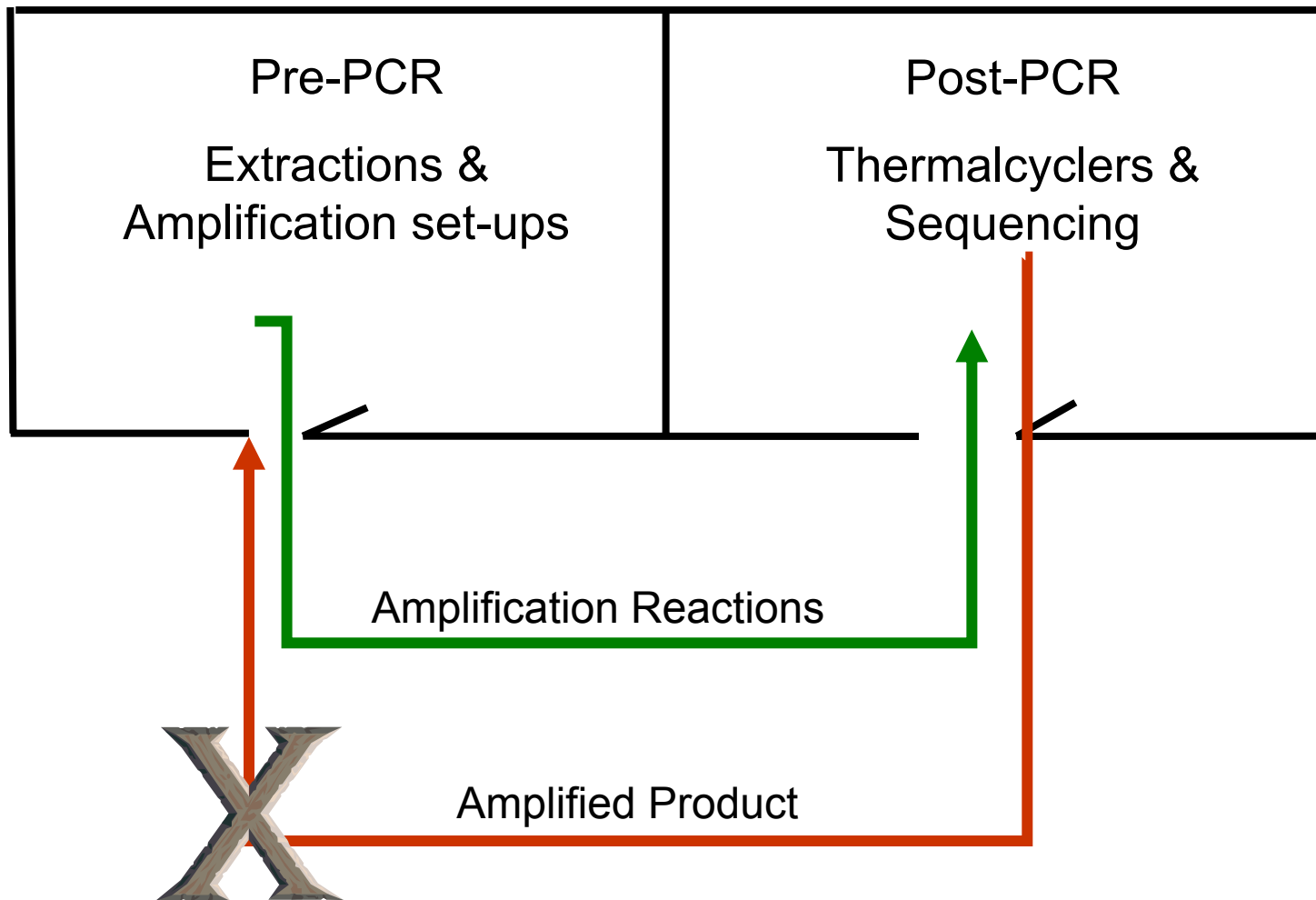

# Pre-PCR Organization

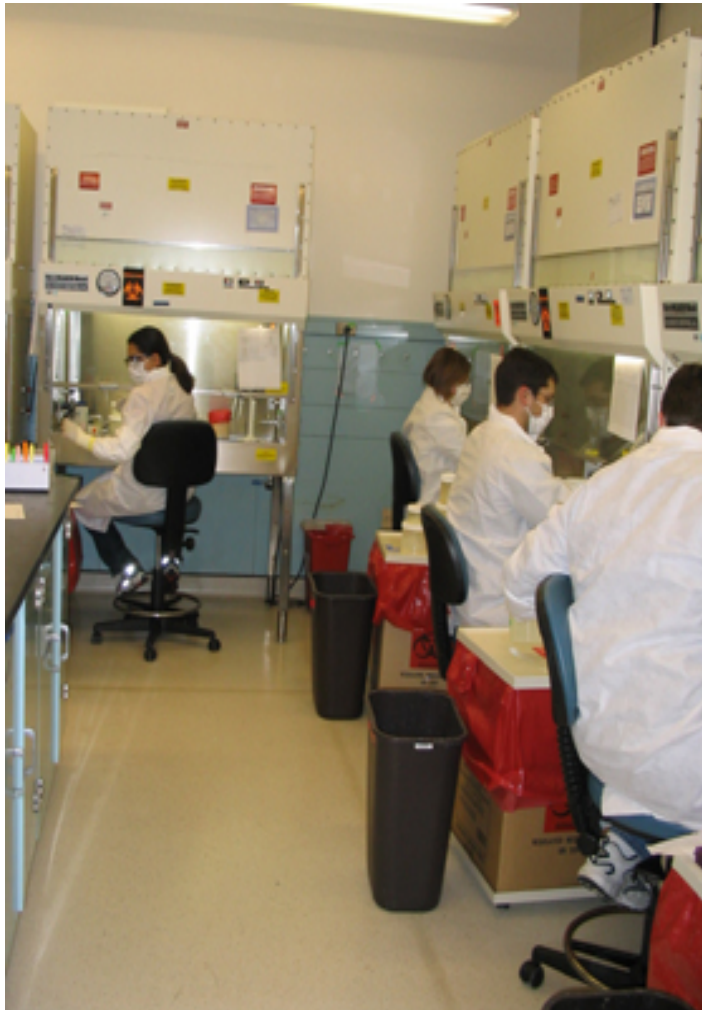

- To further minimize contamination:
  - Pre-PCR lab space can be dedicated to teams of individuals.

# Staff Organization

- Now that the spaces are separated, what do you do with the people?
  - Staff organization can not only reduce contamination but increase efficiency.



# Staff Organization

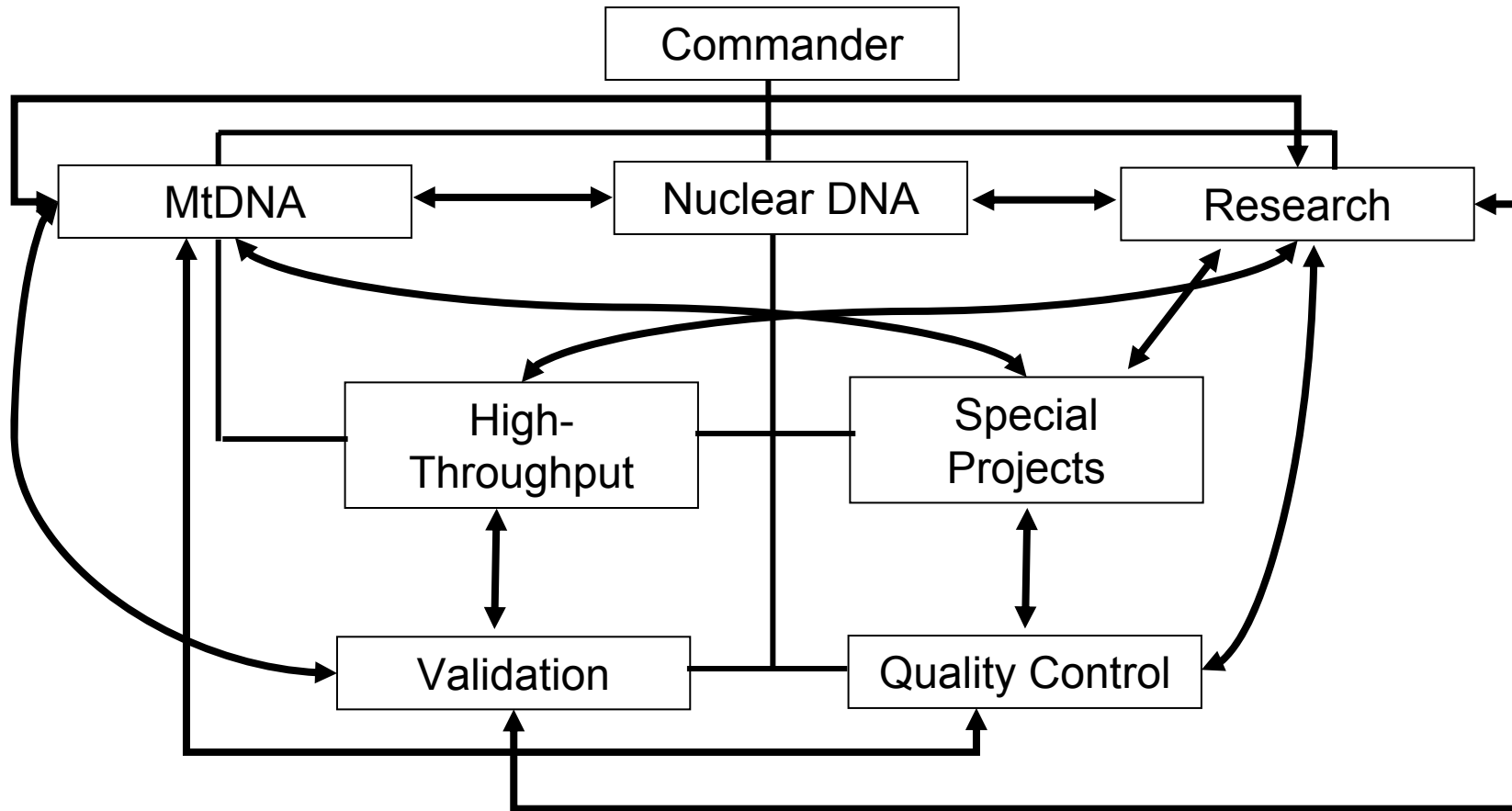

# Division of Labor

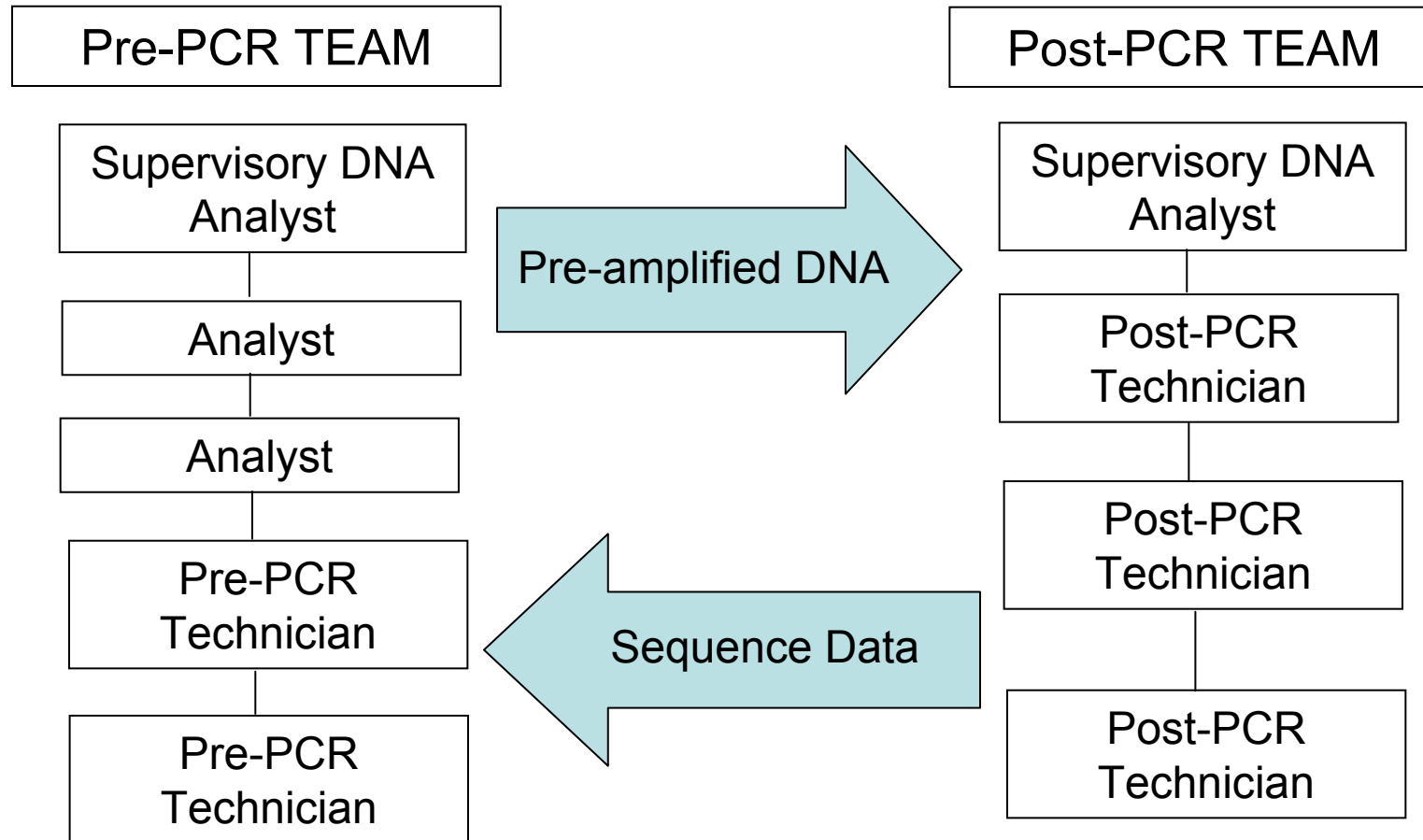

# Evaluation of the Number of Sequencing Reactions Per Month in a Six Month Time Period

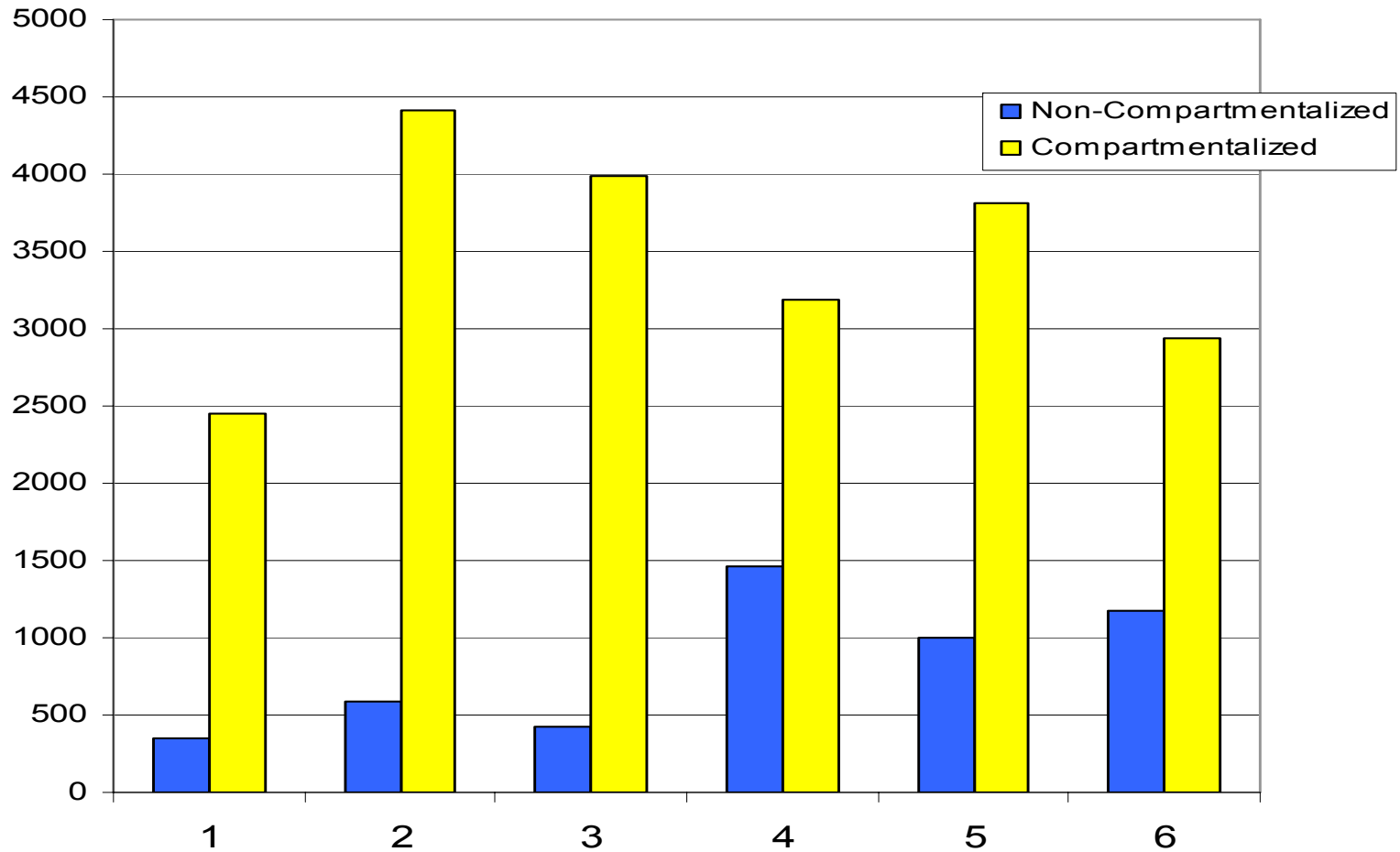



# Sample and Contamination Tracking

- With this type of sample volume comes the additional issues of tracking your samples and contamination.
  - Even if the lab is fairly small, chain of custody issues and overall processing need to be tracked efficiently.
  - Contamination needs to be tracked, found and eradicated before it becomes an issue.

# LIMS System

- An automated computer system is the most efficient method for accomplishing these goals.
- Many laboratory information management systems are available commercially.
- The name of our system is Laboratory Information Systems Application or LISA.

# Case Accessioning



- Names and identifies each piece of evidence that is received.
  - Assigns a sequential case number.
- 
- Controls who has access to which samples based on set of 'privileges'.
  - Tracks Chain of Custody.
  - Every step requires a password even once you are in the system.

# Sample Storage

- Samples need to be stored at the appropriate temperatures.
  - Heat or large temperature fluctuations can cause further degradation of the DNA.
  - Bone material can be stored at  $\leq -20^{\circ}\text{C}$
  - Blood should be dried and stored at  $-20^{\circ}\text{C}$

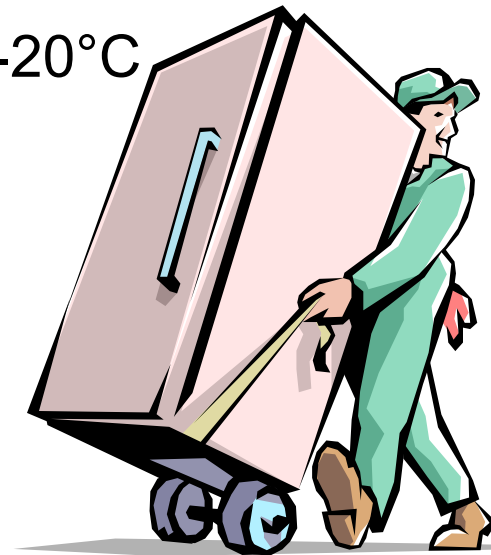

# Lab Processing

- Requires passwords throughout.
- Links all the forms and protocols used at AFDIL together.
- Procedures predicated on the completion of a step are not allowed until that step is finished.
- Designed to be compatible with sequencing equipment.

# Contamination Tracking

- Contamination is a huge challenge in 'ancient' DNA laboratories.
- Must be able to guarantee that the sequence being generated is authentic and not modern.

## How to control for contamination?

- Laboratory design
- Staff databases
- Contamination tracking via LISA
- Amplification controls

# Control Databases

- All members of the staff, laboratory and administrative, at AFDIL have been profiled for both mitochondrial and nuclear DNA.
- The case management module has a separate database specifically for the sequences generated for contaminants

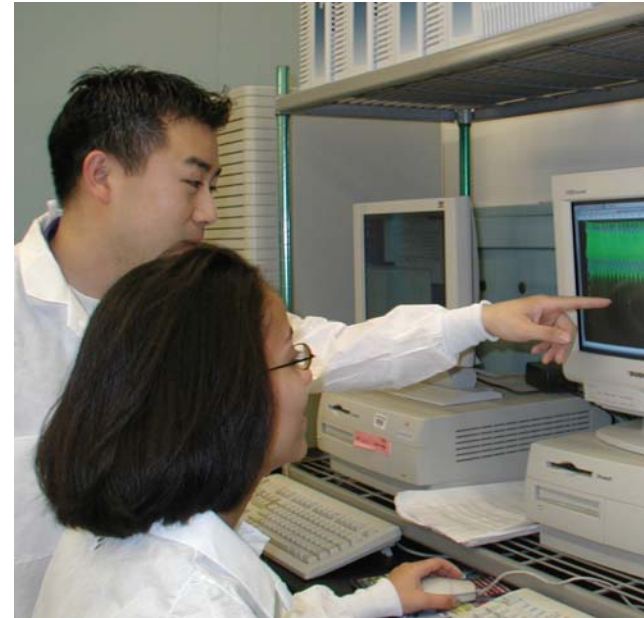

# Contamination Tracking

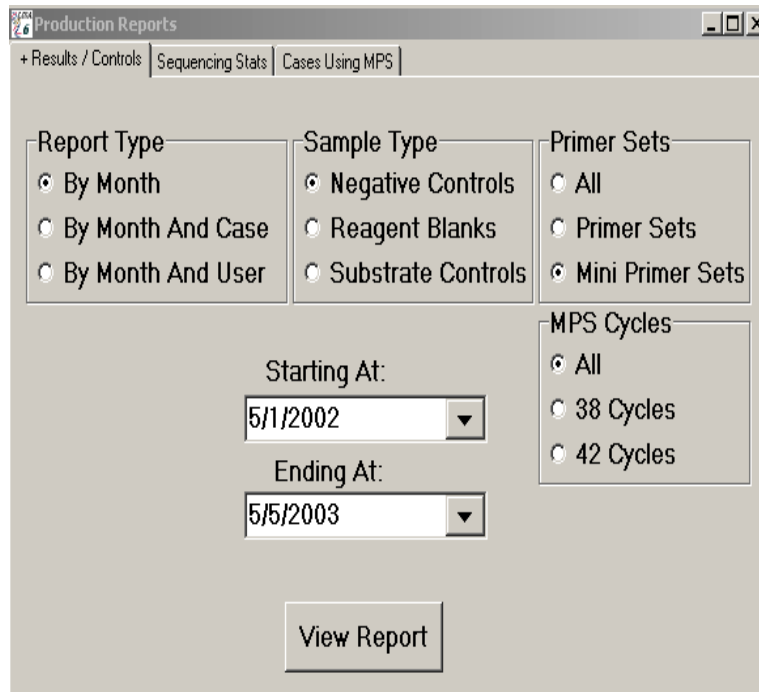

The screenshot shows a software window titled "Production Reports" with three tabs: "+ Results / Controls", "Sequencing Stats", and "Cases Using MPS". The "Cases Using MPS" tab is active. The interface is divided into several sections:

- Report Type:** Three radio button options:  By Month,  By Month And Case, and  By Month And User.
- Sample Type:** Three radio button options:  Negative Controls,  Reagent Blanks, and  Substrate Controls.
- Primer Sets:** Three radio button options:  All,  Primer Sets, and  Mini Primer Sets.
- MPS Cycles:** Three radio button options:  All,  38 Cycles, and  42 Cycles.
- Starting At:** A dropdown menu with the date "5/1/2002" selected.
- Ending At:** A dropdown menu with the date "5/5/2003" selected.
- View Report:** A button located at the bottom center of the form.

- Contamination can be tracked through the processing steps.
  - LISA has a separate database specifically for the sequences generated for contaminants.
- 
- Reports can be generated in LISA per primer pair and scientist to pinpoint a specific issue.



# **Validation & Quality Control**

Necessary and On-Going

# Validation & Quality Control

- Validation is something that you will never stop doing in your laboratory.
- The following items need to be validated prior to use:
  - Equipment
  - Techniques
- Everything needs to be quality controlled, from equipment to consumables.

# Validation

- Every new technique and piece of equipment brought into the lab must be tested for reliability and reproducibility **PRIOR** to implementation by regular casework.
- Both probative and non-probative samples need to be tested in a sufficient quantity to accurately determine the limits of the technique.

# Validation

- This goes for a relatively simple puncher,

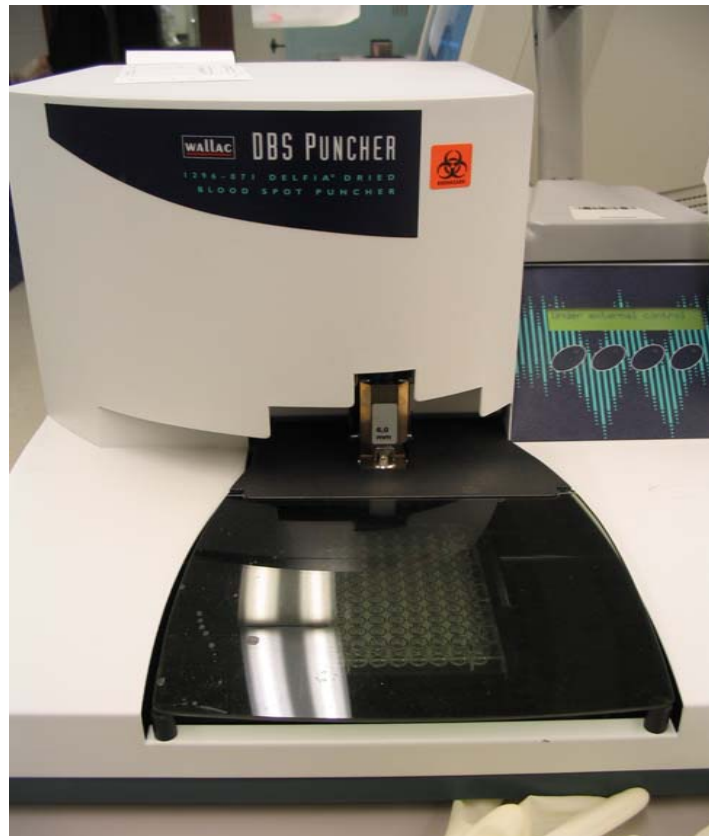

# Validation

- To a more complex robotic platform used in our high-throughput section,



# Validation

- To the primers we use for amplification and sequencing.



# Validation & Quality Control

- Everything....

# Validation & Quality Control

- It is a thankless and complex job, but it is necessary to ensure the quality and reproducibility of your results.



# **Degraded Skeletal Remains**

What to choose and how to generate a full mtDNA profile.

# Degraded Skeletal Remains

- Sample Selection
- Extraction Methods
- Amplification Strategies
- Sequencing Strategies

# Degraded Specimens



- In general terms all skeletal remains are degraded.
- Some are more degraded than others due to environmental stressors.
- Prudent sample selection will increase the rate of success.



# Environmental Effects

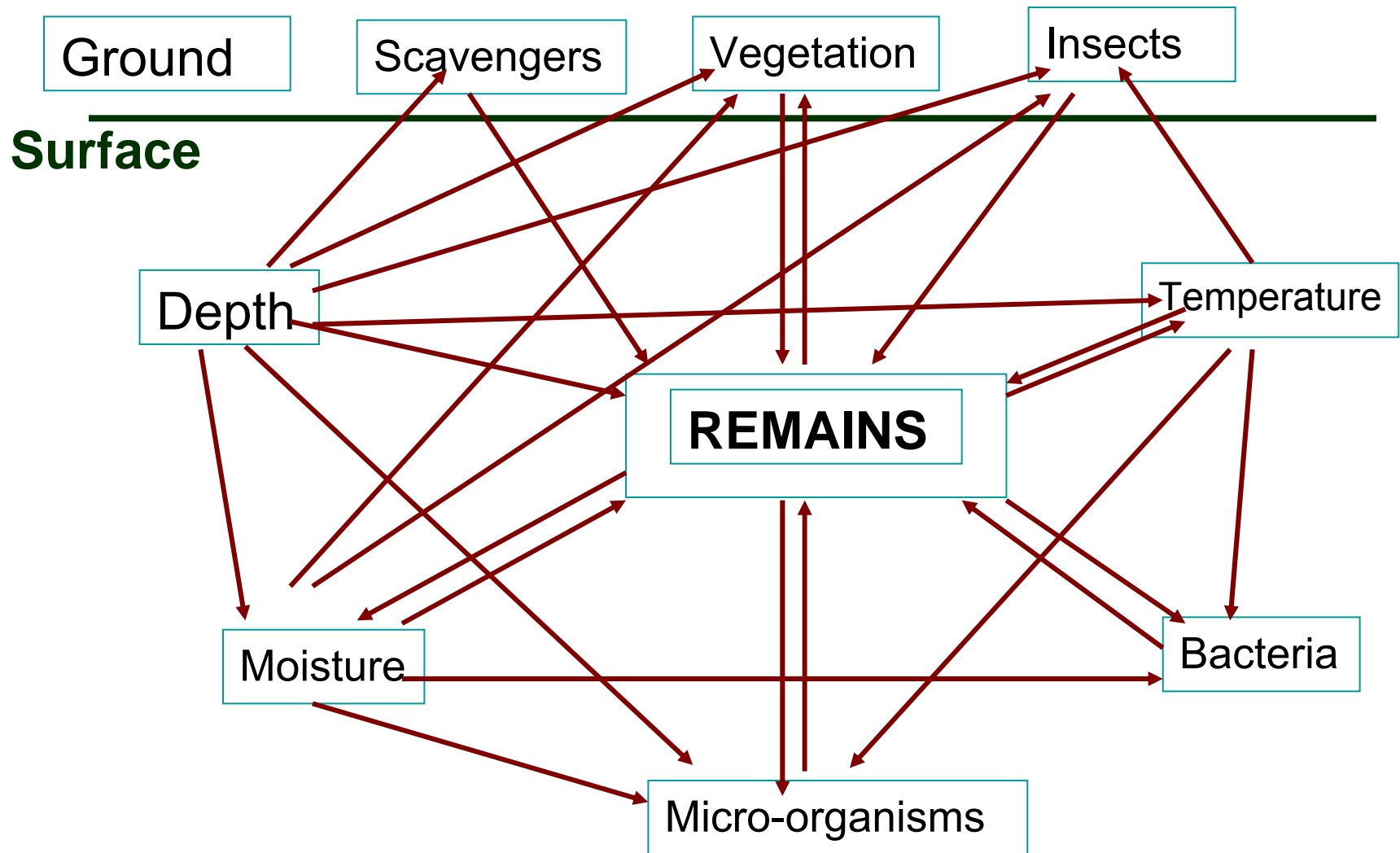

# Environment

- Recovery sites vary
  - Extreme conditions
    - Salt-water marshes
    - Glaciers
  - High/Low temperatures
  - Repeated freezing and thawing
  - High/Low pH
  - High water levels
  - Salt or brackish water



# Environment

- Remains may be
  - On the surface
  - Buried in soil or other substrates
  - Highly fragmented
  - Subjected to burning or high heat
  - Exposed to fuel or other chemicals
  - Disturbed or moved by humans or animals
  - Gnawed or otherwise consumed by animals

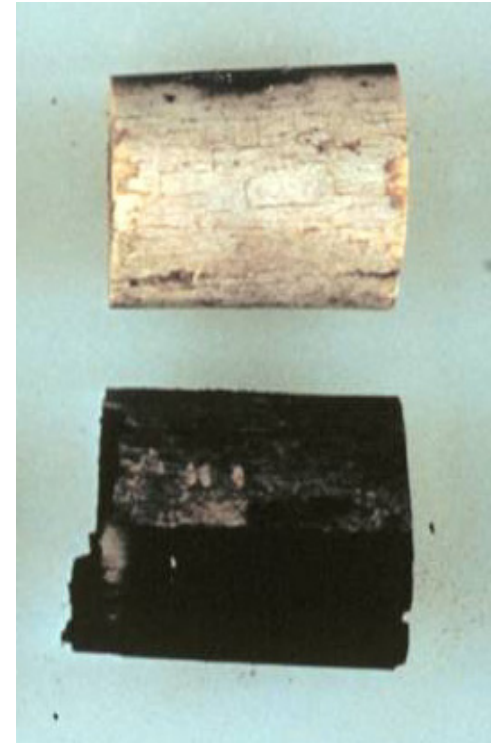

# Animal Effects

- Animals will gnaw on the osseous structures
  - compromising the protection of the DNA afforded by those structures
- Animals will scatter remains
  - Compromising the archaeology of the site
- The effects of animals will depend on the location of the remains
  - Surface burials will be subjected to greater animal scavenging
  - Remains in certain environments will have less

# Storage Effects

- Handling of Remains
- Temperature
- Humidity
- Storage Container

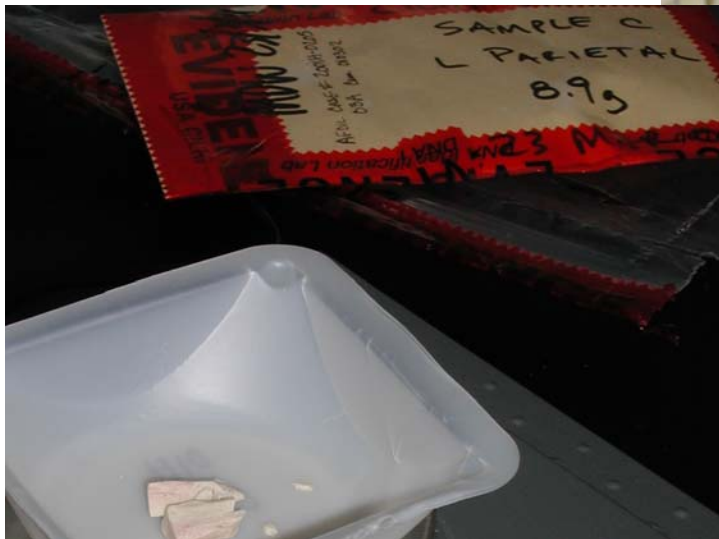



# Sample Selection

- Unknown skeletal remains
  - Remains are examined and samples selected by anthropologists or medical examiners

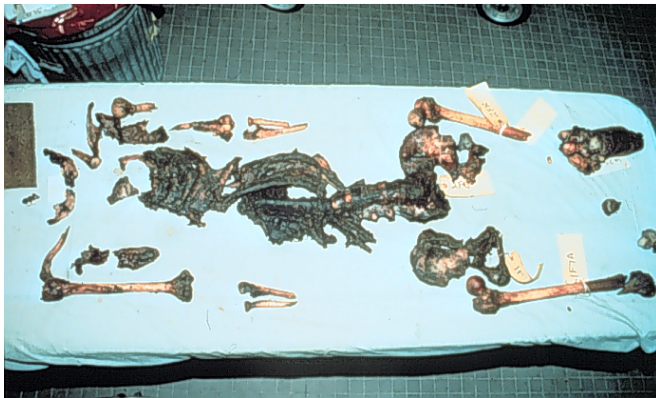

# Selecting samples for analysis

- What are the best skeletal elements to use for analysis?



# Bones Submitted for Analysis

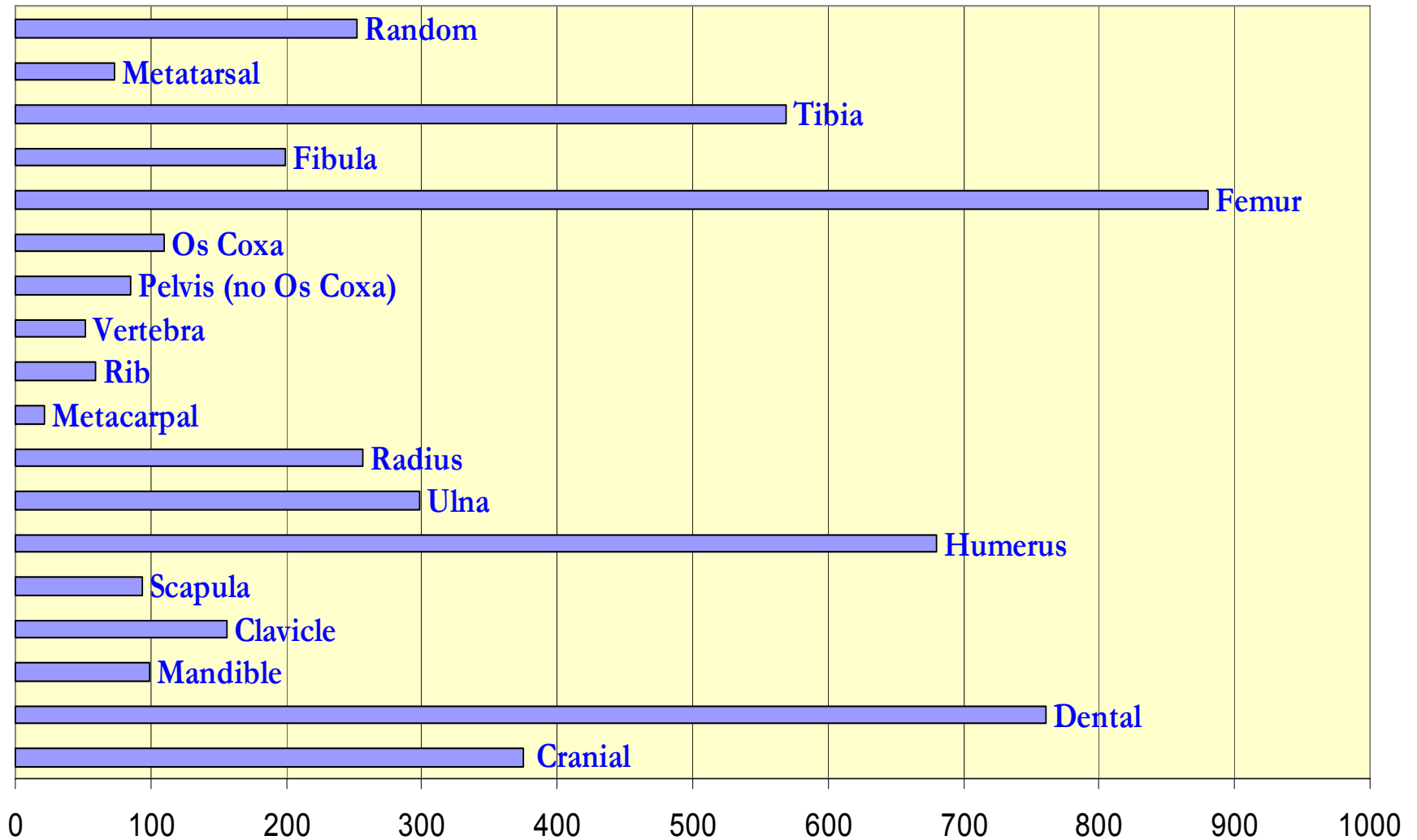

# Skeletal Success Rate

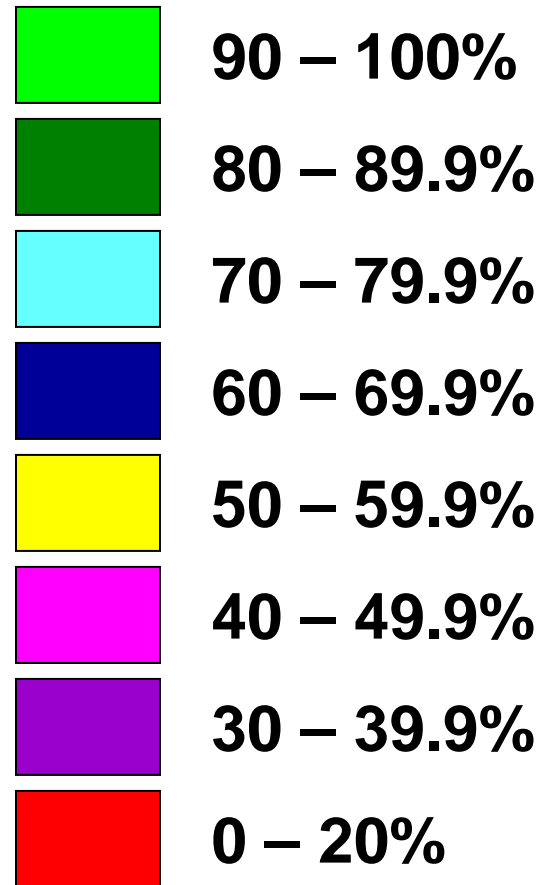
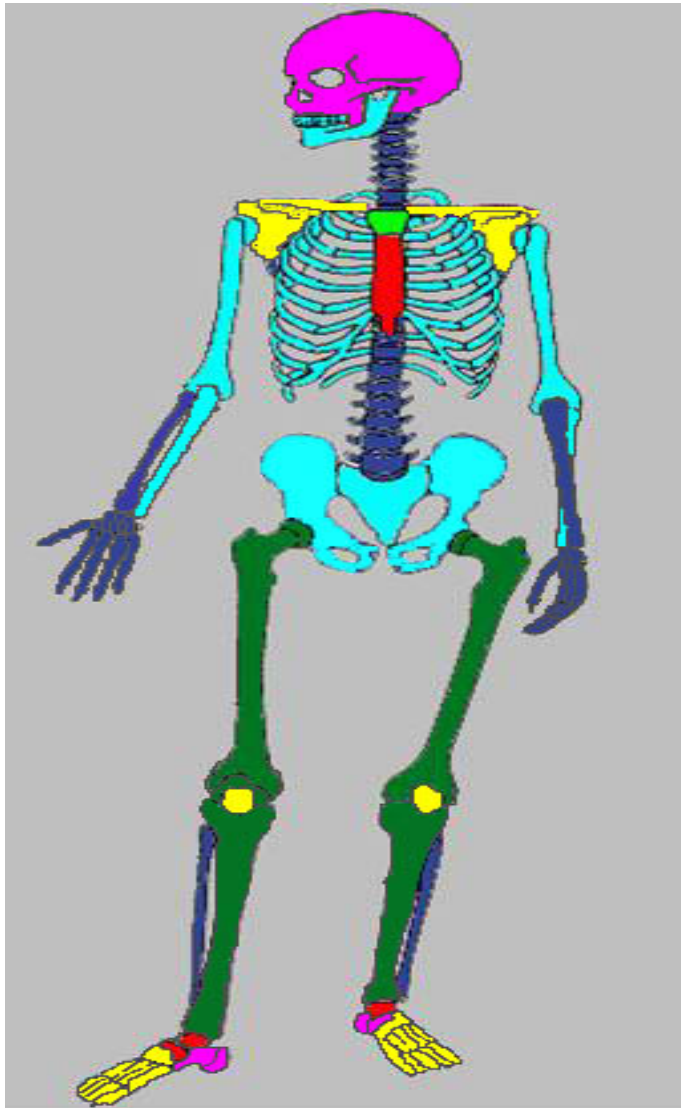

# Skeletal Element Success

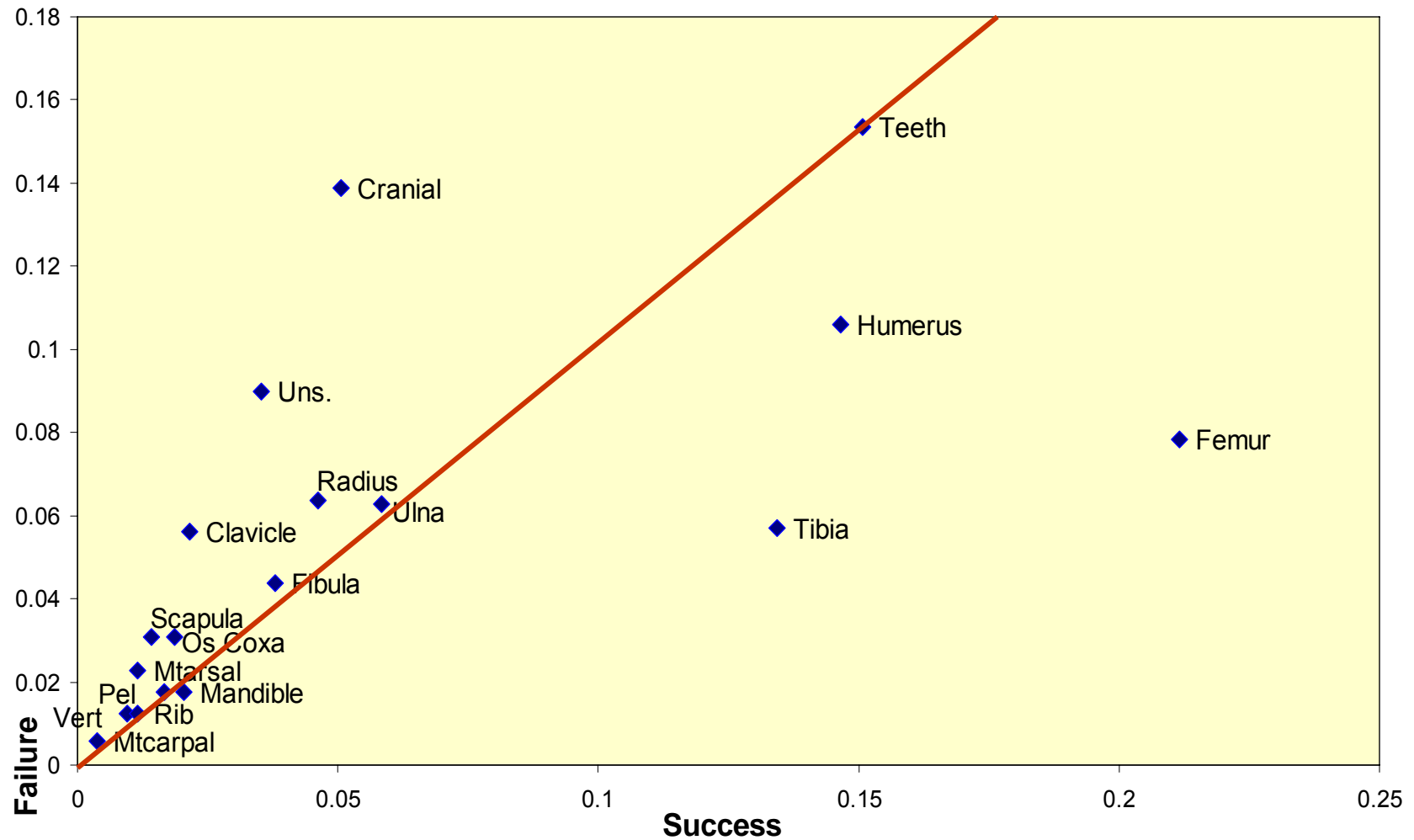

# Head to Toe Success

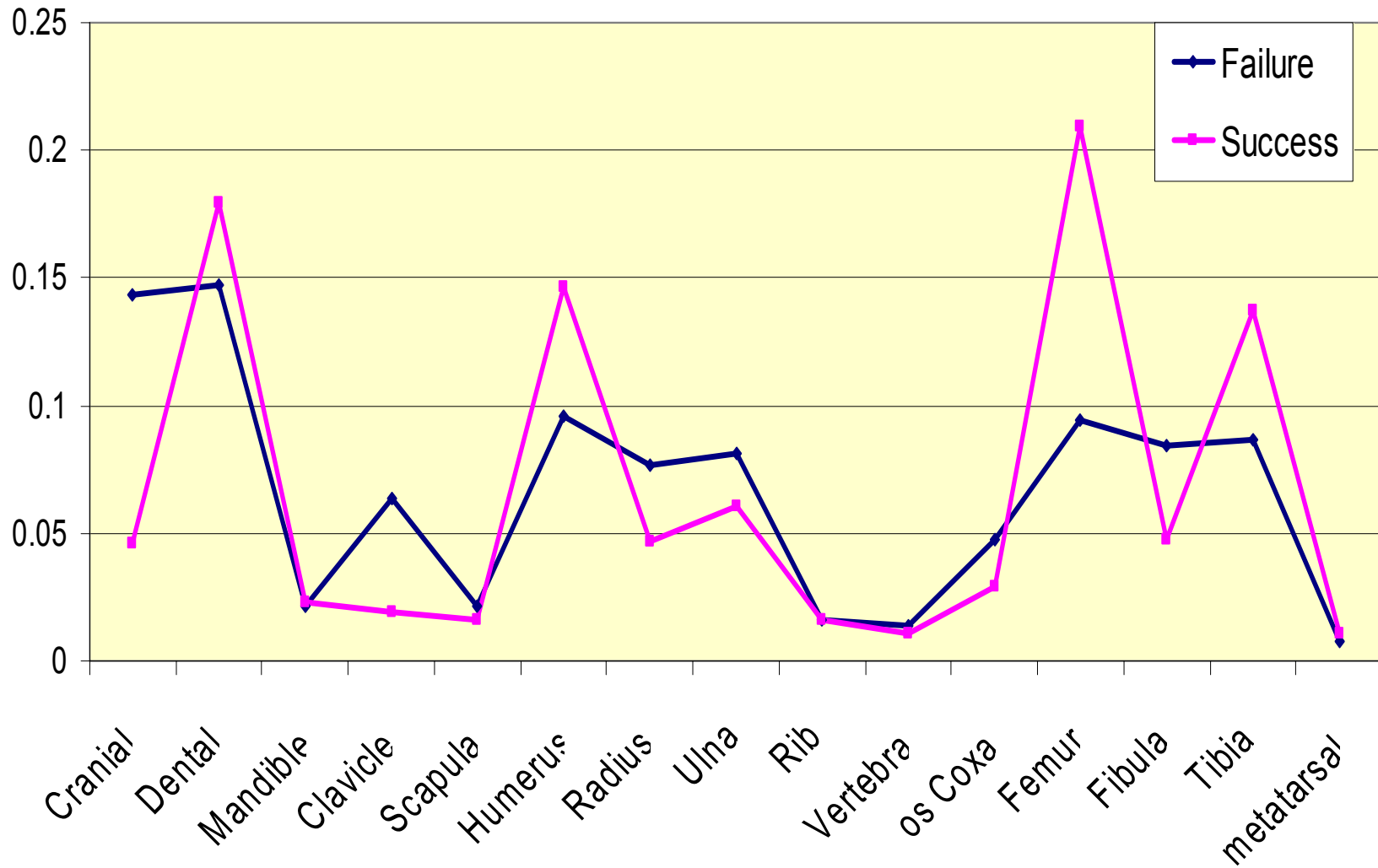

# Bone Structure

- Bones with dense cortical structure tend to have a greater success rate.
  - Compact bone may inherently afford greater protection for it's deeper layers.
  - Trabecular bone and elements composed of thin cortical bone have a greater surface area
- Cranial fragments vary in success
  - Formed of a layer of trabecular bone sandwiched between two layers of cortical bone
  - Temporal and occipital tend to have denser cortical bone

# Cranial Success

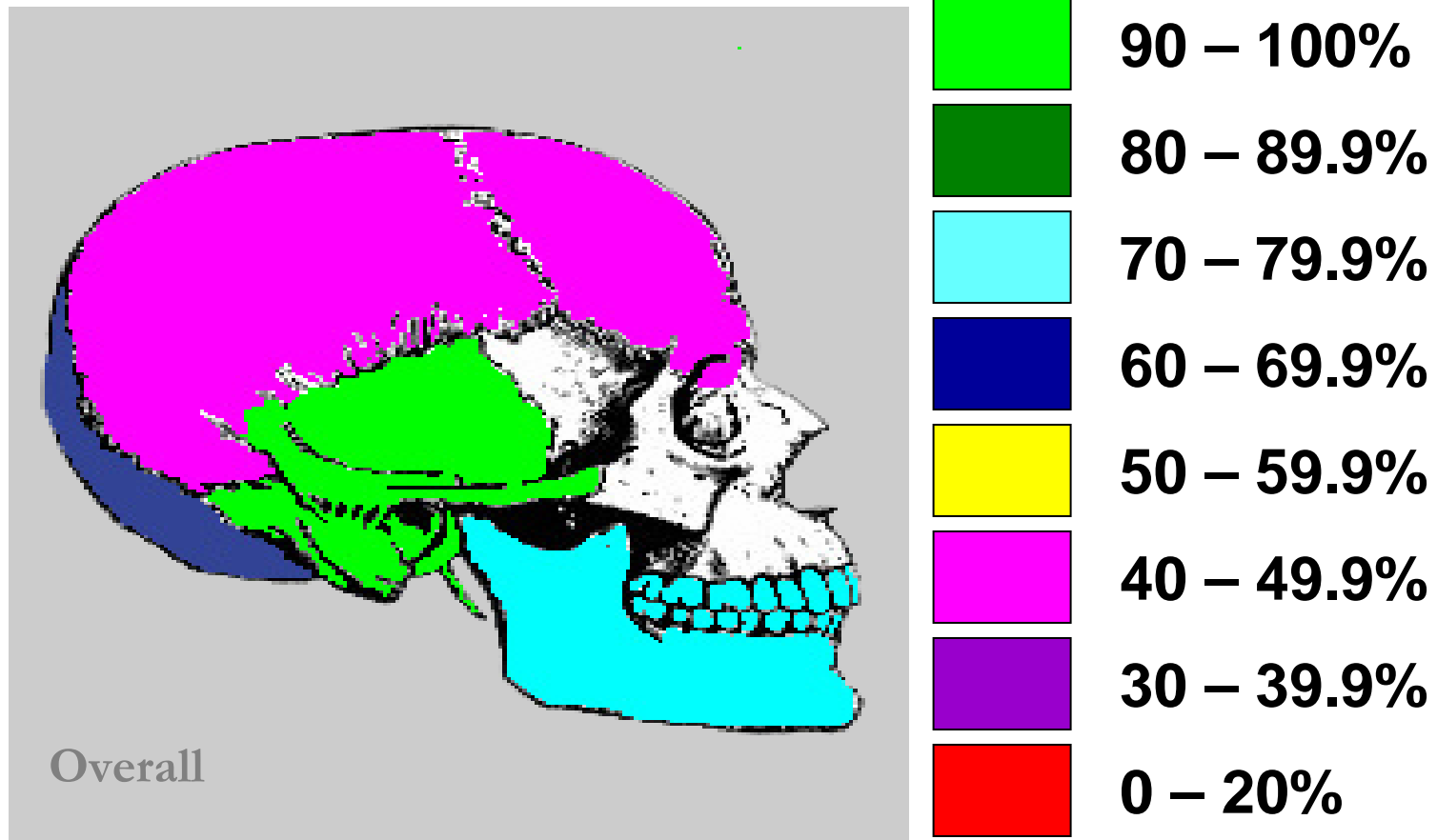



# Dentition



- Dental remains provide a particular challenge
  - The enamel gives a greater protection to the dentin from which the DNA is extracted.
  - Anecdotally shown to provide copious quantities of DNA from even medieval era remains.
  - Require a lot of handling.

# Storage Effects

- Look at two different sets of remains recovered by JPAC-CIL from the same conflict.
  - *In situ* remains
  - Disinterred remains

# *In situ Remains*



- Recovered *in situ*\*\* by JPAC-CIL teams
- Presumably minimal disruption since time of death
- Storage since disinterment climate controlled at the CIL
- 707 samples submitted for mtDNA analysis

# Disinterred Remains

- 208 sets of remains
- Provenience of remains unknown
  - Analysis shows two or more sets of remains in all boxes and evidence of curation / processing
- Storage conditions and degree of handling unknown
- 1426 samples submitted for analysis



# Relative Success

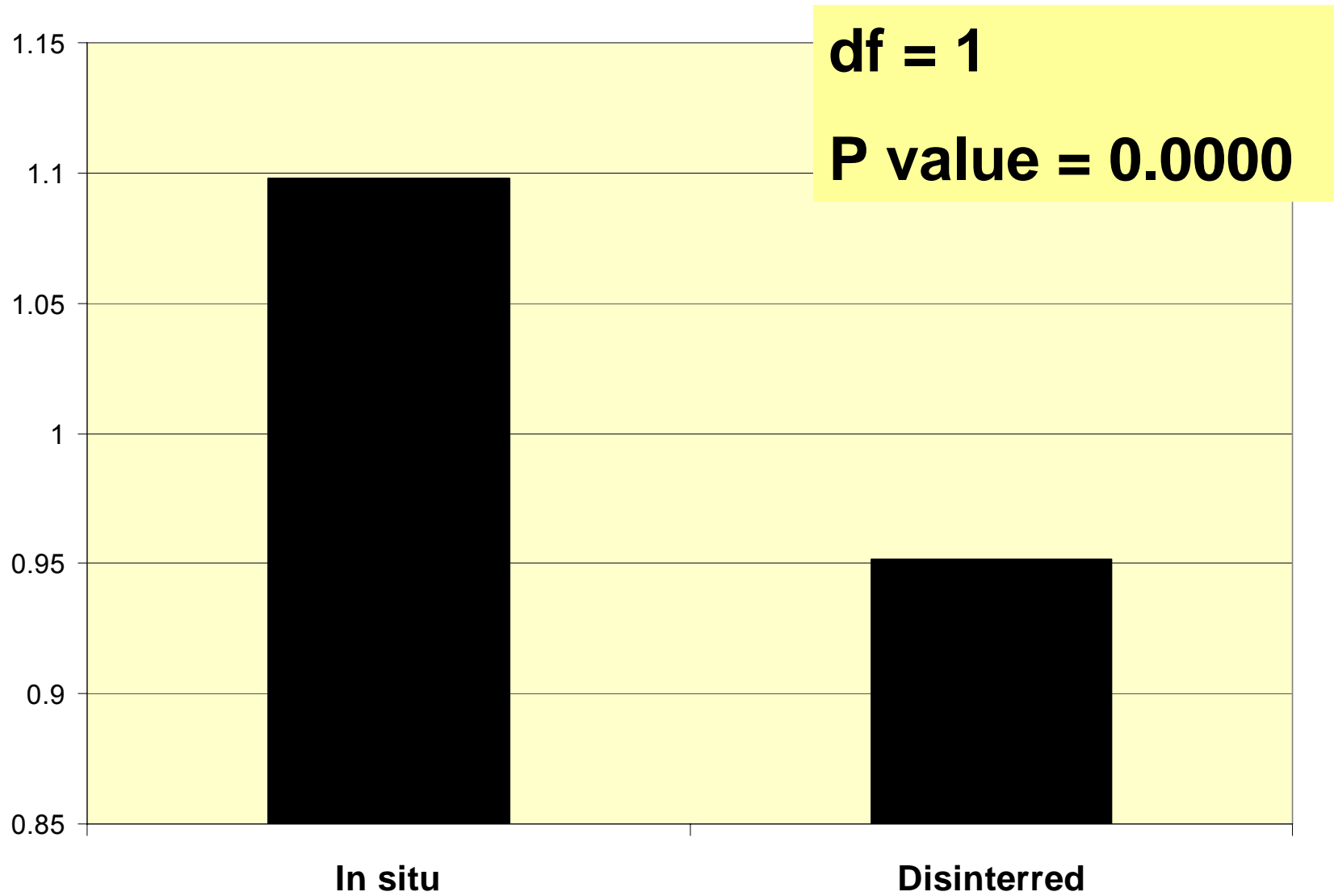

# Success rate comparison

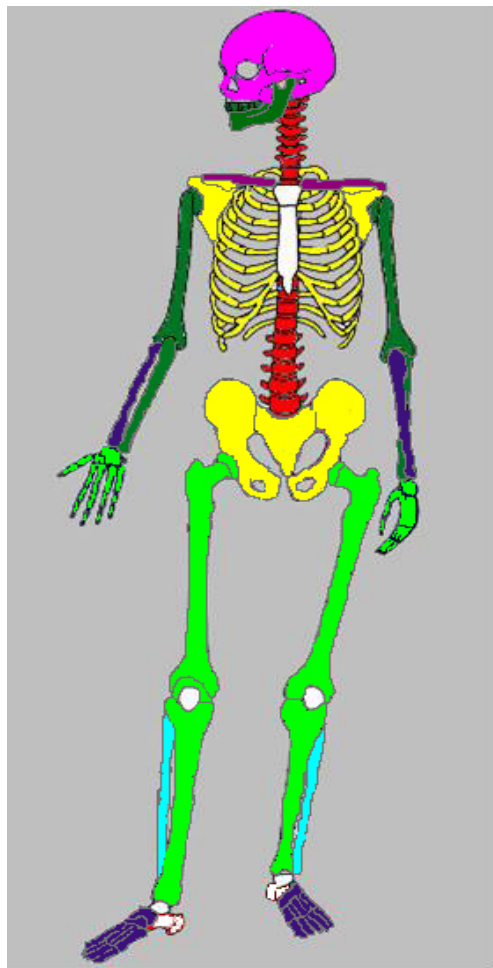

*In situ*

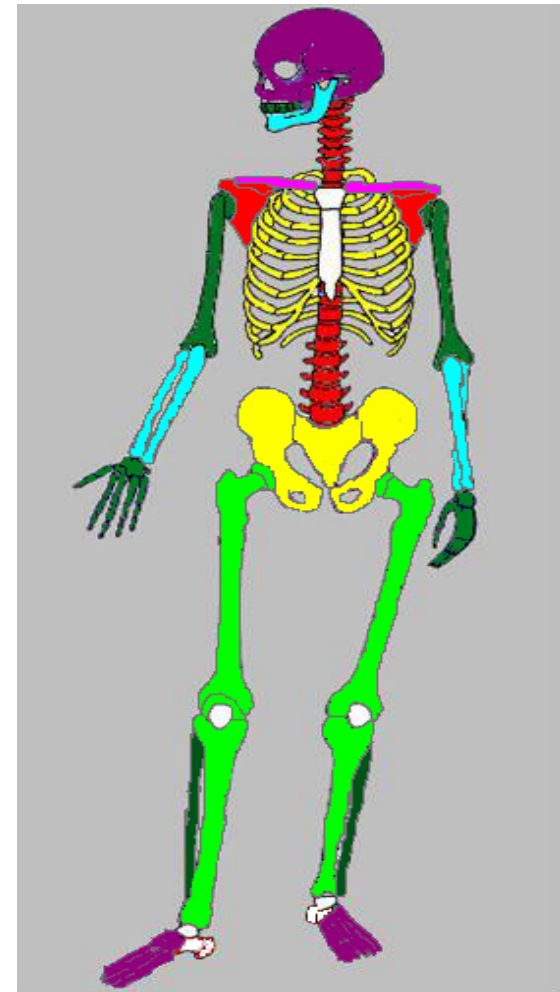
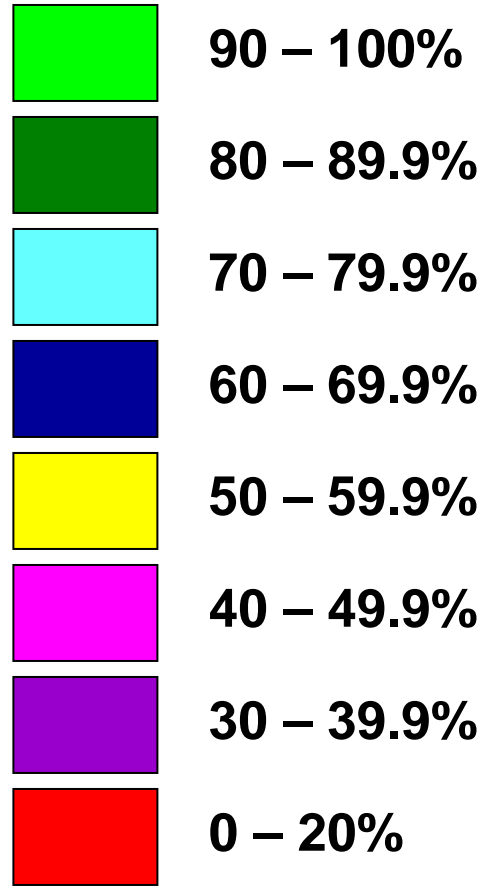

Disinterred

# Success Rate by Element

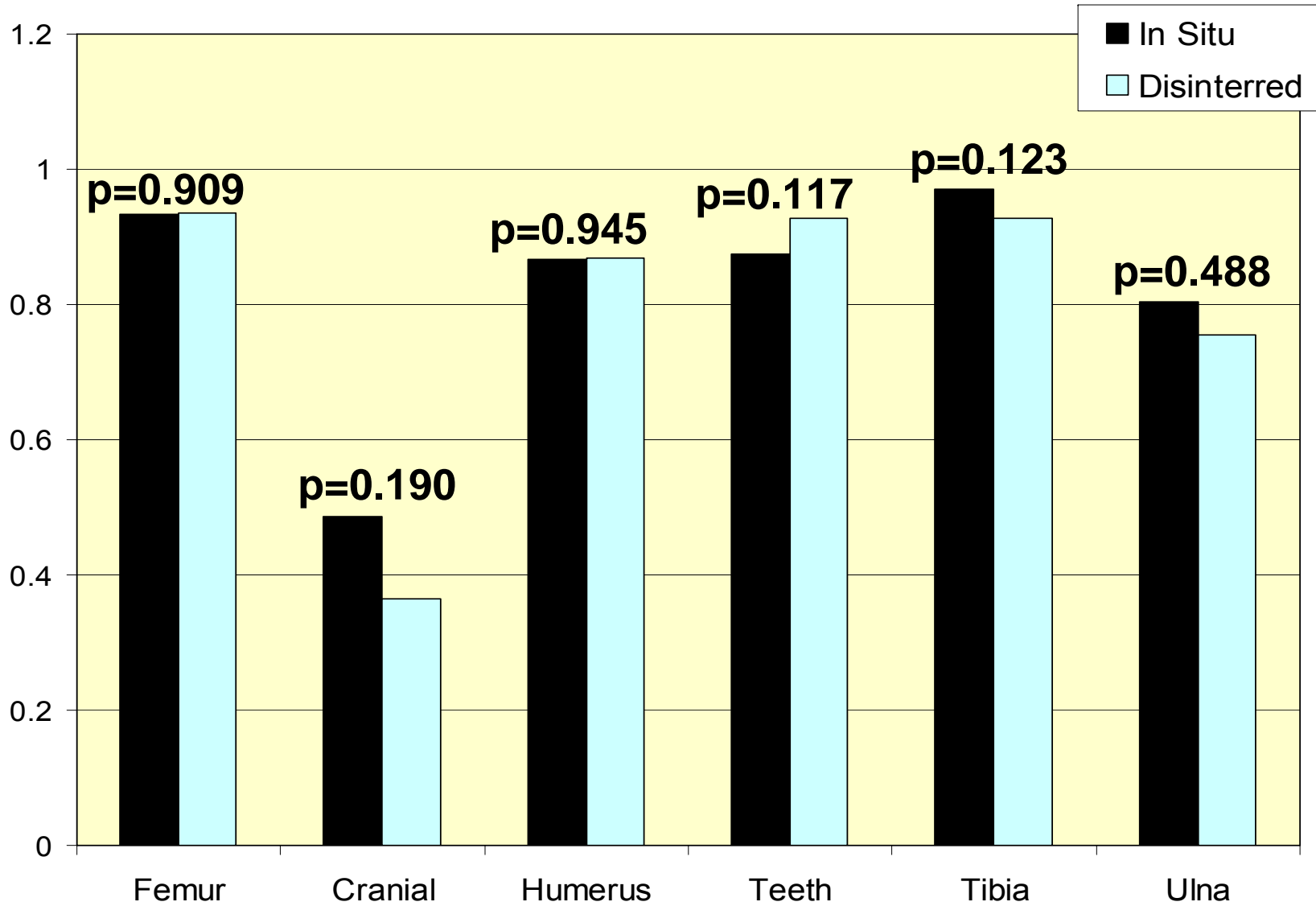

# So?

- There is no significant difference between the success rate of the elements for recovery of DNA from samples that remain *in situ* versus those that are disinterred by a non-professional.
- Why is there such a large difference between the different groups?



# Sampling between Regions

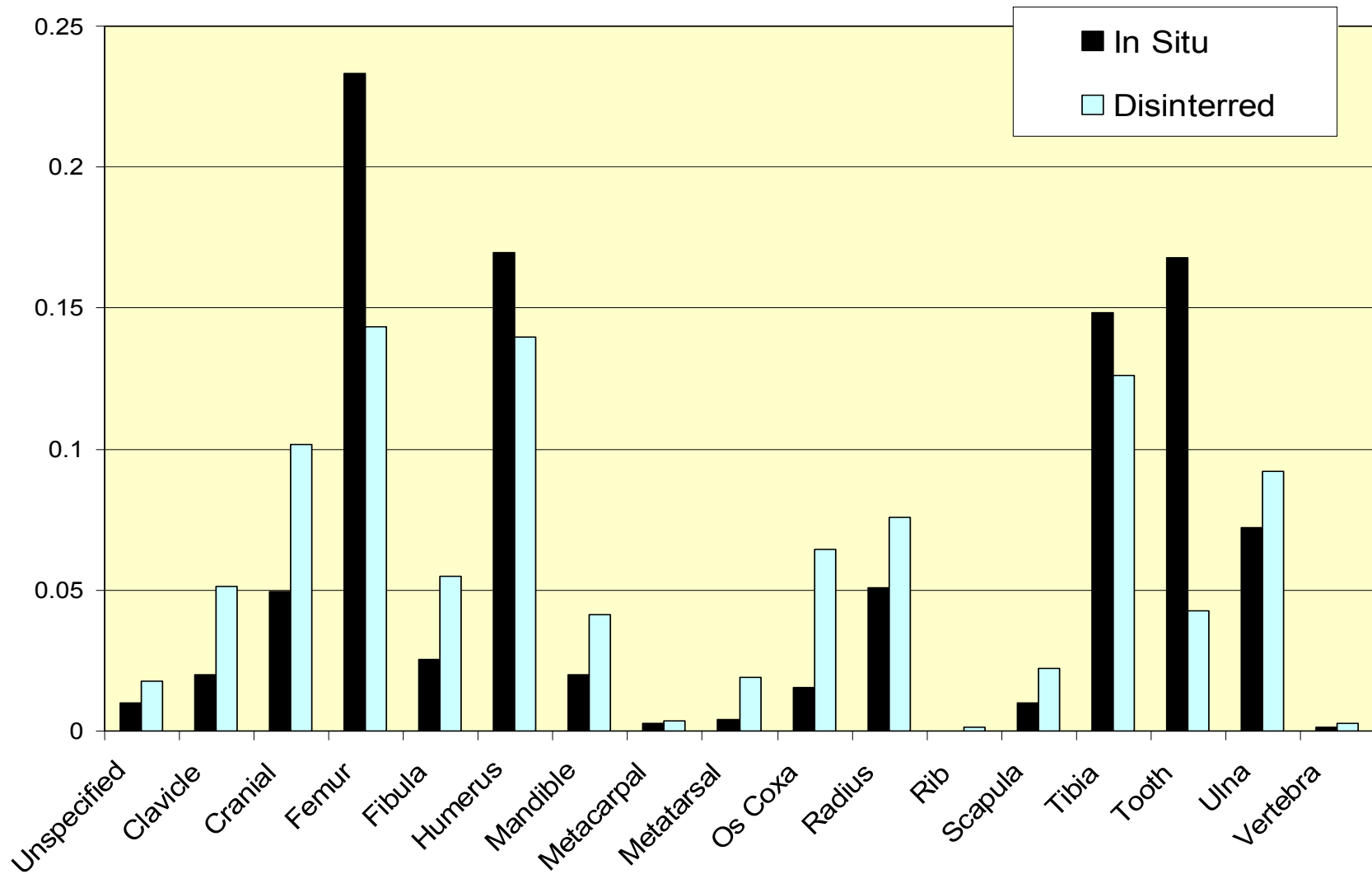

# Sampling of *in situ* Remains

- More or less articulated skeletons
  - Femur and tibia are best single samples for establishing identity.
  - Humerus are best for confirming an upper and lower body association.
  - Teeth confirm association of cranial with post-cranial remains.

# Sampling of Disinterred Remains

- Due to the known chimeric nature of the remains,
  - Anything that cannot be re-associated via anthropology is cut for mtDNA analysis.
  - Leads to the high number of smaller elements being sampled.
- Also a loss of context for recovery.

# Extraction Methods

- Cleaning the samples – how much is too much?
- What protocols give the greatest yield of DNA?
- What method is right for you?
- Trouble-shooting the extraction.

# Cleaning the Sample

- The exterior of the bone fragment needs to be cleaned of any possible contaminants:
  - Dirt
  - Plant material
  - Extraneous DNA
  - Dried Tissue

# Cleaning

- An easy way to clean the surface is using a sanding bit in a Dremel tool.

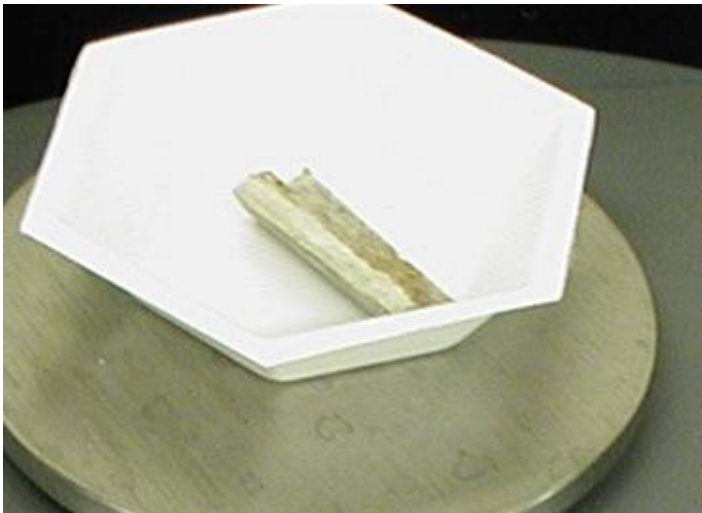

# How far to clean?



- Everything on the surface needs to come off, along with the spongy bone.
- But, you'll hit a point where there is no solid bone left.

# Other Cleaning Methods

- Bleaching
  - Bones can be subjected to a bleach sonication to remove external contaminants.
  - A fresh water sonication should follow to get rid of the bleach or DNA can be lost.
- DNA Off or other DNA

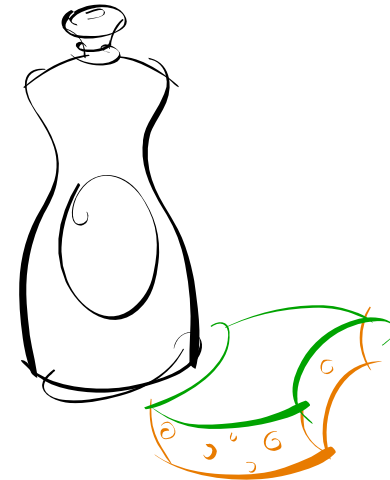



# Too much?

- Aggressive cleaning can remove or otherwise damage available DNA.



# Extraction Methods

- Numerous extraction methods available.
- Involve different methods of –
  - pulverizing the samples
  - removing the DNA from the samples
- Different starting quantities of bone can also be used.

# Pulverization Methods

- Freezer Mill
  - Uses liquid nitrogen and a magnet to pulverize the bone into a very fine powder.
  - Disadvantage:
    - Requires storage and handling of liquid nitrogen.
    - Grinders and sample vials are reused – potential contamination.



# Pulverization Method

- Waring Blender Cup
  - Also grinds bone to a relatively fine powder
  - Disadvantage: Cups are reused, so there is a possibility of contamination.

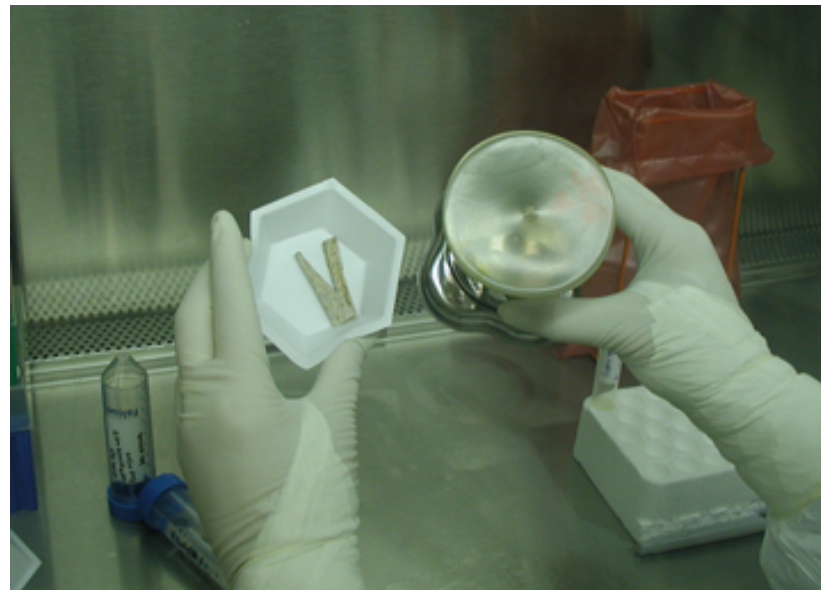

# “Freeing” the DNA

- Samples may be subjected to a decalcification step.
  - Demineralizes the bone matrix.
- Other chemical/physical treatments are commercially available to more easily acquire the DNA.
  - Silica gel
  - Charge Switch™
  - DNA IQ™
  - Pressure Treatment

# Extraction of Skeletal Remains

- The powdered bone is extracted with
  - 20mg/ml Proteinase K and extraction buffer
  - Overnight at 56°C
- DNA is removed from the extraction buffer with
  - a series of washes with Phenol/ Chloroform/ Isoamyl alcohol
  - Purification of product with filters.



# There's DNA, now what?

- Quantification –
  - At AFDIL, we do not quantify prior to amplification.
  - Can quantify using a 1% Agarose gel and ethidium bromide.
  - CalDOJ has a quantitation method for both nuclear and mtDNA using qPCR.
    - Timken, et al. (2005), A duplex real-time qPCR Assay for the quantification of human nuclear and mitochondrial DNA in forensic samples: Implications for quantifying DNA in degraded samples. J. of Fors. Sci. 50(5): 1044-60.

# Amplification Controls

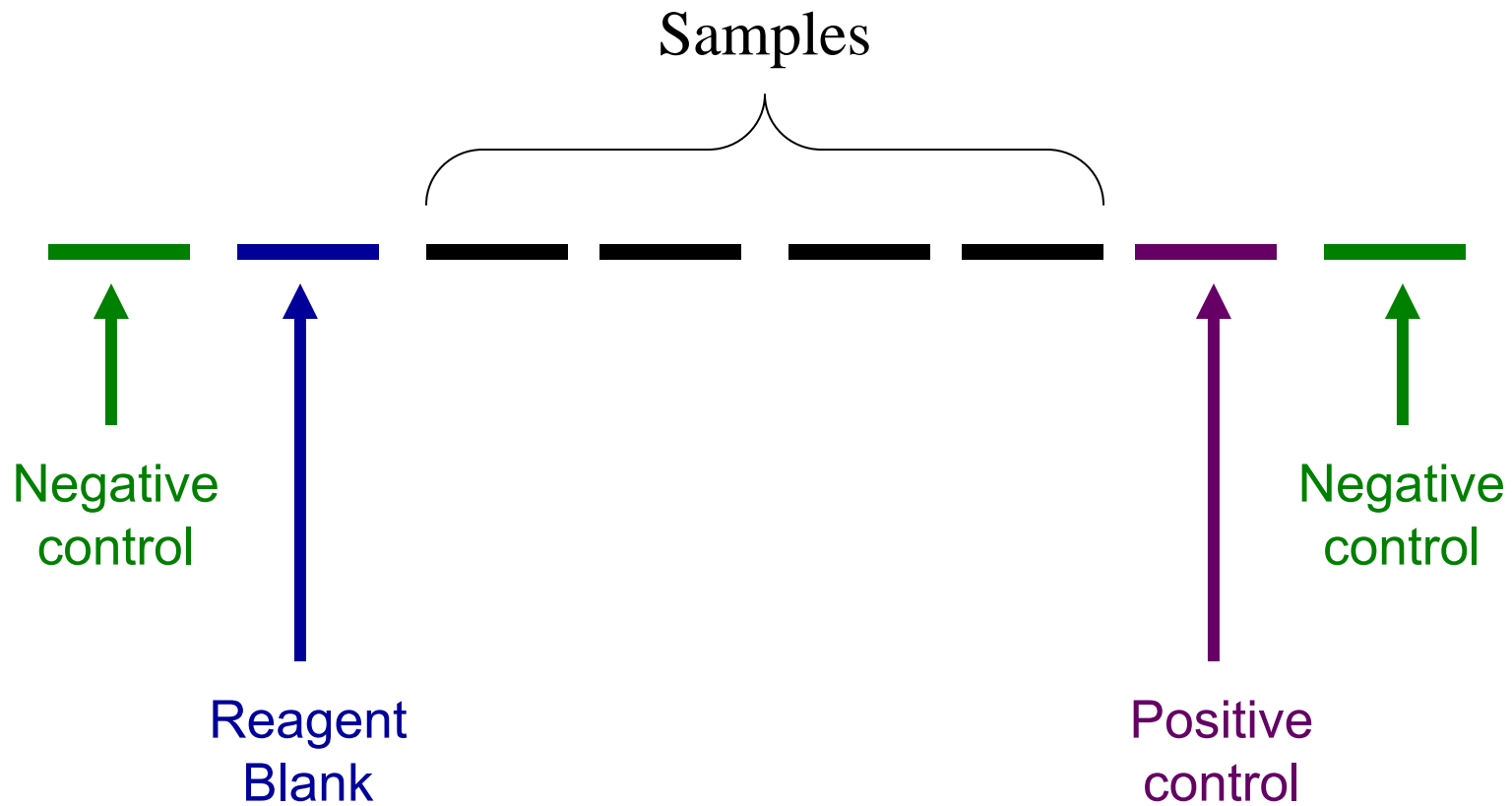



# mtDNA Analysis

Origin of Replication

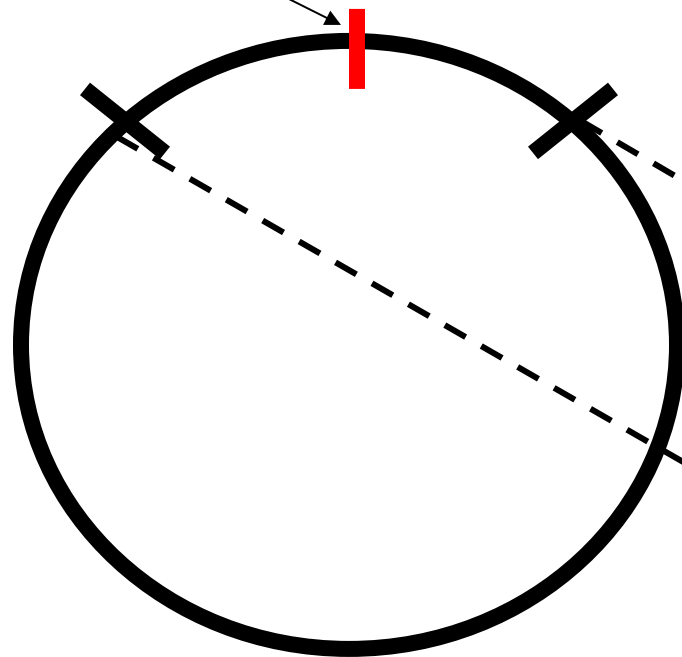

Reporting target for degraded remains is ~650bp

np16024

np576

The Control Region

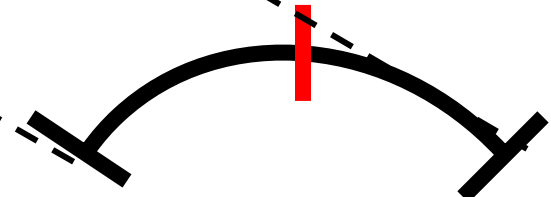

# CR variation

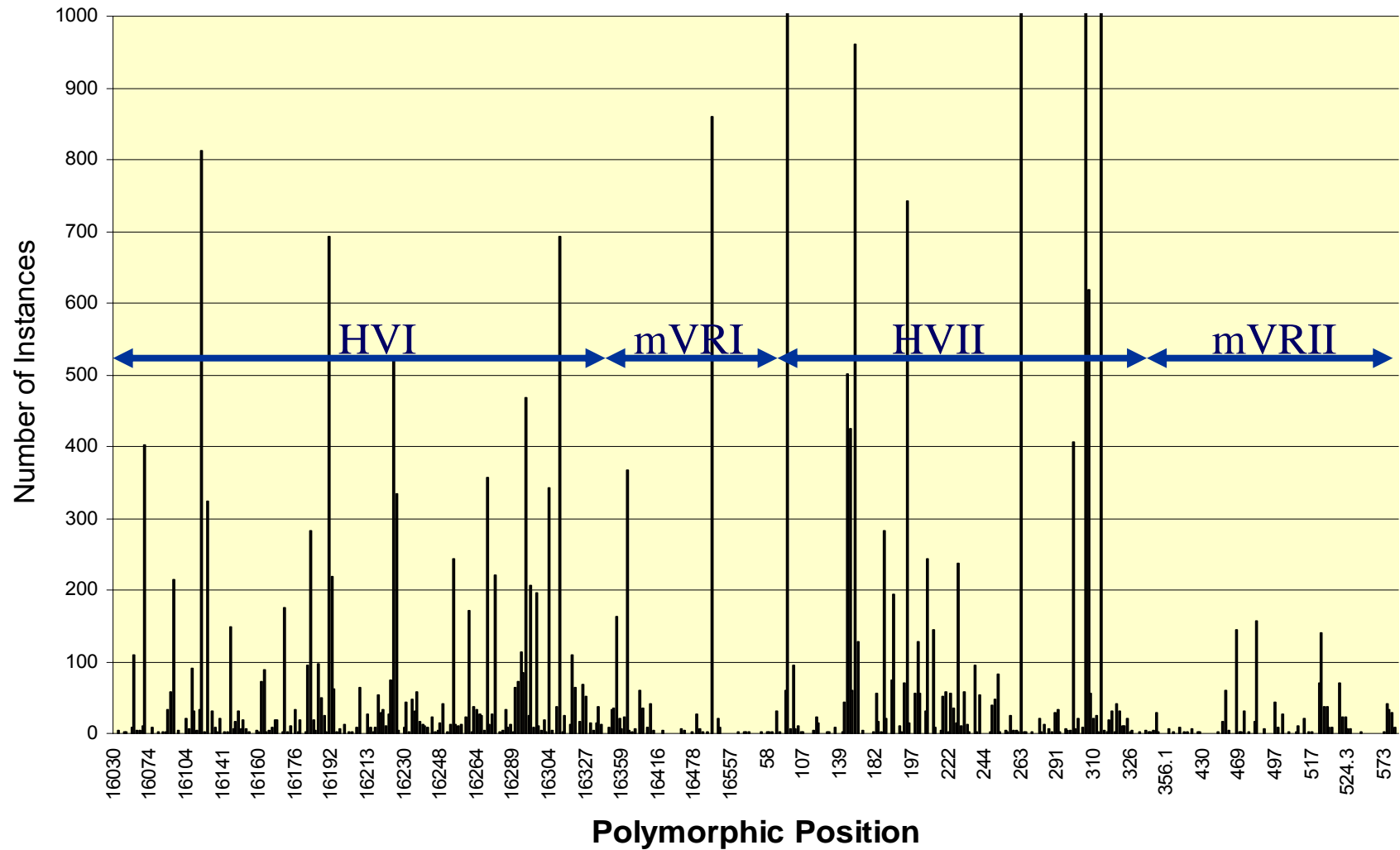

# Amplification

- PCR Master Mix
  - 10X PCR Buffer (100mM Tris-HCl, 500mM KCl, 15mM MgCl<sub>2</sub>)
  - DNA grade Bovine Serum Albumin (BSA, 0.625µg/µL)
  - Deoxynulceoside triphosphate mix (dNTP: 2.5mM each of dATP, dCTP, dGTP, dTTP)
  - Sterile diH<sub>2</sub>O

# Amplification

- A standard program for amplification is used for the 9700's.
- The basic program is modified based on the primer pair used (Gabriel, et al. 2001)
  - 10-minute soak at 96.0°C
  - Followed by 38 cycles of
    - 20s at 94.0°C
    - 20s at 56.0°C
    - 30s at 72.0°C
  - Final hold at 4°C



# Primer Design

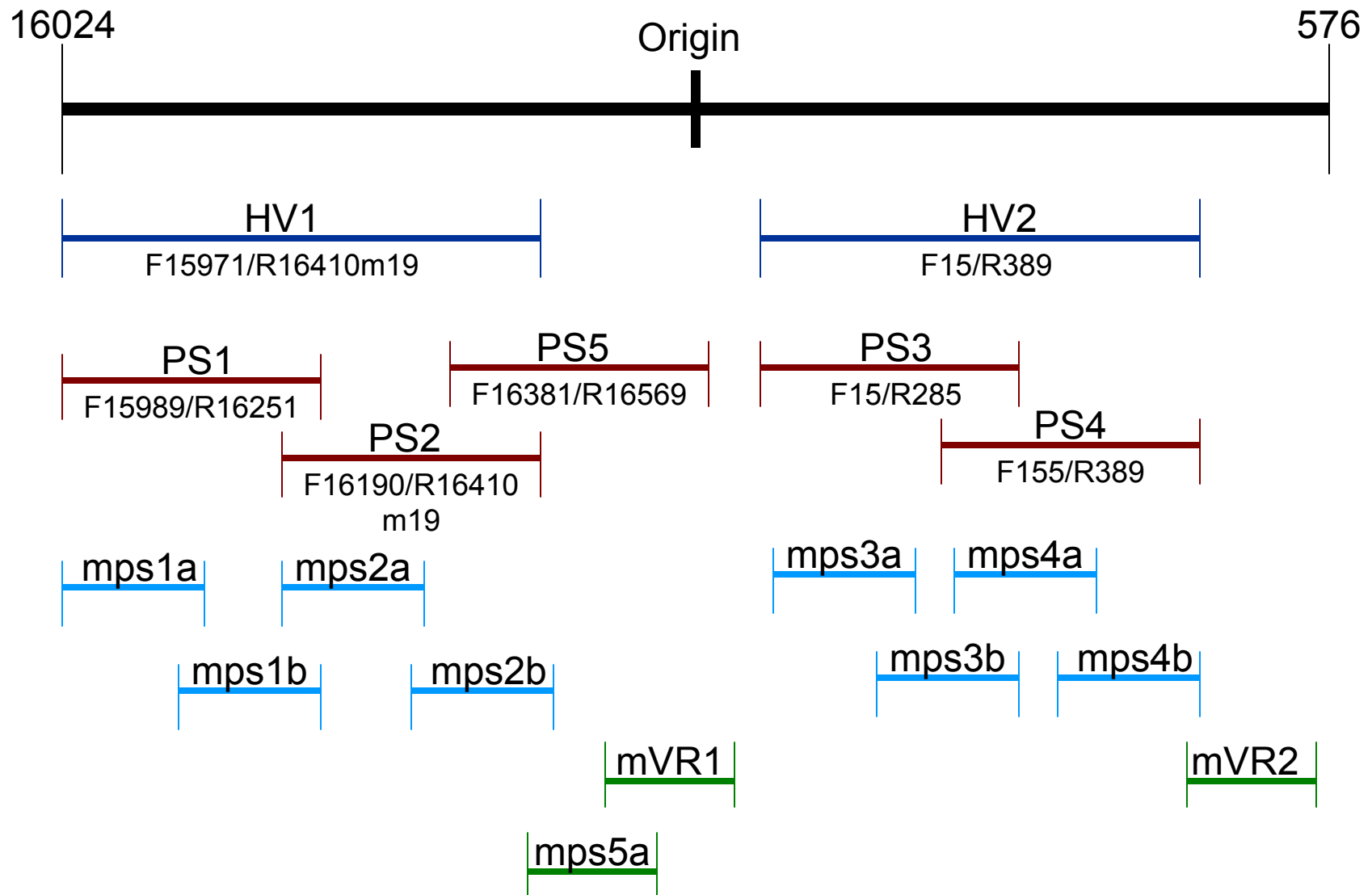

# Primer Design

- There are computer programs that can predict the optimal primer sequence.
  - i.e., Oligo
- Avoid primer sequences with significant secondary structure.
- Avoid primer sequences that have complementarity and can potentially bind to each other.
- Primers should have a moderate GC content



# Primer Design

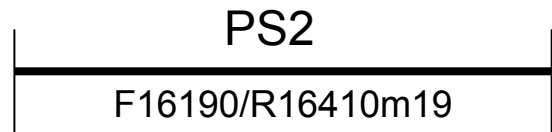

3.0ul DNA  
2.0ul Taq

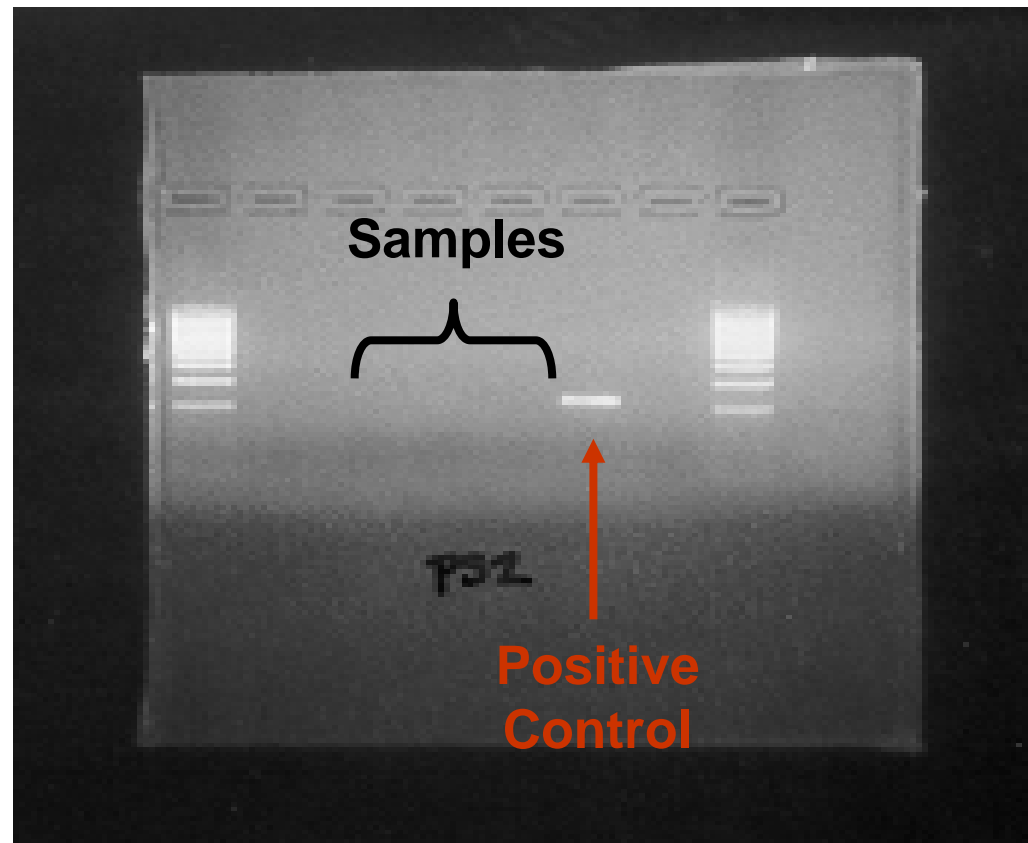



# Primer Design

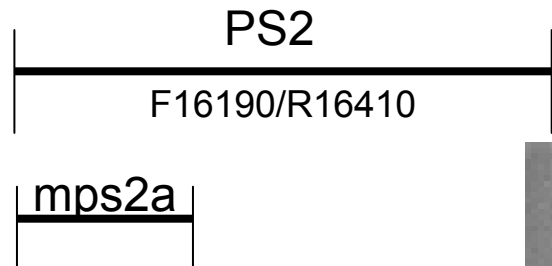

1ul & 4ul DNA  
2.5ul Taq

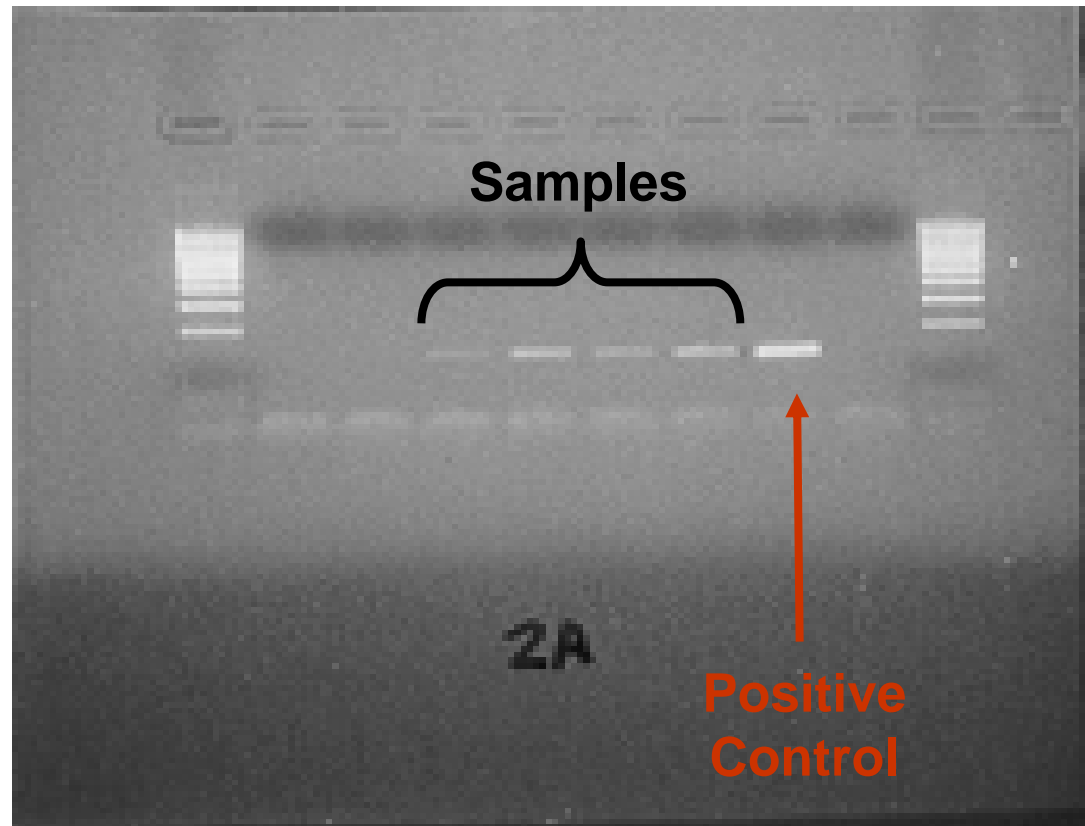

# Primer Design

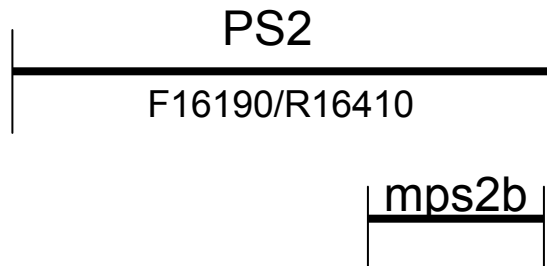

Primer pair is  
F16268/R16410M19.

5ul DNA

2.5ul Taq

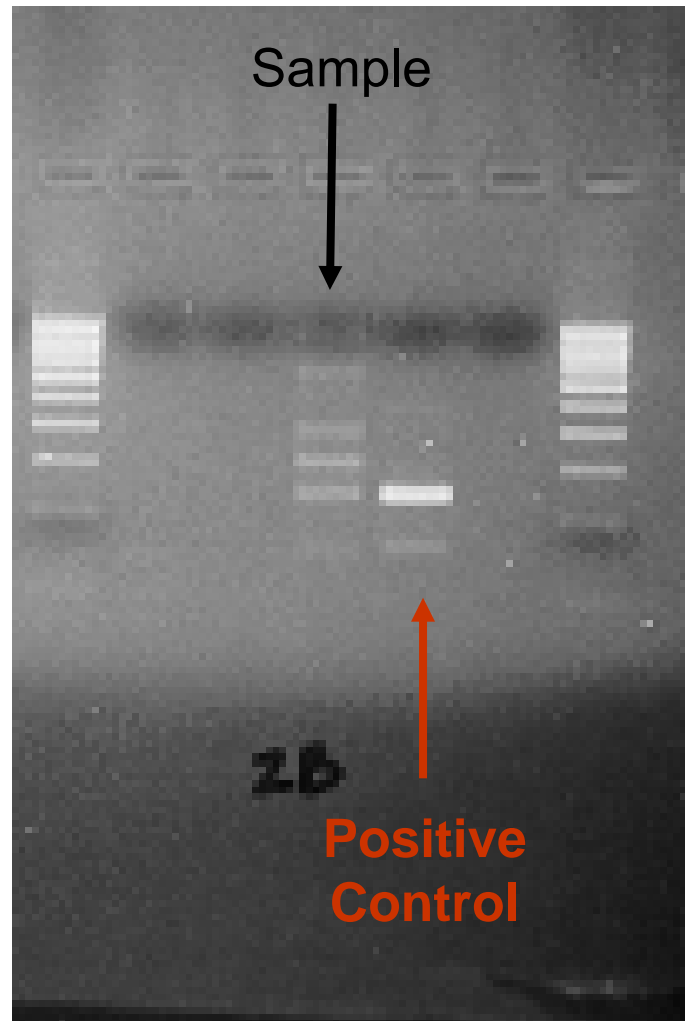

# Primer Design

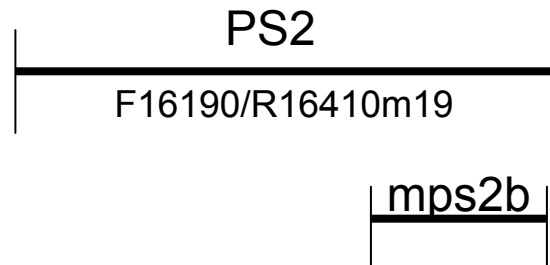

Primer pair is  
F16268/R16400.

6ul DNA

2.5ul Taq

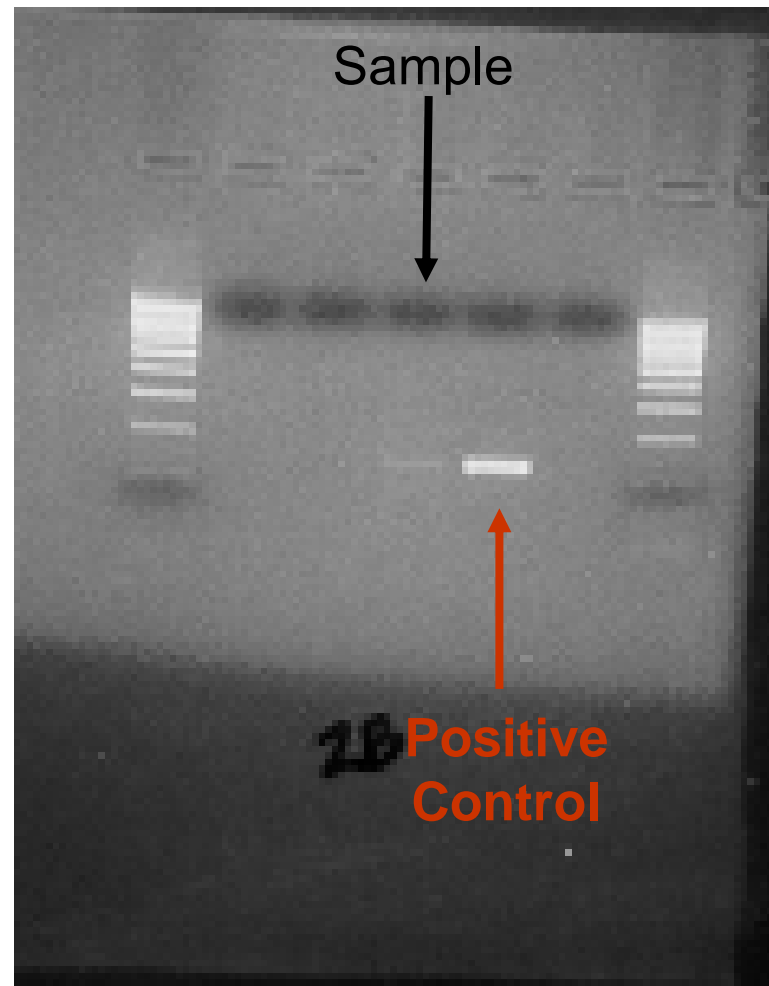

# Polymerase

- We use AmpliTaq Gold™
  - Hot start PCR
  - No proofreading capabilities.
- Other polymerases are available commercially that do have proofreading capabilities and are reportedly more efficient than Taq.
  - A comparative study is underway at AFDIL.

# How much is too much?

- It would be expected that the more polymerase is added to the reaction, the better it would work.
- Not necessarily.....

# Too much?

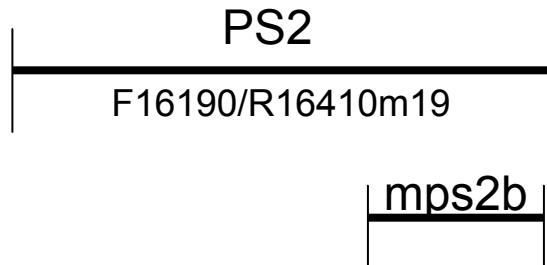

Primer pair is  
F16222/R16410M19

3ul DNA

2.5ul Taq

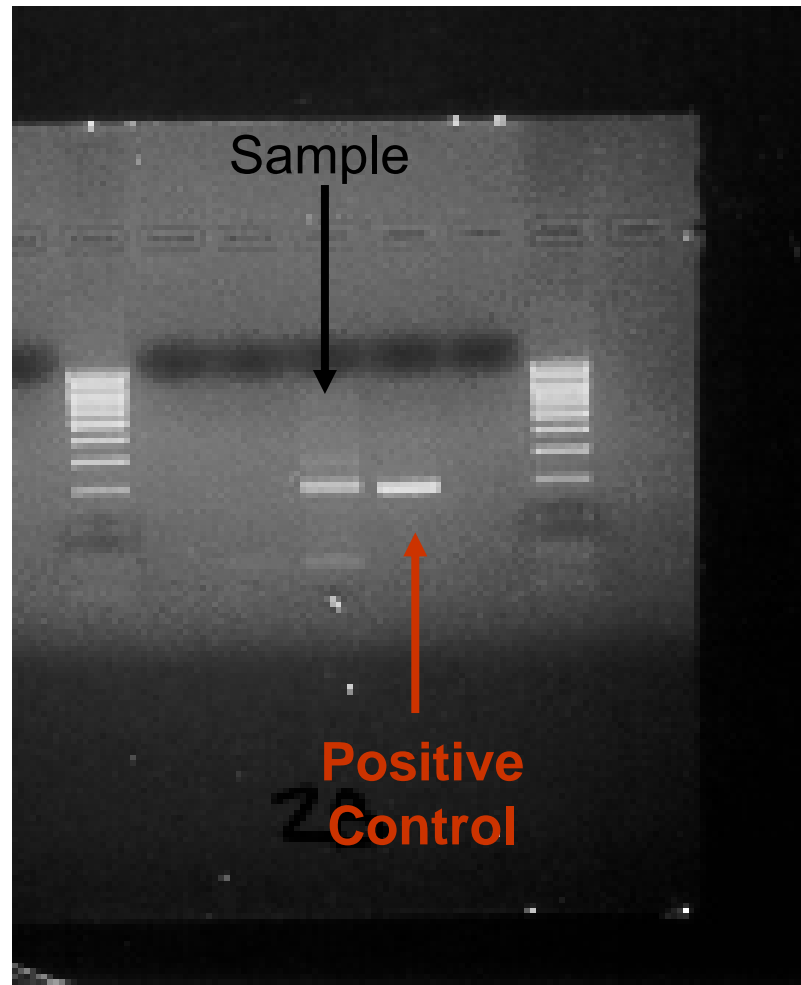

# Better...

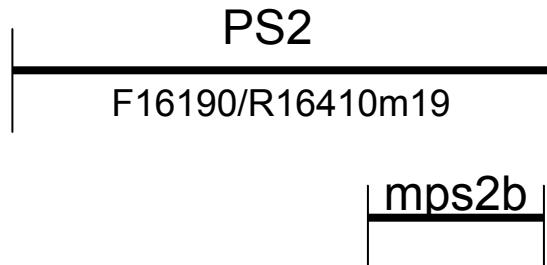

Primer pair is  
F16222/R16410M19

3ul DNA

2.0ul Taq

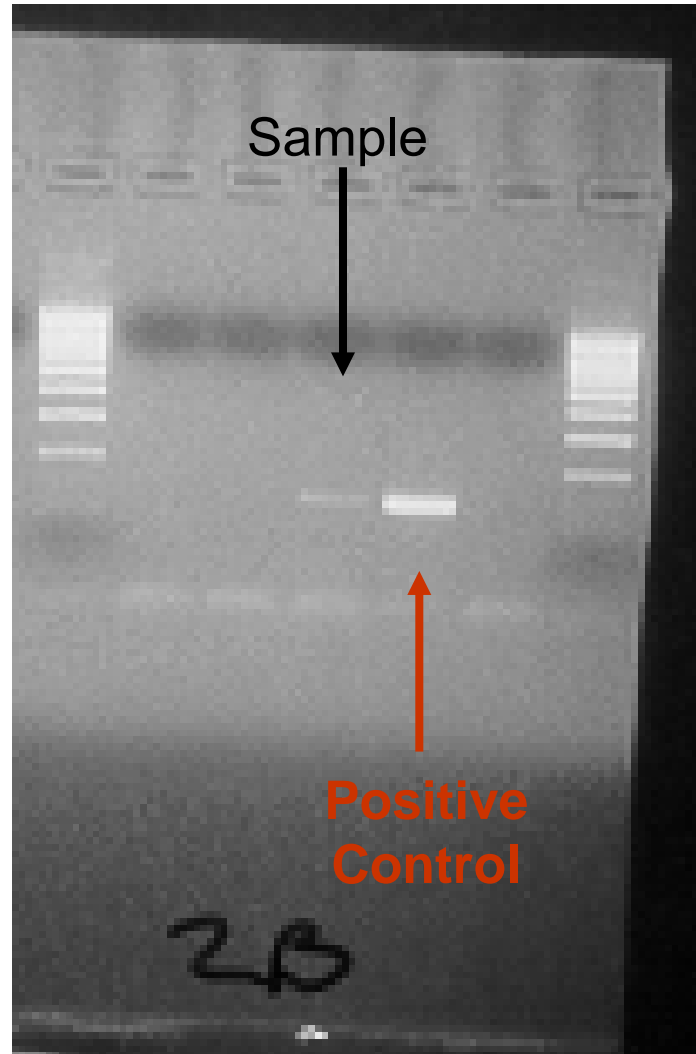

# Post-amplification

- Samples are run on a 2% agarose gel stained with ethidium bromide to verify the presence of amplified product.
- Quantity of DNA added to sequencing reaction is estimated from a comparison to mass ladders run on the gel with the samples.
- There are other methods of post-PCR methods we are exploring, one of which is the Agilent Bioanalyzer.

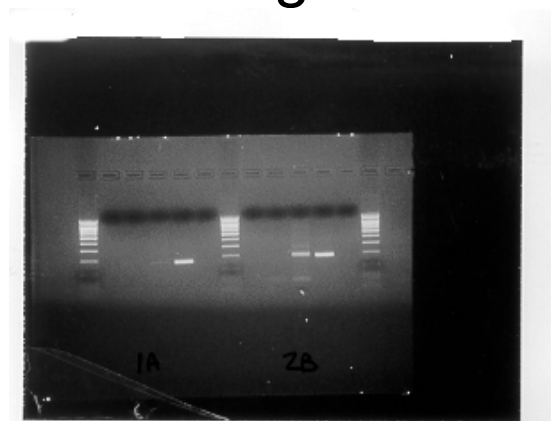



# Sequencing

- Prior to sequencing,
  - DNA from skeletal remains is purified using Centricon-100 centrifugal filters.
  - DNA from blood being processed in 96-well plates is purified chemically using ExoSAP-IT®
- Sequencing reactions take place in 96-well plates for both types of samples.

# Sequencing

- The sequencing contains the following reagents:
  - 10uM of the sequencing primer
  - 1.0-2.0ng of purified PCR product
  - ABI PRISM<sup>®</sup> Dye Terminator Cycle Sequencing Ready Reaction Kit with AmpliTaq<sup>®</sup> DNA Polymerase FS
  - diH<sub>2</sub>O
- And is sequenced in 9700's using 25 cycles of the following program:
  - 15.0s at 96.0°C
  - 5.0s at 50.0°C
  - 2 minutes at 60.0°C
  - Final hold at 4.0°C upon completion

# Sequencing Primers

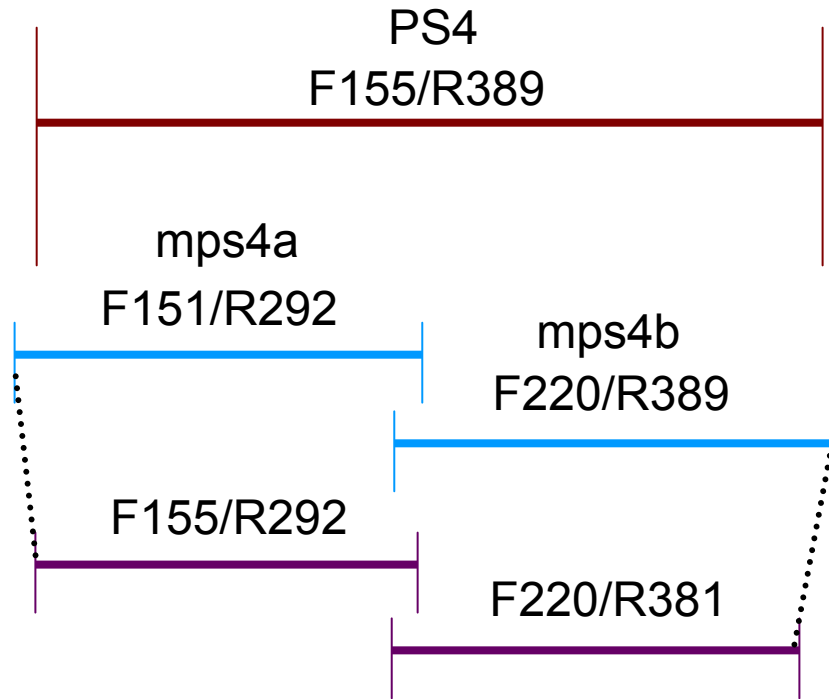

- Overall, the primers available for sequencing are the same as those for amplification.
- However, some are adjusted by a few bp to create a cleaner sequencing product.

# Sequencing

- Degraded samples were loaded onto polyacrylamide slab gels in an ABI377 until 2005.

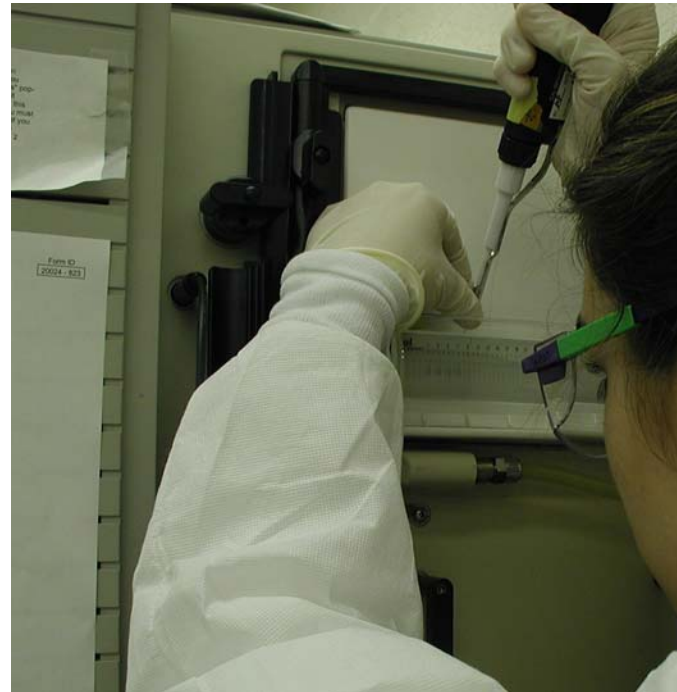

# Sequencing



- Now, all samples are processed in a 96-well format for sequencing and loaded onto an AB3100 Genetic Analyzer.

# Slab Gels vs. CE

- Slab gels are an effective method for visualization of sequencing products.
- However, they are not as sensitive as capillary electrophoresis for low-quantity samples.

# Slab Gel vs. CE

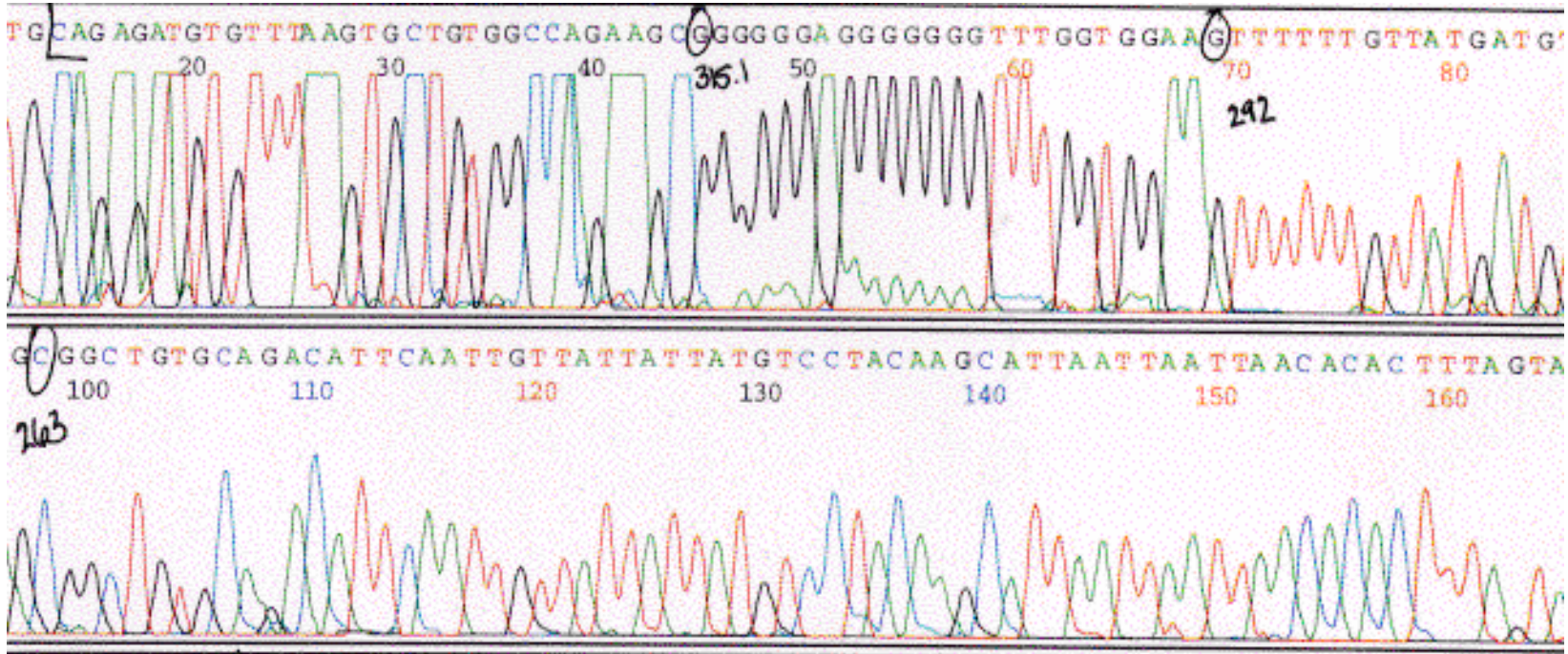

Slab Gel Data

# Slab Gel vs. CE

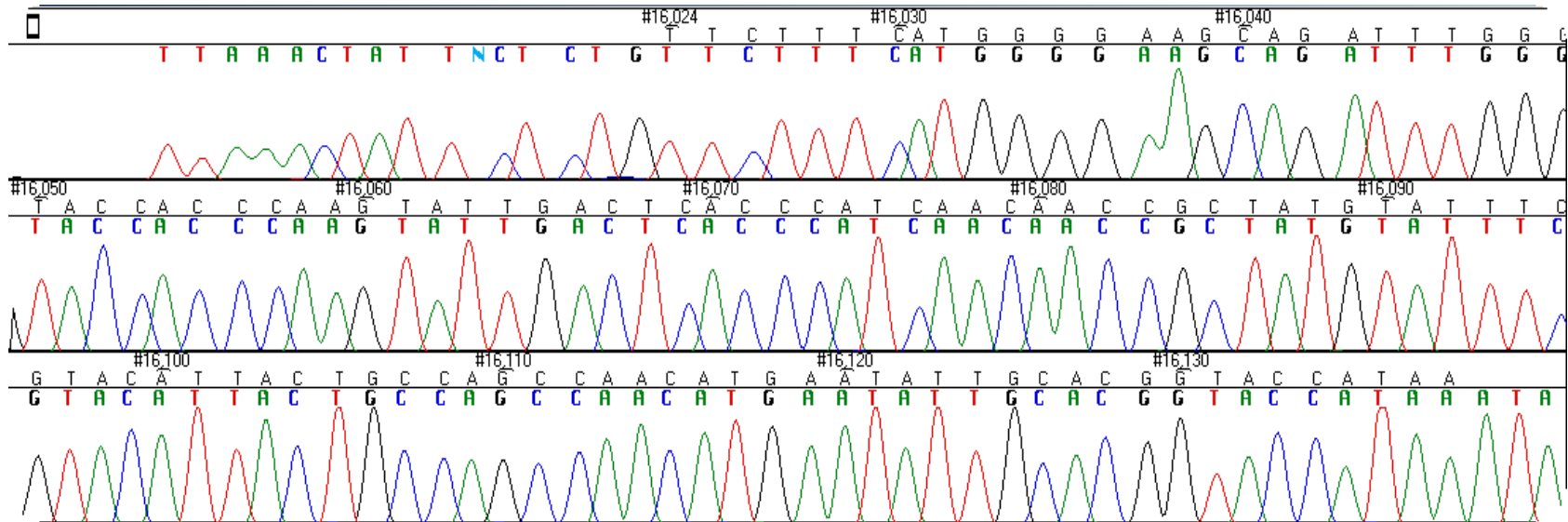

Capillary Electrophoresis Data



# Poor Clean-Up

- Poor clean-up of your sequencing product can cause pull-up or other high background in the electropherograms.

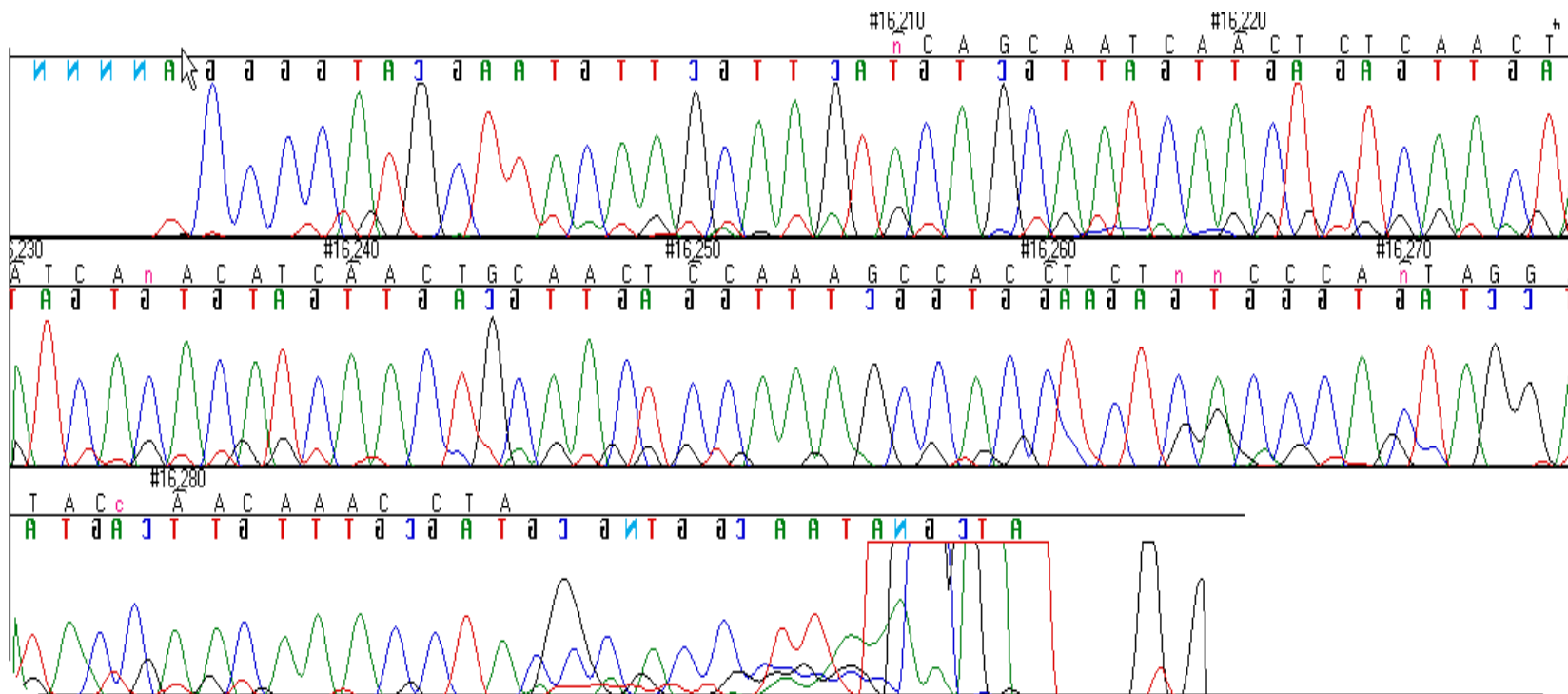

# Taq Error

- Degraded template DNA and non-proofreading can cause mis-incorporation of bases at single positions.

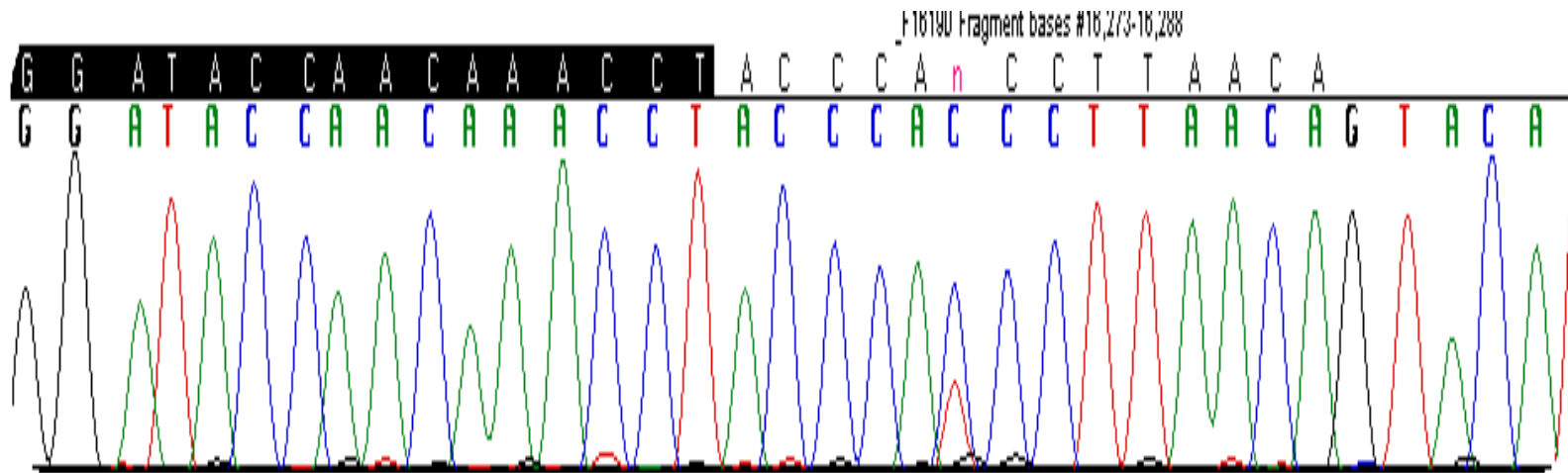

- Reamplification can correct the issue or show possible contamination.

# Mixtures

- Samples can be truly mixed, either at collection, extraction or amplification.

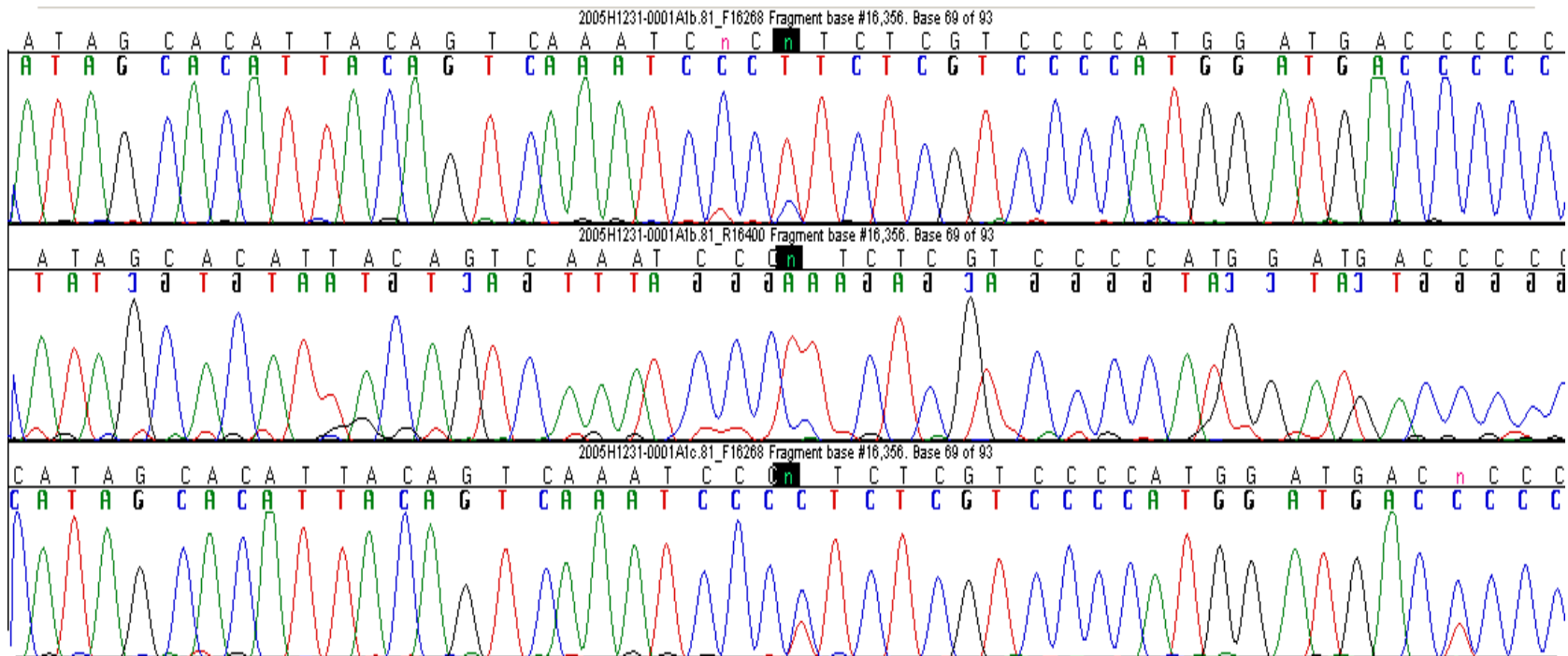

# Heteroplasmy

- Heteroplasmy is having two or more different species of mtDNA present in a single individual.
- Looks a lot like a mixture, but is typically only present at one position in the CR.
- Will verify authenticity of heteroplasmy by a second extraction of the sample.

# Heteroplasmy

- Presence of heteroplasmy varies between tissue types in the same individual.
  - Can be more frequently seen in hair
  - One of the most striking examples of heteroplasmy is seen in the identification of the remains of Tsar Nicholas II.



# Detection of Heteroplasmy

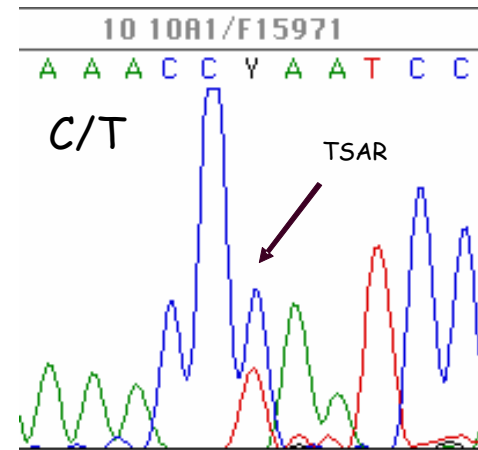
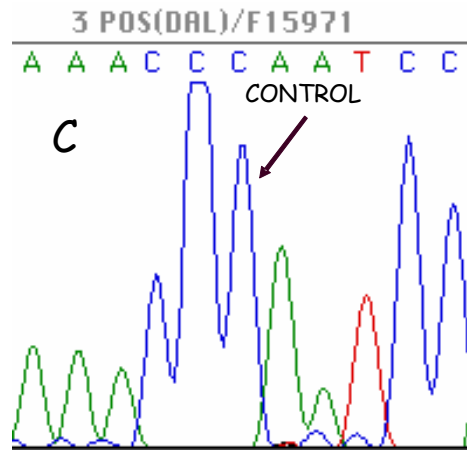

What is this position?

Was it a mixture?

Or is it heteroplasmy?

# Detection of Heteroplasmy

- Nicholas' brother was exhumed and his mtDNA examined....

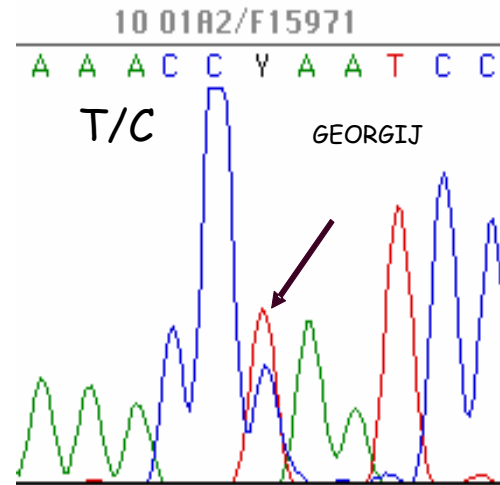
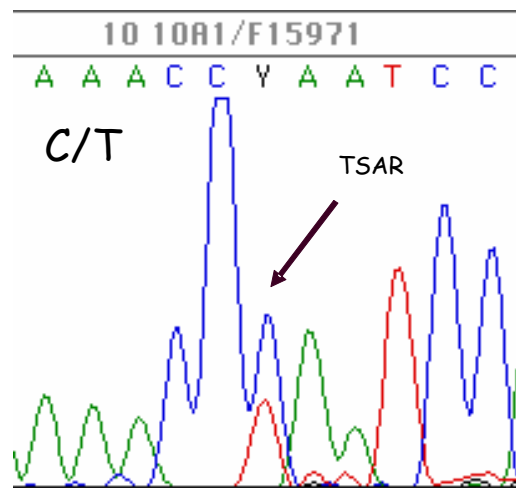

# Data Analysis

- Data generated is analyzed using Sequencher™ Plus software.
- In order to be reported, there must be overlapping data from at least two amplifications or two extractions.
- Data is analyzed by two scientists independently to confirm results.

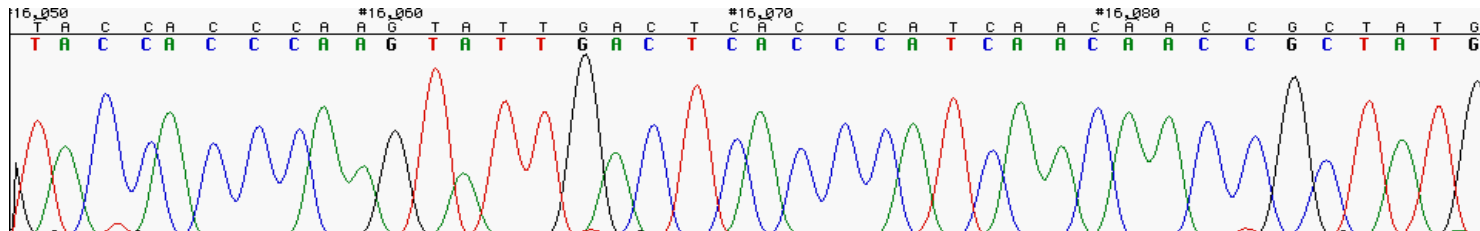



# **Acquisition of Appropriate Reference Materials**

Families are your allies in the  
identification process

# How to Identify?

- Commingled remains are generally separated with a combination of techniques:
  - Dental
  - Anthropology
  - Fingerprints
  - DNA
- Unidentified single sets of remains use the same techniques.
- Clothing and jewelry are not satisfactory for issuing an identification

# How to Identify?

- When remains are highly commingled, fragmented and/or skeletonized, DNA is often the most useful.
- However, depending on the degree of environmental damage to the samples, different types of DNA need to be used.

# Types of DNA

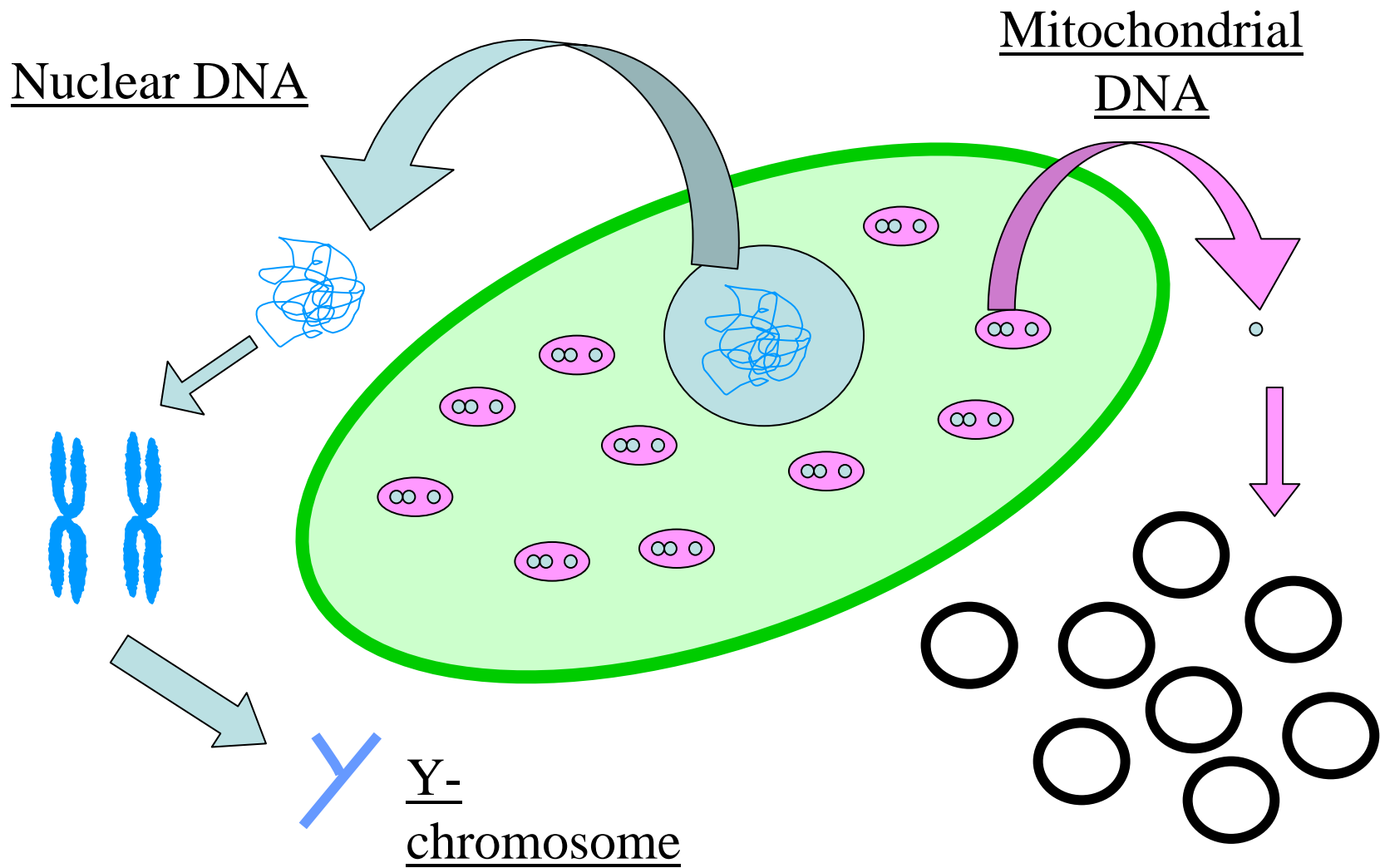

# Nuclear DNA

- STR (Short Tandem Repeat) Analysis.
- Usually needs DNA of good quality to work.
- Usually need either a direct reference or two members of the parentage trio for comparison.
- However, using statistics and relatives of greater distance than parents or children, identification support is possible.



# References Available for Nuclear DNA Analysis

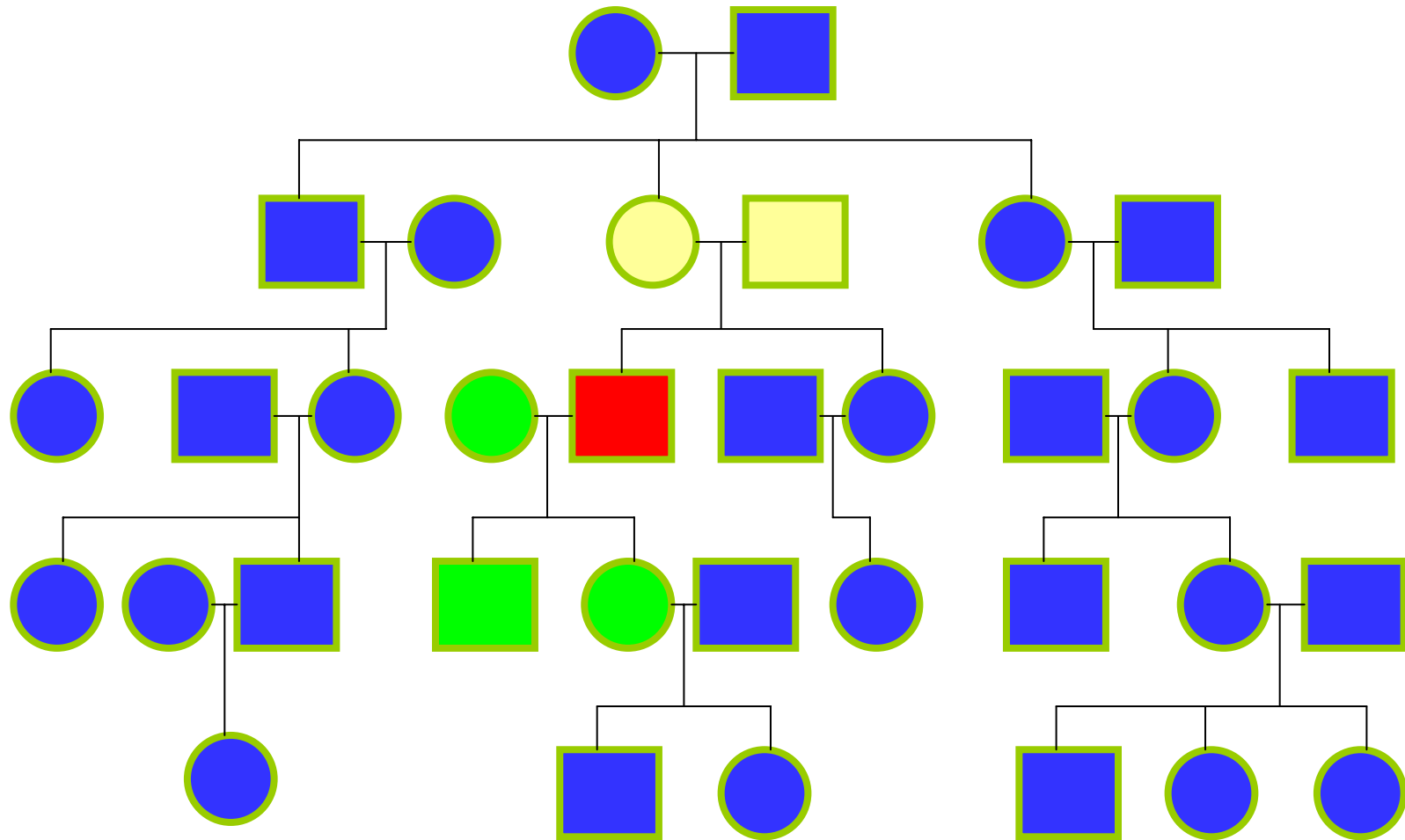

# Y-Chromosome Analysis

- Y-STR analysis looks at the heritable differences on the Y-chromosome.
- Profile and data resemble that of STR analysis.
- Need a relative of direct paternal lineage for comparison.
- Can only use males for comparison.



# References Available for Y-Chromosome Analysis

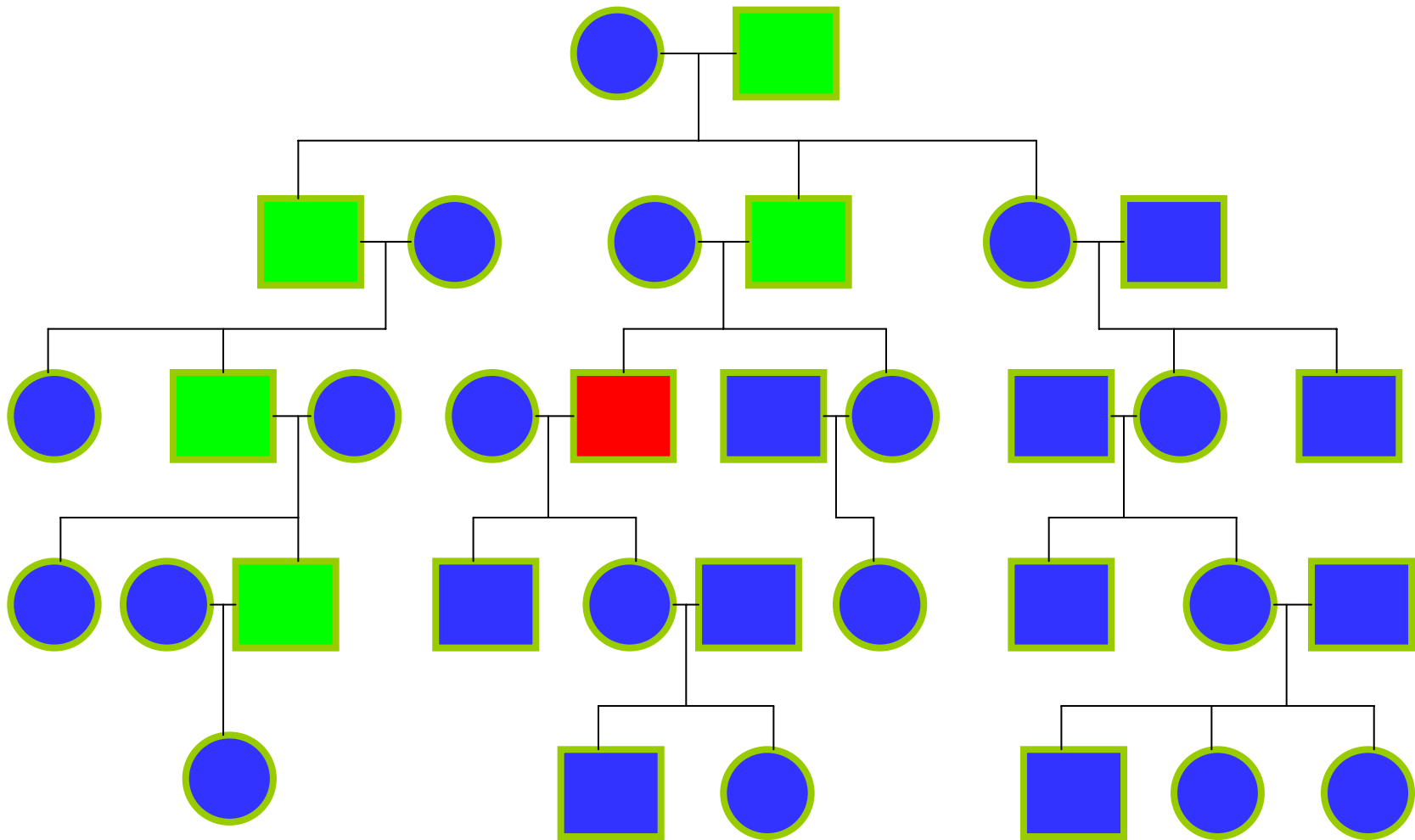



# Mitochondrial DNA

- Use direct sequencing of the control region of the mitochondria to generate a profile for comparison.
- Can use DNA from damaged or degraded remains.
- Relatives from a maternal lineage can be used for comparison.



# References Available for mtDNA Analysis

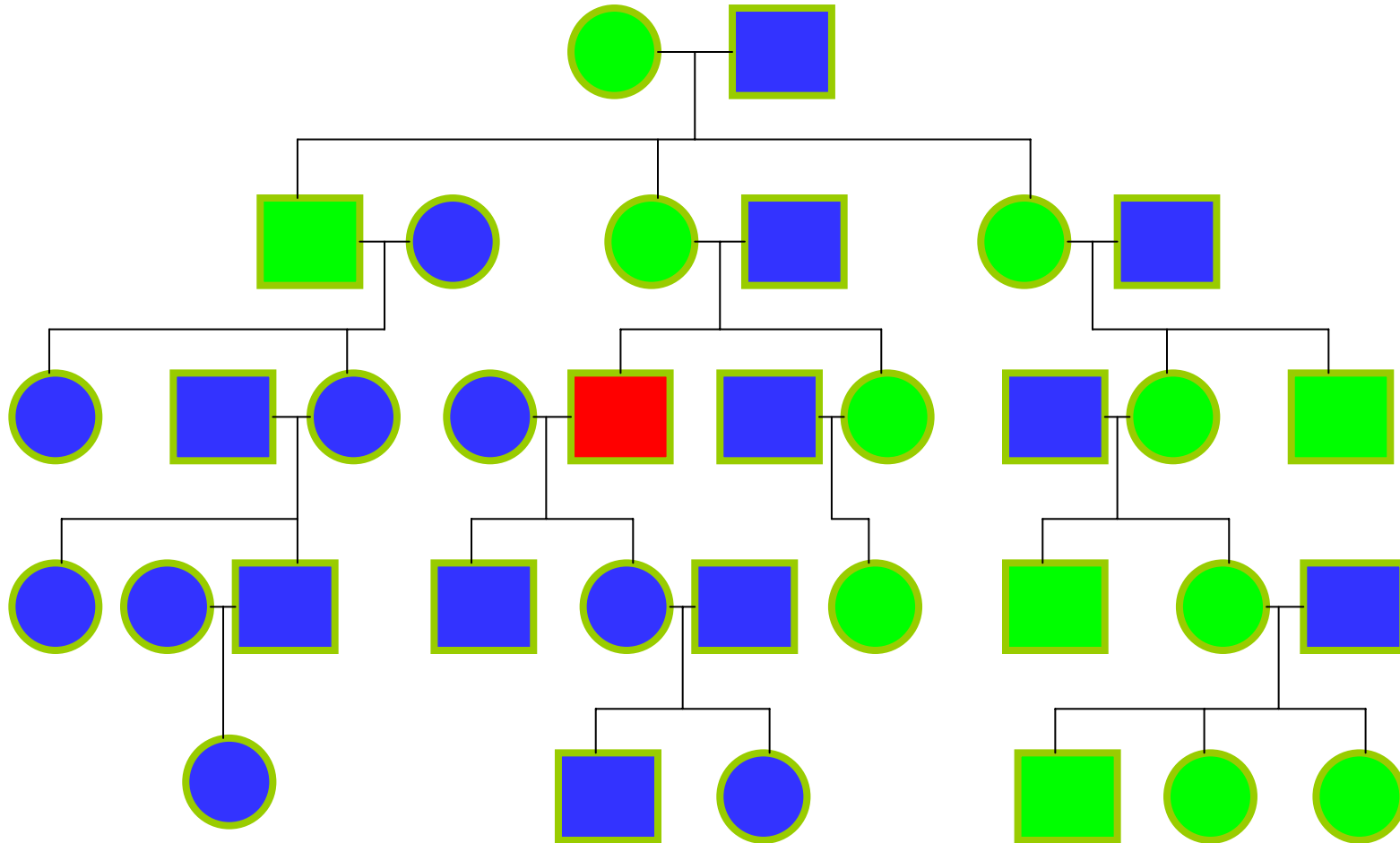

# DNA Reference Material

- Samples acquired from family members for comparison to remains are generally blood or buccal swabs.

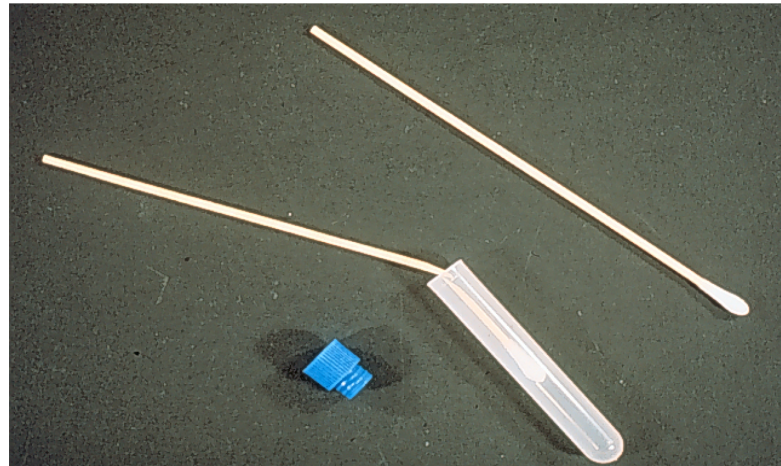
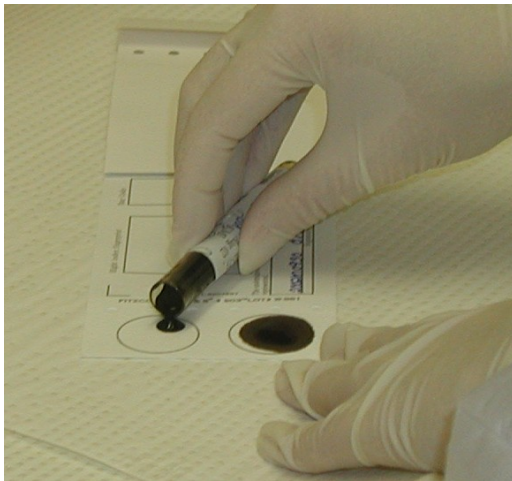

- A variety of direct references can be obtained for comparison.

# Direct References

- Hair

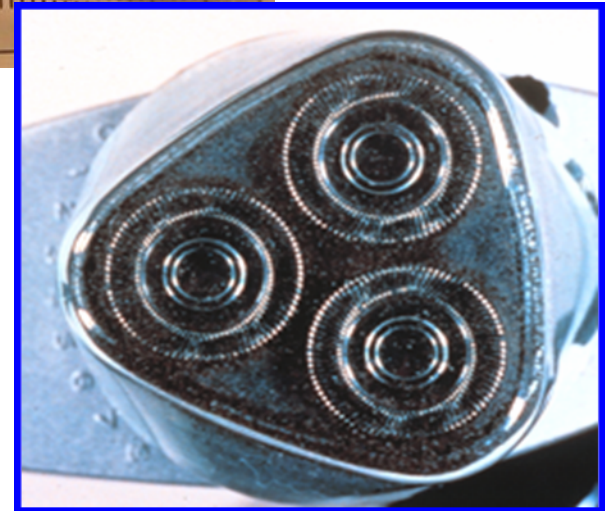
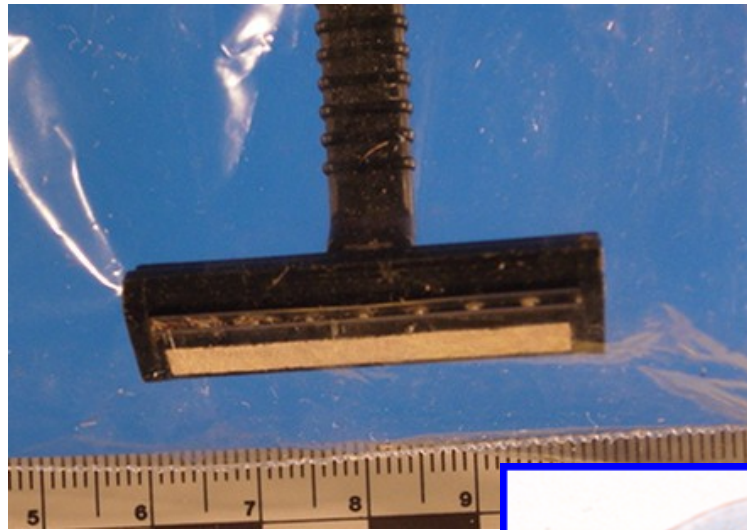
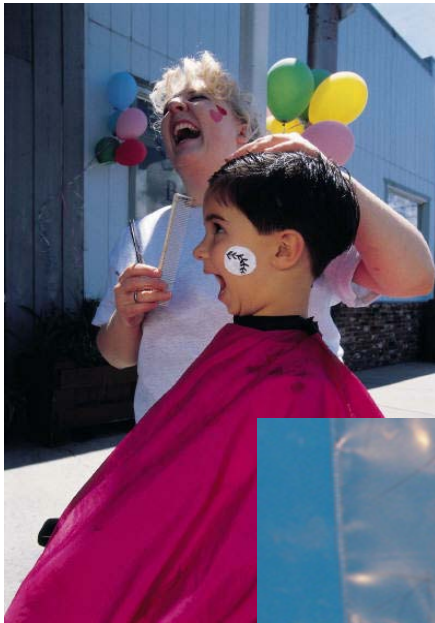

# Direct References

- Hair trapped on other things can also be used.

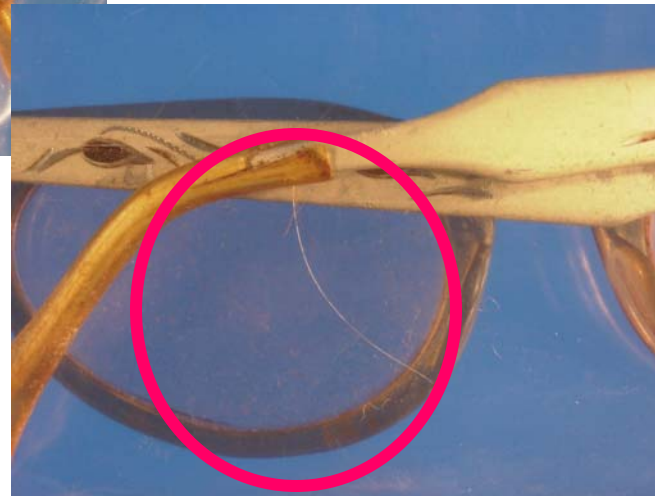

# Direct References

- Grooming remnants

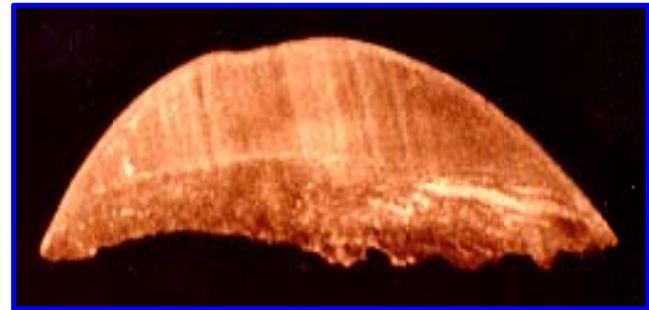
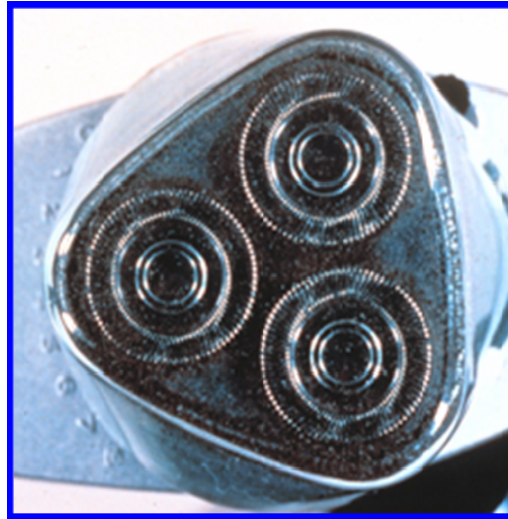
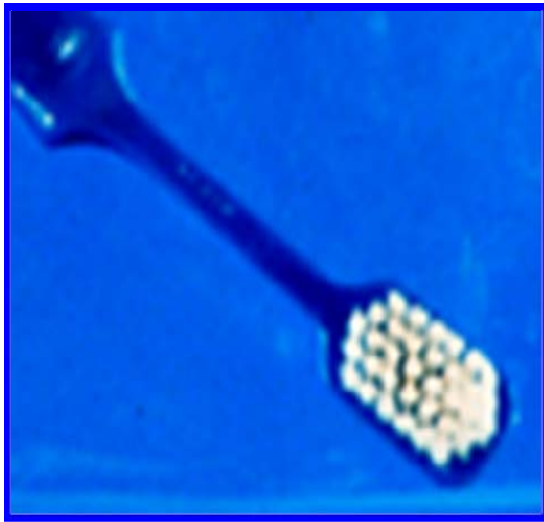

# Direct References

- Clothing



# Direct References

- Shoes and hats





# Direct References

- Hospital Materials



- Stamps and envelopes



# Extracting DNA from Alternate Source References

- Extracting DNA from alternate sources is not always as easy as it is from primary materials such as blood and tissue.
- Special steps need to be taken to ensure the authenticity of the sequence obtained.
- DNA from any of these sources can be used for different types of DNA analysis

# Hair

- Hair is fairly easy to obtain.
- Extracting a mass of hairs from a 'hallmark' haircut is fairly simple as the donor of the hair is generally well-documented.
- However shed-hairs and hairs found in hairbrushes or on garments must be carefully studied.

# Hair

- It is prudent to have a hair examiner study the hairs to be used so as to not extract an animal hair by accident.



# Hair

- Prior to extraction, hair is cleaned with a swab. This swab is dried saved for evidence.
- The hair is then cleaned in repeated washes of water and Terg-A-Zyme using a sonicating water bath to remove any extraneous biological materials.



# Hair

- Hair is ground in a micro-tissue grinder to break up the keratinized material.
- Ground with extraction buffer in the tube to assist grinding.



# Hair

- The ground hair is extracted with
  - 20mg/ml Proteinase K and extraction buffer
  - Overnight at 56°C
- DNA is removed from the extraction buffer with
  - a series of washes with Phenol/ Chloroform/ Isoamyl alcohol
  - Purification of product with filters.

# Grooming materials

- Grooming materials containing hairs are often easy to deal with as the hairs can be plucked directly from the object.
- This is true for hairbrushes and combs.
- However hairs adhered to razors must be treated in another fashion.



# Grooming materials

- The razor head is removed along with the 'lubrication strip' and soaked in extraction buffer and proteinase K overnight at 56°C.
- Extraction continues as if it was a group of head hairs.

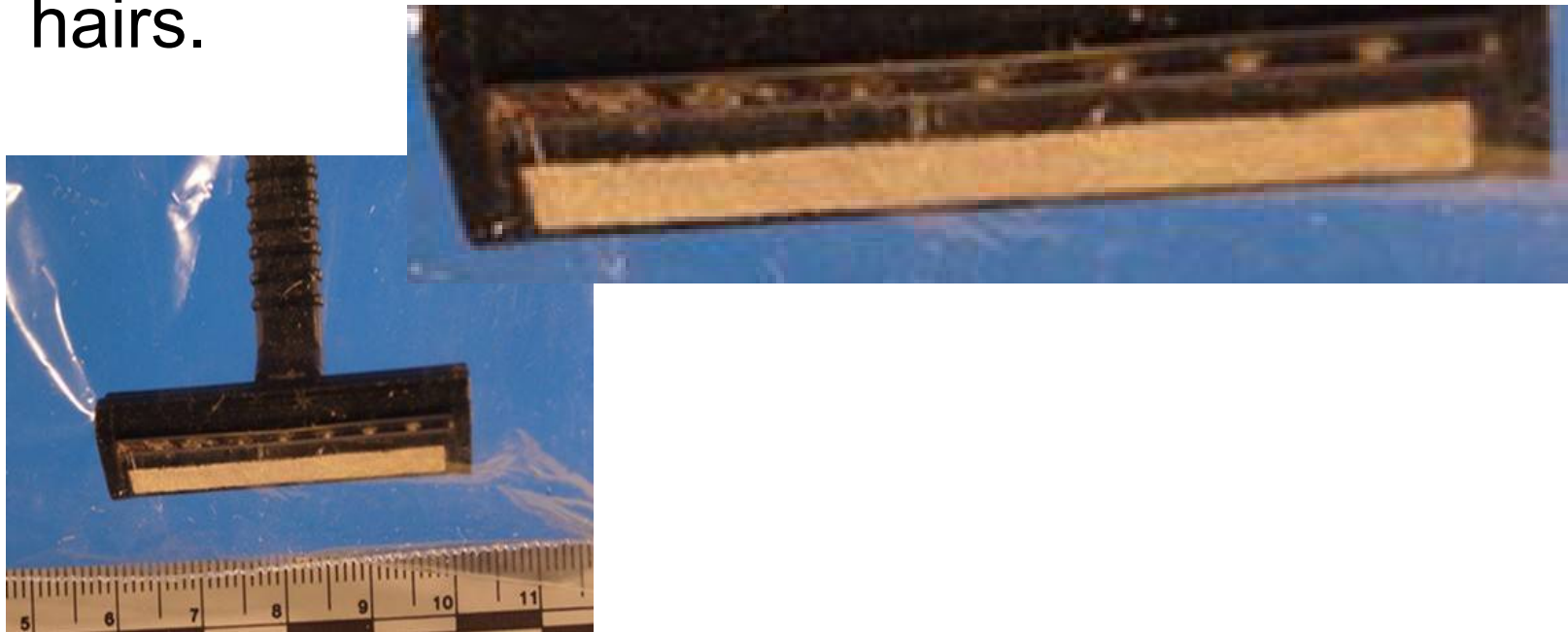

# Stamps and Envelopes



- Most usually seen as alternate references for individuals lost in past military conflicts.
- Must be treated with caution for a number of reasons
  - The person applying saliva to the stamp or envelope is not necessarily the missing person
  - The letter may have been handled repeatedly by the decedent's family.
  - There is not good method for decontaminating these items

# Stamps and Envelopes

- Steam is used to remove the stamp or to unseal the envelope.
- Extraction buffer is applied directly to the gummed surface and removed with a swab.
- The swab can then be extracted using the phenol/chloroform/isoamyl alcohol method and purification columns.

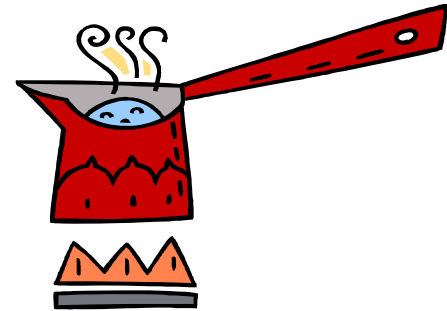

# Garments

- Samples from garments must be removed from unwashed garments.
- If the clothing has been washed or worn by other individuals, the target DNA of the decedent is gone or contaminated.

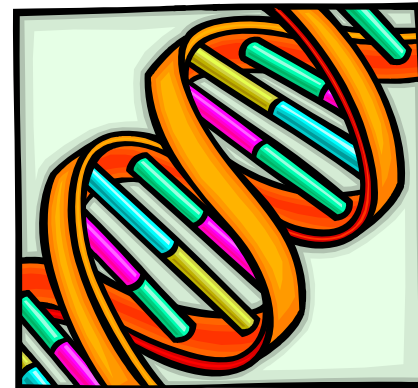
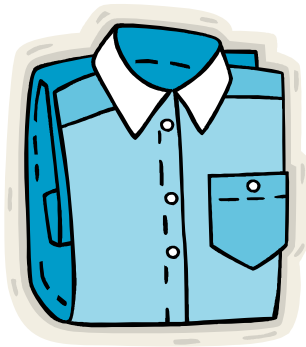

# Garments



- Clean scissors or a razor should be used to remove a portion of the garment.
  - Try to target areas that would rub on the wearer.
- 
- The fragments of cloth are soaked overnight in extraction buffer and proteinase K and the extraction continues in the manner previously described.

# Profile Generation

- After extraction, DNA from these samples can be amplified and sequenced to generate a profile for various DNA types
  - Nuclear DNA
  - MtDNA
  - Y STR's
- What you choose for a reference depends on the type of DNA you will acquire from the remains.

# Case Study

- When receiving remains for a closed population, the identity of the individuals involved are generally known.
- This makes it easier to acquire reference materials.
- However, when the reference material is of questionable origin, and the profiles are not appreciably different, identification becomes more difficult and further steps must be taken.

# Four Missing Airmen

- In the winter of 1972, a B-52 bomber crashed leaving no survivors of the 4-member crew.
- In 1985, JPAC-CIL conducted recovery operations and returned with unburied remains.
- Remains were submitted to AFDIL for extraction of mtDNA.





# mtDNA Profiles

- Full profiles were generated for the samples submitted.
- References were found for three of the four missing persons.
- For the fourth airman there was only envelopes.

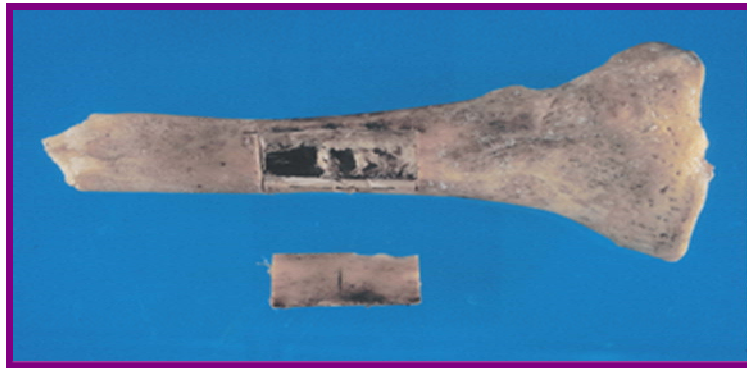

# mtDNA Profiles

- References for two of the missing airmen were consistent with profiles generated in the remains.
- The reference for the last airman and the profile generated from the envelopes were consistent with each other.
- Had the one airman sealed the envelopes for the other? How would we know?

# mtDNA Profiles

- For 5 years this case rested at AFDIL as inconclusive.
- In 2002, a living maternal relative was found for the second airman.
- The sequence for the reference and for the envelopes were consistent.
- The samples were testing with the standards currently in place at AFDIL and the samples were able to be segregated for burial.



# Family Interactions

- Families must be dealt with sensitively, but still provided with accurate information.
- It is families who will provide the laboratories with reference information to make an identification



# Family Interactions

- Providing the families a place to obtain accurate information is preferential.
- It is optimal to have a family outreach center and provide a staff of individuals qualified to take DNA samples.



# Positive Family Interactions

- Treat family members with respect and consideration.
  - Through positive interactions, they are more likely to be helpful in providing reference materials.
- In human identification, you are not only working for the dead, but the living as well.

# Summary

- MtDNA analysis is a challenging process.
- However, it is highly useful in to aid in the identification of degraded human remains.



# Acknowledgements

- Much of this information was taken from the following papers and presentations:
  - General AFDIL information:
    - SM Edson, JP Ross, MD Coble, TJ Parsons, and SM Barritt (2004). Naming the Dead – Confronting the Realities of Rapid Identification of Degraded Skeletal Remains. *Forensic Sci. Rev.* 16: 63.
  - Primer Information:
    - MN Gabriel, EF Huffine, JH Ryan, MM Holland, and TJ Parsons (2001). Improved mtDNA sequence analysis of forensic remains using a mini-primer set amplification strategy. *J. Forensic Sci.* 46: 247.



# Acknowledgements

- Sample selection of skeletal elements:
  - SM Edson, HA Thew, FE Damann, CA Boyer, SM Barritt, and BC Smith (2005). Success rates for recovering mitochondrial DNA (mtDNA) from 4,000 'ancient' human skeletal remains. Presented at the 17<sup>th</sup> meeting of the International Association of Forensic Sciences (IAFS), Hong Kong.
  - SM Edson, SM Barritt, MD Leney, and BC Smith (2006). mtDNA from degraded skeletal remains: Is quality affected by storage conditions? Presented at the 58<sup>th</sup> Annual meeting of the American Academy of Forensic Sciences (AAFS), Seattle, WA.
- Family reference acquisition
  - SM Edson, SM Barritt-Ross, and DA Lee (2004). Separation of individuals in mass disasters and other sets of commingled remains – Acquisition and use of appropriate reference materials. Presented at The International Symposium on the Application of DNA Technologies in Analytical Sciences, in Kaohsiung, Taiwan.

# Acknowledgements

- Suzanne Barritt
  - Christine Boyer
  - Amanda Coute
  - Heather Thew
  - Brion Smith
  - Mark Loney
  - Franklin Damann
  - Michael Coble
  - Jim Ross
  - Thomas Parsons
  - Demris Lee
  - Kerry Maynard
  - Jennifer O'Callaghan
  - Timothy McMahon
  - Jim Canik
  - Jodi Irwin
  - Rebecca Just
  - Mark Wadhams
- All the staff, past, present and future, of AFDIL and JPAC-CIL, without whom, none of this would be possible.



# Contact Information and Disclaimer

- Suni M. Edson  
[Suni.Edson@afip.osd.mil](mailto:Suni.Edson@afip.osd.mil)  
301-319-0193
- Disclaimer  

The views expressed herein are the those of the author and not necessarily those of the Armed Forces Institute of Pathology, the US Army Surgeon General, nor the Department of Defense.

