



NOAA Technical Memorandum NMFS-AFSC-152

# **Using Digital Video Monitoring Systems in Fisheries: Application for Monitoring Compliance of Seabird Avoidance Devices and Seabird Mortality in Pacific Halibut Longline Fisheries**

by

R. T. Ames, G. H. Williams, and S. M. Fitzgerald

**U.S. DEPARTMENT OF COMMERCE**  
National Oceanic and Atmospheric Administration  
National Marine Fisheries Service  
Alaska Fisheries Science Center

April 2005

## NOAA Technical Memorandum NMFS

The National Marine Fisheries Service's Alaska Fisheries Science Center uses the NOAA Technical Memorandum series to issue informal scientific and technical publications when complete formal review and editorial processing are not appropriate or feasible. Documents within this series reflect sound professional work and may be referenced in the formal scientific and technical literature.

The NMFS-AFSC Technical Memorandum series of the Alaska Fisheries Science Center continues the NMFS-F/NWC series established in 1970 by the Northwest Fisheries Center. The NMFS-NWFSC series is currently used by the Northwest Fisheries Science Center.

This document should be cited as follows:

Ames, R. T., G. H. Williams, and S. M. Fitzgerald. 2005. Using digital video monitoring systems in fisheries: Application for monitoring compliance of seabird avoidance devices and seabird mortality in Pacific halibut longline fisheries. U.S. Dep. Commer., NOAA Tech. Memo. NMFS-AFSC-152, 93 p.

Reference in this document to trade names does not imply endorsement by the National Marine Fisheries Service, NOAA.



NOAA Technical Memorandum NMFS-AFSC-152

# Using Digital Video Monitoring Systems in Fisheries: Application for Monitoring Compliance of Seabird Avoidance Devices and Seabird Mortality in Pacific Halibut Longline Fisheries

by

R. T. Ames<sup>1</sup>, G. H. Williams<sup>1</sup>, and S. M. Fitzgerald<sup>2</sup>

<sup>1</sup> International Pacific Halibut Commission  
P. O. Box 95009  
Seattle WA 98145-2009

<sup>2</sup> Alaska Fisheries Science Center  
7600 Sand Point Way N.E.  
Seattle, WA 98115  
[www.afsc.noaa.gov](http://www.afsc.noaa.gov)

## **U.S. DEPARTMENT OF COMMERCE**

Carlos M. Gutierrez, Secretary

### **National Oceanic and Atmospheric Administration**

Vice Admiral Conrad C. Lautenbacher, Jr., U.S. Navy (ret.), Under Secretary and Administrator

### **National Marine Fisheries Service**

William T. Hogarth, Assistant Administrator for Fisheries

April 2005

**This document is available to the public through:**

National Technical Information Service  
U.S. Department of Commerce  
5285 Port Royal Road  
Springfield, VA 22161

*[www.ntis.gov](http://www.ntis.gov)*

### **Notice to Users of this Document**

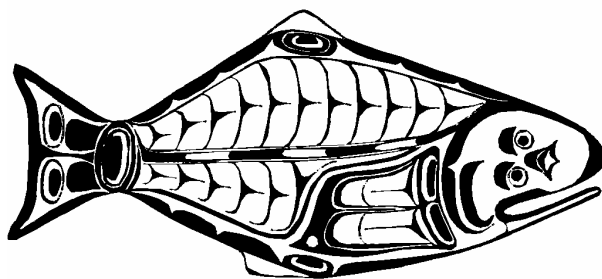
This document is being made available in .PDF format for the convenience of users; however, the accuracy and correctness of the document can only be certified as was presented in the original hard copy format.



## PREFACE

Research presented in this report was conducted by the International Pacific Halibut Commission (IPHC) for the National Marine Fisheries Service under the terms of Order #AB133F-02-SE-1015. This project examined the feasibility of using electronic monitoring systems (EMS) in the Pacific halibut longline fleet operating off the state of Alaska. The project was conducted on two of the IPHC's chartered stock assessment survey vessels fishing in Alaska during 2002. The objectives of the project were to 1) examine the ability of an electronic monitoring system to provide images that would allow an analyst to monitor seabird avoidance devices for regulatory compliance; 2) determine the feasibility of using video images for detecting and identifying incidentally caught seabirds; and 3) discuss options for the future use of electronic monitoring as a fishery management tool.

The IPHC was established in 1923 by a Convention between the governments of Canada and the United States of America. IPHC's mandate is research on and management of the stocks of Pacific halibut (*Hippoglossus stenolepis*) within the Convention waters of both nations. The IPHC conducts research on many aspects of the resource and fishery, including issues which affect the conduct of the halibut fishery. The potential bycatch of seabirds is an important issue facing the commercial halibut fishery and the IPHC is interested in assisting the industry in reducing the potential for seabird bycatch. Recently, regulations have been enacted to minimize bycatch based on the use of streamer lines. This project evaluates means to ensure compliance with those regulations by vessels, through the use of an electronic monitoring system.



International Pacific Halibut Commission  
P.O. Box 95009  
Seattle, WA 98145-2009





---

<b>Executive Summary</b> .....	vii
<b>Glossary of Terms</b> .....	ix
<b>Glossary of Abbreviations</b> .....	xi
<b>Introduction</b> .....	1
<b>Materials and Methods</b> .....	3
<b>Description of an Electronic Monitoring System (EMS)</b> .....	3
<b>Computer control box</b> .....	4
<b>Closed circuit TV cameras</b> .....	4
<b>Global positioning system</b> .....	5
<b>Hydraulic pressure sensor</b> .....	5
<b>Project design</b> .....	5
<b>Vessel selection</b> .....	7
<b>Third sea-sampler monitoring duties</b> .....	7
<b>Electronic Monitoring System Installations</b> .....	8
<b>F/V Heritage</b> .....	8
Setting CCTV camera configurations .....	8
Hauling CCTV camera configurations .....	8
<b>F/V Pacific Sun</b> .....	9
Setting CCTV camera configurations .....	9
Hauling CCTV camera configurations .....	9
<b>Installation of EMS on project vessels</b> .....	9
<b>Streamer lines</b> .....	9
<b>Streamer line mounting locations</b> .....	9
<b>Streamer line enhancements</b> .....	10
<b>Streamer line performance assessment</b> .....	10
Performance based on at-sea observations .....	10
Performance based on video observations .....	11
<b>Seabird Identification Experiments</b> .....	11
<b>Analysis of video images by analyst</b> .....	12
<b>Seabird seminar at NMFS/AFSC</b> .....	12
<b>Detection and identification of seabirds from hauling video</b> .....	13
<b>Results</b> .....	14
<b>Sets and hauls monitored</b> .....	14
<b>Assessment of Setting Video Imagery</b> .....	14
<b>Sea sampler and video streamer line performance comparisons</b> .....	15
<b>Assessment of Hauling Video Imagery</b> .....	16
<b>Seabird Identification Experiment</b> .....	16
<b>Analysis of video images</b> .....	16
<b>Seabird seminar at NMFS/AFSC</b> .....	17
<b>Detection and identification of seabirds from hauling video events</b> .....	17
<b>Discussion</b> .....	18
<b>Assessment of Setting Video Imagery</b> .....	18
<b>Setting CCTV camera(s) assessment</b> .....	18
<b>Setting CCTV camera(s) configurations and lenses</b> .....	18
<b>Streamer line detection and position</b> .....	19
<b>Streamer line performance</b> .....	19
<b>Applications of setting CCTV camera(s)</b> .....	21
<b>Assessment of Hauling Video Imagery</b> .....	22

Hauling CCTV camera assessment.....	23
Seabird Identification Experiment.....	23
Analysis of video images.....	23
Seabird seminar at NMSF/AFSC .....	24
Detection and identification of seabirds from hauling video events.....	24
<b>Potential Costs Associated with Fishery Monitoring.....</b>	<b>25</b>
Results of Cost Comparison.....	26
<b>Conclusions.....</b>	<b>28</b>
<b>Recommendations.....</b>	<b>29</b>
Option One: EMS monitoring of streamer lines.....	29
Option Two: EMS monitoring of streamer lines and seabird incidental catch.....	29
<b>Acknowledgements .....</b>	<b>31</b>
<b>Citations.....</b>	<b>33</b>
<b>List of Tables .....</b>	<b>35</b>
<b>List of Figures.....</b>	<b>37</b>
<b>Appendix 1. Method Of Securing Seabirds To The Longline Gear.....</b>	<b>87</b>
<b>Appendix 2. Basic Statistics of Fishing Effort and Catch .....</b>	<b>89</b>

## EXECUTIVE SUMMARY

The incidental take of seabirds, including rare takes of the endangered short-tailed albatross (*Phoebastria albatrus*), is known to occur in the Alaskan longline fishing fleet. Current fishery regulations do not require observer coverage in the Pacific halibut fishery unless a vessel is greater than 60 feet length overall (LOA) and participating in other federally managed fisheries. The lack of at-sea observations has resulted in little information on the amount of seabird bycatch and on the compliance with seabird avoidance measures within the halibut fishery. The National Marine Fisheries Service (NMFS) contracted with the International Pacific Halibut Commission (IPHC) on a project to examine the feasibility of electronic monitoring systems (EMS) in the Pacific halibut longline fleet operating off the state of Alaska. The project was conducted on two of the IPHC's chartered stock assessment survey vessels fishing in Alaska during 2002. The objectives of the project were to 1) examine the ability of an electronic monitoring system to provide images that would allow an analyst to monitor seabird avoidance devices for regulatory compliance; 2) determine the feasibility of using video images for detecting and identifying incidentally caught seabirds; and 3) discuss options for the future use of electronic monitoring as a fishery management tool.

To determine if an electronic monitoring system (EMS) could be used to assist in compliance determination, a system was placed on the vessels to record images of halibut gear being set and the performance of seabird avoidance devices, or streamer lines, during the setting. Vessel and video observations were compared on 106 setting events. The EMS video observations proved to be successful in detecting streamer line deployment and relative position on 100% of the daytime sets when two cameras were used. The results of the streamer line performance evaluations suggest that accurate performance recognition was positively related to the increase in image recording speed and the video analysts' ability to distinguish measured interval markings that were attached to the streamer lines.

The ability of a video analyst to recognize and identify retrieved seabirds was examined by intentionally setting previously caught frozen seabirds on the fishing gear. No birds were caught incidentally during this study. Using 63 seabird specimens, the results showed a positive relationship between correct seabird species identification and EMS recording frame rates. At a fast recording speed 91% of the deliberately set seabirds were correctly identified as seabirds and 64% were identified accurately according to species. Nine of 12 albatross (*Diomedea* spp.) specimens were correctly identified to species; 1 was determined to be an unidentified albatross, and 2 were incorrectly identified. During a second examination 14 members of the NMFS's North Pacific Groundfish Observer Program staff examined video images of six retrieved seabirds. The results indicated that correct seabird identification is related both to the analyst's knowledge of distinguishing species characteristics, and to the size of the seabird. A third independent evaluation, where an analyst had no advance knowledge of birds being retrieved on the gear, showed that an analyst was capable of detecting 96% of the seabirds deliberately set with the gear, and that 79% of the specimens were correctly identified to species.

The potential costs of two monitoring programs were estimated at two levels of coverage for the halibut fishery off Alaska. The cost of complete monitoring of all setting and haul backs was estimated at \$8.5 million for an on-board observer program; the cost of an EMS was

estimated at \$2.7 million. Coverage levels of 100% for vessels greater than 125 feet LOA, 30% vessels for 60-124 feet LOA, and no coverage of vessels less than 60 feet LOA was estimated at \$0.41 million for an on-board observer program, whereas the cost of an EMS was estimated at \$0.22 million. Electronic monitoring costs could be reduced if fewer hauls were sampled on each vessel than currently realized.

In conclusion, this study suggests that an EMS monitoring program would produce accurate data and enable compliance evaluations for seabird avoidance devices. In addition, an EMS program would be able to detect a high proportion of incidentally caught seabirds. However, additional work is needed on seabird image identification and verification methods and testing the effects of soak time on the physical characteristics of seabirds.

## Glossary of Terms

**Bycatch:** Animals or species taken incidentally in a commercial fishery; bycatch species may be of lesser value than the target species and are often discarded. Some bycatch species are of commercial value and are retained for sale (Froese and Pauly 2003).

**Computer control box:** The electronic monitoring computer control system. The control box contains the operating system, data storage components and power supplies for the video cameras and peripheral vessel sensors.

**Electronic monitoring system:** An integrated assortment of available digital video, sensory receivers, and computer components with a proprietary software operating system.

**Gurdy:** A hydraulic winch used to retrieve longline fishing gear.

**Hauling event:** The retrieval of one set of longline fishing gear.

**Hydraulic pressure sensor:** An electronic transducer used by the computer control box to monitor pressure variations at the gurdy.

**Interval recording rate:** The recording of video images in equally spaced periods of time.

**Longline:** A line of considerable length, bearing secondary lines (gangions) with numerous baited hooks (Froese and Pauly 2003). During this study, the longline rested at or near the bottom of the ocean and was standardized with 500 hooks per set.

**Optically dense:** An object of sufficient size, shape, or color to be visible on the EMS recorded images.

**Real time recording rate:** The continuous recording of video images in actual time.

**Recording frame rate:** The recording speed in frames per second.

**Seabird:** Frozen seabird specimens that were deliberately set with the fishing gear to determine the feasibility of using video images for detecting and identifying incidentally caught seabirds.

**Sea-samplers:** International Pacific Halibut Commission field biologists that are responsible for collecting and recording data during survey operations.

**Setting event:** The deployment of one set or unit of longline fishing gear.

**Streamer line:** A line with streamers used to prevent seabird from accessing the area where the baited hooks are sinking. The devices are composed of a single 90-m line, 5-m spaced streamers, and a drogue at the terminal end. The streamer lines are deployed and towed during setting events.

**Streamer line deployment:** The deployment and the towing of a streamer line behind the vessel for the duration of the setting event.

**Streamer line performance:** The distance between the vessel stern and the first intersection of the line with the seawater.

**Streamer line position:** The location of the streamer line with respect to the main groundline for the duration of setting event.

**Third sea-samplers:** International Pacific Halibut Commission field biologists that were assigned to ensure the EMS project objectives were met and to supervise and maintain the electronic monitoring system equipment.

**Video recording compression ratio:** The mathematical process of reducing the amount of data in a given file. The computer compresses the video images in order to maximize the amount of video on a hard disk. The more the computer compresses the video in a file, the more video the storage disk can hold. The compression process reduces the image quality and is non-reversible.

## **Glossary of Abbreviations**

**AMR:** Archipelago Marine Research Ltd.

**AFSC:** Alaska Fisheries Science Center

**BAD:** Bird avoidance device

**CCTV:** Closed circuit television

**EMS:** Electronic monitoring system

**FPS:** Frame rate per second

**FRFR:** Fast recording frame rate

**GPS:** Global positioning system

**IPHC:** International Pacific Halibut Commission

**LOA:** Length overall

**NMFS:** National Marine Fisheries Service

**NPGOP:** North Pacific Groundfish Observer Program

**NPFMC:** North Pacific Fishery Management Council

**PSMFC:** Pacific States Marine Fisheries Commission

**SIIT:** Seabird Image Identification Techniques

**SRFR:** Slow recording frame rate

**STAL:** Short-tailed albatross (*Phoebastria albatrus*)





## INTRODUCTION

The Pacific halibut (*Hippoglossus stenolepis*) longline fishery operates throughout Alaskan waters. No observer monitoring or other at-sea monitoring of vessels under 60 feet length overall (LOA) is presently occurring, and only limited observer coverage occurs on vessels greater than 60 feet LOA participating in other federally managed fisheries. In the observed longline fleet (targeting halibut and other species), the incidental take of seabirds has been documented, including rare takes of the endangered short-tailed albatross (*Phoebastria albatrus*) (U. S. Fish and Wildlife Service 2003). As a result of the risk to short-tailed albatross, a biological opinion (U. S. Fish and Wildlife Service 1998) was issued for the halibut fishery under Section 7 of the Endangered Species Act that requires the U.S. National Marine Fisheries Service (NMFS) to take certain reasonable and prudent measures to protect the short-tailed albatross. One requirement is:

...the NMFS shall prepare and implement a plan to investigate all options for monitoring the Pacific halibut fishery in waters off Alaska. It will then institute changes to the fishery appropriate to the results of this investigation.

In response, and at the request of the longline fishing industry, the North Pacific Fishery Management Council (NPFMC) recommended that regulations be instituted to protect seabirds from halibut and groundfish longline fishing operations. The industry took a lead role in initiating this effort. These measures were first developed in 1997 and were revised by NMFS in 2004 (NMFS 2004). For the halibut fishery, the regulations require vessels longer than 55 feet LOA fishing off Alaska to deploy paired streamer lines as a seabird deterrent. NMFS regulations stipulate:

.... Streamer lines (paired) must be deployed in such a way that streamers are in the air for a minimum of 131.2 ft (40 m) aft of the stern for vessels under 100 ft (30.5 m), and 196.9 ft (60 m) aft of the stern for vessels 100 ft (30.5 m) or over.

1. For vessels deploying gear from the stern, the paired streamer lines must be deployed from the stern, one on each side of the main groundline.
2. For vessels deploying gear from the side, the paired streamer lines must be deployed from the stern, one over the main groundline and the other on either side of the main groundline.

The intended function of the streamer line design is to deter seabirds from the baited hooks by creating a visual and physical barrier on either side of the gear (Melvin et al. 2001). With proper deployment, the paired streamer lines were shown to be effective at reducing 88% to 100% of seabird bycatch during longline operations, and more specifically, the streamer lines should eliminate albatross bycatch (Melvin et al. 2001).

However, vessels fishing halibut in Alaska have no requirements for observer coverage unless they are longer than 60 feet LOA and are participating in other federally managed fisheries. Thus, there is little information collected at-sea on halibut vessel operations and practices with regard to the amount of seabird bycatch and to the compliance with seabird

avoidance regulations. In a previous report, Geernaert et al. (2001) discussed several options for monitoring potential catch of short-tailed albatross (STAL) in the Pacific halibut fishery, and concluded that video technology provided a possible solution for such monitoring. Potential costs of expanding observer coverage to the current halibut fleet may be prohibitive.

The introduction of regulations requiring the use of seabird avoidance devices by the halibut longline fleet prompted the consideration of ways in which compliance could be monitored. NMFS required a monitoring method in order to determine deployment and performance, but needed information on appropriate methods. Accordingly, NMFS selected the International Pacific Halibut Commission (IPHC) to examine the feasibility of electronic monitoring in the Pacific halibut longline fleet operating off Alaska. The objectives of the project were to

1. Examine the ability of an electronic monitoring system to provide images that would allow an analyst to monitor seabird avoidance devices for regulatory compliance;
2. Determine the feasibility of using video images for detecting and identifying incidentally caught seabirds; and
3. Discuss options for the future use of electronic monitoring as a fisheries management tool.

## **MATERIALS AND METHODS**

The first project objective was examined by using two of the charter vessels selected for the International Pacific Halibut Commission's summer research cruises. The vessels operated during June, July, and August of 2002 and deployed paired streamer lines during all setting operations. Because these seabird mitigation measures were proven to be quite effective (Melvin et al. 2001), we used seabird carcasses obtained from other fisheries and placed them on the longlines during gear deployment so that we could test the effectiveness of the EMS. The various components of this work, which include electronic monitoring systems, project design, vessel selection, sea-sampler monitoring duties, EMS system installation, streamer lines, and seabird identification experiments are described below.

In order to achieve the three project goals, the study consisted of four key components. The first component was to determine the optimal configuration for each camera prior to actual data/image collection. This was an iterative process for each camera, camera location, and vessel, involving the camera lens focal length, recording speeds, and data compression ratios. Once those configurations were determined, we proceeded with the second component -- collection of video during gear setting. This would help us to meet the projects first objective to evaluate EMS for monitoring mitigation measures. At the same time, we implemented the third component, which looked at whether EMS could provide adequate images for seabird identification and counts during gear retrieval (the second project objective). While not an initial objective of the study, the presence of the cameras on the stern of the vessels provided an opportunity to further examine the usefulness of EMS for collection of relevant seabird data, the fourth component of this study.

### **Description of an Electronic Monitoring System (EMS)**

The EMS integrates several widely available digital video and computer components with a proprietary software operating system to create a powerful data collection tool (Fig. 1). The system can operate on either DC or AC voltage to autonomously log video and vessel sensor data during the fishing trip. Four closed circuit TV (CCTV) cameras, a global positioning system (GPS), and a hydraulic pressure sensor are the primary sensors. The system automatically restarts and resumes program functions following unexpected power interruptions. The video storage capacity of the monitoring system depends on the rate of data capture, and on the size and number of storage devices. The system components are described below.

## Computer Control Box

The computer control box contains the operating system, the data storage components, and the power controllers for the video cameras and the peripheral vessel sensors. The computer control box is a durable aluminum container, approximately 55 cm x 33 cm x 12 cm, or the size of a business briefcase. It is water resistant, but is not adequately weatherproof for on-deck deployment. The box requires about one-half of a cubic foot of dry and ventilated interior space for storage. This space must also be reasonably accessible to the setup and service technicians. On larger fishing vessels, the monitoring system is usually powered by the onboard 120-volt AC supply, although it can also be run on a 12-volt DC power source.

The two primary components in the computer control box are the video- and data-logging computers. The data-logging computer captures and records the output from the GPS and the pressure sensor. The data logger is designed to run continuously for the duration of the fishing trip in order to provide a digital time series record of the vessel activities. Post-processed sensor information is used to detect the specific activities on the vessel, such as setting or hauling fishing gear. The chronology of fishing activities that is derived from the time series is used to identify time-matched video segments for review.

The video computer digitizes the incoming analog camera signal and stores the video imagery on removable computer hard disks. The video computer can be set up to collect imagery covering a wide range of time lapse frame rates and digital compression ratios. Video frame rates and compression settings are selected to deliver the highest quality image with the lowest storage space requirement. On this project, the third sea-samplers (see “Third Sea-sampler Monitoring Duties” below) controlled the video computer and the imagery collection by using input keyboards. These keyboard controls allowed the third sea-samplers to start and stop the cameras manually during the setting and hauling events, thereby limiting video data collection exclusively to periods of activity during these events. Alternatively, software on the EMS data-logging computer can be set to activate the video system automatically whenever specific fishing activities, such as a hydraulic pressure increase or drum rotation at a winch, are recognized in the sensor data.

For this study, the computer control box was also equipped with a computer display monitor that presented the user with a status screen showing the GPS and the pressure data, the video control settings, as well as any comments entered at the keyboard (Fig. 2). The screen also displayed the software input/output for the data handling utilities provided to the sea-sampler.

## Closed Circuit TV Cameras

The EMS units used in this study can have up to four analog CCTV cameras connected to the control box. The four-camera arrangement was chosen for this project in order to provide image redundancy at the haul location, and to provide the maximum viewing area of the aft hemisphere during setting. The paired cameras also allowed the selection of different view aspects and fields of view at each workstation. An armored dome camera was chosen for installation on these vessels, and it has proven to be reliable in extreme environmental conditions on long-term deployments. The camera is lightweight, compact, and is easily attached to the

vessel's standing structure with a universal stainless steel mount using band straps. The camera electronics inside the sealed case are attached to a rotary gimbal mount that allows for a quick directional adjustment of the fixed lens camera. Selecting from a set of lenses ranging from fisheye to telephoto, the sea-sampler can adjust the field of view and the image resolution optimally for each application. A TV monitor was included in the EMS to allow real-time viewing of each camera image and permit video playbacks of set and haul imagery (Fig. 2).

### Global Positioning System

An independent GPS receiver was installed and connected to the EMS unit computer control box on each boat. The GPS receiver delivers a digital data stream to the data-logging computer that provides an accurate time base as well as a record of vessel position, speed, and heading. The GPS information is updated and stored on the data logger every 15 seconds and is also captioned at the bottom of the digital video image to provide a "burned in" geo-reference for each video frame.

### Hydraulic Pressure Sensor

An electronic transducer was installed on the input side of the hydraulic longline-hauling winch (i.e., gurdy) in order to monitor hydraulic pressure. When the gurdy is activated for gear retrieval, the corresponding pressure increase is recorded in the data set. When displayed graphically, the pressure variance at the gurdy provides a repeatable digital signature of the gear recovery activities. The chronological pattern of gurdy activity can be used to verify the absence or presence of time-matched video segments documenting the catch processing activities at the haul station.

## **Project Design**

The first component of the study was to determine the EMS's adaptability and the optimal recording configurations. The EMS cameras on both vessels were placed opportunistically and strategically to maximize the quality of the recorded images for monitoring seabird avoidance devices during setting, for seabird identification during gear deployment, and for species identification during gear retrieval. The optimal combination of compression ratio and video recording frame rates was assessed to determine the highest quality image with the lowest computer storage space. The at-sea assessment was conducted on:

- recording image compression ratios,
- lens focal length sizes, and
- image recording speeds (frame rates per second).

The recording compression ratios, lens focal length size selection, and frame rates per second (fps) were assessed qualitatively at sea by the sea-samplers by a review of collected images and can be found in Tables 1 through 4. Digital image recording compression is a mathematical process of reducing the amount of data in a given file. The algorithm process decreases the file size, which is proportional to an increase in the total amount of video recording

time. An increase in image compression is proportional to a decrease in image quality and is non-reversible. An increase in lens focal length size is proportional to an increase in image detail and in clarity at a distance, but is also proportional to a decrease in the horizontal and vertical fields of view. An increase in recording image frame rate is proportional to an increase in the amount of image data in a given file, and to a decrease in the total amount of video recording time. All technical terms and abbreviations are defined in separate glossaries.

The second component of the study was to evaluate the ability of video monitoring to determine regulatory compliance of seabird avoidance devices. To address this issue, the setting cameras' imagery evaluations were divided into three categories:

- The ability of the EMS units to provide images that would allow an analyst to continuously monitor the streamer line **deployment**. Here, deployment refers to the use of a streamer line during the duration of the setting event.
- The ability of the EMS units to provide images that would allow an analyst to monitor the streamer line **position** with respect to the main groundline for the duration of the setting event.
- The ability of the EMS units to provide images that would allow an analyst to monitor the streamer line **performance** for the duration of the setting event. Here, streamer line performance is defined as the distance between the vessel stern and the first intersection of the line with the seawater.

The third component of the study focused on the recorded hauling event images. The purpose of the evaluation was to determine if the analysts could use the images to detect and identify the species of the frozen seabirds<sup>1</sup> that were intentionally attached to the longline. This component of the assessment was divided into three separate areas of evaluation:

- The first image evaluations were to count and identify the species of the 63 frozen seabirds intentionally placed on the longline gear during setting.
- The second area of evaluation consisted of a seminar conducted at the NMFS's Alaska Fisheries Science Center, where participants evaluated selected seabird images.
- The third video evaluation was conducted by a private consulting company to determine if a video analyzer could 1) detect the deliberately set seabirds from the hauling video events, and 2) identify the seabirds to species or to category.

The fourth component was the ability of the setting camera(s) to capture images of seabirds for species identification and abundance determinations during setting events.

---

<sup>1</sup> Frozen seabird specimens were provided by National Marine Fisheries Service, Alaska Fisheries Science Center, North Pacific Groundfish Observer Program, 7600 Sand Point Way NE, Seattle, WA, 98115.

## Vessel Selection

Electronic monitoring systems were installed on two IPHC-chartered longline halibut vessels: the F/V *Heritage* and the F/V *Pacific Sun*, fishing in IPHC Areas 4A, 4B and 4D (Fig. 3) during summer 2002. The IPHC assessment survey and its vessels offered several advantages for this project, which included:

- The IPHC vessels provided a controlled research platform that allowed for at-sea EMS technical and experimental adjustments by trained IPHC sea-samplers. These adjustments allowed greater freedom to change EMS computer configurations and camera mounting locations to optimize EMS performance.
- The vessels provided room for additional IPHC monitoring personnel needed to calibrate the EMS units.
- The vessels were part of the IPHC assessment survey that covered a large area within Alaskan waters. The large area of operations tested the EMS units over a range of different weather, ocean, and tidal conditions.
- The IPHC operations also tested the ability of the EMS to capture images of many seabird species and to record their interactions with the vessels during gear deployment.
- The 3-month survey provided multiple fishing trips and allowed for an extended deployment of the EMS units.
- The two vessels were of different size, shape, and deck layout, which allowed for additional information on the adaptability of the EMS units. The vessels were typical of the larger vessels involved in the halibut fishery. Images of the vessels are provided in Figures 4 and 5.

## Third Sea-sampler Monitoring Duties

Sea-samplers are IPHC field biologists, responsible for collecting and recording data during survey operations. IPHC usually assigns two sea-samplers to each survey vessel. For the EMS project, a third sea-sampler was assigned to each vessel in order to ensure the EMS project objectives were met. The third sea-sampler's duties included:

- Supervising and maintaining the electronic monitoring system and related equipment.
- Triggering the EMS unit to record setting and hauling events.
- Observing and counting seabird interactions with the gear during the setting events.
- Attaching the frozen seabirds to the gear before setting.
- Monitoring the streamer lines and recording their performances during setting events.
- Recording the hook status, including identifying and recording all invertebrates and vertebrates caught during gear retrieval.

## Electronic Monitoring System Installations

### *F/V Heritage*

The *F/V Heritage* is 20 m in length, 7 m in width, and has a typical longline vessel layout with a forward deckhouse (Fig. 6).

*Setting CCTV camera configurations* -- Three different setting camera configurations (Table 1) were evaluated for monitoring the setting operations. These configurations were assessed on the basis of the cameras' ability to perform two different functions simultaneously: their ability to produce images that would allow an analyst 1) to detect the regulatory compliance of seabird avoidance devices, and 2) to determine seabird species and the numbers present. In all configurations, the cameras were mounted at the stern 3.55 m above the water line.

- The first setting camera configuration was used on the initial 59 sets.
- The second setting camera configuration was used on the next 73 sets.
- The third setting camera configuration was used on the final 11 sets.

The first and second configuration had the two setting cameras mounted side-by-side on the bait-shed aft railing, above and to the starboard side of the gear chute (Fig. 7). These two cameras were located near the center of the vessel and were designed to work in tandem by splitting the aft hemisphere into two overlapping images. Each camera was angled in such a way as to maximize the area covered by the image recording instruments.

The third camera configuration employed one setting camera, using an 8 mm focal length lens, to record all setting event tasks as described above.

*Hauling CCTV camera configurations* -- Two cameras were installed to monitor the haul back workstation: a deck camera, which monitored the gear while it came aboard, and an outboard camera aimed at the roller and the area immediately below (Fig. 8). The deck camera was fitted with a 12 mm focal length lens and positioned in two different locations. Table 2 describes the specific camera configurations.

- During the first 38 hauled sets, the deck camera was positioned aft of the roller on the upper and forward part of the bait shed railing.
- For the remaining 106 hauled sets, the deck camera was repositioned on the vessel house railing at a height of 2.5 m above the deck. This camera's field of view included the interior of the retrieval chute and the inside edge of the roller from a distance of 4.3 m.

The roller camera was fitted with 12 mm focal length lens, and it captured images of the incoming gear as it exited the water and traveled to the roller. This camera was mounted exactly 2.91 m from the roller on an aluminum pole that extended 1.65 m from the starboard side of the vessel, at a nominal height of 2.4 m above the water line (Fig. 9).



## *F/V Pacific Sun*

The *F/V Pacific Sun* was the larger of the two vessels, with a length of 37 m, a width of 12 m, and a large open work deck area (Fig. 10). It was designed originally to participate in the crab fishery but was recently refitted for longline operations.

*Setting CCTV camera configurations* -- The *F/V Pacific Sun* employed two setting camera-mounting configurations which were nearly identical to the first and second camera configurations used on the *F/V Heritage* (see above). Camera configurations are shown in Table 3.

- The first setting camera configuration was used on the initial 23 setting events.
- The second setting camera configuration was used on the remaining 22 events.

*Hauling CCTV camera configurations* -- As with the *F/V Heritage*, two cameras were installed on the *F/V Pacific Sun* to monitor the haul back workstation. The deck camera was mounted atop a 2.4 m vertical wooden pole that was secured to the vessel's crab pot launcher and it viewed the inside of the retrieval chute. The roller camera was mounted to the crab block arm, which was swung out starboard during haul back. This camera viewed the line as it emerged from the water and came over the roller (Fig. 11). Both of these cameras were fitted with 8 mm focal length lenses because they were positioned closer to the hauling workstation than their counterparts mounted on the *F/V Heritage* (Table 4).

## Installation of EMS on Project Vessels

A typical EMS installation is a relatively simple procedure. One, or possibly two, technicians can install the EMS electronics, position the cameras, and test the equipment to ensure successful operation in one day.

Both vessel installations performed for this study took longer due to additional project requirements. Archipelago Marine Research (AMR, Victoria, B.C.) was contracted by IPHC to provide the EMSs, including installation and technical support. Installations took considerably longer because the AMR technician had to also train the IPHC sea-samplers on how to service, maintain, adjust, and operate the equipment. Additionally, the sea-samplers needed to learn how to process and review video and sensory data. The *F/V Heritage* installation took over 2.5 working days and the *F/V Pacific Sun* installation took just under 2 working days.

## **Streamer Lines**

### Streamer Line Mounting Locations

As seabird deterrents, the *F/V Heritage* used two standard streamer lines provided by the Pacific States Marine Fisheries Commission (PSMFC) (Figs. 12 and 13). The streamer line specifications can be found in Melvin et al. (2001). The streamer lines were attached to

aluminum poles, each located in a corner of the stern. The poles extended 3.6 m above the bait-shed roof, and approximately 6.6 m above the water line.

The F/V *Pacific Sun* also used PSMFC streamer lines (Fig. 13). These streamer lines were mounted from the starboard side pot hauler and from the port side deck crane. The design was unique and not representative of the mounting locations and configurations used on most traditional Alaskan halibut longline vessels. The streamer lines were towed behind the vessel at a distance of 70 m on the starboard side and 85 m on the port side.

### Streamer Line Enhancements

On the F/V *Heritage*, three enhancements were tested to evaluate the optical recording ability of the EMS setting cameras, and to determine if additional reference marking attachments to the streamer lines were necessary or beneficial. These experiments were as follows:

- For the first 48 sets, the vessel's standard streamer lines were used.
- During the next 53 sets, the streamer lines were customized with bright-colored surveying tape attached at different distance intervals: pink at 40 m, yellow at 45 m, red at 50 m, and pink again at 55 m.
- For the final 43 sets, a second modification of the standard streamer line design involved replacing the bright survey tape with optically dense items (i.e., rubber gloves) at 40, 50, and 60 m distances.

Three similar design experiments were evaluated on the F/V *Pacific Sun*:

- The original streamer line design was used on the first 23 sets.
- On the next seven sets, bright survey tape was attached at distances of 45, 50, and 55 m.
- During the final 15 sets, the survey tape was replaced with optically dense items (i.e., rubber gloves).

### Streamer Line Performance Assessment

Two separate streamer line performance evaluations were conducted for each setting event. Streamer line performance is defined as the distance between the vessel stern and the location where the streamer line first intersects the seawater. An at-sea performance evaluation was conducted by a sea-sampler and a video performance evaluation was conducted on land by a video analyst.

*Performance based on at-sea observations* -- For all setting events, the sea-sampler estimated the streamer line performance from the stern of the vessel at a predetermined time. Different predetermined time strategies were employed during the setting events, but the performance evaluation procedure was the same for each set. For the performance evaluations on both vessels, the sea-sampler estimated the minimum and maximum performance for each setting event visually, and then recorded the average performance to the nearest 5 m interval.

The procedures for evaluating performance by the sea-sampler differed somewhat between the two vessels. On the F/V *Heritage*, the sea-sampler would signal the setting cameras at the beginning and at the end of a predetermined performance evaluation period. These predetermined time intervals provided a reference that would allow a relatively fixed temporal comparison of the vessel and the video performance observations. Streamer line performances were evaluated and recorded once for each of 64 sets, and twice for each of the remaining 80 sets. For the first 64 sets, the performance value was estimated during the deployment of the final skate of gear. That value provided the estimated performance distance for the entire setting event. For the final 80 sets, two visual performance values were recorded during each of the predetermined 2-minute windows: one at the beginning, and one at the end of the setting event. The two recorded performance values (as describe above) were again averaged to the nearest meter, and that value constituted the final setting performance number.

On the F/V *Pacific Sun*, the performance evaluations were conducted at or near the beginning of the setting events, and were only carried out once per set for the duration of the charter.

*Performance based on video observations* -- Analyses were performed on 84 setting events from the F/V *Heritage* that featured the second and the third setting camera configurations. The analyst's performance evaluations used the reference markers (i.e., the streamers, the flagging tape, and the rubber gloves) attached to the streamer lines to assist in estimating the exact location at which the streamer line first intersected the water. These evaluations were conducted using the same protocols employed by the vessel's sea-sampler.

There was no signal to designate the performance evaluation time for the F/V *Pacific Sun*, so a time was arbitrarily selected close to the beginning of the setting event in order to evaluate the performance. The video analyst watched the lines' minimum and maximum performances and recorded the average performance values in the same manner as the sea-sampler.

### **Seabird Identification Experiments**

To address the second project objective, the EMS collected images of seabirds retrieved on the longline gear to observe the appearance and general body behavior as the seabird comes out of the water. Previously caught seabird specimens (specimens) were provided by the NMFS North Pacific Groundfish Observer Program (NPGOP) from Laysan albatross, black-footed albatross, and shearwaters collected by high sea driftnet observers in 1990-1991. EMS video images were recorded during gear retrieval. Procedures followed during this experiment were as follows:

- The longline sets for the seabird specimen identification component were selected opportunistically.
- One to four specimens were attached to the gear before gear deployment and placed randomly throughout the set.
- The specimens were securely attached to a hook and gangion by either 22.7 kg monofilament fishing line and zip straps, or by duct tape and electrical tape.

- The seabird species, hook number, skate number, and station number were recorded before the gear was deployed.
- The fisher working the roller during haul back was instructed to bring the specimen onboard and not to interfere with its retrieval.

This experiment was not designed to estimate seabird drop off rates, and steps were taken to guarantee that the specimens were retrieved during haul back. Five specimens were lost during this experiment due to the forceful manner in which the longline gear was deployed. The intentional setting of frozen seabirds from the vessel stern using longline fishing gear is inconsistent with the way in which seabirds are caught incidentally in the wild. Therefore, the data collected for this study should not be used for estimating underwater seabird drop off rates. Details on the seabird attachment procedures are found in Appendix 1.

### Analysis of Video Images by Analyst

The images of the retrieved seabird specimens were evaluated to determine whether or not the EMS technology was sensitive enough and the images clear enough to allow an analyst to recognize and differentiate the seabirds by species. The seabirds were identified by the analyst using Seabird Image Identification Techniques, a system that incorporates seabird body size, plumage color, bill size and bill color, as well as other features that distinguish seabirds by species. The steps in this technique are sequential (Table 5 and Fig. 14). The criteria used included the physical characteristics associated with the common north Pacific seabirds (National Geographic Society 1987, Armstrong 1995). The records of the retrieved specimens, as they were identified by each of the sea-samplers, were compared for accuracy. The seabird identification comparison proceeded as follows:

1. All retrieved seabirds were compared with the sea-samplers' identification records.
2. The seabirds captured by EMS cameras during "slow recording frame rates" were grouped together and were compared with the sea-samplers' identification records. Hauling events featuring less than 2 fps by the roller camera and less than 1 fps by the deck camera were considered slow recording frame rates (SRFR).
3. Those seabirds captured by EMS cameras during "fast recording frame rates" were grouped together and were compared with the sea-samplers' identification records. Hauling events featuring greater than 2.5 fps by the roller camera and greater than 1.5 fps by the deck camera were considered fast recording frame rates (FRFR).

### Seabird Seminar at AFSC

A seminar was conducted at the Alaska Fisheries Science Center (AFSC) to provide an independent analysis of the seabird specimen images captured by EMS cameras. The seminar was held at the AFSC to take advantage of established knowledge of seabirds possessed by many AFSC staff. The seminar tested the participants' ability to identify the species of individual seabirds solely through viewing the images. Eight of the 14 participants were NPGOP staff and had a wide range of seabird identification experience.

The seminar was divided into two parts. The first section of the seminar provided attendees with an introduction to common seabirds found in the north Pacific, and with appropriate seabird image identification techniques. This was intended to ensure everyone had some minimal amount of seabird identification information. The second part of the seminar gave the attendees an opportunity to examine six video clips of seabird specimens, randomly selected from the total number of retrieved shearwater species, black-footed albatross, and Laysan albatross.

One seabird image from each of the three seabird categories and by vessel was randomly chosen. The *F/V Heritage* random selection process involved 23 shearwater species, three black-footed albatross, and four Laysan albatross. The *F/V Pacific Sun* random selection process involved 28 shearwaters, one black-footed albatross, and four Laysan albatross. The seminar incorporated two untutored examinations and a final tutored examination. The examinations went as follows:

1. During the first examination, a 5-10 second video clip of a specimen during hook-and-line gear retrieval was shown. The 14 participants were instructed to identify the seabird in the clip according to group, species, etc.
2. For the second examination, the group was shown two still images from the 5-10 second video clip. The members of the audience were once again instructed to identify what they saw.
3. The final examination consisted of identifying the seabirds in the same two still images, but this time the attendees were provided with some tutoring. This tutoring involved the presenter pointing out some of the seabirds' key features, but without revealing the seabird's identity. The presenter then instructed the audience to use the Seabird Image Identification Techniques to help in the identification of the particular seabird according to species or category.

#### Detection and Identification of Seabirds from Hauling Video

The seabird specimen detection and identification analysis was conducted by AMR and intended to provide an independent and nonbiased analysis of seabird images. The objective was to determine if a video analyst could: 1) detect the occurrence of specimens from the video images of the hauling events, and 2) determine if seabirds could be identified to species and/or species category.

The video provided to AMR featured camera images from the FRFR group and contained footage of 20 predetermined hauling events from each vessel. The video contained hauls with and without seabird specimens. All hooks were counted, and all animals on the hooks were enumerated and identified according to species. AMR's seabird detection and identification results were then compared to the information recorded by the sea-samplers.

## RESULTS

### Sets and Hauls Monitored

The F/V *Heritage* started survey fishing on 4 June 2002, and finished on 24 August 2002. The F/V *Pacific Sun* started fishing on 20 June 2002, and finished on 10 July 2002. On the F/V *Heritage*, the EMS camera monitored 143 setting events and 144 hauling events. The F/V *Pacific Sun* completed 45 stations, with the EMS monitoring 45 setting events and 45 hauling events. Several minor problems occurred, including the camera lens becoming obstructed by water and debris, a leak into a camera, fuzzy images, untriggered recording, and system interface error possibly due to a cold start of the system. Three of the 10 problem types were likely due to incorrect or improper actions taken by the sea-sampler running the system. A listing of the technical errors and problems encountered during the study is provided in Table 6.

### Assessment of Setting Video Imagery

Evaluations of the video recording functions were conducted at sea. The at-sea qualitative assessment was conducted by the third sea-sampler to determine the optimal combination of compression ratio and video recording frame rates to produce the highest quality images with the lowest computer storage space. The 10 × recording compression ratio was preferred over the 15 × and 20 × ratios because it allowed for a slightly higher quality image resolution, and for finer detail in recording small, distant objects. The small increase in resolution was significant when evaluating streamer line performances and identifying seabirds. The setting cameras needed to be set at a relatively frequent recording speed in order to capture clear images of the seabirds, which was a desired, although not primary, aspect of the study. For this reason, no attempt was made to assess the operation of the camera frame rates at slower than 0.5 frames per second (i.e., one frame for every 2 seconds). Slower frame rates (i.e., one frame per minute) could have led to the collection of higher resolution video images that may be useful for seabird identification, but also may have compromised the ability to adequately monitor the streamer line performance. During the early trial setting events, the sea-sampler experimented with different arrangements of EMS equipment, the computer-recording configurations, and lens selections. These trials provided significant information on “what works best”, but provided insufficient information on the combined objectives of the study to merit detailed video analysis. Therefore, the trial 59 sets from the F/V *Heritage* and 23 sets from the F/V *Pacific Sun* were excluded from the study.

Video analysis was performed on all of the setting events that were completed using the optimal camera mounting locations, lenses, and computer recording configurations. Of the 143 sets on F/V *Heritage*, 84 were analyzed; 73 of these sets used the second setting camera configuration, while 11 used the third camera configuration. On the F/V *Pacific Sun*, 22 of the 45 sets were analyzed. Evaluations were made of the streamer line deployments, their relative positioning, their performance, and the percentage of time the streamer lines were in the video field of view during the duration of the setting events (Tables 7 and 8).

None of the cameras were able to detect streamer lines during three pre-dawn sets. Two setting events were completed before sunrise by the F/V *Heritage* (0740 h and 0745 h), while the F/V *Pacific Sun* had one setting event conducted before sunrise (0657 h).

Almost all (102 of 103) of the daylight setting events on both the F/V *Heritage* and the F/V *Pacific Sun* that were recorded using the second and third stern camera configurations provided streamer line deployment detection and position. Of the 92 sets that were monitored during daylight using two setting cameras, the success rate for line deployment detection and line position was 100%.

### **Sea Sampler and Video Streamer Line Performance Comparisons**

We compared the video observations of streamer line performance with the sea-samplers' observations. On the F/V *Heritage*, the performance values for all the sets were combined, and the mean values were calculated. The starboard side mean value as observed by the sea-sampler was 54 m, while the port side mean value was 57 m. The video analyst recorded the starboard and port side mean values as 52 m and 55 m, respectively. A comparison between the mean values acquired by the sea-samplers and those acquired from the video cameras revealed a 2 m higher average performance on the part of the sea-samplers. The standard deviation of the sea-samplers observations and the video observations from the mean values are provided in Figure 15.

A heteroscedastic t-test was performed that compared the F/V *Heritage's* sea-sampler observations of streamer line performance values with the video analyst's observations on the starboard side of the vessel ( $p = 1.3 \times 10^{-4}$ ;  $n = 81$ ), and the port side ( $p = 3.6 \times 10^{-4}$ ;  $n = 81$ ). The results indicated that there was a significant difference between performance values.

When the sea-sampler and video performance values were graphed together, they revealed a similar pattern. Although the values for each set were not identical, they frequently fluctuated in the same direction, either in an increased or decreased performance. In addition, a linear trend line mapping the sea-sampler and the video observations on streamer line performance showed a positive association between the values (Figs. 16 - 19).

The performance values from the F/V *Pacific Sun* for all the sets were combined and the mean values were calculated. The vessel's sea sampler starboard mean value was 46 m, and port mean value was 55 m, while the video's starboard mean value was 48 m, and the port mean value was 61 m-- differences of 2 m on the starboard side and a 6 m difference on the port side. The standard deviations of the vessel and video observations are provided in Figure 20.

The F/V *Pacific Sun* results were consistent with those of the F/V *Heritage*. When the two methods of measuring streamer line performance were compared for the starboard side, a similar fluctuation pattern was evident, but this pattern was not apparent in the port side observations. A linear trend line also revealed a positive association between the two starboard performance observations. On the port side, however, there were significant differences in the performance

values, and there was no evidence of a performance fluctuation pattern, indicating a data collection error (Figs. 21 - 24).

A heteroscedastic t-test was conducted comparing the F/V *Pacific Sun*'s sea-sampler observations of streamer line performance values with the video analyst's observations on the starboard side of the vessel ( $p = 0.55$ ;  $n = 22$ ) and on the port side ( $p = 2.67 \times 10^{-8}$ ;  $n = 22$ ). The comparison revealed that there was a significant difference between the respective performance values.

### **Assessment of Hauling Video Imagery**

During seabird specimen retrieval, four primary recording frame rates were evaluated. The frame rates were divided into two groups: 1) SRFR and 2) FRFR. The results indicate that the initial compression ratio and lens selection were adequate, but that the roller camera needed to have frame rates greater than 2.5 fps, and the deck camera frame rates greater than 1.5 in order to be effective in identifying incidentally caught seabirds.

### **Seabird Identification Experiment**

On the F/V *Heritage*, a total of 34 seabirds were placed on the gear to obtain haul back images: 27 shearwaters, 3 black-footed albatross, and 4 Laysan albatross. Of these seabirds, three shearwaters were lost during setting, one was retrieved with just one wing attached (the entire body was lost during the setting), and one Laysan albatross was recovered with only bones and a bill intact, the result of predation by isopods and amphipods during gear soak. On the F/V *Pacific Sun*, 34 seabirds were placed on the gear: 28 shearwaters, 2 black-footed albatross, and 4 Laysan albatross. Of these seabirds, one black-footed albatross was lost during setting, and another dropped off the line at the roller during gear retrieval. The remaining seabirds provided sufficient images for the analysis of identification during hauling.

#### **Analysis of video images**

An analysis of the 63 seabird specimen images captured by the hauling cameras during gear retrieval indicated that an analyst was able to identify 83%, or 52 of the 63 specimens as seabirds. The investigation also concluded that 60%, or 31 of the 52 specimens, were correctly identified to species (Table 9). A close examination of the images revealed a positive association between the image recording speeds and a correct identification of seabirds by species. This association is shown in Figure 25.

In those hauling events featuring the SRFR ( $n = 18$ ), the analyst was able to identify the specimen as a seabird 61% of the time (Fig. 26). Of the 18 shearwaters, 2 were identified as shearwaters, 2 were identified as belonging to the northern fulmar/shearwater category, 7 were identified as belonging to the small black seabird category, and the final 7 were deemed to be unknown objects (Table 10). In the hauling events featuring the FRFR ( $n = 45$ ) the video analyst was able to identify the specimen as a seabird 91% of the time (Fig. 27). Of the 33 shearwaters,



20 were identified as shearwaters, 1 was identified as belonging to the northern fulmar/shearwater category, 9 were identified as belonging to the small black seabird category, and the final 3 were deemed to be unknown objects (Table 11). Moreover, of the 12 albatross, 9 were identified to species, 1 was identified as within the Laysan/short-tailed albatross category, 1 drop-off was recorded as an unidentified seabird, and the final specimen was deemed to be an unknown object (Table 11). A comparison of the video analyst's seabird identification records according their SRFR and FRFR groupings are presented in Figure 28. The inability to obtain a correct identification was generally due to a lack of sufficient detail in the specimen's image.

### Seabird Seminar at AFSC

Twenty-five percent of the seminar participants in the first untutored examination of the video images (video footage) correctly identified the six seabird specimens. During the second untutored examination which used still images, 46% of the participants correctly identified the specimens, and on the third tutored examination, 69% of the 14 participants correctly identified the specimens (Fig. 29).

### Detection and Identification of Seabirds from Hauling Video Events

The results of the 27 hauling events reviewed by an AMR analyst revealed that 24 out of the 25 seabirds (96%) were recognized (Fig. 30). The results also showed that the analyst was able to correctly identify 79% of the seabirds as 15 shearwaters and 4 Laysan albatross. The analyst identified 17% to a close seabird species category; three shearwaters were classified as northern fulmars, and one black-footed albatross was labeled as an unidentified albatross. The final seabird, a drop-off, was identified incorrectly as a northern fulmar, when it was actually a black-footed albatross (Fig. 31).

## DISCUSSION

Research conducted on the *F/V Heritage* and *F/V Pacific Sun* provided valuable information on the efficacy of employing the EMS technology. At its present stage of development, the EMS technology has a number of possible fishery applications. This study provides a foundation for the ongoing development of this technology and suggests some directions for its future application in fisheries management.

### **Assessment of Setting Video Imagery**

The EMS computer recording configurations were important components for evaluating the video monitoring capabilities. The results indicate that during daylight both the second and third camera configurations could detect the streamer line deployment and position effectively, and that the cameras would need only a relatively slow interval recording frame rate to complete this task successfully. However, accurate performance determinations are directly related to the image recording speed, and thus a faster interval recording speed and more image storage space would be required. The EMS computer can be configured to record in periodic, relatively infrequent intervals and with high video compression ratios (requiring less video storage space) and still provide an analyst with adequate information on the deployment and position of both streamer lines. However, if objectives called for accurate information on streamer line performance at all times, faster frame rates and lower recording compressions may be necessary. In some applications, continuous real-time recording may not be needed to meet management objectives.

#### Setting CCTV Camera(s) Assessment

The study was designed to meet several objectives based on the capability of the camera system to perform a variety of specific functions. However, video review determined that insufficient image information on seabird identification and abundance off the stern of the vessel was provided by the cameras to support an analysis. Thus, the comprehensive approach did not work well, and it is apparent that the cameras would be utilized most effectively if they were limited to one specific function. Therefore, the primary focus of this component of the report is to assess the effectiveness of the EMS technology with respect to monitoring the regulatory compliance of streamer lines during setting.

### **Setting CCTV Camera(s) Configurations and Lenses**

The comparison of the two video camera configurations used on *F/V Heritage* revealed no significant differences in the detection and performance of streamer lines, and only a slight difference in the amount of time the lines were out of the camera or cameras' field or fields of vision. These assessments indicate that both the second and third camera configurations in the study were effective in determining streamer line deployment, position, and performance. However, only 11 sets were conducted using the single camera or third camera configurations,

and the majority of these sets were carried out during calm weather conditions. In comparing the video configurations, it was determined that the use of an 8 mm lens on the third camera configuration was as precise as the 12 mm lens in detecting the line performance. Moreover, the 8 mm lens provided a larger horizontal and vertical field of vision of the aft hemisphere than did the 12 mm lens. Therefore, the use of 8 mm lenses in the two-camera configurations would provide a significant advantage over the 12 mm lenses. The greatest advantage would be in situations of high vessel motion, or when the streamer lines migrate to the outside edge of the vessel's aft hemisphere, and out of the 12 mm lens' field of vision.

The study also compared the video imagery from the two-camera configurations with the imagery from a single camera configuration, and the results indicate that both configurations are effective. However, the use of one camera did not provide as much horizontal viewing coverage as did the use of two, and did not provide a back-up component. For example, the housing of one of the setting cameras leaked during the study, leaving the camera unusable. This leak, however, was not a manufacturing defect, but was attributed to either an improper setup during installation or a poor seal. Regardless, the use of a second camera provides the following advantages:

- The use of two cameras provides a larger area of vision behind the vessel, and will capture the deployment of the streamer lines in all daylight situations.
- The two cameras provide a viewing overlap of the streamer lines; thus, if one of the cameras is disabled, or if the lens is covered in dirt, bait, and/or ice, the second camera will still provide valuable data for one side.
- A second camera is a relatively inexpensive addition to the system and can be installed easily.

### **Streamer Line Detection and Position**

The use of the EMS units for streamer line detection and position would require relatively few changes to their present design. The second and third setting camera configurations on both vessels provided clear images, affording streamer line detection and relative position on 99% of the daytime setting events, with relatively few problems. On the sets that were monitored using two setting cameras working together, the success rate was 100% for streamer line deployment detection and position. This high success rate endorses the effectiveness of the EMS equipment for this purpose.

### **Streamer Line Performance**

To determine the effectiveness of the EMS technology in measuring streamer line performance, the sea-samplers' performance values from the vessel observations were compared with the video observations. Interestingly, the compared observations have complicated the streamer line performance issue. The performance on any vessel is extremely variable with large fluctuations between high and low performances during the setting events. These fluctuations

are related directly to the weather conditions, streamer line mounting location and height, the vessel's mass, size, shape and stability, and finally the drag of the streamer lines' drogues. All of these factors influence the streamer line performance, making precise performance determinations difficult, regardless if a person is present on the vessel, or is viewing video footage. This problem became clear when the performance values from the sea-sampler observations and the EMS cameras were analyzed (via t-test) and found to be significantly different. Although the values were not parallel, the two groups appeared to follow a similar pattern showing either an increased or decreased performance (Figs. 16, 18, and 21). The values also reveal positive associations, which are represented by the trend lines in Figures 17, 19, and 22. The exception would be the port side on the F/V *Pacific Sun*, where the streamer line was attached to the deck crane. The problem was that the F/V *Pacific Sun* did not consistently tow the streamer lines from the same height and the same distance from the stern during the setting events, and the two observational techniques did not analyze exactly the same time periods during the sets. More importantly, we believe that the sea-sampler's observational data were collected incorrectly or inaccurately on the port side of the vessel. Nevertheless, the patterns from the F/V *Heritage* and starboard side of the F/V *Pacific Sun* indicate that the two observational methods are relatively comparable, and that the differences arise in the setting event's average performance, which may be a simple function of differences in the observational periods.

The question remains: "Does EMS provide image quality sufficient to monitor deployment and performance comparable to an at-sea observer?" The answer is "Yes" but each of the observational techniques has its advantages and disadvantages. The at-sea observation has an advantage over the video observation because the sea-sampler can see exactly where the line intersects the water. The video analyst, on the other hand, can stop the video (replay if necessary) and analyze each individual image, and in this way account for the line fluctuation elements (the highs and lows) in deciphering the true line performance. In any case, the EMS study clearly demonstrates that both observational methods are effective in determining whether or not the line meets the regulatory required performance, provided that there were adequate distance markings attached to the streamer lines.

We conclude that, if measures were taken to create streamer lines that were optically dense, the video analyst would have superior ability to monitor and record the performance values accurately. Alternately, if measures were taken to require that existing commercially used streamer lines be fitted with optically dense distance markings at specified interval(s) (i.e., at the 40 m interval) then a video analyst would be able to determine if the performance requirements were maintained during the setting event. The adoption of this recommendation would, in itself, allow regulators to address the streamer line requirements from a pass/fail perspective.

At present, streamer lines are composed of materials whose diameter makes them difficult, under certain conditions, to distinguish on the recorded video. Especially problematical for the video analyst is determining the exact locations where the line first intersects the water. If streamer lines were more optically dense or were composed of reflective material, this problem could be greatly reduced without affecting streamer line performance. If EMS units were to be implemented commercially, consideration should be given to requiring the use of streamer lines which would facilitate easier identification by a video analyst.

## Applications of Setting CCTV Camera(s)

In summary, results indicate that there are three effective applications of the setting cameras. The first is the detection of streamer line deployment, position, and performance in real-time recording speed. Secondly, the cameras record the deployment, relative position, and the relative line performance in predetermined recording intervals<sup>2</sup>. Finally, the cameras provide detection of the deployment and relative position of the streamer lines behind the vessel.

The study has provided encouraging results in the application of EMS to the detection of streamer line deployment, position, and performance. When considering the application of these systems within the commercial halibut fishery, several issues need to be addressed. These issues include a determination of the primary objective of the camera(s), the most effective camera configuration(s) and recording functions, and the role, if any, of vessel personnel in EMS maintenance.

1. If the primary objective of the EMS units is to accurately detect and continuously monitor the vessel's streamer line positions and performances during setting events, the following elements must be addressed.
  - 1.1 Streamer lines on vessels with EMS technology would need to be standardized for best results. The streamer lines should have multiple markings on the lines at uniform intervals which would indicate the regulatory performance minimum. These reference markings should be optically dense (i.e., of sufficient size and color) so that they would be detectable on the EMS images. An option would be a single marker at the distance of the performance standard. However, this may be less effective, as a vessel could shorten the line such that the marker would not be at the required distance but closer to the vessel. This would lessen the effectiveness of the streamer line but the change in configuration would not be detectable from the EMS images. Using a multiple-marker scheme would make it more likely that at least one marker would remain within the required performance standard distance, depending on the numbers of markers and their location on the line, if such deception is attempted.
  - 1.2 The image recording frame rate would need to be sufficient to allow an analyst to detect the line performance fluctuations (high and low values) in order to determine if the streamer lines continuously meet the regulatory requirements.
  - 1.3 The image recording software would need to be set at 10 × compression in order to achieve maximum resolution to the video images so an analyst could make accurate performance determinations.
  - 1.4 An automatic triggering system would need to be developed to turn the setting camera(s) on and off during setting events, so as to maximize EMS deployment and hard disk storage space if recording were not continuous. Alternately, an

---

<sup>2</sup> The terms "relative position" and "performance" refer to time-lapse recording speed, which is not a real-time recording rate (e.g., the camera(s) record images at 15-second intervals).

increased storage capacity for the EMS unit would be required for continuous recording. This system would need to be installed on all of the traditional longline vessels that use tub or skate-bottom gear, and which have no moving parts that could be used to signal the computer that a setting event has started or ended. This type of a system is possible, but it would, in most conceivable applications, require the support and cooperation of the vessel crewmembers.

2. A simpler and more effective application of the current EMS technology would be to focus first on monitoring the deployment and relative positions of the streamer lines, and then to assess the relative performance of the streamer lines. The difference between the first application and this one is the secondary focus of the performance of the streamer lines. In application two, the performance could and would be noted, but the performance variations between highs and lows would not be tracked continuously during the setting event. Thus, the alternative method would provide a more general idea of the lines' operating performance. In this application of the EMS units, the recording frame rates could be reduced significantly to allow for longer system deployment and to remove the necessity for an automated trigger for the setting event. The setting camera recording frame rate requirements would be set before the vessel's departure from port, and the cameras would record the area aft of the vessel continuously in 10 or 15-second intervals. This type of EMS configuration could be introduced into the commercial fleet with relatively few adjustments to the current equipment, but it would still require all streamer lines to be standardized. Again, the streamer lines would need optically dense distance markings, or a single distance marker that indicates the regulatory performance minimum.
3. In a third application, the setting cameras could be used to monitor the streamer line deployment and relative position behind the vessel in 10 or 15-second intervals, which would require no modifications to the present streamer line equipment. This type of system would require few changes to the EMS units, but it would not address regulatory performance requirements because it would lack adequate streamer line reference markings.

### **Assessment of Hauling Video Imagery**

During their at-sea trials, the F/V *Heritage* and the F/V *Pacific Sun* employed similar camera configurations and computer configurations (Tables 2 and 4). The vessels used different lenses in their EMS cameras during their deployment, but the results revealed no meaningful differences in image quality. The results suggest that the image quality is proportional to the distance from the viewing subject over the range of distances used in this study. Thus, the lens focal length would need to be increased as the distance to the viewing area increases. On both vessels, the camera mounting locations, computer compression ratios, and the final recording frame rates provided excellent quality images. This design could be a useful model for similar applications.

## Hauling CCTV Camera Assessment

Assessment of the hauling cameras was conducted in order to determine if the cameras would provide an analyst with enough information to detect an incidentally caught seabird, and then to identify that seabird to species. The first two assessments of the seabird images provided encouraging results on the ability of the analysts to accurately identify the retrieved seabirds from the images. The third assessment, which was conducted by an independent analyst from Archipelago Marine, Ltd, provided considerable support to the claim that video analysts can successfully detect and identify incidentally caught seabirds using the EMS technology.

### **Seabird Identification Experiment**

#### Analysis of Video Images

The first analysis showed that of the total 63 specimens retrieved, 52 of them were identified as seabirds. These findings suggest that, under similar conditions and with similar seabirds, the EMS cameras could provide video images that would allow analysts to differentiate seabird bycatch from other longline bycatch to an accuracy of 83%.

We believe the combined results of SRFR and FRFR in the first assessment provide an inaccurate picture of the EMS image capabilities because 7 of the 11 seabirds identified as unknown objects were recorded at a SRFR. The image frame rates investigated at less than 2 fps by the roller camera, and at less than 1 fps by the deck camera, significantly reduced the ability of the analyst to identify the seabird specimens and therefore skewed the results. On the other hand, the images received at the FRFR using a more optimal recording frame rate resulted in 91%, or 41 of 45, being identified as seabirds, and 29 of 41 being identified to the correct species (Figs. 27 and 28). Most significantly, the FRFR assessment reveals that on 10 of the 11 sets in which the entire albatross was retrieved intact, the IPHC analyst was able to identify the bird as an albatross. The one albatross that was identified merely as an unspecified seabird was a drop-off, and therefore it provided no clear image from which to make a determination. Additionally, on 9 of the 11 albatross sets, the analyst was able to gather enough species characteristic information from the images to determine the species with relative confidence.

These findings are important because they suggest that, under the conditions experienced during the study, an analyst would be able to successfully differentiate the albatross species from the other north Pacific seabirds commonly encountered during commercial longlining.

As indicated in the study, a definite relationship exists between correct seabird identification and increased recording frame rates. The faster frame rate provided the analyst with a greater number of images of the specimens, and thus created a higher probability of capturing an image that contained a unique species characteristic. However, the relationship between these two variables diminishes after a particular fast frame rate is reached, indicating that the potential for identifying the birds will not increase proportionally as the frame rate increases. This factor is an important consideration when determining the optimal combination

of video recording frame rates and the delivery of the highest quality image with the lowest computer storage space (Figs. 25 and 32).

### Seabird Seminar at AFSC

The seminar at AFSC demonstrated that individuals improved in their ability to correctly identify seabirds when they received instruction in proper seabird identification techniques. In effect, the participants in the seminar exhibited an identification learning curve. The seminar also revealed that individuals have a higher success rate at identifying albatross than the smaller shearwaters. When the participants were asked to rate their ability to identify seabirds, the majority of the NMFS individuals classified their ability as average (Fig. 33). Therefore, we conclude that an analyst's ability to identify seabirds from images would increase in accuracy with training and experience (Fig. 29). Additionally, for the purposes of this component of the study, the seabird images had to be projected onto a large screen thus reducing the quality of the images. We believe, when considering the above factors, that the results from the seminar are a conservative evaluation of the EMS cameras' ability to produce images of seabirds of sufficient clarity to allow accurate identification by dedicated video analysts.

### Detection and Identification of Seabirds from Hauling Video Events

The third assessment was conducted on 27 hauling events from the FRFR group. Only 27 of the 40 prearranged hauling events were analyzed because of time constraints. The results from the AMR seabird detection and identification experiment revealed that a video analyst was able to detect 96% of the seabirds from the images provided by the EMS hard disks. The video analyst was able to correctly identify 79% of the seabirds to species, 17% to category, and 4% to unknown or unidentified seabird. These figures are similar to the IPHC video analyst's results in terms of the accuracy of seabird identification. The high identification success rate recorded in the first and third assessments suggests that the EMS equipment can be employed effectively in detecting and identifying seabird bycatch.



## POTENTIAL COSTS ASSOCIATED WITH FISHERY MONITORING

The potential costs for monitoring compliance with the seabird avoidance regulations and monitoring the fishery catch for seabird bycatch was examined using EMS and observers as contrasting monitoring systems. Data were extracted from the IPHC commercial fishery data base from 2001, the most recent year available. These data represented 62-68% of the landings by weight in each regulatory area. Records were aggregated to the vessel length categories used to determine observer coverage requirements in the Alaskan groundfish fishery (i.e., < 60 feet, 60-124 feet, ≥125 feet).

The vessel logbook data were expanded to total commercial IFQ and CDQ landings to provide estimates of total effort. Estimates of the total number of fishing days, trips, and vessels were made based on the ratio of logbook pounds to total pounds landed, then distributed to the vessel size categories based on the proportions shown in the logbook data. The total number of sets and skates fished was estimated based on the sets or skates per pounds landed from the logbook data, by vessel size category. The resulting set of estimated total fishery effort is shown in Table 12.

Two monitoring levels were used in this analysis: the first illustrates 100% monitoring coverage of all halibut fishing days, and the second reflects current observer coverage requirements. Within these monitoring alternatives, an EMS program was contrasted to an on-board observer program, which is familiar to many involved in Alaskan fisheries management. Thus, the options examined were:

**Option A:** Monitoring 100% of the fishing days for all vessels fishing halibut off Alaska by an on-board observer or EMS. This includes all vessels, regardless of size and area. We use a single onboard observer for comparison. One observer would not be able to monitor 100% of all fishing effort (setting and haulback) while on board, while an EMS system could.

**Option B:** Monitoring vessels fishing days for halibut off Alaska by an on-board observer or EMS based on the following coverage levels: 100% for vessels greater than 124 feet LOA, 30% for vessel between 60 feet and 124 feet LOA; and no coverage (0%) of vessels less than 60 feet LOA. These levels of coverage are those currently utilized in the Alaskan groundfish fishery. Observers are not able to monitor 100% of the effort (sets and haulbacks) while on board.

Several assumptions were necessary to estimate these costs. First, logbook data do not provide information on the time taken to haul the fishing gear back aboard, which is necessary to estimate the quantity of digital video that will be recorded and therefore how much time will be required to analyze the images. A baseline haul duration of 20 minutes per skate was assumed for this purpose. Also, video images could be reviewed at a faster rate than “real time”, therefore a review rate of 0.75:1 was assumed, based on this study. We also used the same equipment costs which were incurred during the study. These included a rate of \$55 per day for the on-board EMS and \$32 per day for the video review equipment. Technician time for image analysis

was assumed at \$101.50 per day (equivalent to a starting salary federal government technician rate). This includes only the direct wages, not overhead for benefits and other costs. Finally, observer cost was estimated at \$355 per day for the observer and \$100 per day in agency costs (J. Terry, NMFS, pers. comm.<sup>3</sup>). Observer costs included salaries, travel, insurance costs paid by the Observer Providers, and other miscellaneous items. Agency costs represent training, briefing, debriefing, and data management. The cost analysis does not include any additional field management required for EMS deployment, such as additional staffing, travel, and other equipment. Also, NMFS may decide that field staff would be needed in ports other than Kodiak and Dutch Harbor, but this additional staffing is not included here. For simplicity, we developed these figures using only a single observer per vessel. Note that one observer could only spot-check the gear setting and monitor a subsample of the haul. On the other hand, this observer could also complete various biological sampling duties as well as monitor the catch.

### **Results of Cost Comparison**

With Option A, the setting and hauling activities of all vessels fishing for halibut off Alaska would be observed. It applies to all areas and vessels, regardless of size. Each vessel would carry a monitoring system (observer or EMS) to provide coverage of all halibut fishing, including those trips where halibut and sablefish are targeted ("mixed" targets).

The calculations showed that an on-board observer program to monitor all setting and haul back activities of vessels fishing for halibut off Alaska would cost \$8.46 million (Table 13), based on data from 2001. This is broken down as Area 2C - \$3.0 million (35% of total), 3A - \$2.6 million (31%), 3B - \$1.2 million (14%), and Area 4 - \$1.6 million (19%). Roughly 86% of the total fishery cost is attributed to observing vessels less than 60 feet LOA. Although the actual amount varies by area, the "less than 60 feet" size class requires the largest amount of funding of all three vessel size classes in every area. This is a direct reflection of the large number of small vessels that fish for halibut.

Using EMS to monitor the fishery is estimated at \$2.7 million (Table 13), about one-third as much as an observer program. This estimate includes system leases, installation and removal on the vessels, video review equipment, and analytic personnel time for fully reviewing all setting and haul back events. The relative cost breakdown among vessel size classes is similar to the observer option, with 82% of the total attributed to the "less than 60 feet" size class, 17% for the 60-124 feet class, and only 1% to the largest vessels, but the actual costs are much lower.

The overall cost of monitoring is reduced considerably with Option B, which excludes small vessels from being monitored and reduces the monitoring of 60-124 feet vessels to 30%. An EMS program is estimated at \$0.22 million, while an observer program with this coverage requirement is \$0.41 million, or almost twice the EMS cost (Table 13). The exclusion of the small vessels is the primary reason for the large reduction in cost from Option A for both EMS and an observer program. With Option B, the bulk of the costs are shifted away from Area 2C,

---

<sup>3</sup>National Marine Fisheries Service, Alaska Fisheries Science Center, REFM Division, 7600 Sand Point Way NE Building 4, Seattle, WA, 98115, personal communication.

into Areas 3A, 3B and 4. Monitoring Area 4 would be the most costly due to the preponderance of larger vessels that fish in the area.

It cannot be emphasized enough that these costs are presented as approximate estimates only. Actual costs will likely be different after objectives are determined and sampling protocols adopted. For example, the estimates include reviewing the EMS for the entire haul back of each vessel. A subsampling procedure could be written to provide only a partial review, thereby reducing the cost of the EMS option.

The EMS costs presented here are based on leasing the systems. Actual program costs may be quite different for several reasons. First, another vendor may charge higher or lower daily leasing rates. Also, leasing a large number of systems may result in lower fees. NMFS may decide to purchase systems rather than leasing, which would result in a higher up-front cost but a reduced annual system cost.

Observer programs can offer more benefits to management than an EMS program. While EMS can provide a comprehensive look at compliance to certain regulations (e.g., seabird avoidance device requirements) it is not as effective at other tasks, such as biological sampling and catch estimation. Observer sampling can provide certain types of information that EMS cannot, simply by virtue of having a sampler on board the vessel.

The need for additional field offices and staff was beyond the scope of this analysis and was not examined. NMFS estimates the annual cost of the Groundfish Observer Program's office in Dutch Harbor at \$130,000. This represents only the basic rent and utilities for the office and part of an apartment for the staff, a leased government vehicle, salary for one employee (GS 9-1, no overtime) and a limited amount of travel. It does not include cost of equipment, furniture, etc. This is considered a low estimate; the real costs will depend on the specifics of what is required, local rent and utility rates, etc. It is likely that an EMS program would also require additional field staff and support structure.

## CONCLUSIONS

This study produced a number of encouraging observations on the effectiveness and the adaptability of EMS technology in the continuing effort to reduce seabird mortality in the halibut longline fisheries. The results of the study suggest two potential applications for this technology, based on differing management objectives. The first application would have a compliance objective, applying the EMS technology to a specified number of commercial halibut vessels solely for monitoring streamer line deployment. The EMS streamer line monitoring program would be, among all existing alternatives, likely the least expensive to operate and to analyze, but the cost structure would be dependant upon choices made for coverage, and sizes and number of vessel in the program. This program would monitor the deployment, relative position, and the vessel's compliance with the streamer line performance regulations but not account for the incidental seabird bycatch.

The second application would have two objectives: compliance and monitoring bycatch. The program would apply to vessels meeting specified criteria (i.e., size, area, and season of fishing) to monitor the deployment, position, and relative performance of the streamer lines, and also monitor incidental catch of seabirds. This program would require significantly more EMS oversight and maintenance, and would have higher analytical costs by virtue of the higher amount of data recorded and attendant analytical/personnel time, than the streamer line monitoring application. Information on cost of these factors is available from work by AMR in the Canadian halibut fishery. At present, AMR is using EMS technology on selected halibut vessels fishing in Canadian waters. The EMS program covered 3.5% of the total Canadian halibut fishing days in 2003 and is being expanded to approximately 6% in 2004 (McElderry, pers. comm<sup>4</sup>). The EMS program is designed and is being used to monitor all target and bycatch species caught during longline operations. At the conclusion of a vessel's fishing trip, an AMR technician retrieves the hard disks from the EMS unit, and an analyst reviews all of the images and records all of the species caught and discarded. The analysis time for any given hauling event is proportional to the amount of gear used. The video analysis takes an estimated 42 minutes for every 60 minutes of actual hauling time. If a similar program were developed for the Alaskan halibut fleet, which concentrated only on monitoring for incidentally caught seabirds, the video analysis time is expected to be equal or less than the Canadian halibut fishery program. The relative cost of an EMS program to monitor the occurrence of incidentally caught seabirds would likely be less than the present AMR program since the analysts would be focusing strictly on seabird bycatch, and not fish bycatch. However, should the system be implemented in order to address seabird bycatch objectives should be reviewed so that decisions to review fish bycatch can be made *a priori*. Both of these options are possible given the present state of EMS technology.

---

<sup>4</sup> H. McElderry, Archipelago Marine Research, 525 Head Street, Victoria, B.C., Canada, V9A 5S1.

## RECOMMENDATIONS

The following recommendations outline the potential next steps in the application of EMS technology to fisheries.

### **Option One: EMS Monitoring of Streamer Lines**

The EMS technology should be evaluated without onboard vessel staff. This would allow a more independent assessment of the EMS capabilities. We recommend that the study incorporate the following steps and procedures.

The project should incorporate a variety of Alaskan commercial halibut vessels. The vessels should be equipped with two setting cameras, an EMS computer, and data recording sensors, paralleling the set up used on the *F/V Heritage*. The aft hemisphere should be divided into two regions. Each setting camera should use an 8 mm focal length lens and should be angled at one of the regions with a large intersecting overlap between the two cameras. This overlap should be of sufficient size to allow each camera to record the majority of the area between the vessel's wake. All vessels with EMS units should use streamer lines that are standardized with mounting configurations similar to the ones used by the *F/V Heritage*. Standardized streamer line materials should be optically dense with a large, optically dense reference marker at distance intervals. These modifications to the streamer lines would allow for easier video analysis, which would be reflected in less analysis time, and would also provide an important diagnostic tool for the vessel crew. The computer video recording functions should be set at 10 × image compression, and should capture images and sensory data continuously in 15-second intervals. With this arrangement the EMS unit could store an estimated 48 days of video images on a 36-gigabyte hard disk, and the sensory data computer could store 45 days worth of data. The required EMS recording specifications are provided in Table 14. Post-processed sensor information could be used to detect and document specific setting event activities for video examination. This procedure would allow for the most cost-effective and time-efficient use of the EMS technology for monitoring streamer lines. Also, the proposed study would provide information on other potential problems not encountered during this study, and would provide an evaluation of the setting cameras and EMS units in a commercial operation.

### **Option Two: EMS Monitoring of Streamer Lines and Seabird Incidental Catch**

A second option would be to monitor the deployment, position and relative performance of the streamer lines as outlined above, and monitor the incidental catch of seabirds.

This program should incorporate a variety of Alaskan commercial halibut vessels and should parallel this study in terms of the mounting locations for the final hauling cameras, computer compressions, and the recording frame rates (Tables 14 and 15). The video hard disk and logging data storage capacity should be increased to allow for multiple fishing trips. The

software on the EMS data-logging computer should be programmed to activate the hauling video cameras autonomously when the hydraulic pressure increases at the gurdy during gear retrieval. The logging computer can provide this function when a hydraulic pressure sensor is installed to the gurdy.

There should be no modifications to the EMS equipment once the vessel has left the dock. This project should require the EMS vessels to retain all incidentally caught seabirds for inspection and identification by NMFS plant observers during vessel offloading. The inspection of the incidentally caught seabirds by NMFS would provide a calibration component by serving as a comparison to the video imagery. The first-hand inspection of incidentally caught seabirds would supply important information on the effects of gear soak on the seabird's physical characteristics. There is concern that the degradation of the seabird through extensive soak time would cause identification difficulties. This option would provide assistance in the development of video seabird identification techniques through a video analysis-training program, and would provide information on possible problems in an operational setting.

## ACKNOWLEDGEMENTS

We are grateful for the support and co-operation of the fishers and owners of the F/V *Heritage* and F/V *Pacific Sun*. Especially, we would like to thank Captains Mike Sharrah and Doug Lyle from the F/V *Heritage*, and Captain Jeff Hochstein from the F/V *Pacific Sun*. In addition, we would like to express our gratitude to the IPHC sea-samplers involved in this project: Antony Zanini for conducting the electronic monitoring project on the F/V *Pacific Sun*, and sea-samplers Julie Kellicutt, Suzanne Sullivan, Ray Byrne, and Joan Forsberg for their assistance. We are also thankful for the advisory and field support provided by NMFS-AFSC, specifically Sharon Davis, and Jennifer Watson.

Additionally, we would like to acknowledge the technical and advisory support provided by Archipelago Marine Research (AMR), in particular Howard McElderry, Dale McCullough, and Jessica Schrader. As well, we would like to thank AMR for the written description of the electronic monitoring system. We would also like to thank Ed Melvin from Washington Sea Grant for advice during the analysis stage of the study. Reviews by Craig Rose (AFSC), Kim Rivera (Alaska Region), and Martin Loefflad (AFSC) were also very helpful. Finally, the report benefited significantly from the advice and direction provided by IPHC staff members, specifically, Bruce Leaman, Claude Dykstra, Tim Loher, Din Chen, and Kelly Van Wormer.





## CITATIONS

- Armstrong, R. H. 1995. Guide to the birds of Alaska, 4<sup>th</sup> edition. Alaska Northwest Books.
- Froese, R. and D. Pauly. Editors. 2003. FishBase. electronic publication. [www.fishbase.org](http://www.fishbase.org). (Accessed 04/21/03).
- Geernaert, T. O., Gilroy, H. L., Kaimmer, S. M., Williams, G. H., and Trumble, R. J. 2001. A feasibility study that investigates options for monitoring bycatch of the short-tailed Albatross in the Pacific halibut fishery off Alaska. Int. Pac. Halibut Comm. Sci. Rep. Contract number 40HANF000046.
- International Pacific Halibut Commission. Unpub. 2002 Stock assessment survey manual. Int. Pac. Halibut Comm., Seattle, WA.
- Melvin, E. F., Parrish, J. K., Dietrich, K. S., and Hamel, O. S. 2001. Solutions to seabird bycatch in Alaska's demersal longline fisheries. Washington Sea Grant Program, University of Washington, WA.
- National Geographic Society. 1987. Field guide to the birds of North America, Second edition, National Geographic Society, Washington D.C.
- National Marine Fisheries Service. 2004. Revised seabird avoidance measures, found at 50 Code of Federal Regulations Part 679. Federal Register announcement 69 FR pp. 1930-1951 is available at <http://www.fakr.noaa.gov/protectedresources/seabirds/regulations.htm>
- United States Fish and Wildlife Service. 1998. Bering Sea/Aleutian Islands and the Gulf of Alaska Halibut Fishery Biological Opinion. March 13, 1998. Available from: Ecological Services Division, U.S. Fish and Wildlife Service, 4<sup>th</sup> Street, Anchorage, AK.
- United States Fish and Wildlife Service. 2003. Programmatic Biological Opinion on the Effects of the Fishery Management Plans (FMPs) for the Gulf of Alaska (GOA) and Bering Sea/Aleutian Islands (BSAI) Groundfish Fisheries on the Endangered Short-tailed Albatross (*Phoebastria albatrus*) and Threatened Steller's Eider (*Polysticta stelleri*). Available from: Ecological Services Division, U.S. Fish and Wildlife Service, 4<sup>th</sup> Street, Anchorage, AK.



## LIST OF TABLES

- Table 1.** Setting camera lenses, compression ratios, and frame rates used to record setting events on the *F/V Heritage*.
- Table 2.** Deck and roller camera lenses, compression ratios, and frame rates used to record hauling events on the *F/V Heritage*.
- Table 3.** Setting camera lenses, compression ratios, and frame rates used to record setting events on the *F/V Pacific Sun*.
- Table 4.** Deck and roller camera lenses, compression ratios, and frame rates used to monitor hauling events on the *F/V Pacific Sun*.
- Table 5.** Seabird image identification techniques (SIIT) used in the seabird identification test.
- Table 6.** Electronic monitoring system errors and problems encountered during the study.
- Table 7.** Number of daylight sets by camera configuration, by percentage of video coverage during setting event, and by the ability of the video analyst to determine the streamer line detection, position and performance on the *F/V Heritage*.
- Table 8.** Number of daylight sets by camera configuration, by percentage of video coverage during setting event, and by the ability of a video analyst to determine the streamer line detection, position and performance on the *F/V Pacific Sun*.
- Table 9.** Identity and total number of seabirds recovered by the *F/V Heritage* and *F/V Pacific Sun*, and the IPHC video analyst identification results. The seabirds were identified as 1) an unknown object, 2) to a seabird category, or 3) to species.
- Table 10.** Identity and number of seabirds recovered (n = 18) at ‘slow recording frame rates’ (SRFR) by the *F/V Heritage* and *F/V Pacific Sun*, and the IPHC video analyst identification results. The seabirds were identified as 1) an unknown object, 2) to a seabird category, and 3) to species.
- Table 11.** Identity and number of seabirds recovered (n = 45) at a ‘fast recording frame rate’ (FRFR) by the *F/V Heritage* and *F/V Pacific Sun*, and the IPHC video analyst identification results. The seabirds were identified as 1) an unknown object, 2) to a seabird category, or 3) to species.
- Table 12.** Estimated total fishery catch and effort for the 2001 fishery for Pacific halibut off Alaska.
- Table 13.** Estimated costs of using EMS and on-board fishery observers to monitor the Pacific halibut hook-&-line fishery off Alaska.
- Table 14.** Optimal setting camera lenses, compression ratios, and frame rates per minute.
- Table 15.** Optimal deck and roller camera lenses, compression ratios, and frame rates per second.



## LIST OF FIGURES

- Figure 1.** Schematic of the electronic monitor system components (courtesy of Archipelago Marine Research, Victoria, B.C.).
- Figure 2.** EMS set-up used on the *F/V Pacific Sun*, featuring the computer control box, status display monitor, and TV monitor.
- Figure 3.** IPHC regulatory areas and 2002 assessment survey stations.
- Figure 4.** The *F/V Heritage*, a 20-m LOA vessel which fishes Pacific halibut, chartered by the International Pacific Halibut Commission to conduct a stock assessment survey.
- Figure 5.** The *F/V Pacific Sun*, a 37-m steel hull vessel which fishes for Pacific halibut, chartered by the International Pacific Halibut Commission to conduct a stock assessment survey.
- Figure 6.** Diagram of the deck on the *F/V Heritage*, showing the approximate location of the EMS cameras on the stern (right side) and roller (upper left).
- Figure 7.** Location of two stern setting cameras on the *F/V Heritage*.
- Figure 8.** EMS GPS receiver (left) and hauling cameras (center and right) and on the *F/V Heritage*.
- Figure 9.** Mounting location and relative position of the roller camera on the *F/V Heritage*.
- Figure 10.** Diagram of the deck on the *F/V Pacific Sun*, showing the approximate location of the EMS cameras on the stern (right side) and roller (upper left).
- Figure 11.** Locations of *F/V Pacific Sun*'s two hauling cameras.
- Figure 12.** Paired streamer lines being towed behind a vessel.
- Figure 13.** Schematic of standardized streamer lines. From Melvin et al. (2001).
- Figure 14.** Flow chart of seabird image identification techniques.
- Figure 15.** Comparison of mean performance values, range (vertical dotted lines), and standard deviations (vertical solid lines) from video and vessel observations collected on the *F/V Heritage*.
- Figure 16.** Comparison of the vessel and video starboard side streamer line performance for each setting event on the *F/V Heritage*.
- Figure 17.** Comparison of the performance of the starboard side streamer line by vessel and video observation on the *F/V Heritage*. The positive trend line represents the linear association of the performance values.
- Figure 18.** Comparison of the vessel and video port side streamer line performance for each setting event on the *F/V Heritage*.
- Figure 19.** Comparison of the performance of the starboard side streamer line by vessel and video observation on the *F/V Heritage*. The positive trend line represents the linear association of the performance values.

- Figure 20.** Comparison of the mean performance values, range (vertical dotted lines), and standard deviation (vertical solid lines) from vessel and video observations collected on the F/V *Pacific Sun*.
- Figure 21.** Comparison of the vessel and video starboard side streamer line performance for each setting event on the F/V *Pacific Sun*.
- Figure 22.** Comparison of the performance of the starboard side streamer line by vessel and video observation on the F/V *Pacific Sun*. The positive trend line represents the linear association of the performance values.
- Figure 23.** Comparison of the vessel and video port side streamer line performance for each setting event on the F/V *Pacific Sun*.
- Figure 24.** Comparison of the performance of the port side streamer line by vessel and video observation on the F/V *Pacific Sun*. No positive trend line or linear association of the performance values was noted.
- Figure 25.** Comparison of correct identification of seabirds by a video analyst at four different frame rates.
- Figure 26.** Comparison of SRFR group (n = 18) and the video analyst' seabird image recognition capabilities.
- Figure 27.** Comparison of FRFR group (n = 45) and the video analyst' seabird image recognition capabilities.
- Figure 28.** Comparison of seabird recognition capabilities by "slow" and "fast" camera recording frame rates.
- Figure 29.** The six seabird specimen image categories and the ability of NMFS North Pacific Groundfish Observer Program staff to identify the seabirds correctly from video images.
- Figure 30.** Seabird detection (n = 25) results from AMR's analysis of 27 hauling video events.
- Figure 31.** Seabird video identification results (n = 24) from AMR's analysis of 27 hauling video events.
- Figure 32.** Relationship between correctly identified seabirds and the increase in recording frame rates. There is an inverse relative between recording frame rate and maximum recording capacity.
- Figure 33.** Self rating by NMFS seminar participants on their personal seabird identification abilities.

**Table 1.** Setting camera lenses, compression ratios, and frame rates used to record setting events on the *F/V Heritage*.

	<b>Initial configuration</b>	<b>Second configuration</b>	<b>Final configuration</b>
<b>No. of sets</b>	59	73	11
<b>Camera 1 lenses</b>	3.6 mm wide angle lens and 12 mm telephoto lens	12 mm telephoto lens	8 mm telephoto lens
<b>Camera 2 lenses</b>	16 mm telephoto lens and 12 mm telephoto lens	12 mm telephoto lens	No camera used
<b>Camera 1 Compression ratios</b>	20 ×, 15 ×, 10 ×	10 ×	10 ×
<b>Camera 2 Compression ratios</b>	20 ×, 15 ×, 10 ×	10 ×	No camera used
<b>Camera 1 frame rates (frames per second)</b>	1, 0.5	1	1
<b>Camera 2 frame rates (frames per second)</b>	1, 2	1	No camera used

**Table 2.** Deck and roller camera lenses, compression ratios, and frame rates used to record hauling events on the F/V *Heritage*.

	<b>Initial configuration</b>	<b>Second configuration</b>
<b>No. of Sets</b>	38	106
<b>Deck Camera lenses</b>	12 mm	12 mm
<b>Roller Camera lenses</b>	12 mm	12 mm
<b>Deck Camera compression ratios</b>	20 ×	20 ×
<b>Roller Camera compression ratios</b>	20 ×	20 ×
<b>Deck Camera frame rates (frames per second)</b>	1	1, 1.5
<b>Roller camera frame rates (frames per second)</b>	1	2, 2.5, 4, 5



**Table 3.** Setting camera lenses, compression rates, and frame rates used to record setting events on the *F/V Pacific Sun*.

	<b>Initial configuration</b>	<b>Second configuration</b>
<b>No. of sets</b>	23	22
<b>Camera 1 lenses</b>	3.6 mm wide angle lens	12 mm telephoto lens
<b>Camera 2 lenses</b>	16 mm telephoto lens	12 mm telephoto lens
<b>Camera 1 compression ratios</b>	20 ×	10 ×
<b>Camera 2 compression ratios</b>	20 ×, 10 ×	10 x
<b>Camera 1 frame rates (frames per second)</b>	1, 0.5	2
<b>Camera 2 frame rates (frames per second)</b>	1	2

**Table 4.** Deck and roller camera lenses, compression rates, and frame rates used to monitoring hauling events on the F/V *Pacific Sun*.

	<b>Initial configuration</b>	<b>Second configuration</b>
<b>No. of sets</b>	23	22
<b>Deck Camera lenses</b>	8 mm	8 mm
<b>Roller Camera lenses</b>	8 mm	8 mm
<b>Deck Camera compression rates</b>	20 ×	20 ×
<b>Roller Camera compression rates</b>	20 ×	20 ×
<b>Deck Camera frame rates (frames per second)</b>	1	2
<b>Roller Camera frame rates (frames per second)</b>	1	1, 2, 5

**Table 5.** Seabird image identification techniques (SIIT) used in the seabird identification test.

<b>Step</b>	<b>Description</b>
1a.	The animal on the hook is in fact a seabird. (Proceed to number 2a.)
1b.	The animal on the hook is not a seabird.
2a.	Estimate of the seabird's size by using known references that appear in the background. For example, size references used were the groundline, halibut hooks, roller horn, rollerman's body or body parts, gaffs, gangions, fishers' boots, etc. (Proceed to number 3a.)
2b.	If unable to determine the size, then the seabird is categorized simply as an unidentified seabird.
3a.	Looked at plumage coloration in order to place the seabird into a given species category. (Proceed to number 4a.)
3b.	Unable to determine plumage coloration, then the seabird is an unidentified seabird within a given size category.
4a.	Look for individual features of the seabird's bill, feet and plumage. (Proceed to number 5a.)
4b.	Unable to identify two or more distinct features associated with a species, then the seabird would be categorized as belonging to a particular group.
5a.	Able to determine the approximate size, along with two or more distinctive features that could be associated with a particular species, conclude that the species could be identified with a reasonable degree of confidence.

**Table 6.** Electronic monitoring system errors and problems encountered during the study.

- 
1. **Both vessels** - Non-triggered recording events. On this project the EMS video recording function was designed to be manually triggered on and off. A non-triggered recording event occurred when the EMS started and stopped recording without instruction. This was an infrequent and minor problem; approximately seven total non-triggered recording events occurred during the study. All non-triggered recording events were under 20 seconds in length. Possible causes include power surges or power fluctuations. A solution would be a regulated power supply and a back up battery power supply to the EMS units.
  2. **F/V Heritage** - encountered two computer hard drive errors or small computer system interface (SCSI) errors during the 3-month deployment. Due to the SCSI error, the computer software would not recognize the hard drive, and therefore would not record events. The system would resolve the error if it were left untouched for an hour. The cause is unknown, but the problem could be a result of a cold EMS start-up. A cold start-up occurs if the system has been turned off or left inactive for a long period of time. If the system has been turned off it may have difficulty recognizing the hard drive during the initial startup. The errors were only encountered when changing hard drives. A possible solution would be to start up the systems after hard drive installation and have them tested before the vessel leaves port.
  3. **F/V Heritage** - Unable to acquire a GPS satellite signal for a few hours during Trips 2 and 3. A possible cause was interference from the vessel wheelhouse. A solution would be to mount the GPS on the vessel's mast with full skyline range.
  4. **F/V Heritage** - The EMS stopped recording on Station 6114. The event was abruptly stopped when the recording keyboard or triggering device came loose from the wall mount, hit the floor, and stopped the recording event. The solution would be the use of an automated system, which does not require a keyboard for operations.
  5. **F/V Pacific Sun** - Station 6088, the recorded images during this station were washed out red. The cause is unknown, but it was most likely technician error.
  6. **F/V Pacific Sun** - Stations 6112, 6110, and 6111 had shaky hauling images. The cause was improper recording set-up by the third sea-sampler.
  7. **F/V Heritage** - the setting cameras were mounted to the bait shed railing. In this location the crew periodically jolted the cameras during gear deployment, changing the viewing angle of the cameras. The solution would be a more permanent-mounting device and location.
  8. **F/V Heritage** - Camera Leak. A water leak into one of the setting cameras leaked rendered the camera unusable. The cause was by either improper set-up during installing or a sea-sampler sealing error.
  9. **Both vessels** - Lens focusing problems. Caused by vessel motion and shaking. The solution was to secure the lens with glue after installation.
  10. **Both vessels** - Obstructions from dirt, bait, excess water and other objects on the cameras outer lens cover that diminishes viewing capabilities of the cameras. Solution would be to securely install the cameras in a semi-permanent location away from vessel crew activities, in an area that is sheltered from the weather and have the lens covers cleaned periodically.
-

**Table 7.** Number of daylight sets by camera configuration, by percentage of video coverage during setting event, and by the ability of the video analyst to determine the streamer line detection, position and performance on the F/V *Heritage*.

No. of Sets	Percent of video coverage of streamer lines	Port side streamer line			Starboard side streamer line		
		<i>Detection</i>	<i>Position</i>	<i>Performance</i>	<i>Detection</i>	<i>Position</i>	<i>Performance</i>
<i>Second camera configuration</i>							
61	100%	yes	yes	yes	yes	yes	yes
5	99%	yes	yes	yes	yes	yes	yes
3	98%	yes	yes	yes	yes	yes	yes
1	97%	yes	yes	yes	yes	yes	yes
1	96%	yes	yes	yes	yes	yes	yes
<i>Third camera configuration</i>							
8	100%	yes	yes	yes	yes	yes	yes
1	99%	yes	yes	yes	yes	yes	yes
1	98%	yes	yes	yes	yes	yes	yes
1	0% <sup>1</sup>	yes	yes	no	no	no	no

<sup>1</sup>The 0% coverage represented the inability of the analyst to detect deployment, position, and performance on the starboard side streamer line for the duration of the setting event.

**Table 8.** Number of daylight sets by camera configuration, by percentage of video coverage during setting event, and by the ability (yes/no) of a video analyst to determine the streamer line detection, position and performance on the F/V *Pacific Sun*.

No. of Sets	Percent of video coverage of streamer lines	Port side streamer line			Starboard side streamer line		
		<i>Detection</i>	<i>Position</i>	<i>Performance</i>	<i>Detection</i>	<i>Position</i>	<i>Performance</i>
<i>Second camera configuration</i>							
15	100%	yes	yes	yes	yes	yes	yes
5	100%	yes	yes	no	yes	yes	no
1	98%	yes	yes	yes	yes	yes	yes

**Table 9.** Identity and total number of seabirds recovered by the F/V *Heritage* and F/V *Pacific Sun*, and the IPHC video analyst identification results. The seabirds were identified as 1) an unknown object, 2) to a seabird category, or 3) to species.

<b>Species</b>	<b>Number retrieved</b>	<b>Category</b>	<b>Identified to species</b>
Shearwater	22	Dark fulmar/ shearwater category	Shearwater
Laysan albatross	6	Short-tailed/Laysan albatross	Laysan albatross
Black-footed albatross	3	Short-tailed/black-footed albatross	Black-footed albatross
<b><i>Total</i></b>	31		
Shearwater	16	Small black seabird category	Unknown
Shearwater	3	Dark fulmar/ shearwater category	Unknown
Laysan albatross	1	Short-tailed/Laysan albatross	Unknown
<b><i>Total</i></b>	20		
Shearwater	10	Unknown object	Unknown
Black-footed albatross	1	Unidentified black seabird	Unknown
Laysan albatross	1	Unknown object	Unknown
<b><i>Total</i></b>	12		

**Table 10.** Identity and number of seabirds recovered (n = 18) at "slow recording frame rates" (SRFR) by the F/V *Heritage* and F/V *Pacific Sun*, and the IPHC video analyst identification results. The seabirds were identified as 1) an unknown object, 2) to a seabird category, and 3) to species.

<b>Species</b>	<b>Number Retrieved</b>	<b>Category</b>	<b>Identified to species</b>
Shearwater	2	dark fulmar/shearwater category	Shearwater
Shearwater	2	dark fulmar/shearwater category	Unknown
Shearwater	7	small black seabird category	Unknown
Shearwater	7	Unknown object	Unknown
<b><i>Total</i></b>	18		



**Table 11.** Identity and number of seabirds recovered (n = 45) at a "fast recording frame rate" (FRFR) by the F/V *Heritage* and F/V *Pacific Sun*, and the IPHC video analyst identification results. The seabirds were identified as 1) an unknown object, 2) to a seabird category, or 3) to species.

<b>Species</b>	<b>Number retrieved</b>	<b>Category</b>	<b>Identified to species</b>
Shearwater	20	dark fulmar/shearwater category	Shearwater
Laysan albatross	6	Short-tailed/Laysan albatross	Laysan albatross
Black-footed albatross	3	Short-tailed/black-footed albatross	Black-footed albatross
<b><i>Total</i></b>	<b>29</b>		
Shearwater	1	dark fulmar/shearwater category	Unknown
Shearwater	9	Small black seabird category	Unknown
Laysan albatross	1	Short-tailed/Laysan albatross	Unknown
<b><i>Total</i></b>	<b>11</b>		
Shearwater	3	Unknown object	Unknown
Laysan albatross	1	Unknown object	Unknown
Black-footed albatross	1	Unidentified black seabird	Unknown
<b><i>Total</i></b>	<b>5</b>		

**Table 12.** Estimated total fishery catch and effort for the 2001 Pacific halibut fishery off Alaska.

<b>IPHC Area and Vessel Size</b>	<b>No. of Vessels</b>	<b>No. of Fishing Days</b>	<b>No. of Trips</b>	<b>Total Pounds Landed</b>	<b>No. of Skates</b>	<b>No. of Sets</b>
<b>Area 2C</b>						
< 60	568	6,527	2,561	8,185,722	71,757	13,813
60-124	17	95	42	217,278	1,176	172
125+	0	0	-	0	-	0
<b>Total</b>	<b>585</b>	<b>6,622</b>	<b>2,602</b>	<b>8,403,000</b>	<b>72,934</b>	<b>13,985</b>
<b>Area 3A</b>						
< 60	613	5,165	2,423	16,165,004	71,036	11,105
60-124	95	596	270	5,179,074	11,562	1,611
125+	3	26	8	196,923	806	92
<b>Total</b>	<b>711</b>	<b>5,788</b>	<b>2,701</b>	<b>21,541,000</b>	<b>83,405</b>	<b>12,808</b>
<b>Area 3B</b>						
< 60	215	1,701	702	8,669,075	31,254	4,502
60-124	89	860	265	7,260,141	21,253	2,651
125+	4	64	19	406,784	2,291	272
<b>Total</b>	<b>309</b>	<b>2,626</b>	<b>986</b>	<b>16,336,000</b>	<b>54,797</b>	<b>7,425</b>
<b>Area 4</b>						
< 60	124	2,569	1,468	6,895,570	34,799	6,955
60-124	64	918	238	6,159,312	20,646	2,863
125+	3	72	10	396,117	1,871	208
<b>Total</b>	<b>192</b>	<b>3,560</b>	<b>1,716</b>	<b>13,451,000</b>	<b>57,316</b>	<b>10,025</b>
<b>TOTAL</b>	<b>---</b>	<b>18,595</b>	<b>8,005</b>	<b>59,731,000</b>	<b>268,452</b>	<b>44,243</b>

**Table 13.** Estimated costs of using Electronic Monitoring Systems and on-board fishery observers to monitor the Pacific halibut hook-and-line fishery off Alaska.

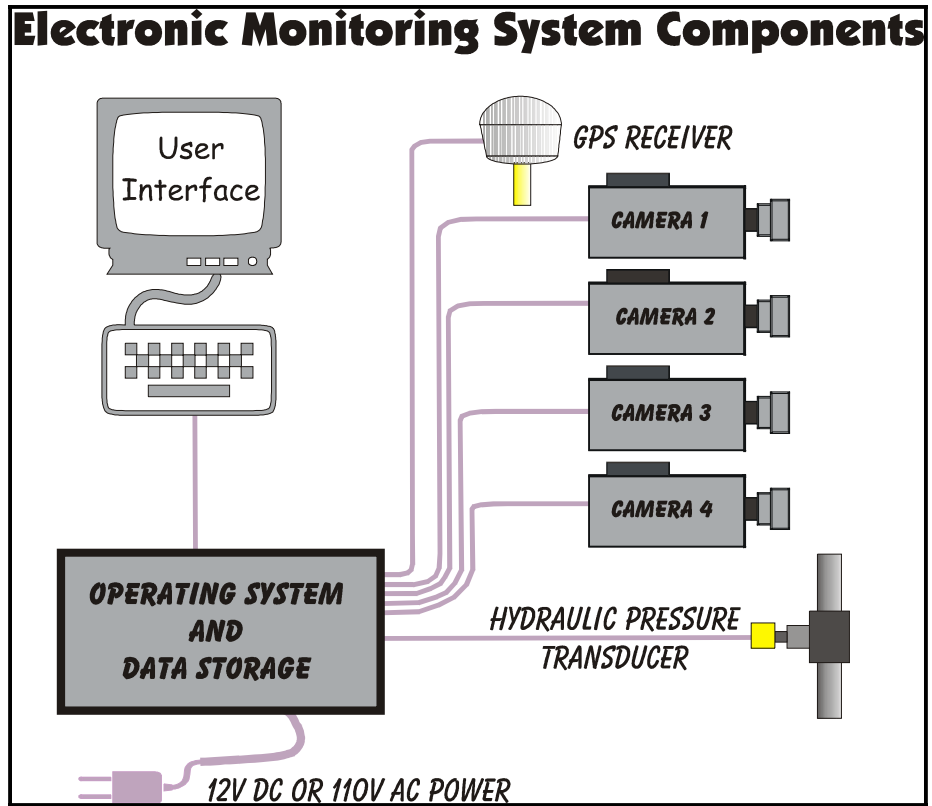
IPHC Area & Vessel Class	OPTION A: 100 PERCENT COVERAGE				OPTION B: 0/30/100 PERCENT COVERAGE			
	EMS		OBS		EMS		OBS	
<b>Area 2C</b>								
<60	\$ 841,864	(98.2%)	\$ 2,969,811	(98.6%)	\$ -	(0.0%)	\$ -	(0.0%)
60-124	\$ 15,153	(1.8%)	\$ 43,071	(1.4%)	\$ 7,868	(100.0%)	\$ 12,921	(100.0%)
125+	\$ -	(0.0%)	\$ -	(0.0%)	\$ -	(0.0%)	\$ -	(0.0%)
<b>Total</b>	<b>\$ 857,017</b>	<b>(31.4%)</b>	<b>\$ 3,012,882</b>	<b>(35.6%)</b>	<b>\$ 7,868</b>	<b>(3.5%)</b>	<b>\$ 12,921</b>	<b>(3.1%)</b>
<b>Area 3A</b>								
<60	\$ 771,532	(86.9%)	\$ 2,350,225	(89.2%)	\$ -	(0.0%)	\$ -	(0.0%)
60-124	\$ 110,873	(12.5%)	\$ 271,350	(10.3%)	\$ 51,818	(89.8%)	\$ 81,405	(87.4%)
125+	\$ 5,893	(0.7%)	\$ 11,766	(0.4%)	\$ 5,893	(10.2%)	\$ 11,766	(12.6%)
<b>Total</b>	<b>\$ 888,298</b>	<b>(32.6%)</b>	<b>\$ 2,633,340</b>	<b>(31.1%)</b>	<b>\$ 57,711</b>	<b>(26.0%)</b>	<b>\$ 93,171</b>	<b>(22.7%)</b>
<b>Area 3B</b>								
<60	\$ 292,976	(61.8%)	\$ 774,157	(64.8%)	\$ -	(0.0%)	\$ -	(0.0%)
60-124	\$ 166,510	(35.1%)	\$ 391,405	(32.8%)	\$ 67,319	(81.8%)	\$ 117,422	(80.0%)
125+	\$ 14,954	(3.2%)	\$ 29,289	(2.5%)	\$ 14,954	(18.2%)	\$ 29,289	(20.0%)
<b>Total</b>	<b>\$ 474,440</b>	<b>(17.4%)</b>	<b>\$ 1,194,851</b>	<b>(14.1%)</b>	<b>\$ 82,274</b>	<b>(37.1%)</b>	<b>\$ 146,710</b>	<b>(35.7%)</b>
<b>Area 4</b>								
<60	\$ 335,291	(65.9%)	\$ 1,169,119	(72.2%)	\$ -	(0.0%)	\$ -	(0.0%)
60-124	\$ 160,704	(31.6%)	\$ 417,543	(25.8%)	\$ 60,743	(82.2%)	\$ 125,263	(79.2%)
125+	\$ 13,123	(2.6%)	\$ 32,964	(2.0%)	\$ 13,123	(17.8%)	\$ 32,964	(20.8%)
<b>Total</b>	<b>\$ 509,119</b>	<b>(18.7%)</b>	<b>\$ 1,619,626</b>	<b>(19.1%)</b>	<b>\$ 73,867</b>	<b>(33.3%)</b>	<b>\$ 158,227</b>	<b>(38.5%)</b>
<b>ALL AREAS</b>								
<60	\$ 2,241,662	(82.1%)	\$ 7,263,312	(85.8%)	\$ -	(0.0%)	\$ -	(0.0%)
60-124	\$ 453,241	(16.6%)	\$ 1,123,369	(13.3%)	\$ 187,749	(84.7%)	\$ 337,011	(82.0%)
125+	\$ 33,970	(1.2%)	\$ 74,019	(0.9%)	\$ 33,970	(15.3%)	\$ 74,019	(18.0%)
<b>Total</b>	<b>\$ 2,728,873</b>	<b>-</b>	<b>\$ 8,460,699</b>	<b>-</b>	<b>\$ 221,719</b>	<b>-</b>	<b>\$ 411,029</b>	<b>-</b>
<b>TOTAL</b>	<b>\$ 2,728,873</b>	<b>-</b>	<b>\$ 8,460,699</b>	<b>-</b>	<b>\$ 221,719</b>	<b>-</b>	<b>\$ 411,029</b>	<b>-</b>

**Table 14.** Optimal setting camera lenses, compression ratios, and frame rates per minute.

<b>Camera specification</b>	<b>Setting configuration</b>
<b>Camera 1 and 2 lenses</b>	8 mm
<b>Camera 1 and 2 compression ratios</b>	10 ×
<b>Camera 1 and 2 frame rates (frames per minute)</b>	4

**Table 15.** Optimal deck and roller camera lenses, compression ratios, and frame rates per second.

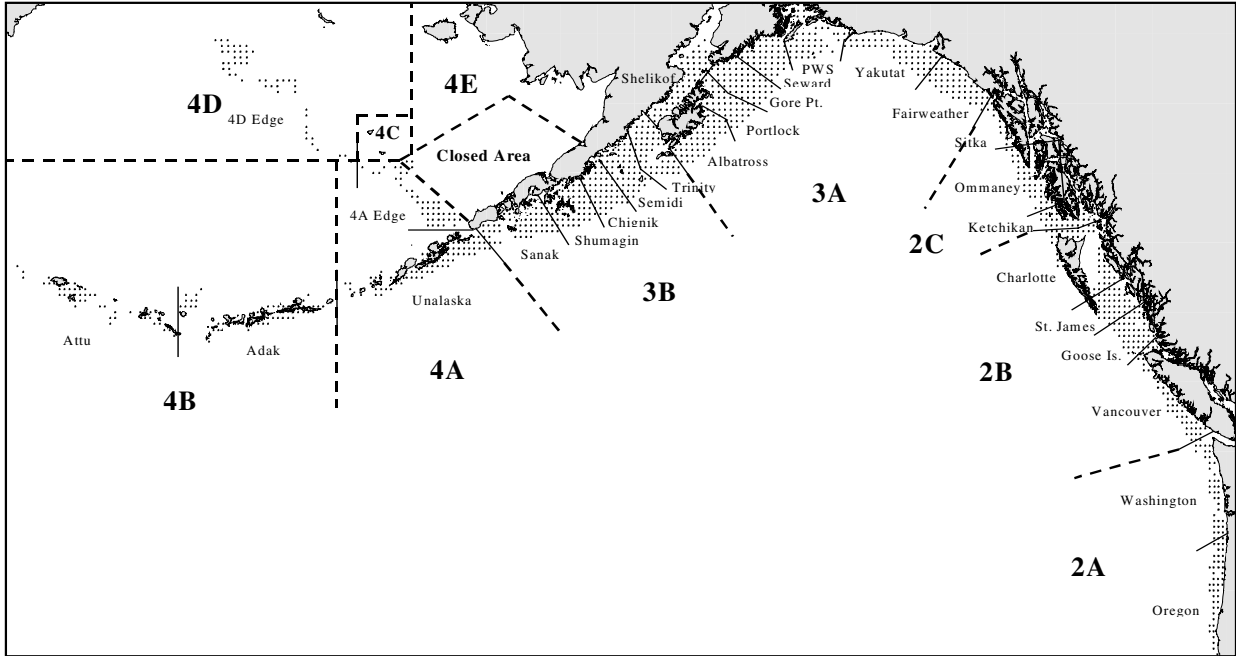
<b>Camera specification</b>	<b>Hauling configuration</b>
<b>Deck and Roller camera lenses</b>	8 mm or 12 mm
<b>Deck and Roller camera compression ratios</b>	20 ×
<b>Deck camera frame rates (frames per second)</b>	1.5
<b>Roller camera frame rates (frames per second)</b>	2.5



**Figure 1.** Schematic features of the electronic monitor system components (courtesy of Archipelago Marine Research, Victoria, B.C.). The computer control box is composed of the operating system and data storage.



**Figure 2.** Electronic Monitoring System set-up used on the F/V *Pacific Sun*, featuring the computer control box, status display monitor, and TV monitor.



**Figure 3.** International Pacific Halibut Commission regulatory areas and 2002 assessment survey stations.

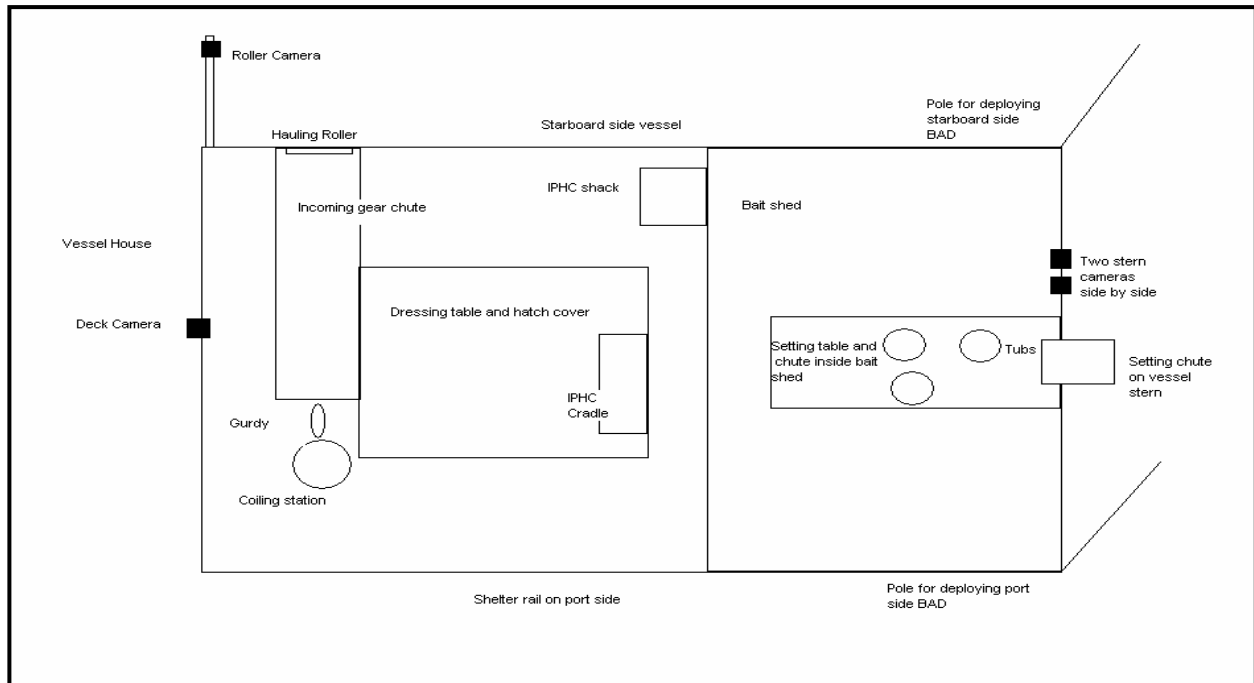




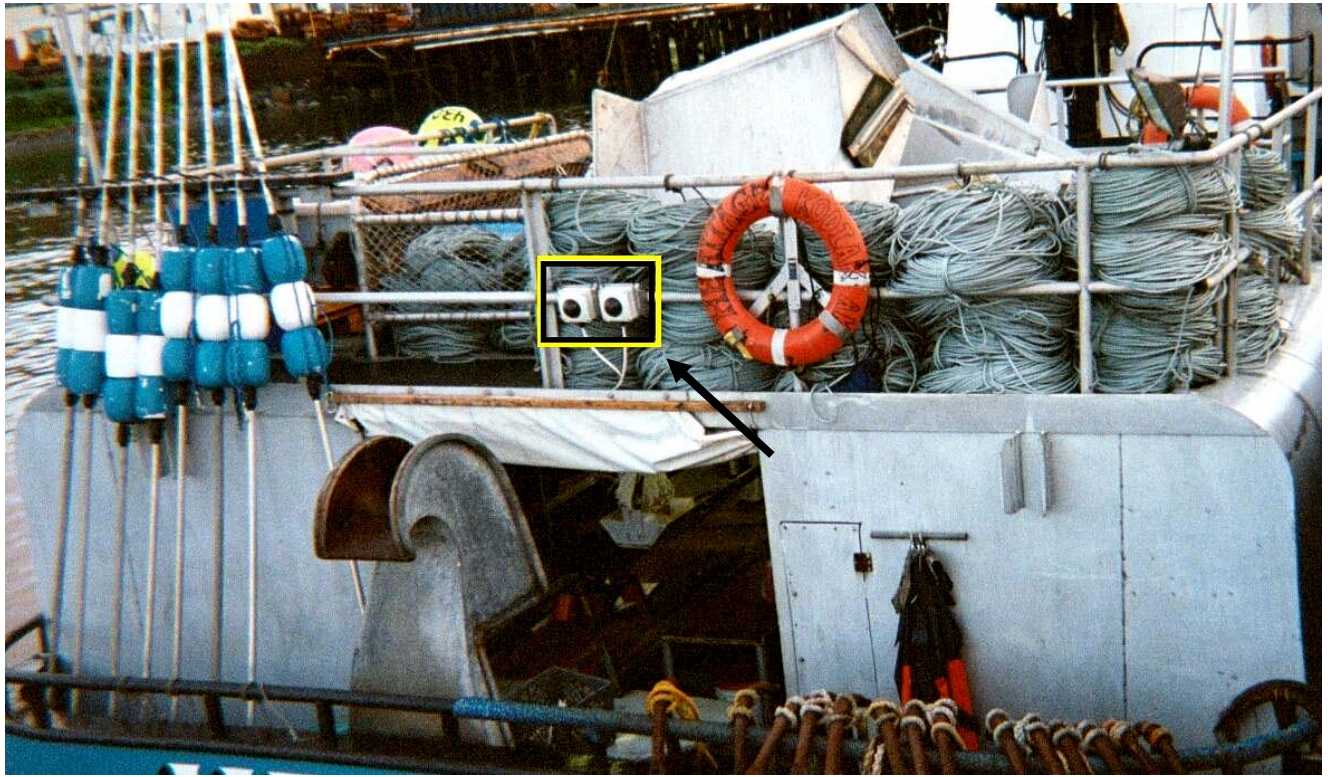
**Figure 4.** The F/V *Heritage*, a 20-m length overall vessel chartered by the International Pacific Halibut Commission.



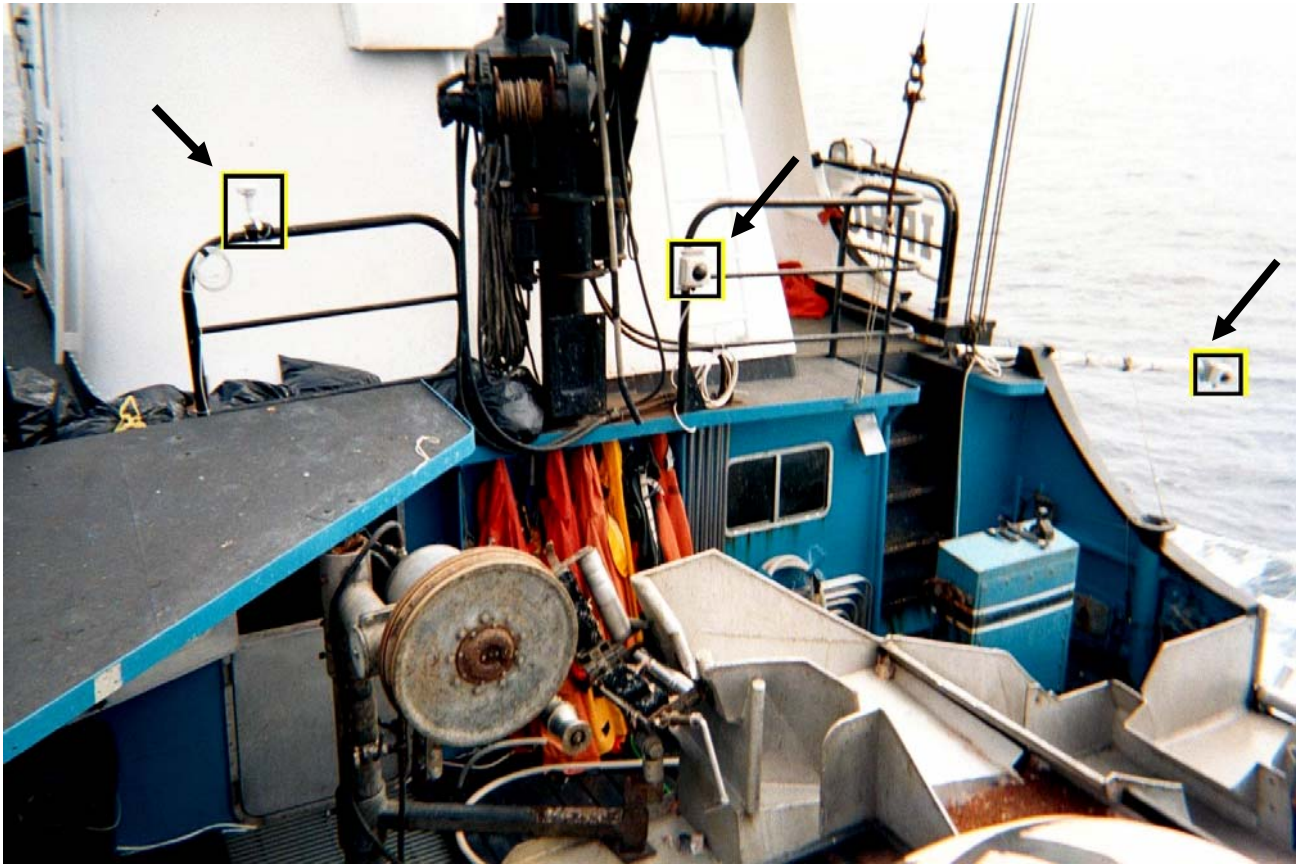
**Figure 5.** The F/V *Pacific Sun*, a 37-m steel hull vessel chartered by the International Pacific Halibut Commission. Photo courtesy Sara Wilson, IPHC.



**Figure 6.** Diagram of the deck on the *F/V Heritage*, showing the approximate location of the Electronic Monitoring System cameras on the stern (right side) and roller (upper left).



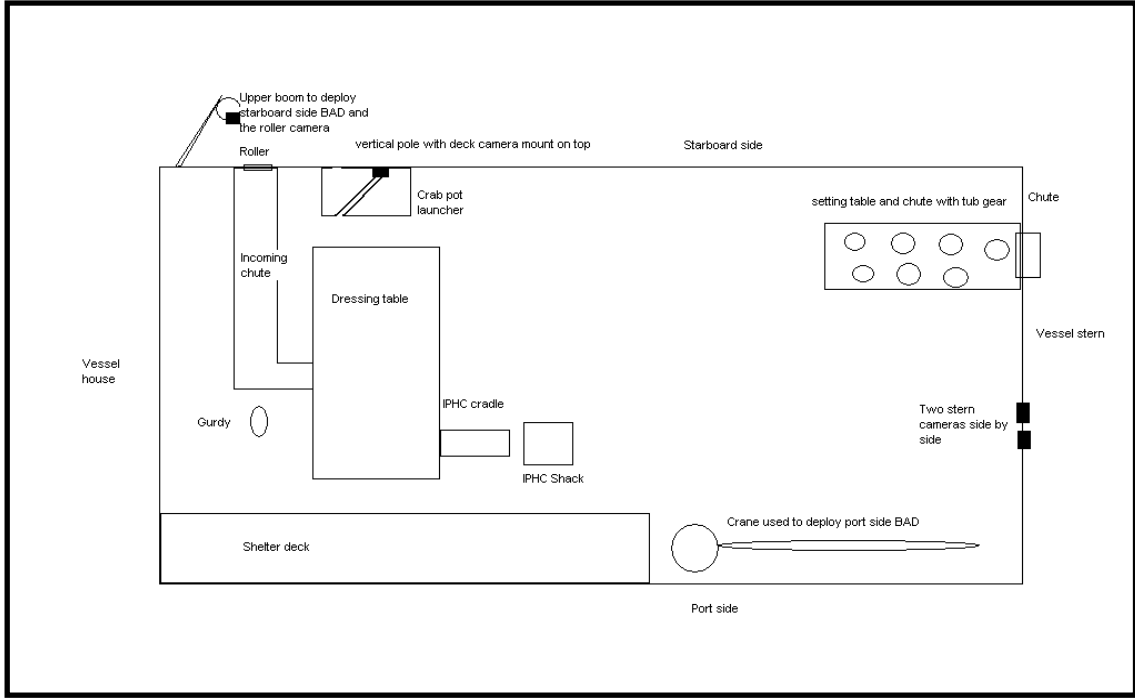
**Figure 7.** Location of the two stern setting cameras on the F/V *Heritage*.



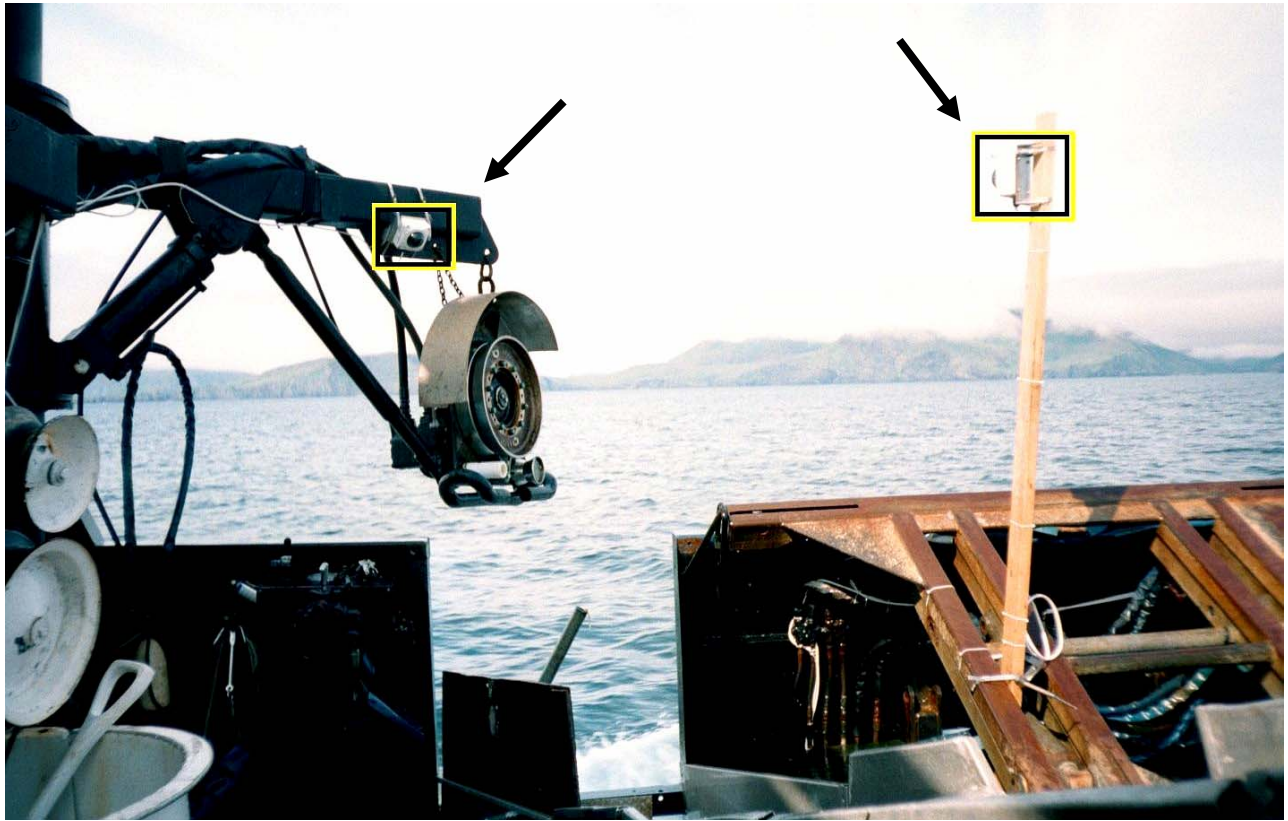
**Figure 8.** Electronic Monitoring System global positioning system receiver (left) and hauling cameras (center and right) and on the F/V *Heritage*.



**Figure 9.** Mounting location and relative position of the roller camera on the F/V *Heritage*.

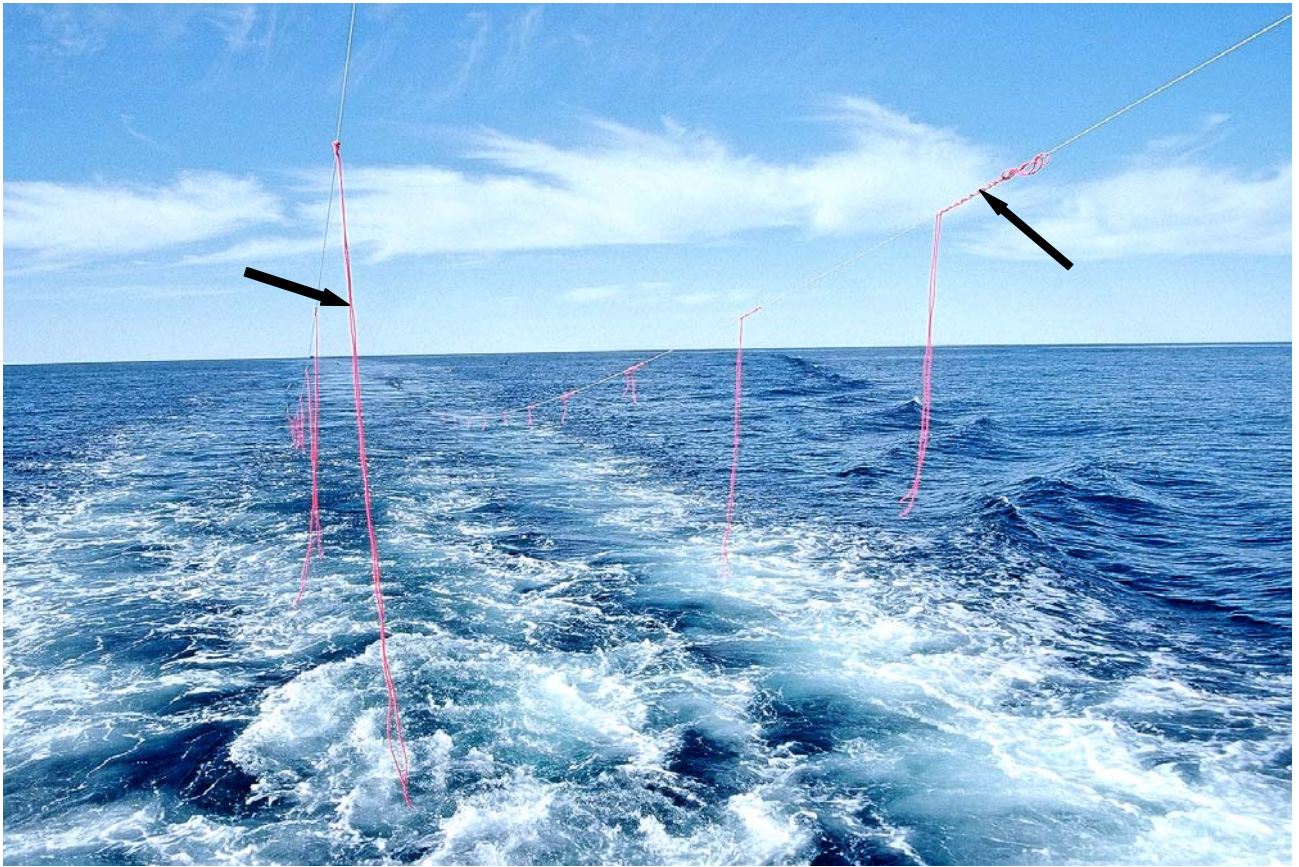


**Figure 10.** Diagram of the deck on the F/V *Pacific Sun*, showing the approximate location of the EMS cameras on the stern (right side) and roller (upper left).

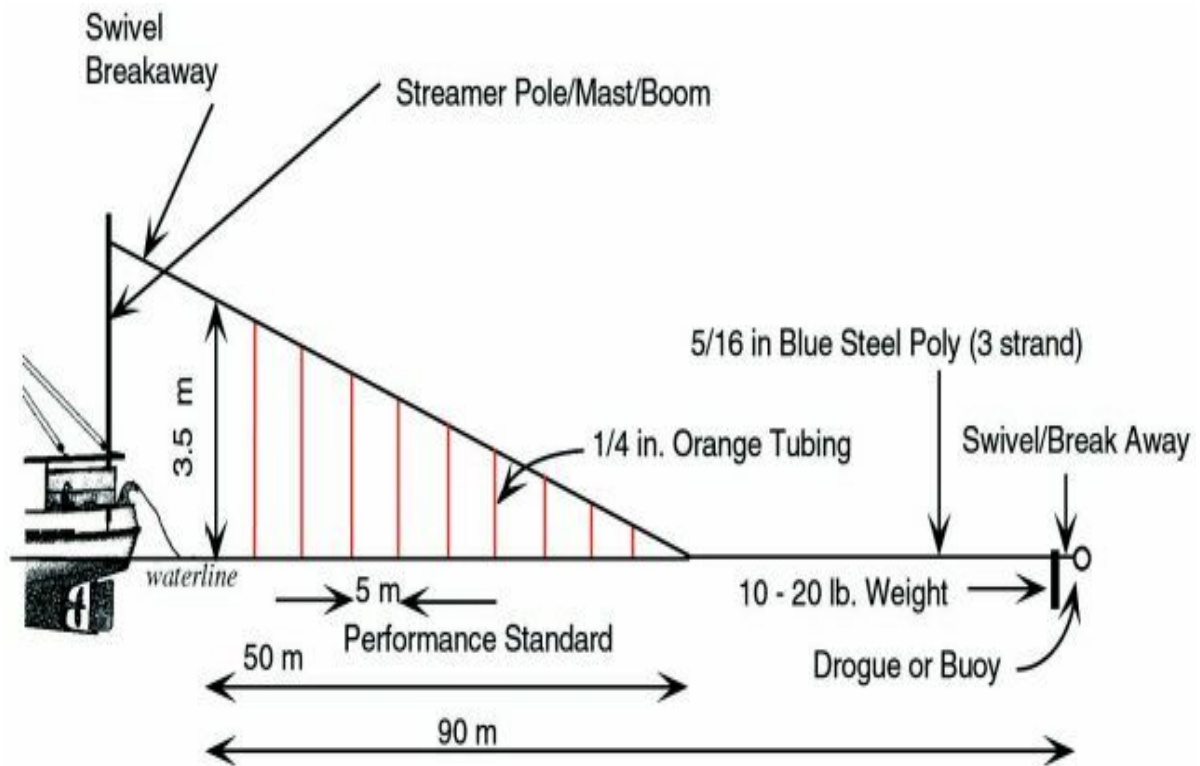


**Figure 11.** Locations of F/V *Pacific Sun*'s two hauling cameras.

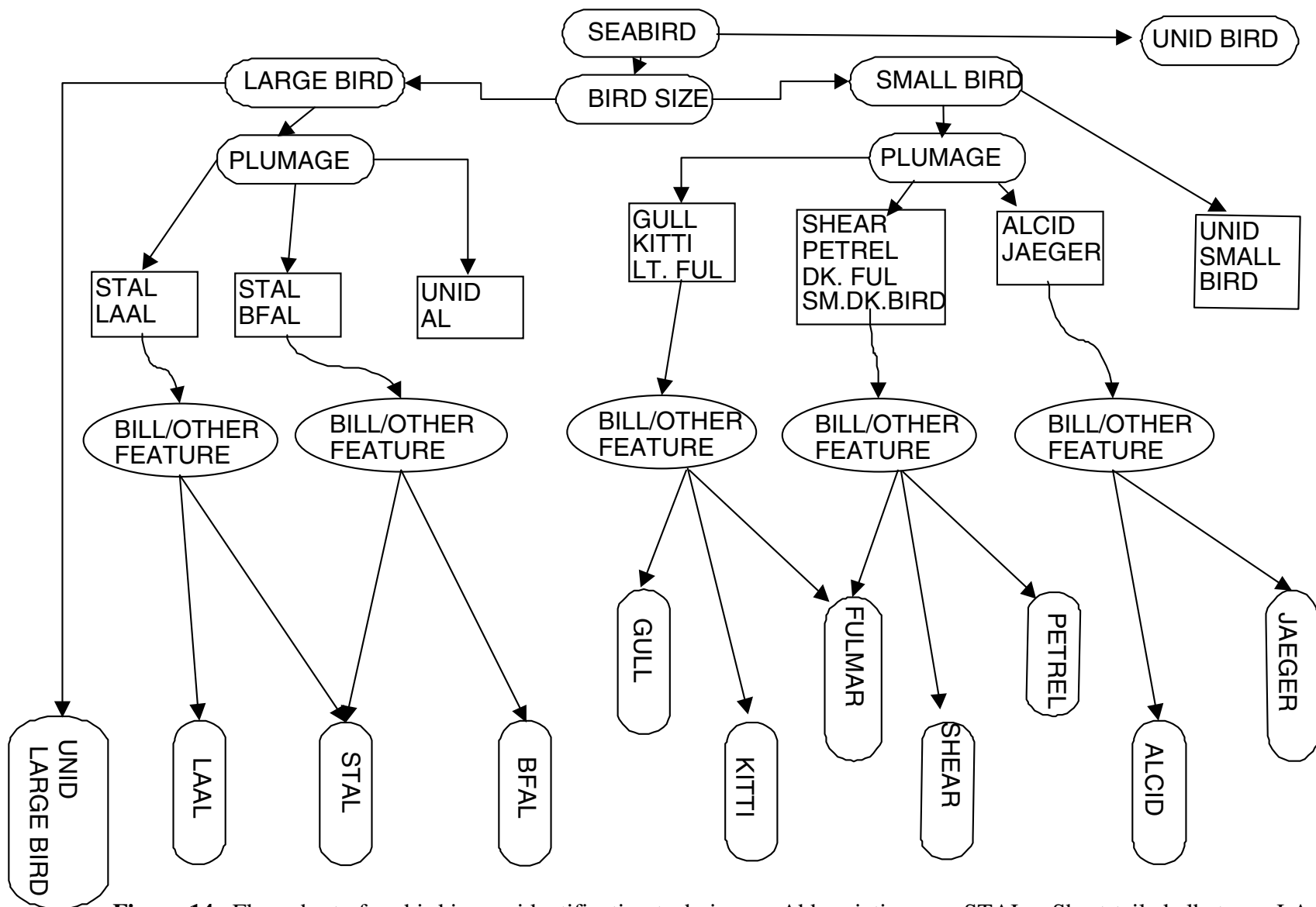




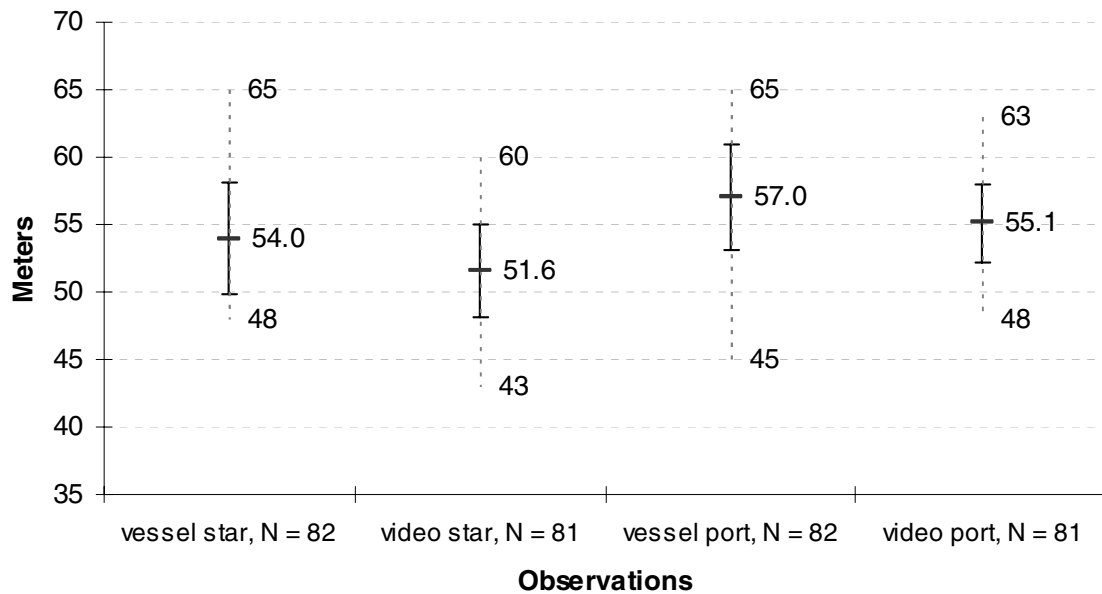
**Figure 12.** Paired streamer lines being towed behind a vessel.



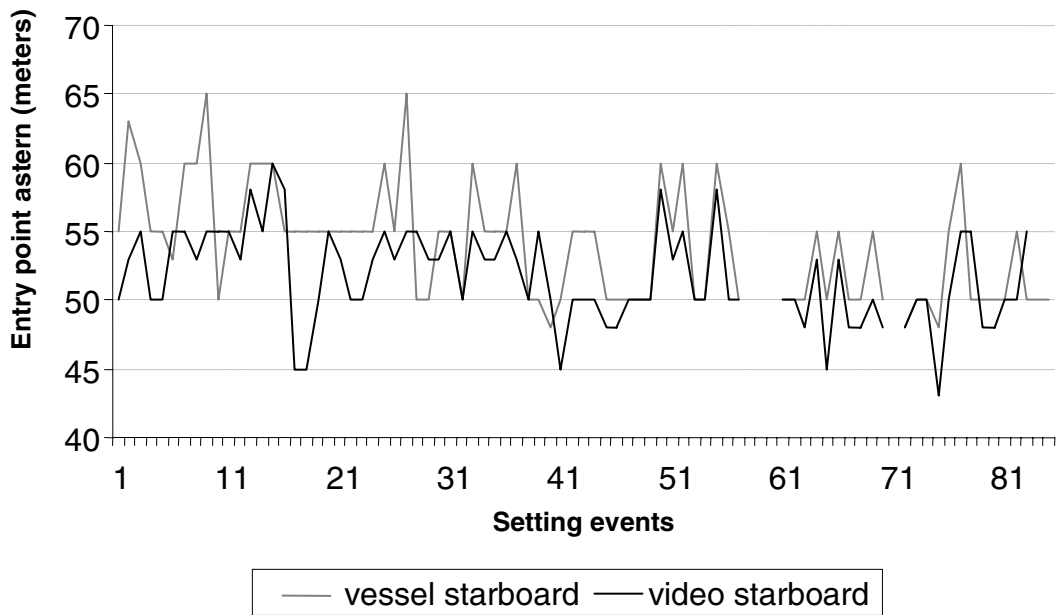
**Figure 13.** Schematic of standardized streamer lines. From Melvin et al. (2001).



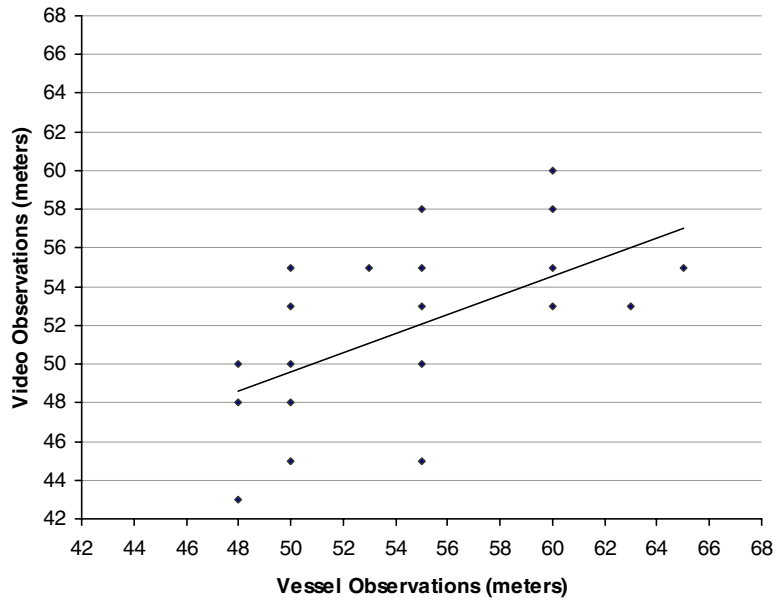
**Figure 14.** Flow chart of seabird image identification techniques. Abbreviations are STAL = Short-tailed albatross; LAAL = Laysan albatross; BFAL = Black-footed albatross; UNID AL = unidentified albatross; GULL = gull spp.; KITTI = kittiwake; LT. FUL = light colored northern fulmar; SHEAR = unidentified dark shearwater; PETREL = petrel spp.; DK FUL = dark colored northern fulmar; SM. DK. BIRD = small dark bird.



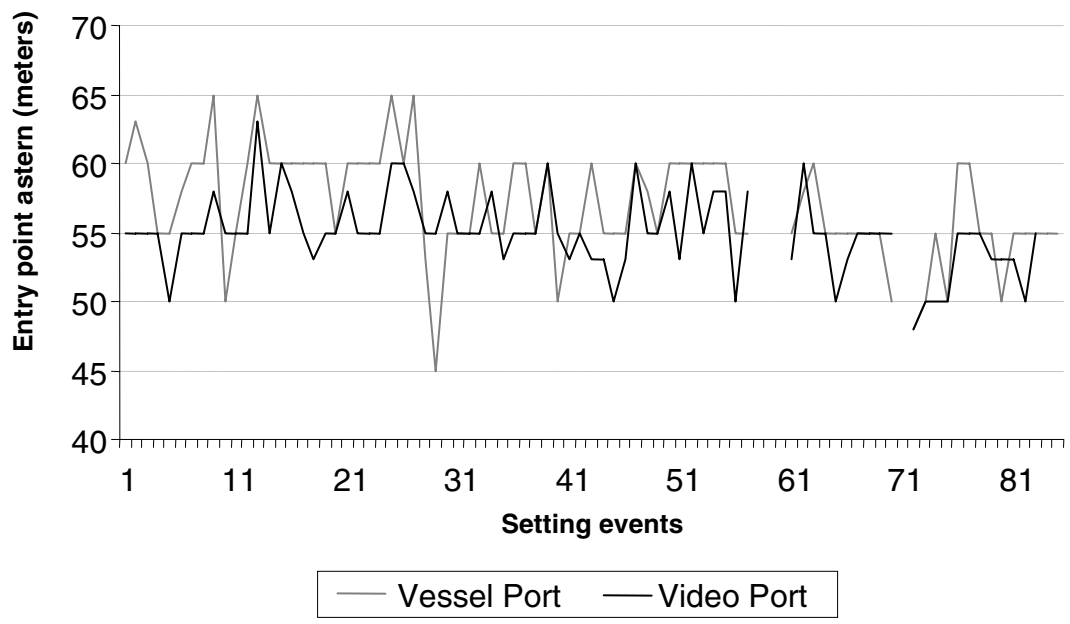
**Figure 15.** Comparison of mean performance values, range (vertical dotted lines), and standard deviations (vertical solid lines) from video and vessel observations collected on the *F/V Heritage*.



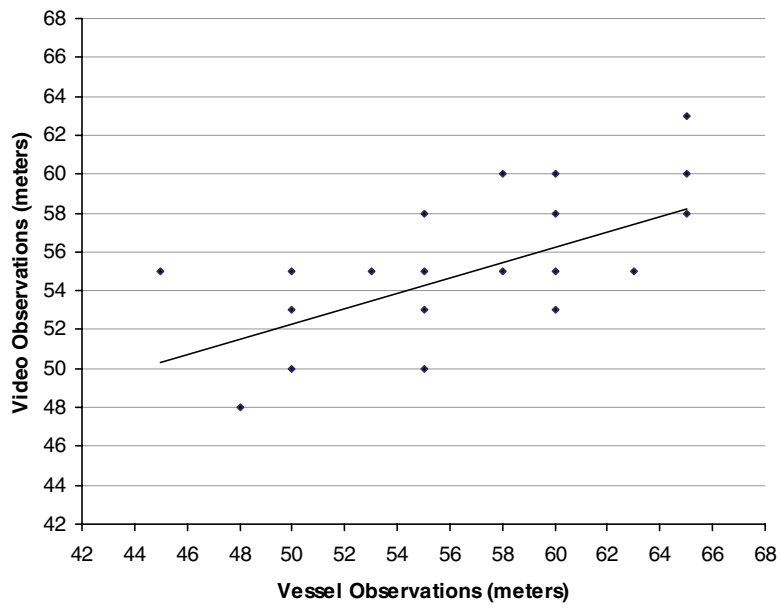
**Figure 16.** Comparison of the vessel and video starboard side streamer line performance for each setting event on the F/V *Heritage*.



**Figure 17.** Comparison of the performance of the starboard side streamer line by vessel and video observation on the F/V *Heritage*. The positive trend line represents the linear association of the performance values.

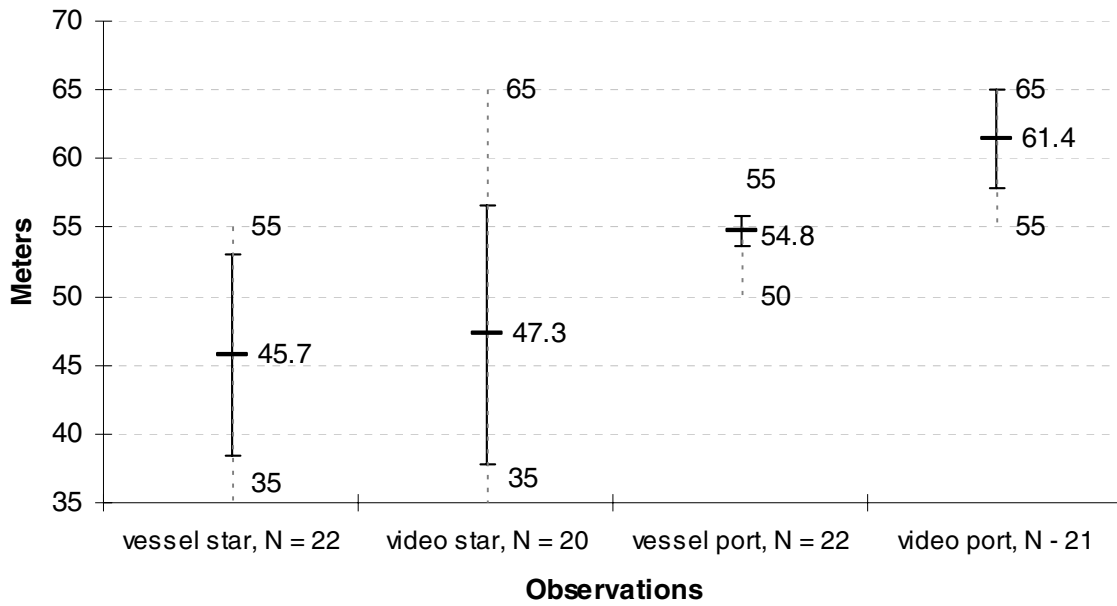


**Figure 18.** Comparison of the vessel and video port side streamer line performance for each setting event on the F/V *Heritage*.

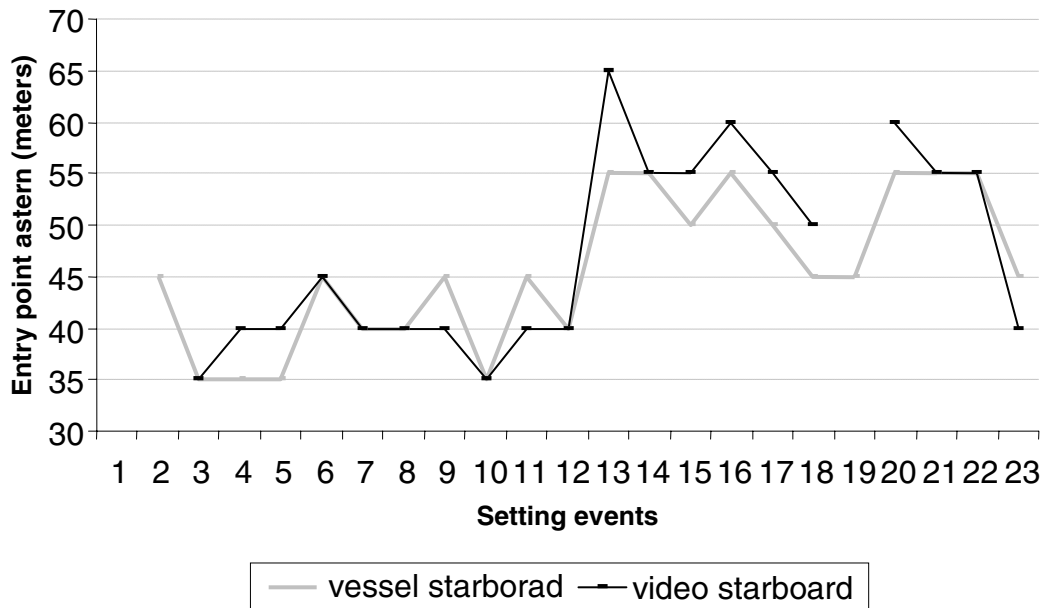


**Figure 19.** Comparison of the performance of the starboard side streamer line by vessel and video observation on the F/V *Heritage*. The positive trend line represents the linear association of the performance values.

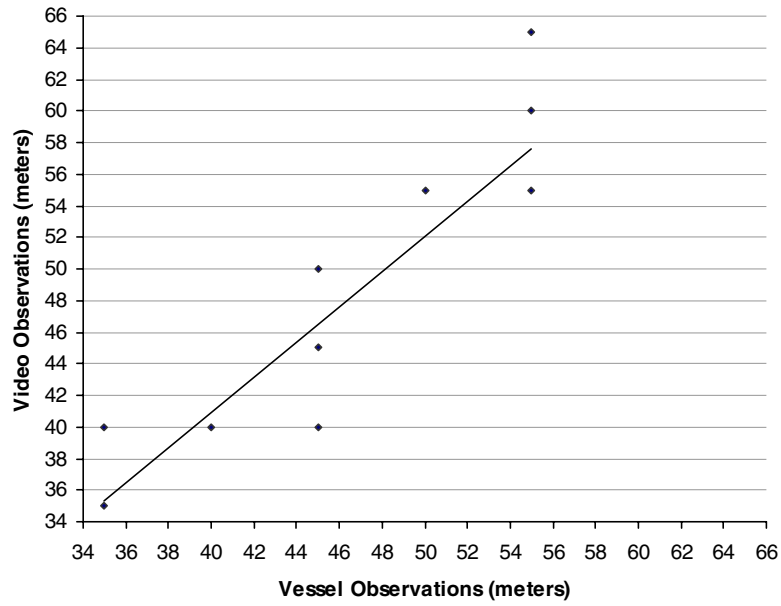




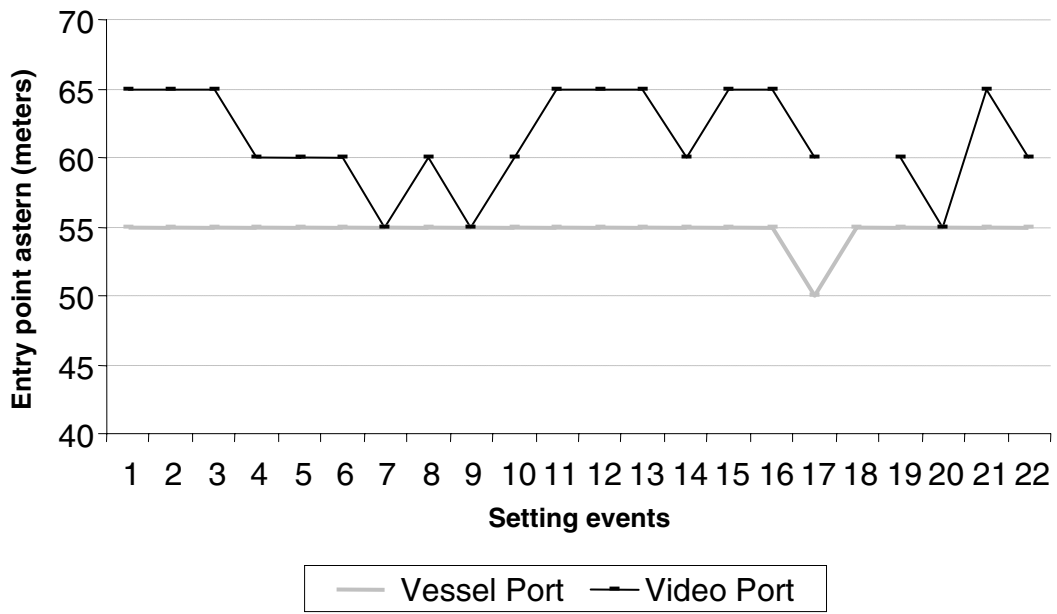
**Figure 20.** Comparison of the mean performance values, in meters behind the vessel, with range (vertical dotted lines), and standard deviation (vertical solid lines) from both sea sampler and video observations collected on the F/V *Pacific Sun*.



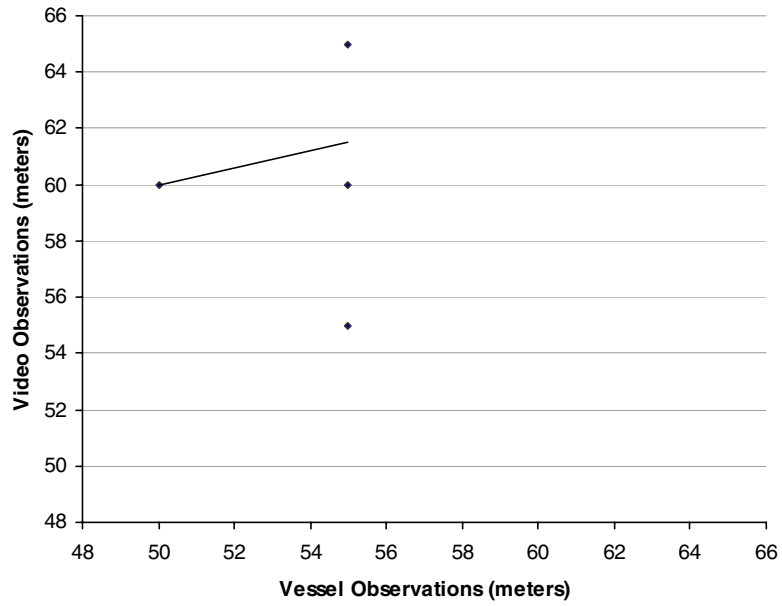
**Figure 21.** Comparison of the vessel and video starboard side streamer line performance for each setting event on the F/V *Pacific Sun*.



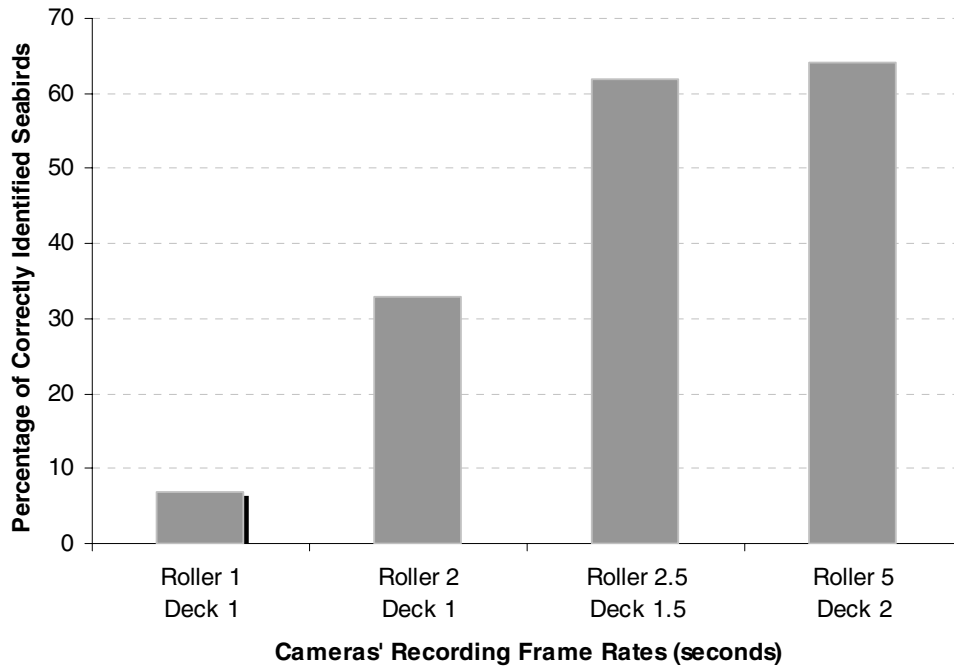
**Figure 22.** Comparison of the performance of the starboard side streamer line by vessel and video observation on the F/V *Pacific Sun*. The positive trend line represents the linear association of the performance values.



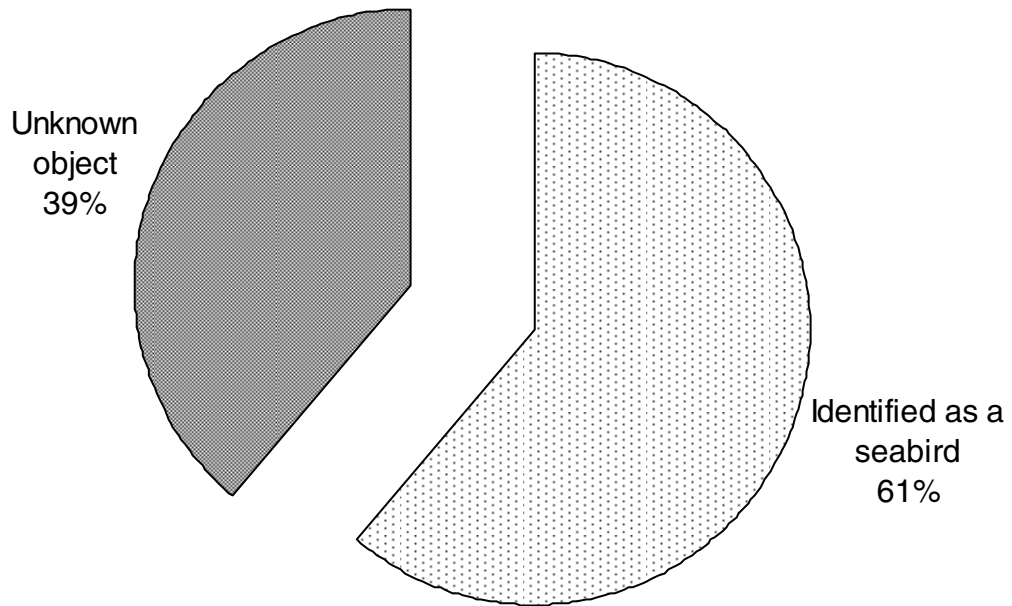
**Figure 23.** Comparison of the vessel and video port side streamer line performance for each setting event on the F/V *Pacific Sun*.



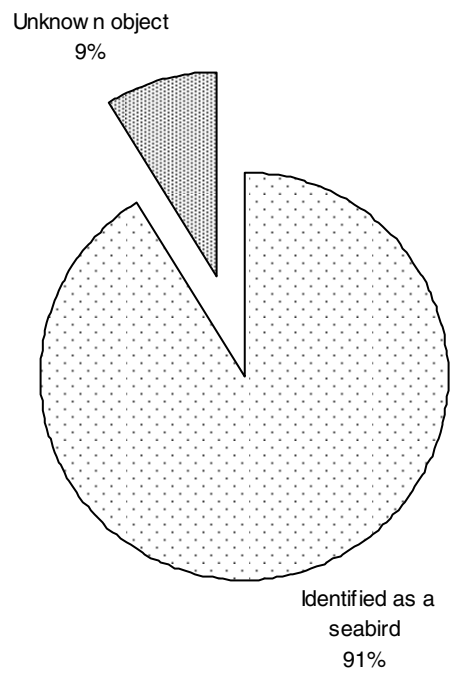
**Figure 24.** Comparison of the performance of the port side streamer line by vessel and video observation on the F/V *Pacific Sun*. No positive trend line or linear association of the performance values was noted.



**Figure 25.** Comparison of correct identification of seabirds by a video analyst at four different frame rates.

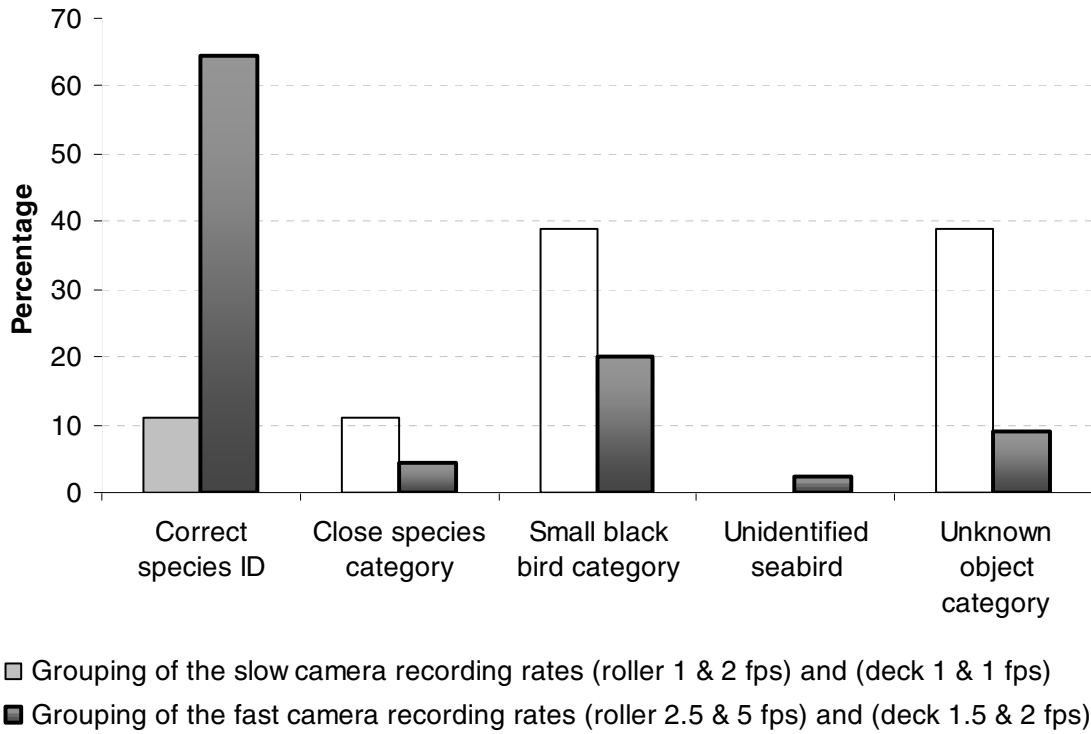


**Figure 26.** Comparison of SRF group (n = 18) and the video analyst' seabird image recognition capabilities.

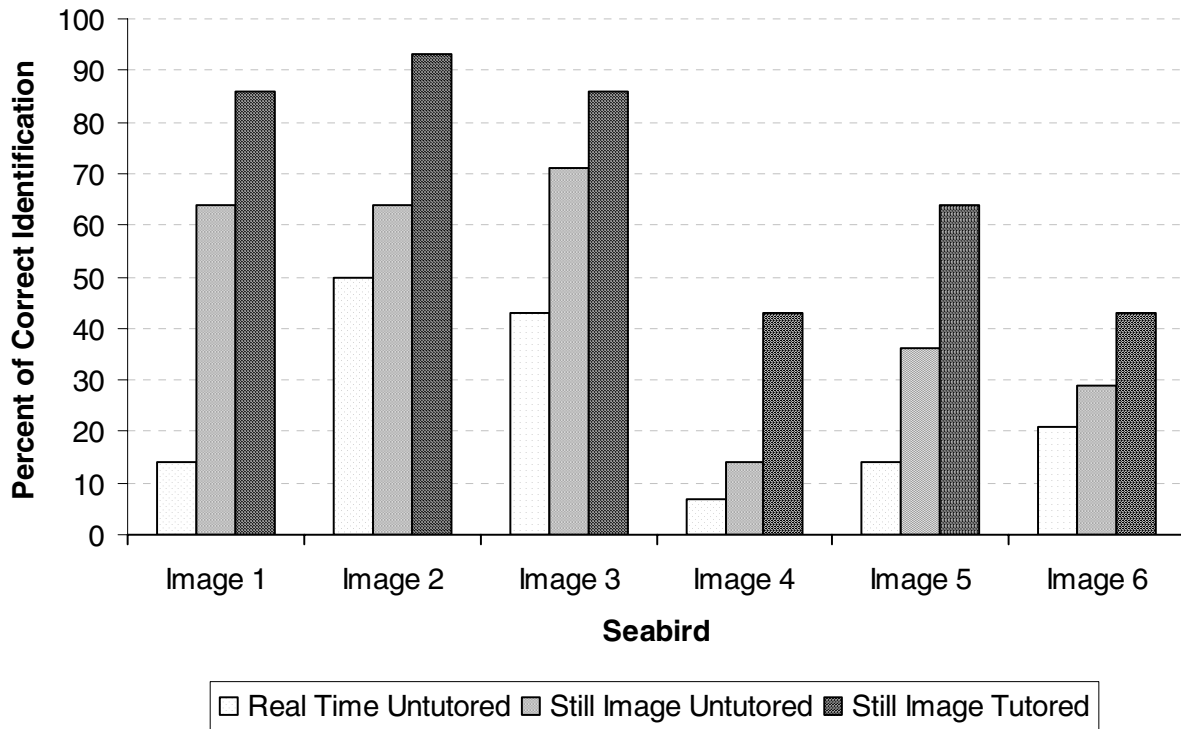


**Figure 27.** Comparison of FRFR group (n = 45) and the video analyst's seabird image recognition capabilities.

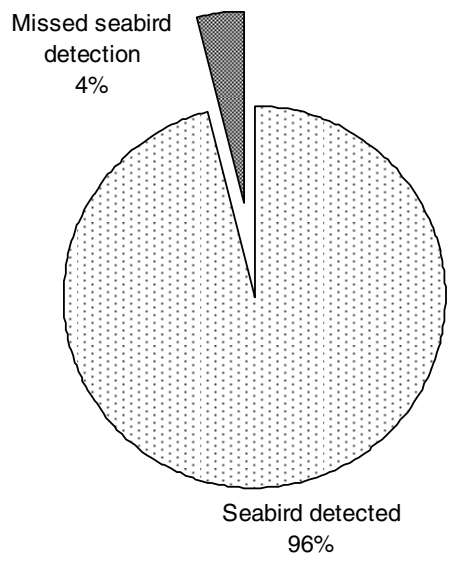




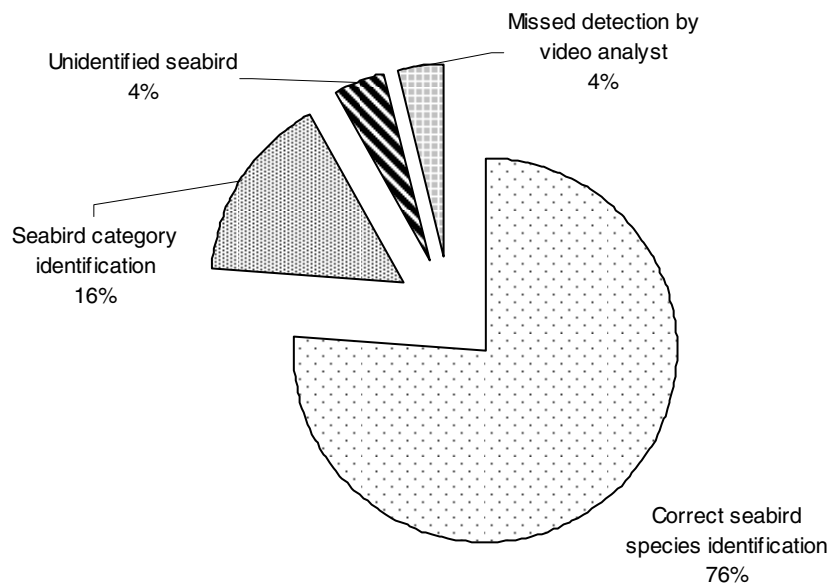
**Figure 28.** Comparison of seabird specimen recognition capabilities by “slow” and “fast” camera recording frame rates (fps = frame rates per second).



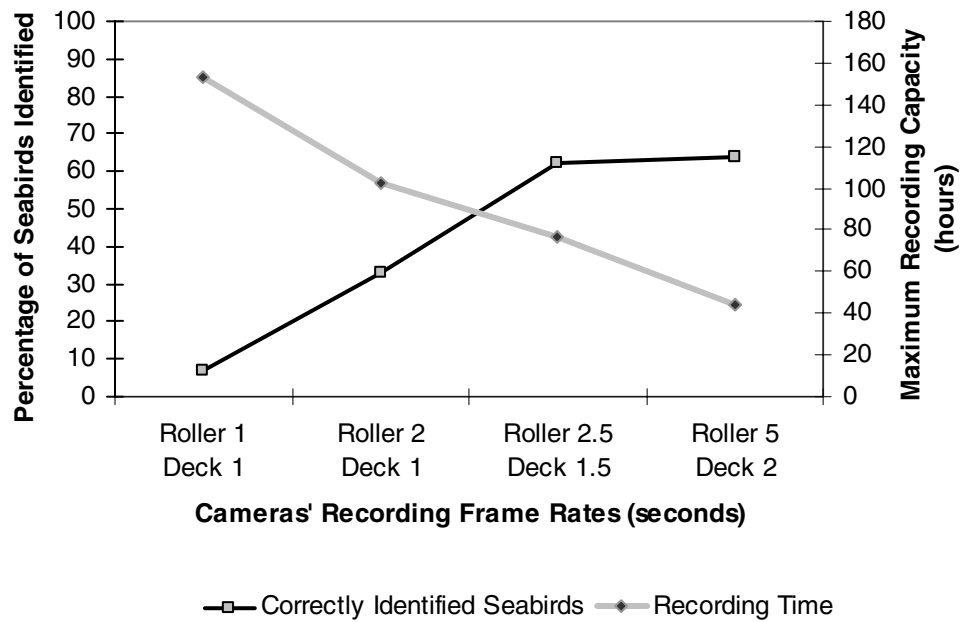
**Figure 29.** The six seabird specimen image categories and the ability of NMFS North Pacific Groundfish Observer Program staff to identify the seabirds correctly from video images.



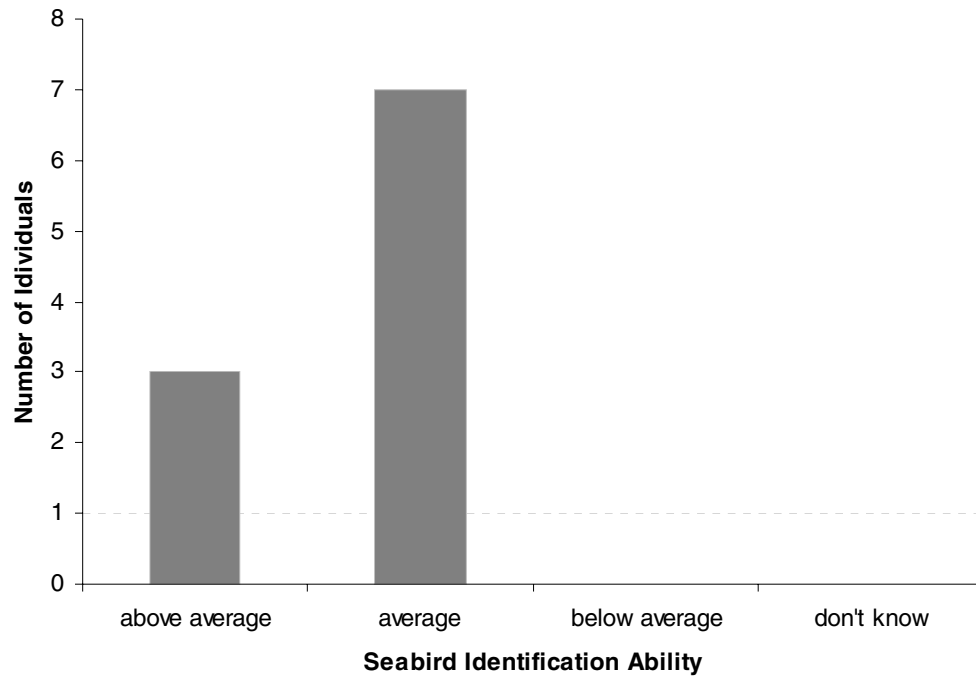
**Figure 30.** Seabird detection (n = 25) results from Archipelago Marine Research’s analysis of 27 hauling video events.



**Figure 31.** Seabird video identification results (n = 24) from Archipelago Marine Research's analysis of 27 hauling video events.



**Figure 32.** Relationship between correctly identified seabirds and the increase in recording frame rates. There is an inverse relative between recording frame rate and maximum recording capacity.



**Figure 33.** Self rating by NMFS seminar participants on their personal seabird identification abilities.

## APPENDIX 1

### Method of Securing Test Seabirds to the Longline Gear

On the F/V *Heritage*, albatross were attached by securing their bodies to the line at two locations. The first method involved threading a hook through the bird's bill, and then closing the bill firmly with a plastic zip strap. The second method involved wrapping the bird's body with 22.7 kg test monofilament fishing line. The fishing line was wrapped tightly around the body at the base of the wings and the neck, and then tied to the eye of a gangion. The smaller shearwaters were attached in two places as well. On two sets, the small birds were hooked through the bill, and then the body was wrapped in a similar fashion to the albatross. On another two sets, the shearwaters were hooked by threading the line through the bird's eye, and then the body was wrapped. In the remaining 23 shearwater sets, the shearwaters were hooked through the wing. The halibut hook was first threaded through the middle wing joint, and then the monofilament line was threaded through the same hole and tied from the wing to the eye of the gangion. Aboard the F/V *Pacific Sun*, frozen seabirds were attached to the line gear by wrapping their wings or their necks around the gangion with either duct tape or electrical tape. All of the albatross were secured to the line gear by taping their necks to a gangion. The 18 shearwaters were attached to the line by taping their necks to the gangion; the final 10 were secured by taping their wings to the gangion and hook.





## **APPENDIX 2**

### **Basic Statistics of Fishing Effort and Catch**

The Statement of Work between the NMFS and IPHC requires the report to provide information on catch and effort. For the duration of the project there were no incidentally caught seabirds. Thus, no seabirds were returned to NMFS. On both vessels, with EMS units, a third sea-sampler was added to the standard IPHC staff solely for the purposes of the project. The sea-samplers were responsible for recording the hook status including identifying and recording all invertebrates and vertebrates caught during gear retrieval.

#### **IPHC 20-Hook Counts**

Five skates of standardized gear were set at each station, each at 1,800 feet in length and fitted with 100 hooks. These hook densities were maintained to an accuracy of within 95% for the duration of the charters. Eighteen-foot spacing separated each of the 24-48 inch gangions. Number 3 (16/0) circle hooks were tied to each gangion and they were baited with 0.25-0.33 pounds of chum salmon. A 5-pound weight was tied between each of the skates. Gear was set after 0500 h, and then hauled after a minimum 5-hour soak. For more information concerning the gear specifications and procedures used during the survey see IPHC (2002).

During gear retrieval, the two samplers identified and recorded the species caught on the first 20-hooks of each skate, for a total of 100 hooks per station. On the 20-hook count all species of vertebrates and invertebrates, as well as bait, skin, empty and missing hooks were recorded. The IPHC bycatch species-sampling protocol did not include species weights. Tables 1 and 2 provide information on the number of animals caught on the 20-hook counts by vessel and by IPHC regulatory area. In addition, catch data from the 20-hook counts were extrapolated up to the full number of set hooks per station, and these results are also shown.

#### **Retained Catch**

The amount of Pacific halibut landed from the 2002 assessment surveys by IPHC Areas 4A, 4D and 4B, and by vessel are found in Table 3. The amount of bycatch landed during the 2002 surveys by vessel and by IPHC area are found in Table 4. Only marketable bycatch of good quality are retained during the IPHC surveys. Therefore, Table 4 does not necessarily represent the total amount of bycatch caught. In addition, all Pacific halibut and bycatch fish weights are calculated by the plants during offload.

**Table 1.** F/V Heritage 20-hook counts and species extrapolation by IPHC regulatory area.

Species Common and Scientific Name	Data	4A	4B	4D	Grand Total
Alaska skate	Sum of extrapolated numbers	426		547	973
<i>Bathyraja pariferma</i>	Sum of observed numbers	86		110	196
Aleutian skate	Sum of extrapolated numbers	129	5	364	497
<i>Bathyraja aleutica</i>	Sum of observed numbers	26	1	73	100
Arrowtooth flounder	Sum of extrapolated numbers	267	25	79	371
<i>Atheresthes stomias</i>	Sum of observed numbers	53	5	16	74
Bering skate	Sum of extrapolated numbers			35	35
<i>Bathyraja interrupta</i>	Sum of observed numbers			7	7
Brown king crab	Sum of extrapolated numbers		5		5
<i>Lithodes aequispina</i>	Sum of observed numbers		1		1
Commander skate	Sum of extrapolated numbers		10		10
<i>Bathyraja lindbergi</i>	Sum of observed numbers		2		2
Unidentified coral	Sum of extrapolated numbers		156		156
Order Scleractinia	Sum of observed numbers		31		31
Dusky rockfish	Sum of extrapolated numbers		15		15
<i>Sebastes ciliatus</i>	Sum of observed numbers		3		3
Flathead sole	Sum of extrapolated numbers			5	5
<i>Hippoglossoides elassodon</i>	Sum of observed numbers			1	1
Golden skate	Sum of extrapolated numbers			35	35
<i>Bathyraja smirnovi</i>	Sum of observed numbers			7	7
Great sculpin	Sum of extrapolated numbers	5	10	10	25
<i>Myoxocephalus polyacanthocephalus</i>	Sum of observed numbers	1	2	2	5
Greenland turbot	Sum of extrapolated numbers	246	101	253	600
<i>Reinhardtius hippoglossoides</i>	Sum of observed numbers	49	20	51	120
Grenadier (rattails)	Sum of extrapolated numbers	315	321	287	923
Family Macrouridae	Sum of observed numbers	63	64	58	185
Jellyfish	Sum of extrapolated numbers		5		5
Class Scyphozoa	Sum of observed numbers		1		1
Kamchatka flounder	Sum of extrapolated numbers	139	50		190
<i>Atheresthes evermanni</i>	Sum of observed numbers	28	10		38
Misc	Sum of extrapolated numbers		20	10	30
	Sum of observed numbers		4	2	6
Northern rockfish	Sum of extrapolated numbers		5		5
<i>Sebastes polyspinis</i>	Sum of observed numbers		1		1
Unidentified Octopus	Sum of extrapolated numbers		15	5	20
Order Octopoda	Sum of observed numbers		3	1	4
Pacific cod	Sum of extrapolated numbers	1,646	747	2,095	4,489
<i>Gadus macrocephalus</i>	Sum of observed numbers	331	149	422	902
Pacific halibut	Sum of extrapolated numbers	1,378	908	2,703	4,989
<i>Hippoglossus stenolepis</i>	Sum of observed numbers	276	181	542	999
Red Irish lord	Sum of extrapolated numbers		5		5
<i>Hemilepidotus hemilepidotus</i>	Sum of observed numbers		1		1
Rougheye rockfish	Sum of extrapolated numbers		25	5	30
<i>Sebastes aleutianus</i>	Sum of observed numbers		5	1	6
Sablefish (black cod)	Sum of extrapolated numbers	84	61	30	175
<i>Anoplopoma fimbria</i>	Sum of observed numbers	17	12	6	35

**Table 1.** (cont'd) F/V *Heritage* 20-hook counts and species extrapolation by IPHC regulatory area.

Species Common and Scientific Name	Data	4A	4B	4D	Grand Total
Sea anemone	Sum of extrapolated numbers	5		30	35
Order Actinaria	Sum of observed numbers	1		6	7
Sea cucumber	Sum of extrapolated numbers	5	5		10
Class Holothuroidea	Sum of observed numbers	1	1		2
Sea pen	Sum of extrapolated numbers		10		10
Class Anthozoa	Sum of observed numbers		2		2
Shells	Sum of extrapolated numbers		20	5	25
	Sum of observed numbers		4	1	5
Shortraker rockfish	Sum of extrapolated numbers	30	15	15	60
<i>Sebastes borealis</i>	Sum of observed numbers	6	3	3	12
Shortspine thornyhead rockfish	Sum of extrapolated numbers		131		131
<i>Sebastolobus alascanus</i>	Sum of observed numbers		26		26
Skate egg cases	Sum of extrapolated numbers	10		5	15
	Sum of observed numbers	2		1	3
Unidentified skates	Sum of extrapolated numbers	109	291	235	635
Order Rajiformes	Sum of observed numbers	22	58	47	127
Sleeper sharks	Sum of extrapolated numbers	40		100	139
<i>Somniosus pacificus</i>	Sum of observed numbers	8		20	28
Sponge	Sum of extrapolated numbers		70		70
Phylum Porifera	Sum of observed numbers		14		14
Starfish	Sum of extrapolated numbers	20	70	69	159
Class Stelleroidea	Sum of observed numbers	4	14	14	32
Unidentified thornyhead rockfish	Sum of extrapolated numbers	15	20		36
Unidentified <i>Sebastolobus</i>	Sum of observed numbers	3	4		7
Unidentified flatfish	Sum of extrapolated numbers	45	64	15	125
Order Pleuronectiformes	Sum of observed numbers	9	13	3	25
Unidentified rockfish	Sum of extrapolated numbers		10		10
Family Scorpaenidae	Sum of observed numbers		2		2
Unidentified roundfish	Sum of extrapolated numbers	5			5
Class Osteichthyes	Sum of observed numbers	1			1
Walleye pollock	Sum of extrapolated numbers	46	5	39	91
<i>Theragra chalcogramma</i>	Sum of observed numbers	9	1	8	18
Whiteblotched skate	Sum of extrapolated numbers	463	330	630	1,423
<i>Bathyraja maculata</i>	Sum of observed numbers	93	66	126	285
Yellow Irish lord	Sum of extrapolated numbers		106		106
<i>Hemilepidotus jordani</i>	Sum of observed numbers		21		21
Sum of extrapolated numbers		5,429	3,639	7,603	16,671
Sum of observed numbers		1,089	725	1,528	3,342

**Table 2.** F/V Pacific Sun 20-hook counts and species extrapolation by IPHC regulatory area.

Species Common and Scientific Name	Data	4B	Grand Total
Alaska skate	Sum of extrapolated numbers	356	356
<i>Bathyraja pariferma</i>	Sum of observed numbers	72	72
Aleutian skate	Sum of extrapolated numbers	84	84
<i>Bathyraja aleutica</i>	Sum of observed numbers	17	17
Arrowtooth flounder	Sum of extrapolated numbers	145	145
<i>Atheresthes stomias</i>	Sum of observed numbers	29	29
Brown king crab	Sum of extrapolated numbers	5	5
<i>Lithodes aequispina</i>	Sum of observed numbers	1	1
Unidentified coral	Sum of extrapolated numbers	64	64
Order Scleractinia	Sum of observed numbers	13	13
Eelpout	Sum of extrapolated numbers	5	5
Family Zoarcidae	Sum of observed numbers	1	1
Great sculpin	Sum of extrapolated numbers	5	5
<i>Myoxocephalus polyacanthocephalus</i>	Sum of observed numbers	1	1
Greenland turbot	Sum of extrapolated numbers	83	83
<i>Reinhardtius hippoglossoides</i>	Sum of observed numbers	17	17
Grenadier (rattails)	Sum of extrapolated numbers	105	105
Family Macrouridae	Sum of observed numbers	23	23
Kamchatka flounder	Sum of extrapolated numbers	127	127
<i>Atheresthes evermanni</i>	Sum of observed numbers	26	26
Unidentified octopus	Sum of extrapolated numbers	30	30
Order Octopoda	Sum of observed numbers	6	6
Pacific cod	Sum of extrapolated numbers	1,055	1,055
<i>Gadus macrocephalus</i>	Sum of observed numbers	214	214
Pacific halibut	Sum of extrapolated numbers	1,336	1,336
<i>Hippoglossus stenolepis</i>	Sum of observed numbers	270	270
Red king crab	Sum of extrapolated numbers	15	15
<i>Paralithodes camtschatica</i>	Sum of observed numbers	3	3
Sablefish (Black cod)	Sum of extrapolated numbers	225	225
<i>Anoplopoma fimbria</i>	Sum of observed numbers	46	46
Sea anemone	Sum of extrapolated numbers	10	10
Order Actinaria	Sum of observed numbers	2	2
Sea urchin	Sum of extrapolated numbers	29	29
Class Echinoidea	Sum of observed numbers	6	6
Searcher	Sum of extrapolated numbers	5	5
<i>Bathymaster signatus</i>	Sum of observed numbers	1	1
Shells	Sum of extrapolated numbers	66	66
	Sum of observed numbers	13	13
Shortraker rockfish	Sum of extrapolated numbers	40	40
<i>Sebastes borealis</i>	Sum of observed numbers	8	8
Shortspine thornyhead rockfish	Sum of extrapolated numbers	60	60
<i>Sebastolobus alascanus</i>	Sum of observed numbers	12	12
Skate egg cases	Sum of extrapolated numbers	10	10
	Sum of observed numbers	2	2

**Table 2.** (cont'd) F/V *Pacific Sun* 20-hook counts and species extrapolation by IPHC regulatory area.

<b>Species Common and Scientific Name</b>	<b>Data</b>	<b>4B</b>	<b>Grand Total</b>
Unidentified skates	Sum of extrapolated numbers	31	31
Order Rajiformes	Sum of observed numbers	6	6
Sleeper sharks	Sum of extrapolated numbers	15	15
<i>Somniosus pacificus</i>	Sum of observed numbers	3	3
Sponge	Sum of extrapolated numbers	96	96
Phylum Porifera	Sum of observed numbers	19	19
Unidentified rockfish	Sum of extrapolated numbers	39	39
Family Scorpaenidae	Sum of observed numbers	8	8
Walleye pollock	Sum of extrapolated numbers	16	16
<i>Theragra chalcogramma</i>	Sum of observed numbers	3	3
Whiteblotched skate	Sum of extrapolated numbers	456	456
<i>Bathyraja maculata</i>	Sum of observed numbers	92	92
Yellow Irish lord	Sum of extrapolated numbers	856	856
<i>Hemilepidotus jordani</i>	Sum of observed numbers	173	173
Sum of extrapolated numbers		5,463	5,463
Sum of observed numbers		1,106	1,106

**Table 3.** Catch (net pounds) of halibut by IPHC regulatory areas and by vessel from the IPHC 2002 assessment survey.

<b>IPHC Regulatory Area</b>	<b>Charter Vessel</b>	<b>Pacific halibut (lbs.)</b>
4A	F/V <i>Heritage</i>	21,252
4B	F/V <i>Heritage</i>	23,324
4B	F/V <i>Pacific Sun</i>	26,622
4D	F/V <i>Heritage</i>	59,955

**Table 4.** Landings<sup>1</sup> of other species<sup>2</sup> from the IPHC 2002 assessment survey by regulatory area, vessel and species.

<b>IPHC Regulatory Area</b>	<b>Charter Vessel</b>	<b>Pacific cod (lbs.)</b>
4A	F/V <i>Heritage</i>	7,338
4B	F/V <i>Heritage</i>	0
4B	F/V <i>Pacific Sun</i>	2,753
4D	F/V <i>Heritage</i>	2,361

<sup>1</sup>Net weights are reported as weighed at the fish plant.

<sup>2</sup>Only marketable bycatch of good quality are retained during the IPHC surveys.



## RECENT TECHNICAL MEMORANDUMS

Copies of this and other NOAA Technical Memorandums are available from the National Technical Information Service, 5285 Port Royal Road, Springfield, VA 22167 (web site: [www.ntis.gov](http://www.ntis.gov)). Paper and microfiche copies vary in price.

### AFSC-

- 151 TESTA, J. W. (editor). 2005. Fur seal investigations, 2002-2003, 72 p. NTIS number pending.
- 150 GULLAND, F. M. D., H. PÉREZ-CORTÉS M., J. URBÁN R., L. ROJAS-BRACHO, G. YLITALO, J. WEIR, S. A. NORMAN, M. M. MUTO, D. J. RUGH, C. KREUDER, and T. ROWLES. 2005. Eastern North Pacific gray whale (*Eschrichtius robustus*) unusual mortality event, 1999-2000: A compilation, 33 p. NTIS number pending.
- 149 RUGH, D. J., K. E. W. SHELDEN, C. L. SIMS, B. A. MAHONEY, B. K. SMITH, L. K. LITZKY, and R. C. HOBBS. 2005. Aerial surveys of belugas in Cook Inlet, Alaska, June 2001, 2002, 2003, and 2004, 71 p. NTIS number pending.
- 148 EILER, J. H., T. R. SPENCER, J. J. PELLA, M. M. MASUDA, and R. R. HOLDER. 2004. Distribution and movement patterns of chinook salmon returning to the Yukon River basin in 2000-2002, 99 p. NTIS No. PB2005-100707.
- 147 MCELDERRY, H., J. SCHRADER, D. MCCULLOUGH, J. ILLINGWORTH, S. FITZGERALD, and S. DAVIS. 2004. Electronic monitoring of seabird interactions with trawl third-wire cables on trawl vessels - a pilot study, 39 p. NTIS No. PB2005-100243.
- 146 WING, B. L., and D. R. BARNARD. 2004. A field guide to Alaskan corals, 67 p. NTIS No. PB2005-100429.
- 145 RUGH, D. J., B. A. MAHONEY, and B. K. SMITH. 2004. Aerial surveys of beulga whales in Cook Inlet, Alaska, between June 2001 and June 2002, 26 p. NTIS No. PB2004-106479.
- 144 ANGLISS, R. A., and K. L. LODGE. 2004. Alaska marine mammal stock assessments, 2003, 224 p. NTIS No. PB2005-100248.
- 143 ZENGER, H. H. JR. 2004. Data report: 2002 Aleutian Islands bottom trawl survey, 247 p. NTIS No. PB2004-105068.
- 142 STEVENSON, D. E. 2004. Identification of skates, sculpins, and smelts by observers in North Pacific groundfish fisheries (2002-2003), 67 p. NTIS No. PB2004-105817.
- 141 HOFF, G. R., and L. L. BRITT. 2003. The 2002 eastern Bering Sea upper continental slope survey of groundfish and invertebrate resources, 261 p. NTIS No. PB2004-101668.
- 140 STONE, R. P., and M. M. MASUDA. 2003. Characteristics of benthic sediments from areas open and closed to bottom trawling in the Gulf of Alaska., 40 p. + Appendices (111 p.). NTIS No. PB2004-100650
- 139 JOHNSON, S. W., M. L. MURPHY, D. J. CSEPP, P. M. HARRIS, and J. F. THEDINGA. 2003. A survey of fish assemblages in eelgrass and kelp habitats of southeastern Alaska, 39 p. NTIS No. PB2004-100139.
- 138 PEREZ, M. A. 2003. Compilation of marine mammal incidental take data from the domestic and joint venture groundfish fisheries in the U.S. EEZ of the North Pacific, 1989-2001, 145 p. NTIS No. PB2004-100649
- 137 MASELKO, J. M., A. C. WERTHEIMER, and J. F. THEDINGA. 2003. Selection and application of a mark-and-recapture technique for estimating pink salmon escapements, 44 p. NTIS No. PB2003-107101.