

U.S. COAST GUARD 133-FOOT BUOY TENDERS



This booklet is part of a documentation project completed by the Historic American Engineering Record (HAER), a division of the National Park Service, for the U.S. Coast Guard. Drawings, photographs, and history that make up the documentation for USCG 133-Foot Buoy Tenders (HAER nos. DC-56, LA-14, LA-15, RI-56, and AL-187) are housed in the collection at the Library of Congress, Washington, D.C. The project team consisted of Todd Croteau, HAER Industrial Archeologist (project leader); Jet Lowe, HAER Photographer; Dana Lockett (architect), Pete Brooks (architect), Candace Clifford, (historian) and Kevin Foster (historian). This booklet was designed by Candace Clifford. Funding was provided by the U.S. Coast Guard Headquarters. The project was directed by Sheri Imel, USCG Environmental Coordinator.

(Cover) USCGC Holly underway in Alaska (1968 USCG photo).



U.S. Department of the Interior
National Park Service
1849 C Street, NW - 2270
Washington, DC 20240
February 2004



Bow view of USCGC White Holly off Juneau, Alaska, September 10, 1968, after her designation was changed from 'WAGL-543' to 'WLM-543' and a new A-framemast and hoist arrangement was added (USCG photo).

INTRODUCTION

Following World War II, the U.S. Coast Guard sought additional vessels for her depleted fleet. Lacking an appropriation to construct buoy tenders to their own specifications, the Coast Guard acquired eight YFs, 'covered lighters, self propelled,' from the U.S. Navy. Part of the YF- 257 class constructed in 1942-43, these yard lighters provided logistical support to naval operations during World War II. Built by three different shipyards: Niagara Shipbuilding, Buffalo, New York; Basalt Rock Company, Napa, California; and Erie Concrete & Steel Supply Company, Erie, Pennsylvania, each yard finished its vessels in a slightly different way. The primary design distinctions were a raked or plum bow stem.

Upon commissioning into the U.S. Coast Guard, the vessels were given the WAGL designation meaning 'auxiliary vessel, lighthouse tender.' All eight vessels were named for a plant, shrub or tree, with 'white' as a prefix: *White Sumac* (WAGL-540), *White Alder* (WAGL-541), *White Bush* (WAGL-542), *White Holly* (WAGL-543), *White Sage* (WAGL-544), *White Heath* (WAGL-545), *White Lupine* (WAGL-546), and *White Pine* (WAGL-547). After 1966, the designation 'WLM' replaced 'WAGL'. 'WLM' indicated 'medium or coastal buoy tender,' with the following duties: hoisting buoys weighing up to 26,000 pounds with dimensions up to nine feet in diameter and 32 feet in length; locating sunken buoys by grapnel or electronic means; and icebreaking. These tenders carried boats, rescue equipment, and electronic equipment to assist in search and rescue operations and had the ability to mount armament to support

antisubmarine warfare and law enforcement. Their hold capacity accommodated supplies for loran stations, light stations, and lightships. By 2002, after a long service main-

taining the nation's maritime navigation needs, all of the 133' vessels had been taken out of service.



YF-339 during her trials on San Pablo Bay, May 16, 1944. YF-339 would later become USCGC White Bush (WAGL-542) (National Archives photo).

EVOLUTION OF THE BUOY TENDER

Before the Coast Guard took over the administration of aids to navigation (AtoN) in 1939, a buoy tender was referred to as a lighthouse tender. Light stations needed replacement parts, paint, oil, coal, wood, and other supplies delivered. Keepers had to be transported to their assignments along with their family property, livestock, mail, etc. Lighthouse inspectors and engineers had to be transported and non-propelled lightships moved on or off their stations.⁶ Another principal duty of the lighthouse tender was inspecting, relieving, repairing, and replacing navigational buoys. Buoy maintenance was scheduled on a regular basis, most often annually.

Over time a specialized form of vessel evolved to serve the needs of maintaining aids to navigation. By the 1920s, rather than classifying tenders according to function, the Bureau of Lighthouses based their four buoy tender classes solely on length and draft. Coastwide or seagoing tenders (type 'A') worked aids to navigation on the open and coastal waters. Lake or bay tenders (type 'B'), slightly smaller vessels, worked in more sheltered waters along the coast or on the Great Lakes. Inside waters tenders (type 'C') worked the smallest aids in sheltered waters. River tenders had shallow drafts and flat bottoms specifically designed to work on the Mississippi, Missouri, and Ohio Rivers and their tributaries. In 1927, a class of Buoy Boats (type 'D') was designated for harbor launches, unnamed small craft with no permanent crew.⁷

Propulsion methods for tenders changed under the Bureau of Lighthouses. In 1918, the single-screw, steam-powered *Oak* was built using steel construction.⁸ The last tender designed by the Bureau, *Juniper*, which served as a prototype for the later 180-foot tenders, was the first all-welded-steel and diesel-electric-propelled coastwide tender.⁹ The 180-foot tenders built by the Coast Guard in the early 1940s were intended to be seagoing tenders. After World War II, the Coast Guard saw the continued need for a smaller, shallower draft tender to handle

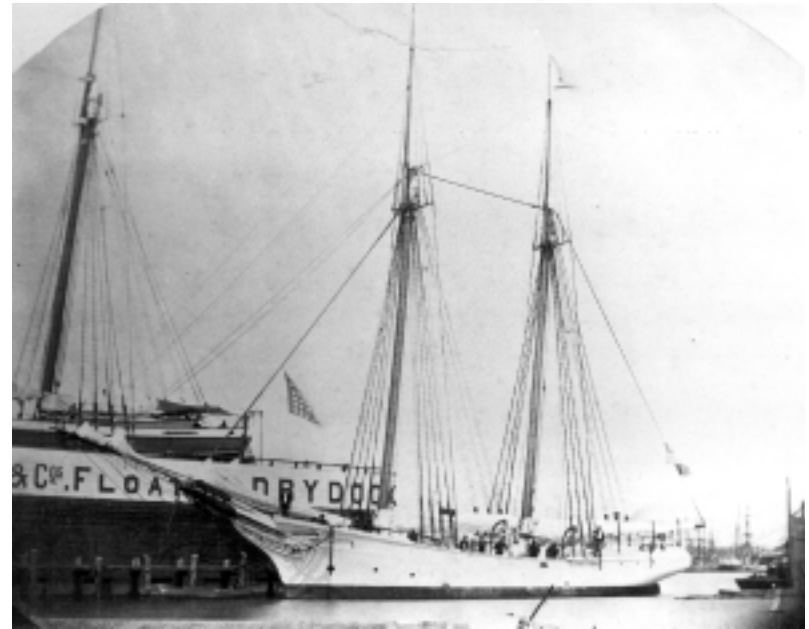

The first lighthouse tenders were powered by sail. Purchased by the U.S. Light-House Board in 1854, Pharos was the last sailing tender in service when declared unseaworthy in 1907 (National Archives photo).

AtoN closer to shore and so took advantage of the availability of surplus Navy vessels to augment their fleet. Eight Navy vessels formed the 133-foot class which served as coastwide tenders.

The evolution of the lighthouse and buoy tender is directly related to the functions they served, the materials and technology available at the time of construction, and the mission

and traditions of the administering agency. Over time, their consistent function has been to service aids to navigation, i.e., buoys, light stations, and lightships. As the technology and care of aids to navigation evolved and changed, so have the vessels which serviced them. In more recent years, tender duties have expanded to include search and rescue, icebreaking, military readiness, and law enforcement—reflecting the expanded mission of the modern U.S. Coast Guard.

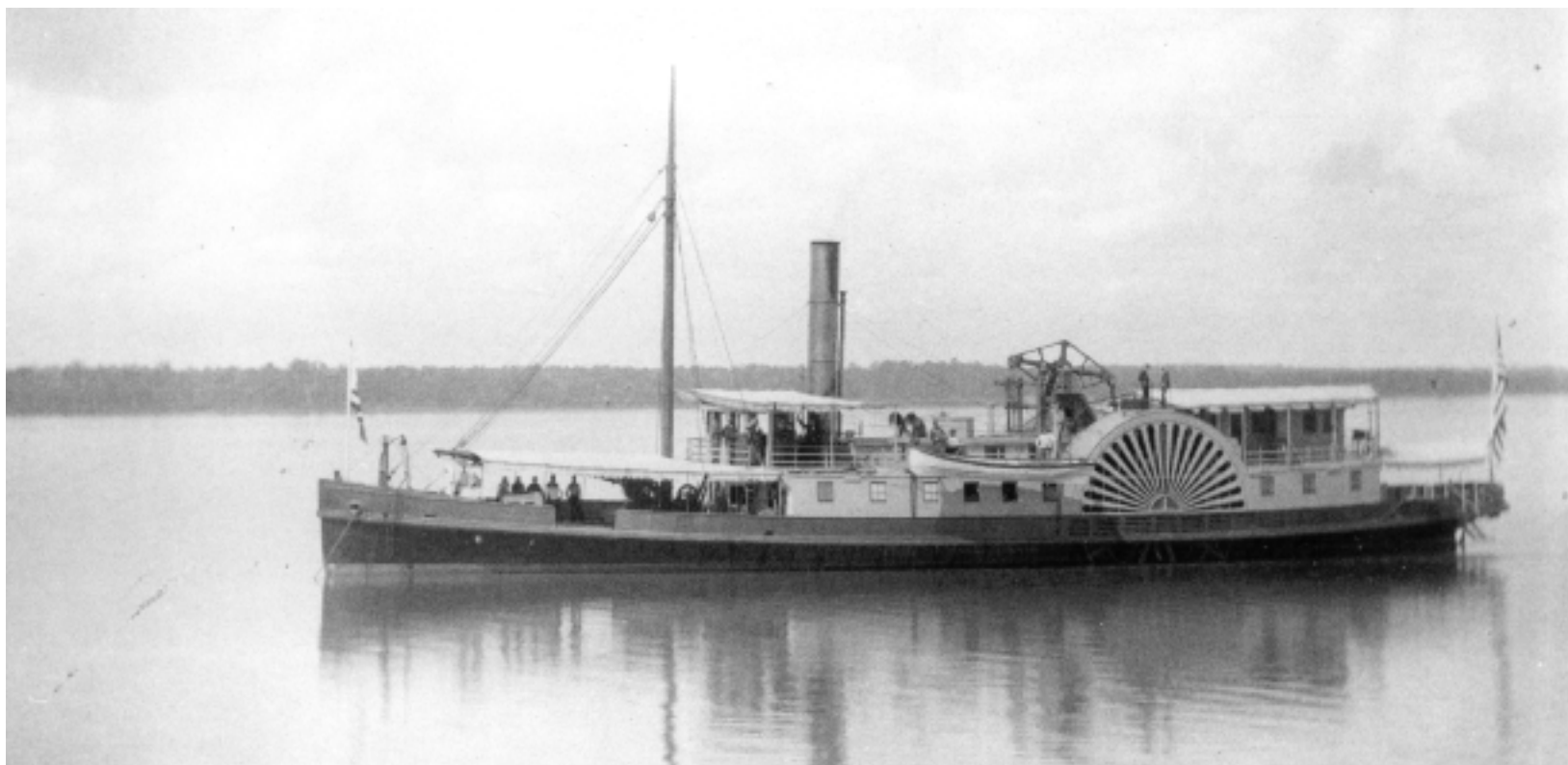

Jessamine (above), built in 1881, was an example of paddlewheel tender (National Archives photo). Steam tender Iris (facing page, top) was commissioned in 1899 (USCG photo). Juniper (facing page, bottom), was constructed in 1939 with Diesel-electric engines. Shown here in 1949, her 177-foot design served as a prototype for the 180s built by the Coast Guard during World War II (USCG photo).



EVOLUTION OF BUOYS

Buoys have also evolved with changing technology. First constructed of wood, buoys were later made more durable with the use of iron and eventually steel. In the 1880s, the U.S. Light-House Board experimented with both light and sound in connection with buoys and both lighted and bell buoys were placed in service. By 1910, lighted buoys abounded. Lit with acetylene or Pintsch gas, care had to be taken to protect buoy tender crews from potential explosions.¹⁰

In addition to lighted buoys, the Lighthouse Service continued to rely on unlighted nuns, cans, and spar buoys for marking rivers and less important channels. The 1913 “Plans and Specifications for Buoys and Appendages” describes eight different kinds of buoys “known as nun, can, bell, mooring, wooden spar, tall nun, and tall can.”¹¹ The nun, can, tall nun, and tall can buoys were divided into three classes, and the wooden spar buoys into four classes according to size. Materials included structural steel, wrought iron, rivet steel, and cast iron. Wooden spar buoys were to be made of “winter cut juniper or cedar.” Buoy interiors and exteriors were to be painted with “two coats of the best quality red lead mixed with best quality of boiled linseed oil.”¹² The 1916 specifications include a section on whistling buoys.¹³

In 1939, when the U.S. Coast Guard took over the administration of aids to navigation, there were 13,432 unlighted buoys without sound signals, 369 unlighted sound buoys, 1,196 lighted buoys without sound signals, and 678 lighted sound buoys—a total

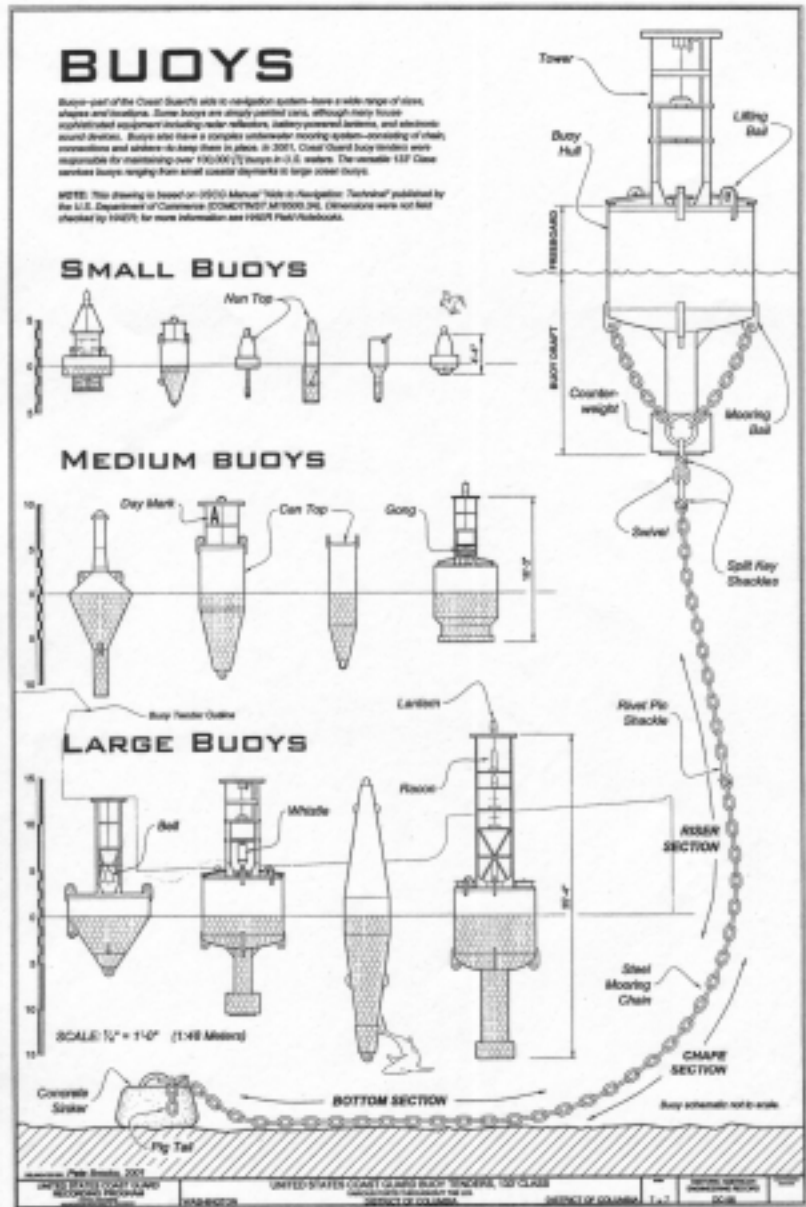

of 15,675.¹⁴ The merging of the Lighthouse Service with the Coast Guard nearly doubled the size of the Coast Guard fleet and brought changes in work patterns to the people who kept the lights. Vessels were expected to make longer voyages. Tender crews were expected to work longer hours. The lavish quarters on board tenders for District Superintendents to use during their inspection voyages were reduced in size and adapted to new uses. Under the U.S. Coast Guard, "Lighthouse tenders" were now called "Coast Guard Cutters." After 1943, "buoy tender" became the official hull classification.¹⁵

The functions of the tenders expanded to include search and rescue (SAR), icebreaking, military readiness, and law enforcement (LE) in addition to servicing AtoN. With the



Bouy lamps and other equipment in White Sumac's No. 1 hold (1999 HAER photo).



Bouy storage in White Sumac's No. 1 hold (1999 Historic American Engineering Record (HAER) photo; all HAER photos by Jet Lowe unless noted).

automation of light stations and the discontinuance of lightships, tenders were used less and less as supply vessels. The Coast Guard continued the tradition of naming tenders for trees, shrubs, and flowers. The Lighthouse Service pennant was replaced with the vertically striped Coast Guard ensignia.¹⁶ Under the Coast Guard, the vessels were classified according to area of operation, i.e., coastwise, bays and sounds, river tenders, and buoy boats.¹⁷

During the 1950s, storage batteries began replacing acetylene as the power source for lighted buoys.¹⁸ By 1963, the Coast Guard had discontinued the use of acetylene buoys.¹⁹ Primary 12-volt batteries in use would remain charged up to three years, depending on the size of the lamp and characteristic.²⁰ In the



White Sumac crew member changes bulb on solar powered buoy (2001 HAER photo by Candace Clifford).

1980s the Coast Guard began to use batteries charged by solar panels, permitting a tremendous cost savings. In 1986, the Coast Guard's *Engineering Digest* reported:

Aids to navigation (AtoN) units have now converted 5,000 aids to solar power and have reached the halfway point of the original goal of 10,000 conversions. . . . Conversion of the aids from expensive primary batteries that contain mercury and are considered hazardous waste will save several million dollars. In addition field units will have more flexibility while conducting AtoN operations since they are no longer constrained by a strict recharge schedule.²¹

The new system consisted of solar panels, voltage regulators, rechargeable batteries, and mounting hardware. The solar panels, photovoltaic devices, convert sunlight directly to electricity which in turn charges a secondary battery that powers the light at night. On structures such as lighthouses, the panels face south to receive the most sunlight. On buoys, the panels are positioned to face directly upward.²²

In the 1970s, the Coast Guard developed large navigational buoys (LNBS), many of which replaced lightships. A large navigational buoy includes a light and sound signal system; many also incorporated a radiobeacon system. These buoys are equipped with a remote control and monitoring system and are capable of collecting weather data. LNBS are serviced quarterly on station and brought dockside for a complete inspection at two-year intervals. Every four years, the buoys are completely stripped of all equipment for hull repairs and recoating.²³



White Sumac crew prepare to release sinker and chain after maintenance of buoy (2001 HAER photo by Dana Lockett).

Although lighting and power systems for buoys evolved during the twentieth century, the buoys themselves changed little. Minor alterations to a hull design used by the Lighthouse Service were made on steel ocean buoys in 1962. A few new designs have augmented the traditional buoy—the hemispherical fastwater buoy, the wineglass discrepancy buoy, and foam buoys. The 1990s saw the establishment of a project, “New Buoy Systems” (NBS), within the Coast Guard’s Research and Development Center, intended to advance buoy designs using computer technology.²⁴

With the development of Differential Global Positioning Systems (DGPS), the positioning of the buoys became far easier and more precise. No longer did crew members have to rely on sextants. As one former Commanding Officer of the *White Pine* indicated,

The advent of Differential Global Position turned the chore of positioning a buoy (often times frustrating and unsuccessful) to an absolutely fun time. It relieved about 50% of the stress involved with setting a buoy, made the operation safer, more predictable and far more enjoyable. Myself and my conning officers used to compete to see who could consistently keep the set position of the aid within 1 meter.²⁵

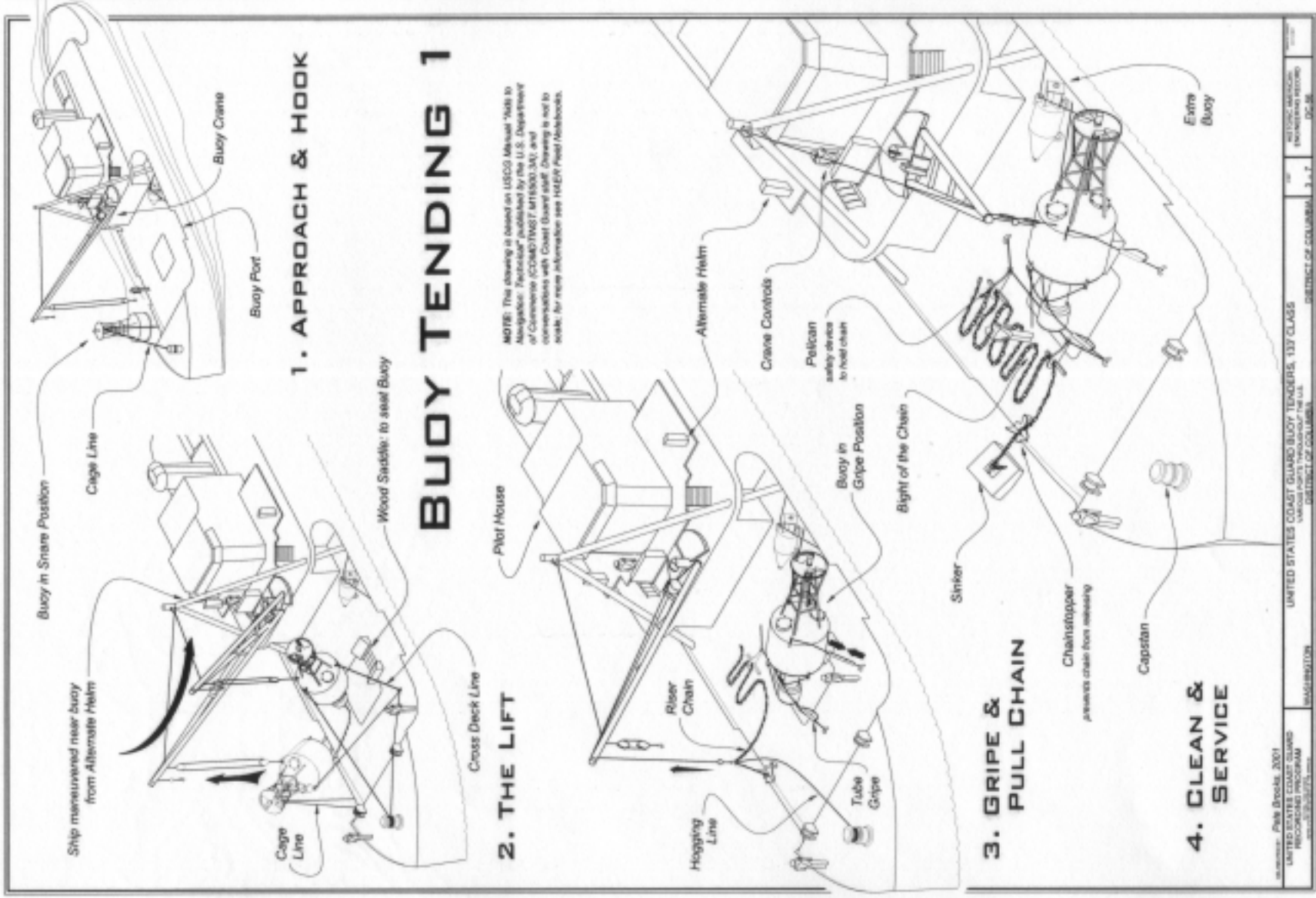

EVOLUTION OF THE 133-FOOT SELF-PROPELLED FREIGHT AND AMMUNITION LIGHTERS

The huge amounts of supplies shipped from United States ports during the Second World War required the augmentation, overhaul, and wholesale replacement of much of America's transportation infrastructure. Harbors and waterways were recognized as potential bottlenecks in the transportation system. Not only ships were needed, but also new piers, warehouses, and harbor craft. Hundreds of barges and lighters were built to speed the flow of cargoes being transhipped in ports around the country. Like other critical parts of the transportation network, barges for use in transshipping cargoes were also upgraded and improved as time went on. One important link in the supply chain was made up of special covered barges for freight and ammunition, called lighters. Experience taught that delays in delivering loaded lighters kept the cargo from arriving where needed, and tied up a scarce transportation vehicle, the lighter itself. To avoid these delays, wartime speed and efficiency demanded that many lighters be made self-propelling to avoid waiting for a tugboat to become available.

One of the most numerous type of self-propelled lighters were "133-foot" vessels built by manufacturing concerns around the country. The U.S. Navy Bureau of Ships drew up specifications for building freight and ammunition lighters (self-propelled).¹ The requirements called for a vessel similar to the very best of small self-propelled commercial lighters in use at the time. Some changes were made to outfit the lighters for military service. Each ship had to be capable of worldwide service, so

full sets of navigational instruments were delivered with each vessel. Naval duty also called for a full set of fire-fighting and damage control gear. Reserve buoyancy was increased by adding an enclosed forecastle and enlarging the deckhouse.² Shallow draft allowed access to inner harbors and to load and transport supplies to large vessels at anchor.

Because of the full employment of most experienced shipyards, contracts to build these vessels were awarded to inexperienced contractors. Erie Concrete and Steel Supply of Erie, Pennsylvania, had never built a ship when they won a contract to build several lighters. Basalt Rock Company of Napa, California, had built only unpowered steel barges when they won a contract for two Navy lighters. They seriously underestimated the cost of their first contract, but went on to build YF self-powered lighters, other smaller types, and became the lead yard for salvage ships (ARS).³

The specifications called for twin-screw, Diesel-driven, steel, self-propelled freight lighters similar to *YF-257*, with some modifications. *YF-257* had been built at Norfolk Navy Shipyard in early 1940 and launched June 29, 1940. The Boston Navy Yard built a sister ship *YF-258*, launched August 22, 1940. Norfolk Navy Yard also built another of the same type the next year. The main hoist consisted of a single mast and boom powered by an electric winch mounted on the working deck. The deckhouse did not extend to the sides, and the forecastle was much smaller than that on the later 133-foot self-propelled

ammunition lighters. The principal dimensions for the 133-foot self-propelled lighters were:

- Length, overall, 132 feet, 6 inches long
- Length, between perpendiculars, 132 feet
- Breadth, extreme, molded, 30 feet
- Depth, molded at side to main deck, amidships, 12 feet, 3 11/16 inches
- Diesel oil, full capacity (estimated), 33.5 tons
- Potable water, full capacity (estimated), 10.0 tons

They drew about 8 feet, 9 inches of water at maximum loading. The class was propelled by twin screws each powered by a 600 BHP Diesel engine. The maximum sustained speed was 10.5 knots giving a 2,450 mile radius of action, or 7.5 knots giving a 2,830 radius. The ships were built of steel except within a five foot radius of the steering compass, where they were built of brass. The hull was broad, nearly flat-bottomed, with a

raised enclosed forecastle deck and a raised deckhouse extending from side to side nearly to the stern. The wide flat bottoms, combined with bilge keels, provided a stable platform during lifting operations.

Contractors were supplied with general arrangement plans, a table of offsets for the prototype vessels of the *YF-257* class, and various specifications. The specifications included instructions for rat-proofing, painting, nomenclature and numbering of decks and compartments, preparation of plans and booklets, and specifications for direct current motors and controllers. Considerably more detail is usually specified to a contractor of government vessels, but the requirements were cut to a minimum to allow rapid construction. The resulting products of different yards varied in detail, while still meeting the same specifications.

Navy YF-257/USCG 133-foot buoy tender class								
	Hull Number		Builder	Keel Laid	Launch- ed	Commissioned		Decommissioned
	Navy	USCG				Navy	USCG	
White Sumac	YF-416	WAGL-540/WLM-540	Niagara Shipbuilding Corp., Buffalo, NY	1942	1943	1943	1947	2002
White Alder	YF 417	WAGL-541/WLM-541	Niagara Shipbuilding Corp., Buffalo, NY	1942	1943	1943	1947	1968 (sank)
White Bush	YF-339	WAGL-542/WLM-542	Basalt Rock Co., Napa, CA	1943	1944	1944	1947	1985
White Holly	YF-341	WAGL-543/WLM-543	Basalt Rock Co., Napa, CA	1943	1944	1944	1947	1998
White Sage	YF-444	WAGL-544/WLM-544	Erie Concrete & Steel Supply Co., Erie, PA	1943	1943	1944	1947	1996
White Heath	YF-445	WAGL-545/WLM-545	Erie Concrete & Steel Supply Co., Erie, PA	1943	1943	1944	1947	1998
White Lupine	YF-446	WAGL-546/WLM-546	Erie Concrete & Steel Supply Co., Erie, PA	1943	1943	1944	1947	1998
White Pine	YF-448	WAGL-547/WLM-547	Erie Concrete & Steel Supply Co., Erie, PA	1943	1943	1944	1948	1999



YF-339 in 1944 (National Archives photo) and White Holly (originally YF-341) in 1954 (USCG photo). Both vessels were built by the Basalt Rock Company, Inc. Coast Guard modifications included a turtle deck extending the crew berthing area from the original structure with portholes added along each side. Chain stoppers and chaffe plates were installed just aft of forecastle on maindeck, and navigation and SARS equipment added to the tower.



White Holly on September 10, 1968, after her single-mast and boom derrick had been replaced with a heavy-duty A-frame mast and hoisting boom system. The electric winch on deck was replaced with a hydraulic winch system housed in the superstructure behind the bulkhead (USCG photo).

FROM YARD LIGHTER . . .

NAVY CONFIGURATION CA. 1943

Designed as a Navy Yard Lighter, the YTs were originally built to assist in the loading and unloading of cargo from deep draft vessels, anchored in a harbor, to shore across shallower waters. The characteristics of the Navy Cutter allowed for an easy transition from Navy to Coast Guard coastal buoy tending service.

TO BUOY TENDER

COAST GUARD CONFIGURATION CA. 1970s

The cutter had a shallow draft, sturdy hull, cargo space for buoy equipment, and an open deck with boom for handling buoys. Little change was needed for the conversion. Crew quarters were expanded aft and the electric-powered mastboom crane was replaced with a hydraulically-powered A-frame rig.

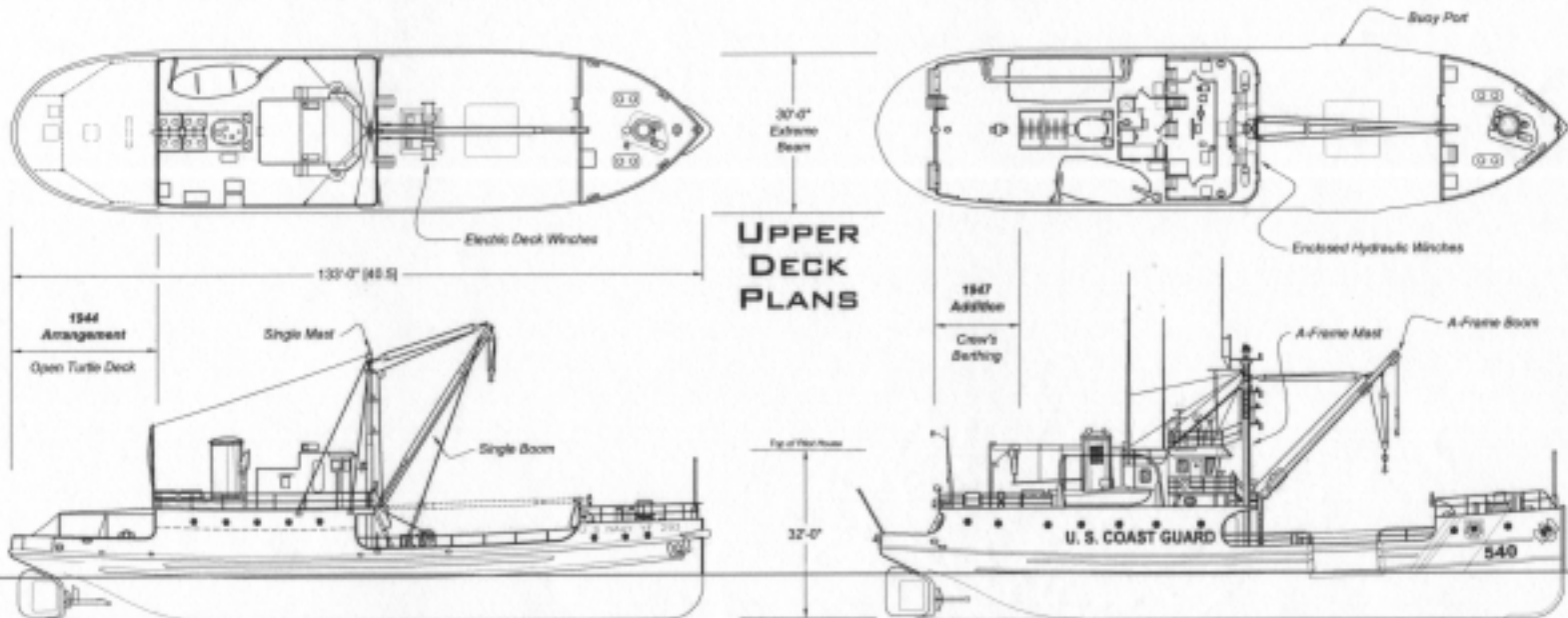

NOTE: This drawing was traced from historic design drawings provided by the USCG, see especially Dep. No. 540-WAGL-0103-20 & Bureau of Ships Plan No. 467,537 (Drawing No. H-488-12). HAER did not field check dimensions or arrangement of features.

UNITED STATES COAST GUARD BUOY TENDERS, 133' CLASS
 DISTRICT OF COLUMBIA, D.C.
 HAER 133-001-001
 2007

Construction could be either riveted or welded, although welding was indicated on the plans. All contractors appear to have used welded construction. Contractors were also allowed to choose between Navy Department or American Bureau of Shipping construction specifications. Specifications for mast height, boom fitting, and other details were left up to the contractors, subject to approval by the Supervisor of Shipbuilding.⁴

An interesting provision in the specifications was the requirement for minelaying tracks to be provided with each ship. Provision was made for the carriage and laying of 64 Mark VI mines weighing 1,450 pounds each, using removable mine tracks on the main deck. The removable tracks were designed to be kept ashore except when needed. This gives some indication of the intended use of the lighters for local minelaying duties.⁵

The 133-foot freight and ammunition lighter class consisted of YFs 335-341, 415-417, 419-421, and 443-454. A similar class of 133-foot torpedo range tenders consisted of YFs 411, 418, 519, and 520. The range tenders were built to the same general plans (YF-257) as the lighters, but without mine rails, and with hard points for installation of various types of torpedo tubes and storage of range rafts used for torpedo and torpedo tube testing. One vessel of the lighter group, YF-418, was transferred to the range tender group before completion.

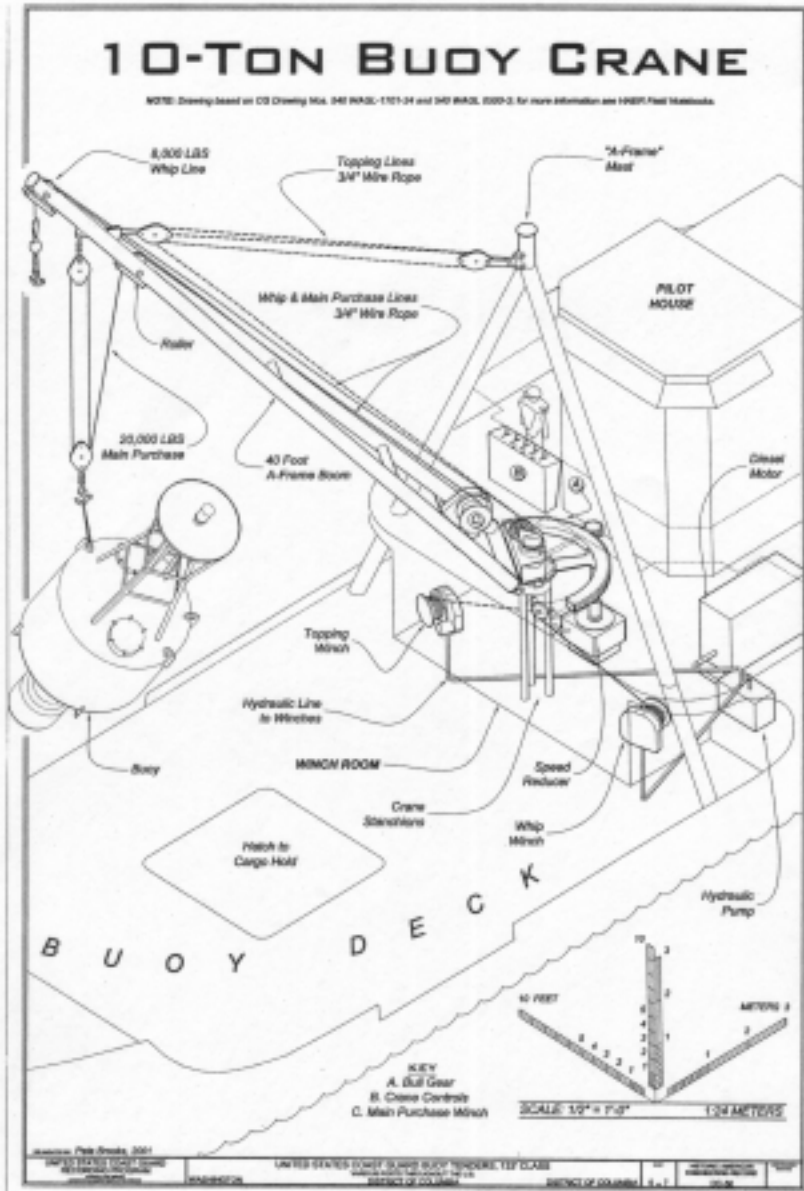

REPLACEMENT TENDERS

As the 133-foot tenders neared the end of their useful service life, the Coast Guard planned a modernized replacement. The most recent tender technology was used in the design of the 175-foot coastal (WLM) *Ida Lewis* or Keeper-class buoy tenders. The first vessel in this class, *Ida Lewis*, was commissioned in 1996. According to the class overview,

The Keeper class design provides a low-cost, state-of-the-art coastal buoy tender that approaches the seagoing tender in capability. Maximum emphasis has been placed on the design of the vessel to keep operational costs to a minimum. The ship can be safely operated with only 18 personnel and has been equipped with the most capable and self-maintaining equipment on the market. The ship's principle working space is

located forward of the bridge in an area that is clearly visible to the Officer of the Deck (OOD). The selection of the propulsion system, the digital data communication system, and the chain winch was the result of intensive trade-off studies and provides the optimum choices for this size ship.²⁶

These 175-foot vessels are equipped with “Z-drive propulsion units instead of the standard propeller and rudder configuration. They are designed to independently rotate 360 degrees” which, combined with a thruster in the bow, gives them unmatched maneuverability. State-of-the-art electronics and navigation systems allow these tenders to maneuver and position aids more accurately and efficiently with smaller crews. Fourteen 175-foot Keeper class vessels were in service in 2003.²⁷



Keeper-class USCGC Marcus Hanna (WLM-554), October 31, 1997 (USCG photo).

HAER DOCUMENTATION OF 133-FOOT BUOY TENDERS

When the U.S. Coast Guard planned to decommission and surplus the four 133-foot buoy tenders still in service in the late 1990s, they arranged for the vessels to be documented to the standards of the Historic American Engineering Record (HAER). *White Holly*, *White Pine*, *White Sage*, and *White Sumac* were all photographed by HAER photographer Jet Lowe in 1999. Drawings were made of *White Holly*, *White Sage*, and *White Sumac* to represent a ship from each of the three shipyards.

White Holly

White Holly began her career as *YF-341*. She was built for U.S. Navy by the Basalt Rock Company, Inc., in Napa, California. The Basalt Rock Company, Inc., was formed in 1920, with its main operations centered on a small rock quarry which supplied rock, sand, and gravel. In 1938, after “difficulty in finding a sufficient number of commercial barges to distribute their raw materials,”²⁸ their Black Rock Unit started building steel barges to supplement their own fleet. In 1940 the company bid for its first Navy contract. In addition to supplying materials to the Navy, Basalt was initially contracted to build cargo barges, oil barges, open lighters, and one self-propelled freight lighter—*YF-295*.

YF-341 was the third YF-type vessel built at Basalt Rock Company under Contract NObs-808.²⁹ The overall contract included YFs 339-341, 420-421.³⁰ (*YF-339* would later become

sistership *White Bush*.) *YF-341*'s keel was laid on August 3, 1943, and she was launched on April 8, 1944. Her trials were held in San Francisco Bay on June 5, 1944, and she was delivered and placed in service the next day. *YF-341* was assigned to the Fourteenth Naval District after being outfitted at the Navy Yard at Mare Island, California. By July 10, 1944, *YF-341* was ready for her assignment in the South Pacific and was sent to Pearl Harbor. She operated out of Honolulu with a complement of 18 men.³¹



Three-quarter view of port bow of *White Holly* (WLM-543) on left, *White Sage* (WLM-544) on right; note differences in hull height and shape (1999 HAER photo).



White Holly's bridge deck (1999 HAER photo).

After the completion of World War II, *YF-341* was acquired by the U.S. Coast Guard in 1946. The fourth vessel in her class, *White Holly* was commissioned into the Coast Guard as WAGL-543 on December 1, 1947, and on December 5, she was taken to Seattle. Once commissioned into the Coast Guard, her colors were switched from Navy grey to Coast Guard black and white.

According to *White Holly's* "Ship's Characteristics Card" dated January 3, 1966, she was 133'-7" in overall length, 132' in length between perpendiculars, 30'-8" in extreme beam, 12'-4" in depth of hold, 8'-6" in draft forward fully loaded, and 5'-3" in draft forward with a light load. Her one mast was 56'-3" high. The vessel displaced 600 tons and had a maximum speed of 10

knots, fully loaded. Her hull, decks, bulkheads, frames, and superstructure were constructed of steel.

Auxiliary boats in 1966 included a cargo boat, aluminum outboard, and three seven-man rubber lifeboats. In 1966, she had her original diesel engines, which were opposed piston Fairbanks-Morse Diesels built by Union Diesel Engine Company in Oakland, California, with two propellers, 300 horsepower each, and two auxiliary diesel generators. In 1972, *White Holly* underwent a major renovation at Curtis Bay, Baltimore, Maryland, and her machinery was modernized in 1975. These modifications included updated equipment to improve her AtoN capabilities.



White Holly's mess hall and galley (1999 HAER photo).

CGC "WHITE HOLLY"

WLM-543

1944

Basalt Rock Company, Inc.

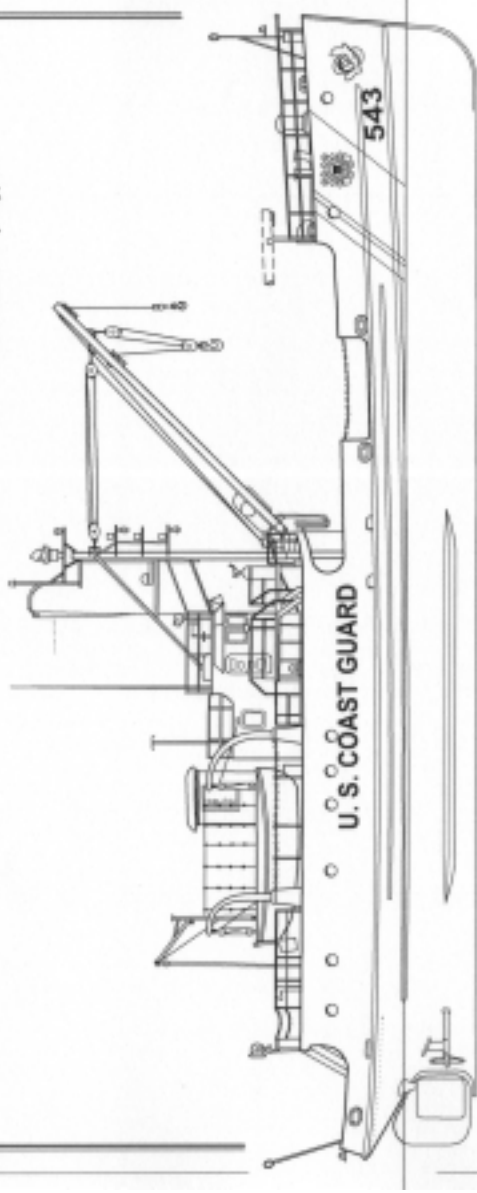

OUTBOARD PROFILE



NOTE: This drawing was traced from historic drawings of the USCGC Cutter WHITE HOLLY (Buoy tender of General Plant) Composite drawing including Plans, Sections & Profiles; Desig. No. 543 (MAGL-9103-17, 7986). AMERI did not field check dimensions or arrangement of features. For more information, see HAZEN Field Notebooks.

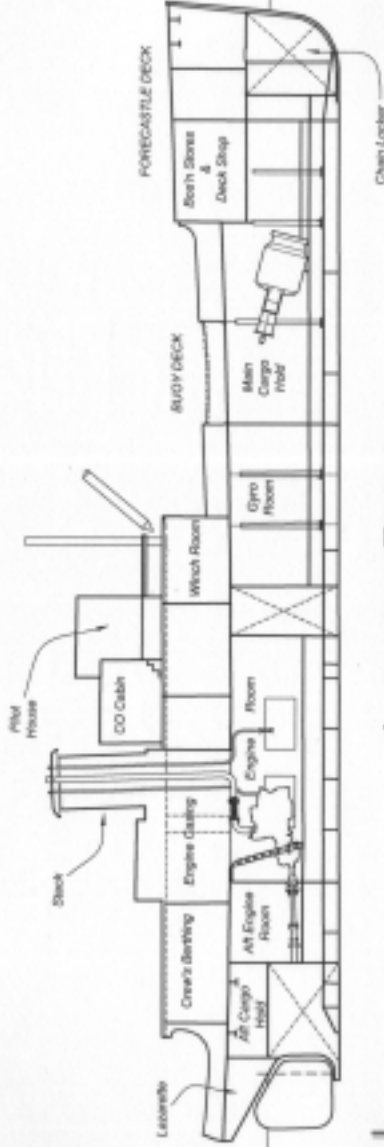

INBOARD PROFILE

The "WHITE HOLLY" was originally constructed as a port lighter (YC-547) for the United States Navy in 1944. This class of vessel provided logistical support to naval operations during World War II. Following the war, the U.S. Coast Guard acquired eight of these vessels to perform service for their role in navigation at buoy tenders.

The United States Coast Guard Receiving Program is part of the Historic American Engineering Record (HAER), a long-term program documenting historically significant engineering, industrial, and maritime sites in the United States. The

HAER program is sponsored by the National Park Service, U.S. Department of the Interior. The USCGC Buoy Tender, 133' Clear Recording Project was sponsored during 2009 & 2007 by the USCGC. See final report.

The measured drawings, historical reports and photographs were prepared under the direction of Eric DeLany, Chief of HAER & Field Crews, Maritime Program Manager. The team consists of Howard Johnson (University of the District of Columbia) & Peter Strouk, architects; Catherine Clifford & Kevin Foster; historians; and Jeff Lowe, photographer.

Illustration: Howard Johnson & Peter Strouk, 2007
UNIVERSITY OF THE DISTRICT OF COLUMBIA
RECORDING PROGRAM

NEW ORLEANS

U.S. COAST GUARD CUTTER "WHITE HOLLY", 0441943

U.S.C.G. ARCHIVE

08L MAR 08/08/08

LOUISIANA

1, 1, 1

HAER-LS-15

CGC "WHITE HOLLY" - FRAMING SECTIONS



SECTION LOCATOR

NOTE: This drawing was traced from historic drawings of the USCG Cutter WHITE HOLLY ("Skelet of General Place" (Composite drawing including Plans, Sections & Profiles) Dwg. No. 640 WAGL-0100-17, 1886). HAER did not field check dimensions or arrangement of features. For more information, see HAER Field Notebooks.

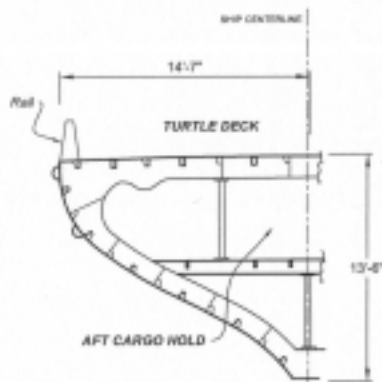

**A. Frame No. 18
looking aft**

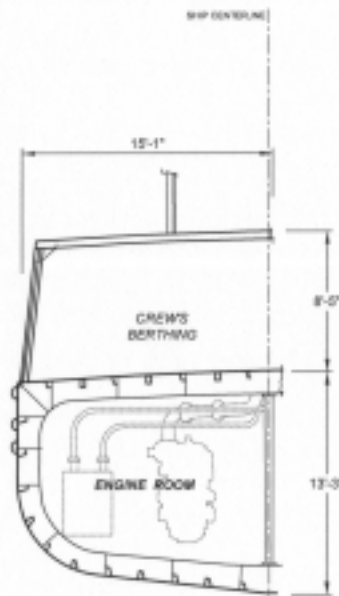

**B. Frame No. 16
looking aft**

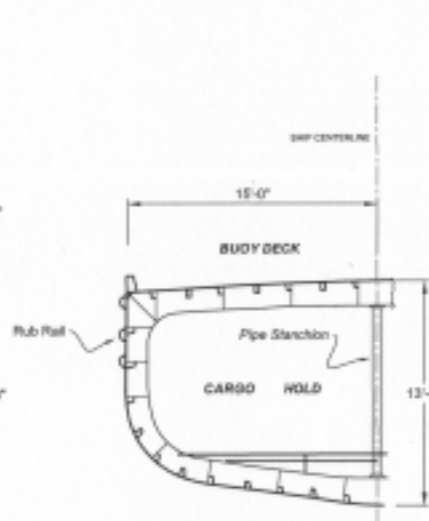

**C. Frame No. 10
looking aft**

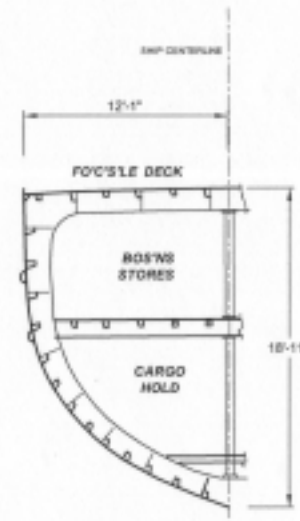

**D. Frame No. 3 1/2
looking aft**



U.S. COAST GUARD CUTTER "WHITE HOLLY", 1847/1847
 HAER 133-BUOY TENDERS
 LOUISIANA 3-1-5
 NEW ORLEANS
 U.S. COAST GUARD CUTTER "WHITE HOLLY", 1847/1847
 HAER 133-BUOY TENDERS
 LOUISIANA 3-1-5
 NEW ORLEANS
 U.S. COAST GUARD CUTTER "WHITE HOLLY", 1847/1847
 HAER 133-BUOY TENDERS
 LOUISIANA 3-1-5
 NEW ORLEANS

CGC "WHITE HOLLY" - BODY PLAN

TABLE OF OFFSETS

		FOREBODY STATIONS											
		STEM	0	1	2	3	4	5	6	7	8	9	10
HALF-BREADTHS	FOOTLINE	--	1-04	0-13	0-00	12-13	13-61	--	--	--	--	--	--
	7" WL	--	--	1-34	3-37	5-18	6-10-1	8-47	9-80	10-11-4	11-10-0	12-6-1	12-0-2
	6" WL	--	--	2-78	5-00	6-08	10-32	11-11-7	13-37	14-02	14-5-1	14-7-4	14-0-2
	5" WL	--	--	3-64	7-17	8-10-7	12-0-7	13-02	14-40	14-10-0	14-11-4	14-11-7	15-0-0
	4" WL	--	3-10	4-73	8-3-4	11-03	12-11-2	14-07	14-80	14-10-0	14-11-0	14-11-7	15-0-0
	3" WL	--	0-24	0-27	0-1	11-02	12-40	14-26	14-80	14-10-4	14-11-0	14-11-0	15-0-0
	2" WL	--	0-6-4	0-7-8	0-5-2	11-11-7	12-58	14-32	14-80	14-10-0	14-11-0	14-11-0	15-0-0
	1" WL	--	0-6-4	0-10-8	0-8-2	12-1-1	12-0-1	--	--	--	--	--	--
	0" WL	--	0-8-1	0-0-3	0-0-2	12-1-1	12-0-1	--	--	--	--	--	--
	2" WL	--	0-10-0	0-0-7	0-0-2	12-1-1	12-0-1	--	--	--	--	--	--
3" WL	--	1-0-8	0-0-7	--	--	--	--	--	--	--	--	--	
HEIGHTS above base	FOOTLINE	--	25-11-4	30-4-7	19-10-0	19-4-4	19-4-2	--	--	--	--	--	--
	7" BUTTE	--	--	3-1-1	1-0-0	0-6-0	0-8-1	0-4-1	0-3-4	0-3-1	0-2-6	0-2-0	0-2-4
	6" BUTTE	--	--	0-6-6	2-6-6	1-5-7	1-0-0	0-9-4	0-7-2	0-6-4	0-5-0	0-5-0	0-5-0
	5" BUTTE	--	--	15-4-4	4-0-2	2-0-0	1-8-0	1-3-2	1-0-6	0-11-2	0-10-1	0-9-4	0-8-0
	4" BUTTE	--	--	--	7-0-6	3-11-2	2-0-2	1-10-1	1-0-0	1-3-0	1-1-6	1-0-7	1-0-2
	3" BUTTE	--	--	--	--	0-1-4	3-0-2	2-7-2	2-0-7	1-8-0	1-6-0	1-4-3	1-3-5
2" BUTTE	--	--	--	--	13-0-0	5-19-4	4-0-0	2-11-5	2-4-7	2-0-6	1-10-0	1-0-0	
1" BUTTE	--	--	--	--	--	7-0-0	5-0-0	3-11-4	3-4-6	3-0-7	2-19-0	--	
		AFTERBODY STATIONS											
		11 III	12	13	14	15	16	17	18	19	20	21	STERN
HALF-BREADTHS	MAIN DECK	15-0-0	15-0-0	15-0-0	15-0-0	15-0-0	14-11-6	14-11-0	14-0-0	14-3-7	13-0-7	13-1-7	--
	7" WL	12-10-0	12-10-0	12-10-0	12-0-0	12-4-0	11-5-0	9-6-0	5-11-4	2-6-7	0-6-8	--	--
	6" WL	14-0-2	14-0-2	14-0-2	14-7-7	14-5-7	14-2-7	12-10-0	10-4-2	8-0-0	0-11-1	--	--
	5" WL	15-0-0	15-0-0	15-0-0	14-11-7	14-11-5	14-10-7	14-4-0	12-11-0	9-7-0	2-7-4	--	--
	4" WL	15-0-0	15-0-0	15-0-0	15-0-0	15-0-0	14-10-4	14-2-0	13-6-0	8-3-7	--	--	--
3" WL	15-0-0	15-0-0	15-0-0	15-0-0	15-0-0	14-11-0	14-5-4	13-11-0	11-0-0	5-1-7	--	--	
2" WL	--	--	--	--	--	--	--	--	--	--	--	--	
HEIGHTS above base	MAIN DECK	12-11-1	12-10-0	12-10-0	12-10-4	12-10-4	12-10-0	12-11-0	12-0-1	12-7-0	12-0-0	12-0-0	12-0-2
	7" BUTTE	0-2-3	0-2-3	0-2-3	0-2-3	0-2-4	0-2-7	0-2-8	0-0-4	1-0-0	3-7-0	0-0-0	--
	6" BUTTE	0-0-0	0-0-0	0-0-0	0-0-0	0-0-7	0-0-8	0-0-8	1-3-2	2-7-0	0-7-1	0-0-4	--
	5" BUTTE	0-0-0	0-0-0	0-0-0	0-0-7	0-0-2	0-10-4	1-1-0	2-0-1	4-1-0	7-2-0	0-11-4	--
	4" BUTTE	0-11-7	0-11-7	0-11-7	1-0-0	1-0-0	1-2-2	1-7-0	2-0-4	0-2-0	1-10-4	10-7-4	--
	3" BUTTE	1-0-1	1-0-1	1-3-1	1-3-2	1-4-1	1-6-0	2-1-1	3-0-4	0-2-7	0-0-3	11-0-3	--
2" BUTTE	1-7-0	1-7-0	1-7-0	1-0-1	1-0-1	2-0-0	3-0-1	0-1-4	7-0-2	10-2-0	--	--	
1" BUTTE	2-15-1	2-10-1	2-10-1	2-10-0	3-4-4	3-7-0	0-2-0	7-5-4	10-0-0	--	--	--	

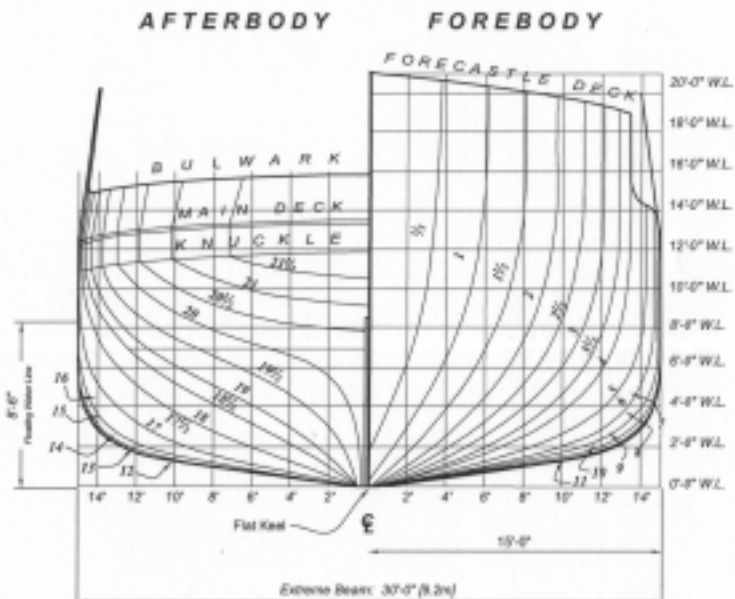

SCALE: 1" = 2 1/2' (1:32)

NOTE

This drawing was traced from an historic design drawing of the "WHITE HOLLY" ("Line Plan", 340 Fig. No. WAGL-0500-3, 1945). HAER did not fit lines or field check dimensions. Offset data were condensed to fit available space; drawing noted above includes more station points and reference lines. See Sheet 4 of 5 for Half-breadth and Sheer Plans; and HAER Field Notebooks for more information. Station spacing is 6'-0"; half-stations at 3'-0". All offset dimensions are given in FEET-INCHES-FRACTIONS OF AN INCH. Example: 11-4-2 = 11' 4 1/2"

U.S. COAST GUARD CUTTER "WHITE HOLLY", 1944-1947
 U.S.C.G. 1944-1947
 HAER 05-00-3
 U.S. COAST GUARD
 HISTORIC AMERICA
 PRESERVATION PROGRAM
 1-1-15

Before decommissioning, *White Holly's* length, beam, and draft remained the same. Cruising capacity was 10.5 knots with a range of 1,810 nautical miles.³² In 1999, *White Holly's* engine was a Caterpillar D353 Diesel reduction (4 to 1), for each screw, which are constant pitch propellers.³³ There were two Detroit 671 Diesels for the 6 KW electric power generators, as well as one Detroit 671 Diesel for the hydraulics. The engine room controls were on an open panel centered in the engine room. She had chill water air conditioning systems (essentially radiators in boxes), which could also use hot water from the hot water boiler in the engine room.

The hull was longitudinally framed with deep web frames at about 5' intervals. They appeared to be predominantly welded, with some riveted sections. The topgallant forecastle on *White Holly* had been extended aft one frame, flared out a bit more, and extended upward several feet. The bulwarks had been partially filled in, replacing the original pipe rails. She had pipe rails port and starboard on the buoy deck. There were flush decks forward with a large hatch set flush with the gently crowned deck. The large hatch was centered on the deck with a smaller access way hatch a few feet forward. *White Holly* also had the superstructure extended aft a frame, making for a smaller quarterdeck. A heavy-duty A-frame boom, which replaced the original single-mast and boom derrick, was used to handle buoys and their anchors. *White Holly* had a partially geared base to the boom.

White Holly had a weather deck broken by a topgallant forecastle raised about 4' above the main deck. The open

foredeck was surrounded by a partial bulwark and pipe rails. The main deck continued at the same level aft through the superstructure onto the small fantail area, aft of the superstructure. Originally, the vessel had a larger fantail (turtle deck), but the crew's quarters were extended further aft, decreasing the size of the fantail.

The superstructure consisted of a single-deck-height house surrounded by a raised pilothouse, and commander's stateroom forward. The engine room casing extended up through the top of the house, topped by skylights, with the funnel amidships forward. Hoses for dewatering pumps were contained in plastic tubing mounted on the centerline above the engine room skylights.

The controls for the boom were located forward of the pilothouse immediately behind the mainmast and boom. The winches for operation of the cargo boom were located in the forward section of the house. The quarters of *White Holly* included a galley with a range and ovens on the interior side and sinks to port. The captain's cabin was aft of the bridge, extended across the full width of the bridge.

White Holly's Service History

At the beginning of her career in the U.S. Coast Guard, *White Holly* was homeported in Ketchikan, Alaska, where she primarily served aids to navigation in the Seventeenth Coast Guard District and provided logistic support to isolated Coast Guard units. Because of her shallow draft and extreme maneuverability, *White Holly* operated primarily in southeastern Alaska,

from Dixon Entrance north to an area between Juneau and Sitka where the water passages are narrow, shallow, and constantly bending.³⁴

In addition to her AtoN duties, *White Holly* performed many assists and rescues. *White Holly's* motto, "GOTCHA COVERED," which was prominently displayed on the vessel, "described the confidence and pride taken by the crew in the prompt response to any job we are assigned." This can be seen in her activities. In addition to aiding numerous vessels in



Detail of *White Holly's* logo displayed on pilothouse (1999 HAER photo).

distress, other more notable events included providing medical assistance in Sitka, Alaska, November 16-17, 1950; fighting a fire in Wrangell, Alaska, on March 22, 1952; transporting the National Guard from Metlakahtla to Ketchikan, Alaska, on October 5, 1953; and transporting aviation fuel to the mouth of Chickmin River in support of relief efforts for an avalanche disaster 43 miles northwest of British Columbia.³⁵

Log entries for September 22, 1953 describe a typical call for assistance:

0430 Launch and crew away to investigate grounded F/V; 0500 Launch returned, F/V *Silver Wave* found high and dry on rock off Canmand Pt., will attempt to refloat at high tide; 0630 Anchored off Canmand Pt. in 6 fath. of water to 25 fath. of chain. . . . 1120 Anchor away, hove to off F/V *Silver Wave*, motor launch in water; 1135 Towing line being passed to F/V; 1138 Commenced heaving on towing line; 1153 F/V *Silver Wave* afloat and clear of rock; 1200 F/V passed off towing line and coming along port side . . .³⁶

In November 1971, *White Holly* began a two-month, 8,000-mile voyage to her new homeport in New Orleans, Louisiana, to replace her sister ship, *White Alder*, which sank after a collision with MV *Helena* on December 7, 1968.³⁷ The vessel was outfitted with supplemental communications and navigational equipment for her voyage. Most of the twenty-two man crew were transferred with the ship. As a tribute to her service in Alaskan waters, a proclamation was made in the House of Representatives by the Honorable Nick Begich on November 18, 1971, soon after the mayor of Ketchikan had



White Holly underway in Alaska, 1961 (USCG photo).

proclaimed November 11, 1971 as *White Holly* Day. The proclamation stated:

Whereas, the U.S. Coast Guard had ordered the transfer of the good ship *White Holly* from its natural and historic role as guardian of the last frontier, and

Whereas, the good ship *White Holly* has played a spectacular role in policing of international waters against foreign fishery encroachment, has assisted in many search and rescue operations involving America's finest fishermen, hunters, loggers and miners, has maintained aids to navigation in some of the most hazardous waters of the world, and

Whereas, Alaska now has attained statehood, the U.S. Coast Guard has mechanized much of its search and rescue operations by using aircraft to speed up its services to the outlying areas, and

Whereas, the officers and enlisted personnel of the good ship *White Holly* have become outstanding examples of the U.S. Coast Guard, have brought its services and relationships closer to the people of greater Ketchikan than to those of any other portion of America, and

Whereas, other portions of the United States of America now need and deserve this humanitarian service long rendered to Alaskans by *White Holly*, and

Whereas, the door to the First City of Alaska remains always open to the *White Holly's* officers and crew who will wish to return here for later duty or retirement,

Therefore, in recognition of the service of this vessel and personnel, I proclaim Thursday, November 11, 1971 as *White Holly* Day in greater Ketchikan and by virtue of the authority in me vested, requested all citizens of Greater Ketchikan to pay appropriate tribute to the good ship *White Holly* and its personnel.

Done under my seal and signature this 5th day of November, 1971.

Her primary duties at her new location were to position and maintain buoys in an area extending from Gulfport, Mississippi, to the Mermentau River on the western border of Louisiana. *White Holly* was responsible for over 190 buoys ranging from small 300-pound buoys marking the bends in the Mississippi river to 13,000-pound buoys placed off harbor entrances in the Gulf of Mexico. In addition to her AtoN duties, *White Holly* was available to perform search and rescue, law enforcement, and environmental protection duties.³⁸

Existing buoys were maintained by lifting them onto the deck of *White Holly*, unshackling them from their anchor chains, cleaning and repainting them. If extensive damage was found, a replacement buoy was used. Lighted buoys, now powered by solar panels, could require new batteries and an inspection to make sure the new light was operating correctly. In the Mississippi River, the current often pushed vessels into the buoy

as they were making turns or passing one another. Stray buoys that had broken from their anchor chains were retrieved.³⁹

Working aids to navigation on the Mississippi River, one of the nation's busiest waterways, presented some unique challenges. Water levels on the river fluctuated with the seasons. In the spring, with melting ice and snow, the water level could rise 15', and during the summer, dry spells could lower the water below the 12' limit. To warn riverboat masters, buoys were placed to mark those areas of low water. The bends in the river required that the officer of the watch relay his position to any vessel around the bend in the river avoid potential collisions. When passing, the tender and the other vessel agreed to pass each other on one whistle indicating port side to port side, or on two whistles indicating starboard side to starboard side. The light marking mile 195 had special significance in that it marked the position of the *White Alder* accident in which seventeen Coast Guard crew members lost their lives.⁴⁰

In 1975, *White Holly* was awarded the National Defense Transportation Association Military Unit Award. For his 1983 rescue of a drowning girl in a swift current off Fort Pickens Beach, Florida, one of *White Holly's* crewmen, BM1 Stephen A. Cirinna, was awarded a Silver Life-Saving Medal.⁴¹

The navigation system along the Gulf Coast is frequently disrupted by hurricanes and tropical storms. In 1985, a newspaper article ran a photograph of *White Holly* relocating channel markers and reported that damage from Hurricane Elena to the navigational system was \$200,000. The operations commander of Coast Guard Group Mobile was quoted as

saying, "One of the requirements that the Coast Guard has after any major storm, whether it be a hurricane, tornadoes in the area, even a major winter storm where you get a lot of surf and tidal surge, is to go out and position check each aid and ensure it's on its position and marking good water for the mariner for a safe transit."⁴²

White Holly was decommissioned in 1998. She was initially transferred to the Canvasback Missions, Inc., in 1999. Found to be deficient in size and configuration for the Canvasback programs, she was sold to the Seamans Training Center, located in Vallejo, California, and is stationed at Mare Island.⁴³

White Pine

White Pine began her career as *YF-448*. Her keel was laid at the Erie Concrete and Supply Company, Erie, Pennsylvania, on June 4, 1943. Erie Concrete and Steel Supply Company was organized in 1913; the shipyard division was established in June 1941. The main plant was engaged in the manufacture of steel structures such as warehouses and bridges. It also acted as a "warehouser and fabricator of steel, and a jobber of mill and plumbing supplies." The shipyard was located on the Lake Erie waterfront on land leased from the Pennsylvania Railroad about a mile from the main plant. The shipyard facility



White Pine off the Coast Guard Yard at Curtis Bay, August 9, 1948, six days after being commissioned into the U.S. Coast Guard (USCG photo).

consisted of six buildings: an office building, mold loft building, storage building, acetylene storage house, erection shop building, and a warehouse building. Their first Navy contract was for “three YF type, 500 ton, self propelled, all welded steel lighters.” Erie subcontracted with the Union Diesel Company in Oakland, California, for the main and auxiliary engines; with the Sperry Gyroscope Company, Brooklyn, New York, for the steering apparatus; and with the McKinnon-Terry Company, Newark, New Jersey, for the windlass.⁴⁴

Erie Concrete and Supply Company built YFs 444-448 under Contract No. NXs156. YFs 444, 445, and 446 would later



Starboard bow view showing White Pine's barge pusher. Spud, shown at right, dropped into mud to hold vessel stationary in currents (USCG photo).

become sister ships *White Sage*, *White Heath*, and *White Lupine*. YF-448 was launched on August 28, 1943. Her trials were held on Lake Erie on April 26, 1944, and she was placed in service on May 20, 1944. YF-448 was delivered to the supply officer at the Brooklyn Navy Yard, New York, on June 20, 1944, and commissioned on July 11, 1944, with a single mast and boom hoist. Assigned to the Fifth Naval District, YF-448 served in the Maintenance Division.

After World War II, the U.S. Coast Guard acquired YF-448 in 1946 and *White Pine* was commissioned into the Coast Guard as WAGL 547 on August 3, 1948. She was the last in her class to receive a commission. Before commissioning, *White Pine* was outfitted with a barge pusher on the bow to adapt her for working aids to navigation on the western rivers.

According to her “Ship’s Characteristics Card” dated August 30, 1965, the U.S. Coast Guard Cutter *White Pine*, was 132'-10" in overall length; 132' in length between perpendiculars; 30'-9 3/4" in extreme beam; 15'-8" in depth of hold; 6'-2" in draft forward fully loaded; and 5' in draft forward with a light load. Her one mast was 48' tall. The vessel displaced 600 tons and had a maximum speed of 9.2 knots fully loaded. Her hull, superstructure, decks, bulkheads, and frames were constructed of steel.

Auxiliary boats in 1965 included a fiberglass outboard and three seven-man inflatable lifeboats. In 1965, she had her original diesel engine built by Union Diesel Engine Company, Oakland, California, with two propellers, 300 horsepower each, and two auxiliary diesel generators. *White Pine* underwent a major

renovation at Curtis Bay in Baltimore, Maryland. These modifications included updated equipment to improve her AtoN capabilities.

Before decommissioning, *White Pine's* length was 133'; beam, 31'; and draft, 8'. Her displacement tonnage was listed at 606 gross tons and her mast height as 37-1/2'. She had a lifting

capacity of 20,000 pounds, using two hydraulic pumps. She had twin Caterpillar Diesel engines, 375 horsepower each, twin propellers, and Detroit Diesel auxiliary generators. Cruising capacity was 10 knots. Her maximum time out to sea was twenty days at 8 knots. Her compliment of officers and crew was twenty-six.



White Pine moored in Memphis with barge attached, July 1961 (USCG photo).



View of *White Pine's* working deck and boom as she approaches Mobile Bay Lighthouse in order to perform maintenance (1999 HAER photo).

White Pine was unique in her class for having “spuds,” which are retractable stanchions that enabled her to service aids in areas other tenders would find difficult or hazardous. Spuds are vertical poles along the ship’s side that are dropped down to the mud bottom to hold the vessel stationary in waters with strong current or where anchors cannot take hold. The spuds are retracted when the buoy work is complete.

White Pine's Service History

White Pine began her career in Memphis, Tennessee, where she replaced the Coast Guard cutter *Wake Robin*. In addition to servicing aids to navigation, she patrolled the Mississippi River for the Marathon Race in 1960. In 1961, she assisted with flood relief at Olive Branch, Tennessee. In late 1961, she was transferred to Curtis Bay, Baltimore, Maryland, where her barge structure was removed to accommodate servicing aids in the Chesapeake Bay. Her hoist was also replaced with an A-frame arrangement and hydraulic power. In 1965, *White Pine* assisted with firefighting on the Columbian motor vessel *Ciudad de Nieva* near Baltimore, Maryland.⁴⁵

In 1976, *White Pine* was sent to Mobile, Alabama, to replace the Coast Guard cutter *Blackthorn*, which was being transferred to Galveston, Texas. After first inspection on August 23, 1976, the Chief of Staff noted, “Welcome to the 8th CG District. The maintenance of the ship and the appearance of the crew is such that the C.O. and the crew can be proud. Your arrival here has set the standard for other ships to strive for. I wish the



White Pine crew at rest while underway on Mobile Bay to train takeover the crew from the Dominican Republic (1999 HAER photo).

White Pine much success in the A/N efforts in which she will be engaged."⁴⁶

White Pine's area of operation was primarily the Gulf Coast between Gulfport, Mississippi, and St. Marks, Florida, where she serviced 200 lighted and unlighted buoys. She also participated in search and rescue, salvage work, survey work, and marine law enforcement. In December 1984, *White Pine* rescued four persons from a sunken private craft in the Gulf of Mexico. *White Pine* was decommissioned on June 29, 1999, and sold to the Dominican Republic.⁴⁷

White Sage

White Sage began her career as YF-444. Her keel was laid at the Erie Concrete & Steel Supply Co., Erie, Pennsylvania, on March 28, 1943. She was launched on June 19, 1943. Her trials were held on Lake Erie on April 17, 1944, and she was placed in service on May 20, 1944. YF-444 and YF-446 departed Erie on May 9, 1994, with YF-640 and YF-641 in tow. Outfitted at the Brooklyn Navy Yard, New York, YF-444 was assigned to the Third Naval District to work in the Naval Ammunition Depot in Earle, New Jersey.⁴⁸ After World War II, YF-444 was acquired by the USCG in 1946. The fifth vessel in her class, *White Sage* was commissioned into the Coast Guard as WAGL 544 on August 9, 1947.

According to her "Ship's Characteristics Card," dated November 21, 1966, *White Sage* was 133'-6" in overall length, 32' in length between perpendiculars, 30'-9" in extreme beam, 12'-2 7/8" in depth of hold, 7'-2" in draft forward fully loaded, and 5'-6" in draft forward with a light load. She is listed as having two masts, the forward mast being 57' tall and the aft 36'. The vessel displaced 476 tons and had a maximum speed of 10 knots fully loaded. Her hull, decks, bulkheads, and frames were constructed of steel, while her superstructure was steel and wood.

Auxiliary boats in 1966 included a motor cargo boat, dinghy, and three seven-man rubber lifeboats. In 1966, she had her original diesel engines, which were opposed piston Fairbanks-Morse Diesels built by Union Diesel Engine Company, in Oakland, California. The engines had two propellers, 300

horsepower each, and two auxiliary diesel generators. In 1971, *White Sage* underwent a major renovation at the U.S. Coast Guard Yard in Curtis Bay, Maryland. Her machinery was modernized in 1975. These modifications brought about many changes, including updated equipment to improve her AtoN capabilities.

Before decommissioning in 1999, *White Sage's* length, beam, and draft remained the same.⁴⁹ The engines in 1999 were Caterpillar D353 Diesel reduction (4 to 1), for each screw.⁵⁰ The screws were constant pitch propellers. *White Sage* and other ships built and later modified at Erie (including *White Sumac*, *White Heath*, and *White Lupine*) had a quiet room for the engine room controls.

White Sage had an oily water separator unique among the ships of the class. In 1999, she still had the original electric engine-augmented shaft-and-cable steering system. She had a chill water air conditioning system (essentially radiators in boxes), which could also use hot water from the hot water boiler in the engine room. Air conditioning for the crew's berthing area was requested by the commander of the First District in a 1971 memo.

White Sage had a heavy-duty A-frame boom, which replaced the original single mast, used to handle buoys and anchors. There was a weather deck broken by a topgallant forecastle raised about 4' above the main deck. The open foredeck was surrounded by a partial bulwark and pipe rails. The main deck continued at the same level aft through the superstructure onto the small fantail area, aft of the superstructure.



The superstructure consisted of a single-deck-height house surmounted by a raised pilothouse, and commander's stateroom forward. The engine room casing extended up through the top of the house, topped by skylights, with the funnel amidships forward. Hoses for dewatering pumps were

contained in plastic tubing mounted on the centerline above the engine room skylights.

The controls for the boom were located forward of the pilothouse, immediately behind the mainmast and boom. The



White Sage (above and facing page) at Curtis Bay Yard, Baltimore, Maryland, in 1964, after the installation of new A-frame mast and boom hoisting system (USCG photos).

CGC "WHITE SAGE"

WLM-544

1943

Erle Concrete & Steel Supply Company

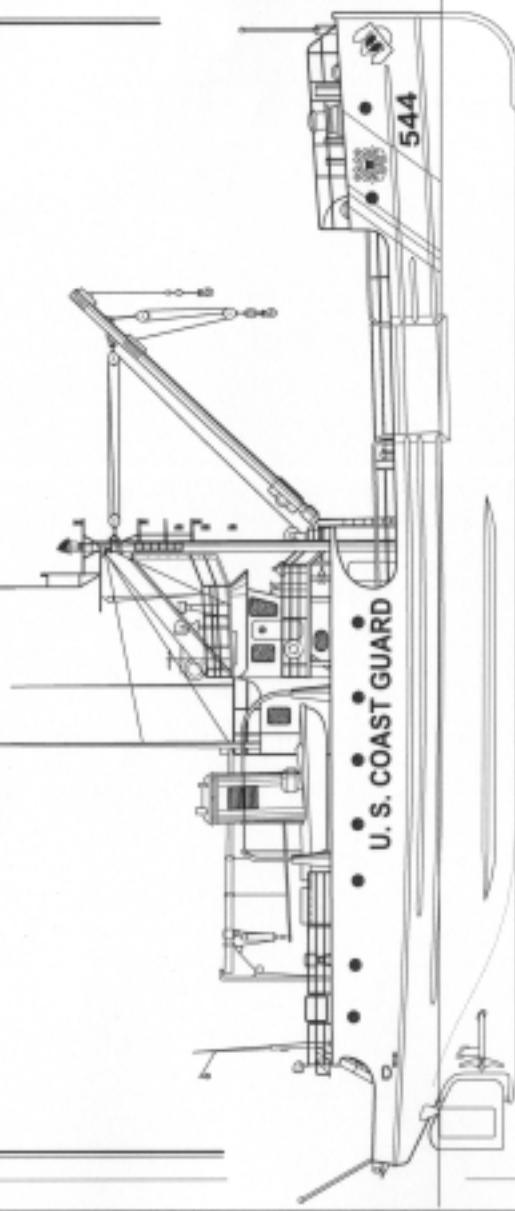

OUTBOARD PROFILE



NOTE: This drawing was traced from historic design drawings of the USCG Cutter WHITE SAGE (Pulvered Pavilion), Dep. No. 54D-WMOL-0103-26 vs. 1970N. HAZER did not field check dimensions or arrangement of features. Upper and Buoy deck features listed in part on HAZER's photographs of the vessel (RI-56-1, RI-56-4 & RI-56-1E).

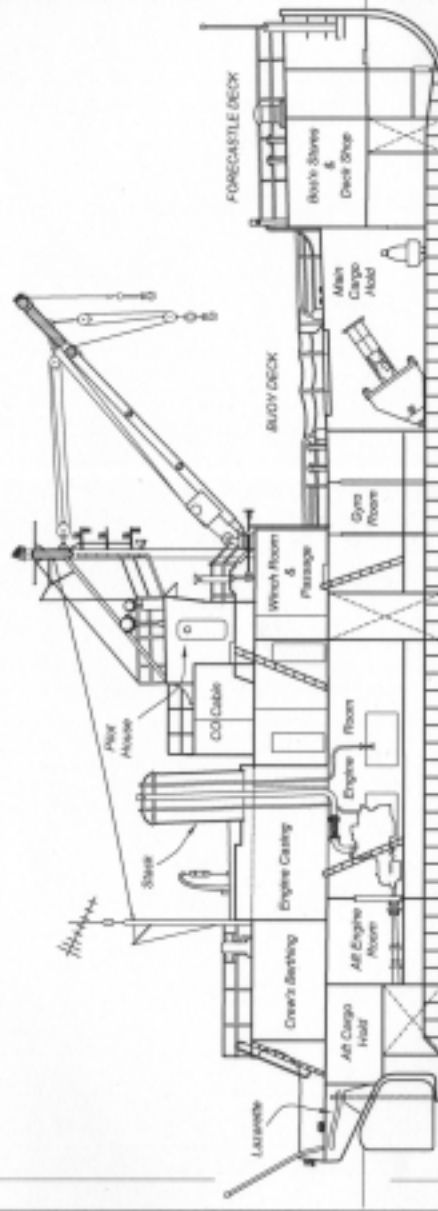

INBOARD PROFILE

The "WHITE SAGE" was originally constructed as a yard lighter (YF 444) for the United States Navy in 1943. This class of vessel provided logistical support to naval operations during World War II. Following the war, the U.S. Coast Guard acquired eight of these vessels to perform service for their aids to navigation as buoy tenders.

The United States Coast Guard Recording Program is part of the Historic Nautical Engineering Record (HAZER), a long-range program documenting historically significant engineering, industrial, and maritime sites in the United States. The

HAZER program is administered by the National Park Service, U.S. Department of the Interior. The USCG Buoy Tenders, 133 Class Recording Project was sponsored during 2000 & 2001 by the USCG, Stret level, Astoria.

The measured drawings, historical reports and photographs were prepared under the direction of Eric Delaney, Chief of HAZER & Tidel Cruisers, Maritime Program Manager. The team consisted of Howard Johnson (University of the District of Columbia) & Peter Brooks, architect; Candace Clifford & Kevin Foster, historians; and Jill Lane, photographer.

DATE: 2007

UNITED STATES COAST GUARD

REGULATED INDUSTRIAL

PHOTOGRAPHY

PHOTOGRAPHY

PHOTOGRAPHY

PHOTOGRAPHY

PHOTOGRAPHY

PHOTOGRAPHY

PHOTOGRAPHY

PHOTOGRAPHY

PHOTOGRAPHY

PHOTOGRAPHY

PHOTOGRAPHY

PHOTOGRAPHY

PHOTOGRAPHY

PHOTOGRAPHY

PHOTOGRAPHY

PHOTOGRAPHY

PHOTOGRAPHY

PHOTOGRAPHY

PHOTOGRAPHY

PHOTOGRAPHY

PHOTOGRAPHY

PHOTOGRAPHY

PHOTOGRAPHY

PHOTOGRAPHY

PHOTOGRAPHY

PHOTOGRAPHY

PHOTOGRAPHY

PHOTOGRAPHY

PHOTOGRAPHY

PHOTOGRAPHY

PHOTOGRAPHY

PHOTOGRAPHY

PHOTOGRAPHY

PHOTOGRAPHY

PHOTOGRAPHY

PHOTOGRAPHY

PHOTOGRAPHY

PHOTOGRAPHY

PHOTOGRAPHY

PHOTOGRAPHY

PHOTOGRAPHY

PHOTOGRAPHY

PHOTOGRAPHY

PHOTOGRAPHY

PHOTOGRAPHY

PHOTOGRAPHY

PHOTOGRAPHY

PHOTOGRAPHY

PHOTOGRAPHY

PHOTOGRAPHY

PHOTOGRAPHY

PHOTOGRAPHY

PHOTOGRAPHY

PHOTOGRAPHY

PHOTOGRAPHY

PHOTOGRAPHY

PHOTOGRAPHY

PHOTOGRAPHY

PHOTOGRAPHY

PHOTOGRAPHY

PHOTOGRAPHY

PHOTOGRAPHY

PHOTOGRAPHY

PHOTOGRAPHY

PHOTOGRAPHY

PHOTOGRAPHY

PHOTOGRAPHY

PHOTOGRAPHY

PHOTOGRAPHY

PHOTOGRAPHY

PHOTOGRAPHY

PHOTOGRAPHY

PHOTOGRAPHY

PHOTOGRAPHY

PHOTOGRAPHY

PHOTOGRAPHY

PHOTOGRAPHY

PHOTOGRAPHY

PHOTOGRAPHY

PHOTOGRAPHY

PHOTOGRAPHY

PHOTOGRAPHY

PHOTOGRAPHY

PHOTOGRAPHY

PHOTOGRAPHY

PHOTOGRAPHY

PHOTOGRAPHY

DECK PLANS



CGC "WHITE SAGE"

PILOT HOUSE TOP

NOTE: This drawing was derived from design drawings of the USCGC Cutter WHITE SAGE, "Main Deck", "Upper Deck", and "Hold" (Dep. No. 540-9943L-0103-20, et. 02705). NAED did not field check dimensions or arrangement of features. See NAED Field Notebook for more information.

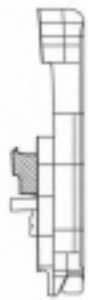
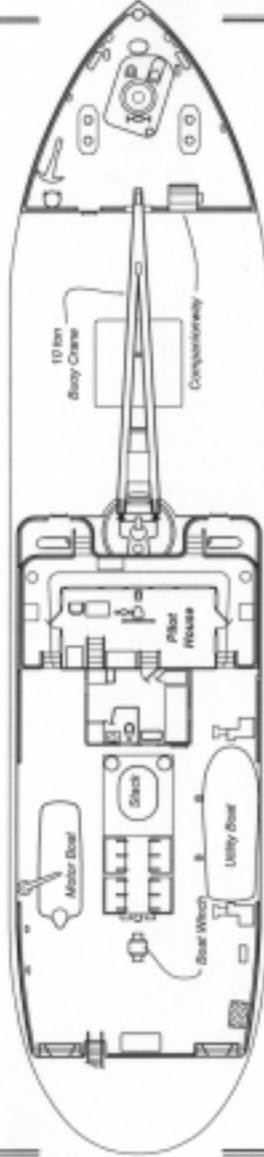

UPPER DECK & FORECASTLE

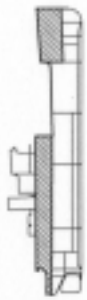
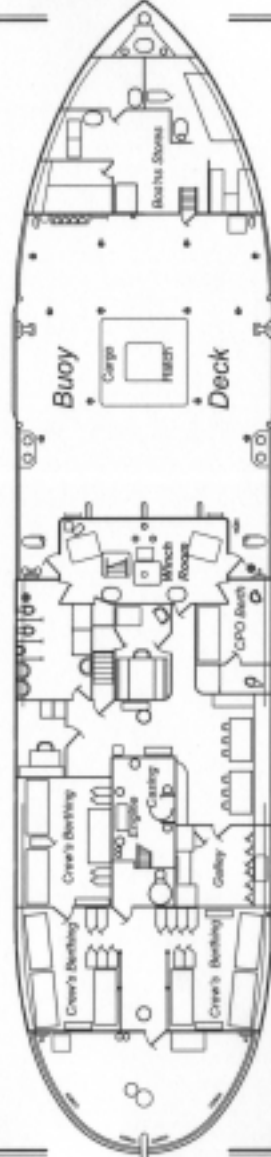

MAIN DECK



HOLD



DRAWN BY: Peter Brooks, 2001
 UNITED STATES COAST GUARD
 RECORDING PROGRAM
 CGC-0103-20

U.S. COAST GUARD CUTTER "WHITE SAGE", "MAIN DECK", "UPPER DECK", AND "HOLD"
 U.S.C.G. 540-9943L-0103-20
 DEPT. OF COMMERCE
 GREAT LAKES DISTRICT
 ERIAS COUNTY

SHEET NO. 2 of 4
 SHEET US-480

NATIONAL ARCHIVES
 COLLECTOR RECORDS
 01-08

CGC "WHITE SAGE" - BODY PLAN

TABLE OF OFFSETS

		FOREBODY STATIONS														
		½	1	1½	2	2½	3	3½	4	5	6	7	8	9	10	11
HALF-BREADTHS	POCISE	3-14	3-0	3-0	3-0	11-10	12-15	12-10	13-5	--	--	--	--	--	--	--
	F'WL	0-0	3-0	3-0	3-0	3-10	5-1	6-7	6-10	6-5	6-6	11-0	11-10	12-2	12-3	12-7
	M'WL	1-14	2-7	4-3	5-0	6-5	8-1	9-7	10-5	10-3	10-5	14-5	14-5	14-7	14-7	14-7
	F'WL	1-2	3-7	4-10	4-7	7-0	9-1	10-4	11-0	12-6	13-17	14-5	14-3	14-10	14-11	14-11
	F'WL	1-10	3-4	3-2	7-14	8-7	9-10	11-0	12-3	14-2	14-0	14-5	14-14	15-0	15-0	15-0
	F'WL	2-4	4-7	6-2	8-7	8-7	10-10	12-1	12-10	14-7	14-1	14-14	14-10	15-0	15-0	15-0
HEIGHTS	POCISE	18-1	18-1	18-0	17-10	17-7	17-4	17-2	17-2	--	--	--	--	--	--	--
	F'BLTT	0-0	2-2	5-2	1-14	3-6	0-7	0-0	3-1	0-4	0-3	3-8	3-8	3-4	0-3	0-3
	F'BLTT	--	0-0	3-10	2-7	1-15	1-5	1-7	0-17	0-6	0-1	3-7	3-2	3-2	3-2	3-2
	F'BLTT	--	--	0-10	4-5	3-1	3-7	1-17	1-7	1-2	1-6	3-11	3-7	3-2	3-7	3-8
	F'BLTT	--	--	14-7	7-0	5-10	3-1	3-2	2-4	1-10	1-7	1-3	1-3	1-4	1-0	1-0
	F'BLTT	--	--	--	--	4-15	0-7	4-7	3-1	2-7	2-6	1-3	1-7	1-2	1-3	1-3
No. 1	POCISE	2-14	3-5	4-2	5-7	6-1	6-10	7-3	7-4	8-3	8-7	8-2	8-0	8-0	8-7	8-4
	F'BLTT	3-8	0-0	0-7	0-0	11-0	12-1	13-4	13-10	13-0	15-11	15-2	15-11	17-1	17-3	17-7
		AFTERBODY STATIONS														
		12	13	14	15	16	17	17 ½	18	18 ½	19	19 ½	20	20 ½	21	21 ½
HALF-BREADTHS	MAIN DECK	15-0	15-0	15-0	15-0	14-10	14-10	14-10	14-10	14-10	14-10	14-10	14-10	14-10	14-10	14-10
	F'WL	12-4	12-4	12-4	12-4	11-8	11-8	11-8	11-8	11-8	11-8	11-8	11-8	11-8	11-8	11-8
	M'WL	14-11	14-11	14-11	14-11	14-11	14-11	14-11	14-11	14-11	14-11	14-11	14-11	14-11	14-11	14-11
	F'WL	15-0	15-0	15-0	15-0	14-10	14-10	14-10	14-10	14-10	14-10	14-10	14-10	14-10	14-10	14-10
	F'WL	15-0	15-0	15-0	15-0	14-10	14-10	14-10	14-10	14-10	14-10	14-10	14-10	14-10	14-10	14-10
	F'WL	15-0	15-0	15-0	15-0	14-10	14-10	14-10	14-10	14-10	14-10	14-10	14-10	14-10	14-10	14-10
HEIGHTS	POCISE	12-3	12-4	12-4	12-4	12-6	12-3	12-7	12-4	12-1	12-7	12-6	12-7	12-6	12-7	12-4
	F'BLTT	0-3	0-3	0-3	0-4	0-7	0-6	0-6	0-6	0-12	1-0	1-11	1-7	1-7	1-7	1-0
	F'BLTT	0-54	0-54	0-54	0-57	0-55	0-6	0-11	1-2	1-10	2-11	4-7	4-7	4-4	4-4	3-10
	F'BLTT	0-6	0-6	0-6	0-2	0-14	1-6	1-4	2-0	2-10	4-13	6-3	6-3	6-3	6-7	6-10
	F'BLTT	1-0	1-0	1-0	1-4	1-2	1-7	2-3	2-4	3-12	5-0	6-2	7-14	7-3	7-3	6-7
	F'BLTT	1-3	1-3	1-3	1-4	1-5	2-1	2-10	3-4	4-11	6-3	7-3	8-3	8-3	8-11	7-10
No. 1	POCISE	17-2	17-2	17-2	17-1	16-6	16-7	16-1	16-1	16-1	16-1	16-1	16-1	16-1	16-1	16-1
	F'BLTT	17-2	17-2	17-2	17-1	16-6	16-7	16-1	16-1	16-1	16-1	16-1	16-1	16-1	16-1	16-1

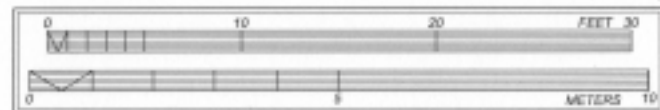
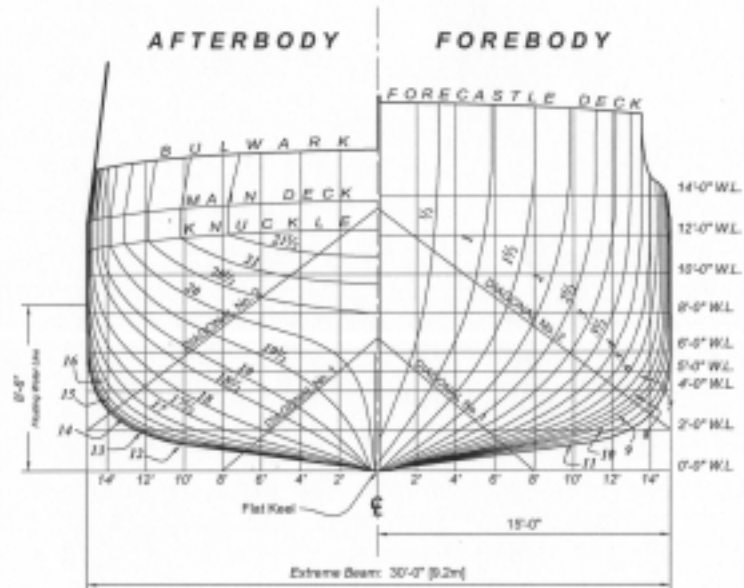

SCALE: 1" = 2½' (1:32)

NOTE

This showing was traced from an historic design drawing of the "WHITE PINE" and "WHITE SAGE" ("Lines & Offsets"; 540 WAGL-0500-7, 1943). HAER did not lift lines or field check dimensions. Offset data were condensed to fit available space; drawing copied above includes many more station points and reference lines. See HAER Field Notebooks for more information. Station spacing is 6'-0". Zero (0) Station is located at the outer edge of stem. All offset dimensions are given in FEET-INCHES-EIGHTHS OF AN INCH. Example: 11-4-3 = 11' 4 3/8"

UNITED STATES COAST GUARD RECORDING PROGRAM
 HISTORIC AMERICAN ENGINEERING RECORDS
 BUZZ SAUNDERS, INC.
 1100 EAST 14TH AVENUE
 DENVER, CO 80202
 303-733-0800
 303-733-0801
 303-733-0802
 303-733-0803
 303-733-0804
 303-733-0805
 303-733-0806
 303-733-0807
 303-733-0808
 303-733-0809
 303-733-0810
 303-733-0811
 303-733-0812
 303-733-0813
 303-733-0814
 303-733-0815
 303-733-0816
 303-733-0817
 303-733-0818
 303-733-0819
 303-733-0820
 303-733-0821
 303-733-0822
 303-733-0823
 303-733-0824
 303-733-0825
 303-733-0826
 303-733-0827
 303-733-0828
 303-733-0829
 303-733-0830
 303-733-0831
 303-733-0832
 303-733-0833
 303-733-0834
 303-733-0835
 303-733-0836
 303-733-0837
 303-733-0838
 303-733-0839
 303-733-0840
 303-733-0841
 303-733-0842
 303-733-0843
 303-733-0844
 303-733-0845
 303-733-0846
 303-733-0847
 303-733-0848
 303-733-0849
 303-733-0850
 303-733-0851
 303-733-0852
 303-733-0853
 303-733-0854
 303-733-0855
 303-733-0856
 303-733-0857
 303-733-0858
 303-733-0859
 303-733-0860
 303-733-0861
 303-733-0862
 303-733-0863
 303-733-0864
 303-733-0865
 303-733-0866
 303-733-0867
 303-733-0868
 303-733-0869
 303-733-0870
 303-733-0871
 303-733-0872
 303-733-0873
 303-733-0874
 303-733-0875
 303-733-0876
 303-733-0877
 303-733-0878
 303-733-0879
 303-733-0880
 303-733-0881
 303-733-0882
 303-733-0883
 303-733-0884
 303-733-0885
 303-733-0886
 303-733-0887
 303-733-0888
 303-733-0889
 303-733-0890
 303-733-0891
 303-733-0892
 303-733-0893
 303-733-0894
 303-733-0895
 303-733-0896
 303-733-0897
 303-733-0898
 303-733-0899
 303-733-0900
 303-733-0901
 303-733-0902
 303-733-0903
 303-733-0904
 303-733-0905
 303-733-0906
 303-733-0907
 303-733-0908
 303-733-0909
 303-733-0910
 303-733-0911
 303-733-0912
 303-733-0913
 303-733-0914
 303-733-0915
 303-733-0916
 303-733-0917
 303-733-0918
 303-733-0919
 303-733-0920
 303-733-0921
 303-733-0922
 303-733-0923
 303-733-0924
 303-733-0925
 303-733-0926
 303-733-0927
 303-733-0928
 303-733-0929
 303-733-0930
 303-733-0931
 303-733-0932
 303-733-0933
 303-733-0934
 303-733-0935
 303-733-0936
 303-733-0937
 303-733-0938
 303-733-0939
 303-733-0940
 303-733-0941
 303-733-0942
 303-733-0943
 303-733-0944
 303-733-0945
 303-733-0946
 303-733-0947
 303-733-0948
 303-733-0949
 303-733-0950
 303-733-0951
 303-733-0952
 303-733-0953
 303-733-0954
 303-733-0955
 303-733-0956
 303-733-0957
 303-733-0958
 303-733-0959
 303-733-0960
 303-733-0961
 303-733-0962
 303-733-0963
 303-733-0964
 303-733-0965
 303-733-0966
 303-733-0967
 303-733-0968
 303-733-0969
 303-733-0970
 303-733-0971
 303-733-0972
 303-733-0973
 303-733-0974
 303-733-0975
 303-733-0976
 303-733-0977
 303-733-0978
 303-733-0979
 303-733-0980
 303-733-0981
 303-733-0982
 303-733-0983
 303-733-0984
 303-733-0985
 303-733-0986
 303-733-0987
 303-733-0988
 303-733-0989
 303-733-0990
 303-733-0991
 303-733-0992
 303-733-0993
 303-733-0994
 303-733-0995
 303-733-0996
 303-733-0997
 303-733-0998
 303-733-0999
 303-733-1000

winches for operation of the cargo boom were located in the forward section of the house. The crew's mess of *White Sage* was remodeled in the 1980s entirely in stainless steel. Her galley was athwartships aft of the crew's mess. The tables and chairs were replaced by booths. All of the class had new bridges and bridge controls installed, reportedly each unique. Some remnants of original technology remained, however, such as the telephone communication system.

White Sage had upside-down "J"-shaped davits to starboard, which were hand-operated. A single angle-iron davit was mounted forward of the funnel to port. The hull was longitudinally framed with deep web frames at about 5' intervals.

White Sage's Service History

White Sage was originally homeported in Bristol, Rhode Island, where she primarily serviced aids to navigation in the First Coast Guard District. In 1950, her homeport was changed to Woods Hole, Massachusetts, also located within the First Coast Guard District. In 1988, her homeport was changed back to Bristol.

White Sage was responsible for 275 AtoN from Chatham to Block Island, which included the waters of Nantucket Sound, Buzzards Bay, and Narragansett Bay. *White Sage* extended her service area out to New Haven, Connecticut, when she took over an additional 160 buoys when the USCGC *Redwood* was placed out of service.⁵¹ *White Sage* transported freight and vehicles to Coast Guard units in the islands of Nantucket and Cuttyhunk, as well as serviced the lights in Buzzards Bay.⁵²

In addition to her AtoN duties, *White Sage* performed many assists and rescues and sometimes acted as an icebreaker. Notable rescue missions included salvaging a capsized boat near Nantucket Island in 1952; providing assistance following the collision between two motor vessels, *Francisville* and *Luckenback*, in July 1959; and assisting the disabled tug, *M. Moran*, two miles east of Cape Cod Canal on March 4, 1960.⁵³

On January 29, 1959, *White Sage* was requested to clear a passage through the ice to East Greenwich Cove, Rhode Island. Fishing boats were stuck, some damaged and sunk. *White Sage* routinely cleared channels after severe storms or nor'easters, including Hurricane Bob in 1991, when the eye of the storm passed directly over Woods Hole and disrupted the

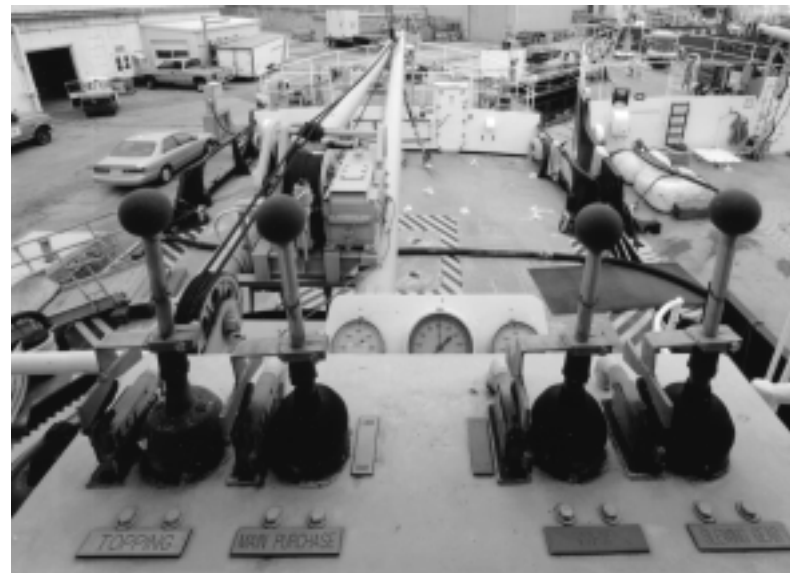

White Sage's boom controls (1999 HAER photo).



White Sage's rescue work included lifting a 40-footer from the bottom, Woods Hole, Massachusetts (USCG photo).

entire aids-to- navigation system. *White Sage* was crucial in keeping open shipping lanes on Narragansett Bay during severe ice conditions during the winter of 1993-1994, ensuring delivery of heating oil to homes in the affected area.⁵⁴

White Sage participated as a Command and Control platform in many marine events including the America's Cup regattas. In addition to serving as a platform to provide support for the small patrol craft, she maintained the security zone for the race course. Before retirement, *White Sage* served as the Command



White Sage's enclosed control room (1999 HAER photo).

and Control platform for the Patrol Commander for the Quonset, Rhode Island, airshow in 1995. *White Sage* played an important role in pollution response, assisting in the North Cape oil spill cleanup off Point Judith.⁵⁵

White Sage was decommissioned on June 7, 1996. She was replaced with the first keeper-class 175' tender, *Ida Lewis*. In 1999, *White Sage* was transferred, along with the *White Holly*, to the Canvasback Missions, Inc.

White Sumac

White Sumac began her career as *YF-416*. Her keel was laid at the Niagara Shipbuilding Corporation in Buffalo, New York, on August 31, 1942, under Contract No. N0bs124. Niagara also completed *YF-417* which later became *White Adler*. *YF-416* was launched on June 14, 1943. Her trials were completed on October 5, 1943, and she departed Buffalo ten days later and proceeded to the Brooklyn Navy Yard, New York, for outfitting. She was placed in service on November 8, 1943, and assigned to the Third Naval District for use of the Degaussing Section of the Navy Yard. On June 1, 1944, *YF-416* was transferred from the Navy Yard to the Naval Ammunition Depot, Earle, New Jersey.

After World War II, *YF-416* was acquired by the U.S. Coast Guard in 1946. *White Sumac* was commissioned into the Coast Guard as WAGL 540 along with *White Adler* (WAGL 541) on September 19, 1947. The remaining six vessels of this class were commissioned the following year.



White Sumac stern view (1999 HAER photo).

According to her "Ship's Characteristics Card" dated October 15, 1962, *White Sumac* was 132'-10" in overall length, 121'-6" in length between perpendiculars, 30' in extreme beam, 12'-2 1/2" in depth of hold, 8'-6" in draft forward fully loaded, and 4'-5 1/2" in draft forward with a light load. Her one mast was 41'-3" tall. The vessel displaced 600 tons and had a maximum speed of 9 1/2 knots fully loaded. Her hull, decks, bulkheads, and frames were constructed of steel, while her superstructure was of wood and steel.

Auxiliary boats in 1962 included a ramp boat, cargo boat, and three seven-man rubber rafts. In 1962, she had her original diesel engine built by Union Diesel Engine Company, of Oakland, California, with two propellers, 300 horsepower each,

and two auxiliary diesel generators. In 1972, *White Sumac* underwent a major renovation at Curtis Bay, Baltimore, Maryland, and her machinery was modernized in 1975. These modifications brought about many changes and updated equipment to improve her AtoN capabilities.

When documented in 1999 as an active vessel, *White Sumac* was in excellent condition. Her length, beam and draft remained the same. Her displacement tonnage was listed at 457 and her mast height as 45'-6". She had a lifting capacity of 20,000 pounds. Her steering was electric/hydraulic; her propulsion was fixed pitch twin screw with two diesel direct engines, two Detroit Diesel 4-71 generators, 60 KW each. Cruising capacity was 10 knots with a range of 2,000 nautical miles.⁵⁶ Her full complement of officers and crew was twenty-four men.⁵⁷

White Sumac's Service History

White Sumac is named for the poisonous bush found in the southeastern part of the United States. *White Sumac* began her career in Key West, Florida. She was homeported at this station until 1970, when she was transferred to Miami, Florida. While homeported in Key West, she was reported as spending a third of her time in the Miami area, making runs between Key West and Miami, checking reef lights, inspecting daybeacons, and taking general observations of aids to navigation.⁵⁸ AtoN included first-, second-, and third-class nun and can buoys. Every month or so, *White Sumac* also delivered fuel and supplies to offshore lighthouses, which at that time had resident keepers. The fuel was carried in 55-gallon drums that were transferred to the lights in a small boat. Once at the

CGC "WHITE SUMAC"

WLM-540

1 9 4 3

Niagara Shipbuilding Corporation

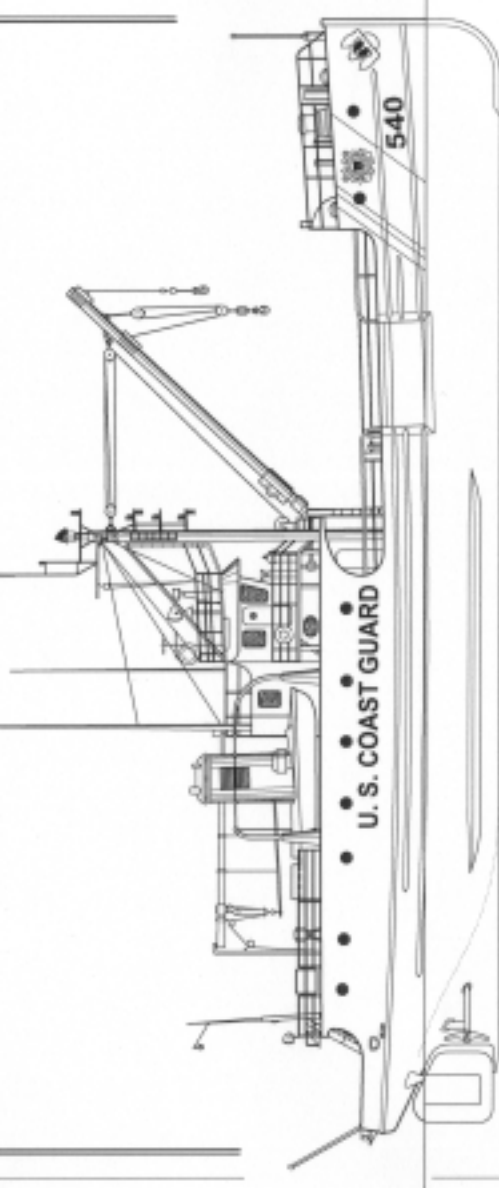

OUTBOARD PROFILE



NOTE: This drawing was traced from historic design drawings of the USCG Cutter WHITE SUMAC (General Arrangement & Profile), original ca. 1947— revised 1971, 1976 & 2006. HAZETT did not field check dimensions or arrangement of features. Upper and Buoy deck features based in part on HAZETT's photographs of the vessel (LA-14-16; LA-14-17 & LA-14-20).



INBOARD PROFILE

The "WHITE SUMAC" was originally constructed as a yard lighter (YF-416) for the United States Navy in 1942. This cutter of warrent provided logistical support to naval operations during World War II. Following the war, the U.S. Coast Guard acquired eight of these vessels to perform service for their role in navigation at buoy markers.

The United States Coast Guard Recreational Program is part of the Historic American Engineering Record (HAER), a long-range program documenting historically significant engineering, industrial, and machine sites in the United States. The

HAER program is administered by the National Park Service, U.S. Department of the Interior. The USCG Buoy Tenders, 133-Foot Buoy Tendering Project was sponsored during 2000 & 2001 by the USCG, Steel River, Lebanon.

The measure's drawings, historical reports and photographs were prepared under the direction of Eric Dalory, Chief of HAER & Tool/Cobalt, Maritime Program Manager. The team consisted of Howard Johnson (University of the District of Columbia) & Phil Brooks, architect; Candace Colford & Kevin Foster, historian; and Jeff Lowe, photographer.

Illustration: Phil Spinks, 2007
 UNITED STATES COAST GUARD
 HISTORIC ARCHIVES
 133-FOOT BUOY TENDERS

NEW ORLEANS

U.S. COAST GUARD CUTTER "WHITE SUMAC", 1943/1947
 U.S. COAST GUARD
 LOUISIANA, L.A.S.

HISTORIC ARCHIVES
 PHOTOGRAPHS
 LA-14

DECK PLANS

PILOT HOUSE TOP



CGC "WHITE SUMAC"

NOTE: This drawing was traced from historic design drawings of the USCGC Cutter WHITE SUMAC ("Casualty Assistance & Protection") original ca. 1947 - revised 1971, 1976 & 1988. NAEDR did not field check dimensions or arrangement of features. See NAEDR Field Handbook for more information.

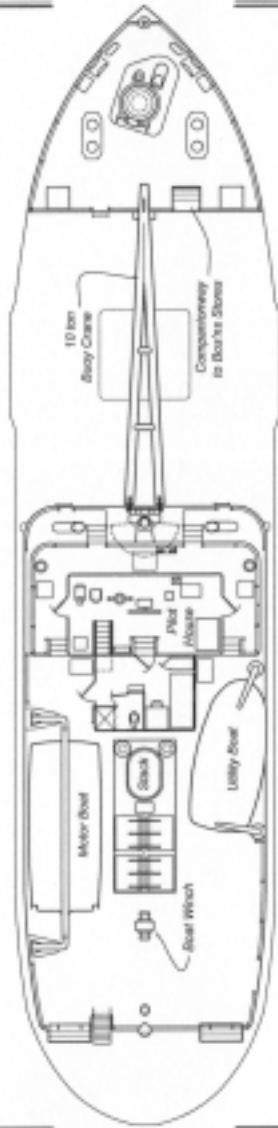

UPPER & FORECASTLE DECKS

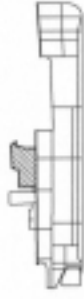

MAIN DECK

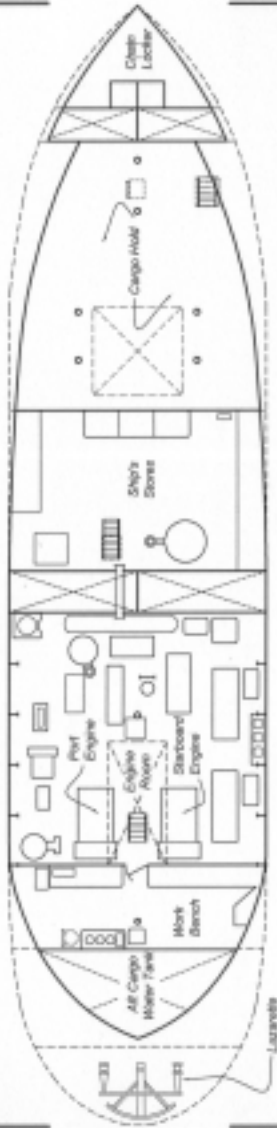
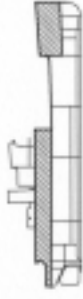

HOLD

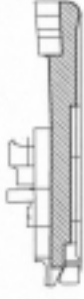

DATE: 10/20/2011
 U.S. COAST GUARD
 RECORDS PROGRAM
 www.uscg.mil

U.S. COAST GUARD CUTTER "WHITE SUMAC", "SQUADRY"
 U.S.C.G. 1947-1988
 2 x 8

U.S. COAST GUARD
 RECORDS PROGRAM
 1A.14

CGC "WHITE SUMAC" - FRAMING SECTIONS

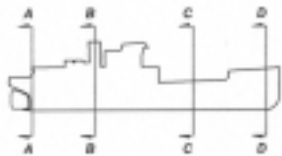

SECTION LOCATOR

NOTE: This drawing was traced from historic design drawings of the USCGC Cutter WHITE SUMAC produced by the Niagara Ship Building Corp. ("Transverse Mid Frame", Des. No. 540 WAGL-1103-1, 1943). HAER did not field check dimensions or arrangement of features. For more information see HAER Field Notebooks.

- A. Shell Longitudinals: 5" x 3½", all normal to shell
- B. Pipe Stanchions: 5" Round
- C. Frame Constructive Joints: Various welds; 60° groove-type most common
- D. 3" x ½" F.B.

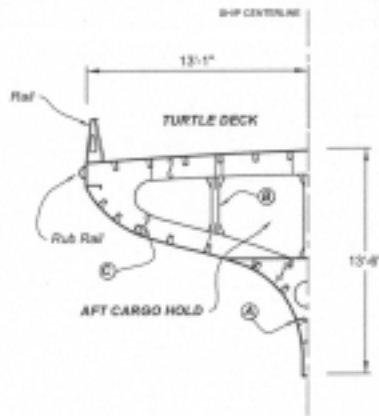

**A. Frame No. 20
looking aft**

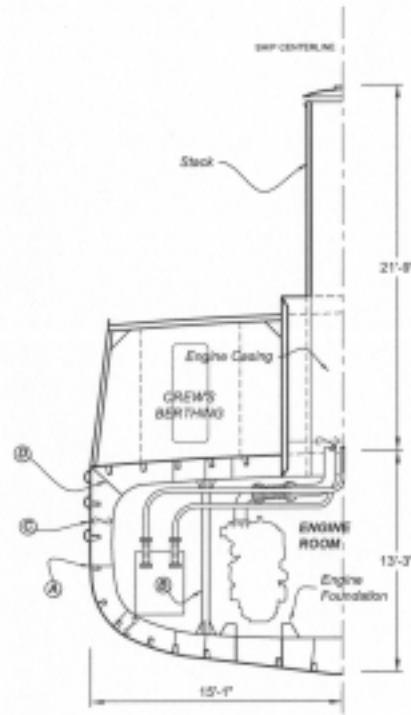

**B. Frame No. 15
looking aft**

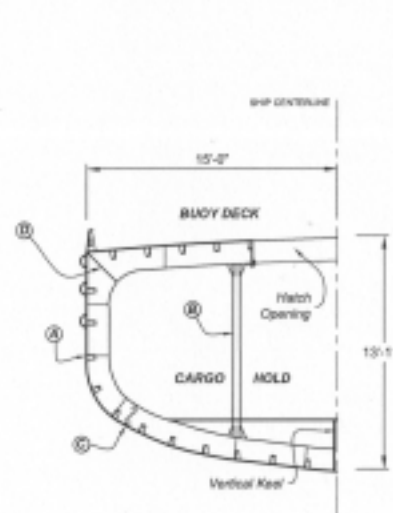

**C. Frame No. 7
looking aft**



**D. Frame No. 1
looking aft**



HAER Field Notebooks
 U.S. COAST GUARD CUTTER "WHITE SUMAC", 1943/1947
 NEW ORLEANS
 U.S. COAST GUARD 133-FOOT BUOY TENDERS
 DELAWARE MARINE

lighthouse, the drums were hoisted aboard by means of block and tackle, and the fuel pumped manually from the drums to the storage tanks. Potable water was pumped from the tender to the lighthouse by means of a fire hose supported by floats.⁵⁹ *White Sumac* also serviced the Fort Jefferson National Monument in Dry Tortugas, Florida.

White Sumac made periodic checks on the unmanned reef lights, which required periodic chipping and painting. These reef lights were fueled by acetylene gas, whose flow was regulated by a sun valve (the flow of gas would turn on when the sun went down). Each light was equipped with four to six tanks of acetylene, which were replaced with the aid of a small boat off *White Sumac*.⁶⁰ During this early period in *White Sumac*'s career the crew was allowed recreation time in Havana, Cuba, every few months. The ship's mascot was a small dog named "Sinbad."⁶¹

In addition to servicing AtoN, *White Sumac* also undertook SAR duties, providing assistance to FV *Commodore Perry* off Dry Tortugas in 1952 and to FV *Elliot* near Key West. She also towed disabled FY *Vkelpie* to Key West in 1954, and rescued forty-seven Haitian refugees from a distressed sloop forty miles east of Andros Island in 1968.⁶²

For the most part life on *White Sumac* was pretty routine. Her log entries indicate numerous drills and inspections. On February 15, 1956, EN1 Price P. Holloway recorded:

8 a.m. to 4 p.m. Moored as before; 1000 Small arms checked and accounted for; 1200 Chaw down; 1300 Departed Base Key West for drills and exercises with

Southern Area Inspectors aboard; 1325 Fire drill; 1330 Secured from drill; 1331 Fire and rescue drill, 1345 Man overboard drill; 1350 Secured from drill, checking CG 83403 Hurricane Mooring Buoy; 1400 Anchored at buoy; 1410 Abandon ship drill; 1425 Secured from drill en route Base Key West; 1445 Moored starboard side to C.G. Base Key West, Fla., Status Baker Six; 1515 Southern Area Inspectors departed; 1600 Liberty granted to off duty sections to expire on board prior to 0545 Thursday February 16, 1956.⁶³

White Sumac was transferred to St. Petersburg, Florida, in 1976, where she worked the waters in and around Tampa Bay and along the Florida's west coast until 1998. On the western gulf coast, she was reported to have serviced 128 floating aid and twenty-four lighted structures between Apalachicola, Florida, to the north and Dry Tortugas to the south.⁶⁴

On June 5, 1978, *White Sumac* responded to a SAR call regarding a fire and explosion on the vessel *Joy Toy* off the coast of Ft. Lauderdale, Florida. In addition to rescuing three crew members from the water and extinguishing the fire, a search of the vessel uncovered 102 bales of marijuana being smuggled into the country.⁶⁵ In another instance, *White Sumac* spent a three-week deployment providing a working platform for Coast Guard and Navy divers conducting rescue and salvage operations on sunken cutter *Blackthorn*.⁶⁶

Buoys under the *White Sumac*'s jurisdiction guided tankers carrying chemicals including oil and ammonium into the shallow waters of Tampa Bay. Because the Bay is so shallow and navigation made hazardous by numerous sandbars, aids to navigation are crucial. On May 9, 1980, the pilot of the ship

Summit Venture lost control in a thunderstorm and rammed into the Sunshine Skyway Bridge, causing 1,200' of deck, along with a bus, pickup truck, and six cars, to fall into the water. Thirty-five people were killed. For three weeks, *White Sumac* assisted with rescue efforts. Other events in which *White*

Sumac participated included bringing up a Volkswagen Beetle with a dredge on the chain of a buoy and returning a beached whale named Byrdie to sea after she was rescued and rehabilitated by Sea World.⁶⁷ November 1980 brought a ten-day operation to recover a Coast Guard helicopter sunk 130



Coast Guard and Navy divers assemble on the buoy deck of White Sumac in preparation for diving on the sunken cutter Blackthorn which sank at the mouth of Tampa Bay on January 28, 1980 (USCG photo).

miles southwest of St. Petersburg. Hurricane seas prevented a successful recovery.⁶⁸

In September 1997, *White Sumac* celebrated “50 Years of Service Excellence in Florida,” reputedly the only Coast Guard cutter to have ever held this distinction. A newspaper article commemorating this event indicated that *White Sumac* was responsible for keeping a fleet of 235 navigational aids afloat and alight along both coasts of Florida.⁶⁹

In 1998, *White Sumac* was transferred to New Orleans to replace the *White Holly*, which was being taken out of commission. *White Sumac* spent four years at her new duty station servicing 175 buoys from Freshwater Bayou, Louisiana, to Gulfport, Mississippi, including the Mississippi River from the Gulf of Mexico to Baton Rouge, Louisiana. After 59 years of U.S. Coast Guard service, *White Sumac* was decommissioned on August 1, 2002. In her new career in the Dominican Republic Navy, *White Sumac* was commissioned *BA-2 Capotillo*. Her new duties—aims to navigation, vessel support and law enforcement—parallel her old.⁷⁰



Pilothouse on White Sumac (1999 HAER photo).

ENDNOTES

¹ U.S. Navy, Navy Dept. Bureau of Ships, *Detail specifications for building freight and ammunition lighters (self-propelled) YFs 335-341, 415-421, 443-454 for the United States Navy*, (Washington, DC: Government Printing Office, 1943) p. 2.

² *Ibid.*, pp. 6, 9.

³ Telephone interview with Don McCain, Erie, Pennsylvania, October 31, 2000; and USS *Bolster* website: <<http://home.neo.rr.com/jacke/conserver.htm>>.

⁴ U.S. Navy, Navy Dept. Bureau of Ships, *Detail specifications for building freight and ammunition lighters (self-propelled) YFs 335-341, 415-421, 443-454 for the United States Navy*, (Washington, DC: Government Printing Office, 1943), pp. 16, 28-29.

⁵ *Ibid.*, pp. 29-30.

⁶ According to Douglas Peterson, *United States Lighthouse Service Tenders, 1840-1839* (Annapolis, Maryland: Eastwind Publishing, 2000), p. xvii, the first propelled lightship was built in 1885.

⁷ *Ibid.*, p. 91.

⁸ Amy Kay Marshall, "Frequently Close to the Point of Peril: A History of Buoys and Tenders in U.S. Coastal Waters, 1789-1939" (Masters Thesis, East Carolina University, 1998), pp. 139-140.

⁹ RADM K.K. Covart, USCG, "Development of Vessels Servicing Aids to Navigation for the U.S. Coast Guard," *The Society of Naval Architects and Marine Engineers Transactions*, Vol. 66 (1958) p 517, p. 524.

¹⁰ Marshall, pp. 4, 100-101, 133.

¹¹ Department of Commerce Lighthouse Service, "Plans and Specifications for Buoys and Appendages, July 1, 1913," (Washington, D.C.: Government Printing Office, 1913), p. 3; found in National Archives, Record Group 26, Entry 50, "Correspondence of the Bureau of Lighthouses, 1911-1938," File 203.

¹² *Ibid.*, pp. 3-5.

¹³ Department of Commerce Lighthouse Service, "Plans and Specifications for Buoys and Appendages, July 1, 1916," (Washington, D.C.: Government Printing Office, 1913), p. 7; found in National Archives, Record Group 26, Entry 50, "Correspondence of the Bureau of Lighthouses, 1911-1938," File 203.

¹⁴ Marshall, p. 149.

¹⁵ Peterson, p. xii.

¹⁶ *Ibid.*, p. 146.

¹⁷ Covart, p. 517.

¹⁸ Wayne Wheeler, "Buoys: Guideposts of the Sea," *The Keeper's Log* (Fall 1986), p. 14.

¹⁹ Marshall, p. 133.

²⁰ Wheeler, "Buoys: Guideposts of the Sea," p. 14.

²¹ "5000th Aid to Navigation Converted to Solar Power!" *Engineer's Digest* (Summer 1986), p. 8.

²² Lt. Geoff Abbott, "A Life in the Sun," *Commandants Bulletin* (May 25, 1984), pp. 22-23.

²³ Harley Cleveland and Paul Glahe, "Everything You Wanted to Know about USCG Experience with Large Navigational Buoys," *Coast Guard Engineer's Digest*, Vol. 22, No. 218 (Spring 1983), pp. 31-33.

²⁴ Lt. Richard L. Boy, "Buoy Construction Changes: Computers, New Materials and Even Old Designs Alter the Way the Coast Guard Does ATON," *Commandant's Bulletin* (August 1990), pp. 30-31.

²⁵ Personal email communication dated August 8, 2001, from Donald L. Vinson, commanding officer on the USCGC *White Pine*, 1985-1988, 1992-1996.

²⁶ "KEEPER CLASS COASTAL BUOY TENDERS," U.S. Coast Guard Brochure, ca. 2001.

²⁷ "US Coast Guard 175' Coastal Buoy Tender," <<http://www.uscg.mil/datasheet/175wlm.htm>>, last updated April 1, 2003.

²⁸ Report in the "Basalt Rock Company" file in National Archives, (College Park, Maryland), Record Group 19: Bureau of Ships General Correspondence, 1940-1945, Box 181.

²⁹ Memo from the Navy Department Office of the Supervisor of Shipbuilding, U.S. Navy, San Francisco, California, to the President, Board of Inspection and Survey, Washington, D.C., dated June 10, 1944; found in *YF-341* file in National Archives, Record Group 19: Bureau of Ships General Correspondence, 1940-1945, Box 70.

³⁰ "Statistical Data" sheet found in *YF-341* file in National Archives, Record Group 19: Bureau of Ships General Correspondence, 1940-1945, Box 70.

³¹ Various correspondence found in *YF-341* file in National Archives, Record Group 19: Bureau of Ships General Correspondence, 1940-1945, Box 70.

³² “Welcome Aboard-USCGC *White Holly* WLM-543,” undated brochure found in ship files, U.S. Coast Guard Historian’s Office, Washington, D.C.

³³ The following description comes from Kevin Foster’s notes, 30 September 1999.

³⁴ Undated Coast Guard memo from Dave Cipra to Joe Leahy, on file in the USCG Historian’s Office, Washington, D.C.

³⁵ Robert L. Scheina, *U.S. Coast Guard Cutters & Craft 1946-1990* (Annapolis: Naval Institute Press, 1990), p. 133.

³⁶ Logbook found in National Archives (Washington, D.C.), Entry 26.

³⁷ Apparently the USCGC *Zinnia* served in the interim period before being decommissioned.

³⁸ “Welcome Aboard–USCGC *White Holly*.”

³⁹ Chuck Kalnbach, “Up the River: Working aids to navigation on the Mississippi River a unique mission,” Coast Guard News Release 91-86, 7 November 1986.

⁴⁰ Kalnbach, “Up the River.”

⁴¹ Dennis Noble, “A History of Coast Guard Operations on the Gulf Coast and the Western Rivers,” reproduced on the U.S. Coast Guard Historian’s web site at <http://www.uscg.mil/hq/g-cp/history/h_Westernrivers.html>.

⁴² Mike Casey and Dave Helms, “More coastal ship channels reopening,” *The Mobile Press Register*, 8 September 1985.

⁴³ “Who We Are: A Short History of Canvasback” reproduced on their web site at <<http://www.canvasback.org/mission/Who.html>> and personal communication dated October 21, 2003, from Cheryl Perry, Special Projects Assistant at the Canvasback Missions, Inc.

⁴⁴ Luther C. Leavitt, Jr., “Original Plant Survey of Erie Concrete and Steel Supply Company at Erie, Pennsylvania,” dated January 8, 1942; found in the “Erie Concrete and Steel Supply Co.” file in National Archives, Record Group 19: Bureau of Ships General Correspondence, 1940-1945, Box 422.

⁴⁵ Scheina, pp. 132-133.

⁴⁶ “Record of Inspections for the USCGC *White Pine* (WLM-547), 8th CG District, from 23 August 1976 to 29 April 1982,” found in ship files, U.S. Coast Guard Historian’s Office, Washington, D.C.

⁴⁷ “World Navies Today: US Navy Vessels Decommissioned Since 1980” at <<http://www.hazegray.org/worldnav/>>.

⁴⁸ Correspondence found in YF-344 file in National Archives, Record Group 19: Bureau of Ships General Correspondence, 1940-1945, Box 79.

⁴⁹ Found in ship files, U.S. Coast Guard Historian’s Office, Washington, D.C.

⁵⁰ The following description is based on Kevin Foster’s notes from site visit, 30 September 1999.

⁵¹ “Welcome Aboard–USCGC *White Sage* WLM-544, 1943-1996,” program for decommissioning ceremony, 7 June 1996, found in ship files, U.S. Coast Guard Historian’s Office, Washington, D.C.

⁵² Memo dated 3 January 1950, from C.L. Jordan, Commanding Officer, Coast Guard Depot, Woods Hole, Massachusetts, to Captain W.B. Chiswell, ATON Section.

⁵³ Scheina, p. 133.

⁵⁴ PA3 Weatherall, fax dated 4 August 1998, containing Coast Guard Cutter *White Sage* history, located in ship files, U.S. Coast Guard Historian’s Office, Washington, D.C.

⁵⁵ Ibid.

⁵⁶ Undated brochure entitled “Welcome Aboard–USCG *White Sumac* WLM-540” found in ship files, U.S. Coast Guard Historian’s Office, Washington, D.C.

⁵⁷ In 1969, her full complement was twenty-one men. Berthing arrangements did not accommodate women crew members; it is not known whether any women served as officers on the 133’ class buoy tenders.

⁵⁸ William Gilmor, YN3, “Gold Coast to Conch Town: Down the Florida Keys with the Cutter *White Sumac*,” undated article found in ship files, U.S. Coast Guard Historian’s Office, Washington, D.C.

⁵⁹ Ibid.

⁶⁰ Ibid.

⁶¹ Ibid.

⁶² Scheina, p. 133.

⁶³ Logbook found in National Archives (Washington, D.C.) Record Group 26.

⁶⁴ “Welcome Aboard–CGC *White Sumac*.”

⁶⁵ Ibid.

⁶⁶ PA1 Lance Jones, “Black hull means hard work,” *Commandant’s Bulletin* (July 20, 1981), p. 11.

⁶⁷ Tiffany Muri, “Cutter celebrates 50 years of service,” *Coastline* (August 1997).

⁶⁸ Jones, “Black hull,” p. 11.

⁶⁹ Murri, “Cutter celebrates 50 years,” p. 6.

⁷⁰ PA2 Fa’iq EL-Amin, “CGC *White Sumac* Leaves Service After 59 Years,” press release from U.S. Coast Guard Eighth District Public Affairs, dated August 1, 2002.



As part of maintenance, White Pine's crew removes rusty ladder for repair (1999 HAER photo).