

NIST

National Institute of
Standards and Technology

Technology Administration

U.S. Department of
Commerce

NISTIR 7369

January 2007

ELECTRONICS AND ELECTRICAL ENGINEERING LABORATORY

OPTOELECTRONICS DIVISION

PROGRAMS, ACTIVITIES, AND ACCOMPLISHMENTS

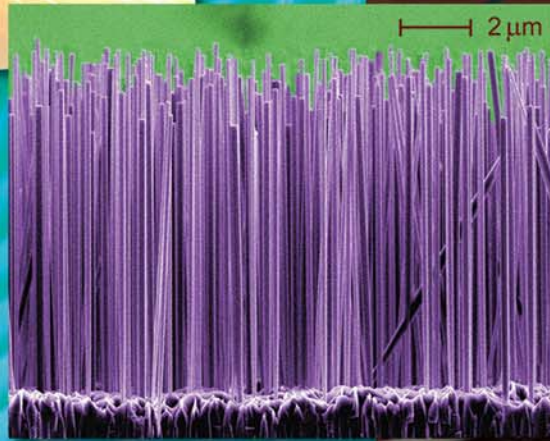
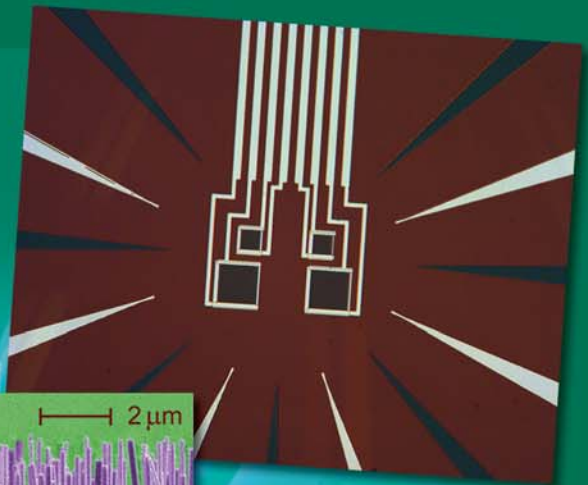
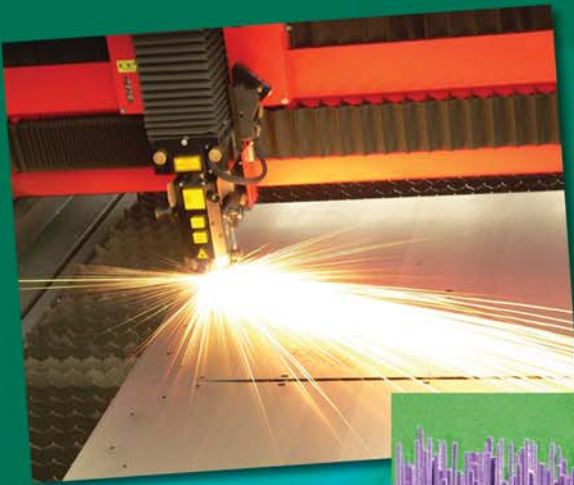

THE ELECTRONICS AND ELECTRICAL ENGINEERING LABORATORY

One of NIST's seven Measurement and Standards Laboratories, EEEL conducts research, provides measurement services, and helps set standards in support of: the fundamental electronic technologies of semiconductors, magnetics, and superconductors; information and communications technologies, such as fiber optics, photonics, microwaves, electronic displays, and electronics manufacturing supply chain collaboration; forensics and security measurement instrumentation; fundamental and practical physical standards and measurement services for electrical quantities; maintaining the quality and integrity of electrical power systems; and the development of nanoscale and microelectromechanical devices. EEEL provides support to law enforcement, corrections, and criminal justice agencies, including homeland security.

EEEL consists of four programmatic divisions and two matrix-managed offices:

Semiconductor Electronics Division

Optoelectronics Division

Quantum Electrical Metrology Division

Electromagnetics Division

Office of Microelectronics Programs

Office of Law Enforcement Standards

This document describes the technical programs of the Optoelectronics Division. Similar documents describing the other Divisions and Offices are available. Contact NIST/EEEL, 100 Bureau Drive, MS 8100, Gaithersburg, MD 20899-8100, Telephone: (301) 975-2220, On the Web: www.eeel.nist.gov

Cover caption: On the right are photographs of a superconducting single photon detector used for measurements, and an optical fiber instrument. Laser welding is depicted on the left, and the photograph in the center shows GaN nanowires grown in our laboratories. These images are overlaid onto a large micrograph of circular Bragg gratings developed to increase the extraction of light from light emitting diodes. All are examples of the diverse uses and applications of optoelectronics served by the Division.

ELECTRONICS AND ELECTRICAL
ENGINEERING LABORATORY

OPTOELECTRONICS DIVISION

PROGRAMS, ACTIVITIES, AND
ACCOMPLISHMENTS

NISTIR 7369

January 2007

U.S. DEPARTMENT OF COMMERCE

Carlos M. Gutierrez, Secretary

Technology Administration

Robert Cresanti, Under Secretary of Commerce for Technology

National Institute of Standards and Technology

William Jeffrey, Director



Any mention of commercial products is for information only; it does not imply recommendation or endorsement by the National Institute of Standards and Technology nor does it imply that the products mentioned are necessarily the best available for the purpose.

CONTENTS

Welcome.....	iv
About the Optoelectronics Division.....	v
Optoelectronics Division Staff.....	vi
Laser Radiometry.....	1
Display Metrology.....	6
High-Speed Measurements.....	10
Interferometry and Polarimetry.....	14
Spectral and Nonlinear Properties.....	19
Nanostructure Fabrication and Metrology.....	23
Quantum Information and Terahertz Technology.....	27
Optical Materials Metrology.....	33
Semiconductor Growth and Devices.....	37
Appendix A: Major Laboratory Facilities.....	41
Appendix B: NRC Post-Doc and Other Research Opportunities.....	42
Appendix C: Conferences and Workshops.....	51
Appendix D: Calibration Services.....	54
Appendix E: Standard Reference Materials.....	58

WELCOME

The Optoelectronics Division is a group of about 60 scientists, engineers, and support staff who work to improve the measurement infrastructure for the optoelectronics industry. Herein, you will find both brief descriptions of our program areas and examples of some of our research, development, and metrology goals. More current information is available on our web site at www.boulder.nist.gov/div815/. Please contact us if we can be of assistance.

We take metrology seriously. In optoelectronics, as in many other fields, it is a key part of the industrial infrastructure that establishes competitiveness. Consistently specified products are essential in fair trade, and measurements are a key element in efficient manufacturing. The cost of measurements often ranges between 10 % and 30 % of the cost of producing a product. So while the optoelectronics industry, along with many other high technology fields, continues to struggle, advancing the field of optoelectronics metrology remains an important task.

We maintain the U.S. national standards for laser power and energy measurements (see Appendix D) and use them to provide the broadest range of laser calibration capabilities available anywhere. Each year we perform over 200 calibrations of power- or energy-measuring instruments for more than 50 customers. We also provide artifact calibration standards, which we call Standard Reference Materials, for over a dozen parameters (see Appendix E for details). These components provide customers with the capability of performing periodic instrument calibrations traceable to national standards in their own laboratories.

We are developing new tools and techniques for measurements in the rapidly advancing field of nanotechnology and quantum optics. We develop measurement techniques for components and subsystems that can be used online and *in situ* in the manufacture of optoelectronic materials. We perform measurements to provide reference data on the optical properties of important optoelectronic materials. And we work closely with major standards-developing organizations, especially the Telecommunications Industry Association (TIA), the Video Electronics Standards Association (VESA), the International Electrotechnical Commission (IEC), and the International Organization for Standards (ISO), in developing industry standards.

Our intent is to be the preeminent source of optoelectronics metrology in the world. We strive to provide the best optoelectronic measurement services possible and perform the research and development that best enhances measurement sciences in optoelectronics. If you have any suggestions on how we can improve or how we can serve the industry better, please let me know.

Kent Rochford
Chief, Optoelectronics Division
National Institute of Standards and Technology
(303) 497-5342
<http://www.boulder.nist.gov/div815>
rochford@boulder.nist.gov

ABOUT THE OPTOELECTRONICS DIVISION

MISSION

The mission of the Optoelectronics Division is to provide the optoelectronics industry and its suppliers and customers with comprehensive and technically advanced measurement capabilities and standards, and traceability to those standards.

HISTORY

The Division is located in Boulder, Colorado, as a part of the NIST Boulder Laboratories. It was established in 1994, succeeding an earlier NIST organizational unit, the Optical Electronic Metrology Group of the Electromagnetic Technology Division. The Division's roots extend to the first NIST (NBS) work on optoelectronics—research begun in the early 1960s to develop techniques for measuring the output power or energy of a laser. Since the late 1960s, NIST research on measurement and standards to support the development and application of lasers has been centered in the Boulder Laboratories. Research related to optical communications was added in the mid-1970s. Research in nanophotonics began in the 1990s, and this now represents more than half of the Division's effort.

ORGANIZATION

The Division is organized into three Groups. Two Groups, the Sources, Detectors and Displays Group and the Optical Fiber and Components Group, focus on the characterization of lasers, detectors, and other optoelectronic components. The third, the Optoelectronic Manufacturing Group, focuses on measurements that can lead to more efficient manufacturing of optoelectronic materials and components, and has significant efforts in nanoscale optoelectronic devices.

RESEARCH AND SERVICES

Most of the research performed in the Division is conducted either with NIST-appropriated funds or under contract to other U.S. government agencies. Results are typically placed in the public domain through publication in the open literature. Some results become the subject of patents, and are available for license. The Division also conducts proprietary research in collaboration with industry and universities through Cooperative Research and Development Agreements (CRADAs).

The Division and its predecessor organizations have been providing calibration services for the characterization of lasers and detectors since 1967, and each year conducts over 200 calibrations for about 50 customers. It also provides the industry with standard reference materials, which are artifact standards that can be used by customers to calibrate their own instrumentation.

The Division maintains close contact with the optoelectronics industry through major industry associations, including the Optoelectronics Industry Development Association (OIDA), the Lasers and Electro-optics Manufacturer's Association (LEOMA), and the Council for Optical Radiation Measurements (CORM). Division staff members represent NIST to the major domestic and international standards organizations active in optoelectronics — the Telecommunications Industries Association (TIA), the International Electrotechnical Commission (IEC), the International Organization for Standardization (ISO), Society for Information Display (SID), and the American National Standards Institute (ANSI) — and provide impartial technical expertise in their negotiations.

OPTOELECTRONICS DIVISION STAFF

DIVISION OFFICE 815.00

<i>Name</i>	<i>Extension*</i>
ROCHFORD, Kent B., Chief	5285
SMITH, Annie J., Secretary	5342
McCOLSKEY, Kathy S., Administrative Officer	3288
CASE, William E. (CTR)	3741
LOMAX, John, Secretary	3842
GORMAN, Mary., Secretary	4384

SOURCES, DETECTORS AND DISPLAYS (815.01)

DOWELL, Marla L. (GL)	7455	LEHMAN, John H. (PL)	3654
BOYNTON, Paul A. (PL)	(301) 975-3014	LEONHARDT, Rodney W.	5162
CROMER, Christopher L.	5620	LI, Xioyu	3621
GILBERT, Katie	4884	LIVIGNI, David J.	5898
HADLER, Joshua A.	4451	RAMADURAI, Krishna (GR)	4977
HALE, Paul D. (PL)	5367	STREET, Lara (CTR)	4969
JARGON, Jeffrey	4961	VAYSHENKER, Igor	3394
KEENAN, Darryl A.	5583	WEPMAN, Joshua (CTR)	5409
KELLEY, Edward F.	4599	YANG, Shao	5409

OPTICAL FIBER AND COMPONENTS (815.03)

ROCHFORD, Kent B. (Act.GL)	5285	ESPEJO, Robert J. (PREP Grad)	7630
CODDINGTON, Ian (NRC PD)	4889	ETZEL, Shelley M.	3287
DENNIS, Tasshi	3507	NEWBURY, Nathan R. (PL)	4227
DRAPELA, Timothy J.	5858	SWANN, William C.	7381
DYER, Shellee D.	7463	WILLIAMS, Paul A. (PL)	3805

OPTOELECTRONIC MANUFACTURING (815.04)

HICKERNELL, Robert K. (GL)	3455	ROWE, Mary A. (CTR PD)	7879
BERTNESS, Kristine A. (PL)	5069	SANDERS, Aric (CTR)	4731
BLANCHARD, Paul (CTR)	4799	SANFORD, Norman A. (PL)	5239
BRILLIANT, Nathan (GR)	4800	SCHLAGER, John B.	3542
CHISUM, Jonathan (PREP-G)	4986	SILVERMAN, Kevin L.	7948
CLEMENT, Tracy	3052	STEVENS, Martin (CTR PD)	4740
DIETLEIN, Charles (GR)	4843	SU, Mark	7368
FENG, Ming Ming (GS)	4808		
GERRITS, Thomas (CTR)	4661		
GREENE, Marion (CTR)	4579		
GROSSMAN, Erich N.	5102		
GRUBER, Stephen (PREP-G)	4913		
HADFIELD, Robert (GR)	5309		
HARVEY, Todd	3340		
LITA, Adrianna (CTR)	4608		
MANSFIELD, Lorelle (PREP-G)	4793		
MIGACZ, Justin, PREP-UG)	4835		
MIRIN, Richard P. (PL)	7955		
NAM, Sae Woo (PL)	3148		
ROSHKO, Alexana	5420		
ROURKE, Devin (PREP-UG)	4908		

Legend:

CTR = Contractor

CTR PD = Contractor Post-doctoral

GL = Group Leader

GS = Guest Scientist

PD = Post-doctoral Appointment

PREP PD = PREP Post-doctoral

PL = Project Leader

* Telephone numbers are (303) 497-XXXX,
with the four-digit extension given after the name

LASER RADIOMETRY

GOALS

Develop measurement methods and standards for characterizing laser sources and detectors used with laser radiation spanning in wavelength coverage from ultraviolet excimer lasers to mid-infrared lasers. Develop and maintain measurement services for laser power and energy, optical-fiber power, and related parameters (spectral responsivity, linearity, etc.).

CUSTOMER NEEDS

Accurate characterization of optoelectronic sources and detectors is important in the development and use of industrial technologies such as lightwave telecommunications, laser-based medical instrumentation, materials processing, photolithography, data storage, and laser safety equipment. The Laser Radiometry Project focuses on selected critical parameters intrinsic to sources and detectors, especially the calibration of optical-fiber power meters and laser power or energy meters at commonly used wavelengths and powers or energies. In addition, special test measurements are available for linearity, spectral responsivity, and spatial and angular uniformity of laser power meters and detectors. Project members participate in national and international standards committees developing standards for laser safety, laser radiation, and optical-power-related measurements. They extend and improve source and detector characterizations, including development of low-noise, spectrally flat, highly uniform pyroelectric detectors; high-accuracy transfer standards for optical-fiber and laser power measurements; and advanced laser systems for measurements of laser power and energy.

The Project supports research on new standards and measurement methods for both continuous wave and pulsed-laser measurements. Accurate measurement methods and standards for characterizing pulsed-laser sources and detectors pose particular research challenges and are critical in a number of industrial applications. Project efforts in the pulsed-laser area include development work in standard detectors, calibration services, and advising customers on in-house measurement capabilities. The bulk of our work in the pulsed-laser area is concentrated on ultraviolet (UV) excimer lasers and to the IR Q-switched lasers. Industrial applications for pulsed lasers include semiconductor manufacturing, metal fabrication, cutting, and

welding with Q-switched IR lasers. In addition, these lasers are used in military settings for target designation and range finding.

TECHNICAL STRATEGY

Meeting the needs of the laser and optoelectronics industries and anticipating emerging technologies requires investigation and development of improved measurement methods and instrumentation for high-accuracy laser metrology over a wide range of powers, energies, and wavelengths.

ACCURACY OF CALIBRATION SERVICES

NIST has historically used electrically calibrated laser calorimeters to provide traceability to the SI units for laser power and energy. In addition, we have a measurement capability based on a Laser-Optimized Cryogenic Radiometer (LOCR) that improves the accuracy of measurement of laser power by an order of magnitude as compared to electrically calibrated radiometers. To meet the increasing demands for higher accuracy over a larger range of optical power and wavelength, it is necessary to improve the accuracy of calibration services through the development of better transfer standards that are traceable to the LOCR. We are also developing the next generation primary standards to bridge the gap between classical and quantum laser radiometry.

STANDARDS FOR OPTICAL FIBER POWER MEASUREMENTS

The continuing development of new optical-based telecommunications systems has led to demands for higher performance and higher accuracy for optical-fiber power meter characterization and calibration. Many of these new systems being developed demand higher power for optical-fiber power meter (OFPM) characterization and calibration. As much as several watts in fiber is being used in systems to pump laser sources for new applications. In addition, the Department of Defense (DOD) is accelerating the implementation of optical fiber in many of its new weapons systems. By developing improved standards for optical fiber power and by developing instrumentation to accurately quantify the uncertainties of the new standards, we can meet these demanding requirements.

Technical Contact:
John Lehman

Staffing (FY06):
7 professionals
2 research associates

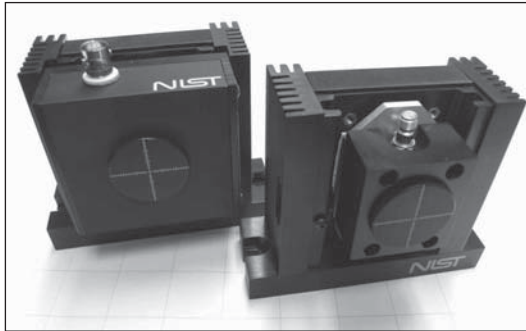

Diode based (left) and pyroelectric (right) transfer standards for optical fiber power measurements.

NEW COATING TECHNOLOGIES FOR LASER STANDARDS

Single-wall (SWNT) and multiwall (MWNT) carbon nanotubes may form the basis of the next generation of absorber coatings for thermal detectors for high-accuracy optical and thermal radiometry, particularly for high-energy and ultraviolet laser radiometry. Currently, all of the primary standards in the U.S. and elsewhere that are used to establish traceability to SI radiometry units are based on thermal detectors. All of these devices employ some form of thermal absorber coating such as a carbon-based paint or diffuse metal coating (*e.g.*, gold-black). We are developing carbon nanotube coatings for thermal detectors as a highly desirable advance over current state of the art. These coatings must be resistant to damage and aging while maintaining desirable optical and thermal (spectral, spatial, directional uniformity, high thermal conductivity) properties. We have recently demonstrated optical detectors with absorptive coating consisting of SWNTs, and MWNTs. In addition we have undertaken the evaluation of damage properties of carbon nanotubes and carbon nanotube composites on a variety of detector platforms

PLAN: Demonstrate the next generation of coatings for laser power and energy measurement standards based on carbon nanotubes (CNTs). The coatings will allow us to expand existing measurement services to include UV laser measurements and high-power laser diode measurements. Demonstrate thermal detectors suitable for the range of laser wavelengths served by our calibration services (0.157 μm to 10.6 μm).

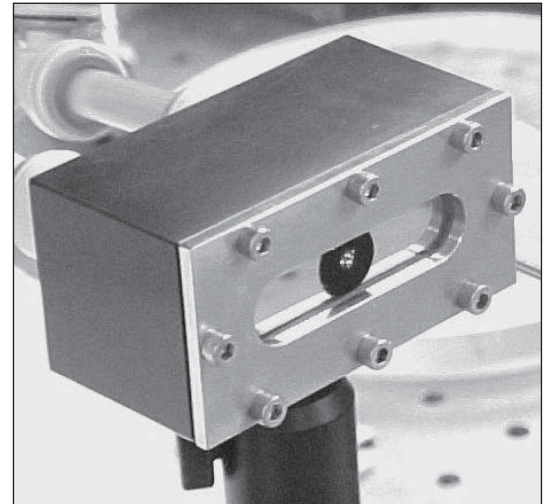

Laser induced damage testing of thermal detector coatings. The orange glow is that of single wall nanotubes (black circular area) exposed to $\sim 1 \text{ kW/cm}^2$ at 10.6 μm .

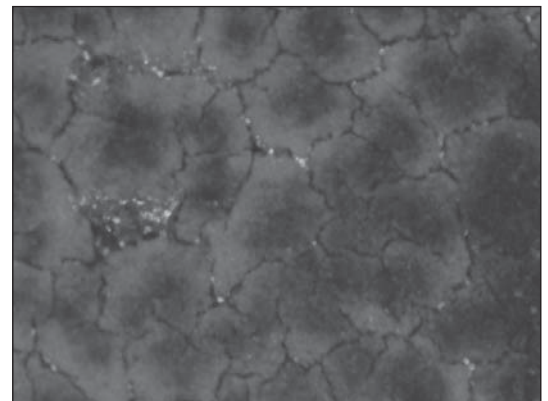

Laser damage of silica based optical absorber (black paint) indicated by cracks and white glassy surfaces.

CHARACTERIZATION OF HIGH-EFFICIENCY DIODE SOURCES

We are expanding our calibration services to include measurements of high-efficiency laser diode sources. These measurements include evaluations of the thermal, optical, and electrical properties of the diode sources. We have developed a water-cooled optical radiometer that is capable of accurate optical power measurements up to approximately 100 W. This work supports ongoing developments of high-power diode sources for diode-pumped lasers for a variety of applications.

PLAN: Provide measurement services for the characterization of high-power diode sources, *e.g.*, wall plug efficiencies and laser beam profiles.

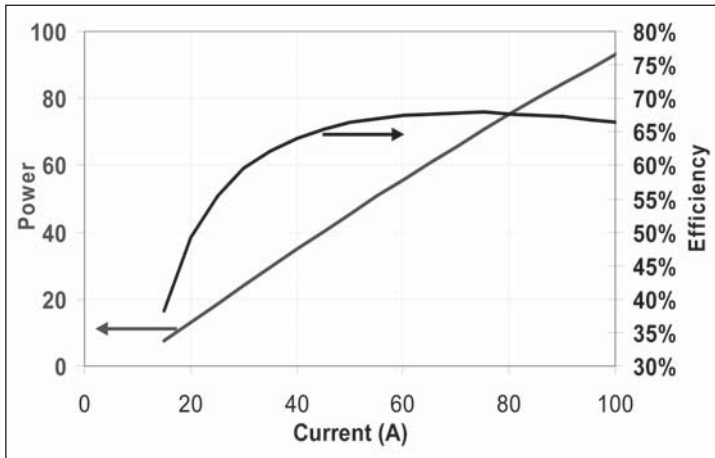

Wall plug efficiency of 980 nm diode bar.

INTERNATIONAL AND NMI COLLABORATION

Along with AIST, METAS and PTB, we have undertaken intercomparisons of optical fiber power measurements in terms of absolute responsivity and linearity. NPL and NIST have recently documented the outcome of several ongoing collaboration efforts to establish improved transfer standards for infrared radiometry. As part of this work we were the first to demonstrate a multiwall carbon nanotube coated detector for spectral responsivity measurements at wavelengths greater than 10 μm . We also recently delivered several optical detectors to METAS to establish the basis of their optical fiber power meter calibrations, particularly at common optical communications wavelengths

PULSED-TO-CW TRANSFER STANDARDS

There is a need for higher-accuracy calibration of laser-energy meters for pulsed-laser radiation from 3 μJ to 30 mJ with 8 ns to 20 ns pulse duration, and pulse repetition rates from 1 Hz to 20 Hz. Currently the uncertainty of these measurements using commercially available meters is at the level of 5 % or higher. Traceability through comparisons using the more accurate LOCR are not possible because of the inabilities of existing transfer standards to accurately measure both cw and pulsed laser radiation. We are developing a transfer standard that will provide traceability to both pulsed and cw NIST primary standards (including the LOCR and Q-series calorimeter).

PLAN: To improve, by at least a factor of five, the uncertainty capability of a transfer standard traceable to the LOCR in cw operation, but used normally in measurements involving pulsed laser energy with the Q-series standards. This project is sponsored by the US Army and Navy to improve measurements related to the evaluation of range finders and target designator systems.

BLUE/UV LASER METROLOGY

We have initiated a program to optimize the LOCR and to develop appropriate transfer standards

for low-power cw laser measurements at laser wavelengths shorter than 400 nm in support of the detection of chemical and biological aerosols. We recently demonstrated a UV calibration of a NIST transfer standard by means of intercomparison with the C-series calorimeter and the Laser Optimized Cryogenic Radiometer, thus extending our range of calibration services to 375 nm. This work will continue as UV laser diodes (expected by OIDA to be a \$4B industry by 2010) at shorter wavelengths (255 nm to 375 nm) become available. We recently reported to the Council for Optical Radiation Measurements that UV photodiodes exhibit large degrees of nonlinearity, depending on laser pulse width, energy and frequency, which is undesirable for most measurement applications. This information is very valuable for making improved laser systems and optimizing new laser applications.

PLAN: Pursue new technologies to improve our measurement capability, including improved transfer standards, improved coatings for thermal detectors, and optimization of the LOCR for blue and UV laser power measurement traceability.

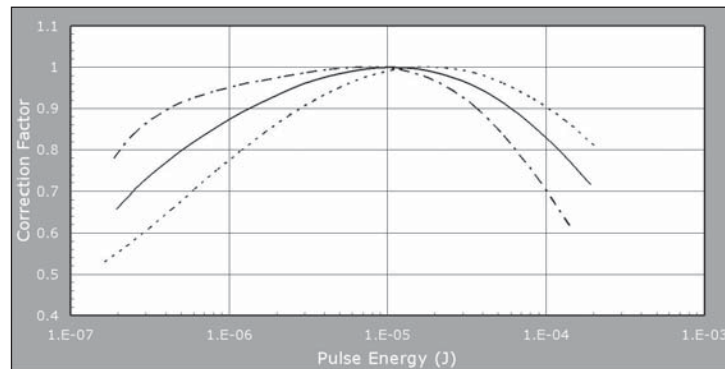

Nonlinearity of UV photodiodes for pulsed laser measurements at three different bias voltages.

METROLOGY FOR EYE-SAFE LASER TARGET SYSTEMS

Recently there has been increasing demand to extend the wavelength range of laser target ranging and designation systems to the eye-safe laser regime. These laser systems provide positional information, such as distance and incident angle, for use in locating targets. There is a need to extend existing pulsed Nd:YAG laser power and energy calibration services to include measurements at 1.55 μm and to reduce the overall uncertainty associated with these measurements. In addition, there is need for high-power attenuators both at 1 μm and 1.5 μm . Commercially available laser attenuators do not have the required durability and linearity when used with the hundreds of millijoules from these high-power Q-switched lasers.

PLAN: Develop capabilities for measurements of high pulse energy at 1.5 μm . Design, build, and characterize an improved calibration service for measurements of attenuators for use with Q-switched Nd:YAG lasers.

ACCOMPLISHMENTS

- Completed the first phase of participation in a DARPA sponsored program to evaluate the wall plug efficiency of high efficiency diode sources. As part of this, we have developed a novel flowing water power meter suitable for measuring optical power from diode sources and that is scalable to kW/cm^2 .

- Evaluated a bulk form of single-wall carbon nanotubes (SWNTs) as a coating for future optical standards. The absorption efficiency of SWNT coatings is greater than that which was expected for the bare (uncoated) detector. Furthermore, the detector's response (and hence the absorption of the SWNT coatings) varies by less than 1 percent as a function of wavelength from 600 nm to 1800 nm. The nanotube-based coatings do not compromise the detector performance. These encouraging results indicate that once an optimized SWNT coating has been achieved, the expected detector responsivity of a SWNT-coated standard should surpass the performance of current gold-black coated standards. The resulting SWNT-coated detector will be a more robust, spectrally flat optical standard.

- Completed intramural comparison of NIST laser and optical fiber power calibration services. The comparison demonstrated equivalence of NIST absolute responsivity measurement services at laser wavelengths of 633, 850, 1060, 1310, and 1550 nm use of NIST check standards. The results indicated

that the responsivity of the check standards, as determined independently by the various calibration services, agreed to within the published expanded uncertainties ranging from 0.02 % to 1.24 %.

- Demonstrated that the accuracy of optical-fiber power measurements depends on the type and manufacturer of the fiber connector. A comparison of absolute responsivity measurement results for four different optical-fiber power meter standards at 850 nm, 1310 nm and 1550 nm for five different types of fiber connectors (FC, ST, biconic, SC, and SMA) produced by three different manufacturers yielded reproducible offsets as large as 4.6 % in detector calibration factors due to fiber connector types.

- Established a measurement system for characterizing detector nonlinearities at 193 nm. This service is an inexpensive alternative to customers who are more concerned with the relative, rather than the absolute, response of their detectors. The primary reason for its lower cost is the reduced turnaround time; a measurement of linearity takes only one-third the time of a full calibration.

- Completed an internal comparison of all three excimer laser calorimeters at 157 nm, 193 nm, and 248 nm. The 193 and 248 nm comparisons show agreement to less than 0.3 %.

CALIBRATIONS

The Optoelectronics Division provides calibration services for laser and optical-fiber power at many wavelengths and power levels from the ultraviolet and far-IR spectral regions, and from picowatt to kilowatt power levels. See Appendix D for a list of available calibrations.

Current information for fees and contact is available at <http://ts.nist.gov/ts/htdocs/230/233/calibrations/optical-rad/laseroptoelectronic.htm>

STANDARDS COMMITTEE

PARTICIPATION

American National Standards Institute: John H. Lehman is a member of committee Z136, subcommittees SSC-01 and SSC-04, which deal with safe use of lasers.

Telecommunications Industry Association: Igor Vayshenker is a member of subcommittee FO-4.9, which deals with metrology and calibration.

International Standards Organization: Marla L. Dowell is a member of working group TC 172/SC 9/WG 1 and WG6, which deals with terminology

and test methods for lasers, and a member of working group TC 172/SC 1/WG 1 and WG6, which deals with general optical test methods.

Optics and Electro-Optics Standards Council (OEOSC): Marla L. Dowell is Chairperson-elect and IEEE-LEOS representative.

U.S. National Committee/International Electrotechnical Commission: John H. Lehman is a member of technical committee TC76, working groups 1 and 3, which deal with laser radiation measurement and safety.

RECENT PUBLICATIONS

E. Theocharous, R. Deshpande, A. C. Dillon, and J. Lehman, "Evaluation of a pyroelectric detector with a carbon multiwalled nanotube black coating in the infrared," *Appl. Opt.*, Vol. 45, pp. 1093–1097 (2006).

K. Gilbert, A. Dillon, J. Blackburn, J. Lehman, "Toward rapid and inexpensive identification of carbon nanotubes," *Appl. Phys. Lett.*, Vol. 88, 143122 (2006).

A. C. Dillon, A. H. Mahan, R. Deshpande, J. L. Alleman, J. L. Blackburn, P. A. Parillia, M. J. Heben, C. Engtrakul, K. E. H. Gilbert, K. M. Jones, R. To, S.-H. Lee, J. H. Lehman, "Hot-wire chemical vapor synthesis for a variety of nano-materials with novel applications," *Thin Solid Films*, Vol. 501, pp. 216–220 (2006).

J. H. Lehman, R. Deshpande, P. Rice, B. To, A. C. Dillon, "Carbon multi-walled nanotubes grown by HWCVD on a pyroelectric detector," *Infrared Physics and Technology*, Vol. 47, pp. 246–250 (2005).

H. Laabs, D. A. Keenan, S. Yang, and M. L. Dowell, "Measurement of detector nonlinearity at 193 nm," *Appl. Opt.*, Vol. 44, No. 6, pp. 841–848 (2005).

J. H. Lehman, A. C. Dillon, C. Engtrakul, "Carbon nanotubes based coatings for laser power and energy measurements using thermal detectors," *Conference on Lasers and Electro-Optics, OSA Technical Digest* (Optical Society of America, Washington DC) (2004).

J. H. Lehman, I. Vayshenker, D. J. Livigni, J. Hadler, "Intramural comparison of NIST laser and optical fiber power calibrations," *J. Res. Natl. Inst. Stand. Technol.*, Vol. 109, pp. 291–298 (2004).

D. L. Livigni, "High accuracy laser power and energy meter calibration service," *NIST Spec. Publ.*, pp. 250–62 (2003).

J. H. Lehman and C. Pannell, "Position and temperature dependence of pyroelectricity in domain-engineered stoichiometric and congruent LiTaO₃," *Ferroelectrics*, Vol. 296, pp. 39–55 (2003).

J. H. Lehman, E. Theocharous, G. Eppeldauer, C. Pannell, "Gold-black coatings for freestanding pyroelectric detectors," *Meas. Sci. Technol.*, Vol. 14, pp. 916–922 (2003).

I. Vayshenker, H. Haars, X. Li, J. H. Lehman, and D. J. Livigni, "Optical-fiber power meter comparison between NIST and PTB," *J. Res. Natl. Inst. Stand. Technol.*, Vol. 108, pp. 391–394 (2003)

J. H. Lehman and C. L. Cromer, "Optical trap detector for calibration of optical fiber power meters: coupling efficiency," *Appl. Opt.*, Vol. 41, No. 31, pp. 6531–6536 (2002).

J. H. Lehman, A. M. Radojevic and R. M. Osgood, Jr., "Domain-engineered thin-film LiNbO₃ pyroelectric-bicell optical detector," *IEEE Phot. Tech. Lett.*, Vol. 13, pp. 851–853 (2001).

C. L. Cromer, M. L. Dowell, R. D. Jones, D. A. Keenan, and S. Yang, "A primary standard for 157 nm excimer laser measurements," in *AIP Conf. Proc., Characterization and Metrology for ULSI Tech.*, No. 683, pp. 409–412 (2003).

H. Laabs, R. D. Jones, C. L. Cromer, M. L. Dowell, V. Liberman, "Damage testing of partial reflectors for 157 nm laser calorimeters," *Proc., SPIE, Laser-Induced Damage in Optical Materials 2001*, Vol. 4679, pp. 332–338 (2002).

DISPLAY METROLOGY

Technical Contact:
Paul Boynton

Staffing (FY06):
2 professionals

GOALS

By merging television, computers, and telecommunications into advanced digital video and computer systems, manufacturers are providing new services for education, engineering, manufacturing, robotics, entertainment, medicine, defense, security, transportation, publishing, advertising, banking, and government. A critical element in this convergence is the use of electronic displays in an interchangeable fashion in all of these systems. Although displays are manufactured primarily offshore, U.S. manufacturers are the largest consumer of displays. To facilitate worldwide commerce in displays, a well-defined method for specification and verification of display quality is needed to ensure that the display will work under the necessary lighting conditions. NIST is working with industry standards-developing organizations to ensure such equity in the marketplace by developing the metrology base for displays.

CUSTOMER NEEDS

The United States is a major buyer of electronic displays for computer, consumer, automotive, medical, telemedicine, and avionics use. Sound metrology is urgently needed in this highly competitive environment of new and emerging display technologies. Furthermore, universally recognized and accepted standards and measurement methods are needed to provide customers with tools to use in choosing the best display for their applications.

TECHNICAL STRATEGY

This project is concerned with display metrology in general and involves numerous ongoing tasks. However, we focus our research on specific issues identified by industry as particularly important.

REFINEMENT OF MEASUREMENT PROCEDURES

We are developing and refining measurement procedures in support of ongoing electronic display metrology, and applying the results in the development of national and international standards for characterization of flat panel displays.

PLAN: To support the revision of the Video Electronics Standards Association (VESA) Flat Panel Display Measurement Standard (FPDM) through the development of new measurement methods and written standards.

CHARACTERIZATION OF REFLECTION COMPONENTS

The measurement systems and methods to characterize the three components of reflection (Lambertian, specular, and haze) associated with displays are being developed. Development and implementation of robust methods are needed to characterize display reflection performance under actual conditions, for example, the readability of automotive displays in high ambient light conditions.

PLAN: Analyze and publish the success of our variable-radius-source method in capturing the specular component and haze peak in making robust reflection measurements. (This is a collaborative effort with NIST's Optical Technology Division). Develop methods to characterize displays for sunlight readability applications.

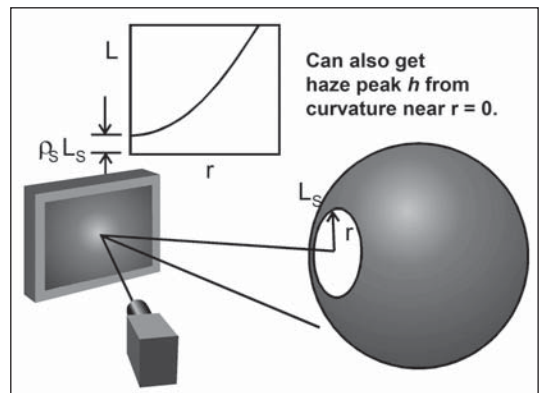

Variable Radius Source Method for Isolation of specular (ζ) and haze (h) reflection components.

NEW INTERLABORATORY COMPARISON STANDARDS

To determine the measurement capabilities of participating laboratories in an interlaboratory comparison effort, this project has developed a multifilter source-display measurement assessment transfer standard (DMATS) that can be shared among participating laboratories. The combination of all the targets will provide a benchmark of the capabilities of participating laboratories in making conventional luminance and color measurements. Typically, light-source calibrations involve only a white point. These new standards include the white point and much of the color gamut. A simplified version of this apparatus employing filter wheels instead of a filter array has been developed. This apparatus is referred to as the gamut assessment standard (GAS). The DMATS/GAS solution is es-

essential to resolving issues of color transportability in E-commerce by assuring that the color measurement instrumentation employed is sufficiently reliable to discriminate color differences. This program is conducted in collaboration with the Physics Laboratory's Optical Technology Division.

PLAN: Investigate the design of a robust light source for using in the gamut assessment standard (GAS) and conduct general interlaboratory comparisons on a regular basis with industry.

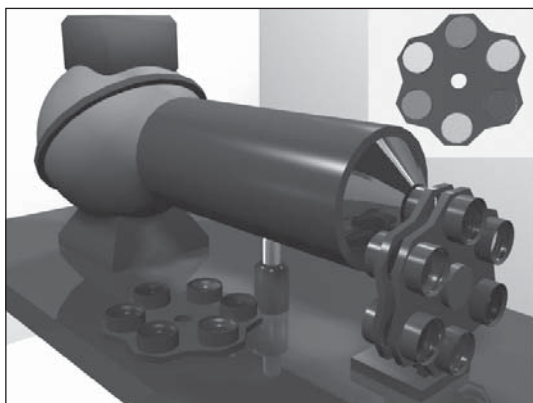

Gamut Assessment Standard (GAS).

DISPLAY CHARACTERIZATION OF THERMAL IMAGERS FOR FIRST RESPONDERS

Thermal imagers used by firefighters and other first responders incorporate visual electronic displays as a key component. In collaboration with the Fire Research Division, we are developing a series of measurement procedures to assist manufacturers and end users in evaluating system performance.

PLAN: Develop basic procedures for measuring grayscale, resolution, and uniformity for incorporation into standards (in collaboration with the BFRL Fire Research Division and the PL Optical Technology Division).

DISSEMINATION OF INFORMATION

A key component of our work is in the education of our customers. We seek to provide our customers with the information that they need through standards activities, conference presentations, invited tutorials, and publications. As a part of this effort, we are developing a one-week hands-on course on good display metrology practices. This course will be offered on an ongoing basis at the NIST-Boulder campus.

PLAN: Continue to offer in-house courses on display metrology providing hands-on laboratory measurements. We plan to teach the in-house course on display metrology at least once per year and as frequently as four times per year.

METROLOGY FOR MEDICAL IMAGING APPLICATIONS

Critical diagnostic and clinical standards and techniques are required for the evaluation of medical images, medical imaging devices (includes both image acquisition devices such as digital cameras and microscopes, and display devices), the evaluation of computer assisted diagnostic tools, and the effects of compression on image quality. The lack of standards is becoming an increasingly critical roadblock as new medical diagnostic and imaging techniques become available and as new or improved display technologies come into use. Diagnosticians in many areas have integrated new imaging devices into their practice. Many doctors take images with them for viewing in the comfort of their homes. Images are routinely emailed to consulting physicians without regard to whether the displays on which they are viewed meet minimum performance standards. Images may be compressed for storage or for transportation across wireless systems. Improved rendering of transmitted medical images will lead to lower cost healthcare services, especially for remote, sparsely populated regions of the U.S.

PLAN: Adapt sunlight readability metrics to measure color and small area contrast of handheld devices for medical imaging applications.

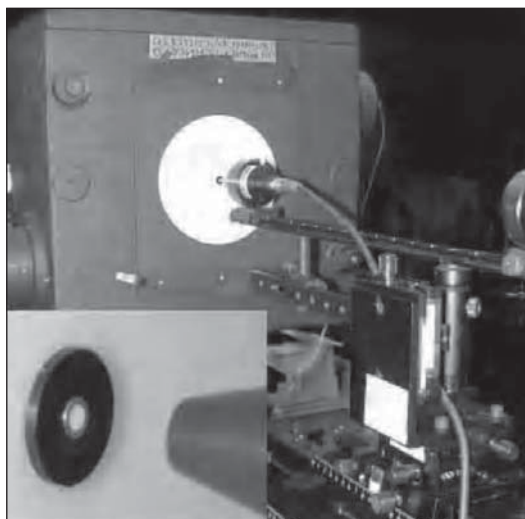

Measurement apparatus for testing probes used to characterize medical displays. Inset shows the tip of the probe pointing at the illuminance head (small white disk) that measures the back reflection from the probe.

ACCOMPLISHMENTS

- Four hands-on short courses have been held at NIST in FY06, all receiving positive reviews. We plan to continue to offer this course up to four times a year. In addition, three invited seminars on Flat Panel Display Measurements and Standards were presented: the Society for Information Display (SID) 2006 International Symposium, the SID Americas Display Engineering and Applications Conference, and the International Broadcasting Convention (IBC) 2006. Emphasis was placed on (1) techniques being as important as good equipment, and (2) reflection metrology is more complicated than currently envisioned by the display industry.

- Beta testing of the gamut assessment standard (GAS) was begun with participating laboratories.

- Developed proposed metrics for characterizing display performance for daylight measurements, and submitted paper to the Journal of the SID.

- As part of a multi-Laboratory effort, developed a relationship with the telemedicine community to explore ways NIST can help address some of their measurement needs. This resulted from a series of USMS Workshops on imaging metrics in telemedicine.

- Evaluated, in collaboration with the Fire Research Division, the effectiveness of present methods for evaluating the performance of thermal imagers used by first responders.

COLLABORATIONS

In addition to the collaborations that follow naturally from standards activities (see below) and other routine advisory roles, there are some specific collaborations of interest that are currently underway:

As described above, the Fire Research Division, the Optical Technology Division and the Display Metrology Project are working together to develop a series of tests to evaluate the system performance of thermal imagers used by first responders.

We are working with the Food and Drug Administration (FDA) on making small-area measurements of radiological images using stray-light-reducing probes for small-area measurements of luminance.

Robust and meaningful reflection measurements for the evaluation of sunlight readability of displays are being developed with DuPont Displays, E-Ink., Qualcomm, Kodak, and Army Research

Laboratory (in conjunction with the US Display Consortium).

A multi-OU effort is underway, working with the American Telemedicine Association, to explore additional ways NIST can support the telemedicine community. This effort is an outgrowth of a series of USMS Workshops on image quality in telemedicine.

STANDARDS COMMITTEE

PARTICIPATION

Video Electronic Standards Association (VESA) Display Metrology Task Group: Edward F. Kelley, former chair of this group, currently serves as editor of the Flat Panel Display Measurement (FPDM) Standard, a scientific and comprehensive document, prepared with significant input from NIST, to address display metrology. Dr. Kelley is responsible for creating and implementing all of the patterns used by the standard in addition to his editorial responsibilities for the next generation document (FPDM3) and associated measurement methods.

International Organization for Standardization TC159/SC4/WG2 Visual Display Requirements: Paul A. Boynton is a member of this committee, which is developing a revision of all of its display standards. NIST is coordinating the development and evaluation of the metrology sections.

International Electrotechnical Commission TC 110/PT 62341-6: Organic Electroluminescent Displays - Part 6: Measuring Methods of Organic Light-Emitting Displays. Paul A. Boynton is providing technical expertise in the development of this standard.

Society for Automotive Engineers J 1757 Standard Metrology for Vehicular Flat Panel Displays: Edward F. Kelley is a member and is providing support in the evaluation of reflection measurements and developing appropriate efficiency metrics.

Council for Optical Radiation Measurements CR-5 (Flat Panel Displays). All project personnel are members; Paul A. Boynton serves as committee chair. The committee is currently evaluating the DMATS and GAS program

Society for Information Display Definition and Standards Committee. All project personnel are members; Paul A. Boynton serves as committee chair.

RECENT PUBLICATIONS

P. A. Boynton and E. F. Kelley, "Comparing methodologies for determining resolution from contrast in projection display systems," *Proc. SPIE*, Vol. 5740, No. 116 (2005).

E. F. Kelley, M. Lindfors, and J. Penczek, "Daylight and sunlight display readability measurement methods" *Council for Optical Radiation Measurements Conference* (2005).

E. F. Kelley, "Challenges in automotive display standards" *Council for Optical Radiation Measurements Conference* (2005).

E. F. Kelley, "Variable-radius source method to separate specular component from haze peak" *Proc. SID Americas Second Display Engineering and Applications Conference*, pp. 1–4 (2005).

E. F. Kelley, "What do the specifications mean?," *Proc. SID Americas First Display Engineering and Applications Conference*, pp. 15–18 (2004).

P. Boynton, "Tools and diagnostics to assess and improve projection display metrology capabilities," *Proc. SID Americas First Display Engineering and Applications Conference*, pp. 15–18 (2004).

E. F. Kelley, "Flat-panel-display measurement techniques and concerns," *2004-SID International Symposium Seminar Lecture Notes, Society for Information Display, Seminar F-1*, Vol. 2, pp. F-1/1-61 (2004).

P. Boynton, "The challenge to display metrology and standards: whom do you trust?" *Workshop and Special Evening Session of the SID 24th International Display Research Conference*, pp. 46–57 (2004).

E. F. Kelley, "Plotting the course of the next VESA flat panel display measurements standard," *2004-SID International Symposium Digest of Technical Papers, Society for Information Display*, Invited Paper 7.1, Vol. 35, Book 1, pp. 78–81 (2004).

E. F. Kelley and J. Penczek, "Scalability of OLED fluorescence in consideration of sunlight-readability reflection measurements," *2004-SID International Symposium Digest of Technical Papers, Society for Information Display*, Paper P.54, Vol. 35, Book 1, pp. 450–453 (2004).

P. Boynton, "Methods for assessing display measurement capabilities," *Cockpit Displays XI, Proceedings of the SPIE*, Vol. 5543, 311 (2004).

P. A. Boynton, E. F. Kelley, and J. M. Libert "Projection display metrology at NIST: measurements and diagnostics," *Liquid Crystal Materials, Devices, and Applications X and Projection Displays X, Proceedings of the SPIE*, Vol. 5289, pp. 302–313 (2004).

J. M. Libert, E. F. Kelley, P. A. Boynton, S. W. Brown, C. Wall, and C. Campbell, "A color gamut assessment standard: construction, characterization and interlaboratory measurement comparison," *Fourth Oxford Conference on Spectroscopy, SPIE*, Vol. 4826, pp. 146–164 (2003).

E. F. Kelley and A. Badano, "Characterization of luminance probe for accurate contrast measurements in medical displays," *NISTIR 6974*, 15 pages (2003).

E. F. Kelley, "Sensitivity of display reflection measurements to apparatus geometry," *2002 SID International Symposium Digest of Technical Papers, Society for Information Display*, Boston, MA, pp. 140–143 (2002).

E. F. Kelley, "Fundamentals of display metrology," *2002 Society for Information Display International Symposium Short Course S-3, 2002 SID International Symposium*, Boston, MA, p. 205, May 19–24 (2002).

HIGH-SPEED MEASUREMENTS

Technical Contact:
Paul Hale

Staffing (FY06):
4 professionals
1 associate

GOALS

Provide advanced metrology, standards and measurement services relating to temporal properties of optical sources, detectors, and signals used in association with optoelectronic systems.

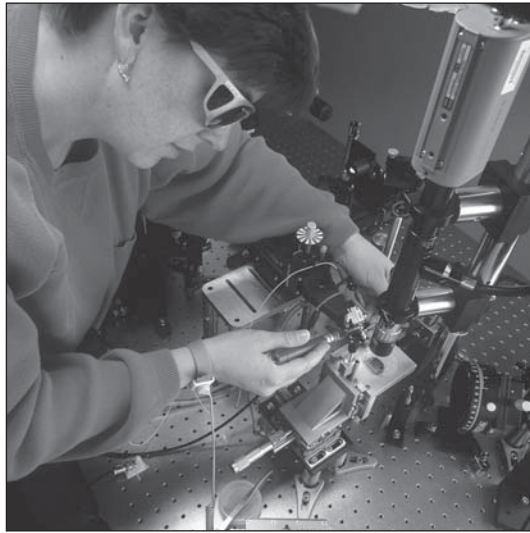

The electro-optic measurement system, shown here being operated by Tracy Clement, measures an electrical pulse on a LiTaO₃ wafer. De-embedding techniques are then used to determine the voltage generated by the photodiode being tested at its coaxial output connector. (© Geoffrey Wheeler)

CUSTOMER NEEDS

High-bandwidth measurements of both optical and electrical devices are needed to support optical communication systems that take advantage of the potential bandwidth of optical fiber. Presently, systems are being installed that operate at modulation rates of 10 gigabits per second by use of time-division multiplexing (TDM). Research laboratories around the world are focused on developing the next generation of TDM systems at 40 gigabits per second and higher. New methods are needed to accurately characterize the scalar and vector frequency response of high-speed sources, detectors, and instrumentation to three to ten times the system modulation rate. Burst-mode operation in asynchronous transfer mode networks requires additional characterization at very low frequencies. Increasingly tight tolerances in both digital and analog systems require new and improved measurements in both frequency- and time-domains with low uncertainty.

High-speed measurements are needed in other areas as well. Microwave and wireless communications are also pushing to ever greater bandwidths by use of complicated modulation formats, while the instruments to measure these waveforms remain only loosely calibrated. This project leverages its expertise in both optical and electrical device characterization to cross disciplinary boundaries in the application of new measurement methods. For example, the intensive use of laser target designators and range finders by the armed forces requires traceable calibration standards for low-level peak power and energy at 1064 nm and 1550 nm.

TECHNICAL STRATEGY

We have developed a suite of highly accurate optoelectronic measurement systems for characterizing high-speed optoelectronic devices. Our optoelectronic techniques also allow calibration of electronic instrumentation with greater accuracy and bandwidth than electrical techniques. When correlations of error components are recorded, they can be used to give full waveform uncertainties in both the time domain and the frequency domain.

OPTOELECTRONIC VECTOR FREQUENCY RESPONSE MEASUREMENTS TO 110 GHz

NIST has developed highly accurate heterodyne techniques at 1319 nm and 1550 nm for measuring the scalar frequency response of detectors. Measurement services are available for modulation frequency-response transfer standards that consist of a photodiode combined with a microwave power sensor, and can measure this type of standard from 300 kHz to 110 GHz or more at 1319 nm. We also have a service for calibrating the frequency-response magnitude of bare photodiodes to at least 50 GHz. Calibration of bare photodiodes is more complicated because it requires calibrated microwave power and measured scattering-parameters.

Optoelectronic phase response, when combined with the magnitude response, is called the vector response. The vector frequency response of a photoreceiver is the Fourier transform of its time-domain impulse response. Measurements of the vector response are required for the design of high-speed optoelectronic systems, but until recently there were no accepted standard methods for this measurement.

Researchers in the High-Speed Measurements Project, in collaboration with the Electromagnetics Division, the Statistical Engineering Division, and the Mathematical and Computational Sciences Division, have demonstrated time-domain techniques for measuring optoelectronic vector response with verifiable accuracy up to 110 GHz by use of electro-optic sampling (EOS). By developing these measurements our project is pioneering a new paradigm for time-domain measurements with frequency-domain calibrations.

PLAN: Extend EOS capability to 400 GHz by use of on-wafer measurement techniques.

APPLICATIONS OF OPTOELECTRONIC MEASUREMENTS

Optical communications analyzers and reference receivers used for measuring digital eye-patterns on optical signals have many similarities to electrical oscilloscopes, but also have advantages of their own. In particular, they can be calibrated over a very high bandwidth because they do not require band-limited microwave calibrations.

Calibrated time-domain measurements, however, possess some unique problems. For example, we must develop methods for removing time-base distortions and deconvolving the oscilloscope response and impedance mismatch. Point-by-point uncertainty analysis in the time domain will enable industry to improve eye-pattern measurements and to quantify the performance of bit-error-ratio testers.

Commercial equipment presently available for characterizing the phase dispersion and phase delay of optoelectronic receivers suffers from high uncertainty, limited bandwidth, and in some cases, unverified calibrations, or calibrations that are not traceable to fundamental physical principles. Traceable vector frequency-response measurements are critical for characterizing balanced receivers that are needed for coherent optical communication applications.

PLAN: Provide calibrated pulse sources for instrumentation and component manufacturers that are traceable to fundamental units. Work with customers to disseminate this capability in a cost effective manner.

WAVEFORM METROLOGY

High-speed/high-bandwidth waveforms contain valuable information missed by current electronic measurement techniques that could be captured with new optoelectronic-based metrology. Waveform measurements verify signal fidelity and stan-

dard compliance for the design and qualification of components and systems. However, current waveform test equipment is characterized only with single-parameter metrics, such as bandwidth or rise-time. Common equipment properties, such as loss, mismatch, modulation response, and jitter, which become significant above a few gigahertz, are typically not corrected or characterized. In many cases, these limitations on waveform measurement equipment arise from a lack of comprehensive metrology.

We are developing fundamentally new techniques and measurement services at bandwidths and rise-times currently unattainable, to verify waveforms for a wide range of applications (*e.g.*, optical communications, high-speed microcircuitry, wireless communication, advanced radar, and remote sensing). This metrology will generate significant savings in production costs stemming from false rejections of functioning devices due to inaccurate signal characterization.

PLAN: Develop accurate measurements of classical pulsed waveform parameters and extend to full waveform calibration using a covariance matrix-based approach.

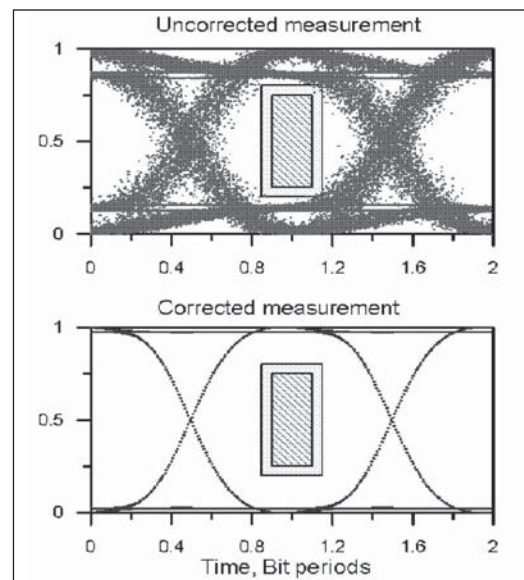

Simulated eye mask test of a long random bit sequence transmitted by a fiber-optic transceiver. The forbidden region in this pass/fail test is shown in the hashed region, surrounded by a 10 % guard band (margin). Although the simulated transceiver meets specifications, the frequency response and jitter errors in the oscilloscope measurement (top) cause the transceiver to fail the test as some samples fall into the guard band. The bottom graph shows the effect of calibrating and correcting the oscilloscope errors, clearly passing a component that would otherwise have been rejected.

METROLOGY FOR EYE-SAFE LASER TARGET SYSTEMS

Military systems involving laser trackers and target designators are converting to and/or adding a capability to operate at laser wavelengths of $1.5\ \mu\text{m}$ because of the eye-safe benefits. However, there are no commercial standards for measuring low-levels of pulsed laser power/energy in this wavelength region. Currently, pulsed laser standards are silicon-based and do not operate at wavelengths longer than $1.1\ \mu\text{m}$ in the infrared, requiring the development of new instrumentation. We are developing new transfer standards, as well as the systems to calibrate them, capable of low-level pulsed power/energy laser measurement in the $1.5\ \mu\text{m}$ wavelength region. These standards will be transitioned to meet Homeland Security requirements and military systems certification. Calibrations will be traceable to national laser power/energy standards and supported by NIST.

PLAN: Provide customers with the capability to deconvolve radiometer impulse response for arbitrary laser pulse shapes.

ACCOMPLISHMENTS

Recent advances in high-speed measurements have been a result of close collaborations with the Electromagnetic Division (EEEL) and with the Statistical Engineering and the Mathematical and Computational Sciences Divisions (ITL).

- Developed an electro-optic sampling system to sample high-speed electrical waveforms on a coplanar waveguide with ultrashort laser pulses via the electro-optic effect. Standard microwave techniques are used to calibrate the response of a photoreceiver at its 1 mm electrical port that is physically removed from the sampling plane.

- Accurately characterized the modulation response magnitude and phase of commercially available photoreceivers to 110 GHz, nearly three times the bit rate of 40 Gb/s optoelectronic systems. The frequency range of the calibration is limited only by the 1 mm coaxial connectors. The characterized photoreceiver has a bandwidth of about 80 GHz; the signal-to-noise ratio of the measurement is greater than 150:1 at 110 GHz.

- Implemented a new slotted-line technique that uses electro-optic sampling to measure the impedance of coplanar waveguide terminations to facilitate on-wafer waveform measurements. This method has the advantage that it can be used to measure impedance into the terahertz range.

- Demonstrated a calibrated on-wafer waveform measurement over a 200 GHz frequency range, with a point-by-point time-domain uncertainty analysis using the new slotted-line technique. Since the frequency range of this measurement was limited only by the bandwidth of the photodiode we used as an electrical pulse generator, we can potentially make calibrated waveform measurements into the terahertz regime, *i.e.*, to pulse widths of less than 1 ps.

- Published a rigorous theory for calibrating the small-signal optoelectronic frequency response of photoreceivers and modulated sources by using an electrical vector network analyzer. Previous theories did not consider effects of optical coherence on such measurements, and this work describes how coherence effects can be avoided to give more accurate measurements.

- Established sampling oscilloscope calibration capability, traceable to the NIST EOS system, with full covariance-based uncertainty analysis. This capability is now available as a Special Test for both internal and external customers.

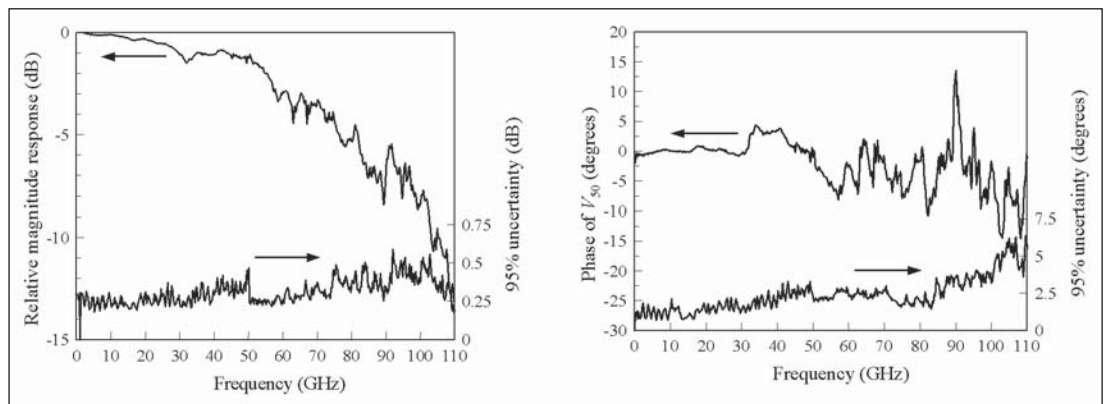

Electro-optic sampling is capable of determining the vector frequency response of a photodiode; that is, it can determine both the magnitude and phase response of the photodiode.

- Implemented new 1.5 μm measurement system for low-level radiometers, leading to an improvement in measurement stability by a factor of two.
- Consolidated high speed measurement programs in Boulder from the Quantum Electrical Metrology Division in Gaithersburg. Transferred impulse spectral amplitude measurement service to Boulder and added phase measurement capability. Transferred pulse parameter measurement service and pulse time delay service.

MEASUREMENT SERVICES

The Optoelectronics Division provides measurement services relating to the temporal properties of optical sources and detectors used with optoelectronic systems, including optical receiver frequency response (scalar or vector), impulse response, and low-level pulse power and energy. Measurement services for electrical oscilloscope impulse response, waveform parameters of pulse generators, and spectrum of pulse generators have also recently been added. For more information see Appendix D, or contact Paul Hale at (303) 497-5367.

STANDARDS COMMITTEE PARTICIPATION

International Electrotechnical Commission: Paul Hale is a member of technical committee TC86, working group 4, which deals with Fiber Optic Test Equipment Calibration.

International Telecommunication Union: Paul Hale is a technical correspondent for ITU-T Study Group 4 working on recommendations for instrumentation measuring jitter and wander in synchronous digital hierarchy (SDH) equipment.

RECENT PUBLICATIONS

P. D. Hale, C. M. Wang, D. F. Williams, K. A. Remley, and J. D. Wepman, "Compensation of random and systematic timing errors in sampling oscilloscopes," accepted for publication in *IEEE Trans. Instrum. Meas.*, Vol. 55 (2006).

T. S. Clement, P. D. Hale, D. F. Williams, C. M. Wang, A. Dienstfrey, and D. A. Keenan, "Calibration of sampling oscilloscopes with high-speed photodiodes," *IEEE Trans. Microwave Theory Tech.*, Vol. 54, pp. 3173–3181 (2006).

A. Dienstfrey, P. D. Hale, D. A. Keenan, T. S. Clement, and D. F. Williams, "Minimum-phase calibration of sampling oscilloscopes," *IEEE Trans. Microwave Theory Tech.*, Vol. 54, pp. 3197–3208 (2006).

D. F. Williams, H. Khenissi, F. Ndagijimana, K. A. Remly, J. P. Dunsmore, P. D. Hale, J. C. M. Wang, and T. S. Clement, "Sampling-oscilloscope measurement of a microwave mixer with single-digit phase accuracy," *IEEE Trans. Microwave Theory Tech.*, Vol. 54, pp. 1210–1217 (2006).

D. F. Williams, A. Lewandowski, T. S. Clement, J. C. M. Wang, P. D. Hale, J. M. Morgan, D. A. Keenan, and A. Dienstfrey, "Covariance-based uncertainty analysis of the NIST electro-optic sampling system," *IEEE Trans. Microwave Theory Tech.*, Vol. 54, pp. 481–491 (2006).

D. F. Williams, P. D. Hale, T. S. Clement, and J. M. Morgan, "Calibrated 200 GHz waveform measurement," *IEEE Trans. Microwave Theory Tech.*, Vol. 53, pp. 1384–1389 (2005).

D. Williams, P. Hale, T. Clement, and C. M. Wang, "Uncertainty of the NIST electrooptic sampling system," *NIST Technical Note 1535* (2004).

R. W. Leonhardt, "Calibration service for low-level pulsed-laser radiometers at 1.06 μm : pulse energy and peak power," *NIST Special Publication 250-64* (2004).

P. Bryant, J. Grigor, P. Harris, B. Rich, A. Irwin, S. McHugh, D. W. King, and R. W. Leonhardt, "Advanced test and calibration systems for integrated multi-sensor platforms with IR, visible, and laser range finder/designator capabilities," *Proc., SPIE, Vol. 5076, The International Society for Optical Engineering, Infrared Imaging Systems: Design, Analysis Modeling and Testing XIV* (2003).

K. J. Coakley, C. M. Wang, P. D. Hale, and T. S. Clement, "Adaptive characterization of jitter noise in sampled high-speed signals," *IEEE Trans. Instrum. Meas.*, Vol. 52, pp. 1537–1547 (2003).

P. D. Hale and D. F. Williams, "Calibrated measurement of optoelectronic frequency response," *IEEE Trans. Microwave Theory Tech.*, Vol. 51, pp. 1411–1429 (2003).

T. S. Clement, D. F. Williams, P. D. Hale, and J. M. Morgan, "Calibrating photoreceiver response to 110 GHz," *IEEE Lasers and Electro-Optics Society Annual Meeting Digest*, pp. 877–878 (2002).

T. S. Clement, P. D. Hale, P. A. Williams, "Tutorial: fiber and component metrology for high-speed communication," *Proc., Optical Fiber Communication Conf.*, March 17–22, Anaheim, CA, WZ1 (2002).

C. W. Wang, P. D. Hale, K. J. Coakley, and T. S. Clement, "Uncertainty of oscilloscope timebase distortion estimate," *IEEE Trans. Instrum. Meas.*, Vol. 51, pp. 53–58 (2002).

INTERFEROMETRY AND POLARIMETRY

Technical Contact:
Paul Williams

Staffing (FY06):
3 professionals
0.5 technician
1 associate

GOALS

To provide supporting metrology for interferometric and polarimetric applications including telecommunications, sensing, and medical imaging by providing measurements, calibrations, standards, and expertise, drawing on a strong technical background in interferometry and polarimetric techniques.

CUSTOMER NEEDS

BIOMEDICAL IMAGING

In the field of medical imaging, *Optical Coherence Tomography (OCT)* is a technique for minimally invasive noncontact three-dimensional imaging of tissue with micrometer-scale resolution. Two innovations are key to enabling broad application in medical diagnostics: increased measurement speed (image quality, screening costs, and patient comfort depend on rapid scans) and better measurement validation (enables technology-invariance and instrument interoperability). These innovations will change OCT, a young biomedical imaging technique, into a widely applicable, quantitative measurement tool for absolute assessment of tissue health.

Measurement speed is limited by a lack of rapidly tuning low-noise lasers and low-noise spectrally shaped broad-band light sources, high-sensitivity detectors, cost-effective near-IR detector arrays, and by measurement noise in general. Measurement validation is limited by the current OCT accuracy assessments, availability of comparable techniques, well characterized and stable phantoms, and an incomplete data bank of optical properties of tissue (refractive index, scattering, and absorption parameters).

OPTICAL FIBER TELECOMMUNICATIONS

In *optical fiber communication* systems, dispersion broadens the optical pulses, making it difficult to distinguish adjacent data bits, causing communication errors. Dispersion in optical fiber arises from the variation of the light's propagation velocity as a function of wavelength or polarization state. Mitigation of system *chromatic dispersion* (through dispersion-tailored fibers, dispersion mapping, and dispersion compensating fibers) requires accurate measurement of the wavelength dependence of chromatic dispersion, and the ability of users to verify this accuracy. Wavelength-dependent

relative group delay (RGD) in optical components (such as narrow-band filters for 40 Gbit/s data rates) is more challenging to characterize and can have requirements for subpicosecond resolution in bandwidths on the order of tens of picometers. To simultaneously optimize these opposing resolutions requires high measurement signal-to-noise ratio and drift reduction.

In *polarization-mode dispersion (PMD)*, where propagation velocity depends on the polarization state of the light, communication systems can require PMD measurements to have temporal resolutions of tens of femtoseconds with spectral resolutions of tens of picometers. Again, this mutual resolution requirement requires low-noise measurements (high spectral efficiency).

OPTICAL FIBER SENSORS

Over the past 10 years *Fiber Bragg Gratings (FBG)* have come to play an important role in passive strain and stress detection. In the simplest form they are used as optical strain gauges. The complete state of stress in a host material can be measured by embedding several of these strain gauge sensors in the material in orthogonal directions. However, this level of complexity can be difficult to implement, and the presence of a large number of sensors may weaken the material. Novel, low-cost measurement approaches are therefore needed to allow a full vector characterization of stress with spatial resolutions less than the dimensions of a single FBG.

TECHNICAL STRATEGY

We address the above metrology needs through the development of unique, high-resolution measurement techniques with rigorous uncertainty analysis, metrology transfer via calibrations, development and distribution of well-characterized artifacts, measurement comparisons, and Special Tests of customer artifacts.

OPTICAL COHERENCE TOMOGRAPHY (OCT)

Phase-Dispersion Light Scattering: We currently have the capability to accurately measure the phase of scattered light as a function of wavelength using swept-source OCT measurement systems operating at both 1320 and 1575 nm. We have demonstrated the ability to extract from this phase-dispersion spectra the size of multiple spherical scatters in the

specimen. This is done with application to determining the size of cell nuclei, which is important as an early indicator of cancer. Healthy nuclei are typically 4-7 micrometers in diameter, while cancerous nuclei are up to 20 micrometers in diameter.

In collaboration with NIST Physics Laboratory and the Information Technology Laboratory researchers, we have used Mie scattering theory to predict the phase spectrum of light scattered from spherical particles, and we have demonstrated theoretically a nonequivalence between this phase scattering spectrum and the more conventional intensity scattering spectrum for the case of a single spherical scatterer. This indicates that both intensity and phase are required for a full characterization of the tissue constituents via spectral light scattering OCT. To this end, we have developed a phase measurement capability and demonstrated it as a technique to measure scatterer size in tissue phantoms composed of small (5-30 micrometers) polystyrene spheres in different configurations: embedded in a glycerin/water solution, monolayers of spheres on microscope slides, and a size domain sample with monolayers of two distinct sizes of spheres adjacent to each other. In addition, raster-scan measurements have been performed on epithelial cheek cells, cancerous liver tissue, and rat vascular endothelial cells.

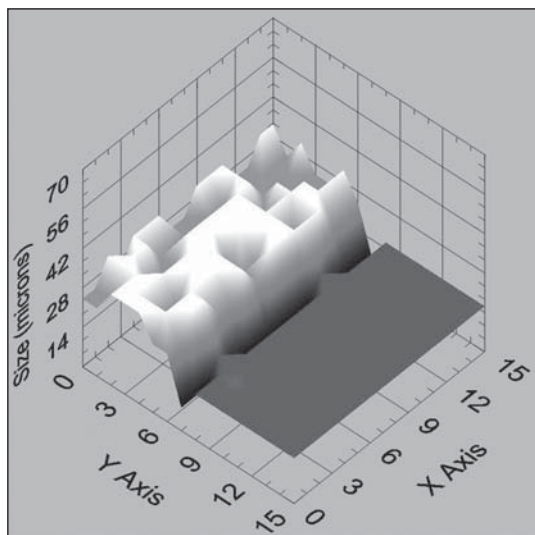

Sphere diameter as a function of position across the boundary between regions of 15 μm and 26 μm spheres measured using phase-dispersion OCT technique.

PLAN: We will evaluate our phase-dispersion contrast measurements of cell and tissue samples in order to verify the measurements, validate the scatterer size, demonstrate contrast, and estimate the measurement uncertainty.

Polarization-Sensitive OCT (PS-OCT) allows the measurement of differential changes in tissue refractive index due to the anisotropic nature of most tissue. PS-OCT increases contrast in many tissues, providing a sensitive measure of tissue health including early identification of glaucoma, characterization of the arterial plaques that lead to heart attacks, and assessment of burn depth. We have assembled a time-domain PS-OCT system to measure tissue birefringence.

PLAN: We are developing adjustable-birefringence tissue phantoms that we will characterize and distribute among researchers and instrument makers to assess the current ability of the biomedical imaging industry to accurately measure tissue birefringence.

CHROMATIC DISPERSION & RELATIVE GROUP DELAY

With our 2 GHz modulation phase shift (MPS) system we offer Special Test measurements of chromatic dispersion and zero-dispersion wavelength on customer-supplied fibers over the wavelength range from 1442 nm to 1620 nm. Using a 200 MHz MPS system, we are able to measure component group delay features with 0.072 ps resolution and a single spectral sweep accuracy of 0.46 ps with a spectral resolution of 3.2 pm. This capability is available to customers as a Special Test over the wavelength range of 1510 nm to 1620 nm.

In 2004, we participated with other national laboratories in a EUROMET comparison of chromatic dispersion, zero-dispersion wavelength, and dispersion slope. The full report is available from the BIPM website at http://www.bipm.org/utis/common/pdf/final_reports/PR/S1/EUROMET.PR-S1.pdf

POLARIZATION-MODE DISPERSION (PMD)

We provide two artifact standards characterized for their PMD (wavelength-averaged differential group delay, DGD), one with polarization-mode coupling to simulate measurements of optical fiber (SRM 2518), and the other, a non-mode-coupled device to simulate measurements of optical components (SRM 2538). We also offer PMD measurements on customer-supplied artifacts. Our narrow-bandwidth PMD metrology yields DGD measurements with 9 fs uncertainty in a 40 pm bandwidth.

OPTICAL FIBER BRAGG GRATING INDEX PROFILE

We currently have the capability to measure the magnitude of transverse stresses on fiber Bragg gratings (FBG) with a spatial resolution of 12 μm

and a minimum detectable stress of $1.4 \text{ N}\cdot\text{mm}^{-2}$. This method uses a four-state polarization analysis combined with a “layer-peeling” algorithm to eliminate the need for polarization-maintaining fiber in the sensor. Our measurement systems are based on low-coherence interferometry and have been implemented in both the time and frequency domains.

COMPONENT SPECTRAL TRANSMISSION/ REFLECTION

We have the capability to characterize spectral reflection/transmission profiles in fiber Bragg gratings with sub-picometer accuracy. This is supported by both frequency-domain and low-coherence interferometry approaches. Spectral characterization systems are currently available for spectral reflectance profiling of a variety of optical filters.

OPTICAL RETARDANCE

We have retardance measurement capability in the near infrared and a high-accuracy ($\sim 0.1^\circ$) quarter-wave retarder artifact for customer measurement verification.

ACCOMPLISHMENTS

- *Multiple Diverse OCT Measurement Systems Developed.* We have assembled four OCT measurement systems: two swept-laser frequency-domain systems in the 1300 and 1550 nm regions for measuring dispersion, a spectral-domain system with a 1260-1560 nm broadband source for high spatial resolution, and a time-domain polarization-sensitive OCT system at 1320 nm for measurement of tissue anisotropy.

- *Measured the Phase Dispersion Spectra of Microscatterers.* We have demonstrated the ability to measure the phase-dispersion spectra of scatterers as small as 5 micrometers. For these measurements, we developed tissue phantoms by embedding small (5-15 micrometers) polystyrene spheres in a glycerin/water solution. We demonstrated that the periodicity of the phase dispersion spectra is directly correlated with the size of the scatterer, and we demonstrated good agreement with theoretic predictions of the phase dispersion spectra.

- *Dispersion Contrast OCT Technique Demonstrated.* We have demonstrated the ability to use phase-dispersion spectra as the contrast mechanism in a surface scan of a tissue phantom composed of two different sizes of polystyrene spheres (15 and 26 micrometer diameters). The result is a false-

color image of the tissue phantom where the local sphere diameter is indicated by color change. In this phantom, the spheres emulate cell nuclei. Our measurements show agreement with theoretical predictions of dispersion based on phase-sensitive Mie scattering theory developed in collaboration with the NIST Physics Laboratory and the Information Technology Laboratory. This technique is important for tissue characterization because nuclear size is one indicator of precancerous conditions.

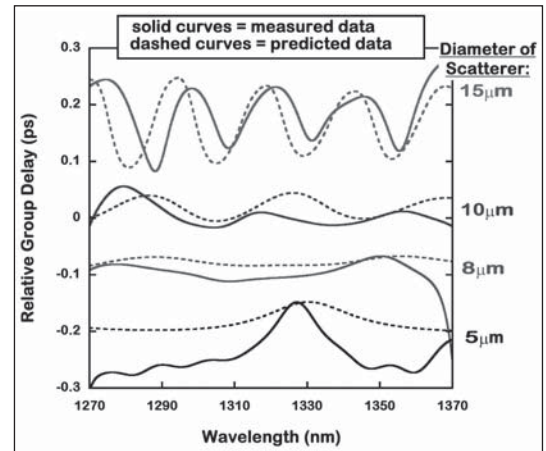

Comparison of measured and predicted phase dispersion spectra of phantoms constructed from polystyrene spheres embedded in a glycerin/water solution.

- *Theoretical Nonequivalence of the Intensity and Phase Scattering Signatures Established.* We have succeeded in demonstrating the theoretical nonequivalence of the spectral intensity and phase scattering signatures from a single spherical particle. Other groups have been using intensity based scattering for sizing of cell nuclei. However, this theoretical result demonstrates the need for both phase and intensity data for full characterization of cell nuclei.

- *Phase-Dispersion Imaging Applied to Tissue and Cell Cultures.* We have developed the ability to produce raster-scanned images of cell cultures and tissue samples with scattering dispersion as the contrast mechanism. Raster-scan measurements have been performed on epithelial cheek cells, cancerous liver tissue, and rat vascular endothelial cells, and we obtained reasonable sizes for the nuclei from those measurements.

- *Model Developed to Identify Sources of Noise in Polarization-Sensitive OCT.* In a collaboration between NIST, the National Physical Laboratory (UK), and the University of Texas, a model has been developed to describe the sources of noise encountered in polarization-sensitive Optical Co-

herence Tomography (PS-OCT). This model will aid the development of noise reduction techniques leading to faster and more sensitive measurements. PS-OCT increases contrast in many tissues, providing a sensitive measure of tissue health. Noise affects PS-OCT results by reducing image quality and increasing measurement time. Three distinct noise mechanisms were identified (intensity noise, polarization speckle, and polarization-dependent scattering).

■ *High Spatial Resolution Measurement of Transverse Stress Achieved with FBG Sensor.* We have demonstrated a new method for measurements at high spatial resolution of the two components of transverse stress in a distributed fiber Bragg grating (FBG) strain sensor. The relative index of refraction as a function of position in the FBG was determined by either time-domain or frequency-domain interrogation systems via a layer-peeling algorithm. With this method we are able to measure changes in the refractive index with resolution better than 5×10^{-6} and a spatial resolution of 12 μm . To determine transverse stress, we repeated the measurement for four different polarization states using a four-state analysis to determine the birefringence as a function of position in the grating. This measurement offers the advantage that it does not require the use of polarization maintaining fiber, which is expensive and more difficult to splice. Measurements of the externally induced birefringence agree well with values predicted by the stress-optic properties and the geometry of the fiber.

■ *Bilateral Comparison of Polarization-Mode Dispersion Completed:* NIST and the Korean Research Institute of Standards and Science (KRISS) have performed a measurement comparison on mode-coupled artifacts constructed of spliced polarization maintaining fiber in a temperature controlled environment.

■ *Body Armor Testing Technique Developed.* Our investigation into a variety of sensing techniques to assess the shape deformation and force distribution of bullet-resistant vests has identified fiber-optic bend loss as a promising technique. We developed the technique further by estimating measurement sensitivity and repeatability.

■ *USMS Workshops Conducted to Assess Measurement Needs.* In support of the United States Measurement System (USMS) assessment, workshops were held to collect industry input on the measurements needed for optical fiber broadband communications, and biophotonic diagnostics.

STANDARDS COMMITTEE PARTICIPATION

IEC TC86/WG4 & IEC SC86C/WG3 Fiber Optics Calibration & Optical Amplifiers

USTAG SC86A IEC U.S. Technical Advisory Group – Optical Fibers and Cables

USTAG SC86C IEC U.S. Technical Advisory Group – Systems and Active Devices

USTAG TC86 IEC U.S. Technical Advisory Group – Fiber Optics

TIA FO-4 Committee on Fiber Optics, subcommittee Vice-Chair, working group Chair

STANDARD REFERENCE MATERIALS (SRM) (SEE APPENDIX E)

<http://www.boulder.nist.gov/div815/SRMS/SRMS.htm>

SRM 2513, Mode-Field Diameter of Single-Mode Fiber.

SRM 2518/2538 Polarization-Mode Dispersion (Mode-Coupled / Non-Mode-Coupled).

SRM 2520, Optical Fiber Diameter

MEASUREMENT SERVICES (NIST SPECIAL TESTS)

Optical Fiber Chromatic Dispersion, Zero-Dispersion Wavelength, and Dispersion Slope

Optical Linear Retardance Standard (high-accuracy quarter-wave retarder)

Polarization-Mode Dispersion

RECENT PUBLICATIONS

http://www.boulder.nist.gov/div815/81503_pubs.htm

S. D. Dyer, T. Dennis, L. Street, S. M. Etzel, T. A. Germer, and A. K. Dienstfrey, "Spectroscopic phase dispersion optical coherence tomography measurements of scattering phantoms," *Optics Express*, Vol. 14, No. 18, pp. 8138–8153 (2006).

R. A. Hoffman, M. Brownstein, T. E. Milner, R. Levenson, M. L. Dowell, P.A. Williams, G. White, A. Gaigalas, J. Hwang, "Biophotonic tools in cell and tissue diagnostics," submitted to *NIST Journal of Research* (2006).

R. J. Espejo, M. Svalgaard, and S. D. Dyer, "Characterizing fiber Bragg grating index profiles to improve the writing process," *IEEE Photonics Technology Letters*, Vol. 18, 2242–2244 (2006).

R. J. Espejo and S. D. Dyer, "High-spatial resolution measurements of transverse stress using four-polarization-state frequency domain interferometry," *18th International Conference on Optical Fiber Sensors*, Oct 23–27, Cancun, Mexico (2006).

P. A. Williams and T. J. Drapela, "Technical Digest, SOFOM 2006: A NIST symposium for photonic and fiber measurements," Boulder, CO. *Special Publication* (NIST SP 1055) (2006).

R. J. Espejo and S. D. Dyer, "High spatial resolution measurements of transverse stress in a fiber Bragg grating using four-state analysis low-coherence interferometry and layer-peeling," *Smart Structures and Materials 2006: Smart Sensor Monitoring Systems and Applications, SPIE Annual Intl Symp. on Smart Structures and Materials*, Feb 26–Mar 02, San Diego, CA (2006).

S. D. Dyer, T. Dennis, P. A. Williams, L. Street, S. M. Etzel, R. J. Espejo, T. A. Germer, and T. E. Milner, "High sensitivity measurements of the scattering dispersion of phantoms using spectral domain optical coherence tomography," *SPIE Coherence Domain Optical Methods and Optical Coherence Tomography in Biomedicine X*, Vol. 6079, paper 43, Jan 21–26, San Jose, CA (2006).

P. A. Williams, N. J. Kemp, D. Ives, J. Park, J. C. Dwelle, H. G. Rylander, and T. E. Milner, "Noise model for polarization-sensitive optical coherence tomography," *SPIE Coherence Domain Optical Methods and Optical Coherence Tomography in Biomedicine X*, 2006, Vol. 6079, paper 56, Jan 21–26, San Jose, CA (2006).

T. J. Drapela, "Measurement 'round robins' support fiber standards development," *Lightwave*, Vol. 23, No. 1, p. 19 (2006).

T. Dennis and P. A. Williams, "Achieving high absolute accuracy for group-delay measurements using the modulation phase-shift technique," *J. Lightwave Technol.*, Vol. 23, No. 11, pp. 3748–3754 (2005).

S. D. Dyer, P. A. Williams, R. J. Espejo, J. Kofler, and S. M. Etzel, "Fundamental limits in fiber Bragg grating peak wavelength measurements," *Proc. of SPIE, 17th International Conference on Optical Fiber Sensors*, May 23–27, Bruges, Belgium, Vol. 5855, pp. 88–93 (2005).

T. Dennis, P. A. Williams, "High-accuracy optical group delay measurements and modulator chirp characterization," *International Topical Meeting on Microwave Photonics*, Oct 04-06, Ogunquit, ME, pp. 32–35 (2005).

T. Dennis and P. A. Williams, "Chromatic dispersion measurement error caused by source amplified spontaneous emission," *IEEE Photon. Tech. Lett.*, Vol. 16, No. 11, pp. 2532–2534 (2004).

P. A. Williams, "PMD measurement techniques and how to avoid the pitfalls," *Journal of Optical and Fiber Communications Reports*, Vol. 1, No. 1, Springer, pp. 84–105 (2004).

R. J. Espejo, S. D. Dyer, and M. Svalgaard, "Analysis of a fiber Bragg grating writing process using low-coherence interferometry and layer-peeling," *Tech. Dig., Symp. on Optical Fiber Meas.*, Sept. 28–30, Boulder, CO, pp. 195–198 (2004).

P. A. Williams and G. W. Day, "Technical digest, symposium on optical fiber measurements," Boulder, CO, *Special Publication (NIST SP 1024)* (2004).

SPECTRAL AND NONLINEAR PROPERTIES

GOALS

Develop techniques for the generation, amplification, dissemination, and characterization of stable, low-noise optical sources for fiber optic-based systems. (Current work focuses on the development and applications of fiber optic frequency combs). Support current wavelength-calibration transfer standards in the near infrared region to help industry calibrate equipment, and explore new techniques for future higher-precision transfer standards.

CUSTOMER NEEDS

In the past, this project concentrated on the measurement needs of the optical fiber communications industry. More recently our focus has expanded to address the broader needs for metrology and stable optical sources in the near-infrared region that arise in a variety of applications, including coherent communications, LIDAR, and optical fiber sensors.

By using many wavelength channels simultaneously, wavelength division multiplexing (WDM) has been very successfully applied to increasing the transmission bandwidth of optical-fiber communication systems. Most WDM systems employ 50 or 100 GHz channel spacing (0.4 or 0.8 nm, respectively) in the 1540 to 1560 nm region. For effective system operation, the source wavelength and the wavelength dependence of any components must be well characterized and controlled. In the past, this project has developed Standard Reference Materials (SRMs) that provide wavelength standards in this region for calibration of measurement equipment. To support requirements of even higher bandwidths, future systems will either expand into other wavelength regions or increase transmission efficiency within the current spectral region and will likely require the development of new, more accurate transfer standards.

Partly because of the dramatic increase in the available sources and components at telecommunication wavelengths, this area of the spectrum finds increasing applications in sensing. For example, optical-fiber sensors can detect small changes in stress, or temperature, based on the wavelength shift of fiber Bragg grating reflection peaks. The sensitivity is determined by the wavelength accuracy of the interrogation unit; some systems need wavelength calibration to better than 1 pm. As another example, coherent LIDAR systems can

be used to probe the atmosphere and for military sensing applications. Operation near 1.5 μm is attractive because it is eye-safe compared to the visible region, there is an abundance of available technology, and there are amplifiers available of increasingly higher power. The ability to generate and transmit highly frequency-stable (*i.e.*, low phase noise) optical sources translates directly into increased sensitivity for coherent LIDAR. Coherent free-space communications shares the same essential features as coherent LIDAR and will similarly benefit from well characterized, frequency-stable optical sources. Therefore, all of these applications share the same basic metrological needs of measuring an optical frequency. The current gold standard for measuring optical frequencies is the optical frequency comb.

TECHNICAL STRATEGY

Supporting optical fiber and component metrology needs requires development and evaluation of new measurement techniques, basic technology, dissemination of this knowledge, and, when appropriate, development of SRMs or other calibration aids to help industry calibrate instrumentation. The project currently focuses on three areas: 1) developing very low-noise fiber- frequency combs covering the near infrared, 2) expanding the applications of these frequency combs to different areas, and 3) supporting current wavelength calibration standards in the near infrared region.

FIBER FREQUENCY COMB DEVELOPMENT

Frequency combs can provide a set of evenly spaced, exactly positioned lines across the near infrared region of the optical spectrum. These combs are ideally suited to supporting very highly accurate metrology in the near-infrared since they can be used as a precise spectral ruler. In addition to their application to wavelength metrology, frequency combs are potentially enabling sources for a number of other applications discussed below. Much of the original work on frequency combs used Ti:Sapphire lasers and took place in the Physics Laboratory at NIST. These Ti:Sapphire frequency combs cover mainly the visible region, and do not reach far enough into the near infrared to cover the “transparent” window of optical fiber (1.1 to 1.7 μm). In order to reach this spectral region, we have been developing optical fiber laser-based frequency combs. To generate an optical frequency comb in the near infrared, pulses

Technical Contact:
Nate Newbury

Staffing (FY06):
2 professional
1 associate

from a mode-locked fiber laser are launched into highly nonlinear optical fiber, which broadens the laser spectrum to a supercontinuum with a width of greater than 1000 nm. Since the laser is pulsed, this broad supercontinuum will actually be composed of discrete frequency lines – a *frequency comb* – spaced by the laser repetition rate. This optical frequency comb can be stabilized to provide discrete frequency or wavelength markers throughout the 1100 to 2000 nm region. Any unknown optical frequency can then be measured by simply comparing its frequency to that of the nearest tooth of the stabilized frequency comb. Fiber laser-based frequency combs can be much more compact, robust, power-efficient, and lighter than bulk optic solid-state laser-based frequency combs, and commercial fiber-laser frequency combs are now available from several companies. Our goal at NIST is to understand the current limitations of fiber frequency combs and to increase their performance, as measured by either the stability or the phase noise of the individual comb lines. Minimization of noise for fiber frequency combs involves research in a wide range of areas, including design and theory of femtosecond fiber lasers, spectral broadening in highly nonlinear optical fiber, linear and nonlinear fiber optic effects that occur during the transmission of cw or pulsed optical signals, and feedback control systems.

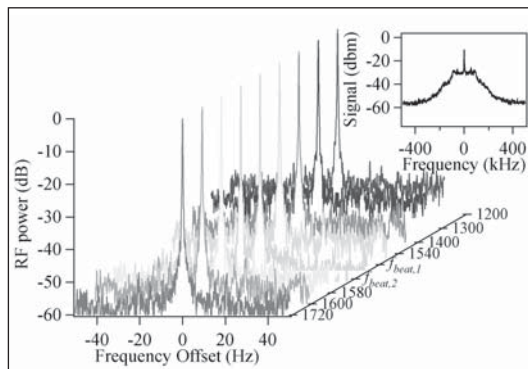

The linewidth of a low phase-noise fiber frequency comb. The individual traces represent the heterodyne beat between two low-noise fiber frequency combs (one from NIST and one from a collaborator) at different points across the spectrum. The inset shows the rf heterodyne beat on a larger scale. The pedestal in that signal represents uncorrected phase noise that amounts to only one radian of optical phase noise.

PLAN:

Develop fiber frequency comb into tool for high accuracy (*i.e.*, hertz-level) optical frequency measurement.

Investigate phase and amplitude noise on fiber-laser based frequency combs

Explore fiber-induced limitations to the dissemination of highly stable cw or pulsed laser light over optical fiber networks.

APPLICATIONS DEVELOPMENT

As discussed above, fiber frequency combs are ideally suited for metrology of optical sources; however, they are also well suited for any other applications that benefit from a low phase-noise, wideband optical source. We are interested in demonstrating the use of fiber frequency combs in both metrological and nonmetrological applications.

Two interesting metrological applications are laser source characterization and fiber-optic dissemination of fundamental wavelength, time, and frequency standards. Currently, the phase noise of commercial lasers is specified by a single, poorly defined linewidth parameter. As lasers are employed in applications requiring significantly lower levels of phase noise, this parameter will be completely inadequate, and much better-defined specifications will be needed. Specifically, lasers are simply optical oscillators and, as such, should have phase noise specifications mirroring those of commercial rf synthesizers. Such information on laser performance is easily provided by comparison with a single tooth from a low-noise fiber frequency comb. A second promising metrological application for combs is the dissemination of wavelength standards, frequency standards, and time over large distances by use of fiber optic networks. The dissemination of these standards is complicated by both linear and nonlinear effects that will degrade the phase quality of the signal. Nevertheless, several groups have demonstrated precise frequency transfer over local area networks. We are interested in conducting experiments to establish the limits of fiber-optic dissemination of wavelength, frequency, and time over very large fiber networks.

A number of applications can benefit from the high stability, low phase noise, wide bandwidth or very low timing jitter provided by fiber frequency combs. These applications range from straightforward spectroscopy to arbitrary optical waveform generation, optical coherence tomography, coherent LIDAR for remote sensing, and precise ranging for semiconductor manufacturing. For example, the wide bandwidth of the comb provides very high range resolution, which can be exploited in any ranging system, whether it be for optical coherent tomography, a ranging coherent LIDAR system, or a precision stepper system in a manufacturing

environment. We have conducted an initial laboratory experiment demonstrating the advantages of a fiber frequency comb source for a ranging LIDAR system. This same system can also provide very precise vibrometry signatures. We will continue to explore the utility of fiber frequency comb sources for these applications through laboratory demonstrations.

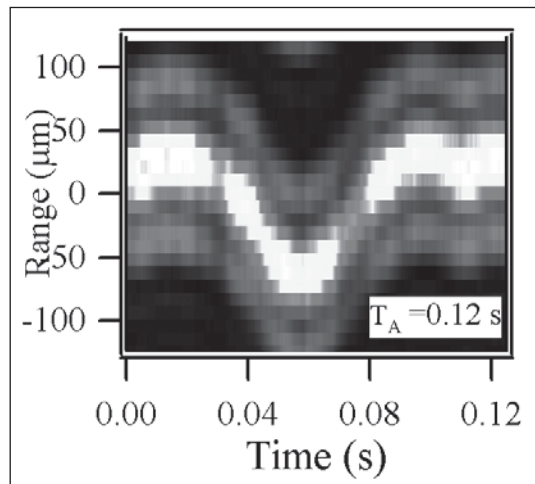

Example range image collected with a fiber frequency comb source and frequency-domain signal processing. The image is of a rotating disk that had a 100 micrometer wobble. The resolution is about 50 micrometers and is limited only by the 25-nm bandwidth of the erbium-doped fiber amplifier used to transmit the fiber frequency comb pulses.

PLAN:

Demonstrate the applicability of fiber frequency comb sources to remote sensing, including precise range-Doppler measurements.

Provide the capability of measuring the stability and phase noise of optical sources in the near-infrared.

Long term: Develop and implement plan to disseminate wavelength/frequency standards via optical frequency combs and optical fiber.

WAVELENGTH CALIBRATION STANDARDS

Fundamental wavelength references based on atomic and molecular absorption or emission lines provide high accuracy, but they are not available in all wavelength regions. The project currently produces four wavelength reference SRMs based on fundamental molecular absorption lines: SRM 2514 (carbon monoxide $^{12}\text{C}^{16}\text{O}$), SRM 2515 (carbon monoxide $^{13}\text{C}^{16}\text{O}$), SRM 2517a (acetylene, high resolution), and SRM 2519a (hydrogen cyanide). Together these SRMs can be used to calibrate the wavelength scale of instruments between 1510 nm and 1630 nm. WDM can expand into

other wavelength regions, such as the 1300–1500 nm region. For the near term, we will continue to support these SRMs as well as monitor industry to anticipate future needs.

ACCOMPLISHMENTS

■ *Sub-Hertz Linewidth Fiber Laser Frequency Comb Demonstrated* — We demonstrated a sub-hertz residual linewidth fiber laser frequency comb in collaboration with an outside company. Each individual comb line had a measurement-limited linewidth of less than 100 mHz and a residual phase noise of less than 1 radian. The extrapolated timing jitter was less than 1 femtosecond. This demonstration indicates that the fiber-laser based comb can have performance approaching that of the Ti:Sapphire based systems.

■ *High Stability Achieved for Fiber Laser Frequency Comb Offset Frequency* — We succeeded in stabilizing the carrier-envelope offset frequency from a fiber laser frequency comb very tightly. In the laser output pulses, the relative jitter between the optical carrier wave and the pulse envelope is below a few radians. This high stability should benefit both high precision frequency metrology and future time-domain experiments with fiber laser frequency combs.

■ *Theory for the Response of Fiber Laser Developed and Verified* — We developed a theory for the response of fiber-laser based optical frequency combs to changes in the pump power, cavity length, and other experimentally-accessible parameters. The theory predicts the comb response in terms of transfer functions. Interestingly, it is a quite a complicated system and there are at least five different mechanisms that can play important roles in the laser response. We have also verified the theory by conducting experimental measurements on frequency combs and showed that the response is consistent with the theory. In addition, the theory predicts that other control parameters could be used to improve the stability of the comb and provide better ultimate performance of the frequency comb.

■ *Frequency-Resolved Coherent LIDAR Technique Developed* — We have demonstrated a six-channel frequency-resolved coherent LIDAR (FReCL) using an optical frequency comb. It provides one-sixth of the noise of conventional LIDAR for speckle-limited signals, drastically reduces the required accuracy and steps of the variable delay line, and permits phase compensation even with significant phase distortions in the signal path. The system can be implemented with many more

channels and a corresponding improvement in signal-to-noise ratio.

■ *High Accuracy Wavelength Calibration SRM for the 1530-1565 nm Region Available* — A new wavelength reference for the 1530 to 1565 nm region is now available as Standard Reference Material 2519a. The SRM is an upgrade of SRM 2519 and is more than an order of magnitude more accurate than its predecessor; a selection of the absorption lines of hydrogen cyanide are certified with an uncertainty of 0.04 pm (about 5 MHz). Thus, SRM 2519a enables wavelength calibration of test and measurement equipment at much higher-accuracy.

STANDARD REFERENCE MATERIALS (SRM) (SEE APPENDIX E)

See <http://www.boulder.nist.gov/div815/SRMS/SRMS.htm> for descriptions

SRM 2513, Mode Field Diameter Standard for Single-Mode Fiber

SRM 2514, Wavelength Calibration Reference for 1560–1595 nm – Carbon Monoxide $^{12}\text{C}^{16}\text{O}$

SRM 2515, Wavelength Calibration Reference for 1595–1630 nm – Carbon Monoxide $^{13}\text{C}^{16}\text{O}$

SRM 2517a, High Resolution Wavelength Calibration Reference for 1510–1540 nm – Acetylene $^{12}\text{C}_2\text{H}_2$

SRM 2519a, High Resolution Wavelength Calibration Reference for 1530–1565 nm – Hydrogen Cyanide $\text{H}^{13}\text{C}^{14}\text{N}$

SRM 2520, Optical Fiber Diameter Standard

RECENT PUBLICATIONS

See http://www.boulder.nist.gov/div815/81503_pubs.htm for publications.

W. C. Swann, J. J. McFerran, I. Coddington, N. R. Newbury, I. Hartl, M. E. Fermann, P. S. Westbrook, J. Nicholson, K. Feder, C. Langrock, M. Fejer, “Fiber-laser frequency combs with sub-Hz residual linewidths,” *Opt. Lett.*, in press.

J. J. McFerran, W. C. Swann, B. R. Washburn, N. R. Newbury, “Pump-induced frequency noise in fiber laser frequency combs and fceo phase excursions suppressed to 1 radian,” submitted to *Appl. Phys. B.*, in press.

J. J. McFerran, W. C. Swann, B. R. Washburn, N. R. Newbury, “Characterization and elimination of the pump-induced frequency jitter of fiber-laser frequency combs,” *Opt. Lett.*, Vol. 31, No. 13, pp. 1997–1999, (2006).

N. R. Newbury, W. C. Swann, I. Coddington, J. J. McFerran, “Fiber frequency combs: development and applications,” *Tech. Dig., Symp. on Optical Fiber Meas.*, Sep 19–20, Boulder, CO, NIST Special Publication 1055, pp. 45–50 (2006).

W. C. Swann, N. R. Newbury, “Frequency-resolved coherent LIDAR using a femtosecond fiber laser,” *Opt. Lett.*, Vol. 31, No. 6, pp. 826–828 (2006).

B. Washburn, W. C. Swann, N. R. Newbury, “Response dynamics of the frequency comb output from a femtosecond fiber laser,” *Optics Express*, Vol. 13, No. 26, pp. 10622–10633 (2005).

N. R. Newbury, B. Washburn, “Theory of the frequency comb output from a femtosecond fiber laser,” *IEEE J. Quantum Electron.*, Vol. 41, No. 11, pp. 1–16 (2005).

R. Fox, B. R. Washburn, N. R. Newbury, L. Hollberg, “Wavelength references for interferometry in air,” *Appl. Opt.*, Vol. 44, No. 36, pp. 7793–7801 (2005).

S. L. Gilbert, W. C. Swann, C. M. Wang, “Hydrogen cyanide $\text{H}^{13}\text{C}^{14}\text{N}$ absorption reference for 1530 nm to 1565 nm wavelength calibration – SRM 2519a,” *Special Publication (NIST SP) 260-137*, 2005 Edition.

W. C. Swann, S. L. Gilbert, “Line centers, pressure shift, and pressure broadening of 1530-1560 nm hydrogen cyanide wavelength calibration lines,” *J. Opt. Soc. Am. B*, Vol. 22, No. 8, pp. 1749–1756 (2005).

K. Kim, B. Washburn, G. Wilpers, C. W. Oates, L. W. Hollberg, N. R. Newbury, S. A. Diddams, J. Nicholson, M. F. Yan, “Stabilized frequency comb with a self-referenced femtosecond Cr:forsterite laser,” *Opt. Lett.*, Vol. 30, No. 8, pp. 932–934 (2005).

B. Washburn, R. W. Fox, N. R. Newbury, J. Nicholson, K. Feder, P. S. Westbrook, C. G. Jorgensen, “Fiber-laser-based frequency comb with a tunable repetition rate,” *Optics Express*, Vol. 12, No. 20, pp. 4999–5004 (2004).

B. Washburn, S. A. Diddams, N. R. Newbury, J. Nicholson, F. Kenneth, P. S. Westbrook, C. G. Jorgensen, “Infrared frequency comb for frequency metrology based on a tunable repetition rate fiber laser,” *Tech. Dig., Symp. on Optical Fiber Meas.*, Sep 28–30, 2004, Boulder, CO, NIST Special Publication 1024, pp. 11–14 (2004).

W. C. Swann, S. L. Gilbert, “Accuracy limits for simple molecular absorption based wavelength references,” *Tech. Dig., Symp. on Optical Fiber Meas.*, Sep 28–30, 2004, Boulder, CO, NIST Special Publication 1024, pp. 15–18 (2004).

NANOSTRUCTURE FABRICATION AND METROLOGY

GOALS

Develop modeling, fabrication, and measurement methods for semiconductor nanostructures, including quantum dots and photonic crystals. Develop fundamentally new devices such as single-photon sources and detectors and entangled-photon sources.

CUSTOMER NEEDS

Semiconductor nanostructures, especially self-assembled quantum dots and photonic crystals, are emerging as an important future direction for optoelectronics. Photonic crystals offer a wide range of possibilities, ranging from improved light-emitting diodes to photonic integrated circuits to spontaneous emission control. Semiconductor quantum dots have an atomic-like density of states that offers substantial opportunities for unique and improved devices. These include ultra-low-threshold laser diodes with low temperature dependence, and semiconductor optical amplifiers with reduced cross-gain modulation and large bandwidth. Several fundamental properties of quantum dots, including resonant absorption cross-sections and homogeneous linewidth, set limitations on device operation. For example, high-spectral-resolution measurement of quantum dots is important for quantifying structural homogeneity as well as providing data to model devices to be used in quantum information applications.

The ability to generate and control single photons offers new opportunities to meet customer needs in quantum-based radiometric measurements where optical power is measured by counting photons. Quantum cryptography is an emerging form of ultrasecure communications that requires an on-demand source of single photons as well as single photon detectors. The single-photon turnstile will allow us to meet the requirements of this new technology. It can be extended to generate pairs of entangled photons. These entangled-photon pairs are useful for a wide range of applications, from fundamental tests of quantum mechanics to reduced dimensions with optical lithography. Semiconductor single photon detectors with reduced timing jitter, higher quantum efficiency, and photoresponse beyond 1000 nm offer advantages in applications such as semiconductor and integrated circuit characterization, LIDAR, and quantum cryptography.

TECHNICAL STRATEGY

GROWTH AND CHARACTERIZATION OF SEMICONDUCTOR QUANTUM DOTS

We use molecular beam epitaxy (MBE) to grow self-assembled quantum dots. We have developed ultrafast pump-probe methods to characterize carrier lifetimes of quantum dots. We have used a novel time-resolved waveguide-coupling method to directly measure the dipole moment of quantum dots. Cavity ring-down spectroscopy provides an extremely sensitive direct measurement of absorption. Differential transmission spectroscopy yields information on carrier transfer and an estimate of the homogeneous linewidth of quantum dots. Spectral hole-burning techniques have been developed to directly measure the lineshape.

PLAN: Directly measure the dependence of the homogeneous lineshape of semiconductor quantum dots on power and applied electric field. Extend the operation of the spectral hole-burning experiment to single-dot absorption spectroscopy.

SINGLE PHOTON SOURCES

For practical implementation, single-photon sources should operate at high temperatures. Colloidal CdSe quantum dots, nitrogen vacancy centers, and single molecules have demonstrated room-temperature single-photon emission; however, the first two systems exhibit blinking, and some single molecules exhibit photobleaching, both of which degrade performance. Epitaxial InGaAs/GaAs quantum dots are attractive as single photon emitters due to their ease of fabrication and inclusion with monolithic microcavities, their short spontaneous emission lifetimes, and the possibility of electrical injection.

The photon repetition rate of the single-quantum-dot, single-photon turnstile (SPT) is controlled by the frequency of an applied AC voltage, allowing precisely defined emission of single photons. The ultimate goal is the embedding of an SPT inside a photonic crystal nanocavity, which will enable enhanced emission efficiency and directionality. We have implemented a Hanbury Brown-Twiss apparatus to measure the photon statistics from our SPT. A true single-photon device exhibits photon emission times that are nonclassical. Specifically, photon antibunching has been observed.

PLAN: Demonstrate an electrically driven single photon turnstile based on a single quantum dot. Determine the path to application in quantum-based radiometry.

Technical Contact:
Rich Mirin

Staffing (FY06):
3.8 professionals
6.5 associates

SINGLE-PHOTON DETECTORS

Photon detectors made with field-effect transistors (FETs) that use an optically addressable floating gate consisting of a layer of quantum dots have the potential to be fast, flexible, and efficient single-photon detectors. With compound semiconductors one can control the absorption spectrum via material choices. In addition, resonant-cavity designs, which raise the efficiency, are compatible with these structures.

PLAN: Optimize a single-photon detector consisting of an optically modulated, quantum-dot field-effect transistor. The detector will be compact, of low noise, have a high quantum efficiency (goal of greater than 90 %), and have photon-number-resolving capability.

SEMICONDUCTOR PHOTONIC CRYSTALS

Photonic crystal cavities and waveguides are expected to play important roles in advanced optoelectronic devices such as ultracompact photonic integrated circuits for communication and sensing. The fabrication of photonic crystals requires the precision growth and anisotropic etching of semiconductor epilayers. We are using a chemically assisted ion-beam (CAIBE) system to etch semiconductor nanocavities in layers grown by MBE. These nanocavities contain quantum dots, and the spontaneous emission from the quantum dots is influenced by the effects of the cavity. Careful control of the cavity structure and the position of the quantum dots within the cavity can lead to weak coupling (enhanced spontaneous emission, also known as the Purcell effect) or to strong coupling (Rabi oscillations).

Semiconductor light-emitting diodes can efficiently generate light throughout the ultraviolet, visible, and near-infrared. However, because of the high index mismatch at the semiconductor-air interface, only a small fraction of light in a conventional LED is extracted normal to the surface, the rest being emitted into the substrate, or trapped and re-absorbed in the active layer. The development of nanophotonic structures such as photonic crystals to enhance light extraction could offer superior efficiency, integration, and cost over present efforts in LED chip shaping and packaging. We are using Bragg gratings to enhance the extraction efficiency of light-emitting devices. Further application of on-chip gratings is to control dispersion in mode-locked lasers.

PLAN: Investigate the application of photonic crystals to emission control in single-photon sources and other devices. Demonstrate dispersion compensation with chirped gratings to shorten pulse widths in monolithic mode-locked diode lasers.

MODE-LOCKED QUANTUM DOT LASERS

There are many applications of ultrashort/broadband optical pulses that are hindered by the cost, complexity and inefficiency of the large-frame mode-locked lasers used to produce such pulses. These include optical atomic clocks, terahertz generation for homeland security, and optical coherence tomography (OCT). The problems would be eliminated if high-performance mode-locked diode lasers could be developed. Efforts to develop mode-locked diode lasers ran up against a fundamental barrier that limited the brevity of the pulses — carrier dynamics in the gain region of semiconductor lasers that result in a complex phase profile of the generated pulse. Ultimately 200 fs pulses have proven to be the shortest achievable from a conventional mode-locked diode laser, *i.e.*, one that uses a simple heterojunction or quantum well(s) for the gain region. This falls well short of the performance (~20 fs pulses) required for the most promising applications.

We plan to overcome this fundamental barrier by utilizing self-organized quantum dots for the gain region. It is anticipated that the quantum dots will be immune to the deleterious effects of complex carrier dynamics and enable a major improvement of pulse durations. In addition, the inherent size distribution in self-assembled QD ensembles leads to a very large inhomogeneously broadened lineshape with the bandwidth necessary to support short-pulse mode locking. This project requires a close coupling between expertise in QD growth, semiconductor laser design and fabrication, and in ultrafast lasers and measurement.

PLAN: Develop mode-locked quantum-dot diode lasers, with an ultimate goal of 20 fs pulse width, and characterize their output.

QUANTUM OPTICAL METROLOGY

Many precision measurements of length or refractive index are based on interferometry. However, the phase resolution of these measurements scales as the reciprocal of the square root of the amount of optical power used for the measurement. This is not a fundamental limitation, however, and the goal of this new project is to explore optical interferometry at the fundamental Heisenberg limit, in which phase resolution increases as the reciprocal of the number of photons.

PLAN: Develop new sources of N entangled photons, such as NOON states and Schroedinger cat states, and use these to perform interferometry.

ACCOMPLISHMENTS

■ *Optically/electrically pumped photon emitter* — Demonstrated prototype device as an important step toward a hybrid optically/electrically pumped single photon emitter. Holes were optically injected by absorption of ~ 800 nm wavelength light in a GaAs layer and stored by an ensemble of InGaAs quantum dots. This was followed by forward biasing to inject electrons into the quantum dots, and subsequent photon emission at 950-1000 nm wavelength. Current research is on reducing the number of quantum dots used for the measurement and on increasing the collection efficiency through use of a transparent contact.

■ *Homogeneous linewidth of quantum dots measured* — Developed and applied a pump-probe, spectral-hole-burning technique to directly measure, with high spectral resolution, the exciton homogeneous absorption linewidth of self-assembled InGaAs quantum dots. The technique uses a local oscillator to separate detection of the collinear pump and probe beams in the waveguide geometry. Pump-power-dependent and temperature-dependent data were collected and modeled.

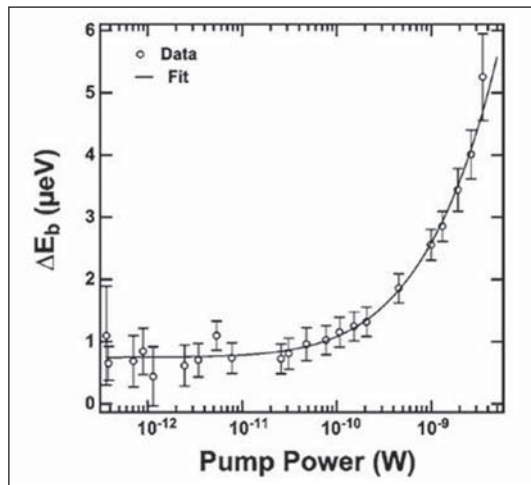

High-resolution spectroscopy of InGaAs/GaAs quantum dots: full width at half maximum of the spectral hole vs. pump power through the waveguide at 9 K.

■ *Quantum dot coherence time measured* — Used high resolution spectral hole burning (SHB) to perform the best measurements of InGaAs/GaAs quantum dot coherence time to date. The measured linewidth is nearly spontaneous-emission-lifetime limited. The SHB method used enabled a measurement of coherence time of 1.76 ns, which is a factor of two longer than other groups have reported, and makes quantum dots more attractive candidates as qubits in quantum logic operations.

■ *Semiconductor single photon detector with high quantum efficiency* — Demonstrated single photon detection using a quantum-dot-gated, field effect transistor (QDOGFET). The detector exhibits time-gated, single-shot, single-photon sensitivity; a linear response to average photon number; and an internal quantum efficiency of 70 % at 4 K through careful design to efficiently detect photons absorbed in the GaAs absorbing layer. The noise in the system was reduced to ~ 0.5 photons ($1/e$), opening the possibility of developing a photon number resolving detector.

■ *Single photon source characterized with low-jitter superconducting detector* — Demonstrated, with the Quantum Information and Terahertz Technology Project, the first use of superconducting single-photon detectors (SSPDs) for single-photon source characterization. The source was an optically pumped, microcavity-coupled, InGaAs quantum dot, emitting single photons at 902 nm. The two SSPDs replaced the silicon Avalanche Photodiodes (APDs) in a Hanbury-Brown Twiss interferometer measurement of the source second-order correlation function. The SSPD system electronics jitter was 68 ps, versus 550 ps for the APD units, allowing the source spontaneous emission lifetime to be measured with improved resolution.

■ *Time-correlated infrared single-photon counting with superconducting detector* — Demonstrated, with the Quantum Information and Terahertz Technology Project, the advantages of a NbN-based superconducting single photon-detector (SSPD) in a time-correlated, single-photon counting scheme to measure short spontaneous emission lifetimes of quantum wells in the infrared. The instrument response function (IRF) of the SSPD was shown to be Gaussian over nearly 5 decades of dynamic range. The FWHM of the IRF, which is a measure of the timing jitter, was 68 ps. These response characteristics are of great advantage over those of Si avalanche photodiodes (APDs) for detailed measurement of emission decay curves with high temporal resolution. In contrast, the IRFs of Si APDs exhibit long tails and multi-component responses. Quantum well emission out to 1650 nm in wavelength was measured with the SSPD, well beyond the photosensitive range of Si. APDs based on InGaAs or Ge can have reasonable detection efficiencies in the infrared, but are limited in available dynamic range.

■ *Light extraction efficiency greatly enhanced* — Demonstrated enhanced light extraction from circular Bragg grating-coupled semiconductor microcavities. A distributed Bragg reflector

(DBR), behind the InGaAs quantum dot emitters and consisting of high-index-contrast GaAs/AlO_x layers, increased the integrated photoluminescence by a factor of 2.7 over that of a device with no oxide DBR, indicating the role of the vertical cavity in enhancing extraction efficiency. To extract guided emission otherwise trapped in the plane of the device, circular Bragg gratings (CBGs) were formed on the periphery of the light-emitting mesa by means of a chlorine-assisted, ion-beam etch. Mode extraction was maximized by near-perfect momentum matching of the guided circular cavity modes to the resonant-extracted modes of the vertical cavity. The effect of the CBGs was an additional measured 7.5 times enhancement of light extraction, yielding a calculated absolute external efficiency of 41 % for the whole device. The modeling of modal dispersion diagrams and light extraction aided the design of the devices and interpretation of the data. The development of nanophotonic structures such as the DBR/CBG device offers potential advantages in efficiency, integration, and cost over present LED chip shaping and packaging for display and biomedical applications.

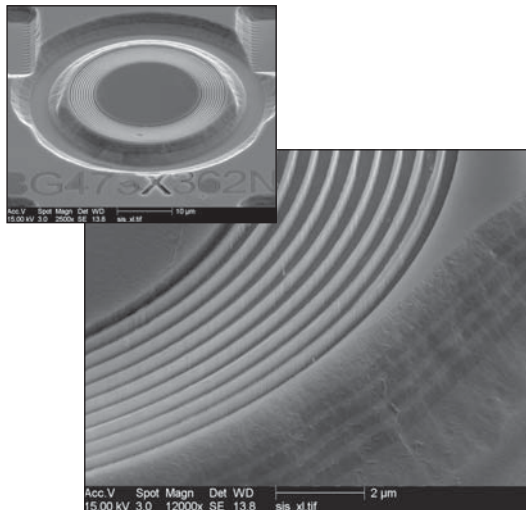

Circular Bragg grating device for light extraction efficiency enhancement.

KEY COLLABORATIONS

CU/JILA: development of mode-locked, quantum dot laser diodes; two-dimensional spectroscopy of coupled quantum wells.

Texas A&M University: nanolithography on GaAs for quantum dot position control and nanoantennas coupled to quantum dots.

Yale University: nanomechanical resonators.

NIST Physics Laboratory: quantum state tomography.

RECENT PUBLICATIONS

M. Stevens, R. Hadfield, R. Schwall, S. W. Nam, R. Mirin, "Fast lifetime measurements of infrared emitters using a low-jitter superconducting single-photon detector," *Appl. Phys. Lett.*, Vol. 89, No. 031109 (2006).

J. J. Berry, M. Stevens, R. Mirin, K. L. Silverman, "High-resolution spectral hole burning in InGaAs/GaAs quantum dots," *Appl. Phys. Lett.*, Vol. 88, No. 061114 (2006).

K. L. Silverman, J. J. Berry, R. Mirin, "High-resolution continuous-wave absorption measurements on InGaAs/GaAs self-assembled quantum dots," *The Proceedings of the state-of-the-art program on compound semiconductors XLIV*, May 07–12, 2006, Denver, CO (2006).

M. Su, R. Mirin, "Enhanced light extraction from circular Bragg grating coupled microcavities," *Appl. Phys. Lett.*, Vol. 89, No. 033105 (2006).

R. Hadfield, M. Stevens, S. Gruber, A. J. Miller, R. Schwall, R. Mirin, S. W. Nam, "Single photon source characterization with a superconducting single photon detector," *Optics Express*, Vol. 13, No.26, pp. 10846–10847 (2005).

K. L. Silverman, R. Mirin, S. T. Cundiff, B. Klein, "Carrier dynamics and homogeneous broadening in quantum dot waveguides," *Proc., SPIE, The International Society for Optical Engineering, Integrated Optoelectronic Devices 2005*, Jan 24–25, 2005, San Jose, CA, Vol. 5734, pp. 94–105 (2005).

R. Mirin, "Photon antibunching at high temperature from a single InGaAs/GaAs quantum dot," *Appl. Phys. Lett.*, Vol. 84, No. 8, pp. 1260–1262 (23-Feb-2004).

K. L. Silverman, R. Mirin, S. T. Cundiff, "Lateral coupling of InGaAs/GaAs quantum dots investigated using differential transmission spectroscopy," *Phys. Rev. B, Rapid Comm.*, accepted 2004.

QUANTUM INFORMATION AND TERAHERTZ TECHNOLOGY

GOALS

Develop superconducting single-photon and photon-number-resolving detectors and evaluate them in quantum communication networks and fundamental physics experiments. Develop and apply terahertz and millimeter-wave technology and metrology for imaging and spectroscopy.

CUSTOMER NEEDS

New quantum-based communication and measurement systems that use single and correlated photons have been developed; however, the current tools for calibrating the components in these systems are inadequate for the emerging applications. For accurate calibration, a detector capable of determining the number of photons in a single pulse of light is needed. We are developing high-efficiency detector systems with this capability in the three telecommunication windows (850 nm, 1310 nm, and 1550 nm). These new instruments will also aid in the understanding and advancement of new photon sources such as the single-photon turnstile and entangled photon sources. They can be used as a spectroscopic diagnostic tool or characterization tool for optical elements, optical materials, and optical systems at ultralow light levels. A near-term use of the detectors is for research in quantum key distribution, a method of communication where security is assured by the laws of quantum mechanics rather than by mathematical complexity.

Imaging in the ~100 GHz to ~2 THz range offers the possibility of concealed weapons detection and remote detection of contraband (for example, explosives under clothing) without the use of ionizing radiation. Spectroscopy in this frequency range has additional applications in industrial processing and remote identification of chemicals. Industry and government agencies require unique capabilities in detectors, optics, and metrology methods and test-beds for improved imaging systems and unbiased, calibrated evaluations of systems and components.

TECHNICAL STRATEGY

TRANSITION-EDGE SENSOR

Superconducting transition-edge sensor (TES) detector technology is suited for counting photons at telecommunication wavelengths or measuring the energy of a single photon. In this device a thin

film of tungsten is cooled to its superconducting transition temperature (~100 mK). The tungsten is biased at its transition from the normal to superconducting state such that the input of a small amount of heat, for example from the arrival of a single infrared photon, dramatically changes the tungsten resistance. The change in resistance is proportional to the heat absorbed.

These TES detectors can be operated in two distinct modes depending on the photon source properties. For single-wavelength (monochromatic) sources such as lasers and spontaneous parametric down-conversion crystals (used for quantum information and metrology), the sensor response is directly proportional to absorbed photon number (photon number discrimination mode). For broadband sources (such as white-light or multiple fluorescence emissions) the energy-resolving ability of the TES devices allows photon-counting spectroscopy to be performed across the entire near-infrared/optical band (2 μm to 200 nm). In this mode, the photon number is discarded in favor of determining the energy of the incoming photons (spectroscopic mode).

We have increased the quantum efficiency of the TES detector system to over 85 % by incorporating the tungsten film in a carefully designed “optical cavity.” Additional improvements will use dielectric mirrors and methods to reduce fiber coupling loss. Our goal is to get as close to 100 % overall system efficiency as possible. Our long-term goal for reduced recovery time of the TES detector is 10 ns. Research on new materials and improved electronic readout schemes may help in this regard.

Conventional semiconductor-based single-photon detectors suffer from high rates of “dark counts” (false positives), at the communication wavelengths of 1300 nm and 1550 nm, which severely limit single-photon applications. The TES detectors have no intrinsic dark counts, allowing them to be operated at much lower light levels than any existing metrological instrument. As the efficiency of TES systems has increased this has led to the investigation of previously unknown sources of dark counts in fiber optic systems.

Their unparalleled sensitivity allows these detectors to be a significant tool in the development of quantum-based communication protocols and the evaluation of the security of optical quantum

Technical Contact:
Sae Woo Nam

Staffing (FY06):
2.5 professionals
5.5 associates

cryptographic systems, which we carry out in collaboration with government and industry partners. Technology transfer is an important part of our strategy.

PLAN: Increase detection efficiency of TES systems to over 92 % using dielectric mirrors and improved fiber coupling. Reduce detector recovery time to 100 ns by use of new materials and electronic readout schemes.

SUPERCONDUCTING SINGLE PHOTON DETECTOR

Superconducting single photon detectors (SSPDs) incorporate a very narrow (~100 nm) serpentine line of metallic superconductor such as Nb or NbN carrying a bias current very close to its critical current. When a photon strikes the superconductor a small “hot spot” is created locally, reducing the critical current to a value below the bias current. This creates an easily detected voltage across the superconductor. While the detector is not photon number resolving (one or more photons will create the hot spot), it is extremely fast, producing pulses of order a few tens of nanoseconds. Such a device is potentially very useful in a quantum communication system. At the present time, it is difficult to couple light to these devices with high efficiency because of their small size (3 micrometer x 3 micrometer), and they are incapable of long-term unattended stable operation. We are working to address both of these issues, including improvement of in-house fabrication capabilities, novel device designs, and development of techniques to reduce timing jitter. We are integrating SSPDs in compact cryocoolers and using them in quantum key distribution links, in long-wavelength, time-resolved, semiconductor nanostructure spectroscopy, and in the characterization of single-photon sources.

PLAN: Develop in-house NbN film deposition techniques suitable for designing devices that are embedded in optical layers so that the detection efficiency can be >80 %. Work with groups inside and outside of NIST on the fabrication of films into devices. Demonstrate use of these detectors in a cryogen-free system for quantum information, lidar, near-infrared time-correlated single-photon studies, and time-of-flight experiments.

QUANTUM OPTICAL METROLOGY

Many of the highest precision optical measurements are based on interferometry. Examples include optical gyroscopes, gravity wave detectors, and optical coherence tomography. Traditionally, interferometers are usually limited by the photon noise (shot noise) of the laser beam or other classical light source that is used for interrogating the sample — the phase resolution scales as $1/\sqrt{N}$,

where N is the mean photon number of the laser. In conventional interferometry, the uncertainty in the measurement is proportional to $1/\sqrt{N}$ because each photon carries independent measurement information. However, recently it has been pointed out that with a properly prepared quantum state of light (properly prepared N -photon state) as the input to our interferometer, we can do Heisenberg-limited interferometry, with a resolution proportional to $1/N$. By using proper photon state preparation and detection, the N photons are no longer independently measuring the interference. Rather, these entangled photons act in unison to perform the measurement. Hence, there is a potentially large improvement in the accuracy of the measurement.

We will leverage our existing expertise in single-photon on-demand sources, parametric down-conversion sources of entangled photon pairs, and photon number resolving (PNR) detectors to generate and detect new quantum states of light. We are developing schemes for generating N -photon states, more formally known as Fock states or photon number states, superpositions of Fock-states (N photons in mode a and 0 photons in mode b superimposed with 0 photons in mode a and N photons in mode b , *i.e.*, NOON states) and superpositions of coherent states of light, often called “cat states.”

We also plan to develop a quantum optical metrology (QOM) testbed where we can attempt to use these new states of light. Examples of possible QOM include Heisenberg limited interferometry, quantum optical coherence tomography (OCT), quantum ellipsometry, and quantum lithography. At present, it is unlikely that any of these techniques will exceed the performance of standard techniques, but investigation of the performance limitations of their quantum counterparts will be important.

PLAN: Generate N -photon states with quantum dot sources and generate cat states with photon-number resolving detectors. Explore NOON state interferometry.

TERAHERTZ TECHNOLOGY

Over the past several years this project has focused on bolometric detectors, initially developed for cryogenic electronic applications, but also useful in the detection or frequency conversion of radiation from millimeter to infrared wavelengths. The work on cryogenic detectors has been extended to antenna-coupled bolometers operating at room temperature. These detectors provide a rugged,

low-cost alternative for Homeland Security applications, for example mobile police units or portal scanners in airports. We have systematically investigated the transmission between 100 GHz and 1 THz of materials commonly used in clothing and have established that imaging in this frequency range has the potential for effectively detecting weapons and contraband concealed by clothing. We fabricated a wafer-scale 120-element focal plane array of antenna-coupled bolometers and demonstrated real time imaging. We have also investigated the efficiency of various illumination schemes establishing the viability of actively illuminated imagers in portal applications.

PLAN: Continue to explore applications of uncooled antenna-coupled microbolometers. Perform side-by-side imaging of the same scenes with passive (see below) and actively illuminated terahertz camera systems. This will help settle many outstanding phenomenological questions, for example, on capability of terahertz systems to selectively identify specific target materials.

MICRO-ANTENNA TESTING FACILITY

The program continues to improve antenna-coupled bolometric detectors and was charged by DARPA to establish facilities and protocols for testing antenna-coupled components developed in industry. Many of the detectors developed in academia and industry are antenna-coupled, and our prior microantenna array experience indicates that the greatest remaining obstacle to uniform and systematic comparison of microantenna device performance lies in unambiguous measurement of coupling efficiencies. This in turn requires amplitude and phase pattern measurement of the microantennas, which is difficult to do with conventional techniques at high frequency because of errors introduced by moving cables. We have built an all quasi-optic test setup for measurement of complex millimeter-wave antenna patterns. This complex pattern data can then be incorporated into a comprehensive analysis of coupling efficiency for each device tested. The complex antenna setup is scalable to terahertz and infrared frequencies because of the quasi-optic nature of the coupling.

Two other metrics that are frequently needed for uniform and systematic comparison of device performance are NETD and spatial resolution. We are developing a radiometric temperature reference (Aqueous Blackbody Calibration or ABC source) and spatial resolution targets for calibration of terahertz imaging systems.

PLAN: Thoroughly characterize the capabilities of the terahertz microantenna range, the ABC source, and the spatial resolution targets, and publish the results and instructions on their use. Distribute copies of the ABC source, and possibly of the spatial resolution targets, to interested measurement laboratories. The terahertz microantenna range will remain available for pattern measurements on non-NIST microantenna devices from the DARPA MIATA (Micro Antenna Arrays: Technology and Applications) program and elsewhere.

PASSIVE MILLIMETER-WAVE/TERAHERTZ IMAGING

When cooled to below the superconducting transition temperature of the bridge material, airbridge microbolometers provide extraordinary sensitivity as millimeter-wave and terahertz detectors, sensitivity far beyond the current state of the art for uncooled detectors. This sensitivity enables mmw/THz imaging for effective concealed weapons detection that is completely passive, using only the ambient blackbody emission of the target and background. Moreover, the high speed of superconducting antenna-coupled microbolometers enables mechanically scanned camera architectures, which eliminates the need for complex and expensive multiplexing and amplification schemes in the focal plane. These advantages of superconducting antenna-coupled microbolometers have been demonstrated in single-pixel experiments on Nb (and to a lesser extent NbN) microbridges, and in a significant amount of passive indoor imagery obtained with a raster-scanned optical setup. Detector NETD (noise-equivalent temperature difference) levels as low as 120 mK have been demonstrated, well below the typical level of temperature fluctuations in ambient indoor environments.

The current plan is to extend the single-pixel imaging to a full-scale mmw/THz imager that operates in real time over a 2m x 4m field of view at a 5 m to 10 m range. This will be done by building a linear, 128-element microbolometer array using the same detector architecture as for the single pixel. A mechanical scanning optic will provide spatial coverage in the orthogonal direction. The array would be mounted in a commercial closed-cycle cryocooler. Readout would be performed with entirely room-temperature electronics, using a novel transimpedance feedback scheme developed by our collaborators in VTT (Helsinki) that does not add noise above the intrinsic detector noise level. The Transportation Security Administration (TSA) Laboratory is funding the work.

PLAN: Extend the single-pixel imaging to a full-scale millimeter wave/terahertz imager that operates in real time. Deliver copy of scanned imager to the TSA Laboratory.

ACCOMPLISHMENTS

■ *Record efficiency and QKD demonstrated with TES single-photon detector* — Achieved a record 88 % quantum efficiency in a superconducting transition-edge sensor (TES), single-photon detector at 1550 nm, the highest quantum efficiency of detection for near-infrared photons in the world. Also, in collaboration with researchers at Los Alamos National Laboratory, demonstrated quantum key distribution (QKD) at 1550 nm using TES detectors with negligible dark-count rates. Clock synchronization between the sender and receiver was achieved with either a bright optical pulse or an electrical signal. The minimum value of mean photon number achieved for a fiber link length of 50 km was used to calculate a maximum distance of 138 km over which one can transmit secret key with the QKD system using a mean photon number of 0.1. The group used bent-fiber filtering of blackbody photons to lower the TES dark-count rate, which is not intrinsically limited, unlike that in other types of detectors. By use of narrowband filtering, it is estimated that one could distribute key securely over a link greater than 250 km.

■ *Record QKD lengths demonstrated* — Demonstrated QKD of record lengths in fiber using a Transition-edge sensor with Los Alamos National Laboratory. For QKD systems utilizing BBBSS91 privacy amplification, we demonstrated a link of 185 km. For a QKD system that is secure from photon-number splitting attack, using a weak coherent source, we demonstrated a fiber link of 68 km. For a QKD link that implements a decoy state protocol for security, we have demonstrated a link of 108 km.

■ *Single photon source characterized with superconducting detector* — Demonstrated, with the Nanostructure Fabrication and Metrology Project, the first use of superconducting single-photon detectors (SSPDs) for single photon source characterization. The source was an optically pumped, microcavity-coupled InGaAs quantum dot, emitting single photons at 902 nm. The two SSPDs replaced the silicon Avalanche Photodiodes (APDs) in a Hanbury-Brown Twiss interferometer measurement of the source's second-order correlation function. The detection efficiency of the superconducting detector system was greater than 2 % (coupling losses included). The SSPD system electronics jitter was 68 ps, versus 550 ps for the APD units, allowing the source spontaneous emission lifetime to be measured with improved resolution. SSPDs offer single-photon counting

at fast rates, low jitter, and low dark counts, from visible wavelengths well into the infrared.

■ *Time-correlated single-photon counting with superconducting detector* — Demonstrated, in collaboration with the Nanostructure Fabrication and Metrology Project, the advantages of a NbN-based superconducting single-photon detector (SSPD) in a time-correlated, single-photon counting scheme to measure short spontaneous emission lifetimes of quantum wells in the infrared. The instrument response function (IRF) of the SSPD was shown to be Gaussian over nearly five decades of dynamic range. The FWHM of the IRF, which is a measure of the timing jitter, was 68 ps. These response characteristics are of great advantage over those of Si avalanche photodiodes (APDs) for detailed measurement of emission decay curves with high temporal resolution. In contrast, the IRFs of Si APDs exhibit long tails and multicomponent responses. Quantum well emission out to 1245 nm in wavelength was measured with the SSPD, well beyond the photosensitive range of Si. APDs based on InGaAs or Ge can have reasonable detection efficiencies in the infrared, but have limited available dynamic range.

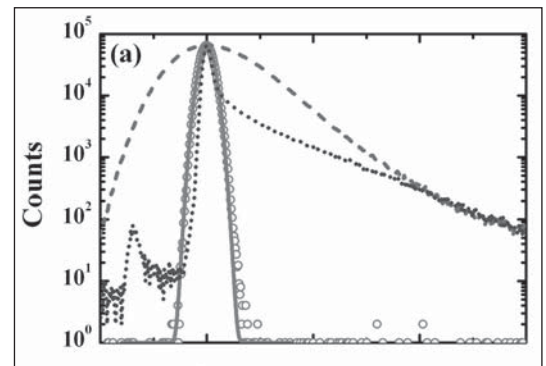

Instrument response functions of three detectors: SSPD — open circles; conventional Si APD — dashed; and fast Si APD — dotted curve. The solid curve is a Gaussian fit to the measured SSPD response function.

■ *High-speed QKD demonstrated with superconducting single photon detector* — Demonstrated, in collaboration with a team of NIST Information Technology Lab and Physics Lab researchers, the operation of a superconducting single-photon detector (SSPD) system in a high-speed NIST quantum key distribution (QKD) link, which was originally equipped with silicon-based single photon detectors. The link operated at a system clock rate of 625 Mbps through 1 km of optical fiber.

The laboratory system produced this “raw” sifted key at a rate of 1 million bits per second, roughly a quarter of the speed of NIST’s recently reported record-breaking performance. However, the error rate from this SSPD system was significantly lower, 1 % as opposed to 3.6 %. The lower error rate results in potentially more efficient conversion of sifted key into secret key (75% vs 50%). The lower error rate is a direct result of lower jitter in this type of detector. Based on the results from this work, it should be possible to implement a QKD link with superconducting-based detectors at a clock rate five times faster than the existing silicon-based detector system. If implemented, this would yield secret key at a new record rate.

■ *Record-low sensitivity millimeter-wave imaging system* — Demonstrated a passive millimeter-wave imaging system with a net-equivalent-temperature-difference sensitivity of record 0.13 K. The detectors are cryogenically cooled, superconducting antenna-coupled microbolometers. Images of contraband concealed under clothing were obtained, clearly demonstrating the potential for passive indoor imaging.

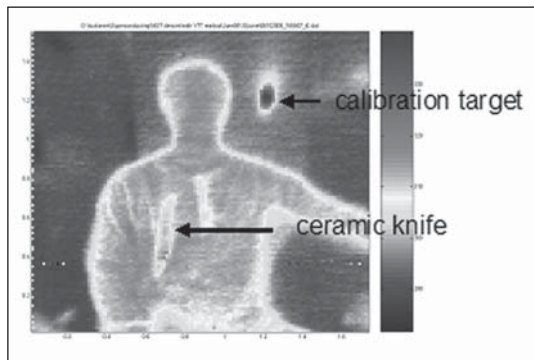

Passive millimeter-wave image of concealed contraband.

■ *Millimeter-wave monochromator* — Demonstrated a novel, circular variable millimeter-wave monochromator spanning an octave in frequency, with interchangeable ranges. Measured a spectral resolving power of 6, reasonably well matched to the width of recently reported spectral signatures of solid explosives, with less than 0.5 dB insertion loss. Because microbolometers are inherently ultrawideband, such a monochromator enables true terahertz color imaging from a microbolometer-based camera.

■ *Millimeter-wave detector testing* — Completed the Phase I testing of millimeter-wave detector arrays for the DARPA MIATA program. Measure-

ments of noise spectral density and responsivity to blackbody temperature changes enabled the most direct and accurate measurement of the noise-equivalent temperature difference for the zero-bias diode and optical modulator-based detectors from the industry and university participants in the program. Coherent measurements using a swept-frequency monochromatic source were made to determine spectral responsivity over the W-band (75 to 110 GHz), and antenna patterns were also measured for some of the detectors using the NIST mm-wave/terahertz antenna range developed by project members. DARPA benefits significantly from the neutral third-party testing role that NIST performs for this program. The detector technology has potential application in areas such as helicopter navigation, firefighting, and concealed weapons detection.

KEY COLLABORATORS

Hughes Research Laboratory – terahertz detector development and characterization

University of Delaware – terahertz detector development and characterization

Northrup Grumman – terahertz detector development and characterization

Rockwell Sciences Center – terahertz detector development and characterization

VTT, Finland – terahertz detector development and characterization

University of California, Santa Barbara – terahertz detector development and characterization

University of Colorado, Boulder – terahertz detector development and characterization

Los Alamos National Laboratory – quantum key distribution

BBN Technologies – quantum key distribution

Boston University – single-photon detector development

Sandia National Laboratory – single-photon detector development

Northwestern University – applications of single-photon detectors

Heriot-Watt University – applications of single-photon detectors

Massachusetts Institute of Technology – single-photon detector development

MIT-Lincoln Laboratory – single-photon detector development

Jet Propulsion Laboratory – applications of single-photon detectors

RECENT PUBLICATIONS

A. Luukanen, E. N. Grossman, A. J. Miller, P. Helisto, J. S. Penttila, H. Sipola, H. Seppa, "An ultra-low noise superconducting antenna-coupled microbolometer with a room temperature read-out," *IEEE Microwave and Wireless Comp. Lett.*, Vol. 16, pp. 464–466 (2006).

M. Stevens, R. Hadfield, R. Schwall, S. W. Nam, R. Mirin, "Fast lifetime measurements of infrared emitters using a low-jitter superconducting single-photon detector," *Appl. Phys. Lett.*, Vol. 89, No. 031109 (2006).

D. Rosenberg, A. Lita, A. J. Miller, S. W. Nam, R. Schwall, "Performance of photon-number resolving transition-edge sensors with an integrated 1550 nm resonant cavity," *IEEE Trans. Appl. Supercond.*, Vol. 15, No. 2, pp. 575–578 (2005).

R. Hadfield, M. Stevens, S. Gruber, A. J. Miller, R. Schwall, R. Mirin, S. W. Nam, "Single photon source characterization with a superconducting single photon detector," *Optics Express*, Vol. 13, No. 26, pp. 10846–10847 (2005).

D. Rosenberg, S. W. Nam, P. A. Hiskett, C. G. Peterson, R. J. Hughes, J. E. Nordholt, A. Lita, A. J. Miller, "Quantum key distribution at telecom wavelengths with noise-free detectors," *Appl. Phys. Lett.*, Vol. 88, 021108 (2006).

D. Rosenberg, A. Lita, A. J. Miller, S. W. Nam, "Noise-free high-efficiency photon-number-resolving detectors," *Phys. Rev. A*, Vol. 71, 061803(R) (2005).

R. Hadfield, A. J. Miller, S. W. Nam, E. N. Grossman, R. Schwall, "Antenna coupled niobium bolometers for 10 (μ)m radiation detection," *IEEE Trans. Appl. Supercond.*, Vol. 15, No. 2, pp. 541–544 (2005).

OPTICAL MATERIALS METROLOGY

GOALS

Develop complementary metrology methods of nonlinear optical analysis, near-field optical spectroscopy, confocal microscopy, time-resolved photoluminescence, and X-ray diffraction analysis for studies of optical, electronic, and structural properties of bulk and thin-film III-nitrides, quantum nanowires, and nitride device structures. Develop prototype nanowire devices. Accumulate a database of refractive index and birefringence for AlGa_N and InGa_N alloy semiconductors and rare-earth-doped III-nitrides.

CUSTOMER NEEDS

Customer needs fall into two main categories: metrology suites for rapid non-destructive characterization of photonic materials in terms of optical, electronic, and structural characteristics for bulk crystals and thin films; and semiconductor nanowire technology and metrology for sensing, biomedical, materials science and electronics applications.

Gallium nitride and related materials have made enormous recent economic impact with the realization of semiconductor lasers and LEDs emitting in the blue and UV for display, optical data storage, water purification, and biological agent detection. Other important applications of this material system include high-power, high-temperature transistors and solar-blind UV detectors. Problems with bulk and thin-film growth of these materials remain, however, hindering the ability to meet the application demands. There persists a fundamental lack of understanding of the role of defects on the electrical, optical, and structural properties of these materials. These issues compel the development of new correlated metrology methods, with resolution on the scale of 20 to 100 nm. Furthermore, the lack of a database for the linear optical properties of the III-nitrides is hampering development of engineering design tools for blue-emitting GaN-based laser diodes.

Semiconductor quantum nanowires (SQNWs) offer new revolutionary applications in biological/chemical sensors, *in-vivo* biomedical diagnostics and therapies, nanoscale electronics, optoelectronics, and nanoscale thermal management. For example, SQNW lasers with emission apertures roughly 20–100 nm in diameter (about the size of a virus) would permit development of a new class of tools for ultra-high-resolution microscopy and cellular-

level imaging. In pursuing such new capabilities, researchers and technologists must confront the facts that fundamental physical properties do not often scale from macro to nano regimes, and that many relevant nanoscale metrology practices are immature or nonexistent. For SQNWs, these issues force an unusually strong coupling of technology development with metrology, and create new challenges and opportunities for both.

TECHNICAL STRATEGY

SPECTROSCOPY OF GROUP III-NITRIDES

Multiphoton luminescence (MPL) spectroscopy offers a means by which the uniformity of an active (buried) quantum well layer in a III-nitride laser or LED structure can be probed regardless of the thickness of the surrounding layers. Standard direct above-bandgap photoluminescence (PL) spectroscopy may often be problematic since the pump beam could be absorbed elsewhere in the structure before exciting the regions of interest. Using MPL spectroscopy, even embedded structures may be examined. Furthermore, it has been demonstrated that MPL intensity in GaN that scales with a non-integer exponent of pump intensity is suggestive of the presence of saturable midgap defect states. We will correlate MPL measurements with cathode luminescence (CL) results, obtained when the capping layer is thin enough (~20 nm) to allow CL examination of the active region through the capping layer, and with those of more realistic device structure where the active layer is buried hundreds of nanometers within the structure. We will continue the development of collection-mode near-field optical methods and examine the group III-nitrides using second-harmonic generation and photoluminescence spectroscopies on a resolution scale of 20 to 100 nm. Time-resolved photoluminescence is also a very important metric for examining material quality in the III-nitrides. We plan on putting more emphasis on building up capabilities in time-resolved PL and applying this tool to both nanowires and thin-film III-nitrides. Additionally, we have recently added spectrally resolved photoconductivity to our suite of spectroscopy tools for examining nitride films and nanowires. This technique will prove important for the examination of persistent photoconductivity in these materials, assist in the evaluation of alloy composition, and be important in the eventual development of Schottky, p-i-n, and heterojunction quantum well devices in nanowires.

Technical Contact:
Norman Sanford

Staffing (FY06):
2.3 professionals
3 associates

PLAN: Correlate near-field optical measurements and MPL studies with CL studies and other high-resolution electron-beam and X-ray metrologies, working closely with collaborators in the NIST Materials Science and Engineering Laboratory (MSEL). Apply nanoscale spatially and temporally resolved spectroscopy to the study of AlGa_N and InGa_N material, thin film structures, and nanowires fabricated in wide-bandgap semiconductors. Develop and apply spectrally resolved photoconductivity to the study of III-nitride films, nanowires, and III-nitride optoelectronic devices.

ELECTRICALLY ADDRESSABLE OPTOELECTRONIC NANOWIRES

We will fabricate UV-blue LEDs and lasers from SQNWs. The SQNWs will be grown in the group III-nitride semiconductor system by plasma-assisted MBE and/or chemical beam epitaxy. Required attributes include high purity, low defect density, the ability to engineer heterostructures and make electrical contact, and precise doping control. A suite of test structures will be developed that will include intrinsic, p- and n-doped wires, “core-sleeve,” and axially alternating junction/heterostructures of SQNWs. We will develop new techniques for selective area growth (these may involve block-copolymers or other high-resolution lithography methodology that will allow the formation of nanoscale templates) and apply these methods to the patterned growth of SQNWs. We will optimize techniques to form electrical contact individually or to arrays of SQNWs. We will use AFM, XRD, TEM, FESEM, Raman spectroscopy, and electron-backscattering diffraction (EBSD) for the structural characterization in this work.

PLAN: Demonstrate optically pumped group III-nitride nanowire lasers. After further development, demonstrate electrically addressable nanowire LEDs and lasers. Also, develop individual nanowire mechanical resonator structures for use as sensors; measure mechanical and piezoelectric properties

REFRACTIVE INDEX MEASUREMENTS OF GROUP III-NITRIDES

We have compiled refractive index and birefringence data for a number of AlGa_N samples ranging in composition from pure GaN to Al_{0.66}Ga_{0.24}N, using prism coupling to waveguide mode techniques that are correlated with spectroscopic reflection and transmission measurements (performed by collaborators in MSEL). Furthermore, the Al mole fraction of this sample set was separately determined by analytical electron microscopy. We also have measured refractive index of InGa_N for low In mole fractions of technological interest. There is new interest in extending this work to examine the refractive index of rare-earth-doped GaN and AlGa_N at telecom wavelengths.

PLAN: Measure the refractive index of Er-doped GaN and AlGa_N in the visible and near-infrared using an improved prism coupling setup.

ACCOMPLISHMENTS

■ *Isolation and alignment of nanowires* — Established methods to disperse and isolate gallium nitride nanowires on silicon and sapphire substrates using solvents. Demonstrated electric-field-assisted alignment of nanowires between metal fingers, enabling electrical contacts and the fabrication of nanowire bridge structures.

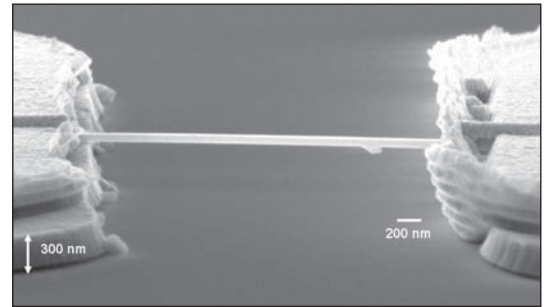

Gallium nitride nanowire bridge.

■ *X-ray characterization of wide bandgap films and nanowires* — Compiled ‘a’ and ‘c’ lattice constants of GaN/InGa_N and GaN/AlGa_N films, GaN nanowires, and ZnO nanowires by collecting and fitting the data from symmetric and asymmetric X-ray diffractions. The samples were supplied in-house (MBE-grown nanowires from the Semiconductor Growth and Devices Project) or by government and industry collaborators. It was demonstrated through X-ray measurements that the in-house MBE-grown GaN nanowires are fully relaxed, aligned to the silicon substrate, and have a high degree of crystalline perfection.

■ *High luminescence efficiency demonstrated in nanowires* — Demonstrated that the GaN nanowire ensembles grown by MBE have high photoluminescence efficiency comparable to that of bulk GaN, without correction for the non-unity fill fraction of the nanowires. This further confirms the low defect density of the nanowires.

■ *Nanowire LED demonstrated* — Co-developed and demonstrated, with members of the Semiconductor Growth and Devices Project, the operation of an ultraviolet light-emitting diode based on gallium nitride nanowires. The LED demonstration required growth of isolated, low-defect-density GaN nanowires on silicon, structural characterization as feedback to growth parameters, removal of the wires from the growth substrate and

dispersal on an n-type GaN substrate, optimization of electrical contacts, and spectroscopy of the LED output to verify emission from the nanowires. The LED emission center wavelength near 385 nm was believed to be the shortest wavelength demonstrated for this type of nanowire device at the time.

■ *Photoluminescence anisotropy of gallium nitride nanowires characterized* — Made polarization-resolved photoluminescence measurements, from 4 K to room temperature, of individual gallium nitride nanowires grown in-house by MBE. The wires were typically 5-10 μm in length and 30-100 nm in diameter. Details of the spectra varied from wire to wire but, in general, spectral peaks associated with free and bound exciton peaks of strain-free GaN were readily identified. The nanowires enabled the first unambiguous room-temperature measurement of photoluminescence anisotropy from unstrained wurtzite gallium nitride that arises from the symmetry, band structure, and selection rules for radiative electronic transitions in the material. These measurements are difficult to perform in typical thin-film gallium nitride or quasi-bulk free-standing platelets of the material but are readily enabled by the natural geometry and strain-free material offered by the nanowires.

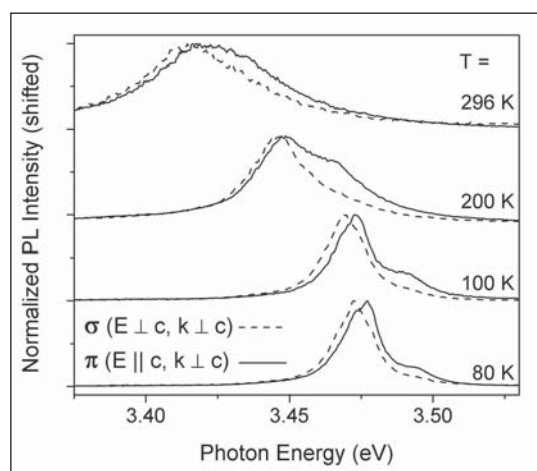

Photoluminescence spectra of GaN nanowire pair showing polarization anisotropy.

■ *Single nanowire FETs demonstrated* — Fabricated and tested single-nanowire, field-effect transistors (FETs) from MBE-grown gallium nitride wires. The individual nanowires were dispersed and aligned to Ti pads on thermally oxidized Si, and e-beam-deposited Ti/Au ohmic contacts were made for the source and drain. Plasma etching before contact deposition proved to be critical in achieving low contact resistance. The back gate contact

was aluminum. Drain current vs. voltage curves as a function of gate voltage were used to estimate electrical transport properties — mobility, carrier concentration, and carrier type — of the nanowires. This appears to be one of the few straightforward ways to measure these properties for nanowires, for which conventional Hall measurements cannot be made. Single nanowire bridge structures were also fabricated, and will be used for conformal coating of various passivation layers in future FET and photoluminescence work.

■ *Photoconductivity of nanowires measured* — Developed new apparatus for the measurement of spectrally resolved photoconductivity in nanowire structures. Initial results point to exploring the development of Schottky diode UV photodetectors based in III-nitride nanowires.

COLLABORATIONS

NIST Materials Science and Engineering Laboratory – TEM, EBSD, CL, and XRD studies of III-nitride films and nanostructures, and studies of electrical contacts to these materials

University of Colorado — mechanical and optical measurements of nanostructures; atomic layer deposition coating of nanowires for surface reactivity modifications; biochemical sensors

National Renewable Energy Laboratory — coating nanowires with amorphous silicon to assist in p-n junction formation

Raytheon – study of GaN field-effect transistors

RECENT PUBLICATIONS

J. B. Schlager, N. A. Sanford, K. A. Bertness, J. M. Barker, A. Roshko, P. T. Blanchard, “Polarization resolved photoluminescence study of individual GaN nanowires grown by catalyst-free MBE,” *Appl. Phys. Lett.*, Vol. 88, 213106 (2006).

K. A. Bertness, N. A. Sanford, J. M. Barker, J. B. Schlager, A. Roshko, A. V. Davydov, I. Levin, “Catalyst-free growth of GaN nanowires,” *J. Electron. Materials*, Vol. 35, pp. 576 (2006).

K. A. Bertness, A. Roshko, N. A. Sanford, J. M. Barker, A. V. Davydov, “Spontaneously grown GaN and AlGaIn nanowires,” *J. Crystal Growth*, Vol. 287, pp. 522 (2006).

J. E. Van Nostrand, K. L. Averett, R. Cortez, J. Boeckl, C. E. Stutz, N. A. Sanford, A. V. Davydov, J. D. Albrecht, “Molecular beam epitaxial growth of high-quality GaN nanocolumns,” *J. Crystal Growth*, Vol. 287, pp. 500 (2006).

I. Levin, A. Davydov, B. Nikoobakht, N. Sanford, P. Mogilevsky, “Growth habits and defects in ZnO nanowires grown on GaN/sapphire substrates,” *Appl. Phys. Lett.*, Vol. 87, 103110 (2005).

N. A. Sanford, L. H. Robins, M. H. Gray, Y. -S. Kang, J. E. Van Nostrand, C. Stutz, R. Cortez, A. V. Davydov, A. Shapiro, I. Levin, and A. Roshko, "Fabrication and analysis of GaN nanorods grown by MBE," *Phys. Stat. Sol. (C)*, Vol. 2, 2357 (2005).

N. A. Sanford, A. Munkholm, M. R. Krames, A. Shapiro, I. Levin, A. V. Davydov, S. Sayan, L. S. Wielunski, and T. E. Madey, "Refractive index and birefringence of InGaN films grown by MOCVD," *Phys. Stat. Sol. (C)*, Vol. 2, 2783 (2005).

N. A. Sanford, A. Davydov, D. V. Tsvetkov, V. A. Dmitriev, S. Keller, U. Mishra, S.P. DenBaars, S. S. Park, J. H. Han, "Measurement of second order susceptibilities of GaN and AlGaIn," *J. Appl. Phys.*, Vol. 97, 053512 (2005).

L. H. Robins, B. Steiner, N. A. Sanford, C. Menoni, "Low-electron-energy cathodoluminescence study of polishing and etching effects on the optical properties of bulk single-crystal gallium nitride," *Proc., Mater. Res. Soc. Symp.*, Dec 02-06, 2002, Boston, MA, Vol. 743, pp. 213-218 (01-Jan-2003).

N. A. Sanford, L. H. Robins, A. Davydov, A. J. Shapiro, D. V. Tsvetkov, V. A. Dmitriev, S. Keller, U. K. Mishra, S. P. DenBaars, "Refractive index study of Al_xGa_{1-x}N films grown on sapphire substrates," *J. Appl. Phys.*, Vol. 94, No. 5, pp. 2980-2991 (01-Sep-2003).

SEMICONDUCTOR GROWTH AND DEVICES

GOALS

Provide advanced materials and devices to support research in industry, other parts of NIST, universities and government laboratories. Develop measurement methods and provide data to support the efficient manufacture of semiconductor nanostructures and optoelectronic devices.

CUSTOMER NEEDS

The continued growth of the U.S. optoelectronics industry is dependent on the high-yield manufacture of devices with smaller dimensions and tighter specifications. Compound semiconductor materials form the basis for LEDs, lasers, photodetectors, and modulators critical to optical communication, display, data storage, sensors, and many other applications. Many of these semiconductor devices now incorporate structures with a high degree of strain and nanostructures so small that the properties of the devices depend on their physical dimensions as well as the bulk materials properties. Measurements of starting materials, epitaxial layers, and nanostructured geometries must be supported by standard procedures and reference materials. Issues of materials purity and uniformity are at the foundation of device yield and performance. In addition, specialty devices are needed for use in metrology systems inside and outside of this project.

TECHNICAL STRATEGY

SEMICONDUCTOR QUANTUM NANOWIRE DEVELOPMENT

Semiconductor nanowires made from group III-nitrides are showing great promise for the next generation of high-efficiency, miniature light sources. Several research laboratories worldwide have demonstrated optically pumped lasing action in group III-nitride nanowires. To accelerate and support commercial development of these materials, we are growing nanowires made of GaN, AlN, InN and related alloys with ultra-low defect densities and high luminescence efficiencies, and are pursuing fundamental studies of nanowire crystal growth using molecular beam epitaxy (MBE) and chemical beam epitaxy. Advanced structures incorporating quantum disks, axial alloy variation, and nucleation control are designed, grown, and characterized. Extensive high-resolution electron microscopy, scanning probe microscopy, and X-ray diffraction have shown that the wires are hexagonal in cross-section and strain-free, with a reproducible

crystal orientation relative to the silicon substrates. Additional optical and structural characterization performed in collaboration with the Optical Materials Metrology Project and the NIST Materials Science and Engineering Laboratory also confirms that the materials are essentially free of chemical impurities and structural defects. Nanowires have also been supplied to a number of collaborators within and outside of NIST.

PLAN: Develop prototype optical and electronic nanowire devices for metrology, sensing, and other applications. Fabricate and characterize p-n heterostructure nanowires in the AlGaInN alloy system as progress towards the goal of demonstrating an electrically pumped group III-nitride nanowire laser.

STRUCTURAL CHARACTERIZATION AND CONTROL OF QUANTUM DOTS AND NANOWIRES

Quantum dots are semiconductor structures with quantized energy levels that result in improved efficiency and tuning range for semiconductor lasers and less sensitivity to environmental changes for lasers and photodetectors. Dot formation is driven by strain during epitaxial crystal growth, but measuring the strain in structures less than 100 nm in lateral dimension presents new challenges. We have contributed to this field through studies correlating substrate preparation and growth parameters with dot density and size as measured by atomic force microscopy (AFM). We are also evaluating the shape of the dots and strain in the region of the dots with transmission electron microscopy (TEM). In addition, we are studying ways to control growth of quantum dots and nanowires and improve uniformity using strain and appropriate growth conditions.

PLAN: Examine the influence of strain on the formation and uniformity of quantum dots and nanowires.

SEMICONDUCTOR COMPOSITION STANDARDS DEVELOPMENT

Inaccuracy of semiconductor composition measurement has been an impediment to achieving consistency of device performance across production lines. It has also inhibited the collection of sufficiently accurate materials parameters for use in the simulation of devices, which is critical to fast product cycle times. A goal of this project is to develop certification techniques for standard reference materials having composition uncertainty specified to a level one tenth as low as

Technical Contact:
Kris Bertness

Staffing (FY06):
2 professionals
4 associates

that of techniques currently in use by industry. Our approach has been to combine conventional methods of determination of composition such as photoluminescence (PL) and X-ray diffraction (XRD) with less common methods (in situ monitoring, electron microprobe analysis (EMPA), and inductively coupled plasma optical-emission spectroscopy (ICP-OES)) to enable certification of alloy composition. This program is the basis for the production of standard reference materials (SRMs) in the AlGaAs and AlInGaN alloy systems. As part of this research, we have quantified error sources and accuracy limits of the indirect composition measurement techniques currently in use by industry, specifically PL and XRD.

PLAN: Investigate the precision of measurement techniques necessary for the development of AlGaIn composition standards.

SOURCE GAS PURITY MEASUREMENT

Contamination is a serious problem in phosphine, arsine, silane, ammonia, and similar gases used in the epitaxial growth of high-purity semiconductor layers. The critical concentrations of the impurities are not well known; however, it is believed that >10 nmol/mol oxygen or water in most process gases is undesirable. This project uses a cavity-ring-down spectroscopic (CRDS) system it developed with researchers in the NIST Chemical Science and Technology Laboratory to measure impurities with very low concentrations in semiconductor source gases. The advantages of this technique are that its accuracy relies primarily on accurate time measurement and detector linearity, rather than measurement of absolute light intensities, and it is insensitive to absorption outside the cavity. We have improved the detection limit of this system to 50 nanomol/mol of water in phosphine. We are using our system to measure the lineshape, absorption coefficients, and frequency of optical transitions for water, phosphine, ammonia, and arsine in the vicinity of 935 nm. This information is critical to facilitate the use of high-sensitivity spectroscopy techniques in these gases. The CRDS capability should ultimately lead to improvements in semiconductor source gas purity, which will allow crystal growers to choose less expensive growth conditions without sacrificing optical emission efficiency and yield in LEDs, semiconductor lasers, and photodetectors. We collaborate with gas suppliers and purity instrumentation manufacturers in this project, including on-site testing of commercial instrumentation built to detect water in hazardous gases.

PLAN: Identify optimal spectral regions for measurement of water in phosphine, arsine and ammonia. Increase the sensitivity of our CRDS apparatus to the detection of water in these gases through the use of stronger absorption lines at longer wavelengths.

ACCOMPLISHMENTS

■ *Gallium nitride nanowires grown* — Demonstrated reproducible growth of isolated GaN nanowires 30 to 250 nm in diameter and 5 to 15 micrometers in length using gas-source molecular beam epitaxy (MBE), without the use of metal catalysts. Low growth rates at substrate temperatures near 820 °C were combined with high nitrogen flux to form the wires, which grew out of an irregular matrix layer containing deep faceted holes. X-ray and variable-temperature photoluminescence measurements, in collaboration with the Optical Materials Metrology Project, and transmission electron microscopy studies, in collaboration with the NIST Materials Science and Engineering Laboratory, showed that the GaN nanowires have a high degree of crystalline perfection.

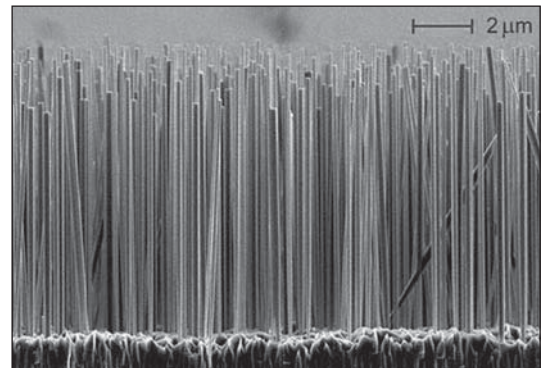

MBE-grown gallium nitride nanowires.

■ *Nanowire ultraviolet LED demonstrated* — Developed and demonstrated, in collaboration with the Optical Materials Metrology Project, operation of an ultraviolet light-emitting diode based on gallium nitride nanowires. The LED demonstration required growth of isolated, low-defect-density GaN nanowires on silicon, structural characterization as feedback to growth parameters, removal of the wires from the growth substrate and dispersal on an n-type GaN substrate, optimization of electrical contacts, and spectroscopy of the LED output to verify emission from the nanowires. The LED emission center wavelength near 385 nm was believed to be the shortest yet demonstrated for this type of device at the time.

■ *Single nanowire photoluminescence measured* — Grew GaN nanowires to enable variable-temperature, polarization-resolved photoluminescence measurements of individual wires. The nanowires enabled the first unambiguous room-temperature measurement of photoluminescence anisotropy from unstrained wurtzite gallium nitride that arises from the symmetry, band structure, and selection rules for radiative electronic transitions in the material (see Optical Materials Metrology Project accomplishments).

■ *Single nanowire FETs demonstrated* — Collaborated with Optical Materials Metrology (OMM) Project in fabrication and demonstration of single-nanowire, field-effect transistors (FETs) from MBE-grown gallium nitride wires (see OMM project for details). Drain current vs. voltage curves as a function of gate voltage were used to estimate electrical transport properties — mobility, carrier concentration, and carrier type — of the nanowires. This appears to be the only straightforward way to measure these properties for nanowires, for which conventional Hall measurements cannot be made. Single nanowire bridge structures were also fabricated.

■ *Temperature dependence of MBE- and MOCVD-grown quantum dot density characterized* — Determined the temperature dependence of the dot density for pulsed and continuously grown MBE samples as well as for MOCVD grown samples. Assuming an Arrhenius dependence of the dot density on temperature, both the activation energies (-1.61 and -1.64 eV) and the pre-exponentials (10^{-8} and 9×10^{-9} dots/ μm^2 , for the pulsed and continuous-growth MBE samples, respectively) are nominally identical. For the MOCVD sample the dependence is quite different. The activation energy is lower (-3.63 eV) and the pre-exponential is smaller (10^{-22} dots/ μm^2). The difference in fit for the MBE and MOCVD dots is probably due to the fact that in MOCVD the adsorption and decomposition of the organometallics, as well as the diffusion and nucleation are controlled by the substrate temperature, while in MBE the flux is controlled independently and only the diffusion and nucleation depend on the substrate temperature.

■ *Uniformity of MBE- and MOCVD-grown quantum dots compared* — Determined that MBE growth of InGaAs/GaAs quantum dots at low, continuous rates leads to uniformity in dot density equal to or better than that from MOCVD growth by collaborators. A nine by nine array of AFM images, taken over the central regions of 5.0 and 7.5 cm diameter wafers, was analyzed to determine the distribution of dot heights and densities. For

MBE samples grown in a pulsed growth mode with a slow rotation rate the standard deviation in the dot density was typically 15–25 % of the average density. However, for samples with a continuous low growth rate and fast rotation rate, the standard deviation in the dot density was typically 3–4 % of the average. This is better than the 10–15 % standard deviation in dot density found for most MOCVD samples. MBE-grown samples, both pulsed and continuously grown, have much narrower dot size distributions than their MOCVD-grown counterparts as shown in the histograms and AFM images below.

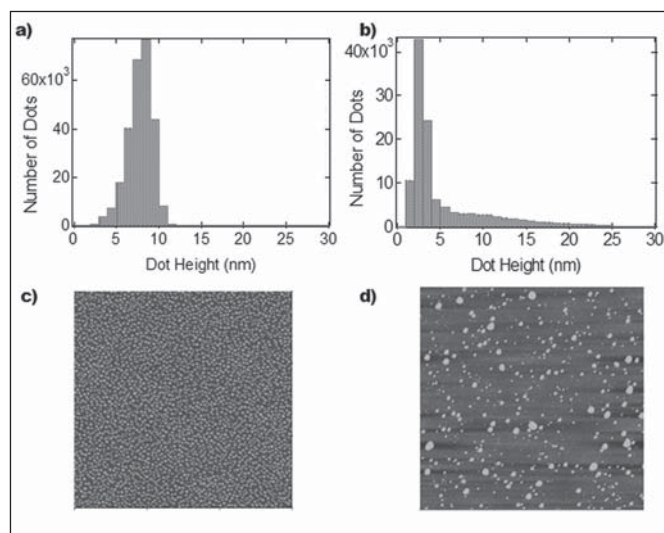

Histograms of the dot heights measured at 81 spots on wafers grown by a) MBE and b) MOCVD, showing the large range of heights for dots grown by MOCVD. AFM images from these same two wafers showing that the large height variations in dots grown by d) MOCVD occur on a local scale (the images are $3 \times 3 \mu\text{m}^2$ and the color scale is 40 nm) consistently across the wafers.

■ *AlGaAs composition standards offered* — Delivered first batch of NIST AlGaAs composition Standard Reference Material (SRM) number 2841. This SRM consists of an epitaxial layer of $\text{Al}_x\text{Ga}_{1-x}\text{As}$ with certified mole fraction x of Al grown on a GaAs substrate. It is intended for use as a reference standard for analytical methods that measure the composition of thin films, such as electron microprobe analysis (EMPA), photoluminescence (PL), Auger electron spectroscopy (AES) and X-ray photoelectron spectroscopy (XPS). The specified Al mole fraction for each of these first AlGaAs SRMs is near $x = 0.2$, with an expanded uncertainty of 0.0014 ($k = 2$ coverage). Also given in the SRM certificate is the uncertified reference photoluminescence peak energy value. SRM 2842 for nominal mole fraction $x=0.3$ is expected to be released soon.

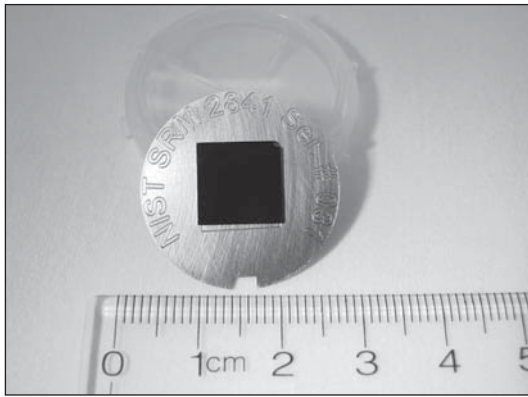

Standard reference material for mole fraction of Al in AlGaAs.

■ **Source gas purity instrumentation calibrated** — Conducted tests of commercial cavity ring-down instrumentation in collaboration with the manufacturer and a semiconductor source gas manufacturer; the tests enabled calibration of the instrument for moisture in phosphine with record sensitivity at the sub-10-ppb level. When tested with arsine gas, this instrument was unable to provide useful moisture measurements because of spectral interference from arsine absorption lines. The manufacturer is pursuing the use of a different spectral region.

KEY COLLABORATIONS

NIST Materials Science and Engineering Laboratory – TEM, cathodoluminescence, and electrical characterization of GaN nanowires

NASA Goddard Space Flight Center – development of GaN photodetectors for space applications

Matheson Tri-Gas – test of commercial instrumentation for measuring water as an impurity in semiconductor source gases

National Renewable Energy Laboratory, Golden, CO – analysis of cathodoluminescence and conductivity of GaN nanowires with scanning probe microscopy; test of flexibility of nanowires; spatially dependent conductivity measurements of nanowires; coating nanowires with amorphous silicon to assist in p-n junction formation

University of Colorado – mechanical and optical measurements of nanostructures; atomic layer deposition coating of nanowires for surface reactivity modifications; biochemical sensors.

Sandia National Laboratory – study of MOCVD quantum dot uniformity

NIST Materials Science and Engineering Laboratory – Electron backscatter diffraction and convergent beam electron diffraction for measurement of strain in compound semiconductor nanostructures

RECENT PUBLICATIONS

J. B. Schlager, N. A. Sanford, K. A. Bertness, J. Barker, A. Roshko, P. Blanchard, “Polarization-resolved photoluminescence study of individual GaN nanowires grown by catalyst-free MBE,” *Appl. Phys. Lett.*, Vol. 88, No. 21, pp. 213106-1–213106-3 (2006).

A. Roshko, T. E. Harvey, S. Y. Lehman, R. Mirin, K. A. Bertness, B. Hyland, “GaAs buffer layer morphology and lateral distributions of InGaAs quantum dots,” *J. Vacuum Sci. Technol.*, Vol. 23, No. 3, pp. 1226–1231 (2005).

K. A. Bertness, A. Roshko, N. A. Sanford, J. Barker, A. Davydov, “Spontaneously grown GaN and AlGaIn nanowires,” *J. Cryst. Growth*, Vol. 287, No. 2, pp. 522–527 (2006).

K. A. Bertness, N. A. Sanford, J. Barker, J. B. Schlager, A. Roshko, A. Davydov, I. Levin, “Catalyst-free growth of GaN nanowires,” *J. Electron. Mater.*, Vol. 35, No. 4, pp. 576–580 (2006).

K. A. Bertness, C. M. Wang, M. L. Salit, G. C. Turk, T. A. Butler, A. J. Paul, L. H. Robins, “High-accuracy determination of epitaxial AlGaAs composition with inductively coupled plasma optical emission spectroscopy,” *J. Vacuum Sci. Technol. B*, Vol. 24, No. 2, pp. 762–767 (2006).

K. A. Bertness, A. Roshko, S. E. Asher, C. L. Perkins, “Storage conditions for high-accuracy composition standards of AlGaAs,” *J. Vacuum Sci. Technol. B*, Vol. 23, No. 3, pp. 1267–1271 (2005).

S. Y. Lehman, K. A. Bertness, J. T. Hodges, “Optimal spectral region for real-time monitoring of sub-ppm levels of water in phosphine using cavity ring-down spectroscopy,” *Journal of Crystal Growth*, Vol. 261, pp. 225–230 (2004).

APPENDIX A: MAJOR LABORATORY FACILITIES

SEMICONDUCTOR GROWTH AND OPTOELECTRONIC DEVICE FABRICATION

The Division makes use of a gas-source molecular-beam epitaxy system and associated *in situ* and *ex situ* measurement equipment for III-V semiconductor growth and characterization. It also maintains a cleanroom facility for thin-film deposition, photolithography, and wet and dry etching. The facilities support the activities described above, particularly for the Optical Materials Metrology, Nanostructure Fabrication and Metrology, and Semiconductor Growth and Devices Projects.

LASER POWER/ENERGY DETECTOR CALIBRATION SYSTEMS

The Optoelectronics Division has established and maintains several state-of-the-art measurement systems for calibrating most types of laser power and energy detectors. These measurement systems incorporate unique, specially designed, electrically calibrated laser calorimeters that are used as primary standards. The calorimeters are used in conjunction with beamsplitter-based optical systems to provide measurement services for laser power and energy that cover a wide range of powers, energies, and wavelengths for detectors used with both cw and pulsed lasers. This assembly of laser power and energy detector calibration systems represents the best overall capability of this kind in the world. In many cases (*e.g.*, excimer laser measurements at 248 nm, 193 nm, and 157 nm), the Division has the only measurement capability in the world.

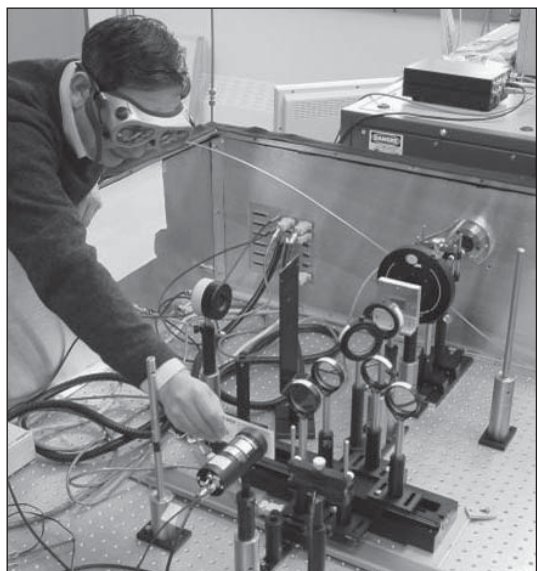

APPENDIX B: NRC POST-DOC AND OTHER RESEARCH OPPORTUNITIES

PROFESSIONAL RESEARCH EXPERIENCE PROGRAM (PREP)

The Professional Research Experience Program (PREP) is designed to provide valuable laboratory experience to undergraduate and graduate students from both the University of Colorado at Boulder and the Colorado School of Mines at Golden, and to recent Ph.D. recipients from these and other universities. Students and postdocs are employed by the University of Colorado or the Colorado School of Mines and normally carry out research at the NIST Boulder Laboratories.

Students are usually hired just before the spring, fall, or summer terms, and may be employed for one or more terms. Postdocs may begin any time during the year. Applications are accepted throughout the year.

NIST pays in-state tuition for PREP undergraduate students during the fall and spring semesters and an hourly wage. Graduate students receive in-state tuition and a stipend. Postdocs receive a stipend.

Eligibility requirements include U.S. citizenship or permanent residency and, for students, a minimum 3.0 GPA (grade point average).

Information is available at <http://www.boulder.nist.gov/div815/ResearchOpps/resopps.htm>

SUMMER UNDERGRADUATE RESEARCH FELLOWSHIPS (SURF)

The SURF NIST Boulder Program provides 12-week appointments for outstanding undergraduates to engage in state-of-the-art research with senior scientists and engineers in the unique research facilities at the NIST campus in Boulder, Colorado.

Eligibility requirements include U.S. citizenship or permanent residency, and undergraduate status at a U.S. university or college with a technical major. A G.P.A. of 3.0/4.0 or better is recommended. Applicants must be covered by a health insurance plan (either through school or family). Students with majors in physics, materials science, chemistry, mathematics, computer science, or engineering are encouraged to apply. There may be research opportunities for students with other majors.

The program duration is May to August, with adjustments to be made to accommodate specific academic schedules (*e.g.*, quarter systems).

Application deadline is February 15. The student's university must submit a grant proposal that provides details about its academic programs and nominates one or more students. Each student must provide a transcript, two letters of recommendation, and a personal statement of interest.

Housing will be provided within easy walking distance of NIST.

Further information is available at <http://SURF.Boulder.NIST.gov>.

NATIONAL RESEARCH COUNCIL ASSOCIATESHIP OPPORTUNITIES

The National Institute of Standards and Technology (NIST), in cooperation with the National Research Council (NRC), offers awards for post-doctoral research in many fields. These awards provide a select group of scientists and engineers an opportunity for research in many of the

areas that are of deep concern to the scientific and technological community of the nation. NIST, with direct responsibilities for the nation's measurement network, involves its laboratories in the most modern developments in the physical, engineering, and mathematical sciences and the technological development that proceed from them. The Research Council, through its Associateship Programs office, conducts an annual national competition to recommend and make awards to outstanding scientists and engineers at the postdoctoral level for tenure as guest researchers at participating laboratories. The deadline for applications each year is February 1 for appointments beginning between July to December, and August 1 for appointments beginning January through June.

THE OBJECTIVES OF THE PROGRAMS ARE:

- To provide postdoctoral scientists and engineers of unusual promise and ability opportunities for research on problems, largely of their own choosing, that are compatible with the interest of the sponsoring laboratories.
- To contribute thereby to the overall efforts of the federal laboratories. Eligibility requirements include U.S. citizenship and receipt of Ph.D. within five years of application. NRC positions involve a two-year tenure at NIST.
- For more detailed information, including instructions for applicants, please contact the Optoelectronics Division Office and request a copy of the NRC Postdoctoral Opportunities booklet. You also may visit the Optoelectronics Division web page (<http://www.boulder.nist.gov/div815>); or the NRC Research Associateship Program web page (<http://www.national-academies.org/rap>, or for a description of the NIST NRC program, see <http://nrc58.nas.edu/pgasurvey/data/aobooks/rapbooks.asp?mode=fntmtr&fntmtrid=43>)

OPPORTUNITIES FOR THE YEAR 2007 WITH THE OPTOELECTRONICS DIVISION THROUGH THE NRC RESEARCH ASSOCIATESHIP PROGRAM

QUANTUM DOT MORPHOLOGY

Advisor: A. Roshko

Quantum dots have attracted a great deal of interest because of their unique properties and possibilities for optoelectronic applications. However, control of dot density, composition, position, size, and shape remain major obstacles for many device applications. We invite proposals to address these issues through an investigation of quantum dot morphology as a function of growth parameters such as temperature, rate, thickness, composition, and dot stacking. Studies of the interrelations between these variables and strain state are also of interest. State-of-the-art molecular beam epitaxy with reflected high-energy electron diffraction, atomic force microscopy, high-resolution X-ray diffraction, and transmission electron microscopy are available for analyzing quantum dot distributions, heights, shapes, spacings, and strain fields. Correlation with optical properties, such as photoluminescence, is also of interest. The work will contribute to a more complete understanding of quantum dot morphology, how it correlates with device performance, and how it can be controlled through the choice of growth conditions.

MOLECULAR SPECTROSCOPY USING RING-DOWN CAVITIES AND ITS APPLICATION TO SEMICONDUCTOR CRYSTAL GROWTH

Advisor: K. A. Bertness

Gases such as phosphine, ammonia, arsine, nitrogen, silane, and germane are widely used in semiconductor synthesis and processing. Most of these processes are highly sensitive to contamination, although the precise incorporation mechanisms and concentrations of concern are

poorly known. We have developed cavity ring-down spectroscopy as a tool for high-sensitivity measurements of impurities in gases along with the capability of using many of these gases in gas-source molecular beam epitaxy growth. The system has a sensitivity for measuring water as an impurity down to approximately 30 ppb in phosphine and 10 ppb in nitrogen using laser light near 935 nm. We anticipate the availability of new laser sources in the next few years that will significantly enhance the flexibility and sensitivity of the instrument. Because of its fast time response, cavity ring-down spectroscopy is also useful for measuring time-dependent effects and confirming the efficacy of purifiers. We invite proposals extending the capability of the instrument to new impurities or host gases (*e.g.*, novel studies of correlations of gas properties with semiconductor crystal properties and fundamental studies of the impurity incorporation process).

PHOTONIC CRYSTALS

Advisor: R. Mirin

Photonic crystals are meta-materials whose optical properties are determined by the photonic band structure that arises from resonant photon scattering off the nanometer-scale physical structure, in direct analogy with well-established concepts of electronic bands in semiconductors. Photonic crystals offer the new possibility of creating materials with custom-tailored bandgaps and dispersion curves, liberating light-emitting devices from the constraints caused by the underlying material dispersion. We are pursuing an active program of photonic crystal dispersion engineering with the aim of vastly enhancing the performance of semiconductor light emitters. Specifically, we are designing, fabricating, and measuring photonic crystal nanocavities for Purcell-enhanced single-photon sources, circular Bragg gratings for enhanced light extraction in LEDs, chirped waveguide gratings for dispersion control in semiconductor mode-locked lasers, and waveguide arrays for nonlinear soliton formation. Our capabilities include electromagnetic modeling, nanofabrication, quantum-optical measurements and ultra-fast measurements.

SEMICONDUCTOR QUANTUM OPTICS

Advisor: R. Mirin

We are developing a regulated source of single photons by fabricating a single photon turnstile with a single quantum dot. Our goals include spontaneous emission control and delivery of the individual photons to any other on-chip location through photonic crystal waveguides. Important technologies for this project include microcavities, microdisks, photonic crystals, and nonlinear optics. We invite experimental and/or theoretical proposals that can complement and expand on this ongoing effort. Available resources include epitaxial semiconductor growth, e-beam lithography, fabrication facilities, and finite-difference time-domain software for electromagnetic modeling.

OPTICAL SPECTROSCOPY OF QUANTUM DOTS

Advisor: R. Mirin

Self-assembled semiconductor quantum dots have been demonstrated for many optoelectronic devices (lasers, optical amplifiers, and photodetectors) and proposed for novel applications such as quantum computing. However, there is still a lack of fundamental knowledge about the optical and electronic properties of these quantum dots, such as homogeneous linewidth, oscillator strength, coupling, and carrier escape mechanisms, especially at the single quantum dot level. We invite proposals that will investigate these or other fundamental characteristics of self-assembled quantum dots.

COHERENT SPECTROSCOPY OF QUANTUM DOTS

Advisor: R. Mirin

We are currently performing high-resolution optical spectroscopy on self-assembled semiconductor quantum dots. Our technique employs narrow linewidth tunable lasers and heterodyne detection. Recent results from our group have shown that these structures are almost purely radiatively broadened at 9 K. We are soliciting proposals to extend this experimental method to investigate multi-exciton and charged exciton complexes. We are interested in the fundamental properties of these transitions as well as the coherence in these coupled-state systems. Optical phenomena such as electromagnetic-induced transparency (EIT) should be observable.

MBE GROWTH OF QUANTUM DOTS

Advisor: R. Mirin

We are developing single photon sources based on epitaxially grown single quantum dots. Many quantum dots are deposited during growth and individual dots are isolated by masking and etching. The goal of this project is to use novel methods of controlling the exact placement and size of the quantum dots. This will enable schemes of coupling two or more quantum dots for applications in quantum information and quantum optics.

ENGINEERED QUANTUM STATES OF LIGHT

Advisors: R. Miri, T. Clement

We are investigating methods of creating new quantum states of light such as Schrodinger cat states, NOON states, and Fock states. These new states have a variety of applications, including linear optical quantum computing, quantum metrology (for example, Heisenberg limited interferometry), and fundamental physics (loophole-free Bell measurements). We are particularly interested in utilizing our high quantum efficiency photon number resolving detectors to enable creation of these states. Our group includes both experimentalists and theorists. We invite proposals to further develop and utilize quantum states of light.

NANOSCOPIC WIDE-BANDGAP MATERIALS CHARACTERIZATION BY CW AND ULTRAFAST NONLINEAR OPTICS

Advisors: N. A. Sanford, J. B. Schlager

Near-field and confocal microscopies provide unique methods of characterizing a wide variety of semiconductor, dielectric, and hybrid optoelectronic materials and interfaces. We are developing methods of nanoscopic multiphoton spectroscopy and nonlinear optics for examining local structural and electronic properties of the wide-bandgap III-nitride alloy semiconductors. The techniques include ultraviolet (UV) second-harmonic generation in addition to cw and time-resolved, multiphoton UV spectroscopy that employ NSOM and confocal techniques. We are particularly interested in the study of local defects, polytyping, inversion domains, and alloy segregation; spectroscopy on the scale of defect separation (roughly 100 nm); and ultrafast processes involving interactions with strong static polarization fields in these materials. The spectroscopic results are correlated with X-ray diffraction imaging, high-resolution cathodoluminescence, and TEM.

METROLOGY AND PROTOTYPING OF WIDE-BANDGAP SEMICONDUCTOR QUANTUM NANOWIRE STRUCTURES AND DEVICES

Advisors: N. A. Sanford, K. A. Bertness, A. Roshko

Semiconductor quantum nanowires offer new applications in areas such as chemical sensors, NEMs, nanolasers, and nanoscale thermoelectric devices. A key aspect of these structures that

makes the research challenging and enables the utility of various nanowire devices is that many physical phenomena do not scale from the macro to nano regimes. Our research primarily focuses on nanowires grown from wide-bandgap semiconductors including the group III-nitride (GaN, AlN, InN) and ZnO material systems. We are interested in nanowire growth techniques that include MBE, vapor transport, and catalyst methods. We are interested in a range of research topics, from the applied to the fundamental, covering such areas as understanding the evolution of the microstructure of nitride semiconductors; development of nanotemplates for patterned growth of nanowires; optimization of p-type doping in nanostructures; developing methods of making electrical contact to single nanowires or arrays of nanowires; and development of new measurement methods for quantifying nanoscale piezoelectric, transport, and optoelectronic phenomena. Current device interests include nanowire lasers, LEDs, photodetectors (primarily in the UV), UV and visible light emitters (*i.e.*, for solid state lighting and water purification), and field emitting ion sources for mass spectrometry. We are also working on the design and fabrication of prototype nanowire electronic devices such as FETs. We welcome proposals aimed at new technological aspects of semiconductor quantum nanowire research and application. Our characterization resources include triple-axis X-ray diffraction, atomic force microscopy, scanning electron microscopy, ultrafast nonlinear optical characterization, near-field scanning optical microscopy, cw and time-resolved photoluminescence, device processing, and electrical measurements. Opportunities exist for collaborative work within NIST for more specialized characterization such as TEM, field-emission SEM, STM, cathodoluminescence, nanoscale electrical and thermal measurements.

Our existing programs use gas-source molecular beam epitaxy growth of nitrides, phosphides, and arsenides with a focus on nanostructures. Other in-house collaboration includes vapor phase and catalyst growth methods for nanowire growth. Also, a wide range of clean room processing equipment is available in order to carry out prototyping of specialized nanostructures.

IN-SITU METROLOGY OF EPITAXIAL CRYSTAL GROWTH FOR SEMICONDUCTOR OPTOELECTRONICS

Advisors: K. A. Bertness, R. K. Hickernell

Semiconductor optoelectronic devices are being employed in a variety of applications, including telecommunications, computer interconnects, data storage, display, printing, and sensor systems. Most of these devices rely on accurate, reproducible epitaxial crystal growth; however, further reductions in growth cost will require further development of in situ and ex situ measurement tools. Our research focuses on optical in situ material probes (*i.e.*, pyrometry, atomic absorption spectroscopy, and broadband normal-incidence optical reflectance) correlated with reflectance high-energy electron diffraction, ex situ X-ray diffractometry, photoluminescence spectroscopy, optical reflectance, and extensive modeling capabilities. Other resources include in-situ mass spectrometry, atomic force microscopy, transmission electron microscopy, electrochemical profiling, and clean room facilities for processing test and device structures. We have recently demonstrated growth of GaN nanowires, and proposals specific to plasma nitrogen characterization and monitoring of rough surfaces are encouraged. We also examine the practical utility of various measurement tools through the growth of device structures, with emphasis placed on vertical-cavity surface-emitting lasers, in-plane lasers, quantum dot lasers, and saturable Bragg absorbers.

SUPERCONDUCTING AND NANOMETER-SCALE DEVICES FOR INFRARED TO MILLIMETER-WAVE APPLICATIONS

Advisor: E. Grossman

Our goal is to explore the physical mechanisms and limitations of devices operating in the frequency range from 0.1 to 100 THz, and to develop novel devices and measurement techniques. For the short wavelength end, we use electron-beam lithography to fabricate the submicron structures required to minimize parasitic impedances. One specific research area includes mixers and harmonic mixers for frequency synthesis and high-resolution spectroscopy; another research area involves IR to millimeter-wave imaging radiometry. Our main focus is on high-sensitivity bolometers and superconducting multiplexers based on SQUIDS. Other devices of interest include high-T_c superconducting bolometers; room-temperature, thin-film bolometers; lithographic and/or micromachined coupling structures, particularly antennas and integrating cavities; superconducting mixers/rectifiers; and room-temperature mixers/rectifiers (*e.g.*, lithographic metal-insulator-metal diodes).

FLAT PANEL DISPLAY METROLOGY

Advisors: E. F. Kelley (Boulder), P. A. Boynton (Gaithersburg)

NIST's flat panel display laboratory serves the display industry by developing and quantifying good electronic display metrology for industrial use. With the explosion of the information age, the Internet, and e-commerce, the use of flat panel displays has become a growing need for US industries. Good display measurement methods are needed for several reasons: (1) specification language needs to rest solidly upon good metrology, (2) fierce competition between technologies requires good metrology to distinguish desirable features, and (3) users and implementers of displays need accurate characterizations of displays for selection purposes. NIST is doing research in (1) equipment on improving measurements made on displays; (2) development of display metrology with various standards organizations; (3) development of display metrology assessment methods and equipment to provide guidance for the implementation of good measurement methods in the display industry; and (4) display reflectance characterization, measurements, and modeling based on the bi-directional reflectance distribution function. Opportunities are available at both Boulder and Gaithersburg campuses.

HIGH SPEED OPTOELECTRONICS MEASUREMENTS

Advisors: P. D. Hale, D. F. Williams

Increasing data rates and bandwidths of optical telecommunications, cable television systems, remote microwave antenna links, and computer data interconnections all require advanced techniques for accurately determining optical transmitter and receiver frequency response in both magnitude and phase. Methods being investigated at NIST include heterodyne and ultrashort pulse technologies. Current research focuses on fully calibratable measurement of frequency response with low uncertainty to 110 GHz and extension to 400 GHz in the near future. We are especially interested in the measurement of response phase with low uncertainty using high-speed sampling techniques and in methods for verifying these measurements in a coaxial or on-wafer environment. Future calibration artifacts will require fabrication of ultrafast photodetectors. We are also interested in theoretical studies of the modulation characteristics, frequency response, spectral response, saturation, and electrical characteristics of optical receivers that would further enhance our metrology effort.

Advisors: P. D. Hale, R. Mirin, D. F. Williams

The need for ever smaller size and increased bandwidth of optoelectronic devices is requiring these devices to be packaged in hybrid modules and optoelectronic integrated circuits. Characterization of the frequency response and electrical properties of these devices requires a change in measurement strategy away from coaxially connected modular devices to on-wafer measurements. We are developing a new fully calibratable on-wafer measurement paradigm for calibrating optoelectronic and electronic devices to bandwidths exceeding 110 GHz. We are interested in fabricating new high-speed receivers that will be used as calibration artifacts in this new measurement strategy. Possible designs might include metal-semiconductor-metal photoconductive switches or p-i-n photodiodes grown in low-temperature GaAs or InGaAs. The work will result in artifacts that will be used to calibrate high-speed measurement equipment.

OPTICAL PULSE CHARACTERIZATION AND SYSTEM MONITORING

Advisors: P. D. Hale, K. B. Rochford, C. M. Wang, K. A. Remley, D. F. Williams

Optical component measurements alone will not be adequate to design and operate the next generation of optical communications, which will include dynamic channel add/drop switching, routing, gain control, equalization, and dispersion compensation. Accurate methods to dynamically characterize system impairment via thorough measurements of optical signal amplitude, phase, jitter, and noise are needed. We are soliciting proposals for methods that will assess system impairment, particularly methods that will discriminate between failure modes and offer insight into the strengths and weaknesses of various modulation, error correction, and dispersion compensation schemes.

CHARACTERIZATION OF DISPERSION COMPENSATION AND EQUALIZATION SCHEMES

Advisors: P. D. Hale, K. B. Rochford, C. M. Wang, K. A. Remley, D. F. Williams

Various optical and electrical methods of dispersion compensation and gain equalization are now being employed to extend the length of short- and long-reach optical communications systems. Electrical impairments known as frequency dependent loss and multipath interference also appear in board-level electrical interconnects, wireless communications, and data storage. Although the impairments appear in systems that differ greatly and can affect vastly different time scales, they can be addressed through similar techniques of equalization and filtering. We are soliciting methods for characterizing equalization and dispersion compensation methods, and particularly their efficacy for correcting low probability impairments.

WAVEFORM METROLOGY

Advisor: P. D. Hale

Current techniques used by industry for characterizing digital waveforms, both electrical and optical, are qualitative at best. As a result, the specifications for test equipment and communication systems are conservative and are not well understood. For example, the computer and communications industries both need measurements of different types of jitter and inter-symbol interference because these effects could cause erroneous bit transmission. We have developed a world-class capability for characterizing and calibrating equipment used in the acquisition of high-speed waveforms. We are looking for proposals that will investigate calibrated waveform measurement and the quantitative study of waveform metrics that characterize parameters such as random jitter, inter-symbol interference, and eye margin.

TUNABLE LASER ENSEMBLE DEVELOPMENT FOR LASER RADIOMETRY

Advisor: J. H. Lehman

The calibration of laser and optical fiber meters over wavelengths ranging from 200 nm to 1800 nm requires laser sources that are stable, broadly tunable, and have well defined optical properties (*e.g.*, polarization, beam quality). Our goal is to go beyond merely demonstrating what wavelengths may be produced by novel methods. We will demonstrate a variety of sources that are continuously tunable over the entire wavelength of interest (200 nm to 1800 nm) and deliver the output of these sources to various laboratories using optical fiber. This will enable cost-efficient, routine, calibration services having low uncertainties. We may employ new methods and equipment or optimize existing methods and equipment to ensure that NIST can provide laser power measurement comparisons to standards laboratories around the world as well as to manufacturers of laser and optical fiber power measurement equipment. Several new projects are currently under consideration to provide novel, robust methods for the generation and transportation of tunable laser light.

CARBON NANOTUBE COATINGS FOR LASER POWER AND ENERGY MEASUREMENTS

Several areas of research are currently being pursued: improved coatings for thermal detectors, ultraviolet detectors resistant to damage and aging, and improved transfer standards for pulsed-laser radiation measurements. In each case, our goal is to develop and maintain optical detectors that are traceable to electrical standards for the purpose of maintaining calibration services in the area of laser power and energy measurements. Nearly all of the primary standards for laser power and energy measurements at NIST are based on thermal detectors. Our goal is to establish carbon nanotube coatings as a practical choice for the next generation of standards. We also employ a variety of photodiode-based detectors as transfer standards for routine laser power calibrations for our customers. In each of these areas, the practical matters of providing cost-efficient, routine calibrations having low uncertainties must be considered. Topics of interest include new technologies and/or methods for developing and transferring detector-calibration information from one area to another.

ULTRAVIOLET LASER METROLOGY

Advisors: J. Lehman, M. L. Dowell

In recent years, ultraviolet (UV) laser — specifically diode lasers — have found increased use in a variety of industrial, commercial, homeland security, and medical applications. For example applications range from high-definition digital video to detection of chemical and biological aerosols. Currently there is no primary standard for calibration of high-power continuous laser power meters. Aging and hardening of materials exposed to UV laser radiation are among the challenges to developing new measurement tools. Currently we are pursuing carbon nanotube based coatings for thermal detectors as well as optoelectronic means of creating artificial spectra for calibration of chemical, biological, and explosive sensors. Our work includes the development of high-accuracy UV primary and transfer standard detectors, beam profile characterization, laser power, energy, and dose measurement services.

Advisor: N. R. Newbury

A supercontinuum of light that spans over an octave in frequency can be generated by launching pulses from femtosecond fiber lasers into highly nonlinear optical fiber. Through recently developed techniques, this supercontinuum can be phase-locked to a reference and thereby provide a stable frequency comb with a spacing equal to that of the laser repetition rate. These frequency combs have the potential to revolutionize optical frequency metrology in the telecommunication band since optical frequencies can now easily be measured relative to the time standard. We invite proposals that explore the generation, properties, and applications of infrared frequency combs. We are particularly interested in the generation of stable frequency combs in the telecommunications band using either femtosecond fiber lasers or other laser technology that could be used for wavelength metrology. Other examples of proposals include developing a better understanding of the noise properties of the frequency comb, and exploring other uses of the frequency comb related to LADAR or optical coherence tomography applications.

APPENDIX C: CONFERENCES AND WORKSHOPS

LASER MEASUREMENTS SHORT COURSE

The Optoelectronics Division offers an annual short course on laser measurements. The 3½-day course emphasizes the concepts, techniques, and apparatus used in measuring laser parameters. A tour of the NIST laser measurement laboratories is included. The most comprehensive seminar of its type, this course is ideal for those who need to understand the characteristics of lasers and laser measurements or who are responsible for laser systems. The seminar is taught by laser experts from NIST, industry, and other government agencies, and is intended to meet the needs of metrologists, scientists, engineers, laboratory technicians, educators, managers, and planners involved in the use of laser systems. A degree in physics or engineering or equivalent experience is assumed, and some experience in the use of lasers is desired.

The Technical Program covers a wide range of topics, such as:

- **Optics for Laser Measurements**
Lenses, spherical aberration, diffraction, laser beams, beam divergence, beamsplitters, detector linearity.
- **Attenuation Techniques**
Filters, specular reflectors, diffuse reflectors, speckle statistics.
- **Basic Laser Power/Energy Standards**
Calorimeter theory and design, data methods, volume absorbers, source standards, absolute quantum detectors.
- **Laser Power/Energy Measurement Techniques**
Calorimetry, beamsplitter system, calibration system, power/energy measurements, documentation, automation.
- **Pulse Measurements**
Pulse parameter definitions, energy measurements, waveform measurements, detector characterization, time-domain techniques, subnanosecond measurements, calibrations.
- **Optical Fiber Power Measurements**
Traceability, calibration system, measurement uncertainty, detector linearity, detector uniformity, tunable lasers, round robins, connector effects, international comparisons.
- **Diode Lasers**
Temperature stability, frequency control, measurement of peak power and energy, beam focusing, beam uniformity, angular divergence.
- **Statistics and Error Analysis**
Errors, uncertainties, measurement process characterization, estimation, statistical control.
- **Laser Safety**
Hazards to the eye, evaluation measurements, beam diagnostics for safety purposes, eye protectors.

The Laser Measurements Short Course is typically held the first week in August. Interested parties should consult the Optoelectronics Division Office or visit the Division Web page at <http://www.boulder.nist.gov/div815/> for information about upcoming courses.

DISPLAY METROLOGY SHORT COURSE

The National Institute of Standards and Technology offers a short course on display metrology in Boulder, Colorado, several times during the year. The three-day course consists of a one-day lecture and two days of hands-on measurements, diagnostics, and experiments. Current short course dates and a description of course contents can be found at www.fpd1.nist.gov/DMSC.html

Lecture topics include:

- Review of radiometry, photometry, and colorimetry
- Discussion of quantities and units used in photometry
- Review of simple photometric calculations
- Review of types of measurement instrumentation
- Veiling glare and management of stray light
- Use of flat masks and frusta
- Display reflection characterization
- Reflection haze and robustness
- Bidirectional reflectance distribution function
- Projection measurements
- Diagnostics
- Measurement uncertainty
- Laboratory redundancy
- Review of reflection measurements in some standards, *e.g.*,
 - SAE J1757 (ISO 15008), ISO 13406 & 9241, and others

Laboratory demonstrations include:

- Reflection robustness (common configurations)
- Projection measurements
- Reflection measurements
- Characterization of white reflectance standard
- Characterization of black glass
- BRDF measurements (low- and high-resolution)
- Diffuse reflection measurements
- Colors and gamut measurements with detector diagnostics
- Comparison of various color measurement instrument technologies
- Use of masks and frusta
- Small-area contrast measurements
- Properties of array cameras (*e.g.*, CCD cameras)
- Considerations for uniform sources

APPENDIX D: CALIBRATION SERVICES

From optical lithography for semiconductor manufacturing to the micromachining of small structures such as ink jet printer nozzles, lasers are finding their way into an increasingly diverse number of industrial applications. As this expansion continues, laser metrology will continue to become more important for improved in-line process control, increased yields, and laser safety. In support of these applications, the Optoelectronics Division provides calibrations services at laser power levels from nanowatts to kilowatts, and pulse energy levels from femtojoules to megajoules. Wavelength ranges include the standard ultraviolet, visible, and near infrared laser lines. In addition to standard laser lines, we have a tunable laser ensemble that can provide measurements of additional laser wavelengths upon request. Detailed information for the division's calibration service capabilities is given in Tables 1 through 6. Other laser-related measurement services are available upon request and will be delivered at cost.

Table 1. Laser power and energy calibration services for optoelectronic devices used with cw laser radiation.

Laser	Wavelength	Power
HeCd	325 nm	1 nW – 50 mW
Argon	488 nm	1 nW – 6 W
	514 nm	1 nW – 10 W
	Other Argon wavelengths available, call for power levels.	
HeNe	633 nm	1 nW – 20 mW
Diode	375, 672, 830, 850, 1310, and 1550 nm	1 nW – 20 mW
Nd:YAG	1064 nm	1 nW – 1 kW (6 kW off-site)
	1319 nm	1 μ W – 50 mW
Erbium	1523 nm	1 μ W – 30 mW
CO ₂	10.6 μ m	100 W – 2 kW (6 kW off-site)
Ti:Sapphire	700 nm – 1 μ m	1 nW – 1 W
Additional dye laser wavelengths available, call for power levels		

Table 2. Laser power and energy calibration services for optoelectronic devices used with pulsed-laser radiation.

Laser	Wavelength	Energy
Q-Switched Nd:YAG	1.06 μ m	1–300 mJ/pulse (1 – 20 Hz) 1 mW to 6 W average
Low Level Nd:YAG	1.06 μ m	10 ⁻⁴ –10 ⁻⁸ W (peak) 10 ⁻¹¹ –10 ⁻¹⁵ J/pulse
KrF	248 nm	5 μ J/Pulse – 250 mJ/Pulse 50 μ W – 7 W average
ArF	193 nm	5 μ J/Pulse – 5 mJ/Pulse 10 μ W – 3 W average
F ₂	157 nm	1 μ J/Pulse – 3 mJ/Pulse 1 μ W – 1 W average

Table 3. Detector characterization services.

Parameter	Wavelength	Range	Status
Optical Detector Spatial Uniformity	635, 850, 1300, and 1550 nm	Detector size: 1 mm – 17 cm Resolution: 0.1 mm	Special Test
Optical Detector Linearity	193, 248, and 1064 nm 10.6 μ m	1 nJ/pulse – 10 mJ/pulse	Special Test

Table 4. Optical fiber power meter measurement services.

Parameter	Wavelength (nm)	Range	Status
Absolute Power Calibration	670, 780, 850, 980 1310, 1550	10 – 100 μ W	Calibration Service
	980	1 – 200 mW	Special Test
	1480	1 μ W – 1 W	Special Test
Optical Fiber Power Meter Linearity	850, 1310, 1550	60 – 90 dB	Calibration Service
Optical Fiber Power Meter Spectral Responsivity	450 – 1750	< 2 % uncertainty	Calibration Service

Table 5. Temporal and frequency response measurements of optical detectors and receivers.

Parameter	Wavelength	Range	Status
Optical Receiver Frequency Response (Magnitude)	1319 nm	300 kHz – 50 GHz	Special Test
	1550 nm	1 MHz – 50 GHz	Special Test
Optical Receiver Vector Frequency Response	1550 nm	200 MHz – 110 GHz	Special Test
Reference Receiver (Optical Oscilloscope) Vector Frequency Response	850 nm 1550 nm	100 fs impulse source	Special Test
Optical Modulation Response Transfer Standard	1319, 1550 nm	300 kHz – 110 GHz	Special Test

Table 6. Temporal and frequency response measurements of electrical signal generators and oscilloscopes.

Parameter	Connector type	Range	Status
Impulse spectrum magnitude and phase	2.4 mm	10 MHz – 50 GHz	Special Test
	1.0 mm	200 MHz – 110 GHz	Special Test
Oscilloscope vector frequency response	2.4 mm	200 MHz – 110 GHz	Special Test
Oscilloscope vector frequency response with time-domain analysis	1.0 mm	200 MHz – 110 GHz	Special Test
Pulse generator pulse waveform parameters: Transition duration Amplitude	3.5 mm 1.0 mm	~10 ps – ~100 ps < ~400 mV 5 ns epoch	Special Test

See <http://www.boulder.nist.gov/div815/Calibrations/Calibrations.htm> for more information.

For technical information contact:

Marla L. Dowell, Group Leader
Sources, Detectors, and Displays Group
NIST 815.01
325 Broadway
Boulder, CO 80305
TEL: 303-497-7455
e-mail: marla.dowell@boulder.nist.gov

For scheduling and shipping information contact:

John Lomax,
Measurement Services Coordinator
Optoelectronics Division
NIST 815.00
325 Broadway, 1-3055
Boulder, CO 80305
TEL: 303-497-3842
FAX: 303-497-4286
e-mail: jlomax@boulder.nist.gov

PRIMARY STANDARDS FOR LASER RADIOMETRY

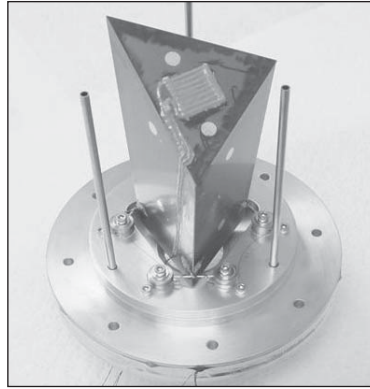

A SiC absorbing cavity for the 157 nm excimer laser calorimeter. Developed over the past few years, we now provide power and energy calibrations at this wavelength to support the semiconductor photolithography industry.

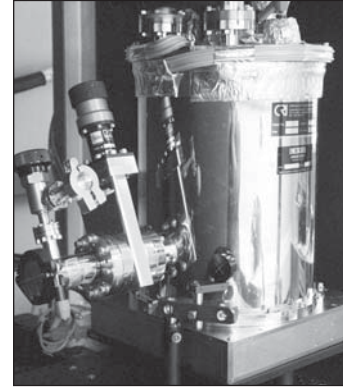

The Laser-Optimized Cryogenic Radiometer, developed in the late 1990s, and used for the highest accuracy measurements with low-level cw lasers, 100 μ W to 1 mW at wavelengths from 0.4 μ m to 2 μ m.

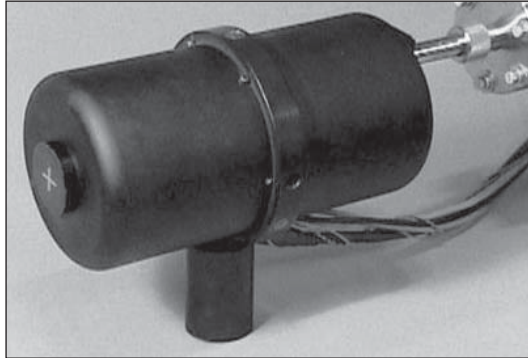

The C-Series Calorimeter, originally developed in the 1970s for use with cw lasers in the range from 50 μ W to 1 W and 0.4 μ m to 2 μ m wavelength. Improved versions are in current use for calibrations.

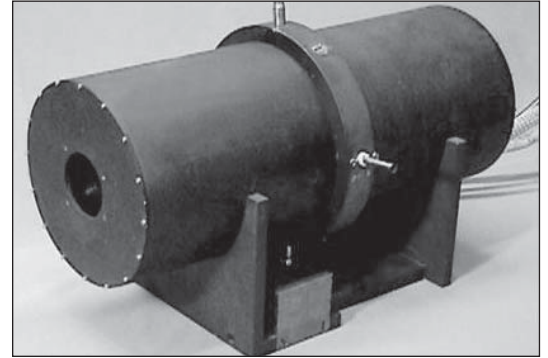

The K-Series Calorimeter, developed in the 1970s, for high-power cw lasers in the range from 1 W to 1000 W and wavelengths from 0.4 μ m to 20 μ m. This calorimeter is in current use for calibrations.

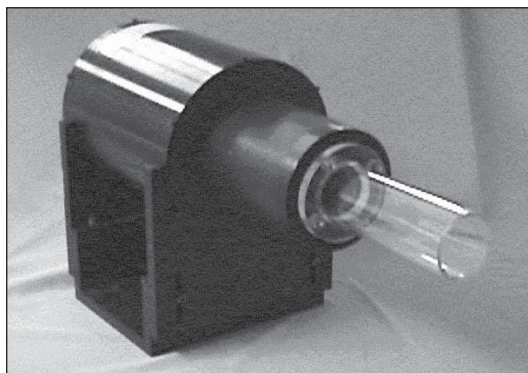

Three versions of this standard are used for pulsed-laser calibrations. The Q-Series, developed in the 1980s, is used for 1.06 μ m lasers. The QUV and QDUV calorimeters, developed in the 1990s, are in current use for calibrations at 248 nm and 193 nm, respectively.

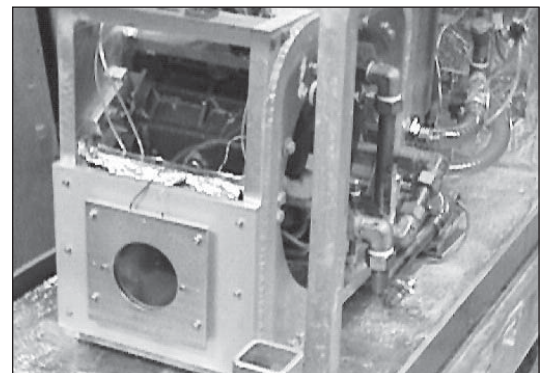

The BB Calorimeter, developed around 1980 for the U.S. Air Force Metrology Laboratory, and is in current use for cw lasers with power levels up to 100 kW.

APPENDIX E: STANDARD REFERENCE MATERIALS

SRM Number	Name	Brief Description
Composition Standards		
2841	Composition Standards for Compound Semiconductors	Standards of epitaxial layers of compound semiconductors for application in calibration of analytical equipment (SIMS, EMPA, AES, XPS, etc.) and photoluminescence mapping. The SRM 2841 is specimens of epitaxial layers of $\text{Al}_x\text{Ga}_{1-x}\text{As}$ grown on GaAs substrates with x near 0.20 and uncertainty of ± 0.002 . Additional mole fractions are also under development.
Wavelength Calibration Standards		
2514	Wavelength Calibration Reference for 1560-1595 nm – Carbon Monoxide ($^{12}\text{C}^{16}\text{O}$)	Fiber-coupled molecular gas absorption cell with absorption lines in the WDM L-band between 1560 nm and 1595 nm. The center wavelengths of the absorption lines are certified with expanded uncertainties ranging from 0.4 pm to 0.7 pm.
2515	Wavelength Calibration Reference for 1595-1630 nm – Carbon Monoxide ($^{13}\text{C}^{16}\text{O}$)	Fiber-coupled molecular gas absorption cell with absorption lines in the WDM L-band between 1595 nm and 1630 nm. The center wavelengths of the absorption lines are certified with expanded uncertainties ranging from 0.4 pm to 0.7 pm.
2517a	High-Resolution Wavelength Calibration Reference for 1510-1540 nm – Acetylene ($^{12}\text{C}_2\text{H}_2$)	Fiber-coupled molecular gas absorption cell with narrow absorption lines between 1510 nm and 1540 nm. The center wavelengths of the absorption lines are certified with expanded uncertainties ranging from 0.1 pm to 0.6 pm.
2519a	High-resolution Wavelength Calibration Reference for 1530-1560 nm – Hydrogen Cyanide ($\text{H}^{13}\text{C}^{14}\text{N}$)	Fiber-coupled molecular gas absorption cell with absorption lines between 1530 nm and 1560 nm. The center wavelengths of the lines are certified with expanded uncertainties ranging from 0.04 pm to 0.24 pm.
Polarization Mode Dispersion Standards		
2518	Polarization Mode Dispersion (mode-coupled)	Simulates mode-coupled PMD in optical fiber; certified for mean DGD from 1480 nm to 1570 nm.
2538	Polarization Mode Dispersion (non mode coupled)	Simulates PMD in discrete components; certified for mean DGD from 1250 nm to 1650 nm.
Fiber and Fiber-Connector Geometry Standards		
2513	Mode Field Diameter Standard for Single-Mode Fiber	Optical fiber specimen with cleaved end and calibrated mode field diameter.
2520	Optical Fiber Diameter Standard	Optical fiber specimen with cladding diameter values known to approximately ± 40 nm.

For additional technical information contact:

Optoelectronics Division (815.00)
National Institute of Standards and Technology
325 Broadway
Boulder, CO 80305
Phone: (303) 497-5342 Fax: (303) 497-7671
E-mail: optoelectronics@boulder.nist.gov

For ordering and shipping information contact:

Measurement Services Division
National Institute of Standards and Technology
100 Bureau Drive, Stop 2322
Gaithersburg, MD 20899-2322
Phone: (301) 975-6776 Fax: (301) 948-3730
E-mail: SRMINFO@nist.gov



Division/Office Publication Editor: Annie Smith
Publication Coordinator: Erik M. Secula
Printing Coordinator: Ilse Putman
Document Production: Technology & Management Services, Inc.
Gaithersburg, Maryland

January 2007

For additional information contact:

Telephone: (303) 497-5342

Facsimile: (303) 497-7671

On the Web: <http://www.boulder.nist.gov/div815/>