

**NISTIR 6608**

**Optoelectronics at NIST:  
Brief Research Summaries from  
Throughout the Institute**



**NIST**

**National Institute of Standards and Technology**  
Technology Administration, U.S. Department of Commerce

**NISTIR 6008**

# **Optoelectronics at NIST: Brief Research Summaries from Throughout the Institute**

Gordon W. Day, Editor  
*Optoelectronics Division*  
*Electronics and Electrical Engineering Laboratory*

June 2001



U.S. Department of Commerce  
*Donald L. Evans, Secretary*

National Institute of Standards and Technology  
*Karen H. Brown, Acting Director*

# TABLE OF CONTENTS

|   |     |
|---|-----|
| <a href="#">Preface</a> .....   | iii |
| <b>1. Fundamental studies</b>   |     |
| <a href="#">Atomic Photonics</a> .....  | 1   |
| <a href="#">Photonic Crystals, Molecules, and Turnstiles</a> .....                            | 2   |
| <b>2. Metrology in support of science and engineering</b>                                     |     |
| <b>2.1 Fundamental standards</b>  |     |
| <b>2.1.1 Time and frequency</b>   |     |
| <a href="#">Optical-Frequency Standards</a> .....   | 3   |
| <a href="#">Small Atomic Clocks Based on Optoelectronics</a> .....                            | 4   |
| <a href="#">Next Generation Tools in Optoelectronic Research</a> .....                        | 5   |
| <a href="#">Phase Control of Ultrashort Pulses: Optical Waveform Synthesis</a> .....          | 6   |
| <a href="#">Optical-Frequency Measurements</a> .....  | 7   |
| <a href="#">Diode-Laser Technology for Metrology Applications</a> .....                       | 8   |
| <a href="#">Ultra-Narrow-Linewidth Lasers</a> .....   | 9   |
| <b>2.1.2 Temperature</b>  |     |
| <a href="#">Radiation Temperature</a> .....   | 10  |
| <b>2.1.3 Photometry and colorimetry</b>   |     |
| <a href="#">Photometric Measurements</a> .....  | 11  |
| <b>2.1.4 Electromagnetic radiation</b>  |     |
| <a href="#">SURF III Facility</a> .....   | 12  |
| <a href="#">Low Background Infrared (LBIR) Metrology</a> .....                                | 13  |
| <a href="#">Spectral Radiometry of Sources</a> .....  | 14  |
| <a href="#">Optical Detector Metrology</a> .....  | 15  |
| <a href="#">Continuous Wave Submillimeter and Terahertz Measurement Technology</a> .....      | 16  |
| <b>2.2 Applied measurements</b>   |     |
| <b>2.2.1 Optical properties of materials</b>  |     |
| <a href="#">Infrared Optical Properties of Materials</a> .....                                | 17  |
| <a href="#">Extreme Ultraviolet Optics Characterization Facility</a> .....                    | 18  |
| <b>2.2.2 Semiconductors</b>   |     |
| <a href="#">Ultrafast Carrier Dynamics in Semiconductors</a> .....                            | 19  |
| <a href="#">DUV Metrology for Lithography</a> .....   | 20  |
| <a href="#">Applications of Femtosecond Terahertz Spectroscopy</a> .....                      | 21  |
| <a href="#">Nonlinear Optical Diagnostics of Interfaces and Thin Films</a> .....              | 22  |
| <a href="#">Optical Scattering Metrology</a> .....  | 23  |
| <a href="#">Infrared Near Field Optical Microscopy of Polymer Photoresists</a> .....          | 24  |
| <b>2.2.3 Ionizing radiation</b>   |     |
| <a href="#">Nuclear Polarization of <sup>3</sup>He by Optical Pumping</a> .....               | 25  |
| <b>2.2.4 Sensing</b>  |     |
| <a href="#">Space Based Radiometry</a> .....  | 26  |
| <a href="#">Environmental and Remote Sensing</a> .....  | 27  |
| <a href="#">Diode-Laser Systems for Trace-Impurity Monitoring</a> .....                       | 28  |
| <a href="#">Photonic Electromagnetic Field Probes</a> .....                                   | 29  |
| <b>2.2.5 Dimensional measurements</b>   |     |
| <a href="#">Near-Field Optics and Microscopy for Nanoscale Optical Characterization</a> ..... | 30  |

|  |    |
|--|----|
| <b>2.2.6 Optics</b>  |    |
| <u>Advanced Optics Metrology</u> .....   | 31 |
| <u>Substrate Thickness, Thickness Variation, and Flatness</u> .....  | 32 |
| <b>3. Metrology in support of the optoelectronics industry</b>   |    |
| <b>3.1 Optical communications</b>  |    |
| <u>Wavelength Division Multiplexing Network Measurements and Management</u> .....  | 33 |
| <u>Phase Stability in Optical-Fiber Links</u> .....  | 34 |
| <u>High-Speed Optoelectronic Measurements</u> .....  | 35 |
| <u>Wavelength Standards for Optical Fiber Communications</u> .....   | 36 |
| <u>Spectral Metrology of Optical Components</u> .....  | 37 |
| <u>Relative Group Delay and Dispersion of Optical Fiber and Components</u> .....   | 38 |
| <u>Polarimetry</u> .....   | 39 |
| <u>Polarization Dependent Loss</u> .....   | 40 |
| <u>Polarization Mode Dispersion</u> .....  | 41 |
| <u>Ultrafast and CW Compact Solid-State Waveguide Lasers</u> .....   | 42 |
| <u>Optical Fiber Ferrule Measurements</u> .....  | 43 |
| <b>3.2 Industrial/medical/military lasers</b>  |    |
| <u>Laser Power Measurements for Optical Telecommunications</u> .....   | 44 |
| <u>Pulsed-Laser Radiometry</u> .....   | 45 |
| <u>Laser Power and Energy Measurements for Industrial/Military Applications</u> .....  | 46 |
| <b>3.3 Flat panel displays</b>   |    |
| <u>Flat Panel Display Laboratory</u> .....   | 47 |
| <b>3.4 Illumination</b>  |    |
| <u>Atomic Data for High Efficiency Lighting</u> .....  | 48 |
| <b>3.5 Compound semiconductor manufacturing</b>  |    |
| <u>Metrology for Compound Semiconductor Manufacturing</u> .....  | 49 |
| <u>Chemical Composition Standards for Optoelectronic Semiconductors</u> .....  | 50 |
| <u>Impurity Concentration Measurements in Semiconductor Source Gases</u> .....   | 51 |
| <u><i>In Situ</i> and <i>Ex Situ</i> Characterization of Compound Semiconductor Growth and Processing</u> .....  | 52 |
| <u>Nanostructure Fabrication and Metrology</u> .....   | 53 |
| <u>Nonlinear Optical Analysis of III-Nitride Alloys</u> .....  | 54 |
| <u>Metallurgy of the Electrical Contacts to GaN-based Semiconductors</u> .....   | 55 |
| <u><i>In Situ</i>, Spatially Resolved Characterization of Free Carrier Concentration and Mobility During III-V Semiconductor Film Growth and Etching</u> ..... | 56 |
| <b>3.6 Component packaging and assembly</b>  |    |
| <u>Calibration and Performance Testing of Planar Micropositioners</u> .....  | 57 |
| <u>Calibration and Performance Testing of 6-D Micropositioners</u> .....   | 58 |
| <b>4. Metrology in support of other industries</b>   |    |
| <b>4.1 Electrical and electronics instrumentation</b>  |    |
| <u>Optical Current and Voltage Transducers for Electric Utility Applications</u> .....   | 59 |
| <u>High-speed Electrical Pulse Metrology, Generation, and Applications</u> .....   | 60 |
| <u>Electro-optic Electrical Waveform Measurements</u> .....  | 61 |
| <u>Noninvasive Waveform Measurement for Digital Integrated Circuits</u> .....  | 62 |
| <b>4.2 Magnetic data storage</b>   |    |
| <u>Magnetodynamics</u> .....   | 63 |
| <u>Magneto-Optical Indicator Film (MOIF) Technique</u> .....   | 64 |
| <u>INDEX</u> .....   | 65 |

## Preface

Optoelectronics is the marriage of optics and electronics that has enabled many familiar and diverse high-technology products and processes—high-quality telecommunications systems, the Internet, laser printing, fax machines, bar-code scanning, optical disc technology, displays, electronic cameras, advanced manufacturing processes, and new medical diagnostic and treatment procedures. The industry is large and growing rapidly as new advances emerge from research laboratories.

NIST's work in optoelectronics is as diverse as the field, and is scattered throughout the Institute. Some of it represents traditional NIST efforts to provide the optoelectronics industry with measurement technology, standards, and traceability. Some of it involves the use of optoelectronic technologies to achieve NIST's goals in other areas—in support of other industries, in support of the scientific community, or in fundamental research. All of it represents expertise and resources that may be applicable to problems well removed from those on which they are currently focused.

This document contains summaries of sixty-four NIST projects in which optoelectronics plays an important role. It has been compiled primarily for NIST scientists, engineers, and managers, to foster collaboration and synergistic approaches to problems of common interest. But it is also being made available to the public as an aid to those who seek NIST expertise in the fields described. Points of contact—email and phone—are provided for each project.

Information on the number of staff and the type of staff involved in each project is approximate and is included only to give a general idea of the size of the activity. Information on sources of funding is provided as an indicator of whether the work is conducted primarily using NIST appropriated funds, or performed as contract research for other government organizations.

Gordon W. Day, Editor  
Chief, NIST Optoelectronics Division

## Atomic Photonics

*Project Leader/contact:*

William D. Phillips, (301) 975-6554, wphillips@nist.gov  
Atomic Physics Division, PL, Gaithersburg

*Approximate staff (FTE):*

1 Professional, 1 Guest Researcher

*Funding sources:*

NIST (100 %)

*Objective:*

Develop laser cooling, trapping, and manipulation techniques for the creation, fabrication, and evaluation of optical materials and devices.

*Constituency:*

Atom optical manipulation has application in the creation of new-generation atomic time and frequency standards, as well as to advanced nanolithography. Manipulation of larger objects has potential application in micromechanical and optical assemblies, for medical laboratory testing and environmental sensing.

*Principal current tasks:*

- Develop atom optical devices for atomic beams
- Develop coherent atomic sources
- Optical manipulation of objects for microassembly and microanalysis
- Creation of novel optical materials with cold atoms
- Creation of optical lattice-based quantum computer prototypes

*Additional information:*

We are studying the basic physics of manipulating atoms to produce atom optical devices useful for measurement and manufacturing, such as atom interferometers for inertial sensing and atom lenses and holograms for nanofabrication. We are investigating the use of the quantum collective behavior of cooled and trapped atoms (Bose-Einstein condensation), having created a tunable "atom laser", a matter wave analogy of an optical laser. Such devices provide coherent sources of matter waves, which may allow for improvements in interferometry, for example. We are applying optical manipulation of micrometer-size objects to the characterization and development of biosensors. Optical tweezers are ideal devices to study adhesion at the molecular level. Adhesion underlies a host of biological processes, such as infection, immune response, and cell transport. We are also investigating the application of the technique for assembly of micromechanical devices. The ability to create optical lattices and atomic gases at ultra-low temperatures provides new opportunities for exploiting the optical characteristics of such media. Periodic media such as optical lattices offer the possibility of photonic bandgaps, and cold gases are ideal for the investigation of coherent nonlinear effects such as electromagnetically induced transparency, and lasing without inversion. We are investigating the use of atoms trapped in optical lattices to create a quantum computer. The atoms in the lattice sites will form the memory register, and the logic operations will be carried out using optical manipulations. Such a computer, when realized at a large enough scale, can solve a class of computational problems that are currently intractable.

## Photonic Crystals, Molecules, and Turnstiles

### *Project Leader/contact:*

Richard P. Mirin, (303) 497-7955, mirin@boulder.nist.gov  
Optoelectronics Division, EEEL, Boulder

### *Approximate staff (FTE):*

2 Professionals, 2 Postdocs

### *Funding sources:*

NIST (100 %)

### *Objective:*

Develop fabrication, measurement, and modeling techniques of photonic crystals, photonic molecules, and single photon turnstiles. Exploit new devices based on these structures to achieve advances in optical measurement technology and the understanding of the quantum statistical properties of photons.

### *Constituency:*

Optoelectronics industry, optical measurement instrumentation manufacturers, and nanoscale metrology equipment developers

### *Principal current tasks:*

- InGaAs quantum dot growth and characterization
- Single photon turnstile development
- Photonic crystal fabrication, modeling, and characterization
- Photon number state generator development

### *Additional information:*

NIST is fabricating and characterizing semiconductor nanostructures to support the optoelectronics industry as it moves into this arena. The development of the single photon turnstile will provide NIST with a regulated source of individual photons. This will allow the development of quantum-based radiometric standards. It will also enable future applications such as quantum cryptography and optical-based quantum computation. Photonic crystals are emerging as a key area for optical networking, and we are developing the tools to measure the performance of these components. Ultra-low-threshold lasers, three-dimensional filters, and optical switches are some of the important outcomes of the technology. In addition, photonic crystal waveguides with lossless 90° bends enable very high packing densities of optoelectronic integrated circuits.

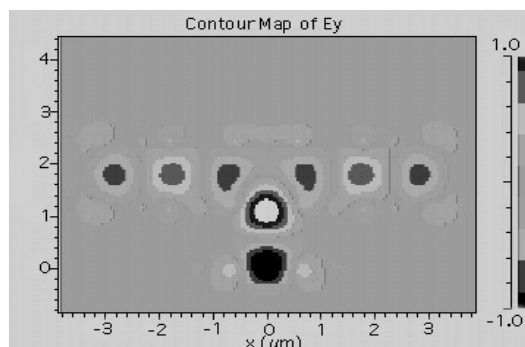

Modeled electric field of photonic crystal tee

## Optical-Frequency Standards

*Project Leader/contact:*

James E. Bergquist, (303) 497-5459, berky@boulder.nist.gov  
Leo Hollberg, (303) 497-5770, hollberg@boulder.nist.gov  
Time and Frequency Division, PL, Boulder

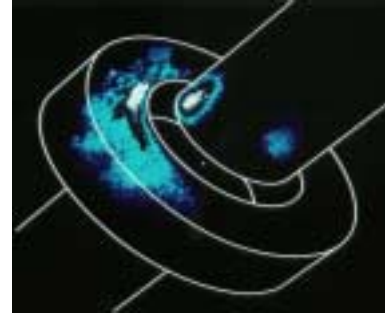

*Approximate staff (FTE):*

2 Professionals

*Funding sources:*

NIST (70 %), Other Agencies (30 %)

*Objective:*

Develop optical-frequency standards to serve as next generation frequency and time standards whose stability and accuracy are expected to approach  $1 \times 10^{-18}$ . These standards can also serve to calibrate standards used for wavelength division multiplexing and as reference for interferometric length measurements.

*Constituency:*

Optical communications industry, machine-tool manufacturers and users, atomic-clock manufacturers

*Principal current tasks:*

- Improve the frequency stability and accuracy of both mercury ion and neutral calcium standards
- Measure the frequency of both optical standards relative to the cesium frequency standard
- Simplify lasers used for cooling the atoms and ions in these standards

*Additional information:*

Modern optical communication systems are rapidly moving to wavelength-division multiplexing (WDM), and there is thus a need for establishing absolute frequency measurements in the optical-communications bands. Such primary standards can then serve to calibrate working standards, thus assuring uniformity of measurements and compatibility of components. These frequency standards can be used directly in high-performance communications systems to assure secure information transfer, and in instances where autonomous operation does not allow for frequent synchronization.

More accurate and simpler methods are needed for making dimensional measurements in the machine-shop environment. Optical-frequency standards with small absolute uncertainty are used as references for interferometric measurements that provide assurance of compatibility of components. Advanced concepts for swept-frequency interferometric measurements, based on optical-frequency standards, offer a number of advantages. These include the removal of requirements for moving stages and the associated difficulty of missing fringe counts during such stage movement. Missed counts can result from beam interruption by personnel or equipment.

The optical difference frequency between the mercury ion frequency (282 nm) and the neutral-calcium frequency (657 nm) has been measured with an uncertainty of about  $10^{-14}$ . Both frequencies are known relative to the cesium primary standard to a level of  $10^{-13}$ , and work is now directed toward reducing the uncertainty of these absolute frequencies, and evaluating their accuracy and stability over time.



## Small Atomic Clocks Based on Optoelectronics

### *Project Leader/contact:*

John Kitching, (303) 497-4083, kitching@boulder.nist.gov  
Time and Frequency Division, PL, NIST

### *Approximate staff (FTE):*

0.3 Professional, 0.7 Contractor, 1 Guest Scientist

### *Funding sources:*

NIST (50 %), Other Agencies (50 %)

### *Objective:*

Develop compact, low-power, diode-laser-based atomic clocks supporting precise timing for telecommunications systems and improved GPS receivers.

### *Constituency:*

Telecommunications industry, instrumentation manufacturers, GPS receiver industry/users, military

### *Principal current tasks:*

- Construct prototype physics package to fit within a volume of 16H13H70 mm
- Conduct stability tests
- Determine long-term stability and frequency uncertainty
- Identify and reduce sources of added noise

### *Additional information:*

Frequency-stability performance beyond that currently available from quartz oscillators is now needed for applications in wireless communication networks. Such networks employ accurate and stable frequency sources at each cell node to assure proper network operation. An additional benefit of good frequency control at these nodes is the ability to determine the locations of individual callers, which is important for emergency (911) operations.

Rapid acquisition of GPS signals for critical navigation operations can be greatly improved by improving the longer-term stability of clocks within the GPS receivers. If the time maintained by the receiver is more accurate, then the receiver can more quickly arrive at a navigation solution. Such rapid navigation solutions are needed, for example, for aircraft guidance, collision-avoidance systems, and certain military applications.

Quartz oscillators are plagued by long-term drift, and where such oscillators are used as time bases for instruments such as counters and synthesizers, this drift results in loss of calibration. The incorporation of simple atomic clocks (oscillators) in these instruments can dramatically improve the long-term stability of such instrumentation, thus increasing the time interval between calibrations.

Small microwave frequency standards (clocks) based on diode lasers (VCSEL) locked to resonances in rubidium and cesium have been demonstrated. The short-term stability of these devices is  $\sim 1 \times 10^{-12} \tau^{-1/2}$  where  $\tau$  is the averaging time. It seems clear that this type of device can be reduced to a very small package with a power requirement of less than 1 W. Further improvement in short-term stability is certainly expected, and the uncertainty of the frequency will certainly be much better than that for quartz, since the frequency is directly controlled by an atomic resonance.

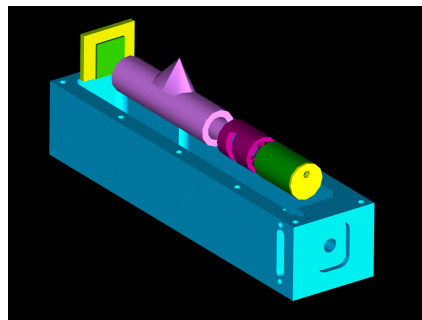

## Next Generation Tools in Optoelectronic Research

### Project Leader/contact:

Jun Ye, (303) 735-3171, Ye@jila.colorado.edu  
Quantum Physics Division, PL, Boulder

### Approximate staff (FTE):

1 Professional, 2 Post-Docs, 2 Graduate Students,  
1 Undergraduate

### Funding sources:

NIST (30 %), Other Agencies (60 %), Other  
(10 %)

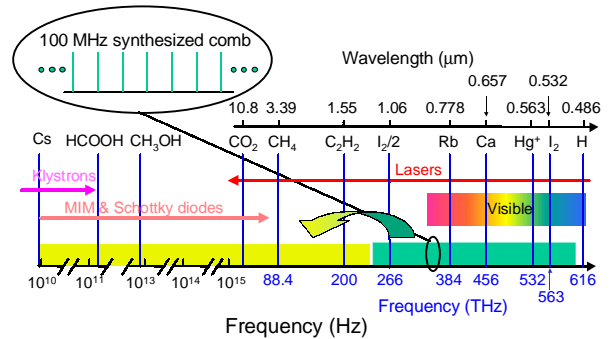

### Objective:

Provide next generation tools in optoelectronic research, including highly accurate frequency/wavelength standards, precisely controlled and compact optical oscillators, and amplitude and phase calibrated ultrashort pulse trains.

### Constituency:

National metrology laboratories, university researchers, laser and optoelectronics manufacturers, optical communication industry, NASA

### Principal current tasks:

- Precision optical frequency/wavelength standards
- Novel laser designs, with following characteristics, compact, robust, tunable with wide wavelength coverage, highly coherent
- Delivery of optical information to the radio frequency, microwave and terahertz domain to facilitate optoelectronic research

### Additional information:

Optoelectronic research and development have traditionally benefited a great deal from the development of novel light sources and new capabilities in optical measurement. Our research is focused on studies of novel aspects of light-matter interactions and their application to precision control and measurement of light field, atomic and molecular structure, and new device physics. In particular, we have two thrust areas under active development. (1) Optical frequency metrology. We are now at the threshold of developing an optical frequency synthesizer. Basically one will have a general purpose test and measurement instrument that produces highly stable, widely tunable optical local oscillators that cover an entire optical spectrum. These frequency marks can be transferred to anywhere in the lower frequency regions. The approach will revolutionize the development processes of optical detectors, optical communication systems, and frequency/wavelength standards. (2) New laser development and stabilization. Precise control of the frequency and phase of optical local oscillators has many enabling capabilities in optical communications as well as in some high precision measurement endeavors such as space-borne optical interferometer experiments. Development of compact, robust, and highly coherent lasers allow simplification in optoelectronic system design and improvement of system efficiency.

The above picture shows the vast spectrum spanning from the traditional rf/microwave frequency standards to the emerging optical standards. The optical frequency comb generator conveniently bridges these frequency gaps with uniformly spaced frequency markers covering one optical octave bandwidth.

## Phase Control of Ultrashort Pulses: Optical Waveform Synthesis

*Project Leader/contact:*

Steven T. Cundiff, (303) 492-7858, steven.cundiff@nist.gov  
Quantum Physics Division, PL Boulder

*Approximate staff (FTE):*

0.3 Professional, 1.0 Student, 0.5 Post-doc

*Funding sources:*

NIST (70 %), NSF (30 %)

*Objective:*

Control the absolute phase of ultrashort pulses with respect to the envelope

*Constituency:*

Optical frequency metrologists; academic researchers.

*Principal current tasks:*

- Obtain shorter pulses (<7 femtoseconds) from modelocked laser
- Perform cross-correlation measurements
- Develop and demonstrate experimental method sensitive to absolute pulse phase

*Additional information:*

The absolute phase is typically thought to not have any physical relevance in optics. However, for ultrashort pulses that are only a few optical cycles in duration, the phase of the carrier with respect to the peak of the envelope can be measured. Currently it is possible to control the relative phase of successive pulses. The goal of this project is to control the absolute phase.

Control of the absolute phase will represent an unprecedented level of manipulation. It will be tantamount to building a waveform synthesizer at optical frequencies. This will enable new forms of coherent control of atomic and molecular excited state populations and electric current in semiconductors that rely on only a single pulse, rather than multiplets of phase locked pulses as has been heretofore necessary. It will allow the optimization of the x-ray yield produced using amplified ultrashort pulses. It will also impact the optical frequency metrology community, which has recently realized that modelocked lasers make outstanding optical frequency synthesizers. This project has the potential to provide the phase control necessary for metrology without employing complex feedback electronics.

Currently the modelocked laser used in this project is being upgraded to produce shorter pulses. This will enhance the effect of the absolute phase. The diagnostic equipment (cross-correlator) will then be verified to work in this regime. Several candidate methods for measuring the absolute phase are under consideration.

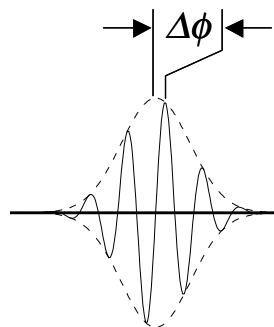

## Optical-Frequency Measurements

### *Project Leader/contact:*

Leo Hollberg, (303) 497-5770, hollberg@boulder.nist.gov  
Scott Diddams, (303) 497-7459, diddams@boulder.nist.gov  
Time and Frequency Division, PL, Boulder

### *Approximate staff (FTE):*

2 Professionals, 0.4 Contractor, 1 Guest Researcher

### *Funding sources:*

NIST (80 %), Other Agencies (20 %)

### *Objective:*

Develop optical-frequency measurement methods based on stabilized lasers and frequency combs generated using femtosecond, mode-locked lasers.

### *Constituency:*

Optical communications industry, machine-tool manufacturers and users, atomic-clock manufacturers

### *Principal current tasks:*

- Develop well-controlled femtosecond lasers and nonlinear fibers for optical-comb generation
- Improve the dynamic range of optical-frequency measurements
- Measure frequencies of  $\text{Hg}^+$  ions and neutral Ca relative to the Cs primary frequency standard
- Simplify and make optical comb generators and measurement systems more robust

### *Additional information:*

Modern optical communication systems are moving to wavelength-division multiplexing (WDM), and there is thus need for establishing absolute frequency measurements in the optical-communications bands. Our primary standards can serve to calibrate working standards, thus assuring measurement uniformity and compatibility of components. Mode-locked lasers with repetition rates locked to frequency standards can also be used as references for timing jitter measurements in optical A-D converters.

An accurate connection between the optical and microwave regions of the spectrum is also required for optical frequency standards of the future. Optical standards could provide for direct distribution, through optical-fiber networks, of clock signals and wavelength references.

More accurate and simpler methods are needed for making dimensional measurements in the machine-shop environment. Optical-frequency standards can be used as wavelength references for interferometric measurements, providing assurance of component compatibility. Advanced concepts for swept-frequency interferometric measurements, based on optical-frequency standards, offer many advantages. These include the elimination of moving stages and the associated difficulty of missing fringe counts during stage movement. Missed counts can result from beam interruption by personnel or equipment.

The optical difference frequency between the mercury ion frequency (282 nm) and the neutral-calcium frequency (567 nm) has been measured with an uncertainty of about  $3 \times 10^{-13}$ . Both frequencies are presently known relative to the cesium primary standard to a level of  $10^{-12}$ , and work is now directed toward reducing the uncertainty of these absolute frequencies to less than  $10^{-14}$ .

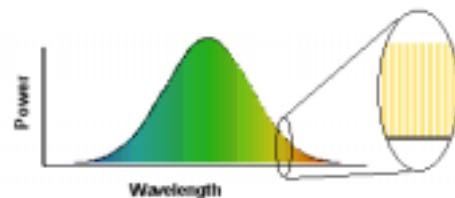

## Diode-Laser Technology for Metrology Applications

### *Project Leader/contact:*

Leo Hollberg, (303) 497-5770, leo.hollberg@boulder.nist.gov

Time and Frequency Division, PL, NIST

### *Approximate staff (FTE):*

1 Professional, 0.6 Contractor

### *Funding sources:*

NIST (100 %)

### *Objective:*

Develop tunable diode-laser systems with narrow-linewidth outputs for metrology applications supporting a broad range of NIST programs.

### *Constituency:*

NIST measurement laboratories, instrumentation industry, telecommunications industry

### *Principal current tasks:*

- Develop improved methods for reducing linewidth and controlling frequency of diode lasers
- Develop simple methods for synthesizing optical signals in important portions of the spectrum
- Improve reliability and reduce size and cost of diode-laser systems
- Demonstrate application of systems to NIST measurement problems
- Adapt monolithic, broadly tunable diode lasers for applications requiring both tunability and narrow linewidth

### *Additional information:*

This program was formed to develop and demonstrate high-performance diode lasers with linewidth and frequency control as well as tunability for applications to metrology. The initial work performed was to construct systems for optical state selection and detection in NIST-7, a primary frequency standard. While the early work focused on laser pumping and laser cooling for atomic frequency standards, there was early recognition that such diode-laser systems could have significant impact in other metrology areas. Systems have now been developed to support length measurements and for chemical analysis, particularly of low concentration levels, and widespread use throughout NIST and the scientific community.

Broadly tunable diode lasers have important applications in interferometry, ranging, and precision length measurements. Concepts for swept-frequency measurements, referenced to optical frequency standards, offer a number of advantages. These include the removal of requirements for moving stages and the associated difficulty of missing fringe counts during such stage movement. Missed counts can result from beam interruption by personnel or equipment. Diode lasers are also playing an increasingly important role in measurement instruments for wavelength-division multiplexing in communication systems.

Both weak and strong optical feedback have been used to narrow the linewidths of simple lasers, and electronic systems for controlling diode-laser parameters have been developed and constructed. DBR (distributed Bragg reflection) lasers have also been studied and are being applied to problems where a broad range of tuning is required. The work has been extended to optical-frequency synthesis using nonlinear materials. In particular, blue light has been generated (through doubling) to cool calcium atoms, and infrared and far-infrared radiation has been generated by mixing signals from two diode lasers.

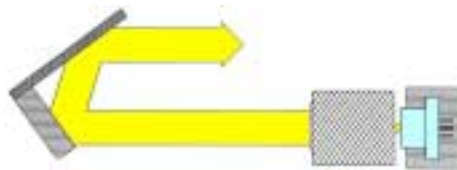

## Ultra-Narrow-Linewidth Lasers

### Project Leader/contact:

James E. Bergquist, (303) 497-5459, berky@boulder.nist.gov  
Time and Frequency Division, PL, Boulder

### Approximate staff (FTE):

1 Professional, 0.5 Guest Researcher

### Funding sources:

NIST (50 %), Other Agencies (50 %)

### Objective:

Develop local oscillators for optical frequency and time, standards, which can be used to calibrate secondary (less accurate) standards of high stability and also can serve to calibrate standards used for wavelength division multiplexing and as reference for interferometric length measurements.

### Constituency:

Optical communications industry, machine-tool manufacturers and users, atomic-clock manufacturers

### Principal current tasks:

- Develop improved vibration isolation methods
- Test laser performance by probing a narrow-linewidth transition in  $\text{Hg}^+$
- Improve methods for reducing noise added in transmission through optical fiber
- Simplify laser systems

### Additional information:

Modern optical communication systems are rapidly moving to wavelength-division multiplexing (WDM), and there is thus a need for establishing absolute frequency measurements in the optical-communications bands. Such primary standards can then serve to calibrate working standards, thus assuring uniformity of measurements and compatibility of components. These frequency standards can be used directly in high-performance communications systems to assure secure information transfer, and in instances where autonomous operation does not allow for frequent synchronization.

More accurate and simpler methods are needed for making dimensional measurements in the machine-shop environment. Optical-frequency standards with small absolute uncertainty are used as references for interferometric measurements that provide assurance of compatibility of components. Advanced concepts for swept-frequency interferometric measurements, based on optical-frequency standards, offer a number of advantages. These include the removal of requirements for moving stages and the associated difficulty of missing fringe counts during such stage movement. Missed counts can result from beam interruption by personnel or equipment.

Using carefully fabricated high-finesse optical cavities as references and extreme care in vibration isolation, an optical linewidth at a frequency of  $10^{15}$  Hz as narrow as 0.22 Hz (for a 20 second averaging time) has been demonstrated.

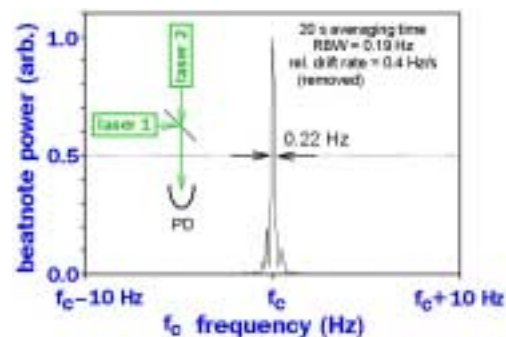

## Radiation Temperature

### Project Leader/contact:

B. Carol Johnson, (301) 975-2322, cjohnson@nist.gov  
Optical Technology Division, PL, Gaithersburg

### Approximate staff (FTE):

2.0 Professionals, 0.3 Contractor

### Funding sources:

NIST (70 %), other Agencies (20 %), Other (10 %)

### Objective:

Provide metrology, standards, and measurement services for radiance temperature from room temperature to 3000 K. The maintenance and dissemination of the International Temperature Scale of 1990 (ITS-90) above the freezing temperature of silver (1234.93 K).

### Constituency:

Pyrometer and blackbody manufacturers, DOD, U.S. industries, other national metrological institutes, pyrometer users

### Principal current tasks:

- Radiance temperature calibrations of pyrometers from room temperatures to 3000 K using a variety of blackbodies ranging from variable-temperature water-bath, oil-bath, Na-heat pipe, Cs-heat pipe, variable-temperature graphite blackbodies
- Radiance temperature calibrations using Sn, Al, Ag, Au freezing-point blackbodies
- Radiance temperature calibrations of tungsten-filament lamps as transfer standards
- Scale realizations based upon gold freezing-point blackbody and research into using absolute detectors traceable to the high-accuracy cryogenic radiometer to measure radiance temperature

### Additional information:

In many industrial and scientific applications, contact thermometry is either impractical or impossible depending on the measurement conditions. In such instances, radiance temperature measurements from non-contact thermometry can be used to implement accurate control of the processes. Accurate temperature determinations are also important in assessing and developing models for improvement and optimization of processes.

Determinations of radiance temperatures above the freezing temperature of silver are based upon the absolute radiometric temperature assignment of the freezing temperature of gold, and radiance temperatures are found using radiance ratios using a well-characterized pyrometer. The pyrometer is constructed with a narrow-band interference filter at 655.32 nm. Work is in progress to increase the number of wavelengths for the assignment of the radiance temperatures. Work is also in progress for the development of pyrometers traceable to the cryogenic radiometer for a detector-based radiance temperature scale.

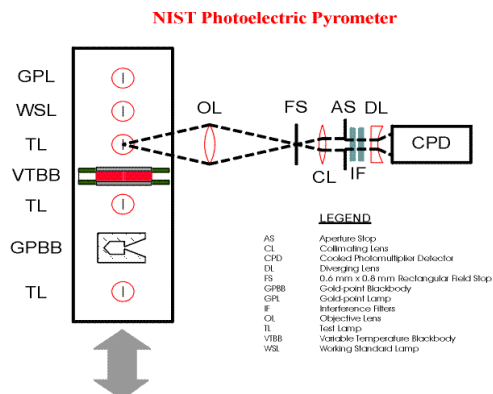

## Photometric Measurements

*Project Leader/contact:*

Yoshi Ohno, 301-975-2321, ohno@nist.gov  
Optical Technology Division, PL, Gaithersburg

*Approximate staff (FTE):*

3 Professionals, 1 Contractor, 1 Guest Researcher

*Funding sources:*

NIST (80 %), Other Agencies (20 %),

*Objective:*

Maintain the national units for photometric quantities, and disseminate the state-of-the-art photometric standards and measurement technologies to the U.S. industry.

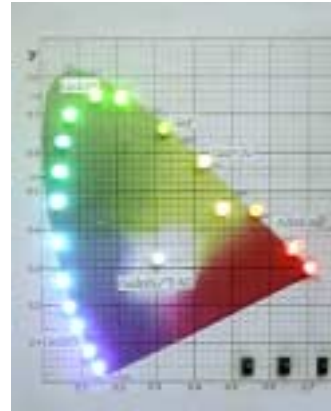

*Constituency:*

Lamp manufacturers, photometric instrument manufacturers, calibration and testing laboratories, optoelectronics, photographic, aerospace, and automotive industries, DOD, and DOE.

*Principal current tasks:*

- Realization of the candela and other photometric units
- Dissemination of photometric and colorimetric standards via calibration services
- Research on photometric and colorimetric measurement technologies for various application areas using lamps, LEDs, and displays
- International standardization activities (CIE, IEC, ISO)

*Additional information:*

NIST is responsible for the realization of the SI base unit, the candela (symbol: cd). The candela is the unit of luminous intensity, and represents a unit of measure of the brightness of a light source in a given direction as observed by the human eye. The candela is realized with a detector-based method that is directly traceable to the NIST's radiometric unit, the watt, based on the international definition of the candela.

From the base unit, the candela, other photometric units such as the lumen (symbol: lm) for luminous flux and the lux (symbol: lx) for illuminance are realized and maintained. The total luminous flux (lumen) is the total light output of a light source, and is an important measure to specify energy efficiency (lumens per watt) of light sources.

Calibration services are provided for luminous intensity, total luminous flux, and color temperature of lamps, as well as illuminance meters, luminance meters, color meters, luminance sources, flashing-light photometers, and other photometric sources and detectors.

Current research includes development of NIST reference spectroradiometer for displays, correction techniques for colorimeters for displays, development of standard LEDs and measurement methods for photometric, colorimetric, and radiometric quantities of LEDs.



## SURF III Facility

*Project Leader/contact:*

Charles W. Clark, (301) 975-3709, charles.clark@nist.gov  
Electron and Optical Physics Division, PL, Gaithersburg

*Approximate staff (FTE):*

5 Professionals, 1 Contractor

*Funding sources:*

NIST (67 %), Other Agencies (33 %)

*Objective:*

Provide the nation's primary standard for source-based radiometry, from the infrared through soft x-ray spectral regions. Generate intense deep ultraviolet and extreme ultraviolet (DUV/EUV) radiation for scientific and engineering applications.

*Constituency:*

Manufacturers of photodiodes and extreme ultraviolet optics; semiconductor stepper industry; SEMATECH; Lincoln Laboratories; NASA; NRL; university and national laboratory research groups; NIST internal research and calibration programs.

*Principal current tasks:*

- Provide calculable standard source of radiation across broad electromagnetic spectrum, continuously improving accuracy and reliability
- Support NIST DUV/EUV transfer standard program and external calibration customers
- Support NIST EUV optics program
- Support NIST DUV detector characterization and optical properties programs
- Provide EUV radiation and associated expertise for external user applications

*Additional information:*

The NIST Synchrotron Ultraviolet Radiation Facility (SURF III) is an electron storage ring that supports stored electron beam energies up to 380 MeV, with initial injection currents in excess of 300 mA. SURF produces a broad spectrum of electromagnetic radiation, extending from the FM radio regime into the extreme ultraviolet (wavelengths of 2.5 nm). The electron beam is confined in an 83 cm radius toroidal vessel, from which radiation is extracted by 12 beam lines and channeled to user end-stations. The magnetic field intensity around the circular electron orbit is uniform to one part in  $10^4$ , which allows the intensity of emitted radiation to be calculated from first principles to sub-percent accuracy. This provides the basis for SURF's role as a primary source-based radiometric standard. In addition, SURF provides broad-band, bright UV and EUV radiation that is useful in many applications where absolute source properties need not be known accurately.

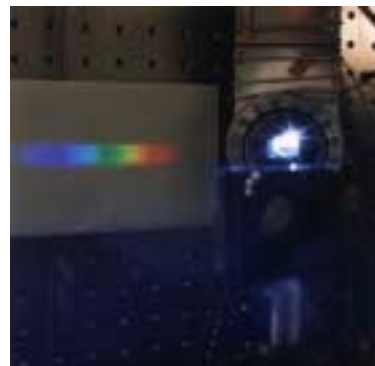

## Low Background Infrared (LBIR) Metrology

*Project Leader/contact:*

Steven Lorentz, (301) 975- 2311, steven.lorentz@nist.gov  
Optical Technology Division, PL, Gaithersburg

*Approximate staff (FTE):*

3 Professionals, 5 Contractors

*Funding sources:*

NIST (30 %), Other Agency (70 %)

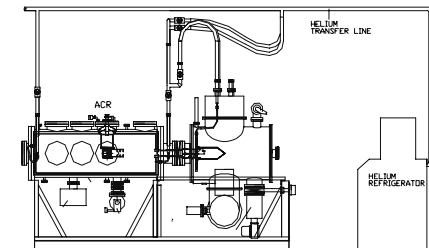

*Objective:*

Develop advanced cryogenic radiometers, low-background infrared measurement methods and transfer standard radiometers; support industry standardization of measurement practice through calibrations of customer cryogenic blackbodies, long wavelength detectors and other optical components.

*Constituency:*

Aerospace contractors, other government agencies, including BMDO, DOD, DOE and NASA.

*Principal current tasks:*

- Low Background Infrared (LBIR) facility for infrared source and detector calibrations
- BMDO transfer standard radiometers (BXR-1 and BXR-2)
- Diffraction correction calculations for IR radiometry setups

*Additional information:*

The project team serves the national needs for low-background infrared measurements. An absolute cryogenic radiometer (ACR) operating at 2 K has been built and characterized as a national standard for LBIR measurements. The NIST LBIR calibration facility, which houses the ACR in a cryogenic chamber, has been serving customers since 1989, providing calibrations for radiance temperature measurements of blackbodies. Spectral capability to provide calibrations of cryogenic detectors has also been added to this facility. An active program to build new transfer standard radiometers called BXR-1 and BXR-2 is underway. These radiometers will be used for the calibration of test chambers in various missile sensor test facilities around the country serving the needs of the Ballistic Missile Defense Organization (BMDO). Radiometers using high- $T_c$  superconductor material properties are also being developed.

## Spectral Radiometry of Sources

### *Project Leader/contact:*

Howard W. Yoon, (301) 975-2482, hyoon@nist.gov  
Optical Technology Division, PL, Gaithersburg

### *Approximate staff (FTE):*

1.5 Professionals, 1 Technician, 0.5 Contractor

### *Funding sources:*

NIST (50 %), other Agencies (20 %), Other (50 %)

### *Objective:*

Provide metrology, standards, and measurement services of sources for spectral radiance and spectral irradiance.

### *Constituency:*

Environmental monitoring, satellite remote sensing community, NASA, secondary optical metrology laboratories, lighting manufacturers, DOD, other national metrological institutes

### *Principal current tasks:*

- Spectral radiance calibration of integrating sphere sources and tungsten-filament lamps from 225 nm to 2400 nm
- Spectral irradiance calibration of tungsten-halogen lamps (type FEL) from 250 nm to 2400 nm
- Spectral irradiance calibration of deuterium lamps from 200 nm to 350 nm
- Scale realizations based upon gold freezing-point blackbody and absolute detectors traceable to the high-accuracy cryogenic radiometer

### *Additional information:*

For monitoring the changes in the environment due to man-made changes or other forces, accurate calibrations of the measuring instruments are important, for instance, in determining the terrestrial solar irradiance in the ultraviolet wavelength region. The calibrated sources are also used in many different industrial and scientific applications.

The current spectral radiance and spectral irradiance scales are derived from the absolute radiometric temperature determination of the freezing-temperature of gold. Work is in progress to base the two scales on detectors calibrated for absolute spectral responsivity traceable to the cryogenic radiometer. The resulting uncertainties in spectral irradiance are expected to be a factor of 2 to 5 lower than the uncertainties based on the current scale. The scales will also be extended to 2500 nm with the new scale realization. Effort is also underway to find transfer sources with better long-term stability than the currently issued standards.

A new facility for spectral irradiance calibrations is under construction. The new facility will be capable of fully automated spectral irradiance calibrations from 250 nm to 2500 nm.

Facility for Automated Spectroradiometric CALibrations  
Spectral Irradiance Measurements

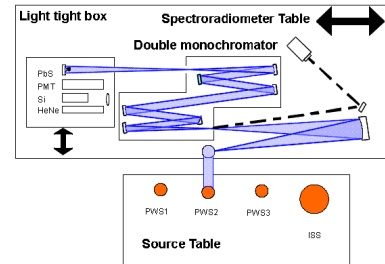

## Optical Detector Metrology

### *Project Leader/contact:*

Keith R. Lykke, (301) 975-3216, lykke@nist.gov  
Optical Technology Division, PL, Gaithersburg

### *Approximate staff (FTE):*

8 Professionals; 1 Student

### *Funding sources:*

NIST (60 %), Other agencies (30 %), Other (10 %)

### *Objective:*

Provide metrology standards and calibration services to measure fundamental radiometric quantities—power, irradiance and radiance—of optical radiation detectors at the lowest possible uncertainty over a wavelength range from the ultraviolet (125 nm) to the infrared (20  $\mu\text{m}$ ).

### *Constituency:*

Optical device and equipment manufacturers and users; optical detector manufacturers; UV lithography industry; DOD; NASA

### *Principal current tasks:*

Spectral responsivity scale realizations for

- Power
- Irradiance
- Radiance

Transfer and working standard radiometer development for the ultraviolet, visible, and infrared spectral regions.

Spectral responsivity measurements of

- Detectors
- Photometers
- Radiometers

### *Additional information:*

Some of the facilities involved include the High-Accuracy Cryogenic Radiometer (HACR), the Spectral Comparator Facilities (SCF), the monochromator/ACR at SURF III, and SIRCUS. Industrial requirements for high-accuracy radiometric calibrations led to the development of a new facility for spectral irradiance and radiance responsivity calibrations (SIRCUS). The facility combines the unique properties—such as high power and extremely narrow bandwidth—of tunable laser sources with state-of-the-art transfer standard radiometers, enabling calibrations of a variety of complex instruments with extremely low uncertainties over a wide wavelength range. For example, the in-band response of a narrow-band (FWHM  $\sim 1$  nm) filter radiometer has been measured with a wavelength uncertainty of less than 0.01 nm, while the out-of-band response—9 orders of magnitude lower—has been measured over a wide spectral range.

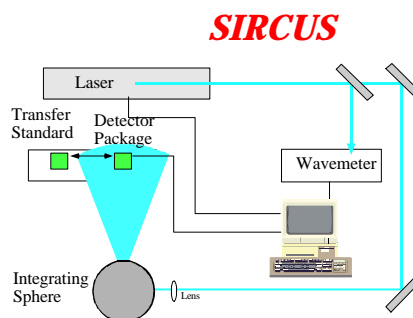

## Continuous Wave Submillimeter and Terahertz Measurement Technology

### Project Leader/contact::

Gerald T. Fraser, (301) 975-3797, gerald.fraser@nist.gov  
Optical Technology Division, PL, Gaithersburg

### Approximate staff (FTE):

2.0 Professionals

### Funding sources:

NIST (100 %)

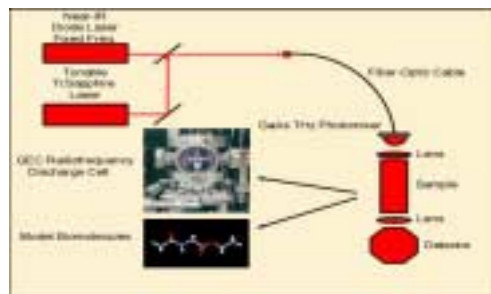

### Objective:

Develop new submillimeter and terahertz technology for the measurement of the absorption spectra of gas-phase molecules important in plasma etching and in the evaluation of molecular modeling codes.

### Constituency:

Plasma etching and equipment manufacturers, optical communications industry, NASA, DOD

### Principal current tasks:

- Submillimeter and terahertz source development
- Submillimeter and terahertz database development for plasma diagnostics
- Development of new approaches for measuring weak absorption bands in the submillimeter and terahertz region

### Additional information:

Submillimeter and terahertz sources based on backward-wave oscillators (BWOs) and near-infrared-laser-pumped solid-state photomixers are being developed for the observation of weak absorption lines found in plasmas and in model biomolecules. The BWOs produce 1 mW to 10 mW of radiation in a linewidth of <100 kHz with frequency coverage from 50 GHz to 800 GHz. The frequency output is referenced to a Cs clock frequency standard. When coupled to a 4 K bolometer detector with an NEP of  $10^{-13} \text{ W Hz}^{-1/2}$  the observation of fractional absorptions of the radiation of better than  $10^{-6}$  is possible, sufficient to allow the quantification of important species in low-pressure F-atom etching plasmas and the observation of weak torsional vibrations in model biomolecules.

The photomixer is pumped by two near-infrared lasers, one of which is tunable. The mixer is based on epitaxial lower-temperature-grown GaAs onto which is deposited an interdigitized electrode structure. The submillimeter/ terahertz radiation output of approximately  $1 \mu\text{W}$  gives reduced sensitivity for absorption measurements compared to the BWO sources, but significantly broader frequency coverage of up to 2 THz.

The two techniques are presently being explored for the chemical and temperature spatial mapping of low-temperature plasmas. Of particular interest is the ability to determine mean column densities for such unstable molecules as CF and  $\text{CF}_2$  in a  $\text{CF}_4$  or  $\text{C}_2\text{F}_6$  plasma, or SF and  $\text{SF}_2$  in an  $\text{SF}_6$  plasma, both used for F-atom etching.

## Infrared Optical Properties of Materials

*Project Leader/contact:*

Leonard Hanssen, (301) 975-2344, hanssen@nist.gov  
Optical Technology Division, PL, Gaithersburg

*Approximate staff (FTE):*

2 Professionals, 2.5 Contractors

*Funding sources:*

NIST (20 %), Other Agencies (80 %)

*Objective:*

Provide infrared optical properties of materials support to industry and government agencies. This is done through the development of measurement and calibration services, standard reference materials, standard data, measurement methodologies and techniques, and new measurement instrumentation.

*Constituency:*

A wide variety of industries and agencies that (a) require optical property information, including manufacturers of optical components, infrared detectors, and spectrophotometers, materials processing industries, and aerospace and defense, or (b) use optical measurement instrumentation, such as the chemical and pharmaceutical industries, food and agriculture, and remote sensing.

*Principal current tasks:*

- Develop, maintain and improve state of the art infrared optical property (transmittance, reflectance, absorbance, emittance, refractive index) measurement facilities.
- Develop calibration services to meet current and future customer requirements.
- Investigate primary sources of measurement error; develop methodologies and instrumentation for high accuracy measurements.
- Maintain and develop SRM suite for infrared optical property measurement.

*Additional information:*

This project is designed to address the need for spectral infrared optical properties of materials in a comprehensive way. A Fourier Transform (FTIR) Spectrophotometry Laboratory has been established that serves as the measurement facility for transmittance and reflectance measurements in the infrared spectral range of 1  $\mu\text{m}$  to 100  $\mu\text{m}$ , with particular emphasis on the 2  $\mu\text{m}$  to 20  $\mu\text{m}$  region. The facility consists of several commercial FTIR Instruments coupled to a number of custom specialized accessories for handling a wide variety of sample types and controlling the three critical parameters of measurement: beam geometry (both illumination and viewing), beam polarization and sample temperature. Additional facilities that support the optical properties effort include FTIR-Microscope and CO<sub>2</sub>-laser-based infrared Bi-directional Reflectance Distribution Function (BRDF) laboratories. Standard reference materials (SRMs) developed in this facility both currently available and under development include a wavelength/wavenumber (1921a), neutral density transmittance (2053, 4, 5, and 6), diffuse reflectance (high and low), and specular reflectance (high), SRM. Measurement services for specular and diffuse, reflectance and transmittance are currently available as special tests and under process to become calibration services. Input to this and related NIST programs is provided by the NIST-Industry Optical Properties of Materials Consortium.

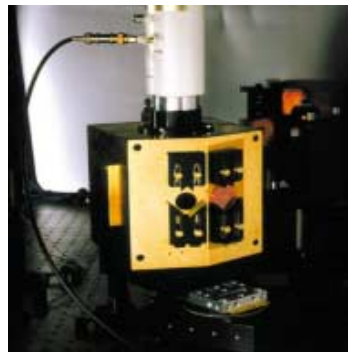

## Extreme Ultraviolet Optics Characterization Facility

*Project Leader/contact:*

Thomas B. Lucatorto, (301) 975-3734, thomas.lucatorto@nist.gov  
Electron and Optical Physics Division, PL, Gaithersburg

*Approximate staff (FTE):*

4 Professionals, 1 Contractor

*Funding sources:*

NIST (100 %)

*Objective:*

Provide complete optical bench capability for measurement of extreme ultraviolet (EUV) optical components and systems. Produce transfer standards for detector-based radiometry in DUV and EUV spectral regions. Resident center of NIST expertise for measurement of DUV/EUV optical materials properties, design of EUV optical systems for microscopy and lithography; x-ray microtomography; fabrication of EUV optical components

*Constituency:*

Lithography system manufacturers, semiconductor manufacturers, detector manufacturers, research laboratories

*Principal current tasks:*

- Provide reflectometry service for EUV optics, including large mirrors of  $\lambda$ -tool EUV stepper
- Provide transfer-standard photodetectors for DUV and EUV radiometry
- Establish principles and demonstrate prototypes of x-ray microtomography systems for inspection of buried interfaces
- Develop pulsed EUV sources for microscopy applications
- Measure DUV/EUV optical constants
- Fabricate EUV optics

*Additional information:*

The Photon Physics Group operates an EUV reflectometry facility at SURF, which performs over 100 calibrations each year, and which is currently the only U.S. facility that can characterize large EUV stepper optics. The EUV transfer standards activity is the world leader in provision of calibrated photodiodes.

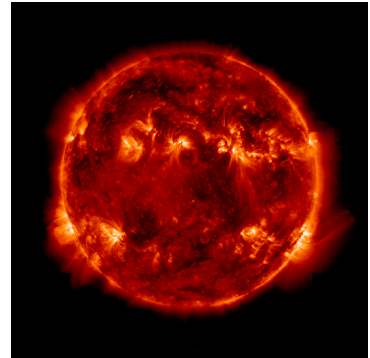

## Ultrafast Carrier Dynamics in Semiconductors

*Project Leader/contact:*

Steven T. Cundiff, (303) 492-7858, steven.cundiff@nist.gov  
Quantum Physics Division, PL, Boulder

*Approximate staff (FTE):*

0.3 Professional, 1.0 Student, 0.2 Guest Researcher

*Funding sources:*

NIST (30 %), NSF (70 %)

*Objective:*

Obtain a fundamental understanding of carrier dynamics in direct gap semiconductors, semiconductor heterostructures and semiconductor quantum dots; understand how the dynamics influence the performance of optoelectronic devices including laser diodes, semiconductor optical amplifiers, detectors and semiconductor modulators

*Constituency:*

Laser diode and optical detector manufacturers; optical communications industry; academic researchers.

*Principal current tasks:*

- Ultrafast transient-four-wave-mixing and pump-probe experiments on multiple quantum well structures
- Propagation measurements on waveguide structures containing electrically pumped quantum dots
- Comparison of experimental results to theory
- Develop 1.03  $\mu\text{m}$  modelocked laser

*Additional information:*

Semiconductor laser diodes and optical amplifiers are widely used in the optoelectronics industry. Direct gap semiconductors or semiconductor heterostructures are used because of their strong optical emission. The fundamental characteristics of these devices are influenced by manybody interactions among the optically active carriers. The time scale for these interactions is subpicosecond, thereby requiring the use of optical pulses of comparable or shorter duration. A thorough understanding of the manybody interactions is required before predictions can be made of device performance.

Devices based on self-organized quantum dots have been demonstrated in the laboratory. These are expected to present several advantages over devices based on quantum wells or bulk material. However, these expectations are based on fundamental properties that have not been measured to date. The experiments on quantum dots in the project will provide measurements of some of the fundamental properties necessary for determining the actual operating characteristics of quantum dot based devices.



## DUV Metrology for Lithography

### *Project Leader/contact:*

Rajeev Gupta, (301) 975-2325, rajeev.gupta@nist.gov  
Optical Technology Division, PL, Gaithersburg  
John Burnett, (301) 975-2679, john.burnett@nist.gov  
Atomic Physics Division, PL. Gaithersburg

### *Approximate staff (FTE):*

4.0 Professionals, 0.5 Technician

### *Funding sources:*

NIST (100 %)

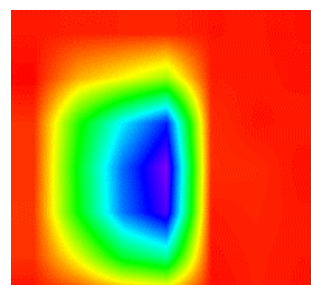

Synchrotron radiation induced damage in a UV photodiode

### *Objective:*

Characterize optical materials, detectors, and sources to help the UV photolithographic technology for manufacture of semiconductor chips.

### *Constituency:*

Photolithographic exposure tool manufacturers, optical material suppliers, optical detector manufacturers, laser and UV source manufacturers.

### *Principal current tasks:*

- High-accuracy measurements of the refractive index and thermal coefficients of optical materials
- Calibration of detectors and measurement of their stability in the UV spectral range
- Measurements of optical properties such as strain, transmission, scatter of optical materials
- Development of UV Fourier Transform Spectrometer for study of optical properties and source characterization

### *Additional information:*

The National Technology Roadmap for Semiconductors identifies improvements in photolithography technology as a critical requirement for shrinking IC feature sizes below the present 250 nm generation. Two key issues are the tightening of photolithography exposure control and the extension to shorter wavelengths. The tightening of exposure control requires improved measurement of absolute irradiance and uniformity at the wafer. We are addressing this issue by investigating new stable UV source and detector standards, and developing more accurate radiometric scales. Extension of photolithography exposure wavelengths from the present-generation 248 nm to 193 nm and 157 nm requires accurate measurements of the optical properties of the materials to be used as the optical elements of the photolithographic steppers at these shorter wavelengths.

We have used a goniometric refractometer to measure the refraction index near 157 nm (with an accuracy of 6 ppm), as well as the dispersion and temperature dependence, for several grades of calcium fluoride and barium fluoride. These measurements are needed for the design of the stepper optics. We are presently developing a higher-accuracy technique (~1 ppm) based on Fourier Transform interferometry. This is a unique facility, using a method that has never been attempted at these wavelengths. A wide variety of detectors have been characterized, e.g., Si-based diodes, PtSi, GaN, and diamond using a radiometric facility at SURF which combines a high-throughput normal incidence monochromator with an absolute cryogenic radiometer to provide absolute detector-based radiometric calibrations in the spectral range from 125 nm to 320 nm.

## Applications of Femtosecond Terahertz Spectroscopy

### Project Leader/contact:

Edwin J. Heilweil, (301) 975-2370, edwin.heilweil@nist.gov  
Optical Technology Division, PL, Gaithersburg

### Approximate staff (FTE):

2.5 Professionals

### Funding sources:

NIST (100 %)

### Objective:

Develop noncontact measurement methods to extract carrier and phonon dynamics, impurity image maps and related optical properties of semiconductors, quantum well structures and materials using ultrashort pulsed far infrared (terahertz) femtosecond laser techniques.

### Constituency:

Researchers and developers of photonic technologies requiring material or device characterization in the terahertz frequency range.

### Principal current tasks:

- Develop a broadband terahertz laser system producing subpicosecond pulses and detection systems to make accurate time-resolved amplitude and phase measurements of terahertz pulses as they interact with various samples.
- Determine linear and nonlinear indices of refraction in the terahertz frequency range for liquids, solids, and semiconductor multilayer structures.
- Perform time-resolved measurements of electron and phonon coupling phenomena in optical materials and structures.
- Develop terahertz imaging methods to study optoelectronic structures and devices appropriate for high-speed, high frequency applications.

### Additional information:

The NIST Optical Technology Division is developing several femtosecond laser sources (pulses of less than 50 fs duration) to produce frequencies in the range 0.3 to 10 THz to measure indices of refraction, carrier dynamics, and other transport properties of photonic materials and structures, using both linear spectroscopy and ultrafast pump-probe methods. Detection methods such as phase-sensitive gated detection with free-space electro-optic sampling are used to extract this information. The effort will provide data for materials and device developers and for improving fundamental understanding of underlying physical and chemical phenomena.

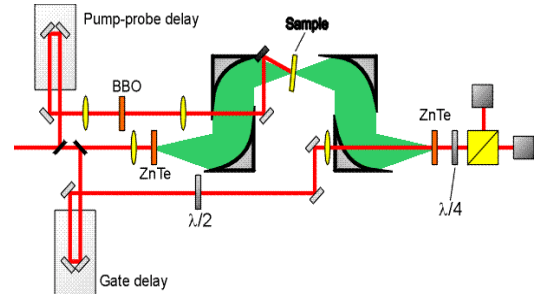

## Nonlinear Optical Diagnostics of Interfaces and Thin Films

*Project Leader/contact:*

John Stephenson, (301) 975-2372, john.stephenson@nist.gov  
Optical Technology Division, PL, Gaithersburg

Lee Richter, (301) 975-4152, lee.richter@nist.gov  
Surface and Microanalysis Science Division, CSTL, Gaithersburg

*Approximate staff (FTE):*

3 Professionals

*Funding sources:*

NIST (100 %)

*Objective:*

Develop advanced measurement methods based on nonlinear optical techniques for the characterization of thin films and their interfaces. Acquire standard data for the nonlinear response of thin films and interfaces.

*Constituency:*

Semiconductor and metrology equipment manufacturers; display manufacturers; researchers and developers of photonic technologies, such as organic electronics.

*Principal current tasks:*

- Real-time characterization of carrier/trap dynamics at thin-film interfaces.
- Determination of surface geometric and chemical structures of organic thin films, including self-assembled monolayers, liquid crystal alignment layers, and other polymer interfaces.
- Study of new materials for thin gate dielectric layers.
- Study of surface species and processes important in electro-deposition processes.

*Additional information:*

NIST has two tunable ultrafast (pulse duration less than 100 fs) laser systems capable of generating tunable light with wavelengths from 200 nm in the ultraviolet to 20 micrometers in the infrared, dedicated to the characterization of the second order nonlinear response of interfaces and thin films. We specialize in vibrationally resonant sum-frequency generation (SFG), having recently developed a new approach for this technique. Nonlinear optical (NLO) techniques such as SFG, made possible by recent advances in laser technology, are excellent nondestructive, *in situ* diagnostics with unique advantages over traditional linear optical techniques. NLO techniques have greater structural sensitivity than linear techniques, and are more surface-sensitive. Examples of recent studies include studying the nonlinear response of GaAs surfaces arising from the surface space charge field, and dynamics of optically injected carriers: optical determination of the orientation of twinned and aligned Si/CoSi<sub>2</sub> interfaces, characterization of alignment layers for liquid crystal displays, development of a new method of characterizing buried polymer interfaces, such as those potentially useful in organic electronics.

This program is collaborative with the Chemical Sciences and Technology Laboratory, Surface and Microanalysis Science Division, Surface Dynamical Processes Group, 837.03. Staffing and funding levels reflect the combined program.

## Optical Scattering Metrology

*Project Leader/contact:*

Thomas Germer, (301) 975-2876. [thomas.germer@nist.gov](mailto:thomas.germer@nist.gov)  
Optical Technology Division, PL, Gaithersburg

*Approximate staff (FTE):*

1.6 Professionals

*Funding sources:*

NIST (100 %)

*Objective:*

Develop advanced light scattering techniques and standard artifacts for the detection and characterization of particles, defects, and surface roughness on a variety of optical quality surfaces, including silicon wafers and optical components. Develop theoretical models and experimental methods for studying the interactions between surface features and electromagnetic waves.

*Constituency:*

Semiconductor metrology equipment manufacturers; optical materials manufacturers

*Principal current tasks:*

- Characterize the directional distribution of light scattered by well-characterized particles on smooth surfaces in order to provide the semiconductor material inspection industry with methodologies for characterizing particulate contaminants.
- Characterize interfacial roughness in a variety of dielectric films by polarized light scattering methods.
- Develop theoretical models for light scattering from material homogeneity, subsurface defects, particulate contaminants, and surface roughness.

*Additional information:*

Light scattering methods allow manufacturers and researchers to rapidly inspect surfaces for homogeneity, subsurface defects, particulate contaminants, and surface roughness. Optimum use of these methods requires an understanding of the characteristics of the light scattered by these different scattering sources, in the materials being inspected. The objective of this program is to develop the theoretical understanding and the experimental methods needed by industry to improve sensitivity and enable classification of defects. The Goniometric Optical Scatter Instrument (GOSI) at NIST enables the measurement of the bidirectional reflectance distribution function (BRDF), which quantifies the angular distribution of light scattered from a surface as a function of wavelength, polarization state, and angle of incidence. The instrument, housed in a class 10 clean area, has an extremely wide dynamic range, high angular resolution, and full polarization capabilities, allowing a nearly complete analysis of the light scattering properties of a wide variety of samples for nearly any incident or scattering direction. Measurements of the polarization of scattered light have been shown to enable the differentiation amongst different scattering mechanisms.



## **Infrared Near Field Optical Microscopy of Polymer Photoresists**

*Project Leader/contact:*

Stephen R. Leone (303) 492-5128, srl@jila.colorado.edu  
Quantum Physics Division, PL, Boulder

*Approximate staff (FTE):*

2.2 Professionals

*Funding sources:*

NIST (50 %), Other Agencies (50 %)

*Objective:*

Provide new metrology techniques for nm scale probing of polymer latent images

*Constituency:*

Manufacturers and users of photolithographic equipment

*Principal current tasks:*

- Develop two-beam difference detection schemes to obtain chemically specific near field optical imaging.
- Adapt an atomic force microscopy type of apertureless near field optical technique for the study of infrared transmission microscopy.

*Additional information:*

Polymer photoresist materials are important for the patterning of semiconductors, flat panel displays, and data storage device components. The rapidly decreasing line dimensions in these polymer photoresist materials, especially with the advent of deep-ultraviolet-exposed, chemically amplified acid-catalyzed photoresist chemistry, places new demands on measurement characterization. In addition, this technology introduces important scientific problems, such as the need for studies of the rates of acid diffusion in polymers and the roughness of lithographic line features on nanometer length scales.

This project involves the development and use of a new method of infrared near field scanning optical microscopy (IR NSOM) to probe "spatially and chemically" the line dimensions patterned by deep-ultraviolet (UV) photochemistry in polymer photoresist materials. The NSOM method itself is now well-developed. Initial experiments with IR NSOM demonstrated that this method is remarkably powerful. Using tapered infrared transparent fiber optic tips and a 3  $\mu$ m tunable color center laser, the project obtained 300 nm spatial resolution ( $\lambda/10$ ) and an absorption sensitivity of 0.01 % transmittance, while probing the OH absorption band modifications in patterned poly(t-butylmethacrylate) PTBMA polymer containing 5 wt % of the photoacid generator (PAG) triphenylsulfonium hexafluoroantimonate deposited on sapphire substrates. The key advantages of the IR NSOM technique are chemical subgroup specificity for determining the locations of regions of various chemical compounds in polymer films by infrared spectroscopy and high spatial resolution.

## Nuclear Polarization of $^3\text{He}$ by Optical Pumping

### Project Leader/contact:

Thomas R. Gentile, (301) 975-5431, thomas.gentile@nist.gov  
Ionizing Radiation Division, PL, Gaithersburg

### Approximate staff (FTE):

2.5 Professionals, 0.2 Technician

### Funding sources:

NIST(75 %), Other Agencies (25 %)

### Objective:

Develop techniques for increased polarization of  $^3\text{He}$  by optical pumping. Explore applications in neutron polarization and analysis, and in low-field magnetic resonance imaging.

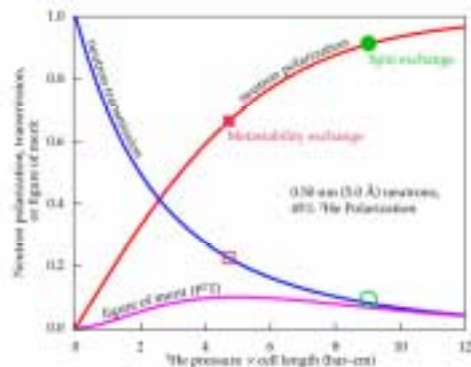

### Constituency:

Condensed matter experimenters from industry, universities, and national laboratories; fundamental physics experimenters; medical imaging researchers

### Principal current tasks:

- Metastability exchange optical pumping of  $^3\text{He}$
- Spin exchange optical pumping of  $^3\text{He}$
- Application of  $^3\text{He}$  neutron spin filters to small angle neutron scattering investigations

### Additional information:

Dense samples of polarized  $^3\text{He}$  obtained by optical pumping techniques have found application as a spin polarizer/analyzer in neutron scattering experiments and in medical imaging.

Many applications for  $^3\text{He}$  neutron spin filters require sample thickness of a few bar-cm. This requirement introduces complications that must be addressed for both optical pumping techniques. Spin exchange optical pumping, for instance, is currently most efficiently performed at  $^3\text{He}$  pressures of several bar. Investigations are underway at NIST to address this difficulty from two fronts: the development of narrowed diode laser arrays at 795 nm, to more effectively polarize at lower pressures, and the development of  $^3\text{He}$  spin exchange cells which are suitably thin but structurally stable at higher pressures.

Metastability exchange optical pumping, on the other hand, is most efficiently performed at  $^3\text{He}$  pressures of just a few mbar. The technical issue here is to then compress the  $^3\text{He}$  gas to pressures suitable for use as a neutron spin filter, while maintaining the  $^3\text{He}$  polarization in the compression process. We have developed a compact compression apparatus by means of modifying a commercially available diaphragm pump.

Magnetic resonance imaging (MRI) using polarized  $^3\text{He}$  has the advantages that a higher signal can be observed and that lower magnetic fields can be used, compared to conventional MRI.

## Space Based Radiometry

*Project Leader/contact:*

Steven Lorentz, (301) 975- 2311, steven.lorentz@nist.gov  
Optical Technology Division, PL, Gaithersburg

*Approximate staff (FTE):*

2 Professionals, 4 Contractors

*Funding sources:*

NIST (20 %), Other Agency (80 %)

*Objective:*

Develop advanced absolute radiometers that would measure radiance from the sun and stars, and emitted and reflected light from the Moon and the Earth as viewed from space. Utilize the space platforms such as the International Space Station (ISS), the space shuttle and other satellite missions for fielding the NIST traceable radiometers in space to provide reference data and cross calibrations to improve the radiometric accuracy of NASA, NOAA, NPOES and other agency remote sensing satellite sensors.

*Constituency:*

The national and international remote sensing community, aerospace contractors; government agencies (NASA, NOAA, NPOES)

*Principal current tasks:*

- Design and build absolute radiometers to fly aboard the deep space Triana satellite mission to L1. These instruments will measure the solar reflected and emitted radiation from Earth.
- Environmental testing of the radiometers for space qualification
- Characterization and calibration of the radiometers for SI traceability

*Additional information:*

The project team serves the national needs to improve the sensitivity and accuracy of absolute radiometers for space-based radiometry. The team undertook the task of building absolute radiometers (NISTAR) to measure both the reflected and emitted light from the Earth from the new vantage point of L1. This point in space provides a stationary view of the sunlit face as the Earth rotates. The distance, of  $1.6 \times 10^6$  km from the Earth, where the radiometers are to be located, makes it a challenge to detect and measure the weak signals accurately. State-of-the-art technology for absolute radiometry has required a significant research effort to solve the measurement problems. This work is being carried out as a sub-contract from the NASA Triana mission for the Scripps Institute of Oceanography. The team has been actively collaborating with Ball Aerospace Corporation and Goddard Space Flight Center. Future goals of the team include building and maintaining radiometers that can be deployed to space platforms such as the International Space Station and retrieved for recalibration in the laboratory. This will enhance the national capability to provide improved absolute measurement scales in space, thereby providing a direct impact on the long-term national goals of climate modeling.

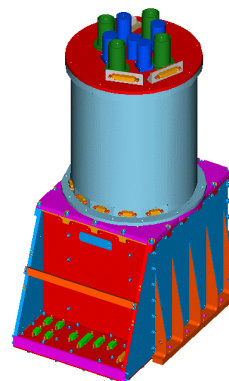

## Environmental and Remote Sensing

### *Project Leader/contact:*

B. Carol Johnson, (301) 975-2322, cjohnson@nist.gov  
Optical Technology Division, PL, Gaithersburg

### *Approximate staff (FTE):*

3 Professionals, 0.5 Contractor

### *Funding sources:*

NIST (33 %), Other Agencies (67 %)

### *Objective:*

Provide metrology, standards, and measurement services relating to radiometric measurement programs designed to produce long-time series data on global climate change.

### *Constituency:*

NASA, NOAA, DOD, USDA, USGS, EPA; aerospace industry; manufacturers of optical sensors, sources, and reflectance artifacts; university research programs; international organizations in global climate change; government-sponsored programs in other countries.

### *Principal current tasks:*

- Develop and maintain program-specific calibrated portable radiometers and sources
- Use the portable artifacts at the calibration sites for the satellite sensors
- Formulate general measurement protocols
- Expand, improve, and adapt NIST calibration services as required
- Publish results and maintain database

### *Additional information:*

The NIST with several U.S. government agencies supports a wide-range of space-based and terrestrial measurement programs. These programs involve long-term monitoring and survey activity, which require consistent calibration of instruments with diverse deployment platforms. In addition to actual calibrations, NIST participates in round robin calibration efforts among the instrument manufacturers and provides cross-calibration with other national laboratories involved in similar activities. Transfer radiometers from the ultraviolet to the far infrared have been built and deployed successfully. Several portable, stable, and in some cases absolute sources have been designed and built. An international round robin on bi-directional reflectance distribution function was recently completed.

This comprehensive program involves a combination of measurement, consultation, and review. Participation by NIST in the U.S. effort for global climate change program facilitates the production of long-time series data sets on global climate change that meet the required accuracy and precision specifications. The NIST involvement also acts to place all satellite and validation instruments on the SI system of units.

Visible Transfer Radiometer (VXR)

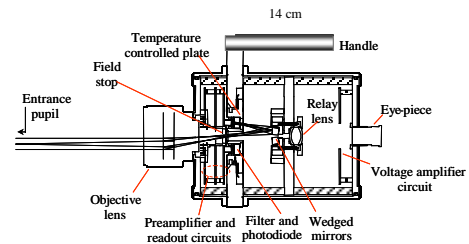



## Diode-Laser Systems for Trace-Impurity Monitoring

### *Project Leader/contact:*

Richard Fox, (303) 497-3478, richard.fox@nist.gov  
Time and Frequency Division, PL, Boulder

### *Approximate staff (FTE):*

1 Professional

### *Funding sources:*

NIST (85 %), Other Agencies (15 %)

### *Objective:*

Develop simple laser-diode systems for generating optical radiation to be used for spectroscopic identification and sensing of trace impurities.

### *Constituency:*

Environmental-monitoring industry, chemical industry, federal government

### *Principal current tasks:*

- Develop tunable diode-laser systems and nonlinear optical materials to reach important wavelength regions
- Collaborate on the testing of these systems with users

### *Additional information:*

Improved methods are needed for detection and measurement of trace impurities in a wide range of applications including: studies of the upper atmosphere, monitoring of gaseous output from industrial plants, and control of chemical production quality. Systems need in such applications must be simpler and less expensive than current analytical methods, and should provide for near real-time measurements as opposed to the sample and laboratory-test methods often used today. Such trace-impurity monitoring can have substantial impact on industrial processes and maintenance of environmental quality.

Spectroscopic identification of specific elements (and even isotopes) in the optical region promises great advantage for such applications. Systems based on diode-laser sources and simple optical detectors can be small, simple, and inexpensive, and can provide real-time measurement of impurity levels provided that the systems are suitably calibrated. The development of such monitoring systems is aided by industrial development of diode lasers with outputs covering an ever-wider region of the spectrum. Of particular interest is the development of tunable uv/blue and infrared sources, since many elements and molecules have significant spectral features in that region.

In pursuing the development of such monitors, systems have been constructed and tested for high-sensitivity detection of CH<sub>3</sub>D, CH<sub>4</sub>, CO<sub>2</sub>, O<sub>2</sub>, NO<sub>3</sub>, IO, and Pb. Systems developed to date have used simple diode lasers, diode lasers coupled to build-up cavities, frequency multiplication in nonlinear crystals, and difference-frequency generation using nonlinear mixers.

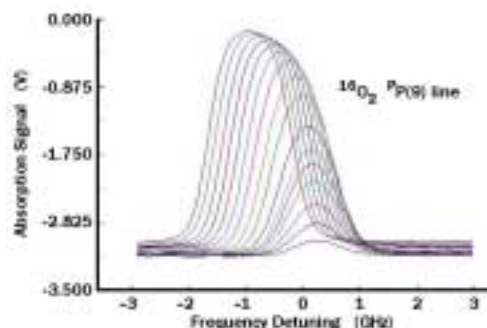

## Photonic Electromagnetic Field Probes

*Project Leader/contact:*

Keith D. Masterson, (303) 497-3756, masterson@boulder.nist.gov  
Radio Frequency Technology Division, EEEL, Boulder

*Approximate staff (FTE):*

1.5 Professionals, 0.5 Technician

*Funding sources:*

NIST (35 %), Other Agencies (65 %)

*Objective:*

Provide metrology, standards, and measurement services relating to determination of amplitude, phase, and power in radiated electromagnetic fields.

*Constituency:*

Electromagnetic interference and compatibility test equipment manufactures, RF test laboratories, wireless communications industry, and DOD

*Principal current tasks:*

- Standard RF dipole with analog, photonic signal link
- Loop antenna with loaded gaps for the simultaneous measurement of E and H fields

*Additional information:*

Accurate measurement of RF and microwave electromagnetic (EM) fields is crucial to the quantitative determination of the efficiency of wireless communications systems, their effects on the health of user populations, and the interference between various electronic systems and subsystems. Large industries are affected by the results of required testing, and national security is dependent on the careful management of electromagnetic effects.

NIST has a leading role in the metrology of EM fields. We have been developing probe systems based on electrooptic modulators and fiber optic signal lines. The probes are passive and require no power in the probe head, or only a small bias voltage obtainable through an optical fiber photovoltaic link. The probes are small, nonperturbing, and immune to pickup on the signal leads. Much of the technology is adapted from the optical-fiber telecommunications industry. We give special attention to adapting this technology to precision measurements in the analog domain. We have collaborated with the Optoelectronics Division in this regard.

NIST constructed a standard RF dipole with a photonic signal link for antenna calibrations over the frequency range of 1 MHz to 1 GHz. The complete characterization of this system is ongoing. We also have demonstrated the ability of a loop antenna with diametrically opposed, resistively loaded gaps to simultaneously measure both the E and H fields. Optical links between the probe head and readout instrumentation are crucial for the antenna's proper operation. The ability to determine both E and H fields is important for near-field measurements near strong sources or large objects that scatter strongly. We are currently building a near-field measurement system that will cover a frequency range from 50 kHz to 300 MHz.

## Near-Field Optics and Microscopy for Nanoscale Optical Characterization

*Project Leader/contact:*

Lori Goldner, (301) 975-3792, lori.goldner@nist.gov  
Optical Technology Division, PL, Gaithersburg

*Approximate staff (FTE):*

1.5 Professional

*Funding sources:*

NIST (100 %)

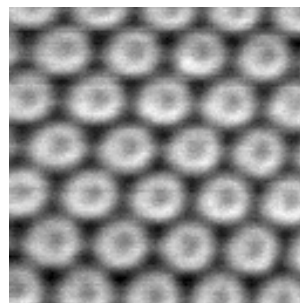

*Objective:*

Develop near-field scanning optical microscopy (NSOM) as a metrological tool for nanometer-scale optical measurements.

NSOM image of a photonic crystal

*Constituency:*

Researchers and developers of photonic technologies; photonic and semiconductor metrology equipment manufacturers

*Principal current tasks:*

- Quantify resolution and contrast mechanisms in NSOM in various applications, including near-field imaging of photonic structures, latent structures in photoresists, and microcrystalline domains in photonic materials.
- Apply NSOM to characterize domain and defect structure in organic electronic materials and devices and optically active organic materials.

*Additional information:*

Near-Field Scanning Optical Microscopy<sup>‡</sup> is an emerging technique capable of producing optical micrographs with a resolution that significantly surpasses that of traditional far-field optical methods. In one type of NSOM, a tapered, metal-coated fiber optic probe with a sub-wavelength aperture at the end is used to illuminate a specimen surface in the near field. Micrographs are generated by scanning this optical probe over the sample surface and measuring the light transmitted by the sample as a function of position. The resulting images can have resolution down to 20 nm. NSOM can be useful for semiconducting and organic specimens for which optical information may be particularly interesting. State-of-the-art NSOM devices allow for spectroscopic, fluorescence, or polarimetric data to be mapped concurrently with transmission and sample topography. We currently have two near-field microscopes in our program, a metrological instrument with polarimetric mapping capabilities and a microscope designed specifically for doing research on wet samples. These instruments acquire optical and topographic data simultaneously.

---

<sup>‡</sup> For a recent review article on NSOM see R.C. Dunn, *Chem. Rev.*, 99, 2891-2927 (1999).

## Advanced Optics Metrology

### *Project Leaders/contacts:*

Chris Evans, (301) 975-3484, cjevans@nist.gov  
Tony Schmitz, (301) 975-8346, tony.schmitz@nist.gov  
Angela Davies, (301) 975-3743, angela.davies@nist.gov  
Robert Polvani (301) 975-3487, robert.polvani@nist.gov  
Manufacturing Metrology Division, MEL, Gaithersburg

### *Approximate staff (FTE):*

2 professionals, 0.2 technician

### *Funding sources:*

NIST (85 %), Other (15 %)

### *Objective:*

Enhance the competitiveness of the highly-leveraged U.S. optics business, and hence multi-billion dollar strategic and commercial sectors such as IC production, by helping minimize controversy in commerce over measurement results and specification compliance through developing and ensuring the availability of traceable optical figure, wavefront and sub-surface damage measurement methods and standards.

### *Constituency:*

Optics manufacturers and users

### *Principal current tasks:*

- Thickness variation measurements of double-sided polished silicon wafers in transmission
- Understand limits of interferometric measurement of radius of curvature
- Commission and operate XCALIBIR, a state-of-the-art 300 mm aperture base measuring interferometer
- Develop techniques for measurement of sub-surface damage in crystals (notably sapphire)
- Photomask substrate interferometry (see ‘Substrate Thickness, Thickness Variation, and Flatness’)

### *Additional information:*

Our approach (like many) to measurement of optical figure is to use phase measuring interferometers (PMIs) using an array of techniques for separation of part errors from the signature of the instrument. Such approaches have shown that they can provide measurement uncertainties of the order of 1 nm for flats and near flats such as the Laser Interferometric Gravitational-wave Observatory optics. Higher uncertainties are obtained in the measurement of spherical optics. For the measurement of aspheric optics (i.e., systematic deviations from a base sphere), there are some basic limitations to the potential of the commercially available PMIs. Concepts for a system combining a PMI with high precision slideways have been developed and implemented (in collaboration with an industrial vendor) in a new measurement capability, known as the NIST X-ray Optics CALIBration InterferometeR (XCALIBIR). The goal is 0.25 nm rms uncertainty in measurement of aspheric optics up to 300 mm diameter with focal lengths up to 2 m. XCALIBIR—designed to have the flexibility to measure flats, spherical, and aspheric optics and radii of curvature—was installed at NIST in the fourth quarter of FY99 and is being commissioned.

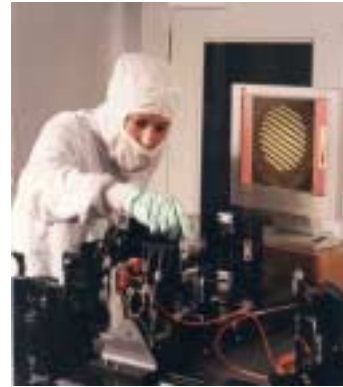

## Substrate Thickness, Thickness Variation, and Flatness

### Project Leaders/contacts:

Chris Evans, (301) 975-3484, cjevans@nist.gov  
Tony Schmitz, (301) 975-8346, tony.schmitz@nist.gov  
Angela Davies, (301) 975-3743, angela.davies@nist.gov  
Manufacturing Metrology Division, MEL, Gaithersburg

### Approximate staff (FTE):

1 Professional, 0.2 Contractor

### Funding sources:

NIST (95 %), Other (5 %)

### Objective:

Provide interferometric measurement methods for plane parallel substrates such as wafers and photomask blanks

### Constituency:

Substrate suppliers and users

### Principal current tasks:

- Thickness variation measurements of double-sided polished silicon wafers in transmission
- Measurement of fused quartz photomask blanks in a double pass reflection configuration

### Additional information:

Deep ultra-violet (DUV) and extreme ultraviolet (EUV) lithographies pose significant new challenges on the as-chucked die site flatness of silicon substrates as well as on the flatness of the reticle, and hence the photomask blank. Similar challenges face users of other substrates (sapphire, quartz, etc) for a broad array of optoelectronic applications. Measurements of the thickness, thickness variation and flatness, independent of the chuck, are needed.

Silicon wafers are commonly measured using capacitance gage based techniques, although it has been widely recognized that interferometric methods have advantages in some circumstances. A number of different interferometric techniques—using either reflected or transmitted wavefronts—have been developed. We are developing a range of different approaches based on the use of interferometry at 633 and 1550 nm. Where substrates transmit, interfering front and back surface reflections provides thickness variation information, provided the variation of refractive index can be considered insignificant. Conversely, that same interference is a serious impediment to measurement of surface flatness.

In these projects we are evaluating techniques for the measurement of thickness variation in transmission, where the substrate itself is the interferometric cavity. This reduces environmental sensitivity and the need for expensive, large optics. For surface measurements, we are evaluating the Ritchey-Common configuration and the use of short coherence length sources.

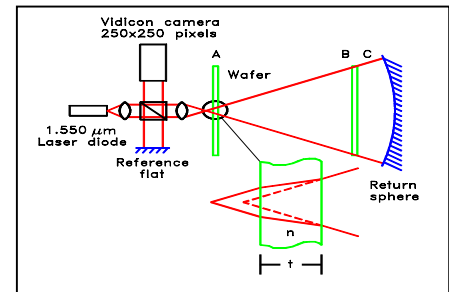

**Measurement in 3 positions (A, B & C (B flipped)) provides center thickness, thickness variation and bow**

## Wavelength Division Multiplexing Network Measurements and Management

### Project Leader/contact:

David H. Su, (301) 975-6194, dsu@nist.gov  
Advanced Network Technologies Division, ITL, Gaithersburg

### Approximate staff (FTE):

2.0 Professionals, 0.5 Contractor, 2.0 Guest Researchers

### Funding sources:

NIST (60 %), Other Agencies (40 %)

### Objective:

Provide performance evaluations of algorithms and protocols to support management and control of WDM networks and to speed up development of WDM network standards.

### Constituency:

Optical network equipment manufacturers, optical network simulation software vendors, optical network operators, DOD.

### Principal current tasks:

- Development of software tool for WDM network modeling and management (MERLiN).
- Evaluation of WDM network routing and wavelength assignment algorithms.
- Evaluation of protocols for support of Internet Quality of Service and traffic engineering over WDM networks.
- Develop fault detection and recovery algorithms and utilize the MERLiN tool to evaluate the effectiveness of these algorithms.

### Additional information:

With rapid development of optical network technologies, new products for optical components, optical switches or cross-connects, optical add/drop multiplexers, and WDM transports are emerging rapidly. The Advanced Network Technologies Division (ANTD) is working with industry to meet the challenge of developing standards for the next generation optical network architectures and protocols, appropriate at very high speeds, and for different environments (e.g., local, metro, and long haul accesses). As part of this effort, ANTD is developing an optical network modeling and planning tool (MERLiN) that can provide rapid and accurate analysis of various algorithms and protocols for network configuration, provisioning, and management.

The explosive growth of Internet traffic has accelerated the deployment of WDM networks as the Internet backbone. The next generation Internet will require integration of WDM network control and management with the Internet traffic engineering and Quality of Service support. New algorithms and protocols for the assignment, control, and routing of wavelength channels, and for detection of faults and reconfiguration of networks need to be evaluated using accepted measurement techniques. The major thrust of this project is to develop tools, methodologies, and a network testbed to measure and evaluate various alternatives in constructing next generation Internet.

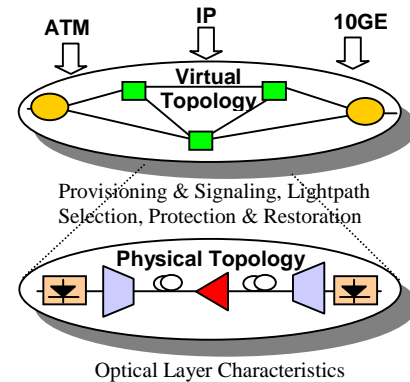

## Phase Stability in Optical-Fiber Links

### *Project Leader/contact:*

John Kitching, (303) 497-4083, kitching@boulder.nist.gov  
Time and Frequency Division, PL, NIST

### *Approximate staff (FTE):*

0.2 Professional, 0.3 Contractor

### *Funding sources:*

NIST (80 %), Other Agencies (20 %)

### *Objective:*

Study time-and-frequency transmission through intermediate lengths of optical fiber strung in a realistic communication environment.

### *Constituency:*

Telecommunications industry

### *Principal current tasks:*

- Develop methods for sampling and removing phase noise generated within the optical fiber
- Compare optical-frequency standards directly through the fiber and establish limitations imposed by noise generated in the fiber
- Transmit timing signals through the fiber and determine levels of fiber-generated noise

### *Additional information:*

In a joint program among the City of Boulder, the Department of Commerce (DOC), the University of Colorado (UC), and the National Center for Atmospheric Research, an optical-fiber network has been installed connecting various organizations dispersed throughout the city. The network acronym is BRAN, meaning Boulder Research and Administrative Network. A number of fibers have been assigned to NIST. Of particular relevance is the assignment of a dark pair (no included optoelectronic interfaces) of fibers connecting optical systems in the NIST Time and Frequency Division at the DOC Boulder Labs to systems within the NIST Quantum Physics Division on the UC campus. The distance between these two sites is approximately 2.2 km. Exceptional microwave and optical frequency standards are located in these two Divisions providing the opportunity to study the performance of this direct fiber connection.

Studies of the noise performance of this optical-fiber connection are relevant to a number of applications including:

Comparison of microwave atomic clocks and frequency standards and transfer of absolute time

Transfer of optical atomic-clock signals at optical frequencies

Accurate transfer of frequency

Calibration and transfer of laser wavelengths at wavelengths important to WDM

Dissemination of optical frequencies used as references for measuring length

Distribution of high-accuracy pulse trains used for time-domain measurements

A preliminary demonstration of the transfer of microwave atomic-clock signals from the DOC site to UC has been completed. The next phase of work will be on comparisons of optical frequency standards.

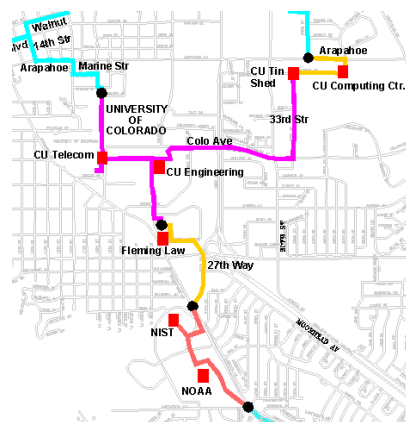

## High-Speed Optoelectronic Measurements

### Project Leader/contact:

Paul D. Hale, (303) 497-5367, hale@boulder.nist.gov  
Optoelectronics Division, EEEL, Boulder

### Approximate staff (FTE):

4.75 Professionals, 0.5 Technician, 0.5 Contractor

### Funding sources:

NIST (65 %), Other Agencies (30 %), Other (5 %)

### Objective:

Provide metrology, standards, and measurement services relating to temporal properties of optical sources and detectors used in association with optoelectronic systems.

### Constituency:

Optoelectronic test equipment manufacturers, laser and optical detector manufacturers, optical communications industry, DOD

### Principal current tasks:

- Frequency-domain detector and receiver measurements and calibration services
- Time-domain detector and receiver measurements and calibration services
- Laser and optical amplifier noise measurements and standards
- Low-level, time-resolved laser radiometry and calibration services

### Additional information:

Modern optical communications systems employ a combination of time-domain multiplexing (TDM) and wavelength-division multiplexing (WDM) to exploit the enormous data transmission capacity of an optical fiber. Systems now being installed use TDM data rates as high as 40 Gb/s on each of 100 or more WDM channels (wavelengths) to achieve total data transmission rates of several Tb/s (one Tb/s is the equivalent of approximately 16 million voice circuits).

The characterization of detectors and receivers for operation at 40 Gb/s requires measurements to frequencies higher than 100 GHz, preferably including both magnitude and phase information. Using an optical heterodyne method, NIST provides calibration services for the magnitude of the frequency response to greater than 50 GHz, limited by microwave instrumentation and standards. Electro-optic sampling methods now under development will provide measurements of both the magnitude and phase of the frequency response to over 100 GHz. In support of this effort, new methods for calibration of sampling oscilloscopes and processing time-domain data are being developed in collaboration with the Statistical Engineering, Radio-Frequency Technology, and Electricity Divisions of NIST.

The design of high-speed communications systems also requires a thorough knowledge of the noise characteristics of lasers and optical amplifiers, as well as detectors. NIST currently provides a Measurement Assurance Program for laser relative intensity noise (RIN) to frequencies of 26 GHz.

Calibration services related to the power and energy measurements of low-level, pulsed-laser radiation are also provided.

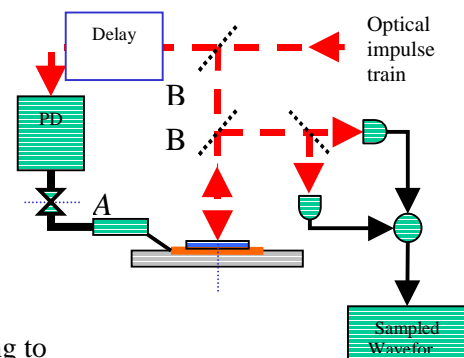



## Wavelength Standards for Optical Fiber Communications

*Project Leader/contact:*

Sarah L. Gilbert, (303) 497-3120, sgilbert@boulder.nist.gov  
Optoelectronics Division, EEEL, Boulder

*Approximate staff (FTE):*

2.5 Professionals, 0.4 Technician

*Funding sources:*

NIST (65 %), Other Agencies (35 %)

*Objective:*

Develop wavelength references for the optical fiber communication bands and provide wavelength calibration transfer standards needed by industry to calibrate optical fiber test equipment.

*Constituency:*

Optical fiber communications industry and DOD

*Principal current tasks:*

- Wavelength calibration transfer standards
- High accuracy wavelength references

*Additional information:*

The project is concentrating on industry and DOD wavelength calibration needs in the near infrared region, particularly wavelength calibration for wavelength division multiplexed (WDM) optical fiber communication systems. In a WDM system, the light sent down a single optical fiber is composed of many wavelength channels. Since each wavelength channel can carry as much information as the older single-wavelength systems, the bandwidth is increased substantially. Current WDM systems operate in the 1500 nm region and typically support about 50 wavelength channels. Future systems will likely use a broader wavelength region and narrower channel spacing.

Wavelength transfer standards are needed to calibrate instruments that measure the wavelengths of sources and characterize the wavelength dependence of WDM components. The project currently produces two wavelength reference Standard Reference Materials, SRM 2517 (acetylene) and SRM 2519 (hydrogen cyanide), that can be used to calibrate the wavelength scale of instruments between 1510 and 1565 nm. WDM will soon expand into other wavelength regions, such as the 1565-1630 nm L band and the 1300-1500 nm region. The project is developing wavelength references for these regions and a versatile hybrid reference incorporating fiber Bragg gratings and a molecular absorption reference.

The project also develops higher accuracy wavelength references for its internal calibration. These references involve high-resolution spectroscopy of atoms and molecules. The 1560 nm reference is a frequency-doubled 1560 nm diode laser stabilized to a 780 nm rubidium transition. The rubidium transition is probed using saturated absorption spectroscopy. In collaboration with the NIST Physics Laboratory Time and Frequency Division, the project recently conducted accurate measurements of a methane line to provide a reference in the 1300 nm region.

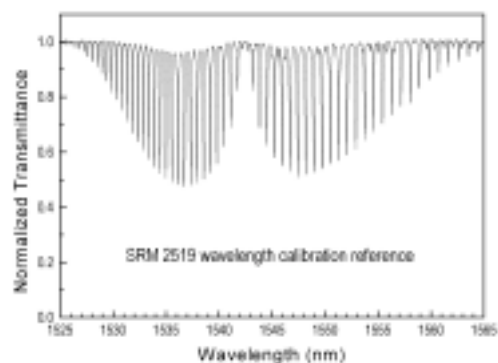

## Spectral Metrology of Optical Components

*Project Leader/contact:*

Sarah Gilbert, (303) 497-3120,  
sgilbert@boulder.nist.gov  
Optoelectronics Division, EEEL, Boulder

*Approximate staff (FTE):*

0.5 Professional, 0.2 Technician

*Funding sources:*

NIST (30 %), OA (70 %)

*Objective:*

Develop metrology to support the optoelectronics industry's component measurement needs.  
Provide standards for industry and government laboratories.

*Constituency:*

Optical communications industry, optical fiber sensor industry, and DOD.

*Principal current tasks:*

- Spectral component metrology support for industry
- Fiber Bragg grating metrology and standards development
- Metrology for optical components and polarization dependent wavelength shift modeling

*Additional information:*

The rapid growth of narrow-channel, 50 GHz, wavelength division multiplexed optical fiber communication systems has greatly increased the need for accurate measurement of fiber component spectral properties. One important component under study is the fiber Bragg grating, which can be used as a wavelength channel filter in fiber communication systems.

The fiber Bragg grating sensor industry is another industry that uses this component to measure strain or pressure for the monitoring of civil and military structures and optimize oil and gas extraction from wells. Despite the extraordinary measurement conditions and monitoring lifetimes that are envisioned in these applications, few calibrations and standards exist. Strain calibration is especially challenging because interfacial mechanisms may not perfectly transfer strain from the target structure to the sensing fiber. Furthermore, direct calibration of sensors and systems in the field is currently limited by the accuracy of instrumentation available for testing.

To assess fiber communication and sensor industry measurement capabilities, the project conducted two round robin intercomparisons for the measurement of spectral reflectance and transmittance of fiber Bragg gratings. Future plans include developing artifacts that can be used to improve the calibration of fiber Bragg grating sensor systems.

Polarization properties play a role in a variety of optical components and systems. The project will use its high spectral accuracy, 0.2 pm, to assess the effect of different polarization states on the spectral properties of a component, such as fiber Bragg grating or arrayed waveguide demultiplexer.

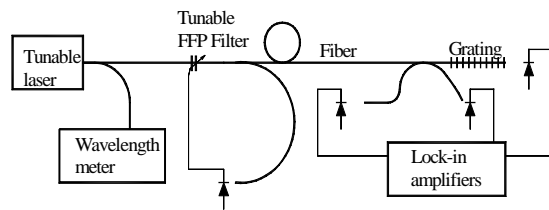

Component spectral reflectance and transmittance system

## Relative Group Delay and Dispersion of Optical Fiber and Components

### Project Leader/contact:

Paul Williams, (303) 497-3805, pwilliam@boulder.nist.gov  
Optoelectronics Division, EEEL, Boulder

### Approximate staff (FTE):

2 Professionals, 1.5 Students

### Funding sources:

NIST (80 %), OA (20 %)

### Objective:

Develop metrology to support the optoelectronics industry's measurement needs for relative group delay (RGD) and dispersion. Provide standards for industry and government laboratories.

### Constituency:

Optical communications industry; fiber and component users and manufacturers

### Principal current tasks:

- RF phase-shift and low-coherence interferometric metrology and standards development
- Develop an artifact for component RGD
- Maintain fiber dispersion metrology and zero dispersion wavelength artifact

### Additional information:

The rapid growth of high-bandwidth optical fiber communication systems has greatly increased the need for accurate measurement of fiber component spectral and dispersion properties. Using low-coherence interferometry, the project has demonstrated the measurement of optical path length, group delay, and dispersion in various components. One important component under study is the fiber Bragg grating, which can be used as a wavelength channel filter or dispersion compensator in fiber communication systems. The project has conducted two round robin intercomparisons for the measurement of spectral reflectance and dispersion of fiber Bragg gratings. The project plans to improve the low-coherence interferometer to complement and support the measurement of RGD and dispersion in components.

A possible RGD artifact under investigation is the spectral SRM 2519. This HCN absorption cell provides a stable absorption at known wavelengths. An individual molecular absorption line will also have a fixed amount of RGD that can be predicted from first principles and the line absorption strength. Dispersion for the absorption line can be determined from the RGD data. If this work is successful, the use of SRM 2519 could be extended to calibrate component measurement systems for RGD measurements.

The project continues to maintain metrology systems for dispersion measurements in optical fiber with SRM 2524 and for special tests at different wavelengths for newer fibers types.

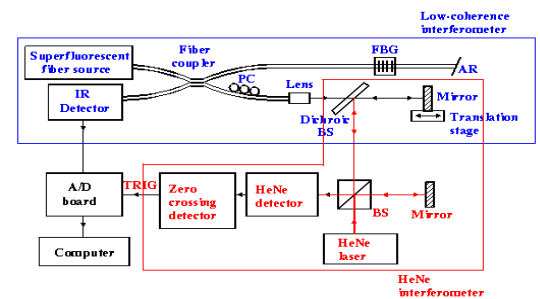

Low-Coherence Interferometer

## Polarimetry

### Project Leader/contact:

Paul Williams, (303) 497-3805,  
pwilliam@boulder.nist.gov  
Optoelectronics Division, EEEL, Boulder

### Approximate staff (FTE):

1.2 Professionals, 0.1 Technician  
0.2 Student

### Funding sources:

NIST (100 %)

### Objective:

Develop polarimetric metrology to support the optoelectronics industry's component measurement needs. Provide standards for industry and government laboratories.

### Constituency:

Optical communications industry, optical fiber sensor industry, manufacturers of polarization components and polarization measuring instruments, DOD and DOE.

### Principal current tasks:

- Polarimetric metrology and standards development
- Imaging polarimeter development
- UV lithography metrology support

### Additional information:

Polarization properties play a role in a variety of optical components and systems. This project supports the measurement of base polarimetric quantities for optical data storage, UV lithography, waveplate manufacturing, optical sensors, and the polarimetric properties of telecommunication components.

The Polarimetry project can measure linear retardance with better than  $0.1^\circ$  expanded uncertainty, supports the standard linear retarder SRM 2525, and performs special tests at visible and near-infrared wavelengths.

As wafer lithography in the semiconductor industry moves to 193 nm and 157 nm wavelengths, the material properties of the optics used must be fully characterized for optimum performance. This project is working with the Pulsed-Laser Radiometry project to measure the retardance of CaF<sub>2</sub> and fused silica; materials commonly used in these lithographic machines.

An imaging polarimeter is being developed for advanced polarimetry of lithographic and other polarimetric components. The imaging polarimeter will provide a full Muller matrix for the imaged sample from which linear and circular retardance, diattenuation, and depolarization can be determined.

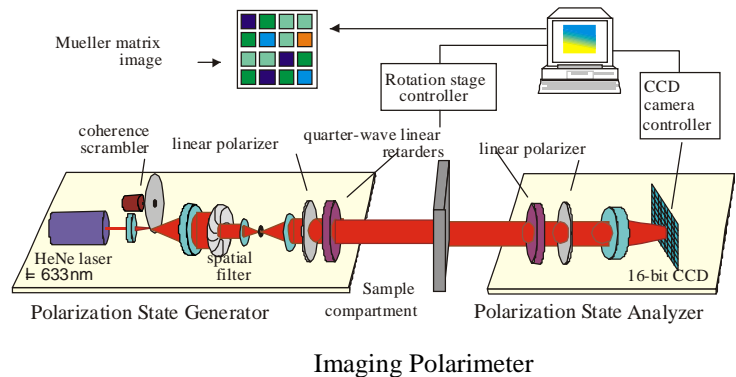

## Polarization Dependent Loss

### *Project Leader/contact:*

Rex Craig, (303) 497-3359, rcraig@boulder.nist.gov  
Optoelectronics Division, EEEL, Boulder

### *Approximate staff (FTE):*

1 Professional, 0.2 Student

### *Funding sources:*

NIST (100 %)

### *Objective:*

Develop polarization dependent loss (PDL) artifacts and metrology to support the optoelectronics industry's component measurement needs. Provide standards for industry and government laboratories.

### *Constituency:*

Optical communications industry, manufacturers of polarization components and polarization measuring instruments, and DOD.

### *Principal current tasks:*

- Complete PDL SRM artifact with 0.1 dB of PDL
- Improve PDL wavelength metrology to an uncertainty of 0.002 dB
- Demonstrate a polarization dependent wavelength shift (PDW) measurement accuracy of 0.01 nm

### *Additional information:*

The rapid growth of high-bandwidth optical fiber communication systems has greatly increased the need for accurate measurement of fiber component polarization dependent loss (PDL) and polarization dependent wavelength shift (PDW) properties. Using all states and four state polarization metrology the project has demonstrated measurement of PDL over a range of operating wavelengths in various components. The completion of the PDL SRM will help industry to calibrate PDL measurement equipment over these wavelengths and improve performance of communication systems by reducing the losses associated with this effect.

In addition, PDW is a significant factor in the performance of optical multiplexing components in wavelength division multiplexed (WDM) optical fiber communication systems. Accurate measurement of this effect will assist industry groups in their attempts to verify computer models of multiplexing and demultiplexing components as well as support efforts to arrive at standards.

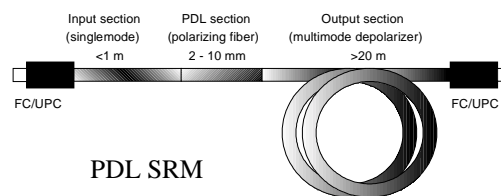

## Polarization Mode Dispersion

*Project Leader/contact:*

Paul Williams (303) 497-3805, pwilliam@boulder.nist.gov  
Optoelectronics Division, EEEL, Boulder

*Approximate staff (FTE):*

1 Professional

*Funding sources:*

NIST (100 %)

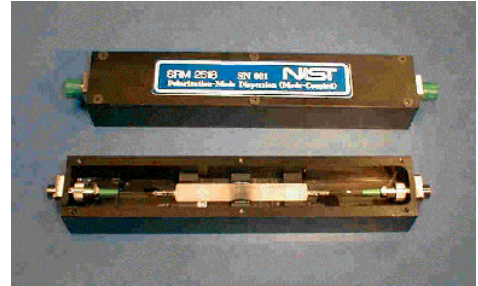

*Objective:*

Develop interferometric and polarimetric metrology to support the optoelectronics industry's fiber and component measurement needs for polarization mode dispersion (PMD). Provide standards and develop improved measurement techniques for industry and government laboratories.

*Constituency:*

Optical telecommunications industry (fiber, component and test equipment manufacturers), manufacturers of polarization components and polarization measuring instruments.

*Principal current tasks:*

- Build and certify more mode-coupled (fiber emulating) SRMs
- Complete the certification paperwork for the single-waveplate (component emulating) SRM
- Procure and certify single waveplate SRMs
- Improve rf phase-shift and polarimetric metrology systems for improved PMD uncertainty at the 1 to 20 fs level and improved spectral resolution at the 0.1 to 2 GHz level.

*Additional information:*

The rapid growth of high-bandwidth optical fiber communication systems has greatly increased the need for accurate measurement of fiber and fiber component PMD properties. PMD is a limiting factor to higher data rates; however, its measurement is made difficult by the statistical nature of PMD in fibers, which places a theoretical limit on the achievable measurement uncertainty. This project seeks to develop measurement artifacts that are stable with respect to environmental conditions, and to perfect measurement techniques that allow more accurate measurement of PMD in the narrower wavelength bands found in many telecommunication components.

## Ultrafast and CW Compact Solid-State Waveguide Lasers

### Project Leader/contact:

Norman A. Sanford (303) 497-5239 sanford@boulder.nist.gov,  
Optoelectronics Division, EEEL, Boulder

### Approximate staff (FTE):

1.6 Professionals, 1 Postdoc

### Funding sources:

NIST (50 %), Other agency (50 %)

### Objective:

Develop compact, passively mode-locked, ultrafast, solid-state waveguide lasers separately operating near 1550 nm and 1064 nm. Develop compact, narrow-line, distributed-Bragg-reflector waveguide lasers operating in the 1550 nm band. Apply these unique sources to attack metrology problems in the study of jitter, all-photonic analog-to-digital conversion, and heterodyne evaluation of fast photoreceivers. Pursue emerging applications of these sources including, for example, compact terahertz wave generation for advanced sensor systems.

### Constituency:

Developers and manufacturers of compact solid-state lasers separately requiring mode-locked or single-frequency operation. Developers and manufacturers of fast photoreceivers. Developers of advanced terahertz sensor and spectroscopy systems.

### Principal current tasks:

- Ultrafast characterization of semiconductor saturable absorber mirrors for ~10 GHz passive mode-locking of solid state waveguide lasers fabricated in rare-earth-doped glass.
- Demonstration of passive mode-locking of solid state waveguide lasers at 1550 nm with pulse widths ~100 fs and jitter on the order of 10 fs.
- Characterization of tunable, single-frequency, distributed-Bragg-reflector waveguide lasers fabricated in rare-earth-doped glass.

### Additional information:

Over the past decade, pioneering work in the development of compact solid-state waveguide lasers has been performed at NIST. This work is now enabling the development of advanced methods for high-speed (100 GHz) detector characterization. This is being performed by heterodyne mixing of the outputs of these extremely quiet and narrow-line waveguide lasers. Additionally, high-speed (upwards of 10 GHz) passive mode-locking of these lasers is being pursued for all-optical analog-to-digital conversion applications and for studies of jitter. Finally, exciting new industrial, research, sensor, and medical applications of femtosecond laser sources continue to emerge. The ultrafast lasers developed by NIST may play a significant new role in these application areas.

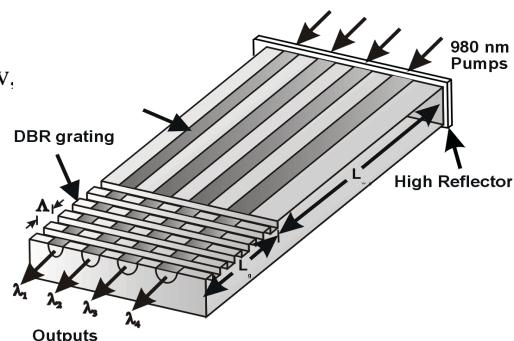

Fig. 1  
Page 10

## Optical Fiber Ferrule Measurements

*Project Leader/contact:*

John Stoup, (301) 975-2321, john.stoup@nist.gov  
Precision Engineering Division, MEL, Gaithersburg

*Approximate staff (FTE):*

0.25 Professional  
On intermittent basis for certifications

*Funding source:*

OSRM

*Objective:*

Provide accurate task-specific measurements traceable through NIST to the SI unit of length for the geometry and critical dimension of optical fiber ferrules

*Constituency:*

Primarily manufacturers and users of components of optical fiber communications equipment, particularly optical ferrules for the interconnections of optical-fiber lines. Most specifically, users of instruments requiring calibration for accurate traceable measurements of diameters of artifacts such as optical fiber ferrules.

*Principal current tasks:*

- Maintain the previously developed capability to performance accurate SI-traceable measurements of the diameter and roundness of standard optical-fiber ferrules
- Certify Standard Reference Material 2523 “Optical Fiber Ferrule Geometry Standard”

*Additional Information:*

NIST is responsible for the realization and dissemination of the SI base unit of length (the meter) at a variety of scales, in a variety of forms, and at different uncertainties specific to industrial needs and applications. To support the effective manufacture and use of optical-fiber communication systems, NIST has developed a Standard Reference Material “Optical Fiber Ferrule Geometry Standard.” The SRM consists of a single optical fiber ferrule with a notch etched into one end to identify the 0° plane used for positioning. The outer diameter has been measured in the center, parallel to the notch. Roundness has also been measured for measurement equipment where roundness of the artifact is an important consideration or for future measurement applications. The artifact may be used to set comparator-type instruments or to calibrate absolute-type instruments. Deformation of the ferrule, with its 0.126 μm axial hole, has been taken into account in certification. The expanded uncertainty of the central 2 mm length of the nominally 2.5 mm diameter ferrule is approximately 40 nm.



**Ferrule diameter measurement with laser micrometer.**



## Laser Power Measurements for Optical Telecommunications

### Project Leader/contact:

Chris Cromer, (303) 497-5620,  
cromer@boulder.nist.gov  
Optoelectronics Division, EEEL, Boulder

### Approximate staff (FTE):

2.6 Professionals, 0.2 Technician

### Funding sources:

NIST (75 %), Other Agencies (19 %),  
Other (6 %)

### Objective:

Develop measurement methods and standards for characterizing laser sources and detectors used primarily for lightwave telecommunications. Develop and maintain measurement services optical fiber power, and related parameters (e.g. spectral responsivity, linearity, spatial and angular responsivity, etc.).

### Constituency:

Users and manufacturers of optoelectronic test equipment, optical fiber power meters.

### Principal current tasks:

- Optical fiber power meter measurements and calibration services
- Calibration services accuracy and facilities improvements and upgrades
- Optical fiber transfer standard detector development
- Tunable-wavelength diode laser development

### Additional information:

To meet the needs of the lightwave telecommunications industries and to anticipate emerging technologies requires investigation and development of improved measurement methods and instrumentation for high-accuracy optical fiber power metrology over a wide range of powers and wavelengths. This project focuses on selected critical parameters intrinsic to optoelectronic sources and detectors, especially the calibration of optical fiber power meters and sources at commonly used wavelengths and powers. In addition, special test measurements are available for linearity, spectral responsivity, and spatial/angular uniformity of optical fiber power meters and detectors. NIST has historically used electrically calibrated laser calorimeters to provide traceability to the SI units for laser power and energy. We recently developed a new measurement capability based on a Laser Optimized Cryogenic Radiometer (LOCR), which provides an order of magnitude reduction in uncertainty for laser power measurements, and has reduced the expanded (K=2) uncertainty of optical fiber power measurements to below 0.5 %. To meet the increasingly demanding needs of higher accuracy over a larger range of optical power and wavelength, it is necessary to further improve the accuracy of calibration services through the development of better transfer standards traceable to LOCR. Project members extend and improve laser sources and detectors, including development of low noise, spectrally flat, highly uniform pyroelectric detectors, high accuracy transfer standards for optical fiber power measurements, and advanced tunable diode laser systems for optical fiber power measurement systems. They also participate in national and international standards committees developing standards for optical fiber power and lightwave instrumentation.

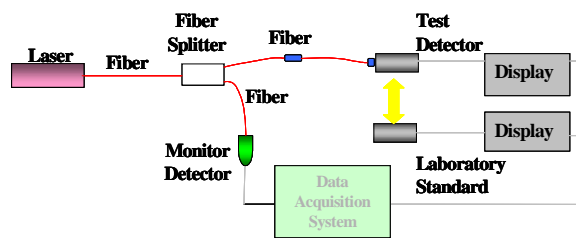

Layout of Optical Fiber Power calibration system.

## Pulsed-Laser Radiometry

### Project Leader/contact:

Marla L. Dowell, (303) 497-7455, mdowell@boulder.nist.gov  
Optoelectronics Division, EEEL, Boulder

### Approximate staff (FTE):

4 Professionals, 1 Postdoc

### Funding sources:

NIST (65 %), Other Agencies (30%), Other (5 %)

### Objective:

Provide metrology, standards, and measurement services relating to pulsed-laser radiometry.

### Constituency:

Laser and optical detector manufacturers, semiconductor manufacturers and their suppliers, optical material manufacturers, DOD, airline industry

### Principal current tasks:

- Pulsed-laser power and energy measurements and calibration services
- Ultraviolet optical material characterization measurements
- Excimer laser beam characterization and homogenization measurements
- Develop primary standards and measurement techniques for pulsed-laser measurements

### Additional information:

Project members of the Pulsed-Laser Radiometry Project develop measurement methods and standards for characterizing pulsed-laser sources and detectors. We work closely with industry to develop standards, new technology and appropriate measurement techniques for pulsed-laser measurements. The majority of this effort is concentrated on ultraviolet (UV) laser metrology using excimer lasers.

Excimer lasers are used in a wide range of industrial applications: optical lithography for semiconductor manufacturing, vision correction procedures, for example photorefractive keratectomy (PRK) and Laser *In-situ* Keratomileusis (LASIK), as well as micromachining of small structures such as ink jet printer nozzles. Our efforts are concentrated primarily on UV laser metrology in support of semiconductor photolithography. Increasing information technology requirements have yielded a strong demand for faster logic circuits and higher density memory chips. This demand has led to the introduction of deep ultraviolet (DUV) laser-based lithographic tools for semiconductor manufacturing, which employ KrF (248 nm) and ArF (193 nm) excimer lasers, and to an increased demand for accurate laser measurements at DUV laser wavelengths. As a result, NIST, with SEMATECH support, has developed primary standard calorimeters for both 193 nm and 248 nm excimer laser power and energy measurements.

There are a number of laser measurements that are important for both tool development and performance. Measurements at the source are used as part of a feedback mechanism to stabilize the source's pulse energy. There is also an optimum laser dose that will lead to the best resolution of small features at the wafer plane. In a photograph, overexposure or underexposure of an object leads to reduced image contrast and poor resolution. Optical material characterization measurements, such as transmittance and birefringence, are important for tool development and performance as well.

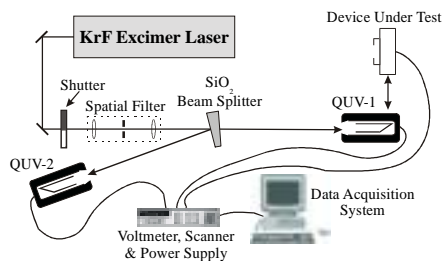

## Laser Power and Energy Measurements for Industrial/Military Applications

### *Project Leader/contact:*

Chris Cromer, (303) 497-5620, cromer@boulder.nist.gov  
Optoelectronics Division, EEEL, Boulder

### *Approximate staff (FTE):*

3.7 Professionals, 0.8 Technician

### *Funding sources:*

NIST (62 %), Other Agencies (36 %), Other (2 %)

### *Objective:*

Develop measurement methods and standards for characterizing laser sources and detectors used for industrial and military applications. Develop and maintain measurement services for laser power and energy and related parameters (e.g., spectral responsivity, linearity, etc.).

### *Constituency:*

Users and manufacturers of optoelectronic test equipment, laser and optical detectors, materials processing equipment, laser-based medical equipment, data storage technology, and laser safety equipment.

### *Principal current tasks:*

- Laser power and energy detector measurements and calibration services
- Calibration services accuracy and facilities improvements and upgrades
- Primary and transfer standard laser power and energy detector development
- Tunable wavelength laser sources development

### *Additional information:*

To meet the present and future needs of the laser and optoelectronics industries requires investigation and development of improved measurement methods and instruments for high-accuracy laser metrology over a wide range of powers, energies, and wavelengths. This project focuses on selected critical parameters intrinsic to optoelectronic sources and detectors, especially the calibration of laser power or energy meters at commonly used wavelengths and powers or energies. In addition, special test measurements are available for linearity, spectral responsivity, and spatial uniformity of laser power meters and detectors. NIST has historically used electrically calibrated laser calorimeters to provide traceability to the SI units for laser power and energy. We recently developed a new measurement capability based on a Laser Optimized Cryogenic Radiometer (LOCR), which provides an order of magnitude reduction in the uncertainty of laser power measurements. To meet the increasingly demanding needs of higher accuracy over a larger range of optical power and wavelength, it is necessary to improve the accuracy of calibration services through the development of better transfer standards traceable to LOCR. Project members extend and improve laser sources and detectors, including development of low noise, spectrally flat, highly uniform pyroelectric detectors, high accuracy transfer standards for laser power measurements, and advanced tunable laser systems for laser power and energy measurement systems. They also participate in national and international standards committees developing standards for laser safety, laser radiation measurements (such as beam profile and pointing stability), and optical-power-related measurements.

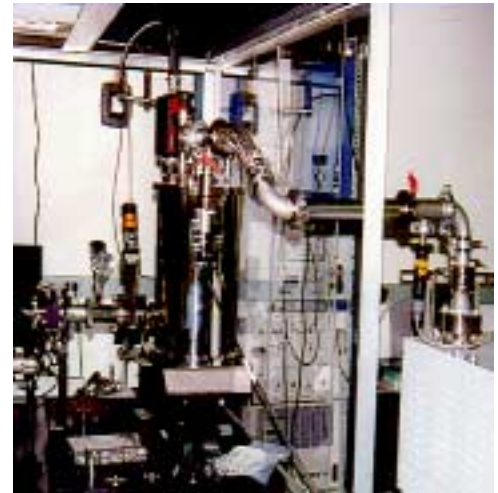

The Optoelectronics Division's Laser Optimized Cryogenic Radiometer (LOCR).

## Flat Panel Display Laboratory

### *Project Leader/contact:*

Edward F. Kelley, 301-975-3842, [kelley@eeel.nist.gov](mailto:kelley@eeel.nist.gov)  
Electricity Division, EEEL, Gaithersburg

### *Approximate staff (FTE):*

3 Professionals

### *Funding sources:*

NIST (85 %), Other Agencies (15 %)

### *Objective:*

Support the need of domestic commercial industry to characterize electronic displays—particularly flat panel displays (FPDs)—by means of robust, reproducible, and unambiguous metrology to enable world commerce of displays. The United States is a major market for electronic displays for computer, consumer, automotive, and avionics use. The specification and verification of display quality depends upon good metrology and is required in this highly competitive environment.

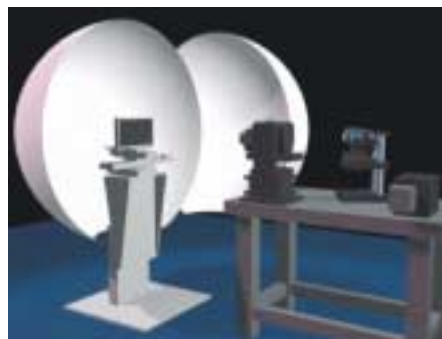

### *Constituency:*

Manufacturers of displays, manufacturers using displays in their products, and users of displays.

### *Principal current tasks:*

**Standards Activities:** A major effort is to compile good display metrology and make it available to various standards organizations.

- VESA Display Metrology Committee: E. F. Kelley, editor. A scientific and comprehensive document has been prepared by this committee to address display metrology: Flat Panel Display Measurements Standard (FPDM). The FPDM is receiving worldwide use. [[www.vesa.org](http://www.vesa.org)]
- ISO TC159/SC4/WG2 Visual Display Requirements, P. A. Boynton, member [[www.iso.org](http://www.iso.org)].
- ANSI & PIMA IT7-3 Electronic Projection, P. A. Boynton, member [[www.ansi.org](http://www.ansi.org)]; [[www.pima.net](http://www.pima.net)].
- SAE J 1757 Standard Metrology for Vehicular Flat Panel Displays, E. F. Kelley, member [[www.sae.org](http://www.sae.org)].

**Display Reflection Measurements:** Characterization of the three components of reflection (specular, diffuse Lambertian, and diffuse haze) associated with displays. Implementation of robust metrics to characterize display reflection performance under typical conditions. Use of bidirectional reflectance distribution function (BRDF) measurements to quantify display reflection. (File: (<ftp://ftp.fpd.l.nist.gov/pub/DisplaysBRDF.PDF>))

**DMATS** — Display Measurement Assessment Transfer Standard: Since displays are often not stable devices, NIST has developed a uniformly lit target assembly to determine the measurement capabilities of participating laboratories in an interlaboratory comparison effort.

**Simulated-Eye-Design (SED) Camera:** A liquid-filled camera is under development that simulates the optics of the eye in order to reduce stray-light contributions to the measured image and enable more accurate luminance measurements of complicated scenes involving high contrasts. (<ftp://ftp.fpd.l.nist.gov/pub/SPIE99-SED01.PDF>)

**Stray Light Control Using Masks, Frustums, and SLETs:** A variety of methods using flat masks, gloss-black frustums, and stray-light-elimination-tubes (SLETs) have been developed to make accurate measurements of displays (both front-projection and direct-view displays) particularly when stray light and veiling glare problems contribute to the measurement errors. (<ftp://ftp.fpd.l.nist.gov/pub/ConeConSID97.PDF>)

## Atomic Data for High Efficiency Lighting

### *Project Leader/contact:*

Craig Sansonetti, (301) 975-3223, craig.sansonetti@nist.gov  
Atomic Physics Division, PL, Gaithersburg

### *Approximate staff (FTE):*

0.66 Professional, 0.5 Guest Researcher

### *Funding sources:*

NIST (60 %), Other Agencies (40 %)

### *Objective:*

Provide basic atomic data needed by the lighting industry for design and modelling of high intensity discharge and fluorescent lamps

### *Constituency:*

High intensity discharge (HID) lamps and fluorescent lamps are produced by all major lamp manufacturers. Atomic data required to better understand and improve these lamps is an infrastructural contribution to the knowledge base on which discharge lamp technology rests. All manufacturers benefit from these data.

### *Principal current tasks:*

- Observe spectra of neutral and singly-ionized rare earth atoms by Fourier Transform Spectroscopy to measure accurate wavelengths and intensities
- Analyze rare earth spectra to obtain energy levels and branching fractions
- Study the absolute radiant output of principle lines in mercury-argon discharges under a wide range of discharge parameters
- Assess feasibility of extending this work to measurements of lifetimes of excited atomic states.
- Publish research results.

### *Additional information:*

Lamp manufacturers are currently developing and attempting to validate computer modelling techniques to predict the operating characteristics of HID and fluorescent lamps. These computer codes may be able to replace costly and time consuming trial-and-error procedures for developing improved lighting systems. A primary limitation in the use of the computer codes is lack of fundamental atomic data for the atoms and ions of interest. Rare earth elements are used in HID lamps to improve their efficiency and color rendering properties. Results of our recently completed studies of dysprosium energy levels and branching ratios are already being used in lamp modelling. Our current work on holmium is focused on another element directly applicable to the design and modelling of HID lamps.

Modelling for mercury-argon discharges used in fluorescent lamps has a longer history and is further advanced than HID lamp modelling. Radiometric and electrical measurements being made by NIST are designed to provide validation data for a wide range of discharge conditions to assess the accuracy of the modelling in operating regimes far removed from those traditionally used in fluorescent lamps.

Improved lighting efficiency is an important priority as lighting consumes approximately 40 % of all electric power used in the commercial sector. NIST's work in support of high efficiency lighting is being carried out in the context of a CRADA with the Electric Power Research Institute.

## Metrology for Compound Semiconductor Manufacturing

### Project Leader/contact:

Joe Pellegrino, (301) 975-2123, joseph.pellegrino@nist.gov  
Semiconductor Electronics Division  
EEEL, Gaithersburg

### Approximate staff (FTE):

2 Professionals

### Funding sources:

NIST (100 %)

### Objective:

Develop new and existing *in situ* and *ex-situ* materials growth monitoring tools, methodologies, and data in support of more efficient manufacturing of compound semiconductor devices for wireless and digital electronics applications.

### Constituency:

Compound semiconductor materials growth industry, and commercial end products dependent on these materials.

### Principal current tasks:

- Demonstrate high accuracy growth temperature control using *in situ* diffuse reflectance scattering (DRS), and establish correlations with device electrical properties
- Demonstrate high accuracy film composition and thickness measurements based on *in situ* ellipsometry
- Measure the pseudo-dielectric parameters of low temperature GaAs
- Calibrate the composition of ternary alloys *in situ* using the unique NIST X-ray fluorescence probe
- Investigate MBE growth on non-(100) substrates for improved carrier mobility applications
- Establish a Hall technique website (<http://www.eeel.nist.gov/semiconductor/hall.html>), and implement a round-robin for industrial consensus

### Additional information:

The Project emphasis is on materials growth as well as the electrical, optical, and structural characterization of III-V heterostructures, including pHEMTs, HBTs, and MSFETs, based on GaAs, AlGaAs, and InGaAs strained superlattice systems. The *in situ* sensors applied during growth include X-ray fluorescence (XRF), diffuse reflectance spectroscopy (DRS), ellipsometry, and reflectance high energy electron diffraction (RHEED). Offline tools also available in the project include photoluminescence (PL), Fourier transform infrared (FTIR), photoreflectance (PR), micro-spot Raman spectroscopy, deep level transient spectroscopy (DLTS), and Hall measurement. Ongoing collaborations exist in RF testing and measurements (RF Technology Division-813), Electromagnetic Technology (814), Optical Technology (844) and Optoelectronics (815). The Project continues to work closely with compound semiconductor materials producers both directly and through standards bodies such as the GaAs MANufacturing TECHNOlogy (MANTECH) Conference Program Committee, SEMI, and ASTM.

Temperature profiles during growth by MBE.

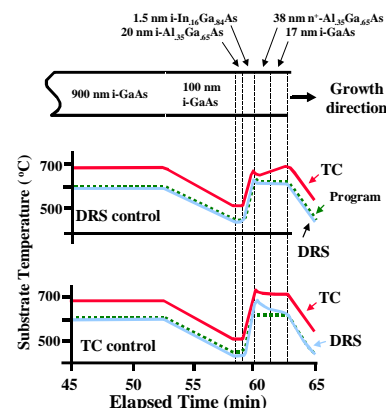

## Chemical Composition Standards for Optoelectronic Semiconductors

### Project Leader/contact:

Kris Bertness, (303) 497-5069, bertness@boulder.nist.gov  
Optoelectronics Division, EEEL, Boulder  
Larry Robins, MSEL, Gaithersburg  
John Armstrong, CSTL, Gaithersburg  
Joseph Pellegrino, EEEL, Gaithersburg

### Approximate staff (FTE):

1.5 Professionals

### Funding sources:

NIST (100 %)

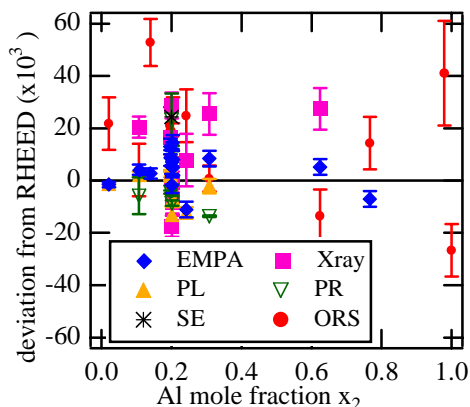

### Objective:

Develop a certification process for the first high-accuracy composition standard reference materials (SRMs) in the important  $\text{Al}_x\text{Ga}_{1-x}\text{As}$  semiconductor alloy system with uncertainty of 1% in  $x$ ; demonstrate how chemical microanalysis techniques can be used to certify the composition; quantify the factors that limit the accuracy of widely used indirect composition measurement techniques.

### Constituency:

Manufacturers of near-infrared laser diodes, light-emitting diodes, photodetectors, and integrated optoelectronic devices

### Principal current tasks:

- Improve accuracy and precision of *in situ* composition measurements of epitaxial  $\text{Al}_x\text{Ga}_{1-x}\text{As}$ -on-GaAs films by reflection high-energy electron diffraction (RHEED), optical reflectance spectroscopy (ORS), and spectral ellipsometry (SE)
- Improve accuracy and precision of *ex situ* measurements by electron microprobe analysis using wavelength-dispersive x-ray emission spectroscopy (EMPA/WDS)
- Investigate the use of inductively coupled plasma-optical emission spectrometry (ICP-OES) to determine the composition of free-standing epitaxially grown films with high accuracy
- Develop improved calibration curve for indirect composition measurement by room-temperature photoluminescence (PL) spectroscopy, based on comparison with RHEED, ORS, and/or EMPA
- Examine effect of carrier concentration on PL spectrum in heavily p-type or n-type doped films; develop doping correction term that improves accuracy of PL composition measurements of heavily doped films

### Additional information:

The development of standard reference materials (SRMs) for compound semiconductor composition and *in situ* monitoring development were top metrology priorities of the Lasers and LEDs group at an Optoelectronics Industry Development Association (OIDA) Metrology Workshop. The inability to accurately measure the composition of semiconductor alloy films (e.g. “ $x$ ” in  $\text{Al}_x\text{Ga}_{1-x}\text{As}$ ) has been a major stumbling block to modeling and simulation of III-V semiconductor devices. This project was undertaken to address the known industry needs. We are assembling the largest group of  $\text{Al}_x\text{Ga}_{1-x}\text{As}$  specimens ever examined with a full range of *in situ* and *ex situ* composition measurement methods. In future years, we may begin the more difficult task of developing composition standards for quaternary alloys such as  $\text{In}_x\text{Ga}_{1-x}\text{As}_y\text{P}_{1-y}$ .

## Impurity Concentration Measurements in Semiconductor Source Gases

### *Project Leader/contact:*

Kris Bertness, (303) 497-5069, bertness@boulder.nist.gov  
Optoelectronics Division, EEEL, Boulder  
Joseph T. Hodges, (301) 975-2605, joseph.hodges@nist.gov  
Process Measurements Div., CSTL, Gaithersburg

### *Approximate staff (FTE):*

0.5 Professional, 0.3 Contractor

### *Funding sources:*

NIST (100 %)

### *Objective:*

Develop and demonstrate new instrumentation that will enable manufacturers to measure, reduce, and certify water contamination in source materials for semiconductor synthesis. The consumers of these products may also find the instrumentation useful to confirm vendor specifications and equipment performance.

### *Constituency:*

Manufacturers of near-infrareds laser diodes for telecommunications and data communications, light-emitting diodes, high-efficiency photovoltaics, high-speed photodetectors, and focal plane arrays.

### *Principal current tasks:*

- Construct continuous-wave ring-down cavity spectroscopic instruments in both CSTL and EEEL
- Measure water line strengths using the CSTL ring-down cavity and the low-frost-point humidity generator
- Measure water impurity concentrations in nitrogen and phosphine using the EEEL cavity with sensitivity less than 1 nmol/mol.

### *Additional information:*

Water and oxygen are extremely detrimental impurities in most light-emitting semiconductor devices; contamination of the source gases used in semiconductor synthesis affects device performance even at amount fractions of 1 nmol/mol. With the cavity ring-down spectroscopy technique used here, no calibration is required as the number density is derived (using first-principles) from measurements of cavity decay times (illustrated in figure above), laser frequency shifts, and from knowledge of a fundamental property of the target molecule—the water line strength. In contrast, other high sensitivity methods based on absorption spectroscopy depend on many additional instrumentation-dependent factors. Improved source purity measurements techniques are called out as a specific project in the Optoelectronics Industry Development Association (OIDA) Technology Roadmap Program (1996). This topic was included in the ATP Photonics Manufacturing white paper and reiterated at the OIDA Metrology Workshop held at NIST in February 1998 (OIDA report “Metrology for Optoelectronics”).

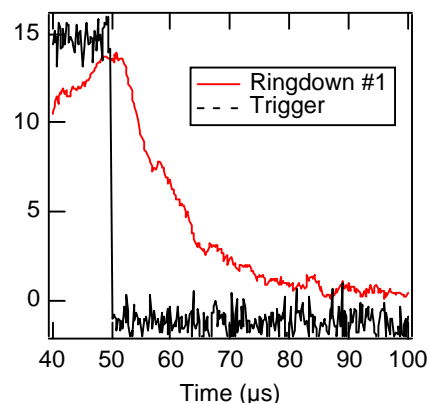



## ***In Situ* and *Ex Situ* Characterization of Compound Semiconductor Growth and Processing**

### *Project Leader/contact:*

Kris Bertness, (303) 497-5069, bertness@boulder.nist.gov  
Optoelectronics Division, EEEL, Boulder

### *Approximate staff (FTE):*

2.5 Professionals, 0.3 Contractor

### *Funding sources:*

NIST (95 %), CRADA (5 %)

### *Objective:*

Develop measurement methods and provide data to support the efficient manufacture of semiconductor optoelectronic devices, and provide advanced devices and materials to support industry, other parts of NIST, universities, and government laboratories.

### *Constituency:*

Manufacturers of near-infrared laser diodes for telecommunications and data communications, light-emitting diodes, photodetectors, and integrated optoelectronic devices.

### *Principal current tasks:*

- Evaluate and improve structural integrity of buried native AlGaAs oxide layers in MBE and MOCVD grown samples (illustrated above; arrows indicate oxidation front).
- Coordinate round robin study on *ex-situ* characterization of InGaAsP using x-ray diffraction, photoluminescence (PL) and photoreflectance (PR), in order to develop reliable measurement and data analysis methods.
- Improve accuracy and precision of *in situ* composition measurements of epitaxial III-V semiconductor films by reflection high-energy electron diffraction (RHEED), optical reflectance spectroscopy (ORS), and atomic absorption flux measurements.
- Develop and promote new techniques of noncontact thermometry for substrate temperature measurement during epitaxial crystal growth.
- Explore methods of creating periodic arrays of quantum dots using nanopatterned substrates (collaboration with industry).

### *Additional information:*

Semiconductor optoelectronics are ubiquitous in modern life—they are both the light sources and receivers for optical fiber communications, the lasers in laser printers and CD-ROM drives, and the sources and detectors for remote control and wireless links. Recent advances in semiconductor materials manufacturing has opened up the path for more energy-efficient lighting using light-emitting diodes (LEDs), currently applied in automotive lighting, traffic signals, and outdoor billboards, with expansion to indoor lighting expected in the next ten years. As these products reach commodity status, improved standardization of measurement of the basic materials properties and controlling manufacturing parameters such as layer strain, layer thickness and growth temperature become more and more important. This project addresses these manufacturing issues directly through experiments using a gas-source molecular beam epitaxy system, processing equipment (including an oxidation furnace), and the materials characterization systems listed above.

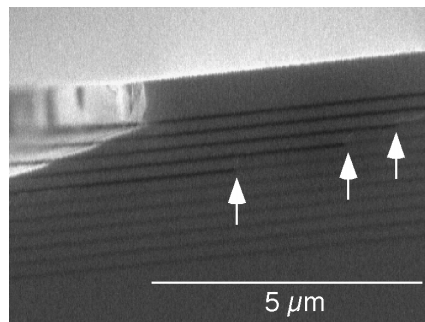

## Nanostructure Fabrication and Metrology

*Project Leader/contact:*

Richard P. Mirin, (303) 497-7955, mirin@boulder.nist.gov  
Optoelectronics Division, EEEL, Boulder

*Approximate staff (FTE):*

1.7 Professionals, 1 Graduate student

*Funding sources:*

NIST (66 %), Other Agency (34 %)

*Objective:*

Develop measurement methods based on epitaxial semiconductor nanostructures. Develop new techniques to fabricate, characterize and model nanostructures.

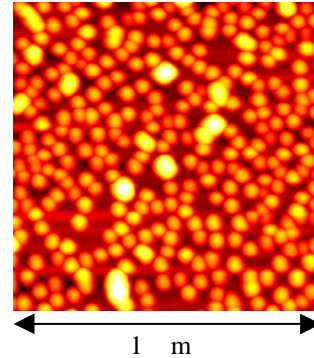

InGaAs quantum dots

*Constituency:*

Optoelectronics industry, nanoscale metrology equipment developers, and measurement instrumentation manufacturers

*Principal current tasks:*

- InGaAs quantum dot growth and characterization
- Investigation of quantum dot semiconductor optical amplifiers
- Broadband tunable laser diode development
- Semiconductor saturable Bragg absorber development

*Additional information:*

NIST is developing the fabrication and metrology of compound semiconductor nanostructures to support the optoelectronics industry in this area. Control and measurement of the size, location, and optical properties of nanostructures are fundamental to their applications. For example, the resonant absorption cross-sections and the homogeneous linewidths of quantum dots have not yet been measured. The ultrafast properties of quantum dots in a waveguide are being studied for the realization of the next-generation of optical devices such as laser diodes, photodetectors, and optical amplifiers. Broadband tunable lasers based on quantum dots and quantum wells are being developed for use in the measurement of the spectral responsivity of detectors. The fabrication and characterization of semiconductor saturable absorbers are being pursued for compact mode-locked solid-state lasers for signal processing applications.

## Nonlinear Optical Analysis of III-Nitride Alloys

### Project Leader/contact:

Norman A. Sanford, (303) 497-5239,  
sanford@boulder.nist.gov  
Optoelectronics Division, EEEL, Boulder

### Approximate staff (FTE):

1.4 Professionals

### Funding sources:

NIST (100 %)

### Objective:

Apply methods of nonlinear optics (NLO) to develop advanced measurements for III-nitride semiconductor bulk crystals and thin films and related materials. Correlate results of NLO analysis with structural features in the materials and with macroscopic and microscopic analytical methods, including x-ray diffraction imaging and cathodoluminescence. Working with collaborators, establish criteria relating results of NLO analysis with device performance and fabrication yield.

### Constituency:

Primarily, developers and manufacturers of lasers, LEDs, UV detectors, and high-temperature electronic devices based in III-nitride semiconductors.

### Principal current tasks:

- Characterization of mixed phases, stacking faults, domain-reversed layers, strains, and piezoelectric fields in thin-film and bulk GaN. Correlation of the x-ray diffraction imaging of these features with NLO analysis.
- Measurement of wavelength dependent refractive index and birefringence in III-nitrides and related alloys.
- NLO examination of GaN surfaces that have been processed with chemically-assisted ion beam etching.

### Additional information:

Group III-nitride materials play a critical role in the manufacture of optical sources for data storage and display applications, UV detectors for solar blind operation, and high temperature electronics. NIST is developing measurement methods and acquiring critical materials data to improve the manufacturing of GaN bulk crystals, thin films of III-nitride compound semiconductors, and the devices fabricated in these materials. To date, this work has involved studying these systems with the complementary methods of nonlinear optical analysis and high-resolution x-ray diffraction imaging. Evolving efforts include correlating this work with results obtained from cathodoluminescence studies. Work in this project builds on the very successful results of characterizing composition, strain, thickness, and domain-inversion, and the uniformity of these parameters in lithium niobate substrates and thin films.

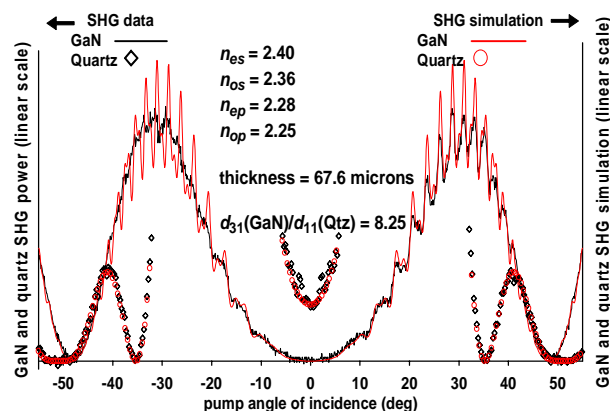

## Metallurgy of the Electrical Contacts to GaN-based Semiconductors

### *Project Leader/contact:*

William J. Boettinger, (301) 975-6160, william.boettinger@nist.gov  
Albert Davydov, (301) 975-4916, albert.davydov@nist.gov  
Metallurgy Division, MSEL, Gaithersburg

### *Approximate staff (FTE):*

0.4 Professional, 1.0 Guest Researcher

### *Funding sources:*

NIST (100 %)

### *Objective:*

Develop metallization information that will enable the design of improved electrical contacts to n- and p-type gallium nitride (GaN) based semiconductors for optoelectronic and electronic device fabrication.

### *Constituency:*

Electronic industry interested in utilizing wide-band-gap semiconductors for optoelectronic and high-frequency, high-power, and high-temperature microelectronic devices.

### *Principal current tasks:*

- Experimental study and thermodynamic analysis of the thermal stability of the base semiconductor material, GaN
- Determination of metallurgical reactions and diffusion paths for metallization of Ti/Al on n-type GaN and Ni on p-type GaN
- Correlation of interfacial reactions in thin films of metal contacts on GaN with bulk diffusion studies and phase equilibria in the Metal-Ga-N systems (Ti-Al-Ga-N and Ni-Ga-N)
- Evaluation of thermal stability and electrical characteristics of metal alloy contacts to n-GaN and p-type GaN coupled with interfacial reaction products

### *Additional information:*

This project examines the effect of the metal-semiconductor interfacial reactions on thermal and electrical performance of metal contacts to n- and p-type GaN. Coupling interfacial reactions with fundamental phase diagram, thermodynamic and kinetic data can be used to develop thermally stable metal contacts with improved characteristics for electronic industry needs.

Present collaborators include University of Florida and TDI Inc., for GaN thin film deposition; Semiconductor Electronics Division at EEEL, NIST (Wen Tseng, wen.tseng@nist.gov) for electrical characterization of metal contacts; Ceramic Division at MSEL, NIST (Laurence Robins, laurence.robins@nist.gov) for optical characterization of near-interface GaN region; and Surface and Microanalysis Science Division at CSTL, NIST (John Small, john.small@nist.gov) for microstructural and compositional investigation of the metal contact/semiconductor interfaces.

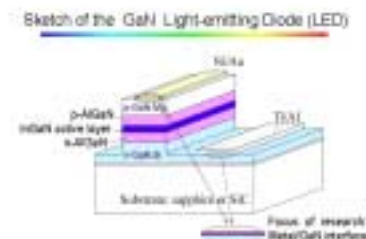

## ***In Situ*, Spatially Resolved Characterization of Free Carrier Concentration and Mobility During III-V Semiconductor Film Growth and Etching**

### *Project Leader/contact:*

James E. Maslar, (301) 975-4182, jmaslar@nist.gov  
Process Measurements Division, CSTL, Gaithersburg

### *Approximate staff (FTE):*

0.75 Professional, 0.25 Technician

### *Funding sources:*

NIST (50 %), ATP (50 %)

### *Objective:*

Develop an *in situ* non-destructive probe of III-V semiconductor carrier properties that is suitable for process monitoring and control during film growth and processing.

### *Constituency:*

III-V semiconductor epilayer and wafer producers, III-V semiconductor processing companies

### *Principal current tasks:*

- Evaluate different Raman spectral models
- Incorporate into the spectral models the dependence on temperature and on each of other appropriate material properties, e.g., band structure, carrier concentration, and carrier effective mass
- Apply new and sophisticated fitting procedures that uniquely utilize complex spectral models to incorporate both carrier and temperature dependent effects
- Examine a broad range of materials to establish the general applicability of this technique

### *Additional information:*

Transport of free carriers is central to the operation of all optoelectronic devices. Therefore, at some stage in device fabrication the measurement of the carrier properties is critical. Hall or capacitance-voltage measurements are traditionally used to obtain this information. However, these techniques require an electrical contact. This precludes their use *in situ* during growth or processing and typically even on actual device layers. As an optical technique, Raman spectroscopy does not suffer from these limitations. In addition, it is nondestructive, spatially resolved, and can be applied to a specific buried layer, sometimes a problem for traditional electrical measurements.

At the heart of this technique is the sensitivity of Raman spectroscopy to interaction between free carriers and polar lattice vibrations. From the Raman spectrum, the majority carrier properties are determined via fitting an appropriate spectral model. In order to evaluate the potential of Raman spectroscopy as a probe of semiconductor majority carrier properties, we are systematically addressing a number of issues. The results of this investigation should allow potential users to determine the suitability of Raman spectroscopy to their application, e.g., material system, processing temperature, majority carrier type, or doping level.

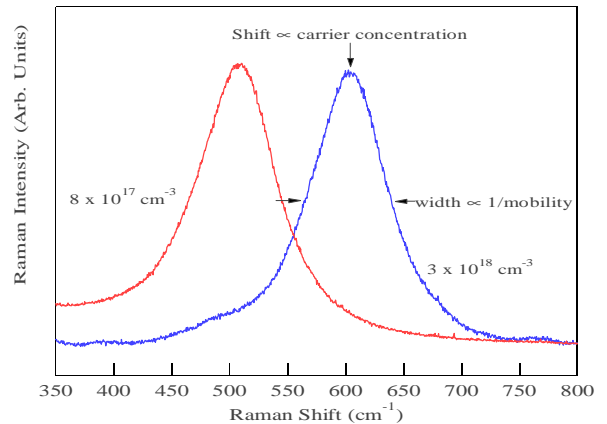

## Calibration and Performance Testing of Planar Micropositioners

### *Project Leader/contact:*

Edward G. Amatucci, (301) 975-3456, edward.amatucci@nist.gov  
Nicholas G. Dagalakis, (301) 975-5845, nicholas.dagalakis@nist.gov  
Intelligent Systems Division, MEL, Gaithersburg

Lowell P. Howard, (301) 975-3227, lowell.howard@nist.gov  
Fredric E. Scire, (301) 975-3499, fredric.scire@nist.gov  
John A. Kramar, (301) 975-3447, john.kramar@nist.gov  
Precision Engineering Division, MEL, Gaithersburg

### *Approximate staff (FTE):*

0.25 of 5 Professionals

### *Funding sources:*

NIST-ATP

### *Objective:*

Develop performance, calibration, and testing techniques for planar micropositioners.

### *Constituency:*

Optoelectronic devices assembly manufacturers, micropositioner manufacturers.

### *Principal current tasks:*

- Fabrication, assembly and calibration of parallel cantilever biaxial micropositioning stage
- Performance testing and development of control systems

*Additional information:* The phenomenal growth of optoelectronic manufacturing and future applications in micro and nano manufacturing has raised the need for low-cost high performance micropositioners. The NIST Advanced Technology Program funded a team of NIST scientists and engineers to address the performance, testing and calibration needs of micropositioners. As a result of this effort various performance testing and calibration techniques are being developed on a new generation of planar micropositioners with low crosstalk, good lateral resolution and strong load capabilities for delicate sub-micron automated assembly and positioning applications. The Parallel Cantilever Biaxial Micropositioning Stage above, is composed of two piezo-electric translators (PZTs) with internal capacitance sensors, two flexure joint couplings, a monolithic mechanical flexure baseplate, two capacitance sensors measuring the inner stage motions, control software, and supporting commercial electronics. Inspired from the PiezoFlex<sup>1</sup> Stage, which has only one cantilever flexure mechanism on each axis, this new micropositioning stage has a novel configuration and design in that it has two parallel sets of cantilever beam flexures. This design reduces crosstalk in the X and Y translations and creates motions that are more linear and independent from each other in the X and Y directions.<sup>2</sup>

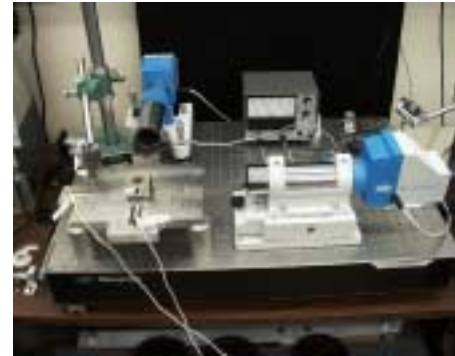

Performance Testing of Parallel Cantilever 2D Micropositioning Stage

---

<sup>1</sup> PiezoFlex is a trademark associated with Wye Creek Instruments design of a flexure stage. This and certain commercial products are identified in this paper to specify experimental procedures adequately. Such identification is not intended to imply recommendation or endorsement by the National Institute of Standards and Technology, nor is it intended to imply that the products identified are necessarily the best available for the purpose.

<sup>2</sup> Amatucci, E.G., Dagalakis, N.G., Kramar, J.A., Scire, F.E., Performance Evaluation of a Parallel Cantilever Biaxial Micropositioning Stage, ASPE Annual Meeting, October 22-26, 2000.

## Calibration and Performance Testing of 6-D Micropositioners

*Project Leader/contact:*

Nicholas G. Dagalakis, (301) 975-5845, nicholas.dagalakis@nist.gov  
Edward G. Amatucci, (301) 975-3456, edward.amatucci@nist.gov  
Intelligent Systems Division, MEL, Gaithersburg

Lowell P. Howard, (301) 975-3227, lowell.howard@nist.gov  
Precision Engineering Division, MEL, Gaithersburg

*Approximate staff (FTE):*

0.75 FTE

*Funding sources:*

NIST-ATP

*Objective:*

Develop calibration and testing techniques for six degrees (6-D) of freedom micropositioners.

*Constituency:*

Optoelectronic devices assembly manufacturers, micropositioner manufacturers.

*Principal current tasks:*

- Calibration of position and orientation sensor
- Calibration of prototype 6-D micropositioner
- Performance testing

*Additional information:*

The phenomenal growth of the optoelectronics market has necessitated the development of new multiple degrees of freedom micropositioner/microrobotic (MPMR) devices. Many of the MPMR devices use deformable kinematic structures, that are capable of very high resolution motions with no backlash or stiction. With the help of proper sensors, grippers and high precision robotic devices, an MPMR can be used to perform complex assembly and testing operations of optoelectronic devices.

With NIST-ATP intramural funding support a group of researchers from the Intelligent Systems Division (ISD) and the Precision Engineering Division (PED) of the Manufacturing Engineering Laboratory (MEL) of NIST are developing calibration and performance testing techniques and metrology sensors for MPMRs. These techniques and sensors are being tested on a 6-D micropositioner prototype of a parallel kinematic structure, with flexures machined at strategic locations, which can deform in a predictable and repeatable way to generate desired tool motions. The deformation is induced by piezoelectric actuators, which can be fast and have no backlash or stiction. The picture shows the micropositioner prototype during a calibration operation. A true square reflecting cube is attached underneath the moving platform stage. The position and orientation of the true square is monitored by a cluster of optoelectronic sensors, which are housed in a well-calibrated sensor nest. Various calibration motions and data analysis algorithms will be investigated.

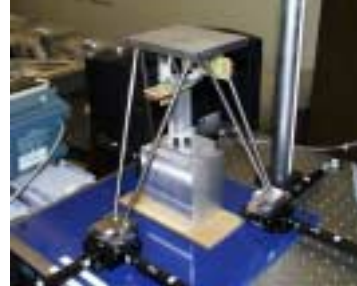

## Optical Current and Voltage Transducers for Electric Utility Applications

### *Project Leader/contact:*

Gerald J. FitzPatrick, (301) 975 2737, fitzpa@nist.gov  
Electricity Division, EEEL, Gaithersburg

### *Approximate staff (FTE):*

1.0 Professional

### *Funding sources:*

NIST (100 %)

### *Objective:*

Provide measurements and calibrations of optical current transducers (OCTs) and optical voltage transducers (OVTs) designed for use in electric power systems for revenue metering, power flow monitoring, and diagnostics applications.

### *Constituency:*

Electric utilities are interested in this work since traceability to NIST is common, and sometimes is required by law. OCT and OVT manufacturers look to NIST for verification of the accuracy of their prototype and production devices.

### *Principal current tasks:*

- Development of digital techniques for OCT and OVT measurements having low signal-to-noise ratios.
- Extension of the application of low-uncertainty analog measurement techniques used with conventional instrument transformers to optical current and voltage transducers.

### *Additional information:*

In the early 1990s, electric utilities viewed all-dielectric optical current sensors as an attractive substitute for conventional oil-filled current transformers after a number of them failed catastrophically. Now with the deregulation of electric utilities, there has been an emergence of many independent power producers (IPPs) and merchant plants. Electric utilities must meter not only the electric power produced by these non-utility power generators, but also the power they consume when off-line. Accurate bidirectional metering is therefore required at vastly different power levels, and utilities are looking to employ optical sensors to perform the task. Optical current and voltage sensors also have much wider bandwidth capability than conventional instrument transformers. They are therefore capable of measuring higher-order harmonics and are better suited to wide-bandwidth diagnostics. NIST has been active supporting equipment manufacturers by providing measurements of prototype OCTs as well as production-model OVTs for metering applications.

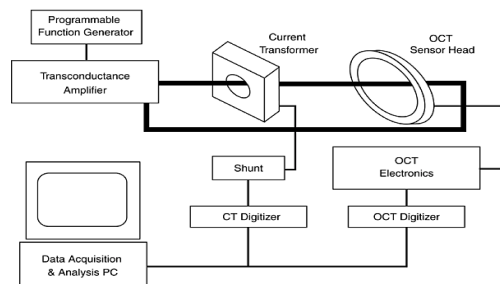



## High-speed Electrical Pulse Metrology, Generation, and Applications

### *Project Leader/contact:*

N. Paulter, 301-975-2405, nicholas.paulter@nist.gov  
Electricity Division, EEEL, Gaithersburg

### *Approximate staff (FTE):*

1 Professional, 0.25 Technician

### *Funding sources:*

STRS (90 %), OA (10 %)

### *Objective:*

Develop well-characterized short-duration or fast-transition electrical pulses for determination of the impulse or step response of the oscilloscope used in our NIST Special Tests for pulse waveform measurements.

Develop a photoconductor- or electrooptic-based sampling system for measuring high-speed/high-frequency electrical signals that will be used to determine the impulse or step response of high-speed samplers and linear circuits. Evaluate the performance of the Optical Microwave Sampling System obtained through an SBIR project. This supports our present Special Test Service.

### *Constituency:*

This effort supports the high-speed oscilloscope and pulse generator/instrument market by providing calibration support for the Electricity Division's pulse parameter special test services. Additionally, manufacturers of high-speed samplers and pulse generators have requested measurement services. Measuring the step response of certain circuits provides an impedance profile which is important to the development of high-speed/high-frequency systems (telecommunications, computers).

### *Principal current tasks:*

- photoconductor device development
- device package development and electrical characterization
- laser-based measurement system development

### *Additional information:*

The photoconductor package was developed to minimize the effects of impedance discontinuities between the scope and package connections and of reflections from the backward-propagating pulse. Target electrical pulse parameters: 0.25 to 0.5 V variable peak amplitude into 50  $\Omega$ , pulsewidth between 0.5 and 1.5 ps, flat baseline over a 10-ns interval, and spurious signals <1 % of peak amplitude (none to 100 ps after peak). For a step-pulse generator, the pulse parameters will be appropriate to provide the same bandwidth as the impulse generator. Hewlett-Packard and Tektronix have requested traceability to NIST for their high-speed (bandwidth exceeding 50 GHz) oscilloscopes. Recently Lecroy introduced a 60 GHz bandwidth sampler. The photoconductor sampling effort was started in Boulder about 1990 with the purchase of a YAG-based short-pulse laser system. Additional equipment purchases necessary to implement the laser-based measurement system were not made until the work was moved to Gaithersburg (about 1992), after which time it was determined that the YAG system was not capable of providing a stable (over hours) optical pulse train. Funding did not permit purchase of a suitable replacement laser system until FY99, when a short-pulse fiber laser was acquired for another technical project.

## **Electro-optic Electrical Waveform Measurements**

*Project Leader/contact:*

N. Paulter, 301-975-2405, nicholas.paulter@nist.gov  
Electricity Division, EEEL, Gaithersburg

*Approximate staff (FTE):*

0.5 Professional

*Funding source:*

STRS (100 %)

*Objective:*

Develop electrooptic- (eo) based techniques for measuring electrical waveform parameters, such as rms voltage, for profiling high-voltage pulses, and for measuring the temporal (and corresponding frequency) characteristics of high-speed/high-frequency waveforms.

*Constituency:*

This is a new project area; consequently, clientele has not been firmly established. Interest in using eo-based rms and power measurement techniques has been expressed by the U.S. Army and U.S. Navy. Test instrumentation industry has stated interest in measuring the phase response of high-speed samplers and the PCS industry is interested in the phase response of amplifiers.

*Principal current tasks:*

- broadband rms voltage measurement system
- high-voltage pulse profiling
- phase response measurement system

*Additional information:*

A prototype rms voltage measurement system was developed providing about 1 % uncertainty up to 1 MHz. Work in this area has stopped due to lack of sponsor(s) to cost share further improvements to system, which has since been disassembled. However, the Navy funded an SBIR effort that was based on our initial work. This effort was in developing a monolithic integrated optic device but, because of low signal-to-noise, was not successful. Work on a high-voltage electrical pulse measurement system was started with ATP funds but discontinued after funding was stopped.

## Noninvasive Waveform Measurement for Digital Integrated Circuits

*Project Leader/contact:*

Dylan Williams, (303)497-3138, dylan@boulder.nist.gov  
Radio Frequency Technology Division, EEEL, Boulder

*Approximate staff (FTE):*

1.0 Professionals, 0.5 Technician, 0.5 Guest Researcher

*Funding sources:*

NIST (100 %)

*Objective:*

Provide metrology, standards, and measurement expertise to support high-speed digital IC manufacturers and users.

*Constituency:*

Digital IC test equipment manufacturers, digital communications industry, high-speed optical telecommunications industry

*Principal current tasks:*

- Optoelectronic primary calibration standard for time-domain sampling heads
- On-wafer integrated noninvasive waveform measurement probes
- Calibrated on-wafer waveform measurement transfer standards
- Calibrated transmission-line measurements on silicon substrates

*Additional information:*

Complex digital processors feature submicron line widths, multiple interconnect levels, and processing speeds of 1 GHz or greater. High-speed optical telecommunication circuits, while simpler in architecture and usually constructed with larger transmission-line widths, integrate optical detectors and transmitters with digital multiplexing and demultiplexing electronics that now operate at speeds as high as 40 GHz. Accurate testing of these circuits requires noncontacting (or noninvasive) on-wafer waveform measurement technologies calibrated to bandwidths of 100 to 200 GHz.

By marrying electrooptic sampling systems and traditional time- and frequency-domain measurement instrumentation, we will help create a new paradigm for the noninvasive test of high-speed digital integrated circuits. This test paradigm will speed design and result in improved performance for the following technologies key to the electronics industry:

- Complex CMOS microprocessors
- New generations of high-speed digital circuits based on nanotechnology
- High-speed optoelectronic telecommunication circuitry

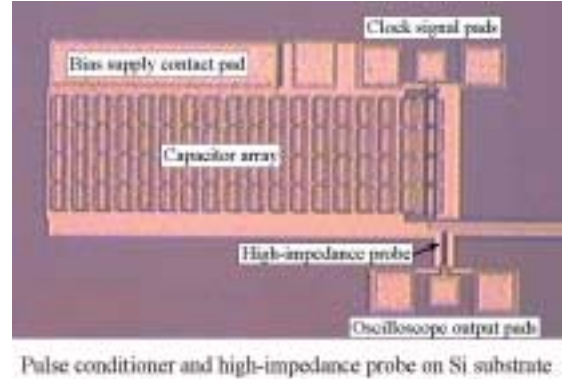

## Magnetodynamics

### *Project Leader/contact:*

Tom Silva, (303) 497-7826, silva@boulder.nist.gov  
Magnetics Division, EEEL, Boulder

### *Approximate staff (FTE):*

2 Professionals

### *Funding sources:*

NIST (80 %), Other Agency (20 %)

### *Objective:*

Develop metrology and understanding of magnetization dynamics in technologically relevant ferromagnetic materials. Assist magnetic data storage industry in improvement of commercial produce data rates.

### *Constituency:*

Magnetic data storage industry, telecommunications industry

### *Principal current tasks:*

- Develop methods for the quantitative study of high speed switching in ferromagnetic films
- Improve understanding of ferromagnetic switching processes
- Discover technologically useful applications for magnetodynamic physics

### *Additional information:*

We have sought to extend magneto-optics for the quantitative measure of magnetization dynamics in practical ferromagnetic films. Methods include time-resolved generalized magneto-optic ellipsometry (TRe-GME), time-resolved second-harmonic magneto-optic Kerr effect (TRe-SHMOKE), and quantitative wide-field Kerr microscopy (Mokeroscope). All these systems rely upon rf waveguide technology for the delivery of fast magnetic field pulses to excite magnetization switching in specimens. The fully functional TRe-SHMOKE system employs a commercial mode-locked Ti:sapphire laser with 10 W solid-state pump. The system is capable of producing 50 fs/15 nJ pulses at an 82 MHz pulse repetition rate (prf). The prf can be adjusted with an electro-optic pulse picker capable of >90 % transmission. The second-harmonic generation (SHG) is detected with a photon counting system consisting of a single-photon sensitive photomultiplier tube (PMT), sub-nanosecond optical trigger, and coincident counting system with a dark count level of less than 50 cps when used at a repetition rate of 1 MHz. The polarization state of the SHG is measured with a photoelastic modulator together with a digital lock-in amplifier. The system has been recently enhanced to include simultaneous linear magneto-optic detection. Primary use of the instrument is the study of disk drive head materials. The Mokeroscope system uses incandescent monochromatic light from a filtered arc-lamp source and fiber-optic episcopic illumination system. Image collection is performed with a high-performance CCD camera system with 16 bit dynamic range. The system has been used successfully to characterize the switching speed of high-coercivity thin films that are capable of storing digital information. The TRe-GME system is presently under development. It will use a 15 ps pulsed diode laser (810 nm) and a balanced photodiode detection system to quantify the spin dynamics in novel spintronics materials, including ferromagnet/semiconductor (FM/SC) heterostructures. The completed optical system will be used in conjunction with an optical cryostat/superconducting magnet system capable of cooling samples to 4 K in an 8 T magnetic field.

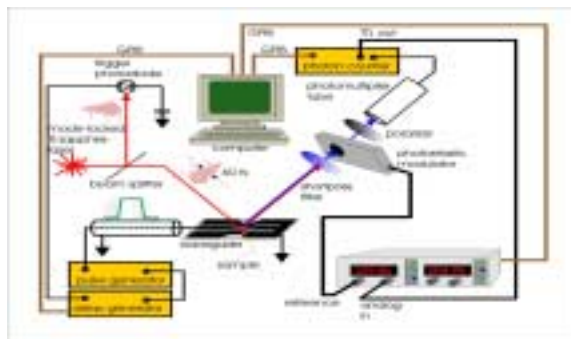

Time-resolved second-harmonic magneto-optic Kerr effect (TRe-SHMOKE) system.

## Magneto-Optical Indicator Film (MOIF) Technique

### *Project Leader/contacts:*

Robert Shull (301) 975-6035, robert.shull@nist.gov  
Alexander Shapiro (301) 975-5970, alexander.shapiro@nist.gov  
Metallurgy Division, MSEL, Gaithersburg

### *Approximate staff (FTE):*

0.5 Professional, 1 Guest Researcher

### *Funding sources:*

NIST (100 %)

### *Objective:*

To implement a technique for non-destructive quality control of ferromagnets and direct experimental studies of the microscopic remagnetization process mechanisms of nanocomposite magnetic materials.

### *Constituency:*

Manufacturers and developers of miniature magnetic devices such as the new generation of magnetic read heads for computer memory and magnetic field sensors.

### *Principal current tasks:*

- Investigation of the domain wall nucleation and motion processes in magnetic multilayers used for GMR devices.
- Observation of the magnetic features and remagnetization of two-dimensional lattices of nanomagnets.
- Study of the exchange-spring behavior in epitaxial hard/soft magnetic bilayers.
- Analysis of the remagnetization mechanisms in spin valves and ferromagnet/antiferromagnet bilayers with unidirectional anisotropy.

### *Additional information:*

The advanced magneto-optical indicator film (MOIF) technique uses a Bi-substituted yttrium iron garnet film with in-plane anisotropy, placed on a specimen to be analyzed, for observation of the magnetic stray fields above the specimen through the magneto-optical Faraday effect created in the garnet film. This optical image of the stray magnetic fields is observed by polarized light optical microscopy. The digital difference technique is used for quantitative analysis of the magneto-optical images. The MOIF technique is especially useful in providing information about magnetic domain structure and its dynamics. Nanocomposite materials under study are:  $\text{Sm}_2\text{Co}_7/\text{Fe}$  films on MgO substrate, Fe/Cr double superlattices, Co/Cu magnetic multilayers, epitaxial NiFe/MnFe bilayers, and artificial two-dimensional arrays of nanostructured magnetic particles (nanomagnets).

Collaborators include: the Johns Hopkins University, Argonne National Laboratory, Institute for Solid State Physics, Russian Academy of Sciences, Los Alamos National Laboratory, Massachusetts Institute of Technology, and University of California–San Diego.

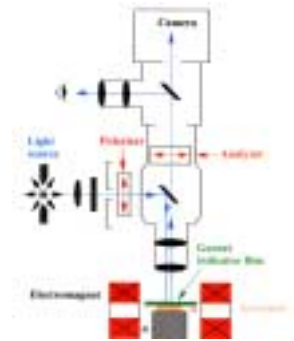

## INDEX

|  |            |  |            |
|--|------------|--|------------|
| absolute phase.....                    | 6          | electron microprobe analysis.....        | 50         |
| absorptance.....                       | 17         | electro-optic waveform measurements..... | 61         |
| absorption spectroscopy.....           | 51         | ellipsometry.....                        | 49         |
| algorithms.....                        | 33         | emission spectroscopy.....               | 50         |
| analog-to-digital conversion.....      | 42         | emittance.....                           | 17         |
| angular response.....                  | 44         | environmental-monitoring.....            | 28         |
| atom interferometer.....               | 1          | excimer lasers.....                      | 45         |
| atom laser.....                        | 1          | extreme ultraviolet (EUV).....           | 12, 18, 32 |
| atom optics.....                       | 1          |  |            |
| atomic absorption flux.....            | 52         | fault detection.....                     | 33         |
| atomic clock.....                      | 3, 4       | femtosecond laser.....                   | 21         |
| atomic spectra.....                    | 48         | ferromagnetic materials.....             | 63         |
|  |            | ferrule diameter.....                    | 43         |
| bidirectional reflectance.....         | 47         | fiber Bragg grating.....                 | 36, 37, 38 |
| biosensor.....                         | 1          | figure error.....                        | 31         |
| birefringence.....                     | 54         | flat panel display.....                  | 47         |
| blackbody.....                         | 10, 13     | flatness.....                            | 31, 32     |
| branching ratios.....                  | 48         | flexure.....                             | 57         |
|  |            | Fourier transform infrared (FTIR).....   | 17, 49     |
| calcium frequency.....                 | 3          | Fourier transform spectrometer.....      | 20         |
| calibration.....                       | 57, 58     | frequency comb.....                      | 5, 7       |
| candela.....                           | 11         | frequency domain measurements.....       | 35         |
| carrier concentration.....             | 50         | frequency response.....                  | 35         |
| carrier dynamics.....                  | 19, 22     | frequency standards.....                 | 3, 4, 5    |
| cathodoluminescence.....               | 54         | fundamental physics.....                 | 25         |
| cavity ring-down spectroscopy.....     | 51         |  |            |
| cesium frequency standard.....         | 3          | global climate change.....               | 27         |
| colorimetry.....                       | 11         | GPS receivers.....                       | 4          |
| components.....                        | 38         | grating.....                             | 18         |
| composition measurements.....          | 50, 52     | growth monitoring.....                   | 49         |
| compound semiconductor.....            | 49, 52     | growth temperature.....                  | 49         |
| cryogenic radiometers.....             | 13         |  |            |
|  |            | high-speed/high-frequency waveforms..... | 61         |
| deep level transient spectroscopy..... | 49         |  |            |
| defect structure.....                  | 30         | III-Nitride Alloys.....                  | 54         |
| depolarization.....                    | 39         | illuminance.....                         | 11         |
| detector linearity.....                | 44         | imaging.....                             | 25         |
| detector.....                          | 15         | impulse response.....                    | 35, 62     |
| diattenuation.....                     | 39         | impurity concentration.....              | 51         |
| diffuse reflectance spectroscopy.....  | 49         | infrared (IR).....                       | 15         |
| diode laser.....                       | 4, 28      | in situ measurement.....                 | 56         |
| dispersion.....                        | 38         | integrating sphere.....                  | 14         |
| displays.....                          | 11         | interfaces.....                          | 22, 55     |
| distributed-Bragg-reflector (DBR)..... | 42         | interferometric length measurements..... | 9          |
| distribution function (BRDF).....      | 47         | interferometry.....                      | 31, 32     |
| dosimetry.....                         | 18         | International Temperature Scale.....     | 10         |
| DUV.....                               | 12, 32, 45 | irradiance.....                          | 15         |
|  |            |  |            |
| Earth Observing System.....            | 27         | jitter.....                              | 42         |
| electric power metering.....           | 59         |  |            |
| electrical contacts.....               | 55         | laser calorimeter.....                   | 44, 46     |
| electrical pulse metrology.....        | 60         | laser micrometer.....                    | 43         |
| electrical substitution.....           | 44, 46     | laser noise.....                         | 35         |
| electromagnetic interference.....      | 29         | laser power and energy measurements..... | 45, 46     |

|                                      |                    |   |               |
|--------------------------------------|--------------------|---|---------------|
| laser radiometry .....               | 35, 46             | optical lithography .....                     | 45            |
| light-emitting diodes (LEDs) .....   | 11, 50             | optical properties .....                      | 20            |
| light scattering .....               | 23                 | optical pumping .....                         | 25            |
| lighting .....                       | 48                 | optical reflectance spectroscopy .....        | 50, 52        |
| light-matter interactions .....      | 5                  | optical tweezers .....                        | 1             |
| linearity .....                      | 46                 | optical voltage transducers .....             | 59            |
| lithography .....                    | 18, 20, 39         | optical-fiber .....                           | 43            |
| loop antenna .....                   | 29                 | optics .....                                  | 18            |
| low-background infrared .....        | 13                 | optoelectronic devices manufacturing .....    | 57, 58        |
| low-coherence interferometer .....   | 38                 | optoelectronics .....                         | 44, 46        |
| lumen .....                          | 11                 | organic materials .....                       | 30            |
| luminance .....                      | 11                 | oscilloscope .....                            | 60            |
| <br>                                 |                    | <br>  |               |
| magnetic materials .....             | 64                 | particulate contaminants .....                | 23            |
| magnetic resonance .....             | 25                 | phase .....                                   | 21            |
| magnetization dynamics .....         | 63                 | phase noise .....                             | 34            |
| magnetodynamics .....                | 63                 | phase shift interferometer .....              | 38            |
| magneto-optic ellipsometry .....     | 63                 | phase stability .....                         | 34            |
| magneto-optic Kerr effect .....      | 63                 | photodetectors .....                          | 50            |
| magneto-optical Faraday effect ..... | 64                 | photodiode .....                              | 12, 35        |
| magneto-optical indicator film ..... | 64                 | photoelectron .....                           | 18            |
| majority carrier properties .....    | 56                 | photolithography .....                        | 20            |
| mercury ion frequency .....          | 3                  | photoluminescence (PL) spectroscopy .....     | 49, 50        |
| mercury .....                        | 48                 | photoluminescence .....                       | 52            |
| metal contacts .....                 | 55                 | photometry .....                              | 11, 15        |
| micromechanical device .....         | 1                  | photon turnstiles .....                       | 2             |
| micro-positioner .....               | 57, 58             | photonic bandgap .....                        | 1             |
| microscopy .....                     | 18                 | photonic crystals, molecules .....            | 2             |
| micro-spot Raman spectroscopy .....  | 49                 | photoreflectance .....                        | 49, 52        |
| microtomography .....                | 18                 | photoresist .....                             | 24            |
| microwave .....                      | 29                 | plasma diagnostics .....                      | 16            |
| mirror .....                         | 18                 | polarimetry .....                             | 39            |
| mode-locked lasers .....             | 6, 7, 42           | polarization dependent loss .....             | 40            |
| multilayers .....                    | 18                 | polarization dependent wavelength shift ..... | 40            |
| <br>                                 |                    | polarization mode dispersion .....            | 41            |
| narrow-linewidth .....               | 9                  | polymer .....                                 | 22, 24        |
| near-field scanning optical          |                    | position and orientation sensor .....         | 58            |
| microscopy (NSOM) .....              | 24, 30             | power .....                                   | 15            |
| network modeling .....               | 33                 | pulse generator .....                         | 60            |
| neutron polarization .....           | 25                 | pulsed diode laser .....                      | 63            |
| neutron scattering .....             | 25                 | pulsed-laser radiometry .....                 | 45            |
| noncontact thermometry .....         | 52                 | pyroelectric detector .....                   | 44, 46        |
| nonlinear optics .....               | 22, 54             | pyrometer .....                               | 10            |
| <br>                                 |                    | PZT coupler .....                             | 57            |
| optical amplifiers .....             | 53                 | <br>  |               |
| optical cavities .....               | 16                 | quantum computer .....                        | 1             |
| optical communications .....         | 35, 36, 44, 46, 62 | quantum dot .....                             | 2, 19, 52, 53 |
| optical components .....             | 37                 | quantum well .....                            | 19            |
| optical constants .....              | 18                 | <br>  |               |
| optical current transducers .....    | 59                 | radiance .....                                | 15            |
| optical fiber .....                  | 29, 34, 38, 41, 43 | radiance temperature .....                    | 10, 27        |
| optical fiber communication .....    | 40                 | radiometers .....                             | 13, 15, 26    |
| optical fiber components .....       | 40                 | radiometric calibration .....                 | 27            |
| optical fiber ferrules .....         | 43                 | radiometry .....                              | 12, 18, 48    |
| optical fiber power meter .....      | 44                 | radius of curvature .....                     | 31            |
| optical frequency standards .....    | 7, 8, 34           | Raman spectroscopy .....                      | 56            |
| optical frequency synthesizer .....  | 5, 6               | rare earth elements .....                     | 48            |
| optical lattice .....                | 1                  | rare-earth-doped glass .....                  | 42            |

|   |                |  |            |
|---|----------------|--|------------|
| reflectance.....  | 17             | tunable diode-laser.....                                   | 8, 28, 53  |
| reflectance high energy electron<br>diffraction (RHEED) ..... | 49, 50, 52     | ultrafast laser.....                                       | 22         |
| reflectometry.....  | 18, 47         | ultrafast .....  | 19         |
| refractive index .....  | 17, 18, 20, 54 | ultrashort pulses .....                                    | 6          |
| relative group delay .....                                    | 38             | ultraviolet (UV) .....                                     | 12, 15     |
| relative intensity noise .....                                | 35             | UV detectors.....  | 20         |
| remagnetization .....   | 64             | UV sources .....   | 20         |
| remote sensing .....  | 26, 27         | UV .....   | 15         |
| responsivity.....   | 14, 15         | vibration isolation .....                                  | 9          |
| retardance .....  | 39             | visible .....  | 15         |
| RF .....  | 29             | waveform measurements .....                                | 62         |
| saturable absorber mirrors .....                              | 42             | waveform synthesizer .....                                 | 6          |
| saturable Bragg absorber .....                                | 53             | waveguide lasers.....                                      | 42         |
| second-harmonic generation.....                               | 63             | wavelength calibration.....                                | 36         |
| semiconductor nanostructures.....                             | 53             | wavelength division multiplexing<br>(WDM) .....            | 33, 36, 40 |
| semiconductor.....  | 23, 50         | wavelength standards.....                                  | 36         |
| semiconductors .....  | 55             | wavelength-dispersive x-ray emission<br>spectroscopy ..... | 50         |
| simulated-eye-design (SED) camera .....                       | 47             | x-ray diffraction.....                                     | 52, 54     |
| source purity .....   | 51             | x-ray fluorescence.....                                    | 49         |
| space based radiometry.....                                   | 26             |  |            |
| spatial response.....   | 44, 46         |  |            |
| spectral ellipsometry.....                                    | 50             |  |            |
| spectral irradiance.....                                      | 14             |  |            |
| spectral metrology .....                                      | 37             |  |            |
| spectral radiance .....                                       | 14             |  |            |
| spectral response.....  | 44, 46         |  |            |
| spectrophotometry .....                                       | 17, 27         |  |            |
| spectroscopy .....  | 28             |  |            |
| spin dynamics .....   | 63             |  |            |
| SRM.....  | 17             |  |            |
| stacking faults .....   | 54             |  |            |
| step response.....  | 60             |  |            |
| strain .....  | 20, 54         |  |            |
| stray light.....  | 47             |  |            |
| submillimeter sources and spectroscopy.....                   | 16             |  |            |
| substrates .....  | 32             |  |            |
| sub-surface damage .....                                      | 31             |  |            |
| subsurface defects.....                                       | 23             |  |            |
| sum-frequency generation .....                                | 22             |  |            |
| Synchrotron Ultraviolet Radiation Facility<br>(SURF) .....    | 12             |  |            |
| surface roughness .....                                       | 23             |  |            |
| swept-frequency.....  | 8              |  |            |
| synchrotron radiation.....                                    | 12, 18, 20     |  |            |
| terahertz .....   | 21             |  |            |
| testing .....   | 57, 58         |  |            |
| thermal coefficients .....                                    | 20             |  |            |
| thickness .....   | 32             |  |            |
| thin films.....   | 22             |  |            |
| THz sources and spectroscopy.....                             | 16             |  |            |
| time standards .....  | 3              |  |            |
| time-domain measurements .....                                | 35, 62         |  |            |
| time-resolved amplitude .....                                 | 21             |  |            |
| trace-impurity .....  | 28             |  |            |
| transmittance.....  | 17             |  |            |