

Science, Service, Stewardship

2009

Observer

Sampling

Manual



OBSERVERS: KEEP THIS MANUAL THROUGHOUT THE 2009 FISHING YEAR

All cover photos by Roy Morse.

Cover photo of Bering Rose and Alaska Rose used by permission.

This document should be cited as follows:

(AFSC) Alaska Fisheries Science Center. 2009 Observer Sampling Manual. Fisheries Monitoring and Analysis Division, North Pacific Groundfish Observer Program. AFSC, 7600 Sand Point Way N.E., Seattle, Washington, 98115.

Reference in this document to trade names does not imply endorsement by the National Marine Fisheries Service, NOAA.

Errata

In the authoring of any document it is difficult to completely avoid mistakes, typographic errors, etc. The staff of the Fisheries Monitoring and Analysis Division (FMA) strives to ensure that there are as few errors in the Observer Sampling Manual as possible. Please contact FMA staff for the most current version of an errata document that serves to correct errors that were not caught prior to publication. Note that several cross-reference issues listed in the errata have been corrected in this disk version of the Manual. If you note anything further that should be corrected, please write to both Allison.Barns@noaa.gov and Brian.Mason@noaa.gov. In your message, please include the chapter name, page number, and describe the error.

Table of Contents

INTRODUCTION	1-1
The Observer Program	1-1
History of the Fishery	1-1
The Fishery Today	1-3
Management Plans	1-4
Certification and Endorsements	1-6
Deployment	1-7
ESSENTIAL INFORMATION	2-1
Introduction	2-2
Duties and Priorities	2-2
Standards of Observer Behavior	2-2
Completing and Organizing Forms	2-4
Observer Logbook Entries	2-7
Calculations	2-8
Selecting Hauls to Sample	2-9
Introduction to Sampling Theory	2-12
Subset Sampling	2-16
Using Your Scales	2-17
Sample Station Requirements	2-20
Working with Two Observers	2-22
Inseason Advisors and Text Messages	2-25
Sending Data	2-26
TRIP INFORMATION	3-1
Introduction	3-1
Safety Orientation	3-1
Become Familiar with Your Vessel	3-2
The Trip Data Form	3-4
TRIP Form QUICKLIST for ALL VESSELS	3-9
TRAWLER CATCH DATA	4-1
List of Priorities	4-1
Introduction	4-1
Documenting Fishing Effort	4-1
Observer Estimates of Catch Weight	4-4
Estimating Discards	4-11
Recording Offload Data on Trawlers	4-11
Recording OHF and VHF Data	4-14
Reviewing Forms for Errors	4-18
HAUL and OFFLOAD FORM QUICKLIST for TRAWLERS	4-26
TRAWLER COMPOSITION SAMPLING	5-1
List of Priorities	5-3
Introduction	5-3
Safety Onboard Trawlers	5-3
Sampling System Guidelines	5-4

Species Sampling Guidelines	5-4
Sample Bias	5-6
Mechanics of Sampling on C/Ps	5-9
Mechanics of Sampling on Catchers	5-10
Random Sampling on Trawlers	5-11
At-Sea Sample Sizes	5-18
Processing your At-Sea Samples	5-21
Offload Census: Pollock C/Vs	5-25
Observers Delivering to Motherships	5-28
Estimating Percent Retained	5-29
Limited Access Privilege Fisheries	5-30
If the Flow Scale is Not Working... ..	5-33
Deck Form Instructions	5-34
Paper Form Instructions	5-36
Reviewing Forms for Errors	5-38

MOTHERSHIP DATA COLLECTION 6-1

List of Priorities	6-1
Introduction	6-1
Catch Information (Haul Forms)	6-2
Observer Estimates	6-4
Codend Delivery Duties	6-4
Pumped Fish Delivery Duties	6-5
Random Sample and Break Table Use	6-5
Length Frequency and Biological Data	6-5
Observers Delivering to Motherships	6-5
Reviewing Forms for Errors	6-5

LONGLINE DATA COLLECTION 7-1

Terminology	7-2
List of Priorities	7-3
Safety Concerns on Longliners	7-3
General Description of Operations	7-3
Offload Data for Longliners	7-5
Fishing Effort Information	7-6
Estimating Discards	7-8
Recording OHF and VHF Data	7-9
Completing the Vessel Haul Form	7-9
Completing the Observer Haul Form	7-11
Verifying Gear	7-13
Composition Sampling Guidelines	7-16
Sample Bias	7-18
Random Sampling on Longliners	7-18
Tally Composition Samples	7-24
Species Identification Rules	7-26
Weight Samples	7-29
Managing Weight vs. Tally Data	7-31
Combined Samples	7-31
When There Are No Fish Encountered During the Sample	7-31
Halibut Injury Assessments	7-32
Seabirds	7-32
Estimating Percent Retained	7-33
Specimen Collection on Longliners	7-33

Individual Fishing Quota (IFQ)	7-34
CDQ Specific Information for Fixed Gear Catcher Vessels	7-35
CDQ Specific Information for Fixed Gear Catcher/Processors	7-36
Deck Form Instructions	7-36
Paper Form Instructions	7-39
Reviewing Forms for Errors	7-41
HAUL FORM QUICKLIST for LONGLINERS	7-53

POT VESSEL DATA COLLECTION 8-1

List of Priorities	8-1
Introduction	8-3
Safety Concerns on Pot Vessels	8-3
Offload Data for Pot Vessels	8-4
Estimating Discards	8-6
Recording Fishing Effort Data	8-6
Composition Sampling Guidelines	8-8
Sampling Designs on Pot Vessels	8-10
Sampling on Pot Vessels	8-14
Combined Samples	8-16
When There Are No Fish Encountered During the Sample	8-16
Estimating Percent Retained	8-16
Halibut Viabilities on Pot Vessels	8-16
Fish Measurements on a Pot Vessel	8-17
Deck Form Instructions	8-17
Paper Form Instructions	8-19
Reviewing Forms for Errors	8-21
HAUL FORM QUICKLIST for POT VESSELS	8-30

SHORESIDE PLANTS AND FLOATING PROCESSORS 9-1

List of Priorities	9-1
Introduction	9-1
Delivery Schedule	9-2
Observer Provider Responsibilities	9-2
Collecting Delivery Information	9-2
ADF&G Fish Tickets	9-3
Verifying Delivery Weights	9-3
After-Scale Area	9-4
Delivery Worksheet Verification	9-4
Assisting Vessel Observers	9-4
Sampling on the Arctic Enterprise	9-7
Sampling at Kodiak Processing Plants	9-8
Deliveries from Tender Vessels	9-8
Halibut Deliveries	9-8
Jig Boat Deliveries	9-8
Level 2 Information for Plant Observers	9-8
Referring Sampling Questions	9-10
Length Frequency Sampling	9-10
Age Structure Sampling	9-11
Special Projects	9-12
Reviewing Forms for Errors	9-12

PROHIBITED SPECIES SAMPLING	10-1
List of Priorities	10-1
Introduction	10-1
Sampling for Lengths and Specimens	10-2
FISH MEASUREMENT AND SPECIMEN COLLECTION	11-1
List of Priorities	11-1
Introduction	11-1
Collecting Fish for Specimen Data	11-2
Measuring Fish	11-3
Otoliths	11-6
Sexing Fish	11-10
Standard and Special Project Data	11-15
Length Specimen Form Instructions	11-15
Reviewing Forms for Errors	11-18
LENGTH and SPECIMEN FORM QUICKLIST	11-29
MARINE MAMMAL INTERACTIONS AND SIGHTINGS	12-1
List of Priorities	12-1
Introduction	12-1
Marine Mammal Protection Act	12-1
Marine Mammal Monitoring	12-2
Marine Mammal Interactions	12-2
Marine Mammal Specimens	12-5
Comment Entries on the MMIS Form	12-9
Tagged and Branded Marine Mammals	12-10
Intentional Feedings	12-10
Marine Mammal Sightings	12-10
Reviewing Forms for Errors	12-12
MARINE MAMMAL INTERACTION and SPECIMEN FORM QUICKLIST	12-17
TAGGED FISH AND CRAB INFORMATION	13-1
List of Priorities	13-1
Introduction	13-1
Electronic Tags	13-1
Tagged Crab	13-1
Tagged Salmon	13-2
Tagged Fish and Crab Form Instructions	13-2
BIRD SIGHTINGS AND INTERACTIONS	14-1
List of Priorities	14-1
Introduction	14-1
Species of Interest	14-2
Incidental Take	14-3
Injured Seabirds	14-3
Dead Bird Identification	14-3
Species Composition	14-4
Tag and Bag Procedures for Retained Seabird Specimens	14-4
Seabird Avoidance Initiatives	14-5
Reducing Seabird Bycatch	14-5
Other Seabird Interactions and Mortality	14-7
Documenting Seabird Interactions	14-7

Banded Birds	14-7
Sightings of Species of Interest	14-8

STOMACH COLLECTION 15-1

Introduction	15-1
Materials for Stomach Project	15-1
Stomach Sampling	15-2
Debriefing Questionnaire	15-6
Stomach Tally Sheet	15-6

ATLAS INSTRUCTIONS 16-1

Introduction	16-1
Starting the Atlas Software	16-1
Trip Data Form	16-4
Haul Data Form	16-5
Offload Data Form	16-6
Non-Fishing or Non-Delivery Day Form	16-6
Species Composition Data Form	16-7
Length Data Form	16-9
Specimen Data Form	16-10
Salmon Data Form	16-11
Marine Mammal Data Form	16-12
Text Messages	16-14
Transmitting Data	16-15
Archive/Backup	16-17
Print/Copy	16-18

HEALTH AND SAFETY INFORMATION 17-1

List of Priorities	17-1
Introduction	17-1
Before You Board	17-2
Issues to Address During A Safety Orientation	17-5
Embarking, Disembarking and Transferring Between Vessels	17-6
First Days Onboard	17-7
Personal Health and Safety	17-7
Illnesses and Accidents	17-10
Emergencies Onboard	17-11
Sending a May Day	17-12
Safety Equipment	17-12
The Seven Steps to Survival	17-15
Summary	17-16
Federal Requirements for Commercial Fishing Industry - Vessels greater than 60 ft.	17-17

REGULATIONS AND COMPLIANCE 18-1

Overview of Federal Groundfish Regulations	18-1
The Observer’s Role in Regulatory Compliance	18-1
Steps to Take if You Suspect a Violation	18-2
Debriefing	18-3
Regulations Applying to Observers	18-4
Regulations Protecting Observers	18-4
Partial Summary Of Federal Groundfish Fishing Regulations For The U.S. EEZ Off Alaska.	18-7
Prohibited Species §679.21	18-8

Halibut §679.7	18-8
BSAI Salmon Regulations §679.21	18-8
Improved Retention/Improved Utilization (IR/IU) §679.27	18-9
Groundfish Observer Program §679.50	18-10
Observer Data Transmission	18-11
Groundfish and Halibut CDQ Fisheries	18-12
AFA C/P and Mothership Vessels	18-12
AFA Inshore Processor Requirements	18-13
Prohibitions Specific to AFA Fisheries	18-13
Observer Provider Responsibilities	18-13
Trawl Gear Definitions §679.2	18-14
Groundfish Pots Requirements	18-15
Marking of Longline Gear	18-15
Seabird Avoidance Gear and Methods For Longliners	18-15
Regulations Concerning Shark Finning	18-16
Regulations Concerning Taking of Marine Mammals (Excerpts taken from 50 CFR 216 and 229)	18-16
Regulations Concerning Steller Sea Lions (excerpts from §679.22 and §223.202)	18-17
Observer Procedures During Coast Guard Boarding	18-18
Marine Pollution (MARPOL) Regulations	18-19
Vessel Operator Obligations	18-20
Marina Obligations	18-20

THE MID-CRUISE AND FINAL DEBRIEFING 19-1

List of Priorities	19-1
Introduction	19-1
Mid-cruise	19-2
Final Debriefing	19-3
Debriefing	19-4
Evaluations	19-5
Briefings	19-5

APPENDICES

GLOSSARY

INDEX



INTRODUCTION

Table of Contents

History of the Fishery.....	1-1
The Fishery Today	1-3
Vessel and Plant Descriptions	1-3
Pot Vessels	1-4
Longline Vessels.....	1-4
Trawl Vessels.....	1-4
Processing Plants	1-4
Management Plans.....	1-4
Time-Area Closures.....	1-4
Limited Access Privilege Programs	1-6
Other Management Agencies.....	1-6
Certification and Endorsements	1-6
Training.....	1-6
Deployment	1-7
Personal Equipment	1-7
Sampling Gear.....	1-9
Assignments	1-9
Communications.....	1-10

THE OBSERVER PROGRAM

The Fisheries Monitoring and Analysis (FMA) Division’s Observer Program collects, maintains, and distributes data for scientific, management, and regulation compliance purposes in the Gulf of Alaska (GOA) and the Eastern Bering Sea/Aleutian Islands (BSAI). The FMA Division is a component of the Alaska Fisheries Science Center (AFSC) of the National Marine Fisheries Service (NMFS). The parent agency for NMFS is the National Oceanic and Atmospheric Administration (NOAA), and NMFS is often referred to as NOAA Fisheries.

The FMA Division deploys over 300 certified groundfish observers each year on a variety of commercial fishing vessels. These observers, in turn, provide the Observer Program with over 37,000 data collection days annually.

An observer's job is unique, challenging and constantly changing. This manual is an indispensable tool both for trainees and experienced observers. It should be used as both a text book for trainees and a field reference manual for observers at sea. It contains the background, procedures and protocols on how to collect the wide variety of information requested, and some ideas on how to cope with specific situations. The methods described in this manual have been tested and

modified throughout the seventeen years of the domestic groundfish Observer Program and will continue to be refined with observer feedback and suggestions.

HISTORY OF THE FISHERY

Commercial fishing has occurred in the eastern Bering Sea since the early 1930s. Over time, the countries harvesting this resource have changed, as have the target fisheries. Prior to the 1960s, Japan and Russia dominated this industry, focusing predominantly on yellowfin sole. In the mid-1960s a decline in the flatfish stocks caused the Russians and Japanese to move toward walleye pollock as their main target species. During the 1960s and 1970s other countries, including Taiwan, the Republic of Korea, and Poland, began fishing in these profitable waters.

In 1973 NOAA Fisheries began placing observers on foreign vessels operating off the Northwest and Alaskan coasts, creating the North Pacific Foreign Fisheries Observer Program. The primary goals of these observers were to determine bycatch rates of Pacific halibut in groundfish catches and to verify catch statistics in the Japanese crab fishery. Later, observers collected data on bycatch of other commercially important species including king crab, Tanner (snow) crab, and salmonids.

INTRODUCTION: History of the Fishery

ABC- Acceptable Biological Catch	MSFCMA- Magnuson-Stevens Fishery Conservation and Management Act
ADF&G- Alaska Department of Fish and Game	MSY- Maximum Sustainable Yield
AFA- American Fisheries Act	NMFS- National Marine Fisheries Service
AFSC- Alaska Fisheries Science Center	NMML- National Marine Mammal Laboratory
ALT- Alaska Local Time	NOAA- National Oceanic and Atmospheric Administration
BBL- The Bird Banding Laboratory of the U.S. Geological Survey	NORPAC- North Pacific database (Observer Program database)
BSAI- Bering Sea & Aleutian Islands	NPFMC- North Pacific Fishery Management Council
C/P- Catcher/Processor	NPFOTC- North Pacific Fisheries Observer Training Center
CDP- Community Development Plan	NPGOP- North Pacific Groundfish Observer Program (FMA Division)
CDQ- Community Development Quota	NSR- Non-Specific Reserve
CFR- Code of Federal Regulations	OFL- Over Fishing Limit
CPR- Cardiopulmonary Resuscitation	OHF- Observer Haul Form
CPUE- Catch Per Unit Effort	OY- Optimum Yield
DCPL- Daily Cumulative Production Logbook	PFD- Personal flotation Device
DMSO- Dimethyl Sulfoxide	PLT- Pacific Local Time
EEZ- Exclusive Economic Zone	PRR- Product Recovery Rate
EPIRB- Emergency Position Indicating Radio Beacon	PSC- Prohibited Species Cap
FCC- Federal Communications Commission	PSQ- Prohibited Species Quota (for CDQ)
FMA Division - Fisheries Monitoring and Analysis Division (formerly NPGOP)	RBT- Random Break Table
FMP- Fishery Management Plan	RKCSA- Red King Crab Savings Area
FUS- Fully Utilized Species	RST- Random Sample Table
GOA- Gulf of Alaska	RSW- Refrigerated Sea Water
GPS- Global Positioning System	SSB- Single Side Band radio
IFQ- Individual Fishing Quota	TAC- Total Allowable Catch
IPHC- International Pacific Halibut Commission	USCG- United States Coast Guard
IR/IU- Improved Retention/Improved Utilization	VHF- Vessel Haul Form (or Very High Frequency radio)
IRCS- International Radio Call Sign	
LOA - Length overall	
MARPOL- Marine Pollution	
MRA- Maximum Retainable Amounts (was Maximum Retainable Bycatch)	

Figure 1-1 :Commonly Used Abbreviations and Acronyms



The flatfish and pollock fisheries remained largely foreign-harvested, off-shore fisheries until passage of the Magnuson Fishery Conservation and Management Act in 1976. This act was re-authorized in 1996 as the Magnuson-Stevens Fishery Conservation and Management Act. With this Act, the U.S. declared management authority over fish resources within 200 nautical miles from their shores - the Exclusive Economic Zone (EEZ). The goals of the Magnuson Act were to Americanize the fishery, implement fishery management plans, and to maintain optimum yield (OY) of the resource while rebuilding depleted groundfish stocks.

Additionally, the Magnuson Act established eight regional councils to manage the nation's fisheries. The North Pacific Fishery Management Council (the Council) has jurisdiction over the 900,000 square mile EEZ off the coast of Alaska.



When the Magnuson Act was passed, American fishers had little knowledge of how to harvest or process the groundfish species found in the North Pacific. To encourage investment in this resource, the American Fisheries Promotion Act was passed in 1980. This act required fish quotas be given preferentially to nations which contributed heavily to the development of the U.S. fishing industry. Instituting joint-venture fisheries, with American catcher vessels delivering their catch to large foreign floating processors, allowed foreign countries to continue receiving their quota, while developing the domestic fleet. By 1991 all foreign commercial fishing within the 200 mile EEZ was terminated, leaving an entirely domestic fishery.

THE FISHERY TODAY

As the fisheries changed, so did the Observer Program. The Council implemented the domestic North Pacific Observer Program to gather data needed to manage the wide variety of fisheries off the coast of Alaska. Observer coverage requirements for vessels are now based on vessel size and gear type, and observer coverage at processing plants is based on the amount of groundfish delivered each month. Vessels and plants arrange for observer coverage through a NMFS-permitted observer provider, and the vessel or plant pays for the cost of the observer. The Federal government covers the costs associated with the operation of the Observer Program, observer certification training and briefing, observer debriefing and management of the data.

Vessel and Plant Descriptions

The North Pacific groundfish fishery today is harvested by a variety of vessel types, but most observer trips occur on one of three types: pot, longline or trawl. Within these three vessel types, there are catcher vessels and catcher processors (C/Ps). Catcher vessels are generally small boats that do not process their catch. Fish are caught, brought aboard, and stored in tanks until the vessel delivers to a processing plant. The majority of catcher boats use refrigerated sea water (RSW) to keep their catch fresh until delivery, but a few use ice. Catcher processors have factories and freezers aboard. They make a preliminary or finished product, and store it in large freezer holds. It is the ability to freeze fish that differentiates C/Ps from catcher boats, and a vessel which freezes whole fish is still considered a C/P.

INTRODUCTION: Management Plans

Pot Vessels

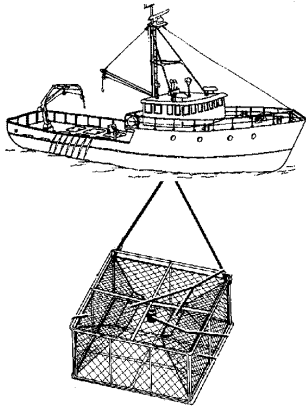

Pot vessels fish with fixed steel traps, or “pots.” The pots work much the same way as a lobster pot. The fish enter the pot in search of bait, and become trapped inside. Most pot vessels are catcher boats, but there are a few C/Ps, producing mainly headed-and-gutted product. Pot boats are used to harvest Pacific cod and, to a much

lesser extent, sablefish (black cod). Observer coverage aboard pot vessels is dependent upon the number of pots retrieved. These vessels must carry an observer during 30 percent of their pot retrievals each quarter.

Longline Vessels

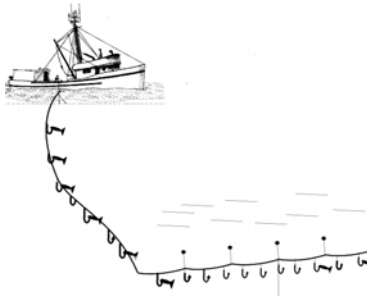

Longline vessels fish with fixed hooks strung along a ground line. The longline can be several miles long, and can have thousands of baited hooks attached. The longline fleet is composed of both

catcher boats and C/Ps. Longliners target Pacific cod, Pacific halibut, sablefish, turbot and some rockfish species. Longline vessels 125' or greater in length overall (LOA) are required to carry an observer whenever they are harvesting groundfish in the EEZ off Alaska. Longliners between 60-124' LOA must carry an observer for 30 percent of their fishing days for each quarter.

Trawl Vessels

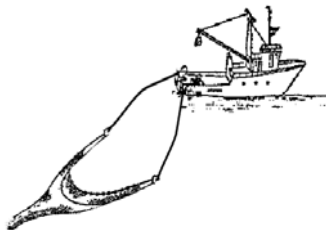

Trawlers fish with a net towed behind the boat. The net is shaped like a large funnel. At the end of this funnel is a bag, called the codend, which collects fish caught by the net. Trawlers make

up the largest portion of vessels which carry observers, and include both C/Ps and catcher vessels. They

participate in all groundfish fisheries and have the same observer coverage requirements as longline vessels.

Processing Plants

Processing plants accept fish from catcher vessels, and make preliminary or final products. Catch is transferred from boats to the plant using a large pump, or Trans-Vac. There are two types of processing plants, shoreside and floating. Shoreside processors are on land and floating processors, or “floaters,” are anchored vessels which do not fish for themselves, but rather accept deliveries of pumped fish. In open-access fisheries, processing plants that process 1,000 metric tons or more of groundfish per month must have an observer present each day they process fish. Plants that process 500-1,000 metric tons each month must arrange for observer coverage for 30 percent of those days.

MANAGEMENT PLANS

Management programs have been implemented to allocate quotas among areas, seasons, gear types, vessel types, cooperatives and even individual fishers. Observer data are used in part for assessing, allocating and monitoring these fish stocks and quotas. This information is used by the Council to write fishery management plans (FMPs) for each of the commercially important species it manages. FMPs must comply with standards laid out in the Magnuson Act in that they must:

- prevent overfishing,
- achieve optimum yield,
- achieve efficiency and utilization of the resource,
- base management on the best scientific data available,
- manage the fishery throughout its range, and
- be fair to all fishers.

Time-Area Closures

Time and area closures are used in all groundfish FMPs. These are closures which pertain to specific management areas over specific dates. A time and area closure may be used to protect a different resource, or to stop directed fishing in an area. An example of some of these time-area closures are shown in Figure 1-2 on

page 1-5. FMPs call for an annual total allowable catch (TAC) to be set for each species, and parts of the TAC are often allocated to particular management areas or user groups. Once an allocation is reached, the area or a specific group's access to this area closes, while the fishery may remain open in other areas. Once the entire TAC has been harvested, the fishery closes. In open access fisheries, removal amounts for each statistical area are calculated using mostly observer data.

Area closures can be mandated by other management measures, such as the Marine Mammal Protection Act (MMPA), which closes areas surrounding critical sea lion and walrus habitat at certain times of the year, and the Red King Crab Savings Area (RKCSA), which closes this area to bottom trawling when female red king crab are gravid. Observer data is used to determine the catch rates for each vessel. Each vessel's bycatch affects the fishery, so those with bycatch rates beyond established limits risk prosecution for exceeding them.



The data you send to NMFS inseason are immediately used by the Regional Office for fishery management purposes.

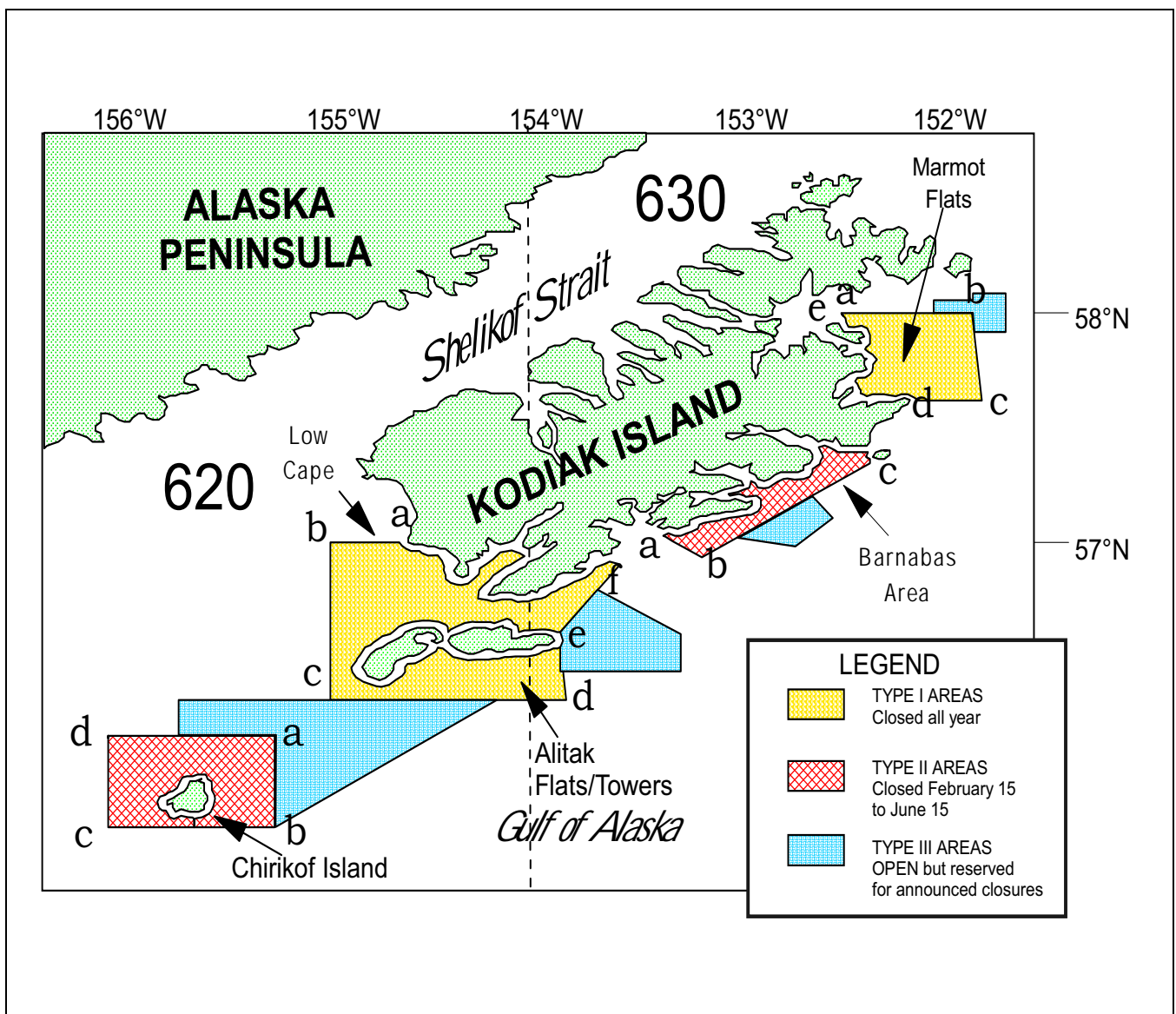

Figure 1-2 Example of Kodiak Island Time-Area Closures for Non-pelagic Gear

INTRODUCTION: Certification and Endorsements

Limited Access Privilege Programs

Most groundfish in the North Pacific is harvested in open-access fisheries. These fisheries can be targeted until the entire quota is caught and anyone with a Federal Fishing Permit may participate. License Limitation Programs restrict the number of participants in some fisheries.

The Individual Fishing Quota (IFQ) program gave permits to fish sablefish and Pacific halibut to fixed gear fisherman and vessels which had historically harvested these species. This reduced the number of vessels targeting these species, and lengthened the amount of time over which they are harvested.

The Community Development Quota (CDQ) program encourages Western Alaskan communities to become involved with the fishing industry by giving them a percentage of the TAC of all groundfish species. Most of these communities do not have the equipment to harvest and process groundfish yet, so they sell their quota to vessels and processors already involved in fisheries. This arrangement has allowed some communities to purchase fishing vessels or shares in fishing companies. Vessels which participate in the CDQ program have to follow strict regulations and be part of a NMFS approved Community Development Plan (CDP). Catch estimates on CDQ vessels are based primarily on observer data, and additional experience is needed to observe during these fisheries.

Congressional legislation has also initiated programs which limit the number of vessels targeting a species. The American Fisheries Act of 1998 (AFA) limited the number of C/Ps targeting Bering Sea/Aleutian Island (BSAI) pollock, and created an opportunity for vessels targeting these fish to form cooperative (co-op) agreements. The AFA also established new allocations for BSAI pollock. This TAC is divided among the inshore and offshore components of the fishery. The inshore TAC is further allocated to individual catcher vessel co-ops. Catcher vessels belonging to these co-ops must deliver at least 90 percent of their catch to the co-op processor.

Although not required under the AFA, catcher processors formed a co-op in 1999 and motherships formed a co-op in 2000. These co-ops assign each vessel part of the pollock TAC, much like the IFQ system. Catcher processor vessels and motherships

regulated by the AFA carry two observers, one of whom must have additional training to observe aboard these vessels.

Other Management Agencies

The FMPs for some species delegate the management to other agencies. The commercial king and Tanner crab fisheries are managed by the Alaska Department of Fish and Game (ADF&G), with Federal oversight. The ADF&G has a Shellfish Observer Program, which collects catch and bycatch data from these fisheries. The fishery for Pacific halibut is managed by the International Pacific Halibut Commission (IPHC), although the Council can also develop regulations to manage this fishery. Groundfish observers are occasionally deployed on halibut IFQ vessels.

CERTIFICATION AND ENDORSEMENTS

Certification and endorsements for observers are granted and maintained by successful completion of four steps: 1) training, 2) demonstrating proficiency during each cruise, 3) receiving satisfactory performance evaluations and 4) briefing and being deployed at least once every 18 months.

Training

A three-week job training is required of all new observers, and for prior observers who have not been to sea in more than 18 months. Training can take place at either the Alaska Fisheries Science Center in Seattle or at the North Pacific Observer Fisheries Training Center (NPFOTC) in Anchorage. The NPFOTC is part of the University of Alaska-Anchorage. The NPFOTC works closely with FMA Division Observer Program staff to provide consistent training at both locations.



Trainees must be sponsored by a NMFS-permitted observer provider. A list of these companies can be found on page A-73.

The purpose of the training is for trainees to gain an understanding of how to collect fishery data which can be used to manage the groundfish stocks in Alaska. Trainees learn and demonstrate the proper techniques of data collection and recording through a variety of in-class and take home practices. Most importantly, trainees learn how to work efficiently under the strenuous conditions of commercial fishing vessels.

Specific requirements for the successful completion of the training course will be provided by your trainer. In general, the training consists of an intensive overview of commercial fishing, sampling protocols, safety at sea, and fish, invertebrates, birds, and mammals of the North Pacific. Trainees must pass a series of tests with a minimum score of 80 percent. Additionally, several homework assignments will be given which must be completed accurately and on time. Through the exams and homework trainees will demonstrate their understanding of, and ability to apply, the following concepts:

- observer priorities and duties,
- methods of independent catch estimation,
- proper recording of catch data,
- methods of sampling and recording species composition data,
- fish identification and use of dichotomous keys,
- gender determination and measurements of fish and crab,
- procedures for collection of age structures,
- applications of volume, weight, density,
- safety and survival skills.

In order to receive a certification training endorsement, trainees must attend and participate in every training session, pass exams, complete all the homework and make any corrections requested by the trainer. Trainees must also pass a safety test including an on-land and in-water test of immersion suit and life raft use. Additionally, trainees must be able to demonstrate to the instructor that they have the attitude and ability required to perform a difficult job independently, and to act professionally in stressful situations.

DEPLOYMENT

The logistical arrangements of your travel, assignments, and debriefing appointments are made by your company. Often, you will receive your assignment prior to leaving your training location and you may be deployed directly after passing the training class.

During one of your last days of training, you will be issued some of the equipment needed to complete your sampling tasks. You are responsible for providing your personal gear. NMFS will supply your sampling gear.

Personal Equipment

Observers are responsible for providing their own raingear. This is your first and most important protection from wind, spray, inclement weather and fish slime. Your raingear should be heavy, brightly colored PVC, lined with cotton for strength and warmth. Grundens, Cofish International, Helly-Hansen and Eriksens are brands that are frequently used by fisherman and observers. You will need a hooded jacket and “bibs.” Dark colors should be avoided, since they are difficult to see on deck, especially at night. You will also need several pairs of gloves and glove liners. Fishing supply stores stock a variety of gloves of different weights and materials. You should choose a pair that are heavy enough to withstand harsh conditions, but flexible enough to allow you to write. Waterproof boots should be warm and sturdy, with a non-slip sole. The Xtra-tuff brand is the standard boot for Alaskan fisherman, processors and observers.

A list of clothes and belongings you may want to bring to sea is provided in Figure 1-3. If you have questions on what to bring to sea, ask prior observers, or NMFS and NPFOTC staff. Generally, first time observers bring too much with them. In one contract you are likely to be on four airplanes, four vessels, and in any number of cabs and hotel rooms. Throughout this you will need to carry both your personal and sampling gear! Rather than taking a lot of clothes, focus on bringing items which can be layered. Working on deck or in the factory of a vessel in Alaska is cold and wet, and layering will help protect you from the elements. Synthetic or wool materials are recommended and will keep you warmer than cotton. Inexpensive clothes are also recommended, since the smell of fish is difficult to remove from fabric. While you are at sea, you may store extra belongings at NMFS in Seattle (no storage is available in Anchorage). Please note that this service is only for observers while they are at sea, and cannot be used between contracts.

INTRODUCTION: Deployment

This list of items is approximately what you will need for a 60-90 day contract. The amount and type of heavy clothing will depend on your personal preferences, the vessel type you are assigned to, and time of year you are working. Items you bring should be old, or inexpensive, since the smell of diesel and fish is difficult to remove. Items which **can** be hand washed are recommended, but items which are so delicate that they **must** be hand washed should be avoided.

Work Clothes

- Raingear-** bib overalls and jacket with hood (1 set)
- Boots-** Xtra-tuff brand highly recommended (1 pair)
- Boot insoles-** wool or felt insoles made for Xtra-tuffs (2 pairs)
- Gloves-** heavy rubber gloves- strong enough for work, but flexible enough to write (6-8 pairs)
- Glove liners-** polypropylene, wool, or poly/cotton blend (3-5 pairs)
- T-shirts-** cotton, polypropylene, or light wool (3 shirts)
- Sweatshirts-** cotton or polypropylene fleece (3- two for work, one for inside)
- Pants-** cotton or polypropylene sweat pants, or wool work pants (2 pairs)
- Shorts-** to sleep in (1 pair)
- Jeans-** a pair of pants for wearing in town (1 pair)
- Sandals-** flip-flops for shower use (1 pair)
- Hiking boots-** lightweight but waterproof boots for town (1 pair)
- Teva or Birkenstock type sandals-** for wearing inside on the vessel (1 pair)
- Long underwear-** polypropylene or other thermal (2 pairs)
- Socks-** wool, polypropylene, or blend (5 pairs)
- Hat-** wool or polypropylene cap that will fit under a hood (2 hats)
- Gloves and hat for town,** also fleece ear and neck bands are useful (1 each)
- Jacket-** any warm jacket for town that will resist rain and heavy winds (1 jacket)

* If you are purchasing a jacket to wear at sea, Stormy Seas, Mustang or another brand of float coat is suggested. This will allow you to wear a PFD while maintaining your range of motion.

Other Items

- Sleeping bag-** lightweight, but warm
- Pillowcase-** some observers carry a flat sheet with them as well
- Towel-** medium sized terry towel (1-2 towels)
- Toiletry articles-** these are available in port or in ship stores but are often expensive
- Seabag-** an old or inexpensive duffel bag, many observers use Army surplus duffles
- Padlock-** for your duffel, also useful if there is a locker on the vessel
- Backpack-** suitable as an airline carry-on bag for fragile items and useful as a day-pack in town
- Glasses or contacts-** bring an extra pair
- Cash or traveler's checks-** observer providers often provide cash advances, many ports do not have an ATM
- Credit card** and/or pre-paid calling card
- Camera** and film
- Sewing kit-** needle, thread, and safety pins. Duct tape is also useful, and common on vessels.
- Watch** and /or travel alarm clock
- Seasickness medication-** Bonine and Dramamine are common brands used by observers
- First Aid kit-** small, you may want some cold medicine, pain reliever, etc... and any prescription medications
- Vitamins and/or nutritional supplements-** especially if you have a restricted diet (i.e.: vegetarian)
- Stationary,** envelopes, stamps, and a small address book
- Books** and/or a journal
- Music** and Discman/Walkman
- Water Bottle-** for keeping water near your bunk

Figure 1-3 :List of Personal Gear

Sampling Gear

Sampling and safety equipment is supplied by NMFS. The gear you receive may not be new, but it will be in good working order. It is your responsibility to maintain your gear and return it in the best condition possible. You may be charged for misuse or neglect of sampling gear. It is best to make cleaning and caring for your gear part of your everyday routine, since you will rely on this equipment to do all of your work. Some suggestions on how to care for your gear are:

1. Keep your gear in a secure place aboard the vessel. Avoid leaving gear on the vessel's deck. If there is no alternative to leaving it out on deck, be sure that it is well secured. Keep only weather proof gear on deck!
2. Keep forms, books, pencils, pens, and unused equipment in a *dry* safe place, such as your room or a secure lazarette. Leave only what you regularly use in the factory or on deck.
3. Keep all gear as clean as possible. This will make it much easier for you to clean your gear when returning it. Use deck hoses to rinse slime, scales, and blood off your baskets, deck sheets, length boards, clipboards, scalpel and knife after each use. Most C/Ps and shoreside plants have high pressure hoses which are excellent for cleaning gear.
4. Keep metal parts clean and well oiled. The NMFS-issued lubricant oil is food-grade and can be kept in the factory or out on deck. Do not put weighing scales, scalpels, knives, thumb counters, measuring tapes or other metal objects in plastic bags or boxes when they are wet. They will quickly rust.
5. If something does happen to your issued gear, document what happened. You will not be charged for gear damage or loss due to documented circumstances that were out of your control.
6. Keep your gear centralized; you will be less likely to forget something when disembarking.



**Treat your gear like the important asset it is!
Without it, you cannot do your job!**

NMFS will also issue you some safety equipment, including an immersion suit and strobe light, a life vest and whistle, a hard hat and ear plugs. These are

provided in order to reduce your reliance on vessel equipment. Keep your immersion suit in a safe place, such as your bunk. It is not a good idea to keep your suit with the crew's, since it may not be easily accessible and may be forgotten when you are disembarking. Both your immersion suit and life vest have zippers on them, which need to be kept waxed to prevent sticking.

The majority of your gear will be issued to you at your training or briefing location. Additional gear may be obtained from the NMFS field offices in Dutch Harbor and Kodiak. Even if you are deployed from these ports, you may be in town for a very short period of time and it is best to take all the gear you will need from Seattle or Anchorage. If your vessel assignment changes at the last minute, you may need to pick up additional thumb counters, baskets, a Mustang suit or a flatbed scale from the field offices. Let your company know your needs so they can arrange the logistics with the vessel.

Assignments

The NMFS has a 90-day limit for each observer cruise. Additionally, observers may not be assigned to more than four vessels and/or plants during one cruise. Finally, observers may not be deployed to the same vessel for more than 90 days in any 365-day period. These limitations were created in order to protect observers from “burn-out,” and to allow NMFS to finalize your data in a timely manner. Often, observers work less than 90 contiguous days because of fishery closures, weather and erratic vessel schedules.

Observers enter into contractual agreements to provide observer services for a NMFS-permitted observer provider. These contracts are generally written for 90 days, but may change dependent on provider and union agreements. If you need to complete a contract by a specific date, tell your company logistics coordinator and get this date written into your contract. You should also have a written understanding of payment and reimbursement agreements prior to leaving, since traveling in Alaska can be unpredictable and expensive.

When beginning a new assignment, take time to adjust to your surroundings before the vessel leaves the dock. Present the “Letter of Introduction” to the vessel operator. Make yourself available to answer any questions the vessel may have. Familiarize yourself with the safety equipment, using the check list on page

INTRODUCTION: Deployment

17-3. Read the “Trip Information,” section beginning on page 3-1 to get an idea of what to look for in a sample station. Ask the captain how many hauls are expected each day to determine your sampling schedule.

If you know your first assignment prior to leaving your training location, you may get specific information about the vessel or plant from a Vessel or Plant Profile, or training report. These reports are created by Observer Program staff and observers and recommend specific sampling types for each vessel and fishery. They also contain information about lodging, gear requirements and past problems and how to solve them. If you only know what vessel type you are getting on, it may be a good idea to read several pertinent profiles to get an idea of general sampling situations.

VESSEL PROFILE		Run Date: November 18, 2003
Vessel:	A001	NORTHERN GLACIER
Length:	201	ADFG NO: 48075
Target Species:	A species of group not listed here	
Topic:	Living Conditions The observers share a room in the hospital. It is very cold in the room, so bring a sleeping bag and warm sleeping attire. The bathroom is connected to another room and shared with four processors.	
Topic:	Communications This is an Atlas boat. When the vessel is facing east it may be difficult to transmit.	
Topic:	Description of Sampling Area The Northern Glacier has an MSCDQ sample station set up, which observers can use during open access fisheries. It is next to the hatch that leads to the engine room, Baader shop, and factory foreman station. There is traffic through the area, but it is large enough to store your samples and allow someone to pass through. The station has a large table, platforms scale, hose, and a sump pump for discard. There is grating throughout the station.	
Topic:	Recommended method for obtaining prohibited species samples Occasionally, observers aboard could whole haul for prohibited species. Usually, the running time is too long, and the hauls simply too large. Partial haul sampling is usually used for all species, including prohibited species. For the most part, the method for obtaining prohibited species samples and composition samples is the same.	

Figure 1-4 Example of a Vessel Profile

Communications

You will be communicating with the Observer Program daily, weekly or on a trip by trip basis depending on your vessel. Vessels requiring 100% observer coverage will have the ATLAS communications system. This computer software was designed to allow you to enter your data on the vessel's computer and transmit it to NMFS. It also allows you to send e-mail messages to Program staff. The e-mail you send is read and responded to by a member of the FMA Division's debriefing staff who is knowledgeable about the boat. They will also be able to look at your data and troubleshoot problems while you are still at sea. If you are on a vessel that does not have ATLAS, you will fax

in your data periodically. For more details on communicating with the NMFS, refer to the Sending Data section beginning on page 2-25.

If you are ill or injured and cannot work for more than one day, you must contact NMFS. If you are on a vessel with ATLAS, contact your inseason advisor. If you are not on a vessel with ATLAS, use an available means of communication (phone, fax, e-mail, radio) as soon as possible. You also must inform your captain of this impediment. If you cannot work for more than three days, you must contact your employer.



You must contact NMFS each day an illness or injury entirely prevents you from sampling.

Vessel operators are required by law to allow observers free access to communication systems for work purposes. Their communication systems are not usually for personal use. If they allow you to use the phone or fax for personal use, you may be responsible for the charges incurred.

Using the Vessel's E-mail System

Some vessels may allow you to use the onboard e-mail system for personal communication. ***The messages you send and receive on these systems are not secure or confidential!*** Consider all communications through vessel e-mail as completely public, even if you are accessing your own e-mail account! Never discuss work, catch, vessel design or other “shop talk” that could be considered a breach of confidentiality, which is grounds for decertification.

Mid-cruise and Field Support

The FMA Division has field stations in Anchorage, Dutch Harbor and Kodiak to provide staff support for observers. When you are in these ports, you should meet with a staff member for a “mid-cruise” debriefing. The mid-cruise allows NMFS staff to review your sampling procedures, calculations and paperwork and ensure that all is going well. It is an opportunity for you to ask questions and receive suggestions on how to solve any problems you may have encountered.

All observers must complete a mid-cruise during each deployment, until they receive an exemption. Although it is termed a mid-cruise, this interview does not necessarily have to take place during the middle of

your cruise. It should be completed early enough to allow you to incorporate suggestions and make improvements on your data collection efforts.

When coming into a field station for a mid-cruise, calling ahead will help ensure that a staff member will be available to work with you at a specific time. More information on mid-cruises can be found on page 19-2.



In-person mid-cruises can be done in Anchorage, Kodiak and Dutch Harbor.

Observer Provider Responsibility

Federal regulations stipulate that you must have a signed contract with your company prior to deployment. The contract must contain the provision that each “...observer completes in-person mid-deployment data reviews, unless: (i)...specifically exempted by the Observer Program, or (ii) the observer does not at any time during his or her deployment travel through a location where Observer Program staff are available for an in-person data review.” The contract must require that an observer who is not able to complete an in-person review complete a phone or fax mid-deployment review as described on page 19-2.

Debriefing

When you complete your cruise, you will debrief with an FMA Division staff member. The main parts of debriefing are to:

- complete a computerized survey for each assignment,
- describe the methods used to collect your data,
- inform FMA Division staff of problems you encountered,
- make corrections or changes to your data,
- get recommendations for future cruises, and
- receive a written performance evaluation.



Debriefing is generally done in Seattle or Anchorage.

Your debriefing is a vital part of your contract because it allows the NMFS to get feedback from you. It is an opportunity for you to discuss your methods and ask for suggestions if you encountered problems in the field. The debriefing process is your chance to demonstrate your understanding of the methods you learned in training and your proficiency at applying them in the field. At the end of your debriefing your debriefer will give you a performance score for each vessel, a written evaluation for your entire cruise and a briefing recommendation. Your briefing recommendation is the level of training you will need prior to your next cruise.

The last step in the debriefing process is another computer survey. The “Observer Survey” is an anonymous questionnaire about your training, deployment and debriefing experience. This is a chance for you to tell FMA Division staff how well you feel you were prepared to do your job and let the Program know what would have made your experience better. This survey only takes about fifteen minutes, and is extremely helpful to our staff.

Briefing

Prior to each subsequent cruise, you will attend a briefing to inform you of any policy changes and to review the priorities and duties on different vessel types. All observers are required to complete a four-day briefing prior to observing in each new calendar year. Upon successful completion of an annual briefing you will receive an “annual general endorsement” to your observer certification. An additional one-day, two-day tutorial or four-day briefing must be completed prior to each additional cruise within the year. Upon completion of these briefings, you will receive a “deployment endorsement” to your certification.

ESSENTIAL INFORMATION



Table of Contents

Duties and Priorities	2-2
Managing Your Time.....	2-2
Standards of Observer Behavior	2-2
Limitations on Conflict of Interest	2-3
Confidentiality	2-3
Signing Statements.....	2-4
Completing and Organizing Forms.....	2-4
Legibility.....	2-5
Organization of Forms	2-5
Page Numbering.....	2-5
Species Identification Forms.....	2-6
Unidentified Fish.....	2-7
Observer Logbook Entries.....	2-7
Daily Notes Section	2-8
The Logbook as Evidence	2-8
Calculations	2-8
Rounding Rules	2-8
Selecting Hauls to Sample	2-9
When All Hauls Should be Sampled.....	2-9
When to Use the Random Sample Table	2-9
How to Use the RST.....	2-10
Vessel Responsibility and the RST.....	2-10
How to Use the Random Break Table (RBT).....	2-10
Documenting RST and RBT Use.....	2-11
If Your Sampling Schedule is Too Rigorous.....	2-11
Frequently Asked Questions About the RST and RBT.....	2-12
Introduction to Sampling Theory.....	2-12
Target vs. Sampled Populations	2-12
Sample Design	2-13
Creating Your Sampling Design.....	2-13
Documenting Design Constraints or Problems.....	2-16
Subset Sampling	2-16
Using Your Scales	2-17
Motion Compensated Electronic Scales.....	2-18
Platform Scale Testing.....	2-18
What To Do When the Platform Scale Fails.....	2-19
Flow Scale Testing.....	2-19
What To Do When the Flow Scale Fails	2-19
Sample Station Requirements	2-20
Observer Sampling Station Inspection Reports.....	2-20
Completing the Observer Sampling Station Verification Checklist	2-20
Working with Two Observers	2-22
Lead Observer's Role.....	2-24
Second Observer's Role.....	2-24
Shared Duties.....	2-24
Inseason Advisors and Text Messages	2-25
Sending Data via ATLAS	2-26
Correcting and Resubmitting ATLAS Data	2-26
Faxing Data	2-26

INTRODUCTION

As an observer, you will need to refer to this manual frequently. For most topics, you can refer directly to the chapter that addresses a task or vessel type. Some topics pertain to all observers on all vessel types. *This information is essential to all observers* and is explained in greater detail here.

DUTIES AND PRIORITIES

Observer duties are listed below in order of priority. Use this list to remind yourself of the different tasks that need to be accomplished for each haul, and recognize which are of a higher priority. There will be times when you cannot accomplish all that you have to do in a day, and lower priority duties should be reduced first. If you find that you cannot complete all the tasks listed, concentrate on those with higher priority.

1. Safety is always your first priority, you must receive a safety orientation before disembarking!
2. Record incidental takes of short-tailed albatross and collect specimens. Record takes of marine mammals. Collect snouts or heads from pinnipeds (except walrus), and tissue samples from cetaceans. Rehabilitate live *endangered* seabirds.
3. Record fishing effort and catch information. Make an independent estimate for as many hauls as possible. Record all calculations for your independent catch estimates in your logbook.
4. Sample randomly selected hauls for species composition.
5. Send your data to the Observer Program in Seattle.
6. Document compliance infractions and suspected violations in your logbook and complete written statements.
7. From hauls sampled for species composition, collect additional biological data on prohibited species.
8. From hauls sampled for composition, collect otoliths from the appropriate species.
9. From hauls sampled for composition, collect sexed length frequency samples from the appropriate species.
10. Maintain your logbook, including: Vessel Safety Checklist, Daily Notes, *all* calculations and formulas, sampling techniques, seabird interactions and banded bird information, scale tests and sample area diagrams.

11. Collect data and specimens for standard projects.
12. Log sightings of seabird “species of interest” and marine mammals.
13. Complete special projects as assigned.
14. Complete mid-cruise and final debriefing requirements (see chapter 19).

Managing Your Time

Your time and effort given to each task should be proportional to its priority. For example, if your vessel catches a killer whale, you should spend as much time as required to gather all the pertinent information and collect a tissue sample, as that is your highest priority. A few suggestions on how to reduce the time and effort you spend on lower priority tasks are:

- Write sightings of seabirds and mammals on your deck sheets so this information can be transcribed onto the appropriate forms during a non-fishing period.
- Collect otoliths and record all necessary data while taking lengths. Avoid measuring a fish twice!
- Write notes on violations on your deck form as you witness them, so this information can later be transferred to your logbook.
- Prepare paperwork at least daily and maintain your logbook at the same time; this will allow you to be ready to send your latest information to NMFS when needed.

STANDARDS OF OBSERVER BEHAVIOR

Standards of observer behavior are stipulated in regulation 50 CFR 679.50. The regulation states that, “Observers must avoid any behavior that could adversely affect the confidence of the public in the integrity of the Observer Program or of the government, including but not limited to the following:

1. Observers must perform their assigned duties as described in the Observer Manual or other written instructions from the Observer Program Office.
2. Observers must accurately record their sampling data, write complete reports, and report accurately any observations of suspected violations of regulations relevant to conservation of marine resources or their environment.

3. Observers must not disclose collected data and observations made on board the vessel or in the processing facility to any person except the owner or operator of the observed vessel or processing facility, an authorized officer, or NMFS.

4. Observers must refrain from engaging in any illegal actions or any other activities that would reflect negatively on their image as professional scientists, on other observers, or on the Observer Program as a whole. This includes, but is not limited to:

- Violating the drug and alcohol policy established by and available from the Observer Program;
- Engaging in the use, possession, or distribution of illegal drugs; or
- Engaging in physical sexual contact with personnel of the vessel or processing facility to which the observer is assigned, or with any vessel or processing plant personnel who may be substantially affected by the performance or non-performance of the observer’s official duties.”

Your behavior must be in accordance with these standards from the moment you enter a briefing until you are completed with your debriefing. Any behavior contrary to these standards, or the intent of these standards, is grounds for decertification. Falsification of data is grounds for decertification, and may be a basis for prosecution.

Limitations on Conflict of Interest

In addition to standards of behavior, 50 CFR 679.50 sets the following limitations on conflict of interest. “Observers:

1. Must not have a direct financial interest, other than the provision of observer services, in a North Pacific fishery managed pursuant to an FMP for the waters off Alaska, including, but not limited to:

- any ownership, mortgage holder, or other secured interest in a vessel, shoreside or floating stationary processor facility involved in the catching, taking, harvesting or processing of fish.
- any business involved with the selling supplies or services to” (“...or any business involved with purchasing raw or processed products from...”)
“any vessel, shoreside or floating stationary

processing facility participating in a fishery pursuant to an FMP in the waters off the coast of Alaska.

2. May not solicit or accept, directly or indirectly, any gratuity, gift, favor, entertainment, loan, or anything of monetary value from anyone who conducts activities that are regulated by NMFS, or who has interests that may be substantially affected by the performance or nonperformance of the observers’ official duties.



Note that this standard restricts observers from accepting home-packed fish without purchase.

3. May not serve as observers on any vessel or at any shoreside or floating stationary processing facility owned or operated by a person who previously employed the observer.

4. May not solicit or accept employment as a crew member or an employee of a vessel, shoreside processor, or stationary floating processor in a North Pacific fishery while employed by an observer provider.”

Confidentiality

While you are deployed, the captain may ask to see your data for his vessel. ***Never share data from your logbook, with the exception of the vessel safety checklist! You may provide the vessel with one of the logbook’s black and white copies of the safety checklist, or make a copy yourself.*** All other data you collect may be shared with the officers of the vessel. Vessel personnel may want this information on a daily basis for their own use. You should provide these data ***when it is convenient for you.*** It may be easiest to give the captain the data when you are sending it to NMFS. This will allow you to give him completed data on a regular schedule. Providing data to the vessel is a low priority, and you should not allow this to prevent you from accomplishing any of your duties. Only the vessel owner or operator, NMFS staff, and you are allowed to see the data you collect. ***Never allow crew from one boat to see any data from another vessel.***

ESSENTIAL INFORMATION: Completing and Organizing Forms



Skippers are often intensely secretive of their operations. They count on you to be discrete when discussing their vessel.

If you are on several vessels during your deployment, keep your data and associated “goldenrod” copies of the vessel logbook from earlier vessels in a safe and secure place. No crew member should ever be allowed to see another vessel’s data. Sharing another vessel’s data, even inadvertently, can be grounds for decertification. Be particularly discreet when discussing problems, “fishing stories,” or assignments in public places, on other vessels, or through e-mail. You may inadvertently give more information than you mean to.

Signing Statements

Vessel or processing personnel have occasionally requested that observers make written statements, or sign prepared statements, regarding observer duties, safety issues, validity of their data or compliance issues. You may discuss these topics with industry members, but it is critical that you ***do not sign any forms that you have not previously seen in a training or briefing.*** Additionally, written statements should be prepared only for NMFS staff. Currently, there are two forms that observers are expected to sign. This is the Record of Daily Scale Tests form for motion compensated flow scales and the Vessel Safety Checklist in your observer logbook. If vessel personnel want more information, please have them contact the Observer Program Office (see “Contact Addresses and Numbers” on page A-45).

Photos and Videos

Any photos or videos taken by an observer while assigned to a vessel or plant are the property of the National Marine Fisheries Service as defined by the Magnuson-Stevens Fishery Conservation and Management Act. This includes any photos or videos that are taken with a personal camera. Photos or videos that can be used to identify a vessel, crew, fishery, or any other potentially sensitive images are of special concern. Although this does not mean you should not take photos or videos when assigned to a vessel, it does mean you must protect the pictures that you do take as if they were written data. For example, posting photos

to the internet is not an authorized use of observer data. If you have concerns about your use of any photos taken during an assignment, contact FMA staff.

Additionally, some vessels and plants may discourage the use of cameras on their vessels. On these vessels you do not have the right to take photos for any non work related reasons. On these vessels you should only take photos as specimens for marine mammal bycatch and fish identification.

COMPLETING AND ORGANIZING FORMS

During an average day on a vessel, you will fill out at least four different forms - usually several of each! The following is a list of data form types available with a use synopsis for each:

- **Trip Form:** All vessel observers fill out this form. It captures additional information not provided by the vessel and observer haul forms. The paper version of this form must be completed by these observers, even if they are using ATLAS.
- **Plant/Vessel Offload Form:** All plant observers and all observers on catcher vessels delivering to a shoreside processor or floating processor must fill out an Offload form. The paper version of this form must be completed by these observers, even if they are using ATLAS. The Offload form captures delivery weight information in addition to other data useful to management.
- **Vessel Haul Form:** All vessel observers, whether entering data into ATLAS or faxing it, must complete this paper form. It captures position data at the haul level.
- **Observer Haul Form:** All vessel observers, whether entering data into ATLAS or faxing it, must complete this paper form. It captures haul specific weight data and other haul specific data critical to management.
- **Deck Form:** All vessel observers, whether entering data into ATLAS or faxing it, must record their raw data on the waterproof form. It is used to capture species composition data and other sample specific information.
- **Species Composition form:** Only vessel observers faxing their data must complete the paper species composition form. It contains the same information

as the deck form, but has to be completed for vessels without ATLAS because the waterproof raw data sheets do not fax well.

- **Length and Specimen Form:** Only vessel observers faxing their data must complete the paper length and specimen form. It contains the same information as the deck form, but has to be completed for vessels without ATLAS because the deck forms do not fax well.
- **Marine Mammal Interaction and Specimen Form:** All observers complete marine mammal interaction and specimen forms. These forms captures single event information for marine mammal interactions and specimens. In addition to completing the paper form, observers on ATLAS vessels enter mammal interaction and specimen data and send it electronically.
- **Species Identification Form:** All observers, whether at a plant or on a vessel, must fill out species identification forms for each new species they see. The form captures in-hand characters of described species and is used to verify observers' species identifications.

Specific directions on how to fill out each form can be found in the following chapters. *Always have your manual with you when you are filling out paperwork.* Refer to the instructions for the form type you're working with when filling out that form. This will save you time by allowing you to complete the form correctly and completely the first time, rather than returning to it much later to fix errors or fill in columns that were missed. More general information for completing your data forms follows.

Legibility

Your data and logbook entries must be clear and legible. If your writing is unclear, incorrect data may be entered into the inseason database used to manage the fishery. During debriefing, these errors need to be fixed, and if the debriefer is unsure of a number, s/he will need to have you present to interpret your data. This will lengthen time spent debriefing, and if questions cannot be resolved, may cause data to be lost.

To ensure that your data are legible:

- write carefully in clear, dark writing,
- check the forms for stray marks or incomplete erasures before faxing, and
- record the data in an organized manner.



Pay particular attention to your handwriting when preparing forms to fax. Faxing degrades the legibility. Illegible data cannot be entered into the inseason database!

Cruise Numbers

The Observer Program refers to the time between training and debriefing as a "cruise." A five-digit cruise number is used as the identifier for data you collect during this time and it must be recorded on every form. Your cruise number will remain the same throughout your cruise. You will receive your cruise number at the end of training or briefing.

Organization of Forms

Keep a separate set of data for each vessel or plant assignment. Additionally, for any assignment, you may have extra forms associated with standard or special projects. *Fill in the header information on every page of every form type for every assignment.*

Observers on vessels or at shoreside processing plants with ATLAS need to keep data backed up and/or archived on their observer issued flash drive for each vessel or plant. *Individuals on assignments with ATLAS must also keep paper copies of the Trip forms, Offload forms, Vessel and Observer Haul forms, Deck forms and Marine Mammal Interaction and Specimen forms.*

Page Numbering

With the exception of Species Identification Forms, all data forms are numbered separately by form type. Page numbers must be entered at the top of each form type in the "page_ of_" fields. Put the number of the page in the first blank as you complete the forms at sea. At the end of your deployment, put the total number of pages in the second space. For example, "Page 3 of 40," indicates that this is the third page of forty for this form type.

ESSENTIAL INFORMATION: Completing and Organizing Forms

Vessel Haul Forms and Observer Haul Forms

Vessel Haul Forms and Observer Haul Forms are two different form types, so they must be numbered separately. To keep these forms orderly, you must have one Vessel Haul Form for each Observer Haul Form and you must be consistent with haul documentation between forms. For example, if you record hauls 1-9 on page number 1 of your Vessel Haul Form, record only these haul numbers on page number 1 of your Observer Haul Form, even if more space is available.

Deck Forms

You will be issued waterproof deck forms so that you can record your data on deck. The deck form is specifically formatted to allow for documenting sample and subsample data on all vessel types.



Deck forms must be used on all assignments to record raw data. Your original raw data should return with you to debriefing.

Following these tips may help you organize your data.

- On vessels with ATLAS, the data entered in ATLAS must match exactly the data on the deck form. If individual basket data are summed to be entered into ATLAS, show this summed value on the deck form.
- All data forms **must** contain the following header information: cruise number, vessel permit, haul or offload or delivery number, date of haul, offload or delivery, and a page number. ***This includes blank waterproof sheets that may be used for additional information.***
- Use extra space to record bin measurements, codend measurements, trawl alley heights, etc.
- Write as large as needed to be able to read your data.
- Rinse off the deck forms often while you are sampling. If you write on top of scales and blood your writing will rinse away with them!
- Write as dark as possible with a pencil. With rinsing, your writing will fade.

- When there are two or more observers on a boat, each **must** write their initials on the Deck forms for the hauls they sample.

Recording Time

When recording time, use the 24-hour clock (0000-2359). Record time using Alaska Local Time (ALT) when your vessel is in Alaskan waters. No colons are used with the 24-hour clock, and they should not be recorded on any forms.



Most digital watches can be set to a 24-hour clock. This makes tracking and recording time easier.

Species Identification Forms

Your species ID sheets are verification of your correct identification of species seen during a deployment. ***Complete, detailed and correct species identification forms are required for all fish, crab and dead non-endangered seabird species that are new to you. All species of interest seabirds, unidentified fish, and unidentified seabirds require a species ID form every time you encounter them.*** First time observers are required to complete species ID forms for the first sighting of all fish, crab and dead seabird species. Prior observers will need to complete ID forms for species which have not had an acceptable form in the past. If a prior observer demonstrates a problem with species identification, s/he may be required to complete ID forms for each species seen during his/her next deployment. The rules for filling out these forms are:

- Species ID forms are not needed for invertebrates other than crab species.
- Species ID forms ***must be filled out with the fish in hand!***
- Species should be identified to the level provided in the keys and guides issued by NMFS.
- If you further identify an organism that only needs to be keyed to family, you must fill out a new form for the identified species (*e.g.*, red Irish lord would need a separate form than Irish lord unidentified).
- Sharks should be identified to species using the Family Key and/or Eschmeyer.

- Species ID forms must describe in detail what you observed from your specimen. **Do not copy information verbatim from the key.**
- Complete a Seabird Species Identification Form for all dead non endangered seabird species encountered for the first time.

During debriefing, you may be asked to provide a verbal description of a fish if you have an incomplete ID form, or none at all. If you are not able to provide an accurate description of a species recorded in your samples, NMFS may require you to attend a four-day briefing and pass a fish ID test. It is advisable that you complete ID forms on species that you do not encounter frequently, even if you have done so for the species already, so that you have a written record to refer to at your debriefing interview.

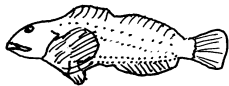
Miscellaneous Species Description Form	
Vessel name: <u>Fishin' Impossible</u>	Vessel code: <u>A123</u>
Species common name: <u>Mystery fish # 5</u>	
Observer: <u>John Doe</u>	Cruise: <u>8800</u>
Haul #: <u>164</u>	Fork length: <u>40cm</u>
Specimen collected? <u>Yes</u>	Weight: <u>0.6 kg</u>
FISHES:	
How many dorsal fins does the fish have?	① 2 3
Is an adipose fin present?	YES NO
Pelvic fins?	Present very small Absent
Pelvic fin position:	abdominal thoracic jugular
Describe the caudal peduncle (if present) and caudal fin shape: <u>short caudal peduncle w/ medium sized fin.</u> <u>Caudal fin is truncate.</u>	
Describe the lateral line(s) if present: <u>Several lateral lines present - (4 counted)</u>	
Draw the fish here: 	
Field characteristics important in recognizing this species: <u>Long dorsal fin with a slight notch posterior of pectoral fin.</u>	

Unidentified Fish

Never guess the identification of a species. If you encounter an individual fish, crab, or bird that you cannot identify, fill out a species description form with as much information as possible. You may find a more identifiable specimen of the same species later, so organize your unidentified fish descriptions with names such as “unidentified dark rockfish #1,” or “mystery

fish #5.” Record all form heading information, so that the data can be changed if the fish is identified later. *Ideally, you should bring the specimen back to NMFS.* If you are unable to bring the fish back, please take photographs of the specimen for ID purposes.

Record unidentified fish on your Species Composition forms with the most appropriate group code. For example, an “unidentified long-faced flatfish” should be recorded using the “flatfish unidentified” group code of 100 because you can positively identify it as being a flatfish. *If you find that you are using the fish unident. (901), flatfish unident. (100), rockfish unident. (300) or roundfish unident. (200) to identify fish on a regular basis, please notify your inseason advisor immediately.*

OBSERVER LOGBOOK ENTRIES

Your logbook is probably the single most important piece of data because it contains additional information about all other data. Have your logbook with you whenever completing paperwork so you can easily record your calculations, make notes regarding your data collection, fill out scale verification records, and document seabird sightings and regulation issues. Many observers make notes on their deck forms to remind them of particular events that happened while they were out on deck or in the factory. This is an excellent idea, but is only effective if the details of the events are filled in as soon as possible in the logbook. Remember, events which seem ordinary to you on this vessel may be unusual to the fleet or fishery, so don't hesitate to write down any information which affects your work or day-to-day life aboard the vessel.

Your logbook is your field biology notebook, and must be treated as such. **Do not use it as a personal journal.** Although you must document any interference or inappropriate behavior toward you, avoid venting frustrations or making slanderous, derogatory or discriminatory remarks in your logbook. Your logbook must be kept private while you are on the vessel, but is a public document and part of the data turned over to NMFS during debriefing. After this, the contents of the logbook and your name may be released.



The Vessel Safety Checklist is the only part of your logbook that may be photocopied or have a copy torn out and given to the vessel. Originals of the checklist must remain intact in the logbook.

Daily Notes Section

Use the Daily Notes section to include notes on problems that occurred while you were aboard the vessel, any illnesses or injuries you suffered, and the reasons you chose all sampling methods used (including those for catch estimation, species composition sampling, length samples, the selection of fish for biological sampling and halibut assessments). Record the circumstances surrounding any violation you witness, including interference with your duties, harassment, mishandling of prohibited species, harassing or harming marine mammals, and MARPOL (marine pollution) violations.



Set aside time every day to write in the Daily Notes section.

Make an entry for every day, describing the day’s events, even if it was what you would consider an “ordinary day.” The more self-explanatory your cruise is, the better. Logbooks may be referred to months or even years after your cruise is complete. Therefore, good documentation is vital to what the NMFS considers “meeting expectations” for a successful cruise.

The Logbook as Evidence

Your logbook is archived and used as a reference to give more information about your data. It may also be used as evidence if regulatory infractions were noted. Therefore, your calculations may be recorded in pencil, but **all other entries must be in ink**. If you need to make a correction, draw a single line through the incorrect word(s) and continue with the correct wording. Do not completely cross-out anything, use correction fluid, or tear out pages or parts of pages! If you obscure any part of an original entry, you leave the reader wondering what was originally there. This may affect the validity of your logbook and data.

CALCULATIONS

All calculations, no matter how small, must be documented. Long, more involved calculations such as observer estimates and delivery weights must be recorded in your logbook. Simple calculations such as summing basket data to enter on the paper composition

DAILY NOTES - INCLUDE DATES
VESSEL/PLANT NAME <i>M/V Whistler continued...</i>
<i>02/24 continued</i>
<i>So, I asked the factory foreman manager, John Baker, if this was always the case. He said that sorting the halibut like this was very usual unusual but that they did do this if the halibut catch was too large (lots of halibut in the haul) or if they had one or two very large halibut. I told him that I thought there were I didn't notice a lot more halibut than in previous hauls and explained to him that this was presorting and shouldn't happen if I was to</i>

Figure 2-1 Properly Corrected Logbook Entries

forms or into ATLAS may be recorded on the Deck forms. Write your calculations directly into your logbook rather than transcribing them from scrap paper. Document all your calculations, and the formulas used, in order to make your data self-explanatory. Record and label your calculations so that another person could easily understand them without any interpretation. Be consistent with the format and location of calculations to ensure they are easy to read and edit.

Calculations which you may think are trivial or obvious must be recorded. This includes, but is not limited to, conversions from pounds to kilograms, halibut length to weight conversions, **and the differences between start and end weights when using a flow scale** for haul weight or sample weight. These small calculations may be recorded on the raw data deck sheets.



Calculations may be in pencil, but all other logbook entries must be made in ink!

Rounding Rules

When you are performing a calculation, carry the numbers out full field until you have reached your **final product**. **Do not round any numbers within the calculation!** For example, values used for height and width in volumetric equations are typically the average of three or more separate values. It is a common mistake to use rounded average height and width measurements in volumetric equations. Rounding within a calculation will cost you time in debriefing!

When you round a final product to enter on a paper form or in ATLAS, round to the number of decimal places required by the column. To round your final product:

- look *only at the first digit* to the right of the number you are rounding,
- if $X \geq 5$ round up, if $X < 5$ round down.

For example, when recording your final density on the Observer Haul Form, you need to round to two decimal places. If your final calculation was 0.9278226, you would round up to 0.93 mt/m³. If your final calculation was 0.9728226, you would round down to 0.97 mt/m³.

SELECTING HAULS TO SAMPLE

Observers must take numerous steps to ensure that their samples are as random as possible. The first step is to randomize which hauls you will sample for species composition. There are three ways in which to randomly select hauls to sample:

1. sample all hauls,
2. use the Random Sample Table (RST), or
3. use the Random Break Table (RBT), either alone or with the RST.



Do not randomize which hauls to sample in any other way unless it has been approved by a NMFS staff member!

When you cannot sample all the hauls, you must use the RST and/or the RBT to determine which hauls to sample. This allows the Observer Program to stand behind your data, and makes it legally and scientifically defensible.

When All Hauls Should be Sampled

Observers aboard catcher-only trawlers participating in the pollock fishery are expected to sample every haul. These vessels make relatively few hauls each day, so sampling all hauls is possible. In general, observers aboard vessels participating in other fisheries can sample all hauls if the vessel is taking three or fewer hauls per day. Catcher/processor longline vessels are the exception to this generality, and observers may need to use the RST or RBT on a longline C/P

retrieving more than two sets a day. Finally, if there are two or more observers aboard a vessel, it is expected that all hauls will be sampled.

When to Use the Random Sample Table

If you doubt that you will be able to sample all of the hauls that your vessel brings aboard on a normal day, use the RST to determine which hauls to sample. It will be necessary to use the RST to select hauls in most fisheries, other than those mentioned above. If you feel that you will usually be able to keep up with all the hauls, but may need an occasional break if fishing picks up or you fall behind on other duties, the Random Break Table (RBT) may be a better choice. A discussion on when and how to use each of these tables follows.

Versions of the Random Sample Table (RST)

There are three versions of the RST. The difference between the tables is the number of “off” hauls in each sequence. Hauls which are not supposed to be sampled are referred to as “off,” and hauls which are to be sampled are referred to as “on.”

The three versions of the RST which you can use are:

1. the RST usually used on catcher vessels,
2. the RST used on C/Ps landing 6 or fewer hauls each day, and
3. the RST used on C/Ps landing more than 6 hauls per day.

The catcher boat table has one “off” haul in each sample sequence, while C/P tables can have between one and three off hauls in each sequence. ***Choose an RST which is appropriate and will best fit your needs.*** You may choose to use a more rigorous schedule, but you may not use a less stringent schedule than your vessel type and fishing activity requires.



Use the RST which is most appropriate to your vessel. You may always use a more stringent table if you can keep up with it!

Look at the title of the table to be sure you are using the correct one. When you first board a vessel, ask the captain how many hauls he expects to land each day. Use this number to determine which table to use. Once

ESSENTIAL INFORMATION: Selecting Hauls to Sample

you choose an RST, you should stick to it, unless the vessel changes fisheries, or drastically changes their fishing habits.



Do not give your RST to vessel personnel. Inform them verbally only when you wish not to be notified!

	A	B	C	D	E	F	G	H	I	J	K	L	M
A	2	3	2	4	4	2	3	2	4	3	4	2	4
	1	1	1	1	1	1	1	1	1	1	1	1	1
B	4	3	4	4	3	2	3	2	3	3	2	3	2
	1	1	1	1	1	1	1	1	1	1	1	1	1
C	2	4	3	3	3	3	3	3	3	2	4	3	3
	1	1	1	1	1	1	1	1	1	1	1	1	1
D	4	4	3	4	4	4	3	4	4	4	4	3	4
	1	1	1	1	1	1	1	1	1	1	1	1	1
E	3	3	3	2	2	3	4	2	4	2	4	3	3
	1	1	1	1	1	1	1	1	1	1	1	1	1

Figure 2-2 Random Sample Table (example)

How to Use the RST

In the RST, the bold-face rows of type indicate the number of consecutive “on” hauls that should be sampled. The normal-face type rows are the number of consecutive “off” hauls that are not sampled. You will be instructed how to enter the RST during your training or briefing. Once you enter, your first hauls selected will always be “on” hauls. From this point, move vertically down through the table sampling or not sampling the number of hauls as indicated. If you reach the bottom of a column, begin again at the top of the next column. If you reach the end of the table (Z, Z) continue at the top of the table (A, A).

Vessel Responsibility and the RST

The RST was designed to randomize the hauls sampled by an observer. It is the vessel personnel's responsibility under CFR 679.50(f) to “notify observers at least 15 minutes before fish are brought on board,...to allow sampling the catch,...unless the observers specifically request not to be notified.” If vessel personnel are not notifying you of retrievals, it can affect your ability to sample according to instructions. Talk to the captain to ensure he understands that you must be notified of fish coming aboard. If problems with notification continue, be sure to document this in your logbook and inform NMFS staff through ATLAS or when you are in port.

The RST is for your use only. Your samples are meant to represent the catch under normal fishing activities. If the crew knows which hauls will or will not be sampled, they could alter their fishing activities. In order to avoid this possible bias, do not give your RST to vessel personnel. If you need to let the captain know your immediate schedule in order to get some uninterrupted rest, do this verbally.

How to Use the Random Break Table (RBT)

Break tables are designed to give observers a six-hour break each day when normal vessel operations do not permit adequate time off. The RBT is another tool that can be used to randomize which hauls are sampled. The RBT can be used alone, when an RST provides too much time off, or in combination with a RST on any vessel type when all hauls cannot be sampled. Remember, the break table should only be used if you cannot sample all the hauls. If your vessel does not fish for part of a day, or makes one long tow (usually at night), you should consider that your break and disregard the break table.



The RBT can be used alone, or with the RST to randomize sampled hauls and time off.

Unlike the RST, you can use the break table on some days, and not on others. Of course, you may also use it every day. Once it is used, you must track each day on the break table, whether the break time is taken or not. For example, if you use the break table one day, then it is not used for two days, record the date on the second and third lines and use the time on the fourth line for a break on the fourth day.

The break table is made up of three columns. The first field reads “DATE,” the second field is for you to record the date and the third field has a break starting time for each day. A 24-hour clock is used, so a day is from 0000 to 2359 ALT. Beginning at the top of the table enter the date of the first day you use the RBT and check to see when you should begin your six-hour break. Work down the first column, filling in the date

of each day, whether or not a break is taken, and taking six-hour breaks when needed (only one per day) using the scheduled time for that date. When you finish the first column, start at the top of the second column and so on.

You are responsible for all the “on” hauls brought aboard the vessel prior to the start of your break, so you may not actually start your break at the time indicated on the table. For example, you are on a longline vessel following only the break table, and your break starts at 1800 hours. The vessel picks up a set at 1745. You need to sample this set, since it started being retrieved before your break began. When you finish your sample at 2015, you would start your six-hour break. To document your change, draw a line through the 1800 on the table and write 2015 next to it. ***Additionally, if you are too exhausted to wait for your break, follow the same documentation procedure, and write the circumstances in your logbook.***

Break Table Use Summary

- Take a break only on days you need it.
- If the retrieval time of an “on” haul is before your break time, complete your sample before taking your six-hour break.
- Break for six hours unless otherwise instructed by NMFS staff.
- Sample the next “on” haul which has a retrieval time after the end of your six-hour break.
- Hauls retrieved during your break continue to be counted against the Random Sample Table.

Documenting RST and RBT Use

Your use of the Random Sample and Break Tables must be documented on the Observer Haul Form. Fill in the “Random Sample Table” and “Random Break Table” columns to indicate what tables you were using. **If you use the break table, staple it into your logbook**, so that any changes you made regarding when you took a break are properly documented.

If Your Sampling Schedule is Too Rigorous

If you find that you cannot sample all the “on” hauls on a vessel, or that your other work is suffering, there are a few things you can try:

DATE	<u>01/16</u>	0800 0245
DATE	<u>01/17</u>	0100
DATE	<u>01/18</u>	0700
DATE	<u>01/19</u>	1300 1415
DATE	<u>01/20</u>	1600 1730
DATE	<u>01/21</u>	1200 1145
DATE	<u>01/22</u>	0400
DATE	<u>01/23</u>	1200 0145
DATE	-----	0100

Figure 2-3 Properly Completed Break Table

1. If you are on a C/P or mothership and are only using the RST, start using the break table on some or all days.
2. Reduce your sampling time by reducing the sample sizes of one or more hauls in the on haul series. ***It is preferred to have random, smaller samples from more hauls than large samples from fewer hauls.***
3. Look ahead at your schedule and plan to make best use of your rest time. For example, if your RST reads that you have a four-on, one-off, four-on series coming up, try getting more rest before this series. Complete paperwork, nap, and eat between samples so you have a larger block of rest time in between during your off haul.
4. If you get caught in an unworkable situation, you can skip one of the hauls in the series to be sampled. If you do not sample an “on” haul, continue sampling the rest of the series as if you had. In the four-on, one-off, four-on series example, if you needed to rest for two hauls, you would sample four hauls, rest for two, and sample three hauls to complete the series. If it is necessary to skip on hauls on a continuing basis, contact with an Observer Program for advice. ***Do not sample off hauls to make up for skipped on hauls!***
5. If you are having difficulty following the RST or RBT regularly, contact NMFS for assistance (see “Contact Addresses and Numbers” on page A-45). Do not use a solution that has not been approved by NMFS!

Frequently Asked Questions About the RST and RBT

Q1: I am supposed to sample four hauls in a row. The third haul comes up at 1450, and I am scheduled to begin a break at 1500. Do I sample that haul?

A1: Yes. Sample the third haul in that block and then take your 6-hour break. When you finish your break you will re-enter the RST. To re-enter, check the fishing schedule against the RST to see when the next “on” haul will be retrieved.

Q2: A haul is retrieved at 0945 and my break starts at 1000. According to the instructions, I should sample this haul, but they don't begin processing until after the fish have aged for four hours. Do I sample this haul?

A2: Yes. While you are waiting for them to begin processing, you can do paperwork, laundry, eat, etc. After you complete your sampling you may begin your 6-hour break if needed, or skip the break for that day.

Q3: Can I skip breaks and only take them on a few days when I need to?

A3: Yes. On the table, record the date of each day whether or not a break was taken. You cannot accumulate break time by skipping a day and taking a longer break the following day. You cannot take more than one break per day.

Q4: Can I sample more hauls than those indicated on the RST?

A4: No. Do not sample “off” hauls on the RST unless you can sample all the hauls. If the number of hauls taken by the boat was overestimated, you may switch to a more rigorous RST. You should not switch more than once unless the vessel changes fisheries or fishing activities.

Q5: My break is over and the haul currently being processed is an “on” haul and is about half processed. Can I take samples from the remaining portion?

A5: No. Since the catch is already half processed, half the population from which you want to sample is unavailable to you. This would interfere with your random sampling design. Additionally, you were not present to verify that no presorting, or other unusual sorting, occurred. Use this time to complete paperwork, get some more sleep, or take some down time for yourself.

Q6: Suppose my break is just ending and the next haul retrieved is an “off” haul, resulting in a longer break than I need. Should I stick to the RST and not sample?

A6: Yes. You must sample only the designated hauls, resulting in a longer break than the six hours scheduled. Consequently, you may not need to take a break the next day.

Q7: I was just assigned to a different vessel (or, my vessel just completed a delivery and is resuming fishing). How does this effect my use of the RST?

A7: When you are assigned to a new vessel, or when fishing resumes after a delivery, continue where you left off on the table if you were in the middle of an “on” series, or were going to start another. If you left off in the middle of an “off” series, or were going to start another, skip to the next “on” series. *Your first haul of each new vessel or trip should be an “on” haul.*

INTRODUCTION TO SAMPLING THEORY

The following section explains some of the basics of sampling theory. For specific sampling instructions you should refer to the appropriate sections on vessel type within this manual. If you have any questions, especially with regard to this section, please contact Observer Program staff.

Target vs. Sampled Populations

Fisheries observers report on catch from commercial fisheries. You provide answers to the questions of what, where, when, and how much was caught. In a perfect world, observers would take a census of the catch: every fact about everything that was hooked, trawled, or trapped would be accounted for. In most situations at sea a census for every species will be impractical. Sampling the population is the next best option to a population census. Through sampling you will provide information necessary for fisheries management.

Any time you sample, you are dealing with two populations: the target population and the sample population. The target population is the population of interest, or the population we want information about. In contrast, the sample population is the population available to you; it is the population that is going to supply information about the target population.

It is your main goal during sampling to ensure that the sample population represents the target population. Recognized differences between sample and target populations need to be noted in your logbook and discussed during debriefing. You must also note any factors you believe may in some way have an effect on the population available to you.

Sample Design

In order for your sample to accurately reflect the population, you must adopt an adequate sampling design. By incorporating randomness into your sampling (*e.g.*, by using a random sampling design), you are increasing the probability that your samples reflect the population sampled.

In random sampling, each and every individual has an equal chance of being in your sample. There are two sample designs used by the Observer Program to incorporate randomness: simple random sampling (SRS) and systematic random sampling (SYS). These systems are discussed further in chapters specific to vessel type.

Sample Frames

Each sampling design uses a sampling frame from which sample units are selected at random. In other words, the sampling design is the type of sampling you will be performing (SRS or SYS), and the sampling frame is the “what” you will be sampling from (the list of all sample units in the population). If the sample frame does not adequately represent the target population, then the data (and any results generated from the data) may be biased.

Sampling frames can either be spatial (based on equal-sized units of space) or temporal (based on equal-sized units of time). Following are examples to illustrate this point:

Example 1: Bob is an observer on a trawler catcher vessel. The catch is dumped onto the deck and generally fills up the entire trawl alley. There is one area of the trawl alley that is not available to Bob, because it is dangerously close to a moving net reel. In this case the trawl alley contains the target population of fish and the sample population excludes fish in the area from which Bob can not sample. Bob visually divides the trawl alley area into equal sections using the trawl alley

bin boards as a guide. He then numbers these sections and randomly chooses sections from which to sample. In Bob’s case, the sample frame is spatial.

Example 2: Sue is an observer on a catcher vessel that dumps its catch into a live tank and then processes it over a sorting belt into holding tanks below deck. She knows that fish go by on the conveyor belt at a fairly steady rate (so much weight per so much time). Because the fish are not accessible all at once but rather over time, Sue decides to sample based on time units. The total amount of time units that the haul takes to go over the conveyor belt comprise a temporal frame.

Example 3: Jasper is sampling on board a catcher processor that uses a flowscale to weigh its catch. As with example 2 above, the fish are available over time (not all at once as in example 1), but because the fish are being weighed by the flowscale, Jasper can also sample spatially, based on weight. Jasper determines that sampling based on weight is the best option and uses a spatial frame of weight units from which to sample.

Creating Your Sampling Design

Create your sample design before you start sampling. In creating your design you must carefully consider the total amount of organisms you can quantify (sort, count weigh) in one sample and the time needed between sampled units of your sampling frame. Estimate the total amount of the catch and divide it into equal sized *manageable* sample units. Keep in mind that the more you can sample from a population the better; the larger the overall sample size, the closer you get to an actual census of the catch.

The Benefits of Multiple Large Samples

Multiple large samples have a positive influence on the data: they produce low variance (*e.g.*, high precision). This is because the variance, or mathematical uncertainty, decreases as more samples are taken.

Data quality is increased when you:

- 1) take random samples,
- 2) take multiple samples,
- 3) make each of those samples as large as possible.

ESSENTIAL INFORMATION: Introduction to Sampling Theory

When in doubt over whether to sacrifice the size or the number of randomly selected samples, take more samples over taking fewer very large samples. At least three samples are necessary for the estimation of variance!

What Does All This Mean for You?

The Bering Sea and Gulf of Alaska Fisheries are among the best managed in the world, in large part due to the data collected by observers. Statisticians and fisheries managers rely heavily on observer data and rely heavily on the assumption that these data have been collected a specific way. It is your job as a North Pacific Fisheries Observer to collect data in the manner dictated by this manual and program staff, and to fully document those instances for which you are unable to do so.

When considering your sample design, there are three key elements to *always* consider, listed here in order of priority or importance:

1. All samples should be *random*;
2. You must maximize the *number* of samples taken per sampled haul;
3. You must maximize the *size* of your samples per sampled haul.

This short list should be referenced in the development of any sample design on any vessel type. All samples should be random; once randomization has been accomplished through Observer Program standards, consider how many samples are feasible on your particular vessel type. The Observer Program encourages a *minimum* of 3 samples per haul when feasible. Finally, once the number of random samples has been maximized, consider sample size. As previously mentioned, larger sample sizes help to ensure higher quality data.

Steps in Developing a Sample Design

Following is a synopsis of sampling steps. These steps are addressed again in the chapters of this manual specific to vessel type:

1. **Define the target populations.** The target population is the group we want to make statements about (inference). In the case of species composition sampling, the target population is defined as all the fish

in a given haul. In the case of biological sampling (*e.g.*, sex/lengths), every individual of the species being sampled comprises the target population.

2. **Determine the type of sample frame best suited to the target population and the vessel.** In practice, you have two general categories of sampling frames on a trawl vessel: *spatial* and *temporal*. Use a spatial frame, such as measured portions of the deck or bin, when all the catch is available at once. Use units of time (*e.g.*, five minute increments) when all the catch passes you at one point, as on catcher vessels when catch is dumped directly into below deck tanks. Although units of time on vessels with a flowscale is an option, observers generally use units of weight. On a longliner or pot boat, your sampling frame can be composed of units of gear (skates or pots, either individual or grouped). Gear based frames are considered spatial frames.



A weight based frame using a flow scales is considered a spatial frame.

3. **Define your sample units and sample population.** If your spatial frame breaks the catch on deck into measured areas, then a single measured area is the sampling unit, and you must be able to collect all the animals from this area. Likewise, a single five minute increment of run time could be a sampling unit for a temporal frame. On a longliner, a sampling unit could be a single skate or a mag (a mag is usually comprised of several skates). On a pot boat the sample units could be a single pot, a group of five pots, or a group of any number of pots. The one significant requirement for all these options is that unit size be consistent throughout the frame.

Sample units should all be of equal size, and as large as possible for a given situation. The size of your sampling unit should be manageable: you must collect or otherwise account for *ALL* the animals within a single unit. Animals or sample units that can not be sampled (are presorted, or unavailable to the observer) are not included in the sample frame, and are therefore not part of the sampled population.

4. **Consecutively number the units in the sample frame.** If your units are sections of deck, assign a

number to each section. If your units are time increments, number them consecutively. Skates or groups of pots can also be numbered consecutively (you need to account for the total number of skates or pots in the entire set).

5. **Pick random numbers.** For a simple random sample, generate random numbers from one to your maximum sample unit number. For systematic random samples, select a random start point between one and your desired sample interval (the process of determining an appropriate *sampling interval* is discussed more fully in this manual’s vessel specific chapters).



Pick random numbers using a random number table, dice, cards, or any other objective method.

6. **Selecting the units from which to sample.** If you are working with a simple random sample design, the randomly generated values of step 5 above represent the units to sample. If working with a systematic sample design, the first randomly chosen sample unit and every *n*th sample unit thereafter (where *n* is the sample interval) constitutes your sample.

7. **Sample the randomly chosen units.** If your sampling units are deck sections, collect **all** of the animals from each randomly selected deck section. If your units are sections of longline gear or pot gear,

account for **all** animals from the randomly selected segments or pots. If your units are time increments, collect **all** of the fish during the time increment. **Sample unit size must be manageable, because every fish in the unit must be accounted for.**

In Figure 2-4, there are three sample frame examples. The colors represent the species composition of the haul, with one color representing one species. For the purposes of this example, you can define the units by either time or space - whichever you are most comfortable with conceptually. The first two frames, A and B, each have 12 units. The last has 6 units, each twice the size of those in frames A and B.

The units marked by a dark “X” are those that were chosen to sample. In Frame A, only 1 large sampling unit is selected, resulting in only 2 species of fish in the sample. In Frame B, 3 smaller sampling units were selected (every 4th unit, starting at unit 3; sample interval (n) = 4). Through a random systematic sample, not 2, but 3 species of fish were selected for sampling. In Frame C, the units themselves are larger and 3 sampling units were selected (every 2nd unit starting at unit 2; sample interval (n)=2). Through a random systematic sample (SYS) and increased sample size, 4 of the 5 species in the haul are represented. If these were real samples of real fish, the last sampling frame and design would provide the most accurate statement about the nature of the catch in that haul.

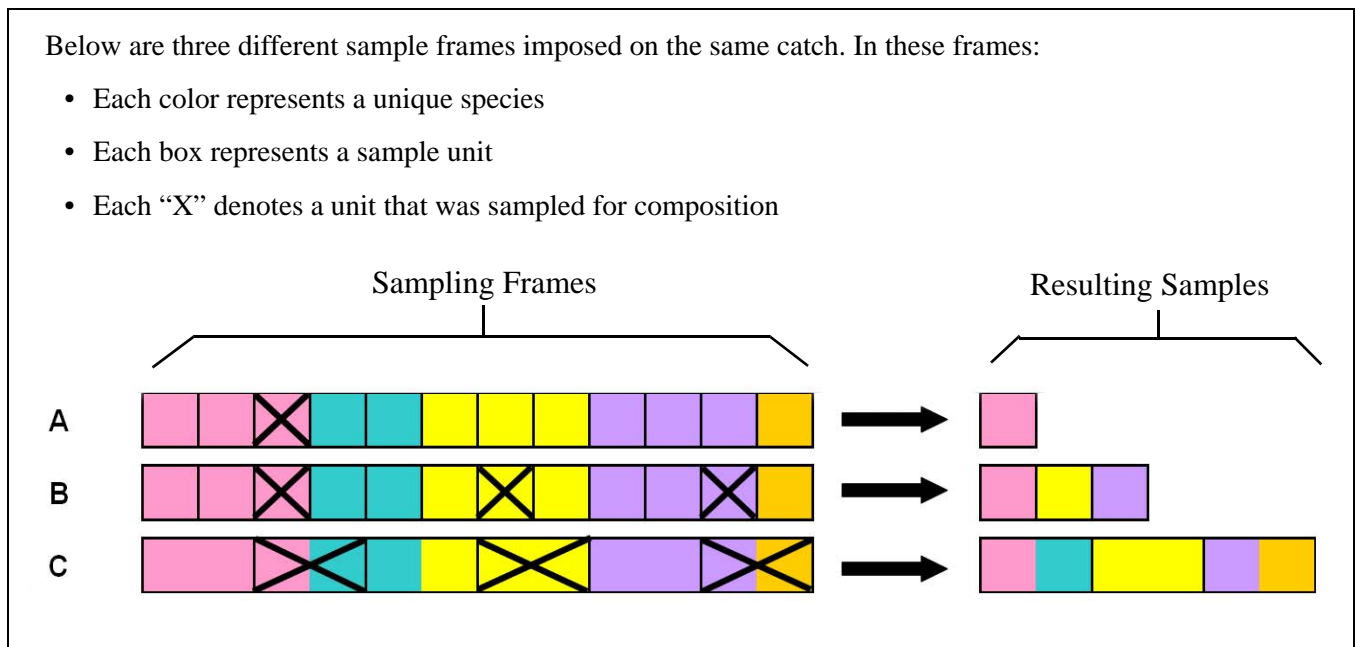

Figure 2-4 Sample frame examples showing benefits of multiple large samples over fewer small samples.

ESSENTIAL INFORMATION: Subset Sampling

Documenting Design Constraints or Problems

In some cases, it will not be possible to systematically sample. For example, limited access and small catch sizes on some catcher vessels make it difficult if not impossible to sample systematically. When you are unable to sample systematically, for whatever reason, a simple random sample method is the next best option.

There will be times when you will not be able to maintain your intended sampling design for a haul. You might find yourself in this situation if a haul becomes unexpectedly dirty, requiring you to sample much less than you planned to, or you misjudge the time you need to sort through one sample. *If you abort or alter a sampling design during the sampling of a haul, for whatever reason, document the circumstances on the “Sample Design Changes” form of your observer logbook.*

How to Use the Random Number Table

To use the random number table, enter the table at a random point. The easiest way to do this is by closing your eyes and placing your finger on the table. The column and row nearest your finger is the starting point. Determine how many digits in the row you are using: if you need numbers between 1 and 250, use three digits in the row, and so on. Decide in which direction you will move through the table. Then proceed in any direction through the table (even diagonally), recording appropriate numbers and skipping numbers too high or repeated, until you have enough random numbers. Unlike on the Random Sample Table, you do not have to keep track of your position in a random number table. You should decide on a direction and enter the table at a different random starting point every time you use it.

For example, if you need to choose 3 numbers between 1 and 25, you could enter the table by placing your finger on the table to choose a column and row. Your criterion is two digit numbers between 01 and 25 (inclusive). For this example, you decided to work up the column from your starting point. As you move up the column, the first number you encounter is 14. This is a two-digit number between 01 and 25; it fits the criterion, so you write it down. The next number is 09; it also fits the criterion, so you write it down. The next number is 58 and does not fit the criterion so you skip

this number. Keep moving up the column, skipping the numbers that do not fit the criterion, until you have chosen all the numbers you need.

SUBSET SAMPLING

Subset sampling is a sampling method that provides data users with additional information on the species or species groups encountered in your samples. In the course of collecting and working up your samples, there may be occasions when it is too time consuming or impossible to weigh *and* count all, or identify all, of a single species in your sample. To handle these situations the observer program allows random subset sampling for number and weight or for species identification.

Subset sampling is a tool that can be used to save time, space, and energy but it should not be over used as actual numbers, weights, and identification of all individuals to species provide the best information.

Subset Sample for Number and Weight

The observer program prefers that a number and weight be provided for all species in your composition data, but sometimes this is not possible. If a species in your sample is so abundant that you are having a difficult time counting and weighing it, you are allowed to reduce your effort by taking a small random subset sample of that species from within the larger sample. You will use this subset sample to provide critical weight and number information for the species. All remaining individuals *not* in the subset sample are counted *or* weighed only. *Whether you count or weigh individuals not in the subset sample depends on vessel type and species, so you must refer to the topic of subset sampling in the vessel specific chapters of this manual!* Managers use the values supplied by the randomly collected subset sample information to determine the weight or number of the individuals of that species in the entire sample.

The implementation of subset sampling for number or weight is dependent on the gear type with which you are working. Please refer to the trawl composition, longline, and pot vessel chapters for specific directions on subset sampling for number or weight.

Subset Sampling for Species Identification

In the process of identifying the individual specimens in your randomly collected samples, you may find fish species which are difficult to distinguish from one another. Identifying each of these fish to species may take unreasonable amounts of time, particularly if a distinguishing characteristic requires a time-consuming task such as counting gill rakers. In these situations, it is appropriate to do a random subset sample for species identification.



Subset samples for species identification are often used for rock sole, Tanner crabs, shortraker/rougheye rockfish and arrowtooth/Kamchatka flounder groups.

To collect a subset sample for species identification, pick random portions of your composition samples (baskets, sampled time units, segments of gear) and collect all the individuals from the species group. Randomly choose between 20 and 30 individuals from the group to identify. The identified animals are listed on separate lines on the Species Composition form with the species name. The remaining individuals from the group, which were not further identified, should be weighed, counted, and recorded under the more general code for that species group.



Do not extrapolate a subset sample into the rest of your sample! Record the fish that were not identified to species with the group code (i.e., rock sole unident., code 104).

For example, you have too many fish from the rock sole group in your sample. You cannot identify each of them, so you choose two random baskets of mixed fish and remove and identify all the rock sole. Upon completion, you find that of the 29 total rock sole in the two baskets, 26 are northern rock sole and 3 are southern rock sole. For the species composition of that sample you would list 26 northern rock sole, 3 southern rock sole, and all the rock sole from your remaining sample as “rock sole unidentified.” If rock sole is the predominant species that you will be measuring, you should also use the identified-to-species rock sole for your length sample and record them on the Length and Specimen Form. An example of recording a subset

sample of rock soles can be found on the Species Composition form example in Figure 5-11 on page 5-40.

USING YOUR SCALES

To obtain accurate weights, you must use the appropriate scale. If your vessel is equipped with a motion compensated electronic platform (MCP) scale which is passing *daily* tests, you may use this scale for all sampling purposes, including weighing individual fish for otolith or scale sampling. MCP scales can be read to the hundredth of a kilogram. Use your NMFS issued scales in the following manner:

- Use the 2.0 kg brass scale for items weighing up to 2.0 kg. This scale can be read to the hundredth of a kilogram.
- Use the 12.0 kg brass scale for items between 2.0 and 12.0 kg. This scale can be read to the hundredth of a kilogram.
- Use the 50 kg Salter scale for weighing items between 12.0 and 50.0 kg. This scale can be read to the tenth of a kilogram.

If you board a small vessel in Dutch Harbor or Kodiak, Chatillon flatbed scales are available from the NMFS field stations. These scales have a gauge that can be read to hundredth of a kilogram, but it is usually not appropriate to do so. Unless the weather is very calm, these scales should be read to the tenth of a kilogram, like your hanging 50 kg Salter scales.

Although your scales look sturdy, they are susceptible to damage and excessive rust. Keep them in good working order by removing them from open areas when you aren't using them and keeping them well oiled. For instructions on how to care for a Chatillon flatbed scale, see page A-49. **Bring your scales into a field station some time during your cruise to retest them and ensure they are still accurate.** Document these test results in the “Scale Verification Record” section of your logbook.



Keep your scales dry and well oiled. It's nearly impossible to use too much oil on a scale!

ESSENTIAL INFORMATION: Using Your Scales

Motion Compensated Electronic Scales

Vessels regulated under a Limited Access Privilege Program must supply and use motion compensated scales. When they are required to, trawlers will have a flow scale and a platform scale on board and longliners will have a platform scale on board. A few catcher vessels have flow scales, but it is unlikely that these are NMFS certified. Flowscales that are not certified may not be used for Observer Estimates or to determine sample weight: they may only be used as a sampling aid.

Motion compensated platform and flow scales are able to accurately weigh catch by comparing the weight on two separate load cells. The first load cell weighs the object with an unknown weight (your basket of fish), the second load cell, or reference load cell, weighs a known weight. The two weights are compared at least 60 times per second and this enables the scale to compensate for motion that would otherwise cause an inaccurate weight reading. Flow scales, or conveyor scales, also monitor belt speed and incorporate that information into the weight calculations. Both scale types, when properly calibrated, provide highly accurate weights.

Platform scales are used to weigh the samples you collect. Vessel crew will also use the platform scale to complete their daily flow scale test. Flow scales are incorporated into a conveyor belt and are used to weigh total catch on C/P and mothership vessels. They may be used to design a weight based random sample frame and for larger samples, can also be used to determine sample size. If your trawl vessel is equipped with a motion compensated flow scale, and it is passing daily accuracy tests, you should use this for determining sample size and Observer Estimate. You may use motion compensated scales even if your vessel is not operating in a fishery where they are required, but they must be tested appropriately each day they are used.

Platform Scale Testing

If you are using an MCP scale, you are required to test this scale at least every 24 hours using certified test weights. When two observers are on board it is recommended that each observer test the scale during their shift. The vessel must provide a combination of test weights that allow the platform scale to be tested at 10 kg, 25 kg, and 50 kg. Most vessels have either gold colored or stainless steel weights. Many vessels also

have standard weights (lbs) that are silver in color that they use to test their production scales. ***Make sure the test weights you use are metric and not standard.***



MCP scales must be off by no more than $\pm 0.5\%$ from the test weight.

When you test the platform scale, the displayed weight should be off by no more than $\pm 0.5\%$ of the known test weight. Record each test, even failed tests, in your Daily Observer Platform Scale Test Log. If the scale fails at any of the designated weights it should be re-tested or calibrated and re-tested. Whether you simply re-test or calibrate and re-test will depend on the make of scale. The vessel should have a copy of the scale instruction manual and you may want to consult with the engineer or factory foreman the first time you calibrate or test the platform scale. ***The MCP scale cannot be used to determine the weight of any part of your sample if it has not passed the daily test.***

To test an MCP scale:

- Test the platform scale at 10 kg, 25 kg, and 50 kg at least every 24 hours. It is recommended that observers test the scale at the beginning of each observer shift. If the platform scale fails, it may be retested or calibrated and retested.
- Record all test results on the Platform Scale Test Record in your logbook.

Marel and Pols Platform Scales

Seventy percent of the NMFS approved platform scales are made by Marel. Both Marel and Pols platform scales have a function called “marine calibration.” Prior to testing these scales for the first time you should perform a marine calibration. Consult the scale instruction manual, the engineer or a factory foreman if you need assistance. Marel scales will display a reminder to perform a marine calibration by the blinking “CAL” light about every three hours of operation. Pols scales will not remind you to perform a marine calibration.

Skanska Platform Scales

The only thing you need to do with Skanska platform scales is perform the daily test. There is no marine calibration for this brand of scale.

What To Do When the Platform Scale Fails

If the platform scale fails the daily test you should test it again. For Marel and Pols scales you can perform a marine calibration and then re-test the scale. For Skanvaegt scales, simply re-test the scale. If the scale does not pass after two or three attempts, consult with the factory manager or the engineer and inform the captain that the scale has failed. It is the captain's decision whether the vessel continues to fish. As an observer your role is simply to inform the captain that the scale has not passed and that it is a violation to continue fishing until the scale is repaired. If the vessel continues to fish you should sample for species composition using your 50 kg Salter and brass scales. You should also notify NMFS, via your inseason advisor, and document the incident in your logbook. **Do not refuse to sample or tell the vessel they can't fish if the platform scale is not functioning.** The flow scale cannot be used to determine sample size or haul weight if the MCP scale does not pass. The accuracy of the weight used to test the flow scale is dependent on the MCP scale.

Flow Scale Testing

On vessels where flow scales are required by regulation, the flow scale must be tested at least one time each 24 hour period in which fish are weighed on the flow scale. It is the vessel's responsibility to (1) test the flow scale each day, (2) notify the observer that they are going to test the flow scale at least 15 minutes in advance, and (3) conduct the test while you are present. The vessel should fill out a Record of Daily Scale Test and you will sign the form signifying that you witnessed the scale test.

While watching the flow scale test and sampling hauls, pay attention to the actions of the crew. The following scenarios may indicate a problem with the flow scale that must be reported to NMFS:

1. The crew needs to make adjustments to the scale prior to each test.
2. The flow scale frequently goes into fault mode during haul processing.
3. The rate-of-flow display indicates that tonnage flow per hour has changed drastically, even though the flow rate appears to be the same (*e.g.*, the crew have been running a full belt of fish at 40 tons/hour and suddenly the flow scale reads a flow at 20 tons/hour,

even though no adjustments to flow rate have been made).



Flow scales must be off by no more than $\pm 3.0\%$ from the MCP scale weight.

In order to do a flow scale test, the vessel must weigh at least 400 kg of fish or an alternative material (sand bags) supplied by the scale manufacturer. Other items such as bags of flour or rice and steel test weights are *not* approved for testing flow scales. After the fish or sandbags are weighed on the flow scale they should be weighed on the platform scale. The maximum permissible error for flow scales is $\pm 3.0\%$. Complete instructions for testing the flow scale appear on the Record of Daily Scale Tests form, provided by the vessel. Vessel personnel will ask you to sign this form. It is the only non-Observer Program form you should sign! In summary, the vessel personnel's responsibilities for flow scale testing include:

- Having the scale certified by the Alaska Regional Office.
- Ensuring that hauls are not mixed.
- Performing a daily 400 kg. materials test, using fish or test materials supplied by the scale manufacturer (sandbags).
- Conducting the flow scale test in the presence of an observer, to verify that the test was conducted in accordance with regulations.
- Recording the flow scale test on the proper form (OMB No. 0648-0330).
- Producing a printout of the total catch weights, which must include the haul number, the date of the haul, and the weight of all the catch as weighed by the flow scale.



If the vessel has trouble with their flow scale, have them contact Alan Kinsolving, NMFS Scale Program Coordinator. Phone (928) 774-4362 Fax (907) 586-7465.

What To Do When the Flow Scale Fails

If the flow scale fails the daily test, it may be re-tested as many times as the crew wishes. The scale may *not* be relied on as a source for total catch weight until it

ESSENTIAL INFORMATION: Sample Station Requirements

has passed the daily test. ***If total catch is weighed on a flow scale that did not pass the daily test, do not use that weight as the Observer Estimate. You must report only the vessel estimate, leave the observer estimate blank, and notify your inseason advisor.***

If the flow scale fails, the *captain* decides whether or not to continue fishing. As an observer, your role is to simply inform the captain that the scale has not passed and that it is a violation to continue fishing with a scale that has not passed the daily test. If the vessel continues to fish, sample for composition using the MCP scale (assuming it has passed). Your sample sizes will be limited by the fact that you must weigh the entire sample on the MCP scale. Notify NMFS, via your inseason advisor, and document the incident in your logbook. ***Do not refuse to sample or tell the vessel they can't fish if the flow scale isn't functioning.***

SAMPLE STATION REQUIREMENTS

Observer sampling stations and motion compensated scales are not required on all vessels participating in CDQ and AFA fisheries. Though they are required to carry a Level 2 observer, CDQ trawl catcher vessels are not required to provide an observer sampling station or motion compensated scale and, under certain circumstances, non-trawl catcher vessels are not required to provide observer sampling stations or scales. In addition, catcher vessels less than 60 ft LOA that deliver all groundfish CDQ, halibut CDQ, and salmon PSQ to an approved processor are exempt from observer coverage, sampling station, and scale requirements.

Vessels required by regulation to have an observer sampling station or motion compensated scales must have those items certified before participating in limited access privilege fisheries such as the CDQ, AFA of limited access non AFA groundfish fisheries. Observer sampling stations are certified by FMA Division staff and motion compensated scales are certified by NMFS Regional Office staff. Certification is good for one year from the date the observer sampling station or motion compensated scale was approved. Once certified, vessels must maintain an Observer Sampling Station Inspection Report and/or Scale Inspection Report on board and make that report available to the observer, NMFS personnel, or to an authorized officer upon request.

Observer Sampling Station Inspection Reports

When boarding a CDQ, AFA or other limited access privilege vessel read the Observer Sampling Station Inspection Report. Note the date the Inspection Report was issued (certification is good for one year), examine the sample station diagram, and compare the setup of your station against the diagram. Before you complete your inspection of the sampling station, make sure the station is completely setup. Many vessels store their motion compensated platform scales when they are not CDQ or AFA fishing or disassemble the observer sampling station. If possible, test the platform scale before your vessel embarks to make sure it passes the daily test. The scale should be turned on at least ½ hour prior to testing so that it can warm up.

If your vessel is not able to produce an Observer Sampling Station Inspection Report, inform the captain of the requirement for maintaining one onboard and to request a copy from their company office. A faxed copy and original inspection report were sent to each vessel's home office following certification and the vessel should be able to obtain a copy. If the captain is unable to obtain a copy, notify your inseason advisor that the vessel does not have a copy onboard. ***Do not refuse to sample or refuse to embark on a vessel that can't produce the inspection report.*** Once you notify your inseason advisor, NMFS will contact the fishing company and take any necessary action.

Each observer deployed on a vessel fishing with a certified sampling station should complete an Observer Sampling Station Verification Checklist in their logbook. The information you provide will be used to determine if sampling stations are functional or if modifications have been made since the station was last inspected. It is very important that you fill out the checklist completely and provide comments when necessary. You may find that your measurements are slightly different from those listed on the inspection checklist. Small differences are to be expected.

Completing the Observer Sampling Station Verification Checklist

The following should be used to fill out the checklist in your logbook. Each item that pertains to your vessel type should be addressed on the checklist. Whenever possible, quantified units should be recorded. ***Both the lead and the second observer are required to return for debriefing with completed checklists.***

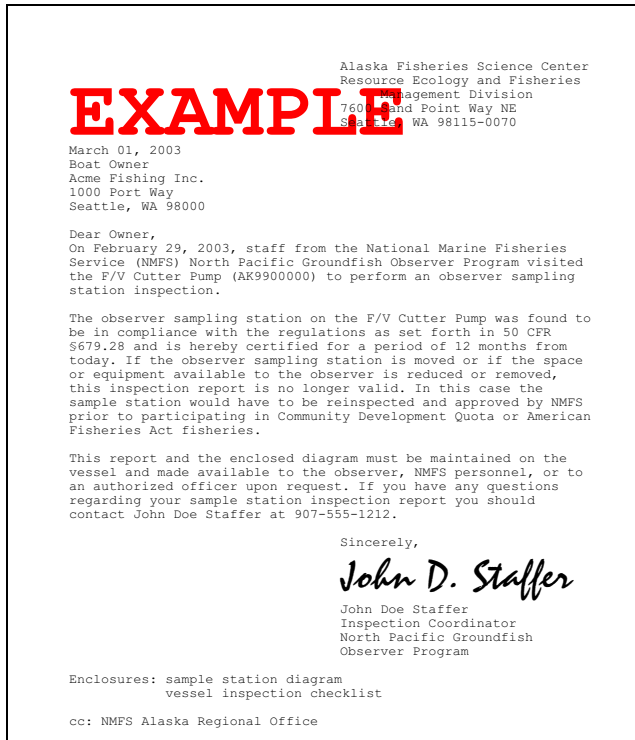

Figure 2-5 Sample Station Certification Letter

Sample Station:

Trawlers: If sample collection points are within the sampling station write “within station.” If you are collecting and weighing your entire sample from a belt outside your station, measure from the nearest point in the sampling station to the closest point of the diverter board (or whatever device is used to collect fish from the belt). If you are sampling a large portion of the haul and sorting and weighing bycatch from the belt (i.e., not weighing predominant catch on observer scales, the MCP scale, or by flowscale), measure from the nearest point in the sampling station to the closest point of the portion of the belt used for bycatch collection.

Non-Trawl: There are three points to be considered for non-trawl vessels. The crucifier or pot launcher is the **point where fish are brought onboard. The collection point** is where you gather fish as they come off the line or are emptied from the pot. The **tally station** is the area in which tally samples are conducted. If the collection point, location where fish is brought on board, or tally station is within the sampling station write “within station.” If outside, record the distance from the nearest point of the sampling station to the specified area.

Minimum Work Space:

The minimum work space must be at least 4.5m², which includes the sample table. Copy the sample station diagram and record the dimensions as you measure the station. If there is any unusable space (e.g., sump pump), record the areas length and width. Unusable space is defined as any area within the sample station where access to the floor is blocked or limited by another object or where height is restricted. A good test of usable space is to simulate moving, storing, and working with a blue basket. If a basket will not fit, then the space is probably not usable.

Table:

The length, width and height of the table should be recorded in the comment box. Measure the outside dimensions (i.e., from the outside of a lip, not from the end of the inside flat surface). If the table is adjustable, note that in the comment box. The area for the scale is in addition to this space, and should not be included in the measurements for the table. If there is any unusable space note the length and width of that area. Unusable table space is defined as an area where setting a blue basket is impossible.

Observer Sampling Scale Location and Height:

This refers only to the MCP scale. The shortest distance from the scale to the table and the height of the platform should be recorded in the comment box. Comment on whether or not the scale has a sticker confirming that its certification is current and what combination of weights are available and where they are kept. Note: MCP scale height cannot exceed 0.70 m.

Flow Scale Display Visibility (trawlers only):

Note if the flow scale display is readable from where you collect unsorted catch and the area where sampling takes place. Note the brand and model number of the flow scale.

Floor Grating:

Diamond plate hatch covers are acceptable in lieu of standard grating, as long as drainage and slipping are not a concern. The comment box should contain notes on type, condition, and location of grating.

Lighting:

Note the number and type of lights directly in the sampling station. Any other light sources should also be recorded.

ESSENTIAL INFORMATION: Working with Two Observers

Hose:

Note whether or not the hose reaches the sampling station, the location of the water valve, and your access to the water valve.

Unobstructed Access:

This refers to movement between the sample collection point and the sample station. Note the width of passageways you must use to move baskets of fish as well any tripping hazards or stairs. Obstructed access is any passageway less than 0.65 m wide and 1.8 m high (floor to ceiling) or a passage which is blocked or limited by objects in the passageway.

Diverter Board (trawl vessels only):

The diverter board must be located after the flow scale and preferably before any sorters. Check that the diverter board is functional. Note: Some vessels have acceptable alternatives for removing catch from the flow of fish for sample collection (e.g., trap doors).

Sample Station Inspection Report:

Note the date and exact pages of the inspection report. Were the sampling station diagram and checklist presented to you with the certification letter?

Additional Comments:

This is the place to record details which are not specifically addressed in the regulations, but are of concern to the FMA Division. Specific points for non-trawl vessels are: tally station details such as location, route between sample station and tally station, and sample collection details

Scale Inspection Reports

All scales required on CDQ, AFA, or other limited access privilege vessels will be marked with a NOAA sticker signifying they are certified. Test weights will be stamped with NOAA insignia to indicate that they are certified. If a scale on your vessel does not have a valid “NMFS Approved Scale” sticker, you should ask to see the Scale Inspection Report. If your vessel is not able to produce a Scale Inspection Report, inform the captain of the requirement for maintaining copies on board. Notify your inseason advisor that the vessel does not have these documents on board. Send another message if the vessel obtains copies from NMFS or their home office. ***Do not refuse to sample or refuse to embark on a vessel that is unable to produce a Scale Inspection Report or a weight certificate.*** Once you notify your inseason advisor, NMFS will contact the fishing company and take any necessary action.

Vessel Types Fishing CDQ,AFA, or LAP	Sampling Station?	Flow Scale?	Platform Scale?
Vessels < 60 ft (no observer required)	No	No	No
Trawl catcher vessels (delivering all catch)	No	No	No
Trawl catcher/processors and motherships	Yes	Yes	Yes
Non-trawl catcher vessels (discarding at sea)	Yes	No	Yes
Non-trawl catcher vessels (delivering all CDQ catch)	No	No	No
Non-trawl catcher/processors	Yes	No	Yes
Non-AFA groundfish BSAI C/P trawl (limited access privilege)	Yes	Yes	Yes

Figure 2-6 Sample Station Requirements by Vessel Type

WORKING WITH TWO OBSERVERS

There are several North Pacific fisheries that require two observers aboard a C/P vessel. These include the CDQ, AFA, limited access privilege and Atka mackerel fisheries. Some vessels voluntarily carry two observers, even during an open access fishery. This presents observers with the unique opportunity to work

together. Both observers are expected to work together as a team to provide consistency in sampling techniques, data recording and communications with vessel personnel. A “lead” observer will be assigned by your employer. The other observer is referred to as the “second.” Although ***the lead observer is not in a supervisory position***, their role is slightly different from that of the second.

Level 2 and Lead Observers

CDQ and limited access privilege program fisheries operate under additional regulatory requirements. These regulations specify that one or more of the observers on board have proven their ability to collect quality data via previous experience on similar vessel types and or/fisheries.

To achieve level 2 status, an observer must successfully complete a cruise that involved at least 60 days of data collection. A successful cruise is defined as one for which you received a debriefing score of “1.” A debriefing score of 1 indicates that you met expectations for data produced throughout your deployment. In order to maintain level 2 status, you must have a “met expectations” score for your most recent assignment. Those who receive a score other

than 1 for a cruise will lose their level 2 status and must successfully complete a cruise before they can regain that status.

A lead observer is an observer that has met the requirements to become level 2 certified, as well as additional experience requirements on specific vessels and gear types. To become a lead observer, you must have successfully completed two cruises and met the experience requirements below.

- Trawl C/P and Motherships: 100 sampled hauls
- Trawl C/V: 50 sampled hauls
- Fixed gear C/P and C/V: At least 10 days and 60 sampled sets.

<i>Component</i>	<i>Requirement (all 100% coverage unless stated otherwise)</i>
CDQ (non pollock)	
Catchers ≥ 60 ft, and all pot gear	One level 2 observer
Catcher/Processors, trawl	2 observers, at least one must be lead level 2
Motherships	One lead level 2 and one level 2 observer
Catchers ≥ 60 ft fixed gear sablefish	30% coverage with one observer (longline > 125ft require 100% coverage)
Catcher/Processors, longline	One lead level 2 and one level 2 observer
Shoreside and Floating Processors	One level 2 observer for each CDQ delivery
AFA & CDQ Pollock	
Catchers ≥ 60 ft	one observer, level 2 not necessary, with 30% or 100% coverage subject to LOA
Catcher/Processors and Motherships	2 observers, at least one must be lead level 2
Shoreside and Floating Processors	one observer, level 2 not necessary, for each 12 hours of AFA or CDQ processing
Amendment 80 (Trawl C/Ps)	
Catcher/Processors in BSAI	2 observers, at least one must be lead level 2
Catcher/Processors in GOA	one observer, level 2 not necessary
Rockfish Pilot Program	
Catcher/Processor	2 observers, at least one must be lead level 2
Catcher vessels	one observer, level 2 not necessary
Shoreside and Floating Processors	one observer, level 2 not necessary, for each 12 hours of receiving deliveries from catcher vessels cooperatives, limited access or entry level

Figure 2-7

Lead Observer's Role

As a lead observer, it is expected that you have more experience on the given vessel type and therefore are given more responsibilities. The lead observer is expected to work closely with the second observer and provide tutelage as needed to ensure the highest quality data. When problems occur on the vessel the lead observer should address these immediately with crew or captain. This assures that vessel personnel receive consistent and timely feedback as problems arise, and allows them the opportunity to work with you in finding a resolution to the issue(s).

As the lead observer, you are responsible for the entire data set. With the exception of the "Haul sampled by" column on the OHF, all data must be recorded under your cruise number, regardless of who actually collected it. All data entry to ATLAS and text messages must be entered and sent under your cruise number. As a lead observer, you are also responsible for ensuring that your data are sent to NMFS on time. You and the second observer(s) should maintain separate Daily Notes in your own logbooks, but all calculations must be recorded in your logbook.

Because lead observers are responsible for the data set, it is necessary for them to direct the sharing of duties and other activities of the observer team. In instances when opinions differ, the lead observer will have the immediate say in the matter. NMFS should be notified immediately and will have the final say.

As the lead, your role in debriefing is far more involved than that of the second. The lead observer is responsible for submitting the entire data set to NMFS and is required to make all necessary corrections to the data set, regardless of which observer made the error. As the lead observer, you need to know how the second observer(s) collected and recorded raw data so that you can make any necessary corrections. It is in your best interest to double check all data according to the instructions given at the end of the chapters describing data collection and form protocols. NMFS staff will try to debrief you and the second observer(s) at the same time if it is logistically possible. This is preferred, since speaking to both observers at the same time makes it easier to clear up any data questions.

Second Observer's Role

The second observer has the same responsibilities for data quality and integrity as the lead. As the second observer, you will record all the data you collect under the lead observer's cruise number except in the "Haul sampled by" column on the OHF where you will record which hauls you sampled. Record all calculations in the lead observer's logbook. The only data that you will collect under your own cruise number are your fish ID forms and your Daily Notes. Any compliance issues that you witness should be documented thoroughly in your logbook and the lead observer should be notified. Sampling problems that arise during your shift should be handled immediately and you should inform the lead observer. Recurring problems should be discussed with the lead observer, and the lead should address the concerns with the vessel.

When you collect salmon scales, these should be recorded under the lead observer's cruise number and kept in numerical order with scales s/he collects. Write your initials on the back of the envelope, so that species identification verification can be done for scales collected by both observers.

If you and the lead observer do not debrief at the same time, you will need to reconstruct your time aboard the vessel during your debriefing interview. Keep very detailed notes in your own logbook regarding how you sampled and any problems you encountered to assist you in remembering specific events aboard the vessel. You may make photocopies of calculations, diagrams or other pertinent information from the lead observer's logbook to bring to debriefing if you would like (this is not required, but some observers have found it helpful). With the exception of making data corrections, your debriefing will be the same as that of a lead or solo observer.

Shared Duties

As a part of the observer team you are expected to maintain effective communication with your fellow observer. You should agree on a specified time between shifts to discuss pertinent fishing and sampling activities that occurred during the previous shift. Decide on a *secure* common area to leave recent data that needs to be entered or checked by your colleague. Each observer is responsible for all hauls during his/her shift. Each observer should be on duty for no more than 12 hours in a 24 hour period. *During CDQ, AFA, and*

other limited access privilege fisheries, you should complete all your duties, including data entry within these 12 hours. If you are unable to complete all your duties within 12 hours, contact your inseason advisor for advice. Both observers should share the responsibility of collecting the data for the Trip form, Vessel and Observer Haul Forms and entering data into ATLAS. Additionally, both observers are responsible for, and should take the initiative in, resolving sampling problems that arise due to the vessel setup and operation. Remember that both observers should always be advised of all pertinent activities and instances related to observer duties. Be sure to establish a system of checking calculations, data, and data entry before sending data. ***Checking someone else’s data for errors is more efficient than checking your own– do both!***

You must work together to establish viable random sample designs. Since each haul represents a population and can be sampled independently, it is not necessary that both observers use the same sample designs. It *is* essential that a design remain the same throughout any individual haul or set. In the event that both observers sample a haul or set, the observer who begins the sample will decide on the appropriate random sample design and the other observer should follow that design. To aid in data correction and verification, each observer ***must*** initial the deck sheet for every sample collected.

Both observers should contact NMFS if there are significant differences of opinion concerning sampling methods. Each observer must describe their sampling technique thoroughly. The inseason advisor will advise you on the proper course of action.

INSEASON ADVISORS AND TEXT MESSAGES

Vessels or plants with ATLAS will have assigned staff acting as inseason advisors. ***Be sure to alert your inseason advisor when you first board the boat.*** Inseason advisors are available to answer sampling and data recording questions. They will answer questions, review inseason data and request corrections. Any time you are uncertain about anything, send a message to your inseason advisor. Quick responses to these questions and corrections will aid in effective communications ensuring quality data for your cruise.

First Message to Inseason Advisor Example:

“Hello! We are settling in pretty well here. We verified the Safety Checklist and the captain ran a hands-on man-overboard drill. The sample design we are using is a systematic spatial design. The haul is divided into 9-12 equal units based on the vessel estimate. The RNT is used to select the first sample within the first 3 units. From here every 3rd unit is sampled (ex: the vessel estimate is 45 mt, gives us 9 units of 5 mt each, RNT=1, we sample 0-5, 15-20, 30-35, and so on). We may need to modify this for small hauls, but we haven’t had any yet. Within the sample frame the RNT is used to select a sample unit and then a basket within that unit to collect sex length fish (if there are too many fish in the basket, we dump the entire basket into 2 baskets side by side and use the RNT to select one of those 2 baskets to get approximately 20 fish). We clear the sorting belt, have fish run onto it and collect all of those for our sample, and we check to see the belt is clear before letting fish flow for the factory again. We used the RNT to select a haul for otoliths (haul 3). The RNT will be used to select fish for S/L/W and otoliths (lining up the fish on the observer table) from the sex length fish. If we have hauls with 2 predominant species a subsample will be collected from the sample that was collected for sex length. Let us know if you have any questions. Thanks! Wally and Polly.

Inseason Messages Do and Don’t

Do

- ***Write to your inseason advisor as soon as you board the vessel.***
- Proofread your messages.
- Be precise when asking a question or describing your methods.
- Notify your advisor when your partner or the target species changes.
- Contact your advisor immediately if any injury, illness, or marine casualty occurs.

Don’t

- Discuss vessel personnel in a derogatory manner.
- Use inappropriate language.

SENDING DATA

During the course of your cruise, you may need to contact NMFS for many reasons, but the most common reason is to send your data. The data you collect at sea is vital for inseason management. When the Observer Program receives your data, preliminary quality control checks are done, and the information is made available to the Sustainable Fisheries Division in Juneau. The Division uses the observer data to determine how much catch has been removed from each regulatory area. If you do not submit data on time, and in the proper format, the Observer Program cannot provide the information necessary for making sound management decisions.

Sending Data via ATLAS

The table in Figure 2-8 describes how often observers with ATLAS communications should send data by vessel type. Send data as required, even if your vessel has not fished in this time period. Send in the non-fishing day positions to let the NMFS know that there was no fishing activity. *If your vessel landed catch, but you were unable to sample for any full day, you must include a text message explaining why.* The Observer Program needs to be able to verify that data was not collected on that day. Plant observers must document non-delivery days on the Offload form. For more information on sending data via ATLAS, refer to page 16-15.

Vessel Type / Fishery	Transmission Frequency
C/P or mothership trawl All fisheries	Once per day
Longline & Pot MSCDQ fisheries	Once per day
Longline & Pot Non-CDQ fisheries	2-3 times per week
Processing plants	2-3 times per week
Trawl catcher vessels All fisheries	Once per day

Figure 2-8 When to Send Data via ATLAS

If you are assigned to a pollock vessel with ATLAS and you disembark your vessel before receiving your final fish ticket **DO NOT** fill out paper forms and fax them once you get your delivery information. If it is possible, go to a field office where a NMFS staff member can load your ATLAS data on a computer and you can enter and transmit via ATLAS. If this is not an option, you may need to wait until you return for debriefing to enter that data.

Correcting and Resubmitting ATLAS Data

If you are on a vessel or at a plant with ATLAS and you need to change your data, see 'ATLAS INSTRUCTIONS' beginning on 16-1 for specific instructions. Any data that you edit in Atlas will automatically be sent to Seattle the next time you prepare and transmit data. If you are asked to resend ATLAS data, select a haul or date range before you prepare your data to be transmitted.

Faxing Data

Observers who use fax communications must fax their data on a weekly or trip by trip basis (whichever is more frequent). If you are using fax communications, your sent data will consist of your Trip Form, Offload Form, Vessel and Observer Haul Forms, and the corresponding forms for species composition, lengths and specimen data, and marine mammal interaction, specimen and sighting data. If no fishing was done for a trip, fax in the Trip Form and both Haul Forms with the non-fishing day locations recorded on them. *If your vessel landed catch, but you were unable to sample for any full day, you must include a text message explaining why.* You may have been ill or the weather may have been bad, but the Observer Program needs to be able to verify that data was not collected on that day.

If you are assigned to a pollock catcher vessel that does not have ATLAS, the observer program keypunch staff must have all of your offload data before it can be entered. This includes the Vessel/Plant offload form, offload census composition and any offload level length or specimen data. You will need to wait for the fish ticket and any after scale information before completing and faxing offload data.

Fax your data to the Groundfish Observer Program in Seattle at 206-526-4066 or 206-526-4207. If you have trouble sending your data don't give up! Call the

Observer Program collect at 206-526-4240 if you continue to have problems. If no one answers, leave a voice mail message. Include your name, cruise number, vessel name, and the reason why you can't send your data.

Questions or text messages can be included with your data on a blank, unlined sheet of paper and may be hand written or typed. Please print or use a large font so faxes can be easily read.

Correcting and Resubmitting Faxed Data

If you have a correction to data that you have previously faxed to the Observer Program, simply correct the information on your paper form(s) and **circle all the changes!** At the top of the form, **circle "resubmission"** so we know you are sending corrections to previously faxed data.

Occasionally, the Observer Program will not receive some or all of your data due to a communications problem. If this happens, you may get a message from your employer instructing you to resend the missing data. In this case, simply fax the missing data.

Cruise			Permit			Year			Observer Haul Form						
20778			1239			2009			Observer name <u>Juan DeFuca</u>						
									Vessel name <u>Astoria Queen</u>						
									Resubmission (Circle All Changes)						
Haul No.	Haul sampled by (cruise no.)	RST on haul? (Y=on, N=off, X=na)	RBT on break? (Y=on break, N=no break)	% Mammals for marine mammals	Vessels total catch estimate in mt	Estimated discard weight in mt	Trawl vessels				# of s li				
							Observers catch estimate in mt	B, C, or W	Density in mt/m ³	Volumetric estimate in m ³		Catcherboat's ADF&G # (motherships only)			
0						
200	20778	X	N	100	4.00	0.25	4.25	W		
201	20752	X	N	100	<u>18.00</u>	<u>0.0</u>	<u>19.12</u>	W		
202	20778	X	N	100	22.00	0.0	23.15	W		
203	<u>20752</u>	X	N	100	<u>16.00</u>	<u>0.0</u>	16.56	W		
204	20778	X	N	0	18.00	0.0	17.12	W		
205	20778	X	N	100	27.00	0.0	30.45	W		
206	20752	X	N	100	24.00	0.19	24.19	W		
207	20752	X	N	100	15.00	0.0	16.57	W		
208	20752	X	N	100	17.00	0.0	18.40	W		
209	20778	X	N	100	20.00	0.0	21.92	W		
210	20778	X	N	100	25.00	0.0	25.49	W		
						

Figure 2-9 Resubmitted Fax Data (example)



TRIP INFORMATION

Table of Contents

Introduction.....	3-1
Safety Orientation.....	3-1
Become Familiar with Your Vessel	3-2
Catcher/Processor Trawler.....	3-2
Catcher-Only Trawler.....	3-3
Longline Vessel	3-3
Pot Vessel.....	3-4
The First Haul.....	3-4
The Trip Data Form	3-4
What Is A Trip?	3-4
Trip Data Form Instructions	3-4

INTRODUCTION

There are several trip by trip elements that are important to your deployment. These include a safety orientation, familiarizing yourself with the vessel configuration, and the collection of trip data.

SAFETY ORIENTATION

The very first thing you will need to do upon boarding a new vessel is to ensure the US Coast Guard Commercial Fishing Vessel Safety Examination Decal (see page 17-2) is valid based on the information noted on the face of the decal. ***You may not board a vessel that does not have a current decal.*** If the vessel does not have a current decal, inform the captain that you are not able to board the vessel without one and immediately inform your employer. Document the decal information in your logbook. (**Please note that the mothership Ocean Phoenix is not required to have this safety decal.*)

Upon boarding the vessel, introducing yourself to the captain should be a priority. Present to the captain the “Letter of Introduction” and use it as a tool to answer any questions the vessel may have. It’s important at this meeting to set the tone for a friendly but business-like working relationship. If the captain is receptive, take this opportunity to mention the following points:

- Tell the captain that it is important for you to routinely see the ship's fishing logs.
- Ask to be informed, in advance, of changes in the fishing schedule so that you may adjust your schedule accordingly.

- Ask to be notified if any marine mammals or short-tailed albatross are found in the catches, regardless of time of day. Request that these animals be held for your examination. Ask to be notified, if possible, of marine mammal and short-tailed albatross sightings.
- Ask how you will be notified of haul backs. Devise a plan with the captain and/or mate.



Observers are to be notified at least 15 minutes before fish are brought onboard, unless the observers specifically request not to be notified.

- Before leaving the dock you must be given a safety orientation and you need to go through your safety checklist (see page 17-3). After this, if you have any questions or concerns that have not been addressed, ask the skipper. Notify your employer and report in your log any unresolved safety problems.

Remember, while the vessel is in port, the captain is usually busy and may not be receptive at this time. Do not be discouraged. Ample opportunity should be available to discuss your issues and concerns with the vessel captain while steaming to the fishing grounds.



Vessels are required to provide observers with accommodations equivalent to those provided for officers or other management level personnel of the vessel.

BECOME FAMILIAR WITH YOUR VESSEL

As quickly as possible, try adapting to the new surroundings by familiarizing yourself with the layout of the vessel and by meeting the people you will be working with. If the previous observer is available, ask that person to give you a tour and orientation of the vessel. Note key areas such as observer quarters, galley, wheel house, factory and sampling area. If the previous observer is not available, vessel personnel are frequently assigned to assist new observers with the familiarization process.

Before the vessel leaves port, make sure you have all of your personal items and sampling equipment onboard. Check your equipment before leaving port for lost or forgotten items. Contact the field offices if you require additional sampling equipment and forms. If you are prone to sea sickness, get as much critical presampling work done before leaving port.

A vessel is required to provide observers with a safe work area adjacent to the sample collection site.

It is important that the observer sampling station on board the vessel facilitates your objectives and goals. Questions you should ask yourself when considering an adequate sampling station are:

- Do you have access to unsorted catch?
- Is the collection site near the sampling station?
- Are there any tripping hazards?
- Do you have adequate room for storing your gear and samples?
- Is there a location in which you can secure a hanging scale; if not, do you need a flatbed scale from the field office?
- Is there a work table or a comparable setup available for your use?
- Is there equipment nearby to adequately clean your gear and samples?

If you have the opportunity, you should view the vessel profile prior to deployment in Seattle or Anchorage, or visit one of the field offices.

Catcher/Processor Trawler

In the first few days, familiarize yourself with life on board and initiate your work with the following:

- If your vessel will be using a flow scale, talk to the skipper to determine who will be responsible for testing the scale and how you can obtain haul by haul scale weights.
- When the deck is inactive, perhaps when the vessel is in port or steaming to the fishing grounds, make measurements which will aid you in estimating codend dimensions and bin volumes.
- Watch the net retrieval and handling. At this time, you can easily decide when and where you will need to take additional measurements. Also, use this time to improve methods for obtaining dimension measurements for codends and bins. Determine whether you require assistance from vessel personnel and enlist their aid.
- Determine the best location for observing the codend retrieval. Remember that the location needs to be in a place that will ensure your safety and allow a full view of the deck activities. Speak with the deck boss for assistance in determining where the best area is with your objectives and goals in mind. Watch how and where the codends are opened and how thick and fast the fish are dumped. Look to see if the crew does any sorting on deck.
- Observe the factory operations. Notice where the catch is being sorted, and what species and sizes are being retained. Follow the fish from the deck to the freezer. This is a good opportunity to determine what method would be suitable for obtaining information on the amount of catch that is discarded. Note what primary and ancillary products are being made. Be aware of all possible hazards.
- Get started with the most obvious methods for making catch weight estimations, for obtaining species composition data, and for collecting other biological samples. As time progresses, and you become comfortable with your duties, consider other methods or implement variations in your methods to improve your sampling and data quality.

Catcher-Only Trawler

Fishing operations are much simpler aboard a catcher-only vessel, but an observer has less opportunity to get oriented as only a few tows are made each trip.

- When the deck is inactive, perhaps when the vessel is in port or steaming to the fishing grounds, make measurements which will aid you in estimating codend dimensions.
- Watch the net retrieval and handling. At this time, you can easily decide when and where you will need to take additional deck measurements. Also, use this time to improve methods for obtaining dimension measurements for codends. Depending on the fishery, you may be using the trawl alley as a bin for volumetric estimates. This would be a good time to measure the trawl alley. Trawl alley measurements may also aid in obtaining codend dimensions. Determine whether you require assistance from vessel personnel and enlist their aid.
- Determine the best location for observing the codend retrieval. Remember that the location needs to be in a place that will ensure your safety and allow a full view of the deck activities. Take special note of hazardous or potentially hazardous areas. The captain or crew members may also have some advice on where possible hazardous situations exist.
- If you will be required to sample at a processing plant, you should locate the plant observer before or immediately after your first deployment, so they can provide an overview on the plant sampling station and typical sampling protocol, (see “SHORESIDE PLANTS AND FLOATING PROCESSORS” on page 9-1).
- Make a note of checker bins or other equipment that will be useful for collecting and storing samples. Space is limited on the smaller vessels so making use of all available resources is a necessity. You may realize at this point that you require an extra basket or two. You can obtain extra baskets or portable totes from the field offices.
- For the first retrieval, be prepared with sampling equipment ready and in hand. Use this time to observe the retrieval of the net and determine the most appropriate area and method for obtaining a

catch estimate, depending on the fishery. Make the effort to measure the codend, or collect bin volumetric dimensions of the catch. Watch how and where the codend is opened and how thick and fast the fish are dumped. Look to see if the crew does any sorting on deck. Observe what is retained and discarded. Observe where and how sorting occurs. By being aware of these situations, you will be able to determine the best method for obtaining discard information and avoiding sample bias.

Longline Vessel

The fishing operations on longline vessels are different from trawl vessels. There are other considerations that should be addressed.

- It is important to be familiar with the units of gear, gear handling, and average number of sets per day. This information will assist you in setting up a routine to complete your duties. Speak with the captain or deck boss to obtain this information. This is also an excellent time to determine the best method of verifying the number of hooks per skate and to apply that method.
- Sampling for species composition requires an area for observing the gear retrieval and everything that is caught on the gear. Depending on the vessel configuration, this is most likely to be on deck. You will also need to locate an area where you can collect, store, and weigh bycatch and target species. This means that you may have more than one sampling station. Remember, working on a longliner imposes many hazards. You need to be aware of all possible dangers and work accordingly.
- During the first gear retrieval, locate an area where you can observe the retrieval of the line and all organisms coming up on the line. You should be near enough to identify most fish to species, family, or to special species groups. Determine what species are being retained and discarded, both at the roller and in the factory. This is a good time to observe the rollerman and determine what type of control you will have over the collection of bycatch. Take into account the retrieval rate of the gear and the amount of gear set in order to conceive a sampling frame. Monitor the quality of gear reparation, as this affects overall gear performance.

Pot Vessel

The fishing operations on pot vessels are similar to those on longline vessels, with few minor differences.

- It's important to be familiar with the units of gear, gear handling, and average number of sets per day. This information will assist you in setting up a routine to complete your duties. Determine hazardous work areas. Speak with the captain or deck boss to obtain this information. Determine the best method to verify the number of pots set per string.
- Sampling for species composition can be quite arduous due to the many hazards you need to be aware of as you are working. Pot vessels are small vessels with constant activity. You will need to set up your sampling station away from the gear retrieval area and all of the potential hazards that may occur in that area. Ask the vessel personnel where observers have historically sampled.
- Locate an area where you can observe the retrieval of the pots, yet remain safe of deck activity. Let the deck crew know what your objectives and goals are so they can work with you. Determine what species are being retained and discarded. Take into account the retrieval rate of the gear and the amount of gear set in order to conceive a sampling frame.

The First Haul

The first catch onboard is an excellent opportunity for you to work out a routine for collecting, sorting, weighing, and counting fish. This time allows you to determine what methods and techniques you will apply to collect species composition samples. Try to collect one or more baskets of fish. Practice collecting biological data from the target species and other species as required. Determine if and what extra assistance will be required to obtain biological data such as sexed length frequencies from the predominant species and halibut viability assessments. Familiarize yourself with the species caught by using the species identification keys and field guides. **Complete species description forms for all species seen.**

These guidelines are general, and are written for observers going to sea their very first time. These guidelines will also assist prior observers who are beginning a cruise onboard a vessel/fishery type with which they are not familiar. Remember that vessel and

plant specific profiles are available. The profiles will facilitate and enhance your first days onboard your boat.

THE TRIP DATA FORM

Trip data information will allow economists to better define the duration of fishing trips and to understand how fishing trips change as fisheries regulations, markets and institutions evolve. **All vessel observers complete this form.**

What Is A Trip?

For our purposes, a trip is defined as “any time a vessel that you are assigned to unties from the dock at a port, floating processor, or tramper, and upon completion of that trip the vessel returns and ties up to a dock in a port, at a processor, or a tramper.” In the event that an “at sea transfer” takes place, an observer is then asked to start or end the trip at the point of embarking or disembarking the vessel at sea. The port code of 18-Transfer at sea would be used. There may be times where a vessel trip doesn't include any fishing. Even though no fishing took place during your deployment, this still needs to be recorded as a trip. Observers are only responsible for documenting trips for which they were physically on board the vessel.

Trip Data Form Instructions

Cruise, Permit, Year: Enter the cruise number supplied in your training or briefing. Vessel permits can be found on page A-25. For “Year” you can enter the full year or just the last two digits (e.g. “09”). ***If data on the Trip Form straddles the end of one year and beginning of the next, write the last two digits of both years, separated by a slash (e.g. “08/09”).***

Observer’s Name/Vessel Name: Enter your name and the name of the vessel.

Resubmission: Circle “Resubmission” if you are sending changes to data previously faxed. ***Circle the items that have changed since your last transmission of the data; this will aid keypunchers in making the appropriate modifications to your data.*** You do not need to start a new form after faxing. You can continue to use the form until all sample blocks are filled with data; just be sure to enter the correct header information for each new sample.

Page Numbers: Number the pages “Page ___ of ___” starting with page one for each vessel or plant and ending with the total number of pages.

Trip Number: Start with 1 for each vessel. *It is not necessary to skip lines between trips.*

Crew Size: Enter the total number of crew (including the captain) on the vessel at the beginning of each trip (do not include the observer(s)).

Fish in hold at trip start?: Enter “Y” if there are fish or product in the hold at the start of the trip. Enter “N” if the hold is empty.

Port Codes: Use the table below to determine the port code of the port the vessel is leaving from or returning to. Enter the port code in the “Port of Trip Start” or “Port of Trip End” column and leave the latitude and longitude columns for trip position data blank. If the port the vessel is docked at is not listed, or the vessel is docking to a catcher processor/tramper anchored in a bay, use the “Other” code. If you use the “Other” code, you must enter position data in the trip start and/or trip end position columns. For at-sea transfers, use code 18 and enter position data.

1-Adak	7-Seward	13-Ketchikan
2-Alitak	8-St. Paul	14-Kodiak
3-Dutch Harbor	9-Yakutat	15-Seattle
4-Juneau	10-Akutan	16-Sitka
5-King Cove	11-Cordova	17-Other
6-Sand Point	12-Homer	18-Transfer @ sea
19-Tacoma	20-Bellingham	

Trip Start Position: If you leave from a port, floating processor or tramper that is not listed in the table above, use the “Other” code and list the latitude and longitude of the port in the trip start position. If you transfer at sea, use code 18 and enter position data. Read the position directly from the ships GPS or ask the skipper for the positions. One hundred+ degrees of longitude are assumed, so do not enter the “1.” Record the position to the level of accuracy available. The observer program collects position data to the nearest second. Vessels may record their positions to the nearest minute, seconds, or hundredths of a minute. If the vessel lists their positions to the hundredths of a minute, you must convert this value to seconds. To convert from hundredths of a minute to seconds,

multiply the hundredths of a minute value by 60. Do not enter degree marks. Fill out the “E or W” column to indicate if the longitude is east or west of the 180 degree line.

Start Date: Enter the month and day the vessel departed the port, processor, or tramper.

Time of Trip Start: Enter the time the vessel left the port, processor, or tramper. If transferring at sea, record the time you boarded the vessel. Use 24 hour time notations, in four digits with no colons. Enter all 2400-hour notations as 0000 hours which starts a new date.

Trip End Position: If you return to a port, floating processor or tramper that is not listed in the previous table, use the “Other” code and list the latitude and longitude of the port in the trip end position. If you transfer at sea, use code 18 and enter the latitude and longitude where the transfer occurred. Follow the same rules as described for “Trip Start Position” when entering the position information. Fill out the “E or W” column to indicate if the longitude is east or west of the 180 degree line.

End Date: Enter the month and day the vessel ties up to a dock at a port, processor, or tramper.

Time of Trip End: Enter the time the vessel ties up to the dock or processor. If transferring at sea, record the time the transfer occurred. Use 24 hour time notations, in four digits with no colons. Enter all 2400-hour notations as 0000 hours which starts a new date.

Did fishing occur?: Enter “Y” if the boat you were assigned to actually fished during the trip. Enter “N” if the vessel did not fish during this trip.

Bait Used (for fixed gear only): Enter the appropriate code of the bait the vessel is using. If the vessel is using a bait that is not listed, enter “7” for “Other.” If the vessel is using a combination of baits listed use “8” for “Combination.” When using code “7” or “8” write in the type of bait they were using in the comment section on the bottom of the page. If your vessel is not using fixed gear leave this column blank.

1- Herring	5-Sardines
2-Squid	6-Salmon
3-Octopus	7-Other
4-Pacific cod	8-Combination

TRIP INFORMATION: The Trip Data Form



Observers are allowed free and unobstructed access to navigation and communication equipment on request.

(rounded to the nearest hour) under the appropriate reason. Your preprinted options are Mechanical problem, Weather related problem, Crew related issue (accident or other problems), USCG/ Enforcement related stoppage, Marine Mammal interaction/ predation, and Other. If "Other" is used please provide an explanation in the comments section at the bottom of the page. If no time was lost while the vessel was out fishing, leave all time lost columns blank.

Time Lost at Sea (Hours): Time lost is any time something unexpected occurs while at sea that changes the ability of the vessel to fish and it has to spend time waiting or repairing something they otherwise wouldn't have done. Enter the total amount of time lost

Cruise 11999		Permit 5677		Year 2009		Trip Data Form										Page <u>1</u> of <u>1</u> for vessel															
Observer name <u>Polly Pollock</u>												Resubmission (Circle All Changes)				Time Lost at Sea (Hours)															
Vessel name <u>CHIMAERA</u>																															
Trip No.	Crew Size	Fish in hold at start?	Port of Trip Start	Trip Start Position						Start Date		Time of trip start	Port of Trip End	Trip End Position						End Date	Time of Trip End	Did fishing occur? (Circle Yes/No)	Bait Used? (Check gear only)	Mechanical problems	Weather related problems	Crew related issues	USCG / Enforcement related stoppage	Marine Mammal interaction/predation	Other <small>(include notes)</small>		
				Latitude (N)			Longitude (100)			Month	Day			Latitude (N)			Longitude (100)													Month	Day
				Deg.	Min.	Sec.	E or W	Deg.	Min.					Sec.	Deg.	Min.	Sec.	Deg.	Min.												
1	56	N	3							06	27	1900	3							06	30	0200	Y								
2	56	Y	3							07	01	0100	3							07	02	1200	Y	2							
3	55	N	3							07	03	0200	8							07	12	1045	Y	15							
4	55	N	8							07	13	0900	3							07	23	1730	Y								
5	55	N	3							07	25	0100	17	53	50	12	W	66	10	24	07	27	0620	Y							
6	56	N	17	53	50	12	W	66	10	25	07	27	1500	3						07	27	1300	N								
Comments: Trip 2. Lost engine power twice, took 2 hours to fix, then headed to port Trip 3. Hid behind island during storm. Trip 5, Offloaded to trawper in Beaver Inlet, then run to BH																															

National Marine Fisheries Service / Fisheries Monitoring and Analysis Division Page _____ of _____ for transmission Rev. 09

Figure 3-1 Trip Form Examples

TRIP INFORMATION: The Trip Data Form

Cruise	Permit	Year	Trip Data Form										Page <u>1</u> of <u> </u> for vessel																				
14821	3459	2009	Observer name <u>Boris Shelikof</u>										Resubmission (Circle All Changes)																				
			Vessel name <u>Kamchatka Klipper</u>										Time Lost at Sea (Hours)																				
Trip No.	Crew Size	Fish in hold at start?	Port of Trip Start	Trip Start Position						Start Date		Time of trip start	Port of Trip End	Trip End Position						End Date	Time of Trip End	Did fishing occur?	Bait Used? (fish gear only)	Mechanical problems	Weather related problems	Crew related issues	USCG / Enforcement related stoppage	Marine Mammal interaction/predation	Other (include notes)				
				Latitude (N)			E or W	Longitude (100)			Month			Day	Latitude (N)			E or W	Longitude (100)											Month	Day		
				Deg.	Min.	Sec.		Deg.	Min.	Sec.					Deg.	Min.	Sec.		Deg.													Min.	Sec.
1	17	N	10							08	12	2130	10						08	19	1410	Y	2										
Comments:																																	

National Marine Fisheries Service / Fisheries Monitoring and Analysis Division Page of for transmission Rev. 09

Cruise	Permit	Year	Trip Data Form										Page <u>1</u> of <u>1</u> for vessel																				
11979	5137	2009	Observer name <u>Bea Potter</u>										Resubmission (Circle All Changes)																				
			Vessel name <u>Dungeness Dreams</u>										Time Lost at Sea (Hours)																				
Trip No.	Crew Size	Fish in hold at start?	Port of Trip Start	Trip Start Position						Start Date		Time of trip start	Port of Trip End	Trip End Position						End Date	Time of Trip End	Did fishing occur?	Bait Used? (fish gear only)	Mechanical problems	Weather related problems	Crew related issues	USCG / Enforcement related stoppage	Marine Mammal interaction/predation	Other (include notes)				
				Latitude (N)			E or W	Longitude (100)			Month			Day	Latitude (N)			E or W	Longitude (100)											Month	Day		
				Deg.	Min.	Sec.		Deg.	Min.	Sec.					Deg.	Min.	Sec.		Deg.													Min.	Sec.
1	13	N	17	61	00	12	W	71	05	20	09	20	1930	8					09	24	1430	Y									1		
2	11	N	8								09	24	1500	3					09	26	2300	Y	2										
Comments: <u>Trip 1. Searching for lost pots.</u> <u>Trip 2. Engine repair</u>																																	

National Marine Fisheries Service / Fisheries Monitoring and Analysis Division Page of for transmission Rev. 09

Figure 3-1 Trip Form Examples

<u>TRIP FORM QUICKLIST FOR ALL VESSELS</u>		
<u>PORT CODES</u>		<u>BAIT CODES</u>
1-Adak	15-Seattle	1-Herring
2-Alitak	16-Sitka	2-Squid
3-Dutch Harbor	17-Other	3-Octopus
4-Juneau	18-Transfer @ sea	4-Pacific Cod
5-King Cove	19-Tacoma	5-Sardines
6-Sand Point	20-Bellingham	6-Salmon
7-Seward		7-Other
8-St. Paul		8-Combination
9-Yakutat		
10-Akutan		
11-Cordova		
12-Homer		
13-Ketchikan		
14-Kodiak		

Figure 3-2 List of Codes for the Trip Form

TRIP INFORMATION: TRIP Form QUICKLIST for ALL VESSELS

TRAWLER CATCH DATA

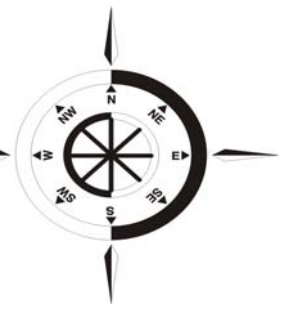

Table of Contents

List of Priorities	4-1
Introduction	4-1
Documenting Fishing Effort	4-1
Electronic Logbooks	4-2
Verifying Logbook Information	4-2
Date and Time of Gear Deployment and Retrieval.....	4-2
Times that Do Not Reflect True Fishing Duration	4-2
Deployment and Retrieval Latitude and Longitude.....	4-4
Vessel Estimates of Catch.....	4-4
Observer Estimates of Catch Weight	4-4
Weighed (“W”) Observer Estimates	4-4
Volumetric Observer Estimates	4-6
Observer Estimates by Bin (“B”) Volumes	4-6
Potential Bin Volume Biases	4-7
Observer Estimates by Codend (“C”) Volume.....	4-8
Measuring Large Codends	4-8
Determining Density	4-10
Prescribed Densities.....	4-10
Calculated Densities.....	4-10
Dumping Partial Codends.....	4-10
Estimating Discards.....	4-11
Recording Offload Data on Trawlers	4-11
Determining Delivery Weight.....	4-12
Prohibited Species Discarded at Sea on Pollock Catcher Vessels.....	4-14
Recording OHF and VHF Data	4-14
Completing Haul Forms on Trawl Vessels	4-14
Completing the VHF on Trawl Vessels	4-15
Completing the OHF on Trawl Vessels.....	4-17

LIST OF PRIORITIES

- Verify and record fishing effort information from the vessel’s official NMFS logbook.
- Obtain independent estimates of catch for at least every haul sampled for composition when required.
- Send data to FMA as directed (see “Sending Data” on page 2-26).
- Collect the “goldenrod” copies of the vessel logbook pages.

INTRODUCTION

This section covers the collection of fishing information for trawl vessels and for motherships taking unsorted codend deliveries. It also includes methods used to obtain independent estimates of total

catch. At the end of this section, instructions are given on how to record fishing effort data and total catch estimates onto the Vessel and Observer Haul Forms. If you are assigned to a shoreside processing plant or a floating processing plant (a vessel that pumps or brails sorted catch from the hold of shoreside delivery vessels) you will need to refer to “Offload Form Instructions” on page 9-6 for record keeping information. Observers aboard longline and pot vessels should refer to “Fishing Effort Information” on page 7-6 (offload) or “Recording Fishing Effort Data” on page 8-6 (pot vessels).

DOCUMENTING FISHING EFFORT

All vessels that carry observers are required by federal regulation to maintain a current NMFS “Alaska Groundfish” logbook for daily fishing and processing activities. The captain or assigned crew member must

TRAWLER CATCH DATA: Documenting Fishing Effort

enter details of fishing activities, effort, and catch in this logbook (called the Daily Catch Production Logbook or DCPL). You will use the logbook to gather the information for the Haul Forms [Observer Haul Form (OHF) and Vessel Haul Form (VHF)]. Under regulation 50 CFR 679.50, observers have the right to inspect and copy the NMFS logbook and all other documentation of fishing effort. For the VHF, you need to obtain the following information from the vessel logbook:

- type of trawl gear used.
- date and time of gear deployment.
- latitude and longitude of gear deployment.
- average bottom depth and average gear depth.
- date and time of gear retrieval.
- latitude and longitude of gear retrieval.
- the vessel crew's estimate of total catch weight.
- whether this haul was from an IFQ, and the CDQ group number, if applicable.

In addition, you need to record a code corresponding to gear performance. Gear performance information is not recorded in the vessel logbook. Ask the captain to let you know if there were any problems during the tow, or document this information somewhere for you.

Electronic Logbooks

Some vessels are using third-party software to maintain their logbooks electronically. This logbook software captures the same information as the paper versions, and is sent to the Alaska Regional office electronically after each trip. Bring a copy of the printout back with you in lieu of a goldenrod copy. Currently, you should expect to see electronic logbooks only aboard catcher vessels. An example of the electronic logbook printout is shown in Figure 4-2.



Be sure all the information you need to complete your VHF/OHF is recorded on your forms before disembarking the vessel!

Verifying Logbook Information

Before recording anything from the vessel logbook onto your data forms, you must verify that the data reported are accurate. If you find that a vessel logbook entry is wrong, you should write down the *corrected* information on the Haul Forms. Document the incorrect data in your logbook, and mention the discrepancy to the captain or person in charge of maintaining the logbook. Please refer your captain to the Region if s/he has questions (see page A-45). Usually, the error will be corrected by the crew member, so you should check the logbook for these changes. It is important that you record the correct information on the Haul Forms even if the logbook entry is never amended. In general, your Haul Forms will match the vessel logbook, with the possible exception of these corrections. Verify the following logbook entries:

Date and Time of Gear Deployment and Retrieval

For every haul, record the time the net reaches fishing depth in the 'time of gear deployment' field of the VHF. The net has reached fishing depth when the winches stop paying out and the vessel speeds up. You must also record the time of gear retrieval for every haul. The time you document should represent when the net was retrieved from fishing depth. Make sure the crew is listing the time gear reaches and leaves fishing depth, not the times the net leaves the stern or is pulled on board. The latter times do not accurately reflect fishing effort (the total time the net was actively fishing). Let the officer in charge of the logbook know if incorrect times are listed. If incorrect data continues to be logged, consult NMFS for advice on how to record your haul data.

Times that Do Not Reflect True Fishing Duration

Sometimes a codend is retrieved from fishing depth and then reset to fishing depth without being dumped on deck. A captain may do this to turn the vessel or check the contents of the net. When this occurs, the start and stop times recorded on the VHF do not reflect the true fishing effort, since the net was not at fishing depth for the entire time. List all "fishing duration affected" tows on the VHF with a code '9' in the gear performance column. Ask the captain to note in the vessel logbook when the true fishing duration is *not* the difference between the start and stop times listed.

TRAWLER CATCH DATA: Documenting Fishing Effort

Expiration Date: 7/31/05

Revised: 10/01/2004

WHITE - Vessel Copy, Keep in Logbook
 ORANGE - Observer Copy
 BLUE - Discard Report, Submit to Processor
 YELLOW - Half Day Report

CATCHER VESSEL DFL GROUND FISH TRAWL GEAR		VESSEL NAME Fishin' Impossible				Date (M - D - Y) 2-4-07 22		PAGE 4	
		OPERATOR NAME AND SIGNATURE Ethan Hunt Ethant Hunt				ADF&G Vessel # 43446		Federal Fisheries Permit No. 4344	
IDENTIFICATION	MANAGEMENT PROGRAM (Check applicable and enter number) CDQ <input type="checkbox"/> Exempted <input type="checkbox"/> Research <input type="checkbox"/> AIP <input type="checkbox"/>		INACTIVE <input type="checkbox"/>	START	END	REASON	OBSERVER INFORMATION		
	GEAR TYPE (circle one) Non-pelagic trawl <input type="checkbox"/> Pelagic trawl <input checked="" type="checkbox"/>		CREW SIZE	FEDERAL REPORTING AREA 517	TRAWL GEAR ONLY (Circle one) COBLZ <input type="checkbox"/> RKCSA <input type="checkbox"/>		OBSERVER NAME AND CRUISE # John Doe 8800		NO. OF OBSERVING VESSEL COMBARD 1

CATCH BY HAUL	HAUL NO	TIME OF GEAR DEPLOYMENT	BEGIN POSITION OF HAUL		AVE. SEA DEPTH (Circle M or FM)	AVE. GEAR DEPTH (Circle M or FM)	DATE AND TIME OF GEAR RETRIEVAL	END POSITION OF HAUL		TARGET SPECIES CODE	ESTIMATED TOTAL ROUND CATCH WEIGHT (Circle Lb or MT)
			LATITUDE	LONGITUDE				LATITUDE	LONGITUDE		
	10	0130	5451	16611	83	82	0745	5450	16558	270	160,000
	11	0400	5452	16554	91	90	1800	5452	16519	270	170,000
	12	1845	5448	16518	71	68	2300	5430	16539	270	100,000
	13	2345	5451	16512	61	60	2330	5444	16518	270	100,000

CATCH DELIVERY INFORMATION		DISCARD/DISPOSITION	SPECIES CODE				PRODUCT CODE				BALANCE FORWARD				DAILY TOTAL				CUMULATIVE TOTAL SINCE LAST DELIVERY			
<input type="checkbox"/> CHECK HERE IF DELIVERIES ARE UNSORTED COD ENDS <input checked="" type="checkbox"/> CHECK HERE IF DELIVERIES ARE PRESORTED AT SEA. IF FISH PRESORTED, INDICATE WHOLE DISCARDS AND DISPOSITION <small>For groundfish and Pacific herring, circle lbs. or nearest 0.001 mt. For Pacific halibut, Pacific salmon, king crab, and Tanner crab, record in numbers</small>				123	122	450	200	98	98	98	98	∅	∅	∅	∅	100 lbs	200 lbs	3	2	100 lbs	200 lbs	3

COMMENTS

Figure 4-1 Vessel Logbook Example

Catcher Vessel Daily Fishing Log 04/02/2007

Vessel Name: Fishy II
 ADF&G Number: 000011
 Federal Permit Number: 1111
 Original

Page No.: 04/02/2007-1
 Printed: 04/04/2007 11:38:48
 Activity: Fishing

Gear Type		Hooks/Skate/ Skates Used		Crew		Observer		Cruise Number						
Non-pelagic trawl		5		1		Tad Pohl		9983						
Haul No.	Set Date/Time	Set Latitude	Set Longitude	Retrieval Date/Time	Ret. Latitude	Ret. Longitude	Target Species	Est. Total Catch Mt	Sorted at Sea	Sea Depth	Gear Depth	FRA	RKCSA	COBLZ
2007-84	04/02/2007 07:30:35	N 5445.098	W 16505.155	04/02/2007 12:00:35	N 5452.000	W 16458.000	110 Pacific Cod	7.000	Y	42	42	509	N	N
Species	Sex	PSC (X if Yes)	Management Plan	Quota Owner	Estimated Weight	Lb or Mt	Estimated Count	Product	Discarded at Sea (X if Yes)					
110 Pacific Cod	U		AFA	103	6.976	Mt	0	01						
121	U		AFA	103	0.010	Mt	0	98	X					
123 Rock Sole	U		AFA	103	0.010	Mt	0	98	X					
122 Flathead Sole	U		AFA	103	0.001	Mt	0	98	X					
160 Sculpins	U		AFA	103	0.001	Mt	0	98	X					
270 Pollock	U		AFA	103	0.001	Mt	0	98	X					
125 Rex Sole	U		AFA	103	0.001	Mt	0	98	X					
200 Pacific Halibut	U	X	AFA	103	0.000	Mt	20	98	X					
931 Bairdi Tanner Crab	U	X	AFA	103	0.000	Mt	2	98	X					
Haul No.	Set Date/Time	Set Latitude	Set Longitude	Retrieval Date/Time	Ret. Latitude	Ret. Longitude	Target Species	Est. Total Catch Mt	Sorted at Sea	Sea Depth	Gear Depth	FRA	RKCSA	COBLZ
2007-85	04/02/2007 12:45:50	N 5452.000	W 16455.000	04/02/2007 17:00:50	N 5452.000	W 16457.000	110 Pacific Cod	1.000	Y	42	42	509	N	N
Species	Sex	PSC (X if Yes)	Management Plan	Quota Owner	Estimated Weight	Lb or Mt	Estimated Count	Product	Discarded at Sea (X if Yes)					
110 Pacific Cod	U		AFA	103	0.700	Mt	0	01						
122 Flathead Sole	U		AFA	103	0.150	Mt	0	98	X					
123 Rock Sole	U		AFA	103	0.100	Mt	0	98	X					
125 Rex Sole	U		AFA	103	0.039	Mt	0	98	X					
270 Pollock	U		AFA	103	0.010	Mt	0	01						
160 Sculpins	U		AFA	103	0.001	Mt	0	98	X					
200 Pacific Halibut	U	X	AFA	103	0.000	Mt	8	98	X					

Figure 4-2 Electronic Logbook Example

TRAWLER CATCH DATA: Observer Estimates of Catch Weight

Deployment and Retrieval Latitude and Longitude

Deployment and retrieval positions are read from a GPS navigation system in the wheelhouse. The deployment location recorded in the vessel logbook should be the ship’s position when the net reached fishing depth. The retrieval position should be the location when the net was removed from fishing depth.

If you notice large changes between deployment and retrieval positions, or between one haul’s position and the next, ask the captain if these distances are correct. Large changes in position are those more than two degrees of latitude or longitude in the same day, or those more than six degrees of latitude or longitude over a two day period. You should occasionally check during haulbacks that the latitude and longitude listed in the logbook match that on the GPS display.



Vessel Estimates of Catch

The vessel operator must make their own estimate of haul weight. By regulation, the estimated catch weight must be entered into the vessel logbook within two hours of gear retrieval. The vessel operator may record this weight in either metric tons or pounds, but *you must record it in metric tons on your OHF. If you need to convert the logbook value from pounds to metric tons, show this calculation in your observer logbook.*

Vessel Estimate Conversion Calculations

Vessel Name: Hali Herring

Haul Number	Vessel Estimate in Pounds	Multiplied by 0.4536 kgs/lb (conversion factor)	Equals Vessel Estimate in Kilograms	Rounded Vessel Estimate in MT (to nearest hundredth)
164	14620	x 0.4536 kgs/lb	6631.632	6.63
165	23898	x 0.4536 kgs/lb	10840.1328	10.84
		x 0.4536 kgs/lb		

Figure 4-3 Documenting conversion calculation of vessel haul estimate in pounds to kilograms

TARGET SPECIES CODE	ROUND CATCH WEIGHT		
	TOTAL HAUL WEIGHT (Metric MT)	IRIU SPECIES CODE	IRIU SPECIES CODE
141	45,000	270	500
		110	800
		SNF	1100

During your first few days on board, *ask the skipper how s/he makes their vessel estimates. Record their response in your observer logbook. You will be questioned about their estimation*

methods during debriefing. The C/P trawl vessel logbook instructions read that, in addition to the total catch weight estimate, the vessel operator must record a separate entry for catch estimates of species managed under the IR/IU regulations (see page 5-30). Make sure that the vessel operator’s documented *total estimate* of catch includes any IR/IU species caught.

OBSERVER ESTIMATES OF CATCH WEIGHT

Independent observer estimates of catch weight are made on most trawlers. The exception is pollock catcher trawlers delivering to a processing plant. Catch from these vessels is weighed at the plant on a certified scale. The delivery weight is reported on the Plant/Vessel Offload form.

Observer estimates of catch weight must be *unbiased* and *made independently*. You must take estimates for as many hauls as possible. There are three methods for determining total catch weight:

- 1) **Weighed (“W”) estimate** - entire catch is weighed using the observer scales or using the vessel’s flow scale.
- 2) **Bin (“B”) estimate** - weight is calculated using a bin volume and density.
- 3) **Codend (“C”) estimate** - weight is calculated using a codend volume and density.

You can use any of these three methods on a vessel, depending upon catch size and composition. Observer estimate methods are indicated by the letters “B,” “C,” or “W” in the “B, C, or W” column on the OHF (see “Completing the OHF on Trawl Vessels” on page 4-17).

Weighed (“W”) Observer Estimates

Independent weighed estimates are obtained using either: 1) NMFS issued observer scales, 2) a motion compensated platform (MCP) scale, or 3) a certified motion compensated flow scale. To be used for catch weight estimates, flow scales and motion compensated platform scales must pass daily tests for accuracy. For small hauls under about 500 kilograms, you could

feasibly use your observer scales or MCP scale to weigh the entire catch. For larger hauls, weighed estimates would have to be by certified flowscale.

Motion compensated flow scales record the weight of catch as it runs over the scale. If you are going to use the flow scale for the observer estimate, the crew must test the scale every 24 hours. You may use the flow scale for deriving an observer estimate *only* if it has been tested for that day, has passed the test, and the test was witnessed by an observer. For more information on flow scales, see “Flow Scale Testing” on page 2-19. **If you are on a vessel that is required to use a certified motion compensated flow scale, you must use the flow scale for the observer estimate and you should not take estimates using any other method.**

Large Items

Occasionally marine mammals or large inorganic items (such as a boulder or 55-gallon drum) are caught by trawlers. To prevent the weight of mammals or other large objects from being misinterpreted by management as fish weight, do not include the weight of the item in the Observer Estimate.

The weight of organisms *other than marine mammals* that are too large to enter the live tanks and go over the flow scale must be included in the observer estimate. If possible, obtain an actual measurement using the MCP or hanging scales, and add this weight to the flow scale weight. If the organism is too large to weigh on the observer scales, estimate the weight of the organism and add the weight to the final flow scale weight for the haul.

Record of Daily Scale Tests

Vessel Name: Pacific Rover Date: 06/01/00
 Time test started: 12:13

I. Weigh Fish on Observer Platform Scale

Basket #	Wt Fish + Basket (kg)	Basket #	Wt Fish + Basket (kg)	Basket #	Wt Fish + Basket (kg)	Basket #	Wt Fish + Basket (kg)
1	46.83	8	43.29	15		21	
2	40.91	9	41.16	16		22	
3	36.22	10	46.32	17		23	
4	38.93	11	37.86	18		24	
5	45.25	12	39.22	19		25	
6	40.01	13		20		26	
7	32.64	14		Total weight all fish+baskets			482.64

II. Calculate Percent Error of Flow Scale
 Scale Indicator: Begin Test: kg
 End Test: kg

Total weight fish and baskets (kg)	Weight of baskets	Platform scale weight of fish (A)	Weight of Fish on Flow Scale (kg) (B)	Error (B) - (A) (C)	% Error = (C) / (A) x 100
482.64	50.76	431.88 (A)	433.62 (B)	1.74 (C)	0.402889%

III. Sea Conditions (Beaufort Scale) at Time of Scale Test (Circle One):
 0 1 (2) 3 4 5 6 7 8 9 10 11 12

Signature of vessel operator: [Signature]
 I observed this test and to the best of my knowledge it was conducted in accordance with 50 CFR 679.28 (b)(3)
 Signature of observer: [Signature]

INSTRUCTIONS

1. Collect approximately 400 kg of fish in baskets and weigh the baskets of fish on the platform scale. Record the weight of each basket of fish (basket plus fish) in Section I.
2. Record the total weight of all baskets plus fish in the first box in Section II.
3. Record the weight of the baskets in the second box. Subtract the weight of the baskets from the total weight of fish plus baskets to determine the weight of the fish only, record this weight in the third box in Section II. This is the platform scale weight of the fish (A).
4. Record the weight displayed on the flow scale before and after the test fish are weighed.
5. Weigh the fish from the baskets on the flow scale. Record the weight in the fourth box of Section II (B).
6. Calculate error of flow scale by subtracting the platform scale weight (A) from the flow scale weight (B). Record the error (C) in the fifth box of Section II.
7. Calculate percent error by dividing the error (C) by the known weight of the fish (A) and multiplying by 100. Record this information in the last box of Section II. The scale is weighing within 3 percent error if the result is between -3.0% and +3.0%.
8. Record Beaufort Scale sea conditions at time of test.
9. Have form signed by vessel operator and observer.



Figure 4-4 Flow Scale and Record of Daily Scale Tests

Volumetric Observer Estimates

The way catch is handled on a vessel will help you determine which catch estimation method is most applicable. On catcher processors, catch is often held in the codend before being dumped into a tank or bin. In these instances, volumes can be determined for the filled codend, or the filled bin. If the boat is a catcher only vessel, the codend may be emptied directly onto the trawl deck for sorting, or into below-deck refrigerated seawater (RSW) tanks. Observers often find that estimates by codend are the most feasible in these cases. Estimates by bin volume may work equally well.

On some vessels, codends are brought up in portions and dumped incrementally onto the deck or into tanks. Obtaining weight estimates in these situations can be challenging. If making codend estimates, try to mark the bag with string or other material so you don't measure and account for an area twice. Work with the crew to see if they can assist you in measuring and keeping track of codend sections. If crew are dumping catch incrementally into bins, ask if they can completely empty the bin before adding more catch from the codend.

Consider the areas where fish will be held before processing and delivery: the codend, trawl alley, checker bins and/or live tanks. Determine which container will be safest to measure, and the easiest to accurately measure.

To calculate the observer estimate, multiply total volume of catch by a density factor (see "Determining Density" on page 4-10). This estimate is recorded on the OHF.



Observer estimates cannot be made by guessing the weight of the catch or by using numbers provided by the crew. They must be calculated using actual measurements taken by you.

Record the measurements you take for each haul on your decksheet. All dimensions, calculations, and methods must be noted in your logbook. You must document and explain your estimation methods in the daily notes pages. When making volumetric estimates of the total catch, keep the following in mind:

- You do not make volumetric estimates on C/Ps or motherships that have a certified, tested motion compensated flow scale, regardless of whether the flow scale has passed the daily test.
- On catcher vessels, make volumetric estimates of checker bins, trawl alleys, codends or codend sections (add the sections together for a total volume as necessary).
- The formula for determining catch weight using volume and density is:

$$\text{volume (m}^3\text{)} \times \text{density (mt/m}^3\text{)} = \text{catch weight (mt)}$$

- Record your total catch weight estimates on the OHF, even if you are not totally confident about the accuracy of the estimate.
- If you find that none of the methods suggested will provide an accurate independent catch estimate, contact NMFS staff as soon as possible for assistance.

Observer Estimates by Bin ("B") Volumes

The steps in making a volumetric estimate of live tanks, trawl alleys, or checker bins are:

1. **Measure the area of the empty bin.** Many fish bins and tanks are irregularly shaped and need to be measured as several independent sections. To do this, sketch out the bin and visually break up the floor area into regularly shaped sections that can be measured easily. Figure 4-5 shows how an unusually shaped trawl alley was divided and measured to calculate a floor area.
2. **Determine the appropriate formulas for each area of the bin.** Consult page A-14 and select the appropriate volumetric formula for each separate shape. Each mathematical formula identifies what dimensions are measured (length, width, height, short radius, diameter, etc.). The sum of the areas for all the sections yields the total area of the bin.
3. **Measure the height of catch in the bin.** The height of the fish in the bin provides the final dimension needed to obtain the volume of the catch. If you are using a fish bin, there may be permanent marks that you can use for a depth measurement. Be sure to verify the accuracy of these marks before you rely on

them for your own measurements. If the bin is unmarked, ask permission to mark the bin with height markers. The vessel crew may be able to provide you with paint or other permanent writing material. Replace marks as they erode over time. The bin or tank should be marked on all four sides and all markings should be visible. Marks should be in increments of no more than 10 cm. On some vessels, you can use a stick marked in centimeter increments to measure the depth of fish in the bin or trawl alley.



Volumes calculated using just one fish height are potentially biased. Take several measurements distributed within the container and average these!

4. Calculate and record bin volume and catch weight. Record height measurements on your deck sheet and record all area and volume calculations in your logbook. When you take multiple measurements for one dimension (e.g., height) use an average in your

final volume calculation. Make sure that all of your measurements are as precise as possible and describe your methods in your logbook.

Potential Bin Volume Biases

The following are factors that may affect the accuracy of your bin volumetric estimates:

- tanks may be enclosed such that the depth of fish cannot be determined;
- tanks may hold fish *and* an indeterminate amount of water;
- tanks may be too difficult to measure because of many irregular shapes; or
- level of fish may be too shallow to obtain an accurate reading.

If you notice any of the potential biases listed, observer estimates by codend volume would be a better alternative. Document all methods used for obtaining independent observer estimates in your logbook. Be sure to include descriptions of any problems you encountered.

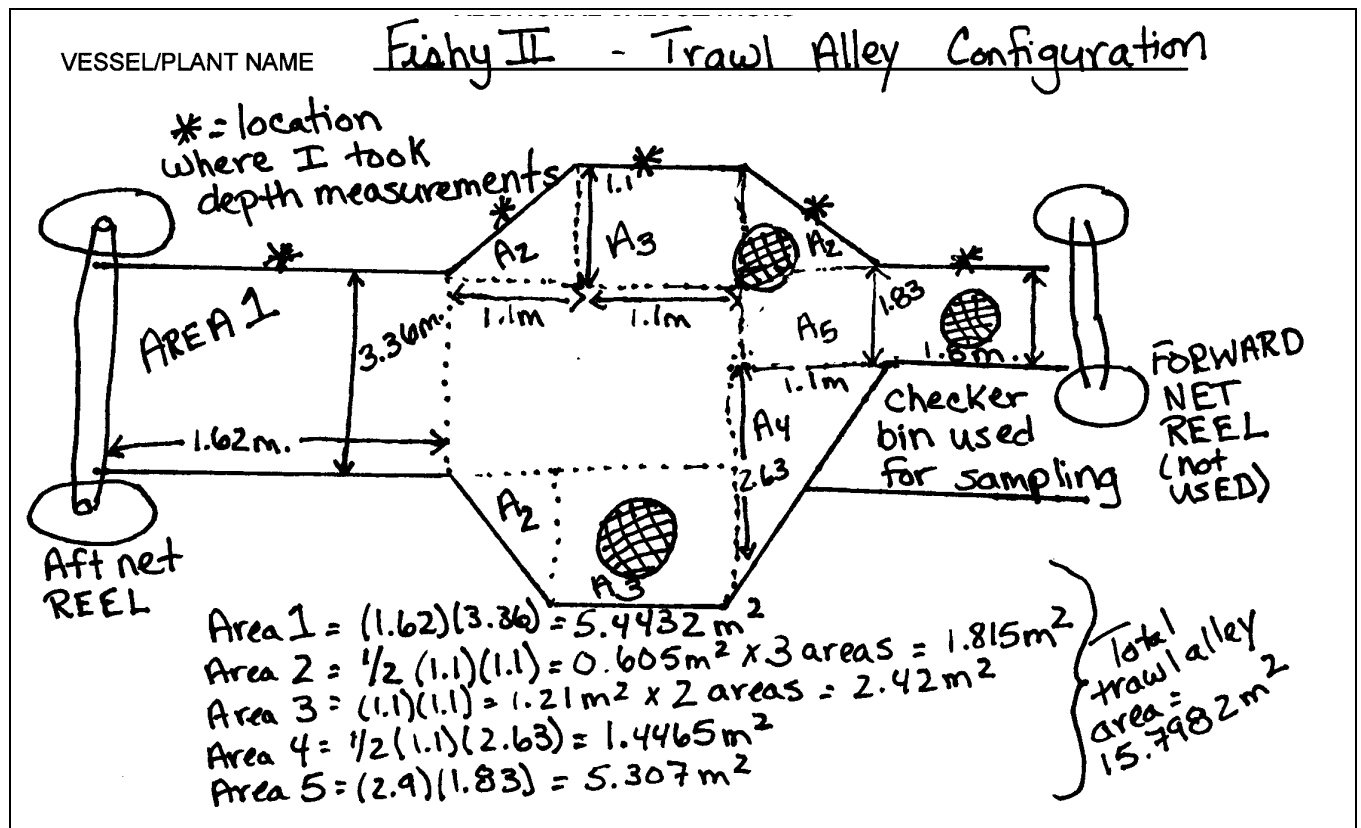

Figure 4-5 Calculating Area of an Irregular Shaped Trawl Alley

Observer Estimates by Codend (“C”) Volume

When measuring a codend always remember that safety is your first concern. Codends tend to slide and roll. Ask crew members for assistance; their help will make the task easier and safer. Follow the steps listed below to take an accurate codend measurement.

1. Determine the appropriate geometric shape(s).

Decide on the appropriate formula(s) to use based on the shape of the codend. Using the formula, determine which dimensions you need to measure in order to obtain a volume. Refer to page A-15 for the formulas required to calculate volumes of various shapes.

2. Measure sections of the codend using actual measurements and/or reference points.

Take height and width measurements from several segments to obtain the average height and width for the net.



You may want to acquire a long stick, or similar item, and mark it for use as a height gauge. When sighting across the net for a height, your eyes should be level with the top of the net. If the net is large, moving around dangerously, or brought aboard in segments, using pre-measured areas of the deck is a safer alternative for measuring codends.

- **Pre-measure the deck, if you are using reference points.** Measure the length of the trawl alley and place marks along its length to determine the codend length.
- **Measure structures on the deck that you can use as a gauge for estimating dimensions of the codend.** Make easily read marks on deck structures in increments of 1/10 to 1/4 meters. Verify the measurements of any marks left by previous observers before using them.
- **The net outline does not often line up nicely with pre-measured deck markings.** You should determine the difference in distance between any marks and where the codend ends. Actual measurements from the pre-measured marks are preferred over visually estimated distances.

- **Measure the width of the entire trawl alley.** If the codend does not fill the entire alley, measure the distance between the codend and the trawl alley walls. This can be done using the tape measure or by pre-measuring your clipboard, a stick, or planks in the deck. Subtract this measurement from the total trawl alley width to determine codend width.
- **If the codend is the same height as your shoulder, head, arm, or other parts of your body, use these heights to gauge codend height.** This is the least preferable method of obtaining a measurement, since it isn't as precise as one obtained with a measuring stick. Use this option if you are unable to take more precise measurements.

3. **Record dimensions, calculations, and volumetric formula.** In your logbook, record the methods, dimensions and calculations used in obtaining your volumetric estimate. Record the calculated volume in cubic meters. Also document the calculations used to obtain the metric tonnage of the catches, including density calculations when appropriate.



Occasionally, large items like boulders are caught. Do not include these items in your estimates of catch. If the item is in the codend, calculate the volume of the item and subtract it from your codend volume.

Measuring Large Codends

Codends can sometimes be longer than the trawl deck. These codends must be emptied in several sections. To determine the codend volume in this situation, measure each codend section as it is brought on board. Use the reinforcing cables or “expansion straps” around the circumference of the filled codend to visually divide it into sections. Determine a volume for each segment of the net and add these together for a total volume. **Each section must be independently measured! Do not apply a predetermined or constant volume to the number of codend segments.**



Volumetric Catch Estimate Calculations

VESSEL NAME NET INCOME

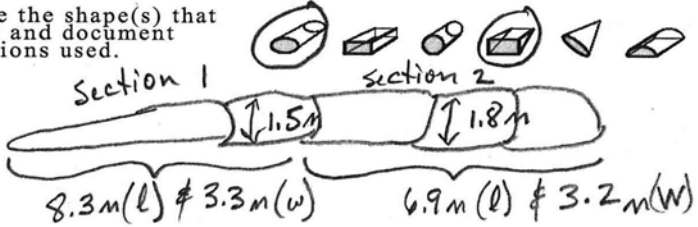
<p>HAUL No. <u>99</u> Total catch weight (MT) <u>47.07 MT</u></p>	<p>Volumetric Calculations (show all your work!). Circle the shape(s) that apply and document equations used.</p>  <p>Section 1: $\frac{1}{2}(1.5m)(3.3m)(8.3m) = 20.5425 m^3$ Section 2: $(\frac{3.1416}{\pi})(0.9m)(1.6m)(6.9m) = 31.214937 m^3$ $\Sigma vol = 20.5425 m^3 + 31.214937 m^3$ $vol = 51.757437 m^3$ Catch weight (TOTAL) = $51.757437 m^3 \times 0.9093542 \frac{MT}{m^3}$ $\Rightarrow 47.065842 MT$</p>
<p>Density Calculations container(s) used: <u>blue baskets</u></p> <p>$\rho = \frac{\Sigma (37.06 kg, 40.20 kg, 36.85 kg, 42.00 kg, 43.00 kg, 36.3 kg)}{6 \times 0.043146 m^3}$ $\rho = \frac{0.23541 MT}{0.258876 m^3}$ $\rho = 0.9093542 \frac{MT}{m^3}$</p>	

<p>HAUL No. <u>100</u> Total catch weight (MT) <u>138.49 MT</u></p>	<p>Volumetric Calculations (show all your work!). Circle the shape(s) that apply and document equations used.</p>  <p>Section 1: $\frac{1}{2}(2m)(3.5m)(9.5m) = 33.25 m^3$ Section 2: $(\frac{3.1416}{\pi})(1.05m)(1.8m)(18.5m) = 109.84604 m^3$ Section 3: Sphere: $\frac{4}{3}\pi(r^3) = \frac{4}{3}\pi((1.3m)^3) = \frac{4}{3}\pi(2.197 m^3) = 9.2027931 m^3$ $\Sigma vol = 33.25 m^3 + 109.84604 m^3 + 9.2027931 m^3$ $\Rightarrow 152.29883 m^3$ Catch wght $\Rightarrow 152.29883 m^3 \times 0.9093542 \frac{MT}{m^3}$ $\Rightarrow 138.49358 MT$</p>
<p>Density Calculations container(s) used: _____</p> <p><u>used density from HAUL 99</u></p>	

Figure 4-6 Measuring Large Codends (example of expected level of documentation)

Determining Density

Once you have obtained a volumetric estimate of the catch, you must calculate the weight of the catch. To do this, you need to multiply the catch volume by a density. Density should be expressed in metric tons per cubic meter. Multiply the density by a codend or bin volume to calculate the catch weight estimate. Densities are either prescribed, or calculated.

Prescribed Densities

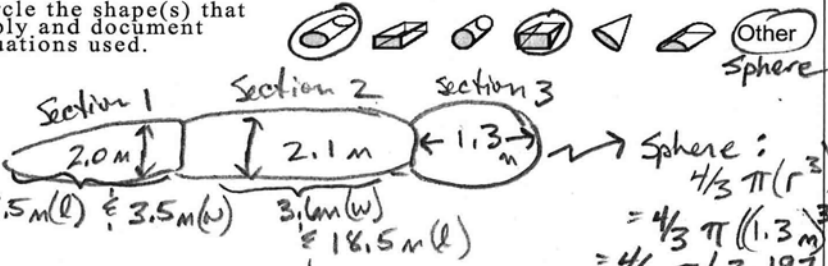
If the catch consists of **50% or more pollock**, apply a density of 0.98 mt/m³ when using bin volume, or a density of 1.02 mt/m³ when using codend volume.

Calculated Densities

If you are calculating density, you must take a density sample whenever there are significant changes in species composition between hauls. If catch composition is relatively constant, **you must take density samples at least once every 24 hour period.**

To calculate density, measure both the volume and weight of an **unsorted** sample of catch. Choose a container that holds 500 kgs or less and has a volume that can be calculated. Oil drums or plastic garbage cans hold about 300 kg and are excellent density containers. A plastic tote, filled part way, is also excellent for calculating density estimates. As a last resort, use **four or more** blue observer baskets for the density sample. Refer to Figure 4-7 when using the Observer Program's standard blue basket to obtain density estimates.



Densities must be taken from unsorted catch. Settle or arrange fish to minimize interstitial spaces. Measure the containers you use for density carefully!

To calculate density:

1. Determine the volume of your container by measuring it using the same methods you would to measure the volume of fish in a bin.
 - If you are using observer program issued blue baskets, you must fill them to the bottom of the handles with unsorted catch and use the volume given in Figure 4-7.

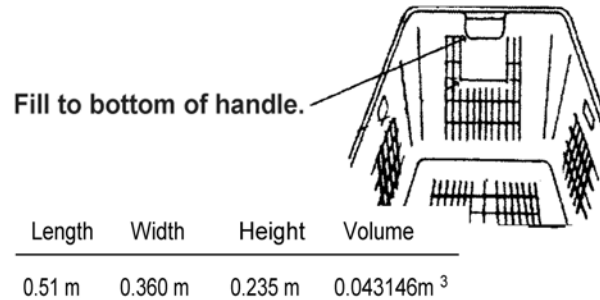

Figure 4-7 Blue Basket Volume

2. Fill the container with randomly selected unsorted catch. In many instances it is easiest to use your species composition sample. Settle or arrange the fish to minimize interstitial space.
3. Fill your containers consistently to the same level or measure the height of the catch in your containers. Record the height value on your deck sheet. If you are using your blue baskets for density, be sure to fill them to the bottom of the handle. This level corresponds with the standard volume given in Figure 4-7. **Some vessels have blue baskets made by another company. These are smaller than Observer Program issued baskets and should not be used to determine densities!**
4. Weigh everything in your density sample. Record this weight on your deck sheet.
5. Use the formula below to calculate density. Document all calculations in your logbook!

$$\text{Density (mt/m}^3\text{)} = \frac{\text{Total wt. of sample (mt)}}{\text{Total volume of sample (m}^3\text{)}}$$

Dumping Partial Codends

Occasionally a vessel will dump a partial codend before bringing it on deck, preventing access to the entire catch. In these cases, measure or visually estimate the amount of catch that was discarded. Add this value to the observer estimate calculated for the accessible portion of catch.

Use reference marks or actual measurements when possible to obtain the estimate of the discarded portion. If this is not possible, use your best judgement and ask the captain or crew to help estimate the total amount

discarded. Document the situation in your logbook. Include why part of the net was discarded and describe the method used for estimating the discarded catch.

ESTIMATING DISCARDS

The weight of all at-sea discards must be estimated independently by the on board observer(s). Discard information is collected in conjunction with percent retained data. By recording discard estimates in a separate field in the data, fisheries managers are able to quantify discards at both the vessel and fleet level. In the pollock fishery, fisheries managers use discard estimates in conjunction with the delivery weight to determine the total catch by trip for a vessel. The time spent on this information should be nominal. Refer to “Estimating Percent Retained” on page 5-29 for further discussion of estimating percent retained and discards on trawlers.

Discard must be estimated for all hauls on board a pollock catcher vessel. On all other catcher vessels and catcher processors, you must record discard for sampled hauls, but you do not need to do so for unsampled hauls. On these vessels, record discard for unsampled hauls only if you can reliably account for them.



If you are on a pollock catcher vessel, you must document any discards for all hauls, whether sampled or unsampled.

The process of estimating total discards differs between catcher vessels and catcher processors. Regardless of the vessel type, *obtaining a discard estimate should only take a few moments*. On catcher vessels, discards are generated on deck, where you can see all the fish at one time. On catcher processors, discard can occur on deck or anywhere in the factory. Familiarizing yourself with the flow of fish on the vessel will help you to recognize areas of potential discard. If vessel personnel sort out and discard undesirable fish, or if portions of the catch are dumped overboard, you must estimate the total weight of these discards. Account for catch discarded in one of the following ways:

1. An actual measurement of the discard contributes the best information, but this method may not be feasible on your vessel type. If the discards are few, try

to weigh everything using your observer scales. If you can not do so, consider the other options discussed here.

2. Volumetrics may be used to determine a discard estimate. If the vessel retains all the discard in the alley or checker bin, the volume of this discard, multiplied by a density, will yield an estimate. Using volume and density is also a good method when whole or partial codends are dumped overboard. When using volumetrics for determining a discard estimate it is acceptable to use known references rather than actual measurements.

3. A simple visual estimate is the easiest method of obtaining an estimate of discards. Using visual cues such as a how many baskets of discards a sample generated can help you to quantify what you are seeing. For example, if all your samples resulted in one basket of discards (approximately 40kg), and those samples were about 1/100th of the entire haul, you can assume there were about 100 baskets of total discards, or about 4000 kg (4 metric tons).

You can refer to the discards information recorded by the vessels in the DCPL or the DFL to verify your independent observations, but *do not use these entries to provide discard data!*

RECORDING OFFLOAD DATA ON TRAWLERS

Observers on catcher trawlers must report offload information on the Vessel/Plant offload form.



The Vessel/Plant Offload Form is used by plant observers as well. For information on how to complete the Vessel/Plant Offload Form as a plant observer please refer to page 9-6.

Data for the Vessel/Plant offload form may be obtained from the Alaska Department of Fish and Game (ADF&G) fish ticket, electronic scale readout, scale weights recorded by a factory representative, the plant's NMFS logbook as well as from observations by the observer. *If you are on a vessel equipped with ATLAS you must maintain a set of offload paper forms in addition to sending these data electronically.*

Cruise Number, Permit, Year, Observer Name, and Vessel/Plant name: Enter the cruise number supplied in your training or briefing. Enter the vessel permit found in the manual on page A-25. For “Year” you can

TRAWLER CATCH DATA: Recording Offload Data on Trawlers

enter the full year or just the last two digits (*e.g.* “09”). Enter your name and the name of the vessel to which you are assigned.

Resubmission: Circle “Resubmission” if you are sending changes to data previously faxed. *Also, please circle the items that have changed since your last transmission of the data; this will aid keypunchers in making the appropriate modifications to your data.*

Processor Name and Processor Permit: In the box in the upper left hand corner, fill in the name and processor permit for each of the plants to which your vessel delivers. You only need to record each plant once for each data set. There is a list of processor permits for shoreside or floating plants and motherships on page A-23. If your vessel delivers to a plant that is not on the list, enter 99999 (for “unknown”) and contact NMFS staff for advice.

Trip Number: Enter the number of the trip during which most of the fishing for the offload occurred. If the vessel made more than one trip to catch fish for the offload, record the trip that includes the majority of the hauls. In ATLAS, the “trip start date” will be auto-filled based on the trip that you selected.

Offload Number: All offloads must be recorded and assigned a number. Offload numbers must be unique for the cruise/vessel and should be sequential and ascending, beginning with “1.”

Completion Date: Enter the month and day the offload was completed. Write the dates in two digit format.

Gear Type and NMFS Area: These columns are used by plant observers only.

Total Delivered, LB or MT: (Refer to “Determining Delivery Weight” on page 4-12 for fishery specific delivery calculation protocol!) Record the total round weight delivered to the plant for that trip. Delivery weights can be entered in either pounds or kilograms. Delivery weights recorded in pounds must be recorded to the nearest whole pound. Weights reported in metric tons must be reported to the nearest 0.01 of a metric ton. Remember that when cut or bled fish are delivered, the round weight must be used. *Round weights are listed at the bottom or end of the fish ticket.*

Total Pollock Weight, Were all Groundfish Weighed?, ADF&G Number of Delivering Vessel: These columns are used by plant observers only.

Receiving Processor Permit Number: For each offload, record the processing plant’s permit number. The permit numbers should be one of those you listed under Processor Name and Processor Permit Number described above. If a delivery is split and sold to more than one processor, you should make an entry on the Vessel/Plant Offload Form for each delivery. If this, or any other incident out of the ordinary occurs, please note the circumstances in your logbook.

Was Catch Sorted (Y/N): Record “Y” for any delivery that was sorted at sea. Record “N” if the crew did not sort the catch before delivery.

Tender Offload (Y/N): Record “Y” if your vessel acted as a tender by receiving catch from another vessel. Otherwise enter “N.”

ADF&G Fish Ticket Number: Record the fish ticket number associated with the delivery for this vessel. As a vessel observer this number will be taken directly from the fish ticket. Record the number exactly as it appears on the fish ticket. If you did not receive a fish ticket, this field may be left blank. If more than one fish tickets were associated with the same offload, record the additional fish ticket number(s) below the first entry for the delivery.

Determining Delivery Weight

When the vessel delivers its catch to a processing plant, the fish are weighed. The scales at each plant are tested by the State of Alaska annually and they do not need to be tested daily in order for you to use this weight as a delivery weight. The delivery weight information must be verified by either yourself or the plant observer. Ultimately, the data used is yours, so do not rely on plant observers to verify your delivery weight unless they have agreed to do so. Plant observers need to give you documentation on how verification was done when *they* complete this task. For more information on this aspect of a plant observer’s duties see “Delivery Worksheet Verification” on page 9-4.



When reporting delivery weight on the Plant/Vessel offload form, you must verify the delivery weight. You are responsible for knowing and documenting how all your data were derived!

Work with the plant observers and plant personnel to determine the best source for accurate weights. You are responsible for your data and must know how all

delivery weights were derived. Delivery weight data can be obtained from the electronic scale readout, scale weights recorded by a factory representative, the Alaska Department of Fish and Game (ADF&G) fish ticket, or the plant's NMFS logbook.

Instructions for Determining Delivery Weight by Fishery Type.

- Observers on non pollock catcher vessels, while required to obtain a delivery weight, are not required to monitor the offload for prohibited species. They can use the prohibited species data provided by the plant for the purposes of determining total delivery weight.
- Observers on pollock catcher vessels must independently account for the presence of prohibited species in the delivery. The value they obtain for weight and number of prohibited species is used in place of the plant's less accurate value for these items.

Determining Delivery Weights on Non Pollock Vessels

Prior to 2008, non pollock catcher vessel observers did not report total delivery weight. As a result, plant personnel may not be accustomed to providing this information to non pollock observers. Work with the plant observer and plant personnel to obtain the fish ticket for your delivery. If a fish ticket is not available, you may obtain your total delivery weight using an alternate method. This includes, but is not limited to, direct observations of scale weights during the offload, verbal confirmation from plant personnel, skipper estimates, or independent measurements. The exact source of delivery weight information will be specific to each scenario. Regardless of how the weights are determined, always document your methods in the daily notes section of your observer logbook.

In the majority of situations, the fish ticket will be the best source of data for determining delivery weight. Plants are allowed to record the number only of prohibited species, however fisheries managers need weight data as well. For observers on non pollock catcher vessels, if you are using the fish ticket for a delivery weight and the fish ticket does not have weights for all species, sum all the weights that were provided on the fish ticket and enter that value for the

total delivery weight. Document the situation in your observer logbook. For information on interpreting fish tickets and tips on how to avoid potential errors see page 9-13.

Determining Delivery Weights on Pollock Vessels.

On pollock catcher vessels, you must always use your own prohibited species weights and numbers when calculating delivery weight. Prohibited species weight data obtained by the observer during the offload replaces the less accurate prohibited species weight (or number only) data provided on the fish ticket by the plant. Prohibited species information is extremely important to the management of this fishery, so there are very few options available to you when it comes to obtaining prohibited species weights. It is preferred that you actually weigh all the prohibited species individuals and sum their weights, but depending on the species, you may have another option:

- **Halibut, King and Tanner Crab:** You must obtain both total numbers and total weight for halibut, and king and Tanner crab.
- **Salmon:** When you are not overwhelmed with salmon, you are expected to weigh all individuals of the species. When you *are* overwhelmed with salmon, you may use average weights to determine total weight of salmon species in the offload. *This option may only be used in those instances when salmon are present in high numbers and you are unable to weigh every individual.* See "When You Are Overwhelmed with Salmon" on page 5-27 for more information on what to when overwhelmed with salmon during the offload.

To obtain an average weight of salmon you should weigh 50 individuals of each species per haul in the offload. For example, a delivery of three hauls would require that you weigh at least 150 salmon of each species. The weight of these salmon divided by the number of weighed salmon is the average weight for that species. To obtain the total weight of the salmon species in the offload, simply multiply the average weight by the total number of salmon of that species encountered (see Figure 4-8).

- **Herring and Small Prohibited Species:** Refer to “The Problem with Offload Censuses for Herring” on page 5-26 for information on sampling herring and small prohibited species.



Remember that weights for halibut, tanner and king crabs must always be actual weights. It is not acceptable to use an average for these species.

When calculating the delivery weight for the entire offload, remember to ensure the weights of the prohibited species are recorded in the same units as the other weights from the fish ticket. The round weights listed on the bottom of the fish ticket are usually recorded in pounds. You may either convert the fish ticket weights of non-prohibited species to kilograms before adding your prohibited species weights or, you may convert your prohibited species weights to pounds before adding them to the summed round weight (in pounds) of all other species. See “Weights, Measures, and Conversions” on page A-15 for the formula to convert pounds to kilograms.

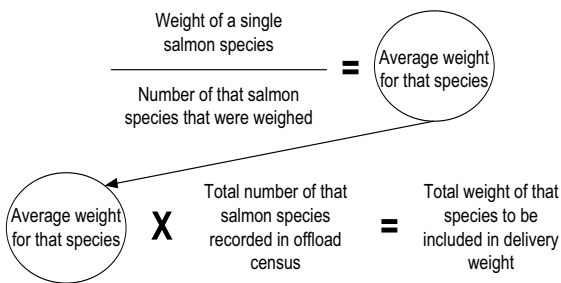

Figure 4-8 Determining total weight of salmon in a delivery from average weight

Prohibited Species Discarded at Sea on Pollock Catcher Vessels

Fisheries managers obtain information regarding the number and weight of prohibited species caught by pollock catcher vessels from the delivery data. To make sure that they have information about *all the prohibited species caught, you must include weight and number data from prohibited species discarded at sea in the delivery data.*

When calculating the total weight of prohibited species in the delivery on your pollock C/V, include all prohibited species that were discarded at sea. Include prohibited species that occurred inside your sample as well as those outside of your sample.

Prohibited species discarded at sea, whether from inside or outside your samples, are not included in your OHF entry of calculated at-sea discards. This is due to the way our database prepares your discard and census data for data users. If you include prohibited species discarded at sea in your discard estimate, they will be double counted! See Figure 4-9 at the end of this chapter for an example of calculating delivery weight on a pollock catcher vessel.

RECORDING OHF AND VHF DATA

All calculations must be recorded in your logbook. In addition, you must record the methods used to determine independent observer estimates and your justifications for using these particular methods. Keep accurate, complete records throughout your deployment! This will enable you to provide staff with pertinent cruise details at your debriefing interview. ***You are responsible for your work and must be able to recall all methods and techniques used to collect your data.***

Completing Haul Forms on Trawl Vessels

In addition to entering data and calculations in the observer logbook, all observers must complete a summary of fishing effort and total catch. This information is recorded on the Vessel Haul and Observer Haul Forms (VHF and OHF). ***If you are on a vessel equipped with ATLAS you must maintain a set of paper forms in addition to sending these data electronically.***

The fishing effort information required on the Vessel Haul form should come from the vessel’s NMFS logbook. Additionally, observers must retain the goldenrod copies of the vessel logbook pages pertinent to their cruise. The goldenrod pages are submitted with all other data for the vessel.

When recording information on the VHF, check carefully to ensure that the data are accurate, reasonable and there are no transcription errors. The OHF contains entries for calculated values. Double check your work! Instructions on how to fill out each of these forms follows.



Keep the “goldenrod” and/or printed copies of the logbook in a secure place. These forms are confidential, and must not be seen by crew from other vessels.

Completing the VHF on Trawl Vessels

An entry must be made for every day you are assigned to a vessel. Start your entries with the day you embark a vessel and end them on the day you disembark the vessel. *Skip a line between each day's entries.* When recording hauls, make sure that you: 1) record all hauls retrieved during your deployment whether you sampled them for species composition or not, 2) record the hauls in the order that they were retrieved, and 3) keep the data from each vessel you are deployed to separate.

Cruise, Permit, Year: Enter the cruise number supplied in your training or briefing. Vessel permits can be found on page A-25. For “Year” you can enter the full year or just the last two digits (e.g., “09”).

Observer’s Name/Vessel Name: Enter your name and the name of the vessel.

Resubmission: Circle “Resubmission” if you are sending changes to data previously faxed. *Also, please circle the items that have changed since your last transmission of the data; this will aid keypunchers in making the appropriate modifications to your data.* You do not need to start a new form after faxing.

Gear type: Enter a code for trawl gear based on the configuration of the gear, not whether it's fished mid-water or on the bottom. If you are on a vessel using a type of trawl gear not listed, please contact the Observer Program for instructions.

- 1 - Non-pelagic trawl
- 2 - Pelagic trawl net

Trip Number: Record the trip number associated with the haul. Trip Form instructions are given in the chapter “TRIP INFORMATION”.

Haul number: All hauls must be recorded and assigned a number. Haul numbers must be unique for the vessel and should be in sequential and ascending

order. Enter a “0” haul number for each non-fishing day. Except for a haul number of “0,” there can be no duplicate haul numbers for a vessel.



Occasionally, you may need to skip haul numbers to match the vessel logbook. Document the reasons for skipped haul numbers in your logbook daily notes.

IFQ? Y/N: On trawlers, always enter a “N” to indicate that no hauls were fished under an Individual Fishing Quota (IFQ). The only IFQ fisheries are Halibut and Sablefish longline. This column must be filled out for all hauls.

CDQ number: For each haul taken under a Community Development Quota (CDQ), record a “C” and the last 2 digits of the CDQ group number. If fishing CDQ, the CDQ number can be found on the vessel’s logbook haul information page under “Management Program.”

Vessel type: Enter a code which identifies how the vessel received and processed fish for any given tow. The codes are:

- 1 - Catcher/processor (C/P): The vessel caught and processed its own catch on this tow. Catch was stored in a freezer hold.
- 2 - Mothership: The vessel received unsorted catch by codend transfer from a catcher vessel for this haul.
- 3 - Catcher-only vessel: The vessel caught its own fish and retained it for delivery to a processing plant. On board, the catch was kept on ice or in refrigerated seawater (RSW) tanks, but was not frozen.
- 4 - A mothership or C/P received this tow as sorted (or potentially sorted) catch from a catcher vessel. Catch was transferred by brailer, by pumping, or by another method other than codend transfer.
- 5 - The catch from this tow was sold over-the-side to other fishing vessels which will utilize the fish for bait.
- 6 - The entire catch from this catcher-only vessel’s haul was discarded and not delivered.

TRAWLER CATCH DATA: Recording OHF and VHF Data

Gear performance: For each haul on a trawler, one of the following codes must be recorded:

- 1 - No Problem.
- 2 - Problem: a crab pot was in the haul.
- 3 - Problem: the net hung up on some obstacle and vessel had to back down.
- 4 - Problem: the net ripped.
- 5 - Problem: Other problem, write an explanation in your logbook daily notes.
- 6 - Problem: trawl net or codend lost.
- 9 - Fishing Duration Affected: the deployment and retrieval times do not reflect true fishing time (do not use when the net is raised solely to enable the vessel to make a turn in direction).

Location code: This column corresponds to the location entered in the “Deployment Information” and “Retrieval Information” tabs. For hauls, enter “R” to indicate the position corresponds to the Retrieval of a net. A day for which no hauls were retrieved is termed a “Non-fishing day.” For these days, enter an “N” to indicate that no hauls were retrieved. There must be a position entry for every day you were on board the vessel. For all non-fishing days, enter a “0” in the Haul Number column, a location code of “N,” and enter the latitude and longitude of the vessel at or around noon, Alaska Local Time (ALT) in the “End Position of Haul” column. If a non-fishing day occurs in between trips, leave the trip number column blank. *Observers on motherships should refer to “Catch Information (Haul Forms)” on page 6-2 for instructions on entering delivery information.*

“Deployment Information” Tab

Month/Day: Enter the month and day the gear was deployed.

Time: Enter the time the gear *reached fishing depth*. Copy this time from the vessel logbook, unless you have identified a problem with these data. If the skipper is entering data that are not accurate (see “Times that Do Not Reflect True Fishing Duration ” on page 4-2), try to provide your own independently collected times. All entries must be in Alaska Local Times (ALT). Use 24 hour time notations, in four digits with no colons.

Latitude: Record the latitude of the “Begin Position of Haul or Set” from the vessel logbook. Record the position to the same level of accuracy as it is recorded in the vessel log book. Vessels may record their

positions to the nearest minute, seconds or hundredths of a minute. If the vessel listed their positions to the hundredths of a minute, you must convert this value to seconds. To convert from hundredth of a minute to seconds, multiply the hundredths of a minute value by 60 (see following formula). Do not enter degree marks or include an “N” to indicate North for latitude.

Formula for conversion of hundredths of a minute to seconds:

$$\text{Hundredths of minutes} \times 60 = \text{Seconds}$$

E or W: Fill out the “E or W” column to indicate if the longitude is east or west of the 180 degree line.

Longitude: Record the longitude of the “Begin Position of Haul or Set” from the vessel logbook. One hundred degrees of longitude are assumed, so do not enter the leading “1.” Record the position to the same level of accuracy as it is recorded in the vessel log book. Vessels may record their positions to the nearest minute, seconds or hundredths of a minute. If the vessel listed their positions to the hundredths of a minute, you must convert this value to seconds. To convert from hundredth of a minute to seconds, multiply the hundredths of a minute value by 60 (see formula above). Do not enter degree marks.

Average bottom depth and Average gear depth: Copy the “Ave. Sea Depth” and the “Ave. Gear Depth” from the vessel logbook. All entries must be to the nearest whole number. Record both depths in the same unit of measure and label them as fathoms (F) or meters (M) in the “M or F” column.

“Retrieval Information” Tab:

Month/Day: Enter the month and day the gear was retrieved. A haul is assigned to a date according to the time the net is retrieved from the fishing depth. This time may not be the same day the net was set or the same day you sample. Hauls with retrieval times before 0000 hours are attributed to the previous day and retrieval times on or after 0000 hours are assigned to the next day.

Time: Enter the time the gear was *removed from fishing depth*. Copy this time from the vessel logbook unless you have identified a problem with these

data. Follow the same rules as described for time under the Deployment Information tab. Hauls retrieved at exactly 2400 hours should be recorded for the following day as 0000 hours.

Latitude and Longitude: Record the positions of the the “End Position of Haul or Set” from the vessel logbook. Follow the same rules as described for deployment.

Non-Fishing Positions: A non-fishing day is one during which no hauls were retrieved. For all non-fishing days, enter the trip number for the trip associated with the date no fishing took place. If the vessel is in port, the trip number column should remain blank. Enter “0” in the haul number column, and a location code of “N.” Record the Month/Day and latitude and longitude of the vessel for that day under the “**Retrieval Information**” tab. Do not include a time. On the remainder of the line, you can write a reason why there was no fishing. All days aboard must be accounted for with either a fishing or non-fishing position. This is the Observer Program’s only way to account for the number of days you were assigned to a vessel.

Port Coordinates

If you are in one of the ports in the following list on a non-fishing day, you can use the coordinates given as the non-fishing day position. One hundred degrees of longitude are assumed, so do not enter the leading “1.”

Port	Latitude	Longitude (W)
Adak	51 53	176 39
Akutan	54 08	165 46
Cordova	60 33	145 45
Dutch Harbor	53 53	166 32
Homer	59 38	151 33
Juneau	58 10	134 18
King Cove	55 03	162 19
Kodiak	57 42	152 15
Sand Point	55 20	160 30
Seattle	47 42	122 13
Seward	60 07	149 27

Completing the OHF on Trawl Vessels

An entry must be made for every day you are assigned to a vessel. Start your entries with the day you embark a vessel and end them on the day you disembark the vessel. *Skip a line between each day's entries.* For every entry on the VHF there must be a corresponding entry on the OHF. When placed side-by-side, you should be able to read the VHF and OHF forms straight across all rows. The information for a haul on one form should line up with the same haul’s information on the other form. Always start a new OHF when you start a new VHF. Keep a separate set of data forms for each vessel to which you are assigned.

Cruise, Permit, Year: Enter the cruise number supplied in your training or briefing. Vessel permits can be found on page A-25. For “Year” you can enter the full year or just the last two digits (e.g. “09”).

Observer’s Name/Vessel Name: Enter your name and the name of the vessel.

Resubmission: Circle “Resubmission” if you are sending changes to data previously faxed. *Also, please circle the items that have changed since your last transmission of the data; this will aid keypunchers in making the appropriate modifications to your data.* You do not need to start a new form after faxing.

Full name of Catcher Boat and ADF&G number box: Fill in these two items on the OHF *only if you are on a mothership.* For all unsorted codends and sorted catch delivered to your ship, you must record the ADF&G permit number of the delivering vessel.

Haul number: Haul numbers must correspond to the ones used on the VHF. If a line is skipped on the VHF, you should skip the same line on the OHF.

Haul sampled by: Enter the cruise number of the observer who sampled this haul. Enter a “0” for unsampled hauls. If more than one observer worked on sampling the haul, use an agreed upon criteria to decide who will receive credit for the haul.

RST on haul?: Enter the code which reflects the haul’s status on the RST:

Y - Yes, this is an “on” haul.

N - No, this is not an “on” haul.

X - RST is not being used, all hauls are sampled.

TRAWLER CATCH DATA: Reviewing Forms for Errors

RBT on break?: Enter the code which reflects whether or not you were taking a break prescribed by the Random Break Table:

Y - Yes, I'm on break during this haul.

N - No, I'm not on break during this haul. If you aren't using the RBT, this is your default code.

Percent monitored for marine mammals: If you monitor for marine mammals during the dumping of the haul, enter "100." If the haul was not monitored for marine mammals, enter a "0." No other values are valid on trawlers.

Vessel's total catch estimate in metric tons: Record the "Estimated Round Catch Weight" from the vessel logbook. Convert the estimate to metric tons if it is recorded in pounds, and round to the nearest two decimal places. Show this calculation in the observer logbook. There must be an entry for every haul.

Estimated discard weight in metric tons: Record the estimated discard weight in metric tons, rounded to the nearest two decimal places. If there were no discards, enter a zero value in the discards column for that haul. If you do not know whether or not there were discards, leave the field blank.

"Trawl Vessels" Tab:

Observer's catch estimate in metric tons: Enter your independent observer estimate for each haul for which an estimate was made. Record the estimate in metric tons, rounded to two decimal places. If you did not estimate the haul weight or actually weigh the entire catch, leave this field blank for that haul. If you determined there was no weight for the catch, enter a value of 0.00 MT in the observer estimate field.

B, C or W: Record how each catch estimate was made with a W, C or B. Enter "W" if the entire catch was weighed by you on your observer scales or on the vessel's certified flow scale, "B" if you used a bin volume calculation or "C" if you used a codend estimate.

Density in mt/m^3 : Record the density used to calculate an estimate from a known volume. Record the density in metric tons per cubic meter, rounded to two decimal places. You must record a density if the observer estimate was obtained using a bin or codend volume.

Volumetric Estimate in m^3 : If your observer estimate was done via a bin or codend volume, enter the volume you calculated to the nearest two decimals. If you did not do an observer estimate or you did a weighed estimate, leave this column blank.

Catcherboat's ADF&G number: Fill in this column on the OHF *only if you are on a mothership*. For all unsorted codends and sorted catch delivered to your ship, you must record the ADF&G permit number of the delivering vessel.

"Longline and Pot Vessels" tab

These fields are for vessels using fixed gear only and are not used for trawl vessels.

REVIEWING FORMS FOR ERRORS

To facilitate the debriefing process you *must* check forms throughout your cruise rather than at the last minute just before your debriefing interview. Observers who regularly review their data at sea generally benefit by having shorter, smoother debriefings. Observers who do not review their data throughout their cruise generally find themselves in lengthy debriefings and with time consuming corrections. It is much easier to check a couple of pages each day over the course of three months than to check a couple hundred pages of data all at once! Follow the guidelines below when reviewing your data for errors.

Check Observer and Vessel Haul Forms For:

- Every day on the vessel has an entry. This includes the day you boarded and disembarked and all days in between.
- Non-fishing days have a non fishing position with a haul number of zero; notes are made in logbook as to the reason the vessel was not fishing.
- No duplicate haulnumbers.
- All haul numbers in consecutive order.
- No decimals other than those already printed on the page.
- For motherships, full name of catcher boat and the ADF&G #s are completed in box at top of page.
- For each delivery to a mothership, the delivering catcher boat's ADF&G# is recorded.

Check Vessel Haul Form for:

- Hauls are ordered by retrieval, not deployment!
- Set and retrieval positions are recorded for all hauls.
- Positions have no minutes or seconds greater than 59. No overlapping of gear deployment and gear retrieval times between hauls (except on motherships).
- Retrieval times of 0000 are attributed to the next day.
- Depths are rounded to whole numbers and fishing depths are never deeper than bottom depths.
- “F” or “M” is recorded for every depth recorded.

- A “Y” or “N” is recorded in the IFQ column.
- CDQ numbers are recorded with the letter “C” followed by the two digits of the CDQ group number (found in the vessel logbook).

Check Observer Haul Form for:

- For catcher boats, plant/processor name, location, and processor permit #s are completed in box at top of the page
- For catcher boats, processor permit is filled out for each haul.
- For discards: if discards are unknown, the field is left blank; if discards are zero, a value of zero is entered.
- Hauls are ordered by retrieval, as on the VHF form, with a line space between days.

ADDITIONAL CALCULATIONS

VESSEL/PLANT NAME Frish Lord

Offload #1 7/15/08 Hauls 164-167

Prohib weight

Halibut - 12 e 36.45 kg + 1 in sample e sea e 3.03 kg = 13 e 39.48 kg

Chum - 200 e 327.19 kg (weighed at plant)
 3 e 4.69 kg (weighed at sea) discarded e sea
203 e 331.88 kg

$$\bar{x} = 331.88 / 203 = 1.634876847 \text{ kg}$$

1246 (tallied e plant) + 203 weighed + 1 e sea discard = 1450
 1450 x 1.634876847 kg = 2370.571428 kg

Chinook - 97 e 319.23 kg (weighed at plant)
 1 e 3.46 kg (weighed at sea) discarded e sea
98 e 322.69 kg

$$\bar{x} = 322.69 / 98 = 3.292755102 \text{ kg}$$

98 (weighed) + 2 (outside sample discard) = 100
 100 x 3.292755102 kg = 329.2755102 kg

Total Prohib. Observer
 39.48 kg - Halibut
 2370.571428 kg - Chum
 329.2755102 kg Chinook
2739.3269382 kg

Del. Wt. - plant prohibs
 98557 lb x .4536 kg/MT =
44705.4552 kg

Total Del. Wt = 44705.4552 kg + 2739.3269382 = 47,444.78213 kg
 47,444.78213 kg = 47.44 MT

Figure 4-9 Example of Logbook Calculations for Total Offload Salmon Weight Using an Average Weight

Cruise 20670	Permit 2345	Year 2009	Gear type 2	Vessel Haul Form										Page <u>1</u> of <u>1</u>															
				Observer name <u>Hali Herring</u>										Resubmission (Circle All Changes)															
				Vessel name <u>Friish Lord</u>																									
Trip No.	Haul No.	IFOP VIN	CDO No.	Vessel Type	Gear performance	Location code	Deployment Information										Retrieval Information												
							Month	Day	Time	Latitude (N)			E or W	Longitude			Average bottom depth	Average gear depth	M or F	Month	Day	Time	Latitude (N)			E or W	Longitude		
										Deg.	Min.	Sec.		Deg. (100)	Min.	Sec.							Deg.	Min.	Sec.		Deg. (100)	Min.	Sec.

National Marine Fisheries Service/Fisheries Monitoring and Analysis Division Page 1 of 12 for transmission Rev. 09

Cruise 20670	Permit 2345	Year 2009	Observer Haul Form										Page <u>1</u> of <u>1</u>			
			Observer name <u>Hali Herring</u>										Full Name of Catcher Boat			
			Vessel name <u>Friish Lord</u>										ADF&G #			
Haul No.	Haul sampled by (cruise no.)	RST on haul? (y=on, n=off, r=rla)	RBT on break? (y=on break, n=no break)	% Monitored for marine mammals	Resubmission (Circle All Changes)		Trawl vessels						Longline and Pot Vessels			
					Vessels total catch estimate in mt	Estimated discard weight in mt	Observers catch estimate in mt	B, C, or W	Density in mt/m ³	Volumetric estimate in m ³	Catcherboat's ADF&G # (motherships only)	# of segments in set	# of hooks per segment	Total hooks or pots in set	Dist. difference	

National Marine Fisheries Service/Fisheries Monitoring and Analysis Division Page 2 of 12 for transmission Rev. 09

Figure 4-10 Examples of VHF and OHF Forms From a Catcher Vessel Fishing for Pollock

TRAWLER CATCH DATA: HAUL and OFFLOAD FORM QUICKLIST for TRAWLERS

HAUL AND OFFLOAD FORM QUICKLIST FOR TRAWLERS		
OHF	VHF	OFFLOAD Form
<u>RST On Haul?</u>	<u>Vessel Type</u>	<u>Catch Sorted?</u>
Y for on haul	1 - catcher/processor (C/P)	Y - catch sorted
N for off haul	2 - mothership	N - catch not sorted
X for did not use RST	3 - catcher-only vessel	<u>Tender Offload</u>
<u>RBT On Haul?</u>	4 - catch transferred to mothership or C/P by method other than codend transfer.	Y - acted as tender
Y for on break	5 - catch sold over-the-side as bait.	N - not tendered
N for off break	6 - entire catch discarded	
N when RBT not used	<u>Gear Type code</u>	
	1 - non-pelagic trawl	
	2 - pelagic trawl net	
	<u>Gear Performance code</u>	
	1 - no problem	
	2 - crab pot caught	
	3 - the net hung	
	4 - the net ripped	
	5 - other problem; detail in notes	
	6 - trawl net or codend lost	
	9 - fishing duration affected	

Figure 4-15 List of Codes and Truncated meanings for OHF, VHF, and Offload Forms



TRAWLER COMPOSITION SAMPLING

Table of Contents

Trawl Sampling Terminology.....	5-2
Sampling System Guidelines.....	5-4
Selecting Hauls to Sample	5-4
Species Sampling Guidelines	5-4
Preferred Sampling Method.....	5-4
Number of Samples per Sampled Haul	5-5
Sample Size Considerations	5-5
Sample Bias	5-6
Recognizing Potential Bias.....	5-6
Deliberate Interference	5-6
Mechanical Biases.....	5-7
Minimizing Sampling Bias by Sample Method.....	5-8
Sampling Methods to Avoid.....	5-9
Mechanics of Sampling on C/Ps.....	5-9
Mechanics of Sampling on Catchers	5-10
Random Sampling on Trawlers	5-11
Random Sampling on C/Ps	5-11
Random Sampling on Catchers.....	5-16
At-Sea Sample Sizes.....	5-18
Catch With High Species Diversity: Small Sample Sizes	5-18
Catch With Low Species Diversity: Censusing the Entire Haul	5-18
Catch With Low Species Diversity: Large Sample Sizes.....	5-19
Clean Catches With One or Two Predominant Species	5-20
If You Can't Meet the Minimum Sample Size Requirements	5-21
Processing your At-Sea Samples.....	5-21
Identification of Sampled Species.....	5-21
Accounting for Pre-Sorted Samples	5-21
Counting and Weighing Sample Items	5-22
Subset Sampling for Species Identification on Trawlers.....	5-24
Seabirds	5-24
Decomposed Fish, Damaged Fish, and Miscellaneous Items.....	5-24
Combined Samples	5-24
Crab Pots.....	5-24
Marine Mammals and Large Items	5-25
Offload Census: Pollock C/Vs	5-25
Offload Census for GOA Pollock Catches.....	5-25
Offload Census for BSAI Pollock Catches.....	5-25
The Problem with Offload Censuses for Herring	5-26
Your First Delivery	5-26
Conducting a Census for Salmon in an Offload	5-27
Estimating Percent Retained	5-29
Limited Access Privilege Fisheries	5-30
Deck Form Instructions.....	5-34
Paper Form Instructions	5-36
Reviewing Forms for Errors.....	5-38

TRAWLER COMPOSITION SAMPLING:

Terminology

Bias - Tending to yield one outcome more frequently than others. Some factors introducing bias to a sample include mechanical sorting of catch by an incline belt and purposeful presorting by a crew member.

Bycatch - Anything caught in fishing operations that is not the predominant species, such as other fish species, prohibited species, marine mammals, seabirds, invertebrates and inert objects.

Composition - In the Observer Program, this refers to the makeup of harvested species in a catch and in the samples you collect.

Fishing mortality - Removal (deaths) of fish from a population due to fishing activity.

Population - The total of individuals occupying an area or making up a whole. When sampling aboard a trawler, a population is defined as the catch from a single haul.

Presorting - The segregation and/or removal of any item(s) or organism(s) from the catch prior to when or where you are collecting your composition sample.

Prohibited species or prohibited species groups - Species whose allowable retention is zero. Salmonids, Herring, Pacific halibut and king and Tanner crabs are always prohibited in Alaska open-access groundfish fisheries. For vessel operators, prohibited species include the above and any other species declared prohibited by regulation.

Random - Relating to a set containing elements which all have an equal probability of occurring in a sample. These elements are chosen as sample units in a manner which eliminates subjectivity.

Sample frame - The population divided into independent countable units.

Sampling - The process of collecting fish from a catch and recording specific data regarding all the individuals in the collection. Resource managers use your sample data to get a picture of what species, and how much, are being caught.

Sample size - The portion of the population that is sampled.

Sample weight - The total weight in kilograms of a composition sample.

Spatial - Refers to a unit of space used in random sampling. For example, a third of a bin or a section of trawl alley are spatial units.

Systematic - Refers to methodical sampling throughout an entire population. For example, collecting a basket of fish every ten minutes or sampling ten tons every other five tons using a flow scale are systematic sampling methods.

Target species - Fishers generally call the species they wish to catch the target species. The Observer Program uses the same definition. The Sustainable Fisheries Division of the NMFS Alaska Region uses delivery and production data to determine target fishery, which may differ from what the vessel records as the target.

Temporal - Referring to a unit of time used in random sampling. For example, one hour of processing time or systematic intervals of ten minutes are examples of temporal units.

Figure 5-1 Trawl Sampling Terminology

LIST OF PRIORITIES

- Your Safety!
- Collect data and specimens from marine mammal and endangered seabird mortalities.
- Rehabilitate endangered and threatened seabirds.
- Sample for species composition.
- Monitor for marine mammals.
- Document any compliance concerns.
- Measure and assess viabilities of Pacific halibut.
- Measure and sex other prohibited species.
- Collect otoliths from the appropriate species.
- Collect sexed length frequencies from the appropriate species.
- Complete special projects.
- Record sightings of bird “species of interest.”
- Record marine mammal sightings.

INTRODUCTION

Species composition sampling is high on the Observer Program’s priority list, but more time is spent on this task than any other. Species composition sampling is the collection of catch samples from a selected haul.

Fisheries managers base their assessment of catch rate on the results of your species composition samples. The data you collect are used to monitor allowable harvest and is used by scientists for population analysis and stock assessment.

SAFETY ONBOARD TRAWLERS

It is always your highest priority to stay safe and be aware of your surroundings aboard every vessel. Each vessel is different and fishing situations are constantly changing. There are several safety concerns specific to trawlers you should be aware of.

When sampling on catcher trawlers, you may be working outside and exposed to the elements for long periods of time. In the winter months, you could experience freezing conditions, snow, spray, and high winds. Dress appropriately!

Decks can become very icy, making the process of transferring sampled catch from collection point to weighing station very dangerous. Reduce the amount of fish you put in each container to make the load lighter, ask crew to assist you in transferring the sample, or push/pull the containers of sample along the deck. In rough weather, waves can break over the stern ramp and temporarily flood the trawl deck. Be aware of this possibility when you are out on deck and when determining where to work up your sample. Choose sheltered areas to work if you can.

The Observer Program expects you to be proactive about your own safety by wearing a personal flotation device whenever you are working on deck, even if you think your sample station is not openly exposed to the elements. You should always notify the captain or crew if you plan to be, or think you will be, out on deck alone.

Many observers deployed to small catcher trawlers report that they had to work dangerously close to tight cables and trawl wires because deck space was at such a premium. If you have to work around vessel gear and tight cables, make sure to communicate with the captain about what times are the best for you to be working in those areas. Often, the captain will ask that you wait for crew to complete the setting or retrieval of gear before going on deck. Requests or suggestions made by the captain pertaining to your safety or safe practices should be listened to and followed!

On catcher processors, sampling is typically accomplished below decks, so weather is less of a contributing factor to one’s immediate safety. Catcher processors do have dangerous areas that catcher trawlers don’t typically have: sharp processing machinery, belt catch points, and hydraulically operated hatches. There are many instances where crew have lost fingers, hands, arms, feet, or legs from getting caught by pinch points, hatch doors, or in machinery. Pay attention to the warning signs posted around factory machinery. Never try and retrieve items that may have become entangled or stuck in the machinery by yourself! Let the vessel’s crew know about the problem, as there are strict lockout/tagout procedures to ensure that whenever machinery is being worked on or cleaned, it is turned off and locked in the “off” position.



Regardless of what vessel type you are on, your continued safety comes down to recognizing the dangers of the environment you're in. Don't become complacent!

SAMPLING SYSTEM GUIDELINES

One of the first things to do when you arrive on a vessel is inspect your sampling station and determine a sampling system. Refer to "TRIP INFORMATION" on page 3-1 for what to look for in a sampling station. When designing a sampling system you must consider:

- where to collect your sample.
- what sampling biases could occur in your collection and how to minimize them.
- how to collect your sample.
- how many samples you will be able to collect.
- what size sample you will be able to collect.
- how you will process your sample.
- do you need to use the Random Sampling Table (RST) or Random Break Table (RBT).

Draw a diagram of your sampling station in your logbook. In the daily notes, discuss the random sample system you intend to use. ***Your sample system will be put to the test once you start sampling, and you may find that you need to make some changes to it.*** When you have settled on a random sample design, fill out a Sample Design Detail form in your logbook. On this form, describe your sampling system in detail, addressing each of the above topics. Day to day minor adjustments to the random sample design can be documented in the daily notes section of your logbook. Refer to your logbook for an example.

You may alter your system as you gain experience, become aware of biases, or as the species composition or target fishery changes. Document all changes in the daily notes section of your logbook and explain why they were made. Random sample designs for trawler sampling are discussed in detail starting on page 5-11. If you have problems designing or implementing a sampling system, contact your ATLAS inseason advisor or other FMA staff member.

Selecting Hauls to Sample

Inexperienced observers may watch the first retrieval to familiarize themselves with the way catch is handled. Familiarity with the catch handling process will allow you to decide on a sampling system that is right for that vessel and fishery.



Observers who are experienced with the vessel type and fishery are expected to sample the first haul! For these observers, it is not appropriate to take the first haul off just because it is the first haul!

Observers on pollock catcher vessels are expected to sample all hauls. Observers familiar with the gear type and fishery are expected to sample all hauls when less than three per day are made. If extenuating circumstances prevent this, you must document the situation in your logbook.

If it is not possible to sample all hauls brought aboard the vessel (with the exception of the first haul if necessary), you must use either the RST, RBT, or both to determine hauls from which to collect species composition samples. Please refer to "How to Use the RST" on page 2-10 for instructions on using the RST and refer to "How to Use the Random Break Table (RBT)" on page 2-10 for instructions on using the RBT.

SPECIES SAMPLING GUIDELINES

The sampling methods you are able to employ will depend greatly on vessel and fishery related factors such as: vessel size, gear, hauling and processing practices, crew assistance, catch diversity, and catch size. There are some guidelines and sampling methodologies that you should try to follow and maintain. These are discussed below.

Preferred Sampling Method

There are several sampling methods available to you for collecting samples. These are covered in "Random Sampling on Trawlers" on page 5-11. As discussed in the section "Introduction to Sampling Theory" on page 2-12, the preferred method is *systematic random*.

To achieve systematic random sampling on trawlers, the catch size or process time must be divided into sampling units of equal size. Choosing units to sample systematically results in samples that are equally spaced throughout the entire haul.

When samples are non-biased and spaced equally throughout the haul, there is a higher probability that these samples as a whole are representative of the catch. The fewer the samples, the less likely the catch is being fairly represented.



Fewer, smaller samples make it less certain that the samples are representative. For this reason, several larger samples within a haul are preferred.

Trawler Samples and Subsamples

On trawlers, you will always have samples, but you may not always have subsamples. Subsamples are only taken in those situations when there are *two* predominant species in the sample. Subsamples must come from *within* samples. In the data, you will use a specific numbering convention to associate a subsample to the sample from which it came. To indicate this relationship in this manual’s text, the term “parent sample” is used. For any *subsample*, the parent sample is the sample from which the subsample was taken. A more thorough discussion of subsamples and *when* to subsample can be found on page 5-20.

Number of Samples per Sampled Haul

You should take as many individual samples within a haul as feasibly possible. ***At least three discrete composition samples are required for every sampled haul to allow data users to assess sample variance.***

There may be fisheries and vessel types where it is not possible to collect multiple species composition samples within a sampled haul. In those instances, you must document the circumstances in your observer logbook daily notes pages.

Sample Size Considerations

Sample sizes within a haul must be equal to each other and it is preferred that sample sizes be as large as possible. The larger the sample size, the larger the portion of catch contributing species composition information. In the best case scenario, the sample size is the entire haul and everything from within it is accounted for. This best case scenario is rarely a feasible one! Taking multiple random samples and making these samples as large as possible is a compromise between the best case scenario and single

small samples. Refer to “At-Sea Sample Sizes” on page 5-18 for specific information regarding sample size options by trawl fishery.

On trawlers, the size of your samples will be influenced by several things, among them:

- the diversity of the catch.
- the space available to you for storing fish from your sample.
- the time you have available to sort fish.
- crew willingness to help sort or slow processing to accommodate sorting.
- whether or not there is a flow scale in use.

When considering how large you can make your samples for any given haul, follow these guidelines:

1. Strive to collect random samples using a random sample design (see “Random Sampling on Trawlers” on page 5-11). When this is not possible, document the reasons in your logbook.
2. Random samples taken within a haul should be of approximately equal size. Catch diversity will be a primary factor in sample size maximums. In order to achieve similar sample sizes over the course of one sampled haul, tailor sample size to accommodate the most diverse portion of the catch



Remember: it is just as biased to increase sample sizes within a haul because it has become clean as it is to cut sampling short because the catch has become dirty!

3. Allocate your time appropriately. Maximize sample size based on the amount of time you can afford per haul, keeping in mind all the other sampling related duties you are required to perform. Keep to the RST and/or RBT schedule. The size of any given sample will be additionally influenced by the following factors:

- **General Health** - The amount of time and energy you can spend on composition sampling will be affected by your general health. Most factory vessels operating 24-hours per day will carry two observers and you will each work a 12-hour shift. When working as the sole observer on a factory vessel using the RST and/or RBT will reduce the

number of hauls you need to sample. You may need to reduce sample size to keep up with your other duties, recover from seasickness, or recover from illness.

- **Size of Hauls** - Consider the amount of catch per haul when deciding on a sample size. In some fisheries, 100 mt codends taking 4-8 hours to process are not uncommon. Weighing and counting everything in a haul this size is difficult due to time constraints and high bycatch.
- **Species Diversity** - It takes longer to sample a “dirty” haul (one with high species diversity) than it does to sample a “clean” haul (one with only one or two predominant species). In fisheries with a lot of bycatch, you will need to reduce your sample size in order to process your samples in a reasonable amount of time. Conversely, in clean fisheries you may be able to take much larger samples.

4. You must sample from unsorted catch

and you must be present to sort, or directly supervise the sorting of, all fish in your sample. If you see or suspect that you are missing individuals in your sample, reduce your sample size and/or change your sampling method. *You must be certain you are accounting for all of the fish in your sample.*



5. With the exception of the offload census, you cannot selectively sample for any one species. *Every species that lands in a sample must be accounted for on the species composition data form.* The species you will encounter can be categorized into three groups:

- **Prohibited species** - In the North Pacific, the five prohibited species groups are: the king crab group, the Tanner crab group, the salmon group, Pacific halibut, and herring.
- **Non-prohibited species** - This is made up of two groups: bycatch species and target species.
- **Seabirds** - This category encompasses all bird species, both migratory and resident, found in Alaskan waters.

SAMPLE BIAS

The goal of the Observer Program is to obtain unbiased samples of the harvested catch in each target fishery. Bias can be minimized when sampling by employing appropriate sampling methods, sampling from *randomly chosen* sample units, and by accounting for other recognized biasing mechanisms.

Recognizing Potential Bias

The vessels you will be working on are not research vessels and most sampling situations you encounter will not be ideal. Assess your collection site for possible biases, document what they are, and how you attempt to avoid them. Some specific sampling biases you need to look for are discussed below.

Deliberate Interference

Federal Regulation 50 CFR 679.7 states that it is unlawful to “interfere with or bias the sampling procedure employed by an observer, including physical, mechanical, or the sorting or discarding of catch before sampling.” In some fisheries it is advantageous for the vessel to intentionally remove certain species prior to sampling. This is especially true for prohibited species bycatch. The removal of organisms prior to catch sampling is called “pre-sorting.” This practice is illegal and biases your samples by misrepresenting the true bycatch rate for these species.

Refer to page 18-2 for a list of steps to take if you suspect deliberate interference with sampling. There are several ways vessel personnel could sort out individuals prior to your sample, so watch for the following:

- **Dumping undesirable catch overboard** - Vessel crew may dump an entire codend overboard, or a portion of one, because of high bycatch levels. This biases your data because you do not have access to the entire catch. Ask the captain not to discard fish from the codend until you have had the opportunity to sample. On factory vessels, this may mean you reduce your sample size and sample on deck. If the captain will not comply, note this in your logbook. If the vessel regularly dumps codends before you can sample, contact your ATLAS inseason advisor or other FMA staff member.

- **Removing and discarding unwanted species** - Vessels may have crew members in the trawl alley, fish bin, or on the sorting line in order to sort out fish. This activity can potentially bias your sample, depending on when it occurs. If fish are removed prior to you taking a sample, such that they never had the opportunity to land in your sample, your samples are potentially biased. Inform the captain or factory manager that you must have access to unsorted catch. To the best of your ability, quantify the amount of fish removed each time this occurs and document this information on your decksheet and in the daily notes section of your observer logbook. Notify the Observer Program or NMFS Enforcement personnel of pre-sorting problems as soon as possible. If you feel this may make your position on the vessel unworkable, you can ask NMFS staff not to confront vessel personnel until you have disembarked.
- **Crewmen in the bins** - The setup of some non-AFA groundfish factory vessels is such that it is necessary for a crew member to push the fish out of the bin door or onto a conveyor belt. This is a potential problem because s/he can push certain species away from the conveyor belt where you are sampling, or hold these species until you are finished sampling. Currently, on limited access non-AFA groundfish vessels, there are regulations that restrict crew activity in the bins when the vessel is fishing. Specifically, observers must be able to view all activities inside the bins. For details on these regulations, see “Regulations Specific to Non-AFA Trawl C/Ps Fishing in the BSAI” on page 5-32. On other vessels with bins, there are ways to deal with the problem of crewmen in the bins. These are listed below. If the problem continues, notify the Observer Program or NMFS Enforcement.
 1. Ask the crew member to step out of the bin when you are sampling.
 2. Randomly select times to take your sample.
 3. Watch the crew in the bin.
 4. Watch the sorting line to see if concentrations of specific species increase when you are not sampling.

5. Look for halibut and/or salmon being held in the bin. Some boats have areas in the bin where fish can be stored until you leave the factory.
6. Speak with the individual responsible, then talk with the factory managers and the captain. Document these discussions in your logbook daily notes.

- **Large animal removal on deck** - Although presorting is never legal, removing large animals on deck to prevent them from entering the factory or RSW tanks is a common practice, and sometimes unavoidable. *You must ask to be notified if this occurs, and include the animals in your species composition data for that haul* (see “Accounting for Pre-Sorted Samples” on page 5-21).



Inform the captain the first time pre-sorting occurs. Document ALL observations, occurrences, and conversations you have regarding this problem!

Mechanical Biases

In addition to deliberate biasing actions by vessel crew, there are mechanical biases to look for when sampling. In order to determine if mechanical bias is affecting your sample population, you must understand how fish flow from the codend to your sample collection point. When assessing fish flow, specifically watch for:

- **Grates** - These sort out large individuals such as sharks, large skates, and large halibut. Look for grates on deck hatches and bin doors. Count and/or weigh anything you see mechanically pre-sorted from the catch and include this in your species composition data as a discrete sample (see “Accounting for Pre-Sorted Samples” on page 5-21).
- **Small openings** - Small openings can exclude large fish from your sample. Watch for exclusion of large fish at the hydraulic door allowing fish to move from the fish bin to the factory processing belts. Often the crew will keep this door open just enough to allow a steady flow of fish. If the door is

TRAWLER COMPOSITION SAMPLING: Sample Bias

not open enough to allow large individuals to pass through, the sample you collect is potentially biased. If you are collecting fish from a trawl alley through an access point in the trawl alley wall (for example by lifting a bin board or gate), make sure the opening is big enough to allow the larger organisms in the haul the same access into your sample as the smaller ones.

- **Inaccessible bins, tanks, or belts** - These will prevent you from setting up a random sampling design because the fish in the inaccessible bin, tank or belt will not have a chance to fall into your sample. While there is little you can do to solve this problem, you should try to randomize your collection as much as possible. Make note of the sampling biases and how you deal with them in your logbook.
- **Conveyor belts** - If a conveyor belt is running too fast or too deep with fish, it is difficult to see and sort bycatch that passes by you. You must be able to account for all individuals in your sample! Ask the crew to slow the belt and run the fish one layer deep. If the vessel crew will not comply, or if you are still unable to sort bycatch from the sample, note this in your logbook and take smaller samples for species composition (*e.g.*, sample sizes of several hundred kilograms or tens of kilograms as opposed to several tons).
- **Incline belts** - Incline belts can affect a sample in many different ways. Some are steep with small tines that don't accommodate large fish. Others allow large fish to move up, but at a different rate than the smaller fish. When this occurs and you are not sampling the entire catch, larger fish have less of a chance of falling into your sample. To alleviate this bias, try to take your sample before the incline belt. If you cannot avoid the incline belt, be sure to **clear all fish** in front of the incline before and after you collect your sample. Fish that did not make it up the incline belt during your sample collection period must be taken from the base of the incline belt and be included in your sample.
- **Pumping the net** - There are a few vessels that pump fish from their codend into the hold. These vessels use transfer tubes that sort out large individuals. Transfer tubes may also be fitted with grinders. There is no way to account for organisms

sorted out in this way. In your logbook, make note of the fact the vessel transfers fish by pump. Include the diameter of the pump tube and the size of the largest organism you observed in the catch. Sample for species composition as if this were not a factor.

Minimizing Sampling Bias by Sample Method

The sampling system you use should take into account any potential biases and limit their effects. Three ways to limit sample biases are:

- **Use random sampling:** By using a random sample design, you will eliminate subjectivity and ensure that every member of the population has an equal probability of occurring in your sample.
- **Maximize your sample size:** Weighing and counting everything in the catch is the best way to obtain information about the catch's population, since the "sample" size in this scenario is the entire catch. In most cases it will not be possible to sample the entire catch and smaller samples will have to suffice. Although larger random samples are preferred, small samples are perfectly viable when they are randomly collected. ***If you have to choose between large, non-random (potentially biased) samples and smaller, random (unbiased) samples, smaller random samples are preferred.***
- **Take multiple samples:** Take as many samples as you can. Your sample units must be of relatively equal size.

Non-Random Sampling Bias

When samples are not collected randomly, fisheries managers cannot assume they are unbiased or use statistical methods of analysis on these data, as they can with random samples. If you determine that you cannot use a random sample design on your vessel, you must document the reasons in your logbook and use a non-random (or "opportunistic") method to collect samples.

- **Opportunistic samples:** These are samples taken either 1) without pre-selecting when, or from where, you are going to sample, or 2) from the only accessible portion of the catch. The following are examples of opportunistic sampling: taking subsequent samples immediately after you have finished sorting the previous sample regardless of

how long it took to sort that sample, sampling from only one area of the codend or deck because all other areas are inaccessible, and taking your sample at the very beginning of a haul because the haul is small and you are worried you are not going to obtain a reasonably sized sample if you don't take it right away. In each one of these examples, not every fish in the population has an equal chance of ending up in your sample; the sampling is opportunistic and potentially biased.

Due to vessel constraints or safety considerations, random sample methods are not possible on some vessels. In these situations, opportunistic samples will have to suffice. If you use opportunistic sampling techniques, document the reasons why you had to do so in your observer logbook.

Sampling Methods to Avoid

Sampling methods to avoid are ones in which you make a decision on when or where to sample based on perceived composition. Never take a sample from a particular area of the haul because you feel the organisms in that area have not been fairly represented in your sample. For example, if you see halibut while the haul is being dumped, but do not get any in your sample, it is *not* appropriate to select an additional portion to sample just because it contains halibut.

MECHANICS OF SAMPLING ON C/PS

Sampling on a catcher processor or mothership usually takes place in the factory, from a conveyor belt. To minimize bias, the sample collection point should be prior to all sorting activities. Usually, the closer you are to where the catch exits the bin or tank, the less chance any mechanical or crew sorting can occur. If your sample collection point choices are limited, take steps to eliminate sample bias from mechanical size sorters, size sorting incline belts or pumps located prior to the collection site.

Sample Collection After an Incline Belt

On many factory trawlers, fish exit a bin or live tank, fill up a trough, then travel up an incline belt before they reach a horizontal sorting belt. To minimize the bias inherent with incline belts, clear the trough and incline belt of fish before taking the sample. If you can,

fill the trough with just your sample fish and run this entire amount into your collection containers. Make sure when sample fish are being allowed into the trough, that the hydraulic door from the fish bin is opened enough to eliminate size biasing.

Sometimes it is too difficult to manipulate the quantity of fish going into a cleared trough. If this is the case, have the crew do the following before you take your sample:

1. Close the hydraulic door to the live tank.
2. Clear the trough and incline belt.
3. Open the hydraulic door to the live tank and begin running fish as they would normally.

As you collect the sample from this flow of fish, watch for any organisms that obviously should be in your collection but are not because they cannot make it up the incline belt.

Sample Collection Off a Conveyor Belt

There are three simple methods for collecting unsorted catch off conveyor belts. Just remember to collect before any sorting activities. Any of these methods can be used within your sampling design. They are:

- **Collecting from the flow of fish:** Hold a container under the flow of fish from the live tank or under the flow of fish falling from one conveyor belt to another. If a fish is legitimately part of your sample but too big to fit in the container, you still include it in your sample!
- **Diverting the flow of fish:** Use a diverter board to spill fish into a container. A diverter board is a board hinged to the side of a conveyor belt that, when open, allows catch to spill off the belt.



Watch your fingers around belts and motors: they can be hazardous catch points! Remember that loose clothing or gear can get dangerously tangled as well.

- **Collecting fish directly off the belt:** Collect all catch in a prescribed area of the belt. If there is no place in the factory that allows collection by diverting the flow of unsorted catch, you can stop the belt and collect all the catch in an area. To do this:

1. Close the bin door and clear the belt by running the fish into the factory. You cannot use these fish, since you cannot be sure that they haven't been sorted.
2. Once the belt is cleared, re-start the flow of fish until the belt contains enough for your sample.
3. Stop the flow of fish and collect all fish from the belt. If you cannot take all the fish off the belt, use a prescribed area (from point A to point B) and collect all fish in the area, regardless of species or size. Never hand select fish to include in a sample.

MECHANICS OF SAMPLING ON CATCHERS

Obtaining random samples on catcher vessels takes creativity and a thorough assessment of how the catch is processed. Catcher boats usually handle their codends in one of two ways:

1. The catch is dumped directly down hatches into the RSW tanks. This is typical on pollock vessels.
2. The entire catch is dumped into the trawl alley and the crew sorts retained fish into RSW tanks. This is typical on Pacific cod, flatfish, and rockfish vessels.

Sampling from a Codend

If your vessel dumps unsorted catch directly into the RSW tanks, you may have to fill your baskets by catching the fish as they are flowing from the net to the deck, or from the deck into RSW tanks. If you choose this method, any large fish that hit your basket are included in your sample, even if they don't fit in your basket. You may need assistance from a crew member to hold your basket under the flow of fish.



Always consider your safety when choosing a collection site. Do not position yourself under the codend when taking a sample!

Sampling Using a Checker Bin

If your vessel has checker bins available (checker bins are compartments on either side of the trawl alley), you can divert unsorted catch into them by lifting a bin board. The crew may also be able to dump some of the codend directly into the bins. Depending on the size of samples collected, weigh all the fish, or use methods to further reduce the sample population within each bin (see page 5-17).

Taking samples from different bins minimizes bias because samples are not coming from only one area of the codend. On some vessels, crew use checker bins to store gear such as extra codends, webbing or chains. If you do not have access to all bins, document in your logbook what bins you can and cannot use to contain samples. If you can only sample from one bin, you may be able to implement a temporal sample design (see page 5-17) to sample over the course of the haul and thereby minimize bias.

Sampling from the Trawl Alley

If catch is dumped onto the trawl deck, take steps to prevent size sorting when selecting your sample. Do not take a sample by shoveling fish into your baskets, by hand selecting fish, or by using your basket as a scoop. Instead, isolate an area from which to collect all fish. You can use an overturned basket to create a "sampling circle" and you would consider any organism touching the rim of the basket as part of the sample. This only works well if the fish are not sliding around while you are collecting them. Another way to isolate a sample is to ask the vessel for extra bin boards; these wooden planks can be used to cordon off an area of the trawl area where you can collect fish for the sample.



Not looking at the fish while you grab, gaff, or shovel them does not eliminate bias! Fish collected in this manner are potentially size biased if you do not have a random sampling system in place for selecting individual fish.



In the Pacific cod, rockfish, and flatfish fisheries, the crew will want to start sorting the catch immediately. You must be sure to take your sample before any active sorting by crew or machines happens.

to *simple* random sampling from spatial or temporal frames. Systematic designs are discussed beginning on page 5-12.

Simple Random Sampling from Spatial Frames on Catcher Processors

Spatial sampling designs are the best to use on catcher processors with operational flow scales. You and the crew will have a good estimate of total catch weight before the haul is processed and, because the catch is passing over a flow scale, you will be able to start your sample at specific, randomly chosen weight values. By using the flow scale to determine the weight value to *stop* sampling, you can easily supply a total weight for each of your samples.

RANDOM SAMPLING ON TRAWLERS

In order to take random samples from a population, you need to establish a framework that ensures all individuals have an equal probability to be included in your sample. A sample design eliminates subjectivity regarding when to take a sample. Without a defined, documented sampling design, your samples cannot be considered random. For further detail on the benefits of sampling designs, see “Introduction to Sampling Theory” on page 2-12.



Deriving sample weight using the flow scale is easy: sample stop weight minus sample start weight is the size of the sample.

On a trawl vessel, the population is all the individuals caught in a haul. The units that make up your frame can either be spatial (units of space) or temporal (units of time). When the entire population is available at one time (*e.g.*, when a codend is dumped out on deck) spatial sampling may be most appropriate. When the entire population is available over time (*e.g.*, dumped into a live tank or run across a factory conveyor belt) both spatial and temporal units are viable options.

To accomplish simple random sampling from a spatial frame, determine the amount you can sample at a time. Sampling units must be equal, so size your sampling units to accommodate the level of species diversity you are seeing in the haul (see “At-Sea Sample Sizes” on page 5-18). Divide the total estimated haul weight by your desired sampling unit size and number these units sequentially. Use the random number table (A-17), a watch, cards, dice, or other method to pick units to sample.

Random sample designs are used only for sample sizes that are less than the weight of the entire haul. Sampling an entire haul is a true census of the population, and is not subject to sample bias.

Temporal Frames on Catcher Processors

Remember, if you abort or alter a sampling design during the sampling of a haul, for any reason, document the circumstances on the “Sample Design Changes” form of your observer logbook (see “Documenting Design Constraints or Problems” on page 2-16).

On vessels without an operational flow scale, temporal frames are often easier to work with. If it takes several hours to process a haul, it is easier to sample at a given time than an estimated weight value. Factory managers will usually have an idea of how many tons of fish per hour the factory can run. Use this weight value per hour estimate as a guideline for how much time it will take the crew to process the entire haul. Ask the factory manager about estimated run time if haul diversity is high, because it may take more or less time than average to run dirty hauls.

Random Sampling on C/Ps

Both temporal and spatial designs are applicable on catcher processors or mothership vessels. Commonly, these vessels have fish bins you can measure or motion compensated flow scales. **Make sure that you have explored *systematic* random sampling from spatial and temporal frames as an option before resorting**

Few catcher processors fish without flow scales. Those catcher processors without flow scales will likely have diverse catch. Therefore, samples will have to be small (*i.e.*, tens of kilograms as opposed to several hundred or thousand). To sample effectively on these vessels

TRAWLER COMPOSITION SAMPLING: Random Sampling on Trawlers

you will need to 1) determine the size of sample you can take, and 2) estimate how long it will take to process this sized sample.

1. Divide the total processing time by the number of minutes you estimate it will take to process a sample. The resulting value represents the number of sampling intervals within the haul.
2. Randomly choose a minute within a generic sampling interval. You will sample at this minute from each sampling interval you choose.
3. Randomly choose intervals from which to sample.

A sampling design structured this way is random yet still provides time for sorting samples.

If you are on a vessel without a flow scale and the catch has only one or two predominant species, you may be able to use a temporal frame with larger time units. The process of sampling this way is a little more complicated, because the size of samples (in kilograms) must be determined by bin volume measurements (see “Sample Sizes by Bin Volume” on page 5-19).

1. Determine how many samples you can take and how large (in this case how many minutes) the unit size can be.
2. After dividing the estimated haul processing time by the sampling unit, choose units randomly with the random number table (A-17), a watch, cards, dice, or other method.
3. To determine the weight of each sample, take bin measurements before and after the sampling unit and calculate weight from the volume of your sample and density.

See Example 5-1 for a simple random sampling design using temporal units.

Systematic Sampling on Catcher Processors

In addition to the statistical benefits of systematic random sampling, there are practical benefits. With ***simple*** random sampling, it is possible to randomly choose back to back sampling sections. Back to back samples can be difficult to manage, because there may be little time to work up the first sample before you have to accommodate the next. With systematic sampling, you are generally guaranteed some amount of time between samples.

Your yellowfin sole vessel lands a 30 ton bag. They process about 7-8 tons per hour, so the expected run time is about 4 hours (= 240 minutes). You know you can collect 3 baskets of fish at a time and it usually takes 20-30 minutes to sort. You divide the estimated processing time by 30 minutes to get the sampling intervals for your frame and randomly choose four of these to sample. You need to choose a random minute within the interval from which to take a sample, otherwise samples are biased towards the beginning of each. You can repeat the chosen sample minute for all other sample intervals. If the randomly chosen sample intervals in this example were 2, 3, 6, and 8, and the randomly chosen sample minute 18, samples would be collected at: 48 minutes; 1 hour 18 minutes; 2 hours 48 minutes; and 3 hours 48 minutes.

Example 5-1 Simple Random Sampling From a Temporal Frame

Systematic sampling involves taking a sample during every “nth” sampling unit, defined as a time interval (for temporal sampling) or space interval (for spatial sampling). For a systematic random design, randomize your sampling start time or space within the first sample section and continue to take samples at equal intervals throughout the rest of the haul or random haul portion.

In order to set up a systematic design, you have to determine two things beforehand: the size of your sampling unit and how many of these you can sample. Once you decide on these two things, you can determine the total number of sampling units in the haul and the sequence of sampled versus unsampled units.

Systematic Sampling from Spatial Frames

Systematic sampling from a spatial frame works very well on vessels with a functioning flow scale. Using the flow scale readout you can determine an exact start and stop weight value for a sample. To create the sample frame, do the following:

1. Determine the size of samples you intend to take. The size of each sample will be dependent on the factors outlined beginning on page 5-5. When the catch has low diversity observers routinely collect multiple samples that when added together equal 1/2 or 1/3 of the entire haul. These samples could be measured in

tons. When the catch is more diverse the samples will be much smaller. These samples would likely be measured in hundreds of kilograms rather than tons.

2. Divide the haul estimate size by the intended size of your sample. Number the resulting sampling units sequentially.

3. Divide the number of sampling units in your frame by the number of samples you intend to take. This value represents your sample interval “*i*.”

4. You can choose a random number within the value of your sampling interval. This resulting number corresponds to the first sampling unit you will sample. Samples are taken at this randomly selected unit and every “*i*” units thereafter (see Figure 5-2).

Sample sizes will depend on haul diversity. If the catch is very diverse, reduce sample size as much as you need in order to appropriately account for all organisms in that sample (see Figure 5-2 and Figure 5-3 for further examples).

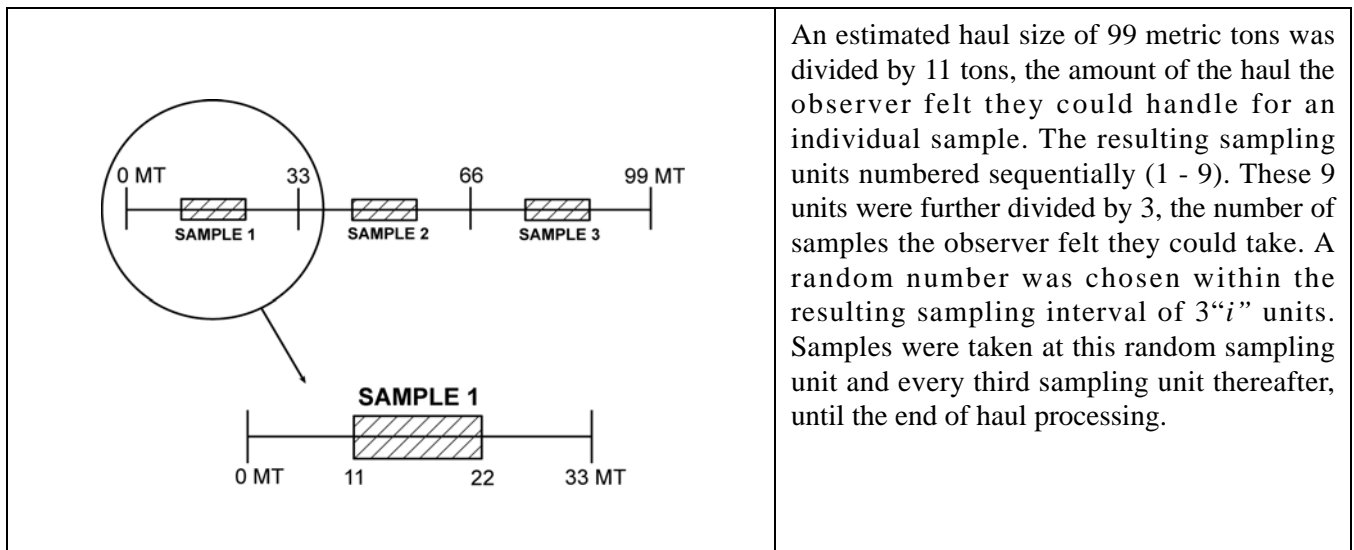

Figure 5-2 Large Systematic Samples on a Vessel with a Flow Scale

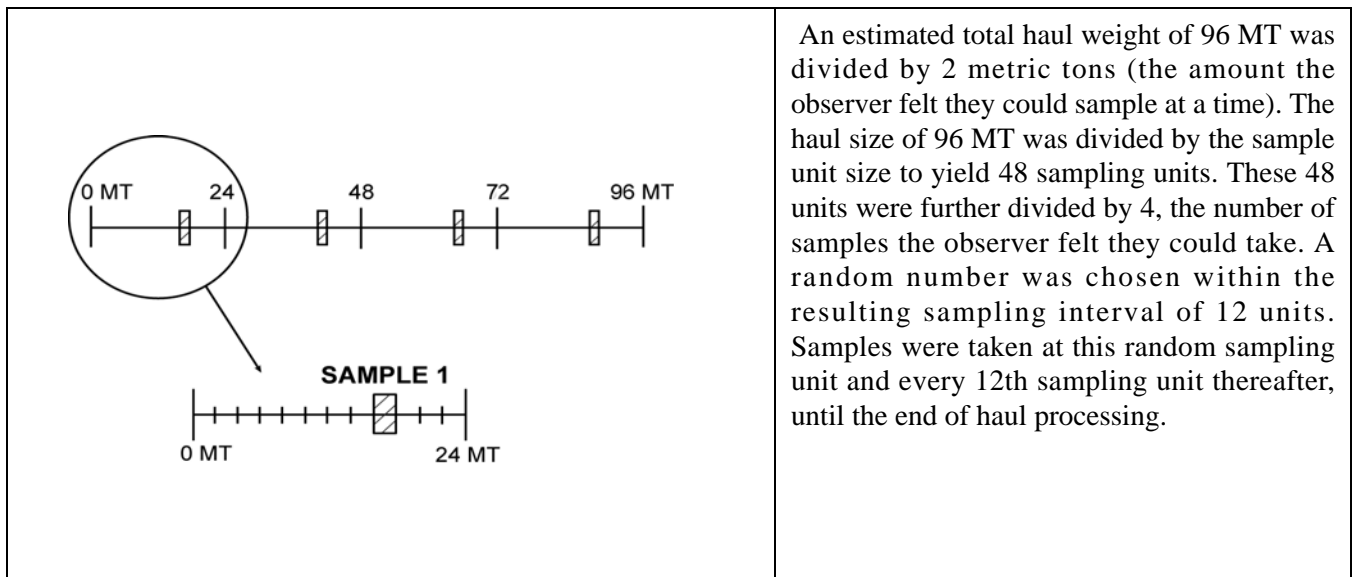
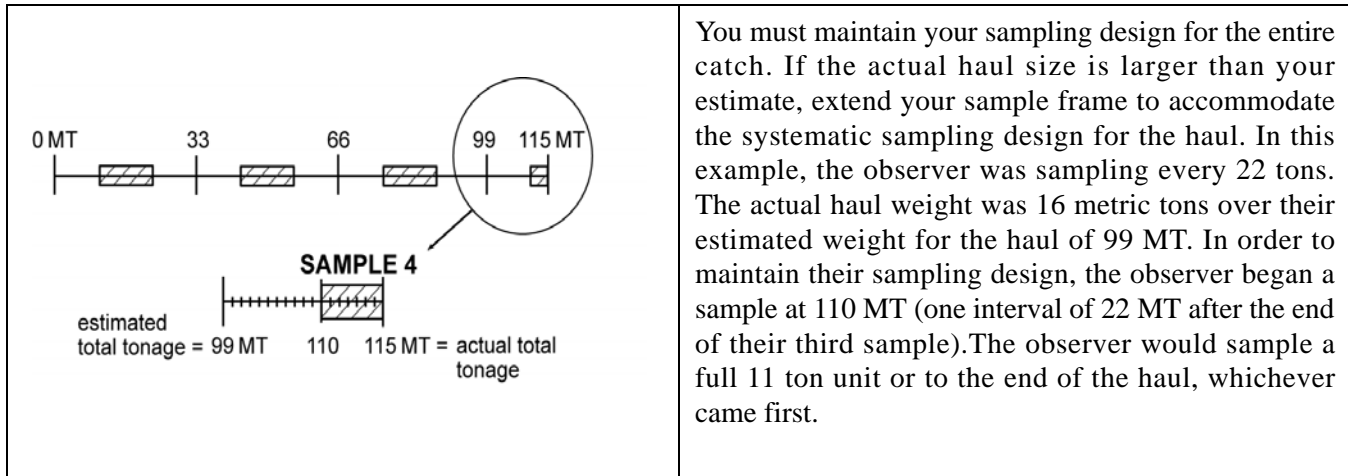

Figure 5-3 Small Systematic Samples on a Vessel with a Flow Scale

TRAWLER COMPOSITION SAMPLING: Random Sampling on Trawlers



You must maintain your sampling design for the entire catch. If the actual haul size is larger than your estimate, extend your sample frame to accommodate the systematic sampling design for the haul. In this example, the observer was sampling every 22 tons. The actual haul weight was 16 metric tons over their estimated weight for the haul of 99 MT. In order to maintain their sampling design, the observer began a sample at 110 MT (one interval of 22 MT after the end of their third sample). The observer would sample a full 11 ton unit or to the end of the haul, whichever came first.

Figure 5-4 Maintain Your Sampling Design for the Entire Catch

Systematic Sampling from a Temporal Frame

Example 5-1 could be turned into one of systematic sampling from a temporal frame by taking small samples at systematically spaced intervals. To sample from a temporal systematic frame, divide the total estimated run time by the number of samples intended. This gives you your equally sized sampling intervals for the haul. Use the random number table, a watch, cards, dice, numbered slips of paper, or some other method, to choose a time within the first interval to take a sample. This random number represents the minute at which you will take the first sample. Subsequent samples are taken at the same minute within each sampling interval. In Example 5-1, if the

number of intended samples was 3, the sampling interval would be 80 minutes. If the randomly chosen minute within the sampling interval of 80 minutes was 17, samples would be taken at 17 minutes, 97 minutes (= 17 + 80 minute sampling interval), and 177 minutes (= 97 + 80 minute sampling interval). If you misjudge processing time and find that you can take another sample from your sampling frame, you *must* do so. If, in the above example, the vessel was still processing at 257 minutes (177 + 80 minute sampling interval) you would need to take another sample at that time. Refer to Figure 5-5 and Figure 5-6 for further examples of temporal based sample designs.

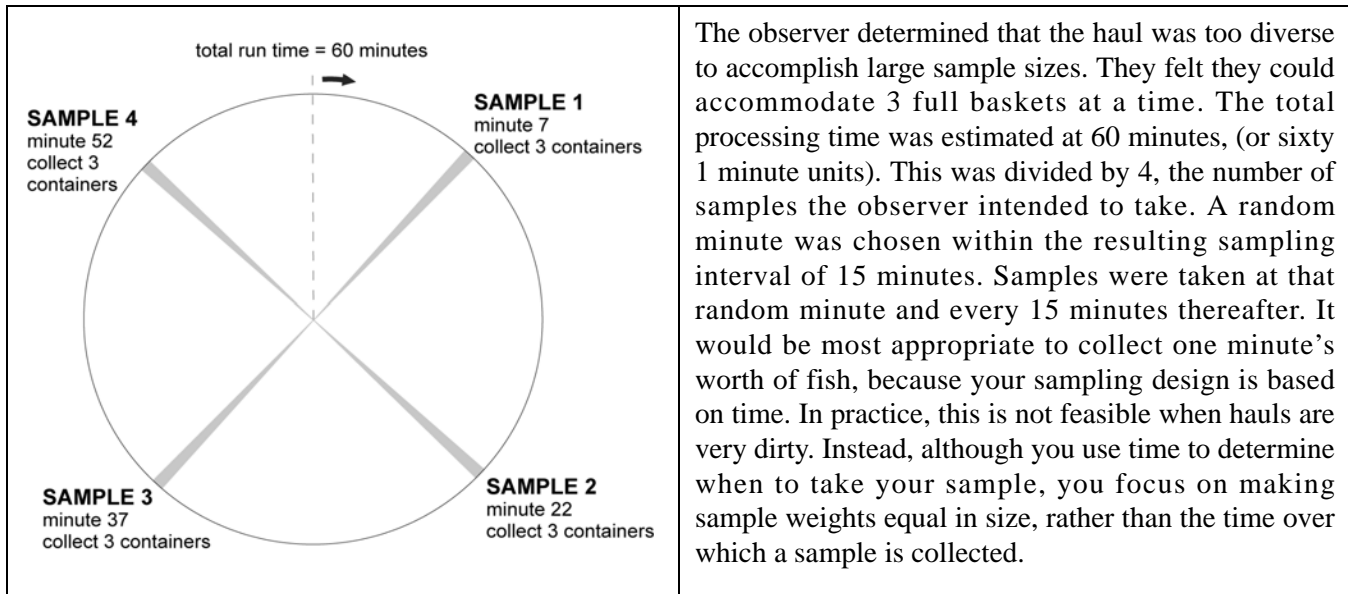

The observer determined that the haul was too diverse to accomplish large sample sizes. They felt they could accommodate 3 full baskets at a time. The total processing time was estimated at 60 minutes, (or sixty 1 minute units). This was divided by 4, the number of samples the observer intended to take. A random minute was chosen within the resulting sampling interval of 15 minutes. Samples were taken at that random minute and every 15 minutes thereafter. It would be most appropriate to collect one minute's worth of fish, because your sampling design is based on time. In practice, this is not feasible when hauls are very dirty. Instead, although you use time to determine when to take your sample, you focus on making sample weights equal in size, rather than the time over which a sample is collected.

Figure 5-5 Small Samples of Equal Weight Sizes Are Collected From the Temporal Frame at a Randomly Chosen Time Unit

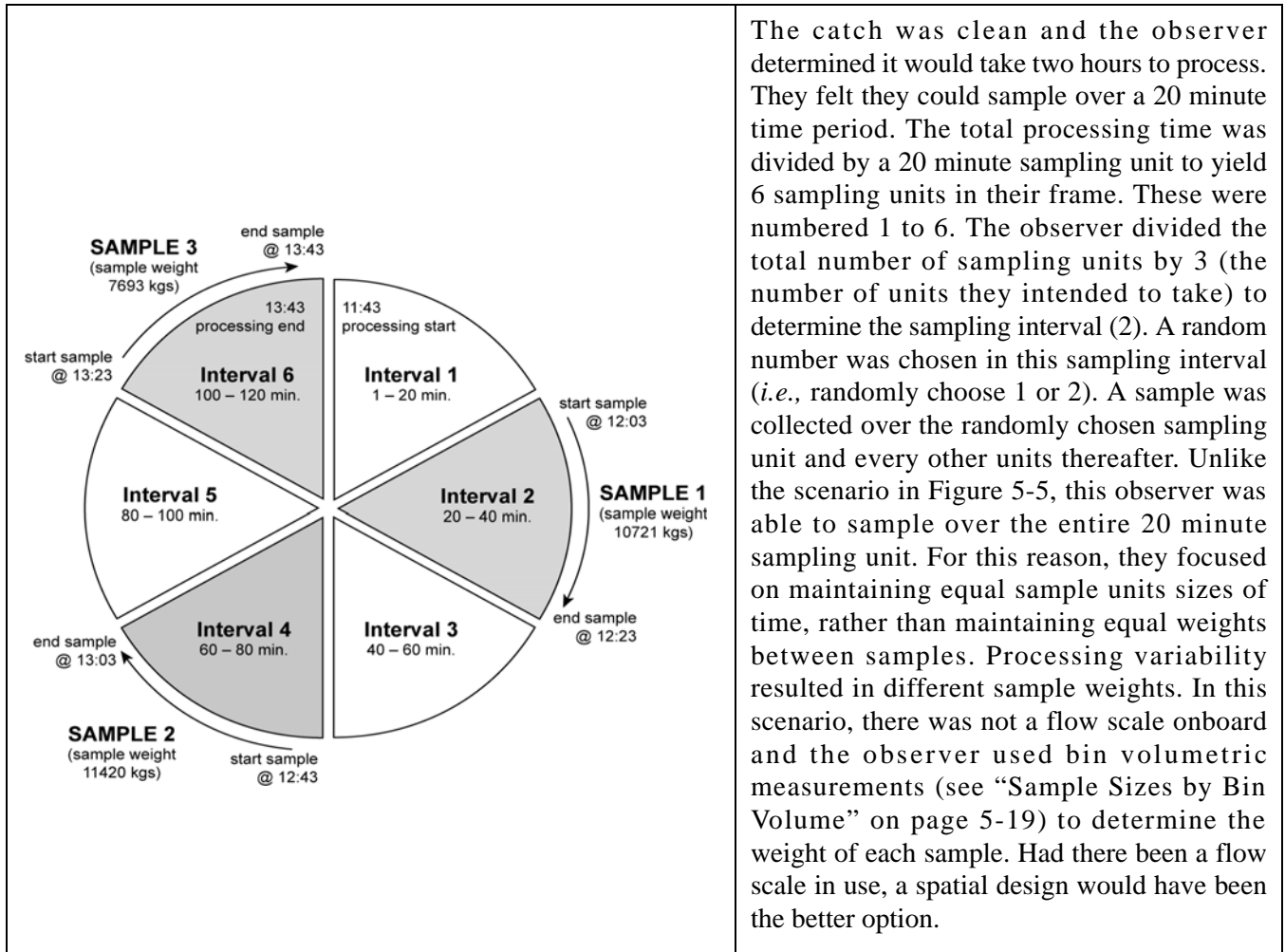

The catch was clean and the observer determined it would take two hours to process. They felt they could sample over a 20 minute time period. The total processing time was divided by a 20 minute sampling unit to yield 6 sampling units in their frame. These were numbered 1 to 6. The observer divided the total number of sampling units by 3 (the number of units they intended to take) to determine the sampling interval (2). A random number was chosen in this sampling interval (*i.e.*, randomly choose 1 or 2). A sample was collected over the randomly chosen sampling unit and every other units thereafter. Unlike the scenario in Figure 5-5, this observer was able to sample over the entire 20 minute sampling unit. For this reason, they focused on maintaining equal sample units sizes of time, rather than maintaining equal weights between samples. Processing variability resulted in different sample weights. In this scenario, there was not a flow scale onboard and the observer used bin volumetric measurements (see “Sample Sizes by Bin Volume” on page 5-19) to determine the weight of each sample. Had there been a flow scale in use, a spatial design would have been the better option.

Figure 5-6 Samples Are Collected Systematically From a Temporal Frame Over the Course of an Entire Time Unit

Addressing Challenging Sampling Situations

On rare occasions when you cannot sample the entire originally chosen sampling unit, you can *systematically sample within* the originally intended sampling unit. Another alternative is to randomly choose just one of your originally intended units to sample and systematically sample this.

Systematically Sampling Within a Larger Unit

If the haul in Example 5-1 was a 60 ton bag, the running time would be eight hours - possibly too long to spend on several small samples! To systematically sample a portion of this bag, you would divide the haul into equal portions and choose one to systematically sample. Using the same systematic design described,

you would take samples within the randomly chosen portion of haul. For example, if the haul was divided in half and the first half chosen to sample, samples would be collected at minute 18, 48, 1 hour and 18 minutes, etc., until four hours of processing time had passed.

Systematically sampling within portions of a haul is a very useful method on catcher processors with flow scales when the haul is dirty. Use a systematic system to create equally sized weight value blocks and choose one or more of these to sample. Apply the systematic method to collect samples systematically from within each of the randomly chosen blocks. See Figure 5-7 for an example of sampling within an originally intended sampling unit on a vessel with a flow scale.

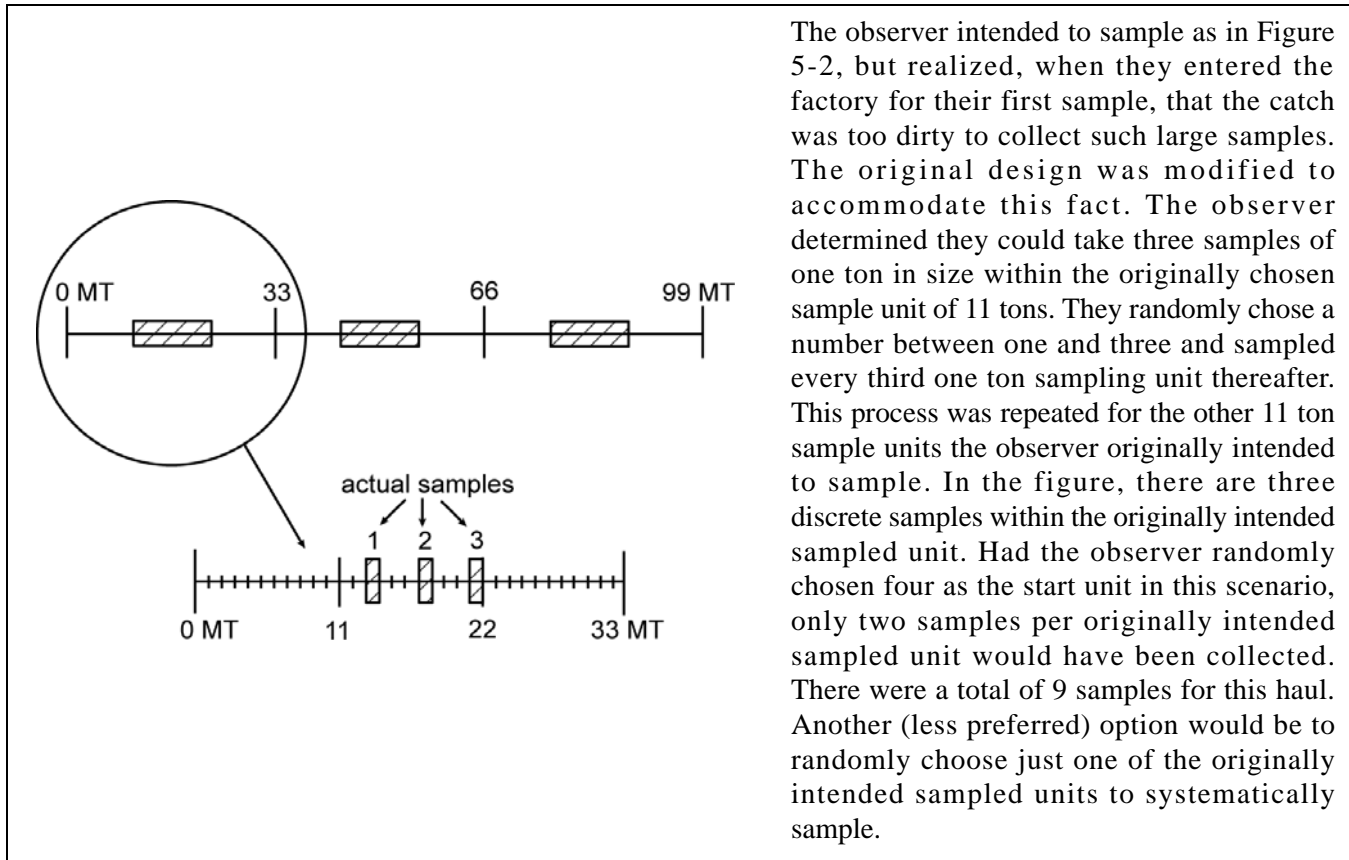

The observer intended to sample as in Figure 5-2, but realized, when they entered the factory for their first sample, that the catch was too dirty to collect such large samples. The original design was modified to accommodate this fact. The observer determined they could take three samples of one ton in size within the originally chosen sample unit of 11 tons. They randomly chose a number between one and three and sampled every third one ton sampling unit thereafter. This process was repeated for the other 11 ton sample units the observer originally intended to sample. In the figure, there are three discrete samples within the originally intended sampled unit. Had the observer randomly chosen four as the start unit in this scenario, only two samples per originally intended sampled unit would have been collected. There were a total of 9 samples for this haul. Another (less preferred) option would be to randomly choose just one of the originally intended sampled units to systematically sample.

Figure 5-7 Systematic Random Sampling Within a Larger, Originally Intended Sample Unit

Random Sampling on Catchers

Random sampling from a temporal or spatial sampling frame on catcher vessels can be very challenging. Try the following methods and document your results. **Make sure that you have explored systematic random sampling from a spatial and temporal frame as an option before resorting to simple random sampling from a spatial or temporal frame. Systematic sampling methods are discussed beginning on page 5-17.**

If you determine that sampling using a random design is not possible, you must document your reasons and give an explanation of the sampling methods used.

Spatial Frames on Catcher Vessels

Spatial frames may work on vessels which dump their entire codend onto the trawl alley before sorting retained species into RSW tanks. One way to create a spatial sample frame is to establish a “grid” pattern on the trawl alley. Mark out a grid pattern or use reference marks such as trawl alley boards, hatch, or scupper openings, etc. Number the grid sections, and use the

Random Number Table on A-17, or other method, to pick areas from which to take samples. If you cannot collect all fish from within a grid, further divide the space into equal quadrants and randomly select one of these (see Figure 5-8). Each collection from within a unique grid or quadrant constitutes a distinct sample for the haul.

If your vessel has several checker bins available for use, it may be possible to implement another type of spatial design. Number the checker bins and use the random number table (RNT) to pick which checker bin(s) to draw samples into. Lifting the checker bin boards allows fish to flow from the trawl alley into the bins. Each checker bin of fish constitutes a discrete sample for the haul (see Figure 5-9).

In the Figure 5-9 example, checker bins were numbered and the observer used the RNT to pick bins 1, 2 and 5 to sample. Bin 6 is unusable (this is documented as a source of potential bias in the observer logbook). Fish were allowed to flow into the

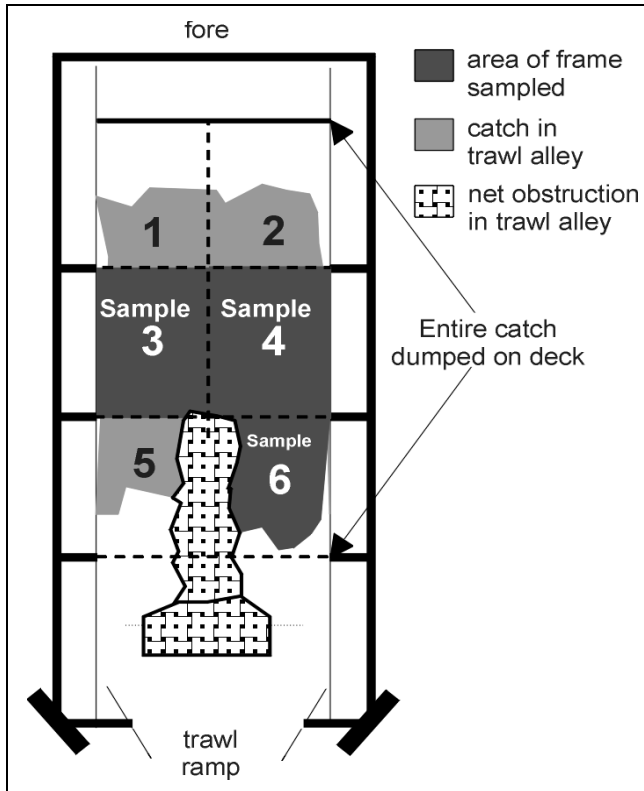

Figure 5-8 Spatial Design Using Trawl Alley

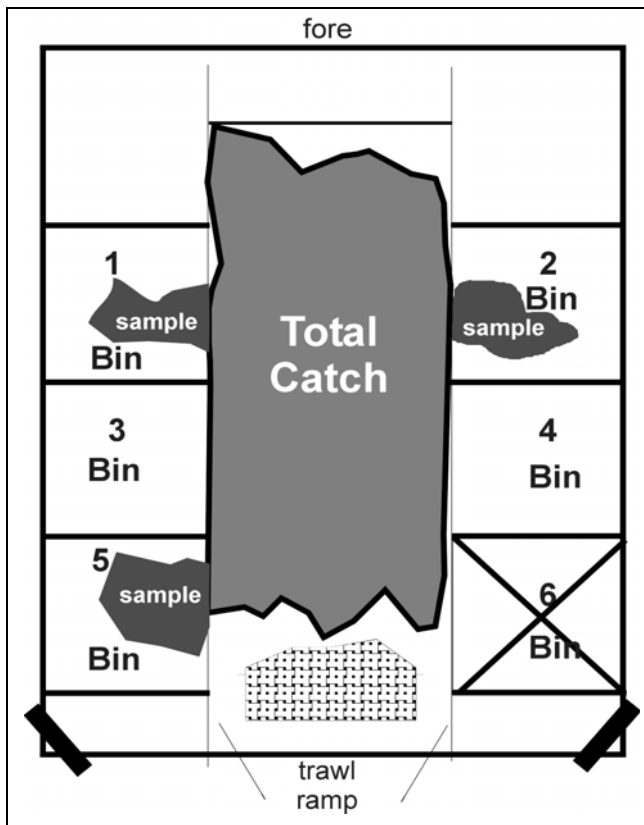

Figure 5-9 Spatial Design Using Checker bins

selected bins when the bin boards were lifted. This design yielded three species composition samples for the haul.

Temporal Frames on Catcher Vessels

Temporal frames can be used when the codend is dumped directly into RSW tanks and sampling requires you to divert the flow of fish from the codend into baskets or other containers. Divide the dumping time into equal numbered intervals. Use the RNT or other method to choose time intervals to collect samples. Collect samples from several intervals and record each of these samples as discrete samples for the haul. If the vessel dumps fish rapidly, you may need to take the entire sample from one interval. You always want to try to get multiple samples within a haul, but if you can't, make sure that the interval you use for your one sample is randomly selected! Document your methods and any possible biases in your logbook.

Systematic Sampling on Catcher Vessels

Systematic sampling involves taking a sample during every "nth" sample unit, defined as a time or space interval. Samples are taken systematically throughout the haul. Of the two frames available to you (spatial and temporal), systematic sampling from a temporal frame is often the most feasible on catcher vessels. Unsorted catch is more likely to be available over time than over space on these vessels. Vessels falling into this category are those that dump their catch directly into a hold, have incline belts out of the trawl alley, or run fish into tanks from a below-deck sorting line.

As with C/Ps, there are practical benefits to systematic sampling on catcher vessels. With simple random sampling, it is possible to randomly choose back sampling sections. Back to back samples can be difficult to manage, because there may be little time to work up the first sample before you have to accommodate the next. With systematic sampling, you are generally guaranteed some amount of time between samples.

Systematic sampling from a temporal frame can be particularly useful on bottom trawl catcher vessels with incline belts carrying fish out of the trawl alley. On these vessels, the crew typically sorts from a horizontal belt located directly after the incline belt. Composition samples can be taken from the sorting belt, just prior to crew sorting activities. Estimate the processing time for

The captain on your pollock catcher boat says it is going to take approximately 35 minutes to dump their 80 metric ton bag into the RSW tanks. You won't have enough time to collect more than three samples for the haul so you divide the dumping time into just three intervals, of 12 minutes each. There is plenty of space on deck to store samples separately from each other, and the collection process is relatively straightforward. You settle on 4 baskets of fish for each sample (a total of 12 for the haul). You choose a random minute between 1 and 12, and take your sample at that minute within each of the twelve minute intervals.

You will have to adjust your sampling approach when the estimated dumping time is more or less than 35 minutes. Sometimes, the haul may get dumped faster than you anticipated, and you either won't get your last sample at all, or you'll get less weight than you planned. When this happens, document the circumstances in your logbook.

Example 5-2 Systematic Sampling from a Temporal Frame on a Catcher Boat

the catch and use a systematic random temporal method to choose times to collect samples. Because there is an incline belt, you must be aware of any items presorted by this feature and account for them using the methods discussed under "Mechanical Biases" on page 5-7. In these sampling scenarios, you must also be particularly watchful of intentional or unintentional crew pre-sorting.

AT-SEA SAMPLE SIZES

It is generally the case that the size of your samples can be larger with clean catch (species diversity is low) than with dirty catch (species diversity is high). Even with clean catch, the factors discussed under "Sample Size Considerations" on page 5-5 play a significant role in sample size maximums.

Catch With High Species Diversity: Small Sample Sizes

On bottom trawl catcher vessels and catcher processors when hauls are "dirty" (there are many different species in the catch), it is unlikely you will be able to obtain sample sizes of several tons as you can on catcher processors with flow scales and a clean catch. With high diversity catches, the observer usually has to resort to taking sample sizes that can be feasibly

weighed using the observer scales or the vessel's MCP scale. *Typically, observers working with high diversity catches are able to routinely sample 300 - 500 kgs for the haul.* Sample sizes totaling from 300 - 500 kgs for hauls taken by bottom trawl catcher vessels (for example, fishing flatfish and Pacific cod) are common because:

- the catch tends to be smaller,
- the catch is usually dumped on deck for sorting,
- processing times are quicker,
- tows are more frequent,
- the catch composition is usually quite diverse,
- space is limited, and
- the catch of prohibited species is usually higher.

On vessels with flow scales (all catcher processors targeting pollock and a large contingent of bottom trawl catcher processors targeting flatfish and Pacific cod) high species diversity in a catch significantly influences the maximum size of species composition samples.

Catch With Low Species Diversity: Censusing the Entire Haul

This option is only viable if there are one or two predominant species in the catch. Sampling an entire haul for species composition requires that you account for all organisms in the haul. This is a haul census. In order to conduct a haul census the following criteria must be met:



- You must be able to see every organism in the catch as it passes you. If you are missing organisms while attempting a sample of all the catch, alter your approach and collect smaller, more accurate samples instead.
- You cannot leave the sorting area, and you cannot do anything other than sort or supervise the sorting of the catch.

- You must sort out all bycatch from the entire catch. If crew members are assisting you in sorting, you must have direct, visual supervision of them! Make sure that the crew realizes you are sampling and know you want all bycatch species set aside.
- You must be able to weigh and count all the bycatch from the haul.
- You must take a subset sample of the predominant species from within the sample unit.
- In instances where there are two predominant species, a subsample for these two species must be taken from within the sample unit.

To fulfill these requirements, your vessel must be participating in a fishery with very low diversity. In the pollock fishery, hauls may have less than 1% bycatch, and sampling the entire haul for species composition might be possible. Keep in mind that you must have time, energy, space, and a low-diversity haul!



Even 1% bycatch in a 50 mt haul is 500 kg - about thirteen 40 kg baskets!

Sampling an entire haul may not be possible if you do not have sufficient access to the catch, space to store bycatch, or time to monitor the entire haul. When this is the case, reduce sampling effort and take several samples (a minimum of three) from the haul instead of the entire haul. Adjust your sample size to the diversity seen, as appropriate.

Catch With Low Species Diversity: Large Sample Sizes

This option is only viable if there are two or less predominant species in the catch. While sampling an entire haul is ideal, it is more often the case that observers obtain large samples from within the haul. This is primarily because processing times for large bags can be lengthy and observers have other sampling duties. The strategies and catch composition criteria for sampling over large sampling unit sizes are the same as those for sampling the entire catch; species diversity must be relatively low, and you must be able to collect and weigh all the bycatch from within your sample.



When sampling over large sampling units, you must obtain a defined sample weight. Visual estimates such as “about half the catch” are not acceptable.

Determining Weight of Large Samples

To determine the weight of large samples the following two options available to you: 1) bin volume, and 2) verified flow scale readout. Of the two methods, sample weight by flow scale readout is the most common.



A bin can be any large container which holds fish. You can use the trawl alley, checker bin, large tote, etc., to obtain a sample weight by bin volume.

Sample Sizes by Bin Volume

A relatively easy way to determine sample weight is to calculate the volume of fish sampled from a bin and apply a density. *If there are more than two predominant species in the catch and the vessel does not have a flow scale, do not attempt sample sizes by bin volume. Instead, take sample sizes you can manage with the observer sampling scales available to you.*

If sampling an entire bin, measure the height of fish in the bin prior to sampling. The height multiplied by the area of the bin will give you the volume sampled. Multiply this volume by density (see page 3-9), to determine the sample weight. If your sample comprises a large portion of the bin, measure fish depth prior to and after sampling. The difference in volume, multiplied by the density, equals sample weight.

$$\text{change in fish ht. (m)} \times \text{bin area (m}^2\text{)} \times \text{density (kg/m}^3\text{)} \\ = \text{sample wt. (kg)}$$

Refer to “Observer Estimates by Bin (“B”) Volumes ” on page 4-6 for instructions on measuring the amount of fish in a bin. You cannot use bin volume to calculate a sample weight if:

- you have not measured or verified the measurements of the bin,

TRAWLER COMPOSITION SAMPLING: At-Sea Sample Sizes

- you cannot see into the bin to accurately read fish depth markings,
- there is standing water in the bin, or
- unknown amounts of fish are added to the bin during your sample period.

Sample Sizes by Flow Scale Readout

If you are sampling over large sampling units during limited access privilege fisheries, verified flow scale readout **must** be used. Sampling in limited access privilege fisheries is discussed in more detail starting on page 5-30. Keep in mind that you may use the flow scale to obtain sample weights during *any* fishery provided the crew is testing the scale correctly, the scale passes these tests (see “Motion Compensated Electronic Scales” on page 2-18), and there are no more than two predominant species in the catch. The maximum size of the sum of your samples for a haul will ultimately depend on the factors discussed on page 5-5. ***Typically, observers working with clean catches and a flow scale are able to routinely sample one-third to one-half of the catch.***

Getting a sample weight by flow scale readout is easy and accurate. Record the weight from the readout prior to sampling ***on your decksheet***. Remove all non-predominant species from the sorting belt after the flow scale. Record the weight from the scale readout after you have completed your sample for species composition ***on your decksheet***. The difference between the end weight and the start weight is the sample weight. How you get the weight of the predominant species will depend on whether there were one or two predominant species in the catch. Refer to the following discussion concerning clean catches with one or two predominant species.



If the flow scale is not working, you must obtain sample sizes via the onboard MCP scale or your observer scales. See “If the Flow Scale is Not Working...” on page 5-33 for more information.

Clean Catches With One or Two Predominant Species

On catcher processors with flow scales and a clean catch (a maximum of two predominant species and low amounts of other species), the flow scale can be used to determine sample size and all non-predominant

bycatch can be weighed by the observer on the MCP scale. Under these sampling conditions it is expected that you obtain very large sample sizes, often several tons in weight. In fact, when catch is clean and there is a flow scale in use, observers are typically able to sample a total of at least 1/3 to 1/2 of the haul. If the haul is small in addition to being clean, you may be able to sample the entire catch.

One Predominant Species

For samples with one predominant species, you allow the predominant species to pass by while you remove all non-predominant bycatch. All bycatch from the sample is weighed and counted. When there is only one predominant species in a sample, you must take a subset sample of this predominant species. Subset samples are discussed on page 2-16 and in this chapter, on page 5-23. The weight of the one predominant species is simply the flow scale sample weight minus the weight of bycatch and the weight of the subset sample.

Two Predominant Species

When there are two predominant species in the catch, all bycatch from within the sample is weighed and counted as above, but you must take a subsample specifically for those two species (see “Subsampling for Two Predominant Species” below).

Subsampling for Two Predominant Species

When there are two predominant species in a catch, there is no way to determine the proportions of each in a sample without actually weighing them. Having to weigh two predominant species in a sample would significantly limit the sizes of samples an observer could obtain. To supply species specific weight information to resource managers and still maintain large samples, you can take a subsample for the two predominant species in the catch. These subsample data effectively give the relative proportion of the two predominant species in the sample. Management extrapolates subsample data to get the relative weight of the two predominant species in the parent sample and ultimately the entire catch.

On trawlers, when there are two predominant species and minimal other bycatch, take one or more subsamples for those two predominant species. If the catch is so diverse that you have more than two predominant species or cannot account for all other bycatch from within your sample, you should not be

subsampling. Consider drastically reducing your sample size so that you can account for all species within the sample!

There are some specific sampling protocols associated with subsamples:

- Subsamples must come from within a sample.
- The minimum size of an individual subsample for two predominant species is **80.0 kgs**.
- ***You must continue to take subsamples until both the predominant species occur in the same subsample.*** Typically, if you have assessed the catch correctly, only one subsample will be necessary to account for the two predominant species. If you are finding that it takes multiple subsample attempts to capture both the predominant species in one subsample, you should reassess predominance!
- In cases where multiple subsamples are attempted for two predominant species, each attempt must be documented in your species composition as a discrete subsample.
- Everything that lands in your subsample is documented in the species composition data for that subsample. If you subsample for pollock and squid, and get pollock, squid ***and flathead sole*** in your sample, you report pollock, squid ***and flathead sole*** in the species composition data for that subsample.
- You must follow the numbering scheme for subsamples discussed on page 5-35.

If you find that you have taken multiple subsamples for two predominant species and none of these has contained both predominant species for which you subsampled for, you cannot enter any of the data for that subsample or its parent sample.

If You Can't Meet the Minimum Sample Size Requirements

The low end sizes suggested for the various sampling situations are the Observer Program's minimums. They should be exceeded whenever possible. If you find that you cannot obtain species composition sample sizes that meet or exceed the Observer Program's minimum expectations, contact your ATLAS inseason advisor or other FMA staff as soon as possible.

Remember to record an explanation in the daily notes section of your logbook for each occurrence when the sum of sample weights for a haul fall below the minimum expected.



Data from smaller than expected samples can be used if the samples were collected in a random, unbiased manner.

PROCESSING YOUR AT-SEA SAMPLES

Once a sample has been collected, sampled species need to be identified, counted, and weighed. Certain aspects of sample processing will depend on space available for sorting, catch diversity, and the size of your sample. For every sampled haul, you are also expected to collect biological information on one or more species. Methods and details pertaining to collection of biological data can be found in the chapters “FISH MEASUREMENT AND SPECIMEN COLLECTION” , “PROHIBITED SPECIES SAMPLING” and “STOMACH COLLECTION” . Keep in mind that you may also need to collect additional specimen samples or information for a special project assignment.

Identification of Sampled Species

Resource managers rely on species specific data to monitor catch rates and quotas. It is important that observers report sampled fish to species level or, where appropriate, group level. The characteristics you used to identify a species must be documented on a Species Identification Form. You are required to fill out a form for every fish seen on your first contract and every new or rare fish seen on subsequent contracts. FMA staff refer to these forms to assess your species identifications as well as your identification skills. You must take the time to complete these forms with the specimen in hand! For details on how and when to complete these, see “Species Identification Forms” on page 2-6.

Accounting for Pre-Sorted Samples

Data on pre-sorted animals are recorded as a discrete sample in the species composition data for the haul. Documenting pre-sorted animals does not validate the illegal practice of pre-sorting.

TRAWLER COMPOSITION SAMPLING: Processing your At-Sea Samples

You may record sample data to account for *any* pre-sorted organism. The animals most often pre-sorted are large sharks, skates and halibut. Refer to “Sample Bias” on page 5-6 for more information on pre-sorting mechanisms. Follow the guidelines below when assessing the catch for pre-sorted organisms.

- To be considered truly pre-sorted, animals must *not* have had a chance to land in a composition sample. Typically, this means that the animal was removed from the catch *prior* to composition sampling. If an animal is removed in between composition samples, or from a part of the deck that is not going to be sampled, it is not truly presorted. That animal had the chance to land in your sample, it just didn't land in your sample because of where or when you happened to take it.
- You must observe the animal being pre-sorted.

Recording Data for Pre-Sorted Items

- Count and/or weigh everything you see pre-sorted out of the catch. Document this data on the species composition form as a discrete sample with its own unique sample number. Any pre-sorted samples must be designated as such by marking the “Y” circle under “Pre-sorted?” for that sample.
- For very large halibut, longnose skates, or big skates you may measure the length and use the appropriate length/weight table to derive a weight. The “Halibut Length to Weight Table” is on page A-37 and the skate length/weight table is provided in training. If you can not obtain an actual length, enter a value in the field for number of individuals but enter a “0” in the weight field. For discard data, use an estimated length to determine weight. Document the situation on your decksheet, along with any estimated lengths.
- For organisms other than halibut, longnose skates, or big skates that are too large to weigh, record the number of individuals and enter a “0” in the weight field. For discard data, use an estimated weight for the pre-sorted individual.
- **The sample size for this pre-sorted sample is the Observer Estimate for the haul, or the Vessel Estimate if an Observer Estimate was not made. Include the weight of the pre-sorted item(s).**

Refer to Figure 5-10 for an example of how to record a pre-sorted item on the species composition form.

Counting and Weighing Sample Items

In most fisheries, observers find it easiest to sort their sample, and then count, weigh, and record each species separately. In low diversity fisheries (for example, pollock) you may choose to weigh unsorted fish and then sort the sample. If you weigh unsorted fish and *then* sort out bycatch, the predominant species weight is the total sample weight minus any bycatch weight!



Every organism in a sample must have a weight associated with it (with one exception) and this weight must be an *actual* weight. The one exception is for large items (other than halibut) that cannot be weighed: for these items, enter zero in the weight field. Estimated weights and weights derived by averaging actual weights will invalidate the data. If you cannot supply an actual weight for every fish (large items that cannot be weighed excepted), the sample data cannot be used. For large halibut, longnose skates and big skates, you can use the length/weight table for these species to supply a weight in the species composition data.



With one exception, trawler species composition data must have true weights for all sampled species. Large items that cannot be weighed are the one exception; for these items, enter a zero in the weight field.

Generally you will be using some container (like a blue basket) to weigh your fish. **Remember to tare the scale for this container!** Check your tare frequently and tare every time you change containers!

Counting and Weighing Prohibited Species Crab and Salmon on Trawlers

Unlike other species encountered in the North Pacific, resource managers regulate the harvest of prohibited species crab and salmon by number and not weight. For

this reason you must always provide a number along with weight for every prohibited species crab and salmon encountered in your trawl samples.

When developing your sample design and preparing to sample an individual haul be sure to consider the additional data requirements for prohibited species. Define the sample unit size accordingly to ensure you can complete all your required duties. If you anticipate being overwhelmed with crab or salmon during your sample, you must reduce the size of the sample to ensure you are able to provide an accurate count of these species. This differs from the data collection techniques specific to collecting offload census data. Please refer to “Offload Census: Pollock C/Vs” on page 5-25 for rules specific to recording data for prohibited species encountered during an offload census.

Recording Crab Parts on Trawlers

There is an exception to the rule that a number must be provided for all prohibited species. On trawlers it is common for prohibited species crab to become broken apart, making the determination of a true number nearly impossible. The Observer Program asks that you record data on prohibited species crabs in the following way:

- Identify all whole crabs to species and report their number and weight. For our purposes, a crab is considered whole if it is essentially whole by weight. It is not necessary for a crab to be completely intact to be considered whole.
- Identify loose crab parts to the best of your ability. Carapaces should be identified to species and legs can usually be identified to the appropriate genus group code. Report the weight of these parts on a separate line from any whole crab weight/number values and enter a value of zero for number of crab.

Subset Sampling for Number and Weight on Trawlers

Sometimes, organisms are too numerous, or too broken, to count accurately. If this is the case, the Observer Program allows you to report a portion of those individuals by weight only, without the number of individuals. For each occurrence, you must weigh and count *at least 50 randomly selected individuals*. *This collection is referred to as a subset sample and these data are reported in your species composition*

data for the sample. For each species in each sample that you take, the number and weight should be recorded at least once.

A subset sample for number and weight provides data users with values necessary to calculate an average weight for the species. On the species composition data form, individuals with weight only are entered on a separate line from those with weight *and* number. For the entry that has no number of individuals, a zero is entered in the number field.

Subset samples will be common for those assigned to catcher processor pollock vessels. In this fishery observers often find themselves sampling for one predominant species. Remember that when sampling for one predominant species and using a flow scale, you provide the weight of the predominant species (which often amounts to several tons) by subtracting the weight of bycatch from the flow scale sample weight. A zero is entered in the number field. A subset sample is needed in these instances to provide data users with values necessary to calculate the predominant species average weight.

Other times when you might take a subset sample for number and weight are:

- during clean catch sampling on flatfish vessels using a flow scale.
- when there are numerous brittle stars or jellies in a sample (these may be bits and pieces, or whole animals).
- when there are hundreds of small individuals of one species (usually flatfish).

Refer to Figure 5-18 for an example of how to record data when you have a subset sample.

If you are sampling for two predominant species, the required subsample will provide the number and weight relationship needed by data users. **Do not confuse the terms subset sample and subsample!** For more information on subset sampling for number and weight, please refer to “Subset Sample for Number and Weight” on page 2-16.

Collecting a subset sample for number and weight is a valuable sampling tool that will allow you to take larger samples, *but this method is not appropriate for prohibited species crab and salmon on trawlers!*

Please refer to “Counting and Weighing Prohibited Species Crab and Salmon on Trawlers” on page 5-22 for more information about sampling these species.

Subset Sampling for Species Identification on Trawlers

Several species have similar morphological characteristics, making it difficult to distinguish one from the other at first glance. A few of these species also tend to be prolific in certain fisheries. Identifying each fish to species would be a time consuming task if a sample was inundated with representatives from these similar species.

The Observer Program allows for subset sampling of these similar species when they occur in quantity. This compromise yields species specific information important for resource management while allowing observers enough time to process samples and complete other sampling related duties.

The species sets that you can subset sample for on trawlers are: Northern/Southern rocksoles, Arrowtooth/Kamchatka flounder, and Shortraker/Rougheye rockfish.



For more information on species subset sampling, please refer to “Subset Sampling for Species Identification” on page 2-17.

Seabirds

Seabirds occur in samples infrequently. This can make sampling for seabirds difficult. Observers on pollock catcher vessels delivering catch to a plant should offload sample for seabirds. For other vessel types, sample for seabirds as you would for all other species. Regardless of the vessel type, if a seabird lands in your at-sea sample, it is reported in that sample!

Decomposed Fish, Damaged Fish, and Miscellaneous Items

Decomposed fish or fish waste (both code 899) are those organisms in an obvious state of decomposition, with a breakdown of muscle and skin. Miscellaneous items (code 900) are garbage, fishing gear, wood and other debris that may appear in your sample. Decomposing fish must be distinguished from damaged fish. Damaged fish should be identified, weighed, and recorded along with other undamaged fish of the same species.

The true weight of decomposed fish and miscellaneous items must be recorded, but the number of these items is irrelevant. If you are able to count the items, you can report this number in the sample composition data. If you are not able to count these items, enter a zero in the number field for this individuals.

Combined Samples

There are going to be occasions when you are processing a sample and come across a fish that you think *might* belong to a previous sample taken for the haul. When you know that a fish should be included in the species composition data for the haul, but do not know exactly what sample, you must resort to “combining” samples. You only combine those samples that you are unsure of; any intact samples are reported as discrete samples for the haul.

On the raw data deck form, mark the samples that will be rolled together as combined by checking the circle next to “Combined” for those samples. The combined samples are reported as one sample in ATLAS or faxed paper form. When reporting combined samples, enter the data for all the samples affected under a single sample number. By combining samples into one in the reported data, you are alerting data users to regard these samples separately from intact samples. Remember, you can have a mixture of combined and non-combined samples for a haul. You combine only those samples you believe may not be intact, complete samples. See Figure 5-20 and Figure 5-21 for decksheet and paper form examples of documenting combined samples.

Crab Pots

Trawlers occasionally pick up a crab pot in the net. Record these instances on your Vessel Haul Form (see page 4-15). Crab pots are not included in the Observer Estimate or the species composition sample. Do not include any crab or fish that are in the crab pot in your sample: the items in the crab pot were caught by the pot, and the pot was caught by the trawl. Note the incident in your logbook, with a description of the pot, any identifying numbers or tags, and an account of the contents.

Marine Mammals and Large Items

Occasionally marine mammals or large items (such as a boulder or 55-gallon drum) are caught by trawlers. To prevent the weight of mammals or other large objects from being misinterpreted by fishery managers as fish weight, do not include the weight of the item in the Observer Estimate. Also, do not include such items in your species composition samples.

OFFLOAD CENSUS: POLLOCK C/Vs

Pollock catcher vessels dump fish into holding tanks onboard and deliver this to shoreside processing plants every few days. In addition to sampling at sea for all species, *observers on catcher boats operating in the pollock fishery must monitor the entire delivery for prohibited species and seabirds.* If you were not able to sample all hauls at sea, for any reason, you must still census the entire delivery for prohibited species and seabirds.



If you are on a catcher vessel that receives a codend from another vessel, do not sample that codend at the plant. The observer on the vessel that caught the fish is responsible for recording all information on their haul forms and acquiring fish ticket information for the transferred haul.

For the delivery, you are expected to collect biological data including: species/length/sex for salmon and crab groups, length/viability for Pacific halibut, and species/weight for seabirds. Scale samples from salmon species are taken as needed. For more information on taking biological data from prohibited species, refer to “PROHIBITED SPECIES SAMPLING” on page 10-1.

Any sampling at a processing plant should be for prohibited species and seabirds only. The NMFS will not accept species composition data for target species and non-prohibited bycatch collected at a plant.

Offload Census for GOA Pollock Catches

In the GOA, crew frequently sort out obvious prohibited species and unwanted bycatch and discard these at sea. This is because in these fisheries fines are associated with retaining prohibited species. All halibut, salmon and prohibited species of crabs discarded at sea must be recorded in the offload census

data for the trip. For both the BSAI and GOA pollock catcher fisheries, you do not include discarded prohibited species in your discard calculations for the trip if you conduct an offload census.

Ideally, you will be able to identify, count, weigh, and measure every discarded prohibited individual. Remember to group these by sex for salmon and crab species, and by viability for halibut. If the quantity of prohibited species crab and salmon being discarded at sea prevents you from weighing them all, you may take a subset sample of 50 individuals and report the rest as another line entry (with number and no weight) in the offload census data. However, you *must* record both number and weight for halibut.

Any prohibited individuals that fall in your samples at sea are accounted for at the sample level and are also included in the offload level census data. Any prohibited species discarded from outside your samples are included in the offload census data as well, along with prohibited species sampled at the plant.

Offload Census for BSAI Pollock Catches

Some pollock catcher boats fishing in the BSAI have sorting belts below deck and do some sorting at sea, but the fish are usually run too deep and fast to accomplish an accurate census of the entire catch for prohibited species and seabirds. On these vessels, a more thorough sorting and census must be done at the plant for these individuals. If prohibited species are discarded at sea, you account for them in the offload census. *Do not add the weight of these prohibited species to estimated discards for the trip.*

Prohibited species individuals that land in your samples at sea should be reported in your offload census for prohibited species, as well as in your at-sea species composition sample. Throw these fish overboard so you do not account for them again at the plant. If the captain is participating in the Terra Marine Program, s/he may insist that you throw the salmon into the tanks; in this case mark the fish so you will recognize it at the plant as an at-sea sample fish. Do not include prohibited species discarded from your samples in discard at sea calculations.



Prohibited species discarded at sea are recorded with your offload composition census data, regardless of whether they were inside or outside your sample. Do not include any prohibited species discarded at sea in your discard calculations.

Prohibited Species Measurement and Specimen Data

You must report weight and number data for all prohibited species discarded at sea in your offload census. ***You do not record any measurement or specimen data for these at the offload level.*** For any data collected from prohibited species at sea, record that data at the level appropriate. For example, if a salmon landed in your sample, record sex/length and specimen data at the sample level; if several salmon are discarded at sea from outside your samples, record data from these at the haul level. Refer to the chapter “PROHIBITED SPECIES SAMPLING” on page 10-1 for more information on prohibited species sampling.

The Problem with Offload Censuses for Herring

Although an offload census at the plant for prohibited species is required by the Observer Program, there are usually circumstances which prevent you from sampling for herring. Frequently, fish at the plant will be run across conveyor belts at high speed and in deep piles causing herring to be missed due to their small size. Typically this makes it impracticable for observers to collect herring at an offload.

The fact that an observer cannot sample for herring at the plant is not a big concern, because herring usually either show up in huge quantities (*e.g.*, several tons worth) or virtually not at all (*e.g.*, less than a kilogram). When there is a large quantity of herring in a catch, you are likely to get some in your at-sea sample. In these cases, resource managers are getting the data they need on herring from your at-sea sample data.

If you are seeing large quantities of herring just collect samples as previously described (see “Random Sampling on Trawlers” on page 5-11) and ignore herring at the plant.

Your First Delivery

The first time your vessel delivers to a plant, meet with the plant observer. He or she will familiarize you with the processing operation, provide you with a Delivery Weight Verification explanation (see page 9-4) and show you the following:

- The best location in the plant to sample for prohibited species.
- The location to check for after-scale prohibited species (see “After-Scale Area” on page 9-4).
- The location of the fax machine for sending data.



The delivery weight must be verified. You are responsible for knowing and documenting how all your data were derived!

All Deliveries

If you expect your offload to take longer than 5 hours, you should make arrangements to have the plant observer give you a break from sampling. Remember, the entire offload must be monitored, therefore you cannot leave the sorting area at any time fish are running unless the plant observer takes over! The plant observer, or dock personnel, should be able to give you an idea of when your offload will begin. A delivery schedule is tentative, and can change with little notice, so stay in touch with your vessel to ensure you don't miss part of the delivery.

Finishing an Offload Census

If your vessel completes a delivery, and is going back out to sea before you are done with all your offload census duties, arrange for the plant observer to finish the census for you. If the plant observer is not available and you must return to your vessel, document this thoroughly in your logbook. Notify the Observer Program **and** your employer. Assisting vessel observers is a priority for plant observers, so it should be a rare event that he or she is not available to relieve you.

Although you may be required to re-board your vessel, you should not be sent to another assignment or to your final debriefing prior to the completion of your offload census for prohibited species and seabirds. It is your

employer's responsibility to ensure that this doesn't happen. If you are put in this situation, contact the Observer Program as soon as possible.



It is unacceptable to miss any portion of an offload. If any of your offload is missed, submit only the at-sea sample data from hauls in the delivery and document the circumstances.

Conducting a Census for Salmon in an Offload

Of all the prohibited species you are likely to encounter at the plant during an offload, the salmon species are the most common. Your approach to conducting an offload census for salmon will depend on whether you have a few hundred, several hundred, or *several thousand* individuals in the delivery. The following are specific sampling guidelines for salmon data collection at an offload. Please refer to the "PROHIBITED SPECIES SAMPLING" chapter for a more extensive discussion on the data required for sampling for prohibited species and salmon in particular.



Salmon are managed by number, not weight. Getting an accurate count of salmon in the delivery is crucial to managing their stocks!

When You Are Not Overwhelmed with Salmon

You are expected to weigh, count, measure, and sex all the salmon in an offload, unless there are too many to do so (see "When You Are Overwhelmed with Salmon" below). To sample salmon from a delivery:

1. Remove salmon from the sorting belt as you come across them.
2. As you get the opportunity, sex and measure the salmon. Record these data on the blank space available on the deck form. Place the salmon in a male or female basket to be weighed by species/sex.
3. Weigh the male and/or female baskets when they are full. Weigh salmon in aggregates by species/sex and record these data accordingly. This method provides less opportunity for addition errors and it is also more practical

when salmon are abundant. The only place you need an individual weight is on salmon scale samples.

4. If you aren't overwhelmed with salmon, continue collecting sex, measurements, and weights by species, throughout the offload.

The offload deck form must show the weight and number by species and sex for all salmon found during the offload. The associated measurement and scale data are recorded on the right side of this form.

When You Are Overwhelmed with Salmon

On occasion, a vessel delivery will contain *several hundred to several thousand* salmon. This is often the case during the fall pollock fisheries when the Chum Salmon Savings Area is open. When there are excessive amounts of salmon in a delivery, you are not expected to weigh them all, but you are *required to count them all*. Remember that salmon are managed by number, not weight, and it is important that salmon counts are accurate.

Following the protocols for sampling when there is an abundance of salmon will lessen your workload and help ensure that an accurate number is being used for management of the stocks.



If you estimate that the offload contains no more than about 500 salmon, you should try to weigh and count them all!

Often you will not realize there are too many salmon to weigh until you are overwhelmed with them, so begin sampling the offload as you would normally (see "When You Are Not Overwhelmed with Salmon" in this section). As it becomes obvious that salmon numbers are going to be high, you may:

1. Stop weighing, sexing and measuring fish when you have gathered data from a minimum of 50 salmon per species per haul in the delivery.
2. Tally the remaining salmon by species as they pass by on the belt.



If you are overwhelmed with salmon, you can opt to take weight, sex and measurement data from a portion of salmon and tally the rest. When overwhelmed with salmon, the Observer Program requests that you collect a minimum of 50 salmon per species per haul in the delivery. To determine how many salmon you need to sample, simply multiply the number of hauls comprising the delivery by 50! Refer to Figure 5-15 on page 5-44.

On the decksheet, enter the weight and number information, by species and sex, of those individuals weighed. Tallyed individuals with no weight or sex get their own line of entry. A deck form example from an offload with an overwhelming number of salmon is on page 5-44.

In order to supply a delivery weight for the trip, you will need to determine an average weight for those individuals you did not weigh. Remember, you must use *your* prohibited species weight information, not the plant's. For a discussion on how to determine and report delivery weight data that includes an average weight for certain prohibited species, see "Recording Offload Data on Trawlers" on page 4-11.

Recording Prohibited Species Data on Pollock C/Vs

1. Composition Data from Prohibited Species in At-sea Samples

Determine the species of each prohibited species in your composition samples. Count and weigh all herring, count and weigh all halibut, and sex, count and weigh salmon and prohibited crab species. Record these data on the Species Composition Form. Be sure to check for eggs on every female crab. These fish will also be included with your offload census composition data, with the exception of herring.

2. Length and Specimen Data from Prohibited Species in At-sea Samples

Record sex/length data for all salmon and prohibited crab species in your samples. Record length for all halibut in your samples. Record halibut viability data if the vessel routinely discards halibut at sea. Be sure to check for eggs on female crab. Record these data on your Length and Specimen Form at the sample level.

3. Census Composition Data from Prohibited Species in the Offload

During the offload, count, weigh and identify every prohibited species encountered (with the exception of herring). Sex all salmon and crab. Remember to include the weight and number of any prohibited species discarded at sea in your offload composition census data. The offload composition census for prohibited species should include every prohibited species caught during the fishing trip (herring excepted).

4. Length and Specimen Data from Prohibited Species in the Offload Census

Record sex/length data for all crab and salmon prohibited species encountered during the actual offload. Record viability/length for any halibut and look for eggs on female crabs. Record these fish at the offload level on the Length and Specimen form. Herring are not typically sampled for at the plant. Refer to "The Problem with Offload Censuses for Herring" on page 5-26 for more information regarding sampling procedures for this species.

When There are No Prohibited Species Encountered in the Offload

On rare occasions you will monitor an offload and find no prohibited species. Knowing that there are no prohibited species in an offload is just as important to fisheries managers as knowing how many there were.

To capture this data on a deck form and a paper composition form, record the date of the offload, your cruise number, vessel permit, sample number of 1, and offload number in the header portion of the form. Record the total delivery weight as the sample size, fill in the keypunch values with zero and write "no prohibits" across the sample block. In ATLAS you will simply enter an "N" in the "Species Comp in sample?" box for that offload sample.

OBSERVERS DELIVERING TO MOTHERSHIPS

It is unusual for catcher boats delivering to a mothership to carry an observer. If you find yourself aboard a catcher boat delivering a few hauls to a mothership before delivering landed catch to a shoreside plant, your duties will depend on how the fish are being delivered.

If the haul is delivered as a codend, the mothership observer is completely responsible for recording and sampling this haul. Do not record this haul on your Vessel or Observer Haul Forms. It will be accounted for by the mothership observer. Your only duties are to obtain catch information to give to the mothership observer and monitor the haul back for marine mammal interactions. If the captain usually gives haul information to the mothership, you must verify that all the data the mothership observer will need was given.

If your vessel is dumping fish into RSW tanks, and then pumping the fish to a mothership, you should treat these hauls as if they were being delivered to a shoreside processor. Obtain an observer estimate and sample for species composition. Collect length frequency and age data from sampled hauls. All data you collect will go on your forms, under your cruise number.

ESTIMATING PERCENT RETAINED

Each species reported in the species composition samples for a haul must have an associated estimation of percent retained. A fish is considered fully retained (100% retained) when more than 15% of its round weight is turned into product. Round weight is the weight of the whole fish, prior to processing. *Percent retained is only an estimation, and your effort and time spent obtaining it should be minimal!*

Percent retained is often difficult to estimate because discard can happen in a variety of places. Make your estimation based on what you see happening, on a haul by haul basis. Potential types of discard include fish falling off belts, dumping of large portions of catch at sea and size sorting of fish. If the vessel dumps a portion of catch at sea, none of the species groups should be considered fully retained. For example, if 30 mt of an 80 mt net is dumped overboard, 3/8^{ths} of all the species have been discarded. Therefore, you would record no more than 5/8^{ths} (or 63%) of any group as retained.



The percent retained you report for a species must be consistent for the species over all the samples collected during that haul.

The percent retained you report for a species in a sample must represent the haul level retention for that species. See Example 5-3 for an example of determining percent retained.

During the processing of your third sample for the haul (out of 6 total), the vessel decides to dump the rest of the catch because the fish have been sitting on deck too long and are rotten. You estimate that the amount of fish overboard is about 50% of the entire catch. Initially, for your first two samples, yellowfin and rocksole were being 100% retained. Ultimately, 50% of the entire catch was dumped overboard; the percent retained for yellowfin and rocksole was 50% for the haul. For every instance that yellowfin or rocksole showed up in your samples, you would record 50% in the percent retained column. Fish that were 0% retained initially would still be 0% retained.



Because the percent retained value must represent the haul level retention for a species, you may find it easier to fill out the percent retained column for fish in your samples *after* you have finished sampling the haul.

Example 5-3 Determining Percent Retained

Percent Retained on C/Ps

In most cases aboard C/P vessels, percent retained will be your visual estimation. Sometimes a C/P will put up product and later discard it to make room in their freezer for a more valuable product. This is called “high-grading” and it should be noted in your logbook as a possible regulation infraction. Since you will not know which hauls the product came from, do not change your earlier figures for percent retained.

Percent Retained on Catcher Vessels

Everything that is delivered to the processing plant from a catcher vessel is considered retained. The processor may later discard it or even give it back to your vessel for discard, but as long as it was delivered, it is considered retained. When recording Offload census data there is no percent retained associated with composition records recorded at the offload level.

Fish that were discarded at sea *prior* to delivery should be considered as not retained. Estimate the amount of each species discarded and adjust the reported percent retained value accordingly.

Percent Retained and Improved Retention/Improved Utilization (IR/IU)

Through industry initiative, the North Pacific Fishery Management Council created a program to reduce bycatch and improve utilization of harvested groundfish. Since 1998, Improved Retention/Improved Utilization (IR/IU) standards have required all vessels to retain and utilize 100% Pacific cod and pollock in the BSAI and GOA when the open access fishery for these species is not closed. In January of 2003, IR/IU regulations were expanded to the shallow water flatfish complex for vessels fishing in the GOA.

The Groundfish Retention Standard (GRS) program further regulates non-AFA groundfish trawl catcher processors. These vessels are currently required to retain 75% of groundfish caught. The GRS schedule for subsequent years calls for a steady increase in retention standards: 80% in 2010, 85% for 2011 and beyond.

Additionally, for all vessels fishing limited access, primary product made must amount to at least 15% of the whole (round) weight of fish caught.

Once the fisheries for IR/IU species are closed, vessels are required to keep the maximum retainable amount for these species. *Note that your sample is not covered under the IR/IU regulations, so fish discarded as a result of you working up your sample (e.g., taking otoliths, sexing fish, or completing a stomach sample) do not need to be factored into percent retained.*

Vessel personnel might challenge you on your percent retained estimations for IR/IU species. You should document your conversations if this happens. *Do not make any changes to your percent retained methodology because of the IR/IU regulations, or pressure from the crew.* The fishing industry has been informed that percent retained estimates are visual estimates only. If vessel personnel have questions about this regulation, refer them to the Alaska Regional Office at (907) 586-7228, or to the NMFS Office of Law Enforcement at (907) 586-7225.

LIMITED ACCESS PRIVILEGE FISHERIES

In the Bering Sea and Gulf of Alaska, vessels you observe on will be participating in either limited access or limited access privilege fisheries. Vessels fishing limited access privilege fisheries are specifically regulated by the American Fisheries Act (AFA),

Community Development Quota (CDQ) program, a non-AFA trawl catcher/processor limited access privilege program in the BSAI, the Rockfish Pilot program in the GOA, and/or laws associated with the Groundfish Retention Standards (GRS) program in the BSAI.

The majority of sampling protocols are the same regardless of whether the vessel is fishing limited access or limited access privilege. For example, there are the same safety concerns and biasing mechanisms, you still must strive to sample randomly using sampling designs endorsed by the Observer Program, and there are preferred sizes and numbers of samples per sampled haul. The Observer Program has some additional sampling protocols for vessels fishing in the limited access privilege fisheries that you should be aware of. Specific policies are noted by vessel type and fishery below.

AFA Pollock Catcher Vessels

Pollock catcher vessels operating under an AFA co-op have the same sampling protocols as limited access pollock fisheries (see previous discussions on sampling mechanics and designs on catcher vessels). These vessels will not have an observer sampling station or motion compensated platform scale. *While AFA fishing, pollock catcher vessels may sort at sea.*

CDQ Pollock Catcher Vessels

Pollock catcher vessels will not have a certified observer sampling station or MCP scale. When the vessels are fishing CDQ, they must deliver all CDQ species and salmon Prohibited Species Quota (or "PSQ") to an eligible processor. The vessel must provide space on deck for you to sort and store samples and a place to hang your scale. The vessel must *retain all halibut PSQ and crab PSQ until it is counted and sampled by you. Halibut PSQ and crab PSQ may be discarded at sea after you sample it.* All other sampling protocols are the same as for limited access.

The processing plant where your vessel delivers is required to sort and weigh catch by species during CDQ deliveries. If you notice that catch is not being sorted to species, document which species the plant is not sorting correctly. You may have to work with the plant observer, who will have access to the ADF&G fish tickets, in order to determine what the plant is reporting. As in limited access, your primary purpose

at the plant is to sample for prohibited species. Monitoring the plant's sorting and weighing activities is secondary to completing your sampling duties.

For both ATLAS and non-ATLAS vessels, send your data as soon as you receive the delivery information and are able to complete your data.

CDQ Non-pollock Trawl Catcher Vessels

Few non-pollock trawl catcher vessels have participated in CDQ fisheries. This may be because their catch is typically diverse and bycatch rates can be very high. These vessels will not have a certified observer sampling station or MCP scale and they must deliver all CDQ species and salmon PSQ to an eligible processor. The vessel must provide space on deck for you to sort and store samples and a place to hang your scale. Finally, halibut and crab must be discarded by the vessel after you have had an opportunity to sample those species. At sea discard information should be given to the plant observer.

For each haul, obtain observer estimates using codend or bin volume estimates. Densities should also be taken for each haul. If an observer estimate is not possible, report the vessel's estimate only and leave the observer estimate blank.

Since the catch is usually diverse, you will most likely take small samples at sea for all species. In rare cases, with very small hauls, you may be able to sample the entire catch. As the vessel observer on a non-pollock trawl catcher vessel, you have no duties at the plant other than notifying the plant observer of any at sea discards and obtaining a total delivery weight for the delivery. It is the plant observer's responsibility to monitor the offload. Data should be faxed each time the vessel delivers.

AFA, CDQ and Non-AFA Limited Access Groundfish on Trawl Motherships and C/Ps Fishing in the BSAI

Regardless of the fishery, trawl C/Ps and motherships fishing in the Bering Sea or Aleutian Islands who are participating in the limited access privilege fisheries are required to carry two observers, have the ATLAS program, a NMFS-certified observer sampling station, a flow scale and a MCP scale. The vessel is required to test the flow scale daily (see "Flow Scale Testing" on page 2-19).

All catch landed by the vessel must be weighed on the flow scale and ***hauls cannot be mixed***. Your duties and responsibilities will be the same no matter what species the vessel targets. The vessel's operating requirements will be the same as well, regardless of the species fished.

It is your responsibility to test the platform scale daily (see "Platform Scale Testing" on page 2-18). It is common for both AFA and non-AFA trawl C/Ps to participate in a variety of fisheries during any given trip. If catch coming onboard may be designated as CDQ, the vessel should provide you advance notice, but the vessel has up to two hours to officially designate a tow as CDQ in their logbook. As the observer, you should only be concerned with whether they treat potential CDQ catch appropriately and whether the catch is designated as CDQ when you record your catch weight information from the vessel's logbook.

Since motherships must coordinate their record keeping with the delivering vessel, they cannot designate catch as potential CDQ and then change it to non-CDQ. Their catch should be designated prior to landing it. Check the logbook information carefully when filling out your haul forms, since a vessel may be fishing for several CDQ groups or participating in multiple fisheries.

Even though vessels are required to weigh all catch, there are certain fish (*e.g.*, sharks, halibut, etc.) that are too large to go over a flow scale. If this occurs, estimate the weight of the organism and add that estimate to the final flow scale weight for the haul. ***Contact your inseason advisor each time part of the catch is not weighed on the flow scale. Your message should include the haul number, what wasn't weighed, the item's estimated weight, and the flow scale weight.*** Document the situation in your logbook so there is a record of why the Observer Estimate is greater than the flow scale total for the haul. If the item not weighed falls under the category of "pre-sorted," it must be accounted for as a unique sample, with the circle next to "Pre-sorted" on the species composition form checked (see "Accounting for Pre-Sorted Samples" on page 5-21).

Regulations Specific to Non-AFA Trawl C/Ps Fishing in the BSAI

Amendment 80 was implemented in 2008. This action allocates several non-pollock trawl groundfish species among fishery sectors in the Bering Sea and Aleutian Islands. Additionally, it facilitates the formation of harvesting cooperatives in the non-AFA trawl catcher/processor sector. All non-AFA trawl catcher/processors must meet the following requirements in addition to those described above for C/Ps.

1. Vessels are prohibited from having more than one operational belt, or other catch conveyance device, between the flow scale and sample collection point.
2. Observers must be able to view all activities inside the bins. There are three ways non-AFA trawl C/Ps fishing in the BSAI can satisfy this requirement:
 - **Option 1: Limited tank access** - No crew are allowed inside the bin unless the flow of fish has been stopped between the tank and the sample collection point, all catch has been cleared between these two points, and the observer has been given notice that crew must enter the tank. The observer must be given the opportunity to monitor crew activity in the bin. When informed by the observer that all sample collection activities are completed for the haul, the crew may enter the tank without stopping fish flow or clearing belts as above.
 - **Option 2: Line of sight** - From the sample collection point and sampling station, the observer must be able to see all areas of the bin where crew could be located. NMFS approved viewing ports would satisfy this requirement.
 - **Option 3: Video** - The vessel may use cameras, monitors and a digital recording system to capture activity in all parts of the bin. The observer must be able to monitor bin activity with this system.

Many vessels participating in the non-AFA groundfish fisheries have chosen the third option, involving installation of video cameras to monitor bin activity. *If Option 2, line of sight, and/or Option 3, video, fail to meet the standard of allowing the observer to view crew activity in the bin, the vessel must revert to Option 1, limited tank access option.*

3. Retaining unsorted catch on deck outside of the codend without an observer present is prohibited,

except in the case that fish is accidentally spilled from the codend during hauling or dumping.

4. The vessel operator is required to document the flow of fish within the vessel's factory, including live tanks, any sorting areas, catch weighing scales, belts and all other fish flow aids or hindrances. The document must include flow scale testing procedures, where test weights are stored, and the name of individuals responsible for testing the flow scale. This detailed description must be made available to the observer as it will help them in recognizing potential violations and assessing the most appropriate sampling procedures.
5. Sample stations must be able to contain 10 observer basket's worth of fish at one time. This space may include vertical storage space as well as deck space.
6. The vessel participant must provide the opportunity for a pre-cruise meeting. Pre-cruise meetings help to establish a professional working relationship between the crew and the observer early on in the deployment, clarify what is expected of each participant according to regulations, and provide both the vessel crew and observer the opportunity to discuss specific issues before they become a problem.

Non-AFA Trawl C/Ps Subject to BSAI Limits While Fishing in the GOA

Non-AFA trawl C/Ps subject to BSAI limits while fishing in the GOA are not restricted by the same regulations as those required in the BSAI. These vessels are not required to have a flow scale, regardless of size or processing facilities onboard. They do not have to carry two observers, offer the opportunity for a pre-cruise meeting or have a certified sampling station.

When fishing in the GOA, non-AFA trawl C/Ps that are subject to BSAI limits must have only one operational sorting line from the fish bins, must have a bin monitoring system in place (described above), cannot hold fish on deck, and cannot mix hauls.

As of 2008, there was one catcher processor vessel, the Golden Fleece, exempted from the regulations specific to vessels fishing non-AFA limited access groundfish. The Golden Fleece is allowed to carry an observer for just 30% of the time and does not need to provide a

flow scale, certified sample station, pre-cruise meeting, or bin monitoring system. They can hold fish on deck and they can mix hauls.

Rockfish Pilot Program in the GOA

The development of the Rockfish Pilot Program was initiated by trawl industry representatives (primarily from Kodiak, Alaska) and catcher/processor representatives in an effort to improve the economic efficiency of the Central GOA rockfish fisheries. The program, a two year project that began in 2007, established cooperatives that receive exclusive harvest privileges for a specific set of rockfish species, and associated species harvested incidentally to those rockfish in the GOA.

Sampling on Trawl Catcher Vessels in the Rockfish Pilot Program

Sampling strategies and methods in this fishery are no different than for catcher vessels participating in other bottom trawl fisheries. If you observe on a catcher vessel participating in the Rockfish Pilot Program, there are three important items that you do need to keep in mind:

1. Participating vessels are required to carry 100% coverage for the times they are participating in the project, regardless of vessel size.
2. Experienced observers who are deployed on participating vessels must not take the first haul off! The fishery is limited, the allocated quota is relatively small and observer deployments may be only a few days at a time. It is critical that observers sample as many hauls as possible!
3. Participating vessels have computers installed with ATLAS, but they do not have the ability to transmit from sea. You *must* enter data at sea so it can be transmitted the instant you get to the plant!

Regulations Specific to C/Ps Participating in the Rockfish Pilot Program in the GOA

Catcher processors participating in the Rockfish Pilot Project are subject to the same regulations as those vessels participating in limited access privilege fisheries in the BSAI (see page 5-32). These vessels must have a bin monitoring plan in place, a flow scale, certified observer sampling station, two observers onboard, no mixing of hauls, no catch dumped on deck, etc.

Sample Sizes in Limited Access Fisheries

Sample size guidelines and determining factors discussed in previous sections of this chapter are applicable to the limited access privilege fisheries. In those instances when a flow scale must be in use, you may be able to increase sample sizes well over those you would take on vessels fishing the same species without a flow scale.

Catcher Processors Fishing AFA and CDQ Pollock

These vessels are required to have flow scales and the fishery tends to be clean, so sample sizes of several tons are common for composition data. Remember that, even in the pollock fishery, bycatch may be too diverse for you to achieve very large sample sizes. If the catch is diverse, drop your sample size to the size necessary to account for all species in the sample (see “Catch With High Species Diversity: Small Sample Sizes” on page 5-18 and “Catch With Low Species Diversity: Large Sample Sizes” on page 5-19). Remember, you must be able to account for all species for which you are sampling!

Vessels Fishing Limited Access Non-AFA Groundfish

The catch in non-AFA limited access hauls tends to be high in diversity. The level of diversity impacts sample size; the higher the diversity, the smaller the sample size has to be. Drop your sample size to the size necessary to account for all species in the sample (see “Catch With High Species Diversity: Small Sample Sizes” on page 5-18). Remember, you must be able to account for all species for which you are sampling!

IF THE FLOW SCALE IS NOT WORKING...

If you are on a C/P or mothership vessel participating in a limited access privilege fishery, *you never measure the codend to obtain an observer estimate of catch*. This holds true even if the flow scale is broken, has faulted (*i.e.*, not weighed a portion of catch), or has failed the daily test. If the flow scale is not working, *leave the observer estimate blank, and make sure to enter a vessel estimate value in the vessel estimate field for that haul!*

If the flow scale is not working, sample weights can only come from the motion compensated platform (MCP) scale or your observer scales. The options for sample sizes in this case would be limited: 1) samples would have to be small enough to weigh on the MCP or

TRAWLER COMPOSITION SAMPLING: Deck Form Instructions

observer scales, or 2) the haul would have to clean enough that you could sample the *entire* haul (weigh all bycatch on your scales).

If the vessel has questions about flow scale requirements, refer them to the Alaska Regional Office in Juneau at (907)586-7228. Do not refuse to sample or tell the vessel they can't fish if the flow scale or platform scale is not functioning (see page 2-19). Simply inform your inseason advisor of the situation and NMFS will take any necessary action.

DECK FORM INSTRUCTIONS

The waterproof raw data forms provided by the Observer Program are meant to be taken out on deck. On ATLAS vessels these replace the paper species composition form. ***Never recopy raw data*** and always return to your debriefing interview with your original data. The deck forms are an important component of your data documentation. It is important to fill out the forms completely and legibly!



All raw species composition data collected by you must be documented on the deck form provided by the Observer Program, whether your vessel has ATLAS or not.

On vessels with ATLAS, you enter data from the deck sheet directly into the ATLAS system. On non-ATLAS vessels, information on the deck form must be transcribed to a paper species composition form and faxed (see "Paper Form Instructions" on page 5-36).

The deck form is double sided with two sample blocks available on each side. The header information at the top of the decksheet must be filled out and pertains to both sample blocks below it. You may have one haul's worth of samples on one side of a decksheet and another haul's worth of samples on the other side, ***but you cannot mix two haul's worth of data on a single side of the decksheet.*** You must maintain a separate set of forms for each vessel you are deployed to.

Multiple samples and subsamples taken within a haul should be maintained completely independent of each other with their own unique sample number and sample block (or blocks) on the deck form. If you have to combine samples later, simply check the circle next to

"Combined?" for the affected samples (for information on combined samples see "Combined Samples" on page 5-24).

Note that the only time you will have subsample data on trawlers is when you have subsampled for two predominant species (see "Subsampling for Two Predominant Species" on page 5-20). Subsamples have a specific numbering system associated with them, explained on page 5-35.



Maintain a separate set of forms for each vessel.

Deck Form Rules for Trawlers

Examples of a completed deck forms can be found starting on page 5-39. ***The following deck form rules must be followed on all vessels and all fields must be filled out completely:***

Observers Name/Vessel Name - For each vessel assignment, write your name and the vessel's name across the top of the first page.

Date, Cruise, Permit: Enter the date (in mm/dd/yy format) the haul was retrieved. The date on this form must correspond to the retrieval information on the Haul Form. Your cruise number will be given to you during training or briefing, or by your employer. Vessel permits are listed on A-25.

Haul No., Offload No: For each sample taken within a haul, enter the haul number the sample came from and leave the offload number blank. If the composition data are from an offload census, enter the offload number for the sample and leave the haul number field blank. Hauls can be numbered sequentially beginning with the number 1, or you can follow the captain's numbering convention ***if the captain is not repeating haul numbers with each new trip.*** Number offloads sequentially for the vessel, beginning with the number 1. Haul numbers and offload numbers ***must*** match entries on your haul and offload forms.

Haul number and offload number must be unique for the vessel. If you disembark the vessel and then embark again at a later date, you can continue numbering the hauls from the number where you left off, continue with the captain's numbering convention (if s/he is not

repeating haul numbers), or skip a few numbers (*e.g.*, if you numbered hauls of the first trip 1, 2, 3, and 4, you could number hauls of the next trip as 11, 12, 13, 14).



Haul numbers do not have to be sequential (although it is easier if they are), but they do have to be unique for the vessel.

Page_ of_ for vessel/plant, Page_ of_ for haul/offload: For each vessel assignment and form type, pages are numbered consecutively starting with 1.

Sample number: Every sample taken from within a haul must have a unique identifying sample number. Number samples taken within a haul sequentially, starting with the number 1. You do not need to make sample numbers between hauls unique; you can start with the number 1 for the first sample of every sampled haul.

If the composition data are from an offload census, enter a sample number of 1.

Subsample number: For trawler sample data, the only time you will have a *subsample* block of data is when there are two predominant species in a sample. Subsamples must be numerically linked to the parent samples they came from. You do this by using a numbering convention designed specifically for subsamples: every subsample number must be three digits in length, with the first digit designating the parent sample from which the subsample came, and the next two digits indicating the number of that subsample for the parent sample. Subsample numbering convention is explained further below:

- The first subsample of sample number 1 for a haul should be numbered 101, the second subsample for sample number 1 of a haul should be numbered 102, the third 103, and so on...
- The first subsample of sample number 2 for a haul should be numbered 201, the second subsample for sample number 2 of a haul should be numbered 202, the third 203, and so on...
- The first subsample of sample number 3 for a haul should be numbered 301, the second subsample for sample number 3 of a haul should be numbered 302, the third 303, and so on...

Sample and subsample size: On trawlers, every sample and/or subsample must have a sample weight. Record the total weight of catch in your sample, in kilograms, and circle the “kgs” text.

If the composition data are from an offload census, the delivery weight is the sample weight.

Species: List each species encountered in the sample by their common name.

Sex: Tanner crab, king crab, and salmon should be listed separately by species and sex. Record an “M” or “F” for these species when sex is determined. Leave the sex field blank for any unsexed items.

Number: Enter the number seen for each species listed. If you do not have a number for individuals seen of that species, enter a zero in the number field for that species. Use as many lines and columns as necessary for each species.

- If you subsampled for two predominant species, you must enter a zero in the number and weight column of the parent sample that included those species. *Number and weight information on the two predominant species is entered in the subsample(s) taken specifically for those two species.* Parent sample entries with a zero placeholder in the weight and number columns alert the data base and data users to expect subsample data for the parent sample. See sample number 3 in Figure 5-11 for an example of how to document number data in a parent sample that has a subsample associated with it. See subsamples 301 and 302 in Figure 5-12 for an example of documenting subsample data. Refer to page 5-20 for information on subsampling for two predominant species.
- For decomposed fish (code 899) and miscellaneous items (code 900) you can enter the actual number of items or, if counting individuals in these categories would be too tedious and time consuming, you may enter a zero in the number field for these individuals.

Weight: Enter the weight of each species written with a well defined decimal. Weights must be recorded to the nearest 0.1 or 0.01. If you feel that your scale cannot be read accurately to the tenth, you must fill in at least a trailing zero. **Do not enter weights to more**

TRAWLER COMPOSITION SAMPLING: Paper Form Instructions

than two decimal places. If a species in your sample was too small to weigh (e.g., one brittle star) **enter the weight as 0.01 kg.**

For trawlers, all species in the composition samples must have an associated *actual weight* (with the exception of large items too big to be weighed which must have a zero in the weight field). If you do not have the weight for any given species, the sample data cannot be included in your data transmission. You may use the length/weight tables to determine the weight of halibut and longnose and big skates that exceed the capacity of your scales. Use as many lines and columns as necessary for each species.

- Remember that for samples with two predominant species, you enter zero in both the number and weight columns. The weight and number information are captured by your subsample(s) for the species.
- Remember that the rules for recording data in the offload census are different than for regular composition samples. Refer to “Offload Census: Pollock C/Vs” on page 5-25 for more information on the offload census and recording these data.

Percent retained: Enter your rough estimate of the percentage of each species kept. Retention applies to organisms kept for any reason, including consumption on the vessel, processing, delivery, or for a home pack. Record the percent retained to the nearest whole number without the “%” symbol. Refer to “Estimating Percent Retained” on page 5-29 for more specifics regarding the protocol for documentation of percent retained.

Combined samples: If the samples for a haul are going to be combined in the reported data, check the circle next to the word “Combined” for **only those samples that will be combined.** When these data are entered into ATLAS or on a paper form, samples designated as combined are rolled up into a single sample entry. See “Combined Samples” on page 5-24 for a description of when samples must be reported as a “combined sample.”

Pre-sorted: If the sample represents pre-sorted species, check the circle next to “Presorted” for the sample. See page 5-21 for more information on accounting for pre-sorted species.

Keypunch: In the spaces to the right of the word “Keypunch,” write the calculated sum for species number and species weight values you recorded for the sample. If your species composition sample has too many species to fit in one sample block, enter the total sums on the keypunch line in the first block for the sample and leave the keypunch line blank for the second block used for the sample.

Keypunches are a valuable tool for staff who edit your data. If the keypunch value the computer calculates does not match the keypunch value you wrote down, staff know to double check for errors in the entries. If you are sloppy with your keypunch calculations, staff have to investigate each discrepancy. This is a waste of valuable time for both you and for staff. Please double check your keypunch summaries!

Length, viability, injury, specimen, tally data, notes: Each sample block on the deck form has a blank area for recording sample specific data such as sex/length/weight information, specimen information, halibut assessments, notes pertaining to any biases to the sample, etc. Make comments about anything unusual with the catch or your sampling technique for the haul. More complete descriptions of these notes should be documented in your logbook. Making note of unusual occurrences on your species composition form will assist in the debriefing process, and help you distinguish one haul from others. **Raw data of this sort must be documented!**

PAPER FORM INSTRUCTIONS

If the vessel does not have ATLAS, you must transfer your raw data from the decksheet to a paper species composition form. You must fax paper forms to the Seattle NMFS office after every trip.

Three samples will usually fit on one species composition page. Each sample must be documented as a distinct sample for that haul (except in cases of combined samples which are rolled up into one sample on the paper form or in ATLAS; see “Combined Samples” on page 5-24). Unlike the deck forms, samples from two or more hauls can go on a single page. On paper forms, you do not need to start a new page for each sampled haul. Maintain a separate set of forms for each vessel you are assigned.

Cruise number, Vessel permit, Observer name and Vessel name: Your cruise number will be given to you during training or briefing, or by your employer. Vessel permits are listed on A-25. Write your full name and the name of the vessel on the lines provided at the top of the form.

Resubmission: Circle “Resubmission” if you are sending changes to data previously faxed. *Circle the items that have changed since your last transmission of the data; this will aid keypunchers in making the appropriate modifications to your data.* You do not need to start a new form after faxing. You can continue to use the form until all sample blocks are filled with data; just be sure to enter the correct header information for each new sample.

Haul No., Offload No.: Copy the sample’s haul or offload number from your deck form.

Sample number: Copy the sample number from your deck form for that haul.

Subsample number: Copy the subsample number from your deck form for that haul.

Sample size: Copy the sample size from your deck form for that haul. Circle “Kgs” to indicate the weight is in kilograms.

Presorted: If the sample represents a presorted sample, check the “Presorted” circle. Make sure your raw data deck form reads the same!

Combined samples: When these data are entered into ATLAS or on a paper form, samples designated as combined on the deck forms for the haul are rolled up into a single sample entry. See “Combined Samples” on page 5-24 for a description of when samples must be reported as a “combined sample.” If the sample represents a combined sample, check the circle next to “Combined.” Make sure your raw data deck form reads the same for all samples you had to combine!

Species name and species code: List each species (or species group) encountered by their common name (or group name) and enter the associated species code. Species codes can be found starting on page A-1. Enter the code that corresponds to the most specific identification you were able to make. *Consolidate the*

data for the number and weight of a single species into a single line of entry. These calculations must be documented on your deck form or in your logbook.

Sex: Tanner crab, king crab, and salmon should be listed separately by species and by sex. Record an “M” or “F” for these species when sex was determined. *Leave the column blank when sex was not determined.* Leave this column blank for halibut, herring, and all other species. Do not put halibut condition codes in this column.

Number: Copy the number of individuals sampled per species from the raw data on the deck form. If you do not have a number for individuals seen for that species, enter a zero in the number field for those individuals.

- Remember that for samples with two predominant species, you enter zero in both the number and weight columns. The weight and number information are captured by your subsample or subsamples for the species.
- Remember that for decomposed fish (code 899) and miscellaneous items (code 900) you can enter the actual number of items, or, if counting individuals in these categories would be too tedious or time consuming, you may enter a zero in the number field for those individuals.

Weight in kgs: Copy the weight value from the raw data on the deck form for the haul/species. Enter weights with two digits following the decimal point printed on the form. If you feel that your scale cannot be read accurately to the tenth, you must fill in at least a trailing zero. **Always enter weights to only two decimal places.** If a species in your sample was too small to weigh (*e.g.*, one brittle star) *enter the weight as 0.01 kg.*

All species must have an associated *actual weight* (with the exception of large items that are too big to be weighed and for pollock offloads when you are overwhelmed with salmon; these must have a weight entry of zero). If you do not have the weight for any given species (large unweighed items and items too small to weigh excepted), the sample data cannot be included in your data transmission. You may use the length/weight table (see page A-34) to determine the weight of halibut over 1 meter long. Use as many lines and columns as necessary for each species.

TRAWLER COMPOSITION SAMPLING: Reviewing Forms for Errors

- Remember that for samples with two predominant species, you enter zero in both the number and weight columns. The weight and number information are captured by your subsample or subsamples for the species.
- Remember that the rules for recording data in the offload census are different than for regular composition samples. Refer to “Offload Census: Pollock C/Vs” on page 5-25 for more information on the offload census and recording these data.

Percent Retained: Enter your rough estimate of the percentage of each species kept. Retention applies to organisms kept for any reason, including consumption on the vessel, processing, delivery or for a home pack. Record the percent retained to the nearest whole number, without a “%” sign. Refer to page 5-29 for additional instructions regarding estimating and recording percent retained.

Keypunch check: In the spaces to the right of the words “Keypunch check,” write the calculated sum for species codes, species number, species weight, and percent retained values you recorded for the sample. If your species composition sample has too many species to fit in one sample block, enter the total sums on the keypunch line in the first block for the sample and leave the keypunch line blank for the second block used for the sample.

Keypunches are a valuable tool for staff who enter your faxed data. If the keypunch value the computer calculates does not match the keypunch value you wrote down, staff know to double check for errors in the entries they made. If you are sloppy with your keypunch calculations, staff have to investigate each discrepancy. This is a waste of valuable time for both you and for staff. Please double check your keypunch summaries!



If the vessel made any product from more than 15% of a fish, the whole fish is considered retained.

REVIEWING FORMS FOR ERRORS

To facilitate the debriefing process you *must* check forms throughout your cruise rather than at the last minute just before your debriefing interview. Observers

who regularly review their data at sea generally benefit by having shorter, smoother debriefings. Observers who do not review their data throughout their cruise generally find themselves in lengthy debriefings and with time consuming corrections. It is much easier to check a couple of pages each day over the course of three months than to check a couple hundred pages of data all at once! Follow the guidelines below when reviewing your species composition data for errors.

Check Species Composition for:

- Pages numbered properly, no skipped or duplicate numbers.
- Every page has your cruise number and vessel permit.
- All fields with pre-printed decimals have numbers recorded to two decimal places and all written decimals are distinct with data recorded to no more than two decimal places.
- Transcription errors between the raw data decksheet and paper form or ATLAS entries.
- All repeat fields are filled in; you cannot arrow down!
- Your handwriting is clear and legible.
- Haul numbers correspond with dates and hauls listed on the VHF.
- Species names match species codes.
- All species codes are listed with corresponding necessary data.
- Sex codes are included only for salmon, Tanner and king crab species.
- If sex is unknown, the sex field is left blank.
- Species weights are recorded for each line of entry.
- All weights are in kilograms.
- Accurate keypunches of numbers, weights, species codes (paper forms), and percent retained (paper forms) are on the top line.
- Percent retained values are entered for all species and are in whole numbers.

TRAWLER COMPOSITION SAMPLING: Reviewing Forms for Errors

DECK FORM

jc

Date	Cruise	Permit	Haul No.	Offload No.	Page <u>2</u> of <u>26</u> for vessel/plant
6/28/09	11999	5677	187		Page <u>2</u> of <u>4</u> for haul/offload

Sample number: <u>2</u>	Sub-sample number:	Sample size: <u>15047</u>	<input checked="" type="radio"/> Kgs <input type="radio"/> Hooks <input type="radio"/> Pots	Combined <input type="radio"/>	Presorted <input type="radio"/>
length, viability, injury, specimen, and tally data					
Species	Sex	#	Weight	% ret.	<p>Total sample wt; 15047.00 Bycatch wt: - 101.94 Pollock subset wt: - 83.80</p> <p>Remainder wt uncounted pollock: ↓ 14861.26 Kgs</p> <p style="text-align: center;">① 2 3 ④ 5 6 ⑦ 8</p> <p>Start: 0 End: 15047</p>
---KEYPUNCH---	<input checked="" type="checkbox"/>	<u>209</u>	<u>15047.00</u>	<input checked="" type="checkbox"/>	
Pollock		<u>0</u>	<u>14861.26</u>	<u>100</u>	
P. cod		<u>12</u>	<u>27.60</u>	<u>100</u>	
Ak. skate		<u>2</u>	<u>19.60</u>	<u>0</u>	
Herring		<u>12</u>	<u>3.54</u>	<u>0</u>	
Jellyfish		<u>8</u>	<u>5.14</u>	<u>0</u>	
Flathead		<u>22</u>	<u>8.04</u>	<u>0</u>	
N. Rocksole		<u>25</u>	<u>10.50</u>	<u>0</u>	
Rexsole u.		<u>63</u>	<u>27.52</u>	<u>0</u>	
Pollock subset:					
Pollock		<u>36</u>	<u>45.20</u>	<u>100</u>	
Pollock		<u>29</u>	<u>38.60</u>	<u>100</u>	

Sample number: <u>3</u>	Sub-sample number:	Sample size: <u>15341</u>	<input checked="" type="radio"/> Kgs <input type="radio"/> Hooks <input type="radio"/> Pots	Combined <input type="radio"/>	Presorted <input type="radio"/>
length, viability, injury, specimen, and tally data					
Species	Sex	#	Weight	% ret.	<p>Chinook scale # 1 M 64 e 2.46 Kgs</p> <p>Sample 2 had only one predominant species. Weight for this species was determined by subtracting bycatch weight and subset sample weight from the total sample flow scale weight. A zero is entered in the number field for the predominant species.</p> <p>start: 45202 End: 60543</p>
---KEYPUNCH---	<input checked="" type="checkbox"/>	<u>102</u>	<u>37.74</u>	<input checked="" type="checkbox"/>	
Pollock		<u>0</u>	<u>0</u>	<u>100</u>	
P. cod		<u>0</u>	<u>0</u>	<u>100</u>	
Rex sole		<u>1</u>	<u>.48</u>	<u>0</u>	
Flathead		<u>73</u>	<u>17.11</u>	<u>0</u>	
Arrowtooth		<u>20</u>	<u>10.01</u>	<u>0</u>	
Ak. skate		<u>1</u>	<u>5.7</u>	<u>0</u>	
Jellyfish		<u>6</u>	<u>1.98</u>	<u>0</u>	
Chinook		<u>1</u>	<u>2.46</u>	<u>0</u>	

Sample 3 had two predominant species. Following protocol, these were subsampled.

Figure 5-11 Example of Sample Data for One and Two Predominant Species on a Pollock C/P

DECK FORM

je

Date	Cruise	Permit	Haul No.	Offload No.	Page <u>3</u> of <u>26</u> for vessel/plant
6/28/09	11999	5677	187		Page <u>3</u> of <u>4</u> for haul/offload

Sample number: <u>3</u>	Sub-sample number: <u>301</u>	Sample size: <u>82.42</u>	<input checked="" type="checkbox"/> Hooks pots	Combined <input type="checkbox"/>	Presorted <input type="checkbox"/>
-------------------------	-------------------------------	---------------------------	--	-----------------------------------	------------------------------------

length, viability, injury, specimen, and tally data

Species	Sex	#	Weight	% ret.																							
----- KEYPUNCH -----	<input checked="" type="checkbox"/>	121	82.42	<input checked="" type="checkbox"/>																							
Pollock		57	39.34	100	<table style="width: 100%; border-collapse: collapse;"> <tr> <th colspan="2">Pollock</th> </tr> <tr> <td>M</td> <td>F</td> </tr> <tr> <td>(51)L</td> <td>(42)L</td> </tr> <tr> <td>50</td> <td>39</td> </tr> <tr> <td>(41)</td> <td>46</td> </tr> <tr> <td>40</td> <td>49</td> </tr> <tr> <td>(45)L</td> <td>41</td> </tr> <tr> <td>48</td> <td>45</td> </tr> <tr> <td>46</td> <td>(38)</td> </tr> <tr> <td>(47)L</td> <td>(43)</td> </tr> <tr> <td>49</td> <td>(50)</td> </tr> </table>	Pollock		M	F	(51)L	(42)L	50	39	(41)	46	40	49	(45)L	41	48	45	46	(38)	(47)L	(43)	49	(50)
Pollock																											
M	F																										
(51)L	(42)L																										
50	39																										
(41)	46																										
40	49																										
(45)L	41																										
48	45																										
46	(38)																										
(47)L	(43)																										
49	(50)																										
Pollock		63	43.06	100																							
Jellyfish		1	.02	0																							
					<table style="width: 100%; border-collapse: collapse;"> <tr> <th colspan="2">Pollock otos</th> </tr> <tr> <td>M</td> <td>49 0.79kg</td> </tr> <tr> <td></td> <td># 427617</td> </tr> <tr> <td>F</td> <td>43 0.60kg</td> </tr> <tr> <td></td> <td># 427616</td> </tr> <tr> <td colspan="2">Maturity Scan:</td> </tr> <tr> <td></td> <td># 427616, 0.55kg (Spent)</td> </tr> </table>	Pollock otos		M	49 0.79kg		# 427617	F	43 0.60kg		# 427616	Maturity Scan:			# 427616, 0.55kg (Spent)								
Pollock otos																											
M	49 0.79kg																										
	# 427617																										
F	43 0.60kg																										
	# 427616																										
Maturity Scan:																											
	# 427616, 0.55kg (Spent)																										
					<table style="width: 100%; border-collapse: collapse;"> <tr> <th colspan="2">Pollock s/l/w</th> </tr> <tr> <td>M</td> <td>51 e .87</td> </tr> <tr> <td>M</td> <td>41 e .50</td> </tr> <tr> <td>M</td> <td>45 e .55</td> </tr> <tr> <td>M</td> <td>47 e .54</td> </tr> <tr> <td>M</td> <td>47 e .56</td> </tr> <tr> <td>F</td> <td>42 e .51</td> </tr> <tr> <td>F</td> <td>38 e .42</td> </tr> </table>	Pollock s/l/w		M	51 e .87	M	41 e .50	M	45 e .55	M	47 e .54	M	47 e .56	F	42 e .51	F	38 e .42						
Pollock s/l/w																											
M	51 e .87																										
M	41 e .50																										
M	45 e .55																										
M	47 e .54																										
M	47 e .56																										
F	42 e .51																										
F	38 e .42																										

This random subsample did not contain both species for which the subsample was taken. Subsamples must be collected until both species are captured within the subsample. All subsample attempts are reported.

Sample number: <u>3</u>	Sub-sample number: <u>302</u>	Sample size: <u>83.46</u>	<input checked="" type="checkbox"/> Hooks pots	Combined <input type="checkbox"/>	Presorted <input type="checkbox"/>
-------------------------	-------------------------------	---------------------------	--	-----------------------------------	------------------------------------

length, viability, injury, specimen, and tally data

Species	Sex	#	Weight	% ret.	
----- KEYPUNCH -----	<input checked="" type="checkbox"/>	77	83.46	<input checked="" type="checkbox"/>	
Pollock		63	41.52	100	<p>This random subsample contains both species for which the subsample was taken. No further subsamples are needed from within the parent sample</p>
P. cod		13	41.12	100	
Arrowtooth		1	.82	0	

National Marine Fisheries Service/Fisheries Monitoring and Analysis Division Ver. 09

Figure 5-12 Example of Subsample Data for Two Predominant Species on a Pollock C/P

TRAWLER COMPOSITION SAMPLING: Reviewing Forms for Errors

DECK FORM

Page 1 of for vessel/plant
 Page 1 of 4 for haul/offload

Date: 7/13/09 Cruise: 20670 Permit: 2345 Haul No.: 165 Offload No.:

Sample number: 1 Sub-sample number: Sample size: 166.78 ^{Kgs} Hooks pots Combined Presorted

Species	Sex	#	Weight	% ret.
----- KEYPUNCH -----	<input checked="" type="checkbox"/>	139	166.78	<input checked="" type="checkbox"/>
Pollock		35	43.8	100
Pollock		18	21.8	100
Pollock		30	40.2	100
Pollock		25	31.6	100
P. cod		2	19.8	100
Flathead		21	5.2	100
Rex sole		3	2.1	100
N. Rocksole		3	1.08	100
Arrowtooth		2	1.20	100

length, viability, injury, specimen, and tally data

Pollock S/L Pollock S/L/W

M	F	M	F
44-1	53-1	44-.74	53-1.24
47-2	54-2	47-.92	56-1.76
48-1	56-1	47-1.28	62-1.72
49-1	59-1	51-1.26	
51-2	62-1	52-1.22	
52-3	66-1		
55-1			
59-1			

maturity scan: #393078 1.60kg, spawning!!

Pollock oto's
 Specimen # 393077 m, 52 @ 1.32 kg
 # 393078 f, 66 @ 2.10 kg
 Total # wts in logbook p. 172

All measured fish, including those that are contributing specimen data, must be documented together. You must circle the lengths corresponding to fish that contributed specimen data.

Sample number: 2 Sub-sample number: Sample size: 185.25 ^{Kgs} Hooks pots Combined Presorted

Species	Sex	#	Weight	% ret.
----- KEYPUNCH -----	<input checked="" type="checkbox"/>	176	185.25	<input checked="" type="checkbox"/>
Pollock		36	43.6	100
Pollock		37	44.2	100
Pollock		30	35.6	100
Pollock		30	37.4	100
P. cod		1	7.8	100
Sturgeon Poacher		1	.04	100
Flathead sole		24	5.20	100
Rex sole		2	1.14	100
Arrowtooth		11	3.76	100
Ak. skate		1	1.82	100
Chum salmon	M	3	4.69	99

length, viability, injury, specimen, and tally data

Chum salmon scales
 M - 45cm @ 1.20kg # 1
 M - 52cm @ 1.84kg # 2
 M - 56cm @ 1.65kg # 3

When reporting percent retained for prohibited species discarded at sea, ask yourself: "Out of the total amount of this species in the catch, how much was retained?" You may have to update your numbers after you census the offload. For example, had there been no other chum salmon in the delivery, Hali would have reported these fish as zero percent retained. **Remember: DO NOT include prohibited species discards in your discard estimate.**

Added to offload
 Total wts + # in logbook p. 172.

National Marine Fisheries Service/Fisheries Monitoring and Analysis Division

Figure 5-13 Example of Sample Data From A Pollock Catcher Trawler

jc

DECK FORM

Date	Cruise	Permit	Haul No.	Offload No.	Page <u>2</u> of _____ for vessel/plant
07/13/09	20670	2345	165		Page <u>2</u> of <u>4</u> for haul/offload

Sample number: <u>3</u>	Sub-sample number:	Sample size: <u>149.47</u>	<small>Kgs Hooks pots</small>	Combined <input type="radio"/>	Presorted <input type="radio"/>
-------------------------	--------------------	----------------------------	---------------------------------------	--------------------------------	---------------------------------

Species	Sex	#	Weight	% ret.	
----- KEYPUNCH -----	<input checked="" type="checkbox"/>			<input checked="" type="checkbox"/>	length, viability, injury, specimen, and tally data Total wt + # in logbook, pg. 172 <u>Chinook</u> F - 65cm e 3.46kg, scale # 1 <u>Halibut</u> D - 64cm, 3.03kg → 6.49kg discard e sea Added to offload Added to offload: outside of sample, 1 chum, 2 chinook - discard e sea
Pollock		<u>30</u>	<u>36.6</u>	100	
Pollock		<u>20</u>	<u>23.8</u>	100	
Pollock		<u>30</u>	<u>35.8</u>	100	
Pollock		<u>21</u>	<u>24.8</u>	100	
P. cod		<u>2</u>	<u>17.2</u>	100	
Flathead		<u>7</u>	<u>3.00</u>	100	
N. Rocksole		<u>2</u>	<u>.72</u>	100	
Arrowtooth		<u>4</u>	<u>1.06</u>	100	
Chinook	F	<u>1</u>	<u>3.46</u>	99	
Halibut		<u>1</u>	<u>3.03</u>	99	

Sample number:	Sub-sample number:	Sample size:	<small>Kgs Hooks pots</small>	Combined <input type="radio"/>	Presorted <input type="radio"/>
----------------	--------------------	--------------	---------------------------------------	--------------------------------	---------------------------------

Species	Sex	#	Weight	% ret.	
----- KEYPUNCH -----	<input checked="" type="checkbox"/>			<input checked="" type="checkbox"/>	length, viability, injury, specimen, and tally data

National Marine Fisheries Service/Fisheries Monitoring and Analysis Division Var 09

Figure 5-14 Example of Pollock Catcher Trawler Sample Data with Salmon Discard Outside Sample

DECK FORM

jc

Date	Cruise	Permit	Haul No.	Offload No.	Page <u>1</u> of _____ for vessel/plant
04/02/09	20778	1239	201		Page <u>1</u> of <u>2</u> for haul/offload

Sample number: <u>1</u>	Sub-sample number:	Sample size: <u>210.67</u>	Kgs Hooks pots	Combined <input type="radio"/>	Presorted <input type="radio"/>								
length, viability, injury, specimen, and tally data													
Species	Sex	#	Weight	% ret.	<p style="text-align: center;"><u>Skates - all AK</u></p> <table style="margin-left: auto; margin-right: auto;"> <tr> <td style="border-right: 1px solid black; padding: 5px;">F</td> <td style="padding: 5px;">M</td> </tr> <tr> <td style="border-right: 1px solid black; padding: 5px;">67</td> <td style="padding: 5px;">51</td> </tr> <tr> <td style="border-right: 1px solid black; padding: 5px;">72</td> <td style="padding: 5px;">70</td> </tr> <tr> <td style="border-right: 1px solid black; padding: 5px;">68</td> <td style="padding: 5px;"></td> </tr> </table> <div style="border: 1px solid black; padding: 5px; margin-top: 10px;"> <p>There were too many brittle stars to count in this sample. 50 individuals were weighed and the rest were weighed only. These were entered on a separate line, with zero entered in the number field.</p> </div> <p style="margin-top: 20px;">Vessel est. = 18MT mcp 10 e 100, 25 e 25.0, 50 e 50.0</p>	F	M	67	51	72	70	68	
F	M												
67	51												
72	70												
68													
----- KEYPUNCH -----	X	211	210.67	X									
Pollock		26	46.30	20									
P. Cod		5	49.12	100									
AK Skate		8	44.52	0									
Flathead sole		96	42.58	100									
N. Rocksole		22	9.83	0									
Yellowfin		4	2.36	0									
Brittle star		50	3.50	0									
Brittle star		0	12.46	0									

Sample number: <u>2</u>	Sub-sample number:	Sample size: <u>221.16</u>	Kgs Hooks pots	Combined <input type="radio"/>	Presorted <input type="radio"/>																														
length, viability, injury, specimen, and tally data																																			
Species	Sex	#	Weight	% ret.	<table style="margin-left: auto; margin-right: auto;"> <tr> <td colspan="2" style="text-align: center;"><u>Flathead sole</u></td> <td style="text-align: center;"><u>Flathead otol's</u></td> </tr> <tr> <td style="border-right: 1px solid black; padding: 5px;">M</td> <td style="padding: 5px;">F</td> <td style="padding: 5px;"></td> </tr> <tr> <td style="border-right: 1px solid black; padding: 5px;">24-1</td> <td style="padding: 5px;">25-1</td> <td style="padding: 5px;">m/42/.82</td> </tr> <tr> <td style="border-right: 1px solid black; padding: 5px;">33-1</td> <td style="padding: 5px;">33-1</td> <td style="padding: 5px;">spec# 430544</td> </tr> <tr> <td style="border-right: 1px solid black; padding: 5px;">35-1</td> <td style="padding: 5px;">34-1</td> <td style="padding: 5px;">f/36/.36</td> </tr> <tr> <td style="border-right: 1px solid black; padding: 5px;">(42-1)</td> <td style="padding: 5px;">(35-2)</td> <td style="padding: 5px;">spec# 430548</td> </tr> <tr> <td style="border-right: 1px solid black; padding: 5px;"></td> <td style="padding: 5px;">(36-1)</td> <td style="padding: 5px;">f/38/.58</td> </tr> <tr> <td style="border-right: 1px solid black; padding: 5px;"></td> <td style="padding: 5px;">(38-5)</td> <td style="padding: 5px;">spec# 430541</td> </tr> <tr> <td style="border-right: 1px solid black; padding: 5px;"></td> <td style="padding: 5px;">40-1</td> <td style="padding: 5px;">f/35/.52</td> </tr> <tr> <td style="border-right: 1px solid black; padding: 5px;"></td> <td style="padding: 5px;">37-3</td> <td style="padding: 5px;">spec# 430542</td> </tr> </table>	<u>Flathead sole</u>		<u>Flathead otol's</u>	M	F		24-1	25-1	m/42/.82	33-1	33-1	spec# 430544	35-1	34-1	f/36/.36	(42-1)	(35-2)	spec# 430548		(36-1)	f/38/.58		(38-5)	spec# 430541		40-1	f/35/.52		37-3	spec# 430542
<u>Flathead sole</u>		<u>Flathead otol's</u>																																	
M	F																																		
24-1	25-1	m/42/.82																																	
33-1	33-1	spec# 430544																																	
35-1	34-1	f/36/.36																																	
(42-1)	(35-2)	spec# 430548																																	
	(36-1)	f/38/.58																																	
	(38-5)	spec# 430541																																	
	40-1	f/35/.52																																	
	37-3	spec# 430542																																	
----- KEYPUNCH -----	X	185	221.16	X																															
Pollock		31	47.90	20																															
P. cod		10	46.84	100																															
Flathead sole		81	35.00	100																															
AK skate		10	20.17	0																															
N. Rocksole		23	10.06	0																															
Rocksole unid.		0	46.52	0																															
Yellowfin sole		30	14.67	0																															

A subset sample was taken from rocksoles in the sample - these fish were reported to species. The rest of the rocksoles were weighed, but not counted or identified to species. These were reported to the group level (as rocksole unident).

National Marine Fisheries Service/Fisheries Monitoring and Analysis Division

Figure 5-18 Example of Documenting Data From Samples on a Flatfish Vessel



MOTHERSHIP DATA COLLECTION

Table of Contents

List of Priorities	6-1
Introduction.....	6-1
Catch Information (Haul Forms)	6-2
Rules for Completing VHF on a Mothership	6-2
Haul Order for C/P Motherships	6-3
Vessel Type	6-4
Monitoring for Marine Mammals	6-4
Observer Estimates	6-4
Codend Delivery Duties.....	6-4
Codend Delivery Problems.....	6-4
Pumped Fish Delivery Duties	6-5
Random Sample and Break Table Use	6-5
Length Frequency and Biological Data.....	6-5
Observers Delivering to Motherships	6-5
Reviewing Forms for Errors.....	6-5

LIST OF PRIORITIES

- Obtain independent catch estimates by bin or codend volume (if required).
- Collect haul information for delivering catcher boats and your vessel if operating as a C/P.
- Send data to FMA as directed (see “Sending Data” on page 2-26.).
- Sample for species composition.
- Collect otoliths for predominant species.
- Collect length frequency data as required.
- Complete assigned standard and special projects.

INTRODUCTION

A mothership is a factory vessel which routinely takes unsorted catch from other vessels. Unsorted catch is usually delivered by codend transfer. Some catcher/processors will act as motherships occasionally, intermittently taking catch from smaller delivering catcher boats while fishing for themselves. There are six vessels that have acted in the capacity of a C/P Mothership in the recent past: the Seafreeze Alaska,



Arctic Storm, Arctic Fjord, Katie Ann, Ocean Rover and the Seafisher. Three vessels act exclusively as motherships: the Ocean Phoenix, the Golden Alaska and the Excellence. These boats do not have the capability to fish for themselves. The Golden Alaska and the Excellence occasionally receive pumped fish, but the majority of their deliveries are from codend transfer.

All of the C/Ps and vessels acting exclusively as motherships listed above are part of a co-op allowed under the American Fisheries Act (see “Limited Access Privilege Programs” on page 1-6). When these vessels participate in the Bering Sea pollock fishery, they carry two or three observers. For more information on the roles of each observer, (see “Working with Two Observers” on page 2-22).

Vessels that routinely pump fish from delivering catcher vessels are considered to be floating processors, or “floaters.” The Northern Victor, the Arctic Enterprise and the Yardarm Knot are floating processors. The fish delivered to these vessels have the potential to be sorted at sea, and the vessel acts the same as a shoreside plant. Follow the directions in “SHORESIDE PLANTS AND FLOATING PROCESSORS” on page 9-1 if your vessel is acting as a floater. If your vessel meets the description of a floater, but is not listed as one, contact NMFS for information on how to report delivered catch.

MOTHERSHIP DATA COLLECTION: Catch Information (Haul Forms)

Please let me know if there are any gear problems or marine mammal interactions reported by the catcher boats. Thanks!

Del.#	Vessel Name	Date Set	Time Set	Set Latitude	Set Longitude	Bottom Depth	Fishing Depth	Date Retrieved	Time Retrieved	Retrieval Latitude	Retrieval Longitude	Catch Estimate
40	M.D.	01/25	1830	54.36'	165.39'	92F	65F	01/26	0025	54.37'	165.39'	36.90
41	O.L.	01/25	1810	55.29'	164.49'	85F	68F	01/25	2030	55.29'	164.48'	39.50
42	Ald.	01/25	2315	54.30'	165.43'	95F	61F	01/26	0335	54.30'	165.64'	38.32

Figure 6-1 Observer Radio Schedule Worksheet (example)

CATCH INFORMATION (HAUL FORMS)

As an observer on a mothership, your most important duty is gathering catch information. This will often take longer than on catcher/processors and involves a lot more coordination and cooperation with the vessel personnel. The fishing effort information required on the Vessel Haul form should come from the vessel’s NMFS logbook. Check carefully to ensure that the data are accurate, reasonable, and that no transcription errors are made when you copy data to this form. The data requested on the Observer Haul Form are those items which you are responsible for calculating or verifying. The instructions on how to fill out each of these forms follows. See “Documenting Fishing Effort” on page 4-1 and “Completing Haul Forms on Trawl Vessels ” on page 4-14 for rules and instructions on how to fill out the Vessel and Observer Haul Forms. The particulars that are specific to motherships are listed and explained below.

Maintain only one set of Vessel and Observer Haul Forms. List self-made tows and deliveries together, in the order which they occurred. Most motherships will have a radio schedule for when they gather fishing data from the catcher boats. This is usually done by the captain, mate, purser, or in rare cases, the observer. If a crew member is getting haul data for you, make sure that they are gathering complete and accurate data from the catcher boats. You should use the delivery schedule to match up specific hauls to a catcher boat. Most motherships will follow a catcher boat delivery order, but these change frequently, and may not be reliable. Some observers create a “worksheet” for the person

doing the radio schedule, although most vessels will already have one. See Figure 6-1 as an example of an Observer Radio Schedule worksheet.

Rules for Completing VHF on a Mothership

Codend Delivery Rules

1. **Trip Number:** Record the trip number associated with the haul. Trip Form instructions are given in the chapter “TRIP INFORMATION,” .
2. **Vessel type:** Enter a “2” to indicate that the vessel received unsorted catch.
3. **Date and Time of Gear Deployment:** You will need to get these data from the catcher vessels. Remember that hauls must be listed by catcher vessels’ date of gear *retrieval*, so *deployment* dates and times may be out of sequence!
4. **Begin Position, Bottom depth, and Gear depth:** Collect these data from the catcher boats.
5. **Date and Time of Gear Retrieval:** Enter the day and time the catcher boat retrieved these hauls. It may be easier to fill these columns out first, so that your haul order is established before filling out the Date, Time and Position of the beginning of the set.
6. **Location Code:** Enter an “R” and the corresponding latitude and longitude of the catcher boat’s retrieval position.
7. **Vessel Estimate:** Enter the catch estimate made by mothership personnel.
8. **Catcher boat’s ADF&G#:** Enter the ADF&G number for the catcher boat which made this delivery.



Pumped Fish Delivery Rules

1. **Vessel type:** Enter a “4” to indicate that the vessel received potentially sorted catch.
2. **Date and Time of Gear Deployment and Bottom Depth and Gear Depth:** Leave these columns blank. Often, pumped fish are made up of several hauls, so these data are not applicable.
3. **Date of gear retrieval:** Enter the day on which the delivery occurred.
4. **Time of gear retrieval:** Enter the time when the delivery occurred.
5. **Location code:** Enter a “D” and the corresponding latitude and longitude of the mothership when it received the delivery. If your vessel is in port when it accepts the pumped fish, you may use one of the port locations given on page 4-17. If your mothership is floating, you will need to record the location of the GPS.
6. **Vessel Estimate:** Enter the mothership’s captain’s estimate of the weight of the entire delivery.
7. **Catcher boat’s ADF&G#:** Enter the ADF&G number for the catcher boat which made this delivery.

Haul Order for C/P Motherships

Vessels that act intermittently as motherships while fishing for themselves will have two vessel logbooks (DCPLs): one for their activity as a catcher processor and one for their activity as a mothership. Typically, the captain will use a different haul numbering system between these two catch logs. It can be difficult for the observer to keep self fished hauls distinct from received hauls if they do not use a separate numbering system for the two types of catch on their haul forms. *If you number self fished and received hauls*

consecutively, your haul number assignments for self fished hauls will differ from the captain’s haul number assignment for those same hauls.

There is an easy solution to this problem that many observers on C/P motherships have used in the past. Remember that haul numbers do not have to be in consecutive ascending order, *but haul retrieval dates do*. You *must* list hauls on the haul forms in ascending order by retrieval data, whether self fished or not. Instead of numbering self fished hauls and received hauls in consecutive order, use the vessel’s numbering system for self fished hauls, and apply a distinct numbering system to received hauls.

You can even apply a distinct numbering system to *each* of the delivering vessels. For example, if you had three vessels delivering to your catcher processor, you could number hauls from one vessel in the 1000 range, hauls from the second in the 2000 range and hauls from the third in the 3000 range. Because you cannot have duplicate haul numbers, you should determine the number range you assign to each delivering vessel based on your C/Ps haul numbering system. For example, if your C/P started their haul numbering at 500, you would want to number hauls from delivering vessels starting in the 1000 range, at least. By doing this, you are giving yourself plenty of room to maintain the skipper’s numbering system for self caught hauls (from 500 to 999) and are in little danger of running into a situation of overlapping haul numbering systems.

Haul Order for Motherships

Vessel acting as motherships exclusively document haul data in only one DCPL. The date and time the delivering vessel retrieves the catch *always* determines the date of the catch. This date and time will not necessarily be the same day the catch was delivered to the mothership. Although the retrieval time determines the date on the VHF, it has no bearing on the order in which codends are delivered to your mothership. *Often, codends are delivered out of sequence. It will be easiest for you to use the order of delivery to number the catches coming aboard*, since that is the way the vessel will be numbering the hauls in their logbook. Your retrieval times will be out of sequence, but most of your haul numbers will correspond to the vessel's delivery numbers. Using this method, the only

haul numbers which may not match the vessel's delivery numbers are those retrieved around midnight, or 0000 hours.

When filling out the VHF, you may find it easier to fill out the gear *retrieval* information first. You will avoid recording hauls on the wrong date if these columns are completed before recording gear *deployment* information. An example of changing the sequence of deliveries in order to keep the haul date correct is shown with delivery 40 in the worksheet example (see Figure 6-1). Note that this delivery has been renumbered as Haul 41 in the VHF example, (see Figure 6-2). Hauls 40 and 41 are out of sequence because Haul 40 (the vessel's 41st delivery) was actually hauled back the day before it was delivered, but the mothership received Haul 41 (the vessel's 40th delivery) first. Note the reason why you deviated from the vessel delivery number in your logbook, or in the "Notes" section of the Observer Haul Form.

Vessel Type

On a C/P acting as a mothership the "vessel type" code and the ADF&G column distinguish which hauls were self-made and which were deliveries. Use a vessel type "1" for self-made tows, and leave the ADF&G column blank. Use a vessel type "2" for codend deliveries. If your mothership pumps fish from the hold of another vessel, enter a vessel type "4," indicating the delivery of potentially sorted catch. For all deliveries, enter the catcher boat's ADF&G number in the appropriate column (see Figure 6-2). At the top of the VHF, list the vessel names and corresponding ADF&G number for all catcher boats delivering to your mothership. One list per data set is sufficient; you do not need a list on each page.

Monitoring for Marine Mammals

On a mothership, it is not possible to watch the true haul back of the delivered codend for marine mammal interaction, since this is done on the catcher boat. It is possible to monitor the catch during the dumping of the codend. If you cannot monitor every delivery, this should be done on as many *randomly selected* catches as possible. If you monitor the dumping of the haul, record this haul as monitored for marine mammals. If there is an observer aboard the delivering catcher vessel, contact him/her to determine if there were any marine mammal encounters during the haul back. If your vessel, or the catcher boats, report marine

mammals nearby or possibly interacting with gear during haul back or delivery, this should be noted in your logbook.

OBSERVER ESTIMATES

All motherships accepting pollock in the Bering Sea must have a motion compensated flow scale, as required by the American Fisheries Act. On these vessels, ***no observer estimates should be taken***. If you are on a mothership that is not regulated by the AFA and does not have a flow scale, use the best method for obtaining independent catch estimates (see "Observer Estimates of Catch Weight" on page 4-4).

CODEND DELIVERY DUTIES

Treat these deliveries as if your vessel caught the fish. Standard C/P prioritized duties should be followed for each haul. These are:

- obtaining an independent observer estimate (if required),
- sampling for species composition (and density, if applicable),
- collecting otoliths for predetermined hauls,
- collecting length frequency samples on prohibited and predominant species, and
- completing your standard and special projects.

Refer to the individual manual section regarding each one of these duties.

Codend Delivery Problems

Usually codend transfers go smoothly. There are two situations that may complicate you getting delivery data or observer estimated catch weights. The first is when the codend is lost during transfer. In this situation, obtain the haul data from the delivering catcher boat and ask them for an estimate of catch weight. Document this in the vessel estimate column of your OHF and leave the observer estimate field blank. Contact your ATLAS inseason advisor to alert them of the incident.

The second situation is when the codend "leaks" fish during transfer. This may happen when the zipper is not secured. If you see fish spilling out from a codend during delivery, make an estimate of the tonnage lost and add this weight to the flow scale read out for your

observer estimate. Again, notify your inseason advisor that the observer estimate did not come exclusively from the flow scale weight.

PUMPED FISH DELIVERY DUTIES

These fish have the potential to be sorted at sea, so they are treated differently than those delivered by codend transfer. If the flow scale is not being used, you should try to make an independent estimate. If the delivery is made up of several hauls, it may be too large to be pumped into a bin at once, or may be pumped into unmarked tanks. In these cases, record only the vessel's estimate. Do not record an observer estimate. Note any difficulties you had in obtaining independent estimates in your logbook. ***Do not sample these hauls for species composition or collect any biological data.*** If your vessel takes nothing but pumped fish, contact a FMA Division office for recording and sampling duties.

RANDOM SAMPLE AND BREAK TABLE USE

All exclusive motherships regulated by the AFA are required to carry two observers. The Ocean Phoenix carries three observers. Therefore, it is rare that a mothership observer will need to use either the Random Sample or Random Break Tables. If there is more than one observer aboard a mothership and an RST or RBT must be used, use the lead observer's tables and document the circumstances in all observers' logbooks.

If you are the only observer on a C/P which is taking outside deliveries, use one of the RSTs, or the RBT (page 2-10) if you cannot sample all hauls. Record the appropriate codes on the Observer Haul Form (see page 4-17).

If you are the only observer aboard an exclusive mothership, you will likely need to use both the RST and RBT. If you find that you cannot get enough rest and complete your observer duties while using both tables, *contact your inseason advisor and document the issue in your logbook.* Your inseason advisor will be able to give you suggestions on how to proceed.

LENGTH FREQUENCY AND BIOLOGICAL DATA

Mothership observers take lengths and biological data following the same protocol as other observers (see page 11-1). If you are the only observer aboard the mothership, you may need to reduce the number of

lengths and biological data taken. If you cannot keep up with all your duties when following the RST and RBT, *contact your inseason advisor and document the issue in your logbook.* Your inseason advisor will be able to give you suggestions on how to proceed. Observers on motherships carrying two observers should be able to collect lengths and biological data according to the Priority Lists starting on page 11-24.

OBSERVERS DELIVERING TO MOTHERSHIPS

It is unusual for catcher boats delivering to a mothership to carry an observer. If you find yourself aboard a catcher boat delivering a few hauls to a mothership before delivering landed catch to a shoreside plant, your duties will depend on how the fish are being delivered.

If the haul is delivered as a codend, the mothership observer is completely responsible for recording and sampling this haul. Do not record this haul on your Vessel or Observer Haul Forms. It will be accounted for by the mothership observer. Your only duties are to obtain catch information to give to the mothership observer and monitor the haul back for marine mammal interactions. If the skipper usually gives haul information to the mothership, you must verify that all the data the mothership observer will need was given.

If your vessel is dumping fish into RSW tanks, and then pumping the fish to a mothership, you should treat these hauls as if they were being delivered to a shoreside processor. Obtain an observer estimate and sample for species composition. Collect length frequency and age data from sampled hauls. All data you collect will go on your forms, under your cruise number.

REVIEWING FORMS FOR ERRORS

Data sets from Motherships are often very large. To facilitate the debriefing process you ***must*** check forms throughout your cruise rather than at the last minute just before your debriefing interview. **Both the lead and second observers must work together in editing and reviewing the data for errors.** Observers who regularly review their data at sea generally benefit by having shorter, smoother debriefings. Observers who do not review their data throughout their cruise generally find themselves in lengthy debriefings and with time consuming corrections. It is much easier to check a couple of pages each day over the course of

MOTHERSHIP DATA COLLECTION: Reviewing Forms for Errors

three months than to check a couple hundred pages of data all at once! Follow the guidelines below when reviewing your data for errors.

Check All Forms For:

- Your name and vessel name on the first page of each form type
- Pages numbered properly, no skipped or duplicate numbers
- Every page has your cruise number and vessel code
- Leading zeros are present only for dates, times, and haul weights of zero weight (0.00 on Vessel Haul Form and Observer Haul Form)
- All fields with pre-printed decimals have numbers listed to two decimal places
- Actual values are entered (no arrow down's or brackets).
- Your handwriting is clear and legible.

Check Observer and Vessel Haul Forms For:

- Every day on the vessel has an entry: this includes the day you boarded and disembarked and all days in between
- Non-fishing days have a non-fishing position with a haul number of zero. Document non-fishing days in your logbook.
- No duplicate haul/set numbers
- No decimals other than those already printed on the page
- For longliners, “# of hooks per segment” and total hooks in a set are in whole numbers
- Every haul has a vessel haul weight estimate, and if appropriate, an independent observer estimate

Check Vessel Haul Form for:

- Set and retrieval positions are recorded for all hauls/sets
- Positions have no minutes greater than 59

- seconds are recorded, not hundredth of minutes
- Retrieval times of 0000 are attributed to the next day
- Depths are rounded to whole numbers and fishing depths are never deeper than bottom depths
- “F” or “M” is recorded for every depth recorded
- For motherships, full name of catcher boat and the ADF&G #s are completed in box at top of page
- For each delivery to a mothership, the delivering catcher boat's ADF&G# is recorded
- A “Y” or “N” is recorded in the IFQ column
- CDQ numbers are recorded with the letter “C” followed by the two digits of the CDQ group number (found in the vessel logbook)

Check Observer Haul Form for:

- Discard estimates are entered as appropriate

Check Species Composition Forms for:

- Haul numbers correspond with dates and hauls listed on the VHF
- Species names match species codes
- No species codes are listed without corresponding data
- Sex codes are included only for salmon, Tanner and king crab species
- If sex is unknown, the sex field is left blank
- Sample weights are recorded for each line of entry, with unknown values recorded with a zero entry.
- Decimal points are distinct and recorded to no more than two decimal places
- All weights are in kilograms
- Percent retained numbers are entered for all species and are whole numbers

Vessel Haul Form

Page 1 of 1

Cruise	Permit	Year	Gear type
20401	4389	2009	2

Observer name Davey Jones
 Vessel name Sierra Madre

Resubmission
(Circle All Changes)

Trip No.	Haul No.	IFCP Y/N	COO No.	Vessel Type	Gear performance	Location code	Deployment Information										Retrieval Information												
							Month	Day	Time	Latitude (N)			E or W	Longitude			Average bottom depth	Average gear depth	M or F	Month	Day	Time	Latitude (N)			E or W	Longitude		
										Deg.	Min.	Sec.		Deg. (100)	Min.	Sec.							Deg. (100)	Min.	Sec.				
1	36	N	CS4	2	R	01 24	1103	55	45	22	W	64	14	55	106	73	F	01 24	1215	55	43	32	W	64	15	01			
1	37	N		2	R	01 24	1602	54	32	39	W	65	18	27	111	102	F	01 24	1815	54	33	59	W	65	17	35			
1	38	N		2	R	01 24	1415	54	09	11	W	65	35	13	144	125	F	01 25	0028	54	11	56	W	65	35	48			
1	39	N		2	R	01 25	1602	54	32	06	W	65	18	47	111	106	F	01 25	2029	54	32	49	W	65	16	36			
1	40	N		2	R	01 25	1810	55	29	02	W	64	49	12	85	68	F	01 25	2030	55	29	40	W	64	48	16			
1	41	N		2	R	01 25	1830	54	36	09	W	65	39	21	92	65	F	01 26	0025	54	37	47	W	65	39	18			
1	42	N		2	R	01 25	2315	54	30	16	W	65	43	25	95	61	F	01 26	0335	54	30	38	W	65	42	59			
1	43	N		4	D													01 26	0900	54	13	19	W	65	35	12			
1	44	N	CS4	2	R	01 26	0601	55	02	10	W	65	33	17	91	80	F	01 26	0945	55	02	50	W	65	33	13			
	0																	01 27		55	53	12	W	66	31	10			

Page _____ of _____ for transmission Rev. 09

Observer Haul Form

Page 1 of 1

Cruise	Permit	Year
20401	4389	2009

Observer name Davey Jones
 Vessel name Sierra Madre

Resubmission
(Circle All Changes)

Haul No.	Haul sampled by (cruise no.)	RST on haul? (Y=on, N=off, X=NA)	RRT on break? (Y=on break, N=no break)	% Monitored for marine mammals	Trawl vessels			Longline and Pot Vessels				
					Vessels total catch estimate in mt	Estimated discard weight in mt	Observers catch estimate in mt	# of segments in set	# of hooks per segment	Total hooks or pots in set	Back distance	
36	20401	X	N	0	90.00	0.0	91.72				56782	
37	20401	X	N	100	28.00	0.13	29.43				78910	
38	20399	X	N	100	36.00	0.0	37.55				12345	
39	20399	X	N	100	25.00	0.0	26.15				56782	
40	20401	X	N	0	38.00	0.0	39.50				78910	
41	20401	X	N	100	39.00	0.0	39.90				56782	
42	20399	X	N	100	37.00	0.0	38.32				12345	
43	0	X	N	0	162.00	.	163.24				56782	
44	20401	X	N	100	38.00	0.0	38.96				12345	
0								offloading @ Dutch Harbor city dock				

Page _____ of _____ for transmission Rev. 09

Figure 6-2 Examples of VHF and OHF Form data from a C/P mothership

LONGLINE DATA COLLECTION



Table of Contents

List of Priorities	7-3
Safety Concerns on Longliners	7-3
General Description of Operations	7-3
Longline Catcher Processor (C/P) Vessels	7-4
Longline Catcher-Only Vessels	7-4
Offload Data for Longliners.....	7-5
Fishing Effort Information	7-6
Information to Transfer from the DCPL.....	7-6
Assuring DCPL Accuracy	7-7
Estimating Discards.....	7-8
Completing the Vessel Haul Form	7-9
Completing the Observer Haul Form.....	7-11
Verifying Gear.....	7-13
Counting Hooks	7-13
Verifying the Number of Segments in a Set.....	7-14
Calculating Total Hooks in the Set.....	7-15
Calculating Total Hooks in Your Sample.....	7-15
Composition Sampling Guidelines.....	7-16
Selecting Sets to Sample	7-16
Preferred Sampling Method.....	7-17
Longline Samples and Subsamples	7-17
Number of Samples per Sampled Set.....	7-17
Sample Size Considerations	7-18
Sample Bias	7-18
Random Sampling on Longliners	7-18
Spatial Frames on Longliners.....	7-19
Temporal-Spatial Sampling Frames on Longliners	7-20
Systematic Sample Frames on Longliners	7-22
Tally Composition Samples	7-24
Method for Tallying Predominant Species	7-24
Method for Tallying Non-predominant Species.....	7-24
Method for Tallying Halibut	7-24
Method for Tallying Predated Items	7-25
Species Identification Rules.....	7-26
Weight Samples	7-29
Weight Samples from Inside the Tally	7-29
Weight Subsamples from Outside the Tally.....	7-30
Managing Weight vs. Tally Data	7-31
Halibut Injury Assessments	7-32
Careful Release Methods for Halibut.....	7-32
Seabirds	7-32
Estimating Percent Retained	7-33
Specimen Collection on Longliners	7-33
Individual Fishing Quota (IFQ).....	7-34
CDQ Specific Information for Fixed Gear Catcher Vessels	7-35
CDQ Specific Information for Fixed Gear Catcher/Processors.....	7-36
Deck Form Instructions.....	7-36
Paper Form Instructions	7-39
Reviewing Forms for Errors.....	7-41

<u>TERMINOLOGY</u>
Flag pole - Aluminum pole with a float that is often topped with a flag, radar reflector, or strobe light
Buoy line - The length of line connecting the buoy assemblage to the anchor.
Running line - The length of line connecting the anchor to the baited gear.
Groundline/Mainline - The length of line to which all the hooks are attached - the “backbone” of the gear.
Skate/Tub/Coil - A segment of the groundline within the set or magazine.
Magazine (Mag) or Rail - A term used to describe a segment of gear within a set. The length of this segment of gear is dictated by the length of the magazine rack on which the hooks and groundline are hung.
Gangion - The length of line connecting the hook to the groundline.
Cannonball - Lead weights attached to the groundline between gear segments, helping to sink the gear and keep it on the sea floor.
Setting Chute - A metal trough that guides the baited gear out a hatch or off the stern of the vessel.
Autobaiter - A machine that cuts bait and places it on the hooks as the groundline is being set.
Block/Hydro/Hauler/Gurdy - Hydraulically driven wheel that the groundline is placed into during gear retrieval. As the wheel spins the groundline is brought on board.
Combi - A machine which hangs gear on the magazine racks as it is brought on board. This term may also refer to a crew member that works both in the factory and on the deck of a catcher processor.
Crucifier - A pair of horizontal or vertical steel rollers with only enough space for the groundline to pass between. Fish are removed from the hooks as they hit the crucifier.
Magazine rack (mag rack or rails) - Metal rails on which the gear hangs prior to setting. The groundline hangs on the metal rail by the groundline hooks.
Roller station/pit - The area where fishermen (rollermen) stand while retrieving the line and gaffing fish.
Rollerman - The crewman in the roller station during the retrieval of the gear. The rollerman lands any commercially valuable fish and prevents any non-commercially valuable fish from being landed.
Roller - A device made up of one or more metal pins that spin, allowing the groundline to be pulled up and over the rail of a vessel during retrieval such that tension and friction on the line is reduced.
Turning/Overhauling gear - Term used to describe the work involved in straightening hooks, replacing gangions, or splicing the damaged groundlines.
Drop-off - Those organisms that fall or are knocked off a hook prior to their being landed.
Horn Off - To knock organisms off of a hook using the butt of a gaff or the horns of the roller.
Hook Counts - The average number of hooks per segment of gear.
Mustang Suit - Insulated and waterproof coveralls worn in the cold winter months while sampling on deck.
Set - The entire length of groundline from the first hook to the last hook, also referred to as a “string” of gear.
Segment of Gear - A standard unit of gear. This could refer to a mag, skate, tub, rail or coil of gear.

Figure 7-1 Longline Vessel Terminology

LIST OF PRIORITIES

- Your safety!
- Collect data and specimens from marine mammal and endangered seabird mortalities.
- Rehabilitate endangered and threatened seabirds.
- Record the vessel's total fishing effort for every set retrieved.
- Determine average hooks per segment and verify total segments per set.
- Sample for species composition.
- Send data to FMA as directed (see "Sending Data" on page 2-26.).
- Document any compliance concerns.
- Measure and assess injury of Pacific halibut.
- Measure and sex other prohibited species.
- Collect otoliths and sexed lengths from requested species.
- Record calculations and daily notes.
- Complete special projects.
- Record sightings of seabird "species of interest."
- Record marine mammal sightings.

SAFETY CONCERNS ON LONGLINERS

It is always your highest priority to stay safe and be aware of your surroundings aboard every vessel. Remember that every vessel is different and fishing situations are constantly changing. There are several safety concerns specific to longliners.

When sampling on longliners, you stand outside for long periods of time and are exposed to the elements. In the winter months, you could experience freezing conditions, snow, spray, and high winds. Summer weather can be chilly. The Observer Program provides Mustang suits and you are strongly encouraged to bring additional winter clothing if you know you will be deployed on a longliner.

On some vessels the "tally station" (where you stand to tally species composition samples) is on the deck above the rollerman. On others, you sample next to the roller station (also called the haul station). Roller

stations are usually open areas near the water line. It is not uncommon to have a wave come through the roller station and you need to be alert to this possibility. Additionally, the roller station is full of moving hooks and line. When moving line wraps around an arm or leg, it can drag a person into machinery. Moving hooks are also a threat. It is not uncommon for crewmembers to be seriously injured by incoming *and* outgoing hooks.

The Observer Program expects you to be proactive about your own safety by wearing a personal flotation device whenever you are tallying or working on deck. You should always notify the captain or crew if you plan to be, or think you will be, out on deck alone.

GENERAL DESCRIPTION OF OPERATIONS

Nearly one third of all observer days are spent aboard longliners. The primary target species in the longline fisheries are Pacific cod, sablefish (black cod), Pacific halibut, and turbot. Often, longline vessels also retain incidentally caught species such as skates, rockfish, arrowtooth flounder, and pollock. The species retained depends upon fishing regulations, such as IR/IU, and upon market prices. Some incidentally caught species are only retained if market prices are high at the time.



Longliners in the North Pacific fish with baited hooks on a line that lies on or near the sea floor. The "backbone" of the gear is the line or "groundline." The length of the groundline depends on the size of the vessel and the species targeted. Hooks are attached to the groundline by another

thinner line, called a gangion (pronounced "gan-yun"). The length of the gangion and the distance between gangions is different depending on the target fishery and vessel. There is an anchor on each end of the groundline (there may be more along the line) and buoys are attached to each of the anchors by buoy lines (see Figure 7-2).

Longline fishers further divide their gear into smaller segments, in order to handle it aboard the vessel. A longline haul (referred to as a "set" or "string") consists

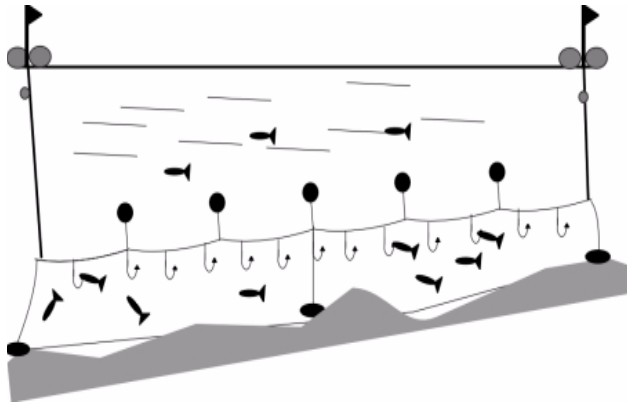

Figure 7-2 Typical Longline Configuration

of several segments of gear tied together by the groundline. Segments of gear can be configured as magazines (“mags”), rails, skates, coils, or tubs. The crew may either use these terms interchangeably or to indicate a specific amount of gear.



Your vessel may call segments of gear “mags,” skates, tubs, coils, racks or rails. We’ll just call them segments!

On some vessels, hooks are baited by hand and the gear is set directly from tubs or canvas mats. Crew tie gear together by the groundline just prior to, or as, it is set. On other vessels, a mechanized “autobaiter” is used to bait gear and the gear is deployed from this machine. Longline gear is set by dropping the buoy and anchor from one end of the groundline out the aft of the vessel. The rest of the gear quickly trails out as the anchor sinks. On the last segment of the set, another anchor and buoy are tied to the end of the line and deployed. The gear is allowed to soak for some time before retrieval.

Longline gear is retrieved by pulling in the groundline so that the hooks come aboard one at a time. The line comes in over the roller, through the crucifier, over the block, and then is either coiled or hung onto racks by the hooks.

Usually longliners set multiple strings, let them soak, and then rotate between hauling and resetting the gear. This cycle may be continued for many sets per day.

Longline Catcher Processor (C/P) Vessels

Longline C/Ps usually conduct fishing operations 24 hours a day, 7 days a week, and have crewmembers working in shifts. You will need to schedule your work time not only to achieve sampling objectives but also to get adequate rest. Lack of adequate rest is a safety concern. Your safety is the highest priority!

Processing strategies aboard C/P longliners will vary vessel to vessel, but generally speaking the operation can be summarized as follows: 1) as the gear is retrieved, fish are removed from the hooks by the crucifier or rollerman and enter the factory area through a series of conveyor belts or troughs, 2) in the factory, fish are mechanically or manually sorted by species and size, 3) processed fish are panned and frozen, and 4) finished product is stored in freezer holds.



To sample effectively aboard longliners, you need to communicate with the crew, especially with the rollermen. This can be difficult aboard C/Ps because the rollermen may not always be able to see you, hear you or understand you. Upon boarding a vessel, seek out the factory manager(s) and the rollermen. Explain your needs before they begin setting gear and you begin sampling. Experienced crew may have suggestions based on how they have worked with previous observers. This may be good information, but you alone need to decide where and how you will sample to obtain the best data. Prior to the first gear retrieval, work out a communications system with the rollerman. For every sampled set, inform the rollerman of your sampling needs. Try different techniques and be creative to achieve your sampling goals.

Longline Catcher-Only Vessels

Catcher-only longliner vessels are similar to C/P longliners in that the gear is deployed and retrieved in a similar manner. Most of the differences between the two vessel types are in the scale of operations. Catcher-only longliners tend to have smaller crews, set fewer hooks and catch less fish. Most catcher-only vessels hand bait their hooks, but a few use autobaiters. Some will set and retrieve gear such that the entire crew gets a 6-8 hour sleep break.

Additionally, catcher-only longliners periodically deliver their catch to processors. You may get some downtime on the way to and from town to complete paperwork and catch up on sleep.



When choosing a sampling area on a catcher-only longliner, work closely with crew members. Space is limited and there may not be a permanent observer sampling station. Be creative; you may need to use baskets or bin boards to construct a sample table, or use the hold hatch cover. Look around, talk to the crew, and use what space is available.

OFFLOAD DATA FOR LONGLINERS

Observers on catcher longliner vessels must report offload information on the Vessel/Plant offload form. Data for the Vessel/Plant offload form may be obtained from the Alaska Department of Fish and Game (ADF&G) fish ticket, electronic scale readout, scale weights recorded by a factory representative, the plant's NMFS logbook as well as from observations by the observer. *If you are on a vessel equipped with ATLAS you must maintain a set of Offload paper forms in addition to sending these data electronically.*



The Vessel/Plant Offload Form is used by plant observers as well. For information on how to complete the Vessel/Plant Offload Form as a plant observer please refer to page 9-6.

Cruise Number, Permit, Year, Observer Name, and Vessel/Plant name: Enter the cruise number supplied in your training or briefing. Enter the vessel permit found in the manual on page A-25. For “Year” enter only the last two digits (*e.g.* “09”). Enter your name and the name of the vessel to which you are assigned.

Resubmission: Circle “Resubmission” if you are sending changes to data previously faxed. *Also, please circle the items that have changed since your last transmission of the data; this will aid keypunchers in making the appropriate modifications to your data.* You do not need to start a new form after faxing.

Processor Name and Processor Permit: In the box in the upper left hand corner, fill in the name and processor permit for each of the plants to which your vessel delivers. You only need to record each plant once for each data set. There is a list of processor permits for shoreside or floating plants and motherships on page A-23. If your vessel delivers to a plant that is not on the list, enter 99999 (for “unknown”) and contact NMFS staff for advice.

Trip Number: Enter the number of the trip during which most of the fishing for the offload occurred. If the vessel made more than one trip to catch fish for the offload, record the trip that includes the majority of the hauls. In ATLAS, the “trip start date” will be auto-filled based on the trip that you selected.

Offload Number: All offloads must be recorded and assigned a number. Offload numbers must be unique for the cruise/vessel and should be sequential and ascending, beginning with “1.”

Completion Date: Enter the month and day the offload was completed. Write the dates in two digit format.

Gear Type and NMFS area: These columns are used by plant observers only. Leave these columns blank.

Total Delivered. LB or MT: Record the total round weight delivered to the plant for that trip. Delivery weights can be entered in either pounds or kilograms. Delivery weights recorded in pounds must be recorded to the nearest whole pound. Weights reported in metric tons must be reported to the nearest 0.01 of a metric ton. Remember that when cut or bled fish are delivered, the round weight must be used. *Round weights are listed at the bottom or end of the fish ticket. Do not include weights of halibut from IFQ halibut deliveries.*

Total Pollock Weight, Were all Groundfish Weighed?, ADF&G Number of Delivering Vessel: These columns are used by plant observers only. Leave these columns blank.

Receiving Processor Permit Number: For each offload, record the processing plant’s permit number. The permit numbers should be one of those you listed under Processor Name and Processor Permit Number described above. If a delivery is split and sold to more than one processor, you should make an entry on the

LONGLINE DATA COLLECTION: Fishing Effort Information

Vessel/Plant Offload Form for each delivery. If this, or any other incident out of the ordinary occurs, please note the circumstances in your logbook.

Was Catch Sorted (Y/N): Record a “Y” for any delivery that was sorted at sea. Record an “N” if the crew did not sort the catch before delivery.

Tender offload (Y/N): Record a “Y” if your vessel acted as a tender by receiving catch from another vessel. Otherwise enter an “N.”

ADF&G fish ticket number: Record the fish ticket number associated with the delivery for this vessel. As a vessel observer this number will be taken directly from the fish ticket. Record the number exactly as it appears on the fish ticket. If you did not receive a fish ticket, this field may be left blank. If more than one fish ticket was associated with the same offload, record the additional fish ticket number(s) below the first entry for the delivery.

Determining Delivery Weight

When the vessel delivers its catch to a processing plant, the fish are weighed. The scales at each plant are tested by the State of Alaska annually and they do not need to be tested daily for you to use this weight as a delivery weight. The delivery weight information must be verified by either yourself or the plant observer. Ultimately, the data used is yours, so do not rely on plant observers to verify your delivery weight unless they have agreed to do so. Plant observers need to give you documentation on how verification was done when *they* complete this task. For more information on this aspect of a plant observer’s duties see “Delivery Worksheet Verification” on page 9-4.



When reporting delivery weight on the Plant/Vessel Offload form, you must verify the delivery weight. You are responsible for knowing and documenting how all your data were derived!

Prior to 2008, non pollock catcher vessel observers did not report total delivery weight. As a result, plant personnel may not be accustomed to providing this information to non pollock observers. Work with the plant observer and plant personnel to obtain the fish ticket for your delivery. If a fish ticket is not available, you may obtain your total delivery weight using an alternate method. This includes, but is not limited to, direct observations of scale weights during the offload,

verbal confirmation from plant personnel, skipper estimates, or independent measurements. The exact source of delivery weight information will be specific to each scenario. Regardless of how the weights are determined, always document your methods in the daily notes section of your observer logbook.

In the majority of situations, the fish ticket will be the best source of data for determining delivery weight. Plants are allowed to record the number only of prohibited species, however fisheries managers need weight data as well. For observers on non pollock catcher vessels, if you are using the fish ticket for a delivery weight and the fish ticket does not have weights for all species, sum all the weights that were provided on the fish ticket and enter that value for the total delivery weight. Document the situation in your observer logbook. For information on interpreting fish tickets and tips on how to avoid potential errors see page 9-13.

FISHING EFFORT INFORMATION

For every set retrieved while you are on board, you need to record set information. You record this information directly from the captain’s Daily Catch Production Logbook or DCPL. Under regulation 50CFR679.5, observers have the right to inspect and copy from the DCPL and any other documentation pertaining to fishing effort.

Vessels Fishing IFQ

All longline and pot vessels (both IFQ and non-IFQ) use the same type of logbook. Data is entered differently depending on whether the vessel is fishing for IFQ species or not. An entry greater than 0.00 in the columns “IFQ Halibut” and/or “IFQ Sablefish” indicates IFQ fishing (see Figure 7-3). For a more detailed description of IFQ, see page 7-34.

Information to Transfer from the DCPL

Transfer the following information from the vessel logbook to your Vessel Haul Form and Observer Haul Form (see Figure 7-14 for examples of proper documentation for these data).

- Individual Fishing Quota (IFQ), Yes or No
- Community Development Quota (CDQ) group number, if applicable
- Date and Time of Gear Deployment

LONGLINE DATA COLLECTION: Fishing Effort Information

- Date and Time of Gear Retrieval
- Position of Gear Deployment (latitude and longitude)
- Position of Gear Retrieval (latitude and longitude)
- Average Sea Depth
- Number of Skates Retrieved (subtract any lost segments)

Assuring DCPL Accuracy

Before copying anything from the vessel logbook to your data forms, make sure you understand exactly what information the captain is documenting. You must determine the accuracy of the information and whether it represents the information you need to report. For example, on the Vessel Haul Form (VHF), the deployment time must indicate the first hook in the water. Does the captain know that this is the information you need and is s/he recording deployment times of the first hook in the water, not the last? Don't assume that the vessel captain knows what data you need to collect!

In addition, record information on any problems associated with the retrieval of the longline gear. This information is not recorded in the vessel logbook. Ask the person responsible for logbook entries to record problems with the gear for you somewhere on the logbook page or on a separate page.

There are both newer and older versions of the DCPL with some variations in format that are valid for use. Please consult the captain if you have any questions regarding the DCPL entries.

Revised: 10/28/05

Expiration Date: 09/30/2008
WHITE - Vessel Copy; Keep in Logbook
 GREEN - IFQ Description
 GOLD/RED - Observer Copy
 YELLOW - H&S Copy; Retain

CATCHER/PROCESSOR DCPL LONGLINE AND POT GEAR				VESSEL NAME <i>Lilly Longline</i>		FEDERAL CRAB VESSEL PERMIT NO.		DATE (M-D-Y) <i>08-17-2009</i>		PAGE <i>146</i>	
				OPERATOR NAME AND SIGNATURE <i>Jack Sparrow</i>				ADP & PROCESSOR CODE <i>134256</i>		FEDERAL FISHERIES PERMIT NO. <i>6543</i>	
IDENTIFICATION	INACTIVE	START	END	REASON	FEDERAL REPORTING AREA <i>517</i>	CREW SIZE <i>16</i>	GEAR TYPE (check one) <input type="checkbox"/> Pot <input type="checkbox"/> Jig <input type="checkbox"/> Troll <input type="checkbox"/> Handline <input checked="" type="checkbox"/> Hook & Line <input type="checkbox"/> Other If Hook & Line, complete boxes immediately below.				
	IFQ		CDQ		OBSERVER INFORMATION		GEAR TYPE (check one) <input checked="" type="checkbox"/> FIXED HOOK <input type="checkbox"/> JIG <input type="checkbox"/> TROLL <input type="checkbox"/> HANDLINE <input type="checkbox"/> OTHER LENGTH OF SHANK (feet) <i>3500</i> Size <i>13</i> Spacing (feet) <i>3-5</i> No. Per Skate <i>200</i>				
	Operator IFQ Permit #	IFQ Permit #	CDQ Group # <i>C54</i>	CDQ Permit #	NO. OF OBSERVERS ONBOARD		OBSERVER NAME & CRUISE # <i>Shiela Sunfish 14821</i> OBSERVER NAME & CRUISE # <i>Sammy Salmon 14795</i>				
	IFQ Permit #	IFQ Permit #	Halibut CDQ Permit #								
IFQ Permit #	IFQ Permit #										
MANAGEMENT PROGRAM <small>(Check if applicable and enter number)</small>				<input checked="" type="checkbox"/> CDQ <input type="checkbox"/> Exempted <input type="checkbox"/> Research <input type="checkbox"/> AIP No. <i>12345</i>		If same as previous page, check <input type="checkbox"/>		Complete these boxes once per delivery			

SET #	DATE SET	DATE HAILED	LOCATION OF SET		BEGIN & END DEPTH (Feet)	IFQC OFFICE USE ONLY	GEAR ID	NUMBER OF SKATES OR POTS	IR/II SPECIES		TARGET SPECIES CODE	CDQ/IFQ HALL/ITTT (Pounds)	IFQ SABL (Pounds)	CR CRAB	HAUL WEIGHT (lb +/-)	BIRD AVOID GEAR
			BEGIN POSITION LATITUDE LONGITUDE	END POSITION LATITUDE LONGITUDE					Round Catch Weight	WT (check 0 if nil)						
105	08-16	08-17	56°45.45 N	172°27.36 W	80		A 17	1	110	10000	110				10650	1
	1030	08-10	172°13.16 W	56°43.10 N	72		A 15	0	110	11000	110				11500	1
106	08-16	08-17	56°39.14 N	172°15.44 W	73		A 17	0	110	13000	110				13600	1
	2030	1045	172°28.23 W	56°43.20 N	65				270	400						
107	08-17	08-17	56°38.51 N	172°27.87 W					110	500						
	0425	1800														

SPECIES CODE	110		270		700	
	8	8	13			
PRODUCT CODE						
BALANCE FORWARD	22000	1100	600			
DAILY TOTAL	33200	1500	250			
WEEKLY CUMULATIVE TOTAL	55300	2600	850			

DATE	8-17		8-17		8-17	
	200	700	101	931		
SPECIES CODE						
PRODUCT CODE	98	98	98	98		
BALANCE FORWARD	121	300	150	0		
DAILY TOTAL	10	100	70	30		
WEEKLY CUMULATIVE TOTAL	181	400	220	30		

Figure 7-3 Example of a Catcher Processor Longline Vessel Logbook

LONGLINE DATA COLLECTION: Estimating Discards

For every set retrieved, you will need to verify the following entries:

- **Date and Time of Gear Deployment and Retrieval:** The documented time of gear deployment should represent the first hook in the water and the documented time of gear retrieval should represent when the last hook came out of the water. Whenever possible, independently note the time when the crew begins to deploy hooks in the set and the time when they retrieve the last hook for that set. You will not be able to verify deployment or retrieval times for all sets. For unverified sets, rely on the information provided by vessel personnel in the vessel's logbook. If your vessel's logbook contains erroneous times, let the officer in charge of the logbook know about the error. If the incorrect data continues to be logged, consult NMFS for advice on how to record your set data.
- **Position of Gear Deployment and Retrieval:** The latitudes and longitudes entered in the "Begin Position of Haul" and "End Position of Haul" columns in the vessel's logbook should be the position of the first hook set and of the last hook retrieved. The captain or mate read these positions from the GPS navigation systems located on the bridge. Occasionally check that the positions listed in the vessel's logbook match the GPS readings. The person responsible for the logbook may have incorrectly entered the position. Question any large changes in position between one set and the next or long distances between set and retrieval positions.

ESTIMATING DISCARDS

The weight of all at-sea discards must be estimated independently by the on board observer(s). Discard information is collected in conjunction with percent retained data. By recording discard estimates in a separate field in the data, fisheries managers are able to quantify discards at both the vessel and fleet level. The time spent on this information should be nominal. Refer to "Estimating Percent Retained" on page 7-33 for further discussion of estimating percent retained on longliners.

The process of estimating total discards differs between catcher vessels and catcher processors. Regardless of the vessel type, *obtaining a discard estimate should*

only take a few moments. On catcher vessels, discards are generated on deck, where you can see all the fish at one time. On catcher processors, discard can occur on deck or anywhere in the factory. Familiarizing yourself with the flow of fish on the vessel will help you to recognize areas of potential discard. If vessel personnel sort out and discard undesirable fish, or if portions of the catch are dumped overboard, you must estimate the total weight of these discards. Account for catch discarded in one of the following ways

1. An actual measurement of the discard contributes the best information, but this method may not be feasible on your vessel type. If the discards are few, try to weigh everything using your observer scales. If you can not do so, consider the other options discussed here.
2. Volumetrics may be used to determine a discard estimate. If the vessel retains all the discard in a tote, or checker bin, the volume of this discard, multiplied by a density, will yield an estimate. When using volumetrics for determining a discard estimate it is acceptable to use known references rather than actual measurements. This method is uncommon for longliners.
3. A simple visual estimate is the easiest and most common method of obtaining an estimate of discards. Using visual cues such as a how many baskets of discards a sample generated can help you to quantify what you are seeing. For example, if all your samples resulted in one basket of discards (approximately 40 kg), and those samples were about 1/6th of the entire haul, you can assume there were about 6 baskets of total discards, or about 240 kg (0.24 metric tons).

You can look at production data for the haul to get a sense of whether or not your estimate is reasonable. Production data is the weight, after processing, of retained catch. Divide this by the appropriate product recovery rate (PRR) to determine round catch weight of the species, before production. Product recovery rate codes can be found in Appendix F on page A-18. If your discard estimate doesn't make sense in relation to this value, modify it. For example, if you estimate that 5 percent (by weight) of total catch was discarded, and document this as 5 tons of discard, but the round weight of processed fish is only 10 tons, the discard estimate of 5 tons is actually 35 percent of total catch. You would reduce your estimated weight of discards to reflect 5 percent of total catch weight.

Also, refer to the discards information recorded by the vessels in the DCPL or the DFL to verify your independent observations. *Do not use these entries to provide discard data!*

RECORDING OHF AND VHF DATA

All calculations must be recorded in your logbook. Keep accurate, complete records throughout your deployment! This will enable you to provide staff with pertinent cruise details at your debriefing interview. *You are responsible for your work and must be able to recall all methods and techniques used to collect your data.*

Completing Haul Forms on Longline Vessels

In addition to entering data and calculations in the observer logbook, all observers must complete a summary of fishing effort and total catch. This information is recorded on the Vessel Haul and Observer Haul Forms (VHF and OHF). *If you are on a vessel equipped with ATLAS you must maintain a set of paper forms in addition to sending these data electronically.*

The fishing effort information required on the Vessel Haul form should come from the vessel's NMFS logbook. Additionally, observers must retain the goldenrod copies of the vessel logbook pages pertinent to their cruise. The goldenrod pages are submitted with all other data for the vessel.

When recording information on the VHF, check carefully to ensure that the data are accurate, reasonable and there are no transcription errors. The OHF contains entries for calculated values. Double check your work! Instructions on how to fill out each of these forms follows.



Keep the goldenrod copy and/or printed copies of the logbook in a secure place. These forms are confidential, and must not be seen by crew from other vessels.

COMPLETING THE VESSEL HAUL FORM

An entry must be made on the VHF for every day you are assigned to a vessel. Start your entries with the day you embark the vessel and end them on the day you disembark the vessel. A non-fishing day must be recorded for each day no fishing occurs, such as during a delivery or day in port. *Skip a line between each*

day's entries. Make sure that all of the sets retrieved during your deployment are recorded on your VHF whether you sampled them or not. Keep separate sets of forms for each vessel to which you are assigned. Refer to Figure 7-14 for an example of a longline Vessel Haul Form.



Longline sets are documented in the order they were retrieved not the order in which they were set. This means you may have out of sequence set numbers. It is OK if your set numbers are out of order because the vessel retrieved gear out of order.

Cruise, Permit, Year: Enter the cruise number supplied in your training or briefing. Enter the vessel permit number found in "Vessel/Plant Names and Permit Numbers" on page A-25. For "Year" you can enter the full year or just the last two digits (*e.g.* "09").

Gear Type: Enter the appropriate gear code in this column. The Gear Type codes are:

- 8 - Longline vessels.
- 7 - Jig vessel.
- 6 - Pot vessels.

Observer name/Vessel name: Enter your name and the name of the vessel.

Resubmission: Circle "Resubmission" if you are sending changes to data previously faxed. *Also, please circle the items that have changed since your last transmission of the data; this will aid keypunchers in making the appropriate modifications to your data.* You do not need to start a new form after faxing.

Trip Number: Enter the trip number for the set. Trips should be numbered consecutively starting with the number one. Refer to the chapter "TRIP INFORMATION" for more details on documenting trips.

Haul Number: There must be an entry for every set of gear retrieved. Each set should have its own distinct number. You may want to number your sets so that they correspond to the set numbers in the vessel's logbook. This should make it easier to track the sets and enter the corresponding data on your forms, especially if gear is retrieved out of order. Enter a "0" in this field for all non-fishing day entries.

LONGLINE DATA COLLECTION: Completing the Vessel Haul Form

IFQ? Y or N: Was the particular set fished under an Individual Fishing Quota? Enter an “N” if it was not. Enter a “Y” if it was. Check the IFQ permit number columns in the vessel’s logbook. An entry in these columns indicates IFQ fishing. For a more detailed description of IFQ, see page 7-34.

CDQ group #: Record a “C” and the two digit CDQ group number for each set taken using the Community Development Quota (CDQ). This number can be found at the top of the vessel logbook in the box marked “CDQ group #.”

Vessel Type: Enter the appropriate code.

- 1 - Catcher Processor (C/P) - vessel processed and froze it’s own catch.
- 3 - Catcher Vessel- vessel has retained fish for delivery to a shore-based plant, a floater or mothership.
- 5 - Bait- vessel used the catch as bait, or sold the catch directly to other vessels to use as bait.

Gear Performance: Enter the appropriate code. This code indicates if there were problems with the gear that may have affected the amount of fish caught. There are seven different codes that are applicable to longline fishing.

- 1 - No problems.
- 2 - Crab pot(s) in set.
- 5 - Problem: Other problem, write an explanation in your logbook daily notes.
- 6 - Some or all gear lost.
- 7 - Considerable predation of the catch by sea lions.
- 8 - Considerable predation of the catch by killer whales.
- 10 - Considerable predation of the catch by sperm whales.

Note: Document what occurred whenever you use a gear performance code other than 1 in your logbook. When codes 7, 8 or 10 are used complete a Marine Mammal Interaction and Specimen Form (see page 12-2).

Location Code: Enter “R” if the location is a retrieval position. Enter a “D” if you are on a mothership receiving catch and are unable to obtain a retrieval position (not common for longline vessels). Enter “N” for each day that no gear is retrieved (vessel is in port,

steaming, or waiting out a storm). There must be a position entry for every day you were on board the vessel. For all non-fishing days, enter a “0” in the Haul Number column, a location code of “N,” and enter the latitude and longitude of the vessel at or around noon, Alaska Local Time (ALT) in the “End Position of Haul” column. If a non-fishing day occurs in between trips, leave the trip number column blank. A list of common ports follows.

<i>Port</i>	<i>Latitude</i>	<i>Longitude (W)</i>
Adak	5153	17639
Akutan	5408	16546
Cordova	6033	14545
Dutch Harbor	5353	16632
Homer	5938	15133
Juneau	5810	13418
King Cove	5503	16219
Kodiak	5742	15215
Sand Point	5520	16030
Seattle	4742	12213
Seward	6007	14927

“Deployment Information” Tab

Month/Day: : Enter the date the *first hook* of a set was deployed. The month and day must be two digits (e.g. 01/01 for January 1st).

Time: Enter the time the *first hook* of a set entered the water. Verify that the captain is entering this time, not the time the anchor or flag entered the water. All entries must be in Alaska Local Time (ALT). Enter four digits with no colon marks.

Latitude: Enter the latitude of the vessel when the *first hook* of the set was deployed. This position can be found in the “Begin Position” field in the vessel logbook. Vessels may record their positions to the nearest minute, seconds or hundredths of a minute. If the vessel listed their positions to the hundredths of a minute, you must convert this value to seconds. To convert from hundredth of a minute to seconds, multiply the hundredths of a minute value by 60 (see following formula). Do not enter degree marks or include an “N” to indicate North for latitude.

E or W: Fill out the “E or W” column to indicate if the longitude is east or west of the 180 degree line.

Longitude: Enter the longitude of the vessel when the *first hook* of the set was deployed. This position can be found in the “Begin Position” field in the vessel logbook. One hundred degrees of longitude are assumed, so do not enter the leading “1.” Record the position to the same level of accuracy as it is recorded in the vessel log book. Vessels may record their positions to the nearest minute, seconds or hundredths of a minute. If the vessel listed their positions to the hundredths of a minute, you must convert this value to seconds. To convert from hundredth of a minute to seconds, multiply the hundredths of a minute value by 60 (see formula above). Do not enter degree marks.

Formula for conversion of seconds to minutes:

Hundredths of minutes x 60 = Seconds

If the vessel is not recording seconds or hundredth of seconds, leave this field blank. Coordinates with minutes greater than 59 are not valid. Enter only *numbers* in the latitude and longitude columns. Do not enter any marks or slashes to indicate degrees, minutes, or seconds.

Average Bottom Depth: Average begin and end depths found in the vessel logbook. Round the depth to the nearest whole number. Do not enter decimals in this field.

Average Gear Depth: Leave this column blank.

M or F: The DCPL instructions request that the bottom depth be recorded in fathoms (F). Check with the captain to ensure that this is the case.

“Retrieval Information” Tab

Month and Day: Enter the date the *last hook* of a set is retrieved. Month and day must both be two digits (*e.g.*, 01/01 for January 1st). Attribute the set to the *day retrieval is completed (i.e. record sets in order of retrieval date)*.

Time: Enter the time the last hook was retrieved. You can find this time in the “Time Hauled” field in the vessel logbook. All entries must be in Alaska Local Time (ALT). Enter four digits with no colon marks.

Latitude and Longitude: Enter the latitude and longitude of the vessel when the *last* hook of the set was retrieved. This position can be found in the “End Position” field of the vessel logbook. Follow the same rules as described for deployment.

COMPLETING THE OBSERVER HAUL FORM

An entry must be made on the OHF for every set made by the vessel, whether it was sampled or not. Follow the same guidelines as for the VHF. Include the same spacing and “0’s” for non-fishing days. *Skip a line between each day’s entries.* When placed side-by-side, you should be able to read the VHF and OHF forms straight across all rows. The information for a haul on one form should line up with the same haul’s information on the other form. Always start a new OHF when you start a new VHF. Keep a separate set of data forms for each vessel to which you are assigned. Refer to Figure 7-14 for an example of a longline Observer Haul Form.

Cruise, Permit, Year: Enter the cruise number supplied in your training or briefing. Vessel permits numbers are listed by vessel on page A-25. For “Year” you can enter the full year or just the last two digits (*e.g.*, “09”).

Observer’s Name/Vessel Name: Enter your name and the name of the vessel.

Resubmission: Circle “Resubmission” if you are sending changes to data previously faxed. *Also, please circle the items that have changed since your last transmission of the data; this will aid keypunchers in making the appropriate modifications to your data.* You do not need to start a new form after faxing.

Catcher Boat’s ADF&G # and Full Name of Catcher Boat box: Fill in these two items only if you are on a mothership (see page 6-1). Longline motherships are rare in the Alaskan fisheries.

Haul #: The set number must correspond with the set number on the VHF and all other data forms. Non-fishing day entries must also match the VHF with a haul number of 0.

Haul sampled by?: This field is used to indicate whether a set was sampled, and by whom. All sets must have one of the following codes in this field:

1. 0 - not sampled
2. The cruise number of observer who sampled that set



If working with another observer, divide the sets that you both sampled evenly between you. Document your system of assigning shared sets in your logbook.

RST on haul?: Enter one of the appropriate letter codes:

- Y - I used the RST and it was an “ON” haul
- N - I used the RST and it was an “OFF” haul
- X - RST is not being used, all hauls were sampled.

RBT on Break?: Enter the code as to whether or not you were using the Random Break Table.

- Y - I am on a break
- N - I am not on a break. If you are not using the RBT, this is your default code.

% Monitored for Marine Mammals: This is the percent of the gear you monitored for the presence of marine mammals. This is normally the percent of the gear that was tallied, but **may include more if you also watched the gear at other times.** Divide the number of segments of gear you watched being retrieved by the total segments of gear in the set, or divide the total time you watched gear being retrieved by the total retrieval time of the set. Multiply this number by 100, round it to the nearest whole percent, and enter it into the **percent Monitored for Marine Mammals** column. See “MARINE MAMMAL INTERACTIONS AND SIGHTINGS” on page 12-1 for duties related to marine mammals.



You may include unsampled gear as monitored for marine mammals as long as you were near enough to the line to ensure that you could have seen any mammal interactions or predated catch.

Vessel's total catch estimate in metric tons: Record the “Haul Weight” from the vessel logbook. Convert the estimate to metric tons if it is recorded in pounds,

and round to the nearest two decimal places. Show this calculation in the observer logbook. There must be an entry for every haul. This value should be recorded directly from the vessel logbook.

Estimated discard weight in metric tons: Record the estimated discard weight in metric tons, rounded to the nearest two decimal places. If there were no discards, enter a zero value in the discards column for that haul. If you do not know whether or not there were discards, leave the field blank.

Trawl Vessels Tab: The information in this tab is for trawlers only, leave these columns blank.

“Longline and Pot Vessels” Tab

of Segments in Set: Enter the total number of segments of gear in the set. Record only the amount of gear that was retrieved. *Do not include gear that has been lost in your value for total segments in a set.* The amount of gear set and lost are recorded in the vessel’s log in the “Number of Skates or Pots” columns. What captains consider to be a “skate” differs between vessels. The captain may be counting skates, mags, tubs, or coils of gear, any of which you may designate as a segment of gear. Remain consistent with what you designate as a segment of gear for the entire time you are on the vessel.

of Hooks per Segment: Enter your calculated average number of hooks per segment (see page 7-13). Use only whole numbers. Enter the average number of hooks for the type of gear segment you are using.

Total Hooks or Pots in Set: Enter the total number of hooks in a set. Total Hooks must be a whole number and there must be an entry for every set. Record only the amount of hooks that were retrieved. *Do not include hooks from segments that have been lost.*

Bird Deterrence Device:

- 1 - Paired streamer line used
- 2 - Single streamer line used
- 0 - No streamers were used
- N - Observer didn’t check deterrent type

See “Seabird Avoidance Initiatives” on page 14-5, “Monitoring Avoidance Measures” on page 14-5, the Streamer Line Schematic on page 7-32, and a summary of Avoidance Regulations on page 18-15.

VERIFYING GEAR

Resource managers calculate catch weights for longliners from the numbers you supply for sample weight, sampled hooks, and total hooks. Successful management of the longline fisheries is dependent on the accuracy of these values. ***It is crucial that the vessel's gear be independently verified by you!*** There are two gear related elements that you must verify: 1) number of hooks per segment, and 2) number of segments per set. In the following sections, methods for obtaining verified values for hooks per segment and segments per set are discussed.

Counting Hooks

One of the very first things you need to do when assigned to a longliner is determine how many hooks are on an average segment of gear. The process of obtaining this information is referred to as getting your "hook counts." ***Hook counts are the foundation of all your other data. Without these numbers, you cannot calculate how many hooks were involved in your sample and how many hooks were in the entire set!*** The species composition data you supply to the Observer Program is extrapolated to the entire set by relating hooks sampled to total hooks in the set. ***Without values for hooks sampled and total hooks in a set, it is impossible to determine the weight of fish harvested!***

Determining Average Hooks Per Segment

The captain will record a number of hooks per segment in his vessel logbook, ***but you must calculate an average hook count independently.*** The captain's estimate often reflects the number of hooks when the gear was first constructed, not the current number. As gear is used, hooks are lost and gear is spliced. Though the crew does try to keep segments relatively similar in length, and replace hooks regularly, used gear will almost always have a hook count that differs from when it was new. ***As gear is repaired over the course of a season, hooks per segment will tend to change. To account for this, hook counts must be performed on a regular basis.***

Determining average hook count is simple:

1. Count hooks on a known number of segments.
2. Divide the total number of hooks counted by the total number of segments assessed. The resulting value

represents the average hook count of a segment within the set.

3. Round this average hook count to the nearest whole number.



You must count at least 1/5 the segments, of a typical sized set of gear, at least twice per week.

$$\frac{\sum \text{number of hooks counted in each segment}}{\text{number of gear segments counted}} = \text{average hook count}$$

Hooks on Halibut vs. Sablefish Gear

Halibut gear has a slightly different configuration than sablefish gear. The gangions on halibut gear are typically farther apart, so there are fewer hooks than on an equal length of sablefish gear.



If the vessel has a Pacific halibut IFQ permit (see page 7-34), the captain may fish two different kinds of longline gear (halibut and sablefish gear) with differing numbers of hooks per gear segment in a single set.

If you are on a vessel fishing for both sablefish and halibut, talk with the captain and examine the gear to determine if 1) some of the gear is different, and/or 2) different gear is mixed within a set. The average number of hooks per segment and number of gear segments of each gear type contained within the set must be determined. Document instances when gear is mixed. Also document the average hook count per gear type, and the number of segments of each type that were within your samples and in the entire set. This information will be necessary if your data needs to be corrected later.

On your OHF, record the total segments for the set and the total hooks for the set. Leave the average hook count field blank. Make sure that your total hook count represents the correct combination of halibut and sablefish segments in the set. Refer to the following discussion on obtaining hook counts and determining average hook counts by gear type.

Methods of Obtaining Hook Counts

Accurate hook counts are essential for longline sampling. You must count the number of hooks attached to segments of gear for at least *one-fifth of a set, twice per week*, the entire time you are aboard the vessel. Update your hook per segment value each time it changes, based on your bi-weekly count. Your approach to counting hooks will depend on how the vessel is storing gear. Methods for obtaining hooks are discussed below.



Do not use the autobaiter counters to verify hook counts. These machines may not be in good repair and the hook counts are not verified.

- **Counting hooks in tubs or on magazine racks**

- Many longliners store their gear in tubs, or on “racks” (also called “mags”) prior to setting it. When the



gear is in tubs or on racks, individual hooks are readily accessible and can be easily counted. Count hooks in these configurations when the vessel is in transit or between sets. Always make sure only overhauled, ready-to-set gear is counted. Use a thumb counter to count hooks since the numbers can get very high.

- **Counting hooks on coiled gear** - A few smaller longline vessels still hand coil their gear onto canvas or plastic mats. Hooks are placed to the center of the coil, making it too difficult to get an accurate count. If the vessel is coiling their gear, you will have to count hooks during non-sample times as the gear is retrieved. *Because this gear has not been through the repair process yet, you must count gangions without hooks as well as those that still have hooks!*
- **Counting hooks as they come aboard during a non-tally period** - Since hooks come aboard one at a time, you can count them as the gear is retrieved. It is *highly recommended* that you perform this duty during units that you are not doing anything else, to ensure you are getting accurate counts.

Because this gear has not been through the repair process yet, you must count gangions without hooks as well as those that still have hooks!

- **Counting hooks as they come aboard during the tally period** - *This option should not be used by inexperienced observers and should not be used on most C/Ps because the gear is retrieved too quickly for you to obtain an accurate empty hook count!* If the gear is being retrieved slowly (*e.g.*, during sablefish and halibut fishing), catch diversity is low, **and** you are experienced in longline sampling, you may find you can perform hook counts during your tally sample by counting empty hooks as well as fish. The sum of the number of organisms you counted plus the number of empty hooks you counted in a segment is the hook count for the segment.



If you are counting hooks as the gear is retrieved, you must count gangions with no hooks as well as those with hooks - the gear likely had all the hooks when it was deployed!

Verifying the Number of Segments in a Set

In order to obtain a value for the total number of hooks in an entire set, you need to know the number of hooks in an average segment *and* the number of segments in a set. You should try to verify gear in a set for as many sets as possible, both sampled and non-sampled.



Keep in mind that on the haul form you need to report the amount of gear *retrieved*. Document the amount of segments set minus segments lost as the value for Total Segments in Set.

You may use any of the following methods to determine the number of segments in a given set:

Count segments before the set is deployed

On catcher vessels and some C/Ps, gear segments are stored in plastic tubs or coiled on canvas mats. If the vessel is using tubs, you can verify the amount of gear on board by: 1) counting the tubs prior to each set, then 2) after each set, determining how many tubs remain. Subtract this remaining number from the total number counted to get the amount of gear in the set. If the crew coils their gear onto mats, they will typically keep a haul’s worth of mats together in a stack at the combi

station. This way, they are readily available for the crew member who is coiling the gear as it is retrieved. To verify the number of segments in these situations, simply count the mats in the stack and confirm that they are all used at the end of the set.

On most C/Ps and some catcher vessels, gear is stored on metal racks, with several segments of gear attached to one another (these grouped segments are often referred to as rails or magazines). Ask the crew how many segments typically compose a full rack of gear and how these grouped segments are distinguished from one another. Every vessel differs in its techniques. Count the total number of magazines or rails before the gear is set, and then again after each set. Subtract the post-set number from the pre-set number to obtain the amount of gear set. It is a good idea to confirm that the number of segments in each magazine or rail is consistent, so make sure to randomly spot check the number of segments in some racks of gear. You may also be able to confirm segments per mag when you are tallying.

Count gear as it is being set

You may be able to count the segments of gear as they are being set, if you are present during this process and the gear is not being set too fast. Keep in mind that you do not include any lost segments in your count of total segments in the set: if gear is lost, you must subtract the amount lost from your original count.

Count gear as it is retrieved

For vessels that use smaller sets with fewer segments, it may be possible to count the gear as it is being retrieved. On many C/P vessels, this method is not feasible because the retrieval of gear may take an entire day or you may not be able to see the gear during the non-tally period.

Count gear segments on the captain's plotter

The captain may be keeping track of set segments on a plotter. If this is the case, you can count the number of distinct segments the captain has marked in a set and use this value to verify number of segments in a set.

Calculating Total Hooks in the Set

Once you have a value for average hooks per segment and total segments per set, you can calculate the total number of hooks for the entire set. Simply multiply the

total number of retrieved gear segments in the set by the average number of hooks per segment. **Remember to round your average hook count to the nearest whole number.**

average hook count	X	total # segments in set	=	Total hooks in set
-----------------------	---	----------------------------	---	--------------------

If the vessel is fishing mixed gear for halibut and sablefish, you will need to determine a separate average hook count for the two types of gear. You will also need to determine how many segments of each type are in the set. Apply the hook count value for the halibut gear to the number of segments of halibut gear in the set and apply the hook count for the sablefish gear to the number of segments of sablefish gear in the set. *Combine these two values for the total hook count in the set.* On the OHF form, record this total hook count and number of segments in the set. Do not record a value in the average hooks field.

Calculating Total Hooks in Your Sample

Average hook counts are also used to determine sampled hooks. Simply multiply the number of gear segments sampled for composition by your average hook count to determine the number of hooks sampled.

average hook count	X	total # segments sampled	=	Total hooks in sample
-----------------------	---	-----------------------------	---	--------------------------

If the vessel is fishing mixed gear for halibut and sablefish, you will need to determine how many segments of each gear type are in your sample and apply the average hook count you calculated for each gear type. Apply the hook count value for the halibut gear to the number of segments of halibut gear in the sample and apply the hook count for the sablefish gear to the number of segments of sablefish gear in the sample. Combine these two values to get your sample hook count.

The calculations for average hooks per segment, total number of hooks in the set, and total number of hooks in your sample must be documented in your logbook.

COMPOSITION SAMPLING GUIDELINES

One of the first things you should do when you arrive on a vessel is inspect your sampling station and determine a sampling system. Refer to “TRIP INFORMATION” on page 3-1 for what to look for in a sampling station. When designing your sampling system, consider:

- where to tally your sample
- where to collect and contain your weight sample
- what sampling biases could occur in your collection and how to minimize them
- how to collect your sample
- how many samples you will be able to collect
- what sample sizes you will be able to collect
- how you will process your sample
- do you need to use the Random Sampling Table (RST) or Random Break Table (RBT)

Equipment - You will need at least three to six thumb counters, a clipboard, and deck forms. Prior observers have devised many innovative techniques that have made using multiple thumb counters easier. The most common is to duct tape multiple thumb counters to a clipboard. Be creative, experiment, and find what works best for you.

Tally Station - The tally station is where you stand to count organisms as the groundline is retrieved. You must have a *clear line of sight to the groundline as it exits the water*. The Observer Program suggests that the tally station is never more than five meters from where fish are landed. From your tally station, you must be able to identify fish as they come aboard and identify drop-offs. Choose a location that is safe, away from direct wave action, and out of the way of the pole gaffer and rollerman. Often, the best place will be on the weather deck, above the roller station. *Never tally from the wheelhouse.*

Sample Station - The sample station is the location where you will weigh and measure catch. Many C/P vessels have a sample station already set up for observer use and some have motion compensated platform scales (see page 2-18). On vessels that do not have established stations, select a location that is out of wave action, out of crew traffic, and that has enough

room to store one or two baskets of fish. The location should be as close as possible to where the fish come on board. On some vessels, you won't have much choice where you set up a sampling station and you will have to work with the area available to you. Explain your needs to the crew and work with them as much as possible.

Draw a diagram of the sampling station in your logbook. In your daily notes, discuss the random sample design you intend to use. Your sample design will be put to the test once you start sampling, and you may find that you need to make some changes to it. When you have settled on a random sample design(s), fill out a Sample Design Detail form in your logbook. On this form, describe your sampling design in detail. Day to day minor adjustments to the random sample design can be documented in the daily notes section of your logbook.

Inexperienced observers may need to watch the first retrieval to familiarize themselves with the way catch is handled. Familiarity with this process will allow you to decide on a sampling system that is right for that vessel and fishery.



Observers who are experienced with the vessel type and fishery are expected to sample the first set! For these observers, it is not appropriate to take the first set off just because it is the first set!

You may alter your system as you gain experience, become aware of biases, species composition changes, or target fishery changes. Document all changes in the daily notes section of your logbook and explain why they were made. Sample designs for longline sampling are discussed in detail starting on page 7-18. If you have problems designing or implementing a sampling design, contact your ATLAS inseason advisor or other NMFS staff member as soon as possible.

Selecting Sets to Sample

On some vessels, you will be able to sample every set. This is typically the case for observers on catcher vessels targeting sablefish and Pacific halibut. If you cannot collect species composition data from all sets, you must randomly select which sets to sample using the appropriate Random Sample Table (RST) and/or Random Break table (RBT).

Please refer to “How to Use the RST” on page 2-10 for instructions on using the RST and “How to Use the Random Break Table (RBT)” on page 2-10 for instructions on using the RBT. Observers with a familiarity with the vessel type and fishery are expected to sample all sets when less than three per day are landed. When extenuating circumstances prevent this, you must document the situation in your logbook.

Preferred Sampling Method

There are several sampling methods available to you for collecting samples. These are covered in “Random Sampling on Longliners” on page 7-18. As discussed in the section “Introduction to Sampling Theory” on page 2-12, the preferred method is to take *systematic random samples*. Longline fishing is unique in that gear can span large distances. Spacing of samples throughout a set accounts for any fish stratification associated with topography changes over these distances.

To achieve systematic random sampling on longliners, the set or estimated hauling time is divided into sampling units of equal size. Units to sample are chosen using a systematic random method.

Longline Samples and Subsamples

Longline species composition sampling is unique from that on other vessel types. The collection of data regarding the types and numbers of individuals within a sample must occur independently of the actual weighing of the sampled species. It is impractical to combine the two sampling elements: the tally station is typically not close to the collection site and weighing fish while at the same time tallying is next to impossible. By physically separating tally sessions from weighing sessions, you are ensuring that the critical process of getting an accurate tally of fish in a sample is given the attention it needs.

The terms *tally-period* and *non-tally period* are used to discuss the two distinct composition data collection periods on longliners. During the tally period, *everything* that comes up on the line during randomly chosen gear segments is counted, or *tallied*. It is very important to remember that *all catch is counted*, including those species that are not retained or brought on board the vessel (drop-offs for example). During the tally period, the only thing you do is tally! The tally period always occurs as gear is being retrieved.

Tallying fish on the line is only a part of the species composition sampling process. Fisheries managers base their assessments of fish mortality rate on weight taken from the biomass. To supply resource managers with the essential information they need, you also collect weight information and biological data for the species tallied. Individuals of non-predominant tallied fish are collected by the rollerman, at your request, during the tally period. The task of weighing them is accomplished during non-tally periods, while the gear is still being retrieved.

Weights and other biological data are also needed for the predominant species, but because you need about 60 individuals total for these data, it is not practical to collect these fish during your tally period. For this reason, individuals of the predominant species are collected outside the tally period. Less frequently, you may need to collect *non-predominant* fish from outside the tally period as well. Two reasons you might resort to this are space constraints and high species diversity. Non-tally periods are also used for assessing halibut injuries and taking halibut measurements, and performing other duties.

Information from a single tally period, and any fish you collect for weights during that tally period, are recorded together as a distinct sample. Fish collected outside the tally period are recorded separately, as a subsample. Observers are asked to try and collect any subsample fish from gear segments as close to the tally period segments as possible. By doing so, statisticians and management can make the assumption that subsample fish are from the same population as the tally period fish.

A specific numbering system is used to link subsample data to tally sample data in the database. This numbering convention is discussed on page 7-37. To indicate this relationship in this manual’s text, the term “parent sample” is used. For any *subsample*, the parent sample is the sample immediately adjacent to the subsample.

Number of Samples per Sampled Set

You should take as many individual samples within a set as feasibly possible. Multiple samples, taken systematically throughout the set, capture any changes to the caught population due to stratification effects. *At*

least three discrete composition samples are required for every sampled haul to allow data users to assess sample variance.

There may be fisheries and vessel types where it is not possible to collect multiple species composition samples within a sampled set. In those instances, you must document the circumstances in your observer logbook daily notes pages.

Sample Size Considerations

When deciding the size of your tally samples, consider your general health, the size of the set and the possible species diversity. Reduce the size of your tally samples if you are not feeling well, have not had enough sleep, or if species diversity has been high.

Tally samples taken within a set should be the same size. This is easy to achieve on longliners, because the crew is working with discrete segments of gear. The total number of segments you are able to sample depends on situation specific factors, but most observers find they can sample at least 1/3 of a set and still have time to attend to their other sampling duties. If you find you can not sample at least 1/3 of a set, document the circumstances in your observer logbook and contact your inseason advisor or other FMA staff member for advice.

SAMPLE BIAS

Many longline catcher processors have incline belts that take fish from a trough in the roller station to a holding bin or processing machine in the factory. Incline belts can be a source of bias: larger fish may not make it up the incline belt at the same rate as smaller fish or visa versa. When collecting fish for weights and biological data, be sure to monitor for size bias and minimize this bias as much as you can. Often you can minimize or eliminate bias by collecting fish from before the incline belt.

If the vessel is retaining skate species, make sure that your weight sample of these organisms is not coming from only the retained skates. Crew tend to toss out skates that are too small to make into product, potentially biasing your sample and the data.

If the crew is collecting fish for you, make sure they are not size selecting fish. Discuss your needs with crew so that they know that you want a random sample with no

size bias. Sometimes crew members will sort fish for processing, not realizing that this activity is negatively affecting your sample.

RANDOM SAMPLING ON LONGLINERS

There are four types of sample designs that can be used on longliners: **1)** spatial based simple random, **2)** temporal-spatial based simple random, **3)** spatial based systematic random, and **4)** temporal-spatial based systematic random. You can use any of these designs for a particular set and you can alternate designs between sampled sets to adjust for different situations. **Make sure that you have explored systematic sampling from a spatial or temporal-spatial frame as an option before resorting to simple random sampling from a spatial or temporal-spatial frame. Systematic sampling from spatial and temporal-spatial frames is discussed beginning on page 7-22.**

In each of these frames, the unit used to sample by is the gear segment, not individual hooks. This is why it is so important to get accurate average hook counts!



Do not use a random sample design that is not listed unless you contact NMFS first!

Remember, if you abort or alter a sampling design during the sampling of a haul, for any reason, document the circumstances on the “Sample Design Changes” form of your observer logbook (see “Documenting Design Constraints or Problems” on page 2-16).

Sampling Design Rules

There are a few rules to keep in mind when determining your sampling design for a sampled set:

- 1. Number of samples trumps quantity of set sampled.** If there is a possibility that you will only have two samples in your frame, reduce your unit size. By reducing the size of units in the sampling frame, you are ensuring that there will be at least three sampled units within the frame. This may mean that you actually take four samples for a set when you intended on only three. It may also mean that you sample less than you intended. Always reselect a start

point if you have adjusted a frame to accommodate three samples taken systematically (see Figure 7-7 on page 7-23).

2. **Size discrepancy between hanging units and other sampling units should be minimized:** If the total number of gear segments is not evenly divisible by the number of segments comprising a sample unit, there will be a unit at the end of your frame that is smaller than all other units. This is called a hanging unit. It is critical that units be equal or as close to equal

as possible, so a rule was developed to deal with this specific case. You must determine if including the hanging unit onto the previous unit of the frame would cause less of a disruption to unit size than leaving it as a discrete unit. For example, if the hanging unit is comprised of 1 segment and the previous unit comprised of 3, unit size will be more consistent if the last two units are combined. For an example of how to reduce size discrepancy in hanging units see Figure 7-4.

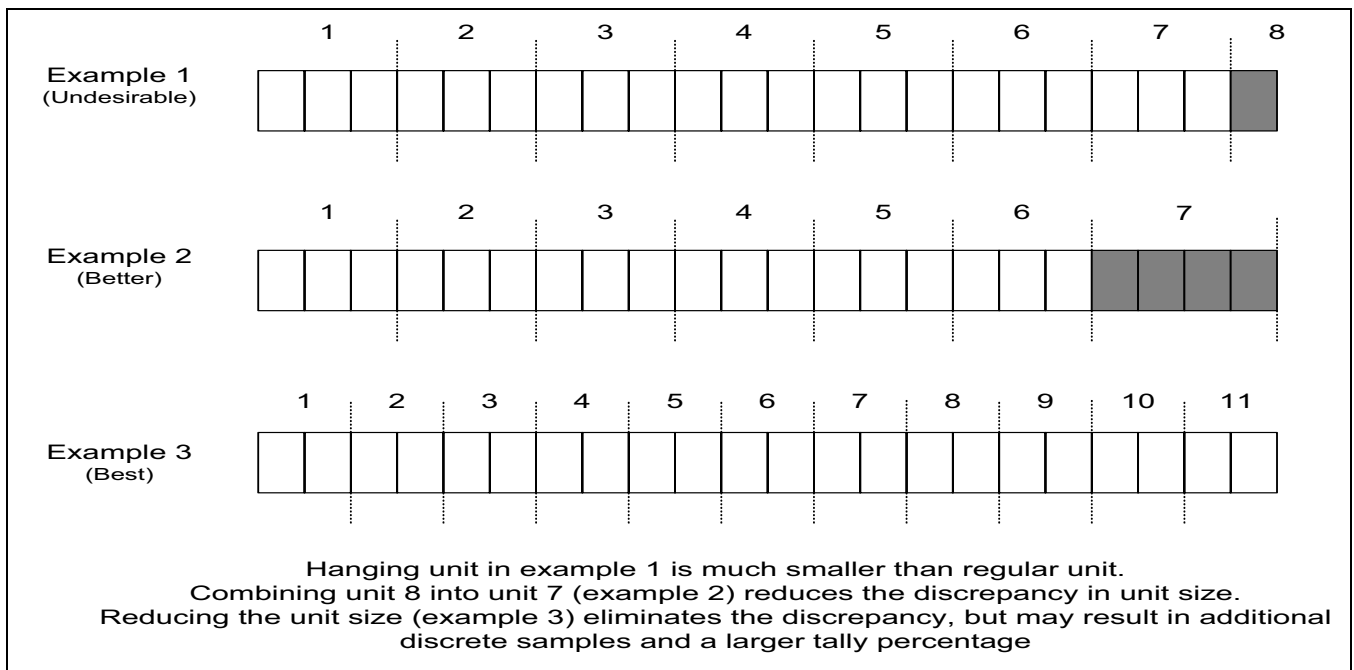

Figure 7-4 Minimizing Size Discrepancy with Hanging Units

Spatial Frames on Longliners

For all sample frames used on a longliner, units must be comprised of whole gear segments. A unit can be one or several segments in length, so long as *they are equal*.

To sample from a spatial frame, determine the number of segments of gear in a set and decide how much of the set you need to tally. Take into account how long you can stand on deck tallying and on how much bycatch can be stored in the fish collection area when deciding on your unit size. In colder months, or where space is limited, you may want to have fewer segments in your sample unit. On vessels with a lot of space, you may be able to have larger tally sample units (*i.e.* more segments per unit).

To create spatial units:

1. Multiply the total number of segments in a set by the fraction you intend to tally. This will give you the total number of segments you need to tally to meet your sample size goal for the set. Always multiply by 1/2, 1/3, 1/4 or 1/5. For example, if a set was 23 segments and you wanted to sample 1/3, you would need to sample 7.66 segments. You must sample full segments, so you would round this value to 8. The observer program expects observers to tally at least 1/3 of a set when it is feasible to do so.
2. Take the total number of segments you need to tally and divide this by the total number of discrete samples you want to collect for the set. If you had to sample 8 segments and wanted to do this over 3 samples, the size of the units would be 2.66. You must

LONGLINE DATA COLLECTION: Random Sampling on Longliners

tally full segments, so you would round appropriately for a total of 3 segments. This value represents your sample unit size.

3. Divide the total number of segments in the set by the number of segments in a unit. This gives you the total number of sampling units in the set.

To complete your sampling design, use the random number table (RNT), dice, slips of paper, or another random method to choose which of these sampling units to tally sample. Document the random selection method in your logbook.

An example of simple random sampling from a spatial frame is illustrated in Figure 7-5. The example set is composed of 24 segments of gear. In order to sample a

third of the set, at least 8 segments must be tallied for composition. The observer had space and time to take three discrete samples. To determine sample unit size, they divided the number of segments needed to sample a third by the number of samples they could take. The resulting value of 2.66 was rounded to 3. The set was divided into sampling units comprised of three segments each and each of these sampling units numbered. Finally, the RNT was used to randomly pick three units within the frame to sample. These units were tallied for species composition (shaded units): 2, 4, and 8. Non-tally periods are those units *not* tallied for species composition.

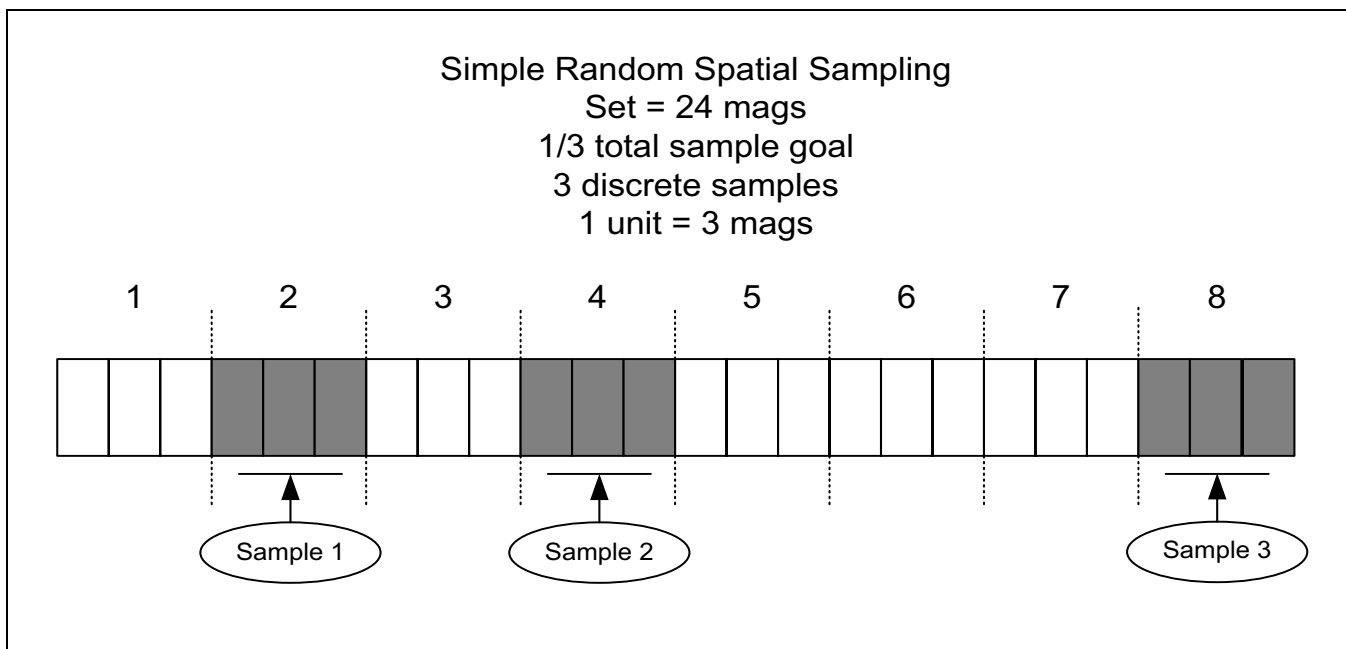

Figure 7-5 Simple Random Samples from a Spatial Frame

Temporal-Spatial Sampling Frames on Longliners

Temporal-spatial frames are based on time, but you track sampled gear by *segments*. The advantage of sampling from a temporal-spatial frame is that you do not have to enter into a tally period at a specific gear segment, but at an approximate time. On vessels with long sets comprised of a very large quantity of gear segments, a sampling system that allows you to disregard the passing of individual segments can be quite useful!

To design a temporal-spatial based sampling system:

1. Multiply the total number of segments in a set by the fraction you intend to tally. This will give you the total number of segments you need to tally to meet your total sample size goal for the set. Always multiply by 1/2, 1/3, 1/4 or 1/5 (observers are typically able to sample at least 1/3 of a set). For example, if a set was 23 segments and you wanted to sample 1/3, you would need to sample 7.66 segments. You must sample full segments, so would round this value to 8.

2. Take the total number of segments you need to tally and divide this by the total number of discrete samples you want to collect for the set. This value represents your sample unit size. On longliners, the smallest a spatial unit can be is one segment. If you had to sample 8 segments and wanted to do this over 3 samples, the size of the sampling units would be 2.66. You must tally full segments, so this value would be rounded to 3.

3. Estimate how long it will take to retrieve one sampling unit. This time estimate represents one *temporal* unit. Number the *temporal* units in the set consecutively.

4. Use the random number table (RNT), dice, slips of paper, or another random method to choose which of these temporal units to tally sample. Document the random selection method in your logbook.

5. Use your temporal unit to determine when to get to your tally station, but tally by spatial units once you get there. **Do not begin tallying until the next full segment of gear.**

An important rule to recognize when sampling from a temporal spatial frame is that, although you are using time to select when to sample, you do **not** start tallying at the beginning of your designated time unit. Instead,

after settling down at the tally station, you **wait until the beginning of the next segment of gear to start** tallying. You must tally full segments of gear, so you do not immediately stop tallying at the end of your designated time interval, but **continue to tally until you have sampled your full spatial unit.**



Do not start or stop tallying in the middle of a segment, regardless of your temporal unit!

Figure 7-6 gives an example of sampling from a temporal-spatial frame. In this example, it was determined that one third of the set, or 8 segments, could be sampled. This value was divided by 4 (the number of samples the observer intended to take) to determine the size of the *spatial* unit: 8/4 equals a spatial unit of two segments. It was estimated that each spatial unit would take 30 minutes to retrieve, for a total of 6 hours. The 30 minute units were numbered 1 through 12. The random number table was used to choose four of these time units (7, 1, 9 and 5) or approximately 1/3 of the set. During these time units they retrieved the following full segments: 1 and 2, 9 and 10, 14 and 15, and 18 and 19. These segments were tallied.

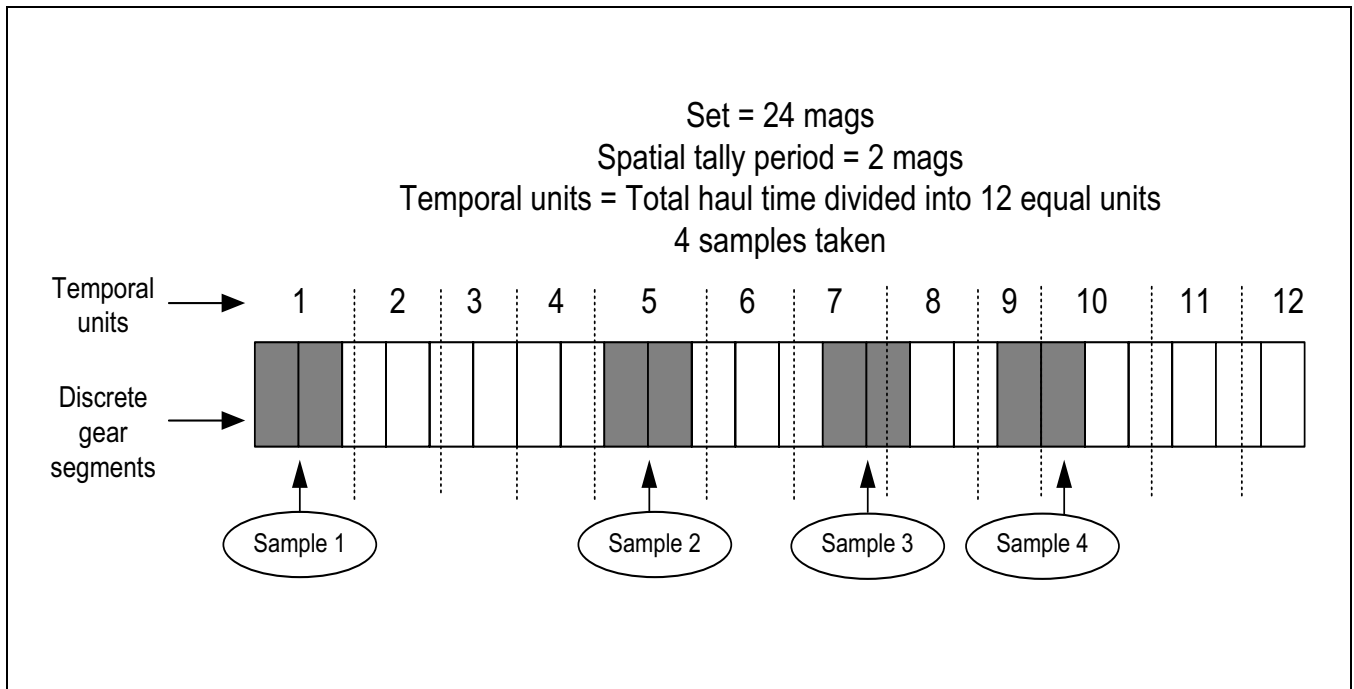

Figure 7-6 Simple Random Samples from a Temporal-Spatial Sampling Frame

Systematic Sample Frames on Longliners

On longliners, there are practical benefits to systematic sampling. With *simple* random sampling, it is possible to randomly choose back to back sampling sections. Back to back samples are difficult to manage on longliners, because there is no time to weigh fish from the first sample before you have to take tally data on the next. Unless there is enough room to separate one weight sample from another, you will not be able to report back to back samples as discrete samples. With systematic sampling, you are guaranteed some amount of time between samples.



A systematic sampling design can be used any time a simple random design can be used. Sampling from a systematic frame may give you more time between the tally and non-tally periods.

A systematic design is one in which you tally sample every “ n^{th} ” sample unit throughout the set. For your sampling design, keep in mind that at least three samples per sampled set is preferred. Sampling units can be defined either spatially or as temporal-spatial units.

The first step in creating a systematic design is to determine which unit type to use for the set. If you can accurately keep track of how many segments have been retrieved, systematic sampling from a spatial frame may be the easiest. If it is too difficult to keep track of each segment during the entire hauling process, systematic sampling from a temporal-spatial frame is best.

Designing a spatial based systematic sampling scheme:

1. Multiply the total segments of gear by the fraction of set you can tally. Always use $1/2$, $1/3$, $1/4$, or $1/5$ (observers are usually able to sample a total of $1/3$ of a set). The resulting value is the number of segments you need to tally to meet your total sample size goal for the set.
2. Divide this value by the number of tally samples you intend to take. The resulting value represents the size of one *spatial* sampling unit. On longliners, the smallest a spatial unit can be is one segment.
3. Number the units in the set consecutively.
4. Systematic sampling requires that you sample throughout the entire set at equal intervals from a

random start point. To determine the sampling start point for the set, refer to the sampling fraction you chose in step one. The denominator in your sampling fraction is the sampling interval “ i ” for the set. For every i , you must tally one full sampling unit. If i is 4, randomly choose a number between 1 and 4. The random number represents the first unit you will sample from your frame. For example, if the random value chosen from a denominator of 4 was 3, you would begin your systematic sampling at unit 3.

5. From the random start point determined in step 4, sample at interval i . For example, if the random start unit was 3, and the denominator of your sampling fraction 4, sampling would occur every 4 units from the random start unit: 3, 7, 11, 15, etc.

Once you have a sample design for the set, assess it to see if there is any chance you will get only two samples for the set. To do this, map out the sampling sequence when you choose the last number in interval i as your start point. If this sampling sequence gives you only two samples for the set, reduce your sampling unit size by one or more segments if possible. For an example see Figure 7-7.

Designing a temporal-spatial based systematic sampling system:

1. Multiply the total segments of gear by the fraction of set you can sample: $1/1$, $1/2$, $1/3$, $1/4$, or $1/5$. Observers are usually able to sample a total of $1/3$ of a set.
2. Divide this value by the number of samples you intend to take. The resulting value is your *spatial* sampling unit. On longliners, the smallest a spatial unit can be is one segment.
3. Estimate the time it will take to retrieve one of your sample units and multiply this by the number of sampling units in the set. This is the total estimated time to retrieve the entire set.
4. Divide the total estimated retrieval time for the set by the estimated time it takes to retrieve one unit. The resulting value is the number of *temporal* units in the set. Number these units sequentially.
5. The fraction of a set you can sample also gives you the sampling interval i . At every interval i , a sample is taken. If you intend to sample $1/4$ of the set, sample one in every four temporal units. If you intend to sample $1/3$, sample one in every three temporal units.

6. Randomly choose a unit within a generic sampling interval from your system. If sampling one in every four units, choose a number between one and four. If sampling one in three units, choose a number between one and three, etc.
7. The random number from step 6 indicates the first sampled unit from your sampling frame for that set.
8. Now that you have your start sampling unit, sample size and sampling interval, you can map out the units that should be sampled to maintain your systematic sampling design for the set.

9. Use your temporal units to determine when to get to your tally station, but tally by spatial units once you are there.

An important rule to recognize when sampling from a temporal spatial frame is that, although you are using time to select when to sample, you do *not* start tallying at the beginning of your designated time unit. Instead, after settling down at the tally station, you *wait until the beginning of the next segment of gear to start tallying*. You must tally full segments of gear, so you do not immediately stop tallying at the end of your designated time interval, but *continue to tally until you have sampled your full spatial unit*.

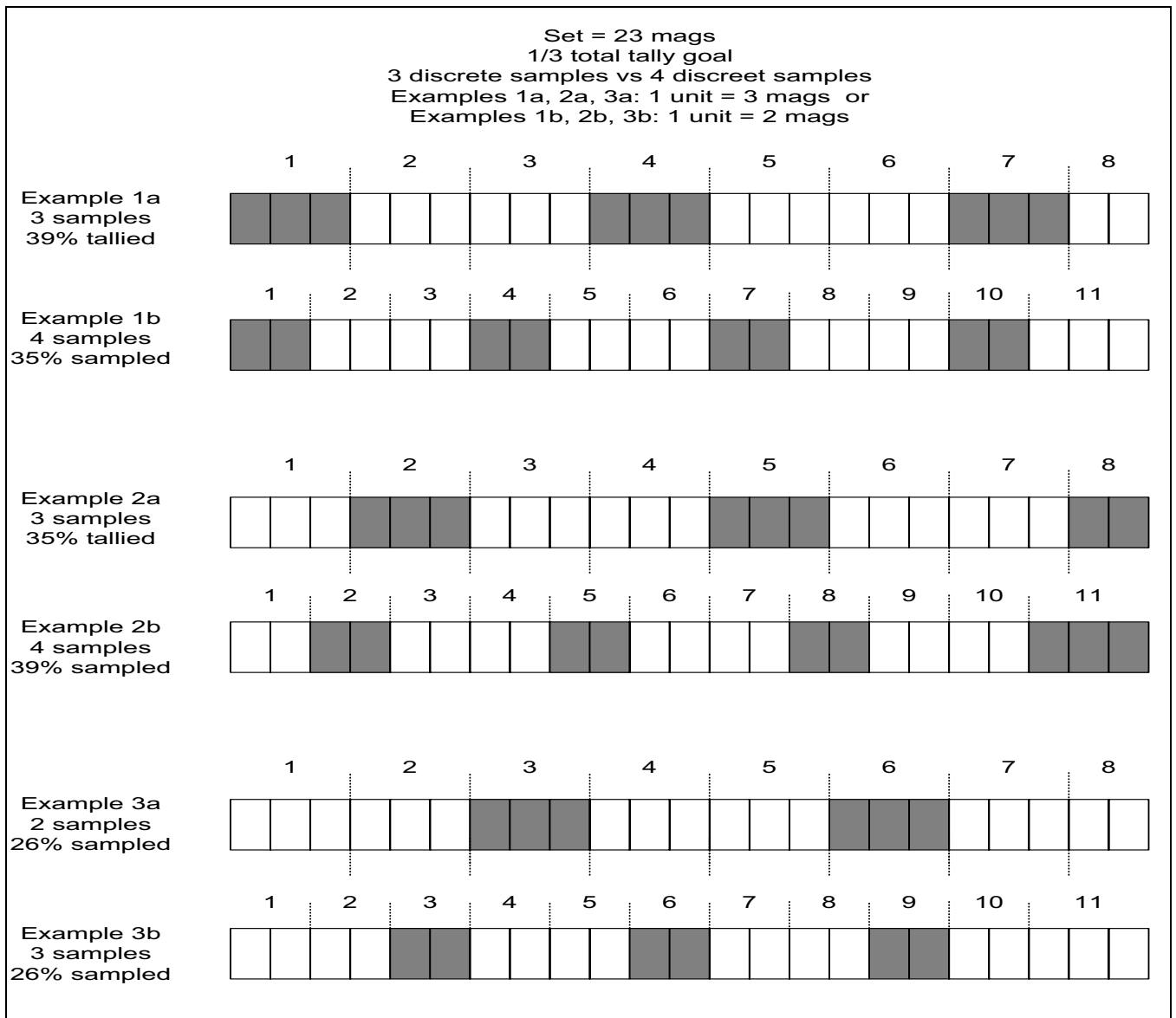

Figure 7-7 Systematic Random Sampling from a Spatial Frame

TALLY COMPOSITION SAMPLES

Tallying species on the line is the most critical aspect of longline composition sampling.

During the longline tally period you count all catch observed on the line as it is retrieved. In this phase of sampling you obtain the **number** of organisms occurring in your sample. Resource managers determine the amount of fish caught by extrapolating tally data up to the entire set. If organisms were not accurately tallied, the data is not accurate and the process of fisheries management is negatively impacted. It is imperative that you **tally everything** that comes up during each of your tally sample periods!



Count everything that comes up on the line during each tally period including drop-offs, organisms that were horned off prior to coming on board, and miscellaneous items like invertebrates and trash!

Method for Tallying Predominant Species

Most observers use thumb counters to tally the predominant species and use the blank space provided on the deck form to keep track of (tally) everything else. **You must record the thumb counter tally number on the decksheet when the sample is completed.** If the gear is retrieved slowly, you may be able to tally empty hooks as well, but because you typically use an average hook value to calculate sampled hooks and total hooks, you don't really need to count empty hooks.

Species predominance will change depending on the area and depth fished. At the beginning of your trip, or when you travel to a new fishing area, ask the crew what species they believe will be predominant in the catch. You will gain experience guessing the predominant species as you spend more time on longliners. Because predominance can sometimes change, be prepared to reassign thumb counters as appropriate to the predominant species in the catch.

Method for Tallying Non-predominant Species

Non-predominant catch is also counted during the tally period, but it is not practical or even possible to have a thumb counter for every species that is caught. For each sample, use spaces provided on the deck form to keep track of these less abundant species (please see

the figures at the end of this chapter containing composition data examples). Create columns or rows for every species or species group observed and make a tally mark in them each time you observe that species. There are some rules pertaining to the level to which you can identify certain groups and species of fish on the line. These are discussed under "Species Identification Rules" on page 7-26.

Method for Tallying Drop-Offs of Retained Species

A vessel will retain various species depending on what markets they have developed. Often only the target species are retained, but vessels may also retain some or all of certain non-predominant or non-target species. Fisheries managers consider any fish that is caught on the longline to be removed from the resource. For this reason you must include any fish captured by the longline in your composition data, even if the fish drops off the line before reaching the vessel.

To track drop-offs of retained species, keep a separate tally of these fish on your deck form and be sure to include their number in your composition data. The Observer Program recommends that you record a single tally for each species (including drop-offs) with a separate tally for the number of this species that dropped off. Be sure that it is clearly indicated on your deck forms the total number of a species that were caught and the number of this species that dropped off.

Please see the deck form examples at the end of this cater for examples of how to record drop-offs on your deck forms.

Method for Tallying Halibut

Halibut are easy to differentiate on the line and can be tallied to species, but the method used for determining the weight of halibut in a sample is different from that for other species. The weight of a halibut in your sample is determined by applying a standard weight to that fish based on its estimated length. This means that you must estimate a length for every halibut in your tally period. Standard weights are obtained from the "Halibut Length to Weight Table" on page A-34.



In addition to being tallied, halibut must also be estimated for length. Unlike other species, weights of halibut in the tally period are derived from estimated lengths, not actual weights.

The species composition raw data examples at the end of this chapter show the commonly used technique for recording halibut data within your tally sample. In the example, a range of size categories are listed in 10 centimeter increments. As halibut are observed on the line, make a visual estimate of the length of each halibut and place a tick mark next to the appropriate size category.

The following suggestions will help you estimate the length of halibut:

- Measure the distance from the roller to weld marks on the side of the vessel or the waterline, if weather permits.
- Measure the distance between the gangions on the groundline and measure the length of the gangions themselves. On most longline vessels, the distance between the gangions and the lengths of the gangions are consistent. Under normal operations, you will be able to see the fish being pulled by the groundline and gangion. Estimate the length of the halibut, in reference to the length of the groundline between the gangions, or the length of the gangion itself.
- Use the length of the gaff or the pole gaff to compare to the lengths of the halibut.
- Pre-measure the length of the longline trough. Some halibut will be brought on board either to be retained or by accident. Having several marked measurements in the trough will allow you to quickly estimate length of the landed halibut.

Test and refine your halibut length estimates. Practice visually estimating halibut landed for injury assessments before you obtain their actual length. Calibrate yourself by comparing your estimates to the actual measurements. With experience, you will become proficient at estimating halibut measurements and knowing which methods work for you in different situations.

After sampling a set, use the length to weight table on page A-34 to determine the proper weight of estimated length groupings. Multiply the number of halibut for each length by the weight on the table. Sum the weights for all sizes to obtain the total weight of halibut in your tally sample. The weight you obtain using this method is reported in the tally sample data. Refer to the figures at the end of this chapter to see examples.

Method for Tallying Predated Items

Whale predation is the most common form of marine mammal feeding interaction observed in the North Pacific. Orcas and sperm whales have been observed feeding on catch from longline gear in both the Bering Sea and Gulf of Alaska.



Sometimes, marine mammal predation is evidenced by hooks with fish lips or partial body parts remaining from the original whole fish. It is important that you tally these items, because they represent fish that were caught. True, they were not utilized by humans, but they were caught by the line none the less! Other signs of whale predation include 1) raked carcasses and/or 2) whales diving on the longline.

To the best of your ability, determine what species the lips or other remaining parts belonged to. Make tally marks for a pair of lips or a body part as you would a whole fish. Typically, whales are interested in turbot and sablefish, so if your vessel is fishing one of these species, left over parts from predation likely belong to individuals of one or the other of these species. Include the tally number for predated items with the rest of the tally data reported for the species. If you are unable to identify a fish to species or group using just the head or lips left on the line, include these animals as “unidentified fish” in your tally sample.

When marine mammal predation occurs, this should be documented in your logbook on a set by set basis.

Important issues to address are:

- How many marine mammals did you see around the line and what were the behaviors you witnessed?
- How much of your tally sample was made up of gear containing “preyed upon” fish?
- What is your estimate of how much of the total line had predation (*i.e.*, were whales feeding from the line only before, during or after your tally or were they consistently feeding throughout the line)?

LONGLINE DATA COLLECTION: Species Identification Rules

- How egregious was the predation (*i.e.*, were whales taking only a few fish, were lots of heads left on the line for you to tally or was the line just empty, etc.)?
- How do you feel about the data you collected? Do you feel that it closely represented the true catch, or did the predation severely effect the composition?

All marine mammal interactions must be fully documented on the Marine Mammal Interaction and Specimen Form. For a more detailed explanation of how to document a marine mammal interaction see page 12-2 in the Marine Mammal Sightings and Interactions section of this manual.

Method for Tallying Fish Consumed by Sandfleas

Sandflea predation is common with fish caught by longline gear. Fish that have suffered from sandflea predation should be tallied to species or appropriate group code along with all fish of that species. Halibut lengths may still be estimated. Do not include fish with major sandflea predation in your weight samples as the weight of the fish may be altered by the predation.

Method for Tallying Pieces of Miscellaneous Items

The database does not accept decimal values for number of individuals. For this reason, observers must use the nearest whole number appropriate for fish and/or invertebrate pieces.

With the exception of predated or sandflea items, observers infrequently may encounter pieces of items on a longline. On the rare occasion that you do encounter a partial organism, tally it as one animal. For example, if one king crab claw comes up during the tally period, report this item as “1” in the number field.

SPECIES IDENTIFICATION RULES

Ideally, you could collect all bycatch organisms from within the tally session. With space on longliners often limited and numbers of fish potentially high, it is more often the case that a small portion of tallied bycatch is collected. This means there will be many organisms that you never get to see up close and in hand.

Many species are quite distinguishable from others. Once you become familiar with them, they can be tallied and identified on the line to species with minimal difficulty. Not having the fish in hand is only a

problem for those groups of species that are too morphologically similar to be reliably identified on the line. These individuals must be accounted for in a very specific way.

For these fish, you will tally individuals at the appropriate group code while collecting a subset for identification to species. For individuals tallied at the group code level, you may identify to species only those you have in hand. This process will be necessary for such morphologically similar fish as arrowtooth and Kamchatka flounder (arrowtooth/Kamchatka group), northern and southern rocksole (rocksole unidentified group), shortraker and rougheye rockfish (shortraker/rougheye group), Bairdi and Opilio Tanner crabs (Unidentified Tanner crabs group), red, blue and brown king crab (unidentified king crab group), certain sculpin species, and the Bathyraja skates.

You should strive to identify organisms to the most accurate category possible *or allowable*. There may be occasions when you need to identify some flatfish as just “flatfish unidentified,” and some roundfish as just “roundfish unidentified.” *If you find that you are using the fish unidentified (901), flatfish unidentified (100), rockfish unidentified (300), or roundfish unidentified (200) on a regular basis, please notify your inseason advisor immediately!*

Tallying Miscellaneous Invertebrates and Items

Observers are expected to tally *everything* they see during their tally sample periods, *even non-prohibited miscellaneous invertebrates, rocks, and trash!* Tally miscellaneous invertebrates to group code or to species as appropriate. Reference your species identification guide(s) to determine the levels to which the observer program expects miscellaneous invertebrates to be identified.

Tallying the Raja and Bathyraja Skates

The two Raja skate species you may encounter are relatively easy to differentiate from each other and the Bathyraja group. Because of this, the Observer Program allows observers to tally the Raja skates to species on the line. The two Raja skates you can tally to species are:

- *Longnose skate*
- *Big skate*

If you are unable to differentiate longnose skates from big skates on the line, use the category *stiff snout skate* (*Raja spp.*) for these animals.

All the other skate species you will see fall into the Bathyraja (soft snout skate) group. The Observer Program does not allow observers to identify Bathyraja skates further to species without the skate in hand. *This means that you cannot differentiate to species those Bathyraja skates during your tally period that were not collected.* Use the Bathyraja spp. code (code 159) for any Bathyraja skates not identified to species in hand.

If you are unable to differentiate Bathyraja skates from Raja skates on the line, then you must use the skate unidentified code (code 90) for all tallied skates. Contact your inseason advisor as soon as possible about this problem. If you do not have an inseason advisor, contact FMA field staff as soon as possible.

During the tally period, collect as many Bathyraja skates as you can. If space is limited, try to get at least 15 total for the set (*e.g.* if three samples taken, five per sample).

Tallying Sculpins

There is one sculpin species and one sculpin species group that can be identified on the line while tallying. They are:

- *Bigmouth sculpin*
- *Irish lord unidentified*

If the sculpin that you are seeing during the tally period do not fall into either of these categories, you must tally them as *sculpin unidentified* (*Cottidae spp.*). Specimens that you collected during your tally periods can be identified further to species when you have them in hand.

During the tally period, collect as many sculpin from the major groups (Irish lord, bigmouth and sculpin unidentified) as you can. If space is limited, try to get at least 15 total for the set (*e.g.* if three samples, five per sample).

Tallying the Arrowtooth/Kamchatka Flounder Complex

Arrowtooth and Kamchatka are too similar in appearance to be tallied to species on the line. For this group, individuals in the tally sample period are tallied

as code 149 or “Kam/arrows.” Specimens that you collected during your tally periods can be identified further to species when you have them in hand.

During the tally period, collect as many individuals from the Arrowtooth/Kamchatka group as you can. If space is limited, try to get at least 15 total for the set (*e.g.* if three samples, five per sample).

Tallying the Northern/Southern Rocksole Complex

Northern and southern rocksole are too similar in appearance to be tallied to species on the line. For this group, individuals in the tally sample period are tallied as code 104 or “rocksole unidentified.” Specimens that you collected during your tally periods can be identified further to species when you have them in hand.

During the tally period, collect as many individuals as you can from the rocksole unidentified group. If space is limited, try to get at least 15 total for the set (*e.g.* if three samples, five per sample).

Tallying the Tanner Crab and King Crab Complex

Individuals within the Tanner crab group and king crab group are too similar in appearance to be tallied to species on the line. For these two groupings, individuals in the tally sample period are tallied by their respective group - either code 3 for “Tanner Crab unidentified” or code 2 for “King Crab unidentified.” Specimens that you collected during your tally periods can be identified further to species when you have them in hand.

During the tally period, collect as many individuals from the Tanner and king crab unidentified group as you can. If the number of crabs is high and space is limited, try to get at least 15 total for the set (*e.g.* if three samples, five per sample). Note that you document weight for whole crab only (see “Dealing with Whole Crab Versus Crab Pieces” on page 7-29).

Tallying the Shortraker /Rougheye Rockfish Complex

Shortraker and rougheye rockfish are common bycatch species in the Pacific cod, Pacific halibut and sablefish fisheries. Currently, the Sustainable Fisheries Division of NMFS Alaska Region manages these rockfish as a single species group. There is growing concern that

LONGLINE DATA COLLECTION: Species Identification Rules

these species may not have similar life histories. If these fish do have significantly different life histories, the agency needs to manage them separately.

To determine whether these species in fact have differing life histories, observers are asked to take the following additional information on shortraker and rougheye species:

- Randomly collect 30-40 big red rockfish *from within your tally sample*.
- Identify these fish in hand to species.
- Weigh these fish by species and report them in your longline sample along with any other fish collected for the sample.
- Collect otoliths

You may choose to collect length/weight and otolith data from additional individuals outside your tally sample periods. If you do so, these data must be reported as subsample data.

Bycatch of shortraker and rougheye rockfish is often high on sablefish vessels, and you should be able to collect 30-40 specimens from within your samples on many sampled sets.

Specimens that you collected during your tally periods can be taken further to species when you have them in hand.

Tallying Other Similar Species

The following species can be confused with other similar species, but fortunately their look-alikes are rare and do not occur with nearly the same frequency. You are allowed to take the fish in the list below to species during the tally period. You are asked to spot check your weight samples of these fish for the more rare, similar species.

- **Flathead sole** - spot check for petrale sole and Bering flounder
- **Shortspine thornyhead** - spot check for longspine thornyhead.
- **Giant grenadier** - spot check for Pacific grenadier or popeye grenadier.

During the tally period, collect as many individuals from each group tallied as you can. If space is limited, try to get at least 15 total per species for the set (e.g. if three samples, five per sample).

If you do not get any of the similar species in a weight sample, you can continue to tally these fish as the more common species. If you *do* get one of the more rare similar species in a weight sample, you must do the following:

- Flathead/Bering/petrale: Collect as many individuals as you can during the tally period to identify in hand later. ***Despite the fact that you are seeing the more rare species, continue to tally this group as flathead. Contact your inseason advisor or field staff if you are seeing Bering flounder and/or petrale sole. Let them know that you are tallying these as flathead.*** Report to species those individuals you had in hand.
- Shortspine/longspine thornyheads: Tally at the group level - Thornyhead Rockfish Unidentified, code 349. Report to species only those individuals identified in hand.
- Giant grenadier/other grenadier: Tally these as grenadier unidentified, code 80. Report to species only those individuals identified in hand.

Tallying Seabirds

All seabirds encountered on the line during your tally period must be tallied, regardless of whether they are dead or alive. This means that you tally seabirds caught on the surface, as the gear was retrieved, as well as those that were caught as the gear was deployed (*i.e.* that are dead). ***NMFS requires the crew to retain all seabirds retrieved during an observer's tally period for the purposes of species identification. Remind the rollerman to keep any seabirds during the tally period.*** Tally any seabirds not landed only to the level you feel confident. Keep in mind that you will have to verbally describe at your debriefing any seabirds taken to species on the line!

If the crew is not keeping seabirds for you, inform the captain and NMFS of this problem. For detailed duties regarding seabirds, see "BIRD SIGHTINGS AND INTERACTIONS" on page 14-1.

WEIGHT SAMPLES

Typically, observers collect weight samples for *bycatch* from within the tally period and weight samples for *predominant* species from outside the tally period. You use non-tally times to weigh those organisms the rollerman collected for you during the tally sample or those organisms you collected outside the tally sample. For this reason, the non-tally subsample periods are often referred to as the “weigh periods.”

Weigh everything collected by species. For items tallied at the group level, it is important that you identify the weight representatives from these groups to species. The weight and number information you report for these species allows resource managers to determine the proportion of one species to the other in the group level tally data.



Do not weigh partial or predated fish as part of your weight sample. *Weigh only whole fish!*

Weight Samples from Inside the Tally

On a longliner you will most likely not be able to weigh every individual that you tally. You will have to collect a subset sample for number and weight. During the tally period, ask the rollerman to retain representatives of the species or species groups you are tallying. On some vessels, the rollerman can collect a few representatives of the more prolific species and most of the uncommon species seen. You will weigh and count these individuals during the non-tally period. These subset samples allow resource managers to determine the average weight of a given species by extrapolating the weight data you collect. ***For this reason, it is very important to collect weight data!*** Following are guidelines for how many individuals you must collect for weights. Weighed fish from within the tally period are recorded as *sample* data.



Even though you think the rollerman is doing an excellent job of collecting fish, *you must always tally everything, because some fish may be displaced by the rollerman or lost before they can be weighed by you.*

Non-Predominant Species Weight Samples

For less predominant species it is preferred that you collect all individuals from within your tally period. In this way, you are providing NMFS with an actual weight for organisms tallied. To collect bycatch species while you are tallying, you must ask the rollerman to retain these species.

In many situations you will not be able to collect *all* tallied bycatch. When this is the case, collect ***as many as you can of each species from every sample***. You must collect at least 15 individuals of a given species per sampled haul. It is preferred that you parse this collection equally over your samples for the haul. If you cannot do so, randomly choose one sample from which to take your 15 (at least) individuals.



Always collect weight samples for any fish for which you are using group codes. Your weighed fish should be keyed to species if collected from inside your tally. All the rest of the tallied fish are recorded in the sample data under the group code.

Determining Halibut Weight in Samples

Halibut are often too large to fit on a scale to obtain an actual weight. Very large halibut may not be brought on board the vessels at all. Vessels are expected to follow careful release methods for halibut (see “Careful Release Methods for Halibut” on page 7-32). For these reasons, observers typically do not collect halibut during the tally period. The International Pacific Halibut Commission (IPHC) has generated a halibut length to weight table (see page A-34) which lists an approximate weight of halibut by its fork length measurement (in centimeters). You are expected to tally halibut by estimated length and later apply a weight from this table to the tallied halibut. The data examples at the end of this chapter show the commonly used technique of recording halibut data within your tally sample and documentation protocol for generating a weight for this species.

Dealing with Whole Crab Versus Crab Pieces

Document weight data for whole crab only. For our purposes, a crab is considered whole if it is essentially whole by weight. It is not necessary for a crab to be intact to be considered whole.

If you find that a crab in your subset weight sample, once whole, is now broken and missing a majority of its weight, you may be able to determine the species

LONGLINE DATA COLLECTION: Weight Samples

but *you must not report the weight of these parts*. Weights that do not represent whole crab are inaccurate from the data user's perspective and negatively impact weight to number relationships otherwise provided by the data.

In summary:

- Tally all crab on the line to the appropriate code.
- Identify all whole crabs in hand to species and report their number and weight.
- Identify crab parts to the best of your ability. Carapaces should be identified to species and legs can usually be identified to the most appropriate genus group code. Do not report the weight of these parts.

Weight Subsamples from Outside the Tally

Weighed samples from outside the tally period are recorded as *subsample* data. Subsample data must have weight *and* number entries for each species in that subsample.

Predominant Species Weight Subsamples

By definition, the predominant species comprise more of the catch than the non-predominant species. The fisheries are managed by weight, so it is important to get accurate estimates for weight. The more individuals of a species that you weigh, the closer your average weight estimate is to the true weight. For this reason, you must collect weight data from more individuals of the predominant species than you do from non-predominant species. You are asked to collect weight data from about 60 total individuals of the predominant species. Try to collect the same number of fish for each of your samples (*e.g.*, if you intend to take four samples for the set, collect 15 predominant fish for weights from each sample).



Collect about 60 fish from the predominant species and weigh them. Spread this collection out over the samples taken and collect approximately equal numbers of fish from each sample. Typically, weighed samples of the predominant species are collected outside the tally period.

Typically, observers collect predominant species weight samples from *outside* the tally sample. This is because there is usually not enough space to collect and store these fish during the tally sample.

If you are collecting fish from outside your tally sample, try to do so right before or right after that sample period. By doing this, statisticians and management can regard these fish as being from the same population as the tally period fish. Fish collected and weighed from outside a tally sample are reported as subsample data. The sample most closely associated with these data is the parent sample to that subsample.

In the database, a subsample must be linked to its parent sample. To accommodate this, there is a numbering convention designed specifically for subsamples. This subsampling numbering convention is discussed on page on page 7-37.



Be sure to account for the biases discussed earlier in this section. If the weight data is skewed because you are only getting big fish or small fish, crucial management decisions are being based on faulty, inaccurate information. This can be harmful to the fishery!

When Halibut is the Predominant Species

It is preferred that halibut weight be obtained by applying weight values from the length/weight table to the estimated lengths of all tallied halibut (see "Method for Tallying Halibut" on page 7-24). When halibut are the predominant species (*e.g.*, on vessels fishing IFQ halibut) it can be nearly impossible to keep up with a tally by estimated lengths. If you are unable to estimate the length of each halibut in your tally, there is an alternate, less preferred method of obtaining weight data for these halibut. This method requires that you tally all halibut from within your sample and actually weigh a randomly selected group of individuals, just as you do for all other species.

You should only use this less preferred option if you are catching a great deal of halibut or if you are unable to accurately estimate the length of the halibut caught. Management still needs to calculate the total weight of halibut caught, so you absolutely must tally all the halibut in your samples! If you decide to use a weight collection, you will need to randomly collect at least 7-10 halibut per sample (or 20 - 30 halibut per set). Collect these individuals during a non-tally sample unit

that is as close, spatially, to a sampled unit as possible. This unit can either be before or after the tally period. **Report the number and actual weight of these halibut as subsample data because they were collected outside your sample. Report the number of halibut tallied as sample data with a zero entry for weight.**

For those halibut that are far too large to weigh, you may actually measure the halibut and use this length with the halibut length to weight table to get their weight.

If some halibut are too big to be landed, try tallying halibut into one of two groups: those that are small enough to be landed and those that are not. For those that are too big to be landed, estimate their length as best you can and use the halibut length to weight table (see page A-34) to determine weight for these larger drop-off individuals.

MANAGING WEIGHT VS. TALLY DATA

Remember that fisheries managers determine how many individuals were caught, and in what proportions, from the **number** you supply for fish seen during your **tally sample**. They determine the relative weight of these caught individuals, and the species of those organisms tallied at the group level, from your **weight data**.

Management decisions are based on the value you supply for number of fish caught during a sample. The total number of fish you report in your sample data for a haul should be the same as the total number of fish you **tallied** for that haul. Because you report weight data together with tally data for any given sample, **for sample data only, you must subtract any weighed fish of a species or species group from the tally number for that species or species group**. If you do not do this, you are essentially reporting a number that represents tally data **plus** weight data!



You **do not** subtract subsample fish from the tallied number of that fish!

See the figures at the end of this chapter for examples of how to document composition tally data (with no weight) and weight data.

COMBINED SAMPLES

The only time you combine sample data on a longliner is when you are unable to distinguish the tally data of one sample from another. This would be the case if, for example, you tallied one sample, did not write down the tally numbers for that sample and forgot to reset your clickers for the next sample. The data in this case are still viable, because you have number of fish caught over a known quantity of gear. To salvage these data, you combine data from the affected samples.

By combining samples into one in the reported data, you are alerting data users to regard these samples separately from intact samples. As with trawlers, you can have a mixture of combined and non-combined samples for a set. You combine only those samples you believe are no longer discrete samples.

On the raw data deck form, mark the samples that will be rolled together as combined by checking the circle next to “Combined” for those samples. The combined samples are reported as one sample in ATLAS or faxed paper form. When reporting combined samples, enter the data for all the samples affected under a single sample number.

- You **do not combine samples when fish** collected for weights are mixed between samples. If this happens, report all your weight fish as a **subsample** to one or the other distinct samples within the haul.

WHEN THERE ARE NO FISH ENCOUNTERED DURING THE SAMPLE

On rare occasions you will monitor a haul and there will be no fish on the line. Fisheries managers assess catch per unit effort and data revealing that there were no fish in a sample is just as important as data that relays what and how much fish were present in the catch.

To report those instances when there were no fish encountered during a sample, record the following on the raw data decksheet (and paper species composition form if applicable): the date of the haul, your cruise number, vessel permit, sample number, total number of hooks in the sample period, and keypunch values of zero. Finally, write “NO FISH” across the body of the sample block.

In ATLAS you simply enter an “N” in the “Species Comp in sample?” box. Please refer to the figures at the end of this chapter for documentation examples and page 16-8 of the ATLAS chapter for information on how to enter these data.

HALIBUT INJURY ASSESSMENTS

The IPHC manages the Pacific halibut fishery. The IPHC sets the total allowable catch of halibut for both the United States and Canada. Accurate accounting of halibut mortality is necessary for the IPHC to assess the health of the halibut stock and determine future allocations. Halibut are a prohibited species in the groundfish fisheries and must be released with minimal harm to the animal (unless the vessel has IFQ). Unlike groundfish, where mortality is assumed to be equal to catch, many halibut survive even after being caught by commercial gear. The IPHC applies mortality rates to the commercial catch of halibut to estimate total mortality. Halibut mortality can potentially close groundfish fisheries if it is exceeded before the target species quotas. By carefully releasing halibut, longline vessels are able to reduce their overall halibut mortality and extend their fishery.

Careful Release Methods for Halibut

The following describes NMFS’ careful release regulations for Pacific halibut. The rollermen may use any of these methods, or a combination thereof.

- Cut the gangion - the rollerman cuts the line attaching the hook to the groundline.
- Twist the hook - the rollerman uses the gaff hook to twist the hook out of the halibut’s mouth (usually called the “twist-and-shake” method).
- Straighten the hook - the rollerman uses the gaff to straighten the hook and slide the halibut off the hook. Note that this is different from “horning off” in that the rollerman will not tear the fish’s mouth using the straightening process.

One of your duties is to assess the way halibut are handled on your vessel. Document the following in your logbook:

- The methods that each rollerman uses to release halibut and the effectiveness of this method in minimizing injuries to halibut.

- Any time that a halibut hits the crucifier. Document the rollerman’s name, the time and date, and any circumstances surrounding the incident. Inform the captain any time you witness halibut hitting the crucifier.
- Whether or not the captain and crew are cooperative with your sampling efforts.

If the rollermen are not utilizing careful release methods, document this thoroughly in your logbook and tell the captain what you are seeing. Document all conversations with the captain on the subject and note if the captain is aware that the halibut are being released improperly. Document whether there is a general disregard of careful release methods or if it is just a particularly careless or inexperienced rollerman. Bring all of these issues to the attention of the FMA staff as soon as possible.

You will need to randomly choose a non-tally segment from which to take halibut injury assessments. ***The injury data you collect must be reported at the haul level.*** Refer to “Halibut Injury Assessments” on page 7-32 for more information on injury assessment methods.

SEABIRDS

Longline vessels attract significant numbers of seabirds which feed on the fish discards. Seabirds near the vessel may become hooked by the gear during gear retrieval. Seabirds may attempt to feed on the baited hooks as the gear is being set. They are often hooked or snagged and dragged down with the gear and drowned. Regardless of when a seabird is hooked, all are considered “caught” and must be included in the species composition sample. Longline vessels are required to use streamer line seabird deterrent devices to reduce the possibility of catching seabirds.

You are encouraged to notify the captain if you observe short-tailed albatross around the vessel. Based on this information, the captain may decide to take alternative or extra measures to reduce the likelihood of interacting with this endangered species. For information on observer duties in regards to seabirds, see “List of Priorities” on page 14-1.

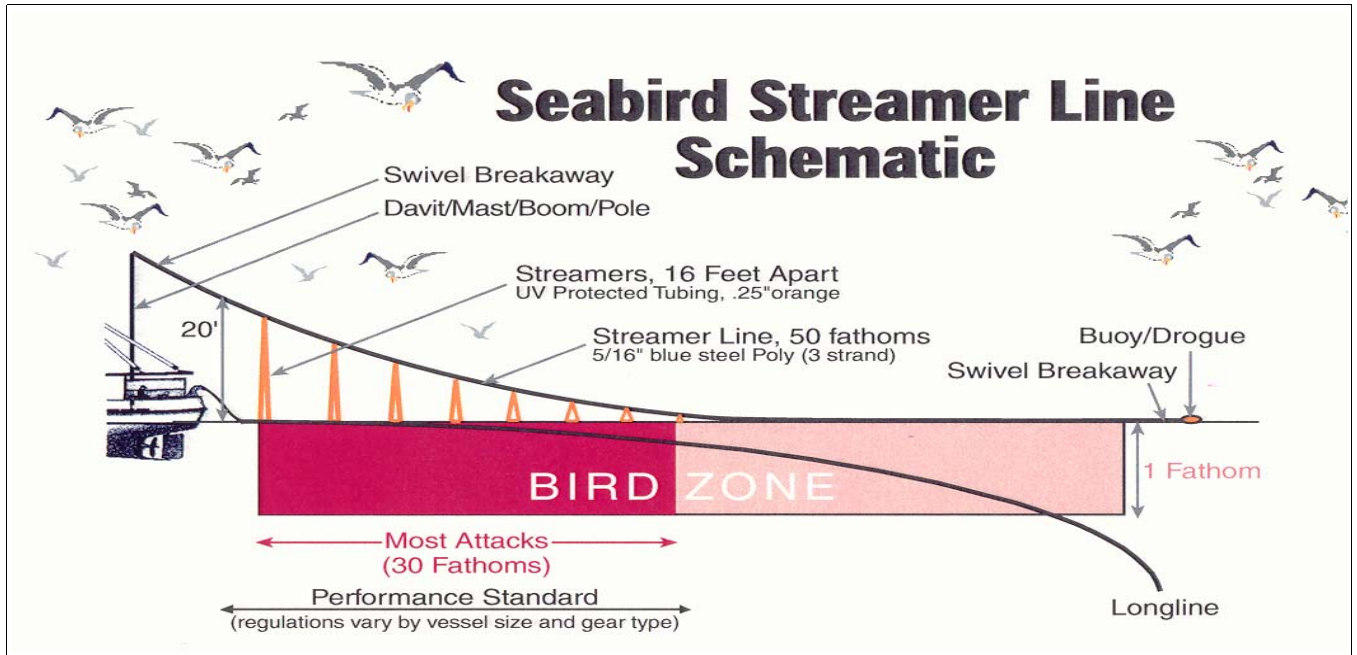

Figure 7-8 Seabird Steamer Line Schematic

ESTIMATING PERCENT RETAINED

Each species reported in the species composition samples for a set must have an associated estimation of percent retained. To obtain this information you must 1) keep a separate count of any drop-off or horned off species that are being retained and 2) check the factory to get an estimate of the amount of fish discarded during processing.

The separate count for drop-offs and discards is used to determine the percent retained for the species. For species not retained for consumption or product, you do not need a separate tally for drop-off and discards because the percent retained for these species is zero. An individual fish is considered fully retained (100% retained) when more than 15% of its round weight is turned into product. Round weight is the weight of the whole fish, prior to processing.



The percent retained you report for a species must be consistent for that species over all the samples collected during the set. For this reason, calculate percent retained after the set is completed.

It is best to calculate percent retained after the set is completed. You can calculate percent retained using the total tally number for the species and the total number

of that species lost or discarded during the tally sample periods. Refer to all the samples collected from the set for this information.

$$\frac{\text{Total number of species caught from all samples} - \text{Total number of drop-offs and discards from all samples}}{\text{Total number of species caught from all samples}} \times 100 = \text{Total percent retained of that species}$$

Every species reported in a sample must have a percent retained record. For examples of recording percent retained, see the species composition data examples at the end of this chapter.

SPECIMEN COLLECTION ON LONGLINERS

Your duties for collecting measurements and other biological data on longline assignments are the same as for all other vessels. On longliners, these may be hindered by lack of space or lack of cooperation from crews. Lack of space can be a problem on smaller catcher vessels. You may be able to collect the required amount of species measurement and specimen data by

LONGLINE DATA COLLECTION: Individual Fishing Quota (IFQ)

collecting a small random number of fish from each sample, rather than all from just one randomly chosen sample. The decksheet examples at the end of this chapter show data collected in this way. If space and time are not issue, you can randomly choose one sample from which to take measurement and specimen data. For more information on length and specimen data, refer to “FISH MEASUREMENT AND SPECIMEN COLLECTION” beginning on page 11-1.

If you are unable to collect measurements or otoliths because of space constraints, contact an Observer Program staff person as soon as possible. In your logbook, document any difficulties encountered and the methods you used.

Specimen Data and Uncooperative Crews

In the past, some longline crews have refused to allow observers to cut the fish as needed to obtain sexed length frequency data. In your logbook, document any interference to your collection of sexed length frequency measurements and contact an Observer Program staff person as soon as possible.

If you encounter difficulties, seek the cooperation of the captain in completing your duties. Vessel crew are required to allow you to determine the sex of fish and we are seeking their cooperation. Be mindful that the crew may only protest to your cutting of fish if the cut damages their final product. If this is the case, ask them which cuts would not damage the product. Many observers have successfully used a pectoral cut to sex roundfish, without destroying product. If the cut you need to use is time consuming or difficult, request crew assistance. Most fishermen are cooperative when they realize the extra time you are taking is to prevent damage to their product.

If the crew continues to be uncooperative, ask the captain if it would be acceptable to cut only a subsample of your measured fish. Request that you be allowed to cut 15 or 10 fish from your approximately 20 measured fish. If you do sex fewer fish than you measure, the sexed subset must be randomly selected. Unsexed data is more valuable than no length data, so if the captain is adamant that no fish are cut, you should collect unsexed length frequency samples. Fully document in your logbook all interactions with the

crew and all methods you used to collect lengths. Please see “Regulatory Support for Cutting Fish to Obtain Sex Data” on page 11-14 for more information.

INDIVIDUAL FISHING QUOTA (IFQ)

In 1993, the North Pacific Fisheries Management Council and the Secretary of Commerce approved the Individual Fishing Quota (IFQ) program for the halibut and sablefish fisheries. This policy changed these fisheries from an open access fishery with a very short season to a limited entry fishery managed through an individual quota assigned to each fisherman. The individual quotas are allocated to fishermen that have historically been involved with either the sablefish or halibut fisheries. The individual shares of the quota can be sold or transferred to different individuals and companies. The IFQ system allows fishermen to fish for their individual quota throughout the fishing season when prices are high or as the weather permits.

Vessels and Gear

Typically, the vessels that fish sablefish and halibut IFQs are smaller vessels, although some larger C/Ps also participate in this fishery. When targeting sablefish, the vessels typically set gear much deeper and retrieve the gear at a slower pace compared to Pacific cod or Greenland turbot fisheries. When targeting halibut, the vessels set their gear in areas that are shallower, but halibut gear tends to have fewer hooks spread farther apart, so the rate of hook retrieval will be equivalent or even slower than sablefish retrievals.

Composition Sampling

The methods of choosing which sets to sample and which sampling methods to use are the same as those discussed earlier in this chapter. IFQ vessels tend to be less automated and gear retrieval is slower. Follow normal sampling procedures for tally and weighing periods to collect your composition samples. On some IFQ vessels, observers have been able to weigh all non-predominant species from the tally period. Obtain average hook counts in the same manner as in the non-IFQ fisheries. Because the gear is maintained by hand and may not be repaired as diligently, you may need to verify hook counts more often. ***Remember, you must verify hook counts on at least 1/5 of a set of gear twice per week.***

When Halibut is the Predominant Species

Your sampling will change slightly when halibut is the predominant species. The following are the sampling protocols that change:

Weight Collection

Because of their size, halibut present a problem for observers when they are the predominant species on an IFQ vessel. When observing on halibut IFQ vessels, you will need to account for halibut on the line either by estimating and recording each fish's length or by collecting a weight sample. If you decide to use a weight collection, you will need to randomly collect at least 20 halibut per set. Do this by using a random starting point and either collecting the next "X" number of halibut or every "nth" halibut. For those halibut far too large to weigh, you may measure them and use their length and the halibut length to weight table to get their weight.

Sex-Length Frequency/Otoliths

Do not collect lengths or injury assessments from halibut in IFQ fisheries. You will need to collect sexed lengths and otoliths for your Length and Specimen Form from the next predominant species in the catch. Only collect lengths and otoliths from species listed on the priority lists beginning on page 11-24.

Halibut Injury Assessments

Do not collect any injury assessments when your vessel is fishing halibut as a predominant species.

CDQ SPECIFIC INFORMATION FOR FIXED GEAR CATCHER VESSELS

Non-trawl (longline and pot) catcher-only vessels are given two options through CDQ regulations. Each option has its own requirements for observer coverage, equipment and operational requirements. To date, all non-trawl catcher-only vessels have chosen Option 1, however it is possible a vessel will choose Option 2 in the future. Inquire as to whether the vessel will be fishing both IFQ and CDQ during a trip.

Option 1

Under Option 1, delivery weights are used to manage the CDQ quota. If there is a plant observer it is their responsibility to monitor the offload. The regulations allow you (the vessel observer) to monitor the delivery if there is no plant observer. This is the only situation on an Option 1 vessel when the working hour

limitations are in effect. The regulations state, "A separate CDQ observer for the shoreside processor is not necessary if the vessel observer can monitor the sorting and weighing of catch at the shoreside processor without exceeding the statutory working hour limits." This is usually only necessary at remote plants such as Adak Seafoods, but it may happen at other plants. If you are called upon to act as the plant observer do not fill out a Plant/Offload Form. Simply document in your logbook that you monitored the sorting and weighing of the catch and any problems that occurred. With the exception of monitoring for the retention of CDQ species and possibly acting as the plant observer, your duties are the same as in open access. For CDQ plant observer duties, see page 9-8

When operating under Option 1, the vessel ***must retain all CDQ species during any trip that CDQ is landed***, commencing with the first CDQ set. Thereafter, even during an IFQ set, all CDQ species must be retained if the vessel is also fishing CDQ during that same trip. Non-trawl catcher-only vessels cannot fish CDQ and open access or CDQ, IFQ and open access during the same trip if they are using Option 1.

Non-trawl catcher-only vessels fishing under Option 1 may fish 24 hours/day and have unsampled sets. In most cases you will be able to sample all sets given this vessel types fishing style. These vessels will not have an observer sampling station or a motion compensated platform scale.

Option 1 is a CDQ catch accounting option that requires the vessel operator to retain all groundfish CDQ and salmon PSQ until it is delivered to a shoreside processor. ***It is the vessel's responsibility to know which species are CDQ species.*** If they have questions please direct the operator to the NMFS Regional Office for clarification. Halibut and crab must be discarded by the vessel after you have had an opportunity to sample those species. Once delivered, the catch is sorted by species, weighed and reported to NMFS.

Option 2

Option 2 is a CDQ catch accounting option where catch may be sorted at sea. Observer data is used for all catch accounting and the processor's reports of landed catch weight are not used as the basis for CDQ catch accounting. If a vessel chooses this option, an observer sampling station and motion compensated platform

scale are required. If you find yourself on one of these vessels, simply follow the sampling protocols for non-trawl C/Ps. Plants receiving CDQ catch from non-trawl catcher vessels using option 2 are not required to have the delivery monitored by an observer.

CDQ SPECIFIC INFORMATION FOR FIXED GEAR CATCHER/PROCESSORS

Longline and pot C/Ps commonly participate in a variety of fisheries during any given trip. Unlike catcher vessels, C/Ps may harvest CDQ, IFQ, and open access fish during a trip. The vessel must notify you which sets are CDQ, or may be CDQ, prior to bringing the catch on board. The vessel has up to two hours to designate a set as CDQ in their logbook after landing it. As long as the vessel treats a set as CDQ they may designate it as such or change their mind and designate it as open access or IFQ. The vessel must record a CDQ group number in their logbook for all CDQ sets to identify which group they are fishing for. Check the vessel's logbook information carefully when filling out your VHF, since a vessel may be fishing for several CDQ groups or participating in multiple fisheries.

Each CDQ set must be sampled for species composition. If a set is not sampled due to weather or illness document in your logbook why you were unable to sample the set. You must notify your inseason advisor if a CDQ set is not sampled. Do not refuse to sample or tell the vessel they can't fish if the platform scale is not functioning. Simply inform your inseason advisor of the situation and NMFS will take any necessary action (see "What To Do When the Platform Scale Fails" on page 2-19).

Sampling on this vessel type should be identical to sampling in open access. Additionally, you will have an observer sampling station and a motion compensated platform scale. You must test the platform scale at least every 24 hours. All non-trawl C/Ps will have the ATLAS program so direct any sampling questions to your inseason advisor. While CDQ fishing, send in your data daily.

If the vessel you are on is fishing under an alternative fishing plan, they have been approved by NMFS to fish with one Level 2 observer. Even with one observer, the vessel must fish in a manner that enables you to sample every CDQ set within the confines of your 12 hour schedule. Discuss fishing plans with the captain,

inform him of your time constraints, and do your best to work with the vessel to find a fishing schedule that accommodates both parties. Some vessels have fished open access and CDQ while fishing with one observer under an alternative fishing plan. The vessel must fish their CDQ sets as outlined in their fishing plan.

DECK FORM INSTRUCTIONS

The waterproof raw data forms provided by the Observer Program are meant to be taken out on deck. On ATLAS vessels these replace the paper species composition form. Never recopy raw data and always return to your debriefing interview with your original data. The deck forms are an important component of your data documentation. It is important to fill out the forms completely and legibly!



All raw species composition data collected by you must be documented on the deck form provided by the Observer Program, whether or not your vessel has ATLAS. PLEASE WRITE LEGIBLY!

On vessels with ATLAS, you enter data from the deck form directly into the ATLAS system. On non-ATLAS vessels, information on the deck form must be transcribed to a paper species composition form and faxed (see "Paper Form Instructions" on page 7-39).

The deck form is double sided with two sample blocks available on each side. The header information at the top of the deck form must be filled out and pertains to both sample blocks below it. You may have one haul's worth of samples on one side of a deck form and another haul's worth of samples on the other side, ***but you cannot mix two haul's worth of data on a single side of the deck form.*** You must maintain a separate set of forms for each vessel to which you are deployed.

Multiple samples and subsamples taken within a set should be maintained completely independent of each other with their own unique sample number and sample block (or blocks). If you have to combine samples later, simply check the circle next to "Combined?" for the affected samples (for information on combined samples see "Combined Samples" on page 7-32).

Remember that sample data represent tally individuals and weight individuals from within the tally period, and subsample data represents weight

individuals from outside the tally period. Subsamples have a specific numbering system associated with them, explained in “Subsample number” below.



Maintain a separate set of forms for each vessel.

Examples of a completed deck form start on page 7-44. **The following deck form rules must be followed for all longline vessels. All fields must be filled out completely:**

Observers Name/Vessel Name - For each vessel assignment, write your name and the vessel’s name across the top of the first page.

Date - Enter the date that the last hook of the set was retrieved. For the month and the day, use leading zeros when needed (*e.g.*, 01/01/09 for January 01, 2009). This date must match the date on all other forms.

Cruise, Permit: Your cruise number will be given to you during training or briefing, or by your employer. Vessel permits are listed onpage A-25.

Haul No., Offload No: For each sample taken within a set, enter the set number the sample came from. Sets can be numbered sequentially beginning with the number one, or you can follow the captain’s numbering convention **if the captain is not repeating set numbers with each new trip.** On longliners, it is generally better if you can follow the captain’s numbering system; when sets are retrieved out of order it can be difficult to track sets if your numbering system is different.

Set numbers must be unique for the vessel. If you disembark the vessel and then embark again at a later date, you can 1) continue numbering the sets from the number you left off with, 2) continue with the captain’s numbering convention (if s/he is not repeating set numbers), or 3) skip a few numbers (*e.g.*, if you numbered sets of the first trip 1, 2, 3 and 4, you could number sets of the next trip as 11, 12, 13, 14). Currently, longline observers are not asked to collect composition or data during an offload. For longline data, leave the offload field blank.



Set numbers do not have to be sequential (although it is easier if they are), but they do have to be unique for the vessel.

Sample number: Every sample taken from within a set must have a unique identifying sample number. Number samples taken within a set sequentially, starting with the number 1. You do not need to make sample numbers *between sets* unique; you can start with the number 1 for the first sample of every sampled set.

Subsample number: For longliner sample data, the only time you will have a **subsample** block of data is when you are reporting weight data for fish taken from outside the tally sample period. Subsamples must be linked to the parent samples from which they came. You do this by using a numbering convention designed specifically for subsamples: every subsample number must be three digits in length, with the first digit designating the parent sample from which the subsample came, and the next two digits indicating the number of that subsample for the parent sample. Subsample numbering convention is explained further below:

- The first subsample of sample number 1 for a set should be numbered 101, the second subsample for sample number 1 of a set should be numbered 102, the third 103, and so on...
- The first subsample of sample number 2 for a set should be numbered 201, the second subsample for sample number 2 of a set should be numbered 202, the third 203, and so on...
- The first subsample of sample number 3 for a set should be numbered 301, the second subsample for sample number 3 of a set should be numbered 302, the third 303, and so on...

Sample size:

- Samples: on longliners, every sample must have a sample size in hooks. Record the total hooks in your sample, and circle the “hooks” text.
- Subsamples: on longliners, subsamples do not have a sample size. Leave the sample size blank for subsample data.

LONGLINE DATA COLLECTION: Deck Form Instructions

Combined samples: If the samples for a set are going to be combined in the reported data, check the circle next to the word “Combined” for *only those samples that will be combined*. When these data are entered into ATLAS or on a paper form, samples designated as combined are rolled up into a single sample entry. See “Combined Samples” on page 7-31 for a description of when samples must be reported as a “Combined Sample.”

Pre-sorted: Do not check this field. You cannot have pre-sorted samples on longliners.

Species: For species (other than halibut) or species groups that you tallied and weighed, there will be one entry for total tally number of that species or species group *minus* any fish of that species or group that you weighed. There will be another entry for the number and weight of the individuals of that species or group that came from within the tally sample and were weighed. Fish tallied to species are listed by their common name. Fish tallied by group are listed by their group name. Fish in hand are listed by their species name or group name as appropriate. Fish from subsamples are listed by their common or group name as appropriate. ***Consolidate the data for the number and weight of a single species (or species group) into a single line of entry. Also consolidate the data for the number only of a single species (or species group) into a single line of entry.*** These calculations must be documented on your deck form.

If you were not able to weigh representatives of species or species group tallied, there will only be one entry for the species or group: the total number tallied.

For halibut, you will typically have a length estimate for all tallied individuals. You need only one line entry in these instances; the total number tallied and total weight for these individuals. The weight is derived from the halibut length/weight table. If you used the less preferred option of obtaining halibut weight information, you will need two entries: one for tallied individuals minus any weighed or actually measured, and one for the weighed or measured fish.

Sex: Tanner crab, king crab, and salmon should be listed separately by species and sex. Record an “M” or “F” for these species when sex is determined. Leave the sex field blank for any unsexed organisms.

Number: For each weighed species, enter the number of individuals weighed. For tally period data, record the number of individuals tallied minus any weighed from that species or species group. ***Every species entry must have a number record!***

Use as many lines and columns as necessary for each species.

- For decomposed fish (code 899) and miscellaneous items (code 900) enter the actual number of items.
- For subsample data, enter the number of individuals weighed. Unlike samples, subsamples must always have a number ***and*** a weight.

Weight: For weighed fish, enter the weight by species with a well defined decimal. Weights must be recorded to the nearest 0.1 or 0.01 kg. If you feel that your scale cannot be read accurately to the tenth, you must fill in at least a trailing zero. ***Do not enter weights to more than two decimal places.*** If a species in your sample was too small to weigh (*e.g.*, one brittle star) ***enter the weight as 0.01 kg.*** This holds true for both sample and subsample data. For halibut tallied by estimated length, use the “Halibut Length to Weight Table” on page A-34 to derive weight.

For fish from the tally period that were not weighed, enter a zero in the weight field by species. Remember to subtract the number of any weighed individuals from that species or species group.

Percent Retained: This is a rough estimate of the percent of each species retained by the vessel. Keep a separate tally for drop-offs and discards of those species being retained by the vessel. Calculate the total percent retained for a given species by dividing the sum of dropoffs and discards of that species (from all your samples in the set) by the sum of tally numbers for the species (from all your samples in the set). Subtract this number from 100 to get percent retained and round to the nearest whole percent in the Percent Retained column on the deck form.



If the vessel made any product from more than 15% of the fish, the whole fish is considered retained.

Length, viability, injury, specimen, tally data, notes:

Use the blank area of the deck form sample block to record tally data. Use this space to record other sample specific information: sex/length information, specimen information, halibut assessments, notes pertaining to any biases to the sample, *etc.* Make comments about anything unusual with the catch or your sampling technique for the set. More complete descriptions of these notes should be documented in your logbook. Making note of unusual occurrences on your species composition form will assist in the debriefing process, and help you distinguish one set from the others. **Raw data of this sort must be documented!**

Keypunch Check: In the spaces to the right of the words “Keypunch check,” write the calculated sum for species number, and species weight that you recorded for the sample. If your species composition sample has too many species to fit in one sample block, enter the total sums on the keypunch line in the first block for the sample and leave the keypunch line blank for the second block used for the sample.

Keypunches are a valuable tool for staff who edit your data. If the keypunch value the computer calculates does not match the keypunch value you wrote down, staff know to double check for errors in the entries. If you are sloppy with your keypunch calculations, staff have to investigate each discrepancy. This is a waste of valuable time for both you and for staff. Please double check your keypunch summaries!

PAPER FORM INSTRUCTIONS

If you are on a vessel without ATLAS, you must transfer your raw data from the decksheet to a paper species composition form. Paper forms are then faxed to the Seattle NMFS office after every trip.

Three samples will usually fit on one species composition page. Each sample must be documented as a distinct sample for that set (except in cases of combined samples - see “Combined Samples” on page 7-31). Unlike the deck forms, samples from two or more sets can go on a single page; on paper forms you do not need to start a new page for each sampled set. Maintain a separate set of forms for each vessel to which you are assigned.

Cruise number, Vessel permit, Observer name and Vessel name: Your cruise number will be given to you during training or briefing, or by your employer. Vessel

permits are listed on page A-25. Write your full name and the name of the vessel on the lines provided at the top of the form.

Resubmission: Circle “Resubmission” if you are sending changes to data previously faxed. **Also, please circle the items that have changed since your last transmission of the data; this will aid keypunchers in making the appropriate modifications to your data.** You do not need to start a new form after faxing. You can continue to use the form until all sample blocks are filled with data. Be sure to enter the correct header information for each new sample.

Haul No., Offload No.: Copy the sample’s set number from your deck form. Leave the offload number blank.

Sample number: Every sample taken from within a set must have a unique identifying sample number. Number samples taken within a set sequentially, starting with the number 1. You do not need to make sample numbers *between sets* unique; you can start with the number 1 for the first sample of every sampled set.

Subsample number: For longliner sample data, the only time you will have a **subsample** block of data is when you are reporting weight data for fish taken from outside the tally sample period. Subsamples must be linked to the parent samples from which they came. You do this by using a numbering convention designed specifically for subsamples: every subsample number must be three digits in length, with the first digit designating the parent sample from which the subsample came, and the next two digits indicating the number of that subsample for the parent sample. Subsample numbering convention is explained further below by way of example:

- The first subsample of sample number 1 for a set should be numbered 101, the second subsample for sample number 1 of a set should be numbered 102, the third 103, and so on...
- The first subsample of sample number 2 for a set should be numbered 201, the second subsample for sample number 2 of a set should be numbered 202, the third 203, and so on...
- The first subsample of sample number 3 for a set should be numbered 301, the second subsample for sample number 3 of a set should be numbered 302, the third 303, and so on...

Sample size:

- Samples: on longliners, every sample must have a sample size in hooks. Record the total hooks in your sample, and circle the “hooks” text.
- Subsamples: on longliners, subsamples do not have a sample size. Leave the sample size blank for subsample data.

Combined samples: If the samples for a set are going to be combined in the reported data, check the circle next to the word “Combined” for *only those samples that will be combined*. When these data are entered into ATLAS or on a paper form, samples designated as combined are rolled up into a single sample entry. See “Combined Samples” on page 7-31 for a description of when samples must be reported as a “Combined Sample.”

Pre-sorted: Do not check this field. You cannot have pre-sorted samples on longliners.

Species name and species code: For species (other than halibut) or species groups that you tallied and weighed, there will be one entry for total tally number of that species or species group *minus* any fish of that species or group that you weighed. There will be another entry for the number and weight of the individuals of that species or group that came from within the tally sample and were weighed. Fish tallied to species are listed by their common name. Fish tallied by group are listed by their group name. Fish in hand are listed by their species name or group name as appropriate. Fish from subsamples are listed by their common or group name as appropriate. Enter the appropriate species code. Species codes can be found starting on page A-1. *Consolidate the data for the number and weight of a single species (or species group) into a single line of entry. Also consolidate the data for the number only of a single species (or species group) into a single line of entry.* These calculations must be documented on your deck form.

If you were not able to weigh representatives of species or species group tallied, there will only be one entry for the species or group: the total number tallied.

For halibut, you will typically have a length estimate for all tallied individuals. You need only one line entry in these instances; the total number tallied and total weight for these individuals. The weight is derived

from the halibut length/weight table. If you used the less preferred option of obtaining halibut weight information, you will need two entries: one for tallied individuals minus any weighed or actually measured, and one for the weighed or measured fish.

Sex: Tanner crab, king crab, and salmon should be listed separately by species and sex. Record an “M” or “F” for these species when sex is determined. Leave the sex field blank for any unsexed organisms.

Number: For each weighed species, enter the number of individuals weighed. For tally period data, record the number of individuals tallied minus any weighed from that species or species group. *Every species entry must have a number record!*

Use as many lines and columns as necessary for each species.

- For decomposed fish (code 899) and miscellaneous items (code 900) enter the actual number of items.
- For subsample data, enter the number of individuals weighed. Unlike samples, subsamples must always have a number *and* a weight.

Weight: For weighed fish, enter the weight by species with a well defined decimal. Weights must be recorded to the nearest 0.1 or 0.01 kg. If you feel that your scale cannot be read accurately to the tenth, you must fill in at least a trailing zero. *Do not enter weights to more than two decimal places.* If a species in your sample was too small to weigh (e.g., one brittle star) *enter the weight as 0.01 kg.* This holds true for both sample and subsample data. For halibut tallied by estimated length, use the “Halibut Length to Weight Table” on page A-34 to derive weight.

For fish from the tally period that were not weighed, enter a zero in the weight field by species. Remember to subtract the number of any weighed individuals from that species or species group.

Percent Retained: This is a rough estimate of the percent of each species retained by the vessel. Keep a separate tally for drop-offs and discards of those species being retained by the vessel. Calculate the total percent retained for a given species by dividing the sum of dropoffs and discards of that species (from all your samples in the set) by the sum of tally numbers for the species (from all your samples in the set). Subtract

this number from 100 to get percent retained and round to the nearest whole percent in the Percent Retained column on the form.

Keypunch check: In the spaces to the right of the words “Keypunch check,” write the calculated sum for species codes, species number, species weight, and percent retained values you recorded for the sample. If your species composition sample has too many species to fit in one sample block, enter the total sums on the keypunch line in the first block for the sample and leave the keypunch line blank for the second block used for the sample.

Keypunch checks are a valuable tool for staff who enter your faxed data. If the keypunch value the computer calculates does not match the keypunch value you wrote down, staff know to double check for errors in the entries they made. If you are sloppy with your keypunch calculations, staff have to investigate each discrepancy. This is a waste of valuable time for both you and for staff. Please double check your keypunch summaries!

REVIEWING FORMS FOR ERRORS

To facilitate the debriefing process you *must* check forms throughout your cruise rather than at the last minute just before your debriefing interview. Observers who regularly review their data at sea generally benefit by having shorter, smoother debriefings. Observers who do not review their data throughout their cruise generally find themselves in lengthy debriefings and with time consuming corrections. It is much easier to check a couple of pages each day over the course of three months than to check a couple hundred pages of data all at once! Follow the guidelines below when reviewing your data for errors.

Check All Forms For:

- Your name and vessel name on the first page of each form type
- Pages numbered properly, no skipped or duplicate numbers
- Every page has your cruise number and vessel code
- Leading zeros are present only for dates and times
- All fields with pre-printed decimals have numbers listed to two decimal places

- All repeat fields have a value entered (do not use arrow downs or brackets)
- Your handwriting is clear and legible

Check Observer and Vessel Haul Forms For:

- Set data is recorded in order of retrieval date
- Every day on the vessel has an entry. This includes the day you boarded and disembarked and all days in between
- Non-fishing days have a non-fishing position with a set number of zero
- No duplicate set numbers
- No decimals other than those already printed on the page
- Number of hooks per segment and total number of hooks in a set entries are in whole numbers

Check Vessel Haul Form for:

- Set and retrieval positions are recorded for all sets
- Positions have no minutes or seconds greater than 59
- Positions recorded to seconds are in seconds, not hundredths
- There is no overlapping of gear deployment and gear retrieval times between sets (except on motherships)
- Retrieval times of 0000 are attributed to the next day
- Depths are rounded to whole numbers.
- “F” or “M” is recorded for every depth recorded
- For each delivery to a mothership, the delivering catcher boat’s ADF&G# is recorded
- A “Y” or “N” is recorded in the IFQ column
- CDQ numbers are recorded with the letter “C” followed by the two digits of the CDQ group number (found in the vessel logbook)

Check Observer Haul Form for:

- For sampled hauls discard weight, if any, is entered
- For all hauls, vessel estimate is entered

LONGLINE DATA COLLECTION: Reviewing Forms for Errors

Check Species Composition Form For:

- Set numbers correspond with dates and sets listed on the VHF
- Species names match species codes (paper forms)
- No species codes are listed without corresponding data (paper forms)
- Sex codes are included only for salmon, Tanner and king crab species
- If sex is unknown, the sex field is left blank

- The number of fish tallied equals the sum number for that species in the reported data
- Decimal points are distinct and recorded to no more than two decimal places
- All weights are in kilograms
- Accurate keypunches of numbers, weights and species codes (paper forms) are on the top line
- Percent retained numbers are entered for all species and are whole number.

Cruise		Permit		Year		Trip Data Form												Page 1 of _____ for vessel														
14821		3459		2009		Observer name <u>Boris Shelikof</u>												Resubmission (Circle All Changes)														
Vessel name <u>Kamchatka Klipper</u>												Port of Trip Start		Port of Trip End		Time of Trip Start		Time of Trip End		Did fishing occur? (This year only)		Bait Used?		Time Lost at Sea (Hours)								
Trip No.	Crew Size	Fish in hold at start?	Trip Start Position					Start Date		Time of trip start	Port of Trip End	Trip End Position					End Date		Time of Trip End	Did fishing occur? (This year only)	Bait Used?	Time Lost at Sea (Hours)										
			Latitude (N)		E	Longitude (100)		Month	Day			Latitude (N)		E	Longitude (100)		Month	Day				Mechanical problems	Weather related problems	Crew related issues	USCG / Enforcement related stoppage	Marine Mammal interaction/predation	Other (include notes)					
Deg.	Min.	Sec.	Of W	Deg.	Min.	Sec.	Month	Day	Deg.	Min.	Sec.	Of W	Deg.	Min.	Sec.	Month	Day															
1	17	N	10				08	12	2130	10						08	19	1410	Y	2												
Comments:																																

National Marine Fisheries Service / Fisheries Monitoring and Analysis Division Page _____ of _____ for transmission Rev. 09

Figure 7-9 Example of trip form for a C/P longline vessel

Vessel Haul Form

Page 1 of

Cruise <u>14821</u>	Permit <u>3459</u>	Year <u>2009</u>	Gear type <u>8</u>
------------------------	-----------------------	---------------------	-----------------------

Observer name Boris Shelikof
Vessel name Kamchatka Klipper

Resubmission
(Circle All Changes)

Trip No.	Haul No.	IFOR Y/N	CDQ No.	Vessel Type	Gear performance Location code	Deployment Information										Retrieval Information														
						Month	Day	Time	Latitude (N)			E or W	Longitude			Average bottom depth	Average gear depth	M or F	Month	Day	Time	Latitude (N)			E or W	Longitude				
									Deg.	Min.	Sec.		Deg. (100)	Min.	Sec.							Deg. (100)	Min.	Sec.						
	0				N													08	12		54	08		W	65	46				
	0				N													08	13		56	36	16	W	71	14	01			
	0				N													08	14		57	54	42	W	73	31	12			
1	102	N		1	R	08	15	1300	56	41	13	W	72	35	15		70	F	08	15	2300	56	45	10	W	72	24	29		
1	103	N		1	R	08	15	1555	56	40	25	W	72	32	45		76	F	08	16	0730	56	44	45	W	72	19	11		
1	104	N		1	R	08	16	0200	56	47	59	W	72	17	33		72	F	08	16	1730	56	44	19	W	72	29	27		
1	105	N		1	R	08	16	1030	56	45	27	W	72	13	10		76	F	08	17	0310	56	41	17	W	72	27	22		
1	106	N		1	R	08	16	2030	56	39	08	W	72	28	14		75	F	08	17	1045	56	43	06	W	72	15	26		
1	107	N		1	R	08	17	0425	56	38	31	N	72	27	52		68	F	08	17	1800	56	43	12	W	72	12	45		
1	108	N		1	R	08	17	1130	56	38	25	W	72	22	21		75	F	08	18	0300	56	42	10	W	72	12	49		
1	109	N		1	R	08	17	1907	56	38	17	W	72	23	39		74	F	08	18	1135	56	42	53	W	72	07	55		
1	110	N		1	R	08	18	0515	57	41	48	N	72	08	01		79	F	08	18	1935	56	37	02	W	72	24	03		

Page of for transmission Rev. 09

Observer Haul Form

Page 1 of

Cruise <u>14821</u>	Permit <u>3459</u>	Year <u>2009</u>	
------------------------	-----------------------	---------------------	--

Observer name Boris Shelikof
Vessel name Kamchatka Klipper

Resubmission
(Circle All Changes)

Haul No.	Haul sampled by (cruise no.)	RST on haul? (Y=on, N=off, F=NA)	RBT on break? (Y=on break, N=no break)	% Monitored for marine mammals	Trawl vessels				Longline and Pot Vessels															
					Vessels total catch estimate in mt	Estimated discard weight in mt	Observers catch estimate in mt	W.E.P.	Density in mt/m ³	Volumetric estimate in m ³	Catcherboat's ADF&G # (motherships only)	# of segments in set	# of hooks per segment	Total hooks or pots in set	Byd distance									
0				
0				
0				
102	14821	X	N	31	10.00	4.50	16	913	14608	1								
103	0	X	Y	0	9.72	15	913	13695	1								
104	14821	X	N	38	5.50	2.00	16	913	14608	2								
105	14821	X	N	44	7.55	3.00	16	913	14608	2								
106	0	X	Y	0	8.00	15	913	13695	2								
107	14821	X	N	35	10.95	6.50	17	913	15521	2								
108	14821	X	N	35	4.55	0.75	17	913	15521	N								
109	14821	X	N	29	9.00	1.00	17	913	15521	N								
110	14821	X	N	35	13.00	2.00	16	1007	16112	N								

Page of for transmission Rev. 09

Figure 7-10 Examples of VHF and OHF data from a C/P longliner fishing for Pacific cod

DECK FORM

JK

Date	Cruise	Permit	Haul No.	Offload No.	Page <u>2</u> of _____ for vessel/plant
8/15/09	14821	3459	102		Page <u>2</u> of <u>2</u> for haul/offload

Sample number: <u>1</u>	Sub-sample number: <u>101</u>	Sample size:	Kgs Hooks pots	Combined <input type="radio"/>	Presorted <input type="radio"/>
Species	Sex	#	Weight	% ret.	length, viability, injury, specimen, and tally data
----- KEYPUNCH -----	<input checked="" type="checkbox"/>	<u>11</u>	<u>87.9</u>	<input checked="" type="checkbox"/>	
<u>P.cod</u>		<u>9</u>	<u>39.7</u>	<u>98</u>	
<u>P.cod</u>		<u>12</u>	<u>48.2</u>	<u>98</u>	

All these fish were collected outside the tally period. Therefore, they must be reported as subsample data for the parent sample from which they came.

P. cod

M	F
(53-1)	54-1
55-1	55-1
56-2	(65-1)
63-1	68-1
66-1	

P.cod otos:

M @ 53, 2.40 kg #521630

F @ 65, 4.60 kg #521631

→ MATURITY SCAN: #521631

2.80 kg SPANNING

Sample number: <u>2</u>	Sub-sample number:	Sample size: <u>1826</u>	Kgs Hooks pots	Combined <input type="radio"/>	Presorted <input type="radio"/>
Species	Sex	#	Weight	% ret.	length, viability, injury, specimen, and tally data
----- KEYPUNCH -----	<input checked="" type="checkbox"/>	<u>0</u>	<u>0</u>	<input checked="" type="checkbox"/>	

NO FISH!

* skipper thinks
line was spanning two
pinnacles ...

Follow this format when there are no fish encountered during your sample.

National Marine Fisheries Service/Fisheries Monitoring and Analysis Division Ver. 09

Figure 7-12 Example of subsample raw data from a longliner

LONGLINE DATA COLLECTION: Reviewing Forms for Errors

Trip Data Form

Page 1 of for vessel

Cruise <u>17218</u>	Permit <u>1257</u>	Year <u>2009</u>	
------------------------	-----------------------	---------------------	--

Observer name Nancy Phelps

Vessel name Swan Dive

Resubmission
(Circle All Changes)

Trip No.	Crew Size	Fish in hold at start?	Port of Trip Start	Trip Start Position						Start Date		Time of trip start	Port of Trip End	Trip End Position						End Date		Time of Trip End	Did fishing occur?	Bait Used? (check gear only)	Time Lost at Sea (Hours)									
				Latitude (N)			Longitude (100)			Month	Day			Latitude (N)			Longitude (100)			Month	Day				Mechanical problems	Weather related problems	Crew related issues	USCG / Enforcement related stoppage	Marine Mammal interaction/predation	Other (include notes)				
				Deg.	Min.	Sec.	E or W	Deg.	Min.	Sec.			Deg.	Min.	Sec.																			
1	12	N	14								07	06	1430	14							07	08	2330	Y	5									
2	12	N	14								07	09	0210	14							07	10	0420	Y	5									

Comments:

Page of for transmission. Rev. 09

Plant/Vessel Offload Form

Page 1 of 1

Cruise <u>17213</u>	Permit <u>1257</u>	Year <u>2009</u>	
------------------------	-----------------------	---------------------	--

Observer name Nancy Phelps

Vessel/Plant name Swan Dive

Resubmission
(Circle All Changes)

Vessels only		Plants only		
Processor name	Processor Permit #	Catcher boat name	Catcher boat ADF&G #	Vessel Permit #
<u>Muddy Mame</u>	<u>72130</u>			
<u>Yakuta's Fresh</u>	<u>56780</u>			

Trip No.	Offload No.	Completion date		Gear type	NMFS area	Total delivered	LB or MT	Total pollock weight	Were all grounds weighed? (Y/N)	ADF&G No. of delivering vessel	Receiving processor permit No.	Was catch sorted? (Y/N)	Tender offload? (Y/N)	ADF&G fish ticket number
		Month	Day											
1	1	07	08			13227	LB				<u>72130</u>	Y	Y	<u>I702345678</u>
2	2	07	10			15432	LB				<u>56780</u>	Y	N	<u>E081234567</u>

Page of for transmission. Rev. 09

Figure 7-13 Examples of trip form and offload form data from a catcher longline vessel fishing for sablefish

DECK FORM

Date	Cruise	Permit	Haul No.	Offload No.	Page <u>1</u> of _____ for vessel/plant
7/07/09	17218	1257	46		Page <u>1</u> of <u>3</u> for haul/offload

Sample number:	Sub-sample number:	Sample size: <u>888</u>	<input checked="" type="radio"/> Kgs Hooks pots	Combined <input type="radio"/>	Presorted <input type="radio"/>
length, viability, injury, specimen, and tally data					

Species	Sex	#	Weight	% ret.																									
----- KEYPUNCH -----	<input checked="" type="checkbox"/>	<u>228</u>	<u>156.47</u>	<input checked="" type="checkbox"/>																									
Commander skate		<u>5</u>	<u>10.8</u>	<u>0</u>	Blackcod - 126 D/O 7																								
Whitebrow skate		<u>4</u>	<u>10.6</u>	<u>0</u>	Bathyraja - 26																								
Arrowtooth		<u>7</u>	<u>8.8</u>	<u>0</u>	Arrowtooth/Kam - <input checked="" type="checkbox"/> <input type="checkbox"/> <input type="checkbox"/> (9)																								
Shortspine thorny		<u>8</u>	<u>3.2</u>	<u>0</u>	Thornyhead - <input checked="" type="checkbox"/> <input checked="" type="checkbox"/> <input checked="" type="checkbox"/> L (17)																								
Dogfish shark		<u>7</u>	<u>11.2</u>	<u>0</u>	Dogfish shark - <input checked="" type="checkbox"/> <input checked="" type="checkbox"/> <input checked="" type="checkbox"/> <input checked="" type="checkbox"/> W (23)																								
Redbanded R.F.		<u>8</u>	<u>9.4</u>	<u>0</u>	Redbanded RF - <input checked="" type="checkbox"/> W (8)																								
Blackcod		<u>126</u>	<u>0</u>	<u>99</u>																									
Bathyraja		<u>17</u>	<u>0</u>	<u>0</u>																									
Arrow/Kam		<u>2</u>	<u>0</u>	<u>0</u>																									
Shortspine thorny		<u>9</u>	<u>0</u>	<u>0</u>																									
Dogfish		<u>16</u>	<u>0</u>	<u>0</u>	Halibut																								
Halibut		<u>19</u>	<u>102.47</u>	<u>90</u>	<table style="font-size: small; border-collapse: collapse;"> <tr> <td>50</td> <td></td> <td></td> <td></td> <td></td> <td></td> </tr> <tr> <td>60</td> <td>L</td> <td>(5)</td> <td>$\times 2.41 = 7.23$</td> <td>90</td> <td>L (2) $\times 8.98 = 17.96$</td> </tr> <tr> <td>70</td> <td>L</td> <td>(7)</td> <td>$\times 3.98 = 27.86$</td> <td>100</td> <td>I (1) $\times 12.64 = 12.64$</td> </tr> <tr> <td>80</td> <td>L</td> <td>(6)</td> <td>$\times 6.13 = 36.78$</td> <td>110</td> <td></td> </tr> </table>	50						60	L	(5)	$\times 2.41 = 7.23$	90	L (2) $\times 8.98 = 17.96$	70	L	(7)	$\times 3.98 = 27.86$	100	I (1) $\times 12.64 = 12.64$	80	L	(6)	$\times 6.13 = 36.78$	110	
50																													
60	L	(5)	$\times 2.41 = 7.23$	90	L (2) $\times 8.98 = 17.96$																								
70	L	(7)	$\times 3.98 = 27.86$	100	I (1) $\times 12.64 = 12.64$																								
80	L	(6)	$\times 6.13 = 36.78$	110																									

Sample number:	Sub-sample number: <u>101</u>	Sample size:	<input type="radio"/> Kgs Hooks pots	Combined <input type="radio"/>	Presorted <input type="radio"/>
length, viability, injury, specimen, and tally data					

Species	Sex	#	Weight	% ret.																					
----- KEYPUNCH -----	<input checked="" type="checkbox"/>	<u>30</u>	<u>79.8</u>	<input checked="" type="checkbox"/>																					
Black cod		<u>10</u>	<u>26.2</u>	<u>99</u>	<table style="font-size: small; border-collapse: collapse;"> <tr> <th style="border-bottom: 1px solid black;">M</th> <th style="border-bottom: 1px solid black;">F</th> </tr> <tr> <td>50-1</td> <td>48-1</td> </tr> <tr> <td>51-1</td> <td>50-1</td> </tr> <tr> <td>52-1</td> <td>(51-1)</td> </tr> <tr> <td>(54-2)</td> <td>54-1</td> </tr> <tr> <td>57-2</td> <td>58-1</td> </tr> <tr> <td>58-1</td> <td>(60-2)</td> </tr> <tr> <td></td> <td>61-2</td> </tr> <tr> <td></td> <td>63-3</td> </tr> <tr> <td></td> <td>67-1</td> </tr> </table>	M	F	50-1	48-1	51-1	50-1	52-1	(51-1)	(54-2)	54-1	57-2	58-1	58-1	(60-2)		61-2		63-3		67-1
M	F																								
50-1	48-1																								
51-1	50-1																								
52-1	(51-1)																								
(54-2)	54-1																								
57-2	58-1																								
58-1	(60-2)																								
	61-2																								
	63-3																								
	67-1																								
Black cod		<u>10</u>	<u>28.6</u>	<u>99</u>																					
Black cod		<u>10</u>	<u>25.0</u>	<u>99</u>																					

Don't forget to refer to the section of this chapter that discusses what you can and cannot ID to species off the line! In this example, thornyheads not in hand were reported to species as shortspine thornyheads because you are allowed to do so if no longspine individuals are in the subset sample. **Keep in mind that there are different rules for different species and reference your manual!**

Oto's
m - 54 1.65kg - #146212
f - 60 2.51kg - #146213
f - 51 1.02kg - #146214

National Marine Fisheries Service/Fisheries Monitoring and Analysis Division Ver. 09

Figure 7-15 Example of sample and subsample raw data from a catcher longliner fishing for sablefish

DECK FORM

Date	Cruise	Permit	Haul No.	Offload No.	Page <u>2</u> of _____ for vessel/plant
7/07/09	17218	1257	46		Page <u>2</u> of <u>3</u> for haul/offload

Sample number: <u>2</u>	Sub-sample number:	Sample size: <u>888</u>	Kgs Hooks pots	Combined <input type="checkbox"/>	Presorted <input type="checkbox"/>
-------------------------	--------------------	-------------------------	----------------------	-----------------------------------	------------------------------------

Species	Sex	#	Weight	% ret.	length, viability, injury, specimen, and tally data								
----- KEYPUNCH -----	X			X									
Whitebrow sk.		7	14.8	0	Blackcod - 76 D/O L Bathyraya - 18 Arrow/Ram - <input checked="" type="checkbox"/> <input checked="" type="checkbox"/> <input checked="" type="checkbox"/> <input checked="" type="checkbox"/> L - (22) Thornyhead - <input checked="" type="checkbox"/> 1 - (6) SR/RE - <input checked="" type="checkbox"/> <input checked="" type="checkbox"/> <input checked="" type="checkbox"/> U - (18) Grenadier - U (3) King crab - (1) - m e 123cm Halibut <table style="width: 100%; border-collapse: collapse;"> <tr> <td style="width: 50%;">50</td> <td style="width: 50%;">90</td> </tr> <tr> <td>60-1 (1) x 2.41</td> <td>100</td> </tr> <tr> <td>70-1 (4) 3.98 = 15.92</td> <td></td> </tr> <tr> <td>80</td> <td></td> </tr> </table>	50	90	60-1 (1) x 2.41	100	70-1 (4) 3.98 = 15.92		80	
50	90												
60-1 (1) x 2.41	100												
70-1 (4) 3.98 = 15.92													
80													
Arrowtooth		10	14.2	0									
SS Thornyhead		6	3.2	0									
Shortraker		8	18.4	0									
Shortraker		7	16.2	0									
Rougheye RF		2	3.1	0									
Giant Grenadier		2	15.6	0									
Grenadier U.		1	2.6	0									
Couesi crab	M	1	0.8	0									
Blackcod		76	0	99									
Bathyraya		11	0	0									
Arrow/Ram		12	0	0									
Shortraker/Rougheye		1	0	0									

Sample number:	Sub-sample number:	Sample size:	Kgs Hooks pots	Combined <input type="checkbox"/>	Presorted <input type="checkbox"/>
----------------	--------------------	--------------	----------------------	-----------------------------------	------------------------------------

Species	Sex	#	Weight	% ret.	length, viability, injury, specimen, and tally data												
----- KEYPUNCH -----	X			X													
Halibut		5	18.33	75	Shortraker R.F. <table style="width: 100%; border-collapse: collapse;"> <tr> <td style="width: 50%; text-align: center;">M</td> <td style="width: 50%; text-align: center;">F</td> </tr> <tr> <td>50-1</td> <td>45-1</td> </tr> <tr> <td>51-1</td> <td>(50-1)</td> </tr> <tr> <td>59-1</td> <td>(60-1)</td> </tr> <tr> <td>60-1</td> <td>62-2</td> </tr> <tr> <td></td> <td>65-1</td> </tr> </table> Oto's SR f. 50-2.62kg #146210 f. 60-2.63kg #146211 Giant Grenadier f - 20 m - 18	M	F	50-1	45-1	51-1	(50-1)	59-1	(60-1)	60-1	62-2		65-1
M	F																
50-1	45-1																
51-1	(50-1)																
59-1	(60-1)																
60-1	62-2																
	65-1																

National Marine Fisheries Service/Fisheries Monitoring and Analysis Division Ver. 09

Figure 7-16 Example of sample raw data from a catcher longliner fishing for sablefish (continued)

LONGLINE DATA COLLECTION: Reviewing Forms for Errors

DECK FORM

Date	Cruise	Permit	Haul No.	Offload No.	Page <u>3</u> of _____ for vessel/plant
7/07/09	17218	1257	46		Page <u>3</u> of <u>3</u> for haul/offload

Sample number: <u>2</u>	Sub-sample number: <u>201</u>	Sample size:	Kgs Hooks pots	Combined <input type="radio"/>	Presorted <input type="radio"/>
Species	Sex	#	Weight	% ret.	length, viability, injury, specimen, and tally data
----- KEYPUNCH -----	<input checked="" type="checkbox"/>	<u>30</u>	<u>131.2</u>	<input checked="" type="checkbox"/>	
Black cod		<u>7</u>	<u>30.6</u>	<u>99</u>	
Black cod		<u>7</u>	<u>33.8</u>	<u>99</u>	
Black cod		<u>7</u>	<u>31.4</u>	<u>99</u>	
Blackcod		<u>9</u>	<u>35.4</u>	<u>99</u>	

Sample number:	Sub-sample number:	Sample size:	Kgs Hooks pots	Combined <input type="radio"/>	Presorted <input type="radio"/>
Species	Sex	#	Weight	% ret.	length, viability, injury, specimen, and tally data
----- KEYPUNCH -----	<input checked="" type="checkbox"/>			<input checked="" type="checkbox"/>	

National Marine Fisheries Service/Fisheries Monitoring and Analysis Division Ver. 09

Figure 7-17 Example of subsample raw data from a catcher longline vessel fishing for sablefish

LONGLINE DATA COLLECTION: Reviewing Forms for Errors

Cruise	Permit	Length and Specimen Form										Page <u>1</u> of <u> </u>				
17218	1257	Observer name <u>Nancy Phelps</u>					Vessel name <u>Swan Dive</u>									
Resubmission (Circle All Changes)																
Species Name	Species code	Haul no.	Offload No.	Sample or Sub-Sample no.	Sample system	Sex	Crabs		Halibut		Length	Freq.	Specimen Data			
							Eggs? Y/N	Viability (trawl/pot) Injury (Longline)	Specimen Type	Specimen Number			Weight	Maturity		
Black cod	203	46		101	2	M					50	1			.	
Black cod	203	46		101	2	M					51	1			.	
Black cod	203	46		101	2	M					52	1			.	
Black cod	203	46		101	2	M					54	2	1	146212	1.65	
Black cod	203	46		101	2	M					57	2			.	
Black cod	203	46		101	2	M					58	1			.	
															.	
Black cod	203	46		101	2	F					48	1			.	
Black cod	203	46		101	2	F					50	1			.	
Black cod	203	46		101	2	F					51	1	1	146214	1.02	
Black cod	203	46		101	2	F					54	1			.	
Black cod	203	46		101	2	F					58	1			.	
Black cod	203	46		101	2	F					60	2	1	146213	2.51	
Black cod	203	46		101	2	F					61	2			.	
Black cod	203	46		101	2	F					63	3			.	
Black cod	203	46		101	2	F					67	1			.	
															.	
Couesi crab	16	46		2	2	M					123	1			.	
Page _____ of _____ for transmission													Ver. 09			

Cruise	Permit	Length and Specimen Form										Page <u>2</u> of <u> </u>				
17218	1257	Observer name <u>Nancy Phelps</u>					Vessel name <u>Swan Dive</u>									
Resubmission (Circle All Changes)																
Species Name	Species code	Haul no.	Offload No.	Sample or Sub-Sample no.	Sample system	Sex	Crabs		Halibut		Length	Freq.	Specimen Data			
							Eggs? Y/N	Viability (trawl/pot) Injury (Longline)	Specimen Type	Specimen Number			Weight	Maturity		
Shortraker RF	326	46		2	2	M					50	1			.	
Shortraker RF	326	46		2	2	M					51	1			.	
Shortraker RF	326	46		2	2	M					59	1			.	
Shortraker RF	326	46		2	2	M					60	1			.	
															.	
Shortraker RF	326	46		2	2	F					45	1			.	
Shortraker RF	326	46		2	2	F					50	1	1	146210	2.62	
Shortraker RF	326	46		2	2	F					60	1	1	146211	2.63	
Shortraker RF	326	46		2	2	F					62	2			.	
Shortraker RF	326	46		2	2	F					65	1			.	
															.	
Giant Grenadier	82	46		2	2	M					18	1			.	
															.	
Giant Grenadier	82	46		2	2	F					20	1			.	
															.	
															.	
Page _____ of _____ for transmission													Ver. 09			

Figure 7-19 Examples of length and specimen paper forms

LONGLINE DATA COLLECTION: HAUL FORM QUICKLIST for LONGLINERS

HAUL FORM QUICKLIST FOR LONGLINERS	
<u><i>OHF</i></u>	<u><i>VHF</i></u>
<u><i>RST On Haul?</i></u>	<u><i>Vessel Types</i></u>
Y for on haul	1 - Catcher/processor (C/P)
N for off haul	2 - Mothership
X for did not use RST	3 - Catcher-only vessel:
<u><i>RBT On Haul?</i></u>	5 - Bait - vessel
Y for on break	<u><i>Gear Performance Codes</i></u>
N for off break	1 - No problems
N When RBT not used	2 - Crab pot caught
<u><i>Bird Deterrence</i></u>	5 - Other problem, explain in "notes"
1 - Paired streamer line used	6 - Some or all gear lost
2 - Single streamer line used	7 - Considerable predation by sea lions
0 - No streamers were used	8 - Considerable predation by killer whales
N - did not check deterrent type	10 - Considerable predation by sperm whales
	<u><i>Gear Codes</i></u>
	8 - Longline vessels
	7 - Jig vessel
	6 - Pot vessels

Figure 7-20 List of codes and truncated meanings for OHF and VHF

LONGLINE DATA COLLECTION: HAUL FORM QUICKLIST for LONGLINERS

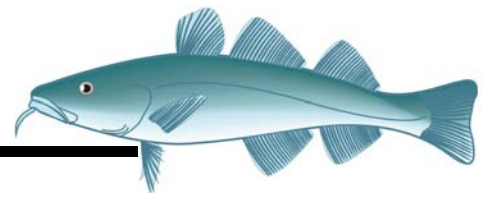

POT VESSEL DATA COLLECTION

Table of Contents

List of Priorities	8-1
Introduction.....	8-3
Safety Concerns on Pot Vessels	8-3
Offload Data for Pot Vessels.....	8-4
Estimating Discards.....	8-6
Recording Fishing Effort Data.....	8-6
Delineating Strings.....	8-7
Verifying Gear.....	8-7
Vessels Fishing IFQ or CDQ	8-8
Vessel Haul Form for Pot Vessels	8-8
Observer Haul Form for Pot Vessels	8-8
Composition Sampling Guidelines.....	8-8
Selecting Hauls to Sample	8-9
Preferred Sampling Method.....	8-9
Pot Vessel Samples and Subsamples.....	8-9
Number of Samples per Sampled Haul	8-9
Sample Size Considerations	8-10
When to Sample for Species Composition	8-10
Minimizing Sample Bias	8-10
Sampling Designs on Pot Vessels.....	8-10
Sampling from Spatial Frames on Pot Vessels.....	8-11
Sampling from Temporal-Spatial Frames on Pot Vessels.....	8-12
Designing a Temporal-Spatial Based Sampling Scheme:	8-12
Systematic Sampling on Pot Vessels	8-13
Designing a Spatial Based Systematic Sampling Scheme:.....	8-13
Collecting Weights for Non-Predominant Catch	8-14
Collecting Weights for Predominant Catch	8-15
Tallying Catch	8-15
When You Cannot Count All the Crab in a Pot.....	8-15
Tips for Sampling on a Pot Vessel.....	8-15
Halibut Viabilities on Pot Vessels	8-16
Deck Form Instructions.....	8-17
Paper Form Instructions	8-19

LIST OF PRIORITIES

- Your Safety!
- Collect data and specimens from marine mammal and endangered sea bird mortalities. Rehabilitate endangered and threatened seabirds.
- Record the vessel’s total fishing effort for every set retrieval.
- Verify the number of pots in your sample and the number of pots in the set.
- Sample for species composition.
- Send data to FMA as directed (see “Sending Data” on page 2-26.).
- Document any compliance concerns.
- Measure and assess viability of Pacific halibut. Measure and sex other prohibited species.
- Collect biological data from predominant species.
- Collect sexed lengths from predominant species.
- Record calculations and daily logbook notes.
- Complete special projects.
- Record sightings of bird “species of interest.”
- Record marine mammal sightings.

<p>Terminology</p> <p>Bait bags/Jars - Containers filled with ground bait that are hung inside pots to attract fish.</p> <p>Bag - Another name for a buoy.</p> <p>Block - Hydraulically driven wheel that is used to retrieve line and lift pots.</p> <p>Bridle - A length of line that attaches two sides of a pot to the buoy line.</p> <p>Bleeder/Sorter - Crewman assigned to sort bycatch out of the catch, and to cut the isthmus (throat) of the cod.</p> <p>Chopper - Machine used to grind frozen herring or squid for bait or the person assigned this duty.</p> <p>Coiler - Person or machine that is designated to coil line as it is retrieved by the block.</p> <p>Diver/Trailer buoys - A small buoy attached to the main buoy with a length of line. The diver buoy “trails” behind the main buoy and allows a larger target for grappling. Some fishers call the main buoy the diver buoy.</p> <p>Dogs - Metal hooks that are hydraulically controlled to secure a pot to a launcher.</p> <p>Door - A panel on a pot that can be unhooked and swung open to remove catch. The door is usually held shut by bungee cords.</p> <p>Fingers/Triggers - Small plastic strips located in the tunnel of a pot which allow fish to enter a pot but not exit.</p> <p>Halibut excluder - A divider located in the tunnel of a pot that restricts the size of the opening, preventing large halibut from entering the pot.</p> <p>Hook - Usually a three pronged grappling hook used to snag the trailer buoy line.</p> <p>Launcher - Hydraulic lift, usually located on the starboard side of a vessel, used to “launch” pots over the side of the vessel and to adjust the angle of the pot when it is being emptied.</p> <p>Longline Pots - Some vessels targeting black cod will connect their pots to each other and create one string.</p> <p>Panel - Mesh netting attached to a square metal frame. Two large panels and four smaller panels are attached to a heavy steel frame box to form the six sides of a pot.</p> <p>Pick/“Running the hook” - Hook connected to the end of the boom which is attached to the bridle and is used to lift a pot onto the launcher as the pot is being retrieved.</p> <p>Plotter - Electronic mapping device that displays the local area and the vessel’s position on it. The plotter allows captains to record the area of a string and also the number of pots in a string on a digital map display.</p> <p>“Run pots” - A phrase used interchangeably with “retrieve pots.” It is the phrase used in the vessel logbook to indicate the number of pots that have been retrieved from a string.</p> <p>Shot - A pre-measured length of buoy line, usually 10 to 20 fathoms long. Normally there are two set lengths, a “Long” shot and a “Short” shot. When setting a string, the captain will tell the crew how many shots to tie to a pot for various bottom depths.</p> <p>Stack - This term is used on pot vessels to refer to pots stacked on the deck.</p> <p>String - Generally pots are deployed individually and are not attached to one another in any way. This term refers to pots set at a similar time in a similar area and depth. What a captain calls a string varies considerably between vessels. Strings are analogous to sets.</p> <p>Tunnel - Short mesh-lined openings on two or three sides of a pot. These are the entrances to the trap. Fish and crab are able to swim in but are unable to make their way back out due to the fingers/triggers.</p>
--

Figure 8-1 Pot Vessel Terminology

INTRODUCTION

The National Marine Fisheries Service defines pot fishing as using a stationary, buoyed line attached to a single trap, or traps attached to a longline, for the purpose of capturing fish. Groundfish observers are only deployed to monitor Pacific cod fisheries and some sablefish fisheries although various species of crab are also fished with pot gear.

Pot Fishing Operations

A pot used to fish groundfish consists of mesh panels attached to a rectangular metal frame. Pots vary in size, but cod pots are most often two meters by two meters by one meter. Fish are attracted by bait attached inside the pots. Mesh tunnels on either side of a pot allow fish to enter and plastic “triggers” prevent them from escaping. Halibut excluders are required for all pot groundfish fisheries. The excluders are fitted into tunnels to restrict the width of the opening. This prevents large halibut from entering the pots while permitting entry of smaller fish.

The deck of a pot boat is equipped with a launcher, crane, and a boom. The launcher is a hydraulic lift usually located on the starboard side of the vessel. The boom is a hydraulic crane usually on the port side of a vessel. To deploy a pot, the crew will use the boom to move a pot into the launcher. Metal hooks or “dogs” from the sides of the launcher grab the pot and hold it secure. The pot is then adjusted so that it is horizontal to the deck. A single length of line is attached to the pot and the coil is set next to the launcher. The pot is baited, the doors shut, and the pot is “launched” over the side. The coil of line plays out as fast as the pot is sinking. A set of buoys are attached at the end of the line with the vessel’s permit number and often a pot number.

To retrieve a pot, a crew member tosses a grappling hook to snag the buoys. The buoys are dragged on deck and the line is placed into the rotating “block.” The block retrieves the line and pulls the pot from the water. When the pot reaches the side of the boat, the picking crane is hooked to the bridle, then the pot is lifted and placed onto the launcher. The angle of the launcher can be adjusted to remove the catch or to redeploy the pot. The “dogs” on the sides of the launcher grab the pot and secure it as the pot door is opened and the contents are dumped into a tote or sorting table. Once all of the

catch has been dumped into the tote or sorting table, the crew pulls the tote or table out of the way, sorts out the bycatch, bleeds the Pacific cod or removes the head of the sablefish (blackcod), and throws the fish into the hold.

If pots are to be redeployed, the bait bag is replaced, the doors are tied shut, and the launcher is lifted to slide the pot back into the water. If the pots are being stacked, the boom drags or lifts the pot to the back of the deck where it is placed on the stack and secured by pot ties and chains.

Pots are deployed in units called “strings.” When the captain decides to set gear, the crew prepares the pots and drops them overboard one at a time. The result is a row or string of pots. Pots may also be deployed in a cluster, grouped around favorable fishing bottom. Captains use various means of recording the numbers and locations of pots set. Most use a computerized plotter, marking the latitude and longitude of each pot. Many captains also record the position of each pot in a personal notebook. Strings can be viewed on the screen as points connected with lines; each point representing a pot. Some captains record detailed data on location, depth, and soak time into the NMFS logbook for each string, while others simply record the total numbers of pots retrieved in a day as one string, regardless of the set information.

SAFETY CONCERNS ON POT VESSELS

On a pot vessel, all work is conducted on deck. Be conscious of your surroundings at all times. Pot vessels have low rails over which the pots are lifted. Waves can easily wash crew and gear overboard. When you first arrive on a vessel, discuss with the deckboss or captain which area would best allow you to access the catch. The area needs to have a clear view of the pots as they leave the water and are emptied, but should be located out of danger from swinging pots. You should never set up your sampling area directly across from the pot launcher.

Regardless of how exposed your sample station is to the elements, the Observer Program expects you to be proactive about your own safety by wearing a personal flotation device whenever you are working on deck. You should always notify the captain or crew if you plan to be, or think you will be, out on deck alone.



Discuss with the crew how best to collect samples. The best option may be to have the crew push full totes or swing the sorting table to you. Be sure to coordinate your activities around the movement of the pots. Be aware of coils of line attaching the buoys to the pot. These are deployed as the pot is launched and have been known to wrap around ankles and drag crew overboard. Pots may slip or jump from the launcher or the pots may break free from ties on the stack. Pots are very heavy, between 350 and 450 kg, and have crushed crew members. While sorting and weighing samples, check deck activity frequently and be attuned to the crew for danger warnings. Be aware of possible hazards and plan a safe response.



The Vessel/Plant Offload Form is used by plant observers as well. For information on how to complete the Vessel/Plant Offload Form as a plant observer please refer to page 9-12.



OFFLOAD DATA FOR POT VESSELS

Observers on catcher pot vessels must report offload information on the Vessel/Plant offload form.

Data for the Vessel/Plant offload form may be obtained from the Alaska Department of Fish and Game (ADF&G) fish ticket, electronic scale readout, scale weights recorded by a factory representative, the plant's NMFS logbook as well as from observations by the observer. *If you are on a vessel equipped with ATLAS you must maintain a set of Offload paper forms in addition to sending these data electronically.*

Cruise Number, Permit, Year, Observer Name, and Vessel/Plant name: Enter the cruise number supplied in your training or briefing. Enter the vessel permit found in the manual on page A-25. For "Year" you can enter the full year or just the last two digits (*e.g.*, "09"). Enter your name and the name of the vessel to which you are assigned.



Processor Name and Processor Permit: In the box in the upper left hand corner, fill in the name and processor permit for each of the plants to which your vessel delivers. You only need to record each plant once for each data set. There is a list of processor permits for shoreside or floating plants and motherships on page A-23. If your vessel delivers to a plant that is not on the list, enter 99999 (for "unknown") and contact NMFS staff for advice.

Figure 8-2 Set, retrieval, and dumping of a pot

Resubmission: Circle “Resubmission” if you are sending changes to data previously faxed. *Also, please circle the items that have changed since your last transmission of the data: this will aid keypunchers in making the appropriate modifications to your data.* You do not need to start a new form after faxing.

Trip Number: Enter the number of the trip during which most of the fishing for the offload occurred. If the vessel made more than one trip to catch fish for the offload, record the trip that includes the majority of the hauls. In ATLAS, the “trip start date” will be auto-filled based on the trip that you selected.

Offload Number: All offloads must be recorded and assigned a number. Offload numbers must be unique for the cruise/vessel and should be sequential and ascending, beginning with ”1.”

Completion Date: Enter the month and day the offload was completed. Write the dates in two digit format.

Gear Type and NMFS area: These columns are used by plant observers only. Leave these columns blank.

Total Delivered, LB or MT: Record the total round weight delivered to the plant for that trip. Delivery weights can be entered in either pounds or kilograms. Delivery weights recorded in pounds must be recorded to the nearest whole pound. Weights reported in metric tons must be reported to the nearest 0.01 of a metric ton. Remember that when cut or bled fish are delivered, the round weight must be used. *Round weights are listed at the bottom or end of the fish ticket.*

Total Pollock Weight, Were all Groundfish Weighed?, ADF&G Number of Delivering Vessel: These columns are used by plant observers only. Leave these columns blank.

Receiving Processor Permit Number: For each offload, record the processing plant’s permit number. The permit numbers should be one of those you listed under Processor Name and Processor Permit Number described above. If a delivery is split and sold to more than one processor, you should make an entry on the Vessel/Plant Offload Form for each delivery. If this, or any other incident out of the ordinary occurs, please note the circumstances in your logbook.

Was Catch Sorted (Y/N): Record a “Y” for any delivery that was sorted at sea. Record an “N” if the crew did not sort the catch before delivery.

Tender offload (Y/N): Record a “Y” if your vessel acted as a tender by receiving catch from another vessel. Otherwise enter an “N.”

ADF&G fish ticket number: Record the fish ticket number associated with the delivery for this vessel. As a vessel observer this number will be taken directly from the fish ticket. Record the number exactly as it appears on the fish ticket. If you did not receive a fish ticket, this field may be left blank. If more than one fish ticket was associated with the same offload, record the additional fish ticket number(s) below the first entry for the delivery.

Determining Delivery Weight

When the vessel delivers its catch to a processing plant, the fish are weighed. The scales at each plant are tested by the State of Alaska annually and they do not need to be tested daily for you to use this weight as a delivery weight. The delivery weight information must be verified by either yourself or the plant observer. Ultimately, the data used is yours, so do not rely on plant observers to verify your delivery weight unless they have agreed to do so. Plant observers need to give you documentation on how verification was done when *they* complete this task. For more information on this aspect of a plant observer’s duties see “Delivery Worksheet Verification” on page 9-4.



When reporting delivery weight on the Plant/Vessel Offload form, you must verify the delivery weight. You are responsible for knowing and documenting how all your data were derived!

Prior to 2008, non pollock catcher vessel observers did not report total delivery weight. As a result, plant personnel may not be accustomed to providing this information to non pollock observers. Work with the plant observer and plant personnel to obtain the fish ticket for your delivery. If a fish ticket is not available, you may obtain your total delivery weight using an alternate method. This includes, but is not limited to, direct observations of scale weights during the offload, verbal confirmation from plant personnel, skipper estimates, or independent measurements. The exact source of delivery weight information will be specific to each scenario. Regardless of how the weights are determined, always document your methods in the daily notes section of your observer logbook.

POT VESSEL DATA COLLECTION: Estimating Discards

In the majority of situations, the fish ticket will be the best source of data for determining delivery weight. Plants are allowed to record the number only of prohibited species, however fisheries managers need weight data as well. For observers on non pollock catcher vessels, if you are using the fish ticket for a delivery weight and the fish ticket does not have weights for all species, sum all the weights that were provided on the fish ticket and enter that value for the total delivery weight. Document the situation in your observer logbook. For information on interpreting fish tickets and tips on how to avoid potential errors see page 9-13.

ESTIMATING DISCARDS

The weight of all at-sea discards must be estimated independently by the on board observer(s). Discard information is collected in conjunction with percent retained data. By recording discard estimates in a separate field in the data, fisheries managers are able to quantify discards at both the vessel and fleet level. The time spent on this information should be nominal. Refer to “Estimating Percent Retained” on page 7-33 for further discussion of estimating percent retained and discards on pot vessels.

The process of estimating total discards differs between catcher vessels and catcher processors. Regardless of the vessel type, ***obtaining a discard estimate should only take a few moments***. On catcher vessels, discards are generated on deck, where you can see all the fish at one time. On catcher processors, discard can occur on deck or anywhere in the factory. Familiarizing yourself with the flow of fish on the vessel will help you to recognize areas of potential discard. If vessel personnel sort out and discard undesirable fish, or if portions of the catch are dumped overboard, you must estimate the total weight of these discards. Account for catch discarded in one of the following ways:

1. An actual measurement of the discard contributes the best information, but this method may not be feasible on your vessel type. If the discards are few, try to weigh everything using your observer scales. If you can not do so, consider the other options discussed here.
2. Volumetrics may be used to determine a discard estimate. If the vessel retains all the discard in a tote, or checker bin, the volume of this discard, multiplied by a

density, will yield an estimate. When using volumetrics for determining a discard estimate it is acceptable to use known references rather than actual measurements.

3. A simple visual estimate is the easiest method of obtaining an estimate of discards. Using visual cues such as a how many baskets of discards a sample generated can help you to quantify what you are seeing. For example, if all your samples resulted in one basket of discards (approximately 40 kg), and those samples were about 1/6th of the entire haul, you can assume there were about 6 baskets of total discards, or about 240 kg (.24 metric tons).

You can look at production data for the haul to get a sense of whether or not your estimate is reasonable. Production data are the weight, after processing, of retained catch. Multiply this by the appropriate product recovery rate (PRR) to determine round catch weight of the species, before production. Product recovery codes can be found (see page A-18). If your discard estimate doesn't make sense in relation to this value, modify it. For example, if you estimate that 5 percent (by weight) of total catch was discarded, and document this as 5 tons of discard, but the round weight of processed fish is only 10 tons, the discard estimate of 5 tons is actually 35 percent of total catch. You would reduce your estimated weight of discards to reflect 5 percent of total catch weight.

Refer to the discards information recorded by the vessels in the DCPL or the DFL to ***verify*** your independent observations. However, ***do not use these entries to provide discard data!***

RECORDING FISHING EFFORT DATA

Under regulation 50CFR679.50 (see “Records” on page 18-11), observers have the right to inspect and copy the vessel's NMFS logbook and all other documentation of fishing effort. You are required to transfer the following information from the vessel logbook to the Vessel and Observer Haul Forms:

- Date and Time of Gear Deployment
- Date and Time of Gear Retrieval
- Position of Gear Deployment (Latitude and Longitude)
- Position of Gear Retrieval (Latitude and Longitude)
- Average Sea Depth

- Individual Fishing Quota (IFQ), Yes or No
- Community Development Quota (CDQ) number, if applicable
- Number of Pots Retrieved

In addition, you need to record in your logbook information on any problems associated with the retrieval of the pots. This information is not recorded in the vessel logbook. Ask the person responsible for entering information in the vessel's logbook to record missing pots or problems with pot retrieval somewhere on the logbook page or on a separate page for you. See Figure 8-5 for paper form examples of these types of data.

Delineating Strings

One of the greatest difficulties faced by observers on pot vessels is determining what constitutes a string of gear. Pots are set individually, each with its own buoy. Though pots of a string may be set at varying depths, areas, and may have different soak times, captains may list the pots individually, in groups of pots, or as a single, long string. Try to obtain the most discrete data you can by working with the captain, consulting the plotter, and tracking the gear retrieval yourself. It may be necessary to designate all the pots retrieved within a 24 hour period as a single string, however, this method does not yield the most discrete data. How you delineate a string of gear will be important in determining the vessel estimate. Be sure to document in your logbook any difficulties you encounter when determining strings on your vessel.

Verifying Gear

Before copying anything from the vessel logbook to your data forms, you must verify that the data reported are accurate. Misunderstandings about how the log is filled out are possible. Note that unlike trawl and longline vessels, observers on pot boats may use different haul data than that from the vessel logbook. You may break a "string" into several separately recorded units, or combine several units into one string if it will provide better data. Please note that this requires that you work closely with cooperative vessel personnel in order to record the correct time and position data for any altered sets. Because of this, you should undertake this endeavor only if you are sure it will increase the accuracy of your data, and that you will be able to obtain the correct haul data.

Whether you use the captain's haul designation system or your own, you must verify the following information, either from the vessel logbook entries or your personal observations:

Date and Time of Gear Deployment, and Date and Time of Gear Retrieval

Whenever possible, note the time when the crew begins to deploy gear and note the time the last pot is retrieved for a set. You will not be able to verify deployment or retrieval times for all sets. For unverified sets, rely on the information provided by vessel personnel in the vessel's logbook. If your vessel's logbook contains erroneous times, let the officer in charge of the logbook know about the error. If the incorrect data continues to be logged, consult NMFS for advice on how to record your set data.

Position of Gear Deployment and Position of Gear Retrieval - Latitude and Longitude

The Begin Position of Set is the position of the vessel when the first pot of a string was deployed. The End Position of Set is the position of the vessel when the last pot of a string was retrieved. The captain or a mate reads these positions from the GPS navigation system located on the bridge. Occasionally, check that the positions listed in the vessel's logbook match that on the GPS display during the retrieval or deployment of a string. Review positions listed in the vessel's logbook. Question any large changes in position between one set and the next if you have not had a long run between sets. The person responsible for the logbook may have incorrectly entered the position.

Number of Pots Run

Resource managers calculate catch weights for pot vessels from the numbers you supply for sample weight, sampled pots, and total pots. Successful management of the pot vessel fisheries is dependent on the accuracy of these values. ***It is crucial that the vessel's gear be independently verified by you!*** On a pot vessel, the only gear related element that you must verify is the number of pots per set.

Never rely solely on the number of pots the captain lists as being run for your total number of pots in a set. Gear deployment strategies and methods captains use to log the number of pots in a string can be quite different. For each pot vessel to which you are deployed, you will need to develop a method for

POT VESSEL DATA COLLECTION: Composition Sampling Guidelines

verifying the number of pots retrieved. Actual counts of the pots are the most reliable. While on deck you may be able to tally all the pots in a string. If it is not possible to count all the pots in a string, count the number of pots in an identifiable section of a string, and cross check these numbers with the plotter and captain's logbook. Make sure to check and verify the "Pots Lost" column and to subtract any lost gear!

Vessel Haul Form for Pot Vessels

The Vessel haul form is used for recording fishing effort data from all gear types. There are very few differences between the VHF information required on a longliner and that required on a pot vessel. Below are those form items for pot vessels that have data elements differing from longline vessels.

- **Gear Type** code for a pot or trap vessel is 6
- There are three **Gear Performance** codes applicable to pot vessels:
 - 1- No Problem.
 - 5- Miscellaneous problem in retrieving gear; document the problem in your logbook daily notes.
 - 6 - Problem: pots were lost.

For information on filling out the rest of the fields on the Vessel Haul Form, please refer to the longline section starting on page 7-9. For a pot vessel VHF example, see Figure 8-5.

Vessels Fishing IFQ or CDQ

All longline and pot vessels (IFQ and non-IFQ) use the same logbook. data are entered differently depending on whether or not the vessel is fishing for IFQ species. On the vessel logbook (see Figure 7-3 on page 7-7), check the columns "IFQ Halibut" and "IFQ Sablefish." A > 0.00 entry in these columns indicates IFQ fishing. For a more detailed description of IFQ, (see page 7-34).

For information about your duties during CDQ, see "CDQ Specific Information for Fixed Gear Catcher Vessels" on page 7-35 or see "CDQ Specific Information for Fixed Gear Catcher/Processors" on page 7-36.

Observer Haul Form for Pot Vessels

Follow the same guidelines as for the VHF. For most of the columns on the OHF, refer to the longline section starting on page 7-11. Include the same spacing and

zeros for non-fishing days as you have entered on the VHF. Always start a new OHF when you start a new VHF. Keep the data from each vessel you are assigned on separate sets of forms. Below are those form items that have data elements differing from longline vessels. For a pot vessel OHF example, see Figure 8-5.

- **% Monitored for Marine Mammals:** This is the percent of the gear you monitored for the presence of marine mammals. Divide the number of pots you watched being retrieved by the total number of pots in the set to obtain this number. See "Marine Mammal Monitoring" on page 12-2 for duties relating to marine mammals.
- **# of segments in set, # hooks per segment, and bird deterrence:** These fields are for longliners only Leave these column blank.
- **Total Hooks or Pots in Set:** Enter the total number of pots for the set. *Do not include lost pots!* Total Pots must be a whole number. There must be an entry in this field for each set.

COMPOSITION SAMPLING GUIDELINES

One of the of the first things you should do when you arrive on a vessel is inspect your sampling station and determine a sampling system. Refer to "TRIP INFORMATION" on page 3-1 for what to look for in a sampling station. When designing your sampling system, consider:

- where to collect and contain your weight sample
- what sampling biases could occur in your collection and how to minimize them
- how to collect your sample
- how many samples you will be able to collect
- what sample sizes you will be able to collect
- how you will process your sample
- do you need to use the Random Sampling Table (RST) or Random Break Table (RBT)

Sample Station - The sample station is the location where you will weigh and measure catch. Many C/P vessels have a sample station already set up for observer use and some have motion compensated platform scales (see page 2-18). On vessels that do not have established stations, select a location that is out of the way of wave action and crew traffic, and that has enough room to store one or two baskets of fish. On

some vessels, you won't have much choice where you set up a sampling station and you will have to work with the area available to you. Explain your needs to the crew and work with them as much as possible.

Draw a diagram of the sampling station in your logbook. In your daily notes, discuss the random sample design you intend to use. Your sampling design will be put to the test once you start sampling, and you may find that you need to make some changes to it. When you have settled on a random sample design(s), fill out a Sample Design Detail form in your logbook. On this form, describe your sampling design in detail. Day to day minor adjustments to the random sample design can be documented in the daily notes section of your logbook.

Inexperienced observers may need to watch the first retrieval to familiarize themselves with the way catch is handled. Familiarity with this process will allow you to decide on a sampling design that is right for that vessel and fishery.



Observers who are experienced with the vessel type and fishery are expected to sample the first set! For these observers, it is not appropriate to take the first set off just because it is the first set!

You may alter your design as you gain experience, become aware of biases, species composition changes, or target fishery changes. Document all changes in the daily notes section of your logbook and explain why they were made. Sample designs for pot sampling are discussed in detail starting on page 8-10. If you have problems designing or implementing a sampling system, contact your ATLAS inseason advisor or other NMFS staff member as soon as possible.

Selecting Hauls to Sample

On some vessels, you will be able to sample every set. This is typically the case for observers on pot vessels targeting sablefish. If you cannot collect species composition data from all hauls you must randomly select which hauls to sample using the appropriate Random Sample Table (RST) and/or Random Break table (RBT).

Please refer to "How to Use the RST" on page 2-10 for instructions on using the RST and "How to Use the Random Break Table (RBT)" on page 2-10 for

instructions on using the RBT. Observers with a familiarity with the vessel type and fishery are expected to sample all hauls when less than three per day are landed. When extenuating circumstances prevent this, document the situation in your logbook.

Preferred Sampling Method

There are several sampling methods available to you for collecting samples. These are covered in "Sampling Designs on Pot Vessels" on page 8-10. As discussed in the section "Introduction to Sampling Theory" on page 2-12, the preferred method is to take *systematic random samples*.

To achieve systematic random sampling on pot vessels, the set or estimated hauling time is divided into sampling units of equal size. Units to sample are chosen using a systematic random method. Pot fishing is unique in that individual pots are deployed over a given area, in clumps or lines. Spacing of samples throughout a set accounts for any fish stratification associated with topography changes over this area.

Pot Vessel Samples and Subsamples

On pot vessels, the fish you weigh will typically come from the same units that you sampled. When fish come from a sampled unit, the data are recorded as sample data.

On rare occasions you may need to collect fish from outside your sampled unit. This would be the case if you forgot to weigh fish from within your samples. If you are reporting information on fish that came from outside your sample, these data must be documented as subsample data.

A specific numbering system is used to link subsample data to sample data in the database. This numbering convention is discussed on page 8-18 of the form instructions section. To indicate this relationship in this manual's text, the term "parent sample" is used. For any *subsample*, the parent sample is the sample immediately adjacent to the subsample.

Number of Samples per Sampled Haul

You should take as many individual samples within a haul as feasibly possible. Multiple samples, taken systematically throughout the set, capture stratification effects. *At least three discrete composition samples are required for every sampled haul to allow data users to assess sample variance.*

There may be fisheries and vessel types where it is not possible to collect multiple species composition samples within a sampled haul. In those instances, you must document the circumstances in your logbook daily notes pages.

Sample Size Considerations

When deciding the size of your samples, consider your general health, the size of the set and the possible species diversity. Reduce the size of your samples if you are not feeling well, have not had enough sleep, or if species diversity has been high.

Samples taken within a haul should be of equal size. This is easy to achieve on pot vessels, because the crew is working with discrete units of gear (a pot). The total number of pots you are able to sample depends on situation specific factors, but most observers find they can sample at least 1/3 of a set and still have time to complete their other sampling duties.

When to Sample for Species Composition

In the pot fishing fleet, there are vast differences in the amount of gear each vessel fishes and how quickly each vessel retrieves and deploys gear. Many catcher vessels do not retrieve pots at night, some vessels spend days prospecting or pulling a few short strings and catcher processors, with larger crew sizes, may set and retrieve pots around the clock. All of these factors will affect your ability to sample for species composition on these vessels. Develop sampling strategies to randomly sample as many strings and pots within a string as possible, while keeping in mind all the other observer duties.

A captain may utilize one of two strategies in deploying pots; he may set one long string of pots or he may set several smaller groupings of pots. How you sample will be determined by the captain's method of setting gear.

- For several short strings of pots use the appropriate random sample table (RST) to determine which strings to sample or use the random break table (RBT). If the strings have greater than 20 pots, use a random sampling design to sample at least 1/3rd of the pots retrieved from each string. When strings have less than 20 pots, observers are generally able to sample every pot in the selected string.

- If the captain sets one or two long strings of gear per day, sample every string. Use a sampling design to sample at least 33% (one third) of the pots retrieved from each string.

Minimizing Sample Bias

Pot vessels typically dump catch from a pot onto a sorting table. If the pot is one of the randomly chosen sample pots, the observer must account for all fish from the pot. If all the fish from the pot are collected, there is no bias to the sample. If a portion of the catch is taken from the pot to weigh, and the rest tallied, it is possible to bias the sample if random methods of fish selection are not employed.

When collecting fish for weights and biological data, be sure to monitor for size bias and minimize this bias as much as you can. Make rules for what fish you will collect from the table or tote. For example: "all the fish in the left hand corner are my weight fish".

SAMPLING DESIGNS ON POT VESSELS

There are many similarities between sampling schemes and sampling concepts on pot vessels and those on longliners. This chapter will often refer you to "Random Sampling on Longliners" (beginning on page 7-18 in the "LONGLINE DATA COLLECTION" chapter) for figures illustrating the various sampling designs available to you.

There are four types of sample designs that can be used on pot vessels: **1)** spatial based simple random, **2)** temporal-spatial bases simple random, **3)** spatial based systematic random and **4)** temporal-spatial based systematic random. You can use any of these designs for a particular set and you can alternate designs between sampled sets to adjust for different situations. **Make sure that you have explored *systematic random sampling from a spatial or temporal frame as an option before resorting to *simple random sampling from a spatial or temporal frame. Spatial and temporal based systematic random sampling is discussed beginning on page 8-13.****



Do not use a random sample design that is not listed above unless you contact FMA first!

While sampling all of the pots in a string is preferred over using a random sampling design, this would require you to count and/or weigh everything in every pot of a string. Sampling all pots may be possible in some situations, but when it is not, you must use a random sampling design to determine which pots to sample.

For all sample frames used on a pot vessel, units must be comprised of whole pots. A unit can be one or several pots in size, so long as *the units are equal*. In colder months, or where space is limited, you may want to have fewer pots in your sample unit. On vessels with a lot of space, you may be able to have larger sample units (*i.e.*, more pots per unit). Take into account how long you can stand on deck tallying and on how much bycatch can be stored in the fish collection area when deciding on your unit size.

Remember, if you abort or alter a sampling design during the sampling of a haul for any reason, document the circumstances on the “Sample Design Changes” form of your observer logbook (see “Documenting Design Constraints or Problems” on page 2-16).

Sampling Design Rules

There are a few rules to keep in mind when determining your sampling design for a sampled haul:

1. **Number of samples trumps quantity of haul sampled.** If there is a possibility that you will only have two samples in your frame, reduce your unit size. By reducing the size of units in the sampling frame, you are assuring that there will be at least three sampled units within the frame. This may mean that you actually take four samples for a haul when you intended on only three. It may also mean that you sample less than your intended sample fraction. Always reselect a start point if you have adjusted a frame to accommodate three samples taken systematically (see Figure 7-7 on page 7-23).

2. **Size discrepancy between hanging units and other sampling units should be minimized.** If the total number of pots is not evenly divisible by the number of pots comprising a sample unit, there will be a unit at the end of your frame that is smaller than all other units. This is called a hanging unit. It is critical that units be equal or as close to equal as possible, so a rule was developed to deal with this specific case. You must determine if including the hanging unit with the

previous unit of the frame would cause less of a disruption to unit size than leaving it as a discrete unit. For example, if the hanging unit is comprised of 1 segment and the previous unit comprised of 3, unit size will be more consistent if the last two units are combined. Refer to the illustration in Figure 7-4 on page 7-19 for an example of how to reduce size discrepancy in hanging units.

Sampling from Spatial Frames on Pot Vessels

Using a spatial frame requires you to identify when selected pots are pulled. This can be accomplished by working closely with the captain and crew. You may be able to track this information using the plotter or, for smaller strings, actually counting pots retrieved.

To create the spatial units of your frame:

1. Multiply the total number of pots in a set by the fraction you intend to tally. This will give you the total number of pots you need to tally to meet your sample size goal for the set. Always multiply by 1/2, 1/3, 1/4 or 1/5. For example, if a set was 121 pots and you wanted to sample 1/3, you would need to sample 40.33 pots. You must sample full pots, so you round this value to 40.
2. Take the total number of pots you need to tally and divide this by the total number of discrete samples you want to collect for the set. If you had to sample 40 pots and wanted to do this over 3 samples, the size of the units would be 13.33 pots. You must tally full pots, so round appropriately for a total of 13 pots. This value represents your sample unit size.
3. Divide the total number of pots in the set by the number of pots in a unit. This gives you the total number of sampling units in the set.

Number the units consecutively starting with one and randomly select at least a third of the total units to sample. Use the Random Number Table, dice, numbers from a hat, or any method that is truly random to select units to sample.

If the number of segments in the set is not equally divisible, the last sampling unit of the frame will not be the same size as all other units in that frame. Refer to Figure 7-4 and “Sampling Design Rules” on page 7-18 of the longline chapter for more details on how to deal with these smaller units.

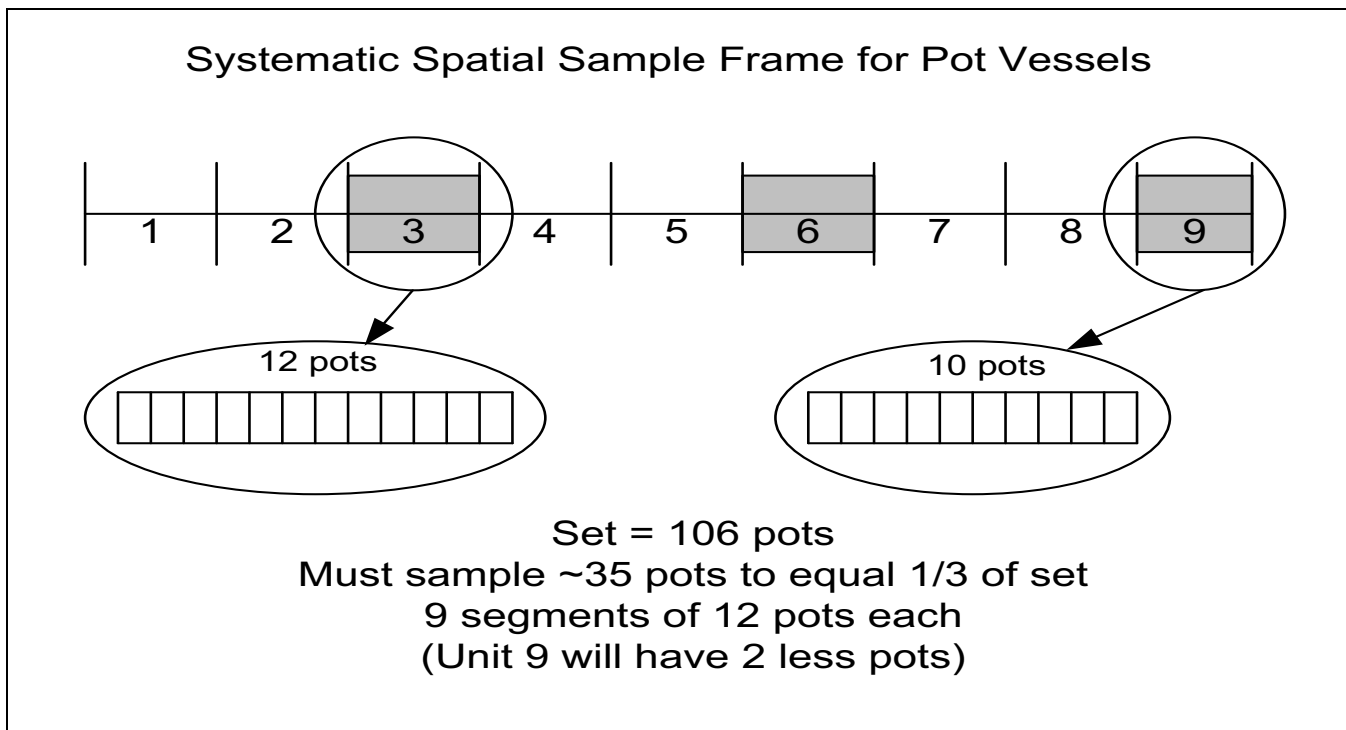

Figure 8-3 Size discrepancy with hanging units

An example of simple random sampling from a spatial frame is illustrated in Figure 7-5 of the Longline Chapter. When referring to the figure, think of the units as groups of pots, rather than segments (the example is described again below with reference to the gear as pots instead of segments). The example set is composed of 24 pots of gear. In order to sample a third of the set, at least 8 pots must be sampled for composition. The observer had space and time to take three discrete samples. To determine sample unit size, they divided the number of pots needed to sample a third by the number of samples they could take. The resulting value of 2.66 was rounded to 3. The haul was divided into sampling units comprised of three pots and each of these sampling units numbered. Finally, the RNT was used to randomly pick three units within the frame to sample. These units were tallied for species composition (shaded units): 2, 4, and 8.

Sampling from Temporal-Spatial Frames on Pot Vessels

Temporal-spatial frames are based on time, but you still track sampled gear by *pots*. The advantage of using a temporal-spatial frame is that you do not have to enter into a sample period at a specific pot, but at an approximate time. On vessels with long sets comprised

of tens of pots, a sampling system that allows you to disregard the passing of individual pots can be quite useful!



When sampling from a temporal spatial frame, you determine the total number of pots sampled by counting them. Do not use "pots per time" to determine the number of pots sampled.

Designing a Temporal-Spatial Based Sampling Scheme:

1. Multiply the total number of pots in a set by the fraction you intend to tally. This will give you the total number of pots you need to tally to meet your total sample size goal for the set. Always multiply by 1/2, 1/3, 1/4 or 1/5 (observers are typically able to sample at least 1/3 of a set). For example, if a set was 23 pots and you wanted to sample 1/3, you would need to sample 7.66 pots. You must sample full pots, so you round this value to 8.
2. Take the total number of pots you need to sample and divide this by the total number of discrete samples you want to collect for the set. This value represents your sample unit size. On pot vessels, the smallest a spatial unit can be is one pot. If you had to sample 8

pots and wanted to do this over 3 samples, the size of the sampling units would be 2.66. You must tally full pots, so this value would be rounded to 3.

3. Estimate how long it will take to retrieve one sampling unit. This time estimate represents one *temporal* unit. Number the *temporal* units in the set consecutively.

4. Use the Random Number Table (RNT), dice, slips of paper, or another random method to choose which of these temporal units to tally sample. Document the random selection method in your logbook.

5. Use your temporal unit to determine when to get to your sample station, but sample by spatial units once you get there. ***Do not begin sampling until the next full pot.***

Refer to “Simple Random Samples from a Temporal-Spatial Sampling Frame” on page 7-21 of the Longline Chapter for an illustration of sampling from a temporal-spatial frame.

Systematic Sampling on Pot Vessels

On pot vessels, there are practical benefits to systematic sampling. With *simple* random sampling, it is possible to randomly choose back to back sampling sections. Back to back samples are difficult to manage on pot vessels, because there is no time to weigh fish from the first sample before you have to take sample data on the next. Unless there is enough room to separate one weight sample from another, you will not be able to report back to back samples as discrete samples. With systematic sampling, you are guaranteed some amount of time between samples.



A systematic sampling design can be used any time a simple random design can be used. Sampling from a systematic frame may give you more time between the tally and non-tally periods.

A systematic design is one in which you tally sample every “ n^{th} ” unit throughout the haul. For your sampling design, keep in mind that at least three samples per sampled haul is preferred. Sampling units can be defined either spatially or as temporal-spatial units.

The first step in creating a systematic design is to determine which unit type to use for the haul. If you can accurately keep track of how many pots have been

retrieved, systematic sampling from a spatial frame may be easiest. If it is too difficult to keep track of each segment during the entire hauling process, a systematic sampling from a temporal-spatial frame is best.

Designing a Spatial Based Systematic Sampling Scheme:

1. Multiply the total pots in the set by the fraction of haul you can sample. Always use 1/2, 1/3, 1/4, or 1/5 (observers are usually able to sample a total of 1/3 of a set). The resulting value is the number of pots you need to sample to meet your total sample size goal for the set.

2. Divide this value by the number of samples you intend to take. The resulting value represents the size of one *spatial* sampling unit. On pot vessels, the smallest a spatial unit can be is one pot.

3. Number the units in the set consecutively.

4. Systematic sampling requires that you sample throughout the entire haul at equal intervals from a random start point. To determine the sampling start point for the set, simply refer to the sampling fraction you chose in step one. The denominator in your sampling fraction is the sampling interval “ i ” for the set. For every i , you must tally one full sampling unit. If i is 4, randomly choose a number between 1 and 4. The random number represents the first unit you will sample from your frame. For example, if the random value chosen from a denominator of 4 was 3, you would begin your systematic sampling at unit 3.

5. From the random start point determined in step 4, sample at interval i . For example, if the random start unit was 3, and the denominator of your sampling fraction 4, sampling would occur every 4 units from the random start unit: 3, 7, 11, 15, etc.

Once you have a sample design for the haul, assess it to see if there is any chance you will get only two samples for the set. To do this, map out the sampling sequence when you choose the last number in interval i as your start point. If this sampling sequence gives you only two samples for the set, reduce your sampling unit size by one or more pots, if possible. Refer to the illustration in Figure 7-7 on page 7-23 for an example of how to adjust your frame design to accommodate at least three samples regardless of your random start point.

Designing a Temporal-Spatial Based Systematic Sampling Scheme:

1. Multiply the total pots in the haul by the fraction of haul you can sample: 1/1, 1/2, 1/3, 1/4, or 1/5. Observers are usually able to sample a total of 1/3 of a set.
2. Divide this value by the number of samples you intend to take. The resulting value is your *spatial* sampling unit. On pot vessels, the smallest a spatial unit can be is one pot.
3. Estimate the time it will take to retrieve one of your sample units and multiply this by the number of sampling units in the set. This is the total estimated time to retrieve the entire set.
4. Divide the total estimated retrieval time for the set by the estimated time it takes to retrieve one unit. The resulting value is the number of *temporal* units in the set. Number these units sequentially.
5. The fraction of haul you can sample also gives you the sampling interval *i*. At every interval *i*, a sample is taken. If you intend to sample 1/4 of the haul, sample one in every four temporal units. If you intend to sample 1/3, sample one in every three temporal units.
6. Randomly choose a unit within a generic sampling interval from your system. If sampling one in every four units, choose a number between one and four. If sampling one in three units, choose a number between one and three, etc.
7. The random number from step 6 indicates the first sampled unit from your sampling frame for that haul.
8. Now that you have your start sampling unit, sample size and sampling interval, you can map out the units that should be sampled to maintain your systematic sampling design for the haul.
9. Use your temporal units to determine when to get to your sample station, but sample by spatial units once you are there.

An important rule to recognize when sampling from a temporal spatial frame is that, although you are using time to select when to sample, you ***do not start sampling at the beginning of your designated time unit***. Instead, you ***wait until the beginning of the next***

pot to start sampling. You must sample full pots, so you do not immediately stop sampling at the end of your designated time interval, but ***continue to sample until you have sampled your full spatial unit***.

SAMPLING ON POT VESSELS

Collection of species composition samples will depend on the amount of gear retrieved, the speed of gear retrieval, and the amount of fish that is being caught. When there is little catch, organisms from each sample may be sorted, counted, and weighed. Most often this method will not be possible.

When counting and weighing everything in a pot is not possible, you should:

1. Tally all the predominant species in your sample.
2. Collect, count and weigh as many individuals of the predominant species from your sample that you can. You should be able to count and weigh at least 60 individuals over the entire haul.
3. Count and weigh all other catch from the sample.

How you collect weights for predominant and non-predominant species will depend on the configuration of the vessel, how the crew processes the catch after dumping it from the pot, and how much is being caught in each pot

Collecting Weights for Non-Predominant Catch

Typically, you will be able to weigh all the non-predominant species in your sample. **The observer program expects you to weigh all individuals of a non predominant species when there are less than 50 in a sample.** You can collect individuals of non-predominant species over the course of the sample, store them in a container and weigh them in between pots or samples.

If there are too many individuals of a species for you to weigh them all, devise a system to avoid hand selection. For example, if the catch is dumped into a tote, divide the tote into halves or quarters and select all the fish from a randomly selected side or quarter. **Regardless of the subset sampling method you choose, be sure to provide a number for all non-predominant catch encountered in your samples.**

Collecting Weights for Predominant Catch

Typically, the predominant species will be too numerous in your sample for you to weigh every individual. **The observer program expects you to collect and weigh at least 60 individuals of the predominant species for the haul.** Randomly determine from which pot(s) in a given sample to collect the predominant fish, prior to gear retrieval. Do this by numbering the sample pots consecutively from 1 to the total number of pots in the sample. Use the random number table to determine the pot or pots from which to collect catch for weighing. It is often difficult to know exactly how many pots you will need, and you may need to rely on opportunistic sampling on occasion.

Try to use a random sampling design as often as possible. For example, if the catch is dumped into a tote, divide the tote into halves or quarters and select all the fish from a randomly selected side or quarter. If you are collecting fish from a sorting table, visually divide the table into sections and pull the fish from a randomly chosen section. If this does not work, do the best you can and document how you collected the predominant species for weights.

Tallying Catch

As a pot is dumped into a tote or onto a sorting table, count the predominant species using thumb counters and collect all other bycatch in a separate tote or your blue baskets. At the same time, randomly collect fish of each species that you are tallying. You must collect approximately 50 individual fish of each species tallied for every string sampled. Try to spread the collection of weight samples over all your samples, rather than taking them from just one sample. If there are significantly less than 50 individuals of a species in your sample you should weigh all of them.

When You Cannot Count All the Crab in a Pot

Occasionally a pot will contain several hundred crab (typically Tanner species). You are not expected to count all these individuals, but you are expected to weigh them. Resource managers manage prohibited crab species by number and not weight. For this reason, ***a subset sample for number and weight must be provided anytime it is not possible to count every individual.*** To do this, randomly select about 50 individual crab to identify to species, count and weigh. The remaining crab can be scooped into baskets and

weighed without providing a total number. Additional biological information can be taken from the 50 individuals that were counted and weighed. ***This method is only an option for crab species and crab parts.*** All other species must have an actual number associated with them.

Dealing with Whole Crab Versus Crab Pieces

Document weight data for whole crab only. For our purposes, a crab is considered whole if it is essentially whole by weight. It is not necessary for a crab to be intact to be considered whole.

If you find that a crab in your sample, once whole, is now broken and missing a majority of its weight, you may be able to determine the species but ***you must not report the weight of these parts.*** Weights that do not represent whole crab are inaccurate from the data user's perspective and negatively impact weight to number relationships otherwise provided by the data.

On pot vessels crab are usually intact and obtaining a number is as easy as counting individuals. If you encounter crab parts along with whole crab in your sample, proceed as follows:

1. Identify all whole crabs to species and report their number and weight. Remember that it is not necessary for a crab to be intact to be considered whole.
2. Identify loose crab parts to the best of your ability. Carapaces should be identified to species and legs can usually be identified to the appropriate genus group code. Report the weight of these parts on a separate line from any whole crab weight/number values and enter a value of zero for number of crab. In these cases you must also provide a subset sample for number and weight. Doing so will allow the observer program to calculate a number of whole crab based on the weight of the parts.
3. If there are too many crab and you are only able to weigh, but not count, all of the whole crabs, it is acceptable to weigh crab parts with whole crab of the same species.

Tips for Sampling on a Pot Vessel

As the vessel is retrieving gear, there is generally enough time between pots to weigh fish from the predominant species for average weights and to weigh bycatch. There may even be enough time to measure fish for length frequencies. The crew tends to be more

POT VESSEL DATA COLLECTION: Combined Samples

willing to cooperate with your sampling needs when you make attempts to reduce your effect on their processing time. This may be accomplished by bleeding or cutting the fish in your sample yourself. Have the crew show you how to bleed or cut the fish in your sample in the same manner as they do. Note that processing the fish in your sample is not required and should not be done if you find yourself running low on time.

COMBINED SAMPLES

There are going to be occasions when you are processing a sample and come across a fish that you think *might* belong to a previous sample taken for the set. When you know that a fish should be included in the species composition data for the set, but do not know exactly what sample, you must resort to “combining” samples. You only combine those samples that you are unsure of; any intact samples are reported as discrete samples for the set.

On the raw data deck form, mark the samples that will be rolled together as combined by checking the circle next to “Combined” for those samples. The combined samples are reported as one sample in ATLAS or faxed paper form. When reporting combined samples, enter the data for all the samples affected under a single sample number. By combining samples into one in the reported data, you are alerting data users to regard these samples separately from intact samples. Remember, you can have a mixture of combined and non-combined samples for a set. You combine only those samples you believe are no longer discrete samples.

WHEN THERE ARE NO FISH ENCOUNTERED DURING THE SAMPLE

On rare occasions you will monitor a haul and there will be no fish in the pots. Knowing that there are no fish in a sample is just as important to fisheries managers as knowing how many there were.

To report this absence of fish on a deck form and paper composition form, record the date of the haul, your cruise number, vessel permit, and sample number in the header portion of the form. Record the total number of pots in the sample period, fill in the keypunch values with zero and write no fish across the sample block. In ATLAS you will simply enter an “N” in the “Species Comp in sample?” box. Please refer to the figures at the

end of this chapter for documentation examples and page 16-8 of the ATLAS chapter for information on entering these data.

ESTIMATING PERCENT RETAINED

Each species reported in the species composition samples for a set must have an associated estimation of percent retained.

An individual fish is considered fully retained (100% retained) when more than 15% of its round weight is turned into product. Round weight is the weight of the whole fish, prior to processing. It is best to enter your estimate of percent retained after the haul is completed. Refer to all the samples collected from the set for this information. See Figure 8-6 for an example of recording percent retained on pot vessels.



The percent retained you report for a species must be consistent for that species over all the samples collected during the set. For this reason, calculate percent retained after the set is completed.

HALIBUT VIABILITIES ON POT VESSELS

The criteria for assessing viability on a pot vessels differs somewhat from that used for assessing trawl caught halibut. The main issues to be concerned with on pot vessels are listed in “Halibut Condition Criteria For Pot Bycatch” on page A-37. Halibut used in viability samples must be in your hands and actually measured. Length *estimates* are not acceptable. All halibut viabilities must be recorded on the Length and Specimen Form or in the ATLAS program. Use E-(excellent), P-(poor), and D-(dead) in the **Viability** column. For halibut viabilities on a pot vessel, place a U in the sex column and leave the injury column blank.

Halibut for viability assessments must be randomly selected from sampled sets. Halibut assessed for viability do not need to come from your species composition sample, but they must reflect how the crew handles the fish. If the vessel is not catching many halibut, it is easiest to assess the viability of every halibut in your composition sample.

If the vessel is catching a lot of halibut, randomly select individual pots and assess halibut viabilities from all the halibut in these pots. Number the pots and then use the random number table to select an appropriate number of pots. Determine the number of pots to

sample for halibut viabilities by estimating the number of halibut that could be in each pot. Assess a maximum of 20 halibut per day for viability.

In your logbook, document all methods you employed for collecting fish and assessing viabilities. Use your best judgment to determine how much time you can spend assessing halibut viabilities. If you assess less than 20 halibut per day, record in your logbook what factors limited your ability to conduct viability assessments.

Other Halibut Related Issues on a Pot Vessel

If the vessel is catching a lot of halibut make sure to verify that the halibut excluder devices are in place. The halibut excluders are required. In your logbook, record any instances of missing excluders. For a specific definition of halibut excluders that must be used see “Groundfish Pots Requirements” on page 18-15.

In addition, be aware of how the crew is discarding halibut. The fish should be supported as it is lifted or slid off the deck. The spine of halibut can be broken by mishandling, especially lifting the halibut by the caudal peduncle. In your logbook, record any incidences of the crew lifting halibut by the caudal peduncle or any other mishandling of halibut by the crew.

FISH MEASUREMENTS ON A POT VESSEL

Your duties for collecting predominant and prohibited species measurements and other biological data are the same as for all other vessels. How these duties are conducted may be further constrained on a pot fishing vessel by the lack of cooperation from crews. In your logbook document any difficulties encountered and the methods you employed. If you are having difficulties with cooperation from the crew please see “Specimen Data and Uncooperative Crews” on page 7-34 for further instructions. Please see “Regulatory Support for Cutting Fish to Obtain Sex Data” on page 11-14 for additional information.

DECK FORM INSTRUCTIONS

The waterproof raw data forms provided by the Observer Program are meant to be taken out on deck. On ATLAS vessels these replace the paper species composition form. Never recopy raw data and always return to your debriefing interview with your original

data. The deck forms are an important component of your data documentation. It is important to fill out the forms completely and legibly!



All raw species composition data collected by you must be documented on the deck form provided by the Observer Program, whether or not your vessel has ATLAS. PLEASE WRITE LEGIBLY!

On vessels with ATLAS, you enter data from the deck sheet directly into the ATLAS system. On non-ATLAS vessels, information on the deck form must be transcribed to a paper species composition form and faxed (see “Paper Form Instructions” on page 8-19).

The deck form is double sided with two sample blocks available on each side. The header information at the top of the decksheet must be filled out and pertains to both sample blocks below it. You may have one haul’s worth of samples on one side of a decksheet and another haul’s worth of samples on the other side, **but you cannot mix two haul’s worth of data on a single side of the decksheet.** You must maintain a separate set of forms for each vessel to which you are deployed.

Multiple samples and subsamples taken within a set should be maintained completely independent of each other with their own unique sample number and sample block (or blocks). If you have to combine samples later, simply check the circle next to “Combined?” for the affected samples (for information on combined samples see “Combined Samples” in the Longline Chapter on page 7-31).

As with longliners, weight data from outside the sample is reported as subsample data and weight and number data from within the sample is reported as sample data. Subsamples have a specific numbering system associated with them, explained in “Subsample number”.



Maintain a separate set of forms for each vessel.

Examples of a completed deck form start on page 8-25. ***The following deck form rules must be followed for all pot vessels. All fields must be filled out completely:***

POT VESSEL DATA COLLECTION: Deck Form Instructions

Observers Name/Vessel Name - For each vessel assignment, write your name and the vessel's name across the top of the first page.

Date - Enter the date that the last pot of the set was retrieved. For the month and the day, use leading zeros when needed (*e.g.*, 01/01/09 for January 01, 2009).

Cruise, Vessel: Your cruise number will be given to you during training or briefing, or by your employer. Vessel permits are listed on page A-25.

Haul No., Offload No: For pot vessel data, leave the offload field blank. For each sample taken within a set, enter the set number the sample came from. Sets can be numbered sequentially beginning with the number one, or you can follow the captain's numbering convention *if the captain is not repeating set numbers with each new trip*. On pot vessels, it is generally better if you can follow the captain's numbering system; when sets are retrieved out of order it can be difficult to track sets if your numbering system is different.

Set number must be unique for the vessel. If you disembark the vessel and then embark again at a later date, you can: continue numbering the sets from the number you left off with, continue with the captain's numbering convention (if s/he is not repeating set numbers), or skip a few numbers (*e.g.*, if you numbered sets of the first trip 1, 2, 3 and 4, you could number sets of the next trip as 11, 12, 13, 14).



Set numbers do not have to be sequential (although it is easier if they are), but they do have to be unique for the vessel.

Sample number: Every sample taken from within a set must have a unique identifying sample number. Number samples taken within a set sequentially, starting with the number 1. You do not need to make sample numbers *between sets* unique: you can start with the number 1 for the first sample of every sampled set.

Subsample number: For pot vessel sample data, the only time you will have a *subsample* block of data is when you are reporting weight data for fish taken from outside sampled pots. Subsamples must be linked to the parent samples from which they came. You do this by using a numbering convention designed specifically for

subsamples: every subsample number must be three digits in length, with the first digit designating the parent sample from which the subsample came, and the next two digits indicating the number of that subsample for the parent sample. Subsample numbering convention is explained further below:

- The first subsample of sample number 1 for a set should be numbered 101, the second subsample for sample number 1 of a set should be numbered 102, the third 103, and so on...
- The first subsample of sample number 2 for a set should be numbered 201, the second subsample for sample number 2 of a set should be numbered 202, the third 203, and so on...
- The first subsample of sample number 3 for a set should be numbered 301, the second subsample for sample number 3 of a set should be numbered 302, the third 303, and so on...

Sample size:

- Samples: on pot vessels, every sample must have a sample size in pots. Record the total pots in your sample, and circle the "pots" text.
- Subsamples: on pot vessels, subsamples do not have a sample size. Leave the sample size blank for subsample data.

Combined samples: If the samples for a set are going to be combined in the reported data, check the circle next to the word "Combined" for *only those samples that will be combined*. When these data are entered into ATLAS or on a paper form, samples designated as combined are rolled up into a single sample entry. See "Combined Samples" on page 8-16 for a description of when samples must be reported as a "Combined Sample."

Pre-sorted: Do not check this field. You cannot have pre-sorted samples on pot vessels.

Species: Enter the common name for each species. Generally you will be able to weigh all of the fish in your samples. In this instance enter the number and weight for each of the species. If a species is too abundant for you to weigh all individuals, you must take a subset sample for number and weight. Enter these data on a separate line from the entry for the individuals of the species that were counted only. *Consolidate the data for the number and weight of a*

single species into a single line of entry. These calculations must be documented on your deck form or in your logbook.

Sex: Tanner crab, king crab, and salmon should be listed separately by species and sex. Record an “M” or “F” for these species when sex is determined. Leave the sex field blank for any unsexed items.

Number: For each species, enter the number of individuals. *Every species entry must have a number record!* The *only* exception is when crab are too abundant to count.

Use as many lines and columns as necessary for each species.

- For decomposed fish (code 899) and miscellaneous items (code 900) enter the actual number of items.
- For subsample data, enter the number of individuals weighed. Unlike samples, subsamples must always have a number *and* a weight.

Weight: For weighed fish, enter the weight by species with a well defined decimal. Weights must be recorded to the nearest 0.1 or 0.01 kg. If you feel that your scale cannot be read accurately to the tenth, you must fill in at least a trailing zero. *Do not enter weights to more than two decimal places.* If a species in your sample was too small to weigh (e.g., one brittle star) *enter the weight as 0.01 kg.* This holds true for both sample and subsample data.

For fish that were not weighed, enter a zero in the weight field by species.

Percent Retained: This is a rough estimate of the percent of each species retained by the vessel. See “Estimating Percent Retained” on page 8-16.



If the vessel made any product from more than 15% of the fish, the whole fish is considered retained.

Keypunch check: In the spaces to the right of the words “Keypunch check,” write the calculated sum for species codes, species number, species weight, and percent retained values you recorded for the sample. If your species composition sample has too many species to fit in one sample block, enter the total sums on the

keypunch line in the first block for the sample and leave the keypunch line blank for the second block used for the sample.

Keypunch checks are a valuable tool for staff who enter your faxed data. If the keypunch value the computer calculates does not match the keypunch value you wrote down, staff know to double check for errors in the entries they made. If you are sloppy with your keypunch calculations, staff have to investigate each discrepancy. This is a waste of valuable time for both you and for staff. Please double check your keypunch summaries!

Length, viability, injury, specimen, tally data: Use the blank area of the deck form sample block to record tally data. Use this space to record other sample specific information such as: sex/length information, specimen information, halibut assessments, and notes pertaining to any biases to the sample, etc. Make comments about anything unusual with the catch or your sampling technique for the set. More complete descriptions of these notes should be documented in your logbook. Making note of unusual occurrences on your species composition form will assist in the debriefing process, and help you distinguish one set from the others. *Raw data of this sort must be documented!*

PAPER FORM INSTRUCTIONS

If you are on a vessel without ATLAS, you must transfer your raw data from the decksheet to a paper species composition form. Paper forms are then faxed to the Seattle NMFS office after every trip.

Three samples will usually fit on one species composition page. Each sample must be documented as a distinct sample for that set (except in cases of combined samples- see “Combined Samples” on page 8-16). Unlike the deck forms, samples from two or more sets can go on a single page; on paper forms, you do not need to start a new page for each sampled set. Maintain a separate set of forms for each vessel to which you are assigned.

Cruise, Vessel, Observer name and Vessel name: Your cruise number will be given to you during training or briefing, or by your employer. Vessel permits are listed on page A-25. Write your full name and the name of the vessel on the lines provided at the top of the form.

POT VESSEL DATA COLLECTION: Paper Form Instructions

Resubmission: Circle “Resubmission” if you are sending changes to data previously faxed. *Also, please circle the items that have changed since your last transmission of the data: this will aid keypunchers in making the appropriate modifications to your data.*

You do not need to start a new form after faxing; you can continue to use the form until all sample blocks are filled with data. Be sure to enter the correct header information for each new sample.

Haul No., Offload No.: Copy the sample’s set number from your deck form. Leave the offload number blank.

Sample number: Every sample taken from within a set must have a unique identifying sample number. Number samples taken within a set sequentially, starting with the number 1. You do not need to make sample numbers *between sets* unique: you can start with the number 1 for the first sample of every sampled set.

Subsample number: For pot vessel sample data, the only time you will have a *subsample* block of data is when you are reporting weight data for fish taken from outside sampled pots. Subsamples must be linked to the parent samples from which they came. You do this by using a numbering convention designed specifically for subsamples: every subsample number must be three digits in length, with the first digit designating the parent sample from which the subsample came, and the next two digits indicating the number of that subsample for the parent sample. Subsample numbering convention is explained further below:

- The first subsample of sample number 1 for a set should be numbered 101, the second subsample for sample number 1 of a set should be numbered 102, the third 103, and so on...
- The first subsample of sample number 2 for a set should be numbered 201, the second subsample for sample number 2 of a set should be numbered 202, the third 203, and so on...
- The first subsample of sample number 3 for a set should be numbered 301, the second subsample for sample number 3 of a set should be numbered 302, the third 303, and so on...

Sample size:

- Samples: on pot vessels, every sample must have a sample size in pots. Record the total pots in your sample, and circle the “pots” text.

- Subsamples: on pot vessels, subsamples do not have a sample size. Leave the sample size blank for subsample data.

Combined samples: If the samples for a set are going to be combined in the reported data, check the circle next to the word “Combined” for *only those samples that will be combined*. When these data are entered into ATLAS or on a paper form, samples designated as combined are rolled up into a single sample entry. See “Combined Samples” on page 8-16 for a description of when samples must be reported as a “Combined Sample.”

Pre-sorted: Do not check this field. You cannot have pre-sorted samples on pot vessels.

Species name and species code: List each species (or species group) encountered by their common name (or group name) and enter the associated species code. Species codes can be found starting on page A-1. Enter the code that corresponds to the most specific identification you were able to make. *Consolidate the data for the number and weight of a single species into a single line of entry.* These calculations must be documented on your deck form or in your logbook.

Generally you will be able to weigh all of the fish in your samples. In this instance enter the number and weight for each of the species. If a species is too abundant for you to weigh all individuals, you must take a subset sample for number and weight. Enter these data on a separate line from the entry for the individuals of the species that were counted only.

Sex: Tanner crab, king crab, and salmon should be listed separately by species and by sex. Record an “M” or “F” for these species when sex was determined. *Leave the column blank when sex was not determined.*

Number: For each species, enter the number of individuals. *Every species entry must have a number record!* The *only* exception is when crab are too abundant to count.

Use as many lines and columns as necessary for each species.

- For decomposed fish (code 899) and miscellaneous items (code 900) enter the actual number of items.

- For subsample data, enter the number of individuals weighed. Unlike samples, subsamples must always have a number *and* a weight.

Weight: For weighed fish, enter the weight by species with a well defined decimal. Weights must be recorded to the nearest 0.1 or 0.01 kg. If you feel that your scale cannot be read accurately to the tenth, you must fill in at least a trailing zero. **Do not enter weights to more than two decimal places.** If a species in your sample was too small to weigh (e.g., one brittle star) **enter the weight as 0.01 kg.** This holds true for both sample and subsample data.

For fish that were not weighed, enter a zero in the weight field by species.

Percent Retained: This is a rough estimate of the percent of each species retained by the vessel. See “Estimating Percent Retained” on page 8-16.



If the vessel made any product from more than 15% of the fish, the whole fish is considered retained.

Keypunch check: In the spaces to the right of the words “Keypunch check,” write the calculated sum for species codes, species number, species weight, and percent retained values you recorded for the sample. If your species composition sample has too many species to fit in one sample block, enter the total sums on the keypunch line in the first block for the sample and leave the keypunch line blank for the second block used for the sample.

Keypunch checks are a valuable tool for staff who enter your faxed data. If the keypunch value the computer calculates does not match the keypunch value you wrote down, staff know to double check for errors in the entries they made. If you are sloppy with your keypunch calculations, staff have to investigate each discrepancy. This is a waste of valuable time for both you and for staff. Please double check your keypunch summaries!

REVIEWING FORMS FOR ERRORS

To facilitate the debriefing process you *must* check forms throughout your cruise rather than at the last minute just before your debriefing interview. Observers who regularly review their data at sea generally benefit

by having shorter, smoother debriefings. Observers who do not review their data throughout their cruise generally find themselves in lengthy debriefings and with time consuming corrections. **It is much easier to check a couple of pages each day over the course of three months than to check a couple hundred pages of data all at once!** Follow the guidelines below when reviewing your data for errors.

Check All Forms For:

- Your name and vessel name on the first page of each form type
- Pages numbered properly, no skipped or duplicate numbers
- Every page has your cruise number and vessel code
- Leading zeros are present only for dates, times, and haul weights of zero weight (0.00 on Vessel Haul Form and Observer Haul Form)
- All fields with pre-printed decimals have numbers listed to two decimal places
- All repeat fields (arrows and brackets) are complete and have the same number at the top and bottom.
- Your handwriting is clear and legible.

Check Observer and Vessel Haul Forms For:

- Every day on the vessel has an entry. Include the day you boarded and disembarked and all days in between
- Non-fishing days have a non-fishing position with a haul number of zero. Document the reason the vessel was not fishing in your logbook daily notes.
- No duplicate haul/set numbers
- All haul/set numbers in consecutive order
- No decimals other than those already printed on the page

Check Vessel Haul Form for:

- Set and retrieval positions are recorded for all hauls/sets
- Positions have no minutes greater than 59
- Retrieval times of 0000 are attributed to the next day
- Bottom depth entries are rounded to whole numbers and fishing depth column is empty

POT VESSEL DATA COLLECTION: Reviewing Forms for Errors

- “F” or “M” is recorded for every depth recorded
- A “Y” or “N” is recorded in the IFQ column
- CDQ numbers are recorded with the letter “C” followed by the two digits of the CDQ group number (found in the vessel logbook)

Check Observer Haul Form for:

- For catcher boats, plant/processor name, location, and processor permit #s are completed in box at top of the page
- For each delivery to a mothership, the delivering catcher boat’s ADF&G# is recorded
- For sampled hauls discard weight, if any, is entered
- For all hauls the vessel estimate is entered

Check Species Composition Form for:

- Haul numbers correspond with dates and hauls listed on the VHF
- Species names match species codes (paper forms)

- No species codes are listed twice except for different sexes of prohibited species
- No species codes are listed without corresponding data
- Sex codes are included only for salmon, Tanner and king crab species
- If sex is unknown, the sex field is left blank
- Zeros are recorded for those number entries with no weight
- Decimal points are distinct and recorded to no more than two decimal places
- All weights are in kilograms
- Accurate keypunches of numbers, weights and species codes!
- Percent retained numbers are whole numbers entered for all species and are consistent between samples for a haul

POT VESSEL DATA COLLECTION: Reviewing Forms for Errors

Vessel Haul Form

Page 1 of 1

Cruise <u>11979</u>	Permit <u>5137</u>	Year <u>2009</u>	Gear type <u>6</u>
------------------------	-----------------------	---------------------	-----------------------

Observer name Bea Potter Resubmission (Circle All Changes)

Vessel name Dungeness Dreams

Trip No.	Haul No.	IFC7 Y/N	CDQ No.	Vessel Type	Gear performance	Location code	Deployment Information										Retrieval Information											
							Month	Day	Time	Latitude (N)			E or W	Longitude			Average bottom depth	Average gear depth	M or F	Month	Day	Time	Latitude (N)			Longitude		
										Deg.	Min.	Sec.		Deg. (100)	Min.	Sec.							Deg.	Min.	Sec.			
1	1	N	3	1	R	09	19	2230	61	10	55	W	71	20	35	27	F	09	21	1700	61	15	01	W	71	33	42	
1	2	N	3	6	R	09	19	1730	61	12	30	W	71	31	10	27	F	09	22	0003	61	15	59	W	71	25	49	
1	3	N	3	1	R	09	20	0050	61	12	49	W	71	31	40	25	F	09	22	1300	61	15	06	W	71	33	02	
1	4	N	3	1	R	09	20	1330	61	13	11	W	71	24	56	24	F	09	22	2035	61	15	49	W	71	33	48	
1	5	N	3	1	R	09	22	1900	61	14	55	W	71	24	30	26	F	09	23	0050	61	13	10	W	71	24	58	
1	6	N	3	6	R	09	23	0250	61	13	42	W	71	24	16	30	F	09	23	1400	61	14	12	W	71	24	55	
1	7	N	3	1	R	09	22	2035	61	15	22	W	71	27	37	32	F	09	23	1600	61	15	01	W	71	34	01	
1	8	N	3	1	R	09	23	1730	61	13	47	W	71	24	14	27	F	09	23	2200	61	15	02	W	71	27	55	
1	9	N	3	1	R	09	23	2330	61	12	46	W	71	31	19	25	F	09	24	1325	61	15	51	W	71	27	15	
2	10	N	3	1	R	09	24	1525	61	13	59	W	71	24	51	26	F	09	25	0900	61	15	50	W	71	33	41	
2	11	N	3	1	R	09	25	1015	61	13	05	W	71	24	06	20	F	09	25	1815	61	14	35	W	71	33	57	
2	12	N	3	1	R	09	25	1500	61	13	17	W	71	40	36	28	F	09	25	2210	61	16	29	W	71	36	12	
0																					53	53	12	W	66	32	27	

Page _____ of _____ for transmission Rev. 09

Observer Haul Form

Page 1 of 1

Cruise <u>11979</u>	Permit <u>5137</u>	Year <u>2009</u>	
------------------------	-----------------------	---------------------	--

Observer name Bea Potter Resubmission (Circle All Changes)

Vessel name Dungeness Dreams

Haul No.	Haul sampled by (cruise no.)	RST on haul? (Y=on, N=off, X=NB)	RBT on break? (Y=on break, N=no break)	% Monitored for marine mammals	Trawl vessels				Longline and Pot Vessels					
					Vessels total catch estimate in mt	Estimated discard weight in mt	Observers catch estimate in mt	B, C, or W	Density in mt/m ²	Volumetric estimate in m ³	Catcherboat's ADF&G # (motherships only)	# of segments in set	# of hooks per segment	Total hooks or pots in set
1	11979	X	N	33	10.00	5.0	106	
2	11979	X	N	33	9.00	2.0	96	
3	0	X	N	0	11.00	106	
4	11979	X	N	33	8.50	2.0	106	
5	11979	X	N	43	10.80	7.0	81	
6	11979	X	N	37	7.00	8.5	75	
7	0	X	N	0	2.00	25	
8	11979	X	N	34	9.00	2.0	106	
9	11979	X	N	33	11.00	1.0	106	
10	11979	X	N	33	4.00	6.5	106	
11	11979	X	N	33	3.50	5.0	106	
12	11979	X	N	43	1.50	5.0	49	
0						

Page _____ of _____ for transmission Rev. 09

Figure 8-5 Examples of VHF and OHF data from a pot vessel

jc

DECK FORM

Date	Cruise	Permit	Haul No.	Offload No.	Page <u>1</u> of <u>3</u> for vessel/plant
9/22/09	11979	5137	4		Page <u>1</u> of <u>3</u> for haul/offload

Sample number: <u>1</u>	Sub-sample number:	Sample size: <u>12</u>	Kgs Hooks pots	Combined <input type="checkbox"/>	Presorted <input type="checkbox"/>
-------------------------	--------------------	------------------------	----------------------	-----------------------------------	------------------------------------

Species	Sex	#	Weight	% ret.	
----- KEYPUNCH -----	<input checked="" type="checkbox"/>	<u>539</u>	<u>133.2</u>	<input checked="" type="checkbox"/>	<small>length, viability, injury, specimen, and tally data</small>
P. cod		<u>25</u>	<u>75.2</u>	<u>100</u>	P. cod (392)
Octopus		<u>1</u>	<u>2.24</u>	<u>100</u>	Octopus 1-e 2.24kg
Yellowfin		<u>26</u>	<u>16.46</u>	<u>0</u>	41 29 30 34
N. rock sole		<u>6</u>	<u>3.0</u>	<u>0</u>	32 37 30 37
Rocksole u.		<u>1</u>	<u>0</u>	<u>0</u>	27 38 32 25
Greatsculpin		<u>6</u>	<u>15.0</u>	<u>0</u>	Halibut
Starfish		<u>37</u>	<u>3.4</u>	<u>0</u>	1- 31 e. 30kg E
Blue King	<u>M</u>	<u>16</u>	<u>10.40</u>	<u>0</u>	Rocksole
Blue King	<u>F</u>	<u>13</u>	<u>7.2</u>	<u>0</u>	□L (7)
Halibut		<u>1</u>	<u>0.3</u>	<u>0</u>	NFS
					□□□□□
					□□□□□
					□□□1 (66)
					Myox
					□1 (6)
					Starfish
					□□□□
					□□□L (37)

Sample number:	Sub-sample number:	Sample size:	Kgs Hooks pots	Combined <input type="checkbox"/>	Presorted <input type="checkbox"/>
----------------	--------------------	--------------	----------------------	-----------------------------------	------------------------------------

Species	Sex	#	Weight	% ret.	
----- KEYPUNCH -----	<input checked="" type="checkbox"/>			<input checked="" type="checkbox"/>	<small>length, viability, injury, specimen, and tally data</small>
P. cod		<u>367</u>	<u>0</u>	<u>100</u>	Blue King crab
Yellowfin		<u>40</u>	<u>0</u>	<u>0</u>	P. cod
					M E
					51-1 43-1
					57-L 55-1
					58-L 62-L
					62-1 67-L
					64-1 74-1
					71-L
					73-1 90-L
					74-L 98-L
					78-1
					N=no eggs
					Y=eggs
					106 pots
					35 pots = 1/3
					12 pots = 1 unit
					P. cod otos:
					#416321 M @ 58 cm, 3.40 kg
					#416320 F @ 74 cm, 5.60 kg
					MATURITY SCAN:
					#416320, 5.20 kg
					DEVELOPING

National Marine Fisheries Service/Fisheries Monitoring and Analysis Division Ver. 09

Figure 8-6 Example of raw data from a pot vessel

POT VESSEL DATA COLLECTION: Reviewing Forms for Errors

je

DECK FORM

Date	Cruise	Permit	Haul No.	Offload No.	Page <u>2</u> of <u>3</u> for vessel/plant
9/22/09	11979	5137	4		Page <u>2</u> of <u>3</u> for haul/offload

Sample number: <u>2</u>	Sub-sample number:	Sample size: <u>12</u>	Kgs Hooks pots	Combined <input type="radio"/>	Presorted <input type="radio"/>
-------------------------	--------------------	------------------------	----------------------	--------------------------------	---------------------------------

Species	Sex	#	Weight	% ret.	length, viability, injury, specimen, and tally data
----- KEYPUNCH -----	X			X	
P. cod		17	43.0	100	P. cod (316) Irish Lord
Yellowfin sole		31	19.62	0	17 24 □□□L (17)
Great sculpin		5	23.2	0	28 18
Yellow Irish lord		12	6.24	0	37 27
Starfish		20	4.21	0	12 33
Halibut		1	.39	0	27 46 <u>Halibut</u>
Blue King crab	M	13	7.37	0	32 15 1-34 e, 39kg E
Blue King crab	F	12	3.28	0	YFS
Kelp		1	.02	0	□□□□□
Hermit crab		2	.01	0	□□□L (42)
					<u>Myox</u> <u>Starfish (58)</u>
					□□□□□
					□□□□□

Sample number:	Sub-sample number:	Sample size:	Kgs Hooks pots	Combined <input type="radio"/>	Presorted <input type="radio"/>
----------------	--------------------	--------------	----------------------	--------------------------------	---------------------------------

Species	Sex	#	Weight	% ret.	length, viability, injury, specimen, and tally data
----- KEYPUNCH -----	X			X	
P. cod		299	0	100	Kelp - 1
Yellowfin sole		11	0	0	Hermit crab - L (2)
Great sculpin		7	0	0	
Yellow Irish lord		5	0	0	
Starfish		38	0	0	
					<u>Blue King crab</u>
					M F
					78-□ 73-1 -N
					88-L 78-2 -N
					93-□ 83-L -N
					98-1 88-□ -N
					103-1 98-1 -N
					113-1 (12)
					(13)

N = no eggs Y = eggs

National Marine Fisheries Service/Fisheries Monitoring and Analysis Division Ver. 09

Figure 8-6 Example of raw data from a pot vessel

<u>Cruise</u>	<u>Permit</u>	Length and Specimen Form										Page <u>2</u> of <u>3</u>					
<u>11979</u>	<u>5137</u>	Observer name <u>Bea Potter</u>					Vessel name <u>Dungeness Dreams</u>										
Resubmission (Circle All Changes)																	
Species Name	Species code	Haul no.	Offload No.	Sample or Sub-Sample no.	Sample system	Sex	Crabs		Halibut		Length	Freq.	Specimen Data				
							Eggs? Y/N	Viability (trawl/pot) Injury (Longline)	Specimen Type	Specimen Number			Weight	Maturity			
Halibut	101	4		1	2	U			E		31	1					
Blue King	6	4		1	2	F	N				63	3					
Blue King	6	4		1	2	F	N				68	4					
Blue King	6	4		1	2	F	N				78	2					
Blue King	6	4		1	2	F	N				83	3					
Blue King	6	4		1	2	F	N				88	1					
Blue King	6	4		1	2	M					63	3					
Blue King	6	4		1	2	M					68	1					
Blue King	6	4		1	2	M					73	5					
Blue King	6	4		1	2	M					78	1					
Blue King	6	4		1	2	M					83	4					
Blue King	6	4		1	2	M					113	2					
Halibut	101	4		2	2	U			E		34	1					
Page _____ of _____ for transmission Ver. 09																	

<u>Cruise</u>	<u>Permit</u>	Length and Specimen Form										Page <u>3</u> of <u>3</u>					
<u>11979</u>	<u>5137</u>	Observer name <u>Bea Potter</u>					Vessel name <u>Dungeness Dreams</u>										
Resubmission (Circle All Changes)																	
Species Name	Species code	Haul no.	Offload No.	Sample or Sub-Sample no.	Sample system	Sex	Crabs		Halibut		Length	Freq.	Specimen Data				
							Eggs? Y/N	Viability (trawl/pot) Injury (Longline)	Specimen Type	Specimen Number			Weight	Maturity			
Blue King	6	4		2	2	F	N				73	1					
Blue King	6	4		2	2	F	N				78	2					
Blue King	6	4		2	2	F	N				83	3					
Blue King	6	4		2	2	F	N				88	5					
Blue King	6	4		2	2	F	N				98	1					
Blue King	6	4		2	2	M					78	4					
Blue King	6	4		2	2	M					88	2					
Blue King	6	4		2	2	M					93	4					
Blue King	6	4		2	2	M					98	1					
Blue King	6	4		2	2	M					103	1					
Blue King	6	4		2	2	M					113	1					
Page _____ of _____ for transmission Ver. 09																	

Figure 8-8 Examples of length and specimen data from a pot vessel (continued)

POT VESSEL DATA COLLECTION: HAUL FORM QUICKLIST for POT VESSELS

HAUL FORM QUICKLIST FOR POT VESSELS	
OHF	VHF
<u>RST On Haul?</u>	<u>Vessel Types</u>
Y - for on haul	1 - Catcher/processor (C/P)
N - for off haul	2 - Mothership
X - for did not use RST	3 - Catcher-only vessel
<u>RBT On Haul?</u>	5 - Bait
Y - for on break	<u>Gear Performance Codes</u>
N - for off break	1 - No problems
N - When RBT not used	5 - Miscellaneous problem in retrieving gear, write explanation in the "Notes" area of the OHF
	6 - Some or all gear lost
	<u>Gear Codes</u>
	6 - Pot vessels

Figure 8-9 List of codes and truncated meanings for OHF and VHF

SHORESIDE PLANTS AND FLOATING PROCESSORS



Table of Contents

Introduction.....	9-1
Delivery Schedule.....	9-2
Observer Provider Responsibilities	9-2
Collecting Delivery Information.....	9-2
ADF&G Fish Tickets	9-3
Round (Whole) Weight Delivered	9-3
Verifying Delivery Weights.....	9-3
After-Scale Area	9-4
Delivery Worksheet Verification.....	9-4
Assisting Vessel Observers	9-4
Relieving Vessel Observers During Pollock Offloads	9-4
Offload Form Instructions	9-6
Sampling on the Arctic Enterprise	9-7
Halibut Deliveries.....	9-8
Level 2 Information for Plant Observers.....	9-8
CDQ Deliveries From Catcher Vessels Less Than 60'.....	9-9
CDQ Deliveries From Catcher Vessels Greater Than 60'	9-10
Referring Sampling Questions.....	9-10
Length Frequency Sampling.....	9-10
Bering Sea & Gulf of Alaska roundfish priority list	9-11
Bering Sea flatfish priority list	9-11
Gulf of Alaska flatfish priority list.....	9-11
Age Structure Sampling.....	9-11
Special Projects	9-12

LIST OF PRIORITIES

- Verify delivery weights for as many deliveries as possible.
- Prepare and distribute a Delivery Weight Verification explanation.
- Collect Offload Form data from captains, logbooks, or vessel observers.
- Record delivery information on the Offload Form
- Assist vessel observers.
- Collect lengths and age structures.
- Complete standard and special projects as assigned.
- Send data to FMA as directed (see “Sending Data” on page 2-26.).

INTRODUCTION

When you are assigned to a shoreside plant or floating processor, your duties and priorities are different from those of a vessel observer. You are responsible for gathering data from incoming vessels delivering to your facility. You are also responsible for assisting vessel observers and informing them about your plant’s processing procedures. Lastly, you may be responsible for gathering target species length frequency data and age structures. Plant observers transmit their data to NMFS at least once each week.

How your employer assigns an observer to a plant can vary, and some observers may be assigned to cover two plants at once. Regardless of how many plants you are assigned to, your time will be under a



great deal of demand. It is important that you understand all of your duties and their relative priority when you arrive. This assignment will be very different than sampling aboard a vessel, so please read this chapter carefully, and refer to it often.

DELIVERY SCHEDULE

In order to gather fishing effort and biological data, you will need to know when to expect delivering vessels. Most plants have a “radio schedule” between one and three times daily.



From the radio schedule, the plant personnel will prepare a delivery schedule. You will need to either attend the radio schedule, or get a reliable copy of the delivery schedule. It is vital that you communicate with the person(s) responsible for updating these schedules. They are not definitive schedules, and changes occur frequently. It is important to check them often in order not to miss vessels! Check in with the plant frequently. Your physical presence at the plant is important, and plant personnel are more willing to cooperate with a person whom they see on a regular basis. Do not rely solely on the plant to page you when there is a delivery.

Plant observers often have the unique situation of being on land. This presents opportunities to move about, and it is understood that you will not always be at your duty station. The decision to leave the plant is up to you. Keep in mind that you are *expected* to meet every delivering vessel and accomplish all other plant observer duties. Missing deliveries due to being absent from the plant is grounds for an unfavorable deployment evaluation. *Depending on severity, tardiness and missed deliveries could be grounds for decertification.*

OBSERVER PROVIDER RESPONSIBILITIES

According to 50CFR679.50 (i) (2) (vi) observer provider companies are responsible for providing all logistics to place and maintain observers aboard fishing vessels or at the site of the processing facility. This includes all travel arrangements, lodging, per diem, and any other services required to place observers aboard

vessels or at processing facilities. Each observer deployed to shoreside processing facilities shall be provided with a working cell phone or pager for notification of upcoming deliveries. If accommodations are more than 1 mile from the assigned shoreside processing facility the observer will be provided with motorized transportation. Therefore, it is your employer’s responsibility to ensure that you have adequate transportation that will ensure your arrival at the processing plant in a timely manner. If you are unable to perform your duties as an observer because there is no reliable transportation to the plant, please contact the FMA Division. If your accommodations are inadequate, contact the FMA Division and let your employer know about the problem.

COLLECTING DELIVERY INFORMATION

One of your duties as a plant observer is to gather haul information from the various vessels delivering to your plant. These data are recorded on the Offload Form. Each day you are assigned to the plant must be accounted for, even if there are no deliveries that day. The required information can be gathered in a variety of ways. You will likely use a combination of the following:

- **Ask the vessel observer.** This is a great way to get reliable data for a delivery, but obviously only works when there is a vessel observer. Asking the observer is the most accurate method of getting information.
- **Consult the vessel’s logbook.** If there is no observer aboard, you can get the gear type and NMFS fishing area from the delivering vessel’s logbook (if they are required to use one). You should always introduce yourself as the plant observer, and inform the skipper of what information you are looking for in the logbook.
- **Interview the captain.** Vessels under 60 feet long are not required to carry NMFS logbooks, so you will need to ask the skipper for the pertinent data. At the King Cove-Peter Pan, Trident-Sand Point, the southeastern Alaskan and Kodiak plants, these boats will make up a large portion of your delivering fleet. In the past, observers have made up “worksheets” for the captain to take with him for each trip, and this is occasionally successful.

Regardless of which method you use, it is important to meet each vessel at the dock when it comes in, and to establish a working relationship with the captain and vessel observer. If you are unable to collect delivery information as described above, an ADF&G fish ticket may be used.



ADF&G FISH TICKETS

If you determine that ADF&G fish tickets are the most reliable way to obtain verified delivery weights, it is important that they are read correctly. Familiarize yourself with how the processor personnel fill out the fish tickets, where their data come from, and if it's accurate at your plant. You will need to pass along this information to vessel observers on delivering catcher vessels, and make sure that they are getting the information they need to complete the delivery information on their Offload Form.

Round (Whole) Weight Delivered

Round weight is the weight of the entire fish, as it was when it was alive. In some fisheries, such as P. cod and sablefish, the catcher vessels begin processing their catch at sea. Pacific cod is usually bled and sablefish are usually headed and gutted. Since parts of the fish have been removed prior to delivery, the recorded delivery weight must be adjusted to represent a delivery *round weight*. The eLandings program, used by all plants, calculates these round weights and lists them at the bottom of the fish ticket.

VERIFYING DELIVERY WEIGHTS

As a plant observer, you will often need to provide delivery weights to vessel observers. During your first few days at the plant you should determine the best method of obtaining this number. Two ways to obtain

delivery weight are: 1) actually sum the scale weights, or 2) interpret the ADF&G fish ticket. You should verify delivered weights whenever possible.

Summing actual scale weights is preferred, but if you find that the fish tickets are consistently accurate when checked against summed weights, you may use them instead. If you determine that the ADF&G fish tickets are *not* reliable, do not use the fish ticket amount for delivery weight. When you are not on hand to record the scale readouts, or check the ticker tape readouts, you will have to use the fish ticket weight as delivery weight.



Plant scales are required to be tested annually by the State of Alaska and display panels are sealed and protected against tampering. Therefore, it is not necessary to verify that the scale displays the correct weight. Plant scales are not tested daily. Plant observers will need to check that plant personnel are recording

the weights accurately and that the entire delivery is weighed.

Items to check:

- Does the scale weigh the entire catch, or is bycatch sorted out first, and weighed separately?
- Do summed scale readouts equal the total delivery weight on the ADF&G fish ticket?
- Do plant personnel subtract a percentage of the pollock weight for water before filling out the fish ticket?
- Does the fork-lift driver record weights for every tote, and how are the tote weights tared on the scale?
- Are product codes on the fish ticket accurate?

Improperly recorded weight data

If you determine that data are not being recorded accurately at your plant, you must verify as many delivery weights as possible. Document how the fish ticket and delivery information is recorded by the plant

personnel, and what you think is the problem. The problem may be easy to correct. For example, if you notice that the plant deducts 3% of the delivery weight as water weight, but you never see any water go over the scale, you can correct the problem by adding 3% back as the target species weight. In the Pacific cod fishery, the catch is often weighed in totes. If the totes are not properly tared, the delivery weight will be inaccurate. Check the tare weight by asking the forklift drivers to weigh empty totes for you. If you find that the totes are not being weighed properly, you must work with the dock personnel to assure correct recording or calculate the weights yourself.

Properly recorded weight data

If you find that the fish ticket weights are recorded properly, continue verifying one or two deliveries per day. In your logbook, document how you are checking these weights. Once you determine the best method for obtaining delivery weights, you should inform vessel observers delivering to your plant should use the same method. In your logbook, document your reasoning for picking the method you did, and any problems or concerns you have with the data.

AFTER-SCALE AREA

The “after-scale” area is another place where weights may not be accurately recorded. This is an area where factory workers will set aside bycatch that has made it past the sorters and into the factory. This bycatch has been weighed as the target species. Factory personnel should deduct the weight of the after-scale bycatch from the target species weight. They also need to add after-scale weights to the appropriate group on the fish ticket. Check to ensure that after-scale bycatch is being recorded as the correct species and not as the target species. You should also ***check the after scale-area for any prohibited species that pollock vessel observers may have missed during sampling.*** Record the species, length, weight, and sex of prohibited species found in the after-scale area and give these data to the vessel observer with the rest of their delivery information.

DELIVERY WORKSHEET VERIFICATION

You will need to let each vessel observer know how you are getting delivery weights. This is a very important task, and crucial to the vessel observers delivering to your plant. To do this, prepare a written

paragraph or two explaining how the delivery weights are verified, and what the weights include. In this description, you will need to address each of the concerns regarding verifying delivery weights listed on page 9-3. Make several copies of this to give to each of the observers delivering to your plant. An example of such a description is shown in Figure 9-1.

ASSISTING VESSEL OBSERVERS

Assisting vessel observers may be one of the most difficult and time consuming of your duties as a plant observer. It is very important to keep in contact with observers aboard vessels delivering to your processor. Try to meet with them every time they come in. Your first few weeks at the plant, you will need to give each vessel observer a tour of the plant and explain to them your delivery weight verification process. The tour of the plant should include:

- the area in which they can sample for prohibited species,
- the “after-scale” area,
- areas of potential size or composition bias (sorters, incline belts, etc.),
- the location of the office, phone, fax machine, and computer,
- where they can obtain verified delivery weights and messages from you,
- potential safety hazards and emergency contingencies.

You will need to set up a method for vessel observers to reach you whenever they are in so that they will be able to reach you to schedule their breaks and to receive delivery data from previous deliveries. Most plants will have quarters with a phone and answering machine available to you, but in some cases you may have to establish a “message board” which is accessible 24 hours a day.

Relieving Vessel Observers During Pollock Offloads

Offloads of pollock can last between one and 24 hours, depending on the plant and the vessel. An observer must be present to monitor the entire offload. Do not expect plant personnel to sort and save fish if an observer is not present! ***It is important that vessel observers are given breaks during this time, and that***

Alaska Processing Inc. Delivery Weight Verification

For All Vessel Observers:

I will verify the delivery weight for each pollock delivery weight in the following manner:

- Delivery weights are usually taken from the ADF&G electronic fish ticket. The plant manager does not want me giving out copies of the fish ticket, so I will give you a copy of all my calculations. I will add up the fish ticket weights myself, after they have been verified. If I find any discrepancies during the verification process, I will use the sum of the scale weights, and leave you a note. (I checked all the fish tickets during cod, and never found any discrepancies.)
- Every fish ticket is checked against the hopper scale ticker-tape for pollock weights. These are stapled to a copy of the fish ticket in the plant office, if you ever need them.
- All bycatch weights are double checked against the tote weights from the dock tally. (These are also stapled to a copy of the fish ticket.)
- Jellyfish weights are not usually listed on the fish ticket. I take this weight directly from the dock tally sheet.
- I try to check the dock tally once a day during a non-observed delivery. The tote tare weights are checked, and I check to ensure the forklift drivers are recording the information correctly. If you notice any totes being weighed incorrectly during your offloads, please let me know!
- Delivery weights will NOT include prohibited species weights! I will give you a separate herring weight, and I'll give you all the necessary data from after scale halibut, salmon and crab. Salmon and crab will be identified to species, and their sex and length will be recorded. I'll give you halibut lengths. The after-scale area is in the north part of the factory (near the break room, by fillet machine #6). Prohibited species are put in the basket, and the delivering vessel is written on the white board above.
- No water weight is deducted at this plant.

Please leave me a note with any salmon and at-sea discard information. I need this information for my Salmon Retention and Offload Form! Thanks!

Figure 9-1 Delivery Weight Verification Process (example)

the plant observer periodically take over monitoring for prohibited species. Near the beginning of each offload, you should ask vessel observers what type of assistance they will need and take this into account when scheduling your other duties. You will likely need to give vessel observers breaks for rest, meals, and time to do paperwork. ***You are required to give longer breaks to observers who need to complete a mid-cruise evaluation.***

There is not a specific amount of break time that you have to give vessel observers, but as a general guideline, give a one hour break for every five hours of sorting and give more frequent breaks in cold weather. For example, an observer with a 10-hour delivery should be given a break after the first five hours to eat and rest. An observer with a 10-12 hour delivery may choose to take two breaks of one hour each, or one

break for two hours. Many observers with extremely long offloads prefer one long break, rather than several short ones. Work out a fair schedule with each observer.



By federal regulation, pollock catcher vessel observers must not be assigned to another vessel or sent to debriefing prior to completing their offload sampling.

While you are monitoring the haul for the vessel observer, you must pull out any prohibited species. Collect the appropriate biological data for these prohibited species including species, length, weight, and sex or condition code. Do not leave it up to the vessel observer to collect data on fish you pulled off the sorting belt while they were on break.



Offload Form Instructions

Record the information that you obtained from the skipper interview, vessel observer, and/or vessel logbooks on this form. Maintain a separate set of forms for each plant.



You must maintain and bring back paper copies of the Offload Form, regardless of the fact that the plant is equipped with ATLAS!

You must make an entry for every groundfish delivery made to the plant. Enter at least one line every day. For days with no deliveries, write in a zero for delivery number and note whether you were assigned to the plant that day, and whether or not they were still processing groundfish. These notes are required by NMFS to verify coverage days.

Cruise number, Plant Permit, Year: Your cruise number will be given to you during training or briefing, or by your employer. The plant permit numbers are listed on page A-25. For “Year” you can enter the full year or just the last two digits (e.g., “09”).

“Vessels Only” Tab

These fields are only completed by vessel observers. Leave these field blank.

Observer Name/Plant Name: Enter your name and the name of the plant.

“Plants Only” Tab

Catcher boat name: Enter the name of each catcher boat delivering to your plant. You only need to list each boat once per data set, and the vessel does not have to be listed at the top of the page where its deliveries are listed. When all the lines on the first page are used up, go on to page 2, etc. Keep the catcher boat list together on the first several pages of your Offload Forms.

ADF&G #: You can find the number written in one foot high numbers on the wheelhouse of each delivery boat. It is also recorded in the vessel and plant logbooks and is often imprinted and written on the fish ticket. If the vessel does not appear to have an ADF&G number, try to locate the Coast Guard number or the NMFS permit number. These numbers will help NMFS staff find the ADF&G number when you debrief.

Vessel permit #: The vessel permit numbers are listed on page A-25.

Trip Number: This field is completed by vessel observers only.

Offload number: These should be sequential numbers, with only one line of data for each delivery. Do not split delivery data due to fishing in two NMFS areas. The “Offload Number” on the Length and Specimen Form must correspond to the offload number on the Offload Form. Plant observers must enter a “0” for any days that no deliveries occurred.

Completion Date: Enter the date of *completion* of each delivery to the processing plant. If the delivery continues over two or more days, use the date when the delivery is complete. This date should coincide with the one used in the NMFS processor logbook and on the fish ticket.

“Plants Only” Tab

Gear Type: Enter the appropriate code from the list below. If the delivering vessel is acting as a Tender, enter the gear type that you believe was used for fishing.

1= Non pelagic trawl	6= Pot or trap
2= Pelagic trawl	7= Jig
3= Mixed trawl	8= Longline
4= Pair trawl	9= Gill net
5= Shrimp trawl	10= Scottish Seine

NMFS area: This is the three digit code for the area in which the delivering vessel fished. If the vessel fished in two or more areas for the delivered catch, record the area in which most of the fish were caught. Do not divide delivery data by area. To determine NMFS areas, see page A-32 or.

Total delivered, LB or MT: Record the total round weight delivered (including pollock) to the plant for that trip. Delivery weights reported in pounds must be recorded to the nearest whole pound. Weights reported in metric tons must be recorded to the nearest 0.01 of a metric ton. Remember that when cut or bled fish are delivered, the round weight must be used and is listed at the bottom of the eLandings fish ticket.

“Plants Only” Tab

Total pollock weight: Complete this column if you meet the following criteria: You are at Alyeska, Westward, Unisea, Trident Seafoods (Akutan), Arctic Enterprise, Northern Victor or Peter Pan Seafoods (King Cove). Gear code must be “2” and all pollock must be from the Bering Sea. Record the total weight of all pollock in that delivery.

Were all groundfish weighed?: Enter “Y” or “N” to indicate if all groundfish *delivered* to the plant were actually weighed. If you enter an “N” you must note why all fish were not weighed in your logbook. For normal groundfish deliveries, enter “Y” if all species delivered were weighed. For halibut IFQ deliveries, enter “Y” if all species other than halibut were weighed.

ADF&G # of delivering vessel: Record the ADF&G number of the delivering catcher vessel. This number should correspond to the vessel name recorded in the “Plants Only” tab on the top of your first few Offload Forms. Do not enter Coast Guard or NMFS permit numbers in this field. If these are the only numbers available to you, leave this column blank and make a note of which vessel the delivery is from.

Receiving processor permit #: This field is completed by vessel observers only.

Was Catch Sorted?: Enter “Y” if catch was extensively sorted at sea, or “N” if it was not. If you are unsure whether or not catch was sorted, enter “Y” and document the circumstances in your logbook.

Tender Offload?: Enter “Y” if fish were delivered by a tender and a “N” if they were not. See “Deliveries from Tender Vessels” on page 9-8 for more information on tender deliveries.

ADF&G fish ticket number: Record the fish ticket number associated with the delivery from this vessel. This number should be recorded in the NMFS fishing and production logs. You can also get it directly off the fish ticket. Record the fish ticket number *exactly* as it appears on the ticket. For single deliveries with multiple fish tickets, record the additional fish ticket number(s) below the first entry for that delivery.

SAMPLING ON THE ARCTIC ENTERPRISE

The Arctic Enterprise begins sorting the fish immediately for a delivery as it is being pumped off the catcher vessel. Vessel observers are able to monitor a portion of their offload. Once the catcher vessel is emptied it is free to leave and the remainder of the offload must be monitored by the onboard plant observer. As the Arctic Enterprise observer you are responsible for the following:

- Once the offloading vessel is emptied and ready to leave, relieve the vessel observer of the offload monitoring.
- Continue to monitor the rest of the sorting and collect information on prohibited species.
- Provide the vessel observer with the delivery weight and prohibited species information upon their next delivery.
- Monitor the crew’s ability to sort and weigh the bycatch species.
- Monitor the “after factory” bycatch area to ensure the bycatch is correctly sorted and weighed by species.
- Monitor the predominant bycatch chute and collection area to ensure there are not mixed species.
- Collect length information from unobserved deliveries.

If you have any further questions please be sure to contact FMA staff.

SAMPLING AT KODIAK PROCESSING PLANTS

Sampling at plants in Kodiak is unique. Plant observers in Kodiak may be assigned to two plants simultaneously and accommodations are not located on site of most plants. As the plant observer, you will have to maintain good communications with personnel at both plants and establish a good messaging system to exchange information with observers on delivering vessels. Each plant is different and you will need to spend some time during the first few days of your assignment learning the operation and meeting key personnel. You are required to fulfill all your duties at each plant every day. Remember that you must keep the data collected for each plant separate!

DELIVERIES FROM TENDER VESSELS

Tender boats are vessels which receive catch from catcher boats. They do not carry observers and they are not set up to process any fish. Rather, they serve as a “middle-man” by picking up fish from several vessels and bringing it to a processing plant. Tender vessel deliveries are potentially sorted and are usually from several different vessels. Tenders will issue their own ADF&G fish tickets to delivering vessels. The fish ultimately delivered to your shoreside plant already have several fish tickets associated with them. When documenting deliveries on the Offload Form follow the protocols below (see Figure 9-5 for an example):

- Do record
 1. the date on which the delivery was completed
 2. the delivery number
 3. gear type
 4. the total weight delivered
 5. the ADF&G number of the tender vessel
- Do not write a fish ticket number on the Offload Form
- Do not fill out the NMFS area fields on the Offload Form

HALIBUT DELIVERIES

When IFQ boats fish for halibut, they are required to keep all incidental catch of rockfish, and abide by IR/IU regulations by keeping some or all pollock and Pacific cod. As the plant observer, you need to record only the groundfish portion of the delivery. In the “Total weight” column on your Offload Form, record the round weight of catch other than halibut. If no groundfish are in the delivery, you do not need to record the delivery on the Offload Form.



JIG BOAT DELIVERIES

Record the delivery information on the Offload Form. Sample for sexed lengths and otoliths unless a state port sampler is present and sampling an offload, then it is not necessary to collect sexed lengths and otoliths from that delivery.

LEVEL 2 INFORMATION FOR PLANT

OBSERVERS

Plant observer duties vary depending on the type of vessel delivering and the fishery the vessel participated in. The 12-hour rule applies during both CDQ and AFA fisheries at all plants. All plants are equipped with the ATLAS program. Send ATLAS data 2-3 times per week.

Plants are required to weigh all CDQ species on certified scales. Unlike flow scales and platform scales, there are no daily test requirements for you or the plant. The State of Alaska tests and certifies scales at plants.

Scale and Catch-Weighing Requirements for AFA and Rockfish Pilot Project Inshore Processors

All plants receiving deliveries from AFA pollock or Rockfish Pilot Program catcher vessels are required to have a Catch Monitoring and Control Plan (CMCP). This plan defines the method in which each individual plant will sort and weigh all species during any AFA or Rockfish Pilot Program deliveries. Upon arriving at the plant you should review a copy of the CMCP with the plant liaison listed in the plan. If the plant is not

following any portion of their CMCP, inform the plant liaison as well as your inseason advisor or staff at an FMA Division office.

The sorting and weighing should occur within view of the observation area designated in the CMCP. As part of a CMCP, a work station is provided for use by the observer. This work station does not have to meet the same requirements as a CDQ sample station. The scale needs to be tested at 10, 25, and 50 kg on a daily basis and the results should be documented in your logbook. Make sure to inform the vessel observers delivering to the plant that the scale has been tested daily. You should be able to walk between the work station and the observation area without encountering any safety hazards.

Each plant's CMCP will be different so be sure to review each plan carefully even if you have worked at plants before. Contact your inseason advisor if you have any questions about the specifics of your plant's CMCP.

The plan should

- Detail the amount and location of space for sorting catch, the number of staff assigned to catch sorting and the maximum rate catch will flow through the sorting area.
- Identify by serial number each scale to be used to weigh groundfish and describe each scale's use.
- Describe the procedure used to test the scale, list the test weights used, list where these weights will be stored and the plant personnel responsible for testing. Observers are not required to request scales be tested or be present when scales are tested. There are no daily test requirements for the plant's scales.
- Identify the delivery point. The delivery point is the first location where fish removed from a delivering vessel can be sorted.
- Designate an observation area. This observation area is the location where an individual may monitor the flow of fish during a delivery. It must be freely accessible to observers and have an unobstructed view of the flow of fish between the delivery point and the location where sorting and

weighing occurs. Plants may use video cameras, parabolic mirrors or other devices to meet this requirement.

- Identify an observer work station. This station should include a platform scale, a table, and a lockable cabinet. The area must be at least 4.5 m³. This work station will not have to meet the same requirements as a CDQ sample station. The work station should correspond to the one detailed in the CMCP. Test weights should be available to test the platform scale. The scale needs to be tested at 10, 25, and 50 kg on a daily basis and the results should be documented in your logbook. Make sure to inform the vessel observers delivering to the plant that the scale has been tested daily. You should be able to walk between the work station and the observation area in less than 20 seconds without encountering any safety hazards.
- Describe the communication equipment for the observer to facilitate communication within the plant. This communications equipment should be the same used by the plant staff.
- Identify a plant liaison. This person is responsible for orienting new observers to the plant and assisting with the resolution of observer concerns.
- Be accompanied by a scale drawing of the plant showing the delivery point, the observation area, the observer work station, the location of each scale used to weigh catch and each location where catch is sorted.

Inshore processors receiving deliveries of groundfish from AFA catcher vessels are required to submit a Shoreside Processor Electronic Logbook Report *daily*. The processor is required to generate and retain printed output of the shoreside processor electronic logbook report at the processing plant for use by NMFS Enforcement and groundfish observers.

CDQ Deliveries From Catcher Vessels Less Than 60'

Vessels less than 60' LOA are not required to carry an observer or complete a groundfish logbook. When fishing halibut CDQ, they are not required to retain or deliver any groundfish to the plant. If no groundfish is delivered, you have no responsibilities as the plant observer and the plant is not required to notify you of these deliveries. If a vessel fished both halibut CDQ

and IFQ, the vessel is required to retain Pacific cod, pollock, and rockfish. Treat those deliveries as halibut IFQ deliveries and **record only the groundfish (non-halibut) in the delivery on your Offload Form** (see “Halibut Deliveries” on page 9-8).

Vessels less than 60' LOA participating in any other CDQ groundfish fishery (e.g., sablefish or Pacific cod) are required to retain and deliver all CDQ species to an eligible processor. All halibut and crab must be discarded at sea. The plant is required to notify you of these deliveries and all CDQ species must be sorted and weighed by species. Monitor the plant's sorting and weighing activities and notify your inseason advisor if the plant is not complying with the regulations. Weighing and sorting generally take place in different locations at the plant. The FMA Division Observer Program does not expect you to monitor all aspects of each delivery, but do your best and monitor as much as you can.

CDQ Deliveries From Catcher Vessels Greater Than 60'

Non-trawl catcher vessels fishing groundfish or halibut CDQ that chose Option 1 in the regulations are required to deliver all CDQ species to an eligible processor. All halibut PSQ (under size halibut for CDQ halibut boats) and crab must be discarded at sea. As the plant observer, it is your responsibility to monitor the delivery. To the best of your ability, monitor the plant's sorting and weighing activities and notify your inseason advisor if the plant is not complying with the regulations. Only report the groundfish portion of the delivery for halibut CDQ deliveries. These vessels must carry an observer, and that observer should help monitor the offload if you have reached your 9-hour sampling limit.

REFERRING SAMPLING QUESTIONS

Plant observers are a tremendous help to vessel observers, but it is important that they do not overstep their boundaries. ***Plant observers should not answer sampling questions that do not pertain to their plants.*** Vessel observers should be encouraged to contact a FMA staff member if possible. If the observer is not at the plant during FMA hours, have them write their question down and fax it to one to the FMA offices. Give the written response back to the vessel observer.

Do not interpret answers or relay the answer to the observer. If your plant is equipped with ATLAS, follow the same procedure for a text message.

LENGTH FREQUENCY SAMPLING

Please see “FISH MEASUREMENT AND SPECIMEN COLLECTION” on page 11-1 for instructions on how to collect a length sample and how to sex and measure fish.

Be sure to work closely with plant personnel at your plant to ensure you minimize your effects on the product quality when collecting length and specimen data.

Plant observers take 20-30 sexed lengths per unobserved delivery that was not size sorted at sea. Selection of sampled fish is based on the following priority lists for roundfish and flatfish:

You should not collect more than 150-200 lengths per day, even if more could be done! You need to take lengths from deliveries meeting the following criteria:

- The delivery is from a vessel with no observer onboard. ***If all vessels delivering to your plant are carrying observers, do not take lengths.***
- There is no at-sea discard of the roundfish target species associated with the delivery. Prior to gathering lengths, ask the skipper if any of the target species was discarded at sea. At-sea discard could introduce a size bias, and lengths should not be taken. ***If all roundfish deliveries are sorted at sea, do not take lengths.*** The exception to this rule is for the flatfish fishery.

If you find that the majority of delivering vessels are carrying observers, or if all roundfish deliveries are sorted at sea, you may not be able to collect lengths everyday. If only a few of the vessels meet the above criteria, track these boats carefully and take lengths from their catch whenever they deliver. Alternatively, you may find that the majority of delivering vessels are small, unobserved boats which report no sorting at sea. In this case, you need to attempt to spread out your length sampling. Attempt to get lengths from a variety of vessels and NMFS fishing areas.

As a plant observer you must take lengths and otoliths from at least **four** deliveries each day, whenever you have four or more vessels which meet the above criteria.

Note that plant observers:

- **Do not** collect pollock length-weight samples.
- **Do not** collect lengths on trawl caught Pacific cod.
- **Do** collect lengths on species from jig deliveries **unless** a state port sampler is present and sampling.
- **Do** collect lengths and ages from observed vessels that **deliver live sablefish**, provided the vessel observer was unable to collect these data.

If more than one preferred target species is delivered, you should take lengths from each delivered species, up to 3 species per delivery. Take 20-30 sexed lengths per sampled delivery for each target species. Please refer to page 11-10 for the correct methods to sex and measure different species of fish.

Bering Sea & Gulf of Alaska roundfish priority list

- Sablefish *
- Rockfish (all species)
- Pollock
- Pacific cod (non-trawl)

**if an observed vessel delivers live sablefish, collect lengths and ages on them if the vessel observer was unable to collect these data.*

Bering Sea flatfish priority list

- Yellowfin sole
- N/S rocksole
- Greenland turbot
- Flathead sole
- Alaska plaice

Gulf of Alaska flatfish priority list

- N/S rocksole
- Flathead sole
- Rex sole
- Dover sole
- Arrowtooth flounder *

**Do not take otoliths from arrowtooth flounder. Collect only sexed lengths from these fish.*



Use a deck form to record and keep your raw length and otolith data. Raw data helps answer data questions during debriefing.

Your plant may be accepting various species of flatfish during your deployment. You may be able to gather lengths on several of these species. Flatfish vessels will always sort at-sea for preferred species. During this process, some size sorting may occur. If all the flatfish vessels delivering to your plant report at-sea sorting of delivered species, take lengths anyway, and document this in your logbook.

Collect your lengths randomly using a random sampling design. If unsorted mixed fish are delivered, divert the flow of fish to half fill a basket. Sex and measure all species in the basket. This will allow you to take randomly collected lengths on a variety of species at once. Fill out the Length and Specimen Form according to standard directions (see page 11-15).



AGE STRUCTURE SAMPLING

Otolith collection is a standard duty for plant observers. Otoliths should be collected from every delivery from which you take lengths. Follow the length priority tables on page 9-10 to determine from which species to collect lengths and otoliths. Otoliths must come from fish that are in your length frequency sample. If you are unable to complete both a length and otolith collection for a delivery, the otolith collection takes priority.

Refer to “Otoliths” on page 11-6 for collection methods. The number of otoliths you collect each day will depend on the number of target species being delivered to your plant. **You should try to collect at least 5 otoliths per delivery sampled for lengths, up to a maximum of 25 otoliths per day.** During some fisheries, there may be many deliveries which fit the unsorted, unobserved criteria for collecting lengths and otoliths. You should not collect more than 25 otoliths per day, even if more could be collected. Collect otoliths according to the following frequencies:

- If only one species is being delivered that is measured for length frequencies, collect five pairs of otoliths per delivery sampled for lengths.

SHORESIDE PLANTS AND FLOATING PROCESSORS: Special Projects

- If two or more species are being delivered that are measured for length frequencies, take two pairs of otoliths per species per delivery sampled for lengths.
- Try to collect otoliths from at least four deliveries per day that meet length frequency collection criteria, for a total of at least 20 otoliths per day.

Note that you should not take otoliths from arrowtooth flounder or trawl caught Pacific cod.

Remember that if you are collecting otoliths from pot or longline caught Pacific cod, the fish will likely have been bled before delivery, you must divide the weight of the individual fish by the PRR of 0.98. Show your calculations in your logbook, and record the calculated weight on the Length and Specimen Form. The Length and Specimen Form should be filled out according to directions on page 11-15.

Sampling Example:

A plant observer sampling a trawl vessel delivery that targeted rockfish in the GOA and retained their MRA's (maximum retainable amounts) of both sablefish and Pacific cod, follows the roundfish priority table. Their length and otolith collection would consist of the following:

1. Sablefish - 20 SLF and 2 otoliths
2. The two most predominant species of rockfish: 20 SLF and 2 otoliths from each species
3. No SLFs or otoliths from trawl caught P.cod

This would be a total of 60 SLFs and 6 pairs of otoliths collected from this delivery.

SPECIAL PROJECTS

Plant observers have the unique arrangement of having access to lots of fish, freezers, field offices, and airports. Therefore, they will frequently be asked to complete fish collections for training use. If you are asked to collect fish, please work with plant personnel to obtain secure, easily accessible freezer space in which to store your collection. During fisheries where sorting at sea is common, you should work with vessel observers to collect requested species. The special project will be assigned to you, so lack of cooperation from vessel observers is not an excuse for not

completing it. Please note that prohibited species cannot be collected without a permit. When you are picking which fish to collect, try to choose fish which have just been delivered, and freeze them individually. Rockfish spines should be folded down, and ***the fish frozen flat***. Small fish are preferred, since more fit in a box, but do not hesitate to bring back fish that are outside of normal size or geographical range. The Observer Program needs to verify any species reported outside these ranges.

Although fish collections are a common special project assignment, there are many projects that may be assigned. Contact an FMA Division Observer Program office if you have questions about your project, or if you are having difficulty completing it while keeping up with your other duties.

REVIEWING FORMS FOR ERRORS

To facilitate the debriefing process you ***must*** check forms throughout your cruise rather than at the last minute just before your debriefing interview. Observers who regularly review their data at sea generally benefit by having shorter, smoother debriefings. Observers who do not review their data throughout their cruise generally find themselves in lengthy debriefings and with time consuming corrections. It is much easier to check a couple of pages each day over the course of three months than to check a couple hundred pages of data all at once! Follow the guidelines below when reviewing your plant data for errors.

Check Offload Form for the following:

- All mandatory information is on the forms. If information is missing, explain the circumstances on the form.
- ADF&G numbers are listed for each of the delivering catcher vessels.
- Every day at the plant is recorded with the date and any sampling activity or lack thereof.
- The entire fish ticket number is listed for each delivery including any letter.

Proper Use of Electronic Fish Ticket Weights

A. Fish tickets will only contain accurate information on the catch delivered. A condition code “98” will indicate an estimate of catch discarded at sea. Catch with code of “98” should not be included in your delivery weights on your Plant/Vessel Offload Form.

B. Fish tickets may contain only numbers of the prohibited species delivered. If the fish ticket does include a prohibited species weight, it is often inaccurate, therefore an observer must weigh them. In the pollock fishery, you and the vessel observers will be sorting prohibited species from the entire catch at the plant. ***Vessel observers should use their own numbers and weights of prohibited species when they calculate their delivery weights.***

C. Completion of fish tickets is often delayed. Coordinate with vessel observers to ensure that they get the delivery weights when they have finally been recorded. This may be during their next offload, or it may require you to fax the information to another port or an FMA Division office.

D. Condition/Delivery codes - Sometimes bled fish are delivered (throat cut/or stuck to bleed the fish and retard spoilage). You need the whole weight of fish caught for your Plant/Vessel Offload Form. Vessel observers will need round weights to calculate delivery weights. Look at the condition codes for the fish weights on the fish ticket. If the code listed is not a “1,” the whole fish has not been weighed. You will need to use the converted round weight listed on the bottom of the fish ticket to calculated total delivery weight.

E. Some of the weights listed may not be correct. Fish of no value to the plant may have weight estimates rather than scale weights. Check for this before using fish tickets.

F. The bycatch species listing is often incorrect, unless the species was paid for. Bycatch species may all be lumped together. You must check that the weight for total bycatch was recorded properly somewhere, even if it was combined under one species listing and one weight. This should not be a concern for you, as you only need the total weight of bycatch and not the species breakdown. Check only that the weights are not estimates and don't worry about species identification. If AFA or CDQ please see page 9-8.

G. Total amount is not the total weight of the delivery. You must add up the whole weights on the fish ticket in order to get a total delivery weight. If a partial delivery took place, a box in the partial delivery box on the fish ticket should be checked. The other fish ticket associated with this offload will be listed on the bottom of the ticket once that offload is completed.

H. Water weight deductions may appear on the fish ticket. These deductions may occur in the pollock fishery, but are not appropriate at all plants. If you do not see water passing over the scale, and feel that the water weight deduction is not necessary, then add the deducted amount back in as target weight and document your reasons in your logbook.

I. Species may be missing from the fish ticket. Some plants do not record other “non-allocated species” weights (such as lancetfish or Pacific flatnose). Processing plants are not required to record these weights, but you must include them in your delivery weights! If AFA or CDQ please see page 9-8.

Figure 9-2 ADF&G Electronic Groundfish Ticket Instructions

SHORESIDE PLANTS AND FLOATING PROCESSORS: Reviewing Forms for Errors

ALASKA DEPARTMENT OF FISH & GAME
ELECTRONIC GROUNDFISH TICKET

DO NOT WRITE IN THIS SPACE

E06 020867

IF boxes are checked, other fish tickets may be associated with this delivery

Statistical Area WorkSheet

Stat. Area	%	Stat. Area	%
655500	20	655530	50
655900	30		

Vessel COMMODORE
ADF&G NO. 53843
Permit MZ2XB 2555W 0601B
OCEAN SHANE
P

Crew Size 6
Observers onboard 1

Mgmt Pgm APA
ID 102

Port of Landing or off-shore operation type
DUT Dutch Harbor/Unalaska

Owner: F6415 Snopac Innovator
Custom Processor: Weights are in LBS

Date Fishing Began (Gear in Water) 09/11/2007
Date Landed 09/14/2007

PARTIAL DELIVERY:
 Partial Delivery
 Last Landing for Trip
 Multiple IFQ Permits

FISH DELIVERED HEREBY WERE CAUGHT IN COMPLIANCE WITH STATE LICENSING LAWS AND STATE LABOR LAWS AND REGULATIONS FORM 11-218EG REVISED 1.05

Permit Holder's Signature _____

Fish Received by _____ **Date** _____

Landing Report ID: 22427 CFEC Serial Number: 332559

Other Fish Tickets: ANY OTHER FISH TICKET ASSOCIATED WITH THIS OFFLOAD WOULD BE LISTED HERE

cod, Pacific (gray) Round Weight: 500 flounder, arrowtooth Round Weight: 36

sole, flathead Round Weight: 162 sole, rock Round Weight: 250

pollock, walleye Round Weight: 258,741 salmon, chinook Round Weight: 22

jellyfish, general Round Weight: 0 shark, salmon Round Weight: 72

ADF&G USE

Interview	
Observer	
Logbook	

Total delivery weight for the "Form A" calculated using round weight numbers = 259,783 lbs
 Since all the fish delivered were whole fish, the total of all the fish listed in the fish ticket match the round weight calculation listed at the bottom of the ticket. This will be common in the pollock fishery. (Vessel observers should never use prohibited species numbers from the bottom of the fish ticket, instead they should use their whole haul data).

Vessel Observers: Be sure to always use your data

Plant Observers: Always verify this data

Do not include code 98 in delivery weight

Code 99 is delivered to the plant, so it is included in the delivery weight.

Figure 9-3 ADF&G Electronic Groundfish Ticket (examples)

**ALASKA DEPARTMENT OF FISH & GAME
ELECTRONIC GROUND FISH TICKET**

DO NOT WRITE IN THIS SPACE

E06 009255

Statistical Area WorkSheet

Stat. Area	%	Stat. Area	%
575731	50	575732	50

Vessel FOUR DAUGHTERS	Crew Size 5	Mgmt Pgm OA	Port of Landing or off-shore operation type SEW Seward Type of Gear used 07 Non-pelagic/bottom trawl
ADF&G NO. 41444	Observers onboard 1	ID	
Permit Owner permit ##### Permit Owners Name			

Owner: F3661 ALASKA ENTERPRISE Custom Processor:	Date Fishing Began (Gear in Water) 03/01/2006 Date Landed 03/05/2006	PARTIAL DELIVERY: <input type="checkbox"/> Partial Delivery <input type="checkbox"/> Last Landing for Trip <input type="checkbox"/> Multiple IFQ Permits
---	---	--

SPECIES	STAT AREA	DELIV. COND	SCALE WEIGHT	NUM	DISP.	SIZE & GRADE	SOLD WEIGHT	PRICE	AMOUNT
110 cod, Pacific (gray)		03 Bled fish	80,370.5		60 Sold for human consumption				
110 cod, Pacific (gray)		03 Bled fish	1,487		60 Sold for human consumption				
270 pollock, walleye		01 Whole fish or shellfish	396		60 Sold for human consumption				
700 skate, other		13 Wings, skates only - both wings removed	854		60 Sold for human consumption				
410 salmon, chinook		01 Whole fish or shellfish	55	8	86 Donated prohibited species - food bank program (whole fish)				
Total Amount:									0.00

FISH DELIVERED HEREBY WERE CAUGHT IN COMPLIANCE WITH STATE LICENSING LAWS AND STATE LABOR LAWS AND REGULATIONS FORM 11-218EG REVISED 1/05

Permit Holder's Signature _____	
Fish Received by _____	Date _____

Landing Report ID: 9705 CFEC Serial Number: 76357

Other Fish Tickets:

cod, Pacific (gray) Round Weight: 83,528.0612 pollock, walleye Round Weight: 396

salmon, chinook Round Weight: 55 skate, other Round Weight: 2,668.75

Total Delivery weight in lbs = 83,528.0612 + 55 + 396 + 2668.75 = 86647.811lbs -> 8,6647.81 lbs

Delivery condition is not a whole fish. PRR's that account for the delivery condition are used to calculate the round weight of these fish. The bottom of the fish ticket contains the round weights of these fish. If you are missing the bottom portion of the fish ticket, you must calculate the round weight in your calculations portion of your logbook using the proper PRR's.

ADF&G USE	
Interview	
Observer	
Logbook	

Figure 9-4 ADF&G Electronic Groundfish Ticket (examples)

SHORESIDE PLANTS AND FLOATING PROCESSORS: Reviewing Forms for Errors

Cruise 20710	Permit 6789	Year 2009	Plant/Vessel Offload Form			Page <u>1</u> of <u>1</u> ✓									
Vessels only			Plants only												
Processor name	Processor Permit #	Observer name <u>Jack Mockrell</u>		Catcher boat name	Catcher boat ADF&G #	Vessel Permit #									
		Vessel/Plant name <u>Pribilof Sfd</u>		<u>Pomfret</u>	<u>10981</u>	<u>2223</u>									
		Resubmission (Circle All Changes)		<u>Leakin Lucy</u>	<u>76542</u>	<u>6765</u>									
				<u>Katzenjammer</u>	<u>32103</u>	<u>5555</u>									
				<u>Hook n' Time</u>	<u>20194</u>	<u>7767</u>									
Plants only			Plants only												
Trip No. <small>Vessels Only</small>	Offload No.	Completion date		Gear type	NMFS area	Total delivered	LB or MT	Total pollock weight	Were all groundfish weighed? (Y/N)	ADF&G No. of delivering vessel	Receiving processor permit No. <small>Vessels only</small>	Was catch sorted? (Y/N)	Tender offload? (Y/N)	ADF&G fish ticket number	
		Month	Day												
0	01	15						No deliveries							
0	01	16						No deliveries							
1	01	17	2	517	187297	LB	180111	Y	10981		N	N	ED2018470		
2	01	18	8	519	6534	LB		Y	20194		Y	N	ED2000083		
3	01	19	2	517	205639	LB	197266	Y	10981		N	N	ED2018472		
4	01	19	2	517	250420	LB	249325	Y	32103		N	N	ED2018473		
5	01	19	8	521	849	LB		Y	20194		Y	N	ED2000084		
6	01	20	2	517	146239	LB	165200	Y	10981		N	N	ED2018479		
7	01	20	2		343196	LB		Y	76542		N	Y			
8	01	21	2	517	213322	LB	211311	Y	32103		N	N	ED2018475		
0	01	22						No deliveries							
9	01	23	2	523	321260	LB	320100	Y	10981		N	N	ED2018476		
0								No deliveries		Disembarked			N	N	ED2018477

National Marine Fisheries Service / Fisheries Monitoring and Analysis Division Page _____ of _____ for transmission Ver. 09

Figure 9-5 Offload Form data by Plant Observer Example

PROHIBITED SPECIES SAMPLING

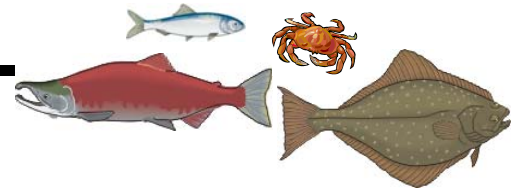

Table of Contents

List of Priorities	10-1
Introduction.....	10-1
Sampling for Lengths and Specimens.....	10-2
Crab Data Collection	10-2
Crab in Species Composition Samples	10-2
Recording Biological Data	10-2
Measurements, Sex Determination, and Egg Presence.....	10-2
Transferring Measurements.....	10-3
Measuring Crab in the Pollock Fishery	10-3
Sexing Crab and Checking for Eggs	10-4
Halibut Data Collection	10-5
Technique for Measuring Halibut	10-5
Assessments on Trawlers and Pot Vessels.....	10-5
Determining Viability of Halibut on Trawlers and Pots.....	10-5
Halibut Injury Assessments on Longliners.....	10-6
Salmon Data Collection	10-7
Salmon in Species Composition Samples	10-7
Sexing Salmon	10-8
Sexing Salmon for Terra Marine	10-8
Measurement Data for Salmon.....	10-8
Scale Sample Collection.....	10-8
Salmon Scale Sampling Guidelines	10-8

LIST OF PRIORITIES

- Count, weigh, and identify all prohibited species in your species composition sample.
- Collect and record crab measurements.
- Collect and record salmon and halibut length measurements.
- Collect and record halibut viabilities or injuries.
- Collect salmon scales.
- Account for all prohibited species discarded at sea on your pollock catcher vessel.

INTRODUCTION

Certain species cannot be retained when fishing in particular fisheries. These species can not be consumed by the crew, even if killed by the fishing operations, and must be returned to the sea as soon as possible. These are referred to as “prohibited species.” These species are also managed by other agencies and the data needs differ slightly from other species encountered in the North Pacific Fisheries. The

prohibited species group includes all Tanner crab species, all king crab species, all salmon species, Pacific halibut, and herring. In addition to data on the abundance of these species in the composition of commercial catches, observers are asked to collect measurements and other significant biological data from most of these animals, *with the exception of herring.*

Just as the length measurements on target species help provide information on what populations are being targeted by fishing operations, the measurements of prohibited species provides information as to which parts of the populations of prohibited species are being caught as bycatch. Specimen data for prohibited species is recorded on the Length and Specimen Form. Data that must be recorded for prohibited species include:

- Sex, length, and scale data from salmon
- Length and condition data from halibut
- Sex and length or width from crab
- Egg presence in female crab

PROHIBITED SPECIES SAMPLING: Sampling for Lengths and Specimens

Tagged prohibited species data are recorded on the paper Tagged Fish Form (see Figure 13-1 on page 13-4).

For instructions on how to fill out the Length and Specimen Form, see “Length Specimen Form Instructions” on page 11-15.

SAMPLING FOR LENGTHS AND SPECIMENS

Most length and specimen data will be collected from the fish encountered in your randomly collected species composition samples. Due to the need for data on prohibited species, it is acceptable to collect random data from outside the composition samples.

All prohibited species fish and crab listed on Length and Specimen Form must be identified to the species level. Biological data from unidentified salmon or crabs are useless to resource managers. If there are too many crab or salmon in a haul for you to sex and measure all individuals, collect a simple random or random systematic sample of about 20 individuals to identify to species, sex, and measure. If there are too many halibut in a haul or set, be sure to randomly collect 20 per day to measure and assess for viability or injury. Refer to “Collecting Fish for Specimen Data” on page 11-2 for instructions on how to collect a random or systematic sample.

You must record raw data on your deck form to assist you and staff if questions arise during your mid-cruise or debriefing interview.

Herring Data Collection

Count and weigh all the herring from within your samples. These data are recorded on the species composition form along with other data for the sample. **You do not measure or sex herring.**



Herring occur most often in the pollock fishery. They can be numerous at times and difficult to sort if samples are large. You must be able to account for all species in a sample, so if you are missing herring, you must reduce your sample size (unless herring are one of two predominant species - in this case you can sample for two predominant species). During offload sampling, fish are often run too deep for reliable sorting of herring. For pollock catcher vessel deliveries, try to account for herring during the offload.

If you can't (because there are too many or you cannot reliably sort them out) disregard them during your offload census.

Crab Data Collection

Complete crab data collection tasks in the following order of priority:



- Count, weigh, and identify every crab in your randomly collected species composition data.
- Measure crabs
- For prohibited species only, sex the crab and check for eggs in the females
- Look for tagged crabs. Refer to “Tagged Crab” on page 13-1 for information on what sort of tags are used and what data to collect.
- Account for all prohibited species crab discarded at sea on your pollock catcher vessel.

Crab in Species Composition Samples

In your species composition samples, identify all crab to species or species group. For the two prohibited species groups (Tanner and king crab) identify the crabs to species and sex, then record their numbers and weights for the sample on the deck sheet. Fisheries managers manage prohibited crab species by number not weight. If there are too many crab to identify, or too many to weigh or count, refer to “Subset Sampling” on page 2-16.

Recording Biological Data

Separate data records for any crab in your samples by species, sex, presence of eggs (females only), and carapace measurements. You **must** record raw data on your deck form to assist you and staff if questions arise during your mid-cruise or debriefing interview.

Measurements, Sex Determination, and Egg Presence

Biological data such as measurements, sex, and the presence of eggs should only be collected from Tanner crab and king crab species within your composition samples. The nine species of concern to the North Pacific Fisheries Management Council are: *Chionoecetes bairdi* Tanner crab, *C. opilio* Tanner crab, *C. bairdi/opilio* hybrid Tanner crab, *C. angulatus* Tanner crab, *C. Tanneri* Tanner crab, brown or golden king crab, blue king crab, red king crab, and Couesi king crab.

Measuring Crab

All prohibited crab species must be measured using the calipers provided by the Observer Program. If you do not have calipers, do not attempt to measure crabs. Never use a tape measure or fish length strip for crabs since these are only accurate to the nearest centimeter.

To measure crab, lay the individual on a flat surface facing away from you to avoid the powerful claws. Spread the calipers across the top of the crab and close the caliper arms until the tips are touching the carapace (see Figure 10-1). If the crab tries to walk away, hold the body down with one hand while you work the calipers with the other hand.

- King crab are measured from the right eye socket to the middle of the *posterior margin of the carapace*. Do not include the second abdominal segment in your measurement. Be careful not to let the caliper tip slip into the eye socket; keep the tip at the socket rim.
- Tanner crab are measured across the carapace. Measure the width across the back, at the widest part of the carapace, excluding any spines at the carapace edge (see Figure 10-1.)

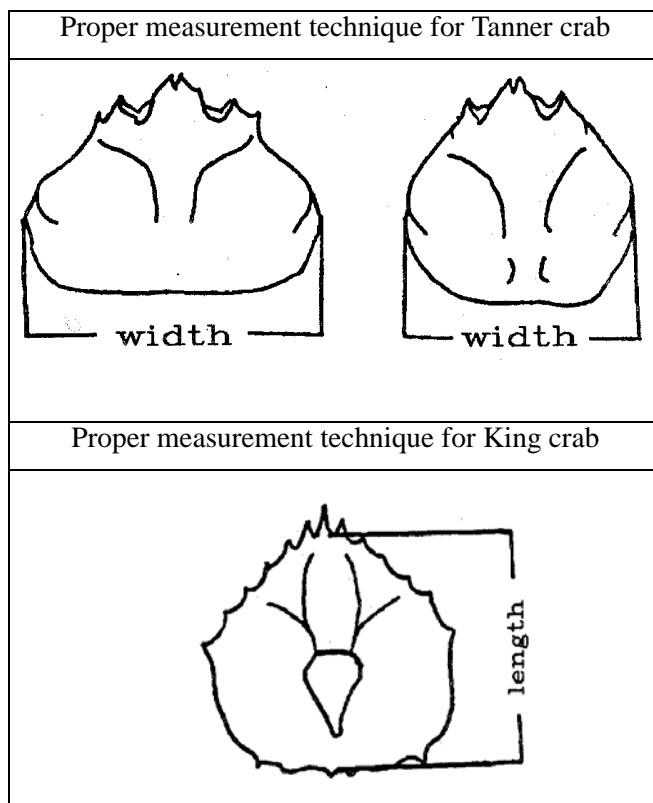

Figure 10-1 Measurement Techniques for Crab

sure to make your mark in the appropriate sex category! If the caliper arm falls directly on a line, report the smaller measurement for this individual. Do not use any other measuring device to determine crab lengths.

Measuring Crab in the Pollock Fishery

All vessels participating in the BSAI pollock fishery are required to use pelagic gear. If you can, watch the intermediate portion of the net during haul back for any crabs. Also check the deck for any crab that may have fallen from the net. The presence of 20 or more of any species of crab indicates the vessel was non-pelagic fishing, or 'fishing the bottom.' When more than 20 crab occur in a pollock haul, observers are asked to do the following: 1) count and measure any crab in the composition samples, regardless of species and 2) *begin measuring all the crab you find*, if there are more than you can handle, measure as many as you can.

Transferring Measurements

You will be given a plastic crab measuring form to record crab measurements. The form is marked in 5 mm increments starting at 3 mm. Crab lengths read from this sheet will always end in digits 3 or 8. For example, all crabs 41 to 45 mm in size would be recorded as 43 mm, crabs 46 to 50 mm would be recorded as 48 mm.

Measure the crab and, without moving the arms of the calipers, lay the tip of one arm on the 'start line' at the bottom of the plastic form. Lay the tip of the other arm perpendicular to the start line and make a pencil mark within the millimeter range indicated by this tip. Be

PROHIBITED SPECIES SAMPLING: Sampling for Lengths and Specimens

Measure prohibited species crab as described previously. For non prohibited species of crab measure as follows:

- For hermit and sponge crab inside of their shell or sponge, measure the width at the widest point of the shell or sponge. On the Deck Form, make sure to indicate that these measurements were of the shells and not the actual crabs. If you are using ATLAS note this in your logbook.
- All other crabs should be measured in the same manner as Tanner crabs (across the width of the carapace).

Do not sex non-prohibited crabs or look for eggs. For specifics on this regulation (see “Crab §679.7” on page 18-8).

Sexing Crab and Checking for Eggs

Refer to Figure 10-2 and Figure 10-3 for images depicting the differences between the abdominal flap shape of male and female crab.

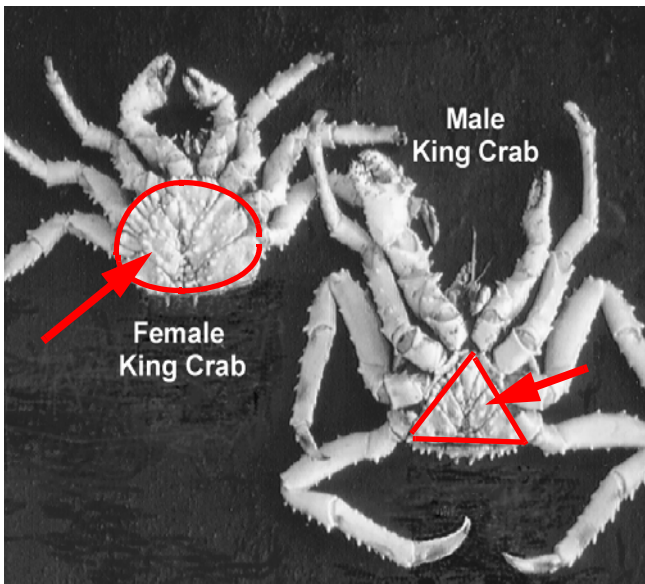

Figure 10-2 Male and female king crab (arrows and lines indicate abdominal flap)

- Female king and Tanner crab have an abdominal flap that completely covers the bottom of the carapace. It is round and extends to the leg insertions on mature females. By lifting the flap slightly, you can determine if females are carrying eggs.

- Male king and Tanner crabs have a V or U-shaped abdominal flap that does not cover the bottom of the carapace. When immature, the abdominal flap is shaped like a finger. When male crabs are mature, the abdominal flap is V-shaped in king crabs and U-shaped in Tanner crabs

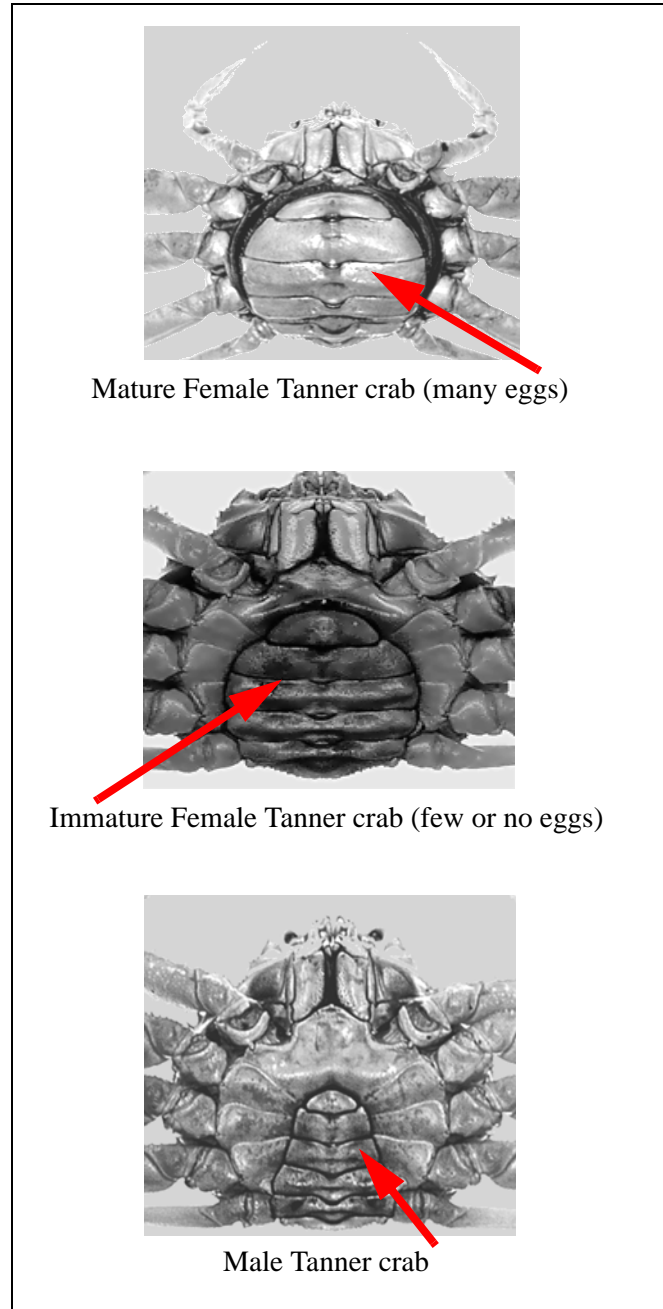

Figure 10-3 Male and Female Tanner Crab (arrows indicate abdominal flap)

Halibut Data Collection

Data collected on halibut is used to monitor the total prohibited species cap (PSC) for halibut. A total of 15% of the total halibut quota is reserved for groundfish fisheries bycatch. The assessment of viability is important because not every halibut caught by groundfish vessels as bycatch are killed. Many halibut are released alive and remain a part of the stock. The International Pacific Halibut Commission (IPHC) relies on observer data to estimate what number of halibut captured should be considered dead (and therefore part of the halibut PSC). With information on halibut length and viability, the IPHC can monitor condition trends as they relate to halibut size, capture and crew handling.



Complete halibut tasks in the following order of priority:

- Obtain the total number and weight of Pacific halibut in your composition sample. Halibut are never sexed by observers for species composition. ***They should only be sexed when a special project directs the observer to sex halibut.***
- For sampled hauls, measure halibut and assess viability (trawlers and pot vessels) or injury (longliners) at the point of discard. Measure and assess a maximum of 20 per day. These fish may be from either inside or outside your composition sample but they **must be representative** of how the crew handles halibut and **they must be randomly collected**. If halibut are from outside your composition samples, record any related data at the haul level, not the sample level.
- Check for tagged halibut. Refer to “TAGGED FISH AND CRAB INFORMATION” on page 13-1 for information on what sort of tags are used and what data to collect from tagged fish.
- Account for all halibut discarded at sea on your pollock catcher vessel



Halibut management and careful release methods for longline vessels are discussed on page 7-32.

Technique for Measuring Halibut

All halibut are measured by fork length; see the definition of fork length in your Species Identification Manual or see page 11-4 of this manual. Lay the halibut on the plastic length strip or on top of a tape measure. Do not obtain measurements derived from laying the tape measure over the top of the fish and ‘sighting down!’ These are curvilinear lengths and they are not viable data for data users!

For large halibut, offset your length strip by twenty or more centimeters, or use your measuring tape. If using the measuring tape, lay the halibut on the tape, or mark the halibut’s length on the deck and measure that. Do not take a curvilinear length! Ignore the F and M for sexes on the top of the length strip and write a viability or injury code for each measured halibut. Record halibut by length/frequency and viability code on the Length and Specimen Form.

Do not record estimated lengths of halibut on the Length and Specimen form! Record only actual measurements!

Assessments on Trawlers and Pot Vessels

On trawl and pot vessels the guidelines listed below must be followed:

- Halibut lengths and viability assessments must be from sampled hauls or sets.
- Halibut must be examined in hand and on both sides - never guess the condition of the halibut!
- The condition of all halibut must be determined at the point of final discard.



Viabilities without a corresponding length cannot be used, but lengths without viability can be used.

Determining Viability of Halibut on Trawlers and Pots

Determine if the condition of the halibut is excellent (code E), poor (code P), or dead (code D). For Discard Condition Criteria use the dichotomous keys in “Key to Pacific Halibut Viability for Trawl Vessels” on page A-36 or the dichotomous key in “Key to Pot Condition Codes for Pacific Halibut” on page A-39. If you were not able to assess the halibut or you cannot determine the viability, record the condition as “U” and measure the individual’s length.

PROHIBITED SPECIES SAMPLING: Sampling for Lengths and Specimens

You **must** record raw data on your deck form to assist you and staff if questions arise during your mid-cruise or debriefing interview.

Viabilities must always be from a sampled haul or set. You may measure and assess viability on halibut from within species composition samples *or* from outside your composition samples. On vessels, use appropriate methods to ensure that your sample for halibut length measurements and viabilities is a simple random or systematic random sample. Also, make sure the halibut you assess are representative of normal crew handling. For offloads, you are expected to sample all halibut in the delivery.

Take assessments at the point of discard. Time on deck and handling procedures affect halibut viability. ***If you cannot gather representative halibut viabilities at the point of discard, do not collect these data!*** For those instances when you are unable to collect viability data, document the circumstances in your logbook.

Example 1: An observer on the factory trawler Aurora Borealis has two possible locations in the factory where he could collect halibut to assess their condition. The first is at the conveyor leaving the live tank, and the second is at the discard area as halibut drop out the discard chute. Between the live tank door and the discard are several belts, some with inclines, that halibut have to pass over, falling back and getting squeezed and spined by other fish, until they reach the discard belt, some 30 minutes later. A halibut that seems to be in excellent condition when it exited the bin may end up in poor or dead condition by the time it is discarded. To determine how the fishing practices and conditions in the factory have affected halibut viability, the observer must choose the discard belt station for measuring halibut and assessing viability.

Example 2: An observer is on the catcher only vessel Pit Bull and the crew normally sorts fish from the trawl alley. As they encounter halibut, they throw them over the side. The observer is only able to collect one sample, due to space and time constraints. The observer collects his entire sample, then tells the crew they can begin to sort. The observer should wait to pull out halibut from his sample until the crew begin to discard halibut from the trawl alley. If the observer were to collect halibut viability data immediately, his assessments would incorrectly document better conditions for the halibut than what normal crew

handling would result in. Another option would be for the observer to inform the crew to put all halibut into a separate checker bin or tote instead of discarding them. The observer could then assess the viability of each halibut as it is put into the bin/tote.

- If you cannot assess halibut viability at the time of discard and your sample is not an indication of the normal handling practices of the crew, **do not** record viability data at all. ***If the halibut were from inside your composition samples, you can still record length data for these individuals!***
- If you are on a catcher vessel delivering **unsorted** catch to a plant, assess and measure halibut at the plant, as this is the place of discard. If any halibut are sorted out at sea, assess them as they are discarded.

Halibut Injury Assessments on Longliners

In order to assign mortality information to halibut bycatch, the IPHC needs an assessment of injuries to halibut caught that are caused by incidental take. These data are analyzed by the IPHC staff and used to estimate future mortality rates. The halibut mortality rates have a direct impact on the duration of the longline fishery. As a



result, you must be careful in conducting your assessments. ***The halibut you assess for injury must be handled in the same manner as the crew normally handles halibut.***

Collect halibut for injuries assessment from outside the tally sample period. Only assess injuries for halibut that you have in hand. ***Attempt to assess injury from a at least 20 halibut per day.*** Collect halibut for the injury assessment using a random or systematic random sampling design. The easiest method is to collect every fifth, tenth, or nth halibut during a randomly selected non-tally period. ***The data you collect for these individuals are recorded at the haul level.***

To complete the halibut injury assessment, measure the halibut, check for injuries using the key found in “Key to Longline Injury Codes for Pacific Halibut” on page A-43, and return the fish to the water.



No halibut injury assessments are collected on vessels fishing in an IFQ fishery.

Follow the rules listed below when assessing halibut injuries on a longliner:

- Assess injuries of halibut from hauls sampled for species composition.
- Halibut used for the injury assessment must actually be *measured*.
- Ensure that vessel personnel use the same release methods when you assess halibut injuries as they use during normal operations.
- Only assess injuries from halibut that you have in hand. These halibut must be landed by the crew.
- Ignore any injuries caused by the crew landing the halibut for the injury assessment, including gaff wounds to large animals.
- Over the duration of your cruise, obtain injury assessments of halibut landed by each rollerman.
- Only include fishing related injuries in your assessment.
- Use the dichotomous key on page A-43 to categorize the injury.
- Do not collect halibut injury assessments if your vessel is fishing an Individual Fishing Quota (IFQ).

Collect halibut injury assessments in a manner that reflects the normal operations of the vessel. Vessel personnel have an incentive to bias these data. Be aware of how halibut are handled when you are not sampling and compare this to when you are sampling. Fully document any differences in your logbook, try to resolve any problems diplomatically, and contact NMFS as soon as possible about the problem.

Salmon Data Collection

Complete the following salmon tasks in order of priority:



- Identify, count, and weigh all the salmon in your species composition samples.
- Sex all salmon from your composition sample.
- Measure all salmon from your composition sample.
- Collect scales from salmon in your composition sample.
- Account for all salmon discarded at sea on your pollock catcher vessel.
- Look for tagged salmon: Refer to “Tagged Salmon” on page 13-2 for information on what sort of tags are used and what data to collect.
- Collect scales from tagged salmon outside of your species composition sample.

You *must* record raw data on your deck form to assist you and staff if questions arise during your mid-cruise or debriefing interview.

Salmon in Species Composition Samples

Determine the species of each salmonid in your composition samples and record the sexes, numbers, and weights for each species on the Species Composition Form. The six species of salmon encountered in the North Pacific are: king (chinook), silver (coho), steelhead, sockeye (red), chum (dog), and pink (humpy) salmon.

Recording Biological Data

Measure and sex all the salmon from inside the species composition samples and record these data at the sample level. Salmon collected from outside of your species composition samples should be measured and sexed, and recorded at the haul level.

Data records for salmon must be separated by species and sex. You *must* record raw data on your deck form to assist you and staff if questions arise during your mid-cruise or debriefing interview

Salmon Discarded at Sea (Pollock Catchers)

If you are on a pollock catcher vessel, all salmon from outside your samples discarded at sea should be measured and their length recorded at the haul level. Include the number and weights of these individuals in

PROHIBITED SPECIES SAMPLING: Sampling for Lengths and Specimens

the offload census composition data. If the salmon was inside your sample and discarded at sea, record the number and weight at the sample level, and also include the number and weight in the offload census composition data.

For more information on collecting and recording data from salmon on a pollock catcher vessel, refer to “Offload Census: Pollock C/Vs” on page 5-25.

Sexing Salmon

Cut open all salmon to determine sex. Salmon gonads are far forward in the body and immediately under the backbone. Make an incision on the salmon from the pectoral fins and across about mid way up from the belly, to see into the top of the peritoneal cavity near the head. The gonads will be two long tubes laying parallel to the backbone. Females, mature and immature, will have tubes containing granular eggs in sacs that are red, pink, yellow, or orange. Mature males will have smooth textured tubes of white or cream color. Immature males will have translucent white tubes that appear empty.

Sexing Salmon for Terra Marine

Some shoreside and floating processors retain delivered salmon bycatch for a food donation program called Terra Marine. If your vessel delivers to a plant participating in this program, it is preferred that you sex salmon with a cut from the anus to the isthmus so as not to damage the product.

Measurement Data for Salmon

Measure all salmon within your composition sample to the fork length (see “How to Take Lengths” on page 11-4). As you encounter salmon in your sample, cut the fish to determine the sex, and then measure it using the plastic length strip. Record salmon length data on the Length and Specimen Form. Salmon measured from outside your species composition sample must be entered at the haul level, not at the sample level.

Scale Sample Collection

Salmon scales are used to verify species identifications during your debriefing. Salmon lose scales easily and lost scales are replaced with regenerated scales. Regenerated or lateral line scales are unreadable. To make sure you have usable scale samples, always collect at least 5 scales from the fish and never collect scales from the lateral line.

Each group of scales taken from an individual is put into a paper envelope to dry. Using paper envelopes keeps the scales from rotting. Record the salmon’s length, weight, etc., on the raw data deck sheet and on the scale envelope. If you are on a vessel without ATLAS, you will need to transfer these data to the Length and Specimen Form.

Salmon Scale Sampling Guidelines

- Collect salmon scales during every cruise you encounter salmon in your species composition samples.
- Collect scales from all tagged salmon. A salmon with a missing adipose fin has a coded wire tag embedded in its snout. If the tagged salmon is from outside your at sea species composition sample, record the data in ATLAS or on the paper form at the haul level and use the large scale envelopes that say “**Scales of tagged salmon from outside sample**”. Refer to “Tagged Salmon” on page 13-2 for how to handle the data recording for tagged salmon.



If the salmon is missing its adipose fin, presume that it is tagged and collect data from that fish!

- Collect no more than 20 scale samples for each species, for the entire time you are deployed for a particular cruise number.
- Collect at least 5-10 scales preferably from the optimal “A” zone (see Figure 10-4). If scales cannot be found in the “A” zone then search for and collect scales from the “B” zone, then the “C” zone if necessary.
- To spread the collection over more time at sea, collect scales from the first 10 salmon per species you encounter in your composition samples, then collect 10 more scale samples from salmon found in your samples throughout your deployment



If you are taking scales from salmon outside the composition samples, use the large manila envelopes which read “Scales of tagged salmon from outside sample”. Data recorded on these large envelopes are recorded on the Length and Specimen Form at the haul level.

If the scales are coated with tissue or blood, or the sample is contaminated with other fish scales, it may be useless. Remember, your salmon rubbed against many other fish, even other salmon of different ages and species. To ensure your hard work produces usable data, make sure your scales are clean:

1. Wipe the area on the fish where you plan to collect scales. This ensures no other fish scales will be mixed in with the individual's scales. It also removes slime, which causes scales to decompose in the scale envelopes.
2. Pluck salmon scales out of the flesh using the forceps or knife. **Minimize mucus on the scales by plucking rather than scraping.**
3. Open a salmon scale envelope and wipe the scales inside. Make sure you collect enough scales. Seal the envelope closed.
4. Weigh the salmon, determine the sex, and measure the length of the fish. Record all of the information on the scale envelope. Remember to include your cruise number and vessel permit. If the scale came from an offload and not a haul, cross out the text "Haul/Set" on the envelope and write in the word "Offload" followed by the associated offload number. Select and record a unique specimen number for the species (1-20 for kings, 1-20 for chums, etc).

- Note: Clean the forceps before collecting scales from another salmon.

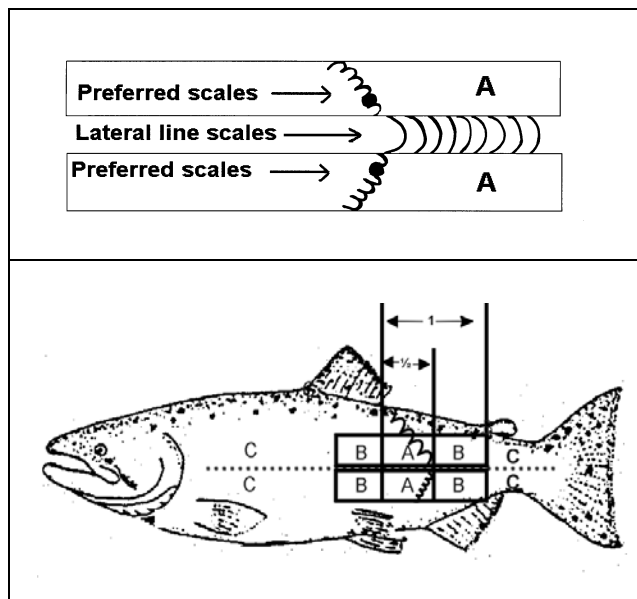

Figure 10-4 Salmon Scale Collection Zones

SPECIES	<u>King Salmon</u>	SPECIMEN NO.	<u>1004</u>
HAUL/SET	<u>offload #6</u>	DATE	<u>09-08-02</u>
FORK LENGTH	<u>67</u>	(CM)	SEX <u>M</u>
WT.	<u>398</u>	(KG)	MISSING ADIPOSE? Y or <input checked="" type="radio"/> N
SCALE ZONE	<u>B-C</u>	CRUISE/	VESEL CODE <u>121911</u>
<u>84184</u>			

Figure 10-5 Salmon Scale Envelope Example

PROHIBITED SPECIES SAMPLING: Sampling for Lengths and Specimens

jc

DECK FORM

Date	Cruise	Permit	Haul No.	Offload No.	Page <u>1</u> of <u> </u> for vessel/plant
7/13/09	20670	2345	165		Page <u>1</u> of <u>4</u> for haul/offload

Sample number: <u>1</u>	Sub-sample number:	Sample size: <u>166.78</u> <small>Kgs Hooks pots</small>	Combined <input type="radio"/>	Presorted <input type="radio"/>
-------------------------	--------------------	--	--------------------------------	---------------------------------

Species	Sex	#	Weight	% ret.	length, viability, injury, specimen, and tally data
----- KEYPUNCH -----	<input checked="" type="checkbox"/>	<u>139</u>	<u>166.78</u>	<input checked="" type="checkbox"/>	Pollock S/L Pollock S/L/W
Pollock		<u>35</u>	<u>43.8</u>	<u>100</u>	M F M F
Pollock		<u>18</u>	<u>21.8</u>	<u>100</u>	<u>44-1</u> <u>53-1</u> <u>44-.74</u> <u>53-1.24</u>
Pollock		<u>30</u>	<u>40.2</u>	<u>100</u>	<u>47-2</u> <u>54-2</u> <u>47-.92</u> <u>56-1.76</u>
Pollock		<u>25</u>	<u>31.6</u>	<u>100</u>	<u>48-1</u> <u>56-1</u> <u>47-1.28</u> <u>62-1.72</u>
P. cod		<u>2</u>	<u>19.8</u>	<u>100</u>	<u>49-1</u> <u>59-1</u> <u>51-1.26</u>
Flathead		<u>21</u>	<u>5.2</u>	<u>100</u>	<u>51-2</u> <u>62-1</u> <u>52-1.22</u>
Rex sole		<u>3</u>	<u>2.1</u>	<u>100</u>	<u>52-3</u> <u>66-1</u>
N. Rocksole		<u>3</u>	<u>1.08</u>	<u>100</u>	<u>55-1</u> <u>59-1</u>
Arrowtooth		<u>2</u>	<u>1.20</u>	<u>100</u>	
					maturity scan: #393078 1.60 kg, spawning!!
					Pollock oto's specimen # 393077 m, 52 @ 1.32 kg # 393078 f, 66 @ 2.10 kg Total # wts in logbook pg 172

Sample number: <u>2</u>	Sub-sample number:	Sample size: <u>185.25</u> <small>Kgs Hooks pots</small>	Combined <input type="radio"/>	Presorted <input type="radio"/>
-------------------------	--------------------	--	--------------------------------	---------------------------------

Species	Sex	#	Weight	% ret.	length, viability, injury, specimen, and tally data
----- KEYPUNCH -----	<input checked="" type="checkbox"/>	<u>176</u>	<u>185.25</u>	<input checked="" type="checkbox"/>	Chum salmon scales
Pollock		<u>36</u>	<u>43.6</u>	<u>100</u>	M - 45 cm @ 1.20 kg # 1
Pollock		<u>37</u>	<u>44.2</u>	<u>100</u>	M - 52 cm @ 1.84 kg # 2
Pollock		<u>30</u>	<u>35.6</u>	<u>100</u>	M - 56 cm @ 1.65 kg # 3
Pollock		<u>30</u>	<u>37.4</u>	<u>100</u>	
P. cod		<u>1</u>	<u>7.8</u>	<u>100</u>	
Sturgeon Poacher		<u>1</u>	<u>.04</u>	<u>100</u>	
Flathead sole		<u>24</u>	<u>5.20</u>	<u>100</u>	
Rex sole		<u>2</u>	<u>1.14</u>	<u>100</u>	
Arrowtooth		<u>11</u>	<u>3.76</u>	<u>100</u>	
Ak. skate		<u>1</u>	<u>1.82</u>	<u>100</u>	
Chum salmon	M	<u>3</u>	<u>4.69</u>	<u>99</u>	Added to offload
					total wts + # in logbook p. 172.

National Marine Fisheries Service/Fisheries Monitoring and Analysis Division

Figure 10-6 Example of expected documentation for prohibited species biological data collections

PROHIBITED SPECIES SAMPLING: Sampling for Lengths and Specimens

je

DECK FORM

Date: 07/15/09 Cruise: 20670 Permit: 2345 Haul No.: Offload No.: 1

Page 3 of _____ for vessel/plant
Page 3 of 4 for haul/offload

Sample number: 1 Sub-sample number: Sample size: 47,444.78 ^{Kgs} Hooks pots Combined Presorted

Species	Sex	#	Weight	% ret.	length, viability, injury, specimen, and tally data
----- KEYPUNCH -----	X	13	39.48	X	
Halibut		12	36.45		Hauls 164-167 <u>Halibut</u> D. 44-1 50-1 51-3 52-1 53-2 55-1 56-2 58-1 *(from haul 165, samp. #3 discarded at sea)
Halibut		1	3.03*		

The weight of any prohibited species discarded at sea is added to the deck form along with the weight of those sampled during the offload census. **The weights of prohibited species discarded at sea are included in the delivery weight!** Biological data (measurements, scales, etc.) for these individuals are reported at the appropriate level.

Sample number: _____ Sub-sample number: _____ Sample size: _____ ^{Kgs} Hooks pots Combined Presorted

Species	Sex	#	Weight	% ret.	length, viability, injury, specimen, and tally data																																																								
----- KEYPUNCH -----	X	1450	331.88	X																																																									
Chum		1246	Ø		<u>Chum</u> - Total # & wts. pg. 170, logbook - 203 sexed, measured, weighed - 1246 tallied only																																																								
Chum	M	19	32.46																																																										
Chum	M	12	19.74		<table border="1" style="width: 100%;"> <thead> <tr> <th colspan="2">M</th> <th colspan="2">F</th> </tr> </thead> <tbody> <tr><td>38-11</td><td>56-1</td><td>41-10</td><td>51-5</td></tr> <tr><td>42-8</td><td>57-2</td><td>42-7</td><td>53-3</td></tr> <tr><td>43-13</td><td>60-3</td><td>43-2</td><td>54-7</td></tr> <tr><td>44-9</td><td>61-3</td><td>44-4</td><td>55-4</td></tr> <tr><td>45-1</td><td>62-7</td><td>45-4</td><td>56-2</td></tr> <tr><td>46-8</td><td>63-6</td><td>46-7</td><td>57-3</td></tr> <tr><td>48-6</td><td>64-2</td><td>47-6</td><td>67-3</td></tr> <tr><td>49-6</td><td>65-4</td><td>48-8</td><td></td></tr> <tr><td>51-2</td><td>67-6</td><td>49-8</td><td></td></tr> <tr><td>52-1</td><td></td><td>50-6</td><td></td></tr> <tr><td>53-6</td><td></td><td></td><td></td></tr> <tr><td>54-5</td><td></td><td></td><td></td></tr> <tr><td>55-1</td><td></td><td></td><td></td></tr> </tbody> </table> <p>Chum scale #4, M, 52 cm @ 1.55 kg</p>	M		F		38-11	56-1	41-10	51-5	42-8	57-2	42-7	53-3	43-13	60-3	43-2	54-7	44-9	61-3	44-4	55-4	45-1	62-7	45-4	56-2	46-8	63-6	46-7	57-3	48-6	64-2	47-6	67-3	49-6	65-4	48-8		51-2	67-6	49-8		52-1		50-6		53-6				54-5				55-1			
M		F																																																											
38-11	56-1	41-10	51-5																																																										
42-8	57-2	42-7	53-3																																																										
43-13	60-3	43-2	54-7																																																										
44-9	61-3	44-4	55-4																																																										
45-1	62-7	45-4	56-2																																																										
46-8	63-6	46-7	57-3																																																										
48-6	64-2	47-6	67-3																																																										
49-6	65-4	48-8																																																											
51-2	67-6	49-8																																																											
52-1		50-6																																																											
53-6																																																													
54-5																																																													
55-1																																																													
Chum	F	11	19.22																																																										
Chum	F	10	12.83																																																										
Chum	F	19	26.46																																																										
Chum	F	30	46.86																																																										
Chum	F	19	29.68																																																										
Chum		1	Ø																																																										
Chum	M	3	4.69																																																										

Discard e sea, outside sample, haul 165
Discard e sea, haul 165, Samp #2

National Marine Fisheries Service/Fisheries Monitoring and Analysis Division Ver. 09

Figure 10-6 Example of expected documentation for prohibited species biological data collections

PROHIBITED SPECIES SAMPLING: Sampling for Lengths and Specimens

Page 2 of _____

Cruise		Permit		Length and Specimen Form										
20670		2345		Observer name <u>Hali Herring</u>					Vessel name <u>Irish Lord</u>					
Resubmission (Circle All Changes)				Crabs		Halibut		Specimen Data						
Species Name	Species code	Haul no.	Offload No.	Sample or Sub-Sample no.	Sample system	Sex	Eggs? Y/N	Viability (swim/pos) Injury (Longline)	Length	Freq.	Specimen Type	Specimen Number	Weight	Maturity
Chum Salmon	221	165		2	2	M			45	1	2	1	1.20	
Chum Salmon	221	165		2	2	M			52	1	2	2	1.84	
Chum Salmon	221	165		2	2	M			56	1	2	3	1.65	
Chinook Salmon	222	165		3	2	F			65	1	2	1	3.46	
Halibut	101	165		3	2	U		D	64	1			.	
Halibut	101		1	1	3	U		D	44	1			.	
Halibut	101		1	1	3	U		D	50	1			.	
Halibut	101		1	1	3	U		D	51	3			.	
Halibut	101		1	1	3	U		D	52	1			.	
Halibut	101		1	1	3	U		D	53	2			.	
Halibut	101		1	1	3	U		D	55	1			.	
Halibut	101		1	1	3	U		D	56	2			.	
Halibut	101		1	1	3	U		D	58	1			.	
Chum Salmon	221		1	1	3	M			52	1	2	4	1.55	

Page _____ of _____ for transmission Ver. 09

Biological data are reported at the appropriate level. The deck form data examples in previous figures indicate prohibited species from which lengths and specimens were collected at sea.

Biological data from prohibited species sampled during the offload census are reported at the offload level

Page 3 of _____

Cruise		Permit		Length and Specimen Form										
20670		2345		Observer name <u>Hali Herring</u>					Vessel name <u>Irish Lord</u>					
Resubmission (Circle All Changes)				Crabs		Halibut		Specimen Data						
Species Name	Species code	Haul no.	Offload No.	Sample or Sub-Sample no.	Sample system	Sex	Eggs? Y/N	Viability (swim/pos) Injury (Longline)	Length	Freq.	Specimen Type	Specimen Number	Weight	Maturity
Chum Salmon	221		1	1	3	M			38	11			.	
Chum Salmon	221		1	1	3	M			42	8			.	
Chum Salmon	221		1	1	3	M			43	13			.	
Chum Salmon	221		1	1	3	M			44	9			.	
Chum Salmon	221		1	1	3	M			45	1			.	
Chum Salmon	221		1	1	3	M			46	8			.	
Chum Salmon	221		1	1	3	M			48	6			.	
Chum Salmon	221		1	1	3	M			49	4			.	
Chum Salmon	221		1	1	3	M			51	2			.	
Chum Salmon	221		1	1	3	M			53	6			.	
Chum Salmon	221		1	1	3	M			54	5			.	
Chum Salmon	221		1	1	3	M			55	1			.	
Chum Salmon	221		1	1	3	M			56	1			.	
Chum Salmon	221		1	1	3	M			57	2			.	
Chum Salmon	221		1	1	3	M			60	3			.	
Chum Salmon	221		1	1	3	M			61	3			.	
Chum Salmon	221		1	1	3	M			62	7			.	
Chum Salmon	221		1	1	3	M			63	6			.	

Page _____ of _____ for transmission Ver. 09

Figure 10-7 Examples of prohibited species biological data reported at the appropriate level

Cruise	Permit	Length and Specimen Form										Page 4 of				
20670	2345	Observer name <u>Hali Herring</u>					Vessel name <u>Irish Lord</u>									
Resubmission (Circle All Changes)																
Species Name	Species code	Haul no.	Offload No.	Sample or Sub-Sample no.	Sample system	Sex	Crabs		Halibut		Length	Freq.	Specimen Data			
							Eggs? Y/N	Viability (Draw Spot) Injury (Longitude)	Specimen Type	Specimen Number			Weight	Maturity		
Chum salmon	221		1	1	3	M					64	2			.	
Chum salmon	221		1	1	3	M					65	4			.	
Chum salmon	221		1	1	3	M					67	6			.	
Chum salmon	221		1	1	3	F					41	10			.	
Chum salmon	221		1	1	3	F					42	7			.	
Chum salmon	221		1	1	3	F					43	2			.	
Chum salmon	221		1	1	3	F					44	4			.	
Chum salmon	221		1	1	3	F					45	4			.	
Chum salmon	221		1	1	3	F					46	7			.	
Chum salmon	221		1	1	3	F					47	6			.	
Chum salmon	221		1	1	3	F					48	8			.	
Chum salmon	221		1	1	3	F					49	8			.	
Chum salmon	221		1	1	3	F					50	6			.	
Chum salmon	221		1	1	3	F					51	5			.	
Chum salmon	221		1	1	3	F					53	3			.	
Chum salmon	221		1	1	3	F					54	7			.	
Chum salmon	221		1	1	3	F					55	4			.	
Page _____ of _____ for transmission												Ver. 09				

Cruise	Permit	Length and Specimen Form										Page 5 of				
20670	2345	Observer name <u>Hali Herring</u>					Vessel name <u>Irish Lord</u>									
Resubmission (Circle All Changes)																
Species Name	Species code	Haul no.	Offload No.	Sample or Sub-Sample no.	Sample system	Sex	Crabs		Halibut		Length	Freq.	Specimen Data			
							Eggs? Y/N	Viability (Draw Spot) Injury (Longitude)	Specimen Type	Specimen Number			Weight	Maturity		
Chum salmon	221		1	1	3	F					56	2			.	
Chum salmon	221		1	1	3	F					57	3			.	
Chum salmon	221		1	1	3	F					67	3			.	
Chinook salmon	222		1	1	3	M					53	3			.	
Chinook salmon	222		1	1	3	M					55	2			.	
Chinook salmon	222		1	1	3	M					56	4			.	
Chinook	222		1	1	3	M					59	5			.	
Chinook	222		1	1	3	M					60	2			.	
Chinook	222		1	1	3	M					61	4			.	
Chinook	222		1	1	3	M					62	3			.	
Chinook	222		1	1	3	M					63	4			.	
Chinook	222		1	1	3	M					64	2			.	
Chinook	222		1	1	3	M					65	6			.	
Chinook	222		1	1	3	M					66	3			.	
Chinook	222		1	1	3	M					68	1			.	
Chinook	222		1	1	3	M					69	4			.	
Chinook	222		1	1	3	M					70	2			.	
Page _____ of _____ for transmission												Ver. 09				

Figure 10-7 Examples of prohibited species biological data reported at the appropriate level

PROHIBITED SPECIES SAMPLING: Sampling for Lengths and Specimens

FISH MEASUREMENT AND SPECIMEN COLLECTION

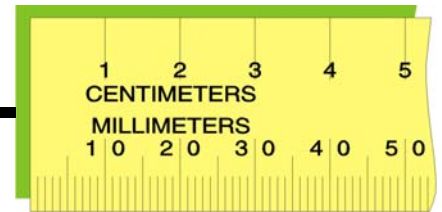

Table of Contents

List of Priorities	11-1
Introduction.....	11-1
Uses of Biological Data	11-1
Collecting Fish for Specimen Data	11-2
Selection of Species for Specimen Samples	11-3
Measuring Fish	11-3
How to Take Lengths	11-4
Otoliths	11-6
How to Collect Otoliths	11-7
Collecting Otoliths from Atka Mackerel and Sablefish	11-9
Broken Otoliths	11-9
Sexing Fish.....	11-10
Roundfish	11-10
Cod, Pollock, and Giant Grenadier	11-10
Rockfish.....	11-11
Atka Mackerel.....	11-12
Sablefish.....	11-12
Flatfish	11-13
Skates.....	11-14
Regulatory Support for Cutting Fish to Obtain Sex Data.....	11-14
Length Specimen Form Instructions	11-15
Completing the Length and Specimen Form	11-16

LIST OF PRIORITIES

- Collect otoliths from randomly selected fish in your length frequency sample. If you are unable to collect both length frequencies and otoliths, the otolith sample takes precedence. The measurements provided for these otolith fish will serve as a small length frequency sample.
- Collect length frequencies from species according to the priority lists at the end of this chapter starting on page 11-24.
- Collect sex/length/weight information from skates and Bering Sea pollock.
- Collect other biological data according to the lists at the end of this chapter starting on page 11-24.
- Collect standard and special project data.

INTRODUCTION

Fish measurements, weights, sex, and otolith collections are used by NMFS fisheries biologists to determine the relative abundance of each year class of predominant and selected bycatch species. Fish measurement data provide information on the abundance of fish in each size category, while otolith and/or scales provide corresponding age information. The age/length relationship of a species may change from year to year and may be quite different for each sex of a species.

Uses of Biological Data

Researchers and resource managers use the length, weight, and sex data you collect for age-length relationships (growth rate), length-weight relationships, sex composition and differences in growth between sexes, abundance of year classes and occurrence of year classes in commercial fisheries, and verification of the length data collected during research cruises by NMFS surveys.

All observers are assigned otolith collections. Otoliths are read by agency staff to determine the age of the fish, then the data are combined with the fish length and weight to provide length-age ratios. Length measurements collected also provide a picture of the abundance of each year class in the catch.

Sexed length, weight, and otolith collections provide information on the sex composition and the differences in the sizes of each sex in the catch. All of these components are used in the determination of the health of the stock and are applied in setting levels of sustainable yield. Commercial fishery quotas will be set, in part, based on observer length data from this and previous years.

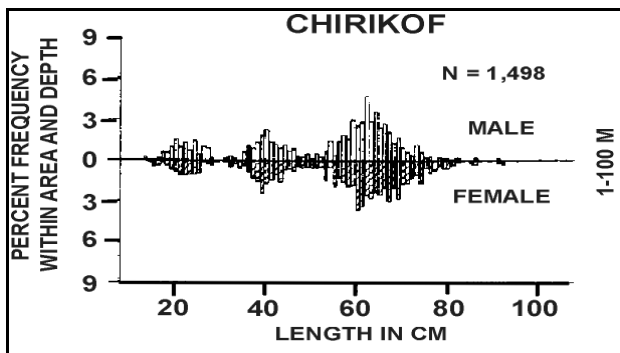

Figure 11-1 Length Frequencies at Depth (examples)

COLLECTING FISH FOR SPECIMEN DATA

In selecting fish for measurement and otolith collection, ensure you are not introducing size or sex bias in your selection technique. Watch how fish are sorted, dumped, and moved to ensure no vessel-caused bias exists. If you suspect that there is bias affecting your samples, contact NMFS staff immediately. Please get their assistance to modify and improve your sampling process before proceeding!

For each haul, determine the sex and record the length for approximately 20 fish of the *most predominant species* that is also listed on the Length and Otolith Priority Lists (lists begin on page 11-24). The Observer Program requests data from only those fish on the priority list. If there is a species that is predominant in the catch, but is not listed on the list, do not collect specimen data for that species. Move to the next most predominant species in the catch and determine whether that species is on the list. If it is, collect specimen data from that species. If it isn't, move to the

next most predominant fish in the catch and so on. Collect a very small number of otoliths from a subset of the measured fish (no more than 10 pairs of otoliths should be collected from any sampled haul). A variable number of "sexed lengths" and otoliths will be collected per day, depending upon the number of sampled hauls. The rate of otolith collection will vary depending on which fishery you are in (Length and Otolith Priority lists begin on page 11-24).

It is important to collect lengths from each sampled haul. You may have to measure less than the requested amount per haul if your time is needed for higher priority tasks. If that is the case, log the reasons and measure and sex as many fish as you can from each sampled haul. Do not measure additional fish from other hauls to compensate for shortages in a given haul.

Measurement and specimen data can be taken at the sample, subsample, haul, or offload level. These data are recorded at the level from which they were collected. For example, measurements taken from species within a sample are reported under that sample number, measurements taken from prohibited species during an offload are reported under the offload number, measurements taken from prohibited species within an at sea sample are reported under the sample number, measurements collected during a haul from halibut outside the samples are reported under the haul number, and so on. While you will collect a majority of specimen information at the sample level, it is important to recognize that the data can be entered at these other levels as well.

For non-prohibited species, it is preferred that you collect measurement and specimen data from within species composition samples. Measurement and specimen data from prohibited species should be taken at the level appropriate. For a sampled haul, you may randomly choose just one sample from which to take lengths. If taking lengths from two or more species, you may collect both species from within the same sample, or you may divvy up the species over two or more samples. ***The only requirement is that the sample or samples be randomly chosen and the fish from within the sample(s) be randomly selected.***

If measurement and specimen data are collected from outside the at-sea species composition sample (as is often the case with prohibited species), that data must be recorded at the haul or offload level, as appropriate.

Selection of Species for Specimen Samples

To determine which species to select for length measurement samples and otolith collections refer to the following guidelines:

- When the predominant species is listed on the otolith priority list for your region (BSAI or GOA), collect from this species. The length otolith priority lists can be found at the end of this chapter starting on page 11-24.
- If there are predominant species of equal proportions, select the highest priority of these.
- If the predominant species are relatively in the same proportions in the catch, and are listed at the same priority, alternate between these species from haul to haul.
- In the GOA, if the predominant species in the catch is arrowtooth, measure arrowtooth for the first through fourth sampled hauls. On every fifth sampled haul for which arrowtooth is predominant, measure another flatfish species in the ranking list (see Figure 11-21) and collect otoliths from this species.
- ***Predominance is determined by your visual estimate*** and you do not need specific weights or numbers of organisms to determine which species to measure.



If rock soles are the predominant species, collect a subset sample for species identification and use the identified fish for the Length and Specimen Form (see "Subset Sampling" on page 2-16).

The species measured will change when species composition changes. For example, Pacific cod may be the predominant species for the first two sampled hauls of the day, but the third sampled haul may contain a large amount of sablefish. In this situation, the table instructs you to measure approximately 20 Pacific cod, approximately 10 shortraker/rougeye, and approximately 5 skates of any species from each of the first two sampled hauls, and measure approximately 20 sablefish, approximately 10 shortraker/rougeye, and approximately 5 giant grenadier from the third sampled haul.

MEASURING FISH

Before you begin collecting fish for length measurement samples, set up a work area to measure fish. You will need to have a space large enough to lay a fish on the plastic length strip. If there is no table set up, use the NMFS aluminum board or baskets for a table, or use deck bin boards or the deck. The size of your length station will be a determining factor in how many fish you can collect at one time.

Fish used for sample level sex/length data may not be collected outside of your species composition sample!

Samples of selected species should be collected in a random fashion for length measurement and otolith collection. The easiest way to collect fish for length samples is to randomly select one or more containers of ***unsorted*** fish from one of your composition samples, then measure all of the fish in the container(s). If you are sampling large portions of catch, randomly collect a basket of unsorted catch. Use the selected species in this basket for your length samples, or, if there are too many of the selected species in the unsorted basket, use the basket dump method or other random system to further reduce the population. Determine the sex of all the measured fish. If you cannot determine the sex of all the fish, determine the sex of a random subsample of the measured fish. Record the unsexed fish lengths with a "U" in the sex column on the Length Specimen Form.



If you use northern & southern rock sole from your species composition sample as your length sample, record these species on your Species Composition Form as well!

If you are aboard a catcher vessel delivering to a plant, collect lengths at sea for each haul rather than at the plant, where fish are mixed from several locations. The data users prefer to have the length data associated with a specific catch location.

It is important to measure fish collected from unsorted catch using a non-size selective method. Once you have devised an unbiased selection method to pick the individuals to measure, look for ways that the layout of the vessel or factory, or the actions of the crew can aid you in carrying out your duties. If there is a diverter board or a belt that can be reversed into a basket, utilize those tools. You must never use a shovel, gaff or your hand to select the fish, but you may use these methods

FISH MEASUREMENT AND SPECIMEN COLLECTION: Measuring Fish

to collect the fish after they have been removed from the sample in an unbiased manner. Ask the crew for help in getting all the fish you selected. For example, if the individual fish selected falls back on an incline conveyor belt, ask a crewman to grab it or push it up, ask rollermen to gaff aboard those fish selected on longliners, or ask sorters not to pull out the large fish until you have your sample.



Under no circumstance should you select sex/length fish by hand from your sorted composition sample. Collect sex/length fish from *inside* your composition sample prior to sorting it!

How to Take Lengths

Fork length is the fish length measurement method used by the Observer Program and by NMFS researchers. Fork length is the length from the tip of the snout or jaw (whichever sticks out most) to the end of the middle rays of the caudal fin (see Figure 11-2).

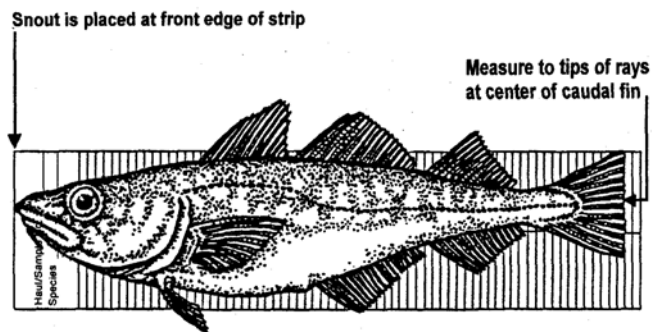

Figure 11-2 Measuring Fish

You will be given plastic measuring strips marked at centimeter increments. The first line printed on the strip is 4.5 cm, and the space between that line and the next line represents a measurement of 5 cm. Check your plastic strip, on both sides, to ensure that the first line is really 4.5 cm. Sometimes the manufacturer has cut the strip incorrectly. Notice that the 10 centimeter increments are not marked with a number. That is so that you can offset the strip by 10, 20, or 30 centimeters for larger fish. Figure 11-3 shows offsetting the plastic strip for measuring large fish. Position the plastic strip on the NMFS aluminum board, the labeled end should be toward the lip of the board so the snout of the fish may be nudged against it. Alternative materials to the

aluminum board may be used for doing measurements, but you must be able to nudge the snout against something. The plastic strip can be held down with thumbtacks, tape, or fish slime (rub the back of the strip on the fish and it will “glue” temporarily to the board).

Steps to Measuring Fish

1. Sex the fish first, if possible.
2. Lay the fish flat on the plastic measuring strip parallel to the center line.
3. Close the jaws.
4. Nudge the fish snout against the end of the aluminum board.
5. Stretch out the caudal fin to find the middle rays (see Figure 11-2).
6. Read the space where the fork length falls and record this length on a deck form.

If the fork length falls on a printed line on the strip, try re-measuring the fish.



If the length falls on the line again, use the *lower* centimeter measurement.

If you choose to write directly on the length strip, it should be cleaned with scouring powder to remove the marks and ready it for the next haul's lengths. Be sure you have recorded your data before you clean it! Don't scrub too hard because you may scour off the centimeter lines!

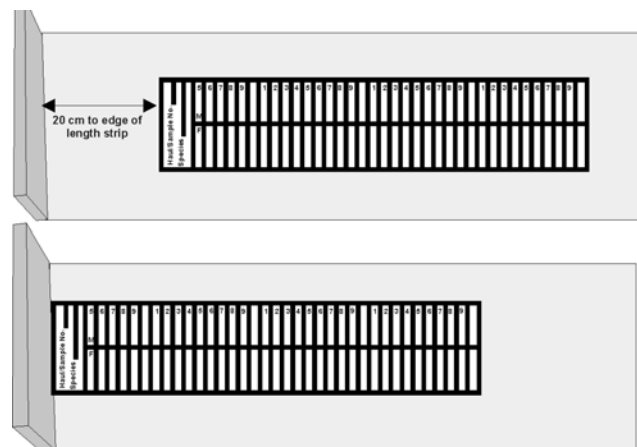

Figure 11-3 Measuring Strip Placement

Measuring Skates

Identification of skates to species may require that you compare the individual's disk length (called precaudal length) to tail length ratio.

- **Precaudal length** is measured from the tip of the snout to the posterior aspect of the anus.
- **Tail length** is from the posterior aspect of the anus to the tip of the tail.

The value you must document on the length form is the **total length**.

- The total length of a skate is defined as the length from the tip of the snout to the tip of the tail (with ventral surface of the skate down).

Measuring Giant Grenadier

The length measurements taken should be pre-anal fin length (PAFL) in cm. This is the measurement from the tip of the snout to the insertion of the first anal fin ray, immediately posterior to the anus. This is the standard because the long tapering tails of giant grenadiers are frequently broken off when they are caught.

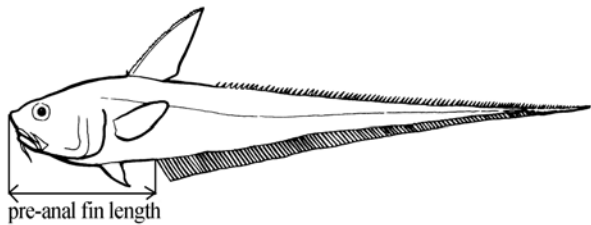

Measuring Squid

Mantle lengths are collected on squid. It is a straight line measurement from the tip of the fin to the center edge of the mantle. Lay the ventral side of the squid on the length strip and align the tip of the fin to the edge of the strip.

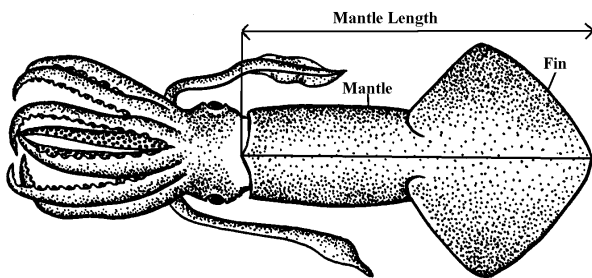

Frequently Asked Questions

Q: Which observers on which vessels collect length-frequency measurements?

A: *ALL* observers on *ALL* vessels and at *ALL* plants collect length-frequency samples.

Q: Which species should be sampled for length-frequency measurements?

A: When there is a predominant species listed on the length and otolith priority list, select that species. **Only measure species on the list.**

If there are dominant species of equal proportions, select the highest priority of these.

If there are several hauls in a row with dominant species in roughly equal proportions and with the same priority, alternate between these species.

Q: How many fish are to be selected for length-frequencies?

A: Depends on the species, but on average you should measure approximately 20 fish per sampled haul.

Q: How should fish be selected for the length-frequency sample?

A: One possible method would be to pre-select from which basket(s) to measure fish, then measure all of the fish in the basket(s). It is preferable to use the composition samples or subsamples for predominant species. When you do this, resource managers benefit from data reported at the sample level.

Q: Which fish should be sexed?

A: Sex all of the fish measured. If you cannot sex all the fish, sex a random subsample of the measured fish.

Figure 11-4 Length Sampling Summary

OTOLITHS

Otoliths should be collected from a subset of fish in the length sample. Depending on the number of otoliths needed for each commercially important species and the number of hauls you sample in a day, you may collect otoliths a few times per day, or only every few days. Use a random systematic sampling system to determine sampled hauls from which to collect otoliths. Pick a haul or set at random to start your otolith samples. For example; to collect otoliths from every 10th sampled haul, you would pick a random number between 1 and 10. Let's call this number q. You would then collect otoliths from the qth sampled haul, the q+10th sampled haul, the q+20th sampled haul, etc. If q = 4 then you would sample from the 4th, 14th, 24th, etc. sampled hauls until the vessel changes fisheries or your cruise ends.

If you miss a sampled haul for some reason, collect otoliths from the next sampled haul, and then continue with your original sequence. Maintain this same

sequence even if you change vessels. For example, if you randomly chose haul 3 to begin taking pollock otoliths, and the vessel only fishes two hauls, you would take otoliths from the next sampled tow on your next vessel, providing it was fishing pollock.



Otolith collections must come from length collections. Otoliths are a higher priority than lengths and there may be times when you can complete only an otolith collection. Record your otolith sample on your Length and Specimen Form.

It may be difficult to track what otoliths to collect, especially if the predominant species the vessel is catching changes often. One way to track when to collect otoliths is to use the Observer Sampling Record in your logbook. Enter the haul numbers, whether the haul was sampled or not, and the predominant species that you measured for each haul. Determine the hauls from which you will be collecting otoliths by reviewing this chart.

OBSERVER SAMPLING RECORD		
(OPTIONAL)		
VESSEL NAME: <i>Aurora Borealis (Gulf of Alaska fishery)</i>		
Haul Number	Sampled (Y/N)	Species
1	<i>No, watched operations</i>	<i>Arrowtooth</i>
2	<i>Yes, will sample all hauls now</i>	<i>Arrowtooth</i>
3	<i>Yes, first otolith haul</i>	<i>N/S rocksole (2nd predom.) (took otoliths)</i>
4	<i>Yes</i>	<i>Arrowtooth (1)</i>
5	<i>Yes</i>	<i>Pacific cod</i>
6	<i>Yes</i>	<i>POP (took otoliths)</i>
7	<i>Yes</i>	<i>Arrowtooth (2)</i>
8	<i>Yes</i>	<i>Arrowtooth (3)</i>
9	<i>Yes</i>	<i>Arrowtooth (4)</i>
10	<i>Yes</i>	<i>Flathead sole (2nd predom) (took otoliths)</i>

Figure 11-5 Example of Tracking Otolith Collections when Predominant Species Changes

Let's say you are fishing in the Gulf of Alaska, sampling all hauls, and have chosen the third haul to begin otolith sampling. The predominant species is arrowtooth flounder, so you measure arrowtooth for the first two hauls. Haul 3 is an otolith haul and otoliths are not collected from arrowtooth, so you must measure and collect otoliths from the second most predominant species. You assess your sample and it looks like rock soles and flathead occur in equal amounts. Since rock soles are higher in priority, you randomly collect approximately 20 rocksoles and key them to northern and southern rock sole while you measure and sex them. Additionally, you collect 5 pairs of otoliths and individual weights from randomly selected sex/length fish, regardless if they are northern or southern rock sole.

Figure 11-6 Length and otolith fish selection example

Collect otoliths from the selected sampled haul using a random or random systematic method. Never use a haphazard method or hand pick your fish. For a random method, simply number your length sample fish from one to the total number, then randomly pick numbers within this range to identify fish from which to collect otoliths. For a random systematic method, divide the number of lengths you collect by the number of otoliths you need to collect. Let's call the resulting number or quotient x . Randomly choose a number from 1 to x . Let's call this number k . Collect otoliths at k , $k+x$, $k+2x$, $k+3x$, etc. until you reach the number of otoliths needed. For example: If you were to collect length measurements from 20 fish and needed to collect 5 otoliths, then x would = 4. Using a random number generator, pick a number between 1 and 4, let's say $k=3$. So you would collect otoliths from the 3rd, $3+4=7$ th, $3+8=11$ th, $3+12=15$ th, and $3+16=19$ th fish. To collect 2 fish from the length sample of 20, $x=10$. Pick a random number k between 1 and 10, and put aside fish numbered k and $k+10$.

This otolith collection technique should result in ages and lengths sampled in proportion to their occurrence in the catch. ***Do not, under any circumstances, select the fish for the otolith samples according to your perception of the size distribution you "should" be getting.*** Use the techniques outlined above to remain as "size-blind" as possible.

Aleutian Islands Pollock Fishery

This fishery is conducted in waters west of 170 degrees longitude and South of 55 degrees Latitude in the Aleutian Islands Sub-Area. Only a small number of vessels participate in this fishery. With the limited amount of coverage that occurs in such a small fishery you are asked to collect 75 sexed lengths and 10 otolith pairs per sampled haul.

Atka Otolith Collection

When a vessel targets Atka Mackerel, the directed fishing takes place in areas 542 and 543. When observing in the directed fishing for Atka Mackerel collect 2 otolith pairs per sampled haul. In all other fisheries where atka mackerel is predominant, you should be collecting 4 otolith pairs per sampled haul.

How to Collect Otoliths

After obtaining the length measurement, weigh the fish. Weigh fish for otolith samples on the brass 2 kg, 5 kg, or 12 kg scales, or your motion compensated platform scale. **Do not use the 50 kg Salter scale for individual fish weights unless the fish is over 12 kg and you do not have access to a motion compensated platform scale!** Record weight, sex, and length on your deck sheet next to the vial number in which the otoliths and/or scales are placed. ***It is important that the numbered vials match the data for that fish.*** A mistake in the numbering used to relate the otoliths to associated biological data makes that sample useless.

Lead and second observers collect otoliths as one collection. All otoliths from both observers should be listed under the lead observer's cruise number. The lead observer is responsible for returning all data and specimens to debriefing.

Otoliths are fragile and must be in good condition to be read. During a non-otolith haul, practice taking otoliths from different species and different size fish. Try a variety of cuts and knife sizes until you feel comfortable. Since these will only be practice fish, the otoliths should not be kept or recorded on any forms.

The otoliths are located ventrally, and to either side, of the brain tissue, just above where the pre-operculum is located. The common methods of cutting into a fish's head to remove the pair of otoliths are: **1)** a vertical cut through the head above the pre-operculum, or **2)** a horizontal cut through the head just above the eyes.

FISH MEASUREMENT AND SPECIMEN COLLECTION: Otoliths

The easiest method to use for most fish is to make a vertical cut down through the top of the head to the location of the otolith pocket. This point is located by a simple rule of thumb: imagine the two points on either side of the fish's head at which, if the lateral lines were extended, they would meet the pre-opercular bones. Plan to cut down to these points. Species with tiny otoliths are best cut using the horizontal technique (see Figure 11-8).

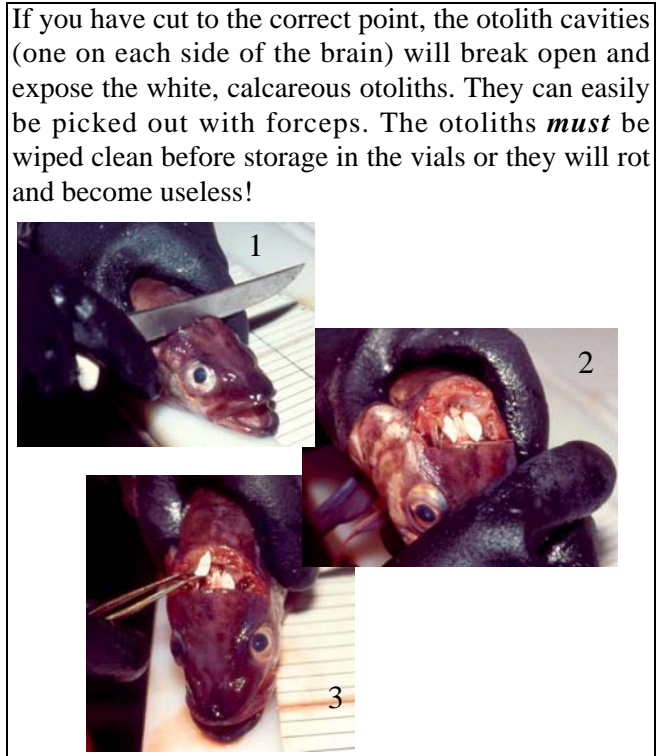

Figure 11-7 : Location of Roundfish Otoliths

Firmly grasp the fish by putting thumb and forefinger into the eye sockets or grasp the fish just behind the head, holding it dorsal side up. Bear down on the knife with even pressure as you cut through the bone of the head. Pay attention to the amount of pressure you are required to apply to make this cut. As soon as the cutting gets easier, ease off pressure on the knife or you will slice through the otoliths. Break the head open with two hands.

Carefully clean the otoliths by rubbing them between your fingers in water, or on a wet sponge or cloth to remove slime and tissue. Dry them as much as possible and place one pair of otoliths in each vial. *It is important to get the otoliths as clean and dry as*

possible before storing them to prevent them from rotting. At the end of the collection period, transfer the data from the deck sheet to the paper Length and Specimen Form or into the ATLAS database. .



Otolith vials should not be filled with any solution prior to debriefing.

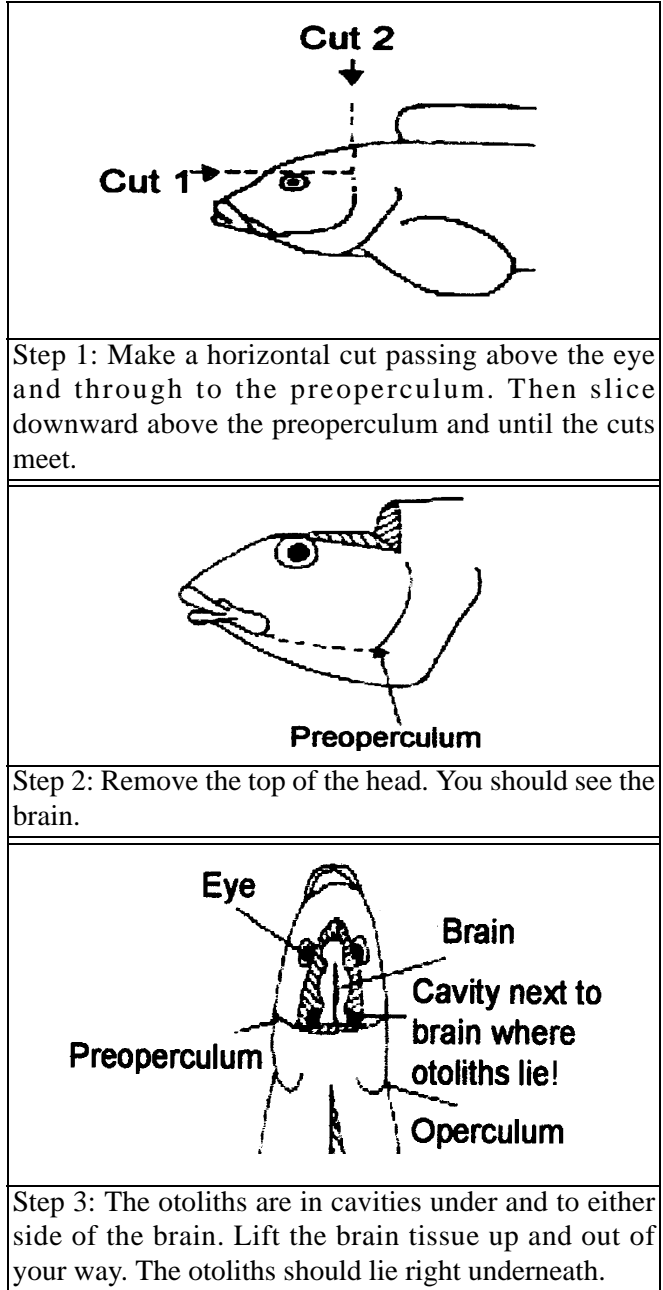

Figure 11-8 The Horizontal Cut for Otolith Removal

Collecting Otoliths from Atka Mackerel and Sablefish

Sablefish and Atka mackerel have very tiny otoliths. Use a horizontal cut method when working with these species. To collect otoliths using the horizontal cut, hold the fish's head and make a horizontal slice into the snout just above the eye. Stop slicing when the knife is just before the preopercle. Make a second cut down into the head until you reach the level of the first cut. Remove the wedge of head (see Figure 11-8). If you have made the cut correctly, there should be no blood flooding the cavity and you should see the brain tissue. The otoliths are just under and beside the brain. Grasp the brain tissue with forceps and pull it out or peel it back from the cavity. On either side of the brain cavity there is a fluid-filled pocket containing an otolith. The otoliths may not be visible yet, but if you insert forceps into the pockets, you will find the bony structures floating within the fluid. If blood fills the cavity, you have cut too deep, and the otoliths may be washed out. It's a good idea to practice this cut. When perfected, the otolith collection is relatively easy.

Broken Otoliths

Some otoliths may break or be cut accidentally during your collection. Keep samples with otoliths that have a single break, if you have both pieces. **Discard samples with a shattered otolith or with only one otolith.** Do not replace the sample by taking otoliths from another fish in that haul.

Each time three or more samples from one species are lost or discarded you should collect otoliths from an additional randomly chosen haul to replace the discarded samples. You do not need to replace samples unless three or more are lost for that species during your cruise. If you find you are consistently breaking otoliths, contact an Observer Program office for advice.

If You Run Out of Otolith Vials

The following steps need to be followed if you run out of otolith vials while you are deployed:

1. Continue to collect otoliths.
2. Wrap each otolith pair in a small piece of foil or paper.
3. Number otoliths with distinct numbers (1, 2, 3, etc.).

Record all information on a Length and Specimen form until you are able to get usable vials with numbers. Once you have vials, you will need to transfer the wrapped otoliths to these vials and revise the specimen numbers on the Length and Specimen form or enter these data into ATLAS as appropriate.

Frequently Asked Questions
<p>Q: Which observers on which vessels are to collect otolith samples?</p> <p>A: <i>ALL</i> observers on <i>ALL</i> vessels are to collect otolith samples.</p> <p>*Since we are only asking for a few otoliths per day every observer will be able to collect otoliths.</p>
<p>Q: Which species are otoliths to be collected from?</p> <p>A: Otoliths should be a random subsample of the length-frequency sample. Take specimens from only those fish listed on the Length and Otolith Priority List.</p>
<p>Q: How many hauls are to be sampled for otoliths?</p> <p>A: Depending on the target fishery, and area fished, it may be:</p> <ul style="list-style-type: none"> - every sampled haul - every 5th or 10th haul <p>*See Figure 11-20“Length and Otolith Priority List for Bering Sea/Aleutian Islands Vessels” and Figure 11-21“Length and Otolith Priority List for Gulf of Alaska Vessels”</p>
<p>Q: How many otoliths are to be collected?</p> <p>A: No more than 2 or 5 pairs per sampled haul, dependent on species.</p> <p>*See Figure 11-22“Length and Otolith Priority List for Plants and Floating Processors”</p>
<p>Q: How should the individual fish be selected for the otolith sample?</p> <p>A: Use a random or random-systematic sampling system.</p> <p>*See “How to Collect Otoliths” on page 11-7.</p>

Figure 11-9 Otolith Sampling Summary

SEXING FISH

Specimens must be recorded together as a group by sex on the deck form, and on the paper Length and Specimen Form or in ATLAS. After the fish are collected in a random/systematic fashion, measure and sex them.

Roundfish

Roundfish gonads are in the visceral cavity, ahead of the vent. Insert your knife or scalpel blade in or near the anus and cut forward toward the head. There will be only two organs attached directly to the anus - the intestine and the gonads. If you carefully move the other organs aside until you get a clear view of the tubes attached to the anus, you can then pull on the tubes and discern intestine (which is coiled and attached to the stomach) from gonads (which end as paired structures near the backbone.)

Cod, Pollock, and Giant Grenadier

The gonads are directly above the vent and are attached to the vent. Slit the skin of the belly near the vent and look behind the stomach area for the paired organs.

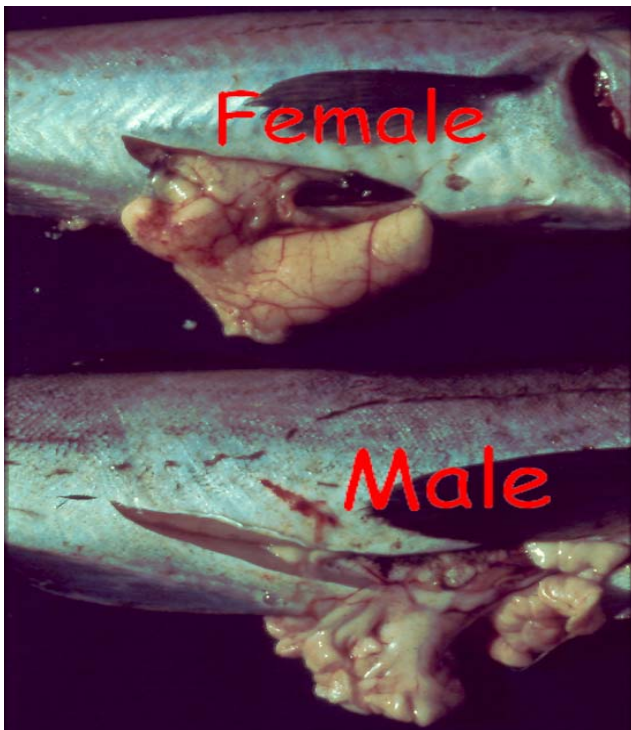

Ovaries

Ovaries are paired sacs which are typically pink or orange (or clear when immature). When ovaries are mature, you should be able to see the eggs inside. The sacs should look granular. Pacific cod ovaries often have a black covering on each sac.

Testes

Testes look very different from ovaries. When mature, the testes are convoluted, opaque and smooth in texture. In a mature male, the testes are best described as “greasy-looking, white, twisted Ramen noodles.” Immature testes will be pink or cream colored, located near the backbone and have a ruffled look to the edges of the tubes.

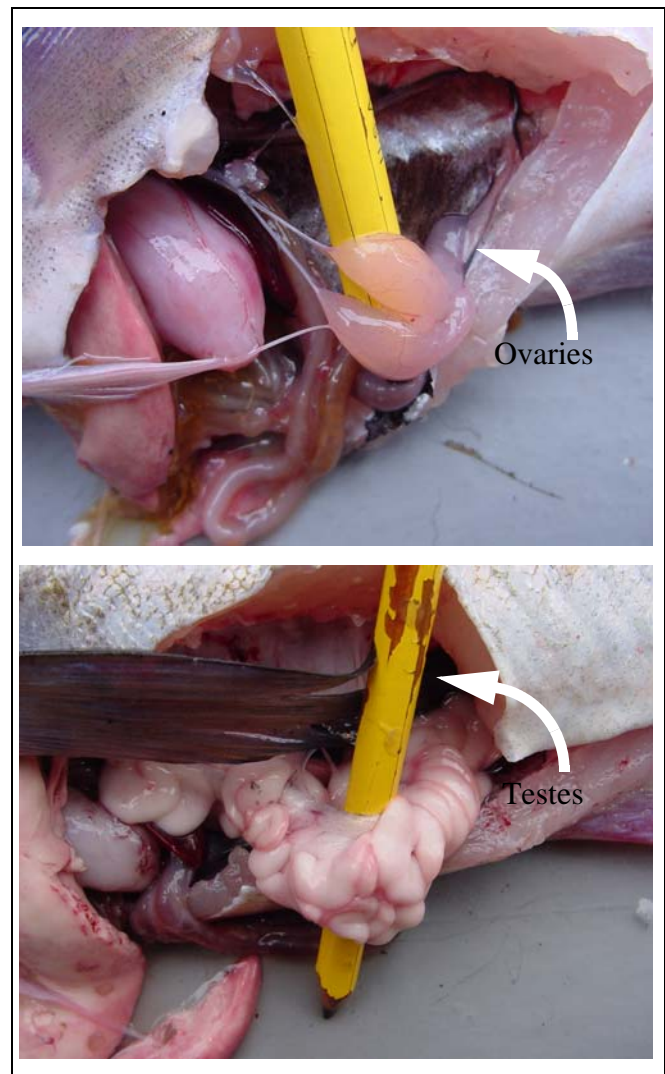

Figure 11-10 Female and Male Pollock Gonads

Rockfish

Rockfish gonads are found near the backbone in the visceral cavity. Trace the gonad strings from the vent upwards until you see the paired organs. There will always be two strings near the anus that have to be traced some ways before you can find the sacs. Sometimes there is another structure directly at the vent that appears to be a single gonad sac, but this is not the sex organ! You must follow the string-like tubes up to the **paired** gonads. Though you may notice external structures at the vent that seem sexually dimorphic, **never sex rockfish using external characteristics**. It is too easy to judge an immature male as a female or a huge female as a male when using external characteristics.

There can be a significant amount of fatty tissue in the visceral cavity of both male and female rockfish. Those observers accustomed to sexing pollock, Pacific cod and grenadier have mistaken this tissue for testes, because it is whitish and ribbon like. Rockfish gonads are smooth and discernible as paired structures: you must move any fatty tissue aside and look dorsally in the visceral cavity to see the gonads!

Ovaries

Ovaries will be elongate ovals with granular insides. They will be pink, orange, yellow, or white. The two sacs will have smoothly rounded sides, as opposed to the male testes which have a three-sided, triangular shape in cross-section. If immature, look closely or cut the gonad open to see the granular insides which identify it as female. Rockfishes are live spawners, so a spawning female will have larvae in the cavity.

Testes

Rockfish testes are cream colored or pink, elongate (5 times as long as they are wide) and smooth in texture. They have three “edges” to the tubes. Instead of a rounded oval tube, testes look triangular in cross section due to the distinct edges. Testes will look like flat tubes when immature, but when examined closely you will see the defined edges and the triangular shape.



Don't mistake the fatty tissue found in the visceral cavity of some rockfish as testes! The testes of rockfish look nothing like those of pollock, Pacific cod and grenadier!

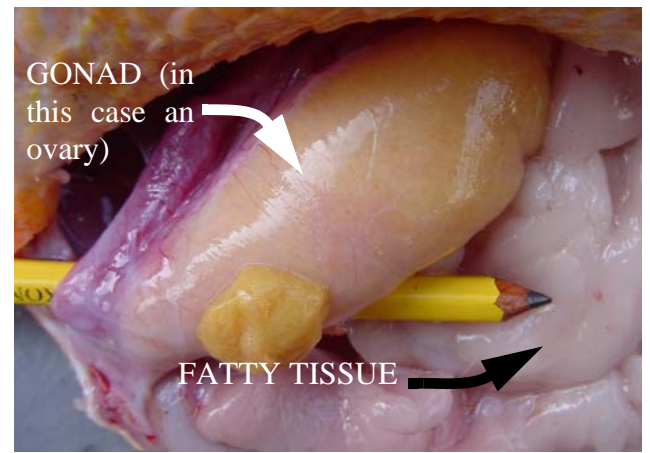
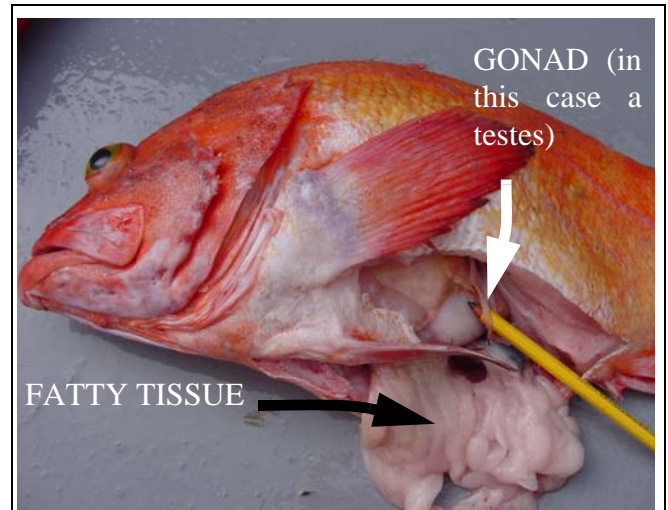

Figure 11-11 Fatty tissue versus gonad in rockfish



Figure 11-12 As with several other species, rockfish testes have discernible edges

Atka Mackerel

Like rockfish, Atka mackerel gonads are at the top of the visceral cavity, close to the backbone. Externally, mature males have a yellow tinge to the white stripes but external color differences cannot be used to sex these fish. The cut and gonad location is the same as with rockfish.



Figure 11-13 Male and Female Atka Gonads

Ovaries

Ovaries are two clear sacs filled with small round eggs that are olive green, tan or brown. Atka mackerel spawn in spurts, so eggs in the ovaries will be a mix of different sizes and stages of development.

Testes

Atka mackerel testes are similar to those in rockfish. The two tubes will be smooth in texture, cream colored and longer than wide. Be aware that males eat the eggs from other Atka mackerel nests. Don't confuse a stomach full of eggs, or eggs loose in the cavity as a female mackerel.

Sablefish

The gonads of sablefish are very different from all other roundfish: they lie directly on the backbone. Remove all the other organs from the visceral cavity and peer at the backbone area near the posterior of the visceral cavity for the gonad tubes. Immature fish will have nearly see-through ribbons, so you will need to probe them apart to count the correct number of lobes. ***It is important to count the lobes at the posterior portion of the gonad, since the lobes will be fused anteriorly and will always look like just two lobes.***

Both females and males have fleshy smooth tubes of a cream or pink color. Mature fish have liver colored gonad tubes. There are no reliable differences in color

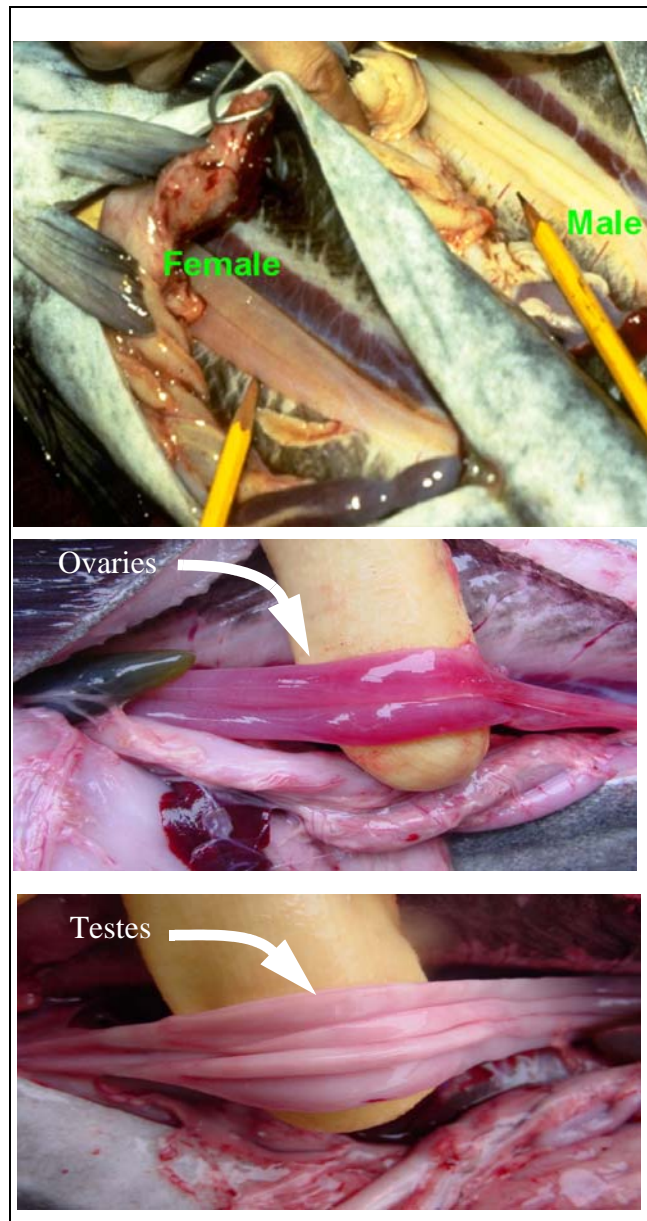

Figure 11-14 Female and Male Sablefish Gonads

or texture between non-ripe males and females. You can reliably tell the difference between males and females based on whether the gonads have two (females) or four (males) lobes. When mature, the ovaries may have a partial fold through each of the two lobes, giving a false impression of four lobes. Cut across the gonad strands and distinguish the true number of lobes.



Male sablefish gonad lobes are fused at the anterior point, making it easy to mistake a male as female. When checking the gonad lobes, look at the posterior portion!

Flatfish

Flatfish gonads are also paired, but are located behind the visceral cavity. If the flatfish has an anal spine, the gonads will begin just behind it. Cut from the anal spine location back toward the tail of the fish. When you gain experience determining sexes using a larger cut, your cut can be made smaller, faster, and in the correct spot for seeing the sex difference.

Flatfish gonads are posterior to the visceral cavity (and the anal spine if there is one) and extend just under the flesh on both sides of the fish, although it is easier to cut on the blind side. Cut back toward the tail from the anus as if skinning the fish. Lift the skin flap and check for a triangular shaped gonad.

Ovaries

Female flatfishes have elongate triangle ovaries that extend from behind the anal spine area almost to the tail when mature. When immature, the ovaries will be almost equilateral triangles with one angle shaped like a smoothly rounded tube extending only slightly back toward the tail (the triangle looks like a funnel in shape). The color will be pink (spent, immature) or orange (ready to spawn). Ovaries always have rounded edges.

Testes

Male flatfishes have a white, equilateral triangle shaped gonad on each side. The triangle will not have a tail extending back toward the caudal fin. Immature males have a small crescent moon shaped, tan colored gonad laying right at or behind the anal spine location. All male flatfishes have “edges” to the triangle. If you lift the gonad with the knife or scalpel and examine the sides of the triangle, you can distinguish the sharp edges (male) or rounded sides (female), even on an immature flatfish.

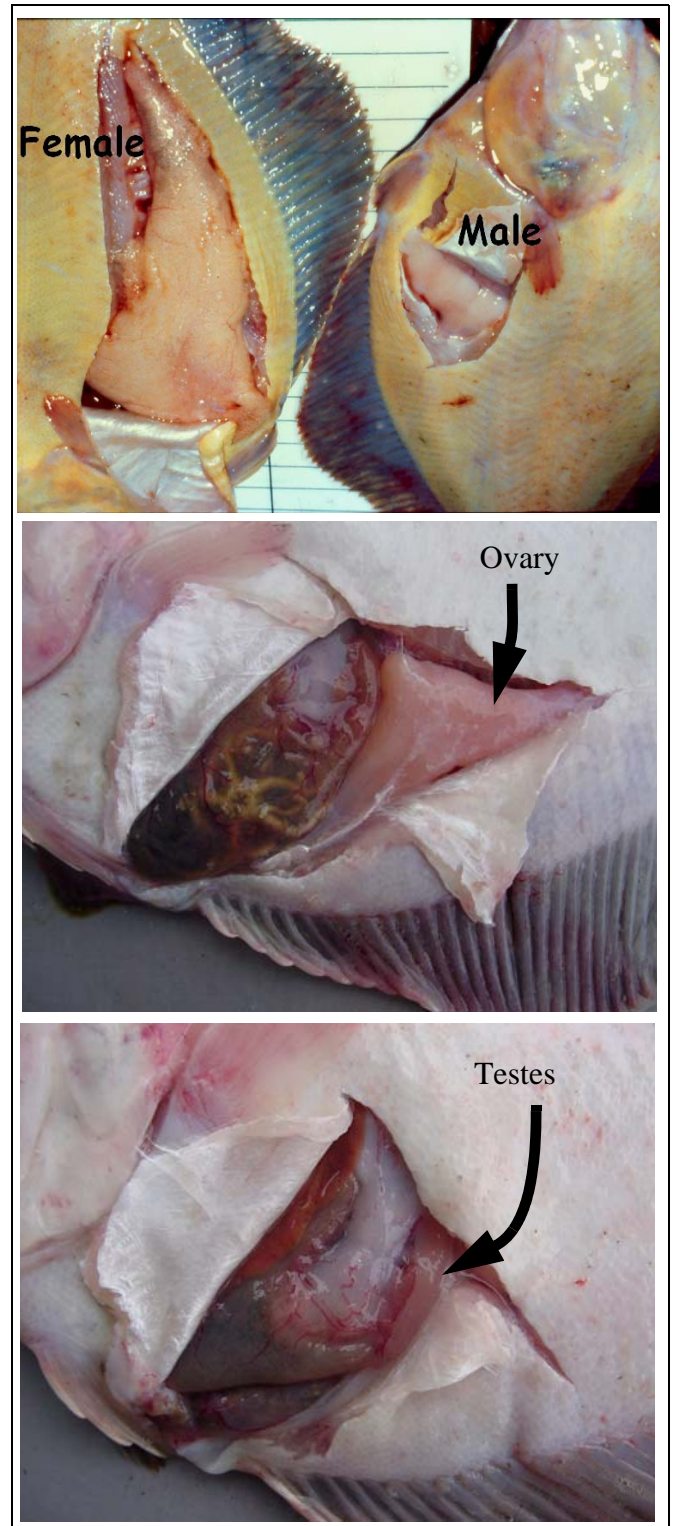

Figure 11-15 Female and Male Flatfish Gonads

Skates

Skates can easily be sexed externally by noting the presence or absence of claspers. The claspers are paired reproductive structures located between the pelvic fin and the base of the tail. In mature males the claspers are large (possibly half the length of the tail), rigid and are easily identified. In immature males the claspers are much smaller and flexible, and may be more difficult to distinguish from the pelvic fin.

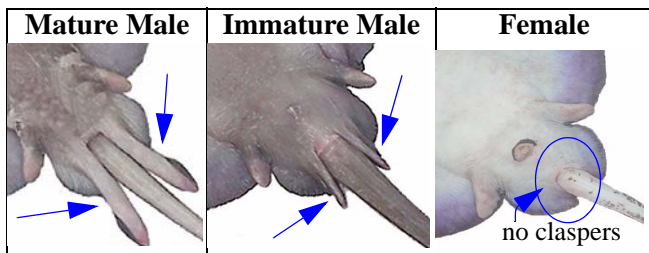

Figure 11-16 Determining Sexing Skate: arrows point to claspers in males and absence of these structures in females.

Regulatory Support for Cutting Fish to Obtain Sex Data

The sexing of the target species provides essential data for managing the fishery. Because of its importance, regulations specifically support observers in cutting fish for sexed lengths. 50CFR 679.50(g)(1)(viii) states that the vessel must, “Provide all other reasonable assistance to enable observers to carry out their duties, including, but not limited to: (E) Allowing the observers to determine the sex of fish when this procedure will not decrease the value of a significant portion of the catch.” If you encounter any resistance to these regulations you will be asked to complete a written statement on the matter in debriefing. Be prepared with detailed daily notes of the conversations you had with the crew regarding this matter.

The crew may not want you to cut the fish because the cut will destroy or reduce the value of the product. The only alternatives to cutting all of the measured fish are as follows:

- If the fish are spawning, you can squeeze the fish to see milt or eggs, but you must cut the ones in your length sample that are not yet spawning to discern sex.

- If the target species is yellowfin sole, you can sex the mature yellowfin by “candling” them without cutting the flesh. Hold the fish up to a strong light and look through the blind side to see the gonad. Immature fish must be cut to discern sex. ***This method can be used for yellowfin only!***
- Ask if a “pectoral cut” would be acceptable on the product (slicing the throat area just under the pectorals across the body, the same way as the crew heads the fish by hand or machine). The gonads can be seen in the opened cavity or pulled out to examine. If this method is used for sablefish, you must carefully examine the gonads to ensure you correctly sex the fish.
- If the target is a flatfish, make a very small cut, parallel to the anal spine, about an inch behind the anal spine and check the gonad (make sure you try this technique in the training or briefing session to see how it is used). The small cut may not be a problem for the product.
- If there is no other way to sex the fish without cutting them, work with the captain to determine a number that you can cut, and list the rest as unsexed.
- If the vessel refuses to allow you to cut any of the fish because it would destroy a major percentage of the target species product or if product is whole or live fish, leave all measured fish as unsexed. Notify NMFS and document the reasons in your logbook.

BSAI Pacific Cod and Pollock Maturity Scan Data

Observers collecting otoliths from Pacific cod or pollock in the BSAI will also collect visual maturity stage data from female specimens. Visual maturity keys for each species are provided to assist you in assigning fish to one of six maturity stages based on visual examination of the ovary. The keys are designed to track the visual changes in three characteristics of the ovary that occur with reproductive development: size, coloration, and consistency (or texture). Researchers recognize that there is subjectivity in assigning categories based on visual examination but find the data to be accurate when observers consider these three characteristics. In addition to assessing the maturity stage, you record the weight of the fish **before**

and *after* removal of the ovary. This allows determination of the weight of the ovary which is useful in validating the maturity stage assignments.

Methods:

1. Sex the fish (take care not to damage the internal organs).
2. If the fish is female, evaluate the maturity stage by comparing the visual characteristics of the ovary and oocytes to the species appropriate key.
3. Remove the ovary and re-weigh the fish.
4. Collect the otoliths.

Recording Data:

1. Record the otolith data on the Length and Specimen Form.
2. The specimen number is the otolith vial number.
3. The maturity stage data are recorded as a second line of entry to the otolith data with the same specimen number.
4. For maturity data, record the weight of the fish after you removed the ovary.

STANDARD AND SPECIAL PROJECT DATA

Observers on all vessel types are expected to collect sex/length/weight, otoliths, and salmon scale data. Instructions on collecting these specimen data are discussed in this chapter. Several vessels are equipped with the stomach collection standard project. Observers on these vessels must complete the project if they are on board during months the project is active. For details on completing the stomach project, refer to "STOMACH COLLECTION" beginning on 15-1.

Some observers will be required to collect additional special project data. Special project kits come with a separate project instruction packet. Refer to this for information on how to proceed with the project and what types of data to collect. If the specimen type collected for the project is listed in the specimen type list on page 11-17, you must enter any collected data on a paper Length and Specimen Form or in ATLAS.

LENGTH SPECIMEN FORM INSTRUCTIONS

The Length Specimen Form is used for recording lengths of predominant and prohibited species (except herring), presence of crab eggs, and halibut viabilities/injuries. It is also used to record specimen data taken from these species and for standard and special projects. ***Do not record estimated lengths on this form.*** Observers using the ATLAS software do not need to complete this form; they transfer data directly from the deck sheets to the ATLAS program. ***Observers aboard vessels that do not have ATLAS are required to fax their Length and Specimen Form data to Seattle.***

The Length and Specimen paper form was structured to mimic the way in which data is entered into the ATLAS program. In ATLAS, after a length has been entered for a species, you can immediately enter specimen data associated with that length. You do not have to create a stand alone record for the specimen (*i.e.*, you do not have to re-enter length data for the specimen). Currently in ATLAS, you cannot have two line entries with the same length value for any given sample. If you have more than one individual at the same length, you indicate this by documenting the number of fish collected at that length. This number is referred to as the length frequency for that length. For example, if you measured 21 pollock and 4 of these were females at 45 centimeters, you would document these data as length 45 cm, with a length frequency of 4.

In ATLAS and in the Observer Program database, specimens are child records of lengths (*i.e.*, specimen data are dependent on length data). In order to relay this relationship on paper, you must document specimen data in the spaces to the right of the length for the fish providing the specimen. Because you may have multiple specimens from the same fish, or multiple specimens for fish of the same length, you may have several specimen entries associated with one length entry.

Length specimens must be grouped by species, sex, sample system, eggs for crab, or by injury/viability for halibut, with a skipped line between species, sample system, sex or injury/viability groupings, and a skipped line between specimens from one sample and those of another. Refer to Figure 11-18 and Figure 11-19 for examples of how to document length and specimen data on the Length and Specimen Form.

FISH MEASUREMENT AND SPECIMEN COLLECTION: Length Specimen Form Instructions

Completing the Length and Specimen Form

Cruise Number, Permit, Observer Name, Vessel Name: Enter your name, cruise number, the vessel/plant name, and vessel/plant permit. A list of these permits can be found on A-25.

Resubmission: Circle “Resubmission” if you are sending changes to data previously faxed. *Also, please circle the items that have changed since your last transmission of the data; this will aid keypunchers in making the appropriate modifications to your data.*

Page Numbers: Number the pages “Page ___ of ___” starting with page one for each vessel or plant and ending with the total number of pages in the Length and Specimen Form set. Keep separate sets of forms for each vessel or plant.

Species Name: Record the common name of the fish or crab. Skip lines between species.

Species Code: Enter the species code for the measured species (a listing of codes starts on page A-1).

Haul Number and Offload Number: List the haul or offload number from which the lengths and specimens were collected.

Sample/Subsample Number: List the sample or subsample number of the sample or subsample from which the specimens or lengths were taken. *If the lengths were collected at the haul level and came from outside a sample or subsample, do not enter a value in this field.* For example, halibut viabilities taken outside your sample on a trawler, or for injuries taken outside of longline samples, are entered at the haul level and do not have a sample/subsample number. *If the lengths were collected at the offload level, enter a “1” in this field.* Skip lines between sample/subsamples.

Sample System: Enter the sample system appropriate for your sample collection:

- **1-Stratified:** Stratified sample collections are those taken to accomplish a specific collection of a certain length. For example, if you were asked to collect lengths from only those pollock measuring between 40 and 50 cm, your collection would be a stratified collection.
- **2-Random:** All length and specimen data collected using random collection methods discussed in this manual should be coded as random.

- **3-Other:** Use for census data (e.g., offload sample data) and when codes 1, 2, 4 or 5 do not apply.
- **4-Size Selected:** If a project requires this type of sampling, instructions will be in the project handout.
- **5-Opportunistic:** Samples taken without preselecting when or where you are going to sample, or samples collected from the only accessible portion of the catch. For example, use this for lengths of presorted halibut.

Sex: In the Sex column, record the fish or crab sex as “F” (female), “M” (male), or “U” (unsexed or uncertain).

Eggs?: This column is filled out only for *female prohibited species crab*. Enter a “Y” in this column when eggs are present and follow with lengths for those carrying eggs. Use another line for female crabs without eggs and enter a “N” in the column. Use another line for female crabs where the presence of eggs is unknown and enter a “U” in the column. Leave the column blank for male crabs and all fish.

Viability and Injury: For all *trawl and pot* caught halibut viability measurements, list viability codes in this column. Use condition codes “E” (excellent), “P” (poor), “D” (dead), or “U” (condition not assessed). See page A-35 for more information.

For all *longline* caught halibut injury assessments, list the injury codes in this column. For more information, see page A-41. Use one of the following injury codes:

1 - Minor	4 - Dead/Sand Fleas/Bleeding
2 - Moderate	9 - Unknown
3 - Severe	

Length: List the lengths you recorded on the deck form. The list must be in ascending order. List only size groups that have a frequency of one or more. *Lengths that contribute to specimen data must be circled on the deck form.* This allows you and others to easily verify that your data is entered completely.

Freq: Frequency represents the number of animals in the particular length group. Length groups must be separated by species, haul or offload, sample or subsample number, sample system, sex, eggs yes/no, or viability/injury code. Do not enter leading zeros in this field.

“Specimen Data” Tab

Specimen Type: Record the specimen type code from this list:

- 1 - Otoliths
- 2 - Salmon Scales
- 3 - Sex/Length/Weight Sample
- 4 - Fin Clips
- 5 - Vertebrae
- 6 - Spines
- 7 - Maturity Scan
- 8 - Maturity
- 9 - Stomach
- 10 - Isotopes
- 11 - Other Tissue

For specific information on specimen types refer to “Specimen Types” on page 11-17.



Keep your otolith collections separate for each species and vessel! This will save you from trying to sort them out during debriefing!

Specimen Number: Specimen numbers must be unique for the vessel/species. *For any given specimen type taken for a species, specimen number must be unique.* Unless otherwise directed, number the first specimen for each specimen type as “1.” Number subsequent specimens of the species/specimen type in consecutive ascending order. *Otoliths and Maturity scans are a known exception; enter the number on the otolith vial for both the otolith and maturity scan specimens.*

Weight: Enter the weight for the specimen when needed. Weights must be listed to two decimal places. The only standard specimen collections that require a weight are sex/length/weights, otoliths, scales, and maturity scans. Refer to your special project packets for the exact requirements for other specimen types.

Maturity: Record the maturity code from this list:

- 1 - Immature
- 2 - Developing
- 3 - Pre-spawn
- 4 - Spawning
- 5 - Spent
- 6 - Resting

Currently, only the maturity scan specimen type requires a maturity code. Unless otherwise noted in your special project packet this column should be left blank.

Specimen Types

Otoliths: Copy the bar coded specimen number on the otolith vial for each pair of otoliths taken for that haul. Each vial number is unique and cannot be altered! Vial numbers do not have to be sequential, although the ATLAS program will auto fill with the next vial number. Be careful of this if using non-sequential vials!

Salmon Scales: Salmon scale envelopes (see page 10-8) must be labeled with a specimen number. For each species, number scale specimens sequentially beginning with the number 1. Start with the number 1 for each vessel you are deployed to. On the Length and Specimen Form, record the specimen numbers from your envelopes in ascending order. Salmon scale specimen numbers must be less than 999.

Sex/Length/Weight: For each sex/length/weight specimen, record a specimen number. Observers typically start numbering sex/length/weights for a species with 1. Number your sex/length/weight specimen consecutively from the starting number. Sex/length/weight specimen numbers must be less than 999.

- **Sex:** Group your data by sex, listing all males together and all females together. Use M, F, or U in this field. **Skip a line between sex groupings!**
- **Weight:** Record the individual fish weight in kilograms. Always list the weights to 2 decimals.

On every fifth haul, the same haul as you collect otoliths, weigh and measure a subsample of the fish from your length-frequency sample not used for otolith samples. Record the data on the Length and Specimen Form with a specimen type of 3 (“Length-Weight

FISH MEASUREMENT AND SPECIMEN COLLECTION: Reviewing Forms for Errors

Sample”). Each fish must be recorded as either an otolith sample or a length-weight sample, but must never be recorded as both

Maturity Scan: Record the maturity stage data as a second line of entry to the otolith data using the otolith vial number as the specimen number. Record the weight of the fish after you removed the ovary. Maturity stages are discussed in the Pacific cod and pollock maturity code keys. Maturity scan codes are:

- 1 - Immature
- 2 - Developing
- 3 - Pre-spawn
- 4 - Spawning
- 5 - Spent
- 6 - Resting

Stomachs and Isotopes: Currently stomach and their related isotope specimen data are being captured using the Specimen Form provided by the Food Habits Lab. These forms are included in the stomach sampling kits or lockers. Do not record stomach or isotope specimen data into ATLAS or on your Length and Specimen Form. Refer to "STOMACH COLLECTION" beginning on 15-1 for instructions on when and how to complete the project.

Special Project Specimens: The specimen types of fin clips, vertebrae, spines, maturity, and other tissue are currently only used for special projects. If completing a special project, refer to the project instructions accompanying the project kit for information on how to proceed with the project, what data to collect, and how/where to record it. Some projects will have project specific data forms and others will utilize the Length and Specimen Form.

REVIEWING FORMS FOR ERRORS

To facilitate the debriefing process you *must* check forms throughout your cruise, not just at the last minute before your debriefing interview. Observers who regularly review their data at sea generally benefit by having shorter, smoother debriefings. Observers who

do not review their data throughout their cruise generally find themselves in lengthy debriefings and with time consuming corrections. It is much easier to check a couple of pages each day over the course of three months than to check a couple hundred pages of data all at once! Follow the guidelines below when reviewing your length and specimen data for errors.

Check Length and Specimen Form For:

- All header information is completed
- Species codes match species names
- No decimal places exist for lengths or frequencies
- No size groups have been transposed with the frequency
- Lengths are recorded in ascending order
- There are no lengths with a frequency of zero
- There are no duplicate length entries for specimens of the same species, sex, eggs code within the same haul.
- All crab unit measurements end in “3” or an “8”
- Sex codes are recorded for each species on every line
- Halibut have condition codes of “E,” “P,” “D,” or “U” for trawl or pot vessels, and injury codes of “1,” “2,” “3,” “4,” or “9” for longline vessels
- Halibut have sex codes of “U”
- For lengths with associated specimen data, specimen type is entered and these lengths are circled on the decksheet
- There are no duplicate specimen numbers for the same species and specimen type
- Skipped scale specimen numbers are noted with an explanation

FISH MEASUREMENT AND SPECIMEN COLLECTION: Reviewing Forms for Errors

Cruise		Permit		Length and Specimen Form							Page <u>1</u> of <u>2</u>					
11982		7891		Observer name <u>Rex Soul</u>			Vessel name <u>Rock n' Roll</u>									
Resubmission (Circle All Changes)																
Species Name	Species code	Haul no.	Offload No.	Sample or Sub-Sample no.	Sample system	Sex	Crabs		Halibut		Length	Freq.	Specimen Data			
							Eggs? Y/N	Viability (crawl/pot)	Injury (Longline)	Specimen Type			Specimen Number	Weight	Maturity	
P. cod	202	216		1	2	F					59	1				
P. cod	202	216		1	2	F					62	1				
P. cod	202	216		1	2	F					63	1				
P. cod	202	216		1	2	F					65	1				
P. cod	202	216		1	2	F					66	1				
P. cod	202	216		1	2	F					67	1				
P. cod	202	216		1	2	M					58	1				
P. cod	202	216		1	2	M					59	1				
P. cod	202	216		1	2	M					60	1				
P. cod	202	216		1	2	M					61	1				
P. cod	202	216		1	2	M					64	1				
P. cod	202	216		1	2	M					66	1				
P. cod	202	216		1	2	M					72	1				
P. cod	202	216		1	2	M					73	1				
Halibut	101	216		1	2	U			E		34	1				
Halibut	101	216		1	2	U			E		38	1				

Page _____ of _____ for transmission Ver. 09

If you refer to the species composition data for the F/V Rex Sole (page 5-49) you'll see that the two samples taken were combined and reported under a single sample number. As appropriate, all data associated with these two samples are reported under this sample number as well.

Cruise		Permit		Length and Specimen Form							Page <u>2</u> of <u>2</u>					
11982		7891		Observer name <u>Rex Soul</u>			Vessel name <u>Rock n' Roll</u>									
Resubmission (Circle All Changes)																
Species Name	Species code	Haul no.	Offload No.	Sample or Sub-Sample no.	Sample system	Sex	Crabs		Halibut		Length	Freq.	Specimen Data			
							Eggs? Y/N	Viability (crawl/pot)	Injury (Longline)	Specimen Type			Specimen Number	Weight	Maturity	
Halibut	101	216		1	2	U			E		40	1				
Halibut	101	216		1	2	U			D		33	1				
Halibut	101	216		1	2	U			D		46	1				
Alaska Skate	88	216		1	2	F					53	1				
AK Skate	88	216		1	2	F					62	1				
AK skate	88	216		1	2	F					65	1				
AK Skate	88	216		1	2	F					82	1				
AK Skate	88	216		1	2	M					69	1				

Page _____ of _____ for transmission Ver. 09

Don't forget to review the length and otolith priority list appropriate to the region and predominant fish from which you are sampling. There may be a request for data from other species!

Figure 11-18 Examples of length and specimen data documentation from a flatfish catcher vessel

FISH MEASUREMENT AND SPECIMEN COLLECTION: Reviewing Forms for Errors

Cruise		Permit		Length and Specimen Form							Page 1 of				
20670		2345		Observer name <u>Hali Herring</u>			Vessel name <u>Irish Lord</u>								
Resubmission (Circle All Changes)															
Species Name	Species code	Haul no.	Offload No.	Sample or Sub-Sample no.	Sample system	Sex	Crabs		Halibut		Specimen Data				
							Eggs? Y/N	Viability (rawl/spot)	Injury (Longline)	Length	Freq.	Specimen Type	Specimen Number	Weight	Maturity
Pollock	201	165		1	2	M				44	1	3	1	.74	
Pollock	201	165		1	2	M				47	2	3	2	.92	
												3	3	1.28	
Pollock	201	165		1	2	M				48	1			.	
Pollock	201	165		1	2	M				49	1			.	
Pollock						M				51	2	3	4	1.26	
Pollock						M				52	3	3	5	1.22	
												1	393077	1.32	
Pollock						M				55	1			.	
Pollock						M				59	1			.	
														.	
Pollock	201	165		1	2	F				53	1	3	6	1.24	
Pollock	201	165		1	2	F				54	2			.	
Pollock	201	165		1	2	F				56	1	3	7	1.76	
Pollock	201	165		1	2	F				57	1			.	
Pollock	201	165		1	2	F				62	1	3	8	1.72	
Pollock	201	165		1	2	F				66	1	1	393078	2.10	
												7	393078	1.60	4

Maturity scan specimens have the same specimen number as the otolith specimen. The maturity scan weight is of the fish without its ovaries!

Page _____ of _____ for transmission Ver. 09

Cruise		Permit		Length and Specimen Form							Page 2 of				
20670		2345		Observer name <u>Hali Herring</u>			Vessel name <u>Irish Lord</u>								
Resubmission (Circle All Changes)															
Species Name	Species code	Haul no.	Offload No.	Sample or Sub-Sample no.	Sample system	Sex	Crabs		Halibut		Specimen Data				
							Eggs? Y/N	Viability (rawl/spot)	Injury (Longline)	Length	Freq.	Specimen Type	Specimen Number	Weight	Maturity
Chum Salmon	221	165		2	2	M				45	1	2	1	1.20	
Chum Salmon	221	165		2	2	M				52	1	2	2	1.84	
Chum Salmon	221	165		2	2	M				56	1	2	3	1.65	
														.	
Chinook Salmon	222	165		3	2	F				65	1	2	1	3.46	
														.	
Halibut	101	165		3	2	U			D	64	1			.	
														.	
Halibut	101		1	1	3	U			D	44	1			.	
Halibut	101		1	1	3	U			D	50	1			.	
Halibut	101		1	1	3	U			D	51	3			.	
Halibut	101		1	1	3	U			D	52	1			.	
Halibut	101		1	1	3	U			D	53	2			.	
Halibut	101		1	1	3	U			D	55	1			.	
Halibut	101		1	1	3	U			D	56	2			.	
Halibut	101		1	1	3	U			D	58	1			.	
														.	
Chum Salmon	221		1	1	3	M				52	1	2	4	1.55	

Page _____ of _____ for transmission Ver. 09

Figure 11-19 Examples of length and specimen data documentation from a pollock catcher vessel

FISH MEASUREMENT AND SPECIMEN COLLECTION: Reviewing Forms for Errors

Cruise	Permit	Length and Specimen Form										Page <u>3</u> of _____				
20670	2345	Observer name <u>Hali Herring</u>					Vessel name <u>Irish Lord</u>									
Resubmission (Circle All Changes)																
Species Name	Species code	Haul no.	Offload No.	Sample or Sub-Sample no.	Sample system	Sex	Crabs		Halibut		Length	Freq.	Specimen Data			
							Eggs? Y/N	Viability (raw/pot) Injury (Longline)	Specimen Type	Specimen Number			Weight	Maturity		
Chum Salmon	221		1	1	3	M					38	11			.	
Chum Salmon	221		1	1	3	M					42	8			.	
Chum Salmon	221		1	1	3	M					43	13			.	
Chum Salmon	221		1	1	3	M					44	9			.	
Chum Salmon	221		1	1	3	M					45	1			.	
Chum Salmon	221		1	1	3	M					46	8			.	
Chum Salmon	221		1	1	3	M					48	6			.	
Chum Salmon	221		1	1	3	M					49	6			.	
Chum Salmon	221		1	1	3	M					51	2			.	
Chum Salmon	221		1	1	3	M					53	6			.	
Chum Salmon	221		1	1	3	M					54	5			.	
Chum salmon	221		1	1	3	M					55	1			.	
Chum Salmon	221		1	1	3	M					56	1			.	
Chum Salmon	221		1	1	3	M					57	2			.	
Chum Salmon	221		1	1	3	M					60	3			.	
Chum Salmon	221		1	1	3	M					61	3			.	
Chum Salmon	221		1	1	3	M					62	7			.	
Chum Salmon	221		1	1	3	M					63	6			.	
												Page _____ of _____ for transmission		Ver. 09		

Cruise	Permit	Length and Specimen Form										Page <u>4</u> of _____				
20670	2345	Observer name <u>Hali Herring</u>					Vessel name <u>Irish Lord</u>									
Resubmission (Circle All Changes)																
Species Name	Species code	Haul no.	Offload No.	Sample or Sub-Sample no.	Sample system	Sex	Crabs		Halibut		Length	Freq.	Specimen Data			
							Eggs? Y/N	Viability (raw/pot) Injury (Longline)	Specimen Type	Specimen Number			Weight	Maturity		
Chum salmon	221		1	1	3	M					64	2			.	
Chum Salmon	221		1	1	3	M					65	4			.	
Chum Salmon	221		1	1	3	M					67	6			.	
Chum salmon	221		1	1	3	F					41	10			.	
Chum salmon	221		1	1	3	F					42	7			.	
Chum salmon	221		1	1	3	F					43	2			.	
Chum salmon	221		1	1	3	F					44	4			.	
Chum salmon	221		1	1	3	F					45	4			.	
Chum salmon	221		1	1	3	F					46	7			.	
Chum salmon	221		1	1	3	F					47	6			.	
Chum salmon	221		1	1	3	F					48	8			.	
Chum salmon	221		1	1	3	F					49	8			.	
Chum salmon	221		1	1	3	F					50	6			.	
Chum salmon	221		1	1	3	F					51	5			.	
Chum salmon	221		1	1	3	F					53	3			.	
Chum salmon	221		1	1	3	F					54	7			.	
Chum salmon	221		1	1	3	F					55	4			.	
												Page _____ of _____ for transmission		Ver. 09		

Figure 11-19 Examples of length and specimen data documentation from a pollock catcher vessel

Cruise 20670	Permit 2345	Length and Specimen Form								Page <u>5</u> of <u> </u>							
Resubmission (Circle All Changes)		Observer name <u>Hali Herring</u>				Vessel name <u>Irish Lord</u>											
Species Name	Species code	Haul no.	Offload No.	Sample or Sub-Sample no.	Sample system	Sex	Crabs		Halibut		Specimen Data						
							Eggs? Y/N	Viability (rawl/pot)	Length	Freq.	Specimen Type	Specimen Number	Weight	Maturity			
Chum salmon	221		1	1	3	F				56	2						
Chum salmon	221		1	1	3	F				57	3						
Chum salmon	221		1	1	3	F				67	3						
Chinook salmon	222		1	1	3	M				53	3						
Chinook salmon	222		1	1	3	M				55	2						
Chinook salmon	222		1	1	3	M				56	4						
Chinook	222		1	1	3	M				59	5						
Chinook	222		1	1	3	M				60	2						
Chinook	222		1	1	3	M				61	4						
Chinook	222		1	1	3	M				62	3						
Chinook	222		1	1	3	M				63	4						
Chinook	222		1	1	3	M				64	2						
Chinook	222		1	1	3	M				65	6						
Chinook	222		1	1	3	M				66	3						
Chinook	222		1	1	3	M				68	1						
Chinook	222		1	1	3	M				69	4						
Chinook	222		1	1	3	M				70	2						

Page _____ of _____ for transmission Ver. 09

Cruise 20670	Permit 2345	Length and Specimen Form								Page <u>6</u> of <u> </u>							
Resubmission (Circle All Changes)		Observer name <u>Hali Herring</u>				Vessel name <u>Irish Lord</u>											
Species Name	Species code	Haul no.	Offload No.	Sample or Sub-Sample no.	Sample system	Sex	Crabs		Halibut		Specimen Data						
							Eggs? Y/N	Viability (rawl/pot)	Length	Freq.	Specimen Type	Specimen Number	Weight	Maturity			
Chinook salmon	222		1	1	3	M				71	1						
Chinook salmon	222		1	1	3	M				75	1						
Chinook salmon	222		1	1	3	F				56	1						
Chinook salmon	222		1	1	3	F				57	2						
Chinook salmon	222		1	1	3	F				58	2						
Chinook salmon	222		1	1	3	F				59	7						
Chinook salmon	222		1	1	3	F				60	4						
Chinook salmon	222		1	1	3	F				61	5						
Chinook salmon	222		1	1	3	F				62	5						
Chinook salmon	222		1	1	3	F				63	3						
Chinook salmon	222		1	1	3	F				64	6						
Chinook salmon	222		1	1	3	F				65	2						
Chinook salmon	222		1	1	3	F				66	3						
Chinook salmon	222		1	1	3	F				67	4						
Chinook salmon	222		1	1	3	F				68	3						
Chinook salmon	222		1	1	3	F				69	2						
Chinook salmon	222		1	1	3	F				73	1						

Page _____ of _____ for transmission Ver. 09

Figure 11-19 Examples of length and specimen data documentation from a pollock catcher vessel

If the predominant is Atka Mackerel...	<u>Sex/Lengths:</u>	<u>Otoliths (taken from s/l fish):</u>	<u>Other Biological Data:</u>
Then Take: ↑	~ 20 Atka Mackerel	2 pairs if directed fishery for Atka	none
Any From Another Species? ↑	20 from Dark/Dusky Rockfish	4 pairs if Atka is the predominant bycatch	none
How Often? ↑	Every Sampled Haul	Every Sampled Haul	none
If the predominant is Bering Sea Flatfish...	<u>Sex/Lengths:</u>	<u>Otoliths (taken from s/l fish):</u>	<u>Other Biological Data:</u>
Then Take: ↑	~ 16 of the most predominant species in the list, chosen by rank in cases of equal predominance	4 otolith pairs, taken from these ~ 16 s/l fish	none
Any From Another Species? ↑	~ 4 from any other species on the list	1 otolith pair, taken from these ~ 4 s/l fish	none
How Often? ↑	5 from skates of any species	none	none
Every Sampled Haul	Every Sampled Haul	Every 5th Sampled Haul	Every Sampled Haul
If the predominant is Rockfish...	<u>Sex/Lengths:</u>	<u>Otoliths (taken from s/l fish):</u>	<u>Other Biological Data:</u>
Then Take: ↑	~ 20 of the most predominant species in the list, chosen by rank in cases of equal predominance	5 otolith pairs, taken from these ~ 20 s/l fish	none
Any From Another Species? ↑	~ 8 from any other species on this list	2 otolith pairs, taken from these ~ 8 s/l fish	none
How Often? ↑	Every Sampled Haul	Every Sampled Haul	Every Sampled Haul
If the predominant is Skates...	<u>Sex/Lengths:</u>	<u>Otoliths (taken from s/l fish):</u>	<u>Other Biological Data:</u>
Then Take: ↑	~ 20 skates identified to species	none	sex/length/weights from the most predominant species in your sex/length collection
Any From Another Species? ↑	none	none	none
How Often? ↑	Every Sampled Haul	Every Sampled Haul	Every Sampled Haul

* For flatfish and rockfish predominant hauls, take biological samples only from those species that are in the species ranking list. If the predominant species in your sample is not in this list, sample from the next most predominant species that *is* in this list.

Figure 11-20 Length and Otolith Priority List for Bering Sea/Aleutian Islands Vessels

Length and Otolith Priority List for Gulf of Alaska

Determine the predominant species in your sample, then consult the block for that species. If the predominant species in your sample is not in this 2 page chart, sample from the next most predominant species that **is** in this chart

If the predominant is Gulf of Alaska Pollock...		Sex/Lengths:	Otoliths (taken from s//fish):	Other Biological Data:
Then Take: ↑	~ 20 pollock		4 pairs	none
Any From Another Species? ↑	none		none	none
How Often?	Every Sampled Haul		Every Sampled Haul	
If the predominant is Pacific Cod...		Sex/Lengths:	Otoliths (taken from s//fish):	Other Biological Data:
Then Take: ↑	~ 20 Pacific cod		2 pairs	none
Any From Another Species? ↑	~ 10 from Shortraker/Rougheye		2 Shortraker/Rougheye otolith pairs	none
How Often?	5 from skates of any species		none	none
	Every Sampled Haul		Every 10th Sampled Haul	Same as Otoliths
If the predominant is Sablefish (aka Black Cod)...		Sex/Lengths:	Otoliths (taken from s//fish):	Other Biological Data:
Then Take: ↑	~ 20 Sablefish		3 pairs	none
Any From Another Species? ↑	~ 10 from Shortraker/Rougheye		2 Shortraker/Rougheye otolith pairs	none
How Often?	~ 5 from Giant Grenadier (grenadier are measured from tip of snout to insertion of first anal fin ray!)		none	none
	Every Sampled Haul		Every Sampled Haul	
If the predominant is Atka Mackerel...		Sex/Lengths:	Otoliths (taken from s//fish):	Other Biological Data:
Then Take: ↑	~ 20 Atka Mackerel		4 pairs	none
Any From Another Species? ↑	~ 20 from Dark/Dusky Rockfish		none	none
How Often?	Every Sampled Haul		Every Sampled Haul	

Figure 11-21 Length and Otolith Priority List for Gulf of Alaska Vessels

<u>Sex/Lengths:</u>	<u>Otoliths (taken from s/l fish):</u>	<u>Other Biological Data:</u>
<p>Sex/Lengths:</p> <p>~ 20 of the most predominant species in list, chosen by rank in cases of equal predominance</p>	<p>Otoliths (taken from s/l fish):</p> <p>5 otolith pairs, taken from these ~ 20 s/l fish</p>	<p>Other Biological Data:</p> <p>none</p>
<p>~ 20 s/l except for otolith hauls. Choose another species from the list to s/l on otolith hauls.</p>	<p>NO OTOLITHS FROM ARROWTOOTH! Choose another species on the list for otolith hauls.</p>	<p>none</p>
<p>5 from skates of any species</p>	<p>none</p>	<p>none</p>
<p>Every Sampled Haul</p>	<p>Every 5th Sampled Haul</p>	
<p>Sex/Lengths:</p> <p>~ 20 of the most predominant species in the list, chosen by rank in cases of equal predominance</p>	<p>Otoliths (taken from s/l fish):</p> <p>5 otolith pairs, taken from these ~ 20 s/l fish</p>	<p>Other Biological Data:</p> <p>none</p>
<p>~ 8 from any other species on this list</p>	<p>2 otolith pairs, taken from these ~ 8 s/l fish</p>	<p>none</p>
<p>Every Sampled Haul</p>	<p>Every Sampled Haul</p>	
<p>Sex/Lengths:</p> <p>~ 20 skates identified to species</p>	<p>Otoliths (taken from s/l fish):</p> <p>none</p>	<p>Other Biological Data:</p> <p>sex/length/weights from the most predominant species in your sex/length collection</p>
<p>none</p>	<p>none</p>	<p>none</p>
<p>Every Sampled Haul</p>	<p>Every Sampled Haul</p>	<p>Every Sampled Haul</p>

* For flatfish and rockfish predominant hauls, take biological samples only from those species that are in the species ranking list. If the predominant species in your sample is not in this list, sample from the next most predominant species that **is** in this list.

National Marine Fisheries Service/Fisheries Monitoring and Analysis Division

Version 2009

Figure 11-21 Length and Otolith Priority List for Gulf of Alaska Vessels

Length and Otolith Priority List for Plants and Floating Processors

Collect only from unobserved vessels (*sablefish deliveries are an exception: if an observed vessel delivers live sablefish, collect lengths and ages on them if the vessel observer was unable to do so). For each sampled delivery, consult the appropriate ranking list below: if the predominant species in your sample is not in the below species lists (by region), sample from the next most predominant species that *is* in the list.

Bering Sea or Gulf of Alaska Roundfish...

Species List
 Sablefish *
 Rockfish (all species)
 Pollock
 Pacific cod (non-trawl)

Bering Sea Flatfish...

Species List
 Yellowfin Sole
 N/S Rocksole
 Turbot (Greenland)
 Flathead Sole
 Alaska Plaice

Gulf of Alaska Flatfish...

Species List
 N/S Rocksole
 Flathead Sole
 Rex Sole
 Dover Sole
 Arrowtooth Founder

	<u>Sex/Lengths:</u>	<u>Otoliths (taken from s/l fish):</u>	<u>Other Biological Data:</u>
How Often Do You Collect Data?	At least 4 deliveries per day, no more than 150 - 200 s/l per day	At least 4 deliveries per day, maximum of 25 pair per day	
How Many? if only one of the species in the list is predominant then:	collect ~ 20 from the species in the list that is most predominant	collect 5 otolith pairs, taken from these ~ 20 s/l fish	none
if more than one of the species in the list is predominant then:	collect ~ 20 from each species in the list that are predominant, up to 3 species	collect 2 pairs from each s/l species, up to 3 species	none
What if it's a Gulf flatfish delivery and the predominant species is arrowtooth?			
if arrowtooth is the only predominant then:	collect ~ 20 from arrowtooth	DO NOT collect otoliths from arrowtooth	none
Any from another species?	~ 20 from another species on the list	collect 5 otolith pairs from the s/l fish of the other species	none
if arrowtooth is one of several predominant species then:	collect ~ 20 from arrowtooth	DO NOT collect otoliths from arrowtooth	none
Any from another species?	~20 from other predominant species on the list, up to 2 species	collect 2 pair from each of the other s/l species	none

FISH MEASUREMENT AND SPECIMEN COLLECTION: LENGTH and SPECIMEN FORM QUICKLIST

<u>LENGTH AND SPECIMEN FORM QUICKLIST</u>		
<u>Specimens</u>		<u>Halibut Assessments</u>
<u>Specimen Types (SP indicates special project)</u>	<u>Maturity Scan Codes</u>	<u>On Trawlers and Pots</u>
1 - Otoliths	1 - Immature	E - Excellent
2 - Salmon scales	2 - Developing	P - Poor
3 - Lengths-weight sample	3 - Pre-spawn	D - Dead
4 - Fin Clips (SP)	4 - Spawning	U - Unknown
5 - Vertebrae (SP)	5 - Spent	<u>On Longliners</u>
6 - Spines (SP)	6 - Resting	1 - Minor
7 - Maturity Scan (see list in next column for scan codes)		2 - Moderate
8 - Maturity (SP)		3 - Severe
9 - Stomach (Standard project - refer to "STOMACH COLLECTION" beginning on 15-1)		4 - Dead/Sand Fleas/ Bleeding
10 - Isotopes (SP)		9 - Unknown
11 - Other Tissue (SP)		
<u>Sample Systems</u>		
1 - Stratified		
2 - Random		
3 - Other		
4 - Size selected		
5 - Opportunistic		

Figure 11-23 List of codes and truncated meanings for Length and Specimen Form

FISH MEASUREMENT AND SPECIMEN COLLECTION: LENGTH and SPECIMEN FORM QUICKLIST

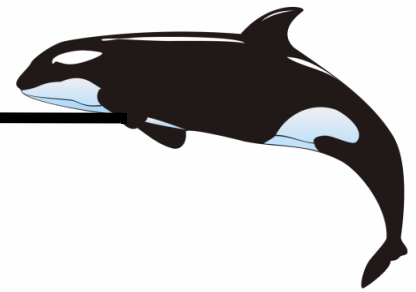

MARINE MAMMAL INTERACTIONS AND SIGHTINGS

Table of Contents

List of Priorities	12-1
Introduction.....	12-1
Marine Mammal Protection Act	12-1
Marine Mammal Monitoring	12-2
Random Sampling.....	12-2
Marine Mammal Interactions	12-2
Entering Interaction Data on the MMIS Form	12-3
Marine Mammal Specimens	12-5
Photos	12-5
Collection of Pinniped Snouts (Except Walrus)	12-6
Collection of Pinniped Skulls (Except Walrus).....	12-6
Measurements of Dead Marine Mammals.....	12-7
Tissue Collection from Dead Cetaceans	12-7
Tissue Collection from Dead Cetaceans	12-7
Entering Specimen Data on the MMIS Form	12-8
Comment Entries on the MMIS Form	12-9
Tagged and Branded Marine Mammals.....	12-10
Intentional Feedings	12-10
Marine Mammal Sightings	12-10
Marine Mammal Sighting Instructions	12-11
List of codes and truncated meanings for MMIS Form.....	12-17

LIST OF PRIORITIES

- Record marine mammal interaction data.
- Record marine mammal specimen data.
- Record marine mammal sightings.

INTRODUCTION

Alaskan waters support one of the largest fisheries in the world and are home to a vast number of marine mammals. Interactions between fishing operations and marine mammals are unavoidable. Observers provide estimates of marine mammal mortality and other interactions due to fishing operations. Vessel owners and operators are required to submit reports of marine mammal injury and mortality that occur as a result of fishing operations. The Observer Program’s independent data help determine the reliability of these reports. Observer data are also used to identify changes

in fishing methods or technology that may increase or decrease incidental injury or mortality to marine mammals.

Marine mammal sighting data collected for the National Marine Mammal Laboratory (NMML) by observers provide important information on the distribution and behavior of marine mammals in Alaskan waters. There are several species in the Gulf of Alaska and Bering Sea which are threatened or endangered, and information on these animals is of great interest.

MARINE MAMMAL PROTECTION ACT

The Marine Mammal Protection Act of 1972 (MMPA) was most recently reauthorized in 1994. In passing the MMPA in 1972, Congress found that:

- certain species and population stocks of marine mammals are, or may be, in danger of extinction or depletion as a result of human activities

MARINE MAMMAL INTERACTIONS AND SIGHTINGS: Marine Mammal Monitoring

- such marine mammal species and population stocks should not be permitted to diminish beyond the point at which they cease to be a significant functioning element in the ecosystem of which they are a part, and, consistent with this major objective, they should not be permitted to diminish below their optimum sustainable population level
- measures should be taken immediately to replenish any species or population stock which has diminished below its optimum sustainable level
- marine mammals have proven themselves to be resources of great international significance, aesthetic and recreational as well as economic

The MMPA established a moratorium, with certain exceptions, on the taking of marine mammals in U.S. waters and by U.S. citizens on the high seas, and on the importing of marine mammals and marine mammal products into the United States. As a NMFS certified observer you are authorized, under provision 50 CFR 229.7 of the Federal Code of Regulations, to take and possess marine mammal specimens (see page 18-16). The only specimen samples you should ever have in your possession are pinniped snouts or skulls and/or tissue samples from cetaceans. ***Do not collect other bones, or parts as specimens.*** They are not needed and will be discarded. Walrus and sea otters are under the jurisdiction of the U. S. Fish and Wildlife Service and you are not allowed to possess any specimen material from them. Possession of any part of a walrus or sea otter is a federal offense.



Sea otters are listed as “threatened” and both NMFS (Sustainable Fisheries) and USFWS should be notified of any incidental takes.

MARINE MAMMAL MONITORING

The role of observers under the MMPA is to conduct statistically reliable monitoring of fishing operations and to record information on all interactions between fishing operations and marine mammals. Observers are asked to determine sex and measure the length of any marine mammal found dead in the catch. If possible, observers should take photographs of any marine mammal involved in an interaction. If Steller sea lions, northern fur seals or elephant seals are found dead in the catch, observers are required to collect the upper

snout including the upper canine teeth, which are used for age and stock determinations. If possible, the entire skull of small seals should be collected to aid in identification. Observers are also asked to collect tissue samples from any large cetaceans captured and killed in fishing operations. Interaction and specimen data are recorded on the Marine Mammal Interaction and Specimen (MMIS) Form.

Random Sampling

To provide statistically reliable information, you must randomly select which hauls are to be monitored for incidental take of marine mammals. If there is any doubt in your mind that you will not be able to monitor all of the hauls during a trip, you must use a method to randomly select the hauls to be monitored. To select which hauls to monitor, use the Random Sample Table and monitor the same hauls you sample for composition. For information on using the RST, see page 2-10. Indicate which hauls or sets you have monitored for marine mammals in the appropriate column on the Observer Haul Form. You may monitor additional sets, but if there are any marine mammal interactions, you must indicate in the remarks section of the MMIS Form that they are not from randomly selected hauls or sets. In the trawl fishery, where you are unable to watch the entire dumping of a haul, it is acceptable to spot check the dumping and still mark the haul as being monitored 100% for marine mammals. ***If using the spot checking option, you must be certain that you would have seen the discard of a marine mammal had it occurred.***



In the trawl fishery, it is acceptable to spot check haul dumping and mark the haul as 100% monitored for marine mammals.

MARINE MAMMAL INTERACTIONS

The Marine Mammal Interaction and Specimen Form is used to document interactions between fishing operations and marine mammals. This may include marine mammals feeding on fish from longline gear, deterrence from feeding, or catches of marine mammals (whole or parts) in fishing gear. When you record mammal interaction data on the MMIS Form,



the Marine Mammal Sighting Form is not needed. Complete a paper MMIS form on all vessels with or without ATLAS. Interactions include the following:

- **Deterrence Used:** marine mammals are subjected to deliberate actions intended to frighten, harm, or discourage them in order to limit or avoid interaction with fishing operations. The animal may be in direct contact with gear or in very close proximity. Authorized deterrence methods include yelling at the animal, and banging pots or other objects. Whatever method is used, it should not result in the serious injury or mortality of the marine mammal. Log deterrence interactions on the MMIS form even if the deterrence had no affect.
- **Feeding On Catch or Discards:** marine mammal feeding on fish from the fishing gear prior to landing, or feeding on discards. Marine mammals such as killer whales, sperm whales, and sea lions are often seen pulling fish from nets or more commonly from longline gear. On a longline vessel, having marine mammals around the vessel and seeing empty hooks is not necessarily an indication of feeding. Look for fish heads or lips or fish that have been bitten or raked by teeth. Do not record intentional feeding of marine mammals by humans on the MMIS Form unless this occurs in conjunction with other interactions. See “Intentional Feedings” on page 12-10.
- **Entangled in Gear:** marine mammals are entrapped or entangled in fishing gear but escape or are released alive by vessel personnel.
- **Killed by Gear:** marine mammals are killed by entanglement or entrapment in fishing gear during a particular haul or set. The animal is not decomposed and did not show any evidence of death by something other than the fishing gear. Evidence of a fresh kill include free flowing blood or other body fluids and bright red blood or meat. Freshly dead animals can be warm or cold, depending on the length of the tow or set, and the time of death. Rigor mortis is not a good indicator, as the period of time an animal is in rigor can vary greatly depending on its physical condition and the environment.



- **Previously Dead:** an animal was already dead before coming in contact with fishing gear. There may be a putrid, rotted smell; bloating; discoloration of the flesh; or loss of the skin/fur. Vessels often catch bones and/or masses of decomposed flesh; these are also considered previously dead. Look for signs of trauma which may have been caused by something other than the fishing gear (i.e., gunshot wounds, decapitation, skinning.) If you believe that the same dead animal has been caught in the gear more than once, record it each time and indicate in your remarks why you believe it to be the same individual.
- **Lethal Removal:** marine mammals are killed by vessel personnel to prevent serious damage to or loss of gear, catch, or human life. The death of these animals is caused directly by the actions of vessel personnel and not solely through contact with the fishing gear.
- **Killed by Propeller:** marine mammals are struck by the propeller of the fishing vessel and die. This has been observed with killer whales and sea lions feeding on vessel discards.
- **Marine Mammal Boarded Vessel:** marine mammals board the fishing vessel and then escape. Sea lions and seals will infrequently board vessels to look for food or to escape predators.

Entering Interaction Data on the MMIS Form

Fill out the MMIS Form as completely as possible. Complete a paper MMIS form on all vessels with or without ATLAS. If you are unsure about any aspect of the data, write your concerns in the Remarks section of the form. Keep a separate set of forms for each vessel to which you are assigned.

Cruise, Vessel Permit - Enter the cruise number, vessel permit, and the last two digits of the year in the fields at the top left hand corner of the form. Start a new sheet for each vessel to which you are assigned.

Trip/Haul/Offload - Mammal data can be entered at the trip, haul or offload level. Enter the trip, haul or offload number associated with the interaction and/or specimen data. Circle Trip, Haul or Offload as appropriate.

MARINE MAMMAL INTERACTIONS AND SIGHTINGS: Marine Mammal Interactions

Interaction Date - If the interaction is not associated with a haul, record the date with leading zeros where appropriate (*i.e.*, 01/09 for January 9).

Species Common Name - Write the common name of the marine mammal species involved. Be as specific as possible. If you are unsure of the identification use a broader classification, such as unidentified pinniped or unidentified dolphin/porpoise. Do not enter different species in the same record. If more than one species of marine mammal are involved in an interaction, repeat the date and trip/haul/offload number in another data block and enter the second species.

Mammal Code - Record the species code. A list can be found on page A-13. Entries must be two characters.

Total number of animals observed - Enter your best estimate of the number of individual animals in the area when the interaction occurred. If there are more than one species involved in the interaction, each species must have a separate record on the MMIS Form. The number must be an exact number. Do not enter a number range. If you are unsure about how many individuals there are, enter your best estimate and include the number range in the Comments field.

Number of Animals in Interaction - Enter your best estimate of the number of individual animals involved in the interaction. If there were more than one species involved in the interaction, each species must have a separate record on the MMIS Form. The number must be an exact number. Do not enter a number range. If you are unsure about how many individuals there are, enter your best estimate and include the number range in the Comments field.

Did you observe mammal? - Record “Y” if you actually saw the animal, and “N” if you did not.

Interaction Code - Enter the appropriate interaction code from the following Marine Mammal Interaction Codes list. If an animal is involved with more than one interaction during one trip/haul/offload, list them as separate records.

Marine Mammal Interaction Codes

1 - Deterrence Used - Marine mammal was deterred or a deterrence was attempted. Log this interaction using this code even if the deterrence was not successful.

2 - Entangled in Gear (Not Trailing Gear) - A marine mammal was captured by the fishing gear and the animal was released/escaped without fishing gear attached.

3 - Entangled in Gear (Trailing Gear) - A marine mammal was captured by the fishing gear and the animal was released/escaped alive with some fishing gear attached.

4 - Killed By Gear - A marine mammal was captured and died due to interactions with the fishing gear.

5 - Killed By Propeller - A marine mammal hit the propeller and died.

6 - Previously dead - A marine mammal was captured by the fishing gear and was dead prior to coming into contact with the vessel or fishing gear.

7 - Lethal removal (Trailing Gear) - Vessel personnel killed a marine mammal entangled in fishing gear, but death was not due entirely to the entanglement. Gear was observed attached to the animal after the animal was removed from the gear.

8 - Lethal removal (Not Trailing Gear) - Vessel personnel killed a marine mammal entangled in fishing gear, but death was not due entirely to that entanglement. No gear was observed trailing from the animal after the animal was removed from the gear.

9 - Boarded Vessel - A marine mammal boarded the vessel on its own volition.

10 - Feeding on Catch (Not Yet Landed) - A marine mammal was observed feeding on catch not yet landed.

12 - Other - Interaction occurred that is not included in the list of interaction codes.

13 - Unknown - The vessel or vessel personnel had some interaction with a marine mammal, but the observer did not directly view the interaction and/or ascertain what the interaction was.

14 - Feeding on Discarded Catch - A marine mammal was observed feeding on discarded catch.

Condition Code - Record the condition of the mammal based on the outcome of the interaction. For example, a live animal that has been lethally removed is to be

considered a carcass and an injured animal released alive is considered alive even if you believe it may eventually die.

- 1 - Carcass, dead animal
- 2 - Bones other than skull
- 3 - Live animal
- 4 - Skull
- 5 - Skull and bones
- 6 - Tusk/teeth (no skull)
- 7 - Baleen only
- 9 - Fur, flesh or skin

Deterrence Code - Fill in this field only for interactions involving marine mammal deterrence, interaction code 1. Refer to the following list for the code that is most appropriate. If the interaction was not one of deterrence, leave this field blank.

Marine Mammal Deterrence Codes:

- 1 - Seal Bombs** - Any explosive device used to frighten marine mammals from the catch.
- 2 - Pole Gaff** - Using the long pole (typically used by crewman to gaff drop-off catch) to scare off marine mammals either by direct contact or by hitting the water.
- 3 - Skiff** - Any use of a skiff to attempt to frighten off marine mammals.
- 4 - Acoustical device** - Any electronic acoustical device designed to frighten or annoy marine mammals.
- 5 - Yelling** - Crew yelling at marine mammals in order to frighten them from the catch.
- 6 - Making noise by any other method** - Any method, other than yelling, of making noise to annoy or frighten marine mammals from the catch.
- 7 - Other** - Any other means, not listed above, of deterring marine mammals. Include instances when the vessel changed fishing behavior, such as “bagging off” gear on a longliner. Document the method or occurrence in your logbook.
- 8 - Unknown** - If a deterrence method was used but its exact nature is unknown.

If the vessel personnel employed more than one method of deterrence, document this in the Remarks field. Also describe in the Remarks field how the deterrence was conducted.

Deterrence Successful? Fill in this field only for interactions involving marine mammal deterrence, interaction code 1. Otherwise leave this field blank. If you observed that the deterrence worked to deter marine mammals from the catch enter a “Y”. Enter “N” if you observed that the deterrence was unsuccessful. Enter “U” if you are unsure as to the success of the deterrence method.

Food Species - Fill in this field only if you have a marine mammal feeding on catch, interaction code 10. Otherwise leave this field blank. Enter the species code of the species upon which the marine mammals are feeding using the codes starting on page A-1. If the marine mammals are feeding upon more than one species, record the predominant species in the Food Species field and list the other species in the Remarks field.

Location During Trip - Enter the latitude and longitude where the interaction occurred. If you do not have an exact location, make a best estimate for the vessel’s position when the interaction occurred. Do not enter a position if the interaction occurred at the haul level.

MARINE MAMMAL SPECIMENS

The MMIS Form is also used to record specimen data from marine mammals (whole or part) caught in fishing gear. Specimen data can include measurements of the animal or part and/or photographs of the animal.



Before touching a marine mammal remember that there are many diseases that are transferable from marine mammals to humans. Always wear gloves when handling a marine mammal.

Photos

Record any photographs taken of marine mammal interactions with a fishing vessel or vessel personnel on the MMIS Form. When taking photos, try to include distinguishing marks of the individuals; old scars and scratches are useful as well as the saddle patch on orcas. The NMFS flash pocket cameras have been supplied only for photographs of incidental take interactions, photographic records of tissues collection samples



from dead cetaceans, and (when possible) some types of groundfish catch feeding interactions by the same pods of sperm and killer whales. Take photographs of fish damaged by predation when possible. See Method for Tallying Predated Items on page 7-24 in the Longline Data Collection section of this manual for more information on predation. These cameras must be returned to NMFS at the time of debriefing, whether used or unused.



The camera issued with your gear should be used for photos of marine mammals or fish that have been damaged by marine mammals only.

Collection of Pinniped Snouts (Except Walrus)

Do not collect snouts, tusks, or skulls from walrus. They are managed by the US Fish and Wildlife Service and are therefore not covered under our MMPA collection permit.

When Stellar sea lions, northern fur seals or elephant seals are caught and killed or found dead in the fishing gear you must collect upper snouts of these animals, including their canine teeth (see Figure 12-1). Canine teeth of these animals are relatively easy to identify and are used to determine the animals age. Stellar sea lions in the Bering Sea, Aleutian Islands and the western Gulf of Alaska have been listed as endangered species. Data on these animals are greatly needed to assist in determining the causes of this species' decline. Combined with the length data you collect, teeth can help determine the general health of the sea lion population.

If harbor, spotted, bearded, ribbon, or ringed seals are found dead, you should try to collect the entire head. Canine teeth of these smaller animals are difficult to differentiate between species, while the complete skull allows for positive identification. **Entire heads are reported as specimen code 7.** If you cannot collect the entire head, collect the snouts, including upper canines.

Collecting the snout of pinnipeds, including complete canine teeth, requires a hacksaw (which you should be able to obtain from the vessel). Cut across the snout, slightly in front of the eyes, in a line that passes between the second and third post-canine teeth. Do not remove the skin as coloration of fur and whiskers aid in species verification back at the lab.

Preserve the snout by placing it in three of the plastic bags provided by NMFS and freeze it. Place a label, which includes your name, date, cruise number, vessel permit, haul number, species and length of pinniped inside the outer bag and another label on the outside.

Never preserve the snout in formaldehyde. This will destroy the area of the tooth needed for age determination.

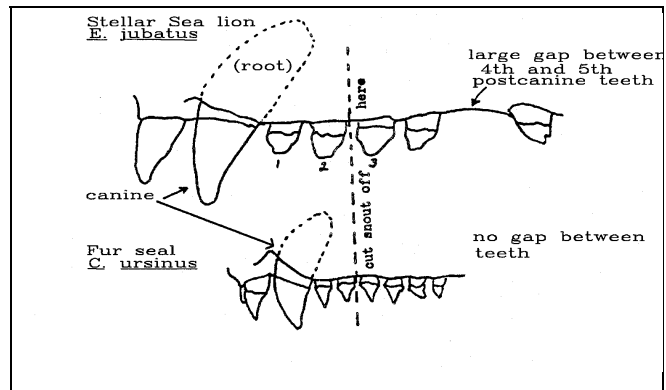

Figure 12-1 Canine Teeth of Sea Lions

Collection of Pinniped Skulls (Except Walrus)

Do not collect snouts, tusks, or skulls from walrus. They are managed by the US Fish and Wildlife Service and are therefore not covered under our MMPA collection permit.

Collecting the skull is often easier than collection of the snout. Determine where the base of the skull is by pressing your fingers along the top of the head until you feel where it ends, or slopes down to its point of attachment with the first vertebra of the neck. Using a sharp knife, cut through the neck muscle about two inches posterior to the base of the skull until you hit neck bone. Using a hacksaw, you can now saw easily through the neck bones. Excess tissue (tongue, trachea, muscle tissue etc.) can be removed from the throat area to reduce weight.

If harbor, spotted, bearded, ribbon, or ringed seals are found dead, you should always try to collect the entire head. Canine teeth of these smaller animals are difficult to differentiate between species, while the complete skull allows for positive identification. If you cannot collect the entire head, collect the snouts, including upper canines. *Snouts are reported as specimen code 2.*

Measurements of Dead Marine Mammals

All dead marine mammals captured during fishing operations must be measured. There are two acceptable methods for measuring marine mammals:

Standard length - This is the preferred method of measurement. It is the length of the animal in a straight line from the tip of the snout or rostrum to the tip of the tail flesh or tail notch on the unskinned body, belly up, ideally with the head and vertebral column on a straight line Figure 12-2. Recorded to the nearest centimeter. Do not record an estimate of length; this field is for actual measurements only. Include length estimates in the remarks section.

Curvilinear length - The shortest surface distance from the tip of the snout or rostrum to the tip of the tail or tail notch along the back, belly, or side. This method is used if rigor has set in or the animal is too large or deteriorated to maneuver. Take the measurements with the flexible measuring tape provided by NMFS. (See Figure 12-2) Recorded to the nearest centimeter. Do not record an estimate of length; this field is for actual measurements only. Include length estimates in the remarks section.

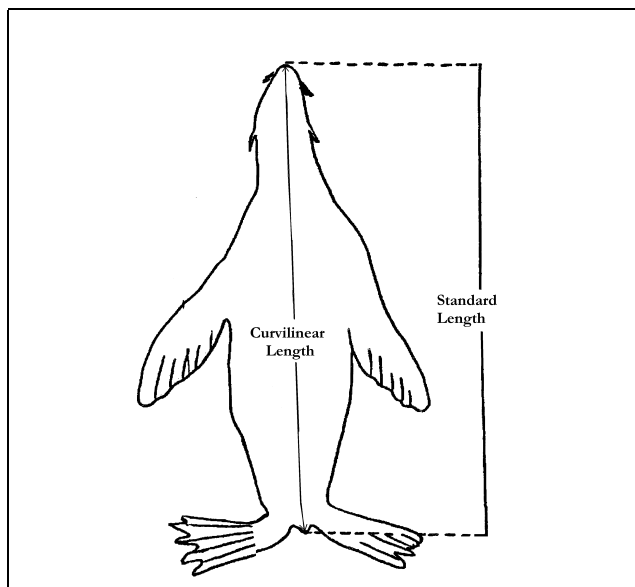

Figure 12-2 Sea Lion and Seal Measurements

Tissue Collection from Dead Cetaceans

Currently, commercial fishing vessels in the Gulf of Alaska and the Bering Sea take several cetaceans per year. Observers have access to cetacean carcasses and can easily collect tissue samples. The National Marine Mammal Laboratory has asked that observers take **two**

tissue samples. A small skin sample and a deeper skin, blubber, and muscle tissue sample. Tissue samples should be taken from all cetacean carcasses regardless of their condition. Specific instructions for each follow.

Cetacean Skin Samples

You have been supplied with a sterile scalpel, a pair of nitrile gloves, and three vials of the preservative Dimethyl Sulfoxide (DMSO). It is preferred that the skin samples be preserved in the vials of DMSO. However, in the event that DMSO vials are unavailable, the skin samples can also be preserved in one of the following ways.

1. The sample can be frozen
2. The sample can be placed in an otolith vial filled with a saturated salt solution
3. The sample can be placed in a plastic bag and covered with table salt.

Skin samples not stored in DMSO are of lesser value but still extremely useful to NMML. Samples collected in this manner will undergo genetic analysis to identify cetacean stock structure.

Warnings about DMSO!

Dimethyl Sulfoxide has exceptional solvent properties for organic and inorganic chemicals and is widely used as an industrial solvent. It has also been used to administer drugs topologically. DMSO is able to penetrate intact skin and will carry anything dissolved into it directly to the blood stream. Side effects from DMSO include nausea, headache, and skin rash. Further, since DMSO is a “carrier” chemical, it could deliver harmful substances into the bloodstream if they are present in impure DMSO or on the skin. Great care should be taken when handling DMSO and you should never allow it to come into contact with your skin. Always wear the nitrile gloves provided when handling DMSO.

To collect a sample:

1. After recording length data for the MMIS Form, exchange your fishing gloves for the non-latex (nitrile) gloves provided by NMML. This is to protect you from possible disease and to protect the sample from you. Any DNA contamination from any mammal may compromise the sample. Do not use latex gloves while handling DMSO.

2. Lightly scrape the sample area on the cetacean clean with a knife to remove fish slime and reduce contamination of the sample. The sample collection area can be anywhere on the animal, but preferably from the back just posterior to the dorsal fin.

3. Using a sterile scalpel cut out a strip of skin approximately 2 cm by 1 cm. Remove any excess blubber from the strip before placing it in the vial of DMSO. Place the skin sample in the vial of DMSO provided. Try not to take a large sample, the skin sample must fit in the DMSO vial and be completely covered by solution.

4. Label each specimen vial with the specimen number, cruise number, vessel permit, haul number, and species name. There should be no more than one specimen to a vial. If there is more than one animal in a haul the skin samples should all be listed as separate specimens, placed in separate vials, and labeled accordingly. Record interaction and specimen information on the MMIS Form. Include in the Remarks section how you obtained the specimen.

Do not freeze DMSO samples, store them at room temperature. More vials of DMSO, gloves, and sterile scalpels can be obtained at the field offices in Dutch Harbor and Kodiak.

Cetacean Deep Tissue Sample

The deeper tissue samples will be analyzed for contaminant, fatty acid, and stable isotope profiles. The resultant chemical profiles will give us information not only about the animal itself but also about their prey.

1. To collect the deep tissue sample: Cut a 2 inch square of tissue from the dead carcass just below and behind the dorsal fin. The depth of the sample should be from the outer skin layer into the muscle layer, including the entire blubber layer, and include at least 1-inch depth of red muscle tissue.

2. To store this second tissue sample, wrap it in aluminum foil if some is available, or seal it in a ziploc bag (aluminum foil is preferred). Place this sealed bag or foil package inside another ziploc bag with a label (list your cruise #, vessel permit number, date, and haul number). ***This sample should be frozen and kept frozen to the best of your abilities during transit.***

Entering Specimen Data on the MMIS Form

The columns under the 'Specimen Data' heading must be filled out in those instances that you collected a specimen. Each specimen taken from an animal is entered separately, with its own unique specimen number. If specimens were taken from more than one animal, the data is entered in a separate data block for each animal. This is the case even if the animals were involved in the same interaction. There are five specimen types that can be recorded on the MMIS Form: length, sex, snout or skull collection, tissue collection, and photos taken.

Animal Number - Animal number is not the same as specimen number! Animal number is used to designate the animal from which a specimen was collected. When there are multiple animals involved in a single interaction, and multiple specimens taken, you use animal number to indicate which animal supplied the specimen. For each interaction, number animals beginning with 1. See Figure 12-7 for an example.

Specimen Number - Enter the specimen number for the specimen taken. Number specimens consecutively starting with the number one. Specimen numbers must be unique for the vessel! Do not repeat specimen numbers while on the same vessel.

Specimen Type - Enter the appropriate code for the specimen type taken from the animal. Codes are as follows:

- 1 - Photo
- 2 - Snout
- 3 - Non-DMSO Tissue
- 4 - Standard Length
- 5 - Curvilinear Length
- 6 - DMSO Tissue
- 7 - Skull

Sex - Record the sex of the individual for which a specimen was collected. In cetaceans, the distance between the anus and the genitals is greater in males. Otherwise, the sexes appear similar because both have external teats, and females have an enlarged clitoris. In pinnipeds, sex can easily be determined by spreading the hind flippers and lifting the tail. Females have two holes (the anus and vaginal opening) between their flippers and males have only one.

Sexing of marine mammals is not difficult. See diagrams in Figure 12-3 to view the morphological differences between male and female pinnipeds and cetaceans.

Value - Photo, standard length and curvilinear length specimen codes must have a corresponding value entry.-

- | | |
|------------------------|--|
| If Specimen code is: | the Value code is: |
| 1- photo | => # of photos taken |
| 4 - standard length | => standard length of mammal in centimeters |
| 5 - curvilinear length | => curvilinear length of mammal in centimeters |

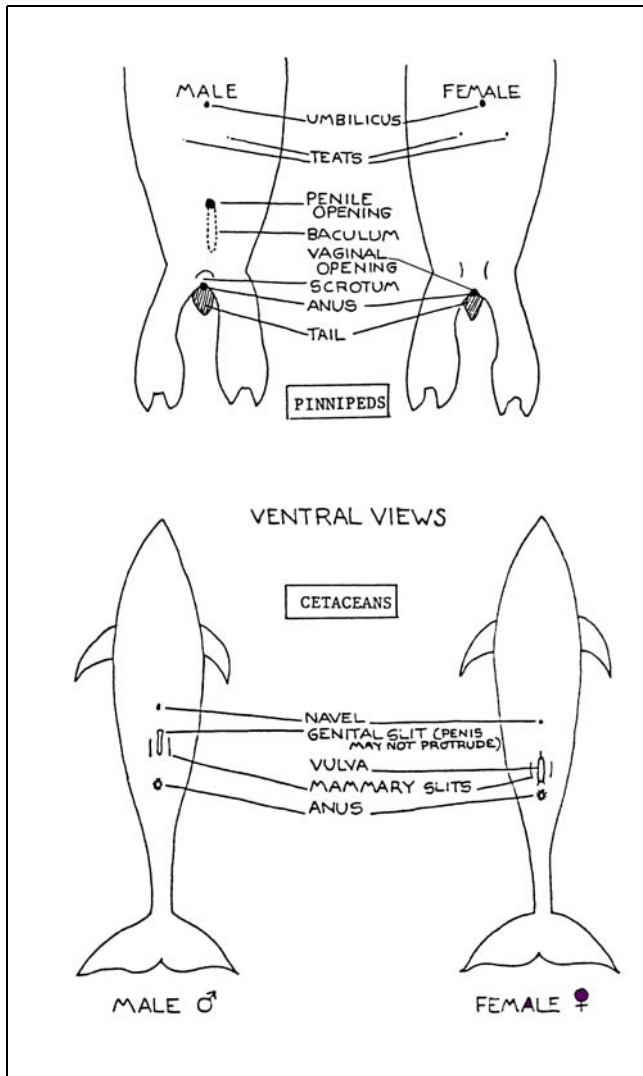

Figure 12-3 Diagram of Pinnipeds and Cetacean Sex Differentiation

COMMENT ENTRIES ON THE MMIS FORM

Write a paragraph describing the interaction. If you did not observe the animal, briefly explain why not and mention where you received your information. Each remark must include the following:

- **Species Identification** - Write a description of the animal and what features led you to believe it was this species. Document any distinguishing characteristics of the individual animal that would help differentiate it from others of its species (i.e., saddle patches in killer whales, spots and scars on other marine mammals).
- **Description of Interaction** - Write a description of the interaction you observed between the vessel and the marine mammal. Be as descriptive as possible. Include names of crew members involved and their actions. In the logbook or on the paper MMIS Form, draw pictures of rare or unusual marine mammal species involved in interactions. Note if there was evidence of marine mammals or cetaceans following the vessel from a previous set or staying with the vessel during the soak time. For feeding interactions, describe the evidence of feeding and proximity of the whales to the vessel. If there was evidence of gear depredation please list the following:
 - Type of bait being used
 - Target species
 - Species of the depredated fish
 - How many hooks had heads only remaining
 - The size of gashes (in cm) found on the fish
 - Total # of fish with evidence of predation
- How sex was determined
- Uncertainties you have concerning the data, if any
- If a snout, skull or tissue specimen was collected, a description of the specimen, your collection method, and your method of storage
- **Condition of the Animal** - Write a description of the general welfare of the animal (e.g., did it look healthy, injured, rotting?).

MARINE MAMMAL INTERACTIONS AND SIGHTINGS: Tagged and Branded Marine Mammals

- **Injured?** - If the condition code of the mammal was code 3, for 'live animal', check whether or not the animal appeared injured. This field is only filled in if the interaction involves a live animal, otherwise, the field is left blank. If there is an interaction with a live animal, record "Y" if you actually observed the animal to be injured, enter "N" if you observed the animal to be uninjured, or "U" if you are unsure as to the condition of the animal.



Any comments not directly related to the specimen data, such as cooperation or hindrance by the crew, should be recorded in your logbook. Reference the trip/offload or haul number to which the comments pertain.

TAGGED AND BRANDED MARINE MAMMALS

The National Marine Mammal Laboratory and several other state and federal programs have on-going projects tracking marine mammals. To do this, they place a tag or brand on the marine mammal. Radio and/or satellite tags have been affixed to Steller sea lions, northern fur seals and elephant seals as well as several species of cetaceans. Flipper tags are also placed on several species of pinnipeds. Commonly brands are found on the side or back of pinnipeds.

If you observe one of these animals, record the tag or brand numbers, color of the tag or marking, and the location of the marking/tag in the daily notes section of your logbook. Also include behavior and the latitude and longitude of where it was observed. A Marine Mammal Sighting Form (see page 12-14) should also be filled in with all pertinent information.

If the animal is killed in the catch, retrieve the tag, and/or record the numbers, color, and location of the marking, and retrieve any research instrumentation/attachments affixed to the animal to return to the NMML. Record length and sex information from the animal. If it is a pinniped, collect the snout or skull, if it is a cetacean, collect a tissue sample. These animals are being tracked for population assessments so any extra information you can provide will greatly help researchers at NMML.

INTENTIONAL FEEDINGS

Under the Marine Mammal Protection act, it is illegal to intentionally feed any marine mammal in the wild. Intentional feeding is considered a form of harassment. If you observe anyone intentionally feeding a marine mammal, you should document the incident fully in your logbook. Please include the name(s) of the person/people involved in the incident, a description of the marine mammal, and a summary of where and how the violation occurred.

MARINE MAMMAL SIGHTINGS

The Marine Mammal Sighting Form helps NMML determine the distribution and behaviors of marine mammals. Data from these forms are integrated into the NMML Platforms of Opportunity database, which has information on marine mammals from throughout the North Pacific Ocean. The Marine Mammal Sighting Form is not only used by the Observer Program but is also given to the U.S. Coast Guard, research ships, and marine mammal enthusiasts on commercial and private vessels. Marine mammal sighting is the lowest priority observer responsibility. These forms should be completed only if it does not interfere with any of your other observer duties.



If you have time, NMML is interested in every species of marine mammal that you encounter. We have provided a marine mammal identification manual to assist you in making identifications. If you are unable to positively identify an animal, then please indicate so on the form. Records of unidentified animals tend to lend credence to those records that include identification. Give a complete description with comprehensive notes and sketches, to fully describe any species you encounter for the first time each cruise.

For more common species (*e.g.*, Dall's porpoise), you do not need to give detailed descriptions of subsequent sightings within one cruise. If sighting involves unusual behaviors or warrants some extra description (*e.g.*, humpback whales mating), give a detailed account.

Marine Mammal Sighting Instructions

Fill out the Marine Mammal Sighting Form as completely as possible. The more information you provide, the more useful the data is to NMML in determining species ranges.

Observer(s), Vessel - Write your name and your vessel's name in these blanks.

Date - Enter year (*e.g.*, 05), month, and day, in that order.

Time - Log the time that the animal was first seen. Use Alaska Local Time (ALT).

Latitude - Record the latitude to tenths of minutes, if possible.

Longitude - Record longitude to tenths of minutes, if possible. Place E or W in box 26.

Sighting conditions - Give a qualitative evaluation of the overall sighting conditions. Excellent: unlimited visibility, flat seas. Good: sighting conditions affected somewhat by glare, sea state, weather, or distance. Fair: Sighting conditions affected by a combination of problems, *e.g.* heavy seas, poor weather, or distance. Poor: Severely limited visibility due to high seas, poor weather, or distance.

Beaufort Scale- Use the scale of sea and wind conditions (listed on the back of the form) to choose the Beaufort scale number that best describes the conditions during your sighting.

Surface water temperature - Record water temperature in degrees centigrade, rounded off to the nearest whole degree. If below freezing, place a “-” in box 28. If above freezing, place “+” in box 28. The surface water temperature often can be obtained from the skipper or fish master. Many new sonars, plotters, and net detectors will also record the surface water temperature. You could also ask the engineer, surface water temperature is taken at the engine inlet thermometer. The conversion from Fahrenheit to Centigrade is: $C^{\circ} = (5/9)(F^{\circ} - 32)$

Species - Write in either the common or scientific name of the marine mammal. Make sure you indicate your level of confidence in your species identification by checking the boxes to the right of the species section. If more than one species are sighted at the same time, note any association in the comments

section and fill out a separate sighting form for each species. If you cannot determine species, enter the most accurate description possible, (*e.g.*, large whale unidentified, porpoise unidentified, pinniped unidentified, etc.). Remember that an inaccurate or erroneous identification is worse than none at all.

Sighting cue - Note what first attracted your attention to the presence of the marine mammal.

Closest approach - Note the distance in meters of the closest approach of the marine mammal. A table of equivalents for converting English to metric is found on page A-15.

Number sighted - Give the best estimate of the number of individuals observed. If you are unable to count all the animals with certainty, estimate the number seen in terms of range (*e.g.*, Best estimate: 15, minimum present: 12, Maximum present: 20) For Dall's porpoise, note if you see splashes from more animals than you can clearly observe.

Cruise number and Vessel Permit - At the bottom of the page, enter the cruise number and vessel Permit.

Body Length Estimate - Check the box that best represents the length of the animal(s) you observed.

Some common behaviors

- Circle all of the behaviors observed during this sighting. For a list of behaviors, (see Figure 12-4 on page 12-13).



Narrative and Sketches

These sections are the most important sections of the form and should be completed with as much detail as possible. Everything that you observed about the animal should be entered. There are several important points that you should address to verify the species and individual marine mammal:

- **Shape and size of dorsal fin and its position on the body** - This is useful in identifying cetaceans. Also note the size and shape of the tail and flippers.
- **Length of animal** - Size is difficult to estimate at sea, so compare unfamiliar species with a species with which you are familiar. You may also compare an animal to a known length on the ship.
- **General shape of the body** - Slender or robust?

- **Shape and size of snout** - Is it long or short? Estimate the length. Is there a definite beak? Is the forehead markedly bulbous?
- **Color patterns on the fins and body** - Look for spots, stripes, patches, or mottling. With Orca sightings, make sure to note the exact shape and shade of the saddle spot on dorsal side directly posterior to the dorsal fin. If possible, try to take a photo of this area. Researchers are able to identify individual Orcas by the saddle patches.
- **Shape, location, and direction of blow** - In cetaceans, note whether the blow is single or double. Note where the blowhole is located on the head and whether it goes forward or goes straight up. Note the general shape of the blow, is it bushy or tall?
- **Scars and scratch marks** - Look for scars or scratch marks that will help identify the individual mammal or help determine its past behaviors. Some seals will have hook scars on their snouts and a number of Orcas may have bullet wounds on the dorsal fins. This will help NMML determine migratory patterns and determine behaviors of individual marine mammals.

Behaviors of animals - Describe in detail the behaviors of the animals observed. If there are several animals, describe how they interact with each other. Describe their diving behavior, and whether the animals were attracted to the vessel because of fishing operations. Were they feeding on discarded fish and fish parts? If so, this should be recorded as a marine mammal interaction.

Silhouettes - On the back of the Marine Mammal Sighting Form are a number of silhouettes of the common marine mammals found in the North Pacific Ocean and Bering Sea. For each sighting, circle the silhouettes that best represent the mammal you observed.

REVIEWING FORMS FOR ERRORS

To facilitate the debriefing process you *must* check forms throughout your cruise rather than at the last minute just before your debriefing interview. Observers who regularly review their data at sea generally benefit by having shorter, smoother debriefings. Observers who do not review their data throughout their cruise generally find themselves in lengthy debriefings and with time consuming corrections. It is much easier to check a couple of pages each day over the course of three months than to check a couple hundred pages of data all at once! Follow the guidelines below when reviewing your data for errors.

Check Marine Mammal Interaction and Specimen Forms For:

- The “Remarks” block includes: features used in identifications; details of the incident; for specimen data, methods of measuring or sexing; for an animal or specimen, its condition
- All codes used are correct
- All specimens have a specimen number and all specimen numbers are unique for the interaction

Check Marine Mammal Sighting Form For:

- Make sure all the non-shaded boxes are complete, including cruise # and vessel permit
- Identifying characteristics are described in detail
- For repeated sightings on the same day, you have at least one sighting form per day

Small Cetaceans	Large Cetaceans	Pinnipeds
<p>Bow riding-- Animals swim beside the bow or in the bow wave of a moving vessel.</p> <p>Leaping entirely out of the water-- Animal jumps fully clear of the surface of the water (as opposed to merely breaking the surface of the water), not for forward locomotion but for other reasons (known only to them).</p> <p>Porpoising-- Animal raises its body to be nearly or fully out of the water while traveling forward at a fast rate of speed, usually in a fluid, arching motion.</p> <p>Rooster-tailing-Animal surfaces at high speed creating a spray of water in front and over the top of the animal which looks like a rooster's tail. Usually seen only in Dall's porpoise.</p> <p>Slow rolling-- Animal comes to the surface to breathe, with the blowhole and dorsal area usually showing, and then rolls back underwater.</p>	<p>Blow visible from a distance-- Blow can be seen from more than 500 meters away. Usually only seen in certain large cetaceans.</p> <p>Breaching-- Used for larger cetaceans (orca sized and larger). The whale accelerates forward underwater and then jumps free of the water, sometimes fully clearing the water's surface, and then lands on the surface of the water, creating a large splash.</p> <p>Flipper slapping-- Whale floats or swims at the surface, turns on its side and slaps one pectoral fin against the water, either once or several times in quick succession.</p> <p>Group feeding-- Seen primarily in humpback whales, when they coordinate feeding by lunging out of the water with their mouths open, engulfing fish and water.</p> <p>Lob-tailing-- Whale raises its tail flukes up out of the water and slaps them down against the surface with great force. This may occur once or be repeated many times.</p> <p>Spy-hopping-- Whale is vertical or upright in the water and raises its head up out of the water, usually with its eye showing.</p> <p>Tail raised on dive-- When diving, the whale's entire tail lifts completely above the water before going underwater.</p> <p>Side and stern wake riding-- Whale is riding in the wake created midships along the side of the vessel, or the wake created by the stern.</p>	<p>Jug handle-- Seal or sea lion floats on its side with one front flipper and one rear flipper above the water, creating what looks like a handle.</p> <p>Porpoising-- Pinniped is swimming fast, jumping at least partially out of the water in fluid, arching motions. This swimming pattern resembles that of dolphins or porpoises seen at a distance.</p> <p>Rafting-- A group of pinnipeds resting at the surface together.</p> <p>Spooked from haulout-- Pinnipeds which had been resting on beach, rocks or ice, dove into the water due to your vessel's interaction with them.</p> <p>Vocalizing-- Pinniped making directed noises at you or at another pinniped.</p>



Figure 12-4 Marine Mammal Behavioral Descriptions

Form 11US

MARINE MAMMAL SIGHTING



NOAA/NMFS/AFSC/NMML
Platforms of Opportunity
7600 Sand Point Way NE
Seattle, WA 98115

Observer(s) JACKSON OBSERVER Vessel FISHNESS IV

year month day local time (24 hr. clock)

0	7	0	5	2	4	1	2	:	4	0
---	---	---	---	---	---	---	---	---	---	---

latitude N/S

5	5	4	3	1		N
---	---	---	---	---	--	---

longitude E/W sighting conditions Beaufort +/- water temp.

1	7	1	2	6	2	W	<input checked="" type="checkbox"/> fair	<input type="checkbox"/> good	<input type="checkbox"/> fair	<input type="checkbox"/> poor	1	+	5	0	3	°C
---	---	---	---	---	---	---	--	-------------------------------	-------------------------------	-------------------------------	---	---	---	---	---	----

species (common and/or scientific name) Please fill out a form for each species confidence
HUMPBACK WHALE sure likely unsure

sighting cue
Saw flipper slap water about 50 m off port

closest approach number sighted (best) number (minimum) number (maximum)

5	0	1	1	1
---	---	---	---	---

For Office Use Only

observer

48	49	50	51	52	53	54	55	56	57	58	59
----	----	----	----	----	----	----	----	----	----	----	----

platform vis. species conf.

60	61	62	63	64	65	66	67
----	----	----	----	----	----	----	----

sighting cue photos roll frames

68	69	70	71	72	73	74	75	76	77	78
----	----	----	----	----	----	----	----	----	----	----

behaviors, cues and interactions

79	80	81	82	83	84	85	86	87	88	89	90
----	----	----	----	----	----	----	----	----	----	----	----

behaviors, cues and interactions length multi

91	92	93	94	95	96	97	98	99	100	101
----	----	----	----	----	----	----	----	----	-----	-----

Narrative

Make identifications only on specific features seen. Mention them here. Include body features, markings and coloration, associated organisms, elaborate on behaviors, etc. The most valuable sightings contain a good amount of detailed information.

Estimated size about 40 ft, dark coloration except for undersides of flukes and flippers. Saw dorsal fin at same time as blow and blow was tall and broad. Whale dove twice in 10 minutes, and on last dive, flukes were visible. At one point, whale slapped water with flipper. Photos taken.

Body Length Estimate

- < 3 m (< 10')
- 3-8 m (10-25')
- 8-16 m (25-50')
- 16-26 m (50-80')
- >26 m (>80')

Some common behaviors (circle these or add your own in narrative section)

Small cetaceans

- Bow riding
- Leaping entirely out of water
- Porpoising (swimming fast, body out of the water)
- Rooster-tailing (usually a Dall's porpoise cue)
- Slow rolling

Large cetaceans

- Blow visible from a distance
- Breaching
- Flipper slapping
- Group feeding
- Lob-tailing
- Spv-hopping
- Tail raised on dive
- Side wake riding
- Stern wake riding

Pinnipeds

- Jug handle (flippers in air)
- Porpoising (swimming fast, at least partially out of the water)
- Rafting
- Spooked from haulout
- Vocalizing

Fishing Interactions ?

Use form 10US

Sketches

When possible, make a sketch noting pigmentation, anatomical features, scarring, posture, anatomical anomalies, group positioning, etc.

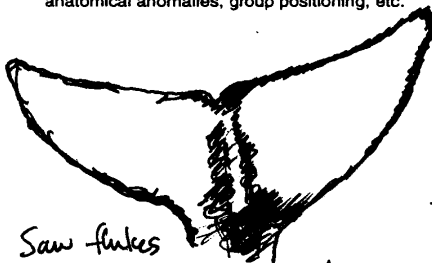

Saw flukes on last dive: underside mostly white with black edging.



Relatively small dorsal fin, dark body color.

Photos/Video (optional)

photographs
 video
 roll/tape # Personal camera
 frame(s) 1-6

Check here if there was more than one species of marine mammal present at this sighting.

cruise number and vessel code

9	2	6	3	3	1	2	0
---	---	---	---	---	---	---	---

Form 11US: ver. IX.98: Balla, Harkness, Hill, Folkens, Lowell, Mizroch

See silhouettes on other side

Figure 12-5 Form 11US - Marine Mammal Sighting Form Example (front side)

MARINE MAMMAL INTERACTIONS AND SIGHTINGS: Reviewing Forms for Errors

These are silhouettes of most genera of marine mammals known to occur in and around North America. Subtleties exist between closely related genera. Care should be taken in identifying species. Assessing one's level of confidence with copious notes and observations is more valuable than a brief misidentification. **Please circle appropriate silhouette(s).**

Common cetacea surface silhouettes (not to scale)

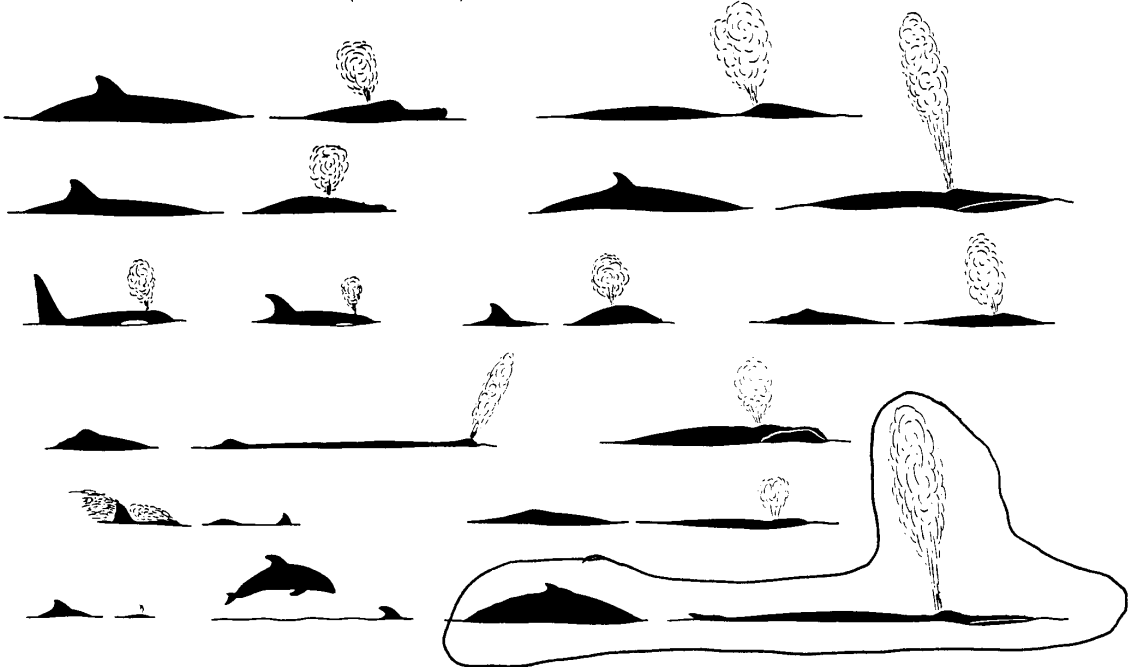

Common other marine mammal surface silhouettes (not to scale)

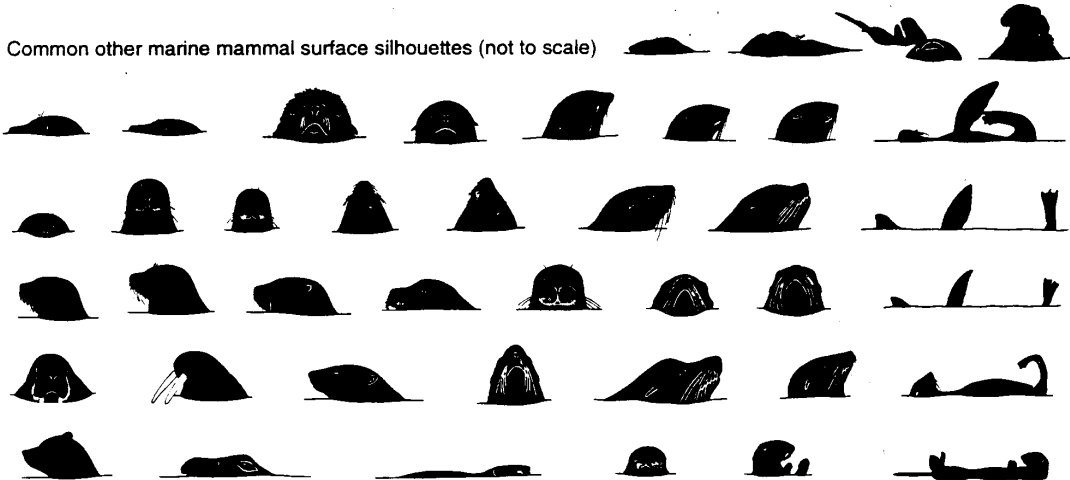

BEAUFORT SCALE (Sea Condition)	wind	wave height
0 glassy, calm	0, 1 kts	calm
1 light ripple	1 < 4 kts	light air 1/4'
2 small wavelets	4 < 7 kts	light breeze 1/2'
3 scattered whitecaps	7 < 11 kts	gentle breeze 2'
4 small waves, frequent whitecaps	11 < 17 kts	moderate breeze 4'
5 moderate waves, many whitecap	17 < 22 kts	fresh breeze 6'
6 all whitecaps, some spray	22 < 28 kts	strong breeze 10'
7 breaking waves, spindrift	28 < 34 kts	near gale 14'
8 medium high waves, foamy streaks	34 < 41 kts	gale 18'
9 high waves, dense foamy streaks	41 < 48 kts	strong gale 22'
10-12 not meaningful (time to go home)		

Figure 12-6 Form 11US - Marine Mammal Sighting Form Example (back side)

Cruise	Permit
17092	4567

Marine Mammal Interaction and Specimen Form

Resubmission
(Circle All Changes)

Page 1 of 1

Observer name Paul Glengary Vessel name Oracle

Trip <input checked="" type="radio"/> Haul <input type="radio"/> Offload <small>(circle one)</small>	Interaction Date		Species Common Name	Mammal code	Total number animals observed	Number of animals in interaction	Did you observe mammal?	Interaction code	Condition Code	Deterrence code	Deterrence successful?	Food species	Location during Trip							Specimen Data				
	Month	Day											Latitude (N)			Longitude				Specimen number	Animal number	Specimen type	Sex	Value
													Deg	min	sec	Deg	min	sec	E/W					
	Comments: (see manual for list of required information)																							
13			Dall's Porpoise	PX	5	1	Y	4	1									1	1	1	M	5		
During the retrieval of haul 13, I saw 4-5 Dall's porpoise swimming around the vessel as the net came up. A freshly dead porpoise was caught in the intermediate portion of the pelagic trawl net. There were no visible signs of trauma other than frothy blood in the mouth. The individual was black in color, with white belly and flanks. It had a small stocky body with small flippers and flukes. The animals in the water were making roostertail splashes. Photos and 2 blubber samples taken, 1 frozen, 1 in DMSO.																	2	1	6	M				
																	3	1	3	M				
																	4	1	4	M	201			
																	5	1	5	M	241			
For condition code 3 was animal injured? YONO <u>U</u> O																								

Trip <input checked="" type="radio"/> Haul <input type="radio"/> Offload <small>(circle one)</small>	Interaction Date		Species Common Name	Mammal code	Total number animals observed	Number of animals in interaction	Did you observe mammal?	Interaction code	Condition Code	Deterrence code	Deterrence successful?	Food species	Location during Trip							Specimen Data				
	Month	Day											Latitude (N)			Longitude				Specimen number	Animal number	Specimen type	Sex	Value
													Deg	min	sec	Deg	min	sec	E/W					
	Comments: (see manual for list of required information)																							
2	03	15	Stellar Sea Lion	ET	1	1	Y	14	3				53	54	29	166	31	40	W					
While waiting outside port to finish processing before offload, a M. stellar sea lion feasted on the discards from the vessel. Most of the discard was heads and entrails. The animal was large, nearly ten feet long with robust body. It was light brown in color and had a thickened neck with obvious ears and large Susital crest. He fed for about an hour before leaving.																								
For condition code 3 was animal injured? YON <u>●</u> UO																								

Figure 12-7 Marine Mammal Interaction and Specimen Form Example

MARINE MAMMAL INTERACTION AND SPECIMEN FORM QUICKLIST				
<i>Interaction Codes</i>	<i>Condition Codes</i>	<i>Deterrence Codes</i>	<i>Specimen Type</i>	<i>Value</i>
1 - Deterrence Used	1 - Carcass, dead animal	1 - Seal Bombs (any explosive)	1 - Photo	[number of photos]
2 - Entangled in Gear (Not Trailing Gear)	2 - Bones other than skull	2 - Pole Gaff	2 - Snout	null
3 - Entangled in Gear (Trailing Gear)	3 - Live animal	3 - Skiff	3 - Non-DMSO Tissue	null
4 - Killed By Gear	4 - Skull	4 - Acoustical device	4 - Standard Length	[standard length in cm]
5 - Killed By Propeller	5 - Skull and bones	5 - Yelling	5 - Curvilinear Length	[curvilinear length in cm]
6 - Previously dead	6 - Tusk/teeth (no skull)	6 - Noise by any other method	6 - DMSO Tissue	null
7 - Lethal removal (Trailing Gear)	7 - Baleen only	7 - Other	7 - Skull	null
8 - Lethal removal (Not Trailing Gear)	9 - Fur, flesh or skin	8 - Unknown		
9 - Boarded Vessel				
10 - Feeding on Catch (Not Yet Landed)				
12 - Other				
13 - Unknown				
14 - Feeding on Discards				

Figure 12-8 List of codes and truncated meanings for MMIS Form

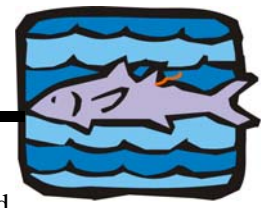

TAGGED FISH AND CRAB INFORMATION

When tagged fish or crabs are encountered, the tag (except from live king crab) and pertinent biological information should be collected and the capture location should be recorded. Do not interrupt your normal sampling to take this information unless it is convenient. If you are busy completing other tasks simply put the tagged fish or crab aside and collect the information after your sample is complete. Collecting information from tagged fish or crabs does not take precedence over other sampling duties, but is an important part of your job.

LIST OF PRIORITIES

- Identify tagged organism to species.
- Collect pertinent biological data and capture location.
- Complete tagged fish information form.

INTRODUCTION

Fish and crabs are tagged for a variety of reasons. Currently there is research being conducted on fish migration, stock separation, fishing related mortality, and population dynamics. These studies are being conducted by the International Pacific Halibut Commission, NMFS, the University of Washington, and the Alaska Department of Fish and Game. Data from tagged fish and crabs is vital to the success of these studies and observer data is an excellent way for fishery biologists to obtain this information.



Species that have been tagged include Atka mackerel, black rockfish, Pacific cod, Pacific halibut, Pacific sleeper sharks, pollock, sablefish, salmon, shortspine thornyhead, turbot, yellowfin sole, Alaska skates, big skates, and king crab. These species may have an external tag on the dorsal surface or on the gill cover, or they may have an internal tag in the snout of the fish. Most external tags consist of a monofilament strand covered in

brightly colored plastic, which is attached to the fish either as a loop or through an anchoring mechanism such as a barbed tip. Tag ID numbers and contact information are usually printed on the tag. On larger

individuals, *e.g.*, skates and sharks, tags may not be immediately obvious. Some fish may have other types of tags, such as plastic discs or plates.

When you arrive at a plant or vessel you should inform the crew that tagged fish or crabs should be saved for you. Also stress to the crew that tags are often useless if they are returned without accompanying information on the capture location and biological attributes (particularly size). If vessel or plant personnel give you an external tag or an externally tagged animal you should write down the person's name and address so they can receive a reward for returning the tag. If you are given just the tag without the animal, collect as much information as possible about the animal. For example, find out what species the tag was from, where it was caught, what haul it was in. Observers cannot collect rewards for tags they submit, so if you find an externally tagged fish or crab in your sample list the captain as the person who found it.

ELECTRONIC TAGS



While spaghetti tags serve only to mark a fish, electronic tags capture data while they are on the fish. Most collect depth and water temperature, providing information about fish behavior and marine environmental conditions. These tags are very expensive and large monetary awards are usually offered for their return. Observers are not eligible for these awards. If you are given one of these tags by a crew member, make sure

that you obtain all contact information required on the Tagged Fish and Crab Form!

TAGGED CRAB

King crabs are tagged with external spaghetti tags which are found inbetween the abdominal flap and the posterior edge of the carapace. If you find a live tagged king crab, record the pertinent information, but do not remove the tag. King crab should be released with the tag intact so they can be captured and identified again. If you find a dead king crab, remove the tag and return it to NMFS with the pertinent information.

TAGGED FISH AND CRAB INFORMATION: Tagged Salmon

After you have collected the necessary information from your specimen, you need to record it on the Tagged Fish Form (see Figure 13-1). For the most part, the form is self explanatory. Be clear and concise in your descriptions, and affix the tag to the form. Remember to include the tag serial number on the form. Often, tags are lost in processing and without a copy of this information, the rest of the data on the form are useless.

TAGGED SALMON

Tagged salmon usually have internal coded wire tags inserted into their snouts but may have external disc shaped tags as well. Coded wire tags are about 1 mm in length, have a distinct code, usually a series of slashes at different intervals engraved in them, and are inserted into the snout of an animal. Salmon with coded wire tags can be identified by a missing or clipped adipose fin. Collect scale samples from all tagged salmon (see “Scale Sample Collection” on page 10-8).

To remove the salmon snout, make a cut one centimeter behind the eye down through the head to the base of the upper jaw. You do not need to include the lower jaw since tags are placed in the upper snout.



Once you have removed the salmon snout, fill out the Coded-Wire-Tagged Salmon Form and keep it with the snout. Please be sure to document where your salmon came from - “in sample” or “outside of sample” in the other comments section of the form. For any salmon snouts collected from deliveries, fill out the snout tag with only the NMFS area where you think the salmon was caught, and not a latitude and longitude. Note whether the adipose fin was missing.



You do not fill out a Tagged Fish Form for tagged salmon. The snout tag replaces the form

Place the snout and form in one of the bags you were issued and put several handfuls of table or rock salt in the bag. Periodically, drain off any liquid that accumulates in the bag and change the salt. If no salt can be found, you can freeze the snout.



Remember to get frozen snouts out of the freezer before you disembark.

See the below example for how to complete these labels.

Coded-Wire Tagged Salmon Form			
Observer Name: <u>Ann Chovie</u>	Cruise No. <u>8242</u>	Vessel / Plant Code <u>P053</u>	Haul / Delivery No. <u>14</u>
Vessel or Plant Name: <u>Aleutian Processor</u>			
Species Name: <u>Chinook Salmon</u>	Species Code: <u>222</u>		
Which Fin Missing?: <u>Adipose</u>	None		
Date of Capture: <u>2/13/07</u>	Time of Capture:	Depth (F): <u>55</u>	
Capture Location: Latitude (N):		Longitude:	E / W
NMFS or ADF&G Area: <u>541</u>	<small>(if lat / long is unknown)</small>		
Source of Capture Information: <u>vessel logbook and fish ticket</u> <small>(e.g. vessel log, navigation equip., crew member, plant personnel, etc...)</small>			
Sex: <u>F</u>	Gonad Maturity (immature, mature, spawning): <u>mature</u>		
Length (cm): <u>71</u>	Weight (kg): <u>3.7</u>		
General Appearance (poor body condition, good body condition): <u>good body condition</u>			
Other Comments: <u>scale envelope # 2, CWT special project - fish # 12</u> <u>from outside sample</u>			

National Marine Fisheries Service / North Pacific Groundfish Observer Program / 2005

TAGGED FISH AND CRAB FORM INSTRUCTIONS

Complete a Tagged Fish and Crab form for every tag that you find or is given to you. Try to complete as much information as possible, and remember that capture location and size are critical pieces of information. If a crew member gives you only a tag (instead of the fish), ask them for the information needed. Any information that can be used to estimate a capture location is valuable (even if it is a very rough estimate, such as a NMFS statistical area).

Cruise Number, Vessel/Plant Permit, Haul/Offload Number, Gear Type: Your cruise number will be given to you during training or briefing, or by your employer. Vessel/plant permits are listed on page A-25. Enter the haul or offload number from which the tagged fish was found. Enter the gear type for the vessel.

Observer Name and Vessel/Plant name, NMFS Permit No.: Write your full name and the name of the vessel on the lines provided at the top of the form. Vessel/plant permits are listed on page A-25.

Reward Recipients Name and Shipment Address: The recipient's name and address are important fields on this form. Tagging agencies provide incentive gifts such as hats and t-shirts to encourage participation in these programs. Most programs using electronic tags offer monetary reward. The recipient's address should be a permanent address, not the address of a processing plant. Tag rewards are often sent 3-6 months after you turn in the paperwork!

Species and Tag Prefix Number: Enter the species name for the tagged fish and record the numbers (if readable) on the tag.

Captains Signature and Printed name: Ask the captain to sign and print his name. If the captain does not want to provide a signature, the FMA may not be able to release the tag and associated data to the tagging agency.

Date of Capture, Time of Capture, Depth, Capture Location, NMFS area, Source of Information: Record capture information to the best of your ability.

If you found the tag during the sample, this information can be taken from the vessel logbook and your haul forms. If the tag was found by a crew member you may be able to use to the logbook information if the tag was a recent discovery. However, it is common for crew to give an observer tags encountered during unobserved trips. In these situations any information the crew can provide is beneficial to the data user.

Sex, Gonad Maturity, Length, Weight, General Appearance, Condition of Tagging Wound, Comments: If you have the fish in hand, record this information. Determining the maturity level is subjective. A spawning fish will be releasing eggs or sperm when squeezed. A mature fish will have gonads that are easily observed and have substance, where a immature gonad may be hard to distinguish from other organs. If you were given only the tag and did not have a chance to examine the fish record this in the comments section.

Tag and Otolith Vial: Remove the otoliths and tape the vial to the fish form along with the tag. If the tagged fish was a randomly selected otolith specimen the otoliths should stay with the data set and not be included with the tag. Record only the vial number instead.

Tagged Fish and Crab Form

Cruise No.	Vessel / Plant Permit	Haul / Offload No.	Gear Type
26420	12345	Haul 14	8 - longline catcher

Observer Name: WALLY OBSERVER

Vessel / Plant Name: FISHY II

Reward Recipient's Name: JOHN J. SKIPPER
(Vessel or Plant Personnel)

Reward Shipment Address: 555 W. 55th AVE
ANCHORAGE, AK.
99513

Species: SABLEFISH Tag Prefix and Serial No.: BC9622726
(e.g. PCA 00392)

I authorize NMFS to provide this form and the tag to the tagging Country/Agency

John J. Skipper
(Captain/Owner Signature)

John J. Skipper
(Captain/Owner Printed Name)

Date of Capture: 03-22-10 Time of Capture: 1430 Depth (F): 280

Capture Location: Latitude (N): 53°39.55' Longitude: 164°34.61' E/W

NMFS or ADF&G Area: _____ (if Latitude / Longitude is unknown)

Source of Capture Information: Vessel Log
(e.g. vessel log, navigation equipment, crew member, plant personnel, etc.)

Sex: MALE Gonad Maturity (immature, mature, spawning) MATURE

Length (cm): 71 Weight (kg): 3.8

General Appearance (poor body condition, good body condition): good body condition

Condition of Tagging Wound (healthy healed tissue, open wound): open w/ no infection

Other Comments: only one otolith recovered, vial # 16740

Tape tag and otolith vial here:



Figure 13-1 Tagged Fish and Crab Form (example)

Halibut

If fish is alive:

- remove tag
- measure fish
- weigh fish if possible
- note body condition
- note condition of tagging wound
- fill in remaining information on Tagged Fish and Crab Form

If fish is dead:

- remove tag
- measure fish
- weigh fish if possible
- collect otoliths, determine sex
- note body condition
- note condition of tagging wound

- fill in remaining information on Tagged Fish and Crab Form

Salmon

If fish is alive or dead:

- measure fish
- weigh fish
- collect scales (see “Scale Sample Collection” on page 10-8)
- determine sex
- collect salmon snout
- fill out a tagged salmon information tag and place in bag with snout

King Crab

If crab is alive then:

- *do not remove tag*
- write down tag number
- measure crab
- weigh crab
- determine sex

- determine condition
- release crab
- fill in remaining information on Tagged Fish and Crab Form

If crab is dead then:

- remove tag
- measure crab
- weight crab
- determine sex
- fill in remaining information on Tagged Fish and Crab Form

All Other Tagged Roundfish and Flatfish

If fish is alive or dead:

- remove tag
- measure fish
- weigh fish
- collect otoliths
- determine sex
- note body condition
- note condition of tagging wound
- fill in remaining information on Tagged Fish and Crab Form

Figure 13-2 Duties for Tagged Fish and Crabs

Sharks and Skates

If shark is alive or dead:

- remove tag
- record recovery location
- determine sex (sharks and skates are sexually dimorphic and gender can be determined by external features)
- note condition of tagging wound
- fill in remaining information on Tagged Fish and Crab Form

Figure 13-2 Duties for Tagged Fish and Crabs



BIRD SIGHTINGS AND INTERACTIONS

Table of Contents

List of Priorities	14-1
Introduction	14-1
Incidental Take	14-3
Injured Seabirds	14-3
Species Composition	14-4
What To Do with Birds in your Samples	14-4
Dead Bird Identification	14-3
Tag and Bag Procedures for Retained Seabird Specimens	14-4
Seabird Avoidance Initiatives	14-5
Albatross.....	14-2
Eiders	14-2
Murrelets and Kittiwakes	14-3
Seabird Avoidance Initiatives	14-5
Reducing Seabird Bycatch	14-5
Monitoring Avoidance Measures	14-5
Other Seabird Interactions and Mortality	14-7
Vessel Strikes	14-7
Seabird Interactions with Trawl Gear.....	14-7
Documenting Seabird Interactions	14-7
Banded Birds	14-7
Sightings of Species of Interest	14-8



- Record sightings of species of interest.
- Record other seabird mortality.

INTRODUCTION

Seabirds in Alaska are managed by the U.S. Fish and Wildlife Service (USFWS), under the authority of the Endangered Species Act (ESA) and the Migratory Bird Treaty Act (MBTA). The National Marine Fisheries Service and the USFWS cooperate to obtain information on the mortality of birds in groundfish fisheries in the Gulf of Alaska and the Bering Sea. Of special interest are six species whose populations are very small, or are declining, referred to here as “species of interest.”



The “species of interest” are: short-tailed albatross, red-legged kittiwake, Steller’s eider, spectacled eider, marbled murrelet and Kittlitz’s murrelet.

LIST OF PRIORITIES

- Record takes of short-tailed albatross, red-legged kittiwakes, Steller’s and spectacled eiders, and marbled and Kittlitz’s murrelets.
- Rehabilitate injured endangered and “species of interest” seabirds.
- For dead endangered and/or “species of interest” seabirds, collect specimen.
- Record takes of all birds inside your species composition sample.
- Record takes of all banded and tagged birds.

Endangered and threatened species status are federal designations of populations that may become extinct if steps are not taken to ensure their continued existence.

BIRD SIGHTINGS AND INTERACTIONS: Species of Interest

Among the species of interest, the short-tailed albatross is endangered and the Steller's and spectacled eiders are threatened throughout their ranges.

In addition to recording incidental take, you may have the opportunity to record sightings of species of interest, report leg bands found on dead birds, document collisions of birds with the vessel superstructure, and report the methods vessels are using to reduce seabird bycatch. The collection of information on incidental takes of birds is critical, and is accomplished as part of your species composition sampling. Information on species of interest is also of high priority. All other bird duties are of low priority but the data are valuable if they can be collected.

Observer data are crucial for the management of seabirds by the USFWS. The USFWS is able to review data collected by observers by accessing the Observer Program's database and copies of appropriate observer logbook pages (Seabird Daily Notes), which are provided several times a year. NOAA Fisheries analyzes your data each year and completes estimates of total seabird incidental take by species. These data are reported annually to the North Pacific Fisheries Management Council through the Ecosystem Chapter of the Stock Assessment and Fishery Evaluation (SAFE) report and through other venues to make the data readily available to managers, scientists, the fishing industry and the environmental community.

SPECIES OF INTEREST

The six species of interest fall into four groups of marine birds: albatross, kittiwakes, murrelets and eiders. These birds are of special interest because some of the populations are very small or are declining. Reliable and accurate identification, to the species level where possible, is the goal for birds in these groups. In addition, there are special requirements for the endangered or threatened bird species.

Albatross



Three species of albatrosses occur in Alaskan waters: Laysan, black-footed, and short-tailed. The short-tailed albatross is an endangered species and it appears that the black-footed albatross are in decline. In

2001, the population estimates for each species were

approximately: 2.3 million Laysan, 250,000 black-footed and 1,600 short-tailed. Observers are required, under the Endangered Species Act (ESA), to report all short-tailed albatross takes and to save all dead individuals for return to NMFS. You must report *any* catches of short-tailed albatross, not only those in your species composition sample. If you are at all unsure about your identification, *bring the specimen back* and experts at NMFS and the USFWS will determine the identification. Follow the procedures for collecting specimens on page 14-4. If you cannot bring back the entire carcass, *bring back at least the head!*

The current ESA Biological Opinion allows for four short-tailed albatross mortalities over a two-year period in the groundfish longline fleet and two short-tailed albatross mortalities over a five year period for trawlers. Industry participants have mistakenly viewed this as a strict quota that, if exceeded, would close the longline fishery. In actuality, if this level of take were to occur, NMFS would initiate consultation with the USFWS. Staff would reevaluate the take limit based on changes in albatross populations, fishing patterns, and other variables. While one possible result would be a fishery closure, other actions are much more likely, such as raising the mortality level or changing seabird avoidance requirements.

Eiders



Four species of eiders occur in Alaskan waters. Two of these species, the spectacled and Steller's eiders, are listed as threatened under the

ESA. Although these birds are highly unlikely to be taken by gear, they may strike vessels. Bird strikes and bird storms (numerous strikes in a short time period), seem to occur in association with bad weather, low ambient light, and the use of bright ship lights. You need to report all bird strikes involving spectacled and Steller's eiders. Include the following in your Seabird Daily Notes: the number of birds involved, species, sex (eiders are sexually dimorphic), weather conditions, time of strike and location (latitude and longitude). In addition, the ESA requires that you retain all carcasses that can be recovered. Follow the procedures for collecting specimens on page 14-4.

Murrelets and Kittiwakes



Two species of kittiwakes and three species of murrelets commonly occur in Alaskan waters: black-legged and red-legged kittiwakes; and ancient, marbled, and Kittlitz's murrelets. Red-legged kittiwakes, marbled murrelets, and Kittlitz's murrelets are species of interest because of low or declining populations. Make every effort to identify dead kittiwakes and murrelets to species and, if possible, take photos. Retain marbled and Kittlitz murrelets, red legged kittiwakes, and any unidentified murrelet or kittiwake. Follow the procedures for collecting specimens on page 14-4.

INCIDENTAL TAKE

One hundred million marine birds of over 80 species occur in Alaskan waters. These birds spend most of their lives foraging at sea for small fish, squid, and crustaceans. Birds are attracted to fishing vessels because of the presence of readily available food in the form of offal, discard, and bait. The most likely seabird species to be caught in trawl gear are shearwaters and alcids (puffins, murres, etc.). The most likely seabird species to be caught in pots are murrelets and murres.

Birds taken during longline operations are attracted to baited hooks when the gear is set; they become hooked at the surface, are dragged underwater and drown. Other times they get hooked on the line as the gear is retrieved. If any bird comes up on a hook during sampling, regardless of when or how it was hooked, it is considered "caught" and must be included in the species composition sample. The most likely species to be caught in longline gear are northern fulmars and gulls, which constitute more than 70% of bird bycatch. The albatross species and dark shearwaters are also taken regularly, although in much lower numbers. Unidentified seabirds make up the third largest category behind fulmars and gulls.

INJURED SEABIRDS

In most cases the best course of action is to end the birds suffering by following the procedures for euthanizing seabirds (see "Protocols for Handling Injured or Sick Seabirds" on page A-61). It is your option to euthanize the bird and collect it as a specimen, attempt rehabilitation, or return the bird to

the sea. Please note that rehabilitation of *endangered and threatened* species is a top priority, while caring for other species must not interfere with any other observer duties.

DEAD BIRD IDENTIFICATION

Identification of marine birds in the Gulf of Alaska and Bering Sea is not easy - some closely-related species are virtually indistinguishable. The beached birds guide provided to you is a key developed specifically to identify dead seabirds in hand. This guide relies on the characteristics of the bill and feet, rather than plumage, which is often in a state of disarray.

Observers are asked to identify birds to the species level where possible. This is crucial for species of interest and those species that could be confused with species of interest (*e.g.*, black-footed and Laysan albatross). In cases where you do not feel comfortable with your identification, use the appropriate species group. For example, you will not be able to identify immature gulls to species and should instead use the group code for "unidentified gull."

Identifying Dead Birds

- With the seabird in hand, use the *Beached Birds: A COASST Field Guide* to identify the bird to the species level where possible.
- At a minimum, attempt to identify albatross, eiders, murrelets, and kittiwakes to species.
- If you cannot identify a bird to species, do not guess! Key it to the highest taxonomic group to which you are confident.
- Identify gulls, dark shearwaters, and murres to group - *e.g.*, gull unid., dark shearwater unid., and murre unidentified.
- If the bird is a species of interest, or an unidentified albatross, eider, murrelet or kittiwake, follow the "Tag and Bag" procedures below.
- Retain banded or tagged seabirds, following the "Tag and Bag Procedures for Retained Seabird Specimens" on page 14-4.
- Complete a Seabird Species Identification Form for all new species seen, and for *every* species of interest encountered. Also complete this form for any unidentified seabird.

BIRD SIGHTINGS AND INTERACTIONS: Species Composition

- Optional: take photos of a dead seabird with a personal camera, supplemental to completing a species ID form.



Takes of unidentified albatross or short-tailed albatross must be reported to NMFS as soon as possible. Do not use the radio!

SPECIES COMPOSITION

Crewmen may try to throw birds overboard as quickly as possible, as there is a superstition that dead birds on a vessel are bad luck. **Be sure to ask the crew to save all seabirds for you regardless of whether or not you are sampling.** Additionally, many longline fishers are concerned that catching a short-tailed albatross may close their fishery - providing an incentive for not reporting these birds. You must report any seabird that lands in your composition samples and should alert crewman to this fact. For more information on how the Endangered Species Act affects fisheries, see page 14-2.

What To Do with Birds in your Samples

In addition to completing the steps outlined in the “Identifying Dead Birds” section, gather the following information on birds inside your composition samples.

1. Weigh each bird individually using your brass scales or a motion compensated platform scale. Drain as much water as possible from the carcass.



Birds are much lighter than they appear. Weights over 5 kg are extremely doubtful!

2. Look for leg bands, nasal tags, and radio tags. If the bird has any of these, see “Banded Birds” on page 14-7.
3. Find the code for each species or group in the species code list and record species, number, and weight information on the Species Composition Form.
4. For birds that drop off longline gear or are thrown overboard before you have a chance to weigh them, identify them as closely as you can and enter a zero in the weight column for that individual.
5. If you see an albatross fall off the gear or thrown overboard and cannot positively identify it, you **must send a text message or call the field office as soon as possible.** Document all circumstances and details associated with the drop-off or discard in your Seabird Daily Notes.

TAG AND BAG PROCEDURES FOR RETAINED SEABIRD SPECIMENS

Seabird specimens are of high scientific value. The Program requests that you save any dead seabirds from your cruise, regardless of whether the catch was from inside or outside your sample. These specimens provide critical information such as geographic data, genetic make-up, age, sex and reproductive condition to a variety of data requestors, including museums, universities and government agencies.

Most cruises have no bird mortality. Of those that do, usually only one or two birds are taken. If you experience high seabird bycatch, please contact your inseason advisor for direction on which species to retain. Follow the instructions below for retaining seabird specimens:

1. Stuff the mouth and throat of the bird with absorbent material (paper towels, cotton balls, etc.) and secure the beak closed.
2. Place the bird in a plastic bag.
3. For each specimen, record the following information on a tag: cruise number, vessel permit, haul number, sample number if applicable, date of capture, latitude and longitude, species and any other pertinent information. All specimen information on the tag must match the information included in your Seabird Daily Notes.
4. Place tag in the bag and close the bag securely. Place this bag in a second bag and close tightly.
5. Place double-bagged bird in the freezer.
6. Remember to retrieve the bird specimen when you reach port and take to a NMFS office!
7. If you are collecting a specimen of a species of interest or an unidentified albatross, eider, murrelet, or kittiwake, **notify NMFS staff as soon as possible.**



NMFS has provided you with a bird specimen collection permit from the USFWS.

SEABIRD AVOIDANCE INITIATIVES

In 1997, NMFS put into law the requirement that specified longline groundfish fishing vessels must use measures to avoid seabird bycatch. These steps were necessary to mitigate longline fishery interactions with the endangered short-tailed albatross and other seabird species. NMFS revised and improved these regulations based on research work completed in 1999 and 2000, and changes to seabird avoidance measures were implemented in February 2004. The regulations require that vessels using hook-and-line gear in the BSAI/GOA groundfish or Pacific halibut fishery must use the following avoidance measures:

- Vessels over 55 feet in length overall (LOA) are required to use paired streamer lines of specified performance and materials standards. The regulations allow for single or no streamer lines to be used only in the case of severe weather.
- Stop directed discharge (through chutes, pipes or other similar devices) of residual bait or offal from the stern of the vessel while setting gear.
- If offal is discharged while gear is being hauled, it must be in a manner which detracts seabirds from baited hooks - either aft of, or on the opposite side of, the hauling station.
- Prior to offal discharge, embedded hooks must be removed from offal.

The Seabird Avoidance regulations listed here have been summarized. The complete regulatory requirements can be found in the Code of Federal Regulations at 50 CFR 679.24.

Monitoring Avoidance Measures

One of an observer's duties aboard longline vessels is to monitor and record the types of seabird avoidance gear your vessel is using. Randomly check the gear setting operations and record what type of seabird avoidance gear is being used. For more information on how to record this information on the Observer Haul Form, see page 7-11.



A summary of seabird avoidance gear and performance standards begins on page 18-15. *You are not asked to actually measure performance standards.* You are asked to document whether the vessel is in compliance with meeting requirements to deploy streamer lines while setting their gear. You can best do this simply through

a spot check of as many sets as possible, noting the number of streamer lines. There typically should be two but vessels can deploy either one or none depending on wind conditions. Refer to the Beaufort Sea State descriptions on page 14-6 to code wind conditions. Document obvious deficiencies of seabird avoidance gear, differences between the seabird avoidance gear recorded in the vessel logbook and what you observe. If your observation of the gear differs than what is recorded in the logbook, talk with the captain. Document any explanations the captain provides for why avoidance measures were not followed. Follow the instructions beginning on page 18-2.

REDUCING SEABIRD BYCATCH

Observers can play an important role in helping captains reduce seabird bycatch. An easy way to accomplish this is to let the captain know if you encounter seabird bycatch during your regular sampling duties. He may make adjustments to his seabird avoidance gear based on this information. This type of immediate feedback, if the captain is amenable, can be a good measure of performance of the seabird avoidance gear. If you have previously worked on a vessel that had effective seabird avoidance gear, you may assist other fishers by making recommendations based on your experience.

Staff from NMFS, USFWS and Washington Sea Grant Program are also interested in your observations. These agencies have been actively involved with the fishing industry in trying to reduce fishing-related mortalities. Please record any information that you think would be helpful in your Seabird Daily Notes.

BIRD SIGHTINGS AND INTERACTIONS: Reducing Seabird Bycatch

Code	Knots	Air	Sea Description	Code	Knots	Air	Sea Description
0	0	Calm Air	Sea like a mirror	7	28-33	Near Gale	Sea heaps up and white foam from breaking waves begins to be blown in streaks in the direction of the wind.
1	1-3	Light Air	Ripples with the appearance of scales are formed, without foam crests.	8	34-40	Gale	Moderately high waves of greater length; the foam is blown in well-marked streaks along the direction of the wind.
2	4-6	Light Breeze	Small wavelets, still short, but more pronounced, crests have a glassy appearance but do not break.	9	41-47	Strong Gale	High waves; dense streaks of foam along the direction of the wind; crests of waves begin to topple, tumble, and roll over; spray may affect visibility.
3	7-10	Gentle Wind	Large wavelets; crests begin to break, foam of glassy appearance; perhaps white caps.	10	48-55	Storm	Very high waves with long overhanging crests; the resulting foam is blown in dense white streaks along the direction of the wind; on the whole, the sea surface takes a white appearance; visibility affected.
4	11-16	Moderate	Small waves, becoming longer, fairly frequent white caps	11	56-63	Violent Storm	Exceptionally high waves, the sea is completely covered with long white patches of foam lying along the direction of the wind; all edges of the wave crests are blown into froth; visibility affected.
5	17-21	Fresh Wind	Moderate waves, taking a more pronounced long form; many white caps are formed (chance of some spray).	12	64+	Hurricane	The air is filled with foam and spray; sea completely white with driving sprays; visibility very seriously affected.
6	22-27	Strong Wind	Large waves begin to form; the white foam crests are more extensive everywhere (probably some spray)				

Figure 14-1 Beaufort Sea State Descriptions



You may pass along information on effective seabird avoidance gear, but protect the privacy of other vessels! Do not give vessel names or fishing operation information.

If you have information or observations that may be helpful to NMFS and the USFWS, such as the effectiveness of the avoidance gear, please record this in your Seabird Daily Notes.

OTHER SEABIRD INTERACTIONS AND MORTALITY

Not all incidental seabird mortality is caused by fishing gear interactions. Seabirds may be killed or injured by colliding with fishing vessels or parts thereof. Report such incidents in your Seabird Daily Notes or, if appropriate, on your Species of Interest Encounter forms.

Vessel Strikes

Incidents of vessel strikes range from the occasional bird found on deck to flocks of birds hitting the ship, referred to as “bird storms.” It appears that birds hit the vessel because they become confused, primarily at night during inclement weather, and when bright lights are being used.

Seabird Interactions with Trawl Gear

On trawlers, observers have reported seeing birds strike the third wire cables, main cables or become entangled in the net wings. The third wire cables are part of the trawl sonar system that consists of a unit, often called the suitcase, attached to the headrope. The suitcase sends signals to the vessel via the third wire cable. Seabirds, attracted to a stream of offal or discard, may collide with this cable. Observers have reported some birds being seriously injured, with possibly broken wings. Collisions have been observed during both day and night. Some observers have documented dead birds wrapped around this cable near the suitcase.

Because of the potential for trawl gear interactions with short-tailed albatross, as well as other seabirds, NMFS and USFWS are interested in information regarding the magnitude of this problem. If you are on deck during gear retrieval, please check for seabirds wrapped around the third wire, main wire or caught in the net wings. Record these mortalities in your logbook.

DOCUMENTING SEABIRD INTERACTIONS

All bird strikes and other mortalities from interactions with trawl gear (in and outside of your samples) that you are aware of should be reported, whether the haul was sampled or not. Use the form in the Seabird Daily Notes section of your Observer Logbook. A detailed example of how to approach documenting the information is included there as well.



Notify your debriefer if you have Seabird Daily Notes. They will expedite getting your information to the data users at USFWS.

In your Seabird Daily Notes, document the number and the species of bird, the weather conditions, the date and time, and the position (latitude and longitude) of the vessel. If the birds are alive, note any bands or tags, and release them (many species are unable to fly off of a deck and will need to be dropped over the rail). Thoroughly wet birds cannot fly or keep themselves warm! To rehabilitate these birds, see the protocols on page A-61. You *must* retain the bird specimen if the birds are dead and are unidentified albatross, short-tailed Albatross, spectacled or Steller’s eider, or are banded or tagged. The program requests that you save all dead seabirds from your cruise, but if this is not possible, keep carcasses of other species of interest, such as murrelets and red-legged kittiwakes.

Intentional killing or maiming of seabirds sometimes occurs. If you see this, record the details in the Seabirds Daily Notes section of your logbook with all necessary information. This includes date, location, species, numbers, vessel name, crew members involved in the incident, and any other pertinent information. As with other violations, you must let the captain know at least once that you witnessed this violation. This will give him the opportunity to correct the behavior in the future.

BANDED BIRDS

Internationally, over one million birds are banded by government and scientific research institutions. Information from recovered bands are an important data source used in the management of migratory birds. In North



BIRD SIGHTINGS AND INTERACTIONS: Sightings of Species of Interest

America, the Bird Banding Laboratory (BBL) of the U.S. Geological Survey and the Banding Office of the Canadian Wildlife Service jointly manage the bird banding program in North America. Analysis of banding data allows calculation of important population parameters.

A tremendous cost is associated with banding efforts and only a small percentage of bands are ever recovered. Reporting recovered bands is extremely helpful to these researchers. Report any tagged or banded bird in your Seabird Daily Notes. Always include the complete tag/band number, colors and configuration of plastic bands, and which leg each band was on.

If the bird is dead, label and freeze it; if this is not feasible, remove the tag/band and return it to NMFS. The tag/band is used to determine rates of wear and other information that contributes to data analysis. ***Even if you retain the bird specimen or bands, record all pertinent data in your logbook.***

If the bird is alive, do not remove the band; record the complete tag/band number, colors and configuration of plastic bands, which leg each band was on, and the position and date of capture, then release the bird.



Always wear heavy gloves when handling live birds.

SIGHTINGS OF SPECIES OF INTEREST

In the course of fulfilling your duties, you will see many birds gathered around the vessel. The distributions of a few species are poorly known, and records of sightings are valuable. ***It is very important that you record sightings of short-tailed albatross.*** Sightings of the other species of interest are also valuable to marine ornithologists. Steller's eiders are commonly seen near ports and do not need to be reported when spotted there. Note any recorded sightings to your debriefer when you return.

Record each sighting in the Species of Interest Encounter Form in the Seabirds section of your logbook. If this section is filled, note the sighting in the Seabirds Daily Notes Section in the format of the "Sightings" form. Observers do not need to log sightings of non-sensitive species of birds (such as fulmars and gulls).

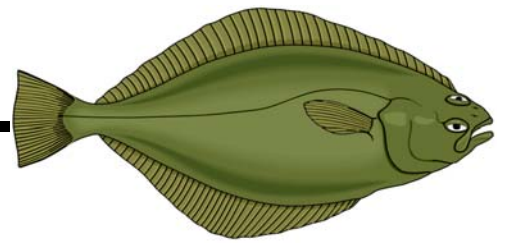

STOMACH COLLECTION

Table of Contents

Materials for Stomach Project.....	15-1
Formalin Handling Protocol for Observers	15-2
Where to Keep Formalin Onboard.....	15-2
Stomach Sampling.....	15-2
Determining Sex and Spawning Condition	15-2
Stomach Collection Procedure	15-2
Isotope Sampling Procedures	15-3
Sample Stratification.....	15-4
Method of Collecting Stomachs from Gadids	15-4
Method of Collecting Stomachs from Flatfish	15-4
Dutch Harbor Catcher Vessel Collection	15-5
Kodiak Catcher Vessel Collection.....	15-5
Labels and Records.....	15-5
Specimen Form	15-5
Stomach Collection Label.....	15-6
Stomach Tally Sheet.....	15-6
Debriefing Questionnaire.....	15-6

INTRODUCTION

The data resulting from successful completion of the stomach collection project is very important. Stomach collections provide data on predation mortality of commercial stocks of fish and crabs, and are used to estimate the degree of this mortality. In addition, these data enhance our understanding of spatial, seasonal, and inter-annual patterns in the marine foodweb.

Your comments and suggestions about this project are important to the Food Habits Lab. At the end of this chapter is a questionnaire about the project to assist you in providing comments to the Food Habits Lab.

The stomach project is assigned to specific vessels rather than to specific observers. Therefore, your participation in the project will depend upon the vessel to which you are assigned. The project is primarily assigned to vessels that have historically provided an adequate sampling platform for this project.

- Please read all instructions carefully.
- Data for the stomach and related isotope collections are not recorded on the standard Length and Specimen Form, and the data is not entered into ATLAS.
- Stop by the Food Habits Lab if you have questions about this project prior to your deployment.

Food Habits Lab - Room 1093

Richard Hibpshman (206) 526-4238

Andy Whitehouse (206) 526-4238

Geoff Lang (206) 526-4196

geoff.lang@noaa.gov



Observers aboard catcher vessels need to read the special instructions for completing stomach projects!

MATERIALS FOR STOMACH PROJECT

Observer Program field staff will provide this gear if it is not already available on your vessel.

- 1 liter of 100% formalin
- 1 5-gallon bucket
- 2 bucket lids (1 cut and 1 uncut)
- 2 large plastic bags
- Assorted sizes of specimen bags
- 100 Stomach Collection Labels
- Specimen Forms
- MSDS for 100% formalin
- MSDS for 10% formalin

STOMACH COLLECTION: Stomach Sampling

Please return all unused forms, supplies, and the empty plastic formalin bottle to the Food Habits Lab or to an FMA Division field office. Do not place unused sampling gear in a bucket with samples!

Formalin Handling Protocol for Observers

- Formalin is a relatively hazardous chemical and must be handled appropriately to ensure your safety. Stomach collections require only a small quantity of formalin and if these guidelines are followed your exposure will be well below established safe exposure levels.
- Read the (MSDS) before using formalin to understand its properties. You can find “Material Safety Data Sheet for 100% Formalin” on page A-66 and “Material Safety Data Sheet for 10% Formalin” on page A-70.
- **ALWAYS** wear gloves, rain gear, and the goggles provided in the kit when handling formalin.
- **ALWAYS** use formalin on an open deck. **Do not** use below decks or in your cabin.
- Inform captain and crew that you have formalin onboard, where it is stored, location of Material Safety Data Sheets (MSDS), potential hazards, and what to do in case of a spill.
- If the formalin is spilled, you have been provided with a small enough quantity to dilute with water and wash overboard.
- Add formalin to a bucket half-full with seawater, rather than adding seawater to the formalin. This will dilute the formalin quickly, and will prevent formalin from splashing on you.
- Use extreme caution when adding formalin to the bucket of seawater. Hold the bucket lid over as much of the bucket opening as possible while pouring the formalin, using it as a shield.
- If formalin comes into contact with your skin or eyes, rinse skin immediately and thoroughly with water for 15 minutes as per the MSDS. Rinse your eyes with saline provided in kit, then use on-board eye wash (if available) or water as needed to flush eyes for 15 minutes as per the MSDS.

- If ingested, Do NOT induce vomiting. If victim is conscious and alert, give 2-4 cupfuls of milk or water. Seek medical attention as soon as possible as per the MSDS.
- If overcome by fumes, move into fresh air. Administer oxygen if necessary and available, as per the MSDS.

Where to Keep Formalin Onboard

Formalin should be stored in a well ventilated space. Pure 100% formalin should be stored at or above 50°F. Below 50°F, a component precipitates out and the formalin loses potency. Pure formalin is a flammable material and should be stored in an appropriate flammable storage area until it has been diluted. Once diluted to a 10% solution, formalin can and should be stored on a weather deck. The solution will not freeze.

Store your bucket securely tied to an immobile object. Leave the bucket in place and carry samples to the bucket. This will avoid the potential of spilling formalin in the factory and will keep the formalin away from fish processing operations.

Do not submerge your gloves in the formalin when you add samples to the bucket. If the samples float, use a pair of forceps or some other tool to submerge the samples. Rinse the tool with water after formalin contact.

Anytime formalin gets spilled and/or inadvertently comes into contact with any object other than your samples, flush the object or area with plenty of water.

STOMACH SAMPLING

Determining Sex and Spawning Condition

To determine sex and spawning condition in flatfish and gadids, give the abdomen a light squeeze. The extrusion of milt (male) or eggs (female) indicates a fish in spawning condition.

Stomach Collection Procedure

1. Prior to the first haul from which you plan to collect stomachs, fill the white five gallon bucket half-full with sea water and add the contents of the one liter bottle of 100% formalin (37% formaldehyde) creating a 10% formalin solution (3.7% formaldehyde).

2. Seal with the cut lid. Add samples to this bucket as you collect them, one stomach per bag.
3. Collect stomach samples according to time of day and length of fish (see “Sample Stratification” on page 15-4).
4. Use the tally sheet on page 15-6 to keep track of the time and length categories that you need to fill.

You may sample fish from any haul, not just those sampled for composition.

Collect fish that do not show signs of net feeding or regurgitation. These signs include prey items (fresh or digested) in mouth or gill rakers or flaccid (loose and bloated) stomachs. **Do not keep these!**



Signs of “natural” stomachs include stomachs that are constricted tightly around the prey inside and naturally empty stomachs, which appear tight and contracted. **Keep these!**



If a fish is discarded due to regurgitation, take the next fish in the basket. If the subsequent fish has food in its stomach, go ahead and collect the specimen. If the subsequent fish has an empty stomach (naturally empty or regurgitated), discard it and go on to the next fish until a non-empty stomach is encountered. This special note applies only to the fish selected immediately after a regurgitation discard, because we don't want you to replace a regurgitated stomach with an empty stomach. A naturally empty stomach is a valid collection when not collected immediately following a regurgitated stomach.

5. Determine the sex, fork length, and spawning condition of each fish and collect the stomach (see methods for individual species).
6. Record all information on the Specimen Form and Stomach Collection Label as described in the “Labels and Records” on page 15-5.
7. Place each stomach in an individual cloth bag of the appropriate size, include a Stomach Collection Label, and preserve. Please close the bag tightly shut

with the drawstrings and secure it with a single overhand knot. Do **not** double knot the drawstrings!

Stop collecting when you have collected 80 stomachs or a full bucket that is loosely packed.

Isotope Sampling Procedures

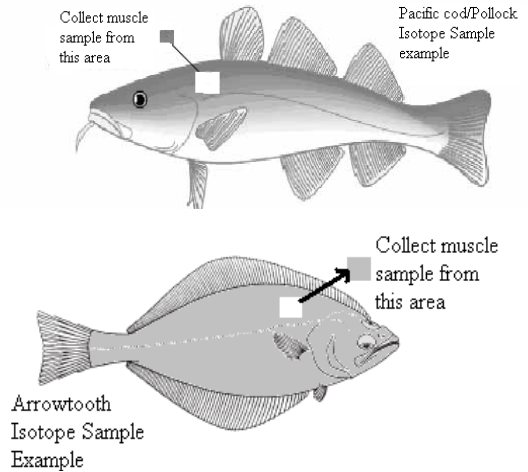

1. When collecting stomachs from Pacific cod, walleye pollock or arrowtooth flounder collect and freeze additional tissue samples - a liver sample and a muscle sample (up to 20 fish per haul and up to 80 per observer). Collect these samples from across a range of lengths
2. Collect the 1 cubic cm muscle sample from the area just below the dorsal fin and above the pectoral fin. Collect a similar sized sample of the liver from the same fish.
3. Place each of these tissue samples in their own ziploc bag. Place the two ziploc bags with the samples in them into another ziploc bag labeled with a specimen tag (a Stomach Collection Label).
4. These samples should be noted on the same Specimen Forms as the stomach collection, by writing “ISOTOPE” in the column adjacent to the specimen number whenever additional tissue samples are collected.
5. FREEZE this sample. **These samples should not come into contact with formalin.** Upon disembarking your vessel, please place all frozen tissue samples into a large plastic bag, labeled with your name, cruise number, and vessel code and drop them off at the Dutch Harbor Field office.

STOMACH COLLECTION: Stomach Sampling

Sample Stratification

Stratify the stomach collection by size of fish and time of collection (net off bottom/haul back time).

Figure 15-1 on page 15-6 shows a chart with species length, time categories, and sample numbers. There are four length categories. Refer to the chart below to determine the size category breakdown for the species from which you are collecting specimens. Fill in the blanks on your stratification chart and your tally sheet according to the appropriate size category.

Pacific cod, Pacific halibut, Greenland turbot, and arrowtooth flounder:	
1) <31 cm	3) 51-70 cm
2) 31-50 cm	4) >70 cm
Walleye pollock:	
1) <30 cm	3) 40-49 cm
2) 30-39 cm	4) >50 cm
Yellowfin sole:	
1) <20	3) 25-29 cm
2) 20-24 cm	4) >29 cm
Flathead sole:	
1) <21 cm	3) 31-40 cm
2) 21-30 cm	4) >40 cm
Sablefish (Gulf of Alaska only)	
1) <50 cm	3) 60-70 cm
2) 50-60 cm	4) >70 cm

Try to collect a minimum of 5 stomachs from a given size/time category in one haul and a maximum of 20 (i.e., all 4 size categories for a given time). It is possible to complete the sampling for this project in as few as 4 hauls (20 stomachs per haul, 5 from each size category), as many as 16 hauls (5 stomachs per haul from 1 size category), or any number in between. Depending on the catch composition while you are sampling, it may take several weeks to fill all of the size/time categories.

You may have difficulty finding specimens for a particular time or size strata (especially if your boat targets large fish). If this happens, take more from the ones you are finding, or wait a few hauls if you think your vessel may catch a different size group.

The total number of samples requested is a maximum. If your bucket is full (i.e., loosely packed) before you have reached 80, **stop collecting**. The number which will fit in a bucket will depend on the size and fullness of the stomachs collected.

Method of Collecting Stomachs from Gadids

1. To examine a stomach for regurgitation, first examine the mouth and gill rakers, then cut through the skin of the fish as shown in Figure 15-2. **Be careful not to cut into the stomach.**
2. Open the body cavity at the incision and examine the stomach, if there is no sign of regurgitation.
3. Excise the stomach by cutting just anterior to the pyloric caeca and posterior to the gill chamber. Include all of the esophagus. Place the stomach in a specimen bag with a Stomach Collection Label and preserve it.

Method of Collecting Stomachs from Flatfish

1. To examine stomachs for regurgitation, cut through the skin of the blind side (see Figure 15-3). **Be careful not to cut through the stomach.**
2. Lift flap and examine body cavity, if there is no sign of regurgitation, keep the fish and continue with the collection process.
3. If the fish is less than 20 cm in length, remove the entire head along with the digestive tract attached and put it in a sample bag with a Stomach Collection Label and preserve it.
4. If the fish is 20 cm or larger, remove the entire digestive tract from the beginning of the esophagus to the posterior end of the intestine just above the anus. Place the stomach with the intestine attached into a stomach bag with a Stomach Collection Label and preserve it.



For all of the large flatfishes (arrowtooth flounder and Greenland turbot) remove only the stomach and leave the intestine behind. Make an incision posterior to the gill chamber and anterior to the pyloric caeca. Be aware that arrowtooth are prone to regurgitation.

Dutch Harbor Catcher Vessel Collection

If you are on a catcher only trawl vessel delivering fish to Alyeska, Unisea or Westward Seafoods that is retrieving the last haul before delivery within 16 hours from port you can complete this collection. You will need to collect supplies from the blue flammable lockers at each plant or from the Dutch Harbor Field office (specimen bags, plastic bags, Stomach Collection Labels and Specimen Forms) prior to your departure from port. During the last haul of the trip you will collect a maximum of 5 stomachs (with no size restrictions) from arrowtooth flounder, Pacific cod, and/or pollock. Stomach collections may be opportunistic or from within your species composition sample. You will fill out the Stomach Collection Label and place them into the specimen bag with the collected stomach, being sure to close the specimen bag carefully. You can store these in plastic bags (do not allow the stomach samples to freeze) until you arrive into port where you will remove them from the plastic bags they were temporarily stored in and place them in the proper stomach collection bucket located in blue flammable lockers at the designated processing plant. Each blue locker has a unique combination which will be give to you during training/briefing. The Specimen Forms will stay with the observer who collected them until debriefing. Any questions about this collection please contact the Dutch Harbor field office @ (907) 581-2060.

Kodiak Catcher Vessel Collection

If you are on a catcher only trawl vessel delivering to a Kodiak processing plant that is retrieving the last haul within 16 hours of the offload you can complete this collection. You will need to collect supplies (mesh bags, plastic bags, Stomach Collection Labels and Specimen Forms) from the SWI bunkhouse, the Kodiak field office or from the flammable lockers located at all processing plants (with the exception of Global Seafoods) prior to your departure from port. These flammable lockers all have unique combinations that will be provided to you during your training/briefing. During the last haul of the trip you will collect a maximum of 5 stomachs (with no size restrictions) from arrowtooth flounder, Pacific cod, and/or pollock. Stomach collections may be opportunistic or from within your species composition sample. You will fill

out the Stomach Collection Label and place them into the specimen bag with the collected stomach, being sure to close the mesh bag carefully. You can store these in plastic bags (do not allow the stomach samples to freeze) until you arrive into port where you will place them in the proper stomach collection bucket located in flammable lockers at the designated processing plant. If you offload at Global Seafoods, please put your samples in the buckets located at the Trident Seafoods processing plant. If you need assistance please ask the plant observer. Any questions about this collection, please contact the Kodiak field office @ (907) 481-1770.

Labels and Records

- Always use a pencil.
- Fill out a Tally Sheet for your species - C/Ps only (see Figure 15-1).
- Fill out a Specimen Form for each haul (see Figure 15-4).
- Fill out a Stomach Collection Label for each sample and place it in the bag with the stomach (see Figure 15-5).

Specimen Form

Record the following information where indicated (see Figure 15-4):

- Vessel permit number and name.
- Cruise number.
- Species name.
- Haul number.
- Your name.
- Date.
- Sex (**1=male, 2=female, 3=unsexed**).
- Spawning stage (**1=spawning, 0=not spawning**).
- Length in centimeters (fork length).
- Specimen number (number assigned consecutively throughout the entire cruise to each sample as it is collected).

STOMACH COLLECTION: Debriefing Questionnaire

Stomach Collection Label

Record the following where indicated.

- Vessel permit number.
- Cruise number.
- Haul number.
- Specimen number.
- Length.
- Sex (M, F or U) and spawning condition.
- Name.

When Your Sea Time Is Finished (C/Ps only)

Label the uncut lid with your name, vessel name, species collected, and year. Seal the bucket with the uncut lid.

Normally, you should return the full bucket to the field office. It is possible to leave it on the vessel, if arrangements have been made to do so through the Observer Program. *Take your forms to debriefing!*

If you are the last observer on your vessel during the current sampling cycle, remove all stomach sampling gear and return it to the field office when you disembark. If you are unsure if this pertains to you, contact your inseason advisor.

During debriefing, please give your debriefer your completed Specimen Forms and debriefing questionnaire (your answers may be recorded in your daily notes and then photocopied).

DEBRIEFING QUESTIONNAIRE

Your Name:

Vessel Name:

1. Did you have any problems in carrying out this project (lack of sufficient equipment, lack of time, etc.)?
2. How long did it take you to collect your samples from one haul?
3. Was it difficult to collect the expected number of samples from different size groups at different time periods?
4. Do you have any suggestions that would improve the sampling procedure for this project?
5. Do you have any suggestions that would make it easier for you to successfully complete this project?
6. Where were the buckets and formalin stored onboard? Did you have difficulty locating them?

<u>STOMACH TALLY SHEET</u>					
Time					
Size	0101 - 0700	0701 - 1300	1301 - 1900	1901 - 0100	Total
1 _____	5	5	5	5	20
2 _____	5	5	5	5	20
3 _____	5	5	5	5	20
4 _____	5	5	5	5	20
Total	20	20	20	20	80

Figure 15-1 Stomach Tally Sheet for Catcher Processor Stomach Collection

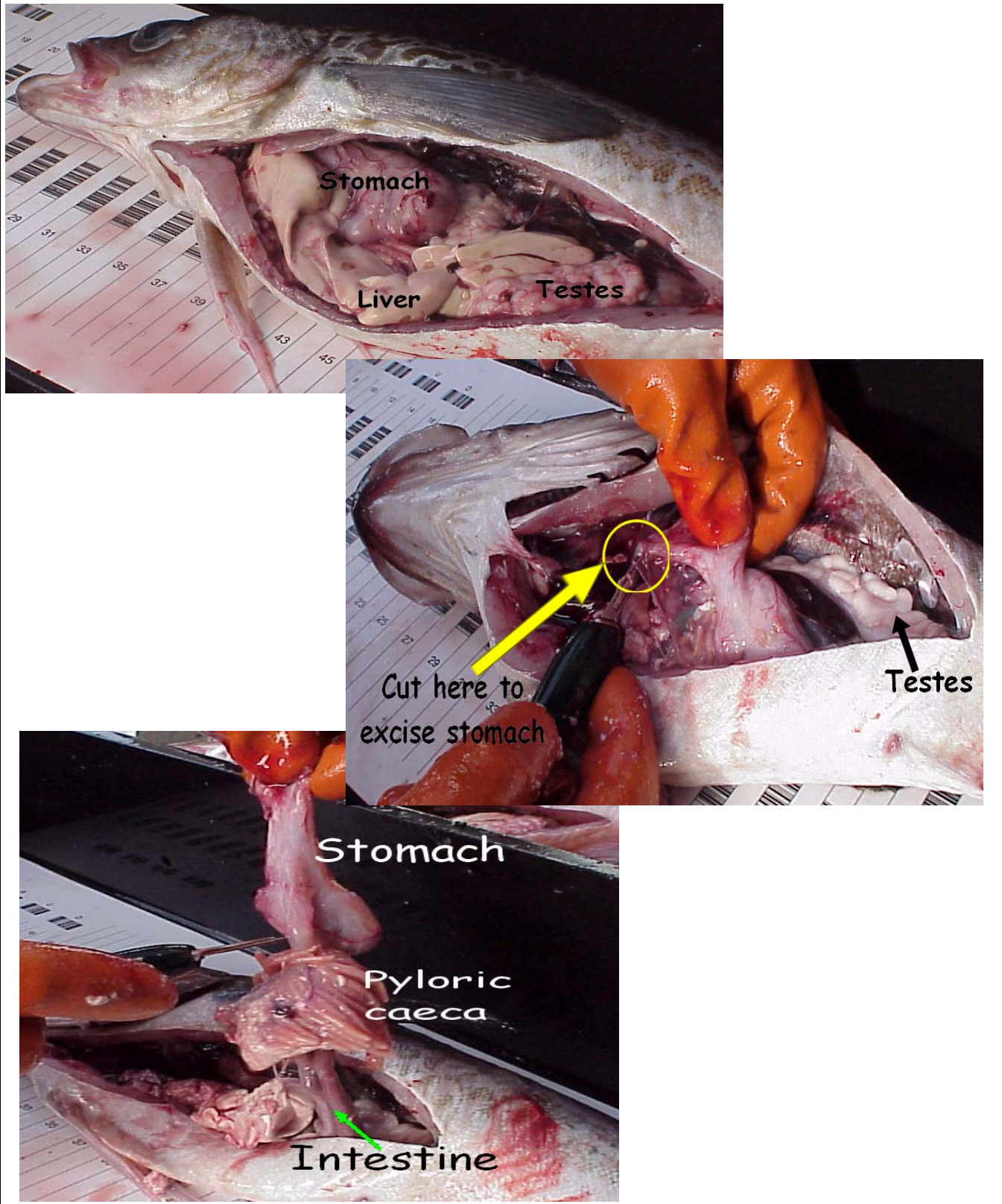

Figure 15-2 Removing a gadid stomach

STOMACH COLLECTION

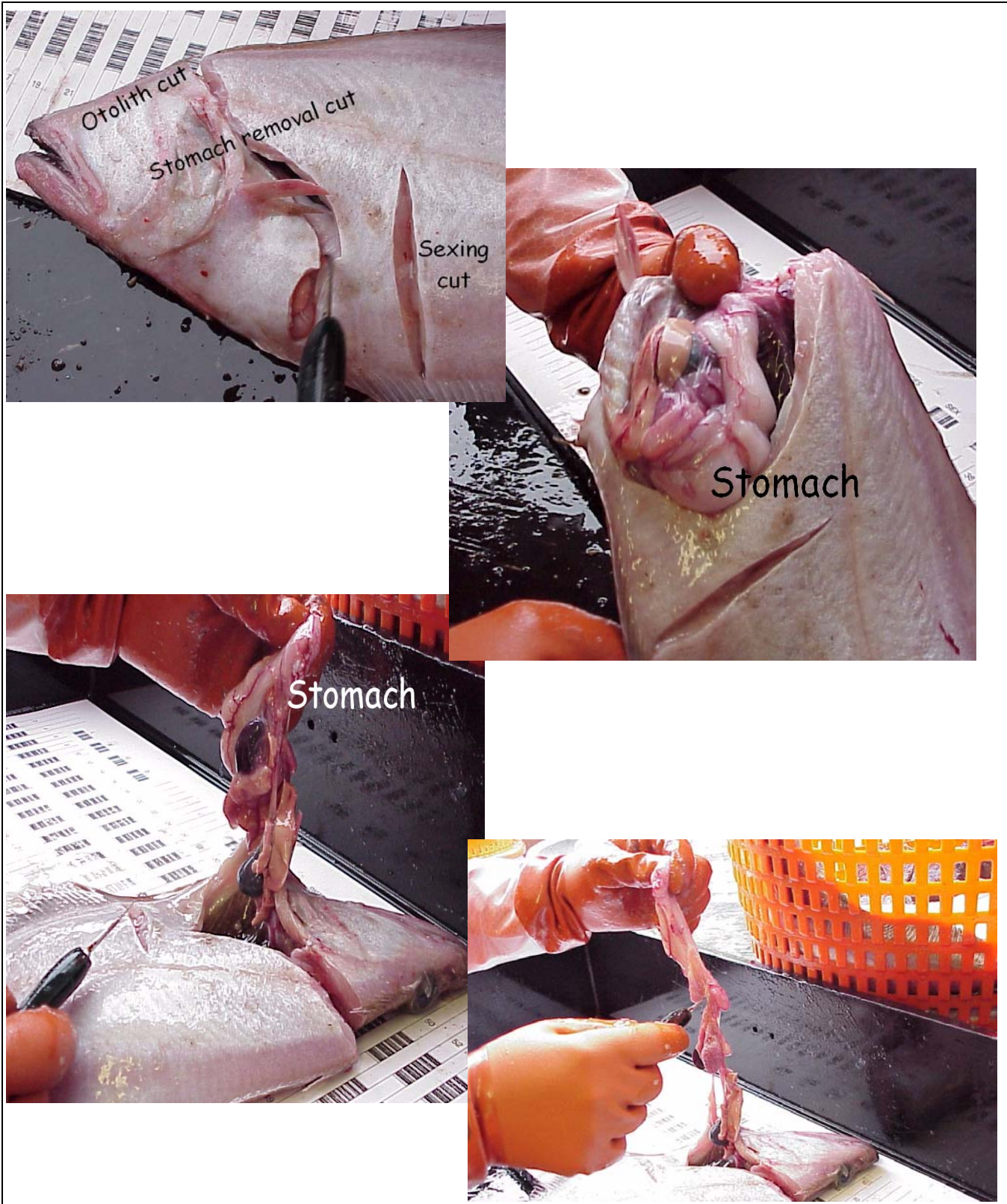

Figure 15-3 Removing a flatfish stomach

Page 3 of

REFM/REEM **SPECIMEN FORM** Food Habits Lab

Vessel 4321 Zephyr Cruise 6999

Species Name Arrowtooth Flounder Haul 16

Your Name Sandi Beach Date 01/17/2009

Sex	Sp/Nsp	Length in cm	Specimen Number	Sample				
1	1	4.7	1.7					
1	0	3.6	1.8					
2	0	4.9	1.9					
2	1	5.3	2.0					
1	0	3.0	2.1					
2	0	5.9	2.2					
3	0	1.5	2.3					
1	0	2.9	2.4					

Figure 15-4 Specimen Form

STOMACH COLLECTION LABEL

National Marine Fisheries Service, Trophic Interactions Lab.
7600 Sand Point Way NE, Seattle, WA 98115-0070

VESSEL 4321 CRUISE 6999 HAUL 16

SPECIMEN NUMBER 19

LENGTH (CM) 49 SEX: M U MATURITY: SP NSP

SPECIES IDENTIFICATION Arrowtooth

COMMENTS Flounder

COLLECTOR'S INITIALS S.B. PRESERVATIVE

☆GPO2004 690-454

Figure 15-5 Correctly Completed Stomach Collection Label

STOMACH COLLECTION

ATLAS INSTRUCTIONS

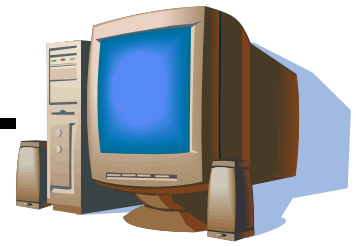

Table of Contents

Introduction.....	16-1
Starting the Atlas Software	16-1
Atlas Security Screen	16-1
Changing Passwords.....	16-2
Atlas Main Menu.....	16-2
Trip Data Form.....	16-4
Haul Data Form	16-5
Offload Data Form	16-6
Non-Fishing or Non-Delivery Day Form	16-6
Species Composition Data Form	16-7
Length Data Form.....	16-9
Specimen Data Form.....	16-10
Marine Mammal Data Form	16-12
Text Messages.....	16-14
Transmitting Data	16-15
Archive/Backup.....	16-17
Print/Copy.....	16-18

INTRODUCTION

The Atlas software is an electronic input program that allows groundfish observers to enter and send data direct from a vessel or plant to NMFS at the Alaska Fisheries Science Center in Seattle. Once the electronic observer data is received by NMFS in Seattle, the data are used by NMFS fisheries managers to make inseason management decisions on those ongoing fisheries. Data are also reviewed weekly by FMA staff (Inseason Advisors) to help ensure that data are of the highest quality. The software also allows observers and FMA staff to communicate via text messages. Text communication serves as a vital link by helping observers in the field, with any issues they may face, both with observer related duties and technical issues.

This manual will provide a basic understanding of the features provided with the Atlas software and how to use those features. This manual assumes that the reader already has some rudimentary understanding of the Windows operating system. Please inform an instructor if you need more computer training prior to departing for your assignment. A tutorial will be given during your regular observer training/briefing. For the rest of these instructions, the word “Atlas” will be used for term “Atlas software.”

STARTING THE ATLAS SOFTWARE

If you are assigned to a vessel or plant that has a computer that is installed with Atlas, you will first need to locate that computer. All catcher processors, motherships and catcher vessels over 125 feet will have Atlas. All plants will have a computer with Atlas. After locating the computer with Atlas, go to the Windows desktop and double click on the icon labeled Observer Atlas.

Atlas Security Screen

Once Atlas starts, the first screen you will see is the Atlas Logon screen.



Figure 16-1 ATLAS Login Screen

New Users

If you are the sole observer or the lead observer on a vessel or in a plant and have never entered any data or text messages, you will need to click on the New User button. After selecting the New User button, you will now need to create a new password (Figure 16-2). Your new password may be any combination of numbers and/or characters. It must be at least 4 characters/numbers long. **Passwords are case sensitive.** Once you have created a new password, you will need to re-type it again for security purposes. Once the password has been re-typed, select the Submit button to continue. Please remember that if you are the lead observer and another observer will also be entering data under your cruise number, you will need to provide the second observer with the password.



Figure 16-2 New Users Screen

If you receive an error message that the re-typed password does not match the new password, you will need to re-enter both fields again.

It is extremely important that you do not share your password with any vessel or plant personnel. If someone besides the second observer gains access to your password, they then have the ability to make changes to your data without your knowledge.

Current Users

If you are logging into Atlas to continue data entry, select the Current User button (Figure 16-1). Type in your current password and select the Submit button to continue (Figure 16-3).

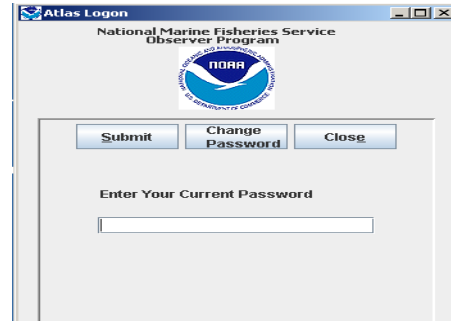

Figure 16-3 Current Users Login Screen

Changing Passwords

In order to change your password, you must know your current password. If you do not know your current password, you will need to contact the FMA Division to gain access to all the data that has been entered so far. To change your password, you must select the Current User button from the first login screen (Figure 16-1). Then select the Change Password button. Enter your current password first, then your new password (Figure 16-4). Re-type your new password again and select the Submit button to continue.



Figure 16-4 Changing Your Password

Atlas Main Menu

Once you have successfully entered your password, the Atlas Main Menu (Figure 16-5) will appear. The Atlas Main Menu is the starting point for the rest of Atlas. The first time you get to this screen, you must enter the required information on the right hand side of the screen. The required fields are: First Name, Last Name and Cruise Number. **If there is more than one observer, only the lead observer should enter their**

information in the required fields. *In most cases, the vessel permit and vessel name field will already be filled out and you won't need to make changes to these fields.* Once you have entered the required fields, you will not have to enter this information again for the rest of your cruise.

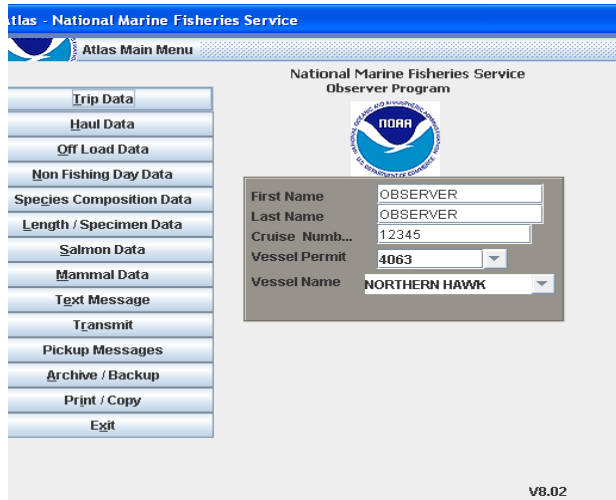

Figure 16-5 Atlas Main Menu

Main Window Navigation Buttons

On the left side of the Atlas Main Menu, you will find the Atlas navigation buttons that will allow you to access the observer electronic forms and other Atlas functions (Figure 16-5). If you are stationed on a vessel, all data entry must start with the Trip Data form (except for Non-Fishing Days). If you are stationed at a plant, all data entry must start with the Offload Data form, or the Non-Fishing Days.

Keyboard Shortcuts

Each Navigation Button in Atlas can be activated by using the mouse or by using a keyboard shortcut. The keyboard shortcut-keys for each button can be identified by the underlined letter of each button. For example, if you look at the Trip Data navigation button, you will notice that the “T” in Trip is underlined (Figure 16-6). To activate the Trip Data navigation button, using only the keyboard, simply press down and hold the <Alt> key then press down the <T> key.

Keyboard Alternatives to the Mouse

The Atlas program is like most Windows applications. When navigating through the program, you can either use the mouse or the keyboard. Basic keyboard

Navigation Title	Navigation Function
Trip Data	Opens Trip Data form for vessel observers.
Haul Data	Opens Haul Data form for Trawl, Pot, Longline.
Offload Data	Opens Offload Data form for catcher boat and plant observers.
Non-Fishing Day	Opens Non-Fishing day form for vessel and plant.
Species Composition Data	Opens Species Comp data form for vessel observers.
Length/Specimen Data	Opens Length/ Specimen Data form for vessel and plant observers.
Salmon Data	Opens Salmon data form for vessel and plant observers
Mammal Data	Opens Mammal data form for vessel and plant observers. The Mammal Specimen form is accessed through the Mammal data form.
Text Messages	Opens the Text form where outgoing text messages are created and incoming text messages are read.
Transmit	Opens Transmit option form for sending data to NMFS in Seattle.
Pickup Messages	Retrieves text messages without preparing and transmitting data.
Archive/Backup	Opens form to access the following functions: Backup and Archive data.
Print/Copy	Copies data for use by the vessel and Prints data for use by the vessel. Does not print text messages.
Exit	For closing out of the Atsea program.



Figure 16-6 Trip Data Navigation Button

navigation is as follows. The <Tab> key will move the cursor from one field to the next. The <Shift>+<Tab> keys will move the cursor backwards from a field to the previous field. If you are in a field and you want to move the cursor within that field, you use the left and right arrow keys.

Drop Down Lists

Many of the data entry fields in Atlas have a drop down list associated with that field. A drop down list is a list that contains all possible values for that particular field. When you are in a field that does contain a drop down list, you will see a down arrow next to that field. A user can then choose to either type in a value or to click on the drop down arrow and expand the list. Once the list is expanded, the user can then select the value they want.

Required Data Entry Fields

Some of the data fields in Atlas are “Required” fields. This means that a valid value must be entered in this field before you can move on to the next field or Atlas form. For example, in the Trip Data form, the Trip Number is required. You will be unable to leave this field until you have entered a valid value.

Data Field Appearance

Some data fields in Atlas will appear or disappear based on certain values in another field. For example, when you open up the Haul Data form you will not see the Total Hooks/Pots field. When you enter a value of 6 or 8, in the Gear Type field, then the Total Hooks/Pots field will appear.

Data Entry Validation

When you enter data into a field in any form, it is possible that this field will automatically validate what has been entered. For example, when you are in the Deployment Time field in the Haul Data Form, you will not be able to enter a time of 2401, as that is not a valid time. This type of field validation will occur throughout Atlas.

Replicating Fields

When you enter data into a form, some fields may already be filled out based on previous entries. This is to help reduce the amount of data entry the observer must do. For example, if you enter haul data and enter the gear code as 2, the next time you enter another haul the gear code field will already be filled out with the number 2. Remember to change a replicating field if the previous value is not correct for the current entry.

Atlas Form Command Buttons

Within each Atlas data entry form, you will find command buttons at the top of the form/screen. These command buttons allow the user to perform certain functions while in that form. There are 3 basic types of command buttons (Figure 16-7).



	Choose this command to ADD new data to a form or to Save data that was entered or edited.
	Choose this command to delete a record.
	Choose this command to close the form.

Figure 16-7 Command Buttons

TRIP DATA FORM

If you are stationed on a vessel (*not a plant*), you must always start by entering data in the Trip Data form. ***No other data (except for non-fishing day data) can be entered in any other data form until you start a trip.*** To open the Trip Data form, select the Trip Data Navigation button, from the Atlas Main Menu (Figure 16-5). The Trip Data form will now open (Figure 16-8).

Specifics on the Trip Data Form

To start a new trip, click on the ADD/SAVE button found at the top of the form. The trip data entry form will now open. The very first time you enter a new trip, the trip number will default to “1.” This may be changed by the user.

When you start a new trip, all the fields in the Trip Start area of the form must be filled out. The Trip End fields can be left blank until the trip is complete (***don't forget to update the Trip End fields when the trip is complete***). If you do enter a Trip End Port Code, the Atlas program will expect you to fill out the Trip End

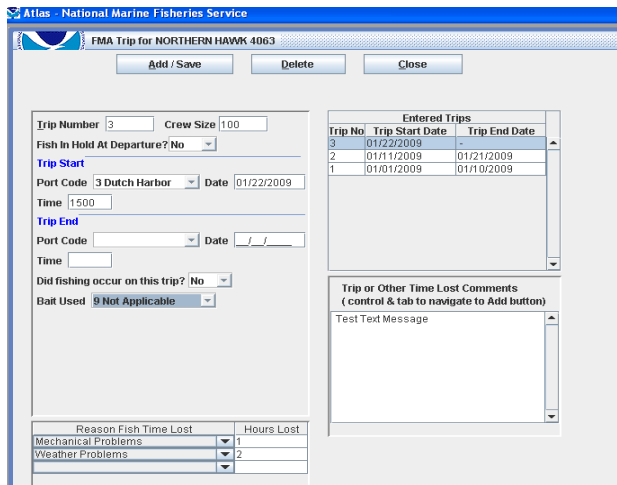

Figure 16-8 Trip Data Form

fields. The bait code field should be filled out regardless of vessel type. On a trawler, a code of 9 - Not Applicable should be entered. It is not possible for you to save another trip until the current open trip has trip end information and is saved. Once you have added all your trip data, select the Add/Save button at the top of the screen to save the data to the database. Once the data has been saved, you will see the trip listed on the right hand side of the screen in the entered trips list.

Editing Trip Data

To edit trip data, first go to the list of entered trips found on the right hand side of the screen (Figure 16-9). Double click on the trip you want to edit. All the previously entered trip data now appears in the trip entry window on the left hand side of the screen. Make the necessary changes, then select the Add/Save button to save your changes.

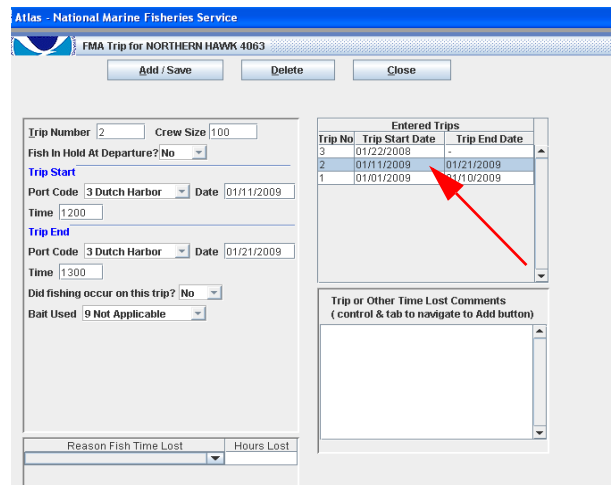

Figure 16-9 Editing Trip Data

HAUL DATA FORM

To open the Haul Data form, select the Haul Data Navigation button from the Atlas Main Menu (Figure 16-5). The Haul Data form will now open. (Figure 16-10).

Specifics on the Haul Data Form

To start adding a new haul, click on the Add/Save button at the top of the screen. The haul entry form will now open. The first field in the haul form is the gear type field. Next you must select to which trip this haul belongs. *The field Purpose Code will default to*

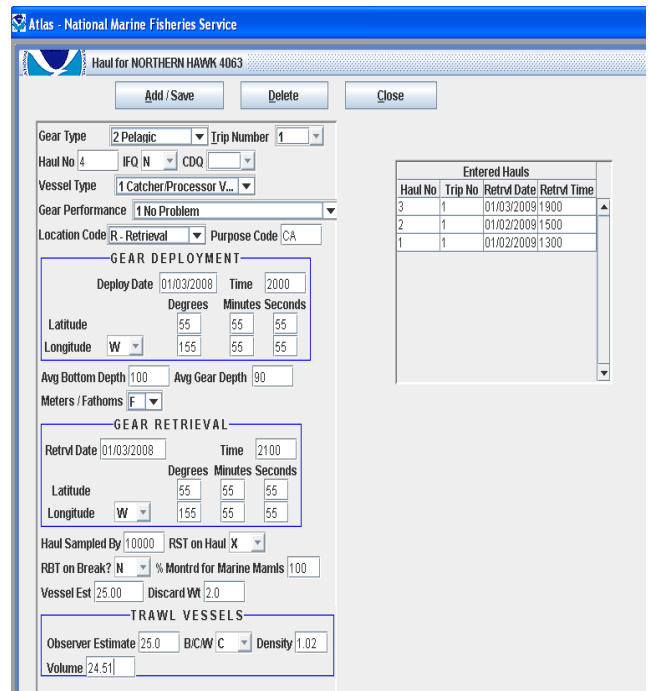

Figure 16-10 Haul Data Form

“CA.” This should not be changed unless otherwise instructed to by FMA staff. Once you have added all your haul data, select the Add/Save button at the top of the screen to save the data to the database. Once the data has been saved, you will see the haul listed on the right hand side of the screen in the entered hauls list. When you begin adding another haul, many of the fields will automatically be filled based on entries from previous hauls.

ATLAS INSTRUCTIONS: Offload Data Form

Editing Haul Data

To edit haul data, first go to the list of entered hauls found on the right hand side of the screen (Figure 16-11). Double click on the haul you want to edit. All the previously entered haul data will now appear in the haul entry window on the left hand side of the screen. Make the necessary changes, then select the Add/Save button to save your changes.

Figure 16-11 Editing Haul Data

OFFLOAD DATA FORM

To open the Offload Data form, select the Offload Data Navigation button from the Atlas Main Menu (Figure 16-5). The Offload Data form will now open. (Figure 16-12).

Figure 16-12 Offload Data Form

Specifics on the Offload Data Form

The Offload Data form will be filled out by observers assigned to catcher boats and observers assigned to a plant. To start adding a new offload, click on the Add/Save button at the top of the screen. The offload entry form will now open. If you are an observer assigned to a catcher boat, the first field you must fill out is the trip number field. Select the trip number to which the offload belongs. If you are an observer assigned to a plant the first field you need to fill out is the delivery number. Once you have added all your offload data select the Add/Save button at the top of the screen to save the data to the database. Once the data has been saved you will see the offload listed in the entered offloads list on the right hand side of the form. When you begin adding another offload many of the fields will automatically be filled out based on entries from previous offloads.

Editing Offload Data

To edit offload data, first go to the list of entered offloads found on the right hand side of the screen (Figure 16-13). Double click on the offload you want to edit. All the previously entered offload data will now appear in the offload entry window on the left hand side of the screen. Make the necessary changes, then select the Add/Save button to save your changes.

Figure 16-13 Editing offload Data

NON-FISHING OR NON-DELIVERY DAY FORM

To open the Non-Fishing Day form, select the Non-Fishing Day button from the Atlas Main Menu (Figure 16-5). The Non-Fishing Day form will now open (Figure 16-14). Plant observers will use the Non-Delivery Day form.

Date	Haul No	Trip No
12/31/2008	NF	0
12/30/2008	NF	0
01/03/2009	4	1
01/03/2009	3	1
01/02/2009	2	1
01/02/2009	1	1
01/01/2009	NF	0

Figure 16-14 Non Fishing Day Form

Specifics on the Non-Fishing or Non-Delivery Day Form

Non-fishing or non-delivery day information must be filled out by both vessel and plant observers. To start adding a new non-fishing or non-delivery day, click on the Add/Save button at the top of the screen. The data entry form will now appear. Enter the date and positions of the non-fishing day (date only for plant observers). The time will automatically be defaulted to 1200. After adding all your data, click on the Add/Save button and your non-fishing/non-delivery day information will be saved. Once the data has been saved, you will see the non-fishing/non-delivery day listed on the right hand side of the screen in the entered list of non-fishing days (non-delivery days for plant observers) and hauls.

Editing Non-Fishing or Non-Delivery Day Data

To edit non-fishing/non-delivery day data, go to the list of entered Non-Fishing or Non-Delivery Days and Hauls found on the right hand side of the screen (Figure 16-15). Find the non-fishing/non-delivery day you want to edit and double click on that row in the list. The data will now appear in the Non-Fishing or Non-Delivery Day entry form on the left hand side of the screen. Make the necessary changes and then click on the Add/Save button.

SPECIES COMPOSITION DATA FORM

Before adding species composition data, you must have already entered a haul or offload. To open the Species Composition form, select the Species Composition navigation button from the Atlas Main Menu (Figure 16-5). The Species Composition Data form will now open. (Figure 16-16)

Date	Haul No	Trip No
12/31/2008	NF	0
12/30/2008	NF	0
01/03/2009	4	1
01/03/2009	3	1
01/02/2009	2	1
01/02/2009	1	1
01/01/2009	NF	0

Figure 16-15 Editing Non Fishing Day Form

Type	Number	#ofRecords
Haul	4	0
Haul	3	0
Haul	2	0
Haul	1	0
Offload	3	0
Offload	2	0
Offload	1	0

Figure 16-16 Species Composition Data Form

Specifics on the Species Composition Data Form

To add species composition data, find the haul or offload in the list of entered Hauls/Offloads found on the right hand side of the screen. Once the haul or offload has been located in the entered list, double click on that row in the list. The haul or offload number will now appear in the upper left side of the screen. Now highlight that haul or offload number on the left side of the screen and click on the New Sample button. When the New Sample button is selected, the species composition data entry panel will open (Figure 16-17).

Adding Species Composition Data

After selecting the New Sample button, the species composition entry panel will open. The first field that must be entered is the sample number field. Once the sample number field is entered, you then must enter the sample weight for a trawl vessel or the number of hooks or pots for a fixed gear vessel. After entering the sample weight or sampled hooks/pots, the species code or species name must be entered. If you enter the species code, the species name field will be filled out

ATLAS INSTRUCTIONS: Species Composition Data Form

Figure 16-17 Species Composition Form with Data Entry Panel Open

based on what species code has been entered. If you enter the species name first, then the species code will be filled out based on what species name was selected. Next the species number and species weight must be entered. Depending on what species is entered, the sex field may appear or disappear. The last field to enter is the percent retained field. The percent retained field is only to be entered for a haul (*not offload*). Once these data have been added, select the Add/Save button found in the lower right hand side of the screen. The entered species will now be added to the Species Composition List (Figure 16-18).

Figure 16-18 Species Composition List

Before the Sample Panel can be closed, a keypunch record must be entered as part of the species composition data. To enter a keypunch record use a

species code of 999 (Figure 16-19). The keypunch must equal the sum of the species number and sum of species weight. Once all species have been added, you can close the entry panel by selecting the Close Sample Panel button.

Figure 16-19 Keypunch Check in Species Composition

Longline, Pot, or Offload Samples With No Fish

If you are sampling an offload, longline set or pot set and there are no fish in the sample, create a sample entry for the haul, number it appropriately, enter the sample size (total delivery weight, sample size in hooks or pots), and choose “N” for “Species Comp in sample?”

Figure 16-20 Enter “N” if no fish were in the sample

Adding a SubSample to Species Composition Data

If you are on a vessel using trawl gear and you want to enter subsample species composition data, you must have first entered a sample that included 2 different species with a weight and number of 0. Once that sample data has been entered, you can now enter your subsample data into the species composition form. In the species composition form in the upper left corner, find the data tree that has all the entered species

composition hauls (Figure 16-21). *For offload data, subsamples are not allowed and for fixed gear data, you can enter a subsample for any sampled haul.*



Figure 16-21 Editing Species Composition Data Tree

Using the data tree, highlight the sample for which you want to enter a subsample. After you highlight that record, click on the New Sample button. The species composition data entry panel will now open (Figure 16-17). You can now begin to enter your subsample data.

Editing Species Composition Data

To edit species composition data, first go to the list of entered hauls or offloads found on the right hand side of the screen (Figure 16-16). Find the haul or offload that contains the data you want to edit and double click on that record. On the left hand side of the screen, you will now see a data tree that contains all the species composition data entered for the selected haul or offload. (Figure 16-22).

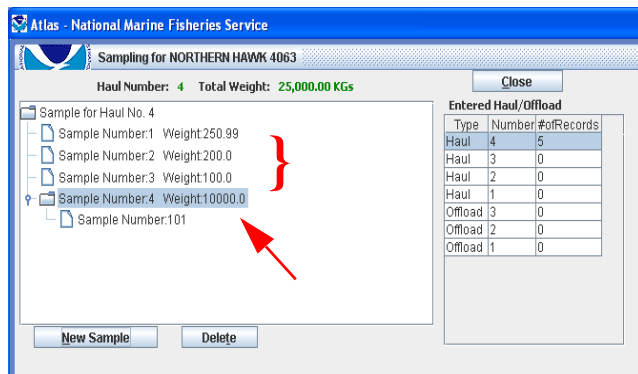

Figure 16-22 Editing Species Composition Data Tree

Using the data tree (Figure 16-22), find the sample number that you want to edit. Double click on that row in the data tree and the sample data will now appear in the species composition data entry screen (Figure 16-23).

Once the entry panel is open, you may begin editing any field. To edit a specific species, find that species in the list of entered species (Figure 16-23) and double click on that row. The species information will appear in the species entry window at the bottom of the form. Now you can begin editing any field. Once you are done editing a specific record, always click on the Add/Save button.

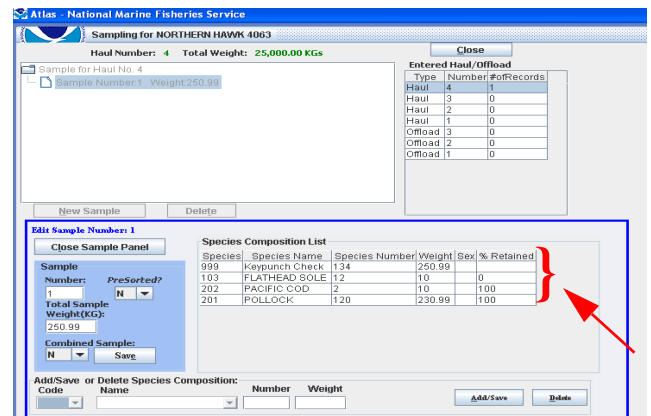

Figure 16-23 Species Composition Data Form with Entry Panel Open

LENGTH DATA FORM

Before adding length data, you must first enter haul, offload, and/or species composition data. Length data may come from any of these 3. To open the Length form, select the Length Data navigation button from the Atlas Main Menu (Figure 16-5). The length selection form will now appear (Figure 16-24).

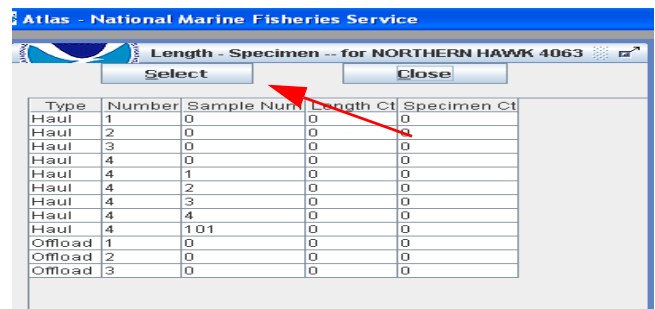

Figure 16-24 Length Selection Window

ATLAS INSTRUCTIONS: Specimen Data Form

Once the length selection window opens, find the row containing the haul number and/or sample number or offload and/or sample number for which you want to enter length data. To open the data entry window, double click on the row or highlight the row and click the Select button (Figure 16-24).

Atlas - National Marine Fisheries Service
Length - Specimen for NORTHERN HAWK 4063
Haul Number: 4 Sample Number: 1 Close
Species|Species Name|Sample System|Sex|Length Size|Freq|Egg|Viability|Injury|Specimen CT
201|POLLOCK|2|M|41|1|0|0|0|0

New Length Delete Specimen

Figure 16-25 Length Data Entry Form

Specifics on the Length Data Entry Form

To add a new length, click on the New Length button found at the bottom of the form. Once the data entry form opens, enter the species code or the species name.

If you are entering length data from a sample, only those species codes that were in your sample will appear in the species code list. If you are entering length data from a haul or offload, the full species code list will be available. The sampling system field will default to 2 (random) and in most cases should not be changed. Next enter the sex and all other fields. Once all fields have been entered, select the Save button at the bottom of the entry panel (Figure 16-26). After selecting the Save button, the cursor will move automatically to the sex field. Also, after selecting the save button, the entered length data will appear in the entered length list at the top of the data form (Figure 16-27).

Editing Length Data

To edit length data, first go to the list of entered lengths. Find the row that contains the data you want to edit and double click on that row (Figure 16-27).

The selected data will now appear in the entry window to edit (Figure 16-27). You can make any changes to the data from here. After making your edits, select the Save button to save your changes.

Atlas - National Marine Fisheries Service
Length - Specimen for NORTHERN HAWK 4063
Haul Number: 4 Sample Number: 1 Close
Species|Species Name|Sample System|Sex|Length Size|Freq|Egg|Viability|Injury|Specimen CT
201|POLLOCK|2|M|41|1|0|0|0|0

New Length Delete Specimen

Species Code: 201 ... POLLOCK - 201
Sample System: 2-Random Sex: M
Length Size: 42 Frequency: 2

Save Cancel

Figure 16-26 Length Data Entry Form with Data Entry Panel Open

Atlas - National Marine Fisheries Service
Length - Specimen for NORTHERN HAWK 4063
Haul Number: 4 Sample Number: 1 Close
Species|Species Name|Sample System|Sex|Length Size|Freq|Egg|Viability|Injury|Specimen CT
201|POLLOCK|2|M|44|1|0|0|0|0
201|POLLOCK|2|M|46|1|0|0|0|0
201|POLLOCK|2|M|47|1|0|0|0|0
201|POLLOCK|2|M|48|1|0|0|0|0
201|POLLOCK|2|M|49|1|0|0|0|0
201|POLLOCK|2|M|51|1|0|0|0|0
201|POLLOCK|2|M|50|1|0|0|0|0
201|POLLOCK|2|M|52|1|0|0|0|0
201|POLLOCK|2|M|41|1|0|0|0|0
201|POLLOCK|2|M|45|1|0|0|0|0
201|POLLOCK|2|M|53|1|0|0|0|0
201|POLLOCK|2|M|42|2|0|0|0|0
201|POLLOCK|2|M|43|1|0|0|0|0

New Length Delete Specimen

Species Code: 201 ... POLLOCK - 201
Sample System: 2-Random Sex: M
Length Size: 53 Frequency: 1

Save Cancel

Figure 16-27 Edit Length List

SPECIMEN DATA FORM

Before adding specimen data, you must have first entered a length record. Each specimen record is entered for a specific length record. The only way to access the specimen entry form is through the Length/Specimen Button on the Main Screen of Atlas (Figure 16-5). This will open the open the entered lengths list.

Find the row that contains the haul or offload number and/or sample number that contains the length data for which you are entering specimen data. Once the row has been located, double click on the row to open the entered length list (Figure 16-24) or highlight the row and hit the Select button. This will open the list of entered lengths.

Once the list of entered lengths is available, highlight the row in the Length form for which you want to enter specimen data (Figure 16-27). After highlighting the row, select the Specimen button, and the Specimen data entry panel (Figure 16-28) will open.

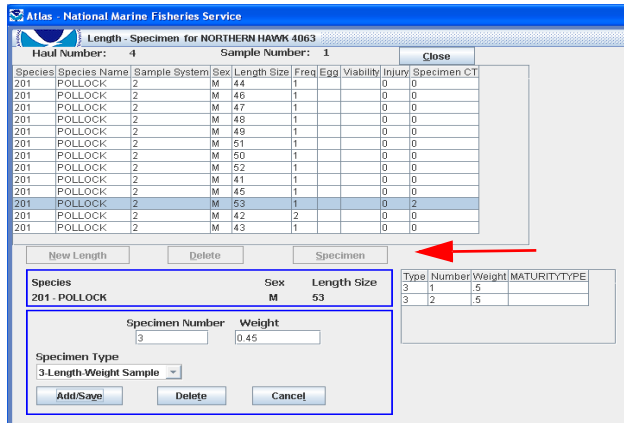

Figure 16-28 Specimen Form With Data Entry Panel Open

Specifics on the Specimen Data Entry Form

Once the specimen data entry window is open, click in the specimen number field to begin adding data. Once all the fields have been filled out, click on the Add/Save button found at the bottom of the window. Your entered specimen data will appear in the table on the right hand side of the screen (Figure 16-29)

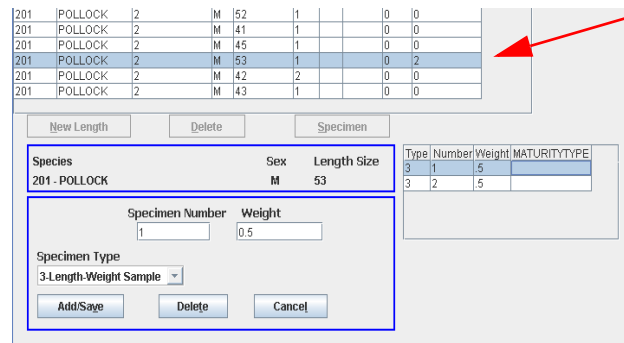

Figure 16-29 Entered Specimen Data List

Editing Specimen Data

To edit specimen data, first go to the list of entered length and specimen records. Lengths with corresponding specimen records can easily be identified by the Specimen Count Column found in the

entered length list. Find the row that contains the data you want to edit and highlight the row, then click on the Specimen button (Figure 16-30).

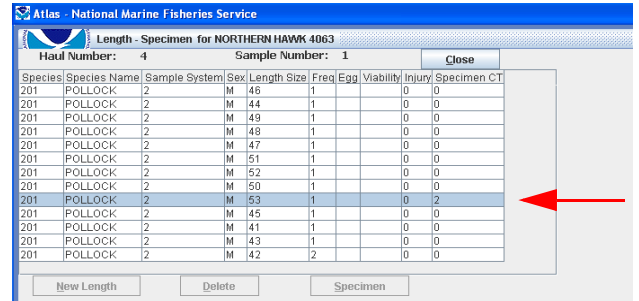

Figure 16-30 Entered Length List

Once the Specimen data entry panel is open, select the specimen record you want to edit. To select a specific record, double click the specimen record in the specimen table on the right of the screen. The selected data will now appear in the entered specimen data list (Figure 16-31). You can make any changes to the data

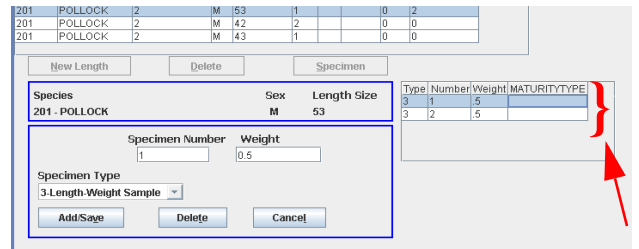

Figure 16-31 Entered Specimen Data List

from here. After making your edits, select the Add/Save button to save your changes (Figure 16-31).

SALMON DATA FORM

To open the Salmon data form, select the Salmon Data Navigation button from the Atlas Main Menu (Figure 16-5). The Salmon Data entry form will now open (Figure 16-32).

Specifics on the Salmon Data Form

To start adding salmon data, go to the list of entered hauls and offloads found on the right hand side of the screen. Highlight the haul or offload you want to enter salmon data for. Now click on the Add/Save button at the top of the screen. The salmon entry form will open. Enter the data in the form, then click on the Add/

ATLAS INSTRUCTIONS: Marine Mammal Data Form

Figure 16-32 Salmon Data Entry Form

Save button to save your entered data. Refer to the handout provided in briefing for information on filling out the salmon data form.

Editing Salmon Data

To edit salmon data, first go to the list of entered salmon data found on the right hand side of the screen (Figure 16-33). Double click on the salmon record you want to edit. All the previously entered salmon data will now appear in the salmon entry window on the left hand side of the screen. Make the necessary changes, then select the Add/Save button to save your changes

Figure 16-33 Salmon Data Entered List

MARINE MAMMAL DATA FORM

Before adding marine mammal data, you must have already entered a trip or haul or an offload. A marine mammal interaction may be documented for a trip, a haul or an offload. To open the Marine Mammal Data form, select the Marine Mammal Navigation button from the Atlas Main Menu (Figure 16-5). The Marine Mammal Data form will now open. (Figure 16-34).

Figure 16-34 Marine Mammal Data Form

Specifics on the Marine Mammal Data Form

To add a new marine mammal find the trip, haul or offload in the entered list of Trips/Hauls/Offloads found on the right hand side of the screen. Once the trip, haul or offload has been located in the entered list, double click on that row in the list. The trip number, haul number, or offload number will now appear in the upper left side of the screen. Now click on the New Mammal button

Figure 16-35 Mammal Data Form with Mammal Panel Open

Adding Mammal Data

After selecting the New Mammal button, the mammal data panel will appear (Figure 16-35). Using the drop down list in the species name field, select the name of the marine mammal. When you leave the species name field, the species code field will automatically update. If you change the species code, the marine mammal name will change when you leave the species code field. In the # of animals field, enter the number of animals. After entering the total # of animals, click on

the New Interaction button. *The New Interaction button will not become available until you enter a number greater than 0 in the # of animals field.*

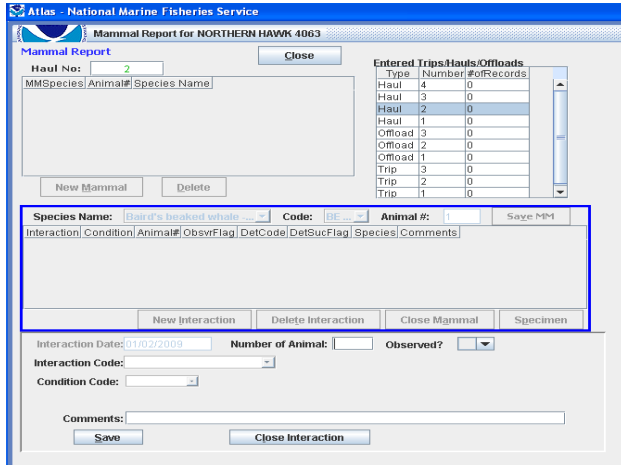

Figure 16-36 Mammal Data Form with Mammal Interaction Panel Open

Adding Mammal Interaction Data

After selecting the New Interaction button, the mammal interaction panel will appear (Figure 16-36). Enter all the specific interaction data in this panel. *Don't forget the comment field is required. Please try to supply as much information as possible about this interaction and mammal.* Once you have entered all the interaction data, you then must click on the Save button at the bottom of the panel. This will now save your interaction information. Your interaction data are now viewable in the mammal data panel (Figure 16-37)

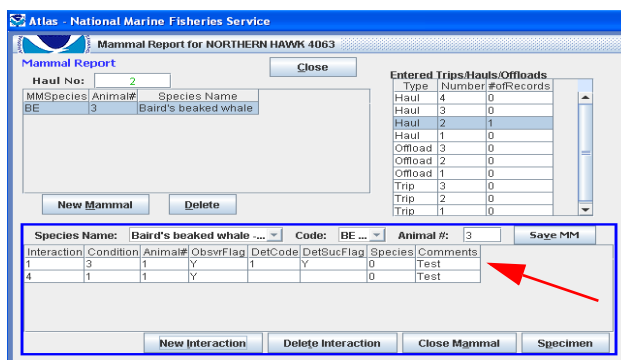

Figure 16-37 Entered Mammal Interaction Data

Editing Mammal Data or Interaction Data

To edit mammal data or interaction data, first go to the list of entered trips, hauls, or offloads found on the right hand side of the screen (Figure 16-34). Find the trip, haul, or offload that contains the data you want to edit and double click on that record. Now, on the left hand side of the screen in the list of entered mammals (Figure 16-38), double click on the mammal you want to edit.

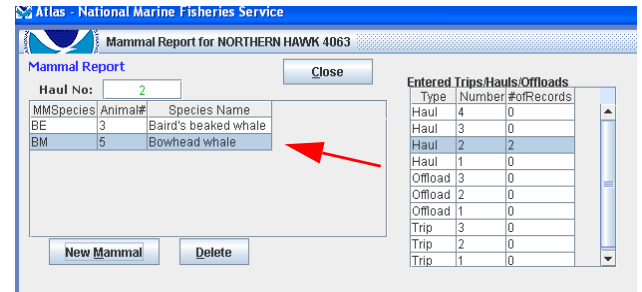

Figure 16-38 Entered Mammal Interaction Data

Now the mammal interaction records will appear in the mammal data panel (see Figure 16-39). Here you can change the marine mammal species name, code or the # of animals.

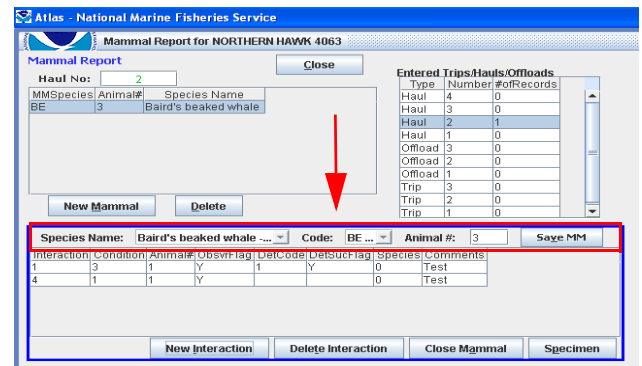

Figure 16-39 Edit Mammal Interaction Data

If you want to edit a specific marine mammal interaction, find that interaction in the entered list (Figure 16-37) and double click on the entry to open up the interaction data in the marine mammal interaction panel.

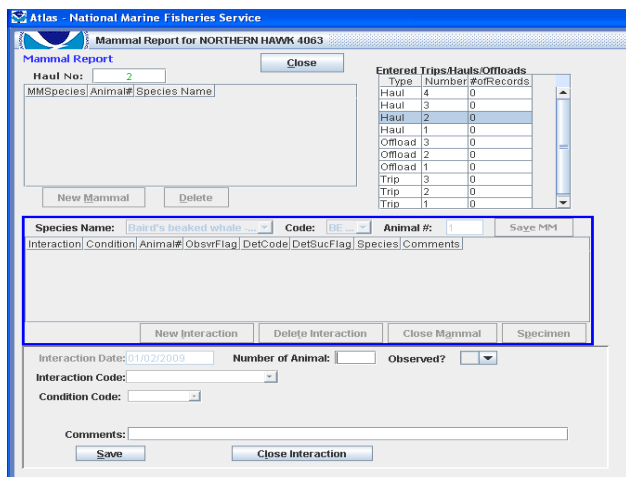

Figure 16-40 Mammal Data Form with Mammal Interaction Panel Open

The marine mammal interaction data will now appear in the interaction panel (Figure 16-40) where the data may be edited. After making changes, you must click on the Save button at the bottom of the interaction panel.

Adding Mammal Specimen Data

Before adding mammal specimen data, you must have entered a marine mammal interaction. Once the marine mammal interaction data has been saved, you can view the specific marine mammal interaction in the marine mammal data panel (Figure 16-37). In the marine mammal data panel, select (highlight) the marine mammal interaction record for which you want to enter mammal specimen data. Once the record has been selected, select the Specimen button. The Marine Mammal Data Specimen form will now open (Figure 16-41).

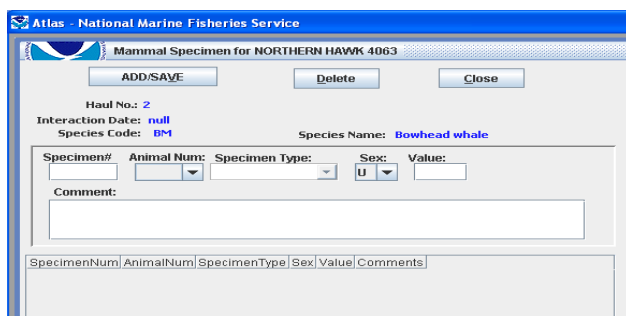

Figure 16-41 Mammal Specimen Data Form

Specifics on the Marine Mammal Specimen Data Form

When the marine mammal specimen form opens, enter all the information in the data entry window. In the comment section, please provide as much detailed information as possible. Once all the data has been entered, click on the Add/Save button.

TEXT MESSAGES

To open the text message form, select the Text Message Navigation button from the Atlas Main Menu (Figure 16-5). The Text message screen will now open (Figure 16-42).

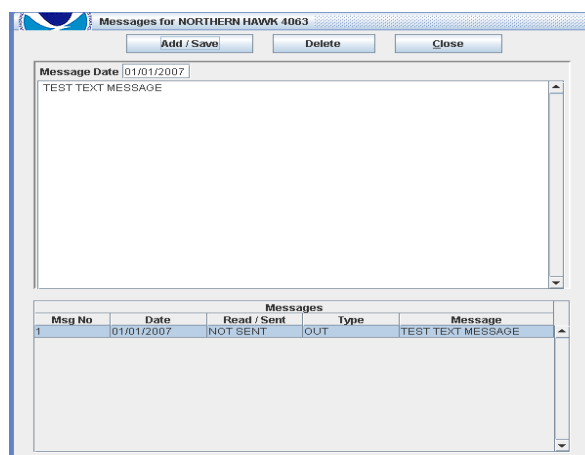

Figure 16-42 Text Message Window

Specifics on the Text Message Form

Text messages are a vital link between the observer and FMA staff. Text messages should only be used for observer related duties and issues, as well as technical problems. The text message form will be used to create both an outgoing text message (created by the observer) and to read incoming text messages (created by FMA staff).

Creating An Outgoing Text Message

To create an outgoing text message, click on the Add/Save button at the top of the screen. The message entry window will now open. Enter the current date, then begin entering your text message. Once the message has been created, click on the Add/Save button again. Your created outgoing message can now be viewed in the list of messages found at the bottom of the screen

(Figure 16-43). *Your created message will be transmitted the next time you prepare and transmit data.*

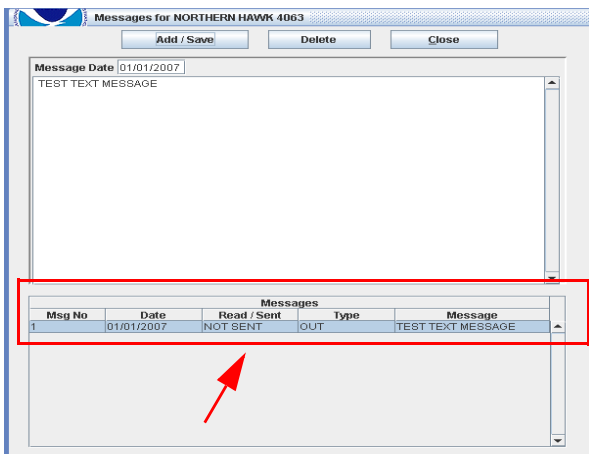

Figure 16-43 Text Message List

Reading An Incoming Text Message

Each time you successfully transmit data to Seattle, any ingoing text messages will be picked up at this time. Once the transmission is complete, go to the Text Message form and see if any incoming messages were received. Once the text message form opens, look in the list of messages found at the bottom of the screen. Find the Type column and look for any INCOMING types. Once you have found a new incoming message, double click on that row in the list (Figure 16-43) and the incoming message can be viewed.

Pickup Messages Button

Incoming text messages can be checked using the Pickup Messages button in the Main Screen of Atlas (see Figure 16-5). Simply click on Pickup Messages and Atlas will open a connection and retrieve any incoming text messages. This button will **NOT** transmit outbound messages or data. Text messages are also received after preparing and transmitting data.

TRANSMITTING DATA

Vessels that are installed with Atlas have the capability to email observer data directly to the FMA Seattle office. *For information on when to send data for your vessel type, please see Figure 2-7 on page 2-22.* Data are emailed from inside of atlas via a satellite phone on the vessel. Shoreside plant Atlas data are emailed from inside atlas over the plants email network. Before an

observer transmits data from a vessel, they should confirm with vessel personnel that the on board satellite phone has a strong enough signal to transmit data. To Transmit observer data, click on the Transmit Navigation button from the Atlas Main Menu (Figure 16-5). The Transmit form will now open (Figure 16-44)

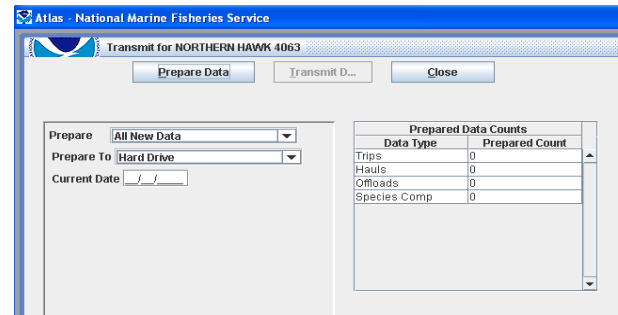

Figure 16-44 Transmit Data Window

Specifics on Transmitting Data

Once the transmit screen has opened, you must first select from the Prepare drop down list which data to prepare. There are 5 different data preparation options (Figure 16-45). *The default option is All New Data and should not be changed unless instructed to do so by FMA staff.*

After selecting the prepare options from the drop down list, enter the current date in the current date field.

Once all the fields in the transmit screen have been filled out, select the Prepare Data button at the top of the screen. Your data will now be prepared for transmission. During the preparation process, the data you have selected is pulled out of the database and compressed into a file that will eventually be emailed to Seattle. When the data preparation is finished, you will receive a message that your data has been prepared. Also, you can view the Prepared Data Count list (Figure 16-44) on the right hand side of the Transmit Form. This list will give you an idea of the number of records that have been prepared for transmission.

Data Transmission

After the data preparation has finished, you may now transmit the data to Seattle. Select the Transmit button at the top of the Transmit screen (*the transmit screen will not become available until you have prepared data*). Atlas will now find and open an ISP connection

Prepare Options	Prepare Functions
All New Data	This is the default option. <i>You should always use this option unless otherwise instructed.</i> This will prepare all new and edited data and any new outgoing text messages.
Hauls by Selected Numbers	Allows user to input a range of haul numbers to send. <i>Only use this option if instructed.</i>
Hauls by Selected Dates	Allows user to input a date range of hauls to send. <i>Only use this option if instructed.</i>
Trips by Selected Numbers	Allows user to input a range of trip numbers to send. <i>Only use this option if instructed.</i>
Trips by Selected Dates	Allows user to input a date range of Trips to send. <i>Only use this option if instructed.</i>
Offloads by Selected Numbers. <i>Only appears for plant observers.</i>	Allows user to input a range of offload numbers to send. <i>Only use this option if instructed.</i>
Offloads by Selected Dates. <i>Only appears for plant observers.</i>	Allows user to input a date range of offloads to send. <i>Only use this option if instructed.</i>

Figure 16-45 Prepare Options

to email the data to Seattle (Figure 16-46).. Once the

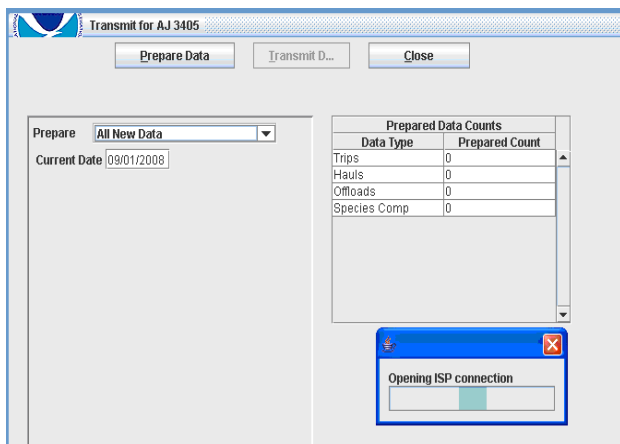

Figure 16-46 Transmission Connection

connection has been opened, the status bar will say “Sending Data to Seattle.” After your prepared out bound data are sent, the system checks for incoming

text messages. A dialog box will notify you of a successful transmission and the number of incoming messages.

You must monitor the transmission to make sure it is completed. Once the transmission is complete, the status bar will state if the data was sent successfully. Most transmissions only take a few minutes. If the transmission does not complete within 10 minutes, then close out of the Atlas transmit screen and try again. To resend data go back in to the transmit screen, and prepare data again and select the Transmit Data Button.

Transmitting Rockfish Pilot Project Data

Data collected for the Rockfish Pilot Project (RPP) must be entered into Atlas. Vessels participating in the RPP do not have the ability to transmit from sea, so all data must be sent via the plant observer. **Once data has been entered you will copy your data to a USB thumb drive and then the plant observer will transmit the data off the thumb drive to the NMFS office in Seattle.**

Data Entry for RPP Vessel Observers

1. Start the Atlas Software by clicking on the observer Atlas Icon on the desktop.
2. Enter your First and Last Name.
3. Enter your Cruise Number.
4. In the Vessel Permit field click on the drop down arrow and select the name of vessel you are on. Once the name of the vessel is selected, the Permit number will then be filled out.
 - If the correct name of the vessel is already there, you can skip this step.
5. Now you can enter your data.

Prepare RPP Data to be Transmitted from the Plant

1. Start the Atlas software by clicking on the Observer Atlas Icon on the desktop.
 - **DO NOT INSERT THE USB THUMB DRIVE YET**
2. Click on the Transmit button on the left side of the screen.
3. Take your USB thumb drive (issued as part of your gear) and insert thumb drive into USB port.
4. In the Prepare option Box select All New Data.

5. In the Prepare to box select USB Flash Drive.
6. Enter the current date.
7. Click on the Prepare Data button at the top of the screen.
8. Close down the atlas program.
9. Give USB Flash Drive to plant observer to send your data that you prepared.
10. Once data has been transmitted by the plant observer they will give you your thumb drive back.

Transmitting RPP Data from a USB Flash Drive

These vessels do not have the ability to transmit Atlas data from the vessel, so the data must be transmitted by the plant observer.

1. Start the Atlas software.
 - **DO NOT INSERT THE USB THUMB DRIVE YET.**
2. Click on the Transmit button on the left side of the screen.
3. Now insert the USB flash drive that was given to you by the vessel observer.
 - *Wait at least 20 - 30 seconds for your computer to recognize the USB flash drive.*
4. In the Prepare option Box select All New Data.
5. Enter the current date.
6. Click on the Prepare Data button at the top of the screen.
 - *If you receive a dialog box that says, “No records found to be prepared” click on the Ok button.*
7. Now click on the Transmit Data button at the top of the screen.
8. You will now receive a dialog box that says “Do You want to copy prepared data from a USB Flash Drive to transmit? Click on the Yes box. All data (including your data if you had any) will be transmitted to NMFS in Seattle.
9. You can now return the thumb drives to the correct vessel observers to be used again.

ARCHIVE/BACKUP

To open the archive/backup form, select the Archive/Backup Navigation button from the Atlas Main Menu (Figure 16-5). The Archive/Backup screen will now open (Figure 16-47).

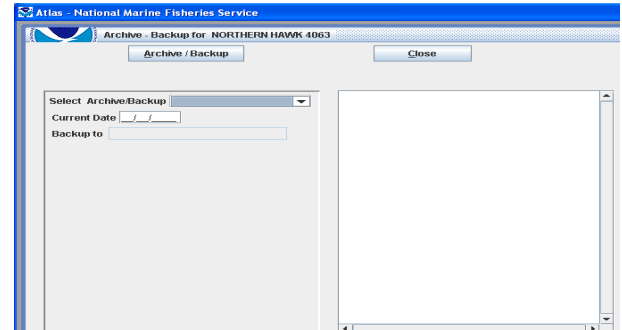

Figure 16-47 Archive/Backup Window

Specifics on the Archive/Backup Form

Before deploying, each observer should have received at least one or two USB flash drive memory sticks. These memory sticks are to be used to perform daily backups on the computer with Atlas. At the end of your cruise, just before disembarking for the last time, you also must perform an archive of the database. When you return for the debriefing process, you must have your memory sticks with you.

Backing up the Atlas Database

Backing up the database must be performed on a regular basis. Typically, after you have finished entering data for the day and after you have transmitted data, you should perform a backup. To backup data, select the Backup Database from the drop down list. Enter the current date. Then take the memory stick and place it in an USB port on the Atlas computer. It does not matter which USB port is used. Then click on the Archive/Backup button at the top of the screen. Your database will now begin backing up. The amount of time to perform the backup can vary depending on how much data are in the database.

Archiving the Atlas Database

Archiving the database must be performed just before the sole or lead observer disembarks the vessel or plant for the last time. *If you are the second observer and are disembarking you should not archive the database.* Archiving will delete all your data from the database so that the next observer will have a fresh

database with which to work. To archive data, select the Archive Database from the drop down list. Enter the current date. Then take the memory stick and place it in an USB port on the Atlas computer. It does not matter which USB port is used. Then click on the Archive/Backup button at the top of the screen. Your database will now begin archiving. The amount of time to perform the backup can vary depending on how much data are in the database.

PRINT/COPY

The Print/Copy feature allows the observer to printout their data for the vessel to use or to copy their data to the computer for the vessel to use. Vessel personnel may ask the observer to make a printout or make a copy of their data. To open the Print/Copy form, select the Print/Copy Navigation button from the Atlas Main Menu (Figure 16-5). The Print/Copy screen will now open (Figure 16-48).

Specifics on Printing Atlas Data

From the Print/Copy form in Atlas, select the haul range of data to print. After selecting the haul range to print, select each form type to print by clicking the box next to each form type. Then select the print button. The data will be printed to the windows default printer. ***Text messages will not be printed out using this print option.*** The printout will consist of column names and the data that was entered by the observer.

The screenshot shows a software window titled "NORTHERN HAWK 4063". The main heading is "Select a range of Hauls and tables". Below this, there are two input fields labeled "From Haul:" and "To Haul:". Underneath these are four checkboxes: "Species Composition Data", "Percent Retain Data", "Sample Data", and "Length Data". A note in parentheses says "(Copy observer data to computer for vessel use)". There are three buttons: "Copy/Save Data", "Print Data", and "Cancel". Below the buttons, another note in parentheses says "(Print for vessel use, does not print text message)".

Figure 16-48 Print/Copy Screen

Specifics on Copying Atlas Data

Copying Atlas data will export the selected data from the Atlas database to a file on the computer with Atlas. Once the file has been copied the vessel can then import this file into other software. The file is in a comma delimited.csv format. From the Print/Copy form in Atlas, select the haul range of data you want to copy. After selecting the haul range to copy, select each form type to copy by clicking the box next to each form type. Then select the copy button. You will now receive a windows dialog box asking you where to save the files. Select the folder in which the vessel asks you to save the files. ***Do not change the file name.*** Click save and the data will be copied into a comma delimited file to the computer. Data for on board use is usually copied into an Excel file, which Atlas uses as a default. ***Text messages will not be copied using the copy option.***

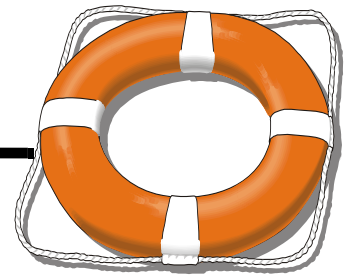

HEALTH AND SAFETY INFORMATION

Table of Contents

List of Priorities	17-1
Introduction	17-1
Before You Board	17-2
Embarking, Disembarking and Transferring Between Vessels	17-6
First Days Onboard	17-7
Personal Health and Safety	17-7
General Safety Precautions	17-7
Working on Decks	17-8
Working in Factories	17-8
Seasickness	17-9
Fish and Mammal Poisoning	17-10
Fatigue	17-10
Illnesses and Accidents	17-10
Emergencies Onboard	17-11
Man Overboard	17-11
Cold-Water Near Drowning	17-11
Fire	17-11
Flooding	17-12
Abandon Ship	17-12
Sending a May Day	17-12
Safety Equipment	17-12
Life Rafts	17-13
Survival Kits	17-14
Personal Locator Beacons, PLBs	17-14
The Seven Steps to Survival	17-15
Summary	17-16
Federal Requirements for Commercial Fishing Industry - Vessels greater than 60 ft.	17-17

LIST OF PRIORITIES

Your own safety is *always your top priority* when working on a vessel. In this chapter, you will find information on:

- how to familiarize yourself with safety equipment and procedures aboard commercial vessels.
- general safety precautions to take onboard and while you are performing your observer duties.
- how to deal with illness and sickness onboard.
- how to transfer between vessels safely.
- how to respond to emergency situations.
- what procedures to follow if you must abandon ship.

INTRODUCTION

Commercial fishing has ranked among “the most deadly occupations” in the United States since 1992, when the Bureau of Labor Statistics began publishing these data. Each year in Alaskan waters, an average of 34 fishing vessels and 24 lives are lost in the commercial fishing industry. Injury rates aboard commercial fishing vessels are also high. Slippery decks, heavy gear, and an inhospitable environment contribute to the hazardous working conditions.

The safety and survival material presented here and in observer training is only an introduction to these topics. There are many pamphlets, books, and videos that provide more detailed information about safety at sea, including the North Pacific Fishing Vessel Owners Association's *Vessel Safety Manual*, and the University

HEALTH AND SAFETY INFORMATION: Before You Board

of Alaska's Marine Advisory Bulletin *Beating the Odds on the North Pacific*. Both are available during training and are carried aboard many vessels.

Safety is a personal responsibility. Take every opportunity to learn as much as you can before an emergency occurs. Most fishing vessels are operated by safety-minded captains who realize the danger of their occupation and consider safety in all they do. Use the knowledge and experience of the vessel's crew for guidance on safety on your vessel. They are concerned about the safety of observers, as guests on their vessel, and will make sure that dangers for you are minimized. No matter how cautious the crew is, it is **your** responsibility to keep yourself safe and know how to react in all emergency situations.

BEFORE YOU BOARD

Prior to boarding any vessel, check for the U.S. Coast Guard Commercial Fishing Vessel Safety Examination Decal. **Do not board a vessel that does not have a current decal.** If you are reboarding the vessel after being deployed to another, you are expected to review the safety equipment again to ensure there were no changes to the equipment in your absence. You must ensure the decal is valid for every vessel based on the information noted on the face of the decal. If the vessel does not have a current decal, inform the captain that you are not able to board the vessel and immediately inform your employer and NMFS. Document both valid and invalid decal information in your logbook.



Please note that the mothership Ocean Phoenix is an inspected vessel and is not required to have a safety decal.

The Commercial Fishing Industry Vessel Safety Act (CFIVSA) of 1988 mandates certain safety equipment, instructions, and drills aboard vessels that operate beyond the boundary line (a federally designated line between points of land) or that carry more than 16

individuals. The CFIVSA applies to most North Pacific vessels on which observers are deployed (see "Federal Requirements for Commercial Fishing Industry - Vessels greater than 60 ft." on page 17-17).

In mid 1998, NMFS adopted regulations to ensure the adequacy and safety of fishing vessels carrying observers. Under 50 CFR Part 600, owners and operators of fishing vessels that carry observers are required to comply with U.S. Coast Guard safety regulations. A vessel is considered inadequate or unsafe if it does not comply with the regulations regarding observer accommodations or if it has not passed a USCG safety examination or inspection.

This rule applies to all vessels designated to carry an observer as part of any mandatory or voluntary Observer Program under the MSFCMA (Magnuson-Stevens Fisheries Conservation and Management Act), the Marine Mammal Protection Act, or any other U.S. law.

Prior to boarding a vessel for the first time, you must check the vessel for compliance with Coast Guard regulations. Complete your "Vessel Safety Checklist" form in your logbook (Figure on page 17-3). Use the "Issues to Address During A Safety Orientation" section below as a reference for what questions to ask yourself while looking at safety gear. Please remember that all "N" responses on the checklist require a comment in the "additional comments" section.

All items in bold blue text on the Vessel Safety Checklist are considered "No go" items. If you feel that you should not board the vessel because it is unsafe or inadequate for you to carry out your duties, contact your employer immediately. A vessel that would normally carry an observer, but is deemed unsafe, is prohibited from fishing without an observer. NMFS will require that the vessel pass a USCG safety examination or correct the deficiency that is causing it to be unsafe.

In addition to completing the Vessel Safety Checklist **you should not board your vessel without a NMFS issued immersion suit and a NMFS issued PLB.** If you do not have these items, contact your employer and NMFS staff immediately.

Vessel Safety Checklist

VESSEL NAME: MISS "B" HAVEN VESSEL PERMIT: 12345

Ensure the USCG Commercial Fishing Vessel Safety decal is not expired based on the information noted on the face of the decal.

Commercial Fishing Vessel Safety EXAMINATION

DATE ISSUED: Nov. 2009 EXPIRES: 2007 2008 2009 2010 2011

VESSEL Documented Undocumented

LOCATION: Beyond Boundary Line Inside Boundary Line

Inside Outside

3 NM 12 NM 20 NM 50 NM >100 NM

THIS VESSEL MEETS ALL USCG COMMERCIAL FISHING INDUSTRY VESSEL REGULATIONS

NO. 51865

CG-5587A (Rev. 6/06) U.S. Department of Homeland Security

Is the decal valid? Y N

LIFE RAFTS:
 Number of: 1
 Total capacity: 8
 # of crew & observer/s on board 7
 Sufficient capacity? Y N
 Life raft(s) able to float free? (Note: some vessels have their rafts in a float free cradle - this is an approved cradling system, so long as the painter line is properly attached to a weak link.) Y N
 Service Due sticker exp. date: 11 / 2010 (expires on date displayed)
 Hydrostatic release exp. date: 11 / 2010 (expires on date displayed)
 Your raft assignment: 1

EPIRB: (Visual inspection only. Please leave all testing/handling to crew)
 Location(s): BACKSIDE of WHEELHOUSE
 Battery exp. date: 12/2010 (expires on date displayed)
 Hydrostatic release expiration date: 12 / 2010 (expires on date displayed)
 Located in a float free location?: Y N
 NOAA Registration Sticker:
 Exp. date: 8/2010 (expires on date displayed)
 Registered to this vessel (name of vessel displayed): Y N
 Alphanumeric code on sticker matches code on EPIRB: Y N
 Signal tested (or asked to see station log in wheelhouse for most recent test. Signal should be tested monthly): Y N

IMMERSION SUIT/PFDs:
 Available for everyone on board? Y N
 Location(s): Storage cabinet in wheelhouse
 Functioning strobe on personal suit? Y N

FIRE EXTINGUISHERS:
 Extinguisher(s) found in every main area/corridor? Y N
 Extinguishers in 'good and serviceable condition' (gauge in the green, low amounts of rust, canister in good condition, unobstructed, hoses attached, service tags available)? Y N

FLARES: (ask captain for assistance)
 Location(s): Box in wheelhouse
 Expiration dates checked? Y N
 (expires on date displayed)
 If checked, number of flares: 12

LIFE RINGS/SLINGS:
 Number of: 4 life rings / 1 sling
 Easily accessible?: Y N
 Name of vessel displayed on each? Y N
 Location(s): 1 on bow, 2 on stern, 2 on wheelhouse

Figure 17-1 Example of completed safety checklist

HEALTH AND SAFETY INFORMATION: Before You Board

<p>ADDITIONAL SAFETY CHECKS:</p> <p>Watertight doors - do they close properly? <input checked="" type="radio"/> Y <input type="radio"/> N</p> <p>Hatches/passageways - are they unobstructed? <input checked="" type="radio"/> Y <input type="radio"/> N</p> <p>Discussed safe places to work on deck and in factory with captain/crew? <input checked="" type="radio"/> Y <input type="radio"/> N</p> <p>Discussed refrigerant leak procedures? Y <input checked="" type="radio"/> N</p> <p>Type of refrigerant used <u>None</u></p> <p>Discussed reporting/identifying inoperative alarm/fire systems? Y <input checked="" type="radio"/> N</p> <p>Did you hear the general alarm? <input checked="" type="radio"/> Y <input type="radio"/> N</p> <p>Where will you go during emergencies: <u>REPORT TO WHEELHOUSE</u></p>	<p>FIRST AID MATERIALS:</p> <p>Location(s): <u>WHEELHOUSE</u></p> <p>Is there an individual trained in CPR/First Aid on board? <input checked="" type="radio"/> Y <input type="radio"/> N</p> <p>Who?: <u>CAPTAIN J. SMITH</u></p> <hr/> <p>Radios:</p> <p>How many SSB and VHF radios?: <u>2 SSB / 2 VHF</u></p> <p>Are emergency call instructions posted? <input checked="" type="radio"/> Y <input type="radio"/> N</p> <p>Were procedures for making an emergency call discussed? <input checked="" type="radio"/> Y <input type="radio"/> N</p>
<p>SAFETY ORIENTATION:</p> <p>If you did not complete drills upon embarking the vessel, did the captain use this safety checklist to complete the required vessel safety orientation? Y <input checked="" type="radio"/> N</p> <p>Did the vessel conduct a safety orientation? <input checked="" type="radio"/> Y <input type="radio"/> N</p> <p>Who gave the orientation? <u>J. SMITH (Captain)</u></p> <p>(Detail what was covered in the comment section below)</p>	<p>EMERGENCY DRILLS AND DATE(S) CONDUCTED:</p> <p>Fire <u>NONE</u></p> <p>Abandon Ship <u>NONE</u></p> <p>Man Overboard <u>NONE</u></p> <p>Vessel Flooding/stabilization <u>NONE</u></p> <p>General alarm activation <u>NONE</u></p> <p>Donning immersion suits <u>1/16/09, 3/2/09</u></p> <p>Radio/visual distress signals <u>NONE</u></p> <p>Were the drills hands-on involving actual gear? <input checked="" type="radio"/> Y <input type="radio"/> N</p> <p>Did you participate in the drills? Y <input checked="" type="radio"/> N</p>

Observer Name: CHRIS P. OBSERVER Cruise #: 14999

Observer Signature: Chris P. Observer Date: 1/5/09

Captain Name: JOHN SMITH

Captain Signature (optional): [Signature] Date: 1/5/09

*Did the vessel request a copy of the Checklist? Y N

*If so, were you able to supply them with a copy? Y N

Additional Comments: (All "N" responses require a comment)

This vessel is a catcher - only vessel, so no refrigerant is required or used. The Captain showed me the engine room that is equipped with an alarm, but I have no reason to be down there. The crew practiced putting on their immersion suits twice, but never included me in the drill.

During my safety orientation, all items on this checklist were discussed.

Figure 17-1 Example of completed safety checklist

ISSUES TO ADDRESS DURING A SAFETY ORIENTATION

Please reference the Federal Requirements for Commercial Fishing Industry Vessels pamphlet for more specific information.

1. Check for safety inspection documentation. Is the decal valid? Look for a current USCG Commercial Fishing Vessel Safety Examination decal or ask for documentation. Record the authorization number in the space provided. These decals are valid as noted on the face of the decal from the month issued, indicated with the hole punch. You cannot board vessels which have an expired decal or if the decal will expire while you are aboard. **Contact your employer and NMFS immediately if the vessel does not have a valid decal!**

2. Locate the life raft(s). Is there enough life raft capacity for everyone aboard including you? Are you assigned to a particular one? Can the raft(s) float free? Check the service due date(s) displayed on the canister(s). Life rafts are to be serviced annually with the exception of new life rafts which have 2 years before having to be serviced. Check the hydrostatic release. Is it installed correctly? Has it expired? If the raft does not have a hydrostatic release and is rigged in an alternative float free manner, is it equipped with a weak link? Please ask the captain or crew if you have any concerns regarding the rigging of the raft or the hydrostatic release.

3. Where are the Emergency Position Indicating Radio Beacon(s) (EPIRB)? Are they in float-free locations? Check to see if the battery is expired. A sticker with the expiration date displayed will be located either on the actual EPIRB or the protective casing of the EPIRB. Are the hydrostatic releases expired? Check the NOAA registration sticker. This sticker is required of each vessel/EPIRB. Make sure it is registered to the vessel as the name will be noted on the sticker. Make sure the alphanumeric code on the actual sticker matches the registration code on the EPIRB. Check the expiration date on the sticker. The EPIRB tests must be recorded in a station log. Please ask the captain to see the log for the most recent test if one was not conducted for you.

4. Check the location of immersion suits and PFDs. Where are the immersion suits and PFDs located? Are there enough for everyone aboard? Are they accessible at all times? You will be issued an immersion suit with

strobe light and a PFD as part of your NMFS sampling gear. You must have your NMFS issued immersion suit before embarking on a vessel. NMFS suits are pressure tested per the manufacturer's recommendations and we can only be certain your NMFS suit has been inspected and tested on a regular basis. Keep yours where you can get to it quickly. Take this opportunity to try your suit on again and check the zipper. Could you put the suit on in 60 seconds? Does the zipper need to be waxed?

5. Where are the flares located? Check the expiration dates. What types of flares does the vessel have?

6. Locate the fire extinguishers. Are they accessible? Are they in good and serviceable condition?" Check to see that the pressure gauge is in the green, there are low amounts of rust, that the overall condition of the canister is good, that it is in an unobstructed location with hoses attached, and that there is a presence of service tags (tags are not a USCG requirement). Did the crew tell you of special extinguishing systems in the engine room or other areas?

7. Check the location of life rings. Where are they? Are they accessible? Is there one on each side of the vessel? Are the lines free of tangles? Is the vessel name on the ring/sling?

8. Where do you go during emergencies? Find the station billet (commonly called the station "bill"), a posted placard describing the role of all hands onboard (including the observer) in an emergency. Familiarize yourself with your role in each type of emergency addressed. As you walk through the vessel, make yourself aware of potentially hazardous areas. Identify the watertight doors, both on the interior and the outside. Can they be secured in case of heavy weather or other emergencies? Are any hatches or passageways blocked or difficult to get to? Ask the crew giving you the orientation to point out doors that must be kept closed during travel, gear retrieval, rough weather or other situations. Discuss safe places to work on deck and/or in the factory with the captain/crew and how to report/identify inoperative alarm/fire systems. What type of refrigerant is the vessel using and what do you do if there is a leak? Did you hear the general alarm? Ask the captain to demonstrate the general alarm. Does the vessel use different signals for different emergencies? If so, what are they?

9. Where are first aid materials kept? Is there a reference book onboard? Who in the crew has had first aid and CPR training?

10. Where are the SSB and VHF radios located? How many are there? Are emergency call instructions posted nearby? Do you know the procedures for making an emergency call and how to operate the radio during the call? If not, ask the captain to show you how!

11. Did the individual giving you the safety orientation use this safety checklist to complete the required vessel safety orientation? Who gave the orientation? If you did not complete the drills upon embarking the vessel, you must be provided with a safety orientation and the following items need to be addressed along with the date(s) that each drill was conducted:

- survival craft embarkation stations.
- fire/emergency/abandon ship signals.
- immersion suit locations and donning instructions.
- procedures for making a distress call.
- essential actions required of each person in an emergency.
- procedures for rough weather at sea.
- procedures for anchoring.
- procedures for recovering a person overboard.
- procedures for fighting a fire.

Never get underway on a vessel without first receiving a safety orientation. If the captain will not provide you with an orientation before leaving the dock you must disembark the vessel. It is not appropriate to receive the orientation after departing.

12. The vessel may request a copy of the checklist. Please sign it and make a copy from your logbook. ***You must keep the original!*** If a copy machine is not available, either duplicate an original color version of the checklist onto a “black and white” version of the checklist and tear that out of the logbook or let the captain know a copy can be mailed to the company, owner, or vessel upon completion of your cruise.

EMBARKING, DISEMBARKING AND TRANSFERRING BETWEEN VESSELS

Wear a PFD at all times when on skiffs or other small vessels and while transferring between boats. When climbing, do not encumber yourself with heavy backpacks or baggage. Balance is important and both hands must be free during transfers. Use a day-pack and wear foot wear such as Xtra-Tuffs or athletic shoes that provide sure footing. Time your actions with the movement of the boat, starting your climb up a ladder from the top of the up-and-down cycle to avoid being pinched against the ladder by a moving boat.

All baggage should be secured with lines and transferred via rope lines or cargo nets. Observer baskets and luggage have been lost overboard because they were thrown between ships without lines attached.

If you use a cargo net, transfer basket, or cage to board a vessel, make sure that a line is attached to the conveyance from both points for greater control and to reduce swinging. Maintain a crouched position to avoid back injury. Be sure to wear your hard hat in addition to your PFD when using this mode of transfer. Keep your arms, elbows, and fingers inside the conveyance when transferring.

Boarding Vessels at the Dock

Many larger vessels provide a gang plank with a safety net for boarding. This is not often the case with smaller vessels. Dock space at plants and other docking areas is minimal. As a result there is not always room for every vessel to secure their lines to the dock. When this happens vessels will tie to other vessels that are secured to the dock. This is called rafting. It is common to see vessels rafted 2 or more deep at the plants or docking areas. ***Boarding vessels that are tied to the dock or are rafted is extremely dangerous!*** Falling between the dock and vessel, or between one vessel and another can result in serious injury or death. The distance between the vessel and the dock or between vessels that are rafted can vary widely with the weather, tides, and currents.

When boarding vessels you should ensure your safety by:

- always wearing some type of personal flotation device when crossing between boats and the dock,

- always insuring someone is around to watch you before attempting to cross. You should clearly communicate your intentions to dock personal or other crew members and ask that they watch you until you are safely aboard your vessel or on the dock, and
- not boarding when it is not safe. Consider conditions such as icy and slippery decks and/or ladders, poor weather, darkness, wind, tides, currents and/or distances greater than you can safely manage.

Transfers at Sea

You will normally board and disembark vessels at the dock, but transfers at sea sometimes may be necessary. Transfers between vessels are potentially hazardous, especially in rough weather. You must assume responsibility for deciding whether or not to transfer based upon your own evaluation of the sea



conditions, transfer vessel, visibility, and distance to travel. An ADF&G crab observer and two crew members died when their small transport skiff overturned in rough water.

Never transfer via a small boat if you cannot see your destination. Do not transfer at dusk, in darkness, or in any other low visibility conditions. If boarding a small skiff or inflatable boat, make sure that the engine has been started and warmed up, and that there are oars stowed as a backup. Do not transfer when the sea state is two meters or more. Always be cautious, you cannot be forced into transferring against your better judgment by an anxious or impatient captain. Under “Vessel Responsibilities,” 50 CFR §679.50(g), an operator of a vessel required to carry one or more observers must:

- Ensure that transfers of observers at sea via small boat or raft are carried out during daylight hours, under safe conditions, and with the agreement of observers involved.

- Notify observers at least three hours before observers are transferred, provide a safe pilot ladder and conduct the transfer to ensure the safety of observers during transfers.
- Provide an experienced crew member to assist observers in the small boat or raft in which any transfer is made.

In some situations observers will be asked to transit on an unassigned vessel between ports. This is a common occurrence between Dutch Harbor and Akutan when there are flight delays. In these situations you must ensure the vessel you are transiting with has all the required safety gear. Before leaving on the vessel use your safety checklist as a guide to review the safety equipment. The most common areas of concern are the number of survival suits available and life raft capacity. If the vessel is missing any of the required safety equipment you should not transit with the vessel.

FIRST DAYS ONBOARD

When you board a vessel, regulations mandate that you receive a safety orientation. This may be as simple as crew members showing you around, but may include watching videos, donning immersion suits, or conducting drills. In addition to the required orientation, drills and instruction must be conducted involving each individual *at least once a month*. You should participate in any drills and instruction.

Memorize the exit route from your cabin, the galley, the galley, and other locations where you spend a fair amount of time. Keep your immersion suit where you can get to it quickly.

PERSONAL HEALTH AND SAFETY

Fishing vessels and processing plants have many potentially dangerous areas. Be aware of your surroundings at all times and keep your eyes and ears tuned to what is going on. Your work hours and environment will be different than what your body is accustomed to. Drinking plenty of water and eating enough food are critically important in maintaining your health in this new environment.

General Safety Precautions

Staying safe aboard a vessel includes more than safety equipment. Follow these guidelines to avoid injury and strain during your work activities:

HEALTH AND SAFETY INFORMATION: Personal Health and Safety

- Wear a personal flotation device whenever you are working on deck, transferring at sea, or disembarking or boarding your vessel.
- Never board or disembark a vessel alone! Always be sure someone is there to watch that you are safely on or off the vessel.
- Avoid loose clothing or apparel with strings. Remove all jewelry prior to going out on deck or into the factory. Long hair should be tied back. These items could be caught in moving equipment.
- Don't run aboard ships, particularly up stairwells. Hold handrails in stairwells and on ladders. Slipping, tripping, and falling are the most common causes of observer injury.
- Step carefully over the combing rising from the bottom of metal doors and passageways, and beware of low overheads in vessel stairwells and on watertight doors.
- Lift correctly! When lifting, get as close as possible to the object, keep your back straight, and use your legs. On a moving vessel, this is critical because unexpected movements can strain your back. Don't be afraid to ask for assistance in moving heavy objects, such as full baskets.
- Fatigue and sleep deprivation suffered by the crew and yourself are threats to your safety. Be aware of the physical state of those around you—whether the person is on watch or in control of the gear. Fatigued individuals make mistakes that could affect you. Monotonous work, such as longline tally sampling, is difficult to do accurately and safely when you are tired. Follow the example of the crew and catch up on sleep when there are breaks in fishing.
- Eat well. Vegetarians (due to common meat-and-potato menus) and diabetics (due to odd eating schedules) need to be especially concerned about getting a proper diet. Dietary supplements or vitamins may be helpful if this is a concern for you.
- If you are not feeling well, use extra caution and reduce your time spent working.
- Do not stay outside on the deck during rough seas. One observer was swept forward over a trawler's winches by waves sweeping up the stern ramp. When you are outside, remain in full view of a second party at all times.
- Watch for slick spots where the deck is wet, oily or frozen.
- Beware of trawl cables under strain, they can give way and have maimed and killed fishermen. Whenever a cable is subjected to tension, stand where a backlash will not hit you. If your sampling station is on deck, stop working and go to a safe place while trawl nets are being set or retrieved.
- Explain to the deck boss that you need to watch the haul-back to monitor for marine mammals and will need to go out on deck for codend measurements once the winches have stopped. Ask for advice on a safe place to stand. When nets are being hoisted off the deck, stand clear. Heavy nets have fallen near observers when the suspending cables parted.
- Watch for moving pots and, if possible, face the pot launcher while you work. Stay away from the bouy line when the crew is launching pots. Crewmen have been caught in a loop, or the "bite," of the line and pulled overboard.
- Wear eye protection on longliners if you are near the moving hooks. Use a gaff to collect fish to protect your hands and keep your body further away from the moving line.

Working in Factories

Factory processing areas are crowded with machinery, electrical lines, and conveyor belts. The maze of equipment often makes it difficult to get to your sampling area. Climbing over, under and around machinery on oily and wet floors, especially in rough weather, is extremely hazardous. Look carefully before stepping or grabbing for handholds.

When collecting samples off conveyor belts, do not try to pry out fish caught between two connecting belts, or grab for fish caught under a diverter board. Your finger or hand may get mangled in the machinery. If you need to retrieve these fish, make sure the belt is stopped first.

Whenever you are in the factory, be aware of factory offal wash out around the scuppers and bilges. This rushing water can affect your balance. Lastly, watch for

Working on Decks

- Wear a hard hat, personal flotation device and boots when on deck.



low beams, belts, hoses, and other equipment; observers frequently hit their heads in unfamiliar factories.

Some factories have sanitation rules, including “foot dips” with cleaning solution and brushes, that observers must follow. Please be aware of these rules and be sure to follow them.

Seasickness

One of the least pleasant aspects of going to sea is the possibility of seasickness. An individual's susceptibility to seasickness is highly variable. If you've experienced motion sickness in cars, planes, or amusement park rides, you may experience seasickness during your cruise. Most people feel some level of discomfort when they first go to sea.



Seasickness results when the signals your brain receives from the inner ear balance mechanism contradicts what your eyes are seeing. For example, inside the cabin of a rocking boat, the inner ear detects changes in linear and angular acceleration as the body bobs with the boat. But since the cabin moves with the passenger, the eyes register a relatively stable scene. Agitated by this perceptual incongruity, the brain responds with stress-related hormones that can lead to headache, dizziness, nausea and vomiting. Its effect can be magnified by strong smells (like diesel fumes or fish, which are part of daily life at sea).

Seasickness usually occurs in the first 12-24 hours after sailing. For most people, seasickness dissipates when the body becomes acclimated to the ship's motion (getting one's “sea-legs”). In rare cases, an individual may stay ill beyond the first couple of days at sea, regardless of sea state. If this occurs, dehydration may become life threatening if it leads to shock.



The “Coast Guard cocktail” can help prevent seasickness. Mix 25 mg of Promethazine with 60 mg of Pseudoephedrine. Reduce the Pseudoephedrine to 25 mg if you feel jumpy.

Take seasickness medication *before* you go to sea. There are several over-the-counter or prescription medications available to minimize seasickness. Antihistamines such as Dramamine (generic name

dimenhydrinate) or Bonine (generic name meclizine) are effective and are available over-the-counter. These drugs cause drowsiness. A two part, prescription-only drug called “Coast Guard cocktail” is Promethazine, a seasick-preventing antihistamine coupled with Pseudoephedrine, which prevents drowsiness. Transderm Scop is another prescription-only motion sickness drug. It is a dime-sized adhesive patch that is worn behind the ear and delivers a continuous dose of scopolamine. Each patch lasts for 72 hours. The main side effects of the patch are dry mouth and occasionally blurry vision, but there is less drowsiness. Acupressure wristbands and eating crystallized ginger are other remedies used with varying success.

Seasick medications must be taken before the symptoms begin. Most take several hours to be absorbed in your system and may not work if you are already vomiting. Even if you doubt you will get seasick, you might want to take the medication before you board as a precaution.

If you should get seasick, take comfort in the fact that recovery is only a matter of time. All that is usually required for a complete recovery is some patience. Here are a few tips and considerations regarding seasickness:

- Continue eating foods such as crackers, dry toast, dry cereal, etc. Avoid food that is greasy, sweet or difficult to digest. Keeping something in your stomach may suppress nausea and eliminate painful “dry heaves.”
- Keep drinking fluids. Seasickness and related medications cause dehydration and headaches. Drink low-acid juices, clear soups and water. Avoid citrus juices, milk and coffee.
- Focus on the horizon to eliminate the visual conflict in your brain. If you must be inside, try to stay toward the middle or aft of the vessel.
- Keep working. Most people find that being busy on deck keeps their minds off their temporary discomfort. Also, the fresh air on deck may help speed recovery.
- Carry a plastic bag. This simple trick allows some peace of mind and eliminates some of the panic of getting sick. If you vomit over the side of a boat, be

HEALTH AND SAFETY INFORMATION: Illnesses and Accidents

aware of the direction of wind and waves. Going to the leeward side will ensure that an unpleasant experience doesn't become any worse!

- Above all, don't be embarrassed or discouraged. If you are sick, chances are that others are sick too. No one is immune to seasickness.

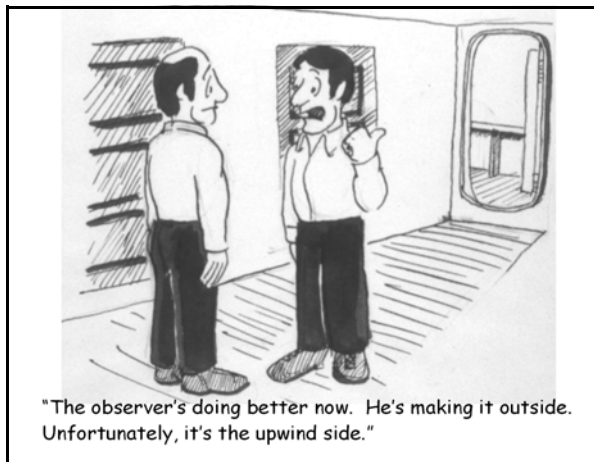

Fish and Mammal Poisoning

Bacteria from fish may lead to infection in cuts, scrapes or punctures. To prevent this "fish poisoning," wash your hands thoroughly after sampling in hot, soapy water. Change your gloves often to keep them dry and discard any torn gloves. Treat *all* minor cuts, especially those on your hands, with an antiseptic such as Betadine to avoid infection from fish slime.

Be cautious whenever wading through fish on deck or in the factory. Fish spines, especially on rockfish, can penetrate rubber boots and cause painful wounds to the feet.

If a wound becomes red or swollen, soak it for 1/2 hour in very hot, soapy water at least three times a day. Dry and bandage the wound. Antibiotics are commonly prescribed for fish poisoning. Vessels very often carry antibiotics onboard should they be needed. Never leave an infection untreated! The threat to your health can become much more serious than simply a pair of inoperative hands.

Take extra precautions against infection when collecting specimens from marine mammals. Because these mammals have similar biological systems to our own, organisms which infect them can infect us. "Seal finger" is a fungal infection of the hands which can easily be contracted by a scratch or bite.

Fatigue

Lack of sleep is as much a part of observing as blue baskets and rain gear. Sleep deprivation can cause serious problems. When you are tired, you are less likely to make good decisions or pay attention to hazards.

The only way to recover from sleep deprivation is to sleep uninterrupted for five to twelve hours. You may be able to get this amount of rest during offloads, weather days or while the vessel is steaming. During regular fishing operations, there are steps you can take to minimize the effects of sleep loss.

- Rotate your tasks. Try alternating weighing, measuring, tallying and doing paperwork. You are less likely to become bored and feel tired when doing a new task.
- Increase your physical activity. Just doing a few jumping jacks or push-ups helps increase circulation and oxygen intake which makes you feel more alert.
- Allow for at least four hours of uninterrupted sleep each day. Supplement this with power naps. These should be either 20 or 90 minutes in duration so as not to disrupt your REM sleep.
- Have a small carbohydrate snack, such as an apple, muffin or cereal. Proteins will give you sustained energy throughout the day, but may exacerbate drowsiness because it is harder to digest.
- Use caffeine sparingly. This stimulant may mask the symptoms of sleep deprivation, but may also inhibit you from napping or falling asleep at the end of your busy day.
- If possible, avoid antihistamines, motion sickness medication and other drugs that may sedate you.

ILLNESSES AND ACCIDENTS

You must contact the NMFS each day an illness or injury prevents you from sampling for a whole day. If you are on a vessel or at a plant with ATLAS, send a message to your inseason advisor. If you are not on a vessel or at a plant with ATLAS, use an available means of communication (phone, fax, e-mail, radio) as soon as possible. Additionally, you must contact your employer if an illness or injury prevents you from sampling for more than three days!

If you become ill onboard, such as coming down with a severe cold or flu or seasickness that inhibits your work, you must inform your employer and NMFS of your situation. If your illness gets worse or continues to affect your work for more than three days, your assignment may need to be changed to protect your health.

By regulation, each vessel must have at least one person onboard certified in first aid and CPR. If you are hurt onboard, contact your employer and NMFS. If the accident is serious, the captain will contact the USCG who will respond as necessary.

EMERGENCIES ONBOARD

Each person onboard plays a vital role in responding to emergencies at sea. The Vessel Safety check list, safety orientation, and participating in required drills should help prepare you for any emergencies which may occur.

Marine Casualties

The term marine casualty or accident includes any accidental grounding, or any occurrence involving a vessel which results in damage by or to the vessel, its apparel, gear, or cargo, or injury or loss of life of any person; and includes among other things, collisions, strandings, groundings, foundering, heavy weather damage, fires, explosions, failure of gear and equipment and any other damage which might affect or impair the seaworthiness of the vessel.

The following incidents must be documented in your logbook and discussed in season or during your debriefing interview:

- fire
- flooding
- man overboard (MOB)
- collision
- grounding
- loss of power
- loss of steering
- any crew injury beyond regular first aid
- gas leaks (ammonia and freon)
- lack of safety drills if onboard for at least 30 days

You are required to complete a written statement for each incident of a marine casualty. These written statements are usually prepared during final debriefing. The more details you have documented in your logbook, the easier completing these statements will be.

Man Overboard

Everyone has an active role in a man overboard emergency. If you witness someone falling over, you must both notify the person at the vessel controls and keep the victim in sight. According to the station bill, crew members are assigned specific tasks such as donning an immersion suit to be the rescue swimmer, launching a life boat, or throwing a life ring. As an extra set of eyes, the best role for you is to keep your eyes on and your arm pointing to the victim to aid the person at the controls.

Cold-Water Near Drowning

Cold-water near drowning is a phenomenon that has been observed in cold waters such as the seas surrounding Alaska. Although the victim may appear to be dead, victims have been revived using CPR even after being immersed in cold water for up to one hour. If you are involved in rescue or recovery effort, keep in mind that persons that have been in the water might be revived with treatment.

CPR is an exhaustive activity that requires more than one caregiver. You are not required to be certified to apply CPR to a victim. It has been said that bad CPR is better than no CPR. Keep in mind that although a victim looks dead, s/he may be revived by this technique.

Fire

A fire needs heat, fuel and oxygen. Remove any one of these components to stop a fire. Ships carry large quantities of fuel and offer few places to go in the event of fire. Station bills give specific duties responding to a fire onboard including who is in charge of the fire fighting team, and what equipment each person is responsible to gather. It is wise to know where fire extinguishers and exits are located in every area of the vessel, especially those areas in which you spend time. Fire extinguishers only have short bursts of fire retardants, so back-up extinguishers should be located and brought to the fire as soon as the fire is discovered. To effectively use a fire extinguisher, fire in short

HEALTH AND SAFETY INFORMATION: Sending a May Day

bursts in a low, sweeping motion. Keep your body low so as to avoid smoke inhalation and heat. Do not attempt to fight anything but the smallest fire (a wastebasket, for example) on your own; sound the alarm immediately before you take action. After a fire, thorough inspection must be made of the area including adjacent walls and rooms, to be sure the fire did not spread and will not flare up again.

Flooding

When a vessel is taking on water the crew usually has time to try and solve the problem. Malfunctioning pumps or leaks in through hull fittings are not uncommon, and can usually be fixed with equipment onboard. If the flooding condition worsens, the Coast Guard can drop pumps to a vessel via aircraft. Observers have a limited role in these types of vessel emergencies but should be prepared to assist if needed.

Abandon Ship

The worst possible emergency requires you to give up your shelter—the vessel. Never abandon the ship unless you are sure that being onboard the vessel is more dangerous than being in the water. Lives have been lost because ships have been abandoned too soon during fires or flooding. Knowing the nearest exits, mustering areas, life raft locations, immersion suit locations, EPIRB locations, and the emergency equipment available become critical factors in helping you survive an abandon ship emergency.

SENDING A MAY DAY

A may day call is for a life threatening emergency. The emergency frequencies are VHF Channel 16 and 2182.0 kHz or 4125.0 kHz on single side band radios. VHF radios are for short range and SSB radios are for long range communications (see Appendix V for more information on radios). Vessels are required to monitor these emergency frequencies at all times. Most radios have a red button that changes to the emergency frequency immediately. Near the radios, there will be a placard posted that describes MAYDAY calls. Be familiar with what constitutes a proper MAYDAY call:

- MAYDAY MAYDAY MAYDAY (say three times)
- Vessel name (said three times)
- Location

- Nature of emergency
- How many persons onboard
- Vessel description
- What radio frequency is being used

SAFETY EQUIPMENT

Personal flotation Devices (PFDs)

No matter how careful you are, you cannot guarantee that you won't end up in the water. NMFS issues all observers personal flotation devices. The Observer Program has several types of PFDs to choose from, including life vests, inflatable suspenders and Mustang suits. During the winter months, you'll find that PFDs will help keep you warm as well as safe.

The best PFD is the one you wear!

If NMFS-provided PFDs don't work for you, consider purchasing one. Mustang, Stormy Seas, and other manufacturers make comfortable, versatile PFDs that are incorporated into rain gear, jackets, belts or vests. Let NMFS know your needs. The PFDs that NMFS provides can change based on your feedback!

Immersion Suits

Immersion suits (often called survival suits) have helped save hundreds of lives because they provide flotation and excellent hypothermia protection. The vessel to which you are assigned is required to carry an immersion suit for all persons aboard. You will be issued a suit by NMFS as part of your safety gear.

Proper fit is vital for an immersion suit to protect you effectively. Try on your immersion suit prior to every cruise! The Observer Program has several brands and sizes with enough options for you to find the very best fitting suit possible. When trying on your suit, wear normal work clothes that you will be wearing at sea.

A strobe light is provided by the Observer Program along with your immersion suit. The strobe light *must* be attached to your suit by a lanyard about 30 inches long allowing you to hold it above your head without obstruction.

You should never embark on a vessel without a NMFS issued immersion suit with an attached functional strobe light.

Quick Donning Technique

Practice putting on your immersion suit. The Observer Program requires trainees to don the suit in *one minute* or less, but the faster you are in an emergency, the better! Practice putting on your suit in different situations, such as in the dark.

1. Sit down and work your legs into the suit. If you take your boots off, bring them with you, you'll need them on shore. Or, slip plastic bags over your boots, allowing your feet to slide easily into the suit.



2. Roll up onto your knees. Put your weak arm into the suit first, then pull the hood over your head. If you have long hair, tuck it into the hood well. If you wear glasses, decide whether you are going to put them in a pocket or wear them.

3. Hold the suit below the zipper with one hand and grab the zipper lanyard with your other hand. Lean back to straighten the zipper and pull up. Secure the face flap. ***Do not inflate the air bladder until you are in the water***



4. Jump into the water only as a last resort. Ease yourself into the water if at all possible. If jumping, protect your head by placing your inboard arm over your head. Cross your feet to protect from floating debris. Inflate your air bladder once in the water. It provides additional flotation and keeps your head out of the water.

Life Rafts

Your assigned vessel must have enough life rafts or life boat capacity for all aboard. Life rafts are stored in canisters that allow them to float free and automatically inflate if the vessel sinks. It is much better to manually launch and inflate the raft if there is time. Know where the rafts are stored, how to remove them from the cradle, where to launch them, and how to inflate them (see Figure 17-3).

Rafts with Alternative Float Free Arrangements

Not all vessels will carry a life raft that is secured to the vessel via a cradle and hydrostatic release. These rafts are classified as having an alternative float free arrangement. The rafts must still be in a float free location, provide sufficient capacity for the entire crew, be serviced at the appropriate intervals, and the painter line must still be secured with a weak link.

Rigid Life Boats

Another alternative to a traditional life raft is a life boat. These rigid capsule like life boats serve the same purpose as a life raft. They must still be located in a float free location and have sufficient capacity for everyone onboard. If your vessel is equipped with a rigid life boat be sure the master of the vessel briefs you on its use prior to embarking.

Valise Life Rafts

Smaller vessels may also use a Valise life raft to achieve the needed capacity for everyone onboard. A Valise raft is a raft that is stored in a bag rather than a canister and is not required to be stored on deck and rigged to deploy automatically. They are required to be easily accessible in an emergency and be serviced annually. Valise rafts are common on smaller vessels that must increase their raft capacity for additional crew such as the observer.

If you have any concerns regarding the survival craft on your vessel contact FMA staff or the USCG. Contact information can be found on page A-45.

EPIRBs

The vessel will have at least one EPIRB (Emergency Position Indicating Radio Beacon) mounted in a float-free bracket that will be automatically activated in the event of sinking. The signal is received by satellite and will identify the sender. It is important to know where the EPIRB is mounted and how to activate it manually. In the event of an abandon ship emergency it is an item

HEALTH AND SAFETY INFORMATION: Safety Equipment

you want to take with you. Someone will be assigned that duty on the station bill. Be sure to locate the EPIRB(s) on your vessel and read the directions on how to activate them.

Personal Locator Beacons, PLBs

You will be issued a Personal Locator Beacon, a small hand held personal EPIRB, along with your observer sampling equipment. The PLBs are GPS equipped units, that when activated, send your exact GPS coordinates along with the 406 alphanumeric signal to the SARSAT/COSPAS Mission Control Center. When the signal is received, the Mission Control Center mobilizes the USCG and provides them with information on the person issued the PLB along with your exact coordinates. This information can drastically decrease rescue times. ***You must never embark on a vessel without your PLB.***

In the case of a serious life threatening emergency your PLB should be activated immediately. Once your PLB is activated in an emergency, do not turn it off until you have been rescued or the emergency is resolved.

If you accidentally activate your PLB you must:

- Turn off the PLB.
- Tell the Captain.

- Report the false alarm to the USCG at 1-800-323-7233 or via radio. You will be asked for the PLB's unique alphanumeric code, date, time and location.
- Call your employer.

Once the emergency that caused you to activate your PLB is resolved, you should contact your employer immediately and inform them of the situation.

If your PLB has been activated for any reason it must be returned to a FMA office and you will be issued another one. All PLBs must be returned to the manufacturer following activation to receive a fresh battery.

Survival Kits

A personal survival kit can take up very little space in an immersion suit, yet greatly enhance your ability to survive. Think of the seven steps to survival and choose items that may help you. Items such as a knife, dental floss (a strong multi-purpose line), plastic garbage bags, matches, signal mirrors, a compass, hard candy, or bouillon cubes are small items that fit in a zip-lock bag and could save your life. Vessels may have an emergency bag stored and a person named in the station bill to bring it.

EMERGENCY ASSIGNMENTS

POSITION	ABANDON SHIP	FIRE	PERSON OVERBOARD	FLOODING
	Go To & Bring	Go To & Bring	Go To & Bring	Go To & Bring
Captain	Wheelhouse, radio maneuver vessel	Wheelhouse, radio maneuver vessel	Wheelhouse, radio maneuver vessel	Wheelhouse, radio maneuver vessel
1st Mate	Life raft, immersion suit	Fight fire	Throw ring, lookout	Plug hole, pump
Deckboss	Life raft, immersion suit	Assist in fire fighting	Wheelhouse, radio maneuver vessel	Assist plugging hole and pumping
Deckhand	Communicate, EPIRB, count crew	Communicate, boundary person, remove hazards, get survival gear	Communicate, assist where needed	Communicate, assist where needed, secure hatches
Observer	Debarkation station, immersion suit	Wheelhouse, immersion suit	Lookout, assist where needed	Debarkation station, immersion suit

Figure 17-2 Example of a Station Bill

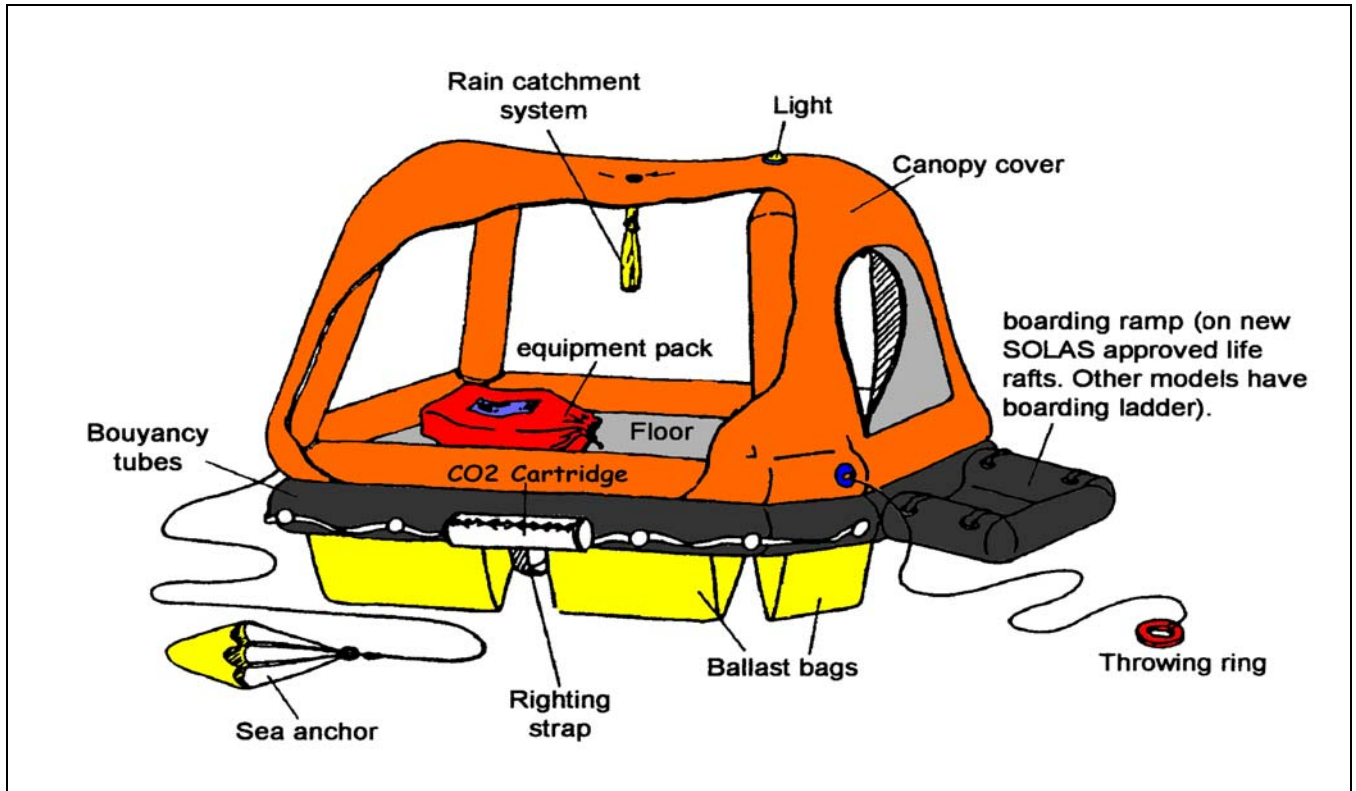

Figure 17-3 Life Raft and Equipment

THE SEVEN STEPS TO SURVIVAL

The Seven Steps to Survival were assembled by the USCG from personal experiences of those who survived emergency situations. Committing the seven steps to survival to memory should be one of your goals in learning how to survive at sea. Every time your situation changes—boarding a raft, reaching land, etc.—the seven steps begin again.

1. Recognition

Quickly recognize the seriousness of the situation and that your life is in danger. Hesitation or denial may cost your life, especially in the harsh environment of Alaska.

2. Inventory

Stop and assess the situation. Decide what you have that will help you survive and what are the hindrances. Inventory equipment, weather, your skills, injuries, and your mental condition. Doing so will help you to make good decisions that will help you survive.

3. Shelter

Your biggest enemy in Alaska is the cold. Shelter can be clothing, an immersion suit, a raft, or an overturned vessel or anything that protects you against the loss of your body heat. Water takes heat away from your body 25 times faster than air, so shelter should keep you as dry as possible. High heat loss areas, including the head and neck, need to be protected most. The added buoyancy of a PFD helps keep your head and neck out of water, therefore conserving heat. In a shore survival situation, the seven steps start over again and shelter is your first priority after you inventory the situation. It takes hours to construct adequate shelter on shore and you must do so as soon as possible.

4. Signals

Anything that attracts attention and conveys a message is a signal. Radios, EPIRBs, and flares are signals carried by vessels. Immersion suits have lights attached. If abandoning ship, anything that can be tossed overboard may help an aircraft spot your position. *Anything that makes you bigger, brighter, or different from your surroundings is a signal*, so attempt to gather items which float from a sinking ship.

HEALTH AND SAFETY INFORMATION: Summary

In a shore survival situation, three of anything (fires, buoys, immersion suits on the beach) is an internationally recognized distress signal.

5. Water

It is recommended that humans drink two liters of water per day to stay healthy. You can live without water for only a few days, and will suffer dehydration from the onset of any abandon ship emergency. Life rafts have limited rations of water, so it is advised to try to gather drinkable water before abandoning ship, if time permits. Have a strategy for gathering extra water in an emergency. *Never drink sea water or urine.*

6. Food

You can go without food much longer than without water. Never eat food without water! Your body requires water to digest food. Life rafts have limited food rations. In a shore survival situation, many types of edibles can be found near shore. Almost any animals or green plants in the intertidal zone are edible, but avoid mussels or clams, they may cause paralytic shellfish poisoning.

7. Play

Studies have shown that mental attitude makes a positive difference in a survival situation. Play is anything that keeps you occupied and prevents your mind from dwelling on the difficulties you are facing. Play could be reading, telling jokes or stories, completing a task, improving your shelter—anything that keeps your mind active and focused.

SUMMARY

You will learn much about sea safety and survival from the vessel personnel, who probably have many years of sea experience among them. *Ultimately, the responsibility is upon you to survive.* It is easy to think “this will never happen to me” and “the skipper will know what to do,” but those thoughts may cost you your life. Take the time to learn as much as you can, and consider what your actions will be in emergency situations. Visualize yourself and your actions in emergency scenarios in the factory, on deck, in your bunk, or anywhere you spend time. Having thought about an emergency will make your actions more automatic, and the time saved may save your life. Your life is worth far more than any data you could collect in the fishery.

FEDERAL REQUIREMENTS FOR COMMERCIAL FISHING INDUSTRY - VESSELS GREATER THAN 60 FT.	
Documentation & Official Number 46 CFR 67-69	<ul style="list-style-type: none"> • Must be measured and documented, documentation must be onboard • Hailing/home port, and official number must be displayed in 4 inch letters on both bows. • Official number must be 3 inch letters and attached to integral interior structure member.
Operator License 46 U.S.C. 8304	<ul style="list-style-type: none"> • The master, mate, and engineers on the vessel of 200 gross tons or more must have appropriate USCG license and operate within the limitations of the licenses.
Commercial Fishing Vessel Safety Inspection Requirements 50 CFR 679.50, 33 CFR Chapter I, 46 CFR Chapter I, 46 CFR 28.710, 46 CFR U.S.C. 3311	<ul style="list-style-type: none"> • Must have a valid Commercial Fishing Vessel Safety Decal issued within the past 2 years that certifies compliance with regulations found in 33 CFR Chapter I and 46 CFR Chapter I. • Must have a valid certificate of compliance issued pursuant to 46 CFR 28.710 • Must have a valid certificate of inspection pursuant to 46 U.S.C. 3311.
Compass 46 CFR 28.230	<ul style="list-style-type: none"> • Each vessel must be equipped with an operable magnetic steering compass with a compass deviation table at the operating station.
Electronic Position Fixing Devices 46 CFR 28.260	<ul style="list-style-type: none"> • Vessels 79 feet or more in length must be equipped with an electronic positioning fixing device such as SAT NAV, GPS, LORAN, OMEGA, or RDF that is capable of providing accurate fixes for the area of operation.
Navigation and Anchor Lights	<ul style="list-style-type: none"> • Must be used from sunset to sunrise and when there is limited visibility.
Navigation Information 46 CFR 28.225	<ul style="list-style-type: none"> • Current corrected charts of the appropriate areas and scale for safe navigation. • Current corrected copy (or applicable extract) of the U.S. Coast Pilot, USCG Light List, National Ocean Service Tide Tables and National Ocean Service Current Tables.
Anchor and Radar Reflectors 46 CFR 28.235	<p>Vessels operating with more than 16 individuals onboard:</p> <ul style="list-style-type: none"> • Each vessel must be equipped with appropriate anchor(s) and chain(s), cable, or rope. • Nonmetallic hull vessels must be equipped with a radar reflector unless it is a vessel rigged with gear that can provide a radar signature at six miles.

HEALTH AND SAFETY INFORMATION: Federal Requirements for Commercial Fishing Industry - Vessels greater than

<p>Radar and Depth Sounding Devices</p> <p>46 CFR 28.400</p>	<p>Vessels with 16 or more individuals that have had their keel laid or major conversion on or after September 15, 1991:</p> <ul style="list-style-type: none"> • Each vessel must be fitted with a general marine radar system for surface navigation with a radar screen mounted at the operating station. • Each vessel must be fitted with a suitable echo depth sounding device.
<p>Communications Equipment</p> <p>46 CFR 28.245, 46 CFR 28.375, 33 CFR 26.03, 47 CFR 80</p>	<ul style="list-style-type: none"> • Each vessel must be equipped with VHF radiotelephone communication equipment operating within 156-162 Mhz band. • If a vessel is operating more than 20 miles from the coastline in waters near Alaska it must also be equipped with radiotelephone communication equipment operating within the 2-27.5 Mhz band. A cellular telephone or satellite communication system, servicing the area of vessel operation, is also acceptable to meet the requirements of this paragraph. • A radio transceiver installed onboard before Sept. 15, 1991, operating on 4-20 Mhz band may continue to be used to meet the requirements for vessels operating more than 100 miles from the coastline in Alaskan waters. • All communications equipment must be operable from the vessel's operating station and must comply with FCC requirements, including a Ship Radio Station License. • Each vessel must be equipped with an emergency source of power that is independent of the main power supply, outside of the main machinery space, and capable of providing power to communications equipment for at least 3 continuous hours.
<p>Personal flotation Devices (PFD)</p> <p>46 CFR 28.105, 46 CFR 28.110, 46 CFR 28.135, 46 CFR 28.140</p>	<ul style="list-style-type: none"> • CG approved immersion suit with 31 square inches of retroreflective tape on the front and back of each side. • Must have CG approved PFD light. • Must be marked with the name of the vessel, owner of device, or the individual to whom it is assigned.
<p>Ring Buoy</p> <p>46 CFR 28.115 & 46 CFR 28.135</p>	<ul style="list-style-type: none"> • Vessels less than 65 feet must have 1 orange Ring Life Buoy at least 24 inch in size, with 60 feet of line, and marked with name of vessel. • Vessels greater than 65 feet must have 3 orange Ring Life Buoys at least 24 inch size with 90 feet of line, marked with the name of the vessel.
<p>Safety Protection Device (SPD)</p>	<ul style="list-style-type: none"> • Vessels less than 65 feet must have a whistle that is audible for 1/2 minute. • Vessels over than 65 feet must have a whistle that is audible for 1 minute.

HEALTH AND SAFETY INFORMATION: Federal Requirements for Commercial Fishing Industry - Vessels greater than

<p>Survival Craft 46 CFR Tables 28.120 (a)</p>	<ul style="list-style-type: none"> • Between shore & 12 miles off coastline - inflatable buoyant apparatus. • Between 12-20 miles off coastline - inflatable liferaft. • Between 20-50 miles off coast line - inflatable liferaft with SOLAS B pack. • Beyond 50 miles off coastline - inflatable liferaft with SOLAS A pack.
<p>Stowage of Survival Craft 46 CFR 28.125</p>	<ul style="list-style-type: none"> • Each inflatable liferaft that is required to be equipped with a SOLAS A or B equipment pack must automatically inflate if the vessel sinks. • Each inflatable liferaft must be kept readily accessible for launching or be stowed so they will float free if the vessel sinks. • Each hydrostatic release unit in a float free arrangement must have a CG approved number starting with 160.062.
<p>Launching of Survival Craft 46 CFR 28.310</p>	<p>Vessels with 16 or more individuals that have had their keel laid or major conversion on or after September 15, 1991:</p> <ul style="list-style-type: none"> • A gate or other opening must be provided in deck rails, lifelines, or bulwarks adjacent to the stowage location of each survival craft which weighs more than 110 pounds, to allow the survival craft to be manually launched.
<p>Embark Stations 46 CFR 28.395</p>	<p>Vessels with 16 or more individuals that have had their keel laid or major conversion on or after September 15, 1991:</p> <ul style="list-style-type: none"> • Each vessel must have at least one designated survival craft embark station (more if necessary) that is readily accessible from each accommodation space and work space. • Each embark station must be arranged to allow the safe boarding of survival craft.
<p>Means of Escape 46 CFR 28.390</p>	<p>Vessels with 16 or more individuals that have had their keel laid or major conversion on or after September 15, 1991:</p> <ul style="list-style-type: none"> • Each space used by an individual on a regular basis or which is generally accessible to an individual must have at least two widely separated means of escape. At least one of the means of escape must be independent of water tight doors. Means of escape include normal exits and emergency exits, passageways, stairways, ladders, deck scuttles and windows.
<p>Visual Distress Signals 46 CFR 28.145</p>	<ul style="list-style-type: none"> • Vessels operating more than 3 miles from shoreline are required to carry 3 parachute flares, 6 hand flares, and 3 smoke signals. • Vessels operating within 3 miles of the coastline are required to carry night and day visual distress signals. Night signals can be one electric distress light or 3 CG approved flares. Day signals can be either one distress flag or 3 CG approved smoke signals.
<p>EPIRB 46 CFR 28.150 & 46 CFR 25.26</p>	<ul style="list-style-type: none"> • Vessels operating beyond coastal waters are required to have an FCC type accepted category 1, float-free, automatically activated, 406 Mhz EPIRB. • Each EPIRB must be marked with vessel name and type II retroreflective material (46 CFR 28.135).

HEALTH AND SAFETY INFORMATION: Federal Requirements for Commercial Fishing Industry - Vessels greater than

<p>General Alarm 46 CFR 28.240</p>	<ul style="list-style-type: none"> • A general alarm system (suitable for notifying individuals onboard) is required with a contact marker at the operating station. The general alarm must be capable of notifying individuals in any accommodation or work space. Under certain circumstances (defined at CFR 28.240), a public address system that is audible in all work spaces meets regulatory requirements. • In noisy work spaces, a flashing red light is required. • The general alarm system must be tested prior to getting underway and at least once each week while underway.
<p>Emergency Instructions 46 CFR 28.265</p>	<ul style="list-style-type: none"> • As applicable, emergency instructions are required for: survival craft embarkation stations and personnel assignments; fire, emergency, and abandon ship signals; immersion suit location and donning information; procedures for making distress calls; list of each individual's emergency and specially established procedures. Specific details and posting requirements are found at 46 CFR 28.265.
<p>Instruction, Drills, and Safety Orientation 46 CFR 28.270, 46 CFR 28.275</p>	<ul style="list-style-type: none"> • The master or individual in charge of each vessel must ensure that drills are conducted and instruction is given to each individual onboard at least once a month. • No individual may conduct the drills or provide the instructions required by this section unless that individual has been trained in the proper procedures for conducting the activity. • Drills and instructions are to include: abandoning the vessel, fire fighting, man overboard recovery, stabilizing vessel after unintentional flooding, launching survival craft, and recovery of life and rescue boats, donning immersion suits, PFD's, fireman's outfits and breathing apparatus, radio and visual distress calls and signals, activating the general alarm and reporting of inoperative alarms and fire detection systems. • Drills must be conducted onboard the vessel as if there were an actual emergency and must include participation by all individuals onboard. • Viewing of videotapes followed by discussion led by a person familiar with the subjects can be used for instruction requirements but not as a substitution for drills or for the safety orientation. • The master must ensure that all individuals who have not received the above instruction or participated in the drills receive a safety orientation before the vessel may be operated. This safety orientation must explain the emergency instructions required by 46 CFR 28.265 and cover the specially established procedures. listed above.

HEALTH AND SAFETY INFORMATION: Federal Requirements for Commercial Fishing Industry - Vessels greater than

<p>High Water Alarms 46 CFR 28.250</p>	<ul style="list-style-type: none"> • Alarms are to be both visual and audible and installed at the operating station. • Alarms are to indicate high water in each of the following normally unmanned areas: a space with a through-hull fitting below the deepest load water line, a machinery space bilge, bilge well, shaft alley bilge, or other space subject to flooding from sea water piping within the space, a space with a non-watertight closure such as a space with a non-water tight hatch on the main deck.
<p>Bilge Systems 46 CFR 28.255</p>	<ul style="list-style-type: none"> • All vessels must be equipped with a bilge pump capable of draining any watertight compartment, other than tanks and small buoyancy compartments, under all service conditions. • If a portable bilge is used to meet this requirement, a suitable suction hose and discharge hose must be provided that will reach the bilges of all watertight compartments it must serve and ensure overboard discharge. The portable pump must be capable of dewatering each space at a rate of at least 2 inches of water depth per minute.
<p>Casualties and Injuries 46 CFR 28.080, 46 CFR 28.090</p>	<ul style="list-style-type: none"> • If any of the following incidents occur, the master or other vessel representative must, as soon as possible, contact the nearest USCG Marine Safety Office and submit written report CG-2692 within five days: <ul style="list-style-type: none"> • groundings, • loss of main propulsion or primary steering, • loss of life, • injury which requires professional medical treatment beyond first aid and renders the victim unfit to perform vessel duties, • any damage over \$25,000, any occurrence affecting the seaworthiness of the vessel such as; fire, flooding, or the failure of or damage to fixed fire extinguishing systems, lifesaving equipment, auxiliary power generating equipment or bilge pumping systems.
<p>Injury Placard 46 CFR 28.165</p>	<ul style="list-style-type: none"> • A placard, at least 5 X 7" stating the requirements of reporting injuries to vessel operator or agent as defined by US law, 46 U.S.C. 10603 must be posted in prominent place.
<p>First aid Equipment and Training, 46 CFR 28.210</p>	<ul style="list-style-type: none"> • Each vessel must have onboard a first aid manual and medicine chest of a suitable size in a readily accessible location. • Vessel with more than 2 individuals must have at least 1 individual certified in first aid and at least 1 individual certified in CPR or 1 individual certified in both. • Vessels with more than 16 individuals onboard must have at least 2 individuals certified in first aid and at least 2 individuals certified in CPR. Individuals certified in both may be counted against both requirements. • Vessels with more than 49 individuals onboard must have at least 4 individuals certified in first aid and at least 4 individuals certified in CPR. Individuals certified in both may be counted against both requirements.

HEALTH AND SAFETY INFORMATION: Federal Requirements for Commercial Fishing Industry - Vessels greater than

<p>Fire extinguishers 46 CFR 28.155 & 46 CFR 28.160 & 46 CFR 25.30</p>	<ul style="list-style-type: none"> • Vessels over 65' are required to have USCG approved fire extinguishers in each of the following locations: Pilot house, service spaces, galleys, paint lockers, accessible baggage and storage rooms, workshops and similar spaces, engine room, auxiliary engine room, auxiliary spaces, and generator spaces. • NOTE: Specifics on the type of extinguishers, number per location, and legal description of spaces where extinguishers are required can be found at 46 CFR 28.155 & 46 CFR 28.160 & 46 CFR 25.30.
<p>Fire Pumps, Fire Mains, Fire Hydrants, and Fire Hoses. 46 CFR 28.316</p>	<p>Vessels with 16 or more individuals that have had their keel laid or major conversion on or after September 15, 1991:</p> <ul style="list-style-type: none"> • Vessels >36' must be equipped with a self-priming, power driven fire pump connected to a fixed piping system. • Specific requirements regarding locations and specifications for fire mains, fire hydrants, and fire hoses can be found at 46 CFR 28.316.
<p>Fireman's Outfits and Self-contained Breathing Apparatus 46 CFR 28.205</p>	<ul style="list-style-type: none"> • Vessels equipped with refrigeration units using ammonia must be equipped with at least 2 self-contained breathing apparatus with spare air bottles for each. • If the vessel has more than 49 individuals onboard, at least 2 firemen's outfits, stowed in widely separated locations, are required. A fireman's outfit consists of one pressure demand open circuit MSHA/NIOSH approved self-contained breathing apparatus with a 30 minute air supply and a full face piece, one lifeline with a belt or suitable harness, one flashlight, a rigid helmet, boots, gloves, protective clothing, one fire axe, and a spare air bottle.
<p>Guards for Exposed Hazards 46 CFR 28.215</p>	<ul style="list-style-type: none"> • Suitable hand covers, guards, or railings must be installed on or near machinery that can cause injury to personnel, such as gearing, chain or belt drives, and rotating shafting. This is not meant to restrict necessary access to the fishing equipment such as winches, drums, or gurdies. • Internal combustion engine exhaust pipes within reach of personnel must be insulated or otherwise guarded to prevent burns.
<p>Watertight and Weathertight integrity 46 CFR 28.560</p>	<ul style="list-style-type: none"> • Each opening in a deck or a bulkhead that is exposed to weather must be fitted with a weathertight or watertight closure devise.
<p>Pollution Prevention 33 CFR 151, 33 CFR 155</p>	<ul style="list-style-type: none"> • Vessels are required to post oil pollution and garbage placards, and to have a written solid waste management plan that describes procedures for collecting, processing, storing, and discharging garbage, and the designated person in charge of carrying out the plan. Restrictions on dumping can be found at 33 CFR 151, 33 CFR 155.
<p>Sexual Abuse Act of 1986 46 CFR U.S.C. 10104</p>	<ul style="list-style-type: none"> • It is the responsibility of the master to report to the USCG any complaints of sexual offenses, including aggravated sexual abuse, sexual abuse, sexual abuse of a minor or ward, or sexual contact per 46 CFR U.S.C. 10104.

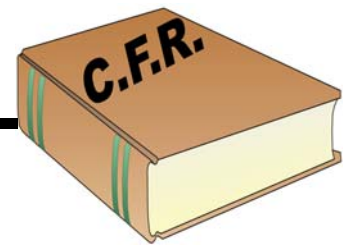

REGULATIONS AND COMPLIANCE

Table of Contents

Overview of Federal Groundfish Regulations.....	18-1
The Observer’s Role in Regulatory Compliance	18-1
Steps to Take if You Suspect a Violation	18-2
Debriefing	18-3
Regulations Protecting Observers.....	18-4
Partial Summary Of Federal Groundfish Fishing Regulations For The U.S. EEZ Off Alaska.....	18-7
Prohibited Species §679.21	18-8
BSAI Salmon Regulations §679.21	18-8
Groundfish Observer Program §679.50	18-10
Regulations Concerning Shark Finning.....	18-16
Observer Health and Safety §600.746	18-19

OVERVIEW OF FEDERAL GROUND FISH REGULATIONS

Federal fisheries regulations in the Bering Sea/Aleutian Islands (BSAI) and Gulf of Alaska (GOA) are developed by the North Pacific Fisheries Management Council (Council), approved by the U.S. Department of Commerce and administered by the National Marine Fisheries Service, also known as NOAA Fisheries. In addition to fisheries regulations, commercial fishers are also required to abide by many other regulations, such as those authorized by the Marine Mammal Protection Act and the Endangered Species Act.

Groundfish regulations in the BSAI and GOA are designed to conserve groundfish stocks and to protect established halibut, herring, crab and salmon fisheries. Regulatory tools used to manage the fisheries include fishing area designations, fishing seasons, gear limits, catch quotas and bycatch quotas.

These regulations are enforced by the NOAA Fisheries Office of Law Enforcement (OLE), Alaska Enforcement Division (AKD) and the U. S. Coast Guard. The AKD works cooperatively with other local, state, and federal enforcement agencies as well. AKD Special Agents work closely with the Observer Program to protect both observers and the resource.



THE OBSERVER’S ROLE IN REGULATORY COMPLIANCE

Observer responsibilities require observers to report accurately any observations of suspected violations of regulations relevant to the conservation of marine resources or their environment. The observer’s role in monitoring compliance with fisheries regulations is quite different from the role of an OLE Special Agent. Observers are not enforcement agents and are not empowered to issue citations, or take any enforcement action. **Observers must not advise the crew of regulations, interpret regulations, waive regulatory requirements or ensure that the crew complies with regulations.** As an observer, you are only responsible for monitoring the activities aboard your assigned vessels, informing the captain of violations you witness and documenting all potential violations in your logbook and completing written statements.

In the past, some observers have misinterpreted their role in fisheries enforcement by either exceeding their assigned duties or by demonstrating a lackadaisical attitude about enforcement. Either of these patterns of behavior could place your certification in jeopardy. If you have any questions regarding your role in fisheries compliance monitoring, contact an Observer Program staff member.

Regulatory information can be found throughout the observer manual in nearly all the sections. Follow the guidance in this section regarding documenting and reporting violations for any violations that you witness. This chapter contains excerpts of regulations which are specific to your work as an observer. Please note that

REGULATIONS AND COMPLIANCE: Steps to Take if You Suspect a Violation

this manual does not contain the entire text of any regulation. If a fisher has a question regarding the intent, scope or applicability of a regulation, refer him/her to the Alaska Enforcement Division. See “Contact Addresses and Numbers” on page U-45.

STEPS TO TAKE IF YOU SUSPECT A VIOLATION

Common sense and good judgment should prevail if you suspect that a violation has occurred on your vessel or at your plant. Your role is straightforward: observe, inform and document. The actions you take will depend upon the type of suspected violation, the circumstances under which it occurred, and the actions and demeanor of vessel or plant personnel. Gathering facts and documenting a suspected violation should be done as part of your routine duties.

Observe

Routine observations of all activities aboard a vessel is your first step in recognizing a possible compliance infraction. You may notice an obvious violation, such as a crew member presorting halibut or discarding plastic bags overboard, but other violations may need more research. You may need to double check your measurements, calculations, and methods, check scale calibrations, logbook entries and production figures. Ask the skipper, plant manager, or other personnel to clarify any questions you have. By asking questions you may determine that no violation has occurred. You can contact Observer Program staff or AKD personnel to see if a particular action would be considered a violation.

Inform

If you think a violation has occurred, notify the vessel’s captain (or the plant manager) as soon as possible. Informing the captain of potential violations is expected by the Program unless the captain or manager has failed to respond to previous reports, or you feel that it may lead to a potential harassment situation. In these cases, document your reasons for not reporting the incident in your Daily Notes section of your logbook. Informing the captain of a problem provides them with an opportunity to correct the problem and prevent violations from recurring. Effective communication with the skipper/plant manager

requires familiarity with the regulations, good judgment and tact. Organize the facts and approach the skipper or manager in a calm and reasonable manner.

The skipper/manager’s response will shape how the violation eventually is handled. In many cases, the problem will be remedied immediately. If he or she ignores your statements and the violations continue, good documentation is required for AKD to deal with the problem. You are in the best position to advise NMFS on the circumstances of the violation and the apparent intent of the skipper/ manager.

If the problem you have witnessed continues, you may contact the Observer Program, NMFS Enforcement, and/or your contractor for help. If you feel the situation has interfered with your ability to complete your duties or caused a hostile work environment, report the situation immediately to the Observer Program, NMFS Enforcement, and/or your contractor. Depending on your circumstance, the Observer Program, NMFS Enforcement, and your contractor may be able to assist you directly. Remember, you are the best judge of your situation. For your safety and privacy, the Observer Program and NMFS Enforcement may wait to take action until you have disembarked the vessel.

Document

Suspected violations should be documented in your logbook under the Daily Notes section. Remember that your logbook may be used as evidence. Your documentation must be thorough and factual. Subjective comments should be left out, as they may jeopardize an enforcement case. All written comments must be in ink, and events should be recorded in chronological order. Good documentation contributes to your credibility as a witness and author of an written statement.

All logbook entries of suspected violations should contain the following basic elements:

Who: Identify the vessel or plant by name, permit number and vessel type.

- Identify the individuals and witnesses involved by first and last name, position (skipper, engineer, deckhand, etc.) and function or duties--especially if related to a suspected violation.
- Identify who was notified and the nature of their reaction.

What: Describe the events and circumstances in narrative form.

- Include what made you suspicious.
- Detail what was discovered when you looked into the matter.
- Describe what occurred (or didn't) as a result of your discussions with the captain and crew.
- Use direct quotes whenever possible.
- Record each instance of a suspected violation.

When: Identify the exact or approximate time of the suspected violation - hour, day, month, year.

- Document the haul or delivery number if appropriate.

Where: Identify your vessel's position or the plant location at the time of the suspected violation.

- Include latitude/longitude or statistical reporting area. If a vessel's exact position is not known, use the closest approximation from the last haul or non-fishing day position.
- Describe where on the vessel (or at the plant) the suspected violation occurred. Draw a diagram identifying the area specifically, if applicable.

Why: Try to determine why the suspected violation occurred. Include your own observations and conversations with the crew members that substantiate why the violation may have occurred. Be as objective as possible and cite factors which may provide mitigating or aggravating information. Consider the following questions:

- Could the problem be due to a mistake, such as a mathematical or transcription error in the logbook?
- Were there circumstances beyond the control of vessel or plant personnel which may have played a factor, such as severe weather, mechanical breakdowns, or injuries?

If you feel the suspected violation was intentional, on whose orders, or with whose knowledge, do you think it was done, and why? Document the reasons why you think the act was intentional, especially in cases of sample interference. Sometimes casual comments by crew members can give insight into the motive behind a suspected violation.

How: Describe the effect the possible violation had on your ability to perform your observer duties. If harassment or intimidation were involved, describe how these actions made you feel.

Documenting Issues in your Logbook

If the vessel or plant you are covering is charged with a violation, all parties concerned will have a legal right to inspect your logbook or any other evidence known to exist. It is important to make your entries factual and to avoid personal opinions. Do not use your logbook to blow off steam. Statements such as, "the deck boss is a slob," are irrelevant to whether a fisheries violation has been committed.

When documenting *fishing violations*, it is important to *remain unemotional* about the violation. If you are experiencing *harassment or intimidation*, it is *critical that you document your feelings and emotions* surrounding the incident.

When you write a statement, it will be much easier if you have taken the time to document the violation as outlined above. Well documented cases are more likely to be prosecuted.

In view of the importance of your logbook and other types of documentation, you should take *special care to safeguard them against loss and tampering*.



When documenting fishing violations, notes should be matter of fact. When documenting instances of harassment or intimidation, it is critical that you express your feelings and emotions surrounding the incident.

DEBRIEFING

If you have witnessed and documented a suspected violation, bring this up with your debriefer. You may be asked to clarify your notes in your logbook, or to complete a written statement describing what you saw. Details for your statement come from the Daily Notes section of your logbook.

Completing Written Statements

If you submit a statement, it will be forwarded to a AKD special agent, who may contact you directly. Provide the Observer Program with a reliable phone number or e-mail address so they may reach you. Your responsibility as a groundfish observer regarding suspected violations may require a simple phone call

with AKD, but could result in a court appearance, if a violation is prosecuted. You are required to cooperate with AKD and NOAA Fisheries General Counsel while this process is underway.

Most times, when you inform the vessel command of a potential violation, they will take steps to change that behavior. Therefore, many complaints submitted by observers fall into the 'voluntary compliance' category. Most of these complaints will not result in an enforcement action against the fishing company. For some non-egregious or mitigated violations, NMFS Enforcement may send a certified letter to the fishing company informing them that future violations may develop into an enforcement action.

Minor violations may be dealt with by a Summary Settlement. The Summary Settlement system allows NMFS Enforcement agents and officers to levy fines up to \$5000 on a vessel company. This form of enforcement action does not have to go through the court system; it is similar to a traffic ticket. More serious violations can end up in civil or criminal prosecutions involving attorneys and possible court trials or hearings.

If your written statement is not acted upon, it will still be added to a database. Over time, this allows enforcement to determine if there is a pattern of behavior. If a pattern of behavior is established, the eventual result may be prosecution. Without complete, objective documentation of a suspected violation, AKD has no background to pursue an investigation. Your detailed notes are the best source of the facts and the intent of the incident.

REGULATIONS APPLYING TO OBSERVERS

Federal groundfish observers are not exempt from laws or regulations. Observers who falsify data, accept bribes, or conspire with someone to do the same may face criminal charges. Observers who violate the Standards of Observer Behavior may face suspension, decertification, and/or other disciplinary action. The collection of reliable data is essential to the effective conservation, management, and scientific understanding of the fishery resources of the United States. As such, false data reports and observer misconduct issues are dealt with seriously by OLE. The FMA Division Standards of Observer Behavior from CFR 679.50(j)(2) can be found on page 2-2.

REGULATIONS PROTECTING OBSERVERS

NMFS strives to promote a safe and harassment-free work environment to protect observers and ultimately contribute to the collection of high quality data. The responsibility is placed mainly upon your employer and the vessel's personnel. Regulations prohibiting various forms of harassment are outlined below.

As stipulated in 50 CFR 600.725, "it is unlawful for any person to do any of the following:

- Harass or sexually harass an authorized officer or an observer.
- Assault, oppose, impede, intimidate or interfere with a NMFS-approved observer aboard a vessel.
- Prohibit or bar by command, impediment, threat, coercion, or refusal of reasonable assistance, an observer from conducting his or her duties aboard a vessel.

In addition to the general prohibitions above, it is unlawful to do any of the following: (50 CFR 679.7 Prohibitions (g) Groundfish Observer Program):

1. Forcibly assault, resist, impede, intimidate, sexually harass, bribe or interfere with an observer.
2. Interfere with or bias the sampling procedure employed by an observer, including physical, mechanical, or other sorting or discarding of catch before sampling.
3. Tamper with, destroy, or discard an observer's collected samples, equipment, records, photographic film, papers, or personal effects without the express consent of the observer.
4. Prohibit or bar by command, impediment, threat, coercion, or by refusal of reasonable assistance, an observer from collecting samples, conducting product recovery rate determinations, making observations or otherwise performing the observer's duties.
5. Harass an observer by conduct that has sexual connotations, has the purpose or effect of interfering with the observer's work performance, or otherwise creates an intimidating, hostile, or offensive environment. In determining whether conduct constitutes harassment, the totality of the circumstances, including the nature of the

conduct and the context in which it occurred, will be considered. The determination of the legality of a particular action will be made from the facts on a case-by-case basis.

6. Fish for or process fish without observer coverage required under §679.7 Subpart E.
7. Require, pressure, coerce, or threaten an observer to perform duties normally performed by crew members, including but not limited to, cooking, washing dishes, standing watch, vessel maintenance, assisting with the setting or retrieval of gear, or any duties associated with the processing of fish, from sorting the catch to the storage of the finished product.

Harassment

The most serious forms of harassment are assaults and sexual assaults. These cases are rare, but can occur. Observer harassment, assault, and sexual assaults are criminal offenses. If you find yourself in one of these situations, first take care of yourself. For your safety and that of future observers, the captain or plant manager and NMFS must be informed immediately. After you have made a report, a team including a NMFS Enforcement Special Agent, Observer Program staff member, and others will be assigned to support you and to help you through the reporting process. If you are still at sea, this team will take cautions to ensure your report does not worsen your situation. If necessary, the team will take immediate actions to ensure your safety. Contacts for NMFS Enforcement AKD can be found in Appendix U of this manual.

Second to your safety is the preservation of evidence. This may include gathering physical evidence and statements from witnesses. While this may be a painful and unpleasant process for you, these actions are necessary to ensure your future safety and the safety of other observers by bringing the perpetrator to justice.

Sexual Harassment

Sexual harassment is a form of sex discrimination that violates Title VII of the Civil Rights Act of 1964. Unwelcome sexual advances, requests for sexual favors, and other verbal or physical conduct of a sexual nature constitutes sexual harassment when submission to, or rejection of, this conduct explicitly or implicitly affect an individual's employment, unreasonably

interferes with an individual's work performance, or creates an intimidating, hostile, or offensive work environment.

Sexual harassment can occur in a variety of circumstances, including, but not limited to the following:

- The victim as well as the harasser may be a man or a woman. The victim does not have to be of the opposite sex.
- The victim does not have to be the person harassed, but could be anyone affected by the offensive conduct.
- Unlawful sexual harassment may occur without economic injury to the victim.
- The harasser must know the conduct is unwelcome.

In most cases, it is necessary for the victim to clearly and directly inform the harasser that the conduct is unwelcome and that it must stop. Remember, no one asks to be sexually harassed. It is not your fault. In addition to contacting your contractor and NMFS, you may choose to use the vessel or shoreside processor employer complaint mechanism or grievance system to report the incident.

A determination of whether alleged conduct constitutes sexual harassment, and the legality of a particular action, will be made from the facts, on a case by case basis. For more information on sexual harassment or any other form of harassment or discrimination consult the Equal Employment Opportunity Commission (EEOC) Website at www.eeoc.gov.



Unalaskans Against Sexual Assault & Family Violence is a support service in Dutch Harbor. If you need to speak to someone confidentially about a harassment case, they can be contacted at 1-800-47U-SAFV.



Standing together Against Rape (STAR) is an Alaska based advocacy organization that provides confidential support for victims of sexual assault and harassment. You may contact STAR 24 hours a day at 1-800-478-8999, 1-907-276-9988, or at star@ak.net.

Intimidation

Black's Law Dictionary defines intimidation as: Unlawful coercion; extortion. Webster's II defines intimidate as: 1. To make timid; Frighten. 2. To inhibit or discourage by or as if by threats. Timid: 1. Shrinking from difficult or dangerous circumstances: Fearful. Intimidation is another form of harassment. Intimidation is an emotional response to someone's actions toward you. Most common is a captain or crew member directing his anger toward you verbally. Some people can ignore this behavior, while others are affected immediately and for some time afterward. If you experience an incident that upsets you or causes you to avoid the public areas of a vessel or plant, this person's behavior may have intimidated you. You have a right as an observer to work in an environment free from this kind of harassment.

Victim Impact and Support

Harassment, assault, and intimidation disrupt the lives of employees, families, co-workers, and many others. Victims may feel shock, depression, guilt, loss of trust, fear, anger, frustration, humiliation, and embarrassment. They may experience a loss of self-esteem, motivation, and privacy. It is normal for victims of crime to minimize the traumatizing event or event to blame or doubt themselves.

You are not to blame! No matter what choices you make, it does not give anyone the right to assault you or treat you in a way that is clearly unwelcome. The person who chooses to commit an act of violence or control is solely responsible for their crime.

You are not alone. After you have reported the crime, a specially trained team including NMFS Enforcement Special Agents, Observer Program staff members, and others will be assigned to support and help you and to answer your questions.

Confidential help is also available. Standing Together Against Rape (STAR) is an Alaska based victim advocacy organization that provides confidential support for victims of all sorts of crime including assault, sexual assault, workplace harassment, and rape. They provide immediate crisis support, support at the hospital if an exam is necessary, law enforcement accompaniment, court and medical accompaniment, advocacy, support, individual crisis counseling, support

groups, information, and referral. You may contact STAR 24 hours a day at 1-800-479-8999 or 1-907-276-9988, or at star@ak.net.

Victim Rights

During the law enforcement investigation, you will be kept informed of the status of your case if you so request. Your case agent will remain your principal contact. If you have questions, be sure to contact him or her as soon as possible. A federal investigation can be complex and lengthy. Remember, your interests are important to NMFS Enforcement. It is normal to have questions. Your case agent is there to help.

Below is a list of rights given to victims under the Crime Control Act of 1990. As a federal crime victim, you have the following rights:

- The right to be treated with fairness and with respect for your dignity and privacy.
- The right to be reasonably protected from the accused offender.
- The right to be present at all public court proceedings related to the offense, unless the court determines that testimony by the victim would be materially affected if the victim heard other testimony at trial.
- The right to confer with the attorney for the Government in the case.
- The right to restitution.
- The right to information about the conviction, sentencing, imprisonment, and release of the offender.

What to Do if You Experience Harassment

If you experience harassment in any form, address it directly and document it completely. If you can, approach the harasser early, before the situation becomes volatile. This will require you to be assertive, professional and diplomatic. By addressing the harasser early you are protecting yourself as well as the next observer on board. You may even prevent future trouble for the harasser, skipper and/or vessel company.



Report any cases of harassment to the Observer Program or NOAA Fisheries Alaska Enforcement Division as soon as possible. The agency is unable to help you with problems they are unaware of.

Think about how you will react. If possible, follow these steps:

1. Say no. Tell the harasser that his/her comments, actions or advances are unwanted and that you want them stopped. Remember that you are the judge of whether another person's actions negatively affect you.
2. Don't fight fire with fire. Keep your behavior professional and avoid being baited by the poor treatment of others. Make sure that your verbal and non-verbal messages to stop the behavior are clear.
3. Document the incident(s) from the very beginning. Even if you are unsure at first if you are experiencing harassment, record the details. They may provide you with the full story if the situation escalates. In your logbook, describe the situation, including who, what, where and when. Detail your attempts to end the harassment and the response you receive.
4. If the problem continues, report it to the skipper. Tell him or her the full story, explain that it is affecting your work, and request that he or she take steps to end the problem. Most skippers do not want trouble on the boat, and if you indicate to him or her that trouble is brewing, he or she should take appropriate action. Document any further incidents and the skipper's actions.
5. If the harassment is sudden and severe or is not addressed by the skipper, or if the problem is with the skipper, report the offense to NMFS and your employer at the first opportunity. They will work together with NMFS enforcement to help you. At your request, arrangements can be made for you to leave the vessel and seek help.
6. If you are concerned for your immediate well being on board, use your ATLAS text messages or other forms of communication avail-

able to alert your inseason advisor, NMFS staff or observer provider of a problem. See "Contact Addresses and Numbers" on page U-45 for emergency contacts.

PARTIAL SUMMARY OF FEDERAL GROUND FISH FISHING REGULATIONS FOR THE U.S. EEZ OFF ALASKA.

This summary of regulations is intended to provide observers with a working knowledge of regulations as they apply to groundfish observer duties. Full regulations are presented in the Code of Federal Regulations (50 CFR 600 and 679) which implement the Fisheries Management Plans (FMP) for the GOA and the BSAI areas. These have been simplified and reorganized for observer convenience. ***This is not a complete summary, nor is it quoted verbatim from federal law.*** For additional information on these regulations and information of recent changes contact the National Marine Fisheries Service (NMFS) offices.

In many cases, copies of the various CFR's are available in local libraries, and State or Federal Court Buildings. Supplementary changes to regulations will be available at offices of the National Marine Fisheries Service. Substantive supplementary changes to groundfish, marine mammal, safety, and marine pollution regulations will be published in the Federal Register. Current information on news releases, fishery closures, restricted area maps and regulations may also be obtained through the Alaska Regional (AKR) Office. To aid the public in accessing this information, the AKR provides public access at the following internet address, <http://www.fakr.noaa.gov>.

This summary does not supersede, amend, or detract from federal regulations or law as printed in the Federal Register or the Code of Federal Regulations. This summary does not, nor is it intended to, create any rights, substantive or procedural (enforceable at law by any party in any matter, civil or criminal) and it may not be relied on for any such purpose. This summary is for general informational purposes only.

PROHIBITED SPECIES §679.21

Retention of prohibited species is unlawful unless authorized by other applicable law, including the regulations of the International Pacific Halibut Commission (IPHC).

Prohibited species include:

- Pacific salmon (all species)
- Steelhead trout
- Pacific halibut
- Pacific herring
- Tanner crab (all species)
- King crab (all species)
- Any groundfish species in any area where the total allowable catch of that species is zero or any groundfish species declared prohibited by a notice of closure.

All Prohibited Species

The operator of each vessel engaged in directed fishing for groundfish in the GOA or BSAI must minimize its catch of prohibited species. After allowing sampling by an observer, the operator of each vessel must sort its catch as soon as possible after retrieval of the gear and return all prohibited species or parts thereof to the sea immediately with a minimum of injury regardless of its condition. It is prohibited to retain or possess prohibited species except as permitted to do so under the prohibited species donation program provided by 679.26 of this part, or as authorized by other applicable law. For exceptions specific to BSAI salmon See “BSAI Salmon Regulations §679.21” on page 18-8.

HALIBUT §679.7

With respect to halibut caught with hook-and-line gear deployed from a vessel fishing for groundfish, except for vessels fishing for halibut as prescribed in § 300.62, the following actions are prohibited:

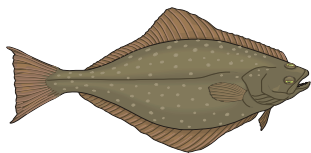

- Fail to release the halibut outboard a vessel's rails;

- Release the halibut by any methods other than:
 1. Cutting the gangion;
 2. Positioning the gaff on the hook and twisting the hook from the halibut;
 3. Straightening the hook by using the gaff to catch the bend of the hook and bracing the gaff against the vessel or any gear attached to the vessel;
- Puncture the halibut with a gaff or other device.
- Allow the halibut to contact the vessel, if such contact causes, or is capable of causing, the halibut to be stripped from the hook.



If fishing Pacific halibut under an IFQ, the minimum legal size that can be retained is 82 cm. Discarding legal sized halibut is considered high-grading, which is a violation.

CRAB §679.7

It is prohibited to have on board at any particular time, 20 or more crab of any species which have a carapace width of more than 1.5 inches (38 mm) at the widest dimension during the following situations:

- When participating in a non-CDQ directed fishery for pollock using trawl gear in the BSAI.
- When participating in a directed fishery for pollock using trawl gear when directed fishing for pollock with non pelagic trawl gear is closed in the GOA.

BSAI SALMON REGULATIONS §679.21

Operators of vessels carrying observers and whose fishing operations allow for sorting of

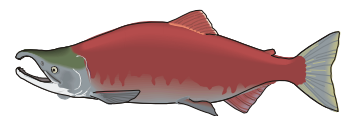

BSAI groundfish catch for salmon must retain all salmon bycatch from each haul in a separate bin or other location that allows an observer free and unobstructed physical access to the salmon to count each fish and collect any data or samples. Salmon from different hauls must be retained separately in a manner that identifies the haul from which the salmon were taken.

Operators of vessels not carrying observers onboard or whose fishing operations do not allow for sorting of BSAI groundfish catch for salmon must ice, freeze, or store in a refrigerated saltwater tank all salmon taken as bycatch in trawl operations for delivery to the processor receiving the vessel's BSAI groundfish catch.

Release of Salmon

BSAI salmon must be returned to federal waters as soon as is practicable, with a minimum of injury, regardless of condition, following notification by a NMFS-certified observer that the number of salmon has been determined and the collection of any scientific data or biological samples has been completed.

BSAI Prohibited Species Donation (PSD) program

The operator of a vessel and manager of a shoreside processor must not discard any salmon or transfer or process any salmon under the BSAI salmon PSD program until the number of salmon has been determined by an observer and the collection of any data or samples has been completed.

Operators of vessels and managers of shoreside processors that are required to retain salmon under the PSD program must designate and identify to the NMFS-certified observer a crew person or employee to be responsible for sorting, retention, and storage of salmon. Upon the request of the NMFS-certified observer, the designated crew person or employee is also responsible for counting salmon under the direction of the observer.



These regulations apply only to BSAI salmon. For regulations regarding GOA salmon, refer to "All Prohibited Species" on page 18-8.

IMPROVED RETENTION/IMPROVED UTILIZATION (IR/IU) §679.27

The owner or operator of a vessel must comply with the IR/IU program set out in this section while fishing

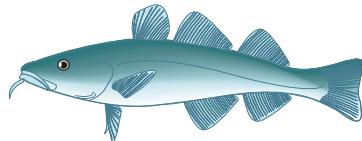

for groundfish in the GOA or BSAI, fishing for groundfish in waters of the State of Alaska that are shoreward of the GOA or BSAI, or when processing groundfish harvested in the GOA or BSAI.

The following species are defined as "IR/IU species" for the purposes of this section:

- Pollock (GOA and BSAI)
- Pacific cod (GOA and BSAI)
- Shallow-water flatfish species complex (GOA only)

Minimum Retention

1. For catcher vessels (any gear type):
 - If directed fishing for an IR/IU species is open, you must retain on board all fish of that species brought on board the vessel until lawful transfer.
 - If directed fishing for an IR/IU species is prohibited, you must retain on board all fish of that species brought on board the vessel up to the maximum retainable amounts (MRA) for that species until lawful transfer.
 - If retention of an IR/IU species is prohibited you must retain on board no fish of that species.
2. For catcher/processors and motherships:
 - If directed fishing for an IR/IU species is open, you must retain on board a primary product from all fish of that species brought on board the vessel until lawful transfer.
 - If directed fishing for an IR/IU species is prohibited, you must retain on board a primary product from all fish of that species brought on board the vessel up to the point that the round-weight equivalent of primary products on board equals the MRA amount for that species until lawful transfer.
 - If retention of an IR/IU species is prohibited, you must retain on board no fish or product of that species.
3. Any action intended to discard or release an IR/IU species prior to being brought on board the vessel is prohibited. This includes, but is not limited to, bleeding codends and shaking or otherwise removing fish from longline gear.
4. Any product from an IR/IU species may not be discarded at sea, unless such discarding is necessary to meet other requirements of this part.

REGULATIONS AND COMPLIANCE: Groundfish Observer Program §679.50

5. The retention requirements of this section apply to all IR/IU species brought on board a vessel, whether harvested by that vessel or transferred from another vessel. At-sea discard of IR/IU species or products that were transferred from another vessel is prohibited.

6. IR/IU species may be used as bait provided that the deployed bait is physically secured to authorized fishing gear. Dumping of unsecured IR/IU species as bait (chumming) is prohibited.

7. The retention and utilization requirements of this section do not apply to incidental catch of dead or decomposing fish or fish parts that were previously caught and discarded at sea.

Minimum Utilization

If you own or operate a catcher/processor or mothership, the minimum utilization requirement for an IR/IU species harvested in the BSAI is determined by the directed fishing status for that species according to the following:

1. If directed fishing for an IR/IU species is open, then your total weight of retained or lawfully transferred products produced from your catch or receipt of that IR/IU species during a fishing trip must equal or exceed 15 percent of the round-weight catch or round-weight delivery of that species during the fishing trip.

2. If directed fishing for an IR/IU species is prohibited, then your total weight of retained or lawfully transferred products produced from your catch or receipt of that IR/IU species during a fishing trip must equal or exceed 15 percent of the round-weight catch or round-weight delivery of that species during the fishing trip or 15 percent of the MRA amount for that species, whichever is lower.

3. If retention of an IR/IU species is prohibited, then your total weight of retained or lawfully transferred products produced from your catch or receipt of that IR/IU species during a fishing trip must equal zero.

GROUNDFISH OBSERVER PROGRAM **§679.50**

The purpose of the Groundfish Observer Program is to allow observers to collect Alaska fisheries data deemed by the Regional Administrator to be necessary and

appropriate for management compliance monitoring and research of groundfish fisheries and for the conservation of marine resources or their environment.

Vessel Responsibilities

An operator of a vessel required to carry one or more observers must:

Accommodations and food

Provide at no cost to observers or the United States, accommodations and food on the vessel for the observer(s) that are equivalent to those provided for officers, engineers, foremen, deck bosses or other management level personnel of the vessel.

Safe conditions

1. Maintain safe conditions on the vessel for the protection of the observers including adherence to all U.S. Coast Guard and other applicable rules, regulations, or statutes pertaining to safe operation of the vessel.

2. Have on board:

- A valid Commercial Fishing Vessel Safety Decal issued within the past 2 years that certifies compliance with regulations found in 33 CFR Chapter I and 46 CFR Chapter I; or
- A certificate of compliance issued pursuant to 46 CFR 28.710; or
- A valid certificate of inspection pursuant to 46 U.S.C. 3311.

Transmission of Data

Ensure that the communication equipment that is used by observers to enter and transmit data is fully functional and operational.

Vessel Position

Allow observers access to, and the use of, the vessel's navigation equipment and personnel, on request, to determine the vessel's position.

Access

Allow observers free and unobstructed access to, the vessel's bridge, trawl or working decks, holding bins, processing areas, freezer spaces, weight scales, cargo holds, and any other space that may be used to hold, process, weigh, or store fish or fish products at any time.

Prior Notification

Notify observers at least 15 minutes before fish are brought on board, or fish and fish products are transferred from the vessel, to allow sampling the catch or observing the transfer, unless the observers specifically request not to be notified.

Records

Allow observers to inspect and copy the vessel's daily fishing logbook, daily cumulative production logbook, product transfer forms, and any other logbook or document required by regulations. Observers are also allowed to inspect and copy printouts or tallies of scale weights, scale calibration records, bin sensor readouts, and production records.

Assistance

Provide all other reasonable assistance to enable observers to carry out their duties, including, but not limited to, assisting observers in measuring decks, codends, and holding bins; providing the observers with a safe work area adjacent to the sampling collection site; when requested by observers, assisting in collecting bycatch, assisting in collecting and carrying baskets of fish; and allowing observers to determine the sex of fish when this procedure will not decrease the value of a significant portion of the catch; collecting all seabirds that are incidentally taken on the observer-sampled portions of hauls using hook-and-line gear or as requested by an observer during non-sampled portions of the hauls.

Transfer at Sea

- Ensure that transfers of observers at sea via small boat or raft are carried out during daylight hours, under safe conditions, and with the agreement of observers involved.
- Notify observers at least 3 hours before observers are transferred, such that the observer can collect personal belongings, equipment, and scientific papers.
- Provide a safe pilot ladder and conduct the transfer to ensure the safety of observers during transfers.
- Provide an experienced crew member to assist observers in the small boat or raft in which any transfer is made.

Shoreside Processor Responsibilities and Stationary Floating Processors

The manager of the shoreside processor facility must:

Safe Conditions

Maintain safe conditions at the shoreside processing facility for the protection of observers by adhering to all applicable rules, regulations, or statutes pertaining to safe operation and maintenance of the processing facility.

Operations Information

Notify the observers, as requested, of the planned facility operations and expected receipt of groundfish prior to the receipt of those fish.

Access

Allow observers free and unobstructed access to the shoreside processor's holding bins, processing areas, freezer spaces, weight scales, warehouses, and any other space that may be used to hold, process, weigh, or store fish or fish products at any time.

Document Access

Allow observers to inspect and copy the shoreside processor's Daily Cumulative Production Logbook, transfer logbook, and any other logbook or document required by regulations; printouts or tallies of scale weights; scale calibration records; bin sensor readouts; and production records.

Assistance

Provide all other reasonable assistance to enable the observer to carry out his or her duties, including, but not limited to, assisting the observer in moving and weighing totes of fish, cooperating with product recovery tests, and providing a secure place to store baskets and sampling gear.

OBSERVER DATA TRANSMISSION

Vessels required to carry at least one observer at all times or operating in certain fisheries must have NMFS-supplied software installed on fully functional and operational computer hardware and communications equipment. The equipment must have the capability such that all tasks and components of the NMFS supplied software including data entry and storage, communications, and transmissions can be executed effectively aboard the vessel.

Observer Use of Equipment

Vessels and shoreside processors must facilitate transmission of observer data by allowing observers to use the vessel's communication equipment and personnel, on request, for confidential entry, transmission, and receipt of work-related messages, at no cost to the NMFS-certified observers or the United States.

GROUNDFISH AND HALIBUT CDQ FISHERIES

The time required for the level 2 observer to complete sampling, data recording, and data communication duties shall not exceed 12 hours in each 24-hour period, and, the level 2 observer is required to sample no more than 9 hours in each 24-hour period.

In a multi-species CDQ fishery a mothership or catcher/processor using trawl gear must have at least two level 2 observers aboard the vessel, at least one of whom must be certified as a lead level 2 observer.

In the pollock CDQ fishery a mothership or catcher/processor using trawl gear must have at least two NMFS-certified observers aboard the vessel, at least one of whom must be certified as a lead level 2 observer.

A catcher/processor using hook-and-line gear must have at least two level 2 observers, unless NMFS approves an alternate fishing plan authorizing the vessel to carry only one lead level 2 observer. At least one of the level 2 observers must be certified as a lead level 2 observer.

A catcher/processor using pot gear must have at least one lead level 2 observer.

A catcher vessel equal to or greater than 60 ft using trawl gear, except a catcher vessel delivering unsorted codends to a processor or another vessel, must have at least one level 2 observer.

Non trawl catcher vessel equal to or greater than 60 ft must meet the following requirements:

- If the vessel operator selected Option 1 for CDQ catch accounting, then at least one level 2 observer must be aboard the vessel.
- If the vessel operator selected Option 2 for CDQ catch accounting, then at least one lead level 2 observer must be aboard this vessel.

Haul Designation

Longline and trawl catcher/processor (C/P) vessel operators fishing in a CDQ fishery may assess the species composition prior to designating a haul as CDQ, AFA, or open access. According to the policy written by the Regional Office, the operator must notify the observer that catch *may* be CDQ prior to the tow being landed. Once the operator has notified the observers that catch may be designated as CDQ they are obligated to have a functional observer sampling station and weigh the catch on the flow scale. If during processing, the operator decides that the catch should accrue against their AFA quota, the open access quota, or another CDQ group they have a two hour period to record that information in the logbook provided at 50 CFR 679.5(a)(14)(iv).

CDQ hauls brought on board by motherships designated as CDQ hauls must be processed as a CDQ haul because of the possible conflict with record keeping and reporting requirements of the catcher vessels delivering to the motherships.

AFA C/P AND MOTHERSHIP VESSELS

The owner or operator of a listed AFA C/P or mothership must provide at least two NMFS-certified observers, at least one of which must be certified as a lead level 2 observer for each day that the vessel is used to harvest, process, or take deliveries of groundfish. More than two observers are required if the observer restriction (c)(5)(iii) of this section would otherwise preclude sampling as required under §679.3(a)(1).

The owner or operator of an unlisted AFA C/P must provide at least two NMFS-certified observers for each day the vessel is used to engage in directed fishing for pollock in the BSAI, or takes deliveries of pollock harvested in the BSAI. At least one observer must be certified as lead level 2 observer. When an unlisted AFA C/P is not engaged in directed fishing for BSAI pollock and is not receiving deliveries of pollock harvested in the BSAI, the observer coverage requirements at paragraph (c)(1)(iv) of this section apply.

All groundfish landed by listed or unlisted AFA C/P or received by AFA motherships must be weighed on a NMFS-certified scale and made available for sampling by a NMFS-certified observer. The owner and operator of a listed AFA C/P or mothership must ensure that the

vessel is in compliance with the scale requirements described at Sec. 679.28(b), that each groundfish haul is weighed separately, and that no sorting of catch takes place prior to weighing.

The owner and operator of a listed or unlisted AFA C/P or AFA mothership must provide an observer sampling station as described at Sec. 679.28(d) and must ensure that the vessel operator complies with the observer sampling station requirements described at Sec. 679.28 (d) at all times that the vessel harvests groundfish or receives deliveries of groundfish harvested in the BSAI or GOA.

AFA INSHORE PROCESSOR REQUIREMENTS

All groundfish landed by AFA catcher vessels engaged in directed fishing for pollock in the BSAI must be sorted and weighed on a scale approved by the State of Alaska as described in Sec. 679.28 (c), and be made available for sampling by a NMFS certified observer. The observer must be allowed to test any scale used to weigh groundfish in order to determine its accuracy.

PROHIBITIONS SPECIFIC TO AFA FISHERIES

It is unlawful for listed AFA C/Ps to process any groundfish that was not weighed on a NMFS-approved scale that complies with the requirements of §679.28(b). Catch may not be sorted before it is weighed and each haul must be sampled by an observer for species composition.

It is unlawful for unlisted AFA C/Ps to process groundfish harvested in the BSAI pollock fishery that has not been weighed on a NMFS-approved scale that complies with the requirements of §679.28(b). Catch may not be sorted before it is weighed and each haul must be sampled by an observer for species composition.

It is unlawful for an AFA mothership to process any groundfish without an observer sampling station as described at §679.28(d). A valid observer sampling station inspection report must be on board at all times when an observer sampling station is required.

OBSERVER PROVIDER RESPONSIBILITIES

According to 50CFR679.50 (i) (2) (vi) observer provider companies are responsible for, providing all logistics to place and maintain the observers aboard the fishing vessels or at the site of the processing facility.

This includes all travel arrangements, lodging and per diem, and any other services required to place observers aboard vessels or at processing facilities.

Each observer deployed to shoreside processing facilities shall be provided with a working cell phone or pager for notification of upcoming deliveries. If accommodations are more than 1 mile from the assigned shoreside processing facility the observer will be provided with motorized transportation. Therefore, it is your employer's responsibility to ensure that you have adequate transportation to the plant from your lodging. If you are unable to perform your duties as an observer because there is no reliable transportation to the plant, please contact a FMA Division office. If your accommodations are inadequate, contact FMA and let your employer know about the problem.

For each observer employed by an observer provider, either a written contract or a written contract addendum must exist that is signed by the observer and observer provider prior to the observer's deployment that contains the following provisions:

- The observer must comply with the Observer Program's drug and alcohol policy,
- All the observer's in-season data submissions between the observer and NMFS are delivered to the Observer Program at least every 7 days, unless otherwise specified by the Observer Program.
- The observer must complete in-person mid-deployment data reviews, unless:
 - exempted by the Observer Program, or
 - the observer is not in a port with a field office, so one is completed by phone, fax or through e-mail.
- The observer must inform the observer provider prior to the time of embarkation if he or she is experiencing any new mental illness or physical ailments or injury since submission of the physicians statement that would prevent him or her from performing their assigned duties.

Responsibilities and duties of observer providers include but are not limited to the following:

1. Providing an observer's salary, benefits and personnel services in a timely manner.

REGULATIONS AND COMPLIANCE: Trawl Gear Definitions §679.2

2. Providing all logistics to place and maintain the observers aboard the fishing vessels or at the site of the processing facility. This includes all travel arrangements, lodging and *per diem*, and any other services required to place observers aboard vessels or at processing facilities.

3. Ensuring that the following deployment conditions are met, unless alternative arrangements are approved by the Observer Program Office:

- Observers must not be deployed on the same vessel or at the same shoreside processor for more than 90 days in a 12 month period.
- A deployment cannot exceed 90 days.
- A deployment cannot include assignments to more than four vessels and/or shoreside processors.
- An observer provider must not move an observer from a vessel or floating or shoreside processor before that observer has completed his or her sampling or data transmission duties.

4. Maintaining communications with observers at sea and shoreside facilities. Each observer provider must have an employee responsible for observer activities on call 24 hours a day to handle emergencies involving observers, or problems concerning observer logistics, whenever observers are at sea, stationed at shoreside facilities, in transit, or in port awaiting boarding.

5. Ensuring that observers complete debriefing as soon as possible after the completion of their deployment and at locations specified by the Regional Administrator.

6. Ensuring all data, reports, and biological samples from observer deployments are complete and submitted to NMFS at the time of the debriefing interview.

7. Ensuring that all sampling and safety gear are returned to the Observer Program Office and that any gear and equipment lost or damaged by observers is replaced according to NMFS requirements.

8. Providing the following to the Observer Program Office by e-mail or by fax.

- Copies of “certificates of insurance” that name the NMFS Observer Program Leader as a “certificate holder.” The certificates of insurance

shall verify the following coverage provisions and state that the insurance company will notify the certificate holder if insurance coverage is changed or cancelled:

- Maritime Liability to cover “seamen's” claims under the Merchant Marine Act (Jones Act) and General Maritime Law (\$1 million minimum).
- Coverage under the U.S. Longshore and Harbor (USL&H) Worker's Compensation Act (\$1 million minimum).
- States Workers' Compensation as required.
- Commercial General Liability with contractual endorsements optional.

9. Reports of observer harassment, concerns about vessel or processor safety, or observer performance problems must be submitted within 24 hours after the observer provider becomes aware of the problem.

10. Observer provider must assign observers without regard to any preference by representatives of vessels and shoreside facilities based on observer race, gender, age, religion, or sexual orientation.

11. An observer provider must verify that a vessel has a valid USCG safety decal before an observer may get underway aboard the vessel. One of the following acceptable means of verification must be used to verify the decal validity:

- An employee of the observer provider, including the observer, visually inspects the decal aboard the vessel and confirms that the decal is valid according to the decal date of issuance, or
- The observer provider receives a hard copy of the USCG documentation of the decal issuance from the vessel owner or operator.

TRAWL GEAR DEFINITIONS §679.2

Non pelagic trawl means a trawl other than a pelagic trawl.

Pelagic trawl means a trawl that:

1. has no discs, bobbins, or rollers;
2. has no chafe protection gear attached to the foot rope or fishing line;

3. has no flotation other than floats capable of providing up to 200 pounds (90.7 kg) of buoyancy to accommodate the use of a net-sounder device; (note: floats on or in the codend are permitted);
4. has no more than one fishing line and one foot rope for a total of no more than two weighted lines on the bottom of the trawl between the wing tip and the fishing circle; and
5. has no metallic component except for connectors (e.g., hammerlocks or swivels) or a net-sounder device aft of the fishing circle or weights on the wing tips.

Breast line means the rope or wire running along the forward edges of the side panels of a net, or along the forward edge of the side rope in a rope trawl.

Fishing circle means the circumference of a trawl, intersecting the center point on the fishing line and perpendicular to the long axis of a trawl.

Fishing line means a length of chain or wire rope in the bottom front end of a trawl to which the webbing or lead ropes are attached.

Foot rope means a chain or wire rope attached to the bottom front end of a trawl and attached to the fishing line.

Headrope means a rope bordering the top front end of a trawl.

GROUND FISH POTS REQUIREMENTS

Each pot used to fish for groundfish must be equipped with a biodegradable panel at least 18 inches in length that is parallel to, and within 6 inches of, the bottom of the pot, and which is sewn up with untreated cotton thread of no larger size than No.30. Each pot used to fish for groundfish must also be equipped with rigid tunnel openings that are no wider than 9 inches and no higher than 9 inches, or soft tunnel openings with dimensions that are no wider than 9 inches.

MARKING OF LONGLINE GEAR

All longline marker buoys carried aboard or used by any vessel regulated under this part shall be marked with the following:

- the vessel's name; and
- the vessel's Federal fisheries permit number; or
- the vessel's ADF&G vessel registration number.

The required markings are to be in characters at least four inches high by one half inch wide, in a contrasting color, and visible above the water line. These markings are to be maintained in good condition, so they are clearly visible.

SEABIRD AVOIDANCE GEAR AND METHODS FOR LONGLINERS

Seabird avoidance measures apply to the operators of vessels using hook-and-line gear as follows:

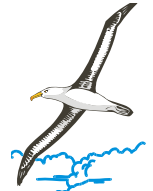

1. IFQ and CDQ Pacific halibut
2. IFQ sablefish
3. Groundfish in the U.S. EEZ waters off Alaska (3-200 nm).

Larger vessels (greater than 55 ft LOA) must deploy a minimum of two streamer lines while setting hook-and-line gear. For stern-setting vessels, streamer lines must be deployed one on each side of the main groundline. Preferably, both streamer lines will be deployed prior to the first hook being set. At least one streamer line must be deployed before the first hook is set and both streamers must be fully deployed within 90 seconds. An exception to this standard would exist in conditions of wind speeds exceeding 30 knots, where it would be acceptable to fly a single streamer from the windward side of the vessel. In winds exceeding 45 knots, the deployment of streamer lines would be discretionary.

Streamer Line Specifications

1. Streamer lines must be a minimum of 300 ft long.
2. Streamers must be spaced every 16.4 ft.
3. Streamers must be of brightly colored, UV protected plastic tubing or 3/8 inch polyester line or material of an equivalent density.
4. An individual streamer must hang attached to the mainline to 0.25 m above the waterline in the absence of wind.

Other Seabird Avoidance Requirements

- Directed discharge (through chutes, pipes, or other similar devices suited for purpose of offal discharge) of residual bait or offal from the stern of the vessel while setting gear is prohibited.

REGULATIONS AND COMPLIANCE: Regulations Concerning Shark Finning

- Prior to offal discharge, embedded hooks must be removed from offal.



Always record weather and sea conditions if you witness or suspect a Seabird Avoidance gear violation.

REGULATIONS CONCERNING SHARK FINNING

The Magnuson Act prohibits the removal of shark fin(s) and the discard of the carcass at sea. Implementing regulations at 50CFR600.1203(a)(1) make it unlawful for any person to ‘engage in shark finning’. Shark finning is defined as “taking a shark, removing a fin or fins, and returning the remainder of the shark to the sea”. Note: fins may not be consumed at sea if the remainder of the shark is discarded.

REGULATIONS CONCERNING TAKING OF MARINE MAMMALS (EXCERPTS TAKEN FROM 50 CFR 216 AND 229)

Definitions (§216.3)

Marine mammals means those specimens of the following orders, which are morphologically adapted to the marine environment, and whether alive or dead, and any parts thereof, including but not limited to, any raw dressed or dyed fur or skin: Cetacea (whales and porpoises), Pinnipedia (seals and sea lions), other than walrus.

Take means to harass, hunt, capture, collect, or kill, or attempt to harass, hunt, capture, collect, or kill, any marine mammal. This includes, without limitation, any of the following:

- The collection of dead animals, or parts thereof; the restraint or detention of a marine mammal, no matter how temporary;
- tagging a marine mammal; or
- the negligent or intentional operation of aircraft or vessel, feeding or attempting to feed a marine mammal in the wild, or the doing of other negligent or intentional acts which result in the disturbing or molesting of a marine mammal.

Feeding is defined as “offering, giving, or attempting to give food or nonfood items to marine mammals in the wild. It includes operating a vessel or providing other platforms from which feeding is conducted or supported. It does *not* include the routine discard of bycatch during fishing operations or the routine discharge of waste or fish by-products from fish processing plants or other platforms if the discharge is otherwise legal and is incidental to operation of the activity.”

Prohibited Taking (§216.11)

Except as noted below, it is unlawful for:

- any person, vessel, or conveyance subject to the jurisdiction of United States to take any marine mammal on the high seas, and
- any person, vessel, or conveyance to take any marine mammal in waters under the jurisdiction of United States.

Prohibited Uses, Possession, Transportation, and Sales (§216.13)

It is unlawful for:

- Any person to use any port, harbor or other place under the jurisdiction of the United States for any purpose in any way connected with the prohibited taking or unlawful importation of any marine mammal or marine mammal product; or
- Any person subject to the jurisdiction of the United States to possess any marine mammal taken in violation of the MMPA or these regulations, or to transport, sell, or offer for sale any such marine mammal product made from any such marine mammal.

Collection of Certain Marine Mammal Parts (§216.26)

- Bones, teeth or ivory (hard parts) of marine mammals may be collected from a beach or from land within 1/4 of a mile of the ocean. (**NOTE: *The Endangered Species Act contains additional restrictions prohibiting the collection of endangered species parts.***)

REGULATIONS AND COMPLIANCE: Regulations Concerning Steller Sea Lions (excerpts from §679.22 and §223.202)

- Unless authorized by exemption, no person may collect or retain any part of a marine mammal that is retrieved in the commercial fishing gear. (*NOTE: Observers are not authorized to collect walrus parts from fishing gear.*)
- No person may purchase, sell, or trade for commercial purpose any marine mammal part collected or imported under this section.

Marine Mammal Fishery Interaction Regulations § 229

Except as noted below, it is unlawful to take any marine mammal incidental to commercial fishing operations.

In addition, it is unlawful to (1) take any California sea otter; or (2) intentionally lethally take any Steller sea lion, any Alaskan sea otter, any cetacean, any depleted species (including the Pribilof Island population of Northern fur seal), or any endangered or threatened marine mammal. If the use of firearms or other means to deter marine mammals results in an injury or mortality of a marine mammal, the taking is presumed to be intentional lethal taking.

- Marine mammals killed during fishing operations which are readily accessible to crew members must be brought aboard the vessel for biological processing, if feasible and if requested by the observer. Marine mammals designated as biological specimens by the observer must be retained in cold storage aboard the vessel, if feasible, until retrieved by authorized personnel of NMFS.
- Any marine mammal incidentally taken must be immediately returned to the sea with a minimum of further injury and may only be retained if authorized by an observer, by condition of the Exemption Certificate, or by a scientific research permit that is in possession of the operator.

Reporting Requirements:

Vessel owners or operators engaged in any commercial fishery must report all incidental mortality and injury of marine mammals in the course of commercial fishing operations to the Assistant Administrator, or appropriate Regional Office, by mail or other means, such as fax or overnight mail specified by the Assistant Administrator. Reports must be sent within 48 hours

after the end of each fishing trip during which the incidental mortality or injury occurred, or, for non vessel fisheries, within 48 hours of an occurrence of an incidental mortality or injury. *An observer's report to NMFS does not replace this notification requirement!*

REGULATIONS CONCERNING STELLER SEA LIONS (EXCERPTS FROM §679.22 AND §223.202)



These regulations apply to all human activities, including commercial fishing, near Steller (northern) sea lions at-sea and near some of the islands where they breed.

- Shooting at or near any Steller sea lion for any reason is prohibited in U.S. waters. Fishermen may use other means which do not result in injury or death to the animal to deter sea lions from interfering with their gear.
- Fishing vessels are not permitted to enter within 3 nautical miles of Steller sea lion rookery sites west of 150° W longitude. Trawling cannot be conducted within 10 nautical miles of Steller sea lion rookery sites during any part of the year. Trawling cannot be conducted within 20 nautical miles of the rookeries on Akun, Akutan, Sea Lion Rock, Ugamak, Seguam, and Agligadak rookeries from January 20 to April 15.
- This section does not prohibit a vessel in transit from passing through listed straits, narrows, or passageways, if the vessel proceeds in a continuous transit and maintains a minimum of 1 nautical mile from the rookery site. Longline and pot vessels may fish within the 10 and 20 mile boundaries, but may not enter inside of 3 nautical miles. Detailed maps and lists of these areas are available from NMFS in Juneau.

The Secretary of Commerce is empowered to place observers on any fishing vessel in order to monitor the accidental capture of sea lions in fishing gear. No more than 675 sea lions may be killed accidentally each year during fishing operations west of 141° W longitude.

Violations of laws protecting Steller sea lions are subject to severe civil and criminal penalties including vessel forfeiture, fines of up to \$25,000, and imprisonment for up to one year for each violation.

REGULATIONS AND COMPLIANCE: Observer Procedures During Coast Guard Boarding

These regulations are due to the designation of the Steller sea lion as threatened throughout its range under the Endangered Species Act on April 5, 1990; and the designation of the western stock (west of 144° W) as endangered on June 4, 1997. These designations are based on declines of 63% since 1985 and 82% since 1960 in observed counts on certain Alaskan rookeries that are in the primary range of the species.

These closures are intended to further reduce any effects that groundfish trawling may have on the Steller sea lions, particularly to their foraging success. The 10 nautical mile closure is based on the average distance traveled by foraging female Steller sea lions during the summer reproductive period. Maintenance of the buffer zones in the non-breeding season is primarily intended to protect juvenile sea lions. Juvenile sea lions are likely to be the most susceptible to prey depletion, since they are less adept predators than adults. These young animals are also less likely to swim far from their rookery of birth, particularly during their first year. Thus, near shore zones proximal to rookeries are likely to be important feeding areas throughout the year.

OBSERVER PROCEDURES DURING COAST GUARD BOARDING

The U.S. Coast Guard makes periodic boardings of fishing vessels to check for fisheries and safety violations. If the Coast Guard boards your vessel, introduce yourself. After that, remain in the background and let the boarding party know where you can be found. Do not join in any discussions between boarding party members and vessel personnel. The Coast Guard or NMFS agent has certain objectives to accomplish in every boarding. If your assistance is needed, they will ask for it.



If the boarding party has questions or requests your assistance, be cooperative. Most Coast Guard officers are not biologists and you may be of assistance in identifying species of fish and invertebrates in bins, processing areas or freezer holds.

Make sure your logbook and paperwork are in order in case the boarding party wishes to inspect them. ***Do not give away your original forms or your logbook!*** Make copies as needed. If your vessel has no copy machine ask if copies can be made on board the Coast Guard

vessel. If this is not a possibility, the Coast Guard may make handwritten copies or you may refer them to the Observer Program Office for copies of inseason data.

If you have information on suspected or actual violations, or other problems, you may or may not wish to relay them to the boarding party. Use your judgement to decide if a potential violation would best be reported to the boarding party or saved for debriefing. If a vessel is issued a ticket immediately based on your report, you may be in an awkward position after the Coast Guard leaves. The Coast Guard is aware that observers may or may not choose to advise them of witnessed violations dependent on the situation.

If you have no information for the boarding party but someone in the boarding party wishes to question you, find a private location for your conversation. On occasion, an uninformed boarding party member may ask you questions in front of vessel personnel. Should this happen, defer the questions until you can speak in private. If that doesn't work, ask if they will accept a written statement from you. If you are questioned in private, answer all questions completely and honestly.

Your role in a Coast Guard boarding is as a source of objective information for the boarding party. The boarding party will conduct their own inspections and investigations, and they may or may not require your assistance. You should cooperate fully, and not hamper the investigation.

Coast Guard Role in Homeland Security

The U.S. Coast Guard was given additional duties after the September 11, 2001 terrorist attacks. They are now required to obtain information on all vessels that could transport foreign nationals into the country. Prior to entering a port, each vessel must submit the full name, date of birth, nationality, passport number or mariner's documentation number and position or duty on the vessel, as applicable, of each crew and passenger. Observers have reported being asked for their social security numbers rather than passport numbers. The Observer Program has an agreement with the USCG that any picture ID, such as a driver's license or your observer ID, will suffice and that social security numbers are not needed. Bag searches may also occur and if there are any problems please contact NMFS and your observer provider.

Beginning in 2009, certain ports and facilities will be requiring an additional level of identification and security clearance known as a TWIC (Transportation Workers Identification Credentials) card for unescorted access. If you are asked for a TWIC card when accessing areas to board your vessel, present your observer ID badge and accept an escort. If you have troubles contact any Observer Program staff member for assistance.

Observer Health and Safety §600.746

An observer is not required to board, or stay aboard, a vessel that is unsafe or inadequate as described in this section.



A vessel is inadequate or unsafe for purposes of carrying an observer and allowing operation of normal observer functions if it does not comply with the applicable regulations regarding observer accommodations or if it has not passed a USCG safety examination or inspection.

A vessel that has passed a USCG safety examination or inspection must display one of the following:

- A current Commercial Fishing Vessel Safety Examination decal, issued within the last 2 years
- A certificate of compliance issued pursuant to 46 CFR 28.710; or
- A valid certificate of inspection pursuant to 46 U.S.C. 3311.
- Upon request by an observer, a NMFS employee, or a designated observer provider, a vessel owner/operator must provide correct information concerning any item relating to any safety or accommodation requirement prescribed by law or regulation. A vessel owner or operator must also allow an observer, a NMFS employee, or a designated observer provider to visually examine any such item.

Pre-Trip Safety Check

Prior to each observed trip, the observer is encouraged to briefly walk through the vessel's major spaces to ensure that no obviously hazardous conditions exist. In addition, the observer is encouraged to spot check the following major items for compliance with applicable

USCG regulations: Personal flotation devices/immersion suits, ring buoys, distress signals, fire extinguishing equipment, emergency position indicating radio beacon (EPIRB), survival craft.

This pre-trip safety check is in addition to completing the Vessel Safety Checklist in the observer logbook. More information on vessel safety regulations and a detailed safety checklist can be found in the Health and Safety chapter, beginning on page 17-1.

Corrective Measures

If a vessel is inadequate or unsafe for purposes of carrying an observer and allowing operation of normal observer functions, NMFS may require the vessel owner or operator either to:

- Submit to and pass a USCG safety examination or inspection; or
- Correct the deficiency that is rendering the vessel inadequate or unsafe before the vessel is boarded by the observer.

The requirements of this section apply both at the time of the observer's boarding, at all times the observer is aboard, and at the time the observer is disembarking from the vessel.

A vessel that would otherwise be required to carry an observer, but is inadequate or unsafe for purposes of carrying an observer and for allowing operation of normal observer functions, is prohibited from fishing without observer coverage.

MARINE POLLUTION (MARPOL) REGULATIONS

The International Convention for the Prevention of Pollution From Ships (MARPOL) and five annexes are international agreements that were designed to halt at-sea disposal of wastes. MARPOL Annex V specifically prohibits the at-sea disposal of all plastics. It also eliminates the discharge of other types of vessel generated garbage to specific distances from land. The at-sea disposal restrictions apply to commercial and publicly owned vessels of all sizes and classes.

Vessels complying with MARPOL Annex V have three options for dealing with wastes. 1) non-plastics can be disposed of at sea within the legal restrictions, 2) they can incinerate wastes onboard the vessel, or 3) they can hold the wastes for shoreside disposal at port.

REGULATIONS AND COMPLIANCE: Vessel Operator Obligations

Plastic debris has been a concern of the NMFS since the early 1980's. Studies conducted in the North Pacific have linked debris generated by commercial ground fishing vessels with detrimental impacts to fish, seabirds, and marine mammals. Fur seals and Steller sea lions have been shown to be vulnerable to entanglement in netting, rope, and packing strap discards. Entanglement in debris is thought to contribute to mortality of individuals through starvation, suffocation, infection in resulting wounds, exhaustion, bleeding, drowning, and possibly increased predation. Studies conducted by the NMFS, National Marine Mammal Laboratory indicate entanglement may be contributing to the decline in northern fur seal population. In addition to entanglement in netting and plastic wastes, other species are also affected by ingestion. Stomach analysis of some seabirds and fish have found indigestible plastics.

VESSEL OPERATOR OBLIGATIONS

Regulations require U.S. recreational and other vessel operators, if their vessel is 26 feet or more in length, to affix one or more placards to their vessel. These placards warn against the discharge of plastic and other forms of garbage within the navigable waters of the United States, and specify discharge restrictions beyond three miles from shore. The placard must also note that State and local regulations may further restrict the disposal of garbage.



Placards

Operators shall ensure that one or more placards are displayed in prominent locations and in sufficient numbers so that they can be observed and read by the crew and passengers.

Each placard must be at least 9 inches wide and 4 inches high, made of durable material, and lettered with letters at least 1/8 inch high.

Waste Management Plans

The regulations require U.S. recreational and other U.S. vessel operators, if their vessel is 40 feet or more in length and engaged in commerce or equipped with a galley and berthing, to carry a Waste Management Plan if the vessel operates, or is certified to operate, beyond three nautical miles from shore.

The Waste Management Plan must be in writing and describe procedures for collecting, processing, storing, and properly disposing of garbage in a way that will not violate regulatory requirements. It must also designate the person who is in charge of carrying out the plan.

MARINA OBLIGATIONS

Ports and terminals that conduct business with a commercial vessel must be capable of receiving garbage from the vessel when it docks. Recreational boating facilities, capable of providing wharfage or other services for ten or more recreational vessels, must also provide adequate garbage reception facilities for any vessel that routinely calls. If a marina or terminal does not want to be directly involved in garbage collection and disposal, local firms may be retained to provide the service at the marina or terminal. Vessels must be conducting business with the facility or marina in order to qualify for the service. Terminals and marinas would not be expected to provide reception services to a vessel whose sole reason for docking was to offload its garbage. The marina or terminal can charge vessel operators reasonable fees for providing the reception service.

Reporting Violations

Vessels denied the ability to offload their garbage wastes at marinas or other terminals should contact the closest U.S. Coast Guard Captain of The Port or Marine Safety Office. Any US citizen may report observations of dumping in violation of Annex V at these same offices. NOTE: Observers reporting a potential MARPOL V violation will complete a questionnaire or written statement during the debriefing process.



THE MID-CRUISE AND FINAL DEBRIEFING

Table Of Contents

List of Priorities	19-1
Introduction.....	19-1
Mid-cruise	19-2
Where Do I Go for my Mid-cruise Debriefing?.....	19-2
What Do I Do if the Office Is Closed?	19-2
When Do I Have a Mid-cruise Debriefing?	19-2
What Do I Do If I Can't Get To a FMA Field Office?	19-2
Final Debriefing	19-3
Paper Forms Required by Assignment.....	19-3
Debriefing	19-4
Scheduling.....	19-4
Vessel Survey.....	19-4
Interview	19-4
Evaluations	19-5
Briefings.....	19-5

LIST OF PRIORITIES

- Schedule and attend, with all your data, a mid-cruise debriefing with FMA staff.
- Complete, organize and prepare all your data and specimens for final debriefing.
- Schedule a final debriefing through your employer.
- Complete a vessel survey for each vessel of your deployment.
- Participate in a final debriefing interview with FMA staff.
- Complete any needed corrections and resubmit your data.
- Clean and turn-in your sampling gear.

INTRODUCTION

The success of the North Pacific Groundfish Observer Program depends on the quality of data collected by observers. The data submitted both in electronic and paper format serves as the backbone of fisheries management in the North Pacific as well as provides insight into the entire ecosystem. The importance of these data requires that observers consistently follow program guidelines and employ scientifically valid methods to collect the data. In order to ensure these methods are consistent with our training, and the data collected are sound, FMA requires that observers

participate in both a mid-cruise and final debriefing. The mid-cruise debriefing will assess your work while in the field. Following your cruise, you will participate in a “final debriefing” with an FM A staff member and prepare a final report for each vessel assignment. A conscientious attitude in collecting the data as well as at sea completion and checking of the data will improve the quality of the data and expedite this process.

At Sea Preparation

The final debriefing does not take place until the end of your last assignment, but there are many things you can do to prepare for this process. This section provides many suggestions on how to check and organize your data. ***Reading and following this section while at sea will simplify and expedite your debriefing.***

Data check: While you are at sea, check your work on a regular basis. The more accurate your work upon returning, the faster you will be finished with debriefing. Consult your manual continuously while doing paperwork and be sure the forms are filled in properly. The examples in the manual represent a complete “set” of data and show how forms are interlinked as well as the correct format for each. See Figure 19-1 below for forms required by assignment.

Logbook: Maintaining entries in your logbook while at sea is a requirement. Inside the front cover (in ink) you need to put your name, cruise number and employer.

THE MID-CRUISE AND FINAL DEBRIEFING: Mid-cruise

List your ship's and/or plant names (for each assignment) and respective vessel or plant permit number. Complete factory/deck and plant diagrams for all assignments. Clearly label all calculations throughout the logbook including all mathematical formulas. Keep daily notes of sampling activities for each vessel. This will be especially helpful in recalling details if your cruise involves multiple vessel assignments.

Observers who have witnessed fisheries violations may be instructed during debriefing to complete a written statement describing what you saw. If you encounter violations they must be documented in your logbook with references to any data that supports these violations. Refer to "Steps to Take if You Suspect a Violation" on page 18-2 for more information.

MID-CRUISE

This debriefing, occurring early on in your deployment, provides the opportunity for both the observer and FMA staff to assess the data collected up to that time, the methods employed, and any difficulties that you have encountered in your assignments. This is also an opportunity to discuss future vessel assignments and discuss any questions that have come up since your last training or briefing.

Where Do I Go for my Mid-cruise Debriefing?



All Program offices are often staffed outside of regular business hours. If you can't make it in during the times listed, call ahead. Staff will usually be able to accommodate your schedule. See "Contact Addresses and Numbers" on page A-45.

If you are in Kodiak, Dutch Harbor or Anchorage during working hours, it is not necessary to call in advance. These offices are staffed Monday through Friday from at least 9:00 a.m. to 5:00 p.m. with variable hours on Saturday and Sunday. Stop by the field office and let a staff member know that you are there for a mid-cruise debriefing. You must bring your logbook, all data collected up to that point, as well as completed species id forms with you in order to complete a mid-cruise. In addition, prepare a list of questions that have come up during any of your assignments. This is the greatest opportunity during the season for you to discuss these issues and obtain answers.

FMA staff are occasionally available in other ports (e.g., Akutan, Sand Point, King Cove) for mid-cruise debriefing. Your employer will have contact information for these FMA staff if they are available at these ports.

What Do I Do if the Office Is Closed?

If your vessel is in town during off hours or on weekends, or you are passing through Anchorage, you should contact the office for a mid-cruise. All FMA offices have answering machines and you may leave a message stating your name, vessel, estimated duration in town, how you can be contacted and the estimated time and date that you will be available for a mid-cruise.

Am I Required To Have a Mid-cruise Debriefing?

All observers on their first and second contract are required to have a mid-cruise debriefing. All other observers, *unless specifically exempted from a mid-cruise during their previous evaluation*, must complete an in-person, mid-deployment data review if they travel through a location where Observer Program staff are available. This debriefing is not an option and must be completed in order to fulfill your responsibilities as an observer. If you are unsure if a mid-cruise debriefing is necessary, ask your employer or stop in to the field station. At the field station, a FMA staff member will review your data or schedule a future appointment as necessary. This debriefing is helpful for all observers and a short time spent in the field office could save you invaluable amounts of time at your final debriefing.

When Do I Have a Mid-cruise Debriefing?

Observers need to report for their mid-cruise debriefing early on in their assignment. Observers on catcher only vessels (trawl, longline and pot) should schedule this debriefing after the first couple of deliveries while those on catcher processors should report during their first offload.

What Do I Do If I Can't Get To a FMA Field Office?

On rare occasions, observers are unable to arrange a meeting time. In this case, and only as a last resort, answer the following questions and fax them to one of the field offices or the main office in Seattle (see "Contact Addresses and Numbers" on page A-45).

1. Describe in detail how the observer estimate was made and how often are you making observer estimates. Describe the collection technique you used to get fish for density. What was the average density value and predominant species in the catch? If certified bins were used, were there any difficulties? If no observer estimates were made, explain why. If you are on a longline or pot vessel, describe your methods for verifying gear (total number of hooks or pots).
2. Give a detailed description of your sampling design. Describe your sampling area, how you collected samples, and if there were any difficulties. What methods did you employ to ensure the least amount of sample bias using random sampling techniques?
3. Did you obtain sexed length frequencies? Please describe methods used and any difficulties you

encountered sexing fishes. Also describe how halibut viabilities and lengths were collected. If none were collected, please explain why.

4. Please describe anything that has affected your ability to effectively conduct your work. Have you been able to complete any special projects or other assignments?

FINAL DEBRIEFING

Reports: Prior to the debriefing interview, you will be completing an electronic report for each vessel that you were assigned.

Be sure that all your data submissions are complete and have been transmitted. Failure to do this could delay your debriefing.

Paper Forms	Vessels Using Paper	Using ATLAS	
		Vessels	Plant
Trip Data Form	X	X	not filled out for plants
Offload Delivery Form	C/Vs only	C/Vs only	X
Vessel Haul Form	X	X	not filled out for plants
Observer Haul Form	X	X	not filled out for plants
Raw Data Deck Forms	X	X	X
Species Composition Paper Form	X	entered in ATLAS only	X
Length and Specimen Form	X	entered in ATLAS only	entered in ATLAS only
Species ID Form	X	X	X
Special Project Forms, Tagged Fish Forms	X	X	X
Marine Mammal Interaction and Specimen Form	X	X	X
Marine Mammal Sighting Form	X	X	X

Figure 19-1 Paper Forms Required by Assignment

All of these forms should be filled out at sea and completed prior to your debriefing interview. Keeping up with your work becomes especially important if you are deployed on more than one vessel or plant. Keep in

mind that some corrections will affect data on other forms and those must be corrected as well. Cross reference the data on all forms to be sure that the correct data is recorded on each form type. Also, if you

THE MID-CRUISE AND FINAL DEBRIEFING: Debriefing

were on more than one ship and/or plant, the data from each will need to be kept separately. Do not mix the data forms together; number the pages separately for each vessel/plant and form type.

Refer to the data check lists at the end of each sampling chapter. Completing these checks will help you to fix mistakes prior to your final debriefing. These lists are not all inclusive! Refer to the respective section in each chapter for more instructions. ***Correcting mistakes before the debriefing improves data quality, demonstrates professionalism, and speeds the debriefing process.***

DEBRIEFING

The final debriefing occurs after the completion of your last vessel assignment. Most likely, this will take place in the Seattle or Anchorage FMA office, though field debriefings are sometimes possible. The debriefing process consists of the following parts: completion of electronic vessel report for each vessel, a debriefing interview, gear check-in, a data check, correction of errors, submission of corrected data, filling out the post-debriefing questionnaire, and a final check-out. The time to complete this process is variable. Beginning with the debriefing interview, observers should expect to spend approximately two to five days to complete the debriefing process.

Completing the debriefing process is a critical part of your duties as an observer! Do NOT make plane reservations until you are sure that your data have been finalized. You are not done with debriefing until your debriefer releases you from debriefing.

At the end of the debriefing, you will receive an evaluation of your work and performance. This evaluation will include a list of specific assessed points covering a variety of aspects pertinent to your overall deployment, as well as comments addressing overall effort in completing duties, level of documentation of activities, and any issues of note that encountered during your debriefing. The evaluation will also include a recommendation (see “Briefings” on page 19-5) for your next briefing requirement.

Scheduling

Once you have disembarked from your last vessel, your employer will contact the Observer Program Office and schedule an appointment for the electronic vessel survey. When you have completed a survey for each

vessel to which you were assigned, you will be scheduled for a debriefing interview. FMA staff will do its part to make sure your debriefing is as thorough as necessary and completed in a reasonable amount of time. Each observer can help expedite this process by being prepared for debriefing and keeping their employer and FMA informed of any difficulties in attending and completing the debriefing process. Remember, ensuring the data are of high quality is the main purpose of the debriefing process.

Vessel Survey

The electronic vessel survey is completed before the scheduled interview. This survey is done for each vessel of your deployment and serves as the most detailed and accurate description of your cruise. The survey is in multiple choice format with some of the questions requesting further comment. ***Detailed answers to these questions are important.*** These are used by many different groups including future observers, fishery managers, your debriefer and other NMFS staff. Any comments unclear or incomplete will be reviewed and corrected during the interview. Responses in the vessel survey will explain and support the respective data collected as well as provide a detailed and accurate description of each vessel assignment. Once again, thoroughness in this step will expedite debriefing! After completion of the vessel survey, you must leave all your data, your printed vessel surveys, and logbook in the debriefing office.

Interview

The interview will be scheduled when you complete the vessel survey, or soon thereafter as debriefing staff become available. During the interview, your debriefer (who has already reviewed your survey) will ask you to clarify or elaborate on any issues not fully addressed in the vessel survey. In addition, each set of data forms will be reviewed in terms of completeness, accuracy, and format.

At this time, both you and the debriefer have the opportunity to discuss your time at sea, your sampling methods, and the resulting data. The most important aspects of the interview are honesty and willingness to discuss problems and difficulties. Tell your debriefer if you feel you could not sample adequately. This facilitates discussion of sampling methodology and ways data collections might be improved. Your feedback makes staff aware of vessel specific sampling

difficulties and can help the next observer deployed on that vessel. Remember, the interview is designed to be a productive process beneficial for both the observer and the debriefer. Professional conduct through cooperation, candor, and effort is expected of all debriefing observers.

The data you transmitted to Seattle from sea will also be available to your debriefer. An error report of the data is produced and checks of the data are performed by the debriefer. The main purpose of the computer error check is to compare data between form types, search for missing data, and flag questionable entries. This report will be reviewed during the interview and all corrections will be made at that time. In addition, all forms will be checked and compared with the electronic data.

Any specimens collected during the cruise must also be prepared and submitted during the debriefing process. Salmon scales need to be mounted for confirmation of species. Otolith vials must be scanned into the database. All tagged salmon snouts need to be salted (if not already). Any halibut, sablefish or other tags are submitted with the corresponding tagged fish form. Specific instructions for these tasks will be given to you at the FMA office.

Special project data are also submitted at this time. Observers who completed stomach projects or special projects may be asked to meet briefly with the data user.

EVALUATIONS

An observer's work and performance are evaluated after each cruise. This evaluation serves two purposes. First, it provides a summary of the work performed, your effort and the quality of the data. Second, it serves as a training tool for future deployments by giving recommendations, suggestions and identifying areas of needed improvement. ***The areas of greatest importance are compliance throughout the contract with established protocols and an understanding of sampling concepts.***

The evaluation is based on many factors:

- sampling methods employed.
- documentation and communication.
- preparedness for debriefing.

- problem solving skills.
- overall effort.

Based on this evaluation, you are given a rating score for each of your assignments. Observers who receive a score of 1 have met the expectations of the Observer Program. This means that proper sampling methods were applied and protocols in terms of collection of data were followed. Observers who receive a score of 1 will receive a written evaluation which describes the work that was done and may include some suggestions to apply during a subsequent cruise.

A score of 0 on any vessel signifies the expectations of the Observer Program have not been met. Based on the severity of the problems, there are several different courses of action. Along with a score, you will receive a written evaluation. If a score of 0 is given, this evaluation should detail the area(s) of your work or performance that were unacceptable. The purpose of this evaluation is to provide you with a tool to improve performance on future cruises.

Observers who are unable to meet our sampling and data recording requirements may be recommended for decertification. The decision to recommend decertification is made by debriefers or other program staff. Most cases of decertification involve conduct and behavior that affects performance or safety, falsification of data, or errors resulting in significant amount of unreliable data or a significant loss of data.

If you are ever recommended for decertification, we will follow NMFS' regulations governing the decertification process. The decertification process provides you the opportunity to present your arguments and perspective on any action we propose to take, and to appeal decisions. It is designed to provide you a fair hearing on any issues that could result in your certification being revoked. A copy of the CFR which includes all Observer Program regulations and procedures can be obtained from any FMA staff member.

BRIEFINGS

Observers who have successfully completed their first contract must attend a briefing before each subsequent deployment. Briefings assigned are either 1, 2 or 4 days in length, depending on previous work and performance:

THE MID-CRUISE AND FINAL DEBRIEFING: Briefings

- **4-Day:** Each observer must attend one annual 4-day briefing prior to the first contract in each calendar year. In addition, observers who have subsequently demonstrated conceptual errors and/or difficulty in fish identification will be must attend a four day briefing. This briefing covers changes in sampling protocol, regulations, data forms, etc. Time is allocated for reviewing fish and bird identification and observers must successfully pass a species identification test in order to be recertified. Other topics include enforcement and random sampling techniques. This briefing is an opportunity to ask questions, familiarize yourself once again with the manual, and review recommendations from your last evaluation.
- **2-day:** This briefing is for observers who may need some review but do not need the detail provided in a 4-day briefing.
- **1-Day:** One day briefings are designed for observers in good standing who have shown no conceptual errors or difficulties in species identification. This briefing covers recent changes in sampling protocol and regulations, reviews sampling priorities and provides the opportunity for observers to ask vessel and/or fishery specific questions.

Table of Contents for Appendices

Species Codes for Fish and Invertebrates	A-1
Species Code List - Seabirds	A-11
Species Code List - Marine Mammals.....	A-13
Weights, Measures, and Conversions	A-15
Random Number Table.....	A-17
Product Recovery Rates (PRR).....	A-18
Product Codes and Description.....	A-20
NMFS Species and Group Codes Used in Vessel Logbooks	A-21
Alaska Department of Fish and Game Fish Ticket Codes	A-22
Processor Permit List	A-23
Vessel/Plant Names and Permit Numbers	A-25
NMFS Reporting Areas for the Bering Sea and Aleutian Islands	A-32
NMFS Reporting Areas for the Gulf of Alaska.....	A-33
Halibut Length to Weight Table	A-34
Halibut Condition Criteria For Trawl Bycatch.....	A-35
Key to Pacific Halibut Viability for Trawl Vessels.....	A-36
Halibut Condition Criteria For Pot Bycatch	A-37
Key to Pot Condition Codes for Pacific Halibut.....	A-39
Halibut Injury Criteria For Longline Bycatch	A-41
Key to Longline Injury Codes for Pacific Halibut.....	A-43
Contact Addresses and Numbers	A-45
Radio Instructions	A-47
Beam Balance Flatbed Scale Care and Maintenance.....	A-49
Flatfish Species Description Form.....	A-51
Rockfish Species Description Form	A-53
Miscellaneous Species/ Crab Description Form.....	A-55
Skate Species Description Form.....	A-57
Seabird Species Description Form (for Dead Birds)	A-59
Protocols for Handling Injured or Sick Seabirds	A-61
Material Safety Data Sheet for DMSO	A-63
Material Safety Data Sheet for 100% Formalin.....	A-66
Material Safety Data Sheet for 10% Formalin.....	A-70
NMFS-Permitted Contractors for the Fisheries Monitoring and Analysis Division	A-73



Appendix A. Species Codes for Fish and Invertebrates

<i>Code</i>	<i>Common Name</i>	<i>Scientific Name</i>
106	Alaska Plaice	<i>Pleuronectes quadrituberculatus</i>
610	Anchovy, Northern	<i>Engraulis mordax</i>
55	Anemone, Sea - unidentified	Actiniaria
43	Ascidians, Sea Squirt, Tunicate	Urochordata
204	Atka Mackerel	<i>Pleurogrammus monopterygius</i>
48	Barnacles	Cirripedia
770	Barracudina - unidentified	Paralepididae
27	Brachiopod, Lampshell - unidentified	Brachiopoda
54	Bristleworm (Polychaete unidentified)	Annelida
32	Bryozoans	
604	Capelin	<i>Mallotus villosus</i>
44	Chiton - unidentified	Amphineura
29	Clams, Mussels, Oysters, Scallops	Pelecypoda
211	Cod, Arctic *	<i>Boreogadus saida</i>
203	Cod, Black (Sablefish)	<i>Anoplopoma fimbria</i>
202	Cod, Pacific	<i>Gadus macrocephalus</i>
209	Cod, Pacific Tomcod	<i>Microgadus proximus</i>
208	Cod, Saffron	<i>Eleginus gracilis</i>
214	Codling - unidentified (See also Flatnose, Pacific)	Moridae
32	Coral - unidentified	
833	Coral, Red Tree	<i>Primnoa willeyi</i>
1	Crab - unidentified (Family Unknown)	
11	Crab, Box	<i>Lopholithodes foraminatus</i>
49	Crab, Cancer	<i>Cancer pregonensis</i>
39	Crab, Decorator	<i>Oregonia gracilis</i>
12	Crab, Dungeness	<i>Cancer magister</i>
841	Crab, Fuzzy	<i>Acantholithodes hispidus</i>
7	Crab, Hair (Horsehair)	<i>Erimacrus isenbeckii</i>
15	Crab, Hermit - unidentified	Paguridae
2	Crab, King - unidentified	<i>Lithodes & Paralithodes</i>

* If you encounter these species, please bring a specimen back to NMFS

<i>Code</i>	<i>Common Name</i>	<i>Scientific Name</i>
6	Crab, King, Blue	<i>Paralithodes platypus</i>
8	Crab, King, Brown (Golden)	<i>Lithodes aequispina</i>
16	Crab, King, Couesi	<i>Lithodes couesi</i>
13	Crab, King, Red	<i>Paralithodes camtschatica</i>
14	Crab, Lithodid unidentified (Brown, Couesi or Golden)	<i>Lithodes</i> spp.
37	Crab, Lyre, Arctic (Rounded Carapace)	<i>Hyas coarctatus</i>
9	Crab, Lyre (Sharp Spined Carapace)	<i>Hyas lyratus</i>
840	Crab, Lyre - unidentified	<i>Hyas</i> spp.
17	Crab, <i>Paralomis Multispina</i>	<i>Paralomis multispina</i>
38	Crab, <i>Paralomis Verrilli</i>	<i>Paralomis verrilli</i>
842	Crab, Rhinoceros	<i>Rhinolithodes wosnessenskii</i>
31	Crab, Scaled	<i>Placetron wosnessenskii</i>
3	Crab, Tanner - Unidentified	<i>Chionoecetes</i> spp.
19	Crab, Tanner, Angulatus	<i>Chionoecetes angulatus</i>
4	Crab, Tanner, Bairdi	<i>Chionoecetes bairdi</i>
47	Crab, Tanner, Bairdi/Opilio Hybrid	<i>Chionoecetes hybrid</i>
5	Crab, Tanner, Opilio	<i>Chionoecetes opilio</i>
18	Crab, Tanner, Tanneri	<i>Chionoecetes tanneri</i>
23	Crab, Telmessus	<i>Telmessus cheiragonus</i>
53	Crinoids - unidentified	Crinoidea
144	Dab, Longhead	<i>Limanda proboscidea</i>
679	Daggertooth	<i>Anotopterus pharao</i>
899	Decomposed Fish	
690	Dreamer - unidentified	Oneirodidae
250	Eelpout - unidentified	Zoarcidae
253	Eelpout, Twoline	<i>Bothrocara brunneum</i>
251	Eelpout, Wattled	<i>Lycodes palearis</i>
91	Egg Case, Skate	
34	Eggs, Snail	Gastropoda
601	Eulachon (Candlefish)	<i>Thaleichthys pacificus</i>
901	Fish - unidentified	Osteichthyes
100	Flatfish - unidentified	Pleuronectiformes

* If you encounter these species, please bring a specimen back to NMFS

Code	Common Name	Scientific Name
210	Flatnose, Pacific (Codling)	<i>Antimora microlepis</i>
146	Flounder, Arctic *	<i>Liopsetta glacialis</i>
141	Flounder, Arrowtooth	<i>Atheresthes stomias</i>
145	Flounder, Bering *	<i>Hippoglossoides robustus</i>
149	Flounder, Kamchatka/Arrowtooth - unidentified	
147	Flounder, Kamchatka	<i>Atheresthes evermanni</i>
142	Flounder, Starry	<i>Platichthys stellatus</i>
390	Greenling - unidentified	<i>Hexagrammos</i> spp.
392	Greenling, Kelp	<i>Hexagrammos decagrammus</i>
393	Greenling, Rock	<i>Hexagrammos lagocephalus</i>
391	Greenling, Whitespotted	<i>Hexagrammos stelleri</i>
80	Grenadier, (Rattail) - unidentified	Macrouridae
82	Grenadier (Rattail), Giant	<i>Albatrossia pectoralis</i>
430	Gunnel - unidentified	Pholidae
77	Hagfish - unidentified	Myxinidae
206	Hake, Pacific	<i>Merluccius productus</i>
101	Halibut, Pacific	<i>Hippoglossus stenolepis</i>
611	Herring, Pacific	<i>Clupea harengus pallasi</i>
350	Idiotfish (Shortspine Thornyhead)	<i>Sebastolobus alascanus</i>
902	Invertebrate - unidentified	
33	Isopod - unidentified	Isopoda
207	Jack Mackerel	<i>Trachurus symmetricus</i>
35	Jellyfish - unidentified	Scyphozoa
900	Kelp - miscellaneous	
608	King-of-the-Salmon (Ribbonfish)	<i>Trachipterus altivelis</i>
75	Lamprey - unidentified	Petromyzontidae
785	Lancetfish, Longnose	<i>Alepisaurus ferox</i>
700	Lanternfish - unidentified	Myctophidae
52	Leech - unidentified	Hirudinea
45	Limpet - unidentified	
603	Lingcod	<i>Ophiodon elongatus</i>
525	Lumpsucker - unidentified	Cyclopteridae

* If you encounter these species, please bring a specimen back to NMFS

<i>Code</i>	<i>Common Name</i>	<i>Scientific Name</i>
530	Lumpsucker, Pacific Spiny	<i>Eumicrotremus orbis</i>
531	Lumpsucker, Smooth	<i>Aptocyclus ventricosus</i>
204	Mackerel, Atka	<i>Pleurogrammus monoptyerygius</i>
207	Mackerel, Jack	<i>Trachurus symmetricus</i>
199	Mackerel, Pacific (Chub)	<i>Scomber japonicus</i>
774	Manefish	<i>Caristius macropus</i>
289	Melamphid - unidentified	Melamphaeidae
900	Miscellaneous - unidentified (rocks, mud, garbage, etc)	
29	Mussels, Clams, Oysters, Scallops	Pelecypoda
25	Nudibranch (Sea Slug)	Nudibranchiata
60	Octopus - unidentified	Octopoda
61	Octopus, Pelagic	Vampyromorpha
297	Opah	<i>Lampris guttatus</i>
295	Oreo, Oxeye	<i>Alloctytus folletti</i>
29	Oysters, Clams, Mussels, Scallops	Pelecypoda
301	Pacific Ocean Perch	<i>Sebastes alutus</i>
762	Paperbones, Scaly - unidentified	Notosudidae
450	Poacher - unidentified	Agonidae
452	Poacher, Sturgeon	<i>Podothecus acipenserinus</i>
201	Pollock (Walleye Pollock)	<i>Theragra chalcogramma</i>
54	Polychaete - unidentified (Bristleworm, Leech)	Annelida
765	Pomfret - unidentified	Bramidae
750	Prickleback - unidentified	Stichaeidae
205	Prowfish	<i>Zaprora silenus</i>
280	Ragfish	<i>Icosteus aenigmaticus</i>
99	Ratfish, Spotted	<i>Hydrolagus colliei</i>
80	Rattail, (Grenadier) - unidentified	Macrouridae
82	Rattail (Grenadier), Giant	<i>Albatrossia pectoralis</i>
90	Ray, (Skate) - unidentified	Rajiformes
563	Ribbonfish - unidentified	Trachipteridae
300	Rockfish - unidentified	Scorpaenidae
353	Rockfish, Aleutian Scorpionfish *	<i>Adelosebastes latens</i>

* If you encounter these species, please bring a specimen back to NMFS

Code	Common Name	Scientific Name
306	Rockfish, Black *	<i>Sebastes melanops</i>
316	Rockfish, Blue *	<i>Sebastes mystinus</i>
302	Rockfish, Bocaccio	<i>Sebastes paucispinis</i>
351	Rockfish, Broadbanded Thornyhead *	<i>Sebastolobus macrochir</i>
332	Rockfish, Brown	<i>Sebastes auriculatus</i>
314	Rockfish, Canary	<i>Sebastes pinniger</i>
346	Rockfish, China	<i>Sebastes nebulosus</i>
327	Rockfish, Copper *	<i>Sebastes caurinus</i>
345	Rockfish, Dark (was Dark Dusky)	<i>Sebastes ciliatus</i> (was <i>S. sp. cf. ciliatus</i>)
311	Rockfish, Darkblotched	<i>Sebastes crameri</i>
330	Rockfish, Dusky (was Light Dusky)	<i>Sebastes variabilis</i> (was <i>S. ciliatus</i>)
317	Rockfish, Gray *	<i>Sebastes glaucus</i>
313	Rockfish, Greenstriped	<i>Sebastes elongatus</i>
323	Rockfish, Harlequin	<i>Sebastes variegatus</i>
352	Rockfish, Longspine Thornyhead	<i>Sebastolobus altivelis</i>
303	Rockfish, Northern	<i>Sebastes polyspinis</i>
301	Rockfish, Pacific Ocean Perch (POP)	<i>Sebastes alutus</i>
335	Rockfish, Pygmy *	<i>Sebastes wilsoni</i>
343	Rockfish, Quillback	<i>Sebastes maliger</i>
308	Rockfish, Red Banded	<i>Sebastes babcocki</i>
324	Rockfish, Redstripe	<i>Sebastes proriger</i>
309	Rockfish, Rosethorn	<i>Sebastes helvomaculatus</i>
307	Rockfish, Rougheye	<i>Sebastes aleutianus</i>
304	Rockfish, Sharpchin	<i>Sebastes zacentrus</i>
326	Rockfish, Shortraker	<i>Sebastes borealis</i>
354	Rockfish, Shortraker/Rougheye unidentified	<i>S. borealis</i> or <i>aleutianus</i>
350	Rockfish, Shortspine Thornyhead	<i>Sebastolobus alascanus</i>
310	Rockfish, Silvergray	<i>Sebastes brevispinis</i>
315	Rockfish, Splitnose	<i>Sebastes diploproa</i>
328	Rockfish, Stripetail *	<i>Sebastes saxicola</i>
349	Rockfish, Thornyhead unidentified	<i>S. alascanus</i> or <i>altivelis</i>
329	Rockfish, Tiger	<i>Sebastes nigrocinctus</i>

* If you encounter these species, please bring a specimen back to NMFS

<i>Code</i>	<i>Common Name</i>	<i>Scientific Name</i>
331	Rockfish, Vermilion *	<i>Sebastes miniatus</i>
305	Rockfish, Widow	<i>Sebastes entomelas</i>
322	Rockfish, Yelloweye	<i>Sebastes ruberrimus</i>
320	Rockfish, Yellowmouth *	<i>Sebastes reedi</i>
321	Rockfish, Yellowtail	<i>Sebastes flavidus</i>
240	Ronquil - unidentified	Bathymasteridae
200	Roundfish - unidentified	
203	Sablefish (Black Cod)	<i>Anoplopoma fimbria</i>
220	Salmon - unidentified	<i>Oncorhynchus</i> spp.
221	Salmon, Chum (Dog)	<i>Oncorhynchus keta</i>
222	Salmon, Chinook (King)	<i>Oncorhynchus tshawytscha</i>
223	Salmon, Coho (Silver)	<i>Oncorhynchus kisutch</i>
225	Salmon, Pink (Humpback)	<i>Oncorhynchus gorbuscha</i>
224	Salmon, Sockeye (Red)	<i>Oncorhynchus nerka</i>
226	Salmon, Steelhead (Ocean-run Rainbow Trout)	<i>Oncorhynchus mykiss</i>
40	Sand Dollars, Sea Urchins	Echinoidea
670	Sand Lance, Pacific	<i>Ammodytes hexapterus</i>
136	Sanddab - unidentified	Bothidae
144	Sanddab, Longhead	<i>Limanda proboscidea</i>
137	Sanddab, Pacific	<i>Citharichthys sordidus</i>
239	Sandfish, Pacific	<i>Trichodon trichodon</i>
614	Sardine, Pacific	<i>Sardinops sagax</i>
607	Saury, Pacific	<i>Cololabis saira</i>
29	Scallops, Clams, Mussels, Oysters	Pelecypoda
353	Scorpionfish, Aleutian *	<i>Adelosebastes latens</i>
400	Sculpin - unidentified	Cottidae
402	Sculpin, Bigmouth	<i>Hemitripterus bolini</i>
410	Sculpin, Brown Irish Lord	<i>Hemilepidotus spinosus</i>
415	Sculpin, Butterfly	<i>Hemilepidotus papilio</i>
409	Sculpin, Crested	<i>Blepsias bilobus</i>
395	Sculpin, Darkfin	<i>Malacocottus zonurus</i>
405	Sculpin, Great	<i>Myoxocephalus polyacanthocephalus</i>

* If you encounter these species, please bring a specimen back to NMFS

<i>Code</i>	<i>Common Name</i>	<i>Scientific Name</i>
418	Sculpin, Irish Lord - unidentified	<i>Hemilepidotus</i> spp.
434	Sculpin, Longfin Irish Lord	<i>Hemilepidotus zapus</i>
440	Sculpin - <i>Myoxocephalus</i> unidentified	<i>Myoxocephalus</i> spp.
399	Sculpin, Plain	<i>Myoxocephalus jaok</i>
407	Sculpin, Red Irish Lord	<i>Hemilepidotus hemilepidotus</i>
398	Sculpin, Warty	<i>Myoxocephalus verrucosus</i>
414	Sculpin, Yellow Irish Lord	<i>Hemilepidotus jordani</i>
55	Sea Anemone - unidentified	Actiniaria
41	Sea Cucumber - unidentified	Holothurioidea
689	Sea Devil - unidentified	Ceratiidae
59	Sea Mouse	<i>Aphrodita aculeata</i>
42	Sea Onions - unidentified	<i>Boltenia</i> spp.
58	Sea Pen, Sea Whip - unidentified	Pennatula
57	Sea Potato - unidentified	<i>Halocynthia</i> spp.
25	Sea Slug - unidentified	Nudibranchiata
56	Sea Spider - unidentified	Pycnogonida
43	Sea Squirts, Onions, Potatoes, Tunicates	Urochordata
40	Sea Urchins, Sand Dollars	Echinoidea
58	Sea Whip, Sea Pen - unidentified	Pennatula
54	Sea Worms (Polychaetes) - unidentified	Annelida
242	Searcher	<i>Bathymaster signatus</i>
900	Seaweed - miscellaneous	
606	Shad, American	<i>Alosa sapidissima</i>
65	Shark - unidentified	Squaliformes, etc.
69	Shark, Blue	<i>Prionace glauca</i>
68	Shark, Brown Cat	<i>Apristurus brunneus</i>
62	Shark, Pacific Sleeper (Mud)	<i>Somniosus pacificus</i>
67	Shark, Salmon	<i>Lamna ditropis</i>
78	Shark, Sixgill	<i>Hexanchus griseus</i>
64	Shark, Soupfin	<i>Galeorhinus galeus</i>
66	Shark, Spiny Dogfish	<i>Squalus acanthias</i>
63	Shark, Thresher	<i>Alopias vulpinus</i>

* If you encounter these species, please bring a specimen back to NMFS

<i>Code</i>	<i>Common Name</i>	<i>Scientific Name</i>
70	Shrimp - unidentified	Arthropoda
90	Skate - unidentified	Rajiformes
88	Skate, Alaska	<i>Bathyraja parmifera</i>
85	Skate, Aleutian	<i>Bathyraja aleutica</i>
97	Skate, Bering	<i>Bathyraja interrupta</i>
94	Skate, Big	<i>Raja binoculata</i>
163	Skate, Commander	<i>Bathyraja lindbergi</i>
92	Skate, Deepsea *	<i>Bathyraja abyssicola</i>
95	Skate, Longnose	<i>Raja rhina</i>
165	Skate, Mud	<i>Bathyraja taranetzi</i>
161	Skate, Okhotsk *	<i>Bathyraja violacea</i>
166	Skate, Roughshoulder *	<i>Raja badia</i>
89	Skate, Roughtail	<i>Bathyraja trachura</i>
159	Skate - Soft Snout unidentified	<i>Bathyraja</i> spp.
167	Skate - Stiff Snout unidentified	<i>Raja</i> spp.
164	Skate, Whiteblotched	<i>Bathyraja maculata</i>
162	Skate, Whitebrow	<i>Bathyraja minispinosa</i>
212	Skilfish	<i>Erilepis zonifer</i>
602	Smelt - unidentified	Osmeridae
604	Smelt, Capelin	<i>Mallotus villosus</i>
601	Smelt, Eulachon (Candlefish)	<i>Thaleichthys pacificus</i>
605	Smelt, Rainbow	<i>Osmerus mordax</i>
613	Smelt, Surf	<i>Hypomesus pretiosus</i>
30	Snail - unidentified	Gastropoda
34	Snail, Eggs	
36	Snail, Empty Shell	
500	Snailfish - unidentified	Liparidae
559	Snipe Eel - unidentified	Nemichthyidae
109	Sole, Butter	<i>Isopsetta isolepis</i>
118	Sole, C-O *	<i>Pleuronichthys coenosus</i>
117	Sole, Curlfin *	<i>Pleuronichthys decurrens</i>
110	Sole, Deepsea	<i>Embassichthys bathybius</i>

* If you encounter these species, please bring a specimen back to NMFS

Code	Common Name	Scientific Name
107	Sole, Dover	<i>Microstomus pacificus</i>
108	Sole, English	<i>Parophrys vetulus</i>
103	Sole, Flathead	<i>Hippoglossoides elassodon</i>
116	Sole, Hybrid *	<i>Inopsetta ischyra</i>
108	Sole, Lemon	<i>Parophrys vetulus</i>
112	Sole, Petrale	<i>Eopsetta jordani</i>
105	Sole, Rex	<i>Glyptocephalus zachirus</i>
104	Sole, Rock Sole unidentified	<i>Lepidopsetta</i> sp.
120	Sole, Rock Sole, Northern	<i>Lepidopsetta polyxystra</i>
121	Sole, Rock Sole, Southern	<i>Lepidopsetta bilineata</i>
114	Sole, Roughscale *	<i>Clidoderma asperrimum</i>
115	Sole, Sand *	<i>Psettichthys melanostictus</i>
111	Sole, Slender	<i>Lyopsetta exilis</i>
140	Sole, Yellowfin	<i>Limanda aspera</i>
26	Sponge - unidentified	Porifera
270	Squaretail, Smalleye	<i>Tetragonurus cuvieri</i>
50	Squid - unidentified	Decapoda
511	Squid, Humboldt	<i>Dosidicus gigas</i>
51	Squid, Robust Clubhook	<i>Moroteuthis robusta</i>
20	Starfish - unidentified	Asteroidea
21	Starfish, Basket	<i>Gorgonocephalus</i> spp.
22	Starfish, Brittle	Ophiuroidea
24	Starfish, Sunstar	<i>Solaster</i> spp.
226	Steelhead	<i>Oncorhynchus mykiss</i>
230	Sturgeon - unidentified *	<i>Acipenser</i> spp.
810	Sunfish, Ocean	<i>Mola mola</i>
113	Tonguefish, California	<i>Symphurus atricauda</i>
807	Tubeshoulder - unidentified	Searsiidae
43	Tunicates, Ascidians, Sea Squirts	Urochordata
102	Turbot, Greenland	<i>Reinhardtius hippoglossoides</i>
805	Viperfish - unidentified	Chauliodontidae
757	Warbonnet, Decorated	<i>Chirolophis decoratus</i>

* If you encounter these species, please bring a specimen back to NMFS

<i>Code</i>	<i>Common Name</i>	<i>Scientific Name</i>
899	Waste -- Decomposed Fish	
762	Wearyfish, (Paperbones) - unidentified	Notosudidae
540	Whalefish, unidentified	Cetomimidae
779	Wolffish, Wolf-eel - unidentified	Anarhichadidae
780	Wolf-eel	<i>Anarrhichthys ocellatus</i>
781	Wolffish, Bering	<i>Anarhichas orientalis</i>
760	Wrymouth, Giant	<i>Delolepis gigantea</i>
783	Wrymouth, Dwarf	<i>Lycconectes aleutensis</i>

* If you encounter these species, please bring a specimen back to NMFS

Appendix B. Species Code List - Seabirds



<i>Code</i>	<i>Common Name</i>	<i>Scientific Name</i>
849	Albatross - unidentified	<i>Diomedidae</i> spp.
852	Albatross, Black-footed	<i>Phoebastria nigripes</i>
851	Albatross, Laysan	<i>Phoebastria immutabilis</i>
850	Albatross, Short-tailed *	<i>Phoebastria albatrus</i>
883	Alcid - unidentified	Alcidae spp.
893	Auklet/Murrelet - unidentified	
895	Auklet, Rhinoceros	<i>Cerorhinca moncerata</i>
998	Bird - unidentified	Aves
861	Cormorant - unidentified	<i>Phalacrocoracidae</i> spp.
866	Eider, Common	<i>Somateria mollissima</i>
863	Eider, King	<i>Somateria spectabilis</i>
864	Eider, Spectacled **	<i>Somateria fischeri</i>
865	Eider, Steller's **	<i>Polysticta stelleri</i>
854	Fulmar, Northern	<i>Fulmarus glacialis</i>
846	Grebe - unidentified	Podicipedidae
884	Guillemot - unidentified	<i>Cepphus</i> spp.
874	Gull - unidentified	<i>Laridae</i> spp.
878	Gull, Glaucus	<i>Larus hyperboreus</i>
879	Gull, Glaucus-winged	<i>Larus glaucescens</i>
877	Gull, Herring	<i>Larus argentatus</i>
871	Jaeger/Skua - unidentified	<i>Stercorariidae</i> spp.
876	Kittiwake, Black-legged *	<i>Rissa tridactyla</i>
875	Kittiwake, Red-legged *	<i>Rissa brevirostris</i>
898	Land Bird - unidentified	
844	Loon - unidentified	Gaviidae
887	Murre - unidentified	<i>Uria</i> spp.
889	Murre, Common	<i>Uria aalge</i>
888	Murre, Thick-billed	<i>Uria lomvia</i>
893	Murrelet/Auklet - unidentified	
896	Murrelet, Kittlitz's	<i>Brachyramphus brevirostris</i>

<i>Code</i>	<i>Common Name</i>	<i>Scientific Name</i>
894	Murrelet, Marbled	<i>Brachyramphus marmoratus</i>
854	Northern Fulmar	<i>Fulmarus glacialis</i>
853	Petrel/Shearwater - unidentified	<i>Procellariidae</i> spp.
868	Phalarope - unidentified	Phalaropodidae spp.
890	Puffin - unidentified	<i>Fratercula</i> spp.
891	Puffin, Horned	<i>Fratercula corniculata</i>
892	Puffin, Tufted	<i>Fratercula cirrhata</i>
897	Seabird - unidentified	
855	Shearwater, Dark - unidentified	<i>Puffinus</i> spp.
853	Shearwater/Petrel - unidentified	<i>Procellariidae</i> spp.
857	Shearwater, Short-tailed	<i>Puffinus tenuirostris</i>
856	Shearwater, Sooty	<i>Puffinus griseus</i>
867	Shorebird - unidentified	Charadriiformes
871	Skua/Jaeger - unidentified	Stercorariidae
858	Storm Petrel - unidentified	Hydrobatidae
880	Tern - unidentified	<i>Sterninae</i> spp.
848	Tube-noses - unidentified	Procellariiformes
862	Waterfowl - unidentified	Anseriformes

Please note occurrences of “Species of Interest” in the seabird section of your logbook.

* Note in logbook whether these animals are:

- adult (A)
- sub-adult (S)
- immature (I)
- unknown (U)

** Note in logbook whether these animals are:

- male (M)
- female (F)
- unknown (U)

For more information, refer to the “Beached Birds” guide provided by NMFS.

Appendix C. Species Code List - Marine Mammals



<i>Code</i>	<i>Common Name</i>	<i>Scientific Name</i>
CU	Northern Fur Seal	<i>Callorhinus ursinus</i>
EJ	Steller (Northern) Sea Lion	<i>Eumetopias jubatus</i>
ZC	California Sea Lion	<i>Zalophus californianus</i>
UO	Unidentified Otariid *	
EB	Bearded Seal	<i>Erignathus barbatus</i>
PV	Harbor Seal	<i>Phoca vitulina</i>
MA	Northern Elephant Seal	<i>Mirounga angustirostris</i>
PF	Ribbon Seal	<i>Phoca fasciata</i>
PH	Ringed Seal	<i>Phoca hispida</i>
PL	Spotted Seal (Larga Seal)	<i>Phoca largha</i>
OR	Walrus	<i>Odobenus rosmarus</i>
US	Unidentified Phocid *	
UP	Unidentified Pinniped *	
TT	Bottlenose Dolphin	<i>Tursiops truncatus</i>
DD	Common Dolphin	<i>Delphinus delphis</i>
PX	Dall's Porpoise	<i>Phocoenoides dalli</i>
LH	Frasier's Dolphin	<i>Lagenodelphis hosei</i>
PP	Harbor Porpoise	<i>Phocoena phocoena</i>
LB	Northern Right Whale Dolphin	<i>Lissodelphis borealis</i>
LO	Pacific Whitesided Dolphin	<i>Lagenorhynchus obliquidens</i>
GG	Risso's Dolphin	<i>Grampus griseus</i>
SB	Rough Toothed Dolphin	<i>Steno bredanensis</i>
SL	Spinner Dolphin	<i>Stenella longirostris</i>
SA	Spotted Dolphin (Central Pacific)	<i>Stenella attenuata</i>
SG	Spotted Dolphin (Eastern Pacific)	<i>Stenella attenuata</i>
SC	Striped Dolphin	<i>Stenella coeruleoalba</i>
UD	Unidentified Dolphin/Porpoise	
BE	Baird's Beaked Whale	<i>Berardius bairdii</i>
DL	Beluga	<i>Delphinapterus leucas</i>
MS	Bering Sea Beaked Whale	<i>Mesoplodon stejnegeri</i>
BG	Black Right Whale	<i>Balaena glacialis</i>

<i>Code</i>	<i>Common Name</i>	<i>Scientific Name</i>
BL	Blue Whale	<i>Balaenoptera musculus</i>
BM	Bowhead Whale	<i>Balaena mysticetus</i>
BX	Bryde Whale	<i>Balaenoptera edeni</i>
PC	False Killer Whale	<i>Pseudorca crassidens</i>
BP	Fin Whale	<i>Balaenoptera physalus</i>
ZX	Goosebeak Whale	<i>Ziphius cavirostris</i>
ER	Gray Whale	<i>Eschrichtius robustus</i>
MN	Humpback Whale	<i>Megaptera novaeangliae</i>
OO	Killer Whale	<i>Orcinus orca</i>
BA	Minke Whale	<i>Balaenoptera acutorostrata</i>
MM	Narwhal	<i>Monodon monoceros</i>
FA	Pygmy Killer Whale	<i>Feresa attenuata</i>
BB	Sei Whale	<i>Balaenoptera borealis</i>
GM	Shortfin Pilot Whale	<i>Globicephala macrorhynchus</i>
PM	Sperm Whale	<i>Physeter macrocephalus</i>
UX	Unidentified Small Whale	
UZ	Unidentified Large Whale	
UW	Unidentified Whale	
UC	Unidentified Cetacean *	
EL	Sea Otter	<i>Enhydra lutris</i>
ZZ	Unidentified Mammal	

* The following characteristics define animals belonging to these groups.

Otariid: This family includes fur seals and sea lions. They have visible, cartilaginous ears, large foreflippers and their hind flippers can be turned under the body. Their flippers are partially furred and they have three claws on their hindflippers, and none on their foreflippers. Males have scrotal testes.

Phocid: These are the true seals. They have no external cartilaginous ears, their small foreflippers are used for guidance only, and their hind flippers cannot be turned under the body. Their flippers are fully furred and five claws on each. Males have internal testes.

Pinniped: This group includes otariids, phocids and the walrus, which has characteristics from both families.

Cetacean: This class includes all whales and porpoises. The body is streamlined with the tail developed into horizontal flukes used for propulsion.

Appendix D. Weights, Measures, and Conversions

Abbreviations

inch	in	millimeter	mm	quart	qt	grams	g
foot	ft	centimeter	cm	liter	L	kilograms	kg
mile	mi	meter	m	minute	min	metric ton	mt
fathoms	f	kilometer	km	pounds	lbs	fahrenheit	F °
nautical mile	nm					Celsius	C °

Conversions

1 in = 2.540 cm	1 L = 1.0567 qt
1 cm = 10 mm = 0.3937 in	F° = (1.8 x C°) + 32C° = 5/9(F° - 32)
1 ft = 0.3048 m = 0.1667 f	1 mi = 5,280 ft = 1.609 km = 0.86899 nm = 880 f
1 m = 3.2808 ft = 0.5468 f	1 nm = 1.15078 mi = 1 min lat = 1.852 km = 1,012.6859 f = 1,852 m
1 f = 6 ft = 1.829 m	1 f = 0.0009875 nm = 0.0011364 mi
1000 m = 1 km = 0.6214 mi	
1 lb = 0.4536 kg	total catch wt. in lbs x 0.4536 = total catch wt. in kg
1 mt = 1,000 kg	

Area, Volume and Product Formulas

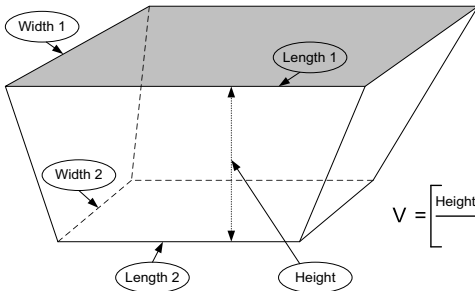
Number of Product Units x Average Unit Weight = Total Weight of Product
Product Weight ÷ Recovery Rate = Whole Weight of fish used to make the product
Product Weight x Conversion Factor = Whole or Fresh Weight of fish used for product
Area of a circle = πr^2 Circumference = $2\pi r$ ($\pi = 3.1416$)
Area of a square or rectangle = length x width
Area of a triangle = $1/2 \times \text{base} \times \text{height}$
Length of the triangle hypotenuse "c" where a and b equal the length of the opposite two sides: $a^2 + b^2 = c^2$ and $\sqrt{c^2} = c$
Volume of a right angle cone = $1/3 \times \pi r^2 h$
Volume of a Sphere = $\frac{4}{3} \times \pi \times r^3$
Volume of a Trapezoid:  $V = \left[\frac{\text{Height} (\text{Length 1} + \text{Length 2})}{2} \right] \left[\frac{(\text{Width 1} + \text{Width 2})}{2} \right]$

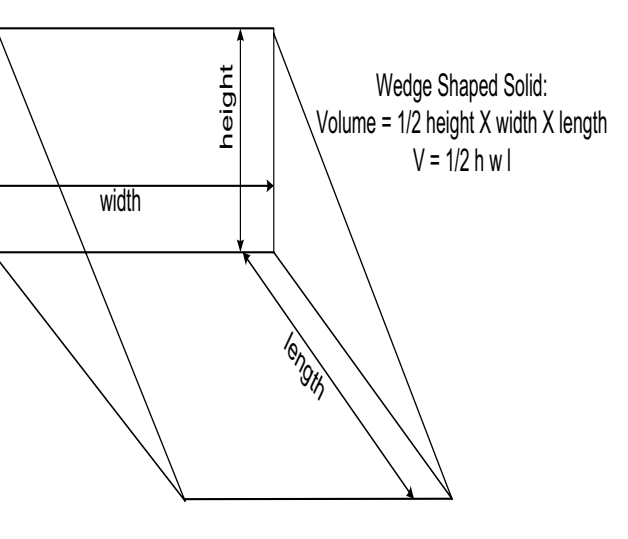
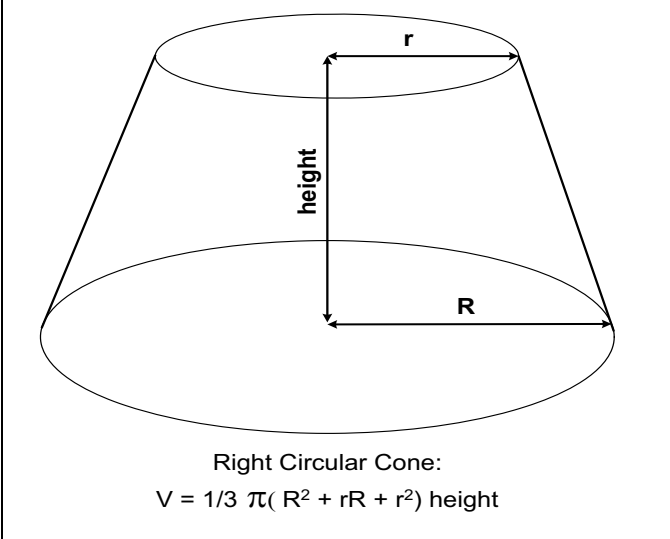
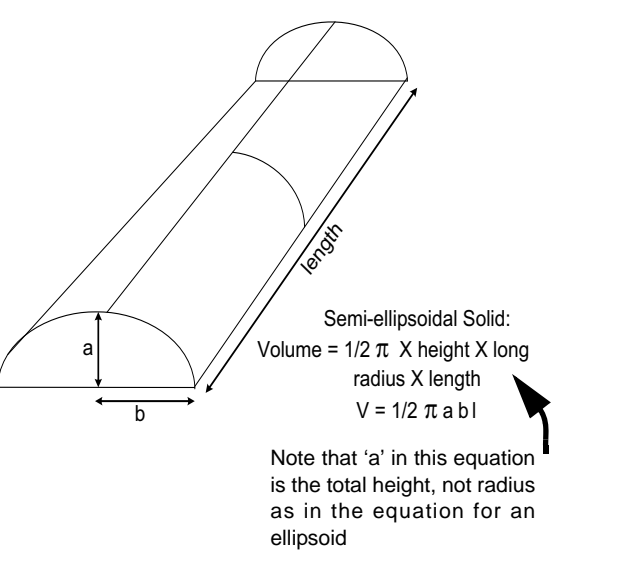
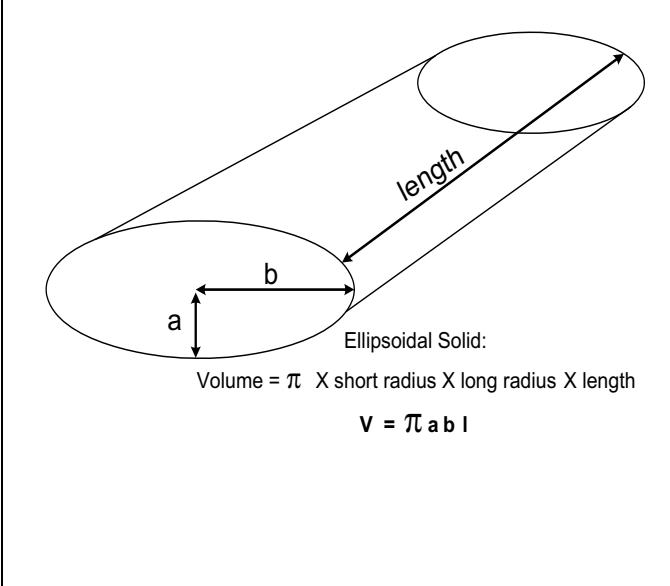
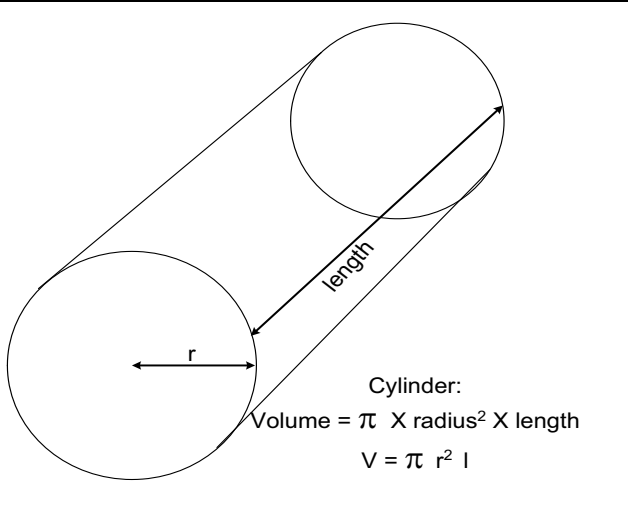
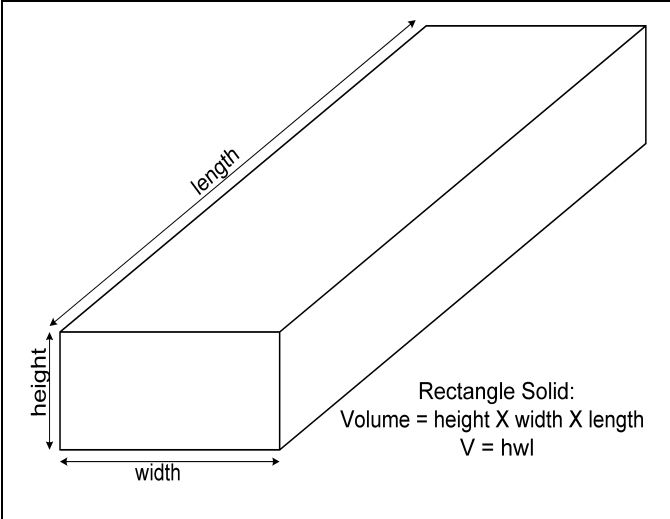

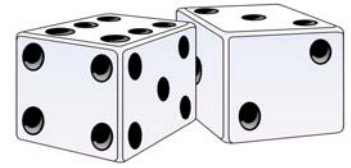

Appendix E. Random Number Table

	col. 1 to 5	col. 6 to 10	col. 11 to 15	col. 16 to 20	col. 21 to 25	col. 26 to 30	col. 31 to 35	col. 36 to 40	col. 41 to 45	col. 45 to 50
1	5 6 7 2 4	0 5 8 7 5	1 1 9 6 7	9 7 4 8 2	6 6 4 1 2	8 7 2 1 0	1 0 5 1 1	6 5 3 8 8	2 5 6 3 4	9 4 5 7 6
2	0 8 3 5 4	9 6 2 0 8	2 5 9 9 4	9 6 2 6 8	2 5 0 9 5	6 3 9 5 2	4 5 4 3 9	3 5 6 8 9	0 6 2 8 0	3 8 8 2 4
3	8 4 8 8 4	4 1 4 0 3	7 8 4 6 8	3 4 3 9 4	2 9 3 2 8	3 6 8 5 5	3 2 2 0 1	7 1 0 2 1	9 5 2 4 0	7 5 0 2 6
4	1 0 4 3 7	1 6 3 1 5	2 8 7 6 8	2 2 8 5 2	7 6 0 4 5	0 2 9 1 0	8 5 7 0 8	7 5 5 7 9	2 8 7 3 3	2 9 3 5 7
5	6 4 5 9 2	5 4 8 9 6	4 2 3 2 1	2 6 5 5 3	4 0 2 0 1	1 1 6 1 6	1 0 8 2 5	2 5 8 7 0	7 9 7 8 5	5 9 9 9 8
6	3 0 3 5 0	8 5 1 0 5	3 7 3 2 1	7 1 7 9 9	9 9 1 3 6	8 3 4 5 5	1 9 9 4 7	9 3 9 9 5	8 9 9 0 1	1 2 9 2 5
7	1 8 2 6 0	5 7 7 4 2	9 6 2 2 3	1 9 6 7 5	5 8 7 1 3	4 9 5 1 1	8 2 6 1 9	3 6 3 5 2	4 5 3 1 2	6 3 9 6 0
8	2 5 9 2 5	5 7 1 4 5	4 6 7 6 5	1 3 2 3 7	3 6 2 2 5	4 0 8 6 0	7 1 4 8 8	3 8 2 3 1	2 7 6 0 1	6 3 8 5 4
9	9 8 5 8 5	6 7 5 3 5	3 8 9 4 6	7 4 0 4 6	1 4 3 6 2	9 1 6 8 8	4 4 7 3 2	2 0 9 0 9	5 8 8 4 8	2 4 7 9 4
10	2 4 4 8 8	0 6 0 2 6	4 8 8 3 4	3 7 1 7 7	0 4 1 2 4	0 6 0 8 7	1 0 1 7 7	9 0 1 7 1	5 0 9 9 5	4 0 6 0 6
11	6 9 9 8 2	8 8 6 6 6	5 3 2 9 3	4 0 2 7 2	7 0 3 2 0	7 1 5 3 1	8 5 3 9 3	7 1 0 0 6	7 7 8 4 5	1 5 5 6 7
12	6 6 6 3 6	9 2 7 7 5	0 7 5 4 9	7 7 9 7 8	7 5 7 3 5	7 8 4 6 8	6 8 7 4 7	7 2 9 6 7	3 0 7 9 5	7 2 3 1 7
13	8 4 0 2 1	1 9 5 0 1	5 0 3 6 0	6 2 0 1 2	2 9 7 4 4	0 7 2 5 0	5 8 1 1 0	5 7 5 8 5	9 3 9 2 2	5 1 3 7 7
14	5 6 1 4 3	4 6 2 0 6	5 8 9 0 5	3 2 6 7 9	4 7 9 9 1	2 6 8 9 2	3 2 1 5 6	3 5 6 0 6	6 5 8 9 4	3 3 3 5 4
15	9 6 0 4 9	0 0 3 7 7	3 2 2 9 7	8 8 9 0 6	6 3 5 6 2	2 8 9 1 6	7 3 2 6 7	7 5 0 2 6	2 8 0 1 7	0 6 2 6 4
16	7 7 2 2 2	1 2 9 0 4	5 1 4 5 3	9 4 6 5 9	6 6 1 1 7	7 9 0 6 2	5 7 5 4 4	7 0 9 6 8	5 1 8 9 6	6 5 9 6 4
17	3 3 0 5 2	5 0 6 3 7	4 7 5 9 3	8 7 7 4 1	4 1 8 3 6	7 6 6 3 8	9 3 1 4 0	0 2 7 2 3	5 7 8 2 8	8 9 5 7 0
18	4 7 3 3 7	0 3 2 0 8	8 6 3 0 0	7 4 6 3 1	8 5 5 6 5	0 2 8 1 2	3 3 0 5 9	7 7 7 8 4	6 8 0 2 2	7 5 3 1 6
19	8 1 2 4 4	4 6 8 2 3	2 2 4 8 4	3 5 3 0 0	7 5 2 3 3	7 5 2 4 5	8 5 4 9 1	3 5 7 2 4	3 0 5 7 9	5 5 8 0 4
20	8 2 6 0 2	8 5 9 6 4	6 3 3 6 4	8 3 5 4 6	6 6 4 8 9	5 2 6 5 6	1 0 3 0 1	5 5 4 4 6	8 8 8 4 5	8 9 8 3 6
21	1 4 7 8 5	0 5 3 4 5	9 5 6 3 4	6 7 9 0 3	0 6 2 6 2	9 6 5 6 3	4 7 9 7 0	9 5 5 7 3	6 1 1 1 9	3 3 7 4 9
22	5 0 9 5 8	2 3 9 1 8	4 8 1 1 6	9 0 4 3 3	0 7 7 1 2	4 2 7 8 7	9 7 0 5 7	0 1 7 1 8	7 3 8 4 7	4 0 5 8 4
23	4 5 2 2 8	1 0 9 9 8	3 4 9 3 5	2 8 0 0 4	7 2 1 8 1	8 8 9 3 6	0 0 1 1 0	4 5 4 2 2	9 3 5 3 8	3 8 6 1 0
24	0 5 7 7 6	6 7 6 4 8	3 8 6 1 5	0 4 7 4 8	1 5 2 4 0	3 8 3 4 7	2 1 8 7 9	9 0 1 2 4	2 8 6 6 6	3 6 4 3 4
25	2 2 3 1 6	2 7 5 6 9	1 3 9 5 9	3 8 4 7 7	8 5 8 9 8	9 6 3 5 4	1 5 7 2 7	8 1 8 1 1	5 6 2 9 1	3 9 3 8 1
26	1 5 4 7 3	7 8 7 7 1	5 1 4 3 0	6 3 7 4 7	6 0 0 7 7	1 8 2 8 5	5 4 2 3 0	8 8 0 0 5	6 6 8 4 7	0 0 1 0 7
27	2 2 8 4 7	0 5 0 0 0	6 9 8 2 6	3 0 5 9 0	6 6 1 3 7	8 9 4 9 4	3 8 0 3 3	5 1 4 0 7	0 4 0 1 6	5 1 8 9 6
28	9 1 4 0 2	7 5 5 0 4	2 7 6 1 8	7 5 8 2 6	5 9 3 8 2	5 3 6 8 1	5 9 6 9 3	0 8 9 2 2	3 6 1 0 2	3 1 8 1 4
29	8 0 0 1 6	1 4 2 8 0	0 9 5 2 6	3 3 5 3 2	0 0 8 4 2	7 7 7 7 4	1 7 3 0 6	3 0 7 7 6	6 3 0 1 7	0 0 9 3 1
30	3 6 2 8 4	6 9 6 6 8	6 6 1 8 3	8 7 9 0 5	9 3 1 8 1	6 0 1 5 9	7 3 9 9 7	3 0 3 5 4	5 5 6 3 6	0 6 7 6 6
31	0 7 9 2 8	1 0 3 4 7	9 2 9 0 3	6 8 7 2 6	0 8 1 4 6	1 6 0 0 0	3 0 1 7 6	0 2 4 5 7	0 3 1 7 4	0 4 7 4 0
32	5 0 8 3 3	1 6 4 1 5	7 6 5 4 4	4 5 3 6 3	4 9 7 6 0	6 7 6 0 9	3 1 9 7 5	9 2 5 2 6	1 1 2 1 7	5 7 7 3 6
33	1 9 2 7 9	8 1 4 8 8	4 0 1 6 1	4 7 2 5 8	6 9 9 5 9	7 4 6 3 5	2 7 0 4 5	5 7 5 8 1	1 2 1 7 3	6 3 5 8 4
34	1 7 7 3 8	1 4 0 4 9	6 2 1 0 9	4 7 4 4 0	3 9 5 1 1	7 3 7 8 3	6 1 8 8 5	4 8 1 0 4	6 0 6 2 4	6 8 5 8 0
35	7 9 3 4 8	3 6 2 4 9	8 3 0 2 2	9 4 1 9 8	0 0 2 3 4	7 0 0 4 6	2 0 6 1 9	9 1 8 5 9	7 4 9 6 7	2 2 5 2 4
36	0 7 5 7 9	4 3 8 7 1	6 2 4 6 4	6 5 1 2 0	4 0 7 9 1	7 5 9 9 7	6 9 4 4 4	7 0 6 1 4	1 9 5 3 3	4 2 0 2 9
37	5 1 4 2 1	8 8 1 7 9	5 5 0 8 6	9 1 9 6 4	5 0 2 8 9	2 0 6 9 5	6 1 6 9 6	3 9 3 7 9	5 9 4 9 7	2 5 5 5 0
38	5 3 5 8 9	6 1 8 2 1	9 7 6 3 4	2 2 3 1 1	3 8 6 2 8	7 5 2 4 8	5 4 4 8 5	1 3 1 1 4	0 4 9 1 4	7 9 0 2 3
39	2 0 6 5 5	1 8 9 1 1	6 7 9 7 7	6 1 3 0 5	0 6 9 0 7	8 8 3 3 8	4 8 1 7 7	1 9 2 1 5	3 8 7 4 5	1 7 1 6 3
40	6 9 7 2 0	7 9 0 3 7	2 4 5 6 1	3 7 4 2 6	8 0 6 9 2	9 3 0 2 3	9 9 5 8 4	8 7 4 4 5	1 0 0 3 5	0 9 2 9 0
41	8 8 7 6 8	5 4 9 9 6	0 8 6 7 0	7 5 3 0 4	0 1 0 3 0	2 4 9 4 5	6 7 4 4 0	5 6 7 7 3	5 6 4 0 2	1 7 5 1 8
42	9 2 8 8 6	0 5 6 4 0	5 7 9 3 7	8 8 7 5 5	2 8 1 4 0	3 0 7 8 9	9 8 0 1 2	2 3 1 4 2	1 0 9 0 0	7 7 9 0 2
43	9 9 1 6 9	2 8 2 3 9	2 6 8 0 1	7 1 4 6 9	0 5 5 5 0	1 8 3 5 4	8 7 0 5 8	8 5 8 4 1	2 5 0 1 4	0 2 0 6 9
44	7 5 4 9 5	6 7 1 5 0	5 1 5 0 9	1 8 2 3 6	1 1 1 7 9	5 5 2 8 5	4 2 4 2 3	0 1 9 1 3	1 6 4 2 2	8 5 9 4 2
45	4 5 0 7 8	0 5 4 0 3	4 4 8 8 3	1 3 6 2 4	4 6 6 1 6	5 5 2 0 2	0 5 7 1 7	5 7 7 2 0	9 9 1 9 1	3 4 1 3 0
46	7 6 0 8 8	6 8 7 3 6	5 3 7 7 5	9 9 6 6 2	3 6 1 9 2	8 5 2 8 1	6 8 2 3 0	2 9 5 4 6	7 2 9 6 0	6 5 0 0 5
47	6 1 3 5 8	8 1 5 6 7	9 5 7 7 2	2 8 9 4 5	1 9 6 9 5	2 0 6 9 1	6 2 6 1 4	0 6 0 7 9	7 6 4 0 2	9 9 5 2 3
48	7 9 0 8 0	7 4 0 3 0	6 6 5 1 7	2 5 4 0 5	2 8 0 1 5	3 9 9 9 2	2 1 8 7 1	5 8 1 9 5	7 6 9 1 6	2 1 9 8 8
49	2 4 3 6 4	5 6 5 3 2	2 0 9 1 7	9 8 5 8 3	5 5 4 9 4	1 2 1 9 2	9 5 5 1 9	7 4 8 5 5	7 1 3 3 0	7 6 2 7 9
50	7 4 6 5 4	1 5 7 4 8	0 0 8 3 1	3 0 2 2 4	0 9 9 6 2	6 7 1 7 7	5 4 2 4 2	5 6 1 6 6	1 6 6 9 0	1 4 2 0 3

Appendix F. Product Recovery Rates (PRR)

Product recovery rate (PRR) represents that proportion of an organism that is used for product. The PRR is also referred to as the recovery ratio. Recovery rates can be used for estimating the fresh weight of a catch from the tonnage of product produced. The following equation can be used for estimating round weight from product weight. **Remember to add in discards.**

$$(\text{product weight} \div \text{recovery rate}) = \text{round weight (before processing)}$$

Recovery rates are commonly expressed as a percent or as a ratio. Headed and gutted cod may have a recovery ratio of 0.62 to 1, or 62% recovery, while fish frozen whole would have a recovery ratio of 1.00 to 1, or 100% recovery. The weight of product divided by the weight of the fish before processing is the recovery ratio. The fish weighed before processing should be sorted to species and be of the size and condition needed for the product.

$$(\text{product weight} \div \text{round weight}) = \text{product recovery rate}$$

The product weight as defined here assumes 100% efficiency in production. If fifty fish are weighed before processing, the product weight should represent the product from all fifty fish. If the product weight is less, because of loss along the production line, the result should be called an efficiency ratio rather than a product recovery ratio.

A wide range of recovery rates are used to describe the utilization of different species in a variety of products. The type of processing, the size of the fish, the area and season of the year, the experience of the processing crew, and the vessel type all have a bearing on the recovery rate of a particular species.

A conversion factor is a number which can be multiplied times the product weight to obtain the round weight (whole weight of the fish). **A conversion factor is always greater than 1** (for example, the conversion factor of surimi weight to pollock weight may be 6.67). To convert a conversion factor to a recovery rate, take the reciprocal of the conversion factor, (i.e., divide the number 1 by the conversion factor).

Appendix G. Product Codes and Description

Code	Description	Code	Description
1	Whole fish/food fish (PRR = 1.00)	31	Minced fish
2	Whole bait fish (PRR = 1.00)	32	Fish meal (meal from whole fish or fish parts, includes bone meal)
3	Bled only (throat slit to allow blood to drain)	33	Fish oil
4	Gutted only (head on, belly slit and viscera removed)	34	Milt (in sacs, or testes - ancillary product only)
6	H & G, with roe	35	Stomachs (includes all internal organs - ancillary product only)
7	H & G, Western cut (head removed <i>in front</i> of pectoral girdle)	36	Octopus/squid mantles (flesh after removal of viscera and arms)
8	H & G, Eastern cut (head removed <i>behind</i> pectoral girdle)	37	Butterfly (split, no backbone, head removed, fillets still attached)
10	H & G, tail removed (usually a Western cut with tail also removed)	41	Whole fish destined for off site fish meal (PRR=1.00)
11	Kirimi (head, gut and tail removed by cuts perpendicular to spine)	42	Bled fish destined for fishmeal
12	Salted and split	51	Whole fish with ice and slime (IFQ sablefish only)
13	Wings (from skates, side fins are cut off next to body)	54	Gutted, head on with ice and slime (IFQ halibut and sablefish only)
14	Roe only (eggs, either loose or in sacs or skeins)	57	H & G, Western cut with ice and slime (IFQ sablefish only)
15	Pectoral girdle only (collar bone and associated bones, cartilage and flesh)	58	Gutted, head on with ice and slime (IFQ halibut and sablefish only)
16	Heads (heads only, regardless where severed - ancillary product only)	86	H & G, Western cut with ice and slime (IFQ sablefish only)
17	Cheeks (muscles on sides of head - ancillary product only)	92	H & G, Eastern cut with ice and slime (IFQ sablefish only)
18	Chins (lower jaw (mandible), muscles and flesh - ancillary product only)	93	Donated prohibited species destined for food bank
19	Belly (flesh in region of pelvic and pectoral fins and behind head - ancillary product only)	95	Whole fish used for bait onboard. Not sold. (PRR = 1.00)
20	Fillets with skin and ribs	96	Whole fish damaged by observer's sampling procedures (PRR = 1.00)
21	Fillets with skin, no ribs	97	Whole fish for personal use or consumption (not sold or used as bait) (PRR = 1.00)
22	Fillets, with ribs, no skin	98	Discard, decomposed fish. Flea or parasite infested fish, decomposed or previously discarded fish. (PRR 0.0)
23	Fillets, skinless/boneless	99	Other retained product (description and PRR must be provided)
24	Deep skin fillets	51	Whole fish with ice and slime (IFQ sablefish only)
30	Surimi (paste from any of the fish flesh and additives)		

Appendix H. NMFS Species and Group Codes Used in Vessel Logbooks

Species or Group Code	Species or Group Description
193	Atka mackerel
121	Arrowtooth flounder and/or Kamchatka flounder
870	Octopus
110	Pacific cod
270	Pollock
122	Flathead sole
123	Rock sole (includes northern, southern and unidentified rock soles)
124	Dover sole
125	Rex sole
127	Yellowfin sole
134	Turbot (Greenland)
143	Thornyheads (all <i>Sebastolobus</i> species)
160	Sculpins
511	Eulachon
516	Capelin
689	Sharks (general)
700	Skates (general)
710	Sablefish
875	Squid
Group Code 118	Shallow water flatfish complex (SWF) in the Gulf of Alaska include: yellowfin sole, rock soles, English sole, starry flounder, butter sole, Alaska plaice and sand sole.
Group Code 120	Other Flatfish (OFLAT) (All flatfish without a separate code (e.g: petrale sole)
130	Lingcod (non-allocated species)
136	Northern rockfish
Group Code 168	Demersal shelf rockfish (canary, china, copper, quillback, rosethorn, tiger and yellow-eye)
Group Code 169	Pelagic shelf rockfish (dusky, yellowtail and widow)
Group Code 144	Slope rockfish (aurora, blackgill, Bocaccio, chilipepper, darkblotch, green-striped, harlequin, pygmy, redbanded, redstripe, sharpchin, shortbelly, silvergray, splitnose, stripetail, vermillion, and yellowmouth)
141	Pacific ocean perch
151	Rougheye rockfish
152	Shortraker rockfish

Appendix I. Alaska Department of Fish and Game Fish Ticket Codes

Code Species	Code Species	Code Species	Code Species
110 cod, Pacific (gray)	158 rockfish, redstripe	400 salmon, roe	Shellfish
121 flounder, arrowtooth	159 rockfish, darkblotched	410 salmon, chinook	810 clam, butter
122 sole, flathead	160 sculpin, general	420 salmon, sockeye	812 clam, surf
123 sole, rock	166 rockfish, sharpchin	430 salmon, coho	815 clam, geoduck
124 sole, dover	167 rockfish, blue	440 salmon, pink	820 clam, cockle
125 sole, rex	170 sardine, Pacific	450 salmon, chum	830 clam, razor
126 sole, butter	175 rockfish, yellowmouth	511 smelt, eulachon	840 clam, little-neck
127 sole, yellowfin	176 rockfish, harlequin	515 smelt, surf	842 clam, eastern softshell
128 sole, english	177 rockfish, blackgill	516 smelt, capelin	850 scallop, weathervane
129 flounder, starry	178 rockfish, chillipepper	521 Arctic char	851 scallop, pink (or calico)
130 lingcod	179 rockfish, pygmy	531 Dolly Varden	855 blue mussel
131 sole, petrale	180 shad	540 trout, steelhead	860 abalone
132 sole, sand	181 rockfish, shortbelly	600 lamprey, Pacific	870 octopus
133 plaice, Alaska	182 rockfish, splitnose	625 jellyfish	875 squid
134 turbot, Greenland	183 rockfish, stripetail	680 sturgeon, general	890 snails
135 rockfish, greenstripe	184 rockfish, vermilion	689 shark, general	892 urchin, red sea
136 rockfish, northern	185 rockfish, aurora	690 shark, salmon	893 urchin, green sea
137 rockfish, bocaccio	191 greenling, rock	691 shark, spiny dogfish	895 sea cucumber
138 rockfish, copper	192 greenling, whitespot	692 shark, Pacific sleeper	899 coral
141 perch, Pacific Ocean	193 greenling, atka mackerel	700 skate, general	900 crab, box
142 rockfish, black	194 greenling, kelp	701 skate, longnose	910 crab, Dungeness
143 rockfish, thornyhead	200 halibut	710 sablefish (blackcod)	921 crab, red king
145 rockfish, yelloweye	210 eels or eel-like fish	714 ratfish	922 crab, blue king
146 rockfish, canary	211 wrymouths	715 skilfish	923 crab, brown king (golden)
147 rockfish, quillback	212 hagfish, Pacific	720 albacore	924 crab, scarlet king (couesi)
148 rockfish, tiger	213 grenadier (rattail)	Forage Fish	931 crab, Tanner, bairdi
149 rockfish, China	214 grenadier (giant)	206 Pacific sand fish	932 crab, Tanner, opilio
150 rockfish, rosethorn	215 prowfish	207 gunnel	933 crab, Tanner, grooved (tanneri)
151 rockfish, rougheye	216 lumpsucker	208 prickleback	934 crab, Tanner, triangle (angulatus)
152 rockfish, shortraker	220 saury, Pacific	209 bristlemouth	940 crab, korean horsehair
153 rockfish, redbanded	230 herring, Pacific (directed fishery)	772 lanternfish	951 crab, multispina
154 rockfish, dusky	235 herring, Pacific (bycatch)	773 deep-sea smelt	953 crab, verrilli
155 rockfish, yellowtail	250 tomcod, Pacific	774 Pacific sand lance	961 shrimp, pink
156 rockfish, widow	260 Pacific Flatnose	800 krill	962 shrimp, sidestripe
157 rockfish, silvergray	270 pollock, walleye		963 shrimp, humpy
			964 shrimp, coonstripe
			965 shrimp, spot

Appendix J. Processor Permit List

Permit	Processor	Location
5470	10th & M Seafoods	Anchorage
29501	Absolute Fresh Seafoods, Inc.	Seattle
27101	Adak Fisheries	Adak
5504	Alaska Custom Seafoods Inc.	Homer
5343	Alaska Fresh Seafoods Inc.	Kodiak
5945	Alaska Glacier Seafood Co.	Juneau
5342	Alaska Pacific Seafood	Kodiak
5797	Alaskan Premier Seafoods	Hyder
5320	Alyeska Seafoods Inc.	Unalaska
26238	Anderson's Alaska Specialty Seafood	Homer
5394	Annette Island Packing Co. Cold Storage	Metlakatla
5314	Arctic Enterprise	
3978	Arctic Star	
5424	Arrowac Fisheries Inc.	Bellingham
5303	Atka Pride Seafoods Inc.	Atka
6053	Auction Block (The)	Homer & Seward
28843	Bear & Wolf Salmon Company	Seattle
5482	Bell's Seafood	Haines
5437	Bellingham Cold Storage	Bellingham
3531	Bering Star	
18592	Big Blue Fisheries	Sitka
5380	Bornstein Seafoods Inc.	Bellingham
29503	Captain's	Yakutat
5435	Coastal Cold Storage	Petersburg
28721	Copper River Fine Seafoods, Inc.	Anchorage
6293	Copper River Fine Seafoods, Inc.	Cordova
5298	Deep Creek/ Custom Packing Inc.	Ninilchik
3877	Discovery Star	

Permit	Processor	Location
5376	E.C.Philips	Ketchikan
4111	Excellence	
5383	FAVCO	Anchorage
28197	Fee's Custom Seafoods	Anchorage
26030	Fish Factory	Homer
5386	Fishhawk Fisheries Inc.	Astoria
5372	Glacier Village Supermarket Inc.	Juneau
27989	Global Seafoods	Kodiak
1607	Golden Alaska	
5484	Great Pacific Seafoods Inc.	Anchorage
28629	Harbor Crown Seafoods, Inc.	Dutch Harbor
5335	Hoonah Cold Storage	Hoonah
5638	Horst Seafood Inc.	Juneau
5332	Icicle Seafoods	Homer
30032	Icicle Seafoods INC.	Egegik
5300	Icicle Seafoods-Petersburg Fisheries	Petersburg
5299	Icicle Seafoods-Seward Fisheries	Seward
5490	Icy Straits Seafoods Inc.	Juneau
3259	Independence	
5392	International Seafoods of AK (True World Seafoods)	Kodiak
28695	Island Fish Co. LLC	Kodiak
5302	Kachemak Bay Seafood	Homer
30336	Kake Foods	Kake
1996	Katie Ann	
5645	Kingfisher Seafoods Co	Unalaska
30132	Kodiak Smoking & Processing	Kodiak
6238	Norquest Seafoods Inc.	Chignik
5338	Norquest Seafoods Inc.	Cordova
5336	Norquest Seafoods Inc.	Ketchikan
5337	Norquest Seafoods Inc.	Petersburg

Permit	Processor	Location
5341	North Pacific Seafoods, Inc.	Cordova
4078	Northern Victor	
5370	Ocean Beauty Seafoods Inc.	Kodiak, AK
28116	Ocean Beauty Seafoods Inc.	Excursion Inlet
5518	Ocean Beauty Seafoods Inc.	Seattle
5369	Ocean Beauty Seafoods Inc.	Cordova
5431	Ocean Beauty Seafoods Inc.	Petersburg
5443	Ocean Beauty Seafoods Inc.	Naknek
28114	Ocean Beauty Seafoods Inc.	Alitak, SW Kodiak
27328	Ocean Beauty Seafoods	Nikiski
27324	Ocean Beauty Seafoods	Seward
3703	Ocean Phoenix	
5349	Osterman Fish	Dutch Harbor
5344	Pacific Salmon Company Inc.	Edmonds
5442	Pacific Star Seafoods Inc.	Kenai
5921	Pelican Seafoods	Pelican
28113	Peter Pan Seafoods Inc.	Dillingham
5357	Peter Pan Seafoods Inc.	Valdez
5358	Peter Pan Seafoods Inc.	King Cove
29550	Polar Equipment Inc. DBA Polar Sfds	Seward
5333	Prime Alaska Seafoods Inc.	Unalaska
5423	Prime Select Seafood Inc.	Cordova
5925	R & J Seafoods	Kasilof
5438	Resurrection Bay Seafoods L.L.C.	Seward
30133	Royal Aleutian Seafoods Inc.	Dutch Harbor
5460	Salamatof Seafoods Inc.	Kenai
28043	Sea Level Seafoods Inc.	Wrangell
5371	Seafood Producers Cooperative	Sitka
3592	Snopac	Adak
7124	Snug Harbor Seafoods	Seward

Permit	Processor	Location
5362	Stellar Sea	
27991	SE AK Smoked Salmon Co., Inc.(Taku Fisheries)	Juneau
26247	North Pacific Seafoods	Togiak
7061	Tonka Seafoods	Petersburg
27990	Trident Seafoods	Kodiak
5305	Trident Seafoods Corp.	Sand Point
5306	Trident Seafoods Corp.	Akutan
5307	Trident Seafoods Corp.	St. Paul Island
27444	Trident Seafoods Corp.	Chignik
5392	True World Seafoods (International Seafoods of AK)	Kodiak
5310	Unisea Inc. - Dutch Harbor	Dutch Harbor
99999	Unknown Location	
5348	Wards Cove Packing Company	Kodiak
29502	Western Alaska Fisheries Inc.	Kodiak
5323	Westward Seafoods Inc.	Dutch Harbor
6258	Wrangell Fisheries, Inc.	Wrangell
29504	Yakutat Seafoods, LLC	Yakutat
5891	Yki Fisheries Inc.	Yakutat

Appendix K. Vessel/Plant Names and Permit Numbers

Vessel or Plant Name	Len. ft.	USCG #	NMFS Permit #
ADAK PLANT			27101
AIREDALE	130	521431	3374
AJ	150	599164	3405
ALASKA BEAUTY	98	544967	2046
ALASKA CHALLENGER	105	597377	3387
ALASKA DAWN	90	1051463	6097
ALASKA FRESH SFDS			5343
ALASKA JURIS	238	569276	2443
ALASKA MIST	174	586179	2833
ALASKA OCEAN	376	637856	3794
ALASKA PACIFIC SFDS			5342
ALASKA PATRIOT	177	513392	3816
ALASKA PIONEER	196	555645	3308
ALASKA ROSE	120	610984	515
ALASKA SPIRIT (CATCHER ONLY)	98	605674	4105
ALASKA SPIRIT (C/P)	221	554913	3819
ALASKA VICTORY	227	569752	4093
ALASKA WARRIOR	215	590350	3423
ALASKAN	65	510811	2010
ALASKAN BEAUTY	105	590340	5133
ALASKAN COMMAND	184	599383	3391
ALASKAN LEADER	150	971836	4598
ALDEBARAN	132	664363	901
ALEUTIAN	68	227566	2256
ALEUTIAN BALLAD	107	656806	4458
ALEUTIAN BEAUTY	98	536852	4638
ALEUTIAN LADY	165	504762	4102
ALEUTIAN MARINER	118	602229	495
ALEUTIAN NO. 1	126	611139	3687
ALEUTIAN SPRAY	98	522870	427
ALICIA JEAN	105	967014	5571
ALLIANCE (Trawl)	107	622750	2924
ALLSTAR	62	578815	2111
ALPINE COVE	76	1113073	26728
ALRITA	73	248401	52
ALSEA	124	626517	2811
ALSKA	63	553667	1562
ALYESKA	122	560237	395
ALYESKA SEAFOODS			5320

Vessel or Plant Name	Len. ft.	USCG #	NMFS Permit #
AMATULI	111	511315	3227
AMERICAN BEAUTY	123	613847	1688
AMERICAN DYNASTY	272	951307	3681
AMERICAN EAGLE	120	558605	434
AMERICAN LADY	126	550276	2309
AMERICAN NO. 1	160	610654	1879
AMERICAN TRIUMPH	285	646737	4055
AMERICAN WAY	100	662562	2099
ANDRONICA	99	622780	4560
ANITA J	130	560532	1913
ANNA MARIE	86	524384	1627
ANNETTE	68	562157	1430
ARCTIC DAWN	96	634806	4676
ARCTIC EAGLE	126	967106	4555
ARCTIC ENTERPRISE	339	248169	5314
ARCTIC EXPLORER	155	936302	3388
ARCTIC FJORD	275	940866	3396
ARCTIC HUNTER	98	592242	1550
ARCTIC LADY	133	604215	2841
ARCTIC MARINER	125	618374	4582
ARCTIC SEA	134	596137	3381
ARCTIC STAR (Plant)	258		3978
ARCTIC STORM	334	903511	2943
ARCTIC VENTURE	124	1087790	7161
ARCTIC WIND	123	608216	5137
ARCTURUS	132	655328	533
ARGOSY	124	611365	2810
ARICA	186	550139	3694
ARROW	70	223621	97
ATKA PRIDE SEAFOODS			5303
ATLANTICO	98	524452	625
AUGUSTINE	90	635397	3093
AURIGA	193	639547	2889
AURORA	193	636919	2888
AUROUS	117	270744	3585
AUTUMN DAWN	127	259779	4619
BALLAD	67	590537	2017
BALLYHOO	176	501812	1921
BARANOF	180	598508	1248
BARBARA J	110	648690	4979

Vessel or Plant Name	Len. ft.	USCG #	NMFS Permit #
BARWELL	88	265952	2189
BAY ISLANDER	86	521200	1193
BEAUTY BAY	127	959086	4533
BELLA-K	130	631084	2929
BERING LEADER	124	1160196	29997
BERING PACIFIC SFDS			18671
BERING PROWLER	124	973006	4540
BERING ROSE	124	624325	516
BERING SEA	114	554126	3380
BERING STAR(Plant)	199	597734	3531
BERING STAR (Pot)	108	593310	4658
BIG BLUE	88	601825	1907
BIG VALLEY	92	515719	2412
BILLIKIN	135	550190	277
BLAZER	73	973389	4486
BLUE ACE	131	569573	4529
BLUE ATTU	137	624429	4377
BLUE DUTCH	180	642653	3376
BLUE FIN	120	546234	5040
BLUE FOX	85	979437	4611
BLUE GADUS	152	580852	2090
BLUE NORTH	174	604676	3339
BLUE PACIFIC	180	569927	4618
BLUE STAR	138	250464	2008
BLUE WAVE	200	509280	5361
BOUNTIFUL	165	593404	278
BRISTOL EXPLORER	180	647985	3007
BRISTOL LEADER	167	106051	6323
BRISTOL MARINER	125	608397	5448
BRITTANY	106	600856	5127
BUCCANEER	76	558467	1106
BULLDOG	132	583974	4106
CAITLIN ANN	103	960836	3800
CALIFORNIA HORIZON	90	590758	412
CAPE FLATTERY	71	241146	589
CAPE HORN	158	653806	2110
CAPE KIWANDA	76	618158	1235
CAPE OMMANEY	85	246336	3770
CAPRICE	86	565511	1912
CAPT'N ART	83	544628	1945
CAPTAIN BANJO	88	602316	6343
CARAVELLE	86	583916	3402
CAROL M	61	225374	2259
CASCADE MARINER	101	557441	3699

Vessel or Plant Name	Len. ft.	USCG #	NMFS Permit #
CENTAURUS	149	530652	5780
CHANDALAR	70	632162	5747
CHELISSA	70	617797	6222
CHELSEA	70	224464	2187
CHELSEA K	150	976753	4620
CHESAPEAKE	67	231395	2164
CLIPPER ENDEAVOR	124	633593	3242
CLIPPER EPIC	172	619796	4463
CLIPPER EXPRESS	161	236979	3385
CLIPPER SURPRISE	124	628555	2718
COHO	71	622773	1230
COLLIER BROTHERS	90	593809	2791
COLUMBIA	123	615729	1228
COMMODORE	133	914214	2657
CONFIDENCE	100	523762	4980
CONSTELLATION (Pot)	127	604998	5781
CONSTELLATION (C/P)	150	640364	4092
CONSTITUTION	73	211928	302
CONTROLLER BAY	88	942350	5530
COOK INLET PROC.- KODIAK			5321
COOK INLET-KENAI			5364
CORNELIA MARIE	126	957458	5178
COURAGEOUS	180	606117	1276
DAWN	92	532081	5
DECEPTION	126	640956	5031
DEEP PACIFIC	124	640128	2872
DEFENDER	200	554030	3257
DEFENDER (C/P)	123	665983	4635
DEFIANT	66	619236	2198
DESTINATION (Pot)	109	632374	5329
DESTINATION (Trawler)	180	571879	3988
DESTINY	100	590962	4177
DETERMINED	111	600071	1114
DISCOVERY STAR	160		3877
DOMINATOR	124	602309	411
DOMINION	66	620062	642
DONA MARTITA	152	651751	2047
DR. K	99	615699	7113
DUSK	86	550418	4
EARLY DAWN	108	591603	4571
ECHO BELLE	86	617234	1974
ECLIPSE	72	226744	878
ELIZABETH F	90	526037	823

Vessel or Plant Name	Len. ft.	USCG #	NMFS Permit #
ENTERPRISE	78	557952	2579
ENTERPRISE (C/P)	120	657383	5822
ERLAN	117	598365	10067
EVENING STAR (LL)	65	248539	200
EXCALIBUR II	71	636602	410
EXCELLENCE	367	967502	4111
EXITO	126	273458	5091
EXODUS	94	598666	1249
FARRAR SEA	100	973143	5478
FARWEST LEADER	101	606083	3226
FIERCE ALLEGIANCE	166	588849	4133
FIERCE CONTENDER	156	589883	4110
FRIGIDLAND	74	235921	4853
FORUM STAR	97	925863	4245
FRONTIER EXPLORER	135	975015	4450
FRONTIER MARINER	135	951440	3672
FRONTIER SPIRIT	135	951441	3673
GINNY C	65	251357	3088
GLACIER BAY	154	600325	5325
GLADIATOR	124	598380	1318
GLOBAL SEAFOODS - KODIAK			27989
GOD'S WILL	85	513397	2808
GOLD RUSH	93	521106	1868
GOLDEN ALASKA	305	651041	1607
GOLDEN DAWN	149	604315	1292
GOLDEN FLEECE	104	609951	367
GOLDEN PISCES	98	599585	586
GOLDEN SABLE	100	625096	5001
GRAND DUCHESS	114	625876	2228
GRANT	68	225264	289
GREAT PACIFIC	124	608458	511
GREEN HOPE	100	609993	685
GRUMPY J	82	514665	1232
GUARDIAN	99	972714	4627
GUIDING STAR	94	530653	527
GULF MAIDEN	72	514505	1591
GUN-MAR	172	640130	425
HALF MOON BAY	122	615796	249
HARBOR CROWN SFDS			28629
HAZEL LORRAINE	90	592211	523
HERITAGE	68	582098	5744
HICKORY WIND	107	594154	993
HIGHLAND LIGHT	270	577044	3348

Vessel or Plant Name	Len. ft.	USCG #	NMFS Permit #
HOONAH COLD STORAGE			5335
HORIZON	148	586183	1301
HUSKY	133	586918	3375
ICICLE SFDS -HOMER			5332
ICICLE SFDS SEWARD			5299
ICICLE SFDS-PBURG			5300
INDEPENDENCE (Floater)	351	237743	3259
INDEPENDENCE (Longline/Pot)	78	552513	792
INTERNATIONAL SEAFOODS OF AK (TRUE WORLD SFDS)			5392
INTREPID EXPLORER	124	988598	4993
IRENE H	82	520337	2899
ISLAND ENTERPRISE	304	610290	3870
ISLAND FISH CO			28695
JADE ALASKA	122	553592	1139
JAMIE MARIE	90	932586	4999
JEANINE KATHLEEN	58	972086	4195
JEANOAH	82	530164	1497
JENNIFER A	98	597611	10446
JOANN MARIE	60	533613	1285
JUDI B	92	562772	1695
KAMILAR	66	629244	362
KARIEL	66	626555	3759
KARIN LYNN	127	592291	5384
KATHERINE	86	599072	3583
KATIE ANN	296	518441	1996
KATIE K	108	552364	3354
KATRINA EM	101	607434	1980
KEMA SUE	80	589000	1701
KESIA DAWN	66	629009	274
KETA	97	576029	5330
KEVLEEN-K	104	517481	4769
KILKENNY	75	510076	3248
KISKA SEA	124	965726	4179
KJEVOLJA	110	612616	1632
KODIAK	111	600072	1109
KODIAK ENTERPRISE	275	579450	3671
KONA WIND	81	934764	4373
KONA-KAI	108	669025	2342
KRISTEN GAIL	114	618791	1686

Vessel or Plant Name	Len. ft.	USCG #	NMFS Permit #
KRISTIANA	69	247187	576
KUSTATAN	100	959432	5489
LABRADOR	126	284504	4589
LADY ALASKA	138	972591	4978
LADY ALEUTIAN	116	640544	5474
LADY GUDNY	103	615085	4285
LADY KISKA	174	500871	5675
LADY KODIAK	126	972646	4893
LAST FRONTIER	99	667407	4962
LAURA	93	508622	1571
LEGACY	132	664882	3367
LESLIE LEE	91	584873	1234
LILLI ANN	141	976538	4569
LIN-J	96	538018	1705
LNDY	77	227167	357
LISA MARIE	79	1038717	6172
LISA-MELINDA	81	584360	4506
LONE STAR	86	520494	213
LORELEI II	63	251968	1257
LUALDA	63	259740	1665
MAJESTY	106	962718	3996
MAR DEL NORTE	86	523219	435
MAR DEL SUD	110	524524	1287
MAR PACIFICO	96	524001	1674
MAR-GUN	113	525608	524
MARATHON	87	596156	1191
MARCY J	97	517024	2142
MARGARET LYN	123	615563	723
MARK I	98	509552	1242
MASONIC	70	228492	1279
MELANIE	102	512191	1934
MELISSA BETH	77	677261	3397
MEMORIES	65	251934	2264
MESSIAH	83	610150	6081
MICHELLE RENEE	112	966996	4131
MIDNITE SUN	85	548491	3060
MILKY WAY	72	599711	3038
MISS BERDIE	87	913277	3679
MISS CONCEPTION	77	533411	171
MISS CORINNE	58	607659	1314
MISS LEONA	86	522643	1482
MISS SARAH	103	921578	4989
MONRAD FARSTAD	80	550564	4161
MORNING STAR	148	610393	208

Vessel or Plant Name	Len. ft.	USCG #	NMFS Permit #
MS. AMY	73	920936	2904
MUIR MILACH	102	611524	480
NANCY H	85	268442	2998
NEAHKAHNIE	110	599534	424
NEW LIFE	79	504299	6182
NEW STAR	188	285304	3491
NEW VENTURE	100	565816	1137
NEW WEST FISHERIES			5400
NIGHTWATCH	74	575942	854
NIP 'N TUCK	66	611459	2340
NOR' QUEST	110	609064	3425
NORCOASTER	62	563617	181
NORDIC FURY	110	542651	1094
NORDIC MARINER	120	591077	6191
NORDIC STAR	123	584684	428
NORDIC VIKING	130	608399	6202
NORQUEST (SILVER LINING)			5336
NORQUEST SEAFOODS			6238
NORQUEST SEAFOODS INC.			5338
NORSEMAN	108	553713	5128
NORTH CAPE	123	950038	3692
NORTH PACIFIC PROCESS			5341
NORTH POINT	85	296653	5389
NORTH SEA	126	606565	3382
NORTHERN	69	226833	307
NORTHERN AURORA	155	596308	1613
NORTHERN EAGLE	341	506694	3261
NORTHERN ENDURANCE	78	1182027	30102
NORTHERN GLACIER	201	663457	661
NORTHERN HAWK	341	643771	4063
NORTHERN JAEGER	336	521069	3896
NORTHERN MARINER	110	556251	4543
NORTHERN MARINER	73	958549	3741
NORTHERN PATRIOT	152	637744	2769
NORTHERN PRINCE	60	563437	5912
NORTHERN SPIRIT	90	613825	3736
NORTHERN VICTOR	379	248959	4078
NORTHWEST EXPLORER	162	609384	3002
NORTHWESTERN	126	587816	4973

Vessel or Plant Name	Len. ft.	USCG #	NMFS Permit #
NORTON SOUND	136	936017	5294
NOTORIOUS	120	291882	4185
NUKA ISLAND	105	604208	1959
NUNIVAK	86	264094	506
OBSESSION	107	603285	2212
OCEAN ALASKA	107	623210	528
OCEAN BALLARD	114	974507	4573
OCEAN BEAUTY SFDS-KODIAK			5370
OCEAN BEAUTY-CORDOVA			5369
OCEAN BEAUTY - SEWARD			6009
OCEAN CAPE	99	583721	1615
OCEAN DAWN	81	550890	1936
OCEAN EXPLORER	155	678236	3011
OCEAN FURY	124	586441	5368
OCEAN HARVESTER (Longline)	72	524908	649
OCEAN HARVESTER (Pot/Trawl)	108	549892	5130
OCEAN HOPE I	108	652395	1640
OCEAN HOPE III	111	652397	1623
OCEAN HUNTER	100	622324	1964
OCEAN LEADER	120	561518	1229
OCEAN PEACE	219	677399	2134
OCEAN PHOENIX	635	296779	3703
OCEAN PROWLER	155	632751	3336
OCEAN ROVER	256	552100	3442
OCEANIC	122	602279	1667
OSTERMAN FISH			5349
PACIFIC ALLIANCE	105	612084	2816
PACIFIC CHALLENGER	104	518937	657
PACIFIC EXPLORER	155	678237	3010
PACIFIC FURY	110	561934	421
PACIFIC GLACIER	276	933627	3357
PACIFIC KNIGHT	185	561771	2783
PACIFIC MAIDEN	69	598959	1520
PACIFIC MARINER	126	560501	4581
PACIFIC MIST	87	293053	1923
PACIFIC MONARCH	166	557467	2785
PACIFIC PEARL	162	614930	276
PACIFIC PRINCE	149	697280	4194
PACIFIC PRODUCERS			

Vessel or Plant Name	Len. ft.	USCG #	NMFS Permit #
PACIFIC RAM	82	589115	4305
PACIFIC SOJOURN	72	664245	751
PACIFIC STAR	79	633001	2781
PACIFIC STORM	82	604146	2797
PACIFIC SUN	121	604581	3648
PACIFIC VENTURE	103	523423	3238
PACIFIC VIKING	127	555058	422
PATHFINDER	180	591678	4306
PAVLOF	166	597532	3406
PEGASUS (LL/Pot)	72	567048	952
PEGASUS (Trawler)	96	565120	1265
PEGGY JO	99	502779	979
PELICAN SEAFOODS, INC.			5385
PERSEVERANCE	93	982610	4803
PERSEVERANCE	87	536873	2837
PERSISTENCE	76	581823	5381
PETER PAN SFDS-KING COVE			5358
PETER PAN SFDS-VALDEZ			5357
POLAR LADY	105	609940	5123
POLAR SEA	104	589317	4590
POLARIS	76	210966	51
POSEIDON	117	610436	1164
PREDATOR (Trawl)	90	547390	1275
PRIME ALASKA SFDS			5333
PRO VISION	92	552625	2905
PROGRESS	114	565349	512
PROSPERITY	137	615485	3361
PROVIDENCE	70	682689	2420
PROWLER	115	623837	1622
QUEEN - EAST PT KODIAK			5326
QUEST	65	604314	438
RAMBLIN ROSE	103	957380	7158
RAVEN	92	629499	1236
REBECCA IRENE	140	697637	1610
REBEL	98	596135	3689
RELIANCE	165	516256	5393
REPUBLIC	86	211802	221
RESOLUTE (LL)	72	223688	46
RESURRECTION BAY SFDS			5438

Vessel or Plant Name	Len. ft.	USCG #	NMFS Permit #
RETRIEVER	133	598975	4588
ROCKY B	66	614651	1042
ROGUE	90	944290	4138
ROLLO	107	555403	5449
ROSELLA	90	509579	2861
ROYAL ALEUTIAN SFDS			5313
ROYAL AMERICAN	105	624371	543
ROYAL ATLANTIC	124	559271	236
ROYAL VIKING	108	542375	5455
RUFF & REDDY	90	514964	651
SAGA	107	606800	5792
SCANDIES ROSE	130	602351	5456
SEA ALASKA			3231
SEA FISHER	166	296512	20
SEA MAC	87	525516	1043
SEA ROVER	108	546728	7133
SEA STAR	104	521201	439
SEA STORM	123	628959	420
SEA VALLEY I I	66	625137	2853
SEA VENTURE	104	525572	2122
SEA WARRIOR	105	563829	11798
SEA WOLF	125	609823	1652
SEABROOKE	109	614410	3035
SEADAWN	124	548685	2059
SEAFISHER	230	575587	3835
SEAFOOD PRODUCERS COOPERATIVE			
SEAFREEZE ALASKA	295	517242	2733
SEATTLE ENTERPRISE	270	904767	3245
SEEKER	98	924585	2849
SEYMOUR	82	210939	283
SHAMAN	110	558637	602
SHELLFISH	94	506986	290
SHERRIE MARIE	61	509415	3541
SIBERIAN SEA	137	975853	4578
SILVER SPRAY	116	964016	4101
SITKA SOUND-SITKA			5346
SITKA SOUND-YAKUTAT			5359
SNOPAC	190	596827	3592
SNOPAC INNOVATOR	311	594619	5293
SNUG HARBOR	78	948313	3940
SOJOURN	67	626614	1157

Vessel or Plant Name	Len. ft.	USCG #	NMFS Permit #
SOUTHEAST	66	694038	1798
SOUTHERN SEAS	66	950624	4333
SOVEREIGNTY	165	651752	2770
ST. JOHN I I	65	245779	485
STARBOUND	240	944658	3414
STARFISH	123	561651	1167
STARLITE	123	597065	1998
STARWARD	123	617807	417
STELLAR SEA			5362
STORM PETREL	123	620769	1641
STORMBIRD	90	656842	1751
SUNDANCER	64	634057	4659
SUNSET	65	223408	333
SUNSET BAY	122	598484	251
SUNWARD	65	251957	2075
SUSTINA	85	603312	1901
TAASINGE	73	547210	912
TAKU SMOKERIES			27991
TANI RAE	90	542076	5158
TEMPEST	112	506261	3479
THOR	68	224713	1628
TIME BANDIT	114	973238	4984
TOPAZ	86	575428	405
TORDENSKJOLD	75	209487	592
TRACY ANNE	95	904859	2823
TRAILBLAZER	134	596514	3343
TRAVELER	109	929356	3404
TREMONT	124	529154	2018
TRIDENT SFDS KODIAK			27990
TRIDENT SFDS-AKUTAN			5306
TRIDENT SFDS-SAND POINT			5305
TRIDENT SFDS-ST PAUL			5307
TRUE WORLD SFDS (INTERNATIONAL SEAFOODS OF AK)			5392
TUXEDNI	102	513354	3589
U.S. INTREPID	185	604439	2800
U.S. LIBERATOR	162	611520	372
UNIMAK	185	637693	3369
UNISEA: G1 & G2			5310

Vessel or Plant Name	Len. ft.	USCG #	NMFS Permit #
VAERDAL	124	611225	2123
VALIANT	111	522574	5717
VAN ELLIOTT	76	524557	1575
VANGUARD	94	617802	519
VANSEE	87	210906	61
VERNON	50	220310	3646
VESTERAALEN	124	611642	517
VIEKODA BAY	102	939078	4593
VIGOROUS	67	250226	937
VIKING	144	565017	1222
VIKING EXPLORER	124	605228	1116
VIN CE	82	679775	3796
VIXEN	98	1063312	6210
WALTER N	95	257365	825
WARDS COVE-ALITAK			5348
WARDS COVE-KODIAK			5414
WESTERLY	72	507754	1286
WESTERLY	90	656740	16856
WESTERN AK FISHERIES			29502
WESTERN DAWN	113	524423	134
WESTERN QUEEN	177	284906	2647
WESTERN STAR	80	612319	2511
WESTERN VIKING	101	507161	5131
WESTLING	108	633577	2150
WESTWARD I	135	615165	1650

Vessel or Plant Name	Len. ft.	USCG #	NMFS Permit #
WESTWARD SFDS-DUTCH HARBOR			5323
WESTWARD WIND	160	595289	3274
WINDJAMMER	75	515274	2076
WINONA J	69	645410	1433
WIZARD	156	594470	4532
WONIYA	72	636605	1979
YARDARM KNOT	323	250424	3116
YUKON QUEEN	166	509115	3616
ZENITH	124	628313	440
ZOLOTOI	101	625095	3016

The following vessel names recently changed. You may need to look up vessel profiles by the former name.

Cascade Mariner formerly the Cascade.

Tremont formerly the Alaskan Rose.

Ocean Alaska formerly the Beagle.

Northern Mariner formerly the Northern Cascade.

Arctic Star (plant) formerly the Bering Star.

Blue Ace formerly the Storjord

Blue Star formerly the Seattle Star

Appendix L. NMFS Reporting Areas for the Bering Sea and Aleutian Islands

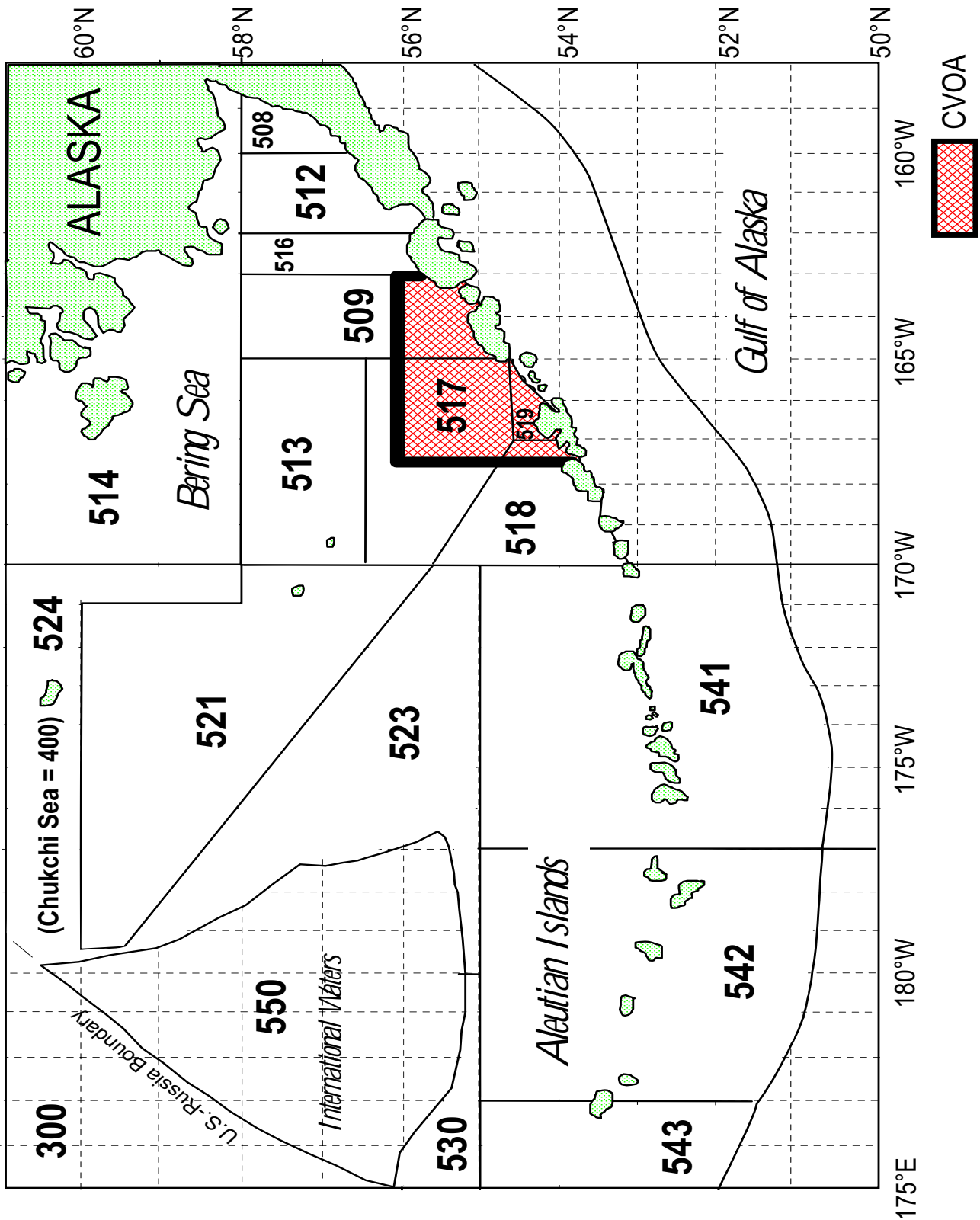

Appendix M. NMFS Reporting Areas for the Gulf of Alaska

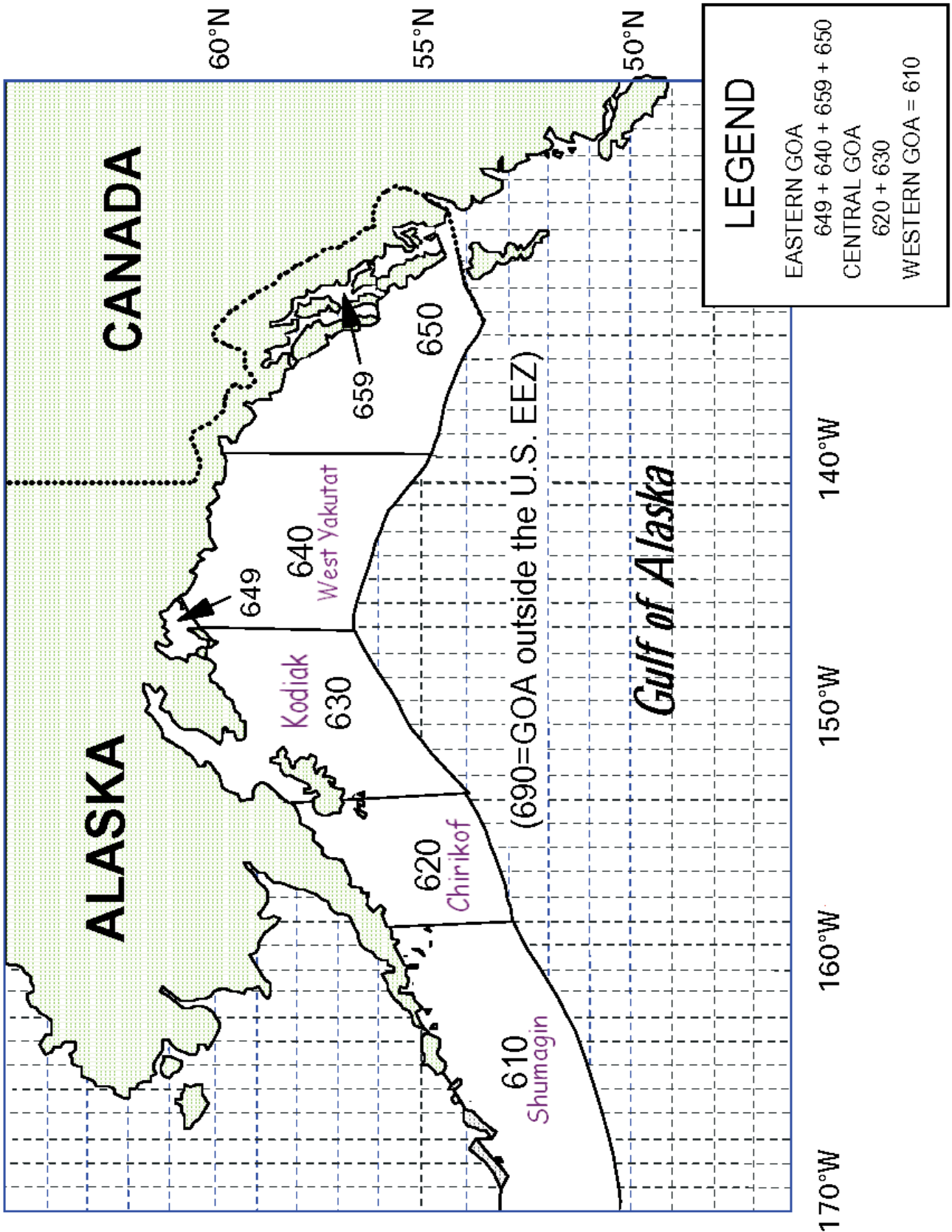

Appendix N. Halibut Length to Weight Table

cm.	kg.	cm.	kg.	cm.	kg.	cm.	kg.	cm.	kg.	cm.	kg.
10 - 12	.01	54	1.72	94	10.34	134	32.61	174	76.02	214	148.63
13 - 14	.02	55	1.82	95	10.70	135	33.41	175	77.45	215	150.89
15 - 16	.03	56	1.93	96	11.07	136	34.22	176	78.89	216	153.18
17	.04	57	2.05	97	11.45	137	35.04	177	80.35	217	155.49
18	.05	58	2.16	98	11.83	138	35.87	178	81.83	218	157.82
19	.06	59	2.29	99	12.23	139	36.72	179	83.33	219	160.18
20	.07	60	2.41	100	12.64	140	37.59	180	84.85	220	162.56
21	.08	61	2.55	101	13.05	141	38.46	181	86.39	221	164.97
22	.09	62	2.69	102	13.47	142	39.35	182	87.94	222	167.40
23	.11	63	2.83	103	13.91	143	40.26	183	89.52	223	169.85
24	.12	64	2.98	104	14.35	144	41.18	184	91.11	224	172.33
25	.14	65	3.13	105	14.80	145	42.11	185	92.73	225	174.84
26	.16	66	3.29	106	15.26	146	43.06	186	94.36	226	177.37
27	.18	67	3.45	107	15.73	147	44.02	187	96.01	227	179.93
28	.21	68	3.62	108	16.21	148	45.00	188	97.39	228	182.51
29	.23	69	3.80	109	16.71	149	45.99	189	99.11	229	185.11
30	.26	70	3.98	110	17.21	150	47.00	190	101.10	230	187.75
31	.28	71	4.17	111	17.72	151	48.02	191	102.83	231	190.40
32	.32	72	4.36	112	18.24	152	49.06	192	104.58	232	193.09
33	.35	73	4.56	113	18.77	153	50.12	193	106.36	233	195.80
34	.38	74	4.76	114	19.32	154	51.18	194	108.16	234	198.53
35	.42	75	4.98	115	19.87	155	52.27	195	109.97	235	201.29
36	.46	76	5.19	116	20.44	156	53.37	196	111.81	236	204.08
37	.50	77	5.42	117	21.01	157	54.49	197	113.67	237	206.90
38	.55	78	5.65	118	21.60	158	55.62	198	116.00	238	209.74
39	.60	79	5.89	119	22.20	159	56.77	199	117.45	239	212.61
40	.65	80	6.13	120	22.81	160	57.93	200	119.37	240	215.50
41	.72	81	6.38	121	23.43	161	59.11	201	121.32	241	218.43
42	.76	82	6.64	122	24.07	162	60.31	202	123.28	242	221.38
43	.82	83	6.91	123	24.71	163	61.53	203	125.27	243	224.35
44	.88	84	7.18	124	25.37	164	62.76	204	127.28	244	227.36
45	.95	85	7.46	125	26.04	165	64.01	205	129.32	245	230.39
46	1.02	86	7.75	126	26.72	166	65.27	206	131.37	246	233.45
47	1.10	87	8.05	127	27.41	167	66.55	207	133.45	247	236.54
48	1.17	88	8.35	128	28.12	168	67.83	208	135.55	248	239.66
49	1.25	89	8.66	129	28.83	169	69.17	209	137.67	249	242.80
50	1.34	90	8.98	130	29.56	170	70.51	210	139.82	250	245.98
51	1.43	91	9.31	131	30.31	171	71.86	211	141.99		
52	1.52	92	9.64	132	31.06	172	73.23	212	144.18		
53	1.62	93	9.99	133	31.83	173	74.62	213	146.39		

Appendix O. Halibut Condition Criteria For Trawl Bycatch

The criteria are listed in order of importance.

Excellent: Fish is alive, showing no stress, and injuries, if any, are slight.

1. External injuries.
 - Superficial nicks or cuts on body.
 - Little (<10% of fin area) or no fraying of dorsal and anal fin.
 - Hemorrhaging (redness) of skin on white side limited to 5-10% of surface area.
2. Operculum pressure.
 - Fish is able to close operculum tightly for at least 5-10 seconds.
 - Muscle tone and physical activity.
 - Strong and lively, perhaps flopping around on deck if provoked.
 - Fish can tightly clench its jaw.
3. Bleeding.
 - No bleeding observed.
4. Gills and gill color.
 - Deep red in color.

Poor: Fish is alive, but showing signs of stress.

1. Injuries are apparent.
 - Body abrasions have damaged the skin but skin is still present, not missing.
 - Cuts and lacerations in body extend through skin just into flesh and are not deep.
 - Between 10 and 50% of dorsal and anal fins are frayed.
 - Slight bleeding from fin edges.
 - Approximately 10-25% of skin on white side of fish shows hemorrhaging.
2. Operculum pressure.
 - Fish closes operculum weakly and not sustained.
3. Muscle tone or physical activity.

- Weak, intermittent movement. May respond if stimulated or provoked.
 - Body is limp, but not in rigor mortis.
4. Bleeding.
 - Blood is continually flowing from gills, but not profusely.
 5. Gills and gill color.
 - Deep to bright red in color.

Dead: No sign of life or, if alive, likely to die from severe injuries or suffocation.

1. Injuries are apparent.
 - Body cavity ripped open.
 - Internal organs exposed and damaged.
 - Cuts and lacerations in body extend deeply into the flesh.
 - Sediment in mouth.
 - Hemorrhaging in skin on 25% or more of white side.
2. Operculum pressure.
 - Fish does not close operculum.
3. Muscle tone and physical activity.
 - No sign of muscle tone (limp) or fish is in rigor (stiff).
 - Physical activity absent or limited to fin ripples or twitches.
 - Little, if any, response to stimuli.
 - Jaw is hanging open.
4. Bleeding.
 - Blood is flowing freely and continuously in large quantity from a torn or severed gill arch, or a body injury.
5. Gills and gill color.
 - Gills appear washed out, *e.g.*, dull red, pink, or white in color.

Appendix P. Key to Pacific Halibut Viability for Trawl Vessels

Codes: Excellent = E, Poor = P, Dead = D, Unknown = U

- 1a.** Fish is aliveGo to 2a
1b. Fish is dead when sorted from the catch.....code **DEAD**
Fish is in rigor and lifeless, even if no apparent injuries. Gills appear washed out, i.e., dull red, pink, or white in color. Mouth may contain sediment.
- 2a.** Body of fish appears uninjured, or has only minor injuries.....Go to 3a
2b. Injuries to fish are significant and obvious.....code **DEAD**
Body cavity is ripped open, exposing internal organs. Body tissue may be torn or ripped in a rough, ragged manner. Red hemorrhaging observed on 25% or more of the white side.
- 3a.** Fish is able to close operculum when stimulatedGo to 4a
Operculum is closed strongly or weakly, but pressure is evident. Operculum may not stay closed for long, though pressure may last up to 5 seconds or longer.
3b. Fish cannot close operculum, even when stimulatedcode **DEAD**
- 4a.** Fish displays activity and has muscle tonego to 5a
Fish displays a minimal amount of activity, especially when stimulated. May be able to clench jaw tightly.
4b. Fish exhibits no muscle tonecode **DEAD**
- 5a.** Fish is not bleeding, or only slightly bleeding, if at allgo to 6a
5b. Blood is flowing freely and continuously in large quantity (profusely).....code **DEAD**
Bleeding is coming from a torn or severed gill arch, or a body injury.
- 6a.** Body injuries are minimal, perhaps difficult to find.....go to 7a
May consist of superficial nicks or cuts on body. Less than 10% of dorsal and anal fin area is frayed.
6b. Body injuries are readily apparent..... code **POOR**
Skin is damaged with abrasions. Cuts and lacerations in body extend through the skin and just barely into the flesh (not deeply). Dorsal and anal fin area is frayed between 10-50% Fin edges may be bleeding. Roughly 10-25% of the white side of fish shows red hemorrhaging.
- 7a.** Operculum pressure is strong and sustained.....go to 8a
7b. Operculum pressure is weak and not sustained code **POOR**
- 8a.** Fish is strong and lively, displaying good muscle tonego to 9a
Fish is flopping around the deck, hard to control. Jaw may be tightly clenched, difficult to open.
8b. Fish appears weak..... code **POOR**
Movement is intermittent, perhaps occurring when provoked or stimulated. Body is limp.
- 9a.** Fish is bleeding from gills code **POOR**
Blood is flowing continuously, slow and steadily, but not profusely. Gills are deep to bright red in color.
9b. No bleeding observed code **EXCELLENT**
Gills are deep red in color.

Appendix Q. Halibut Condition Criteria For Pot Bycatch

The criteria are listed in order of importance

Excellent: Fish is alive, showing no stress, and injuries, if any, are slight.

1. External injuries.
 - Superficial nicks or cuts on body.
 - Little (<10% of fin area) or no fraying of dorsal and anal fins.
 - Hemorrhaging (redness) of skin on white side limited to 5-10% of surface area.
2. Operculum pressure.
 - Fish is able to close operculum tightly for at least 5-10 seconds.
3. Muscle tone and physical activity.
 - Strong and lively, perhaps flopping around on deck if stimulated.
 - Fish can tightly clench its jaw.
4. Bleeding.
 - No bleeding from gills, body, or fins observed.
5. Gills and gill color.
 - Deep red in color.
6. No penetration of the body or head by sand fleas. No predation by crabs.
 - Membranes surrounding eyes and anus are intact, without any holes from sand fleas.
 - A few sand fleas may be seen on body, but can be wiped off with your hand. Typically, no penetration has occurred when only a few (*e.g.*, <10) sand fleas are found on the body.

Poor: Fish is alive, but displaying physical injuries and signs of stress.

1. External injuries are apparent.
 - Body abrasions have damaged the skin but skin is still present, not missing.
 - Cuts and lacerations in body extend through skin just into flesh and are not deep.

- Between 10 and 50% of dorsal and anal fins are frayed.
 - Slight bleeding from fin edges.
 - Approximately 10-25% of skin on white side of fish shows hemorrhaging.
2. Operculum pressure.
 - Fish closes operculum weakly and not sustained.
 3. Muscle tone or physical activity is weak.
 - Intermittent body movement. May respond if stimulated.
 - Body appears limp, but not in rigor mortis.
 4. Bleeding.
 - Blood is not flowing profusely, but is oozing continuously from fin edges or body wounds.
 5. Gills and gill color.
 - Gills are deep to bright red.
 6. No penetration of the body or head by sand fleas. No crab predation.
 - Membranes surrounding eyes and anus are intact, without any holes from sand fleas.
 - A few sand fleas may be seen on body, but can be wiped off with your hand. Typically, no penetration has occurred when only a few (*e.g.*, <10) sand fleas are found on the body.
 - No damage to the fish from crabs, if any, in the pot.

Dead/Fleas: No sign of life or, if alive, likely to die from injuries or predation.

1. External and internal injuries.
 - Body cavity may be ripped open.
 - Internal organs may be exposed and damaged.
 - Body tissue may be torn or ripped in a rough, ragged manner.
 - Hemorrhaging in skin on 25% or more of white side.

(Condition criteria continued on next page.)

2. Operculum pressure.
 - Fish does not close operculum.
3. Muscle tone and physical activity.
 - No sign of muscle tone (limp) or fish is in rigor (stiff)
 - Physical activity absent or limited to fin ripples or twitches.
 - Little, if any, response to stimuli.
 - Jaw may be open and slack.
4. Bleeding.
 - Blood is flowing profusely from fin edges or body.
5. Gills and gill color.
 - Gills appear washed out, *e.g.*, dull red, pink, or white in color.
6. Sand fleas have penetrated the body via the eyes, fins, or anus. Crab predation may also occur.
 - Membrane surrounding eye may be partially or completely eaten by sand fleas.
 - Dorsal and/or anal fin membranes may be eaten away, leaving fin rays exposed. Skin on the body is separated from tissue where sand fleas have eaten.
 - Crabs in the pot may also have attacked and eaten the “dead” fish.

Appendix R. Key to Pot Condition Codes for Pacific Halibut

Codes: Excellent = E, Poor = P, Dead = D, Unknown = U

- 1a.** Fish is alive Go to 2a
1b. Fish is dead when sorted from the catch code **DEAD**
Fish is in rigor and lifeless, even if no apparent injuries. Gills appear washed out, i.e., dull red, pink, or white in color.
- 2a.** No penetration of the body or head by sand fleas Go to 3a
Membranes surrounding eyes and anus are intact, without any holes from sand fleas. A few sand fleas may be seen on body and can be wiped off with your hand. Typically, no penetration has occurred when only a few (e.g. <10) sand fleas are found on the body.
- 2b.** Sand fleas have penetrated the body via the eyes, fins, or anus code **DEAD**
Membrane surrounding eye may be partially or completely missing. Dorsal and/or anal fin membranes may be eaten away, leaving fin rays exposed. Skin on the body is separated from tissue where sand fleas have eaten.
- 3a.** No predation of the fish's body by crabs in the pot is noted Go to 4a
3b. Predation by crabs has occurred code **DEAD**
Crabs in the pot may have attacked and eaten the fish.
- 4a.** Body of fish appears uninjured, or has only minor injuries go to 5a
4b. Injuries to fish are obvious and significant code **DEAD**
Body cavity is ripped open, exposing internal organs. Body tissue may be torn or ripped in a rough, ragged manner. Red hemorrhaging observed on 25% or more of the white side.
- 5a.** Fish is able to close operculum when stimulated go to 6a
Operculum is closed strongly or weakly, but pressure is evident. Operculum may not stay closed for long, though pressure may last up to 5 seconds or longer.
- 5b.** Fish cannot close operculum, even when stimulated code **DEAD**
- 6a.** Fish displays activity and has muscle tone go to 7a
Fish displays a minimal amount of activity, especially when stimulated. May be able to clench jaw, perhaps tightly.
- 6b.** Fish exhibits no muscle tone code **DEAD**
Physical activity absent or limited to fin ripples or twitches. Little, if any response to stimuli. Jaw is hanging open and is slack.
- 7a.** Fish is not bleeding, or only slightly bleeding, if it all go to 8a
7b. Blood is flowing freely and continuously in a large quantity (profusely) code **DEAD**
Bleeding is coming from fin edges or a body injury.

(Key continues on next page)

8a. Body injuries are minimal, perhaps difficult to find.....go to 9a
May consist of superficial nicks or cuts on body. Less than 10% of dorsal and anal fin area is frayed. Hemorrhaging of skin on white side limited to < 10% of surface area.

8b. Body injuries are readily apparent..... code **POOR**
Skin is damaged with abrasions. Cuts and lacerations in body extend through the skin and just barely into the flesh (not deeply). Dorsal and anal fin area is frayed between 10-50%. Fin edges may be bleeding slightly. Roughly 10-25% of the white side of fish shows red hemorrhaging.

9a. Operculum pressure is strong and sustained.....go to 10a
Fish should be able to close operculum for at least 5-10 seconds.

9b. Operculum pressure is weak and not sustained..... code **POOR**

10a. Fish is strong and lively, displaying good muscle tonego to 11a
Fish is flopping around the deck, hard to control. Jaw may be tightly clenched, difficult to open.

10b. Fish appears weak..... code **POOR**
Movement is intermittent and of short duration, perhaps occurring when provoked or stimulated. Body appears limp, not in rigor mortis.

11a. Fish is bleeding from fin edges or body..... code **POOR**
Blood is oozing continuously from fin edges or body wounds. Gills are deep to bright red in color.

11b. No bleeding observed code **EXCELLENT**
Gills are deep red in color. Fins are not bleeding.

Appendix S. Halibut Injury Criteria For Longline Bycatch

The criteria are listed in order of importance

Minor injuries: Injuries, if any, are slight and inconsequential to health of the fish.

1. Injuries around the mouth from the hook and hook removal are slight.
 - A hook entrance/exit hole around the jaw or in the cheek.
 - The lip (skin covering the external portion of the jaw) may be torn and hanging.
 - The hook and some length of residual ganglion may be hanging from the mouth if the ganglion was cut.
2. Very little bleeding, if any.
 - Bleeding is seen only in the area surrounding the jaw.
 - Bleeding may have stopped, or may be continuing very slowly a few drops at a time.
3. No penetration of the body or head by sand fleas.
 - Membranes surrounding eyes and anus are intact, without any holes from sand fleas.
 - A few sand fleas may be seen on body and can be wiped off with your hand. Typically, no penetration has occurred when only a few (*e.g.*, <10) sand fleas are found on the body.

Moderate injuries: Injuries are present, but are not severe.

1. Injuries may have been inflicted to the jaw, cheek, eye, or body.
 - Lower jaw may be broken into 2 pieces at the snout, but each is still attached at the base of the jaw.
 - Jaw is torn on one side or the other, possibly extending through the cheek.
 - Hook may have punctured the eye or eye socket.
 - Wounds on head and abdomen limited to surface scratches on skin.

- No wounds of any kind to abdominal organs. Abdominal cavity wall not punctured.
 - Wounds in body consist of puncture holes in skin, with possibly a flesh tear.
2. Bleeding is occurring but not from gills.
 - Blood may be seen around mouth and jaw.
 - Blood is not flowing profusely, but is oozing continuously.
 3. No penetration of the body or head by sand fleas.
 - Membranes surrounding eyes and anus are intact, without any holes from sand fleas.
 - A few sand fleas may be seen on body and can be wiped off with your hand. Typically, no penetration has occurred when only a few (*e.g.*, <10) sand fleas are found on the body.

Severe injuries: Severe life-threatening injuries can be seen.

1. Injuries to the head and/or jaw have occurred. Any of the following will be present, individually or in combination:
 - Skin on head (forward of preopercle) is ripped and torn deeply, exposing tissue and internal organs.
 - Side of the head, possibly including the jaw, has been torn loose and missing from the fish.
 - Lower jaw has been torn away and is missing.
 - No wounds of any kind to abdominal organs. Abdominal cavity wall not punctured.
2. No penetration of the body or head by sand fleas.
 - Membranes surrounding eyes and anus are intact, without any holes from sand fleas.
 - A few sand fleas may be seen on body and can be wiped off with your hand. Typically, no penetration has occurred when only a few (*e.g.*, <10) sand fleas are found on the body.

(Condition criteria continued on next page.)

Dead/Fleas/Bleeding: Fish is lifeless, sand flea predation, severe bleeding.

1. Fish is already dead when brought to the surface on the gear

- Fish is in rigor and lifeless, even if no apparent injuries.
- Gills appear completely devoid of blood (light pink or white in color).

2. Marine mammals have taken bites out of the fish

- Usually taken out of the back of the fish or from the abdominal cavity.

3. Sand fleas have penetrated the body via the eyes, fins, or anus.

- Membrane surrounding eye may be partially or completely missing.
- Dorsal and/or anal fin membranes may be eaten away, leaving fin rays exposed. Skin on the body is separated from tissue where sand fleas have eaten.

4. Bleeding is severe, especially from the gills.

- Blood is flowing freely and continuously in large quantity.
- Bleeding is occurring from a torn or severed gill arch.

5. Internal organs are damaged, possibly by a gaff.

- Abdominal cavity wall is punctured or torn.
- Viscera are visible and exposed, and may be protruding.

Appendix T. Key to Longline Injury Codes for Pacific Halibut

Codes: 1 = Minor, 2 = Moderate, 3 = Severe, 4 = Dead/Sand Fleas/Bleeding, 9 = Unknown

- 1a. Fish is alive Go to 2a
1b. Fish is dead when brought to the surface on the gear..... code DEAD
Fish is in rigor and lifeless, even if no apparent injuries. Gills appear completely devoid of blood (light pink or white in color).
- 2a. Body shows no signs of marine mammal predation Go to 3a
Fish's body is intact. Flesh may be torn, but no missing tissue.
2b. Body is missing pieces of flesh code DEAD
Pieces of tissue are missing from predation by marine mammals. Missing pieces are typical of bites from sea lions or other large marine mammals.
- 3a. No penetration of the body or head by sand fleas..... Go to 4a
Membranes surrounding eyes and anus are intact, without any holes from sand fleas. A few sand fleas may be seen on body and can be wiped off with your hand. Typically, no penetration occurs when only a few (e.g. <10) sand fleas are found on the body.
3b. Sand fleas have penetrated the body via the eyes, fins, or anus code DEAD
Membranes surrounding eye may be partially or completely missing. Dorsal and/or anal fin membranes may be eaten away, leaving fin rays exposed. Skin on the body is separated from tissue where sand fleas have eaten.
- 4a. No wounds of any kind to abdominal organs. Abdominal wall not punctured go to 5a
4b. Abdominal organs are damaged, possibly by a gaff..... code DEAD
Abdominal cavity wall is punctured or torn. Viscera are visible and exposed, and may be protruding.
- 5a. Fish is not bleeding from gills (but may be bleeding from elsewhere) go to 6a
5b. Fish is bleeding from gills code DEAD
Bleeding is occurring from a torn or severed gill arch.
- 6a. Fish is not bleeding at all, or bleeding is minor to moderate (not from gills) go to 7a
Blood may be seen around mouth and/or jaw. Blood may be oozing continuously, or bleeding may be continuing very slowly a few drops at a time, or bleeding may have stopped.
6b. Bleeding is severe code DEAD
Blood from any source is flowing freely and continuously in large quantity.
- 7a. Injuries to head and/or jaw are minor to moderate, but no structures are missing go to 8a
7b. Major injuries to head and jaw, resulting in missing pieces code SEVERE
Side of the head, possibly including the jaw, has been torn loose and missing from the fish, and/or lower jaw has been torn away and is missing.

(Key continues on next page)

8a. Wounds to the head (forward of preopercle and above cheek and jaw) are only surface scratches on the skingo to 9a

8b. Skin on head (forward of preopercle) is ripped and torn deeply code SEVERE
Internal organs are likely exposed.

9a. Eye or eye socket is not punctured.....go to 10a

9b. Eye or eye socket is punctured code MODERATE

10a. No wounds to the body are evident..... go to 11a

10b. Wounds in body consist of puncture holes in skin, with possibly a flesh tear..... code MODERATE

11a. Lower jaw is significantly damaged code MODERATE

Lower jaw may be broken into 2 pieces at the snout, but each is still attached at the base of the jaw. Jaw may be torn on one side or the other, possibly extending through the cheek.

11b. Damage to lower jaw, if any, is slight.....code MINOR

Injuries include the hook entrance/exit hole around the jaw or in the cheek, or a tear in the cheek. A piece of the lip may be torn and hanging from the jaw. If the ganglion was cut, the hook and some length of residual ganglion may be hanging from the mouth.

Appendix U. Contact Addresses and Numbers

North Pacific Groundfish Observer Program

During work hours, staff members will accept collect calls. After-hours, voice mail accepting collect calls is available at (206) 526-4240. Leave a message, even if only to tell us you are trying to reach us.

Address

NMFS Observer Program,
7600 Sand Point Way NE
Seattle, WA 98115-0070

Data Receiving Lines:

Fax: (206) 526-4066 or 526-4207
Standard A, B mini-M, or Iridium for ATLAS (206) 526-4121

Staff Lines:

Training & Debriefing: (206) 526-4192
ATLAS software or communication questions:
(206) 526-4240
Gear Room Bldg. 33: (206) 526-6827

Anchorage Field Station

Physical Address

Federal Building Annex
222 W. 8th Ave., Suite A41
Anchorage, AK 99513

Phone: (907) 271-1313
Fax: (907) 271-1315

Enforcement

If you are the victim of an observer crime and you would like to report directly to law enforcement, you may contact one of the Observer Liaison Program Special Agents in Anchorage, Alaska. Nathan, John, and Mike are the primary Enforcement contacts for observer crimes:

Nathan Lagerwey
Office: (907) 271-3031
Cell: (907) 360-2616
Nathan.Lagerwey@noaa.gov

John Kingeter
Office: (907) 271-1791
John.Kingeter@noaa.gov

Mike Adams
Office: (907) 271-1693

Mike.Adams@noaa.gov

If you are in one of these Alaska ports, you may also contact the local NOAA Fisheries Enforcement office:

Kodiak	(907) 486-3298
Dutch Harbor	(907) 581-2061
Seward	(907) 224-5348
Homer	(907) 235-2337
Sitka	(907) 747-6940
Ketchikan	(907) 247-5804
Petersburg	(907) 772-2285
Juneau	(907) 586-7225

To report a fishery or marine mammal violation, you may also contact the NOAA Fisheries Enforcement Hot Line 1-800-853-1964.

Standing Together Against Rape (STAR) is a victim advocacy organization that provides confidential support for victims of assault, sexual assault, workplace harassment, and rape. They provide immediate crisis support, law enforcement accompaniment, legal support and accompaniment, advocacy, crisis counseling, support groups, information, referrals, and more. You may contact STAR 24 hours a day at 1-800-479-8999, 1-907-276-9988, or at star@ak.net.

North Pacific Groundfish Observer Program

Dutch Harbor Field Station**Physical Address**

FTS Office Complex, Suite 104
Dutch Harbor, AK 99692

Phone: (907) 581-2060 or (907) 581-2063
Fax: (907) 581-2066
VHF Channel 16: Monday - Friday 0900-1700

Mailing Address

P.O. Box 920225
Dutch Harbor, AK 99692

Kodiak Field Station**Address**

NMFS Observer Program
301 Research Court
Kodiak, AK 99615

Phone: (907) 481-1770
Fax: (907) 481-1771

North Pacific Fisheries Observer Training Center (OTC) (Anchorage, AK)

Address

707 A St.
Suite 207
Anchorage, AK 99501

Phone (907) 257-2770
Fax (907) 257-2774

Alaska Regional Office

Address

National Marine Fisheries Service
P.O. Box 21668
Juneau, AK 99802-1668

Phone: (907) 586-7228 or Fax: (907) 586-7465

This office will accept collect calls from observers on matters directly related to observer work. They will not answer "quota remaining" or "fishery closure" questions.

International Pacific Halibut Commission (IPHC)

Gregg Williams

Phone: (206) 634-1838 ext. 209

E-mail: gregg@iphc.washington.edu

Please contact Gregg or Cal with questions regarding halibut viability or injury assessments.

Cal Blood

Phone: (206) 634-1838 ext. 228

E-mail: cal@iphc.washington.edu

U.S. Coast Guard

Anchorage..... LCDR Mike Delury @ (907) 271-6727
or Chief Steve Garcia @ (907) 271-1954

Kodiak..... Marine Safety Detachment @ (907) 487-5750

Unalaska (Dutch Harbor)..... Charlie Medlicott@ (907) 581-3466

Appendix V. Radio Instructions

The radios that you will encounter most often are **VHF-FM** (Very High Frequency Modulation), used for short-range vessel-to-vessel and vessel-to-shore communication, and **HF-SSB** (High Frequency-Single Side Band), used for communication when the stations are out of VHF range with each other. Both types offer certain special advantages, and each requires a specific operating procedure.

VHF Radios

In the United States, the VHF band is broken up into 71 channels, with a frequency range of from 156.000 to 163.000 MHz, including six WX (Weather) channels. By law, all operating VHF stations are required to have at least three of these channels: channel 6, channel 16, and at least one other working channel.

Channel 6

(156.300 MHz) is the Intership Safety Channel, used for intership safety purposes, search-and-rescue (SAR) communications with ships and aircraft of the U.S. Coast Guard, and vessel movement reporting within ports and inland waterways. This channel must not be used for non-safety communications.

Channel 16

(156.800 MHz) is the International Distress, Safety, and Calling Channel (Intership and Ship-to-Coast). This channel must be monitored at all times the station is in operation (except when actually communicating on another channel). This channel is also monitored by the U.S. Coast Guard, Public Coastal Stations, and many Limited Coastal Stations. Calls to vessels are normally initiated on this channel. Then, except in an emergency, you must switch to a working channel. ***It is against FCC regulations to conduct business on this channel.*** In addition, vessels calling must use their assigned call sign at the beginning and end of each transmission.

Channel 22A

(157.100 MHz) is the US Coast Guard Liaison Channel. This channel is used for communications with Coast Guard ships, aircraft, and coastal stations after first establishing contact on channel 16. Navigational

warnings and, where not available on WX channels, Marine Weather forecasts are also broadcast on this frequency.

SSB Radios

To communicate over distances beyond twenty miles, you need to use satellite communication or a medium-to-high frequency radiotelephone referred to as Single Side Band (SSB) radio. All ship SSB radiotelephones must be capable of operating **frequency 2182 kHz, the international distress and calling frequency**, and at least 2 other frequencies. Frequency 2670 kHz is only used for communicating with the Coast Guard and should not be used for other purposes.

When using SSB radiotelephone, you must observe radio silence at Frequency 2182 kHz, the emergency channel, for 3 minutes immediately after the hour and the half-hour. The purpose of radio silence on the emergency hailing channel is to clear the airwave for weak or distant distress signals. No radio silence is used on the VHF emergency channel.

Every ship and all Coast Guard stations continually listen to the emergency frequencies. These channels cannot be used for other communication and extraneous conversation is illegal and dangerous. The emergency channels are:

- VHF Channel 16 (international distress channel)
- VHF Channel 13 (for ships to use to avoid collisions, cannot be used to contact the USCG shore stations)
- SSB Frequency 2182 (international distress frequency)

If you are required to send an emergency message or relay information to the Coast Guard, use the following procedures:

- When trying to establish communications, repeat the USCG Station's name and your name at least twice.
- Use radio punctuation words ("over," "clear," "out," "roger," "say again," "standing by," and "break"). Radios transmit in only one direction at a time and these words signal your intentions to the receiving station. Speak directly into the microphone, speaking loudly, slowly and distinctly.

- To be clear when using letters (for call signs or other codes), use the phonetic alphabet:

A = Alpha	N = November
B = Bravo	O = Oscar
C = Charlie	P = Papa
D = Delta	Q = Quebec
E = Echo	R = Romeo
F = Foxtrot	S = Sierra
G = Gulf	T = Tango
H = Hotel	U = Uniform
I = India	V = Victor
J = Juliet	W = Whiskey
K = Kilo (keelo)	X = X-ray
L = Lima (leema)	Y = Yankee
M = Mike	Z = Zulu

- Upon completing a transmission, sign off by identifying your vessel and using the words “clear” or “out.” If you expect to resume contact soon with the same station, use the phrase “standing by.”

A correctly sent message would be as follows:

You (on VHF Channel 16): Coast Guard Station Kodiak, Coast Guard Station Kodiak. This is the fishing vessel Starry Flounder, Whiskey Tango Zulu

four, one, nine, zero. This is the fishing vessel Starry Flounder, Whiskey Tango Zulu four, one, nine, zero on channel sixteen, over.

C.G.: *Fishing vessel Starry Flounder this is Coast Guard Station Kodiak shift and answer on channel eleven, out.*

You (now on VHF Channel 11): Coast Guard Station Kodiak. Coast Guard Station Kodiak. This is the Starry Flounder on channel eleven, over.

C.G.: *Fishing vessel Starry Flounder, this is Coast Guard Station Kodiak. Send your traffic, over.*

You: Kodiak this is the Starry Flounder, I am the observer relaying a message for the captain. A crewman has a badly crushed arm and needs hospitalization. Can you evacuate the crewman? Over.

C.G.: *Vessel Starry Flounder, this is Kodiak. Affirmative. What is your current position? Over.*

You: Kodiak this is the Starry Flounder. Position is five-five degrees five-zero minutes north, one-five-seven degrees, two-four minutes west, over.

You would continue to provide information as requested by the Coast Guard until they end the communications by ending their final message with “out.”

Appendix W. Beam Balance Flatbed Scale Care and Maintenance

Flatbed scales are available from the Kodiak and Dutch Harbor field offices. They are particularly helpful on small vessels that have no convenient location to hang a 50 kg Salter scale. Although useful, these scales are delicate and expensive. They require proper care and maintenance to survive your deployment.

Before You Use the Scale

As with all scales issued to you the flatbed scale must be checked for accuracy before going into the field. Be sure to check the scale at 10Kg., 20Kg. and 35Kg. Record the results of this test in your logbook. This should serve to familiarize you with the operation of the scale.

Field Care and Use of Flatbed Scales

The Beam Balance Flatbed Scale is likely the most valuable piece of equipment issued to observers. It is important that it be treated as such to ensure its longevity. A few simple precautions and light maintenance can easily prevent irreparable damage to your scale. By following these steps the life span of these flatbed scales can be improved, and provide observers with high quality equipment. ***Thanks for doing your part!***

1. Lock both the platform and the beam balance at all times when the scale is not in use. The motion of the boat keeps the scale “working” whenever it is not locked, which can wear out the scale. Lock the platform using the black knob on the right side of the scale. Turn the lever back to lock the platform and forward to unlock. To lock the beam in place use the lever that pivots up under the right side (near the balance indicator).
2. Always protect the scale from impact damage. Even seemingly moderate impacts to the balance or the unlocked platform can damage the floating hangers under the scale. Once these hangers are damaged the

precision of the scale is forever and irreparably compromised. Do not drop baskets of fish onto the platform. ***Do not throw fish into baskets on the platform.*** Fill your baskets and then place them on the platform.

3. Keep the scale as clean and dry as possible. These scales are not designed for the marine environment. Corrosion of the internal hangers, zero adjustment and poise weights are the leading cause of scale damage. Rinse the scale off when finished with it, ***preferably with fresh water***, and store it in a dry location until its next use.
4. Lubricate the scale often. Lubricate the poise weight bars, the zero adjustment and the floating hangers under the scale with a light oil as often as possible. This will reduce corrosion and improve the performance of the scale.
5. Move the zero adjustment daily. The zero adjustment assembly (located on the top left side of the balance beam) is the first part of the scale to fail due to corrosion. The weight and screw are prone to seize together. Be sure to move it at least five full turns every day to prevent this. Lubricate it often with a product such as WD-40 or LPS, commonly found on boats.



If you have any questions about the use or care of your flatbed scale please consult a staff member.

Returning the Scale

Before checking-in the scale, ***rinse it well with fresh water***. The scale will need to be retested upon your return. Test the scale at 10, 20 and 35 kg and record the results in your logbook. Check the results against the NMFS acceptable accuracy range. If your scale does not fall within acceptable limits be sure to note this in your logbook and bring it up during your debriefing.

This page intentionally left blank.

Appendix X. Flatfish Species Description Form

Flatfish Species Description Form

Complete the diagram below using the specimen in your hand. Include:

- | | |
|------------------------------|--|
| 1. mouth, showing the size | 4. lateral line shape |
| 2. preopercle and tail shape | 5. ADB size |
| 3. eyes, size and position | 6. distinctive markings or structures
(spots, distinctive scales, etc.) |

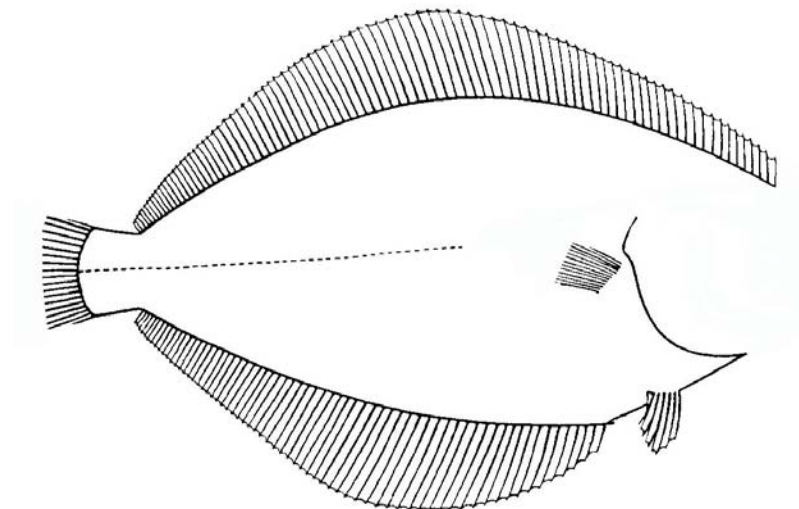

Field characteristics used in recognizing this species:

(OVER)

Appendix Y. Rockfish Species Description Form

Rockfish Species Description Form

Which color category is this specimen? _____

Head spine strength (circle one):
WEAK STRONG

Circle the numbers of all head spines present:

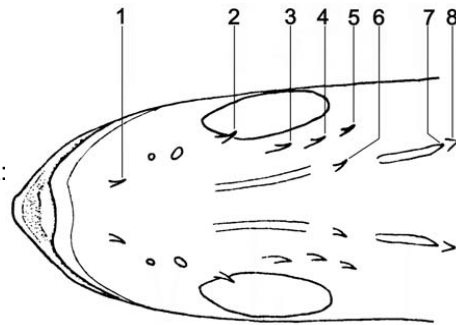

Draw the characteristics you used to identify this species, including the following:

- | | |
|--------------------|--------------------------------|
| 1. Symphyseal knob | 3. Anal fin spine and membrane |
| 2. Maxilla | 4. Pigment pattern |

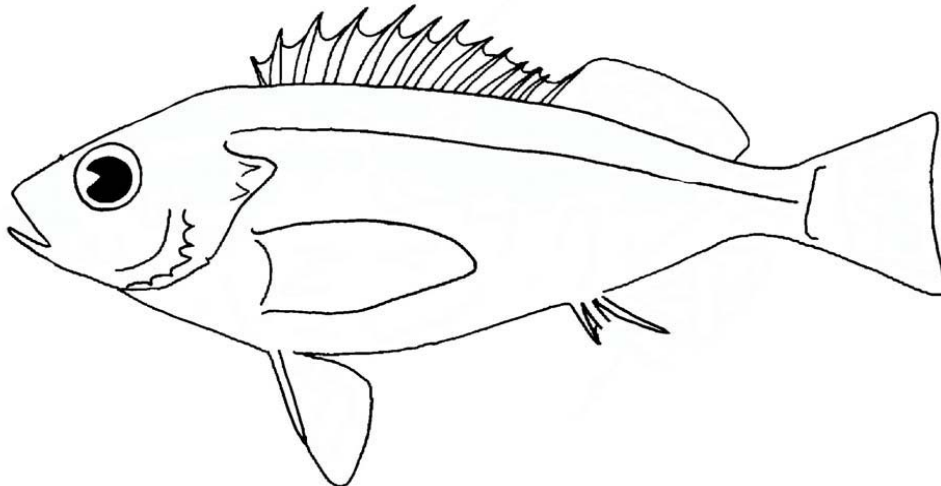

(OVER)

Rockfish Species Description Form

Is a symphyseal knob present? If so, describe it: _____

Dark blotches on body? – (Draw these on front of form)

None Bars extending below lateral line
 Above lateral line only Dispersed all over body

Markings on opercle? – (Draw these on front of form)

None Diffuse opercular blotch
 Bars radiating from eye Distinct opercular blotch

Peritoneum color: _____

Describe the anal fin slant relative to body axis and relative length of anal spines:

Are suborbital spines present? (and if so, how many?): _____

Coloration and other field characteristics important in recognizing this species:

Appendix Z. Miscellaneous Species/ Crab Description Form

Miscellaneous Species Description Form

FISHES:

How many dorsal fins does the fish have?	1	2	3
Is an adipose fin present?	YES		NO
Pelvic fins?	Present		Absent
Pelvic fin position:	abdominal	thoracic	jugular

Describe the caudal peduncle (if present) and caudal fin shape:

Describe the lateral line(s) if present:

Draw the fish here:

Field characteristics important in recognizing this species:

Crab Species Description Form

CRABS:

How many pairs of walking legs does the crab have? _____

Describe the carapace shape as well as any spines, bumps, hairs, or decorations present on the carapace and legs: _____

Draw the crab here, including a full view of the carapace as well as a detailed view of the rostrum:

Field characteristics important in recognizing this species:

Appendix AA. Skate Species Description Form

Skate Species Description Form

Which series of thorns are present?

- Rostral
- Orbital
- Nuchal

- Scapular
- Mid-dorsal

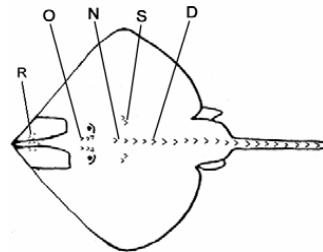

Draw the thorns and any distinctive pigment patterns on this diagram:

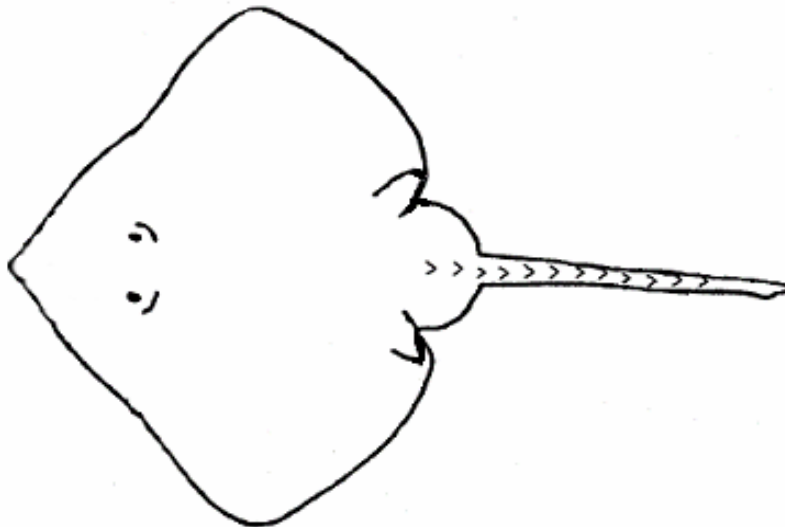

Additional field characteristics used to identify this species:

(OVER)

Skate Species Description Form

What is the dorsal coloration of the skate?

uniform brown or gray

dark with light blotches

uniform black

dark with white "eyebrows"

other: _____

What is the ventral coloration of the skate?

uniform light

light, with dark tail

uniform dark

dark, with white areas

other: _____

Describe the pattern of denticles on the dorsal (upper) and ventral (lower) surface:

Appendix AB. Seabird Species Description Form (for Dead Birds)

Seabird Species Description Form

Species common name: _____ Cruise #: _____
 Permit #: _____

Date: _____ Haul # OR Lat / Long: _____

Specimen collected: Y N Drop off location: _____ Photos taken? Y N

Length of bird - measure straight line from the tip of bill to longest tail feather: _____ cm

Foot type: (Circle one or describe)

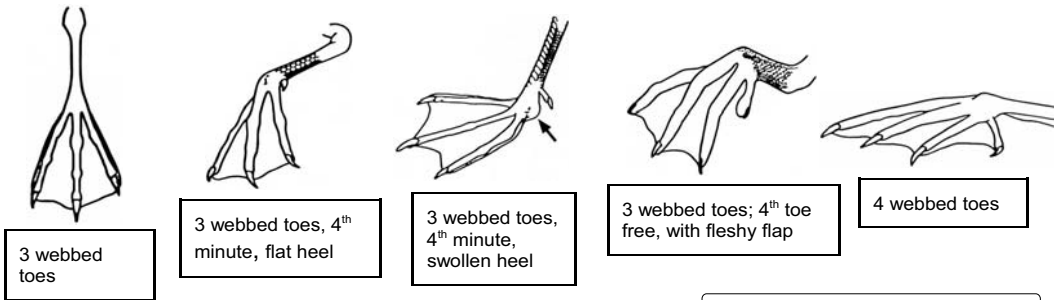

Other foot type, describe and draw: _____



Tarsus measurement: (For all tubenoses and unidentified birds)

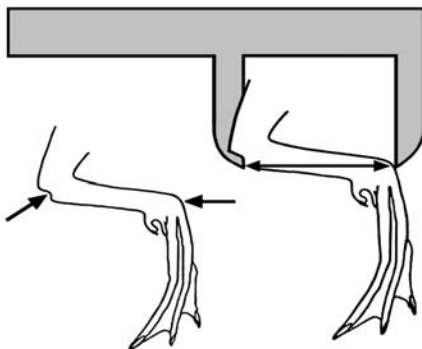

The tarsus or leg measurement is the long bone connecting the ankle to the foot. It is measured diagonally across the bone from the middle groove of the ankle joint to the top edge of the foot.

Tarsus length: _____ mm

All images © COASST 2002. This data sheet may only be reproduced in whole and not in part.

Bill shape: (Circle one or describe)

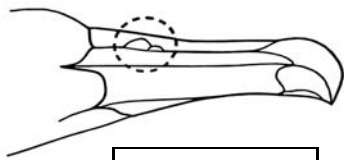

Hooked bill
Nasal tubes on side

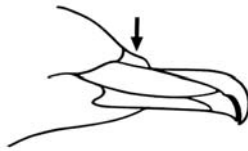

Hooked bill
Nasal tubes on top



Hooked bill
Arch on lower mandible



Dark, smooth, pointed bill; arch on lower mandible

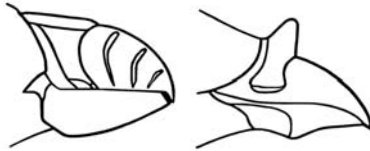

Orange, with grooves, horn or bump



Duck-like bill with feathers



Duck-like bill with knob



Other bill shape, describe and draw.

Bill measurement: (All birds)

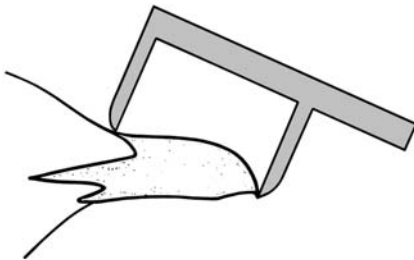

Bill length or exposed culmen, is the straight-line distance between the tip of the bill and the point where the bill meets the skin or feathers of the forehead. Place one end of the dividers at the tip of the bill and measure the diagonal distance to the forehead feathers.

Bill length: _____ mm

Wing chord measurement: (All birds)



In a relaxed folded wing, the wing chord is the distance between the wrist bend and the tip of the longest primary feather. Do not stretch out the wing. For accuracy, gently lay the wing against the ruler (do not flatten) and line the end of the ruler up with the wrist.

Wing chord length: _____ cm

Additional identifying characteristics or notes:

All images © COASST 2002. This data sheet may only be reproduced in whole and not in part.

Appendix AC. Protocols for Handling Injured or Sick Seabirds

Safety First! Be very careful when handling live birds. Heavy rubber protective gloves are advised. All birds have sharp beaks and strong jaws that can cause serious injury.

If you encounter an injured or sick *endangered or threatened* seabird species follow the protocols outlined below and contact your inseason advisor or NMFS staff as soon as possible.

All other seabirds can be treated using these same protocols. However, this is lowest in priority of your observer duties and does not require notifying NMFS personnel.

SEABIRD HANDLING SAFETY

Do not attempt to recover a sick or injured seabird when it is not safe. Seabirds may become aggressive if they feel threatened. Seabirds carry diseases that are transmissible to humans. Avoid contact with bodily fluids. When handling seabirds, keep them at or below your waist protecting your face. Clean and treat all cuts and scratches. Wash hands thoroughly after handling seabirds.

OILED SEABIRDS

Properly cleaning oiled seabirds is a highly specialized and labor intensive process. These birds cannot be properly cared for at sea. Even slightly oiled birds stand little chance of recovery. Your best course of action is to euthanize and collect the seabird, unless it is an ESA species. If you have an ESA species, assess it's condition and contact your inseason advisor. If you are not comfortable euthanizing the bird you may return it to the sea. Please record these instances in your logbook and relay them to your debriefer. Euthanizing the bird and saving the carcass supports U.S. Fish and Wildlife bilge oil monitoring and compliance programs. The specimen will be further valued by supporting other scientific uses as well. Most importantly, you end the birds suffering. Please euthanize the seabird, wrap it in aluminum foil, and save it following the bag and tag instructions (see "Tag and Bag Procedures for Retained Seabird Specimens" on page 14-4)

INJURED OR SICK BIRDS

For apparently minor injuries (e.g.: small lacerations, web tears, minor stunning, etc.), release the bird if:

- you are so advised, or
- the bird meets *all* the following release criteria.

Release Criteria

1. Bird can stand and walk using both feet.
2. Bird can flap both wings and there is no apparent wing droop.
3. Bird is alert, active, holds its head up and reacts to stimuli (motion, light, etc....).
4. Bird is not bleeding freely.
5. Wing and tail feathers have not been lost and are in good condition.
6. Bird is waterproof (water beads up on feathers).

Retain birds that do not meet all of these criteria!

Rehabilitating Seabirds

Take the following steps to rehabilitate the seabird:

1. Wear gloves, eye protection, and rain gear.
2. Capture the bird without jeopardizing the safety of yourself or the crew and place it in box or container. The bird should not have enough room to further injure itself.
3. Do not restrict a live bird from opening its bill with tape or a rubber band, etc.
4. Ensure adequate ventilation of the container.
5. Never put a bird in an overly warm place (e.g.: engine room) or use external heat sources to dry a wet bird (e.g.: hair dryer, space heater, etc.).
6. Treat a wet bird by gently blotting excess water from the bird with paper towels.
7. Keep bird inside the container in a quiet, dry place and minimize handling.
8. For species of interest, contact your inseason advisor or NMFS staff immediately. Record recovery location (latitude and longitude), time, persons

involved and why and how the bird was recovered. Also record when the bird eats or drinks.

9. Place a container of cool, fresh water with the bird, if the possibility of spilling is minimal.

10. Place absorbent material in the bottom of the container to minimize contact with feces. Replace the material when soiled.

11. Food may be offered if the bird is alert. Try offering a hard-boiled egg or small pieces of fish liver.

12. Release species of interest birds only when advised to do so.

13. Release all other seabird species when all "Release criteria" are met.

Transporting Sick or Injured Birds

Sick or injured species of interest may need to be transported. You will get specific care and transport instructions when you contact NMFS staff.

SACRIFICING BIRDS

If the bird is seriously injured, sick, suffering, oiled or appears to be dying and it *is not* a threatened or endangered species, you may euthanize the bird. For threatened or endangered species, attempt to contact NMFS staff before proceeding with euthanization. Note any band or tag information in your logbook.

Field Procedures for Sacrificing Birds

Administer euthanasia away from the crew. The preferred field methods for euthanizing birds are cervical dislocation (breaking the neck) and decapitation.

Cervical Dislocation

Place the bird's head, bottom of the bill down, on a flat, solid surface. Place a solid rod (stick, dowel, etc.) on the neck directly behind the head. Holding the rod firmly on the neck, seize the body in the other hand, and give a quick, definite and strong yank backwards without letting the head move. You should feel the neck stretch and break. A slow or tentative motion will not work. It may help to pull the bird's body up as well as backward. The bird may shudder or tremble for a minute. Repeat the procedure if necessary.

Decapitation

Wear gloves to reduce contact with bodily fluids. Use a large, heavy knife or axe. Cut through the neck in one stroke. This procedure is quick and minimizes suffering.

Retaining Euthanized Specimens

For all species of interest, follow the "Tag and Bag Procedures for Retained Seabird Specimens" on page 14-4, unless advised otherwise. For all other species, discard at sea, unless advised otherwise.

Appendix AD. Material Safety Data Sheet for DMSO

SECTION 1: CHEMICAL PRODUCT AND COMPANY IDENTIFICATION

MSOS Name: Dimethyl Sulfoxide

Catalog Numbers: S79994REAG, BP231 I, BP231 4, BP231-1, BP231-4, BP2311, BP2314, BP2314 001, BP2314 002, BP2314001, BP2314002, BP2620100, 0128 1, 01284, 0128500, 0128-1, 0128-4, 0128-500, 01281, 01284, 0128500, 01361, 0136-1, 01361, NC9529973, NC9530475, NC953 1964, NC9750632, XXBP23120BLI, XXBP23120LI, XXBP23120LI/SP, XXEP231ET4LI

Synonyms: Methyl Sulfoxide; DMSO; Sulfinylbis (Methane).

Company Identification: Fisher Scientific I Reagent Lane, Fairlawn, NJ 07410. For information, call: 201-796-7100. **Emergency Number:** 201-796-7100

For CHEMTREC assistance, call: 800-424-9300. For International CHEMTREC assistance, call: 703-527-3887

SECTION 2: COMPOSITION, INFORMATION ON INGREDIENTS

CAS#	Chemical Name	%	EINECS#
67-68-5	Methane, Sulfinylbis	100	200-664-3

Hazard Symbols: XI

Risk Phrases: 22 36/38

SECTION 3: HAZARDS IDENTIFICATION

Emergency Overview: Harmful if swallowed. Irritating to eyes and skin. Hygroscopic.

Potential Health Effects

Eye: Produces irritation, characterized by a burning sensation, redness, tearing, inflammation, and possible corneal injury. May cause chemical conjunctivitis.

Skin: May cause irritation with burning pain, itching and redness. Substance is rapidly absorbed through the skin. **Ingestion:** May cause gastrointestinal irritation with nausea, vomiting and diarrhea. May cause liver and kidney damage. May cause garlic smell on the breath and body.

Inhalation: May cause respiratory tract irritation. Can produce delayed pulmonary edema. **Chronic:** Prolonged or repeated skin contact may cause dermatitis. May cause liver and kidney damage. Effects may be delayed.

SECTION 4: FIRST AID MEASURES

Eyes: Immediately flush eyes with plenty of water for at least 15 minutes, occasionally lifting the upper and lower eyelids. Get medical aid.

Skin: Get medical aid. Flush skin with plenty of soap and water for at least 15 minutes while removing contaminated clothing and shoes. Wash clothing before reuse.

Ingestion: Never give anything by mouth to an unconscious person. Get medical aid. DO NOT induce vomiting. If conscious and alert, rinse mouth and drink 2-4 cupfuls of milk or water.

Inhalation: Remove from exposure to fresh air immediately. If not breathing, give artificial respiration. If breathing is difficult, give oxygen. Get medical aid. DO NOT use mouth-to-mouth resuscitation.

Notes to Physician: Treat symptomatically and supportively

SECTION 5: FIRE FIGHTING MEASURES

General Information: As in any fire, wear a self-contained breathing apparatus in pressure-demand, MSHA/NIOSH (approved or equivalent), and full protective gear. Vapors may form an explosive mixture with air. During a fire, irritating and highly toxic gases may be generated by thermal decomposition or combustion. Use water spray to keep fire-exposed containers cool. Vapors may be heavier than air. They can spread along the ground and collect in low or confined areas. Containers may explode when heated.

Extinguishing Media: Cool containers with flooding quantities of water until well after fire is out. Use water spray, dry chemical, carbon dioxide, or appropriate foam.

SECTION 6: ACCIDENTAL RELEASE MEASURES

General Information: Use proper personal protective equipment as indicated in Section 8.

Spills/Leaks: Absorb spill with inert material (e.g. vermiculite, sand or earth), then place in suitable container. Do not flush into a sewer. Clean up spills immediately, observing precautions in the Protective Equipment section. Remove all sources of ignition. Provide ventilation.

SECTION 7: HANDLING AND STORAGE

Keep from contact with oxidizing materials. Store in a cool, dry, well-ventilated area away from incompatible substances.

SECTION 8: EXPOSURE CONTROLS, PERSONAL PROTECTION

Engineering Controls: Facilities storing or utilizing this material should be equipped with an eyewash facility and a safety shower. Use adequate ventilation to keep airborne concentrations low.

Personal Protective Equipment

Eyes: Wear appropriate protective eyeglasses or chemical safety goggles as described by OSHA's eye and face protection regulations in 29 CFR 1910.133 or European Standard EN166.

Skin: Wear appropriate protective gloves to prevent skin exposure.

Clothing: Wear appropriate protective clothing to prevent skin exposure.

Respirators: A respiratory protection program that meets OSHA's 29 CFR:1910.134 and ANSI Z88.2 requirements or European Standard EN 149 must be followed whenever workplace conditions warrant a respirator's use.

SECTION 9: PHYSICAL AND CHEMICAL PROPERTIES

Physical State	liquid	Appearance	clear
Odor	slight, sulfur- or garlic-like	pH	not available
Vapor Pressure	0.4 mm Hg at 20	Vapor Density	2.7 (air = 1)
Evaporation Rate	not available	Viscosity	1.1cp @ 27 deg
Boiling Point	189 deg C	Freezing Point	18.45 deg C
Autoignition Temp.	215 deg C	Flash Point	95 deg C
Explosion Limits (upper)	42.00 vol%	Explosion Limits (lower)	2.60 vol%
Decomp. Temp.	> 200 deg C	Solubility	soluble
Specific Gravity	1.10 10g/cm ³	Molecular Formula	C ₂ H ₆ O ₅
Molecular Weight	78.13		

SECTION 10: STABILITY AND REACTIVITY

Chemical Stability: Stable at room temperature in closed containers under normal storage and handling conditions. Conditions to Avoid: Incompatible materials, excess heat, strong oxidants.

Incompatibilities with Other Materials: Strong oxidizing agents, strong acids, strong bases.

Hazardous Decomposition Products: Carbon monoxide, oxides of sulfur, carbon dioxide.

Hazardous Polymerization: Has not been reported.

SECTION 11: TOXICOLOGICAL INFORMATION

RTECS#: CAS# 67-68-5: PV6210000

LD50/LC50: CAS# 67-68-5: Draize test, rabbit, eye: 500 mg/24H Mild; Draize test, rabbit, skin: 500 mg/24H Mild; Oral, mouse: LD50 = 7920 mg/kg; Oral, rat: LD50 = 14500 mg/kg; Skin, rat: LD50 = 40 gm/kg.

Carcinogenicity: Methane, Sulfinylbis- -Not listed by ACGIH, IARC, NIOSH, NTP, or OSHA.

Epidemiology: No information available.

Teratogenicity: No information available.

Reproductive Effects: No information available.

Neurotoxicity: No information available.

Mutagenicity: No information available.

Other Studies: No information available.

See actual entry in RTECS for complete information.

SECTION 12: ECOLOGICAL INFORMATION

Other: For more information, see "Handbook of Environmental Fate and Exposure Data."

SECTION 13: DISPOSAL CONSIDERATIONS

Dispose of in a manner consistent with federal, state, and local regulations.

SECTION 14: TRANSPORT INFORMATION

US DOT No information available; Canadian TDG No information available.

SECTION 15: REGULATORY INFORMATION

US Federal

TSCA CAS# 67-68-5 is listed on the TSCA inventory. This material does not contain any Class 2 Ozone depleters. Clean Water Act: No information available.

OSHA: None of the chemicals in this product are considered highly hazardous by OSHA.

State

Methane, Sulfinylbis- is not present on state lists from CA, PA, MN, MA, FL, or NJ.

California: No Significant Risk Level: None of the chemicals in this product are listed.

Canada

CAS# 67-68-5 is listed on Canada's DSL List. CAS# 67-68-5 is listed on Canada's Ingredient Disclosure List.

SECTION 16: ADDITIONAL INFORMATION

MSDS Creation Date: 12/12/1997 Revision #4 Date: 8/02/2000

The information above is believed to be accurate and represents the best information currently available to us. However, we make no warranty of merchantability or any other warranty, express or implied, with respect to such information, and we assume no liability resulting from its use. Users should make their own investigations to determine the suitability of the information for their particular purposes. In no way shall the company be liable for any claims, losses, or damages of any third party or for lost profits or any special, indirect, incidental, consequential or exemplary damages, howsoever arising, even if the company has been advised of the possibility of such damages.

Appendix AD. Material Safety Data Sheet for 100% Formalin

SECTION 1: CHEMICAL PRODUCT AND COMPANY INFORMATION

MSDS Name: FORMALDEHYDE SOLUTION 37%

Catalog Numbers: S74337, S74338, S80018-2, BP530-25, BP530-500, BP53025, BP531-25, BP53 1-500, F75P20, F75P4, F77 20, F77 200, F7720, F77200, F77200LC, F7720LC, F77P 20, F77P 4, F77P20, F77P4, F79 I, F79 20, F79 200, F79 4, F79 500, F791, F7920, F79200, F794, F79500, F79J4, F79P 20, F79P 4, F79P20, F79P4, NC9475399, S74337MF, S74338MF

Synonyms: None.

Company Identification: Fisher Scientific I Reagent Lane, Fairlawn, NJ 07410. For information, call: 201-796-7100. **Emergency Number:** 201-796-7100

For CHEMTREC assistance, call: 800-424-9300 For International CHEMTREC assistance, call: 703-527-3887.

SECTION 2: COMPOSITION, INFORMATION ON INGREDIENTS

CAS#	Chemical Name	%	EINECS#
50-00-0	Formaldehyde	37	200-001-8
67-56-1	Methyl alcohol	15	200-659-6
7732-18-5	Water	48	231-791-2
Not avail.	Odor mask	0.0-1.1	unlisted

Hazard Symbols: T

Risk Phrases: 1023/24/25 344043

SECTION 3: HAZARDS IDENTIFICATION

Emergency Overview: Flammable. Toxic by inhalation, in contact with skin and if swallowed. Causes burns. Possible risks of irreversible effects. May cause sensitization by skin contact.

Potential Health Effects

Eye: Causes eye irritation. May cause chemical conjunctivitis and corneal damage.

Skin: Causes skin irritation. May cause skin sensitization, an allergic reaction, which becomes evident upon re-exposure to this material. May cause cyanosis of the extremities.

Ingestion: May be fatal or cause blindness if swallowed. Causes gastrointestinal irritation with nausea, vomiting and diarrhea. May cause liver and kidney damage. May cause central nervous system depression, characterized by excitement, followed by headache, dizziness, drowsiness, and nausea. Advanced stages may cause collapse, unconsciousness, coma and possible death due to respiratory failure. May cause central nervous system depression.

Inhalation: Inhalation of high concentrations may cause central nervous system effects characterized by nausea, head-ache, dizziness, unconsciousness and coma. Causes respiratory tract irritation. May cause asthmatic attacks due to allergic sensitization of the respiratory tract. Aspiration may lead to pulmonary edema. Vapors may cause dizziness or suffocation. May cause burning sensation in the chest.

Chronic: Repeated exposure may cause skin discoloration and thickening and nail decay. Repeated inhalation is associated with nasal and nasopharyngeal cancer.

SECTION 4: FIRST AID MEASURES

Eyes: Flush eyes with plenty of water for at least 15 minutes, occasionally lifting the upper and lower eyelids. Get medical aid immediately. Do NOT allow victim to rub or keep eyes closed.

Skin: Immediately flush skin with plenty of soap and water for at least 15 minutes while removing contaminated clothing and shoes. Get medical aid if irritation develops or persists. Wash clothing before reuse. Destroy contaminated shoes.

Ingestion: Do NOT induce vomiting. If victim is conscious and alert, give 2-4 cupfuls of milk or water. Never give anything by mouth to an unconscious person. Get medical aid immediately.

Inhalation: Get medical aid immediately. Remove from exposure to fresh air immediately. If not breathing, give artificial respiration. If breathing is difficult, give oxygen.

SECTION 5: FIRE FIGHTING MEASURES

General Information: As in any fire, wear a flash back. Will burn if involved in a fire. Use water spray to keep fire-exposed containers cool. Containers may explode in the heat of a fire. Flammable liquid and vapor.

Extinguishing Media: For small fires, use dry chemical, carbon dioxide, water spray or alcohol-resistant foam. For large fires, use water spray, fog, or alcohol-resistant foam. Use water spray to cool fire-exposed containers. Water may be ineffective. Do NOT use straight streams of water.

SECTION 6: ACCIDENTAL RELEASE MEASURES

General Information: Use proper personal protective equipment as indicated in Section 8.

Spills/Leaks: Absorb spill with inert material (*e.g.* vermiculite, sand or earth), then place in suitable container. Avoid runoff into storm sewers and ditches which lead to waterways. Clean up spills immediately, observing precautions in the Protective Equipment section. Remove all sources of ignition. Use a spark-proof tool. Provide ventilation. A vapor suppressing foam may be used to reduce vapors.

SECTION 7: HANDLING AND STORAGE

Handling: Wash thoroughly after handling. Remove contaminated clothing and wash before reuse. Use only in a well-ventilated area. Ground and bond containers when transferring material. Use spark-proof tools and explosion proof equipment. Avoid contact with eyes, skin, and clothing. Empty containers retain product residue, (liquid and/or vapor), and can be dangerous. Keep container tightly closed. Avoid contact with heat, sparks and flame. Avoid ingestion and inhalation. Do not pressurize, cut, weld, braze, solder, drill, grind, or expose empty containers to heat, sparks or open flames.

Storage: Keep away from heat, sparks, and flame. Keep away from sources of ignition. Store in a cool, dry, well-ventilated area away from incompatible substances. Flammables-area. Keep containers tightly closed.

SECTION 8: EXPOSURE CONTROLS, PERSONAL PROTECTION

Engineering Controls: Facilities storing or utilizing this material should be equipped with an eyewash facility and a safety shower. Use adequate general or local exhaust ventilation to keep airborne concentrations below the permissible exposure limits.

PERSONAL PROTECTIVE EQUIPMENT

Eyes: Wear appropriate protective eyeglasses or chemical safety goggles as described by OSHA's eye and face protection regulations in 29 CFR 1910.133 or European Standard EN166.

Skin: Wear appropriate protective gloves to prevent skin exposure.

Clothing: Wear appropriate protective clothing to prevent skin exposure.

Respirators: Follow the OSHA respirator regulations found in 29CFR 1910.134 or European Standard EN 149. Always use a NIOSH or European Standard EN 149 approved respirator when necessary.

SECTION 9: PHYSICAL AND CHEMICAL PROPERTIES

Physical State	liquid	Appearance	not available
Odor	none reported	pH	not available
Vapor Pressure	not available	Vapor Density	> 1.0
Evaporation Rate	not available	Viscosity	not available
Boiling Point	212 deg F	Freezing Point	32 deg F
Autoignition Temp.	not available	Flash Point	122 deg F
Explosion Limits (upper)	not available	Explosion Limits (lower)	not available
Decomp. Temp.	not available	Solubility	soluble in water
Specific Gravity	not available	Molecular Formula	Mixture
Molecular Weight	not available		

SECTION 10: STABILITY AND REACTIVITY

Chemical Stability: Stable under normal temperatures and pressures.

Conditions to Avoid: Incompatible materials, ignition sources, excess heat, oxidizers.

SECTION 11: TOXICOLOGICAL INFORMATION

RTECS#: CAS# 50-00-0: LP8925000; CAS# 67-56-1: PC1400000; CAS# 7732-18-5: ZC0110000

LD50/LC50: CAS# 50-00-0: Draize test, rabbit, eye: 750 ug/24H Severe; Draize test, rabbit, eye: 750 ug Severe; Draize test, rabbit, eye: 10 mg Severe; Draize test, rabbit, skin: 2 mg/24H Severe; Draize test, rabbit, skin: 50 mg/24H Moderate; Inhalation, mouse: LC50 = 454 gm/rn3/4H; Inhalation, rat: LC50 = 203 mg/rn3; Oral, mouse: LD50 = 42 mg/kg; Oral, rat: LD50 = 100 mg/kg; Skin, rabbit: LD50 = 270 uL/kg. CAS# 67-56-1: Draize test, rabbit, eye: 40 mg Moderate; Draize test, rabbit, eye: 100 mg/24H Moderate; Draize test, rabbit, skin: 20 mg/24H Moderate; Inhalation, rat: LC50 = 64000 ppm/4H; Oral, mouse: LD50 = 7300 mg/kg; Oral, rabbit: LD50 = 14200 mg/kg; Oral, rat: LD50 = 5628 mg/kg; Skin, rabbit: LD50 = 15800 mg/kg. CAS# 7732-18-5: Oral, rat: LD50 = >90 mL/kg.

Carcinogenicity: Formaldehyde - ACGIH: A2 suspected human carcinogen; California: carcinogen; initial date 1/1/88; NIOSH: occupational carcinogen; NTP: Suspect carcinogen; OSHA: Possible Select carcinogen; IARC: Group 2A carcinogen. Methyl alcohol- Not listed by ACGIH, IARC, NIOSH, NTP, or OSHA. Water- Not listed by ACGIH, IARC, NIOSH, NTP, or OSHA.

Epidemiology: No data available.

Teratogenicity: No data available.

Reproductive Effects: No data available.

Neurotoxicity: No data available.

Mutagenicity: No data available.

Other Studies: No data available.

SECTION 12: ECOLOGICAL INFORMATION

SECTION 13: DISPOSAL CONSIDERATIONS

Dispose of in a manner consistent with federal, state, and local regulations.

SECTION 14: TRANSPORT INFORMATION

US DOT Shipping Name: FORMALDEHYDE, SOLUTIONS, FLAMMABLE; Hazard Class: 3; UN Number: UN1198; Packing Group: III; Canadian TDG No information available.

SECTION 15: REGULATORY INFORMATION

US Federal

TSCA CAS# 50-00-0, CAS# 67-56-1 and CAS# 7732-18-5 are listed on the TSCA inventory. This material does not contain any Class 2 Ozone depletors.

Clean Water Act: CAS# 50-00-0 is listed as a Hazardous Substance under the CWA. None of the chemicals in this product are listed as Priority Pollutants under the CW A. None of the chemicals in this product are listed as Toxic Pollutants under the CWA. OSHA: CAS# 50-00-0 is considered highly hazardous by OSHA.

State

Formaldehyde can be found on the following state right to know lists: California, New Jersey, Florida, Pennsylvania, Minnesota, Massachusetts. Methyl alcohol can be found on the following state right to know lists: California, New Jersey, Florida, Pennsylvania, Minnesota, Massachusetts. Water is not present on state lists from CA, PA, MN, MA, FL, or NJ. The following statement(s) is (are) made in order to comply with the California Safe Drinking Water Act: WARNING: This product contains Formaldehyde, a chemical known to the state of California to cause cancer. California No Significant Risk Level: CAS# 50-00-0: no significant risk level = 40 ug/day.

Canada:

CAS# 50-00-0, CAS# 67-56-1 and CAS# 7732-18-5 are listed on Canada's DSL List. CAS# 50-00-0 and CAS# 67- 56-1 are listed on Canada's Ingredient Disclosure List. CAS# 7732-18-5 is not listed on Canada's Ingredient Disclosure List.

SECTION 16: ADDITIONAL INFORMATION

MSDS Creation Date: 7/12/1999 Revision #6 Date: 08/02/2000

The information above is believed to be accurate and represents the best information currently available to us. How- ever, we make no warranty of

merchantability or any other warranty, express or implied, with respect to such information, and we assume no liability resulting from its use. Users should make their own investigations to determine the suitability of the information for their particular purposes. In no way shall the company be liable for any

claims, losses, or damages of any third party or for lost profits or any special, indirect, incidental, consequential or exemplary damages, howsoever arising, even if the company has been advised of the possibility of such damages.

Appendix AD. Material Safety Data Sheet for 10% Formalin

SECTION 1: CHEMICAL PRODUCT AND COMPANY IDENTIFICATION

MSDS Name: 10% BUFFERED FORMALIN

Catalog Numbers: SF99 20, SF99 4, SF9920, SF994

Synonyms: None.

Company Identification: Fisher Scientific 1 Reagent Lane, Fairlawn, NJ 07410 For information, call: 201-796-7100. **Emergency Number:** 201-796-7100

For CHEMTREC assistance, call: 800-424-9300. For International CHEMTREC assistance, call: 703-527-3887

SECTION 2: COMPOSITION, INFORMATION ON INGREDIENTS

CAS#	Chemical Name	%	EINECS#
50-00-0	Formaldehyde	37	200-001-8
67-56-1	Methyl alcohol	15	200-659-6
7732-18-5	Water	48	231-791-2
127-09-3	Sodium Acetate	1.2-2.0	204-823-8

Hazard Symbols: None Listed.

Risk Phrases: None Listed.

SECTION 3: HAZARDS IDENTIFICATION EMERGENCY

Emergency Overview: Not available.

POTENTIAL HEALTH EFFECTS

Eye: Causes eye irritation.

Skin: Causes skin irritation. May cause skin sensitization, an allergic reaction, which becomes evident upon re- exposure to this material.

Ingestion: Cannot be made non-poisonous. May cause central nervous system depression, kidney damage, and liver damage. Causes gastrointestinal irritation with nausea, vomiting and diarrhea.

Inhalation: Causes respiratory tract irritation. May cause allergic respiratory reaction.

Chronic: May cause cancer according to animal studies. May cause reproductive and fetal effects.

SECTION 4: FIRST AID MEASURES

Eyes: Immediately flush eyes with plenty of water for at least 15 minutes, occasionally lifting the upper and lower eyelids. Get medical aid immediately.

Skin: Get medical aid. Flush skin with plenty of soap and water for at least 15 minutes while removing contaminated clothing and shoes.

Ingestion: Do NOT induce vomiting. If victim is conscious and alert, give 2-4 cupfuls of milk or water. Never give anything by mouth to an unconscious person. Get medical aid.

Inhalation: Remove from exposure to fresh air immediately. If not breathing, give artificial respiration. If breathing is difficult, give oxygen. Get medical aid.

SECTION 5: FIRE FIGHTING MEASURES

General Information: As in any fire, wear a self-contained breathing apparatus in pressure-demand, MSHA/NIOSH (approved or equivalent), and full protective gear. During a fire, irritating and highly toxic gases may be generated by thermal decomposition or combustion.

Extinguishing Media: For small fires, use dry chemical, carbon dioxide, water spray or alcohol-resistant foam. Cool containers with flooding quantities of water until well after fire is out.

SECTION 6: ACCIDENTAL RELEASE MEASURES

General Information: Use proper personal protective equipment as indicated in Section 8.

Spills/Leaks: Absorb spill with inert material (e.g. vermiculite, sand or earth), then place in suitable container. Avoid runoff into storm sewers and ditches which lead to waterways. Clean up spills immediately, observing precautions in the Protective Equipment section.

SECTION 7: HANDLING AND STORAGE

Handling: Wash thoroughly after handling. Wash hands before eating. Use only in a well-ventilated area. Do not get in eyes.

Engineering Controls: Use adequate general or local exhaust ventilation to keep airborne concentrations below the permissible exposure limits.

SECTION 8: EXPOSURE CONTROLS, PERSONAL PROTECTION

Engineering Controls: Facilities storing or utilizing this material should be equipped with an eyewash facility and a safety shower. Use adequate general or local exhaust ventilation to keep airborne concentrations below the permissible exposure limits.

PERSONAL PROTECTIVE EQUIPMENT

Eyes: Wear appropriate protective eyeglasses or chemical safety goggles as described by OSHA's eye and face protection regulations in 29 CFR 1910.133 or European Standard EN166.

Skin: Wear appropriate protective gloves to prevent skin exposure.

Clothing: Wear appropriate protective clothing to prevent skin exposure.

Respirators: Follow the OSHA respirator regulations found in 29CFR 1910.134 or European Standard EN 149. Always use a NIOSH or European Standard EN 149 approved respirator when necessary.

SECTION 9: PHYSICAL AND CHEMICAL PROPERTIES

Physical State	liquid	Appearance	not available
Odor	none reported	pH	not available
Vapor Pressure	not available	Vapor Density	not available
Evaporation Rate	not available	Viscosity	not available
Boiling Point	not available	Freezing Point	not available
Autoignition Temp.	not available	Flash Point	194 deg F
Explosion Limits (upper)	not available	Explosion Limits (lower)	not available
Decomp. Temp.	not available	Solubility	soluble in water
Specific Gravity	not available	Molecular Formula	Mixture

SECTION 10: STABILITY AND REACTIVITY

Chemical Stability: Stable under normal temperatures and pressures. Conditions to Avoid: Incompatible materials, excess heat.

Incompatible with Other Materials: Strong oxidants.

Hazardous Decomposition Products: Irritating and toxic gases. Hazardous Polymerization: Has not been reported.

SECTION 11: TOXICOLOGICAL INFORMATION

RTECS#: CAS# 50-00-0: LP8925000; CAS# 67-56-1: PC1400000; CAS# 127-09-3: AJ4300010; CAS# 7732-18-5: ZCOIIIOOOO

CAS# 50-00-0: Draize test, rabbit, eye: 750 ug/24H Severe; Draize test, rabbit, eye: 750 ug Severe; Draize test, rabbit, eye: 10 mg Severe; Draize test, rabbit, skin: 2 mg/24H Severe; Draize test, rabbit, skin: 50 mg/24H Moderate; Inhalation, mouse: LC50 = 454 gm/m³/4H; Inhalation, rat: LC50 = 203 mg/m³; Oral, mouse: LD50 = 42 mg/kg; Oral, rat: LD50 = 100 mg/kg; Skin, rabbit: LD50 = 270 uL/kg. CAS# 67-56-1: Draize test, rabbit, eye: 40 mg Moderate; Draize test, rabbit, eye: 100 mg/24H Moderate; Draize test, rabbit, skin: 20 mg/24H Moderate; Inhalation, rat: LC50 = 64000 ppm/4H; Oral, mouse: LD50 = 7300 mg/kg; Oral, rabbit: LD50 = 14200 mg/kg; Oral, rat: LD50 = 5628 mg/kg; Skin, rabbit: LD50 = 15800 mg/kg. CAS# 127-09-3: Draize test, rabbit, eye: 10 mg Mild; Draize test, rabbit, skin: 500 mg/24H Mild; Inhalation, rat: LC50 = >30 gm/m³/4H; Oral, mouse: LD50 = 6891 mg/kg; Oral, rat: LD50 = 3530 mg/kg; Skin, rabbit: LD50 = >10 gm/kg. CAS# 7732-18-5: Oral, rat: LD50 = >90 mL/kg.

Carcinogenicity: Formaldehyde - ACGIH: A2 - suspected human carcinogen; California: carcinogen; initial date 1/1/88; NIOSH: occupational carcinogen; NTP: Suspect carcinogen; OSHA: Possible Select carcinogen; IARC: Group 2A carcinogen Methyl alcohol - Not listed by ACGIH, IARC, NIOSH, NTP, or OSHA. Sodium Acetate - Not listed by ACGIH, IARC, NIOSH, NTP, or OSHA. Water - Not listed by ACGIH, IARC, NIOSH, NTP, or OSHA.

Epidemiology: No data available.

Specific Development Abnormalities: craniofacial and musculoskeletal, ipr-mouse TDLo = 240 mg/kg.

Reproductive Effects: Formaldehyde effects on Fertility: male index, itt-rat TDLo=400 mg/kg; post-implantation mortality, ims-mouse TDLo=259 mg/kg. Paternal Effects: spermatogenesis, orl-rat TDLo=200 mg/kg; testes/sperm duct/ epididymis, ipr-rat TDLo=80 mg/kg.

Neurotoxicity: No information available.

Mutagenicity: Formaldehyde DNA Damage: human fibroblast 100 umol/L DNA Inhibition: human cell types 210 umol/L. Unscheduled DNA Synthesis: rat cell types 50 umol/L. Gene Mutation in Mammalian Cells: human lymphocyte 130 umol/L.

Other Studies: No data available.

SECTION 12: ECOLOGICAL INFORMATION

Ecotoxicity: Atlantic salmon LC50=173 uL/L/96H; Catfish (fresh water) TLm=32ppm/24H; Flounder (salt water) TLm=100-330 ppm/48H; Fathead minnow LC50=10-100 uL/L/96H; Rainbow trout LC50= 168mg/L/48H; Zebrafish LC50=41mg/L/96H; Water flea LC50=52 mg/L/24H. Cas# 50-00-0: LC50(96Hr.) rainbow trout = 0.12 mL/L; flowthrough bioassay; LC50(96Hr.) fathead minnow = 24.1 mg/L; flowthrough conditions; LC50 (96Hr.) bluegill = 0.10 mg/L; Flow-through conditions; EC50 (96Hr.) water flea = 20 mg/L; EC50 (30 min) photobacterium phosphorum = 3.00-10.2 mg/L; Microtox.

SECTION 13: DISPOSAL CONSIDERATIONS

Dispose of in a manner consistent with federal, state, and local regulations.

SECTION 14: TRANSPORT INFORMATION

US DOT Shipping Name: AVIATION REGULATED LIQUID, N.O.S (10% FORMALIN); Hazard Class: 9; UN Number: UN3334; Packing Group: No information available; Canadian TDG No information available.

SECTION 15: REGULATORY INFORMATION

US Federal

TSCA CAS# 50-00-0, CAS# 67-56-1, CAS# 127-09-3 and CAS# 7732-18-5 are listed on the TSCA inventory. This material does not contain any Class 2 Ozone depletors. Clean Water Act: CAS# 50-00-0 is listed as a Hazardous Substance under the CW A. None of the chemicals in this product are listed as Priority

Pollutants under the CW A. None of the chemicals in this product are listed as Toxic Pollutants under the CWA. OSHA: CAS# 50-00-0 is considered highly hazardous by OSHA.

State

Formaldehyde can be found on the following state right to know lists: California, New Jersey, Florida, Pennsylvania, Minnesota, Massachusetts. Methyl alcohol can be found on the following state right to know lists: California, New Jersey, Florida, Pennsylvania, Minnesota, Massachusetts. Sodium Acetate is not present on state lists from CA, P A, MN, MA, FL, or NJ. Water is not present on state lists from CA, PA, MN, MA, FL, or NJ. The following statement(s) is (are) made in order to comply with the California Safe Drinking Water Act: WARNING: This product contains Formaldehyde, a chemical known to the state of California to cause cancer. California No Significant Risk Level: CAS# 50-00- 0: no significant risk level = 40 ug/day.

Canada

CAS# 50-00-0, CAS# 67-56-1, CAS#127-09-3 and CAS# 7732-18-5 are listed on Canada's DSL List. CAS# 50-00-0 and CAS# 67-56-1 are listed on Canada's Ingredient Disclosure List. CAS#127-09-3 and CAS# 7732-18-5 are not listed on Canada's Ingredient Disclosure List.

SECTION 16: ADDITIONAL INFORMATION

MSDS Creation Date: 7/12/1999 Revision #6 Date: 8/02/2000

The information above is believed to be accurate and represents the best information currently available to us. However, we make no warranty of merchantability or any other warranty, express or implied, with respect to such information, and we assume no liability resulting from its use. Users should make their own investigations to determine the suitability of the information for their particular purposes. In no way shall the company be liable for any claims, losses, or damages of any third party or for lost profits or any special, indirect, incidental, consequential or exemplary damages, howsoever arising, even if the company has been advised of the possibility of such damages.

Appendix AE. NMFS-Permitted Contractors for the Fisheries Monitoring and Analysis Division

Alaskan Observers, Inc. (AOI)
130 Nickerson, Suite 206
Seattle, WA 98109
Phone: (206) 283-7310
Fax: (206) 283-6519
E-mail: aoistaff@alaskanobservers.com
www.alaskanobservers.com

Saltwater, Inc. (SWI)
733 N. Street
Anchorage, AK 99501
Phone: (907) 276-3241
Fax: (907) 258-5999
E-mail: anne@saltwaterinc.com
www.saltwaterinc.com

NWO, Inc.
P.O. Box 624
Edmonds, WA 98020
Phone: (425) 673-6445
Fax: (425) 673-5995
E-mail: alaska@nwoinc.com
www.nwoinc.com

TechSea International Corp.
12510 33rd Avenue NE
Suite L-103
Seattle, WA 98125
Phone: (206) 285-1408
Fax: (206) 285-1535
E-mail: info@techsea.com
www.TechSea.com

MRAG Americas Inc.
1810 Shadetree Circle
Anchorage, AK 99502
Phone: (907) 677-8772
Fax: (907) 677-6022
E-mail: bryan.belay@mragamericas.com
www.mragamericas.com

GLOSSARY

A - B

ABC - “Acceptable Biological Catch” - the annual harvest level that a stock can sustain to maintain the maximum sustainable yield (MSY)

Aft - towards the stern or back end of a vessel

Allocation - distribution of the opportunity to fish among user groups or individuals; sometimes based on historical harvest amounts

Amidships - midway between the bow and stern of a ship, or on the centerline

Anchor/Buoy lines - Sections of line that join the groundline and anchors on the bottom of the ocean to the buoys or “bags” on the surface.

Athwart ships - side-to-side across a ship, perpendicular to the centerline

Autobaiters - A piece of machinery that cuts bait into strips and places the strips on the hooks as the groundline is being set.

Bag - the codend or another name for a buoy.

Bait bags/jars - Containers filled with ground bait that are hung inside pots to attract fish.

Beam - width of a ship

Benthic - living in direct relation with the bottom

Bias- Tending to yield one outcome more frequently than others. Factors affecting the randomness of a sample, including possible mechanical sorting of catch by an incline belt, or purposeful presorting by a crew member, will introduce bias.

Bight - a loop or turn in a line

Bin - a large compartment built into a ship for holding fish. Also called live tank, refrigerated seawater tank (RSW tank), lobby.

Bleeder/Sorter - Crewman assigned to sort bycatch out of the catch, and to cut the “throat” of the cod.

Block/Hydro/Hauler - Hydraulically driven wheel into which the groundline is placed during gear retrieval. As the wheel spins the groundline is drawn on board.

Boat Share - the percentage of the gross which goes to the vessel owner

Bobbin - a round, rubber or steel roller used in the footrope of a bottom net to protect the net from damage

Bosun - person in charge of a ship’s rigging, anchors, cables and deck crew

Bottom - (1) ocean floor, (2) fishing depth, or (3) a ship hull. Which meaning to apply must be taken from context.

Bow - the front section of a boat or ship

Bowline - a type of knot used to form an eye in the end of a rope

Brailer - a type of netting that is attached to a crane and used to transport fish and other materials from one vessel to the dock or to another vessel

Breech - a behavioral characteristic of some marine mammals such as humpback whales, where they rise vertically out of the water, and then with most of their body above the surface, they fall to their back or side

Bridge - the control center of a ship

Bridle - wire attached to the headrope, footrope or side panel of a net, by which the net is towed

Bulkhead - a wall separating compartments of a ship

Bulwarks - the upper section of the side plating of a ship, which extends above and around the upper deck

Bycatch- Anything caught in fishing operations that is not the target species, such as other fish species, prohibited species, marine mammals, seabirds, invertebrates, and inert objects.

C

Capstan (gypsy) - an upright, spool-shaped, power rotational cylinder around which cables or hawsers are wound

Carrying capacity - the number of organisms the resources of an area can support

Catch - the amount of fish caught (retained or not)

Catch Per Unit Effort (CPUE) - the number of fish caught per amount of effort (effort is generally a combination of gear type, gear size and length of time the gear is used); CPUE can be used as a measurement of relative abundance of a caught species

Catcher boat - vessel that is used for catching fish and that does not process (freeze) fish on board

Catcher/processor - vessel that is used for, or equipped to be used for, catching fish and processing (freezing) fish products

Chaffing gear - protective carpeting (or strands of nylon forming a carpet pile) on the outer, underside of the trawl net to keep it from catching and ripping on obstacles on the bottom

Chief - the engineer; responsible for care of engines and deck machinery

Choker, choke strap - a loop of wire or rope used to cinch off the net or codend

Chopper - Machine used to grind frozen herring or squid for bait or the person assigned this duty.

Cleat - a heavy piece of wood or metal having two horns around which ropes may be made fast or belayed, usually secured to a fixed object such as the dock or deck

Coded wire tag - small tag (3mm) etched with binary code that are inserted into the snout of fishes for later identification

Codend - the end "bag" of a trawl net where the majority of the fish are collected and held

Coiler - Person or machine that is designated to coil line as it is retrieved by the block.

Combi - A piece of machinery through which the groundline, gangions, and hooks move during gear retrieval. The combi mechanically places hooks into the magazine racks allowing the gangions and groundline to be hung in an orderly fashion. This term may also refer to a crew member that works both in the factory and on the deck of a factory vessel.

Combing - a low partition that separates the trawl deck from the side pockets

Companionway - entrance/stairway from deck to fo'c'sle and engine room

Compliance - being in accordance with the fishing regulations

Composition - In the groundfish Observer Program, this refers to the makeup of harvested species in a catch, and the sample you collect.

Cookie (disc) - a flat, round piece of rubber with a hole in the center strung on a wire rope or chain to protect it from abrasion and to stir up a mud cloud. Used on non-pelagic trawl gear.

Crucifier - A pair of rollers or steel pegs which stand vertically with only enough room for the groundline to pass between. During gear retrieval the groundline passes between the rollers and the hooks are pulled out of the fish.

D - E

Demersal - dwelling at or near the bottom

Directed fishing - targeting or fishing for a species quota

Disembark - to get off a vessel

Diver/Trailer buoys - A small buoy attached to the main buoy with a length of line. The diver buoy "trails" behind the main buoy and allows a larger target for grappling.

Dogs - Metal hooks that are hydraulically controlled to secure a pot to a launcher.

Donut Hole - The isolated area in the Bering Sea surrounded by waters under the jurisdiction of Alaska and Russia. This area is considered international waters and is generally closed to commercial fishing.

Door - a large steel or alloy structure attached to each main wire (in front of the net) to spread the net horizontally by means of hydrodynamic and friction forces

Draft - vertical distance from keel to waterline of a ship

Drop-off - Those organisms that fall or are knocked off of a hook prior to their being landed.

Drum - a metal spool or cylinder around which cable, etc. is wound

Drumhead - the top of a capstan, into which bars are inserted for leverage in turning it

Ebb tide - outgoing tide

EEZ - "Exclusive Economic Zone" - the term for the 200 mile jurisdiction zone, in which a nation has exclusive fishing rights, formerly called the FCZ

Embarkation - to board a vessel

EPIRB - "Emergency Position Indicator Radio Beacon"

Expansion straps (container lines) - a series of lines running around the circumference of a codend to provide strength and help maintain the shape of the bag

F

Fathom - a measure of length or depth equal to six feet

Fingers/Triggers - Small plastic strips located in the tunnel of a pot which allow fish to enter a pot but not exit.

Fishfinder - an electronic device for locating schools of fish under a vessel

Fishing line - a length of chain or wire in the bottom, front end of a net between the footrope and the bolsh line

Fishing mortality - Removal (deaths) of fish from a population due to fishing activity.

Flatfish - fish which are laterally compressed and orient themselves in the water with their lateral surfaces or sides towards the surface and bottom

Flatlink - a piece of cut or cast hardware, generally oblong in shape, with leg diameter smaller in certain areas to allow attachment of a G-hook; used where wires must be connected and disconnected frequently

Flood tide - incoming tide

Fo'c'sle (from: forecastle) - the forward part of a ship where sailor's quarters are located

Footrope - on a non-pelagic net, a series of bobbins, tires or discs strung on chain or wire rope attached to the bottom front of a bottom net to protect the net from damage. On a midwater net, the rope or wire running along the front, bottom edge of the net.

Forward - towards the bow of a vessel

Fresh weight - the weight of the whole fish (or animal) as it was when alive. Also called round weight, whole weight.

FUS - "Fully Utilized Species" - a designation given to bycatch species whose quota has been taken while other directed fisheries are permitted to continue. Fully Utilized Species must be discarded from the catch like prohibited species.

G

Galley - ship's kitchen and/or mess hall

Gallows - structure from which trawl blocks are hung; separate units port and starboard

Gangion - The length of line that connects the hook to the groundline. It is often only two to three feet long.

Gantry - a frame structure, usually at the aft of a vessel, which supports pulleys (blocks) used in setting and retrieving trawl nets

Gas bladder - a sac filled with air or similar gases in the body cavity of a fish. May or may not be attached to the throat by a duct.

G-hook - a piece of cut or cast iron hardware in the shape of a "G", used with a flatlink where wires must be connected and disconnected frequently

Gill rakers - bony tooth like structures on the anterior edges of the gill arches. For protection or straining out food.

Gilson - a single hookline (as distinguished from a multiple block) used to assist in setting, hauling and moving gear on deck

Groundline/Mainline - The length of line to which all of the hooks are attached. This line is the “backbone” of the gear

Gunnel or Gunwale - the upper edge of the side of a boat

Gurdy - special winch for hauling of longlines or trolling lines

Gypsyhead - a metal drum with a smooth concave surface, usually mounted on a winch. Several wraps of line around the gypsy provide enough friction while it is turning to raise heavy loads smoothly because the line slips and is easily controlled, like the friction on a clutch plate.

H - K

Halibut excluder - A divider located in the tunnel of a pot that restricts the size of the opening.

Harvest - the total amount of fish caught and retained from an area over a period of time

Hatch - an opening in a deck or bulkhead of a ship

Haul - a catch of fish from one tow of a net or longline

Haulback - when the vessel lifts the net out of the fishing depth

Hawser - any large rope (generally five inches or more in circumference) used primarily for towing, mooring or hauling

High grading - when a vessel puts up product but later discards it overboard in favor of a more valuable product

Hook - Usually a three pronged grappling hook used to snag the trailer buoy line.

Hook Counts - The average number of hooks per segment of gear.

Horn Off - To knock organisms off of a hook using the butt of a gaff.

I-beam - a steel beam shaped like an “I” in cross section

Incidental catch or species - catch taken while fishing for the primary purpose of catching a different species

Intermediate - a gradually tapered section, generally of small mesh, between the back body of a trawl and the codend

Joint Venture - a cooperative fishing/processing effort between vessels of different nationalities

Knot - a measure of time multiplied by distance, equaling speed. One knot equals one nautical mile (6080 feet) in one hour.

L - O

Landings - the total amount of fish unloaded at a buying station by commercial fishermen or brought to shore by recreational fishermen; landings are reported at the points at which fish are brought to shore or delivered to an at-sea processing facility

Launcher - Hydraulic lift, usually located on the port side of a vessel, used to “launch” pots over the side of the vessel and to adjust the angle of the pot when it is being emptied.

Lay - the direction in which the strands of a rope are twisted (right or left) or the degree of tightness with which they are twisted (soft, medium, hard, etc.)

Lazaret - a storage place between the decks of a ship

Lee, Leeward - the side protected from the wind, opposite the “windward” side

Live Tanks - tanks or bins on factory trawler vessels where the catch is dumped prior to sorting or processing

Lobby - another name for a fish bin on a catcher/processor

Magazine - (Mag) A term used to describe a segment of gear within a set containing up to as many as ten thousand hooks. The length of this segment of gear is dictated by the length of the magazine rack on which the hooks and groundline are hung.

Magazine rack - (Mag rack or Rails) A piece of equipment onto which hooks are slid. The gangions and the groundline then hang from the hooks. This equipment functions in a similar fashion to a coat hanger on a closet rod.

Main Wires - the two large cables used to connect the trawl net to the vessel while fishing

Master - fishing master and/or captain

Mothership - a processing vessel at-sea (under way) whose fish come from catcher boat's deliveries

Motion Compensated Flow Scale - a scale built into a conveyor belt; the scale maintains a running tally of weight moving across the belt, in addition to comparing it to a constant weight in order to compensate for vessel movement

Motion Compensated Platform Scale - an electronic flatbed scale with a constant weight load cell which allows for compensation of the vessel's movement

MSY - “Maximum Sustainable Yield” - an estimate of the largest average annual catch or yield that can be taken over a significant period of time from each stock under prevailing ecological and environmental conditions. Since MSY is a long term average, it need not be specified annually.

Mustang suit - Insulated and waterproof coveralls worn in the cold months while sampling on deck.

Net reel - a hydraulic drum on the deck on which the net and most of the rigging are wound

Otter trawl - the type of net gear used on stern trawlers

Otterboard - another name for a trawl door

OY - “Optimum Yield” - the harvest level for a species that achieves overall benefits including economic, social and biological considerations

Overcapitalization - a level of investment resulting in a non-economically productive fishing effort level (too much effort may drive down economic profits)

Overfishing - harvesting at a rate that will exceed the management goal; an amount of fishing mortality that jeopardizes the capacity of a fishery to produce MSY on a continuing basis (MSFCMA definition); an over-fishing level (OFL) is determined for every species or species group for which there is a TAC

P

Panel - Mesh netting attached to a square metal frame. Two large panels and four smaller panels are attached to a heavy steel frame box to form the six sides of a pot.

Pelagic - midwater

Peritoneum - the lining of the gut cavity

Pew, Pew stick - a sharp-ended pole which is used to skewer fish and toss them to another location

Pick/"Running the hook" - Hook connected to the end of the boom which is attached to the bridle and is used to lift a pot onto the launcher as the pot is being retrieved.

Plotter - Electronic mapping device that displays the local area and the vessel's position on it. The plotter allows skippers to record the area of a string and also the number of pots in a string on a digital map display.

Pod - a school of marine mammals; such as seals, whales or dolphins

Population - The total of individuals occupying an area or making up a whole. When sampling aboard a trawler, a population is defined as the catch from a single haul.

Porthole - a window in the hull or the outside bulkhead of a ship

Pot Tie - A short piece of line used to tie pots together when they are stacked on deck.

Predominant species - species which are the most abundant in the catch - not necessarily the target species

Presorting - the segregation and/or removal of any item(s) or organism(s) from the catch prior to the point where an Observer is collecting a sample

Prohibited species or prohibited species groups - Species whose allowable retention is zero. Salmon, herring, halibut, king crab, and Tanner crab are always prohibited in North Pacific open access groundfish fisheries. For vessel operators, prohibited species include the above and any other species declared prohibited by a notice of closure.

Prohibited species sampling - the weight of groundfish catch sorted by the Observer to determine only the numbers and weights of salmon, herring, halibut, king crab, and tanner crab present

PSC - "Prohibited Species Catch" - a harvest limit usually placed on halibut, salmon, crabs or other species which must be discarded in the groundfish fisheries

R

R.D.F. - Radio direction finder

Radio Call Sign - four letters and/or numbers which are an international identifier of a vessel. The International Radio Call Sign (IRCS) is painted in large letters on the side of each vessel and on the deck of the flying bridge.

Random - Relating to a set, each of whose elements have an equal probability of occurring in a sample. These elements are chosen as sample units in a manner which eliminates subjectivity.

Random sample frame - The population divided into independent countable units.

Regenerated scale - a fish scale which has grown in to replace one that was lost. Regenerated scales are useless for aging a salmon, but can be used to identify it to species.

Reserve - a portion of quota set aside at the beginning of the fishing year to allow for uncertainties in preseason estimates of DAP catch

Riblines - heavy lines or chains that run down the length of the trawl net to strengthen it

Roller - A device made up of one or more metal pins that spin allowing the groundline to be pulled up and over the rail of a vessel during retrieval such that tension and friction on the line is reduced.

Roller station/pit - Term used to describe the area where fishermen stand while retrieving the line and gaffing fish coming in over the roller.

Rollerman - A crewman who stands in the roller station and monitors the retrieval of the gear. The rollerman lands any commercially valuable fish and excludes any non-commercially valuable fish from being landed.

Rostrum - a pointed, calcareous, median extension on the anterior end of crab carapaces

Round weight - the weight of the whole fish (or animal) as it was when alive, synonymous with fresh weight and whole weight

Roundfish - fish that orient themselves in the water with the dorsal side towards the surface and ventral side towards the bottom

RSW - refrigerated sea water, usually referring to a tank for holding fish

RSW Tanks - holding tanks or bins that use refrigerated sea water to keep fish fresh until delivery

“Run pots” - A phrase used interchangeably with “retrieve pots.” It is the phrase used in the vessel logbook to indicate the number of pots that have been retrieved from a string.

S

Sample size - The portion of the population that is sampled.

Sample weight - The actual weight in kilograms of a composition sample.

Sampling - The process of selecting part of a population for the purpose of determining the parameters, or characteristics, of the whole population. Composition sampling refers to taking samples of a haul in order to determine the fishing mortality of species occurring in the sample.

Scupper - a hole in the bulwarks which allows water to drain from the deck

Segment of Gear - In this manual a segment of gear refers to the standard unit the vessel uses for measuring gear. This could refer to a mag, skate, tub, or coil of gear.

Set - The entire length of groundline from the first hook to the last hook, also referred to as a “string” of gear.

Sheave - a wheel with a grooved rim, such as is mounted in a pulley block to guide the rope or cable

Shot - A pre-measured length of buoy line, usually 10 to 20 fathoms long. Normally there are two set lengths, a “Long” shot and a “Short” shot. When setting a string, the skipper will tell the crew how many shots to tie to a pot for various bottom depths.

Skate - a length of longline gear, usually 100 fathoms or 600 feet long

Skate bottom - a fabric square with lines on the corners to tie it into a bundle once a longline “skate” has been coiled onto it

Skate or Mag markers - Markers in the groundline that separate the sections of gear. These may be fluorescent tape woven onto the line, knots, line splices, carabineers, or magazine (mag) clips.

Skates/Tubs/Coils - Terms used to describe the smaller segments of gear within a set or a magazine.

Spatial - Referring to a unit of space used in random sampling. For example: a third of a bin, or a section of trawl alley, are spatial units.

Species composition sample - to sort a defined weight of catch such that each organism sampled for is grouped by family or by species and to determine the number and weight of the organisms in each group

Spring line - a mooring line attached amidships

SSB - “Single Side Band” radio used for long distance contact

Stack - This term is used on pot vessels to refer to pots stacked on the back deck.

Starboard - the right side of a ship (when one is looking forward)

Stern - the aft or back end of a vessel

Stern ramp (slip) - a sloping ramp in the stern of a trawler between the deck and the water line, through which the net is set and hauled

Stern trawler - any of various sized fishing vessels which trawl a conical shaped mesh net through the water, haul it up a ramp through the stern of the ship, empty, and process the catch to make a wholesale fish product. These vessels may fish for a month or more at sea without support.

Stock - a grouping of fish usually based on genetic relationship, geographic distribution and movement patterns; managed as a unit of fish

Stock assessment - an evaluation of the size and/or health of a predefined population including all activities that fishery biologists do to describe the conditions or status of a stock; the result is a report on the health of a stock and recommendations that would maintain or restore the stock

String - Pots deployed individually and are not attached to one another in any way. This term refers to pots set at a similar time in a similar area and depth. What a skipper calls a string varies considerably between vessels. Strings are analogous to sets.

Sub-sample - the weight of catch designated by the Observer which weighs less than the sample weight and is processed for a supplemental task to determining the composition of a haul, such as sampling for average weight

Surimi - minced fish meat paste usually produced from pollock

T - Z

Table - Some vessels have a sorting table on the back deck that pivots on one axis. The contents of a pot are dumped onto the table, and the table is swung out of the way to re-launch the pot.

TAC - “Total Allowable Catch” - annual recommended harvest levels based on biological, economic and social factors that is still within the range of the ABC

Taper - to cut webbing according to a given formula for fitting into a trawl

Tare - a deduction from gross weight to obtain net weight. Usually made to allow for the weight of a container.

Target species - Vessel personnel will generally call the species they wish to catch the target species. For Observer Program purposes, target species is what the vessel claims as their target. The Sustainable Fisheries Division of the NMFS Alaska Region uses delivery and production data to determine target fishery, which may differ from what the vessel claims as their target.

Temporal - Referring to a unit of time used in random sampling. For example: one hour of processing time, or systematic intervals of ten minutes, are examples of temporal units.

Trawl - a cone shaped net, towed through the water to catch fish

Trawl Alley - the central passage on a trawl vessel where the codend is placed after haulback

Trawl Doors - often referred to as “doors,” these are two metal plates, each attached to a main wire, designed to keep the mouth of the net open while fishing

Trip - the time period from when the vessel leaves harbor until it returns to harbor to offload product or catch

Tuning/Overhauling gear - Term used to describe the work involved in straightening hooks, replacing gangions, or splicing the damaged groundlines.

Tunnel - Short mesh-lined openings on two or three sides of a pot. These are the entrances to the trap. Fish and crab are able to swim in but are unable to make their way back out due to the fingers/triggers.

Under way - vessel in forward motion, running. According to Coast Guard regulation, a vessel is under way if it is not at anchor or at dock, so a vessel adrift is technically under way.

Vessel Code - a code used only by the Observer Program to identify a ship

Warp (main wire) - the cables on a trawler which run from the main winches to the trawl doors on the net

Weighed sample - the catch sampled by the Observer is weighed on a scale.

Winch - a hydraulic machine with one or more drums on which to coil rope, chain, or cable for hauling or hoisting

Wing - the sides off a trawl net near the opening, usually with larger mesh than the rest off the net

Wrister - a coated cloth tube worn on the arm, extending from the elbow and covering the wrists. Keeps arms warm and dry. Fish blood and slime are more easily washed out from these than from shirt sleeves.

INDEX

A

Abandon Ship 17-12
Abbreviations, List of 1-2
Accidents on Board 17-10
ADF&G
 fish tickets 9-3
 groundfish ticket 9-3
 example (fig) 9-14, 9-15
 instructions (fig) 9-13
 Shellfish Observer Program 1-6
AFA See American Fisheries Act
AFA Trawl C/Ps and Motherships 5-31
AFA Trawl Vessels 5-30
After-Scale
 area at plants 9-4
Agencies, Management 1-6
 ADF&G 1-6
 Shellfish Observer Program 1-6
Ages
 at the haul, sample, subsample, offload level
 11-2
 collecting guidelines for all observers 11-2
 frequently asked questions 11-9
 sampling for at plants 9-11
 selection of species 11-3
 when to collect 11-6
Alaska Department of Fish and Game. See
ADF&G
Alaska Plaice
 collection priorities at plants 9-11
Albatross 14-2
American Fisheries Act 1-6, 2-18, 6-1, 6-4
Arrowtooth Flounder
 collection priorities at plants 9-11
 stomach collection procedures 15-4
 stomach specimen length stratification (table)
 2-17, 15-4
 subset sampling
 on trawlers 5-24
 tallying on longliners 7-27

Assessing Viability of Pacific Halibut
 on pot and trawl vessels 10-5
Assisting Vessel Observers
 at plants 9-4
Atka Mackerel
 collecting otoliths from 11-9
 description of gonads 11-12
 frequency of biological samples 11-12
ATLAS Data
 when to send 2-26

B

Bait
 codes for trip data 3-5
Banded Seabirds 14-7
Beaufort Sea State Descriptions
 for marine mammal data 12-11
 for seabird data 14-5
Bias
 on longliners 7-18
 on pot vessels 8-10
 on trawlers
 minimizing 5-10
 non random samples 5-8
 recognizing 5-6
Bias. See Also Sampling Bias
Bin Estimate
 biases and 4-7
 definition of 4-4
 steps to measuring for 4-6
Bins
 irregular shapes and 4-6
Biological Data
 collection of on motherships 6-5
 fish measurements on longliners 7-33
 uses of 11-1
Boarding
 safety procedures before 17-2
Bottom Depth, Recording Of 4-16, 7-11
Branded Marine Mammals 12-10
Break Table. See Random Break Table
Briefings 1-11, 19-5
Bycatch
 seabirds, reducing on longliners 14-5

C

Calculations

- average hook count 7-13
- converting seconds to minutes 7-11
- determining volume of irregular bin (fig) 4-7
- general rules for 2-8
- keypunch on longliners 7-41
- recording in logbook 4-14
- see also Formulas
- species percent retained on longliners 7-33
- total hooks in sample 7-15
- total hooks in set 7-15

Canine Teeth

- collecting form dead sea lions (fig) 12-6

Careful Release Methods For Halibut 7-32

Catch

- on longliners
 - counting 7-17
 - tallying 7-24
- on trawlers
 - dumping overboard 5-6

Catch Information

- for motherships 6-2

Catch Messages

- faxing 2-26
- importance of 2-25
- sending via ATLAS 2-26

Catch Monitoring and Control Plan 9-8

Catch Weight Estimates

- on trawlers
 - observer's 4-4

Catch Weight Estimates see Vessel Estimate

Catcher Boat Name

- entering on Offload Form 9-6

Catcher Processors

- as motherships and haul order 6-3

Catcher Vessels (trawl)

- delivering to motherships 5-28, 6-5
- familiarizing yourself with 3-3

CDQ

- deliveries from vessels under 60 feet 9-9
- haul designation on C/Ps 5-31
- haul designation on longliners 18-12
- information for longline C/Ps 7-36
- information for longline catchers 7-35

- non-pollock trawl catcher vessels 5-31

- on trawlers 5-30

- trawl catcher processors and motherships 5-31

Certification of Observers 1-6

Cetacean

- sex differentiation (fig) 12-9

Closures, Time-Area 1-4

CMCP See Catch Monitoring and Control Plan

Codend 6-4

- delivery duties on motherships 6-4
- delivery problems to mothership 6-4
- shapes D-15

Codend Estimates

- definition of 4-4
- large codends and 4-8
- steps to measuring for 4-8

Coils, Counting Hooks In 7-14

Cold-water Near Drowning 17-11

Collecting

- fish for length and otolith samples 11-2
- otoliths from Atka mackerel and sablefish 11-9
- scale samples from salmon 10-8
- stomachs 15-2

Combined Samples

- on longliners 7-31
- on pot vessels 8-16
- on trawlers 5-24

Communications

- observer responsibilities regarding 1-10

Community Development Quota See CDQ

Completing and Organizing Forms 2-4

Composition, Species See Species Composition

Condition Codes

- at plants, of delivered catch 9-13
- for pacific halibut 11-16

Conduct, Standards of 2-2

Confidentiality 2-3

- on vessel e-mail, lack of 1-10

Conflict of Interest 2-3

Contractors

- contact information AE-73
- responsibilities of 9-2

Conversions D-15

Conveyor Belts

- on trawlers 5-8

Correcting

- atlas data 2-26
- faxed catch messages 2-27
- Counting Fish
 - on trawlers 5-22
- Coverage Requirements 1-3
 - on longliners 1-4
- Crab
 - after-scale at plants and 9-4
 - measurement techniques for (fig) 10-3
 - measuring 10-2
 - sexing and checking for eggs 10-4
 - tasks for data collection 10-2
- Crab Pot
 - diagram of (fig) 1-4
 - in trawl net 5-24
- Crews
 - on trawlers
 - deliberate interference 5-6
 - in bins 5-7
 - uncooperative
 - on longliners 7-34
- Cruise Assignments
 - limits 1-9
- Cruise Numbers 2-5
- Curvilinear Length
 - measuring for marine mammals 12-7
- Cutting Fish to Sex
 - regulations supporting 11-14

D

- Daily Notes Section 2-8
- Data Forms
 - checking for errors on longliners 7-42
- DCPL
 - trawlers and 4-1
- Debriefing
 - purpose of 1-11
 - scheduling of 19-4
 - steps of 19-4
 - suspected violations, documenting of 18-3
- Deck Form Instructions
 - on longliners 7-36
 - on pot vessels 8-17
 - on trawlers 5-34
- Decks

- working on 17-8
- Decomposed Fish
 - accounting for
 - on trawlers 5-24
- Delineating Strings 8-3
- Deliveries
 - after-scale and 9-4
 - catcher vessel schedules 9-2
 - checking forms for 9-12
 - collecting information for 9-2
 - documenting days with no deliveries 9-6
 - duties for codends 6-4
 - duties for pumped fish 6-5
 - from tender vessels 9-8
 - numbering for tender vessels 9-8
 - of codends to mothership 6-4
 - of pacific halibut 9-8
 - recording on the offload form 9-6
 - round (whole) weight for 9-3
 - to Arctic Enterprise 9-7
 - to motherships from catcher vessels 5-28, 6-5
 - verifying weights for 9-3
 - weight verification process (fig) 9-5
- Delivery Number
 - recording on a longliner 7-5
 - recording on a mothership 6-4
 - recording on a pot vessel 8-5
 - recording on a trawler 4-12
 - recording on the length and specimen form 11-16
- Delivery Weight
 - and longliners 7-6
 - and plants 9-3
 - and pot vessels 8-5
 - and trawlers 4-12
- Densities
 - calculating, on trawlers 4-10
- Deployment
 - logistics 1-7
- Description of Operations
 - longliners 7-3
 - longline catcher processors 7-4
 - longline catcher vessels 7-4
 - pot vessels 8-3
 - vessels and plants 1-3
- Discards

- estimating on longliners 7-8
- estimating on pot vessels 8-6
- estimating on trawlers 4-11
- DMSO 12-7
- Documenting RST and RBT Use 2-11
- Dover Sole
 - collection priorities at plants 9-11
- Drop offs
 - tallying on longliners 7-24
- Drowning 17-11
- Duties and Priorities 2-2
 - on a mothership
 - codend delivery 6-4
 - pumped fish delivery 6-5
 - shared 2-24

E

- EEZ (Exclusive Economic Zone) 1-3
- Eggs 10-2
 - checking for in crab 10-4
- Eiders 14-2
- Electronic Logbooks
 - on trawlers 4-2
- E-Mail
 - vessel 1-10
- Emergencies on Board 17-11
- Empty Hooks
 - tallying 7-24
- EPIRBS 17-14
- Equipment
 - of life raft (fig) 17-15
 - personal 1-7
- Estimates
 - bin, definition of 4-4
 - captain's
 - on trawlers 4-4
 - codend, definition of 4-4
 - observer's
 - on trawlers
 - volumetric 4-6
 - weighed 4-4
 - weighed, definition of 4-4
- Estimating
 - discards
 - on longliners 7-8

- on pot vessels 8-6
- on trawlers 4-11
- halibut lengths on longliners 7-29
- percent retained
 - on longliners 7-33
 - on pot vessels 8-16
 - on trawlers 5-29
- Evaluations
 - as a result of debriefing 19-5
- Evidence, The Logbook as 2-8

F

- Factories, Working in 17-8
- Faxing Catch Messages 2-26
- Federal Groundfish Fishing Regulations 18-7
- Feedings, Intentional
 - of marine mammals 12-10
- Field Support
 - mid-cruise and 1-10
- Fire 17-11
- First Days on Board 17-7
 - a catcher/processor trawler 3-2
 - first haul, the 3-4
 - on a catcher trawler 3-3
 - on a longline vessel 3-3
 - on a pot vessel 3-4
- Fish
 - collecting for length and otolith samples 11-2
 - cutting, regulations supporting 11-14
 - decomposed
 - on trawlers 5-24
 - measuring of 11-3
 - sexing of 11-10
- Fish Poisoning 17-10
- Fish Tickets
 - ADF&G 9-3
- Fisheries Monitoring and Analysis (FMA) Division
 - description of 1-1
- Fisheries, Restricted Access 1-6
- Fishery
 - history of 1-1
 - today 1-3
- Fishery Management Plans See FMPs
- Fishing Duration

- on trawlers
 - inaccurate times and 4-2
- Fishing Effort Data Collection
 - on a mothership 6-2
 - on longliners 7-6
 - on pot vessels 8-6
 - on trawlers 4-1
- Flatfish
 - sexing of 11-13
- Flathead Sole
 - collection priorities at plants 9-11
 - stomach specimen length stratification (table) 15-4
- Flooding 17-12
- Flowscale
 - failing test 2-19
 - testing 2-19, 4-5
 - weighed observer estimates and 4-4
- FMPs 1-4, 1-5
- Form Instructions
 - for otolith specimens 11-9
 - observer haul form
 - on longliners 7-11
 - on pot vessels 8-8
 - on trawlers 4-17
 - paper, on longliners 7-39
 - paper, on pot vessels 8-19
 - see also Deck Forms, Paper Forms, VHF, OHF, etc.
 - vessel haul form 8-8
 - on longliners 7-10
 - on pot vessels 8-8
 - on trawlers 4-15
- Formalin
 - handling protocol 15-1
 - where to keep on board 15-2
- Forms
 - catch information
 - mothership 6-2
 - checking of
 - motherships 6-6
 - pot vessels 8-21
 - completing and organizing 2-4
- Formula
 - area, volume, and product D-15
 - catch weight using density and volume 4-6

- for calculating density 4-10
- Frequency of Length Collection
 - on a mothership 6-5

G

- Gangion 7-3, 7-32, 1-iv
 - release methods and 18-8
- Gear
 - on longline vessels
 - verifying 7-13
 - on pot vessels
 - delineating strings 8-7
 - number of pots run 8-7
 - personal (fig) 1-8
 - required maintenance of 1-9
- Gear Deployment Data
 - description of required data
 - on longliners 7-8
 - on pot vessels 8-7
 - on trawlers 4-2
- Gear Depth 4-16, 7-11, 8-6
- Gear Performance
 - codes for longliners 7-10
 - codes for pot vessels 8-8
 - codes for trawlers 4-16
- Gear Retrieval Data
 - description of required data
 - on longliners 7-8
 - on pot vessels 8-7
 - on trawlers 4-2
- Gear Type
 - obtaining from vessel log (plant observers) 9-2
 - recording on longliners 7-9
 - recording on trawlers 4-15
- Gear, Sampling 1-9
- Grates
 - on trawlers 5-7
- Greenland Turbot
 - collection priorities at plants 9-11
 - frequency of otolith and length samples at sea 15-4
 - stomach specimen length stratification (table) 15-4
- Groundfish
 - Fishing Regulations 18-7

H

Halibut

- after-scale at plants and 9-4
- data collection for 10-5
- on longliners
 - careful release methods 7-32
 - estimating length 7-24, 7-30
 - injury assessments 7-32
 - tallying 7-24
- on pot vessels
 - issues 8-17
 - measurements 8-16
- on trawlers
 - in composition samples 5-36, 5-37
 - sampling when predominant 7-35
 - viabilities on pot vessels 8-16

Hanging Units

- on longliners 7-19
- on pot vessels 8-11

Harassment

- responding to and reporting 18-7
- sexual 18-7

Haul

- order for motherships 6-3
- order of on C/P mothership 6-3
- selecting which to sample 2-9
 - on longliners 7-16
 - on pot vessels 8-9
- when to sample all 2-9

Haul Backs

- notification rules for 3-1

Haul Data

- observer recording requirements and 4-14

Haul Form Information

- completing
 - on trawlers 4-14
- haul order
 - recording on motherships 6-2
- observer haul form
 - on longliners 7-11
- problems with
 - on longliners 7-7

Health Aboard Vessels 17-7

History

- of the Fishery 1-1

Hooks

- average hooks 7-13
- counting 7-13
 - during gear retrieval 7-14
 - during tally 7-14
 - in coils 7-14
 - in tubs, magazines, racks 7-14

I

Identification Forms, Species 2-6

IFQ

- on longliners
 - fishing effort 7-6

Illness on Board

- notification of 1-10, 17-10

Immersion Suit, Donning the 17-12

Inaccessible Tanks

- on trawlers 5-8

Incline Belts

- bias from
 - on trawlers 5-8

Individual Fishing Quota (IFQ) 1-6

- on longliners 7-34

Injury Assessments

- halibut 7-32

International Pacific Halibut Commission 7-32

Interview

- debriefing 19-4
- mid-cruise 1-10

IR/IU

- and halibut deliveries 9-8

J

Jig Vessels

- age specimens from 9-12
- gear type code 9-6
- sample type code 7-9, 7-53

K

Keypunch Check 5-35

King Crab

- after-scale at plants and 9-4

Kittiwakes 14-3

L

Labels for Stomach Samples 15-5

Large Organisms

removal on deck 5-7

Lead Observer's Role 2-24

Legibility, Importance of 2-5

Length Samples

at plants 9-10

collecting fish for 11-2

on a mothership 6-5

regulations supporting collection of 11-14

salmon measurements 10-8

selection of species for 11-3

stratified, definition of 11-16

systematic, definition of 11-16

Letter of Introduction 1-9, 3-1

Level 2 Info for Plant Observers 9-8

Life Rafts 17-13

and Equipment (fig) 17-15

Limited Access Fisheries 1-6

trawl fleet and 5-30

Location Code

recording on longliners 7-10

recording on pot vessels 8-7

recording on trawlers 4-17

Logbook, Industry

plant 9-12

verifying on trawler 4-2

Logbook, Observer

as evidence 2-8

importance of entries 2-7

Longline Vessels

and offloads 7-5

bait codes for trip data 3-5

careful release of halibut 7-32

checking forms 7-41

combined samples 7-31

definition of non tally period 7-17

definition of samples 7-17

definition of subsamples 7-17

definition of tally period 7-17

description of 1-4

description of operations 7-3

longline catcher processors 7-4

longline catcher vessels 7-4

determining delivery weight 7-6

documenting fishing effort 7-6

equipment needed 7-16

estimating discards and 7-8

familiarizing yourself with 3-3

gangions 7-3

halibut injury assessments 7-32

hook counts

methods of obtaining 7-14

in coiled gear 7-14

in tubs, magazines, racks 7-14

measuring fish 7-33

non predominant species

weight samples 7-29

non tally period

counting hooks during 7-14

paper form instructions

species composition 7-39

random sampling frames

spatial frames 7-19

systematic frames 7-22

spatial 7-22

temporal-spatial 7-22

temporal-spatial frames 7-20

random sampling on 7-18

recording vessel estimates 7-12

safety concerns 7-3

sample bias 7-18

sample size considerations 7-18

sample station, the 7-16

seabirds 7-32

selecting hauls to sample for species composi-

tion 7-16

species identification

rules of 7-26

subsamples 7-30

tally period

counting hooks during 7-14

samples during 7-24

tally station, the 7-16

tallying

arrowtooth 7-27

halibut 7-24

Kamchatka 7-27

non-predominant species 7-24

predated items 7-25

- rocksoles 7-27
- sculpin 7-27
- seabirds 7-28
- shortraker/rougheye rockfish 7-27
- similar species 7-28
- skates 7-26
- tallying Tanner crab 7-27
- uncooperative crews 7-34
- verifying gear 7-13
 - counting hooks 7-13
 - determining average hooks 7-13
 - segments in set 7-14
- weight samples 7-29

M

- Mackerel See Atka Mackerel
- Magazines, Counting Hooks In 7-14
- Magnuson-Stevens Act 1-3
- Man Overboard 17-11
- Management Agencies 1-6
- Management Plans 1-4
- Manual
 - as an indispensable tool 1-1
- Marel Platform Scales 2-18
- Marine Mammal Interaction and Sightings Form 12-2
- Marine Mammal Interaction and Specimen Form
 - completing 12-3
- Marine Mammal Protection Act 1-5, 12-1
- Marine Mammals
 - behavioral descriptions for (table) 12-13
 - intentional feeding of 12-10
 - interaction codes 12-4
 - interactions 12-2
 - deterrence 12-3
 - monitoring for 12-2
 - predation on longliners 7-25
 - regulations concerning taking of 18-16
 - sightings of 12-2, 12-10
- Materials for Stomach Project 15-1
- May Day 17-12
- MCP Scales
 - weighed observer estimates and 4-4
- Measuring
 - crab 10-2, 10-3

- fish 11-4
 - on longliners 7-33
- salmon 10-8
- sea lions (fig) 12-7
- seals (fig) 12-7
- Messages, Catch. See Catch Messages
- Mid-cruise 19-2
 - support 1-10
- Miscellaneous Items
 - accounting for
 - on trawlers 5-24
- MMIS Form See Marine Mammal Interaction and Specimen Form
- Monitoring for Marine Mammals
 - duties 12-2
 - motherships and 6-4
- Motherships
 - codend delivery duties 6-4
 - codend delivery problems 6-4
 - delivering to 5-28, 6-5
 - haul order 6-3
 - haul order for C/Ps 6-3
 - pumped fish delivery duties 6-5
 - vessel observers and 6-5
- Motion Compensated Platform Scales
 - definition of 1-vi
 - failing daily tests 2-19
 - general use of 2-18
 - testing 2-18
 - using to weigh individual fish 11-7
- Multi-Species Community Development Quota (MSCDQ) 1-6
- Murrelets 14-3

N

- Near Drowning, Cold-water 17-11
- NMFS area
 - for tender deliveries 9-8
 - obtaining from catcher log 9-2
 - recording on offload form 9-7
 - recording on salmon snout tag 13-2
- NMFS Permit
 - recording on the offload form 9-6
- Non Predominant Species
 - tallying on longliners 7-24

Non Tally Period
 counting hooks during 7-14
 definition of 7-17
 weight subsamples from 7-30
 Non-fishing Day Entries
 for plants 9-6
 on longliners 7-11
 on pot vessels (see longline) 8-8
 on trawlers 4-16
 Notes, Daily 2-8
 Notification Requirements
 of haul back 3-1

O

Observer Biological Sampling Record 11-6
 Observer Estimate
 determining on motherships 6-4
 volumetric, on trawl vessels 4-6
 weighed 4-4
 Observer Estimate see Catch Weight Estimate
 Observer Haul Form
 completing on longliners 7-11
 Observer Logbook Entries 2-7
 Observer Program
 partial summary of fishing regulations 18-7
 Observer Provider Responsibility 1-11
 Observer role
 as lead 2-24
 as second 2-24
 Observer Sampling Station Verification Checklist 2-20
 Observer Scales
 weighed estimates and 4-4
 Observer Training
 passing requirements and 1-7
 Observers
 delivering to motherships 5-28, 6-5
 formalin handling protocol for 15-1
 Offload Form. See Plant/Vessel Offload Form
 Offload Number
 recording on the length and specimen form 11-16
 Offloads
 after-scale at plant and 9-4
 and prohibited species discards at sea 4-14

 data for on longline catchers 7-5
 prohibited species weight and 4-13
 relieving vessel observers during 9-4
 OHF
 completing on trawlers 4-14, 4-17, 7-9
 Operations, Pot Fishing 8-3
 Opportunistic Sampling
 on pot vessels
 predominant species 8-15
 Orca Predation
 accounting for on longliners 7-25
 Organization of Forms 2-5
 Otolith Sampling 11-6
 collecting fish for 11-2
 collecting from Atka mackerel and sablefish 11-9
 on a mothership 6-5
 roundfish, location in (fig) 11-8
 selection of species for 11-3
 Otoliths see Ages
 Overboard, Man 17-11

P

Pacific Halibut
 deliveries to plants 9-8
 determining viability on trawl and pot vessels 10-5
 on longliners
 careful release methods 7-32
 Paper Form Instructions
 species composition
 on longliners 7-39
 on pot vessels 8-19
 on trawlers 5-36
 Parent Sample
 definition of
 on trawlers 5-5
 Percent Retained
 estimating on longliners 7-33
 estimating on pot vessels 8-16
 estimating on trawlers 5-29
 recording on deck form 7-38, 7-41
 relating to IR/IU 5-30
 Personal Equipment 1-7
 Personal Health and Safety 17-7

Phone Numbers, for Contacts U-45

Pinnipeds
 sex differentiation (fig) 12-9

Plans, Management 1-4

Plant/Vessel Offload Form
 completing on longliners 7-5
 completing on pot vessels 8-4
 completing on trawlers 4-11
 determining delivery weight
 on longliners 7-6
 on pot vessels 8-5
 on trawlers 4-12

Plants, Processing
 checking forms 9-12
 description of 1-3, 1-4

Plastic Deck Sheet 2-6

Platform Scales See Motion Compensated Platform Scales

Poisoning, Fish 17-10

Pols Platform Scale 2-18

Port Codes
 for trip data 3-5

Pot Vessels
 and vessel estimate 8-8
 bait codes for trip form 3-5
 combined samples 8-16
 description of 1-4
 description of operations 8-3
 estimating discards and 8-6
 estimating percent retained 8-16
 familiarizing yourself with 3-4
 halibut measurements on 8-16
 halibut related issues and 8-17
 pacific halibut data collection tasks 10-5
 paper form instructions
 species composition 8-19
 random sampling frames
 spatial frames 8-11
 systematic frames 8-13
 temporal-spatial frames 8-12
 safety concerns on 8-3
 sample bias 8-10
 sample size considerations 8-10
 sample station, the 8-8
 selecting hauls to sample for species composition 8-9
 tallying catch 8-15
 verifying gear 8-7
 vessel haul form for 7-10, 8-8
 weight collection of non predominant catch 8-14
 weight collection of predominant catch 8-15

Pots, Crab
 diagram of (fig) 1-4
 in the trawl net 5-24

Precautions on Board, General Safety 17-7

Predated Items
 tallying on longliners 7-25

Predominant Species
 on longliners
 halibut as 7-35
 tallying 7-24
 weighing 7-30
 on pot vessels 8-15

Preferred Sampling Method
 on trawlers 5-4

Presorted Items
 on trawlers 5-7
 recording data for 5-22

Presorting 2-12, 18-2, 1-i
 definition of 5-2, 1-vii
 large organisms 5-7

Priorities and Duties 2-2

Priorities, List of
 for lengths and otoliths 11-1
 for marine mammals 12-1
 for prohibited species 10-1
 for seabirds of interest 14-1
 for shoreside plants and floating processors 9-1
 for tagged fish and crab 13-1
 on longliners 7-3
 on motherships 6-1
 on Pot Vessels 8-1
 on trawlers 5-3

Processing Plants. See Plants, Processing

Processor Permit
 entering on haul forms 4-12, 7-5, 8-4

Profiles, Vessel 1-9

Prohibited Species 18-8
 after-scale at the plant and 9-4
 offload
 observer weight and 4-13

Project, Materials for Stomach 15-1

Pumped Fish

catchers delivering to motherships 5-29

motherships

delivery duties 6-5

Pumping Fish 4-15

Pumping Water

during emergency 17-14, 17-21

R

Racks, Counting Hooks In 7-14

Raft, Life 17-13

figure of, showing equipment 17-15

Random Break Table

documenting use of 2-11

example 2-11

frequently asked questions 2-12

how to use 2-10

on motherships 6-5

Random Monitoring

for marine mammals 12-2

Random Number Table

appendix chart E-17

how to use 2-16

Random Sample Table

documenting use of 2-11

example 2-10

frequently asked questions 2-12

how to use

on motherships 6-5

versions of 2-9

vessels responsibilities regarding 2-10

when to use 2-9

Random Sampling

on longliners 7-18

on trawl C/Ps 5-11

on trawl catchers 5-16

theory of 2-12

Random Sampling Frames

on longliners

spatial frames 7-19

systematic frames 7-22

temporal-spatial frames 7-20

on pot vessels 8-10

spatial frames 8-11

systematic frames 8-13

temporal-spatial frames 8-12

simple random on C/Ps 5-11

temporal on C/Ps 5-11

RBT See Random Break Table

Records and Labels (stomach) 15-5

Regulations

concerning taking of marine mammals 18-16

for vessels in the U.S. EEZ off Alaska 18-7

supporting cutting fish for sexed lengths 11-14

Restricted Access Fisheries 1-6

codend estimates 1-6

IFQ 1-6

MSCDQ 1-6

see also IFQ, CDQ, MSCDQ, Limited Access Fisheries

Rex Sole

collection priorities at plants 9-11

Rock Soles

collection priorities at plants 9-11

frequency of otolith and length samples at sea 11-7

on longline vessels 7-27

species sub-sampling for 2-17

Rockfish

dumped in the trawl alley 5-10

location of gonads 11-11

with halibut deliveries 9-8

Role

of lead observer 2-24

of second observer 2-24

Rougeye rockfish

on longliners 7-27

Round (Whole) Weight Delivered 9-3

Roundfish

gonads, location of 11-10

otoliths, location in (fig) 11-8

RST See Random Sample Table

RSW (Refrigerated Sea Water)

on catchers 1-3

Rules, Rounding 2-8

S

Sablefish

location of otoliths 11-9

- Safety
 - concerns on longliners 7-3
 - concerns on pot vessels 8-3
 - concerns on trawlers 5-3
 - equipment 1-9
 - formalin and handling 15-2
 - precautions on board 17-7
 - vessel safety examination decal
 - checking for 3-1
- Salmon
 - after-scale at the plant and 9-4
 - checking for tags 13-2
 - collecting data for 10-7
 - sexing 10-8
- Sample Bias
 - haphazard samples on trawlers 5-8
 - non random samples on trawlers 5-8
 - on longliners 7-18
 - on pot vessels 8-10
 - recognizing on trawlers 5-6
- Sample Sizes
 - considerations on longliners 7-18
 - considerations on pot vessels 8-10
 - considerations on trawlers 5-5, 5-18
- Sample Station
 - collecting fish from on catcher vessels 5-10
 - collection fish in on trawlers 5-9
 - on longliners 7-16
 - on pot vessels 8-8
 - requirements for 2-20, 3-2
- Sample Stratification for collecting stomachs 15-6
- Samples
 - definition of
 - on pot vessels 8-9
 - on trawlers 5-5, 7-17
 - preferred number of
 - on longliners 7-17
 - on pot vessels 8-9
 - on trawlers 5-5
 - selection of species for length and otolith 11-3
 - weight, on longliners 7-29
 - with one or two predominant species in catch
 - on trawlers 5-20
- Sampling
 - at plants
 - for length frequency 9-10
 - for a subset 2-16
 - gear, list of 1-9
 - guidelines
 - preferred method on trawlers 5-4
 - length frequency and otoliths 6-5
 - on the Arctic Enterprise 9-7
 - schedule problems 2-11
 - stomachs 15-2
 - tips for pot vessels 8-15
 - unsorted catch on trawlers 5-6
- Sampling Bias
 - mechanical, on trawlers 5-7
 - methods to avoid 5-9
 - on longliners 7-18
 - on pot vessels 8-10
 - on trawlers
 - crew in bins 5-7
 - minimizing 5-10
- Sampling Design Rules
 - on longliners 7-18
 - on pot vessels 8-11
- Sampling for Species Composition See Species Composition Sampling
- Sampling Form Instructions See Form Instructions
- Sampling Frames
 - temporal based systematic on C/Ps 5-14
- Sampling Station
 - what to look for in 3-2
- Scale Samples, Salmon 10-8
- Scales, Observer Weigh
 - general use of 2-17
- Sculpins
 - tallying 7-27
- Sea Depth
 - obtaining from vessel logbook 4-2, 7-7, 8-6
 - recording on vessel haul form 4-16
- Sea Lions
 - collecting canine teeth of (fig) 12-6
 - measurements for (fig) 12-7
- Seabirds
 - albatross 14-2
 - avoidance initiatives 14-5
 - monitoring 14-5
 - banded 14-7
 - Beaufort Sea State Descriptions 14-5
 - eiders 14-2

- identification of 14-3
- incidental take of 14-3
- interactions and mortalities
 - documenting 14-7
 - vessel strikes 14-7
 - with trawl gear 14-7
- kittiwakes 14-3
- murrelets 14-3
- on longliners 7-32
- reducing bycatch of 14-5
- species of interest 14-5
 - sightings of 14-8
- species of interest, the 14-1
- tag and bag procedures 14-4
- tallying on longliners 7-28
- Seals
 - and interaction regulations 18-17
 - measurements for (fig) 12-7
- Seasickness 17-9
- Second Observer's Role 2-24
- Segments
 - verifying on longliners 7-14
- Selecting Hauls to Sample 2-9
 - on longliners 7-16
 - on pot vessels 8-9
 - on trawlers 5-4
- Selecting Species
 - for length and otolith samples 11-3
- Sending
 - a may day 17-12
 - catch messages 2-25
 - catch messages via atlas 2-26
- Seven Steps to Survival 17-15
- Sex
 - determining in cetaceans (fig) 12-9
 - determining in crab 10-4
 - determining in fish 11-10
 - determining in pinnipeds (fig) 12-9
 - determining in salmon 10-8
 - regulations supporting cutting fish for 11-14
- Sexual Harassment 18-7
- Sheet, Plastic Deck 2-6
- Shellfish Observer Program 1-6
- Shorthead rockfish
 - on longliners 7-27
- Shortspine Thornyhead 13-1
 - tallying on longliners 7-28
- Sightings
 - of marine mammals 12-10
 - of seabirds of interest 14-8
- Signing Statements 2-4
- Skandvaegt Platform Scales 2-18
- Skates
 - length weights for 11-1
 - tallying 7-26
- Spatial Frames
 - on longliners 7-19
 - on pot vessels 8-11
 - on trawl catchers 5-16
 - simple random on C/Ps 5-11
 - systematically sampling from
 - on C/Ps 5-12
 - on longliners 7-22
 - on pot vessels 8-13
- Special Projects
 - plant observers 9-12
- Species
 - selection for length and otolith samples 11-3
- Species Codes
 - for fish and invertebrates A-1
 - for marine mammals C-13, G-20
 - for seabirds B-11
- Species Composition 10-5
- Species Composition Samples
 - combined samples
 - on longliners 7-31
 - on pot vessels 8-16
 - on trawlers 5-24
 - on IFQ longliners 7-34
 - on longliners
 - guidelines for collecting 7-16
 - selecting hauls to sample for 7-16
 - tallying arrowtooth 7-27
 - tallying halibut 7-24
 - tallying Kamchatka 7-27
 - tallying predated items 7-25
 - tallying rocksoles 7-27
 - tallying rougheye 7-27
 - tallying rougheye rockfish 7-27
 - tallying sculpin 7-27
 - tallying seabirds 7-28
 - tallying shorthead 7-27

- tallying shortraker rockfish 7-27
- tallying similar species 7-28
- tallying skates 7-26
- weight samples 7-29
- weight subsamples 7-30
- on pot vessels 8-10
 - selecting hauls to sample for 8-9
- on trawlers
 - counting and weighing 5-22
 - decomposed, damaged fish 5-24
 - high diversity 5-18
 - miscellaneous species 5-24
 - processing 5-21
 - sampling entire catch 5-18
- presorted
 - on trawlers 5-21
 - recording data for 5-22
- salmon in 10-7
- seabirds in 14-4
- selecting hauls to sample 2-9
- Species Composition Sampling
 - on longliners 7-24
- Species Diversity
 - affects on sample size
 - on longliners 7-18
 - on trawlers 5-6
 - on trawlers
 - sampling when high 5-18
 - sampling when low 5-18
- Species Identification
 - on trawlers 5-21
 - subset sampling for 5-24
 - rules on longliners 7-26
- Species Identification Forms 2-6
- Species of Interest
 - albatross 14-2
 - description of 14-5
 - eiders 14-2
 - in samples 14-4
 - kittiwakes 14-3
 - murrelets 14-3
 - seabirds 14-1
 - see also Seabirds
 - sightings of 14-8
- Species Sampling
 - tallying
 - on longliners 7-24
- Species Subset Sampling
 - on trawlers 5-24
 - when to 2-16
- Specimens
 - collection on longliners 7-33
- Sperm Whale Predation
 - accounting for on longliners 7-25
- Standard Length
 - measuring for marine mammals 12-7
- Standards of Conduct 2-2
- Station Bill, Example of a (fig) 17-14
- Steps to Survival 17-15
- Stomach Sampling 15-2
 - collection procedure 15-2
 - project materials 15-1
- Stratification, Sample 15-4
- Stratification, Species Lengths for Use in Sample 15-6
- Stratified Lengths
 - definition of and code for 11-16
- Strings, Delineating on Pot Vessels 8-3
- Subsample
 - definition of
 - on longliners 7-17
 - on pot vessels 8-9
 - on trawlers 5-5
 - for lengths and otoliths 11-3
 - numbering system 7-37, 8-18, 8-20
 - on longliners 7-30
- Suit, Donning the Immersion 17-12
- Supporting the Observer Cutting Fish for Obtaining Sexed Lengths, Regulations 11-14
- Survival, The Seven Steps to 17-15
- Systematic Sample Frames
 - on longliners 7-22
 - on pot vessels 8-13
 - on trawl catchers 5-17
 - on trawler C/Ps 5-12
 - on trawlers 5-4

T

- Tag and Bag Procedures
 - dead seabirds 14-4
- Tagged

- fish and crab form 13-2
- marine mammals 12-10
- salmon 13-2
- Tally Period
 - counting hooks during 7-14
 - definition of 7-17
 - estimating halibut lengths 7-30
- Tally Sampling
 - on longliners 7-24
- Tally Station 7-16
- Tallying
 - arrowtooth on longliners 7-27
 - catch on pot vessels 8-15
 - drop-offs 7-24
 - Halibut 7-24
 - Kamchatka on longliners 7-27
 - predated items 7-25
 - predominant species sampling 7-24
 - rocksoles 7-27
 - rougheye rockfish 7-27
 - sculpin 7-27
 - seabirds 7-28
 - shortraker rockfish 7-27
 - similar species 7-28
 - skates 7-26
 - Tanner crab 7-27
- Tanner Crab
 - after-scale at plants and 9-4
 - tallying on longliners 7-27
- Teeth of Sea Lions, Canine
 - collecting (fig) 12-6
- Temporal Frames
 - on trawl catchers 5-17
 - simple random on C/Ps 5-11
 - systematic sampling on C/Ps 5-14
- Temporal-Spatial Frames
 - on longliners 7-20
 - on pot vessels 8-12
 - systematically sampling from 8-14
 - systematically sampling from 7-22
- Tender Vessels
 - deliveries from 9-8
- Terminology
 - for longliners 7-2
 - for pot vessels 8-2
 - for trawl vessels 5-2
- Theory, Random Sampling 2-12
- Time Lost at Sea
 - trip data and 3-6
- Time, Managing 2-2
- Time, Recording 2-6
- Time-Area Closures 1-4
- Tool
 - Observer Program Manual 1-1
- Training, Observer 1-6
- Trawl Catch
 - on motherships 6-2
- Trawl Vessels
 - bias
 - crew in bins 5-7
 - catchers
 - offload prohibited species weight and 4-13
 - combined samples 5-24
 - counting and weighing samples 5-22
 - description of 1-4
 - dumping catch 5-6
 - estimating discards and 4-11
 - halibut viability and 10-5
 - haphazard samples 5-8
 - incline belts 5-9
 - list of priorities 5-3
 - mechanical biasing mechanisms
 - conveyor belts 5-8
 - grates 5-7
 - inaccessible bins, etc. 5-8
 - incline belts 5-8
 - pumping fish 5-8
 - small openings 5-7
 - methods to avoid 5-9
 - non random samples 5-8
 - parent samples, definition of 5-5
 - preferred number of samples 5-5
 - presorted organisms 5-7
 - presorted samples
 - recording 5-21
 - random sampling on C/Ps 5-11
 - random sampling on catchers 5-16
 - recognizing bias 5-6
 - safety concerns 5-3
 - sample bias
 - minimizing 5-8
 - samples of convenience 5-8

- sample sizes
 - entire haul 5-18
- samples
 - decomposed, damaged fish in 5-24
 - miscellaneous items in 5-24
- samples vs. subsamples 5-5
- sampling
 - catch with high diversity 5-18
- simple random sampling on C/Ps 5-11
- spatial frames on catchers 5-16
- species subset samples 5-24
- systematic sampling from a temporal frame 5-14
- systematic sampling from spacial frames 5-12
- systematic sampling on C/Ps 5-12
- systematic sampling on trawl catchers 5-17
- temporal frames on catchers 5-17
- unsorted catch 5-6

Trip

- bait codes and 3-5
- crew size and 3-5
- definition of 3-4
- end date and 3-5
- end position and 3-5
- end time and 3-5
- port codes and 3-5
- start position and 3-5
- time lost at sea and 3-6
- trip data 3-4
 - form instructions 3-4

Tubs, Counting Hooks In 7-14

U

Uncooperative Crews

- on longliners 7-34

USCG

- Commercial Fishing Vessel Safety Examination Decal 3-1

Uses of Biological Data 11-1

Using the RST and RBT See Random Sample Table and Random Break Table

Using Your Scales 2-17

V

Verifying

- delivery weights at plants 9-3

- gear on longliners 7-13

- gear on pot vessels 8-7

- logbook information on trawler vessels 4-2

Versions of the Random Sample Table (RST) 2-9

Vessel Estimates

- on pot vessels 8-8

- on trawlers

- captain's 4-4

- recording on longliners 7-12

Vessel Haul Form

- completing on longliners 7-6, 7-9

Vessel Haul Form. See Forms

Vessel Logbook

- electronic in place of 4-2

- information for haul forms and 4-2

- pot vessels and 8-6

- trawlers and 4-1

Vessel Observers

- assisting at plant 9-4

Vessel Profiles 1-9

Vessel Requirements

- access to equipment and 3-6

- accommodations and 3-1

- sample station and 3-2

Vessel Survey 19-4

Vessel Type

- code for longliners 7-10

- codes for motherships 6-4

Vessel's E-mail System 1-10

Vessels

- description of

- longliners 1-4

- pot vessels 1-4

- trawlers 1-4

VHF

- completing on mothership 6-2

- completing on trawlers 4-14, 7-9

Viability, Halibut

- assessment on trawl and pot vessels 10-5

- on pot vessels 8-16

Volume

- formulas D-15

Volumetric Observer Estimates 4-6

W

Weighed Estimate

definition of 4-4

scales and 4-4

Weighing Fish

on trawlers 5-22

Weight

delivered, round (whole) 9-3

verifying delivery weight 9-3

Weight Samples

non predominant species

on longliners 7-29

on pot vessels 8-14

predominant species

on pot vessels 8-15

Weight Subsamples

on longliners 7-30

for halibut 7-30

Whale Predation

accounting for on longliners 7-25

Working

in factories 17-8

on decks 17-8

Y

Yellowfin

candling 11-14

collecting stomachs from 15-4

length and otolith collection priorities at plants

9-11