

# New and Innovative Advances in Biology/Engineering with Potential for Use in Aquaculture

*Proceedings of the Fourteenth  
U.S.-Japan Meeting on Aquaculture  
Woods Hole, Massachusetts  
October 16-17, 1985*

Albert K. Sparks (editor)

---

## NOAA TECHNICAL REPORT NMFS

The major responsibilities of the National Marine Fisheries Service (NMFS) are to monitor and assess the abundance and geographic distribution of fishery resources, to understand and predict fluctuations in the quantity and distribution of these resources, and to establish levels for their optimum use. NMFS is also charged with the development and implementation of policies for managing national fishing grounds, development and enforcement of domestic fisheries regulations, surveillance of foreign fishing off United States coastal waters, and the development and enforcement of international fishery agreements and policies. NMFS also assists the fishing industry through marketing service and economic analysis programs, and mortgage insurance and vessel construction subsidies. It collects, analyzes, and publishes statistics on various phases of the industry.

The NOAA Technical Report NMFS series was established in 1983 to replace two subcategories of the Technical Reports series: "Special Scientific Report—Fisheries" and "Circular." The series contains the following types of reports: Scientific investigations that document long-term continuing programs of NMFS; intensive scientific reports on studies of restricted scope; papers on applied fishery problems; technical reports of general interest intended to aid conservation and management; reports that review in considerable detail and at a high technical level certain broad areas of research; and technical papers originating in economics studies and from management investigations. Since this is a formal series, all submitted papers receive peer review and those accepted receive professional editing before publication.

Copies of NOAA Technical Reports NMFS are available free in limited numbers to governmental agencies, both Federal and State. They are also available in exchange for other scientific and technical publications in the marine sciences. Individual copies may be obtained from: U.S. Department of Commerce, National Technical Information Service, 5285 Port Royal Road, Springfield, VA 22161. Although the contents have not been copyrighted and may be reprinted entirely, reference to source is appreciated.

34. Additions to a revision of the shark genus *Carcharhinus*: Synonymy of *Aprionodon* and *Hypoprion*, and description of a new species of *Carcharhinus* (Carcharhinidae), by J. A. F. Garrick. November 1985, 26 p.
35. Synoptic review of the literature on the Southern oyster drill *Thais haemastoma floridana*, by Philip A. Butler. November 1985, 9 p.
36. An egg production method for estimating spawning biomass of pelagic fish: Application to the northern anchovy, *Engraulis mordax*, by Reuben Lasker (editor). December 1985, 99 p.
37. A histopathologic evaluation of gross lesions excised from commercially important North Atlantic marine fishes, by Robert A. Murchelano, Linda Despres-Patanjo, and John Ziskowski. March 1986, 14 p.
38. Fishery atlas of the northwestern Hawaiian Islands, by Richard N. Uchida and James H. Uchiyama (editors). September 1986, 142 p.
39. Survey of fish protective facilities at water withdrawal sites on the Snake and Columbia Rivers, by George A. Swan, Tommy G. Withrow, and Donn L. Park. April 1986, 34 p.
40. Potential impact of ocean thermal energy conversion (OTEC) on fisheries, by Edward P. Myers, Donald E. Hoss, Walter M. Matsumoto, David S. Peters, Michael P. Seki, Richard N. Uchida, John D. Ditmars, and Robert A. Paddock. June 1986, 33 p.
41. A stationary visual census technique for quantitatively assessing community structure of coral reef fishes, by James A. Bohnsack and Scott P. Bannerot. July 1986, 15 p.
42. Effects of temperature on the biology of the northern shrimp, *Pandalus borealis*, in the Gulf of Maine, by Spencer Apollonio, David K. Stevenson, and Earl E. Dunton, Jr. September 1986, 22 p.
43. Environment and resources of seamounts in the North Pacific, by Richard N. Uchida, Sigeiti Hayasi, and George W. Boehlert (editors). September 1986, 105 p.
44. Synopsis of biological data on the porgies, *Calamus arctifrons* and *C. proridens* (Pisces: Sparidae), by George H. Darcy. September 1986, 19 p.
45. Meristic variation in *Sebastes* (Scorpaenidae), with an analysis of character association and bilateral pattern and their significance in species separation, by Lo-chai Chen. September 1986, 17 p.
46. Distribution and relative abundance of pelagic nonsalmonid nekton off Oregon and Washington 1979-84, by Richard D. Brodeur and William G. Pearcy. December 1986, 85 p.
47. Reproduction, maturation, and seed production of cultured species: Proceedings of the twelfth U.S.-Japan meeting on aquaculture, Baton Rouge, Louisiana, October 25-29, 1983, by Carl J. Sindermann (editor). February 1987, 73 p.
48. Widow rockfish: Proceedings of a workshop, Tiburon, California, December 11-12, 1980, by William H. Lenarz and Donald R. Gunderson (editors). January 1987, 57 p.
49. Reproduction, movements, and population dynamics of the southern kingfish, *Menticirrhus americanus*, in the northwestern Gulf of Mexico, by Stephen M. Harding and Mark E. Chittenden, Jr. March 1987, 21 p.
50. Preparation of acetate peels of valves from the ocean quahog, *Arctica islandica*, for age determinations, by John W. Ropes. March 1987, 5 p.
51. Status, biology, and ecology of fur seals. Proceedings of an international workshop, Cambridge, England, 23-27 April 1984, by John P. Croxall and Roger L. Gentry (editors). June 1987, 212 p.
52. Limited access alternatives for the Pacific groundfish fishery, by Daniel D. Huppert (editor). May 1987, 45 p.
53. Ecology of east Florida sea turtles: Proceedings of the Cape Canaveral, Florida, sea turtle workshop, Miami, Florida, February 26-27, 1985, by Wayne N. Witzell (convener and editor). May 1987, 80 p.
54. Proximate and fatty acid composition of 40 southeastern U.S. finfish species, by Janet A. Gooch, Malcolm B. Hale, Thomas Brown, Jr., James C. Bonnet, Cheryl G. Brand, and Lloyd W. Reiger. June 1987, 23 p.
55. Proximate composition, energy, fatty acid, sodium, and cholesterol content of finfish, shellfish, and their products, by Judith Krzynowek and Jenny Murphy. July 1987, 53 p.
56. Some aspects of the ecology of the leatherback turtle *Dermochelys coriacea* at Laguna Jolova, Costa Rica, by Harold F. Hirth and Larry H. Ogren. July 1987, 14 p.
57. Food habits and dietary variability of pelagic nekton off Oregon and Washington, 1979-1984, by Richard D. Brodeur, Harriet V. Lorz, and William G. Pearcy. July 1987, 32 p.
58. Stock assessment of the Gulf of Menhaden, *Brevoortia patronus*, fishery, by Douglas S. Vaughan. September 1987, 18 p.
59. Atlantic Menhaden, *Brevoortia tyrannus*, purse seine fishery, 1972-84, with a brief discussion of age and size composition of the landings, by Joseph W. Smith, William R. Nicholson, Douglas S. Vaughan, Donnie L. Dudley, and Ethel A. Hall. September 1987, 23 p.
60. Gulf Menhaden, *Brevoortia patronus*, purse seine fishery, 1974-85, with a brief discussion of age and size composition of the landings, by Joseph W. Smith, Eldon J. Levi, Douglas S. Vaughan, and Ethen A. Hall. December 1987, 8 p.
61. Manual for starch gel electrophoresis: A method for the detection of genetic variation, by Paul B. Aebersold, Gary A. Winans, David J. Teel, George B. Milner, and Fred M. Utter. December 1987, 19 p.
62. Fishery publication index, 1980-85; Technical memorandum index, 1972-85, by Cynthia S. Martin, Shelley E. Arenas, Jacki A. Guffey, and Joni M. Packard. December 1987, 149 p.
63. Stock assessment of the Atlantic Menhaden, *Brevoortia tyrannus*, fishery, by Douglas S. Vaughan and Joseph W. Smith. January 1988, 18 p.
64. Illustrated key to penaeoid shrimps of commerce in the Americas, by Isabel Perez Farfante. April 1988, 32 p.
65. History of whaling in and near North Carolina, by Randall R. Reeves and Edward Mitchell. March 1988, 28 p.
66. Atlas and zoogeography of common fishes in the Bering Sea and Northeastern Pacific, by M. James Allen and Gary B. Smith. April 1988, 151 p.

NOAA Technical Report NMFS 70

# New and Innovative Advances in Biology/Engineering with Potential for Use in Aquaculture

*Proceedings of the Fourteenth  
U.S.-Japan Meeting on Aquaculture,  
Woods Hole, Massachusetts  
October 16-17, 1985*

Albert K. Sparks (editor)

*Panel Chairmen:*  
Conrad Mahnken, United States  
Shigekatu Sato, Japan

*Under the U.S.-Japan Cooperative Program  
in Natural Resources (UJNR)*

November 1988



U.S. DEPARTMENT OF COMMERCE

C. William Verity, Jr., Secretary

National Oceanic and Atmospheric Administration

William E. Evans, Under Secretary for Oceans and Atmosphere

National Marine Fisheries Service

James Brennan, Assistant Administrator for Fisheries

## PREFACE

---

The United States and Japanese counterpart panels on aquaculture were formed in 1969 under the United States-Japan Cooperative Program in Natural Resources (UJNR). The panels currently include specialists drawn from the federal departments most concerned with aquaculture. Charged with exploring and developing bilateral cooperation, the panels have focused their efforts on exchanging information related to aquaculture which could be of benefit to both countries.

The UJNR was begun during the Third Cabinet-Level Meeting of the Joint United States-Japan Committee on Trade and Economic Affairs in January 1964. In addition to aquaculture, current subjects in the program include desalination of seawater, toxic microorganisms, air pollution, energy, forage crops, national park management, mycoplasmosis, wind and seismic effects, protein resources, forestry, and several joint panels and committees in marine resources research, development, and utilization.

Accomplishments include: Increased communication and cooperation among technical specialists; exchanges of information, data, and research findings; annual meetings of the panels, a policy-coordinative body; administrative staff meetings; exchanges of equipment, materials, and samples; several major technical conferences; and beneficial effects on international relations.

Conrad Mahnken - United States  
Shigekatu Sato - Japan

The National Marine Fisheries Service (NMFS) does not approve, recommend or endorse any proprietary product or proprietary material mentioned in this publication. No reference shall be made to NMFS, or to this publication furnished by NMFS, in any advertising or sales promotion which would indicate or imply that NMFS approves, recommends or endorses any proprietary product or proprietary material mentioned herein, or which has as its purpose an intent to cause directly or indirectly the advertised product to be used or purchased because of this NMFS publication.

# CONTENTS

---

**Kawauchi, Hiroshi, and Syunsuke Moriyama**

Chum salmon growth hormone: Isolation and effects on growth of juvenile rainbow trout 1

**Itoh, Seiga, Susumu Sekine, and Hiroshi Kawauchi**

Cloning and expression of cDNA for salmon growth hormone in *Escherichia coli* 7

**Chen, Thomas, T., Rebecca J. Van Beneden, Luis B. Agellon, Duane A. Howard, and Ronald A. Sonstegard**

Molecular toxicology: A new frontier 9

**Teshima, Shin-ichi, and Akio Kanazawa**

Necessity of dietary sterols and phospholipids for growth of the prawn, *Penaeus japonicus* Bate 15

**Dickhoff, Walton W.**

Applications of endocrinology to salmon culture: Hormonal induction of spawning of adults and hormone patterns during development of juveniles 21

**Kito, Hitoshi**

Isolation and development of protoplast in *Porphyra* 23

**Cheney, Donald P.**

Genetic engineering and biotechnology of economically important seaweeds 27

**Takahashi, Kanji, and Akimitsu Koganezawa**

Mass culture of *Ulveella lens* as a feed for abalone, *Haliotis discus hannai* 29

**Weiner, Ronald M., Levent Dagasan, Michael P. Labare, Rita R. Colwell, Dale B. Bonar, and Steven L. Coon**

Bacterial products and polysaccharide films as cues and enhancers of oyster set 37

**Laufer, Hans, David Borst, Fred C. Baker, and David A. Schooley**

Juvenile hormone in crustacea 39

**Manzi, John J., and Nancy H. Hadley**

Recent advances in nursery culture of bivalve mollusks in North America 41

**Saga, Naotsune, and Yoshiaki Sanbonsuga**

Tissue culture and genetic engineering for seaweed aquaculture 47

**Ellis, Lehman L.**

Preliminary investigations on cryopreservation of marine bivalve gametes and larvae 55

**Kanazawa, Akio, and Shin-ichi Teshima**

Microparticulate diets for fish larvae 57

**Ito, Hiroshi**

Sowing culture of scallop in Japan 63



---

# Chum salmon growth hormone: Isolation and effects on growth of juvenile rainbow trout

HIROSHI KAWAUCHI  
SYUNSUKE MORIYAMA

Laboratory of Molecular Endocrinology  
School of Fisheries Sciences  
Kitasato University  
Sanriku-cho Kesen-gun  
Iwate Prefecture, 022-01 Japan

## ABSTRACT

Two molecular forms of salmon growth hormone, GH I and II, have been isolated from the pituitary glands of the chum salmon, *Oncorhynchus keta*. A two-step procedure was employed for extraction of the salmon GHs under an alkaline (pH 9-10) condition, subsequent to acid acetone extraction. The GHs were then purified by isoelectric precipitation at pH 5.6, gel filtration on Sephadex G 100, and high-performance liquid chromatography on ODS. A molecular weight of 22,000 was estimated for both forms of salmon GH by gel electrophoresis in sodium dodecyl sulfate. Isoelectric points, by gel electrofocusing, of 5.6 and 6.0 were estimated for salmon GH I and II, respectively, with differences present in the amino acid composition and the N-terminal residue, suggesting that they may be genetic variants coded on two separate genes. The partial amino acid sequence of salmon GH I at both terminal regions has been determined.

Intraperitoneal injection of salmon GH I at doses of 0.01  $\mu\text{g}$  and 0.1  $\mu\text{g}/\text{g}$  body weight resulted in a significant increase in body weight and length of juvenile rainbow trout. The growth-promoting effect lasted longer even after cessation of GH treatment. The long-lasting effect of GH treatment was also induced by a single injection at higher doses of 5 to 50  $\mu\text{g}/\text{fish}$  (30 g body weight).

Growth hormone (GH) stimulates animal growth throughout the vertebrates. In view of the potential applications in fish culture, interest is increasing in the study of fish pituitary hormone in general, and the growth hormone in particular. However, until recently chemical knowledge of GH has been mainly confined to mammals, although many attempts have been made to purify these hormones in lower vertebrates such as shark (Lewis et al. 1972), tilapia (Farmer et al. 1976), salmon (Higgs et al. 1978; Komourdjian and Idler 1979, Wagner et al. 1985), sturgeon (Farmer et al. 1981), and carp (Cook et al. 1983). Our recent studies on the isolation and characterization of chum salmon GH (Kawauchi et al. 1986a) and the gene cloning (Sekine et al. 1985) will promote a better understanding of fish physiology and application to fish culture.

The present paper describes isolation and characterization of two genetic variants of chum salmon GHs (I and II) and examines effects of salmon GH on growth of juvenile rainbow trout.

---

## Materials and methods

### Materials

Mature female chum salmon, *Oncorhynchus keta*, 3 to 5 years old were caught by a fishweir 300 m from the mouth of the Tsugaruishi River in Iwate Prefecture, Japan, and kept in a live well overnight. Whole brain and pituitary were dissected from the side of the pharynx using a cylindrical borer (2.5 cm in diameter, 20 cm in length) made of stainless steel within 20 min after transfer from the live well. Pituitary glands were frozen immediately in liquid nitrogen and maintained until use. *Escherichia coli*-sGH has been expressed by the cDNA encoding salmon GH in *E. coli* (Sekine et al. 1985).

### Isolation

The pituitary glands (50 g) were initially extracted with acid-acetone as described for sPRL (Kawauchi et al. 1983a). The residue of the acid acetone extract was re-extracted with 250 mL of water adjusted to pH 9-10 with  $\text{Ca}(\text{OH})_2$  at 4°C for 1 h. The supernatant was adjusted to pH 5.6 with 0.1 N HCl, and the resulting precipitate redissolved in 200 mL of water at pH 9.0, followed by reprecipitation at pH 5.6. The precipitate was dissolved in 30 mL of 0.05 M ammonium acetate, pH 10, and the supernatant subjected to gel filtration on a Sephadex G-100 (5  $\times$  70 cm) column, equilibrated with the same buffer. Growth-promoting activity of the putative GH fraction was examined using juvenile rainbow trout as described below. The biologically active fraction was dissolved in 0.1% trifluoroacetic acid containing urea (about 1 M) and subjected to high-performance liquid chromatography on a reverse phase (TSK-Gel ODS-120T, 5  $\mu\text{m}$ ) column (0.4  $\times$  25 cm), at a column temperature of 40°C and a flow rate of 1 mL/min. Linear gradient elution was performed with acetonitrile containing 0.1% trifluoroacetic acid. The eluate was monitored by measuring the absorbance at 220 nm, and each GH peak was collected in one tube.

### Chemical and physicochemical characterization

The purified GHs were examined by slab gel electrophoresis at pH 4.3 in 7.4% polyacrylamide gel, and by gel electrofocusing in 5%

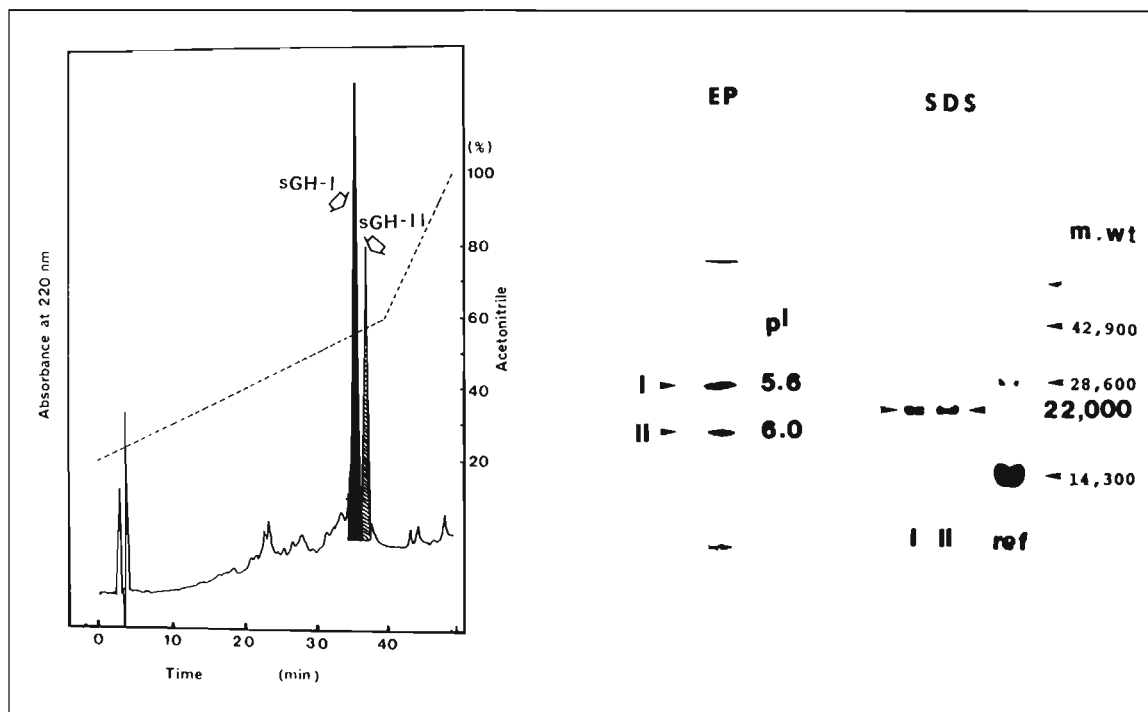

**Figure 1**

**HPLC:** High-performance liquid chromatography of fraction 2 on TSK gel ODS-120T column (0.4×25 cm, 5 $\mu$ m). The fraction was dissolved in 1 M urea containing 0.1% trifluoroacetic acid. Elution was performed by a linear gradient of acetonitrile containing 0.1% trifluoroacetic acid. The flow rate was 1 mL/min. Two molecular forms were designated as salmon GH I and II according to the order of elution. **EP:** Gel isoelectric focusing patterns of salmon GH I and II. **SDS:** SDS-gel electrophoresis patterns of salmon GH I and II.

polyacrylamide gel at 2% ampholine (pH 3.7-10). The molecular weight was estimated by sodium dodecyl sulfate (SDS) slab gel electrophoresis.

For amino acid analysis, the proteins were hydrolyzed for 22 h at 110°C with constant boiling HCl. The analysis was carried out in an LKB automated amino acid analyzer (Type 4400). N-terminal analysis was performed by the DNS method (Gray 1967).

Cyanogen bromide cleavage of salmon GH I was performed in 70% formic acid, followed by performic acid oxidation. The resulting fragment peptides were subjected to HPLC on a TSK-Gel ODS-120T column using a linear gradient with 0.1% trifluoroacetic acid and acetonitrile.

Automatic microsequencing was performed with a gas-liquid sequencer (Applied Biosystems, model 470A) (Hewick et al. 1981). Identification of phenylthiohydantoin amino acid was carried out by HPLC (Spectro Physics, SP8100 system) on a C8 reverse phase column (Senshu Kagaku SEQ-4, 7  $\mu$ , 0.46 × 30 cm) using a gradient elution with 40 mM sodium acetate (pH 4.9) and acetonitrile.

### Growth-promoting activity

Growth-promoting activity of the purified salmon GH I and *E. coli*-sGH was examined using juvenile rainbow trout, *Salmo gairdneri*. All animals were maintained in running water under a natural photoperiod from August to December. The water temperature varied between 13 and 15°C during the period of treatment, and gradually decreased to 4°C by the end of December. The hormones were dissolved in a small volume of 1 M urea and then diluted in saline (0.9% NaCl), or in a minimum volume of water at pH 10 and then diluted in saline containing 1% bovine serum albumin, and injected intraperitoneally at 4-day or 1-week intervals, or only

once. Doses of the hormones were 0.01 and 0.1  $\mu$ g/g body weight in repeated injections and 5, 10, and 50  $\mu$ g/fish of ~30 g body weight in a single injection. Fish were fed to satiation with a commercially prepared diet (Masu No. 4P, Nihonhaigo Shiryo Co.) twice daily. Growth-promoting activity was evaluated by body-length increase and weight gain.

## Results

### Isolation of two salmon GHs

Chum salmon GH was extracted from the residue of the acid acetone extract of the pituitary glands at pH 9, and purified by repeating the isoelectric precipitation at pH 5.6. The wet precipitate was immediately dissolved in 0.05 M ammonium acetate, pH 9.0, and subjected to gel filtration on Sephadex G 100. The salmon GH fraction produced a single band on SDS and polyacrylamide gel electrophoresis at pH 4.3, but produced two bands in gel electrophoresis (pH 3.5-10). These two components were separated by HPLC on an ODS column and designated as salmon GH I and II, according to the order of elution (Fig. 1).

### Chemical and physicochemical properties

Salmon GHs were hardly soluble in an aqueous buffer. The isoelectric points of salmon GH I and II were estimated to be 5.6 and 6.0, respectively, by gel electrofocusing. Both salmon GH I and II exhibited an identical molecular weight of 22,000 daltons, estimated by SDS gel electrophoresis (Fig. 1). However, they differed in amino acid compositions as presented in Table 1, suggesting that



**Table 1**  
Amino acid compositions of salmon growth hormones.

Amino acid	sGH I	sGH II	cDNA‡	Human GH‡‡
Asp	28.0	25.1	28	20
Thr	6.8	5.7	7	10
Ser	11.7	10.1	17	18
Glu	22.5	25.6	20	27
Pro	3.7	3.9	5	8
Gly	7.3	9.3	8	8
Ala	6.6	5.0	6	7
Cys#	3.3	3.4	4	4
Val	10.7	9.6	10	7
Met	2.7	4.0	3	3
Ile	10.6	10.3	12	8
Leu	28.5	28.3	28	26
Tyr	6.8	5.5	8	8
Phe	6.8	6.7	7	13
Trp##	1.0	1.0	1	1
His	4.2	4.3	3	3
Lys	12.6	14.7	12	9
Arg	8.6	8.5	9	11
Total	182.3	181.0	188	191
N-terminus	Ile	ND	Ile	Phe

‡Based on the nucleotide sequence of the cDNA cloned sGHmRNA (Sekine et al. 1985).

‡‡Taken from Martial et al. 1979.

#Determined after performic acid oxidation.

##Detected by UV absorption.

ND Not detected by the dansyl method.

they are not electroisomers generated by deamidation. The total number of basic and acidic amino acids is comparable with that of human GH. A relatively high value of Val and Ile, and a low value of Phe, may be characteristic of salmon GHs.

### Partial amino acid sequence of salmon GH I

Isoleucine was identified as a sole amino-terminal residue of salmon GH I, but no N-terminal amino acid was found for salmon GH II by the dansyl method. The amino acid sequence of the N-terminal 33 residues of salmon GH I was identified, by an automatic microsequencer with 40 µg of salmon GH I, as follows: H-Ile-Glu-Asn-Glu-Arg-Leu-Phe-Asn-Ile-Ala-Val-Ser-Arg-Val-Gln-His-Leu-His-Leu-Leu-Ala-Gln-Lys-Met-Phe-Asn-Asp-Phe-Asp-Gly-Thr-Leu-Leu-. Cyanogen bromide cleavage followed by performic acid oxidation after fractionation by HPLC resulted in three fractions from salmon GH I.

The first fraction gave a sole amino-terminal residue His. The sequence was determined as follows: H-His-Lys-Val-Gln-Thr-Tyr-Leu-Thr-Val-Ala-Lys-(Cys)-Arg-Lys-Ser-Leu-Glu-Ala-Asn-Cys-Thr-Leu-. The second fraction gave a sole N-terminal residue of Ile. The amino acid composition is consistent with that of GH (1-24). The third fraction gave three amino-terminal residues, Ile, Phe and Val, suggesting contamination of three fragment peptides.

### Biological activity

The effects of salmon GH I on growth of intact juvenile rainbow trout are shown in Figure 2A. Animals received a total of seven

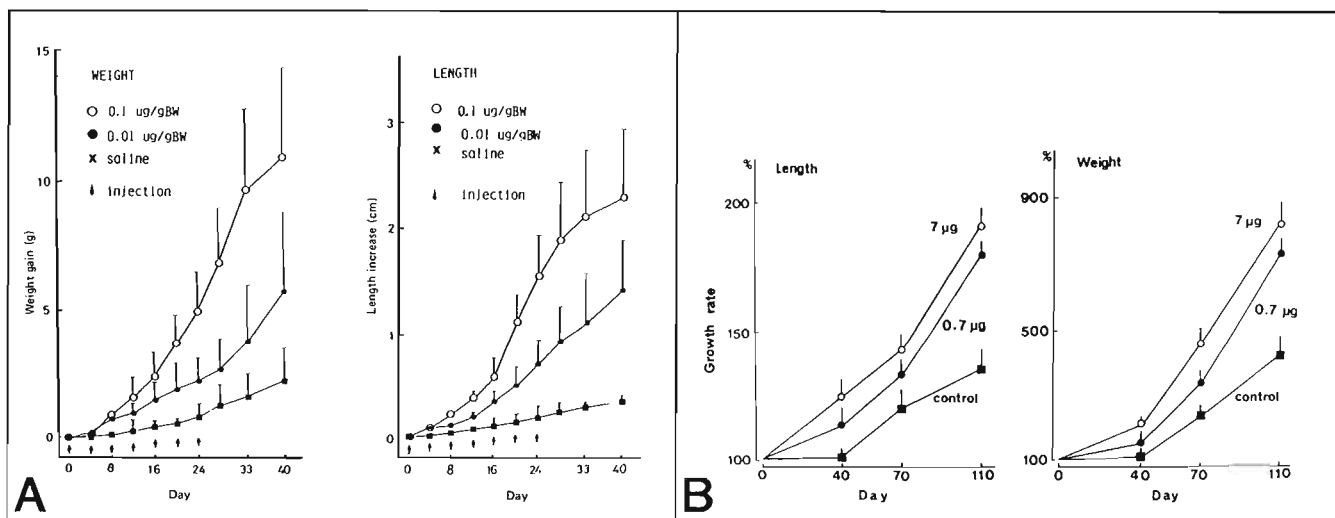

**Figure 2**

Effects of salmon GH I on growth of juvenile rainbow trout. (A) During treatment: Fish received a total of 7 intraperitoneal injections at a dose of either 0.01 µg or 0.1 µg/g body weight every 4 days. Initial body weight and fork length ( $\bar{x} \pm \text{SE}$ ,  $n=15$ ) for control group (■),  $9.70 \pm 1.33$  g and  $9.16 \pm 0.15$  cm; for 0.01 µg group (●),  $10.26 \pm 1.15$  g and  $9.06 \pm 0.63$  cm; for 0.1 µg group (○),  $10.86 \pm 1.93$  g and  $9.36 \pm 0.53$  cm, respectively. (B) After treatment: Growth of these groups was followed for 110 days. Vertical lines represent one standard error of mean. Arrows represent time of injection.

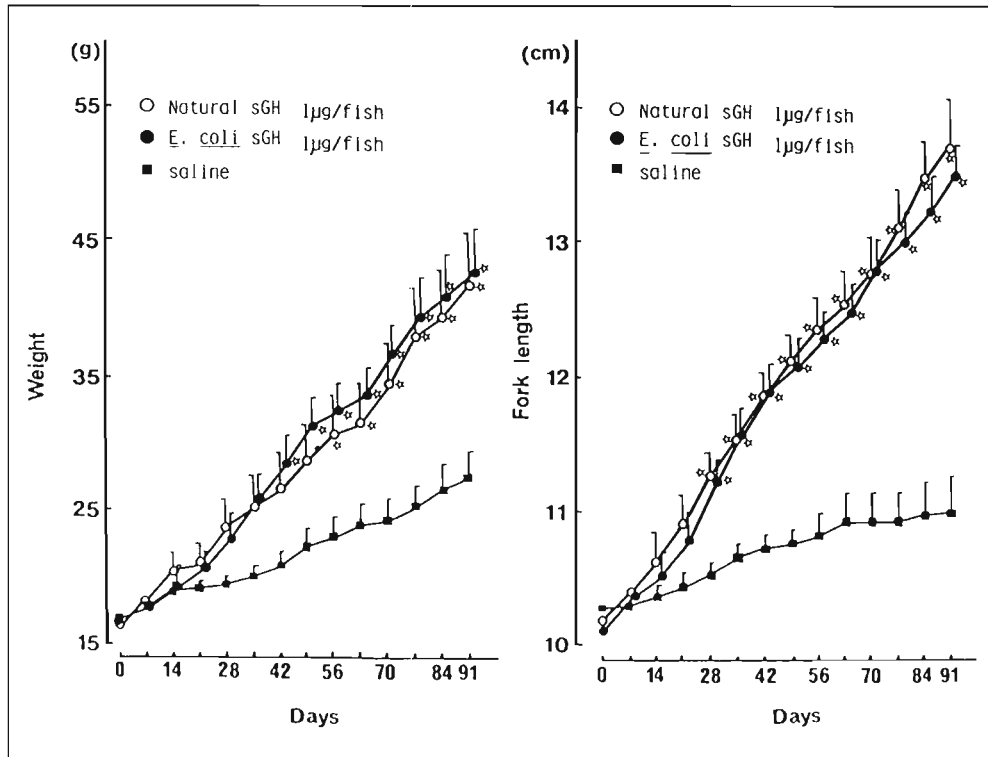

Figure 3

Effects of the natural salmon GHs and *E. coli*-sGH of growth of juvenile rainbow trout. Fish received intraperitoneal injections at a dose of 0.1  $\mu\text{g/g}$  body weight once a week. Saline group (■); natural salmon GHs (a mixture of I and II) group (○); and *E. coli* group (●). Vertical lines represent one standard error of mean. † Significantly different from saline-injected control at 0.05.

injections of either 0.01  $\mu\text{g}$  or 0.1  $\mu\text{g/g}$  body weight at 4-day intervals. Salmon GH-injected groups had greater increases in weight and length than the control group. Furthermore, there is a clear dose-response relationship in both weight gain and length increase. Figure 2B represents the growth after cessation of the treatment. The GH-treated groups maintained higher growth rate than the control group. The growth-promoting effects of *E. coli*-sGH and a combination of natural salmon GH I and II at a dose 0.1  $\mu\text{g/g}$  of body weight once a week are summarized in Figure 3. It is evident that both GHs are equipotent in growth-promoting activity over a 13-week period. Figure 4 shows the growth-promoting effect of a single injection of salmon GH. The single injection of doses of 5, 10, and 50  $\mu\text{g}$  salmon GH also significantly stimulated growth of juvenile rainbow trout (30 g), whereas they did not show any dose dependence.

## Discussion

Prolactin (Kawauchi et al. 1983a) together with proopiomelanocortin-related hormones (Kawauchi et al. 1980ab, Kawauchi 1983) and MCH (Kawauchi et al. 1983b) were successfully isolated from an acid acetone extract of chum salmon pituitaries. However, no presumptive GH fraction was found in the extract, suggesting that the salmon GH might not be extractable with acid acetone. In fact, an alkaline extraction procedure described for mammalian GH by Papkoff and Li (1958) has been exclusively employed for the isolation of fish GHs such as shark (Lewis et al. 1972), tilapia (Farmer et al. 1976), salmon (Higgs et al. 1978, Komourdjian and Idler 1979, Wagner et al. 1985), sturgeon (Farmer et al. 1981), and carp (Cook

et al. 1983). Nevertheless, alkaline extraction resulted in only limited success for the isolation of salmon GH. This may be due, in part, to contamination with gonadotropin (Higgs et al. 1978) which is the predominant component in the pituitary of the mature fish (Kawauchi et al. 1986b). Hence the residue of the acid acetone extract was subjected to re-extraction in alkaline pH. HPLC revealed that the major components in the alkaline extract were putative salmon GH and various glycoproteins, which were assigned as subunits of glycoprotein hormone. It was also confirmed that none of these glycoproteins in this alkaline extract exhibited gonadotropic activity in rainbow trout, but possessed potent antigenicity in rabbits. Thus the two-step extraction procedure adapted for isolation of salmon GH is superior to the direct extraction with alkaline pH in preventing contamination by biologically active hormones. An isoelectric fractionation procedure was employed to remove the glycoproteins. The preparation, however, still had two bands on gel electrofocusing. The two components, salmon GH I and II, could be separated by HPLC on a reverse phase column.

There was no apparent size heterogeneity between salmon GH I and II (Fig. 1). Although it appeared that they were electroisomers derived from deamidation, their amino acid composition and analyses of N-terminal residues strongly suggest that they are genetic variants. Indeed, it has been noted that the salmon pituitary gland characteristically secretes two isoforms of  $\alpha$ -,  $\beta$ -melanotropins andendorphins, and proposed that they may be derived from two distinct proopiomelanocortins, coded on two separate genes (Kawauchi 1983). This unusual multiplicity of molecular forms has also been found in salmon PRL preparations, which differ from each other by replacements of only 4 of 187 residues (Yasuda et al. 1986). The genetic variant forms observed in the chum salmon pituitary hor-

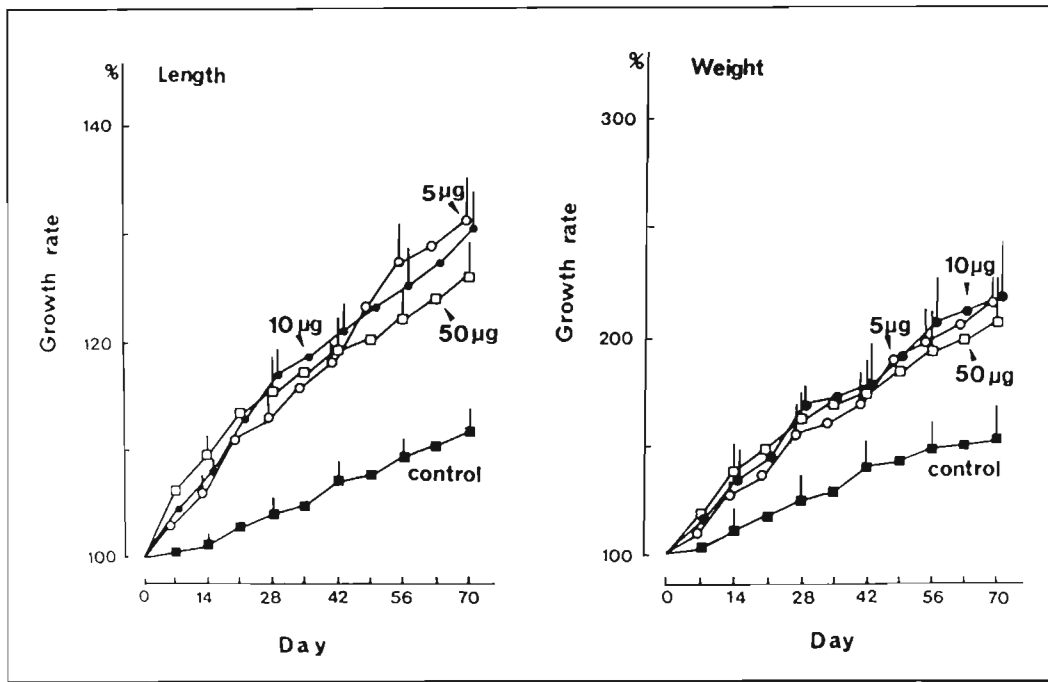

**Figure 4**

Effects of salmon GH (a mixture of I and II) on growth of juvenile rainbow trout. Fish ( $N=10$ ) received a single intraperitoneal injection at a dose of either 5  $\mu\text{g}$  or 10  $\mu\text{g}$ /g or 50  $\mu\text{g}$ /fish ( $\sim 30$  g). Control group ( $\blacksquare$ ); 5  $\mu\text{g}$  group ( $\circ$ ); 10  $\mu\text{g}$  group ( $\bullet$ ); 50  $\mu\text{g}$  group ( $\square$ ). Body weight and fork length were measured once a week. Vertical lines represent one standard error of mean.

mones may be accounted for by the tetraploid hypothesis of salmonidae (Allendorf and Thorgaard 1984).

cDNA of salmon GH has been cloned from a cDNA library prepared from chum salmon pituitary gland poly(A)<sup>+</sup>RNA with synthetic DNA probes corresponding to the residues 23-28 of salmon GH I. The sequence analysis of nucleotide of the cDNA revealed that the cDNA codes for a polypeptide of 210 amino acids (Sekine et al. 1985). The N-terminal 38 residues of salmon GH I and the C-terminal 22 residues are identical to the segments between 23 and 61 and between 182 and 210, respectively, in the predicted amino acid sequences. Thus, it is clear that a putative signal peptide of 22 amino acids is cleaved from a pre-salmon GH of 210 residues, to produce the 188-amino-acid salmon GH I. The amino acid composition of salmon GH I is consistent with the values based on the structure of 188 residues. Moreover, the recombinant salmon GH corresponding to the nucleotide sequence has been expressed in *E. coli*, and found to be identical to salmon GH I on HPLC.

The highly purified salmon GH, as well as *E. coli*-sGH, elicited profound growth-stimulating effects on juvenile rainbow trout at doses of 0.01 and 0.1  $\mu\text{g}$ /g body weight, the natural and the recombinant salmon GHs being equipotent. The effects of salmon GH were more marked on weight gain than on length increase, and similar effects of GH have been shown in the carp (Cook et al. 1983) and coho salmon (Higgs et al. 1976). Even after cessation of treatment, salmon GH-treated groups maintained higher growth rates than the control group (Fig. 2B). This long-lasting effect has also been observed by a single injection of salmon GH. It should also be noted that the growth rates during treatment were lower than post-treatment, particularly in the control group (Fig. 2B), which may be due to handling stress during injections and measurements of body weight and length under anesthesia. In fact, when fish received frequent injections at 2-day intervals, they lost weight and showed high mortality.

## Acknowledgments

We thank Mr. Yamaguchi and Tokyo Research Laboratories, Kyowa Hakkou Kogyo Co., for their assistance in the sequence determination. This work was supported in part by grants-in-aid for scientific research from the Japan Ministry of Education, Science and Culture, and from the Nihon Kagaku-Kenkyukai Foundation to H.K.

## Citations

- Allendorf, F.W., and G.H. Thorgaard.  
1984. Tetraploidy and the evolution of salmonid fishes. In Turner, B.J. (ed.), Evolutionary genetics of fishes, p. 1-53. Plenum, New York.
- Cook, A.N., A.W. Wilson, and R. Peter.  
1983. Development and validation of a salmon growth hormone radioimmunoassay. Gen. Comp. Endocrinol. 50:335-347.
- Farmer, S.W., H. Papkoff, T.A. Bewley, T. Hayashida, R.S. Nishioka, H.A. Bern, and C.H. Li.  
1976. Isolation and properties of teleostean growth hormone. Gen. Comp. Endocrinol. 30:91-100.
- Farmer, S.W., T. Hayashida, H. Papkoff, and A.L. Polenov.  
1981. Characteristics of growth hormone isolated from sturgeon (*Acipenser guldentadi*) pituitaries. Endocrinology 108:377-381.
- Gray, W.R.  
1967. Sequential degradation plus dansylation. In Hirs, C.H.W. (ed.), Methods in enzymology, Vol. 11, p. 469-475. Academic Press, New York.
- Hewick, R.M., M.W. Hunkapiller, L.E. Hood, and W.J. Dreyer.  
1981. A gas-liquid solid phase peptide and protein sequencer. J. Biol. Chem. 256:7990-7997.
- Higgs, D.A., E.M. Donaldson, H.M. Dye, and J.R. McBride.  
1976. Influence of bovine growth hormone and L-thyroxine on growth, muscle composition, and histochemical structure of the gonads, thyroid, pancreas, and pituitary of coho salmon (*Oncorhynchus kisutch*). J. Fish. Res. Board Can. 33:1585-1603.

- Higgs, D.A., E.M. Donaldson, J.R. McBride, and H.M. Dye.**  
 1978. Evaluation of the potential for using a chinook salmon (*Oncorhynchus tshawytscha*) pituitary extract versus bovine growth of coho salmon (*Oncorhynchus kisutch*). *Can. J. Zool.* 56:1226-1231.
- Kawauchi, H.**  
 1983. Chemistry of proopiocortin-related peptides in the salmon pituitary. *Arch. Biochem. Biophys.* 227:343-350.
- Kawauchi, H., M. Tsubokawa, A. Kanezawa, and H. Kitagawa.**  
 1980a. Occurrence of two different endorphins in the salmon pituitary glands. *Biochem. Biophys. Res. Commun.* 92:1278-1288.
- Kawauchi, H., Y. Adachi, and B. Ishizuka.**  
 1980b. Isolation of another  $\beta$ -melanocyte stimulating hormone in the salmon pituitary glands. *Int. J. Pept. Protein Res.* 16:79-82.
- Kawauchi, H., K. Abe, A. Takahashi, T. Hirano, S. Hasegawa, N. Naito, and Y. Nakai.**  
 1983a. Isolation and properties of chum salmon prolactin. *Gen. Comp. Endocrinol.* 49:446-458.
- Kawauchi, H., I. Kawazoe, M. Tsubokawa, M. Kishida, and B.I. Baker.**  
 1983b. Characterization of melanin-concentrating hormone in the chum salmon pituitaries. *Nature* 305:321-323.
- Kawauchi, H., S. Moriyama, A. Yasuda, K. Yamaguchi, K. Shirahata, J. Kubota, and T. Hirano.**  
 1986a. Isolation and characterization of chum salmon growth hormone. *Arch. Biochem. Biophys.* 244:542-552.
- Kawauchi, H., Suzuki, K., Y. Nagahama, S. Adachi, N. Naito, and Y. Nakai.**  
 1986b. Occurrence of two distinct gonadotropins in chum salmon pituitary. *In* Yoshimura, F., and A. Gorbman (eds.), *Pars Distalis of the pituitary gland*, p. 383-390. *Excerpta Medica, Amsterdam-New York-Oxford.*
- Komourdjian, M.P., and D.R. Idler.**  
 1979. Chum salmon pituitary fractions: Somatotropic activity and cytoimmuno-fluorescence studies. *Gen. Comp. Endocrinol.* 37:343-349.
- Lewis, U.J., R.N.P. Singh, B.K. Seavey, R. Lasker, and G.E. Pickford.**  
 1972. Growth hormone- and prolactin-like proteins of the blue shark (*Prionace glauca*). *Fish. Bull., U.S.* 70:933-939.
- Martial, J.A., R.A. Hallewell, J.D. Baxter, and H.M. Goodman.**  
 1979. Human growth hormone: Complementary DNA cloning and expression in bacteria. *Science (Wash., DC)* 205:602-607.
- Papkoff, H., and C.H. Li.**  
 1958. The isolation and characterization of growth hormone from anterior lobes of whale pituitaries. *J. Biol. Chem.* 231:367-377.
- Sekine, S., T. Mizukami, T. Nishi, Y. Kuwana, A. Saito, M. Sato, S. Itoh, and H. Kawauchi.**  
 1985. Cloning and expression of cDNA for salmon growth hormone in *Escherichia coli*. *Proc. Natl. Acad. Sci. (USA)* 82:4306-4310.
- Wagner, G.F., R.C. Fargher, J.C. Brown, and B.A. McKeown.**  
 1985. Further characterization of growth hormone from the chum salmon (*Oncorhynchus keta*). *Gen. Comp. Endocrinol.* 60:27-34.
- Yasuda, A., H. Itoh, and H. Kawauchi.**  
 1986. Primary structure of chum salmon prolactins: Occurrence of highly conserved regions. *Arch. Biochem. Biophys.* 244:528-541.

# Cloning and expression of cDNA for salmon growth hormone in *Escherichia coli*<sup>1</sup>

SEIGA ITOH  
SUSUMU SEKINE

Tokyo Research Laboratory  
Kyowa Hakko Kogyo Co., Ltd.  
3-6-6 Asahicho, Machidashi  
Tokyo, 194 Japan

HIROSHI KAWAUCHI

School of Fisheries Sciences  
Kitasato University  
Sanriku, Iwate 022-01, Japan

Human growth hormone (hGH) and other mammalian hormones (GHs) can now be produced by recombinant DNA technology, but there is no report on cloning and expression of salmon growth hormone (sGH). Massive supplies of sGH produced in *Escherichia coli* will provide new means to fish husbandry. Recently, sGH was purified from chum salmon (*Oncorhynchus keta*) pituitaries (Kawauchi et al. 1986). To clone sGH cDNA, total RNA was extracted from salmon pituitaries and purified by oligo(dT) cellulose column.

Using this poly(A)<sup>+</sup> RNA, a cDNA library was constructed by the Okayama and Berg (1983) method. Two types of DNA probes (A and B) were synthesized based on the partial amino acid sequence of sGH. First, probe A was used to screen this cDNA library and the candidate clones were also confirmed by hybridization with probe B. Finally, eight clones were found to hybridize with these two probes and possessed 1-1.3 kb cDNA insert.

One of the cDNA from the candidate clone was sequenced, and results showed that the deduced amino acid sequences (1-40 and 167-188) were completely identical with the partial amino acid sequence for sGH. This sequence predicts that sGH will be synthesized as a precursor consisting of 210 amino acids which includes 22 NH<sub>2</sub>-terminal amino acids as a signal peptide. Consequently, mature sGH consists of 188 amino acids, whereas hGH and bovine GH consist of 191 and 190 amino acids, respectively. To calculate amino acid homologies between sGH and hGH, the sequences are aligned by introducing arbitrary gaps to maximize their homologies. sGH has 35% amino acid and 50% nucleotide homology with hGH.

For the expression of mature sGH, a plasmid vector which contains tandem *trp* promoter and *lpp* terminator was chosen, because IFN- $\gamma$  was expressed in a large amount. Purified *Mbo* II-*Sal* I fragment and *Sal* I-*Bam* HI fragment from this cDNA were inserted into *trp*-vector together with a synthetic linker which contains initiation codon just in front of mature sGH. This approach allows direct expression of mature sGH in *E. coli*, and the product was checked by NaDodSO<sub>4</sub>/PAGE.

The amount of sGH synthesized in *E. coli* carrying psGHIB-2 and its improved vector was estimated to comprise about 15% and 25% of total cellular protein, respectively. In addition, inclusion bodies were observed in the *E. coli* cells containing psGHIB-2, and the particles were easily recovered and purified from sonicated cells by centrifugation. The particles collected by centrifugation were solubilized in 8M urea solution and renatured by dilution and dialysis as described by Marston et al. (1984) with a slight modification. The partially purified sGH sample was tested for its growth-promoting activity on rainbow trout. sGH was injected intraperitoneally into rainbow trout less than 1 year old (9-9.5 cm fork length and 10-12 g body weight), and weight and length were measured every week. The results clearly show that sGH synthesized in *E. coli* is equipotent to the natural sGH in promoting increases in weight and length of rainbow trout.

Since the cloning and expression of sGH has made possible the production of this hormone in large quantities, we would like to study the use of this hormone on a variety of fish. If sGH is effective on many fish by a practical method such as dipping or feeding, this hormone may have great potential value in fish culture.

<sup>1</sup>The complete paper has been published in Proc. Natl. Acad. Sci. U.S.A. 82:4306-4310 (July 1985).

## Citations

---

**Kawauchi, H., S. Moriyama, A. Yasuda, K. Yamaguchi, K. Shirahata, J. Kubota, and T. Hirano.**

1986. Isolation and characterization of chum salmon growth hormone. Arch. Biochem. Biophys. 244:542-552.

**Marston, F.A.O., P.A. Lowe, M.T. Doel, J.M. Schoemaker, S. White, and S. Angal.**

1984. Purification of calf prochymosin (prorennin) synthesized in *Escherichia coli*. Bio-Technology (N.Y.) 2:800-804.

**Okayama, H., and P. Berg.**

1983. A cDNA cloning vector that permits expression of cDNA inserts in mammalian cells. Mol. Cell. Biol. 3:280-289.

# Molecular toxicology: A new frontier

THOMAS T. CHEN

Center of Marine Biotechnology  
University of Maryland  
600 E. Lombard Street  
Baltimore, Maryland 21202

REBECCA J. VAN BENEDE<sup>1</sup>

Chesapeake Bay Institute  
The Johns Hopkins University  
Baltimore, Maryland 21218

LUIS B. AGELLON<sup>2</sup>

Department of Biology  
The Johns Hopkins University  
Baltimore, Maryland 21218

DUANE A. HOWARD<sup>3</sup>

RONALD A. SONSTEGARD<sup>4</sup>  
Department of Biology  
McMaster University  
Hamilton, Ontario L8S 4K1 Canada

## ABSTRACT

We are investigating sensitive biochemical and molecular biological parameters for assessing pathobiological effects of chemical toxicants to fish at sublethal levels in the aquatic environment. In rainbow trout, the production of vitellogenin (VG) in the liver can be induced by treatment of fish with 17 $\beta$ -estradiol. The levels of VG in sera of induced fish can be measured quantitatively by rocket immunoelectrophoresis. In a series of feeding experiments, it was found that Aroclor and/or Mirex suppressed the production of VG induced by 17 $\beta$ -estradiol. These results suggest that the production of VG induced by estradiol can be used as a biochemical parameter for evaluating the effects of halogenated hydrocarbons on fish reproduction at sublethal levels. Via molecular cloning, complementary DNA (cDNA) genes to VG and other estrogen-responsive mRNA have been prepared. These cDNA genes have been used as probes in a quantitative dot blot hybridization analysis to monitor the expression of estrogen-responsive genes *in vivo* and *in vitro* in response to the stimulation by 17 $\beta$ -estradiol. By employing the quantitative immunochemical and molecular hybridization assays, we are studying the effects of halogenated hydrocarbons on fish reproduction at sublethal levels.

The genetic element responsible for the oncogenic activity of avian myelocytomatosis virus (MC29) has been determined to be the *v-myc* gene. Genomic DNA of chicken, human and mouse are found to contain sequences homologous to *v-myc*, and are termed *c-myc*. Using *v-myc* and chicken *c-myc* as probes, *c-myc* gene sequence has also been isolated from a rainbow trout gene bank. The gene was characterized by restriction enzyme analysis and DNA sequence determination. This is the first *c-myc* gene identified from a lower vertebrate. Using rainbow trout *c-myc* as a probe, we have screened northern pike lymphosarcoma DNA for amplification or rearrangement of *c-myc* gene. Differences were detected on Southern blots between endonuclease restriction patterns of DNA of normal and lymphosarcoma tissues. These results suggest that lymphosarcoma in northern pike may involve rearrangement of *c-myc* gene. Work is underway to develop *in vitro* systems for assessing effects of chemical pollutants on oncogene activation in the aquatic environment.

The widespread use of polyhalogenated and/or polynuclear aromatic hydrocarbons and other organic compounds for various industrial purposes in recent years has resulted in serious accumulation of these compounds or their metabolites in aquatic ecosystems. There are numerous reports documenting detrimental effects caused by these compounds on humans, birds, and fish (for review see Safe 1984). In humans, for instance, polychlorinated biphenyls (PCB's) can cause nausea, anorexia, dermal cysts, comedos, and a vast array of other symptoms (Safe 1984). Recent reports by Hickey and Anderson (1968), Peakall (1975), and Eroschenko and Wilson (1975) have shown independently that birds eating fish with high accumulated levels of halogenated hydrocarbons produced eggs with unusually thin shells, suggesting possible dysfunction in calcium homeostasis. These eggs also resulted in low hatch. Furthermore, there are positive correlations between levels of halogenated hydrocarbon contamination in fish and reproductive dysfunction (Wasserman et al. 1979). Unfortunately, the biochemical mechanisms of the toxic effects of these compounds in fish reproduction await elucidation.

Large populations of fish in the Great Lakes bear a wide range of tumors, such as papilloma in white sucker (near 50%), thyroid hyperplasia in coho salmon (about 80% in Lake Ontario), lymphosarcoma in northern pike or muskellunge (about 20%), and hepatoma in rainbow trout (Sonstegard 1977). In recent years there has been increasing concern about the effects on oncogenesis in fish from nonvolatile halogenated hydrocarbons and other organo-pollutants in the aquatic environment and the potential health effects to humans from consuming fish living in such an environment. Therefore, molecular biological and biochemical studies should be conducted to investigate the cause of neoplasia formation in fish. In addition, it is also essential to devise a reliable system for the assessment of potential carcinogenic effects of chemical pollutants in the aquatic environment.

Although there are methods available for detecting the presence of polyhalogenated and/or polynuclear aromatic hydrocarbons in the aquatic environment, these methods are unsuitable for assessing the earliest biological effects caused by these chemical pollutants at sublethal levels. There is an urgent need to establish rapid, reliable, and sensitive bioassays for detecting the adverse effects of these organic pollutants in our aquatic environment at these levels. Such methods are essential in generating needed information for assessment and management of polluted lakes and rivers because the effects to humans from consumption of contaminated fish (especially by pregnant women and young children) have yet to be determined.

Our laboratory is addressing a number of these issues using rainbow trout as a model fish species. In this paper we shall discuss some examples to illustrate our approaches.

## Vitellogenin

The egg-yolk precursor protein, vitellogenin (VG), in all oviparous vertebrates is synthesized in the liver under the control of estrogen.

### Current addresses:

<sup>1</sup>Duke University Marine Lab., Beaufort, NC 28516.

<sup>2</sup>College of Physicians and Surgeons, Columbia University, New York, NY 10032.

<sup>3</sup>Schering Canada, 3535 Trans-Canada Hwy, Pointe Claire, Quebec H9R 1B4, Canada.

<sup>4</sup>Department of Comparative Medicine, School of Veterinary Medicine, Tufts University, Grafton, MA 01536.

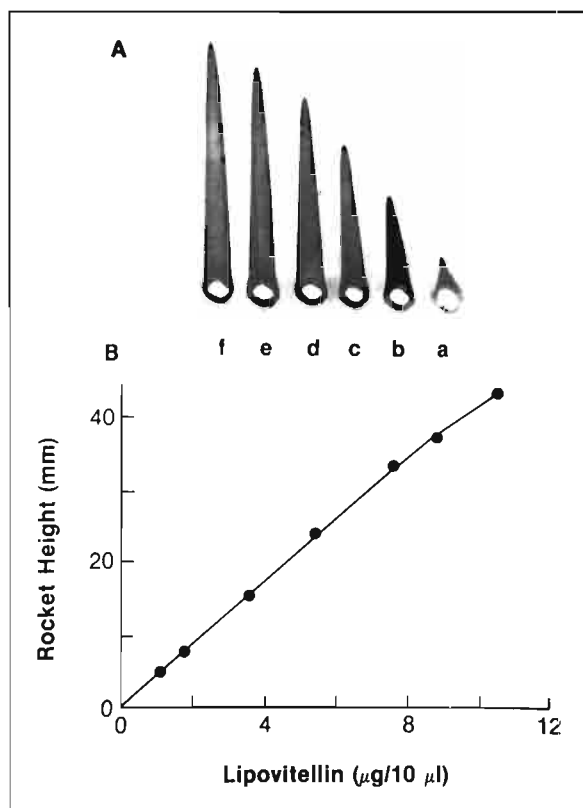

**Figure 1**

Quantitative measurement of lipovitellin by rocket immunoelectrophoresis carried out in a 1.5-mm-thick slab agarose gel (1.0%) containing 0.05% anti-VG serum of rainbow trout. (A) Increasing amounts of lipovitellin in each sample well was electrophoresed at 40 V overnight at 4°C. (B) Linear relationship between peak height and amount of lipovitellin in each well (from Chen et al. 1986 with permission).

After synthesis, it is secreted into the vascular system and deposited in the oocytes as lipovitellin and phosvitin (Tata and Smith 1979). In rainbow trout, VG is synthesized as a polypeptide of 160,000 daltons, which is post-translationally processed into its mature form of 170,000 daltons (Chen 1983). Upon treatment of juvenile male and female or mature male rainbow trout with 17B-estradiol, the production of VG can be determined quantitatively by rocket immunoelectrophoresis (Fig. 1; Chen et al. 1986). This method can detect VG levels as low as 0.05 mg/mL of serum and gives reliable quantification of VG in both hormone-induced and non-induced fish.

The dose-response relationship of VG accumulation in the serum of juvenile rainbow trout following 17B-estradiol treatment has recently been studied. Estradiol at the concentration of 2 µg/100 g body weight induces detectable levels of VG in the serum. Maximum induction of VG accumulation can be achieved at the dose of 200 µg/100 g body weight of the hormone (Chen et al. 1986).

We have begun to investigate the effect of polyhalogenated hydrocarbons on the induction of VG synthesis in rainbow trout. Groups of juvenile fish were exposed to Aroclor 1254 and/or Mirex in the diet. After feeding for 6 months, both control and experimental animals were treated with 17B-estradiol at the concentration of 20 or 80 µg/100 g body weight, and the levels of serum VG were determined by quantitative rocket immunoelectrophoresis. As shown in Table 1, Aroclor 1254, Mirex, and a mixture of Aroclor 1254 and Mirex significantly suppressed levels of VG induced by 17B-estradiol (Chen et al. 1986). Although the mechanisms by which halogenated hydrocarbons exert reproductive toxicity are unknown, they may be related to altered steroid metabolism (Safe 1984). It is conceivable that mixed-function oxidase induction by halogenated hydrocarbons may elevate estradiol catabolism, thus decreasing VG levels. Similarly, PCB's and Mirex are hepatic toxins in fish as evidenced by hepatomegaly and histopathological effects (Leatherland et al. 1979). This may lower VG synthesis at the organ level. Although more in-depth analyses are required, the above results strongly suggest that estradiol-induced VG synthesis can be used as a sensitive biochemical parameter for assessing or screening chemicals that may be hepatotoxins or may disturb reproductive physiology.

There are some problems inherent in the bioassay described above: (1) the relatively long time required for the test chemicals or hormones to reach the target organ; (2) higher levels of the chemicals and hormones required to show adverse effects; (3) high mortality of test animals due to injury caused by injection of hormones; (4) fluctuation of hormone levels retained in individual animals due to leakage of hormones. Development of an *in vitro* bioassay using rainbow trout hepatoma cell line or primary hepatocytes as target cells would help to overcome these problems.

## Estrogen-responsive cDNA genes

Recently Chen (1983) reported that treatment of mature male or juvenile rainbow trout of both sexes with 17B-estradiol resulted in the induction of VG mRNA and another mRNA (ULER2) with a size smaller than that of the 18S rRNA. The cDNA genes of these

**Table 1**  
Effect of Aroclor and/or Mirex on serum vitellogenin levels.

Estradiol (µg/100 g body weight)	Vitellogenin present in the serum (mg/mL ± SD)							
	Control	Aroclor 1254			Mirex			Aroclor 1254/Mirex 30/5 µg/g
		3 µg/g	30 µg/g	300 µg/g	0.5 µg/g	5 µg/g	50 µg/g	
80	5.06±0.45	2.00±0.86	1.12±0.27	1.41±0.17	3.96±0.62	2.20±0.51	1.10±0.48	1.82±0.30
20	2.72±0.54	1.95±0.40	1.50±0.23	1.27±0.23	2.51±0.56*	1.71±0.35	1.54±0.28	1.24±0.42

Groups of fish were fed diets contaminated with known quantities of chemicals indicated for a period of 6 months. Serum samples were collected 6 days following treatment with 17B-estradiol. A group of 20 fish was used per treatment (from Chen et al. 1986 with permission).

\*Not significant using student *T*-test ( $P < 0.05$ ).



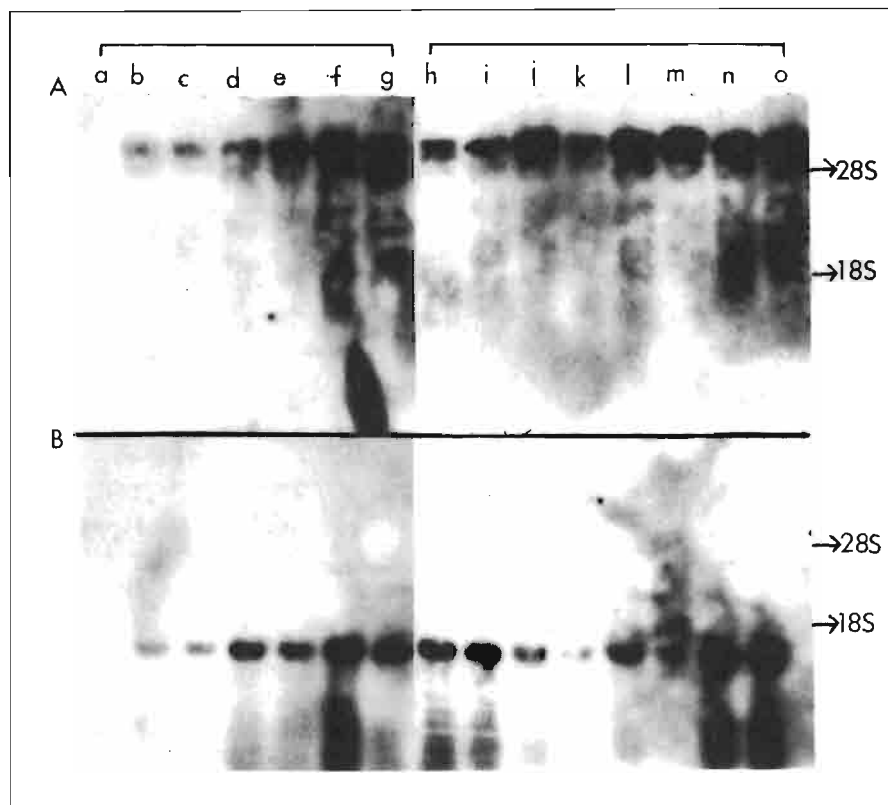

**Figure 2**

Appearance of estrogen-responsive mRNA in fish treated with 17 $\beta$ -estradiol *in vivo*. Juvenile rainbow trout each received 100  $\mu$ g/100 g body weight of 17 $\beta$ -estradiol, and RNA was prepared from livers of the treated fish at different time intervals. Following electrophoresis on 1.4% agarose gels, the RNA was transferred to nitrocellulose filter, and probed with radiolabeled pRTC2 and pRTC5 DNA. (A) RNA samples probed with radiolabeled pRTC2. (B) RNA samples probed with radio-labeled pRTC5. (a) control; (b-g) 12, 24, 48, 72, 96 h after 17 $\beta$ -estradiol treatment. A second dose of 17 $\beta$ -estradiol (100  $\mu$ g/100 g body weight) was injected into animals 2 weeks after primary induction. (h-o) 12, 24, 36, 48, 72, 96, 120, 144 h after hormone injection.

two estrogen-responsive mRNA sequences have been isolated by molecular cloning (Chen et al. 1988) and are named as pRTC2 and pRTC5, respectively. Using these two cDNA genes as probes, the expression of estrogen-responsive genes induced *in vivo* by 17 $\beta$ -estradiol has been monitored by RNA northern blot analysis (Fig. 2). In order to measure the levels of estrogen-responsive mRNA sequences in the target tissue accurately, a quantitative molecular hybridization method (dot blot hybridization method) has been developed, using pRTC2 and pRTC5 as probes (Fig. 3; Chen et al. 1988). By employing this method, the dose-response relationship and the time course of accumulation of estrogen-responsive mRNA in juvenile rainbowtrout following 17 $\beta$ -estradiol treatment have been studied (Chen et al. 1988).

Estradiol at a concentration of  $1 \times 10^{-9}$  was found to induce expression of estrogen-responsive genes in a rainbow trout hepatoma cell line. This finding has opened the possibility of developing a rapid *in vitro* bioassay for screening chemicals that may disrupt the reproductive physiology of fish. In addition, it also provides an ideal system for elucidating the actions of chemical pollutants on fish reproduction at the molecular level. Figure 4 summarizes such a proposed *in vitro* testing system, in which rainbow trout hepatocytes or hepatoma cells are exposed to the test chemicals for various lengths of time. Following exposure, the cells are treated with 17 $\beta$ -estradiol, and the expression of the estrogen-responsive genes is measured quantitatively by radioimmunochemical analysis of the

protein products and by dot blot hybridization of the mRNA. The effect of mammalian S-9 activation on the toxicity of the test chemicals can also be investigated. There are several unique features associated with this testing method: (1) It detects the adverse effects of testing chemicals at the levels of transcription and translation; (2) shorter exposure time is required for the test; (3) every cell receives homogeneous levels of the test chemicals or hormones; and (4) compared with the *in vivo* bioassay, lower levels of the test chemicals and hormones are required.

### Cellular *myc* gene (*c-myc*) in fish

Avian myelocytomatosis virus (MC29) is a replication-defective retrovirus that induces a broad spectrum of malignant diseases, including myelocytomas, renal and liver tumors, carcinomas, sarcomas, and erythroblastosis (Bishop 1983). The genetic element responsible for the oncogenic transformation activity of the virus has been identified as the *v-myc* gene of about 1568 base-pairs (bp) (Lautenberger et al. 1981). Genomic DNA from a variety of species, from mammals to insects, has been shown to contain sequences homologous to *v-myc* by Southern blot analysis (Shilo and Weinberg 1981). However, these sequences have been isolated only by molecular cloning from chicken, mouse, and human, and are known

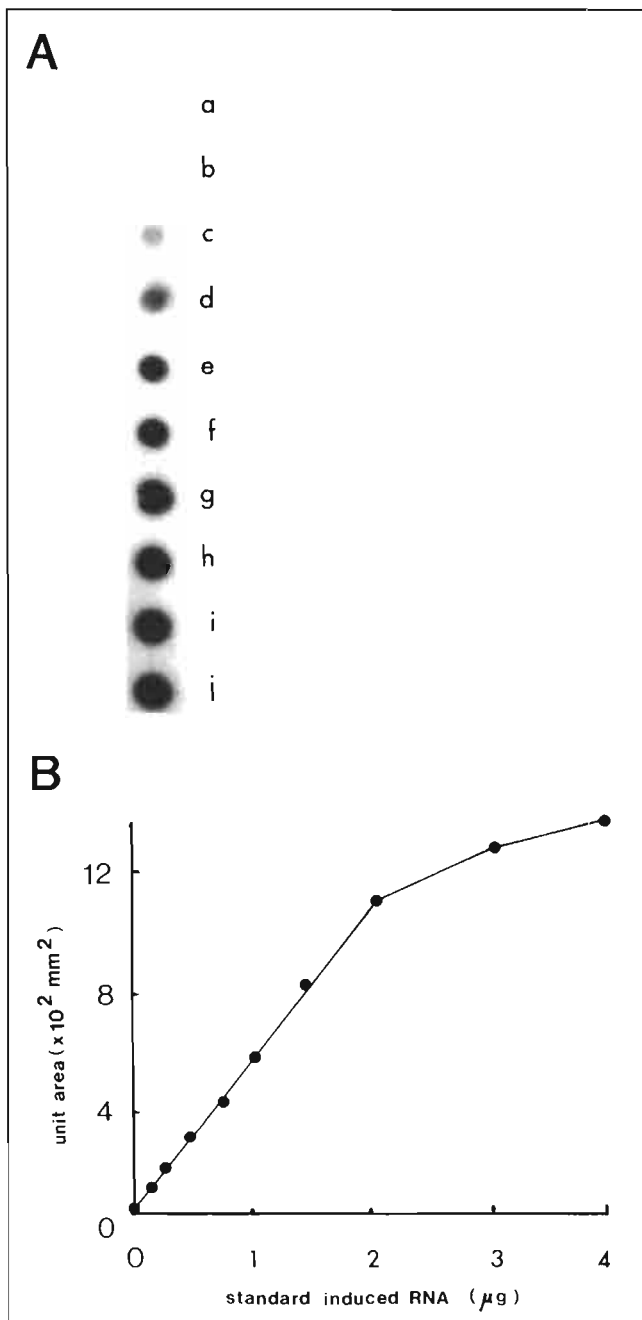
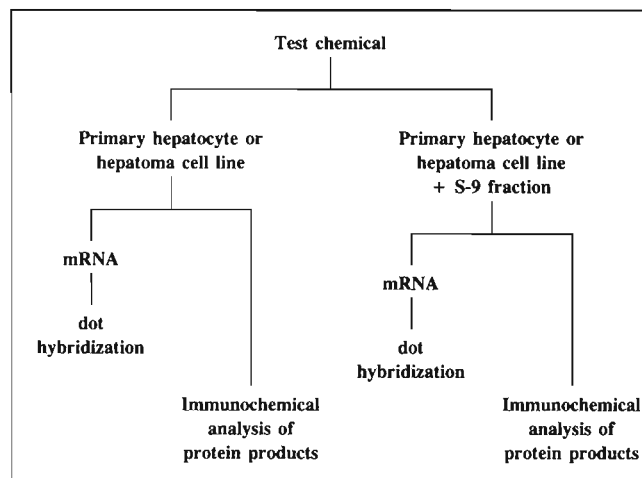

**Figure 3**

A representative standard curve of the quantitative RNA dot blot hybridization. Different amounts of total induced RNA in 50  $\mu\text{L}$  was spotted on nitrocellulose filters, and then hybridized to [ $^{32}\text{P}$ ] - pRTC2 DNA ( $1 \times 10^8/\mu\text{g}$  DNA). The amount of hybridization in each spot was determined by scanning the resulting autoradiogram. (A) RNA blot; (B) linear relationship between the amount of RNA in each spot and the amount of hybridization. (a) 4.00  $\mu\text{g}$  control RNA; (b-j) induced RNA 0.125, 0.25, 0.5, 0.75, 1.00, 1.50, 2.00, 3.00, and 4.00  $\mu\text{g}$ . (Chen et al. 1988 with permission)

as cellular *myc* (*c-myc*) genes (Watson et al. 1983a,b; Stanton et al. 1984).

The fact that *c-myc* genes are conserved among many species of organisms studied suggests that they may play an important role in cellular growth and/or differentiation (Bishop 1983). Therefore, comparison of *myc* gene sequences from widely divergent species is an important step towards our understanding of the evolution and



**Figure 4**

Summary of proposed *in vitro* testing system.

function of the gene. The most primitive class of vertebrates found to date by Southern blot analysis to contain *myc* gene sequences are the bony fishes. Hence, we have initiated studies to isolate and characterize the *c-myc* gene from rainbow trout. Several recombinant phage clones containing *c-myc* sequences have been isolated from a rainbow trout gene bank, using *v-myc* gene as a probe under relaxed conditions (30% formamide, 5 xSSC, 37°C) (Van Beneden et al. 1986). Further characterization of these clones involved restriction enzyme analysis and hybridization using chicken *c-myc* exon II (190 bp Pst-1 - Hinf-1 fragment) and exon III (849 bp Cla-1 - EcoR1 fragment) as probes. A 3.7 Kb EcoR1 DNA fragment from one of the positive clones (RTC-1) was found to contain sequences homologous to both chicken *c-myc* exon II and III. This DNA fragment was subcloned into plasmid pBR325, and was termed C1-81. The nucleotide sequence of this DNA insert was determined by the method of Maxam and Gilbert (1977). Examination of the nucleotide sequence of rainbow trout reveals the presence of two exons (II and III). Trout exon II is shorter (664 bp) than those of chicken (702 bp), mouse (757 bp), and human (771 bp) (Watson et al. 1983a,b; Stanton et al. 1984; Van Beneden 1986). On the other hand, trout exon III is longer (578 bp) than those of chicken, mouse, and human, all of which have 561 nucleotides. Trout exons II and III are interrupted by an intron (332 bp) which is considerably shorter than those of chicken (971 bp), mouse (1.2 kb), and human (1.38 kb). These observations strongly suggest that more primitive organisms have smaller introns.

The *c-myc* exon I has been localized for chicken (Linial and Groudine 1985), mouse (Stanton et al. 1984) and human (Hamlyn and Rabbits 1983) genes. However, using a DNA probe derived from either chicken or human exon I, it has not been possible to detect homologous sequences in rainbow trout (Van Beneden et al. 1986). This result suggests that *c-myc* gene exon I has diverged more rapidly relative to exons II and III.

The degree of homology in nucleotide and predicted amino acid sequence among *c-myc* genes of rainbow trout, chicken and human has been determined (Van Beneden et al. 1986). Overall, the third exon is more conserved than the second exon at both nucleotide and amino acid levels. However, several segments of the second exon are highly conserved among the three organisms, including the two *myc* box regions (A and B) homologous to *N-myc* (Schwab et al. 1983). In addition, it is rather interesting to note that these

three *c-myc* genes have inserted sequences in the second exon unique to themselves. There are two such unique regions in the human *c-myc* sequence (HU1 and HU2), whereas chicken and trout each contain a single unique region (CUI and TU1, respectively) (Van Beneden et al. 1986). In conclusion, the human and chicken *c-myc* sequences show more homology to each other than to fish. This observation is consistent with a phylogenetic model in which birds and mammals share a common lineage that diverged from the line leading to modern fishes.

### Restriction polymorphism in *c-myc* gene from fish tumors

Both human Burkitt's lymphoma and mouse myeloma cells display specific chromosomal translocations involving immunoglobulin gene loci and the *c-myc* gene (Erikson et al. 1983; Gelman et al. 1984; Stanton et al. 1984). As a result of the *c-myc* gene translocation, the levels of *myc* mRNA are greatly elevated in the tumor cells. Although the biological function of the *c-myc* gene remains to be elucidated, it is believed that abnormal expression of this gene could lead to oncogenesis. Lymphosarcoma has also been found in several fish species, such as northern pike and muskellunge collected from the field (Sonstegard 1976). Studies conducted by Whang-Peng et al. (1976) showed karyotypic abnormality associated with lymphosarcoma of northern pike. Therefore, it would be of interest to investigate whether rearrangement or translocation of the *c-myc* gene is associated with these tumors. High-molecular-weight DNA isolated from normal and tumorous tissues of northern pike was used to prepare Southern blots. These blots were hybridized to nick-translated trout *c-myc* sequences. A 5.8 Kb fragment generated by EcoR1 digestion of the DNA sample from the normal kidney tissue of pike hybridized to the probe. On the other hand, two fragments of 6.2 and 4.4 Kb from feral lymphosarcoma DNA hybridized to the same probe. The findings suggest that rearrangement and/or translocation of the *c-myc* gene may have occurred in the northern pike lymphoma cells.

Activated oncogenes are found in association with chemically induced or naturally occurring neoplasm in mammals. For instance, activated *c-ras* gene is found in human bladder and lung carcinoma (Goldfarb et al. 1982; Santos 1984), and an activated *c-myc* gene is found in human Burkitt's lymphoma (Erikson et al. 1983; Gelman et al. 1983; Stanton et al. 1984). Furthermore, a *c-ras* gene has been activated by treatment with chemicals *in vitro* (Phillips and Marshall 1984). These findings suggest that activation of a specific oncogene can be regarded as an early sign of oncogenesis. In addition, chemicals that can activate any specific cellular oncogene *in vivo* or *in vitro* should be considered prime suspects as carcinogens. As mentioned earlier, large populations of fishes have tumors of one type or the other; hence, there is a need for investigating the relationship between neoplasia in fishes and chemical pollutants present in waters. Besides, there is an urgent need to devise reliable and sensitive methods for assessing the carcinogenic potentials of chemical pollutants in contaminated waters. We are actively working toward developing an *in vitro* bioassay for this purpose.

### Acknowledgments

The authors would like to thank D. M. Davies and A. Oaks for critically reading this manuscript. This study was supported by grants to the senior author from the Natural Science and Engineering Research Council of Canada, the Department of Fisheries and Oceans, and the U.S. Geological Survey.

### Citations

- Bishop, J.M.  
1983. Cellular oncogenes and retroviruses. *Ann. Rev. Biochem.* 52:301-354.
- Chen, T.T.  
1983. Identification and characterization of estrogen-responsive gene products in the liver of rainbow trout (*S. gairdneri*). *Can. J. Biochem. Cell Biol.* 61:802-810.
- Chen, T.T., P.C. Reid, R.J. Van Beneden, and R.A. Sonstegard.  
1986. Effect of Aroclor 1254 and Mirex on estradiol induced vitellogenin production in juvenile rainbow trout (*Salmo gairdneri*). *Can. J. Fish. Aquat. Sci.* 43:169-173.
- Chen, T.T., D.A. Howard, L.B. Agellon, C.M. Liu, and S.L. Davies.  
1988. Estrogen controlled gene expression: Induction of two estrogen-responsive genes in the liver of rainbow trout (*S. gairdneri*). *Physiol. Zool.* (in press).
- Erikson, J., A. ar-Rushdi, H.L. Drwinga, P.C. Nowell, and C.M. Croce.  
1983. Transcriptional activation of the translocated *c-myc* oncogene in Burkitt lymphoma. *Proc. Natl. Acad. Sci. (USA)* 80:820-824.
- Eroschenko, V.P., and W.O. Wilson.  
1975. Cellular changes in the gonads, livers and adrenal glands of Japanese quail as affected by the insecticide kepone. *Toxicol. Appl. Pharmacol.* 31:491-504.
- Gelman, E.P., M.C. Psallidopoulos, T.S. Papas, and R. Dalla-Favera.  
1983. Identification of reciprocal translocation sites within the *c-myc* oncogene and immunoglobulin u locus in a Burkitt lymphoma. *Nature* 306:799-803.
- Goldfarb, M., K. Shimizu, M. Perucho, and M. Wigler.  
1982. Isolation and preliminary characterization of a human transforming gene from T24 bladder carcinoma cells. *Nature* 296:404-409.
- Hamlyn, P.H., and T.H. Rabbitts.  
1983. Translocation joins *c-myc* and immunoglobulin r1 genes in a Burkitt lymphoma revealing a third exon in the *c-myc* oncogene. *Nature* 304:135-139.
- Hickey, J.J., and D.W. Anderson.  
1968. Chlorinated hydrocarbons and eggshell changes in raptorial and fish-eating birds. *Science (Wash. D.C.)* 162:271-273.
- Lautenberger, J.A., R.A. Schulz, C.F. Garon, P.N. Tschlis, D.D. Spyropoulos, T.W. Pry, K.E. Rushlow, and T.S. Papas.  
1981. The transforming sequences of avian myelocytomatosis virus (MC29). *J. Supramol. Struct. Cell. Biochem.* 16:193-207.
- Leatherland, J.F., R.A. Sonstegard, and H.V. Holdrinet.  
1979. Effect of dietary Mirex and PCB's on hepatosomatic index, liver lipid, carcass lipid, and PCB and Mirex bioaccumulation in yearling coho salmon (*Oncorhynchus kisutch*). *Comp. Biochem. Physiol.* 63:243-246.
- Linial, M., and M. Groudine.  
1985. Transcription of three *c-myc* exons is enhanced in chicken bursal lymphoma cell lines. *Proc. Natl. Acad. Sci. (USA)* 82:53-57.
- Maxam, A.M., and W. Gilbert.  
1977. A new method for sequencing DNA. *Proc. Natl. Acad. Sci. (USA)* 74:560-564.
- Peakall, D.B.  
1975. PCB's and environmental effects. *CRC Crit. Rev. Environ. Control*, p. 469-511.
- Phillips, D.H., and C.J. Marshall.  
1984. Activation of a cellular proto-oncogene by *in vitro* modification with a chemical carcinogen. *In Proc. RNA Tumor Viruses Meeting*, p. 112. Cold Spring Harbor Lab., Cold Spring Harbor, NY 11724.
- Safe, S.  
1984. Polychlorinated biphenyls (PCB's) and polybrominated biphenols (PBB's): biochemistry, toxicology, and mechanism of action. *CRC Crit. Rev. Toxicol.* 13:319-395.
- Santos, E.  
1984. Malignant activation of a k-ras oncogene in lung carcinoma but not in normal tissue of the same patient. *Science (Wash. D.C.)* 223:661-664.

- Schwab, M., K. Alitalo, K. Klempnauer, K.H. Varmus, J.M. Bishop, F. Gilbert, G. Brodeur, M. Goldstein, and J. Trent.**  
 1983. Amplified DNA with limited homology to myc cellular oncogene is shared by human neuroblastoma cell lines and a neuroblastoma tumor. *Nature* 305: 245-248.
- Shilo, B.Z., and R.A. Weinberg.**  
 1981. DNA sequences homologous to vertebrate oncogenes are conserved in *Drosophila melanogaster*. *Proc. Natl. Acad. Sci. (USA)* 78:6789-6792.
- Sonstegard, R.A.**  
 1976. Studies of the etiology and epizootiology of lymphosarcoma in Esox (*Esox lucius* L. and *Esox masquinongy*) from the United States. *Prog. Exp. Tumor Res.* 20:141-155.  
 1977. Environmental carcinogenesis studies in fishes of the Great Lakes of North America. *Ann. N.Y. Acad. Sci.* 298:261-269.
- Stanton, L.W., P.D. Fahrlander, P.M. Tesser, and K.B. Marcu.**  
 1984. Nucleotide sequence comparison of normal and translocated murine c-myc genes. *Nature* 310:423-425.
- Tata, J.R., and D.P. Smith.**  
 1979. Vitellogenesis: a versatile model for hormonal regulation of gene expression. *Rec. Prog. Hormone Res.* 35:47-56.
- Watson, D.K., E.P. Reddy, P.H. Duesberg, and T.S. Papas.**  
 1983a. Nucleotide sequence analysis of the chicken c-myc gene reveals homologous and unique coding regions by comparison with the transforming gene of avian myelocytomatosis virus MC29,  $\Delta gag-myc$ . *Proc. Natl. Acad. Sci. (USA)* 80:2146-2150.
- Watson, D.K., M.C. Psallidopoulos, K.P. Samuel, R. Dalla-Favera, and T.S. Papas.**  
 1983b. Nucleotide sequence analysis of human c-myc locus, chicken homologue, and myelocytomatosis virus MC29 transforming gene reveals a highly conserved gene product. *Proc. Natl. Acad. Sci. (USA)* 80:3642-3645.
- Van Beneden, R.J., D.K. Watson, T.T. Chen, J.A. Lautenberger, and T.S. Papas.**  
 1986. Cellular myc (c-myc) in fish (rainbow trout): Its relationship to other vertebrate myc genes and to the transforming genes of the MC29 family of viruses. *Proc. Natl. Acad. Sci. (USA)* 83:3698-3702.
- Wasserman, M., D. Wasserman, S. Cucos, and H.J. Miller.**  
 1979. World PCBs map: Storage and effects in man and his biologic environment in the 1970s. *Ann. N.Y. Acad. Sci.* 320:69-123.
- Whang-Peng, J., R.A. Sonstegard, and C.J. Dawe.**  
 1976. Chromosomal characteristics of malignant lymphoma in northern pike (*Esox lucius*) from United States. *Cancer Res.* 36:3554-3560.

# Necessity of dietary sterols and phospholipids for growth of the prawn, *Penaeus japonicus* Bate

SHIN-ICHI TESHIMA  
AKIO KANAZAWA

Faculty of Fisheries  
Kagoshima University  
4-50-20 Shimoarata  
Kagoshima, 890 Japan

## ABSTRACT

From the viewpoint of comparative biochemistry and nutrition, lipid nutrition of the prawn *Penaeus japonicus* is unique in that it requires dietary sources not only of sterols but also of some phospholipids for growth and survival. Our reexamination of sterol requirements for juvenile prawn has shown that the absence of sterols in diets results in a marked decrease in weight gain, feed conversion efficiency (FCE), and protein efficiency ratio (PER). In terms of weight gain, FCE, and PER, cholesterol had the highest nutritive value as a sterol source, with 24-methylcholesta-5,22-dienol,  $\beta$ -sitosterol-cholesterol (9:1), and  $\beta$ -sitosterol following in descending effectiveness. Cholesterol was more effectively retained in the prawn's body than 24-methylcholesta-5,22-dienol and  $\beta$ -sitosterol.

Some phospholipids in the diets were shown to be indispensable for sustaining growth and survival of the prawn; especially the larvae, which suffered 100% mortality prior to attaining the mysid stage when fed on diets without phospholipids. Feeding experiments have revealed that the requisite for effective phospholipids was possession of choline and inositol groups and unsaturated fatty acid moieties in the molecules. Recently, we have conducted feeding experiments using  $^{14}\text{C}$ -labeled lipids to clarify the mechanism by which dietary phospholipids enhance the growth of the prawn. Results suggest that retardation of growth in the prawn receiving a phospholipid-deficient diet results from the insufficient transport of dietary lipids, particularly cholesterol, in the body. Understanding nutritional requirements of the prawn will contribute to improvement of techniques for rearing larval and juvenile prawns using live feeds and artificial diets.

Lipids have been regarded only as energy sources in fish diets until recently. Recent studies, however, have strongly emphasized the importance of lipids in fish diets as sources of essential fatty acids (EFA) and as carriers of fat-soluble biologically active substances (Watanabe 1982). In contrast to fish and other higher animals, the prawn *Penaeus japonicus* is unique in that it requires both sterols and some phospholipids for good growth and survival (Teshima 1978, 1983). The present paper reviews our current investigation on the nutrition of sterols and phospholipids, with particular emphasis on the nutritive values of sterols other than cholesterol and also the mechanism by which dietary phospholipids exert a growth-enhancing effect.

## Sterol nutrition

The prawn *P. japonicus* (Kanazawa et al. 1971, Teshima et al. 1983), and the American lobster *Homarus americanus* (Castell et al. 1975) have been shown to require dietary sources of sterol for normal growth, resulting from a lack of *de novo* sterol synthesis in crustaceans (Teshima 1978). Previous studies have also shown that juvenile prawns utilized some  $\text{C}_{28}$  and  $\text{C}_{29}$  sterols as substitutes for cholesterol to some extent, suggesting the possible C-24 dealkylation of these sterols to cholesterol, a  $\text{C}_{27}$  sterol, in the body (Teshima 1983, Teshima et al. 1983). However, little is known of the effects of sterols other than cholesterol on the feed conversion efficiency (FCE), protein efficiency ratio (PER), and retention rate (%) of dietary lipids and sterols in the prawn body.

To approach this, recent feeding trials were conducted using prawn juveniles, weighing about 0.25 g each (Teshima and Kanazawa 1985b). The prawns were maintained on test diets (Table 1) containing 0.5% levels of cholesterol,  $\beta$ -sitosterol, a 9:1 mixture of  $\beta$ -sitosterol and cholesterol, and 24-methylcholesta-5,22-dienol as a sterol source, or a sterol-free diet in 30-liter aquaria for 32 days at 24-28°C. The base ration of test diets was the same as that reported previously, except for lipid sources and the binder (gluten M; Riken Vitamin Co., Ltd., Japan) (Kanazawa et al. 1977). Test

**Table 1**  
Composition of test diets and results of a 32-day feeding trial on juvenile *P. japonicus* prawns.

Test diet <sup>1</sup>	Dietary sterol	Survival rate (%)	Weight gain (%)	FCE <sup>2</sup>	PER <sup>3</sup>
D-1	0.5% Cholesterol	90	200	0.70	1.55
D-2	0.5% $\beta$ -Sitosterol	90	118	0.57	1.26
D-3	0.45% $\beta$ -Sitosterol + 0.05% Cholesterol	80	104	0.64	1.42
D-4	0.5% 24-Methylcholesta- 5,22-dienol <sup>4</sup>	75	136	0.65	1.45
D-5	Sterol-deficient	70	55.2	0.37	0.82

<sup>1</sup>Base ration of test diets was the same as that reported previously (Kanazawa et al. 1977), except for the binder and lipid sources; 8% pollock liver oil used in the previous study was replaced with 6% pollock liver oil and 2% soybean lecithin. Twenty prawns were used for each experimental group at start.

<sup>2</sup>Feed conversion efficiency (FCE) = Avg. weight gain (g)/Avg. food intake (g).

<sup>3</sup>Protein efficiency ratio (PER) = Avg. weight gain (g)/Avg. protein intake (g).

<sup>4</sup>24-Methylcholesta-5,22-dienol was a mixture of the 24R- and 24S-isomers (about 1:1, w/w).

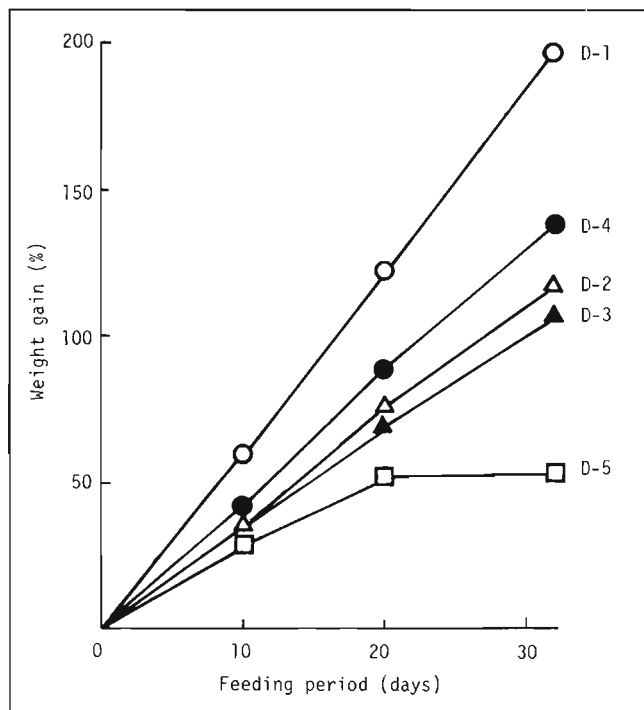

**Figure 1**

Weight gains (%) of *P. japonicus* prawns reared on diets containing different sterols. D-1 to D-5 indicate test diets (see Table 1).

diets contained 6.0% pollock liver oil, 2.0% soybean lecithin, and 0.5% cholesterol as lipid sources.

Figure 1 shows the growth of the prawns receiving different sterols. Weight gain was markedly low on a sterol-deficient diet (diet D-5). The addition of each sterol examined improved the weight gain. However, cholesterol was most effective in improving the weight gain as previously observed in the larvae (Teshima et al. 1983), with 24-methylcholesta-5,22-dienol, the 9:1 mixture of  $\beta$ -sitosterol and cholesterol, and  $\beta$ -sitosterol following. As for the FCE and PER, cholesterol gave the highest values among the sterols examined (Table 1). Interestingly, however, 24-methylcholesta-5,22-dienol resulted in an FCE and PER equally as high as cholesterol.

After the feeding trial, lipid, sterol, and protein concentrations of prawn bodies were analyzed to determine body retention rates (%) of these dietary nutrients. Prawns receiving diets containing  $\beta$ -sitosterol or 24-methylcholesta-5,22-dienol had small amounts of 24-methylenecholesterol (3.3-4.5% of total sterols), one of the possible intermediates in the C-24 dealkylation of  $\beta$ -sitosterol and 24-methylcholesta-5,22-dienol to cholesterol. Body retention rates of dietary proteins and lipids were notably lower on the sterol-deficient diet than on the sterol-supplemented diets (Table 2). Body retention rates of total dietary sterols varied with the kind of sterols. Cholesterol gave the highest body retention rate of total dietary sterols, with 24-methylcholesta-5,22-dienol,  $\beta$ -sitosterol-cholesterol (9:1), and  $\beta$ -sitosterol following with descending values.

Figure 2 shows the body retention rates of individual sterols. Cholesterol was retained in the whole body more effectively than  $\beta$ -sitosterol and 24-methylcholesta-5,22-dienol. In prawns receiving a mixture of  $\beta$ -sitosterol and cholesterol (9:1), the retention rate of dietary cholesterol exceeded 100%. This suggests the bioconversion of  $\beta$ -sitosterol to cholesterol in the body, because the prawn is incapable of *de novo* sterol synthesis and all sterols occurring

**Table 2**  
Body retention rates (%) of dietary proteins, lipids, and total sterols in *P. japonicus* prawns fed different sterols.

Dietary sterol	Body retention rate (%) <sup>1</sup>		
	Proteins	Lipids	Total sterols
Cholesterol	33.9	64.5	91.7
$\beta$ -Sitosterol	20.3	32.7	47.8
$\beta$ -Sitosterol-Cholesterol (9:1)	21.8	39.2	52.8
24-Methylcholesta-5,22-dienol	26.7	39.4	79.3
Sterol-deficient (diet D-5)	9.5	-2.9	

<sup>1</sup>Body retention rate (%) =  $B \times 100/A$   
A = Intake of dietary nutrient (g)/one prawn  
B = Increase in the nutrient of body (g)/one prawn

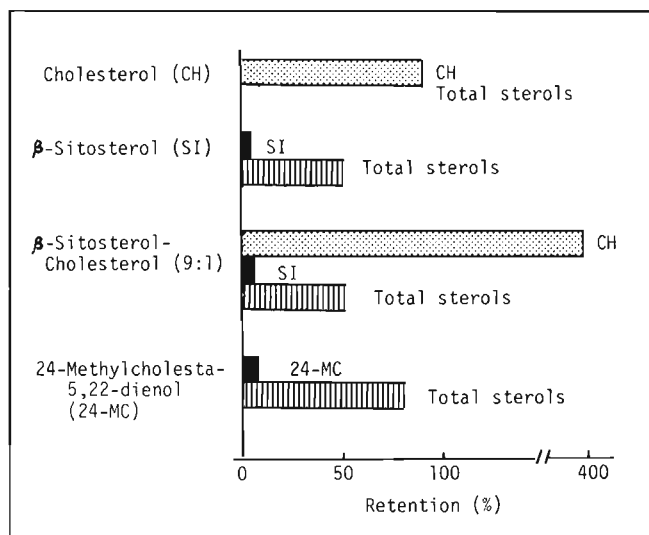

**Figure 2**

Body retention rates (%) of individual sterols in *P. japonicus* prawns reared on diets containing different sterol sources.

in the tissues are of dietary origin and/or their metabolites (Teshima 1983).

Kanazawa et al. (1971) have demonstrated that survival rates of juvenile prawns receiving ergosterol, stigmasterol, or  $\beta$ -sitosterol were high, but growth was inferior when compared with that of prawns receiving cholesterol as a sterol source. In addition, prawn larvae have also been shown to grow well with high survival rates on the microparticulate diets containing 22-dehydrocholesterol, 24-methylenecholesterol, ergosterol, or isofucosterol (Teshima et al. 1983).

Considering these facts and observations, we conclude the following. First, dietary sources of some  $C_{28}$  and  $C_{29}$  sterols are likely to be utilized by larval and juvenile prawns for growth after being transformed to cholesterol via 24-methylenecholesterol and desmosterol in the body in a sequence similar to that found in insects (Svoboda et al. 1978). It therefore seems reasonable to believe that a nutritive value of  $C_{28}$  and  $C_{29}$  sterols as substitutes for cholesterol depends on how easily they are converted to cholesterol in the body after being ingested. Since 24-methylcholesta-5,22-dienol had a higher nutritive value than  $\beta$ -sitosterol to both juveniles (Table 1) and larvae (Teshima et al. 1983), the former may be con-

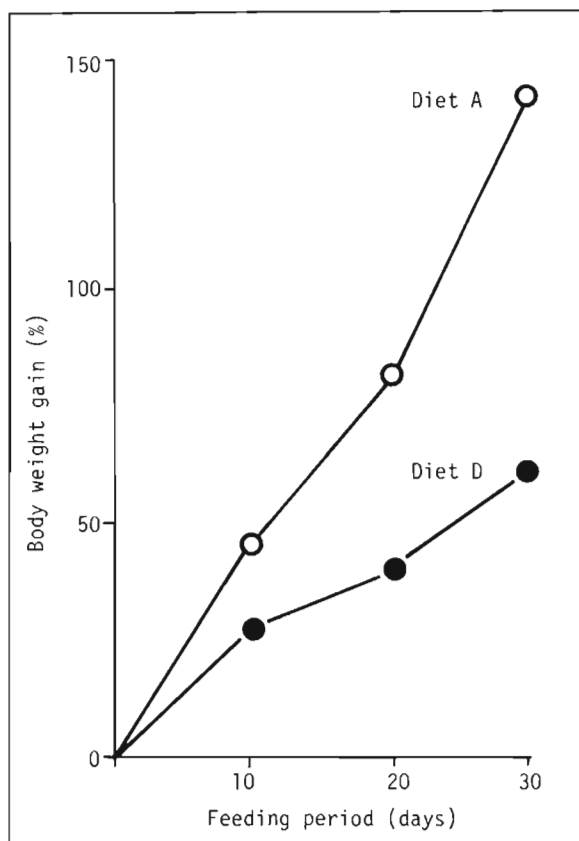

**Figure 3**  
Weight gains (%) of *P. japonicus* prawns receiving phospholipid-added (A) and phospholipid-deficient (D) diets.

verted to cholesterol in the body more easily than the latter. Second, dietary cholesterol plays an important role in the effective utilization of dietary lipids and proteins in the prawn, as the lack of cholesterol in diets results in a marked decrease in protein and lipid levels in the body. We assume that sterols may function primarily as components of subcellular membranous structures in the prawn as well as in insects (Clayton 1964, Svoboda et al. 1978). Since cholesterol was retained in the body more effectively than 24-methylcholesta-5,22-dienol and  $\beta$ -sitosterol (Fig. 2), cholesterol may be required to fill a structurally specific space in the subcellular membranes of this prawn. The role of cholesterol and other sterols in crustacean species remains to be more fully elucidated in the future.

## Roles of dietary phospholipids

Some phospholipids in diets have also been demonstrated to be indispensable for sustaining growth and survival of crustaceans such as the prawn (Kanazawa 1983, Teshima 1985) and the American lobster (Conklin et al. 1980, D'Abramo et al. 1981); especially to prawn larvae which suffered 100% mortality prior to attaining the mysid stage when they were fed a phospholipid-deficient diet. We have also shown that the requisite for effective phospholipids in prawn larvae was possession of choline or inositol groups in addition to unsaturated fatty acid moieties in the molecules (Kanazawa et al. 1985, Teshima 1985). However, it was not clear why dietary phospholipids exerted a growth-enhancing effect in the prawn *P. japonicus*.

**Table 3**  
Weight gain, survival rate, feed conversion efficiency (FCE), and body retention rate (%) of dietary lipids in prawns receiving phospholipid-added (A) and phospholipid-deficient (D) diets.

Remark	Diet A <sup>1</sup> (PL-added)	Diet D <sup>1</sup> (PL-deficient)
Number of prawns	15	15
Feeding period (day)	30	30
Initial avg. body weight (g)	1.03	1.06
Final avg. body weight (g)	2.51	1.72
Body weight gain (%)	144	62.3
Survival rate (%)	100	80
FCE (gain/diet intake)	0.49	0.22
Body retention rate (%) <sup>2</sup>		
Total lipids	41.8	30.3
Cholesterol	88.0	32.3
Neutral lipids except cholesterol	29.0	21.6

<sup>1</sup>Basal ration of diets A and D was similar to that reported previously (Kanazawa et al. 1977) except for a binder (gluten M; Riken Vitamin Co., Ltd.). Diet A contained the following ingredients (g/100 g): casein 50.0; glucose 5.5; sucrose 10.0;  $\alpha$ -starch 4.0; glucosamine HCl 0.8; sodium citrate 0.3; sodium succinate, 0.3; DL-methionine 1.0; L-tryptophan 0.5; pollock liver oil 6.0; cholesterol 0.5; vitamin mixture 3.0; mineral mixture 8.6; soybean lecithin 3.0; cellulose 6.5 (equal to 100%). To this, 8.0% gluten M was added. Diet D contained the same composition as diet A, except for the absence of 3.0% soybean lecithin.

<sup>2</sup>Body retention rate (%) =  $B \times 100/A$

A = Intake of dietary nutrient (g)/one prawn

B = Increase in the nutrient of body (g)/one prawn.

Quite recently, we have examined the effects of dietary phospholipids on the growth, body retention rates of dietary lipids, and body composition of juvenile prawns as part of defining the nutritional role of dietary phospholipids (Teshima and Kanazawa 1985a). In a 30-day feeding trial using juveniles weighing about 1 g each, weight gain was markedly lower on a phospholipid-deficient diet than on a 3% soybean lecithin-added diet (Fig. 3, Table 3). The FCE, survival rate, and retention rates of dietary lipids and sterols were also lower on the phospholipid-deficient diet than on the phospholipid-added diet (Table 3). Thus, the prawn was shown to be incapable of effectively utilizing dietary lipids, especially cholesterol, for growth when fed the phospholipid-deficient diet.

Since the digestibilities of dietary lipids such as triglycerides and cholesterol in the prawn are high, more than 85% (Teshima and Kanazawa 1983), we thought that dietary phospholipids might take some part in the lipid transport in the body. Our next experiments, therefore, investigated the effect of dietary phospholipids (3% soybean lecithin) on the postprandial variation in lipid concentrations of the hepatopancreas, hemolymph, muscle, and so on, after feeding of diets containing 6% pollock liver oil and 0.5% cholesterol as basal lipids. Three and six hours after feeding, the lipid concentrations of hepatopancreas and hemolymph were higher in prawns receiving the phospholipid-added diet than in those receiving the phospholipid-deficient diet (Fig. 4). The increase in lipid concentrations of the hepatopancreas and hemolymph in prawns receiving the phospholipid-added diet was due mainly to the rise in triglycerides, cholesterol, and phospholipids such as phosphatidylcholine. As for the muscle, however, the two diet groups did not show a notable difference in the postprandial variation in lipid compositions. These results indicate that dietary phospholipids accelerate the mobilization of lipids such as dietary triglycerides and cholesterol from the digestive gland and hepatopancreas to the hemolymph and other extrahepatic tissues. To confirm this, the postprandial variation in radioactive lipid classes was investigated after feeding of

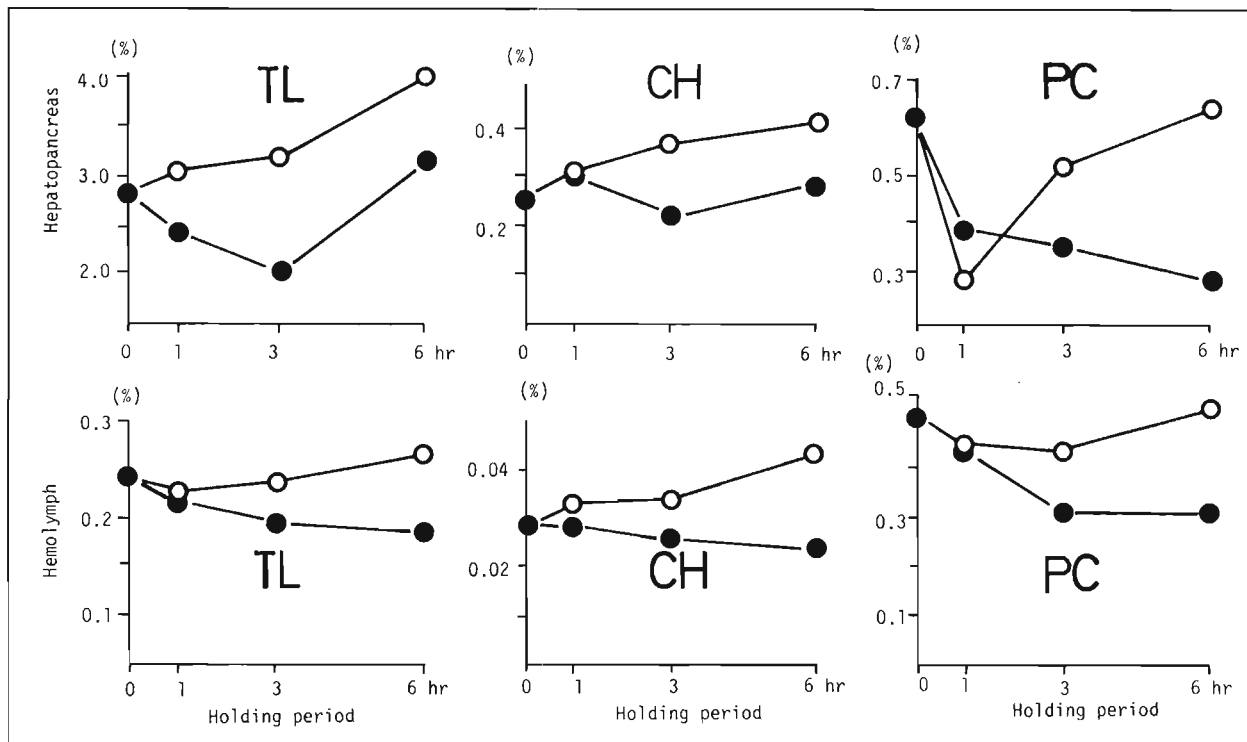

Figure 4

Postprandial variation in total lipid (TL), cholesterol (CH), and phosphatidylcholine (PC) concentrations (% of fresh matter) in the hepatopancreas and hemolymph of *P. japonicus* prawns after feeding of phospholipid-added (○) and phospholipid-deficient (●) diets.

tripalmitin-<sup>14</sup>C and cholesterol-<sup>14</sup>C with or without dietary phospholipids.

When the prawns received tripalmitin-<sup>14</sup>C, the inclusion of phospholipids (3% soybean lecithin) in the diets resulted in an increase in radioactive phospholipids, especially phosphatidylcholine, in both the hepatopancreas and hemolymph (Teshima et al. 1986a). The supplementation of phospholipids to diets also brought on an increase in radioactive triglycerides in the hepatopancreas but not in the hemolymph. Figure 5 (Teshima et al. 1986b) shows the postprandial variation in free and esterified sterol fractions of the hepatopancreas and hemolymph after feeding of cholesterol-<sup>14</sup>C. When fed the phospholipid-added diet, the radioactivities of hepatopancreatic free and esterified sterols increased quickly and reached maximum levels 3 and 1 hours after feeding, respectively, and then decreased, while those of free and esterified sterols in the hemolymph increased with the lapse of time and reached maximum levels 9 hours after feeding. Thus, when fed the phospholipid-deficient diet, dietary cholesterol remained as a free sterol for a long time in the hepatopancreas and entered into the hemolymph slowly, and also the formation of cholesteryl esters in the hepatopancreas proceeded at a slow rate. These results suggest that dietary phospholipids accelerate the incorporation of dietary cholesterol to the hepatopancreas, the formation of cholesteryl esters in the hepatopancreas, and the movement of hepatopancreatic cholesterol to the hemolymph.

We have shown that lipid transport in the prawn *P. japonicus* was basically conducted in the form of lipoproteins containing abundant phospholipids (Teshima and Kanazawa 1980). Considering the present observations and information available to date, we believe that dietary phospholipids are necessary for the smooth transport of dietary cholesterol, an essential nutrient, rather than dietary triglycerides in the body. Although dietary lipids such as cholesterol

and triglycerides could easily enter the hepatopancreas regardless of the presence of phospholipids in diets (Teshima and Kanazawa 1980), they (especially cholesterol) may not be released effectively from the hepatopancreas to the hemolymph when diets are lacking in phospholipids. We suggest that the prawn *P. japonicus* possibly cannot satisfactorily synthesize the phospholipids that are utilized as constituents of lipoproteins responsible for transport of cholesterol and other lipids.

There is no information on the mechanism by which dietary cholesterol is transported in crustaceans. In higher animals such as mammals, most of the dietary cholesterol comes into the blood system after being esterified by the action of lecithin:cholesterol acyltransferase (LCAT), which catalyzes the transfer of an acyl group from the  $\beta$ -position of phosphatidylcholine to the  $3\beta$ -hydroxy group of cholesterol. Mankura et al. (1980) have demonstrated that the hemolymph of the crab *Portunus trituberculatus* has a low but substantial LCAT activity and also that the LCAT activity of this crab is highly increased by the addition of hepatopancreatic lecithin from the carp *Cyprinus carpio*. We assume that the retardation of growth in prawns receiving the phospholipid-deficient diet is possibly due to the insufficient transport of lipids, especially cholesterol, in the body. In the prawn, dietary phospholipids, specifically phosphatidylcholine containing unsaturated fatty acid moieties, may be utilized as constituents of lipoproteins responsible for cholesterol transport and also may accelerate LCAT activity in the hemolymph.



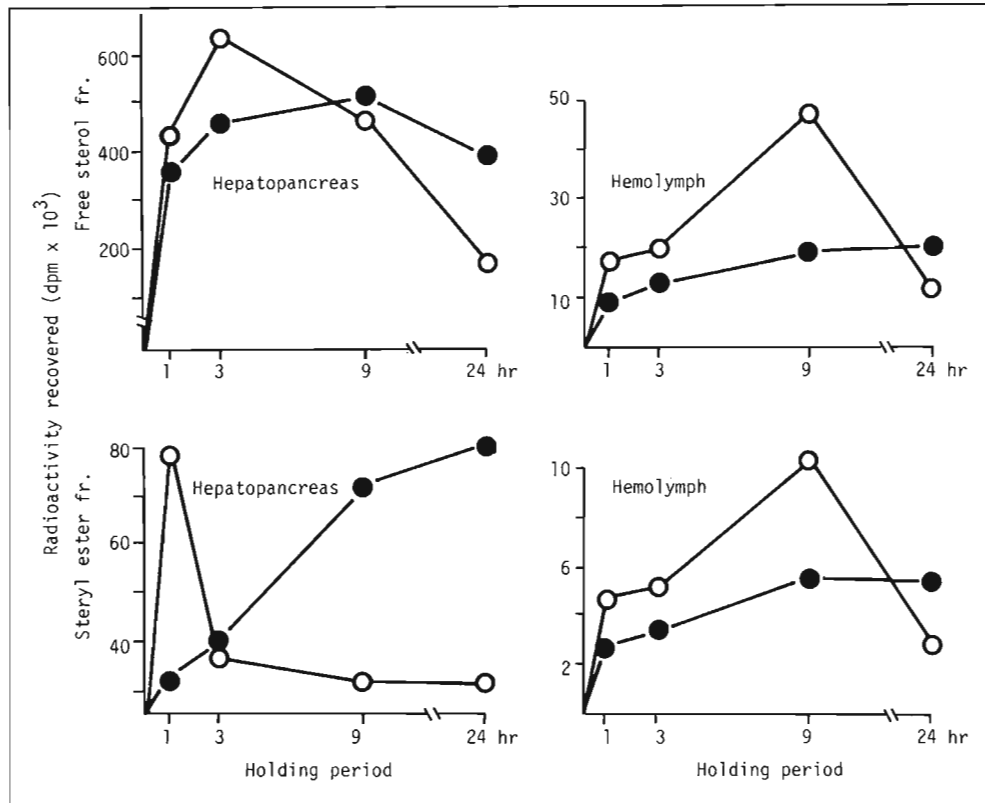

**Figure 5**  
Postprandial incorporation of radioactivity into free sterol and esterified sterol fractions of the hepatopancreas and hemolymph in *P. japonicus* prawns after feeding of cholesterol- $4^{14}\text{C}$  in (○) phospholipid-added diets and (●) phospholipid-deficient diets.

## Conclusions

The prawn *P. japonicus* required dietary sources of both sterols and some phospholipids for growth and survival. The lack of dietary sterols resulted in a marked decrease in weight gain, FCE, and body retention (%) of dietary proteins, lipids, and sterols in juvenile prawns. As a sterol source, cholesterol had a higher nutritive value than  $\beta$ -sitosterol,  $\beta$ -sitosterol-cholesterol (9:1), and 24-methylcholesta-5,22-dienol. The nutritive values of  $\text{C}_{28}$  and  $\text{C}_{29}$  sterols for the prawn are likely to depend upon how easily they are converted to cholesterol in the body.

The lack of dietary phospholipids in diets also reduced the growth of the larval and juvenile prawns. As a phospholipid source, phosphatidylcholine and phosphatidylinositol containing unsaturated fatty acid moieties were effective in improving growth and survival of prawn larvae. To clarify the role of dietary phospholipids in the prawn, the postprandial variation in lipid compositions of the hepatopancreas, hemolymph, muscle, etc., was investigated after feeding diets containing tripalmitin- $^{14}\text{C}$  and cholesterol- $^{14}\text{C}$  with or without 3% soybean lecithin. It seems likely that dietary phospholipids are required for the smooth transport of dietary lipids, especially cholesterol, through the hemolymph.

## Citations

- Castell, J.D., E.C. Mason, and J.F. Covey.  
1975. Cholesterol requirements of juvenile American lobster (*Homarus americanus*). J. Fish. Res. Board Can. 38:1431-1435.
- Clayton, R.B.  
1964. The utilization of sterols by insects. J. Lipid Res. 5:3-19.
- Conklin, D.E., L.R. D'Abramo, C.E. Bordner, and N.A. Baum.  
1980. A successful purified diet for the culture of juvenile lobsters: The effect of lecithin. Aquaculture 21:243-249.
- D'Abramo, L.R., C.E. Bordner, D.E. Conklin, and N.A. Baum.  
1981. Essentiality of dietary phosphatidylcholine for the survival of juvenile lobsters. J. Nutrition 111:425-431.
- Kanazawa, A.  
1983. Penaeid nutrition. In Pruder, G.D., C. Langdon, and D.E. Conklin (eds.), Proceedings of the Second International Conference on Aquaculture Nutrition, p. 87-105. Spec. Publ. 2, World Maricult. Soc., La. State Univ., Baton Rouge.
- Kanazawa, A., N. Tanaka, S. Teshima, and K. Kashiwada.  
1971. Nutritional requirements of prawn. II. Requirement for sterol. Bull. Jpn. Soc. Sci. Fish. 37:211-215.
- Kanazawa, A., S. Teshima, and S. Tokiwa.  
1977. Nutritional requirements of prawn. VII. Effect of dietary lipids on growth. Bull. Jpn. Soc. Sci. Fish. 43:849-856.
- Kanazawa, A., S. Teshima, and M. Sakamoto.  
1985. Effects of dietary lipids, fatty acids, and phospholipids on growth and survival of the prawn (*Penaeus japonicus*) larvae. Aquaculture 50:39-49.
- Mankura, M., D. Dalimunthe, and M. Kayama.  
1980. Comparative biochemical studies on plasma cholesterol. II. Relationship between plasma esterified cholesterol and lecithin: cholesterol acyltransferase activity. Bull. Jpn. Soc. Sci. Fish. 46:583-586.
- Svoboda, J.A., M.J. Thompson, W.E. Robbins, and J.N. Kaplanis.  
1978. Insect steroid hormone metabolism. Lipids 13:742-753.

Teshima, S.

1978. Essential fatty acids and necessity of sterols in crustaceans. *In* Japanese Society of Scientific Fisheries (ed.), Fish culture and dietary lipids. Suisangaku Ser. 22, p. 60-77. Koseisha-koseikaku, Tokyo (in Jpn.).
1983. Sterol metabolism. *In* Pruder, G.D., C. Langdon, and D.E. Conklin (eds.), Proceedings of the Second International Conference on Aquaculture Nutrition, p. 205-216. Spec. Publ. 2, World Maricult. Soc., La. State Univ., Baton Rouge.
1985. Lipids. *In* Yone, Y. (ed.), Fish nutrition and diets. Suisangaku Ser. 54, p. 20-30. Koseisha-koseikaku, Tokyo (in Jpn.).

Teshima, S., and A. Kanazawa.

1980. Lipid transport in crustaceans. Min. Rev. Data File Fish. Res. Kagoshima Univ. 1:1-25.
1983. Digestibility of dietary lipids and cholesterol in the prawn. Bull. Jpn. Soc. Sci. Fish. 49:963-966.
- 1985a. Role of dietary phospholipids in the utilization of lipids and cholesterol by the prawn (*Penaeus japonicus*). Abstracts of Papers. Biological Assessment of Nutritional Requirements and Availability in Fish. Satellite Symposium, XIII. International Congress of Nutrition, held at Brighton, U.K., 17-18 August 1985.
- 1985b. Sterol nutrition in the prawn, *Penaeus japonicus* - I. The nutritive values of cholesterol, 24-methylcholesta-5,22-dienol, and  $\beta$ -sitosterol. Abstracts, autumn meeting, Jpn. Soc. Sci. Fish, p. 105.

Teshima, S., A. Kanazawa, and H. Sasada.

1983. Nutritive value of dietary cholesterol and other sterols to the larval prawn, *Penaeus japonicus*. Aquaculture 31:159-167.

Teshima, S., A. Kanazawa, and Y. Kakuta.

- 1986a. Role of dietary phospholipids in the transport of [<sup>14</sup>C] tripalmitin in the prawn. Bull. Jpn. Soc. Sci. Fish. 52:519-524.
- 1986b. Role of dietary phospholipids in the transport of [<sup>14</sup>C] cholesterol in the prawn. Bull. Jpn. Soc. Sci. Fish. 52:719-723.

Watanabe, T.

1982. Lipid nutrition in fish. Comp. Biochem. Physiol. 73B:3-15.

---

# Applications of endocrinology to salmon culture: Hormonal induction of spawning of adults and hormone patterns during development of juveniles

**WALTON W. DICKHOFF**

*National Marine Fisheries Service, NOAA  
Northwest and Alaska Fisheries Center  
2725 Montlake Blvd. E.  
Seattle, Washington 98112  
and*

*School of Fisheries WH-10  
University of Washington  
Seattle, Washington 98195*

The many applications of endocrinology in fish culture can be categorized into two major types. One involves establishing the functions of hormones and measuring their activities during normal physiological processes. The other involves the application of hormones (or their synthetic agonists or antagonists) in order to control some aspect of the animal's physiology. Two examples of these types of applications will be discussed. The changes in blood plasma concentrations of hormones during the parr-to-smolt transformation of juvenile salmon reveal a complex pattern of endocrine activities that may be used to predict the optimal time for transferring salmon from fresh- to seawater. The use of hormones to induce spawning of captive broodstock salmon in either fresh water or seawater is a good example of applications of hormones to facilitate broodstock husbandry.

The developmental period known as the parr-to-smolt transformation (smoltification) prepares the freshwater resident juvenile salmon for downstream migration and entry into the estuary and ocean. Smoltification is associated with a variety of morphological, biochemical, and behavioral changes in the fish. This developmental process appears to be influenced primarily by photoperiod and temperature, among other environmental factors. Control of smoltification is mediated at least in part through neuroendocrine and endocrine mechanisms. Histological studies have implicated involvement of the thyroid, pituitary, interrenal, pancreas, Corpuscles of Stannius, ultimobranchial, urophysis and catecholaminergic (head kidney) tissue. Application of radioimmunoassay to determine blood plasma concentration of hormones has verified a role for some of these glands and implicated others as possible mediators of smoltification. Increased activity of the thyroid during smoltification is associated with increases in plasma thyroxine (T<sub>4</sub>) and, depending on the species, triiodothyronine concentration. Plasma cortisol levels increase subsequent to or coincident with the increase in circulating T<sub>4</sub>. In some cases, plasma estradiol concentration has been shown to follow a pattern of increase and decrease similar to that of T<sub>4</sub>. Daytime levels of plasma melatonin appear to be constant throughout smoltification. Plasma levels of insulin increase in parr immediately prior to the beginning of smoltification. A similar increase in insulin-like growth factor I (IGF I) may also occur at this time. Plasma levels of norepinephrine and epinephrine become elevated near the end of smolt development. The large number of pituitary-dependent and independent hormones that change during smoltification suggests that there is a hypothalamic or general endocrine activation during juvenile development of salmon (Dickhoff and Sullivan 1987). The appropriate order or sequence of activation of the various endocrine glands during normal development remains to be established. Furthermore, the interactions of various hormones that change during smoltification need to be examined.

The natural process of spawning in teleost fish is accomplished through neuroendocrine and endocrine pathways. Environmental stimuli (photoperiod, temperature) are perceived by the brain which regulates the release of neuropeptides and catecholamines which in turn control the release of gonadotropic hormone (GtH) by the pituitary gland. Pituitary GtH released into the blood acts on the gonads to promote the release of gametes (spermiation and ovulation). Release of GtH by the pituitary is stimulated by the brain peptide, gonadotropin-releasing hormone (GnRH). In teleost fishes spawning can be induced by the injection of GtH or GnRH. A synthetic analogue of GnRH, desGly<sup>10</sup>, D-Ala<sup>6</sup>GnRH, (GnRH<sub>a</sub>), is particularly effective in inducing spawning of salmonid fish.

Salmonids normally spawn in fresh water, although some species may spawn in brackish water. Attempts to spawn salmonids maintained in seawater have yielded mixed results. Frequently maturing adults retained in seawater will die before spawning. If spawning does occur in seawater, the gametes are often not viable. There are several biological mechanisms that may be operating to inhibit spawning in seawater or be responsible for a reduction in gamete fertilizability or viability. Residence in seawater may block the activation of neuroendocrine and endocrine pathways that normally control spawning. Alternatively, prolonged seawater residence may cause ionic or osmotic imbalances in the blood or tissues and have direct adverse effects on the gonads. Experiments were carried out to test these possibilities (Dickhoff unpubl.). Four-year-old Atlantic salmon (*Salmo salar*) of the Gaspé stock were maintained in floating seawater netpens in Puget Sound near Manchester, Washington. Near the time of sexual maturation, two groups of fish were retained in seawater (29‰), two groups were transferred to fresh water, and a third set of two groups was transferred to floating netpens in which a layer of dilute seawater (17 to 19‰) was established. One group in each of the three environments was injected with GnRH $\alpha$  (10  $\mu$ g/kg) on days 1 and 3. The control groups were injected with 0.9% saline. In comparison with controls, spawning was advanced in all groups injected with GnRH $\alpha$ . Prespawning mortality was high in the group maintained in full-strength seawater and injected with saline. The cumulative percent fertilization and survival to the eyed stage for gametes and embryos was similar in hormone- and saline-injected groups in fresh water and in dilute seawater for the hormone-injected group that was spawned within one week after injection.

Fertilization and survival of embryos were reduced in the groups in dilute seawater at day-10 after injection and in the group in full-strength seawater. These results indicate that spawning of salmonids in seawater can be induced by injection of GnRH $\alpha$ . Egg fertilizability and gamete viability may be reduced when adults are maintained in full-strength seawater or for a prolonged period in dilute seawater. The results support the hypothesis that in maturing salmonids in seawater the neuroendocrine pathway controlling spawning is inhibited by the central nervous system.

## Acknowledgments

---

This work was supported in part by Washington Sea Grant (R/A 42) and the National Science Foundation (Grant DCB 8416224). The author wishes to thank the following for their assistance: F.W. Waknitz, J.L. Mighell, C.V.W. Mahnken, E. Plisetskaya, P. Swanson, C.V. Sullivan, and A. Gorbman.

## Citation

---

Dickhoff, W.W., and C.V. Sullivan.

1987. Thyroid involvement in salmon smoltification with special reference to metabolic and developmental processes. In Dadswell, M.J., et al. (eds.), Common strategies of anadromous and catadromous fishes, p. 197-210. Symp. ser. 1, Am. Fish. Soc., Bethesda, MD 20014.

---

# Isolation and development of protoplast in *Porphyra*

HITOSHI KITO

Seikai Regional Fisheries Research Laboratory  
Fisheries Agency  
49 Kokubu-machi  
Nagasaki, 850 Japan

Several species of seaweeds belonging to the genus *Porphyra* are used for food ("Nori"). The complete life history of these species was not known until Drew (1949), an English algologist, discovered a small shell-boring algae (*Conchocelis*) thought to belong in a different genus from *Porphyra* but which is, in fact, the summer form of *Porphyra*. Later research has demonstrated that the chromosome number of the *Conchocelis* is diploid; that of the thallus, which is actually used for food, is haploid; and the chromosome number used for culture is  $n=3$ .

In current Nori culture, the thallus stage is cultured, controlled, and produced at sea from autumn to spring, and the *Conchocelis* stage is cultured and controlled as seeds in land equipment from spring to autumn. Through the whole process, two applications are considered in the use of protoplasts as seeds. One application is the productive technical system which, concretely, is able to eliminate the *Conchocelis* stage from the process of Nori culture by direct use of a budding body of protoplasts as seeds. We can preserve the thallus of *Porphyra* from several months to several years by semidehydrofreezing at  $-20^{\circ}\text{C}$ . This is done from early spring, when the Nori culture ends, to early autumn when the spores are placed in culture nets. When spores are needed, the thallus is thawed to provide protoplasts that are set directly in culture nets.

Another application attempts to improve the breed through partial use of a breeding technique called cell fusion, consisting of treating the protoplasts to bring about artificial variation in genes. As mentioned above, *Porphyra* is a haploid-chromosome-number stage; thus, improving it by crossbreeding is much more difficult than in the case of land plants. To date, only selection has been introduced as a breeding technique. With cell fusion, however, new combinations of genes can be produced without sexual reproduction. For this reason, there is a strong hope that cell fusion using the haploid-chromosome-number stage can be used as a plant breeding technique.

Among the more popular and larger algae, protoplasts of the following species have been isolated: *Bryopsis plumosa*, *Enteromorpha intestinalis*, *Enteromorpha* sp., *Porphyra yezeensis*, and *Laminaria japonica*.

Algal cell wall structures, as well as their chemical components, are very different from those of land plants. Many land plants are composed of cellulose and pectin, and the enzymes sold on the market to dissolve them are largely ineffective on the cell walls of marine algae. Also, there are remarkable differences between species of algae. That is why we need to discover enzymes for dissolving cell walls that are suitable to each algae.

## Components of the *Porphyra* cell wall and the search for dissolving enzymes

---

There is a thin membrane of protein in the outermost structure of the *Porphyra* cell wall, and beta-1-4 mannan, a polysaccharide, is inside this membrane. Further in, there is beta-1-3 xylan in a microfibril structure. Moreover, porphyran is the substance that makes up the cell wall. Thus, polysaccharides with different structures from land plants are in the cell wall. The digestive enzymes of small animals that eat marine algae and enzymes produced by marine bacteria effectively dissolve these polysaccharides. However, we have so far been unable to develop refined enzymes that effect a specific polysaccharide.

**Table 1**  
Former results of protoplast isolation in *Porphyra*.

Species	Enzyme or organisms from which enzyme was reduced	Results of protoplast		
		Yielded quantity	Development	References
<i>P. yezoensis</i>	<i>Pseudomonas</i> sp. (isolated from <i>Porphyra</i> sp.)	Number not counted, but positively recognized		Fujita et al. 1982
<i>P. yezoensis</i>	Digestive enzyme of sea urchin	10 <sup>3</sup> /mL	—	Saga and Sakai 1984
<i>P. perforata</i>	AAP (Abalone Aceton Powder)	>100 cells/field*	Regenerated to thalli	Polne-Fuller et al. 1984
	Agarase	<2-5 cells/field		
	Macerase	<2-5 cells/field		
	Macerase + AAP	>100 cells/field		
	Pectinase	<2-5 cells/field		
	Pectinase + AAP	>200 cells/field		
<i>P. perforata</i>	Sulfatase	<2-5 cells/field		Polne-Fuller and Gibor 1984
	Sulfatase + AAP	>100 cells/field		
<i>P. perforata</i>	AAP	~10% of cells in the material	Regenerated, concluded life cycle	Polne-Fuller and Gibor 1984
<i>P. yezoensis</i>	Papain + enzyme bacilli from sea bottom + <i>Aeromonas</i> sp. + bacteria from seaweeds	Number not counted, but many recognized	Cell division	Hatate et al. 1986
<i>P. yezoensis</i>	<i>Pseudomonas</i> sp. (isolated from <i>Porphyra</i> sp.)	Number not counted, but positively recognized	Regenerated to thalli, monospore	Fujita and Migita 1985
<i>P. yezoensis</i>	Papain and AAP	10% of cells in the material	Regenerated to thalli, monospore conchocelis	Kito 1985

\*Microscopic field used ×10 object lens.

In past experiments, the enzymes used in most cases to dissolve cell walls of marine algae were crude ones extracted by the researcher. The only enzyme on the market is one extracted by acetone from abalone (Abalone Aceton Powder, Sigma Co.). The enzymes used and subjects of extraction in attempts to dissolve the *Porphyra* cell wall are shown in Table 1.

### Extraction method of the enzyme and its characteristics

For the purpose of dissolving the *Porphyra* cell wall, we isolated the bacteria that could dissolve xylan and mannan from cultured *Porphyra* plantlets. Two strains with especially strong dissolving power were selected from these bacteria. They were cultured in large quantities and the enzyme produced in the culture solution collected. The dissolving power of these enzymes against *Porphyra* crude fiber was examined.

Both strains were identified as *Vibrio fisheri*. It was found that adding about 2% crude fiber substance extracted from *Porphyra* to standard culture medium, Zobell 2216E, substantially increases the enzyme's dissolving power. These enzymes showed the highest activation at pH 8.

We do not know the process of preparation of Abalone Aceton Powder (AAP). What we do know is that this powder does not react to the thin membrane of protein that forms the outermost layer of *Porphyra* plantlets, but dissolves the layer of mannan, xylan, and porphyrin inside this thin membrane. Optimum pH of reaction is

in the vicinity of 5.5 to 6.0. The dissolving power of this powder is a little stronger than the enzyme produced by marine bacteria. Because of its commercial availability, AAP is considered to be the most useful at present.

### Isolating protoplasts

The technique for isolating protoplasts from the *Porphyra* plantlet is shown in Figure 1. In this process, the germ-free technique is omitted because many marine algae have viscous substances on their body surfaces, making it difficult to produce germ-free plantlets. To experiment with completely germ-free plantlets, the plantlet will have to be reared from a budding body in germ-free culture.

### Culturing a budding body from protoplasts

The number of cells isolated as protoplasts varies considerably with the age (days after beginning the culture) of plantlets used. A plantlet of ~40 days with a length of ~3-5 cm is most suitable. In this case, approximately 10% of the cells are isolated as protoplasts (see Figure 2a). Protoplasts obtained by reaction of the enzyme solution are washed thoroughly in seawater, then collected together by slowly centrifuging (at 600 rpm for 5 min), and cultured. SWM-3 is a good culture solution. The first stage of culture consists of setting the protoplasts in a 5-cm-diameter petri dish. These are stationary

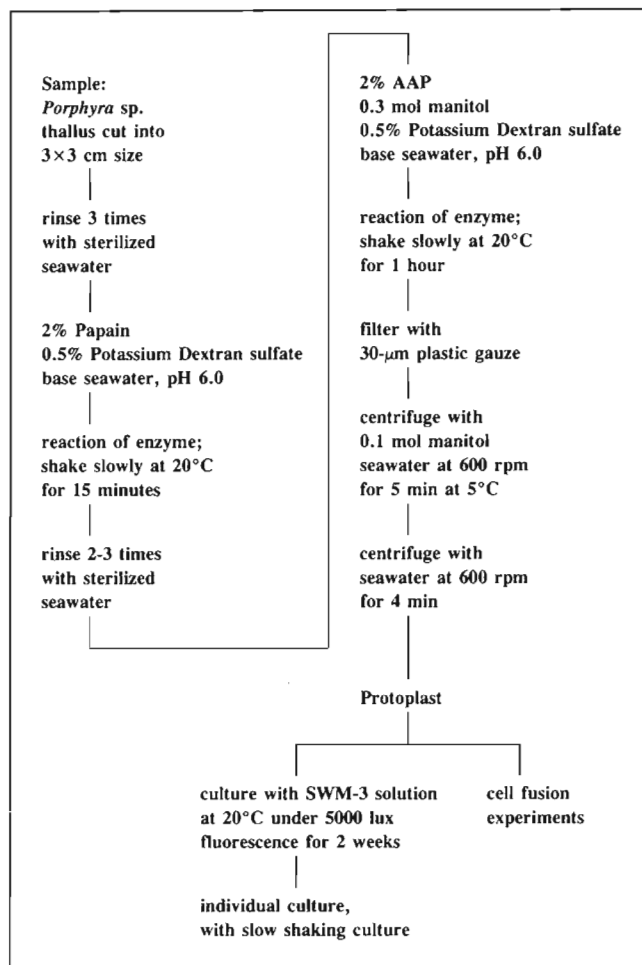

**Figure 1**  
Protoplast isolation technique.

cultures at a temperature of 20°C and an illumination of ~5000 lux with fluorescent lamps.

Five days after beginning the culture, protoplasts begin cell division and gradually develop into germlings of plural cells. When germlings consist of about 10 cells each (see Figure 2b), they are separated and placed in culture vessels with many separate chambers and maintained at 15°C and ~5000 lux. Further, when germlings attain ~1.0 mm in length, we transfer them into culture bottles (30 mL each) and place them into shaking culture. After that, depending on their growth, we move them into *Porphyra* culture vessels with an air-pipe at the bottom of a round-bottomed flask containing ~500 mL culture medium.

### Early budding of protoplasts and growth to plantlet

By culturing protoplasts of *Porphyra yezoensis* in a small petri dish, the volume of each germling begins to increase gradually and develop into an egg shape. After about one week, cell division begins (see Figure 2b).

In the first cell division, at the budding time of general conchospores and monospores, two cells of the same size are formed. But in the case of protoplasts, a boundary cell wall is formed and the sizes of the divided cells are uneven. In many cases the boundary cell wall is indistinct. Such unevenness of cell sizes disappears during further division and development to a plantlet. In the early stages, the cells form many layers and develop to a massive germling with many folds.

When this massive germling attains ~50 µm in diameter, one to several large transparent cells develop in the margin of the germling, and one or more rhizoids extend from it (see Figure 2c). By setting it into a shaking culture, this germling grows into a unilayered juvenile plantlet with many folds (see Figure 2d). The juvenile plantlet of about 5-mm body length consists of many layers of cells, and releases monospores. These monospores develop into a plantlet with cell divisions the same as that of a normal juvenile plantlet.

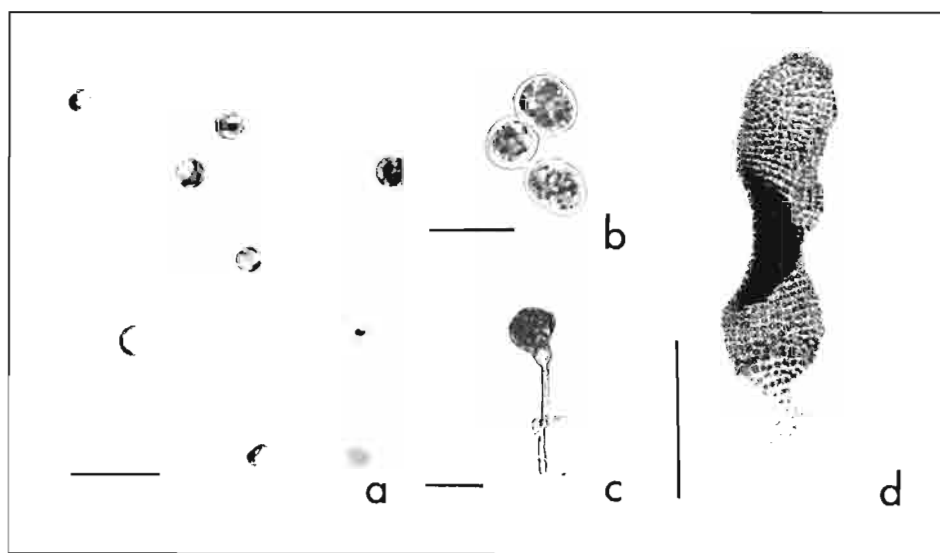

**Figure 2**  
(a) Protoplast; (b) Germlings of protoplast, 13-d-old after liberated; (c) Germlings of protoplast, 30-d-old after liberated; (d) Juvenile thallus, 65-d-old after liberated. Scale: a-c, 50 µm; d, 1 mm.

The plantlets from protoplasts grow much slower (~15 cm during 120 days of culture) than the budding body from conchospores and monospores, but there are no differences in growth mechanisms. At 90 days of age, recognizable reproductive cells are formed. Conchocelis are obtained by removing part of a carpospore into a small test tube for culture.

## Discussion

In attempts to isolate protoplasts with unicellular algae, some of the many researchers report that fused cells begin to form cell walls and at times even propagate. However, in multicellular algae production for food in Japan, observation of the beginning of protoplast cell division is rare.

As mentioned above, the thallus is haploid in chromosome number. Therefore, if the diploid Conchocelis stage could be obtained from the clonal plantlet from this protoplast by accelerating self-fertilization of each plantlet, it would be easy to produce a homozygote and improve the breed. Because the thallus is haploid, it should also be possible to produce a homozygote by self-fertilization of a normal thallus. However, according to recent reports, meiosis of *Porphyra* is observed at the first cell division after budding of conchospores. In this case, four kinds of cells whose genes are different from one other will be present in the *Porphyra* plantlet. Therefore, we need to first make protoplasts and then form plantlets from them and make homogenes by self-fertilizing the plantlets. It is thought that selection can increase the effectiveness of this technique.

Up to now, the Conchocelis has been cultured by boring into oyster shells which have functioned well to release conchospores effectively and to attach them evenly in culture nets. However, the summer stage of the Conchocelis production could be omitted, although it would have a great impact on the entire system of Nori culture as it is practiced in Japan at present. Therefore, it is necessary to look at the problem from many viewpoints.

In the cell fusion experiment, we obtained protoplasts from red- and green-pigment mutant species, used these mutant species as markers, and repeated the experiment with the polyethylene glycol (PEG) method for land plants. At present, we can obtain the fused cell. After this, it is important to culture the fused cells to adult thalli.

Finally, we think extreme caution is necessary in producing organisms through biotechnology that do not presently exist in the natural world and discharging them into the sea. Even if this industry disposes of whole products in the form of aquatic culture, it is absolutely impossible to completely and reliably isolate part of a water mass; therefore, genetic mixtures with wild species may occur. It is necessary to investigate the use of newly produced seeds used in sea farming for release in the sea. It is important to preserve gene resources, and a plan for gene preservation for useful aquatic species is being developed. It was begun in 1985 by a group of national fisheries laboratories with the financial help of the Japanese Agriculture, Forestry, and Fisheries Council.

## Citations

Drew, K.M.

1949. Conchocelis phase in the life-history of *Porphyra umbilicalis* (L.) Kutz. Nature 164:748-749.

Fujita, Y., T. Thompson, and S. Migita.

1982. Isolation and culture of protoplast from *Porphyra* and *Enteromorpha* prepared by bacterial enzyme. Abstr. Annu. Meet. Jpn. Soc. Sci. Fish., 211 p. (in Jpn.).

Fujita, Y., and S. Migita.

1985. Isolation and culture of protoplast from some seaweeds. Bull. Fac. Fish. Nagasaki Univ. (57):39-45 (in Jpn.).

Hatate, H., Y. Aoki, T. Araki, and M. Kitamikado.

1986. Preparation of bacterial enzymes capable of degrading the cell wall of red algae *Porphyra yezoensis*. Bull. Jpn. Soc. Sci. Fish. 52(3):545-548 (in Jpn.).

Kito, H.

1985. Isolation and development of protoplast in *Porphyra*. Res. J. Food Agric. 8(9):20-24 (in Jpn.).

Polne-Fuller, M., M. Biniaminov, and A. Gibor.

1984. Vegetative propagation of *Porphyra perforata*. Hydrobiologia 116/117: 308-313.

Polne-Fuller, M., and A. Gibor.

1984. Developmental studies in *Porphyra*. I. Blade differentiation in *Porphyra perforata* as expressed by morphology, enzymatic digestion, and protoplast regeneration. J. Phycol. 20:609-616.

Saga, N., and Y. Sakai.

1984. Isolation of protoplast from *Laminaria* and *Porphyra*. Bull. Jpn. Soc. Sci. Fish. 50(6):1085.



---

# Genetic engineering and biotechnology of economically important seaweeds

DONALD P. CHENEY

Biology Department  
Northeastern University  
Boston, MA 02115

Increased commercial utilization of seaweeds in the United States and other developed countries will most likely depend upon the successful cultivation of newly developed, genetically improved strains. Genetic engineering techniques have the potential to produce valuable new strains of seaweeds not otherwise possible by classical breeding methods. Genetic engineering involves the *in vitro* transfer of genes from one organism to another in the absence of sexual reproduction. Methods by which gene transfer can be accomplished include protoplast fusion-somatic hybridization, microinjection, direct gene transfer, and the use of vectors such as the Ti plasmid of *Agrobacterium*. Although such techniques are being applied to a great many land plants today, they are just beginning to be developed for seaweeds. Indeed, the current status of genetic engineering in seaweeds is much like it was for land plants in the 1960s; that is, the basic knowledge and techniques for protoplast, cell, and tissue culture are still in an early stage of development. Nevertheless, rapid progress has been made in these essential supportive techniques in the past few years and the future for such research looks bright. The purpose of this report is to briefly review the current status of work in this area, and to describe recent research in my laboratory on protoplast production and tissue culture of phycocolloid-producing red seaweeds.

Protoplast and tissue culture research in seaweeds is a relatively new field, starting less than 10 years ago. To date, there has been a total of 16 species (9 genera) of seaweeds from which protoplasts have been isolated (see review by Cheney 1986). Examples include *Enteromorpha*, *Monostroma*, *Ulva*, *Laminaria*, *Macrocystis*, and *Porphyra*. Our laboratory has recently reported on methods for producing large numbers of viable protoplasts from the agarophytes *Gracilaria tikvahiae* and *G. lemaneiformis* (Cheney et al. 1986, Cheney 1984). Protoplast-produced cell masses up to the 16-32 cell stage have been grown in culture; however, efforts to regenerate a whole plant have been unsuccessful to date. We and several others have reported (presumed) protoplast fusion, although unequivocal evidence of heterokaryon production is thus far lacking.

The ability to grow a plant as undifferentiated callus or as single cells rather than organized into a thallus is a recent development in seaweeds. To date, a total of 21 species of seaweeds have reportedly been regenerated from cell or tissue culture (Cheney 1986). Tissue culture has been reported for *Enteromorpha*, *Ulva*, *Laminaria*, *Undaria*, *Macrocystis*, *Porphyra*, and *Chondrus*. We have developed tissue culture methods for the carrageenophyte *Agardhiella subulata*. This is the first time a true tissue culture system (capable of repeated subculture and controlled plant regeneration) has been developed for an anatomically complex, higher red alga.

Although clearly it will be some time before genetic engineering techniques can be applied to economically important seaweeds on a practical basis, protoplast and tissue culture technology can and will undoubtedly play an important role in the future of seaweed genetic improvement and mariculture.

## Additional note

---

Since this report was first prepared, considerable progress has been made in the protoplast and tissue culture of red seaweeds in our laboratory. In particular, we've developed methods for the successful regeneration of *Gracilaria* protoplasts to whole plants, as well as a true tissue culture system for the carrageenophyte *Agardhiella*.

Protoplasts have now been successfully regenerated to whole plants for several strains of *Gracilaria tikvahiae*. Several factors proved important in obtaining these successful results, including the careful selection of starting material, the gradual dilution of culture media after protoplast production, and the control of bacterial growth with a specially formulated antibiotic mixture. Interestingly, protoplast regeneration did not occur in axenic cultures, as is usually the case in higher plants. Protoplast regeneration only occurred in those cultures in which bacteria growth was not eliminated but rather controlled with antibiotics. The antibiotic mixture we used contained a total of eight different antibiotics. These were specifically selected from a wide variety of antibiotics by using a new method we've termed the "one-step, antibiotic disk method" (Bradley et al. In press). This method provides a simple and rapid technique for determining which antibiotics are effective against a plant's bacterial flora. Further details of our protoplast culture methods will be described elsewhere.

Upon the successful development of protoplast regeneration methods, we initiated protoplast fusion experiments with *Gracilaria*. Protoplasts from a wild-type, red pigmented *Gracilaria tikvahiae* strain were fused with protoplasts from a green mutant strain using the chemical fusant polyethylene glycol (PEG). The methods we used were basically similar to those commonly used with higher plants, incorporating a high pH-high  $Ca^{++}$  dilution step after protoplast agglutination (e.g., see Kao and Michayluk 1974). Protoplast agglutination, but not complete fusion, was observed microscopically. After subsequent culture, several red and green bicolor germings developed. These eventually developed into red and green chimeric whole plants. Such chimeras were produced at too great a frequency to have been caused by either mutations or reversions. Since bicolor heterokaryons were not observed microscopically, the development of these chimeras may simply have been caused by the adherence of red and green protoplasts to each other without fusing. Regardless, the production of such red and green bicolor chimeras is unusual. To our knowledge, this is the first report of chimera production from protoplasts in a seaweed. Protoplast fusion in *Gracilaria* is currently under further investigation in our laboratory.

A second area in which considerable progress has been made is in the tissue culture of *Agardhiella*. Since *Agardhiella* shares a number of similarities with the commercially farmed seaweed *Eucheuma*, we have been using *Agardhiella subulata* as a model for *Eucheuma*. Our tissue culture of *Agardhiella* is unusual in that two distinct types of tissue growth have been produced in culture: true callus and masses of elongated, uniseriate filaments. Callus consisting of masses of unorganized, pigmented, spherical cells have been produced from medullary cores grown in enriched seawater. Filaments (up to 5 mm long) develop from outer cortical cells of cross-sectional disks cultured in ASP-12-NTA media. Such filaments can be easily subcultured to form filamentous masses. Both callus and filamentous masses have been subcultured for over a year and regenerated into whole plants. A preliminary report on the filamentous tissue culture system has been presented elsewhere (Cheney et al. In press).

One of the most interesting features of the filamentous tissue culture system is its relatively fast growth rate. Under optimal growth conditions, the filamentous masses grew at rates quite comparable to that of whole plants; that is, around 1-3% per day based upon wet weight. This is a fast growth rate for a tissue culture system and allowed us to conduct chemical analyses of the filamentous tissue. In particular, we were interested in determining how the carrageenan composition of the tissue culture compared with that

of whole plants. Our results have been described in detail elsewhere (Cheney et al. In press). However, basically we found that the filamentous tissue culture produces a type of *iota* carrageenan similar to that found in whole plants but perhaps slightly higher in its content of precursor molecules. Additional biochemical studies are underway with the *Agardhiella* filamentous tissue culture system. Furthermore, this system is also being used to produce mutants *in vitro*.

## Acknowledgments

---

This work was supported in part by a grant from the National Science Foundation, PCM-8312607, and was conducted with the able help of Peter Bradley and Clif Duke.

## Citations

---

- Bradley, P., D. Cheney, and N. Saga.  
In press. One step antibiotic disk method for obtaining axenic cultures of multicellular marine algae. *Plant Cell Tissue Organ Cult.* 12.
- Cheney, D.  
1984. Genetic modification in seaweeds: application to commercial utilization and cultivation. In Colwell, R., E. Pariser, and A. Sinskey (eds.), *Biotechnology in the marine sciences*, p. 161-175. Wiley-Interscience, NY.  
1986. Genetic engineering in seaweeds: applications and current status. *Nova Hedwegia* 83:22-29.
- Cheney, D., E. Mar, N. Saga, and J. van der Meer.  
1986. Protoplast isolation and cell division in the agar-producing seaweed *Gracilaria* (Rhodophyta). *J. Phycol.* 22:238-243.
- Cheney, D., A. Luistro, and P. Bradley.  
In press. Carrageenan analysis of tissue cultures and whole plants of *Agardhiella subulata*. *Hydrobiologia* 151/152.
- Kao, K., and M. Michayluk.  
1974. A method for high-frequency intergeneric fusion of plant protoplasts. *Planta* 115:355-367.

# Mass culture of *Ulvella lens* as a feed for abalone, *Haliotis discus hannai*

KANJI TAKAHASHI

Kesenuma Miyagi Prefectural Fisheries  
Experimental Station  
Hajikami-Uchinuma 119  
Kesenuma, 98802 Japan

AKIMITSU KOGANEZAWA

Tohoku Regional Fisheries Research Laboratory  
Shiogama, Japan

Of the 10 species of *Haliotis* that inhabit Japan, four species, *H. discus hannai*, *H. discus*, *H. sieboldii*, and *H. gigantea*, are economically significant. The geographical distribution of these species is shown in Figure 1. *Haliotis discus hannai* ranges along the northern areas such as Hokkaido and the Pacific littoral, near which a cold current flows, and the other species along the littoral near which a warm current flows.

The landings and yields of abalone for 10 years between 1973 and 1983 are shown in Figure 2. Annual landings fluctuated between 4,607 and 5,839 tons, averaging 5,626 tons. Annual yields varied between \$41.0 million and \$83.8 million, averaging \$72.6 million. Thus, abalones are important species for coastal fisheries and a staple product in Japanese Aquaculture Centers established for seed production. Numbers of seed abalones produced and released in 1983 are shown in Table 1.

The seed producing systems in Japan vary from prefecture to prefecture according to their localities. In principle, however, they are based on the method introduced by Kikuchi and Uki (1974a,b), and Seki (1980). Such technical systems have the following problems to be solved.

Annual production of the northern abalone species by each farm is 1.217 million compared with 496,000 for the southern species, which means that production of the former is 2.5 times as great as the latter. This difference is thought to be caused by the fact that, although research on gonadal maturation of the southern species has been conducted, adult conditioning is not as efficient in southern as in northern areas.

Northern growers begin intermediate rearing of seed abalones, distributed to them by seed abalone farms, in the spring and release them before winter because seed abalones stop growing in winter and their rearing becomes difficult to control. Thus, the sizes of

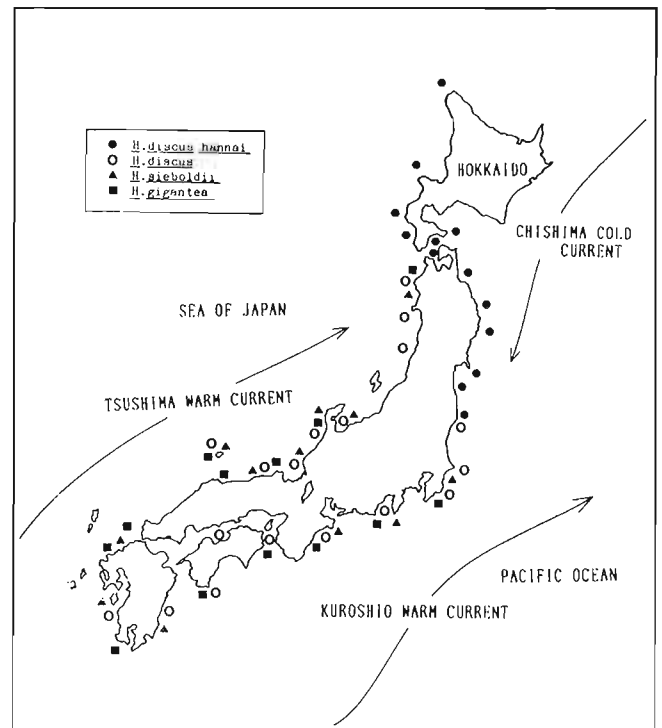
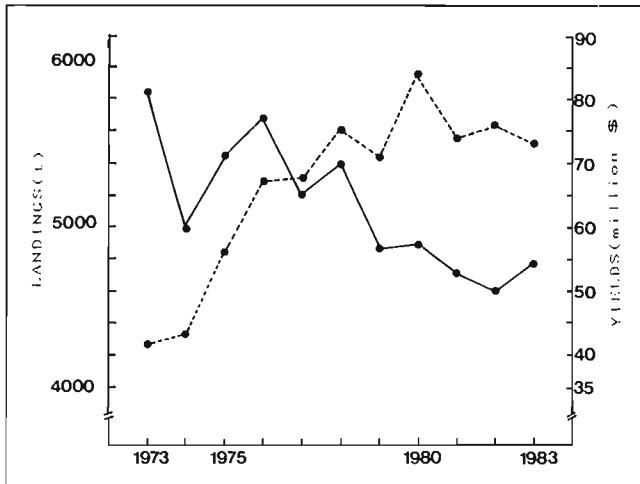

Figure 1  
Distribution of industrially significant abalones in Japan.



**Figure 2**  
Abalone fisheries in Japan.  
Solid line = landings; dotted line = yields.

	Northern species		Southern species		Total
	<i>H. discus hannai</i>	<i>H. discus</i>	<i>H. seiboldii</i>	<i>H. gigantea</i>	
Production	13,394,000	10,911,000	518,000	0	24,823,000
Release	11,888,000	6,018,000	423,000	5,000	18,334,000
No. of prefectures	11	23	4		34

released juveniles depend on the size of the juveniles distributed by the seed farms. When seed is collected during the natural spawning season from August to September, the average size of distributed juveniles one and a half years later in the spring will be 15 mm. Though the desired size of released juveniles is more than 30 mm, juveniles of intermediate rearing are released when smaller than 30 mm under certain circumstances.

Therefore, to increase the juvenile recapture rate, it is necessary to increase the size of distributed seed abalones. As a means to that end, early seed collection in June and July, which hastens the growth of early juveniles by taking advantage of summer water temperatures, is thought to be effective. However, the conventional method to produce food for early juveniles by controlling algal communities is difficult because of low water temperatures during the algae culture period.

Therefore, the authors developed a method to guarantee a stable and systematic diet for early juveniles through the mass culture of *Ulvelia lens* which can be obtained as the second-phase algae community, except in summer. At present, this method is incorporated into the seed abalone production system in the northern areas and has resulted in stabilization of the production process, as well as the production of larger seed abalones and increased landings. This paper reports on the ecological aspects of *Ulvelia lens* and the method of its mass culture.

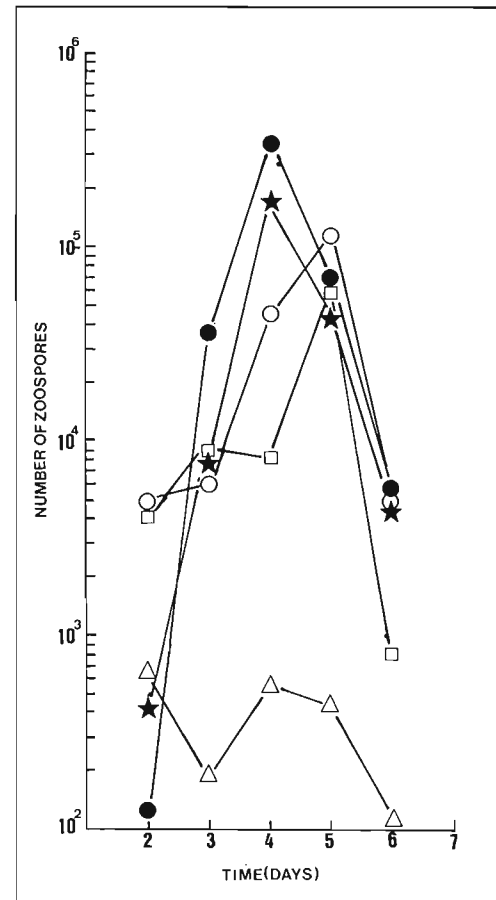

**Figure 3**  
Relationship between water temperature and the number of zoospores released by sporophytes of the green alga, *Ulvelia lens*. Sporophytes were immersed in 1-L beakers kept at constant temperatures of 8°C (Δ), 12°C (□), 15°C (○), 20°C (●), and 25°C (★), by means of water baths on 9 March 1983. Vinyl chloride plates were set at setting substrate for zoospores. Density counts on the plates were begun on the second day following temperature stimulation.

## Ecology of *Ulvelia lens*

### Relationship between spawning of zoospores and water temperature

The relationship between spawning and water temperatures was studied when the culture water temperatures of adult sporophytes were 7.4°C (Experiment 1) and 9.2°C (Experiment 2), and the results are shown in Figures 3 and 4. In Experiment 1, the daily settlement of zoospores at the immersion water temperature of 8°C was less than 1,000 and no daily variations were recognized. The settlement increased daily at 12, 15, 20, and 25°C, with maximum settlement at 20 and 25°C on the fourth day and at 12 and 15°C on the fifth day. The total settlement for 5 days was highest at 20°C.

In Experiment 2, no settlement occurred at the immersion water temperature of 30°C. At water temperatures of 12, 15, 20, and 25°C, maximum settlement occurred on the third day. The total settlement for 5 days was highest at 15°C.

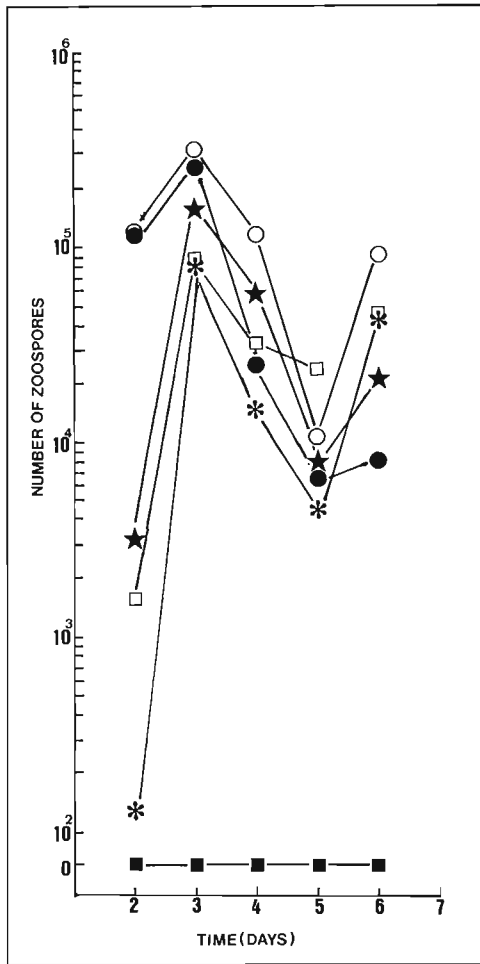

Figure 4

Relationship between water temperature and the number of zoospores released by sporophytes of the green alga, *Ulvella lens*. Sporophytes were immersed in 1-L beakers kept at constant temperatures of 10°C (\*), 12°C (□), 15°C (○), 20°C (●), 25°C (★), and 30°C (■), by means of water baths on 18 April 1983. Vinyl chloride plates were set at setting substrate for zoospores. Density counts on the plates were begun on the second day following temperature stimulation.

The settlement at 10°C in Experiment 2 rapidly increased to 56 times greater than that at 8°C obtained in Experiment 1. It can be inferred from this result that very few zoospores are spawned at water temperatures lower than 10°C. Therefore, securing adult sporophytes to cultivate the diet for seed collection must be completed before water temperature falls below 10°C.

The settlement at 15°C was 2.3 times greater than at 12°C in Experiment 1, and 4 times greater in Experiment 2. Thus, the lowest water temperature suitable for obtaining spores is somewhere around 15°C. Maximum water temperature appears to be about 20°C, because settlement at 20°C was higher than that at 25°C, and no settlement was seen at 30°C in Experiment 2. Judging from this, the suitable water temperatures for zoospore release seem to be between 15 and 20°C, a range that can be maintained by atmospheric temperature from late April in standing immersion water.

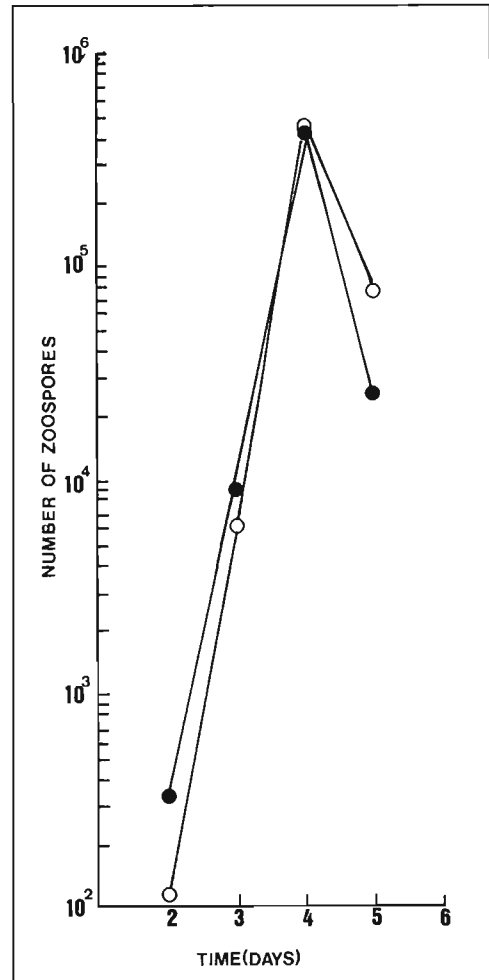
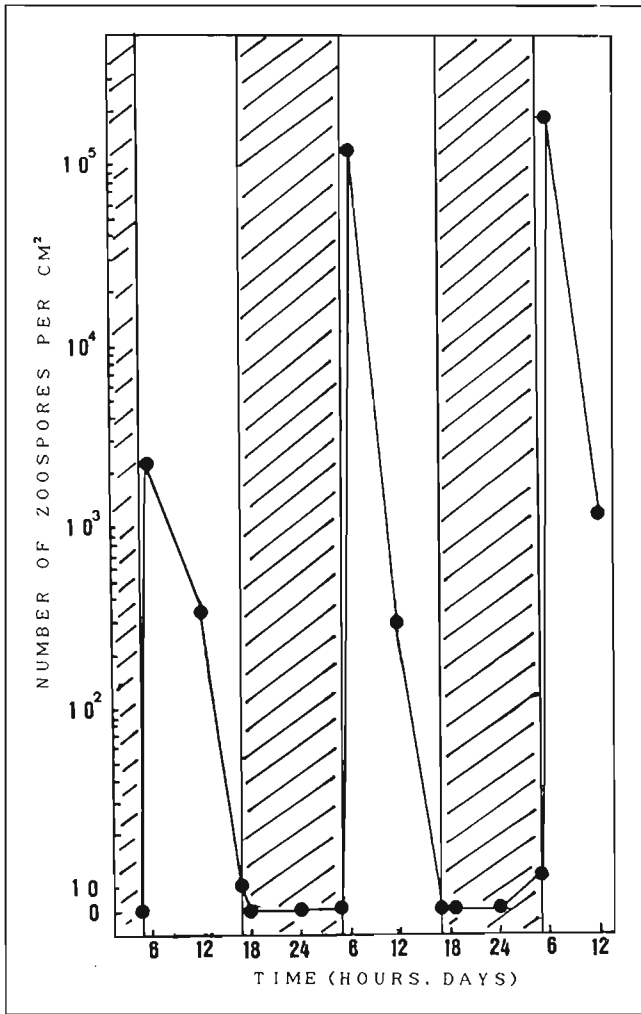

Figure 5

Relationship between water temperature and the number of zoospores released on mature spawning by sporophytes of the green alga, *Ulvella lens*. Sporophytes previously spawned at constant temperatures of 15°C (●) and 20°C (○) on 20-23 April 1983 were thereafter kept under natural water-temperature condition (10°C) and respawed on 2-6 May to assess fertility of the sporophytes. Comparisons with Figures 1 and 2 show comparable fertility under multiple spawning.

### Respawning of sporophytes

Adult sporophytes that had spawned zoospores at 15 and 20°C in Experiment 2 were kept in running water at an average 10.1°C for 10 days, and their respawning of zoospores at the immersion water temperature of 20°C was investigated. The result of the zoospore settlement is shown in Figure 5. Maximum settlement occurred on the fourth day, one day later in Experiment 2, and the number produced was greater. Apparently sporophytes of a different developmental stage were growing because of the long time since adult sporophyte culture was begun. It is obvious, therefore, that adult sporophytes, which have spawned zoospores can be used again if they are kept in natural seawater at about 10°C.

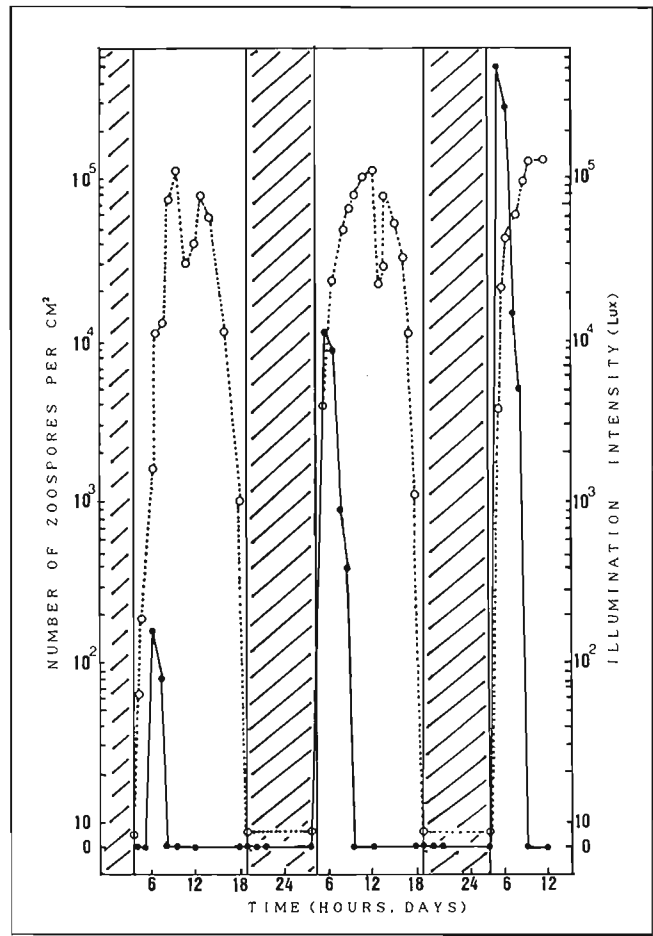

**Figure 6**

Relationship between artificial photoperiod and the number of zoospores released by sporophytes of the green alga, *Ulvelia lens*, spawned at constant temperatures of 20°C on 24 April 1983. Under a photoperiod of 12 hours of light (□) and 12 hours of darkness (▨), it was observed most spores were released 1 hour following light stimulation.

### Daily periodicity for zoospore release

**Artificial photoperiod**—Photoperiod was set for a 12-hour light period from 5 a.m. to 5 p.m. and a 12-hour dark period from 5 p.m. to 5 a.m. The change of settlement with the passage of time is shown in Figure 6. The maximum settlement for each day occurred at 6 a.m., one hour after the light period began. The settlement rate (settlement at the hour/daily total settlement × 100) at this hour was 85.5% for the second day, 99.7% for the third day, and 99.8% for the fourth day. Zoospores were spawned within one hour after the dark period shifted into the light period. An extremely small number of zoospores settled at 5 p.m. in the dark period on the fourth day, but never on other days. These results indicate that the spawning of zoospores can be induced by light stimulation and controlled by adjusting the photoperiod.

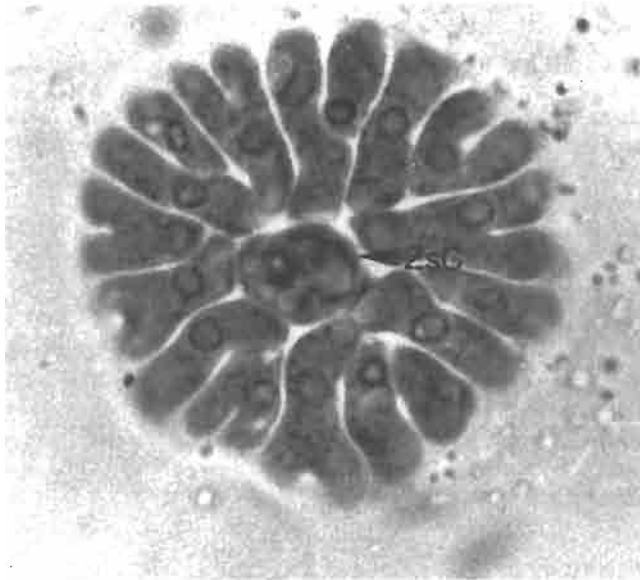

**Figure 7**

Relationship between natural photoperiod and the number of zoospores released by sporophytes of green alga, *Ulvelia lens*, spawned at constant temperatures of 21°C on 1-4 May 1983. Under natural photoperiod, it was observed most spores were released 1 hour following sunrise. Similar results were observed under artificial photoperiod (see Figure 6). (—●—) number of zoospores, (···○···) illumination intensity, (□) light, (▨) darkness.

**Natural photoperiod**—The settlement of zoospores and the variation of light intensity in the natural photoperiod are shown in Figure 7. Daily settlements were 240 on the second day, 21,380 on the third day, and 901,960 on the fourth day. The daily settlement increased with an increasing number of immersion days and on the fourth day in particular rose to 42 times greater than the previous day, while daily variations of settlement showed an identical tendency irrespective of number of immersion days. The settlement reached its maximum one hour after daybreak when the light intensity rose over 0 lux and gradually decreased as the light intensity increased, reaching zero by 4 hours after daybreak. The total settlement occupancy rates measured one and two hours after daybreak were 93.5% on the third day and 97.8% on the fourth day. Thus, the spawning of zoospores in the natural photoperiod commences at daybreak, lasts two hours, and ends in three hours.

Therefore, it is inferred that removal of adult sporophytes can take place during the period of zoospore settlement without concern for spawning of zoospores and that one settlement examination per day is sufficient.



**Figure 8**

Eight-day-old discoid germling of *Ulvella lens* ( $\times 1000$ ). Initial zoospore cell (ZsC) is formed in the center.

### Light intensity and cell morphology

Eight-day-old discoid germlings of  $29.3 \mu$  diameter with initial zoospore cells formed on the central parts (Fig. 8) were cultured without fertilizer in running water in an outdoor tank covered with 90% shading cloth obtained from the market. The results of the shaded and nonshaded cultures on the 14th day are shown in Figures 9 and 10, respectively.

The shaded and nonshaded culture groups differed in cell morphology. In the shaded culture group, pyrenoid is clearly present and has a small intercellular space. On the other hand, no pyrenoid is found in the nonshaded group, although cytoplasmic granules are present. There is less chloroplast than in the shaded culture group and a large intercellular space. The reason pyrenoid does not occur in the nonshaded culture group seems to be because starch grains are not formed around a pyrenoid matrix. The formation of granules and the large intercellular space appear to be caused by the dissociation of chloroplast and cell walls, respectively.

As far as cell morphology is concerned, the shaded culture group grows more normally than the nonshaded group. From this, it is concluded that after formation of the initial zoospore cell, shaded culture is superior because abnormal growth is caused by too much sunlight in the nonshaded culture.

The disc diameter of the shaded culture group was  $101.5 \mu$  and that of the nonshaded group was  $172.6 \mu$ , but their daily growth was  $5.6 \mu$  and  $11.1 \mu$ , respectively. Thus the nonshaded culture group grew better than did the shaded culture.

When *Ulvella lens* is cultured in the stagnant, nutrient-added culture solution, *Plasinocladia marina* propagates itself so much as to color not only the *Ulvella*-growing plates but also the entire culture tank green. This type of algae community is thought to be unsuitable as feed for early abalone juveniles because it is unstable and often falls off the substrate or covers early juveniles and causes them to fall off. The shaded culture of *Ulvella lens* prevents *Plasinocladia marina* and diatoms from growing, thus stabilizing the culture. Thus, it is advantageous to grow *Ulvella lens* in shaded rather than in nonshaded culture, despite its slower growth.

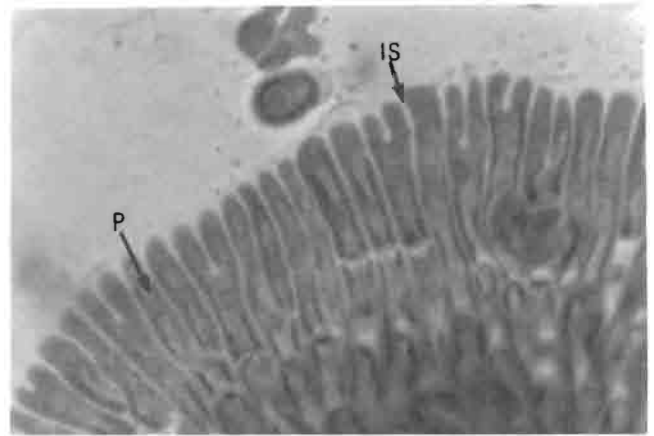

**Figure 9**

Shaded culture *Ulvella lens* on the 14th day ( $\times 1000$ ). Pyrenoid (P) is clearly found and intercellular space (IS) is not enlarged.

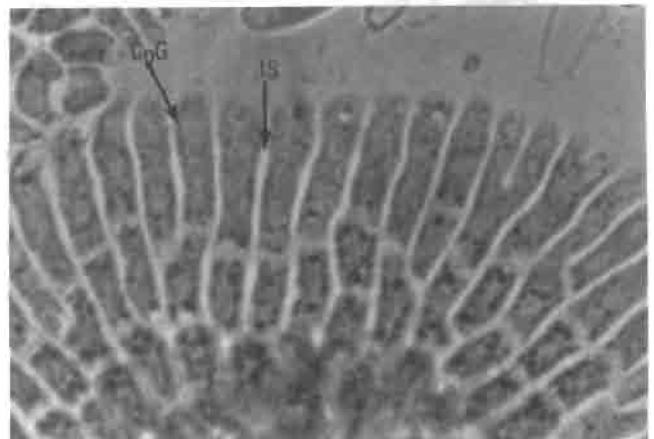
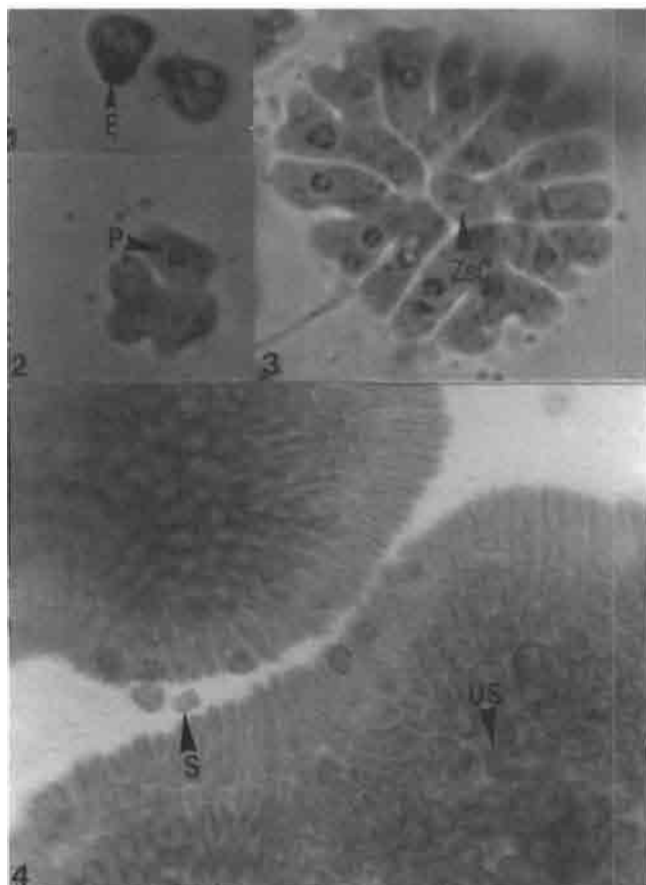

**Figure 10**

Nonshaded culture *Ulvella lens* on the 14th day ( $\times 1000$ ). No pyrenoid is found and cytoplasmic granules (CpG) are present. Intercellular space (IS) is enlarged.

### Development of zoospores

The zoospores of *Ulvella lens* are pear-shaped with a red eyespot. Their four flagella of equal length protrude from the anterior end of the head. They lose their flagella and become  $5\text{-}\mu$  length spores 4-5 minutes after settlement (Fig. 11-1). The spores germinate in 24 hours and become a 2-3 cell germling on the third day (Fig. 11-2) and a 4-8 cell disc on the fourth day. By the 8th day, the disc grows to  $21\text{-}32 \mu$  diameter, averaging  $26.6 \mu$ , and initial zoospore cells can be recognized on discs of  $30 \mu$  diameter (Fig. 11-3). Then individual variations in size occur as they grow, and on the 19th day when they have grown to  $60.0\text{-}107.5 \mu$ , with an average diameter of  $76.6 \mu$ , zoospore spawning is observed (Fig. 11-4).



**Figure 11**

Development of *Ulvella lens* under sunlight. (1) Spore with red eyespot ( $\times 1000$ ); (2) Two-cell stage germling with a pyrenoid ( $\times 1000$ ); (3) Nine-day-old discoid germling with initial zoospore cell. After this stage, germlings were cultured under 90% shading conditions ( $\times 1000$ ); (4) 19-day-old adult sporophyte forming unilocular sponangia. Spores are detected ( $\times 400$ ); (E) Eyespot; (P) Pyrenoid; (S) Spore; (US) Unilocular sporangium; (ZsC) Initial zoospore cell.

## Seed collection and the growth of abalone juveniles

The question of whether or not cultured *Ulvella lens* can be used as a feed for early abalone juveniles was investigated using a seed collection tank ( $2.4 \times 1.5 \times 0.6$  m, containing 300 plates) used for abalone production. The results are shown in Table 2.

### Larval inducement by mucus secreted from the pedal sole

In Experiment 1 (Table 2), there were marked differences in setting time, depending on the presence or absence of mucus. Thus, the sole mucus essential to cultured *Ulvella lens* must be secured by transferring juveniles onto *Ulvella*-growing plates and used for seed collection in order to make all swimming larvae settle in a planned setting density.

### Spawning of zoospores and the capture rate

After transferring setting larvae into a seed collection tank, zoospore spawning was controlled by making the photoperiod dark until the following day in Experiment 4(1) (Table 2). In Experiment 5(1), there was no zoospore spawning because *Ulvella lens* was at its spore stage. From the results of Experiment 4(1) and 5(1), it is inferred that the capture rate of larvae can be increased by controlling zoospore spawning.

### Growth of early juveniles

The results of Experiment 2 (Table 2) show that early abalone juveniles grew better in the light and dark photoperiod [2(1)] than in the continuous light photoperiod [2(2)] for 7 days until they were transferred to an outdoor tank following seed collection.

The results of Experiment 3(2), 4(1), and 5(2), in which juveniles were reared in the light and dark photoperiod, suggest that they

**Table 2**  
Seed collection and juvenile growth of abalone, *Haliotis discus hannai*, on *Ulvella lens* cultured artificially.

Exp. no.	Collector for settling larvae		Creeping period of abalone (days)	Environmental conditions of larval collection		Daily photoperiod for juvenile rearing	Captured rate		Shell length of juvenile	
	Culture period of <i>Ulvella lens</i> (days)	Mucus of abalone		Time of stagnant water (hours)	Released spores		Larva (%)	Juvenile (%)	Avg. ( $\mu$ )	Range ( $\mu$ )
1	34	-	-	5	+++	← 7 →	67.1	63.9	459	440-470
	34	+	4	5	+++	← 7 →	94.2	90.3	459	445-470
2	45	+	6	8	+++	← 3 → * ← 4 →	96.1	92.4	512	465-530
	45	+	6	8	+++	← 3 → * ← 4 →	96.0	92.8	485	460-505
3	44	+	7	7	+++	* ← 1 → ← 6 →	92.4	91.5	512	490-530
	44	+	7	7	+++	* ← 1 → ← 6 →	92.2	90.0	522	500-540
4	37	+	9	8	+++	← 3 → * ← 4 →	92.7	90.4	522	500-545
	37	+	9	8	+	← 3 → * ← 4 →	99.7	97.3	502	470-525
5	1	+	8	8	-	← 3 → * ← 4 →	100.0	96.0	481	470-510
	24	+	8	8	+ - + +	← 3 → * ← 4 →	93.9	90.4	479	460-520

Note: After larval settlement was observed by the naked eye, water supply was started. Larval loss is measured on the following day after water supply. Photoperiod: Continuous light; Continuous darkness; 8 h light and 16 h darkness. Collected juveniles are transferred into outside rearing tanks on the 8th day after larvae are placed in collecting tanks.





**Figure 12**

Adult sporophyte plates are put into holder containing spore settlement plates in alternate position. (AsP) Adult sporophyte growing plates; (SP) Spore settlement plates.



**Figure 13**

Holders containing adult sporophytes and spore settlement plates are immersed without aeration in stagnant water of outdoor tank.



**Figure 14**

Thin yellow film formed by aggregation of zoospore. Film was removed at the center.

grew differently depending on the developmental stages of *Ulvella lens*. However, further detailed studies are necessary because, although the rearing-water temperature was the same in all the experiments, they were performed on different days.

The average shell length of abalone juveniles was 512-522  $\mu$  at the time they were transferred into outdoor tanks in Experiment 2(1), 3(2), and 4(1). Cultured *Ulvella lens* is thought to be a suitable feed for early juveniles, as compared with their shell length of about 480  $\mu$  in the past.

## Mass culture of *Ulvella lens*

### Securing adult sporophytes

When the abalone juveniles are transferred onto plastic plates covered with *Navicula* or *Nitzschia* to continue rearing them, adult *Ulvella lens* can be secured after wintering providing the juvenile density is appropriate. To secure the plastic plates covered with adult *Ulvella lens*, juveniles must be transferred onto the plates when water temperatures exceed 15°C, because water temperature decreases as the juveniles feed on diatoms and the desired water temperatures for zoospore spawning are above 12°C.

### Securing zoospores

**Releasing of zoospores**—After removing the abalone juveniles setting on adult sporophyte plates by using a narcotic (Ethyl Aminobenzoate), these plates are put into holders which contain spore settlement plates in alternate positions (Fig. 12). The holders are immersed without aeration in stagnant water of outdoor culture tanks (Fig. 13). When the immersion water is stagnant, suitable water temperatures for zoospore spawning can be maintained by atmospheric temperatures without any other heat sources.

**Removal of adult sporophytes**—When the culture water temperature of the adult sporophyte rises above 10°C, the maximum settlement occurs by the fourth day after immersion. The adult sporophyte plates are removed no later than the fourth day to prevent *Spirobis foraminosus* from settling on them. The mass release of zoospores can be observed by the naked eye unless it is rainy or windy because a thin yellow film is formed on the surface of the water by the aggregation of spores (Fig. 14).

The developmental stage for removal of adult sporophytes ranges from the spore stage to the 5-cell germling, and the dominant stages are the spore stage and the 2-cell germling.

When adult sporophytes are reused, they must be stored in running water, avoiding sunlight to prevent diatom propagation.

Ingredient	Amount
NaNO <sub>3</sub>	1,000 gm
NaH <sub>2</sub> PO <sub>4</sub>	200 gm
Clewat	500 gm
KI	60 gm
Tap water	12,000 cc

Culture medium is added in the 10-t culture tank.



**Figure 15**

Nutrient is added to culture water by a watering pot after removal of sporophyte plates.



**Figure 16**

Culture tanks are shaded with 90% shading cloths after initial zoospore cells were formed.



**Figure 17**

Abalone juveniles detached by narcotic are transferred onto adult *Ulvella* growing plate to secure the sole mucus.

## Cultivation of spores

Aeration is started after removal of adult sporophytes and the nutrients indicated in Table 3 are added to the culture water (Fig. 15). Spores are then cultivated in stagnant culture water without shading for 7-8 days.

## Cultivation of young sporophytes

When the disc diameters reach 30-40  $\mu$  and initial zoospore cells are formed, the plates are moved alternately to fill the vacant parts of holders. The holders filled with the plates are moved into clean tanks for storage. To prevent *Plasinocladia marina* propagation, culture tanks are shaded with 90% shading cloths (Fig. 16), and cultivation of young sporophytes is then continued with aeration by running water. The culture period is determined by a required disc diameter greater than 200  $\mu$  and greater than 60% zoosporangium regions. The culture period averages about 40 days.

## Transferring juveniles

The abalone juveniles are transferred onto *Ulvella* growing plates 7 days before seed collection to secure mucus secreted from the sole (Fig. 17). The shading culture causes no problems in preparing seed collection plates because juveniles react to the light intensity of 90% shading.

The juvenile density necessary to obtain abalone mucus without the consumption of *Ulvella lens* was not investigated in detail. When 10 juveniles of an average 15 mm shell length were transferred onto each plate (40 $\times$ 30 cm) and their plates changed every seven days to supply them for seed collection, the juveniles' intake of *Ulvella lens* was detected microscopically, but not by the naked eye. This is thought to be because the juveniles selectively fed on diatoms growing on the surface of *Ulvella lens*.

## Summary

The diet needed for earlier collection of abalone in June and July cannot be obtained by the prevalent culture method because of low water temperatures. Therefore, we have developed the mass culture of *Ulvella lens* for feeding the early abalone juveniles.

This new method contributed to the development of the seed abalone production system, wherein collected juveniles are detached from the collectors during Fall and made to grow at high density on artificial food before the spawning season. By this technical system the productive expansion and increase of seed abalones were achieved. At present it is possible to produce 2 million abalones of 2 cm length each year in Miyagi Aquaculture Center, Japan.

## Citations

Kikichi, S., and N. Uki.

1974a. Technical study on artificial spawning of abalone, genus *Haliois*. 1. Relation between water temperature and advancing sexual maturity of *Haliois discus hannai*. Bull. Tohoku Reg. Fish. Res. Lab. 33:69-78 (with Engl. summ.).

1974b. Technical study on artificial spawning of abalone, genus *Haliois*. 2. Effect of irradiated sea water with ultraviolet rays on inducing to spawn. Bull. Tohoku Reg. Fish. Res. Lab. 33:79-86 (with Engl. summ.).

Seki, T.

1980? An advanced biological engineering system for abalone seed production. In Int. Symp. Coastal Pacific Marine Life, Bellingham, WA, October 15-16, 1979, p. 45-54. Cosponsored by W. Wash. State Univ. and Office of Sea Grant, NOAA. [Avail. Library, W. Wash. State Univ., Bellingham, WA 98225.]

---

# Bacterial products and polysaccharide films as cues and enhancers of oyster set

**RONALD M. WEINER**  
**LEVENT DAGASAN**  
**MICHAEL P. LABARE**  
**RITA R. COLWELL**

*Department of Microbiology  
University of Maryland  
College Park, Maryland 20742*

**DALE B. BONAR**  
**STEVEN L. COON**

*Department of Zoology  
University of Maryland  
College Park, Maryland 20742*

The planktonic larvae of many marine invertebrates preferentially set in habitats that support growth and reproduction of adults of the species. Chemical cues induce set in many invertebrates including the oysters, *Crassostrea virginica* and *C. gigas*.

Oyster set can be divided into two clearly definable phases: settlement and metamorphosis. The settlement phase can be subdivided into three stages, i.e., two behavioral and one physiological components. The first stage of settlement, during which a competent larva swims with its foot extended forward, is termed "swim/search." During the second stage settlement, "crawl/search," the larva begins traversing the surface in characteristic crawling patterns, with the target area becoming increasingly focused. In the last settlement stage, "cementation," the larva secretes a cement which affixes it permanently to the surface. The second phase of oyster set, metamorphosis, is characterized by the morphogenetic transition from larva to juvenile or spat. Prior to cementation, set is reversible and is contingent upon presence of the appropriate cue. If an oyster fails to encounter a suitable external cue, it does not set, and dies within 15 days.

Three species of bacteria, a new marine species (LST), *Vibrio cholera* HTX, and *Hyphomonas jannashiana* VP<sub>1</sub>, synthesize a cue for swim/search and crawl/search behavior. Synthesis of this cue correlates with melanin production, and the specific cue is believed to be L-DOPA, or a DOPA mimetic molecule, since L-DOPA is a precursor of melanin and purified L-DOPA triggers searching behavior.

LST is the only species tested that produced a polysaccharide adhesive viscous exopolymer (PAVE), serving as a marine biofilm, to induce or entice oyster larvae to attach and metamorphose. Thus, a neurotransmitter precursor may cue behavioral aspects of oyster set, and PAVE may cue physiological aspects, notably cementing to the surface.

Requirement of a chemical cue (or cues) in set of marine invertebrates is well documented. Only few such cues, however, have actually been identified. Fewer still are in systems that have aquaculture potential. Of these, the oyster (discussed here) and abalone (Morse 1984) have immediate potential to increase aquaculture productivity, especially where inefficient and low set affects the aquaculture potential.

Surfaces coated with LST enhanced set several thousand percent, compared with glass surfaces, and several hundred percent better than non-acclimated cultch. It is hypothesized that LST provides a) an appropriate searching cue, b) an appropriate cementing cue, c) nutritive value, and d) antimicrobial activity serving to control harmful organisms. Other organisms that synthesize DOPA, e.g., *Aeromonas*, *Streptomyces*, *Azotobacter*, and *Proteus*, are unsuitable for aquaculture application because they are pathogenic for the oyster, halointolerant, and/or their growth is suppressed in oyster habitats.

It is now possible to prepare several liters of LST for hatchery use, but we cannot yet scale up to the 50,000-gallon quantities that are required for commercial use. A significant problem is that secondary metabolism, including exopolymer synthesis, is repressed when LST is transferred to seawater from the growth medium, or from lyophilis, even when the receiving seawater is copiotrophic, i.e., contains abundant oyster metabolic products. If controls regulating synthesis of cues could be bypassed and production amplified by cloning, then scale-up of LST production for hatchery use would be feasible. Also, if, indeed, a specific determinant present in PAVE, e.g., mannuronic acid, acts as the cue for larvae

metamorphosis, then artificial cultch can be manufactured. Investigations of these possibilities are in progress.

## **Acknowledgments** \_\_\_\_\_

This material is based on work supported by the National Science Foundation under Grant No. PCM-8316178 and research sponsored in part by NOAA Office of Sea Grant, Department of Commerce, under Grant NO. NA 84-AA-D-00014.

## **Citation** \_\_\_\_\_

**Morse, D.E.**

**1984.** Biochemical and genetic engineering for improved production of abalones and other valuable molluscs. *Aquaculture* 39:263-282.

# Juvenile hormone in Crustacea<sup>1</sup>

**HANS LAUFER**

*Department of Molecular and Cell Biology  
University of Connecticut  
Storrs, Connecticut 06268*  
and  
*Marine Biological Laboratory  
Woods Hole, Massachusetts 02543*

**DAVID BORST<sup>2</sup>**

*Department of Molecular and Cell Biology  
University of Connecticut  
Storrs, Connecticut 06268*

**FRED C. BAKER**

**DAVID A. SCHOOLEY**

*Zoecon Research Institute  
Palo Alto, California 94304*

## ABSTRACT

Juvenile hormone (JH) is known to play important roles in insect development and reproduction. We and others have shown that JH analogues, such as methoprene, also have potent effects on these same processes in crustaceans, suggesting that there may be JH-like compounds in this arthropod class. One possible source of such a crustacean JH is the mandibular organ (MO), a tissue shown by others to affect reproduction in the spider crab, *Libinia emarginata*.

To test this hypothesis, we incubated MOs from several crustaceans, including *Libinia*, *Callinectes sapidus*, and *Homarus americanus*, in Patin's or lobster saline for 2 hours supplemented with methyl-labeled methionine. Secreted products were extracted from the culture medium and analyzed by HPLC. MOs from all three species secreted radio-labeled methyl farnesoate (MF). The chemical identification was confirmed by GC/MS. The synthetic rate for MOs from *Libinia* ranged from 3 to 38 ng/gland · hour. Radio-labeled JHIII was also secreted by *Libinia* MOs, at a rate that was less than 0.1% of that observed for MF. Stereoisomer analysis of this material revealed the presence of both enantiomers, suggesting that it may have been formed by the nonspecific chemical oxidation of MF. MF was also detected in hemolymph samples from *Libinia*, using a GC/MS procedure, with circulating levels of 10-50 ng/mL. These samples also contained small amounts of JHIII, 3-30 pg/mL, but these were probably produced by the oxidation of MF during analysis.

Our data demonstrate that MF is a tissue-specific and major secretory product of the crustacean MO. Since MF has JH activity in insects, and its concentration appears to correlate with the reproductive state of the organism, this compound may be a crustacean JH. Alternately, MF may be a prohormone, similar to the ecdysone, that is converted to some other compound, such as JHIII, by peripheral tissues.

The control of metamorphosis and reproduction seems, at least in part, to be regulated by the MO and its secretory product(s). Analysis of the crustacean MO, its secretions, and how they affect reproduction should lead to better strategies for crustacean aquaculture. (Supported in part by Sea Grant NA82AA-D-00018.)

<sup>1</sup>The information in this abstract is included in the following article: Laufer, H., D. Borst, F.C. Baker, C. Carrasco, M. Sinkus, C.C. Reuter, L.W. Tsai, and D.A. Schooley. 1987. Identification of a juvenile hormone-like compound in a crustacean. *Science* (Wash., D.C.) 235:202-205.

<sup>2</sup>Present address: Department of Biological Sciences, Illinois State University, Normal, IL 61761.



---

# Recent advances in nursery culture of bivalve mollusks in North America<sup>1</sup>

JOHN J. MANZI  
NANCY H. HADLEY

South Carolina Wildlife and Marine Resources Department  
P.O. Box 12559  
Charleston, South Carolina 29412

## ABSTRACT

Nursery systems in common use in North America for the culture of bivalve mollusks are surveyed. Special attention is given to the use of upflow culture in recirculating systems for young post-set and in open flowthrough systems for seed production. The first year's operation of a commercial nursery system using upflow culture is discussed. Results showed that seed clam, *Mercenaria mercenaria*, growth in upflow culture was directly related to water flow rates. Biomass increases as high as 1400% per month were achieved in upflow systems at stocking densities of 0.3 to 0.5 g/m<sup>2</sup>, and flow rates of 80 to 120 L/min · kg. Results from commercial and experimental upflow systems indicate that they are attractive alternatives to raceways. The potential benefits include maximizing space utilization, low construction cost, ease of maintenance, and operational longevity.

The successful culture of bivalve mollusks is dependent upon the availability of large quantities of set or seed. In areas where dense sets reliably occur, the problem is reduced to the labor and logistics of harvesting the set. In North America, the culture of bivalves has, for the most part, relied upon more controlled methods of providing seed for the industry. Large quantities of hatchery-reared set can be supplied throughout the year but costs of production, and subsequent value of the set, place an economic imperative on high survival and fast growth of set to field planting size (Brown et al. 1983). The success and popularity of mollusk hatcheries in North America and Western Europe has thus led to the development of nursery systems capable of accepting and capitalizing upon the hatchery-produced set.

The large majority of field growout techniques used in commercial hard clam aquaculture require a minimum initial clam seed size of 7-10 mm SL (Castagna and Kraeuter 1977, 1981; Claus 1981; Manzi 1985) while scallops and surf clams must be 10-20 mm (Rhodes et al. 1981) and oysters should be 1-5 g whole wet weight (Bayes 1981). It is generally not economically feasible to raise seed to this size in hatcheries. Nurseries are the link connecting hatcheries with field growout operations, providing the intermediate growth to bring hatchery-produced set to the size seed required for field growout activities. The semi-controlled conditions provided by nursery systems are necessary in culture operations that depend on high survival and fast growth for economic viability. In this regard, nurseries are pivotal to the success of commercial bivalve mariculture. This paper reviews the recent advances in bivalve nurseries in North America and provides some comparative data and performance characteristics from experimental and commercial-scale systems.

## Post-set maintenance

---

Perhaps the most critical period in the production of bivalve seed occurs between the time the larvae metamorphose (set) and the time the set attain a size of one millimeter. Most hatcheries retain the metamorphosing larvae and recent set in their larval rearing containers. Culture water is changed daily, and the cultures are fed relatively large amounts of cultured algae (10<sup>5</sup>-10<sup>6</sup> cells/mL · day). Alternatively, post-set cultures are provided with a steady low flow of prefiltered (10-25 μm) raw seawater if ambient phytoplankton concentrations are suitable. Eyed oyster larvae are often placed in shallow trays with shell particles covering the bottom. This results in "cultchless" spat that can be handled similarly to other bivalves. After a short time interval, the post-set are transferred to a number of different post-set rearing systems, depending on the hatchery's production system and location. Most large production facilities continue static water culture of post-set in flat-bottom tanks. Others use water tables that introduce a flow of coarsely filtered ambient seawater across a broad, shallow area. These water tables or raceways can promote excellent growth and high survival when ambient conditions are suitable.

Recently, recirculating upflow culture units have been introduced in post-set culture. These units utilize an upward vertical flow of water through a cylinder suspended in a reservoir tank (Fig. 1). Fine nylon mesh (100-150 μm) is stretched over the bottom of the cylinder and an airlift penetrates a side wall. The mesh supports the young post-set (200-300 μm SL) in the path of an upflow current created by the airlift pump. The water in the reservoir is thus recirculated up through the cylinder and back out into the reser-

---

<sup>1</sup>Contribution No. 203 from the South Carolina Marine Resources Center.

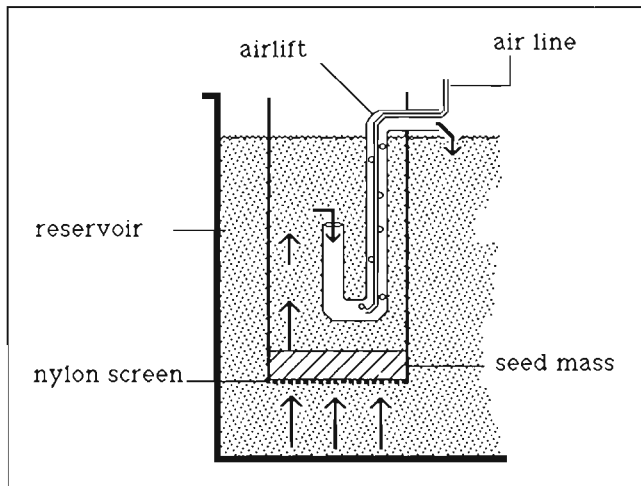

**Figure 1**

Recirculating upflow culture unit for post-set culture. Schematic shows cross-section of a typical unit in a reservoir tank. Arrows indicate direction of water flow.

voir via the airlift pump. At the Waddell Mariculture Center in South Carolina, preliminary experiments with recirculating upflow culture for juvenile *Mercuraria* spp. indicated that such units are effective for post-set as small as 300  $\mu\text{m}$  SL. At least one commercial clam mariculture operation has incorporated recirculating upflow culture for post-set introducing the clams to the system as soon as they set (190-230  $\mu\text{m}$  in size).

Recirculating upflow culture requires appreciable energy expenditures. The Waddell Mariculture Center uses seawater heating and chilling units to maintain optimum reservoir temperatures. Reservoir water must be changed daily and algae must be available in sufficient quantities to maintain efficient feeding concentrations ( $0.5\text{-}1.0 \times 10^5$  cells/mL·day). In addition, post-set populations require frequent inspection and thinning to maintain uninterrupted growth. Despite the demand on resources, recirculating upflow culture of post-set bivalves appears to offer controlled rapid growth and high survival. Space and water requirements are not large, and total time required to bring post-set to sizes large enough ( $\geq 1$  mm) for flow-through nurseries is minimized. These systems are thus reasonable and possibly preferable methods of post-set culture for both research and commercial facilities.

## Field nursery systems

Field nurseries utilize protected natural areas for the intermediate growth of bivalve seed. Shallow subtidal or low intertidal areas are suitable for a number of types of bottom nursery culture. Castagna and Kraeuter (1981) describe low intertidal bottom nurseries using aggregate cover and plastic mesh tenting to provide protection from predators. Tray and rack nursery culture systems are also employed in low intertidal or shallow subtidal areas. Trays, constructed of wood or plastic frames with mesh of various materials and sizes, are placed directly on the bottom or stacked in tiers, two to several trays high. These systems provide good protection but require appreciable labor to maintain adequate water flows through the trays, particularly in areas where silt or fouling are problems.

Suspended nursery culture has a long history in bivalve culture in North America. Rafts, suspended trays, lantern nets, and pearl nets have been used and to some degree are still used, in commer-

cial bivalve culture, primarily for oyster and scallop growout. Although the techniques and designs vary, they all attempt to hold seed up in the water column near higher concentrations of phytoplankton and away from benthic predators. Rafts are probably the oldest field nursery systems in North America. They are generally simple in design, consisting of a culture unit or units, flotation devices, and an anchoring system. Rafts are normally deployed in chains or pods to decrease expense and provide some mutual protection. Despite their traditional use, suspended culture systems in general, and rafts in particular, have become less used in commercial mariculture operations. The general consensus is that, although they work, suspended culture systems are expensive to construct and maintain and are extremely susceptible to storm damage.

Recently, ponds and impoundments have been reexamined as field nursery systems. Shrimp and fish culture has been extremely successful in ponds, and there is growing interest in biculturing mollusks with shrimp or compatible fish. In the southeastern United States, where pond culture of shrimp is beginning in earnest, bivalves offer a possible offseason crop allowing use of ponds on a year-around basis. A recent study (Stevens et al. 1985) evaluated the use of shrimp culture ponds in South Carolina for overwintering bivalve seed from the northeastern states. Results indicated that several bivalves, including seed hard clam, *M. mercenaria*, exhibit high growth rates and low mortality in ponds used as overwintering nurseries. In general, 5-6 months of culture in trays deployed in vacant shrimp ponds in South Carolina yielded seed size increases of 3-10 mm and survivals  $\geq 80\%$ .

## Onshore nursery systems

Hatcheries in North America have long used onshore nursery systems to grow young seed to commercially salable sizes. Onshore nursery systems provide a more controlled environment for rearing young bivalve seed. They require adequate siting and sufficient technical input, however, to insure that uninterrupted and appropriate quantities of high-quality estuarine waters are available.

Onshore nurseries have traditionally used raceways or tiers of shallow trays, continuously supplied with raw, ambient seawater. Raceways are generally long shallow tanks or troughs, constructed of epoxy-coated wood, fiber glass, or concrete. Seawater, pumped from an adjacent source, enters the raceway at one end and is directed horizontally along the tank to drains at the opposite end. In shallow raceways, a single layer of seed is spread over the bottom and the water level is adjusted by standpipes so that the horizontal flow of water is just deep enough to cover the seed. This insures proper water mixing and efficient ratios of water use per unit biomass of seed. In deeper raceways, racks or tiers of plastic mesh are used to layer seed and thus take advantage of the increased tank capacity. Deeper raceways also commonly use baffles to mix the water as it flows along the structure.

Tiers of shallow trays have been used in bivalve nursery culture on a commercial scale. Rectangular fiber glass trays, 7-10 cm deep, with substantial sidewall lips are supported in a rack-like structure. Each tray is supplied with substrate (usually sand) or small mesh plastic netting stretched across a wooden frame, to support a layer of bivalve seed. Ambient seawater is delivered to each trap which in turn overflows through a standpipe or sidedrain into a common tier drain. Although excellent for small seed, water flows are generally not sufficient for the biomass loads of larger seed. Maintenance is also a problem with tiers of trays, making them impractical in commercial nursery systems.



Upflow nursery systems for bivalve seed have been in use since the mid-1960's (Bayes 1981) but commercial interest in these systems has been revived in North America only in the past five years (Manzi and Whetstone 1981, Manzi et al. 1984, Manzi et al. 1986). Upflow systems utilize a vertical water flow directed up through a seed mass, rather than a horizontal flow across the seed as in raceway systems. Two upflow culture systems are in common use in flowthrough bivalve nurseries: active flow that forces water under pressure up through a layer of seed, and passive flow that "pulls" water up through a seed mass. Figure 2 compares schematic illustrations of typical passive and active upflow culture systems. Active systems are constructed of closed-bottom cylinders plumbed to accept water, under pressure, at or near the bottom of the cylinder. The seed are suspended above the water intake on a plastic screen of appropriate mesh size to retain the seed. The water is forced up through the screen, partially fluidizing the seed mass, and exits through drains positioned near the top of the cylinder. Active (or force) flow cylinders are normally employed in banks and used primarily for very small seed. Passive upflow systems use open-ended containers (usually cylinders of PVC pipe) suspended in a reservoir. A screen with an appropriate mesh size forms the bottom of the container and supports the seed mass, which covers the screen, often to a depth of several centimeters. Water entering the reservoir can exit only through drains located in the upper section of each container, although some reservoirs also use a single standpipe to maintain a desired water column depth. Incoming water enters the reservoir and is drawn up into each upflow container, accelerating rapidly as it passes through the seed mass and decelerating upon reaching the overlying pool between the seed mass surface and the unit drain. If flow rates are appropriate, wastes and silt are swept through the seed mass and settle as a loose layer at the seed mass surface as the flow decelerates in the upper section of each cylinder.

## Nursery culture comparisons

In general, field nursery systems are less successful than onshore facilities. Although they require simple low-energy input, they have several distinct disadvantages, including high maintenance requirements, incomplete predator protection, limited access, minimal control of stocked populations, and susceptibility to environmental perturbations, vandalism, and theft. In contrast, onshore systems provide maximum protection, access and control over stocked populations, but require appreciable energy input. Survival and growth of bivalve seed in land-based systems are high, thus providing economic justification for the greater operational costs. On-shore systems are also generally more longevous than field systems, allowing the amortization of capital construction costs over several years. Raceway and upflow culture are the principal land-based nursery systems in use in North America; therefore, comparison of some of their attributes is appropriate.

The use of raceways is a longstanding tradition in bivalve nursery operations in North America, and recent research attests to their efficacy in seed growth of hard clams, *M. mercenaria* (Hadley and Manzi 1984), surf slams, *Spisula solidissima*, and bay scallops, *Argopecten irradians irradians* (Rhodes et al. 1981). In comparisons of growth rates of seed *M. mercenaria* in subtidal field units and in raceways in South Carolina, Hadley and Manzi (1984) reported similar growth at high stocking densities (20,000/m<sup>2</sup>) but significantly greater growth in raceways at low densities (740/m<sup>2</sup>).

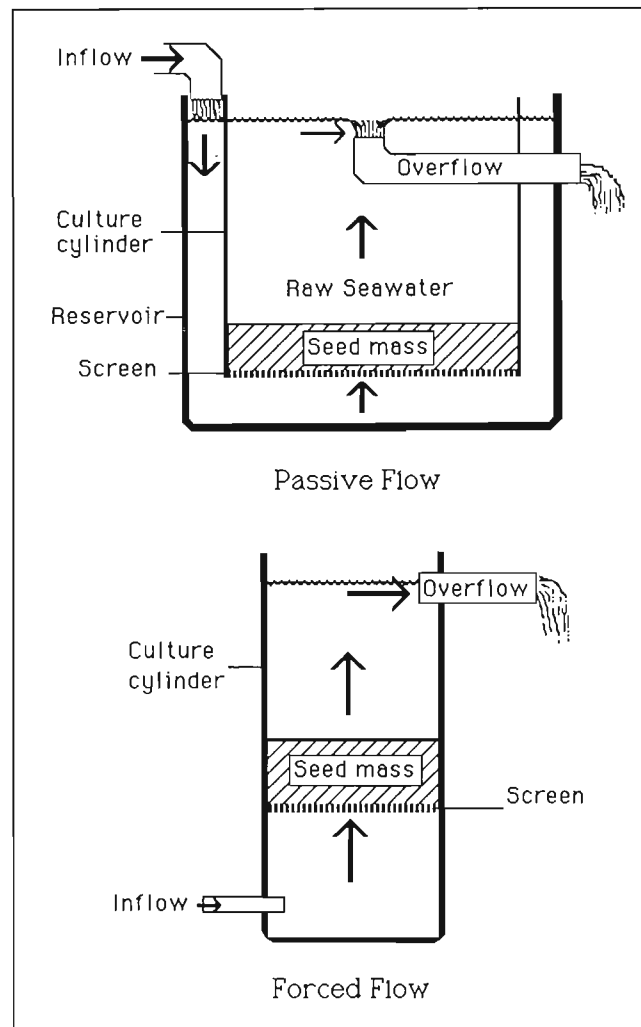

**Figure 2**  
Diagrammatic representation of forced and passive upflow culture systems (after Manzi et al. 1984).

These differences between growth in field units and raceways adjacent to one another and deriving water from the same well-mixed estuary are difficult to resolve. One factor that obviously differs is the water-flow characteristics in subtidal field units and land-based raceways. Raceway flowrates are constant and unidirectional. Hadley and Manzi (1984) reported good seed mean growth at flowrates as low as 3L H<sub>2</sub>O per L seed/min, but water flowrates two to three times higher were necessary for maximum growth. Rhodes et al. (1981) reported flow requirements of 5 and 6.5 L H<sub>2</sub>O per L seed/min for surf clams and scallops, respectively.

Water flow requirements for nursery culture depend, to a large extent, on food supply per unit volume of water. Rhodes et al. (1981) reported that growth of surf clams in raceways was controlled by food supply and recommended that flowrates be adjusted so that at least 1 µg/L of chlorophyll should remain in the nursery effluent to assure adequate food supply. Kirby-Smith (1972) suggested that at least 60% of the incoming chlorophyll should remain in the effluent for bay scallops to grow well in raceways. Hadley and Manzi (1984) demonstrated a strong correlation between chlorophyll removal and growth of hard clam seed in raceways.

The relationships between water flowrates, food availability, and stocking density emphasize a primary problem with raceway culture.

**Table 1**  
Mean total increase in length (mm) of seed clams (initial mean size = 3.9 mm) grown in raceways at four densities, February-August 1981 (data from Hadley and Manzi 1984).

Approx. mean distance (cm) from inflow	Density (clams/m <sup>2</sup> )				$\bar{y}$
	740	2200	6600	19980	
13	16.44	15.09	13.23	10.29	13.76
42	13.68	13.87	10.24	9.03	11.70
71	11.39	11.83	9.72	8.49	10.36
100	10.61	10.91	9.20	7.34	9.52
$\bar{y}$	13.03	12.92	10.60	8.79	

The effective flowrate, or the rate at which new water is available to the seed, decreases as the water travels down the raceway. An example of this effect was reported by Hadley and Manzi (1984) who correlated growth of hard clam seed in raceways with distance from inflow (Table 1). As distance from the inflow increased, the rate of growth of seed clams at all densities decreased. Maximum growth occurred at the lowest stocking densities nearest the inflow and minimum growth in the highest densities nearest the outflow. Growth rates of seed clams at the same density were noticeably different when separated by as little as 29 cm from the inflow. Significant decreases in growth rate occurred over the first meter of raceway length. Thus, flow rates per unit biomass in raceway culture must be adjusted in relation to distribution of the seed. This is often difficult to put into practice, as increased flow rates and/or maintenance requirements may be difficult to justify economically in many extant raceway culture systems.

The performance characteristics of upflow culture systems for bivalve seed have received recent attention (Rodhouse et al. 1981, Rodhouse and O'Kelly 1981, Manzi 1985, Manzi et al. 1984, 1986). These systems apparently create conditions for rapid growth and high survival at relatively dense concentrations of bivalve seed. Bayes (1981) indicated that as much as 1000 kg of cultchless oyster seed could be maintained in an upflow container with a volume of only 1.5 m<sup>3</sup>. In a study of upflow culture at experimental flowrates and stocking densities, Manzi et al. (1986) showed a positive correlation between flowrate and growth of hard clam seed (Table 2). At four initial stocking densities, equivalent to 2.5, 5.0, 10.0, and 20.0 kg/m<sup>2</sup>, seed clams exhibited high growth rates at flowrates equal to or greater than 29 L/min·kg when ambient water temperatures were relatively high ( $\bar{y}$  = 22.1°C). At lower temperatures (~15-17°C) flowrates of at least 10 L/min·kg of biomass were necessary for acceptable seed growth. These data, however, are confounded by ambient chlorophyll levels, or food availability. Table 3 presents an experimental relationship between growth and ambient chlorophyll removal for the data presented in Table 2. In general, growth in upflow culture units was directly related to ambient chlorophyll-*a* available to the seed and effective chlorophyll-*a* removal. Since this makes energetic sense, in that an individual clam expends less energy for more food, a comparison of chlorophyll-*a* removal would be valid for density effects within specific time intervals. At optimum ambient water temperatures, moderate growth in clam seed occurred at flowrates  $\geq$  9 L/min·kg and chlorophyll-*a* availability between 100 and 500  $\mu$ g/min·kg. Exceptional growth occurred at flowrates  $\geq$  16 L/min·kg and ambient chlorophyll-*a* availability of 500  $\mu$ g/min·kg or greater. When chlorophyll-*a* concentrations were highest (first 30 days), greatest growth occurred when chlorophyll-*a* removal exceeded 150  $\mu$ g/min

**Table 2**  
Relationship between water flowrate (L/min·kg) and clam seed biomass increase (g/100 g) in an experimental-scale upflow culture system (data from Manzi et al. 1986).

Days	Initial density (kg/m <sup>2</sup> )							
	2.5		5.0		10.0		20.0	
	Flow	Growth	Flow	Growth	Flow	Growth	Flow	Growth
30 (22.1)*	120	266.8	58	256.5	29	213.1	15	125.6
60 (16.8)	33	75.1	16	67.1	9	47.7	6	32.7
90 (15.7)	19	26.4	10	14.9	6	6.2	5	5.4
120 (10.4)	14	15.5	8	7.7	6	3.7	5	1.0
Cumulative		837.5		636.9		409.4		218.5
$\bar{y}$	40	209.4†	20	159.2	11	102.4	7	54.6

\*Mean water temperature (°C) for each 30-day period.  
†Cumulative percent increase divided by the number of months (4).

**Table 3**  
Relationship between ambient chlorophyll-*a* and clam seed biomass increase in an experimental-scale upflow culture system (data from Manzi et al. 1986).

Days (n)	Density (kg/m <sup>2</sup> )	Ambient Chl- <i>a</i> ( $\mu$ g/min·kg)	Chl- <i>a</i> removal ( $\mu$ g/min·kg)	Growth (g/100 g)
30	2.5	2064	168	267
	5.0	999	161	257
	10.0	500	159	213
	20.0	249	118	126
60	2.5	472	66	75
	5.0	234	51	67
	10.0	134	48	48
	20.0	93	46	33
90	2.5	128	31	26
	5.0	67	37	15
	10.0	43	24	6
	20.0	34	23	5
120	2.5	141	13	16
	5.0	81	22	8
	10.0	56	19	4
	20.0	44	17	1

for each kg of biomass maintained in the system (Table 3). At these levels, the lowest stocking density (2.5 kg/m<sup>2</sup>) removed only 8.2% of the available chlorophyll-*a*, while the highest density (20 kg/m<sup>2</sup>) removed nearly 48%. Kirby-Smith (1972) reported that scallop growth was reduced when more than 40% of the available chlorophyll-*a* was utilized. Data presented here from Manzi et al. (1986) suggest that growth of seed clams in upflow culture may be reduced when chlorophyll-*a* reduction exceeds 25-30%.

Data directly comparing raceway and upflow culture are not yet available, but previous data from raceways (Hadley and Manzi 1984) and from experimental upflow units (Manzi et al. 1986) indicate similar performance of the two systems for clam seed nursery culture, at least at the higher flowrates. In experimental scale upflow units, mean monthly rates of biomass increase (MBI) varied from 73 to 126% at temperatures of 16-18°C and flowrates of 7-118 L/min·kg. In raceways, seed grew at mean rates of 125 to 132% (MBI) at water temperatures of 13-16°C and flowrates of 56-1483 L/min·kg. A direct comparison of growth data and water flowrates from both studies is presented in Figure 3. The raceway study design

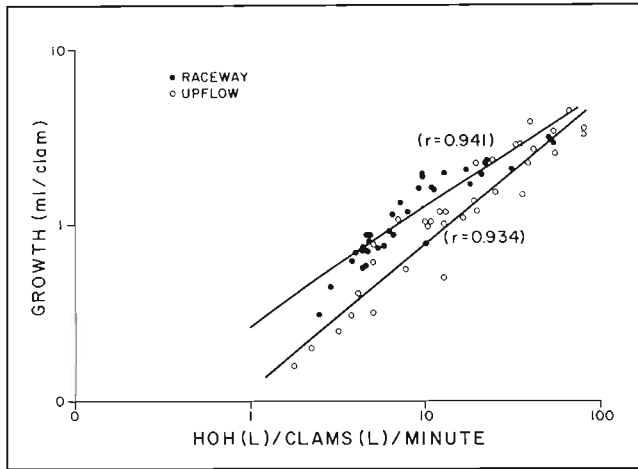

**Figure 3**

Mean monthly biomass increases (%) of seed clams raised at various waterflow rates (L/min · kg) in raceways and upflow columns. (Data from Hadley and Manzi 1984, Manzi et al. 1986.)

employed very low stocking densities and subsequent high effective flowrates, while the upflow unit study used relatively high stocking densities and resultant low effective flowrates. Despite these discrepancies, an analysis of the individual and combined data sets show similar responses of seed clam growth to water flow (Fig. 3). Upflow units, however, can support much greater biomass per unit area than raceways. In the raceway study, an area of 0.1 m<sup>2</sup> was used to support a maximum biomass of 31 g, while an upflow column of similar area could support 150 times that biomass. The two systems performed similarly in the one aspect most important to commercial interests: the length of time required to raise seed to field planting size. Both systems produced planting size seed (7-8 mm) in a minimum of 60 days of culture.

In conclusion, a comparison of raceways and upflow units for the nursery culture of hard clam seed indicated that both systems provide conditions for good seed growth and survival. Upflow systems, however, provide several distinct advantages over raceways, including ease of maintenance, effective space utilization, longevity of service, and ease and economy of construction. Upflow units are reasonable and economic alternatives to the more traditional raceway culture of bivalve seed.

### Upflow culture: Commercial application

A commercial-scale application of upflow culture in a hard clam nursery was recently reported (Manzi et al. 1984). The nursery consisted of 60 forced-flow cylinders, arranged in banks of 20, and 160 passive-flow cylinders, arranged as 8 unit "batteries" in 20 reservoir tanks. A 25-hp centrifugal pump supplied approximately 360 m<sup>3</sup>/hr (1600 gpm) of high-salinity estuarine water to the nursery.

Active upflow cylinders (20-cm diameter) were used for the smallest seed clams (<3 mm) and were usually stocked with recently purchased 1-mm seed at densities of 100,000 to 300,000 per unit (0.3-1.0 g/cm<sup>2</sup>). Each unit received water at a flowrate between 11 and 15 L/min, a flow just sufficient to partially fluidize the seed mass. As the seed grew, fluidization became less effective and seed clams were transferred to the larger diameter (46 and 56-cm)

**Table 4**  
Ideal (I) and actual (A) stocking schedules for a commercial hard clam nursery in South Carolina, March-December 1983 (after Manzi et al. 1984).

Month	Input (kg)		Net production (kg)		Residual (kg)		Space utilization*	
	I	A	I	A	I	A	I	A
March		158.7				158.7		68
April	4	1.5	3.6	-11.3	7.6	59.6	4	20
May	4	2.2	14.0	-10.3	25.6	51.5	25	33
June	4		87.5	10.6	54.6	37.5	59	27
July	4	8.3	196.0	207.0	104.6	89.3	94	75
Aug.			312.4	262.7	142.0	227.0	100	100
Sept.			352.0	209.3	144.0	247.0	98	100
Oct.			283.5	113.3	115.0	267.0	66	100
Nov.			175.0	-11.7	65.0	255.5	31	97
Dec.			55.0	43.1	20.0	215.4	8	92
Total	16	170.7	1,479.0	812.8	20.0	215.4		

\*Percent of total space available.

passive-upflow cylinders. These were stocked initially at 500 to 850 g/unit (0.2-0.35 g/cm<sup>2</sup>) or approximately 50,000 to 85,000 seed at 3 mm SL, and provided with a flow of 25-35 L/min.

The nursery had a theoretical instantaneous capacity of 4 to 16 million seed clams, depending on seed size. An idealized stocking schedule for the nursery is compared with the actual stocking in Table 4. Ideally, 16 million 1-mm seed would have been imported over a 4-month period from April to July. Assuming a 75% survival to planting size (7-8 mm), net production would be 1480 kg or a 9250% biomass increase in 9 months. Instead, the nursery stocking period was preceded by the introduction of 158 kg of residual seed from previous nursery operations, and the majority of new seed (>12 million) were imported and stocked in the nursery in July. From April to December 1983, 3.5 million seed were transferred from the nursery to field culture units as they attained planting size. At the end of December, almost 4 million seed (215 kg) still remained in the nursery. Net production for the year was 813 kg, and survival was approximately 38%. The low production and poor survival were primarily the results of an inappropriate stocking schedule. Hatcheries were unable to meet scheduled commitments, resulting in only 3.8 million seed arriving during the ideal stocking period (Table 4). The bulk of imported seed, over 12 million, arrived during a 2-week period in July when ambient water temperatures were 29-30°C, which is above the range suitable for growth of *M. mercenaria*. The nursery was thus understocked during the spring and early summer when best growth occurs and nursery carrying-capacity is greatest, and stocked at full capacity during late summer, fall, and winter when poorer conditions exist.

Growth of seed clams in the nursery system was directly related to stocking densities and water temperatures. The smaller seed (<3 mm) stocked in active flow units exhibited mean monthly biomass increase rates (% MBI) that were relatively high throughout the summer. The MBI over the first 60 days of each stocking ranged from a low of 277% to a high of 1147% at 21 and 30°C, respectively. Apparently the high flowrates and fluidizing effect attained in these cylinders fostered growth even under high-temperature conditions. Growth rates in the larger passive cylinders were lower. Seed larger than 3 mm grew from 115 to 336% (MBI) over the first 60 days of culture at temperatures of 24 to 29°C and flowrates ranging from 17 to 117 L/min · kg.

**Table 5**

Recommended stocking densities and flow rates for various size seed clams in active and passive upflow culture cylinders in a commercial nursery system in South Carolina (data from Manzi et al. 1984).

Unit type	Seed size (mm)	Initial density (g/cm <sup>2</sup> )	Initial flow (L/min·kg)	Final density (g/cm <sup>2</sup> )	Final flow (L/min·kg)
Active flow (20 cm dia.)	<2	0.31	120	1.08	34
	2-3	0.46	80	1.23	30
Passive flow (56 cm dia.)	<2	NR	—	—	—
	2-3	0.16	80	0.62	23
	3	0.20	70	0.65	22
	4	0.35	41	0.69	21
	5	0.47	30	0.82	18
	6	0.61	23	1.24	12

NR = Not recommended for this size seed.

Growth rates observed at the various stocking densities, flowrates, and water temperatures experienced during the first year of clam nursery culture were used by Manzi et al. (1984) to determine appropriate stocking densities for upflow culture in South Carolina (Table 5). While these recommended densities are appropriate for this particular system, the carrying capacities of any nursery depend upon site-specific characteristics. In this nursery, active flow cylinders could be stocked at 0.31-0.46 g/cm<sup>2</sup> (depending on seed size) at flowrates approximating 80-120 L/min·kg. Seed stocked in these units had to be redistributed frequently, at about 2-week intervals, so that densities did not exceed 1.1-1.2 g/cm<sup>2</sup> and flowrates were not reduced below 30 L/min·kg. Seed clams smaller than 2 mm did not grow well in the larger diameter passive-upflow cylinders. Small seed produce byssal threads that tended to precipitate the formation of seed clumps. The clumping resulted in uneven seed distribution and subsequent "fountaining" of water through the seed mass. Larger seed grew well in passive-upflow culture if the seed were redistributed frequently to avoid densities greater than 0.6-0.7 g/cm<sup>2</sup> and flowrates lower than 23-30 L/min·kg (Table 5). In general, seed clams could be left in the upflow cylinders until the stocked volume, or biomass, doubled and then redistributed to reduce the biomass to an appropriate initial density.

Although the first year of operation of a commercial upflow nursery system yielded results that were below expectations (Manzi et al. 1984), the system demonstrated that seed clams can grow rapidly at high densities in upflow culture. Biomass increases were as high as 1400% (MBI) in active-flow cylinders and 800% (MBI) in passive-flow cylinders, and compared favorably with growth rates reported previously for raceways and experimental upflow systems. Poor survival over the first season can be attributed, at least in part, to factors that can be eliminated with better planning.

## Summary

Bivalve nurseries are used to bridge the gap between hatcheries and field operations, providing protected growth conditions for post-set and small seed at a reasonable cost. In North America, post-set are generally maintained within the hatchery in shallow flowthrough raceways, static flat-bottomed tanks, or recirculating upflow cylinders. When post-set reach a size of ~1 mm SL, they are transferred to field or onshore nurseries. Field nurseries, located in pro-

tected natural areas, are simple and inexpensive but are difficult to maintain and are subject to predation and environmental damage. Onshore nurseries, while more expensive to construct and operate, provide reliable rapid growth and high survival. Onshore systems have traditionally employed raceways, but upflow nurseries have become popular in the last few years because they are easier to maintain than raceways and make optimum use of space.

## Acknowledgments

This work was sponsored by NOAA, National Sea Grant College Program Office, U.S. Department of Commerce, and the South Carolina Sea Grant Consortium.

## Citations

- Bayes, J.C.  
1981. Forced upwelling nurseries for oysters and clams using impounded water systems. In Claus, C., N. DePauw, and E. Jaspers (eds.), Nursery culturing of bivalve molluscs, p. 73-83. Spec. Publ. 7, Eur. Maricult. Soc., Bredene, Belgium.
- Brown, J.W., J.J. Manzi, H.Q.M. Clawson, and F.S. Stevens.  
1983. Moving out the learning curve: an analysis of hard clam, *Mercenaria mercenaria*, nursery operations in South Carolina. Mar. Fish. Rev. 45(4-6): 10-15.
- Castagna, M., and J.N. Kraeuter.  
1977. *Mercenaria* culture using stone aggregate for predator protection. Proc. Natl. Shellfish. Assoc. 67:1-6.  
1981. Manual for growing the hard clam *Mercenaria*. Spec. Rep. 249, Va. Inst. Mar. Sci., Gloucester Point, VA 23062.
- Claus, C.  
1981. Trends in nursery rearing of bivalve molluscs. In Claus, C., N. DePauw, and E. Jaspers (eds.), Nursery culturing of bivalve molluscs, p. 1-33. Spec. Publ. 7, Eur. Maricult. Soc., Bredene, Belgium.
- Hadley, N.H., and J.J. Manzi.  
1984. Growth of seed clams, *Mercenaria mercenaria*, at various densities in a commercial scale nursery system. Aquaculture 36:369-378.
- Kirby-Smith, W.W.  
1972. Growth of the bay scallop: the influence of experimental water currents. J. Exp. Mar. Biol. Ecol. 8:7-18.
- Manzi, J.J.  
1985. Clam aquaculture. In Huner, J.V., and E.E. Brown (eds.), Crustacean and mollusk aquaculture in the United States, p. 275-310. AVI Publ. Co., Westport, CT.
- Manzi, J.J., and J.M. Whetstone.  
1981. Intensive hard clam mariculture: A primer for South Carolina watermen. South Carolina Sea Grant Consort. Mar. Adv. Publ. 81-01, Charleston, SC 29401.
- Manzi, J.J., N.H. Hadley, C. Battey, R. Haggerty, R. Hamilton, and M. Carter.  
1984. Culture of the northern hard clam, *Mercenaria mercenaria* (Linné), in a commercial-scale, upflow nursery system. J. Shellfish. Res. 4(2):119-124.
- Manzi, J.J., N.H. Hadley, and M.B. Maddox.  
1986. Seed clam, *Mercenaria mercenaria*, culture in an experimental-scale upflow nursery system. Aquaculture 54:301-311.
- Rhodes, E.W., R. Goldberg, and J.C. Widman.  
1981. The role of raceways in mariculture systems for the bay scallop, *Argopecten irradians irradians*, and the surf clam, *Spisula solidissima*. In Claus, C., N. DePauw, and E. Jaspers (eds.), Nursery culturing of bivalve molluscs, p. 227-251. Spec. Publ. 7, Eur. Maricult. Soc., Bredene, Belgium.
- Rodhouse, P.G., and M. O'Kelly.  
1981. Flow requirements of the oysters *Ostrea edulis* and *Crassostrea gigas* Thunb. in an upwelling column system of culture. Aquaculture 22 (1,2):1-10.
- Rodhouse, P.G., B. Ottway, and G.M. Burnell.  
1981. Bivalve production and food chain efficiency in an experimental nursery system. J. Mar. Biol. Assoc. U.K. 61:243-256.
- Stevens, F.S., J.J. Manzi, R.L. Walker, and R.A. Kraus.  
1985. Growth of overwintering northern shellfish in mariculture ponds and estuarine systems in the Southeast. Abstracts, 77th Annual Meeting, Natl. Shellfish. Assoc., Norfolk, VA, June 17-20, p. 15.

---

# Tissue culture and genetic engineering for seaweed aquaculture

NAOTSUNE SAGA  
YOSHIAKI SANBONSUGA

Hokkaido Regional Fisheries Research Laboratory  
Fisheries Agency of Japan  
116 Katsura-koi  
Kushiro City, Hokkaido, 085 Japan

## ABSTRACT

In this paper, the following several subjects on economically valuable seaweeds are briefly reviewed: Tissue culture (callus formation and regeneration, suspension cell culture); cell engineering (protoplast formation and regeneration, somatic hybridization using protoplasts); and genetic engineering (mutant production, improvement vector, and recipient cell system). To date, tissue culture has been achieved in 10 genera and 16 species of seaweeds, and protoplast isolation in seaweeds has been achieved in 9 genera and 16 species. The studies of somatic hybridization using protoplasts and transformation using recombinant DNA techniques in seaweeds have just begun.

Seaweeds are important marine resources and have many uses. During the last decade, they have been regarded as a promising biomass for fine chemicals and alternative energy production. Recently, cultivation of economically valuable seaweeds has become a big industry in Japan. 'Nori' (*Porphyra*), 'Wakame' (*Undaria*), and 'Kombu' (*Laminaria*) are three major marine food-crops, and their annual yields are about 300,000, 120,000, and 30,000 tons (dry weight), respectively. The seaweed-cultivation industry is estimated to be worth over \$1 billion per year.

Tissue culture and genetic engineering hold extraordinary promise for aquaculture of seaweeds. We expect much help from these innovative techniques in breeding and seedling production. In order to develop improved seaweed strains, we are performing the following several projects: tissue culture (including callus formation and regeneration, and suspension cell culture); cell engineering (protoplast formation and regeneration, somatic hybridization using protoplasts, microinjection of foreign nucleus and cytoplasmic organella); and genetic engineering (mutant production and selection, gene cloning and sequence analysis, improvement of vector and recipient cell systems, transformation using Ti-plasmid). We are very optimistic of obtaining good results by applying these techniques newly introduced into the marine sciences.

## Tissue culture of seaweed

---

### Acquisition and isolation of axenic strains

The easiest way to obtain algal strains is to depend on culture collection centers. There are more than 50 algal culture collection centers in the world (Haines et al. 1982). In these centers most strains are microalgae, and marine macrophytes (so-called seaweeds) are a minor group. For example, UTEX is a famous culture collection center, and there are only 120 seaweed strains out of 2,200 algal strains.

If we cannot find needed strains in a culture collection center, we must isolate our own strains. Several methods to obtain axenic strains of algae were summarized by Chapman (1973). The pipette washing method, a basic one, is usually used for isolation of axenic strains, but it is time-consuming, and skilled technique is required. On the other hand, methods employing chemical sterilants for obtaining an axenic culture were published: antibiotics (Provasoli 1958, Boalch 1961, Iwasaki 1961, Tatewaki and Provasoli 1964); iodine (Fries 1963); potassium tellurite (Ducker and Willoughby 1964); sulfa drugs (Kanazawa 1968); and antibiotics and sodium hypochlorite in combination (Druehl and Hsiao 1969). These methods, although convenient, were inadequate in terms of efficiency of sterilization and toxicity of chemicals.

A convenient and secure method for obtaining axenic culture, the one-step selection method, has been established by Saga and Sakai (1982a). Following are the procedures of this method using the brown alga, *Dictyosiphon foeniculaceus* (Fig. 1):

- 1) Fertile plants are wiped with a clean gauze, rinsed several times in autoclaved seawater, and cut into lengths of ~1 cm;
- 2) Ten pieces of the organisms are transferred into a glass vessel containing 100 mL ABM\* and stocked in a refrigerator at 5°C for 2 days;

---

\*ABM = antibiotic mixture.

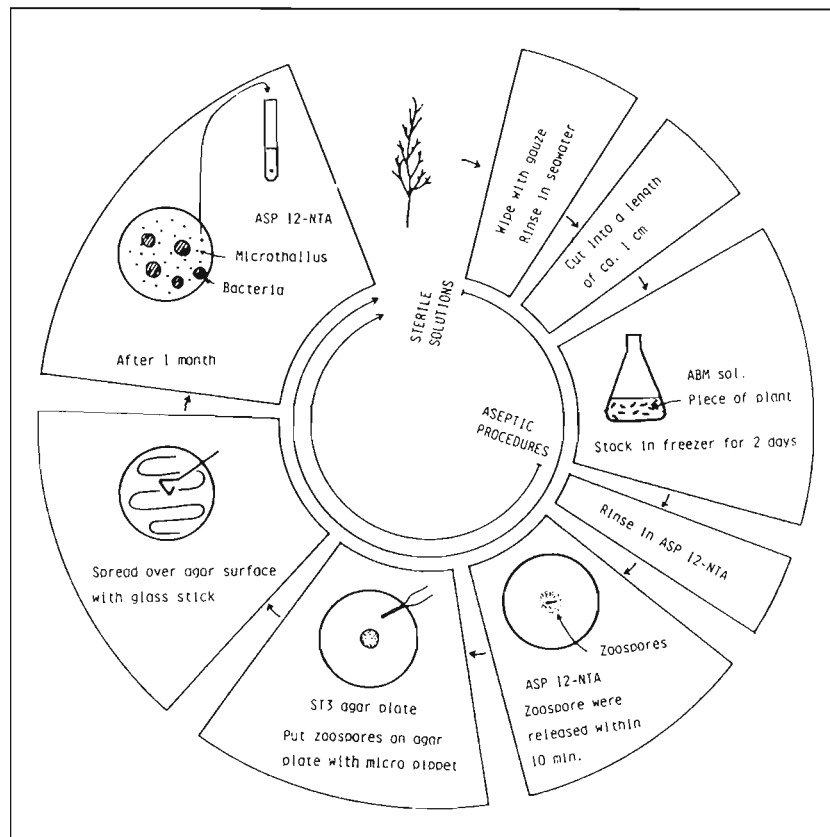

**Figure 1**  
Procedure for one-step selection method of isolating axenic strains of seaweeds.

3) One piece is rinsed several times in sterile ASP\* 12-NTA medium, and numerous zoospores are released within 10 minutes;

4) Two or three drops of the medium containing many zoospores are put on an agar plate with a pipette and spread over an agar surface with a glass rod. The agar plate is cultured for 1 month;

5) After 1 month the germlings will develop into 0.5-1.0 mm masses of profusely branched filamentous thalli, and bacteria which survived step 2 above grow to 3-5 mm diameter colonies. Clean algal masses growing on an agar plate should be selected and inoculated into 10 mL ASP 12-NTA medium in test tubes. This treatment serves both as an isolation of axenic algal strains and a sterility test for bacteria.

6) These cultures are maintained in an incubator for 1 month, and ~3 mm masses of axenic microthalli can be obtained.

Recently, Bradley et al. (1986) have developed an improved one-step selection method using antibiotic disks.

### Media for axenic cultures

There are two major kinds of media for seaweeds: one is an enriched seawater type (Table 1), and the other is an artificial seawater type (Table 2). Following are the representative media of the enriched seawater type: Erd-Schreiber (Føyn 1934), PES (Provasoli 1968), PESI (Tatewaki 1966), and ESS (Saga and Gibor 1986). Erd-Schreiber and ESS are usually used for general seaweeds, PES is suitable for culture of red and green algae, and PESI for culture of brown algae.

	Erd-schreiber <sup>1</sup>	PES <sup>2</sup>	PESI <sup>2</sup>	ESS <sup>3</sup>
Distilled water		100 mL	100 mL	60 mL
Seawater	100 mL			
NaNO <sub>3</sub>	10 mg	350 mg	350 mg	600 mg
Na-glyceroPO <sub>4</sub>		50 mg	50 mg	80 mg
Na <sub>2</sub> HPO <sub>4</sub> · 12H <sub>2</sub> O	2 mg			
Fe (as EDTA; 1:1 mol)		2.5 mg	2.5 mg	
Fe-sequestren				40 mg
PII metals <sup>4</sup>		25 mL	25 mL	40 mL
Vitamin B <sub>12</sub>		10 µg		
Thiamine		0.5 mg		
Biotin		5 µg		
Vitamin mix ESS <sup>5</sup>				1 mL
Soil extract	5 mL			
Tris		500 mg	500 mg	
HEPES				1 g
KI			100 µg	
pH		7.8	7.8	7.8

<sup>1</sup>Use directly.  
<sup>2</sup>For PES or PESI medium add 2 mL PES or PESI stock solution to 100 mL autoclaved seawater, respectively.  
<sup>3</sup>For ESS medium add 1 mL ESS stock solution to 100 mL autoclaved seawater.  
<sup>4</sup>1 mL PII metals contains: Na<sub>2</sub>-EDTA 1 mg, Fe (as Cl<sup>-</sup>) 0.01 mg, B (as H<sub>3</sub>BO<sub>3</sub>) 0.2 mg, Mn (as Cl<sup>-</sup>) 0.04 mg, Zn (as Cl<sup>-</sup>) 0.005 mg, Co (as Cl<sup>-</sup>) 0.001 mg.  
<sup>5</sup>1 mL vitamin mix ESS contains: Vitamin B<sub>12</sub> 10 µg, Biotin 10 µg, Thiamine · HCl 1 mg, Nicotinic acid 1 mg, Ca-pantothenate 1 mg, *P*-aminobenzoic acid 100 mg, Inositol 10 mg, Thymine 1 mg.

\*ASP = artificial seawater of Provasoli.

**Table 2**  
Media for seaweeds (artificial seawater type, 100 mL).

	ASP1	ASP2	ASP6	ASP7	ASP12	KDX	ASS1
NaCl	2.4 g	1.8 g	2.4 g	2.5 g	2.8 g	1.9 g	2.5 g
NaSO <sub>4</sub>						0.32 g	
MgSO <sub>4</sub> ·7H <sub>2</sub> O	0.6 g	0.5 g	0.8 g	0.9 g	0.7 g		1.0 g
MgCl <sub>2</sub> ·6H <sub>2</sub> O	0.45 g				0.4 g	0.87 g	
KCl	0.06 g	0.06 g	0.07 g	0.07 g	0.07 g		0.07 g
Ca (as Cl <sup>-</sup> )	40 mg	10 mg	15 mg	30 mg	40 mg	50 mg	30 mg
NaNO <sub>3</sub>	10 mg	5 mg	30 mg	5 mg	10 mg	8.5 mg	10 mg
(NH <sub>4</sub> ) <sub>2</sub> SO <sub>4</sub>						0.66 mg	
K <sub>2</sub> HPO <sub>4</sub>	2 mg	0.5 mg					
K <sub>3</sub> PO <sub>4</sub>					1 mg		
NaH <sub>2</sub> PO <sub>4</sub> ·H <sub>2</sub> O						0.7 mg	
Na <sub>2</sub> SiO <sub>3</sub> ·9H <sub>2</sub> O	2.5 mg	15 mg	7 mg	7 mg	15 mg		
NaCO <sub>3</sub> ·H <sub>2</sub> O		3 mg					
NaHCO <sub>3</sub>						8.8 mg	10 mg
Na <sub>2</sub> -glycerophosphate			10 mg	2 mg	1 mg	0.14 mg	2 mg
Fe (as Cl <sup>-</sup> )		50 µg					
PII metals <sup>1</sup>	1 mL	3 mL		3 mL	1 mL		
SII metals <sup>2</sup>					1 mL		
P8 metals <sup>3</sup>			1 mL				
Metal mix ASS <sup>4</sup>							1 mL
Vitamin B <sub>12</sub>	0.02 µg	0.2 µg	0.05 µg	0.1 µg	0.02 µg		
Biotin					0.1 µg		
Thiamine·HCl					10 µg		
Vitamin mix S <sub>3</sub> <sup>5</sup>		1 mL		1 mL			
Vitamin mix 8A <sup>6</sup>	0.05 mL		0.1 mL				
Vitamin mix ASS <sup>7</sup>							0.1 mL
KDS solution <sup>8</sup>						1 mL	
KDTM solution <sup>9</sup>						1 mL	
Tris	0.1 g	0.1 g	0.1 g	0.1 g	0.1 g		
Glycyl-glycine						75 mg	
HEPES							100 mg
pH	7.6	7.8	7.6	7.8-8.0	7.8-8.0	8.3-8.4	8.0

<sup>1</sup> 1 mL PII metals contains: Na<sub>2</sub>-EDTA 1 mg, Fe (as Cl<sup>-</sup>) 0.01 mg, B (as H<sub>3</sub>BO<sub>3</sub>) 0.2 mg, Mn (as Cl<sup>-</sup>) 0.04 mg, Zn (as Cl<sup>-</sup>) 0.005 mg, Co (as Cl<sup>-</sup>) 0.001 mg.

<sup>2</sup> 1 mg SII metals contains: Br (as Na<sup>+</sup>) 1 mg, Sr (as Cl<sup>-</sup>) 0.2 mg, Rb (as Cl<sup>-</sup>) 0.02 mg, Li (as Cl<sup>-</sup>) 0.02 mg, Mo (as Na<sup>+</sup>) 0.05 mg, I (as K<sup>+</sup>) 0.001 mg.

<sup>3</sup> 1 mg P8 metals contains: Na<sub>2</sub>H-EDTA 3 mg, Fe (as Cl<sup>-</sup>) 0.2 mg, B (as H<sub>3</sub>BO<sub>3</sub>) 0.2 mg, Mn (as Cl<sup>-</sup>) 0.1 mg, Zn (as Cl<sup>-</sup>) 0.05 mg, Co (as Cl<sup>-</sup>) 0.001 mg, Mo (as Na<sup>+</sup>) 0.05 mg, Cu (as Cl<sup>-</sup>) 0.002 mg.

<sup>4</sup> 1 mL metal mix ASS contains: Fe (as Fe-sequestren) 100 µg, B (as H<sub>3</sub>BO<sub>3</sub>) 100 µg, Mn (as Cl<sup>-</sup>) 100 µg, Zn (as Cl<sup>-</sup>) 10 µg, Co (as Cl<sup>-</sup>) 1 µg, Mo (as Na<sub>2</sub>MoO<sub>4</sub>) 10 µg, Cu (as Cl<sup>-</sup>) 1 µg, Br (as K<sup>+</sup>) 1 mg, Sr (as Cl<sup>-</sup>) 100 µg, Rb (as Cl<sup>-</sup>) 10 µg, Li (as Cl<sup>-</sup>) 10 µg, I (as K<sup>+</sup>) 1 µg.

<sup>5</sup> 1 mL vitamin mix S<sub>3</sub> contains: Thiamine·HCl 50 µg, Nicotinic acid 10 µg, Ca-pantothenate 10 µg, *p*-aminobenzoic acid 1 µg, Biotin 0.1 µg, Inositol 500 µg, Folic acid 0.2 µg, Thiamine 300 µg.

<sup>6</sup> 1 mL vitamin 8A contains: Thiamine·HCl 200 µg, Nicotinic acid 100 µg, Putrescine·2HCl 40 µg, Ca-pantothenate 100 µg, Riboflavin 5 µg, Pyridoxine·2HCl 20 µg, *p*-aminobenzoic acid 10 µg, Biotin 0.5 µg, Choline-H<sub>2</sub>-citrate 500 µg, Inositol 1 mg, Thimine 800 µg, Orotic acid 260 µg, Cyanocobalamine 0.05 µg, Folic acid 2.5 µg, Folinic acid 0.2 µg.

<sup>7</sup> 1 mL vitamin mix ASS contains: Thiamine·HCl 100 µg, Nicotinic acid 100 µg, Putrescine·2HCl 10 µg, Ca-pantothenate 100 µg, Riboflavin 10 µg, Pyridoxine·2HCl 10 µg, Pyridoxamine·2HCl 10 µg, *p*-aminobenzoic acid 10 µg, Biotin 1 µg, Inositol 1 mg, Choline-H<sub>2</sub>-citrate 100 µg, Thymine 100 µg, Orotic acid 100 µg, Cyanocobalamine 1 µg, Folic acid 1 µg, Folinic acid 0.1 µg.

<sup>8</sup> 1 mL KDS solution contains: KBr 7.84 mg, KCl 54.2 mg, SrCl<sub>2</sub>·6H<sub>2</sub>O 1.95 mg, Cyanocobalamine 0.01 µg, Biotin 0.05 µg, Thiamine·HCl 10 µg.

<sup>9</sup> 1 mL KDTM solution contains: H·EDTA 668.4 µg, H<sub>3</sub>BO<sub>4</sub> 1.14 mg, FeSO<sub>4</sub>·7H<sub>2</sub>O 199.0 µg, CuSO<sub>4</sub>·5H<sub>2</sub>O 3.9 µg, Na<sub>2</sub>MoO<sub>4</sub>·2H<sub>2</sub>O 12.6 µg, MnCl<sub>2</sub>·4H<sub>2</sub>O 36 µg, ZnSO<sub>4</sub>·7H<sub>2</sub>O 44 µg, CoCl<sub>2</sub>·6H<sub>2</sub>O 4.0 µg, NH<sub>4</sub>VO<sub>3</sub> 2.3 µg, KI 3.9 µg.

Following are the representative media of the artificial seawater type: ASP1, ASP2, ASP6, ASP7, ASP12 (Provasoli et al. 1957), KDX (Bonneau 1977), and ASS1 (Saga and Gibor 1986). ASP1 and ASP7 are suitable for culture of green algae, ASP2 and ASP6 for culture of red algae, and ASP12 for brown algae (Tatewaki 1971). ASS1 is suitable for culture of general seaweeds and also good for a basal medium of algal tissue culture.

## Tissue culture

The first report of seaweed tissue culture, presented by Chen and Taylor (1978), involved tissues of the red alga, *Chondrus*. In their study, nonpigmented medullary cubes regenerated into complete thalli. In the same year, single cells were obtained from callus-like tissue of the brown alga, *Laminaria*, and they regenerated into whole *Laminaria* plants (Saga et al. 1978). This was the first established clone plant production using tissue culture methods in seaweeds. Tissue culture of seaweeds to date has been achieved in 10 genera; 16 species so far as we know (Table 3).

**Table 3**  
Present status of tissue culture study in seaweeds.

Phylum	Species	Culture	References
Rhodophyta	<i>Chondrus crispus</i>	Tissue	Chen and Taylor 1978
	<i>Euclheuma uncinatum</i>	Tissue	Polne-Fuller et al. 1986
	<i>Porphyra perforata</i>	Cell	Polne et al. 1984
	<i>P. yezoensis</i>	Tissue and cell	Zhao and Zhang 1981, 1984
Phaeophyta	<i>Dictyosiphon foeniculaceus</i>	Tissue and cell	Saga et al. 1982
	<i>Laminaria angustata</i>	Sporophyte cell	Saga et al. 1978
	<i>L. angustata</i>	Diploid tissue	Saga and Sakai 1983
	<i>L. angustata</i>	Haploid tissue	Saga and Sakai 1982b
	<i>L. digitata</i>	Tissue	Fries 1980
	<i>L. hyperborea</i>	Tissue	Fries 1980
	<i>L. japonica</i>	Tissue	Fang et al. 1983, Chen 1984
	<i>L. saccharina</i>	Tissue	Lee 1985
	<i>Macrocystis pyrifera</i>	Tissue	Chen 1984, Saga (in prep. a)
	<i>Sargassum muticum</i>	Tissue	Polne-Fuller et al. 1986
	<i>S. heterophyllum</i>	Tissue	Mooney and van Staden 1985
	<i>Fucus spiralis</i>	Tissue	Fries 1984
<i>Undaria pinnatifida</i>	Tissue	Zhang 1982, Fang et al. 1983, Chen 1984	
Chlorophyta	<i>Enteromorpha intestinalis</i>	Tissue	Saga (in prep. a)

To obtain axenic primary cultures, there are two possibilities: one is a punching method that is applicable to relatively large seaweeds, e.g., members of Laminariales or Fucales; the other is a method using cell lines previously sterilized, possibly appropriate for relatively small seaweeds, e.g., members of Ectocarpales, Chordariales, or Dictyosiphonales.

Following is the protocol for the punching method using *Laminaria* plants (Saga and Sakai 1983):

- 1) Stipes of the thalli are cut into lengths of 5 cm, wiped with a clean gauze, and rinsed several times in autoclaved seawater;
- 2) Both ends of the cleaned stipes are dipped in absolute ethanol, burned with an alcohol lamp, and cut off with a sterile knife;
- 3) The ends are punched out axially by a sterile cork borer (4.0 mm diameter), and these columnar medullary tissues are cut into 2-mm thick sections;
- 4) Tissues obtained should be inoculated on 50-mL ASP 12-NTA medium solidified with 1.0% agar and maintained in an incubator at 14°C and illuminated with cool white fluorescent lamps at 2,000 lux with a 14-hr and 10-hr dark cycle;
- 5) A sterility test of the discoid tissues obtained by the aforementioned method is tried using ST-3 medium;
- 6) After 1 month's culture, callus masses 2-3 mm in diameter can be derived from the inocula.

Following is the protocol for the method using axenic strains of *Dictyosiphon* (Saga et al. 1982):

- 1) Axenic tissues that develop into a mass 1.0 mm are inoculated into an Erlenmeyer flask containing the ASP C-1 medium (Table 4);
- 2) After culture for 1 month on this medium, the inoculum develops into callus masses ~5 mm in diameter;
- 3) Since these calli are comprised of round and fragile cells, small cellular aggregates and single cells can be obtained by suspension culture or by hand-crushing;

**Table 4**  
Composition of ASP C-1 medium<sup>1</sup> (100 mL).

NaCl	2.8 g	SII metals <sup>3</sup>	1 mL
KCl	0.07 g	Vitamin B <sub>12</sub>	0.02 µg
MgSO <sub>4</sub> ·7H <sub>2</sub> O	0.7 g	Biotin	0.1 µg
MgCl·6H <sub>2</sub> O	0.4 g	Thiamine·HCl	10 µg
Ca (as Cl <sup>-</sup> )	40 mg	NTA	10 mg
NaNO <sub>3</sub>	10 mg	Mannitol	3 g
K <sub>3</sub> PO <sub>4</sub>	1 mg	Yeast extract	0.1 g
Na <sub>2</sub> ·glyceroPO <sub>4</sub>	1 mg	Tris	0.1 g
Na <sub>3</sub> SiO <sub>3</sub> ·9H <sub>2</sub> O	15 mg	(Agar) <sup>4</sup>	1.5 g
PII metals <sup>2</sup>	1 mL	pH	7.8-8.0

<sup>1</sup>Saga et al. 1982.

<sup>2,3</sup>See footnotes in Table 2.

<sup>4</sup>Agar should be omitted in a liquid medium.

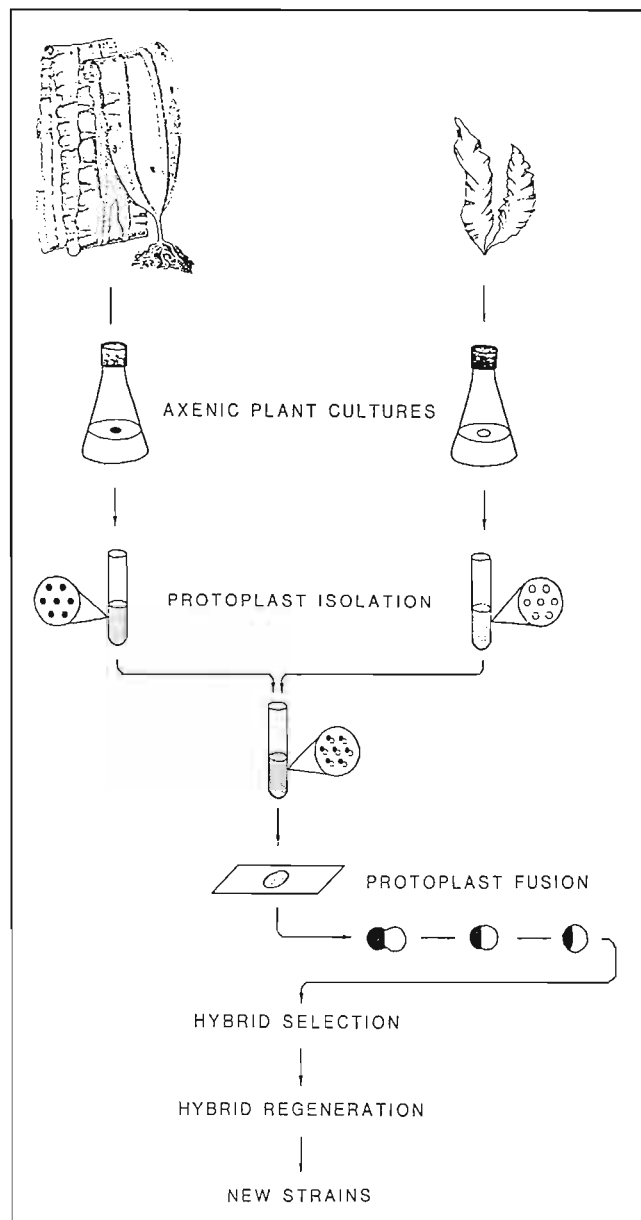

**Figure 2**

Procedure for genetic improvement of seaweeds applying somatic hybridization.



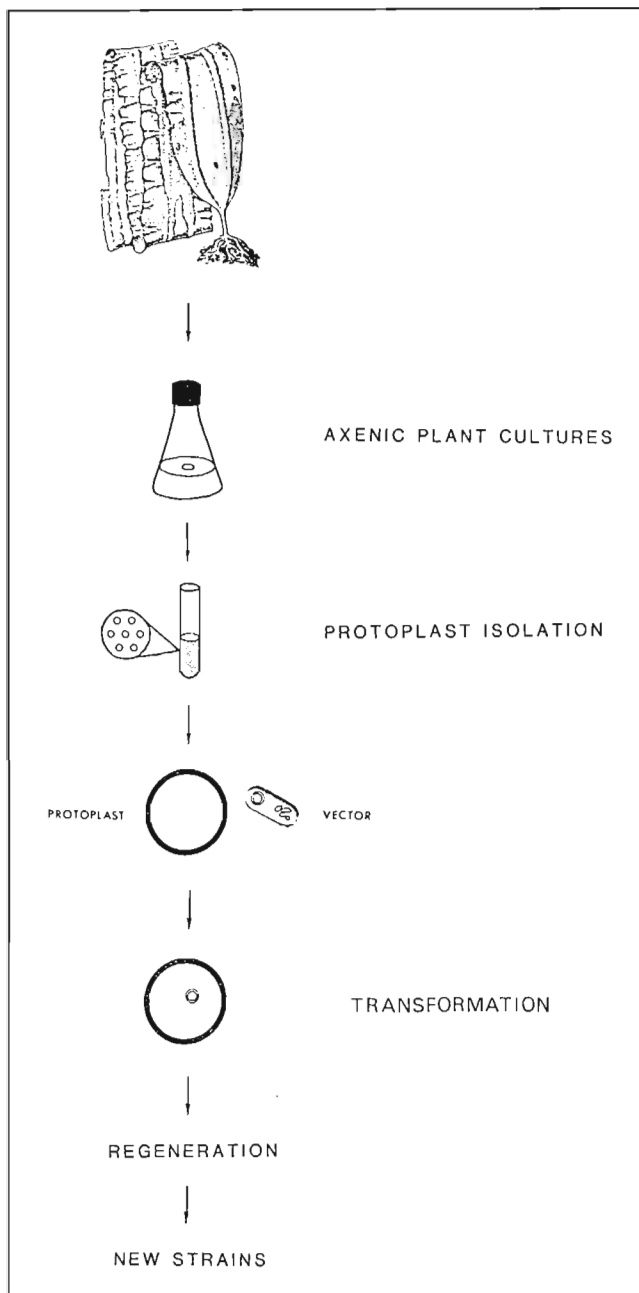

**Figure 3**

Procedure for genetic improvement of seaweeds applying transformation.

4) These cellular aggregates or single cells regenerate into complete thalli.

Micropropagation using tissue culture methods promises to provide an improved system for the mass-production of seaweed seedlings in the future.

**Table 5**  
Present status of protoplast isolation in seaweeds.

Phylum	Species	References
Rhodophyta	<i>Gracilaria tikvahiae</i>	Cheney 1984, Cheney et al. 1986
	<i>G. lemaneiformis</i>	Cheney et al. 1986
	<i>Porphyra perforata</i>	Polne-Fuller and Gibor 1984
	<i>P. suborbiculata</i>	Tang 1982
	<i>P. yezoensis</i>	Saga and Sakai 1984, Fujita and Migita 1985, Kito 1985, Hatate et al. 1986
Phaeophyta	<i>Laminaria japonica</i>	Saga and Sakai 1984
	<i>Macrocystis pyrifera</i>	Saga et al. 1986
	<i>Sargassum muticum</i>	Saga et al. 1986
	<i>Undaria pinnatifida</i>	Fujita and Migita 1985
Chlorophyta	<i>Enteromorpha intestinalis</i>	Millner et al. 1979, Saga et al. 1986
	<i>E. linza</i>	Saga 1984, Fujita and Migita 1985
	<i>Monostroma angicava</i>	Zhang 1983, Saga (in prep. b)
	<i>M. nitidum</i>	Fujita and Migita 1985
	<i>M. zostericola</i>	Saga 1984
	<i>Ulva linza</i>	Zhang 1983
	<i>U. pertusa</i>	Saga 1984, Fujita and Migita 1985

## Cell and genetic engineering of seaweeds

### Protoplast isolation

Genetic manipulation of protoplasts will offer new means of breeding seaweeds. Somatic hybridization using protoplasts provides a method of combining the genomes of different plants that are sexually incompatible (Fig. 2). Also, protoplasts are essential materials for transformation involving direct gene transfer of foreign DNA using plasmids as vectors (Fig. 3). The first report of protoplast isolation in seaweeds was by Millner et al. (1979) for the green alga, *Enteromorpha intestinalis*. Protoplast isolation of seaweeds has been achieved in 9 genera and 16 species to date (Table 5).

Protoplast isolation of green algae is relatively easy, because the components of their cell walls are the same as higher plants, and cellulase and pectinase can be used for protoplast isolation of some green algae. Following is the protocol for the protoplast isolation of green algae (Saga 1984) (Fig. 4):

1) Thalli are cut into small pieces, and 1 g is inoculated in 10 mL enzyme solution containing 2% Cellulase Onozuka R-10 (Kinki Yakult Mfg. Co. Ltd.), 1.2 M sorbitol at pH 6.0;

2) Incubation should be carried out at room temperature (~20°C) and continued for several hours with shaking (90 excursions/min);

3) Isolated protoplasts should be separated from debris by filtration through nylon mesh (60 µm pore size), collected by centrifugation at 500 xg for 5 min, and washed several times with 0.1 M Tris buffer containing 1.2 M sorbitol and 3.5 mM CaCl<sub>2</sub> at pH 8.0;

4) Resulting pellet should be resuspended in Tris-sorbitol buffer and stored at 5°C. Figure 5 shows protoplasts isolated from *Monostroma angicava* using the above procedure.

Protoplast isolation of red or brown algae is relatively difficult, because their cell wall components are quite different from those of higher plants, and cellulase or pectinase cannot be used for protoplast isolation of red or brown algae. For successful isolation of their protoplasts, we must look for sources of enzymes that will digest their cell walls. The most promising enzyme sources are gut juice of some marine herbivorous invertebrates or culture filtrate

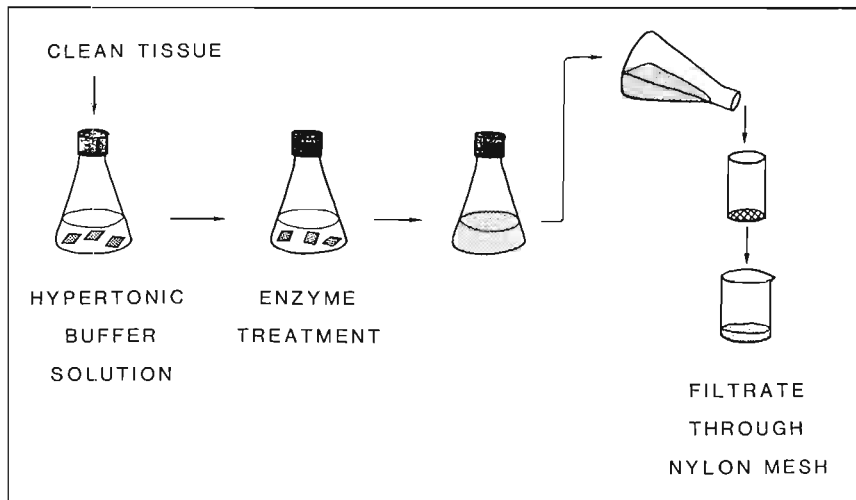

**Figure 4**  
Procedure for protoplast isolation from seaweeds.

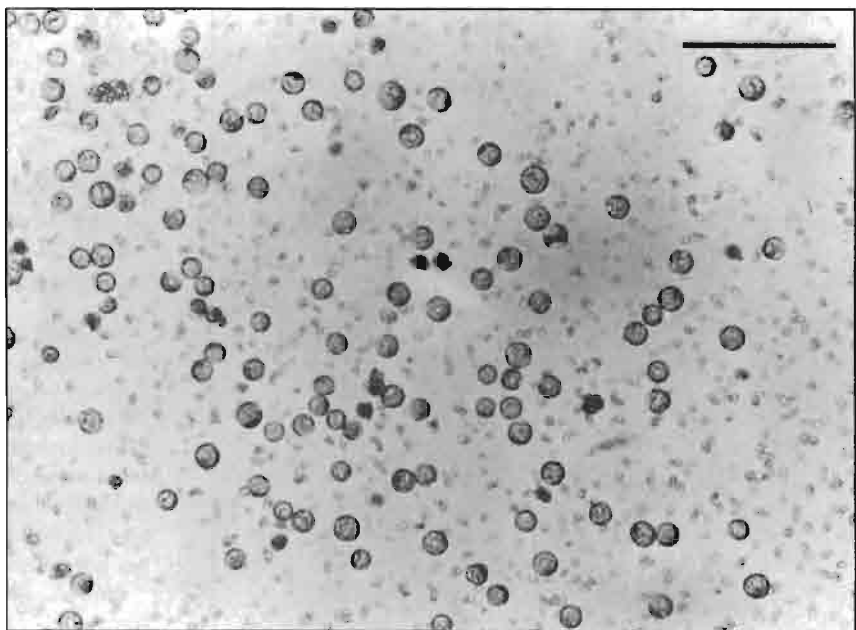

**Figure 5**  
Freshly isolated protoplasts from gametophytes of *Monostroma angicava*. Bar = 100  $\mu\text{m}$ . (Saga unpubl.)

of some marine epiphytic bacteria which can digest the thalli of red or brown algae. Following is the protocol for the protoplast isolation from red or brown algae (Saga et al. 1986):

- 1) Thalli are cut into small pieces and 1 g is inoculated in 10-ml solution of an abalone enzyme mixture;
- 2) Incubations are carried out at room temperature for 10 hours with rotary shaker (25 rpm), and subsequent procedures are similar to those described above for the green algae;
- 3) Prescription of the abalone enzyme mixture is a) 20 g abalone acetone powder in 100 mL 0.1 M Tris buffer at pH 7.0, homogenized for 10 min, stirred with magnetic stirrer overnight, and centrifuged at 12,000  $\times g$  for 20 min; b) 2% Cellulase Onozuka R-10, 1% Macerozyme R-10, and 1% pectinase (Sigma Chem. Co.) dissolved in the supernatant, and this enzyme mixture dialyzed with a cellulose visking tube against deionized water for 12 hours, with dialysis tubes changed every 3 hours; c) after dialysis, the solution is made to contain 1.0 M sorbitol, 50 mM  $\text{MgCl}_2 \cdot 6\text{H}_2\text{O}$ , 50 mM KCl and 10 mM  $\text{CaCl}_2$ , and finally adjusted to pH 6.0;
- 4) Abalone acetone powder is prepared by collecting abalone locally, immersing 100 g of the digestive tract and hepatopancreas

in 500 mL ice-cooled acetone and homogenizing with a blender, then filtering through filter paper, rinsing with 100 mL ice-cooled ether, maintaining in a vacuum desiccator for several days, and storing in a freezer ( $-20^\circ\text{C}$ ).

### Protoplast regeneration

There have been several reports on successful regeneration of protoplasts into complete thalli in green algae (Zhang 1983, Saga 1984, Fujita and Migita 1985, Saga in prep. b). There have been no reports on successful regeneration of protoplasts into complete thalli in red or brown algae except *Porphyra* (Tang 1982, Polne-Fuller and Gibor 1984, Fujita and Migita 1985, Saga et al. 1986). In comparison with *Porphyra*, it is more difficult to culture protoplasts of anatomically complex red or brown algae. Cheney et al. (1986) have recently succeeded in cell division (16-32 stage) in *Gracilaria* protoplasts, and Saga (unpubl.) also has observed cell division in *Laminaria* protoplasts. However, Cheney et al. (1986) and Saga (unpubl.) have not attained protoplast regeneration into whole plants.

## Cell fusion and transformation

There are very few reports of cell fusion in seaweeds. Reports concerning cell fusion utilizing protoplasts in seaweed include those of Saga et al. (1986) for *Enteromorpha intestinalis* using an electrofusion method, and Zhang (1983) for intergeneric fusion of *Ulva* and *Monostroma*. Spontaneous protoplast fusion also has been observed in *Gracilaria* (Cheney et al. 1986). Transformation studies using protoplasts and recombinant DNA techniques have just begun in several microalgae, and there is no report on the transformation study in seaweeds (Saga and Gibor 1986). We are now searching for a suitable vector for algae and are attempting to isolate a nutritionally-deficient and drug-resistant mutant which may be essential to the establishment of a host-vector system in algae.

## Conclusion

Cheney (1984) listed the following four future research needs for development of algal biotechnology: 1) Improvement in the basic methodology of seaweed cell and tissue culture; 2) Improvement in methods of seaweed protoplast isolation and regeneration; 3) Development of discriminating selection system for the recovery of hybrid cells; 4) Development of basic molecular biology, and recombinant DNA techniques for seaweed.

As a developing marine biotechnology, we can expect the following benefits: Effective mass-production of seaweed seedlings using a micropropagation system and the effective breeding of seaweed strains using somatic hybridization and recombinant DNA techniques, e.g., disease-resistant, stress-tolerant, high-growth, and specialty chemical-rich strains. Marine biotechnology will contribute new and exciting advances to the applied marine sciences.

## Citations

- Boalch, G.T.**  
1961. Studies on *Ectocarpus* in culture. I. Introduction and methods of obtaining uni-algal and bacteria-free cultures. *J. Mar. Biol. Assoc. U.K.* 41:279-286.
- Bonneau, E.R.**  
1977. Polymorphic behavior of *Ulva lactuca* (Chlorophyta) in axenic culture. I. Occurrence of *Enteromorpha*-like plants in haploid clones. *J. Phycol.* 13:133-140.
- Bradley, P.M., D.P. Cheney, and N. Saga.**  
1986. A new method for obtaining axenic cultures of marine algae. *Appl. Phycol. Forum* 3(2):4-5.
- Chapman, A.R.O.**  
1973. Methods for macroscopic algae. In Stein, J.R. (ed.), *Handbook of phycolological methods*, p. 87-104. Cambridge Univ. Press, London.
- Chen, J.**  
1984. Tissue culture from the sporophyte of *Laminaria japonica*, *Undaria pinnatifida* and *Macrocystis pyrifera*. *Mar. Fish. Res.* 6:27-33.
- Chen, L.C.M., and A. Taylor.**  
1978. Medullary tissue culture of the red alga *Chondrus crispus*. *Can. J. Bot.* 56:883-886.
- Cheney, D.**  
1984. Genetic modification in seaweeds: applications to commercial utilization and cultivation. In Colwell, R., E. Pariser, and A. Sinskey (eds.), *Biotechnology in the marine sciences*, p. 161-175. Wiley-Interscience, NY.
- Cheney, D.P., E. Mar, N. Saga, and J. Van Der Meer.**  
1986. Protoplast isolation and cell division in the agar-producing seaweeds *Gracilaria* (Rhodophyta). *J. Phycol.* 22:238-243.
- Druehl, L.D., and S.I.C. Hsiao.**  
1969. Axenic culture of Laminariales in defined media. *Phycologia* 8:47-49.
- Ducker, S.C., and L.G. Willoughby.**  
1964. Potassium tellurite as a bacteriostatic agent in isolating algae. *Nature* 202:210.
- Fang, T., Z. Yan, and Z. Wang.**  
1983. Some preliminary observation on tissue culture in *Laminaria japonica* and *Undaria pinnatifida*. *Kexue Tongbao* 28:247-249.
- Føyn, B.**  
1934. Lebenszyklus, Cytology und Sexualität der Chlorophyceen *Cladophora suhriana* Kütz. *Arch. Protistenkd.* 83:1-56.
- Fries, L.**  
1963. On the cultivation of axenic red algae. *Physiol. Plant.* 16:695-708.  
1980. Axenic tissue cultures from the sporophyte of *Laminaria digitata* and *Laminaria hyperborea* (Phaeophyta). *J. Phycol.* 16:475-477.  
1984. Induction of plantlets in axenically cultivated rhizoids of *Fucus spiralis*. *Can. J. Bot.* 62:1616-1620.
- Fujita, Y., and S. Migita.**  
1985. Isolation and culture of protoplasts from some seaweeds. *Bull. Fac. Fish. Nagasaki Univ.* 57:39-45 (in Jpn.).
- Haines, K.C., K.D. Hoagland, and G.A. Fryxell.**  
1982. A preliminary list of algal culture collections of the world. In Rosowski, J.R., and B.C. Parker (eds.), *Selected papers in phycology II*, p. 820-826. *Phycol. Soc. Am., Inc., Lawrence, KS.*
- Hatate, H., T. Aoki, T. Araki, and M. Kitamikado.**  
1986. Preparation of bacterial enzymes capable of degrading the cell wall of red alga *Porphyra yezoensis*. *Bull. Jpn. Soc. Sci. Fish.* 52:545-548 (in Jpn.).
- Iwasaki, H.**  
1961. The life-cycle of *Porphyra tenera* in vitro. *Biol. Bull. (Woods Hole)* 121:173-187.
- Kanazawa, A.**  
1968. Axenic culture of multicellular algae-I. Treatment of algae with sulfa drugs. *Bull. Jpn. Soc. Sci. Fish.* 34:570-575.
- Kito, H.**  
1985. Isolation and development of protoplast in *Porphyra*. *Kenkyu J.* 8(9):20-24 (in Jpn.).
- Lee, T.**  
1985. Aposporous gametophyte formation in stipe explant from *Laminaria saccharina* (Phaeophyta). *Bot. Mar.* 28:179-185.
- Millner, P., M. Callow, and L. Evans.**  
1979. Preparation of protoplasts from the green alga *Enteromorpha intestinalis*. *Planta* 14:174-177.
- Mooney, P.A., and J. Van Staden.**  
1985. *In vitro* plantlet formation and multiple shoot induction in *Sargassum heterophyllum*. *S. Afr. J. Bot.* 51:41-44.
- Polne, M., M. Biniaminov, and A. Gibor.**  
1984. Vegetative propagation of *Porphyra perforata*. *Proc. Int. Seaweed Symp.* 11:308-313.
- Polne-Fuller, M., and A. Gibor.**  
1984. Developmental studies in *Porphyra*. I. Differentiation and protoplast regeneration in *Porphyra perforata* (Rhodophyta). *J. Phycol.* 20:609-616.
- Polne-Fuller, M., N. Saga, and A. Gibor.**  
1986. Algal cell, callus, and tissue cultures and selection of algal strains. *Beih. Nova Hedwigia* 83:30-36.
- Provasoli, L.**  
1958. Effect of plant hormones on *Ulva*. *Biol. Bull. (Woods Hole)* 114:375-384.  
1968. Media and prospects for the cultivation of marine algae. In Hattori, A. (ed.), *Proc. U.S.-Jpn. Conf., Cultures and Collection of Algae*, p. 63-75. *Jpn. Soc. Plant Physiol., Kyoto.*
- Provasoli, L., J.J.A. McLaughlin, and M.R. Droop.**  
1957. The development of artificial media for marine algae. *Arch. Mikrobiol.* 25:392-428.
- Saga, N.**  
1984. Isolation of protoplasts from edible seaweeds. *Bot. Mag. Tokyo* 97:423-427.  
(In prep. a). Tissue culture in marine algae.  
(In prep. b). Isolation and culture of protoplasts from the edible marine alga *Monostroma angicava*.
- Saga, N., and A. Gibor.**  
1986. Pure culture of algae. In Yamada, Y., and Y. Okada (eds.), *Plant biotechnology*, p. 55-71. Tokyo Kagaku Dojin (in Jpn.).
- Saga, N., T. Motomura, and Y. Sakai.**  
1982. Induction of callus from the marine brown alga *Dictyosiphon foeniculaceus*. *Plant Cell Physiol.* 23:727-730.
- Saga, N., M. Polne-Fuller, and A. Gibor.**  
1986. Protoplasts from seaweeds: Production and fusion. *Beih. Nova Hedwigia* 83:37-43.
- Saga, N., and Y. Sakai.**  
1982a. A new method for pure culture of macroscopic algae, the one step selection method. *Jpn. J. Phycol.* 30:40-43.

- 1982b. Tissue culture study in seaweeds. Proc. 31st Annual Meet., Bot. Soc. Jpn., Hokkaido Branch: 4-5 (in Jpn.).
1983. Axenic tissue culture and callus formation of the marine brown alga *Laminaria angustata*. Bull. Jpn. Soc. Sci. Fish. 49:1561-1563.
1984. Isolation of protoplasts from *Laminaria* and *Porphyra*. Bull. Jpn. Soc. Sci. Fish. 50:1085.
- Saga, N., T. Uchida, and Y. Sakai.  
1978. Clone *Laminaria* from single isolated cell. Bull. Jpn. Soc. Sci. Fish. 44:87.
- Tang, Y.  
1982. Isolation and cultivation of the vegetative cells and protoplasts of *Porphyra suborbiculata* Kjellm. J. Shandong Coll. Oceanol. 12:37-50.
- Tatewaki, M.  
1966. Formation of crustaceous sporophyte with unilocular sporangia in *Scytosiphon lomentaria*. Phycologia 6:62-66.  
1971. Cultures of seaweeds. Kaiyo Kagaku 3(11):40-45 (in Jpn.).
- Tatewaki, M., and L. Provasoli.  
1964. Vitamin requirements of three species of *Antithamnion*. Bot. Mar. 6:193-203.
- Zhang, D.  
1983. Study on the protoplast preparation, culture and fusion of somatic cells from two species of green algae - *Ulva linza* and *Monostroma angicava* Kjellm. J. Shandong Coll. Oceanol. 13(1):57-65.
- Zhang, J.  
1982. Some experiments and observations on the tissue and cell culture of *Undaria pinnatifida*. J. Shandong Coll. Oceanol. 12(3):29-38.
- Zhao, H., and X. Zhang.  
1981. Isolation and cultivation of the vegetative cells of *Porphyra yezoensis*. J. Shandong Coll. Oceanol. 11(1):61-66.  
1984. On the cultivation of the isolated vegetative cells of *Porphyra yezoensis* Ueda. J. Shandong Coll. Oceanol. 8(3):197-202.

---

# Preliminary investigations on cryopreservation of marine bivalve gametes and larvae

LEHMAN L. ELLIS

*College of William and Mary  
Virginia Institute of Marine Science  
Gloucester Point, Virginia 23062*

## ABSTRACT

Techniques for the cryopreservation of gametes and/or embryos of several vertebrate species have been developed, but similar work on invertebrates has been attempted for only a few species and reproducible techniques for long-term storage are still being developed. In this study, embryos and early larvae of oysters, *Crassostrea virginica*, and clams, *Mercenaria mercenaria*, were cooled in several cryoprotectant solutions at rates between  $-0.2$  and  $-5^{\circ}\text{C}/\text{min}$  to temperatures between  $0$  and  $-100^{\circ}\text{C}/\text{min}$  and immediately thawed or immersed in liquid nitrogen. No survival occurred in embryos or trochophore larvae after immersion in liquid nitrogen. Embryos or trochophore larvae that were immediately thawed showed survival after cooling to temperatures down to  $-60^{\circ}\text{C}$ , and reduced or no survival after cooling to temperatures below this level. The highest survivorship was seen in cryoprotectant solutions with  $\text{Me}^2\text{SO}$  or ethylene glycol, and no survivorship was seen in cryoprotectant solutions containing glycerol. Survival was also affected by the freezing rate with rates between  $-2$  and  $-5^{\circ}\text{C}/\text{min}$  yielding the most survivors in all cryoprotectant solutions. Vitrification has also been evaluated as a means of cryopreserving embryos and larvae. Survival in these experiments has only been about 1% regardless of whether embryos or larvae were immersed in liquid nitrogen. The principal factor in low survivorship in these experiments appears to be damage from osmotic changes, since the embryos and larvae appear unchanged until the vitrification solution is removed. In similar work on gametes, sperm from oysters or clams are motile after thawing in several cryoprotectant solutions; however, the level of fertilization of fresh ova by thawed sperm is very poor. Ova frozen at controlled rates in cryoprotectant solutions are shrunken and brownish after thawing and do not bind fresh sperm. Vitrified ova after recovery from liquid nitrogen retain their original color and size and bind sperm, but pronuclear fusion does not occur. (Supported in part by Sea Grant Project R/A-16.)



---

# Microparticulate diets for fish larvae

AKIO KANAZAWA  
SHIN-ICHI TESHIMA

Faculty of Fisheries  
Kagoshima University  
4-50-20 Shimoarata  
Kagoshima, 890 Japan

## ABSTRACT

In the seed production of aquatic animals for aquaculture, live foods such as the rotifer, *Brachionus plicatilis*, and *Artemia salina* have been widely used throughout the world. However, it requires much in terms of facilities, maintenance expense, and labor to safely produce a constant amount of live foods. Therefore, it is necessary to develop microparticulate diets as a substitute for live foods to further increase the productivity of seed for fish culture. We have attempted to rear larval fish with microparticulate diets for several years. As a result, seed production of fish such as the Ayu, *Plecoglossus altivelis*, starry flounder, *Paralichthys olivaceus*, and red sea bream, *Chrysophrys major*, was successfully achieved by partial or even complete substitution of microparticulate diets for live food.

Microparticulate diets for larval fish require the following:

- (1) Small particles of 5-300  $\mu\text{m}$  diameter that are stable in water until consumed by the larvae.
- (2) Nutritionally well-balanced ingredients that are digestible in the alimentary canal, since digestive systems of some fish are not fully developed in the prelarval stage.
- (3) Particle size and specific gravity of diets should be adjusted to the developmental stages of larvae.

Various types of microparticulate diets have been prepared by several workers (Adron et al. 1974, Gatesoupe and Luquet 1977, Gatesoupe et al. 1977, Métailler et al. 1979, Teshima et al. 1982, Kanazawa et al. 1982, Kanazawa and Teshima 1983, Dabrowski et al. 1983, Bromley and Howell 1983, Kanazawa 1985a,b, Kanazawa et al. 1985). The microparticulate diets reported are roughly categorized into three groups:

Micro-encapsulated diets (MED)	Micro-bound diet (MBD)	Micro-coated diet (MCD)
Nylon-protein	Carrageenan	Zein
Gelatin-gum acacia	Agar	Cholesterol- lecithin
Egg albumin	Zein	Nylon-protein
Glyco peptide	Alginic acid	
Chitosan	Gelatin	

## Materials and preparation of microparticulate diets

---

The nutritional components of microparticulate diets for fish larvae should be determined on the basis of the requirements of the larval fish for proteins, amino acids, lipids, carbohydrates, vitamins, and minerals. However, because the requirements of larval fish are still undefined, protein resources having a high nutritional value are used, such as krill meal, squid meal, scallop meal, short-necked clam extract, chicken egg, skim milk, casein, gelatin, egg albumin, yeast, and fish meal (Teshima et al. 1982).

Details of the procedures for preparation of microparticulate diets are described elsewhere (Teshima et al. 1982, Kanazawa and Teshima 1983, Kanazawa 1985c).

## Effects of microparticulate diets on growth and survival of larval starry flounder

---

Attempts to rear larvae of the starry flounder, *Paralichthys olivaceus*, with several microparticulate diets have been carried out. Three types of microparticulate diets were prepared: the cholesterol-lecithin microcoated diet (MCD), zein microbound diet (MBD), and  $\kappa$ -carrageenan microbound diet (MBD). The composition of the three diets were as shown in Tables 1 and 2. The starry flounder larvae were grouped into 1000 fish/100-L tank for feeding trials. The larvae were reared with microparticulate diets only for 40 days after hatching at 18-22°C. The feeding amount and size of microparticulate diets were as shown in Table 3. The rotifers, *Brachionus plicatilis*, used as a live food were cultured with a marine type of *Chlorella*. Dietary value was evaluated in terms of growth and survival rate.

**Table 1**  
Composition of microparticulate diet for starry flounder.

Ingredient	g/100 g dry diet
Chicken egg yolk	24.0
Short-necked clam extract powder	8.0
Bonito extract powder	5.0
Milk casein	10.0
Egg albumin	15.0
Soluble yeast powder	10.0
Amino acid mixture <sup>1</sup>	5.0
Vitamin mixture <sup>2</sup>	8.0
Mineral mixture <sup>3</sup>	6.0
Bonito egg lecithin	3.0
Squid liver oil	4.0
Soybean oil	2.0
Total	100.0

<sup>1</sup>Amino acid mixture; see Table 2.  
<sup>2</sup>Halver.  
<sup>3</sup>USP XII and trace elements.

**Table 2**  
Composition of amino acid mixture.

Amino acid <sup>1</sup>	g	Amino acid	g
Arginine	0.8	Threonine	0.3
Histidine	0.2	Tryptophan	0.1
Isoleucine	0.3	Valine	0.5
Leucine	0.5	Cystine	0.2
Lysine	0.7	Alanine	0.3
Methionine	0.2	Na aspartate	0.2
Phenylalanine	0.6	Glycine	0.1

<sup>1</sup>Total amount 5.0 g.

**Table 3**  
Diets and feeding amount.

Size of fish (mm)	Feeding amount	Size of diet (µm)
<b>Microparticulate diet</b>		
3.0 - 6.0	0.2 g × 10 times/day	125
6.0 - 8.0	0.3	125-250
8.0 - 10.0	0.5	250-350
10.0 - 12.0	1.0	250-350
12.0 - 14.0	1.5	250-350
14.0 - 16.0	2.0	250-350
16.0 - 18.0	2.5	250-350
<b>Control (live food)</b>		
<b>Rotifer</b>		
3.0 - 4.0	2 individuals × mL/day	
4.0 - 5.0	3	
5.0 - 18.0	5	
<b>Artemia</b>		
5.0 - 8.0	30 individuals × fish/day	
8.0 - 15.0	60	
15.0 - 18.0	90	

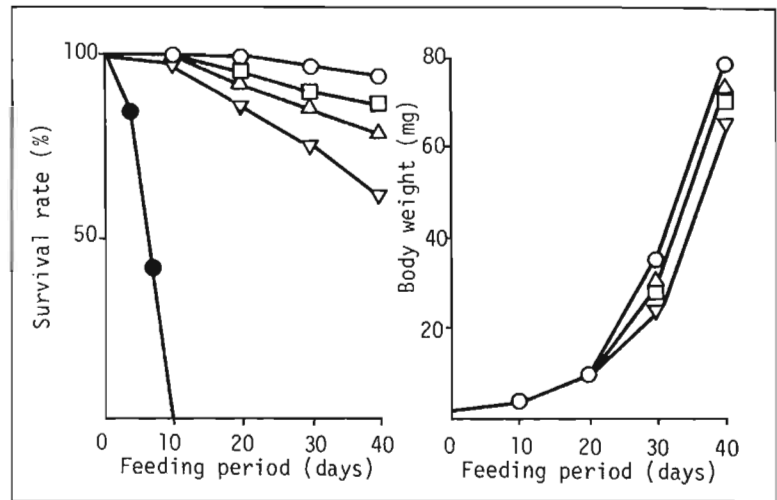

**Figure 1**  
Growth of larval starry flounder on microbound (MBD) and microcoated (MCD) microparticulate diets. ○ = control (live food), □ = cholesterol-lecithin MCD, △ = Zein MBD, ▽ = α-Carrageenan MBD, ● = no food.

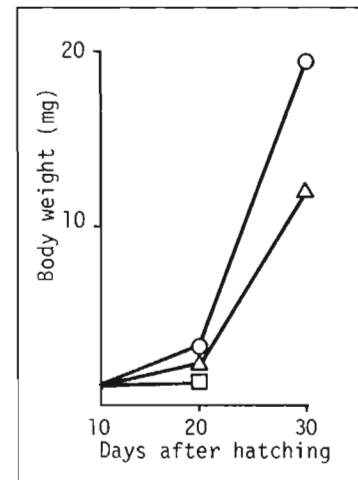

**Figure 2**  
Effect of soybean lecithin on growth of red sea bream larvae. ○ = control (rotifer), △ = microparticulate diet containing 3% pollock liver oil + 5% soybean lecithin, □ = microparticulate diet containing 3% or 6% pollock liver oil.

Figure 1 shows the results of the feeding trials. The cholesterol-lecithin MCD and zein MBD gave good growth and high survival of the starry flounder larvae. However, growth and survival on the α-carrageenan MBD were inferior to that of the groups receiving cholesterol-lecithin MCD and zein MBD. These results show that the microparticulate diets alone were sufficient to sustain growth and survival of the newly hatched larvae of the starry flounder.



Incidence of malformation	Rotifer + commercial diet	Rotifer + microparticulate diet including 3% lecithin
Pughead	1	0
Protrusion of thrax	1	0
Twist of jaw	8	3
Scoliosis	10	0
Twist of caudal peduncle	35	0
Incidence (%)	63	5

### Necessity of dietary phospholipids for growth of fish larvae

Kanazawa et al. (1983a) examined the effects of supplemental phospholipids on the growth of larval red sea bream, *Chrysophrys major*, using purified microparticulate diets. Ten-day-old larvae reared for 20 days showed better growth and survival on a diet containing 3% pollock liver oil (PLO) plus 5% soybean lecithin (SBL) than when given diets containing 3% or 6% PLO alone (Fig. 2). The SBL-supplemented diet had a higher nutritive value, corresponding to the live food (rotifers) in terms of growth and survival rate. These results indicate that the attempt to substitute the beneficial effects of SBL with  $\omega$ 3-highly unsaturated fatty acid was unsuccessful, and that lecithin is an essential dietary component for larval fish.

The necessity of dietary phospholipids for growth of larval fish was investigated on the knife jaw, *Oplegnathus fasciatus* (Kanazawa et al. 1983a), and Ayu, *Plecoglossus altivelis* (Kanazawa et al. 1981, 1983b, 1985).

Also, the effects of dietary phospholipids on the incidence of malformation in the larval Ayu were investigated (Kanazawa et al. 1981). As shown in Table 4, it was suggested that the incidence of malformation in larval Ayu, especially scoliosis and twist of jaw, was reduced by the supplement of lecithin.

### Digestibility of protein in ayu larvae fed a microparticulate diet

We have succeeded in rearing the larvae of a prawn, *Penaeus japonicus*, to postlarvae on the microencapsulated diet (MED) with a nylon-cross linked protein membrane (Jones et al. 1979). Accordingly, the MED may be expected to be a promising microparticulate diet for the larvae and juveniles of some fish, although it is questionable whether larval fish assimilate the MED as effectively as observed in crustacean larvae. As a part of resolving the above question, we planned to clarify the digestibility of protein in the larvae of Ayu fed the MED containing radioactive protein.

To the homogenate (2.5 g) of whole chicken egg, [ $^{14}$ C] methylated ovalbumin (1.0  $\mu$ Ci) dissolved in 0.01 M sodium phosphate buffer (pH 7.2) was added, and the mixture was microencapsulated by the interfacial polymerization procedure of Chang et al. (1966). The MED so prepared had a radioactivity of 1.30 dpm/capsule.

Group (Days after hatching)	Digestibility (%) <sup>1</sup>
3	—
10	11
20	32
70	65

<sup>1</sup>Mean values from three experiments using the Ayu larvae.

After hatching, the Ayu larvae were fed on rotifers until use. Four stages of postlarvae were used in the feeding experiments (Table 5). At each larval stage, 100-150 larvae were put in two beakers, each containing 300 mL of seawater and 3000 microcapsules with [ $^{14}$ C] ovalbumin. About 1 hr after administration of the MED, the larvae were taken out from one of the beakers, washed with seawater, and subjected to radioactive measurements to determine the quantity of ovalbumin intake by the larvae (A: expressed as cpm). Another beaker was covered with a light-intercepting cover about 1 hr after administration of the MED and maintained for subsequent 12 hrs. Then, the larvae were removed and the radioactivity of the whole body (B: expressed as cpm) measured. Sampling times of the larvae were estimated on the basis of microscopic observation, which showed the presence or absence of microcapsules in the digestive tracts. The apparent digestibility (%) of [ $^{14}$ C] methylated ovalbumin was calculated as follows: Digestibility (%) = B/A  $\times$  100.

As shown in Table 5, the digestibility of [ $^{14}$ C] ovalbumin determined on the 10-day larvae of the Ayu was only 11% of the [ $^{14}$ C] ovalbumin intake. Also, the attempt to determine digestibility on the 3-day larvae was unsuccessful because more than half of the larvae died during the treatments, probably due to a physiologically weak vitality at this stage, the so-called "critical period" (Tanaka 1975). However, the digestibilities of [ $^{14}$ C] ovalbumin on the 20-day and 70-day larvae were 32% and 65%, respectively. These results suggest that with maturation the postlarvae of the Ayu is likely to break down the membrane of MED, probably by intestinal peristalsis, and assimilate dietary proteins such as ovalbumin to some extent.

### Microparticulate diets adjusted to amino acid patterns of starry flounder

Generally, proteins having an essential amino acid (EAA) pattern similar to that of whole body or egg proteins are likely to have a high nutritive value for fish. Therefore, we analyzed the amino acid composition of whole body proteins of the starry flounder, and then made four test diets using various protein sources to simulate the amino acid patterns of the body protein of larval starry flounder. Four microparticulate diets were formulated with a white fish meal, brown fish meal, bonito powder, yeast powder, crab meal, gluten meal, and/or krill meal (Tables 6 and 7). Their nutritive values were compared with a live food control by a feeding trial during some larval stages until the bottom-dwelling period.

Table 8 shows the results of a 38-day feeding trial. The test diet groups had 36.1-44.8% survival and 19.5-19.7 mm total length, whereas the live food control receiving the rotifer and *Artemia* had 51.7% survival and 21.4 mm total length. The incidence (%) of abnormal pigmentation (whitening of the skin) was lower on the test diet groups (8.4-14.2%) than the control group (88.4%). Thus, the microparticulate diets were found to reduce the incidence of abnormal pigmentation.

**Table 6**  
Composition of microparticulate diets for starry flounder.

Ingredient	Diet			
	1	2	3	4
	(g/100 g dry diet)			
White fish meal	30.0			
Bonito powder	11.9	11.9	13.2	
Squid gristle	9.0		8.5	
Yeast powder	25.0			14.0
Brown fish meal		45.9		
Crab meal		15.0		
Soybean meal			16.8	25.0
Gluten meal			22.5	
Krill meal			12.0	20.0
Egg albumin				10.0
Milk casein				2.5
Cellulose	2.1	5.2	5.0	6.5
Squid liver oil	8.0	8.0	8.0	8.0
Soybean lecithin	3.0	3.0	3.0	3.0
Mineral mixture	5.0	5.0	5.0	5.0
Vitamin mixture	6.0	6.0	6.0	6.0
Total	100.0	100.0	100.0	100.0

**Table 7**  
Relative ratio of essential amino acid (EAA) to methionine in starry flounder and diets.

EAA	Starry flounder	Diet			
		1	2	3	4
MET	1.00	1.00	1.00	1.00	1.00
THR	1.34	1.34	1.20	1.37	1.16
VAL	1.46	1.57	1.45	1.67	1.63
ILE	1.32	1.50	1.37	1.67	1.63
LEU	2.45	2.91	2.69	4.30	2.88
PHE	1.30	1.67	1.51	2.17	1.68
HIS	0.70	0.69	0.64	0.81	0.69
LYS	3.19	2.98	2.65	2.85	2.45
TRP	0.73	0.83	0.92	1.40	1.03
ARG	1.95	2.29	2.13	2.14	1.89

**Table 8**  
Effect of microparticulate diets on growth and survival of starry flounder.

Diet no.	Initial		Final	
	Total length (mm)	Survival rate (%)	Total length (mm)	
1	4.9±0.5	39.2	19.6±1.6	
2	4.9±0.5	36.1	19.5±1.3	
3	4.9±0.5	44.8	19.6±1.5	
4	4.9±0.5	43.9	19.7±1.5	
Control (Live food)	4.9±0.5	51.7	21.4±2.0	

## Seedling mass production with microparticulate diets

### Ayu

Ayu larvae, numbering 100,000 and 400,00, were placed in 50- and 100-ton tanks, respectively. Feeding trials were carried out for 83 days at 11.1-27.0°C. Larvae received the MBD 10 times daily. Dietary values of diets were evaluated in terms of total length, body weight gain, and survival rate. Furthermore, the incidence of malformation was checked 83 days after hatching. Two groups of larval Ayu were fed the diets as shown in Figures 3 and 4. One group was fed mostly live food such as rotifer and *Artemia*, and another group was fed mostly MBD containing one-half rotifer and one-fifth *Artemia*.

The results of growth and survival of larval Ayu reared for 83 days are shown in Table 9 and Figure 5. The survival of the MBD and live food groups at the end of the feeding trial was 44% and 54%, respectively. Total lengths of the MBD and live food groups were 50 and 47 mm, respectively. These results indicate that a microparticulate diet has a nutritive value corresponding to live food in terms of growth and survival rates. Also, such abnormalities as scoliosis were rarely found when the Ayu larvae were reared with MBD containing lecithin.

### Red sea bream

We have previously shown the probable utilization of microparticulate diets as a substitute for rotifer and *Artemia* in the practical seed production of the Ayu. In the present study, a similar feeding experiment was conducted on the larval red sea bream with commercial microparticulate diets (Kyowa Hakko Kogyo Co., Ltd.) using a 50-ton tank. The hatched red sea bream larvae (900,000 fish) were reared on Type A microparticulate diet (particle sizes 250 µm) along with rotifers for 30 days, followed by Type B microparticulate diet (particle sizes 250-400 µm; a substitute for *Artemia*) for 3-6 days, and then by a larger Type C microparticulate diet (particle sizes 700 µm; a substitute for minced fish flesh) until 56 days after hatching (Figs. 6, 7).

Results of the feeding experiments are shown in Table 10. When the newly hatched red sea bream received a combination of the microparticulate diet and rotifer (about 1:1, ww), 112,000 fish with 10 mm total length were produced with 12.4% survival rates. The 30-day larvae reared successively on the microparticulate diet alone grew to the 14-mm total length equally as well as the control group receiving *Artemia* and krill alone. Larval fish of 14 mm total length were transferred from the tank on land to a cage in the sea and reared on the microparticulate diet alone until reaching 26.3 mm total length, the size of shipment. As a result, total replacement of minced fish flesh by the microparticulate diet was found to be successful in terms of both growth and survival rate.

**Table 9**  
Growth and survival of larval Ayu fed on microbound diet (MBD).

Diet	No. fish		Survival (%)	Total length (mm)	Avg. body weight (mg)
	Initial	Final (H-83)			
Control	394,000	213,000	54.3	47.1	433
MBD	105,000	46,500	44.4	49.8	410

Experiment	Diet	Hatching	10	20	30	40	50	60	70	80(days)
Control	Rotifer (individual/fish)	1010	2488	2866	1124	150	400	565	563	(H-75)
	Artemia (individual/fish)	(H-14)	62	50	117	193	237	145	142	(H-81)
	Commercial diet (mg/fish)	(H-13)	0.25	0.53	0.75	1.04	1.61	4.35	9.46	(H-83)
	Egg yolk (mg/fish)	(H-14)	0.05	0.04	0.08	0.08	0.09	0.42	0.63	(H-83)
MBD	Artificial diet (mg/fish)	(H-6)	0.67	2.28	2.78	2.86	5.78	6.00	7.80	12.10 (H-81)
	Rotifer (individual/fish)	869	1520	1581	1614	(H-40)				
	Artemia (individual/fish)				(H-40)	115	63	53	52	(H-75)

**Figure 3**  
Diets and feeding amount used in each experimental group of larval Ayu.

Experiment	Diet	Hatching	10	20	30	40	50	60	70	80(days)
Control	Rotifer	(H-1~H-75) 240.68 X 10 <sup>8</sup> individual								
	Artemia	(H-14~H-81) 21.274 X 10 <sup>8</sup> individual								
	Commercial diet	(H-13~H-83) 45350 g								
	Egg yolk	(H-14~H-83) 3860 g								
MBD	Artificial diet	(H-6~H-81) 20640 g								
	Rotifer	(H-1~H-40) 38.8 X 10 <sup>8</sup> individual								
	Artemia	(H-41~H-75) 1.198 X 10 <sup>8</sup> indi.								

**Figure 4**  
Total amount of diets used in each experimental group of larval Ayu.

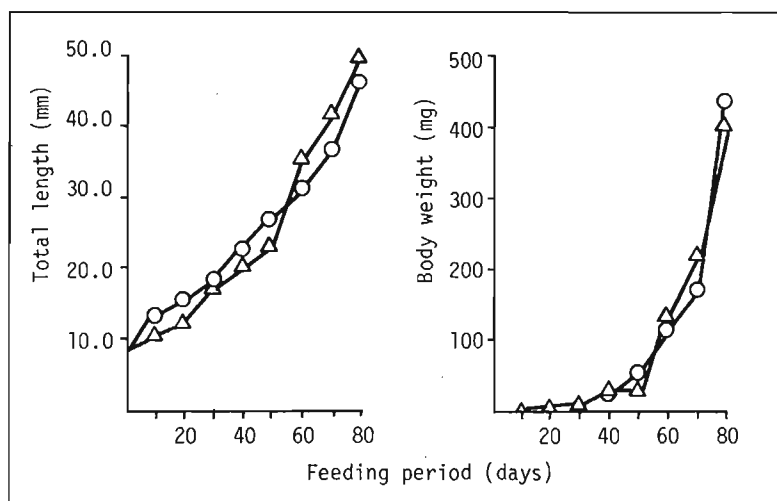

**Figure 5**  
Growth of larval Ayu fed on microparticulate diets.  
○ = control, △ = microbound diet (MBD).

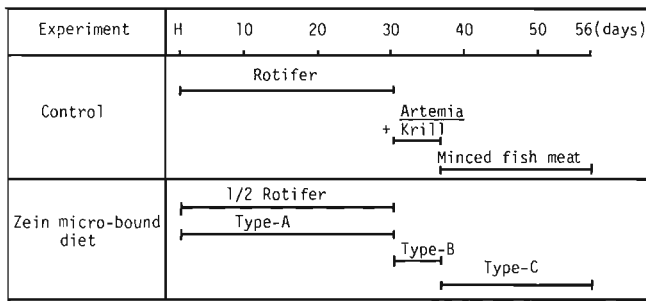

**Figure 6**  
Series of diets used for mass production of larval red sea bream.

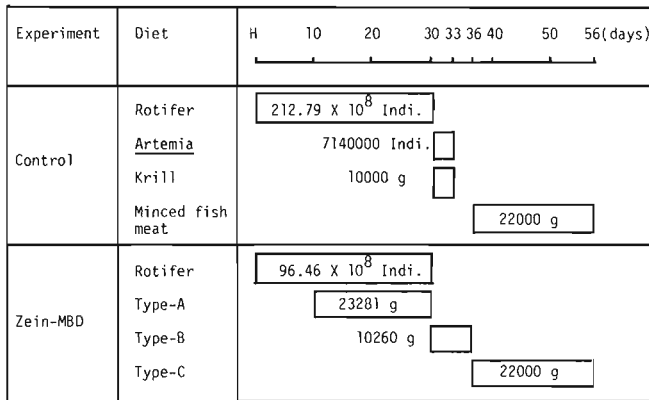

**Figure 7**  
Total amount of diets used for mass production of larval red sea bream.

Total length	No. fish						
	10 mm		14 mm		26.3 mm		
	Days post-hatch	10	30	31	36	37	56
Control diet			69,000	54,000*	15,000	6,100	
				(80%)		(45%)	
Zein micro-bound diet	900,000	112,000	43,000	30,000	15,000	9,000	
		(12.4%)		(70%)		(60%)	

\*33 days-old.

## Citations

- Adron, J.W., A. Blair, and C.B. Cowley.  
1974. Rearing of plaice (*Pleuronectes platessa*) larvae to metamorphosis using an artificial diet. Fish. Bull., U.S. 72:352-357.
- Bromley, P.J., and B.R. Howell.  
1983. Factors influencing the survival and growth of turbot larvae, *Scophthalmus maximus* L., during the change from live to compound feeds. Aquaculture 31:31-40.
- Chang, T.M.S., F.C. MacIntosh, and S.G. Mason.  
1966. Semipermeable aqueous microcapsules I. Preparation and properties. Can. J. Physiol. Pharmacol. 44:115-128.
- Dabrowski, K., R. Bardega, and R. Przedwojski.  
1983. Dry diet formulation study with common carp (*Cyprinus carpio* L) larvae. Z. Tierphysiol. Tierernaehr. Futtermittelkd. 50:40-52.
- Gatesoupe, F.-J., and P. Luquet.  
1977. Recherche d'une alimentation artificielle adaptée à l'élevage des stades larvaires des poissons I. Comparaison de quelques techniques destinées à améliorer la stabilité à l'eau des aliments. 3d Meeting, ICES Working Group on Mariculture, Brest, France, 4, p. 13-20.
- Gatesoupe, F.-J., M. Girin, and P. Luquet.  
1977. Recherche d'une alimentation artificielle adaptée à l'élevage des stades larvaires des poissons II. Application à l'élevage larvaire du bar et de la sole. 3d Meeting, ICES Working Group on Mariculture, Brest, France, 4, p. 59-66.
- Jones, D.A., A. Kanazawa, and S. Abdel-Rahman.  
1979. Studies on the presentation of artificial diets for rearing the larvae of *Penaeus japonicus* Bate. Aquaculture 17:33-43.
- Kanazawa, A.  
1985a. Essential fatty acid and lipid requirement of fish. In Cowey, C.B, A.M. Mackie, and J.G. Bell (eds.), Nutrition and feeding in fish, p. 281-298. Academic Press, London.  
1985b. Nutritional requirements of larval fish. Sea Farming Technol. Res. 14:87-96 (in Jpn.).  
1985c. Microparticulate diets. In Yone, Y. (ed.), Fish nutrition and diets, p. 99-110. Suisangaku ser. 54, Koseisha-Koseikaku, Tokyo.
- Kanazawa, A., and S. Teshima.  
1983. Development of microparticulate diets for the larvae of fish, crustaceans, and shellfish. Yoshoku 20:97-101 (in Jpn.).
- Kanazawa, A., S. Teshima, S. Inamori, T. Iwashita, and A. Nagao.  
1981. Effects of phospholipids on growth, survival rate, and incidence of malformation, in the larval Ayu. Mem. Fac. Fish. Kagoshima Univ. 30:301-309.
- Kanazawa, A., S. Teshima, S. Inamori, S. Sumida, and T. Iwashita.  
1982. Rearing of larval red sea bream and Ayu with artificial diets. Mem. Fac. Fish. Kagoshima Univ. 31:185-192.
- Kanazawa, A., S. Teshima, S. Inamori, and H. Matsubara.  
1983a. Effects of dietary phospholipids on growth of the larval red sea bream and knife jaw. Mem. Fac. Fish. Kagoshima Univ. 32:109-114.
- Kanazawa, A., S. Teshima, I. Kobayashi, M. Takae, T. Iwashita, and R. Uehara.  
1983b. Necessity of dietary phospholipids for growth of the larval Ayu. Mem. Fac. Fish. Kagoshima Univ. 32:115-120.
- Kanazawa, A., S. Teshima, and M. Sakamoto.  
1985. Effects of dietary bonito-egg phospholipids and some phospholipids on growth and survival of the larval Ayu, *Plecoglossus altivelis*. Z. Angew. Ichthyol. 4:165-170.
- Métailler, R., C. Manant, and C. Depierre.  
1979. Microparticules alimentaires inertes destinées à l'élevage larvaire des poissons marins. Utilization des alginates. In Proc. World Symp. on Finfish Nutrition and Fishfeed Technology, Hamburg, p.181-190.
- Tanaka, M.  
1975. Digestive organ of larval fish. In Japan. Soc. Sci. Fish. (ed.), Feeding and growth of larval fish, p. 7-23. Suisangaku ser. 8, Koseisha-Koseikaku, Tokyo.
- Teshima, S., A. Kanazawa, and M. Sakamoto.  
1982. Microparticulate diets for the larvae of aquatic animals. Min. Rev. Data File Fish. Res., Kagoshima Univ. 2:67-86.

# Sowing culture of scallop in Japan

HIROSHI ITO

Hokkaido Regional Fisheries Research Laboratory  
Fisheries Agency of Japan  
116 Katsura-koi, Kushiro City  
Hokkaido, 085 Japan

## ABSTRACT

Recent information on sowing culture (bottom culture) of the Japanese scallop, *Patinopecten yessoensis*, is briefly outlined. Scallop mariculture, sowing culture, and hanging culture, developed rapidly in the mid 1960's due to technical development of methods for mass production of scallop seeds (spat collection and intermediate culture). After the mid 1970's, sowing culture production rapidly increased, mainly on the north-east Hokkaido coasts facing the Okhotsk Sea. In 1984, the production of sowing culture and wild scallops amounted to 135,239 metric tons (mt) and the hanging culture reached 73,981 mt, for a total production of 209,220 mt. At present, most of the production of sowing culture and wild populations is attained around Hokkaido and Aomori Prefecture, and sowing culture keeps the Japanese scallop industry active.

Japan's fishery production surpassed 10 million metric tons (mt) in 1972 and amounted to 12.82 million mt in 1984 (Fig. 1). After 1977, establishment of the 200-nautical-mile exclusive zones reduced the production of Japan's distant fisheries. Reduction of these fisheries was compensated by offshore and inshore fisheries, including mariculture. Recent mariculture and sea farming are supporting the development of Japan's fisheries. Sea farming is a new and profitable technology for utilizing natural productivity. Scallop culture is large-scale and leads in the development of sea farming fisheries (Table 1). Therefore, this report briefly outlines the scallop sowing culture in Japan.

## Scallop production in Japan

Japanese scallop, *Patinopecten yessoensis*, production increased rapidly after the 1970's because of successful development of hanging and sowing culture (Figs. 2, 3). Before then, almost all production was from the natural scallop population. Over a quarter of a century, after World War II and prior to 1968, the catch declined to less than 22 thousand mt. The average yearly catch of 106 thousand mt in 1969-84 was nine times that of 12 thousand mt in

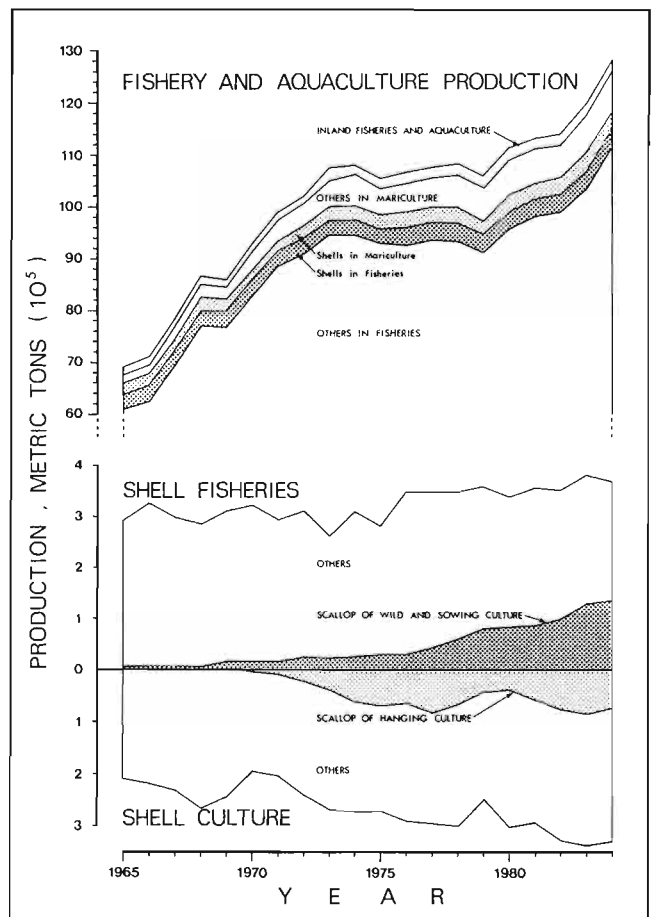
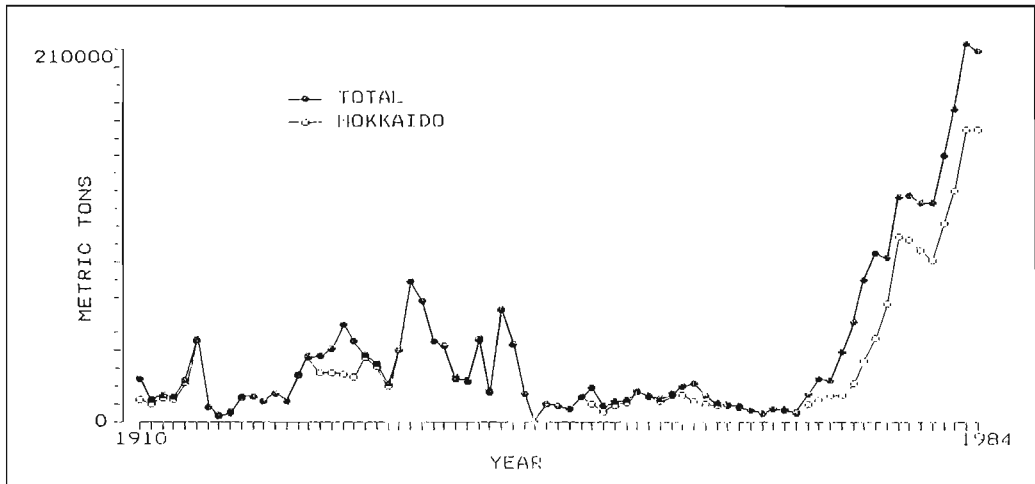

Figure 1

Annual production of fisheries and aquaculture in Japan, 1965-84. (Source: Japan Ministry of Agriculture, Forestry and Fisheries)

**Table 1**  
Seed input (10<sup>3</sup> fish) of main species for sea farming in Japan, 1977-84.  
(Source: Japan Fisheries Agency survey)

Year	Scallop	Kuruma shrimp	Blue crab	Abalone	Sea bream
1977	2,139,363	255,515	6,917	7,015	4,667
1978	1,566,655	280,075	7,870	7,143	5,109
1979	1,699,127	337,229	12,171	8,462	8,600
1980	1,525,333	297,843	11,519	10,560	10,358
1981	2,127,447	302,138	11,212	12,074	12,044
1982	1,647,327	275,402	14,997	12,279	12,866
1983	1,607,213	300,584	19,523	18,334	15,619
1984	1,776,130	293,620	19,972	19,014	16,176



**Figure 2**  
Annual production of the scallop *Patinopecten yessoensis* in Japan, 1910-84.

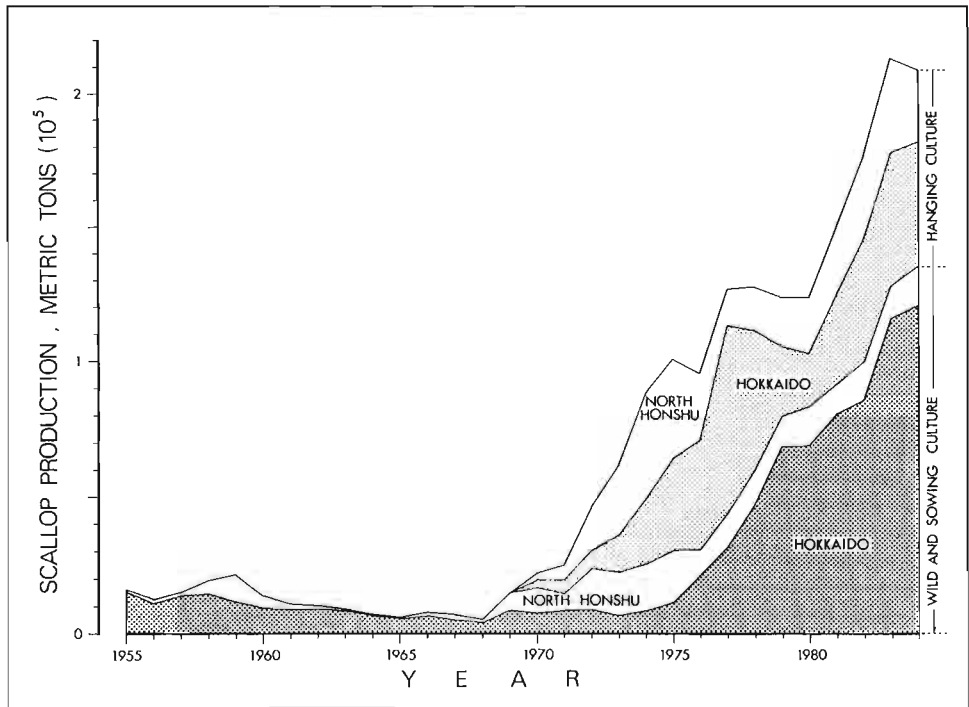

**Figure 3**  
Main regions of scallop sowing culture in Hokkaido Prefecture, northern Japan.

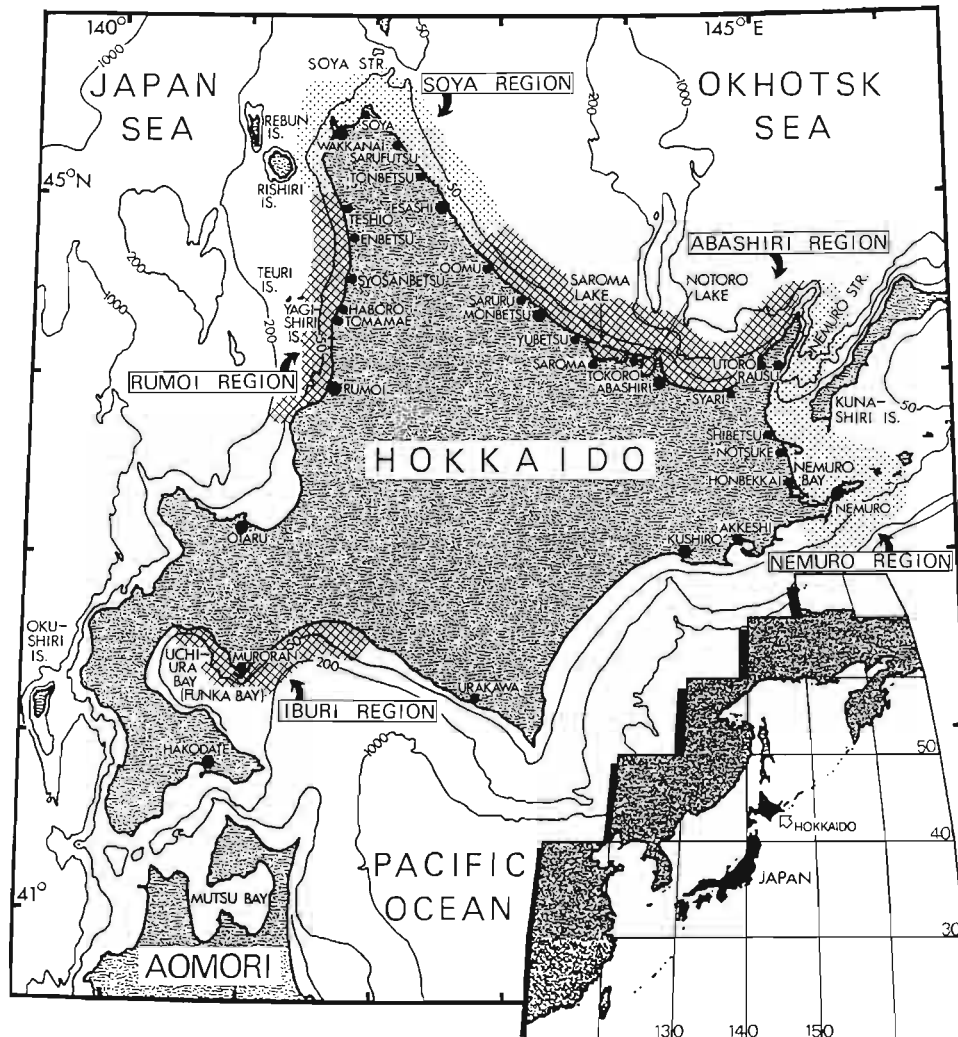

**Figure 4**  
Annual production of the scallop *Patinopecten yessoensis* in Japan, 1955-84. (Source: Japan Ministry of Agriculture, Forestry and Fisheries)

1910-68. Historically, the scallop fishery in Japan, 1910-84, consists of six periods (modified from Tanaka 1963, Kanno and Wakui 1978, Tsubata 1982):

**1910-1923** Temporary high landings, annual catch fluctuated with one sharp peak in 1915;

**1924-1932** Stable high landings, annual average catch of 37 thousand mt;

**1933-1944** Extremely high landings, average 43 thousand mt;

**1945-1968** Stable low landings, catch dropped to an average 12 thousand mt with no peaks;

**1970-1976** Hanging culture production rapidly increased, average 57 thousand mt;

**1977-1984** Sowing and hanging culture period, with production exceeding 10 thousand mt in 1977 and the scallop industry developing into a mass production phase, averaging 156 thousand mt.

The major landings have always been around Hokkaido in northern Japan (Fig. 4). Scallops caught in Hokkaido represented 79% of all Japanese scallop production during the period 1910-84. The sowing culture and wild production harvested from the sea bottom around Hokkaido contributed 86% of the total scallop production

in Japan, 1977-84. Effects of seed input on scallop harvests have not been accurately determined, because sowing culture harvests are included among wild scallop fisheries in the landing statistics. However, following are some analyses on the sowing culture around Hokkaido.

### Seed input around Hokkaido

A half-century has passed since the first trial in 1936 of scallop seed sowing in the Abashiri district coasts of northeast Hokkaido facing the Okhotsk Sea (Kinoshita 1949); however, nothing resulted from the many efforts during the first 32 years. Survival of the sowed scallop population was monitored in both the Okhotsk Sea coasts of Tokoro, Abashiri district, and Sarufutsu, Soya district, from the late 1960's to the early 1970's. On the Tokoro coast, 23 million seed shells with one-year-old seed scallops were sowed on the culture bottom in 1967. The sowed scallop population at the age of 2 years was estimated to have a survival rate of 54.7-98.0% (Okesaku and Tanaka 1969). Additionally, seed input on Sarufutsu coast was 14-60 million shells in the years 1971-73. These three

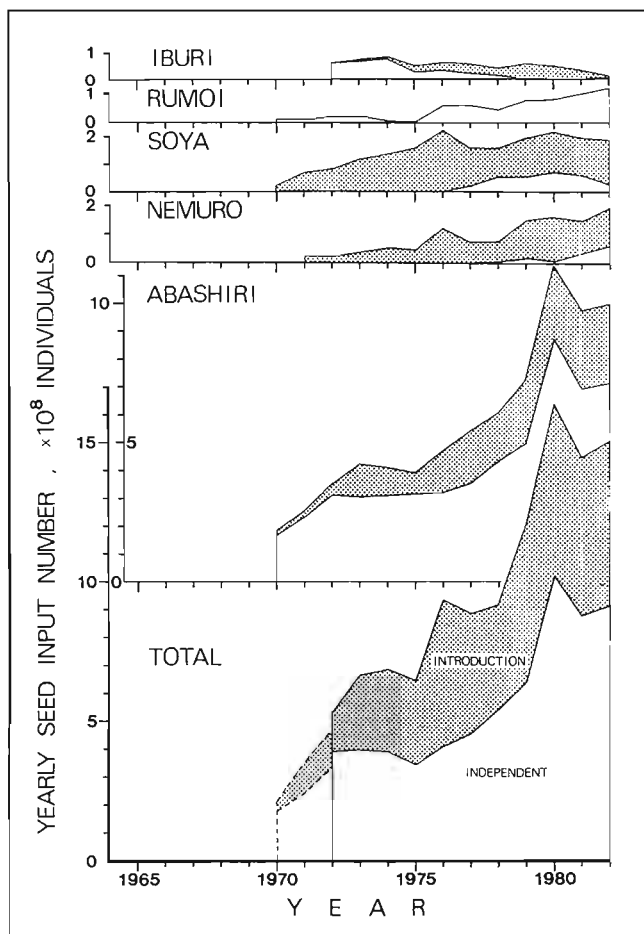

**Figure 5**

Yearly seed input number of the scallop *Patinopecten yessoensis* for sowing in five main culture districts in Hokkaido, Japan.

populations of three-year-old scallops were estimated to have survival rates of 5.5-28.9% in 1973-75 (Hayashi et al. 1976). After these studies, seed sowing began to evolve on a large scale because of the development of mass seed production in the 1970's (Fig. 5). Yearly seed input sowed around Hokkaido amounted to 1,500 million shells in 1982, a threefold increase in the last 10 years. Most of the seeds were sowed on the coasts of north and east Hokkaido in the following order: Abashiri (990 million shells, 66%), Nemuro (200 million, 13%), and Soya (180 million, 12%). Of the 1,500 shells planted around Hokkaido, 920 million were produced locally by independent intermediate culture and 590 million by introduction of seed produced in other areas. Seed production in the Abashiri district is almost self-sufficient because the brackish lakes of Saroma and Notoro are good for seed production. In the other districts, almost all seed is dependent on importation from other areas. Seed supply has been chronically insufficient, because of recent excessive demand. To eliminate seed deficiency, a new technology of off-shore spat collection and intermediate culture on the open sea coast is developing rapidly.

## Effects of seed sowing

Relationships between seed input and scallop production (wild and sowing culture) around Hokkaido are shown in Figure 6. Usually in Hokkaido, sowed scallops are harvested at four-years-old from one of four rotational culture grounds. Each point is dotted a coordinate location of the harvest in each year (vertical axis) in pairing with the corresponding seed input. Dots are plotted on the assumption that every seed scallop generation would be harvested at 4-years-old. In other words, the year of seed input is based on assumed spat-collecting time (generating time of the scallop), traced back four years before harvesting (horizontal axis). Harvests tend to relate positively with the seed input. So, fitted relationships between seed input and production are calculated (Fig. 7). A highly significant effect on the harvest appears to result from large-scale seed input such as in the Abashiri district; however, no apparent increase occurs with small-scale seeding such as in the Rumoi and Iburi districts. A large-scale seed input of more than 100 million shells might be successful in sowing culture. In the Soya district, the catch was remarkably level, though seed input was relatively small. The recent scallop stock for harvesting was kept at a high level with the wild population on the Sarufutsu coast, Soya district (Tomita et al. 1982). The sowing culture contributed no more than 10% to the recent Sarufutsu scallop production. Moreover, seed sowing had been stopped in 1980-85 because of large populations of wild scallops on this coast. Therefore, detailed results of seed sowing were different in every locality and case. The statistical scallop harvest records in Japan unfortunately include production from the wild population. Therefore, accurate analyses are still not possible because of the lack of separate harvest data on sowing culture. Statistical analyses are the primary and important step to investigate scallop culture technology. Further researches and analyses are needed to answer questions of effect of sowing culture on harvests.

## Citations

- Hayashi, T., K. Tomita, T. Wakui, H. Ito, and M. Matsuya.  
1976. Propagation of scallop by transplantation of seed in the Okhotsk Sea coast of northern Hokkaido. *J. Hokkaido Fish. Exp. Stn. (Hokusuisi Geppo)* 33(9): 1-16 (in Jpn.).
- Kanno, H., and T. Wakui.  
1978. Hotate-gai bo-gai shudan no zosei (Cultivation of mother shell population of the scallop, *Patinopecten yessoensis*). *Suisan-gaku ser.* 23:79-89 (Tokyo) (in Jpn.).
- Kinoshita, T.  
1949. Hotate-gai no zoshoku ni kansuru kenkyu (Studies on sea farming of the scallop, *Patinopecten yessoensis*). *Suisan kagaku sosho* 3 (Sapporo, Hokkaido), 106 p. (in Jpn.).
- Okesaku, H., and S. Tanaka.  
1969. Hotate-gai chi-gai no gaikai horyu koka ni tsuite (On the effects of seed sowing of the scallop, *Patinopecten yessoensis*, in the open sea coast). *J. Hokkaido Fish. Exp. Stn. (Hokusuisi Geppo)* 26(3):32-49 (in Jpn.).
- Tanaka, S.  
1963. Hokkaido ni okeru hotate-gai gyogyo to kenkyu-jyo no sho-mondai (Some problems on fishery and researches of the scallop, *Patinopecten yessoensis*, around Hokkaido). Symposium at 1963 meeting, *Jpn. Soc. Sci. Fish.*, p. 142-150 (in Jpn.).
- Tomita, K., K. Tajima, M. Uchida, M. Mori, and T. Wakui.  
1982. On the population of scallop, *Patinopecten yessoensis* (JAY), in Sarufutsu, Hokkaido. *J. Hokkaido Fish. Exp. Stn. (Hokusuisi Geppo)* 39(6):111-125 (in Jpn.).
- Tsubata, F.  
1982. Mutsu-wan hotate-gai gyogyo kenkyu-shi (A history of the fisheries researches of the scallop, *Patinopecten yessoensis*, in Mutsu Bay). Aomori Prefecture, 120 p. (in Jpn.).



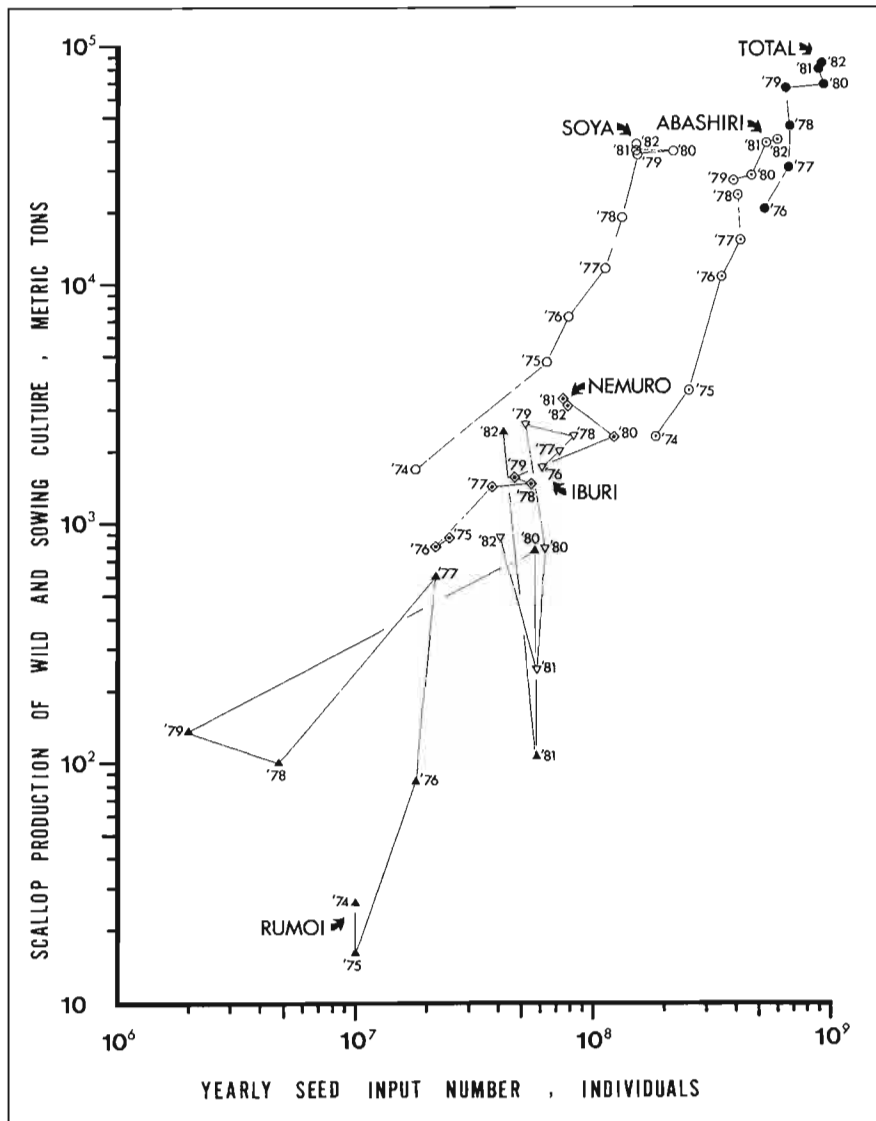
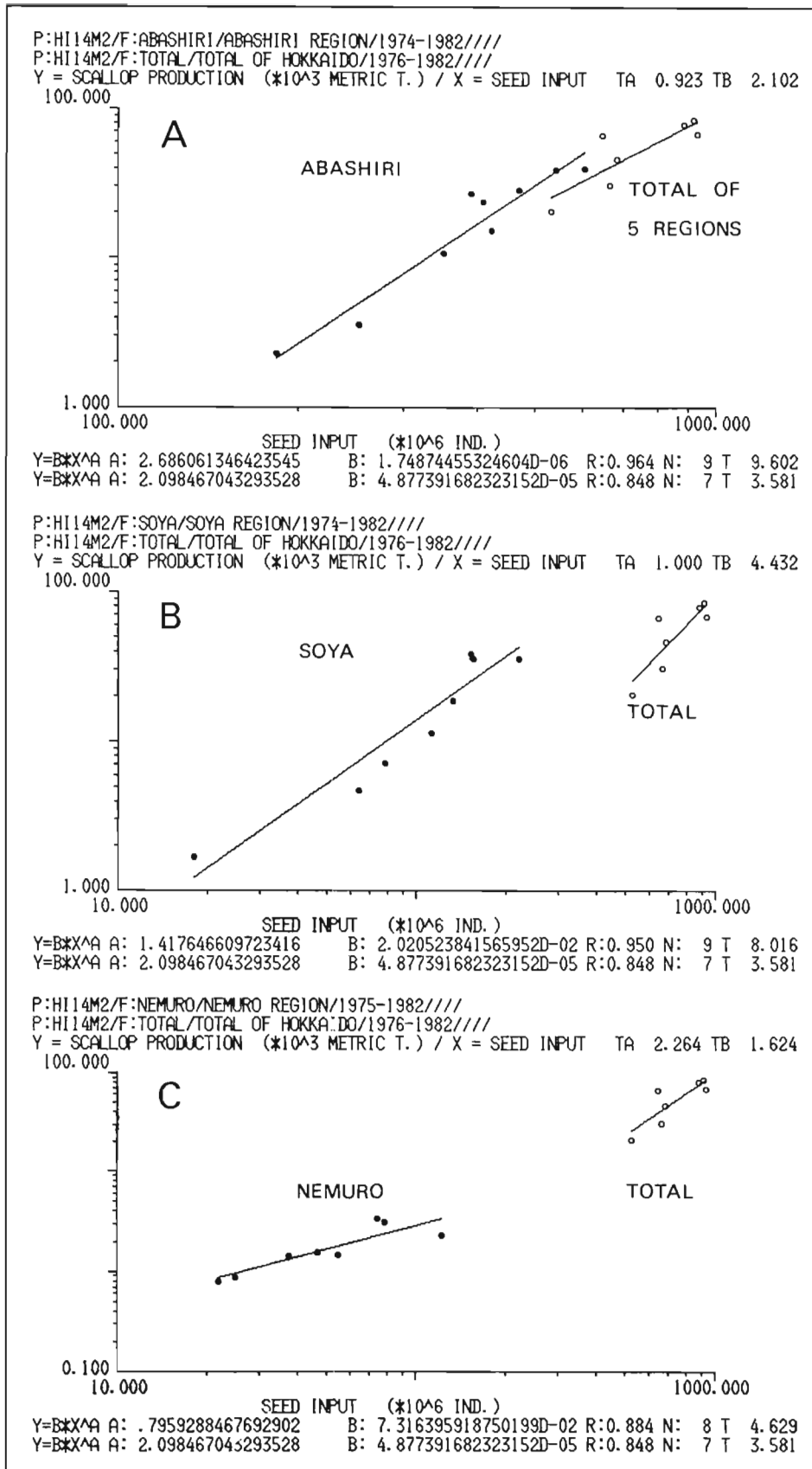

Figure 6

Relationship between seed input and production (wild and sowing culture) of the scallop *Patinopecten yessoensis* in five main culture districts around Hokkaido, Japan, 1974-82. Seed input numbers represent corresponding values in assumed previous spat-collecting time (generating time of the scallop), traced back 4 years before harvesting.



**Figure 7**  
Fitted relationship between seed input and production (wild and sowing culture) of the scallop *Patinopecten yessoensis* in five main culture districts (A-E) in Hokkaido, Japan. Seed input numbers represent corresponding values in assumed previous spat-collecting time (generating time of the scallop), traced back 4 years before harvesting.

P:HI14M2/F:IBURI/IBURI REGION/1976-1982////  
P:HI14M2/F:TOTAL/TOTAL OF HOKKAIDO/1976-1982////  
Y = SCALLOP PRODUCTION (\*10<sup>3</sup> METRIC T.) / X = SEED INPUT TA 0.550 TB 0.129  
100.000

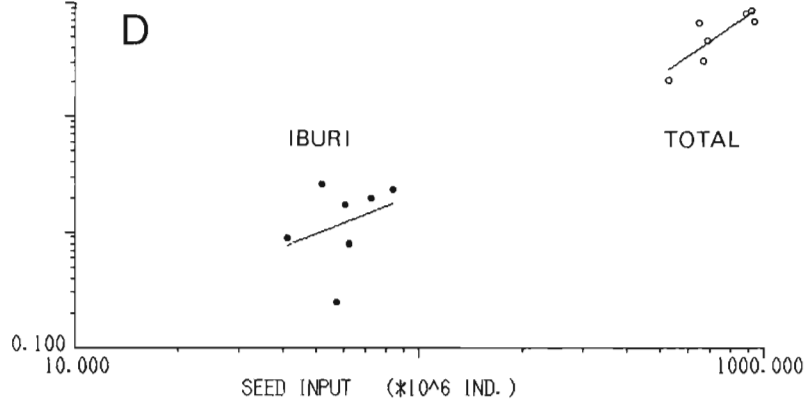

SEED INPUT (\*10<sup>6</sup> IND.)  
Y=B\*X^A A: 1.167935070085008 B: 9.944002521736505D-03 R:0.320 N: 7 T 0.756  
Y=B\*X^A A: 2.098467043293528 B: 4.877391682323152D-05 R:0.848 N: 7 T 3.581

P:HI14M2/F:RUMOI/RUMOI REGION/1974-1982////  
P:HI14M2/F:TOTAL/TOTAL OF HOKKAIDO/1976-1982////  
Y = SCALLOP PRODUCTION (\*10<sup>3</sup> METRIC T.) / X = SEED INPUT TA 0.627 TB 2.045  
100.000

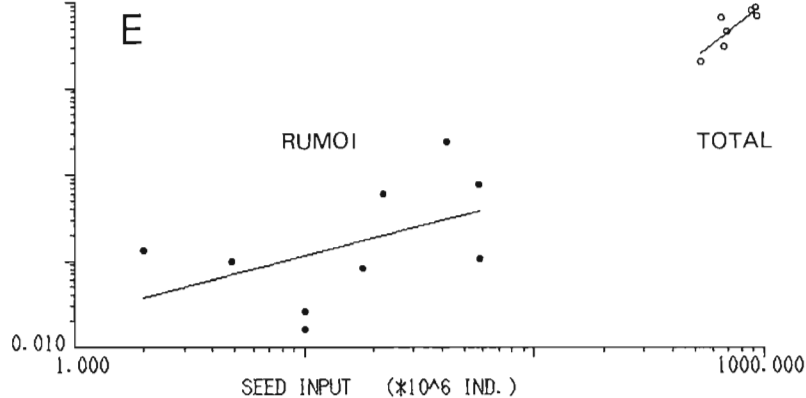

SEED INPUT (\*10<sup>6</sup> IND.)  
Y=B\*X^A A: .6904272872067725 B: 2.338649264698675D-02 R:0.489 N: 9 T 1.484  
Y=B\*X^A A: 2.098467043293528 B: 4.877391682323152D-05 R:0.848 N: 7 T 3.581

