

# Survey of Fish Protective Facilities at Water Withdrawal Sites on the Snake and Columbia Rivers

George A. Swan  
Tommy G. Withrow  
Donn L. Park

---



U.S. DEPARTMENT OF COMMERCE  
National Oceanic and Atmospheric Administration  
National Marine Fisheries Service

The major responsibilities of the National Marine Fisheries Service (NMFS) are to monitor and assess the abundance and geographic distribution of fishery resources, to understand and predict fluctuations in the quantity and distribution of these resources, and to establish levels for their optimum use. NMFS is also charged with the development and implementation of policies for managing national fishing grounds, development and enforcement of domestic fisheries regulations, surveillance of foreign fishing off United States coastal waters, and the development and enforcement of international fishery agreements and policies. NMFS also assists the fishing industry through marketing service and economic analysis programs, and mortgage insurance and vessel construction subsidies. It collects, analyzes, and publishes statistics on various phases of the industry.

The NOAA Technical Report NMFS series was established in 1983 to replace two subcategories of the Technical Reports series: "Special Scientific Report—Fisheries" and "Circular." The series contains the following types of reports: Scientific investigations that document long-term continuing programs of NMFS; intensive scientific reports on studies of restricted scope; papers on applied fishery problems; technical reports of general interest intended to aid conservation and management; reports that review in considerable detail and at a high technical level certain broad areas of research; and technical papers originating in economics studies and from management investigations. Since this is a formal series, all submitted papers receive peer review and those accepted receive professional editing before publication.

Copies of NOAA Technical Reports NMFS are available free in limited numbers to governmental agencies, both Federal and State. They are also available in exchange for other scientific and technical publications in the marine sciences. Individual copies may be obtained from: U.S. Department of Commerce, National Technical Information Service, 5285 Port Royal Road, Springfield, VA 22161.

1. Synopsis of biological data on the Blue Crab, *Callinectes sapidus* Rathbun, by Mark R. Millikin and Austin B. Williams. March 1984, 39 p.
2. Development of hexagrammids (Pisces: Scorpaeniformes) in the Northeastern Pacific Ocean, by Arthur W. Kendall, Jr., and Beverly Vinter. March 1984, 44 p.
3. Configurations and relative efficiencies of shrimp trawls employed in southeastern United States waters, by John W. Watson, Jr., Ian K. Workman, Charles W. Taylor, and Anthony F. Serra. March 1984, 12 p.
4. Management of northern fur seals on the Pribilof Islands, Alaska, 1786-1981, by Alton Y. Roppel. April 1984, 26 p.
5. Net phytoplankton and zooplankton in the New York Bight, January 1976 to February 1978, with comments on the effects of wind, Gulf Stream eddies, and slope water intrusions, by Daniel E. Smith and Jack W. Jossi. May 1984, 41 p.
6. Ichthyoplankton survey of the estuarine and inshore waters of the Florida Everglades, May 1971 to February 1972, by L. Alan Collins, and John H. Finucane. July 1984, 75 p.
7. The feeding ecology of some zooplankters that are important prey items of larval fish, by Jefferson T. Turner. July 1984, 28 p.
8. Proceedings of the International Workshop on Age Determination of Oceanic Pelagic Fishes: Tunas, Billfishes, and Sharks, by Eric D. Prince (convener and editor), and Lynn M. Pulos (editor). December 1983, 211 p.
9. Sampling statistics in the Atlantic menhaden fishery, by Alexander J. Chester. August 1984, 16 p.
10. Proceedings of the Seventh U.S.-Japan Meeting on Aquaculture, Marine Finfish Culture, Tokyo, Japan, October 3-4, 1978, by Carl J. Sindermann (editor). August 1984, 31 p.
11. Taxonomy of North American fish Eimeriidae, by Steve J. Upton, David W. Redaker, William L. Current, and Donald W. Duszynski. August 1984, 18 p.
12. Soviet-American Cooperative Research on Marine Mammals. Volume I—Pinnipeds, by Francis H. Fay, and Gennadii A. Fedoseev (editors). September 1984, 104 p.
13. Guidelines for reducing porpoise mortality in tuna purse seining, by James M. Coe, David B. Holts, and Richard W. Butler. September 1984, 16 p.
14. Synopsis of biological data on shortnose sturgeon, *Acipenser brevirostrum* LeSueur 1818, by Michael J. Dadswell, Bruce D. Taubert, Thomas S. Squiers, Donald Marchette, and Jack Buckley. October 1984, 45 p.
15. Chaetognatha of the Caribbean sea and adjacent areas, by Harding B. Michel. October 1984, 33 p.
16. Proceedings of the Ninth and Tenth U.S.-Japan Meetings on Aquaculture, by Carl J. Sindermann (editor). November 1984, 92 p.
17. Identification and estimation of size from the beaks of 18 species of cephalopods from the Pacific Ocean, by Gary A. Wolff. November 1984, 50 p.
18. A temporal and spatial study of invertebrate communities associated with hard-bottom habitats in the South Atlantic Bight, by E. L. Wenner, P. Hinde, D. M. Knott, and R. F. Van Dolah. November 1984, 104 p.
19. Synopsis of biological data on spottail finfish, *Diplodus holbrooki* (Pisces: Sparidae), by George H. Darcy. January 1985, 11 p.
20. Ichthyoplankton of the Continental Shelf near Kodiak Island, Alaska, by Arthur W. Kendall, Jr., and Jean R. Dunn. January 1985, 89 p.
21. Annotated bibliography on hypoxia and its effects on marine life, with emphasis on the Gulf of Mexico, by Maurice L. Renaud. February 1985, 9 p.
22. Congrid eels of the eastern Pacific and key to their Leptocephali, by Solomon M. Raju. February 1985, 19 p.
23. Synopsis of biological data on the pinfish, *Lagodon rhomboides* (Pisces: Sparidae), by George H. Darcy. February 1985, 32 p.
24. Temperature conditions in the cold pool 1977-81: A comparison between southern New England and New York transects, by Steven K. Cook. February 1985, 22 p.
25. Parasitology and pathology of marine organisms of the world ocean, by William J. Hargis, Jr. (editor). March 1985, 135 p.
26. Synopsis of biological data on the sand perch, *Diplectrum formosum* (Pisces: Serranidae), by George H. Darcy. March 1985, 21 p.
27. Proceedings of the Eleventh U.S.-Japan Meeting on Aquaculture, Salmon Enhancement, Tokyo, Japan, October 19-20, 1982, by Carl J. Sindermann (editor). March 1985, 102 p.
28. Review of geographical stocks of tropical dolphins (*Stenella* spp. and *Delphinus delphis*) in the eastern Pacific, by William F. Perrin, Michael D. Scott, G. Jay Walker, and Virginia L. Cass. March 1985, 28 p.
29. Prevalence, intensity, longevity, and persistence of *Anisakis* sp. larvae and *Lacis-torhynchus tenuis* metacestodes in San Francisco striped bass, by Mike Moser, Judy A. Sakanari, Carol A. Reilly, and Jeannette Whipple. April 1985, 4 p.
30. Synopsis of biological data on the pink shrimp, *Pandalus borealis* Krøyer, 1838, by Sandra E. Shumway, Herbert C. Perkins, Daniel F. Schick, and Alden P. Stickney. May 1985, 57 p.
31. Shark catches from selected fisheries off the U.S. east coast, by Emory D. Anderson, John G. Casey, John J. Hoey, and W. N. Witzell. July 1985, 22 p.
32. Nutrient Distributions for Georges Bank and adjacent waters in 1979, by A. F. J. Draxler, A. Matte, R. Waldhauer, and J. E. O'Reilly. July 1985, 34 p.
33. Marine flora and fauna of the Northeastern United States. Echinodermata: Echinoidea, by D. Keith Serafy and F. Julian Fell. September 1985, 27 p.
34. Additions to a revision of the shark genus *Carcharhinus*: Synonymy of *Aprionodon* and *Hypoprion*, and description of a new species of *Carcharhinus* (Carcharhinidae), by J. A. F. Garrick. November 1985, 26 p.
35. Synoptic review of the literature on the Southern oyster drill *Thais haemastoma floridana*, by Philip A. Butler. November 1985, 9 p.

NOAA Technical Report NMFS 39

**Survey of  
Fish Protective Facilities  
at Water Withdrawal Sites  
on the Snake and Columbia Rivers**

George A. Swan  
Tommy G. Withrow  
Donn L. Park

April 1986



**U.S. DEPARTMENT OF COMMERCE**

Malcolm Baldrige, Secretary

**National Oceanic and Atmospheric Administration**

John V. Byrne, Administrator

**National Marine Fisheries Service**

William G. Gordon, Assistant Administrator for Fisheries

The National Marine Fisheries Service (NMFS) does not approve, recommend or endorse any proprietary product or proprietary material mentioned in this publication. No reference shall be made to NMFS, or to this publication furnished by NMFS, in any advertising or sales promotion which would indicate or imply that NMFS approves, recommends or endorses any proprietary product or proprietary material mentioned herein, or which has as its purpose an intent to cause directly or indirectly the advertised product to be used or purchased because of this NMFS publication.

# Contents

---

Introduction 1

Objectives and Procedures 2

    Inventory and Data Processing 2

    Field Inspections 2

    Biological Surveys 3

Results 3

    Inventory and Inspection Surveys 3

    Biological Surveys 5

Subsequent Actions 5

Recommendations 6

Acknowledgments 6

Figures 8

Appendix: Fish Screening Facility Criteria of the National Marine Fisheries Service 34



# Survey of Fish Protective Facilities at Water Withdrawal Sites on the Snake and Columbia Rivers

GEORGE A. SWAN  
TOMMY G. WITHROW  
DONN L. PARK

*Coastal Zone and Estuarine Studies Division,  
Northwest and Alaska Fisheries Center,  
National Marine Fisheries Service, NOAA,  
Building 900, Big Pasco Industrial Park,  
Pasco, Washington 99301*

## ABSTRACT

Proliferation of water withdrawals and new pump intake and screen designs has occurred with the growth of irrigated agriculture along the Columbia and Snake Rivers. Concern for the protection of anadromous and resident fish populations resulted in formulation of a survey of the water withdrawal systems. The survey included distribution studies of juvenile fish near pump sites and field inspection of those sites to determine adequacy of screening for protection of fish. A total of 225 sites were inspected in 1979 and 1980, with a follow-up inspection of 95 sites in 1982. Results indicated a definite trend toward lack of concern for the condition of fish protective facilities. Only 4 out of 22 sites not meeting criteria in 1979 had been upgraded to acceptable conditions. Of more concern, 13 of the sites meeting criteria in 1979 were below criteria when reinspected in 1982. Some of the discrepancies included lack of protective screens, poorly maintained screens, and screens permitting excessive velocity that could result in impingement of larvae or small fish. A conclusion from these surveys is that if adequate protection for fish is to exist, screens for water withdrawals need to be properly installed, inspected, and maintained.

## INTRODUCTION

Among the many uses of Columbia and Snake River water are withdrawals for irrigation, industry, and municipalities, cooling of thermal powerplants, and fish and wildlife propagation. Agricultural and industrial uses require the largest volume of water withdrawn. In the Columbia Basin alone, it has been estimated by the U.S. Army Corps of Engineers (1976)<sup>1</sup> that the land under irrigation will increase by 1.7 million ha (4.2 million acres) between the years 1970 and 2020, reaching a total of 4.5 million ha (11.2 million acres). The upper and middle Snake River, Big Bend, and Horse Heaven Hills areas of Washington and the Umatilla area of Oregon are the major areas of irrigation expansion. This rapid growth in irrigated lands is expanding the use of existing water withdrawal sites and escalating the numbers of new pumping plant sites being constructed. As an example, the total horsepower (as determined from field inspections) of pump sites authorized in the area by the Portland and Walla Walla Districts of the U.S. Army Corps of Engineers (CofE) increased from 58,870 in 1969 to 109,942 in 1979.

The impact of expanded water withdrawal on populations of anadromous and resident fishes in the Columbia Basin continues to be a major concern to fisheries agencies. Fish protective facilities are required by the CofE as a condition for permits to install and operate water withdrawals on navigable waters. A 1973 survey of mid-Columbia River pumping plants by the Fish Commission of Oregon (FCO) indicated a need for a continuing inspection program (Fish Commission of Oregon<sup>2</sup>). In 1975, the U.S. Fish and Wildlife Service organized an interagency investigation of irrigation pumping plants on the same reach of the Columbia River as the FCO's survey, and out of 27 sites visited, 14 had inadequate fish protective facilities. Of those 14 sites, several still had the same discrepancies (inadequate fish protective facilities) noted in the 1973 inspection (U.S. Fish and Wildlife Service<sup>3</sup>). Thus, definite needs were indicated for further studies to assess the impact of present and future water withdrawals, for a continuing inspection program, and for enforcement of established fish screening criteria.

Proliferation of pumping stations and new pump intakes and screen designs has occurred with the growth of agriculture along the Columbia and Snake Rivers. Concern for the protection of anadromous and resident fish populations resulted in formulation of a more comprehensive study conducted by the National Marine Fisheries Service (NMFS) in 1979 and 1980 with funding provided by the Bonneville Power Administration. The purpose was to survey all types of water withdrawals on the main stem Columbia River from Bonneville Dam to Wells Dam and on the main stem Snake River from its confluence with the Columbia River to Lewiston, Idaho (Fig. 1). The study was two-phased: The first phase consisted of an inventory of withdrawal sites; the second phase included efforts to determine whether juvenile salmonids and resident fish were being afforded adequate protection and to develop recommendations for improving fish protection where necessary. In 1982, the CofE funded a follow-up inspection of water withdrawal sites in the Walla Walla District. The results of these field studies are contained in this report.

<sup>1</sup>U.S. Army Corps of Engineers. 1976. Irrigation, depletions/instream flow study. Columbia River and tributaries review study, 904 p. Walla Walla District, U.S. Army Corps of Engineers, Building 602, City-County Airport, Walla Walla, WA 99362.

<sup>2</sup>Fish Commission of Oregon. 1973. FCO pumping station survey. Unpubl. manusc., 10 p. Oregon Department of Fish and Wildlife, P.O. Box 3503, Portland, OR 97208.

<sup>3</sup>U.S. Fish and Wildlife Service. 1975. Columbia River irrigation pumping plant fish screen investigation. Unpubl. manusc., 15 p. Division of River Basin Studies, U.S. Fish and Wildlife Service, 919 N.E. 19th Ave., Portland, OR 97232.

## OBJECTIVES AND PROCEDURES

In our survey, the jurisdictional areas of these three districts of the North Pacific Division (NPD) of the CofE were adopted as major subdivisions of the study area (Fig. 1): Portland, Walla Walla, and Seattle. The survey was coordinated with state and federal fishery and water management agencies to ensure maximum review and use of the data.

The objective in the first year was to survey, inventory, and inspect fish protective facilities at water withdrawal sites on the Snake and Columbia Rivers. This survey was intended to serve as a base-line for a subsequent evaluation of fish protective facilities at water withdrawal sites.

The objectives in the second year were to:

- 1) determine fish distribution in selected water withdrawal areas,
- 2) ascertain whether fish protective facilities for juvenile salmonids and resident fish at water withdrawal sites functioned as designed, and
- 3) develop recommendations for improving the effectiveness of fish protection facilities.

As a result of the 1979 and 1980 surveys, the CofE issued notice to all operators of pumping plants located on the Snake and Columbia Rivers within the Walla Walla District that a follow-up inspection of their fish screening facilities would be conducted by the NMFS during the summer of 1982 to verify compliance with the fish screening and intake velocity requirements of their pumping permits.

### Inventory and Data Processing

Public records of water rights and CofE structure permits provided a starting point for the inventory. Information on water rights was compiled from records furnished by the Washington Department of Ecology, Oregon Water Resource Department, and the Idaho Department of Water Resources. The CofE, pursuant to Section 10 of the River and Harbor Act of 1899 (33 U.S.C. 403), is responsible for permits authorizing structures located in or on navigable waters and on adjacent federal shorelines. CofE permits were available for review of structures not owned by the CofE and built after December 1968 (structures established prior to December 1968 were exempt from the permit requirement by a grandfather clause in Federal Regulation CFR 322.46).

During initial efforts to locate withdrawal sites, the authors received assistance from the Regulatory Functions Unit of NPD and each of its districts. In addition, the Columbia River and Tributaries Review Study (CRT) provided data for our survey (U.S. Army Corps of Engineers<sup>4</sup>).

Available records of water appropriations and CofE public notices and structure permits were reviewed, and pertinent information on description, location, ownership, mode of operation, and authorized volume of withdrawal were entered into our data bank. Some water rights data were obtained by cross-referencing name and legal description of property; water rights for a number of withdrawal sites are still undetermined.

Site locations obtained from public records were noted on aerial photos, maps, and navigation charts. These were cross-checked with

<sup>4</sup>U.S. Army Corps of Engineers. 1977. Reach inventory, mid-1980's system description. Columbia River and tributaries review study, 301 p. North Pacific Division, U.S. Army Corps of Engineers, P.O. Box 2870, Portland, OR 97208.

actual aerial, river, and land surveys to reveal all site locations, including "grandfathered" sites and some sites operating without any known water rights or permit of record. As anticipated, some sites were not found in the records search but were located by close shoreline inspection.

Each site was assigned an inventory number which allowed location by river mile and River Kilometer (Rkm) as follows:

#### Site Inventory Number

##### Codes:

- CLW = Clearwater River
- Col = Columbia River
- Snk = Snake River
- Umt = Umatilla River
- L = left bank
- R = right bank
- Is = island
- A = first site, same location
- B = second site, same location
- C = third site, same location, etc.

Example: Col 301.7 LB = A withdrawal site located on the Columbia River at River Kilometer 485.5 (River Mile 301.7), on the left bank (facing downstream), and the second site (facing downstream) at the same approximate river kilometer.

The data for each site were entered into a computerized data base, permitting easy access for adjustments, selection, and sorting in a variety of combinations. A standard printout of this information is presented in Appendix A of Swan et al. (1980<sup>5</sup>) and Appendix A of Swan (1981<sup>6</sup>).

Photographic records were made of sites located by actual survey. Drawings were also made of representative sites to illustrate the variety of structures and fish protective facilities noted in the field surveys (see Figs. 3-29).

### Field Inspections

Each site was visited by boat or automobile, and more detailed information on the structure, pumps, and screening facility was collected to supplement and corroborate data obtained from the records search.

Underwater inspections by divers were conducted at each withdrawal site to determine dimensions of the underwater structure, type and mesh size of screening, and condition and cleanliness of screen material. Observations of fish at or near intakes were noted. Diving was sometimes restricted due to high turbidities or extremely cold water.

<sup>5</sup>Swan, G. A., T. G. Withrow, and D. L. Park. 1980. Survey of fish protective facilities at water withdrawals on the Snake and Columbia Rivers. Fiscal year 1979 report of research, 193 p. Northwest and Alaska Fish. Cent., Natl. Mar. Fish. Serv., NOAA, 7600 Sand Point Way N.E., Seattle, WA 98115. (Prepared for Bonneville Power Administration, Portland, Oregon, under contract DE-A179-79BP10684).

<sup>6</sup>Swan, G. A. 1981. Survey of fish protective facilities at water withdrawals on the Snake and Columbia Rivers, Phase 2. Fiscal year 1980 report of research, 28 p. Northwest and Alaska Fish. Cent., Natl. Mar. Fish. Serv., NOAA, 7600 Sand Point Way N.E., Seattle, WA 98115. (Prepared for Bonneville Power Administration, Portland, Oregon, under contract DE-A179-80BP18490).



Federal and state agencies have established criteria for the open area of screening material and the flow velocities at intakes. Although there are some differences between agencies regarding criteria, NMFS criteria for salmonid fry call for a maximum clear opening of 3.56 mm (0.14 inch) and a maximum approach velocity of intake water immediately in front of the screen of 15.2 cm/s (0.5 ft/s) (National Marine Fisheries Service<sup>7</sup>). These criteria were used as the baseline for our inspections of the fish protective facilities. Complete NMFS fish screening criteria are presented in the Appendix to this report. Rough measurements of intake velocities were taken by divers with a flowmeter when intake flows could be detected. At some sites only limited data on flow conditions in and around the intake structures were obtained because pumps were not operating.

## Biological Surveys

To determine if small fish are present and exhibit any adverse effects from the withdrawal site, extensive sampling at a water withdrawal installation is required to properly assess its potential impact on salmonid and resident fishes. With the funds and staff available in 1980, only two areas could be adequately sampled. One was near Wenatchee, Washington, where a large number of water withdrawal installations are known to exist, and the second was in the reservoir of McNary Dam (Lake Wallula), where there are several large installations that 0-age chinook salmon, *Oncorhynchus tshawytscha*, pass each year on their seaward migration (Fig. 1). Other areas were investigated, but less extensively.

Traditionally, sampling of small fish in reservoirs of the Columbia Basin has been conducted primarily with beach seines, purse seines, gill nets, trap nets, and two-boat trawl nets. However, studying the distribution and abundance of smolts and the young of resident fishes with traditional gear near many of the withdrawal sites was not feasible due to shallow water, rock outcrops, or thick aquatic weed growth.

Since the water withdrawal sites chosen for intensive sampling at the McNary Reservoir were shallow, we developed a sampling technique for collecting fish in shoreline fringe areas. The system consisted of two nets attached to 4.3 m (14-ft) outriggers mounted on a 6.4 m (21-ft) workboat powered by a 165-horsepower in-board/outboard motor. The outriggers extended from each side of the boat at midship and were trussed by a cable and a binder to

<sup>7</sup>National Marine Fisheries Service. [1974.] NMFS fish screening facility criteria. Unpubl. manuscr., 1 p. Environmental and Technical Services Division, Northwest Regional Office, Natl. Mar. Fish. Serv., NOAA, P.O. Box 4332, Portland, OR 97280.

a point on the bow (Fig. 2). A depth finder and the power tilt out-drive unit facilitated operation in water as shallow as 0.9 m (3 ft). An electromagnetic flowmeter was mounted on one outrigger to measure the velocity of water into the trawl nets.

All tows were made in a downstream direction parallel to the shoreline with the boat motor held at a constant 2,000 rpm. Tow netting was attempted over a 24-h period, but was later restricted to daylight hours because sampling at night was impractical due to safety considerations and because from late afternoon until dusk provided almost all of the sampled fish. To minimize mortality of sampled fish, tows averaged about 12 minutes each. Most of the season, nets were towed at a speed of about 2.0 m/s (6.7 ft/s). Toward the end of the sampling period, new nets were developed which were towed about 2.7 m/s (9 ft/s). We assumed that fish which could avoid our tow nets could avoid the highest approach velocities of the pump intakes measured in this study, at the time about 45.7 cm/s (1.5 ft/s). Three types of tows were made: 1) near the left shoreline, 2) mid-river, and 3) near the right shoreline. This method worked well until longer hours of sunlight and higher water temperatures promoted the growth of thick beds of aquatic vegetation which plugged the nets. The reservoir was sampled from upstream of Richland, Washington (Rkm 555), to McNary Dam (Rkm 470) on nine separate days between 10 and 27 June 1980.

In addition to tow nets, scuba diving and underwater TV were used to observe distribution and behavior of fish near the intakes of the pumping facilities. Scuba diving was also used at water withdrawal sites surveyed in 1980 to observe condition of screens, impingement of fish on screens, and water velocity at screens. Gill nets and hoop nets were used on a limited basis.

Divers conducted inspections and made observations of fish activity at various water withdrawals during 27 days between 11 April and 29 September 1980. Divers also monitored three large withdrawal sites in the Wenatchee, Washington area throughout the season.

## RESULTS

### Inventory and Inspection Surveys

A summation of fish protective facilities (by district) at the 205 withdrawal sites located within the initial area of study is presented in Table 1. The large difference between number of sites and number of CofE permits is due to the CofE not issuing permits for sites installed prior to the end of December 1968 ("grandfathered" sites) and sites owned by the CofE. The horsepower rating of pump

Table 1.—Information gathered from inspection of water withdrawal sites along the Columbia and Snake Rivers in 1979. In areas where salmonid fry are present, the maximum mesh size for screens on intake pipes was 3.56 mm (0.14 inch) as recommended by NMFS.

CofE District	No. of sites inspected	No. of sites inspected with CofE permits	Pump size*		Screen Data					
					Open mesh			No screens	Screening unknown	
					<3.56 mm (0.14 inch)	>3.56 to <6.35 mm (0.25 inch)	>6.35 mm			
Portland	27	22	3	7	17	13	4	5	3	2
Walla Walla	57	47	13	16	28	24	17	5	8	3
Seattle	121	8	89	21	11	25	31	56	5	4
Total	205	77	105	44	56	62	52	66	16	9

\*S≤50 hp; M = 50-499 hp; L ≥500 hp.

motors was used as an indication of the relative size of water withdrawals. Screen data are separated into categories based on the maximum size of the screen's clear opening. Intakes with no screening or those with screening completely deteriorated were combined into the "no screen" category. The screening of nine sites is unknown because we were unable to locate the end of the intake line due to debris or poor visibility.

Several basic types of water withdrawal sites were noted during the survey:

- 1) vault-like structure with an underwater, screened opening (Figs. 3-6);
- 2) pier-like structure out from the shoreline supporting turbine pumps (Figs. 7, 8);
- 3) combination pier/vault created by enclosing the area under a pier with driven sheet piling or other material (Figs. 9, 10);
- 4) single large screened intake pipe (Figs. 11-14);
- 5) vault-like structure incorporating traveling screens (Figs. 15, 16) or circular rotating screens (Figs. 17, 18);
- 6) simple arrangement of a pump with a single intake line extending to a depth below the low water elevation (Figs. 19, 20);
- 7) simple pump and intake line incorporated with an additional debris and weed seed straining device (Figs. 21, 22).

A variety of screening techniques was also encountered during the survey. The withdrawal sites having pump motors larger than 50 hp were generally screened with some form of commercially manufactured screening. Commercial screening materials observed included wire mesh or hardware cloth, monofilament mesh, and stainless steel screening. These materials were incorporated into stationary vertical screen panels, traveling screens, or box or cylinder shapes to strain water for individual or multiple pumps.

Smaller pump sites (less than 50 hp) generally incorporated a single intake line with a straining device on the end. With the exception of some commercially manufactured check valves with built-in screening (commonly called foot valves), most screening used on smaller sites was some form of an improvised screen device such as bars or screen material tack-welded over the end of the intake pipe, a perforated metal oil drum attached to the end of an intake line, a cylinder or cone fashioned from wire mesh or expanded metal grating, special sections of perforated pipe (Fig. 23), or a metal pipe with slashes cut with a welding torch (Figs. 24, 25).

The mesh size (clear opening) and the condition of screening material used at withdrawal sites are of primary interest because large populations of salmonid fry and fingerlings migrate past many of the sites surveyed. Obviously, if a large number of screened structures do not meet the criteria (e.g., mesh size opening too large or tears in the screen) losses of young fish could be serious. In 1979, 205 withdrawal sites were inspected and 146 (71%) did not meet the criteria. The highest percentage of below-standard sites (80%) were in the Seattle District (upstream of Richland, Washington); the lowest percentage (56%) were found in the Walla Walla District (Table 2). The overall average of 71% not meeting the criteria—higher than the 52% found below standard by the U.S. Fish and Wildlife Service in 1975 (footnote 3)—should be cause for concern by fishery agencies. The most common reasons why sites did not meet the criteria were:

- 1) screens with oversize open areas;
- 2) screens in poor condition with breaks or missing sections;
- 3) no screening; and
- 4) intakes with excessive flows.

Deterioration of screens was caused by damage from rough handling or ice build-up and plugging from debris or severe stages of rust or corrosion, causing an increase in head loss and eventual collapse of screen panels, resulting in gaps or openings in the screen-

ing. Plugging of screens by the growth of aquatic vegetation or impinged debris was a serious problem at many sites (especially the smaller ones). A small number of sites had mild electrical fields in conjunction with underwater screening. Apparently this was an effort to control the fouling of the screens with plant and animal material.

Based on interviews with operators of pumping stations and observations by divers, we arrived at some general conclusions regarding screen materials. Wire mesh screening was least durable because of rust and corrosion. Monofilament mesh has only been in use in this area a few years, and prolonged exposure to sun and weather caused brittleness and eventual breakdown. Stainless steel screens, such as manufactured by Johnson Screen™, appeared to be holding up very well with minimum maintenance.

During 1980, 20 additional withdrawal sites within the study area were located, bringing the total to 225 sites surveyed in 1979-80. Of the additional 20 sites, 15 were owned and operated by the CofE for another government agency.

A number of withdrawal sites (mostly in the Seattle District, upstream of Richland, Washington) that were inspected and found to have problems in 1979 were inspected again in 1980. All 14 sites reinspected were found to be in the same or worse condition (Table 3). A similar situation was noted by U.S. Fish and Wildlife personnel in their reinspections of sites in 1975 that were first surveyed by the Fish Commission of Oregon in 1973 (footnote 3).

**Table 2.—Number of water withdrawal sites inspected along the Columbia and Snake Rivers in 1979 which had either no intake screening or existing screening that did not meet criteria.**

CofE District	No. of sites inspected	No. of sites below criteria*
Portland	27	17 (63%)
Walla Walla	57	32 (56%)
Seattle	121	97 (80%)
Total	205	146 (70%)

\*The more restrictive criteria of the National Marine Fisheries Service for salmonid fry served as the limits for considering whether or not a site met criteria.

**Table 3.—Water withdrawal sites along the Columbia and Snake Rivers inspected in 1979 which showed uncorrected problems when reinspected in 1980.**

Inventory no.*	Intake condition
Col340.8 R	Measured flows >15.2 cm/s (0.5 ft/s)
Col345.0 R	Oversize mesh opening
Col397.1 L	Badly deteriorated mesh
Col448.8 R	Rusted, damaged, and oversize
Col448.9 L	Solid rust; badly deteriorated
Col449.5 RA	Rusted shut; large hole
Col 449.6 L	Rusted and bent panels
Col449.9 RA	Deteriorated mesh
Col450.2 L	Rusted shut on top
Col462.5 RA	No mesh
Col493.6 R	Oversize mesh openings
Col504.0 L	Oversize mesh openings
Col514.1 R	Oversize mesh openings
Snk020.2 R	New screens to 1.8 m (6 ft) below surface; remaining area was unscreened.

\*Inventory numbers based on U.S. CofE river mile system.

Four withdrawals operated by the CofE as part of the levee at Lewiston, Idaho, were of interest because they are siphons in use year-round (Fig. 26). One is located on the Snake River, and three are on the Clearwater River. The purpose of the siphons is to introduce more water into a level, groundwater drainage ditch to create higher flow in the ditch and avoid water stagnation. NMFS divers inspected them on 3 and 18 September 1980 and found impinged organisms (turtles, crayfish, and decomposed small fish); intake velocities, measured with an electromagnetic flowmeter, were found to be much greater (100.6 cm/s or 3.3 ft/s) than the acceptable fish protective criteria (15.2 cm/s or 0.5 ft/s). As soon as the deficiencies were made known to the CofE, corrective action was taken.

## Biological Surveys

Initially, we expended near-equal sampling effort over hours of daylight and darkness. However, most of the fish captured in our tow nets were taken from late afternoon until dusk. Numbers captured reflected increased surface activity of smaller fish near shorelines during those hours. Thus, late afternoon sampling was preferred. Most fish taken were fall chinook salmon ranging from 40 to 75 mm fork length with a mean length of 55 mm. The majority of the fish were taken in the nearshore tows, with 73% of the fish captured in the tow net adjacent to the shoreline (Table 4). Since the nets were only about 2 m apart, the data strongly suggest that these small fish are quite concentrated next to the shoreline. A concurrent study by the U.S. Fish and Wildlife Service also reported that the smaller fish were found nearshore, whereas larger fish were found primarily in midwater (Gray and Rondorf<sup>8</sup>).

Table 4.—Catch of fall chinook salmon by tow netting in McNary Reservoir, 1980.

Location	Number of tows	Fall chinook sampled (no.)	% of catch in net closest to shore
Left shore	30	116	74
Midriver	13	4	—
Right shore	32	199	72
Total	75	319	

Gill nets and hoop nets used along the shoreline fringe on a very limited basis revealed the presence of small (~80 mm or less total length) young-of-the-year fish such as juvenile carp, *Cyprinus carpio*; sculpin, *Cottus* spp.; yellow perch, *Perca flavescens*; chinook salmon; bluegill, *Lepomis macrochirus*; and crappie, *Pomoxis* spp.

In addition to examining data from net catches, we attempted to monitor distribution by visual observations. Because underwater visibility in the lower Columbia and Snake Rivers is generally poor when salmonids are migrating, only limited data were obtained.

Fish behavior and distribution were observed at the mouth of the Chelan River at Chelan Falls, Washington, where underwater visibility averaged 3.7-4.6 m (12-15 ft). There in a backwater location, typical of many areas where water withdrawal sites are located, 11 species of fish were sighted with juvenile bass (*Micropterus* spp.), bluegill, and crappie being abundant. Several adult bluegill were observed guarding eggs on nest sites near the shoreline.

<sup>8</sup>G. Gray, and D. Rondorf. National Fisheries Research Center, Pasco Substation, 750 S. Lake Road, Route 6, Pasco, WA 99301, pers. commun., January 1981.

Underwater visual observations were also possible at a boat moorage at Rkm 764 (Rmi 475) upstream from Wenatchee, Washington, on 16 May 1980. No water withdrawal facility was located in the area, but the configuration of the site was typical of many withdrawal sites along the river and thus provides some indication of small fish behavior and distribution near the shoreline. About 100 fall chinook salmon (40-50 mm long) were observed with a group of threespine stickleback, *Gasterosteus aculeatus*, in a school holding in a back eddy along the talus rock shoreline in 0.6-0.9 m (2-3 ft) of water.

Our tow, gill, and hoop net data and visual observations confirmed the presence of juvenile salmon and other fish nearshore. The presence of bluegill nests indicates that larval fish are also present in some nearshore areas.

Although the underwater inspection was conducted after the major seaward migration of anadromous fish, juvenile salmon (*Oncorhynchus* spp.) were observed in the immediate vicinity of some withdrawals. Impingement of juvenile salmonids was not observed at these withdrawals, but impingement and entrainment of several hundred threespine sticklebacks were observed at a withdrawal site near Wenatchee, Washington. This appeared to be a result of an accumulation of aquatic vegetation on the vertical screen panel which caused an increase in intake velocity through the remaining open area of the screen. The increased flow had impinged stickleback on the screen panels and pulled more stickleback around the ends of the screen panels into the pump chamber. A similar impingement situation was noted on a simple 15.2 cm (6-inch) diameter foot valve.

At the three large withdrawal sites monitored in the Wenatchee area in 1980, very few fish and no impinged fish were observed around two of the three sites. However, large numbers of threespine stickleback were observed in the vicinity of the third site, and, as in 1979, there were threespine stickleback impinged on the intake screens.

## SUBSEQUENT ACTIONS

As a result of the 1979 and 1980 surveys, the CofE issued a notice to all operators of pumping plants located on three major rivers within the Walla Walla District (the Columbia, the Snake, and the Clearwater) that an inspection of their fish screening facilities would be completed during the summer of 1982 to verify compliance with the fish screening and intake velocity requirements of their pumping permits. CofE permits for pump intakes require screens having openings not in excess of 6.35 mm (0.25 inch) and an approach velocity to the intake not to exceed 30.5 cm/s (1.0 ft/s). (Note that this approach velocity meets NMFS established criteria for fingerlings but not for salmonid fry.)

The NMFS scuba divers, under contract from the CofE, conducted inspections of these screens between July and October 1982. Any discrepancies noted in the inspection were provided to the CofE for enforcement of permit stipulations. Discrepancies noted during the diving inspections ranged from oversize mesh openings and screening damaged by cuts and tears in the screen fabric to solid rust and collapse of screening or no screens at all.

A summation of the findings in the inspection of the fish protective facilities at the 95 withdrawal sites located within the CofE Walla Walla District in 1982 is presented in Table 5. A total of 59 sites were within criteria, 34 sites (36%) had some type of discrepancy, and 2 were questionable. Specifics on each of the 95

**Table 5.—Number of water withdrawal sites in the U.S. CofE Walla Walla District in 1982 which had acceptable intake screening (within criteria) or unacceptable existing screen materials or no intake screening at all (below criteria).**

No. of sites inspected	Condition		
	No. questionable*	No. within criteria	No. below criteria
95	2 (2%)	59 (62%)	34 (36%)

\*The intake for one site was apparently covered with rock and could not be located, and divers were unable to dive at the other site.

**Table 6.—Condition of fish screening facilities at 64 water withdrawal sites in the CofE Walla Walla District reinspected in 1982 relative to the initial inspection conducted in 1979.**

Number	1979		1982	
	Criteria		Criteria	
	Within	Below	Within	Below
29	x		x	
13	x			x
4		x	x	
18		x		x

sites inspected in 1982 are contained in Swan (1982)<sup>9</sup>. A greater number of sites were inspected in 1982 than in 1979, due to the following:

- 1) new sites installed after 1979,
- 2) sites overlooked in the initial survey, and
- 3) sites on the Hanford reach of the Columbia River which were placed under the jurisdiction of the Walla Walla District of the CofE after 1979.

The condition of fish screening facilities found over a 3-year period at 64 water withdrawal sites is summarized in Table 6. Of the 64 sites inspected in 1979 and reinspected in 1982, only 4 of the 22 sites which did not meet criteria earlier had been upgraded to acceptable conditions. Of more concern, 13 sites which had been at or above standard in 1979 were below standard when reinspected in 1982.

<sup>9</sup>Swan, G. A. 1982. Inspection of pumping plant intake screens. Annual report, 11 p. Northwest and Alaska Fish. Cent., Natl. Mar. Fish. Serv., NOAA, 7600 Sand Point Way N.E., Seattle, WA 98115. (Prepared for U.S. Army Corps of Engineers, North Pacific Division, Portland, Oregon, under contract DACW68-78-C-0051.)

## RECOMMENDATIONS

1. Current fish screening criteria of the NMFS appear generally adequate for protection of fry and fingerling size fish (as no impinged salmonids were found on fish screens), but only if screens are properly installed, inspected, and maintained.
2. Designs that enlarge gross screen area or move the screen mesh farther away from the intake pipe are desirable to reduce velocities through the screen. This not only offers more protection for fish and other aquatic life, it also reduces maintenance of intake screens by reducing impingement of debris.
3. Intake designs which draw from deeper water should be less likely to entrain and/or impinge the small or larval stages of fish which were observed to inhabit the cover of aquatic vegetation in the littoral zone (the shallow-water region with light penetration to the bottom; typically occupied by rooted plants). Those intake designs should also require less maintenance because at depths below the littoral zone, plugging from aquatic vegetation was found to be minimal. In addition, locating intakes in the main flow of a river as opposed to backwaters should provide the benefits of increased bypass of debris and attendant reduction in maintenance costs.
4. This report provides a comparison with similar, less intensive studies conducted previously and will serve as a baseline to evaluate future changes in intake screening practices and compliance with regulatory criteria. Furthermore, it provides the basis for an assessment of the impact of present and future water withdrawals on fishes of the Columbia Basin. More detailed studies are needed to determine the occurrence, distribution, migration routes and timing, and behavior of fish populations near water withdrawal sites. Those studies should also quantify fish losses, test improvements in fish protective facilities, and develop more accurate specifications for facilities at water withdrawals.

## ACKNOWLEDGMENTS

This work is a result of cooperative research sponsored in part by the Bonneville Power Administration and the U.S. Army Corps of Engineers. The authors would like to thank the staff of the Environmental and Technical Services Division, Northwest Region, National Marine Fisheries Service, for their advice and assistance in this study.



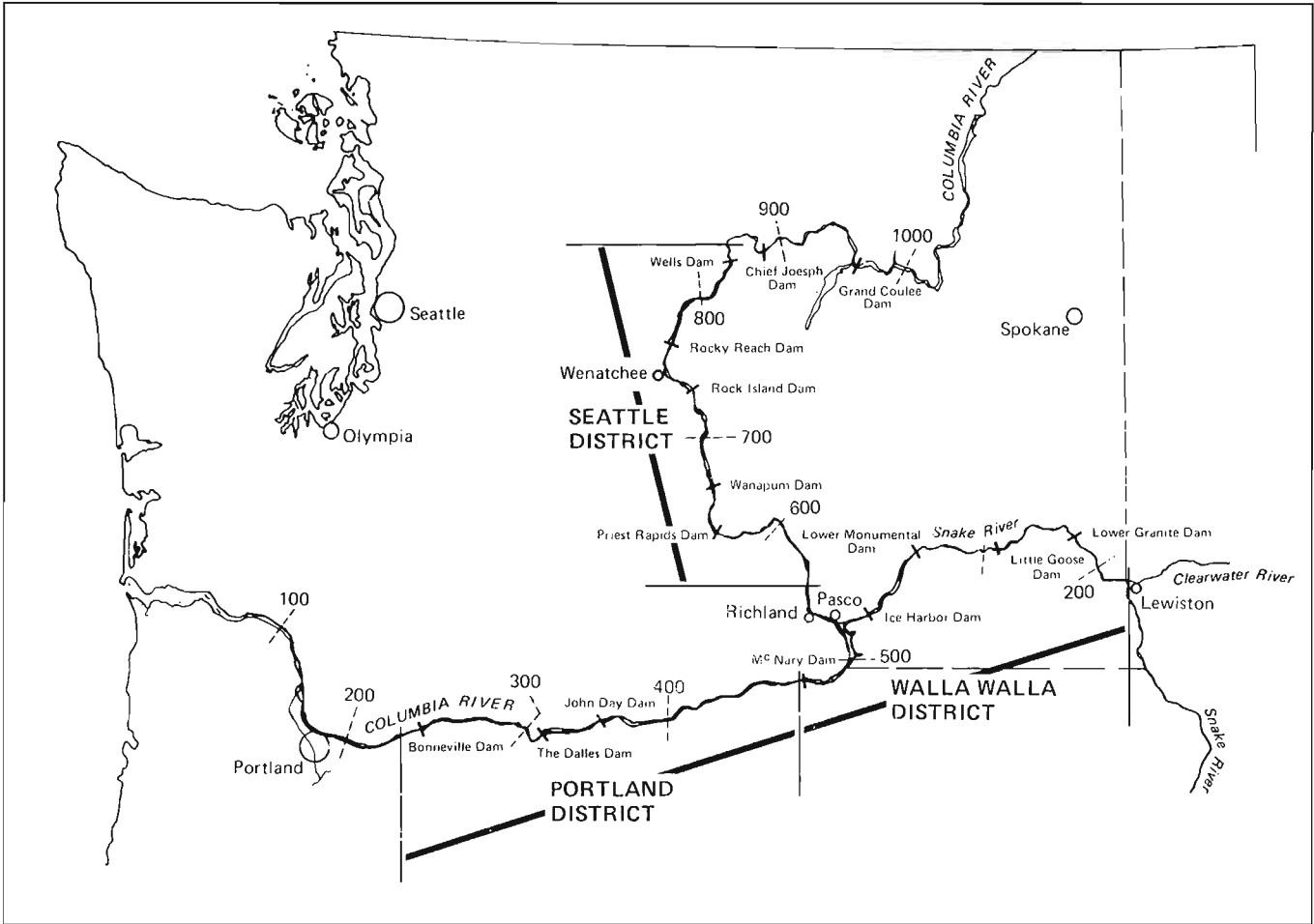

Figure 1.—Portions of the Columbia and Snake Rivers surveyed in 1979 and 1980 by the National Marine Fisheries Service. Selected river kilometers and U.S. CofE districts having responsibility are shown.

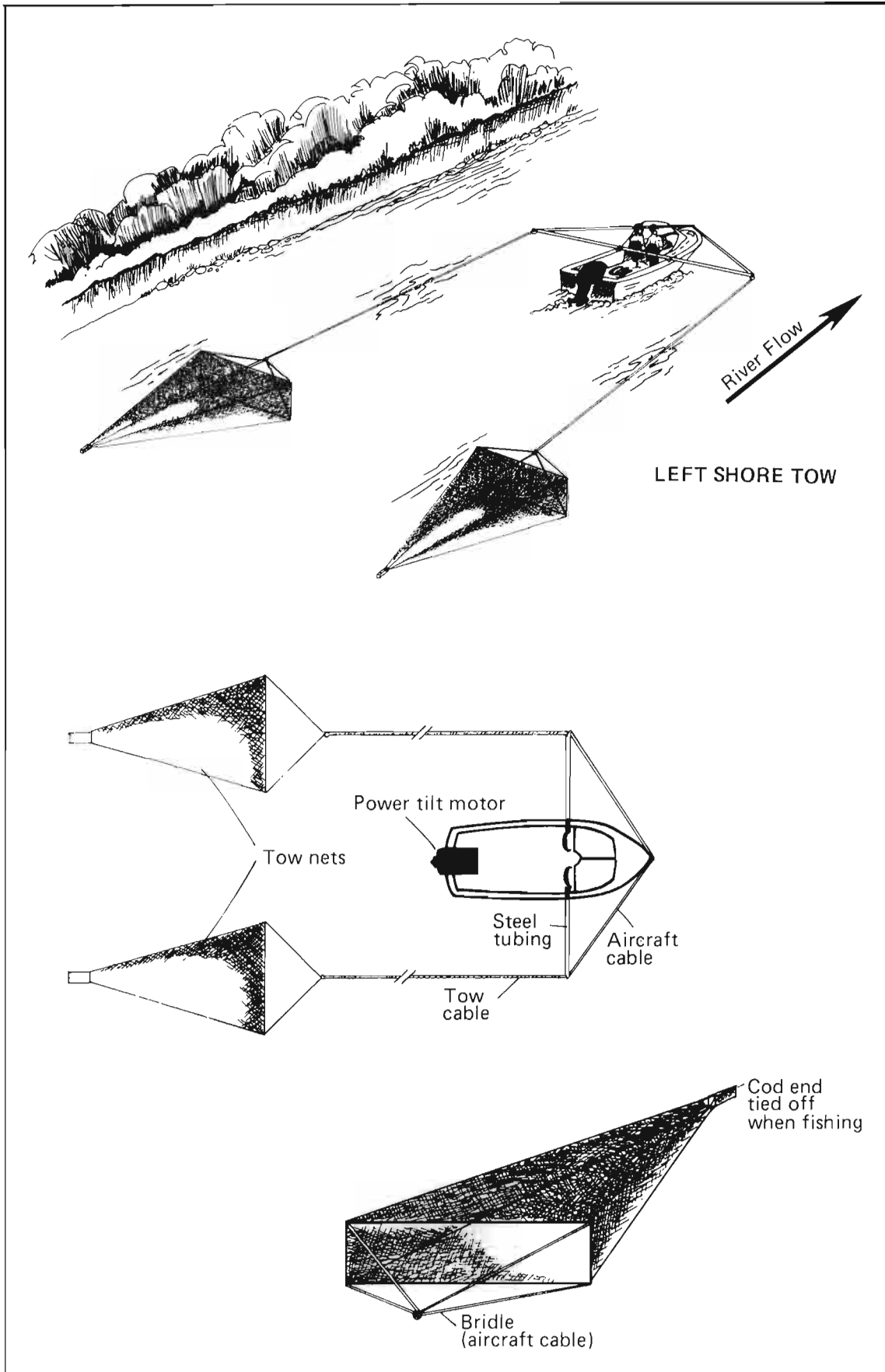

Figure 2.—Outrigger tow net system which allowed sampling of fish in the shallow water off the shoreline fringe of McNary Dam Reservoir, Columbia River.

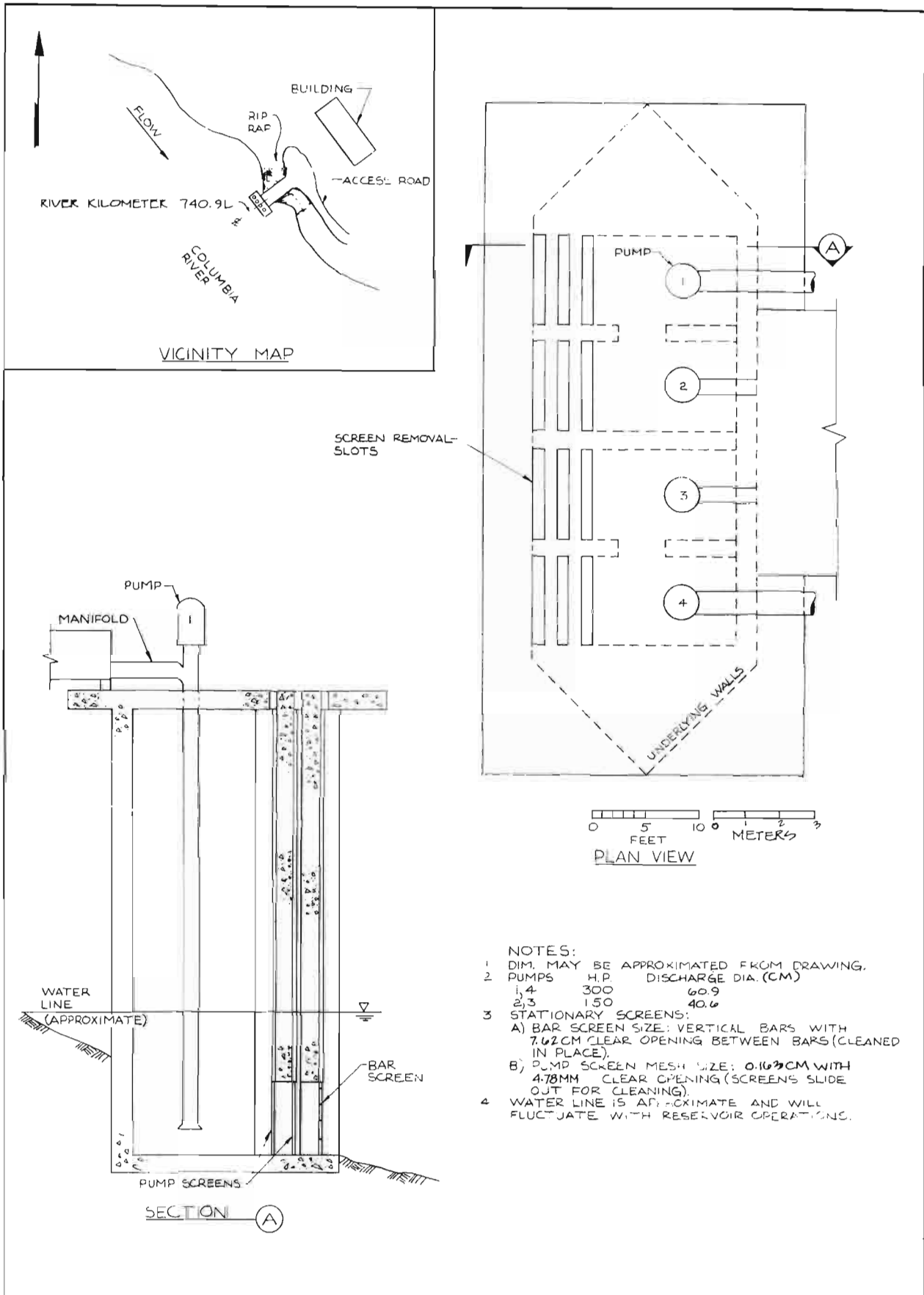

Figure 3.—Water withdrawal plan of Greater Wenatchee Irrigation District (river mile Col460.5L).



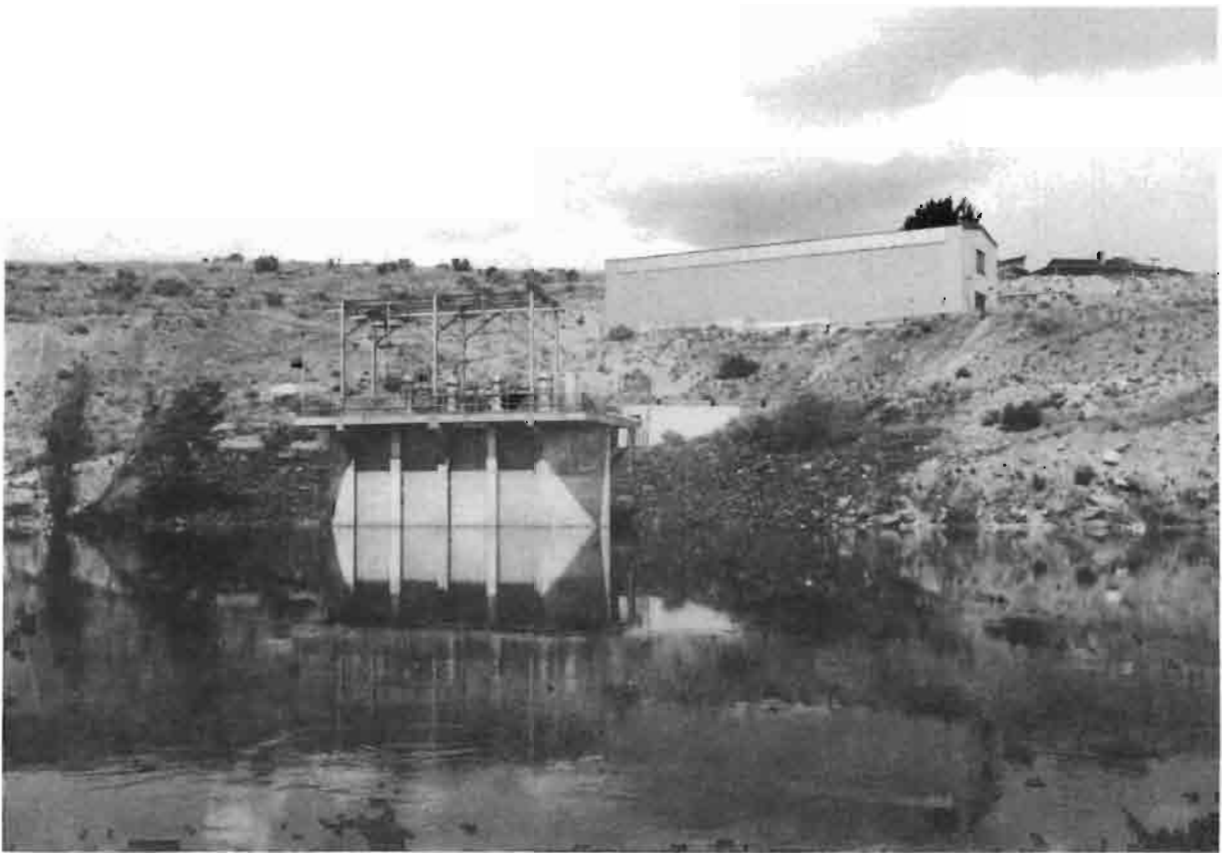

Figure 4.—(Above) Aerial view of water withdrawal site, Greater Wenatchee Irrigation District. (Below) View of the vault-like water withdrawal structure with underwater screened opening.

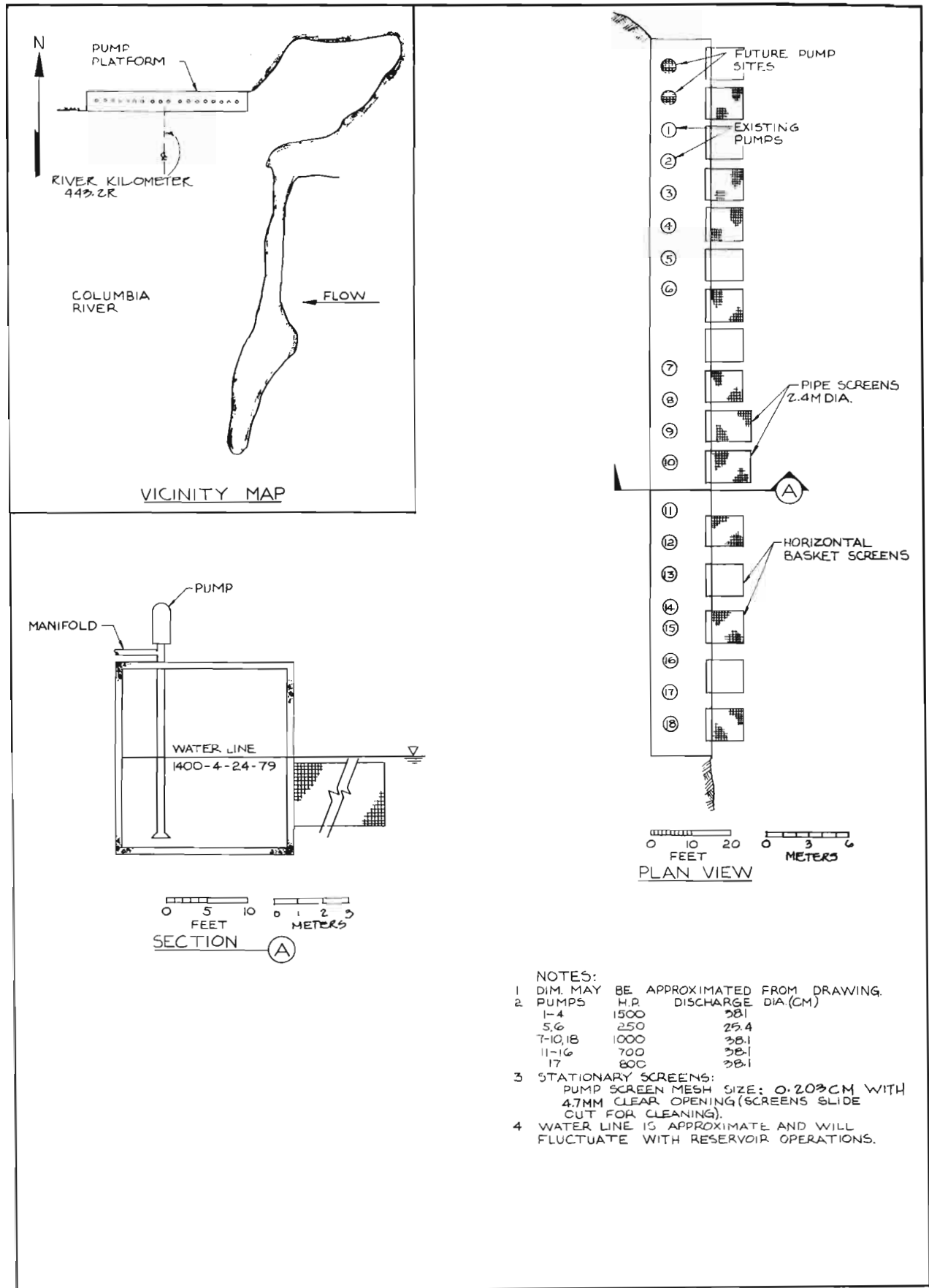

Figure 5.—Water withdrawal plan of Paterson Irrigation Project (river mile Col275.5R).

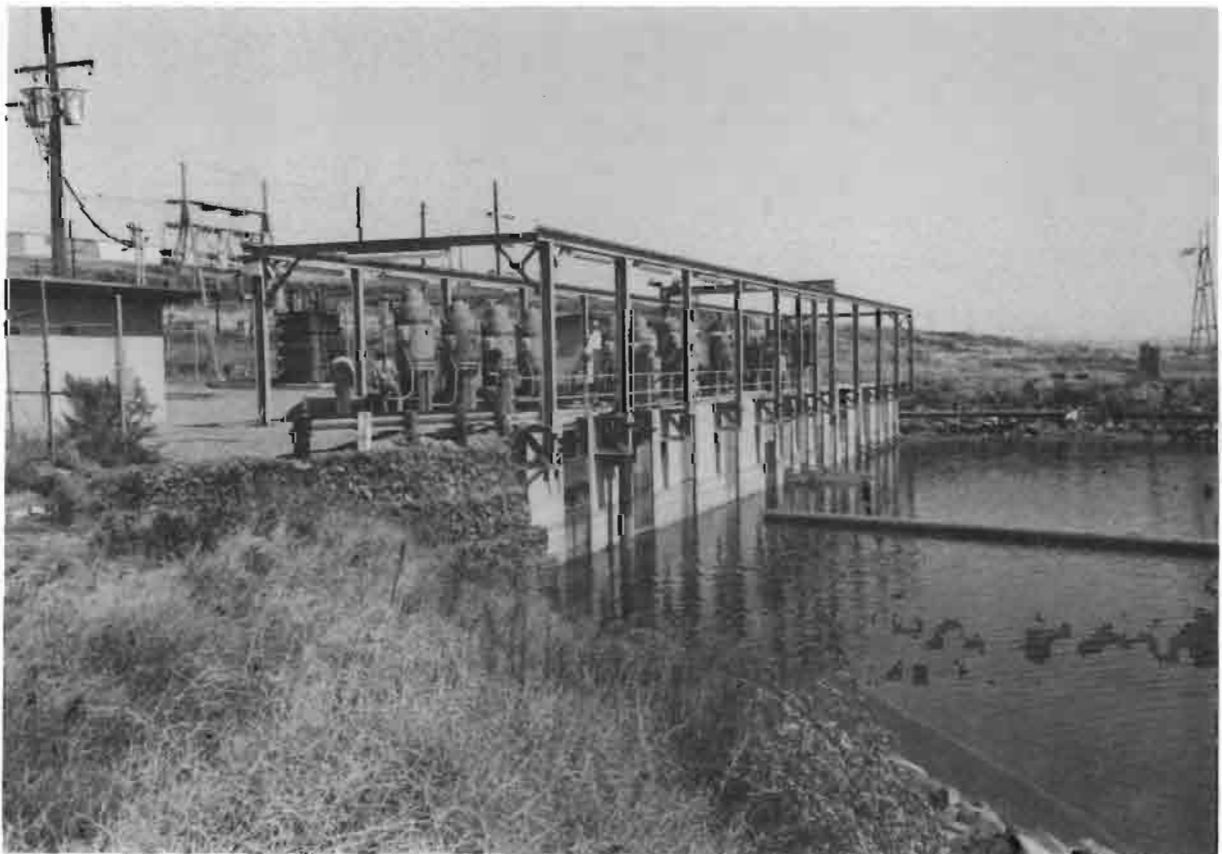

Figure 6.—(Above) Aerial view of Paterson Irrigation Project. (Below) View of the vault-like water withdrawal structure with underwater screened opening.

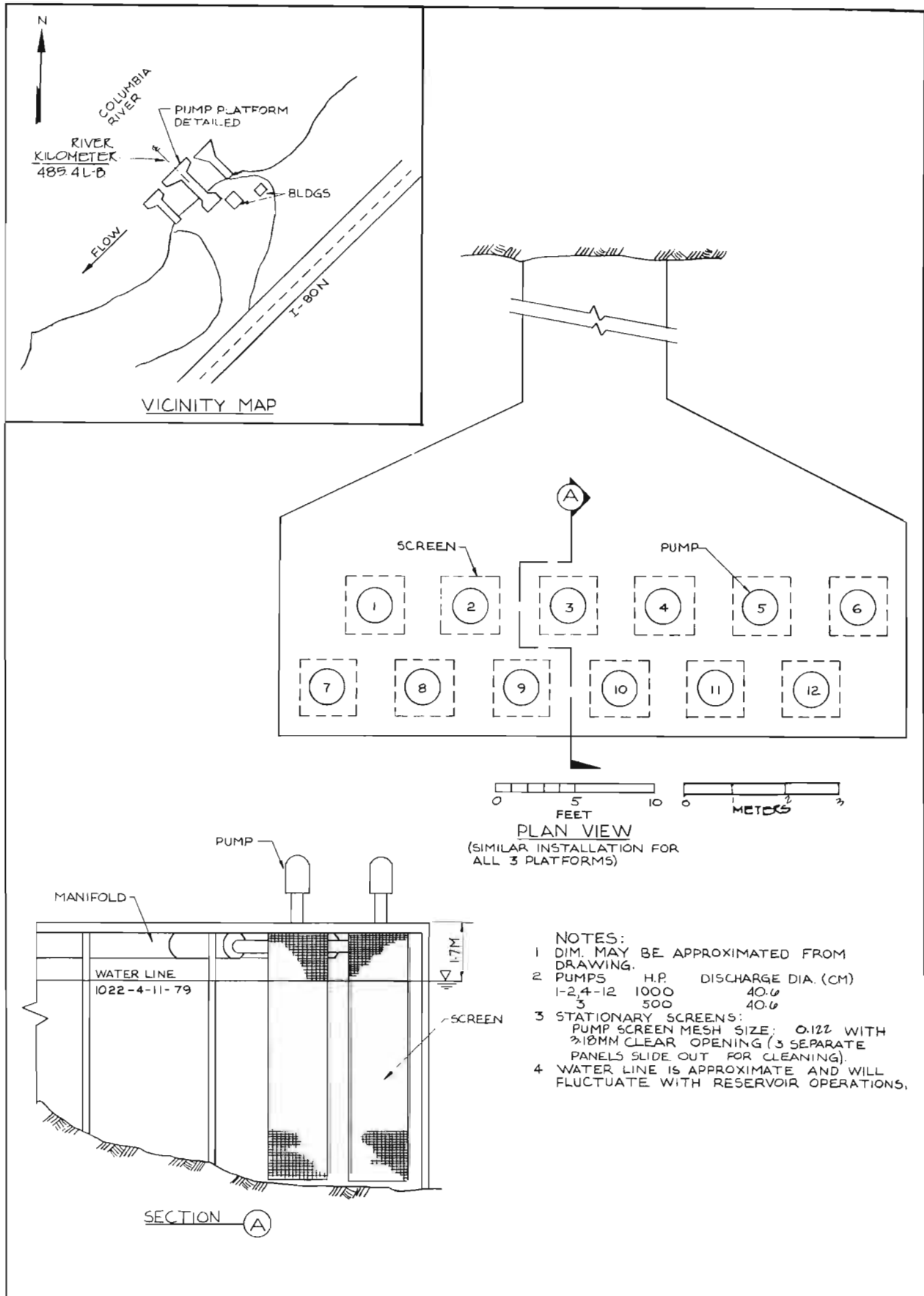

Figure 7.—Water withdrawal plan of Mikami Brothers (river mile Col301.7LB).



Figure 8.—(Above) Aerial view of water withdrawal site of Mikami Brothers. (Below) View of the pier-like water withdrawal structure out from the shoreline supporting turbine pumps.

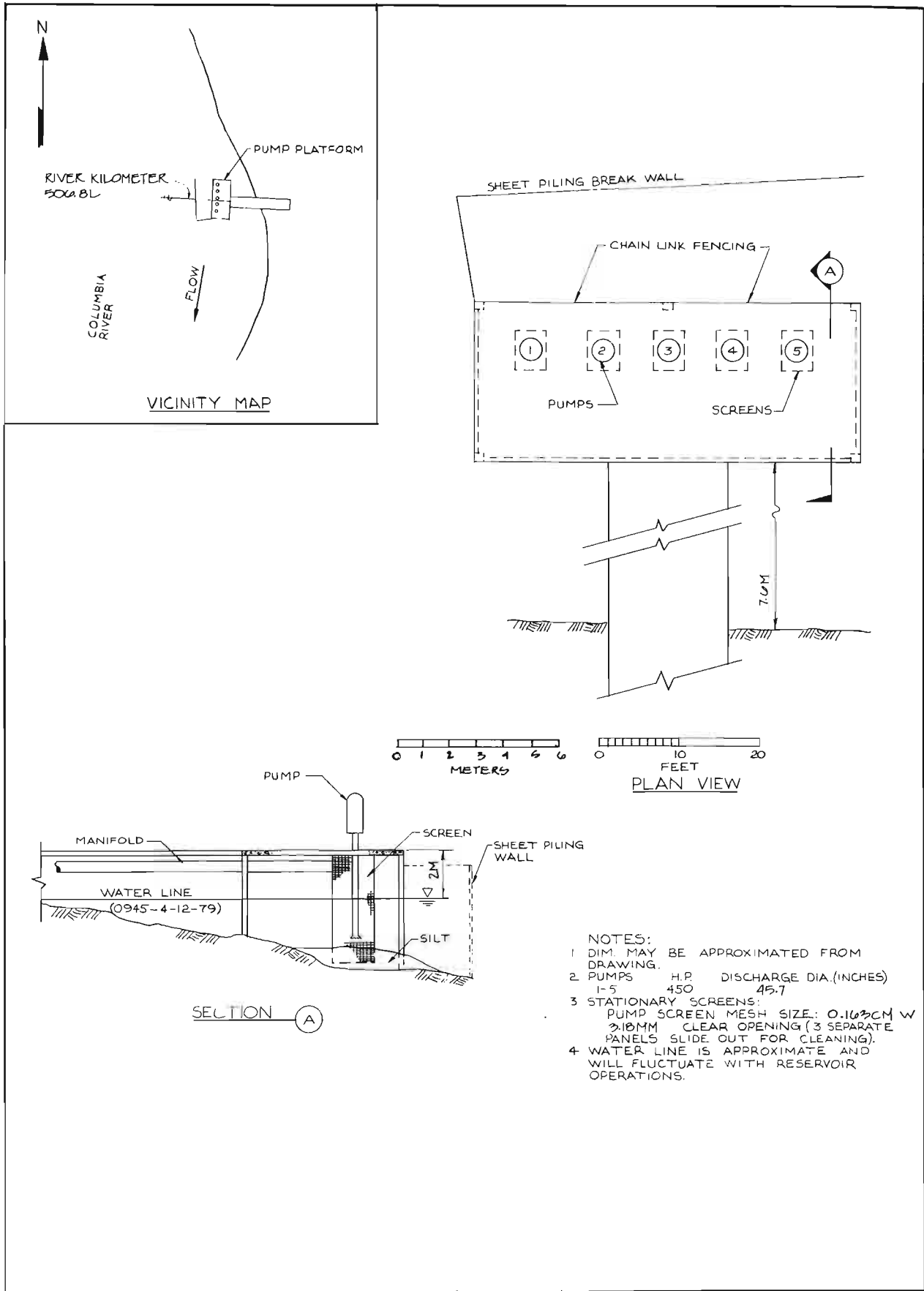

Figure 9.—Water withdrawal plan of Nedrow Farms (river mile Col1315.0L).



Figure 10.—Views of Nedrow Farms' combination pier/vault created by enclosing the area under a pier with driven sheet piling or other material.

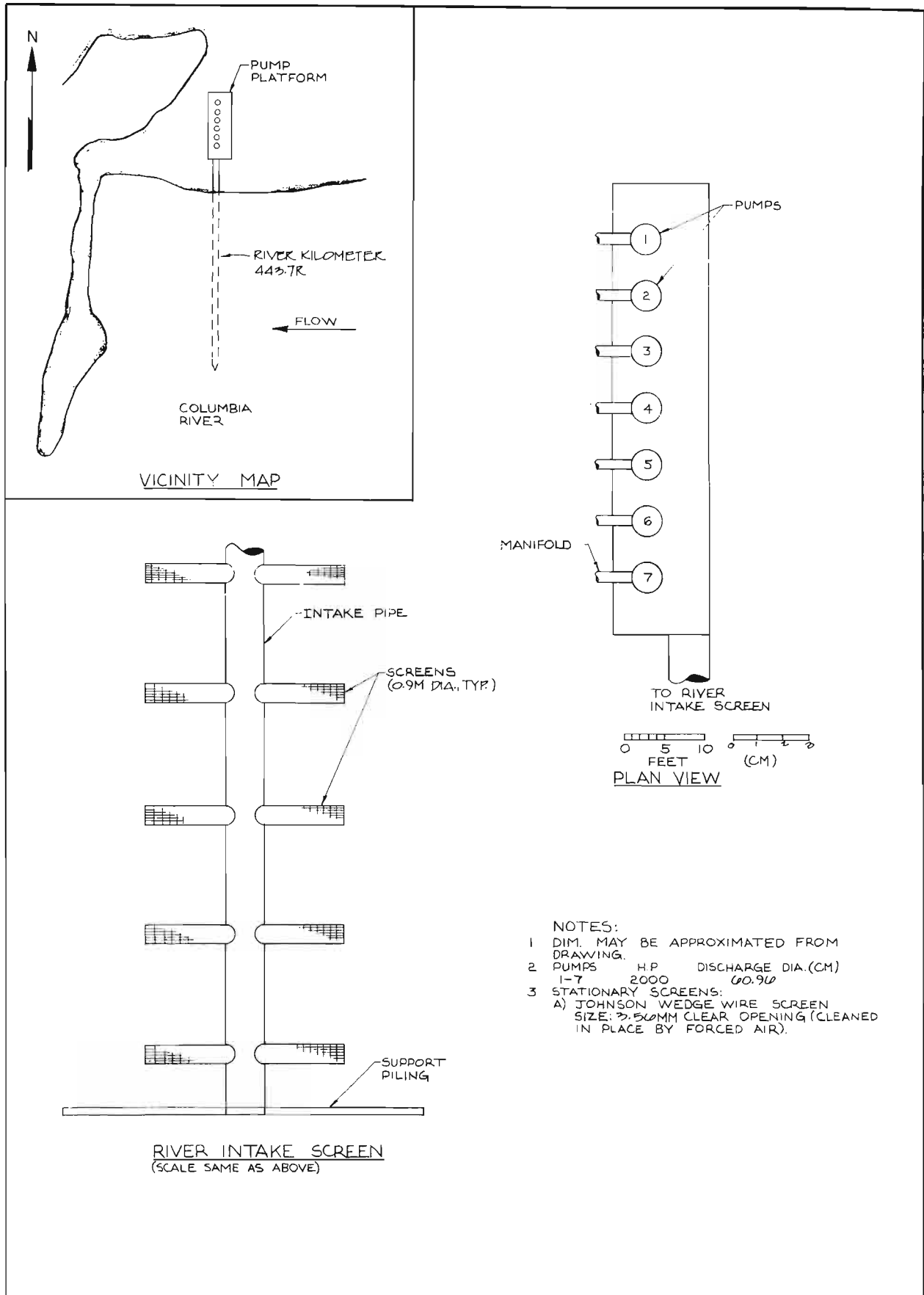

Figure 11.—Water withdrawal plan of Lorin Munn (river mile Col275.8R).





Figure 12.—Aerial view of Lorin Munn's water withdrawal site showing single, large, screened intake pipe.

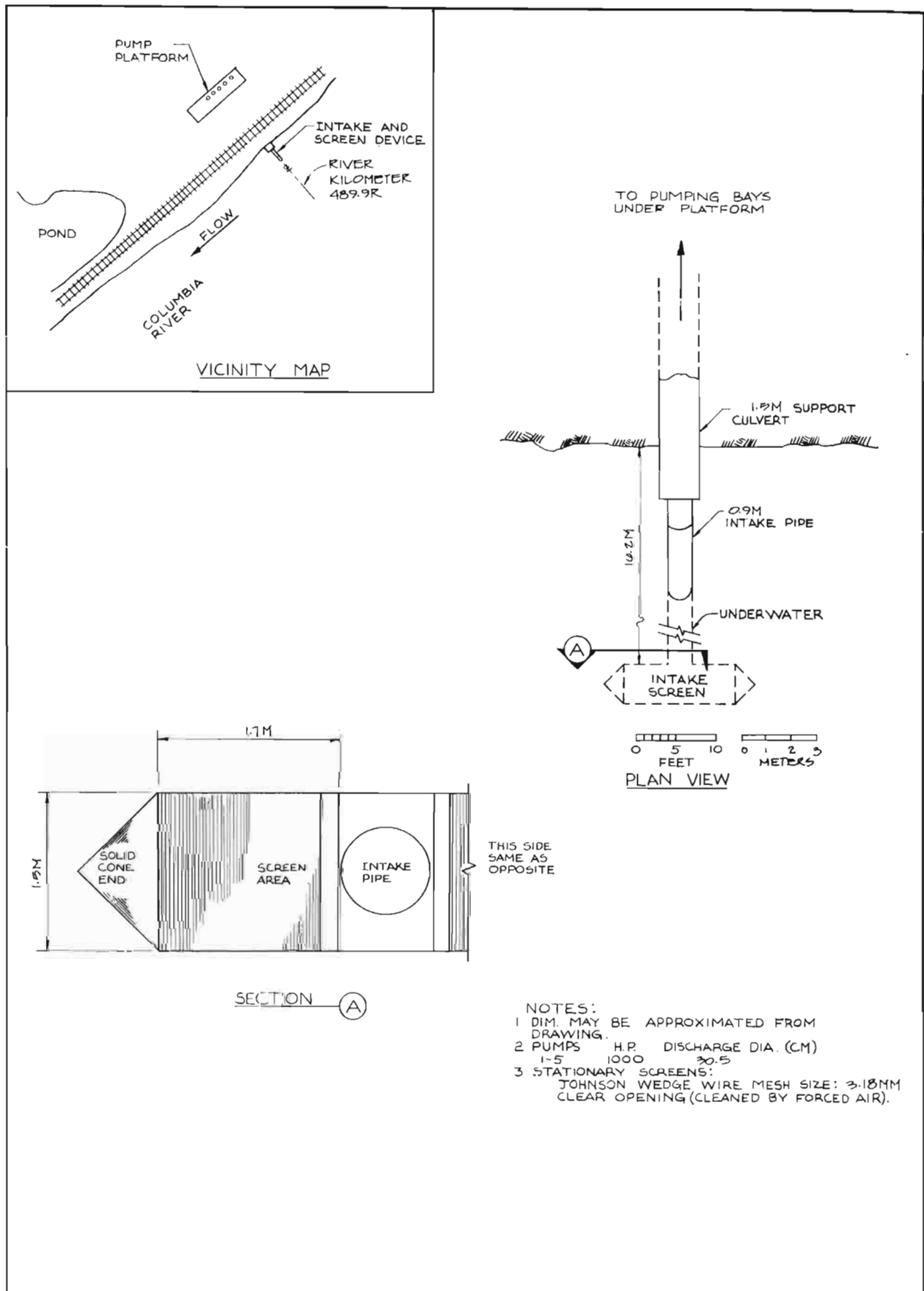

Figure 13.—Water withdrawal plan of Barborosa Farms (river mile Col304.5R).

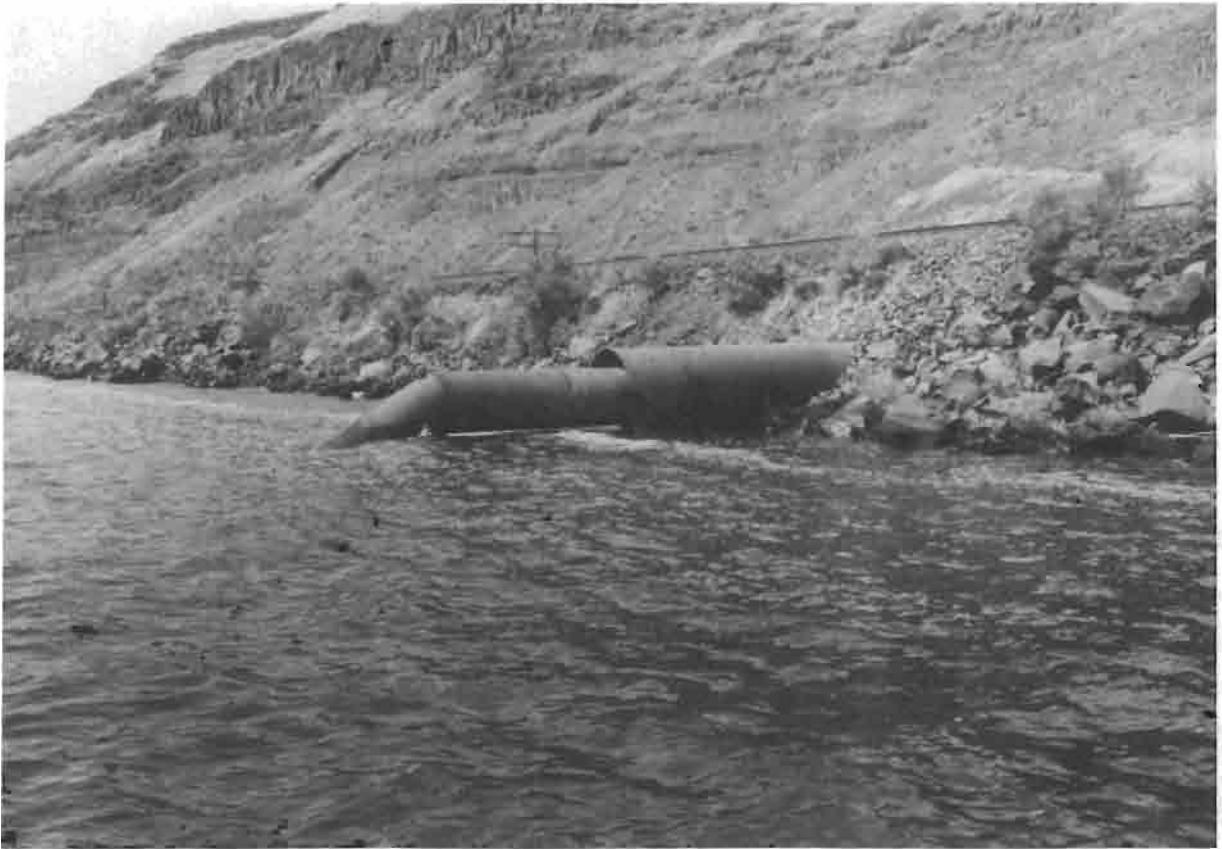

Figure 14.—View of Barborosa Farms' single, large, screened intake pipe.

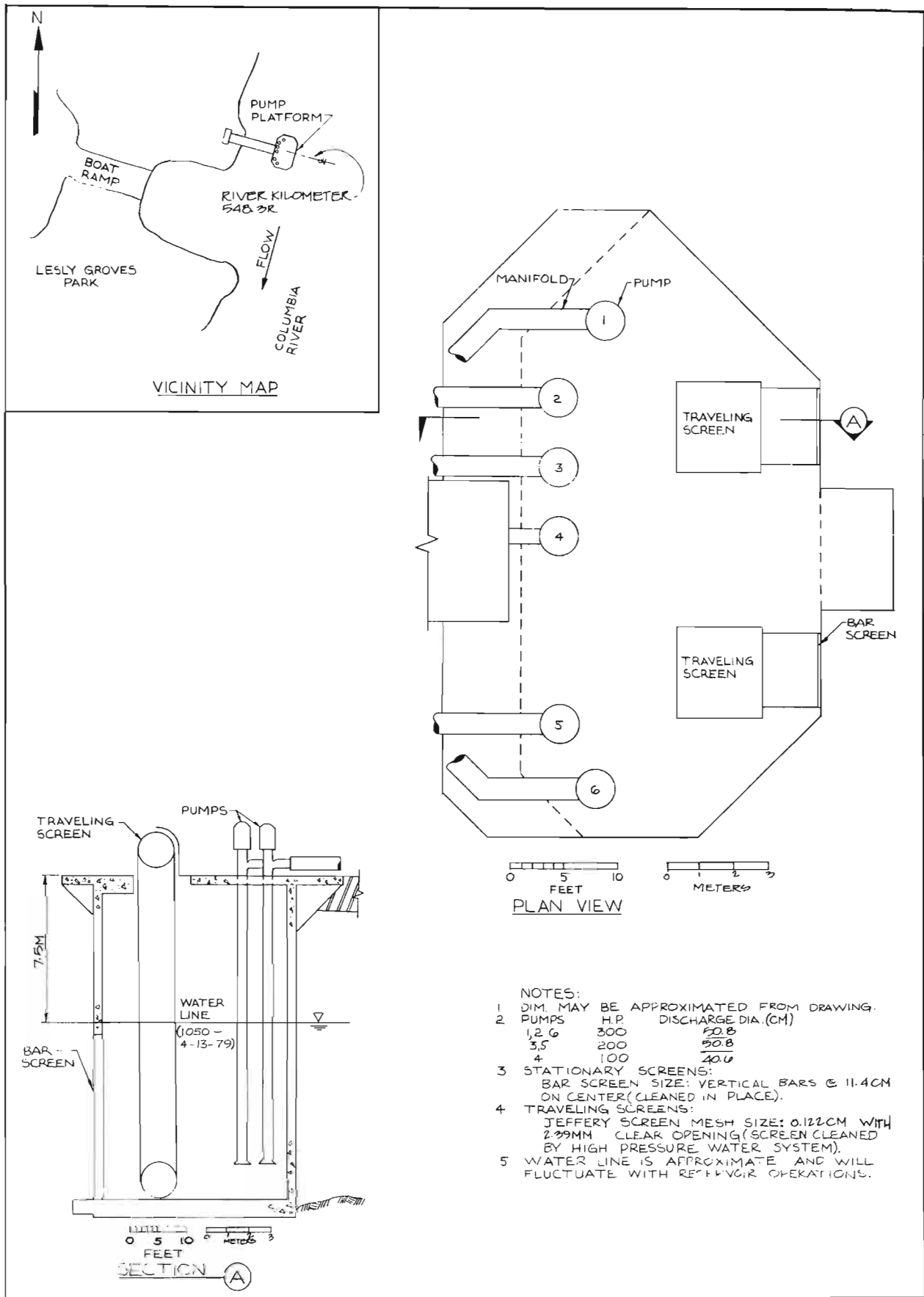

Figure 15.—Water withdrawal plan, City of Richland, Washington (river mile Col340.8R).

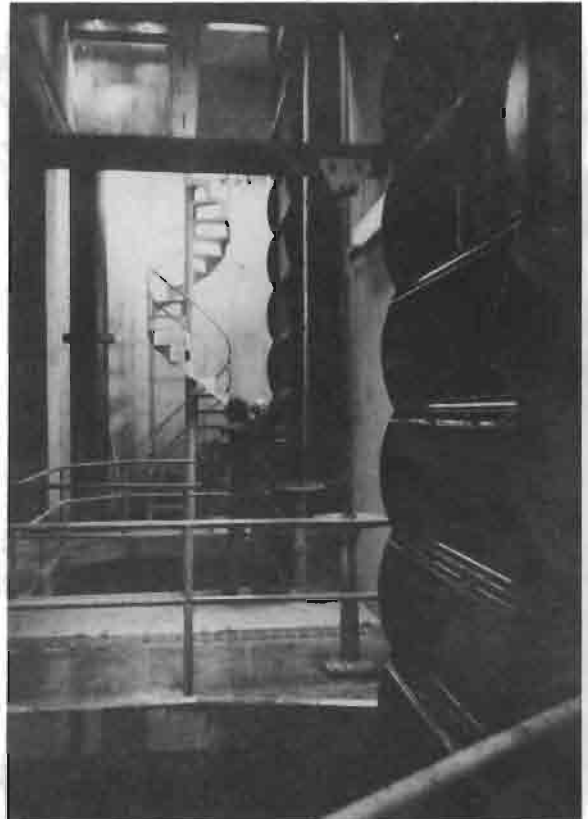
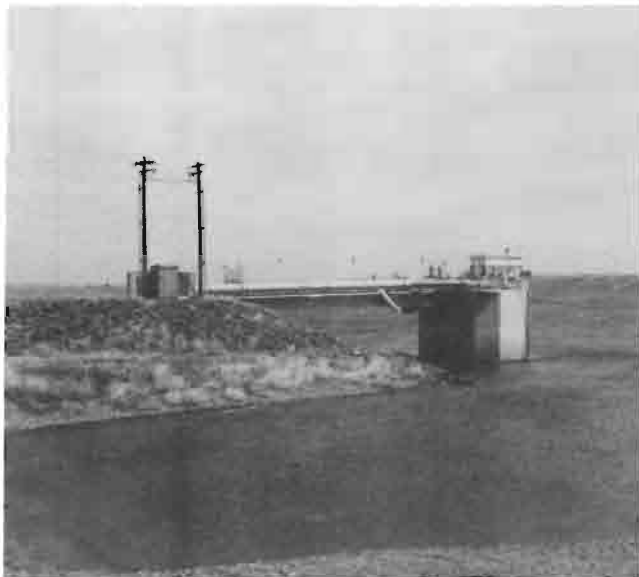

Figure 16.—(Above) Aerial view of water withdrawal site, City of Richland. (Bottom left) View of the vault-like water withdrawal structure incorporating traveling screens. (Right) Vertical traveling screens used for municipal water supply.

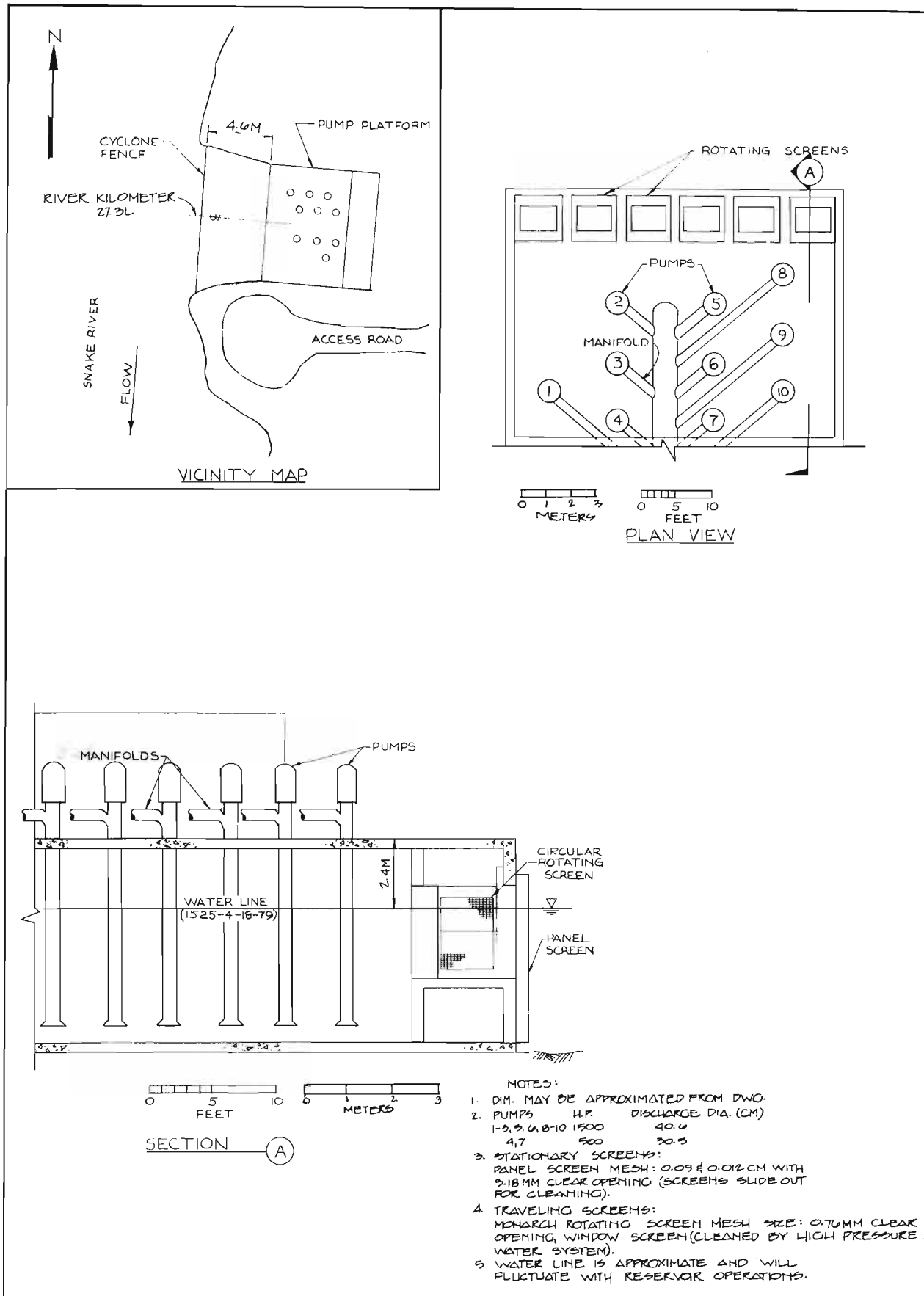

Figure 17.—Water withdrawal plan, K2H Farms, Inc. (river mile Snk017.0L).

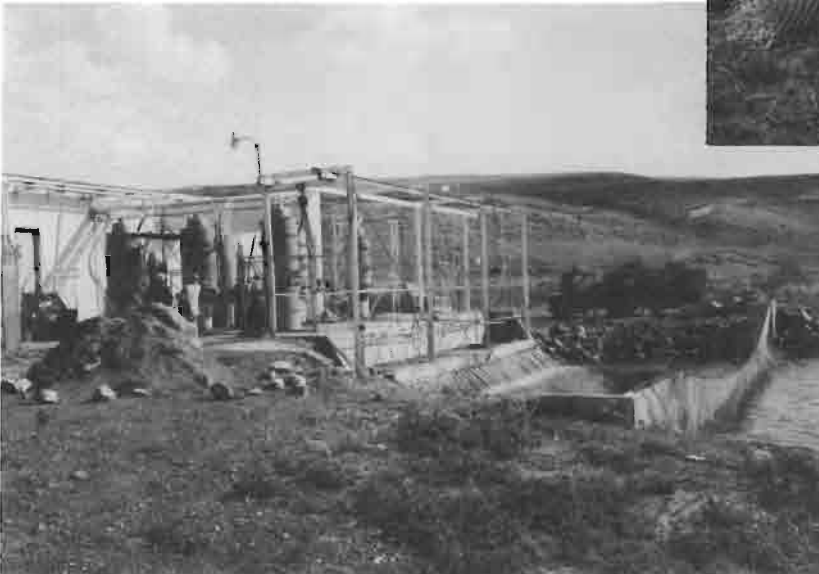
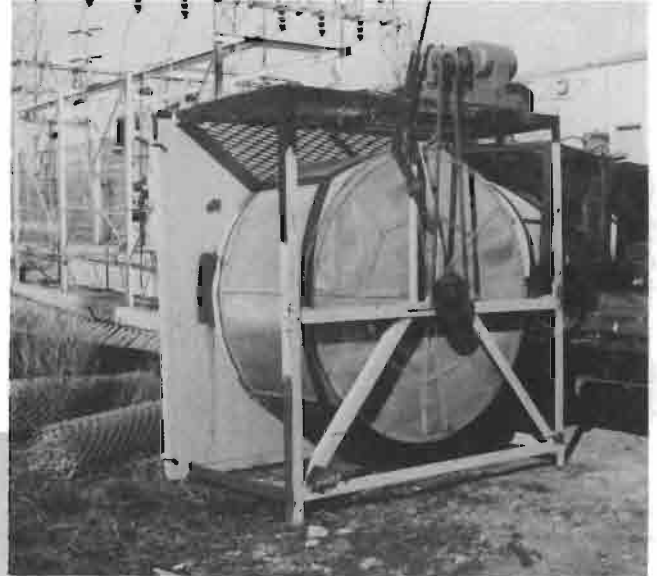

Figure 18.—(Top) Aerial view of water withdrawal site, K2H Farms. (Bottom left) View of the vault-like water withdrawal structure incorporating circular rotating screens. (Right) Fine mesh revolving drum screen used at K2H Farms to remove waterborne weed seeds from irrigation water. Small fish may also benefit from such a screen.

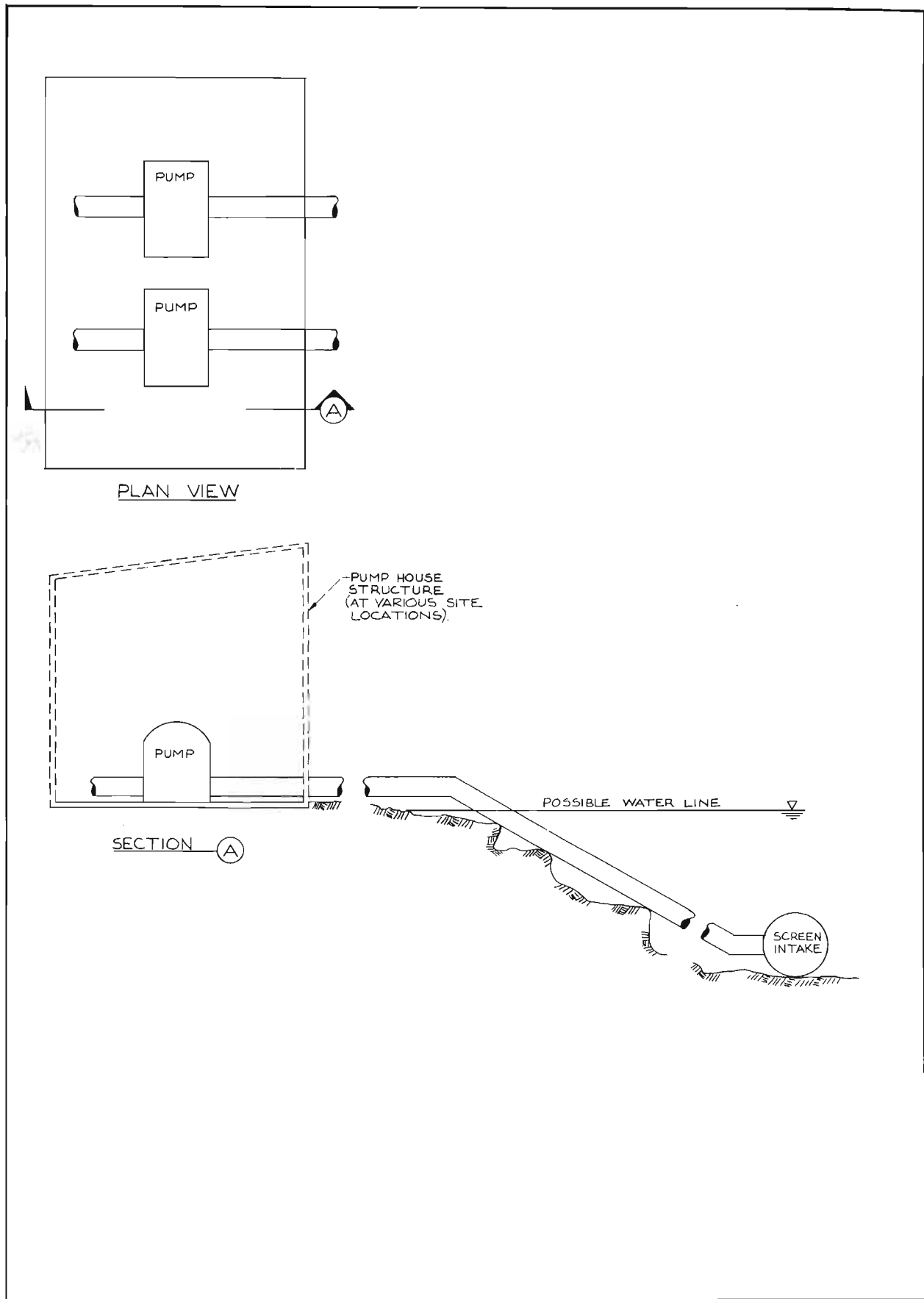

Figure 19.—Schematic of a typical small pump installation located throughout the study area.

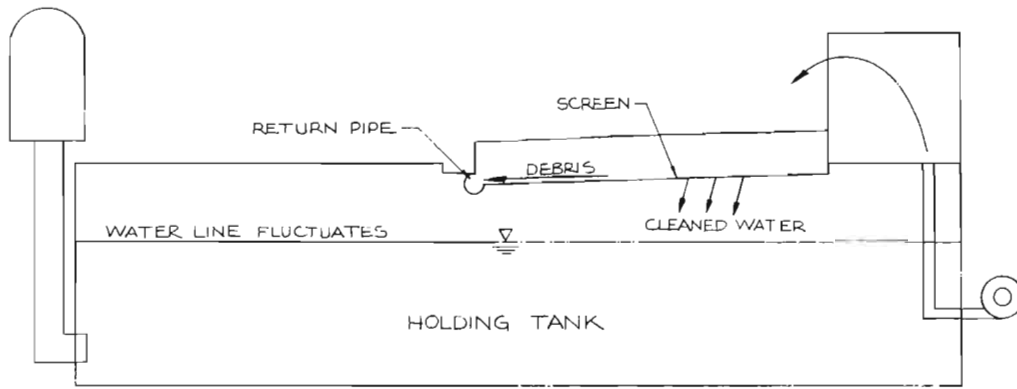
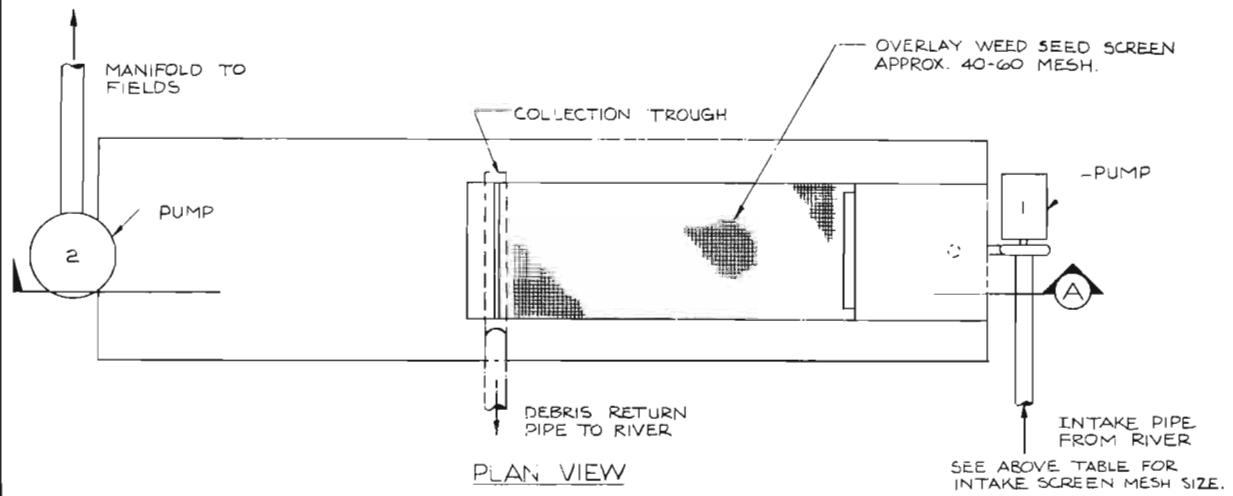



Figure 20.—Views of typical small pump installations throughout the study area. Note single intake line extending to a depth below the low water elevation.

INVENTORY NO	INTAKE PIPE H.P.	DISCHARGE DIA. (CM)	WIRED MESH (MM)	CLFAR (MM) OPENING
COL. 450 5LA	20	20.32	4.88	9.53
COL. 450 5LB	10	20.32	5.09	0.98
COL. 489 6L	10	15.24	6.40	1.27
COL. 514 1R	10	7.62	—	12.70

LOCATIONS



SECTION A-A

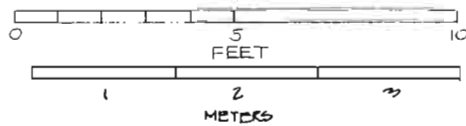
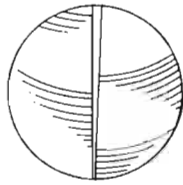
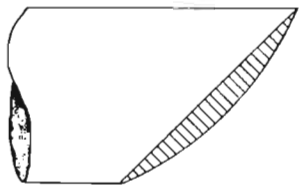

Figure 21.—Schematic of a typical small water withdrawal and screen system used at several sites along the upper Columbia River.



Figure 22.—Views of a typical small water withdrawal and screen system used along the upper Columbia River: a simple pump and intake line incorporated with an additional debris and weed seed straining device.



9.53MM BARS WITH 9.53MM SLITS.

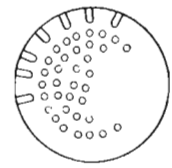
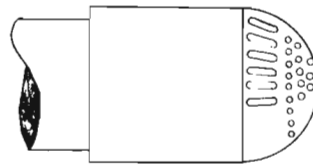

9.53MM SLITS WITH 6.35MM HOLES.

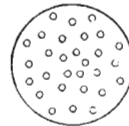

6.35MM HOLES

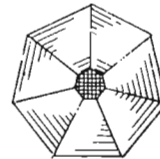
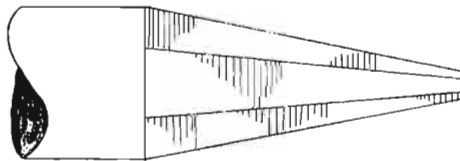

6.35MM BETWEEN WIRES, 6.35MM CLEAR OPENING, MESH ON END.

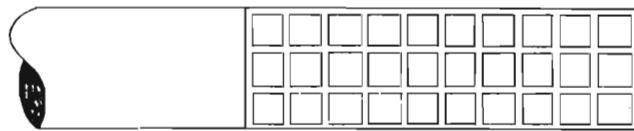

3.81CM CLEAR OPENINGS, END CLOSED.

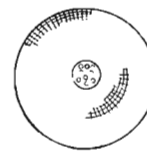
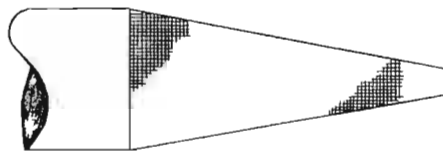

6.35MM CLEAR OPENING MESH, END DRILLED WITH 6.35 OR 4.78MM HOLES.

Figure 23.—Examples of screens used on single-line intakes

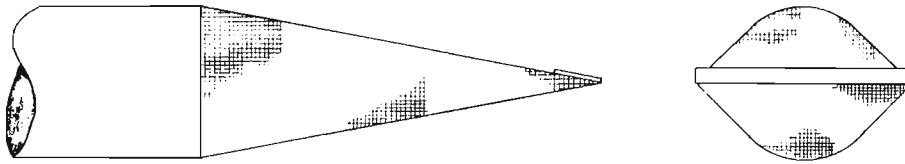

6.25 MM CLEAR OPENING MESH, FLATTENED ON THE END.

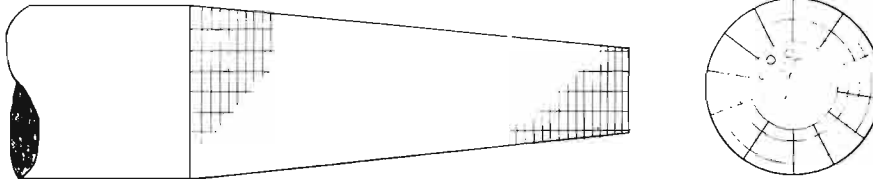

9.53MM SEPARATING RINGS, 9.53MM HOLES IN THE END.

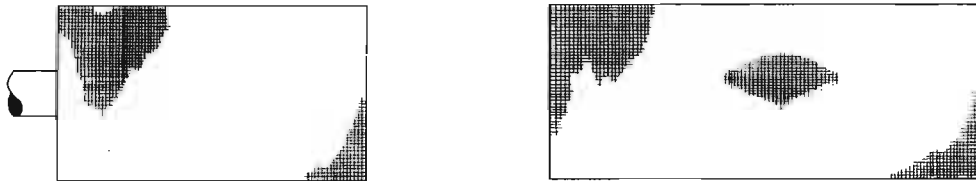

WOOD FRAME COVERED WITH WINDOW SCREEN.

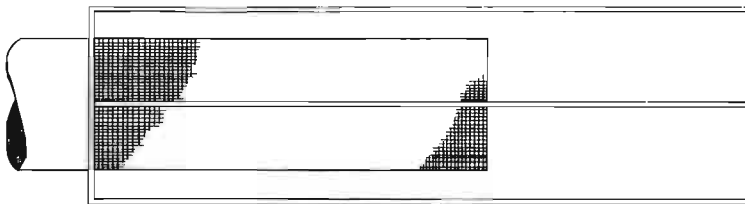

ELECTRIFIED SCREEN INTAKE.

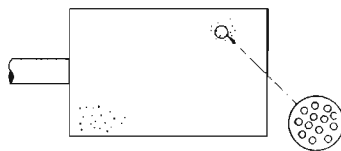

STEEL DRUM PERFORATED WITH 2.18MM HOLES

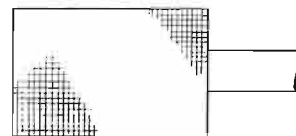

STEEL DRUM FRAME COVERED WITH 1.91CM CLEAR OPENING, 0.640CM WIRE MESH.

throughout the study area.

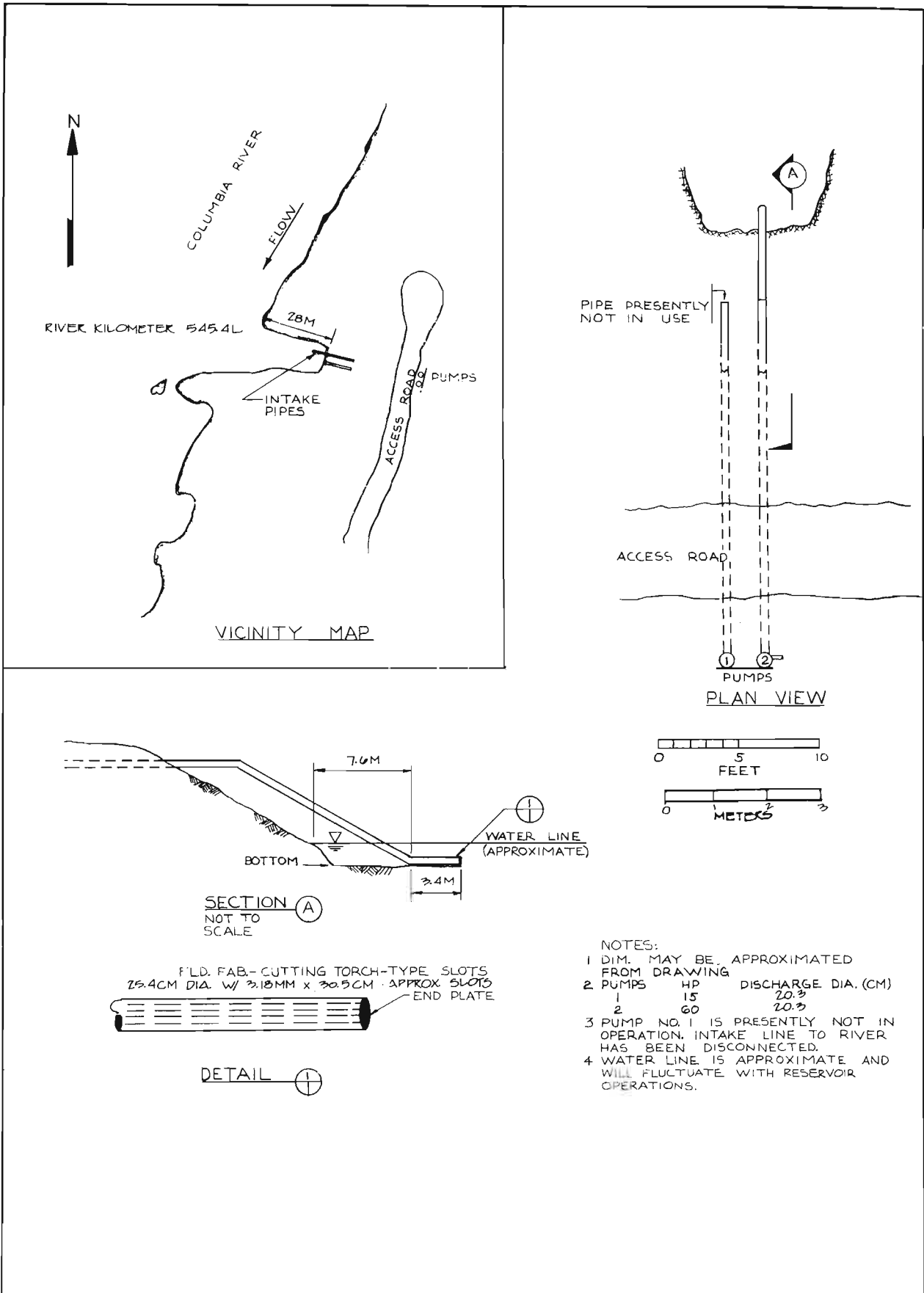

Figure 24.—Water withdrawal plan of W. Ketchersid (river mile Col339.0L).

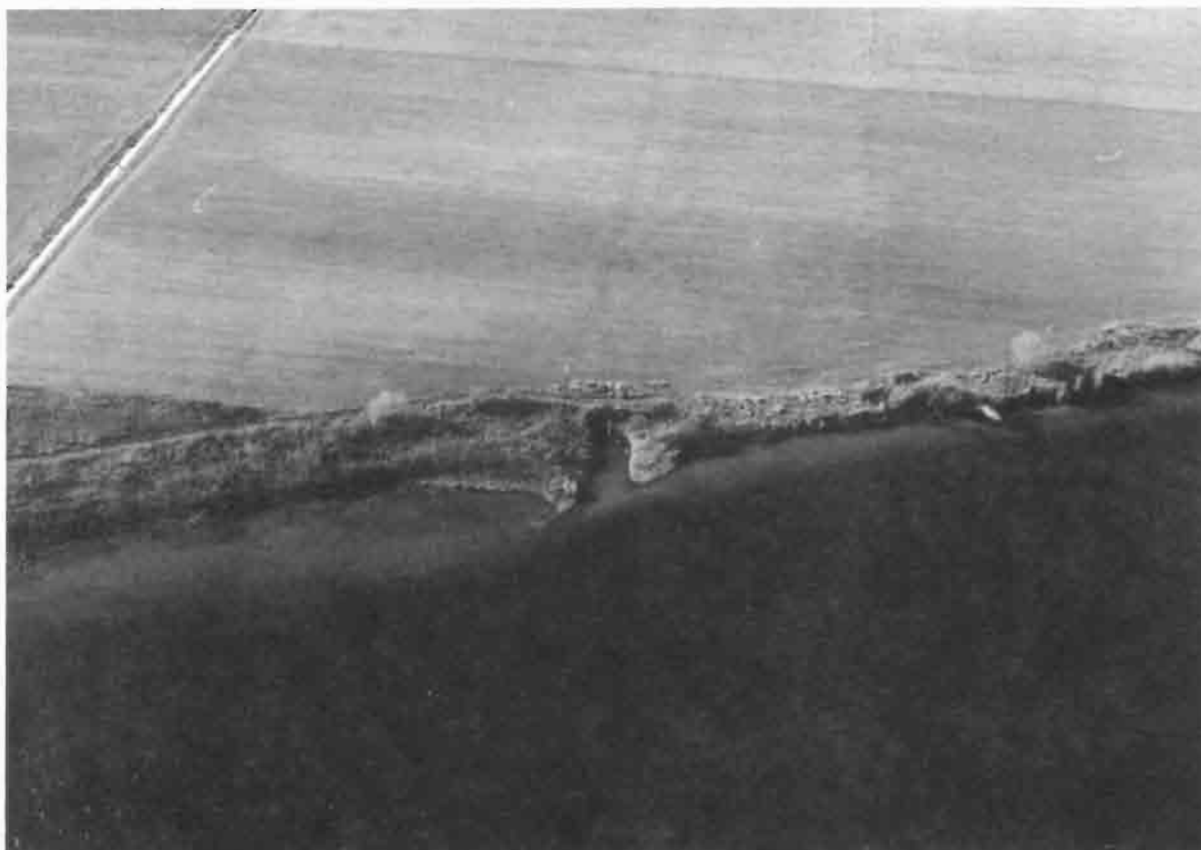

Figure 25.—(Above) Aerial view of water withdrawal site of W. Ketchersid. (Below) Example of a metal pipe straining device with slashes cut with a welding torch.

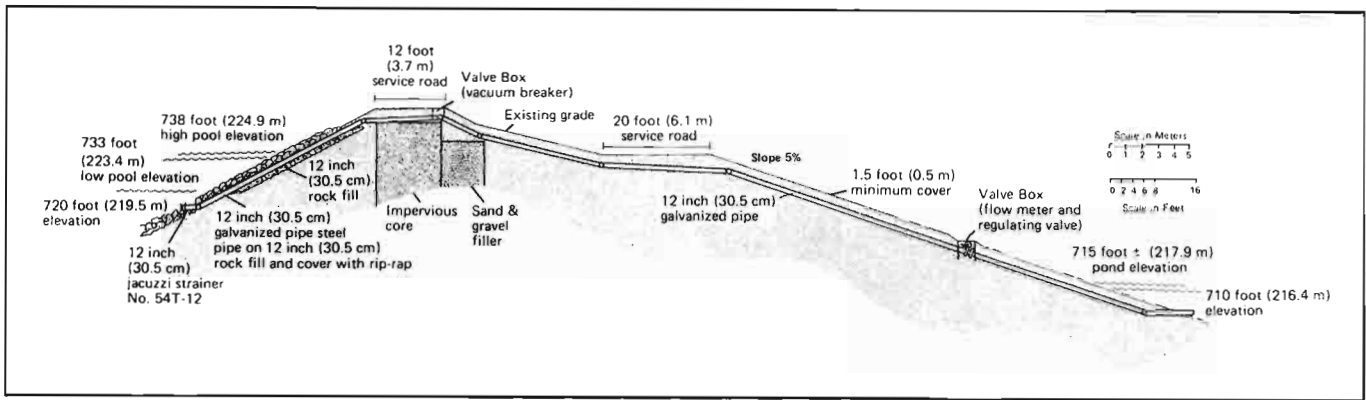

Figure 26.—Siphon No. 1 on West Lewiston Levee, Snake River. Typical of three other siphons on East Lewiston Levee, Clearwater River, except for longer and greater head loss.

## APPENDIX

### FISH SCREENING FACILITY CRITERIA\* OF THE NATIONAL MARINE FISHERIES SERVICE

#### Salmonid Fry

Screening material with clear openings not to exceed 3.56 mm (0.14 inch).

An approach velocity of the intake water not to exceed 15.2 cm/s (0.5 ft/s) immediately in front of the screen.

A bypass flow to lead fish from the face of the screen to the main streamflow. Velocity of the current should be no less than the screen approach velocity.

#### Salmonid Fingerlings

Screening material with clear openings not to exceed 0.25 inch.

An approach velocity of the intake water not to exceed 30.5 cm/s (1.0 ft/s) immediately in front of the screens.

A bypass flow to lead fish from the face of the screen to the main streamflow. Velocity of the current should be no less than the screen approach velocity.

\*Recommended guidance for use by permit-issuing authorities; also intended to provide design criteria at water withdrawals. Because they are for guidance only, criteria are open to interpretation in exceptional cases.

#### Bass, Herring Cyprinids, etc.

Some of these fish have eggs and/or very small fry which are moved with any water current, tides, or streamflows. Installations where these species are present sometimes require special screening and/or bypassing facilities, including microscreen, louvre installations, bypass pipes or canals, and almost always require individual evaluation of the proposed project.

#### General Considerations

In many instances, detailed and specific evaluation of the plan and design of the proposed project is mandatory. Some factors may require significant evaluation by project sponsors and fishery experts, such as local flow patterns, marine weather and hydraulics, total discharge, season of discharge or water intake, location of water intake, presence of marine or freshwater species.

#### Special Considerations

Proposed new (nonconventional) screening methods must include biological basis for the concept, an acceptable plan for evaluating the prototype installation, and an alternate plan should the initial plan not prove acceptable.