

# Apollo Television

By [Bill Wood](#), former Apollo MSFN station engineer

Copyright 2005 Bill Wood

Back in 1962 the early planning for the Apollo project called for a new communication concept in which all voice, telemetry, television, and ranging information for near-earth and lunar distances would be transmitted over a single frequency system. This system, called [Unified S-Band](#) (USB), specified that voice and biomedical data would be carried on a 1.25 MHz FM subcarrier, telemetry data on a 1.024 MHz bi-phase modulated subcarrier, and that a pseudo-random ranging code would use a common phase-modulated S-band downlink frequency. These were 2287.5 MHz for the Command and Service Module and 2282.5 MHz for the Lunar Module.

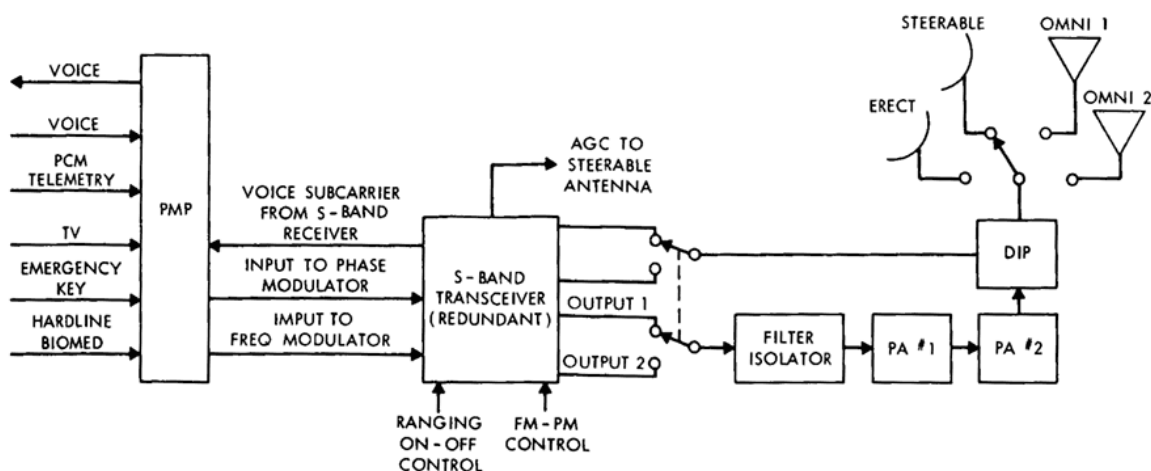

Lunar Module S-Band Block Diagram

To accommodate television on the single Lunar Module downlink, the ranging code was removed and the modulation changed from Phase to Frequency Modulation. This left 700 kHz of clear bandwidth available below the subcarriers for a narrow bandwidth television signal on the S-band downlink. A 320 horizontal progressive line, 10 frame per second, format was chosen to fit in this space. This slow-scan format used only one-tenth of the 5 MHz bandwidth of the 525 interlaced lines, 30 frames per second format that was standard for television in the United States at the time.

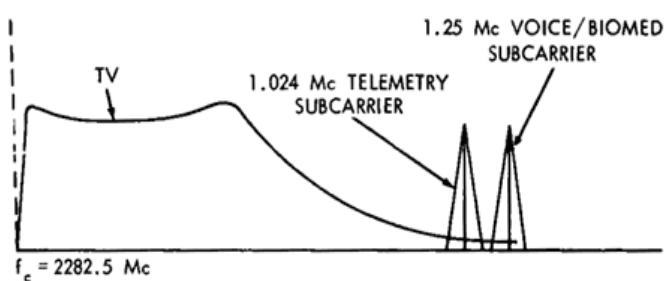

Lunar Module FM Downlink Spectrum

NASA awarded contracts to both RCA and Westinghouse to develop the special slow-scan, black and white, television cameras for the Apollo project. RCA's Astro Electronics Division, East Windsor, New Jersey, for the Command and Service Module spacecraft and Westinghouse Electric's Aerospace Division, Baltimore, Maryland, for the Lunar Module.

NASA's Goddard Space Flight Center, as part of its management of the world-wide Manned Space Flight Network (MSFN), contracted with RCA Astro Electronics Division to design and provide a number of ground station devices to convert the Apollo slow-scan TV format to the normal American television format.

After a number of high level reviews, NASA finally approved the addition of television cameras aboard both the CSM and LM. The first use of a television camera was set for the Earth orbital flight of Apollo 7 in mid 1968. Both the installation and operation of the camera was to be on a non-interference basis to both the launch and operation of the spacecraft. The camera was to be used only as time and opportunity would permit.

## Apollo 7

The television camera first used on Apollo 7 was the CSM, slow-scan, black and white, camera made for NASA by RCA. The 85-cubic-inch TV camera weighed 4.5 pounds and required 6.75 watts at 28 volts dc. It had a 1-inch vidicon tube. It was fitted with a wide angle lens with coverage of 160 degrees. It used the same 320 line, 10 frames per second, progressive scan format that was dictated by the limited bandwidth available on the sole Lunar Module S-band downlink transmitter.



The actual camera carried on Apollo 7 *NASM Photo*

However, the final Block II CSM, developed after the tragic Apollo 1 fire, included an additional S-band downlink transmitter that was capable of handling the full video bandwidth of broadcast quality television signals. But there was neither the incentive nor the time to provide a new camera to take advantage of the increased bandwidth then available on the CSM. Since the RCA slow-scan video camera was already flight qualified for the CSM the decision was made to use it on Apollo 7.

To keep interference with crew activities to a minimum the camera was attached to a fixed position that could view the center and left side of the CSM crew seats with the wide angle lens. The astronauts were expected to use the television camera to show their colleagues in Mission Control, and the public watching TV, how they got along in their living quarters in the weightlessness of space.

But, when flight plan changes crowded their schedule, spacecraft commander Walter Schirra canceled the first of several planned television demonstrations. Deke Slayton tried to change Wally's mind, but was told sharply that there would be no TV show that day!

When the broadcasts finally began the crew appeared to enjoy them, using cue cards, such as "Keep Those Cards and Letters Coming In, Folks" and "Hello from the Lovely Apollo Room high atop everything." The cue cards were supplied by record producer Michael Kapp, who also provided cassettes for their musical enjoyment.

In mid-1968 only two ground stations were equipped with prototypes of the new RCA Slow-Scan Converters. These were the MSFN stations in Corpus Christi, Texas (TEX) and Merritt Island, Florida (MIL). This, coupled with the fact that Apollo 7 was in low Earth orbit, restricted the time a television broadcast could be received and processed to just seven short passes over the TEX and MIL MSFN stations.



Fairchild slow-scan TV photo at Goldstone

## Apollo 8

During Mercury, Gemini, and Apollo orbital missions, there were periods of communications silence, especially in the southern hemisphere, because the worldwide tracking network did not cover all areas. But, the flight of Apollo 8 around the Moon was able to make much greater use of the RCA Slow Scan television camera.

The continuous coverage by the three prime, 26-meter, MSFN stations, located in Canberra, Australia (HSK), Goldstone, California (GDS) and in Madrid, Spain (MAD), made it possible to receive and process six different broadcasts for a total of ninety minutes of television, using their newly installed RCA Slow-Scan Converters. Only Goldstone passed on the TV broadcasts to Houston as there were no real-time video circuits set up from HSK or MAD.



Astronaut Frank Borman halfway to the Moon on Apollo 8

The first Apollo 8 TV broadcast started some 31 hours into the mission. The use of a 9 mm wide angle lens inside the spacecraft provided good pictures. Frank Borman acted as both director and narrator, Jim Lovell as an actor preparing a meal, and all three crewmen as Cameramen. However, problems were encountered when Bill Anders replaced the interior wide-angle lens with a telephoto lens so he could show the Earth from halfway to the Moon.

The initial views were of poor quality because of the higher-than expected contrast between the earth and its background. The automatic light control of the camera adjusted to a value determined by averaging the light over the entire view field. This caused the very bright Earth to be considerably overexposed making it impossible to obtain a usable image.

The telephoto lens problem pointed out the need for better flight crew training as well as the need for television camera experts on hand at Mission Control. When coupled with the lack of a sighting device or a monitor for the crew to see what the TV camera was seeing, most of this first broadcast was spent trying to figure out the problem.

To read the Apollo 8 transcript, during the problems with the TV camera, on the Apollo 8 Flight Journal go to GET 031:10:23 on this link: [http://history.nasa.gov/ap08fj/07day2\\_maroon.htm](http://history.nasa.gov/ap08fj/07day2_maroon.htm). The fix worked out on the ground was read up to the crew at GET 031:10:23. Check this link for details: [http://history.nasa.gov/ap08fj/09day3\\_green.htm](http://history.nasa.gov/ap08fj/09day3_green.htm)

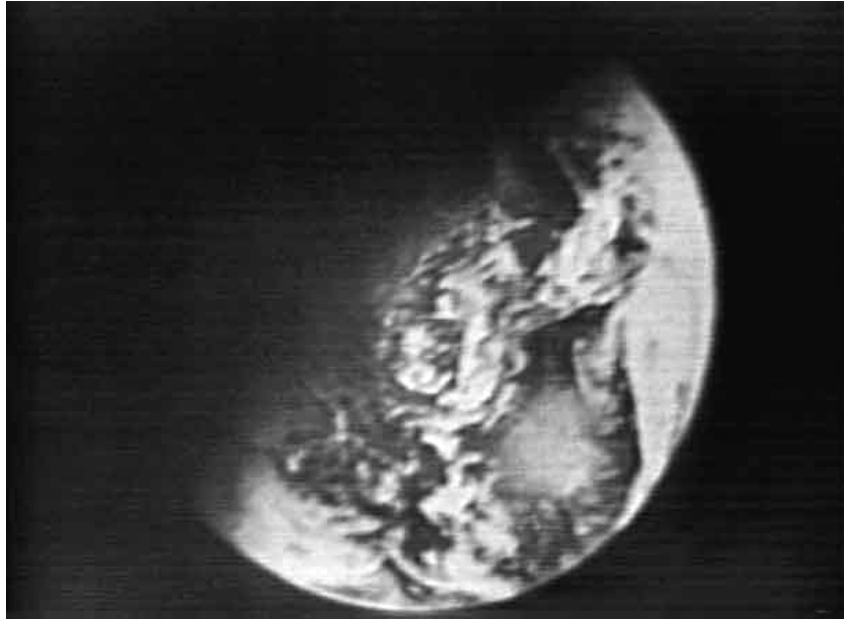

Later in the mission the crew again unstowed the television camera. This time they attached filters from the 70-mm camera to the telephoto lens with tape. Then the camera was attached to the TV mounting point on the Commander's side of the hatch with an adjustable bracket to point out rendezvous window number 2.

The rendezvous windows are designed to look along the spacecraft's plus-X axis as an aid to guiding the CSM when performing a rendezvous and docking with the Lunar Module. By attaching the camera to a bracket, the camera will be made to look along a well defined axis that is 30° away from the plus-X axis. Thus, the spacecraft itself becomes a steerable platform that can be used to aim the camera at the Earth in a controlled fashion. Subsequent telecasts of the earth using the telephoto lens with the filters were satisfactory.

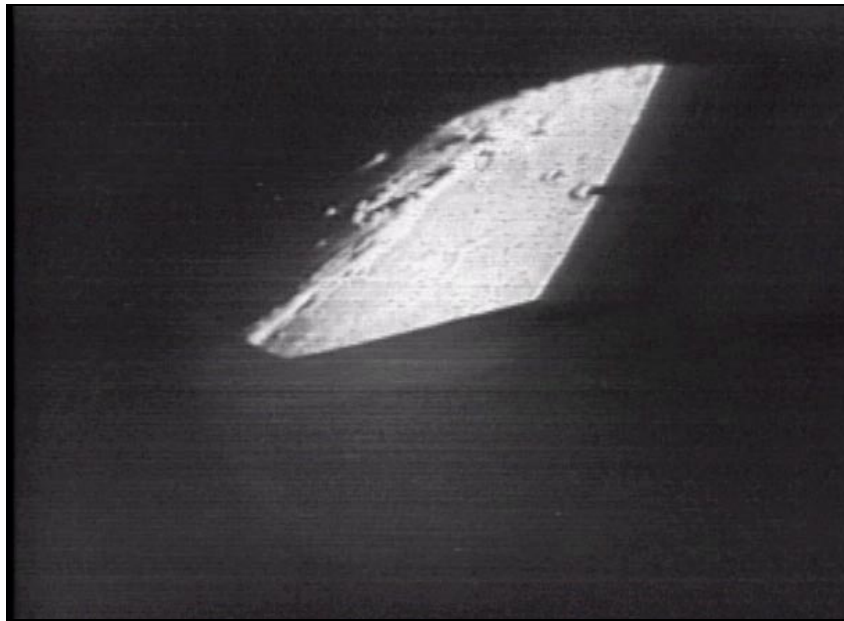

View of the Moon at the end of the Apollo 8 crew's "Genesis" Message

Once Apollo 8 entered Moon orbit, the crew conducted three more television broadcasts for a total of 49 minutes. Jim Lovell, using his optical devices to get a better look, described what was being photographed. Anders raced from window to window for the best vantage points for photographing the lunar surface, especially the areas being considered for landing sites.



## Use of the RCA Slow Scan Converter

The Apollo 8 slow-scan television signals were received by the three primary Manned Space Flight Network stations and converted to NTSC black and white television images using devices manufactured by the RCA Astro Electronics Division for this purpose.

In the days before solid-state frame synchronizers RCA had quite a challenge putting together a system that would convert the progressive 320 line, 10 frames per second Apollo camera format to the interlaced 525 line, 30 frames per second broadcast television standard in real time. To accomplish this RCA used an off-the-shelf vidicon camera to view the screen of a special monitor that displayed the Apollo camera picture.

The RCA TK-22 camera chosen was developed years earlier for broadcast television film chain use. The camera was focused on the screen of a 10-inch diameter, slow-scan, cathode ray tube (CRT) mounted in the same triple-width equipment rack. This optical configuration was very similar to the kinescope recording system used in the days before the introduction of video tape recorders in the mid 1950's.

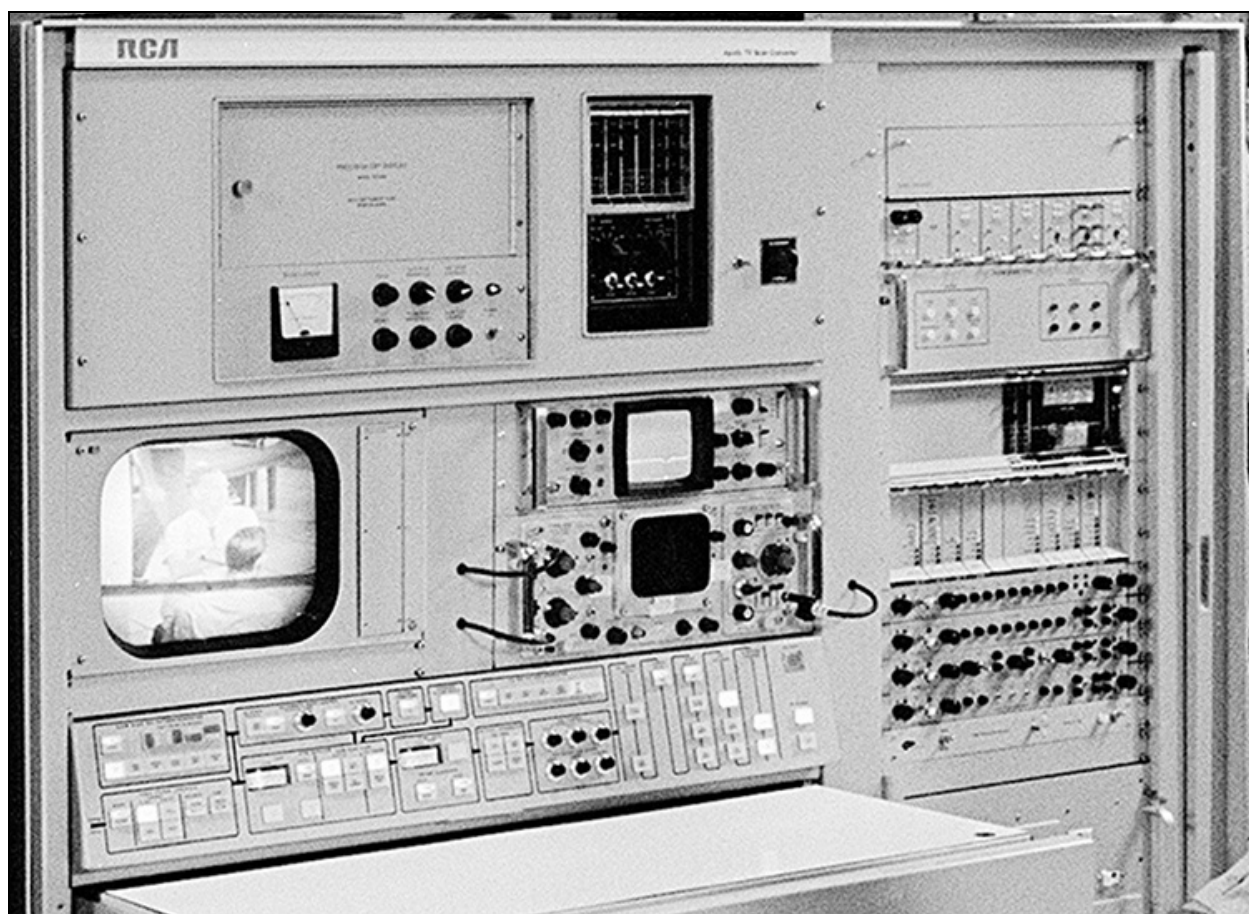

Operating Console of the RCA Apollo Slow Scan Converter

The operating controls for the slow-scan monitor are seen in the upper left of this photograph. The black operating panel for the TK-22 camera can be seen in the top center of the console. The slow-scan monitor had a high persistence phosphor to keep a visible image from one frame to the next. The camera was gated to capture one incoming frame just after it was written on the monitor screen.

The TK-22 camera operated at the NTSC interlaced frame rate. It had to scan two fields of 262.5 lines to complete one full 525 line NTSC frame. It takes a total of 33 milliseconds to scan one full NTSC frame. However the camera had to capture one full Apollo camera frame during the

slow scan monitor's short, 2.5 millisecond, vertical retrace period. This was not a problem for the first TK-22 262.5 line field. But the slow scan monitor would start writing the next Apollo camera frame before the TK-22 vidicon could start scanning the second 262.5 line field to complete the full 525 line frame. So the second field would show the top of second Apollo frame overlapped with the fading first Apollo camera frame

RCA solved this problem by limiting the scan converted video to one 262.5 line field scan of each Apollo camera frames. This field was fed to the converter output and also to a magnetic disk recorder for later playback. The disk recorder used was originally designed for slow-motion television replays of sports events. It was modified to act as a field store recorder.

This left the problem of how to fill in for the missing second 262.5 line field in the converter video output. To do this RCA used a quartz video delay line to shift the first 262.5 line field so that it would fall halfway between the displayed lines of the first field.

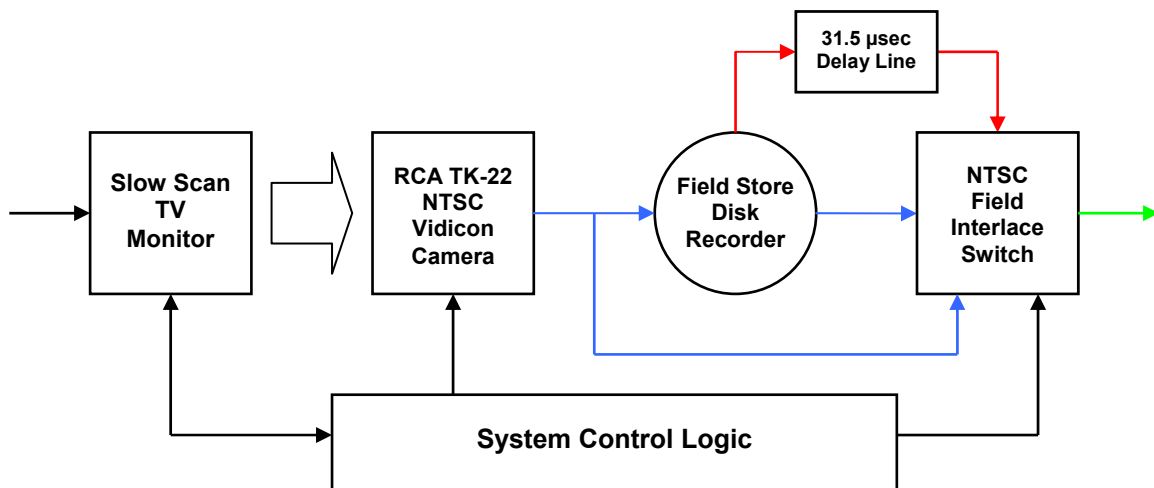
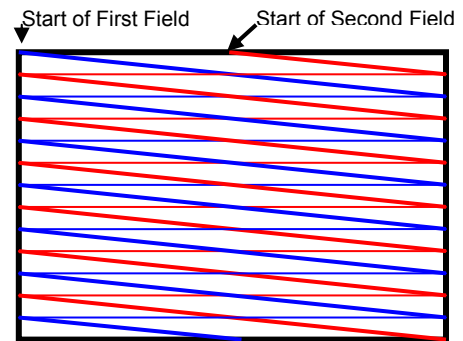

Scan Converter Simplified Block Diagram

The processing sequence of events was as follows:

1. Write the first Apollo camera frame on the slow-scan monitor screen.
2. Scan the displayed frame with one 262.5 line TK-22 field, record this field on the disk recorder and route it in real-time to converter video output.
3. Play back the recorded field from the disk recorder; delay it by 31.8 microseconds in a quartz video delay line to emulate the second 262.5 line field position in the video output signal. This completes the first full frame of 525 NTSC interlaced lines.
4. Play back the same recorded field but do NOT delay it. Just route it to the video output of the converter.
5. Playback the recorded field and delay it by 31.5  $\mu$ sec before routing it to the video output.
6. Repeat steps 4 and 5, four more times, to complete six interlaced 262.5 line fields to make up three full 525 line frames.
7. Repeat steps 1 through 6 for the second lunar camera frame and so on.

Because of the optical transfer medium and the limited 262 line vertical resolution the RCA scan conversion process produced results on a par with the old broadcast television optical kinescope recorders used in the 1950's. As with kinescope recordings, there was a considerable loss of visual detail in the process. As a result slow scan images converted during the Apollo missions were considerably lower than normal broadcast quality.



Photo courtesy Richard Diehl, webmaster [Lab Guy's World](#)

The NTSC output of the slow scan converter was recorded on Ampex VR-660B video recorders for later playback in the event of a microwave circuit failure between the station and Houston. The VR-660 was one of the first professional recorders using helical scan that was to become the standard scan method for Beta and VHS VCR's used throughout the World in the 1980's and 1990's. The VR-660 recorder used two-inch wide tape and operated at a tape speed of 3.7 inches per second. The recorder was normally loaded with 5540 foot, 12.5 inch diameter, reels that could record up to five hours of NTSC television signals.

Unconverted Apollo slow-scan television signals were recorded on wide-band analog tape recorders at each of the prime receiving stations. The video output of the Unified S-band Signal Data Demodulators (SDDS) were routed to Mincom M-22 or Ampex FR-1400 analog recorders running at 120 inches-per second (IPS) to capture the full bandwidth of the downlink TV signal.

The recorders were loaded with 9600 foot reels of one-inch wide instrumentation recording tape. Each recorder would run only 15 minutes at this high speed. As a result two recorders were run alternately so that one could be unloaded and reloaded with a new reel of tape while the first recorder was being used.

The recordings of the unconverted slow-scan television broadcasts were retained on station in case it was necessary to use these tapes after the fact in the event of an RCA Slow Scan Converter failure. However, this never happened. The stations were instructed to reuse the tapes on later missions. As a result no such recordings are known to exist today.

## Apollo 9

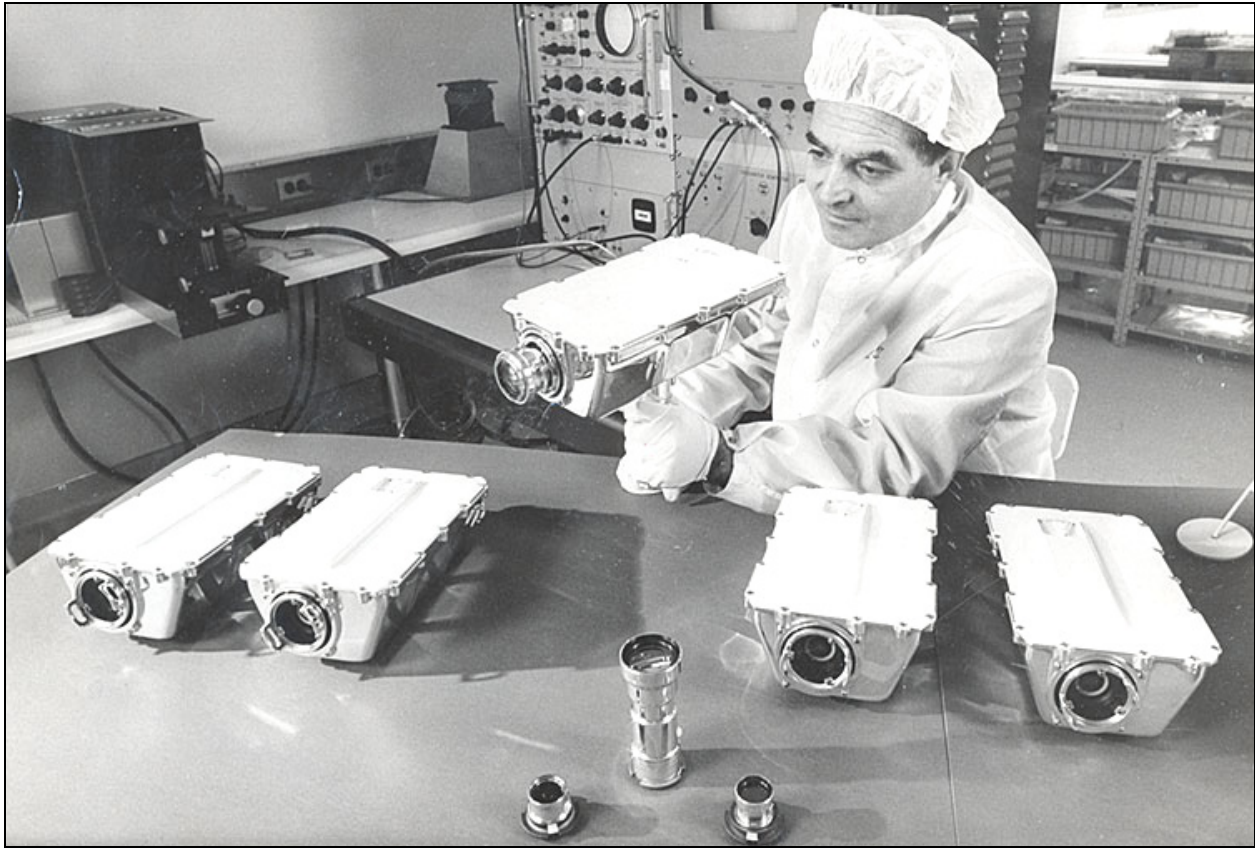

Stan Lebar, the WEC camera project manager, displays the Westinghouse Lunar Camera

Apollo 9 marked the first use of the Westinghouse slow-scan Lunar Camera. Since this was the first manned use of the Lunar Module the mission was conducted in low Earth orbit. The TV camera was stowed inside the LM ascent stage so the crew could operate it.



Rusty Schweickart wearing the EVA PLSS



Rusty Schweickart and Jim McDivitt in the LM after the EVA

Not long after Jim McDivitt and Rusty Schweickart entered the LM the camera was powered up and used briefly to beam their activities to Mission Control starting at 46:28 GET.

The second and longer TV transmission started at 74:58 GET shortly after Rusty Schweickart's EVA. The original flight plan called for Rusty to take the TV camera outside the LM during the EVA. However, the EVA was shortened due to Rusty's motion sickness the previous day and the TV coverage of the EVA was scrubbed.



## Apollo 10

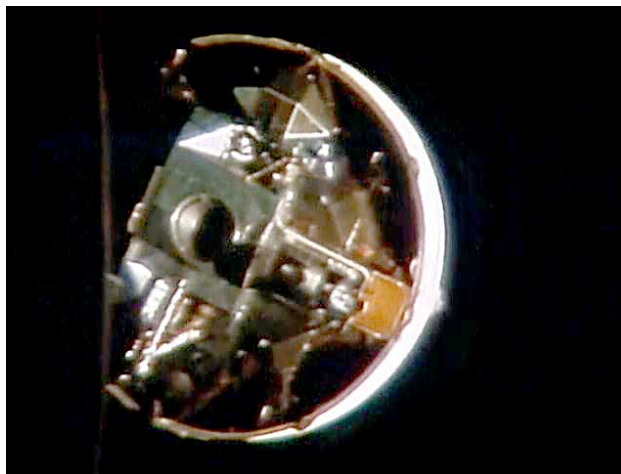

The LM still attached to the S-IVB

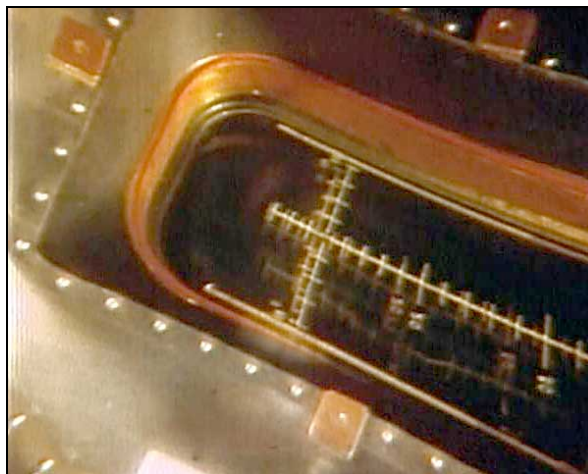

LM Rendezvous Window after Docking

Apollo 10 marked the first use of color television on the CSM. The Apollo 10 crew gave viewers on the Earth a front row seat to the docking of the CSM with the LM shortly after translunar injection. Color views of the SIVB third stage were shown after the separation.



Tom Stafford and John Young in the CSM



Stafford holding the LM's Namesake

Later the interior of the CSM and pictures of each of the crew members were seen. Once in lunar orbit the world was treated to views of the surface of the Moon. In the first four days the crew broadcast more color television – about 3 hours – than was planned for the whole mission.

Aviation Week and Space Technology reporter Warren Wetmore said in a [May 26, 1969 AW&ST article](#) that the crew's enthusiasm for the TV system appeared greater than that of previous Apollo crews and is attributed largely to spacecraft commander Thomas P. Stafford. "As far as we're concerned, he was the prime mover" on getting color television capability into the Apollo 10 command module, an Apollo TV engineer said. "He influenced our management, and they influenced us." The ground-based color conversion equipment was put together in about four months.





### Westinghouse Field Sequential Color Camera

Westinghouse engineers had already decided in 1968 that NASA would need a color TV camera for space missions, and had begun work to build one. An NTSC color TV camera was clearly impractical; as such devices were big and far too unreliable in harsh environments. However, a color-wheel camera, first developed by CBS in 1940, was not much more complicated than a black and white camera, and could be easily built as a small hand-held unit.

The main problem was that the color-wheel camera, with its sequential red-green-blue images, was not compatible with the NTSC system, which broadcast all three colors at once. Westinghouse engineers got around the obstacle by recommending that a conversion device be installed in the Houston Mission Control Center that would store the camera's sequential images on magnetic media, and then convert these into a standard NTSC color broadcast signal.

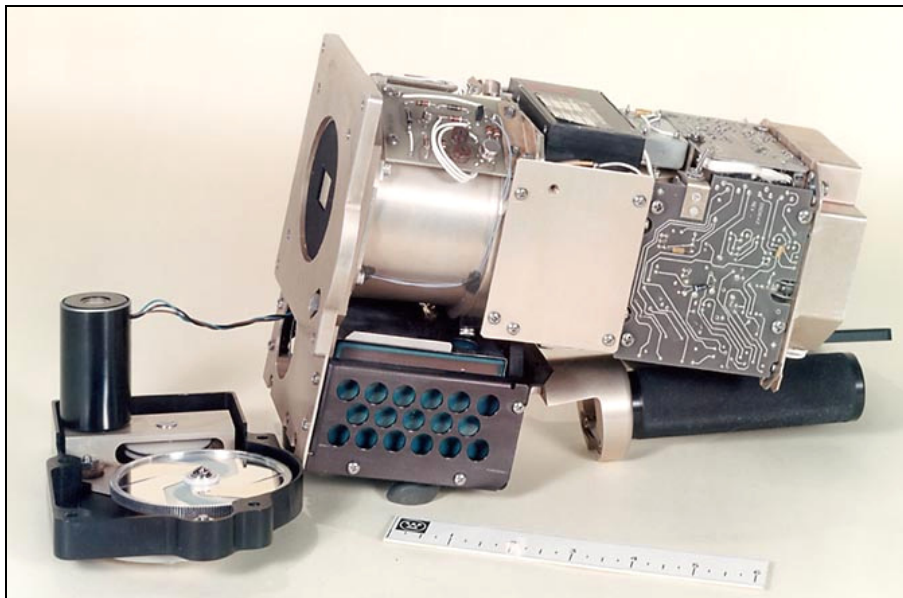

Uncased color wheel assembly and camera



To give the astronauts a viewfinder Westinghouse also developed a very small black and white TV monitor that could be attached to the camera or used separately to allow the astronaut cameramen to see what the camera saw. To accomplish this effort in the shortest time Westinghouse adapted the design of an off-the-shelf Japanese manufactured micro-TV receiver for use aboard the CSM.

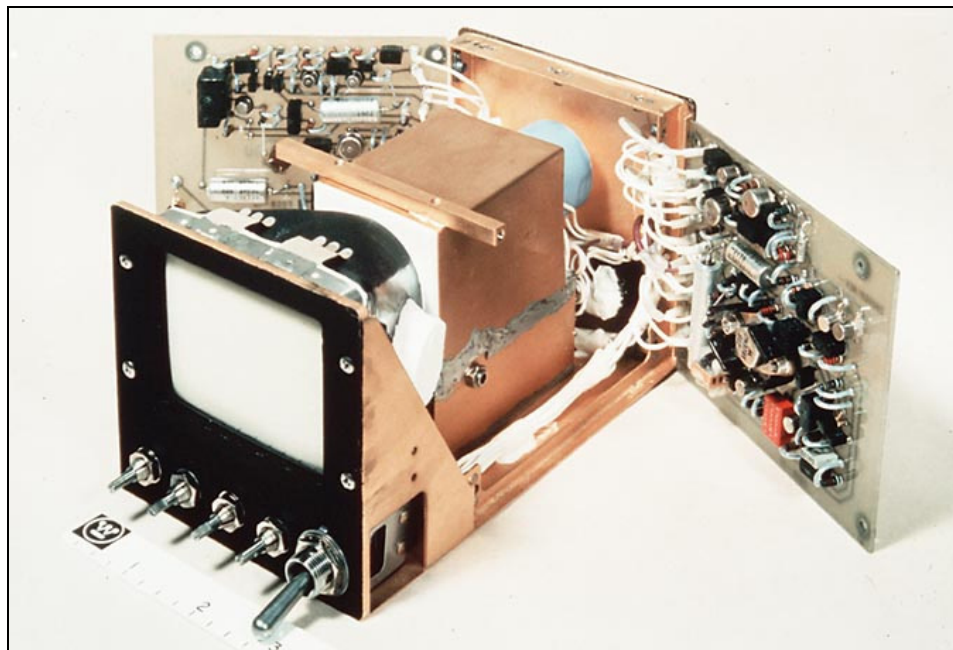

All of the monitor components, with the exception of the CRT and deflection yoke, were fabricated using NASA and Mil-Spec standards. Since no suitable CRT and yoke could be obtained that would meet NASA specifications without encountering excessive costs, Westinghouse engineers chose to use original manufacturer's parts. The high voltage components were potted with special materials to operate in the spacecraft environment.

The camera and monitor was ready in 1969, and was taken along on the Apollo 10 Moon-orbiting mission and on the Apollo 11 Moon-landing mission, though it was not used to take images during Moon walks. Later landings would use the color-wheel camera to transmit images of excursions on the Moon's surface.

For more information about the FS Color Camera go to these links for PDF copies of

1. Westinghouse Color Camera [Operation and Training Manual](#).
2. WEC News Release [May 16, 1969](#).
3. Invention and Technology, Summer 1997, The [Color War Goes to the Moon](#) article

## Apollo Color Television Signal Handling

The three primary MSFN ground stations, in Australia, California and Spain, handled the field sequential color downlink without converting it. In fact, the fast scan black and white proc amps and other Grass Valley video processing modules in the RCA Slow Scan Converter were used to send the unconverted video to Houston by way of satellite and microwave links. As on Apollo 8, only Goldstone had real-time video transmission circuits scheduled up to Houston.

Local recording of the Apollo 10 field sequential color signals was done on Ampex 2-inch helical VR-660B black-and-white video tape recorders. Station display of the color pictures was made possible through the use of modified Conrac 21-inch NTSC monitors. The modification gated the monitor CRT red, green and blue electron guns on and off sequentially in a manner similar to the rotation of the color wheel in the camera.

## Field Sequential Color Conversion

After the field sequential color signals were received at the Houston Manned Spacecraft Center these were converted to NTSC by an ingenious combination of two 2-inch Quad VTR's and three full-field video storage devices that used a high speed magnetic disk recorders as a field store device back in the dark ages of video.

In the days before solid-state frame synchronizers, the problem of how to lock the space borne camera's signal to the USA TV Network NTSC standard was neatly solved by the use of two 2-inch quad VTR's operating in tandem. The raw field-sequential color signal was recorded on the first VTR, which was locked to the incoming signal. Then the tape was fed to the second VTR via a tape loop. The second VTR ran in the reproduce mode and its speed was locked to the USA NTSC network sync standard. Camera time-base variations, caused by downlink Doppler shifts and the camera's sync generator temperature changes, were effectively removed through the use of the tandem VTR system.

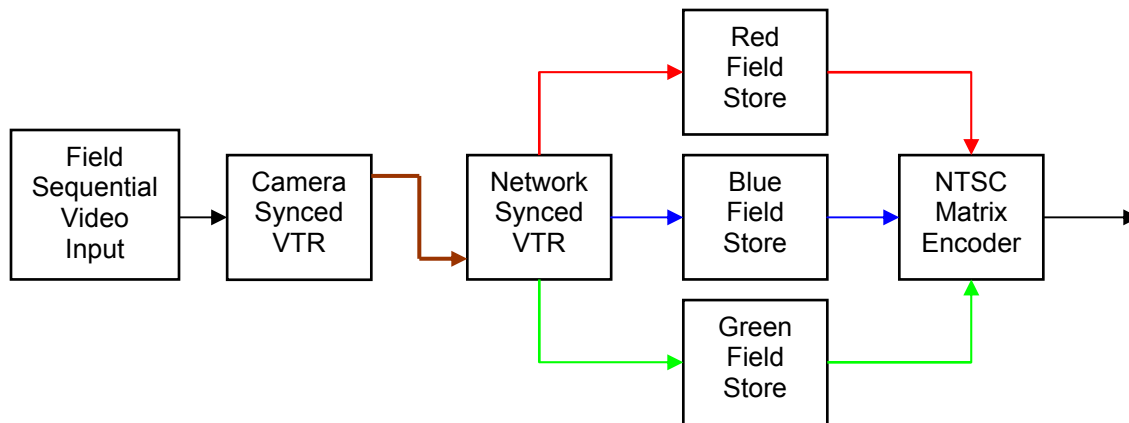

As each of the sequential red, green and blue fields was reproduced on the second VTR each color was recorded on separate tracks of a magnetic-disk video recorder. Since field or frame store devices did not exist in 1969, NASA adapted available video disk recorders, commonly used by US commercial TV broadcast networks for sports slow-motion playback, for this task.

Since the disk recorder continued to run, the red channel video output would be repeated two additional fields while the Blue and Green fields were being received and stored in their designated recorder tracks. The Blue and Green field store recorder tracks would also repeat the same field two more times while waiting for their respective color fields to be received.

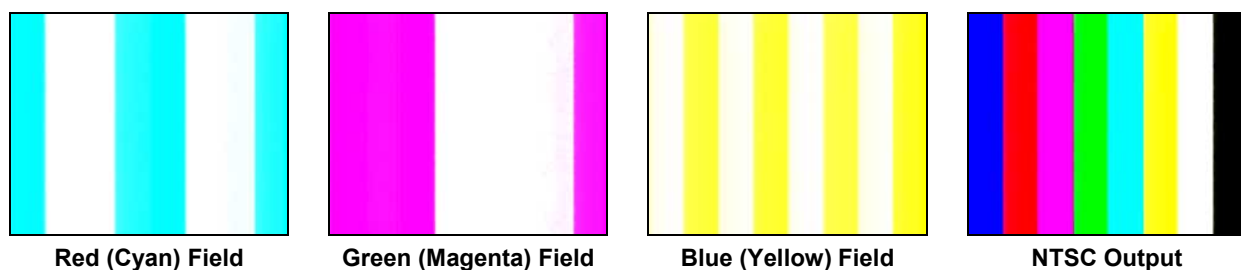

**Subtractive Representation of the Field Sequential to NTSC Color Conversion Process**

The result of this process was the production of three separate red, blue and green channels that were each updated 20 times per second instead of the normal 60 fields per second for the USA black and white TV standard. The three channels were matrixed together to produce an NTSC output signal that was synchronized to the USA national NTSC time base so it could be released in near real-time to the US television networks, delayed only by the time the tape took to move from the record VTR to the playback VTR.



## Apollo 11

Television, the one item of worldwide public impact, was very important on this flight. Deke Slayton even urged the addition of an erectable antenna on the lunar surface. After all, the crewmen could not be expected to wait patiently in the lander - until the earth moved Goldstone, California, and its 64-meter dish into line with the spacecraft - before they climbed out onto the surface. [38](#)

Before the Apollo 11 mission NASA arranged for the support of the first lunar landing by two 64-meter diameter antennas at Goldstone, California and at Parkes, Australia. The larger dishes improved the Apollo downlink signal levels by between 8 and 10 dB making it possible to receive signals considerably weaker than those received by the normal 26-meter Apollo antennas.

The added sensitivity of the Goldstone 64-meter antenna proved invaluable when the Apollo 11 Lunar Module encountered antenna pointing problems during the powered descent. It allowed controllers at Houston to see the LM data and to tell the Astronauts that they were “GO” on computer overload alarms displayed just before the landing on the Moon



Goldstone DSS-14 64-meter Antenna, July 1969

At Goldstone the DSS-14 Mars DSN Block III S-band receiver 50 MHz IF and baseband outputs were sent over a new Collins Radio C-band microwave link to the nearby Apollo MSFN station to be demodulated and processed there. The top microwave dish next to the operations building in this photograph sent the signals to a similar dish at the Goldstone Prime site via a passive repeater located on a hilltop between the Mars station and the Apollo station.





Pioneer DSS-11 DSN Station, 1969

Additional back-up support was provided by the Pioneer Deep Space Network station at Goldstone. This station had a MSFN wing added to the operations building that duplicated the antenna and Unified S-band equipment that was available at the Prime Apollo station. The Wing station was connected to the Prime station by an X-band microwave link.



Goldstone 26-meter MSFN Station, July 1969

The FM modulated downlink television signals were demodulated and sent along to Houston via two different common carrier microwave links housed in the small building in the right foreground of the photograph above. Two different microwave paths were used to provide redundancy in case of a failure of one link to Houston.





64-meter Radio Telescope, Parkes, Australia, 1969 [CSIRO Photo]

In Australia, the 64-meter radio-telescope at Parkes was made available by the Australian government to improve the signal gathering capabilities when the Moon was within view of the MSFN station near Canberra, Australia. Goddard Space Flight Center dispatched engineers and equipment to Australia to assist in the modification of the Parkes antenna to receive the Apollo downlink. A very complete account of how the Parkes radio-telescope was used to support the Apollo 11 mission was published by the Astronomical Society of Australia in 2001. Go here for a PDF version: [On Eagles Wings](#).



26-meter DSS-42 Deep Space Network Station, Tidbinbilla, Australia, 1969

As at the two other 26-meter MSFN stations, a nearby 26-meter DSN station was equipped with a duplicate Unified S-Band system to provide an additional backup tracking capability in case the USB system at the Honeysuckle Creek Prime suffered a failure. The baseband and 50 MHz IF signals were sent to HSK over a microwave link.



Honeysuckle Creek MSFN Station, Australia

Both the DSS-42 and Parkes microwave links were configured to carry the telemetry and voice signals to the Honeysuckle Creek MSFN station. HSK was the Australian hub for voice and data communications with the Apollo spacecraft. It was connected to the Canberra NASCOM facility in the Deakin suburb of the Australian Capital Territory by landline and a microwave link for television signals. Canberra NASCOM was connected via the Australian Post Master General (PMG) circuits to Sydney Video in the Overseas Telecommunications Commission (OTC) office in Paddington and on to the Australian Intelsat terminal at Moree



The television signal from Parkes was sent direct to Sydney Video, over a separate PGM microwave link, where a choice was made between the HSK or Parkes television signals as to which would be sent on to Houston via satellite. The RCA Slow Scan Converter in the center of this photograph was used for the Parkes video feed. Sydney Video also fed the Australian Broad-



casting Commission's (ABC) country-wide network of television stations with a 625 line version of the signal being fed to Houston. Australia's three commercial networks, Channel 7, 9 and 10, received a feed of the Apollo 11 Moonwalk from the Australian Broadcasting Commission.



Houston Mission Operations Control Room during Apollo 11

## Color Television in the CSM

Color television was so effective on Apollo 10 that it was adopted for Apollo 11, but only in the command module. Max Faget was more than mildly upset when he learned that the television, motion picture, and much of the still photography planned for Apollo 11 would be in black and white. To him, it was "almost unbelievable" that the culmination of a \$20-billion program "is to be recorded in such a stingy manner." [40](#)



Mike Collins demonstrates the CSM DSKY

The Apollo 11 path to the moon was accurate, requiring only one midcourse correction, a burst from the service propulsion engine of less than three seconds to change the velocity by six meters per second. Not having much to do gave the pilots an opportunity to describe what they were seeing and, through color television, to share these sights and life inside a lunar-bound spacecraft with a worldwide audience. [6](#)



Apollo 11 CSM Interior video showing motor drive hum bars

One problem was uncovered with the color camera during Apollo 11. During the relatively dim lighting inside the CSM two horizontal bars could be seen in the picture. The camera AGC circuit increased the video gain during dim lighting and made the problem more visible. After the mission Westinghouse found and corrected an internal ground loop that caused color wheel motor drive current variations to be induced in the camera video output.

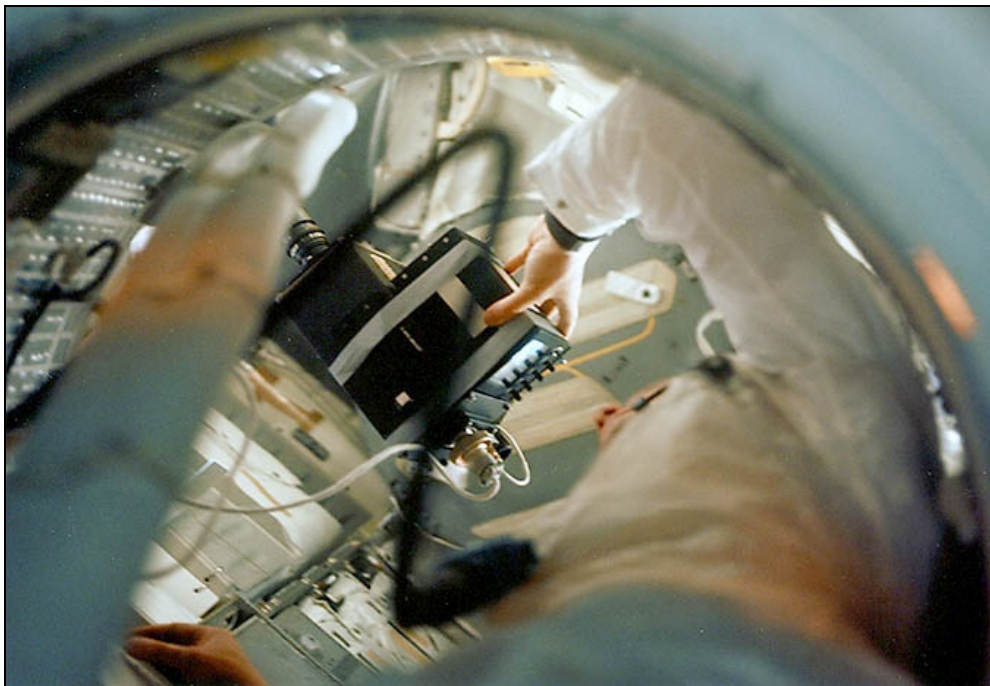

Color TV Camera and Monitor in use by Neil Armstrong inside the LM

On Saturday, 19 July, television viewers in both hemispheres had watched as the crew removed the probe and drogue and opened the tunnel between the two craft. Aldrin slid through, adjusted his mind to the new body orientation, checked out the systems, and wiped away the moisture that had collected on the lunar module windows, while the world watched over his shoulder.

## Apollo 11 Lunar Surface Camera

Early in the Apollo program NASA became aware of a special low-light television imaging tube that Westinghouse had developed for the Department of Defense. Due to the war in Viet Nam, the Army was developing low light devices for use as jungle surveillance devices and on aircraft to spot a downed pilot at night.

To meet the DOD requirements Westinghouse developed a sensitive image tube that combined a variable-gain light intensifier with a secondary electron conduction (SEC) target. The SEC tube had the capability to reproduce objects in motion, at low light levels, without the normal smearing produced by vidicon or image orthicon tubes.



Westinghouse Lunar Surface Camera

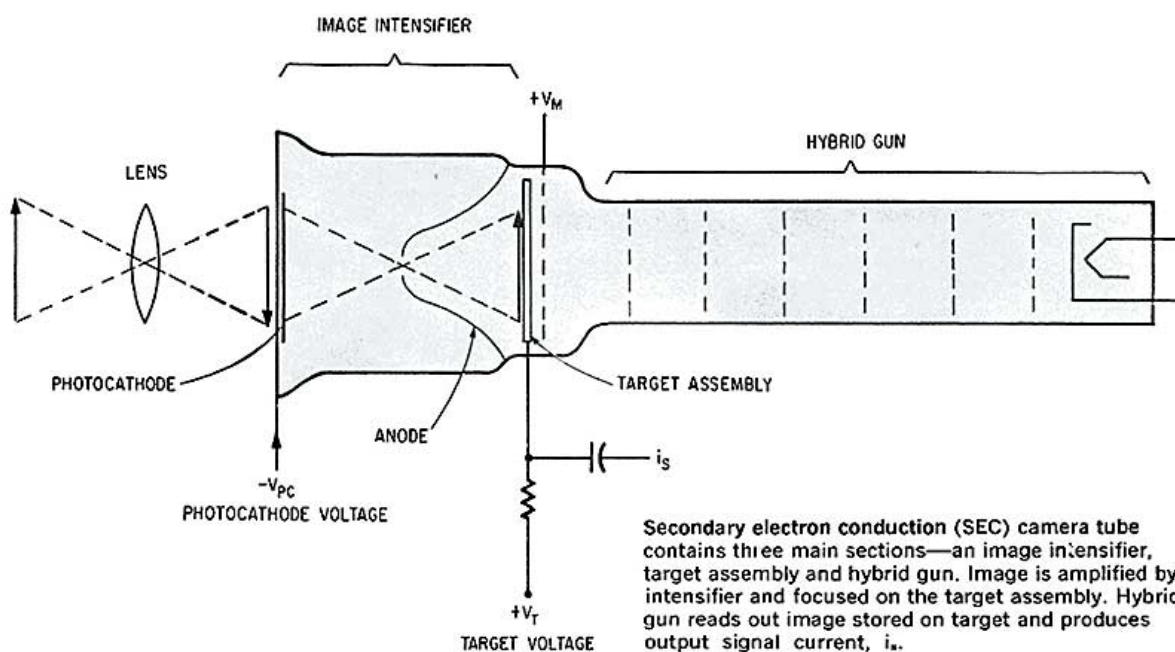

At the time the SEC tube had a DOD security classification as befitted such a device. Since there were no other device that could possibly meet the Apollo TV camera mission requirement to operate unattended at both lunar day and lunar night and survive all phases of the Apollo mission, the DOD was asked to allow Westinghouse to use the SEC tube for the Apollo TV Camera program.

The SEC tube was in its early stages of development and the Westinghouse Apollo TV Camera program took on the task of developing the unique Apollo SEC tube (at the Westinghouse Tube Div. in Elmira, NY by Dr. Gerhard Götze) which was ultimately used on Apollo 9 and operated from the LM porch in earth orbit and subsequently Apollo 11 on the lunar surface.



The camera was handled by Westinghouse internally as an unclassified device (except for the classified items as stated above). Stan Lebar, the WEC Apollo Lunar Camera Project Manager said “we did not bring any attention to the classification and I doubt if the many hundreds of people that handled the assembly during its production ever knew its classification status.”

Since there were no restrictions on the photographs of the assembled camera or its characteristics, the media was given both press releases and demonstrations on its capabilities. The fact that an SEC tube was used was clearly stated in the technical articles written during that time.

Westinghouse made extensive use of custom made microelectronic circuits that keep the camera small, light and reliable. Of the 43 integrated circuits used, 24 are of different types and 19 of these were especially designed for the camera. The custom circuits are of both monolithic silicon and multiple-chip hybrid designs. Since the sync circuit requires the largest number of integrated circuits – 12 flip-flop packages and 7 gate packages – it was essential to use devices with low power switching capability.

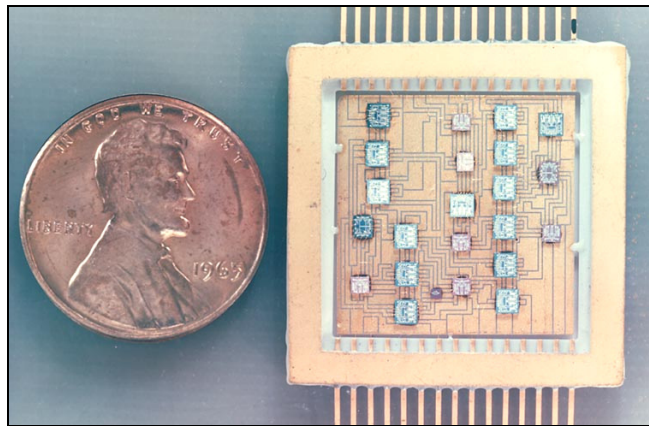
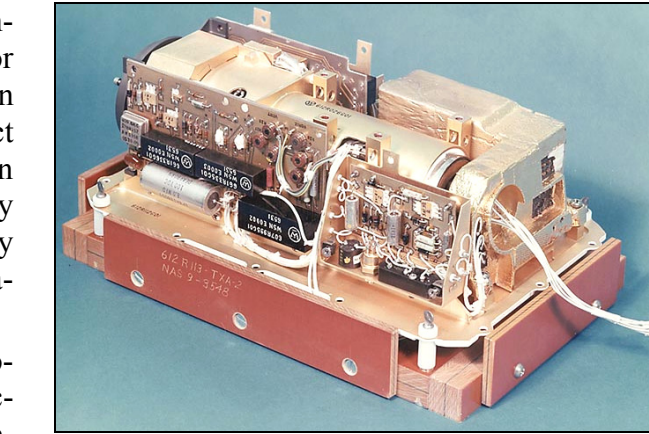

Multi-chip Hybrid Microelectronic Sync Circuit

To capture Man’s first steps upon the Moon the TV camera was stowed on a special shock-mounted angled mount on the LM MESA. It was positioned so that the camera would be nearly vertical and upside down when the MESA was released by Neil Armstrong after he first emerged from the LM. There was not enough space between the stowed MESA and the descent section of the LM for an adapter to put the camera closer to vertical. As a result the Apollo 11 TV images are tipped to the right, showing the lunar horizon some 11 degrees off horizontal.

The inside of the MESA was covered with a special insulating blanket to protect the contents from temperature extremes during the flight to the Moon. Just before launch Paul Coan, the MSC TV camera manager, asked the Grumman personnel to cut a hole in the blanket to allow the lens to poke through it. After Neil Armstrong went on the surface he removed the blanket to allow access to the camera and other equipment stowed on the MESA. Neil later removed the camera and set it up away from the LM on a tripod.

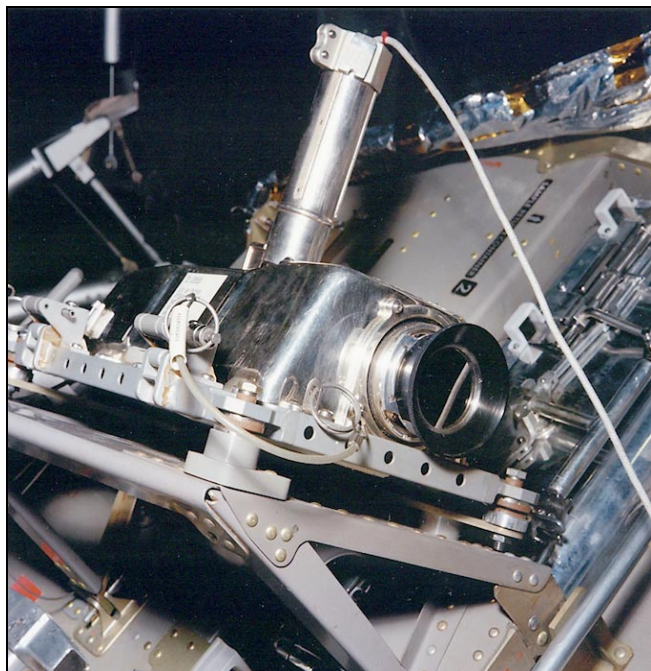





Buzz Aldrin deploring the Solar Wind experiment

The TV images of Neil's climb down the ladder and first steps on the surface were transmitted to Earth through the steerable high-gain antenna on the LM. However the crew could have deployed an erectable S-Band antenna to provide stronger signals. Since both the Goldstone and Parkes 64-meter dishes were on line, this was not necessary.

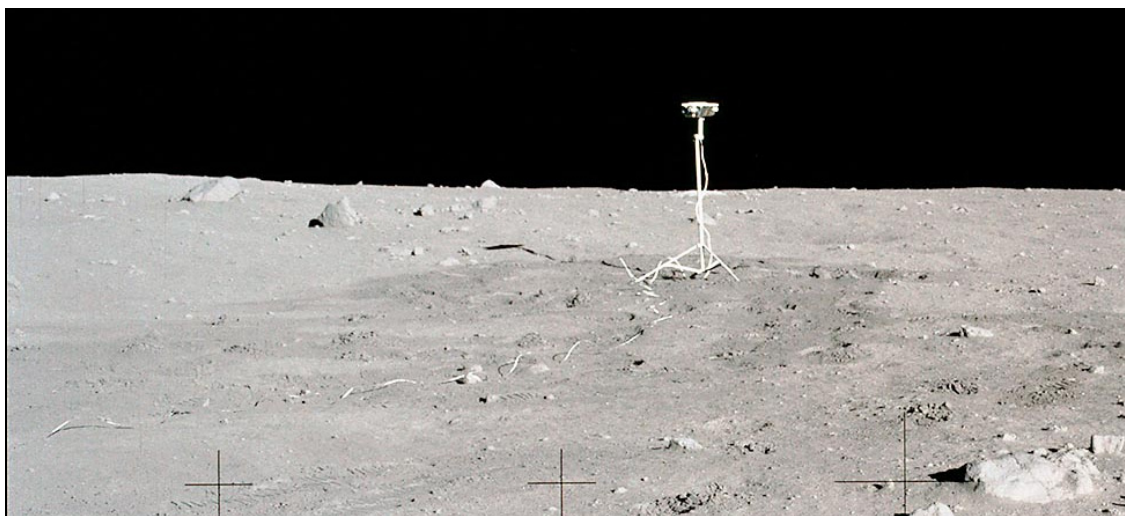

Hasselblad image showing Apollo 11 placement of TV camera and cable

For more information about the Slow Scan Lunar Camera go to these links for PDF copies of

1. Manned Spaceflight Center [Lunar Camera Statement of Work](#).
2. WEC Reprint "Electronics" [March 6, 1967 article](#) on the SS Lunar Camera
3. Westinghouse "Engineer" [March 1968 article](#) on the SS Lunar Camera
4. The original Westinghouse [Lunar Camera Operations Manual](#)
5. Manned Spaceflight Center [Pre-Installation Acceptance Test Plan](#).
6. Aviation Week & Space Technology [Editorial, July 28, 1969](#)

Interesting Internet links about the Apollo 11 Lunar Camera:

1. [On Eagle's Wing](#) The Story of the Parkes Apollo 11 Support
2. Newseum's "[Live from the Moon!](#)"

## MSFN Performance during Apollo 11 Lunar Camera Operation

Before the EVA started the crew configured the LM S-band downlink to combine the TV video with the 1.024 MHz TLM and 1.25 MHz voice subcarriers on a single FM modulated 2282.5 MHz carrier.



DSS-14 Video via Goldstone, GET 109:22:06

Right after Buzz Aldrin depressed the TV camera circuit breaker a video signal was received both at the Goldstone and Honeysuckle Creek. However Houston was connected to Goldstone's video and only saw an upside down picture that was stark black and white with little visible detail.



DSS-14 Video via Goldstone, GET 109:22:32

After Houston Video instructed the Goldstone scan converter operator to place the converter Invert switch to the correct position the video display was flipped over but still had too high a contrast to make out any details in the shadow of the LM.



DSS-14's video via Goldstone, GET 109:23:44

In the meantime Houston Video was checking the video signal that was being sent from Honeysuckle Creek via the Sydney Video switching center. It was immediately clear that the video signal from HSK was superior that that being received from GDS.

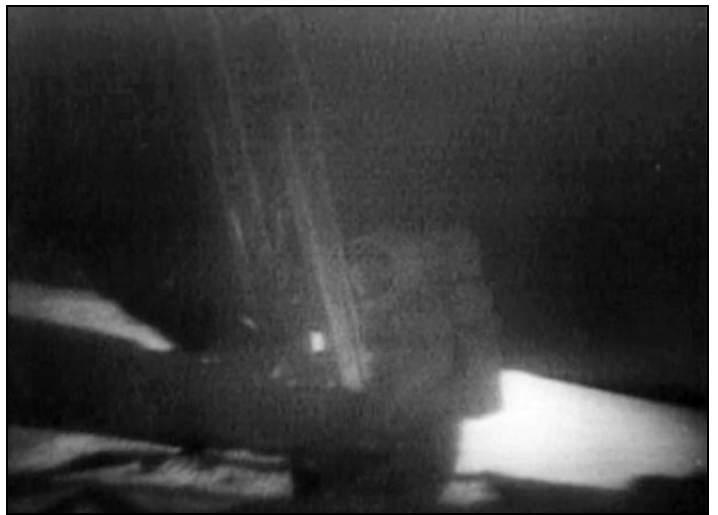

Honeysuckle Creek's Video, GET 109:23:48

Note the improvement in the shadow detail as well as the increase in video snow. Note also the light spot in the upper center of the GDS picture. This is a defect in the slow scan converter camera that makes it easy to identify when Goldstone's video is being seen.

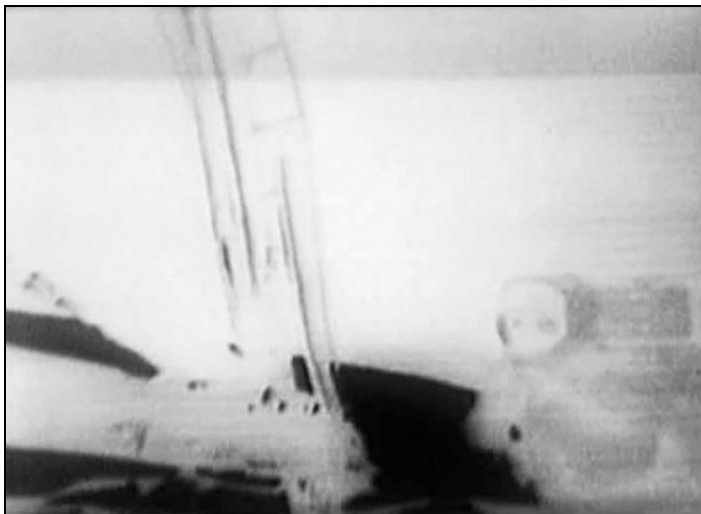

DSS-14 Negative Video via Goldstone, GET 109:27:05

Houston Video switched to Goldstone at GET 109:26:53 when they saw what looked like an improved picture after the Goldstone TV Tech inverted the video polarity of the SS monitor in an attempt to troubleshoot their problem.



The Same DSS-14 video frame re-inverted to Positive

After the Apollo 11 mission NASA restored the negative video to positive for the archive copy of the EVA telecast. This shows a much improved picture for this short section of video. At the time no one realized the significance of this.

Only recently (2004) was the cause of the problem with the Goldstone Slow Scan Converter discovered. After a careful review of archived video sources it was found that the GDS Slow Scan Converter internal monitor black level was set at a level that compressed the dim shadow details into black. The HSK and Sydney Video scan converters were set properly.



DSS-14 video via Goldstone, GET109:30:55

At the time of Armstrong's first step on the Moon the Parkes 64-meter dish was still at its lower elevation limit. After the Parkes dish started tracking Sydney Video advised Houston Video that the best signal was from the 8 dB stronger Parkes antenna.



Parkes video via Sydney, GET109:31:00

After Houston saw the much improved television image from the Parkes 64-meter antenna they stayed with Parkes for the rest of the Apollo 11 EVA.



## Before and After Scan Conversion Comparisons

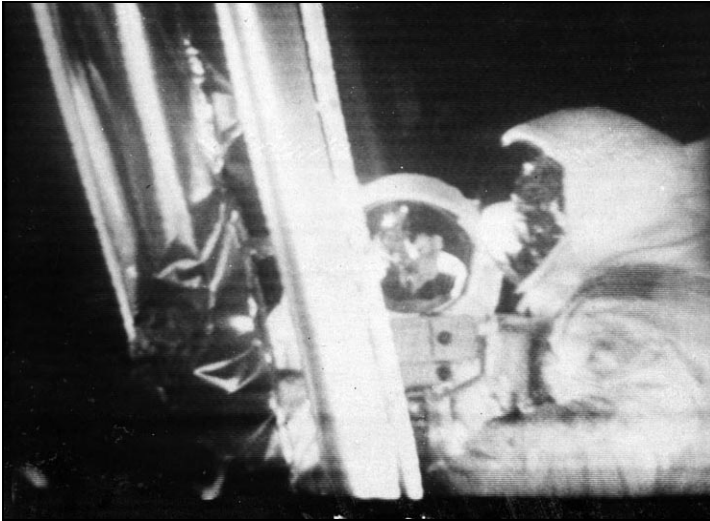

Original 320 line, 10 frame per second Parkes Image, GET 109:52:35

This photograph was taken directly off a Fairchild 320 line, 10 frames per second monitor located at Sydney Video control room using Polaroid PN-55, 4 by 5-inch, film. Look at the reflection in Buzz Aldrin's visor and compare it with the after conversion photo.

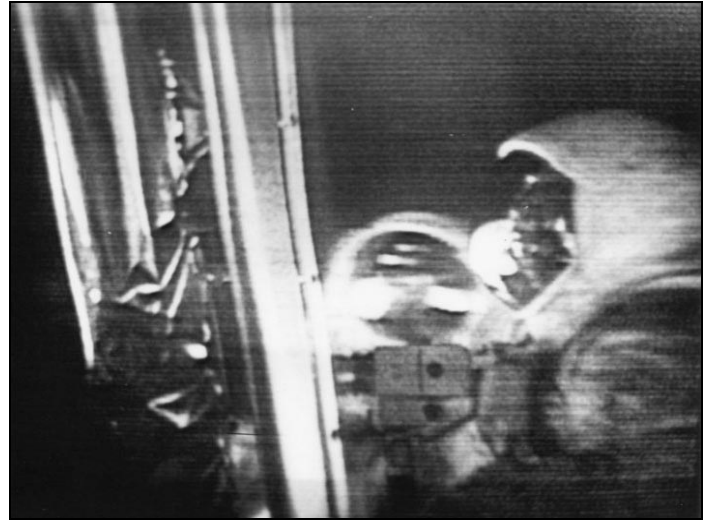

Scan Converted 525 line, 30 frame per second Image, GET 109:52:30

This photograph was taken of an NTSC monitor after scan conversion at Sydney Video very close to the time the unconverted photo was taken. This shows the loss of resolution and shadow detail that occurred during the conversion process.



Goldstone Fairchild Monitor Polaroid Photo

This photograph was taken in real-time off the Slow Scan monitor used by the GSFC Public Affairs Officer to provide press representatives with photographs of the EVA. It shows the higher resolution and increased shadow detail that the Westinghouse camera was capable of producing.



Similar scene from NASA video archive

This is a frame capture of a similar scene from Spacecraft Films Apollo 11 DVD set, disk 2, EVA TV. The source was from the NASA archive of Apollo television material. What looks like a staff in the Moon dirt to the right of the flag is actually an internal lens reflection from the very bright quad leg to the left of the Astronaut.

## Why did the Apollo 11 EVA television images appear rather dark?

TV camera tubes at the time, including the Apollo TV cameras, produced an output voltage that was proportional to the light falling on the sensor surface. However, the light output of the cathode ray tube normally used to view television signals is NOT proportional to the video signal applied to the CRT. The television broadcast industry required the inclusion of a gamma correction circuit in TV cameras to make the light output on TV screens proportional to the light on the camera tube. (Check this excellent [chapter on gamma](#) from Charles Poynton's book "A Technical Introduction to Digital Video" for information about the need for gamma correction.)

However, the video circuits in the Westinghouse Apollo television cameras did not include gamma correction circuit as did most broadcast TV cameras of the period. During the early design phase Westinghouse engineers decided that, since the television images might be used for scientific purposes, it would be preferable to keep the video imaging device and the camera video circuits operating in a linear, or a gamma 1.0, mode. As a result a gamma correction circuit was not included in any of the Westinghouse cameras used in the Apollo project.

This caused the EVA scene mid-tones to be considerably darker than would have been observed had the video signal been gamma corrected to correct for the non-linear response of the cathode ray tubes used in broadcast television receivers.

The Apollo Slow Scan Lunar Camera was never used again after Apollo 11. However, the cameras were carried on Apollo 13, 14, 15 and 16 in case the Westinghouse color cameras failed. But its television footage will be shown forever, as long as there is interest in how man took those first steps on the moon.

## Apollo 12

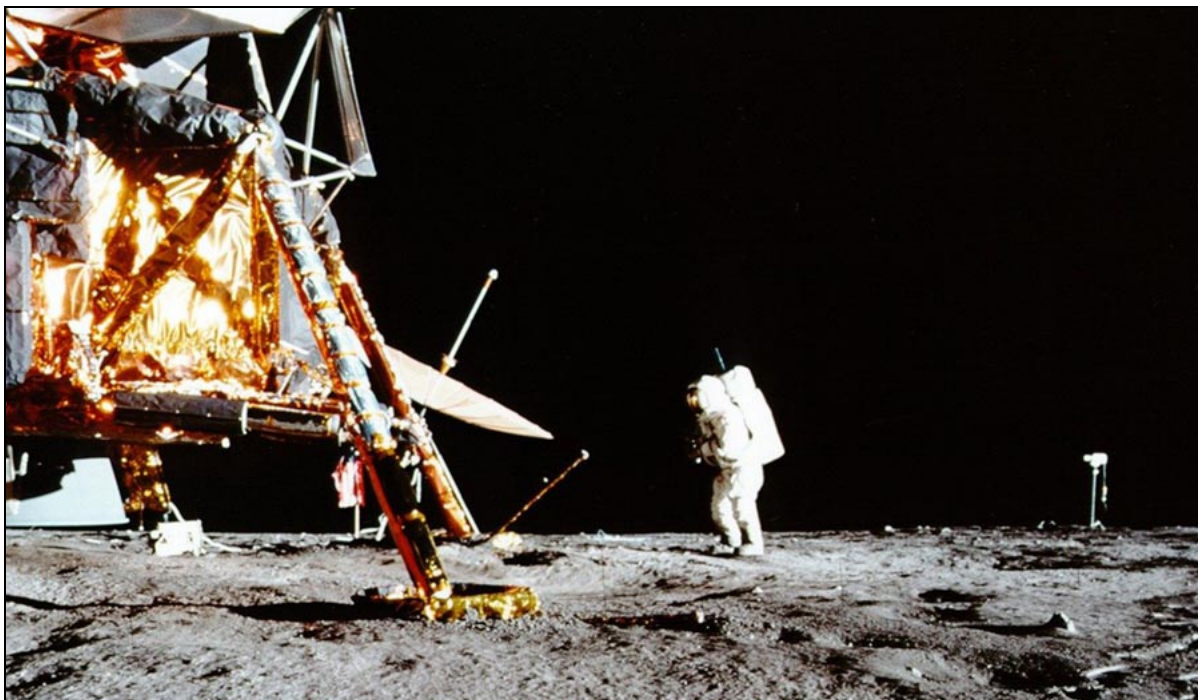

Apollo 12 erectable S-band dish antenna and color TV camera location NASA AS12-46-6779

## Westinghouse Lunar Color Camera

After the successful operation of the Westinghouse field sequential color cameras in Apollo 10 and 11 Command and Service Modules the decision was made to use it on the lunar module for Apollo 12. Westinghouse took the camera used on Apollo 10 and modified it for use in the vacuum of space on the surface of the Moon.

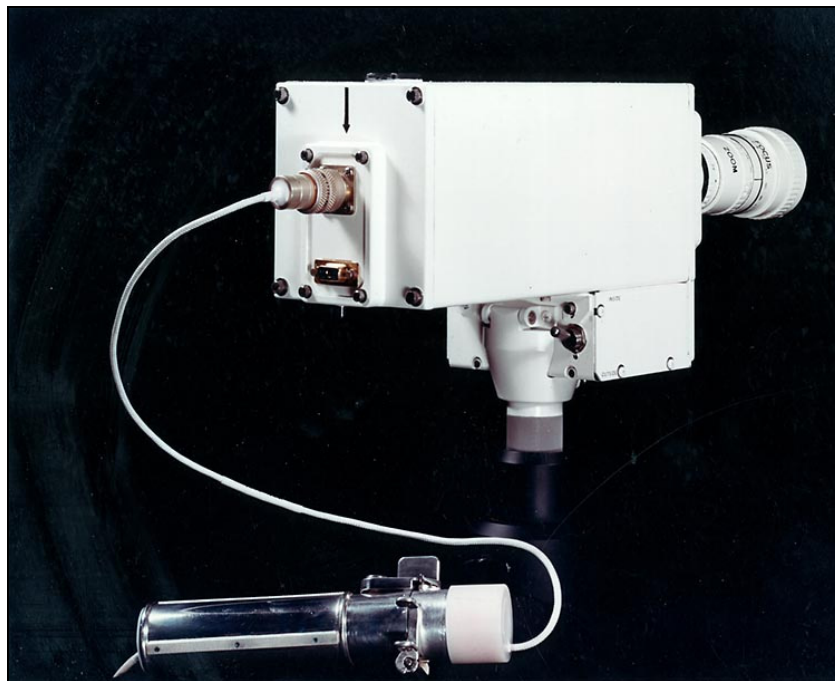

Apollo 12 camera showing camera adapter plug

The modifications included painting exterior white for thermal control, substituting coated metal gears for plastic gears in the color-wheel drive mechanism, provision for internal heat conduction paths to the camera outer shell for radiation and use of a special bearing lubricant. In addition, the Apollo 12 Command Module TV was the same camera flown in the Apollo 11 Command Module.

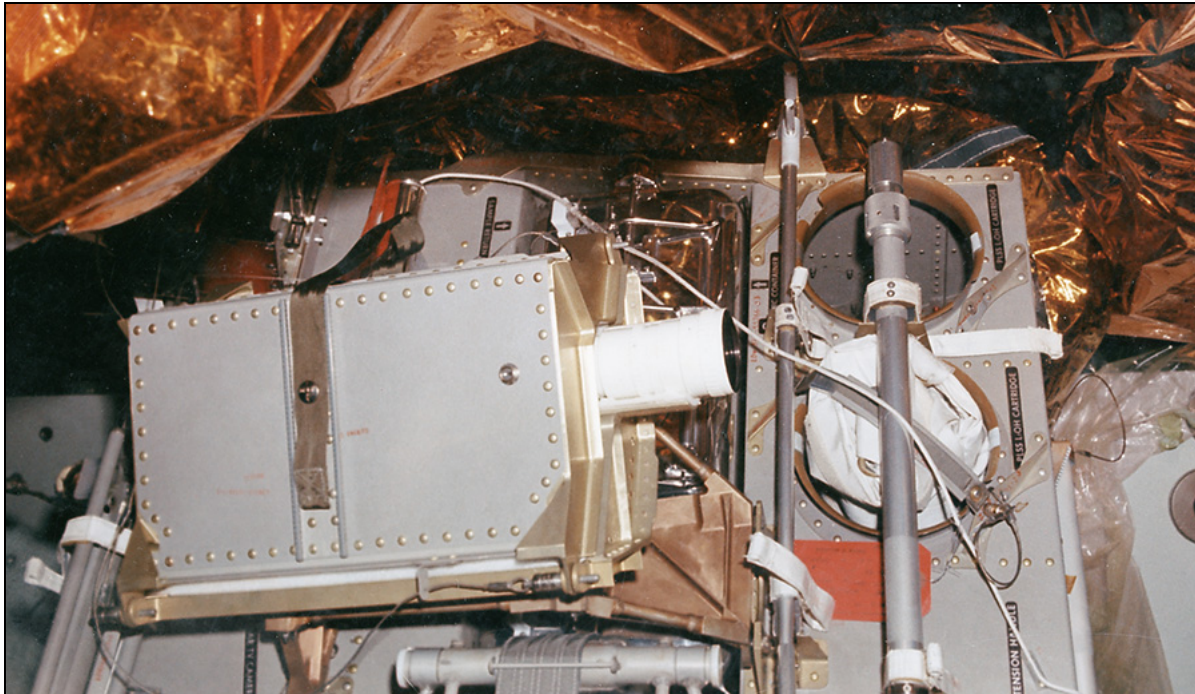

Apollo 12 Color TV Camera mounted on the LM MESA

As with the Apollo 11 lunar camera, the color TV camera was installed on a special angled adapter that would place the camera roughly vertical when the MESA was first deployed. When the strap is removed from the front of the adapter it could swing out allowing the astronaut to remove the camera from the MESA.





Pete Conrad removes the MESA insulating blanket after descending the ladder



Alan Bean on the lunar surface after the TV camera is flipped out for removal

After the start of the first Apollo 12 EVA the color TV camera performed as expected after being passed through a bandwidth limiting low-pass filter at the Goldstone MSFN station. This was necessary to prevent the LM TLM and voice subcarriers from interfering with the received television picture. The Westinghouse color camera video signal ran out to nearly 3 MHz while the subcarriers were at 1.024 MHz and 1.25 MHz.

Right after the MESA insulating blanket was removed Pete Conrad flipped out the TV camera mount rotating it nearly upside down. All of the remaining TV images, before the camera was removed, were taken with it in this position.



The camera has just started to directly image the Sun at GET 115:58



Downlinked TV picture after second series of hammer blows

At GET 115:58, Alan Bean removed the TV camera from the MESA camera mount. In the process of placing the camera on the tripod it was pointed directly into the Sun. Go to the [Apollo 12 transcript](#) to follow the discussion between the astronauts and Mission Control as they try to resolve this problem.

The damaged TV camera would never provide a usable picture after the Sun pointing, in spite of considerable effort by people on the ground and on the Moon. The crew was asked to bring the camera back with them so that it could be examined. The Apollo 12 camera when returned to NASA was carried directly to Westinghouse and unpacked and where all of the work was performed to verify cause of failure, power up the camera and disable the ALC to allow for viewing the camera image.

The [Apollo 12 Mission Report](#) contains a technical discussion of the TV camera failure:

"[Post-flight] ground tests using an Apollo-type image sensor (secondary electron conducting vidicon tube) exposed the camera system to extreme light levels. The resulting image on a monitor was very similar to that seen after the flight-camera failure.

After decontamination and cleaning, the flight camera [which Pete and Al brought back to Earth] was inspected and power was applied. The image, as viewed on a monitor, was the same as that last seen from the lunar surface. The automatic light-level control circuit was (then) disabled by cutting one wire.



The camera then reproduced good scene detail in that area of the picture which had previously been black, verifying that the black area of the target was undamaged (as shown in the figure). The finding also proved that the combination of normal automatic light control action and a damaged image-tube target caused the loss of picture.

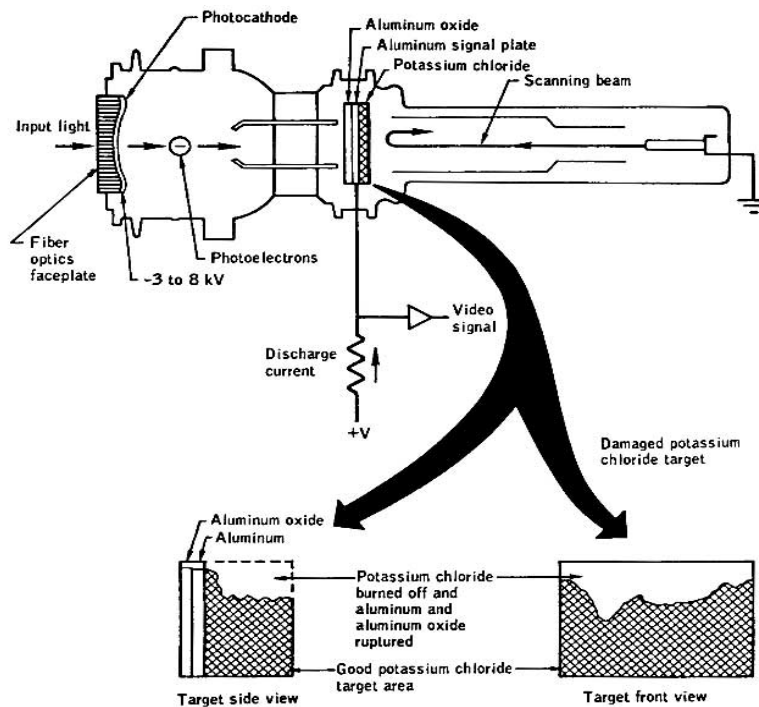

In the process of moving the camera on the lunar surface, a portion of the target in the secondary electron conductivity vidicon must have received a high solar input, either directly from the sun or from some highly reflective surface. [An examination of the TV record indicates that Al pointed the TV at the Sun while mounting the camera on the tripod]. That portion of the target was destroyed, as was evidenced by the white appearance of the upper part of the picture.

Training and operational procedures, including the use of a lens cap, are being changed to reduce the possibility of exposing the image sensor to extreme light levels. In addition, design changes are being considered to include automatic protection, such as the use of an image sensor which is less susceptible to damage from intense light levels."

Finally, Eric Jones reviewed the Apollo 12 video tapes in late 1993; he noticed that during the period immediately following the camera failure, Al is faintly visible in the black portion of the image as he moves in front of the camera.]





Gene Kranz watching the last TV broadcast from Apollo 13

## Apollo 13

Although the Apollo 13 mission was cut short after an oxygen tank explosion on the Service Module, there had been considerable efforts to improve the reliability and performance of the television systems. This ranged from the installation of a Westinghouse Apollo style field sequential camera at the top of the Launch Umbilical Tower to the addition of a backup camera on the LM.

A total of three television cameras were flown on Apollo 13. These were a B&W slow-scan camera stowed inside the LM ascent stage to be used in the event of problems with the white colored field-sequential color camera mounted on the MESA of the LM descent stage. The third camera was a black color camera to be used in the CSM.

To improve launch coverage Westinghouse worked with the American Broadcasting Company, the TV pool operator, to install an Apollo style field sequential camera on the top of the launch umbilical tower (LUT). The camera was mounted inside an insulated steel box to protect it from the blast of the Saturn V rocket engine exhaust as it rose above the LUT.

A special Westinghouse field-sequential to NSTC converter was installed near the pool TV operations room to provide close-up broadcast quality color TV signals during the launch sequence.

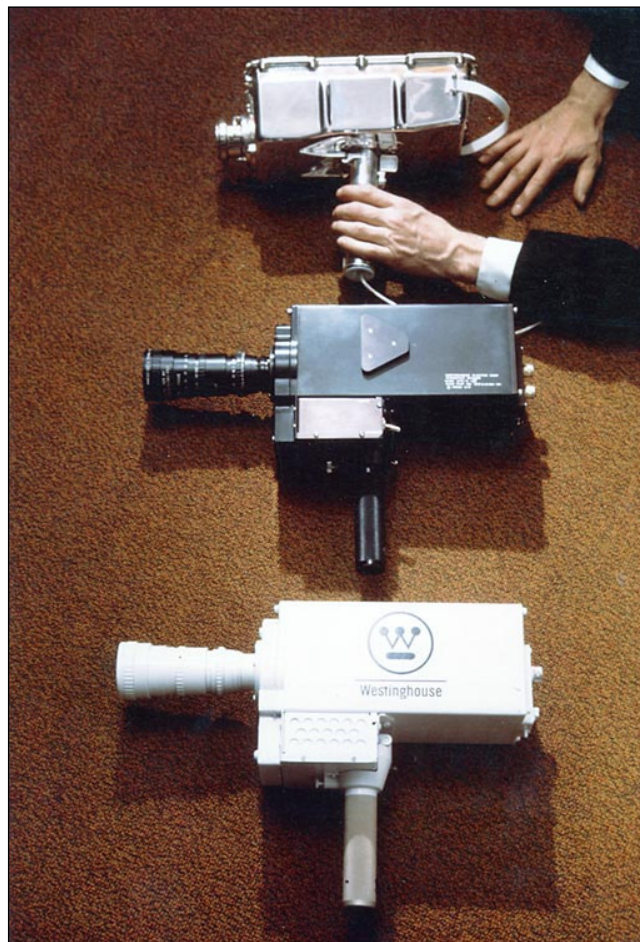



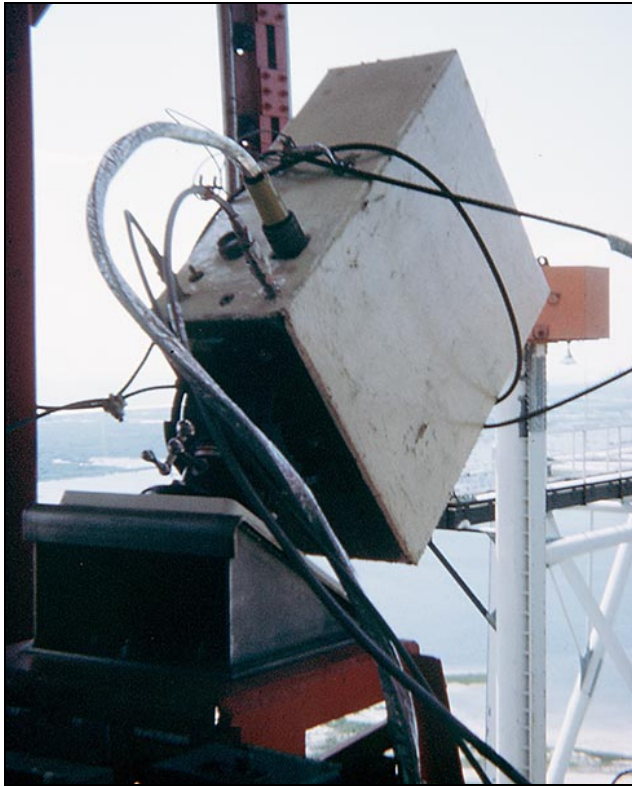

Westinghouse FS Color camera mounted on top of the Apollo 13 Launch Umbilical Tower

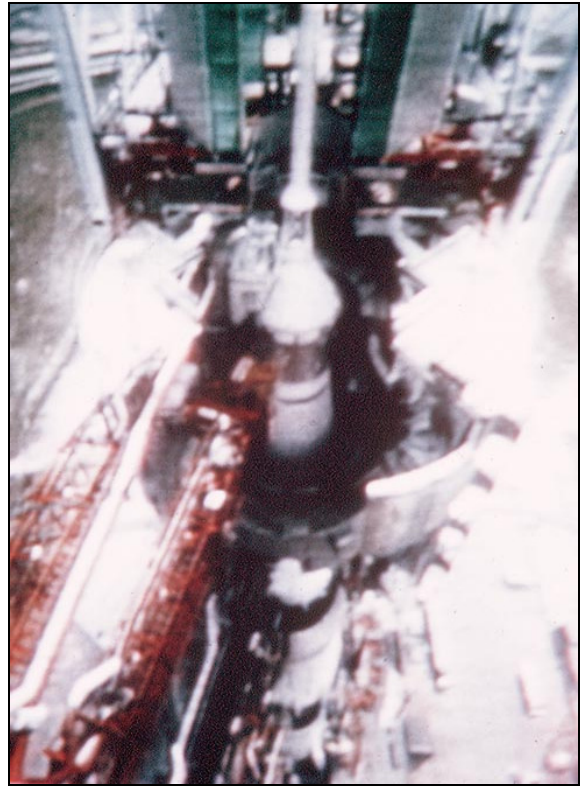

FS TV camera view on the Apollo 13 TV pool control room monitor



Westinghouse Color Camera in MESA mount, with the added lens cap, before Apollo 13 LM Closeout

To reduce the chance of accidental exposure to direct sunlight the Apollo 13 camera was fitted with an easy-to-handle soft rubber lens cap permanently attached to the lens neck. Astronaut camera handling procedures were changed to cap the lens whenever the camera was moved from one place to another on the Moon. See the Westinghouse [Apollo 13 Press Release](#) for more detailed information.



## Apollo 14

Apollo 14 was provided with the same complement of two Westinghouse field sequential color cameras and one slow-scan black and white camera. This was the second mission to deploy the folding S-band dish to increase the downlink circuit margin. Further, to reduce the chance of damage from the Sun the LM camera was equipped with an astronaut-usable lens cap to be used whenever the camera was moved about. However, the camera's video output still had a gamma response that made nearly all lunar surface scenes appear too dark.



Scene with Camera set to "Peak"



Scene with Camera set to "Average"

Starting at 114:08 MET the crew and ground controllers tried a number of different settings that included changing the camera peak-average switch and the lens aperture settings. The "peak" camera setting produced very dark scene details while the "average" setting produced good shadows but scene highlights, especially the white spacesuits, appeared overexposed and blooming.



Astronauts near the Lunar Module



Astronauts deploying the ALSEP station

When various lens aperture settings were tried the camera's automatic video gain circuit kept the output signals essentially unchanged from f44 all the way open. As a result the ground controllers asked the astronauts to operate the camera in the "average" position because the lunar surface looked better in that mode.

Unfortunately, the blooming of the white surfaces of the astronauts suits made them look somewhat like Casper the Ghost when moving about. When coupled with the use of a brute-force low pass filter to remove the LM downlink subcarriers, this made for a less-than-optimum color television image.



Al's famous Golf Shot with the camera set to "peak"

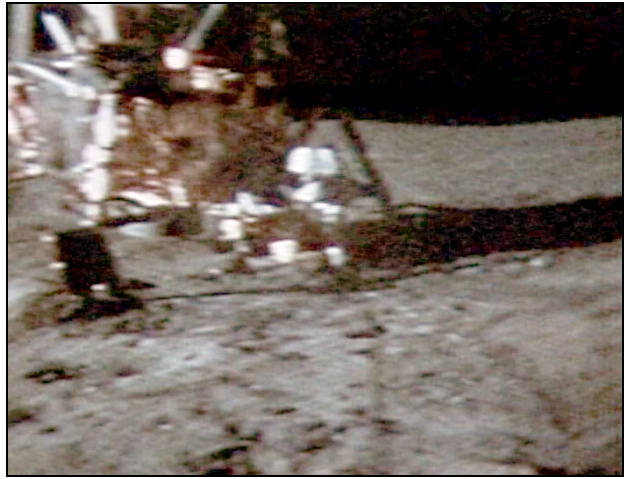

Gamma Corrected Image

If the Apollo 14 lunar camera video had been gamma corrected from 1.0 to the current 2.2 broadcast TV gamma, the lunar scenes would have looked like this with the camera set to "peak" instead of the degraded images actually observed at the time.



Apollo 14 LM returning to the CSM



Apollo 14 in-flight news conference

The Westinghouse color camera used aboard the Apollo 14 Command and Service module was not bandwidth restricted and performed as it had on earlier missions. There were a number of TV broadcasts showing in-flight activities.



NASA Mission Control Room during Apollo 14 Lunar Module Extraction



## Apollo Subcarrier Cancellation Unit

After the less-than-spectacular performance of the lunar color camera on Apollo 12 and 14, NASA investigated ways of improving the television images from the surface of the Moon on the remaining flights. While the new color camera planned for the RCA built Ground-Commanded Television Assembly (GCTA) had the promise of far better lunar surface color television performance, there was still the problem of the presence of voice and telemetry subcarriers right in the middle of the video bandpass at 1.024 MHz and 1.25 MHz.

This was unavoidable because the Lunar Module and Rover had only one transmitter each (2282.5 and 2265.5 MHz) to send voice, data and TV signals back to the Earth. On the other hand, the Command and Service Module had separate voice/data and television transmitters (2287.5 and 2277.5 MHz) for this and did not have this interference problem. The interfering subcarriers were removed by the use of a simple low-pass filter during the Apollo 12 and 14 missions. This effectively limited the upper video bandwidth to 750 kHz, resulting in a considerable loss of picture detail.

During the Apollo 14 mission the TRW Corporation was asked to test a prototype interference reduction device at the Goldstone MSFN station. This device was based on the concept of forward error estimation and correction. It would analyze the spectrum of an interfering signal and then to generate a model of the interference to reduce or eliminate the interfering signal. However the device was unable to make any significant improvement in the Apollo 14 composite video downlink.

That unsuccessful test prompted Goldstone personnel to explore other ways to accomplish the same purpose after the completion of the Apollo 14 mission. After a series of tests using off-the-shelf test equipment, Goldstone demonstrated a subcarrier cancellation process that removed the offending voice and telemetry signals from the LM downlink by reconstructing the two subcarriers and adding equal and opposite versions to the combined signal.

Dick Nafzger, the GSFC MSFN television systems engineer, worked with the Applied Physics Laboratory MSFN support personnel, who took the Goldstone concept and implemented it into hardware for the three 26-meter MSFN stations,

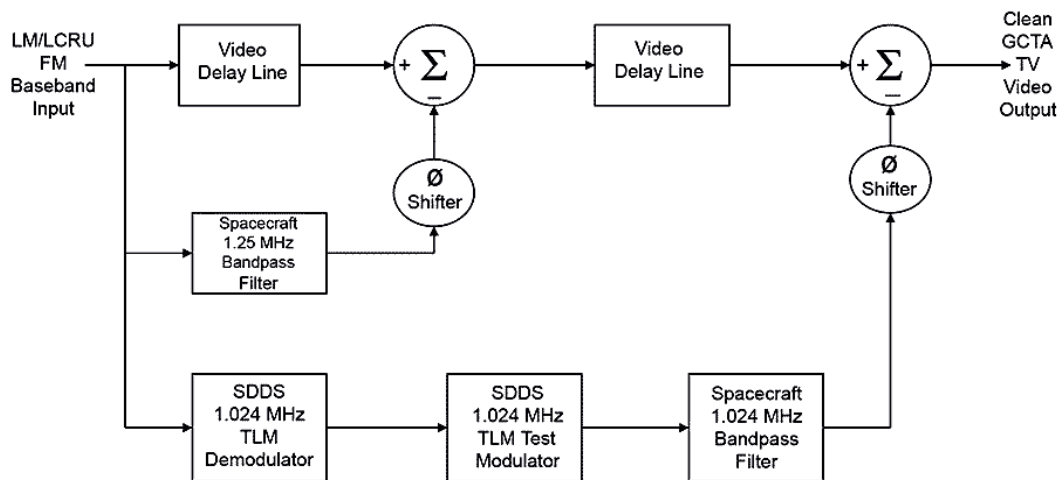

Subcarrier Cancellation Unit Simplified Block Diagram

The final design used the same bandpass filters used in the LM and in the Rover LCRU transmitters to produce the actual waveforms needed to algebraically subtract the actual voice and telemetry subcarriers from the combined FM downlink. While only the 1.25 MHz subcarrier was present in the Rover LCRU 2265.5 MHz downlink, the Subcarrier Cancellation Unit had to handle a 1.25 MHz voice/biomed subcarrier and a second 1.024 MHz telemetry subcarrier used on the LM's 2282.5 MHz downlink.

First the 1.25 KHz filter was used to isolate the voice/biomed subcarrier from the combined FM baseband signal. The FM demodulated baseband signal was delayed in a quartz video delay line to compensate for the time delay introduced by the narrow bandpass of the cancellation unit 1.25 MHz filter. Then the delayed baseband signal was summed with an equal amplitude, but opposite polarity, signal from the narrow bandpass filtered 1.25 MHz subcarrier. The result was the nearly complete cancellation of the 1.25 MHz subcarrier in the baseband video signal.

The wider and more complex spectrum caused with the added 1.024 MHz telemetry subcarrier when transmitting the initial EVA TV pictures using the LM S-band downlink required a different approach. Spare Signal Data Demodulator System (SDDS) modules were built into the Subcarrier Cancellation Unit to decode the real-time TLM bitstream and then to remodulate an isolated 1.024 MHz subcarrier to provide an input for the second summation amplifier.

The SDDS TLM test modulator was phase synchronized with the demodulator to make it coherent with the delayed S/C TLM subcarrier. Then a second video delay line compensated for the longer demod-remod-filter time delay. As in the 1.25 MHz cancellation process an actual spacecraft 1.024 MHz bandpass filter was used to produce an accurate spectrum that would provide the maximum attenuation of the unwanted subcarriers.



Photo taken during SCU manual adjustment



Photo taken after the adjustment was completed

Both the level and phase of the reinserted subcarriers could be adjusted manually to ensure the maximum rejection of the subcarriers was obtained. It was occasionally necessary for the MSFN station television technician to manually tweak the level and phase settings during the television downlink transmission. These photos show the effect on picture quality by even a slight misadjustment of the Subcarrier Cancellation Unit.

The Apollo subcarrier cancellation unit was used on Apollo 15 through 17. That capability was developed at Goldstone and implemented by the Applied Physics Laboratory for Goddard Space Flight Center. This ability to remove the interfering subcarriers from the Lunar Module and Rover downlinks was a key factor in the production of broadcast-quality color television images.

## Apollo 15



### Ground-Commanded Television Assembly (GCTA)

Apollo 15 marked the first use of the [Lunar Rover](#) with its remotely controlled color television camera. Back during the engineering phase for the J-missions, William E. (Bill) Perry, a young engineer in the Engineering and Development Directorate (E&D) came up with a proposal to provide a remote controlled color television camera and pan and tilt mount on the Rover. The camera would be controlled from the INCO consoles in the JSC MCC.

The concept of a ground controlled color television camera was enthusiastically endorsed by MSC Deputy Director Christopher Kraft, who asked Max Faget, Ed Fendell and his INCO group to work closely with JSC E&D and RCA, the selected contractor. The result was a television camera system that could be easily controlled from the INCO consoles in the MOCR. A PDF version of the [Operation and Checkout Manual](#) for the GCTA provides considerable detail and can be reviewed by those interested.

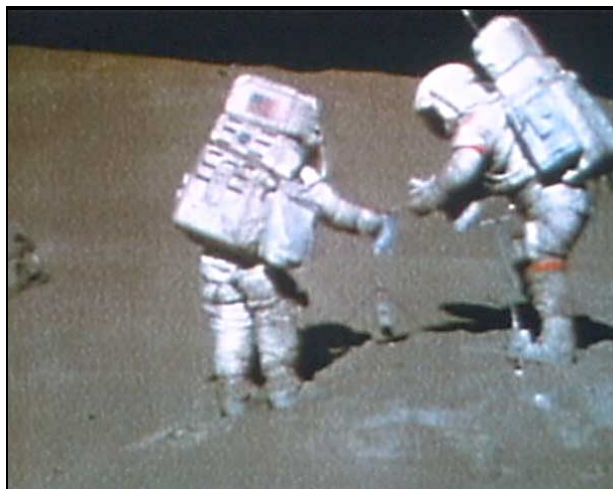
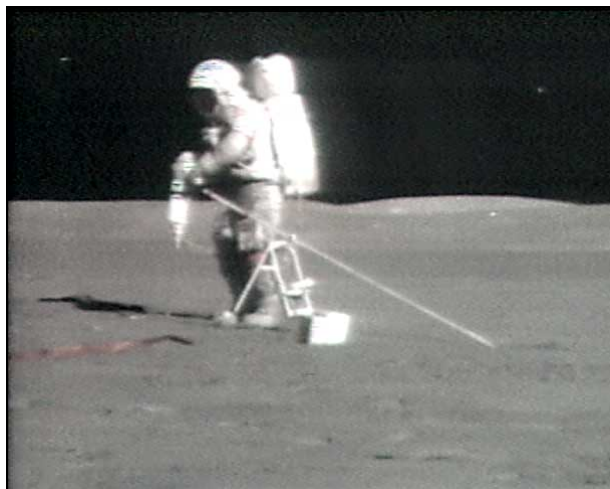

The first GCTA worked amazingly well during the Apollo 15 mission. At each stop the astronauts would activate the camera and orient its antenna toward earth. For the first time, scientists at Mission Control would be able to look over the astronauts' shoulders during surface exploration.



Unlike the rover itself, the camera could be controlled from earth by Ed Fendell's INCO team, allowing scientists to direct the lunar activity, if necessary, on the basis of what they could see. Alternatively, they could use the camera to survey the area for interesting features while the astronauts carried out their preplanned activities.

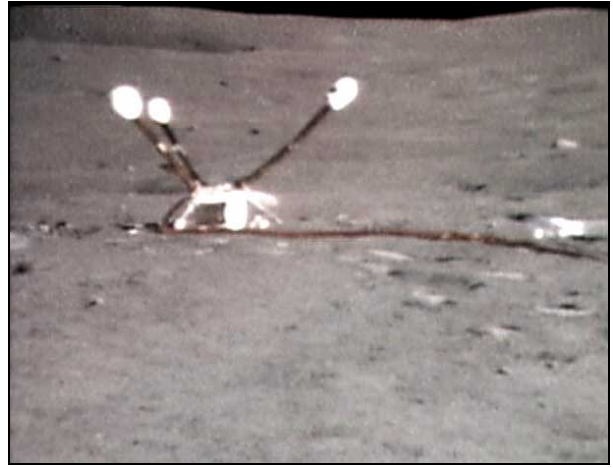
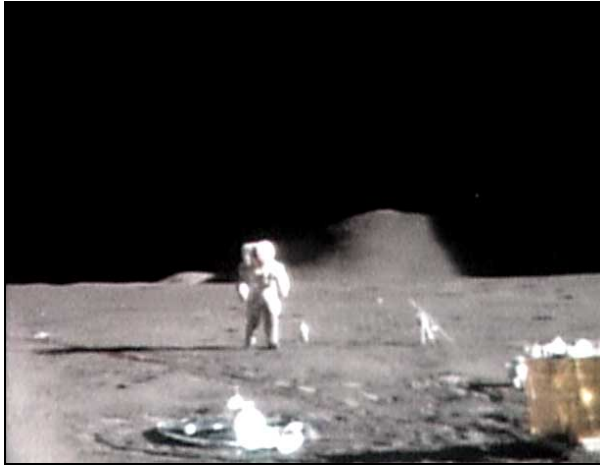

Finally, as the last EVA was about to end, the astronauts parked the Rover where the GCTA could observe the LM during the departure from the surface of the Moon. Then, while the television camera watched, *Falcon's* ascent stage shot up from the surface in a shower of fragments of insulation, visible for only a second or two. Flight controllers had intended to follow *Falcon* with the camera, but decided against it after a problem developed in the camera's elevation drive. The result contrasted sharply with the majestic rise of a Saturn V; with a "quick pop" and "a shower of sparks [that] looked more like something left over from the Fourth of July," as New York Times columnist Tom Wicker put it, *Falcon* quickly disappeared from the TV screen.

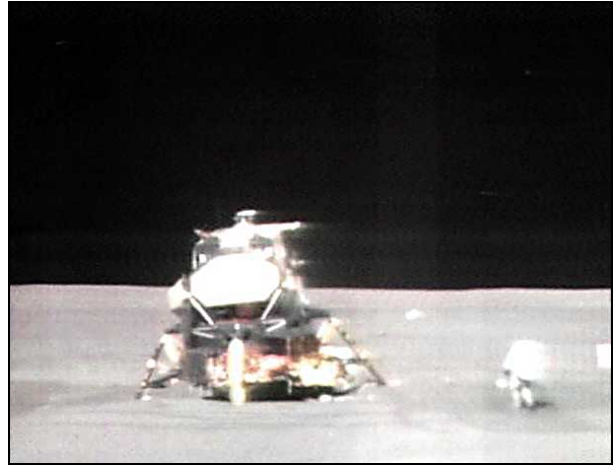

The Apollo 15 Lunar Module Liftoff as seen in the Houston MOCR

Much information was collected about the GCTA system performance that is detailed in the [Interim Final Report](#), RCA R-3838F, 25 February 1972. The only problem that affected operation was elevation clutch slippage when the camera was driven down near the lower stop. Several times it was necessary for the crew to manually raise the camera out of the slippage area.

The elevation clutch problem prevented the planned coverage of the Apollo 15 LM ascent from the surface of the Moon. After the Apollo 15 mission, RCA redesigned the camera elevation clutch to better operate in the extremes of the lunar environment. Check out Sam Russell's excellent first-person account; [Shooting the Apollo Moonwalks](#). Sam was part of the RCA Astro Electronics group who supported the Apollo 15 through 17 missions at the Manned Spacecraft Center in Houston.

## Image Transform

While the Apollo 15 lunar surface color television was very impressive, there was yet another technological breakthrough that would improve the quality of the images from the Moon still further. In spite of the use of the two big 64-meter dishes on the Earth, a slight amount of video noise (or snow) was present in the lunar surface broadcasts. This was caused by the use of a wide 5 MHz video bandwidth on the frequency modulated S-band downlink. That reduced the overall circuit margin experienced during earlier Apollo missions.

Image Transform, a small North Hollywood start-up company, had opened its doors only a few months before the Apollo 16 mission to make video-to-film transfers. The company developed the first practical temporal noise reduction system to enable them to clean up the video before making new films. John Lowry, the founder of Image Transform, used their new image processing system to improve a sample recording of the Apollo 15 television downlink. John was so encouraged by this that he contacted NASA to tell them about what they had done.

In February of 1972, two months before the Apollo 16 launch, John Lowry visited Col. James McDivitt at MSC to show him the results of the Image Transform process. John demonstrated about two minutes of before and after processing of three scenes from the Apollo 15 lunar video. As a direct result of this demonstration Image Transform was contracted to process and clean up the lunar surface video for Apollo 16.

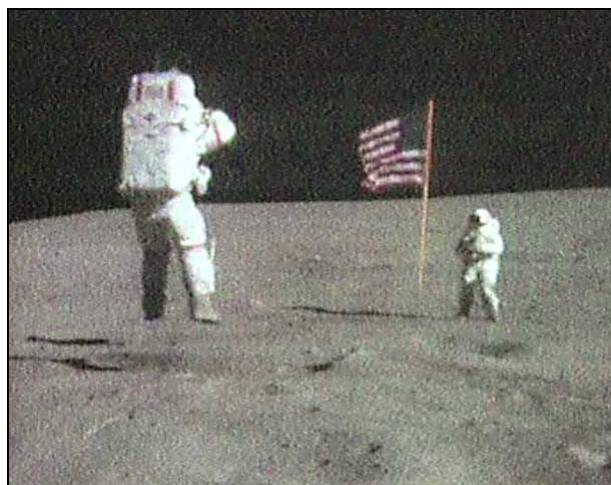

Unprocessed Apollo 16 Image

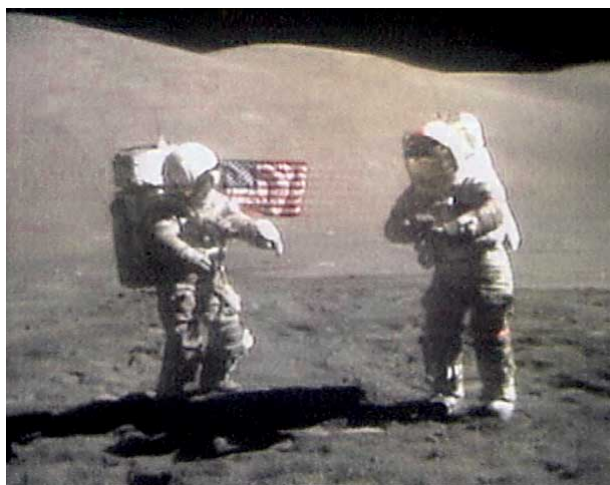

Processed Apollo 17 Image

To add an effective 3db to 6 db improvement in video SNR the Apollo 16 video was routed from Houston to Image Transform in North Hollywood for processing. This is how the Image Transform System worked:

Video noise is random from one frame to next. However, the static areas of the images are largely correlated frame-to-frame. By separating areas of motion from the static portions of the picture, the Image Transform System continuously combined four frames of video to make each new frame.

In static regions of the pictures the noise was reduced by a factor of four enabling significant enhancement of the detail. The areas that were in motion were spatially filtered to reduce the noise a little, but did not impair the quality perception of the images seriously due to the speed of the motion. The spatially filtered static and temporally filtered motion portions of the images were recombined in such a manner as to leave few, if any, artifacts relating to the images having been processed.

The random video noise was quite obviously reduced, the images were enhanced, and the final broadcast pictures looked remarkably good. This process not only improved the SNR of the low light cameras and other noisy parts of camera chains but also cleaned up the noise from the Apollo color TV downlinks and microwave distribution paths.

Here was the lunar surface video processing chain for Apollo 16 and 17:

1. Reception at one of the three Apollo MSFN ground stations. Removal of the 1.024 MHz TLM and 1.25 voice/biomed subcarriers from the S-band FM Lunar Module downlink. Transfer the resulting field-sequential video to Houston MSC.
2. Conversion of the field-sequential color signal to NTSC at Houston MSC. Transfer the converted NTSC signal to Image Transform in North Hollywood, California.
3. Video noise reduction and image enhancement by the Image Transform process. Transfer the cleaned up NTSC video back to Houston via microwave for recording and release to the media.

There were a minimum of three long-haul video circuits involved from Goldstone to Houston to North Hollywood and back to Houston process. Another three or four long haul video circuits were added between Parkes and Honeysuckle and Sydney in Australia to provide the video from those ground stations.

Since Spain did not have one of the large 64-meter antennas most TV coverage was scheduled through Goldstone and Australia. There was some coverage through the Madrid 26-meter MSFN station on occasion. The first pictures broadcast were from the Madrid station providing Image Transform with a real challenge. Yet these pictures were remarkably better than those from any of the prior Apollo missions.

The images from the Goldstone station were bordering on what was considered at the time as studio quality. There were artifacts created whenever the field-sequential color cameras were used to cover fast moving targets. This resulted in things that were in motion appear in short bursts of red, green or blue colors.

For instance, the lift-off of the Apollo 17 Lunar Module ascent stage was covered perfectly by Ed Fendell programming the remote tilt of the Rover color camera. When the engine ignited it blew "confetti" colored stuff in all directions!



John Lowry, the founder of Image Transform, continues working in this field today with his follow-on company, Lowry Digital Images, which specializes in super resolution for motion picture restoration and enhancement. He has digitally restored over 100 major films making pristine DVDs and/or new film negatives.



## Apollo 16

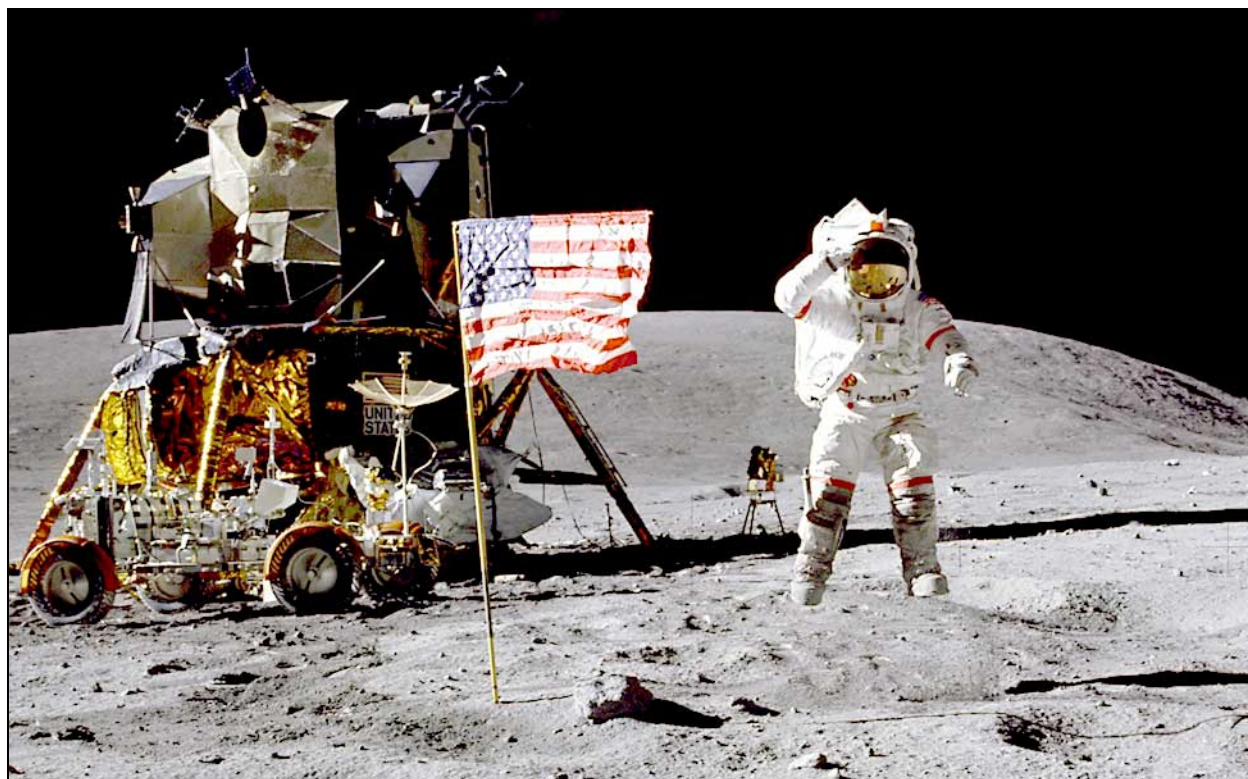

Commander John Young makes his famous leaping salute that was also captured by the GCTA camera

In addition to the Westinghouse color TV camera in the CSM the Apollo 16 LRV carried an RCA Ground-Controlled Television Assembly that had been improved based on experience during the Apollo 15 mission. This was also the first mission where Image Transform was contracted to provide a near real-time clean-up and enhancement of the television pictures from the surface of the Moon. This provided the clearest television images to that point in time.

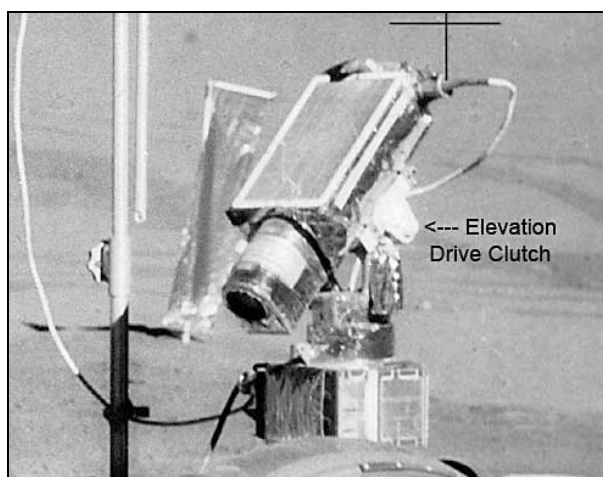

Apollo 15 TV Camera

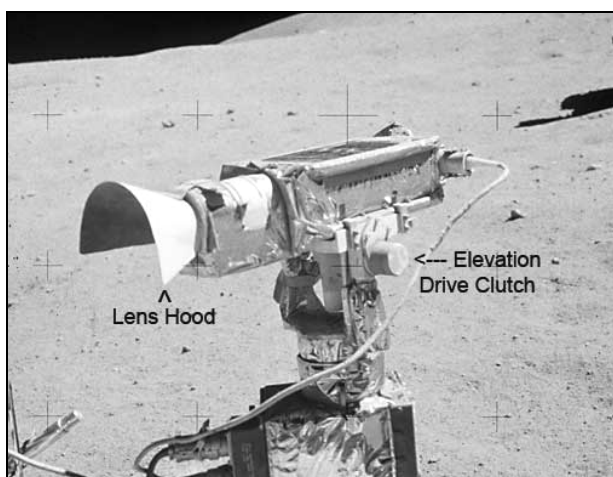

Apollo 16 TV Camera

Chief among the camera changes were improved azimuth and elevation clutches and changes to the azimuth stops to permit viewing on the astronauts while seated in the LRV. The larger single spring slip clutches allowed the camera to be rotated in the temperature extremes encountered during three "days" of operation. The astronauts were also given a special lens hood to place on the camera to reduce the amount of glare caused when direct sunlight fell on the front of the lens. RCA's GCTA [Interim Final Report](#) details the changes made for Apollo 16 and 17.



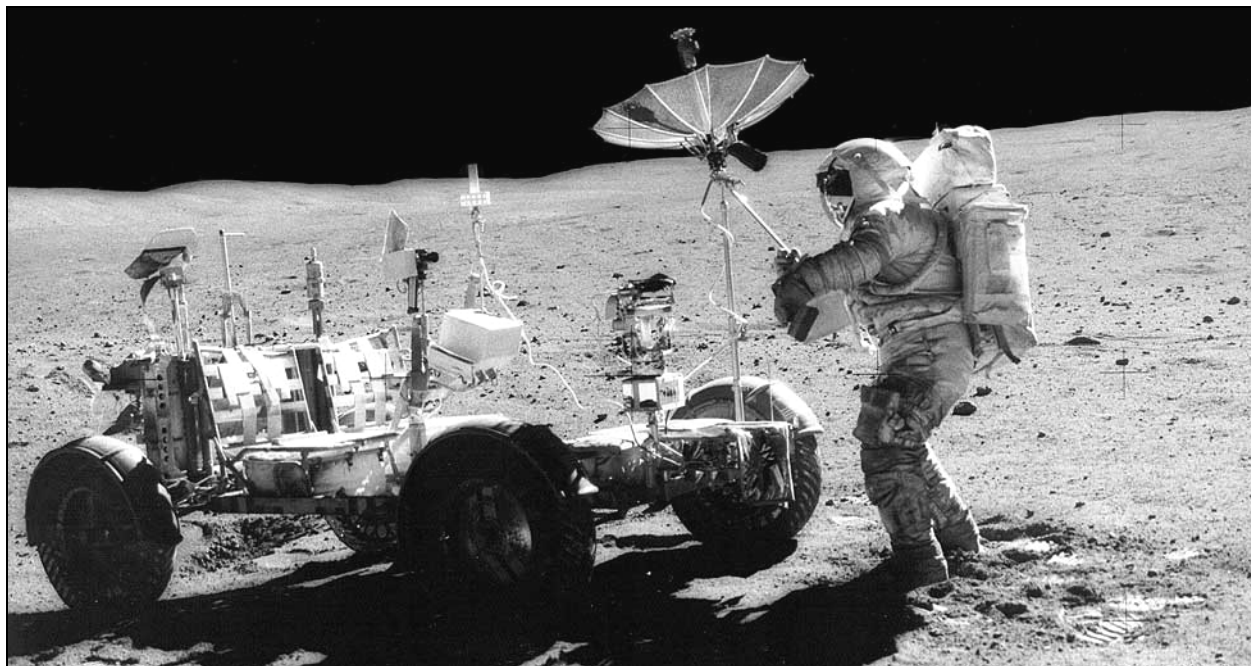

Astronaut John Young aligns high-gain antenna at Station 8



John Young filling a sample return bag



Charles Duke picking up a football sized rock



Astronauts near House Rock



Loading the Rover with Moon samples

Screen captures from Spacecraft Films Apollo 16 DVD sets show the high level of performance of the RCA GTCA camera and the ground station signal processing.





Apollo 16 Liftoff from the Moon

The Rover's camera was able to capture the Lunar Module's ascent stage departing the Moon's surface by the careful programming of elevation motion commands by Ed Fendell's INCO crew in the Houston mission control center. The timed command sequence was started slightly before the actual firing of the engine to take into account the 1.25 seconds it took for the signal to travel from the Earth to the Moon. One can see the cloud of Moon dust stirred up by the rocket engine as the LM ascent stage departs

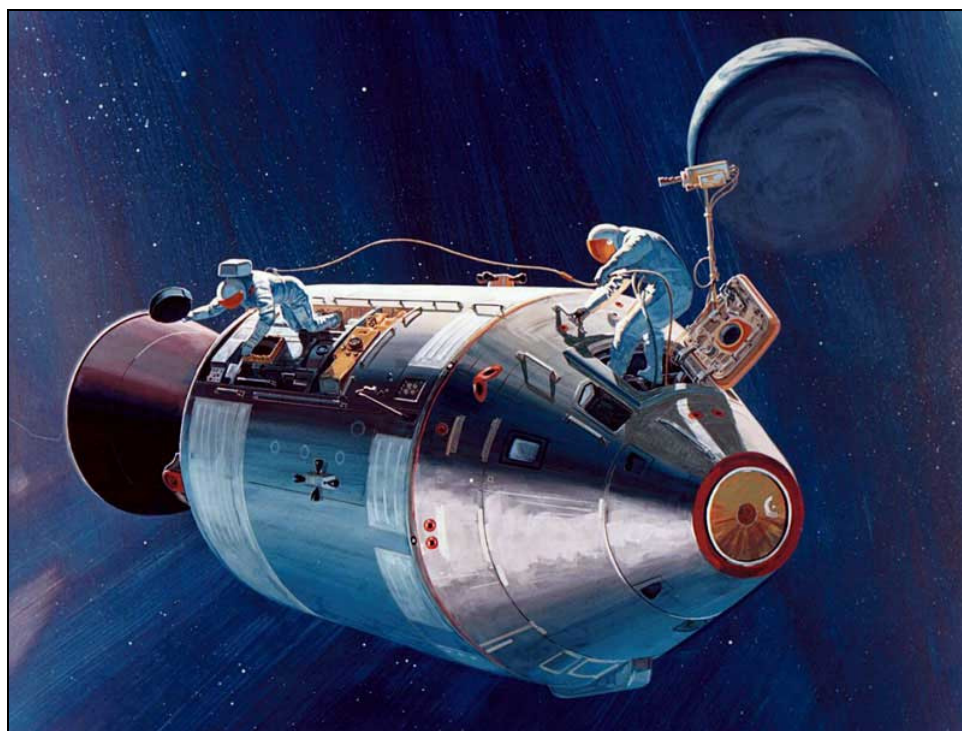

Artist depiction of the Trans-Earth EVA TV coverage

All three Apollo J-series missions (15, 16 and 17) conducted CSM EVA's on the way back to the Earth. This was necessary to recover film packages from the Service Module SIM bay. The Westinghouse field-sequential color camera was mounted as shown in the drawing to cover each of the EVA's.

This photo shows Apollo 16 astronaut "TK" Mattingly returning the PAN camera cassette to the Command Module from the Service module SIM bay. Later "TK" retrieved the Mapping camera film cassette.





## Apollo 17

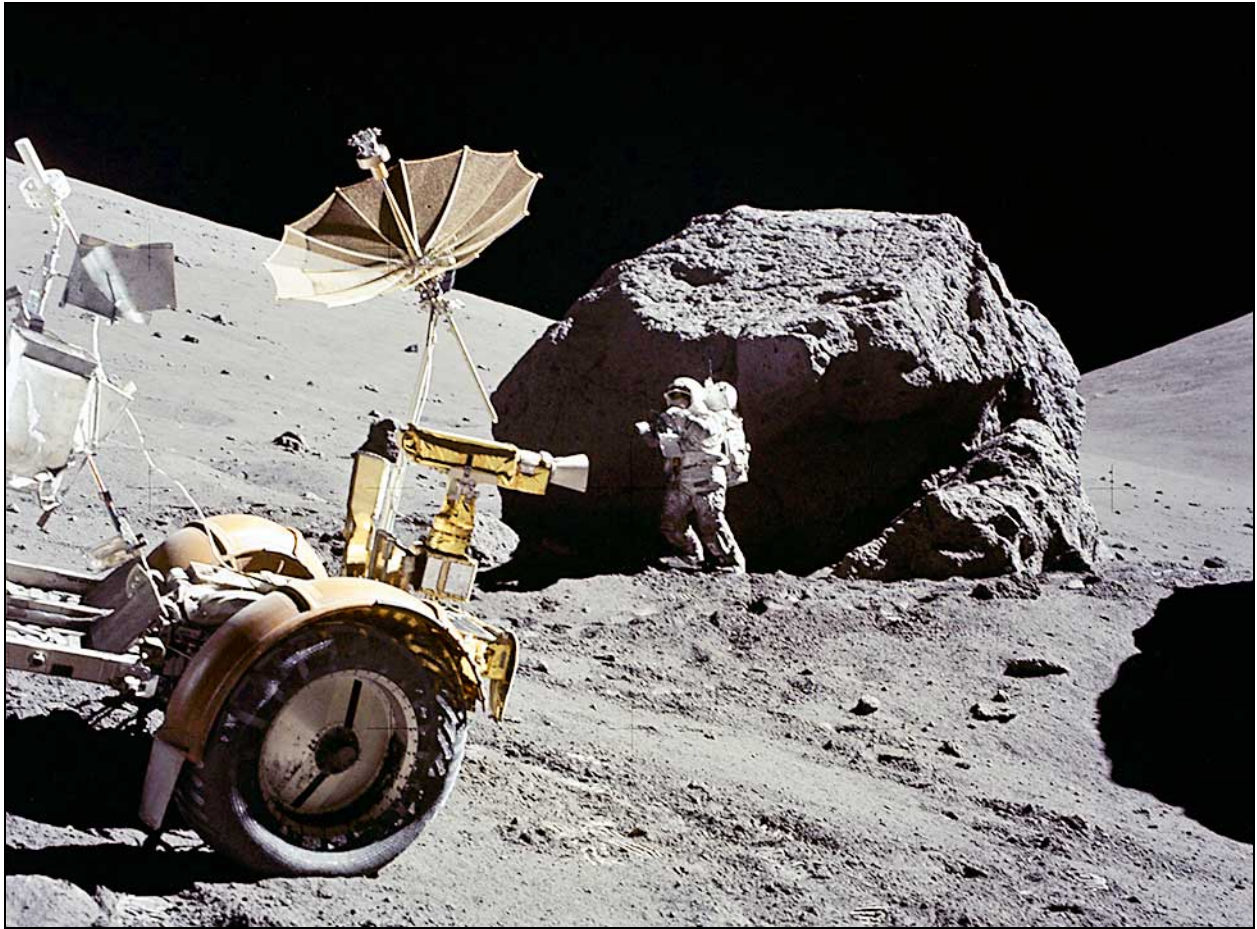

The LRV and Harrison Schmitt near the large rock at EVA 2, Station 6

The sixth and final Apollo visit to the surface of the Moon was the most productive of all. All of the primary mission objectives were met. The astronauts used the Rover to travel some 22 miles (35 km) around the Taurus-Littrow valley. The total length of the lunar stay was just short of 75 hours or just over three Earth days. The GCTA color television broadcasts totaled nearly 22 hours during three EVA periods. There were no problems experienced with the TV camera or its associated ground controlled pan and tilt unit.

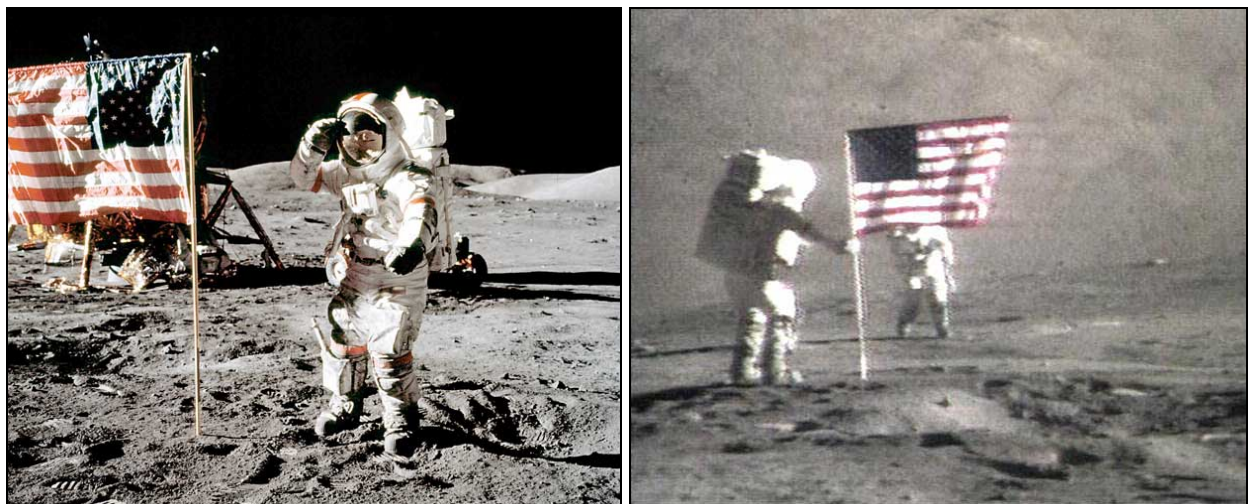

A comparison between a Hasselblad photograph and a TV image, both taken after the flag raising



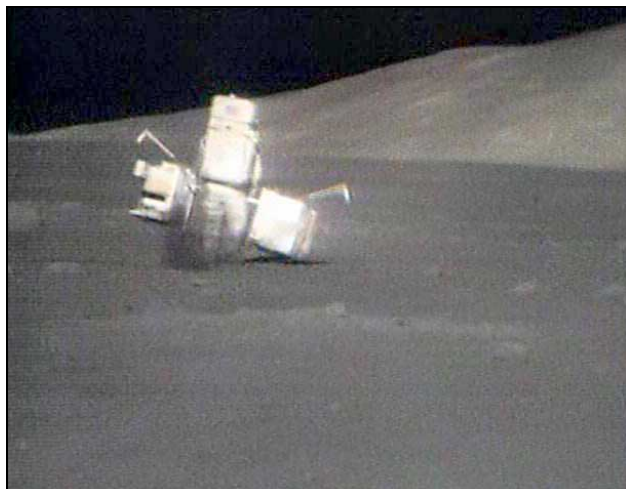

During the first EVA Jack Schmitt carries the ALSEP package out to the placement point

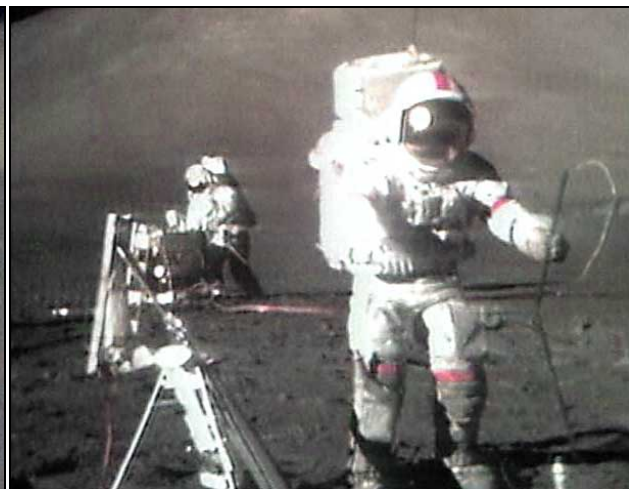

Gene Cernan gets ready to place a Heat Flow sensor after drilling and inserting the sensor casing.



After a misplaced hammer ripped off part of the right read fender during EVA 1, the crew works to install a jury-rigged extension made from a map and "duct" tape.



Jack and Gene search for samples during EVA 2



Gene Cernan gets ready to stow the Hasselblad camera with a 500 mm lens after a telescopic pan.

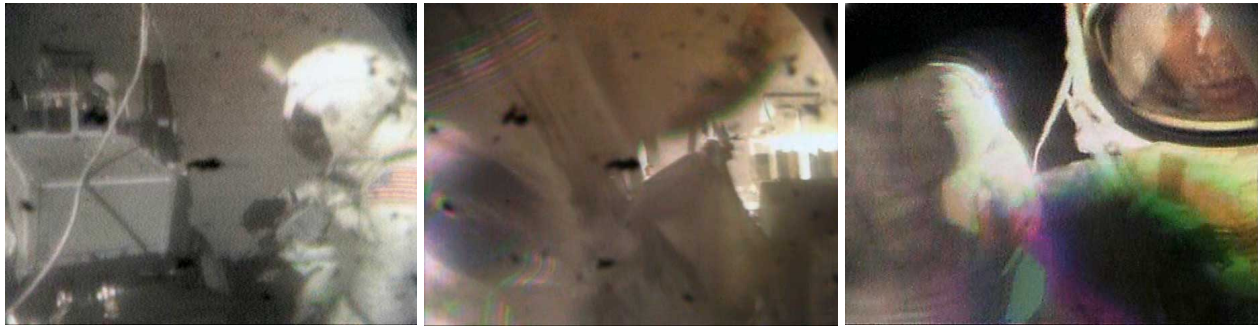

During the travel between EVA stations pieces of lunar dirt and dust was thrown up onto the front of the GTCA camera lens. In this sequence of TV screen captures Gene Cernan uses a small round brush to remove the accumulated dirt and dust from the front of the camera lens.

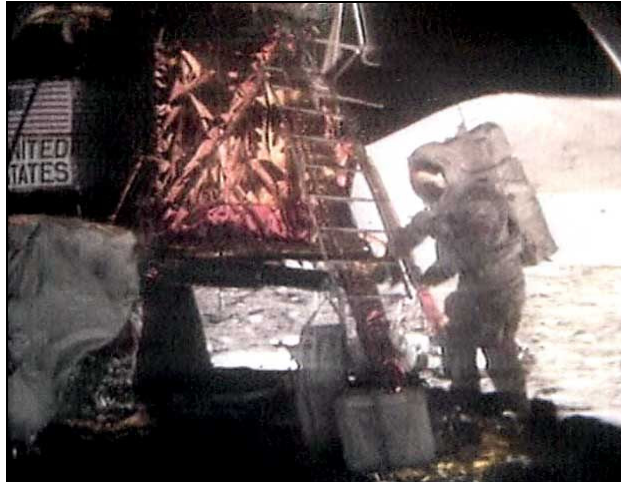

Gene Cernan unveils the Apollo 17 plaque

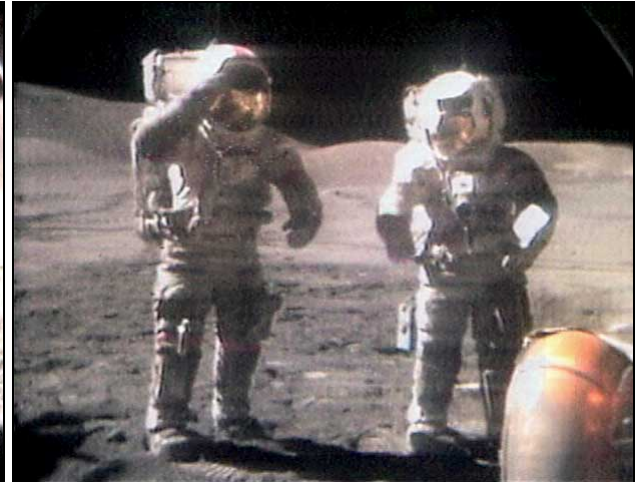

The crew salutes NASA Administrator Dr. Fletcher

Final close-out formal activities

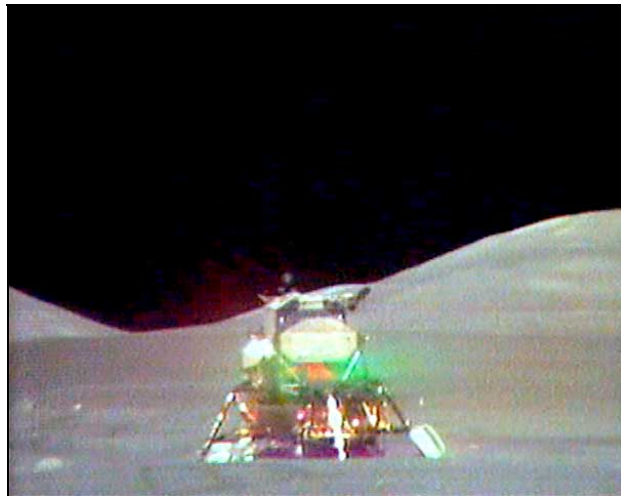

Apollo 17 LM ascent stage engine ignition!



Apollo 17 LM descent stage remains on the Moon

The performance of the Ground Controlled Television Assembly (GCTA) and the Lunar Communications Relay Unit (LCRU) was nearly flawless during the Apollo 17 stay in the Taurus-Littrow region on the Moon. The Rover color TV camera continued to operate for at least 27 hours after the Challenger liftoff at GET 188:01:36 when it was used to observe the detonation of Explosive Package Nr. 7. Some time after this the LCRU suffered an over-temperature failure preventing further use of the camera.



## Acknowledgements:

This discussion of the Apollo television systems would not be possible without the contributions of the following people:

Charles Caillouet, former JSC television engineer

Paul Coan, former JSC Television System Manager

Paul was a key source of information about Apollo spacecraft television systems.

Check his very detailed NASA [Technical Note TN-D-7476](#) published near the end of the Apollo program in 1973.

Mike Dinn, former Honeysuckle Creek MSFN Assistant Station Director

Dwight Elledge, former Taft Broadcasting television Engineer, Houston MSC

Ed Fendell, former JSC Apollo Flight Controller

Ken Glover, ALSJ Contributor

Olin Graham, retired JSC Manager

Mark Gray, Spacecraft Films

Nearly all of the television screen captures used in this paper were obtained from

Spacecraft Films excellent and comprehensive Apollo DVD series.

Dick Holl, former MSFN Slow Scan Converter engineer

Eric Jones, ALSJ Editor

Stan Lebar, retired Westinghouse Lunar Camera Program Manager

Stan made available many documents and photographs he collected during his many years of association with Westinghouse.

Hamish Lindsay, former Honeysuckle Creek MSFN Station technician

John Lowry, cofounder Image Transform

Colin Mackellar, Honeysuckle Creek Webpage Editor

Dick Nafzger, GSFC Television Engineer

Larkin Niemyer, former Westinghouse lunar camera engineer

Sam Russell, former RCA Astronautics television engineer

John Sarkissian, Operations Scientist, Parkes Observatory

John Saxon, former Honeysuckle Creek MSFN Station Operations Supervisor

Gary Sealoft, Johnson Space Center Archive

Ed Tarkington, former JSC television engineer