

Wildfire

Recovery Tips for Idaho



Helping People Help the Land.



Produced by:
USDA
Natural Resources Conservation Service
Boise, Idaho
August 2006
www.id.nrcs.usda.gov

For more copies call: (208) 378-5700

The Natural Resources Conservation Service (NRCS) is an agency of the U.S. Department of Agriculture (USDA). Since the 1930s, NRCS has provided private landowners voluntary technical and financial assistance to care for their natural resources.

Helping People Help the Land.



Contents

As more homeowners move into rural areas to get away from crowded urban areas, they can unknowingly place themselves in harm's way.

Building homes in wooded and/or brushy areas is visually pleasing, but homeowners need to be aware of the potential dangers from wildfire and how to protect their home sites.

Homes even far away from a fire can still be impacted. Slopes left denuded by range or forest fires are especially susceptible to accelerated soil erosion, flash flooding and debris flows due to the absence of

vegetation and roots to bind the soil. Home sites near waterways or on downstream slopes could also be susceptible.

This publication contains some techniques, practices and information that homeowners can use to reduce the chances of damage from wildfires and related flooding events.

The Natural Resources Conservation Service (NRCS) and your local conservation district are available to answer any questions and provide assistance.



A house in danger from a brush fire.



Sound fire prevention techniques saved this house.

Prevention	2	Sandbag Protection	10
Revegetation	3	Silt Fence	12
Vegetative Practices		Straw Bale Check Dams	14
Recommended Grasses & Forbs, Northern Idaho	4	Straw Bale Dikes	16
Recommended Grasses & Forbs, Eastern & Southern Idaho	5	Straw Mulching	18
Seeding	5	Hazards from Debris Flows	20
Hydroseeding & Hydromulching	8	For Additional Information	20
Structural Practices			
Jute Netting	9		



Prevention

It's best to be proactive instead of reactive. There are many things you as a homeowner can do to protect your home from wildfires.

Step 1:

Plan your home site location to reduce the risk of damage caused by wildfires.

Check with local officials to find out about the availability of fire protection for your location. Evaluate your site for accessibility by fire protection equipment and the placement of your home on a level site versus a sloped site. Ensure that your homesite and access roads are clearly identified.

Step 2:

Work with your architect, contractors, and local fire officials during construction to create a home that is fire-wise and aesthetically pleasing.

Use fire resistant roofing and wall materials. Keep flammable vegetation, woodpiles and other debris at a safe distance from the home. If your home has a fireplace make sure the fireplace is an approved unit and the chimney has noncombustible wire mesh screening. Windows should have thick-tempered safety glass. Double pane windows may be appropriate but contact your local fire officials to determine what is most suitable.

Step 3:

Maintain the landscape and create a defensible space or safety zone around your home.

This zone can be created by selecting fire resistant landscape plants and by mowing or clipping the herbaceous vegetation at least 30 feet around your home

to a 3-4 inch height. Waiting to mow until the plants have set seed (late spring to early summer) will help maintain the vigor of your grasses and forbs. Mowing around trees and shrubs, up to and beyond 100 feet, will create mulch to help reduce soil erosion and reduce a fire's ability to climb into trees and brush. As the slope of your lot increases, your safety zone may need to be extended beyond 100 feet. Consult with local fire officials on the creation and maintenance of your safety zone.

Clean roofs, gutters, and eaves as a regular maintenance activity. Stack firewood away from the house and other outdoor buildings.

Most importantly: Develop a fire escape plan that details escape routes and a meeting location outside the home. Rehearse your plan so all family members know what to do and where to go in an emergency.



Even a home not surrounded by trees will need a firebreak around it to prevent grass/range fires.

The following pages provide information for restoration after a fire.

Revegetation



After a fire, vegetation is one of the most important factors influencing soil erosion. It helps control erosion by shielding the soil from the impact of raindrops and maintains a soil surface capable of absorbing water by slowing the amount and velocity of runoff.

There's a good chance seeds and plants are still alive and will germinate or regrow. Old and new vegetation will

help protect the soil from erosive rains. In severely burned areas, seeding may be needed.

Your first step is to field check the burned area and map out severely burned areas having very little seed under the ash.

White ash shows where the fire was very hot and seeds most likely destroyed. Burned areas found in thick brush without a grass understory will not have enough seed.

Desirable seeds are grasses and forbs. The minimum amount needed is 25 viable seeds per square foot drilled and 50 seeds per square foot broadcast.

Exposed earth areas like new roads, firebreaks and steep embankments – including cut and fill slopes – should also be planted.

Hydrophobic Soils

Wildfires burn dead and living vegetation which accumulates on the soil surface. Burning sometimes produces volatile hydrophobic or water repellent substances that can penetrate the soil up to six (6) inches deep.

When these substances penetrate the cool soil, they condense and coat the soil particles, making the soil hydrophobic.

Soils that are water repellent exhibit a decreased water infiltration rate and an increased runoff rate creating extreme soil erosion potential.

Initially, rain or irrigation water will run off hydrophobic soils instead of soaking in and promoting seed germination and root growth. This condition makes it difficult to establish a stand of vegetation.

Water repellent soils will be the worst where vegetation was thickest and burn temperatures extreme, especially under trees, thick brush and around buildings that burned to the ground.

Field Check

Field check for water repellent soil conditions by digging a shallow trench with a vertical wall and applying water droplets from the surface down in 1-centimeter increments.

- If water sits as a ball on the soil for 10 to 40 seconds, it is moderately hydrophobic.
- If more than 40 seconds, it is strongly hydrophobic.

Treatment

On gentle slopes, chisel the soil a few inches deep, perpendicular to the slope, to break up the hydrophobic layer. This will allow water to penetrate the soil surface for seed germination and root growth.

On steeper slopes, lightly spray the soil surface with a soil wetting product (surfactant). This will break up the hydrophobic substances coating the soil particles the way dishwashing detergent breaks up grease so water can penetrate. Soil wetting products can be purchased at lawn and garden stores.

Methods of Seeding

Seeds can be broadcast by hand, with a hand-operated seeder, hydroseeder, drilled or air seeded.

Most homeowners and small landowners will find broadcasting to be the most economical method. Hydroseeding requires roads for equipment access and a nearby water supply. Use drill seeding when possible or aerial seeding on large acreages.

When to Seed

The best time to seed is after October 20 and before winter rains or snow. Timeliness of rains will affect how well the plants will grow next spring.

Protect exposed earth areas like roads, firebreaks and steep embankments with straw mulch at a rate of two (2) tons per acre. Anchor the mulch by punching with shovels or crimping equipment. A 74-pound bale of straw will cover 800 square feet.

Recommended Grasses, Forbs

Northern Idaho

These plants were selected based on the depth and types of soil, average annual rainfall, availability of seed, reseeding ability and amount of growth produced.

Seeds are available from commercial seed suppliers listed in the yellow pages of your telephone directory under “Seeds and Bulbs – Wholesale and Growers.”

‘Sherman’ Big Bluegrass is a long-lived native bunchgrass. Recommended sites include intermediate and favorable brush sites, sunny places on mountain brush ranges, burned-over forested areas and meadows at lower elevations.

‘Covar’ and ‘Bighorn’ Sheep Fescue is a long-lived, short statured, introduced bunchgrass with short leaf blades. It is more drought tolerant than other fescues. Top growth is short, but ground cover and root production are excellent. A very good erosion control and understory species that competes well with weeds.

‘Goldar’ and ‘Anatone’ Bluebunch Wheatgrass is a long-lived, drought tolerant, wide-spread native bunchgrass. It begins growth early in spring and again with fall rains. Recommended sites include sagebrush, Ponderosa pine, mountain brush and juniper ranges. Secar Snake River wheatgrass can be used on hot, droughty, southerly slopes as an alternative.

‘Luna’ Pubescent Wheatgrass and ‘Rush’ Intermediate Wheatgrass are sod-forming, long-lived introduced grasses. They begin growth very early in the spring and remain green into mid-summer.

‘Pryor’ Slender Wheatgrass is a short-lived native bunchgrass with good seedling vigor. It is valuable in erosion-control seed mixes because it develops rapidly, is drought tolerant and compatible with other species. It tolerates a wide range of conditions and adapts well on mountain brush areas.

‘Sodar’ Streambank Wheatgrass is a long-lived, drought tolerant, creeping sod-former adapted to fine-medium textured, well drained soil. It has good seedling vigor and is well adapted for erosion control.

‘Bannock’ and ‘Critana’ Thickspike Wheatgrass is a long-lived, native sod-forming grass characterized by drought tolerance and early spring growth. It is adapted to disturbed range sites and dry areas subject to erosion.

‘Garnet’ and ‘Bromar’ Mountain Brome is a short-lived native bunchgrass with good seedling vigor. It is valuable in erosion control seed mixes because it develops rapidly, is moderately shade tolerant and compatible with other species. Recommended sites include mountain brush, aspen, conifer forest and areas in mountain valleys.

‘Durar’ Hard Fescue is a long-lived, short statured, introduced bunchgrass with short leaves. Top growth is short, but ground cover, root production, erosion control and weed competition are excellent. Recommended for forestlands and other higher rainfall areas.

‘Manchar’ Smooth Bromegrass is a long-lived, introduced sod-forming grass. Once established it has the ability to suppress invasion of undesirable vegetation. Recommended for mountain brush and burned-over forestlands.

‘Latar’ and ‘Paiute’ Orchardgrass is a long-lived, shade tolerant introduced bunchgrass. It is well adapted to mountain brush and pine zones for erosion control mixes.

Alfalfa is a very productive introduced perennial legume. Varieties for low precipitation sites include ‘Ladak’, ‘Trevois’, ‘Ranger’, ‘Nomad’ and Spreader III. All are excellent for wildlife forage.

‘Delar’ Small Burnet is a perennial winter-active forb that grows to two (2) feet tall. It is semi-evergreen and deep rooted. Growth is most vigorous in fall and spring. It establishes with ease in mountain brush and mountain valley areas. Excellent for wildlife forage and vegetative firebreaks.

Yellow Sweetclover is an introduced, tall, stemmy, deep-rooted biennial legume commonly used as a cover crop for perennial seeding. ‘Madrid’ is an adapted variety.

Recommended Grasses, Forbs

Southern & Eastern Idaho

These plants were selected based on the depth and types of soil, average annual rainfall, availability of seed, reseeding ability and amount of growth produced.

Seeds are available from commercial seed suppliers listed in the yellow pages of your telephone directory under "Seeds and Bulbs – Wholesale and Growers."

'Sherman' Big Bluegrass is a long-lived native bunchgrass. Recommended sites include intermediate and favorable brush sites, sunny places on mountain brush ranges, burned-over forested areas and meadows at lower elevations.

'Covar' and 'Bighorn' Sheep Fescue is a long-lived, short statured, introduced bunchgrass with short leaf blades. It is more drought tolerant than other fescues. Top growth is short, but ground cover and root production are excellent. A very good erosion control and understory species that competes well with weeds.

'Goldar' and 'Anatone' Bluebunch Wheatgrass is a long-lived, drought tolerant, wide-spread native bunchgrass. It begins growth early in spring and again with fall rains. Recommended sites include sagebrush, Ponderosa pine, mountain brush and juniper ranges.

'Hycrest' and 'Nordan' Crested Wheatgrass are long-lived, drought tolerant, introduced bunchgrasses adapted to a wide range of sites and precipitation zones as low as 10 inches. Growth begins early in spring and again with fall moisture. Recommended sites are sagebrush, Ponderosa pine, mountain brush and juniper-piñon ranges.

'Luna' Pubescent Wheatgrass is a long-lived, introduced, aggressive sod former adapted to low fertility sites and fine textured soils. It remains green into mid-summer when soil moisture is limited.

'Rush' Intermediate Wheatgrass is a mild sod-forming, long-lived introduced grass. It begins growth very early in the spring and remains green into mid-summer.

'Pryor' Slender Wheatgrass is a short-lived native bunchgrass with good seedling vigor. It is valuable in erosion-control seed mixes because it develops rapidly, is drought tolerant and compatible with other species. It tolerates a wide range of conditions and adapts well on mountain brush areas.

'Secar' Snake River Wheatgrass is related to thickspike wheatgrass, but is similar in appearance to bluebunch wheatgrass. It is long-lived, begins growth early in spring and regrows with fall rains. It is well adapted to hot, droughty, southerly slopes.

'Vavilov' and 'P-27' Siberian Wheatgrass is similar to crested wheatgrass, but has finer leaves and retains its greenness and palatability later into the summer. It is recommended for sites with 7-12 inches of precipitation and especially useful on sagebrush and juniper sites. Once established it is well adapted to light, droughty soils and can withstand extended periods of drought better than crested wheatgrass.

'Sodar' Streambank Wheatgrass is a long-lived, drought tolerant, creeping sod-former adapted to fine-medium textured, well drained soil. It has good seedling vigor and is particularly well adapted for erosion control.

'Bannock' and 'Critana' Thickspike Wheatgrass is a long-lived, native sod-forming grass characterized by drought tolerance and early spring growth. It is adapted to disturbed range sites and dry areas subject to erosion.

Alfalfa is a very productive perennial. Varieties for low precipitation sites include 'Ladak', 'Trevois', 'Ranger', 'Nomad' and Spreader III. All are excellent for wildlife forage.

'Delar' Small Burnet is a perennial winter-active forb that grows to two (2) feet tall. It is semi-evergreen and deep rooted. Growth is most vigorous in fall and spring. It establishes with ease in mountain brush and mountain valley areas. It is excellent for wildlife forage.

Yellow Sweetclover is an introduced, tall, stemmy, deep-rooted biennial legume commonly used as a cover crop for perennial seeding. 'Madrid' is an adapted variety.

Seeding

Seeding Guide

<u>Recommended Plants</u>	<u>Seeding Rate lbs/acre</u>	<u>Drill Broadcast Rate lbs/acre</u>	<u>Seeding Rate lbs/10,000 sq.ft area</u>
Bluegrass, Big	2.0	4.0	1.0
Fescue, Sheep and Hard	4.0	8.0	1.9
Wheatgrass, Bluebunch (SRW)	7.0	14.0	3.2
Wheatgrass, Intermediate	10.0	20.0	4.6
Wheatgrass, Pubescent	10.0	20.0	4.6
Wheatgrass, Slender	6.0	12.0	2.8
Wheatgrass, Streambank	6.0	12.0	2.8
Wheatgrass, Thickspike	6.0	12.0	2.8
Mountain brome	10.0	20.0	4.6
Smooth brome	5.0	10.0	2.3
Orchardgrass	4.0	8.0	1.9
Alfalfa	5.0	10.0	2.3
Small Burnet	20.0	40.0	9.2
Yellow sweetclover	4.0	8.0	1.9
Crested wheatgrass	5.0	10.0	2.3
Siberian wheatgrass	6.0	12.0	2.8

Seed mix: These seeding rates are full rates per acre if seeded as a single species. If you desire different species in a mix, multiply this rate by the percent of each kind you want in your mix to total 100% or more.

Seed Specifications

The total amount of seed purchased should equal the acres burned multiplied by the recommended seeding rate per acre. Include any roads and firebreaks in the burned acreage.

If the seed is coated by the supplier or is less than 80% Pure Live Seed (PLS), then adjust the amount of seed purchased. Check seed tags for each species to determine the percent germination and purity. $PLS = \% \text{ germination} \times \% \text{ purity}$.

Keep each species' seeds in separate bags in a cool, dry environment.

Check seed tags for species and the percent of germination and purity. Increase the seeding rate if percent germination multiplied by the percent purity shows less than 80% PLS.

Low PLS Adjustment

Example: When the recommended seeding rate is 10 pounds per acre and your seed has a 90% purity and a 70% germination rate, then your PLS = 63% PLS ($.9 \times .7 = .63$). Since the PLS is less than the recommended 80%, you need to adjust the seeding rate. An adjustment factor is calculated by dividing the suggested PLS (80%) by your actual PLS (63%). In this example the adjustment factor is 1.3 ($80/63 = 1.3$). To calculate the actual seeding rate, multiply the adjustment factor by the recommended seeding rate ($1.3 \times 10 \text{ lbs/acre} = 13 \text{ pounds per acre}$).

No adjustment is needed when you inoculate alfalfa or other legume seeds.

continued...

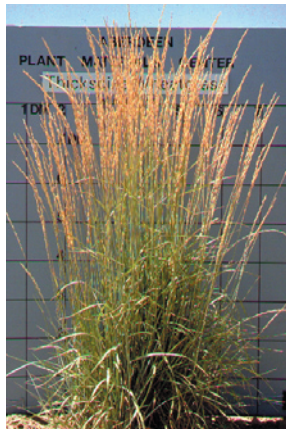

'Bannock' thickspike wheatgrass

Seeding

Recommended seeding rates are based on uncoated seed and need to be adjusted as shown in the following example after making any adjustment for low PLS.

Example: Coated alfalfa seed or other small seeded legumes with a suggested seeding rate of six (5) pounds per acre. The adjustment factor = 1.5; therefore, the adjusted seeding rate is 1.5×5 lbs/acre which equals 7.5 lbs/acre.

Equipment and Materials Needed

Equipment and materials should be ready before you start. This list of items will minimize disruptions and let you finish seeding in one day for small areas.

- One (1) hand operated cyclone seeder for each person doing the seeding
- Weight scale with at least a 20-pound capacity
- A minimum of two (2) plastic buckets
- Seed targets. At least two (2) pieces of 2x2-foot soft cloth or cardboard with corrugations exposed, nailed to a small wood frame or at least four (4) pieces of 1x1-foot soft cloth attached to an open wire frame
- Four (4) paper grocery bags and two (2) markers
- Inoculant. Specific type for each legume. Omit if supplier coats seed.

Getting Started

Inoculating legumes enables them to “fix” nitrogen. This improves the health of the plant and provides additional fertility for other plants.

If the supplier hasn't, inoculate alfalfa and other legume seeds the evening before or early on seeding day so the seed will be dry before use. Re-inoculate seed over 30 days old or that has not been kept cool and dry.

Seeding Specifications

Divide each species' seed into equal amounts and label bags. Keep cool and dry. When using a mixture, broadcast each species separately, if possible, to get a uniform distribution.

Adjust the seeder according to the manufacturer's instructions. If seeding in arid areas, use half the

seeding rate listed. Base it on the full seeding rate when doing a simple once-over seeding. Set out two (2) seed targets 10 feet apart and offset 10 feet. With the hand-operated seeder half full, start broadcasting and walk between the seed targets. Stop and check the seed count at each target. Adjust the seeder and repeat until the number of seeds per square foot agrees with your approximate target of no less than 50 seeds per square foot.

When seeding, walk in (two) 2 directions to achieve a uniform distribution. Using half the seed of a given species, broadcast the seed as you walk across the slope, starting at the top of the burn area. Notice how far the seed is thrown. When you reach the other edge, move down slope an equal distance to the width of the throw.

Continue broadcasting and walk back across the slope, trying to avoid gaps. Repeat this process all the way to the bottom. When several people are seeding an area, move across the slope together. Adjust your walking pace so you have enough seed to finish.

Repeat this procedure going both up and down slope with the remaining half of the seed. On steep slopes, it is best to broadcast only going down because you need to maintain the same walking speed used to calibrate the seeder. Using several people will make this task easier.

Broadcast in one direction if conditions do not allow seeding in two directions. Broadcast the remaining seed in the same direction across the slope while walking midway between your previous lines of travel.

Repeat the above process for each species.

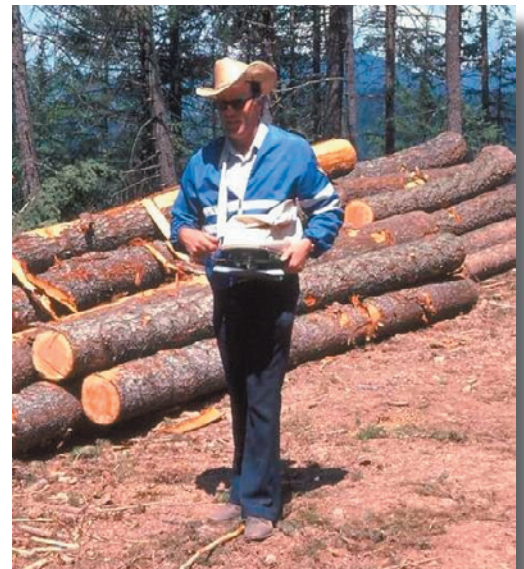

Broadcast seeding.

Hydroseeding & Hydromulching

The terms hydroseeding and hydromulching are often used interchangeably.

Hydroseeding is applying a mixture of water, wood fiber mulch, seed and fertilizer to the soil surface to prevent soil erosion and provide an environment conducive to plant growth.

Hydromulching is applying a mixture of water, wood fiber mulch and often a tackifier to a slope to prevent soil erosion.

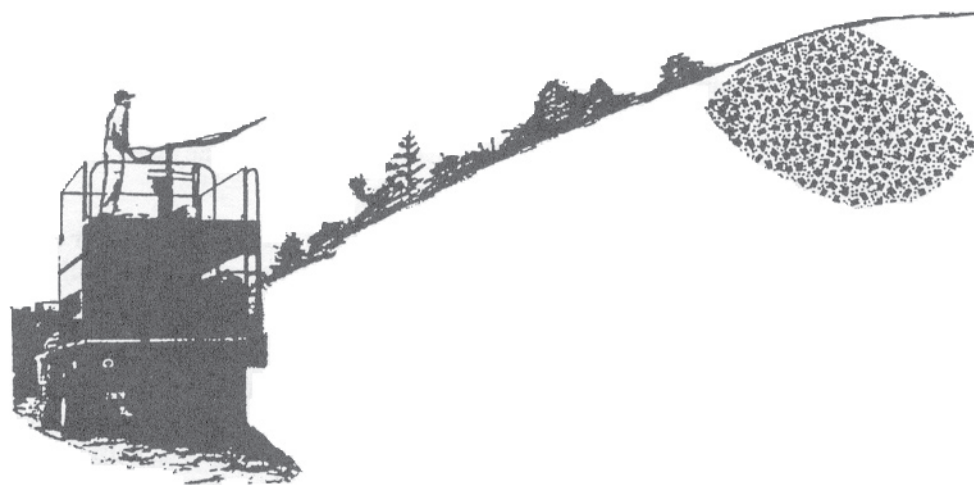

During hydroseeding, truck-mounted nozzles can treat slopes up to 125 feet away. For downslopes, it can reach out to 150 feet.

200-225 feet of slope can be treated by first using 100-150 feet of hose pressurized by the tank truck.

When to Use

General recommendation: On steep, highly erosive slopes that have been partially or completely denuded of vegetation due to fire, apply seed to the site first and then hydromulch over it to keep the seed from washing off the slope.

This is a fairly expensive control method that is often reserved for areas close to roads, bridges, homes and other structures. Use is sometimes restricted due to lack of access roads and adequate water supplies.

Slope lengths of 125 to 225 feet can be treated.

For small landowners, this technique will need to be hired out. Check the listings under "Landscape Contractors," "Erosion Control," or "Seeding Contractors" in the yellow pages of your telephone directory.

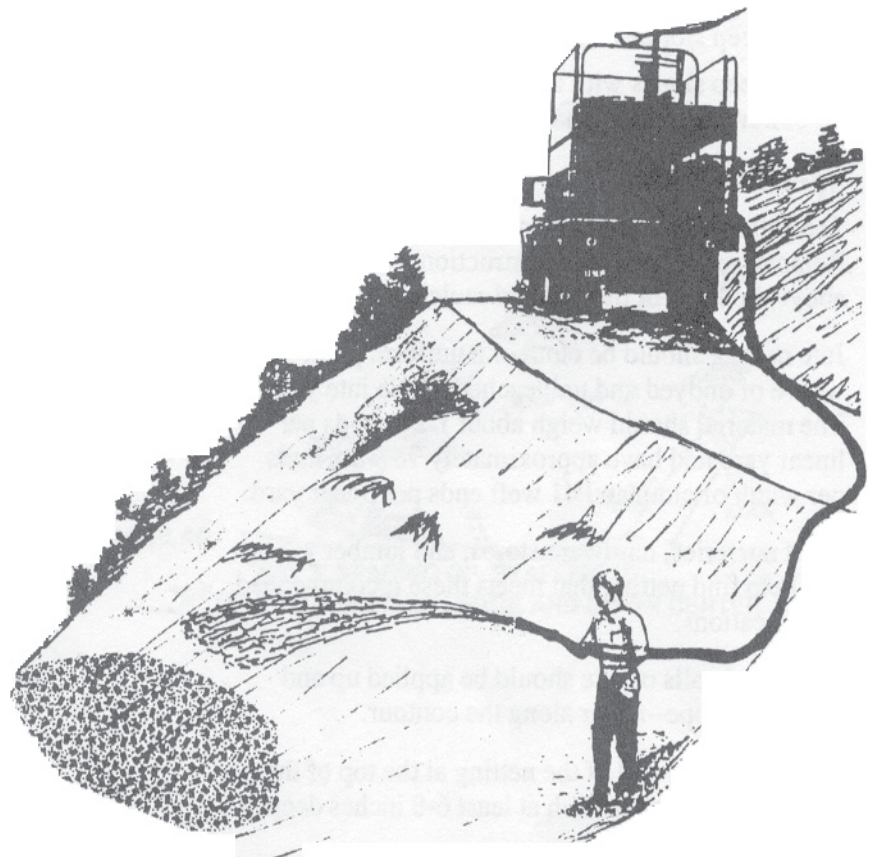

Jute Netting

Netting made of jute can be laid and anchored over straw or other mulch to help protect the soil from wind and water damage. Netting helps reduce soil erosion and provides a good environment for vegetative regrowth.

Since jute is a biodegradable material, it will eventually decompose and is not a threat to the environment or wildlife.

When to Use

Jute netting can be used on areas that may erode near structures such as homes, roads and bridges or on small, steep disturbed areas.

Netting can be applied alone (without mulch) as an alternative to straw or wood mulches on flat sites for dust control and seed germination enhancement.

It should never be used alone where high water runoff amounts are expected.

The use of jute netting is not appropriate in all situations. Examples include:

- Steep slopes with sandy soils
- Steep slopes with many surface rocks
- Steep slopes with a significant amount of burned vegetation remaining

Specifications

The soil surface should be reasonably smooth. Remove rocks and other obstructions higher than the level of the soil or mulch.

Jute netting should be a uniform, plain-woven cloth of undyed and unbleached single jute yam. The materials should weigh about 1.2 pounds per linear yard, with approximately 78 warp ends per width and 41 weft ends per linear yard. Most nurseries and hardware stores can help find netting that meets these specifications.

Individual rolls of jute should be applied up and down the slope, but never along the contour.

Bury the upper end of the netting at the top of the disturbed area in a trench at least 6-8 inches deep. Lay out rolls so edges overlap by at least four (4) inches.

Extremely important: When more than one roll is required going down slope, the ends should overlap by at least three (3) feet.

Secure the netting to the soil surface with anchor pins or staples. Anchor pins are made of rigid 0.12-inch diameter or heavier galvanized wire with a minimum length of 10 inches for hook or “J” type pins. Use wire staples 0.09 inches or greater in diameter, and have U-shaped legs that are at least six (6) inches long. Longer staples are needed for sandy soils.

Staples or anchor pins need to be driven perpendicular into the slope face and should be spaced about five (5) feet apart down the sides and center of each roll. Spacing between staples at the upper end of a roll, and at the end overlap of two (2) rolls, should not be greater than one (1) foot.

The netting should go beyond the edge of the mulched or seeded area at least one (1) foot on the sides and three (3) feet at the bottom. If there is vegetation at the boundaries of the seeding area, the netting should be continued into the stable vegetated area or to the edge of a structure.

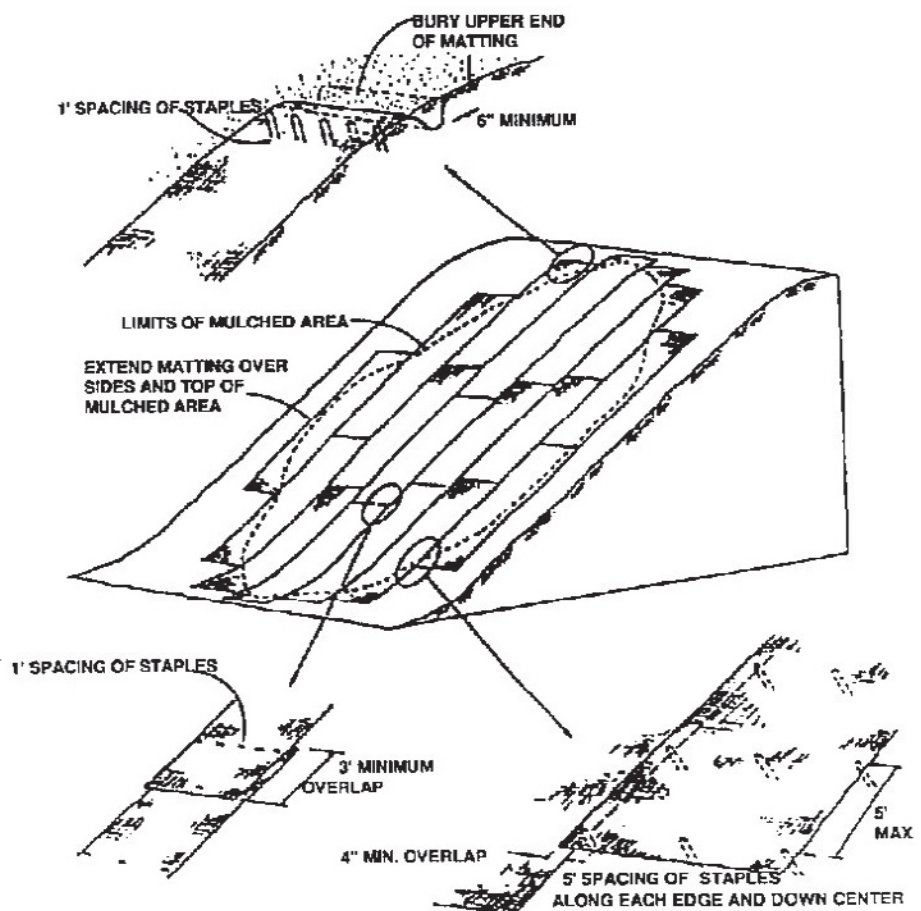

Sandbag Protection

An inexpensive, temporary barrier or wall that's 1-2 feet high can be constructed by stacking sand- or earth-filled sandbags. These can be placed to divert mud and other debris flows away from buildings. They will not, however, provide protection from high debris flows.

When to Use

- To protect building sites vulnerable to low mud debris flows from steep, erodible slopes that are partially or completely void of vegetation due to wildfire burns.
- As an inexpensive, temporary protection method for a home before predicted heavy rainfall.

Note: Sandbags deteriorate when exposed to continued wetting and drying for several months. If the bags need to be used for more than a few months, cement can be mixed with the sand. The cement and sand mixture will harden when the bags dry.

Methods and Materials

Sandbag barriers are easy to construct. Burlap bags, sand, plastic, lumber, cement and plywood are readily available at local lumberyards. Some fire stations and other emergency centers can also help with materials.

Place filled sandbags to direct debris flows away from buildings, pools and other structures. Clear a path for the debris. Do not try to dam or stop debris flows.

Protect your most valuable property first. Debris can enter a building through doors and windows, so they should be boarded up and waterproofed with plastic sheets.

Remember: Sandbags will not seal out water.

Work with your neighbors and be prepared to use your property to provide good protection for the community.

How to Fill Bags

Fill sandbags one-half full. Use sand, if available, or local soil. Fold the top of the sandbag down and place the bag on its folded top (see illustration on page 11).

How to Place Bags

Refer to the illustrations on the facing page. Place each sandbag, as shown, finishing each layer before starting the next. Limit placement to two layers unless they are stacked against a building or pyramided.

It is important to place bags with the folded top in the upstream or uphill direction facing the flow of water to prevent them from opening when water runs by.

Sandbag Protection

FILL HALF FULL
FOLD TOP UNDER

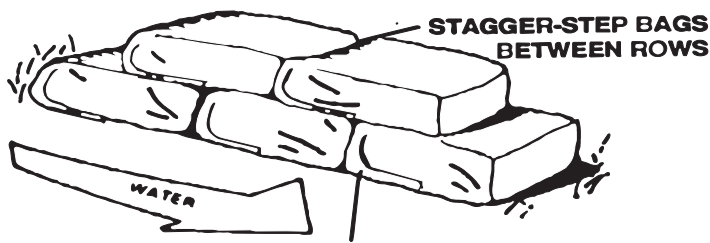
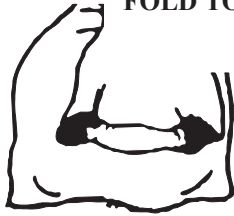

PLACE BAG WITH FLAP UNDER BAG

OVERLAPPED

STAIRSTEPPED

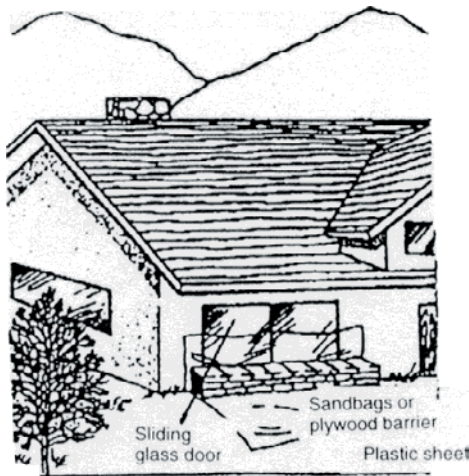
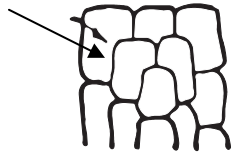
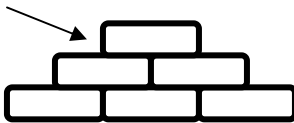

Sliding glass door sealing

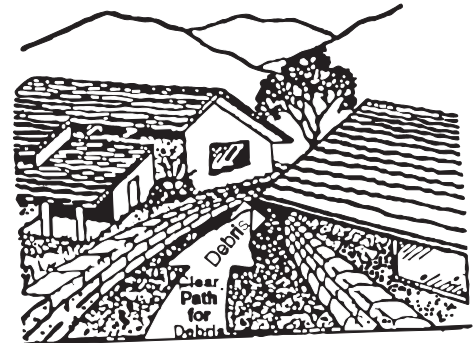

Directing flows between buildings

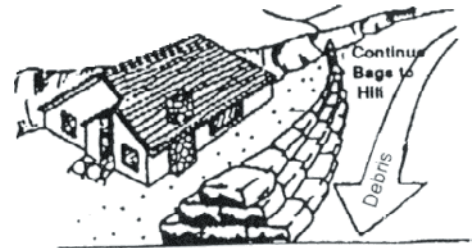

Directing debris away from buildings

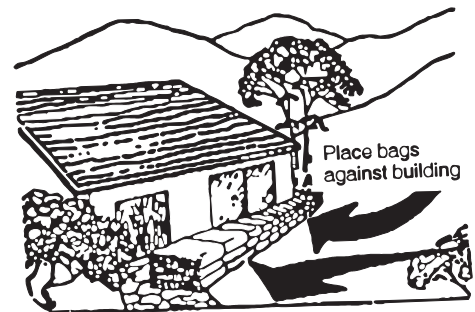

Building protection

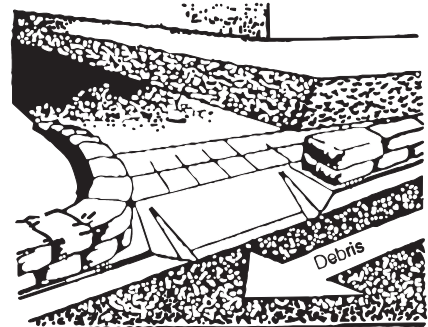

Controlling debris/storm flows in streets

Silt Fences

A silt fence made of woven wire and fabric filter cloth is a temporary barrier that can be used to catch sediment-laden runoff from small areas of disturbed soil. They are easy to construct with materials available from hardware stores, nurseries and lumber yards.

When to Use

Major considerations for using silt fences are slope, slope length and the size of drainage area from which the fence will catch runoff.

Here are some design considerations:

Slope Steepness	Maximum Slope Length
2:1 = 50%	50 feet
3:1 = 33%	75 feet
4:1 = 25%	125 feet
5:1 = 20%	175 feet
<5:1 = <20%	200 feet

For longer slopes, add additional silt fences.

Drainage Area

The area that contributes runoff to be caught by the silt fence should not be greater than one-half acre for every 100 feet of fence.

Type of Runoff

Silt fences are designed to catch runoff that is in the form of “sheet flow,” not in a concentrated flow.

Sheet flow differs from concentrated flow since the runoff is spread evenly over the ground surface, like a sheet, rather than concentrated in small rills or gullies.

Methods and Materials

Fence Posts: Posts should be at least 36 inches long. Wood posts should be of hardwood with a minimum cross section area of three (3) inches. Steel posts should be a standard “T” or “U” section and should weigh no less than one (1) pound per linear foot.

Wire: Wire fence should be at least 14 gauge with openings no larger than 6x6 inches.

Extremely Important: Bury the fence at least eight (8) inches below ground level and install the fence following the contour (perpendicular to the slope).

Silt fences are not permanent structures and must be maintained and/or inspected on a regular basis. Debris trapped behind it should be removed.

Silt Fences

Fabric Properties:

Filter fabric properties should be as follows (hardware store personnel can help you with these):

Fabric Property	Minimum Acceptable Value	Test Method
Grab tensile strength (LBS)	90	ASTM D1682
Elongation at Failure (%)	50	ASTM D1682
Mullen Burst Strength (PSI)	190	ASTM D3786
Puncture Strength (lbs)	40	ASTM D751 (mod)
Slurry flow Rate (gal./min/sf)	0.3	
Equivalent Opening Size	40-80	US Std Sieve
Ultraviolet Rad. Stability	90	ASTM-G-26

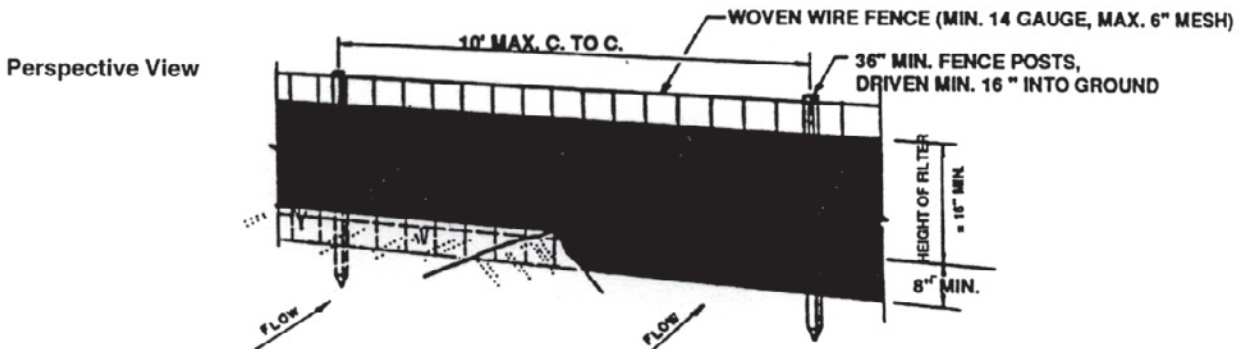

Section View

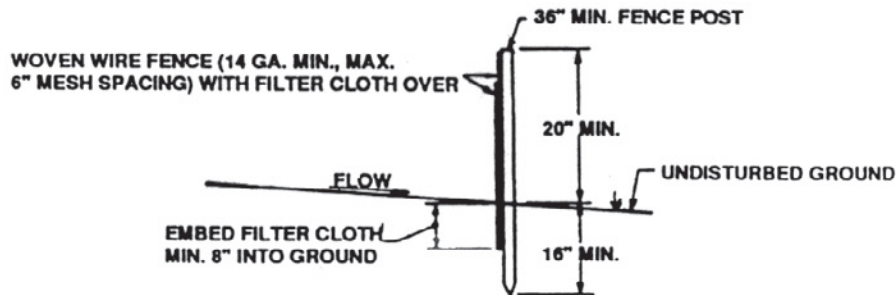

Construction Notes

1. Woven wire fence to be fastened securely to fence posts with wire ties or staples.
2. Filter cloth to be fastened securely to woven wire fence with ties spaced every 24" at top and midsection.
3. When 2 sections of filter cloth adjoin each other, they shall be overlapped by 6" and folded.
4. Maintenance shall be performed as needed and material removed when "bulges" develop in the silt fence.

Straw Bale Check Dams

Straw bale check dams are temporary sediment barriers constructed of straw bales located across small drainages. They are used to slow debris flows in small channels until bare soil is revegetated. They are not intended to provide protection from large storm events nor to control debris flows in water bodies such as creeks, streams or rivers.

Planning Criteria

0-15% slope:

- Maximum drainage area: one acre
- Maximum slope length between dams: 200 feet

15-20% slope:

- Maximum drain area: one-half acre
- Maximum slope length between dams: 100 feet

Greater than 20% slope:

- Not recommended

Methods and Materials

Bales should be bound with wire or nylon string. Those bound with jute twine are less durable. Place the bales in rows with ends tightly abutting adjacent bales. Bales should contain clean, weed-free straw.

Downstream Row (see illustration on page 15):

Dig a trench across the small channel that's wide enough and deep enough that the top of the bale row, placed on the long, wide side, is level with the ground.

The bale tops, across the center of the channel, should be level and set at the same elevation. Place the bales in position and stake them according to the instructions that follow.

Upstream Row:

Dig another trench across the small channel, upstream and immediately adjacent to the first row of bales. This trench should be wide enough to accommodate a row of bales set vertically on their long edge. It should be deep enough so that at least six (6) inches of each bale is below ground, starting with the bale in the channel bottom.

The trench should be as level as possible so the tops of the bales across the center of the channel are level and water can flow evenly across them. Continue this trench up the side slopes of the small channel to a point where the unburied bottom line of highest bale (point "C" in illustration) is higher than the top of the bales that are in the center of the channel (point "D").

Staking

Drive 2x2 stakes or #4 rebar, or T-fence posts with the "T" knocked off, through the bales and into the ground 1½ -2 feet for anchorage. The first stake in each bale should be driven toward a previously laid bale to force them together (see illustration).

Maintenance

Inspect bale check dams after each storm period. Shovel work may be needed to rebuild the soil berm on the upstream side. Remove any loose straw so it does not enter storm drains.

Remove the bales and stakes once vegetation, permanent drainage ways and stabilization are re-established. Reuse the straw as mulch in other areas.

Straw Bale Check Dams

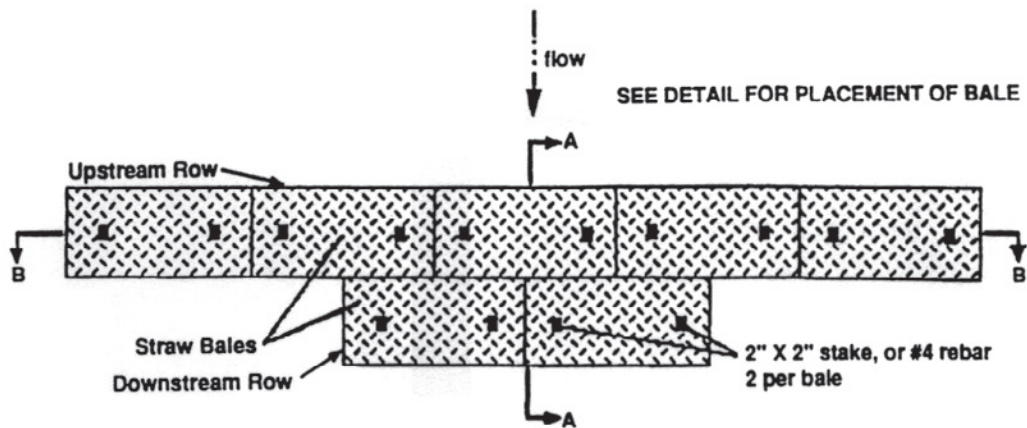

Section A-A

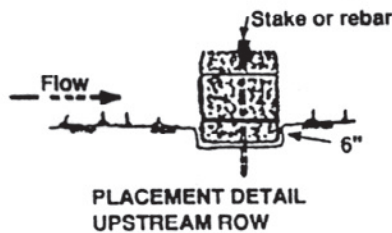
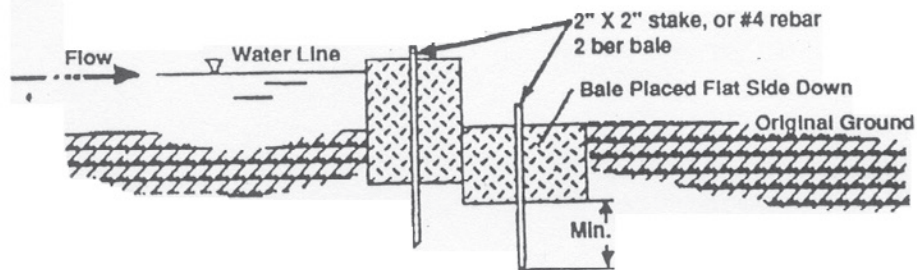

Remove #4 rebar after straw bales are no longer in place

Section B-B

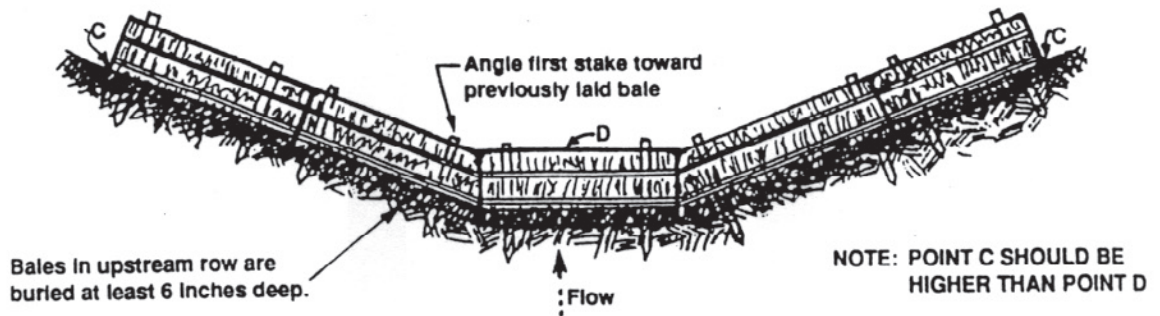

Straw Bale Dikes

Straw bale dikes are a temporary sediment barrier constructed of straw bales located downslope of a disturbed area or around a storm drainage outlet to redirect debris flows or trap debris materials.

They are usually installed in areas requiring protection from sedimentation expected from predicted rainfall events likely to cause erosion.

They are intended to provide protection for a limited time, usually less than three (3) months.

Installation Tips

Drainage area limits are as follows:

0-15% slope:

Maximum drainage area: one acre

Maximum slope length: 200 feet

15-20% slope:

Maximum drain area: one-half acre

Maximum slope length: 100 feet

Greater than 20% slope:

Not recommended

Bind bales with wire or nylon twine. Jute twine-bound bales are less durable. Bales should contain clean, weed-free straw. Place bales in a row with ends tightly abutting adjacent bales. Do not place bales with wire or twine touching (see illustration on page 17). Compress some loose straw between adjacent bales to close voids. The tops of bales should all be level and set in the same direction.

Staking

Each bale should be embedded in the soil a minimum of four (4) inches. Drive 2x2 stakes or #4 rebar, or T-fence posts with the “T” knocked off, through the bales and into the ground 1½ - 2 feet for anchorage. The first stake in each bale should be driven toward a previously laid bale to force the bales together (see illustration).

Maintenance

Inspect dikes and provide necessary maintenance following each storm event. It is important to ensure that loose straw does not enter storm drain facilities. Remove bales once permanent drainage and stabilization are re-established. Use the straw as mulch in other areas.

Straw Bale Dikes

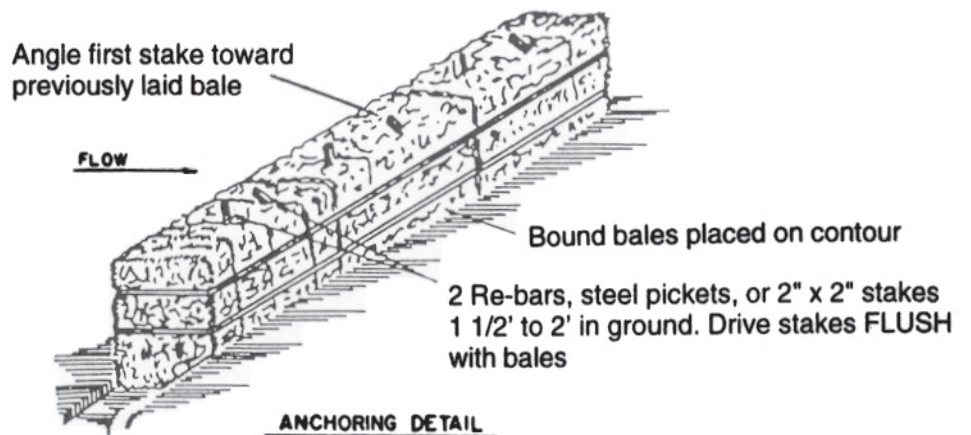
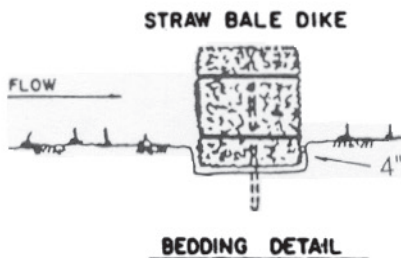
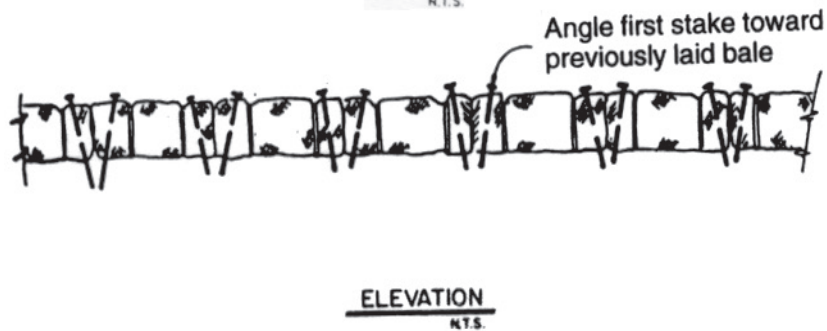
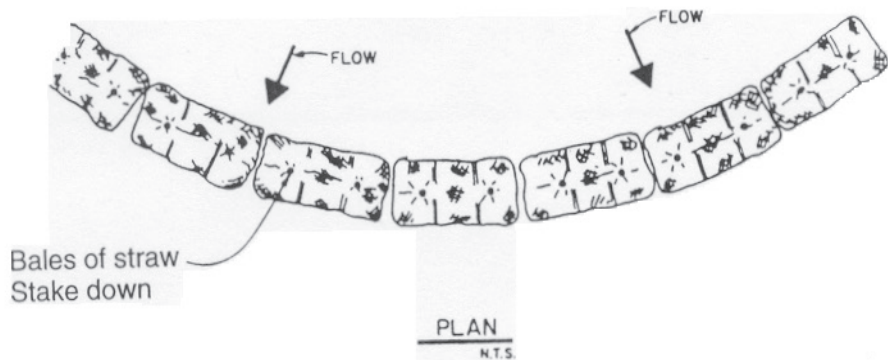
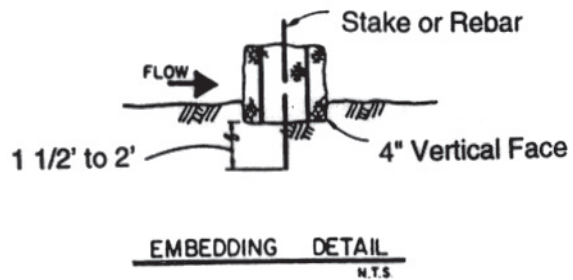

Straw Mulching

Straw mulching should be used on slopes that have been seeded and have high potential for erosion. It will provide a protective cover to reduce erosion, increase water infiltration and aid in revegetation.

Mulching requires some type of anchoring by matting, crimping or other method to prevent the straw from blowing or washing away.

Straw mulch forms a light layer when applied over a loose soil surface. To protect the mulch from wind drifting or being moved by water, it must be covered with netting such as jute, punched into the soil with a spade, roller, or mulch tucker or sprayed with a tacking agent.

Straw mulch should cover the entire seed or bare area and extend into existing vegetation or be stabilized on all sides to prevent wind or water damage which can start at the edges.

Methods and Materials

On gentle to moderate slopes, straw mulch can be applied by hand broadcasting to a uniform depth of 2-3 inches. On steep slopes, the straw should be blown onto the slope to achieve the same degree of cover. When applied properly, about 5%-10% of the original ground surface can be seen. The application rate per acre should be about two (2) tons or one 74-pound bale per 800 square feet. Straw should be clean, weed-free barley or wheat straw.

Anchoring

Hand Punching: Use a spade or shovel to punch straw into the slope until all areas have straw standing perpendicularly to the slope and embedded at least four (4) inches into the slope. It should be punched about 12 inches apart.

Roller Punching: A roller equipped with straight studs not less than six (6) inches long, from 4-6 inches wide and about 1-inch thick is rolled over the slope.

Crimper Punching: Like roller punching, the crimper has serrated disk blades 4-8 inches apart that force straw mulch into the soil. Crimping should be done in two directions with the final pass across the slope.

Matting: Use on large, steep areas that cannot be punched with a roller or by hand. Jute, wood excelsior or plastic netting can be applied over unpunched straw.

Straw Mulching

SPREAD THE STRAW

MARK OFF 800 SQ FT. PLOTS

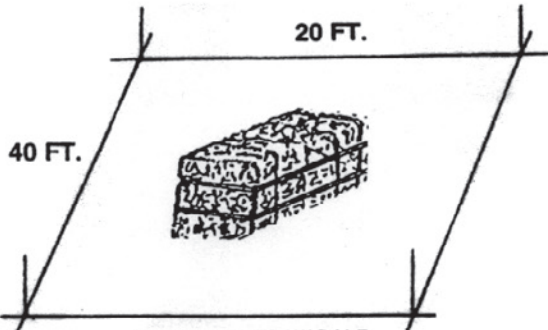

PLACE ONE STRAW BALE PER PLOT (~74 POUNDS). THIS IS EQUIVALENT TO 2 TONS PER ACRE.

SPREAD EVENLY

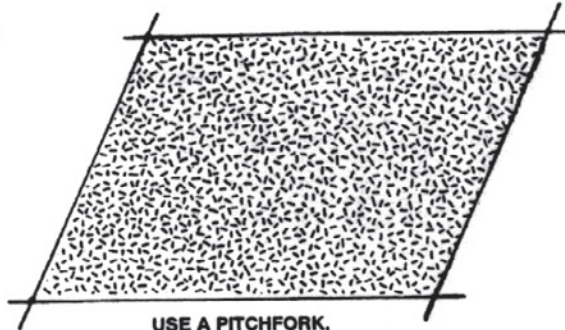

USE A PITCHFORK, SPADING FORK, OR BY HAND

ANCHOR THE STRAW

CRIMP BY HAND

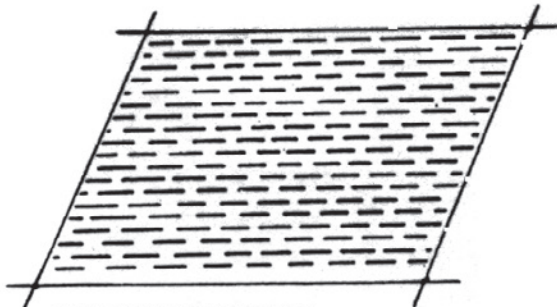

WORK ACROSS THE SLOPE. PUNCH STRAW 4 INCHES DEEP. A SQUARE END SPADE WORKS WELL. MAKE PUNCH EVERY 12 INCHES.

OR

USE PLASTIC NETTING

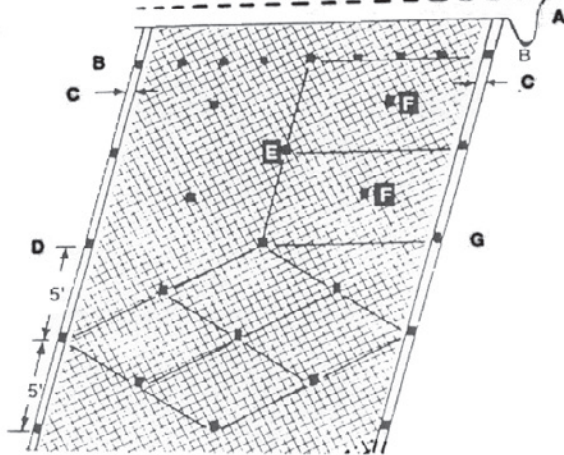

Construction Notes

1. Lay matting in strips down the slope over the straw. Bury upper end in 6-8 inch deep and wide trench. Most netting comes in 14-17 feet wide rolls.
2. Secure the upper end with stakes every 2 feet.
3. Overlap seams on each side 4-5 inches.
4. Secure seams with stakes every 5 feet.
5. Stake down the center every 5 feet.
6. Stake middles to create diamond pattern that provides stakes spaced 4-5 feet apart.
7. Use pointed 1x2 inch stakes 8-9 inches long. Leave 1-2 inch top above netting or use "U" shaped metal pins at least 9 inches long.
8. When joining 2 strips, overlap upper strip 3 feet over lower strip and secure with stakes every 2 feet like in "B" above.

Hazards from Debris Flows

Debris flows are shallow landslides saturated with water that travel rapidly downslope as muddy slurries carrying rocks and debris.

Even moderate precipitation can cause major flooding on a wildfire-damaged watershed due to lack of vegetation and roots to bind the soil. Areas directly downslope are especially subject to damage.

What can be done to avoid or reduce the hazard of debris flows? To be safe, assume that all drainages in steep, hilly areas are capable of carrying debris flows. They are especially vulnerable after a wildfire.

- Avoid building at the bottoms and mouths of steep ravines and drainage courses. These areas are the most likely to be inundated. The outer banks of bends along such ravines should also be avoided because swiftly flowing debris avalanches can “ride” up and out of the channel.
- Avoid building on or below steep slopes. In general, the steeper the slope, the greater the risk. If these areas must be used, consult with a soil engineer and engineering geologist. They will be able to evaluate the site for potential problems and give advice on the best way to minimize the risk to life and property.
- Limit the height and slope of cuts and fills in human-modified slope cuts. Properly compact fills, key them into bedrock and properly control the flow of water onto slopes.
- Be cognizant of the amount of rain falling in your area during rainstorms. Concerns for flooding and debris flows are based on moderate to high amounts of moisture over short periods. Minimal precipitation rates, especially after previous storms, could possibly trigger flooding and debris movement events.

For Additional Information

For more information on reducing wildfire risk, please visit the following websites:

www.firewise.org

www.usfa.dhs.gov/subjects/wildfire/

www.fs.fed.us/psw

www.unce.unr.edu/fire/firepage.html

Additional information regarding floods, debris flows, and erosion control can be found at:

www.fema.gov/areyouready/landslide.shtm

www.abag.ca.gov/bayarea/enviro/erosion/eyoudo.html



Helping People Help the Land.

