

NASA SP-4101

GPO PRICE \$ 4.00

CFSTI PRICE(S) \$ \_\_\_\_\_

Hard copy (HC) \_\_\_\_\_

Microfiche (MF) 2.25

ff 853 July 65

# AN ADMINISTRATIVE HISTORY OF NASA, 1958-1963

**N66 28006**

(ACCESSION NUMBER)

(THRU)

456

(PAGES)

1

(CODE)

(NASA CR OR TMX OR AD NUMBER)

34

(CATEGORY)

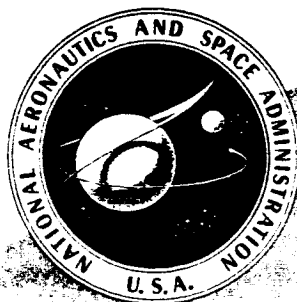

**NATIONAL AERONAUTICS  
AND SPACE ADMINISTRATION**

***AN ADMINISTRATIVE  
HISTORY OF NASA,  
1958-1963***

**ROBERT L. ROSHOLT**

**Prepared under the auspices of the  
NASA Historical Staff**



*Scientific and Technical Information Division*

**NATIONAL AERONAUTICS AND SPACE ADMINISTRATION**  
*Washington, D.C.*

1966

---

For sale by the Superintendent of Documents,  
U.S. Government Printing Office, Washington, D.C. 20402  
Price \$4.00  
*Library of Congress Catalog Number 66-60083*

## FOREWORD

This administrative history of NASA for the years 1958-1963 was prepared by Dr. Robert Rosholt under a contract to the University of Minnesota. This is the first of a series of NASA histories and is based, to a considerable extent, on documentary analysis.

Even the most careful study of documents cannot give the full flavor of the very difficult period covered by this history. NASA (*a*) was being organized from components of government agencies already in existence, (*b*) was instituting large new programs to increase our national capability in both aeronautics and space and at the same time was carrying forward those that had been started in constituent units, and (*c*) was undertaking the large buildup of this Nation's manned space-flight capability called for by President Kennedy's message to the Congress in May 1961. Dr. Rosholt recognized this and conducted interviews with many participants, which added great value to his review of documents. He has faithfully recorded his findings from both documents and interviews and his work will undoubtedly constitute a milestone in NASA's effort to provide adequate historical materials for future assessment.

Dr. Rosholt's work is of high quality and speaks for itself. However, a personal word as to the administrative climate of that time, the objectives sought and actions jointly taken by the late Dr. Hugh L. Dryden, Dr. Robert C. Seamans, and me may help in giving perspective and that is the purpose of this foreword.

When I joined the National Aeronautics and Space Administration as Administrator in February of 1961, I found that the first Administrator, Dr. T. Keith Glennan, had left a thorough and complete record of matters important to my proper discharge of the responsibilities of the office, and a number of valuable studies which he had prepared for guidance as the program of the agency developed. Dr. Seamans had joined the agency as Associate Administrator in September of 1960, but the election of President Kennedy two months later had left his status in a state of considerable uncertainty. Dr. Dryden, who had served since the organization of the agency as Deputy Administrator, was serving as Acting Administrator but had received no notification of his appointment from the new administration. A report, quite critical of the program and certain aspects of the organization of the agency, had been filed with President Kennedy by a panel established prior to his inauguration. Serious questions were being raised,



particularly by groups of scientists, as to the merit of manned space flight and of continuing the Mercury program.

At the time I took the oath of office on February 14, 1961, I stated to the assembled officials that Dr. Dryden would remain as Deputy, and that Dr. Seamans would remain as Associate Administrator, with strong support to implement fully his organizational position as general manager of operations. I stated that my purpose would be to work toward creating an environment within which NASA could be as innovative in the management of its programs as it was in aeronautics and space science.

Dr. Dryden, Dr. Seamans, and I immediately set to work to end uncertainty, to make unmistakably clear our support for the manned space flight program, to define necessary additions to the budget for Fiscal Year 1962 that had already been sent to Congress by the outgoing administration, and to establish personal and official relationships conducive to effective leadership. The three of us decided *together* that the basis of our relationship should be an understanding that we would hammer out the hard decisions *together* and that each would undertake those segments of responsibility for which he was best qualified. In effect, we formed an informal partnership within which all major policies and programs became our joint responsibility, but with the execution of each policy and program undertaken by just one of us. This meant that everyone in and out of the agency knew all three of us would be involved in all major decisions; that with policy established, the orders for its execution could be issued by any one of us; and that, while NASA had an Administrator as a single point of final decision, to the fullest extent possible we would act together. From my point of view, and I believe also from that of Dr. Dryden and Dr. Seamans, this was a most happy and productive relationship. In every major matter, we worked intimately together to establish a sound foundation for our policies and actions. Each of us helped to bring capable and valued associates into positions of responsibility. When one of us found the burden of his work too heavy, the others stepped forward to share it.

It seems to me that there are several areas where the application of this method of administrative leadership and the basis for and effects of the decisions we made are not fully clear, either from the documentation in this history or Dr. Rosholt's comments. I hope this foreword will suggest to interested scholars that the importance of understanding our pattern of thought and action may well justify further analysis and study to trace the development of NASA's present competence in administration.

The first area to which I wish to call attention was our decision, after the May 1961 expansion of space activity, to lay out our plan of organization and administration for the initial period so as to enable Dr. Seamans to maintain a close control of the agency's resources and so that major personal contacts between Headquarters and our center directors would run directly to his office. At that time, it was important that his central position as general manager be clearly

understood and his effectiveness in that position assured. Since he, Dr. Dryden, and I were in constant contact, the three of us viewed this arrangement as the best way to provide a single focal point. This way we could take all actions necessary to make sure that basic research and the resource base of the agency would keep step with the expanding development programs. This way the three of us could participate directly (without an intervening layer of management) to ensure a continuing evaluation of the performance and growth potential of our senior personnel.

An additional purpose was to create the kind of flexible organizational and administrative framework within which the procedures used and the responsibilities, even of quite senior officials, could be readjusted without embarrassment or great difficulty. We wanted to begin our expansion in an environment within which people would not be frozen into rigid assignments, and through which the three of us could take action to foster an atmosphere at senior management levels of readiness to accept change in organization and duties. Our initial purpose was to maintain this status until we could form our judgments as to the capability of the men on whom the major responsibilities would rest and had stabilized a pattern that would enable us to make a proper division of the workload. We wanted enough time, in a fluid state, to make a more permanent match of the men with the work assignments.

Dr. Rosholt seems to feel that the immediate establishment of a pattern of organization having a narrower span of control would have been better. In my view, a deeper and more penetrating analysis will show the wisdom of the method chosen. In any event, by November 1963 we were in a position to narrow the span of control and fix a pattern that has proven effective and has steadily gained strength.

A second major area in which the reasons for our decisions and the results of them are not fully reported relates to our determination to build a management system that would emphasize the importance of first-class performance and individual competence at each level of organization. We attached high importance to the development of competence in all phases of administration as well as in the scientific and engineering disciplines, and other specialties. Our policy was to utilize and emphasize the importance we attached to patterns of administration that would foster a pervasive development of careful judgment as an almost instinctive approach to important problems by all key personnel.

An illustration of this is in the field of procurement. Here, Dr. Dryden, Dr. Seamans, and I determined that we would personally examine, in detail, the results of the work of all source evaluation boards on competitively negotiated contracts that amounted to 5 million dollars or more. We expected these boards to appear before us personally in a formal setting and make a full and complete presentation of (1) the method chosen to break down for evaluation the contractor proposals, (2) the results achieved in the application of this method, and (3) the judgment of the board on each of the categories of the breakdown. The effect

of this systematic approach to a continuous emphasis on the *judgment factor* has been that for five years, on innumerable occasions and for extended periods, the three senior officials of NASA have sat side by side and personally examined in detail, and tested by question and answer, the quality of the individual and collective contributions of these boards to major decisions affecting the area where ninety percent of our resources are expended. We thus formed our own personal judgments, based on a great deal of personal involvement, as to the validity of board findings. We deeply immersed ourselves on a daily basis in very complete analyses of the main factors, within NASA and at the plants of our contractors, on which our projects depend for success, and the views, approaches, and analytical judgment of our senior personnel. In this process we were able to observe and evaluate how rapidly the organization and its contractors were developing their capabilities, and how effective our effort to get nine-tenths of NASA's work done by contractors was proving. We believe this constant and visible personal contact among NASA's three senior officials and the other responsible personnel involved in the hard problems and decisions in procurement provided a great deal of stimulation, motivation, and innovation throughout the organization.

The fact that the three senior officers of the agency would take the time to conduct what amounted to a thorough hearing and question-and-answer period on each contractor selection action enabled all levels of management, in Headquarters and in our Centers, to get their questions out on the table before all three of us for debate and clarification. Another important result was that when the presentation to the three of us was over, everyone involved had a clear understanding of the elements basic to a proper decision and everyone in NASA concerned with the matter was aware of this. The burden then passed to Dryden, Seamans, and me to make the final decision, and the personnel of the boards were in position to form their own judgments as to whether the three of us did in fact arrive at the best decision as indicated by the facts and analysis. Further, an important element of a NASA-wide and pervasive self-policing system was thereby established. This has had an important effect on maintaining high standards throughout the agency.

One additional area of requirement for effective administrative leadership that I would like to touch upon is the lack of recognition given in this history to the difficulty we had in bringing high-level executive people in from various backgrounds and fitting them into our organization, letting each serve in such a way as to derive satisfaction while serving the organization, and then either remaining or departing depending on performance. There is inadequate recognition, I believe, of the consequences of our decision, at the time Dr. George E. Mueller joined us, to create in our Office of Manned Space Flight a group of men not only dedicated to NASA's program, but also who could have the full confidence of the Department of Defense and the Air Force. There is also little of the flavor of the creation, in this period, of the managerial competence that

put into effect the extremely difficult and complex all-up systems test concept that is now showing its value in the successful flight program.

The management structure in NASA is still evolving and for a long time will remain anything but static. The fact that contracts are administered on a decentralized basis from widely dispersed Civil Service contract administrative organizations has introduced the requirement that contract officers, supported by professional staffs of attorneys, accountants, auditors, and inspectors, must also work with large numbers of scientific, engineering, and other technical specialists not under their direct administrative control. Further, the necessity of operating a wide variety of complex programs as a coherent whole with internal balance in each has meant the establishment of thorough-going management systems for financial, technical, and schedule reporting with critical-path analysis and configuration control. These systems cover work being done by some 20,000 prime and first- and second-tier subcontractors. The magnitude of this undertaking and the significance of the methods by which the administrative problems have been solved needs, it seems to me, to be more clearly spelled out than is done in this administrative history.

Dr. Rosholt was able to obtain from his interviews and the documents much that should underlie valid historical conclusions, but certainly not all. In fact, many facets of the NASA administrative system are still so new that adequate documentation was not available when Dr. Rosholt completed his contract, and in some cases is still in a draft or experimental stage.

All of us in NASA genuinely appreciate the work of the University of Minnesota and of Dr. Rosholt, which has produced this most important contribution to the beginning of NASA's historical series. We will endeavor to deepen and broaden this important beginning of a base for a full and complete history of NASA by cooperation with other interested institutions and scholars.

JAMES E. WEBB.

*February 3, 1966.*

## PREFACE

This study focuses on NASA administrative matters, not on the specific content of NASA's programs and policies. It has an historical framework rather than a topical one. The first five chapters cover the antecedents and first years of the National Aeronautics and Space Administration. The remaining four chapters deal with the change in political administrations and the acceleration of the space program in 1961 and the organizational consequences through 1963.

Five administrative themes are emphasized: (1) organizational structure, including intra-agency relationships; (2) administrative procedures, with emphasis on intra-agency coordination; (3) personnel administration; (4) finance administration; (5) procurement administration, especially contracting. Other topics such as NASA-DOD relations and national space policy have necessarily been woven in from time to time. Brief periodic summaries of NASA's program have been included to help retain the context within which administrative actions were taken. For a synopsis of the study's scope and content, the reader is referred to the highly detailed Table of Contents; the Index will serve specific queries. Description and documentation rather than interpretation have been emphasized.

Research has been based primarily on public documents, internal NASA documents, and interviews with most of the key people. Inasmuch as certain documents are more accessible than others and some individuals are more available for interviews, there may be unevenness. Critique of an earlier comment edition by NASA officials eliminated some of the unevenness and closed some of the inevitable gaps.

The study was prepared in accordance with NASA research contract NASr-148 between the University of Minnesota and NASA. The author was a research associate in the university's Public Administration Center. In preparing the study he worked closely with the NASA Historical Staff. Documents collected and collated in this research project have been incorporated in the NASA Historical Archives.

The study was conceived during 1961 when the author was a summer employee in NASA's newly created Office of Programs. The accelerated space program, including the manned lunar landing, had just been announced. The author became convinced that NASA's administrative response to the lunar landing challenge would make an important study in public administration. Employment on the NASA Historical Staff during the summer of 1962 opened up vistas

of NASA's early years. The project emerged in its present form in the fall of 1962; the first complete draft was completed in July 1964; some 90 select participants were asked to comment on this draft and their comments were assimilated into the final manuscript by March 1965.

I am deeply indebted to two organizations, NASA and the University of Minnesota, and scores of individuals.

Two University of Minnesota professors have been involved in the project from its beginning. Prof. Lloyd Short of the Department of Political Science has given advice on method and content and has read the entire first draft of the manuscript. Prof. George Warp, director of the Public Administration Center, has handled the project's administrative details as well as rendering other assistance.

The cooperation of NASA has been gratifying, and research freedom has been complete. The NASA Historical Staff has served as a base of operations and the Historical Archives has been the most important single source of data. Dr. Eugene Emme, NASA Historian, and Dr. Frank Anderson, Deputy NASA Historian, have given assistance in all phases of the project. The pitfalls they have saved me from have been numerous. The help of Helen Wells and Sally Holman of the NASA Historical Staff has been greatly appreciated.

It is impossible to name all the NASA officials who made inputs into the study. The list of interviews in the Bibliography reveals many of them. Don Cadle, formerly of NASA and my supervisor during the summer of 1961, is responsible for arousing my interest in NASA. Albert Siefert and John Young gave me valuable data at a crucial time in my research and greatly contributed toward whatever depth there might be in the study.

I mention these individuals only to acknowledge my debt to them. They should not be thought of as sharing any blame for the study's defects. I take full responsibility for those.

ROBERT L. ROSHOLT.

*March 1965.*

#### POSTSCRIPT

It is with personal as well as professional interest that I have read the Foreword by Mr. Webb, commenting on his portion of the period studied. His addition is invaluable for the light it casts on many decisions taken and for the underlying rationale. As indicated in the introduction to Chapter 8, my documentation, level of detail, and perspective dwindled steadily as I moved into the more recent, very dynamic period after 1961. I believe that scholars will find special value in having both text and a management commentary on it between the same set of covers.

R. L. R.

*February 15, 1966*

# CONTENTS

## PART I: 1958-1960

<b>Chapter One: Background of Establishment of NASA</b>	
<b>I. Sputnik—The Reason for NASA's Establishment</b> .....	<b>Page</b> 3
<b>A. U.S. Space Activity at the Time of Sputnik</b> .....	4
Military Missile Activity.....	4
IGY Scientific Satellite Activity.....	5
NACA Space-Related Activities.....	5
<b>B. Initial U.S. Reactions to Sputnik</b> .....	6
<b>II. The Administration's Plan</b> .....	8
<b>A. Provisions of the March 5 Memorandum</b> .....	9
<b>B. Preparation of the April 2 Documents</b> .....	10
<b>C. Contents of the April 2 Documents</b> .....	11
<b>III. The Enactment of the Space Act</b> .....	12
<b>Title I—Statement of National Policy</b> .....	13
<b>Title II—Coordination of Aeronautical and Space Activities</b> .....	13
<b>Title III—Miscellaneous</b> .....	15
<b>Summary and Conclusions</b> .....	16
<b>Chapter Two: NASA's Organizational Predecessor, NACA</b>	
<b>I. A Brief History of NACA</b> .....	19
<b>II. NACA Organization in 1958</b> .....	23
<b>A. Committees and Subcommittees</b> .....	23
<b>B. Agency Leadership</b> .....	23
<b>C. Agency Installations</b> .....	28
<b>D. Headquarters Organization and Function</b> .....	29
<b>E. Intra-NACA Relationships</b> .....	32
<b>III. NACA's Reaction to Sputnik</b> .....	34
<b>Chapter Three: The Launching of NASA</b>	
<b>I. Developments Prior to NASA's Formal Establishment</b> .....	37
<b>A. The Genesis of NASA's Space Flight Development Program</b> .....	37
<b>B. NACA-DOD Discussions</b> .....	38
<b>C. Planning NASA's Initial Organization</b> .....	39
<b>D. Nomination and Confirmation of Glennan and Dryden</b> .....	40
<b>E. Glennan's August and September Actions</b> .....	42
Initial Decisions on Organization and Staffing.....	42
Talks Resumed with DOD.....	43
Documents Establishing NASA.....	43

	Page
II. NASA's First 4 Months . . . . .	44
A. The Nature and Importance of the Transfers From DOD to NASA . . . . .	44
The Transfer of Project Vanguard . . . . .	44
ARPA and Air Force Transfers . . . . .	45
Transfer of JPL and the Attempted Transfer of ABMA . . . . .	45
Other Transfers . . . . .	47
B. The Evolution Toward NASA's Initial Organizational Structure . . . . .	48
C. The McKinsey Report on Organizing Headquarters Functions . . . . .	50
A Brief Evaluation of the McKinsey Report . . . . .	55
D. Personnel . . . . .	56
Numerical Growth Summary . . . . .	56
Appointments to Excepted Positions . . . . .	56
E. Finance . . . . .	58
Funding Flexibility . . . . .	59
Finance Administration . . . . .	60
The Role of Congress . . . . .	60
Preparing for Fiscal Year 1960 . . . . .	60
F. Procurement/Contracting . . . . .	61
Policies Governing NASA Contracting . . . . .	61
NASA's Contracting Machinery . . . . .	62
Steps in the Contracting or Procurement Process . . . . .	63
G. Miscellaneous Administrative Developments . . . . .	65
Weekly Staff Meeting . . . . .	65
Assignment of Responsibility to Dryden . . . . .	65
Utilization of Ad Hoc Advisory Committees in Nontechnical Areas . . . . .	65
H. External Relationships . . . . .	66
I. Early Program Developments . . . . .	69
<b>Chapter Four: 1959—Internal Consolidation, External Difficulties</b>	
I. NASA's 1959 Space Program . . . . .	72
A. The Overall Program . . . . .	72
B. Launch Vehicle Development Program Changes . . . . .	72
C. Manned Space Flight . . . . .	76
D. Other 1959 Program Developments . . . . .	77
II. Internal Organizational and Administrative Developments . . . . .	78
A. Organizational Changes . . . . .	78
A Comparison of Organization Charts . . . . .	78
Changes Not Shown on Organization Charts . . . . .	79
The Establishment of the Goddard Space Flight Center . . . . .	79
B. Administrative Procedures Established . . . . .	81
Internal Reporting . . . . .	81
The Establishment of a Management Manual . . . . .	81
The Monthly Flight Schedule . . . . .	83
C. Personnel . . . . .	83
D. Finance . . . . .	85
Requests for a Fiscal Year 1959 Supplemental and Fiscal Year 1960 Regular . . . . .	85
Authorization and Appropriation . . . . .	86
The Preparation of the Fiscal Year 1961 Budget . . . . .	88
NASA's Budget Request Modified as a Result of Saturn Transfer . . . . .	90
E. Procurement/Contracting . . . . .	91
F. Miscellaneous Organizational and Administrative Matters . . . . .	93
McKinsey & Co.'s JPL and WCO Studies . . . . .	93
1959 Activity in the Life Science Area . . . . .	96
Decision-making . . . . .	97



CONTENTS

xiii

	Page
<b>III. NASA's External Relationships</b> .....	97
<b>A. Relations With Congress</b> .....	97
The "Privileged Information" Controversy.....	98
The "Production of Documents" Controversy.....	99
<b>B. Relations With the Department of Defense</b> .....	102
NASA-DOD Coordination Machinery.....	103
1959 NASA-DOD Agreements.....	103
<b>IV. Policy Problems</b> .....	105
<b>V. 1959 Transfers and Related Headquarters Reorganization</b> .....	107
<b>A. Changing Circumstances—October 1958 to October 1959</b> .....	108
<b>B. The Decision To Transfer to NASA</b> .....	109
<b>C. Transfer Gets Underway Immediately</b> .....	110
Basic NASA-DOD and NASA-Army Agreements.....	110
The Detailed Transfer Plan.....	111
The Role of McKinsey & Co.....	112
<b>D. The Interim Status of the Saturn Program</b> .....	114
<b>E. The December Reorganization of NASA Headquarters</b> .....	115
<b>Chapter Five: 1960—Orderly Progress</b>	
<b>I. Organizational Changes</b> .....	117
<b>A. The Huntsville Transfer Consummated</b> .....	117
Transfer Plan Submitted to Congress.....	118
Congressional Reaction to the Transfer Plan.....	118
Transfer Becomes Effective.....	119
NASA Establishes Huntsville Facility.....	120
Huntsville Facility Given a Name.....	120
Preparation for the July 1 Mass Transfer.....	120
<b>B. Other Field Installation Changes</b> .....	123
LOD Established.....	123
Joint NASA-AEC Office Established.....	124
Space Task Group Becomes Independent.....	124
Goddard Institute for Space Studies Established.....	124
<b>C. The Establishment of the Office of Life Science Programs</b> .....	124
The Report of the Bioscience Advisory Committee.....	124
Implementation of the Report.....	126
<b>D. Other Organizational Changes in NASA Headquarters</b> .....	127
Office of Technical Information and Educational Programs Established.....	127
Office for the United Nations' Conference Established.....	127
Office of Research Grants and Contracts Reorganized.....	128
Developments Relating to the Office of the Associate Administrator.....	129
<b>II. Internal Administrative Developments</b> .....	129
<b>A. Long-Range Planning</b> .....	130
The Preparation of NASA's First Long-Range Plan.....	130
The Plan Unveiled.....	130
The Planning Process.....	131
<b>B. Finance</b> .....	132
Basic Problems Facing NASA.....	132
Key Financial Management Positions Filled.....	133
The Huntsville Project.....	133
Innovations in Budgeting.....	134
Innovations in Accounting.....	134
Innovations in Financial Reporting.....	134
Fiscal Year 1961 Budget Enacted.....	136
Fiscal Year 1962 Budget Prepared.....	138

	Page
<b>C. Personnel</b> .....	139
Growth in the Number of NASA Employees .....	139
Personnel Complement Ceiling Problems .....	139
"Excepted Position" Developments .....	140
New NASA Civil Service Examination .....	141
Training .....	144
Other Personnel Developments .....	146
<b>D. Procurement/Contracting</b> .....	146
Contracts for Services .....	146
Procurement Activity Trends .....	147
<b>E. Program Integration</b> .....	148
Problems Relating to the Office of the Associate Administrator .....	148
Organizational Changes .....	149
Procedural Developments .....	150
Biweekly Project Status Review .....	151
The Staff Conference .....	152
The Space Exploration Program Council .....	152
Formal Project Authorization .....	153
<b>III. Organizational and Administrative Self-Evaluation</b> .....	154
<b>A. Background for the Self-Evaluation Studies</b> .....	154
<b>B. The McKinsey Study of NASA Contracting</b> .....	154
Objectives .....	154
Method .....	155
Findings .....	155
<b>C. The Study of NASA's Organization (The Kimpton Report)</b> .....	161
Method .....	161
Committee Selected, McKinsey & Co. Chosen to Assist .....	161
Glennan's March 18, 1960, Memo to the Committee .....	161
The Work of the Kimpton Committee .....	162
Findings and Recommendations .....	164
NASA's Reaction to the Kimpton Report .....	167
An Evaluation of the Kimpton Report .....	168
<b>IV. External Relations</b> .....	169
<b>A. 1960 Relations With Congress</b> .....	169
The President's January 1960 Legislative Request .....	169
NASA Submits Draft Amendments .....	170
Congressional Reaction .....	170
The Annual Authorization Problem .....	171
House Astronautics Committee Very Active .....	171
<b>B. 1960 Relations With DOD</b> .....	172
AACB Established .....	172
Other 1960 NASA-DOD Agreements .....	173
<b>C. Other External Relationships</b> .....	174
NASA-Industry Conferences .....	174
<b>V. The Glennan Era—Summary and Conclusions</b> .....	175
<b>A. Space Program Accomplishments During the Glennan Era</b> .....	175
<b>B. Administrative and Organizational Changes</b> .....	176
<b>C. The Glennan Legacy</b> .....	178

PART II: 1961-1963

<b>Chapter Six: Transition From Eisenhower to Kennedy</b>	
The Presidential Election Campaign .....	Page 183
Uncertainty Following Kennedy's Election.....	184
The Wiesner Report.....	185
Selecting the New NASA Administrator.....	187
NASA Asked To Review Its Program.....	188
DOD Reorganizes Its Space Program.....	188
Space Act Amended.....	189
The March Budget Amendment.....	190
Impact of the Gagarin Flight.....	191
The President's May 25 Message.....	192
Long-Range Ramifications of the President's Decision.....	193
Details of the March and May Budget Amendments.....	193
<b>Chapter Seven: Reorganization for Program Acceleration</b>	
I. Webb's First Look at NASA Organizational Problems.....	198
A. Summary of NASA's 1960 Administrative Self-Evaluation.....	198
B. The February "Summary Look".....	199
C. Reactions to the March Program Acceleration.....	201
II. Strengthening General Management.....	202
A. The April 14, 1961, Study on General Management.....	203
Recommendations of the April 14 Study.....	204
B. Implementation of the Recommendations of April 14.....	206
III. Overall Reorganization Restudied.....	209
A. The June 12 Staff Study.....	209
Change in Tone.....	209
Program Realignment Necessary.....	209
The Headquarters-Field Center Relationship Problem.....	209
One of Four Alternatives Preferred.....	210
B. The Silverstein Alternative.....	211
IV. Program Developments Following the May Decision.....	211
A. Planning Studies.....	212
The Fleming Report.....	212
The Golovin Study.....	213
B. Facility Problems Attacked.....	213
Manned Spacecraft Center Established.....	213
Launching Site Selected.....	214
Vehicle Fabrication and Test Site Selected.....	215
C. Major Manned Lunar Landing Contractors Selected.....	216
V. The November 1, 1961, Reorganization.....	217
A. The August 7 Staff Study.....	218
Basic Management Concepts Delineated.....	218
Structural Alternatives Presented.....	219
Ways and Means of Expediting the Lunar Landing Program.....	219
Narrowing the Choices.....	219
Relationships Within the Structure.....	220
Functional Management.....	220
B. Details of the November 1, 1961, Reorganization.....	221
NASA Leadership, November 1, 1961.....	222
Headquarters Realigned.....	224
Headquarters-Field Relationships.....	224
C. Unfinished Business.....	225

	Page
VI. Other 1961 Developments .....	227
A. Program Management and Related Procedures .....	228
The Project Planning and Implementation System .....	228
Flexibility for Top Management Sought .....	229
Reprogramming .....	231
Project Progress Reporting—PERT .....	231
B. Finance .....	233
Congress Ratifies the Lunar Landing Decision .....	233
Budget Preparation and Execution .....	234
C. Personnel .....	234
D. Procurement/Contracting .....	235
The Draper Report .....	235
The October Conference .....	235
Procurement Training .....	236
Headquarters Procurement Branch Established .....	236
III E. Other Nonadministrative Happenings .....	237
External Relations .....	237
Program Highlights as Indicated by Major Launchings .....	238
Other Program Activity .....	238
Kennedy Enunciates Communications Policy .....	239
<b>Chapter Eight: Rapid Growth/Organizational Readjustments</b>	
I. Gross Measurements of NASA's Rapid Growth, 1962-1963 .....	241
A. Growth of NASA Budgets and Spending .....	242
B. Growth in Total Personnel .....	242
C. Changes in Procurement Patterns .....	244
II. Program Developments, 1962-1963 .....	245
A. Manned Space Flight .....	246
B. Space Sciences .....	248
C. Applications .....	249
D. Advanced Research and Technology .....	249
E. Tracking and Data Acquisition .....	250
III. Organizational Developments, 1962-1963 .....	251
A. Field Installation Changes .....	251
Cape Canaveral Facility Given Full Field Center Status .....	251
Northeastern Operations Office Established .....	252
Electronics Research Center Proposed .....	252
Contract Administration Office Established at Downey .....	253
The Organization of NASA's Nuclear Activities .....	254
B. Headquarters Changes .....	255
Director of MSF Named Deputy Associate Administrator .....	255
Deputy Associate Administrator for Defense Affairs .....	257
Deputy Associate Administrator for Industry Affairs .....	257
Other Headquarters Changes .....	258

	Page
<b>IV. Administrative Developments, 1962-1963</b> .....	259
<b>A. Finance</b> .....	260
Sources of Funds .....	260
Flow of Funds .....	260
Destination of Funds .....	262
Auditing .....	262
<b>B. Personnel</b> .....	264
Recruitment .....	264
Characteristics of Newly Hired Scientists and Engineers .....	265
Unique Examination for R&D Administrative Positions .....	266
Excepted-Position Developments .....	268
The Inspection of NASA by the Civil Service Commission .....	268
Personnel Management Evaluation System .....	269
Miscellaneous Personnel Developments .....	269
<b>C. Procurement/Contracting</b> .....	270
Special Procurement Study .....	270
Geographic Distribution of NASA Contracts .....	272
Cost Control .....	273
<b>D. Program and Project Management</b> .....	274
The Management Council .....	274
Management Advisory Committee Established .....	275
Contractors Hired for Technical Coordination .....	275
<b>E. Other Administrative Developments</b> .....	276
OSS-OMSF Coordination .....	276
ADP Developments .....	277
Project Approval Procedures .....	277
Patent Regulations Revised .....	278
<b>V. Miscellaneous 1962-1963 Developments</b> .....	278
<b>A. Non-NASA Space Developments, 1962-1963</b> .....	279
<b>B. Miscellaneous External Relationships</b> .....	279
<b>C. Unresearched Areas</b> .....	280
 <b>Chapter Nine: Reorganization for Program Operations</b>	
<b>I. The Change in Climate, 1963 vis-a-vis 1961</b> .....	282
<b>A. The Debate Over NASA's Mission</b> .....	282
<b>B. The Changing Pattern of External Support</b> .....	283
<b>C. The Leveling Off of NASA's Program</b> .....	284
NASA's Fiscal Year 1964 Budget Affected by Fiscal Year 1963 Actions .....	284
NASA's Fiscal Year 1964 Budget Submitted to Congress .....	285
The Enactment of NASA's Fiscal Year 1964 Budget .....	286
<b>II. The November 1963 Reorganization</b> .....	289
<b>A. Events Leading to the Reorganization</b> .....	290
<b>B. Provisions of the Reorganization</b> .....	292
Headquarters-Field Relationships .....	292
Changes in Headquarters .....	295
<b>C. An Evaluation of the Reorganization</b> .....	296
<b>D. NASA Leadership, November 1963</b> .....	297
<b>III. Webb's First 33 Months—Summary and Conclusions</b> .....	298
<b>A. NASA's Program</b> .....	298
<b>B. Organizational and Administrative Changes</b> .....	299
General Management Powers Clarified .....	300
NASA's Goals Redefined .....	300
NASA's Expanding Program Organized and Managed .....	300
Some Stability and Continuity Maintained .....	301
<b>C. NASA in Transition</b> .....	302

	Page
Appendix A—National Aeronautics and Space Act, as Amended.....	304
Appendix B—NASA Organization Charts.....	328
Appendix C—Growth of NASA Personnel, 1958-1963.....	347
Appendix D—NASA Finances, 1958-1963.....	349
Appendix E—Trends in NASA Procurement.....	350
Appendix F—Excerpts From "Administration and the Conquest of Space".....	351
Classified Bibliography of Sources Cited.....	355
Index.....	371

### TABLES

*Table*

3-1 Sources of NACA/NASA Funds, Fiscal Year 1959.....	59
4-1 Planned Disposition of Fiscal Year 1959 and Fiscal Year 1960 Funds.....	74
5-1 Action on NASA's Fiscal Year 1961 Budget.....	137
6-1 Summary, NASA's Fiscal Year 1962 Budget.....	195
7-1 Requests, Authorization, and Appropriations, Fiscal Year 1962.....	233

### FIGURES

*Figure*

2-1 NACA Organization Chart, March 3, 1958.....	25
2-2 NACA Organization Chart, March 3, 1958.....	26
2-3 NACA Organization Chart (Headquarters), July 8, 1955.....	27
2-4 NACA Organization Chart (Headquarters), September 30, 1958.....	31
3-1 NASA Organization Chart, August 11, 1958.....	48
3-2 NASA Organization Chart, October 24, 1958.....	48
3-3 NASA Organization Chart, January 29, 1959.....	48
7-1 NASA Organization Chart, January 17, 1961.....	223
7-2 NASA Organization Chart, June 1, 1961.....	223
7-3 NASA Organization Chart, November 1, 1961.....	223
9-1 NASA Organization Chart, Prior to November 1, 1963.....	293
9-2 NASA Organization Chart, Effective November 1, 1963.....	294

**PART ONE**

**1958-1960**



NASA TOP MANAGEMENT, 1958-1960

T. Keith Glennan, Administrator (center); Hugh L. Dryden, Deputy Administrator (left); and Richard E. Horner, Associate Administrator (right).



## Chapter One

# BACKGROUND OF ESTABLISHMENT OF NASA

The official establishment of the National Aeronautics and Space Administration as a legal and functioning organizational entity occurred on October 1, 1958. The basic White House decision leading to the establishment of a civilian space agency was made 7 months earlier on March 5, 1958. The March 5 decision, in turn, was the result of several months of study on how the United States could best respond to the challenge imposed by Russia's successful orbiting of the world's first artificial earth satellite, *Sputnik I*, on October 4, 1957.

An administrative history of NASA must begin much earlier. NASA was not a completely new creation, but was instead a transformed or reincarnated National Advisory Committee for Aeronautics (NACA), a civilian agency of the U.S. Government founded in 1915. NASA also inherited projects, programs, people, and installations which had their origin in the military services.

This chapter and the next one cover these "beginnings," focusing on the events which brought NASA into being, with emphasis on the administration's legislative proposal and the reaction of Congress to it. Chapter 2 focuses on NACA, NASA's organizational predecessor and the nucleus around which NASA grew.

### I. SPUTNIK—THE PRINCIPAL REASON FOR NASA'S ESTABLISHMENT

The orbiting of *Sputnik I* was a dramatic technical achievement which brought immediate repercussions. It revealed Russia's competence in rocket technology as much greater than generally believed. This, in turn, suggested that Russia's general competence in science and technology was substantial, and bore out the contentions of those who claimed that the U.S.S.R.'s educational system was producing scientists and technicians at a rate greatly in excess of that of the United States. It confirmed Russia's claim of August 1957 that it had an intercontinental ballistic missile capability, and thus Soviet rocket technology was a much more immediate threat to U.S. national security than had generally been thought. The prestige which Russia gained from its spectacular Sputnik success helped magnify its worldwide image. The fact that Russia was first in space tarnished the world image of the United States as a technological leader.

### A. U.S. Space Activity at the Time of Sputnik

At the time of Sputnik, the United States did not have an integrated national space program—probably one of the principal reasons why the U.S.S.R. was first in orbiting an artificial earth satellite. The evolutionary development of the somewhat unintegrated space activities of the United States is a complex story and beyond the scope of this chapter. The following highlights provide minimal historical perspective on post-sputnik events.<sup>1</sup>

**Military Missile Activity.** In 1957, most of the rocket-related activities of the United States were centered around the urgent development of ICBM's and IRBM's. These activities were being carried out by the three military services and their respective industrial contractors. Five missile systems accounted for most of this activity. The Air Force was developing the Atlas and Titan ICBM's and the Thor IRBM, the Army, the Jupiter IRBM, and the Navy, the Polaris IRBM. Big money did not start flowing into missile programs until 1955. By November of that year, the Atlas, Thor, and Jupiter programs, shared the highest national priority.

The feasibility of the large liquid-fuel ballistic missile for carrying warheads had been demonstrated during World War II by Germany during its 1944 V-2 campaign against England and the Lowlands. The United States "acquired" many of the German V-2 scientists and engineers together with rocket plans and hardware (Project Paperclip). These "acquisitions" constituted the base for test and upper atmosphere experimentation activities carried out by the Army and Navy with civilian scientists at the White Sands Proving Grounds, N.Mex., in the late forties. Until the early fifties the Air Force was largely preoccupied with the manned jet bomber as a global nuclear-weapon delivery system and the development of air-breathing missiles (i.e., pilotless aircraft).

At the time the first Sputnik was orbited, the United States had had two unsuccessful test flights of the Atlas, four unsuccessful test flights out of five of the Thor, and two unsuccessful test flights out of four of the Jupiter.<sup>2</sup> The only operational missile of any size at all was the Army's 200-mile tactical Redstone missile. In addition to these better known missile programs, the military services were also engaged in other space-related research and development, some of which was of an advanced nature. NACA had also been brought into the picture.

<sup>1</sup> Three sources were especially helpful in preparing this summary: U.S. Congress, House, Select Committee on Astronautics and Space Exploration, *Astronautics and Space Exploration*, Hearings on H.R. 11881, 85th Cong., 2d sess. (Washington: GPO, 1958) (hereafter cited as House Hearings, *Astronautics and Space Exploration*); David S. Akens, *Historical Origins of the George C. Marshall Space Flight Center*, MSFC Historical Monograph No. 1 (Huntsville, Ala.: NASA, 1960) (hereafter cited as Akens, *Historical Origins of the George C. Marshall Space Flight Center*); Eugene M. Emme (ed.), *History of Rocket Technology*, special issue of *Technology and Culture*, Fall 1963, revised and augmented book with same title (Detroit: Wayne State Univ. Press, 1964) (hereafter cited as Emme, *History of Rocket Technology*).

<sup>2</sup> U.S. Congress, House, Committee on Science and Astronautics, *A Chronology of Missile and Astronautic Events*, H. Rept. 67, 87th Cong., 1st sess. (Washington: GPO, 1961), pp. 161-167.

Since the Air Force and Navy did most of their work by contract, many private corporations were engaged in space-related activity.

*IGY Scientific Satellite Activity.* The International Geophysical Year (IGY) (July 1, 1957, through December 31, 1958) was a scientific undertaking sponsored by an international organization of scientists and designed to promote a broad worldwide investigation of the earth and its environment. The participation of the United States was primarily under the jurisdiction of the National Academy of Sciences, with most of the financial support coming from the National Science Foundation. The idea of including the orbiting of a small earth satellite as part of the U.S. contribution to the IGY stemmed from various proposals, including a 1953 proposal of the American Rocket Society. The high cost of such an undertaking necessitated substantial governmental support. On July 29, 1955, President Eisenhower announced that the United States would undertake the satellite project as a contribution to the IGY. It was to be done with minimal interference with the military missile programs.

This project, designed to place a 20-pound sphere in a 300-mile orbit around the earth, was to be mainly a civilian scientific effort. However, most of the national competence in the all-important launch vehicle field was centered in the military services and their contractors, and thus the military had to be brought into the picture. With the help of a committee of civilian scientists, the DOD Committee on Special Capabilities was to work out the details for the satellite project. The Committee canvassed the three military services for proposals. After what would seem to have been adequate investigation and review, the decision was made to use most of the elements of the Naval Research Laboratory proposal, which was based on the Navy's Viking/Acrobee-Hi launch vehicle technology.<sup>3</sup> Thus, Project Vanguard, as it was named, became for all practical purposes a Navy-civilian project under the Navy's Office of Naval Research. Its scientific aspects were under the purview of the U.S. IGY Committee of the National Academy of Sciences.

Subsequent events have revealed that Project Vanguard suffered from the decisions which gave it a "shoestring" status in terms of national priorities and resources.<sup>4</sup> As it turned out, the orbiting of the first manmade satellite became a very potent "weapon" in the cold war. This was not fully understood until after the great propaganda success of *Sputnik I*.

In comparison with *Sputnik*, Project Vanguard came to be viewed as some-

<sup>3</sup> Hindsight has revealed that an earlier interservice (but primarily Army) project, Project Orbiter, might well have yielded a better payoff had it been adopted, as it would have made better use of research and development already completed. Recapitulations of the Orbiter-Vanguard controversy can be found in several places. For example, see House Hearings, *Astronautics and Space Exploration*, pp. 155-157; R. Cargill Hall, "Early U.S. Satellite Proposals," in Emme, *History of Rocket Technology*, pp. 67-106.

<sup>4</sup> U.S. Congress, Senate, Committee on Armed Services, Preparedness Investigating Subcommittee, *Inquiry Into Satellite and Missile Programs*, Hearings, Part I, 85th Cong. (Washington: GPO, 1958), pp. 142-191 (hereafter cited as Senate Hearings, *Inquiry Into Satellite and Missile Programs*).

thing too little and too late.<sup>5</sup> As a result it has been easy to overlook its long-run technological and scientific contributions. One very fundamental thing revealed by Project Vanguard was that a successful space program would have to be built on a foundation of well-formulated basic policy and planning, be effectively organized, be firmly supported with resources, and given high priorities.

**NACA Space-Related Activities.** The space-related activities of NACA at the time of Sputnik were a natural outgrowth of its basic aeronautical research and its structures and propulsion work in support of DOD missile projects. Most of NACA's space-related activities were of an advanced research and advanced technical development nature rather than related to a hardware-using flight program. An important exception was the NACA-Air Force-Navy "edge of space" X-15 rocket airplane development project initiated in 1954. NACA claimed that at the time of Sputnik, almost 50 percent of its overall effort could be labeled "space related." Even so, the actual dollar amount was relatively small—under \$35 million annually. NACA's program will be described in greater detail in Chapter 2.

### B. Initial U.S. Reactions to Sputnik

The period immediately following Russia's successful orbiting of *Sputnik I* on October 4, 1957, was characterized by messages of congratulations to the U.S.S.R., claims that the United States could have been first if certain mistakes had not been made, and a fairly widespread concern about the country's military preparedness and a possible missile gap. It was also pointed out that the U.S.S.R.'s large rockets were necessitated by their large and heavy (i.e., less advanced) nuclear warheads.

Before any significant actions were made public, the Russians orbited *Sputnik II* (November 5, 1957) weighing over 1,100 pounds (six times the weight of *Sputnik I*) and carrying a dog. Public concern soared higher than ever. To allay public fears, President Eisenhower made a major speech on November 7 in which he declared U.S. defenses sound, and revealed that the United States had made a space "breakthrough" by perfecting a nose cone capable of surviving entry into the earth's atmosphere at ICBM speeds.<sup>6</sup> He announced that the position of Special Assistant to the President for Science and Technology had been created and that James R. Killian, the renowned president of the Massachusetts Institute of Technology, had been appointed to fill it. He also announced that the President's Scientific Advisory Committee had been reconstituted. Killian and the President's Scientific Advisory Committee were to play an important role in the establishment of NASA. Bringing the voice of science into the White House was itself of historical significance.

<sup>5</sup> After two successful test shots out of four, the first Vanguard satellite was orbited on Mar. 17, 1958, 5½ months after *Sputnik I* and 1½ months after *Explorer I*, the first successful U.S. satellite launched by the Army on Jan. 31, 1958. Subsequently two more Vanguard satellites were orbited out of eight attempts.

<sup>6</sup> For text, see *The Washington Post & Times Herald*, Nov. 8, 1957, p. A14.

Developments during the remainder of 1957 and early 1958 fall roughly into two areas. First, the status of existing space-related activities was reexamined and measures taken to assure that progress was what it should be.<sup>7</sup> Second, the nature, scope, and organization of the Nation's long-range space program were debated.<sup>8</sup> The principal issue was not whether there should be an accelerated and organized space program but rather the extent to which the space program should be civilian in orientation and organization.

Important congressional hearings, conducted by the Military Preparedness Subcommittee of the Senate Committee on Armed Services during November and December 1957, and January 1958, developed the distinctions between the militarily significant ballistic missile and the more scientifically significant earth satellite.<sup>9</sup>

<sup>7</sup> On Nov. 8, 1957, Secretary of Defense McElroy directed the Army to attempt two satellite launchings in March 1958. The Army's Jupiter C launch vehicle was to be used. On Nov. 15, DOD announced that William Holaday, McElroy's Special Assistant for Guided Missiles, had been named Director of Guided Missiles and given greater power to ride herd on DOD missile projects. Overtime restrictions on the Atlas ICBM program, an economy measure dating from July 1, 1957, were lifted by DOD on Dec. 2. On Dec. 5, DOD announced that a major DOD reorganization would be made in early 1958 when the Advanced Research Projects Agency (ARPA) would be established. In January President Eisenhower announced that all DOD anti-missile and space satellite activity would be put under ARPA. ARPA was created by an order of the Secretary of Defense on Feb. 7 and Roy Johnson of General Electric was named Director. Congress paved the way for this action by authorizing the Secretary of Defense to engage in "advanced research projects." (Public Law 85-325, signed Feb. 12, 1958.) ARPA was to be an operating agency and several space projects of the military services were transferred to it. Actually the military services served as "contractors" for ARPA. DOD's establishment of an operating agency apart from the three services was a radical departure from standard DOD practice and may have muddied the picture rather than clarified it. It should be pointed out, of course, that ARPA was initially regarded as a 1-year agency. On March 27, 1958, ARPA received Presidential approval of a rather ambitious space program including plans for several lunar probes.

<sup>8</sup> The debate is almost impossible to summarize. Scientists, Congressmen, and those involved in national defense did most of the talking. On Nov. 21, 1957, the prestigious Rocket and Satellite Research Panel of the National Academy of Sciences, James Van Allen, Chairman, proposed the establishment of a scientifically oriented National Space Establishment to conduct space research and exploration. On Dec. 4, it was revealed that the American Rocket Society had made a similar proposal on Oct. 14. The two groups made a joint proposal on Jan. 4, 1958. (For text, see U.S. Congress, Senate, Special Committee on Space and Astronautics, *Compilation of Materials on Space and Astronautics, No. 1*, Committee Print, 85th Cong., 2d sess. (Washington: GPO, 1958), pp. 17-19 (hereafter cited as Senate Print, *Compilation . . . , No. 1*). On Jan. 14 NACA released a staff study entitled "A National Research Program for Space Technology" which recommended an interagency space program embracing NACA, DOD, the National Science Foundation, and the National Academy of Sciences. (This will be covered in greater detail in Ch. 2.) Most public attention was focused on the congressional inquiry conducted during November, December, and January.

<sup>9</sup> The Preparedness Investigating Subcommittee of the Senate Committee on Armed Services began an "Inquiry Into Satellite and Missile Programs" on Nov. 25, 1957. Lyndon Johnson was subcommittee chairman. Hearings were held on 20 different days between Nov. 25 and Jan. 23, 1958. Most of the 70 witnesses were from the Department of Defense. The printed hearings total 2,300 pages. Johnson quickly became the chief national spokesman on space matters. On Feb. 23, Apr. 3, and July 24, 1958, the Secretary of Defense appeared before the subcommittee and reported on DOD accomplishments in implementing the subcommittee's Jan. 23 recommendations. For full citations on the entire series of hearings, see the Bibliography.

The administration took action in regard to existing space-related activities but showed little progress in resolving the broader long-range issues. Congress forced the administration's hand, however. In January 1958 numerous bills were introduced in Congress, each providing a particular solution to the problems which Sputnik raised.<sup>10</sup> One bill, introduced by Senator Clinton Anderson on behalf of the Joint Committee on Atomic Energy, amended the Atomic Energy Act by giving the Atomic Energy Commission a major portion of the Nation's space program. The administration decided to oppose this bill, but at the same time felt compelled to present an alternative. On February 4, 1958, President Eisenhower announced that he had assigned Dr. James R. Killian the job of coming up with a definitive solution.<sup>11</sup> Killian turned to the Space Sciences Panel of the President's Scientific Advisory Committee (PSAC) for assistance.<sup>12</sup>

## II. THE ADMINISTRATION'S PLAN

On March 5, 1958, President Eisenhower approved the recommendations of his Advisory Committee on Government Organization that the "leadership of the civil space effort be lodged in a strengthened and redesignated National Advisory Committee for Aeronautics," and that legislation be enacted "to give NACA the authority and flexibility" to carry out its expanded responsibilities.<sup>13</sup>

President Eisenhower's advisers (primarily Killian, PSAC, and the Bureau of the Budget) had been moving in this direction for some time. It is very difficult to pinpoint precisely when NACA moved out in front in the competition for jurisdiction over the space program. NACA had begun to sell itself in January by proposing an interagency space program embracing NACA, DOD, NSF, and NAS.<sup>14</sup> NACA's leaders, such as Hugh L. Dryden, had many friends on the President's Scientific Advisory Committee, including PSAC's Chairman, Dr. Killian. James Doolittle, NACA's titular head, was a member of the PSAC. Apparently NACA was already the front runner in early February when the administration decided to come up with a specific proposal.<sup>15</sup>

Eisenhower's March 5 decision was based on a memorandum dated the same day and signed by Nelson Rockefeller, Chairman of the President's Advisory Committee on Government Organization; Percival Brundage, Director of the Bureau of the Budget; and James Killian, Special Assistant for Science and Tech-

<sup>10</sup> For a complete listing and text of all such bills, see U.S. Congress, Senate, Special Committee on Space and Astronautics, *Compilation of Materials on Space and Astronautics, No. 2*, Committee Print, 85th Cong., 2d sess. (Washington: GPO, 1958), pp. 308-354 (hereafter cited as Senate Print, *Compilation . . . , No. 2*).

<sup>11</sup> *New York Times*, Feb. 5, 1958, p. 1.

<sup>12</sup> Letter, Killian to the author, Aug. 14, 1963.

<sup>13</sup> Memorandum for the President from the President's Advisory Committee on Government Organization, Mar. 5, 1958. Subject: Organization for Civil Space Programs.

<sup>14</sup> NACA's January proposal is discussed in greater detail in Ch. 2.

<sup>15</sup> One researcher claims that by Feb. 4 ". . . the Executive Offices had already agreed that the new civilian space agency would be built upon NACA." See p. 12 of Enid Bok's "The Establishment of NASA: The Political Role of Advisory Scientists," a paper delivered at the Dec. 27, 1962, meeting of the American Association for the Advancement of Science.

nology.<sup>16</sup> Dr. Killian calls the President's March 5 action "the conclusive act with respect to building a civilian space agency upon the NACA structure."<sup>17</sup> The contents of the memo warrant summarization.

#### A. Provisions of the March 5 Memorandum

The memorandum opened by declaring that the U.S. civil space program will "entail increased expenditures and the employment of important numbers of scientists, engineers, and technicians," that "an aggressive space program will produce important civilian gains in general scientific knowledge and the protection of the international prestige of the United States," and that the "long-term organization for federal space programs . . . should be under civilian control."

The memorandum recommended that the "leadership of the civil space effort be lodged in a strengthened and redesignated National Advisory Committee for Aeronautics." The factors favoring this approach were these: (1) NACA was a going research agency with a large technical staff and sizable research facilities; (2) NACA had progressively moved into space research; (3) if NACA would not be allowed to move further into the space field, its whole future would be in doubt; (4) NACA had a long history of close cooperation with DOD; (5) NACA was a civilian agency in spite of its close cooperation with DOD; and (6) NACA's liabilities could be easily overcome.

The memo then went on to list these liabilities: (1) NACA does not have an across-the-board space competence nor has it had much experience in the administration of large-scale developmental contracts; (2) most of the Nation's spacework has been done by or for DOD, and NACA would have to tap this competence without impairing the military space program; (3) "NACA is not in a position to push ahead with the immediate demonstration projects which may be necessary to protect the Nation's world prestige"; (4) NACA is limited by the somewhat inflexible hiring and pay provisions of civil service regulations; and (5) NACA's organization and procedures are geared to a much lower level of expenditure than will be the case after its expansion.

The memo recommended that these liabilities be overcome or mitigated by enacting appropriate legislation. Four specific recommendations were made. First, NACA should be renamed the National Aeronautical and Space Agency (NASA). Second, NASA should be permitted to establish pay rates in excess of those of the Classification Act of 1949. Third, the agency head should be appointed by the President with the advice and consent of the Senate. (NACA's Director was selected by NACA's 17-member governing committee.) Fourth, the composition of the 17-member governing committee should be changed.

The memo closed by listing the immediate steps that would have to be taken if the basic recommendations were accepted. First of all, legislation would have

<sup>16</sup> The President's Advisory Committee on Government Organization was brought into the picture only as a matter of form. Killian made the presentation to the President.

<sup>17</sup> Letter, Killian to the author, Aug. 14, 1963. (Cited in footnote 13.)

to be drafted immediately if Congress was to act during the current session. Supplemental appropriations would have to be requested. Relationships between NASA and DOD would have to be worked out. The memo implied that certain projects would eventually be transferred from other agencies to NASA. The memo also clearly implied that NASA would have to do much of its work by contract. Finally, the memo suggested that NACA be advised that it was being charged with "the responsibility for developing and arranging for the execution of the civil space program."

In an attachment to the memo, the pros and cons of alternative organizational arrangements were set forth. DOD was not recommended because of the desire for civilian scientific emphasis and DOD's deep involvement in the missile program. The Atomic Energy Commission was not recommended because its program was not closely enough related to the technology of the space program. Also, an agency with a single head was deemed best for the space program. Putting the civil space program under the often-proposed Department of Science and Technology was not recommended because of the great delays in getting started and the fact that the administration was not in favor of the creation of such a department.

#### **B. Preparation of the April 2 Documents**

On April 2, 1958, draft legislation establishing NASA was sent to Congress and a directive was issued to NACA and DOD instructing them to take certain actions pending congressional action on the draft legislation. The April 2 documents were three in number: President Eisenhower's message to Congress, draft legislation sent to Congress by the Bureau of the Budget, and President Eisenhower's directive to NACA and DOD concerning interim actions.<sup>18</sup>

The documents were drafted by the Bureau of the Budget with assistance from NACA and Killian's office.<sup>19</sup> Chief participants were Finan, Dean, and McClure of BOB's Office of Management and Organization; Shapley and Gathwright of BOB's Military Division; Dembling of NACA; and Johnston of Killian's office. The Department of Defense was not brought into the picture until the end of March when the draft bill was sent to various agencies for comment.<sup>20</sup>

<sup>18</sup> All three documents have been reprinted in House Hearings, *Aeronautics and Space Exploration*, pp. 3-5, 11-15, 967-969.

<sup>19</sup> Drafting was done under pressure as President Eisenhower wanted to send the draft legislation to Congress before it recessed for Easter.

<sup>20</sup> The lack of DOD participation in the preparation of the Apr. 2 documents was discussed on several occasions during the hearings on the space act. See the May 7 testimony of Donald Quarles and Roy Johnson and the May 13 testimony of Maurice Stans in U.S. Congress, Senate, Special Committee on Space and Aeronautics, *National Aeronautics and Space Act*, Hearings on S. 3609, Parts 1 and 2, 85th Cong., 2d sess. (Washington: GPO, 1958) (hereafter cited as Senate Hearings, *National Aeronautics and Space Act*). See also the May 12 testimony of Roy Johnson and Herbert York in House Hearings, *Aeronautics and Space Exploration*.



In comparing the April 2 documents with the March 5 memorandum, two significant developments stand out. First of all, the draft legislation was much more comprehensive than what had been suggested in the March 5 memo.<sup>21</sup> The second change involved the use of a board for high-level policymaking purposes. The BOB position in favor of single-headed agencies reporting directly to the President won out over the NACA position that a research agency needs some kind of a buffer at the top to shield it from the external forces such as politics.<sup>22</sup> As a gesture to NACA, the board was retained but with few substantive powers.<sup>23</sup>

### C. Contents of the April 2 Documents

The Administration's plan can be divided into three categories: (1) Recommendations on a national space policy; (2) specific proposals concerning a new space agency; and (3) interim measures to move ahead under existing arrangements.

The message and the Declaration of Policy of the draft legislation (Sec. 2) set forth the general national space policy recommended by the administration. The President declared that a space program was essential to the general welfare and security of the Nation and recommended that Congress promote or further the national space program by the enactment of appropriate legislation. The space program should be given high priority and be soundly organized. In terms of civilian orientation, the President said, "I recommend that aeronautical and space science activities sponsored by the United States be conducted under the direction of a civilian agency, except for those projects primarily associated with military requirements." The civilian agency should be a new one and include aeronautical activities as well.

The specific details concerning the creation of a new space agency were set forth in the draft legislation and summarized in the message. It was recommended that the new agency be called the National Aeronautics and Space Agency. Headed by a Director appointed by the President and confirmed by the Senate, the functions of the new agency would be to take over the aeronautical activities of NACA and develop and execute a civilian space program.

A special effort was made to give the new agency adequate power to accomplish its objectives. The authorized powers as enumerated, in addition to the usual ones of rulemaking, acquiring and disposing of property, entering into contracts, etc., included liberal provisions for hiring and paying certain scientific and technical specialists, and the power to transfer (for a period of 3 years) unto

<sup>21</sup> The Mar. 5 memo talked about amending NACA's basic law and strengthening NACA. The draft legislation stressed that NASA would be a new agency and few references were made to NACA. Paul Dembling recalls that in his first draft he attempted to "write around" every possible restriction that NACA had been facing. (Interview, Dec. 5, 1962.)

<sup>22</sup> Interview with Willis Shapley, Bureau of the Budget, May 7, 1964.

<sup>23</sup> Interview with Paul Dembling, Dec. 5, 1962.

itself the functions of other agencies, providing the agency and the President consented.

The draft legislation also provided for the establishment of a National Aeronautics and Space Board, not to exceed 17 members, to meet at least quarterly and to serve without compensation, and to serve in a general advisory capacity to both the President and the NASA Director. In addition, the Board was to make recommendations to NASA on general policies, programs, appropriations, and major appointments. In effect, the Board would function similarly to the Main Committee of NACA but with fewer substantive powers.

The April 2 document not yet discussed, was the President's letter to DOD and NACA instructing the two agencies as to what actions they should be taking pending final congressional action on the proposed legislation. These actions were based on the assumption that Congress would eventually act along the lines recommended. NACA was instructed to prepare a full explanation of the proposed legislation for presentation at the congressional hearings. NACA was also to make plans to reorient its "programs, internal organizations, and management structure to carry out the functions to be assigned to the National Aeronautics and Space Agency" and to lay the groundwork for whatever expansion might be necessary to implement the legislation when enacted. DOD and NACA were to jointly review current DOD space programs to determine which ones should be transferred to NASA and to what extent facilities should be transferred with them. Unnecessary facility duplication was to be avoided. NACA was to discuss with the National Academy of Sciences, the National Science Foundation, and other similar organizations the best ways and means of securing the participation of the scientific community in the national space program. Finally, DOD was to "identify those programs" needed in support of "well-defined military requirements." Any problems arising from these instructions were to be discussed with either Dr. Killian's office or the Bureau of the Budget.

### III. THE ENACTMENT OF THE SPACE ACT

The Democratically controlled Congress was well prepared to receive the draft legislation. Both the House and Senate had formed ad hoc committees to deal with matters concerning space. On February 6, 1958, the Senate created the Special Committee on Space and Astronautics. Lyndon B. Johnson, the Senate majority leader, was named its chairman. On March 5, the House created the Select Committee on Astronautics and Space Exploration. To match the action of the Senate, John W. McCormack, House majority leader, was picked as chairman.

Hearings got underway in the House on April 15. Three months later Congress passed the National Aeronautics and Space Act of 1958.<sup>24</sup> It was signed

<sup>24</sup> See Appendix A: *National Aeronautics and Space Act, as amended*, through the 87th Cong., Oct. 13, 1962.

by President Eisenhower on July 29, 1958.<sup>25</sup> The Space Act's legislative history has already been published and will not be recounted here.<sup>26</sup>

The most significant differences between the Space Act and the administration's draft legislation stemmed from congressional concern over the relationship between space and national defense. As indicated earlier, the administration's proposals had an overwhelmingly civilian emphasis, whereas congressional concern following Sputnik was largely in the area of military security. Congress wrestled manfully in its attempt to bring about a satisfactory solution to this basic dichotomy. In the brief summary and analysis of the Space Act which follows, parenthetical comparisons are made with the provisions of the draft legislation described earlier in this chapter.

**Title I—Statement of National Policy.** The emphasis of the statement of national policy was that the U.S. space program was to be of benefit to the security and general welfare of the United States and to all mankind. Peaceful objectives were to be pursued, human scientific knowledge in aeronautical and space-related matters be expanded, international cooperation in space be promoted, public and private efforts in space coordinated, U.S. leadership in space preserved, and the long-range effects of a space program studied. Furthermore, the space program was to be the responsibility of a civilian agency, except that activities "associated with the development of weapons systems, military operations or the defense of the United States" were to be the responsibility of DOD, with the President determining jurisdiction in borderline cases. (The only significant change made in the draft legislation was a general "tightening" of the language concerning the space role of DOD.)

**Title II—Coordination of Aeronautical and Space Activities.** Whereas the draft legislation provided for a Space Board advising the NASA Director, the Space Act provided for a Space Council advising the President (Sec. 201). The two bear almost no resemblance to each other.

The Council, composed of the President, Secretary of Defense, Secretary of State, NASA Administrator, AEC Chairman, and up to one other public member and up to three private members, was to advise the President in his planning, developing, and coordinating a comprehensive national space program. NASA-DOD coordination was mentioned specifically. The Council was given the power to hire its own staff to be headed by a civilian executive secretary, appointed by the President and confirmed by the Senate. The idea of a Space Council was generally associated with Senator Lyndon Johnson and his efforts to keep both the military and civilian emphasis strong and to guarantee that nothing vital to

<sup>25</sup> Public Law 85-568; 72 Stat. 426; 42 U.S.C. 2451. Text can be found in several places, including NASA's first two semiannual reports. NASA General Management Instruction 1-2-1 includes all subsequent amendments as well and has been reproduced in App. A.

<sup>26</sup> For a detailed legislative history of the Space Act, see Alison Griffith, *The National Aeronautics and Space Act: A Study of the Development of Public Policy* (Washington: Public Affairs Press, 1962). Covering much the same ground is the unpublished seminar paper of Mary Stone Ambrose, "The National Space Program, Phase I: Passage of the 'National Aeronautics and Space Act of 1958'" (The American University, 1960).

the Nation's interests would get lost or overlooked by having responsibilities shuffled between NASA and DOD.

Section 202 of the Act established the National Aeronautics and Space Administration (rather than Agency) to be headed by an Administrator (rather than Director) and a Deputy Administrator, both appointed by the President and confirmed by the Senate. (The draft legislation made no provision for a Deputy Director.)

The functions of NASA as enumerated in section 203 were only three in number: (1) to "plan, direct, and conduct aeronautical and space activities"; (2) to arrange for the participation of the scientific community in these activities; and (3) to widely disseminate information about these activities. (The last point was not explicitly included in the draft legislation.)

The powers of NASA as authorized in Section 203 were almost identical with those included in the draft legislation; e.g., make rules, hire employees, acquire property, accept gifts, enter into contracts, enter into agreements with other agencies, utilize the services of advisory committees, hire consultants, coordinate with other public and private organizations, etc. Perhaps the most important grant of power, one which will be referred to quite often in later chapters, was the one giving the NASA Administrator authority to hire up to 260 persons at rates of pay up to \$19,000 (\$21,000 for 10 positions) without regard to the Classification Act of 1949. These excepted positions gave the Administrator great flexibility in staffing top positions. The Administrator was also authorized to hire new scientists and engineers at two grades above those provided for by the General Schedule of the Classification Act of 1949. This provision was intended to ease NASA's problem in recruiting newly graduated scientists and engineers.

The problems of military-civilian coordination were dealt with in Section 204, which established the Civilian-Military Liaison Committee. A Presidentially appointed chairman, together with at least one representative from DOD and each of the three services, matched by an equal number from NASA, would serve as a means by which NASA and DOD could "advise and consult with each other on all matters within their respective jurisdictions relating to aeronautical and space activities . . ." and keep each other fully and currently informed with respect to such activities. If DOD or NASA could not come to an agreement on some matter, either agency head was explicitly authorized to refer the matter to the President for a final decision. (No provision for such a liaison committee was included in the draft legislation and the push for it came largely from the House of Representatives.)

Two other sections under Title II warrant mentioning. Section 205 gave legislative recognition to the need for NASA to cooperate with other nations, providing it is done within the framework of U.S. foreign policy, and Section 206 provided for an annual Presidential report to Congress on the Nation's space program and a semiannual NASA report to the President and Congress on NASA space activities.

*Title III—Miscellaneous.* Section 304 put NASA under the general internal security provisions of public law.

Section 305, the most lengthy section in the Act, dealt with the somewhat specialized subject of patents. Included was a provision for the establishment, within NASA, of an Inventions and Contributions Board which was to consider waivers to the general agency policy that inventions made using NASA resources (in-house or contract) became U.S. property, as do the patents based on the inventions. This has been a very controversial area and will be discussed again in later chapters.

Section 306 gave the NASA Administrator the power to make monetary awards for valuable scientific and technical contributions to NASA. Awards were to be based on the recommendations of the Inventions and Contributions Board mentioned above. (The draft legislation did not include provisions similar to Secs. 305 and 306.)<sup>27</sup>

Two transitory sections are significant. Section 302 gave the President a 4-year grant of power to transfer to NASA space-related functions of other agencies. If the transfer was made before January 1, 1959, Congress only had to be informed of the fact. Any subsequent transfers, however, would be subject to a 60-day congressional veto period, a provision identical to a basic feature of the Reorganization Act of 1949. (The draft legislation provided for a less restrictive 3-year transfer period, but placed more emphasis on bilateral agreements between NASA and the affected agency.) The important use of this transfer power will be covered in Chapter 3.

Section 301 provided for the transition from NACA to NASA to take place 90 days after the Act became law, or earlier if properly proclaimed by the NASA Administrator.

The Act was signed into law on July 29, 1958. On August 8, President Eisenhower nominated Dr. T. Keith Glennan, president of the Case Institute of Technology to be NASA Administrator, and Dr. Hugh Dryden, Director of NACA, to be Deputy Administrator. The nominations were confirmed by the Senate on August 15 and the two individuals were sworn in on August 19. On September 25, Administrator Glennan issued a proclamation that NASA was ready to commence operations.<sup>28</sup> Its publication in the *Federal Register* on September 30 fulfilled the procedural requirement and on October 1, NASA was in business, almost exactly 1 year after Russia's Sputnik had kicked off the whole chain of events.

<sup>27</sup> Patent matters were not discussed in the hearings on the space bill. In fact, the patent provisions were expanded and rewritten while the bill was in conference. See Paul Dembling's "National Coordination for Space Exploration," *The JAG Journal*, February 1959.

<sup>28</sup> The proclamation read in part: "By virtue of the authority vested in me by the National Aeronautics and Space Act of 1958 . . . I hereby proclaim that as of the close of business September 30, 1958, the National Aeronautics and Space Administration has been organized and is prepared to discharge the duties and exercise the powers conferred upon it. . . .

"In accordance with the provisions of the Act, all functions, powers, duties, and obligations, and all . . . property, personnel . . . , funds, and records of the National Advisory Committee

### SUMMARY AND CONCLUSIONS

The events during the 12 months following *Sputnik I* may be subject to various interpretations. To some they indicated the inability of a democracy to move ahead quickly when faced by novel and difficult problems. To others they indicated the ability of a democracy to choose the best long-term alternatives through the deliberate and systematic working of the democratic process. To some they revealed the failures of a Democratic administration between 1945 and 1953; to others, the shortcomings of a Republican administration from 1953 to 1958. Some felt that had the military been given a free rein, progress would have been much faster, while others held that interservice rivalry had already done enough damage and would probably get worse.

The delays in getting started do not appear as significant today as they probably did at the time. As basic legislation, the Space Act has stood up rather well. Amendments have been few and of relatively minor importance.

Congress showed more aggressiveness than the administration in getting the Nation moving forward in space. A bipartisan approach to the problem was taken and congressional leaders themselves took an active interest in working out the best possible solution. Congress made a very determined effort to achieve an optimum relationship between military and civilian efforts, but in doing so included organizational details in the Space Act which have not stood up too well as initially implemented. Congress indicated great willingness to accept the Russian challenge and probably would have supported a crash program had one been proposed. Its plans for continued interest in space matters was evidenced by the conversion of the ad hoc space committees into standing committees.

The administration has been given credit for stressing the need for a primarily civilian program. The widespread support for its April 2 proposal indicates a careful formulation of its plans. However, it seems safe to say that the administration may have failed to see the full implications of what the U.S.S.R. had achieved, especially its international psychological impact. On the other hand, Congress probably underestimated the actual difficulties of meeting the Russian challenge, especially in terms of the time required to overcome a late start in certain areas of technology.

The main elements of the Nation's space policy, as determined during the period just discussed, can be summarized as follows:

(1) The national space program was to be under the jurisdiction of several agencies, with military activities centered in DOD and civilian activities in NASA. Effective coordination among all involved organizations was to be maintained at all times.

for Aeronautics are hereby transferred to the National Aeronautics and Space Administration. . . .

"Existing policies, . . . and procedural instructions governing the activities of the National Advisory Committee for Aeronautics, . . . shall be continued in effect until superseded or revoked. . . ."

The proclamation was dated Sept. 25, 1958, and signed by T. Keith Glennan, NASA Administrator. It appeared in the *Federal Register* on Sept. 30, 1958 (23 F.R. 7579).

(2) Overall policy direction was to come from a high-level council chaired by the President himself.

(3) Congressional oversight was to be carried on by two newly created standing committees.

(4) The urgency of action and the long-range objectives sought would be largely determined (unofficially) by the Russian challenge. Unfortunately this last element was not a clear-cut guide to action.

The implementation of the Space Act, examined from the administrative point of view, is the central theme of this study. Emphasis will be placed on the role of NASA. But before this story gets underway in Chapter 3, it is necessary to take a look at NASA's organizational predecessor, NACA. This is done in the next chapter.

## Chapter Two

### NASA'S ORGANIZATIONAL PREDECESSOR, NACA

On March 5, 1958, President Eisenhower approved the proposal which essentially lodged the Nation's civilian space program in a strengthened and redesignated National Advisory Committee for Aeronautics (NACA). On September 30, 1958, a notice appeared in the *Federal Register* that as of the close of business that day, NACA would cease to exist, and that a new agency would come alive on October 1 as the National Aeronautics and Space Administration. Legal transition from NACA to NASA took place overnight. The actual transformation of NACA into NASA, however, took much longer and was accompanied by additions of people and programs from the outside. To understand NASA's early administrative history, a knowledge of NACA's organizational structure and historical development is essential.

#### I. A BRIEF HISTORY OF NACA <sup>1</sup>

Although the United States had pioneered in many of the early developments in aviation after the first demonstrations of the Wright brothers in 1903, technological progress in the next few years, especially in the use of the airplane in both civilian and military affairs, lagged behind that of Europe.<sup>2</sup> This lag did not go unnoticed and several Americans, such as Alexander Graham Bell, urged the Federal Government to do something about it. Great Britain supplied a pattern for action by establishing an Advisory Committee for Aeronautics in

<sup>1</sup> No history of NACA has been published. The two most readily available partial accounts are Jerome Hunsaker, "Forty Years of Aeronautical Research," *Smithsonian Report for 1955*, pp. 241-271 (Washington: Smithsonian Institution, 1956), and George W. Gray, *Frontiers of Flight: The Story of NACA Research* (New York: A. Knopf, 1948). Arthur L. Levine's unpublished Ph. D. dissertation, entitled "United States Aeronautical Research Policy, 1915-1958" (Columbia University, 1963), is very helpful. The files of the NASA Historical Office contain random portions of two historical drafts, one apparently prepared by John F. Victory, the other by Ruth Walrad.

<sup>2</sup> Hunsaker reported in 1914 that the United States had only 23 military airplanes as compared with over 3,500 in France, Germany, Russia, and Great Britain. (p. 243 of "Forty Years of Aeronautical Research.")



1910, but several abortive tries were made and World War I actually began before the United States was able to establish a similar committee in 1915.<sup>3</sup>

The U.S. committee, also called the Advisory Committee for Aeronautics (the Committee itself inserted the word "National" at its first meeting), consisted of 12 members, appointed by the President, who served without compensation.<sup>4</sup> The Committee's duty was to "supervise and direct the scientific study of the problems of flight, with a view to their practical solution, and to determine the problems which should be experimentally attacked, and to discuss their solution and their application to practical questions." Further, "in the event of a laboratory, or laboratories, either in whole or in part, being placed under the direction of the committee, the committee may direct and conduct research in aeronautics in such laboratory or laboratories. . . ."<sup>5</sup>

Since only \$5,000 was appropriated for its first year, the Committee could do little more than hold occasional meetings, sponsor or encourage a few university research projects, and hire one clerk.<sup>6</sup> As war approached for the United States, the Committee's policy role grew in importance. The growth of NACA, subsequent to this modest beginning, is shown in the following table.<sup>7</sup>

TABLE 2-1

Year	Number of permanent personnel (approximate)	Total appropriations	Year	Number of permanent personnel (approximate)	Total appropriations
1915.....	1	\$5,000	1940.....	650	\$4,374,546
1920.....	20	175,000	1945.....	6,800	40,492,330
1925.....	130	470,000	1950.....	7,150	53,000,000
1930.....	240	1,508,000	1955.....	7,600	56,860,000
1935.....	300	747,830	1958.....	8,000	117,276,209

<sup>3</sup> Public Law 271, 63d Cong., Mar. 3, 1915. This was the Naval Appropriation Act of 1915 and the provision for an Advisory Committee for Aeronautics was a rider. Charles D. Walcott of the Smithsonian Institution and members of the National Academy of Sciences led the battle for expanded aeronautical research.

<sup>4</sup> Two each from the War and Navy Departments; one each from the Smithsonian Institution, Weather Bureau, National Bureau of Standards; plus five others.

<sup>5</sup> 38 Stat. 930. A helpful source for the original wording and all subsequent amendments is "Legislation Pertaining to the National Advisory Committee for Aeronautics as of April 1958," prepared in Office of Legal Adviser, NACA (mimeographed).

<sup>6</sup> That clerk was John F. Victory, who was still with NACA when it went out of existence in 1958 and who had risen to the position of Executive Secretary, the second highest career position in the agency.

<sup>7</sup> Appropriation figures are for fiscal years and are taken from NACA's annual reports. Personnel figures came from a variety of sources. In 1950 NACA also received an appropriation of \$75 million under the authorization of the Unitary Wind Tunnel Plan Act of 1949. For a year-by-year account of NACA requests, BOB approvals, and congressional appropriations, see Arthur Levine, "United States Aeronautical Research Policy, 1915-1958" (unpublished Ph. D. dissertation, Columbia University, 1963) (hereafter cited as Levine, "United States Aeronautical Research Policy, 1915-1958").

NACA began to conduct in-house research in 1917 when its first field installation went into operation. Located at Langley Field near Hampton, Va., the Langley Memorial Aeronautical Laboratory was the locus of NACA's research activities for the next 24 years. In 1939, as war clouds gathered, Congress authorized a second laboratory, and in early 1941 the Ames Aeronautical Laboratory began operations at Moffett Field in the San Francisco area. In 1940 a flight propulsion laboratory was authorized, and in 1942 this facility, later named the Lewis Flight Propulsion Laboratory, began operations adjacent to Cleveland's Municipal Airport. Both the Ames and Lewis facilities were planned and staffed by Langley personnel.

The opening of these two new laboratories, together with an increased level of effort at Langley demanded by World War II, meant rapid growth for NACA between 1940 and 1945. NACA's contribution to the air successes of the Allies during World War II was substantial. Many of these contributions came from basic research done during the 1930's, however, and most of NACA's World War II work involved perfecting or improving existing aircraft on the basis of existing knowledge. With the end of World War II, NACA was free once again to move ahead to the frontiers of aeronautical research. At this point the resources of the agency, both personnel and facilities, were 10 times what they had been before the war. Postwar work focused on more speed, higher altitudes, and new and better power plants, including both jet and rocket engines. To aid research work in these areas, a Pilotless Aircraft Research Station for launching rockets was established in 1945 at Wallops Island, Va., as an adjunct to Langley Laboratory, and in 1947 a somewhat more autonomous High Speed Flight Station was set up at Edwards Air Force Base in southern California.

NACA's specific research accomplishments are difficult to summarize both because of their technical nature and because no authoritative history of these accomplishments exists. There is no doubt that scores of aircraft improvements should be credited to NACA research. NACA is usually given credit for the overall superiority of conventional Allied fighter planes in World War II, a factor viewed by some as the principal reason why the Allies won control of the air in Europe, which, in turn, made possible the land victory.<sup>8</sup> In the postwar era, the contributions of NACA to transonic and supersonic flight were substantial, culminating in the well-known flights of the X-1 and later the X-15 rocket research airplanes.

So far attention has been focused primarily on quantities: numbers of personnel, numbers of laboratories, amounts of appropriations. But quantitative terms alone do not explain NACA's role. The following qualitative factors were probably the most important reasons why NACA was chosen to play such a prominent part in the Nation's expanding space program:

<sup>8</sup> In comments on this sentence, Eugene Emme, NASA Historian, pointed out that Nazi Germany had emulated NACA before World War II and that this contributed to the rapid increase in the power of the Luftwaffe between 1933-39 and the appearance of jet aircraft in 1943.

1. *Competent Personnel.* NACA had good success in attracting and retaining competent young scientists and engineers initially entering the job market. Research freedom and an overall esprit de corps were important factors in this. In addition, NACA was willing to do battle with the Civil Service Commission and others in looking out for the interests of its employees.

2. *Good Research Facilities.* In 1958 NACA research facilities were valued at \$300 million and, qualitatively, some were the best in the world. NACA's ability to get much from its construction and equipment appropriation was probably due to the fact that NACA personnel often played key roles in designing the research facilities and improving research equipment. For example, the wind tunnel was NACA's most important aerodynamic research tool and breakthroughs in wind tunnel design were often the product of NACA employees.<sup>9</sup>

3. *Overall In-House Capability.* Almost all of NACA's money was spent by its own personnel conducting research in its own laboratories. As a result, NACA's research competence extended over a broad front, and few organizations could match it. By 1958 much of this competence was in space-related areas.

4. *Good Working Relationships With Other Organizations.* Much of NACA's work was directed toward solving the problems of other organizations, particularly aircraft manufacturers, and, most important, the Department of Defense. Through its university research program, NACA maintained close relationships with a large segment of the scientific community. NACA's elaborate committee and subcommittee structure, described later in this chapter, promoted these extra-agency relationships.

5. *Congressional Respect.* NACA was respected by Congress, especially its Appropriations Committees, for its fiscal integrity and tightfisted fiscal management.

While the factors listed above meant that NACA would not be ignored in consideration of a reorganized and expanded national space program, there were also reasons why NACA might not be called upon to spearhead such an effort. When *Sputnik I* forced the United States to reexamine its space program, the future role of NACA could not be predicted with certainty.

One of the general factors working against NACA was its known administrative conservatism. As good scientists and engineers do, NACA moved ahead in an orderly step-by-step process, facing new problems as old ones were solved. The agency had a reputation for cautious spending and prided itself in turning back to the Treasury a small portion of each year's appropriation. Although these characteristics are usually desirable, many national leaders felt that the Russian space challenge required a bold response, perhaps even a crash program, and this raised doubt concerning the role NACA would play.

Another factor working against NACA was that its reputation was built almost entirely on in-house research capability. NACA had little experience in

<sup>9</sup> A good example of this was Langley Laboratory's 1950 "slotted throat" transonic wind tunnel, associated with the name of NACA employee John Stack.

conceiving, planning, and executing large-scale projects requiring the teamwork of many people and organizations, and expenditure of large amounts of money, much of it through contracts.<sup>10</sup> NACA's contracting experience was relatively narrow in scope and its contracting staff was small in terms of numbers. In addition, much of NACA's work was in response to requirements of other organizations, whereas the agency charged with the new space program would have to take the lead in initiating requirements.

Perhaps the most important argument working against NACA was the claim by the military that because the Russian challenge was a threat to the Nation's security, the military services would have to play the prime role in meeting it. In view of the uncertain status of the U.S. missile program, this argument had much support, especially in Congress. As it turned out, the civilian orientation espoused by President Eisenhower, Dr. Killian, and the President's Scientific Advisory Committee prevailed. To what extent the Department of Defense voluntarily acquiesced to this is difficult to determine. NACA's reserve of good will with DOD, earned over many years, was probably a factor in the administration's winning DOD support for its proposals. DOD may well have expected a continuation of the same working relationship with NASA as it had had with NACA. What changed the relationship was that NASA's elevation into the "big league" automatically made it a competitor rather than a valuable support agency.

## II. NACA ORGANIZATION IN 1958

NACA's organization was unique in comparison with most Government agencies. The name was misleading in that it referred to both a 17-member committee and an 8,000-employee agency, and neither was purely advisory. A more descriptive name would have been "National Aeronautical Research Agency."

NACA's official organization charts (figs. 2-1, 2-2, and 2-3) identify organizational elements mentioned below. The first (fig. 2-1) outlines committee and subcommittee structure, agency headquarters organization, and agency field installations. The second (fig. 2-2) amplifies the subcommittee organization, and the third (fig. 2-3) further details NACA Headquarters.

### A. Committees and Subcommittees

NACA's basic legislation gave plenary power to a presidentially appointed committee, the basic functions of which were stated at the beginning of this chapter. Subject to presidential approval, the committee was empowered to

<sup>10</sup> Project Vanguard, not considered a large project, cost \$110 million. This was greater than NACA's entire annual appropriation.

formulate "rules and regulations" for the conduct of its work.<sup>11</sup> This power gave the committee organizational flexibility necessary to adjust to changing conditions. To distinguish it from the rest of the agency, the presidentially appointed committee will be referred to as the "Main Committee."

In 1958 the Main Committee consisted of 17 members.<sup>12</sup> The statutory formula provided for a minimum of 10 Government members (5 from DOD) and up to 7 members from outside government. An annual meeting was held in October, a semiannual meeting in April, and about eight additional meetings each year. Members were paid expenses only. The Main Committee functioned as a "board of directors." It formulated basic general policy governing the work of the agency and approved such items as major program changes, major facility changes, and the annual budget. For certain actions it resolved itself into an "Executive Committee."<sup>13</sup>

Early in its history the Main Committee realized that additional committees and subcommittees would be necessary if nationwide coordination of aeronautical research was to be achieved. Therefore it was decided that membership on subordinate committees should not be confined to Main Committee members. In this way a large number of people with varying backgrounds and affiliations were brought into the picture. In 1958, about 450 individuals, drawn from interested Government agencies, private corporations, and key universities, served on the 5 technical committees and their 23 subcommittees.<sup>14</sup>

The technical committees and subcommittees did not share in the decision-making power of the Main Committee. Their purpose was to promote the exchange of information on aeronautical research problems, to ascertain in what areas research effort was needed, and to make appropriate recommendations. Their influence in technical programs and related policy matters was substantial. Meetings were held about two or three times a year.<sup>15</sup> A NACA career employee

<sup>11</sup> The last edition of these rules and regulations was dated May 3, 1949, and was only four pages long. All quotations are from "Rules and Regulations for the Conduct of the Work of the National Advisory Committee for Aeronautics with Amendments Approved by the President to May 3, 1949" NACA (mimeographed) (hereafter cited as "Rules and Regulations for the Conduct of the Work of NACA, 1949").

<sup>12</sup> Membership was 12 from 1915 to 1929, 15 from 1929 to 1948, and 17 after 1948.

<sup>13</sup> The rules also provided for an executive committee to give month-by-month attention to the details of the research and business affairs of the agency. Since the executive committee was to consist of seven members elected from and by the Main Committee, plus those Main Committee members from the Washington area, it was possible to make the executive committee identical with the Main Committee, a practice that prevailed after World War II. Thus meetings of the executive committee were really special meetings of the Main Committee. The effect was that the operating freedom of the agency was limited in that the Main Committee had the authority and opportunity to inaugurate a system of closer supervision if it felt it necessary.

<sup>14</sup> For the 1958 membership of these committees (and the organizations represented), see *Forty-Fourth Annual Report of the National Advisory Committee for Aeronautics, 1958* (Final Report) (Washington: GPO, 1959), pp. 83-93 (hereafter cited as *Forty-Fourth Annual Report of the NACA, 1958*).

<sup>15</sup> For a summary of meeting places and frequency of meetings, see U.S. Congress, House, Committee on Appropriations, Subcommittee on Independent Offices, *Independent Offices Appropriations for 1959*, Hearings, p. 2, 85th Cong., 2d sess. (Washington: GPO, 1958), p. 592.

ORGANIZATION CHART  
NATIONAL ADVISORY COMMITTEE FOR AERONAUTICS

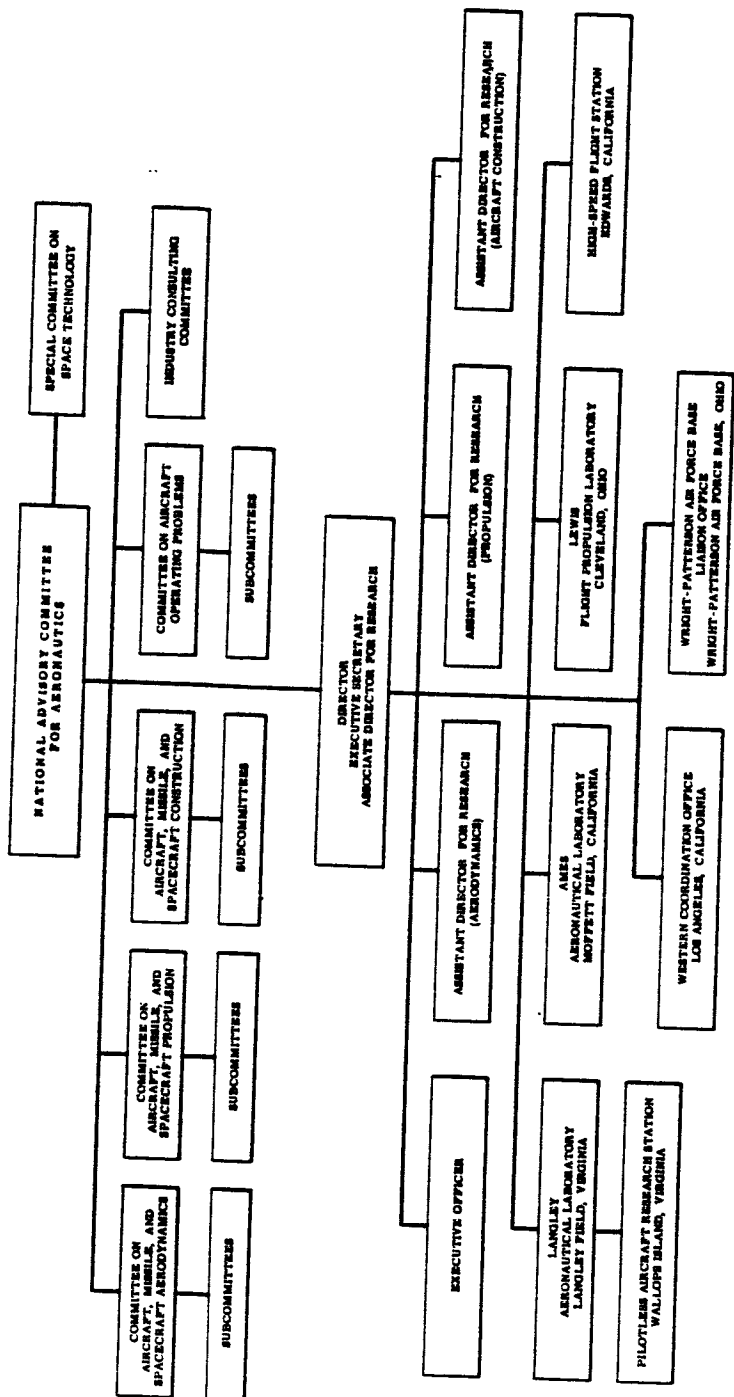

APPROVED: *Walter D. Doolittle*  
Director  
Date: March 3, 1958  
NACA

FIGURE 2-1

ORGANIZATION CHART  
NATIONAL ADVISORY COMMITTEE FOR AERONAUTICS  
COMMITTEES AND SUBCOMMITTEES

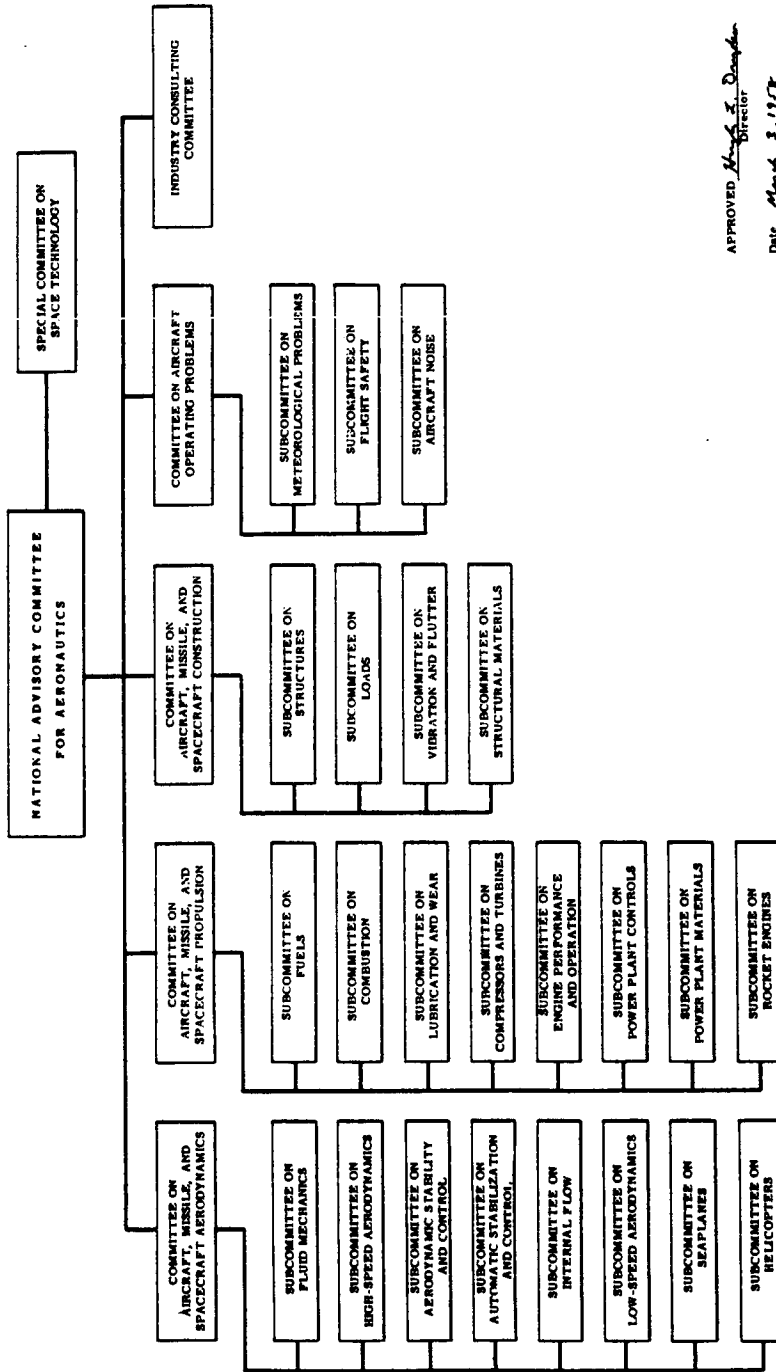

APPROVED *Harold G. Douglas*  
Director  
Date March 3, 1957  
NACA

FIGURE 2-2

NASA'S ORGANIZATIONAL PREDECESSOR, NACA

ORGANIZATION CHART  
 NATIONAL ADVISORY COMMITTEE FOR AERONAUTICS  
 NACA HEADQUARTERS, WASHINGTON, D. C.

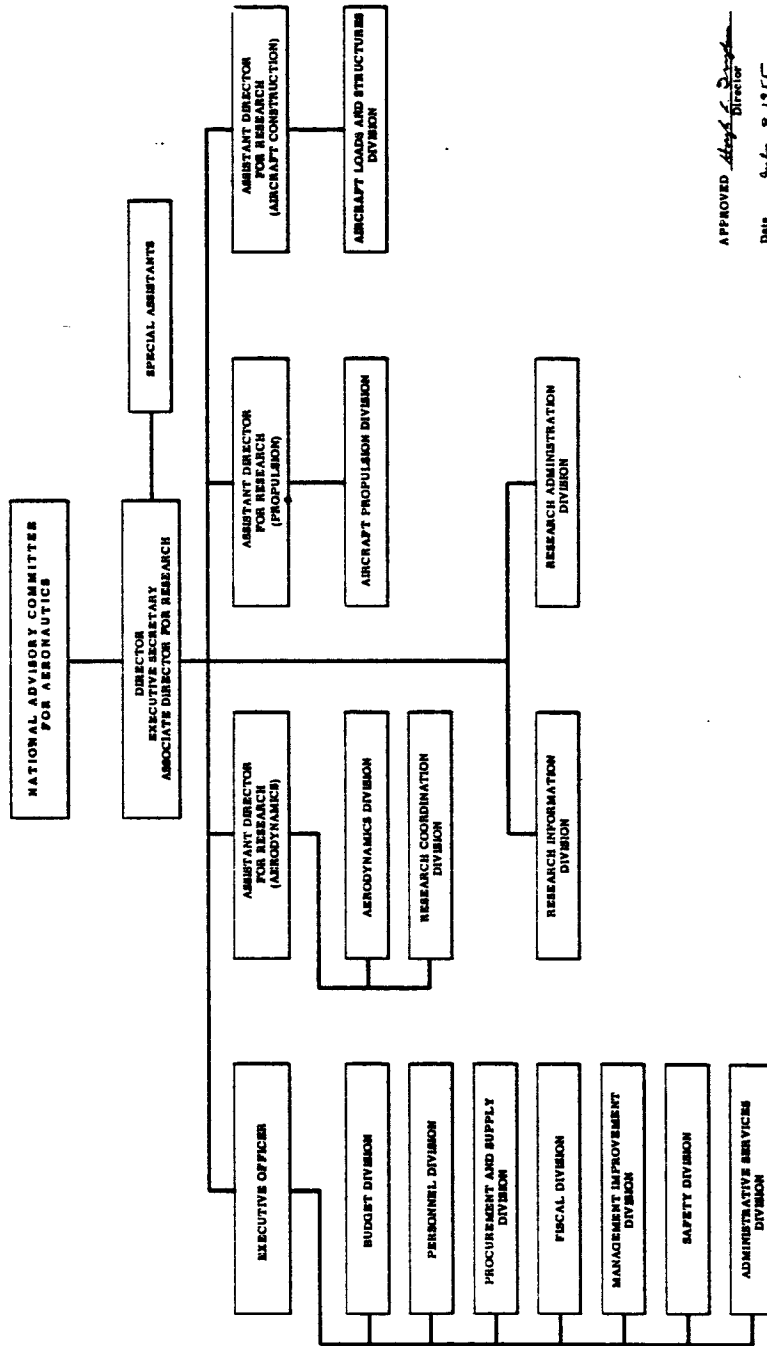

APPROVED *Alfred L. Duggan*  
 Director  
 Date *July 8, 1957*  

FIGURE 2-3



served as part-time secretary to each committee and subcommittee, giving continuity to the work.

### B. Agency Leadership

Article II of the regulations of the Main Committee provided for the selection of five "officers." A Chairman and Vice Chairman were to be elected by the Main Committee from its membership; a Director, Executive Secretary, and Associate Director for Research (hereafter referred to as the "Top Three") were to be appointed by the Chairman with the approval of the Main Committee reconstituted as the Executive Committee.<sup>16</sup> Although not specified in the regulations, the Top Three were Civil Service employees.

The regulations stated the powers and duties of the Top Three as follows:

The Director shall execute the policies and direct the activities of the Committee, and shall be the head of the agency in all matters except those which by law or regulation require action by the [Main Committee] Chairman. He shall prepare programs for the allocation and coordination of scientific research in aeronautics, and shall direct the prosecution of investigations conducted at the Committee's laboratories and of special investigations financed by the Committee. He shall be ex officio a member of each standing technical subcommittee.

The Executive Secretary shall be the assistant head of the agency and shall supervise and direct its administrative work.

The Associate Director for Research shall supervise and direct the scientific and technical activities of the agency.<sup>17</sup>

Although NACA regulations stated that the Director was "head of the agency," the fact that the Main Committee Chairman appointed all of the Top Three suggests that they may have constituted a type of triumvirate, with the Director being only a "first among equals." Each could claim his authority stemmed from the Main Committee.

NACA did have a split-leadership problem during part of its history, but it was not a three-way split. Rather, it was a two-way split between the Executive Secretary, John Victory, who had been with NACA from its beginning, and the Director, Hugh L. Dryden, who came to NACA from the outside (the National Bureau of Standards) in 1947. It took Dryden several years to become agency head. This was accomplished only with the assistance of several high NACA officials who wanted the leadership question firmly resolved.<sup>18</sup>

<sup>16</sup> The status of the executive committee is explained in footnote 13.

<sup>17</sup> "Rules and Regulations for the Conduct of the Work of NACA, 1949." The Executive Secretary also served as secretary for the Main Committee and could be authorized by the Director to exercise the powers of Deputy Director.

<sup>18</sup> Interview with Robert Lacklen, NASA Personnel Director, who was also NACA Personnel Director, Apr. 17, 1963.

### C. Agency Installations

In 1958 the Top Three directed the activities of an agency consisting of 8,000 civil service employees with an annual budget of \$100 million and with facilities costing \$300 million. Each installation is described briefly.<sup>19</sup>

**Headquarters.** From John F. Victory's appointment as clerk in 1915, a Headquarters organization existed in Washington, D.C. Headquarters employees numbered 170 in 1958, and organizational arrangements were largely as depicted on the latest chart, dated 1955 (fig. 2-3). (The organization and function of Headquarters will be covered in greater detail later.)

**Langley Aeronautical Laboratory.** NACA's oldest and largest laboratory employed 3,200 people in 1958 in facilities costing \$126 million. Langley's research program included aerodynamic, structural, and operating problems of aircraft and spacecraft at all speed ranges. According to NACA's own calculations, 40 percent of its research activities could be classified as "space related."

**Pilotless Aircraft Research Station.** Located about 75 miles northeast of Langley and under Langley's jurisdiction, this station employed 80 persons in 1958 in facilities costing \$3,500,000. Free flight research on aircraft and spacecraft was conducted by launching rockets and telemetering their flights. Ninety percent of this research was classified as space related.

**Ames Aeronautical Laboratory.** In 1958 this Laboratory employed 1,450 persons in facilities costing \$87 million. Like Langley, Ames consisted of multi-purpose research facilities, but Ames placed less emphasis on structures research and more emphasis on high-speed aerodynamics. Twenty-nine percent of its research was classified as space related.

**Lewis Flight Propulsion Laboratory.** In 1958 this laboratory employed 2,700 persons in facilities costing \$120 million. As the name implies, Lewis' research program was centered around propulsion systems and powerplants for aircraft and spacecraft. Thirty-six percent of its research was classified as space related.

**High-Speed Flight Station.** In 1958, 300 persons were employed at this station in facilities costing \$16,500,000. Research was conducted on the actual flight of manned, high-speed aircraft. Forty-two percent of this research was classified as space related.

In addition to the major installations, listed above, NACA maintained small liaison offices in Dayton, Ohio (Wright-Patterson AFB), and Los Angeles, Calif. (Western Coordination Office).

### D. Headquarters Organization and Function

A more detailed examination of Headquarters organization and function will facilitate a later discussion of relationships among NACA's organizational components.

<sup>19</sup> Based on chart facing p. 404 of House Hearings, *Astronautics and Space Exploration*. No basis was given for how "space relatedness" was determined.

Figure 2-4 helps give a picture of Headquarters as it operated in 1958. This organization chart, based on a position complement report of September 30, 1958 (NACA's last day of business), shows the size of each organizational unit and the composition of each in terms of professionals (GS-11 and above) and nonprofessionals (below GS-11).<sup>20</sup>

**The Top Three.** The functions of the Top Three were described earlier in this section. The Director, a typical agency head, was involved in the gamut of internal and external agency activity. Though he might personally be a specialist (as Dryden was), the Director's role was that of a generalist. Specialization began with the Executive Secretary and the Associate Director for Research.

**The Offices.** This term applies to those organizational elements which gave direct assistance to the Top Three and which in some cases constituted the link between the Top Three and the agency's principal operating divisions. In the administrative area, the Executive Secretary was assisted by the Office of the Executive Officers, the Office of the General Counsel, the Office of Public Relations, and the Security Office (called the Security Division). The Executive Officer supervised the work of seven divisions, in which the bulk of the administrative work was done.

Assisting in the research area were several special assistants to the Director and three assistant director offices, each office supervising a technical subject-matter area.

**The Divisions.**<sup>21</sup> Seven administrative divisions operated under the Executive Officer. The one-man Safety Division recommended regulations and made periodic inspections. Staffwork on the preparation of the annual budget and the allocation of agency funds among organizational units was accomplished by the three-man Budget Division. Personnel functions for Headquarters—recruitment, placement, training, position classification, etc.—and preparation and monitoring of agencywide personnel policies were performed by the Personnel Division. The two-man Management Improvement Division conducted special administrative studies. The Fiscal Division, largest of the seven, kept the agency's accounts and conducted preaudits. The purchase of goods and services for research operations and the administrative work on the construction and maintenance of research facilities was done by the Procurement and Supply Division. The Administrative Services Division handled mail and reproduction work.

Six other Headquarters divisions were associated with NACA research work. Four were under the jurisdiction of the Assistant Directors for Research, while the other two were attached directly to the Top Three. The names and functions of these six divisions are discussed in the next few paragraphs.

The Research Information Division directed and controlled the reproduction

<sup>20</sup> The position complement report was a regular report of the NACA personnel division. It was carried over into the NASA era and is an excellent source for organizational details. It was discontinued about the end of 1962.

<sup>21</sup> This subsection is based primarily on a Functional Statement Chart for NACA Headquarters for July 1954 prepared by Howard Braithwaite of NACA's Personnel Division.

Code: X = GS-11 and above  
O = Below GS-11

NACA Headquarters, September 30, 1958

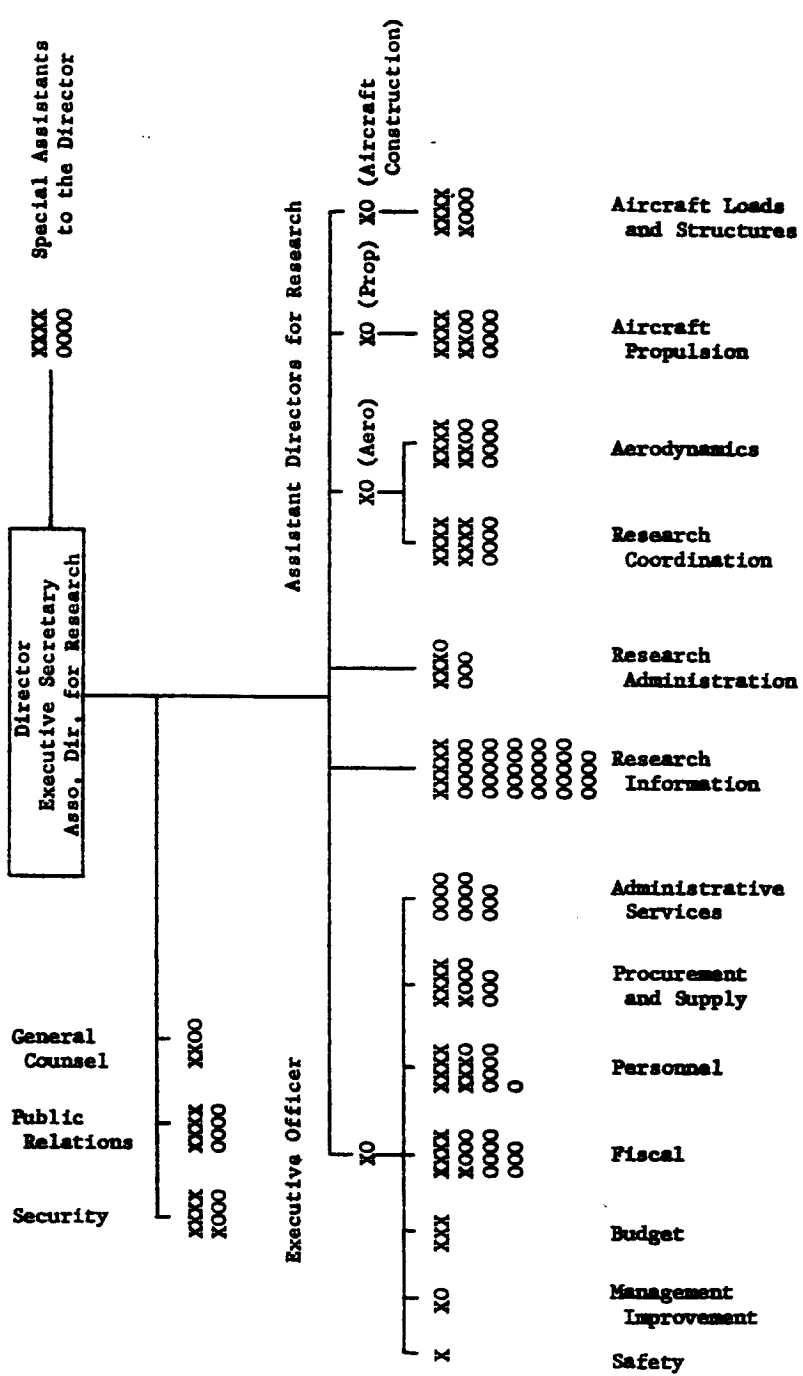

FIGURE 2-4

and distribution of NACA research reports. It also maintained a technical reference service and a library containing a large collection of aeronautical literature.

The Research Administration Division served as control center for the systematic review of all NACA-originated research reports. Prior to publication or presentation at technical meetings, such reports had to be approved by this Division. The security classification of published reports was also reviewed periodically. The NACA patent adviser was attached to this Division.

Two of the three branches of the Research Coordination Division were responsible for conducting NACA's external (contract) research program. This involved reviewing proposals submitted to NACA and recommending action on them, and, if a contract resulted, maintaining liaison and controlling reports submitted.<sup>22</sup>

The Operating Problems Branch of the Research Coordinating Division and the three remaining divisions—Aerodynamics, Aircraft Propulsion, and Aircraft Loads and Structures (see fig. 2-4)—had the function of keeping abreast of their subject-matter areas so they could make recommendations concerning aeronautical research. Technical specialists in each division made detailed studies of proposals for in-house research, maintained familiarity with research conducted in NACA research laboratories, and kept up with problems encountered in industry and the military services.<sup>23</sup> Working from this base, the divisions studied research reports and approved them for publication, prepared detailed evaluations of research proposals, and made recommendations on research needs and problems.

#### E. Intra-NACA Relationships

NACA has been described primarily in terms of its organizational elements and their functions—a policymaking Main Committee, several standing technical committees, over 20 technical subcommittees, an agency headquarters, 3 field laboratories, 2 field stations, and several smaller units. How these elements fit together is only partially explained by an organization chart. In this section, this picture can be broadened by focusing on two basic relationships—that between the various committees and the rest of the agency, and that between headquarters and the field installations.

**Committee-Agency Relationships.** While it is probably true that the immediate effect of the committees on the rest of the agency was small, there was a long-run cumulative contribution made by the committee system. It was considered one of the major factors contributing to the excellence of the agency.<sup>24</sup>

<sup>22</sup> These two branches formed the nucleus of NASA's Office of Research Grants and Contracts.

<sup>23</sup> Most of these technical specialists also served as secretaries for the standing technical committees and subcommittees.

<sup>24</sup> Arthur Levine concludes that NACA had a distinguished record of accomplishment and that the committee system contributed to the establishment of the type of insulated environment which scientists like so well. However, he goes on to claim that the NACA system was dysfunctional in the areas of coordination and innovation because it militated against disputes. Greater

As mentioned earlier, the meetings of the technical committees and subcommittees served as forums for the exchange of information, problems, and findings on specific matters. None of the technical committees or subcommittees had decision-making authority over the affairs of the agency; rather, they influenced agency behavior through their advisory capacity. It should be noted that the use of technical committees and subcommittees continued after the establishment of NASA—an indication of their value and usefulness.

The relationship between the Main Committee and the agency was somewhat different in that the Main Committee had substantive control over program and resources. The Main Committee neither led nor followed the agency. There was genuine give and take on the part of both.<sup>25</sup> The chief influence of the Main Committee came through its Chairman. He was usually the only noncareer person to testify before Congress, he took ceremonial precedence over the Director, and he often served as public spokesman for the agency.

The workability of the arrangement just discussed depended on maintenance of cooperative relationships. The Main Committee, by exercising self-restraint, was able to create an environment in which the Director could manage the agency along traditional lines. The Director, in turn, acknowledged the role that the Main Committee was designed to play and accepted it. The impetus for reducing the power of the Main Committee, as provided in the draft legislation for the new space agency came primarily from the Bureau of the Budget.

**Headquarters-Field Relationships.** The relationship between NACA Headquarters and NACA field installations appears to have been relatively happy. The field centers were generally free to manage their own day-to-day affairs, Headquarters direction coming primarily in the area of administrative policy and overall program scope and direction. Informal communication channels prevailed and worked quite well. This informality stemmed from several sources: the smallness of the agency; the homogeneity of its program and employees; and an effort to keep paperwork at a minimum.

The *precise* degree of Headquarters control was not revealed by the research done for this chapter; however, several things can be surmised. In 1958, Headquarters personnel numbered only 170, a ratio of 1 person for every 30 in the field. Since only 30 of the 170 were aeronautical professionals, it can be assumed that Headquarters did not have the manpower to get involved in day-to-day review of field operations.

On the other hand, Headquarters was closely knit and could well speak with one voice which would be readily heard in the field. NACA's Top Three, by maintaining close and informal contact with all Headquarters personnel, were

coordinating efforts would have led to disputes with the aircraft industry and the military services and greater innovating efforts would have led to disputes with BOB and Congress. For his complete argument, see Levine, "United States Aeronautical Research Policy, 1915-1958," Ch. 6.

<sup>25</sup> The give and take between the Chairman and the Director in the area of policy was not dysfunctional in the way that the Director-Executive Secretary relationship had been in the area of operations.

able to utilize Headquarters as one large staff office in controlling the agency's activities. Apparently the Top Three, aided by Headquarters personnel and backed by the prestige of the Main Committee, constituted the unifying essence which kept the several field installations moving along in a reasonably coordinated manner.

There were numerous formal procedures, of course, covering such activities as authorization and alteration of research projects, fiscal reporting, and accountability for property. Nor did the field centers acquiesce in everything Headquarters wanted; many times great efforts were required to obtain field center agreement. During the 1950's there was an effort to overhaul certain practices to achieve tighter control over agency work and to facilitate a better flow of information for making decisions.<sup>26</sup>

### III. NACA'S REACTION TO SPUTNIK

As indicated earlier, NACA was involved in space-related research, which by 1957 had reached an estimated 40 to 50 percent of its total effort.<sup>27</sup> NACA had made inputs into the Vanguard project, the DOD missile program (especially nose cones), and was largely responsible for the "edge of space" X-15 project. There was some tension in the agency on the degree of NACA involvement in space research apart from that associated with aeronautics. This dispute proceeded at a relatively leisurely pace until Sputnik caused extensive reexamination of the Nation's space efforts in late 1957 and early 1958. The position of the space enthusiasts in NACA was greatly strengthened by Sputnik, and the agency's leadership realized that the issue would have to be resolved sooner than had been anticipated.<sup>28</sup>

Dryden came to realize that the future of the agency was possibly at stake. If NACA concentrated solely on aeronautical research, it would lose many of its best employees to whatever agency would emerge with the Nation's space program; on the other hand, if NACA were to take on the Nation's space program it would face radical changes. To make sure that his actions were broadly based, Dryden attempted to appraise the sentiments of younger employees, including those in the field centers. An example of this is what has come to be called the "Doolittle Dinner," held at the Hotel Statler in Washington, D.C., on December 18, 1957, to which Dryden and Doolittle invited "third echelon" NACA employees who would be the future managers of the agency. (The "second echelon" was actually excluded from the dinner to permit greater freedom of discussion.) At this dinner Dryden pointed out the implications of various alternative courses of action and asked for the opinion of those assembled. The sentiment was overwhelmingly in favor of NACA moving into the space field.

<sup>26</sup> Based primarily on interview with Clotaire Wood, Apr. 23, 1963.

<sup>27</sup> See footnote 19.

<sup>28</sup> The material in this paragraph and the next one has been fitted together from statements made by Paul Dembling, Robert Lacklen, Clotaire Wood, and Addison Rothrock in interviews with them.

After thus exposing himself to a large sample of agency opinion, Dryden led the preparation of a series of documents and proposals which were made public in January 1958. On January 12, Chairman Doolittle announced the formation of a Special Committee on Space Technology. On January 14, the "Dryden Plan," entitled "A National Research Program for Space Technology," was revealed.<sup>29</sup> The plan was an ingenious attempt by Dryden to steer a calculated but difficult course which would preserve the best of the old while permitting transition into the new.

The Dryden Plan did not call for establishment of a new agency. Instead it proposed a space effort based on intercooperation of existing organizations. NACA would expand its space research program by enlarging its staff, building a new space research laboratory, and increasing its contract research program; it would also step up its flight program, while limiting it to basic research. Large-scale flights associated with military requirements would be under DOD with appropriate NACA inputs. The National Academy of Sciences and the National Science Foundation would assume responsibility for the nature and planning of experiments to be conducted, mostly by the private scientific community.

On January 16 the NACA Main Committee passed a resolution calling for a joint program along the lines of the Dryden proposal,<sup>30</sup> and on February 10 the agency issued an internal document outlining details of the contemplated NACA expansion.<sup>31</sup> This latter document called for an increase in NACA staff from 8,000 to 17,000 over a 3-year period, with a corresponding increase in budget from \$80 million to \$180 million. The cost of the proposed new laboratory was estimated at \$380 million over a 5-year period, while existing facilities were to be expanded at the rate of \$55 million per year for 5 years.

The March 5 memo to President Eisenhower which recommended that NACA be given jurisdiction over the civilian space program cited the Dryden proposal, the Main Committee's resolution, and NACA's February 10 expansion plan, as indications of NACA being prepared to move forward in space.<sup>32</sup> However, the idea of total authority and responsibility in one agency under one man was considered by the administration as the best solution to a problem requiring urgent action. The administration's April 2 proposals incorporated few of Dryden's original organizational suggestions.<sup>33</sup>

<sup>29</sup> The four-page multilithed text is footnoted "A staff study of the NACA, January 14, 1958." I have assumed that it was released to the public on the 14th and that it incorporates Dryden's thinking. There is little doubt that other people made inputs, and I am sure Dryden would call it the "NACA Plan."

<sup>30</sup> For text, see Senate Print, *Compilation . . .*, No. 2, pp. 293-294.

<sup>31</sup> "A Program for Expansion of NACA Research in Space Flight Technology With Estimates of the Staff and Facilities Required," prepared by the NACA staff and dated Feb. 10, 1958.

<sup>32</sup> The Mar 5 memo was discussed at length in Ch 1 (Sec II.A).

<sup>33</sup> Arthur Levine, in his doctoral dissertation, "United States Aeronautical Research Policy, 1915-1958," indicates that several NACA leaders strongly opposed the Administration's space agency proposal: "NACA leaders, on the other hand, were firmly convinced that the committee-type-executive pattern under which NACA had operated for over 40 years was superior to the single executive in running a science agency which had extensive relationships with the military,



The merits of the Dryden proposal lay in its recognition that the breadth of the Nation's space program was greater than the program of any single agency and in the probability that it provided the best means of integrating DOD into the Nation's space efforts. Congress showed great concern for these problems as it converted the administration's proposals into law.

The transformation of NACA into NASA began in March 1958. This is where the next chapter will begin.

universities, industry and other groups. Disturbed by the way the administration bill was developing, NACA leaders requested friendly Congressmen to introduce measures which would give NACA the space role, while preserving the traditional NACA organizational pattern" (p. 155). The footnote for this statement is: "Interviews with J. C. Hunsaker, J. H. Doolittle, J. F. Victory. Review of NACA Minutes 1957-58" (p. 241).

## Chapter Three

# THE LAUNCHING OF NASA

This chapter spans events from March 1958, when the transformation from NACA to NASA got underway, to January 1959, when initial organizational efforts had been largely completed. October 1, 1958, the date of NASA's formal establishment, was merely one point in time along this 11-month continuum. During the 7-month "gestation period" prior to October 1, efforts were made to get NASA off to a running start. Another 4 months passed before the preparatory efforts were to be completed.

### I. DEVELOPMENTS PRIOR TO NASA'S FORMAL ESTABLISHMENT

The administration's March 5 decision to build NASA around NACA gave NACA the green light to start laying plans for the expansion of its program into the space-flight development area. President Eisenhower's April 2 directive to NACA and DOD stepped up preparatory activity even further by opening up two additional areas—NACA-DOD division of effort and organizational planning for the new space agency. The nomination of Glennan as NASA Administrator in early August slowed the pace somewhat pending his appearance on the scene. Glennan began to devote full time to NASA beginning in early September, after which events moved rapidly toward the October 1 establishment.

#### A. The Genesis of NASA's Space Flight Development Program

The March 5 decision permitted NACA to think seriously about the implementation of some of the program proposals that it had been making during the previous 2 months. NACA's February 10 staff study had delineated some of the important program problems that would face a new space agency.<sup>1</sup> Since NACA possessed substantial competence in space-related research, the study focused on technical development, especially the design and building of space hardware.

Dryden understood the difficulties that would occur in this area and the importance of attacking them vigorously and early. Dryden felt that aggressive leadership was especially important, so he selected Abe Silverstein, Associate Di-

<sup>1</sup> See Ch. 2 (Sec. III). See also general discussion in *Historical Sketch of NASA* (Washington: NASA, EP-29, 1965).

rector of NACA's Lewis Propulsion Laboratory, to come to Washington and organize a space-flight development program.<sup>2</sup> This turned out to be rather an important decision in NASA's early administrative history. Silverstein is a good example of the importance of personality in administration.<sup>3</sup> He was to play a key role in Headquarters for over 3 years. As an administrator he kept very close tabs on program details and participated in small decisions as well as large ones. Yet he did not seem to stifle the initiative of his subordinates and he was surprisingly successful in developing and training good managers.

Silverstein's initial efforts, starting in March 1958, were directed toward defining the dimensions, both qualitatively and quantitatively, of the new space agency's flight development program.<sup>4</sup> Also involved was early planning for a new space-flight development field center. Putting price tags on new projects and new facilities was part of the process in order to permit the preparation of a supplemental request for appropriations. As time went by it became increasingly important to integrate into NACA's planning the projects that were earmarked for transfer from DOD.

#### B. NACA-DOD Discussions

On April 2, the same day that the draft legislation establishing NASA was sent to Congress, President Eisenhower directed NACA and DOD to "jointly review the pertinent [space] programs currently under way within or planned by the Department [of Defense, and to recommend] . . . which of these programs should be placed under the direction of the new Agency." In addition, the two agencies were to make arrangements either for the transfer of pertinent DOD facilities to the new agency or for the cooperative utilization of the facilities. The President's Special Assistant for Science and Technology, Dr. James Killian, and the Bureau of the Budget were to help in settling any problems that might arise between NACA and DOD.<sup>5</sup>

The talks got underway immediately and were under the general cognizance of NACA Director Dryden and Deputy Secretary of Defense Quarles. The initial effort was directed toward the identification of what DOD projects should be considered for transfer.<sup>6</sup>

<sup>2</sup> Interview with Hugh L. Dryden, Apr. 9, 1963.

<sup>3</sup> Silverstein was born in 1908 and educated in engineering at Rose Polytechnic Institute in his native Terre Haute, Ind. He joined NACA's Langley Laboratory in 1929 and did wind-tunnel design and research. In 1943 he was transferred to NACA's new propulsion laboratory at Cleveland, Ohio, where he directed the work in several of the lab's major facilities. He was appointed Associate Director in 1952. He served on many NACA committees and interagency advisory boards. In 1958 he received an honorary doctorate from Cleveland's Case Institute of Technology.

<sup>4</sup> Interview with Abe Silverstein, Jan. 18, 1964.

<sup>5</sup> See Ch. 1, Sec. II.C.

<sup>6</sup> See Dryden's letter to ARPA Director Roy Johnson, Apr. 15, 1958. In addition to requesting descriptions of ARPA space projects, Dryden indicates that he had selected Crowley, Abbott, and Gilruth to represent NACA in talks with ARPA's Johnson and York who had been appointed by Quarles.

There was ready agreement that the Advanced Research Projects Agency's space science program (Project Vanguard, lunar probes, etc.) should be transferred because it was essentially civilian in nature. The reconnaissance satellite project was left with DOD because of its military significance. There were numerous projects in a gray area between military and civilian including the very important man-in-space area. NACA and DOD initially attempted one solution to this problem by making a joint project out of the man-in-space program.<sup>7</sup> BOB frowned on jointly managed projects, however, and that approach to the first manned satellite program was dropped by early May.<sup>8</sup>

Discussions on gray-area projects continued, but no decisions were made pending the passage of the Space Act.<sup>9</sup>

### C. Planning NASA's Initial Organization

NACA, in response to President Eisenhower's April 2 instructions that it should "formulate such detailed plans as may be required to reorient its present programs, internal organization, and management structure to carry out the functions to be assigned . . ." to NASA, established an Ad Hoc Committee on NASA Organization, chaired by Ira Abbott, NACA Assistant Director for Aerodynamic Research.<sup>10</sup>

On the basis of existing NACA organization, provisions of the draft legislation submitted to Congress, informal talks with NACA officials, several earlier staff studies, and personal experience, the Abbott Committee came up with a preliminary report in May.<sup>11</sup> The report included organization charts for NASA and functional statements for each Headquarters office. The May draft was circulated for information and comment prior to a series of formal internal discussions of specific details.<sup>12</sup>

As a result of the internal discussions, several minor revisions of the report were made.<sup>13</sup> The final report was dated August 12, 1958. It proposed a

<sup>7</sup> See transcript of Dryden's remarks on the Apr. 27, 1958, CBS broadcast of "Face the Nation," reprinted in House Hearings, *Astronautics and Space Exploration*, pp. 950-956.

<sup>8</sup> Interview with Willis Shapley, Bureau of the Budget, May 7, 1964. See also "Statement Regarding Negotiations Between . . . NACA and . . . ARPA . . . May 9, 1958," House Hearings, *Astronautics and Space Exploration*, pp. 949-950. See forthcoming *This New Ocean: A History of Project Mercury* (Washington: NASA SP-4007, 1966).

<sup>9</sup> Documents related to NACA-DOD discussions during the summer of 1958 have not been located by this researcher.

<sup>10</sup> Other members were Ralph Cushman, Procurement Officer; Paul Dembling, General Counsel; Robert Lacklen, Personnel Officer; Ralph Ulmer, Budget Officer; and Clotaire Wood, Special Assistant to the Director. Dryden appointed the Committee, Apr. 14, 1958. A memo from Lacklen to Victory recommending committee membership is dated Apr. 4, 1958.

<sup>11</sup> The report is identified by the covering memo dated May 21, 1958: "Memorandum for the Director, NACA. Subject: Report of Ad Hoc Committee on NASA Organization." All six members signed the memorandum.

<sup>12</sup> See Abbott memo to Chamberlin et al., May 23, 1958. Subject: Organization and Staffing of NASA Headquarters.

<sup>13</sup> Two interim reports, dated June 2, 1958, and July 25, 1958, were made prior to the final report of Aug. 12, 1958. The July and August versions incorporated the provisions of

continuation of the existing NACA organization with one important modification and three important additions. The financial management function of NACA was modified by raising it several echelons and placing it under a comptroller who was directly under the agency head. The additions consisted of two new program areas (space-flight development, which Silverstein was already pulling together, and space sciences), and a new space-flight development field center.

The final report was not made until after it had become known that Glennan, an outsider, would become NASA's Administrator rather than Dryden. The extent to which the report made an impact into NASA's initial organizational structure is discussed later in this chapter.

#### D. Nomination and Confirmation of Glennan and Dryden

From April through July it had been generally assumed that NACA Director Hugh Dryden would probably head NASA. Born in 1898, graduated from John Hopkins with a Ph.D. in physics in 1919, he was named head of the National Bureau of Standards Areodynamic Section in 1920, and in 1946 he became the Bureau's Associate Director.<sup>14</sup> A year later he left the Bureau to become NACA's Director of Research. He not only established a fine reputation as a research scientist but also served on numerous national and international committees, was awarded numerous honors, and was a member of many societies. His list of publications is long. His reputation as an administrator of research was good. He was quietly efficient, firm but not a desk pounder, and rational. He proceeded on the basis of facts and reality and hesitated in taking chances without weighing carefully all possible consequences. He was highly respected by his subordinates, though sometimes considered too cautious by more aggressive younger elements.

It is difficult to ascertain why Dryden did not receive the official nomination as NASA Administrator. The public record indicates that he was "vetoed" by the members of the House Select Committee on Astronautics and Space Exploration largely because of his candid testimony at an August 1, 1958, hearing in which he declared himself unwilling to spend large sums of money on a crash program in which the payoff would be highly uncertain.<sup>15</sup> He thought there

the Space Act dealing with the National Aeronautics and Space Council, the Civilian-Military Liaison Committee, and the Inventions and Contributions Board.

<sup>14</sup> For a more detailed biography, see U.S. Congress, Senate, Special Committee on Space and Astronautics, *Nominations*, Hearing on the Nomination of T. Keith Glennan . . . and Hugh L. Dryden, Aug. 14, 1958, 85th Cong., 2d sess. (Washington: GPO, 1958), pp. 21-26, hereafter cited as Senate Hearing, *Nominations* (Glennan and Dryden).

<sup>15</sup> U.S. Congress, House, Select Committee on Astronautics and Space Exploration, *Authorizing Construction for the National Aeronautics and Space Administration*, Hearings on H.R. 13619, 85th Cong., 2d sess. (Washington: GPO, 1958), pp. 9, 12 (hereafter cited as House Hearings, *Authorizing Construction for the National Aeronautics and Space Administration*). For the newspaper account, see the *New York Times*, Aug. 6, 1958, p. 10. For an editorial defending Dryden's candor and realism on what could and could not be done, see the *New York Times*, Aug. 7, 1958, p. 24.

was a limit to the amount of money that NASA could effectively utilize, and that if the agency found that more could be used, it should be asked for at that time. Many Congressmen thought a bolder approach was necessary if the Russians were to be leapfrogged.<sup>16</sup> It should also be pointed out that the Eisenhower administration made a practice of appointing Republicans to high positions. Dryden was a career civil servant and a nominal Democrat.<sup>17</sup>

The responsibility for finding the person to head NASA was given to Killian.<sup>18</sup> The extent of the search that was conducted has not been made public. On August 7, 1958, Killian, with Eisenhower's approval, telephoned Glennan and asked him to come to Washington to discuss the position.<sup>19</sup> President Eisenhower offered Glennan the job and he accepted.

Thomas Keith Glennan had been president of Cleveland's Case Institute of Technology since 1947.<sup>20</sup> During his tenure Case had been transformed into one of the top engineering schools in the Nation. Born in 1905, he received a bachelor's degree in electrical engineering from Yale and spent most of his pre-World War II career in the motion picture industry, specializing in sound systems. His move toward public service started during World War II when he headed the Navy's Underwater Sound Laboratories. From 1950 to 1952 he served as a member of the Atomic Energy Commission, an experience which greatly influenced many of his actions as NASA Administrator. He had received five honorary doctorates. He was a member of numerous boards (NSF, IDA, AEC General Advisory Committee, Standard Oil of Ohio, etc.) from which he resigned upon becoming NASA Administrator.

At the time of his nomination little was known about his abilities as an administrator. It turned out that he was not unlike Dryden in solid deliberateness and unwillingness to make promises without knowing that he could deliver the goods. He, too, proceeded rationally. One of his great frustrations stemmed from the absence of a clear national space policy and the guidelines for action that would flow from it.

The nominations were sent to the Senate on August 9. The August 14 public hearing conducted by the Senate Special Committee on Space and Astronautics

<sup>16</sup> For a statement of the House committee's "leapfrog" concept, see U.S. Congress, House, Select Committee on Astronautics and Space Exploration, *Establishment of the National Space Program*, H. Rept. 1770 on H.R. 12575, 85th Cong., 2d sess. (Washington: GPO, 1958), p. 4.

<sup>17</sup> The timetable of events suggests that this factor may have been more important in the failure of Dryden to get the nomination as Administrator. The Space Act was signed July 29. Dryden gave his frank testimony to the House committee Aug. 1. However, the committee members' dissatisfaction was not picked up by the news services until Aug. 5. Glennan was contacted on Aug. 7. In the meantime several persons had been asked to serve as Administrator and had declined. A further complicating factor was that James Doolittle, NACA Chairman, was offered the job, declined it, and then later reconsidered, only to decline it once again. All this suggests that finding someone to serve in what was regarded as a difficult position was not easy and may have taken some time.

<sup>18</sup> Letter, Killian to the author, Sept. 3, 1963.

<sup>19</sup> Interview with T. Keith Glennan, Jan. 18, 1964.

<sup>20</sup> For a more detailed biography, see Senate Hearing, *Nominations* (Glennan and Dryden), pp. 2-3.

was relatively friendly and the nominations were unanimously approved.<sup>21</sup> Full Senate confirmation came on August 15, and Glennan and Dryden were sworn in at the White House on August 19.<sup>22</sup>

#### E. Glennan's August and September Actions

Had Dryden been named NASA Administrator, NACA's preparatory work paving the way for NASA would have constituted a basis for action with little modification. The appointment of Glennan meant the views of an outsider must be incorporated. This began the day Glennan and Dryden were sworn in.

**Initial Decisions on Organization and Staffing.** Glennan met with NACA officials on August 19 to review the proposals of the Abbott Committee and to determine the initial organizational structure for the agency.<sup>23</sup>

Even though an interim structure was agreed upon, Glennan recognized that the problems of the agency's long-run organization required more careful study. As Administrator he wanted greater opportunity to mold the new agency along lines of his own choosing, and he felt the need for an outside evaluation of plans and proposals formulated by NACA. He sought the advice of several "outsiders," including John Corson, manager of the Washington office of McKinsey & Co., a management consulting firm.<sup>24</sup> By the end of September, McKinsey & Co. had been hired to make an organizational study of NASA which was to serve as the basis for the long-run structure of the agency.<sup>25</sup> In addition, Corson voluntarily supplied Glennan with the names of several individuals, a few of whom Glennan later appointed to important NASA positions.<sup>26</sup>

<sup>21</sup> Senate Hearings, *Nominations* (Glennan and Dryden).

<sup>22</sup> Glennan began devoting his full time to NASA Sept. 9. Before that he divided his time between NASA and Case Institute.

<sup>23</sup> The details of this meeting and what was decided are presented later in this chapter.

<sup>24</sup> Glennan became acquainted with Corson when McKinsey & Co. had done a study in 1955 on atomic energy (*The McKinsey Report on Peaceful Uses*).

<sup>25</sup> On the basis of a Sept. 14 meeting with Glennan, Corson wrote a Memorandum for Discussion (Sept. 16) outlining a plan for the study of NASA's organization. Glennan agreed to the plans and a contract was entered into (NASw 1, Oct. 10, 1958). The details of this study are presented later in this chapter. Corson's Sept. 16 memo also reveals some of Glennan's thinking on the scope of the task before him. Five areas are identified as requiring Glennan's personal attention: formulation of NASA's program; establishment of effective external relationships; decisions on the transfers of programs and facilities to NASA; plans for satisfying the demand for information on NASA; and structuring and staffing the organization. Two paragraphs reflect Glennan's determination to stay on top of the organization rather than become engulfed in it: "Obviously, you cannot personally find time to handle each of these several essential activities. And equally obviously, you will want to have a major part in the formulation of NASA's program, and you cannot be relieved of the necessity of establishing personal relationships with legislative and executive leaders and (eventually—and soon) of meeting the demands of the press, the radio, television, and many groups for personal statements and personal appearances.

"You will want to have the determining role in most decisions as to the organizational structure to be established, its administrative policies, and the key personnel to be recruited. On these tasks, this Firm can be of some assistance."

<sup>26</sup> Since McKinsey & Co. did not engage in executive search activity, help in this area was given on an informal, volunteer basis. Corson prepared three lists of names: one list for the

**Talks Resumed With DOD.** Although talks between NACA and DOD during April and May had identified the DOD projects susceptible of transfer, no formal decisions had been made pending the passage of the Space Act and the appointment of the individuals who could legally act for the new agency. With Glennan and Dryden sworn in, talks with DOD were resumed. On August 20 they met with DOD officials to determine where matters stood.<sup>27</sup> Earlier efforts paid off and there was general agreement on the projects to be transferred. No agreements were reached, however, on the transfer of facilities. DOD expressed some concern over the Bureau of the Budget's effort to get as much transferred as possible.

It was agreed that details of the transfer of Project Vanguard (the IGY earth satellite project and the most complicated project transfer contemplated) could be worked out by direct negotiations between the Naval Research Laboratory (NRL), its manager, and a NACA/NASA designee named by Glennan. An October 1 target date was agreed upon for all project transfers, but it was acknowledged that facility transfers would have to proceed more slowly.

The facility transfer problem partially stemmed from a lack of detailed knowledge of various alternatives. It was agreed that teams of NACA officials, accompanied by an ARPA representative, should visit various DOD installations and make appropriate recommendations.<sup>28</sup> A September 9 deadline was established for completing this operation. As it turned out, no transfers took place until December 1958.

The transfer efforts ran into a legal snarl in that the Space Act provided explicitly for the transfer of functions and facilities but said nothing about the transfer of projects, except by implication. This made drafting the transfer documents a more difficult task than originally contemplated.<sup>29</sup>

**Documents Establishing NASA.** The Space Act provided for the NACA-to-NASA transfer to take place 90 days after the date of enactment, or earlier if the NASA Administrator announced in the *Federal Register* that NASA had been organized and was ready to begin work.<sup>30</sup> October 1 was a convenient date from a reporting point of view because it was both a monthly and quarterly dividing point. The announcement, or proclamation as it was called, was read at an emotion-charged meeting of NACA Headquarters personnel on September

position of Administrative Assistant to the Administrator, another for the position of Director of Business Administration, and the third for the position of General Counsel. The three individuals appointed, Wesley Hjernevik, Albert Siepert, and John Johnson, were all on Corson's lists. (Interview with John Corson, Apr. 26, 1963.) Johnson's appointment was not related to this, however. (Interview with T. Keith Glennan, Jan. 18, 1964.)

<sup>27</sup> See "Notes of Conversation" (Glennan, Quarles, et al.), Aug. 20, 1958, and "Notes of Discussion With Rear Admiral Rawson Bennett," Aug. 20, 1958.

<sup>28</sup> Only a few records concerning the work of these teams have been located. Two teams were used, one covered the West, the other the East.

<sup>29</sup> Interview with Willis Shapley, Bureau of the Budget, May 7, 1964.

<sup>30</sup> Sec. 301e.



25, 1958.<sup>81</sup> It appeared in the *Federal Register* September 30, and persons who left work Tuesday as NACA employees came back the next morning, October 1, as NASA employees.

The proclamation was not the only significant document at this time. On October 1, President Eisenhower issued an executive order transferring several space projects and over \$100 million in appropriations from DOD to NASA.<sup>82</sup> The details of these transfers are discussed in the next section.

As mentioned earlier, NASA's formal establishment was only one discrete event on a long continuum. NASA on October 1 was virtually identical with NACA on September 30. Even the transfers from DOD were largely paper—their impact did not come until months later. Legally and psychologically, however, October 1 is significant. It symbolized the readiness of the United States to move forward in space.

## II. NASA'S FIRST 4 MONTHS

### A. The Nature and Importance of the Transfers From DOD to NASA

The transfer of DOD projects and facilities to NASA had administrative and technical facets not measurable in quantitative terms. Mere transfer is one thing; true integration is something else. One of the most difficult administrative problems that NASA has had to face has been creating a truly integrated and smoothly functioning organization out of the various groups and programs that were pulled together. This theme will emerge again and again in later chapters.

*The Transfer of Project Vanguard.* The transfer to NASA of the U.S. Scientific Satellite Project was fully expected and agreed to by all parties involved. The October 1 Executive Order made the legal transfer. To keep the project going while details were worked out, NASA immediately delegated back to NRL the authority to run the project. Details worked out in the course of NASA and NRL/DOD negotiations were finalized in an agreement signed by Glennan and Deputy Secretary of Defense Quarles on November 20, 1958.<sup>83</sup>

Under the provisions of this agreement almost all the civilian personnel complement of NRL's Vanguard Division was to be transferred en masse, without

<sup>81</sup> For a partial text, see footnote 28 of Ch. 1.

<sup>82</sup> Executive Order 10783, 23 F.R. 7643. In addition, numerous news releases, fact sheets, and similar documents were also issued. For examples, see NACA Release, "NASA To Take Over NACA September 30," Sept. 26, 1958; NACA Announcement, "Notice of Change of Address," Sept. 30, 1958; NASA Release, "Fact Sheet on the Transfer of Certain Functions from Department of Defense . . ." Oct. 1, 1958; NASA Release, "Glennan Announces First Details of New Space Agency Organization," Oct. 5, 1958; NASA Release, ". . . brief biographies of the top officers . . ." Oct. 5, 1958.

<sup>83</sup> "Agreement Between Department of Defense and National Aeronautics and Space Administration Regarding Transfer of Records, Property, Facilities, and Civilian Personnel of Project Vanguard." Cover Letter, Quarles to Glennan, Nov. 20, 1958 (31 pages with enclosures).

change of title, grade, or salary, as of November 16, 1958. Also to be transferred were items (property, equipment, supplies, etc.) purchased with Vanguard money, as well as unexpended Vanguard funds (about \$25 million). To keep the Vanguard project going smoothly, the team was to continue to use NRL facilities in southeast Washington, D.C., until January 1, 1960, when a physical move to NASA's new Beltsville space research laboratory was expected. NRL would continue to give the same support as in the past (for which it would be reimbursed by NASA), except for those areas in which NASA might wish to provide its own support. NRL would continue to handle all contractual matters until completion of existing contracts. Certain supply items and a small contingent of personnel at Cape Canaveral and the IGY passive tracking network (Mini-track) with personnel scattered through several Latin American countries were also included in the transfer package.

The mass personnel move did not take place until November 30, when 148 persons were transferred.<sup>34</sup> John Hagen, Vanguard Director, had been transferred on an individual basis on November 5.

**ARPA and Air Force Transfers.**<sup>35</sup> In addition to Vanguard, jurisdiction over several other projects without specific names, personnel, facilities, etc., was transferred to NASA, together with related funds. Jurisdiction over two lunar probes being executed by the Air Force Ballistic Missile Division (AFBMD) was transferred from ARPA to NASA. In effect, the Air Force became a type of contractor or executive agent for NASA rather than for ARPA. Two lunar probes and three satellite projects (including two inflatable sphere projects) being executed by the Army Ballistic Missile Agency (ABMA) were also transferred from ARPA to NASA. Money that ARPA was to have paid to the Air Force and the Army was transferred to NASA so that NASA could pay it out. The amount involved was \$59.2 million.<sup>36</sup>

Several engine development projects were transferred directly from the Air Force, including the important million-pound-thrust, single-chamber engine (the F-1) for which the Air Force had a study contract with North American Aviation. Money transferred with these projects amounted to \$57.8 million.

**Transfer of JPL and the Attempted Transfer of ABMA.** That part of the Army's space program transferred to NASA consisted of two lunar probes and three satellite projects. On the basis of the reports of its facilities fact-finding teams, NASA decided to seek the transfer of the facilities related to these projects.

<sup>34</sup> Some accounts put the figure at 157. See "Report to the House Committee on Science and Astronautics (Requested in Hearings before the Committee on March 9, 1959)," Mar. 17, 1959 (prepared by NASA Personnel Division, mimeographed) (hereafter cited as "Report to the House Committee on Science and Astronautics," Mar. 17, 1959).

<sup>35</sup> Account based on Executive Order 10783, 23 F.R. 7643, and NASA Release, "Fact Sheet on the Transfer of Certain Functions From Department of Defense . . ." Oct. 1, 1958.

<sup>36</sup> Lest there be created the impression that ARPA had been stripped of all its projects, it should be noted that antimissile missiles; solid propellants; warning, navigation, communication, and meteorological satellites; and large boosters were left with ARPA, involving FY 1959 funds of \$420 million.

On October 14 Glennan made a formal request for transfer, citing the transfer provision of the Space Act.<sup>37</sup> In view of the fact that the same Army organizational elements were involved in a similar request a year later, it is well to clarify exactly what those elements were.<sup>38</sup>

In early 1958 the Army had consolidated its missile development program in the Army Ordnance Missile Command (AOMC) with headquarters at the Redstone Arsenal (RA) adjacent to Huntsville, Ala. Under AOMC were three subordinate commands: the Army Ballistic Missile Agency (ABMA), the Army Rocket and Guided Missile Agency (ARGMA), and the White Sands (N. Mex.) Missile Range (WSMR). The Army-owned Jet Propulsion Laboratory (JPL), staffed and operated by the California Institute of Technology (Cal Tech) under a contractual arrangement with the Army, was responsive to AOMC. Three well-known personalities were associated with these organizations: Maj. Gen. John Medaris, head of AOMC; William Pickering of JPL; and Wernher von Braun of ABMA's principal operating element, the Development Operations Division. The Army, true to the Army Ordnance Corps' "arsenal concept," had concentrated in AOMC complete capability to design, manufacture, and launch large, multistage vehicles; with JPL help, the payload could be included as well. ABMA and JPL together formed the Army team responsible for *Explorer I*, the U.S. first satellite, launched late in January 1958.

This capability was exactly what NASA needed. Without it NASA would have had to depend almost completely on contractors or follow the slow process of developing its own capabilities. Accordingly, NASA requested transfer of JPL and about half of ABMA's Development Operations Division.

It would appear that NASA's request was supported by top DOD officials. The Army, however, strongly opposed it, claiming that the ABMA Development Operations Division (the von Braun team) could not be broken up without dire consequences.<sup>39</sup> Statistics were offered to show that the overwhelming portion of ABMA's effort was directly related to battlefield needs and thus essential to national defense.<sup>40</sup> The Army had been very proud and protective of its Redstone and intermediate ballistic missile program. Its strong opposition to a transfer that would have dealt the program a death blow was a natural reaction. In fighting the proposed transfer, the Army marshaled its friends in Congress and among the public by going outside of official channels and leaking the story to the *Baltimore Sun*.<sup>41</sup>

<sup>37</sup> *New York Times*, Oct. 15, 1958, p. 1.

<sup>38</sup> For greater detail, see U.S. Congress, Senate, Committee on Aeronautical and Space Sciences, Subcommittee on Governmental Organization for Space Activities, *Investigation of Governmental Organization for Space Activities*, Hearings, 86th Cong., 1st sess. (Washington: GPO, 1959), pp. 220-245 (hereafter cited as Senate Hearings, *Investigation of Governmental Organization for Space Activities*).

<sup>39</sup> *New York Times*, Oct. 16, 1958, p. 14; Oct. 19, p. 16; Oct. 23, p. 1.

<sup>40</sup> See testimony of General Medaris, U.S. Congress, Senate, Committee on Aeronautical and Space Sciences, NASA Authorization Subcommittee, *Transfer of Von Braun Team to NASA*, Hearing on H.J. Res. 567, 86th Cong., 2d sess. (Washington: GPO, 1960), p. 36 (hereafter cited as Senate Hearing, *Transfer of Von Braun Team to NASA*).

<sup>41</sup> Medaris, Maj. Gen. J. B., *Countdown for Decision*, G. P. Putnam's Sons, 1960, Ch. 19.

The subsequent uproar forced DOD to modify its position and the issue was taken to the National Aeronautics and Space Council, where a compromise solution was arranged. JPL would be transferred to NASA, and ABMA would be kept intact under the Army, with the proviso that it would be responsive to NASA's needs. This decision gave rise to three significant documents.

A December 3, 1958, Executive Order transferred to NASA all JPL's non-military functions and related Government property, including appropriations of \$4,078,250.<sup>42</sup> The detailed agreement, worked out by NASA and DOD and also dated December 3, provided for organic transfer on December 31.<sup>43</sup> JPL was to be transferred in its entirety, except that the Army was to maintain contractual relationships with JPL/Cal Tech in several specific areas (most notably the Sergeant program) through 1959, by which time most Army activities would be phased out. Thus NASA and JPL were to be responsive to Army requirements.

In another document, also dated December 3, the Army agreed to make the resources of ABMA and other AOMC units responsive to NASA requirements, although Army military requirements would have first priority.<sup>44</sup> In effect, this agreement permitted NASA to bypass the Pentagon and deal directly with General Medaris.

**Other Transfers.** In addition, numerous individuals transferred to NASA from many Federal agencies. For example, NASA's Beltsville Space Center, later the Goddard Space Flight Center, was to be populated almost entirely by transferees. Its Vanguard Division was composed of persons transferred from the Naval Research Laboratory with the transfer of Project Vanguard described earlier.<sup>45</sup> John W. Townsend, Jr., head of Beltsville's Space Science Division, transferred from NRL's Upper Atmosphere Sounding Rocket group on October 20 and brought with him 46 NRL scientists who officially transferred to NASA December 28. Robert Jastrow, head of the Theoretical Division, transferred from NRL November 10, and Thomas Jenkins followed suit December 15 to become administrative officer for the new NASA center. NRL also supplied several high NASA Headquarters officials—Homer Newell, John Clark, and Milton Rosen—all of whom transferred to NASA October 20. Although NRL accounted for a large number of transferees, many other agencies were also involved.<sup>46</sup>

**Summary.** By the time NASA's blanket transfer authority expired December 31, 1958, it had acquired Project Vanguard with about 150 people and over \$25 million, JPL and the Cal Tech contract to staff and operate it, and control over several DOD projects and \$100 million in appropriations related

<sup>42</sup> Executive Order 10793, 23 F.R. 9405.

<sup>43</sup> For the text of the agreement, see *First Semiannual Report to Congress of the National Aeronautics and Space Administration* (Oct. 1, 1958 through Mar. 31, 1959) (Washington: GPO, 1959), pp. 81-84 (hereafter cited as NASA, *First Semiannual Report*).

<sup>44</sup> For the text of the agreement, see NASA, *First Semiannual Report*, pp. 85-87.

<sup>45</sup> All data on NRL transfers are taken from "Report to the House Committee on Science and Astronautics," Mar. 17, 1959.

<sup>46</sup> *New York Times*, Nov. 17, 1958, pp. 1, 7. Also see Alfred Rosenthal, *Early Years of the Goddard Space Flight Center* (Greenbelt, Md.: GSFC, 1963).

thereto. In addition to the Vanguard personnel, about 50 scientists and technicians had transferred from NRL. An additional 200 individuals had been added from other sources. With the approximately 8,000 NACA transferees, NASA's roster as of December 31, 1958, stood at 8,420. The next large transfer of personnel did not take place for a year and a half.

### **B. The Evolution Toward NASA's Initial Organizational Structure**

NASA's first official organization chart was dated January 29, 1959, and depicted an organizational structure that was to prevail without major change for almost 12 months. The January 1959 chart evolved over a period of several months during which numerous "proposed" and "tentative" charts were prepared and discussed. Tracing out the changes from one chart to the next reveals how the January 1959 structure emerged. The pertinent charts, eight in number, can be found in Appendix B. The three most important ones have also been reproduced in this chapter.

Comparing the charts can be facilitated by dividing NASA's organization into five segments—top management (the Administrator, Deputy Administrator, and Associate Administrator or general manager); external and legal relations (the hard-to-classify offices reporting directly to the Administrator); administration (personnel, financial management, etc.); research (the NACA program core); development (the new program area). These segments appear most clearly on the January 1959 chart (fig. 3-3). The following is a comparison of the charts themselves—the underlying substance is discussed in the next section where the reports of a management consulting firm, McKinsey & Co., are examined in detail.

The first attempt to meld the NACA nucleus, Silverstein's space flight development plans, the provisions of the Space Act, and certain additional innovations, was made by the Abbott Committee and has already been briefly discussed.<sup>47</sup> The organizational proposals of this committee, depicted by its August 11, 1958, chart (fig. 3-1) included several significant changes in the then-existing NACA organization. The space-flight development activity was given a coequal but separate status vis-a-vis research activity. This was in accordance with Dryden's position that these two activities must be kept divorced from each other as much as possible.<sup>48</sup> The Abbott Committee also proposed a separate status for space sciences and an upgrading of the financial management and facility coordination functions. The proposed space-flight development center was given jurisdiction over NACA's existing Wallops Pilotless Aircraft Station. An Assistant for International Activities was added to the "external relations" segment, and the security and publications functions were shifted to the "administration" segment.

<sup>47</sup> See Sec. I.C of this chapter.

<sup>48</sup> Interview with Hugh L. Dryden, Apr. 9, 1963.









The chart dated August 21 represented initial decisions by Glennan and Dryden concerning the Abbott Committee Report.<sup>49</sup> The space science program area was eliminated, and an Office of Program Planning and Evaluation added.<sup>50</sup> Thus Glennan accepted, initially, most of the Abbott Committee proposals.

The October 24 chart (fig. 3-2) represented second thoughts on several important items. The space science function was given a home in the "development" segment. The university contracting program was detached from the "research" segment and added to the "development" segment—a paper move that never materialized. The most fundamental change concerned the Comptroller and Facility Coordinator: both were shifted from the "top management" segment to the "administration" segment, where they had been under NACA. This development is explained in detail in the next section. The November 14 chart contained no substantive changes.

In December, McKinsey & Co. made its report, including a structural chart depicting its recommendations for NASA's organization. This chart included an exceedingly important feature not appearing previously—the position of Associate Administrator, to be a kind of general manager. Lesser changes included the reappearance of an Office of International Activities, addition of an audit office to the "administration" segment, and the return of the university contracting office to its old home in the "research" segment. Not all these changes can be attributed solely to McKinsey & Co.; this will be discussed in the next section.

The official chart signed by Glennan on January 29, 1959 (fig. 3-3), was almost identical to the December chart prepared by McKinsey & Co.<sup>51</sup> An Assistant Administrator for Congressional Affairs was added. The newly acquired Jet Propulsion Laboratory was added to the "development" segment. Although an Inventions and Contributions Board was established December 16, 1958, and

<sup>49</sup> On Aug. 19, 1958, the day Glennan and Dryden were sworn in, there was a meeting of Glennan, Dryden, Crowley, Gilruth, and the six members of the Abbott Committee, at which the Committee's final report was discussed. In addition to the changes described in the above paragraph, the position of Executive Assistant to the Administrator was scratched and the titles of Associate Administrator and Assistant Administrator were changed to Director and Assistant Director. (Information based on Clotaire Wood's marked-up Aug. 12 organization chart.) The Aug. 21 chart was exhibited and explained by Glennan at the final meeting of the NACA Main Committee held that day. He emphasized the importance of the Office of Program Planning and Evaluation (*Forty-Fourth Annual Report of the NACA, 1958*, p. 95).

<sup>50</sup> The Office of Program Planning and Evaluation was to serve as a long-range planning office and Glennan put much personal effort into staffing it. The program evaluation aspect was never fully clarified. The international activities function stemmed from Sec. 205 of the Space Act—"The Administration . . . may engage in a program of international cooperation in work done pursuant to this Act. . . ."

<sup>51</sup> When the chart was distributed, there was attached a memo signed by Glennan (dated Jan. 30, 1959), in which he called it the "organizational structure . . . approved for the National Aeronautics and Space Administration at this time." He went on to say that it "establishes . . . the lines of authority and responsibility to be observed by NASA employees." He stated that it was based on the McKinsey recommendations after "extensive review by NASA staff."

new research advisory committees January 1, 1959, these elements did not appear on an organization chart until March 31, 1959.<sup>52</sup>

Except for Wallops Station, the former NACA laboratories were continuously viewed during this period as part of the "research" segment. The only change was that the individual to whom the laboratory directors reported (Crowley) was now one step farther down the NASA hierarchy.

The significant organizational decisions made through January 1959 were establishment of the position of Associate Administrator, establishment of the space-flight development program, establishment of a space-flight development field center, acquisition of JPL, rejection of the comptrollership concept, and rejection of a separate space science program. Another decision, the establishment of the Office of Program Planning and Evaluation, did not prove to be as significant as originally intended.

### C. The McKinsey Report on Organizing Headquarters Functions

Glennan did not wish to ratify what he had inherited without getting an expert, outside point of view. Therefore he hired McKinsey & Co., a highly respected management consulting firm, to make a study of NASA's organization that would aid him in establishing the best possible base for the long-run growth of the agency.<sup>53</sup>

The \$33,000 McKinsey contract was dated October 10, 1958.<sup>54</sup> Through analysis of the Abbott Report, discussions with NASA Headquarters personnel and BOB officials, and visits to at least two field installations, McKinsey & Co. was to make recommendations on the best organization for NASA Headquarters, the proper function of each Headquarters office, and how potential transfers to NASA could best be accommodated.<sup>55</sup> NASA was to cooperate by making records and office space available.

<sup>52</sup> The Inventions and Contributions Board was authorized by Sec. 305 of the Space Act (see Ch. 1, Sec. III). James Hootman was named full-time secretary to the five-member board, composed of Robert Littell, Paul Dembling, Allen Crocker, Elliott Mitchell, and C. Guy Ferguson. (See NASA Release, Dec. 16, 1958.) The proposal to reconstitute the 28 NACA technical committees and subcommittees into 13 NASA Research Advisory Committees was made by J. W. Crowley's memorandum for the Administrator, Oct. 28, 1958. Subject: Recommendation for Establishment of NASA Research Advisory Committee. Glennan approved the proposal. (See Glennan's letter to NACA committee chairmen, Nov. 10, 1958.) The NACA committees went out of existence Dec. 31, 1958. For a more detailed description, see NASA Release, Nov. 21, 1958; "Functions and Responsibilities of Research Advisory Committees of the National Aeronautics and Space Administration," Jan. 1, 1959; and NASA General Directive No. 10, Feb. 10, 1959.

<sup>53</sup> See Sec. I.E above, especially footnote 25.

<sup>54</sup> It was Headquarter's first contract, NASw-1. Corson's initial proposal was dated Sept. 16. A more detailed proposal followed on Sept. 26 and the letter contract, drawn up by NASA, followed Corson's proposal quite closely.

<sup>55</sup> The last objective was not fulfilled in the December report, but instead gave rise to a contract amendment which will be discussed in the next chapter.

The study began October 15 and stayed on schedule.<sup>56</sup> A brief interim report was made November 17,<sup>57</sup> a preliminary oral report was presented December 2, and the 150-page final report was dated December 31.<sup>58</sup> The final report was divided into two parts: the first summarized the reasoning behind the proposed organizational plan and presented findings and recommendations in specific problem areas; the second contained statements of functions, responsibilities, and interrelationships of 22 major Headquarters offices. There seems little doubt that the report was designed to arrive at the best possible objective solution to agency problems, as well as to justify decisions already made (i.e., to rationalize Glennan's intuitive ideas). Two examples of the latter element are worth noting.

First, Glennan insisted on establishing the position of general manager in the face of almost unanimous opposition.<sup>59</sup> Internal opposition stemmed from the fact that such a move would add an important layer between the two political appointees and the rest of the agency. Corson initially opposed the idea on the basis that NASA was too small to require a general manager, but Glennan was adamant and was able to bring Corson to his point of view.<sup>60</sup>

The second more complicated example involves financial management and facility coordination. The Abbott Committee had recommended establishment of a comptroller and facilities coordinator directly under the Administrator. Glennan initially agreed with this proposal; however, the person he sought for the position of Director of Business Administration, Albert Siepert of NIH, believed that financial management was an integral part of a broader, comprehensive administrative function and felt that his experience would not be particularly useful to NASA if the financial function were separated from other administrative support.<sup>61</sup> Glennan subsequently concurred in Siepert's point of view, and the matter could have been considered closed. Still, the McKinsey study went through a process of rationalizing this decision, made 2 months earlier. This suggests a lingering concern over the correctness of the decision. This problem is discussed in greater detail later in this section.

In spite of the tendency toward rationalization indicated by these two examples, the McKinsey Report is worth systematic examination. In the account which follows, an attempt has been made to present the report's major recommendations in rough order of importance. (All parenthetical page references pertain to Part I of the report unless otherwise indicated.)

<sup>56</sup> Principal investigators were to be John Corson, one-third time, and John D. Young, full time. Young, who worked on several subsequent McKinsey contracts with NASA, eventually transferred to NASA and is now Deputy Associate Administrator for Administration.

<sup>57</sup> The interim report is significant only in that it indicated Glennan's chief areas of concern, which were: the need for a general manager, comptroller, and facilities coordinator; organization of the contracting and space-flight development functions; and the role of the Office of Program Planning and Evaluation.

<sup>58</sup> McKinsey & Co., Inc., *Organizing Headquarters Functions, National Aeronautics and Space Administration*, December 1958. Cover letter to Glennan is dated Dec. 31, 1958.

<sup>59</sup> Glennan was familiar with the concept from his AEC experience.

<sup>60</sup> Interview with John Corson, Apr. 26, 1963.

<sup>61</sup> Interview with Albert Siepert, Apr. 9, 1963.

**Overall Organization** (1-1 to 1-13). The organizational structure recommended by the report was briefly described earlier in this chapter.<sup>82</sup> Since the idea of an associate administrator was Glennan's, it can be said that no *major* structural innovations resulted from the McKinsey study.

**The Position of General Manager** (2-18 to 2-23). The report posed the question: "Is there need for establishing an additional position to supplement the Administrator and Deputy Administrator?" Evidence was found to support a "yes" answer. During a 60-day test period in October, November, and December, it was found that the Administrator and Deputy Administrator spent over 60 percent of their time in meetings and discussions with outside persons and groups. When Congress reconvened in January, the percentage would probably rise even higher. This did not leave the two top leaders enough time for internal relationships. Though the newly appointed Directors could be expected to increase their effectiveness and though the staff of assistants to top management could be expanded, there was still need for someone to assume full responsibility for implementing operating decisions and solving jurisdictional problems. The effectiveness of the Administrator and Deputy Administrator would be enhanced if they could be relieved of this load.

The importance of Glennan's decision on an Associate Administrator cannot be overestimated. Each subsequent reorganization revolved around this position. There now seems to be consensus that subsequent developments have fully vindicated Glennan's action and Corson's supporting reasons.

**Financial Management** (2-13 to 2-17). The McKinsey Report recognized that the job facing NASA in this area would be considerably more complex than the one that had faced NACA. The pros and cons of two alternative approaches were presented. The "comptrollership approach"—in which auditing, accounting, and budgeting would be under one person reporting directly to the top man—put the financial management function at a very high level in the hierarchy and assured that financial matters would receive adequate consideration. The other alternative—the "integrated business services approach"—placed auditing, accounting, and budgeting under an individual who would report directly to the top man but who would also be in charge of other management functions such as personnel and procurement. This alternative promoted the coordination of all management functions and reduced the agency head's span of control. It would permit many management problems to be solved at a level below the agency head.

The McKinsey Report declared both alternatives workable if run properly. Since the decision had already been made to use the second approach, the report recommended it on the basis of the "span of control" argument. Under this approach it was recommended that accounting and budgeting be kept together in the same division within the Office of Business Administration so that a closely integrated working relationship between the two subfunctions would develop.

<sup>82</sup> See the December 1958 chart in App. B.

It was recommended that auditing be placed in a separate division to keep that function somewhat independent from other divisions and offices. This recognized that valid arguments exist for placing the audit function at a high level, well insulated from organizational units to be audited.

A good case can be made that financial management has been a "soft spot" in NASA, and part of the difficulty may have stemmed from the lack of a solid position on financial management during this early period. Siepert argued cogently against the comptrollership approach for NASA on the grounds that it was an outmoded concept for a research and development agency,<sup>63</sup> and if the Abbott Committee, in recommending this approach, had based its position solely on the reasoning that comptrollerships were "in vogue," Siepert would have won the argument. The Abbott Committee, however, had additional specific reasons to back up its recommendation—reasons that were no doubt not fully known to Glennan, Siepert, or anyone else outside NACA. The Abbott Committee knew that NACA's financial management system had become inadequate with the rise of agency expenditures after 1950, largely because of the independence of NACA field installations. Expecting even greater expenditures under NASA, the Abbott Committee realized that a sharp break with the NACA pattern was needed.<sup>64</sup> This break, according to the Abbott Committee, should involve moving the financial management function to a very high level in order to get more leverage over the independent field centers. This, to them, meant installation of the comptrollership concept. In view of NACA's financial management experiences, it is possible that more attention to this area by NASA at this time might well have lessened subsequent problems.<sup>65</sup>

*Facility Coordination* (2-7 to 2-21). The discussion of this area closely parallels that of financial management, except that NACA facility coordination difficulties (e.g., failure to coordinate facility proposals, lack of Headquarters follow-through) were presented to support the argument that NASA's problem would be even greater. The Abbott Committee's recommendation in this area was the same as for the comptroller. The McKinsey Report, relying on the same arguments used for financial management, recommended that this function be handled by an Assistant to the Director of Business Administration.

The report admitted that the magnitude of the NASA facility problem (e.g., site selection, new construction, need to integrate old and new facilities, complex facility utilization scheduling, and leadtime problems) required the attention of all parts of the agency and that the staff assistant for facility coordination would

<sup>63</sup> Siepert was not opposed to the comptrollership concept for all organizations, but felt that in an R&D agency, the important variables entering into management decisions are financial only in part, and that too great a reliance on financial tools for control purposes can actually inhibit agency progress. Interview, Apr. 9, 1963.

<sup>64</sup> This interpretation was suggested by Clotaire Wood, Committee member. Interview, Apr. 23, 1963.

<sup>65</sup> Siepert in reflecting upon the later difficulties in achieving adequate staffing and upon the subsequent doubling in NASA's budgets for each of the next 4 years, readily agrees with this conclusion. Interview, Apr. 9, 1963.

be an information gatherer and adviser to top management rather than a coordinator. To promote coordination, the report suggested that "NASA may find it useful to establish a facilities review board" made up of representatives from all three major Headquarters offices. The staff assistant would serve as an executive secretary to the board. As things turned out, an Assistant for Facilities Coordination was not established until mid-1959.

**Contracting Problems** (2-2 to 2-6). The McKinsey Report acknowledged the greatly increased importance of contracting in NASA. Two basic organizational questions were asked: To what extent should the responsibility for contracting be decentralized? and To what extent should NASA utilize the capabilities of the military services? A policy of decentralization was recommended in answer to the first question. The administration of cost-type contracts (the kind primarily used in R&D work) involved day-to-day field supervision,<sup>66</sup> and Headquarters responsibility for policy and program formulation and overall supervision of field activities would suffer if Headquarters became too involved with contract details.<sup>67</sup> To answer the second question, it was recommended that the military services be used to supplement NASA efforts, especially in contract administration and during the interim period prior to the time when NASA would be fully effective.

**Organization of Aeronautical and Space Research** (1-3 to 1-5). The McKinsey Report agreed with Abbott Committee recommendations that this area be left much as it was under NACA. It was pointed out that NASA would have to face the difficult problem of integrating this area into the agency as a whole while preserving the former working relationships that had functioned so well.

**Organization of Space Flight Development** (1-5 to 1-9). The McKinsey Report recognized the soundness of the Abbott Report recommendation to separate this activity from research so that research resources would not be dissipated in solving day-to-day development problems. It recommended that the newly established Headquarters office formulate programs, define and assign projects, and review project progress. Field centers would supply information, prepare contract specifications, supervise the execution of contracts, conduct R&D, and perform certain ground testing. Thus the recommended system was a decentralized one, even though this area was new and complicated.

A major problem was recognized. Normal Headquarters-field relationships could not exist because the Space Project Centers (Beltsville, JPL) were not yet operational in the way eventually planned. This meant that the Headquarters Space Flight Development Office (under Silverstein) would have to get involved

<sup>66</sup> The report suggested that in meeting this requirement, NASA might wish to establish field administration offices in or near contractor plants.

<sup>67</sup> For a recommended distribution of functional responsibility for each step in the contracting process by organizational unit, both at Headquarters and in the field, see Exhibit V at the end of Part I of the report.

in the short run in operating activities such as contract administration. The danger lay in this short-run activity permanently distorting the role of Headquarters and thereby inhibiting eventual decentralization.

Two other problems were noted. Since Beltsville and JPL had many similar capabilities, a problem arose in allocating responsibilities between them to avoid duplication yet fully exploit their capabilities. Another problem stemmed from the possibility of Space Sciences eventually becoming engulfed by hardware development problems. If this should come true, the report recommended that Space Sciences be separated and given some type of coequal status, as recommended by the Abbott Committee. It was also suggested that experience might reveal the desirability of separating flight operations from flight development.

*Location of the Office of Contract (University) Research* (2-24 to 2-25). The Abbott Committee had recommended that this function be located within the Office of Aeronautical and Space Research. Later it was moved (on paper) to the Office of Space Flight Development, because developmental research was to be emphasized. At the December 2 oral presentation, McKinsey & Co. recommended that it be given a neutral home under the Associate Administrator. Subsequent thinking suggested that a technical base would be desirable and that the Associate Administrator should not be involved. The final McKinsey Report recommended that the office be placed under Aeronautical and Space Research because this would distribute the workload more evenly between the research and development segments. Also a research-oriented environment would be advantageous.<sup>68</sup>

*Miscellaneous Matters.* Some additional findings and recommendations of the McKinsey Report are worth noting. The statement was made that it would be exceedingly dangerous to assume that NASA could get along solely with existing NACA staff and support services (1-9, 1-12). An audit and updating of the organizational structure of the research centers (NACA laboratories) was recommended (1-14). An additional recommendation suggested that interim arrangements to support Beltsville staff (NRL transferees) should be made by Headquarters personnel who were independent of those involved in the policy formulation for and supervision of the Beltsville center (2-5).

*A Brief Evaluation of the McKinsey Report.* The December 1958 McKinsey Report furnishes the only systematic and comprehensive discussion of the major administrative problems facing the new agency. Although the precise degree to which it influenced agency behavior is difficult to determine, it is safe to say that its direct and immediate influence was relatively small. It satisfied the need felt by Glennan for an outside point of view and probably gave NASA leadership the feeling that organizational problems had been adequately studied. While it tended to "rubberstamp" what already had been decided, it did go an important step further and identify certain danger spots. The acumen of the

<sup>68</sup> The arguments must not have been conclusive, however, as the office has been moved twice since.

McKinsey investigators has been borne out by subsequent developments. Many of the danger spots, "redflagged" in the report, turned into full-fledged problems later on. Preparing the report educated McKinsey & Co. and enhanced its usefulness in conducting subsequent studies for NASA.

#### D. Personnel

Throughout this chapter reference has been made to personnel matters such as the transfer of persons and the choosing of leaders. Manpower is a basic element in an organization, deserving a comprehensive and systematic presentation.

**Numerical Growth Summary.**<sup>69</sup> Glennan and Dryden were sworn in August 19, 1958, and became NASA's first employees. They were followed on October 1 by 7,966 NACA employees, on November 30 by 148 NRL/Vanguard employees, and on December 28 by 46 miscellaneous NRL employees. During the period from October 1 to January 31, 1959, a total of 566 individuals were hired by NASA and 278 left NASA, for a net gain of 288 and a net total of 8,450. Headquarters grew from 180 to 301, a 68-percent increase, and field installations from 7,786 to 8,149, a 5-percent increase, over half of which were NRL transferees. Thus the dramatic changes occurred in Headquarters, as would be expected. The transfer of the JPL contract to NASA December 31 added about 2,300 contractor employees, 27 percent of total NASA employment.

**Appointments to Excepted Positions.** The Space Act gave the NASA Administrator wide discretionary authority in selecting top-level assistants. Section 203(b) authorized him to appoint 260 scientific, engineering, and administrative personnel without regard to Civil Service appointment and compensation laws. A \$19,000-per-year ceiling was placed on 250 of these positions and a \$21,000 ceiling on the remaining 10. In comparison, the highest rate under the Classification Act, GS-18, had a single rate of \$17,500. The \$21,000 rate was the rate provided in the Executive Salary Act of 1956 for the Director of Central Intelligence, the Commissioner of Internal Revenue, the Administrator of General Services, the Administrator of Housing and Home Finance, and the Under Secretaries of all departments other than State and Defense. The authority given the NASA Administrator permitted him to define the organization of the new agency and to modify it with a maximum of freedom. In most other agencies, the naming of specific positions and salaries for top-level positions tended to dictate the formal organization.<sup>70</sup> Persons appointed under this authority are excepted from the General Schedule (GS) of the Classification Act of 1949 and fill what have come to be called "excepted" positions.

NACA had been authorized, under similar legislation (the so-called Public Law 313 shared by NACA with DOD from 1949 on), to establish 90 similar posi-

<sup>69</sup> A table showing the number of NASA employees by quarter and by installation has been included as app. C.

<sup>70</sup> Based on memo from Howard Braithwaite to NASA Historical Office, Nov. 10, 1964.



tions, and the question arose whether the wholesale transfer of NACA's property, functions, powers, and personnel to NASA included this Public Law 313 power.<sup>71</sup> In response to a September 29, 1958, inquiry from Glennan, the Comptroller General ruled that the 90 NACA positions were part of, rather than additions to, NASA's 260 excepted slots.<sup>72</sup>

The initial excepted position appointments were made October 1, 1958. Ten NACA Public Law 313 incumbents were given new positions in NASA<sup>73</sup> (6 with salary increases) and 20 more were given excepted appointments without change of title or compensation. By October 24, six more had been appointed from outside NASA.<sup>74</sup>

Out of necessity, Glennan made immediate appointments to excepted positions. For the long run, however, he felt that specific guidelines would have to be developed. The first major assignment given the new Director of Business Administration (Siefert) was to draw up a policy statement on Section 203(b) appointments, aided by the Director of Personnel and others.<sup>75</sup> This policy statement was promulgated October 20, 1958.<sup>76</sup> Its main provisions were that authority to make excepted appointments would be used to attract and retain personnel vital to the agency, that salaries would be made as competitive with industry as possible, and that identical eligibility criteria would be used for existing and for new personnel. The salary scale was to extend from \$14,500 to \$21,000.<sup>77</sup> The Deputy Administrator and the Directors of the three large operating offices (Administration, Research, Development) were to make recommendations to the Administrator on establishment of excepted positions and appointments to fill them. Recommendations on appointments were to be based on careful evaluation of the individual using objective eligibility criteria, with merit the chief cornerstone. All positions were to be reviewed annually.

On the basis of the above-mentioned policy, the Administrator and an Executive Salary Committee established 79 additional excepted positions October 24,

<sup>71</sup> Prior to June 30, 1958, NACA's Public Law 313 authority included only 30 positions. When the NACA transfer to NASA took place 3 months later, none of the additional 60 positions had been filled because Dr. Dryden felt reluctant to tie the hands of a future NASA Administrator. *Ibid.*

<sup>72</sup> Letter from Glennan to Joseph Campbell, Comptroller General of the United States, Sept. 29, 1958. Reasoning was that Congress had passed the Space Act after increasing NACA's Public Law 313 authority to 90 positions and thus had made a redetermination of the total special positions the new agency should have.

<sup>73</sup> Crowley, Silverstein, Abbott, Rothrock, Rhode, Sanders, Victory, Reid, DeFrance, and Sharp.

<sup>74</sup> Stewart, Johnson, Siefert, Newell, Hyatt, Nunn.

<sup>75</sup> Interview with Albert Siefert, Apr. 9, 1963.

<sup>76</sup> Memorandum from the Administrator . . . Subject: Establishment and approval of excepted positions and salaries under the authority of Sec. 203(b) of the National Aeronautics and Space Act, Oct. 20, 1958.

<sup>77</sup> Top grade pay for a GS-15 at the time was \$13,970.

1958, making a total of 115, and 17 GS-16 employees were appointed to them.<sup>78</sup> A cautious appointment policy was evidenced by the fact that those appointed totaled one-third of those recommended. There is little doubt that the flexibility given NASA by this special appointing power has been an important factor in whatever success the agency has had in attracting and holding high-grade talent.

*Miscellaneous.* Additional personnel flexibility came through Civil Service Commission policy to give new agencies a 3-year grace period during which there is an informal relaxation of civil service rules. This permitted NASA personnel officials to concentrate to top-priority management requirements, such as the recruitment and placement of new people, at the expense of long-run control activities such as position classification.

### E. Finance

NASA's funding pattern for fiscal year 1959 was abnormal and complex. Fiscal year 1959 (July 1, 1958, through June 30, 1959) was already underway when NASA was established on October 1, 1958. The funds at NASA's disposal for obligation during the remainder of fiscal year 1959 came from three sources—transfers from DOD (50 percent); transfers from NACA (25 percent); appropriations to NASA (25 percent).

NACA's regular appropriation for fiscal year 1959 was \$101,100,000.<sup>79</sup> By the end of September 1958, \$29 million of this amount had been obligated and thus a little over \$72 million was transferred to NASA.<sup>80</sup> In a supplemental appropriation bill, Congress appropriated \$80 million directly to NASA.<sup>81</sup> Trans-

<sup>78</sup> The Civil Service Commission ruled that the Sec. 203(b) authority was granted in lieu of "supergrade" positions (GS-16 to 18 under the General Schedule). According to CSC, NASA's 20 GS-16 positions could be retained only if the incumbents remained in their positions. If an incumbent was appointed to a higher salaried excepted position, the vacated GS-16 position would revert to CSC. NASA, in order to give equal pay for equal work, had to give 17 of the GS-16 incumbents excepted appointments at higher salaries. For additional information on the subject of excepted positions, see: "Attachment 'B'—Duties and Responsibilities of Certain Basic Types of Positions" appended to NASA's reports to Congress for fiscal years 1962, 1963, and 1964 covering excepted positions made during those years.

<sup>79</sup> The administration's January 1958 budget for fiscal year 1959 included a request of \$106,700,000 for NACA (\$80,480,000 for S&E and \$26,220,000 for C&E). Public Law 85-617, Aug. 8, 1958 ("Authorizing funds for construction of aeronautical research facilities by the National Advisory Committee for Aeronautics") authorized \$29,933,000 for C&E. Public Law 85-844, Aug. 28, 1958 ("Independent offices appropriation for fiscal year 1959") appropriated \$101,100,000 to NACA, \$23 million of which was for C&E. The Senate had wanted to appropriate more, but agreed to the House figure in the light of pending NASA legislation. As it turned out, the NASA appropriation was enacted first and was much lower than earlier anticipated by the Senate.

<sup>80</sup> Amount obligated by NACA during July, August, and September includes small amounts actually associated with NASA. Data supplied by NASA Financial Management Division.

<sup>81</sup> On July 30, 1958, the administration requested \$125 million for NASA (\$7 million for S&E, \$70,200,000 for R&D, and \$47,800,000 for C&E; S. Doc. 112, 85th Cong., 2d sess.). The amount requested for C&E was authorized in full (Public Law 85-657, Aug. 14, 1958). Supplementary appropriation action was initiated in the Senate and on Aug. 13 the Senate

fers from DOD totaled almost \$155 million.<sup>82</sup> This is broken down into salaries and expenses (S&E), research and development (R&D), construction and equipment (C&E) in the following table:<sup>83</sup>

TABLE 3-1.—Sources of NACA/NASA Funds, Fiscal Year 1959

Source	S & E	R & D	C & E	Total
NACA Regular (Public Law 85-844) . . .	\$78, 100, 000	.....	\$23, 000, 000	\$101, 100, 000
NASA Supplemental (Public Law 85-766) . . . . .	5, 000, 000	\$50,000,000	25, 000, 000	80, 000, 000
NASA Supplemental (Public Law 86-30) . . . . .	3, 186, 300	.....	.....	3, 186, 300
ARPA Transfers (Executive Order 10783) . . . . .	.....	67,200,000	.....	67, 200, 000
Air Force Transfers (Executive Order 10783) . . . . .	.....	57,800,000	.....	57, 800, 000
Navy (NRL) Transfers (Executive Order 10783) . . . . .	.....	25,541,282	.....	25, 541, 282
Army (JPL) Transfers (Executive Order 10793) . . . . .	.....	4,078,250	.....	4, 078, 250
Total . . . . .	\$86, 286, 300	\$204,619,532	\$48, 000, 000	\$338, 905, 832

By the end of fiscal year 1959, NASA had succeeded in obligating 89 percent of the funds available.<sup>84</sup> The remainder was carried over into fiscal year 1960.

**Funding Flexibility.** Carryover was possible because section 307 of the Space Act provided that R&D and C&E funds "shall remain available until expended." These "no-year" appropriations greatly contributed to NASA's funding flexibility.

Another factor in NASA's funding flexibility was the small number of appropriation accounts. Initially three were used: Salaries and Expenses (S&E), Research and Development (R&D), and Construction and Equipment (C&E).

Appropriations Committee reported a \$75 million NASA appropriation (\$5 million for S&E, \$35 million each for R&D and C&E) with the statements, "In the event additional funds are needed after the first of the year, the Committee will be glad to consider such requests" and ". . . the committee feels that planning for the Space projects center can be deferred until a later decision" (S. Rept. 2350, p. 14). Lyndon Johnson led a Senate floor action which on Aug. 15, 1958, restored everything cut by the committee. In conference, however, an \$80 million figure was agreed to (\$5 million for S&E, \$50 million for R&D, and \$25 million for C&E). This became Public Law 85-766 ("Fiscal 1959 supplemental appropriation") signed on Aug. 27, 1958. In early 1959 a second supplemental appropriation for pay increases (Public Law 86-30, May 20, 1959) included \$3,186,300 for NASA's S&E account.

<sup>82</sup> Project transfers related to this money were described earlier. See Sec. II.A of this chapter.

<sup>83</sup> U.S. budget for fiscal year 1961 shows an actual figure of \$59,200,000 for the ARPA transfers.

<sup>84</sup> Of the \$309,900,000 available, \$275,600,000 was obligated. All of the S&E, 90 percent of the R&D, and 75 percent of the C&E were obligated.

C&E was later modified slightly and became Construction and Facilities (CoF). During fiscal year 1963, S&E and R&D were combined into one account: Research, Development, and Operations (RD&O). This proved to be temporary, however, and during fiscal year 1964 RD&O was split by Congress into R&D and Administrative Operations (AO). NACA had used only two accounts, S&E and C&E.

**Finance Administration.** No uniform and coherent financial management system could be devised because of the constant "firefighting" that had to be carried on during most of fiscal year 1959. Accounting for the transfer of funds and their subsequent obligation was a thorny job. NACA's accounting system geared to S&E and C&E had to be modified to accommodate NASA's R&D activities.

**The Role of Congress.** NACA's construction budget was authorized annually by the armed forces committees of Congress, and appropriations for the entire NACA budget were handled through the Independent Offices Subcommittees of the Committees on Appropriations. Section 307 of the Space Act gave blanket authorization for all NASA appropriations except land acquisitions and construction items over \$250,000. This continued the pattern followed by NACA. NASA's first appropriation act, however, included a rider stating that "No appropriation may be made to the National Aeronautics and Space Administration for any period prior to June 30, 1960, unless previously authorized by legislation hereafter enacted by Congress."<sup>85</sup> A year later this requirement was extended indefinitely.<sup>86</sup>

This so-called "Johnson rider" greatly increased contact between Congress and NASA. NASA had to appear before both House and Senate Space Committees in support of an annual authorization for its entire budget and then appear before both House and Senate Independent Offices Appropriations Subcommittees in support of an annual appropriation act.

**Preparing for Fiscal Year 1960.** NASA was coming into existence about the time that its fiscal year 1960 budget requests should have been submitted to the Bureau of the Budget, so the time schedule obviously had to be modified. The fiscal year 1960 budget totals were determined in late 1958 with a minimum amount of detailed analysis.<sup>87</sup> A special effort was directed toward sorting out

<sup>85</sup> Public Law 85-766, Aug. 27, 1958, 72 Stat. 873. This is the so-called "Johnson rider." For an account of its passage, see U.S. Congress, Senate, Special Committee on Space and Astronautics, *Final Report*, S. Rept. 100 pursuant to S. Res. 256 of the 85th Cong., 86th Cong., 1st sess. (Washington: GPO, 1959).

<sup>86</sup> Public Law 86-45, June 15, 1959, 73 Stat. 75. This was NASA's fiscal year 1960 Authorization Act. For an account of a procedural hassle stemming from this provision, see U.S. Congress, Senate, Committee on Appropriations, *Supplemental Appropriation Bill for 1960*, Hearings on H.R. 7978, 86th Cong., 1st sess. (Washington: GPO, 1959), p. 6 (hereafter cited as Senate Hearings, *Supplemental Appropriation Bill for 1960*). See also Mary S. Ambrose, "The National Space Program, Phase II, Implementation of the National Aeronautics and Space Act of 1958," unpublished (but NASA reproduced) seminar report for the American University, 1961, pp. 148-150 (hereafter cited as Ambrose, "The National Space Program, Phase II").

<sup>87</sup> Interview with Abe Silverstein, Jan. 18, 1964.

the funding for NASA's program from that of DOD's space program.<sup>88</sup> President Eisenhower's January budget request to Congress included \$485,300,000 for NASA, of which \$94,430,000 was for S&E, \$333,070,000 for R&D and \$57,800,000 for C&E. The enactment of this budget is discussed in the next chapter.

#### **F. Procurement/Contracting**

It was assumed from the beginning that much of NASA's work would be done by contract, especially in hardware development. It was also recognized that NASA's mission necessitated large-scale contracting that would constitute NASA's major departure from the NACA way of doing business.<sup>89</sup> Thus contracting looms large as one of NASA's basic administrative problem areas.

The way NASA wrestled with contracting problems can best be depicted by systematically reviewing the entire contracting process. It should be remembered that NASA is an R&D agency which requires that most of the goods and services that it procures by contract are unique, and not readily available from commercial sources. The variety of supplies and services procured by NASA include: multimillion dollar launch vehicles, small electronic instruments for particular spacecraft, feasibility studies and investigations, construction of research facilities, and administrative supplies and equipment.

*Policies Governing NASA Contracting.* The Space Act granted NASA broad powers to develop, construct, test, and operate space vehicles and to make contracts for the conduct of its work with individuals, corporations, Government agencies, and others. It also extended to NASA the procurement authority contained in the Armed Services Procurement Act of 1947 (ASPA), now codified as Title 10, Chapter 137, U.S. Code. This latter act relates to procedures governing the making of contracts by the Department of Defense, the Coast Guard, and NASA (and formerly NACA). Thus NASA and the Department of Defense are governed by the same procurement statute and deal to a considerable extent with the same segment of industry.

The Armed Services Procurement Act was enacted in February 1948 by Congress to provide the agencies included in the act sufficient flexibility to conduct their procurement programs not only by the traditional method of advertising for competitive bids and awarding contracts to the lowest responsible bidder but also by the method of negotiation, a technique developed largely during World War II to meet the needs of the war effort. In 1949 the Federal Property and Administrative Services Act which established the General Services Administration also extended similar procurement authority to the civilian agencies of

<sup>88</sup> Interview with Willis Shapley, Bureau of the Budget, May 7, 1964.

<sup>89</sup> One of the first attempts to take a comprehensive view of NACA-NASA procurement organization was undertaken during the summer of 1958 and resulted in a document entitled "Brief Discussion of Procurement Organization and Practices of NACA-NASA," prepared under the direction of Ralph Cushman, Chief, NACA Procurement Division, August 1958.

the Government, pursuant to recommendations contained in the First Hoover Commission Report.<sup>90</sup>

Section 305(b) of the Space Act provided that the Armed Services Procurement Act was to apply to NASA. Section 203(b)(5) suggests, however, that Congress may have wished to grant NASA special procurement authority similar to that given AEC.<sup>91</sup> Whether or not NASA had a choice between the two approaches was never clarified. On October 30, 1958, Glennan announced that NASA contracting would be handled in accordance with ASPA.<sup>92</sup> The announcement went on to say that NASA's procurement and contracting regulations now being developed will conform in every practicable way to the Armed Services Procurement Regulations [ASPR] . . . This decision should be welcomed by potential NASA contractors since industry has become quite familiar with the ASPR in the past 10 years. They will not be required to learn how to operate under widely divergent NASA regulations, nor will this change procedures for those contractors now engaged in projects which have recently been transferred from the Department of Defense to NASA.<sup>93</sup>

NASA soon realized that using ASPA (the act) as a policy guide worked well enough, but adhering closely to the more detailed ASPR (the regulations) tended to lessen the agency's long-run procurement flexibility.<sup>94</sup>

*NASA's Contracting Machinery.* NASA's first procurement machinery was carried over from NACA. Most of the major procurement actions taken during the time period covered by this chapter, however, were handled on an individual basis without conformance to an elaborate formalized procedure.

The necessity for expanding NASA's procurement staff was soon recognized. In January 1959 Glennan appointed Ernest Brackett, an Air Force procurement specialist, to head NASA's Procurement Division.<sup>95</sup> Since NASA would follow ASPR, the military services became the primary source from which to recruit

<sup>90</sup> For a fuller discussion, see "Legal Framework of NASA's Procurement Program," by Walter D. Sohler, Assistant General Counsel, NASA, in *NASA-Industry Program Plans Conference*, July 28-29, 1960, pp. 105-108.

<sup>91</sup> See Paul G. Dembling, "National Coordination for Space Exploration: The National Aeronautics and Space Act of 1958," *The JAG Journal*, February 1959, p. 19.

<sup>92</sup> "NASA Announces Contracting Procedures," NASA Release, Oct. 30, 1958.

<sup>93</sup> *Ibid.* During the writing of the Space Act, NACA procurement officials favored complete agency autonomy on procurement matters. An attempt was made to prepare a set of regulations upon which NASA could operate. This effort fell short, however, and Glennan was not presented with a complete and comprehensive package. There was also a certain amount of uncertainty among NACA officials as to what approach would be best. This is suggested by interviews with Ralph Cushman, who was in charge of NACA's Procurement Division, and Mary Ambrose, a procurement specialist under both NACA and NASA.

<sup>94</sup> For a fuller statement reflecting the views of NASA's procurement professionals on the matter of procurement policy, see NASA Staff Paper, "Recommendations Toward a Sound Procurement Policy for NASA," Nov. 15, 1958. This paper is attributed to Carl Schreiber, who had been the No. 2 man in NACA's Procurement Division.

<sup>95</sup> Ernest Brackett was a Contract Specialist (Negotiation) at Wright-Patterson AFB. He became Director of Procurement and Contracting for NASA (an "E" position), Jan. 19, 1959.

procurement specialists. NASA's General Counsel, John Johnson, an official closely associated with procurement matters, also came to NASA from the Air Force.

Early problems in contract administration, DOD's role in assisting NASA with its procurement activities, and the question of procurement centralization versus decentralization have been mentioned in the discussion of McKinsey & Co.'s recommendations.<sup>96</sup>

*Steps in the Contracting or Procurement Process.* Although NASA's procurement process was not fully developed during the time frame covered in this chapter, a bird's-eye view of the nature and problems of that process will facilitate the discussion of procurement in later chapters. The major steps in the procurement process are described below.<sup>97</sup>

*The Procurement Request:* Once a project has been approved and a decision made as to the degree of external participation, the responsible organizational unit prepares a procurement request (PR).<sup>98</sup> The PR, after approval by the proper operating officials, becomes the basic working document for the procurement specialist. The PR includes a description of what is wanted and additional information as needed (suggested suppliers, security classification, etc.).

*The Procurement Plan:* On the basis of the PR and other available information, the procurement specialist draws up a procurement plan. This plan outlines in detail each subsequent step to be taken to carry out the procurement action. It includes a description of the items to be procured, a list of all known sources, a time schedule for completing each major phase of the action, the recommended type of contract to be used, and special provisions to be included in the contract. If the items to be procured can be clearly and completely defined in specifications and drawings, formal advertising for competitive bids is possible. If the items cannot be well defined (and most R&D work cannot), the negotiation route must be taken, whereby negotiations with potential suppliers (called "sources") are conducted on the basis of competitive technical and business proposals submitted to NASA. The "formal advertising" route usually results in a fixed-price contract whereas the "negotiation route" usually involves a cost-reimbursement contract—normally the cost-plus-a-fixed-fee (CPFF) variety. In NASA, 90 percent of the procurement dollar is spent via the negotiation route. When the procurement plan has been approved by the proper authorities, the stage is set for solicitation.

<sup>96</sup> See *Contracting Problems* in Sec. II.C above.

<sup>97</sup> For a more complete description, see the following: "Selling to NASA," a 32-page pamphlet published by NASA, April 1962; *NASA Procurement Management Seminar*, a much longer publication, prepared for NASA by Harbridge House, Inc., to serve as a textbook for training seminars, 1962; Ernest Brackett's presentation at NASA-Industry Program Plans Conferences, July 28-29, 1960, and Feb. 11-12, 1963; Ambrose, "The National Space Program, Phase II," pp. 90-101. Preparation of the description was facilitated by interviews with Mrs. Ambrose.

<sup>98</sup> The project approval process is an important topic in itself and is covered in later chapters.

*Soliciting Proposals:* At this stage an attempt is made to keep things as competitive as possible. When formal advertising is used, the procurement action is publicized as widely as possible and an "Invitation for Bid" (IFB) is sent to each interested supplier. The IFB contains all information needed to prepare a bid. It is the crucial instrument in bringing user and supplier together.

Negotiation is more complicated. An instrument called a "Request for Proposal" (RFP) is used instead of an IFB. Since a proposal is infinitely more complicated and expensive to prepare than a bid, NASA attempts to limit the sending of RFP's to parties known to be qualified. This necessitates a screening process, which may be done informally through letters and telephone calls or formally through a "preproposal conference" held with interested parties. On the basis of the screening, RFP's are sent to firms considered to have the required experience, facilities, and capabilities. A firm may submit a proposal even if it does not initially receive an RFP. All larger RFP's are announced in the Department of Commerce's *Business Daily* and thus a firm can request them.

*Bid and Proposal Evaluation:* When formal advertising is used, it is necessary to make sure that the low bidder is responsible and that his bid meets all requirements. When negotiation is used, a much more elaborate evaluation process is necessary, since cost figures are only one factor to be considered. Proposals are usually evaluated from three angles—the quality of the proposal (design, cost, schedules, etc.); the technical competence of the proposer (personnel, facilities, experience); and the managerial competence of the proposer (reporting system, accounting system, etc.). The RFP includes the criteria on which the evaluation is made. Administrative and legal personnel, as well as technical personnel, participate in proposal evaluation.

*Source Selection, Contract Negotiation, and Contract Award:* In the case of formal advertising, a standard-type contract is awarded to the lowest responsible and responsive bidder. When negotiation is used, a decision is made, based on the evaluation described above, on the supplier to do the work. After selection, negotiations are begun to iron out the details of the contract. Since a CPFF contract is used in most cases, thorny problems of clarifying costs and determining the fee must be solved. When both sides agree, the actual contract award is made.

*Contract Administration:* The award of a contract is only part of the overall procurement process. What follows may be even more significant. It is true that the contractor has primary responsibility for performance and, for routine procurements, contract administration may only involve taking delivery of the goods or services. In R&D contracting, however, numerous interim problems arise in which NASA has a vital interest. In such cases, reviewing and evaluating the contractor's progress is very important and may become a specialty in itself. Elaborate reporting techniques have been developed which sometimes reveal the need for NASA to render technical or administrative assistance to the contractor. NASA may approve certain contractor actions which involve changes in costs. In certain cases the contract may have to be modified or terminated.



Contract administration involves NASA operating technicians, procurement specialists, and people from such activities as safety, reporting, and security.

The foregoing discussion has left several questions to be answered in later chapters. Some of the related topics which will be treated later are: procedural variations related to the size of the procurement; the role of source evaluation boards; the role of boards of contract appeals; types of contracts and contract innovations; patents and the role of the Inventions and Contributions Board; small business participation in NASA procurement; subcontracting; problems of cost overruns; NASA's reliability program; NASA's special grant and research contract program; the role of DOD in NASA procurement; and changes in NASA's procurement organization structure.

### G. Miscellaneous Administrative Developments

*Weekly Staff Meeting.* Soon after NASA's establishment, Glennan inaugurated a program of weekly staff meetings with NASA's top Headquarters officials.<sup>99</sup> The purpose of these meetings was to "provide a forum for discussion of problems, an opportunity for the exchange of information, and a means of determining on action programs following the frank comments of all participants."<sup>100</sup> Although the weekly staff meeting was not a decision-making organ, per se, it provided an opportunity for top officials to achieve consensus which, when agreed to by Glennan, constituted the agency's position.

*Assignment of Responsibility to Dryden.* The management role that Dryden would play was uncertain when NASA was established. Glennan attempted to clarify this problem in December 1958 when he asked Dryden to "pay particular attention" to three specific programs: the space science program, which would involve extensive liaison with the Space Science Board of the National Academy of Sciences; NASA's man-in-space program (Project Mercury), which had grown out of earlier NACA efforts and in which Dryden had played a key role in winning NASA jurisdiction; and NASA's University Research Support Program, including policies to govern it.<sup>101</sup> How Dryden's responsibilities in these programs would mesh with those of Abe Silverstein who had organizational jurisdiction over them was not determined at this time.

*Utilization of Ad Hoc Advisory Committees in Nontechnical Areas.* On several occasions, Glennan utilized ad hoc committees to obtain advice on nontechnical matters. (In 1960 one such committee was to play a significant role in a study of NASA's organization.) In December 1958 Glennan convened a group of 11 persons, primarily academicians, to discuss the social and political problems of the space age.<sup>102</sup> This meeting was prompted by the Space Act require-

<sup>99</sup> Memorandum, Glennan to Hjernevik, Oct. 10, 1958. It is interesting to note that Glennan suggested that Hjernevik investigate the way AEC conducted its weekly staff meeting—another example of the influence of Glennan's AEC experience.

<sup>100</sup> *Ibid.*

<sup>101</sup> Memorandum, Glennan to Dryden, Dec. 24, 1958.

<sup>102</sup> Minutes of the Dec. 18, 1958, meeting were attached to a Feb. 9, 1959, letter from Glennan to each participant. James A. Perkins served as chairman of the meeting.

ment that there be "long-range studies of the potential benefits to be gained from the opportunities for, and the problems involved in, the utilization of aeronautical and space activities for peaceful and scientific purposes."<sup>103</sup> The importance of this meeting lay not in the conclusions reached but in clarification of problems. An internal NASA committee on long-range studies was established and a contractor hired to do detailed research and writing.<sup>104</sup>

#### H. External Relationships

During the time period covered by this chapter, several important external relationships were newly established by NASA or renewed from NACA days. The following are a few examples.

*DOD*: NASA's relationships with DOD were broad and deep. First, there was a carryover of former NACA-DOD relationships in aeronautical research and of relationships from the NACA-Navy-Air Force X-15 project.<sup>105</sup>

Second, there was a close relationship necessary to carrying out the several projects transferred from DOD to NASA. Either the Army or the Air Force served as executive agent for all major space launchings during NASA's first 4 months.

Third, ARPA was given a direct role in "assisting" NASA in its high-priority Project Mercury man-in-space program.<sup>106</sup>

Fourth, NASA-DOD cooperative agreements were made concerning launch vehicles and tracking. A National Space Vehicle Program, designed to eliminate possible duplication in the development of the very expensive vehicles used to launch payloads into space, was agreed to in December 1958,<sup>107</sup> and on January 10, 1959, agreement was reached on a "National Program To Meet Satellite and

<sup>103</sup> Sec. 102(c)(5).

<sup>104</sup> The Committee on Long Range Studies under the chairmanship of John Johnson, NASA General Counsel, was established May 18, 1959. Its major report was prepared by the Brookings Institution and is entitled *Proposed Studies on the Implications of Peaceful Space Activities for Human Affairs*, November 1960. The report has been published as H. Rept. 242, Committee on Science and Astronautics, 87th Cong., 1st sess. (Washington: GPO, 1961).

<sup>105</sup> The original NACA-Navy-Air Force agreement was signed Dec. 23, 1954. A similar agreement for a follow-on project—Project Dyna Soar—was entered into by NASA and the Air Force Nov. 14, 1958. Pertinent memoranda have been reprinted in Senate Hearings, *Investigation of Governmental Organization for Space Activities*, pp. 524-525.

<sup>106</sup> A Memorandum of Understanding was signed by Glennan and ARPA's Roy Johnson Nov. 20, 1958. ARPA agreed to furnish \$8 million of fiscal year 1959 funds; NASA agreed to have ARPA representatives serve on the working committee. This memorandum is reprinted in Senate Hearings, *Investigation of Governmental Organization for Space Activities*, pp. 524-525.

<sup>107</sup> Documentation on this program is very elusive. Evidently the program was informally arrived at in the course of DOD and NASA comparing their budgets for fiscal year 1960. See Glennan's testimony on p. 77 and York's testimony on p. 608 in Senate Hearings, *Investigation of Governmental Organization for Space Activities*. A formal statement was issued on Jan. 27, 1959, entitled "The National Space Vehicle Program." This has been reprinted on pp. 17-24 of the Senate Hearings just mentioned.

Space Vehicle Tracking and Surveillance Requirements for FY 1959 and FY 1960."<sup>108</sup>

Fifth, a Civilian-Military Liaison Committee (CMLC), a NASA-DOD consultative organ required by Section 204(a) of the Space Act, was formally established October 29, 1958.<sup>109</sup> The next day President Eisenhower appointed William Holaday, DOD Director of Guided Missiles, to serve as CMLC chairman.

*AEC:* In 1955, AEC began Project Rover, designed to develop a nuclear rocket engine for propulsion purposes. Responsibility for development of certain nonnuclear components was transferred from the Air Force to NASA on October 1, 1958, and Rover became an AEC-NASA project.<sup>110</sup> NASA also became involved in AEC's attempts to develop a system for converting nuclear energy into electricity (Project Snap).

*Department of Commerce:* NASA-Bureau of Standards relationships were a continuation of events begun under NACA. Relationships with the Weather Bureau developed in anticipation of the transfer of DOD's meteorological program to NASA. (See Ch. 4.)

*National Science Foundation (NSF):* NSF helped to bridge the gap between NASA and the scientific community, as well as to sponsor research of interest to NASA.

*Smithsonian Institution:* NASA received tracking support from the Smithsonian Astrophysical Observatory, which operated optical tracking stations.

*Executive Office of the President:* All agencies have an important and close relationship with the Bureau of the Budget (BOB), and NASA was no exception. NASA was responsive to the requirements of the Office of Civil and Defense Mobilization (OCDM) and its plans for national emergency preparedness.

NASA was involved in two new Executive Office organizations established during 1958—the Federal Council for Science and Technology (FCST) and the National Aeronautics and Space Council (NASC). Although not formally established until March 13, 1959, FCST actually began work in December 1958, with Dr. James R. Killian as chairman.<sup>111</sup> Its job was to improve the planning

<sup>108</sup> A copy of the agreement is reprinted in U.S. Congress, Senate, Committee on Aeronautical and Space Sciences, *NASA Authorization for Fiscal Year 1960*, Hearings on S. 1582, 86th Cong., 1st sess. (Washington: GPO, 1959), p. 321 (hereafter cited as Senate Hearings, *NASA Authorization for Fiscal Year 1960*).

<sup>109</sup> The Oct. 29, 1958, "Terms of Reference—Civilian-Military Liaison Committee to the National Aeronautics and Space Administration and the Department of Defense" have been reprinted in Senate Hearings, *Investigation of Governmental Organization for Space Activities*, pp. 500-501.

<sup>110</sup> See Senate Hearings, *NASA Authorization for Fiscal Year 1960*, pp. 112-114.

<sup>111</sup> For full details, see the Dec. 27, 1958, "Statement by the President" on the "Report of the President's Science Advisory Committee." Also Executive Order 10807, "Federal Council for Science and Technology," Mar. 13, 1959. These, and other related documents, have been reproduced in U.S. Congress, Senate, Committee on Government Operations, Subcommittee on Reorganization and International Organizations, *Science Program—86th Congress*, S. Rept. 120 of 86th Cong., 1st sess. (Washington: GPO, 1959), pp. 91-109.

and coordination of Federal programs in science and technology. The NASA Administrator was an ex officio member.

NASC, created by Section 201 of the Space Act, has been briefly described in Chapter 1. Composed of the President and the heads of DOD, NASA, AEC, and the Department of State, NASC was formed September 24, 1958, to formulate a comprehensive national space program and to advise the President on space policy and plans.<sup>112</sup> NASA played a special role in the operation of NASC by furnishing its Executive Secretary.<sup>113</sup> NASC held three meetings during 1958. The most controversial topic discussed was the proposed transfer of Army facilities to NASA, described earlier in this chapter.<sup>114</sup>

*Other Executive Branch Agencies:* The Department of State worked with NASA on international scientific relations, especially in regard to NASA's worldwide tracking system. The Federal Aviation Agency and the Civil Aeronautics Board were concerned with NASA's aeronautical research program, especially the areas of supersonic airplane development and flight safety. In addition, NASA maintained standard administrative relationships with the Civil Service Commission, the General Services Administration, the Treasury Department, and the General Accounting Office (actually an agency of the legislative branch).

*Other Organizations:*<sup>115</sup> The National Academy of Sciences (NAS), especially its Space Science Board, helped facilitate liaison between NASA and the scientific community.<sup>116</sup> Affiliated with NAS was the Committee on Space Research (COSPAR) of the International Council of Scientific Unions (ICSU). COSPAR was established by ICSU in late 1958 to continue international cooperation in the scientific exploration of space along the lines of the expiring

<sup>112</sup> In addition to the five designated members, the President could appoint one other governmental member and not more than three nongovernmental members to the Council. On Sept. 4, 1958, President Eisenhower made a recess appointment of William Burden to the Council. In May 1959, Burden and John Rettaliata, the president of the Illinois Institute of Technology, were nominated to serve as nongovernmental members. The Senate agreed to the nominations. For biographies, see U.S. Congress, Senate, Committee on Aeronautical and Space Sciences, *Nominations*, May 19, 1959, Hearing on Nominations of William Burden and John Rettaliata, 86th Cong., 1st sess. (Washington: GPO, 1959).

<sup>113</sup> On Dec. 26(?), 1958, Glennan wrote a letter to President Eisenhower suggesting that the Executive Secretary could be detailed from his [Glennan's] office, and recommended that his assistant, Frank Phillips, replace incumbent Robert Piland, who wanted to return to NASA's Langley Research Center. The President approved this plan in a letter to Glennan, Jan. 5, 1959.

<sup>114</sup> See sec. II.A. Meetings were held Sept. 24, Oct. 29, and Dec. 3. No agreement on the Army-NASA dispute could be reached at the Oct. 29 meeting (*New York Times*, Oct. 30, 1958, p. 14).

<sup>115</sup> Relationships between NASA and Congress have been mentioned frequently and will not be repeated here.

<sup>116</sup> The Aug. 3, 1958, press release of the National Academy of Sciences entitled "National Academy of Sciences Establishes Space Science Board" has been reprinted in Senate Hearings, *Investigation of Governmental Organization for Space Activities*, pp. 734-736.

International Geophysical Year. In December 1958 the United Nations established an ad hoc Committee on the Peaceful Uses of Outer Space.<sup>117</sup>

NASA's technical advisory committee system, described earlier in this chapter, served as a means for promoting the exchange of ideas and information between NASA and a large number of private and public organizations.

### I. Early Program Developments

A full description of NASA's aerospace program is beyond the scope of this study. On the other hand, the administration of a program cannot be divorced from the program itself; because of this, program summaries are included in almost every chapter. The next chapter opens with a discussion of NASA's program for fiscal year 1959, which includes the time frame covered by this chapter. Several program developments were intimately connected with NASA's establishment and warrant summarization here.

NASA's "inherited" program has already been alluded to. From NACA it inherited a program of basic aeronautical and space research. From DOD it inherited several projects involving the scientific investigation of space using earth satellites and lunar probes. Also from DOD it inherited several engine development programs.

During the summer of 1958 it had been determined that NASA would have jurisdiction over the Nation's manned space flight activities.<sup>118</sup> NACA, primarily through a specially created Space Task Group at Langley Laboratory, had developed a specific manned space-flight project and one of the first important decisions of the new space agency was to go ahead with what shortly became known as Project Mercury.<sup>119</sup> It was NASA's best known project for 5 years. NASA moved ahead quickly.<sup>120</sup> On October 21, 1958, tentative specifications on the Mercury capsule were sent to prospective contractors. In early November a preliminary bidders conference was held at Langley Research Center. Requests for proposals were issued about a week and a half later. Twelve firms submitted

<sup>117</sup> For a copy of General Assembly Resolution 1348(XIII), see U.S. Congress, Senate, Committee on Aeronautical and Space Sciences, *Documents on International Aspects of the Exploration and Use of Outer Space, 1954-1962*, Staff Report issued as S. Doc. 18, 88th Cong., 1st sess. (Washington: GPO, 1963), pp. 88-89.

<sup>118</sup> The precise timetable by which NASA obtained jurisdiction over manned space flight has not been made public. For the best account, see James Grimwood, *Project Mercury: A Chronology*, NASA SP-4001 (Washington: GPO, 1963), pp. 21-23. See forthcoming L. Swenson, C. Alexander, and J. Grimwood, *This New Ocean: A History of Project Mercury* (Washington: NASA SP-4007, 1966).

<sup>119</sup> *Ibid.*, p. 27. The date of the decision is given as Oct. 7, 1958.

<sup>120</sup> For a more detailed account, see U.S. Congress, House, Committee on Science and Astronautics, *The Production of Documents by the National Aeronautics and Space Administration for the Committee on Science and Astronautics*, Hearings, 86th Cong., 2d sess. (Washington: GPO, 1960), pp. 112-136 (hereafter cited as House Hearings, *The Production of Documents . . .*). Organizational arrangements for Project Mercury are discussed in Ch. 4, Sec. II.A.

proposals and in early January the McDonnell Aircraft Corp. of St. Louis was selected to develop the capsule.

Another major program development moved along on an even earlier time schedule. By the middle of December, the Rocketdyne Division of North American Aviation, Inc., was selected to develop the 1- to 1½-million-pound thrust, single-chamber (F-1) engine, studies for which NASA inherited from the Air Force.<sup>121</sup>

Both the Rocketdyne and McDonnell contracts were large ones. The Chairman of the Source Selection Committee in both cases was Dr. Abe Silverstein, the Director of NASA's Space Flight Development Program.

The third major program development in late 1958 was the recognition that NASA did not have adequately performing launch vehicles to carry out a satisfactory space exploration program.<sup>122</sup>

During 1958 the Army and Air Force each attempted two major launchings on behalf of NASA. Three were scientific lunar probes, one was a scientific earth satellite. None of them was completely successful.<sup>123</sup> NASA participated only to the extent of being in on the postmortems to ascertain what went wrong.<sup>124</sup> NASA had to wait until August 1959 for its first completely successful major launching.

<sup>121</sup> *Ibid.*, pp. 91-111.

<sup>122</sup> This problem is covered in detail in Ch. 4.

<sup>123</sup> See "Chronology of Major NASA Launchings . . ." prepared by the NASA Historical Office.

<sup>124</sup> Interview with Abe Silverstein, Jan. 18, 1964.

## Chapter Four

### 1959—INTERNAL CONSOLIDATION, EXTERNAL DIFFICULTIES

Glennan was the NASA Administrator 29 months. His first 5 months, the period during which NASA got started, were discussed in Chapter 3. The remaining 24 months are covered in this chapter (for 1959) and the next one (for 1960). This division is not as artificial as it may first appear, because 1959 and 1960 differ in several significant respects. The year 1959 was one of uncertainty and frustration for NASA. Congressional and White House support seemed ambivalent. NASA's space program was still largely inherited and the first completely successful launch did not occur until the year was almost two-thirds over. Additional project and facility transfers added to the uncertainty. The efficacy of the Space Act to provide the environment for positive progress was questioned.

On the other hand, 1960 was characterized by improvements on all fronts. Congressional and White House support became firm. All transfers were consummated. Changing circumstances made fundamental policy questions seem less significant and more emphasis was placed on the pragmatic solving of problems. In general, a more positive atmosphere prevailed.

During early 1959, NASA's top officials had to devote much effort to the problem of filling out the organizational skeleton set up during 1958. This emphasis on internal administrative matters gave way to involvement in external affairs stemming primarily from the authorization and appropriation activities of Congress and from congressional inquiries into NASA-DOD relations. This "involvement" climaxed during April, May, and June. Frustrations stemming primarily from external relations led to a questioning of the fundamental policy which guided NASA and delineated its role in the Nation's space program. Concern over basic policy, however, gave way before the major event of 1959—the October decision to transfer from DOD to NASA the Saturn super booster program and the Army installation closely associated with it.

This interpretation of 1959 events has been used as the basis for presenting NASA's 1959 administrative history. After an introductory section on NASA's 1959 space program, NASA's internal administrative and organizational develop-

ments are presented. This is followed by a section on NASA's external relationships, with emphasis on DOD and Congress. The fourth section discusses problems of basic policy, and the last section details the transfer of the Saturn program. Reviewing NASA's space program early in the chapter provides a program-oriented atmosphere for the discussion of administrative and policy matters.

### I. NASA'S 1959 SPACE PROGRAM

Any attempt to summarize NASA's space program runs into several problems. First, there is the tendency to unduly emphasize the dramatic and the tangible (e.g., major launchings) when possibly the most notable achievements were in laying groundwork for the future. Second, program evaluation is difficult because there are no generally accepted criteria by which an evaluation can be made. Events which may be classified objectively as failures may nevertheless be important steps forward. These problems tend to be compounded when the description and evaluation is highly condensed. With these qualifiers, the following summary of NASA's 1959 space program is presented.<sup>1</sup>

#### A. The Overall Program

In 1959 NASA's space program was shaken down and rounded out. By the end of the year the last major project and installation transfers had been determined. The paucity of "successes" during 1959—against the larger number of satisfying achievements during 1960—suggests that 1959 was a year of preparation. Developments in two areas, launch vehicle development and manned space flight, were especially important.

To give perspective to NASA's overall program, the following table (Table 4-1) has been constructed showing NASA's funding pattern for fiscal year 1959 and fiscal year 1960.<sup>2</sup> The table is based on data revealed by NASA at its authorization and appropriation hearings held during April and May 1959, and gives a good picture of how NASA's original spending plan was drastically modified to accommodate important program changes concerning the development of launch vehicles.

#### B. Launch Vehicle Development Program Changes

NASA had inherited most of its fiscal year 1959 program. Over half of the money for R&D was earmarked for the scientific investigation of space using

<sup>1</sup> For a longer summary, see *U.S. Aeronautics and Space Activities, January 1, to December 31, 1959*, the second annual report of the President on the Nation's activities in the fields of aeronautics and space. Published as H. Doc. No. 349, 86th Cong., 2d sess. (Washington: GPO, 1960), pp. 6-21.

<sup>2</sup> The table is based on data found in Senate Hearings, *NASA Authorization for Fiscal Year 1960*, pp. 754, 795, 806.



either “jury rigged” DOD launch vehicles or the newly developed but small Vanguard vehicle.<sup>3</sup> The R&D budget for fiscal year 1960, formulated during November and December 1958, was an extension of the same program with some strengthening in manned space flight, applications (meteorology and communications), and high-energy propulsion technology.

While NASA’s initial fiscal year 1960 budget was being formulated, Abe Silverstein and other NASA officials were conferring with DOD on the problem of U.S. deficiency in the area of large and reliable launch vehicles.<sup>4</sup> Existing vehicles were simply not good enough to permit an economical and successful space-flight program by NASA or DOD. From these talks an interagency launch vehicle development program emerged.<sup>5</sup>

The program called for phasing out the “jury rigged” Thor-Able and Juno II vehicles and the underpowered Vanguard vehicle, and for the development of a family of new vehicles designed to provide a complete range of capability in payload size and mission. The great expense involved in developing such a family of vehicles precluded either DOD or NASA from attempting it alone. For NASA, DOD cooperation was absolutely essential, as all new vehicles would be based on missile groundwork already laid by DOD. The plan, as agreed to in early 1959, called for certain vehicles to be developed by NASA, others by DOD. The plan was to be kept tightly coordinated so that duplication would be avoided and a maximum of information exchanged.

NASA was to have primary responsibility for the development of the small, inexpensive, all-solid Scout vehicle, the small- to medium-sized Thor-Delta (regarded as an interim vehicle), and the medium-sized Atlas-Vega. The somewhat larger Atlas-Centaur, especially important for space because it used liquid hydrogen for fuel, was to be transferred to NASA at the beginning of fiscal year 1960 (July 1, 1959). DOD was to develop the small- to medium-sized Thor-Hustler, the medium-sized Atlas-Hustler, and the larger-sized Saturn. A “super-sized” Nova vehicle would be studied by NASA but not developed.

By the end of 1959, the Thor-Hustler and Atlas-Hustler vehicles had evolved into the Thor-Agena and Atlas-Agena, and the Atlas-Vega had been canceled altogether because it was too similar in size to the Atlas-Agena and Atlas-Centaur.<sup>6</sup>

<sup>3</sup> The term “jury rigged” was used by Silverstein in testimony before the Senate Committee on Aeronautical and Space Sciences. U.S. Congress, Senate, Committee on Aeronautical and Space Sciences, *NASA Supplemental Authorization for Fiscal Year 1959*, Hearings on S. 1096, 86th Cong., 1st sess. (Washington: GPO, 1959), p. 32. He gave a lucid description of the various vehicles involved—see especially pp. 32–36.

<sup>4</sup> Interview with Abe Silverstein, Jan. 18, 1964. See also his July 13, 1959, testimony at Senate Hearings, *Supplemental Appropriation Bill for 1960*, p. 50.

<sup>5</sup> An unclassified version of the program was issued in January: *The National Space Vehicle Program*, prepared by the National Aeronautics and Space Administration in consultation with the Advanced Research Projects Agency of the Department of Defense, Jan. 27, 1959. This was reprinted in Senate Hearings, *Investigation of Government Organization for Space Activities*, pp. 17–24.

<sup>6</sup> A \$33 million contract with Convair (of General Dynamics) for the development of Vega was let in March 1959 and canceled in December. Unrecoverable expenditures were estimated at about \$17 million.

TABLE 4-1. *Planned Disposition of Fiscal Year 1959*  
 [In millions]

	Fiscal year 1959		
	Original	Revised	Change
<b>A. S&amp;E money (in-house):</b>			
1. Operating NASA Headquarters.....	4.9		
2. Operating former NACA field installations.....	78.8		
3. Operating the Beltsville Space Center.....	2.6		
Subtotal.....	86.3		
<b>B. R&amp;D money (contract):</b>			
4. Operating JPL.....	8.2		
5. Manned space-flight program.....	37.7		
6. Scientific satellites, probes, and rockets.....	85.0	53.8	-31.2
7. Project Vanguard (scientific satellite program).....	25.5		
8. Meteorology and communications.....	8.1	6.0	-2.1
9. Scout vehicle development.....		6.0	+6.0
10. Delta vehicle development.....		13.8	+13.8
11. Vega vehicle development.....		22.8	+22.8
12. Centaur vehicle development.....			
13. Million-pound engine development.....	12.0	10.0	-2.0
14. Nuclear engine development.....	8.5	4.5	-4.0
15. Other engine and propulsion activities.....	8.5		
16. Tracking and data acquisition.....	4.3	3.3	-1.0
17. Miscellaneous research contracts.....	5.5	3.0	-2.5
18. Other R&D.....	1.3	1.5	+2.2
Subtotal.....	204.6		
<b>C. C&amp;E money (contract):</b>			
19. Langley Research Center.....	11.4		
20. Ames Research Center.....	3.7		
21. Lewis Research Center.....	7.8		
22. Flight Research Center.....			
23. Wallops Island.....	21.2		
24. Beltsville Space Research Center.....	3.9		
25. Other.....			
Subtotal.....	48.0		
Grand total.....	338.9		

*and Fiscal Year 1960 Funds—NACA/NASA*  
of dollars]

	Fiscal year 1960		
	Original	Revised	Change
<b>A. S&amp;E money (in-house):</b>			
1. Operating NASA Headquarters .....	6.4		
2. Operating former NACA field installations .....	89.9		
3. Operating the Beltsville Space Center .....	14.7		
Subtotal .....	111.0		
<b>B. R&amp;D money (contract):</b>			
4. Operating JPL .....	8.2		
5. Manned space-flight program .....	70.0		
6. Scientific satellites, probes, and rockets .....	118.2	46.7	-71.6
7. Project Vanguard (scientific satellite program) .....			
8. Meteorology and communications .....	28.0	15.5	-12.5
9. Scout vehicle development .....		2.0	+2.0
10. Delta vehicle development .....		13.3	+13.3
11. Vega vehicle development .....		42.8	+42.8
12. Centaur vehicle development .....		41.0	+41.0
13. Million-pound engine development .....	30.2		
14. Nuclear engine development .....	8.0		
15. Other engine and propulsion activities .....	26.0	14.0	-12.0
16. Tracking and data acquisition .....	11.5		
17. Miscellaneous research contracts .....	8.2	5.2	-3.0
18. Other R&D .....	8.0		
Subtotal .....	316.4		
<b>C. C&amp;E money (contract):</b>			
19. Langley Research Center .....	4.6		
20. Ames Research Center .....	6.6		
21. Lewis Research Center .....	6.7		
22. Flight Research Center .....	2.8		
23. Wallops Island .....			
24. Beltsville Space Research Center .....	14.0		
25. Other .....	23.0		
Subtotal .....	57.8		
Grand total .....	485.2		

In addition, the Saturn had been transferred to NASA, something not planned for at the beginning of the year. Centaur was transferred to NASA as planned.

When NASA agreed to develop several new launch vehicles, it was faced with the problem of finding the necessary funds. This was done by drastically revising its R&D budget for both fiscal year 1959 and fiscal year 1960. Table 4-1 shows this very clearly. NASA substantially cut back on the flight program for scientific satellites and probes. With unreliable vehicles this made sense because the chances for a successful flight program were not too great anyway.

All in all, getting the national launch vehicle program largely straightened out was one of the major space accomplishments of 1959.<sup>7</sup>

### C. Manned Space Flight

Project Mercury, which had gotten off to a fast start in 1958, continued to progress at a good pace during 1959.<sup>8</sup> In January, NASA contracted with the McDonnell Aircraft Corp. for the procurement of the Mercury capsule. During early 1959, NASA and DOD made arrangements for the Army to supply Redstone vehicles for suborbital flights, the Air Force to supply Atlas vehicles for orbital flights, and the Navy to assist in recovery operations. In April, seven astronauts were chosen and their training begun.<sup>9</sup> Also in April, Project Mercury was given a DX priority procurement rating, the highest rating possible, and of great assistance in tooling and materials crises. In July, Western Electric was selected to build the Mercury tracking network. During the latter third of 1959, several tests were made with boilerplate Mercury capsules and ad hoc Little Joe and Big Joe vehicles. In September, Walter C. Williams, the head of NASA's Flight Research Center, was named Associate Director for Project Mercury Operations, an indication that the operations phase of the program was about to begin.

<sup>7</sup> Delta proved so successful that its interim status was soon forgotten. Since Centaur suffered many delays and since the leadtime on Saturn was so long, most of NASA's program during 1961 through 1963 was carried out using Scouts, Deltas, and Atlas-Agenas. During 1959 and 1960, NASA used Vanguard, Juno II, and Thor-Able vehicles together with some special-purpose vehicles created for Project Mercury.

<sup>8</sup> For a much more complete account, see Grimwood, *Project Mercury: A Chronology* (Washington: NASA SP-4001, 1965) and forthcoming *This New Ocean: A History of Project Mercury*, by L. Swenson, C. Alexander, and J. Grimwood (Washington: NASA SP-4201, 1966).

<sup>9</sup> Establishing the qualifications for and then selecting the astronauts was an unprecedented job. It was an important recruiting and examination task that has not been discussed in the "Personnel" sections of this study. Also see Mae M. Link, *Space Medicine in Project Mercury* (Washington: NASA SP-4003, 1965), pp. 44-47.

#### D. Other 1959 Program Developments

**Scientific Investigation of Space.** During 1959, NASA launched eight scientific earth satellites; and two lunar probes were launched under NASA auspices. Three of the launches, all scientific satellites, were completely successful.<sup>10</sup> Most of the important discoveries were associated with Van Allen radiation belt findings. The space science program suffered greatly because of the absence of reliable vehicles. One of the complete successes was *Vanguard III*, launched on September 18, 1959. With it the Vanguard flight program ended.<sup>11</sup>

**Space Applications.** NASA's applications program began to take shape during 1959 with the transfer from DOD to NASA of Project Tiros, a meteorological satellite project. This project is an interesting example of one involving a large degree of interagency cooperation—in this case among NASA, DOD, and the Weather Bureau. NASA made progress on its passive communication project by the suborbital testing of the ejection and inflation of a 100-foot sphere (Project Echo).<sup>12</sup>

**Engine Development.** The largest engine development project was the 1- to 1½-million-pound-thrust (F-1) engine being developed for NASA by North American. Other engines being developed by NASA were of various sizes and used a variety of liquid and solid fuels, including liquid hydrogen. In conjunction with AEC, nuclear engines were being worked on.<sup>13</sup>

**Other Program Activities.** NASA made progress in the construction of its three tracking networks—one for scientific earth satellites, another for manned orbital flights, and the third for deep-space probes. NASA carried on NACA's aeronautical research program. To what extent it suffered as a result of the emphasis being placed on space is difficult to measure. The X-15 research airplane made its first powered flight in September 1959.<sup>14</sup>

During 1959, the U.S.S.R. made several notable space achievements by sending a satellite into solar orbit (*Lunik I*), making a hard landing on the moon (*Lunik II*), and taking TV pictures of the "back" of the moon (*Lunik III*). The Air Force succeeded in orbiting six Discoverer satellites.

<sup>10</sup> See "Chronology of Major NASA Launchings . . ." prepared by the NASA Historical Office.

<sup>11</sup> A full history of Project Vanguard, the first U.S. scientific satellite program, is presently being sponsored by NASA.

<sup>12</sup> Cf. John Ashby, "A Preliminary History of the Evolution of the Tiros Weather Satellite Program" (Unpublished, NASA historical note No. 45, September 1964). See G. R. Thompson, "History of NASA Comsat Development" (Unpublished, NASA historical monograph No. 8, November 1965).

<sup>13</sup> Cf. E. M. Emme, *Aeronautics and Astronautics, 1915-1960* (Washington: NASA, 1961), pp. 106-135; David S. Akens, *Historical Origins of Marshall Space Flight Center* (Huntsville, Ala.: MSFC, 1961).

<sup>14</sup> See Wendell H. Stillwell, *X-15 Research Results* (Washington: NASA SP-60, 1965), Bibliography, pp. 103-116.

## II. INTERNAL ORGANIZATIONAL AND ADMINISTRATIVE DEVELOPMENTS

In Chapter 3 it was pointed out that even though NACA had been a going concern with an established organization and procedures, it served only as a base or nucleus for NASA. NASA was to be a new agency. This meant that numerous old practices would have to be changed or discarded and many new ones added. A new agency head would have to be accommodated, new projects and facilities integrated, and an almost entirely new (to NACA) method of doing business established (i.e., R&D contracting). Certain Space Act requirements, not previously part of NACA's mandate, would have to be implemented. Although progress during 1958 was substantial, it was still only a beginning and it was readily recognized that much of the detailed work would have to come later. Until the transfer issue arose during the last quarter of 1959, the year could be characterized as one of consolidating and filling in the details of 1958 decisions.

### A. Organizational Changes

*A Comparison of Organization Charts.* The only major organizational change occurring during 1959 came at the end of the year and was related to the most significant event of the year—the transfer to NASA of the Saturn program and the Army installation associated with it. The details of this transfer and related NASA organizational changes are presented later in this chapter.<sup>15</sup>

A few minor organizational changes are revealed by comparing the several official organization charts issued during 1959. (These charts are reproduced in App. B.) In Chapter 3 the evolution of NASA's first official organization chart (dated January 29, 1959) was presented.<sup>16</sup> It was noted that the January 29 chart should have included two items which did not show up until the March 23 chart—namely, the Inventions and Contributions Board and the Research Advisory Committees. Other than the two items just mentioned, the only change indicated by the March 23 chart was that the Western Coordination Office had been placed directly under the Associate Administrator. This was done in accordance with recommendations made in a study prepared for NASA by McKinsey & Co.<sup>17</sup>

Except for a few name changes, the only development revealed by the May 1 chart was the establishment of the Program Coordination Office in the Office of Space Flight Development. This Office was to coordinate and review the various programs of the Office of Space Flight Development so as to maximize the utilization of resources and minimize all types of duplication.<sup>18</sup> John P. Hagen, who was heading the Vanguard Project at the time, was named to head the new office.

<sup>15</sup> See Sec. V of this chapter.

<sup>16</sup> See Ch. 3, Sec. II.B.

<sup>17</sup> This is covered in subsec. F below.

<sup>18</sup> NASA News Release 59-123, Apr. 30, 1959.

The September 15 chart is identical to the May 1 chart except for the names of some of the individuals filling certain positions. The December 29 chart depicts the major reorganization associated with the Saturn transfer. It should also be noted that the Office of Associate Administrator is given a slightly different position on the December 29 chart to indicate more clearly that the jurisdiction of the Associate Administrator was primarily over the basic program of the agency.

**Changes Not Shown on Organization Charts.** A change in the name of an organizational unit often is evidence of a substantive change in scope or function. Changing the name of the Western Coordination Office to Western Operations Office (WOO) was part of the August 1959 expansion of that Office. This expansion is described in more detail later.

In September 1959, all of NASA's high-speed test-flight operations were consolidated and centralized at the High Speed Flight Station, Edwards, Calif.<sup>19</sup> Its name was changed to Flight Research Center.

Some units shown on organization charts are not operational because they have not been officially established or have not been staffed. For example, the position of Facilities Coordinator was recommended by the December 1958 McKinsey Report and appeared on NASA's January 29, 1959 chart, but the position was not established until May.<sup>20</sup> Another example is the position of Associate Administrator, which appeared on the January 29 chart but which was not filled until Richard Horner reported for duty on June 1.<sup>21</sup>

**The Establishment of the Goddard Space Flight Center.**<sup>22</sup> The idea that a new field installation would have to be established to supplement existing NACA installations dates from early 1958. No specific site was considered until mid-1958 when the transfer of the Vanguard team was discussed. To facilitate the transfer it was decided to establish the new center near Washington, D.C., where Minitrack and the worldwide communications network came to focus, and where the Vanguard people worked.<sup>23</sup> On August 1, 1958, Senator J. Glenn Beall of Maryland was accorded the honor of announcing that the new NASA field center would be located in Maryland on surplus land which was part of the Department of Agriculture's Beltsville Agricultural Research Center.<sup>24</sup>

NASA's fiscal year 1959 authorization included \$3,750,000 for a "Space projects center" to be located in the "vicinity of Washington, D.C."<sup>25</sup> However,

<sup>19</sup> NASA, *Second Semiannual Report*, p. 93; NASA "Quarterly Manpower Utilization Report," Oct. 30, 1959, pp. 1, 3.

<sup>20</sup> Memo, Siefert to Glennan, May 7, 1959. Glennan's approval came in a memo to Siefert, May 19, 1959.

<sup>21</sup> The appointment in June of Richard Horner as NASA's first Associate Administrator is covered later.

<sup>22</sup> For more detail, see A. Rosenthal, *The Early Years, Goddard Space Flight Center, Historical Origins and Activities Through December 1962* (Greenbelt, Md.: NASA, GSFC, 1963).

<sup>23</sup> Interview with Abe Silverstein, Jan. 18, 1964.

<sup>24</sup> Release by Senator J. Glenn Beall, Aug. 1, 1958.

<sup>25</sup> Public Law 85-657, Aug. 14, 1958. House Hearing, *Authorizing Construction for the National Aeronautics and Space Administration*, was held on Aug. 1, 1958.

only \$25,000,000 of the \$47,800,000 authorized for NASA's overall construction budget was appropriated, and the Senate Appropriations Committee, in justifying this cutback, said, "the committee feels that planning for the Space projects center can be deferred. . . ." <sup>26</sup>

In spite of the Senate Appropriations Committee's suggestion, NASA went ahead and allotted \$3.9 million for the new center. By September 16, 1958, the initial specifications for the center had been completed. Glennan approved the engineering master plan in November and construction activity got underway the following April.<sup>27</sup> Occupancy was planned for early 1960.

On May 1, 1959, NASA announced that the center would be named the Goddard Space Flight Center in honor of Robert H. Goddard, American rocket pioneer.<sup>28</sup> On the same day Glennan issued a memorandum setting forth the function and authority of the center.<sup>29</sup>

The center was assigned the broad functions of planning and developing vehicles and payloads for scientific, applications, and manned space-flight programs and conducting flight operations related thereto.<sup>30</sup> The director of the center was to report to the Director of Space Flight Development (Silverstein) in NASA Headquarters.

As of May 1 the heads had been selected for four of the Goddard Center's five principal activity areas. Two were from NACA (Gilruth, head of Project Mercury, from Langley and Vaccaro from Lewis), one from the Naval Research Laboratory (Townsend), and one from NRL/Vanguard (Mengel). The fifth one, named in October, was also from NRL/Vanguard (Winkler). In September, Dr. Harry J. Goett of the NACA/NASA Ames Research Center was appointed Director of the Goddard Center.

It should be kept in mind that during most of 1959 the Beltsville/Goddard Center was without a director or a central location. It was more like an umbrella under which certain activities were grouped. The person "holding" the umbrella was the Director of Space Flight Development in NASA Headquarters (Silverstein).<sup>31</sup> The various organizational segments of the Goddard Center were physically located at NASA's Langley Research Center in Virginia (the Space Task Group), and at the Naval Research Laboratory, the Anacostia Naval Station, and several other places in the Washington, D.C., area. The first

<sup>26</sup> S. Rept. 2350, 86th Cong. The Appropriation Act was Public Law 85-766, Aug. 27, 1958.

<sup>27</sup> See NASA contract NAS5-1(w), Dec. 4, 1958; Glennan's Memorandum of Record, Nov. 19, 1958.

<sup>28</sup> NASA News Release 59-125, May 1, 1959.

<sup>29</sup> Memorandum from the Administrator. Subject: Functions and Authority—Goddard Space Flight Center (GSFC), May 1, 1959.

<sup>30</sup> Most manned space-flight activities, principally Project Mercury, were carried out by the Space Task Group, headed by Robert Gilruth and housed at the Langley Research Center where it had been informally initiated while a part of NACA. The Space Task Group thus maintained a unique status in NASA's organizational structure. See forthcoming *This New Ocean*.

<sup>31</sup> Interview with Abe Silverstein, Jan. 18, 1964.



permanent building at the new site was not occupied until late 1960. During these early months, Wallops Station, the former NACA Pilotless Aircraft Research Station off the coast of Virginia, was considered to be under the Beltsville Center, as were NASA's activities at Cape Canaveral, Fla.<sup>32</sup>

### B. Administrative Procedures Established

**Internal Reporting.** The need for a systematic method of program reporting, to be used by NASA's top management in directing the agency's affairs, was discussed at NASA's April 1959 Staff Conference.<sup>33</sup> As a result, a committee was appointed to "plan the format, content, frequency and distribution of a program reporting system for NASA."<sup>34</sup> The committee came up with a sample report in May. Glennan found it useful enough to request its further development and its continuation on a permanent basis.<sup>35</sup> This was the beginning of the monthly Administrator's *Progress Report*, a report which continued in existence for almost 5 years.

The Administrator's *Progress Report* was established "to keep the Administrator currently informed on the progress of NASA programs and projects."<sup>36</sup> The report was to "identify and highlight current or potential problem areas . . ." and include ". . . an outline of steps proposed or being taken to resolve such problems." A standard format was to be followed, but clarity and brevity rather than form were to be emphasized. The report was for internal use only and since some of the information in it was classified, the entire report was classified.<sup>37</sup>

The long-run contribution of the report is hard to measure. If longevity is a function of usefulness, the very fact that it was used for almost 5 years is significant. A usefulness not explicitly recognized at the time of its establishment was its use by lower level personnel in keeping abreast of agency affairs.

**The Establishment of a Management Manual.** The role of a management manual in an agency's administrative history is difficult to ascertain. In the case of NASA, the manual always lagged behind practice—usually true of

<sup>32</sup> A Directorate of NASA Tests was established for NASA by the Air Force on Nov. 11, 1958. Melvin Gough was the Director. This evolved into what came to be called by mid-1959 as the NASA Atlantic Missile Range Operations Office (AMROO). See Jarrett, Francis E., and Lindemann, Robert A., "Historical Origins of NASA's Launch Operations Center to July 1, 1962" (Cocoa Beach, Fla.: KMM-1, April 1964).

<sup>33</sup> See Draft for Discussion Purposes. Subject: Administrator's Report, Apr. 6, 1959.

<sup>34</sup> Memo, Glennan to Silverstein, Crowley, and Siepert. Subject: Program Reporting, Apr. 7, 1959. Committee members appointed were: Hjernevik, Ulmer, Hodgson, Ames, Rhode, Hagen, and Fuhrman.

<sup>35</sup> Memorandum from the Administrator. Subject: Establishment of the Administrator's Progress Report, May 27, 1959.

<sup>36</sup> Management Manual Issuance No. 6-2-1. Subject: Administrator's Progress Report, July 1, 1959. (See also No. 6-2-2, Subject: Preparation of Administrator's Progress Report, July 1, 1959.)

<sup>37</sup> This has limited the report's usefulness for general historical research.

any new agency—and even after several years many important items were not included in it. Naturally there are always outdated and outmoded entries in a manual. Thus the NASA manual has not been nor can it be a complete or entirely accurate reflection of the agency's actual organization and procedures.

On the other hand, the manual has played an indispensable role in codifying the major regulations governing NASA's internal operations. Many new or changed policies and procedures became effective only upon their appearance in the manual. The entry of an item in the manual usually indicated that the item had gone through a process of formal review and rewriting, and had been generally agreed to as an adequate statement of the particular issue. As NASA became larger, the manual played an increasingly significant role in promoting agencywide policy, procedural uniformity, and communications. It also became useful for training new employees.

One of the items NASA inherited from NACA was its management manual, including its issuance system. Pending the establishment of a new system geared specifically to NASA, the NACA issuance system was dropped and an interim procedure adopted.<sup>38</sup> The interim system was used until June 1, 1959, when the system now in use was inaugurated.<sup>39</sup>

In view of its importance as a communicative, integrating, and legal device, a brief description of NASA's management manual is warranted.<sup>40</sup> "The *NASA Management Manual* is a basic source of reference covering NASA organization, continuing operating policies, regulations, and procedures. It includes any written materials designed to provide official instructions for approved courses of action."<sup>41</sup>

The manual had an open-ended design so that it could be expanded to accommodate future issuances in a systematic way. Part I was made up of "General Management Instructions." These were statements of basic policy, functions, duties, intra- and inter-organizational relationships, sources and limits of authority, etc. Part II consisted of more detailed "Administrative Regulations and Procedures" which described the way individual functions (personnel, procurement, auditing, etc.) were to be carried out. Parts III, IV, etc., consisted of technical regulations and procedures and other miscellaneous instructions, but they have not been used to any great extent. Items of a temporary, emergency,

<sup>38</sup> NASA General Notice, "Interim procedure for issuing NASA Management Manual Instructions," Oct. 1, 1958.

<sup>39</sup> The interim system, as a system, need not be described here. The issuances themselves span a very crucial 8 months of NASA's history and are of great historical interest. The interim "manual" consisted of 17 General Directives, 7 General Notices, and 12 Administrative Memorandums. A complete set of all 36 items can be found in the Management Manual Issuance Office of NASA's Headquarters. The current manual issuance system was drafted during March, April, and May, 1959. Al Hodgson and William Shea headed the effort.

<sup>40</sup> The system is more fully described in General Management Instruction-Introduction, Subject: NASA Issuance System (TS 1, June 1, 1959, TS 15, July 22, 1959), and Administrative Regulations and Procedures—No. 6-1-1, Subject: NASA Issuance Procedures (same dates).

<sup>41</sup> Management Manual Issuance 6-1-1, June 1, 1959.

tentative, or experimental nature, which were to have the force and effect of a regular manual entry, were issued as NASA Circulars and were keyed to the appropriate manual section.

Also part of the manual system were handbooks, to be used for training and detailed guidance purposes, and announcements, to be used to transmit items of a purely informational nature. Except for announcements, a formal clearance and approval procedure had to be followed for all issuances. The Office of Business Administration coordinated this effort and "kept" the manual.

*The Monthly Flight Schedule.* An early indication of the efforts of the new Associate Administrator, Richard Horner, to integrate or pull together NASA's program was the establishment of a monthly flight schedule in August 1959.<sup>42</sup> All contemplated space vehicle launchings for the next 2-year period were to be listed in a composite schedule which was to form the basis for initial official approval of the launchings. Subsequent additions and changes would be approved by top management on the basis of a schedule revised each month.<sup>43</sup> Since space launchings constituted the most tangible "output" of the agency, and were a chief item of interagency and international comparison, and since each one represented the expenditure of millions of dollars, the flight schedule became a vital element in top management control.

### C. Personnel

During 1959, the number of NASA employees increased from 8,420 to 9,567, an increase of 14 percent.<sup>44</sup> The Beltsville Space Center, renamed the Goddard Space Flight Center on May 1, 1959, grew from 216 to 1,117. Over half of this increase came about with the transfer of the Space Task Group (STG) (the Project Mercury team) from the jurisdiction of Langley to that of Beltsville. (The unique organizational location of STG makes personnel statistics for 1959 difficult to summarize.) Headquarters increased 65 percent (up 182 employees). Goddard, apart from the STG transfer, increased almost 200 percent (up about 400 employees). Langley and STG together increased about 13 percent (up about 450 employees); Ames and Lewis stayed virtually constant (up 55 employees). The Flight Research Center (FRC) increased 18 percent (up 54 employees) as a result of the consolidation mentioned above and the fact that FRC figures included the Western Operations Office, which was expanding rapidly toward the end of 1959.

<sup>42</sup> Memo, Horner to Silverstein, Abbott, Siepert. Subject: Program Management, Aug. 3, 1959.

<sup>43</sup> The schedule is classified "Confidential." A less detailed version appears in the monthly edition of "Pocket Statistics," a small, compact NASA publication containing basic information of use to NASA managers.

<sup>44</sup> For detailed data on numbers of personnel, see App. C.

Seventy percent of NASA's increase in personnel came during the first half of 1959, one effect of approaching the end of a fiscal year. The NASA Personnel Division had this to say about filling positions:

Our Spring recruiting efforts (beginning in January-February) enabled us to fill all but 75 of our authorized vacancies as of June 30th. However, because of salary limitations, we are still unable to extract men from industry to staff key positions at the top, or to fill intermediate positions under our present leaders. . . . As a result, most of our increases in technical staff, above entrance level, have been from other government agencies.<sup>45</sup>

During 1959 the number of excepted positions increased from 122 to 198, still well within but much closer to the 260 positions authorized by law. Of the 198 excepted employees at the end of 1959, only about 6 had come to NASA from private industry.<sup>46</sup> The most important excepted position filled during 1959 was the position of Associate Administrator. On April 23, 1959, President Eisenhower announced that as of June 1, 1959, Richard Horner, the Assistant Secretary of the Air Force for Research and Development, would be NASA's Associate Administrator, the agency's highest civil service position.<sup>47</sup>

The size of the Headquarters Personnel Division (about 20) changed very little during 1959 and because of the recruitment and placement workload very little else could get done. (The Headquarters Personnel Division serviced the agency as a whole and also acted as a personnel office for NASA Headquarters.) A preliminary study of an executive development program was initiated during the last quarter of 1959, but the real push on agency training programs did not come until 1960.<sup>48</sup> Also during 1959, work was begun on updating the NACA-developed Aeronautical Research Scientist (ARS) examination to incorporate NASA's space mission.<sup>49</sup> The end product would be the new Aerospace Technologist (AST) examination. This will be covered in detail in Chapter 5.

<sup>45</sup> NASA's "Quarterly Manpower Utilization Report for Quarter Ending June 30, 1959," dated July 20, 1959, p. 3. On Sept. 8, 1959, Admiral Bennett of the Office of Naval Research expressed the hope that the steady transfer of NRL personnel to NASA could be slowed down. About 70 transfers from NRL had taken place between Jan. 1 and Sept. 30, 1959, in addition to the 200 transferring to NASA during 1958. In a Sept. 9, 1959, memo to Horner, Glennan requested that NASA discourage further transfers from NRL.

<sup>46</sup> Information supplied by NASA's Personnel Division.

<sup>47</sup> Horner, born in 1917, received a B.S. in aeronautical engineering from the University of Minnesota in 1940 and a master's degree from Princeton in 1947. His entire career had been with the Air Force, as an officer until 1949 and then as a civilian. NASA Release No. 59-121, Apr. 23, 1959.

<sup>48</sup> NASA's "Quarterly Manpower Utilization Report for Quarter Ending December 31, 1959," dated Jan. 29, 1960, p. 2. (Action was prompted by Glennan's great concern in this area. See his memo to Horner, Aug. 28, 1959.)

<sup>49</sup> NASA's "Quarterly Manpower Utilization Report for Quarter ending June 30, 1959," dated July 20, 1959, pp. 4-5. The updating of the examination was primarily the work of Allen Gamble of NASA's Personnel Division. He was an old NACA employee who returned to NASA in November 1958 after 3 years with the National Science Foundation. His 1959 efforts will be recounted in Ch. 5.

#### D. Finance

As mentioned in Chapter 3, 75 percent of NASA's funding for fiscal year 1959 had been "inherited," either from NACA or DOD. It was also mentioned that the normal budget cycle for fiscal year 1960 funding could not be followed because the agency was just coming into existence about the time it would normally submit fiscal year 1960 figures to the Bureau of the Budget. As a result, NASA's entire fiscal year 1960 cycle was out of phase with the regular U.S. budget for the year. Oddly enough, the irregular route which NASA followed arrived at the finish line 2 weeks ahead of the route followed by the regular budget.<sup>50</sup> The irregular route was a complicated one, and the account which follows has been highly distilled.<sup>51</sup>

*Requests for a Fiscal Year 1959 Supplemental and Fiscal Year 1960 Regular.* During the congressional consideration of NASA's 1959 appropriation (the 25 percent not "inherited"), the \$125 million asked for by the President was reduced to \$80 million with the invitation that if more was needed it could be supplied by means of a supplemental when Congress reconvened in January 1959.<sup>52</sup>

The invitation was accepted and in January the Eisenhower administration revealed that it would ask Congress for the following: <sup>53</sup>

Fiscal year 1959 supplemental, R&D and CoF.....	\$45,000,000
Fiscal year 1959 supplemental, S&E (pay increase).....	3,354,000
Fiscal year 1960 regular.....	485,300,000
<b>Total package.....</b>	<b>\$533,654,000</b>

The \$485,300,000 request for fiscal year 1960 does not represent a very large increase over fiscal year 1959. In fact, a good case can be made that almost no increase was intended. If the fiscal year 1959 supplementals (\$48 million) are combined with the amount transferred to NASA (about \$225 million) and NASA's initial appropriation (\$80 million), the total amounts to \$353 million. This was for a 9-month period, or about \$39 million per month. On a 12-month basis, this would amount to about \$470 million, which is very little less than the amount requested for fiscal year 1960. It must be remembered, of course, that 80 percent of NASA's appropriation is "no year" money and fiscal-year labels

<sup>50</sup> NASA Appropriation Act, Public Law 86-213, Sept. 1, 1959. Regular Appropriation Act, Public Law 86-255, Sept. 14, 1959.

<sup>51</sup> For a more detailed account, see Ambrose, "The National Space Program, Phase II," pp. 130-152. See also Senate Hearings, *Supplemental Appropriation Bill for 1960*, pp. 1-19.

<sup>52</sup> Report of the Senate Appropriations Committee, S. Rept. 2350, Aug. 13, 1958, p. 14: "In the event additional funds are needed after the first of the year, the Committee will be glad to consider such request."

<sup>53</sup> The word "revealed" has been used rather than "requested" because the January budget estimates presented the request for NASA under the special heading, "for later transmission." The formal requests were not sent to Congress until the authorization acts had been passed in accordance with the provisions of the Johnson rider discussed in the last chapter, which provided that NASA appropriations had to be preceded by specific congressional authorization.

are somewhat meaningless. As it turned out, the foibles of the appropriation process resulted in actual appropriations increasing 55 percent from fiscal year 1959 to fiscal year 1960. Money actually obligated went from a \$30 million average monthly rate during fiscal year 1959 to a \$40 million monthly rate during fiscal year 1960, an increase of about 35 percent.<sup>54</sup>

**Authorization and Appropriation.** Since authorization had to precede appropriation, the administration, on January 19, 1959, submitted to Congress a draft authorization bill for its funding package. Congress responded very favorably. In the hope of expediting matters, the 1959 supplemental was separated from the 1960 regular. The final results were two authorization laws granting everything the administration had asked for:

	S & E	R&D	CoF	Total
Public Law 86-12, fiscal year 1959 <sup>1</sup> . . . .	\$3,354,000	\$30,750,000	\$24,250,000	\$48,354,000
Public Law 86-45, fiscal year 1960 <sup>2</sup> . . . .	94,430,000	333,070,000	51,800,000	485,300,000

<sup>1</sup> Fiscal 1959 supplemental authorization for the National Aeronautics and Space Administration. Apr. 22, 1959.

<sup>2</sup> Fiscal 1960 authorization for the National Aeronautics and Space Administration. June 15, 1959.

Subsequent appropriation action was a different story, at least in the House of Representatives. The requests for appropriations were sent to Congress as soon as the authorization laws had been enacted. The only change in comparison with the January authorization requests was that the \$3,354,000 pay raise supplemental had taken a separate road and was no longer part of what now had become two separate funding packages—a \$45 million supplemental for fiscal year 1959 and a \$485.3 million regular for fiscal year 1960.<sup>55</sup>

Smooth sailing ended abruptly in the House Appropriations Committee where the 1959 funds were cut 8 percent and 1960 funds 9 percent. On the House floor a point of order killed the fiscal year 1959 supplemental altogether.<sup>56</sup> The net result of House action was to cut NASA's original request by 13 percent. The Senate restored all amounts cut by the House, but in conference the differences were compromised. The final result was as follows:

<sup>54</sup> Information of NASA obligations furnished by NASA's Financial Management Division.

<sup>55</sup> For the fiscal year 1959 supplemental request, see H. Doc. 114, 86th Cong., Apr. 20, 1959. For the fiscal year 1960 regular request, see H. Doc. 173, 86th Cong., June 16, 1959.

<sup>56</sup> For a full explanation, see Senate Hearings, *Supplemental Appropriation Bill for 1960*, p. 6.

	S & E	R & D	CoF	Total
Public Law 86-213, fiscal year 1960 <sup>1</sup> . . . . .	\$91, 400, 000	\$335, 350, 000	\$73, 825, 000	\$500, 575, 000

<sup>1</sup> Supplemental Appropriation for fiscal 1960. Sept. 1, 1959.

Public Law 86-213 was worded in such a way that even though the money was all fiscal year 1960 money, \$38,500,000 of it was based on a fiscal year 1959 authorization (Public Law 86-12) and \$462,075,000 on a fiscal year 1960 authorization (Public Law 86-45). The beneficial effect of this was that it left an excess fiscal year 1960 authorization of \$23,225,000 which could be, and later was, used as the basis for a supplemental appropriation. In January 1960, the administration requested a supplemental appropriation of \$23 million, the money to be earmarked for Project Mercury.<sup>57</sup> Congressional approval came in March 1960:

	S & E	R & D	CoF	Total
Public Law 86-425, fiscal year 1960 <sup>1</sup> . . . . .		\$12, 200, 000	\$10, 800, 000	\$23, 000, 000

<sup>1</sup> Supplemental Appropriation Act. Apr. 14, 1960.

The only other changes in the fiscal year 1960 funding picture were certain transfers made by NASA within the overall appropriation total. A total of \$15 million was transferred to CoF—\$550,000 from S&E and \$14,450,000 from R&D.<sup>58</sup> Thus the actual new obligational authority (NOA) for NASA for fiscal year 1960 was:

	S & E	R & D	CoF	Total
NASA Fiscal Year 1960 NOA . . . . .	\$90, 850, 000	\$333, 100, 000	\$99, 625, 000	\$523, 575, 000

If supplemental appropriations were requested by the administration purely to offset earlier cuts, the net effect for fiscal year 1959 and fiscal year 1960, lumped together, was that Congress ended up appropriating everything asked for except the equivalent of the \$3 million pay increase. If the supplemental requests were based upon an expanded program not previously contemplated or contingencies not anticipated, gross cuts could be estimated at a maximum of \$78 million, or about 11 percent of what was requested. There must have been

<sup>57</sup> H. Doc. 301, 86th Cong., Jan. 18, 1960.

<sup>58</sup> As revealed in the Budget Estimates for 1962.

dysfunctional effects resulting from all the delays and uncertainties involved in NASA's funding picture for 1959 and 1960. R&D work cannot be turned on and off like a faucet. It must be planned in advance, given adequate leadtime, and funded in such a way that there is assurance that it can move along systematically.

The House cuts prompted Glennan to say:

These cuts, if sustained, would have disastrous consequences. . . . The degree of success or failure of the U.S. space effort, vis-a-vis that of the Russians, will be gravely influenced by what Congress decides in this crucial matter.<sup>59</sup>

Glennan indicated that he could not understand how Congress could try to force money on NASA one year, and less than a year later make "crippling reductions" in an "already lean NASA budget."<sup>60</sup>

In addition to the authorization and appropriation of money, the laws discussed above contained other provisions of administrative importance to NASA. The requirement that specific authorization had to precede appropriation, originally a 1-year rider to NASA's fiscal year 1959 appropriation (Public Law 85-766), was restated in general terms in NASA's fiscal year 1960 authorization (Public Law 86-45). The three fiscal acts passed during 1959 all contained provisions permitting NASA to make transfers among its three appropriation accounts (S&E, R&D, CoF) as long as S&E was not increased and as long as no account was changed more than 5 percent. The flexibility resulting from these provisions was greatly appreciated by NASA and used quite often.<sup>61</sup>

***The Preparation of the Fiscal Year 1961 Budget.*** In addition to the enactment of the fiscal year 1960 budget during 1959, the preparation of the fiscal year 1961 budget also took place. Obviously the ad hoc procedures used to pull together the fiscal year 1960 budget would not have to be used for 1961 because the agency was now a going concern and a more systematic budget preparation system could be established. Apparently, however, there was some uncertainty about what system would be best, because the new procedures were not formally established until May 1959, which was after the normal cycle would have begun and after an initial BOB deadline had passed.<sup>62</sup>

<sup>59</sup> Senate Hearings, *Supplemental Appropriation Bill for 1960*, p. 20.

<sup>60</sup> *Ibid.*, pp. 19, 21. It should be noted that the cuts made by the House stemmed from the Subcommittee on Independent Offices of the Committee on Appropriations, Albert Thomas, Chairman. It was this committee that had regularly cut NACA's appropriation request. It should be further noted that the hearing on NASA's 1960 budget held on Apr. 29, 1959, was NASA's first appearance before this subcommittee (fiscal year 1959 funding was handled by the Senate Appropriation Committee, with the House Committee participating only in conference) and there would be a natural tendency for the committee to want to assert itself.

<sup>61</sup> This topic is covered in much greater detail in later chapters.

<sup>62</sup> Budget preparation procedures were discussed at the Staff Conference held during Apr. 2-5, 1959. On Apr. 27, Hjernevik, the Assistant to the Administrator, submitted a memo to Glennan outlining a plan for a high-level review of NASA's budget. In a Memorandum from the Administrator, dated May 25, 1959, procedures for preparing NASA's budget were established on a tentative basis. On the same day Glennan wrote a letter to BOB Director Stans acknowl-



The new procedures encompassed five basic elements: establishing guidelines, preparing preliminary estimates, reviewing the preliminary estimates, deciding on final budget content, and preparing the detailed estimates for submission to BOB.<sup>63</sup>

The guidelines were to be the product of a seven-member Budget Policy Committee, composed of the highest officials in the agency. The guidelines were to be ready by March 1 of each year. During 1959 this step took place during May.<sup>64</sup> On the basis of the guidelines, the major Headquarters offices (working with the field installations) were to prepare preliminary estimates for all organizational units under their jurisdiction. A June 1 deadline was established for the preliminary estimates. During 1959 this step was completed by June 8. Preliminary estimates totaled about \$835 million.

The preliminary estimates, after being assembled by NASA's budget office, were to be analyzed by a Budget Analysis Team. This team, appointed by the Associate Administrator, was to integrate the various estimates submitted, reconcile them with existing intra- and inter-agency policies, and do whatever other review was necessary to present top management with a comprehensive report on all matters requiring decisions. This report was to be completed by July 1. The team for the fiscal year 1961 budget was composed of the Assistant to the Administrator (Hjornevik), the Director of Program Planning and Evaluation (Stewart), and one individual from each of the three principal program offices (Hagen, Ames, and Siepert). Siepert, the Director of Business Administration, was team chairman.<sup>65</sup> During 1959 this analysis was completed about mid-July. On the basis of the preliminary estimates and the Budget Analysis Team's report, top management (Glennan, Dryden, and Horner), by July 15, would make the necessary decisions as to budget totals and program content. During 1959 this step was completed by July 31. The approved package totaled \$782 million.

On the basis of these top-level decisions, the operating units, under the surveillance of the budget office, were to prepare detailed estimates. The agency's budget, put together in final form by the budget office, would be submitted to BOB in time to meet the September 30 deadline. On September 21, 1959, Glennan gave final approval to the budget and a \$783,300,000 agency request was submitted to BOB on schedule.

edging that NASA procedures for fiscal year 1960 had been wholly inadequate, that the fiscal year 1961 budget could have used more staffwork, but that the new procedures should guarantee good work on the fiscal year 1962 budget.

<sup>63</sup> The description of the new procedure is based on the tentative draft of a Management Manual Issuance (No. 10-1-2) attached to the May 25, 1959, Memorandum from the Administrator.

<sup>64</sup> For a more detailed account of the preparation of the fiscal year 1961 budget (i.e., events taking place during 1959), see U.S. Congress, Senate, Committee on Aeronautical and Space Sciences, *NASA Authorization for Fiscal Year 1961*, S. Rept. 1300, 86th Cong., 2d sess. (Washington: GPO, 1960), pp. 2-4 (hereafter cited as Senate Report, *NASA Authorization for Fiscal Year 1961*).

<sup>65</sup> See Memorandum from the Administrator, May 25, 1959 (cited in footnote 62).

*NASA's Budget Request Modified as a Result of Saturn Transfer.* The decision to transfer the Saturn program from DOD to NASA introduced an element into NASA's fiscal year 1961 funding picture not previously counted on. If Saturn was to be a NASA project, and if NASA was to establish a new field installation at Huntsville, Ala., built around a nucleus transferred from the Army (to have jurisdiction over the Saturn project and other large launch vehicles), the NASA budget for fiscal year 1961 would have to be substantially increased. The size of the increase was indicated by DOD's having included \$140 million in its fiscal year 1961 budget for the Saturn program.

For reasons not entirely clear, Glennan offered to run Saturn and NASA's new Huntsville installation for only \$67 million in addition to NASA's regular request of \$783.3 million (for an overall total of about \$850 million). In a letter to President Eisenhower, Glennan stated that the transfer would permit NASA to consolidate its launch vehicle program and as a result effect savings in the amount of approximately \$75 million.<sup>66</sup> This offer was made on October 20, the day before the announcement of the transfer was made public and right before the transfer agreement was presented to Eisenhower for his approval. One can only speculate whether it was done to make the transfer more palatable to Eisenhower (or possibly Congress), or if it was done out of the honest belief that such savings could be achieved.

This was only the beginning of NASA's funding difficulties. BOB, after careful review, did not allow the \$850 million. On December 11, 1959, BOB approved a total of \$802 million for NASA to be included in the administration's January budget.<sup>67</sup> This figure included \$140 million for the Saturn project and \$35,783,000 for other expenses of NASA's new Huntsville installation, very little of which had been in the \$783 million figure earlier submitted to BOB. Thus for all of its activity during fiscal year 1961, apart from Saturn and the work of its Huntsville installation, NASA found itself with only about \$626 million being requested from Congress. This was about \$157 million, or 20 percent, less than the amount originally requested from BOB.

In January 1960, the decision was made to accelerate the Saturn project and a \$113 million budget amendment was submitted to Congress by President Eisenhower, making an overall NASA request of \$915 million. The House authorized the full amount, but the Senate went one step further and made an additional emergency authorization of \$55 million. The House appropriated 4 percent less than what was asked for, but the Senate appropriated 5 percent more than what was asked for. The net result was an appropriation of exactly what was requested. A year later an additional \$49 million was appropriated as a supplemental, making an overall appropriation for fiscal year 1961 of \$964 million. The details of these 1960 events are presented in the next chapter.

<sup>66</sup> Letter, Glennan to President Eisenhower, Oct. 20, 1958.

<sup>67</sup> Senate Report, *NASA Authorization for Fiscal Year 1961*, pp. 3-4.

Another aspect of NASA's fiscal year 1961 funding picture was NASA's 10-year plan unveiled before Congress in early 1960. This also will be covered in the next chapter.

#### E. Procurement/Contracting <sup>68</sup>

There were several noteworthy developments in the procurement and contracting area during 1959. One of them, a controversy with Congress on the disclosure of information on source selection, is covered in this chapter. Since procurement activity is basically a buyer-seller relationship between NASA and external organizations, there has been a deliberate effort on NASA's part to give procurement activities wide publicity. A great deal of attention has been focused on the legal aspects of procurement and the related procedural arrangements. One result of this is a plethora of information that defies condensation here. Perhaps the best picture of developments during 1959 can be obtained by using, as a framework, the items that appeared in the *Federal Register*.

On December 12, the *Federal Register* contained a notice of Glennan's December 4 establishment of NASA's Inventions and Contributions Board.<sup>69</sup> In March, the first of a series of entries on NASA's patent policy appeared.<sup>70</sup> NASA's patent problem was basically this: In the Space Act there is a lengthy provision (Sec. 305) which requires that inventions (and patents related thereto) made in the performance of contracts for NASA become the property of the U.S. Government, unless waived (in which case the Government retains a royalty-free license for the use of the invention). The waiver of U.S. rights to an invention was made the responsibility of the NASA Administrator, assisted by the Inventions and Contributions Board. Waivers were to be made only to enhance the public interest.

This statutory policy was similar to the statutory policy guiding AEC, but very different from the policy which DOD had been allowed to promulgate administratively. DOD, the Nation's largest buyer of R&D and the agency with an industrial clientele similar to NASA's, followed a more liberal policy (from the contractor's point of view) in which the invention remained the property of the contractor, with the provision that the Government was to have a royalty-free license for the use of the invention. In other words, NASA had to invoke the

<sup>68</sup> For a more detailed account, see Ambrose, "The National Space Program, Phase II," pp. 90-113.

<sup>69</sup> 23 F.R. 9646, Dec. 12, 1958. See Ch. 3, Sec. II.B.

<sup>70</sup> 24 F.R. 1644, Mar. 5, 1959; 24 F.R. 3574, May 5, 1959; 24 F.R. 6615, Aug. 14, 1959; 24 F.R. 8788, Oct. 29, 1959. On Jan. 29, 1959, Glennan delegated authority on patent matters to NASA's General Counsel, John A. Johnson (24 F.R. 1816, Mar. 12, 1959; NASA General Directive No. 9, Jan. 29, 1959). NASA's patent policy has been very controversial. It warrants attention in an administrative history because it has been a substantive factor in NASA's ability to achieve its objectives. In this regard it could be put into the same category as the power of the Administrator to make excepted appointments, except that NASA's patent policy is generally regarded as an inhibiting or detrimental factor rather than a beneficial one.

waiver procedure to grant the same privileges to a contractor that DOD could grant outright in the contract itself.

The patent provision enacted in the Space Act was written by the conference committee and was not discussed in the hearings or floor debates.<sup>71</sup> It was patterned after AEC on the belief that NASA and AEC, as new scientifically oriented agencies, had much in common in terms of the problems they would have to face. In reality, of course, NASA had much more in common with the R&D efforts of DOD, and NASA fought a perennial battle to get the patent section of the Space Act amended. Although NASA favored Government-wide uniformity on patent matters, it wanted, as a minimum, to be able to follow a policy similar to DOD.<sup>72</sup> This would further promote the uniformity of contracting policies between NASA and DOD, as intended when NASA agreed to follow the Armed Services Procurement Regulations.

In June 1959, a Board of Contract Appeals was established to handle contract appeals made to the NASA Administrator. At the same time, a Contract Appeal Procedure was promulgated. In September, a Contract Adjustment Board was established to act in those areas where special defense requirements called for a departure from normal procedure. At the same time, Extraordinary Contractual Adjustments procedures were promulgated.<sup>73</sup>

In July, NASA established a small-business program.<sup>74</sup> NASA declared that whenever possible it would promote small-business participation in NASA procurement. The Director of Procurement was to be responsible for NASA's small-business program and was to designate a senior staff member as a small-business adviser.<sup>75</sup> Each field installation was to have a small-business specialist as well. These specialists were to examine NASA's procurement transactions to determine suitability for small-business participation.

In August, NASA promulgated a formal procedure for selecting the recipients of very large NASA contracts.<sup>76</sup> The procedure provided that the NASA Administrator was to select all contractors when the intended contract exceeded \$1 million. Advising him on this decision were ad hoc source selection boards, primarily composed of technical specialists. In addition to advising the Administrator, the board would also establish the selection criteria for each contract. The boards were appointed by the Director of Business Administration for Headquarters contracts, and by the Director of each field center for all contracts under the jurisdiction of the field center.

<sup>71</sup> See Ch. 1, Sec. III.

<sup>72</sup> See items cited in footnotes 77 and 78 below.

<sup>73</sup> 24 F.R. 5178, June 25, 1959; 24 F.R. 5183, June 25, 1959; 24 F.R. 7638, Sept. 23, 1959; 24 F.R. 7639, Sept. 23, 1959. On June 25, Glennan appointed Paul Dembling, Chairman, Robert Nunn, and Ray Harris, all from NASA's General Counsel Office. NASA News Release 59-167, June 25, 1959.

<sup>74</sup> 24 F.R. 6086, July 30, 1959.

<sup>75</sup> On May 28, 1959, NASA announced the appointment of Jacob Roey as Small Business Adviser. NASA News Release 59-153, May 28, 1959.

<sup>76</sup> 24 F.R. 6907, Aug. 26, 1959. (1960 witnessed several revisions of this procedure: 25 F.R. 403, Jan. 19, 1960; 25 F.R. 2100, Mar. 12, 1960.)

Starting in August, a subcommittee of the House Astronautics Committee held hearings on the divergent patent policies of U.S. Government agencies.<sup>77</sup> These hearings were prompted by NASA's patent policy. John Johnson, NASA's General Counsel, was the opening witness. The report of the subcommittee recommended that the Space Act be amended to modify Section 305 to give NASA greater flexibility on patent matters.<sup>78</sup> The report declared that NASA should have discretionary authority in writing patent provisions into its contracts as long as the public interest is served and an unrestricted license for the use of the invention is secured for the Government. By the end of 1959, only two waiver requests had been submitted to NASA.<sup>79</sup> Both were eventually granted.

Statistical data on NASA procurement are available in a variety of reports, monthly, quarterly, and annual. These reports are very sketchy for NASA's first 9 months (fiscal year 1959).<sup>80</sup> The outstanding characteristic of NASA procurement during fiscal year 1959 was NASA's heavy reliance on procurements from other Government agencies. This, of course, is directly related to the fact that the Army and the Air Force carried out most of NASA's operational space program during this period.

During the first 9 months (October 1, 1958, through June 30, 1959), NASA procurements totaled, on an obligations basis, \$213 million. Of this total, 46 percent was procured from other Government agencies, 41 percent from private business firms, 11 percent from JPL, and 3 percent from all other sources, primarily universities. Of the 27,000 procurement actions, about 93 percent were with business firms and 6 percent with other Government agencies. Of the amount awarded to business firms, 17 percent went to small business. The ratio of the number of contracts awarded by negotiation to those awarded through formal advertising was approximately 2 to 1. (For the next reporting period, fiscal year 1960, the ratio was 4½ to 1.)

#### F. Miscellaneous Organizational and Administrative Matters

*McKinsey & Co.'s JPL and WCO Studies.* In December 1958, McKinsey & Co., the management consulting firm which had just completed a comprehensive

<sup>77</sup> U.S. Congress, House, Committee on Science and Astronautics, *Property Rights in Inventions Made Under Federal Space Research Contracts*, Hearings, 86th Cong., 1st sess. (Washington: GPO, 1959).

<sup>78</sup> U.S. Congress, House, Committee on Science and Astronautics, *Proposed Revisions to the Patent Section, National Aeronautics and Space Act of 1958*, Committee Print of Subcommittee Report, 86th Cong., 2d sess. (Washington: GPO, 1960). The report summarized the 8 days of hearings and made specific recommendations along the lines advocated by NASA.

<sup>79</sup> NASA, *Third Semiannual Report . . .*, p. 133.

<sup>80</sup> The first in the series of annual reports on NASA procurement activity was issued in September 1960 and covered the period from Oct. 1, 1958 to June 30, 1960. It was broken down into two sections, one on the entire 21-month period and the other on fiscal year 1960, the latter 12 months of the 21-month period. For some reason data were not broken out for the last 9 months of fiscal year 1959. The above figures were arrived at by subtracting the 12-month figures from the 21-month figures and making some rough approximations.

study of NASA Headquarters, proposed a similar study of NASA field installations.<sup>81</sup> Instead of a comprehensive study, NASA contracted for a much more limited study confined to the relationship between the Jet Propulsion Laboratory and NASA, and the future role of the Western Coordination Office (WCO).<sup>82</sup> These studies were conducted during February and the final report submitted on March 12, 1959.<sup>83</sup>

*The JPL Study:* The study of JPL was based on an analysis of actual Army-JPL relationships, the experience of AEC with its contractor-operated laboratories (Argonne and Brookhaven), and interviews with JPL personnel. The end product was a 10-page report which identified the key factors basic to sound working relationships between a Government agency and a contractor-operated facility. The report related these factors to the NASA-JPL situation in a general way, but made no detailed recommendations concerning day-to-day affairs between the two organizations.<sup>84</sup>

It was noted that JPL would have to be given a fair measure of operating freedom, with NASA keeping to a minimum the "number of individual transactions it will approve." On the other hand, JPL must be furnished with policy guidelines and these should be mutually arrived at. NASA would have to audit JPL operations periodically to make sure that JPL was adhering to the mutually-arrived-at policies.

The report went on to say that NASA must recognize that JPL's performance would be directly related to the competence of its staff and the adequacy

<sup>81</sup> On Dec. 2, 1958, McKinsey & Co. made its oral report to Glennan on Headquarters organization. The next day the transfer of JPL to NASA was announced. On Dec. 4, Corson had lunch with Glennan and the possibility of further McKinsey help was discussed. The immediate outcome was a Dec. 8 memorandum from Corson to Glennan entitled, "Next Steps in Organization of the National Aeronautics and Space Administration." Corson suggested four areas, in order of priority, where further organizational analysis would be desirable: (1) The relationship between NASA and JPL; (2) the organization of the Beltsville Space Research Center; (3) the need for field offices (including the role of WCO); (4) an organizational audit of the former NACA research laboratories. Put together, the studies in these four areas would form the nucleus of an overall plan for the organization of NASA's field installations.

One sentence from Corson's memo is worth noting as an interesting comment on organizational behavior. In connection with area (4) he said, "However, [a organizational audit of the former NACA laboratories] should not be delayed so long that the present propitious climate for such a study has been dissipated." Corson, who is an old pro in management problems, recognized that change is difficult to achieve once organizational rigidity sets in. Glennan used this argument as the basic rationalization behind a comprehensive study of NASA organization conducted during 1960, one of the main topics of Ch. 5.

<sup>82</sup> Corson's proposal was reviewed by Silverstein, Crowley, Siefert, Stewart, Hjernevik, and Hodgson on Dec. 11 and a much less elaborate project was agreed to. Corson submitted a scaled-down proposal on Dec. 18 which formed the basis for the actual contract—an amendment (Feb. 3, 1959) to the NASw-1 contract of October 1958. The additional cost was set at \$33,250.

<sup>83</sup> McKinsey & Co., Inc., "NASA-JPL Relationships and the Role of the Western Coordination Office," March 1959.

<sup>84</sup> According to John Young of NASA, then with McKinsey & Co, a series of 10 action reports on JPL-NASA relationships had been prepared.

of its research facilities. In addition, there must be present the more intangible factor of JPL considering itself part of the national space effort. This latter factor could be promoted by giving JPL major responsibility for conceiving, planning, conducting, and evaluating specific space projects, with final approval of a project the responsibility of NASA. The report pointed out that the use of JPL personnel in the supervision of contracts not related to JPL projects must be kept at a minimum so as not to spread JPL's capability too thinly. The principal point of contact between JPL and NASA should be NASA's Office of Space Flight Development, headed by Abe Silverstein.

The lack of specificity in this report suggests that interorganizational relationships cannot be easily predetermined. The report favored a middle-of-the-road relationship with elements of both JPL freedom and NASA control. The optimum mixture of the two was recognized as something that could only be worked out over time. Later events were to confirm that achieving this optimum mixture is very difficult.

*The WCO Study:* This study had a different flavor than the JPL study in that it was very detailed and specific in recommending what should be done.<sup>85</sup> In 1939 NACA established the Western Coordination Office in Los Angeles where a large number of airplane manufacturing companies was concentrated. Serving as a liaison office between NACA and the aircraft companies and as an information gatherer for NACA Headquarters, the office had only two employees up to 1957 and only six at the time the McKinsey study was made. The workload, even under NACA, had greatly increased over the years as new companies were established and NACA's university program expanded. With the establishment of NASA, a new and very important element was added—contracts with area firms. These contracts were some of NASA's largest (e.g., the engine contract with Rocketdyne of North American Aviation and most nearly unique (the contract with Cal Tech to run JPL).

The McKinsey report recommended a large increase in WCO staff and responsibilities.<sup>86</sup> The most important enlargement of responsibilities recommended was in contract administration. The JPL contract and contracts where military assistance was not available would furnish a large enough workload to warrant a buildup starting immediately. In support of the contract administration function, the Western Office would have to conduct security checks, audits, accounting, budgeting, public relations, and certain legal services.

Aside from contract administration, a need was indicated for technical specialists to gather information for project managers and give technical advice to

<sup>85</sup> Whereas a 1-page list of research objectives gave rise to the 10-page JPL report, a 1-sentence statement of research objectives gave rise to the 30-page WCO study.

<sup>86</sup> The alternatives of using NASA's Ames Research Center near San Francisco, or the High Speed Flight Station 80 miles from Los Angeles, to carry out the functions contemplated for WCO, were rejected because of the importance of having an office right in the Los Angeles area, and also the fact that Ames and HSFS both emphasized in-house research.

contracting officials. A team of specialists could give technical support to both project management and contract administration.

The report recommended that the name of the Western Coordination Office be changed to Western Operations Office (WOO) to reflect the change in function. A staff of 28 by the end of 1959 and 40 by the end of 1960 was suggested. The Office should be under the direction of a manager who would report directly to NASA's Associate Administrator. This was because WOO's functions would cut across the three major program areas in Headquarters.

The McKinsey Report furnished the blueprint for the expansion of WOO which was announced in August 1959.<sup>87</sup> By the end of 1960 personnel numbered 50. Concern over the size and function of a field office like WCO was recognition that there is no complete substitute for day-to-day, face-to-face contacts and the conduct of business at close range.

**1959 Activity in the Life Science Area.**<sup>88</sup> *Sputnik I* had prompted NACA to appoint a Special Committee on Space Technology under the chairmanship of H. Guyford Stever of MIT. One of the subcommittees of the Special Committee was the Working Group on Human Factors and Training chaired by Dr. W. Randolph Lovelace II, of the Lovelace Foundation. This working group made a report to NASA dated October 27, 1958, which recommended that NASA: (1) appoint a Director of Life Sciences Research in NASA Headquarters, (2) establish a Life Science Committee, and (3) establish a Life Science Research Center.<sup>89</sup>

On October 27, 1958, Glennan established a Special Committee on Life Sciences as an advisory committee to Project Mercury, the project most directly related to human factors and therefore to the life sciences.<sup>90</sup> Lovelace was appointed Chairman, but only one other member, Brig. Gen. Don Flickinger (USAF), was carried over from the Working Group.

The basic problem confronting NASA was that there were numerous life science programs and facilities already in existence, including the very large School of Aviation Medicine (SAM) of the Air Force. NASA had to make sure that it would not duplicate existing programs or facilities. This was a matter of lively concern in both the White House and Congress. To determine what should be

<sup>87</sup> The transformation from WCO to WOO was announced on Aug. 25, 1959. Robert Kamm, of the Arnold Engineering Development Center, was named Director as of Sept. 1, 1959. NASA News Release 59-206, Aug. 25, 1959.

<sup>88</sup> The life science area has presented NASA with many thorny policy and administrative problems. These problems are discussed in greater detail in the next chapter in connection with the January 1960 report of the Bioscience Advisory Committee and subsequent establishment of the Office of Life Science Programs in NASA Headquarters.

<sup>89</sup> "Human Factors and Training." (Part of "Recommendations to the NASA Regarding a National Civil Space Program," prepared by the Special Committee on Space Technology, Oct. 28, 1958.)

<sup>90</sup> NASA, *First Semiannual Report*, p. 10.



the exact nature and extent of NASA's life science activity, Glennan established an ad hoc Bioscience Advisory Committee in July 1959.<sup>91</sup>

The Committee was given the mandate to: (1) acquaint itself with existing space-related life science programs, both public and private; (2) evaluate the programs; (3) determine the extent to which NASA's needs would be met by existing programs; (4) make specific recommendations on how NASA could best utilize the Nation's existing capabilities; (5) make recommendations on whether NASA should have its own life science program, and if so, how large a program and how organized.

A September 1959 deadline for the Committee's report was originally contemplated but had to be changed as the Committee's membership was not completed until August. Dr. Seymour S. Kety of the Public Health Service was appointed Chairman. Dr. Clark T. Randt, who had been appointed to the expected position of Scientist for Space Medical Research in NASA Headquarters on April 1, 1959, was named executive secretary.<sup>92</sup>

**Decision Making.** In September 1959, Glennan expressed to Associate Administrator Horner concern for the general tendency of NASA officials to procrastinate in making decisions affecting external parties.<sup>93</sup> In passing this thought along to his subordinates, Horner pointed out that the dynamics of space experimentation did not allow as much margin for slowly made decisions as did the dynamics of basic research with which so many NASA officials were familiar.<sup>94</sup> He stated that the timeliness of decisions is often more important than their being perfect decision and that NASA must "demonstrate agility in the decision-making process" if it was to establish a reputation as an organization capable of managing large-scale programs.

### III. NASA'S EXTERNAL RELATIONSHIPS

The year 1959 was a formative period in the building of effective working relationships between NASA and the two external organizations most important to NASA's long-run well-being—Congress and the Department of Defense.

#### A. Relations With Congress

NASA's relationships with the 1st session of the 86th Congress, which convened in January 1959, were on balance unhappy ones. The ambivalence of congressional support in funding a civilian space program for fiscal year 1960

<sup>91</sup> See Glennan's Memorandum for Headquarters Staff. Subject: Bioscience Advisory Committee, July 7, 1959.

<sup>92</sup> Randt later became Director of the Office of Life Science Programs. This is discussed in the next chapter.

<sup>93</sup> Memo, Glennan to Horner, Sept. 9, 1959.

<sup>94</sup> Memorandum for Director, OBS, OASR, OSFD. Subject: Necessity of Timely Decisions, Sept. 24, 1959.

has already been discussed.<sup>95</sup> In addition, there were two controversies of significance, both related to the establishment of the exact balance of power between Eisenhower/NASA, on one hand, and Congress/GAO, on the other. The outcome was a clearer understanding of one another, something upon which a more solid relationship could be and eventually was built.

*The "Privileged Information" Controversy With the Senate Space Committee.* Several large-scale hearings on space matters were conducted by various congressional committees early in 1959. Most of them were devoted to the technical aspects of civilian and military space programs. An exception was the hearings of the Senate Space Committee's Subcommittee on Governmental Organization for Space Activities (under the chairmanship of Senator Symington), which examined the way the executive branch was organized to conduct the Nation's space program.<sup>96</sup> The objective was to eliminate overlap and duplication between and within agencies and to point out the need for maximum efficiency in the organizational structure and in the functioning of rapidly expanding space activities.<sup>97</sup>

Glennan was the lead-off witness. Most of the questions asked him dealt with the problem of interagency coordination and the way the overall space policy of the Nation was made. When asked whether there had been any "discussions of a comprehensive national program in the Space Council," Glennan replied that the deliberations of the Space Council "must be considered to be confidential in nature as confidential advice given to the President, and I, therefore, cannot answer that question."<sup>98</sup> The subcommittee members made several attempts to obtain information about the deliberations of the Space Council, but each time Glennan pleaded executive privilege. The members argued that if Congress was to legislate in the space field, it must have a comprehensive picture of the Nation's entire space program, including the role of the Space Council. Glennan agreed to discuss with the White House the possibility of setting aside executive privilege on Space Council matters.<sup>99</sup> However, in a letter 2 weeks later, Glennan informed Symington that he had talked with the President and that the President had "restated his view that in order to provide for the full effectiveness of the Space Council members in carrying out their advisory responsibilities to him as set forth in the National Aeronautics and Space Act, it was necessary that the activities of the Council be considered confidential to the Chief Executive."<sup>100</sup>

In his testimony, Glennan admitted that he had disclosed the type of information now being sought by the subcommittee on two previous appearances before congressional committees.<sup>101</sup> He had done so because of his desire to be

<sup>95</sup> See Sec. II.D of this chapter.

<sup>96</sup> Senate Hearings, *Investigation of Governmental Organization for Space Activities*.

<sup>97</sup> *Ibid.*, p. 1.

<sup>98</sup> *Ibid.*, p. 11-12.

<sup>99</sup> *Ibid.*, p. 33.

<sup>100</sup> Letter, Glennan to Symington, Apr. 7, 1959.

<sup>101</sup> On Jan. 30, 1959, Glennan listed some of the topics considered by the Space Council. U.S. Congress, Senate, Committee on Aeronautical and Space Sciences, *Missile and Space Activi-*

as frank as possible. He indicated that he would not want to commit this error again and therefore had to stand very firm. Glennan had to bear the brunt of the subcommittee's efforts to obtain information about the deliberations of the Space Council, since the one White House official called to testify, Dr. Killian, did not appear. The subcommittee was not hostile to Glennan and finally dropped the matter. In its recommendations, the subcommittee urged the administration to make a more determined effort to improve the effectiveness of the Space Council.

*The "Production of Documents" Controversy With the House Astronautics Committee.* A similar controversy occurred later in 1959, except that it was related to NASA's internal operations and was much more unpleasant. The episode touched upon several key elements very pertinent to NASA's administrative operations, such as the role of the Administrator in awarding large contracts, the relationship between the person who makes a decision and those who advise him, and the privileges of the executive branch in administering public law. It also touched upon the investigative role of Congress and its arm, the General Accounting Office. It epitomized Congress' attempt to assert its role in the oversight of NASA's new programs.

The episode began in May 1959 when a subcommittee of the House Astronautics Committee (Representative Sisk, chairman) began a general exploratory investigation of NASA's procedures for awarding contracts.<sup>102</sup> The immediate object of investigation was NASA's \$102 million contract with the Rocketdyne Division of North American Aviation, Inc., for the development of a 1.5-million-pound-thrust single-chamber rocket engine, which had been signed in January 1959. To facilitate the subcommittee's investigation, Representative Brooks, chairman of the House Astronautics Committee, wrote to Glennan and requested that certain documents pertaining to the contract be turned over to the committee for examination.<sup>103</sup> In his reply, Glennan indicated that NASA would comply with the request except for one document—the report of the Source Selection Board.<sup>104</sup> Before examining the reasons for this refusal, it would be well to recount how the document came into existence.<sup>105</sup>

*ties*, Joint Hearings with Armed Services Subcommittee, 86th Cong., 1st sess. (Washington: GPO, 1959), p. 159. On Mar. 13, 1959, he related that the President had given NASA certain duties in formulating a national space program. U.S. Congress, House, Committee on Government Operations, Military Operations Subcommittee, *Organization and Management of Missile Programs*, Hearings, 86th Cong., 1st sess. (Washington: GPO, 1959), p. 540 (hereafter cited as House Hearings, *Organization and Management of Missile Programs*).

<sup>102</sup> The basic public document pertaining to this episode is House Hearings, *The Production of Documents . . .*, previously cited. The hearings were conducted on Jan. 27 and 28, 1960. The Addenda to the printed hearings contain reprints of all pertinent 1959 documents. All footnote references to p. 79 and above pertain to the Addenda rather than the public hearings, per se.

<sup>103</sup> Letter, Brooks to Glennan, May 28, 1959 (p. 81 of Addenda).

<sup>104</sup> Letter, Glennan to Brooks, June 15, 1959 (pp. 82-83 of Addenda).

<sup>105</sup> See "NASA Statement of Reasons for Selection of Rocketdyne Proposal" (pp. 106-108 of Addenda).

The Rocketdyne contract was one of NASA's earliest and largest; it was awarded before formal source-selection procedures were promulgated. Normal procurement procedures were followed. Events began on October 21, 1958, when a Preliminary Bidders' Conference was held in NASA Headquarters at which NASA outlined its large-engine requirement to seven invited firms. No written record was made of the proceedings at this conference. On October 23, proposals were solicited from all seven firms and a November 25 deadline was set for their submission to NASA. Six proposals were received and each one was evaluated by two teams—a technical assessment team and a management assessment team. The findings and conclusions of these two teams were presented orally to a five-member source-selection board on December 9, 10, and 11. The board reviewed the work of the two teams, evaluated the entire matter, and on December 12 recommended to Glennan, in writing, that the Rocketdyne proposal be selected as the basis for further negotiations. The culmination was a January 19, 1959, contract. The written record, up to this point, consisted of the request for proposal (specifications HS-10), the six proposals, the report of the Source Selection Board, and the contract.

In his letter to Brooks, Glennan agreed to turn over all documents except the report of the board. Of this, he said:

This document contains the personal evaluations and recommendations of certain officials of NASA whom I consulted to aid me in reaching my decision on the selection of a prospective contractor. Since this document discloses the personal judgments of subordinates made in the course of preparing recommendations to me, I am sure you will agree with me that it would not serve the interests of efficient and effective administration of this agency for such a document to be reviewed by anyone outside of NASA.<sup>106</sup>

This reply prompted Brooks to solicit the aid of GAO in conducting the investigation. In July, GAO informed Brooks that the investigation was underway and that a report would be forthcoming in early August. In August, GAO wrote to NASA and claimed that their investigation could not be successfully completed until the refused document was made available for examination. Glennan replied that the same conditions applied to GAO as to a congressional committee and that "the privilege of the executive to withhold documents in cases such as this has a constitutional rather than a statutory basis."<sup>107</sup> Thus the requirements of the various laws under which GAO worked would not apply to this particular situation.

On October 16, 1959, the GAO submitted its report to the House Astronautics Committee claiming that because of incomplete NASA files, it "could not ascertain whether the selection of the contractor was in any way related to the evaluations

<sup>106</sup> Letter, Glennan to Brooks, June 15, 1959, *op. cit.*

<sup>107</sup> Letter, Glennan to Campbell, Aug. 28, 1959 (pp. 85-86 of Addenda).

performed by the technical and administrative personnel and consequently [GAO can] express no opinion on the adequacy of the procedures followed. . . ."<sup>108</sup>

GAO expressed concern that NASA's refusal had occurred in connection with the first contract it (GAO) had attempted to review. The report went on to say:

We do not contend that the withholding of the report . . . was made for the purpose of concealing wrong doing. . . . We do contend, however, that, when an agency, through its contracting officers, has broad discretion in selecting contractors and negotiating prices, it has the attendant responsibility of making available for audit all of the documents that evidence good procedure and sound decision.<sup>109</sup>

The only procedure that GAO could evaluate was the one NASA used in "evaluating the cost substantiation submitted by Rocketdyne prior to the negotiation of the contract. . . ." <sup>110</sup> GAO found this to be satisfactory.

The GAO-NASA controversy was given a public airing in January 1960 when the House Astronautics Committee conducted hearings at which both GAO and NASA presented their cases. By now, several other documents had been withheld from GAO and the committee. In a case involving the January 1959 selection of the McDonnell Aircraft Corp. to build Mercury spacecraft, NASA withheld three documents—the written report of the Source Selection Board and the written reports of the two assessment teams (assessments were written in this case; they had been presented orally in the Rocketdyne case).

At the public hearing, GAO maintained that unless it was given full access to all pertinent materials, its function of auditing would be hamstrung and there would be no effective way of assuring that the public interest would be protected. Glennan maintained that all pertinent data had been turned over to GAO; if they had not, he would be glad to dig them out. He declared that the documents in question were not factual and would not supply additional data to the auditor. In the interest of administrative effectiveness, he had to keep the adviser-advisee relationship inviolate. President Eisenhower backed him up as a matter of Executive privilege, he said, so he would not turn the documents over to GAO or the committee.

Glennan was subjected to a barrage of questions, many of which were designed to force him to change his position. It was recalled how NACA had been all but made part of the House Committee when the Space Act was being enacted, and that at the time NACA and the committee were completely open with one another.<sup>111</sup> It was also pointed out that the House Astronautics Committee had been very loyal in its support of NASA's program, but that this

<sup>108</sup> "Review of Procedures Followed by the National Aeronautics and Space Administration in Awarding Contract NASw-16 to North American Aviation, Inc.," Oct. 16, 1958 (pp. 91-105 of Addenda).

<sup>109</sup> *Ibid.*, p. 103.

<sup>110</sup> *Ibid.*, p. 105.

<sup>111</sup> House Hearings, *The Production of Documents* . . . , p. 39.

relationship could change very rapidly; Glennan should think twice before alienating the committee from which so much of NASA's support must come.<sup>112</sup> The administrative headaches coming from a hostile Congress would far exceed those that might result from Glennan's cooperation on the documents in question. About the only note of compromise came at the end of the hearing when Glennan was admonished to "examine his conscience" once again and telephone "Joe" [Comptroller General Joseph Campbell] to see if they could not come to an understanding.<sup>113</sup> Presumably the committee would be satisfied if GAO was.

Neither side addressed itself to the problem of defining the basic issue—full disclosure of all pertinent information. Neither GAO nor the committee elaborated on why the documents in question were essential ingredients for a successful audit. Nor did Glennan expand on his basic reason why they were not essential. This is one reason why the committee accused him of evasiveness.

The committee yielded to the temptation always existing in Congress—that Executive privilege should be attacked at every conceivable point no matter what the merits of the individual case might be. This position prompted the majority of the committee members to carry the matter far beyond the point where further argument was serving a useful purpose. When certain members found that persuasion was not working, they turned to emotion and coercion.

Fortunately the skirmish did not leave deep scars. The committee claimed ultimate victory by declaring that NASA complied with a subsequent request "by furnishing, voluntarily, documents similar to those previously refused the committee."<sup>114</sup> A little over a month later, the House Astronautics Committee reported out NASA's fiscal year 1961 authorization bill without cutting the administration request. So at least the committee did not demonstrate hostility by its actions.

#### **B. Relations With the Department of Defense**

One of the topics discussed at NASA's April 1959 biannual Staff Conference at Williamsburg, Va., was NASA's relationships with DOD. This, coupled with the hearings being conducted by the Symington subcommittee in the Senate and the Holifield subcommittee in the House, prompted Glennan and Dryden of NASA and Secretary of Defense McElroy and Deputy Secretary of Defense Quarles of DOD to meet together on April 15, 1959.<sup>115</sup> At this meeting, Glennan pointed out that almost all NASA-DOD relations fall into one of five channels—the Space Council, the Civilian-Military Liaison Committee (CMLC), the head-

<sup>112</sup> *Ibid.*, p. 66.

<sup>113</sup> *Ibid.*, p. 73.

<sup>114</sup> U.S. Congress, House, Committee on Science and Astronautics, *Report on the Activities of the Committee on Science and Astronautics*, H. Rept. 2215, 86th Cong., 2d sess. (Washington: GPO, 1960), pp. 6-7.

<sup>115</sup> "Memorandum to record the results of the conversation between Messrs. McElroy, Dryden and Glennan, who were joined later at lunch by Dr. Quarles," Apr. 15, 1959.

of-agency level (McElroy/Quarles-Glennan/Dryden), the top-operations level (Horner-ARPA Director Roy Johnson), and the group and committee working level. Glennan stated that the Space Council level had to be reserved for only the most important items, that the CMLC was not working too well, and that the head-of-agency level presented the problem that aerospace matters were only one small concern of DOD whereas they were the entire concern of NASA. Dryden noted that the relationships which were working reasonably well were at the operating level involving programs currently underway and that the chief areas of difficulty were in policy and future planning. Glennan and Dryden thought more frequent contacts between top operating people (regular luncheon meetings, etc.) would solve certain policy and planning problems and earmark others for decision at a higher level. McElroy countered with the suggestion that the CMLC could be made more effective and that he would be willing to release its Chairman, William Holaday, to serve full time on the CMLC. It was agreed that this course of action should be taken.

NASA-DOD relations were a favorite topic of congressional concern during 1959, cropping up in just about every hearing involving space and missile matters. Congress was concerned whether the provisions of the Space Act for military-civilian coordination were working out as planned. The extensive revamping of the Space Act proposed by the administration in January 1960 indicated that they were not.

NASA-DOD relationships, looked at from an administrative point of view, can be divided into two categories: coordination machinery and specific agreements.

**NASA-DOD Coordination Machinery.** The Space Act provided for the establishment of a Civilian-Military Liaison Committee (CMLC) composed of NASA and DOD representatives and to serve as an intermediary through which NASA and DOD "shall advise and consult with each other. . . ." <sup>116</sup>

Congressional hearings in 1959 revealed that NASA and DOD were making little use of the CMLC. Its Chairman, William Holaday, suggested that the CMLC was "nothing more than a post office." <sup>117</sup> Probably as a result of congressional criticism, a new charter was drawn up which increased the authority of the Committee, empowering it to initiate certain types of action on its own rather than merely respond to the requests of either agency. <sup>118</sup> A further attempt to strengthen the CMLC was made by freeing its Chairman from all other DOD duties to devote full time to the work of the Committee. Neither the revised

<sup>116</sup> Sec. 204.

<sup>117</sup> Senate Hearings, *Investigation of Governmental Organization for Space Activities*, p. 504. *New York Times*, June 30, 1959, p. 3.

<sup>118</sup> Reprinted in U.S. Congress, Senate, Committee on Aeronautical and Space Sciences, *Governmental Organization for Space Activities*, S. Rept. 806, 86th Cong., 1st sess. (Washington: GPO, 1959), pp. 56-58 (hereafter cited as Senate Report, *Governmental Organization for Space Activities*).

charter nor a full-time chairman helped matters appreciably. During 1960, Holaday resigned and the Committee fell into disuse. A replacement organization, the Aeronautics and Astronautics Coordinating Board, was established.<sup>119</sup>

**1959 NASA-DOD Agreements.** The use of a formal written agreement between two agencies is a common device for establishing new legal relationships, clarifying jurisdictional problems, arriving at a common understanding on some matter, or providing for the performance of certain acts. During 1958, NASA and DOD had entered into agreements on such matters as the transfer of projects, the transfer of facilities, and DOD support for Project Mercury. During 1959, the most important agreements concerned the transfer from DOD to NASA of Project Saturn and the Army installation associated with it. This is discussed later in great detail. The January 1959 agreements on launch vehicles and tracking have already been mentioned. The following are examples of some of the other agreements reached during 1959: In January, NASA and the Navy entered into an agreement whereby the Chincoteague Naval Air Station, located in close proximity to NASA's Wallops Island launching facilities, would be transferred to NASA when deactivated by the Navy on July 1, 1959.<sup>120</sup> In April, President Eisenhower gave his approval to an agreement between NASA and the Departments of Defense, Army, Navy, and Air Force, providing for the detailing of military personnel to NASA in accordance with Section 203(b)(12) of the Space Act. The agreement was designed to facilitate the detailing of military personnel to NASA and designated the Civilian-Military Liaison Committee as the agent to coordinate the activity.<sup>121</sup> In June, NASA and DOD agreed on a joint Industrial Security Program whereby DOD would, in effect, perform all security services in connection with NASA's contracts with industry.<sup>122</sup> In August, the Air Force and NASA entered into an agreement whereby the Air Force would assist NASA in the administration of NASA contracts, the placement of NASA contracts, and, in some cases, technical assistance in the monitoring of contractor efforts.<sup>123</sup> This agreement was especially significant because so many of NASA's contractors were also Air Force contractors. In November, an agreement between NASA and DOD was signed which clarified the manner in

<sup>119</sup> This development is discussed in the next chapter.

<sup>120</sup> NASA News Release, Jan. 24, 1959.

<sup>121</sup> "Agreement Between the Departments of Defense, Army, Navy, and Air Force and the National Aeronautics and Space Administration concerning the Detailing of Military Personnel for Services with NASA." Approved by the President on Apr. 13, 1959. Attachment A of NASA General Management Instruction No. 2-3-3, Sept. 1, 1959.

<sup>122</sup> NASA Announcement No. 2. Subject: Joint DOD-NASA Industrial Security Program; June 8, 1959.

<sup>123</sup> "Agreement Between the Department of the Air Force and the National Aeronautics and Space Administration Concerning Air Force Assistance to NASA . . ." signed by Douglas and Glennan in October but effective Aug. 15, 1959. Attachment A of NASA General Management Instruction No. 2-3-4, Nov. 16, 1959.



which the two agencies would reimburse one another for costs incurred in exchanging goods and services.<sup>124</sup>

The subject matter of these agreements is a good indication that the day-to-day working contacts between NASA and DOD were numerous and comprehensive. In most cases it was DOD that was rendering services to NASA. As NASA grew in size and developed programs of its own, there was a tendency on NASA's part to want to build in-house capabilities so that less reliance would have to be placed on DOD.

#### IV. POLICY PROBLEMS

One of the most fundamental variables in the determination of an organization's administrative behavior is the basic policy which states the organization's purpose and objectives. This basic policy should serve as a guide to the organization's program and, in the case of public agencies, a legal framework within which the agency operates. As a guide and as a framework, the policy has to be somewhat detailed. Yet to avoid straitjacketing the agency, the policy cannot be too detailed. Policy can, and probably should, change over time.

The basic policy underlying the Nation's space program and NASA's role in it is found primarily in the Space Act of 1958. This policy was both too general and too detailed. It was too general to serve as a guideline for NASA's program, yet too detailed in establishing the framework for implementing NASA's program, at least in the area of DOD-NASA coordination. This latter problem was touched upon earlier in this chapter. The former problem was one with which the agency wrestled throughout most of 1959.

Not only was NASA concerned about defining its own role in the Nation's space program but there is evidence that NASA had been given a special role in formulating the space program of the Nation as a whole. In a prepared statement read at a March hearing of a House subcommittee, Glennan said:

A most important duty placed on the President by the Space Act is to develop a comprehensive program of aeronautical and space activities to be conducted by agencies of the United States.

Preparation of such a program for ultimate approval by the President has been delegated by him to NASA with the assistance and cooperation of the Department of Defense.

Very substantial progress has been made in developing national space programs—the national booster program—the national tracking and communications program—the national space sciences programs.<sup>125</sup>

<sup>124</sup> "Agreement Between the Department of Defense and the National Aeronautics and Space Administration Concerning Principles Governing Reimbursement of Costs," Nov. 12, 1959. Attachment A of General Management Instruction No. 2-3-5, Nov. 17, 1959.

<sup>125</sup> House Hearings, *Organization and Management of Missile Programs*. Glennan testified on Friday, Mar. 13, 1959.

Eleven days later, Glennan retracted the statement that the President had "delegated" to him the responsibility for preparing the national space program. Rather, NASA had been asked to "initiate and bring together, with the assistance of the Department of Defense, a total program, which would then be submitted to the President."<sup>126</sup>

Even though the President's request can be interpreted in various ways, it seems clear that NASA, and especially Glennan, felt a very real responsibility for making sure that its program dovetailed with the broader national program. Whether it was given special responsibilities or not, NASA had to concern itself with the Nation's overall space program if it was to optimize its own. This meant that NASA was concerned with both the division of the overall space program between NASA and other agencies and the magnitude and direction of the civilian space program for which it was responsible.

A good statement of this problem was a "think" paper which Glennan wrote during the early summer of 1959.<sup>127</sup> Glennan pointed out that 18 months of experience since *Sputnik I* had revealed that space projects were much more expensive than had been earlier predicted and that the technical difficulties were greater than had been anticipated. This meant that both budget levels and time schedules would have to be changed. Even then, there would remain the difficult job of choosing among alternative courses of action. Glennan estimated that an annual NASA budget of \$1 billion could be utilized quite easily. He felt that there was a need to develop a "rationale that will support such a level" of expenditure—one that could serve as the basis for both administration and congressional support.<sup>128</sup> Glennan found that achieving the objectives set forth in his "Rate and Scale" paper was very difficult. The "rationale" he desired was never developed. The attempt to develop it, however, did help clarify matters somewhat.

The first attack on the problem was an attempt to establish a general advisory committee to assist the NASA Administrator in developing a well-balanced civilian program in determining the rate at which it should be implemented, and in establishing the rationale undergirding it.<sup>129</sup> The attempt proved abortive.<sup>130</sup> As a result, a less formal approach was attempted in which a panel of thoughtful

<sup>126</sup> Senate Hearings, *Investigation of Governmental Organization for Space Activities*, p. 82.

<sup>127</sup> "Memorandum on Need for Study to Develop Supportable Position on Rate and Scale in Space Research," June 19, 1959.

<sup>128</sup> Glennan and NASA were caught in the middle of several cross-currents. President Eisenhower, and especially BOB Director Stans, favored a fiscal policy which stressed balanced budgets. Eisenhower emphasized the scientific aspects of the space program, whereas NASA felt great pressure to achieve propaganda successes as well. Congress stressed the need to catch up with the Russians, but also had a tendency to support military programs more generously than civilian programs.

<sup>129</sup> NASA hired the RAND Corp. to address itself to this basic problem and come up with a course of action. A plan for an advisory committee was formulated and presented to Glennan in a report dated Aug. 7, 1959, entitled "Operational Plan for NASA Advisory Committee."

<sup>130</sup> In a Sept. 2, 1959, letter to Rettaliata, a member of the Space Council, Glennan indicated that the RAND effort fell short of expectations and that he [Glennan] was having great difficulty in getting an advisory committee going on his own.

individuals was brought together to discuss particular problems.<sup>131</sup> Conferences were held in October and December.<sup>132</sup> The consensus of the October meeting was that the Russian space challenge was the most important factor shaping U.S. space policy. Nevertheless it was absolutely essential that the American public realize that space superiority should not be confused with military superiority and that the U.S. space program should not be construed as the leading edge in the cold war. NASA must be free to move ahead on a vigorous course of action without having to worry about its every move being thought of in national security terms. The President should take the lead in making sure that this was clearly understood. NASA's program must be a systematic one, making maximum use of existing small vehicles at present, developing larger ones as rapidly as possible, and concentrating on measurement by instrument until high reliability would permit achievement of the ultimate goal—manned flight.<sup>133</sup>

Plans for the October meeting were made before there was any inkling that the Saturn project would be transferred to NASA. The meeting itself, however, was held after the transfer decision had been made public. This probably dulled the meeting's impact and made the December meeting even more anticlimactic.

The net results of Glennan's efforts to clarify basic policy were not very substantial. The chief benefit was the attainment of a better understanding of policy problems, which, when coupled with the Saturn transfer, created a positive and self-assured attitude on NASA's part as it entered 1960.<sup>134</sup>

## V. 1959 TRANSFERS AND RELATED HEADQUARTERS REORGANIZATION

The transfer to NASA of the Saturn project and the Army installation associated with it was the most significant event in NASA's history between its establishment in October 1958 and the Kennedy announcement of May 1961 to greatly accelerate NASA's space program.

In October 1958, NASA asked for, but failed to receive, a portion of the Development Operations Division of the Army Ballistic Missile Agency (ABMA),

<sup>131</sup> Glennan invited Crawford Greenwalt, the president of Du Pont, to chair the panels. Letter, Glennan to Greenwalt, Aug. 14, 1959.

<sup>132</sup> The October meeting was held on the 22d and 23d and participants were: Crawford Greenwalt, Chairman, Frank Stanton, Paul Nitze, James Perkins, Walt Rostow, Mervin Kelly, Edward Purcell, Lee DuBridge, Raymond Saulnier, and George Kistiakowsky. The December meeting, held on the 10th, included the same people except for Saulnier and the addition of Daniel Hickson and Gen. Robert E. Cushman, Jr.

<sup>133</sup> "Summary of Discussion at Conference on National Space Program held October 22, 23, 1959," Nov. 2, 1959.

<sup>134</sup> This is evidenced in Glennan's six-page Nov. 16, 1959, letter to President Eisenhower in which he outlined in a positive manner several recommendations on how the Space Act should be amended and how President Eisenhower could take the offensive both in clarifying the muddled policy picture and in enunciating a civilian space program that would command the support of Congress and the public.

Huntsville, Ala.<sup>135</sup> In October 1959, NASA acquired, with the blessings of the Department of Defense, the entire Division. The story of this change in circumstances is complex. Even more complex, however, were the consequences.

#### A. Changing Circumstances—October 1958 to October 1959

The 1958 decision to leave ABMA intact was not accepted by NASA as final.<sup>136</sup> Nevertheless the December 1958 NASA-Army agreement of cooperation worked out reasonably well and as late as September 7, 1959, Glennan was able to indicate satisfaction with the arrangement.<sup>137</sup>

During the summer of 1959, the Department of Defense, prodded by congressional criticism, reexamined the organization of its space activities. On September 23, 1959, the main outline of a DOD reorganization was revealed. ARPA was to be downgraded by stripping it of most of its projects and distributing them to the individual services.<sup>138</sup>

The transfer of the Saturn super booster project from the Army to the Air Force was also contemplated; this is the crux of the subsequent developments affecting NASA. The Saturn booster, which generated 1½ million pounds of thrust by clustering eight engines, was the pride and joy of the von Braun team at ABMA. The Redstone and Jupiter missiles had become achievements of the past; except for the smaller Pershing missile, the future of ABMA was tied to Saturn. The Army, within its assigned military mission, had no use for this super booster. If any military service could use it, it would be the Air Force. But even the Air Force had no immediate military application in mind for it and there was fear that the Air Force would not give it the priority which its partisans felt necessary.<sup>139</sup>

NASA's program, on the other hand, would eventually require large boosters.<sup>140</sup> Since NASA's own super booster concept, the Nova launch vehicle, was still very far in the future, NASA would be the logical recipient of the project, if it had to be moved. This would be the best way to match requirements with

<sup>135</sup> The October 1958 controversy was described in Ch. 3, Sec. II.A.

<sup>136</sup> This is most clearly stated by Glennan in House Hearings, *Organization and Management of Missile Programs*, p. 556.

<sup>137</sup> Letter, Glennan to Medaris, Sept. 8, 1959.

<sup>138</sup> *New York Times*, Sept. 24, 1959, pp. 1, 10.

<sup>139</sup> Hanson Baldwin, *New York Times*, Oct. 13, 1959, pp. 1, 12. The development of Saturn was authorized by ARPA in August 1958. The program led a somewhat precarious life throughout much of 1959 as DOD was uncertain about the proper level of support. The name "Saturn" dates from February 1959.

<sup>140</sup> In the January 1959 National Space Vehicle Program, NASA listed these uses for Saturn: launching manned laboratory around the earth, ferry vehicle to supply space station, launching synchronous communications satellite, send mobile robot explorers to the moon, make soft landings on Venus and Mars. Russia's successful Lunik series demonstrated NASA's need for a powerful launch vehicle. In January 1959 *Lunik I* was launched toward the moon and became the world's first successful deep space probe. *Lunik II* impacted on the moon on Sept. 13. On Oct. 4 *Lunik III* was launched. It took pictures of the far side of the moon.

capabilities. And if the alternatives were those of either transferring the Saturn project to the Air Force or to NASA, or leaving it with the Army, the most neutral move from the point of view of interservice rivalry would be to transfer it to NASA.<sup>141</sup>

### B. The Decision To Transfer to NASA

Secretary of Defense McElroy initially approached Glennan only about NASA's interest in acquiring ABMA's Development Operations Division. NASA's response was that it was still interested.<sup>142</sup> A little later, at McElroy's and Glennan's direction, a paper was prepared examining the whole problem of large space boosters such as Saturn.<sup>143</sup> On October 7, 1959, a high-level meeting was held at the White House to discuss the entire ABMA and Saturn situation.<sup>144</sup> By October 20, an agreement was worked out whereby NASA fell heir to both ABMA's Development Operations Division and the Saturn project as well. On the 21st the plan was presented to President Eisenhower. He approved it and it was announced to the public.<sup>145</sup>

Virtually everyone, even the Army to some extent, was relieved that the decision had been made. The October 21 announcement pointed out that the transfer was to be accomplished according to the provisions of the Space Act. This meant the *de jure* transfer could not take place until a formal transfer plan had been before Congress for 60 days. Since Congress would not be in session until January 1960, the earliest the legal transfer could take place would be March 1960. The actual timetable turned out to be as follows:

Oct. 21, 1959.....	Decision made to transfer
Jan. 14, 1960.....	Transfer plan submitted to Congress
March 15, 1960.....	Transfer plan takes effect
July 1, 1960.....	Mass transfer of personnel takes place and transfer regarded as consummated

<sup>141</sup> See the testimony of General Medaris on Feb. 18, 1960, Senate Hearings, *Transfer of Von Braun Team to NASA*, pp. 38-39.

<sup>142</sup> Glennan testimony, *ibid.*, p. 17.

<sup>143</sup> "National Space Vehicle Program," prepared by William Holaday, Chairman of the CMLC, dated Sept. 30, 1959.

<sup>144</sup> Glennan memo to Dryden et al., Oct. 7, 1959.

<sup>145</sup> *New York Times*, Oct. 21, 1959, p. 1; Oct. 22, 1959, pp. 1, 10. The Oct. 21 decision came earlier than originally scheduled and no document was in final form for President Eisenhower's approval. The polished document was not ready until Oct. 30, but it was given an Oct. 21 date. Eisenhower's approval of this document did not come until Nov. 2. The document was a memorandum for the President from Gates of DOD and Glennan of NASA. Subject: Responsibility and organization for certain space activities, Oct. 21, 1959. (Reprinted in Senate Hearings, *Transfer of Von Braun Team to NASA*.)

### C. Transfer Gets Underway Immediately

The transfer of ABMA's Development Operations Division from the Army to NASA involved a highly complex series of actions. Great efforts were made to make it as smooth as possible and not delay the Nation's space effort one iota.

The elements involved were these: (1) Determining precisely what was to be detached from the Army: This involved a NASA-DOD agreement on policy and a NASA-Army agreement on details. (2) Preparing the host to receive the new group: This involved NASA's efforts to change its own organization and procedures to accommodate this new addition. A NASA Headquarters reorganization was one aspect of this. (3) Planning the details of the transfer: This involved a detailed NASA-Army agreement. (4) Making the transfer: This involved detaching and reattaching certain supporting pipelines. (5) Repairing the gap: This was an Army problem but one in which NASA would have to cooperate. (6) Followup efforts to accomplish total integration and iron out difficulties—an activity extending over several years.

Side by side with these primarily administrative matters were two policy matters concerning the Saturn program: (1) Determining the precise disposition of the Saturn program during the 6- to 9-month transfer period: This involved NASA-DOD agreements on policy and procedures. (2) The future of the Saturn program in general, its objectives, its level of support, etc.: This involved a decision at the White House-BOB level.

Most of the material which follows pertains to the administrative details involved in the transfer of the installation. Saturn program developments are summarized in a later subsection.

**Basic NASA-DOD and NASA-Army Agreements.** The October 21, 1959, NASA-DOD agreement, to which President Eisenhower gave his approval, included the following provisions: <sup>146</sup> (1) NASA should have responsibility for the Nation's super booster program; (2) the Nation's most advanced super booster, Project Saturn, should be NASA's responsibility; (3) the organizational unit most closely related to Project Saturn, ABMA's Development Operations Division, should be transferred to NASA, together with all Saturn money; (4) NASA should utilize the Development Operations Division as fully as possible with as few disruptions as possible, and the new NASA installation built around it should be the organizational core of NASA's super booster program; (5) NASA need not reimburse the Army for the tangible assets transferred; (6) the Army's Redstone Arsenal would support NASA's new installation on a reimbursable basis; (7) NASA would be responsive to DOD's requirements in the super booster field; (8) NASA would cooperate in the orderly phasing out and/or transfer of the military activities now being carried out by the Development Operations Division; (9) further details should be worked out by NASA-DOD (Army) negotiations.

<sup>146</sup> *Ibid.*

On October 21, the same day the agreement was announced, Glennan appointed Albert Siefert, NASA's Director of Business Administration, to be NASA's principal negotiator, an indication of the administrative nature of the task. Major General Schomburg, the Army Deputy Chief of Ordnance, was principal negotiator for the Army. A November 16 supplemental agreement between the Army and NASA provided for the preparation of a detailed transfer plan by the principal negotiators and their subordinate negotiation teams.<sup>147</sup> This plan was to be ready for submission to the President by December 15 and was to serve as the basis for the President's request to Congress and as a detailed guide for implementing activities.

**The Detailed Transfer Plan.** The 41-page transfer plan was completed on schedule and given a December 11, 1959, date.<sup>148</sup> Its main provisions were as follows:

1. *Timing.* The transfer of ABMA's Development Operations Division, and its personnel, was to take place on July 1, the start of the new fiscal year. The 3½-month period between the date when the transfer would be authorized (estimated at mid-March 1960) and July 1 would be utilized by NASA to build its new Huntsville organization and transfer certain support personnel to it.
2. *Funding.* Funding for fiscal year 1960 would not be altered, except that R&D funds for Saturn project contracts would be transferred to NASA as of the date the transfer was legally authorized.
3. *Personnel.* All 4,000 Development Operations Division personnel would be transferred to NASA, except for a maximum of 350 which the Army could recruit for its weapon programs. Up to 815 personnel not part of the Development Operations Division could be transferred to NASA from other units of the Army's Redstone Arsenal.
4. *Services.* NASA would perform financial, personnel, procurement, office, security, and maintenance services. The Arsenal would provide, on a reimbursable basis, such station wide services as utilities, road maintenance, railroad service, and fire protection.
5. *Land and Buildings.* NASA would be granted a long-term use permit on specified land and buildings, and other facilities, both at the Arsenal and at Cape Canaveral, Fla. Certain facilities would be shared for an interim period.
6. *Equipment and inventories* would be transferred on a nonreimbursable basis.

<sup>147</sup> The Nov. 16, 1959, agreement, signed by Glennan and Brucker of the Army, is entitled, "Agreement Between the Department of the Army and NASA on the Objectives and Guidelines for the Implementation of the Presidential Decision To Transfer a Portion of ABMA to NASA." (Reprinted in Senate Hearings, *Transfer of Von Braun Team to NASA.*)

<sup>148</sup> *Army-NASA Transfer Plan*, Dec. 11, 1959. The plan was approved and signed by Glennan, Brucker, and James Douglas, Acting Secretary of Defense.

The December 11 plan earmarked certain lands, facilities, equipment, and inventories for transfer. Other items not yet agreed upon would be subject to further negotiation.

In effect, the December 11 plan provided for the transfer, virtually intact, of an operating line unit. NASA was to use this as the basic building block for a new field installation. In the buildup of the new installation as a whole, the Army would cooperate by supplying certain services and permitting the transfer of some of its own support personnel. In many ways the job was more difficult than starting from scratch; it could not be done piecemeal or gradually but had to be all ready to go as of a given moment.

*The Role of McKinsey & Co.* Preparing the December 11 transfer plan represented only one element in the total problem of developing the organization and administrative arrangements necessary to effectuate the transfer. For this broader problem, NASA turned for help to McKinsey & Co., the management consulting firm whose services NASA had hired twice previously.<sup>149</sup>

McKinsey & Co., primarily in the person of John D. Young, was to:<sup>150</sup>

1. Assist in the planning and coordinating of the efforts of NASA functional specialists in their assembly of data concerning the administrative and supporting technical services now being provided the Development Operations Division by various elements of the Army.
2. Analyze alternative proposals concerning the administrative and supporting technical services that (a) NASA should assume responsibility for, and (b) those that NASA should rely on the Army to provide.
3. Prepare a written time-phased plan for the provision of administrative and supporting technical services required by the Development Operations Division, when transferred to NASA.

The work was to be completed by January 15, 1960.

Basically, McKinsey & Co. furnished the service of a management expert, not to prepare a formal report but to participate in the actual day-to-day transfer efforts. The finished report, therefore, was only a compilation of some of the interim planning and action documents prepared along the way.<sup>151</sup>

The way things unfolded was as follows: Under the chairmanship of Siepert, the principal NASA negotiator, NASA set up a 24-member Task Group. Young,

<sup>149</sup> Selection of McKinsey & Co. for this assignment was made by Siepert, primarily to obtain the services of John Young who had done much of the work on the two earlier McKinsey studies. Interview with Albert Siepert, Apr. 9, 1963.

<sup>150</sup> See NASA contract NASw-131. The \$15,000 contract was dated Nov. 13, 1959, and based on Corson's proposals to Glennan, dated Nov. 2, 1959. A comment draft of the Nov. 2 proposal was dated Oct. 29. However, the contract provided for the work to be performed during the period Oct. 27, 1959, through Jan. 15, 1960. This suggests that Young was on the job within a week after Siepert had been appointed principal negotiator.

<sup>151</sup> The report is entitled "Providing Supporting Services for the Development Operations Division," January 1960. The summary report to Siepert is dated Jan. 16, 1960.



of McKinsey & Co., served as executive officer or secretary. The initial job of the Task Group was to:

1. Clarify the role that the Development Operations Division was to play in NASA's space program;
2. Determine the organizational location of the Development Operations Division in NASA's organizational structure;
3. Determine the way the Development Operations Division would be funded after its transfer to NASA;
4. Determine the management and supporting technical services which the Development Operations Division would require after its severance from the Army.<sup>152</sup>

The first three tasks could be done in Washington. The fourth one required intensive factfinding at the Redstone Arsenal. It involved a description of all services (legal, administrative, etc.) now being provided, ascertaining their current effectiveness, measuring them in some quantitative way, identifying whether the services were being performed by civil servants, military personnel, or contractor personnel, and determining the pros and cons of various alternatives for assuring that supporting services would be continued.<sup>153</sup>

Each member of the Task Force was selected for factfinding assignments on the basis of his specialty. Factfinding was to be completed by November 21, 1959. The information gathered was to be analyzed and a memorandum prepared recommending a particular course of action in each functional area. From the recommendations for each of 19 management and technical areas, Young was to prepare an overall plan for the provision of administrative and other supporting services for NASA's new Huntsville installation. This was to be completed by December 5. The December 11 agreement incorporated many of the findings made by the Task Group.

The December 11 agreement cleared the way for Task Group members to prepare detailed implementation plans. These implementation plans were to include details on how the particular service would be organized and staffed; what administrative procedures would be followed; what facilities, equipment, and supplies would be required, and how they would be obtained; what arrangements would have to be made in order to contract for any support; and what temporary staff augmentation would be necessary to carry out the implementation plans. These details were to be submitted by January 8, 1960.<sup>154</sup>

<sup>152</sup> "Study outline for development of an operating plan to provide business and supporting services to the Development Operations Division upon its transfer to NASA," Nov. 2, 1959. Exhibit I of the final report.

<sup>153</sup> *Ibid.* ABMA made great use of contractor personnel to do what might be ordinarily thought of as in-house work.

<sup>154</sup> Siepert memo of Dec. 10, 1959, Exhibit V of the final report.

In January 1960, McKinsey & Co. received the draft implementation plans and found some good and others deficient.<sup>155</sup> McKinsey & Co. recommended that the draft plans be revised in consultation with Army personnel so that everything would be ready to go by the time congressional intent became known. Developing an accounting system was viewed as an immediate need because of the long leadtime involved. The full story of executing the implementation plans, together with a brief account of the legal promulgation of the transfer, is presented in the next chapter.

#### **D. The Interim Status of the Saturn Program**<sup>156</sup>

As mentioned earlier, the decision to transfer the Saturn program to NASA was made in October 1959. Since the transfer would have to await congressional approval several months hence, a method was devised whereby NASA could be brought into the picture as soon as possible. On November 10 an agreement was reached with DOD whereby the technical responsibility for Saturn was transferred from the Advanced Research Projects Agency to NASA as of November 18. ARPA immediately began routing all orders concerning the Saturn project through Milton Rosen of NASA's Office of Space Flight Development for his informal approval. This procedure worked so well that it was continued until July 1, 1960, even though the legal approval of the transfer in March would have permitted the removal of ARPA from the picture altogether.<sup>157</sup>

Under the chairmanship of Abe Silverstein, a NASA-ARPA technical committee was given jurisdiction over the Saturn program. In December 1959, this committee reached an important decision on the configuration of the upper stages of the Saturn launch vehicle. DOD had been unable to make a decision on this matter because of conflicting opinions on the eventual uses of the vehicle. The decision was approved by Glennan on December 31.

Also in December, von Braun, Director of ABMA's Development Operations Division, and Associate Administrator Horner of NASA discussed the optimum funding level for the Saturn program.<sup>158</sup> Von Braun claimed that \$218 million for fiscal year 1961 would permit sizable savings in time as compared with the \$140 million level already agreed to by the Bureau of the Budget. During January 1960, this question was studied intensively; the result was a decision on the part of the Eisenhower administration to accelerate the Saturn program along the lines suggested by von Braun. The Saturn budget was subsequently increased to \$230 million.

<sup>155</sup> Memo to Siefert from McKinsey & Co., Jan. 13, 1960, Exhibit VI of the final report.

<sup>156</sup> Unless otherwise indicated, this subsection is based on the "Saturn Chronology" prepared by the Historical Office of the Marshall Space Flight Center (MHR-1).

<sup>157</sup> Interview with Milton Rosen, Sept. 4, 1963.

<sup>158</sup> Memorandum, Glennan to Horner, Dec. 10, 1959.

On March 16, 1960, the transfer of the Saturn program became effective and NASA took charge of the administrative direction of the program as well as its technical direction. Since no transfer of funds occurred during fiscal year 1960, most of the administrative details continued to be performed on an inter-agency basis.

#### **E. The December Reorganization of NASA Headquarters**<sup>159</sup>

In December 1959, NASA Headquarters was reorganized. This was done in anticipation of the transfer of ABMA's Development Operations Division and because of NASA's involvement in the Saturn project. Although generally considered of major significance, the reorganization proved to be an interim one.

To fully understand this reorganization, it must be recalled that NASA's internal operations were under three Headquarters program offices—one administrative and two technical. The technical offices were the Office of Aeronautical and Space Research (OASR) under Crowley and the Office of Space Flight Development (OSFD) under Silverstein. In October 1959, the former office numbered around 70 and had been carried over almost intact from NACA. The latter office numbered almost 100 and had grown from almost nothing in only 1 year. It had jurisdiction over the rapidly expanding space development program (Project Mercury, scientific satellites, engine development, etc.) and was spending most of NASA's R&D budget. It had jurisdiction over NASA's new field installation, Goddard, and contractor-operated facility, JPL.

Logically the Saturn program and NASA's new Huntsville installation would have been put under the jurisdiction of Silverstein's office. Instead they were put under a new Headquarters program office, the Office of Launch Vehicle Programs (OLVP). For OLVP, NASA brought in as director, Air Force Maj. Gen. Don Ostrander, acting head of ARPA. (ARPA had had jurisdiction over the Saturn program prior to its transfer to NASA.)

The chief reason for doing it this way was to give launch-vehicle development a coordinate status in NASA to make sure that its requirements were given attention and understanding equal to other NASA program elements.<sup>160</sup> Another factor was that Silverstein's office would have become disproportionately large.<sup>161</sup> The argument that a military man could better deal with what had been a DOD project carried out primarily in a military installation was a relatively minor consideration.<sup>162</sup>

<sup>159</sup> See NASA Announcement No. 58. Subject: Establishment of New Headquarters Staff Component, Dec. 14, 1959. Also NASA Releases 59-270 (Dec. 8, 1959) and 59-285 (Jan. 1, 1960). Data on numbers of personnel are taken from Position Complement Reports.

<sup>160</sup> Interview with Albert Siepert, Apr. 9, 1963.

<sup>161</sup> Interview with Abe Silverstein, Jan. 18, 1964.

<sup>162</sup> NASA Associate Administrator Horner picked Air Force General Ostrander for the position because Horner had come to NASA from the Air Force and had known Ostrander quite well.

In December 1959, the newly formed Office of Launch Vehicle Programs consisted of its head, Major General Ostrander, and about 25 individuals transferred from Silverstein's Office of Space Flight Development. What had been one office (OSFD) with four major divisions (Advanced Technology, Space Sciences, Space Flight Operations, and Propulsion) became two separate offices—the Office of Space Flight Programs (OSFP) with three major divisions (Advanced Technology, Space Sciences, Space Flight Operations), and the Office of Launch Vehicle Programs (OLVP) with three major divisions (Vehicles, Propulsion, and Launch Operations). To provide nomenclature uniformity, the name of the Office of Aeronautical and Space Research was changed to Office of Advanced Research Programs (OARP).

It will be noted in later chapters that putting payload and spacecraft responsibility in one office and launch vehicle responsibility in another created a very basic integration problem. Within a year, there were agitations for another change. But the next major NASA Headquarters reorganization was not to occur until November 1961.

## Chapter Five

### 1960—ORDERLY PROGRESS

The year 1960 was one in which NASA attacked organizational and administrative problems over a wide front. Substantial progress was made in solving many of them.<sup>1</sup>

For some time Glennan had planned to leave NASA at the end of President Eisenhower's term of office and return to the presidency of the Case Institute of Technology, a position from which he was on leave.<sup>2</sup> He made special efforts in 1960 to make NASA "tidy" so as to pass on to his successor as sound an organization as possible. This is epitomized by the two self-evaluation studies prepared during 1960. It was also a factor in the efforts to make the Huntsville transfer as smooth as possible.

This chapter divides 1960 administrative developments into four major sections. The first one focuses on structural changes, with emphasis on the establishment of NASA's new Huntsville installation and the transfer of ABMA's Development Operations Division to it. This is followed by a section on administrative and procedural developments, with special attention paid to NASA's efforts to bring about both program and organizational integration. The third section is devoted to the two large self-evaluation studies conducted during 1960. The last section is on external relations, with emphasis on changes in NASA-DOD working relationships. The chapter is concluded with a summary of the entire period during which Glennan was NASA Administrator.

#### I. ORGANIZATIONAL CHANGES

##### A. The Huntsville Transfer Consummated

In Chapter 4 the transfer of ABMA's Development Operations Division to NASA was traced from October 1959, when the decision to transfer was made, to

<sup>1</sup> Early in 1960, the first NASA "Ten-Year Plan" was presented to the Congress, a coherent outline of future goals based upon the entire complex of inherited projects, facilities, and responsibilities. See general discussion in *Historical Sketch of NASA* (Washington: NASA EP-29, 1965), p. 26. See Sec. II.A of this chapter.

<sup>2</sup> Glennan clearly indicated this in letters as early as Sept. 29, 1959.

the end of 1959, by which time the basic transfer guidelines had been established and implementation plans formulated.<sup>3</sup> During 1960 the transfer received congressional approval, the implementation plans were executed, the mass transfer of personnel took place, operating agreements were entered into, and the transferred installation was named and dedicated. The new Center became NASA's largest by a sizable margin and accounted for one third of NASA's total personnel by the end of the year.

***Transfer Plan Submitted to Congress.*** On January 14, 1960, President Eisenhower submitted a 600-word transfer plan to Congress.<sup>4</sup> The action was based on the special transfer provision of the Space Act (Sec. 302). The plan provided for the transfer to NASA of "those functions . . . relating to the development of space vehicle systems . . . which are being performed by the Army Ballistic Missile Agency of the Department of the Army . . ." (i.e., the Saturn program). Accompanying the transfer of the function would be the transfer from the Army to NASA of funds (the amount of which would be determined by BOB), personnel (the number of which would be determined jointly by DOD and NASA), records and property (the specifics of which would be arrived at jointly by DOD and NASA), and certain special personnel privileges (relating to supergrades and scientists) pertaining to ABMA's Development Operations Division.

The "functions" were to be transferred in 60 days unless Congress, by adopting a concurrent resolution, determined otherwise. The transfer of personnel, property, etc., would take place thereafter on whatever date NASA and DOD would agree to. The transfer was to be made under the cognizance of BOB which would resolve all questions not resolved directly by NASA and DOD.

In his message accompanying the transfer plan, President Eisenhower pointed out that "in order to carry on a vigorous and effective program for the exploration of space . . .," NASA would need large boosters. Since there was "at present no clear Department of Defense requirement" for large boosters, it was logical that sole responsibility for them be given to NASA (as the administration had done in October 1959). In view of the October 1959 decision, it was logical to "provide NASA with an organization capable of and equipped for developing and operating large space vehicle boosters. . . ." This action would not endanger national security, as NASA would "be fully responsive to specific requirements of the Department of Defense for the development of very large boosters for future military missions."

***Congressional Reaction to the Transfer Plan.*** To allow the transfer plan to go into effect all that Congress had to do was take no action. Congress would have to take positive action in order to veto the transfer proposal. In this particular transfer situation, Congress came very close to acting positively—not to veto the transfer but to shorten the 60-day waiting period. On January 21, 1960,

<sup>3</sup> See Ch. 4, Sec. V.

<sup>4</sup> H. Doc. No. 297, 86th Cong., 2d sess., Jan. 14, 1960.

Representative Sisk of the House Astronautics Committee introduced a joint resolution calling for the transfer to take place upon the enactment of the resolution.<sup>5</sup> The resolution expressed congressional concern for the lag in U.S. space achievements and the desire on the part of Congress to help overcome the lag. The resolution specifically stated that speeding up the transfer might well help keep the "von Braun team" intact.

The hearings on the resolution revealed that NASA's July 1, 1960, target date for the mass transfer of personnel and property would not be altered by the passage of the resolution.<sup>6</sup> However, both NASA and DOD supported the resolution, feeling that it would help dispel uncertainties and permit the earlier performance of certain preparatory steps. There were rumors that von Braun would lose many of his top-level assistants to private industry as a result of the transfer. Those sponsoring the resolution hoped that a gesture of firm congressional support would help keep the "team" together.

The resolution passed the House of Representatives on February 8, 1960, but died in the Senate, primarily because the Senate was involved in lengthy debate on civil rights.<sup>7</sup>

**Transfer Becomes Effective.** In the absence of final congressional action one way or the other, the transfer plan automatically went into effect on March 14, 1960.<sup>8</sup> It is difficult to depict precisely what was changed by the plan going into effect. The only thing which legally happened immediately was that the large booster program, formerly a function of ABMA, now became a function of NASA. The men and facilities performing the function remained, legally, with ABMA for another 3½ months. Even the transfer of Saturn funds called for by the December 11 transfer plan did not materialize.<sup>9</sup> The fact that the Saturn project was now the complete responsibility of NASA made little difference in how the project was being run, although changes could have been made if the parties involved had believed them desirable. The "gentlemen's agreement"

<sup>5</sup> H.J. Res. 567, 86th Cong., 2d sess., "Joint Resolution to Effect Immediately the Transfer of the Development Operations Division of the Army Ballistic Missile Agency to the National Aeronautics and Space Administration." (For a text, see p. 2 of the following entry.)

<sup>6</sup> U.S. Congress, House, Committee on Science and Astronautics, *Transfer of the Development Operations Division of the Army Ballistic Missile Agency to the National Aeronautics and Space Administration*, Hearing on H.J. Res. 567, 86th Cong., 2d sess. (Washington: GPO, 1960). Hearing was held on Feb. 3, 1960. The Senate Hearing, *Transfer of Von Braun Team to NASA*, cited previously, was held on Feb. 18, 1960.

<sup>7</sup> The Senate Space Committee amended the resolution and reported it out on Feb. 26, 1960.

<sup>8</sup> There is some uncertainty as to whether or not the first day after the 60-day waiting period was Mar. 14 or 15. The plan was published in the *Federal Register* on Mar. 16 (25 F.R. 2151).

<sup>9</sup> The detailed work involved in effecting a transfer of funds proved to be too great to be worth the effort. This was primarily because the financing of the outstanding R&D contracts was exceedingly complex. It was not until March 1961 that fiscal year 1960 funds were identified accurately enough to permit the transfer from ARPA to NASA of about \$2½ million in unobligated fiscal year 1960 balances. (Information furnished by NASA Office of Financial Management, September 1963.)

on the management of the Saturn project, entered into in late 1959 by NASA and ARPA, the DOD agency funding Saturn, was working so well that it was decided to let the system operate without change until the end of the fiscal year.

Under this gentlemen's agreement, ARPA issued no orders or funds to ABMA without consulting NASA. If NASA wanted something changed, ARPA readily complied. In effect, ARPA continued doing all the paperwork subject to NASA's approval on all substantive matters. In November and December 1959, most of NASA's inputs were primarily technical. Gradually, however, the technical blended into the administrative and by March 14, 1960, the management of the Saturn project was already a NASA activity.<sup>10</sup>

***NASA Establishes Huntsville Facility.*** Timed to coincide with the transfer becoming effective was NASA's official establishment on March 14 of the NASA Huntsville Facility as a NASA field installation.<sup>11</sup> Mr. Delmar Morris of AEC was named acting head of the installation. He was to serve in this capacity until July 1 when Wernher von Braun would become Director of the installation with Morris serving as Deputy Director for Administration. The immediate function of the Facility was to help pave the way for the mass transfer on July 1, 1960.

***Huntsville Facility Given a Name.*** On March 15, 1960, President Eisenhower signed an Executive order which designated the Huntsville Facility as the George C. Marshall Space Flight Center, effective immediately.<sup>12</sup> Although often abbreviated to MSFC, it is probably best to refer to the center as the "Marshall Center."

***Preparations for the July 1 Mass Transfer.*** In Chapter 4 it was noted that the transfer of tangibles from the Army to NASA involved a complicated series of actions. The basic problem was to transfer an operating line division from a larger organization which furnished the vital supporting services to a newly established organization consisting only of supporting elements. The NASA Task Force, which was given the assignment of solving the NASA aspects of this problem, had to pursue two main objectives. One was a factfinding operation—to learn the exact amount of effort currently being used to support the operating line division. The other was to recommend the way that the support could be furnished the line division after the transfer.<sup>13</sup>

The factfinding operation revealed that the Army was expending about 1,347 man-years per year in support of the Development Operations Division's 4,200

<sup>10</sup> Information on NASA-ARPA relationships supplied by Milton Rosen, Sept. 4, 1963. Rosen, serving under Silverstein in 1959 and Ostrander in 1960, was in charge of ARPA-NASA clearances.

<sup>11</sup> NASA Circular No. 57, Mar. 14, 1960. Subject: Establishment of NASA Huntsville Facility.

<sup>12</sup> Executive Order 10870, 25 F.R. 2197, Mar. 17, 1960.

<sup>13</sup> See Ch. 4, Sec. V.F.



technical personnel.<sup>14</sup> The following list shows how these 1,347 man-years were distributed:

Materials and equipment warehousing	327
Maintenance, utilities, engineering	270
Procurement	124
Security	131
Motor pool	103
Accounting	90
Personnel	68
Other	234

About half of this support was furnished by ABMA and half by the Redstone Arsenal, the base housekeeper.

NASA decided that instead of building a support base of 1,347 persons, it would set a goal (i.e., ceiling) of 1,200 as an adequate level of support.<sup>15</sup> The next step was to "organize" the 1,200 positions into an Office of Procurement, an Office of Personnel and Management Services, an Office of Technical Services, an Office of Financial Management, and several much smaller offices.<sup>16</sup> Next, the responsibilities of these positions were determined. In some cases the position was a carbon copy of the position as it existed under the Army. In other cases the position had to incorporate NASA characteristics. In a few cases a completely new way of doing business was contemplated.<sup>17</sup>

So far everything had been done on paper. The next step, a very crucial one, was to fill the positions and get incumbents working. This operation could not be done overnight. Some of it had to be done in advance of the mass transfer of the operating line people and was the reason why the Huntsville Facility was established in March 1960. Although NASA had to pay for all positions filled prior to July 1 out of its own fiscal year 1960 funds (something not provided for in the fiscal year 1960 budget), it went ahead and authorized the filling of 100 positions at the time it established the Huntsville Facility. In April it was determined that an additional 270 people would be needed to complete the preparations for the July 1 mass transfer.<sup>18</sup> This meant that NASA would exceed its fiscal year 1960 personnel ceiling. BOB approval was obtained to do so.<sup>19</sup>

Filling the positions was facilitated by the NASA-Army agreement which authorized NASA to recruit up to 815 individuals from Army units. In exchange,

<sup>14</sup> For a good account of NASA's preparations for the mass transfer, see "Manpower Utilization Aspects of the Transfer to the NASA of the Former 'Development Operations Division,' ABMA, Army Ordnance Missile Command," Annex "D" to the Quarterly Manpower Utilization Report for the Quarter ending Sept. 30, 1960. Prepared by the Management Analysis Staff of the NASA Office of Business Administration. Oct. 25, 1960. Attachment B.

<sup>15</sup> *Ibid.*, p. 11.

<sup>16</sup> *Ibid.*, Attachment C.

<sup>17</sup> *Ibid.*, pp. 7-10.

<sup>18</sup> Memorandum for the Administrator, from Aaron Rosenthal and Don Ostrander, Apr. 29, 1960.

<sup>19</sup> *Ibid.*

the Army was authorized to retain 315 Development Operations Division personnel for its missile program.<sup>20</sup>

The actual buildup of personnel to staff the Marshall Center proceeded as follows: Of the 370 positions authorized to be filled prior to July 1, 26 had been filled by the end of March, 48 by the end of April, 138 by the end of May, and all 370 by the end of June.<sup>21</sup> Eighty-one of these had been recruited from ABMA.<sup>22</sup>

On July 1 there was a mass transfer of 311 persons from ABMA's Technical Materials and Equipment Branch (a warehousing operation) to NASA. In the mass transfer of ABMA's Development Operations Division to NASA, 3,989 of its 4,179 employees were transferred. Thus on July 1, when von Braun took over as Director, NASA's Marshall Center employed 4,670 persons.<sup>23</sup>

Two other mass transfers occurred on July 3, when 41 persons were transferred from ABMA and 178 from the Redstone Arsenal's Post Engineer Office.<sup>24</sup> This brought the Marshall Center's total to about 4,900. It went over 5,000 by the end of July. By the end of 1960 the total reached 5,367.<sup>25</sup>

A fundamental transfer objective was that the work of the Development Operations Division should continue without interruption. This meant that it would have to occupy the same facilities after the transfer and that the level of support would have to remain constant before and after the transfer. Since Development Operations Division facilities were located in the midst of a large Army installation, it made economic sense to have the Army supply certain services (of a base housekeeping nature) on a long-term and reimbursable basis, rather than have NASA duplicate the facilities required to supply such services. Since support services had to be rendered without interruption and since the buildup of NASA support personnel was on a gradual basis, it was necessary for the Army to continue supplying certain services on an interim basis. This meant that NASA had to enter into both interim and long-run support agreements with the Army. Also subject to some type of formal agreement or understanding was the transfer of property, equipment, and inventories.

The agreements and letters of understanding were numerous. Their dates ranged over all of 1960.<sup>26</sup> Although more detailed, they conformed quite closely

<sup>20</sup> See Ch. 4, Sec. V.E.

<sup>21</sup> Data supplied by NASA Personnel Division.

<sup>22</sup> Data supplied by MSFC Historical Office on Aug. 21, 1963, letter to NASA Headquarters Historical Office (Jarrell to Wells). Number of personnel recruited from other Army units is not available.

<sup>23</sup> *Ibid.* Other sources give slightly different figures.

<sup>24</sup> *Ibid.*

<sup>25</sup> Information is not available as yet on exactly how many ABMA and other Army support personnel transferred to NASA by the end of 1960. The figures just presented account for 621. This is over half of the 1,200 positions authorized for support purposes.

<sup>26</sup> In Akens, *Historical Origins of the George C. Marshall Space Flight Center*, the following items were given special mention: "Files Transfer Procedures . . ." May 31, 1960; "Procedures

to the basic agreement entered into in December 1959. The major exception was the decision to transfer to NASA more of the Army's Cape Canaveral facilities than initially contemplated.<sup>27</sup>

Unique features of the Huntsville transfer make a comparative evaluation difficult. It seems safe to say that the transfer went about as smoothly as could be hoped, even though not all of the original objectives were met. Top officials probably viewed it as having gone more smoothly than did lower level personnel who were involved in working out the innumerable details.

Even more difficult to ascertain is NASA's success in truly integrating the Marshall Center into NASA.<sup>28</sup> It is not uncommon to hear complaints in NASA Headquarters, even today, about the independent attitude of the Marshall Center. The Marshall Center early preferred to do things "in-house," rather than have them done "out-of-house" by contract, the more prevalent way by which NASA did developmental work. There is little doubt that the transfer added enormously to NASA's technical capability. No opinion has been voiced that the transfer decision was unwise.

#### B. Other Field Installation Changes

**LOD Established.** One of the subdivisions of ABMA's Development Operations Division was the Missile Firing Laboratory located at Cape Canaveral. One of the most thorny transfer problems was to determine how much of the Army's Cape Canaveral facilities should be transferred to NASA. It was finally decided that most of the facilities should be transferred.<sup>29</sup> This gave NASA a substantial launch capability of its own at Cape Canaveral. NASA's Atlantic Missile Range Operations Office (AMROO) had been little more than a liaison office between NASA and the Atlantic Missile Range (AMR), basically an Air Force installation.

On June 13, 1960, NASA announced that all general field responsibilities for launchings at either the well-established AMR or the newer Pacific Missile Range (PMR) would be assigned to the Launch Operations Directorate (LOD), a semi-autonomous unit of the Marshall Center.<sup>30</sup> LOD absorbed both ABMA's Missile Firing Laboratory and AMROO, with the Laboratory's Director, Dr. Kurt Debus,

for the Transfer of Procurement and Contracting Functions . . .," June 27, 1960; ". . . Equipment" agreement, June 30, 1960; "Agreement . . . for Use of Land and Facilities . . .," Aug. 15, 1960; and, most important of all, the basic operating agreement, Aug. 16, 1960. See pp. 77-80.

<sup>27</sup> The Dec. 11, 1959, transfer plan contemplated the Army retaining control over launch complex 26. Instead, it was transferred to NASA to free the Army from the burden of administering something that would be of marginal value to them. See the June 9, 1960, letter from AOMC's Barclay to NASA's Ostrander.

<sup>28</sup> Some readers might find President Eisenhower's dedication remarks of historical interest. See D. S. Akens, *Historical Origins of MSFC*, App. F.

<sup>29</sup> Letter, AOMC's Barclay to NASA's Ostrander, June 9, 1960.

<sup>30</sup> NASA Announcement 156, June 13, 1960. Subject: NASA Organizational Changes at AMR and PMR.

serving as LOD Director. In 1962 LOD became an independent field installation, the Launch Operations Center, which, in turn, was renamed the "John F. Kennedy Space Center, NASA," in December 1963.

Effective October 27, 1960, NASA established, under the jurisdiction of LOD, a Test Support Office at PMR.<sup>31</sup> This small office was not to launch vehicles, only to serve as a liaison between NASA and the military-operated PMR. It was planned that all NASA launchings at PMR would be carried out by NASA contractors.

**Joint NASA-AEC Office Established.** One of NASA's important long-range projects was the development of a rocket propelled by hydrogen gas heated by a nuclear reactor (Project Rover). The development of the reactor itself was the responsibility of AEC. To facilitate this joint effort on a nuclear rocket, a joint AEC-NASA Nuclear Propulsion Office was established on August 29, 1960.<sup>32</sup> The Office was headed by a NASA official and located at AEC Headquarters at Germantown, Md.

**Space Task Group Becomes Independent.** On January 3, 1961, the Space Task Group (STG), an autonomous subdivision of NASA's Goddard Center but physically located at the Langley Center, was made an independent NASA field installation responsible for the project management of Project Mercury.<sup>33</sup>

**Goddard Institute for Space Studies Established.** In December 1960 Glennan gave his approval for the establishment of the Goddard Institute for Space Studies.<sup>34</sup> Although a subdivision of the Goddard Center, the Institute was located in New York City on the premise that its function of conducting theoretical research in the area of space sciences would be greatly facilitated by its being located in close proximity to the many graduate schools and technical organizations in the Greater New York area. The Institute was formally established on January 29, 1961. It was staffed by personnel from Goddard's Theoretical Division.

### C. The Establishment of the Office of Life Science Programs

**The Report of the Bioscience Advisory Committee.** In July 1959 NASA established an ad hoc Bioscience Advisory Committee to make definitive recommendations on what NASA should be doing in the bioscience or life sciences area.<sup>35</sup> On January 25, 1960, the Advisory Committee made its report.<sup>36</sup>

<sup>31</sup> General Management Instruction 2-2-9.1, Oct. 27, 1960 (T.S. 207, Jan. 19, 1961). See also NASA News Release 60-300, Nov. 17, 1960.

<sup>32</sup> NASA, *Fourth Semiannual Report*, pp. 106, 195.

<sup>33</sup> NASA, *Fifth Semiannual Report*, p. 153.

<sup>34</sup> Memo, Glennan to Silverstein, Dec. 14, 1960.

<sup>35</sup> See Ch. 4, Sec. II.F.

<sup>36</sup> "Report of National Aeronautics and Space Administration Bioscience Advisory Committee," Jan. 25, 1960. The cover letter from the Committee Chairman, Seymour Kety, to Glennan was dated Jan. 22, 1960. Also see Link, *op. cit.*

The report pointed out the important role that life sciences were playing, and would continue to play, in the Nation's space efforts. Current space-related life science activities were predominantly in the areas of applied medicine and applied biology. Important as these activities were, it was crucial that more effort be devoted to basic biology and the medical and behavioral sciences.

Concerning the question of whether or not it was necessary for NASA to increase its efforts in the life science area, the Committee answered emphatically that it was. Not only should NASA help fill the gaps in the Nation's present research efforts but NASA had to have its own program because it was the organization that had the national responsibility for manned space flights and for possible contact with extraterrestrial life.

The idea that NASA had to have its own program was stated very bluntly. Even though NASA-DOD cooperation was working well in Project Mercury, the fact remains that authority for ensuring the health, safety, and effective functioning of the astronauts is not firmly in the hands of the agency responsible for the success of the project as a whole. The medical personnel were not selected by NASA but by representatives of the military services which provided them on a loan basis for this particular task. Their continued presence in the project is as much a matter of continuing good will as it is a clear contractual agreement, and the individuals themselves must of necessity feel a primary loyalty to the services in which they have elected to develop their entire careers.<sup>37</sup>

The Committee recommended the establishment of an Office of Life Sciences in NASA Headquarters with a director coordinate in rank with the existing program directors. The Committee felt that it was essential that "biomedical interests and skills . . . have adequate representation in important decisions" and that the life science program receive "strong financial support. . . ." <sup>38</sup> The Office should be divided into sections on Basic Biology, Medical and Behavioral Sciences, Applied Medicine and Biology, and Extramural Programs. The extramural program would be based on research grants to or contracts with individual scientists and organizations.

Concerning the controversial question on the scope of NASA's intramural life science activities, the Committee recommended that in the long run it should be extensive. This would mean that NASA would have to establish a "central facility," preferably in the Washington, D.C., area, with specialized laboratories to conduct both basic and applied research. In addition, NASA would have to establish a limited number of auxiliary facilities at several of its existing installations.

The Committee recommended that the development of NASA's intramural life science program be "deliberate and gradual," with detailed planning left to the Director of Life Sciences and his staff.<sup>39</sup> In the meantime, while the in-house

<sup>37</sup> *Ibid.*, p. 24.

<sup>38</sup> *Ibid.*, p. 4.

<sup>39</sup> *Ibid.*, p. 24.

buildup was taking place, NASA would have to continue to rely on cooperative arrangements with outside organizations, especially the military services in view of their current excess capacity in certain aeromedical facilities.

The establishment of an Office of Life Sciences in NASA will greatly improve its capability for discharging its biomedical responsibilities. Even though the agency will probably wish to continue to draw on many other sources for help in solving its biological problems, the presence of at least a small staff of highly qualified biologists and medical men is essential for the formulation of overall policy, the direction of research and operations within NASA, and the negotiation of satisfactory working agreements with other Government agencies and the military services.<sup>40</sup>

**Implementation of the Report.** On March 1, 1960, NASA established an Office of Life Science Programs. Dr. Clark Randt, who had come to NASA the previous April and had been Executive Secretary for the Advisory Committee, was named Director of the Office.<sup>41</sup> A personnel complement of 32 was planned for fiscal year 1961 and a program level of \$5 million.<sup>42</sup>

NASA proceeded much more slowly in establishing the research facilities recommended in the January 25 report. NASA had a much harder time justifying building its own facilities in the light of underutilized military facilities than in winning approval for a Headquarters office for program planning and coordination. NASA wanted to avoid the cardinal sin of duplicating existing facilities.

Congress asked NASA about this very shortly after the Office of Life Science Programs had been established.<sup>43</sup> NASA answered that it would not duplicate existing facilities, but rather supplement them by concentrating on problems unique to NASA's space exploration missions. Congressional fears were satisfied by NASA's constant reiteration of this theme, by NASA's extreme caution in moving ahead with the building of facilities, by a measure of support for NASA's plans from the military services, and by positive progress by NASA and DOD in working out a scheme for even better interagency cooperation.<sup>44</sup>

<sup>40</sup> *Ibid.*, pp. 24-25.

<sup>41</sup> Clark T. Randt, M.D., came to NASA from Western Reserve University, Cleveland, Ohio, where, since 1956, he had been director of the Division of Neurology in the Department of Medicine.

<sup>42</sup> U.S. Congress, Senate, Committee on Aeronautical and Space Sciences, *NASA Authorization for Fiscal Year 1961*, Hearings on H.R. 10809, 86th Cong., 2d sess. (Washington: GPO, 1960), p. 38 (hereafter cited as Senate Hearings, *NASA Authorization for Fiscal Year 1961*).

<sup>43</sup> At a Mar. 9, 1960, hearing, Representative Daddario asked Glennan several questions about NASA's action in establishing the Office of Life Science Programs. U.S. Congress, House, Committee on Science and Astronautics, *To Amend the National Aeronautics and Space Act of 1958*, Hearings on H.R. 9675, 86th Cong., 2d sess. (Washington: GPO, 1960), pp. 83-86 (hereafter cited as House Hearings, *To Amend the National Aeronautics and Space Act of 1958*).

<sup>44</sup> At a Mar. 28, 1960, hearing of the Senate Committee on Aeronautical and Space Sciences, Glennan was asked to supply answers for the record to questions concerning NASA's life science program. For Glennan's Apr. 9, 1960, reply, see Senate Hearings, *NASA Authorization for Fiscal Year 1961*, pp. 36-40. Special hearings were also held in the House on June 15 and 16, 1960: U.S. Congress, House, Committee on Science and Astronautics, *Space Medicine Research*, Hearings, 86th Cong., 2d sess. (Washington: GPO, 1960). The report based on these hearings

As it turned out, the Headquarters Office was built up much more slowly than planned—reaching only 16 by the end of fiscal year 1961 instead of the goal of 32.<sup>45</sup> A small research facility at NASA's Ames Research Center was established in February 1961, but plans for a larger and separate "central facility" never materialized. Randt resigned from NASA effective April 1, 1961, and the Office itself was drastically realigned in NASA's November 1, 1961, reorganization.

#### D. Other Organizational Changes in NASA Headquarters

**Office of Technical Information and Educational Programs Established.** In May 1960, NASA Headquarters' five major program offices (four technical and one administrative) were joined by a sixth one (informational). This new program office, the Office of Technical Information and Educational Programs (OTIEP), was established to give better focus to the Space Act requirement that NASA "provide for the widest practicable and appropriate dissemination of information concerning its activities and results thereof."<sup>46</sup> OTIEP was formed initially by consolidating several existing activities under a Director and Deputy Director brought in from AEC.<sup>47</sup>

In spite of the seemingly external orientation of the functions of OTIEP, it was placed under the jurisdiction of the program-oriented Associate Administrator.<sup>48</sup> This inconsistency was corrected in 1962 with the establishment of the Office of Public Affairs directly under the Administrator.

**Office for the United Nations' Conference Established.** In December 1959, the U.N. General Assembly passed a resolution calling for an international conference on the peaceful uses of outer space. NASA was given the assignment to prepare for possible U.S. participation in a fall 1961 conference. On January 29, 1960, NASA established an ad hoc Office for the United Nations' Conference (OUNC).<sup>49</sup> John Hagen was named Director, his second change in assignments in less than 1 year.

was H. Rept. 2227, *Life Sciences and Space*. On July 15, 1960, the Senate Committee on Aeronautical and Space Sciences issued a report, *Space Research in the Life Sciences: An Inventory of Related Programs, Resources, and Facilities*, Committee Print, 86th Cong., 2d sess. (Washington: GPO, 1960).

<sup>45</sup> "Position Complement List" as of June 30, 1961. Actually the Office reached a peak of 22 in late 1960. Buildup was as follows: 3 as of Mar. 31, 1960; 11 as of June 30; 17 as of Sept. 30; 22 as of Dec. 31; 19 as of Mar. 31, 1961; and 16 as of June 30.

<sup>46</sup> Sec. 203a(3).

<sup>47</sup> The Director, Shelby Thompson, had been the Deputy Director of AEC's Division of Information Services. The Deputy Director, Melvin Day, had been Director of Technical Information Services in AEC. The elements initially consolidated were the Technical Information Division (numbering 28 persons) of the Office of Business Administration, and the Exhibits, Publications, Audio-Visual, Historical, and Reports activities (totaling 16 persons) of the Office of Public Information. The Technical Information Division had been one of the largest divisions in NACA Headquarters, and upon NASA's establishment had been placed under the Office of Business Administration for want of a better home.

<sup>48</sup> General Management Instruction 2-1-13, May 30, 1960. (T.S. 105, June 30, 1960.)

<sup>49</sup> General Management Instruction 2-1-2, Jan. 29, 1960.

Since the conference would probably be a one-shot affair, NASA wanted to avoid setting up a permanent office, on the one hand, or completely distorting the activities of the Office of International Programs, on the other. Instead, NASA chose to set up a small office on a temporary basis—one that could easily be disbanded—and then detail to this Office the large number of individuals required to make U.S. participation a success.<sup>50</sup> Consequently 110 persons were programed for OUNC, with 15 constituting its permanent complement and 95 detailed in and out as the workload required. The Office was placed directly under Deputy Administrator Dryden.

When the conference failed to materialize, the OUNC was disbanded as of September 30, 1961.<sup>51</sup> Much of its planning work was utilized for subsequent activities.<sup>52</sup>

*Office of Research Grants and Contracts Reorganized.* Although this Office was very small at the time and not a very big spender, its 1960 reorganization is worth noting.

The Office of Grants and Research Contracts (its current name) has been moved as much as any office in Headquarters and is an interesting example of the administrative problem of finding an optimum organizational home for a function which does not have a natural home in an agency's hierarchy.

At the time NASA was established, it was felt that NACA's small "research by contract" program would have to be expanded considerably, with much of the expansion centered in research contracts with nonprofit organizations, especially universities. The program area in which much research was needed was in the space-flight development program headed by Silverstein. A controversy developed as to whether or not the University Research Program Office (as it was called in 1958 and early 1959) should be put under Silverstein (the area of need) or under the Office of Aeronautical and Space Research (Crowley) as recommended by the Abbott Committee. A neutral home directly under the Associate Administrator was considered but finally rejected. Glennan settled the controversy by putting it under the Office of Aeronautical and Space Research.<sup>53</sup>

The Office had a budget of its own and took care of most of the details of running a "research by contract" program, except to the extent that it was dependent on the technical program offices for the technical review and evaluation

<sup>50</sup> NASA Circular No. 55, Mar. 7, 1960. Subject: Detail of Personnel to the Office for the United Nations' Conference.

<sup>51</sup> NASA Circular No. 163, Sept. 1, 1961. Subject: Closing of the Office for the United Nations' Conference.

<sup>52</sup> See Wilfred J. Smith, "History of Office for United Nations' Conference," NASA Historical Monograph No. 2, September 1961. Work of OUNC proved useful at the various Geneva conferences on peaceful uses of space. Technical exhibit program was largely incorporated in the space exhibit at the Seattle World's Fair in 1962.

<sup>53</sup> See Ch. 3, Sec. II.C.



of research proposals and for monitoring research and on the NASA Procurement Division for assistance in contract negotiation.<sup>54</sup>

In May 1960 several important changes were made in this cooperative procedure.<sup>55</sup> The Office of Research Grants and Contracts (its name from April 1959 to October 1961) was made into more of a coordinator of research conducted for NASA by nonprofit institutions. The Headquarters program offices were given the chief decision-making power as to what research should be done and by whom. Secondly, the Office was given its own contract writing and negotiation staff so that it was no longer dependent on the Procurement Division. A measure of decentralization was provided for by giving field installations the power to negotiate and administer research contracts after their approval at Headquarters level. Thirdly, the Office of Research Grants and Contracts no longer funded the research contracts. Instead they were funded by the program office approving the project.

Since several program offices were involved, it was felt that the coordinating office, the Office of Research Grants and Contracts, should have a neutral home in the organizational hierarchy. It was moved from the Office of Advanced Research Programs to the Office of Business Administration.<sup>56</sup>

*Developments Relating to the Office of the Associate Administrator.* During 1960 several significant changes were made in the Office of the Associate Administrator. At the beginning of the year the Office consisted of the Associate Administrator (Horner) and two Special Assistants (Harris and King). A year later a much more elaborate arrangement prevailed. Some of the changes were the work of Horner, others were made by his successor, Robert Seamans. These changes, important in the overall management of the agency, are discussed in detail later in this chapter in connection with a discussion of agency management and program integration.<sup>57</sup>

## II. INTERNAL ADMINISTRATIVE DEVELOPMENTS

During 1960 two "thrusts" can be detected in the internal management of NASA. One was the "regularization" of certain activities arrived at by trial and error in 1959. The other was a movement toward more sophisticated management practices. Long-range planning and budget preparation are examples of the former, program management and budget execution of the latter. NASA demonstrated the ability to consolidate and innovate simultaneously. This proved to be good experience for the great challenges of 1961.

<sup>54</sup> Memorandum from the Administrator, Apr. 6, 1959. Subject: Functions and Authority—Office of Research Grants and Contracts. Its activities were not confined to nonprofit institutions and some contracts with industrial companies were written. Most contracts for research by industrial concerns were handled directly by the Office of Space Flight Development.

<sup>55</sup> NASA Announcement No. 134, May 17, 1960. Subject: Reorganization of the Office of Research Grants and Contracts.

<sup>56</sup> Accompanying the reorganization was a change in directors from Lloyd Wood to Thomas Smull.

<sup>57</sup> See Sec. II.E later in this chapter.

### A. Long-Range Planning

*The Preparation of NASA's First Long-Range Plan.* One of Glennan's earliest decisions on organizational matters was to establish an Office of Program Planning and Evaluation (OPPE) to assist him in the development of long-range policies and programs.<sup>58</sup> Glennan exerted a considerable amount of personal effort to staff the Office. Dr. Homer Stewart of the California Institute of Technology was recruited to serve as Office Director. It was Glennan's intention that the Office be small but highly effective.<sup>59</sup> At the end of 1959 it consisted of eight persons, four of whom had excepted positions.<sup>60</sup>

Although the OPPE concerned itself with a variety of long-range problems (e.g., equatorial launch sites, deep space exploration), one of its principal functions was the preparation of a comprehensive long-range plan.

Initial thinking on a long-range plan dated from early 1959.<sup>61</sup> The discussion of a comprehensive civilian space program at the March 1959 Symington subcommittee hearings pointed out the utility of long-range planning.<sup>62</sup> By June, OPPE had produced a working draft of a plan, with the chief inputs coming from Silverstein's Office of Space Flight Development. From September through November, revised drafts were discussed with the President's Science Advisory Committee, the Space Council, various DOD agencies, and various NASA units. The final product prepared in December, the "NASA Long Range Plan," was regarded as an internal planning document and classified "secret." A less detailed version, called the "NASA Ten Year Plan," was classified "confidential."

*The Plan Unveiled.* Although not volunteered to the House Astronautics and Senate Space Committees, the "Ten Year Plan" was supplied to them upon their request.<sup>63</sup> Some of the highlights of the plan were presented at an open hearing of the Senate Space Committee.<sup>64</sup>

What was revealed was a fairly broad-based program with emphasis on lunar exploration. Annual budgets over a 10-year period were estimated to average between \$1.2 and \$1.5 billion. The plan was keyed to certain large launch vehicles becoming operational, giving NASA the capability to launch heavy pay-

<sup>58</sup> See Ch. 3, Sec. II.B.

<sup>59</sup> Memo, Stewart to Glennan, Nov. 12, 1958.

<sup>60</sup> The excepted employees were: Stewart of Cal Tech; Rothrock of NACA; Clement of Rand; Scull of Cal Tech/JPL. In addition, there was a GS-14 and three secretaries. See the Position Complement Report for Dec. 31, 1959.

<sup>61</sup> Later in this chapter the work of the Kimpton Committee is discussed. One of the workpapers (No. 2) prepared for the Committee's use was entitled: "The Ten Year Plan: How did it come into being? When? How generally did the Offices and Centers of NASA participate?" One of the exhibits (A) was entitled, "The Steps by which the Ten Year Program Came into Existence."

<sup>62</sup> These hearings were discussed in Ch. 4, Sec. III.A. Glennan feels that NASA's long-range plan was a direct result of these hearings. Interview with T. Keith Glennan, Jan. 18, 1964.

<sup>63</sup> Memo, Glennan to Stewart, Feb. 24, 1960. Subject: Distribution of "The Ten Year Plan," a Confidential Document of NASA.

<sup>64</sup> Senate Hearings, *NASA Authorization for Fiscal Year 1961*, pp. 19-22.

loads. The important turning point on heavy-payload launch capability was expected to be fiscal year 1963 when the Saturn vehicle would come into use.

NASA felt that its plan was adequate to permit the United States to win, in the long run, more gold medals in the space Olympics than any other nation.<sup>65</sup> NASA conceded that other nations would win some gold medals, especially early in the Olympics.

NASA's long-range plan was basically an attempt to predict what the state of the arts would permit in the years ahead. Because of this it was scientifically and technically oriented, rather than administratively or politically oriented. Thus there was a great need to integrate it with intermediate- and short-range plans. Uncertainties, both technical and nontechnical, demanded that the plan be constantly revised.

*The Planning Process.* During 1959 there was a certain amount of built-in integration between long- and short-range planning by virtue of the fact that the same people were engaged in both. For example, the Director of OPPE was also a member of the Budget Analysis Team. During 1960 long-range/short-range integration was pushed even further.<sup>66</sup> The December 1959 long-range plan served as one of the important bases for the preparation of budget guidelines for the fiscal year 1962 budget. The budget preparation and review activity during the middle of 1960 constituted one of the basic inputs into the fall revision of the long-range plan. Other inputs into the fall revision came from budget execution and program management plans (both of which are discussed later in this chapter).

Revising the long-range plan was the function of OPPE. A criticism leveled at the 1959 preparation process was that the NASA field installations had not been brought into the process enough.<sup>67</sup> Steps were taken during 1960 to correct this deficiency.<sup>68</sup>

If the long-range plan was to be used as an overall blueprint for future administrative action, it would require a preparation and execution system far more comprehensive than the one prevailing in NASA at the end of 1960. Staffing, budgeting, and organizing factors would have to be added to the listing of desirable scientific and technical possibilities.<sup>69</sup>

<sup>65</sup> U.S. Congress, House, Committee on Science and Astronautics, *1961 NASA Authorization*, Hearings on H.R. 10246, 86th Cong., 2d sess. (Washington: GPO, 1960), pp. 485-486.

<sup>66</sup> See Workpaper No. 2 cited in footnote 61. Exhibit B consists of a memo from Horner to the Headquarters Directors, Mar. 22, 1960. Subject: Planning Schedule for the 1960 Long Range Plan.

<sup>67</sup> This criticism was made in the final report of the Advisory Committee on Organization (pp. 5-7) which is covered in detail later.

<sup>68</sup> Memo, Siepert to Glennan, Jan. 13, 1961.

<sup>69</sup> Perhaps DOD had a more realistic attitude. When a DOD representative (York) was asked if DOD had a long-range plan similar to NASA's, the response was that it did not. The reason given was that DOD's space program was tied to the overall defense program and could not be formulated independently. See Senate Hearings, *NASA Authorization for Fiscal Year 1961*, p. 508.

## B. Finance

NASA activity in the area of finance was substantial during 1960. Much of this activity centered around NASA's efforts to improve its financial management system. The 1959 traumas concerning White House and congressional funding support were not repeated during 1960. Of course, NASA had to live with 1959 funding decisions, which made budget execution an especially important function.

NASA's 1960 financial activities were complex. Three fiscal years were involved—executing the fiscal year 1960 budget, defending the fiscal year 1961 budget, and preparing the fiscal year 1962 budget. Important Headquarters financial management positions were filled. A new financial management system was developed for NASA's Marshall Center. Numerous innovations were made in budgeting, accounting, and financial reporting. The following discussion covers only some of the highlights.

**Basic Problems Facing NASA.** The basic financial management problem facing NASA was that its activities and spending were expanding at a faster rate than its ability to integrate and control them. The system of financial control inherited from NACA was geared to an annual spending level of under \$100 million, most of which was spent in-house for salaries and the other expenses of running large research laboratories. This system was inadequate for NASA with its much larger and more diverse program, most of which was accomplished out-of-house by means of cost-plus contracts. The problem was compounded by the fact that the press of everyday business inhibited any drastic overhaul of the system itself. The temptation was for NASA to meet only the fiscal requirements imposed from the outside. The role of financial data in the overall planning and control of internal operations was a relatively impotent one.<sup>70</sup>

The two basic requirements which have to be met by an agency's financial management system are legal requirements imposed from without and managerial requirements generated from within. The basic activities designed to meet these requirements can be divided into three categories—budgeting, accounting, and financial reporting. All three categories have external and internal aspects and are closely interrelated.

To meet these requirements successfully and completely, a financial management system must be soundly conceived and expertly maintained. This involves good procedures, optimum amounts of paperwork, command over detail (which requires that the system be largely mechanized), and adequate manpower. Such conditions are not easy to bring about in a new program which is growing rapidly and which involves uncertainties and unforeseen difficulties.

During 1960 NASA grappled manfully with these problems. Some were solved during 1960, but many carried over into 1961 and later.

<sup>70</sup> Memorandum, Rosenthal to Siepert, Aug. 16, 1960. Subject: Status of Financial Management System.

**Key Financial Management Positions Filled.** On February 1, 1960, the financial management activities of NASA were put under the direction of a person brought in from the outside. The person appointed to the excepted position of Director of Financial Management, Aaron Rosenthal, had been the Controller of the Veterans Administration, an agency considerably larger than NASA.<sup>71</sup>

Prior to Rosenthal's appointment, almost all of the senior officials engaged in financial activities had been carried over from NACA.<sup>72</sup> Most of the procedures followed had been NACA procedures. As stated earlier, these procedures were inadequate for the type of R&D activity that NASA was engaged in. There was a need for extensive modernization, including mechanization.

The Headquarters organization for financial management was modified during 1960 by adding an Accounting Systems Division staffed with four high-grade professionals. The Budget Division was strengthened by adding three high-grade budget analysts. The total financial management staff increased from 23 to 38.<sup>73</sup>

One of the major efforts to which the attention of the Office of Financial Management was devoted during the first half of 1960 was the development of a financial management system for NASA's new field installation at Huntsville, Ala.

**The Huntsville Project.** The transfer of ABMA's Development Operations Division to NASA presented several extremely difficult problems in the area of financial management. Until this transfer NASA had acquired projects and people at a slow enough rate so that they could be readily assimilated into the NACA/NASA way of doing things. The Huntsville transfer posed a much more complicated problem, especially in the light of NASA's already inadequate financial management system. It was deemed undesirable to install NASA's existing financial management system at Huntsville, and adopting Huntsville's existing Army system for all of NASA was unthinkable. The only viable alternative was to install a system at Huntsville which could be easily integrated into what was hoped to be a new and improved system for all of NASA.

Initially it was hoped that agencywide budgeting, accounting, and reporting classification codes could be developed for the Marshall Center and the rest of NASA simultaneously. Time and manpower shortages prevented this. Developing an agencywide coding system was deferred until after the Marshall Center's system had been installed.<sup>74</sup>

<sup>71</sup> NASA Announcement No. 85, Feb. 2, 1960. At the same time the excepted position of Director of Audits was filled (Raymond Einhorn). NASA Announcement No. 86, Feb. 2, 1960. The audit function will be discussed in later chapters.

<sup>72</sup> See Position Complement Lists for NASA Headquarters.

<sup>73</sup> *Ibid.*

<sup>74</sup> "Summary of Meeting With Mr. Finney, April 27, 1960." Prepared by Rosenthal, Apr. 28, 1960.

The objectives in developing a financial management system for the Marshall Center were these:

1. The system should be compact, yet all embracing;
2. It should be operated and administered by the Marshall Center's Financial Management Office as a *service* to the rest of the Center;
3. It should serve all levels of NASA management from the NASA Administrator down;
4. It should cover *all* costs, in-house and out-of-house;
5. It should permit total operating and program costs to be budgeted, accounted, and reported in a meaningful, comprehensive, and current manner;
6. It should include accrued costs whenever feasible;
7. It should become operational by July 1, 1960, when the mass transfer was to take place.<sup>75</sup>

Using the basis of a preconceived "Time Phase Plan" and written "Project Assignment Sheets," several "Project Teams," each responsible for a major segment of activity, worked diligently on the complex problems. The new system was installed by July 1; even though there were deficiencies in the system and even though considerable "debugging" had to be done, it was operational and an important factor in the relatively smooth mass transfer.<sup>76</sup>

Because so much effort had to be expended on the Huntsville project, the work on an overall NASA financial management system was slowed. Nevertheless several important things were accomplished.

***Innovations in Budgeting.*** Extensive changes were made in 1960 in NASA's system of budget execution. The existing system, reflecting NACA procedures, provided for fairly tight Headquarters control over money appropriated for S&E (Salaries and Expenses) and C&E (Construction and Equipment), but very loose control over money appropriated for R&D (Research and Development).<sup>77</sup> The chief control mechanism was the quarterly allotment by which Headquarters set ceilings on what could be spent on particular line items. The larger the number of line items for which separate allotments were made, the tighter would be central control.

This system was changed by reducing the number of items for which allotments were made but at the same time requiring more detailed planning on the part of line units in advance of the time when the allotments were made. In other words, the line units could plan, within fairly large categories, as to how they would use the funds appropriated by Congress. When approved by Headquarters, these plans, called Financial Operating Plans (FOP's), became the basis for making the allotments at the start of the fiscal year.<sup>78</sup>

<sup>75</sup> Report, Finney to Rosenthal. Summary Progress Report No. 5. Subject: Development and Installation of New Financial Management System at MSFC. [As of May 28, 1960.]

<sup>76</sup> Memorandum, Rosenthal to Siepert, Aug. 16, 1960 (cited in footnote 70).

<sup>77</sup> *Ibid.*

<sup>78</sup> In a draft summary of NASA's budget cycle, submitted to Siepert on Jan. 11, 1961, Rosenthal described (pp. 7-8) the FOP system. Also see Rosenthal's Memorandum for the Administrator. Subject: Fiscal Year 1961 Financial Operating Plans, Aug. 4, 1960. Allotments for

Once approved, the FOP became a basic guide for operations. Changes in the plan could be made only by following certain prescribed procedures, some of which had to receive formal Headquarters approval. FOP's for Salaries and Expenses were reviewed quarterly, but R&D and C&E FOP's were reviewed semiannually. Line units could reprogram funds within certain limits. Beyond that, the approval of the Associate Administrator was necessary.

Central control entered the picture only at the time the FOP's were approved or when departures from plan exceeded prescribed limits. The smaller number of items for which allotments were made cut down on red tape and gave operating line units a large spending latitude.

*Innovations in Accounting.* Changing an accounting system is very difficult; it is a specialized area involving a large amount of detail. The NACA/NASA system was overly detailed in certain areas (S&E) and insufficiently detailed in others (R&D). The expanding agency workload kept the bookkeepers constantly behind, especially since almost all work was done manually. The system was neither comprehensive nor integrated and could not supply the detailed and current information that management needed for operational decision making.

One of the biggest projects undertaken during 1960 (not implemented until 1961) was the preparation of an agencywide coding structure. This was a necessary first step in the establishment of a comprehensive and integrated accounting system as it would provide "a uniform system of accumulating costs for planning, programming, budgeting, accounting and reporting purposes throughout NASA."<sup>79</sup>

The 16-digit coding structure devised for NASA during 1960 provided a sixfold breakdown for each cost item. For example, a two-digit element identified the installation (Langley, Goddard, etc.), a four-digit element the program (each of the four digits representing a different aspect of each program), a three-digit element the project (Echo, Mercury, etc.), a one-digit element the fiscal year, a three-digit element the funding source and funding document, and a three-digit element the cost element (salary, rent, travel, supplies, etc.).<sup>80</sup>

A cost item is thus categorized several different ways by simply assigning a 16-digit code to it. Totals for each category (i.e., the total of all cost items having the same code for a particular category) can be relatively easily obtained and the information used for whatever purposes desired.

A coding structure must be open ended so that it can be expanded as the activities of the agency change. This was a very crucial factor for NASA because its program changed very rapidly. The coding structure has to be soundly conceived to accumulate the right kind of cost data. The data accumulation process is greatly improved by mechanization, and a coding structure is a necessary part

S&E were on a quarterly basis, for R&D on a semiannual basis, for C&E on a project basis. Also see General Management Instruction No. 3-5-3, effective date June 14, 1960.

<sup>79</sup> Memo from NASA Headquarters (Rosenthal) to Program Directors *et al.* Subject: Agency-wide Coding Structure, Nov. 14, 1960.

<sup>80</sup> *Ibid.*

of a mechanized system. During 1960, mechanization moved ahead in the field centers because they had computer capability on hand and the experienced people to assist in programing. Little progress was made in NASA Headquarters because these elements were lacking.<sup>81</sup>

Accounting for in-house activity was a difficult task in itself. Obtaining meaningful and detailed data on contractor costs was even more difficult. Very little progress in this direction was made during 1960. The importance of the problem was recognized, however.<sup>82</sup>

***Innovations in Financial Reporting.*** Reports are the usable end product of an accounting system and reflect what the accounting system is able to do. The NACA/NASA accounting system was able to supply only a fraction of the timely information needed for management purposes. But improvements in the reporting system had to await the improvement of the accounting system.

As a stopgap measure, the Office of Financial Management prepared a monthly Financial Management Highlight Report.<sup>83</sup> This report was first issued for March 1960, and was usually distributed to top management within 2 or 3 days after the end of the month. It was designed to give top management a bird's-eye view of NASA finances by comparing the actual with the planned for such items as S&E obligations for NASA and each installation, R&D obligations and commitments for NASA and each major program, C&E appropriation accounts, and the agency's personnel complement.<sup>84</sup> Early reports were hand-tooled and based on estimated rather than actual cost figures because the accounting system could not supply actual amounts quickly enough.

Although accomplishments during 1960 in the area of financial management were substantial, the real payoff to 1960 efforts was to have come in 1961. Subsequent problems, many of them associated with President Kennedy's 1961 acceleration of NASA's program, put the 1960 efforts to a severe test, and not everything planned for materialized.

To round out the discussion of 1960 NASA finance, the remainder of this subsection is devoted to an account of the enactment of NASA's fiscal year 1961 budget and the preparation of the fiscal year 1962 budget.

***Fiscal Year 1961 Budget Enacted.*** For Fiscal Year 1961 Congress appropriated to NASA everything the Eisenhower administration had requested, and authorized even more. This is summarized in the following table:

<sup>81</sup> See the memo from Rosenthal to Stephen Grillo, Director of Administrative Services. Subject: Mechanization of Financial Accounting and Reporting, Apr. 10, 1961. Also the memo from Rosenthal to Siepert. Subject: Mechanization of Fiscal and Reporting Operations, Apr. 25, 1961.

<sup>82</sup> Memorandum, Rosenthal to Siepert, Aug. 16, 1960 (cited in footnote 70).

<sup>83</sup> *Ibid.*

<sup>84</sup> The report is still being issued, although both format and content have changed over time.



TABLE 5-1

[In thousands of dollars]

Date	Action	S & E	R & D	C & E	Total
Jan. 18, 1960	Regular budget . . . . .	\$167, 560	\$545, 153	\$89, 287	\$802, 000
Feb. 8, 1960	Budget amendment . . . . .	3, 200	76, 300	33, 500	113, 000
	<b>Total request . . . . .</b>	<b>170, 760</b>	<b>621, 453</b>	<b>122, 787</b>	<b>915, 000</b>
Mar. 9, 1960	House authorization . . . . .	170, 760	621, 453	122, 787	915, 000
Apr. 29, 1960	Senate authorization . . . . .	170, 760	671, 453	127, 787	970, 000
June 1, 1960	Public Law 86-481 . . . . .	170, 760	671, 453	127, 787	970, 000
Apr. 20, 1960	House appropriation . . . . .	166, 500	602, 240	107, 275	876, 015
June 22, 1960	Senate appropriation . . . . .	170, 760	671, 453	122, 787	965, 000
July 12, 1960	Public Law 86-626 . . . . .	170, 760	621, 453	122, 787	915, 000
Jan. 18, 1960	Supplemental request . . . . .		49, 606		49, 606
Mar. 31, 1961	Public Law 87-14 . . . . .		49, 000		49, 000
	<b>Total requests . . . . .</b>	<b>170, 760</b>	<b>671, 059</b>	<b>122, 787</b>	<b>964, 606</b>
	<b>Total authorizations . . . . .</b>	<b>170, 760</b>	<b>671, 453</b>	<b>127, 787</b>	<b>970, 000</b>
	<b>Total appropriations . . . . .</b>	<b>170, 760</b>	<b>670, 453</b>	<b>122, 787</b>	<b>964, 000</b>

In the last chapter it was pointed out that the regular budget request of \$802 million was considerably less than what NASA asked for and far below what NASA might well have asked for in the light of the impending transfers.<sup>55</sup>

The budget amendment of \$113 million stemmed from what can be regarded as a breakthrough in White House support for the civilian space program, together with the realization on the part of the administration that the development of large launch vehicles was the Nation's No. 1 space need. In December 1959 Saturn officials claimed that a year could be saved on Saturn's development by accelerating spending during fiscal year 1961.<sup>56</sup> On January 14, 1960, in a letter to Glennan, President Eisenhower directed NASA, ". . . to make a study . . . of the possible need for additional funds . . . to accelerate the superbooster program. . . ." As a result NASA asked for an additional \$125 million. BOB allowed \$113 million, of which \$90 million was earmarked for Saturn. This made a total NASA budget request of \$915 million.

The action of the Senate in authorizing for appropriation \$55 million more than had been requested stemmed from a feeling on the part of the Senate Space Committee, especially its chairman, Lyndon Johnson, that NASA had been boxed in both by BOB and its own miscalculations on how much it would cost to run the Saturn program. Thus NASA needed some type of contingency cushion to

<sup>55</sup> See Ch. 4, Sec. II.D.

<sup>56</sup> See Senate Hearings, *NASA Authorization for Fiscal Year 1961*, pp. 22, 228.

give it operating leeway.<sup>87</sup> Senator Johnson's great influence was evidenced by the Senate Appropriations Committee and the Senate as a whole following the Senate Space Committee's recommendations almost exactly. The action of the Senate in appropriating more than requested offset the cuts made by the House. The action of Congress in authorizing more than had been asked for greatly facilitated the passage of a supplemental appropriation 9 months later.

It is interesting to note that NASA's fiscal year 1961 Appropriation Act cleared conference by June 30, 1960, which was before the beginning of the new fiscal year. This feat has not been repeated since.

*Fiscal Year 1962 Budget Prepared.* The same budget preparation procedure was followed for the 1962 budget as for the 1961 budget.<sup>88</sup> This meant that the substantive budget analysis was done by an ad hoc team rather than a central budget office. The strengthening of the Headquarters Budget Division came too late in 1960 to have much effect on the preparation of the fiscal year 1962 budget.

The preparation cycle began in February 1960 when Glennan issued budget guidelines. He declared that the 1962 estimates would be based "on the program objectives and levels outlined in the 10-year plan. . . ." <sup>89</sup> A budget ceiling of \$1.1 billion was established together with a personnel ceiling of 19,202 employees (which included 2,400 contractor employees for JPL). Glennan also asked that the operating units include in their preliminary estimates information on what 10 percent and 25 percent more money could buy, personnel numbers being kept constant. The OLVP/OSFP interface problem was recognized in Glennan's admonition to these two principal Headquarters program offices to make sure that their programs were coordinated.

NASA's 1962 budget was one of the important topics discussed at NASA's semiannual Staff Conference held in March 1960 at Monterey, Calif.<sup>90</sup> The ceilings established by the guidelines were explained as being more of a baseline than an absolute ceiling.<sup>91</sup> The operating units preparing the preliminary estimates were to demonstrate how additional money could improve NASA's program. Glennan pointed out that the emphasis should be put on developing contractor capabilities rather than in-house capabilities.<sup>92</sup>

In May the preliminary budget estimates were received by the Budget Analysis Team. The Bureau of the Budget was informed that the tentative agency

<sup>87</sup> U.S. Congress, Senate, Committee on Aeronautical and Space Sciences, *NASA Authorization for Fiscal Year 1961*, S. Rept. 1300, 86th Cong., 2d sess. (Washington: GPO, 1960), p. 13.

<sup>88</sup> See Ch. 4, Sec. II.D.

<sup>89</sup> Memo from Glennan to Headquarters Directorates, Feb. 2, 1960. Subject: 1962 Budget Guidelines.

<sup>90</sup> The conference, held Mar. 3-5, was attended by NASA's top officials. Also in attendance was Wernher von Braun of the not-yet-transferred Development Operations Division of ABMA. For a list of attendees, see pp. 62-63 of the Conference Report. One of the purposes of the conference was to give the Headquarters program directors the opportunity to discuss the budget guidelines with the field center officials under them.

<sup>91</sup> See p. 37 of the Conference Report.

<sup>92</sup> See p. 56 of the Conference Report.

estimates totaled \$1.376 billion. After additional analysis and review, however, this amount was revised downward to \$1,250 million in NASA's formal request to BOB. Yet another downward revision in December gave a new total of \$1,139,500,000. In January 1961 NASA was notified that the President's budget would include a total of \$1,109,630,000 for NASA, almost precisely equal to the original "ceiling" established by Glennan's February guidelines. The Bureau had cut NASA's R&D request by about 5 percent but increased S&E and C&E slightly so that the overall cuts amounted to about 2.6 percent.<sup>93</sup>

Before NASA's fiscal year 1962 budget was enacted into law, President Eisenhower's January 1961 request was amended upward by over \$650 million by the Kennedy administration. This upward revision was part of Kennedy's accelerated space program and will be discussed in later chapters.

### C. Personnel

Although there was no overhaul of NASA's personnel policies and practices during 1960 in the same manner that procurement had been overhauled in 1959 or financial management in 1960, there were several developments of note.

**Growth in the Number of NASA Employees.** During 1960 the total number of NASA employees increased from 9,567 to 16,042, an increase of 68 percent. Most of this increase was accounted for by the mass transfer of over 4,000 personnel from the Army to NASA as part of the transfer of ABMA's Development Operations Division to NASA. NASA Headquarters increased 45 percent (up 204 employees) and Goddard 68 percent (up 764 employees). All other installations taken together increased by only 140 employees. The Marshall Center accounted for all the rest. Some installations declined in size slightly.<sup>94</sup>

**Personnel Complement Ceiling Problems.** Throughout most of its history, NASA has operated within an overall personnel complement ceiling. At certain times this ceiling has been imposed from without, at other times from within. In some cases the ceiling has been little more than a gentlemen's agreement between NASA and either Congress or the Bureau of the Budget. The amount of the appropriation requested for salaries was based on a certain number of employees. If the request was trimmed by BOB or Congress, the number of employees was cut back accordingly, even though this was never explicitly written into the appropriation acts. Representative Albert Thomas, chairman of the Independent Offices Subcommittee of the House Appropriations Committee, was especially interested in personnel totals, and NASA's adherence to the total upon which the appropriation was based was done primarily in deference to him. Whenever

<sup>93</sup> A "Chronology of Budget Preparation—Fiscal Year 1962" for NASA can be found on pp. 170–171 of Senate Hearings, *NASA Authorization for Fiscal Year 1962*.

<sup>94</sup> Wallops Station and the Western Operations Office became independent field installations for reporting purposes on Jan. 1, 1960. Previously the Wallops employees were included as part of Langley and WOO as part of Flight Research Center. See App. C.

departures from the numbers originally agreed to were contemplated, they were cleared with him before any action was taken.<sup>95</sup>

The Eisenhower administration was also interested in total personnel numbers and attempted (and at times succeeded) to reduce the overall number of executive branch employees. NASA, being new and expanding, was never able to meet the Eisenhower objective of annual personnel reductions of from 2 to 3 percent.

Even though personnel numbers grew while Glennan was Administrator, there was a fair amount of feeling within NASA that he was too diligent in keeping the total number down.<sup>96</sup> This, of course, was in keeping with his deference to the wishes of President Eisenhower and with the Dryden/NACA tradition which he inherited.

At the March 1960 Staff Conference, Glennan expressed the idea that there was a need for some kind of arbitrary limitation on NASA's size.<sup>97</sup> By limiting the number of employees, NASA would limit its in-house capability and thus be forced to develop the capabilities of contractors in the course of expanding its space program.<sup>98</sup> Subsequent discussion at the conference revealed that the field centers were very unhappy with the various limitations imposed upon them in the personnel area.<sup>99</sup> Some of these limitations (e.g., budget controls on salaries and promotions) had been imposed by the Office of Business Administration in NASA Headquarters, others were related to the overall personnel ceilings associated with Glennan, BOB, and Congress.<sup>100</sup>

The personnel ceiling (excluding JPL) suggested in Glennan's February 1960 budget guidelines for fiscal year 1962 was 16,802. This was only 429, or less than 3 percent, above the total authorized for fiscal year 1961.<sup>101</sup> The Kennedy administration's space program acceleration resulted in an actual increase of 43 percent.

*"Excepted Position" Developments.*<sup>102</sup> When NASA was given the authority (in the Space Act) to establish and fill 260 excepted positions at salaries above the GS-15 rate, the decision to give NASA the jurisdiction over the Nation's super-booster program had not been made. This large addition to its program, and the transfer of ABMA's Development Operations Division along with it, prompted

<sup>95</sup> The information in this paragraph is a synthesis of the views of Robert Lacklen and Ralph Ulmer in telephone conversations, September 1963.

<sup>96</sup> This statement is based on the general impression gained from interviews with numerous NASA officials.

<sup>97</sup> [Summary of] NASA Staff Conference, Monterey, Calif., Mar. 3-5, 1960, p. 56.

<sup>98</sup> *Ibid.*

<sup>99</sup> Memo, Glennan to Siepert, Mar. 7, 1960. Glennan asked Siepert to "clarify, at the earliest possible date, the salary-promotion-complement limitation situation discussed with so much vigor on the West Coast." Glennan asked that whatever could be done internally should be done.

<sup>100</sup> The stringent budget controls on promotions, the chief complaint, were discarded in 1960. Letter, Siepert to the author, Dec. 23, 1964.

<sup>101</sup> Compare Glennan's 1962 Budget Guidelines with the "Summary Financial Plan for Fiscal Year 1961, NASA" submitted to BOB on Aug. 19, 1960.

<sup>102</sup> For a more complete summary, see Senate Hearings, *NASA Authorization for Fiscal Year 1961*, pp. 371-375.

NASA to ask for an additional 30 excepted positions. The need for 30 additional positions stemmed primarily from the fact that the ratio of such positions to the total number of professional positions was much lower in the Development Operations Division than in existing NASA field installations. The Army-NASA transfer plan provided that 18 of the Development Operations Division's 19 high-level positions would be transferred to NASA. Since top-level Marshall Center officials would compare themselves with their peers in NASA rather than with their former cohorts in the Army, it was necessary for morale purposes to bring Marshall in line with the rest of NASA. It was estimated that an additional 36 positions would be necessary to do this. The establishment of the Marshall Center would also require the establishment of several high-level positions in NASA Headquarters. NASA decided, however, that its overall requirement could be met with a total of 290 excepted positions, plus the 18 high-level positions transferred from the Army.<sup>103</sup>

NASA's March 1, 1960, request for the 30 additional positions received the approval of both BOB and the Civil Service Commission. In a March 31, 1960, letter to the Senate Space Committee, the Chairman of the Commission, Roger Jones, stated that the Commission preferred a Government-wide solution to the pay problems of high-level executive and technical positions, but that the NASA situation was an emergency one which could not await a general solution. The Commission felt that NASA's request was "a modest and thoroughly defensible extension in view of the President's recent decisions to enlarge substantially the NASA responsibilities in development of superboosters and to transfer to NASA the Army space team under Dr. von Braun."<sup>104</sup>

Congress authorized the additional 30 positions<sup>105</sup> and by the end of 1960 all but 27 of the 290 overall total had been established.

*New NASA Civil Service Examination.*<sup>106</sup> One of the items NASA had inherited from NACA was its tailor-made civil service examination system. NACA had filled its professional technical positions from a register based on the Aeronautical Research Scientist (ARS) examination, an examination fitted to NACA's requirements and used rarely by other agencies. The ARS examination was competitive, unwritten, and unassembled, and was used to fill positions from GS-5 to GS-15. Ratings were made on the basis of an evaluation of education and experience, with the goal of selecting precisely the type of person who would best contribute to NACA's research effort.

<sup>103</sup> Of the 30 additional positions requested, 3 were in the "above \$19,000" category, raising the total in this category to 13. In March 1960, nine had been filled, one was earmarked for von Braun, one for the Director of OLVP in Headquarters (at that time being filled by an AF general), and two were left for a reserve.

<sup>104</sup> The Mar. 31, 1960, letter is reprinted on pp. 374-375 of Senate Hearings, *NASA Authorization for Fiscal Year 1961*.

<sup>105</sup> Public Law 86-481, June 1, 1960, NASA's Fiscal Year 1961 Authorization Act.

<sup>106</sup> Most of the data on this topic were furnished by Dr. Allen Gamble of NASA's Personnel Division.

NACA's movement into space-related research after 1955 made the ARS examination obsolescent, and the transition to NASA speeded up the obsolescence process even further. Updating the ARS examination was an early order of business for NASA's Personnel Office. The person assigned to the task was Dr. Allen Gamble, the person who had developed the ARS examination for NACA, and who had returned to NASA in November 1958 after 3 years with the National Science Foundation.

By June 1959, Gamble was able to convince the Civil Service Commission that a complete revision of the ARS examination was necessary, even though it would take more time than merely amending it.<sup>107</sup> The Commission agreed, but wanted the revision to be completed as quickly as possible. Several thorny problems delayed matters. One was the Commission's reluctance to go along with Gamble's standards for determining entrance grade and salary. (Gamble wanted to be able to reward graduate students and superior students.)

By December 1959 a reasonably well-polished draft of a revised examination was ready for distribution to NASA's field installations for comment.<sup>108</sup> These comments were sought before the examination was presented to the Commission for final approval. The name of the draft examination was "Aero-Space Technologist." Replies were received during December 1959 and January 1960.

During the first half of 1960, the draft was extensively revised to meet both the requirements of the Commission and the suggestions of the field centers. The revised draft, dated July 1, 1960, was distributed to the field centers for further comment and the Civil Service Commission for approval.<sup>109</sup> The wording on the title page of the revised draft is revealing:

. . . Examination for Professional Positions in Aero-Space Technology . . . for work in Aero-Space functions of Research, Development, Design, Operations, Administrative Management, Information, for College Graduates with Degrees in appropriate fields of Physical Science, Mathematics, Engineering, or in certain specialties of Biology, Medicine, Psychology, social science, or other fields if supplemented by special qualifications. . . .

Enclosed with the submission to the Commission was a "Justification of College Education Requirement for Professional Aero-Space Technology Administrative Management and Information Positions in the National Aeronautics and Space Administration."<sup>110</sup> This was the major substantive area to which the Commission had not already given its prior approval. It proved to be the item to which the Commission objected most strenuously. NASA's argument was that a certain number of administrative and information positions in NASA

<sup>107</sup> See Gamble's Memo of Record, June 8, 1959.

<sup>108</sup> Gamble's cover memo is dated Dec. 11, 1959.

<sup>109</sup> Draft sent to the Civil Service Commission with Glennan's letter to Jones, July 15, 1960. Draft distributed to NASA field installations on July 19, 1960. Gamble's seven-page cover memo compares the July 1960 draft with the December 1959 draft.

<sup>110</sup> Dated July 1, 1960.

required "close working contacts with scientists and engineers," a "working knowledge of scientific and engineering terminology and concepts," and an understanding of the various problems peculiar to an R&D organization. NASA proposed that some amount of education in the engineering, physical, or biological sciences be required for anyone considered for such positions.

The Commission replied that it was not convinced that "specific course-work in science . . . is an absolute prerequisite to the acquisitions of knowledge of an agency's scientific programs which is needed for technical administrative positions."<sup>111</sup> The Commission felt that the NASA proposal would violate the Veterans' Preference Act which provides that "No minimum educational requirement will be prescribed in any civil service examination except for such scientific, technical, or professional positions the duties of which the Civil Service Commission decides cannot be performed by a person who does not have such education." The Commission, emphasizing the importance of work experience and the fact that educational requirements were primarily screening devices, argued that the Federal Service Entrance Examination (FSEE) provided a good basis for obtaining highly qualified candidates for "entrance level management positions." The Commission went on to say: "In the light of the relatively small number of management positions in NASA to be filled and the supply of well-qualified prospective candidates, it would be both unnecessary and undesirable to include administrative management and information positions in the proposed examination announcement."

The end result was to leave the administrative area for later negotiation (discussed in Ch. 8) and proceed in the scientific and engineering fields. On December 6, 1960, the Commission approved a two-part Aero-Space Technology examination.<sup>112</sup> Part A covered work in the physical sciences, engineering, and mathematics. Part B covered work in the life sciences and related fields. No written test was required. Applicants submitted to NASA a Standard Application Form 57, a transcript of college coursework, and certain pertinent papers, all of which were then evaluated by NASA professionals sitting as a Board of U.S. Civil Service Examiners. (The degree requirement for engineers was unique to NASA.) The applicant would be given a rating score and placed on the register of eligibles for the particular specialty for which the applicant was best suited. In 1960 these specialty registers numbered over 40.

The chief benefit that NASA has derived from having its own examination system is that it gives the agency the hiring flexibility to keep pace with the fast-changing technology upon which its program is based. Espousers of the AST examination have listed four major features: (1) It is work centered; (2) it uses an interdisciplinary approach; (3) it emphasizes demonstrated ability in contrast

<sup>111</sup> Letter, Jones to Glennan, Aug. 23, 1960.

<sup>112</sup> See USCSC Announcement No. 252B, Parts A and B. Part C, "Research and Development Administration," was approved June 15, 1962, and will be discussed in later chapters.

with experience only; (4) it is scored by NASA's own professionals who are experts in the specialties they evaluate.<sup>113</sup>

*Training.* An agency such as NASA whose program is on the frontiers of knowledge has to promote the self-development of its employees to be assured that they stay abreast of the latest scientific, technical, and professional developments. On the other hand, the workload of a new agency in getting a large-scale program going is so great that the use of resources for training, which has primarily long-range benefits, is greatly inhibited.

Until the end of 1960 almost all of NASA's training activities were related to scientific and technical research and development. Several training programs had been carried over from NACA. An apprentice training program was designed to train, both in the classroom and on the job, the skilled craftsmen such as machinists, instrument makers, model makers, etc., needed to support the in-house research effort in the NACA/NASA research laboratories. A co-op students program was designed to support engineering students while they were still in school with a view to recruiting them for regular employment with NACA/NASA upon graduation. A graduate study program, one of NASA's largest in number of participants, provided a means by which agency employees were encouraged to take graduate courses at local universities.<sup>114</sup> NASA professionals often taught graduate courses at nearby universities, as well.

It was recognized early that NASA's chief deficiencies in the training area were in the administrative, managerial, and executive development areas. The Eisenhower administration was especially concerned about executive development and Glennan took upon himself the responsibility to push for a NASA executive development program.<sup>115</sup>

In February 1960, NASA's Personnel Division appointed an Employee Development Officer in its Examination and Standards Branch.<sup>116</sup> High priority was given to the formulation of an executive development program. A draft proposal was completed by NASA's Personnel Division by the middle of July.<sup>117</sup>

The draft proposal declared that NASA recognized that "the quality of its executive leadership is a key factor in fulfilling the agency's mission."<sup>118</sup> NASA's policy was to have "a comprehensive program for the selection, appraisal, and professional development of its executives to insure maximum utilization of their

<sup>113</sup> See "The Utilization of Technical Personnel in the Space Age," an address by Hugh Dryden at the Engineering Manpower Conference, Denver, Colo., May 8, 1961.

<sup>114</sup> See "Annual Training Report" for fiscal years 1960, 1961, and 1962, prepared by the NASA Personnel Division. At the Apr. 25, 1960, meeting of the Space Exploration Program Council, Abbott discussed the Apprentice Training Program at Langley and revealed that the number of potential trainees had declined to the point where the future of the program was in jeopardy.

<sup>115</sup> See Annual Training Report for fiscal year 1960, p. 1. Also Glennan's memo to Lacklen, Aug. 1, 1960.

<sup>116</sup> Position Complement List for NASA Headquarters, Mar. 31, 1960.

<sup>117</sup> "NASA Executive Development Program," July 15, 1960.

<sup>118</sup> *Ibid.*, p. 1.



skills and to provide a reasonable reserve of talent qualified to move into positions of major executive responsibility as future needs of the organization develop.”<sup>119</sup>

The word “comprehensive” aptly describes the program recommended in the draft proposal. Basically, there were only two aspects to it. One was to identify and inventory the positions and individuals, generally GS-14’s and above, that would profit by executive training. The other was to develop an individual training plan for each person selected. In tailoring the training plan to the individual, a wide variety of training devices were listed: Extended residence study, short courses, off-duty study, selected readings, staff conferences, understudying, etc.

The proposal was never implemented. One reason was that it was almost too idealistic in attempting to tailor individual training plans to such a large number of individuals. A second reason was that a slight shift in priorities took place. The shift was away from executive development and toward the development of project managers.<sup>120</sup>

The project manager was a key person in the successful accomplishment of NASA’s program objectives. In most cases NASA’s existing program managers were excellent technical people but lacked experience in managing large projects. In view of this condition, Glennan agreed that emphasis should be placed on “a training program to improve our competence in *project management*.”<sup>121</sup> The only way that NASA could do this on a large scale was to do it on the job.

NASA hired a contractor, Harbridge House, Inc., to develop and present 2-week training courses in project management.<sup>122</sup> The courses, beginning in December 1960, were held at relatively isolated locations such as Williamsburg, Va. They were attended by personnel from all NASA installations. Attendance was not limited to project management personnel alone, but included general administrative types. Books such as Barnard’s *The Function of the Executive* and Metcalf and Urwick’s *Dynamic Administration* were used to stimulate thought. The main emphasis was on a number of case studies prepared by the contractor from actual, but camouflaged, R&D problems faced by NASA and DOD. Top NASA officials addressed the participants as did top managers from private industry.

It is generally agreed that the “seminars,” as they were called, were quite successful. Participants were able to “share each other’s operating experiences and to point up areas of practice where the talents of individuals and capabilities of the facilities in different Centers could be more fully and directly utilized as the role of the project manager is clarified and procedures for tapping these resources worked out.”<sup>123</sup> A certain measure of agencywide uniformity in project man-

<sup>119</sup> *Ibid.*

<sup>120</sup> See Glennan’s letter of Aug. 5, 1960, to Mr. Ralph Besse, president of Cleveland’s Electric Illuminating Co. This switch in emphasis probably stemmed from findings made in the course of the evaluation being made of NASA’s organization and contracting by the Kimpton Committee and McKinsey & Co. This evaluation is discussed later in this chapter.

<sup>121</sup> Memo, Glennan to Siepert, Sept. 1, 1960. This was recommended by McKinsey & Co. See footnote 165 below.

<sup>122</sup> Contract NASw-200.

<sup>123</sup> “Quarterly Manpower Utilization Report . . . For Quarter Ending December 31, 1960,” p. 7.

agement was achieved by the simple fact that the participants, with exceedingly diverse backgrounds, could meet together and exchange ideas. The seminars, inasmuch as attendance was not confined to project management personnel only, also helped to achieve some of the objectives of an executive development program.

**Other Personnel Developments.** NASA's Personnel Division, prior to July 5, 1960, performed the function of servicing Headquarters personnel in addition to its broader functions of giving overall direction to NASA's personnel program and establishing agencywide policies and procedures. This condition tended to diffuse the efforts of Division personnel and muddy their priority pattern. Servicing Headquarters personnel required a slightly different focus than the generalistic orientation of servicing agencywide activities. The problem was solved by establishing a Headquarters Personnel Office as an autonomous branch within the Personnel Division.<sup>124</sup>

In the fall of 1960, NASA's Personnel Division addressed itself to the problem of establishing a system for evaluating personnel management in all agency installations and correcting deficiencies when discovered. Such a system would require that performance standards be clearly stated and that inspections be conducted to make sure that the standards were being met.<sup>125</sup> This type of activity would become more and more important as the Civil Service Commission's period of grace for new agencies came to an end. It took about 2 years for the system to be established.

#### D. Procurement/Contracting

During 1960 NASA contracted with an outside consulting firm (McKinsey & Co.) to conduct a comprehensive evaluation of its contracting practices and procedures. This important study is discussed in a separate section later in this chapter.

Some of the contracting procedures established in 1959 and discussed in the last chapter were refined during 1960, but no major changes were made.<sup>126</sup>

**Contracts for Services.** The large number of requests in early 1960 for legal advice on service contracts prompted NASA's General Counsel Office to issue a 10-page memorandum as a first step in clarifying NASA's policy concerning them.<sup>127</sup> Fuller clarification came in 1963 and the following is intended only as a brief summary of the problem as NASA encountered it in 1960.

Historically it has been the policy of the Government, as evidenced by many

<sup>124</sup> NASA Announcement No. 165, June 30, 1960. Subject: Establishment of Headquarters Personnel Office.

<sup>125</sup> See Oct. 13, 1960, Memorandum by Grove Webster. Subject: Personnel Management Evaluation for NASA.

<sup>126</sup> The major entries in the *Federal Register* were as follows: 25 F.R. 403, Jan. 19, 1960 (Source Selection Boards, Procurement Advisor Committees); 25 F.R. 2100, Mar. 12, 1960 (Source Selection Boards); 25 F.R. 10766, Nov. 11, 1960 (Patents); 25 F.R. 10763, Nov. 11, 1960 (Contracts).

<sup>127</sup> Memorandum for Director of Business Administration from Paul Dembling, Assistant General Counsel, Apr. 26, 1960. Subject: Contracts for Services.

decisions of the Comptroller General of the United States, that regular employees of the Government responsible to the Government and subject to Government supervision shall perform the services necessary in connection with governmental activities.

However, it has been recognized in many recent studies and reports, including the so-called Bell Committee report, that the requirements of programs in the field of research, development, test, and engineering have entailed drastic alteration of traditional concepts of conducting Government business. This is especially true in NASA which has found it increasingly necessary to contract out services which have been or theoretically could be performed by civil service employees.

The factors which are considered by NASA contracting offices prior to contracting out of services include the following:

1. The services require special knowledge or skills not readily available through the Civil Service.
2. Performance of the services requires the furnishing and use of special equipment not readily available to the Government.
3. The services are temporary or intermittent, thus making impracticable the full-time employment of Government personnel.
4. Contracting for the services is more economical than performance by Government employees.
5. The services are of such a nature that direct supervision by Government employees is not required.
6. The services are to be performed at the contractor's plant or elsewhere off the Government installation.
7. Industry normally contracts out for the services required.

On the basis of these factors, NASA's General Counsel Office felt that most of the requests made by the field centers at that time (early 1960) would be allowable if the contracts were carefully written and thoroughly justified.

*Procurement Activity Trends.* The data in the following table depict some of the important trends in NASA's procurement activities: <sup>128</sup>

	Fiscal year 1959 (9 months)	Fiscal year 1960	Fiscal year 1961
Number of actions.....	27,000	44,000	94,000
Percent private business.....	93	95	89
Total value.....	\$213,000,000	\$337,000,000	\$756,000,000
Percent Government.....	46	32	29
Percent private business.....	41	52	56
(Percent to small business).....	(17)	(17)	(15)
(Percent by negotiation).....	(68)	(82)	(91)

<sup>128</sup> Data for Fiscal Year 1959 and Fiscal Year 1960 taken from "NASA Procurement, October 1, 1958, to June 30, 1960" and for Fiscal Year 1961 from "Annual Procurement Report, Fiscal Year 1961."

These figures hide the fact that much of the dollar value went to a very small number of firms in a small number of states. For example, in fiscal year 1961, 50 percent of the value of all awards to business went to seven firms. Seventy-two percent of the value of "direct action procurements over \$25,000" was placed with prime contractors in California (39 percent), New York (12 percent), Missouri (11 percent), and Alabama (10 percent).

In fiscal year 1961, 34 percent of the total value of all procurement was procured through the Marshall Center and 21 percent through the Goddard Center. In fiscal year 1960, before Marshall had been established, Langley, Headquarters, and Goddard accounted for 92 percent of the total value of all procurements.

### E. Program Integration

NASA was formed primarily by bringing together separate and sometimes diverse programs, projects, organizational units, ideas, etc. This "bringing together," or consolidation process, kept NASA in a constant state of flux for many months. The first good opportunity to "amalgamate" or "integrate" NASA's "brought together" program came in connection with planning for fiscal year 1961.<sup>129</sup> The effort to integrate NASA's program was made on a broad front and involved a variety of devices. Several devices already discussed were the long-range plan, the system of financial operating plans, and the personnel complement ceiling. The main thrust in program integration came from the Office of the Associate Administrator. Committee and conference approaches were also utilized.

*Problems Relating to the Office of the Associate Administrator.* As pointed out in chapter 3, the Office of the Associate Administrator was established primarily at the insistence of Glennan who wanted a high-level official to have jurisdiction over all of NASA's internal operations.<sup>130</sup> The operations of the several Headquarters program offices and the several field installations were put under the day-to-day jurisdiction of an officer just one level below the two political appointees, the Administrator and Deputy Administrator.

Two factors made it difficult, initially, for the Associate Administrator to control the elements under him. First, the top program and administrative directors (Crowley, Silverstein, Siepert) were powerful individuals in their own right. All were on the scene several months before the position of Associate Administrator was filled. Second, the former NACA laboratories had had a history of partial autonomy and built-in resistance to central controls.

The tripartite division of programs under the Associate Administrator (Research, Development, Administration) was natural and relatively simple, and the control and integrating problems were not beyond the capabilities of one man

<sup>129</sup> The early planning for fiscal year 1961 had to be drastically revised because of the decision to transfer the Saturn project to NASA.

<sup>130</sup> See Ch. 3, Sec. II.C.

and a small staff. As additional field installations and Headquarters program offices were established, and as the number of programs and projects increased, control and integrating problems multiplied, probably geometrically. Especially thorny was the interface problem stemming from the establishment of two separate Headquarters program offices in the developmental area—one for launch vehicles, the other for spacecraft.<sup>127</sup>

During 1960 the hand of the Associate Administrator in controlling NASA's overall program was greatly strengthened. Part of this strengthening was organizational, part was procedural.

**Organizational Changes.** In terms of sheer numbers, the Office of the Associate Administrator increased from 6 to 25 during 1960.<sup>128</sup> Most of the increase was accounted for by the establishment of two new suboffices—the Office of Program Management and the Office of Reliability and Systems Analysis.

The Office of Program Management (sometimes called the Office of Program Analysis and Control) was established during February and March 1960. This Office, about 12 persons in size, was given the responsibility for “integrating, formalizing, recording, and presenting program plans and reports” under a Program Management System.<sup>129</sup> (The Program Management System is described a little later.)

The Office of Reliability and Systems Analysis was established in March 1960. This Office was given overall responsibility for NASA's reliability program.<sup>130</sup> Included in this responsibility was the quantitative evaluation of NASA's programs and a definition of the technical difficulties that had to be overcome. This Office was attached to the Associate Administrator, so it could supply him with some of the detailed information needed to evaluate and direct NASA's program. The Office was staffed almost entirely by mathematicians and emphasis was placed on the statistical probability approach in determining reliability.

In addition to the establishment of two suboffices, the Office of the Associate Administrator was strengthened by the establishment of several “deputy”- and “assistant”-type positions. Two special assistants (one excepted, the other military) had been appointed during 1959. In January 1960 a Deputy Associate

<sup>127</sup> See Ch. 4, Sec. V.H.

<sup>128</sup> See Position Complement Lists for NASA Headquarters.

<sup>129</sup> Administrative Regulation and Procedure 6-2-3, May 5, 1960. Subject: NASA Program Management System.

<sup>130</sup> Preparations for the establishment of a reliability program were begun in 1959. Glennan called it “an activity which should be activated just as soon as possible” (Memo, Glennan to Horner, Nov. 16, 1959). The objectives of the program were to quantitatively measure the reliability of existing components, to determine what had to be done technically to increase reliability, and to devise a method for assuring that what should be done was done. An individually tailored reliability program would be established for specific systems. The several programs would be carried out by the field centers and NASA contractors under the guidance of Reliability Steering Committees. (See Golovin's presentation at March 1960 Staff Conference, pp. 50-54 of the Conference Report.)

Administrator (a \$19,000 excepted position) was appointed to share the full scope of the Associate Administrator's functions.<sup>135</sup>

Horner's resignation as of July 15, 1960, brought about further changes. His successor, Robert Seamans, did not report for duty until September 1.<sup>136</sup> During this interim Glennan assumed the duties of Associate Administrator.<sup>137</sup> Horner agreed to return to NASA as a consultant in order to brief Seamans after his arrival. The Deputy Associate Administrator (Golovin), who had also resigned (as of August 31), agreed to serve as a consultant to shepherd NASA's fledgling reliability program.

Seamans attempted to give a more formal structure to his Office by establishing, in October, two positions directly under him—an Assistant Administrator for Programs and an Assistant Administrator for Resources. The Assistant Administrator for Programs was given "staff responsibility for assuring adequate conception, programming, integration, and execution of NASA research and development projects."<sup>138</sup> He also supervised the two suboffices and served as acting Associate Administrator when Seamans was absent.

The Assistant Administrator for Resources was given "staff responsibility for assuring adequate programming, coordination, and use of resources and services as required to carry out approved NASA operating plans and programs of all types."<sup>139</sup> This involved the "allocation and utilization of manpower, funding, facilities and service support arrangements. . . ."<sup>140</sup>

The two positions were filled by detailing relatively high-ranking officials from other Headquarters offices. Perhaps the chief significance of these positions was in their being the first step toward the establishment of an Office of Programs in 1961—an event which gave the Associate Administrator the staff capability to cope with NASA's mounting integration problems.

*Procedural Developments.* In 1960 NASA established what was called a Program Management System.<sup>141</sup> This system was basically a reporting system designed to keep track of what was going on and compare it with what had been planned for. For each project which the Associate Administrator chose for

<sup>135</sup> NASA Announcement No. 71, Jan. 18, 1960. Subject: Arrival of New Deputy Associate Administrator. The person appointed, Dr. Nicholas Golovin, came to NASA from ARPA.

<sup>136</sup> Dr. Robert C. Seamans, Jr., was born in 1918. He received a B.S. from Harvard, and an M.A. and Ph.D. from MIT. He held various teaching and project management positions at MIT and was director of MIT's flight control laboratory in 1955 when he became a high-level manager of RCA. He had served on NACA Advisory Committees and was a member of the Scientific Advisory Board of the Air Force when he came to NASA. NASA Announcement No. 173, July 19, 1960. Subject: Appointment of Associate Administrator.

<sup>137</sup> NASA Circular No. 93, Aug. 3, 1960. Subject: Interim Operating Plans—Office of the Associate Administrator.

<sup>138</sup> NASA Circular No. 110, Oct. 21, 1960. Subject: Establishment of Positions of Assistant Administrator for Programs and Assistant Administrator for Resources—Office of Associate Administrator.

<sup>139</sup> *Ibid.*

<sup>140</sup> *Ibid.*

<sup>141</sup> Administrative Regulation and Procedure No. 6-2-3, May 5, 1960. Subject: NASA Program Management System.

inclusion in the system, a master Program Management Plan (PMP) was prepared. This plan stated who does what and when. "Action Milestones" were identified and used as checkpoints to measure progress.

A reporting cycle was established based on biweekly progress reports. This "Report of Progress Against Program Requirements" was prepared by the contractor or NASA installation doing the work. It included information on all "milestones" scheduled for completion during the reporting period and any other data that would alter the original PMP. The progress report was then routed through the NASA project officer, the Headquarters program office, and ended up in the Office of Program Analysis and Control. On the basis of the report, a revised PMP was prepared. The progress of a project was tracked in a systematic way and all levels of management informed accordingly.

Overall monitoring of the system, including the revision of the PMP's, was the function of the Office of Program Analysis and Control. It was also the responsibility of this Office to "Provide the Associate Administrator with appraisals of project and program consistency and progress against plans in respect to schedules, resources, and overall NASA plans and objectives. . . ." <sup>142</sup> The first project covered by the system was Tiros, followed by Mercury and Saturn. <sup>143</sup>

The PMP system was supplemented by the more sophisticated PERT system in 1961. <sup>144</sup> In the meantime the PMP system served two very useful purposes. First, it educated NASA on what a reporting system was like and what it could do. Second, it was NASA's first disciplined scheduling system and was a sharp contrast to the NACA "level of effort" environment where deadlines were not as serious as in a complex flight development system. <sup>145</sup>

**Biweekly Project Status Review.** The PMP system generated information which pinpointed problems. <sup>146</sup> Identifying problems, however, is only the first step in their solution. In August 1960 Glennan inaugurated a system of biweekly meetings at which specific problems were analyzed and solutions worked out right on the spot. <sup>147</sup> This "Review for the Administrator" was meshed with the PMP reporting cycle and was chaired by the Associate Administrator. It was attended by the top one or two officials from the two major program development offices,

<sup>142</sup> *Ibid.*

<sup>143</sup> See p. 49 of the report of the Staff Conference of March 1960.

<sup>144</sup> The PERT system is discussed in later chapters. The PMP system was developed in-house by personnel who had come to NASA from various elements of the Department of Defense. In addition to the in-house effort, a contract was entered into with Ramo-Wooldridge (NASw-145) for a study of the problems of management and program control. Ramo-Wooldridge proposed a "NASA Management and Control System" in its final report of Nov. 30, 1960. By then the PMP system was well underway. Instead of using the Ramo-Wooldridge system for the next generation of systems, NASA chose to adapt the PERT system to NASA.

<sup>145</sup> Based on telephone conversation with Walter Haase of NASA Headquarters, Sept. 26, 1963.

<sup>146</sup> According to Walter Haase of NASA Headquarters, the PMP system revealed wide discrepancies (up to 6 months) between the schedules for a spacecraft and the schedules for the companion launch vehicle. (Telephone conversation, Sept. 26, 1963.)

<sup>147</sup> See Robert King's memo to Ostrander and Silverstein, Aug. 24, 1960. Subject: Initiation of Review for the Administrator.

OSFP and OLVP, with lesser officials brought in only when needed. These biweekly meetings were discontinued after Glennan's departure.

*The Staff Conference.* Twice a year NASA's top officials met together to discuss what NASA was doing, where the agency was headed, and what problems were being encountered. Glennan personally initiated the semiannual conference as a device for promoting Headquarters-field communications. Although the conferences were not decision making institutions, the exchange of information and views often led to the solution of problems and prevented others from occurring.

For example, the report of the March 1960 conference held at Monterey, Calif., reveals that several thorny administrative problems were discussed. The former NACA laboratories complained that they were being caught in a vise.<sup>148</sup> Their workload was increasing, primarily because of the demands placed on them by NASA Headquarters, but at the same time they were all but being forced to decrease their total staff. The overall dollar limitation on salary expense, imposed by Headquarters, was forcing the field center to reduce total numbers of employees to meet the costs of in-grade pay increases and grade promotions. Another problem was that NASA's Research Advisory Committee system was not working out as planned and required a certain amount of revision.<sup>149</sup>

*The Space Exploration Program Council (SEPC).* The contribution of the semiannual conference toward agency integration was real but somewhat intangible. The establishment of the SEPC was intended to promote agency integration still further. The Council was formed in 1960 to "provide a mechanism for the timely and direct resolution of technical and managerial problems that are common to all Centers engaged in the space flight program."<sup>150</sup>

The Council met quarterly in the Office of the Associate Administrator and was composed of a small number of very high officials—the Directors of Goddard, Marshall, and JPL (Goett, von Braun, and Pickering); the Directors of the Headquarters Program Offices, except for Life Sciences (Abbott, Silverstein, Ostrander, and Siefert); and, of course, the Associate Administrator and some of his assistants. Other officials sat in from time to time, including Glennan and Dryden. Meetings were based on a formal agenda distributed in advance.

The efficacy of the SEPC was based on the concept that high-level officials can best solve problems, or at least arrange for the solution of problems, by attacking them around a conference table rather than by an exchange of paper. The exchange of views and information which meetings afforded prevented other problems from developing. The subject matter was generally confined to space exploration problems (i.e., NASA's flight program), as that was where the timeliness of decisions was especially important. (Needless to say, most problems faced by the Associate Administrator could not await the convening of a quarterly conference.)

<sup>148</sup> See pp. 24-30 of the Conference Report.

<sup>149</sup> See pp. 32-33 of the Conference Report.

<sup>150</sup> [Minutes of the] Space Exploration Program Council Meeting, Feb. 10-11, 1960.



Problems dealt with were far ranging. The first meeting in February 1960 discussed the precise allocation of power between the Headquarters Reliability Office and the project office in the administration of NASA's reliability program. Attention was devoted to the problem of having launch pads available in time for launches. The management of the Agena B program was discussed. (The Agena B, an upper stage of a launch vehicle, is a good example of a problem of coordination. The stage was developed by the Air Force and Lockheed and used by both the Air Force and NASA with both Thor and Atlas first stages. NASA used the Agena B stage in several of its programs and "interface" problems were substantial. The coordination machinery was quite elaborate.)

The April meeting discussed over 15 separate topics ranging from NASA's Financial Operating Plans to a discussion on when to switch *Pioneer V* over to its high-power transmitter.<sup>151</sup> Subsequent meetings were held in July and September 1960, and January 1961. After Glennan's departure, no more SEPC meetings were held even though several had been planned. The concept of a "super-council" was not abandoned; it was used later in connection with the management of NASA's manned space-flight program.

**Formal Project Authorization.** Prior to 1961 NASA had no standard system for the official authorization of new projects. The formulation of a standard authorization procedure was undertaken in November 1960.

In anticipation of the new system, an attempt was made to draw up a list of all projects authorized in the past.<sup>152</sup> This attempt revealed a variety of past approval methods.<sup>153</sup> Some projects had been approved verbally only, some had been in the budget but no formal approval action could be found, some were under contract implying some type of formal approval, some were commitments made in letters to outside organizations, some had appeared in a variety of places (flight schedule, PMP's, etc.) and could be presumed to have been approved.

In January, Glennan issued a document listing all projects which had been authorized for program execution while he had been Administrator.<sup>154</sup> The document was designed to give the new Administrator a base for future project authorizations. At the same time NASA issued instructions for a formal system of project approvals.<sup>155</sup> These were two of Glennan's final actions as NASA Administrator. The January instructions were revised 4 months later. The details of the original and revised system are presented in Chapter 7.

<sup>151</sup> Minutes, Space Exploration Program Council Meeting, Apr. 25-26, 1960.

<sup>152</sup> Memo, Cortright to Silverstein and Ostrander, Nov. 3, 1960.

<sup>153</sup> See Ostrander's Nov. 14, 1960, memo and Wyatt's Nov. 18, 1960, memo, both to Cortright in reply to his memo of Nov. 3, 1960.

<sup>154</sup> Document is classified "Confidential."

<sup>155</sup> General Management Instruction No. 4-1-1, Jan. 18, 1961. Subject: Planning and Implementation of NASA Projects.

### III. ORGANIZATIONAL AND ADMINISTRATIVE SELF-EVALUATION

#### A. Background for the Self-Evaluation Studies

"To help the Administrator assess the effectiveness of NASA philosophies of operation and internal organization," two studies were undertaken by NASA during 1960.<sup>156</sup> One was a study of NASA's "contracting philosophy and the relationship that should exist between NASA and industry."<sup>157</sup> The other was a study of NASA's overall organization. The former was done entirely by McKinsey & Co., the management consulting firm hired by NASA on three previous occasions. The latter was done by an ad hoc advisory committee, assisted by McKinsey & Co. and a group of NASA personnel. Taken together, these two studies and the reports that flowed from them give a comprehensive picture of NASA's organization and management as it had evolved during NASA's first 2½ years.

Early thinking on the studies took place during late 1959 and the early details were worked out by one of Glennan's close advisers, John Corson of McKinsey & Co.<sup>158</sup> Corson and Glennan agreed that the opportunity to make comprehensive changes in NASA's organization and procedures would not exist too much longer; i.e., bureaucratic hardening of the arteries would make change more and more difficult as the agency became older and larger.<sup>159</sup>

Although the two studies were interrelated and had a common origin and although McKinsey & Co. was contracted to work on both of them, it is desirable to discuss them separately. The contracting study is discussed first as it moved along on a slightly earlier time frame than did the organizational study and the information generated in the contracting study was used in the organizational study.

#### B. The McKinsey Study of NASA Contracting

*Objectives.* On February 26, 1960, NASA entered into a \$65,000 contract with McKinsey & Co. for a "Management study covering the appraisal of NASA's Contracting Policies and Industrial Relationships."<sup>160</sup> The objectives of the study were to obtain answers to several fundamental questions on how NASA should conduct its operations. The basic question to be answered was what was the best way for NASA to utilize the R&D capabilities of private industry, other

<sup>156</sup> See p. 56 of the report of the March 1960 NASA Staff Conference.

<sup>157</sup> *Ibid.*

<sup>158</sup> It would appear that external rather than internal influences prompted the studies. The external influences were: The suggestions of Crawford Greenwalt, president of Du Pont (Letter, Glennan to Greenwalt, Feb. 10, 1960), and an article by John Corson, "Government and Business: Partners in the Space Age," *Management Review*, September 1959 (Letter, Glennan to Corson, Nov. 18, 1959).

<sup>159</sup> See Corson's Jan. 26, 1960, letter to Glennan, and Glennan's Mar. 18, 1960, memo to the members of the Advisory Committee on Organization.

<sup>160</sup> NASA Contract NASw-144.

Government agencies, and its own field installations. More specifically, NASA wanted to know what the role of its own development centers (Goddard, Marshall, and JPL) should be in out-of-house contracting; i.e., should the centers, in connection with a specific project, behave like a prime contractor and let contracts with several firms for the subsystems of the project, or should the centers merely monitor the performance of a contractor who is given almost complete responsibility to carry out the project? What approaches and techniques should NASA use in supervising the operation and in evaluating the performance of its contractors? What innovations should be made in the types of contracts used?

All answers were to be within the framework of NASA's 10-year program, its current in-house R&D resources, and its policy of decentralizing "major elements of the contracting job to the Development Centers."

**Method.** To answer these questions, McKinsey & Co. was to engage in a fact-finding and analysis operation with three distinct facets. First, McKinsey & Co. was to closely examine "a sample of representative contracts" that NASA had already entered into. Second, it was to "appraise the experience of other Government . . . agencies in contracting for research and development projects," such as the Navy's Polaris, the Army's Jupiter, and the Air Force's Atlas. Third, it was to "analyze the contracting approaches and techniques" then being employed by three different organizations—Langley, a former NACA laboratory; JPL, a contractor-operated, NASA-owned facility; and ABMA's Development Operations Division, an Army installation in the process of being transferred to NASA.

On the basis of the fact-finding and analysis operation, a preliminary report would be circulated among NASA officials for comment. Agency comments would then be incorporated into a final report which in effect would then become an agreed upon blueprint for action. An original target date of July 31 was set for the final report, but this was later extended to October 31, 1960.<sup>161</sup>

**Findings.**<sup>162</sup> The final report, almost 100 pages in length, was submitted to NASA in October 1960.<sup>163</sup> It was entitled "An Evaluation of NASA's Contracting Policies, Organization, and Performance." The report consisted of recommendations and included some of the evidence upon which the recommendations were based.<sup>164</sup> The recommendations were directed primarily toward creating a healthy overall environment for NASA's contracting operations, and detailed directives on what should be changed were kept at a minimum. To put it another way, the recommendations were designed to establish a uniform, agencywide contracting philosophy, rather than to reveal all the little things that may have been wrong with NASA's existing procurement system.

<sup>161</sup> The reason for the deadline extension was that the original contract was amended to provide for the participation of the McKinsey & Co. in the study of NASA's organization.

<sup>162</sup> The parenthetical page references which follow are intended to serve as a guide to the contents of the final report.

<sup>163</sup> Letter of transmittal was dated Oct. 28, 1960.

<sup>164</sup> It is generally recognized that McKinsey & Co.'s John D. Young was primarily responsible for the report. Two months later he was hired to head NASA's Management Analysis Division.

The recommendations can be divided into four major categories: (1) How to achieve the optimum balance between in-house and out-of-house efforts; (2) how best to internally allocate responsibility for NASA projects; (3) how best to supervise out-of-house efforts; (4) how best to reorganize and strengthen NASA's contracting machinery.

(1) To achieve the optimum in-house/out-of-house balance, the report set forth several guidelines. NASA's in-house capability should be concentrated on two things. One was the capability to "undertake the conceptual and preliminary design elements of development projects in each major program area . . .," or at least be able to "effectively review and approve conceptual and preliminary design elements of projects submitted by contractors" (p. 2-10). This capability was absolutely necessary if NASA was to fulfill its responsibilities in directing the Nation's civilian space program. The second was the capability to design, fabricate, assemble, test, and check out the elements of at least one vehicle (or stage if a large one) and one spacecraft unique to each major program. The launch vehicle and spacecraft selected for in-house attention should be the ones which "extend the state of the art . . ." (p. 2-11). Being able to do a complete job, even though only a small number of launch vehicles and spacecraft were involved, would give NASA the necessary capability to formulate realistic requirements or specifications in soliciting proposals from contractors, to develop realistic cost and budget items, to supervise contractor efforts, and to plan its space program realistically.

By and large, all other developmental activity should be done by contract. NASA's in-house conceptual and preliminary design efforts should be supplemented by the use of study contracts, primarily to educate industry (p. 2-11). The detailed design, fabrication, assembly, test, and checkout of all launch vehicles and spacecraft should be contracted out except for the representative few done in-house. All "production manufacturing efforts," including relatively standard parts and components for in-house developmental work, should be done by contract (p. 2-13). NASA should even go so far as to contract out "total space vehicles," which in effect would give NASA a completed or finished product and give industry the overall experience which they would need to support NASA's large projects of the future. (The thought was that NASA's in-house "systems engineering" and "systems integration" capabilities could only be spread so far and would have to be supplemented by U.S. industry.) Finally, NASA should contract with the scientific community for 70 to 85 percent of all space-flight experiments, relying heavily upon universities (p. 2-14).

The report implied that if NASA adhered to these guidelines, the departures from current tendencies would be primarily in magnitude (i.e., stepped-up out-of-house effort) rather than in substance. By codifying the best of NASA's contracting tendencies, a desirable and uniform basis to guide future actions was established.

(2) In terms of the best internal allocation of responsibilities for NASA's development projects, the report advocated a system that would keep inter-install-

tion coordination at a minimum. In other words, assign the execution of an entire project to one installation. Projects should be assigned on the basis of logic and common sense (i.e., consider the capabilities and specialities of the installation in relation to the primary objectives of the project, assign similar projects to the same installation, etc.) (pp. 3-6, 3-7).

By giving overall management responsibility for each project to a particular field installation, a decentralized system would be established which would free NASA Headquarters from the heavy workload of intra-project coordination and permit it to concentrate on inter-project coordination. Headquarters would review and approve projects in the light of the overall objectives, schedules, and costs of the entire agency (p. 3-8).

If a decentralized system was to work, the report stated, NASA would have to strengthen the project management capabilities of its field installations. Especially important would be the development of 10 to 20 outstanding project managers (p. 3-11). The report stated this in very emphatic terms. The responsibilities of the project manager would be manifold. He should participate in the initial planning of the project, be its advocate in getting it approved, devise the organizational structure for carrying it out, determine who does what and when, evaluate contractor proposals, coordinate all efforts, and in general see to it that things moved along satisfactorily (p. 3-12).

The report recommended that NASA adopt as its regular project management policy the method used extensively by industry and private laboratories, i.e., using an "integrated project management team" headed by a "full-time project Manager reporting directly to the Director or Deputy Director" of the installation assigned the project (p. 3-13).

The team should consist of both technical and managerial personnel, with the larger projects requiring the full-time membership of specialists in both areas. The project manager would combine within himself both technical and managerial skills. If NASA were to maintain an adequate number of highly competent managers, it would have to create a healthy work environment with an optimum balance among responsibility, authority, status, pay, and challenge. The need was so great and so imminent that NASA should expand its efforts to train its own project managers (p. 3-15).<sup>165</sup>

(3) The report revealed that NASA's record in managing its contract efforts was spotty. Difficulties had arisen because NASA neglected certain basic prerequisites to effective contractor supervision, such as adequate statements of work, sufficient and flexible funding, and properly focused technical responsibility. (A basic problem in connection with the last-named prerequisite was NASA's tendency to establish two channels of supervision—one from Headquarters, the other from the field center.)

NASA's supervisory job was difficult in that it could neither use the "trust the

<sup>165</sup> NASA's effort to train project managers was discussed earlier in this chapter, Sec. II.C. It was this recommendation that prompted Glennan to support the project manager training program.

contractor" approach (high reliability was too crucial to be left to the contractor alone) nor the "tight control" approach (which would "discourage contractor creativity and initiative") (pp. 4-6, 4-7). Therefore NASA had to follow a middle course which combined contractor operating freedom with close NASA guidance. To achieve this balance there must be a constant flow of information back and forth between NASA and the contractor. This flow could be promoted by periodic progress review meetings between NASA and the contractor, the placement of a NASA representative in the contractor's plant (to permit continuous face to face communication), and the use of a progress reporting system (such as the PMP system previously described) (p. 4-9).

The report devoted several pages to the problem of NASA's controlling contractor's costs (pp. 4-12 through 4-17). NASA's problem in this area was substantial because it relied heavily on cost-plus contracts, encouraged the use of subcontracts "as a means of distributing contract dollars to more firms," and relied on DOD to do much of its contract administration.

It was pointed out that NASA's cost supervisory job would be made much easier if, before a contract was awarded, NASA could be assured that the contractor had a good accounting system, a realistic "make or buy" policy, and a good purchasing system. Even though a pre-award evaluation revealed that the contractor had an adequate cost-management system, there was still a need for post-award cost controls. The report commended NASA's effort in developing its "Proposed System for Financial Reporting by NASA Contractors Holding Cost-Type Contracts" and urged its early implementation.

In closing the discussion of contractor supervision, the report recommended that NASA continue to make use of the military services for contract administration and other "field service functions," but at the same time increase its own activities in these areas by approving all major subcontracts, by handling "special situations" directly, and by periodically evaluating the job done by the military services.

(4) The final chapter of the report concerned the deficiencies in NASA's procurement machinery and what should be done to correct them. The basic indictment of NASA was that it had neglected the "procurement function" even though it was basic to NASA's function and should have claimed the attention of officials at every level in NASA's hierarchy from the Administrator down. "To date, NASA has not effectively organized to perform the whole contracting function, and the needed procurement leadership has not been developed" (p. 5-4).

The following specific deficiencies were noted (pp. 5-4 through 5-11):  
(a) "The headquarters Procurement and Supply Division has not yet been effectively established and staffed." As a result of this, in turn, "a complete set of procurement regulations to guide technical and management staffs has not been developed and issued . . . ." The Division Director (Brackett) has been "unable to devote adequate time" to the important affairs external to the Division because he has been too involved in "internal division management . . . ." This partly stemmed from the fact that "Statements of responsibility and authority

for the principal jobs within the Division have not been agreed to and issued." One underlying reason for this situation was that "the headquarters procurement staff has not been given sufficient organizational status to enable it to carry out its responsibilities effectively." (b) "NASA technical staffs have repeatedly manifested a lack of understanding of the whole contracting process." Some technical people have dismissed as unimportant the role that the procurement staff can play. As a result, the technical people have frequently gotten themselves into trouble by not allowing sufficient time for procurement planning and negotiation, by making commitments in advance and then expecting the procurement people to write the contract accordingly, and by neglecting cost analysis in evaluating proposals. (c) "The principle of integrating technical supervision and contract administration has been frequently negated." Often the technical people made changes without informing the contract administration people. Similarly, the contract administration people, especially when poorly program-oriented, failed to anticipate the needs of the technical staffs. The lack of coordination often existed in NASA when the technical staff was associated with one installation and the contracting people with another. This situation was actually promoted by NASA in December 1959 when the Associate Administrator "decentralized procurement activities to the field, but failed to remove technical supervision of contracts from headquarters."

What should be done about these deficiencies? Several recommendations were made. Concerning the Headquarters Procurement and Supply Division, the report recommended that current plans to increase the staff from 36 to 56 be implemented, together with a general internal realignment (p. 5-8).<sup>166</sup> The position of Assistant Director should be established to take over the problems of day-to-day management of the Division, thus permitting the Director to concentrate on external working relationships (p. 5-6).<sup>167</sup> The Division's status within NASA could be improved by increased support from the Associate Administrator (p. 5-8).

The problem of educating technical people as to the important role that procurement people can and should play would be difficult to solve. NASA's top management should take the lead by stressing the necessity of team action in procurement matters.

On the problem of coordinating technical supervision and contract administration, the main recommendation was that the activity of NASA Headquarters in technical supervision be reduced, and the task of integrating technical supervision and contract administration be centered in the project manager in the field (p. 5-12).

<sup>166</sup> The report recommended that the planned realignment be modified by establishing a separate division within the Office of Business Administration for facility planning and coordination. This is another example of the difficulty NASA had in determining the best way to handle the problem of facilities coordination.

<sup>167</sup> This had already been done by the time the report was issued.

The above has been a summary of the October 1960 Report on NASA Contracting prepared by McKinsey & Co. The extent to which it incorporated comments made by NASA officials on the basis of a draft report circulated 2 months earlier is difficult to ascertain.<sup>168</sup> There is one interesting statement in a draft that does not appear in the final report. "If these steps [the recommendations for strengthening NASA procurement] do not produce stronger procurement leadership within the next fiscal year, a separate Office of Procurement reporting directly to the Associate Administrator should be established."<sup>169</sup> This statement expresses the belief that the location of an office in an agency's overall hierarchy makes a substantial difference. It also is prophetic, as the action recommended in the draft was actually taken in 1963.

The precise manner in which the preparation of the report influenced subsequent agency behavior is difficult to ascertain. There is some evidence that the discussions held between NASA officials and McKinsey officials prior to the preparation of the draft report actually resulted in certain changes being made, or at least hurried along changes previously contemplated.<sup>170</sup> There is also some evidence that circulating the draft report for comment also produced the implementation of several of the report's recommendations.<sup>171</sup> Lastly, the final report itself was circulated for comment.<sup>172</sup> There is evidence that this also resulted in certain recommendations being implemented.<sup>173</sup>

<sup>168</sup> Comparing the draft with the final report did not readily reveal significant differences. It should be noted, however, that some of the comments made by NASA officials took violent exception to some of the statements made in the draft report. The draft was circulated during August and comments were returned about Sept. 1. The final report was submitted to NASA on Oct. 28, which suggests that McKinsey & Co. had sufficient time to analyze agency comments. The following is a list of the documents uncovered by the author and pertaining to the contracting study:

Draft of Ch. 3 (returned to Young with marginal notes by Corson, July 27, 1960).

Draft of Chs. 2, 3, and 4 (prepared by Young during the first half of August, and circulated among NASA officials).

Draft of what could be Ch. 1; no identifying characteristics, however. 15 pp.

Letter from Sparks of JPL to Young of McKinsey, Sept. 1, 1960. (JPL comments on draft report.)

Memo, Cortright to Silverstein, Aug. 12, 1960. Subject: The management of projects involving simultaneous participation of JPL, GSFC, and MSFC.

Memo, Sanders to Newell et al., Aug. 15, 1960. (Comments on draft report.)

Memo, Cortright to Sanders, Aug. 23, 1960. (Comments on draft report.)

Memo, Jenkins to Newell and Silverstein, Aug. 23, 1960. (Comments on draft report.)

Memo, Sanders to Kelly, Aug. 26, 1960. (Comments on draft report.)

See also: Memo, McKinsey & Co. to Glennan, June 3, 1960. Subject: Progress Report on Study of Contracting Policies; Letter, Glennan to Corson, June 6, 1960.

<sup>169</sup> The quotation is the last paragraph on the final page of a 15-page draft of what appears to be Ch. 1. Title page is stamped "Draft" and has the same title used for other drafts and the final report—"An Evaluation of NASA's Contracting Policies, Organization, and Performance."

<sup>170</sup> This is suggested by several passages in the final report.

<sup>171</sup> See Cortright's memo to Sanders, Aug. 23, 1960. Subject: Some comments on "An Evaluation of NASA's Contracting Policies, Organization, and Performance" by McKinsey & Co.

<sup>172</sup> Glennan asked for comments on the final report in a Nov. 16, 1960, memo to principal NASA officials.

<sup>173</sup> See Letter, Gorman of MSFC to Hodgson of Headquarters, Dec. 9, 1960.



### C. The Study of NASA's Organization (The Kimpton Report)

The study of NASA's overall organization ran roughly parallel with the contracting study just discussed. The organizational study was, of course, much broader in scope—embracing any organizational or administrative problem which the study group chose for inclusion. The purpose of the study was to improve NASA's organizational and administrative arrangement while the agency was still young and flexible and susceptible to change.

*Method.* The method by which the evaluation was performed was proposed by McKinsey & Co. It involved the creation of an advisory committee made up of men "experienced in large-scale organization for research and development activities and in government operations."<sup>174</sup> The Committee, after being thoroughly briefed on all important activities and problems of NASA, would prepare a report setting forth the Committee's views on NASA's organizational and administrative arrangements.

Corson (of McKinsey & Co.) strongly recommended that the Committee be provided with a professional staff. This would permit the Committee to engage in its own fact-finding and not have to rely on information supplied by the object being studied. This would also permit the busy men serving on the Committee to concentrate on their fundamental task—drawing conclusions based on their own experience and what they found out about the NASA experience.

*Committee Selected, McKinsey & Co. Chosen to Assist.* With the help of Corson, Glennan succeeded in lining up a seven-member committee by the middle of March 1960. The Chairman of the Advisory Committee on Organization was Lawrence Kimpton, the Chancellor of the University of Chicago—hence the terms "Kimpton Committee" and "Kimpton Report."<sup>175</sup>

NASA hired McKinsey & Co. to assist the Kimpton Committee in planning the Committee's work, preparing the agenda of its meetings, making all arrangements for its meetings, and engaging in fact-finding and analysis for the Committee.<sup>176</sup> A series of working papers were to be prepared on a number of different topics. McKinsey & Co. were also to prepare a draft of the Committee's final report (due October 28, 1960). The Committee's work was further facilitated by NASA arranging to have the Director of its Office of Management Analysis (Hodgson) assist the Committee on a full-time basis.

*Glennan's March 18, 1960 Memo to the Committee.* The basic charter guiding the Committee's work took the form of a 12-page memo from Glennan

<sup>174</sup> Memo, Corson to Glennan, Jan. 26, 1960. Subject: A Plan for Appraising NASA's Contracting Policies and Over-all Organization.

<sup>175</sup> Kimpton had resigned from the University of Chicago and was on his way to a job with Standard Oil. Other Committee members were: Elmer Lindseth, president of the Cleveland Electric Illuminating Co.; Morehead Patterson, chairman of the board of the American Machine & Foundry Co.; Nathan Pearson, vice president of T. Mellon & Sons; James A. Perkins, vice president of the Carnegie Corporation; Charles Stauffacher, executive vice president of the Continental Can Co.; Fletcher Waller, vice president of Bell & Howell.

<sup>176</sup> See Amendment No. 1 of NASw-144, May 20, 1960. This was an \$85,000 amendment to the \$65,000 contracting study contract.

to the Committee members.<sup>177</sup> In addition to presenting a tentative schedule for the Committee's work and a short briefing on what NASA is and what it does, the memo presented six basic concepts underlying NASA's present organizational arrangements and a list of the readily apparent organizational problems facing the agency. Since the memo was a reasonably well-polished document, it gives a valuable picture of NASA's view of itself.

The six basic concepts underlying NASA's organizational arrangement were these: (1) NASA is a civilian agency; (2) NASA has to use effectively the resources of other Government agencies, especially DOD; (3) internally, NASA separates its research activities from its developmental activities so that the latter do not consume the former. (It should be remembered that the three research centers—Langley, Lewis, and Ames—reported to the Office of Advanced Research Programs in NASA Headquarters, whereas the three development centers—Goddard, JPL, and Marshall—reported to the Offices of Space Flight Programs and Launch Vehicle Programs); (4) NASA uses in-house technical personnel to supervise its development contracts. (The transfer of installations from the Army had resulted in more in-house capability than originally envisioned); (5) NASA believes in decentralizing its operations to the field. (The space-flight development area was centralized in Headquarters initially because of the absence of any appropriate field installations—it had taken many months to get Goddard going, JPL had been transferred in December 1958 but was contractor operated, Marshall was just being established at the time Glennan issued the memo); (6) NASA has to utilize private industrial and institutional resources extensively to achieve its program objectives.

What problems did NASA want the Committee to study? In addition to wanting the Committee to appraise the six basic concepts themselves, NASA wanted answers to four fundamental questions:

1. Is NASA utilizing its field installations in an optimum manner? (This involved the distribution of jobs among the field centers and between the centers and outside organizations.)
2. What should be the proper balance between Headquarters activities and field activities?
3. Is NASA's top management structure suited for the job it has to do?
4. Does NASA's overall organizational arrangement inhibit optimum external relationships?

In effect, the Committee was asked to address itself to just about all problems except the overall policy undergirding the Nation's space program, on the one hand, and the minutiae of internal NASA functions and relationships, on the other.

*The Work of the Kimpton Committee.* The Committee held a total of

<sup>177</sup> Memorandum for members of the Advisory Committee on Organization, from Glennan, Mar. 18, 1960. Subject: The Evaluation of NASA's Organization: The Problem, Suggested Approaches, and the End Objective. The memorandum was written by Corson and Young of McKinsey & Co.

eight 2-day meetings, the first one in April 1960, the last one in September.<sup>178</sup> Five of the meetings were in Washington, one at Marshall, one at Langley, and one at Cape Canaveral, primarily to watch the launch of the Echo satellite.

The meetings followed a fairly standard format. Each meeting was devoted to two or three principal topics. The topics were discussed on the basis of workpapers (nine in all) prepared by McKinsey & Co. and presentations made by NASA officials. Some of the workpapers were prepared at the request of the Committee.

After several meetings devoted to the discussion of particular topics, the Committee began to consider the content of its final report. For this consideration, McKinsey & Co. prepared workpapers of a summary nature (three in all). The final product was a 22-page report dated October 12, 1960, and signed by the Committee members—the so-called Kimpton Report.

The Kimpton Report represents only one of several products flowing from the overall effort to evaluate NASA's organization. Workpapers 1-9, although basically descriptive, contained suggestions of an evaluative nature.<sup>179</sup> Workpapers 10-12 pinpointed the principal problem areas and presented alternative ways of approaching them. These summary workpapers served as a "cafeteria line" from which the Committee members could choose items for inclusion in the final report.

The work of McKinsey & Co. preparing the report on NASA contracting and giving staff assistance to the Kimpton Committee became so intertwined that there is a considerable amount of overlap between the Contracting Report and the Kimpton Report.<sup>180</sup>

The stimulus of the Committee's work led to the generation of several other documents worthy of note. The Bureau of the Budget took an interest in what the Committee was doing and submitted its views on some of NASA's organizational

<sup>178</sup> The following is a list of all meetings and the topics discussed: (1) Apr. 15-16, primarily organizational; (2) May 6-7, Marshall, fact-finding, Workpapers 1-3, NASA's mission, the 10-year plan, the Space Flight Centers, Stewart, Horner, Hjernevik, Pickering, Goett, von Braun; (3) May 26-27, Langley, fact-finding, Workpapers 4-5, Research Centers, Integration of the Space Flight Centers; (4) June 23-24, fact-finding, Workpapers 6-8, in-house/out-of-house, Headquarters/field, NASA/scientific community, Low, Canright, Cortright, Nicks, Dryden, Newell, Abbott, Silverstein, Ostrander, Siepert; (5) July 7-8, fact-finding, Workpapers 9-10, top organization, contents of the final report, Frutkin, Bonney, Thompson, Gleason, Johnson, Siepert, Glennan, Horner; (6) July 28-29, Workpapers 10-11, Aeronautics, International Activities, Final Report; (7) August 12(?), Cape Canaveral(?); (8) Sept. 29-30. Between meetings 4 and 5 there was a meeting of Corson and Young of McKinsey & Co., Hodgson of NASA, and Staats, Schaub, Shapley, Beckett, Morris, and Byrd of BOB.

<sup>179</sup> There were two versions of Workpaper No. 9. The "official" version was rather bland. The other was much more provocative. It expressed the views of Prof. Donald Stone, whom McKinsey & Co. had hired to help with the study. It reflected Stone's interview with NASA's Director of Financial Management and was quite critical of NASA's past practices in the finance area, especially budgeting.

<sup>180</sup> The original deadline for the Contracting Report was "slipped" several months in order to permit McKinsey & Co. to assist the Kimpton Committee.

problems.<sup>181</sup> At about the same time (July 1960), General Ostrander of NASA Headquarters presented his solution to the problems of Headquarters organization.<sup>182</sup>

*Findings and Recommendations.* To completely analyze and synthesize all these reports, workpapers, memoranda, etc., would be very difficult. What follows is a presentation of the principal findings and recommendations flowing from the Committee's work, with emphasis on the contents of the Kimpton Report.<sup>183</sup>

(1) *Findings and recommendations concerning the "basic concepts" guiding NASA.* The Committee recommended no departures from the basic concepts which Glennan had stated were guiding NASA.

The Committee favored the idea of keeping development activity separated from research activity. However, it felt that NASA could be a bit more flexible on this, with the research centers being permitted to carry on a limited number of development projects and the development centers a limited amount of basic research (p. 15).

NASA's policy of decentralization was viewed as being a good one. However, the Committee felt that decision-making should be decentralized as well as research and development operations (p. 11). The Committee felt that NASA had quite a way to go before it would overcome the habits developed initially when so much of the space-flight development activity had to be centered in Headquarters.

The Committee felt that as much work as possible should be contracted out (p. 9). Even though NASA's in-house/out-of-house balance was good, the Committee felt that guidelines for determining the balance should be promulgated (p. 7). The guidelines recommended were those formulated by McKinsey & Co. in connection with its study of NASA contracting (p. 8).<sup>184</sup>

Although NASA was aware of its great dependence on outside organizations, it had failed to utilize the resources of universities as much as it could and should (p. 16). NASA should also improve the exchange of research information between itself and outside organizations (p. 16). The Committee recommended that Glennan's plan to establish a General Advisory Committee (à la AEC) be implemented as soon as possible in order to improve communications between NASA and the external community (p. 10).

(2) *NASA's overall organizational structure.* The Committee felt that NASA's organizational structure was "soundly conceived" and that the agency had built an "effective organization." "We found no crises, no serious deficiencies; we did find opportunities for further improvements" (p. 1). This attitude is a definite softening of the views of McKinsey & Co. which called for "significant

<sup>181</sup> See "Attachment A, Suggested Additional Points for Consideration by NASA Advisory Committee on Organization" and "Attachment B, Suggested Organizational and Operating Pattern for NASA." Both are dated July 15, 1960.

<sup>182</sup> Memo, Ostrander to Glennan, July 27, 1960.

<sup>183</sup> "Report of the Advisory Committee on Organization," October 1960. All parenthetical page references are to this report only.

<sup>184</sup> See Sec. III.B above.

organizational changes” in order to “increase the effectiveness of NASA.”<sup>185</sup> The suggestions made by the Bureau of the Budget indicated that it also favored significant organizational changes.<sup>186</sup>

(3) *Intra-agency relationships.* The Committee felt that NASA’s most pressing organizational problem lay in the area of Headquarters-field relationships, especially distribution of power and responsibilities between Headquarters and the field and among field installations (p. 10).

NASA’s problems in this area were thorny ones: First of all, inter-installation coordination, especially among the space-flight development centers, was absolutely essential because of the very nature of the projects involved. This could be easily demonstrated by analyzing a completed project and ascertaining the origin of all the inputs going into it and the step-by-step process by which it moved toward completion.<sup>187</sup> The need for inter-installation coordination had promoted two dysfunctional tendencies—one was that “decision-making had been over-centralized in the headquarters technical staffs” (p. 11), and the other was that the large number of inter-installation technical interface problems had generated delays, conflicts, and duplicate technical staffs (p. 11).

A second thorny problem was that NASA’s practice of having its field installations report to three different Headquarters program offices made the management of the installations on an agencywide basis very difficult. In other words, NASA’s practice promoted Headquarters control in specific technical matters, but left central control fuzzy in general agencywide administrative and technical matters.

Both BOB and McKinsey & Co. suggested that a possible solution to these problems would be to have all field installations made responsible to the Associate Administrator, with the technical people in Headquarters serving as a staff arm of the Associate Administrator.<sup>188</sup> This would establish the myth of unity of command. Since the Associate Administrator had to avoid becoming a bottleneck, he would tend to permit a dual-channel system to evolve, whereby the Headquarters staff would supervise their field counterparts in specialized areas through one channel and the Associate Administrator would exercise command authority through another.

The Committee did not buy this suggestion. After indicating that serious consideration had been given it, the Committee recommended that no structural change be made in the relationships between Headquarters and the centers (p. 14). Instead, the Committee recommended only that certain changes be made *within* the existing structure. It recommended that complete responsibility for a project be assigned to a single field center and that the effort going into a project be integrated by means of center-based project management teams. The Committee also advocated restraint on the part of Headquarters and technical

<sup>185</sup> Workpaper No. 11, p. 3.

<sup>186</sup> Attachment B, *op. cit.*

<sup>187</sup> This was done for the Committee by McKinsey & Co. The project was still in progress—the Ranger A project. See App. A of Workpaper No. 12.

<sup>188</sup> Attachment B and Workpaper No. 12.

staffs in the dealings with the centers. (These recommendations appeared in the McKinsey workpapers and also were part of McKinsey's Contracting Report.)

Apart from the need to assign total project responsibility to a single center, the Committee felt that the general distribution of responsibilities among the centers was appropriate in view of the facilities and capabilities of the centers. (Marshall was identified with launch vehicles, Goddard with earth satellites and sounding rockets, and JPL with lunar and planetary satellites and probes.) McKinsey & Co. had recommended that the Committee give serious consideration to the question of whether or not NASA should establish two new centers, one for life sciences and the other for manned space flight.<sup>189</sup> (Manned space flight was under the Space Task Group, a part of Goddard but physically located at Langley—a somewhat unorthodox arrangement.) The Committee report was silent on this topic.

(4) *Headquarters organization.* No immediate reorganization of NASA Headquarters was recommended, but a potential reorganization was delineated (p. 14). In the long run, the Committee felt, NASA would have to recombine into an integrated Office of Space Development the activities of the existing Office of Space Flight Programs and Office of Launch Vehicle Programs (p. 13).<sup>190</sup> (This would mean that all three space-flight development centers—Goddard, Marshall, and JPL—would report to the same Headquarters office.) The Committee felt that NASA's current setup resulted in conflicts between OSFP and OLVP, duplication of technical staffs, and undue demands on the Associate Administrator in resolving "interface" problems.

The Committee recommended a gradual movement toward combining the two existing offices (p. 14). "The existing . . . structure should not be reorganized immediately." "In the interim [the two offices] should be maintained as presently constituted." "In the meantime, it can be made to work more effectively." How? By more "understanding" on the part of the Headquarters staffs and a "greater decentralization of technical decision making."

The long-run recombination recommendation bore a close resemblance to a recommendation made to Glennan by Ostrander, the head of one of the offices involved (OLVP).<sup>191</sup> Ostrander claimed that solving interface problems between the two offices consumed too much time. "Cumbersome and time-consuming committee or coordination procedures" had to be resorted to because the Associate Administrator was just too busy to solve all of them. Instead of two separate offices, Ostrander recommended one office with three major divisions—payloads, vehicles, and operations.

The workpapers prepared by McKinsey & Co. recognized the problem and presented a number of alternative solutions.<sup>192</sup> There was a basic disagreement

<sup>189</sup> Workpaper No. 11, p. 22.

<sup>190</sup> For an explanation of how these two offices came into being, see Ch. 4, Sec. V.H.

<sup>191</sup> Memo, Ostrander to Glennan, July 27, 1960.

<sup>192</sup> Workpapers Nos. 11 and 12.

in the Committee on the alternatives and this probably accounted for the cautious approach taken. On the other hand, McKinsey & Co. did claim that the existing system could work if certain reforms were made.<sup>193</sup>

The Committee addressed itself to other Headquarters organizational problems, but in most cases advocated the continuation of the status quo. It was felt that the Office of Program Planning and Evaluation should remain under the Administrator rather than be put under the Associate Administrator (p. 21). The Office of Public Information should remain under the Administrator and the Office of Technical Information and Educational Programs under the Associate Administrator, rather than be combined (p. 21). The management analysis function should be expanded and established as a regular division within the Office of Business Administration. Its professional staff "should be increased significantly" (p. 22).

(5) *Miscellaneous.* In regard to NASA's internal management, the Committee made several recommendations not already discussed. The Committee made frequent references to the important role of the Associate Administrator in integrating NASA's internal operations. The Committee urged "the strengthening of the means" by which the Associate Administrator "links together . . . programs, budgets, and development plans" (p. 6). It recommended that NASA's program management system (the PMP's, etc.) be integrated with the financial management system (the FOP's, etc.) into a single set of operating reports for top management.<sup>194</sup> The Committee made the same recommendations concerning the use of project managers and project management teams as those made by McKinsey & Co. in its Contracting Report.

The Committee commended NASA's long-range plan, but suggested that NASA's planning could be improved by broader participation, especially by field personnel (p. 5). The Committee felt that aeronautics was in danger of being subverted by space activities. It recommended that aeronautical activity be given a high-level spokesman in Headquarters (p. 17).

The Committee felt that NASA's training program was inadequate. It recommended the implementation of NASA's "Proposed Executive Development Program" (p. 19).<sup>195</sup> It felt that NASA's plans for training project managers should be supplemented by an "exchange of on-the-job experience with industrial counterparts." The Committee felt that administrative personnel should strive for a better technical orientation, and technical personnel for a better administrative orientation (p. 19).

*NASA's Reaction to the Kimpton Report.* On November 3, 1960, Glennan sent a memo to principal agency officials asking them to study the report and

<sup>193</sup> Workpaper No. 11, p. 24. The Committee's disagreement on the alternatives was revealed by John D. Young in his notes to the NASA Historical Office dated Jan. 1, 1965.

<sup>194</sup> For a discussion of FOP's and PMP's, see Secs. II.B and II.E above.

<sup>195</sup> See Sec. II.C above.

comment on it.<sup>196</sup> During November and early December, 23 Headquarters officials and 6 field center directors submitted comments.<sup>197</sup>

The comments were very diverse. On balance, the commenters agreed with the recommendations of the Kimpton Committee much more often than they disagreed. In several cases there were statements that certain recommendations had already been implemented.

There was general agreement with those recommendations which duplicated the recommendations made in the Contracting Report. An important exception, however, was the way in which the Kimpton Committee expressed NASA's need to do as much work out-of-house as possible. Most NASA officials felt that in-house activity had to be more than the minimum amount necessary to keep tab on out-of-house efforts.

Another area of disagreement concerned the one substantial structural change recommended—the long-run recombination of the Offices of Space Flight Programs and Launch Vehicle Programs. The basic criticism of this recommendation was that it was only a partial solution—that it would only shift the arena of conflict one level farther down in the hierarchy and not remove the sources of conflict. Many officials expressed the view that Headquarters needed reorganization, but indicated doubts that the Kimpton Committee's solution was the optimum one.

*An Evaluation of the Kimpton Report.* The Kimpton Report has developed the reputation of having been too bland.<sup>198</sup> There is no doubt that its recommendations were cautious and conservative and in most cases advocated the continuation of the status quo. The Committee may have been cautious in deference to Glennan (i.e., recommending sweeping changes could be construed as a criticism of his performance as an administrator). If so, this was unfortunate. There is little doubt that Glennan genuinely wanted to pass on to his successor the most tidy ship possible.

There is some evidence of a basic disagreement between the two top McKinsey & Co. officials (Corson and Young) on a very fundamental organizational question—whether the field centers should be responsible to the several Headquarters program offices or to the Associate Administrator.<sup>199</sup> Corson favored retaining the status quo on the basis that the Associate Administrator's span of control should not be extended any further. Young, backed by the Bureau of the Budget, favored having the center directors report directly to the Associate Administrator. The Committee went along with Corson.<sup>200</sup>

The diversity of comments on the Kimpton Report suggests that there may have been great diversity in the presentations made to the Committee by NASA officials. In the face of diverse and sometimes conflicting information and advice from NASA itself, the Committee may well have taken a cautious and noncontroversial course for want of a clear mandate for change.

<sup>196</sup> No copy located as yet.

<sup>197</sup> The Office of Business Administration summarized the comments in a January 1961 memo to Glennan. See Siepert's memo to Glennan, Jan. 13, 1961.

<sup>198</sup> Based on the consensus of several NASA officials interviewed during 1963.

<sup>199</sup> See Young's memo to Webb, July 24, 1961. Subject: Additional Item on Organization.

<sup>200</sup> The November 1961 reorganization put field centers under the Associate Administrator. The November 1963 reorganization put field centers under the program directors.



Perhaps the most disappointing aspect of the Kimpton Report is that it contained very few, if any, original ideas. One of the reasons for assembling a small group of men experienced in the ways of large-scale organizations was to profit from the ideas which they would generate in the course of their deliberations. Perhaps the absence of original ideas is a commentary on the complexity and uniqueness of NASA's job.

Even though the Kimpton Report did not come up to everybody's expectations, there is little doubt that the overall effort was worthwhile. During 1961 NASA made two major organizational changes. The preparations for these changes were part of an unbroken line of activity going back to the work of the Committee. The momentum toward change was one of the major inheritances that Glennan passed on to his successor.

#### IV. EXTERNAL RELATIONS

##### A. 1960 Relations With Congress

NASA's somewhat stormy relationship with Congress during 1959 calmed down considerably during 1960. It has already been pointed out that during 1960, Congress appropriated everything asked for and authorized for appropriation even more. The administration's effort to amend the Space Act did not fare so well, however.

*The President's January 1960 Legislative Request.* On January 14, 1960, President Eisenhower asked Congress to enact amendments to the Space Act "to clarify management responsibilities and to streamline organizational arrangements. . . ." <sup>201</sup>

The President declared that the Space Act, as enacted in 1958, attempted to create the myth that the United States had one space program. To assure that only one program existed, elaborate inter-agency coordination machinery was established and the President was given a personal responsibility for developing a comprehensive space program. To advise him, a high-level Space Council was established.

The President went on to declare that there were really two separate areas of space activity: one civilian, the other military. The military needed no special mandate to carry on its space activities; it had a general mandate to provide for the Nation's security and presumably space would be an area in which the military would have to operate. The activity which needed a mandate was the civilian space program, and it was this area with which the Space Act should be concerned. NASA should be given complete responsibility for the civilian space program. The overall responsibility of the President should flow from his office,

<sup>201</sup> H. Doc. 296, 86th Cong. (The substance of the President's request, of course, had nothing to do with NASA-Congress relations and could properly be discussed in other sections of this chapter. So as not to fragment the overall legislative story, a brief summary of the entire request is made here.)

not from a provision of the Act. This would permit the abolishment of the Space Council (which had already served its purpose) and also the Civilian-Military Liaison Committee (which had never really functioned).

Since NASA and DOD would use much of the same hardware in their respective programs, it would only be natural for the two agencies to want to coordinate their efforts, as they now were doing. Since launch vehicles constituted the major hardware item which both agencies would use, the President suggested that Congress might well want to give him the special responsibility of determining which agency should develop which vehicles.

**NASA Submits Draft Amendments.** NASA was given the responsibility to submit draft legislation to Congress and defend it.<sup>202</sup> The draft legislation embraced the ideas in the President's message and in addition included a complete revision of the patent section (Sec. 305) of the Space Act. Several other amendments also were included, some purely technical in nature, others substantive but only designed to give NASA certain basic powers that most agencies are given.

The major provisions of the draft legislation were as follows:

1. Section 201 of the Space Act, which provided for the Space Council and gave the President certain personal responsibilities for the national space program, was repealed.

2. Section 204, which established the Civilian-Military Liaison Committee, was also repealed.

3. Section 305, the "Property Rights in Inventions" section, was drastically revised by giving NASA discretionary authority on patent matters; each contract could be tailor-made to fit either the DOD practice or the AEC practice, with the objective "to protect the public interest and the equities of the contractor."<sup>203</sup>

4. A new section (numbered 309) was designed to pull together various provisions on DOD's space efforts and NASA-DOD coordination, some of which had been part of the sections to be repealed. The new section declared that the Space Act does not preclude DOD from undertaking space activities vital to national defense. It asked NASA and DOD to advise and consult with one another. It provided that the responsibility for developing new launch vehicles should be assigned to either NASA or DOD on the basis of the "most efficient utilization of resources."<sup>204</sup> Finally, it declared that the heads of NASA and DOD should take unresolvable disagreements to the President for decision.

**Congressional Reaction.** A bill incorporating most of the NASA proposals was passed by the House.<sup>205</sup> No action was taken by the Senate, primarily because Lyndon Johnson opposed any changes in the Space Act at the time.<sup>206</sup>

<sup>202</sup> See Glennan's 14-page letter to Speaker of the House, Jan. 14, 1960, in which was enclosed a draft of the bill and a sectional analysis of it.

<sup>203</sup> *Ibid.*, p. 6.

<sup>204</sup> *Ibid.*, p. 11 of the sectional analysis.

<sup>205</sup> H.R. 12049, passed June 9, 1960.

<sup>206</sup> See *Congressional Record* (Daily edition), Vol. 106, No. 147, Aug. 31, 1960, p. 17215. Cited in Ambrose, "The National Space Program, Phase II," p. 256. Johnson felt that the new administration, which would come along in 5 months, might have entirely different ideas on amending the Space Act. As it turned out, he was in a position to make sure his prediction came true.

The hearings held by the House Astronautics Committee revealed that DOD supported the NASA proposals.<sup>207</sup> In the course of the hearings it was also revealed that NASA and DOD had been solving inter-agency problems by means of working-level coordination groups rather than the formal channel provided for in the Space Act (i.e., the CMLC), and that the two agencies were prepared to institutionalize the coordination machinery that had evolved. One result of this revelation was that the House Astronautics Committee, in the only major departure made from the NASA proposals, wrote into its bill provisions for the establishment of an Aeronautics and Astronautics Coordinating Board. (All NASA had wanted was a general statement on the necessity for NASA-DOD cooperation.)

Except for a few minor amendments concerning the leasing of office space and the total number of excepted employees, the Space Act was the same when Glennan left NASA as it was when he became NASA Administrator 29 months earlier.

*The Annual Authorization Problem.*<sup>208</sup> President Eisenhower, in his January 1960 budget message, made a general request that Congress turn away from the "growing tendency to require the annual enactment of authorizing legislation before appropriations may be made." Backed with this statement and BOB approval, NASA asked Congress to repeal the provision requiring annual authorization of NASA's appropriation. A bill was introduced but it made no progress whatsoever.

*House Astronautics Committee Very Active.* During 1960 the House Astronautics Committee continued the high level of activity begun in 1959. According to the Committee's own count, the Committee conducted 57 investigations, issued 46 reports, held 265 hearings, and heard 658 witnesses during the 86th Congress (1959 and 1960).<sup>209</sup> NASA affairs and NASA officials were involved in much of this activity. The public record accumulated in the course of this activity reveals a great deal about NASA's history.<sup>210</sup>

The Committee advocated an aggressive space program. In July 1960 it urged NASA to revise its long-range timetable and undertake a high-priority program to place a manned expedition on the moon before the end of 1970, rather than "beyond 1970" as provided for in NASA's long-range plan.<sup>211</sup> President Kennedy made the same proposal 10 months later.

<sup>207</sup> See House Hearings, *To Amend the National Aeronautics and Space Act of 1958*.

<sup>208</sup> Information and quotations in this paragraph were taken from the final draft of a letter from Glennan to the Speaker of the House. The actual letter was dated Jan. 12, 1961.

<sup>209</sup> U.S. Congress, House, Committee on Science and Astronautics, *Report on the Activities of the Committee on Science and Astronautics*, H. Rept. 2215, 86th Cong., 2d sess. (Washington: GPO, 1960), p. v (hereafter cited as House Report, *Report on the Activities of the Committee on Science and Astronautics*).

<sup>210</sup> House Astronautics Committee hearings are not indexed, unfortunately. The indexed Senate Space Committee publications are more usable for research purposes.

<sup>211</sup> House Report, *Report on the Activities of the Committee on Science and Astronautics*, p. 5. See also *New York Times*, July 3, 1960, p. 2.

## B. 1960 Relations With DOD

During NASA's early days, many of its space-flight projects were carried out (i.e., executed) by the Army and the Air Force and much of the money NASA spent went to DOD. By 1960 this particular type of activity had all but disappeared. In the meantime NASA's total program had significantly increased, which in turn increased the volume of day-to-day contacts between the two agencies. By 1960, relationships between the two agencies tended to become regularized. By the end of 1960 a formalized system for top-level coordination had been established.

*Aeronautics and Astronautics Coordinating Board Established.* In September 1960, NASA and DOD entered into an agreement establishing an Aeronautics and Astronautics Coordinating Board (AACB).<sup>212</sup> The AACB was to be responsible for facilitating (1) the planning of NASA and DOD activities so as "to avoid undesirable duplication and . . . achieve efficient utilization of available resources"; (2) "the coordination of activities in areas of common interest"; (3) the "identification" of common problems; (4) the "exchange of information."

The AACB was to have cochairmen, the Deputy Administrator of NASA (Dryden) and the DOD Director of Defense Research and Engineering (York). The Board was to be large enough to give proper representation to all major interests. NASA and DOD were to have an equal number of members. Initial membership totaled six from each agency. Meetings were to be held at least once every 2 months. A secretariat was established to facilitate the work of the Board.

Six sub-board organizations called panels were established—Manned Space Flight, Unmanned Spacecraft, Launch Vehicles, Space Flight Ground Environment, Supporting Research and Technology, and Aeronautics. Membership usually numbered from 8 to 10. Panels were to meet at least once every 2 months. Sub-panels also were authorized.

In contrast with the CMLC, the substantive power of the AACB and its panels was based on the inherent power of the individual members. This was the basic element of realism in the board-panel system. With top-level officials serving on the Board and panels, the number of unresolvable problems would probably be small. If disagreements could not be resolved within the system, the normal decision-making channels would then have to be resorted to.<sup>213</sup> The chief objective of the system was to arrive at a common position. Implementing action would be initiated by the same top-level officials upon their return to their respective top-level positions.

<sup>212</sup> "Agreement between the Department of Defense and the National Aeronautics and Space Administration Concerning the Aeronautics and Astronautics Coordinating Board," promulgated Sept. 13, 1960. (Attachment A to GMI 2-3-10, Sept. 13, 1960.)

<sup>213</sup> See Glennan's testimony, Hearings, *To Amend the National Aeronautics and Space Act of 1958*, p. 525.

The agreement officially establishing the AACB would have been promulgated earlier in 1960 except for the fact that NASA and DOD waited to see if the Space Act would be amended, thereby furnishing a legislative base for what otherwise would be purely an administrative action. There is evidence that the AACB, as a formal system, was conceived to meet the congressional desire for formal coordination machinery. The administration's proposal to abolish the Space Council and the CMLC was initially defended by Glennan and Dryden on March 8, 1960.<sup>214</sup> They indicated that effective inter-agency coordination was currently being achieved on an informal basis and would continue to be so. Six days later the Deputy Secretary of Defense, James Douglas, suggested that the informal procedure might well be formalized and an Activities Coordinating Board established.<sup>215</sup> By April 4, 1960, the last day of the amendment hearings, this had become a commitment on the part of NASA and DOD.<sup>216</sup> The House Astronautics Committee then incorporated the NASA-DOD plan into its bill. Only after the House bill died in the Senate did NASA and DOD officials officially promulgate the agreement which had already begun operation.<sup>217</sup>

Perhaps the best evidence that the AACB system worked was that the responsibility for accomplishing inter-agency planning for the very important national launch vehicle program was entrusted to the AACB and that this arrangement was confirmed by the new NASA-DOD leadership which came along with the new Kennedy administration.<sup>218</sup>

**Other 1960 NASA-DOD Agreements.** During 1960, several new NASA-DOD agreements were entered into and several old ones revised. Only one was as fundamental or important as those prior to 1960. It was with the Army Corps of Engineers and greatly benefited NASA. It established procedures by which the Corps was "to perform design and construction services" for NASA at Huntsville, Cape Canaveral, "and elsewhere."<sup>219</sup> As NASA's construction activities expanded, the agreement took on added significance.

<sup>214</sup> *Ibid.*, p. 33.

<sup>215</sup> *Ibid.*, p. 133.

<sup>216</sup> *Ibid.*, p. 525. This was presumably worked out at a Mar. 30, 1960, meeting of Glennan, Dryden, and Horner of NASA with Douglas, York, and others from DOD. See Glennan's letter to Douglas, Mar. 25, 1960.

<sup>217</sup> By Sept. 13 the Board had had two meetings. See NASA News Release 60-260, Sept. 13, 1960.

<sup>218</sup> See the Letter of Understanding from the Secretary of Defense to the NASA Administrator, Feb. 23, 1961. (Reprinted in Senate Hearings, *NASA Authorization for Fiscal Year 1962*, p. 151.)

<sup>219</sup> The agreement is printed as Attachment A to General Management Instruction 2-3-7, Apr. 7, 1960. For some other 1960 agreements, see GMI 2-3-4, Sept. 15, 1960, and GMI 2-3-11, Mar. 21, 1961. All of these have been reprinted in U.S. Congress, House, Committee on Government Operations, *Systems Development and Management, Part 5*, Hearings, 87th Cong., 2d sess. (Washington: GPO, 1962), pp. 1905-1913, 1889-1895, and 1950-1952 (hereafter cited as House Hearings, *Systems Development and Management, Part 5*).

### C. Other External Relationships

During 1960 NASA made a substantial effort to strengthen its relationships with U.S. industry. The contracting study described earlier in this chapter was part of that effort. NASA experience on Federal-industry aspects was consolidated in a staff study on "Managing Major New Technologies" by the Assistant General Counsel (Sohier).<sup>220</sup> Another step in this area was the four NASA-industry conferences held during the latter half of 1960.

**NASA-Industry Conferences.** The important role that U.S. industry would have to play in the Nation's space program was recognized even before NASA was established. The military services had been highly dependent on private industry in achieving space-related defense objectives and were primarily responsible for the buildup of the U.S. aerospace industry. NASA wanted to tap the resources of industry and also wanted to educate industry on NASA's unique requirements (e.g., reliability). The need to inform industry about NASA's program and plans was the basic reason for holding the conferences.<sup>221</sup>

Four conferences were held; a general one at NASA Headquarters and specialized ones at each of the three development centers: Goddard, Marshall, and JPL.<sup>222</sup> It was planned that all attendees have security clearances. Admission to the conferences was to be by invitation only and the major industrial aerospace associations were utilized in drawing up a list of invitees.<sup>223</sup>

The first conference was held in Washington, D.C., and was attended by about 1,300 persons. Almost all of NASA's top Headquarters officials made presentations.<sup>224</sup> In addition to briefing the invitees about overall space program and plans, NASA made presentations on its patent policy, procurement policy, and procurement procedures.<sup>225</sup> NASA distributed a pamphlet, "Selling to NASA," in the hope of facilitating relationships between NASA and the large number of new concerns (many of which were relatively small) who were uninitiated in the ways of Government procurement.

The classified nature of the proceedings drew criticism from the press. This led to an investigation of the situation by Representative Moss' House Government Operations Subcommittee, the "watchdog" of administration security practices.<sup>226</sup> Partly as a result of this the two final conferences were unclassified and efforts were made to accommodate the wishes of the press.

<sup>220</sup> Walter T. Sohier, "Managing Major New Technologies," Oct. 1, 1960, 39 pp.

<sup>221</sup> Memo, Golovin to Program Directors, Apr. 8, 1960. Subject: NASA Program Presentation to Industry. See also NASA News Release 60-231, July 22, 1960.

<sup>222</sup> Dates were: Headquarters, July 28-29; Goddard, Aug. 30; Marshall, Sept. 27-28; JPL, Oct. 26, 1960.

<sup>223</sup> Memo, Golovin to Horner, Apr. 13, 1960. Subject: Principal Conclusions of the Meeting of Apr. 13, 1960, NASA-Industry Conference.

<sup>224</sup> Attendance figure taken from NASA, *Fourth Semi-annual Report*, p. 204.

<sup>225</sup> An unclassified edition of the conference proceedings was published. *NASA-Industry Program Plans Conference, July 28-29, 1960* (Washington: GPO, 1960):

<sup>226</sup> Memo, King to Bonney et al., Sept. 16, 1960. Subject: Follow-on Industry Conference.

## V. THE GLENNAN ERA—SUMMARY AND CONCLUSIONS

The end of Glennan's 29-month "reign" as NASA Administrator marks an excellent place to pause and take a backward look at NASA's history.

### A. Space Program Accomplishments During the Glennan Era <sup>227</sup>

Space program accomplishments, as measured by NASA's flight program, were greater during 1960 than during 1959 and included some very notable individual successes. During 1959 NASA's major flight accomplishments (as measured by fully successful orbital missions) were limited to the orbiting of three scientific earth satellites. During 1960 NASA succeeded in orbiting a passive communications satellite (*Echo I*), two meteorological satellites (*Tiros I* and *II*), a scientific solar satellite (*Pioneer V*), and a scientific earth satellite (*Explorer VIII*). In addition, two new launch vehicles, Scout and Thor-Delta, were successfully used. NASA's manned space flight program, Project Mercury, conducted successful suborbital equipment tests during both 1959 and 1960.

On balance, however, NASA's flight program during the Glennan period was characterized by a very high percentage of unsuccessful launches. This stemmed from unreliable launch vehicles. As mentioned in Chapter 4, NASA early recognized its dilemma; NASA's alarm over the situation was the motivating factor behind the establishment of the NASA-DOD national launch vehicle program and NASA's own reliability program. The detrimental results of launch vehicle unreliability are revealed by an analysis of NASA's attempts to orbit satellites either around the earth or around the sun. During 1958, 1959, and 1960, NASA made 25 orbital attempts. The launch vehicle performed successfully only eight times and partially successfully only four times. In other words, over half of the attempts were completely unsuccessful and only one out of three was completely successful. During 1958 and 1959, 15 launches were attempted, of which only 3 were completely successful and 4 partially successful. Thus only one out of five was completely successful. In 1960 out of 10 attempts, 5 were completely successful, or one out of two. The percentage improved a little during 1961, but it was not until 1962 that a dramatic improvement in launch vehicle reliability was demonstrated.

These data apply to the performance of the launch vehicle only. In a very few cases the partially unsuccessful performance of the payload meant a less than completely successful flight mission even though the launch vehicle performed satisfactorily. Average payload size increased significantly in 1960. The five payloads orbited in 1959 weighed a total of 410 pounds, whereas the five orbited in 1960 weighed over twice as much—867 pounds. <sup>228</sup>

<sup>227</sup> Unless indicated otherwise, the data on NASA launchings are based on the "Chronology of Major NASA Launchings, October 1, 1958, Through December 31, 1962," prepared by the NASA Historical Office.

<sup>228</sup> Based on "Chronicle of Earth Satellites and Space Probes, 1957-1960," App. A of *Aeronautics and Astronautics, 1915-1960* by Eugene Emme, NASA Historian (Washington: GPO, 1961).

It should be pointed out again that these data refer only to orbital attempts. The percentage of successful suborbital flights was fairly high. It should also be repeated that launches constituted only a portion of NASA's overall program. Accomplishments in other areas were substantial but not subject to easy measurement. There is no doubt that the scientific knowledge of space increased dramatically during the 1958-60 period.

A comparison of NASA's overall aerospace program between what existed during NASA's early months and what existed at the end of the Glennan era reveals several important changes. NASA's initial program emphasized aeronautical and space research, the unmanned scientific exploration of space, the manned exploration of space near the earth, and rocket engine development. To this base was added launch vehicle development on a large scale, a program of applying space technology to areas such as communications and meteorology, research in the life sciences, and the very beginnings of a program for the eventual (i.e., beyond 1970) manned exploration of the moon. The building blocks for a permanent space program were cemented together, such as Mercury, Mariner, the F-1 engine, the Delta workhorse vehicle, and the Saturn super-booster.

#### **B. Administrative and Organizational Changes During the Glennan Era**

NASA, at the end of the Glennan era, was vastly different from the agency which had come into existence 28 months earlier. The total number of employees increased from just under 8,000 (which had comprised NACA) to just over 16,000. The 16,000 figure excludes about 2,500 contractor employees working at the NASA-owned Jet Propulsion Laboratory. Of the 8,000 increase, about 4,500 had been transferred to NASA en masse, almost all of them from the Army. The NACA field installation system of three research laboratories and two flight stations (one for rockets) was expanded under NASA by the building or acquisition of three space-flight development centers and several worldwide tracking networks. Facilities and working arrangements were also established at the two major national rocket launching ranges, AMR and PMR.

A Headquarters organization with five identifiable "segments" (top management, external relations, internal administration, aerospace research, and space-flight development) evolved into one with nine "segments" (with the addition of internal management, launch vehicle development, life sciences, and information).

The annual budget of under \$100 million which had funded NACA's primarily in-house research activities was only about 10 percent of the almost \$1 billion budget that was funding NASA when the Glennan era ended, most of which (about 85 percent) was spent out-of-house by contract.

The gross measurements of growth just presented tell little about NASA's efforts to solve its administrative and organizational problems. A listing of these



problems, together with NASA's attempts to solve them, can serve as a device for summarizing NASA's major administrative actions during its first 28 months. The listing which follows includes administrative and borderline administrative/program items, but excludes the many problems basically program in nature.

**Problem 1.** A new public program had to be expanded rapidly. In its attempt to get its program moving rapidly, NASA mobilized industry and the universities. This meant that extensive work had to be done by contract, which in turn meant that contracting policies and procedures had to be attended to.

At the same time in-house efforts had to be expanded. New field installations were acquired (JPL and Marshall) or established (Goddard), or old ones altered (STG at Langley). The NASA staff had to be increased. This required a major recruiting effort. The Civil Service Commission helped by relaxing its control so as to give NASA flexibility in personnel matters. A new Civil Service examination was formulated. Ways had to be devised to promote the more efficient and responsible spending of money.

**Problem 2.** The rapidly expanding program had to be internally managed and integrated. This was probably NASA's fundamental administrative problem. In attempting to solve it, NASA established the position of Associate Administrator (i.e., general manager). The Associate Administrator was given a staff. A program management system was installed. A financial management system was improved. Operations were decentralized. A regional office (WOO) was established for administrative purposes only. The Headquarters program offices (e.g., OSFP and OLVP) were reorganized. A training system for project managers was established. Special efforts were made to evaluate the quality of organization and management (e.g., the McKinsey studies and the Kimpton Report).

**Problem 3.** Inter-agency coordination had to be achieved. Both for its own good and to satisfy the desires of the White House and Congress, NASA had to establish effective working relationships with DOD and AEC. When statutory machinery (the CMLC and the Space Council) did not work, new machinery (the AACB) was established administratively. Inter-agency agreements were entered into whereby agencies helped one another in areas of mutual concern. NASA-AEC coordination was facilitated by the establishment of a joint office (AEC-NASA NPO) which was organically part of both agencies.

**Problem 4.** The program had to be adjusted, shaken down, and rounded out. Program changes were both continual and episodic. A special study committee was established to determine NASA's program in the life science area. Much effort was expended in working out inter- and intra-agency programs for the development of launch vehicles. In response to a Space Act requirement, an information and education program was established. Toward the end of the Glennan era, serious attention was devoted to the formulation of a moon exploration program. Long-range plans were prepared by an office specially created

for that purpose. Intermediate-range planning was accomplished in part through a budget preparation process. Numerous committees, study groups, advisory panels, etc., were established to help give purpose and direction to NASA's program.

*Problem 5.* An environment conducive to scientific and technical creativity had to be established and maintained. NASA tried to prevent problems of a "firefighting" variety from interfering with its steady-paced research efforts. A conscious effort was made to keep developmental activities separated from research activities. NASA tried to keep red tape at a minimum and maintain maximum operating flexibility. An effort was made to attract new employees and hold on to older ones by making the work as challenging as possible and at the same time giving workers as high a grade (GS rating) and pay as possible.

### C. The Glennan Legacy

Dr. T. Keith Glennan served as a focal point for much of the administrative history of NASA presented in the last three chapters. This is not meant to suggest that everything NASA did during its first 28 months revolved around him. On the other hand, his role was more important than that of any other one individual in shaping the new agency and establishing the direction of its program. It may be well in closing a discussion of the Glennan period to summarize what his contribution to NASA appears to have been.

First of all, it is safe to say that Glennan turned over to his successor an organization in reasonably solid shape. Glennan showed a great concern and talent for systematically solving problems as they arose. As a result there was no serious backlog of problems for the new Administrator to dispose of. Glennan was very conscious of the long haul and often concentrated on long-term problems even when short-term efforts might have had an immediately bigger payoff with Congress and the public.

Glennan was very deliberate and usually proceeded cautiously. He remained very loyal to President Eisenhower (often having to endure the ire of the space zealots), even when he could have pursued a more independent course in view of the strong public and congressional support which the space program commanded. His relations with Congress, industry, the academic, and the general public were satisfactory, at least in overall balance.

Although he was concerned with all aspects of the agency's activities, Glennan paid particular attention to the following: (1) Almost singlehandedly he established the position of Associate Administrator as a general manager of NASA's basic program. (2) He led the effort to expand NASA's out-of-house R&D activity. (3) He was the leading exponent of the idea that NASA should be kept from mushrooming in size and that in-house expansion must be kept at a minimum. (4) He gave strong support to NASA's reliability program, its execu-

tive training program, and its long-range planning program. (5) He was primarily responsible for NASA's 1960 self-evaluation.

Not all of NASA's early organizational and administrative objectives were achieved and some of the objectives that were achieved turned out to have only interim value.

The sizable program acceleration that occurred during 1961 kept constant pressure on NASA's problem-solving capability, both technical and administrative. The fact that the subsequent acceleration and expansion was accomplished within the basic framework of what had evolved during the Glennan era is a commentary on the soundness of that framework.

**PART TWO**

**1961-63**



NASA TOP MANAGEMENT, 1961-1963

James E. Webb, Administrator (center); Hugh L. Dryden, Deputy Administrator (left); and Robert C. Seamans, Jr., Associate Administrator (right).

## Chapter Six

### TRANSITION FROM EISENHOWER TO KENNEDY

Under President Eisenhower the civilian space program occupied an uncertain position on his administration's list of long-range national objectives. As an end (the scientific exploration of space) it was supported at a level which permitted orderly but only moderate progress. As a means to such objectives as national security and international prestige, it was probably underrated. Time and again the Eisenhower Administration asserted that the U.S. space program was adequate, that the United States was not in a "space race" with the U.S.S.R., and that Russian space achievements, per se, were not a threat to national security.

Not everyone felt this way. Sputnik had deeply hurt American pride, it caused a decline in American prestige, it indicated a lag in American technology, and suggested the possibility of a gap in U.S. defenses.<sup>1</sup> In the 3 years following Sputnik, this outward situation had not changed appreciably. Pride had not been restored and the international prestige of the United States had not risen by reason of spectacular space accomplishments. There was no proof that the technological lead of the U.S.S.R. had been cut down. Nor was it well known publicly that the United States actually had a ballistic missile superiority over the U.S.S.R., a condition stemming to some degree from the fact that the Russian missile buildup was less than had been expected.

*The Presidential Election Campaign.* In the presidential election campaign of 1960, Senator Kennedy attacked the Eisenhower space record, Vice President Nixon defended it. Nixon claimed that the Eisenhower administration had closed a missile gap inherited from the Truman administration. Kennedy claimed that shortsighted Eisenhower policies had left the United States in a second-best position, a situation he would change.<sup>2</sup>

<sup>1</sup> For an extended analysis of these factors, see Vernon Van Dyke, *Pride and Power: The Rationale of the Space Program* (Urbana: University of Illinois Press, 1964).

<sup>2</sup> A detailed analysis of the role of space in the campaign is beyond the scope of this chapter. The so-called "missile gap" was a major campaign issue, space was a somewhat peripheral issue.

A report prepared by the U.S. Information Agency, entitled "World Reaction to the U.S. and Soviet Space Programs," was made public in late October 1960.<sup>3</sup> It bore out Kennedy's contention that the United States had suffered a significant loss of prestige from lagging behind the U.S.S.R. in space achievements.

Senator Lyndon Johnson, who had taken a very active interest in space matters since Sputnik, was Kennedy's running mate. Kennedy often looked to Johnson for the lead on space matters and promised that if they were elected, Johnson would be given significant responsibilities in space matters.

*Uncertainty Following Kennedy's Election.* Kennedy's November election victory ushered in a period of uncertainty—a type of interregnum when those in command were lame-ducks and when the policies and personalities of the future had not yet been determined.

It was generally assumed, in view of Kennedy-Johnson campaign statements, that space matters would receive greater emphasis in the new administration. There was no assurance, however, that NASA's civilian-oriented program would be expanded or even maintained. Many Kennedy statements made during the campaign had stressed the military and national security aspect of space. The military services argued that Russia was concentrating on the development of a "near-earth" operational capability for military purposes, something which NASA's civilian-scientific program could not counter.

In the power vacuum following the November election, the military services loudly asserted their point of view. Outside of the missile projects and some anti-missile R&D, the Eisenhower administration had kept tight rein over the space activities of the military services. Under Kennedy they hoped to win a larger share of the national effort.

Most of their lobbying came in December. For example, on December 1, 1960, an "Air Force Information Policy Letter for Commanders" gave reasons why the Air Force was ready and able to assume a larger role in the Nation's space program.<sup>4</sup> On December 6 the Air Force announced plans for orbiting a monkey into the Van Allen radiation belts.<sup>5</sup> On December 8 the Air Force announced plans to orbit a passive communications balloon satellite.<sup>6</sup> Also in December the Navy announced its intention to initiate a series of new space satellite projects.<sup>7</sup> These various announcements were made unilaterally by the individual services and had not been coordinated by DOD.<sup>8</sup>

In the light of the "offensive" by the military services, NASA's future grew more and more uncertain. Even tail-end support by the Eisenhower administration faltered. Maurice Stans, the Director of the Bureau of the Budget, tried to

<sup>3</sup> For text, see *New York Times*, Oct. 29, 1960, p. 10.

<sup>4</sup> U.S. Congress, House, Committee on Science and Astronautics, *Defense Space Interests, Hearings*, 87th Cong., 1st sess. (Washington: GPO, 1961), pp. 93-96 (hereafter cited as *House Hearings, Defense Space Interests*).

<sup>5</sup> *New York Times*, Dec. 7, 1961, p. 21.

<sup>6</sup> *New York Times*, Dec. 9, 1961, p. 7.

<sup>7</sup> *House Hearings, Defense Space Interests*, p. 11.

<sup>8</sup> *Ibid.*

keep NASA's fiscal year 1962 budget at an absolute rockbottom level.<sup>9</sup> Several well-justified requests were trimmed, particularly those associated with post-Mercury manned flight. For the first time even Administrator Glennan felt that BOB and the White House had not given NASA the support it deserved.<sup>10</sup>

NASA's response to the uncertainties of December was similar to that of NACA back in 1958. In 1958 NASA was given responsibility for the Nation's first man-in-space program, in spite of much greater Air Force agitation for it, because NACA had developed a detailed and feasible program for manned flight based on existing technology.<sup>11</sup> In late 1960, NASA quietly polished plans to implement its "Ten Year Plan," including post-Mercury manned flight, and which called for a lunar landing by an American after 1970.<sup>12</sup> A task force was created on October 17, 1960, to develop a preliminary lunar landing plan.<sup>13</sup> Later in October, NASA selected several industrial contractors for the preparation of Project Apollo feasibility studies on a three-man spacecraft for extended earth-orbit and circumlunar flight.<sup>14</sup> In early January, Glennan had to warn NASA's manned lunar exploration planners that NASA could not proceed on such a large undertaking but would have to await a White House decision on the matter.<sup>15</sup> On the other hand, Glennan felt that NASA could legitimately claim that a manned lunar landing could and would be accomplished eventually, and could proceed with its planning.<sup>16</sup>

NASA's intense planning did not bear fruit until May 1961. During the interregnum, uncertainty continued. In January 1961, a hoped-for clarification, the report of President-elect Kennedy's Ad Hoc Committee on Space, fell short of expectations and confused matters more than it clarified them.

*The Wiesner Report.* To help him evaluate the status of the Nation's space program, President-elect Kennedy had appointed a nine-member Ad Hoc Committee on Space. Jerome Wiesner of MIT served as Chairman. The Committee submitted its report to the President-elect on January 10, 1961.<sup>17</sup>

The report was quite critical of the Nation's space program, both for its military and civilian phases. One of the report's findings contributed to an important reorganization of DOD's space program. Its comments on NASA, however,

<sup>9</sup> Based on interviews.

<sup>10</sup> Interview with T. Keith Glennan, Jan. 18, 1964.

<sup>11</sup> See forthcoming history of Project Mercury, *This New Ocean*.

<sup>12</sup> See *Historical Sketch of NASA* (Washington: NASA EP-29, 1965), pp. 28-29.

<sup>13</sup> See the minutes of the Jan. 5-6, 1961, meeting of the Space Exploration Program Council.

<sup>14</sup> See Low testimony, U.S. Congress, House, Committee on Science and Astronautics, *1962 NASA Authorization*, Hearings, 87th Cong., 1st sess. (Washington: GPO, 1961), p. 358 (hereafter cited as *House Hearings, 1962 NASA Authorization*).

<sup>15</sup> SEPC minutes of Jan. 5-6, 1961.

<sup>16</sup> *Ibid.*

<sup>17</sup> "Report to the President elect of the Ad Hoc Committee on Space" made public on Jan. 12, 1961. (See *New York Times*, Jan. 12, 1961, p. 14.) (A portion of the report on military space programs was classified.) Committee members were: Kenneth BeLieu, Trevor Gardner, Donald Hornig, Edwin Land, Max Lehrer, Edward Purcell, Bruno Rossi, and Harry Watters.



have been discounted somewhat for being too hastily drawn and based on insufficient fact-finding. Even though the Committee's Chairman became President Kennedy's Special Assistant for Science and Technology, the report made a relatively minor long-run impact on Kennedy and Johnson.<sup>18</sup> Because of its short-run impact, the report warrants examination.

The report listed five principal motivations for the Nation pursuing a space program: "national prestige, . . . national security, . . . opportunities for scientific observation and experiment, . . . practical non-military application, . . . possibilities for international cooperation."<sup>19</sup>

The Committee felt that the objectives sought in the U.S. space program had not been achieved to the necessary degree. Even the excellent achievements in the scientific area had "not been impressive enough" against the background of the spectacular exploits of the U.S.S.R. The shortcomings of the U.S. program were not due to any lack of ability, but rather a lack of "efficient and effective leadership" together with "organizational and management deficiencies" and problems of "staffing and direction." Problems existed at the "executive and other policy making levels of Government," within DOD, and within NASA.<sup>20</sup>

To fill the void existing at the top policy making level, the report supported, as could have been predicted, the Kennedy-Johnson plan for reactivating the National Aeronautics and Space Council. The Council was needed to coordinate the Nation's space activities, to advise the President, and to settle "conflicts of interest" between NASA and DOD.<sup>21</sup> DOD was criticized for having a "fractionated" space program. The report advocated that responsibility for "all military space developments" be assigned to "one agency or military service" within DOD.<sup>22</sup>

In addition to coming under the blanket condemnation of having organizational and management deficiencies, NASA was accused of being preoccupied "with the development of an in-house research establishment" and that "too large a fraction of the NASA program . . . is being channeled into NASA operated facilities." NASA was accused of giving aeronautics too low an organizational position.<sup>23</sup> The report recommended that NASA have a "vigorous, imaginative, and technically competent top management," including, in addition to the Administrator and Deputy Administrator, Directors for "propulsion and vehicles, . . . scientific programs, . . . non-military space applications, . . . and aerodynamic and aircraft programs."<sup>24</sup> The report did not state why this fourfold breakdown was deemed best.

<sup>18</sup> See text of President Kennedy's Jan. 25, 1961, news conference, *New York Times*, Jan. 26, 1961, p. 10.

<sup>19</sup> See Pt. I of the report.

<sup>20</sup> *Ibid.*

<sup>21</sup> Pt. III.

<sup>22</sup> *Ibid.*

<sup>23</sup> *Ibid.*

<sup>24</sup> Summary. No reasons were given for presenting such detailed recommendations on NASA's internal organization.

As to the content of the Nation's space program, the report indicated satisfaction with the scientific program only; it called for review and redefinition in the areas of large boosters, manned space flight, the military use of space, and the application of space technology to practical ends. It urged more attention to post-Saturn launch vehicles.<sup>25</sup> It suggested that manned space flight (i.e., Project Mercury) was too high on the priority list.<sup>26</sup> It urged a vigorous applications program, especially in communications and meteorology, and declared that it should be a joint industry-Government undertaking with governmental organizational machinery established to carry it out.<sup>27</sup> The various statements on manned space flight suggest that the Committee was uncertain about the size of the program and what organizations should be involved. It questioned some of the technical aspects of Project Mercury. It is generally felt that the Committee's factfinding was especially inadequate in the manned space flight area.

In the course of the next several months, several of the recommendations included in the Wiesner Report were implemented. Several were not, however, and in some cases diametrically opposite action was taken.

*Selecting the New NASA Administrator.* The Wiesner Report recommended that NASA's top leaders be "vigorous, imaginative, and technically competent." One reason given for the relatively long delay in selecting a replacement for Glennan was that Lyndon Johnson favored a tried and proven administrator, whereas other advisers, presumably including Jerome Wiesner, advocated that a technical man be appointed.<sup>28</sup> The Johnson point of view prevailed, although there were rumors that several technical persons (such as Berkner, Pickering, Gardner, DuBridge, and Draper) had been considered.<sup>29</sup> On January 30, 10 days after Glennan had left NASA, President Kennedy announced that James E. Webb had been nominated for the post of NASA Administrator and that Hugh L. Dryden had been asked to stay on as Deputy Administrator.<sup>30</sup>

The Senate Space Committee's hearing on Webb's nomination was held on February 2, several days before the nomination was actually received.<sup>31</sup> This was done "in the interest of expediency" so that the Senate could take "prompt action" as soon as the nomination was received.<sup>32</sup>

The hearing revealed that Mr. Webb was a dynamo of activity, being engaged simultaneously in a large number of activities both public and private.<sup>33</sup> He was born in North Carolina in 1906 and graduated with a degree in education from the University of North Carolina. He studied law at George Washington University

<sup>25</sup> Pt. IV.

<sup>26</sup> Pt. VI.

<sup>27</sup> Pt. VII.

<sup>28</sup> *New York Times*, Jan. 31, 1961, p. 18.

<sup>29</sup> *Washington Evening Star*, Jan. 20, 1961.

<sup>30</sup> *New York Times*, Jan. 31, 1961, p. 18.

<sup>31</sup> U.S. Congress, Senate, Committee on Aeronautical and Space Sciences, *Nomination, Hearing on Nomination of James Edwin Webb*, Feb. 2, 1961, 87th Cong., 1st sess. (Washington: GPO, 1961). Replacing Lyndon Johnson as committee chairman was Robert Kerr, one of Webb's principal sponsors.

<sup>32</sup> *Ibid.*, p. 1.

<sup>33</sup> *Ibid.*, pp. 2-3.

and was admitted to the bar. From 1936 to 1943, his longest stint with any one organization, he worked for the Sperry-Gyroscope Co. During World War II he served as a major in Marine Corps aviation. From 1946 to 1949 he was Director of the Bureau of the Budget and from 1949 to 1952 was Under Secretary of State. Subsequent activity was far ranging. At the time he was nominated NASA Administrator, he was, among other things, the chairman of the Municipal Manpower Commission (a study commission financed by the Ford Foundation), a director and officer of Kerr-McGee Oil Industries, Inc., and a director of McDonnell Aircraft Corp. (one of NASA's major contractors). He agreed to sever all relationships with firms doing business with NASA.

His interest in policy and administration was evidenced by his being a member of such organizations as the American Society for Public Administration, the American Political Science Association, the American Academy of Political & Social Science, the American Society for the Advancement of Management, the American Management Association, and the National Planning Association.

Webb's nomination was enthusiastically endorsed by the Senate Space Committee and was confirmed by the Senate on February 9. He was sworn in as NASA Administrator on February 14.

*NASA Asked To Review Its Program.* During the 3½ weeks between Glennan leaving NASA and Webb being sworn in, NASA was under the direction of Dr. Hugh L. Dryden whose resignation had not been accepted by President Kennedy, and who, therefore, stayed on as Deputy Administrator. Dryden then served as Acting Administrator during this interim period. At a House Astronautics Committee hearing, Representative Fulton asked Dryden if he had received any instructions from the White House while he was Acting Administrator "to speed up anything." Dryden replied that he had not. He added, however, that the new Administrator had received a letter from the White House asking Webb "to review all the programs of the agency and to make his recommendations."<sup>84</sup> The results of this review are discussed later in this chapter.

*DOD Reorganizes Its Space Program.* On March 6, 1961, President Kennedy's new Secretary of Defense, Robert McNamara, issued a directive designed to improve DOD's space program by "better organization and clearer assignment of responsibility."<sup>85</sup> The directive assigned responsibility for all "research, development, test and engineering of Department of Defense space development projects" to the Air Force. A "DOD space development project" was one that had been approved by the Secretary or Deputy Secretary of Defense. All DOD agencies could conduct "preliminary" research and draw up proposals for R&D programs and projects. These proposals would then be reviewed by the Director of Defense Research and Engineering. Only after formal approval at the top would they be turned over to the Air Force. The directive dealt only with

<sup>84</sup> U.S. Congress, House, Committee on Science and Astronautics, *Discussion of U.S. Satellite Tracking System*, Hearings, Feb. 15, 1961, 87th Cong., 1st sess. (Washington: GPO, 1961), p. 9.

<sup>85</sup> Department of Defense Directive No. 5106.32, Mar. 6, 1961. Subject: Development of Space Systems. (The quotation is from McNamara's covering memo.)

development. Operational programs were assigned to the individual services on an item-by-item basis.

The directive was the outgrowth of three factors. One was the December lobbying by the military services which revealed they had a large amount of freedom to make program changes on their own. Second, the Wiesner Report had strongly recommended a pinpointing of responsibility in DOD's space efforts. Third, a study of DOD's space program by McNamara's new Office of Organization and Management Planning Studies revealed that the Air Force was already responsible for over 90 percent of DOD's space R&D. The Wiesner Report prompted McNamara's special study.<sup>38</sup>

DOD claimed that the reorganization would have no detrimental effect on NASA-DOD relations.<sup>37</sup> Some Congressmen feared that the Air Force was being given too large a role in space. Air Force Chief of Staff Gen. Thomas White was quick to point out that there was plenty of work for all.<sup>38</sup> On May 16, 1961, the administration revealed that the Air Force had been given a role in the superbooster field, limited to the use of solid fuels, however. NASA was to concentrate on superboosters using liquid fuels.<sup>39</sup>

*Space Act Amended.* Chronologically the next major event was the March amendment to NASA's budget. But so that the March and May budget amendments can be discussed together, it is probably best to break the chronological sequence of events and discuss first the April amending of the Space Act. It should be kept in mind that amending the Space Act was not related to the acceleration of NASA's program being contemplated at the time.

On April 10, 1961, President Kennedy asked Congress to amend Section 201 of the Space Act. Section 201 provided for the establishment and functioning of the National Aeronautics and Space Council to be composed of the President, the Secretaries of State and Defense, the heads of NASA and AEC, and no more than four other appointed members. It was to advise the President in his performance of certain duties enumerated in the Space Act. Except during NASA's early history, President Eisenhower had not utilized the Space Council; indeed, he had advocated that it be abolished because it was not needed.<sup>40</sup> During the 1960 election campaign, Kennedy indicated that he would reactivate the Council. In December he announced that he would seek to have the Space Act amended so that Vice President Johnson, rather than himself, could head the Council.<sup>41</sup> It should be recalled that Johnson was responsible for the creation of the Council back in 1958. It is uncertain why President Kennedy waited until April to propose the amendment.

<sup>38</sup> The DOD reorganization was the principal subject of House hearings, *Defense Space Interests*, beginning Mar. 17, 1961. Many pertinent documents, including the Mar. 6 directive, were inserted into the printed hearings.

<sup>39</sup> *Ibid.*

<sup>40</sup> *New York Times*, Mar. 19, 1961, p. 1.

<sup>41</sup> *New York Times*, May 17, 1961, p. 18.

<sup>42</sup> This has been discussed in Ch. 5, Sec. VI.A.

<sup>43</sup> *New York Times*, Dec. 21, 1960, p. 1.

Congress responded with dispatch.<sup>42</sup> Four basic changes were made. First, the Council was given an organizational home in the Executive Office of the President. Second, the Vice President was made Chairman of the Council in place of the President. Third, the four appointed members were eliminated, thus reducing the Council to five statutory members. Fourth, when requested by the President, the Council was to "assist" him as well as advise him.

The staff of the Council, almost nonexistent during the Eisenhower administration, was expanded. Dr. Edward C. Welsh was named Executive Secretary.<sup>43</sup>

*The March Budget Amendment.* In response to President Kennedy's directive that NASA reexamine President Eisenhower's January budget, NASA responded with a request for an additional \$308,191,000,<sup>44</sup> an increase of 28 percent in the \$1,109,630,000 January budget for fiscal year 1962. This March request was trimmed 60 percent by the Bureau of the Budget and the formal budget amendment submitted to Congress on March 28 totaled \$125,670,000.<sup>45</sup> This amendment did little more than give NASA the fiscal year 1962 budget it had hoped to get from the Eisenhower administration. The new administration felt at this time that many of its "new frontier" projects "on earth" were of higher priority.<sup>46</sup>

The cuts in NASA's March budget request suggest that the philosophy of the Wiesner Report may have had some influence, as the new administration had little confidence in or few contacts with the NASA organization at this point. NASA had requested additions to almost all of its programs. BOB approved only a narrow range of items—launch vehicle development, launching facilities, and communications satellite development. The entire additional \$42,600,000 requested for Project Apollo, the manned space-flight project to follow Project Mercury, was disallowed. All requests for scientific exploration of space were disallowed. This was in keeping with the Wiesner Report's emphasis on launch vehicle development and practical applications, its feeling that the scientific program was sound, and its uncertainty on future manned space-flight programs.<sup>47</sup>

<sup>42</sup> President Kennedy's request was dated Apr. 10, 1961. The House Space Committee held a hearing on Apr. 12. A bill was reported out (Report 225) on Apr. 13 and it passed the House on Apr. 17. The Senate Space Committee held a hearing on the bill on Apr. 19 and it was reported out (S. Rept. 174) the same day. The Senate completed action on Apr. 20. Public Law 87-26 was signed by the President on Apr. 25.

<sup>43</sup> On Mar. 21, 1961, Dr. Edward Welsh, an economist on the staff of Senator Symington, was appointed to the \$20,000 position of Executive Secretary. A staff of 20 to 25 persons was contemplated.

<sup>44</sup> U.S. Congress, Senate, Committee on Aeronautical and Space Sciences, *NASA Authorization for Fiscal Year 1962*, S. Rept. 475, 87th Cong., 1st sess. (Washington: GPO, 1961), pp. 2-7 (hereafter cited as Senate Report, *NASA Authorization for Fiscal Year 1962*).

<sup>45</sup> *Ibid.*

<sup>46</sup> Based on interview.

<sup>47</sup> Dryden, in an appearance before the House Space Committee, testified that President Kennedy had not ignored manned space flight during the March review but had "reserved" it for "further study within the executive branch." Dryden went on to say, "I think at the time most of us felt he was contemplating reconsidering this in connection with the following budget." See House Hearings, *1962 NASA Authorization*, p. 1037 of Part 3.

BOB's action made sense to the extent that the Saturn vehicle, especially the larger C-2 version, was the pacing item for all future manned space-flight programs, and that the fiscal year 1963 budget could fund the spacecraft involved. NASA admitted that the March add-on, modest as it was, permitted an acceleration of the Apollo flight schedule.<sup>48</sup> Flights around the earth using the Apollo spacecraft were moved up from 1967 to 1965, and circumlunar flights from 1969 to 1967. The add-on even permitted the establishment of a target date for a lunar landing in the 1969-70 time period.

Publicly NASA did not protest the action of BOB in cutting back the March request. There seemed to be a general acceptance, even by the aggressive House Astronautics Committee, that the March budget amendment was a sufficient step forward.<sup>49</sup>

Then, on April 12, came the dramatic news that Yuri Gagarin of the U.S.S.R. had become the first human to orbit the earth in space.

*Impact of the Gagarin Flight.* The impact of the Gagarin flight in *Vostok I* was like that of *Sputnik I*. Even though there were numerous warnings that Russia's big boosters would permit it to make spectacular achievements in space, including manned space flight, there was a great chagrin in the United States. Once again it had come in second best.

It did not take the House Astronautics Committee long to zero in on exactly what NASA had asked for in March and what it had received. In remarkable testimony on April 14, 1961, 2 days after the Gagarin flight, Associate Administrator Seamans reluctantly told the House Astronautics Committee everything it wanted to hear.<sup>50</sup> Yes, BOB had knocked out everything that NASA had requested for manned space flight. Yes, NASA felt that Project Apollo would benefit by having more money spent on it during fiscal year 1962, even though the launch vehicle, the Saturn C-2, was still the pacing item. Yes, spending large amounts of money could achieve a telescoping of NASA's 10-year plan and possibly permit, if everything went perfectly, a manned landing on the moon by 1968 or even as early as 1967. (1967 was regarded as a crucial date; there were rumors that the U.S.S.R. would attempt a lunar landing as part of its celebration of the 50th anniversary of the 1917 Bolshevik revolution.) Seamans clearly indicated, however, that NASA had no plans to ask the Bureau of the Budget for more money for fiscal year 1962.<sup>51</sup> Actually, Vice President Johnson had been studying the future of manned space flight for some time, but this was not known publicly.<sup>52</sup>

<sup>48</sup> See Seamans' testimony of Apr. 14, 1961. House Hearings, 1962 *NASA Authorization*, p. 375.

<sup>49</sup> A reading of the transcript of the Webb-Dryden-Seamans news conference on the March budget amendment, however, reveals, if one looks for it, a definite lack of enthusiasm on what the March amendment could achieve and an unspirited defense of the adequacy of the amendment. (For the transcript, see NASA News Release 61-65, Mar. 28, 1961.)

<sup>50</sup> See House Hearings, 1962 *NASA Authorization*, pp. 360-382.

<sup>51</sup> *Ibid.*, p. 361.

<sup>52</sup> See Dryden comments to NASA Historical Office, Aug. 4, 1964.

The Gagarin flight accelerated the reappraisal of the U.S. space program.<sup>53</sup> On April 21 President Kennedy formally instructed Lyndon Johnson and the Space Council to make a study of what space projects must be pushed if the United States intended to surpass the U.S.S.R. in space.<sup>54</sup> On May 5, the date of Astronaut Shepard's suborbital Mercury flight, President Kennedy revealed that a second budget add-on was a possibility.<sup>55</sup> On May 25, 6 weeks after the Gagarin flight, President Kennedy announced a sizable acceleration of the Nation's space program.<sup>56</sup>

*The President's May 25 Message.* On May 25, 1961, President Kennedy, at a joint session of Congress, delivered a State of the Union message.<sup>57</sup> After discussing the domestic economy, national defense, and foreign affairs, the President came to his last and major point—space. He declared that the time had come to “take longer strides” in space, that it was time for a “great new American enterprise,” time for the United States “to take a clearly leading role in space achievement.” He claimed that the United States had the “resources and talent,” but had never made the national decision to use these assets to achieve world leadership in space. The head start of the U.S.S.R. should not discourage the United States. “For while we cannot guarantee that we shall one day be first, we can guarantee that any failure to make this effort will make us last.”

The President called for the Nation to commit itself “to achieving the goal, before this decade is out, of landing a man on the moon and returning him safely to the earth.” He pointed out that this would be an expensive venture, one that would consume time, talent, and resources that could be spent elsewhere. He believed it would be worth it, however, and he asked Congress and the American people to consider the matter so that the entire Nation could arrive at a truly national decision and make it a truly national venture.

In addition to asking for a large acceleration of the effort related to a manned lunar landing, the President asked for an accelerated effort in three other areas—the development of a nuclear rocket, the development of communications satellites, and the development of meteorological satellites.

The President indicated that the degree of acceleration he had in mind would increase the fiscal year 1962 budget by an additional \$531 million.

<sup>53</sup> For other more detailed accounts, see Jay Holmes, *America on the Moon: The Enterprise of the Sixties* (Philadelphia: J. B. Lippincott Co., 1962), Ch. 15; also “The Expanded Space Program,” *Historical Sketch of NASA*, pp. 27-31.

<sup>54</sup> *New York Times*, Apr. 22, 1961, p. 1. The Bay of Pigs fiasco had occurred on Apr. 17 and is generally regarded as an additional reason for the administration's interest in doing something dramatic in space.

<sup>55</sup> *New York Times*, May 6, 1961, p. 14. The Shepard flight, because of the open and widespread coverage, was a worldwide propaganda success for the United States even though it did not compare with the Gagarin flight as a technical achievement.

<sup>56</sup> The full inside history of the January-May events has yet to be written.

<sup>57</sup> For text, see *New York Times*, May 26, 1961, p. 12.

Budgets over the following 5 years would have to be increased by a total of from 7 to 9 billion additional dollars.<sup>58</sup>

*Long-Range Ramifications of the President's Decision.* The Kennedy administration's space program acceleration decision immediately altered NASA's long-range planning, especially its lunar-related aspects.<sup>59</sup> Time tables were significantly compressed. This could only be achieved by spending larger amounts of money over a shorter period of time. The fiscal year 1962 budget amendments were only an initial down payment on a large long-range spending program.

The most significant timetable change was the target date for a manned lunar landing. The timetable inherited from the previous administration called for a post-1970 lunar landing date, with 1971 considered the earliest possible date. President Kennedy called for a pre-1970 date, with 1967-68 regarded as the earliest possible date.

The planning date for a manned flight around the moon (circumlunar, not lunar orbital) was changed from 1969 to 1967, or earlier. The flight of a three-man space "laboratory" in orbit around the earth was changed from 1967 to 1965.

To carry out these very large undertakings, much new hardware would have to be developed and much research conducted. The only applicable hardware items actually under development in early 1961 were the Saturn C-1 vehicle, which was to launch the three-man laboratory into orbit around the earth, and two large engines that could be used in post-Saturn vehicles. The January budget had included small amounts of money for moving ahead in fiscal year 1962 with the development of the three-man capsule (the Apollo capsule) and the vehicle to launch the capsule on a circumlunar flight (the Saturn C-2). Since the lunar landing and return would require a spacecraft with its own propulsion system, the vehicle for the lunar landing mission would have to be considerably larger than the Saturn C-2.

In early 1961 there were many unknowns concerning the problems that would be encountered in achieving a manned lunar landing. The Kennedy budget amendments constituted NASA's best estimates on which objectives to pursue first.

*Details of the March and May Budget Amendments.* The budget amendment that President Kennedy sent to Congress the day following his May 25 message was over four times as large as his March amendment.<sup>60</sup> Taken together,

<sup>58</sup> The public utterances on the future costs of the Nation's space program were very confusing. At a May 25, 1961, budget briefing given by Webb, Dryden, and Seamans, it was indicated that NASA's budget over the 9 fiscal years beginning with fiscal year 1962 would amount to \$40 billion, which is about \$28 billion more than projections made by the Eisenhower administration. The overall price tag for developing the capability to make a manned lunar landing was generally estimated to be between \$20 and \$40 billion. For text of budget briefing, see NASA News Release 61-115, May 25, 1961.

<sup>59</sup> Cf. Seamans' and Hyatt's testimony on Mar. 23, 1961 (House Hearings 1962 *NASA Authorization*, pp. 167-190), with various testimonies after May 25.

<sup>60</sup> President Kennedy's letter to Speaker Rayburn was dated May 26, 1961. The budget amendment was published as H. Doc. 179, May 29, 1961, 87th Cong.



the two budget amendments provided for a 61-percent increase in President Eisenhower's fiscal year 1962 request. The details of the March and May amendments, together with the January request, are presented in Table 6-1.<sup>61</sup> This table gives a comprehensive picture of precisely what was changed as a result of the acceleration. It should be remembered that the amendments were to the fiscal year 1962 budget and thus for a fiscal year that was to get underway only 5 weeks after the May 25 message.

The March and May amendments increased "New Obligational Authority for Construction of Facilities" by 163 percent (line 28). This was an indication of the importance placed on getting started on long lead time construction items.<sup>62</sup> In keeping with NASA's policy of relying heavily on outside contractors, "Research and Development" (line 27) was increased at a much faster rate than "Salaries and Expenses" (line 26). Nevertheless, plans for 4,080 new positions constituted an ambitious in-house expansion program for a 1-year period (line 5).

As mentioned earlier, the March amendment emphasized launch vehicle development almost exclusively. The March funds for Saturn (line 6) were designed to permit an immediate go-ahead on the large-scale development of the Saturn C-2, the vehicle that was to be used for circumlunar flights. The funds for Centaur (line 7) and related AMR construction (line 18) were designed to beef up the development of a vehicle upon which many important future flights depended (e.g., the Surveyor soft lander on the moon), and which also was to be the proving ground for a liquid-hydrogen propulsion system intended for use in the upper stages of Saturn vehicles.

Many items were increased in the May amendment. The biggest increase was for the Apollo project (line 9). This change meant that a large-scale effort could be made to develop a spacecraft with the eventual capability of landing men on the moon and returning them to earth.

Closely associated with the Apollo project was the item providing for the construction of a new laboratory for manned space flight projects (line 19). Eventually located in Houston, Tex., this new NASA installation was to have jurisdiction over the development of the Apollo spacecraft and its eventual flight program, including flights to the moon.

The large additions to the lunar and planetary program (line 11) were designed to strengthen NASA's program for the unmanned exploration of the moon, using hard-landing Ranger Spacecraft and soft-landing Surveyor spacecraft. The unmanned exploration of the moon was considered an absolutely essential step preparatory to a manned landing.

The May amendment included \$133 million for the so-called Nova launch vehicle and related propulsion systems and facilities (lines 8, 12, 20, 21). The

<sup>61</sup> Based primarily on data on pp. 3-7 of Senate Report, *NASA Authorization for Fiscal Year 1962*.

<sup>62</sup> CoF constituted 9 percent of the January budget and 14 percent of the much larger May budget.

TABLE 6-1.—Summary, NASA's Fiscal Year 1962 Budget

Line and item	New obligational authority, in thousands			
	January budget	March amendment	May amendment	Revised total
1. Salaries and Expenses . . . . .	\$189,986	\$6,700	\$30,000	\$226,686
2. Research and Development . . . . .	819,819	99,720	376,000	1,295,539
3. Construction of Facilities . . . . .	99,825	19,250	143,000	262,075
4. Total . . . . .	1,109,630	125,670	549,000	1,784,300
5. Positions . . . . .	(17,342)	(780)	(3,300)	(21,422)
Major R&D changes:				
6. Saturn Vehicle Development . . . . .	168,160	56,000		224,160
7. Centaur Vehicle Development . . . . .	30,800	25,600		56,400
8. Liquid Propulsion . . . . .	68,700	9,320	15,000	93,020
9. Apollo Project . . . . .	29,500		130,500	160,000
10. Life Sciences . . . . .	8,620		12,000	20,620
11. Lunar and Planetary . . . . .	103,899		56,000	159,899
12. Launch Vehicle Technology . . . . .	15,000		12,000	27,000
13. Nova Vehicle Development . . . . .			48,500	48,500
14. Communications Satellite Development . . . . .	34,600	10,000	50,000	94,600
15. Meteorology Satellite Development . . . . .	28,200		22,000	50,200
16. Nuclear Systems Technology . . . . .	24,000	4,000	8,000	36,000
17. All Other . . . . .	308,340	-5,200	22,000	325,140
Major CoF changes:				
18. Atlantic Missile Range . . . . .	32,583	17,000		49,583
19. Manned Flight Laboratory . . . . .			60,000	60,000
20. Nova Launch Facilities . . . . .			28,000	28,000
21. Liquid Propulsion Facilities . . . . .	1,175		30,000	31,175
22. Nuclear Technology Facilities . . . . .			15,000	15,000
23. All Other . . . . .	66,067	2,250	10,000	78,317
Percentage increases based on January budget:				
24. March Amendment . . . . .				11
25. March and May Amendments . . . . .				61
26. Salaries and Expenses . . . . .				19
27. Research and Development . . . . .				58
28. Construction of Facilities . . . . .				163
Major R&D categories:				
29. Applications Programs . . . . .				131
30. Manned Exploration of Space . . . . .				126
31. Launch Vehicle Development . . . . .				63
32. Scientific Exploration of Space . . . . .				38
33. All Other . . . . .				25

Nova was an interim name given to a very large launch vehicle which would cluster the large F-1 and J-2 engines that NASA was developing. Supposedly it was to be the vehicle that would launch the Apollo spacecraft, including its propulsion unit and a three-man crew, directly to the moon.

As far as the manned lunar landing was concerned, the budget amendments left two major questions in abeyance. One was whether to begin a sizable national program for the development of large solid-fueled vehicles to parallel the liquid system upon which NASA was concentrating. The other was whether to pursue simultaneously several methods of achieving a manned lunar landing, such as the direct approach using one large vehicle, and the earth orbit rendezvous approach using several smaller vehicles. (The lunar orbit rendezvous approach, the one selected a year later, was not given much consideration in early 1961.)

In addition to the lunar projects, NASA's space program was accelerated in two other areas—practical applications and nuclear technology. It was felt that the U.S.S.R. could very likely be bested in both these areas. Funds for communications and meteorological satellites were increased 131 percent (lines 29, 14, 15). Nuclear-systems technology and related facilities received an additional \$42 million (lines 16, 22).

**Conclusions.** The turnover in the national administration led to three basic changes that significantly affected NASA's subsequent history. First, a top-level policymaking body for the entire national space program, the National Aeronautics and Space Council, was reestablished and staffed. Second, NASA obtained a new administrator with more of an administrative orientation than a technical one. Third, the civilian space program was significantly accelerated with a growth potential that would make NASA one of the largest agencies in the Federal Government.

Continuity forces also were at work. Webb's replacing Glennan was the only major change in NASA's top management.<sup>63</sup> Everyone else stayed in their old jobs including the appointed Deputy Administrator. Although DOD's space program was reorganized, NASA-DOD relations, partially institutionalized by the Aeronautics and Astronautics Coordinating Board, continued much as before. NASA's organizational and administrative response to the acceleration of its program is the topic of the next chapter.

<sup>63</sup> It should be noted at this point that Glennan took great care in putting NASA's house in order and preparing a set of transition notes for the incoming Administrator.

## Chapter Seven

### REORGANIZATION FOR PROGRAM ACCELERATION

The previous chapter covered the period of transition from the Eisenhower administration to the Kennedy administration and the extremely important decision to substantially accelerate NASA's space program. This chapter covers the rest of 1961.

There seems to be little doubt that 1961 was the most eventful of NASA's first 5 years. Agency officials must have been reeling by the time the year ended. Momentous decisions on both program and administrative matters had been made in quick succession. There were at least two administrative decisions of major importance. One was the decision to strengthen NASA's general management by greatly strengthening the staff of the Associate Administrator, the other was the decision to reorganize NASA as a whole. The November 1, 1961, reorganization was the climax of NASA's 1961 administrative history. The events leading to it were complex.

By way of introduction, it may be well to summarize briefly the organization and program that the new Administrator took over in February 1961. NASA consisted of over 16,000 employees, more than 95 percent of whom worked in field offices located in California, Ohio, Alabama, Florida, Virginia, and Maryland. Yet only about 15 percent of its \$1 billion annual budget was spent directly in-house. The rest was spent by contract, primarily with the aerospace industry, but also with the construction industry, universities, and nonprofit organizations. Its program of basic aeronautical and space research, spacecraft and launch vehicle research and development, and space exploration had achieved several notable successes, especially in the scientific field. Significant progress had been made in other fields, especially manned space flight. Among Federal agencies, it ranked 13th in number of personnel and 8th in terms of its budget (i.e., obligational authority).<sup>1</sup>

NASA faced the usual problems of all large organizations. In addition, it faced problems unique to the technical program for which it was responsible, and

<sup>1</sup>Based on the President's fiscal year 1961 budget requests. In terms of obligational authority, only DOD, Treasury, VA, USDA, HEW, AEC, and Foreign Aid were larger. In number of personnel, all of the executive departments except Labor were larger, as were the VA, FAA, and GSA. TVA was about the same size.

to the contracting arrangements by which it did most of its work. These problems were compounded by what was generally regarded as something short of a clear-cut statement as to NASA's long-range objectives. At the time it lacked the support which a clientele-oriented agency can muster, although some support from the scientific community could be obtained. It lacked the security which an agency performing indispensable functions such as defense, foreign policy, or tax collecting has. It was not a multifaceted agency where declines in certain areas could be matched by advances in others. In early 1961, NASA was still a "reactive" agency—a manifestation of the reaction or response of Congress and the President to the challenge of outside events. As it turned out, the pressure of outside events continued for a long enough period to permit NASA to become somewhat better entrenched. By 1964 the agency's organization and program had become somewhat stabilized.

This is not to suggest that the only problem NASA faced in early 1961 was its mandate. There were numerous internal administrative and organizational problems to which the new Administrator had to address himself. At the same time much of his attention had to be devoted to the external activity of working with Kennedy and Johnson concerning a reformulation of NASA's mandate.

#### I. WEBB'S FIRST LOOK AT NASA ORGANIZATIONAL PROBLEMS

Glennan departed from NASA 3 weeks before Webb appeared on the scene and thus was never able to brief his successor on NASA's administrative and organizational problems.<sup>2</sup> He was able to pass on to his successor information and recommendations on those problems. In addition, Webb inherited the small group of NASA officials who had closely participated in Glennan's organizational studies and who were thus familiar with what had been done and what was still left to do.<sup>3</sup>

The following is a brief summary of the information and recommendations which Webb inherited.<sup>4</sup>

##### A. Summary of NASA's 1960 Administrative Self-Evaluation

In October 1960, a McKinsey & Co. report on NASA contracting recommended a strengthening of NASA's procurement practices, policies, and machinery, and a general tightening in the area of project management.<sup>5</sup>

<sup>2</sup> This was a source of frustration for Glennan. See his letter to Richard Horner, former Associate Administrator, Jan. 12, 1961.

<sup>3</sup> The Director of the Office of Business Administration, Albert Siepert; his deputy, Wesley Hjernevik; and special assistant Alfred Hodgson, all came to NASA shortly after its establishment. The head of NASA's Management Analysis Division, John Young, came to NASA in December 1960 from McKinsey & Co. where he had been in on almost all of the studies that McKinsey & Co. had done for NASA.

<sup>4</sup> See Ch. 5, Sec. III, for full details.

<sup>5</sup> See Ch. 5, Sec. III.B.

In November 1960, the report of the Advisory Committee on Organization (the Kimpton Report) made mild recommendations on NASA's organizational arrangements and delineated several areas for agency attention.<sup>6</sup> The report concluded that eventually NASA would have to realign its Headquarters program offices to eliminate the "built-in" integration problem caused by the existence of separate offices for spacecraft development and launch vehicle development. No other significant structural recommendation was made. The areas earmarked for attention were these:

1. The balance between research, on one hand, and development, on the other, and the proper insulation of one from the other (more flexibility needed).
2. The optimum degree of decision making and operational decentralization (more decentralization needed).
3. The balance between in-house and out-of-house activity (the more of the latter the better).
4. The optimum utilization of university resources (underused at that time).
5. Better allocation of responsibilities among NASA installations (responsibility should be better pinpointed).
6. The role of the Associate Administrator (his power should be strengthened).
7. The organizational status of aeronautics (should be elevated).

The self-evaluation activity of which the Kimpton Report and the McKinsey Contracting Report were a part also generated other ideas which were more or less floating around at the end of Glennan's term.<sup>7</sup> One such idea was that the field centers might more properly be directly under the Associate Administrator rather than under Headquarters program directors. Another was that new field centers were needed, especially for life science and manned space flight activities. A third was that NASA needed more rather than less in-house activity. A fourth was that NASA Headquarters needed a more comprehensive reorganization than merely eliminating the bifurcation between launch vehicles and spacecraft.

With the impending change in national administrations and no immediate crises demanding attention, comprehensive implementation of the various recommendations was not attempted in late 1960. The pot was simmering, however, when Webb became NASA's second Administrator.<sup>8</sup>

#### **B. The February "Summary Look"**

As a lawyer-administrator, Webb was very interested in organizational and administrative matters. Shortly after being sworn in he was briefed by NASA's

<sup>6</sup> See Ch. 5, Sec. III.C.

<sup>7</sup> NASA officials were asked to comment on the Kimpton Report. See Ch. 5, last portion of Sec. III.C.

<sup>8</sup> It should be recalled that the January 1961 Wiesner Report included several organizational and administrative recommendations. See Ch. 6.

specialists on organizational structure and administrative processes (Siepert, Hjernevik, Hodgson, and Young). He quickly gave a green light to preparation of an analysis of NASA's organizational problems and of a set of alternative structures should major reorganization seem necessary.<sup>9</sup>

The first document to be produced, entitled "A Summary Look at 'the Headquarters Organization Problem,'" is significant in that it revealed the thinking of NASA's organizational specialists and also turned out to be the base for subsequent analysis.<sup>10</sup> It is dated February 27, 1961, prior to any inkling that the space program might be significantly accelerated.

No recommendations were made. Instead, problems were listed and several alternative solutions presented. Certain assumptions were set forth which had definite implications as to which solutions would be most desirable.<sup>11</sup> These assumptions were that NASA's general management needed strengthening, that planning and programming should be improved in NASA Headquarters, that operations be decentralized as much as possible, and that the multipurpose role of the field centers be continued. These assumptions implied that changes were necessary and that the power of the Headquarters technical program offices was too great relative to general management, on one hand, and the field centers, on the other. In effect, NASA's trend toward a bureau system of organization should be nipped in the bud.

Before it went into detail on NASA's specific problems and possible solutions, the "Summary Look" suggested that the relationship among the top three agency officials need not continue along the same lines as under Glennan. (Under Glennan the top three acted as a trinity in making major decisions, but with Glennan primarily serving as "Mr. Outside," Seamans as "Mr. Inside," and Dryden as "Mr. Science," responsible for relationships with the scientific community, national and international, but with few operating responsibilities.)<sup>12</sup> The "Summary Look" pointed out that Mr. Webb, not being a technical man, might want to loosen the trinity somewhat by detaching himself from certain technical decision-making activities (in favor of Dryden). The report was careful to point out that Mr. Webb would determine the arrangement and could even go so far as to convert the Deputy Administrator's position into one of general manager.<sup>13</sup>

NASA's administrative and organizational weaknesses were delineated:

1. Program budgetary and management reporting were too fragmented among Headquarters offices.
2. The organizational separation of spacecraft from launch vehicles was causing undue coordination problems.
3. There was imbalance among Headquarters program offices (the Office

<sup>9</sup> See pp. 3-4 of "List of Basic Steps and Documents Involved in NASA Reorganization of November 1, 1961" prepared by John Young, 1962.

<sup>10</sup> "A Summary Look at 'The Headquarters Organization Problem,'" Feb. 27, 1961. (Prepared by Hjernevik, Siepert, Hodgson, and Young, 37 pages, 4 organization charts.)

<sup>11</sup> *Ibid.*, p. 1.

<sup>12</sup> *Ibid.*, pp. 2-3.

<sup>13</sup> *Ibid.*, p. 4.

of Life Science Programs was too weak, the Office of Space Flight Programs was too strong).

4. Headquarters-field relationships presented problems, mostly because of the large number of echelons between the field center director and the NASA Administrator. Because centers lacked direct access to NASA's general management, the centers did not develop an "agencywide" point of view and did not participate in "agencywide" policy-making.<sup>14</sup>

To correct current deficiencies, the paper presented a series of alternative organizational arrangements ranging from a slight modification of the status quo to its wholesale revision. Since the maximum change suggested (labeled "Alternative D") incorporated most of the innovations of less drastic alternatives, it affords the best means of summarizing the various innovations deemed feasible.

Alternative D departed from the status quo in four principal ways: (1) It provided that the field centers report directly to the Associate Administrator rather than to the Headquarters program directors; (2) it strengthened the hand of the Associate Administrator by creating a staff office responsible for program management and attaching the Office of Business Administration directly to the Associate Administrator to strengthen his hand in administrative management; (3) it realigned the functions of the old Headquarters program offices, primarily to eliminate the organizational separation of spacecraft from launch vehicles; (4) it concentrated program integration at the general management level (which is actually the result of changes (1)-(3) and the fact that the old program offices, in effect, were converted into staff offices rather than line offices).

Changes (2) and (3) could stand alone. Change (1) required change (2) unless a highly decentralized system of decision-making and program integration was desired, which it was not.

By the end of 1961, most of the features of Alternative D had been implemented, except that the May manned lunar landing decision contributed toward a different realignment of the Headquarters program offices than that envisioned in February. Change (2) was brought about by the establishment of the Office of Programs in June. The other changes came in November. The course of reorganization in 1961 was not without its ups and downs; program decisions, personality clashes, and structural rationalizations all affected the outcome. One is left with the feeling, however, that some of NASA's top leaders may well have developed a "mind-set" on NASA's optimum organization as early as February and thus became somewhat inflexible toward other points of view that developed subsequently.

### C. Reactions to the March Program Acceleration

The "Summary Look" examined fundamental intra-agency relationships on the basis of past experience. The fiscal year 1962 budget add-on of \$125 million in March, with its potential for a sizable increase in fiscal year 1963, prompted a

<sup>14</sup> *Ibid.*, pp. 6-10.



look at organizational and administrative problems in the light of future program objectives. On March 31, John Young, the head of the Management Analysis Division, sent a memo to Webb which attempted to list all areas requiring attention.<sup>15</sup> In addition to fundamental areas such as those covered in the "Summary Look" (program integration, Headquarters alignment, interinstallation relationships), the following also were listed: (1) In-house versus out-of-house division of effort (not new, a major area of attention under Glennan); (2) the planning and management of research (in 1960, emphasis was on the balance between research, on the one hand, and development, on the other); (3) the role of DOD in supporting NASA's program; (4) additional improvements in procurement, especially in incentive contracting; (5) improved liaison with the scientific community; (6) maintaining NASA's technical and scientific competence and skill, basically a personnel problem; (7) better recognition of the social, political, and economic implications of the civilian space program; (8) the establishment of a manned space flight center; (9) the future role of the Office of Business Administration.

The implications of this listing were, of course, that internal organizational problems were only a portion of an even larger number of problems requiring attention, many of which involved external relationships, the area of Webb's particular concern.

## II. STRENGTHENING GENERAL MANAGEMENT

The program acceleration decisions of the March-through-May period had to be taken into consideration before proceeding with a major agency reorganization or any significant overhaul of basic operating procedures. Time was needed to analyze fully the long-run implications of program acceleration. Furthermore, NASA had to await Congress' ratification of the President's policy decision before it could act on the basis of the new policy. A clearer picture had to develop as to the nature and scope of necessary in-house expansion. For these and other reasons, and in spite of a flurry of study during May, the overall reorganization of NASA was not agreed upon until September and did not become effective until November.

One important problem predated the March-May program acceleration decisions, however, and was ripe for early attention. The problem was NASA's system of weak general management. Top NASA officials had been aware for some time that power was not centered in general management (personified by the Administrator, Deputy Administrator, and Associate Administrator) as much as in the Headquarters program offices and in the field centers. Many officials felt that NASA was actually at the crossroads; it would develop either into an

<sup>15</sup> "Major Problems of Concern in the Organization and Management of the Civilian Space Program," a draft memorandum prepared by John Young for James Webb, Mar. 31, 1961.

agency of several strong and semiautonomous bureaus or into an agency integrated under strong central management at the top.<sup>16</sup>

The several "rearrangements" and staff additions made in the Office of the Associate Administrator during 1959 and 1960 were only a partial strengthening of general management.<sup>17</sup> The turnover in Associate Administrators in September 1960 and in Administrators in January 1961 negated much of the strengthening effort.

Webb's appearance on the scene provided a logical time for a reappraisal of the role of NASA's general management. The end result was a significant strengthening of general management—one of the most important developments in NASA's administrative history. A staff study prepared by the Management Analysis Division became the blueprint for the changes that were made.<sup>18</sup>

#### A. The April 14, 1961, Study on General Management

The April 14 study focused on the roles and responsibilities of NASA's general management (Administrator, Deputy Administrator, and Associate Administrator) and the adequacy of the organizational and staffing arrangements available to its three top officials.

The roles of NASA's top three officials were stated as being much the same in 1961 as in 1958 when the idea of an Associate Administrator was first suggested.<sup>19</sup> The Administrator served as the principal link between NASA and the President and Congress, and was the chief formulator of top-level policy. The Deputy Administrator was precisely that, a deputy whose power and function was as broad in scope as that of the Administrator. The Associate Administrator, however, was internally oriented and responsible for the internal execution of policy decisions—a type of general manager. He also maintained relationships with DOD and the military services in connection with joint technical programs.

In regard to the basic concepts underlying NASA's top three positions, the April 14 study recognized two developments. One was that the new Administrator was not a technical man. The other was that Deputy Administrator Dryden had established himself as the NASA official chiefly responsible for relationships with the scientific community, especially the international scientific community.

The study did not evaluate the roles of NASA's top three officials but rather regarded them as set. The variable was the organizational and staffing arrangement surrounding the top three. Here problems existed.

<sup>16</sup> The need for agencywide integration under general management has been emphasized in several early 1961 studies, such as the "Summary Look" mentioned in footnote 9 above. The idea that the development of bureaus had to be clipped was seldom, if ever, stated in writing.

<sup>17</sup> See Ch. 5, Sec. II.E.

<sup>18</sup> "Clarifying and Strengthening the Role of NASA's General Management," Apr. 14, 1961 (37 pages). Study was prepared by John Young, head of NASA's Management Analysis Division.

<sup>19</sup> *Ibid.*, Exhibit A.

The most serious problem was that staff arrangements were inadequate for central program review and analysis.<sup>20</sup> There was no "effective means for bringing together the review of short-term agency programs and projects, the central programming of related resources, and reprogramming actions related to major on-going programs and projects." NASA's program budgeting and budget execution mechanism was too fragmented. The same was true of NASA's management reporting and evaluation system. As a result, the Associate Administrator was not being supplied with the information he needed to make budget, project, and reprogramming decisions. Nor was the system by which the Associate Administrator could identify problem areas an adequate one.

A second problem was the lack of a central secretariat service.<sup>21</sup> Efforts were fragmented; there was a need for a "general reappraisal and improvement" in normal secretariat functions.

The third and final problem was that the three top officials needed adequate staff assistance to serve them directly (i.e., there was a need for more "assistants to" positions)<sup>22</sup> so that "unfiltered" information could be pulled together, "spot analyses" made, and followup work done. (In addition, such positions would be useful opportunities for training future executives.)

*Recommendations of the April 14 Study.*<sup>23</sup> To solve the problems just mentioned, several actions were recommended: Each of the top three NASA officials should be provided with anywhere from one to three personal assistants; a central secretariat should be established directly under the already established Assistant to the Administrator position; an Office of Programs should be established directly under the Associate Administrator. This, in turn, would necessitate a clarification of the role and responsibilities of the already existing Office of Business Administration.

The recommendations concerning the Office of Programs and the Office of Business Administration were very significant and warrant detailed discussion, especially since they were implemented almost in their entirety only a little over a month later.

It should be recalled that NASA's Office of Business Administration (OBA), with its Financial Management, Personnel, Procurement, Security, Administrative Service, Management Analysis, and other divisions, was generally regarded as one of the several large Headquarters program offices reporting directly to the Associate Administrator, even though many of its functions were not line functions in the ordinary sense. The Office was not considered a staff arm of the Associate Administrator. The early 1961 staff of the Associate Administrator consisted of several immediate assistants, an Office of Program Analysis and Control, and an Office of Reliability. It should also be recalled that budget analysis and review was performed by ad hoc teams rather than a central office.

<sup>20</sup> *Ibid.*, p. 2.

<sup>21</sup> *Ibid.*, p. 3.

<sup>22</sup> *Ibid.*, p. 4.

<sup>23</sup> *Ibid.*, pp. 5-16.

The April 14 study recommended a drastic overhaul in the existing setup. It recommended the establishment of a sizable office to serve as the staff arm of the Associate Administrator for such matters as budget preparation, management reporting, project evaluation and review, facility coordination, and general control over the two fundamental resources of manpower and money. These were matters which the Associate Administrator had to have jurisdiction over if he was to act as a true general manager.

The overall functions and power contemplated for this "Office of Programs" are revealed by an examination of its four proposed subordinate divisions—management reports, resources programming, project review, and facilities coordination. The proposed management reports division was to operate a program and project reporting system (at the time built around the older Project Management Plan and the incoming PERT system) designed to supply data for "program planning, scheduling, and status reporting" to all levels of NASA management.

The proposed resources programming division was to have several important substantive functions. It was to formulate budget policy guidelines and present them to top management for decision. It was to analyze the budget estimates from program offices in terms of adequacy of justification, adequacy of inter-office coordination, absence of duplication, and general all around soundness and balance. After review by top management, the resources programming division would prepare the data for NASA's budget. In addition to budget preparation, the division was to play a major role in analyzing the status of "near term projects" and make recommendations on all requests for program adjustments involving money or manpower. The division was to supply substantive analytical information for use by other offices.

The proposed facilities coordination division was to perform the somewhat specialized function of keeping tab on all NASA construction and facility acquisition activities, including the review and evaluation of budget estimates for new construction and acquisitions.

The proposed project review division was technically oriented. It was to have general jurisdiction over NASA's reliability program, make a special effort to keep track of NASA's many study activities, and, most important of all, to conduct a final technical evaluation of all requests for new projects or significant changes in old ones. (The innovations in project approval procedures are discussed later.)

As a whole, the Office of Programs was to have the capability to advise the Associate Administrator on any normal internal management situation that would arise. Its loyalty would be to the Associate Administrator rather than to any one program or group of programs, or to any combination of field installations or program offices. It was to give the Associate Administrator the capability to be a true general manager instead of a mediator among power blocks.

The involvement of the Office of Programs in the control of money and manpower and in such things as budget preparation, budget execution, manage-

ment reporting, and facilities coordination raised the question of what should be the substantive powers and functions of the Office of Business Administration. The April 14 study called for a reconceptualization and reclarification of the role of the Office of Business Administration. It suggested that OBA be thought of primarily as a staff arm of general management, but with the understanding that it was to render service to all of NASA.

Since most OBA activities related to the internal operations of NASA (e.g., accounting, auditing, procurement, personnel administration, security), it made sense to place the office directly under and close to the Associate Administrator. On the other hand, OBA activities were also related to the activities of the Administrator and Deputy Administrator (e.g., organization and management work), the Headquarters technical offices (e.g., procurement, contract research), and the field installations where counterpart offices were located. This multifaceted orientation of the Office of Business Administration posed a thorny problem. The April 14 study indicated that it was still being studied and would be worked out some time in the future.

#### **B. Implementation of the Recommendations of April 14**

On June 5, 1961, NASA announced the establishment of the Office of Programs.<sup>24</sup> At the same time, the Office of Business Administration was renamed the "Office of Administration" and the Western Operations Office put directly under it. In taking these actions, NASA adhered very closely to the recommendations of the April 14 study.

The June 5 announcement revealed the names of those appointed to the Office of Programs and thereby suggested a tactical reason for the Office's establishment, whereas the April 14 study had been couched in terms of administrative principles. The tactical reason for establishing the Office of Programs was to decide once and for all that Associate Administrator Seamans was to be the center of power in NASA rather than the Headquarters program directors, especially Silverstein, the head of the Office of Space Flight Programs.<sup>25</sup> For this reason the establishment of the Office of Programs was one of the most significant events in NASA's administrative history. The train of events, as it related to individual personalities, warrants recapitulation.

During the Glennan period the most powerful positions in NASA Headquarters, and in many ways in all of NASA, were the Administrator, Deputy Administrator, Associate Administrator, and the Directors of Aeronautical and Space Research, Space Flight Development, Launch Vehicle Development, and

<sup>24</sup> NASA Announcement 314, June 5, 1961. Subject: Organizational and Functional Changes in NASA Headquarters.

<sup>25</sup> Based on the author's own synthesis of information gathered from several sources, including his experience as an employee of the Office of Programs shortly after it was established, interviews with several NASA officials, and an interview with Aaron Rosenthal of NSF, former head of NASA's Financial Management Division.

**Business Administration.** For a variety of reasons, disproportionate amounts of power gravitated toward the Director of Space Flight Development (Silverstein). Four reasons are identifiable: position continuity, inherent powers of individual positions, the characteristics of NASA's program, and the personalities of the individuals. It was a combination of these factors which led to the accumulation of Silverstein's power.

*Continuity:* Silverstein; Dryden, the Deputy Administrator; and Siefert, Director of the Office of Business Administration, held the same positions in 1961 as they did in 1958. However, Siefert had come to NASA from the outside. Dryden had come from being Director of NACA to Deputy Administrator of NASA. Silverstein held the same position in NASA that he had held for several months in NACA. Glennan, on leave from the Case Institute of Technology, became a "short-timer" as soon as the end of the Eisenhower administration came in sight. The position of Associate Administrator was not filled until mid-1959 and there was a turnover from Horner to Seamans in mid-1960. The original Director of Aeronautics and Space Research, Crowley, was succeeded by Abbott in mid-1959. The Director of Launch Vehicle Development, Major General Ostrander, was appointed in December 1959.

*Inherent powers:* All three top positions were powerful ones. However, the power of Dryden (who rated high in continuity) was probably lessened somewhat by the very nature of his being a deputy, a type of vice president.

*Characteristics of NASA's program:* The new and rapidly growing portion of NASA's space program, space flight development, had been put under Silverstein in 1958. Much of the activity in this area was centralized in Headquarters because the development centers (Goddard, STG, JPL) all lacked true field center characteristics during NASA's early years. Silverstein's area swallowed the lion's share of NASA's R&D and CoF budget, most of it being spent by contract. The establishment of a separate Launch Vehicle Development Office helped restore a better balance, but only somewhat. The Director of Aeronautical and Space Research had the four large former NACA centers under him. Ordinarily this would be a source of power, but the centers were relatively stable, powerful in themselves, and somewhat independent.

*Personalities:* Silverstein was technically competent and aggressive, and quite successful in building a team of diligent assistants. He readily filled any vacuum that may have developed. Because of the first three factors listed, the best coalition to achieve central control would have been Glennan, Seamans, and Siefert. However, Siefert believed in evolutionary organizational change and hesitated in trying to force the establishment of a centralized control system during NASA's early years.

The establishment of the Office of Programs in June 1961 restored (or perhaps "moved" is a better word) the locus of power to NASA's center. It did this by taking several of Silverstein's key assistants and making them responsible to Associate Administrator Seamans. To help make the new Office of Programs

effective, Siepert gave up the last hold he had on the budget function and his small budget office was split to pieces in staffing the Office of Programs.

The five key appointments were as follows. The person chosen to head the Office of Programs was Silverstein's Director of Program Planning and Coordination, DeMarquis Wyatt. The head of the Project Review Division became William Fleming, who had been one of Wyatt's principal assistants. To head the management reporting operation, Thomas Jenkins, another one of Wyatt's assistants, was selected. (One reason for Silverstein's strength was that Wyatt ran a good program planning and coordination operation for him.)

Ralph Ulmer, head of Siepert's budget office, was put in charge of facilities coordination. The person named to head the resource programming operation was the Bureau of the Budget's NASA budget examiner, Don Cadle.

The Office of Programs also absorbed the Office of Reliability and Quality Assurance headed by Landis Gephart. This Office dated from March 1960 and had been part of the Office of the Associate Administrator.

The appointment of Wyatt, an engineer, to head the Office of Programs, rather than a financial management person, was designed to make the move as palatable as possible to the Headquarters technical program offices, including the one headed by Silverstein.

The establishment of the Office of Programs greatly strengthened the hand of the Associate Administrator in managing NASA's internal affairs. The people assigned to the Office of Programs soon became engaged in a variety of activities. Some activities were ad hoc in nature, such as the special studies and special analyses prepared for the Associate Administrator. Many were exploratory and experimental, such as working out relationships between the Office of Programs and other organizational units. Certain activities were inherited, such as the work associated with budget preparation and execution, and with the various management reporting systems. During 1961 there were significant developments in program management which were tied closely to the Office of Programs. Most of these activities and developments were procedural rather than structural and are discussed elsewhere in this chapter.<sup>26</sup>

The Office of Programs had to get off to a swift start, as problems were dumped in its lap right from the beginning. The fiscal year 1963 budget had to be prepared and the fiscal year 1962 budget (much larger than foreseen 6 months earlier) executed. Manned lunar landing problems were complicated and took high priority. Facility construction was especially urgent and problems associated with it complex. The manned lunar landing time schedule made management reporting more important than ever.

It was generally recognized that the establishment of the Office of Programs was only a partial solution to the general problem of reorganization. At the same time that decisions were being made on the establishment of the Office of Programs, a broader study was being undertaken on the fundamental questions of Headquarters' division of responsibility and inter-installation relationships.

<sup>26</sup> Sec. VI.A and Sec. VI.B.

### III. OVERALL REORGANIZATION RESTUDIED

During May, NASA's specialists on organizational structure made a much more detailed analysis of NASA's overall organizational structure than they had made earlier in February. Their purpose was to come up with a more complete set of alternative structures that could be used as the basis for making decisions on agency reorganization. They organized themselves into an informal task force and generated numerous papers, organization charts, etc. Their work was summarized in a draft study dated June 12, 1961.

#### A. The June 12 Staff Study<sup>27</sup>

The June 12 study is a landmark because it systematically depicted the status of NASA's organizational problem after the Office of Programs had been established and after the May 25 program acceleration had been made public. This was revealed by its title, "Reappraising NASA's Organizational Structure To Achieve the Objective of an Accelerated Program."

*Change in Tone.* The June 12 study included many ideas, comments, proposed solutions, etc., contained in previous studies, but these took on a new dimension in the face of a major program acceleration. For example, statements concerning NASA's general dependence on outside organizations, such as the aerospace industry, DOD, and the universities, now were stated as matters of immediate and prime concern.

*Program Realignment Necessary.* Apart from the change in tone, the major additional points made in the June 12 study were these: (1) NASA must assure that organizational arrangements for the manned space-flight program will accommodate the program's high-priority status, attract the necessary leadership talent, and ensure utmost coordination with all supporting elements. Yet it will have to be an integrated part of the overall space program. (2) NASA must assure that the "application" area (communications and meteorology) will be given a proper organizational home. (3) Programs in life sciences, space sciences, advanced research, advanced technical development, and launching, tracking, and communication support all have to be accommodated.<sup>28</sup> In effect, these three "findings" said that the current arrangement had to be revised.

*The Headquarters-Field Center Relationship Problem.* In the area of Headquarters-field relationships, two points were made: there was too great a gulf between the centers and general management and the center directors were too far down in the organizational hierarchy. The study went on to analyze the Headquarters-field relationship in great detail.<sup>29</sup> Since this problem had been

<sup>27</sup> The draft study entitled "Reappraising NASA's Organizational Structure To Achieve the Objectives of an Accelerated Program" was undated. The cover memorandum written by John Young was dated June 12, 1961.

<sup>28</sup> *Ibid.*, pp. 6-12.

<sup>29</sup> *Ibid.*, pp. 12-15.



the crux of almost all the organizational difficulties that NASA faced in the next 2 years, it warrants considerable amplification.

The Headquarters-field relationship problem as seen by NASA's organizational specialists was this:

The then-current NASA practice of making the field centers subordinate to the Headquarters program directors (rather than to general management) gave rise to several problems. One has already been mentioned—the gulf between general management and the center. Another problem was that almost all centers were multipurpose; that is, engaged in two or more types of activities such as research support, technology support, project management support, systems and subsystems development, and space flight projects. The Headquarters office to which the center was responsible was less “multipurpose” and tended to restrict certain center activities which might be beneficial to the agency as a whole.

Also, the current system gave inadequate recognition to the fact that “. . . the centers must be dealt with on two different but closely interrelated bases: a. General management of the centers as institutions and going concerns. b. Functional management of the same activities carried on at two or more centers. . . .”<sup>80</sup>

Complex and multifaceted functional management has built-in conflict problems. These problems are not insurmountable, however, as long as a center manager, faced with functional crossfire, can have an easy access to a level of management that can authoritatively resolve conflicts. This was very difficult in NASA because the line of command was routed through parochial Headquarters program directors.

The report suggested that the problem could be most easily solved by placing the NASA field centers directly under the general manager and by establishing smoothly functioning machinery to promote efficient functional management. Line authority would be simplified, and specialized functional relationships made no more complicated—a net gain, supposedly.

*One of Four Alternatives Preferred.* This bias in favor of having center directors report directly to the Associate Administrator colors the remainder of the report, in which the pros and cons of four alternative organizational arrangements were presented. Only one of the alternative arrangements would accommodate all the basic problem areas delineated. The Headquarters organization had to give due consideration to manned space flight and application without causing life sciences, space sciences, advanced research, advanced technical development, and launching, tracking, and communication support to suffer. The field centers would have to report directly to general management.

The alternative which incorporated these features was called “Alternative D.” Other alternatives were presented as being only partial solutions to the problems that NASA faced. The November 1 reorganization conformed quite closely to Alternative D.

<sup>80</sup> *Ibid.*, p. 13. See also J. Casper, “Functional Management in NASA,” historical note No. 53.

### B. The Silverstein Alternative

None of the alternatives proposed in the June 12 study gave the manned space flight program a position of power in the agency commensurate with the amount of money that would be poured into it. None of them suggested that the manned space flight program should be given a semiautonomous position in the agency which would set it apart from other agency activity. As early as April, Abe Silverstein suggested that the manned lunar landing could be best achieved by giving the job to a semiautonomous bureau in NASA with almost complete self-sufficiency in terms of overhead staff.<sup>31</sup>

This approach flew in the opposite direction of the school of thought that the bureau approach was undesirable and the locus of power in NASA should be centered in general management.

The high priority assigned to the manned program gave weight to the Silverstein approach. This was recognized by NASA's organizational specialists. When the June 12 study was revised in August, an alternative similar to the Silverstein approach was incorporated in it.

The Silverstein concept emphasized the importance of program objectives in determining an organization's structure. This was also recognized by NASA's specialists on organizational structure in their August revision. They quoted approvingly from a textbook in public administration: "One of the most important reasons why activities are grouped in particular ways is to secure emphasis on what are conceived to be the most important aspects of a governmental program."<sup>32</sup>

In view of the important relationship between the program of an agency and its organization, it would be well to describe certain program developments during the summer and fall of 1961 before examining the November 1 reorganization and the August study and other events leading directly to it. The discussion of NASA's program in the section which follows focuses on key decisions related to the manned lunar landing program.

## IV. PROGRAM DEVELOPMENTS FOLLOWING THE MAY DECISION

The March and May budget amendments accelerated NASA's program over a broad front. There is little doubt, however, that the manned lunar landing was the focal point around which most agency activity revolved. The feasibility of the lunar landing had been established in the February 1961 report of the Manned Lunar Landing Task Force (the Low Committee) which had been established by

<sup>31</sup> The so-called Silverstein approach, has been pieced together from a variety of sources, most of it through interviews.

<sup>32</sup> The quotation is from Simon, Smithburg, and Thompson, *Public Administration* (New York: Alfred A. Knopf, 1950), p. 168. The Aug. 7, 1961, staff study in which it was quoted is cited later in the chapter.

Glennan on January 6, 1961. This section examines the developments designed to get the manned lunar landing program off to the fastest possible start.<sup>33</sup>

Three distinct areas of activity can be discerned following the May manned lunar landing decision. First of all, planning studies had to be completed to form the basis for action. Two action areas then moved forward in parallel. One involved in-house facilities, the other out-of-house R&D contracts. By the end of 1961 all key program decisions had been made.

#### A. Planning Studies

Two planning studies were especially important. One was the Fleming Report on the overall manned lunar landing mission; the other was the Golovin Study on launch vehicles for the manned lunar landing.

*The Fleming Report.* On May 2, 1961, the Associate Administrator appointed an ad hoc task group to make an intensive study of what had to be done, and when, if the manned lunar landing was to be accomplished within the 6½- to 8½-year time frame hoped for.<sup>34</sup> Intermediate goals were to be delineated as well as pacing items and major decision points. The study was to be used as the basis for realistic program and budget planning. The study was to be based on a direct ascent to the moon using one large vehicle rather than the rendezvous method using several not-so-large vehicles.

The task group, chaired by William Fleming of NASA Headquarters, made its report (classified "Confidential") on June 16. The report, called the Fleming Report, concluded that the manned lunar mission could be performed within the time frame hoped for.<sup>35</sup> The chief pacing items were declared to be the first, or booster, stage of the launch vehicle and facilities for static testing the booster and launching it. (It turned out that the spacecraft was the chief pacing item.) Early attention would have to be given to acquiring information on the effects of solar flare radiation and lunar surface characteristics, since spacecraft design would be directly affected. The report made special mention of the need for a strong management organization.

The job of the Fleming Committee had been a difficult one. Over 2,000 separate progress events had to be dovetailed, and most of them were highly interdependent. A special technique (called PERT) for synthesizing sequential but interrelated events was used. NASA's existing program was dovetailed with the accelerated manned lunar landing program.

The Fleming Report provided a sufficient basis for taking certain actions in

<sup>33</sup> For perspective on NASA's overall program plans for fiscal year 1962, the reader is referred to Table 6-1 in Ch. 6.

<sup>34</sup> "NASA Lunar Program and Large Booster Chronology" (Draft), HHN-33, prepared by the NASA Historical Staff, Mar. 15, 1964.

<sup>35</sup> The work and findings of the task force were briefly described by Dryden in a speech, entitled "The National and International Significance of the Lunar Exploration Program," delivered at an AAAS meeting in Denver, Colo., Dec. 29, 1961. (See NASA News Release 61-286.)

the area of spacecraft development and facility construction. The biggest question not answered by the Fleming Report concerned the detailed configuration of the launch vehicle to be used.

*The Golovin Study.* On May 25, NASA established a task group to study the launch-vehicle problem. Its report (the Lundin Report) on June 10 was apparently inconclusive, because on July 20 a more elaborate study was undertaken under the cognizance of both NASA and DOD.<sup>26</sup> This joint study, cochaired by Dr. Nicholas Golovin of NASA and Dr. Laurence Kavanau of DOD, was to take a look at the entire national launch vehicle program, not only in connection with the manned lunar landing program but also in connection with all NASA and DOD needs for the next 10 years.

The joint committee making the study, the Large Launch Vehicle Planning Group, worked over a 4-month period and was mentioned in the trade press as the Golovin Committee. It soon recognized that the large vehicle concept (called Nova), upon which the Fleming Report relied, posed technical and reliability problems too immense to permit meeting the time schedule. Thus serious consideration was given to the use of the rendezvous technique using two or more "Nova Juniors" or "Advanced Saturns."<sup>27</sup> The Golovin Committee made its final report in December 1961. By then the direct-ascent approach using Nova had been pretty well discarded in favor of an earth-orbital rendezvous approach using an Advanced Saturn.

Even though not all technical decisions had been made on the launch vehicle for the manned lunar landing, NASA, on the basis of the Fleming Report and preliminary reports on launch vehicles, was able to go ahead and take certain initial actions on testing facilities, launching facilities, spacecraft contracts, and certain launch vehicle hardware contracts.

#### **B. Facility Problems Attacked**

Even though U.S. industry would be called on to do much of the work on the manned lunar landing, a fair amount of in-house expansion was deemed necessary.

Facility construction was given very high priority because leadtimes were very long, especially for launching facilities, and the facility had to be constructed before it could be put to work. By the end of October, four important decisions on facilities had been made. One had been contemplated for some time, the others were made in a matter of weeks.

*Manned Spacecraft Center Established.* Since late 1960, NASA was concerned with its inadequate facilities for manned space-flight training and operations. NASA's Space Task Group, the field element carrying out Project Mer-

<sup>26</sup> *Ibid.*, p. 3.

<sup>27</sup> *New York Times*, Oct. 8, 1961, p. 35. It should be noted that the so-called Heaton Report of September 1961 is pertinent here. No information on the classified Heaton Report was obtained.

cury, was housed at NASA's Langley Research Center in Virginia. Glennan had favored converting NASA's Ames Research Center in California to a manned flight laboratory.<sup>38</sup> After Webb became Administrator, NASA asked (in its March 1961 request) for money for a new laboratory but BOB disallowed it.<sup>39</sup> However, \$28 million was approved in the May amendment. Work was begun almost immediately on selecting a site for the new field center, although public announcement of the site selection activity was not announced until after the Appropriation Act was passed in August.<sup>40</sup> On September 1, NASA asked the Army Corps of Engineers to manage the construction of the new manned spacecraft center in Houston.<sup>41</sup> On September 19, NASA announced that the new center would be located near Houston, Tex.<sup>42</sup> There was considerable speculation that the selection of the Houston site was influenced by the fact that a Texan, Lyndon Johnson, was Vice President and Chairman of the Space Council and that a Houston Congressman, Albert Thomas, was the chairman of the House Independent Offices Appropriations Subcommittee, the subcommittee handling NASA appropriations.<sup>43</sup>

The chief responsibilities of the new center (called the Manned Spacecraft Center, or MSC) were to engage in manned spacecraft research and development, to plan the manned flight missions, to train the astronauts, and finally to conduct the flight missions.

A 2½-year construction program was begun in late 1961. By the middle of 1962, the new Center, formed from the Space Task Group formerly housed at the Langley Research Center, was moved into temporary quarters in Houston.<sup>44</sup>

**Launching Site Selected.** A more expensive activity was building the launching facilities for the very large vehicles needed for the manned lunar landing. Leadtime on launch facilities was especially long and NASA moved very rapidly in selecting the site. In June, a NASA-DOD survey team was established to study launch problems and evaluate potential sites. The resulting report (the Debus-Davis Report) was dated July 31, 1961.<sup>45</sup> In early August the choices were narrowed down and on August 24 it was announced that the Cape Canaveral area had been selected as the site from which the American astronauts would be

<sup>38</sup> Interview with T. Keith Glennan, Jan. 18, 1964.

<sup>39</sup> See Ch. 6.

<sup>40</sup> See the report of Webb's meeting with Senator Byrd and others from Virginia on July 26, 1961, in the *Newport News Daily Press*, July 27, 1961.

<sup>41</sup> NASA Historical Staff is presently preparing "The Decision To Use Army Engineers for Management of New Construction" (HHN-17).

<sup>42</sup> NASA News Release No. 61-207, Sept. 19, 1961. For a detailed account of Houston's selection, see Stephen B. Oates, "NASA's Manned Spacecraft Center at Houston, Texas," *The Southwestern Historical Quarterly*, January 1964, pp. 350-375.

<sup>43</sup> See the Oates article just cited.

<sup>44</sup> Grimwood, *Project Mercury: A Chronology*, p. 168. Cf. U.S. Congress, House, Committee on Science and Astronautics, *Master Planning of NASA Installations* (H. Rept. No. 167), Mar. 15, 1965.

<sup>45</sup> "NASA-DOD Joint Report on Facilities and Resources Required at Launch Site To Support NASA Manned Lunar Landing Program, Phase I," July 31, 1961.

launched on the flight to the moon.<sup>46</sup> Hand in hand with the selection of Cape Canaveral was the necessity for a sizable enlargement of the then-existing launch area. On September 1, NASA asked Congress to authorize the purchase of 80,000 acres of land on Merritt Island immediately to the north of the existing area.<sup>47</sup>

On September 21, Webb requested the Army Corps of Engineers to undertake this land acquisition.<sup>48</sup> Congress adjourned before any authorization was enacted. Without the authorization, NASA could not ask for an appropriation. Yet land acquisition had to get underway immediately. NASA went ahead and used its reprogramming authority to begin acquisition before the end of 1961.<sup>49</sup>

*Vehicle Fabrication and Test Site Selected.* In September NASA announced that it would take over an unused Government manufacturing plant in Michoud (near New Orleans), La., and convert it into a launch vehicle assembly plant to be used by NASA industrial contractors in their launch vehicle fabrication operation.<sup>50</sup> By renovating an existing plant, NASA would not have to pay a contractor to build or modify its own private facilities. Furthermore, the plant was large enough to accommodate several contractors working on different but interrelated boosters. Having this activity under one roof would facilitate the supervision of the contractors' activity by the Marshall Center, of which the Michoud plant was to be an extension. The plant had been built late in World War II but not really used until the Korean War when Chrysler Corp. manufactured tanks there.

A key asset of the plant was that it was located on a water transportation route to the Gulf of Mexico, an important consideration in the transport of large boosters to Cape Canaveral.

After boosters are assembled, they have to be test fired. The engines going into the boosters also have to be tested. In October, NASA announced that it was going to establish a Government owned and operated central test facility near the Michoud plant across the State line in southwestern Mississippi.<sup>51</sup> The Mississippi Test Facility, as it was named, was also to be an extension of the Marshall Center. A water route connected the test facility and the Michoud plant and thus there was a water connection with Cape Canaveral on the Florida coast.

<sup>46</sup> The decision was made on Aug. 18. U.S. Congress, Senate, Committee on Appropriations, *Second Supplemental Appropriation Bill for 1962*, Hearings on H.R. 11038, 87th Cong., 2d sess. (Washington: GPO, 1962), p. 148 (hereafter cited as Senate Hearings, *Second Supplemental Appropriation Bill for 1962*).

<sup>47</sup> U.S. Congress, Senate, Committee on Aeronautical and Space Sciences, *Amending the NASA Authorization Act for Fiscal Year 1962*, Hearing on S. 2481, Sept. 1, 1961, 87th Cong., 1st sess. (Washington: GPO, 1961). At the hearing NASA revealed how the selection had been made.

<sup>48</sup> Letter from NASA Administrator Webb to Lt. Gen. W. K. Wilson, Chief of Engineers, U.S.A., Sept. 12, 1961.

<sup>49</sup> NASA transferred funds from its R&D account to its CoF account. It had to advance money to the Army Corps of Engineers, which acted as NASA's agent in carrying out the land acquisition action. The authorization-appropriation difficulty was straightened out during 1962. See Senate Hearings, *Second Supplemental Appropriation Bill for 1962*, p. 154.

<sup>50</sup> NASA News Release 61-201, Sept. 7, 1961.

<sup>51</sup> NASA News Release 61-236, Oct. 25, 1961.

NASA pointed out that the manned lunar landing program was being carried out in a year-round warm-weather area bordering the Gulf of Mexico (Texas, Louisiana, Mississippi, Alabama, and Florida). Needless to say, the area would benefit greatly by the economic stimulus afforded.

By the middle of October, decisions had been made on: (1) the location of a new manned spacecraft center; (2) the launch site of the manned lunar launchings and its expansion; (3) a large launch vehicle assembly installation; and (4) an engine and booster testing facility.

NASA's field installation pattern, viewed geographically, underwent few changes over the course of the next 2 years.

By December, NASA had also determined to use the Army Corps of Engineers to manage its construction of new facilities which had to be completed on schedule and could exploit the experience of the Corps in serving the Air Force on missile site construction.<sup>52</sup>

### C. Major Manned Lunar Landing Contractors Selected

On the basis of numerous studies carried on both in-house and by contract beginning in 1959, NASA felt certain that ground and flight hardware could be developed, within the existing state of the engineering arts, and that methods of operation could be perfected to successfully accomplish the manned lunar landing by the end of the decade. Even though configuration of the launch vehicles to be used had not been finalized, NASA felt it knew enough to bring contractors on board.

In July 1961, NASA conducted a NASA-industry conference on the Apollo project (the name given the manned lunar landing program) attended by 1,200 representatives from 300 companies.<sup>53</sup> Industry was briefed on what it would be called upon to do.

In August a much smaller number of firms was briefed on detailed requirements for the Apollo spacecraft.<sup>54</sup> In September several firms were invited to bid on various major hardware systems.

In early October, five firms submitted proposals for the development of the Apollo spacecraft.<sup>55</sup> In November, NASA announced that North American Aviation had been selected as prime contractor for the very important job.<sup>56</sup>

The configuration of the launch vehicle to do the manned lunar landing mission was decided upon in late 1961. The largest vehicle under development, the Saturn, was not large enough for this purpose. The extremely large vehicle

<sup>52</sup> NASA's view of placing responsibility for construction contracting of new facilities on the Army Corps of Engineers was contained in a letter from the Director of Administration (Siepert) to the Chief of Engineers, U.S.A. (Wilson), Dec. 12, 1961.

<sup>53</sup> NASA, *Sixth Semiannual Report*, p. 26.

<sup>54</sup> *Ibid.*

<sup>55</sup> *Ibid.*

<sup>56</sup> NASA News Release 61-263, Nov. 28, 1961.

necessary to accomplish the manned lunar landing using the direct-ascent approach was deemed to be too great a step forward from the Saturn. The decision taken at this time, therefore, was to combine a somewhat smaller vehicle with some form of rendezvous in space. By the end of the year, the configuration of a vehicle called the Advanced Saturn (which evolved into Saturn V) was tentatively agreed upon.<sup>57</sup> Three contractors were selected to build it. In December, Boeing was selected to build the first, or booster, stage, and Douglas was selected to build the third stage, a modification of the second stage of the smaller Saturn which it was also building.<sup>58</sup> Earlier, in September, North American had been selected to build a stage which became the second stage of the Advanced Saturn.<sup>59</sup> The selection of Boeing, Douglas, and North American eventually resulted in contracts worth billions of dollars.

#### V. THE NOVEMBER 1, 1961, REORGANIZATION

The digression on the manned lunar landing program was designed to give a more realistic setting for the NASA reorganization announced on September 24, 1961, and effective November 1.<sup>60</sup> The account clearly indicated that decisions on agency reorganization were only a portion of the large number of important decisions being made at the time.

Earlier in this chapter the course of reorganization was traced from early 1961 to the middle of June. The analytical activity of NASA's specialists on organizational matters was emphasized, culminating in the June 12 staff study. Mention was made of a reorganization plan, labeled "the Silverstein approach," which included features that conflicted with the alternatives proposed elsewhere.<sup>61</sup>

During the period following the June 12 study, a certain amount of discussion and argument led to a revision of the June 12 study. The revised study, dated August 7, incorporated many of the features of the Silverstein approach. The August 7 revision can be viewed as the "mature" document upon which the November 1 reorganization was based.

Before looking at the August 7 revision in detail, it would be well to briefly review the argument that must have been going on in NASA Headquarters at the time. NASA's drift toward becoming an agency made up of several somewhat autonomous bureaus was to be nipped by the determination of NASA's general management to assert itself as the basic policy-making and program-integrating element in NASA. The establishment of the Office of Programs was to have supplied the chief means by which this central control could be made possible. However, the tight timetable of the manned lunar landing pro-

<sup>57</sup> NASA, *Sixth Semiannual Report*, p. 9.

<sup>58</sup> NASA News Releases 61-281 (Dec. 15, 1961) and 61-284 (Dec. 20, 1961).

<sup>59</sup> NASA News Release 61-203, Sept. 11, 1961.

<sup>60</sup> NASA News Release 61-213, Sept. 24, 1961.

<sup>61</sup> The so-called "Silverstein approach" was worked up by some of the same persons who had worked on the other studies.



gram, which got its green light in May, immediately suggested the need for a fast-paced program under powerful leadership.

The record does not reveal whether there was a lineup of officials on one side or the other. Top management would tend to favor integrating the manned space flight program into NASA's overall program, whereas program managers, seeking maximum operating freedom, would tend to favor a separation of the manned program from the rest of NASA. Since Silverstein was regarded as one of the most likely persons to head the manned space flight program, his point of view had to be taken into consideration. The specialists on organizational problems took the top-management position for the most part—in fact, they probably took the lead in convincing general management of its desirability. The August 7 study reveals, however, that second thoughts developed; the study does a remarkable job in steering a middle course between the two basic positions.

#### A. The August 7 Staff Study <sup>62</sup>

The August 7 study attempted to answer the question, How can NASA achieve a centralization of power in the hands of general management and at the same time give manned flight activities the authority and freedom necessary to accomplish the manned lunar landing?

The following is a summary of what was new in the August 7 study when compared to the June 12 study.

**Basic Management Concepts Delineated.**<sup>63</sup> It was recommended that several basic management concepts be adopted by NASA to promote implementation of its accelerated space program: (1) The concept of program imbalance. NASA would have to recognize that manned space flight will have to be given special treatment, including a degree of freedom not given other program areas. (2) NASA would have to establish open and direct communications (i.e., shortest communication routes) with minimum delays at all points. The study implied that this is something that does not come naturally but has to be worked on. (3) The concept of functional management. This was a favorite concept of NASA's organizational specialists:

A functional manager's responsibilities are those delegated by general management to a functional specialist to oversee and direct a program or activity wherever it may be located in the organization structure. The functional manager has certain specified responsibilities for the performance of counterpart activities in headquarters and in the field establishment. . . . Proper application of functional management reduces to a marked degree the approval processes by the staff around the official to whom a given center may report.<sup>64</sup>

(4) Overall systems integration must be emphasized. This meant that attention

<sup>62</sup> "Organizing To Achieve the Objectives of an Accelerated Civilian Space Program," Aug. 7, 1961 (Draft).

<sup>63</sup> *Ibid.*, pp. 6-12.

<sup>64</sup> *Ibid.*, pp. 8-9. (Functional management is covered in more detail later in this section.)

must be paid to systems engineering—the specialty of integrating subsystems. (In the case of the manned lunar landing, the subsystems would be the vehicle, the spacecraft, and certain other supporting items.) (5) Clearance and approval procedures must be efficient.

NASA in a short period of less than 3 years has acquired some “bureaucratic practices” which generally come much later in the historical development of an organization. Many of these practices fall in the area of clearance and approval procedures. In order to accomplish the proposed objectives within the tight time limitations, it is absolutely necessary that these procedures be reduced to the minimum essential to prudent management.<sup>65</sup>

***Structural Alternatives Presented.*** A major addition was made to the four alternative plans presented in the June study.<sup>66</sup> Incorporating the Silverstein approach, a plan was presented in which NASA would have two associate administrators instead of one. One of them would be in charge of manned space flight, the other would be in charge of everything else. Some NASA field centers would report to one associate administrator, the others would report to the other associate administrator.

***Ways and Means of Expediting the Manned Lunar Landing Program.***<sup>67</sup> In line with the concept of program imbalance, the August 7 study suggested that the manned flight program would have to be given special powers not given to the other programs.

The report recommended that the director of the manned flight area be delegated substantial discretionary powers in such matters as budgeting, procurement, reprogramming, altering facilities, etc. Special priorities, both external (related to the Nation’s DX system) and internal, would have to be assigned to all projects of the manned lunar landing program. Interagency agreements might have to be altered or new ones entered into. Certain supporting services might have to be wholly within the control of the manned flight office. Other agency-wide supporting services might have to be subject to manned space-flight priorities.

***Narrowing the Choices.***<sup>68</sup> In contrast with the June study, NASA’s organizational specialists were much less inclined to advocate the alternative (labeled “Alternative D”) providing for maximum centralized control. Nor were they willing to make a complete turnabout and advocate the full bureau approach which has been termed the “Silverstein approach.” Being administrative realists, they advocated a compromise mixture of the two (see the next paragraph). Although Alternative D was closest to what was finally decided upon, it is worth noting that the plan advocated in the August 7 study bore many similarities to the November 1, 1961, reorganization *after* it had been modified several times during 1962.

<sup>65</sup> *Ibid.*, pp. 11–12.

<sup>66</sup> *Ibid.*, pp. 55–60.

<sup>67</sup> *Ibid.*, pp. 61–76.

<sup>68</sup> *Ibid.*, pp. 77–85.

Thus it is possible to delineate three distinct approaches to the problem of NASA reorganization: (1) The top-management approach, with program planning and integration placed in the hands of general management to which all the field centers would report; (2) the Silverstein approach, with manned space flight placed under a high-level official to which the pertinent field centers would report; and (3) what might be termed the "Young approach," a compromise in which the director of manned space flight would be a "first among equals" to which the key field centers concerned with the manned program would report, with all other field centers reporting to general management (which would also have a large role in overall program planning and integration). As stated before, the reorganization plan decided upon adhered quite closely to what has been termed the "top-management approach."

*Relationships Within the Structure.* Getting the formal structure straightened out was only part of the problem. Certain intra-agency relationships flowed automatically from the formal structure; others did not. When the formal organization was announced in September, several relationships had not been worked out. There is a school of thought which holds that some relationships never did get worked out and that the 1963 reorganization was a manifestation of this.<sup>69</sup>

The core of the relationship problem was a problem prevalent in most large organizations; namely, the impossibility of maintaining perfect unity of command (i.e., a situation where there are straight-line relationships up and down a pyramidal hierarchy). Relationships in a large organization more often resemble a lattice (rather than a pyramid) in which there are vertical, diagonal, and horizontal relationships.<sup>70</sup> It is customary to think of two management systems working simultaneously—the general management system which embraces the overall, agencywide command line coming down from the apex of the agency, and the specialized function-management system, which is particularistic and technical and which may or may not be agencywide.

*Functional Management.* The concept of functional management was thought of by NASA's specialists on organizational matters as an important key to a smoothly operating system of intra-organizational relationships. It is a frank declaration that workers get orders from more than one individual and that this is normal, necessary, and workable. It declares that the specialist has got a job to do and it is impossible to do it by working through a single command channel running down from the top of the agency.

The functional manager is the person responsible for carrying out certain functions. A function can be viewed here as a distinct and specialized facet of operations as a whole. Typical examples are personnel, budgeting, accounting, auditing, and procurement. In addition, there may be functions peculiar to a particular agency—in NASA's case, functions such as data acquisition, spacecraft tracking, spacecraft launch vehicle development, and launching operations. It

<sup>69</sup> The author's general impression based on many interviews with NASA officials.

<sup>70</sup> NASA's organizational specialists used the term "matrix" rather than "lattice."

could be argued in a general way that everyone below the very top level of general management is a functional specialist.

The specialists engaged in the agency's prime activity (in NASA's case, space research and development) usually have a special direct-line relationship with top management. Specialists not on this direct line of command have a crossed or latticed relationship with the rest of the agency.

The key question is: To what extent does the person in the direct-line relationship have to take orders from someone positioned on the lattice outside of the direct line? This would be an especially acute question if the reorganization of NASA were to move toward placing all field centers directly under the general manager, since all of Headquarters would then be outside of the primary direct-line relationship and lattice relationships would be widely prevalent. Some type of legitimization of the lattice relationship was necessary. This was done primarily through a functional management system.

NASA's specialists on organizational matters devoted much effort to constructing a workable functional management system for NASA. It went through many drafts and was still in the process of formulation when the November organization went into effect.<sup>71</sup>

#### B. Details of the November 1, 1961, Reorganization

Webb declared that the two major objectives of the reorganization were to realign Headquarters program offices "to provide clearer focus and greater emphasis on NASA's major programs," and to provide center directors "an increased voice in policy making and program decisions."<sup>72</sup>

The most significant features of the NASA reorganization were there:

1. All of NASA's field centers (with the exception of the Western Operations Office—a contract administration office) were put directly under the Associate Administrator (Seamans). To help him in supervising the field centers, the position of Deputy Associate Administrator was created (Dixon).

2. The former Headquarters program offices of: (a) Advanced Research Programs (Abbott); (b) Space Flight Programs (Silverstein); (c) Launch Vehicle Programs (Ostrander/Dixon); and (d) Life Science Programs (Roadman) were abolished.

3. Four new Headquarters program offices were established: (a) Advanced Research and Technology (Abbott); (b) Space Sciences (Newell, formerly Silverstein's deputy); (c) Manned Space Flight (Holmes, a new appointee from RCA); and (d) Applications (vacant).

4. An agencywide support office called "Tracking and Data Acquisition" was established (Buckley).

<sup>71</sup> This is discussed in more detail in the next subsection, entitled "Unfinished Business." Cf. J. Casper, "Functional Management in NASA," historical note No. 53.

<sup>72</sup> NASA News Release 61-213, Sept. 24, 1961, *op. cit.*

5. The Office of Technical Information and Educational Programs, formerly under the Associate Administrator, and the Office of Public Information, formerly under the Administrator, were placed under an Assistant Administrator for Public Affairs (Cox) who was directly under the Administrator.

6. Other Headquarters offices were changed very little except that the Office of Research Grants and Contracts was moved from the Office of Administration to the newly formed Office of Space Sciences.

These changes are shown very clearly in the following three organization charts. Figure 7-1 is the last chart signed by Glennan before he left NASA in January 1961. Figure 7-2 shows the important change made in June by the creation of the Office of Programs and the renaming of the Office of Business Administration. Figure 7-3 depicts NASA organization on November 1, 1961.

It is readily apparent that the reorganization decided upon was far removed from that advocated by Silverstein. It is generally known that he was offered the position of Director of Manned Space Flight, but declined it because he felt that he could not accomplish the manned lunar landing objectives with the type of organization adopted. Instead, he accepted the directorship of NASA's Lewis Research Center in Cleveland where he had been Deputy Director prior to coming to NACA Headquarters in 1958.

*NASA Leadership, November 1, 1961.* The personnel changes accompanying the reorganization reshuffled NASA leadership somewhat with the net result of slightly diluting the old NACA influence. The officials comprising NASA's top two echelons can be divided into six groupings based on whether they had once been part of NACA, whether Glennan had brought them in from the outside, whether Webb had brought them in, and whether the official was in Headquarters or a field center:

	<i>NACA</i>	<i>Glennan</i>	<i>Webb</i>
Headquarters.....	Dryden Abbott *Wyatt *Buckley Dembling	Seamans *Newell Siepert Johnson Hyatt Frutkin	*Dixon *Holmes *Cox
Field.....	Gilruth Goett Silverstein Thompson DeFrance Bikle Krieger	von Braun	

\*Entered top echelons under Webb.



# NATIONAL AERONAUTICS AND SPACE ADMINISTRATION

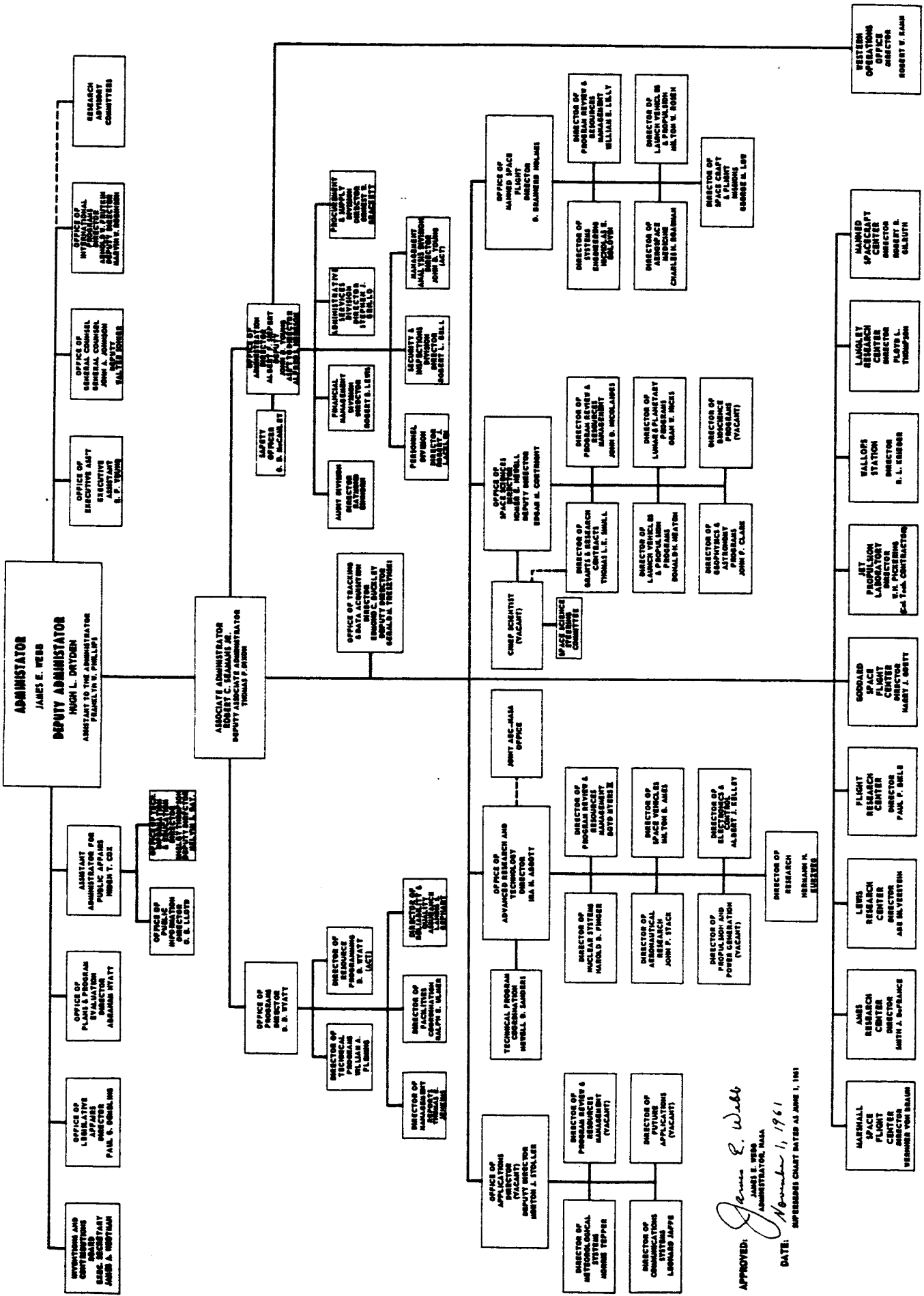

APPROVED: *James E. Webb*  
 JAMES E. WEBB  
 ADMINISTRATOR  
 DATE: November 1, 1961  
 REISSUED CHART DATED AS JUNE 1, 1961

FIGURE 7-3

NATIONAL AERONAUTICS AND SPACE ADMINISTRATION

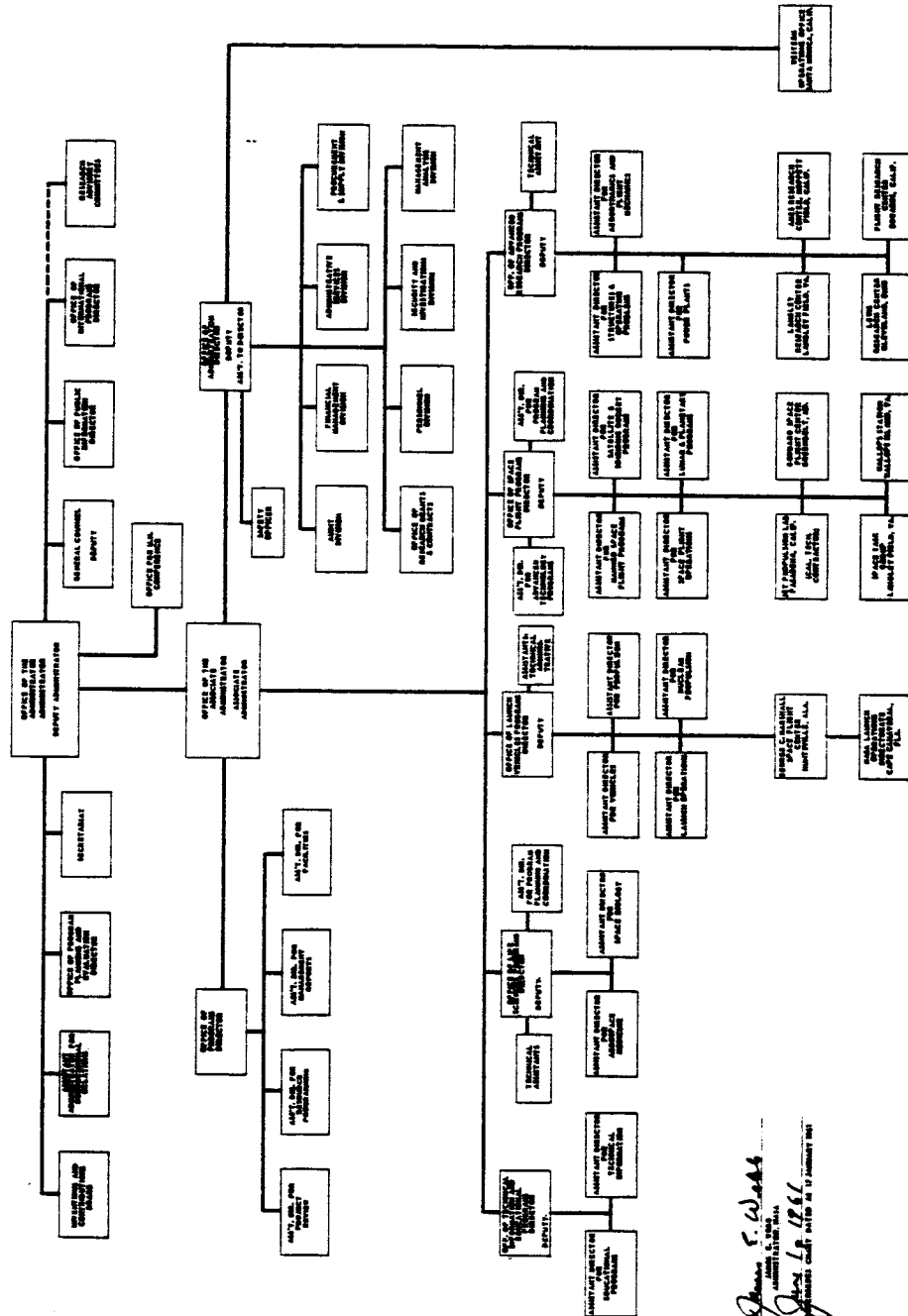

FIGURE 7-2



**Headquarters Realigned.** One of the most important features of the November 1 reorganization was a rather extensive reshuffling of the technical program offices in Headquarters. The four existing offices were abolished. The Office of Advanced Research Programs (OARP), the old NACA core, numbered about 70 and had been responsible for Aeronautical and Astronautical Research of the advanced variety, largely done in-house. The Office of Space Flight Programs (OSFP) numbered about 105 and had been responsible for the development of spacecraft and their flight programs. The Office of Launch Vehicle Programs (OLVP) numbered about 70 and had been responsible for the development of launch vehicles and their flight tests. The Office of Life Science Programs (OLSP) numbered under 20 and had been responsible for an uncertain NASA life science program.

These four program offices were replaced by four new program offices and an agencywide support office. This realignment involved a dozen interoffice shifts. The five new offices were: The Office of Advanced Research and Technology (OART) absorbed the old OARP, plus an advanced technology unit of the OSFP and the nuclear propulsion research program of OLVP. The Office of Space Sciences (OSS) absorbed about half of the old OSFP, plus the "small" launch vehicle programs of OLVP, plus some of the bioscience activity of OLSP, plus the Office of Research Grants and Contracts which had been part of the Office of Administration. The Office of Applications (OA) absorbed the communications and meteorological programs of the old OSFP. The Office of Manned Space Flight (OMSF) represented the most significant organizational change. It absorbed most of the large vehicle and engine development programs of OLVP, much of the life science activity of OLSP, and all of the manned flight program (primarily Project Mercury) of OSFP. The Office of Tracking and Data Acquisition (OTDA), the agencywide support office, absorbed the Space Flight Operation's Office of OSFP. Graphically the realignment of offices and people is shown in figure 7-4.<sup>73</sup>

Since neither the old nor the new arrangements were "pure" forms, it is difficult to say that there was a conscious shift from one organizational basis to another basis. It is possible to discern a shift from an organization in which various "means" were put into different categories, to one in which program objectives or "ends" were the main basis for division. The reorganization 2 years later continued the second approach.

**Headquarters-Field Relationships.** Of equal importance to the realignment of program offices in Headquarters was the change in the way the field installations were related to Headquarters. Before the reorganization, the field centers reported to various Headquarters program offices. After the reorganization, they reported to the general manager, the Associate Administrator. This change meant several things. One was that the field center directors were raised a notch in the

<sup>73</sup> Prepared from data in the Sept. 30 and Nov. 1, 1961, Headquarters Position Complement Lists. There are several minor discrepancies.

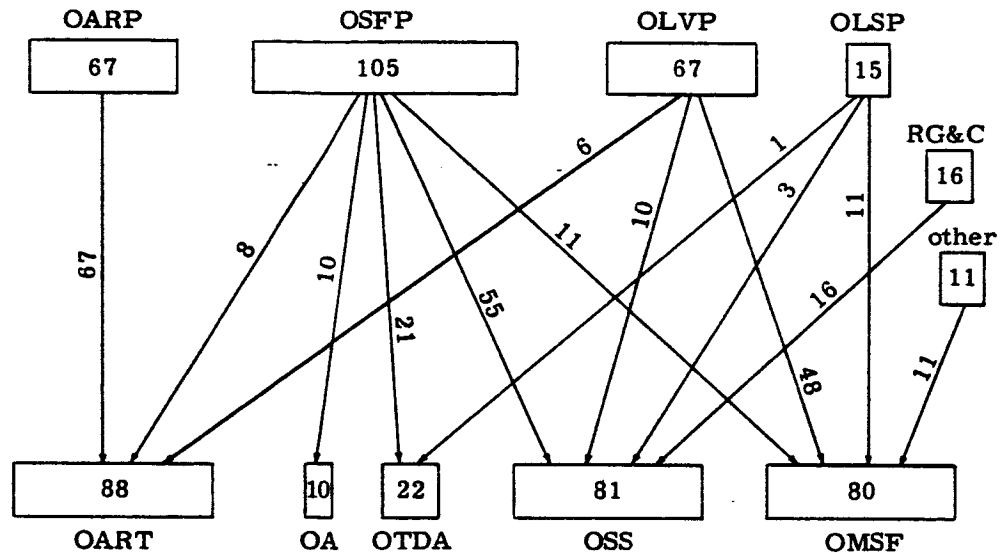

agency's hierarchy. Secondly, it meant that the field centers now looked to general management for their resources (money and manpower) and to the Headquarters program offices for program direction. The program offices continued to be responsible for program goals and progress, but their authority did not extend over the allocation of the resources being used to carry out the programs. In resource allocation matters, they took on the appearance of staff offices to the Associate Administrator. It is difficult to describe precisely how subsequent practice worked out; formal myth and informal practice clouded things considerably. NASA made "adjustments" in the arrangement over the next 2 years. In November 1963 it was significantly altered by an overall agency reorganization.

### C. Unfinished Business

To promulgate a new organizational structure is one thing; to make it work is much more difficult. The November reorganization was drastic enough to require a reworking of many basic intra-agency relationships. These relationships were still in the process of being worked out when the reorganization went into effect.

This whole area was exceedingly thorny and it is difficult to fit all the parts together, to say nothing of delineating the parts in the first place. At least four separate relationships were of concern: the relationship between the field centers and the general manager; between the field centers and the Headquarters program offices; between the field centers and the Office of Administration; and the flow of work between and among all units of the agency.

The flow of work involved procedures governing the flow of paper. These procedures are discussed later in this chapter.

The other relationships involved more than a flow of paper and the approval and concurrence actions tied thereto. Involved was the whole concept of giving and taking orders; the responsiveness to influence, both formal and informal; and the effectiveness of whatever paper-flow systems were devised.

The first requirement that had to be satisfied was the need for formal statements on basic intra-agency relationships. These statements were worked on during the summer and fall of 1961.<sup>74</sup> Not until June 15, 1962, were satisfactory versions issued as a part of NASA's Management Manual.<sup>75</sup> Even then they were labeled "informational."

The statements, two in number, were first drafted in July 1961. They were rewritten numerous times and an outside management expert was hired to comment on them.<sup>76</sup> It is virtually impossible to trace the changes that took place from draft to draft. What follows is a summary of the final version issued in June 1962.

The first statement, entitled "General Responsibilities and Functions of a NASA Headquarters Program Director," applied to the Directors of the Headquarters Offices of Manned Space Flight, Space Sciences, Application, Advanced Research and Technology, and Tracking and Data Acquisition.<sup>77</sup> It pointed out that these directors were both "advisers" and "operators." "He is the principal adviser to the Associate Administrator in regard to his assigned program area" and "He is the principal headquarters operating official in regard to management of his assigned program."

One sentence pinpoints very well the director's relationship with the field centers. "Within authorities delegated by the Associate Administrator, he directs his assigned program by working directly with center directors and their project

<sup>74</sup> The great difficulty in preparing the formal statements was indicated by the large number of draft statements that were prepared. Here is a list of some of them:

"The Responsibility of the Office of Administration for Counterpart Activities in the Research and Space Flight Centers," June 19, 1961.

"Management of Technical and Administrative Activities in the Research and Space Flight Centers," July 13, 1961.

"Responsibilities and Authorities of a NASA Headquarters Technical Program Director," Sept. 25, 1961.

"General Responsibilities and Functions of a Headquarters Program Director," Oct. 20, 1961.

"Functional Management Responsibilities of the Office of Administration," Nov. 1, 1961.

Others dated Sept. 8, Sept. 18, and Nov. 1, 1961, and Jan. 27, 1962, are known to exist.

<sup>75</sup> NASA Circular No. 233, June 15, 1962. Subject: Informational Material on Assignment of Responsibilities in NASA Headquarters. Attachment "A" was entitled "General Responsibilities and Functions of a NASA Headquarters Program Director." Attachment "B" was entitled "Functional Management Responsibilities of the Office of Administration."

<sup>76</sup> NASA contracted with John Diebold & Associates, Inc., for management consulting services in connection with the Nov. 1, 1961, reorganization. (Contract No. NASw-272, Aug. 7, 1961.) Services were rendered by William Finan, the former BOB official who had helped write the Space Act. Finan submitted both written and oral reports; the final report was dated Dec. 21, 1961.

<sup>77</sup> Quotations are from Attachment "A" of NASA Circular No. 233, *op. cit.*

and system managers." In other words, the Headquarters program director's power over a field center was confined to the management of particular projects. It should be recalled that the field centers were multipurpose. Often a center was working on projects in several program areas. Any one field center could be involved in projects under the supervision of all five Headquarters program offices.

To make sure that the projects for which he was responsible met all objectives, the Headquarters program director was authorized, within certain limits, to spend money, reprogram funds, communicate with contractors, and even issue instructions to center directors. It should be remembered that the center directors themselves were responsible only to the Associate Administrator, except to the extent which the Associate Administrator might provide otherwise. The statement implied that the Associate Administrator would settle conflicts that might arise.

The second statement was entitled "Functional Management Responsibilities of the Office of Administration."<sup>78</sup> The concept of functional management has already been described in general. The June 1962 statement spelled out how it would work in practice. The functional managers (financial management and reports, personnel, procurement, security, etc.) were responsible "to see that their assigned administrative activities are performed throughout NASA in a manner to accomplish . . ." the objectives of uniformity, legality, and efficiency. The functional managers were to prescribe standards and procedures, conduct surveys and reviews, communicate with counterparts in the various NASA installations, and participate in the selection of key counterpart personnel. This had to be done within the authority delegated by the Associate Administrator. No major policy or program changes could be made. The concurrence of other officials was necessary whenever the action went beyond the confines of the specific function itself. Conflicts would be resolved at the Associate Administrator's level.

It is easy to see that both statements described a situation in which the Associate Administrator played the key role, both in the powers he delegated and in the conflicts he resolved.

In April 1962, NASA Administrator Webb described NASA's organization and management in a speech to the American Society for Public Administration. It covers much the same ground as this section and may help clarify what has been said. It is excerpted in Appendix F.

## VI. OTHER 1961 DEVELOPMENTS

In this section an attempt is made to cover important 1961 administrative activity not directly related to the manned lunar landing program nor directly in the mainstream of reorganization activities.

<sup>78</sup> Quotations are from Attachment "B" of NASA Circular No. 233, *op. cit.*

### A. Program Management and Related Procedures

During 1961 there were several significant developments in program management and related "paperwork" procedures. These developments were not necessarily related to the acceleration of NASA's program in 1961, although program acceleration certainly enhanced the need for them. Basically the developments reflected the normal bureaucratic response to problems of running an expanding agency, in which informal face-to-face contacts no longer were as feasible a way of doing business as they were earlier.

At the beginning of 1961, two major paperwork systems were already in use. One was the system of Financial Operating Plans (FOP's) by which central control over funding was attempted.<sup>79</sup> The other was the Program Management System with its Program Management Plans (PMP's) designed to keep top management informed on project progress and to pinpoint problem areas.<sup>80</sup> During 1961 a Project Planning and Implementation System was inaugurated and the PMP system was supplemented by a more advanced project-reporting system called NASA-PERT.

*The Project Planning and Implementation System.* The Project Planning and Implementation System was developed in late 1960, partly as a result of recommendations made in the 1960 McKinsey and Kimpton Reports and partly out of the realization that a forthcoming change in administrators called for precise definitions of what projects had been officially authorized and with what restrictions. Two of Glennan's last official acts were signing a list of authorized projects and signing a General Management Instruction providing for a formal system of planning and implementing programs.<sup>81</sup>

The system was designed to pinpoint responsibility for projects and sub-projects, to provide for top-level approval of projects, and to clarify the overall perimeters within which the project was to be undertaken, especially in regard to resources and manpower.

The first step in the system, as outlined in the management instruction, was some type of proposal that a specific project be undertaken. Ordinarily projects were proposed as a result of a study conducted by or for a field center. On the basis of the details in the study, the field center would prepare a Project Development Plan (PDP), a document summarizing the project, justifying it, giving its history, setting forth both a technical plan and management plan for its accomplishment, stating what resources would be required, the results to be obtained, and so forth.

The PDP would then be submitted to the appropriate technical program office in NASA Headquarters. If the technical office approved the PDP, it would

<sup>79</sup> See Ch. 5, Sec. II.B.

<sup>80</sup> See Ch. 5, Sec. II.E.

<sup>81</sup> The list of authorized projects was discussed in Ch. 5, Sec. II.E. The General Management Instruction (No. 4-1-1) was dated Jan. 18, 1961. Subject: Planning and Implementation of NASA Projects (TS 205).

then be circulated to other offices for comment. Eventually it would reach the Office of the Associate Administrator and only with his approval would it become an authorized project. PDP's were to be reviewed and updated annually. Certain types of interim modifications were to receive Headquarters approval by means of such devices as Program Management Plans and Financial Operating Plans.

If the preparation of the PDP would involve considerable expense, as it might for large and complex projects, a less elaborate Preliminary Project Development Plan (PPDP) could be used to request approval. The regular PDP would be prepared as soon after the approval of the PPDP as possible.

The PDP system was significantly modified in early 1962. The system, as set forth in the January 1961 instruction, ran into a snag—the PDP's submitted from the field varied greatly in content. In a highly detailed PDP, the Associate Administrator was faced with details which neither he nor anyone on his staff could evaluate. The best example of this was the PDP for the Ranger spacecraft submitted in the summer of 1961. It was several inches thick and departed greatly from what PDP's were intended to be. As a result, a call went out in August 1961 for ideas on how the PDP system could be improved.<sup>82</sup> In May 1962 a formal change was made in which the Headquarters technical office would process the PDP's and submit to the Associate Administrator a summary PDP.<sup>83</sup> On the basis of the summary PDP, the Associate Administrator prepared a one- or two-page Project Approval Document which then became the official authorization for the inauguration of a new project.

***Flexibility for Top Management Sought.*** Shortly after its establishment, the Office of Programs attempted to work out a system by which operating flexibility could be combined with central control.<sup>84</sup>

Two avenues of control were employed—program control and funding control. Prior to 1961, program control was unsystematic, much of it handled informally. As stated earlier, one of Glennan's last acts was to issue a list of approved projects and inaugurate the Project Development Plan system just discussed. The Associate Administrator was designated as the focal point for all project approvals. The approval of a project carried with it the authorization to make money commitments, but not to make money obligations.<sup>85</sup>

<sup>82</sup> Memorandum from D. D. Wyatt, Director, Office of Programs, to Program Directors, Aug. 24, 1961. Subject: Content and structure of Project Development Plans (PDP's) and Preliminary Project Development Plans submitted to the Associate Administrator for approval.

<sup>83</sup> NASA Circular No. 219, May 7, 1962. Subject: Planning and Implementation of NASA Projects—Interim Changes to.

<sup>84</sup> The following memos are pertinent to this topic. They are all from Associate Administrator Seamans to Program Directors and/or Heads of Offices:

July 28, 1961. Subject: Financial Operating Plans.

Aug. 8, 1961. Subject: Financial Operating Plans.

Aug. 23, 1961. Subject: Call for Financial Operating Plan Obligations Estimates for the Fiscal Year 1962 Construction of Facilities Appropriation.

<sup>85</sup> There is a legal requirement that an agency honor all of its obligations. Obligations are ordinarily based on legal instruments such as contracts or purchase orders. A commitment is more of an administrative earmarking of funds or a declaration of intent to obligate—a decision to spend made in advance of the execution of the legal instruments.

The public laws governing the financial affairs of an agency focus on obligations. Obligational authority comes from Congress and a strict system of control has to be maintained. An agency has to be able to prevent overobligation. In NASA this was done by the system of allotments. This was not, of course, an effective managerial control device for the Associate Administrator. Prior to 1961 the paperwork involved in funding control was done by the Division of Financial Management, but most of the substantive decision-making power on program matters was in the hands of the Headquarters technical program offices.

With the establishment of the Office of Programs and the implied decision to make the Associate Administrator the center of agency management, there was an attempt to focus control at the center of NASA by whatever means were deemed best. Through the use of Project Development Plans (PDP's), Project Approved Documents (PAD's), and Financial Operating Plans (FOP's), both program and funding control could be maintained.

It was all basically a pie-cutting operation. Of course, any time a pie is cut in advance (i.e., at the beginning of the fiscal year) there is the danger that subsequent events may dictate a different cut. To provide for this possibility, NASA felt it wanted to cut only a portion of the pie at first. It also wanted to devise a system for changing the size of the pieces cut initially.

The program line offices were given authority to make commitments only on what was initially approved by the Associate Administrator. The portion of the program which the Associate Administrator declared "unfirm," even though part of the "budget," had to receive subsequent formal approval before commitments could be made. High-priority items coming along later could "bump" an unfirm project out of the budget. Thus there was an incentive for the line divisions to firm up the unfirm.

The control over programs was supplemented by detailed control over money. Although program approval permitted commitments, the more legalistic act of obligating could only be made on the basis of allotments made to the line divisions (i.e., field centers). Allotments were made on basis of FOP's prepared by the line division. The FOP's had to agree with the project approvals and the related commitment authority. Allotments were initially set at only 75 percent of the amount approved for commitment, the remaining 25 percent to be kept in reserve pending review of the obligation trends as the fiscal year moved along. This gave Headquarters a reserve for flexibility. When the line divisions could prove need for additional funds, the funds would be allotted provided, of course, that newer projects with higher priority had not come along and "soaked" up the reserve.

NASA experience revealed that there was usually a lag in getting money obligated for its R&D projects. One reason was that R&D money was "no-year" money—NASA had it to obligate in any fiscal year it chose and thus there was no absolute requirement to spend it during the fiscal year for which it was appropriated. Furthermore, R&D work has an uncertain element in it and planning

can never be 100 percent accurate. In view of this, the funding flexibility just described was used to accommodate a system of overprogramming by which NASA attempted to promote as high an obligational level as possible.<sup>66</sup>

Overprogramming—i.e., approving more for commitment than funds available for obligation—was especially enticing to NASA in 1961 because of the urgency associated with the manned lunar landing deadline. In addition, NASA faced dramatically increasing budgets over the next few fiscal years. Thus future appropriations could be used to cover the “over-commitments” of any one fiscal year. The only thing NASA had to be assured of was that it did not overobligate, as that was against public law. Once the budget leveled off, overprogramming would have to be checked. As it turned out, NASA showed great ability to obligate its regular program on schedule and a tight fiscal situation developed at the end of fiscal year 1963.

In fiscal year 1962, however, overprogramming did allow new projects to get going without having to await the budget for the new fiscal year.

**Reprogramming.** Shifts in funds among projects and locations were permitted. The Associate Administrator was to be kept informed of all reprogramming actions. His approval was necessary only when the technical scope of the project was significantly changed, when the approved number of spacecraft or launch vehicles was changed, or when time schedules were significantly altered.<sup>67</sup>

**Project Progress Reporting—PERT.** Whereas the PDP system was designed to get a project launched in the best possible way, the PERT system was designed to promote project planning and secondarily to use the project plan as a basis for progress assessment. The initials stand for “Program Evaluation and Review Technique.” The technique was perfected by the Navy in connection with its Polaris IRBM program.

PERT is similar in its objectives to the Program Management System described in Chapter 5. It provides a method of synthesizing a large number of judgments into a comprehensive project plan. PERT is a more sophisticated system, however. It can be computerized and can handle a very large number of variables, which, of course, is important for large and complex projects. Both systems use the concept of checkpoints or milestones in measuring progress. PERT more easily handles complex chains of events where individual events may occur simultaneously or may affect several subsequent events. PERT is designed to sort out all the events involved in completing a project and measure time intervals between them. A critical path through the pinpointed events can then be charted to give a realistic picture of the minimum total time interval from beginning to completion and at the same time identify the points which warrant special managerial attention.

PERT thus is a tool for the project manager. It does not evaluate the quality of management, but can help the manager manage more effectively. A

<sup>66</sup> See attachment “A” of Seamans’ Aug. 8, 1961, memo to Program Directors and Heads of Offices. Subject: Financial Operating Plans.

<sup>67</sup> *Ibid.*



PERT system can generate information useful to all levels of management. Top management, however, is more interested in the fact that it is being used than the details of the results obtained from its use.

In early 1960, NASA hired a PERT specialist from the Navy (Walter Haase) who more or less conducted a one-man lobby to get NASA to adapt PERT to its use. Navy PERT was simplified slightly, the result being termed "NASA-PERT."

On January 17, 1961, Seamans was briefed on NASA-PERT and gave the green light to develop it further.<sup>88</sup> It was felt that PERT had to be sold, not decreed from above, and during 1961 most NASA officials were briefed on what NASA-PERT was and how it could be of value to NASA. In July, a 50-page NASA-PERT Handbook was issued. Several projects were "PERT'ed" in 1961 with beneficial results. The field centers did not have the trained personnel needed to apply PERT to their projects, so much of the early detailed work was done by Headquarters officials.<sup>89</sup>

PERT was "established" as an official NASA system by a management instruction dated September 1, 1961.<sup>90</sup> One statement in the instruction reveals the effort to sell it. "Voluntary use of the PERT technique for project management is encouraged, since PERT has proved to be a systematic and logical management tool heretofore missing in the planning and execution of projects." The instruction went on to state that the Associate Administrator could require the use of NASA-PERT on certain projects. In such cases PERT would supersede the PMP system for those projects. As with the PMP system, the PERT system was under the overall direction of the Associate Administrator, with specific responsibility lodged with the Office of Management Reports, one of the offices in the newly created Office of Programs.

Considerable progress in the job of selling the idea was made in 1961, but the job of training personnel to execute it did not get underway on a large scale until 1962 when a contractor was hired to conduct a training program.<sup>91</sup>

One of PERT's principal attributes—the dovetailing of complex development schedules—was especially pertinent to NASA in connection with the decision to achieve a manned lunar landing before 1970. The June 1961 Fleming Report on a manned lunar landing used PERT techniques in drawing up its timetable.<sup>92</sup> However, the first Director of Manned Space Flight, D. Brainerd Holmes, was not a PERT enthusiast and did not make extensive use of the technique. His successor, George E. Mueller, has made much greater use of it. As a result,

<sup>88</sup> Interview with Walter Haase, Jan. 29, 1964.

<sup>89</sup> *Ibid.*

<sup>90</sup> General Management Instruction 4-1-5, Sept. 1, 1961. Subject: NASA Program Evaluation and Review Technique—PERT System.

<sup>91</sup> Contract No. NASw-536 with Management Systems Corp.

<sup>92</sup> Interview with Walter Haase, Jan. 29, 1964.

most hardware development projects of the Apollo program have now been PERT'ed.<sup>33</sup>

In 1962 the NASA-PERT system was combined with NASA's Contractor Financial Management Reporting System to form what was called the "NASA-PERT and Companion Cost System." By integrating time data and cost data, a major step toward the establishment of an all-inclusive project management system was achieved.<sup>34</sup>

### B. Finance

It is difficult to untangle the story of NASA finances in 1961 because of the many changes that occurred in the course of the year. In the areas of budget preparation and execution, the end of the year bore little resemblance to the beginning of the year. In the areas of accounting and auditing, few significant changes were made.

*Congress Ratifies the President's Manned Lunar Landing Decision.* In Chapter 6 a detailed account was given of how NASA's fiscal year 1962 budget was twice amended upward by the Kennedy administration. In March, \$126 million was added and in May \$549 million more. The following table (Table 7-1) traces the fortunes of this budget:

TABLE 7-1.—*Requests, Authorizations and Appropriations, NASA Budget, Fiscal Year 1962*

[In thousands]

	S&E	R&D	CoF	Total
January 1961 submission.....	\$189,986	\$819,819	\$99,825	\$1,109,630
March 1961 amendment.....	6,700	99,720	19,250	125,670
May 1961 amendment.....	30,000	376,000	143,000	549,000
<b>Total 1961 requests.....</b>	<b>226,686</b>	<b>1,295,539</b>	<b>262,075</b>	<b>1,784,300</b>
Authorization (Public Law 87-98, July 21, 1961).	226,686	1,305,539	252,075	1,784,300
Appropriation (Public Law 87-141, Aug. 17, 1961).....	206,750	1,220,000	245,000	1,671,750
Supplemental appropriation (Public Law 87-332, Sept. 30, 1961).....	+10,000	-10,000	.....	.....
Request for supplemental (Feb. 7, 1962).....	.....	85,000	71,000	156,000
Supplemental appropriation (Public Law 87-545, July 25, 1962).....	.....	82,500	71,000	153,500

<sup>33</sup> Based on comments submitted to the NASA Historical Office by Jay Holmes of NASA's Office of Manned Space Flight, December 1964.

<sup>34</sup> A draft "NASA PERT and Companion Cost System Handbook," was issued June 30, 1962. The revised handbook (NPC 101) was dated Oct. 30, 1962. A more detailed system designed for the performing unit level, the "DOD and NASA Guide PERT Cost Systems Design," was jointly published by DOD and NASA at about the same time.

Excluding a late fiscal year 1962 supplemental, Congress authorized everything the Kennedy administration asked for, but appropriated 6 percent less. It is generally held that in authorizing the full amount, Congress overwhelmingly ratified the President's manned lunar landing decision.<sup>95</sup> The cut of 6 percent amounted to a little over \$100 million; while not critical, it was sizable enough to give NASA some concern.

It is difficult to trace the vicissitudes of NASA's budget as it moved through Congress. Much of the work was underway before the budget amendments came along; as a result, many things were worked out in the semi-secret actions of conference committees. In general, however, the regular pattern prevailed in which the House and Senate Space Committees gave strong support, the House Appropriations Committee held back somewhat, the Senate Appropriations Committee was relatively generous, and the House and Senate differences were compromised by the conference committee.

*Budget Preparation and Execution.*<sup>96</sup> 1961 developments in these two areas included both procedural experimentation and organizational rearrangements. By the end of 1961 most of the substantive work in both areas had gravitated to the Office of Programs, established 6 months earlier. The role of the Office of Administration was reduced to little more than the routine processing of documents.

Budget execution procedures for the fiscal year 1962 budget were worked out on an experimental basis. The system of project approvals, financial operating plans, allotments, overprogramming, and reprogramming has already been discussed.

The preparation of the fiscal year 1963 budget was primarily the responsibility of the Office of Programs. NASA hired the Bureau of the Budget's examiner for NASA (Cadle) to direct NASA's budget activity. Several budget specialists were recruited from other agencies. In view of the state of flux that existed, only minimum analysis and review could be accomplished. Heavy reliance had to be placed on the estimates submitted by the operating line divisions. The fiscal year 1963 budget as finally submitted to the Bureau of the Budget in the fall of 1961 was over three times as large as the one submitted the previous fall.

### C. Personnel

Developments during 1961 in the personnel area were relatively quiet compared with developments in other areas of NASA activity. This was only the lull before the storm, however, because a large increase in personnel was slated for 1962. During 1961, total NASA personnel increased by about 3,000, but

<sup>95</sup> The only recorded vote on the authorization bill was the House vote on the conference report. It was passed 354 to 59. (Data supplied by NASA's Office of Legislative Affairs, January 1964.)

<sup>96</sup> This topic based primarily on observation while employed in the NASA Office of Programs.

during 1962 the total increase was almost 6,700.<sup>97</sup> In November 1961, NASA announced that it would conduct a comprehensive recruiting drive for 2,000 new scientists and engineers.<sup>98</sup>

In 1961, total agency personnel increased 2,945, or 18 percent. All NASA installations grew in size. Headquarters grew 45 percent (up 300 employees), Goddard 53 percent (up 643), and Space Task Group, which became an independent field installation in January 1961, 72 percent (up 478).<sup>99</sup>

During 1961, NASA converted its professional scientific and engineering positions from the old Aeronautical Research Scientist (ARS) category to the new, more up-to-date Aero-Space Technology (AST) category.<sup>100</sup> Of the approximately 5,000 positions affected, 4 subcategory groupings accounted for 70 percent of the total—Fluid and Flight Mechanics (27 percent), Measurement and Instrumentation (18 percent), Flight Systems (13 percent), and Experimental Facilities and Equipment (12 percent). Life Sciences and Space Sciences accounted for less than 3 percent. The conversion was a major undertaking and had been worked on for about 2 years. It was closely intertwined with the AST examination which has been discussed at some length.<sup>101</sup>

#### D. Procurement/Contracting

NASA's procurement problems were omnipresent by the very fact that its out-of-house program was constantly expanding and continued to involve activities somewhat unique in character. Policies and procedures were almost constantly under review, and 1961 was no exception.

*The Draper Report.*<sup>102</sup> The relationship between the Headquarters procurement division and the field center procurement offices was critically examined by one of Webb's consultants, Gen. W. H. Draper. The Draper Report recommended that Headquarters should put greater emphasis on the development of agencywide policies and regulations. At the same time, there should be an improvement in the means of ensuring the solution of problems on an agencywide basis. A continuing program of field review by Headquarters, and frequent procurement conferences were recommended.

*The October Conference.*<sup>103</sup> A major intra-agency procurement conference was held in October 1961. Although most of the topics were technical and of

<sup>97</sup> For a more detailed account of 1961 personnel trends, see App. C.

<sup>98</sup> NASA News Release 61-244, Nov. 3, 1961.

<sup>99</sup> The Space Task Group was redesignated "Manned Spacecraft Center" on Nov. 1, 1961.

<sup>100</sup> For a more detailed account, see the NASA "Quarterly Manpower Utilization Report for the Quarter ending June 30, 1961," dated Aug. 1, 1961.

<sup>101</sup> The conversion of positions from ARS to AST has been given less attention than the AST examination because it was a much more technical operation and information was not as available. Its importance should not be underestimated.

<sup>102</sup> No copy of the 1961 Draper Report could be located. The information which follows is based on a summary of the report found in the "Conference Notes" of the October 1961 NASA Procurement Conference held at the Lewis Research Center.

<sup>103</sup> For a detailed account, see the "Conference Notes" just cited.

interest only to the procurement specialists, the conference did discuss several things of a broader nature. For example, frequent mention was made of the fact that NASA procurement had to operate in a goldfish-bowl environment. Not only were potential contractors interested in NASA's honesty, fairness, and efficiency, but Congress and the General Accounting Office were as well. All procurement decisions would have to have sound reasoning behind them. NASA would have to accommodate Congress' warm attitude toward small business.

The discussion of technical problems focused on such things as NASA's frequent use of letter contracts in expediting procurement actions, the difficulty in ascertaining the correctness of the price of the contract, the use of service contracts, and the need for greater efforts to keep costs under control.

**Procurement Training.** Training is generally regarded as an important means of improving the competence of workers, which in turn facilitates the solution of broader problems. Training requires time and money and is often considered a luxury which an agency with a heavy workload cannot afford. Thus, training programs usually start small. A start in a NASA procurement training program was made in 1961.<sup>104</sup>

NASA began by utilizing the several procurement training courses offered by the military services. An in-house program was also deemed desirable and in late 1961 NASA hired Harbridge House to plan and present a 2-week training course for NASA personnel.<sup>105</sup> The course was not confined to procurement specialists, but to include program personnel as well. The training program got underway in 1962.

**Headquarters Procurement Branch Established.** Prior to July 1, 1961, procurement for NASA Headquarters, with two exceptions, was done by the procurement office of NASA's Goddard Center. This was designed to keep NASA's Procurement Division in Headquarters free from line operations and also to promote decentralization of procurement by not building up a Headquarters procurement capability.

The "Goddard for Headquarters" procurement system did not work out well.<sup>106</sup> Goddard had plenty of thorny procurement activity of its own and the 20 miles between Goddard and Headquarters hindered frequent face-to-face contacts.

Dissatisfaction with the system prompted Headquarters technical program offices to threaten to set up their own procurement offices, which would have

<sup>104</sup> There were two areas of concern—training the procurement specialist and training the nonspecialist who is involved in procurement matters. A study emphasizing the former was prepared by Richard Fesler of the Headquarters Procurement Division and submitted to Brackett, the Division's Director, on June 6, 1961. The latter area, termed "procurement management," was discussed as early as April 1961. (See letter to George Vecchietti, Assistant Director of the Headquarters Procurement Division, from Harbridge House, Inc., Apr. 25, 1961.)

<sup>105</sup> Contract No. NASw-337, dated Oct. 1, 1961.

<sup>106</sup> See Brackett's memorandum to Siepert, Mar. 6, 1961. Subject: Suggestion for Centralized Headquarters Procurement Office.

added to the two specialized ones already in existence.<sup>107</sup> (One of the two procured office supplies and equipment, primarily from GSA. The other serviced the Office of Research Grants and Contracts.)

Brackett, the head of NASA's Procurement Division, recommended that one procurement office should service all of Headquarters.<sup>108</sup> He felt that the Headquarters procurement workload was heavy enough so that an efficient operation could be established. He did not feel that such a move would promote the centralization of NASA procurement.

Effective July 1, 1961, the Headquarters Procurement Branch was established as an autonomous unit of the Procurement Division.<sup>109</sup> The two existing specialized procurement units were not altered.

**Miscellaneous.** The House Astronautics Committee studied NASA's program for promoting small-business participation. The study concluded that "NASA is doing a commendable job in guaranteeing to small business an adequate participation in the national space program."<sup>110</sup>

The statistical data on NASA procurement released for fiscal year 1962 revealed that the number of procurement actions increased 32 percent over fiscal year 1961, whereas the total value of the actions increased 100 percent.<sup>111</sup> Sixty-six percent of the value went directly to private business, a significant increase over fiscal year 1961. Data for fiscal year 1962 reflect the large Apollo program contracts, many of them awarded to aerospace firms in California. (See App. E for more detail on NASA procurement trends.)

#### E. Other Nonadministrative Happenings

The year 1961 was an eventful year in NASA's history that overlooking significant but less-publicized activity is quite possible. This section is designed to fill some of the gaps.

**External Relations.** 1961 was a peak year in the number of formal agreements that NASA entered into with other agencies of the Executive Branch.<sup>112</sup> Almost half of the new interagency agreements were with the Department of Defense, apart from those with the Army, Navy, and Air Force.

In general, the agreements were less fundamental than earlier ones, many of them being amendments to earlier ones. The chief exceptions to this were agreements concerning rocket ranges in general and Cape Canaveral in particular.

<sup>107</sup> *Ibid.*

<sup>108</sup> *Ibid.*

<sup>109</sup> NASA Circular 147, July 1, 1961. Subject: Functions and Authority—Headquarters Procurement Branch.

<sup>110</sup> Quotation is from Ducander's Sept. 25, 1961, letter to Representative Miller, the chairman of the House Astronautics Committee, upon the transmittal of a staff study, U.S. Congress, House Committee on Science and Astronautics, *Small Business Participation in the NASA Research and Development Programs*, 87th Cong., 1st sess. (Washington: GPO, 1961).

<sup>111</sup> See NASA, *Annual Procurement Report, Fiscal Year 1962*.

<sup>112</sup> Based on listing supplied by NASA Secretariat Services Branch.

Relations with the Space Committees of Congress were affected somewhat by a turnover in chairmen. Lyndon Johnson was replaced by Senator Robert Kerr (Democrat, Okla.) in January 1961. Representative George Miller (Democrat, Calif.) became chairman of the House Astronautics Committee upon the death of Representative Overton Brooks (Democrat, La.).

*Program Highlights as Indicated by Major Launchings.* Quantitatively, 1961 was similar to 1960 in earth-orbiting and deep-space-probing activity.<sup>113</sup> Thirteen major launch attempts were made, of which only six were completely successful, three partially successful. Eleven suborbital and orbital launches were made in connection with Project Mercury, including Shepard's and Grissom's suborbital flights and the orbital flight of Enos, the chimp. The Ranger lunar reconnaissance program got underway, but with only partial success. NASA's large launch vehicle, the Saturn, was successfully tested in October.

*Other Program Activity.* As NASA's budgets increased over the years, the scope and diversity of its program grew likewise. This makes a brief recapitulation of NASA's overall program more and more difficult.<sup>114</sup>

No major programs were canceled during 1961 and relatively normal progress was made on most of the ongoing projects. The program changes related to the Kennedy amendments to NASA's budget (i.e., manned space flight, applications, nuclear technology) have already been covered. Perhaps the only major program item not mentioned so far (and one which gave many spending headaches in later years) was Project Gemini.

Project Gemini was approved in December 1961.<sup>115</sup> The objective of the project was to develop and then orbit a two-man spacecraft for lengthy missions around the earth and for rendezvousing with another object in orbit. The spacecraft was conceived to be an enlarged Mercury capsule (the Mercury Mark II) and the launch vehicle, a modified version of the Titan II, the Air Force two-stage ICBM with greater thrust than the Atlas. Project Gemini was thought of as being a halfway house or stepping stone between Mercury and Apollo. The fact that it was approved well after Apollo was announced suggested the possibility that Gemini may have been designed to sustain interest and gain experience in manned space flight while the sophisticated and complex Apollo spacecraft was being developed. In 1961 it was argued that the Gemini spacecraft could be developed cheaply and quickly as it was to be built along the same lines as the Mercury spacecraft.<sup>116</sup> Nevertheless, the Gemini project represented a significant technical step beyond Mercury and the manifestation of a cautious building-block approach to manned space flight. The need for developing the rendezvous

<sup>113</sup> Based on "Chronology of Major NASA Launchings," app. B of *Astronautical and Aeronautical Events of 1962*, prepared by the NASA Historical Office.

<sup>114</sup> For a brief but very good summary of NASA's program for 1961, see the President's Annual Report to Congress, *United States Aeronautics and Space Activities, 1961*, pp. 7-31.

<sup>115</sup> NASA News Release 61-273, Dec. 7, 1961.

<sup>116</sup> The Gemini concept was first introduced in May 1961 by McDonnell Aircraft Corp., the builder of the Mercury spacecraft. (See Grimwood, *Project Mercury: A Chronology*, p. 145.) It was added to NASA's budget in about August 1961. McDonnell was picked to build it.

technique became crucial inasmuch as the rendezvous approach to the moon had superseded the direct ascent approach in late 1961. The development of the rendezvous capability was also of interest to the Department of Defense.

***Kennedy Enunciates Communications Policy.*** In July President Kennedy announced his concurrence in the Space Council's recommendations on a national policy on communication satellites.<sup>117</sup> The statement favored private ownership, as long as standards of broad coverage, nondiscrimination, and broad participation were followed. The U.S. Government would cooperate in developing the system and in supervising related international agreements. It would also maintain absolute control over the launching of any communication satellite.

This was basically an elaboration of the elementary Eisenhower-Glennan private-ownership policy on the same subject. The year 1962 revealed that there was a vocal minority in Congress which thought the policy did not adequately protect the public interest.

***Miscellaneous.*** During 1961 NASA put the finishing touches on two important worldwide tracking networks: the Mercury Network for the manned Mercury flights and the Deep Space Network for lunar, solar, and planetary probes.

## CONCLUSION

The year 1961 will probably be regarded as the most hectic year in NASA's history. There is little doubt that the Presidential decision to broaden and accelerate the space program and undertake a definite program leading to a manned lunar landing greatly altered NASA's subsequent history. President Kennedy regarded it "as among the most important decisions that will be made during my incumbency. . . ." <sup>118</sup>

It was repeatedly stated that the manned lunar landing could be achieved within the current state of the art. This would suggest that the manned lunar landing was essentially a management and engineering problem, rather than a scientific one. Subsequent developments revealed that the management and engineering problems were even more difficult than expected.

<sup>117</sup> For a copy of the President's July 24, 1961, statement, see *United States Aeronautics and Space Activities, 1961*, pp. 105-106. (App. C).

<sup>118</sup> Speech at Rice University, Houston, Tex., Sep. 12, 1962.



## Chapter Eight

### RAPID GROWTH/ORGANIZATIONAL READJUSTMENTS

Previous chapters traced NASA's administrative history from its establishment in 1958 through what could be viewed as a reestablishment in 1961. A leveling off which appeared to be manifesting itself at the end of the Glennan period did not materialize, largely because of the decision by the Kennedy administration to enlarge and accelerate NASA's program significantly. Thus, instead of leveling off at 20,000 employees and a \$1.5 billion budget, NASA again grew dramatically and a leveling off was not contemplated until 34,000 employees and budgets of \$5 to \$6 billion were reached. Most of the growth took place over a 2- to 3-year period, which meant that the rate of growth was extremely rapid.

It goes without saying that periods of rapid growth in any organization tend to be less than tidy. Certainly NASA was no exception and it has been argued that NASA grew too rapidly. But inexorable deadlines existed for its most important programs and thus time was the most important governing determinant. As long as NASA's chief objective, the manned lunar landing, was not questioned, its rapid rate of growth was accepted without much question. A "honeymoon" between NASA and Congress existed for 2 years. It would appear that the "honeymoon" ended in 1963.

The term "honeymoon" refers to the nature of the external support given NASA. It does not mean that there was internal bliss. In fact, just the opposite was true. The 1962-63 period is often characterized as a period of constant firefighting during which new conflagrations occurred as fast as (or faster than) old ones were put out.

The chief objectives of this chapter are to quantitatively depict NASA's rapid growth during the 1962-63 period, to delineate some of the management problems faced and how they were solved, and to analyze the manner in which the November 1961 reorganization appeared to have worked out in practice. Other developments during the period are treated only in summary fashion.<sup>1</sup>

#### I. GROSS MEASUREMENTS OF NASA'S RAPID GROWTH, 1962-63

NASA's rapid growth can be readily measured in three areas—finances, numbers of personnel, and procurement activity.

<sup>1</sup> The reader should keep in mind that the rather detailed coverage of NASA organizational and administrative developments of earlier chapters cannot be continued in light of the increased tempo of agency activity. Furthermore, the period is so recent that there is no way of knowing what activities warrant special attention from the long-range point of view.

### A. Growth of NASA Budgets and Spending

In January 1961, the President requested \$1.1 billion for NASA for fiscal year 1962; 2 years later the amount requested was \$5.7 billion, a 500-percent increase. Actual appropriations did not increase so dramatically, of course, as the fiscal year 1962 budget was amended upward by President Kennedy and the appropriation for fiscal year 1964 was \$600 million less than what was asked for.

A more concrete measure of increasing agency activity, both in-house and out-of-house, is the amount of money actually obligated and expended. This is depicted in the following table:<sup>2</sup>

Period	Obligations [in millions]	Expenditures [in millions]
January-June 1961.....	567	411
July-December 1961.....	697	479
January-June 1962.....	1, 143	778
July-December 1962.....	1, 415	1, 015
January-June 1963.....	2, 101	1, 538
July-December 1963.....	2, 070	1, 844
Fiscal year 1962.....	1, 840	1, 257
Fiscal year 1963.....	3, 516	2, 553

Thus obligations and expenditures were twice as great during the first half of 1963 as they were in the first half of 1962, and four times what they were before the acceleration of NASA's program.

Doubling 2 years in a row applied to the primarily out-of-house research and development and construction of facilities accounts. The salary-and-expense account doubled during 1962 and then began leveling off, whereas R&D kept rising. Amounts for CoF moved up and down irregularly because of the way construction contracts worked out. During the first half of 1963, obligations for CoF peaked at \$356 million.

Period	Obligations [in millions]		
	S & E	R & D	CoF
January-June 1961.....	\$91	\$424	\$51
July-December 1961.....	99	486	112
January-June 1962.....	117	819	107
July-December 1962.....	198	999	217
January-June 1963.....	228	1, 517	356
July-December 1963.....	243	1, 627	200

<sup>2</sup> Data supplied by NASA's Financial Management Division. For greater detail, see app. D.

It should be kept in mind that the first half of the calendar year is the second half of the fiscal year. Since NASA's appropriation bills did not become law until well into each fiscal year, there was a tendency for January-June spending activity to be considerably higher than July-December activity. Thus new highs would likely be attained during the first half of 1964.

### B. Growth in Total Personnel

T. Keith Glennan, NASA's first Administrator, made a conscious effort to hold down the number of new employees in NASA. Of the 16,000 NASA employees at the end of his period of office, over 78 percent had been transferred to NASA en masse and only about 3,500 came aboard as new employees, primarily to staff Headquarters and the new Goddard Center.

With the acceleration of NASA's program under the Kennedy administration, personnel numbers for a period moved sharply upward. This is revealed in the following table:<sup>3</sup>

As of—	Number of NASA employees	Increase over previous period	Percentage increase
Dec. 31, 1960.....	16,042		
June 30, 1961.....	17,471	1,429	9
Dec. 31, 1961.....	18,987	1,516	9
June 30, 1962.....	23,686	4,699	25
Dec. 31, 1962.....	25,667	1,981	8
June 30, 1963.....	29,934	4,267	17
Dec. 31, 1963.....	30,069	135	.....

As can be seen from the table, the personnel numbers increased 50 percent during the 18 months from the beginning of 1962 to the middle of 1963. To increase by that amount (almost 11,000 individuals), NASA hired about 18,000 persons. (It should be pointed out, however, that the 7,000 separations during the period included regular turnovers, plus those persons who had been hired for temporary summer jobs. The agency's turnover rate was normal.)

During the 18-month period, certain NASA installations grew much faster than others. The Manned Spacecraft Center in Houston almost tripled in size. The Cape Canaveral facility went from a 300-man adjunct of the Marshall Center to a 1,200-man independent field center (the Launch Operations Center). Headquarters more than doubled in size and the Goddard Center increased almost 90 percent. The large contracts with west-coast firms were reflected in the Western Operations Office increase in size of over 350 percent.

Did the rapid increase in personnel result in any change in the composition of NASA's work force? Only a little bit. The recruitment emphasis was on

<sup>3</sup> Data supplied by NASA's Personnel Division (SF 113). For greater detail, see App. C.

scientists and engineers (i.e., aerospace professionals) and the result was that the number of persons in this classification increased from 32 percent of the total at the end of 1961 to 37 percent by the end of 1963. Administrative types increased from 7 percent to 10 percent of the total, a larger percentage gain than the aerospace professional category. The Wage Board category decreased from 32 percent to 23 percent of the total.<sup>4</sup>

The problem of recruiting scientists and engineers is examined in a later section in this chapter.

### **C. Changes in Procurement Patterns During the Period of Rapid Growth**

A comparison between NASA procurement patterns for fiscal year 1961, the last period before program acceleration, and fiscal year 1963, the last period for which data are available and by which time two-thirds of the acceleration had taken place, reveals several significant changes.<sup>5</sup> Not all the changes are indicative of long-run trends, of course, nor are all of them directly related to the program acceleration. Cause-and-effect relationships are difficult to establish and the following comparisons only reveal gross changes.

From fiscal year 1961 to fiscal year 1963, the total value of NASA procurements increased over 325 percent. The number of procurement actions only doubled, so there was a sizable increase (112 percent) in the average value of a procurement action.

The value of direct awards to large business increased at a rate over twice that of small business and nonprivate organizations. NASA's 25 largest private contractors received 78 percent of the awards to business in fiscal year 1963 compared with 70 percent for fiscal year 1961.

Awards to business based on noncompetitive procedures increased faster than awards based on competitive procedures.

In regard to the type of contract used, an interesting development took place. Both the desirable firm-fixed-price-type contract and the undesirable cost-plus-fixed-fee-type contract declined in use (relatively speaking, and the former more than the latter) in favor of more sophisticated contracts, many of which contained incentive features.

A dramatic shift occurred in regard to the Government agencies which procured goods and services for NASA. Procurements by the Department of the Army for NASA increased almost fourteenfold from fiscal year 1961 to fiscal year 1963, whereas the procurements by the Air Force increased only by 60 percent, the same rate as that for all other Government agencies. This was a reflection of NASA's dependence upon the Army Corps of Engineers for land acquisition and new facility construction.

<sup>4</sup> Data supplied by NASA's Personnel Division.

<sup>5</sup> Comparison based on data in NASA's Annual Procurement Reports for fiscal year 1961 and fiscal year 1963. For greater detail, see App. E.

The pattern of procurement activity of individual NASA installations changed somewhat. In comparison with the average agency increase of 328 percent, Marshall increased 268 percent, WOO 216 percent, Goddard 96 percent, and the Manned Spacecraft Center 798 percent. These four installations accounted for 74 percent of NASA procurement in fiscal year 1963 compared with 83 percent for fiscal year 1961.

California improved its position as chief recipient of NASA awards directly to business by moving from 39 percent of the total in fiscal year 1961 to 50 percent in fiscal year 1963. The spread among other states improved slightly during the same period.

In summary, the acceleration of NASA's program enhanced the role of (1) the Manned Spacecraft Center, (2) the Army Corps of Engineers, (3) the large California aerospace firms, (4) noncompetitive procedures. The position of small business worsened as far as prime contracts were concerned, but very likely improved when subcontracts are taken into consideration. In general, the substantial overall increase in the amount of goods and services NASA procured resulted in heavy demands on U.S. industry.

## II. PROGRAM DEVELOPMENTS, 1962-63

The Kennedy administration's fiscal year 1962 budget add-ons in March and May of 1961 set off a rapid acceleration of NASA's program. By fiscal year 1964, only 2 years later, NASA's budget was over \$5 billion, at which point it leveled off.

NASA's budget experts have broken NASA's fiscal years 1962-64 program down into the same fivefold division used in the reorganization of NASA Headquarters. The following table shows how one program category quadrupled, one tripled, and the other three doubled:<sup>6</sup>

[Fiscal years; millions of dollars]

	1962	Percent of total	1963	Percent of total	1964	Percent of total
Manned Space Flight.....	923.2	(50.7)	2,242.1	(60.8)	3,758.2	(65.8)
Space Sciences.....	442.7	(24.3)	634.7	(17.2)	836.7	(14.6)
Applications.....	76.2	(4.2)	118.1	(3.2)	140.7	(2.5)
Advanced Research and Technology..	260.7	(14.3)	496.7	(13.5)	597.2	(10.5)
Tracking and Data Acquisition.....	118.9	(6.5)	196.1	(5.3)	379.2	(6.6)
Total.....	1,821.7	.....	3,687.7	.....	5,712.0	.....

<sup>6</sup> U.S. Congress, Senate, Committee on Aeronautical and Space Sciences, *NASA Authorization for Fiscal Year 1964*, Hearings on S. 1245, 88th Cong., 1st sess. (Washington: GPO, 1963), p. 778 (Pt. 2) (hereafter cited as Senate Hearings, *NASA Authorization for Fiscal Year 1964*).

**A. Manned Space Flight**

It is easy to see from the above table that manned space flight was the area into which NASA poured the lion's share of its resources. Within the manned space flight area most programs expanded, a few contracted. Compare the budget requests for fiscal year 1962 with fiscal year 1964 for some of the major manned space flight activities.<sup>7</sup>

[Millions of dollars]

	Fiscal year 1962	Fiscal year 1964
Mercury (1 man, earth orbital).....	42.3	0.2
Gemini (2 men, earth orbital and rendezvous).....	58.9	335.3
Apollo (3 men, earth orbital and lunar landing).....	84.6	1,263.2
Saturn I (the original Saturn).....	257.4	158.6
Saturn IB (different 2d stage).....	.5	76.0
Saturn V (the 5 F-1 cluster, moon rocket).....	69.5	799.7
Engine development.....	123.9	192.4
Construction of facilities (primarily launch).....	245.4	564.5
Other R&D.....	40.7	368.3
<b>Total.....</b>	<b>923.2</b>	<b>3,758.2</b>

A major program decision, not directly revealed in the above data, was made public in July 1962, when NASA announced that instead of concentration on the direct ascent approach to the moon, as contemplated in the Fleming Report of June 1961, or the earth orbital rendezvous approach, as suggested by the Golovin Report in December 1961, NASA would rely primarily on a lunar orbital rendezvous (LOR) approach. This decision was made after a million man-hours of engineering studies demonstrated that it would be the cheapest method and would result in the earliest possible accomplishment of a manned lunar landing. The LOR approach required the development of a smaller lunar landing craft than earlier contemplated—the two-man lunar excursion module, rather than a three-man landing craft. The size of the required launch vehicle would be smaller than under the direct ascent approach. An orbital tanker would not be required as under the earth orbital approach. The Apollo spacecraft would consist of a three-manned command module, a propulsion or service module, and the lunar excursion module in which two members of the three-man crew would descend to the surface of the moon while the third member stayed in the command module in orbit around the moon. For the return to earth, the two-man lunar excursion module would launch from the surface of the moon and rendezvous with the rest of the Apollo spacecraft in lunar orbit.

<sup>7</sup> *Ibid.*, p. 779.

Only the three-man command module would return to earth. In November 1962, NASA announced that the Grumman Aircraft Engineering Corp. had been selected to develop the lunar excursion module, thus completing the selection of major hardware contractors for the Apollo program.

The manned lunar landing mission would be achieved by putting the 5-ton command module (being built by North American), the 12-ton lunar excursion module (Grumman), and the 5-ton service module (North American) loaded with 20 tons of fuel, on top of the 150–200-ton three-stage Saturn V launch vehicle (first stage, Boeing; second stage, North American; third stage, Douglas) loaded with over 2,500 tons of fuel. Launched from Cape Canaveral, the 45-ton payload would be put first into earth orbit, then hurled on its flight toward the moon.<sup>8</sup>

Using power furnished by the service module, the Apollo spacecraft would maneuver into an orbit around the moon, from which the lunar excursion module would descend as earlier described. To assemble the launch vehicle stages and the spacecraft modules, NASA planned the construction of a mammoth vertical assembly building at Cape Canaveral. The assembled space vehicle would then be transported in a vertical position 3 miles to the launch pad.

The foregoing description touches on only a few of the aspects of the extremely complex manned lunar landing endeavor. Although it was not a three-shift, parallel-course crash program, the sheer magnitude of the fast-paced program ate dollars at a furious rate.

In 1963, Project Mercury was completed. This project, as old as NASA itself, culminated in a 22-orbit mission (Cooper flight) on May 15–16. Two manned suborbital missions had been flown in 1961 (Shepard, Grissom), and three orbital missions in 1962 (Glenn, Carpenter, and Schirra). The program had cost almost \$400 million, including the \$125 million invested in a tracking network.<sup>9</sup> Although costing more and taking longer than originally contemplated, the project met its objectives and can only be classified as completely successful.

In June, Webb announced that with the end of Project Mercury, the Mercury team and its facilities would be utilized in the Gemini and Apollo programs.<sup>10</sup>

It should also be mentioned that during 1962–63 the Gemini project, originally conceived as a relatively simple projection of Project Mercury, was upgraded into a much more sophisticated (and expensive) project.<sup>11</sup> The Air Force was very interested in NASA's Gemini program, since the program included near-earth orbital operations—something considered to have future military signifi-

<sup>8</sup> For a good description of the Apollo mission, see Holmes' statement, *ibid.*, pp. 484–497 (Pt. 1).

<sup>9</sup> *Mercury Project Summary* . . . , NASA SP-45 (Washington: GPO, 1963), p. 25.

<sup>10</sup> Grimwood, *Project Mercury, A Chronology*, p. 196.

<sup>11</sup> U.S. Congress, House, Committee on Science and Astronautics, *1964 NASA Authorization*, Hearings on H.R. 5466, 88th Cong., 1st sess. (Washington: GPO, 1963), pp. 873, 884 (Pt. 2b) (hereafter cited as House Hearings, *1964 NASA Authorization*).

cance. Interagency agreements were entered into providing for close NASA-Air Force liaison on the project.<sup>12</sup> A NASA-Air Force Gemini program planning board was established and DOD agreed to contribute funds to help attain Gemini program objectives. Project management remained with NASA.

### B. Space Sciences

The following table compares the fiscal year 1962 budget with the fiscal year 1964 budget for the major space science program areas:<sup>13</sup>

[Millions of dollars]

	Fiscal year 1962	Fiscal year 1964
Geophysics and astronomy (e.g., OSO, OGO, OAO, International).	119.8	232.6
Lunar and planetary exploration (e.g., Ranger, Mariner).....	164.6	331.4
Launch vehicle development (smaller than Saturn).....	100.9	149.5
Bioscience.....	4.1	41.3
Grants (primarily to universities).....	13.5	56.4
Construction of facilities.....	39.8	25.5
<b>Total.....</b>	<b>442.7</b>	<b>836.7</b>

The lunar and planetary exploration program included unmanned exploration of the moon, a vital input into the manned lunar landing endeavor. Unfortunately by the end of calendar year 1963, none of the unmanned flights to the moon had been successful. A very notable success was scored in planetary exploration in late 1962 when the Mariner II spacecraft scanned Venus as it passed within 21,000 miles.

The Geophysics and Astronomy program achieved seven out of seven successful launches in 1962, and three out of three in 1963. The large multiexperiment scientific earth satellites, such as the orbiting astronomical observatory and the orbiting geophysical observatories were being developed for launching during 1964 and later.

In the launch vehicle development area, a significant milestone was passed—the successful test of the Centaur liquid hydrogen launch vehicle on November 27, 1963.

The NASA grant program provided for the construction of research facilities, the training of research students, and the funding of research projects at U.S. universities and colleges. The NASA University Program was considered an essential part of NASA's long-range investment to make sure that space-skilled researchers and researched information would be constantly forthcoming from

<sup>12</sup> *Ibid.*, pp. 406-410. (A copy of the Jan. 21, 1963, NASA-DOD agreement is printed on p. 407.)

<sup>13</sup> Senate Hearings, *NASA Authorization for Fiscal Year 1964*, p. 782.



the university and college area. The fourfold increase shown in the table is a manifestation of Administrator Webb's keen interest in this area.<sup>14</sup>

### C. Applications<sup>15</sup>

[Millions of dollars]

	Fiscal year 1962	Fiscal year 1964
Meteorological satellites.....	39.7	73.1
Communications satellites.....	35.5	55.8
Other (including industrial application).....	1.0	11.8
<b>Total.....</b>	<b>76.2</b>	<b>140.7</b>

During 1962 and 1963, NASA successfully launched five Tiros weather satellites, demonstrating operational utility far exceeding expectations for an R&D spacecraft. Widely publicized were the 1962 successfully launched Telstar and Relay communications satellites. In 1963 another successful Telstar and two Syncom satellites were launched. Both Syncoms were placed in a 22,000-mile orbit in which they remained relatively stationary over one point on earth. Only the second one was successful for communications purposes.<sup>16</sup>

### D. Advanced Research and Technology<sup>17</sup>

[Millions of dollars]

	Fiscal year 1962	Fiscal year 1964
Propulsion (including nuclear).....	84.3	214.7
Space power (including solar and nuclear).....	21.3	54.1
Space vehicles (including reentry).....	88.4	195.1
Aeronautics.....	28.8	45.1
Construction.....	37.9	88.3
<b>Total.....</b>	<b>260.7</b>	<b>597.3</b>

<sup>14</sup> See T. K. L. Smull, *The Nature and Scope of the NASA University Program* (Washington: NASA SP-73, 1965); T. P. Murphy and T. W. Adams, "Decision Making in NASA for University Cooperation," paper given at American Political Science Association, Washington, D.C., Sept. 8, 1965.

<sup>15</sup> Senate Hearings, *NASA Authorization for Fiscal Year 1964*, p. 784.

<sup>16</sup> See forthcoming G. R. Thompson, "NASA Comsat Development," NASA Historical Monograph No. 8.

<sup>17</sup> Senate Hearings, *NASA Authorization for Fiscal Year 1964*, p. 785.

It is interesting to note that the program area labeled "Aeronautics" was less than 1 percent of NASA's budget in fiscal year 1964.

The construction money in 1964 included money to begin a new field center—the Electronics Research Center—slated for the Boston area. It also included money for a Nuclear Rocket Development Station in Nevada. Both are examples of NASA's functional and geographic spreading out for the long-term conquest of space.<sup>18</sup>

#### E. Tracking and Data Acquisition<sup>19</sup>

The tracking and data acquisition program brought together certain specialized activities common to all of NASA's space exploration projects. It involved the building, expansion, and operation of NASA's worldwide tracking facilities, together with providing communications among them, and handling and processing data received through them.

[Millions of dollars]

	Fiscal year 1962	Fiscal year 1964
Network operations .....	51.8	105.8
Equipment and components .....	16.4	134.0
Supporting research and technology .....	15.7	21.8
Construction of facilities .....	35.1	117.6
<b>Total</b> .....	<b>118.9</b>	<b>379.2</b>

Three major networks were involved—the satellite network, the manned flight network, and the deep space network. The first 2 involved about 15 stations each; the latter involved 3 stations. Most of the stations were outside the United States. In addition, local networks were maintained for activities at Wallops Island and Flight Research Center, the latter in association with the X-15 program.

The fiscal year 1964 construction budget included \$90 million to outfit 3 old ships with the necessary instruments to convert them into mobile tracking stations.

In appraising NASA's program during 1962 and 1963, it should be kept in mind that the payoff in new knowledge and flight exploits from the accelerated activity of 1961 on was still to come some time in the future. The publicized

<sup>18</sup> Details are supplied later in the chapter.

<sup>19</sup> Senate Hearings, *NASA Authorization for Fiscal Year 1964*, p. 787. See also U.S. Congress, House, Committee on Appropriations, Subcommittee on Independent Offices, *Independent Offices Appropriations for 1964*, Hearings, 88th Cong., 1st sess. (Washington: GPO, 1963), pp. 493-499 (Pt. 3).

accomplishments of the 1961-63 period were actually the culmination of NASA's program laid down during the Eisenhower-Glennan era. Nor should it be forgotten that the organizational and administrative problems NASA faced during 1962 and 1963 were related primarily to the vast activity involved in preparing for what later would hit the headlines and be judged worthwhile or otherwise. In the meantime, who could really judge NASA's efficiency and wisdom?—probably not even NASA itself.

### III. ORGANIZATIONAL DEVELOPMENTS, 1962-63

This period was one of overall organizational stability. One major change was made in the field and two in Headquarters. All other changes were relatively minor. The major agency reorganization at the end of 1963 (discussed in the next chapter) suggests that other things were happening beneath the surface.

#### A. Field Installation Changes

*Cape Canaveral Facility Given Full Field Center Status.* In 1960, NASA had consolidated its Atlantic and Pacific Missile Range activity under the Launch Operations Directorate (LOD), a somewhat autonomous extension of the Marshall Center in Huntsville, Ala.<sup>20</sup> On March 7, 1962, LOD was split into three segments, two of which became independent field installations.<sup>21</sup> That portion of LOD at Cape Canaveral, Fla., became the Launch Operations Center (LOC). That portion at Point Mugu, Calif., became the Pacific Launch Operations Office (PLOO). The Marshall Center retained a segment of LOD and it was designated the "Launch Vehicle Operations Division."

Dr. Kurt Debus, the head of LOD, was named Director of LOC. Initially, it consisted of 338 persons transferred from the Marshall Center (i.e., LOD). It grew rapidly and by the end of 1963 numbered 1,269.<sup>22</sup> LOC's mission was threefold. One was to aid in the NASA launchings made from Cape Canaveral. The second was to supervise the mammoth construction going on at the Cape in connection with the manned lunar landing program. The third was to maintain relationships with the Air Force which had overall control of the Atlantic Missile Range.

LOC's director did not report to Associate Administrator Seamans, as did most NASA's field center directors. Instead he reported to D. Brainerd Holmes, the Director of Manned Space Flight in NASA Headquarters. Seamans stated that this would assure that LOC would be immediately responsive to the many requirements of the manned lunar landing program.<sup>23</sup> Although manned space

<sup>20</sup> See Ch. 5, Sec. I.B.

<sup>21</sup> NASA Circular No. 208, Mar. 7, 1962. Subject: Establishment of the Launch Operations Center at AMR and the Pacific Launch Operations Office at PMR.

<sup>22</sup> See App. C.

<sup>23</sup> NASA News Release No. 62-53, Mar. 7, 1962.

flight was the "major user," the LOC would also serve other program areas. Thus NASA seems to have violated one of the concepts of the previous November reorganization—that of having all multipurpose centers report to general management.<sup>24</sup> As it turned out, this was only the first retreat from the concept.

The Pacific Launch Operations Office, in keeping with the "major user" concept, reported to Homer Newell, the Director of Space Sciences in NASA Headquarters, thus having the same type of relationship with Headquarters as LOC. PLOO was very small; it numbered only 11 to begin with and by the end of 1963 had grown to only 19. NASA contractors did most of the work in connection with the few actual launchings that NASA made at the Pacific Missile Range.

NASA's rapidly expanding activities in the Cape Canaveral area brought into question the degree to which these activities should be under the cognizance of DOD, which had overall responsibility for the Atlantic Missile Range. After some heated debate, NASA and DOD entered into an agreement in early 1963 calling for a somewhat different division of responsibility.<sup>25</sup> The Air Force was to continue to be "host agency" for the existing 15,000-acre Cape Canaveral launch area, but NASA was to be "host agency" for the massive new 87,000-acre Merrit Island Launch Area to the northwest. DOD continued to have responsibility over certain fundamental range functions involving the scheduling of launches, safety, and "downrange" activities. The agreement gave NASA much greater freedom in conducting its construction activities.

**Northeastern Operations Office Established.** On July 3, 1962, NASA announced the establishment of a Northeastern Operations Office, to be located in Boston.<sup>26</sup> The action was designed to facilitate day-to-day contacts with the universities and corporations in the New England area. The Office was to serve NASA centers in the conduct of their business with area firms and to maintain technical and administrative liaisons with NASA contractors and grant recipients. It was not large, numbering 10 by the end of 1962 and 29 by the end of 1963.

**Electronics Research Center Proposed.** In the budget guidelines of March 2, 1962, NASA's Associate Administrator directed the Office of Advanced Research and Technology to prepare, for inclusion in the fiscal year 1964 budget, a plan to strengthen NASA's electronic capability.<sup>27</sup> NASA's concern for its electronic capability stemmed from the fact that on the order of 70 percent of the cost of spacecraft is for electronic components. Furthermore, electronics was proving the key to mission reliability and success. NASA had not "inherited" competence in electronics to the extent it had inherited competence in other scientific and technical areas.<sup>28</sup>

<sup>24</sup> John D. Young in his comments to the NASA Historical Office dated Jan. 1, 1965, makes the point that LOC was not a fully integrated center and that two separate launching organizations existed within it, each of which was somewhat single purposed.

<sup>25</sup> NASA News Release No. 63-11, Jan. 22, 1963.

<sup>26</sup> NASA News Release No. 62-155, July 3, 1962.

<sup>27</sup> "NASA Electronics Research Center, Staff Report," Jan. 1963, p. 6.

<sup>28</sup> Letter, Webb to Miller, Chairman of House Astronautics Committee, Mar. 21, 1963. (Reproduced in House Hearings, 1964 NASA Authorization, pp. 3012-3015.)

As a result of the Associate Administrator's directive, the Electronics and Control Directorate of the Office of Advanced Research and Technology conducted a study. The result was a recommendation for an Electronics Research Center, eventually costing \$50 million to construct and employing 2,000 persons.<sup>29</sup> The fiscal year 1964 budget, submitted to Congress in January 1963, included \$5 million to begin the Center. NASA also stated that Boston had been selected as the tentative location for the Center because of the abundant university and industrial electronic resources there.

It turned out that NASA might have used different tactics in seeking congressional approval for the Center. Members of the House Astronautics Committee questioned both the need for the Center and its proposed location.<sup>30</sup> NASA was somewhat vulnerable to criticism because it had not used a formal site selection procedure, probably because it felt the selection of the Boston area had overwhelming merit. NASA was accused of selecting Boston for political reasons, and in view of the limited documentation on why other sites were rejected the charge was difficult to refute.<sup>31</sup> The upshot was that Congress required NASA to rejustify the need for the Center and, in addition, to submit a detailed analysis of potential locations. If Congress was satisfied with the results of this effort, it would release the money to get the Center started.<sup>32</sup> (It eventually did.)

*Contract Administration Office Established at Downey, Calif.* In May 1962, NASA established an on-site management unit at the Downey plant of North American Aviation.<sup>33</sup> The Downey plant was unique in that two of NASA's largest contracts were centered there. One was for the Apollo spacecraft and was under the jurisdiction of the Manned Spacecraft Center. The other was for the second stage of the Saturn V launch vehicle and was under the jurisdiction of the Marshall Space Flight Center. The Downey office was an extension of NASA's Western Operations Office, but also included project representatives from the two centers. The reason for its establishment was the need for a "single NASA face" on matters transcending individual projects.<sup>34</sup>

NASA usually relied on representatives of the military services to conduct certain types of on-site activities when contracts with both NASA and DOD

<sup>29</sup> "NASA Electronics Research Center, Staff Report," Jan. 1963.

<sup>30</sup> See discussions on pp. 2956-2964 and 3011-3018 of House Hearings, 1964 NASA Authorization.

<sup>31</sup> In the selection of Houston for the Manned Spacecraft Center, NASA used a formal site selection procedure which may or may not have been the deciding factor in the decision, but at least it satisfied some of the critics. In the case of the Electronics Center, NASA was accused of helping Senator Ted Kennedy do more for Massachusetts, something Kennedy had claimed he could do in his 1962 campaign.

<sup>32</sup> See NASA Fiscal Year 1964 Authorization Act, Public Law 88-113, Sept. 6, 1963. See also NASA News Release 63-233, Oct. 21, 1963.

<sup>33</sup> NASA News Release 62-115, May 11, 1962. See also General Management Instruction 2-2-16.1, May 11, 1962. Subject: Establishment and Functions of the National Aeronautics and Space Administration Office—Downey.

<sup>34</sup> Memo, Walter Hahn to Albert Siepert et al., Mar. 1, 1962. Subject: NASA Representative at North American—Downey.

existed. In the case of the Downey plant, however, NASA activity greatly exceeded that of DOD. The on-site NASA representatives were involved in such things as postaward contract administration, cost analysis, subcontract review, in-plant inspection, etc. Over 100 NASA personnel were involved.

In 1963 a similar but smaller office was established at a General Electric office in Daytona Beach, Fla.<sup>35</sup> Initially, it was an integral part of NASA's Office of Manned Space Flight; later it was transferred to the Launch Operations Center.

*The Organization of NASA's Nuclear Activities.* NASA's nuclear activities were primarily joint activities with AEC. As a result, a rather complicated organizational structure was used. In 1960 a joint AEC-NASA Nuclear Propulsion Office was established, headed by a NASA official and housed at AEC Headquarters.<sup>36</sup> An AEC-NASA agreement in early 1961 clarified the contracting powers of the joint office and established a pattern for field extensions.<sup>37</sup> At least one field extension was to be under NASA cognizance at NASA facilities in Cleveland, Ohio, and another, under AEC cognizance, at AEC facilities in Albuquerque, N. Mex.

The acceleration of NASA's program in 1961 included the acceleration of the nuclear rocket program. The need arose to more clearly spell out how the joint program was to operate, lest it suffer from its uncertain interagency status. In July 1961 a more comprehensive AEC-NASA agreement was entered into.<sup>38</sup> The joint office was renamed the "Space Nuclear Propulsion Office" (SNPO) of AEC-NASA. The Albuquerque extension (SNPO-A) was to maintain liaison with AEC's Los Alamos Scientific Laboratory, and the Cleveland extension (SNPO-C) with NASA's Lewis Research Center. Considerable authority was delegated to the Manager of SNPO to carry out the Rover nuclear rocket project. In October 1961, NASA announced that the Cleveland extension (SNPO-C) had been activated.<sup>39</sup>

Most of the developmental work on the nuclear rocket was being done under contract. As technical development progressed, the need arose to test what had been developed. In February 1962, NASA announced the establishment of the Nuclear Rocket Development Station at AEC's Nevada Test Site.<sup>40</sup> The need for such a facility had been recognized for some time and a facility architectural

<sup>35</sup> NASA Circular 267A, June 23, 1963. Subject: Establishment of a NASA Manager, Daytona Beach Operation (LOC), Daytona Beach, Fla.

<sup>36</sup> See Ch. 5, Sec. I.B.

<sup>37</sup> "Agreement Between NASA and AEC on Management of Nuclear Rocket Engine Contracts," signed by Seamans of NASA and Alvin Luedecke, General Manager of AEC, Feb. 1, 1961.

<sup>38</sup> "Inter-agency Agreement on the Program for the Development of Space Nuclear Rocket Propulsion (Project Rover)," signed by Seamans and Luedecke, July 28, 1961.

<sup>39</sup> NASA Announcement No. 384, Oct. 23, 1961. Subject: Activation of the Joint AEC-NASA Space Nuclear Propulsion Office—Cleveland. It should be noted that Lewis was engaged in its own advanced nuclear propulsion studies. The Plum Brook Station, located about 40 miles west of Lewis' main area, had a nuclear reactor which went to full power in April 1963.

<sup>40</sup> NASA News Release 62-37, Feb. 19, 1962.

and engineering study contract had been let in late 1960.<sup>41</sup> Since existing Nevada Test Site facilities were being fully used, some consideration was given to locating the rocket development facility elsewhere, but the February announcement confirmed the Nevada location. In June 1962, a SNPO extension (SNPO-N) was established in Las Vegas, Nev., to manage the Nuclear Rocket Development Station.<sup>42</sup> The Nevada extension was activated in October.<sup>43</sup>

By the end of 1963, NASA personnel numbered 13 at SNPO Headquarters, 59 at SNPO Cleveland, and 30 at SNPO Nevada.

The Manager of SNPO (Harold Finger) was also Director of Nuclear Systems in NASA's Office of Advanced Research and Technology. In this capacity he gave program direction to activities related to NASA's in-house nuclear program. He was in a good position to assure that NASA activities and SNPO activities were coordinated.<sup>44</sup>

*Miscellaneous Developments.* During 1962, three significant projects were transferred from the Marshall Center to the Lewis Center. One was Dr. Ernst Stuhlinger's electric propulsion program; the second was the very important Centaur launch vehicle development project; the third was the Agena launch vehicle program. The effect was to make Marshall a more single-purpose center (Saturn vehicles) and Lewis even more of a multipurpose center.<sup>45</sup>

## B. Headquarters Changes

During the period between the November 1, 1961, reorganization and the November 1, 1963, reorganization, two significant changes and several minor ones were made in NASA's Headquarters organization. Both major changes centered around the Office of the Associate Administrator.

*Director of Manned Space Flight Named Deputy Associate Administrator.* The Office of the Associate Administrator, following the November 1, 1961, reorganization, consisted of the Associate Administrator (Seamans), a Deputy Associate Administrator (Dixon), and a staff assistant (Romatowski). This Office had jurisdiction over one staff office (Programs); one staff-service office (Administration); one agencywide support office (Tracking and Data Acquisition); four program offices (Advanced Research and Technology, Space Sciences, Applications, Manned Space Flight); and nine field centers (Langley, Ames, Lewis, Flight, Goddard, Wallops, Marshall, Manned Spacecraft, and JPL). This gave Seamans a span of control of 16. Dixon was to assist in the overall direction of the centers and in the overall direction of sub-Saturn launch vehicles, the area of his special technical competence.

<sup>41</sup> Joint AEC-NASA Release No. 60-319, Dec. 19, 1960.

<sup>42</sup> NASA Announcement No. 513, June 5, 1962. Subject: Bob P. Heigeson Appointed Chief, Space Nuclear Propulsion Office—Nevada Extension.

<sup>43</sup> NASA News Release No. 62-215, Oct. 12, 1962.

<sup>44</sup> For an overall diagram of the nuclear rocket program organization, see Senate Hearings, *NASA Authorization for Fiscal Year 1964*, p. 653.

<sup>45</sup> NASA News Releases Nos. 61-255, Nov. 11, 1961; 61-209, Sept. 29, 1962; 62-261, Dec. 12, 1962.

The bottleneck, which on the face of it would seem inevitable, was to be avoided by developing intra-agency relationships which did not follow traditional hierarchical lines but rather crisscrossed the agency in a latticelike fashion.<sup>46</sup>

An early indication (March 1962) that this may not have been working out as planned was the decision to put the newly established Launch Operations Center directly under the Director of Manned Space Flight instead of under the Associate Administrator.<sup>47</sup>

A clearer indication that it was not working out was the action taken on October 30, 1962, when a new Deputy Associate Administrator position was established.<sup>48</sup> The new position was named "Deputy Associate Administrator for Manned Space Flight Centers," and had jurisdiction over the Marshall Space Flight Center, the Manned Spacecraft Center, and the Launch Operations Center. Dixon, the existing Deputy Associate Administrator, was given a somewhat more limited jurisdiction over NASA's other seven centers and he was later given the unwieldy title of "Deputy Associate Administrator for Other Than Manned Space Flight Centers."<sup>49</sup>

Most significant of all was that the person named to the new position was D. Brainerd Holmes, the Director of Manned Space Flight in NASA Headquarters, a position he continued to fill. By giving Holmes two hats, and giving Dixon a certain amount of responsibility for specific centers, NASA was able to drastically modify the November 1961 organization by a move that appeared to be only an adjustment. In one action, Seamans' span of control was reduced from 16 to 8.<sup>50</sup> At the same time, Holmes was given both "institutional" and "program" management authority over the key field centers involved in the manned lunar landing program, and thus could balance positions and facilities (resources) with program requirements (needs).

An interesting facet in this episode was provided by the change in the relationship of the Launch Operations Center to Headquarters. Prior to October 30, the Center reported to the Director of Manned Space Flight (Holmes). After October 30 it reported to the Deputy Associate Administrator for Manned Space Flight Centers (Holmes), and thus was on a par with all other NASA Centers.

The NASA October announcement on the new position called the action "a move aimed at adapting NASA's management structure to the agency's rapid growth . . ." and "another step in the evolution of NASA's emerging organiza-

<sup>46</sup> See Ch. 7, Sec. V.A.

<sup>47</sup> See Sec. III.A above.

<sup>48</sup> NASA News Release No. 62-233, Oct. 30, 1962.

<sup>49</sup> This new arrangement was very similar to one of the alternatives rejected by top management the year before. See Ch. 7, Sec. V.A.

<sup>50</sup> Dixon resigned as of Mar. 1, 1963, and his successor, Earl Hilburn, did not report until July 12, 1963. This meant that Seamans' respite was not continuous. Actually Dixon's control over the centers under him was nominal compared to that of Holmes, partly due to the fact that Dixon never had the staff resources that Holmes had, and even Holmes did not build up a staff that was adequate for the job. (See comments by Jay Holmes, submitted to NASA Historical Office in December 1964. Also letter, Siepert to Rosholt, Dec. 24, 1964.)



tion." This was putting it a bit euphemistically, as it was probably more an attempt to repair an untenable managerial arrangement.<sup>51</sup>

*Deputy Associate Administrator for Defense Affairs Appointed.* Action concerning a third Deputy Associate Administrator's post was revealed in November when NASA announced that Vice Adm. Walter Boone (USN, retired) had been named to fill the newly created position of Deputy Associate Administrator for Defense Affairs.<sup>52</sup> The Office of Defense Affairs was established to improve and strengthen the overall working relationships between NASA and DOD, to expedite the flow of information between the two agencies, and to promote coordination on matters of mutual interest. It was to be the focal point for all major defense-related matters within NASA and thus had to work with just about every major office in NASA.

In dealing with DOD and the military services, the Deputy Associate Administrator for Defense Affairs could speak (within established policy) for the entire agency. He served as the alternate to the NASA Cochairman of the Aeronautics and Astronautics Coordinating Board. The office which he headed provided the NASA secretariat for the Board and consequently the focal point for all NASA matters relating to the Board.<sup>53</sup>

*Deputy Associate Administrator for Industry Affairs Appointed.* A fourth Deputy Associate Administratorship was established in March 1963.<sup>54</sup> This action was not as much of a firefighting action as were the changes made the previous October. It was more evolutionary and stemmed from the ever-increasing contacts (and contracts) that NASA had with U.S. industry. The action was designed to bring relationships with industry right into the outer office of NASA's general manager (the Associate Administrator).<sup>55</sup> Contracting problems were brought to a higher managerial level which facilitated an agency-wide attack on them.

Appointed to the position of Deputy Associate Administrator for Industry Affairs was Walter Lingle, a former Procter & Gamble executive who had joined NASA in June 1962, and had served, successively, as a special assistant to Webb, acting Assistant Administrator for Public Affairs, and Assistant Administrator for Management Development.

The most significant aspect of the new position was that NASA's Procurement Division was put directly under it. Thus instead of being one of several divisions in the Office of Administration, the Procurement Division became the all-important division under a Deputy Associate Administrator. (The

<sup>51</sup> At least this is the consensus of several NASA officials interviewed.

<sup>52</sup> NASA News Release No. 62-249, Nov. 21, 1962.

<sup>53</sup> Based on comments from the Office of Defense Affairs to the NASA Historical Office, Aug. 17, 1964. It should also be noted that the establishment of the Office of Defense Affairs was related in the change of AACB cochairmanship from Dryden to Seamans.

<sup>54</sup> NASA News Release No. 63-44, Mar. 4, 1963.

<sup>55</sup> For Webb's comments, see House Hearings, *1964 NASA Authorization*, p. 24; for Siepert's statement, see p. 433; for Seamans' statement, see Senate Hearings, *NASA Authorization for Fiscal Year 1964*, p. 212.

Headquarters Procurement Operations Branch remained in the Office of Administration.)

The feasibility of this move was anticipated 2½ years earlier by John Young, then of McKinsey & Co., in his 1960 study of NASA contracting.<sup>56</sup> In 1963, NASA's contracting problems were infinitely more complex than they had been earlier, especially in view of the fact that the hardware development contracts for the manned lunar landing were just beginning to hit their stride.

In addition to the Procurement Division, the Deputy Associate Administrator for Industry Affairs was given jurisdiction over the Western Operations Office (WOO) and the Northeastern Operations Office (NEO), NASA's two contract administration and industry liaison offices. In August 1963, NASA established an Office of Construction and made it part of the Office of Industry Affairs. This action was an outgrowth of 1½ years of study prompted by Mr. Webb's concern for the way NASA's mammoth construction program could be protected from irregularities, inefficiencies, and the like. A program of systematic evaluation and review of NASA's construction activities was undertaken.<sup>57</sup>

**Other Headquarters Changes.** In January 1962, a provision of the November 1, 1961, reorganization was implemented when the Office of Public Affairs was established. Under it were grouped three units—the Office of Public Service and Information (formerly directly under the Administrator), the Office of Educational Programs and Services, and the Office of Scientific and Technical Information (which two offices had been formerly combined in the Office of Technical Information and Educational Programs directly under the Associate Administrator.<sup>58</sup> The Office of Public Affairs was put directly under the Administrator).

An activity which NASA widely publicized in 1962 and 1963 and which fostered several minor organizational readjustments was the application of new knowledge and techniques, resulting from NASA's R&D activity, to the economic world outside of NASA. Various terms were used to describe this activity—technical "spinoff," technical "fallout," industrial applications, technology utilization, and so forth. The fact that all sectors of the economy (not just the aerospace industry) stood to gain from NASA's pioneering R&D work was thought of by NASA as a further justification for its multibillion-dollar budget.

Although there is no set process by which this "spinoff" takes place, NASA felt that it could increase the spinoff pace by singling it out as an area of special concern and giving it organizational recognition.<sup>59</sup>

<sup>56</sup> The idea had appeared only in a draft of the procurement study. However, Young transferred to NASA and in early 1963 was Deputy Director for Administration. See Ch. 5, Sec. III.B.

<sup>57</sup> For a more complete account, see the Annual Report of the Office of Construction, June 30, 1964.

<sup>58</sup> NASA General Management Instruction 2-1-6, Jan. 24, 1962. Subject: Functions and Authority—Assistant Administrator for Public Affairs.

<sup>59</sup> In his January 1963 Economic Report to the Congress, President Kennedy stated that "spinoff" was not automatic, that it had to be fostered, and that his administration would foster it. See *International Science and Technology*, Mar. 1963.

The Office of Applications established by the November 1961 reorganization included a small unit called "Industrial Applications." In August 1962, an Industrial Applications Advisory Committee was established.<sup>60</sup> The objective was to work out a system that would place newly discovered knowledge and techniques into the hands of potential users at the earliest possible time.

In March 1963, the Industrial Applications Division of the Office of Applications was transferred to the Office of Public Affairs and was renamed "Technology Utilization Division." (In a nomenclature travesty, NASA renamed the Office of Public Affairs the "Office of Technology Utilization and Policy Planning.")<sup>61</sup> This was considered a better home for the function as it could be tied in with NASA's scientific and technical information program. The Technology Utilization Division was given overall cognizance of NASA's \$2 to \$3 million technology utilization program.<sup>62</sup>

The many changes made within the Headquarters program offices involve detail beyond the scope of this study. Many changes were made within the Office of Manned Space Flight and were important in the management of NASA's largest program area.

#### IV. ADMINISTRATIVE DEVELOPMENTS, 1962-63

The 2-year period following the November 1961 reorganization was a dynamic one. Routine operations constituted a heavy and ever-increasing workload. At the same time NASA constantly had to grapple with new and complex situations not faced before. Administrative procedures were under continuous strain.

The 1961 reorganization, in placing maximum control at the center, implied that NASA's program was a "whole entity" and that the entire agency should work together to achieve a common set of objectives. The manned lunar landing was a NASA objective, not just the objective of the Office of Manned Space Flight. All NASA field installations were to contribute to its accomplishment, not just the centers labeled as manned space flight centers. Agencywide functions such as finance, personnel, and procurement were to be performed for the benefit of the entire NASA program, not just one segment of it.

NASA's general management strove to get the entire agency moving forward in step. The tendency to get out of step was great. Keeping the manned space flight program in step proved to be a difficult task in itself. Problems of administrative operations and agency coordination are covered in this section.

<sup>60</sup> NASA News Release No. 62-179, Aug. 7, 1962.

<sup>61</sup> NASA General Management Instruction 2-1-6, Apr. 26, 1963. Subject: Functions and Authority—Assistant Administrator for Technology Utilization and Policy Planning.

<sup>62</sup> Involved in the program were innovation identification, innovation evaluation, and information dissemination. Several contractors were hired to assist in the program. See House Hearings, 1964 NASA Authorization, pp. 3445-3449.

### A. Finance

Money was without a doubt the basic common denominator which touched upon all phases of NASA's activity. Whether NASA hired in-house personnel or contracted for goods and services to be produced out-of-house, money was always involved.

The source of the money was Congress; the ultimate destination was primarily U.S. business. The in-between flow was complex and many flow channels and control gates existed. The flow was rapid and spillage was inevitable.

**Sources of Funds.** For fiscal year 1963, Congress appropriated almost \$3.7 billion, 97 percent of what was asked for. For fiscal year 1964, the appropriation totaled \$5.1 billion, 89 percent of what was asked for. Both appropriations represented sizable increases over the previous year. Both were passed well into the fiscal year to which they applied, especially fiscal year 1964.<sup>65</sup>

**Flow of Funds.** No significant developments took place during the 1962-63 period concerning procedures related to the flow of funds through NASA. After funds were apportioned to NASA by the Bureau of the Budget, they were systematically doled out to the various NASA installations and programs. The manned space-flight program consumed two-thirds of NASA's total appropriation, and the Marshall and Manned Spacecraft Centers spent about half of the NASA total.

Substantive control over spending was maintained by the Associate Administrator and his Office of Programs (primarily through the allotment process).<sup>64</sup> The Office of Administration (Financial Management Division) took care of the detailed accounting and was responsible for detecting all deviations from what had been officially approved. The Office of Administration (Audit Division) performed the postaudit function.

Money was always a scarce resource around NASA in spite of NASA's sizable appropriation. The program people could always find ways to spend it. Departures from the original spending plan, the budget, were often necessitated by fast-changing events. As a result, the reprogramming of funds was frequently required.

NASA's reprogramming actions had to be done within a framework established by Congress. For example, the Authorization and Appropriation Acts for fiscal year 1963 contained these limitations: <sup>65</sup> (1) Maximum transfer of funds between NASA's two lump-sum appropriations—Research, Development, and Operations (RD&O) and Construction of Facilities (CoF)—was limited to 5 percent; (2) NASA could use up to three-fifths of the 5 percent transferable from RD&O to CoF for "new" projects not part of the original CoF authorization; (3) NASA could reprogram \$30 million of its CoF appropriation for "new" construction projects; (4) CoF funds were authorized on a "per location" basis (15 in all in

<sup>64</sup> Congressional action on NASA's fiscal year 1963 and fiscal year 1964 budgets is covered in detail in Ch. 9.

<sup>65</sup> Ch. 7, Sec. VI.A.

<sup>66</sup> See Senate Hearings, *NASA Authorization for Fiscal Year 1964*, pp. 1094-1109. See also "Summary of Reports to the Congress . . .," NASA Office of Legislative Affairs, Jan. 25, 1963.

fiscal year 1963) and "per location" spending could vary only 5 percent from the figure authorized per location, as long as such variation would not result in total CoF spending exceeding the total authorized; (5) the use of RD&O funds for constructing contractor and university facilities and the use of CoF funds for minor repairs was permissible, but only under certain conditions; (6) the standard requirement that NASA had to fulfill in exercising the second, third, and fifth provisions was notifying the House Astronautics and Senate Space Committees of the actions taken.

Within the RD&O appropriation, no limitation was placed on the reallocation of funds among programs (i.e., reprogramming), although there was a gentlemen's agreement between NASA and the Space Committee that NASA would not use reprogrammed funds to carry out programs or projects specifically deleted from NASA's budget by the Committees.<sup>66</sup>

All in all, NASA's spending freedom was quite great. During fiscal year 1963, NASA took almost the maximum possible action within the limitations outlined above.<sup>67</sup> In addition, it reprogrammed within its RD&O appropriation extensively. If the fiscal year 1963 budget is compared with the fiscal year 1963 column in the fiscal year 1964 budget, the following major reprogramming actions are revealed:<sup>68</sup>

	<i>Changes (millions of dollars)</i>
Manned space-flight programs.....	-123
Project Gemini.....	+43
Project Apollo.....	-144
Saturn vehicle development.....	+76
Nova vehicle development.....	-155
Other.....	+57
Space science programs.....	+46
OGO, OSO, OAO.....	-25
Ranger.....	+37
Surveyor.....	-34
Mariner:	
Mars lander.....	-54
Mars flyby.....	+29
Centaur vehicle development.....	+33
University program.....	+21
Other.....	+39
Advanced research and technology programs.....	+13
Aeronautics.....	+13
RIFT.....	-14
Other.....	+14

<sup>66</sup> See Senate Hearings, *NASA Authorization for Fiscal Year 1964*, p. 1092.

<sup>67</sup> *Ibid.*, p. 1098.

<sup>68</sup> Data based on information found in Senate Hearings, *NASA Authorization for Fiscal Year 1964*, pp. 1058, 1071, and in House Hearings, *1964 NASA Authorization*, pp. 608, 1704, 2434.

	<i>Changes</i> (Millions of dollars)
Applications programs.....	-19
Meteorological satellites.....	+13
Communications satellites.....	-35
Other .....	+3
Tracking and data acquisition programs.....	+15
Network equipment.....	+11
Other .....	+4

Reprogramming activity involved large sums and represented an important and sizable administrative job. Most of the reprogramming actions were handled by the Headquarters program offices. For certain larger ones, the Associate Administrator and the Office of Programs became involved.<sup>69</sup>

**Destination of Funds.** During fiscal year 1963, NASA spent about 12 percent of its funds for in-house activities (termed "administrative operations") and 88 percent on out-of-house activities (R&D and CoF). Over half of the 12 percent was used to pay the salaries and personal benefits of NASA's 28,000 employees. The rest went for such things as travel, transportation, communications, utilities, supplies, equipment, miscellaneous services, etc. The 12 percent was spent at NASA field centers in roughly the following pattern: Marshall, 26 percent; Lewis, Goddard, Langley, Headquarters, and Manned Spacecraft, about 12 percent each; with eight other installations accounting for 15 percent.<sup>70</sup>

The 88 percent spent out-of-house was distributed initially as follows: private business, 70 percent; Government agencies (primarily Army and Air Force), 20 percent; the Jet Propulsion Laboratory, 7 percent; and educational and non-profit institutions, 3 percent. Ninety percent of the amount going initially to Government agencies went ultimately to private business, as did over 75 percent of the funds going to JPL. Thus the ultimate destination of NASA's R&D and CoF dollar was: private business, 93 percent; JPL, 2 percent; Government agencies, 2 percent; and educational and nonprofit institutions, 3 percent.<sup>71</sup>

**Auditing.** Auditing is a somewhat specialized function, crucial to an agency's long-term well-being. In NASA it has consisted of the detailed and independent review, analysis, and evaluation of the Agency's operations, with special emphasis on the effectiveness of administrative activities and their compliance with policies and procedures.<sup>72</sup>

NASA auditing has been done by two separate groups working in close liaison with one another. One group is the Audit Division of NASA Headquarters which has been responsible for all in-house auditing and has had cog-

<sup>69</sup> See ch. 7, sec. VI.A.

<sup>70</sup> Based on data on p. 771 of the appendix to the U.S. Budget for Fiscal Year 1965.

<sup>71</sup> Based on NASA, *Annual Procurement Report for Fiscal Year 1963*, p. 5.

<sup>72</sup> NASA General Management Instruction 2-1-9.8, Jan. 17, 1962. Subject: Function and Authority—Audit Division.

nizance over NASA auditing in general. The other group is the audit agencies of the three military services. Early in NASA's history the policy decision was made to have NASA utilize DOD audit services whenever feasible.<sup>73</sup> This was an extension of the existing pattern whereby the three military services utilized each others' audit services. The result has been a "single government face" in the auditing of most Government contracts. As a result, most of the auditing of NASA contracts has been done by the Air Force, Navy, and Army audit agencies.

NASA's Audit Division dates from late 1958 when the decision was made to establish it as a separate division in the Office of Business Administration.<sup>74</sup> The Office of Business Administration was one of several offices reporting to the Associate Administrator. Placing the Audit Division so far down in the organization's hierarchy might have compromised its independence—something crucial to an effective auditing operation. Independence has been maintained, however, by procedural safeguards and the delegation of a considerable amount of discretionary authority to the Division's Director.<sup>75</sup>

The Division has established its own regional offices. The NASA field centers have been precluded from establishing their own counterpart audit units.<sup>76</sup> In late 1963, 75 percent of the Division's personnel were attached to regional offices located and functioning at all major NASA installations except the Ames and Langley Research Centers.<sup>77</sup>

A good picture of the nature and scope of the Division's work can be obtained by analyzing the allocation of effort among major audit activities.<sup>78</sup> For example, during the period from July 1, 1963, through March 31, 1964, about 29 percent of the effort of the Division's staff was devoted to procurement-related activities. This 29 percent embraced NASA-DOD audit liaison (8 percent), the audit of in-house procurement operations (4 percent) and the direct audit of NASA contracts (17 percent). DOD audit agencies did almost all auditing of NASA contracts. The exceptions were NASA's Michoud operations and several somewhat unique contracts where top management deemed NASA auditing necessary.<sup>79</sup>

The remaining 71 percent of the Division's staff effort was broken down approximately as follows: GAO liaison, 5 percent; special assignment and assist audits, 4 percent; audit of in-house operations related to construction, 3 percent; audit of in-house financial management operations and other operations, 16 percent; management supervision, 8 percent; secretarial and clerical, 20 percent; and leave, training, and travel, 15 percent.

This allocation of effort was based on NASA's particular needs for a particular period. Since these needs changed from period to period, the work assign-

<sup>73</sup> Ch. 4, Sec. III.B.

<sup>74</sup> Ch. 3, Sec. II.C.

<sup>75</sup> Interviews with Walter Shupe, June 11, 1964, and Raymond Einhorn, June 15, 1964.

<sup>76</sup> NASA General Management Instruction 2-1-8.8, Jan. 17, 1962, *op. cit.*

<sup>77</sup> Interview with Raymond Einhorn, June 15, 1964.

<sup>78</sup> Data supplied by NASA Audit Division.

<sup>79</sup> Interview with Raymond Einhorn, June 15, 1964.

ments of the Division's professional auditors have varied accordingly.<sup>80</sup> The GAO liaison activity has always received high priority.<sup>81</sup>

## B. Personnel

NASA's dramatic growth in numbers of employees has already been depicted. Personnel administration takes on added dimensions under such conditions. The press of day-to-day recruitment, examination, and placement activities often took priority over long-range "tidying up" activities. The latter could not be ignored, however, especially with the Civil Service Commission showing an increased interest in NASA's personnel affairs.

**Recruitment.** On November 3, 1961, NASA announced the start of a nationwide drive to recruit 2,000 scientists and engineers.<sup>82</sup> The effort was an agencywide one and a team approach was used. During late 1961 and early 1962, 15-member recruiting teams visited all major U.S. cities, interviewing prospective employees, many of whom were initially informed of NASA openings by extensive advertising and other public relations activity. Teams were composed of both aerospace professionals and personnel specialists. By the time the "Major City" phase of the drive was completed in March 1962, over 14,000 contacts had been made and over 5,000 interviews conducted. Thirty-one prime cities and over 150 satellite and supporting cities were visited.<sup>83</sup>

By the end of fiscal year 1962 (June 30, 1962), NASA had hired almost 3,000 scientists and engineers. Total recruiting costs for the year were estimated to be \$1,222,000, or about \$420 per hire.<sup>84</sup> The major-city drive accounted for about one-third of the total cost, but probably a smaller percentage of new hires.

Experience gained in the fiscal year 1962 recruiting drive was utilized in conducting an even more successful recruiting effort during fiscal year 1963. The approach was modified somewhat, however. The major-city drive was scaled down with only half as many cities visited and less advertising used. The advertising used was less general and better designed to attract only the persons who could meet NASA's relatively stringent requirements. Greater use was made of NASA's employment offices in New York, Dallas, and Los Angeles. The result of NASA's overall requirement efforts during fiscal year 1963 was the hiring of over 3,500 scientists and engineers.<sup>85</sup>

Fiscal year 1963 recruitment was facilitated by the pay increases which were

<sup>80</sup> Interview with Walter Shupe, June 11, 1964.

<sup>81</sup> *Ibid.*

<sup>82</sup> NASA News Release No. 61-244, Nov. 3, 1961.

<sup>83</sup> "Quarterly Manpower Utilization Report for Quarter ending March 31, 1962" (dated Apr. 20, 1962), pp. 7-8.

<sup>84</sup> See Siefert testimony, House Hearings, 1964 NASA Authorization, p. 2955.

<sup>85</sup> Information supplied by John Duggan, NASA Personnel Division, Mar. 24, 1964. (The change in emphasis occurred after the drive had begun. See NASA Headquarters Personnel Bulletin, HPB 3-62, Nov. 2, 1962.)



part of the Salary Reform Act of 1962.<sup>66</sup> NASA also got a lot of "free" publicity as a result of the widespread coverage given its activities.

In nontechnical areas, NASA usually received large numbers of job applications without having to do any recruiting. NASA was a glamour agency, and being new, its grade structure was quite flexible. As a growing agency, opportunities for promotion were good.

NASA faced its toughest recruitment problem in trying to locate top managers. The disparity between public and private salary schedules almost precluded NASA from attracting experienced managers from private industry. NASA contracted for "executive search services" in late 1962, but the effort proved abortive.<sup>67</sup>

*Characteristics of Newly Hired Scientists and Engineers.* Quantitatively, NASA met its recruitment goals during fiscal year 1962. Qualitatively, the results appear to have been satisfactory also. The results of NASA's recruiting efforts were analyzed in a special study based on questionnaires completed by 93 percent of the 3,710 scientists and engineers hired between July 1, 1961, and September 30, 1962.<sup>68</sup> The study revealed the following:

*Residence before joining NASA:* 65 percent of the 3,448 completing the questionnaire were from the 8 states in which NASA installations were located: Alabama, 15 percent; Ohio, 9 percent; Virginia, 9 percent; California, 8 percent; Maryland, 7 percent; District of Columbia, 7 percent; Texas, 6 percent; and Florida, 3 percent. These were the top eight states. (Pennsylvania and New York were tied for 9th and 10th.) It should be pointed out that most of the new scientists and engineers went to work for the Marshall Center in Alabama, the Lewis Center in Ohio, the Manned Spacecraft Center in Texas, the Goddard Center in Maryland (near Washington, D.C.), and the Langley Center in Virginia.

*Reason for interest in NASA:* 27 percent stated that a friend had first prompted interest in NASA as an employer. Other personal contacts (family, teacher, etc.) accounted for 6 percent. NASA recruiters accounted for 12 percent, NASA advertising for 10 percent, recruitment brochures for 4 percent, and college placement offices for 6 percent—a total of 32 percent for what might be termed "organized recruiting efforts." News stories about NASA accounted for 12 percent and "other" sources accounted for the remaining 24 percent.

*Where primarily employed (or studying):* 40 percent had been employed by the Federal Government (including 7 percent employed by NASA), 32 percent by industry, and 22 percent had been students. College and university staffs furnished less than 2 percent. Almost half of the industry recruits came from NASA's principal contractors, several of which were experiencing work cutbacks. A third of the students came from 17 schools, 9 of which had co-op training agreements with NASA. Total schools represented numbered 203.

<sup>66</sup> Public Law 87-793, Oct. 11, 1962.

<sup>67</sup> NASA Contracts NASw-526 and NASw-527, Sept. 24, 1962.

<sup>68</sup> "AST and Engineering Recruiting Results (July 1, 1961-September 30, 1962)," prepared by C. Guy Ferguson of the NASA Personnel Division.

*Education:* In regard to the highest degree held, 3 percent were doctor's, 14 percent master's, and 80 percent bachelor's. This conformed very closely to NASA's existing pattern as did the academic fields represented. Engineering degrees accounted for 68 percent; the physical sciences, 18 percent; mathematics, 10 percent; and life sciences, 2 percent. Mechanical, electrical, and aeronautical engineering accounted for 52 percent of the overall total. Of the total, 35 percent claimed they had been in the fourth quartile of their undergraduate class, 40 percent in the third quartile, 11 percent in the second quartile, 2 percent in the lowest quartile, and 12 percent gave no response. Thus at least 75 percent said they were in the upper half of their classes.

*Salaries:* Of those coming to NASA from other jobs, 39 percent received higher salaries, 12 percent lower, and 49 percent about the same. Of those coming from industry, 37 percent received higher salaries, 24 percent lower. For transferees from other Federal agencies, the figures were 37 percent higher salaries and 2 percent lower, which meant that about 60 percent were lateral transfers. Of the small number of teachers recruited, 80 percent received higher salaries upon coming to NASA.

*Unique Examination for R&D Administrative Positions.* In 1960 the Civil Service Commission approved a two-part Aero-Space Technology (AST) examination for NASA to use. Part A covered the physical sciences, engineering, and mathematics. Part B covered work in the life sciences and related fields. NASA had asked for approval for a third part to cover certain types of administrative positions, but the Civil Service Commission deferred action on Part C pending further study.<sup>89</sup> Approval came in 1962, culminating an intricate, difficult, and protracted project requiring much innovation and extensive negotiation.

Part C of the Aero-Space Technology examination was "for work in Research and Development Administration."<sup>90</sup> It was to be used to fill positions in NASA only—no other Federal agencies could use it. It applied only to GS-9 positions and above. GS-5 and GS-7 positions were to be filled by means of the Federal Service Entrance Examination (FSEE) and the Management Intern Examination (MI).

R&D Administration was defined to cover five occupational fields: (1) Administration; (2) Procurement and Property Management; (3) Financial Management; (4) Personnel; (5) Information, Editing, and Library. Within each occupational field were several specialties. The announcement declared that "R&D administrative work involves detailed discussion, analysis, evaluation and solution with scientists and engineers of administrative problems directly interwoven with aerospace research, development, design, and operations programs."<sup>91</sup>

The key to what made the examination unique was the education and experience requirement. All applicants had to have a bachelor's degree or equivalent,

<sup>89</sup> See Ch. 5, Sec. II.C.

<sup>90</sup> Announcement No. 252B, Pt. C, issued June 15, 1962.

<sup>91</sup> *Ibid.*, p. 5.

all had to have experience and/or graduate study (the amount depending on the grade of the position sought), and all had to have—

Evidence of knowledge of the basic concepts, methods, and objectives of *science or engineering*, and also (for grade GS-12 and above) evidence of understanding of *research and development organizations* and their specialized problems, organizational structures, functions, operations, and characteristics.<sup>92</sup>

Training in science and engineering and work experience in R&D organizations were listed as acceptable means of meeting the “knowledge and understanding” requirement.

The announcement was issued in June 1962. The rating procedure was approved in the fall of 1962 and the training of examiners was begun in late October. In December, rating the accumulated backlog of applications was begun.

Ratings were made by NASA specialists sitting as Boards of U.S. Civil Service Examiners and were based on an evaluation of the applicant's training and experience. By the end of fiscal year 1963 (after almost a year of operation), 3,482 applications had been processed and 1,233, or 35 percent, of the applicants were found eligible and placed on registers. However, only 189 appointments were made. R&D administrative positions embraced about 10 percent of the total number of NASA positions. Most of NASA incumbents at the time Part C went into effect were “grandfathered” in.<sup>93</sup>

NASA viewed Part C as an important innovation in its personnel management program. It was called a “milestone” and an “advance in selective examining and recruiting.”<sup>94</sup> NASA pointed out that Part C was the “first Federal examination for a broad range of administrative positions which recognizes the close interrelationships of administrative functions with the substantive program operations of a Federal agency.”<sup>95</sup> NASA was happy with the “open-endedness” of the examination; that is, specialties could be added without amending the announcement, and training and experience requirements could be interpreted in such a way as to enhance the examiner's discretion in determining eligibility. Since the examination was for NASA's exclusive use and since NASA professionals were the examiners, it is easy to see that NASA's hiring freedom was fairly great.

At the time of its approval, the Civil Service Commission viewed Part C as an experiment. If it worked in NASA, the concept might possibly be tried on a Federal-wide basis.<sup>96</sup>

Parts A, B, and C of the Aero-Space Technology examination, when taken together, provided a means for NASA to fill almost all of what could be termed its

<sup>92</sup> *Ibid.*, p. 9.

<sup>93</sup> Information supplied by NASA Personnel Division (Donald Holum). See also Headquarters Personnel Bulletin, HPB 4-62, Nov. 13, 1962, Item 1.

<sup>94</sup> Memo, Siepert to Directors of Headquarters Program and Staff Offices and NASA Centers and Installations, Oct. 19, 1962. Subject: New Examination Announcement for R&D Administration Positions: Part C of the Aero-Space Technology Announcement.

<sup>95</sup> *Ibid.*

<sup>96</sup> *Ibid.*

"professional" positions. This, combined with the power of the Administrator to make "excepted" appointments, gave NASA almost complete control over whom it hired.

*Excepted-Position Developments.* In February 1963 Administrator Webb asked the Bureau of the Budget for permission to submit proposed legislation to Congress increasing the number of excepted positions from 425 (the October 1961 figure) to 750, an increase of 76 percent. An alternative was to use GS-16, -17, and -18 supergrades for which more liberal provisions had been made in the Federal Employees Salary Act of 1962. NASA felt that problems would arise in mixing the two types of pay systems and asked that its existing system be extended to meet all needs for positions above GS-15.

In July 1963 the Bureau of the Budget informed NASA that the policy of the Executive Office of the President was to work toward one system—the General Schedule system—and that no further extensions of special pay systems would be permitted.

Faced with no alternative, NASA issued instructions to program and center directors to prepare justifications for appointments to GS-16 positions. In October and November, some 200 cases were presented to the Civil Service Commission for approval. About 165 were approved.

Although problems arose immediately, the really acute problems would not come until a few years had passed and the junior-level men at GS-16 had advanced into the upper levels of the salary structure.<sup>97</sup>

*The Inspection of NASA by the Civil Service Commission.* During October and November 1962, the Civil Service Commission made its first comprehensive inspection of NASA. Although the complete findings were not made public, a variety of sources suggest that numerous deficiencies existed—something to be expected in a new, fast-growing agency, originally formed by combining several groups with diverse backgrounds.<sup>98</sup>

NASA was commended for giving personnel management a high place in the agency's overall management and for its positive attitude on the necessity for constant improvements in personnel management. Its imaginative recruiting, technical training programs, and new personnel program evaluation system received favorable comment, as did the esprit de corps of NASA employees.

NASA's chief deficiencies stemmed from NASA not having paid enough attention to matters essential to the long-term well-being of the agency. NASA had processed a very large number of applications, but had not maintained adequate control over them nor processed all of them according to CSC regulations. Deficiencies were readily noted in NASA's merit promotion system—something

<sup>97</sup> Entire section based on information supplied by Howard Braithwaite in memo to the NASA Historical Office, Nov. 10, 1964.

<sup>98</sup> Chief "sources" were: Interview, Robert Lacklen, Apr. 17, 1963; "Briefing Regarding the Commission's Agency-wide Evaluation of Personnel Management in NASA," Apr. 12, 1963; Headquarters Personnel Bulletins, late 1962.

which in the long run could significantly lower employee morale. NASA's incentive-award program was declared to be spotty.

Perhaps NASA's greatest deficiencies lay in the area of position documentation and classification. Not only was the position classification system not being fully kept up but the system itself had deficiencies.

Many of NASA's deficiencies were attributed to the lack of clear-cut agency-wide policies on particular personnel matters. This meant that the Personnel Division in NASA Headquarters would have to take the lead in clearing up the deficiencies. It did so by stepping up the issuance of policy directives and by moving ahead faster with its personnel management evaluation (i.e., field inspection) activities.<sup>99</sup>

**Personnel Management Evaluation System.** Although the need for a systematic review of field-center personnel management had been recognized for some time,<sup>100</sup> NASA did not start developing the actual system until the middle of 1962, just before the CSC inspection.<sup>101</sup> The system, as it evolved, was based on periodic evaluations or inspections of NASA installations by personnel management program specialists from the Personnel Division at Headquarters. The evaluation focused on how well the installation was complying with NASA and CSC policy directives. The "Report on Evaluation of Personnel Management Activities" was submitted to the installation's director and to the Civil Service Commission, with information copies going to NASA's Director of Administration, the installation's director of administration, and director of personnel. The report, when approved by NASA's Director of Personnel, became the basis for seeking improvements in the field installation's program. By the end of fiscal year 1964, evaluations were made or scheduled for all NASA installations.

**Miscellaneous Personnel Development.** In 1962, NASA began participating in the Federal Management Intern Program administered by the Civil Service Commission.<sup>102</sup> Nine interns were selected for NASA Headquarters and seven each for the Lewis Research and Manned Spacecraft Centers. To participate in the program, NASA had to establish a 12-month on-the-job training cycle during which the selectively picked interns would rotate among job assignments.

In November 1962, NASA conducted an Employee-Management Cooperation Seminar to acquaint interested NASA personnel with the Federal Government's new policy encouraging employee-management cooperation.<sup>103</sup> On the program were such topics as "Negotiation," "Arbitration," "Conduct of Elections," etc.<sup>104</sup>

<sup>99</sup> See Headquarters Personnel Bulletin, HPB 5-62, Nov. 27, 1962, Item 1.

<sup>100</sup> See Ch. 5, Sec. II.C.

<sup>101</sup> Interview, Walter Wilson, Apr. 17, 1963.

<sup>102</sup> NASA Announcement No. 558, July 16, 1962. Subject: Management Intern Program Now Underway.

<sup>103</sup> Executive Order 10988, Jan. 17, 1962. See also Personnel Methods Series No. 15, August 1962, published by the Civil Service Commission.

<sup>104</sup> See agenda of the Nov. 7-9, 1962, seminar.

### C. Procurement/Contracting

NASA continued to devote a great deal of attention to procurement policies and procedures during the 1962-63 period. The growth in procurement activity has already been described in this chapter, as has the "upgrading" of the procurement policy and procedure function by putting it directly under a Deputy Associate Administrator.<sup>105</sup>

*Special Procurement Study.* In April 1962, Webb established a study group to conduct a 6-month special procurement study.<sup>106</sup> The Study Director was Walter Sohler, NASA's Deputy General Council, and the Study Group Chairman was Ernest Brackett, the Director of NASA's Procurement Division. A contractor, Harbridge House, Inc., was hired to assist in the study.<sup>107</sup> The objectives of the study were: to analyze NASA's source evaluation procedures; to study contract innovations (including incentive provisions) which would improve contractor performance; and to determine what performance data were most pertinent in evaluating the competence of potential contractors.<sup>108</sup>

The study was prompted by the so-called Bell Report made public in April 1962, which in turn had been prompted by a letter of President Kennedy dated July 31, 1961. The Kennedy letter asked BOB Director David Bell to "review the effectiveness of this means [i.e., R&D contracts] of accomplishing the Government's purposes."<sup>109</sup> Participating with Bell in the review were Webb of NASA and the heads of DOD, AEC, CSC, and the Special Assistant to the President for Science and Technology.<sup>110</sup> The product was to be a set of recommendations to guide future Executive action.

The Bell Report acknowledged the need for the Federal Government to contract for research and development and did not recommend that problems could be solved by cutting back on the amount of contracting.<sup>111</sup> Rather, the solution lay in improving the existing system. Two approaches were recommended. One was to improve the in-house competence of the Government so it would always be in "control" of the situation. Retaining competent in-house personnel was viewed as the key to this, and thus salary reform turned out to be the report's key recommendation. Secondly, the report recommended that procurement machinery be improved by using incentive contracts, by devising better methods of evaluating potential contractors, by devising means of assuring quality contractor performance, etc. It was the second area with which NASA's 1962 Special Procurement Study was concerned.

<sup>105</sup> See this chapter, Secs. I.C. and III.B.

<sup>106</sup> NASA Contract NASw-445, May 28, 1962.

<sup>107</sup> NASA Circular No. 231, May 29, 1962. Subject: Special Procurement Study.

<sup>108</sup> Letter, Kennedy to Bell, July 31, 1961. (Reprinted on p. 25 of S. Doc. 94 cited below.)

<sup>109</sup> The Director of the National Science Foundation was added later.

<sup>111</sup> "Report to the President on Government Contracting for Research and Development," prepared by the Bureau of the Budget, Apr. 30, 1962. Issued as S. Doc. 94, 87th Cong., May 17, 1962 (Washington: GPO, 1962).

The Special Procurement Study was concluded in February 1963. The overall accomplishments of the study were substantial. An analysis and evaluation of these accomplishments are beyond the scope of this study. The final report of the Study Director (Sohier) can serve, however, as a means of identifying the most significant results of the study.<sup>112</sup>

Sohier, in his final report, stated that the Study Group had disposed of the incentive contracting topic early in the game.<sup>113</sup> The Group had recommended that NASA increase its use of incentive provisions in its contracts but to do so very cautiously. (The implementing circular provided that the Director of NASA's Procurement Division had to give advance approval to all procurement in which incentive provisions were *contemplated*.) NASA's caution, in comparison with DOD, stemmed from the uniqueness of so many NASA procurements and the high degree of technical direction which NASA wanted to maintain over its contracts. The Group felt that NASA's first step must be to improve its ability to handle incentive contracting—something much more difficult than ordinary contracting. Thus Harbridge House, Inc., was hired to conduct training courses in incentive contracting for NASA procurement personnel.<sup>114</sup> NASA also experimented with a simplified incentive-type contract (called a cost-plus-award-fee contract) in which the contractor is rewarded for meeting certain predetermined objectives on the basis of an after-the-fact evaluation rather than on an elaborate before-the-fact formula, as in a cost-plus-incentive-fee contract.<sup>115</sup>

Concerning the problem of the evaluation of potential contractors (called source evaluation), two products resulted. One was a study of current and proposed practices on the evaluation and selection of R&D contractors done for NASA by Harbridge House, Inc.<sup>116</sup> The second product was a draft manual on source evaluation prepared by NASA on the basis of the Harbridge House study just mentioned and other efforts including extensive discussions with DOD and people from private industry.<sup>117</sup> According to Sohier, neither the Harbridge House study nor the draft manual advocated any dramatic changes in NASA's source evaluation and source selection procedures. Rather they favored refinements, agencywide uniformity (within a framework of discretionary freedom of local action), and slight changes in emphasis in existing policies and procedures.<sup>118</sup>

<sup>112</sup> Memo, Sohier to Webb, Feb. 21, 1963. Subject: Conclusion of Special Procurement Study.

<sup>113</sup> Memo, Sohier to Webb, July 20, 1962. Also NASA Circular No. 242, effective Sept. 1, 1962. Subject: Use of Incentive Contracts.

<sup>114</sup> NASA Contract NASw-590, Dec. 18, 1962. Harbridge House, Inc., prepared a "NASA Incentive Contracting Guide," dated September 1962.

<sup>115</sup> P. 3 of Sohier memo of Feb. 21, 1963, *op. cit.* See also the discussion in House Hearings, 1964 *NASA Authorization*, pp. 3008-3011.

<sup>116</sup> "The Evaluation and Selection of Major R&D Sources," by Harbridge House, Inc., dated Feb. 28, 1963.

<sup>117</sup> "NASA Guide to Source Evaluation and Selection," a draft guide dated Oct. 1, 1963.

<sup>118</sup> "Principal Conclusions Stemming From the Special Study of Source Evaluation and Selection Procedures." Included as "Tab C" in Sohier's memo of Feb. 21, 1963, *op. cit.* NASA's lack of uniformity was depicted by Gordon Tyler, Goddard's Procurement Officer, at NASA's September 1962 procurement conference. See p. 13 of the Conference Summary.

The Study Group felt that NASA had to strike a realistic balance between selecting a contractor on the basis of the proposal submitted, on the one hand, and on the contractor's intrinsic competence, on the other. In comparison with past practice, more emphasis on the latter was recommended. In fact, there was a great need to bring "brochuremanship" under control so that individual firms would not waste resources on the unnecessary preparation of proposals.<sup>119</sup>

Concerning the third area of effort, the work of the Study Group was less conclusive. It concerned the evaluation of contractor performance. Here NASA combined its efforts with DOD which had a high-level study of the same topic underway.<sup>120</sup> The DOD study culminated in a "DOD Guide to the Evaluation of the Performance of Major Development Contractors."<sup>121</sup> The Study Group felt that NASA should adapt the DOD Manual to its own use.<sup>122</sup> The DOD system involved a series of evaluation reports on each contract, together with the appointment of special groups to review the reports. NASA decided to field-test the DOD system before attempting to prepare its own system. NASA's objective was to devise a system that would evaluate a contractor's performance both periodically and terminally. This performance evaluation would then become a significant part of the source selection process for subsequent contracts.

It is safe to predict that the Special Procurement Study will not be the last ad hoc study of NASA's procurement policies and procedures. With 90 percent of its money being spent by contract, NASA will have to continue to give diligent attention to procurement matters.

**Geographic Distribution of NASA Contracts.** The geographic distribution of NASA contracts was a touchy political problem. Congressmen were sensitive to the fact that most of NASA's procurement dollar was spent in a handful of states. NASA's answer was that the competence of a contractor rather than his location was the basis for awarding contracts. Also, the statistics were based on prime contracts only; if subcontracts were taken into consideration, a broader geographical pattern would emerge. To be able to back such a statement with evidence, NASA inaugurated, during 1962, a system for obtaining information on subcontracts. A simple "postcard" system was adopted by which NASA's 12 largest contractors would report on their first-tier subcontractors, who in turn would report on second-tier subcontracts.<sup>123</sup>

<sup>119</sup> NASA wanted to keep its procurement as competitive as possible. The Study Group stressed the need for NASA to "harness" competition, not exploit it. Better definitions of work to be done, the use of preliminary proposals, and the use of less detailed proposals (in terms of technical content) were regarded as desirable.

<sup>120</sup> See pp. 6-7 of Sohler's memo of Feb. 21, 1963, *op. cit.* See also NASA News Release No. 62-195, Sept. 13, 1962. In February 1962, NASA and DOD had held a "Procurement Management Improvement Conference."

<sup>121</sup> Final version is dated July 26, 1963.

<sup>122</sup> "Summary of Main Elements of the Joint DOD-NASA System for Evaluating Contractor Performance." Included as "Tab E" in Sohler's memo of Feb. 21, 1963, *op. cit.*

<sup>123</sup> NASA Circular No. 243, Aug. 16, 1962. Subject: Geographic Distribution of NASA Subcontracts.



The results of the "postcard" system, even though only partial data were received, clearly bore out NASA's contention. States like Pennsylvania, Minnesota, Massachusetts, Maryland, and Iowa fared much better on subcontracts than on prime contracts (24 percent of reported subcontracts versus 6 percent for all prime contracts).<sup>124</sup>

**Cost Control.** Controlling cost was not an activity peculiar to the procurement function, per se, but since NASA spent most of its money by contract, the procurement area was a natural place on which to focus attention.

NASA found that most of its projects cost more than originally estimated and thus in spite of larger and larger appropriations the agency almost always found itself in a tight financial condition. Accelerations in costs quickly consumed any slack that may have been in the budget to start with. Increases in the cost of a project were often due to NASA's decision to acquire more sophisticated hardware than originally contemplated and continued insistence on the highest degree of reliability and quality control. Probably just as often, however, costs increased because of cost overruns which frequently stemmed from such causes as overoptimistic initial prognostication, inept management, inefficient contractors' operations, insufficiently comprehensive estimating techniques, and the like. Under cost-plus-a-fixed-fee contracts, cost overruns were borne entirely by NASA.

The most complete compilation as to the scope and amount of cost overruns was revealed in the 1963 hearings of the House Astronautics Committee on NASA's fiscal year 1964 authorization bill (H.R. 5466). A few of the most extreme examples of cost overruns were these: the Orbiting Astronomical Observatory (\$24 million in cost overruns out of a \$57 million total); Nimbus meteorological satellites (\$5 million out of \$9 million); Mercury spacecraft (\$50 million out of \$140 million).<sup>125</sup> In 1963 NASA analyzed a sample of R&D contracts over \$1 million to determine the general pattern of cost overruns. On the basis of comparing initial and June 30, 1963, cost estimates for the sample, NASA estimated that cost overruns would average between 25 and 30 percent.<sup>126</sup> In view of the fact that NASA procures complex and unique items for which accurate cost estimating is difficult, it is impossible to tell whether this figure is moderate, excessive, or what.

NASA recognized the importance of keeping cost overruns at a minimum and attacked the problem from several directions. One avenue, the use of incentive contracts, has already been discussed. The establishment of a contractor performance evaluation system was being developed in late 1963, whereby historical data on the performance on past contracts is accumulated to serve as a guide to the selection of more efficient contractors for future projects. NASA constantly

<sup>124</sup> Based on data in NASA's Annual Procurement Report for Fiscal Year 1963, pp. 35, 39.

<sup>125</sup> House Hearings, 1964 NASA Authorization, pp. 1766-1768.

<sup>126</sup> Letter, Richard Callaghan of NASA to Charles Ducander of the House Space Committee, Nov. 8, 1963.

improved its proposal and source evaluation process and its contract administration process.

Studies were made of other methods of cost reduction also, such as the standardization of components, more ground testing before flight testing, a more rigorous system of quality control in manufacturing, and even the possible use of recoverable boosters.<sup>127</sup>

#### D. Program and Project Management

D. Brainerd Holmes, who was appointed to head NASA's gigantic manned space flight program, was fond of saying that the major requirement for getting to the moon was good management. He also felt that "the national experience of managing a research and development program of this magnitude is an added benefit, beyond the technological dividend that we shall obtain from the manned lunar landing program."<sup>128</sup>

Holmes' position implied that NASA should be benefiting from U.S. experience with such earlier large-scale projects as the development of the Polaris IRBM. However, NASA's program and problems were sufficiently unique so that many things had to proceed ahead largely on trial and error. The benefits of past experience seemed more in the area of training individuals (e.g., a number of people came to NASA from the Polaris project) than in developing management practices and principles of widespread applicability (PERT is an example of an exception to this).

*The Management Council.* An early and significant managerial innovation in NASA's manned space flight program following the November 1961 reorganization was the establishment in December 1961 of a Management Council to coordinate the manned space flight program.<sup>129</sup> The Council was chaired by Holmes and was initially composed of the top two officials of the two manned space flights centers (Marshall and Manned Spacecraft) and Holmes' five principal subordinates in Headquarters. Regular monthly meetings were held. When the Council was formed, the two field centers were not under Holmes' line of command, but rather were under Associate Administrator Seamans. Holmes sought to use the Council as a means of arriving at a unanimous position on major matters without having to worry whether the action was within his rather complete program authority or not. According to Holmes, the Council was to "spot and identify problems as early as possible and to resolve them quickly."<sup>130</sup>

The Council was not able to solve all problems, however. Because von Braun (Director of Marshall Center) and Gilruth (Director of Manned Spacecraft

<sup>127</sup> U.S. Congress, House, Committee on Science and Astronautics, *Ways and Means of Effecting Economies in the National Space Program*, Hearings, 87th Cong., 2d sess. (Washington: GPO, 1962).

<sup>128</sup> House Hearings, *1964 NASA Authorization*, p. 132. Holmes also said in regard to the manned lunar landing, "The only major breakthroughs required are in the area of management."

<sup>129</sup> NASA News Release No. 61-287, Dec. 31, 1961.

<sup>130</sup> *Ibid.*

Center) held equal status with Holmes in NASA's organizational hierarchy, they had the theoretical ability to go over his head. As described earlier in this chapter, this situation was changed in October 1962, by giving Holmes another hat at the Deputy Associate Administrator's level.<sup>131</sup> This move created a better decision-making environment... Holmes spoke very approvingly of what the Council was able to achieve and he regarded it as a significant part of the management of the manned space-flight program.<sup>132</sup>

**Management Advisory Committee Established.** In March 1963 a Management Advisory Committee for Manned Space Flight was established to advise the Deputy Associate Administrator for Manned Space Flight Centers on the organization and management of the manned space flight program.<sup>133</sup> Dr. Mervin Kelly, the retired and renowned head of Bell Laboratories, was named committee chairman.<sup>134</sup> The action was a further indication that management was regarded as a critical factor in the manned space-flight program.

**Contractors Hired for Technical Coordination.** During 1961 most of the prime hardware contractors for Project Apollo were selected. The problem remained as to how NASA was to put the hardware together and get the mission completed. The Air Force solution to such a problem might well have been to hire a nonhardware contractor to help a single prime contractor integrate the various hardware subsystems. The NACA-NASA solution would be to develop the necessary in-house competence to do the integration job. NASA moved in this latter direction by establishing a systems engineering office as one of the principal divisions of the Office of Manned Space Flight in NASA Headquarters. A highly qualified systems engineer (Shea) was found to head the office.<sup>135</sup>

But the problems in this area were complex and pressing. Faced with hiring restrictions characteristic of public agencies (relatively low salaries, etc.), NASA simply could not develop in-house competence at a fast-enough rate. It turned to private industry for assistance.

In February 1962, Webb wrote to the president of the American Telephone & Telegraph Co., explaining NASA's problem and asking the Bell System to assist NASA "by providing an organization of experienced men capable of giving responsible NASA officials the benefit of the most advanced analytical procedures and the factual basis they need to make the wide range of systems engineering decisions required for the successful execution of the manned space flight mission."<sup>136</sup>

AT&T responded favorably and organized a separate subsidiary corporation,

<sup>131</sup> See Sec. III.B. of this chapter.

<sup>132</sup> For example, see House Hearings, 1964 *NASA Authorization*, pp. 129, 138.

<sup>133</sup> NASA General Management Instruction 2-5-5, Mar. 29, 1963. Subject: Management Advisory Committee for Manned Space Flight.

<sup>134</sup> NASA Circular No. 277, Mar. 29, 1963.

<sup>135</sup> To head the Systems Office, NASA hired Dr. Joseph Shea of Space Technology Laboratories.

<sup>136</sup> Letter, Webb to Kappel, Feb. 21, 1962. (Reprinted in House Hearings, 1964 *NASA Authorization*, p. 372.)

Bellcomm, Inc., to do the work. Bellcomm drew many of its employees from AT&T, the Bell Telephone Laboratories, and Western Electric Co. A year later, in March 1963, Bellcomm consisted of 96 technical people and a supporting staff of 60. A size of 250 was aimed for. Most of the personnel were located in Washington, D.C. Top Bellcomm salaries were considerably higher than NASA salaries. Twenty-one earned over \$20,000, four over \$30,000.<sup>137</sup>

According to the multimillion-dollar contract with Bellcomm, the organization was to "perform studies, technical fact finding and evaluation, analytical investigations, consulting effort and related professional activities in support of manned space flight and related programs in NASA."<sup>138</sup>

It should be stressed that Bellcomm supported a NASA technical office (Office of Systems). NASA maintained its own control over high-level technical and administrative decision-making.

Bellcomm's inputs were primarily in the basic conceptual decisions that NASA had to make concerning the overall integration of all aspects of the Apollo mission. Implementing these decisions was an even bigger job in terms of manpower and technical activity, and involved hardware development for such jobs as systems checkout. For assistance in the overall integration of Project Apollo, including checkout, systems integration, and mission reliability, NASA hired the General Electric Co.<sup>139</sup> The GE contract was much larger than the Bellcomm contract and involved many more individuals.

Both the Bellcomm and GE contracts gave programwide support to NASA's manned space flight program, especially its massive Project Apollo, and represented an interesting experiment in utilizing the talents of private industry at a very high level and yet keeping the Government on top when it came to decision-making.

Bellcomm's and GE's activity made them privy to certain internal administrative and technical matters which would have given them a certain advantage over other corporations in subsequent procurement actions. To prevent this from happening, ground rules were established restricting their participation in future hardware procurements.<sup>140</sup>

#### E. Other Administrative Developments

*OSS-OMSF Coordination.* To maximize coordination between NASA's manned and unmanned space exploration programs and to promote the scientific objectives of manned flights, NASA established a Joint Working Group, made

<sup>137</sup> See House Hearings, *1964 NASA Authorization*, pp. 372-377, 3238.

<sup>138</sup> NASA Contract NASw-417.

<sup>139</sup> NASA Contract NASw-410, Oct. 12, 1962. See also House Hearings, *1964 NASA Authorization*, pp. 1074, 1101, 3257.

<sup>140</sup> For details, see Webb's letter to McNeely of AT&T, Apr. 11, 1962 (reprinted in House Hearings, *Systems Development and Management*, p. 1701), and NASA Circular No. 280, Apr. 16, 1963. Subject: Restrictions on Contracting With the General Electric Company Where Competitive Advantage May Exist. See also General Management Instructions 3-3-7.1 and 3-3-7.2, May 10, 1963.

up of full-time representatives from both NASA's Office of Space Sciences and Office of Manned Space Flight.<sup>141</sup>

**ADP Developments.** In March 1963, the General Accounting Office reported to Congress that the U.S. Government could save money by doing more purchasing and less leasing of its automatic data processing (ADP) equipment.<sup>142</sup>

The report was of interest to NASA, since NASA was a heavy user of ADP equipment. Among Federal agencies, only DOD and AEC were heavier users.<sup>143</sup> In NASA both the Goddard and Marshall Centers had many ADP units and so would the Manned Spacecraft Center in due time. Most NASA ADP equipment was for scientific and engineering work, rather than administrative use.<sup>144</sup> In terms of rental versus purchase, NASA generally agreed with the GAO report. But because of its rapidly changing program, NASA felt that it had to maintain maximum flexibility so that it could take advantage of the rapidly improving computers that were coming on to the market. Thus it would have to continue to rent many more computers than it would purchase.<sup>145</sup>

With ADP operations becoming more prevalent in the Federal Government, the BOB exerted greater effort to assure that certain standard policies on the acquisition of ADP equipment were followed on a Government-wide basis.<sup>146</sup> NASA established ADP policies to meet BOB requirements.<sup>147</sup> To permit as much decentralization of ADP decision-making as possible and still conform to BOB rules, NASA established an Inter-Center Committee on Automatic Data Processing.<sup>148</sup> The chief function of the Committee was to promote uniform ADP policies on an agencywide basis and to facilitate intra-agency communications on ADP matters.<sup>149</sup>

**Project Approval Procedures.** Project approval procedures as inaugurated in 1961 and modified in 1962 were further modified in 1963. The net effect was to strike a better balance among the five Headquarters Program Offices, the Office of Programs, and the Associate Administrator, in terms of the paperwork involved. The Associate Administrator remained the sole approving authority.<sup>150</sup>

<sup>141</sup> NASA News Release No. 62-251, Nov. 27, 1962.

<sup>142</sup> "Study of Financial Advantages of Purchasing Over Leasing of Electronic Data Processing Equipment in the Federal Government," a report to the Congress, March 1963. (Reprinted in House Hearings, 1964 *NASA Authorization*, pp. 1421-1436.)

<sup>143</sup> See the Bureau of the Budget's "Inventory of Automatic Data Processing (ADP) Equipment in the Federal Government . . .," August 1962.

<sup>144</sup> NASA was not very progressive when it came to the mechanization of administrative operations. See Ch. 5, Sec. II.B.

<sup>145</sup> See discussion in House Hearings, 1964 *NASA Authorization*, pp. 2922-2928.

<sup>146</sup> BOB Circular No. A-54, Oct. 14, 1961. Subject: Policies on Selection and Acquisition of Automatic Data Processing (ADP) Equipment.

<sup>147</sup> General Management Instruction 3-6-1, July 5, 1963. Subject: Automatic Data Processing (ADP) Equipment and Services.

<sup>148</sup> General Management Instruction 3-6-2, Oct. 4, 1963. Subject: NASA Inter-Center Committee on ADP.

<sup>149</sup> On Oct. 10-11, 1962, NASA held an agencywide workshop on ADP.

<sup>150</sup> For details, see General Management Instruction 4-1-1, Mar. 8, 1963. Subject: Planning and Implementation of NASA Projects. See also Ch. 7, Sec. VI.A.

**Patent Regulations Revised.** NASA's patent policies and procedures were based on the Space Act of 1958. The discretionary powers given the NASA Administrator on patent matters permitted NASA to steer a middle road between the positions of AEC (which catered to the Government) and DOD (which catered to contractors).<sup>151</sup> NASA attempted to get the Space Act amended to bring its congressional mandate in line with DOD's. Congress was unreceptive. In late 1962, NASA took a different tack by attempting to streamline its patent regulations within the framework of the Space Act.

Three separate actions were taken. First, the patent clauses of NASA contracts were changed to require contractors to be more diligent in reporting inventions and innovations made in the performance of NASA contracts.<sup>152</sup> These inventions and innovations would ordinarily automatically become the exclusive property of the United States.

Second, NASA issued new licensing regulations designed to facilitate the economic exploitation of Government-owned patents.<sup>153</sup>

Third, NASA announced public hearings on a proposed revision of the very important waiver regulations under which NASA could waive its exclusive claim to a patent in favor of a contractor.<sup>154</sup> The revision was designed to make the waiver device a broader and more effective means of achieving greater economic exploitation of the many discoveries flowing from the space program.

The new technology reporting clause, the new licensing regulation, and the proposed waiver regulations could all be viewed as manifestations of NASA's increasing effort to step up the economic utilization of space-age technology.<sup>155</sup>

As it turned out, the proposed waiver regulation was not promulgated as planned. NASA held off to await the results of President Kennedy's attempt to bring about the adoption of a Government-wide patent policy. In October 1963, the White House issued a statement on patent matters which became the basis for further study and revision of NASA patent regulations.<sup>156</sup>

## V. MISCELLANEOUS 1962-63 DEVELOPMENTS

This chapter has presented only a partial account of NASA's administrative history during the dynamic 1962-63 period. Special attention was focused on three areas: (1) NASA's rapid growth and several key administrative activities related to it, such as personnel administration, finance administration, and con-

<sup>151</sup> See Ch. 4, Sec. II.E.

<sup>152</sup> See Gerald O'Brien's "NASA Patent Policy and Procedure," delivered at NASA's Feb. 12, 1963, NASA-Industry Conference. (*Proceedings of the Second NASA-Industry Program Plans Conference*, NASA SP-29 (Washington: GPO, 1963), pp. 203-206, especially 204.)

<sup>153</sup> NASA News Release No. 62-228, Oct. 26, 1962.

<sup>154</sup> 27 F.R. 10460, Oct. 26, 1962. See also O'Brien, "NASA Patent Policy and Procedure," *op. cit.*

<sup>155</sup> The technology reporting clause and related clauses were further revised in October 1963. See General Management Instruction 18-9-101, Oct. 26, 1963.

<sup>156</sup> 28 F.R. 10943, Oct. 12, 1963.

tracting; (2) the expansion pattern of NASA's major program activities; (3) adjustments in the organizational structure and related procedures which NASA had established in the reorganization of November 1961.

Before ending this chapter it would be well to summarize a few topics not yet covered and also-acknowledge some of the gaps that exist.

#### **A. Non-NASA Space Developments, 1962-63**

During 1962-63, the U.S.S.R. made several notable achievements in its manned space flight program. In August 1962, the tandem flight of Nikolayev (64 orbits) and Popovich (48 orbits) took place. In June 1963, another tandem flight was conducted by Cosmonauts Bykovsky (81 orbits) and Tereshkova (48 orbits) (first woman to fly in space).

The U.S.S.R. also orbited many unmanned satellites around the earth. Their unmanned lunar exploration efforts were no more successful than those of the United States. Their planetary efforts were less successful than those of the United States. United States-U.S.S.R. cooperation in space is touched on in the next chapter.

The space activity of other nations gained momentum during 1962-63. Some of it was completely independent of NASA and the United States, but much of it was done in cooperation with the United States under NASA's international program. The U.N. continued its interest in space law and the peaceful uses of outer space.

Non-NASA space activity in the United States was substantial. In fiscal year 1964, the United States budgeted \$7,038 million in new obligational authority for space, of which \$5,189,500,000 was for NASA, \$1,615,800,000 for DOD, \$227,600,000 for AEC, \$2,700,000 for the Weather Bureau, and \$2,400,000 for the National Science Foundation.<sup>157</sup>

#### **B. Miscellaneous External Relationships**

In addition to the very important NASA-DOD agreement on the Atlantic Missile Range, the NASA-Air Force cooperation on the Gemini program, and the NASA-Army understanding on the role of the Army Corps of Engineers in NASA's extensive construction program, all covered earlier in this chapter, many other NASA-DOD agreements were entered into, embracing a variety of topics beyond the scope of this study.<sup>158</sup>

NASA-DOD cooperation was greatly facilitated by the liaison activity of the NASA-DOD Aeronautics and Astronautics Coordinating Board (AACB) established in 1960.<sup>159</sup>

<sup>157</sup> *United States Aeronautics and Space Activities, 1963*, Report to the Congress from the President of the United States, Appendix E-1 (p. 142).

<sup>158</sup> The NASA Historical Office has a list of all NASA-DOD agreements.

<sup>159</sup> See Ch. 5, Sec. IV.B.

In 1962 and 1963, the AACB was supplemented in several ways. In April 1962, the Air Force named Maj. Gen. O. J. Ritland to maintain liaison between General Schriever's Air Force Systems Command and NASA's Office of Manned Space Flight.<sup>160</sup> Ritland set up his office right in NASA Headquarters. In July 1963, the Air Force established a three-man Gemini liaison and support office at NASA's Manned Spacecraft Center.<sup>161</sup> In September the Air Force Systems Command announced the establishment of a substantial field office at Manned Spacecraft Center to serve as the contact point between AFSC and MSC.<sup>162</sup>

NASA and the Federal Aviation Agency worked closely together on the development of a commercial supersonic transport aircraft, actual development of which was ordered by the President in June 1963.<sup>163</sup> NASA and the Weather Bureau of the Department of Commerce worked closely together on a meteorological satellite system.<sup>164</sup>

NASA's happy relations with Congress during 1962 and unhappy relations during 1963 are discussed in the next chapter.

### C. Unresearched Areas

It might be well to list some of the topics not covered in this chapter.

Nothing has been said about the internal operation of any of NASA's field centers. Little has been said about procedural changes. This stemmed from the fact that most of the changes were gradual and of a refining nature. Gradual changes eventually may alter basic relationships, of course, but this was not explored in this chapter.

The role of the White House and the Space Council in NASA's administration and management has not been systematically researched.

Certain NASA activities such as information dissemination, educational programs, international programs, legislative liaison, and relations with the scientific community have been pretty well ignored. No attempt was made to present a perfectly balanced picture of NASA's aerospace program.

The difficulty in integrating into one account all of the major facets of NASA's activities during the 1962-63 period is probably a manifestation of that period's dynamic and turbulent character. Some of the loose ends are tied together in the next chapter, which covers NASA's November 1963 reorganization.

<sup>160</sup> *Astronautical and Aeronautical Events of 1962*, Apr. 26, 1962.

<sup>161</sup> *Astronautics and Aeronautics, 1963* (Washington: NASA SP-4004, 1964), July, pp. 262-292.

<sup>162</sup> *Ibid.*, Sept. 2, 1963.

<sup>163</sup> See NASA-FAA agreements, dated June 28, 1961, Sept. 25, 1961, and Jan. 8, 1964.

<sup>164</sup> See NASA-Department of Commerce agreements, dated Jan. 10, 1962, and Jan. 18, 1962.



## Chapter Nine

### REORGANIZATION FOR PROGRAM OPERATIONS

On October 1, 1963, NASA was 5 years old. The occasion was marked by press releases, special publications, and official celebrations, as could be expected. Yet the occasion lacked the joyousness usually associated with significant anniversaries and the celebrants seem to lack spontaneity.

To suggest that NASA was preoccupied with other matters would be putting it mildly. The major milestone that NASA passed in 1963 was not its fifth anniversary but rather the end of one era and the beginning of another. All of NASA's first 5 years were dynamic, of course, and all had elements of transition in them. But 1963 will be remembered as the year when numerous pent-up matters finally broke loose. The result was that NASA emerged somewhat battered and bruised, but very likely at the threshold of a much more stable era.

The November 1963 reorganization could be viewed as an effort to clear the decks of some of the fallen debris and to get the agency moving forward in harmony. Webb stated that the reorganization was intended to "strengthen our management structure, to bring it in line with our needs, to correct mistakes of the past, and to look as far into the future as we can to anticipate our needs."<sup>1</sup> The reorganization was also linked to the end of Project Mercury, but exactly how was not made clear.<sup>2</sup>

NASA's reorganization in 1963 occurred in a much different climate than that which prevailed at the time of the last major reorganization in 1961. In late 1963, NASA was emerging from a very turbulent period of criticism. In 1961 general silence had prevailed. A brief examination of this change in climate will help recreate the general external conditions facing NASA at the time of its November 1963 reorganization. (This is not meant to suggest that the reorganization was a direct result of the change in climate; changing circumstances within NASA were probably more important.)

<sup>1</sup> U.S. Congress, House, Committee on Science and Astronautics, *Briefing on NASA Reorganization, Project Mercury Summary*, Hearing, 88th Cong., 1st sess. (Washington: GPO, 1963), p. 2 (hereafter cited as House Hearing, *Briefing on NASA Reorganization . . .*).

<sup>2</sup> *Ibid.*

## I. THE CHANGE IN CLIMATE, 1963 VIS-A-VIS 1961

The change in climate manifested itself in three areas—the debate over NASA's mission, the changing pattern of external support, and the leveling off of NASA's budget.

### A. The Debate Over NASA's Mission

In May 1961 President Kennedy called for a national debate on the future scope and objectives of the U.S. space program before making any major decisions on his proposal for an accelerated program built around a manned lunar landing. The decisions were made but the debate failed to materialize, at least in 1961. A major debate on fundamental national objectives in space did not occur until 1963, by which time NASA and the space program had already gained a momentum that was not easily deflected. The debate included a wholesale criticism of the national space program and proved healthy in most respects in spite of some rather intense feelings.

The debate was probably triggered by President Kennedy's \$5.712 billion budget request for NASA for fiscal year 1964.<sup>3</sup> This request not only placed NASA among the big spenders (exceeded only by the Departments of Defense, Agriculture, and Health, Education, and Welfare)<sup>4</sup> but was considerably higher than the \$5 billion figure that had come to be associated with the leveling-off point for NASA's budget.

Furthermore, the acceleration in NASA's spending from its previous \$1.8 and \$3.7 billion budgets had already made an impact on U.S. resource allocation. Some people regarded this impact desirable, others not desirable.

Several schools of thought flourished at one time or another during the course of the 1963 debate. Omnipresent was the perennial "more space funds for the military" school with its Pentagon exponents and Capitol Hill supporters. The "economy-in-government/balanced budget" school viewed the space program as filled with unnecessary boondoggles. This was the general Republican position and former President Eisenhower was the chief spokesman.<sup>5</sup> Another school questioned allocating so many resources to space when there were other more urgent needs, such as education, oceanography, etc., which were felt to be more urgent. Killian and Abelson could be regarded as the chief spokesmen for this school.<sup>6</sup> The allocation of resources *within* NASA was also questioned; i.e.,

<sup>3</sup> On Jan. 27, 1963, a *New York Times* (Western Edition) editorial called for a debate on the space program in view of the high budget sought for NASA and the resource allocations determined thereby.

<sup>4</sup> Based on New Obligational Authority. Interest payments of the Treasury Department are ignored.

<sup>5</sup> See Eisenhower's article in *Saturday Evening Post*, May 18, 1963, pp. 15-19.

<sup>6</sup> James R. Killian, Jr., president of MIT and former Science Adviser to President Eisenhower; Philip H. Abelson, director of Carnegie Institution's Geophysics Laboratory and editor of *Science*.

too much emphasis was on manned flight, not enough on unmanned scientific efforts.

Related to the "misallocation of resources" school was the argument that NASA was unduly diverting scarce technical manpower away from other important national goals. The validity of this argument hinged on whether a scarcity actually existed, but this was never demonstrated.

The "efficiency of operation" school raised the question whether NASA was wasteful in conducting its operation. The *New York Times* suggested that Congress had been too uncritical of NASA's plans and performance and that a more determined effort should be made to cut the fat out of NASA's budget.<sup>7</sup> Many moderates had the firm if unspecific feeling that the geometric budget increases had to mean a loose and wasteful program.

The "stretchout" school felt that NASA was placing too much emphasis on the 1970 deadline for the manned lunar landing. NASA's objectives were viewed as satisfactory except for their timing. This school argued that the conditions prevailing at the time of the 1961 commitment had changed. First, the price tag to meet the deadline was apparently higher than had been earlier thought. Second, it was uncertain whether the U.S.S.R. was in a race for the moon. Not only had Khrushchev issued statements suggesting it was not, but, in addition, President Kennedy seemed to indicate a willingness to settle for a tie rather than push for a win. The stretchout argument was enticing to Congressmen who were simultaneously faced with both a large budget and a tax-cut proposal.

Finally, the "support the space program" school, of which NASA was the prime spokesman, stressed such things as the race with the U.S.S.R. for international prestige, the potential national security benefits resulting from increased space capability, the economic and technical "fallout" from the space program, and the value of scientific discoveries. NASA claimed that both a speedup and the stretchout would be less efficient and actually more expensive per unit of return.<sup>8</sup>

#### **B. The Changing Pattern of External Support**

The debate over the space program revealed that the pattern of support for NASA had changed over time. For example, the scientific community tended to be more divided and in general less firm in support than it had been earlier in NASA's history. NASA was accused of a preoccupation with manned flight to the moon at the expense of purely scientific exploration. On the other hand, NASA endeared itself to many university administrators and certain academic disciplines through its sizable grant program which included research grants, training grants, and grants to build facilities. Those not in a position to participate may well have been jealous.

<sup>7</sup> See editorial in *New York Times*, June 28, 1963. Also Jan. 27, 1963, editorial, *op. cit.*

<sup>8</sup> See Webb testimony, House Hearings, 1964 *NASA Authorization*, p. 31.

Congress was much less firm in its support of NASA. The best evidence of this was manifested in Congress' action on NASA's fiscal year 1964 budget, a topic discussed in detail later in this chapter.

The support of NASA's program by the White House, the Space Council, and the Bureau of the Budget seemed to stay firm. President Kennedy's statement in September to the U.N. on United States-U.S.S.R. cooperation very likely damaged NASA's funding position with Congress, however. The fact that NASA asked BOB for up to \$6.2 billion for fiscal year 1964 but was allowed \$5.7 billion was probably not an indication of any serious deterioration in White House support for or confidence in the space program.

The area where NASA picked up its greatest external support was among what could be termed its clientele—the aerospace industry. This industry was one of the fastest growing in the United States and its economic impact in certain areas was very great. The political influence of the industry grew also and NASA took its place among those agencies which could count on a type of grassroots support from several geographic areas.

The net effect of this changing pattern of support is difficult to evaluate. A powerful economic bloc got a vested interest in NASA's program. It is too early to say whether this economic bloc would ever be able to significantly influence NASA's policies. If so, this would be unfortunate, at least if the Space Act is regarded as a wise and fruitful mandate for NASA. The bipartisan Space Act stressed aeronautical and space research, scientific exploration, and the development of space flight capability. NASA seemed willing to expand on this to include both economic and educational impact.

### C. The Leveling Off of NASA's Program

The terminal point of this study roughly coincides with the point in time when NASA's growth curve turned the corner and started flattening out. Thus it is too early to say what the precise results of this leveling off will be. It has been generally assumed that once the period of rapid expansion was over, NASA could tidy up and attack problems previously neglected. Furthermore, with in-house staff pretty well built up, NASA would be able to manage its programs and projects in a manner which would permit administrative efficiency and maximum program progress.

The psychological impact of the leveling off was felt as early as 1963 in connection with the enactment of NASA's fiscal year 1964 budget. Action on the fiscal year 1964 budget epitomizes the change of climate which NASA felt in 1963 and thus warrants amplification.

*NASA's Fiscal Year 1964 Budget Affected by Fiscal Year 1963 Actions.* In 1962 NASA's fiscal year 1963 budget moved through Congress quite smoothly. The 342-to-0 vote of the House of Representatives approving a \$3.6 billion NASA authorization bill, the high-water mark of congressional support, was truly satisfy-

ing to NASA's leadership and may well have given many NASA officials an overly optimistic view of future congressional support.

The story of NASA's fiscal year 1963 budget can be briefly recapitulated: NASA's request was for \$3,787,276,000, a figure twice as large as the previous year. The House Astronautics Committee made only small selective cuts (3 percent) in this figure. The House approved this unanimously on May 24, 1962. In June, the Senate Space Committee approved an authorization of \$3,749,515,250, only 1 percent below NASA's request, which action received Senate approval in July. The House-Senate conferees agreed to a figure very near the Senate one—\$3,744,115,250.<sup>9</sup>

The House voted a \$3,644,115,000 appropriation bill and the Senate a \$3,704,115,000 one, both chambers approving the actions of their respective Appropriation Committees. The compromise arrived at was \$3,674,115,000, a figure less than 2 percent below the authorization. The Appropriation Act was signed by the President on October 3, 1962.<sup>10</sup>

During the same period, Congress passed a \$153,500,000 supplemental appropriation for fiscal year 1962.<sup>11</sup>

Some congressional sniping at NASA did occur in 1962, especially from Senator Proxmire. John Finney of the *New York Times* reported that congressional misgivings on the cost of the space program were growing, that these had not come out into the open during 1962, but might well lead to demands for large cuts in NASA's fiscal year 1964 budget.<sup>12</sup>

Toward the end of 1962, NASA discovered that its program, especially manned space flight, had achieved a momentum which was consuming money faster than expected and that the fiscal year 1963 appropriation was uncomfortably marginal. The decision had to be made either to try to squeeze by, possibly slowing the pace somewhat, or to request a \$400 million supplemental appropriation. A third alternative may have been to bring the Air Force in on funding the Gemini program.

None of the alternatives was appealing. Webb, sensing the congressional undercurrent, felt the climate was not ripe to request a sizable supplemental on the heels of a budget that had just doubled the one for the previous year. So NASA attempted to squeeze by, reprogramming funds from less important to more important projects and hoping to recoup some of the money in its fiscal year 1964 appropriation.<sup>13</sup>

**NASA's Fiscal Year 1964 Budget Submitted to Congress.** The NASA budget presented to Congress in January 1963 totaled \$5,712 billion in new

<sup>9</sup> Became Public Law 87-584, signed Aug. 14, 1962.

<sup>10</sup> Public Law 87-741.

<sup>11</sup> Public Law 87-545, July 25, 1962. \$82.5 million for R&D and \$71 million for CoF.

<sup>12</sup> Finney's prophetic words appeared in the *New York Times* on July 25, 1962, p. 12.

<sup>13</sup> See Seamans' testimony, House Hearings, *1964 NASA Authorization*, pp. 3259-3260. (Holmes, head of manned space flight, evidently felt that the supplemental was needed, and the sooner the better. This difference of opinion between Holmes and general management is rumored to have marked the end of the honeymoon between NASA and Holmes.)

obligational authority, an increase of \$2 billion over the previous year. Evidently President Kennedy asked NASA to prepare three budgets—\$5.2, \$5.8, and \$6.2 billion.<sup>14</sup> NASA felt the \$6.2 billion figure would permit optimum progress. The President, pushing for a tax cut, tried to hold the budget deficit down and wanted the lowest possible NASA budget consistent with the national space commitment. The \$5.7 billion figure was agreed to. Only \$50 million of the budget (less than 1 percent) was for new projects.<sup>15</sup> Eleven months were to pass before NASA's fiscal year 1964 appropriation was enacted. During that period a wide-ranging debate took place. For NASA, the sailing was rough.

*The Enactment of NASA's Fiscal Year 1964 Budget.* The NASA Appropriation Act, signed by President Johnson in December 1963, totaled \$5.1 billion, over 10 percent less than NASA's original request.<sup>16</sup>

The enactment process got underway in early March when the House Astronautics Committee began hearings on an authorization bill for NASA. These hearings were exhaustive and both NASA and the Astronautics Committee put a great deal of effort into them. Three subcommittees worked simultaneously and with painstaking care. Hearings were held on 39 different days ranging over 4 months. The printed record totaled almost 3,500 pages.<sup>17</sup> Since the House committee departed from normal practice and prepared an 80-page index, these hearings are an excellent source of information on NASA and the space program.

After this careful scrutiny, the House Astronautics Committee cut a half billion dollars from NASA's request. The cuts were selective ones in that no percentage formula was used. Construction was cut 13.5 percent; R&D, 7.2 percent. All program areas were cut, ranging from 7.4 percent for manned space flight to 12.7 percent for space sciences.

The report of the House Astronautics Committee of July 25, 1963, recommending a \$5,238,119,400 NASA authorization, was in itself a remarkable document.<sup>18</sup> The first 169 pages were devoted to justifying the authorization recommended. The next 18 pages explained the modifications that the committee had made in NASA's request. Three pages were devoted to justifying new provisions of the authorization bill designed to restrict further NASA's discretionary spending authority. The committee also expressed its views on what it felt to be problem areas: <sup>19</sup> (1) Interagency coordination still left something to be desired; (2) not enough emphasis was being placed on the national security aspects of the space program; (3) greater interagency cooperation on the use of facilities was needed; (4) NASA should exercise care not to give preference to any one contractor; (5) R&D on high-energy fuels should be accelerated. Most of these were time-worn

<sup>14</sup> See Webb's testimony, *ibid.*, p. 30.

<sup>15</sup> *Ibid.*, p. 28.

<sup>16</sup> Public Law 88-215, Dec. 19, 1963.

<sup>17</sup> House Hearings, *1964 NASA Authorization*. See bibliography for complete citations.

<sup>18</sup> U.S. Congress, House, Committee on Science and Astronautics, *Authorizing Appropriations to the National Aeronautics and Space Administration*, H. Rept. 591, 88th Cong. 1st sess., July 25, 1963 (Washington: GPO, 1963).

<sup>19</sup> *Ibid.*, pp. 190-194.

positions and the absence of any other points suggests that the committee still supported the principal NASA objectives. Several committee members wrote dissenting views on certain topics, however.<sup>20</sup>

The action of the House Astronautics Committee was highly significant, as this committee was responsible for the detailed scrutiny of NASA. Not only were money cuts made but the authorization bill also tightened the reprogramming discretion given the agency. NASA's proposal for a new electronics center in Boston was given only qualified approval.

On the floor of the House, two Republican-sponsored amendments resulted in two additional cuts, and the authorization bill, as finally passed by the House on August 1, 1963, totaled \$5,203,719,400.<sup>21</sup>

Meanwhile, the Senate Space Committee was fulfilling its traditional role of restoring House cuts. Even though NASA had lost a staunch supporter as a result of the death of Senator Robert Kerr, chairman of the Senate Space Committee and close friend of Mr. Webb, it picked up a strong supporter in Senator Clinton Anderson, the new chairman. The Senate Space Committee trimmed NASA's budget only 3½ percent, thus restoring 60 percent of the cuts made by the House. The Senate ratified the committee's action on August 9 when it passed a \$5,511,520,400 authorization bill. Action on the Senate floor almost reduced the authorization to the amount of the House bill.<sup>22</sup> The vote was 37 to 32 against the reduction. (This is in sharp contrast with the action on the floor of the Senate in 1959 when the amount recommended by the Senate Space Committee was increased to a level which was higher than what NASA had asked for.)

Later in August, House-Senate conferees compromised on a \$5,350,820,400 figure which became Public Law 88-113 on September 6, 1963. This law included several clauses designed to shrink slightly NASA's discretionary spending power. Reprogramming of R&D funds for "new" construction was cut from 3 percent of the R&D appropriation to 2 percent. NASA's freedom to reprogram among major existing program areas and to reprogram into new program areas was restricted by a tightening of the language requiring the prior notice to the House Astronautics and Senate Space Committees.

Authorization action was being completed about the same time that appropriation action was getting underway. Since appropriations almost always fell short of authorizations, NASA did not face very pleasant prospects in September 1963. Lateness alone was causing anxiety and administrative headaches.

On Monday morning, August 19, 1963, NASA officials marched up to Capitol Hill to face the House Appropriations Subcommittee on Independent Offices and its chairman, Albert Thomas. The 37 NASA officials making an appearance included just about all of NASA's top leadership. Administrator Webb opened the hearings with a plea that NASA needed every penny author-

<sup>20</sup> *Ibid.*, pp. 196-206.

<sup>21</sup> *The Wall Street Journal*, Aug. 2, 1963.

<sup>22</sup> *New York Times*, Aug. 10, 1963.

ized.<sup>25</sup> (The House-Senate authorization compromise had not been made as yet and Webb claimed the Senate's \$5.5 billion authorization figure was the minimum appropriation that NASA could tolerate and still maintain optimum momentum.)

In spite of the extensive and intensive work of the House Astronautics Committee, the Thomas subcommittee also took a careful look at NASA's request, especially for construction. The hearings took the greater part of 1 week. NASA's testimony failed to stem the tide, however, and the Thomas subcommittee decided on a \$5.1 billion appropriation figure for NASA. This was about 11 percent below NASA's request and 5 percent below the amount Congress had authorized for appropriation.

NASA came close to suffering much deeper cuts. On September 20, 1963, President Kennedy, in an address to the United Nations General Assembly, stated that in the field of space there was room for United States-U.S.S.R. "cooperation," for "joint efforts," including the possibility of a "joint expedition to the moon."<sup>24</sup> "Why should the United States and the Soviet Union, in preparing for such expeditions, become involved in immense duplications of research, construction and expenditures?" The President did not propose a cooperative program, but asked only that the possibility of cooperation be explored.

President Kennedy's U.N. speech raised numerous questions on Capitol Hill and in the press.<sup>25</sup> The very next day Representative Thomas felt required to ask the President if he had changed his position on the need for a strong U.S. space program.<sup>26</sup> The President's September 23 reply stated that a strong U.S. space program was essential so that any possibilities of United States-U.S.S.R. cooperation could be explored from a position of strength.<sup>27</sup>

The *New York Times* reported that the President's speech triggered an effort in the Thomas subcommittee to cut NASA's appropriation an additional and probably crippling \$900 million.<sup>28</sup> The vote was 4 to 4, thus sustaining the \$5.1 billion figure. Representative Cannon, the Chairman of the full Appropriations Committee, joined the three subcommittee Republicans in the reduction effort.

In early October the House Committee on Appropriations reported out a \$5.1 billion NASA appropriation, which figure was ratified by the whole House. NASA

<sup>25</sup> See Webb's testimony, U.S. Congress, House, Committee on Appropriations, Subcommittee on Independent Offices, *Independent Offices Appropriations for 1964* (Pt. 3), Hearings, 88th Cong., 1st sess., (Washington: GPO, 1963), pp. 82-90.

<sup>26</sup> Text of the Sept. 20, 1963, speech can be found in the *Washington Post*, Sept. 21, 1963, p. A10.

<sup>27</sup> Other 1963 events added to the confusion. Khrushchev was quoted and misquoted on several occasions concerning Russia's manned lunar landing plans, with the net result that there was some uncertainty whether Russia was in the race for the moon. The March 1963 Dryden-Blagonravov agreement on space communications and meteorology suggested that space cooperation was feasible.

<sup>28</sup> Thomas' Sept. 21, 1963, letter was reprinted in Senate Hearings, *Independent Offices Appropriations, 1964*, pp. 1616-1617.

<sup>29</sup> *Ibid.*, pages 1617-1618.

<sup>30</sup> *New York Times*, Sept. 28, 1963.



recovered very little from the Senate Committee on Appropriations, which reported out a \$5.19 billion appropriation in early November. In Senate floor action a Fulbright amendment to cut \$519 million, or 10 percent, was defeated 46 to 36, but a Proxmire amendment to cut \$90 million was passed 40 to 39.<sup>29</sup> Thus the Senate and House both agreed on a \$5.1 billion figure. The appropriation bill was signed by President Johnson on December 19, 1963, almost 6 months into the fiscal year to which it applied.<sup>30</sup> Included was a provision that no funds made available to NASA under the act could be used for "expenses of participating in a manned lunar landing to be carried out jointly by the United States and any other country without consent of the Congress."

In summary, the tax-cut proposal and economy moves flowing therefrom, NASA's budget being larger than expected, the easing of cold-war tensions, the Dryden-Blagonravov agreement, Khrushchev's statements on Russia's lunar landing plans, and Kennedy's statements on United States-U.S.S.R. space cooperation all contributed toward NASA's budget woes for fiscal year 1964. It is too early to state what the final impact will be. In early 1964, NASA gave indications that its internal economizing and reprogramming were permitting it to stay close to schedule—providing, of course, that its fiscal year 1965 request of \$5.3 billion (plus a fiscal year 1964 supplemental appropriation of \$141 million for manned space flight) would be appropriated in full.<sup>31</sup>

## II. THE NOVEMBER 1963 REORGANIZATION

The remainder of this chapter is devoted to the November 1963 reorganization. This is not meant to suggest that the reorganization was a dramatic climax to the first 5 years of NASA's administrative history. This was not the case. The reorganization, after the chaff of title changes is blown away, had only one truly fundamental provision—it undid the provision of the 1961 reorganization which put the field centers under the institutional control of the Associate Administrator.

Nor should the reorganization be viewed as NASA's reaction to its external troubles—except, of course, to the extent that NASA knew that strong internal management would always enhance its position vis-a-vis external parties. The reorganization was primarily a reaction to basic internal problems related to the balancing of program requirements with institutional resources, and the discussion of the 1963 change of climate was designed only to recreate the general external conditions that prevailed at the time the reorganization took effect.

Reorganization is both continual and episodic. The 1961 and 1963 reorganizations were episodic because they involved changes in fundamental relationships. Organizational changes made on a continual basis were usually designed to accommodate a particular new development or solve a particular problem.

<sup>29</sup> *New York Times*, Nov. 21, 1963.

<sup>30</sup> Public Law 88-215.

<sup>31</sup> See Webb's testimony, House Hearings, *1965 NASA Authorization*, pp. 9-10.

(It should be added that when an episodic reorganization takes place, the occasion is often used to announce several less fundamental adjustments, many of which would have been made anyway.)

The fundamental changes made in 1961 involved the power and authority of general management, the alignment of program offices in Headquarters, and the relationship between Headquarters and the field centers. The 1963 reorganization involved all three elements also, but with the visible change confined primarily to the third one—headquarters-field relationships. The fundamental change made was not an innovation but more in the nature of a return to an arrangement that had prevailed during the first 3 years of NASA's history. It recombined program and institutional management by placing the field centers under the Headquarters program directors instead of under general management (i.e., the Associate Administrator). It confirmed the new division of work that had been initiated in 1961 and perfected subsequently.

In its less fundamental provisions it eliminated the Office of Applications as a separate Headquarters program office by combining it with the much larger Office of Space Sciences; it altered some of the offices reporting directly to Webb and Dryden; and it gave new titles to most top-echelon officials.

#### **A. Events Leading to the Reorganization**

Strictly speaking, the November 1963 reorganization was a two-step reorganization like the November 1961 reorganization. In 1961, the first step was the establishment of the Office of Programs in June. In 1963 the first step was giving the Director of Manned Space Flight a second hat, that of Deputy Associate Administrator for Manned Space Flight Centers in October 1962.<sup>32</sup> In fact, the November 1963 reorganization can be viewed as doing for all of NASA what the October 30, 1962, "adjustment" had done for the manned space flight area.

Thus the reasons for the 1962 adjustment are the reasons for the 1963 reorganization. It should be recalled that the 1962 adjustment was made because the November 1961 reorganization was not working out as smoothly as hoped for. The arrangement whereby center directors looked to NASA general management (i.e., Robert Seamans, the Associate Administrator) for men and money (resources) and to the Headquarters program offices for program direction did not work well. The center directors found it difficult to balance the program demands placed on them with the resources given them. Furthermore, the center directors often had inadequate or conflicting working arrangements and management systems imposed on them by Headquarters.<sup>33</sup>

<sup>32</sup> See Ch. 8, Sec. III.B.

<sup>33</sup> In September 1962 the Management Analysis Division of the Office of Administration prepared a draft memo outlining these problems. One draft, dated Sept. 28, 1962, was titled "Inadequate and Conflicting Management Systems."

It is not easy to state with certainty whether the 1961 reorganization was poorly conceived, whether the 1961 reorganization was well conceived but inadequately implemented, or whether well conceived and well implemented but simply unable (as any other arrangement also would have been) to cope with the dynamic growth that NASA was experiencing. A good case can be made that it was well conceived to cope with the problems being faced at the time but that a combination of factors interfered with its evolving into a viable setup for NASA's long-range needs.

In order for NASA to have: (1) successfully changed the basis for dividing up its program (i.e., to one based on major objectives); (2) succeeded in asserting the control of general management over all subordinate organizational units; and (3) coped with problems stemming from its rapid growth, it would have had to have: (a) personnel who could successfully submerge their own parochial interests in favor of an agencywide point of view; (b) a good training program to make up for any deficiencies that may have existed among its top managers; (c) widespread agreement on basic administrative processes; (d) a staff surrounding the general managers that would serve as a true intermediary between the program offices and the field, correctly interpreting to the general manager the problems that arise; and (e) some way of coping with the general manager's overly large span of control, i.e., solving most problems without having to take them to the general manager. There were deficiencies in one or more of these areas.<sup>34</sup>

As described earlier, the 1961 structure was modified in 1962 when one of the major program areas, manned space flight, was given institutional control over the three field centers primarily involved in its program. Thus, for several months NASA had a chance to compare two different arrangements side by side.

The 1962 adjustment revealed that significant progress had been made in strengthening NASA's general management. If one of the objectives of the 1961 reorganization was to curb or even stop the trend toward the development of autonomous bureaus in NASA, the 1962 adjustment raised the possibility of the trend being resumed, at least in one very important program area. In June 1963, the Director of Manned Space Flight resigned from NASA, in part because general management felt he was pursuing too independent a course (or looked at from the reverse side, because he was not allowed to pursue as independent a course as he thought necessary). This helped clarify the accountability of the program directorates to general management and helped create the necessary environment for the 1963 reorganization.

In April 1963, Webb ordered a review of NASA's organization in the light of its \$5.7 billion budget request, the definitizing of its major manned lunar landing contracts, and the knowledge gained as to who could manage and how.<sup>35</sup>

The review was not as formal as that conducted in 1961, nor were the alterna-

<sup>34</sup> Based on comments submitted to the NASA Historical Office by Albert Siepert (Dec. 24, 1964) and John Young (Jan. 1, 1965).

<sup>35</sup> See Webb's testimony, House Hearing, *Briefing on NASA Reorganization* . . . , p. 15.

tive courses of action as diverse or numerous.<sup>36</sup> NASA had a much greater store of knowledge and experience to draw from.

In September the final round of discussions was held and on October 9, 1963, the details of the reorganization were made public.<sup>37</sup> On the same day the House Astronautics Committee was briefed on the changes made.<sup>38</sup>

#### B. Provisions of the Reorganization<sup>39</sup>

The changes, effective November 1, 1963, resulting from the reorganization, can best be shown by comparing the 'before' and 'after' organization charts (figs. 9-1 and 9-2).

**Headquarters-Field Relationships.** The fundamental change was combining program and center management by placing the field centers under the line command of the Headquarters program directors instead of under general management. The program directorate to which a center reported was determined by the center's primary activity. Thus the Marshall, Manned Spacecraft, and Launch Operation Centers were put under Mueller, Holmes' successor in the Office of Manned Space Flight. Goddard, Wallops, PLOO, and JPL were put under Newell, the head of the Office of Space Sciences and Applications. The four former NACA labs—Langley, Ames, Lewis, and Flight—were restored to their old position under the Office of Advanced Research and Technology (Bisplinghoff).

The increased authority and responsibility of Mueller, Newell, and Bisplinghoff was recognized by giving them new titles ("Associate Administrator for —").

NASA listed two major benefits accruing from this move: (1) "Clearer and more direct lines of authority and responsibility between Headquarters and field installations will be established," (2) "The Associate Administrator will have more time to discharge his 'general manager' responsibilities and to consult on policy matters with the Administrator and Deputy Administrator."<sup>40</sup>

The precise reduction in Seamans' span of control is difficult to measure because the responsibilities of the two Deputy Associate Administrator positions established in October 1962 were never entirely clear. Certainly after the 1963 reorganization it was crystal clear that Seamans' principal subordinates for program and center management were Mueller, Newell, and Bisplinghoff.

<sup>36</sup> Interview with Leonard Carulli, NASA Management Analysis Division, Apr. 2, 1964.

<sup>37</sup> NASA News Release No. 63-225, Oct. 9, 1963.

<sup>38</sup> House Hearing, *Briefing on NASA Reorganization* . . . .

<sup>39</sup> Unless indicated otherwise, the information in this subsection is based on a Staff Paper prepared by the Office of Administration, October 1963, and titled "Adapting NASA's Organization and Management to Future Challenges."

<sup>40</sup> *Ibid.*, p. I-4.

**PRESENT ORGANIZATION  
NATIONAL AERONAUTICS AND SPACE ADMINISTRATION**

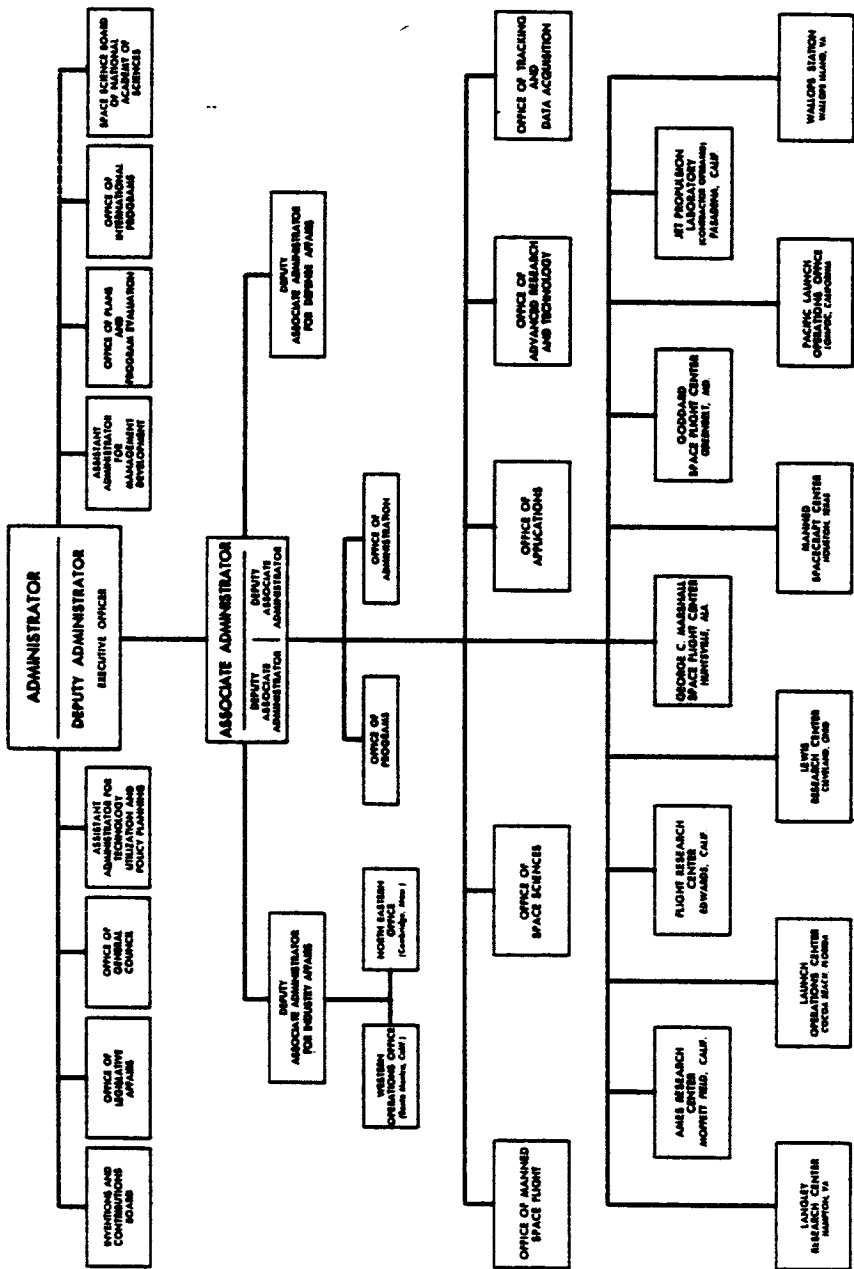

OCTOBER 1963

FIGURE 9-2

ORGANIZATION EFFECTIVE NOVEMBER 1, 1963  
NATIONAL AERONAUTICS AND SPACE ADMINISTRATION

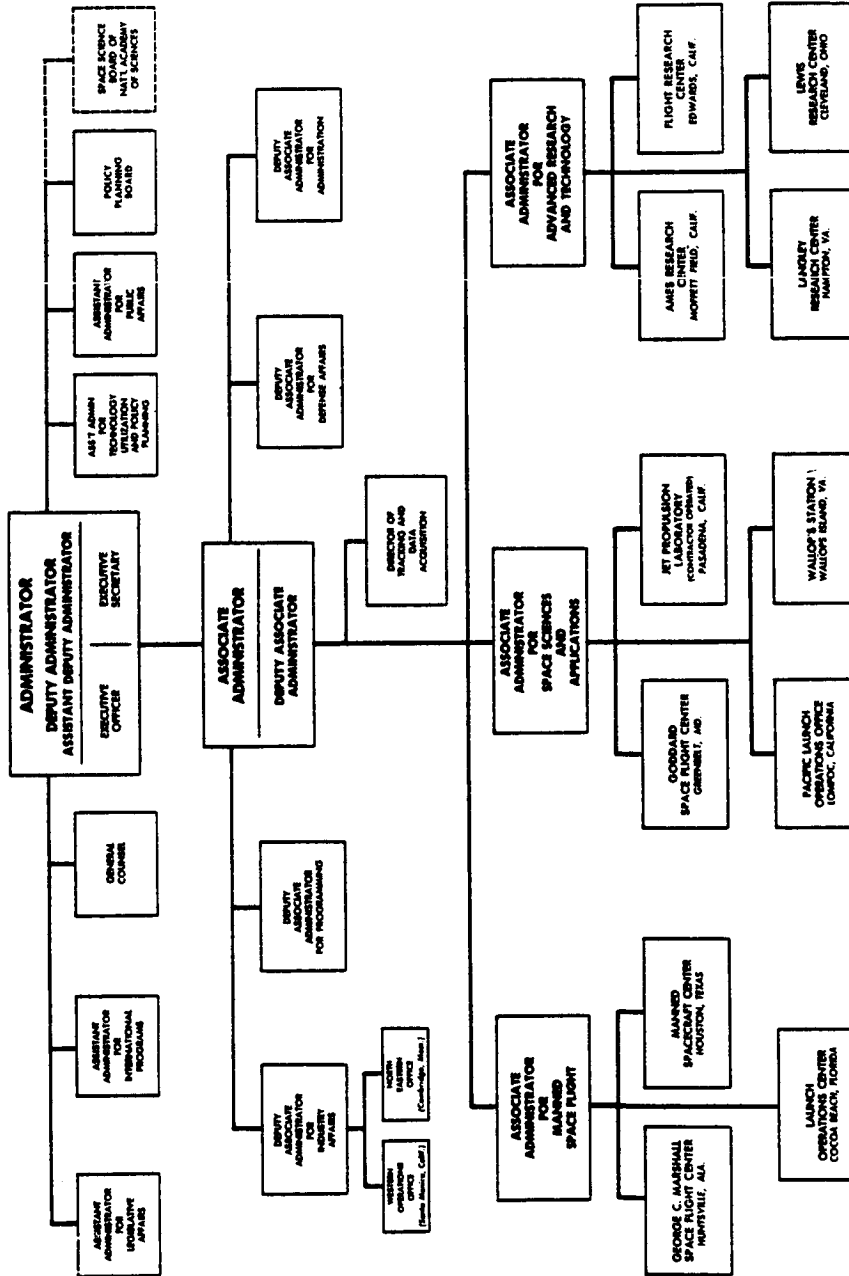

FIGURE 9-1

*Changes in Headquarters.* The 13 principal Headquarters offices can be divided, for discussion purposes, into three groups. Group One consists of those reporting to Seamans and having program execution responsibilities. Group Two consists of those reporting to Seamans and having advisory, functional, and service responsibilities directly related to NASA's aerospace program. Group Three consists of those reporting to Webb/Dryden.

Group One changes: The number of offices in this group was reduced from five to four by combining the Office of Applications and the Office of Space Sciences. The former was a small office and in the execution of its program it employed the same launch vehicles and the same field centers as the much larger Office of Space Sciences. The newly appointed head of the office (Robert Garbarini) cooperated by giving up his coequal hierarchical status and agreeing to serve under Homer Newell, the Associate Administrator for Space Sciences and Applications. It should be recalled that Space Sciences and Applications had been together under Silverstein before the November 1961 reorganization.

The Office of Tracking and Data Acquisition was not structurally altered by the reorganization. Its head (Buckley) retained the title of Director, signifying that he had no field centers under him, in contrast with the three "Associate Administrators for ——" Before the reorganization, the Office of Tracking and Data Acquisition worked directly with Goddard, Wallops, and JPL in allocating resources for NASA's tracking network. After the reorganization, it had to coordinate this effort with the Associate Administrator for Space Sciences and Applications under whom the centers were now located.

Group Two changes: On the surface, the changes were relatively minor. The heads of the four offices involved were all given titles of "Deputy Associate Administrator for ——" The Office of Administration and the Office of Defense Affairs were not changed at all. The Office of Industry Affairs was expanded by transferring two activities to it. The Reliability and Quality Assurance Division was transferred from the Office of Programs, and the Inventions and Contributions Board was transferred from its semiautonomous position under Webb.

It is still too early to know precisely how the functions of the Office of Programs (now named Office of Programming) were altered as a result of the reorganization. It would appear that the Office would do less firefighting and solve fewer jurisdictional disputes inasmuch as Associate Administrator Seamans became less involved in the management of NASA's field centers. This would allow the Office of Programming to concentrate on fundamental agencywide matters of an overall control nature. The Office would serve as "Comptroller," "Intermediate and Short-Range Planning Agent," and "Program Evaluation Agent" all rolled into one.

The Deputy Associate Administrator's position was altered somewhat. Previously it was program and center oriented. In keeping with the talents of the new incumbent (Lingle), it was slanted more in the direction of organization and management in general.

The heads of the eight offices reporting to Associate Administrator Seamans

were constituted as a Management Committee under the chairmanship and vice chairmanship of Seamans and Lingle. The Committee was to "assist and advise the Associate Administrator on agencywide management systems and on managerial, organizational, and operational matters and problems involving more than one agency element."<sup>41</sup>

Group Three changes: Several changes were made among the offices reporting directly to Webb and Dryden. The old Office of Program Planning and Evaluation, Glennan's first organizational creation back in August 1958, was abolished. This move had been in the mill ever since NASA canceled its long-range planning activities in early 1963. An interim substitute had been the 5-year projections handled by the Office of Programs and Associate Administrator Seamans. The staff of the old Office of Program Planning and Evaluation was put under the Assistant Administrator for Technology Utilization and Policy Planning (Simpson), with the responsibility for assisting in policy formulation and evaluation. Policy formulation and evaluation was to be the special responsibility of a newly created Policy Planning Board made up of senior NASA officials from Headquarters and the field. The Board was to advise the Administrator and Deputy Administrator on fundamental policy matters.

The public affairs/technology utilization organizational pattern which evolved in a somewhat confusing manner in 1962 was clarified by putting Public Information, Educational Programs and Services, and a Special Activities Division (exhibits, etc.) under an Assistant Administrator for Public Affairs (Scheer). Technological Utilization and Scientific-Technical Information, together with the expanded policy planning activity, were placed under an Assistant Administrator for Technology Utilization and Policy Planning (Simpson).

Simpson was given another job as well, that of Assistant Deputy Administrator.<sup>42</sup> This position was established to provide overall monitorship of top-level business while the Administrator and Deputy Administrator were away. It is too early to say whether the Assistant Deputy Administrator will tend to become a "layer" between Webb/Dryden and the offices directly under them. At least such was not the intent.

The title changes announced with the reorganization (Assistant Administrators, Associate Administrators, Deputy Associate Administrators) are somewhat confusing and unwieldy to write about. Webb suggested that fancy titles were a psychic reward to underpaid, hard-working civil servants.<sup>43</sup>

### C. An Evaluation of the Reorganization

It is still too early to know what the long-range results of the reorganization will be. Webb is quick to point out that it will not be NASA's last reorganization.<sup>44</sup>

<sup>41</sup> *Ibid.*, p. I-11.

<sup>42</sup> This position was originally named "Associate Deputy Administrator" but was changed so as not to be confused with the position of "Deputy Associate Administrator."

<sup>43</sup> House Hearing, *Briefing on NASA Reorganization . . .*, p. 7.

<sup>44</sup> *Ibid.*, p. 6.



Reconciling the conflicting rationales behind the 1961 and 1963 reorganizations is difficult. The most plausible explanation is that the 1961 approach was the best approach at the time, but that changing circumstances called for a different approach later on. The 1961 reorganization was designed to clarify the powers of general management and prevent the development of autonomous bureaus in NASA. To do this, many powers and activities were centralized in the hands of the general manager. The 1963 reorganization emphasized the dispersion of power and promoted decision-making at lower organizational levels. The 1961 reorganization emphasized cross-relationship and dual-command channels. The 1963 reorganization emphasized simplified command lines with multi-directional information channels.

The 1963 reorganization would seem to form a good basis for the refinement and perfection of administrative processes. Command lines seem cleaner and more easily understood than before the reorganization. Delegations of authority from the Associate Administrator to the heads of the four program areas to the center directors can be maximized. The setup would seem to give the heads of the four program areas the authority commensurate with their responsibility. This, in turn, should promote the optimizing of management and organization within each program area. (Changes within the four program areas have not been dealt with in this study. It should be acknowledged that those in the Office of Manned Space Flight were far reaching and important.)

NASA moved rapidly in the formulation of basic administrative processes based on the operating concepts and philosophy of the 1963 reorganization. By February 1964, a document was issued establishing basic policies and ground rules in such areas as authorizations and appropriations, budget execution, project and facility planning and approval, reporting, procurement, agencywide management, functional management, etc.<sup>45</sup>

#### **D. NASA Leadership, November 1963**

A list of NASA's top leaders following the November 1963 reorganization reveals the extent of Webb appointments in NASA Headquarters. A similar listing based on the November 1961 reorganization makes an interesting comparison.<sup>46</sup> In the following chart, NASA officials are broken down into six groupings based on whether they had once been part of NACA, whether Glennan had brought them in from the outside, whether Webb had brought them in, and whether the official was in Headquarters or a field installation. A comparison of the 1961 and 1963 charts reveals a stability in field center leadership and a large turnover in Headquarters leadership.

<sup>45</sup> NASA Basic Administrative Processes, NPC 107, February 1964.

<sup>46</sup> See Ch. 7, Sec. V.B.

	<i>NACA</i>	<i>Glennan</i>	<i>Webb</i>
Headquarters.....	Dryden *Wyatt *Buckley	Seamans *Newell *Young Johnson Frutkin	*Simpson *Lingle *Mueller *Bisplinghoff *Hilburn *Boone *Callaghan *Scheer
Field centers (over 500 employees).....	Gilruth Goett Silverstein Thompson DeFrance Bikle Krieger	von Braun *Debus	

\*Entered top echelons under Webb.

### III. WEBB'S FIRST 33 MONTHS—SUMMARY AND CONCLUSIONS

Webb had served about 33 months at the time of NASA's fifth anniversary and its 1963 reorganization. This period was roughly comparable in length with the 28-month administration of his predecessor, Dr. T. Keith Glennan. The two eras were almost as different as the two men themselves. (In the following summary of NASA's accomplishments during the Webb period, frequent comparisons are made with developments during the Glennan era.)<sup>47</sup>

#### A. NASA's Program

Without a doubt the most significant development during the Webb period, and one which pervaded almost everything NASA did, was the national policy decision to accomplish a manned lunar landing, with the time factor (7 to 9 years) more important than the cost factor (anywhere from \$20 to \$40 billion). An administrative history cannot reveal what would have happened had an alternate road been taken in 1961. In view of Webb's personality and public interests, it seems safe to assume that significant changes would have been wrought anyway, but certainly not on the scale of those stemming from the manned lunar landing decision.

Since the manned lunar landing tended to permeate, and in fact was designed to animate, almost everything NASA did, it is extremely difficult to appraise changes in the rest of NASA's program. NASA's own claim that only 1 percent of its fiscal year 1964 budget was for new programs suggests a considerable amount of program stability. Nevertheless, there are several program developments that show the Webb imprint.

For example, the University Program was expanded to include training and facility grants as well as increased funding for research grants. This program was budgeted for over \$50 million in fiscal year 1964, a level over 10 times as

<sup>47</sup> See Ch. 5, Sec. V.

great as in fiscal year 1960 under Glennan.<sup>48</sup> The Technology Utilization Program was structured during 1962 and 1963 and budgeted at \$3.5 million for fiscal year 1964. Both programs have an element of social and economic engineering in them and represent Webb's willingness to interpret the Space Act in the broadest possible terms. It is conceivable that NASA might have branched out into other marginal space programs if the manned lunar landing had not been such a high-priority, resource-consuming endeavor. No account is available of the valid program proposals rejected.

The year 1963 represented something of a transition point in NASA's flight program. Prior to 1963, most of NASA's flight program was the manifestation of pre-Webb R&D activity. The year 1964 would see the beginning of flight missions associated with NASA's accelerated program following the 1961 lunar landing decision. Most of the expensive hardware being developed would not fly until 1966 and after. During 1963, NASA attempted only 13 major launches, which was about half the total for 1962 and far below the 34 to 42 launches that had originally been scheduled for the year.<sup>49</sup> This development represented slippages because of technical difficulties and cancellations because of budget difficulties. The final story of this has yet to be revealed. Of the 13 major launch attempts, 5 were in the "applications" category (meteorology and communications), 3 in the scientific earth satellite category, 2 each in the vehicle development (Saturn and Centaur) and "reentry" categories, and 1 in the manned flight category (Cooper's 22-orbit mission). Not a single lunar and planetary launch was made. There was no major launch for a 4-month period between July 26 and November 26, 1963.

NASA's extensive fiscal year 1963 reprogramming, its 1963 reorganization, and the revision of its 1963 flight program all point to 1963 as a period of shakedown. In March 1963, Webb declared that NASA was in ". . . the process of shaking down into a hard-boiled capably managed operation a total organization that has doubled every year for the past 5 years. . . ." <sup>50</sup>

In any case, NASA's major program accomplishments during Webb's first 33 months must be measured not in its flight program but in the momentum gained toward the accomplishment of flight missions during the last half-decade of the 1960's.

### **B. Organizational and Administrative Changes**

Under Glennan, NASA went from the 8,000 NACA core to 16,000 employees, with over half of the increase coming from mass transfers from other agencies. During a comparable period under Webb, numbers increased from 16,000 to 30,000. During its first 28 months, NASA obligated \$1,250 million. During Webb's first 33 months, obligations totaled \$6,670 million.

<sup>48</sup> The tenfold increase is a rough estimate, as data is not directly comparable. (Compare Senate Hearings, *NASA Authorization for Fiscal Year 1960*, p. 708, with House Hearings, *1964 NASA Authorization*, p. 76.)

<sup>49</sup> See Seaman's testimony, House Hearings, *1965 NASA Authorization*, p. 92.

<sup>50</sup> House Hearings, *1964 NASA Authorization*, p. 22.

NASA's outward structural appearance changed dramatically during the formative years under Glennan as new program offices were formed and new field centers established. Changes resulting from expansion continued under Webb, but, in addition, numerous changes resulted from rearranging the existing organization.

***General Management Powers Clarified.*** Glennan's objective of molding a unified agency out of four previously separate units (NACA, the Vanguard Division of the Naval Research Laboratory, the Development Operations Division of the Army Ballistic Missile Agency, and the Jet Propulsion Laboratory) was not achieved in full. Webb's arrival provided a good opportunity to take one more significant step—that of bringing the entire agency more closely under the control of general management. Thus the establishment of the Office of Programs in June 1961 and the agency's reorganization in November 1961 represented the high-water mark of NASA as a centralized organization.

It is probably a natural tendency for a new Administrator to want to make sure the reins of authority are firmly in his grasp. Once this "feeling" is established, the reins can be loosened. The November 1963 reorganization represented the loosening of the reins as held by general management. Whether or not general management had ever truly established its complete authority in NASA is debatable, as NASA's rapid growth tended to outpace efforts for central control.

***NASA's Goals Redefined.*** At the same time that NASA, under Webb, was clarifying the role of general management, the very objectives of the agency itself were being clarified. As stated before, the national policy decision on a manned lunar landing before 1970 was the single most important event in NASA's history. The effect, in terms of agency growth and administrative and program problems, taxed the entire agency's problem-solving ability.

***NASA's Expanding Program Organized and Managed.*** Right after NASA was established, a sizable expansion of its program took place. Following the 1961 program acceleration, the cycle was repeated and many of the same approaches were used, only on a larger scale. Under Glennan, NASA decided to give U.S. industry the major role in aerospace R&D. The same policy was followed under Webb and in almost an unbelievably short period of time several contractors were selected for multimillion-dollar R&D contracts. Contracting policies and procedures deemed so important under Glennan took on even more significance as a result of NASA's multibillion-dollar budgets.

Even though out-of-house efforts expanded faster, in-house expansion was substantial. All NASA field centers grew by at least 50 percent and many of them doubled, tripled, or more. Several centers were changed substantially. One center, the Space Task Group housed at the Langley Research Center in Virginia, was moved to Houston and greatly expanded. Another unit at Cape Canaveral was made independent and greatly expanded. In addition, the already large Marshall Center was expanded by establishing facilities near New Orleans (Michoud Operations) and southwestern Mississippi (the Mississippi Test Facility). During the 33-month Webb period under discussion, NASA obligated

over \$1 billion for the construction of facilities, six times as great as during NASA's first 28 months. Many of the facilities were to be used by NASA contractors and thus located in diverse places.

Managing the accelerated program was NASA's fundamental administrative problem. It is still too early to evaluate NASA's success in this. NASA faced one severe problem that is basic to good management; namely, securing good managers. The turnover in two crucial areas (the Manned Space Flight Office in Headquarters and the Manned Spacecraft Center in Houston) was substantial. The type of managers needed (someone who can integrate in-house and out-of-house efforts and also cooperate with other segments of the organization) was not easy to come by. Webb was fond of saying that NASA's most significant achievements were in pulling together the team of individuals to do the job.<sup>51</sup>

NASA did not achieve timely solutions to all of its problems in the areas of administrative relationships and administrative procedures. As stated before, the November 1963 reorganization could be viewed in part as the abandonment of a 2-year centralization experiment that did not work out as planned. The slowing down in NASA's rate of expansion may give NASA an opportunity to bring a lot of freewheeling activity under control. The decentralization accompanying the November 1963 reorganization may permit more efficient handling of detail without loss of fundamental central control.

*Some Stability and Continuity Had To Be Maintained.* NASA, growing as it initially did on a piecemeal basis, always had a past to contend with. Preserving what was good from the past naturally was desired. During the Glennan era, NASA attempted to retain some of NACA's good qualities by keeping research activity and development activity separated from one another, even to the point where particular centers were earmarked to concentrate on one or the other. The old NACA labs were kept largely intact. After the manned lunar landing decision, the press of developmental work forced the labs to step up their work in development. The labs were allowed to grow in size. Under Glennan the total personnel in NACA's four principal field centers (Langley, Ames, Lewis, Flight) stayed constant at about 7,800.<sup>52</sup> In 33 months under Webb, the figure moved up to 11,800, an increase of 50 percent. Thus even the most stable portion of NASA had to change considerably. The story of the transition of the old NACA labs to NASA research centers, devoting most of their efforts to space work, has yet to be told.

Much continuity was afforded by NASA's ability to hang on to its employees, even though temptations to go with private industry were substantial. Continuity in leadership was substantial, except for some areas in the dynamic and fast-changing manned space flight program.

An expanding and interesting program, opportunities for promotion, relatively high salaries (for public officials, that is), and other similar factors, all helped foster a high level of morale among NASA employees. Whether NASA

<sup>51</sup> For example, see Webb statement quoted in *Space Business Daily*, Jan. 3, 1964, p. 10.

<sup>52</sup> Actual figures went from 7,786 to 7,796. In the interim, however, about 700 personnel had been transferred en masse to other centers (STG and Wallops).

has created a long-range environment for employee creativity has yet to be determined.

### C. NASA in Transition

Late 1963 has been selected as the terminal point for this study. Although any breaking point in the story of an ongoing organization is somewhat arbitrary, some breaking points are better than others. By late 1963, NASA had passed its 5-year milestone. The program with which the American public was most familiar, Project Mercury, had been successfully completed. NASA's period of rapid growth had turned the corner. Congressional oversight of NASA was tightening up. NASA reorganized itself by combining the best of its two previous organizational arrangements.

An additional factor pointing to late 1963 as a good breaking point in NASA's administrative history was the untimely death of President Kennedy. His May 25, 1961, challenge to the Nation, reinforced by his speech at Rice University in September 1962, set the tone for NASA's endeavors. It was symbolically fitting to have the place from which the United States would launch its lunar spaceships named after him. On November 29, 1963, President Johnson signed an Executive Order renaming U.S. facilities at Cape Canaveral the John F. Kennedy Space Center. On December 20, 1963, Administrator Webb redesignated NASA's Launch Operations Center as the John F. Kennedy Space Center, NASA.

It is too early to ascertain the precise effects on NASA and the space program of Lyndon Johnson's assumption of the Presidency. On the basis of past events, it seems safe to assume that White House support will stay firm. Johnson has been close to the space program for many years. In 1957, while Senator and Majority Leader, he headed the first congressional investigation of the U.S. space program following Sputnik, and became the Nation's most outspoken advocate of an accelerated program. In 1958 he chaired the ad hoc Special Committee on Space and Astronautics which helped write the Space Act. He also became chairman of the standing Senate Committee on Aeronautical and Space Sciences. He led a successful Senate floor action to get an appropriation for NASA that was larger than NASA's request. In the 1960 campaign he was the chief Democratic spokesman on space matters. President Kennedy had the Space Act amended so that Vice President Johnson rather than himself would head the National Aeronautics and Space Council. As Space Council Chairman, he helped lay the groundwork for the manned lunar landing decision in 1961. He had a hand in James Webb's appointment as NASA Administrator and Hugh Dryden's retention as Deputy Administrator.

Even as President Kennedy symbolized the action of getting the Nation moving rapidly forward in space and the national aspirations associated with it, so might President Johnson symbolize the era which NASA is now entering—that of hardheaded realism and sure-footed operations.

## **APPENDIXES**

215-892 O-66-21

**APPENDIX A**

**THE NATIONAL AERONAUTICS AND SPACE ACT, AS  
AMENDED**

The copy of the National Aeronautics and Space Act which follows was prepared by the staff of the Senate Committee on Aeronautical and Space Sciences and includes amendments through the end of the 87th Congress, October 13, 1962. The same text has been incorporated into the NASA Management Manual (General Management Instruction 1-2-1A, March 17, 1964). Minor amendments have been indicated by brackets (deleted language) and italics (new language). Section 201 was extensively changed in 1961. The original text of Section 201 has been appended together with related legislation affecting the Space Act.



[COMMITTEE PRINT]

**NATIONAL AERONAUTICS AND SPACE  
ACT, AS AMENDED**

**AN ACT**

To provide for research into problems of flight within and outside the earth's atmosphere, and for other purposes

*Be it enacted by the Senate and House of Representatives of the United States of America in Congress assembled,*

**TITLE I—SHORT TITLE, DECLARATION OF  
POLICY, AND DEFINITIONS**

National  
Aeronautics  
and Space  
Act of 1958.

**SHORT TITLE**

Sec. 101. This Act may be cited as the "National Aeronautics and Space Act of 1958".

**DECLARATION OF POLICY AND PURPOSE**

Sec. 102. (a) The Congress hereby declares that it is the policy of the United States that activities in space should be devoted to peaceful purposes for the benefit of all mankind. 42 U.S.C. 2451.

(b) The Congress declares that the general welfare and security of the United States require that adequate provision be made for aeronautical and space activities. The Congress further declares that such activities shall be the responsibility of, and shall be directed by, a civilian agency exercising control over aeronautical and space activities sponsored by the United States, except that activities peculiar to or primarily associated with the development of weapons systems, military operations, or the defense of the United States (including the research and development necessary to make effective provision for the defense of the United States) shall be the responsibility of, and shall be directed by, the Department of Defense; and that determination as to which such agency has responsibility for and direction of any such activity shall be made by the President in conformity with section 201(e).

72 Stat. 426.

72 Stat. 427.

(c) The aeronautical and space activities of the United States shall be conducted so as to contribute materially to one or more of the following objectives:

(1) The expansion of human knowledge of phenomena in the atmosphere and space;

(2) The improvement of the usefulness, performance, speed, safety, and efficiency of aeronautical and space vehicles;

(3) The development and operation of vehicles capable of carrying instruments, equipment, supplies, and living organisms through space;

(4) The establishment of long-range studies of the potential benefits to be gained from, the opportunities for, and the problems involved in the utilization of aeronautical and space activities for peaceful and scientific purposes;

(5) The preservation of the role of the United States as a leader in aeronautical and space science and technology and in the application thereof to the conduct of peaceful activities within and outside the atmosphere;

(6) The making available to agencies directly concerned with national defense of discoveries that have military value or significance, and the furnishing by such agencies, to the civilian agency established to direct and control nonmilitary aeronautical and space activities, of information as to discoveries which have value or significance to that agency;

(7) Cooperation by the United States with other nations and groups of nations in work done pursuant to this Act and in the peaceful application of the results thereof; and

(8) The most effective utilization of the scientific and engineering resources of the United States, with close cooperation among all interested agencies of the United States in order to avoid unnecessary duplication of effort, facilities, and equipment.

(d) It is the purpose of this Act to carry out and effectuate the policies declared in subsections (a), (b), and (c).

#### DEFINITIONS

SEC. 103. As used in this Act—

(1) the term "aeronautical and space activities" means (A) research into, and the solution of, problems of flight within and outside the earth's atmosphere, (B) the development, construction, testing, and operation for research purposes of aeronautical and space vehicles, and (C) such other activities as may be required for the exploration of space; and

(2) the term "aeronautical and space vehicles" means aircraft, missiles, satellites, and other space vehicles, manned and unmanned, together with related equipment, devices, components, and parts.

## TITLE II—COORDINATION OF AERONAUTICAL AND SPACE ACTIVITIES

### NATIONAL AERONAUTICS AND SPACE COUNCIL

SEC. 201.<sup>1</sup> (a) There is hereby established, in the Executive Office of the President, the National Aeronautics and Space Council (hereinafter called the "Council") which shall be composed of—

National Aeronautics and Space Council, membership, 72 Stat. 427, 42 U.S.C. 2471.

- (1) the Vice President, who shall be Chairman of the Council;
- (2) the Secretary of State;
- (3) the Secretary of Defense;
- (4) the Administrator of the National Aeronautics and Space Administration; and
- (5) the Chairman of the Atomic Energy Commission.

(b) The President shall from time to time designate one of the members of the Council to preside over meetings of the Council during the absence, disability, or unavailability of the Chairman.

(c) Each member of the Council may designate another officer of his department or agency to serve on the Council as his alternate in his unavoidable absence.

75 Stat. 47.  
75 Stat. 46.

(d) Each alternate member designated under subsection (c) of this section shall be designated to serve as such by and with the advice and consent of the Senate unless at the time of his designation he holds an office in the Federal Government to which he was appointed by and with the advice and consent of the Senate.

(e) It shall be the function of the Council to advise and assist the President, as he may request, with respect to the performance of functions in the aeronautics and space field, including the following functions:

Functions.

- (1) survey all significant aeronautical and space activities, including the policies, plans, programs, and accomplishments of all departments and agencies of the United States engaged in such activities;
- (2) develop a comprehensive program of aero-

<sup>1</sup> Sec. 201 of the National Aeronautics and Space Act of 1958 (72 Stat. 427; 42 U.S.C. 2471) was amended April 25, 1961, by Public Law 87-26, 75 Stat. 46, to place the National Aeronautics and Space Council within the Executive Office of the President; to remove the President from the Council and from the chairmanship thereof and replace him with the Vice President; to provide that the Council shall be composed of the Vice President, the Secretary of State, the Secretary of Defense, the Administrator of the National Aeronautics and Space Administration, and the Chairman of the Atomic Energy Commission; to remove from the Council the additional Government member of the Council appointed by the President and the three civilian scientific members also appointed by the President under the previous law; to authorize the President to designate other Council members to act as Chairman when the Vice President is absent or otherwise unavailable; to enlarge the role of the Council by removing the language which makes it the specific duty of the President to formulate the national space program and to add language requiring the Council "assist" the President in the "performance of functions in the aeronautics and space field"; to broaden the duty of the Council to help provide for cooperation between the National Aeronautics and Space Administration and the Department of Defense to include cooperation "among all departments and agencies of the United States engaged in aeronautical and space activities"; to repeal the provision authorizing per diem compensation to civilian members of the Council. See part II of appendix for original language of Sec. 201.

nautical and space activities to be conducted by departments and agencies of the United States;

(3) designate and fix responsibility for the direction of major aeronautical and space activities;

(4) provide for effective cooperation among all departments and agencies of the United States engaged in aeronautical and space activities, and specify, in any case in which primary responsibility for any category of aeronautical and space activities has been assigned to any department or agency, which of those activities may be carried on concurrently by other departments or agencies; and

(5) resolve differences arising among departments and agencies of the United States with respect to aeronautical and space activities under this Act, including differences as to whether a particular project is an aeronautical and space activity.

Employees  
compensation.

(f) The Council may employ a staff to be headed by a civilian executive secretary who shall be appointed by the President by and with the advice and consent of the Senate and shall receive compensation at the rate of \$20,000 a year. The executive secretary, subject to the direction of the Council, is authorized to appoint and fix the compensation of such personnel, including not more than ~~three~~ <sup>seven</sup><sup>2</sup> persons who may be appointed without regard to the civil service laws or the Classification Act of 1949 and compensated at the rate of not more than \$19,000 a year, as may be necessary to perform such duties as may be prescribed by the Council in connection with the performance of its functions. Each appointment under this subsection shall be subject to the same security requirements as those established for personnel of the National Aeronautics and Space Administration appointed under section 203(b)(2) of this Act. *Other provisions of law or regulations relating to Government employment (except those relating to pay and retirement) shall apply to council employees reporting directly to the chairman to the extent that such provisions are applicable to employees in the office of the Vice President.*<sup>3</sup>

63 Stat. 954.  
5 U.S.C. 1071.

Security  
check.  
72 Stat. 428.

[(g) Members of the Council appointed from private life under subsection (a)(7) may be compensated at a rate not to exceed \$100 per diem, and may be paid travel expenses and per diem in lieu of subsistence in accordance with the provisions of section 5 of the Administrative Expenses Act of 1946 (5 U.S.C. 73b-2) relating to persons serving without compensation.]

<sup>2</sup> Sec. 201(f) of the National Aeronautics and Space Act of 1958 (72 Stat. 428; 42 U.S.C. 2471(f)), was amended October 4, 1961, by Public Law 87-867 authorizing the Executive Secretary of the National Aeronautics and Space Council to employ not to exceed seven persons at rates of annual compensation of not to exceed \$19,000, instead of three as formerly authorized. (See appendix A.)

<sup>3</sup> See appendix A, Public Law 87-584, sec. 7. (75 Stat. 385.)

NATIONAL AERONAUTICS AND SPACE ADMINISTRATION

SEC. 202. (a) There is hereby established the National Aeronautics and Space Administration (hereinafter called the "Administration"). The Administration shall be headed by an Administrator, who shall be appointed from civilian life by the President by and with the advice and consent of the Senate, and shall receive compensation at the rate of \$22,500 per annum. Under the supervision and direction of the President, the Administrator shall be responsible for the exercise of all powers and the discharge of all duties of the Administration, and shall have authority and control over all personnel and activities thereof.

Administrator.  
72 Stat. 427.  
42 U.S.C. 2472.

(b) There shall be in the Administration a Deputy Administrator, who shall be appointed from civilian life by the President by and with the advice and consent of the Senate, shall receive compensation at the rate of \$21,500 per annum, and shall perform such duties and exercise such powers as the Administrator may prescribe. The Deputy Administrator shall act for, and exercise the powers of, the Administrator during his absence or disability.

Deputy  
Administrator.

(c) The Administrator and the Deputy Administrator shall not engage in any other business, vocation, or employment while serving as such.

Restriction.

FUNCTIONS OF THE ADMINISTRATION

SEC. 203. (a) The Administration, in order to carry out the purpose of this Act, shall—

- (1) plan, direct, and conduct aeronautical and space activities;
- (2) arrange for participation by the scientific community in planning scientific measurements and observations to be made through use of aeronautical and space vehicles, and conduct or arrange for the conduct of such measurements and observations; and
- (3) provide for the widest practicable and appropriate dissemination of information concerning its activities and the results thereof.

42 U.S.C. 2473.

(b) In the performance of its functions the Administration is authorized—

- (1) to make, promulgate, issue, rescind, and amend rules and regulations governing the manner of its operations and the exercise of the powers vested in it by law;
- (2) to appoint and fix the compensation of such officers and employees as may be necessary to carry out such functions. Such officers and employees shall be appointed in accordance with the civil-service laws and their compensation fixed in accordance with the Classification Act of 1949, except that (A) to the extent the Administrator deems such action necessary to the discharge of his responsibilities, he

Rules and  
regulations.

Employees.

68 Stat. 954.  
5 U.S.C. 1071

may appoint and fix the compensation (up to a limit of \$19,000 a year, or up to a limit of \$21,000 a year for a maximum of [thirteen] *thirty*<sup>3</sup> positions) of not more than [two hundred and sixty] *four hundred and twenty-five* (of which not to exceed three hundred and fifty-five may be filled prior to March 1, 1962 and not to exceed three hundred and ninety may be filled prior to July 1, 1962)<sup>4</sup> of the scientific, engineering, and administrative personnel of the Administration without regard to such laws, and (B) to the extent the Administrator deems such action necessary to recruit specially qualified scientific and engineering talent, he may establish the entrance grade for scientific and engineering personnel without previous service in the Federal Government at a level up to two grades higher than the grade provided for such personnel under the General Schedule established by the Classification Act of 1949, and fix their compensation accordingly;

72 Stat. 429.  
72 Stat. 480.

Acquisition  
of property.

(3) to acquire (by purchase, lease, condemnation, or otherwise), construct, improve, repair, operate, and maintain laboratories, research and testing sites and facilities, aeronautical and space vehicles, quarters and related accommodations for employees and dependents of employees of the Administration, and such other real and personal property (including patents), or any interest therein, as the Administration deems necessary within and outside the continental United States; *to acquire by lease or otherwise, through the Administrator of General Services, buildings or parts of buildings in the District of Columbia for the use of the Administration for a period not to exceed ten years without regard to the Act of March 3, 1877 (40 U.S.C. 34)*; <sup>5</sup> to lease to others such real and personal property; to sell and otherwise dispose of real and personal property (including patents and rights thereunder) in accord-

NASA.  
Lease of  
buildings.  
72 Stat. 480.  
42 U.S.C. 2478.  
19 Stat. 870.  
78 Stat. 21.

<sup>3</sup> See appendix A, Public Law 87-584, sec. 7. (76 Stat. 385.)

<sup>4</sup> As originally enacted sec. 203(b)(2) of the National Aeronautics and Space Act of 1958 (72 Stat. 429; 42 U.S.C. 2478(b)(2)) authorized the Administrator of the National Aeronautics and Space Administration to "appoint and fix the compensation (up to a limit of \$19,000 a year, or up to a limit of \$21,000 a year for a maximum of ten positions) of not more than two hundred and sixty of the scientific, engineering, and administrative personnel \* \* \*". Sec. 5 of the Act of June 1, 1960, Public Law 86-481, 74 Stat. 151 amended the foregoing by striking out "ten" and inserting in lieu thereof "thirteen" and striking out "two hundred and sixty" and inserting in lieu thereof "two hundred and ninety." Thereafter, sec. 206(a) of the act of October 4, 1961, Public Law 87-367, 75 Stat. 791 amended the foregoing again by striking out "thirteen," and inserting in lieu thereof "thirty", and by striking out "two hundred and ninety" and inserting in lieu thereof "four hundred and twenty-five (of which not to exceed three hundred and fifty-five may be filled prior to March 1, 1962 and not to exceed three hundred and ninety may be filled prior to July 1, 1962)". Sec. 206(b) also requires the Administrator of the National Aeronautics and Space Administration to submit to the Congress at the close of each fiscal year pertinent information concerning the individuals obtained to fill these positions. (See appendix A.)

<sup>5</sup> Sec. 203(b)(3) of the National Aeronautics and Space Act of 1958 (72 Stat. 429; 42 U.S.C. 2478) was amended May 18, 1959 by Public Law 86-20, 78 Stat. 21, to authorize the National Aeronautics and Space Administration to lease office space in the District of Columbia through the Administrator of General Services for a period not to exceed ten years.

ance with the provisions of the Federal Property and Administrative Services Act of 1949, as amended (40 U.S.C. 471 et seq.); and to provide by contract or otherwise for cafeterias and other necessary facilities for the welfare of employees of the Administration at its installations and purchase and maintain equipment therefor;

68 Stat. 377.

(4) to accept unconditional gifts or donations of services, money, or property, real, personal, or mixed, tangible or intangible;

Gifts.

(5) without regard to section 3648 of the Revised Statutes, as amended (31 U.S.C. 529), to enter into and perform such contracts, leases, cooperative agreements, or other transactions as may be necessary in the conduct of its work and on such terms as it may deem appropriate, with any agency or instrumentality of the United States, or with any State, Territory, or possession, or with any political subdivision thereof, or with any person, firm, association, corporation, or educational institution. To the maximum extent practicable and consistent with the accomplishment of the purpose of this Act, such contracts, leases, agreements, and other transactions shall be allocated by the Administrator in a manner which will enable small-business concerns to participate equitably and proportionately in the conduct of the work of the Administration;

Contracts, etc.  
60 Stat. 809.

(6) to use, with their consent, the services, equipment, personnel, and facilities of Federal and other agencies with or without reimbursement, and on a similar basis to cooperate with other public and private agencies and instrumentalities in the use of services, equipment, and facilities. Each department and agency of the Federal Government shall cooperate fully with the Administration in making its services, equipment, personnel, and facilities available to the Administration, and any such department or agency is authorized, notwithstanding any other provision of law, to transfer to or to receive from the Administration, without reimbursement, aeronautical and space vehicles, and supplies and equipment other than administrative supplies or equipment;

Agency cooperation.

(7) to appoint such advisory committees as may be appropriate for purposes of consultation and advice to the Administration in the performance of its functions;

Advisory committees.

(8) to establish within the Administration such offices and procedures as may be appropriate to provide for the greatest possible coordination of its activities under this Act with related scientific and other activities being carried on by other public and private agencies and organizations;

Coordination.  
72 Stat. 490.

72 Stat. 431.  
60 Stat. 810.

Employment  
of aliens.

Retired  
officers.

68 Stat. 18.  
Agreements.

Claims.

Report to  
Congress.

(9) to obtain services as authorized by section 15 of the Act of August 2, 1946 (5 U.S.C. 55a), at rates not to exceed \$100 per diem for individuals;

(10) when determined by the Administrator to be necessary, and subject to such security investigations as he may determine to be appropriate, to employ aliens without regard to statutory provisions prohibiting payment of compensation to aliens;

(11) to employ retired commissioned officers of the armed forces of the United States and compensate them at the rate established for the positions occupied by them within the Administration, subject only to the limitations in pay set forth in section 212 of the Act of June 30, 1932, as amended (5 U.S.C. 59a);

(12) with the approval of the President, to enter into cooperative agreements under which members of the Army, Navy, Air Force, and Marine Corps may be detailed by the appropriate Secretary for services in the performance of functions under this Act to the same extent as that to which they might be lawfully assigned in the Department of Defense; **[and]**

(13) (A) to consider, ascertain, adjust, determine, settle, and pay, on behalf of the United States, in full satisfaction thereof, any claim for \$5,000 or less against the United States for bodily injury, death, or damage to or loss of real or personal property resulting from the conduct of the Administration's functions as specified in subsection (a) of this section, where such claim is presented to the Administration in writing within two years after the accident or incident out of which the claim arises; and

(B) if the Administration considers that a claim in excess of \$5,000 is meritorious and would otherwise be covered by this paragraph, to report the facts and circumstances thereof to the Congress for its consideration **[.]**; and

(14) *to reimburse, to the extent determined by the Administrator or his designee to be fair and reasonable, the owners and tenants of land and interests in land acquired on or after November 1, 1961, by the United States for use by the Administration by purchase, condemnation, or otherwise for expenses and losses and damages incurred by such owners and tenants as a direct result of moving themselves, their families, and their possessions because of said acquisition. Such reimbursement shall be in addition to, but not in duplication of, any payments that may otherwise be authorized by law to be made to such*



*owners and tenants. The total of any such reimbursement to any owner or tenant shall in no event exceed 25 per centum of the fair value, as determined by the Administrator, of the parcel of land or interest in land to which the reimbursement is related. No payment under this paragraph shall be made unless application therefor, supported by an itemized statement of the expenses, losses, and damages incurred, is submitted to the Administrator within one year from (a) the date upon which the parcel of land or interest in land is to be vacated under agreement with the Government by the owner or tenant or pursuant to law, including but not limited to, an order of a court, or (b) the date upon which the parcel of land or interest in the land involved is vacated, whichever first occurs. The Administrator may perform any and all acts and make such rules and regulations as he deems necessary and proper for the purpose of carrying out this paragraph. All functions performed under this paragraph shall be exempt from the operation of the Act of June 11, 1946, as amended (5 U.S.C. 1001-1011)<sup>6</sup> except as to the requirements of section 3 of said Act. Funds available to the Administration for the acquisition of real property or interests therein shall also be available for carrying out this paragraph.<sup>7</sup>*

## CIVILIAN-MILITARY LIAISON COMMITTEE

SEC. 204. (a) There shall be a Civilian-Military Liaison Committee consisting of— 42 U.S.C. 2474

(1) a Chairman, who shall be the head thereof and who shall be appointed by the President, shall serve at the pleasure of the President, and shall receive compensation (in the manner provided in subsection (d)) at the rate of \$20,000 per annum;

(2) one or more representatives from the Department of Defense, and one or more representatives from each of the Departments of the Army, Navy, and Air Force, to be assigned by the Secretary of Defense to serve on the Committee without addition—

(3) representatives from the Administration, to be assigned by the Administrator to serve on the Committee without additional compensation, equal in number to the number of representatives assigned to serve on the Committee under paragraph (2).

<sup>6</sup> U.S.C. 1001-1011 is the Administrative Procedure Act.

<sup>7</sup> Sec. 6 of Public Law 87-584; 76 Stat. 382 (see appendix A) amends the Space Act to provide for the reimbursement of moving expenses incurred by owners and tenants of land acquired by NASA.

(b) The Administration and the Department of Defense, through the Liaison Committee, shall advise and consult with each other on all matters within their respective jurisdictions relating to aeronautical and space activities and shall keep each other fully and currently informed with respect to such activities.

(c) If the Secretary of Defense concludes that any request, action, proposed action, or failure to act on the part of the Administrator is adverse to the responsibilities of the Department of Defense, or the Administrator concludes that any request, action, proposed action, or failure to act on the part of the Department of Defense is adverse to the responsibilities of the Administration, and the Administrator and the Secretary of Defense are unable to reach an agreement with respect thereto, either the Administrator or the Secretary of Defense may refer the matter to the President for his decision (which shall be final) as provided in section 201(e).

72 Stat. 481.  
72 Stat. 482.

Chairman.

(d) Notwithstanding the provisions of any other law, any active or retired officer of the Army, Navy, or Air Force may serve as Chairman of the Liaison Committee without prejudice to his active or retired status as such officer. The compensation received by any such officer for his service as Chairman of the Liaison Committee shall be equal to the amount (if any) by which the compensation fixed by subsection (a) (1) for such Chairman exceeds his pay and allowances (including special and incentive pays) as an active officer, or his retired pay.

#### INTERNATIONAL COOPERATION

42 U.S.C. 2475. SEC. 205. The Administration, under the foreign policy guidance of the President, may engage in a program of international cooperation in work done pursuant to this Act, and in the peaceful application of the results thereof, pursuant to agreements made by the President with the advice and consent of the Senate.

#### REPORTS TO THE CONGRESS

SEC. 206. (a) The Administration shall submit to the President for transmittal to the Congress, semiannually and at such other times as it deems desirable, a report of its activities and accomplishments.

(b) The President shall transmit to the Congress in January of each year a report, which shall include (1) a comprehensive description of the programed activities and the accomplishments of all agencies of the United States in the field of aeronautics and space activities during the preceding calendar year, and (2) an evaluation of such activities and accomplishments in terms of the

attainment of, or the failure to attain, the objectives described in section 102(c) of this Act.

(c) Any report made under this section shall contain such recommendations for additional legislation as the Administrator or the President may consider necessary or desirable for the attainment of the objectives described in section 102(c) of this Act.

(d) No information which has been classified for reasons of national security shall be included in any report made under this section, unless such information has been declassified by, or pursuant to authorization given by, the President.

### TITLE III—MISCELLANEOUS

#### NATIONAL ADVISORY COMMITTEE FOR AERONAUTICS

SEC. 301. (a) The National Advisory Committee for Aeronautics, on the effective date of this section, shall cease to exist. On such date all functions, powers, duties, and obligations, and all real and personal property, personnel (other than members of the Committee), funds, and records of that organization, shall be transferred to the Administration.

Termination.  
Transfer of  
functions.

(b) Section 2302 of title 10 of the United States Code is amended by striking out "or the Executive Secretary of the National Advisory Committee for Aeronautics." and inserting in lieu thereof "or the Administrator of the National Aeronautics and Space Administration."; and section 2303 of such title 10 is amended by striking out "The National Advisory Committee for Aeronautics." and inserting in lieu thereof "The National Aeronautics and Space Administration."

Definitions.  
70A Stat. 127.

(c) The first section of the Act of August 26, 1950 (5 U.S.C. 22-1), is amended by striking out "the Director, National Advisory Committee for Aeronautics" and inserting in lieu thereof "the Administrator of the National Aeronautics and Space Administration", and by striking out "or National Advisory Committee for Aeronautics" and inserting in lieu thereof "or National Aeronautics and Space Administration".

64 Stat. 476.  
72 Stat. 482.  
72 Stat. 488.

(d) The Unitary Wind Tunnel Plan Act of 1949 (50 U.S.C. 511-515) is amended (1) by striking out "The National Advisory Committee for Aeronautics (hereinafter referred to as the 'Committee')" and inserting in lieu thereof "The Administrator of the National Aeronautics and Space Administration (hereinafter referred to as the 'Administrator')"; (2) by striking out "Committee" or "Committee's" wherever they appear and inserting in lieu thereof "Administrator" and "Administrators", respectively; and (3) by striking out "its" wherever it appears and inserting in lieu thereof "his".

68 Stat. 936.

Effective  
date.

Publication  
in F.R.

(e) This section shall take effect ninety days after the date of the enactment of this Act, or on any earlier date on which the Administrator shall determine, and announce by proclamation published in the Federal Register, that the Administration has been organized and is prepared to discharge the duties and exercise the powers conferred upon it by this Act.

#### TRANSFER OF RELATED FUNCTIONS

42 U.S.C. 2453.

SEC. 302. (a) Subject to the provisions of this section, the President, for a period of four years after the date of enactment of this Act, may transfer to the Administration any functions (including powers, duties, activities, facilities, and parts of functions) of any other department or agency of the United States, or of any officer or organizational entity thereof, which relate primarily to the functions, powers, and duties of the Administration as prescribed by section 203 of this Act. In connection with any such transfer, the President may, under this section or other applicable authority, provide for appropriate transfers of records, property, civilian personnel, and funds.

Reports to  
Congress.

(b) Whenever any such transfer is made before January 1, 1959, the President shall transmit to the Speaker of the House of Representatives and the President pro tempore of the Senate a full and complete report concerning the nature and effect of such transfer.

(c) After December 31, 1958, no transfer shall be made under this section until (1) a full and complete report concerning the nature and effect of such proposed transfer has been transmitted by the President to the Congress, and (2) the first period of sixty calendar days of regular session of the Congress following the date of receipt of such report by the Congress has expired without the adoption by the Congress of a concurrent resolution stating that the Congress does not favor such transfer.

#### ACCESS TO INFORMATION

42 U.S.C. 2454.

SEC. 303. Information obtained or developed by the Administrator in the performance of his functions under this Act shall be made available for public inspection, except (A) information authorized or required by Federal statute to be withheld, and (B) information classified to protect the national security: *Provided*, That nothing in this Act shall authorize the withholding of information by the Administrator from the duly authorized committees of the Congress.

## SECURITY

SEC. 304. (a) The Administrator shall establish such security requirements, restrictions, and safeguards as he deems necessary in the interest of the national security. The Administrator may arrange with the Civil Service Commission for the conduct of such security or other personnel investigations of the Administration's officers, employees, and consultants, and its contractors and subcontractors and their officers and employees, actual or prospective, as he deems appropriate; and if any such investigation develops any data reflecting that the individual who is the subject thereof is of questionable loyalty the matter shall be referred to the Federal Bureau of Investigation for the conduct of a full field investigation, the results of which shall be furnished to the Administrator.

Requirements.  
42 U.S.C. 2455.

72 Stat. 433.  
72 Stat. 434.

Referral to  
F.B.I.

(b) The Atomic Energy Commission may authorize any of its employees, or employees of any contractor, prospective contractor, licensee, or prospective licensee of the Atomic Energy Commission or any other person authorized to have access to Restricted Data by the Atomic Energy Commission under subsection 145b. of the Atomic Energy Act of 1954 (42 U.S.C. 2165(b)), to permit any member, officer, or employee of the Council, or the Administrator, or any officer, employee, member of an advisory committee, contractor, subcontractor, or officer or employee of a contractor or subcontractor of the Administration, to have access to Restricted Data relating to aeronautical and space activities which is required in the performance of his duties and so certified by the Council or the Administrator, as the case may be, but only if (1) the Council or Administrator or designee thereof has determined, in accordance with the established personnel security procedures and standards of the Council or Administration, that permitting such individual to have access to such Restricted Data will not endanger the common defense and security, and (2) the Council or Administrator or designee thereof finds that the established personnel and other security procedures and standards of the Council or Administration are adequate and in reasonable conformity to the standards established by the Atomic Energy Commission under section 145 of the Atomic Energy Act of 1954 (42 U.S.C. 2165). Any individual granted access to such Restricted Data pursuant to this subsection may exchange such Data with any individual who (A) is an officer or employee of the Department of Defense, or any department or agency thereof, or a member of the armed forces, or a contractor or subcontractor of any such department, agency, or armed force, or an officer or employee of any such contractor or subcontractor, and (B) has been authorized to have access to Restricted Data under the pro-

Access to  
AEC restrict-  
ed data.

68 Stat. 942.

68 Stat. 942.

visions of section 143 of the Atomic Energy Act of 1954 (42 U.S.C. 2163).

Espionage  
and  
Censorship.  
62 Stat. 786-  
788; 65 Stat.  
719.  
18 U.S.C.  
791-798.  
Violation.

(c) Chapter 37 of title 18 of the United States Code (entitled Espionage and Censorship) is amended by—

(1) adding at the end thereof the following new section:

“§ 799. Violation of regulations of National Aeronautics and Space Administration

“Whoever willfully shall violate, attempt to violate, or conspire to violate any regulation or order promulgated by the Administrator of the National Aeronautics and Space Administration for the protection or security of any laboratory, station, base or other facility, or part thereof, or any aircraft, missile, spacecraft, or similar vehicle, or part thereof, or other property or equipment in the custody of the Administration, or any real or personal property or equipment in the custody of any contractor under any contract with the Administration or any subcontractor of any such contractor, shall be fined not more than \$5,000, or imprisoned not more than one year, or both.”

Penalty.

(2) adding at the end of the sectional analysis thereof the following new item:

“§ 799. Violation of regulations of National Aeronautics and Space Administration.”

72 Stat. 434.

72 Stat. 435.  
Protection of  
U.S. officers  
and employees.  
62 Stat. 756.

(d) Section 1114 of title 18 of the United States Code is amended by inserting immediately before “while engaged in the performance of his official duties” the following: “or any officer or employee of the National Aeronautics and Space Administration directed to guard and protect property of the United States under the administration and control of the National Aeronautics and Space Administration.”

Permission to  
use firearms.  
42 U.S.C. 2456.

(e) The Administrator may direct such of the officers and employees of the Administration as he deems necessary in the public interest to carry firearms while in the conduct of their official duties. The Administrator may also authorize such of those employees of the contractors and subcontractors of the Administration engaged in the protection of property owned by the United States and located at facilities owned by or contracted to the United States as he deems necessary in the public interest, to carry firearms while in the conduct of their official duties.

#### PROPERTY RIGHTS IN INVENTIONS

42 U.S.C. 2457.

SEC. 305. (a) Whenever any invention is made in the performance of any work under any contract of the Administration, and the Administrator determines that—

(1) the person who made the invention was employed or assigned to perform research, develop-

ment, or exploration work and the invention is related to the work he was employed or assigned to perform, or that it was within the scope of his employment duties, whether or not it was made during working hours, or with a contribution by the Government of the use of Government facilities, equipment, materials, allocated funds, information proprietary to the Government, or services of Government employees during working hours; or

(2) the person who made the invention was not employed or assigned to perform research, development, or exploration work, but the invention is nevertheless related to the contract, or to the work or duties he was employed or assigned to perform, and was made during working hours, or with a contribution from the Government of the sort referred to in clause (1),

such invention shall be the exclusive property of the United States, and if such invention is patentable a patent therefor shall be issued to the United States upon application made by the Administrator, unless the Administrator waives all or any part of the rights of the United States to such invention in conformity with the provisions of subsection (f) of this section.

(b) Each contract entered into by the Administrator with any party for the performance of any work shall contain effective provisions under which such party shall furnish promptly to the Administrator a written report containing full and complete technical information concerning any invention, discovery, improvement, or innovation which may be made in the performance of any such work.

Contract provision.

(c) No patent may be issued to any applicant other than the Administrator for any invention which appears to the Commissioner of Patents to have significant utility in the conduct of aeronautical and space activities unless the applicant files with the Commissioner, with the application or within thirty days after request therefor by the Commissioner, a written statement executed under oath setting forth the full facts concerning the circumstances under which such invention was made and stating the relationship (if any) of such invention to the performance of any work under any contract of the Administration. Copies of each such statement and the application to which it relates shall be transmitted forthwith by the Commissioner to the Administrator.

Patent application.

(d) Upon any application as to which any such statement has been transmitted to the Administrator, the Commissioner may, if the invention is patentable, issue a patent to the applicant unless the Administrator, within ninety days after receipt of such application and statement, requests that such patent be issued to him on behalf

72 Stat. 435.

72 Stat. 436.

Board of  
Patent  
Interferences.

of the United States. If, within such time, the Administrator files such a request with the Commissioner, the Commissioner shall transmit notice thereof to the applicant, and shall issue such patent to the Administrator unless the applicant within thirty days after receipt of such notice requests a hearing before a Board of Patent Interferences on the question whether the Administrator is entitled under this section to receive such patent. The Board may hear and determine, in accordance with rules and procedures established for interference cases, the question so presented, and its determination shall be subject to appeal by the applicant or by the Administrator to the Court of Customs and Patent Appeals in accordance with procedures governing appeals from decisions of the Board of Patent Interferences in other proceedings.

(e) Whenever any patent has been issued to any applicant in conformity with subsection (d), and the Administrator thereafter has reason to believe that the statement filed by the applicant in connection therewith contained any false representation of any material fact, the Administrator within five years after the date of issuance of such patent may file with the Commissioner a request for the transfer to the Administrator of title to such patent on the records of the Commissioner. Notice of any such request shall be transmitted by the Commissioner to the owner of record of such patent, and title to such patent shall be so transferred to the Administrator unless within thirty days after receipt of such notice such owner of record requests a hearing before a Board of Patent Interferences on the question whether any such false representation was contained in such statement. Such question shall be heard and determined, and determination thereof shall be subject to review, in the manner prescribed by subsection (d) for questions arising thereunder. No request made by the Administrator under this subsection for the transfer of title to any patent, and no prosecution for the violation of any criminal statute, shall be barred by any failure of the Administrator to make a request under subsection (d) for the issuance of such patent to him, or by any notice previously given by the Administrator stating that he had no objection to the issuance of such patent to the applicant therefor.

Waiver.

(f) Under such regulations in conformity with this subsection as the Administrator shall prescribe, he may waive all or any part of the rights of the United States under this section with respect to any invention or class of inventions made or which may be made by any person or class of persons in the performance of any work required by any contract of the Administration if the Administrator determines that the interests of the United States will be served thereby. Any such waiver may be made upon such terms and under such conditions as the



Administrator shall determine to be required for the protection of the interests of the United States. Each such waiver made with respect to any invention shall be subject to the reservation by the Administrator of an irrevocable, nonexclusive, nontransferrable, royalty-free license for the practice of such invention throughout the world by or on behalf of the United States or any foreign government pursuant to any treaty or agreement with the United States. Each proposal for any waiver under this subsection shall be referred to an Inventions and Contributions Board which shall be established by the Administrator within the Administration. Such Board shall accord to each interested party an opportunity for hearing, and shall transmit to the Administrator its findings of fact with respect to such proposal and its recommendations for action to be taken with respect thereto.

Inventions and Contributions Board.

(g) The Administrator shall determine, and promulgate regulations specifying, the terms and conditions upon which licenses will be granted by the Administration for the practice by any person (other than an agency of the United States) of any invention for which the Administrator holds a patent on behalf of the United States.

License regulations.

72 Stat. 436.  
72 Stat. 437.

(h) The Administrator is authorized to take all suitable and necessary steps to protect any invention or discovery to which he has title, and to require that contractors or persons who retain title to inventions or discoveries under this section protect the inventions or discoveries to which the Administration has or may acquire a license of use.

Protection of title.

(i) The Administration shall be considered a defense agency of the United States for the purpose of chapter 17 of title 35 of the United States Code.

Defense agency.  
66 Stat. 805-808.

(j) As used in this section—

Definitions.

(1) the term "person" means any individual, partnership, corporation, association, institution, or other entity;

(2) the term "contract" means any actual or proposed contract, agreement, understanding, or other arrangement, and includes any assignment, substitution of parties, or subcontract executed or entered into thereunder; and

(3) the term "made", when used in relation to any invention, means the conception or first actual reduction to practice of such invention.

CONTRIBUTIONS AWARDS

Sec. 306. (a) Subject to the provisions of this section, the Administrator is authorized, upon his own initiative or upon application of any person, to make a monetary

49 U.S.C. 2458.

award, in such amount and upon such terms as he shall determine to be warranted, to any person (as defined by section 305) for any scientific or technical contribution to the Administration which is determined by the Administrator to have significant value in the conduct of aeronautical and space activities. Each application made for any such award shall be referred to the Inventions and Contributions Board established under section 305 of this Act. Such Board shall accord to each such applicant an opportunity for hearing upon such application, and shall transmit to the Administrator its recommendation as to the terms of the award, if any, to be made to such applicant for such contribution. In determining the terms and conditions of any award the Administrator shall take into account—

(1) the value of the contribution to the United States;

(2) the aggregate amount of any sums which have been expended by the applicant for the development of such contribution;

(3) the amount of any compensation (other than salary received for services rendered as an officer or employee of the Government) previously received by the applicant for or on account of the use of such contribution by the United States; and

(4) such other factors as the Administrator shall determine to be material.

(b) If more than one applicant under subsection (a) claims an interest in the same contribution, the Administrator shall ascertain and determine the respective interests of such applicants, and shall apportion any award to be made with respect to such contribution among such applicants in such proportions as he shall determine to be equitable. No award may be made under subsection (a) with respect to any contribution—

(1) unless the applicant surrenders, by such means as the Administrator shall determine to be effective, all claims which such applicant may have to receive any compensation (other than the award made under this section) for the use of such contribution or any element thereof at any time by or on behalf of the United States, or by or on behalf of any foreign government pursuant to any treaty or agreement with the United States, within the United States or at any other place;

(2) in any amount exceeding \$100,000, unless the Administrator has transmitted to the appropriate committees of the Congress a full and complete report concerning the amount and terms of, and the basis for, such proposed award, and thirty calendar days of regular session of the Congress have expired after receipt of such report by such committees.

APPROPRIATIONS <sup>8</sup>

Sec. 307. (a) There are hereby authorized to be appropriated such sums as may be necessary to carry out this Act, except that nothing in this Act shall authorize the appropriation of any amount for (1) the acquisition or condemnation of any real property, or (2) any other item of a capital nature (such as plant or facility acquisition, construction, or expansion) which exceeds \$250,000. Sums appropriated pursuant to this subsection for the construction of facilities, or for research and development activities, shall remain available until expended. 72 Stat. 433.

(b) Any funds appropriated for the construction of facilities may be used for emergency repairs of existing facilities when such existing facilities are made inoperative by major breakdown, accident, or other circumstances and such repairs are deemed by the Administrator to be of greater urgency than the construction of new facilities.

Approved July 29, 1958.

<sup>8</sup> See appendix A, Public Law 86-45.

## APPENDIXES

## APPENDIX A

## RELATED LEGISLATION AFFECTING THE SPACE ACT

(1) Section 4 of the Act of June 15, 1959, Public Law 86-45, 73 Stat. 75, 42 U.S.C. 2459 provides that—

notwithstanding the provisions of any other law, no appropriation may be made to the National Aeronautics and Space Administration unless previously authorized by legislation hereafter enacted by Congress.

(2) Sections 206 and 207 of the Act of October 4, 1961, Public Law 87-367, 75 Stat. 791, 42 U.S.C. 2471 provide the following:

SEC. 206. (a) Section 203(b)(2) of the National Aeronautics and Space Act of 1958 (72 Stat. 429; 42 U.S.C. 2473(b)(2)), authorizing the Administrator of the National Aeronautics and Space Administration to establish not more than two hundred and ninety scientific, engineering, and administrative positions in the National Aeronautics and Space Administration, is amended by striking out "thirteen", and inserting in lieu thereof "thirty", and by striking out "two hundred and ninety" and inserting in lieu thereof "four hundred and twenty-five (of which not to exceed three hundred and fifty-five may be filled prior to March 1, 1962, and not to exceed three hundred and ninety may be filled prior to July 1, 1962)".

74 Stat. 153.

(b)(1) The Administrator of the National Aeronautics and Space Administration shall submit to the Congress not later than forty-five days after the close of each fiscal year a report which sets forth, as of the close of such fiscal year—

Report to Congress.

(A) the number of positions established under section 203(b)(2) of the National Aeronautics and Space Act of 1958, as amended (42 U.S.C. 2473(b)(2));

Supra.

(B) the name, rate of compensation, and description of the qualifications of each incumbent of each position established under such section 203(b)(2), together with the position title and a statement of the duties and responsibilities performed by each such incumbent;

(C) the position or positions in or outside the Federal Government held by each such incumbent, and his rate or rates of compensation, during the five-year period immediately preceding the date of appointment of such incumbent to such position; and

(D) such other information as the Administrator may deem appropriate or which may be required by the Congress or a committee thereof.

Nothing contained in this subsection shall require the resubmission of any information required under subparagraphs (B) and (C) of this subsection which has been reported pursuant to this subsection and remains unchanged.

(2) In any instance in which the Administrator may find full public disclosure of any or all of the matter covered by paragraph (1) of this subsection to be detrimental to the national security, the Administrator is authorized—

National security matters. Omission of information.

(A) to omit in such report those matters with respect to which full public disclosure is found to be detrimental to the national security;

(B) to inform the Congress of such omission; and

(C) at the request of any congressional committee to which such report is referred, to present all information concerning such matters.

INCREASE IN NUMBER OF EMPLOYEES OF NATIONAL AERONAUTICS AND SPACE COUNCIL UNDER SECTION 201 (F) OF THE NATIONAL AERONAUTICS AND SPACE ACT OF 1958

SEC. 207. Section 201(f) of the National Aeronautics and Space Act of 1958 (72 Stat. 428; 42 U.S.C. 2471(f)), authorizing the executive secretary of the National Aeronautics and Space Council to employ not to exceed three persons at rates of annual compensation of not to exceed \$19,000, is amended by striking out "three" and inserting in lieu thereof "seven".

(3) Sections 6 and 7 of the Act of August 14, 1962, Public Law 87-584, 76 Stat. 382, provide the following:

42 U.S.C. 2473. SEC. 6. Section 203(b) of the National Aeronautics and Space Act of 1958, as amended (72 Stat. 429, 431), is amended by (i) striking out the word "and" where it appears after the semicolon at the end of section 203(b)(12); (ii) striking out the period at the end of section 203(b)(13) and inserting in lieu thereof a semicolon and the word "and"; and (iii) adding at the end thereof the following new paragraph:

"(14) to reimburse, to the extent determined by the Administrator or his designee to be fair and reasonable, the owners and tenants of land and interests in land acquired on or after November 1, 1961, by the United States for use by the Administration by purchase, condemnation, or otherwise for expenses and losses and damages incurred by such owners and tenants as a direct result of moving themselves, their families, and their possessions because of said acquisition. Such reimbursement shall be in addition to, but not in duplication of, any payments that may otherwise be authorized by law to be made to such owners and tenants. The total of any such reimbursement to any owner or tenant shall in no event exceed 25 per centum of the fair value, as determined by the Administrator, of the parcel of land or interest in land to which the reimbursement is related. No payment under this paragraph shall be made unless application therefor, supported by an itemized statement of the expenses, losses, and damages incurred, is submitted to the Administrator within one year from (a) the date upon which the parcel of land or interest in land is to be vacated under agreement with the Government by the owner or tenant or pursuant to law, including but not limited to, an order of a court, or (b) the date upon which the parcel of land or interest in the land involved is vacated, whichever first occurs. The Administrator may perform any and all acts and make such rules and regulations as he deems necessary and proper for the purpose of carrying out this paragraph. All functions performed under this paragraph shall be exempt from the operation of the Act of June 11, 1946, as amended (5 U.S.C. 1001-1011), except as to the requirements of section 3 of said Act. Funds available to the Administration for the acquisition of real property or interests therein shall also be available for carrying out this paragraph".

60 Stat. 237,  
238.

72 Stat. 427.  
42 U.S.C. 2471. SEC. 7. Section 201(f) of the National Aeronautics and Space Act of 1958 is amended by adding at the end thereof the following new sentence: "Other provisions of law or regulations relating to Government employment (except those relating to pay and retirement) shall apply to council employees reporting directly to the chairman to the extent that such provisions are applicable to employees in the office of the Vice President."

## APPENDIX B

ORIGINAL TEXT OF SECTION 201 OF THE NATIONAL  
AERONAUTICS AND SPACE ACT OF 1958

SEC. 201. (a) There is hereby established the National Aeronautics and Space Council (hereinafter called the "Council") which shall be composed of— **Establishment.**

(1) the President (who shall preside over meetings of the Council);

(2) the Secretary of State;

(3) the Secretary of Defense;

72 Stat. 427.

72 Stat. 428.

(4) the Administrator of the National Aeronautics and Space Administration;

(5) the Chairman of the Atomic Energy Commission;

(6) not more than one additional member appointed by the President from the departments and agencies of the Federal Government; and

(7) not more than three other members appointed by the President, solely on the basis of established records of distinguished achievement, from among individuals in private life who are eminent in science, engineering, technology, education, administration, or public affairs.

(b) Each member of the Council from a department or agency of the Federal Government may designate another officer of his department or agency to serve on the Council as his alternate in his unavoidable absence. **Alternate.**

(c) Each member of the Council appointed or designated under paragraphs (6) and (7) of subsection (a), and each alternate member designated under subsection (b), shall be appointed or designated to serve as such by and with the advice and consent of the Senate, unless at the time of such appointment or designation he holds an office in the Federal Government to which he was appointed by and with the advice and consent of the Senate.

(d) It shall be the function of the Council to advise the President with respect to the performance of the duties prescribed in subsection (e) of this section.

(e) In conformity with the provisions of section 102 of this Act, it shall be the duty of the President to— **Duties of President.**

(1) survey all significant aeronautical and space activities, including the policies, plans, programs, and accomplishments of all agencies of the United States engaged in such activities;

(2) develop a comprehensive program of aeronautical and space activities to be conducted by agencies of the United States;

(3) designate and fix responsibility for the direction of major aeronautical and space activities;

(4) provide for effective cooperation between the National Aeronautics and Space Administration and the Department of Defense in all such activities, and specify which of such activities may be carried on concurrently by both such agencies notwithstanding the assignment of primary responsibility therefor to one or the other of such agencies; and

(5) resolve differences arising among departments and agencies of the United States with respect to aeronautical and space activities under this Act, including differences as to whether a particular project is an aeronautical and space activity.

**Employees.** (f) The Council may employ a staff to be headed by a civilian  
**Compensation.** executive secretary who shall be appointed by the President by  
 and with the advice and consent of the Senate and shall receive  
 compensation at the rate of \$20,000 a year. The executive secre-  
 tary, subject to the direction of the Council, is authorized to  
 appoint and fix the compensation of such personnel, including  
 not more than three persons who may be appointed without re-  
 gard to the civil service laws or the Classification Act of 1949  
 and compensated at the rate of not more than \$19,000 a year,  
 as may be necessary to perform such duties as may be prescribed  
 by the Council in connection with the performance of its func-  
 tions. Each appointment under this subsection shall be subject  
 to the same security requirements as those established for per-  
 sonnel of the National Aeronautics and Space Administration  
 appointed under section 203(b) (2) of this Act.

**63 Stat. 954.**  
**5 U.S.C. 1071.**

**Security check.**

**Per diem.** (g) Members of the Council appointed from private life under  
 subsection (a) (7) may be compensated at a rate not to exceed  
 \$100 per diem, and may be paid travel expenses and per diem in  
 lieu of subsistence in accordance with the provisions of section 5  
 of the Administrative Expenses Act of 1946 (5 U.S.C. 73b-2)  
 relating to persons serving without compensation.

**72 Stat. 428.**  
**72 Stat. 429.**  
**69 Stat. 394.**

**APPENDIX B**  
**NASA ORGANIZATION CHARTS**

CONTENTS

<i>Date</i>	<i>Subject</i>	<i>Authorization</i>
1955, July 8	NACA Headquarters	Hugh L. Dryden
1958, Mar. 3	NACA	Hugh L. Dryden
1958, Mar. 3	NACA	Hugh L. Dryden
1958, May 20	Proposed NASA	(Abbott Committee)
1958, June 2	Proposed NASA	(Abbott Committee)
1958, July 18	Proposed NASA	(Abbott Committee)
1958, Aug. 11	Proposed NASA	(Abbott Committee)
1958, Aug. 21	Proposed NASA	(Glennan meeting)
1958, Oct. 24	Tentative NASA	(Internal use only)
1958, Nov. 14	Tentative NASA	
1958, Dec. 31	Proposed NASA	(McKinsey & Co.)
1959, Jan. 29	NASA	T. Keith Glennan
1959, Mar. 23	NASA	T. Keith Glennan
1959, May 1	NASA	T. Keith Glennan
1959, Sep. 15	NASA	T. Keith Glennan
1959, Dec. 29	NASA	T. Keith Glennan
1960, Feb. 7	NASA	T. Keith Glennan
1960, Apr. 4	NASA	T. Keith Glennan
1960, Aug. 15	NASA	T. Keith Glennan
1960, Oct. 12	Proposed NASA	(Kimpton Committee)
1961, Jan. 17	NASA	T. Keith Glennan
1961, June 1	NASA	James E. Webb
1961, Nov. 1	NASA	James E. Webb
1962, Mar. 1	NASA	James E. Webb
1962, Aug. 17	NASA	James E. Webb
1962, Nov. 23	NASA	Hugh L. Dryden
1963, Apr. 26	NASA Headquarters	James E. Webb
1963, Apr. 26	NASA	James E. Webb
1963, Nov. 1	NASA	James E. Webb



ORGANIZATION CHART  
 NATIONAL ADVISORY COMMITTEE FOR AERONAUTICS  
 NACA HEADQUARTERS, WASHINGTON, D. C.

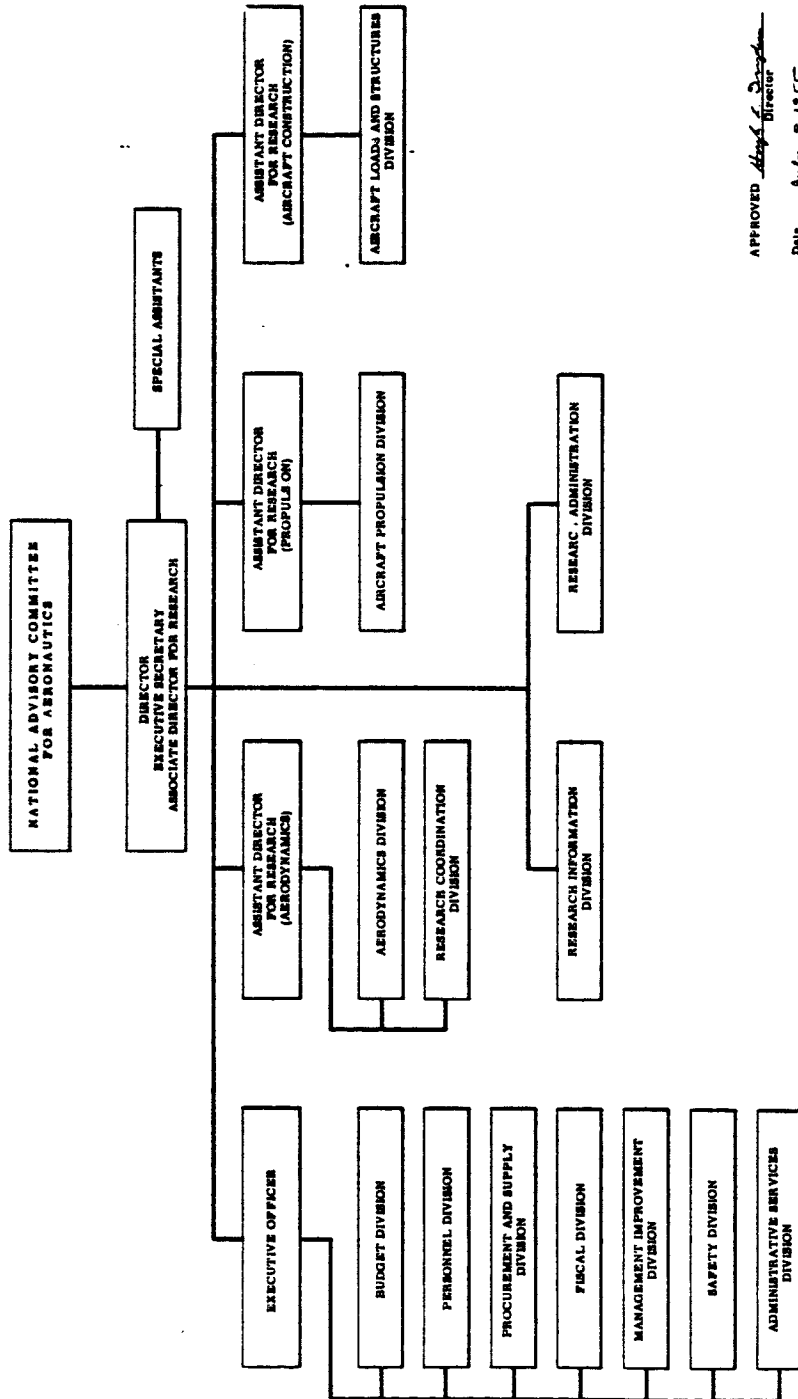

APPROVED *Alfred C. Degenhart*  
 Director  
 Date *July 8, 1955*



ORGANIZATION CHART  
NATIONAL ADVISORY COMMITTEE FOR AERONAUTICS

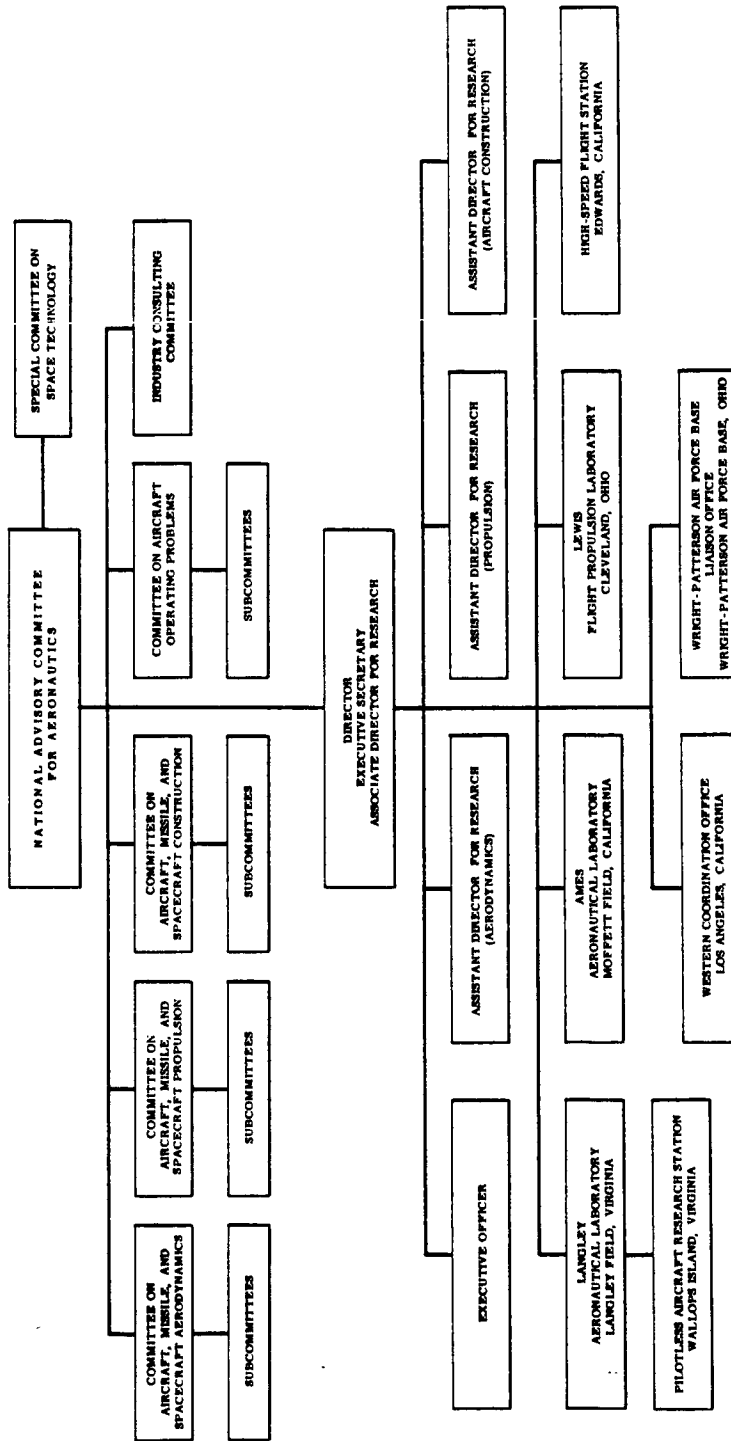

APPROVED: *Alvin K. Draper*  
Director  
Date: March 3, 1958  
NACA

ORGANIZATION CHART  
 NATIONAL ADVISORY COMMITTEE FOR AERONAUTICS  
 COMMITTEES AND SUBCOMMITTEES

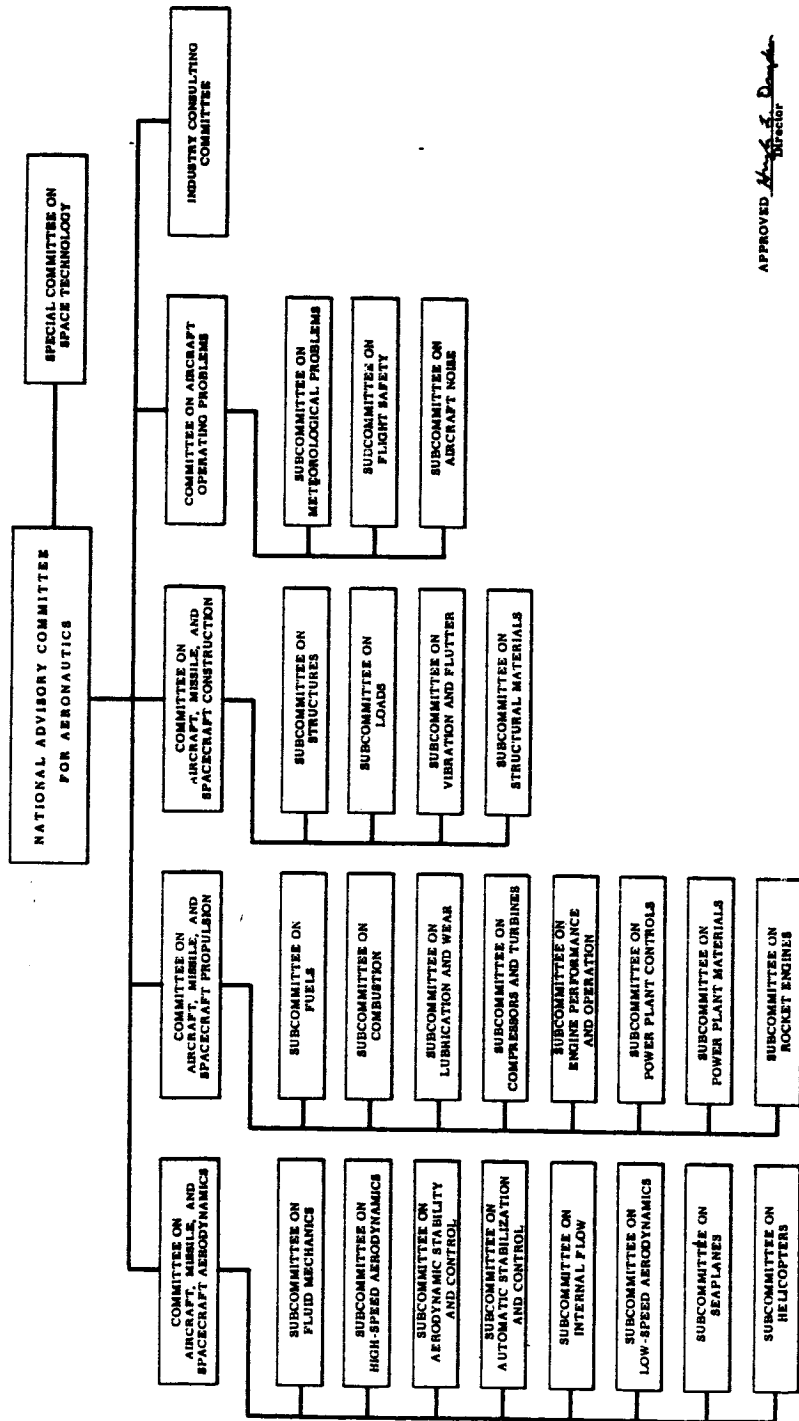

APPROVED *Alvin Karp*  
 Director

Date *March 9, 1978*





JUN 4, 1968

NATIONAL AERONAUTICS AND SPACE AGENCY  
HEADQUARTERS ORGANIZATION

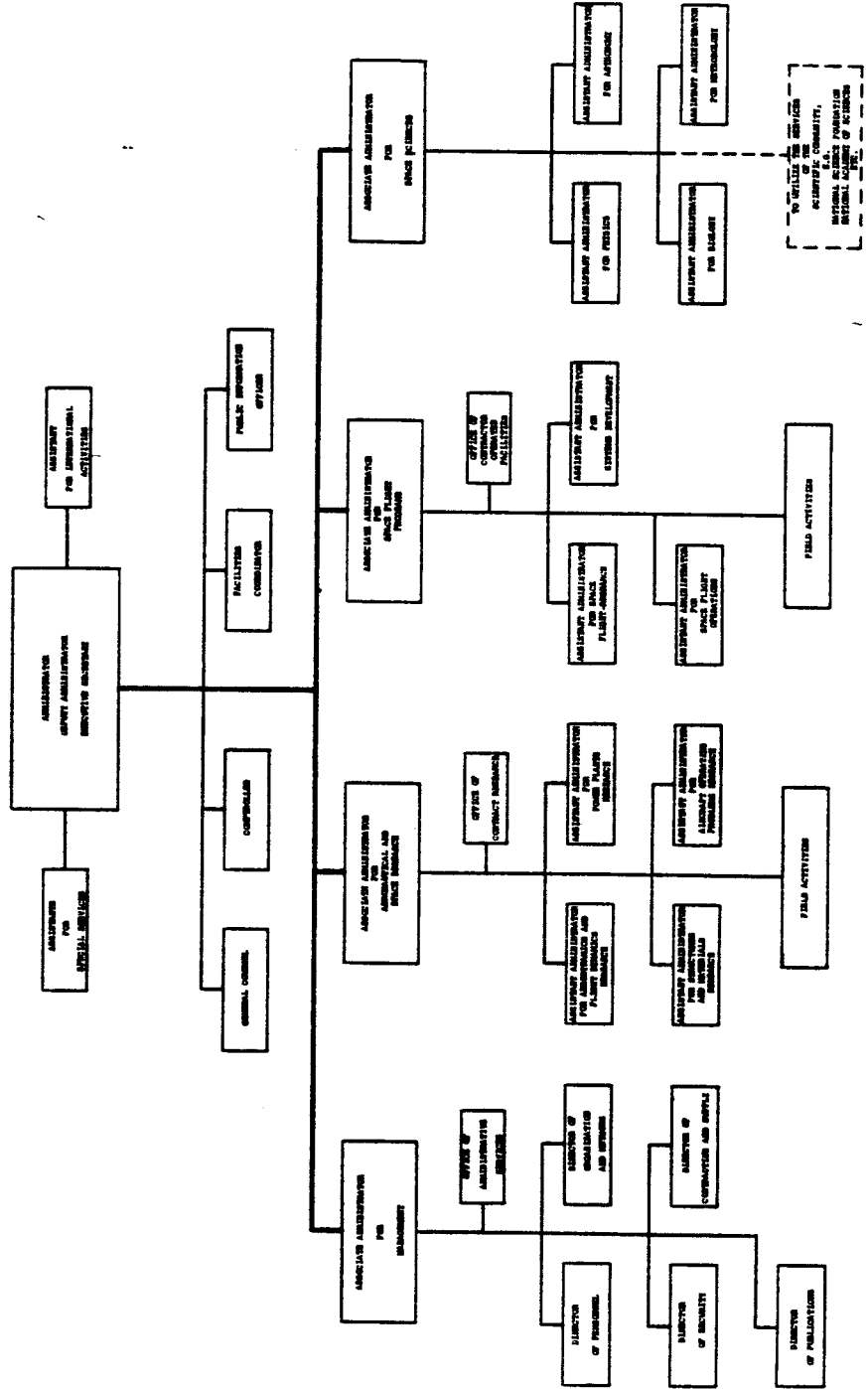



**PROPOSED ORGANIZATION OF THE NATIONAL AERONAUTICS AND SPACE ADMINISTRATION**

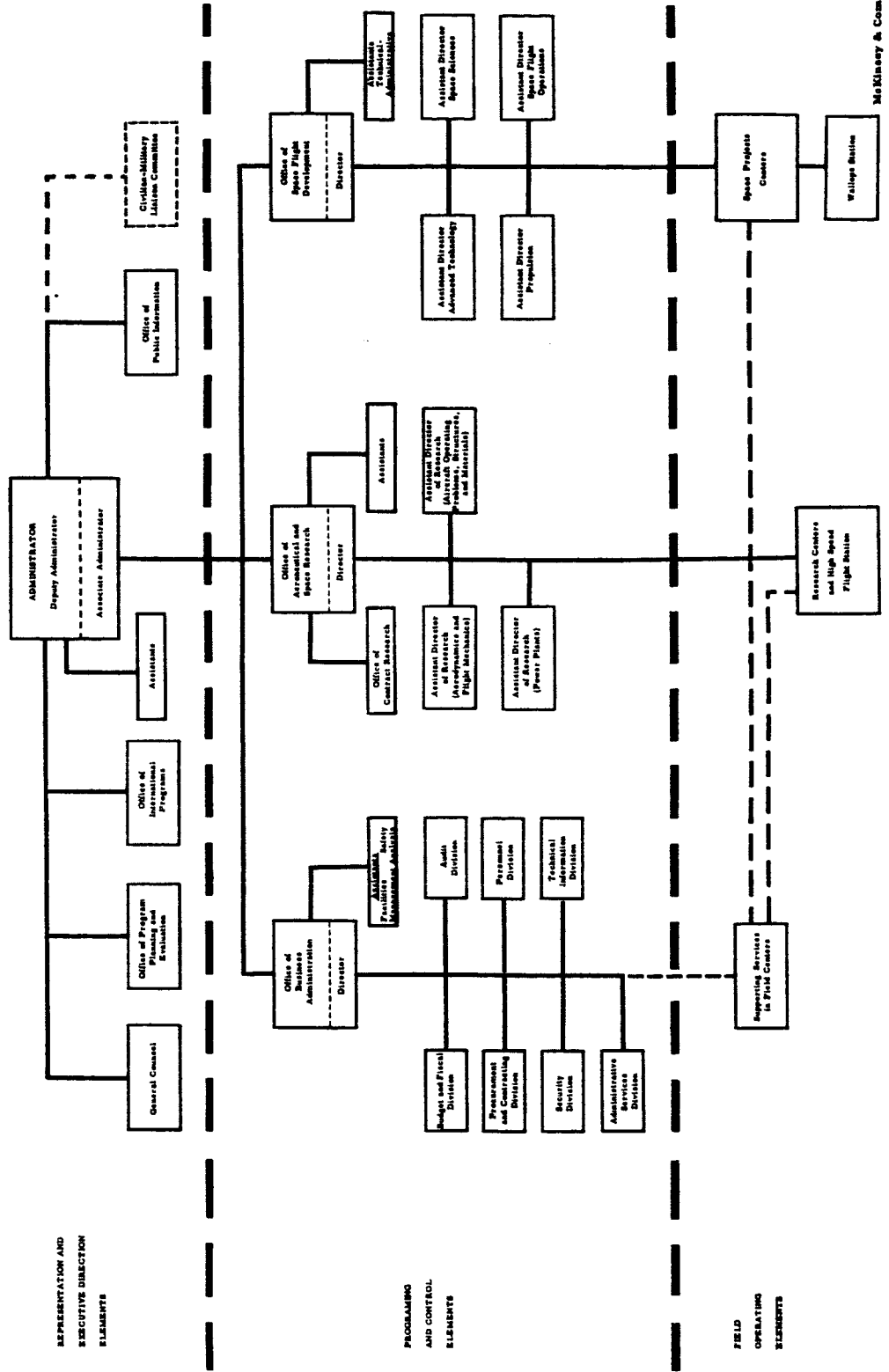

McKinsey & Company, Inc.







(COPY)

NATIONAL AERONAUTICS AND SPACE ADMINISTRATION, ORGANIZATION CHART (8-21-58)

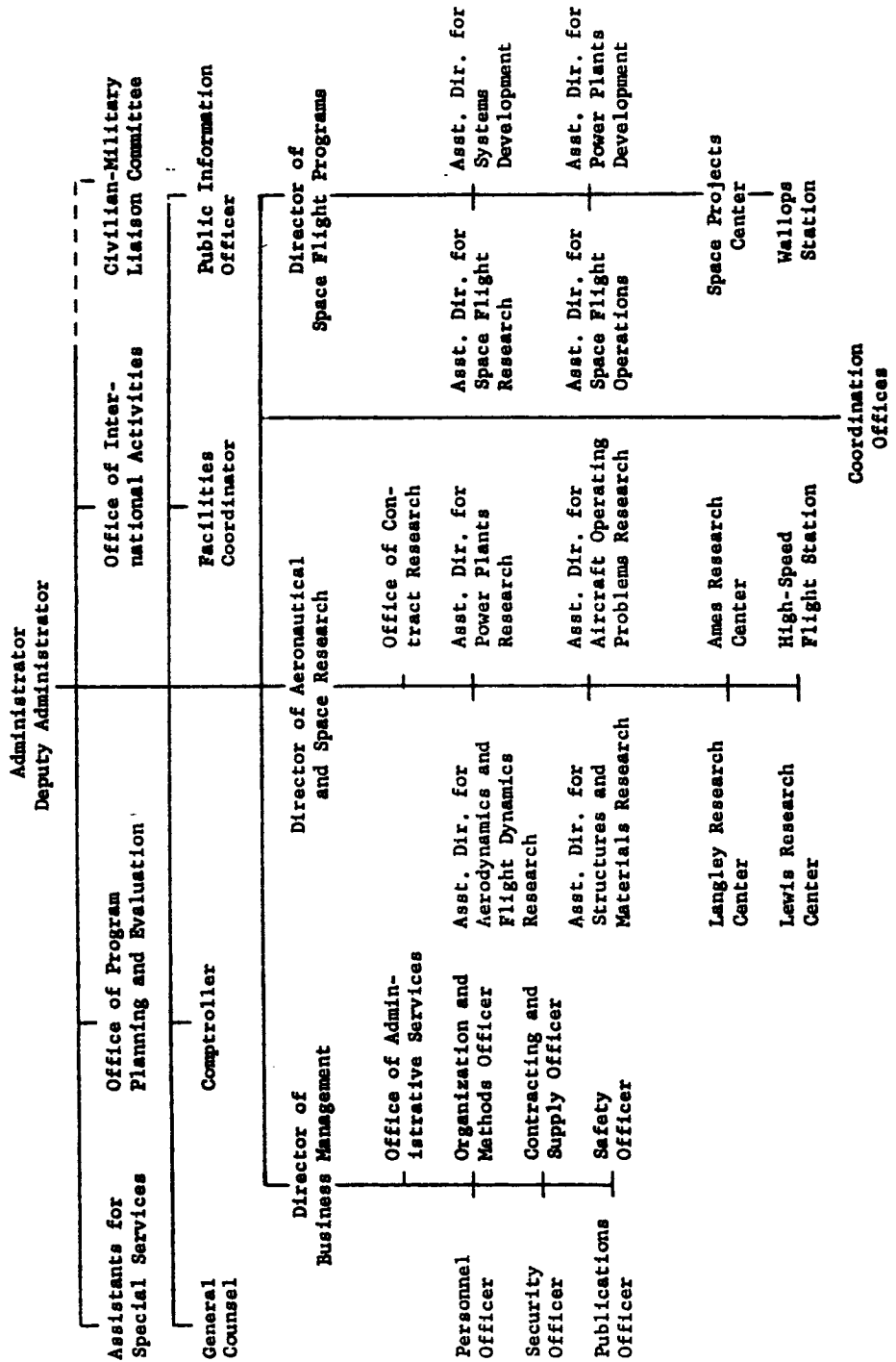





NATIONAL AERONAUTICS AND SPACE ADMINISTRATION

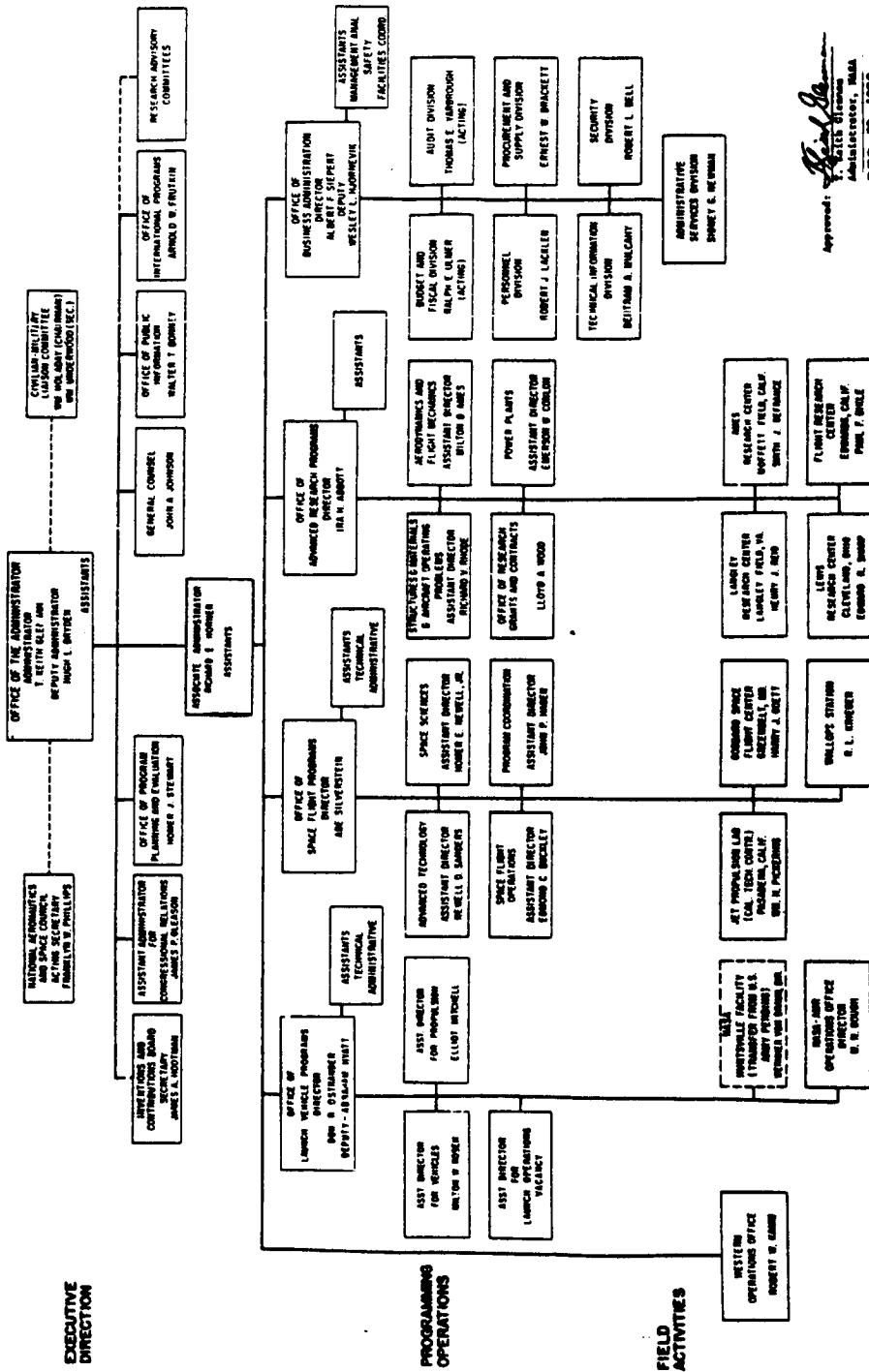

Approved: *Robert R. Taylor*  
 Director, NASA  
 December 29, 1963

NATIONAL AERONAUTICS AND SPACE ADMINISTRATION

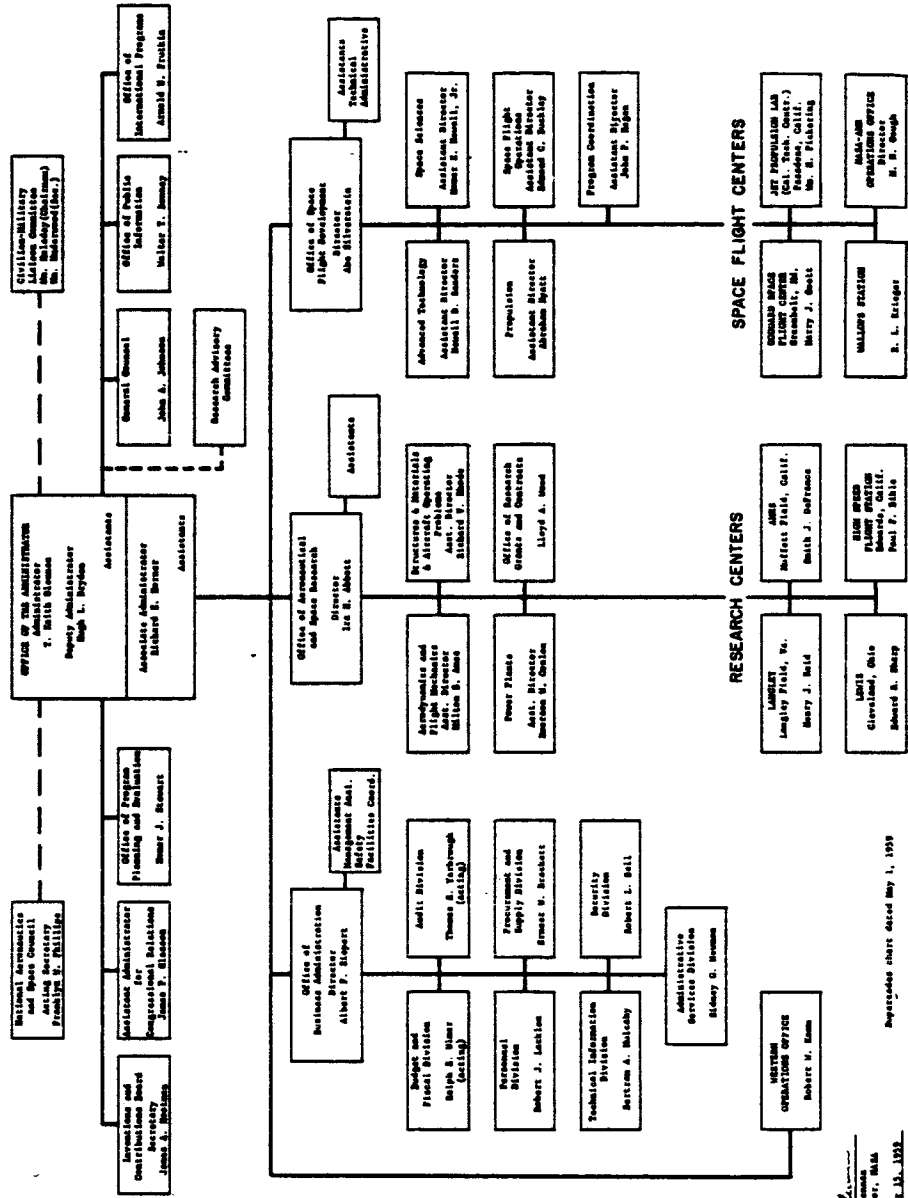

EXECUTIVE DIRECTION

PROGRAMMING OPERATIONS

FIELD ACTIVITIES

Approved: *[Signature]*  
T. Keith Glennan  
Administrator, NASA  
Date: September 15, 1959  
Replaces chart dated May 1, 1959



# NATIONAL AERONAUTICS AND SPACE ADMINISTRATION

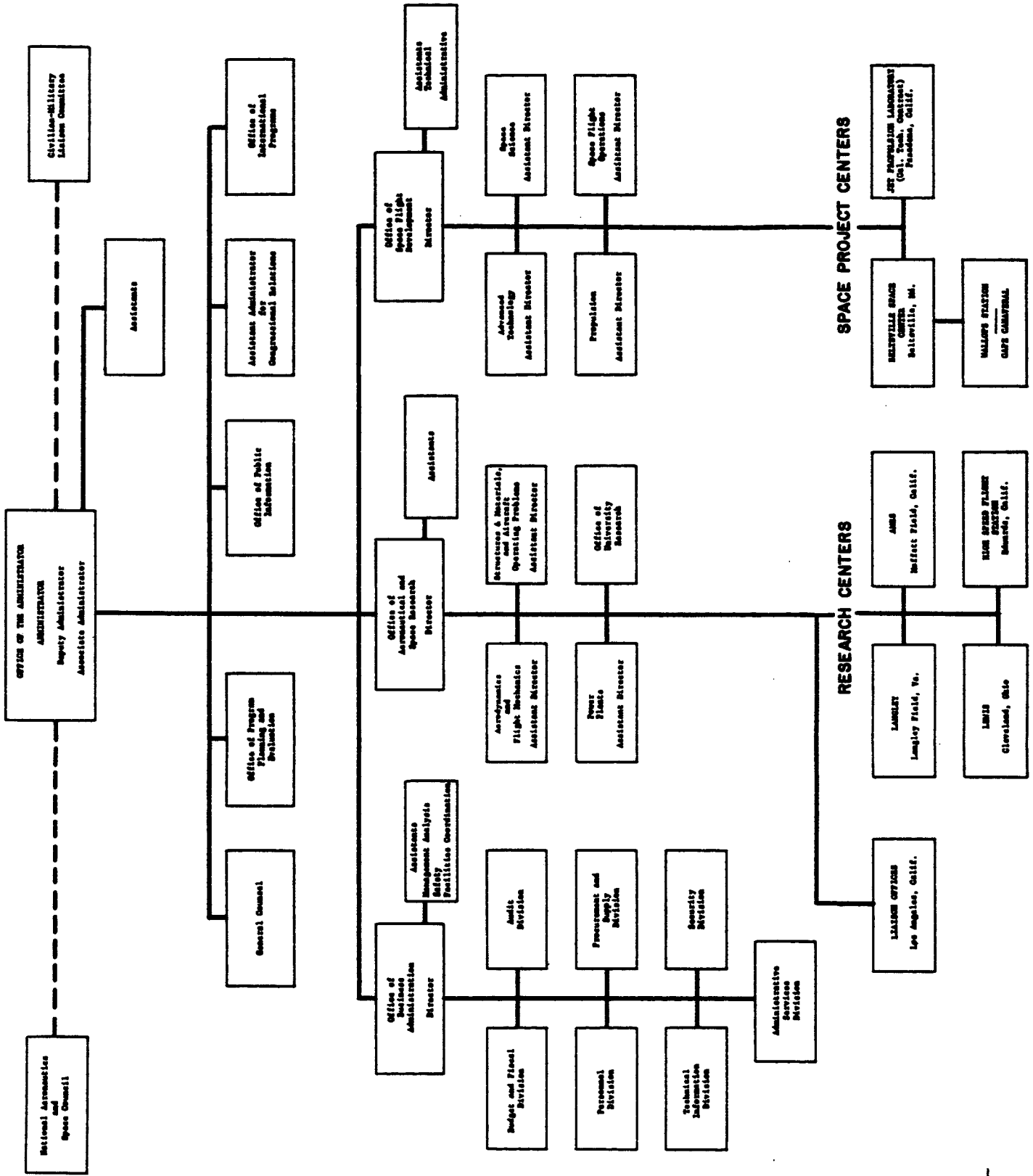

**EXECUTIVE DIRECTION**

**PROGRAMING OPERATIONS**

**FIELD ACTIVITIES**

Approved: *Walloffe*  
 W. WALLOFFE  
 Administrator, NASA  
 Date: 29 June 1959







N\*

Y

ID

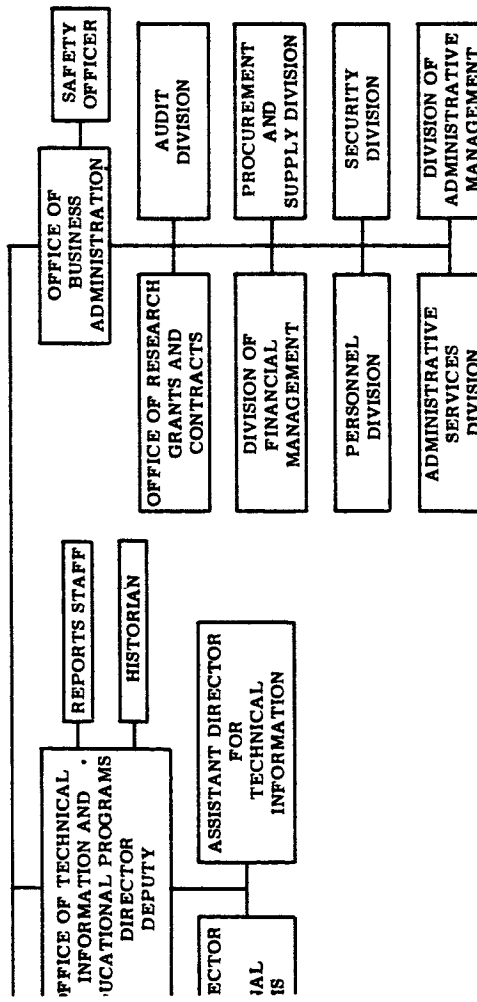
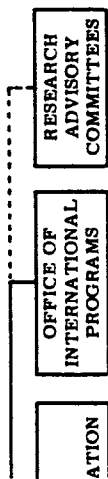

3









# NATIONAL AERONAUTICS AND SPACE ADMINISTRATION HEADQUARTERS ORGANIZATION

APPROVED: *James E. Webb*  
Administrator, NASA

DATE: *January 26, 1963*  
Replaces chart dated Nov. 23, 1962

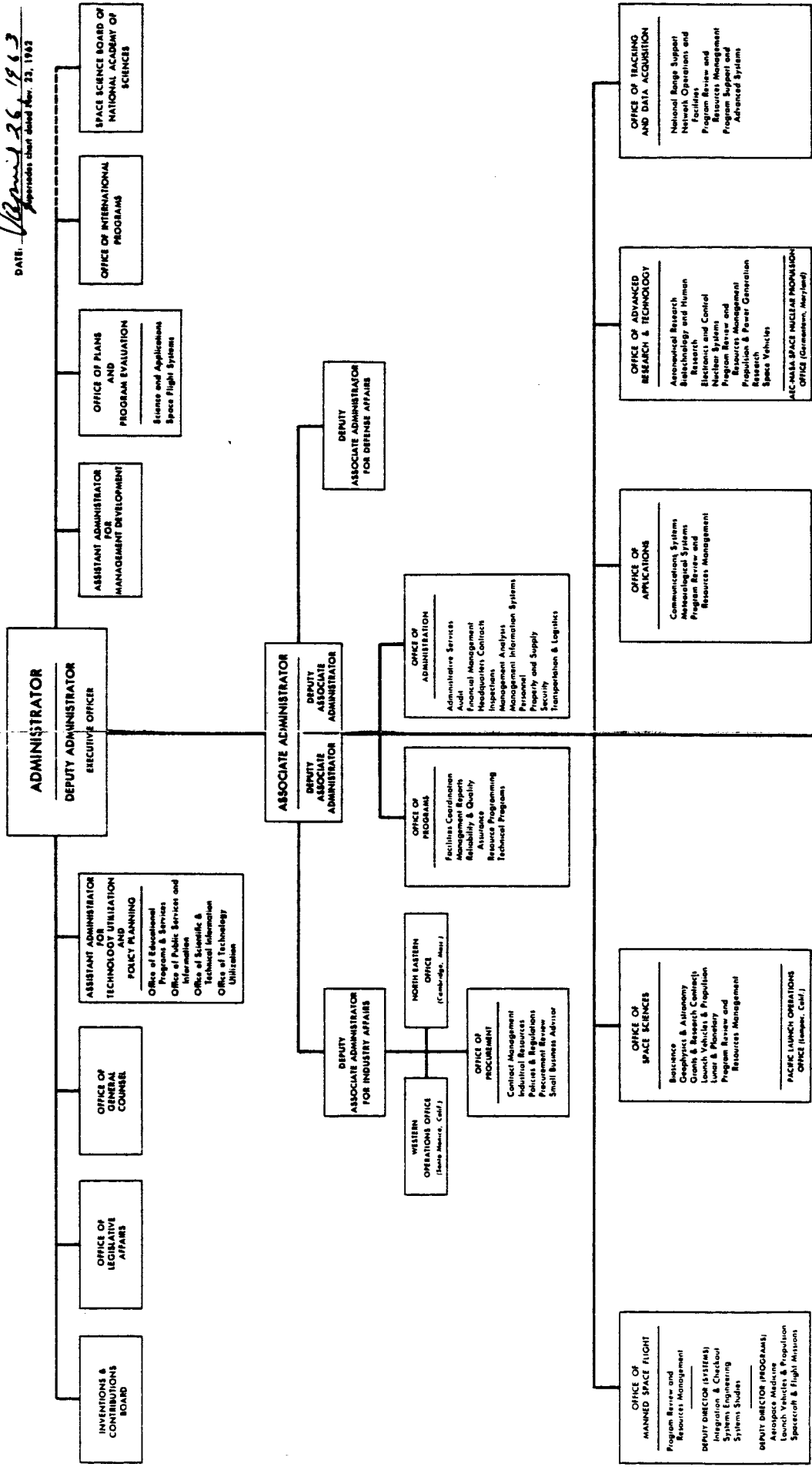

MAJOR FIELD INSTALLATIONS

2



- Forty-fourth Annual Report of the National Advisory Committee for Aeronautics, 1958* (Final Report). Washington: GPO, 1959.
- Congressional Record* (Daily Edition). Aug. 31, 1960. (Vol. 106, No. 147, p. 17215.)
- " . . . Aero Space Technology . . . ." U.S. Civil Service Commission Announcement No. 252B, Parts A and B, Issued Dec. 6, 1960.
- "Report to the President-elect of the Ad Hoc Committee on Space." Released Jan. 12, 1961. (Jerome Wiesner, Chairman.)
- Department of Defense Directive No. 5106.32. Mar. 6, 1961. Subject: Development of Space Systems.
- Bok, Enid. "The Establishment of NASA: The Political Role of Advisory Scientists." Paper read before the meeting of the American Association for the Advancement of Science, Dec. 27, 1962.
- U.S. Aeronautics and Space Activities, January 1 to December 31, 1959.* (The Second Annual Report of the President on the Nation's activities in the fields of aeronautics and space. See also the First, Third, Fourth, Fifth, and Sixth Annual Reports.)
- C. ITEMS NOT DIRECTLY RELATED TO SPACE
- Kennedy, President John F. Letter to David Bell, BOB. July 31, 1961.
- BOB Circular No. A-54. Oct. 14, 1961. Subject: Policies on Selection and Acquisition of Automatic Data Processing (ADP) Equipment.
- Report to the President on Government Contracting for Research and Development.* Apr. 30, 1962. Prepared by BOB. (Issued as S. Doc. 94, 87th Cong., Washington: GPO, 1962.)
- "Inventory of Automatic Data Processing (ADP) Equipment in the Federal Government . . . . August 1962." Prepared by BOB.
- Personnel Methods Series No. 15.* August 1962. Published by the Civil Service Commission.
- "Study of Financial Advantages of Purchasing Over Leasing of Electric Data Processing Equipment in the Federal Government." March 1963. Prepared for Congress by GAO.
- D. DISSERTATION AND SEMINAR PAPERS
- Levine, Arthur. "United States Aeronautical Research Policy, 1915-1958." Unpublished Ph. D. dissertation, Columbia University, 1963.
- Ambrose, Mary Stone. "The National Space Program, Phase I: Passage of the National Aeronautics and Space Act of 1958." Unpublished seminar paper, The American University, 1960.
- Ambrose, Mary Stone. "The National Space Program, Phase II: Implementation of the National Aeronautics and Space Act of 1958." Unpublished (but NASA reproduced) seminar paper, The American University, 1961.

## XI. Interviews and Letters to the Author

### A. FORMAL INTERVIEWS

- Glennan, T. Keith. Jan. 18, 1964.
- Dryden, Hugh L. Apr. 9, 1963.
- Dembling, Paul. Dec. 5, 1962.
- Ostrander, Don. Feb. 17, 1964.
- Siepert, Albert. Mar. 19 and Apr. 9, 1963.
- Silverstein, Abe. Jan. 18, 1964.
- Wyatt, DeMarquis. Dec. 17, 1963.
- Bowman, Donald. Dec. 17, 1963.
- Carulli, Leonard. Apr. 2, 1964.
- Clagett, Albert. Apr. 22, 1963.
- Einhorn, Raymond. June 15, 1964.

Haase, Walter. Jan. 29, 1964.  
 Jenkins, Thomas. Dec. 17, 1963.  
 Lacklen, Robert. Apr. 17, 1963.  
 Romatowski, Ray. Jan. 31, 1964.  
 Rosen, Milton. Sept. 4, 1963.  
 Rosenthal, Aaron. Apr. 24, 1963.  
 Rothrock, Addison. Apr. 28, 1963.  
 Shea, William. Jan. 15, 1963.  
 Shupe, Walter. June 11, 1964.  
 Sload, Philip. Mar. 28, 1963.  
 Thompson, William. Apr. 29, 1963.  
 Wilson, Walter. Apr. 17, 1963.  
 Wood, Clotaire. Apr. 23, 1963.  
 Corson, John. McKinsey & Co. Apr. 26, 1963.  
 Shapley, Willis. Bureau of the Budget. May 7 and 29, 1964.

#### B. PARTIAL LIST OF INFORMAL INTERVIEWS

Ambrose, Mary	Gavin, Patrick	Quintrell, William
Baker, Luther	Gilson, Lucy	Rachlin, Henry
Braithwaite, Howard	Hochberg, Charles	Schreiber, Carl
Cadle, Don	Hodgson, Alfred	Smull, Thomas
Cushman, Ralph	Holum, Kenneth	Tiemann, Robert
Daniels, Walter	Littel, Robert	Ulmer, Ralph
Duggan, John	Maggin, Bernard	Valentine, Burl
Ferguson, Guy	Manning, John	Wheeler, Catherine
Fessler, Richard	Mecuthchen, Edward	Young, John
Fields, Daisy	Neill, Thomas	
Gamble, Allen	Pickering, Harlan	

#### C. LETTERS TO THE AUTHOR

Killian, James. Massachusetts Institute of Technology. Aug. 14 and Sept. 3, 1963.

#### XII. Types of Items Not Included in This Bibliography

United States Budgets  
 NASA Budgets  
 NASA Contracts  
 Kimpton Committee Workpapers

## INDEX

- AACB. *See* Aeronautics and Astronautics Coordinating Board, NASA-DOD
- Abbott Committee (*see also* Ad Hoc Committee on NASA Organization), 39-40, 42, 48-50, 51, 53, 54, 128
- Abbott, Ira A., 39
- ABMA. *See* Army Ballistic Missile Agency
- Ad Hoc Committee on NASA Organization (*see also* Abbott Committee), 39-40
- Ad Hoc Committee on Space (*see also* Wiesner Report), 185
- Administrative procedures
- automatic data processing (ADP), 277
  - budget, 88-89, 130-131, 134-135
  - contracting/procurement, 54, 62-65, 92, 95-96, 146-147, 154-160, 198
  - finance, 52, 53, 60, 135-136
  - internal reporting, 81, 136
  - management manual, 81-83
  - monthly flight schedule, 83
  - NASA-PERT, 151, 205, 212, 231-233
  - personnel, 141-144, 146
  - planning, 39-40, 130-131
  - problems, 177-178
  - Program Management System, 150-151
  - project authorization, 153, 277
  - project management, 145-146, 151-152, 157-158
- Advanced Research Projects Agency (ARPA), DOD, 38<sup>n</sup>, 108
- establishment, 7<sup>n</sup>
  - transfer, 39, 43, 45, 59, 114-115, 120
- Advisory Committee for Aeronautics (U.K.), 19-20
- Advisory Committee for Aeronautics (U.S.). *See* National Advisory Committee for Aeronautics (NACA)
- Advisory Committee on Government Organization, 8-10
- AEC. *See* Atomic Energy Commission
- Aeronautical Research Scientist (ARS) examination, NACA-NASA, 84, 141-142, 235
- Aeronautics and Astronautics Coordinating Board (AACB), NASA-DOD (*see also* Civilian-Military Liaison Committee (CMLC), NASA-DOD), 104, 171, 172-173, 196, 257, 279
- Aerospace Technologist (AST) examination, 84, 141-144, 235, 266-268
- Agena, 255
- Agena B, 153
- Agreement
- Dryden-Blagonravov, 288, 289
- NASA
- AEC, 124, 254-255
  - Air Force, 104, 248
  - Army, 47, 104, 108, 110-111, 118, 121-122, 122-123
  - DOD, 47, 66-67, 104-105, 110-111, 172-173, 237, 252, 279
  - Navy, 104
  - NRL-DOD, 44-45
- Agriculture, Department of, 79
- Air Force. *See* U.S. Air Force (USAF)
- Ambrose, Mary S., 62<sup>n</sup>
- American Rocket Society (ARS), 5, 7<sup>n</sup>
- American Society for Public Administration, 227, 351
- American Telephone & Telegraph Co. (AT&T), 275-276
- Ames Aeronautical Laboratory, NACA (*see also* Ames Research Center), 21
- Ames Research Center (ARC), NASA (*see also* Ames Aeronautical Laboratory, NACA), 75, 83, 214
- AMR. *See* Atlantic Missile Range, USAF
- AMROO. *See* Atlantic Missile Range Operations Office, NASA
- Anacostia Naval Station, 80
- Anderson, Sen. Clinton P., 8, 287
- AOMC. *See* Army Ordnance Missile Command
- Apollo, Project (*see also* Manned space flight), 238, 247
- budget, 90, 194
  - capsule, 193
  - conference on, 216
  - contracts, 216-217, 237, 253, 275-276
  - feasibility, 185
  - flight schedule, 191
  - launch vehicle, 196
  - module, 246-247
- Appropriations. *See* National Aeronautics and Space Administration (NASA) and U.S. Congress
- ARC. *See* Ames Research Center, NASA
- ARGMA. *See* Army Rocket and Guided Missile Agency
- Armed Services Procurement Act of 1947 (ASPA), 61, 62
- Armed Services Procurement Regulations (ASPR), 62<sup>n</sup>, 63<sup>n</sup>, 92

- Army. *See* U.S. Army (USA)  
 Army Ballistic Missile Agency (ABMA) (*see also* Marshall Space Flight Center (MSFC), NASA; *and* Saturn), 45, 46-47, 107-114, 117-123, 133, 139, 140-141, 155  
 Army Ordnance Missile Command (AOMC), 46, 47  
 Army Rocket and Guided Missile Agency (ARGMA), 46  
 Arnold Engineering Development Center, 96n  
 ARPA. *See* Advanced Research Projects Agency, DOD  
 ARS. *See* American Rocket Society  
 Atlantic Missile Range (AMR), USAF, 123, 176, 194, 251, 279  
 Atlantic Missile Range Operations Office (AMROO), NASA, 81n, 123-124  
 Atlas, 4, 153  
 Atlas-Agena, 73, 76n  
 Atlas-Centaur, 73  
 Atlas-Hustler, 73  
 Atlas-Vega, 73  
 Atomic Energy Act, 8  
 Atomic Energy Commission (AEC), 8, 41, 62, 65, 67, 77, 94, 120, 124, 254-255  
 AT&T. *See* American Telephone & Telegraph Co.  
  
*Baltimore Sun*, 46  
 Beall, Sen. J. Glenn, 79  
 Bell, Alexander Graham, 19  
 Bell Committee Report, 147, 270  
 Bellcom, Inc., 276  
 Beltsville Space Center, NASA (*see also* Goddard Space Flight Center (GSFC), NASA), 45, 47, 54, 55, 74, 75, 83  
 Bennett, R/A Rawson (USN), 43  
 Big Joe, 76  
 Bioscience Advisory Committee, NASA, 96n, 97, 124-126  
 Bisplinghoff, Raymond L., 292  
 BOB. *See* Budget, Bureau of  
 Boeing Co., 217  
 Bomber, manned jet, 4  
 Boone, V/A Walter (USN Ret.), 257  
 Brackett, Ernest W., 62, 63n, 270  
 Brooks, Rep. Overton, 99, 100, 238  
 Brundage, Percival, 8  
 Budget. *See* National Aeronautics and Space Administration (NASA)  
 Budget, Bureau of (BOB), 8, 12, 33, 38, 39, 43, 50, 60, 67, 88, 89, 90, 110, 114, 118, 121, 137, 138-139, 141, 163-164, 165, 190, 284  
     legislation, draft, 10, 11  
     Management and Organization, Office of, 10  
     Military Division, 10  
 Budget Policy Committee, 89  
 Burden, William A., 68  
  
 CAB. *See* Civil Aeronautics Board  
 Cadle, Don, 208  
 California Institute of Technology (Cal Tech), 46, 47, 95, 130  
 Cal Tech. *See* California Institute of Technology  
  
 Campbell, Joseph, 57, 102  
 Cape Canaveral, Fla. (*see also* Kennedy Space Center, NASA; Launch Operations Center (LOC), NASA; *and* Launch Operations Directorate (LOD), NASA), 45, 81, 123, 173, 214-215, 247, 251-252, 302  
 Cape Canaveral Launch Area, USAF, 252  
 Carpenter, LCdr. M. Scott (USN), 247  
 Case Institute of Technology, 15, 41, 42n, 117, 207  
 Centaur, 76, 194, 248, 255  
 Chicago, University of, 161  
 Chincoteague Naval Air Station, 104  
 Civil Aeronautics Board (CAB), 66  
 Civil and Defense Mobilization, Office of (OCDM), 67  
 Civil Service Commission (CSC), 58n, 68, 141-144  
 Civilian-Military Liaison Committee (CMLC), NASA-DOD (*see also* Aeronautics and Astronautics Coordinating Board (AACB), NASA-DOD), 14, 67, 102-104, 109, 170, 171, 172  
 Clark, John F., 47  
 Classification Act of 1949, 14, 56  
 Cleveland, Ohio, 21  
 CMLC. *See* Civilian-Military Liaison Committee, NASA-DOD  
 Committee on Space Research (COSPAR), 68-69  
 Conferences  
     NASA-Industry, 174, 216  
     staff, 138, 152  
 Congress. *See* U.S. Congress  
 Contract, 42, 45, 50, 73n, 74, 92, 94, 99-102, 123, 146, 147, 154, 161n, 162  
     cost-plus-fixed-fee, 63, 64, 132, 158  
     geographical distribution, 272-273  
 Contracting/procurement  
     administration, 54, 64-65, 95-96, 158-159, 236-237, 253-254, 257-258  
     authority, 61-62  
     Board of Contract Appeals, 92  
     Contract Adjustment Board, 92  
     cost control, 273-274  
     facilities, 45  
     patents, 91-92, 93  
     policy, 61-62, 174  
     procedures, 62-65, 146-147  
     R&D, 63, 64  
     statistical data, 93, 147-148, 237, 244-245  
     study, 42, 50, 54, 154-160, 163, 164, 167, 235-236, 270-272  
     training, 236  
     trends, 350  
 Convair, 73  
 Cooper, Maj. L. Gordon (USAF), 247  
 Corps of Engineers, Army, 173, 214, 215, 244  
 Corson, John J., 42, 50n, 51, 52, 94n, 154, 161, 168  
 COSPAR. *See* Committee on Space Research  
 Cost-plus-fixed-fee (CPFF) contract, 63, 64, 132, 158  
 Crocker, Allen J., 50n

- Crowley, J. W., 50, 148  
 CSC. See Civil Service Commission  
 Cushman, Ralph E., 39n, 61n, 62n
- Daddario, Rep. Emilio, 126  
 Day, Melvin S., 127n  
 Dayton, Ohio, 29  
 Debus, Dr. Kurt H., 123, 251  
 Debus-Davis Report, 214-215  
 Deep Space Network, 239  
 Defense, Department of (DOD) (see also U.S. Air Force; U.S. Army; and U.S. Navy), 10, 24, 69  
   Advanced Research Projects Agency (ARPA), 7n, 38n, 39, 43, 45, 59, 108, 114-115-120  
   agreements, NASA-DOD, 47, 66-67, 104-105, 110-111, 172-173, 237, 252, 279  
   Committee on Special Capabilities, 5  
   contract, 61, 62  
   cooperation  
     NACA, 23  
     NASA, 9, 23, 63, 66-67, 73-76, 77, 125, 126, 158, 162, 171, 214-215  
   coordination  
     Aeronautics and Astronautics Coordinating Board (AACB), NASA-DOD, 104, 171, 172-173, 196, 257, 279  
     NASA-DOD, 13, 14, 16, 67, 102-104, 105, 170  
   patents, 91-92, 170  
   space program  
     funding, 61  
     launch vehicle, 73  
     missile projects, 4-5, 6, 10  
     nature, 13, 16, 23  
     plan, long-range, 131n  
     reorganization, 108, 185  
     satellite, 39, 67  
     transfers to NASA, 12, 38-39, 43, 44-48, 58, 59, 62, 90, 107-115, 117-123  
 Dembling, Paul G., 10, 11, 34n, 39n, 50n, 92  
 Directorate of NASA Tests, 81  
 Doolittle, L/G James H. (USAFR), 8, 34, 35  
 "Doolittle Dinner," 34  
 Douglas, James H., 173  
 Douglas Aircraft Co., 217  
 Downey, Calif., 253  
 Draper, Gen. W. H., 235  
 Draper Report, 235  
 Dryden, Hugh L., 8, 28, 29, 34-36, 37-38, 39, 40-41, 42, 43, 48, 57, 65, 89, 102, 128, 140, 172, 173, 187, 188, 190, 200, 203, 207, 302  
 Dryden-Blagonravov agreement, 288, 289  
 Dryden Plan, 35-36
- Echo Project, 77  
 Echo I, 175  
 Edwards AFB, Calif., 21  
 Einhorn, Raymond, 133n  
 Eisenhower, Pres. Dwight D., 35, 90, 98, 101, 140, 282  
   appointments, 6, 15, 40, 41, 67, 68n, 84  
   budget requests, 61, 90, 136-137, 139, 171  
   committees  
     Advisory Committee on Government Organization, 8-10  
     President's Scientific Advisory Committee, 6, 8, 23, 130  
   directives, 10, 11, 12, 37, 38, 39  
   Executive order, 44, 47, 120  
   messages to Congress, 10, 11-12, 118, 171  
   National Aeronautics and Space Act of 1958, 12-13, 15, 169-171  
   space policy, 11, 16-17, 23, 169-170, 183, 184-185  
   speech, space, 5, 6  
   transfers to NASA, 104, 109, 110-111, 118  
 Electronics Research Center, NASA, 250, 252-253  
 Emme, Eugene M., 21n  
 Europe, 19  
 Executive privilege, 98-102  
 Explorer I, 6, 46  
 Explorer VIII, 175
- FAA. See Federal Aviation Agency  
 FCST. See Federal Council for Science and Technology  
 Federal Aviation Agency (FAA), 68, 280  
 Federal Council for Science and Technology (FCST), 67  
 Federal Property and Administrative Services Act of 1949, 61-62  
 Federal Register, 15, 18, 21, 43, 44, 91, 146n  
 Federal Service Entrance Examination (FSEE), 43  
 Ferguson, C. Guy, 50n  
 Fessler, Richard, 236n  
 Finance, 40, 48, 349  
   accounting, 52, 135-136  
   administration, 60  
   auditing, 52, 53, 262-264  
   funding, 59-60, 85-91, 260-262  
   "Johnson rider," 60  
   management, 51, 52-53, 132-136, 167, 229-231  
   personnel, 133  
   reporting, 136  
 Finger, Harold B., 255  
 Finney, John W., 285  
 Fleming, William A., 208, 212  
 Fleming Report, 212-213  
 Flickinger, B/G Don (USAF), 96  
 Flight Research Center (FRC), NASA (see also High Speed Flight Station, NACA), 75, 76, 79, 83, 250  
 FSEE. See Federal Service Entrance Examination  
 Fulbright, Sen. J. William, 289
- Gagarin, Yuri, 191-192  
 Gamble, Allen, 84n  
 GAO. See General Accounting Office  
 Gemini, Project, 238, 247-248, 280, 285  
 General Accounting Office (GAO), 68, 100-101, 102  
 General Dynamics Corp., 73n  
 General Electric Co. (GE), 7n, 276

- General Services Administration (GSA), 61, 68, 237  
 Geneva, Switzerland, 128  
 George C. Marshall Space Flight Center. *See* Marshall Space Flight Center  
 Gephart, Landis, 208  
 Germantown, Md., 124  
 Germany, 4  
   Luftwaffe, 21*n*  
 Gilruth, Robert, 80  
 Glenn, L/C John H., Jr. (USMC), 247  
 Glennan, T. Keith, 43, 68*n*, 71, 88, 89, 94*n*, 98-102, 105-106, 117, 126, 157, 173, 185, 196, 200, 207  
   administrative actions, 42-44, 62, 65-66, 81, 90, 91, 96, 97, 114, 124, 128, 144, 148, 151-152  
   appointments, 57, 62, 111  
   background, 15, 41  
   budget, 137, 138  
   evaluation of, 175-179  
   initial decisions, 42-44, 46, 130  
   nomination and confirmation of, 15, 37, 41-42  
   proclamation, 15-16, 43-44  
   project authorization, 80, 153, 228, 229  
   studies, 42, 49, 50-56, 106-107, 109, 161-162, 168  
 Goddard, Robert H., 80  
 Goddard Institute for Space Studies, NASA, 124  
 Goddard Space Flight Center (GSFC), NASA (*see also* Beltsville Space Center, NASA), 47, 79, 80, 83, 124, 139, 148, 155, 174, 236, 243, 245, 292  
 Golovin, Dr. Nicholas E., 150, 213  
 Golovin Study, 213  
 Gough, Melvin N., 81  
 Great Britain. *See* United Kingdom (U.K.)  
 Grillo, Stephen, 136*n*  
 Grissom, Maj. Virgil I. (USAF), 238, 247  
 Grumman Aircraft Engineering Corp., 247  
 GSA. *See* General Services Administration  
 GSFC. *See* Goddard Space Flight Center, NASA  
 Gulf of Mexico, 216  
  
 Hagen, John P., 45, 78, 89, 127-128  
 Hampton, Va., 21  
 Harbridge House, Inc., 145, 236, 270-271  
 Harris, Ray, 92  
 High Speed Flight Station, NACA (*see also* Flight Research Center), 21  
 High Speed Flight Station, NASA, 79  
 Hjernevik, Wesley L., 43*n*, 65*n*, 88, 89, 200  
 Holaday, William, 7, 67, 103, 109*n*  
 Holifield, Rep. Chet, 102  
 Holmes, D. Brainerd, 232, 251, 256  
 Hootman, James A., 50*n*  
 Hoover Commission Report, First, 62  
 Horner, Richard E., 79, 83, 84, 97, 114, 115*n*, 129, 150, 207  
 House of Representatives. *See* U.S. Congress  
 Houston, Tex., 194, 214  
 Houston Manned Spacecraft Center. *See* Manned Spacecraft Center (MSC), NASA  
 Huntsville, Ala., 46, 90, 108, 133, 173, 251  
 Huntsville Facility (*see also* Army Ballistic Missile Agency (ABMA) and Marshall Space Flight Center (MSFC), NASA), 120, 121  
  
 ICBM. *See* Missiles, ballistic, intercontinental  
 ICSU. *See* International Council of Scientific Unions  
 IGY. *See* International Geophysical Year  
 Illinois Institute of Technology, 68*n*  
 International Council of Scientific Unions (ICSU), 68  
 International Geophysical Year (IGY), 5-6, 45, 69  
 Inventions and Contributions Board, 15, 49, 50*n*, 65, 78, 91, 295  
 IRBM. *See* Missiles, ballistic, intermediate range  
  
 Jastrow, Robert, 47  
 Jenkins, Thomas E., 47  
 Jenkins, William, 208  
 Jet Propulsion Laboratory (JPL), 46-47, 49, 50, 54, 55, 59, 74, 93, 94-95, 155, 174, 292  
 John F. Kennedy Space Center. *See* Kennedy Space Center, NASA  
 Johns Hopkins University, 40  
 Johnson, John J., 43*n*, 63  
 Johnson, Pres. Lyndon B., 286, 289, 302  
 Johnson, Sen. Lyndon B., 7*n*, 12, 13, 59*n*, 137-138, 170, 184, 302  
 Johnson, Vice Pres. Lyndon B., 187, 189, 191, 214, 238  
 Johnson, Roy, 7*n*, 10*n*, 38  
 Joint Working Group, NASA, 276-277  
 JPL. *See* Jet Propulsion Laboratory  
 Juno II, 73, 76  
 Jupiter, 4, 108  
 "Jury rigged" launch vehicles, 73  
  
 Kamm, Robert W., 96*n*  
 Kavanau, Laurence L., 213  
 Kennedy, Pres. John F., 270, 278, 302  
   appointments, 187-188  
   budget, 190-191, 192-196, 233-234, 242, 282, 286  
   communications satellites, 239  
   cooperation, U.S.-U.S.S.R., 284, 288  
   election campaign, 183-184  
   manned lunar landing, 192-193, 201, 202, 233-234  
   national debate, 282-283  
   space policy, 107, 136, 140, 171, 189, 192-193, 239  
   study, space program, 185-187, 188  
 Kennedy Space Center, NASA (*see also* Cape Canaveral; Launch Operations Center (LOC), NASA; and Launch Operations Directorate (LOD), NASA), 124, 302  
 Kerr, Sen. Robert S., 238, 287  
 Kety, Dr. Seymour S., 97, 124  
 Khrushchev, Chairman Nikita (U.S.S.R.), 283, 288*n*, 289  
 Killian, James R., Jr., 6, 8-9, 10, 12, 23, 38, 41, 67  
 Kimpton, Lawrence, 161

- Kimpton Committee (*see also* Kimpton Report), 161, 162-163, 168  
 Kimpton Report, 161-169, 199
- Lacklen, Robert J., 28*n*, 34*n*, 39*n*, 140*n*  
 Langley Field, Va., 21  
 Langley Memorial Aeronautical Laboratory, NACA (*see also* Langley Research Center, (LaRC), NASA), 21, 69  
 Langley Research Center (LaRC), NASA (*see also* Langley Memorial Aeronautical Laboratory, NACA), 68*n*, 69-70, 75, 80, 83, 124, 155, 214  
 LaRC. *See* Langley Research Center, NASA  
 Large Launch Vehicle Planning Group, NASA-DOD, 213  
 Launch Operations Center (LOC), NASA (*see also* Cape Canaveral; Kennedy Space Center, NASA; *and* Launch Operations Directorate (LOD), NASA), 124, 243, 251-252, 256, 302  
 Launch Operations Directorate (LOD), NASA (*see also* Cape Canaveral; Kennedy Space Center, NASA; *and* Launch Operations Center (LOC), NASA), 123-124, 251
- Launch vehicle  
 assembly plant, 215-216  
 development, 72-76, 137, 195-196, 255  
 "jury rigged," 73  
 Large Launch Vehicle Planning Group, NASA-DOD, 213  
 launching site, 214-215  
 operations and capability, 130-131, 175  
 program, 90, 108-109, 115, 173, 175  
 study, 213  
 test facility, 215-216
- Lewis Flight Propulsion Center, NACA (*see also* Lewis Research Center), 21  
 Lewis Research Center (LRC), NASA (*see also* Lewis Flight Propulsion Center, NACA), 75, 83, 222, 254
- Lindseth, Elmer, 161*n*  
 Lingle, Walter L., Jr., 257, 295  
 Littell, Robert, 50*n*  
 Little Joe, 76
- LOC. *See* Launch Operations Center, NASA  
 LOD. *See* Launch Operations Directorate, NASA
- Los Alamos Scientific Laboratory (LASL), AEC, 254  
 Los Angeles, Calif., 29  
 Lovelace, Dr. W. Randolph, II, 96  
 Lovelace Foundation, 96  
 Low Committee, 211-212
- LRC. *See* Lewis Research Center, NASA
- Lunar (*see also* Lunar program *and* Manned space flight)  
 circumlunar, 185, 193, 194  
 exploration, 130, 185, 248, 283  
 landing, 185, 193, 194, 196, 208, 211-213, 217-218, 239, 251, 259, 298  
 lunar orbital rendezvous (LOR), 246-247  
 probe, 7*n*, 39, 45, 77, 239  
 reconnaissance, 238
- Lunar program (*see also* Lunar *and* Manned space flight)  
 acceleration, 192-193  
 contractors for, 216-217  
 criticism, 282-283  
 facilities, 213-216  
 manned flight and landing, 185, 193, 194, 196, 208, 211, 217-218, 239, 246-248, 251, 259, 298  
 study, 212-213  
 Lundin Report, 213  
 Lunik I, II, and III, 77
- McCormack, Rep. John W., 12  
 McDonnell Aircraft Corp., 70, 76, 101  
 McElroy, Neil H., 7*n*, 102, 103, 109  
 McKinsey and Company (*see also* McKinsey Report), 42, 49, 50, 51*n*, 55, 56, 63  
 McKinsey Report on Peaceful Uses, 42*n*  
 studies  
 contracting/procurement, 146, 154-160, 199  
 Jet Propulsion Laboratory (JPL), 93, 94-95  
 organization (Kimpton Report), 161-169, 199  
 transfers to NASA, 112-114  
 Western Coordination Office (WCO), NASA, 78, 95-96
- McKinsey Report, 42, 49, 50-56, 63, 79  
 McNamara, Robert S., 188
- Management, 148-149, 149-150, 167, 225-227, 290-291, 299-301  
 concepts, 218-221  
 contract, 54, 64-65, 95-96  
 financial, 51, 52-53, 60, 132-136, 167  
 flexibility, 229-231  
 Management Council, 274-275  
 manual, 81-83  
 NASA-PERT, 151, 205, 212, 231-233  
 personnel, 58  
 planning, 39-40, 228-229  
 Program Management System, 149, 150-151  
 project, 145-146, 151-152, 157-158, 205, 273-276  
 study, 200-201, 203-209, 218-221
- Manned Spacecraft Center (MSC), NASA (*see also* Space Task Group (STG), NASA), 245, 253, 280  
 established, 213-214  
 personnel, 243
- Manned space flight (*see also* Apollo, Project, *and* Gemini, Project), 77, 194, 210  
 circumlunar, 185, 193, 194  
 cooperation, 66  
 expenditure, 74  
 lunar exploration, 185, 248, 283  
 Lunar landing, 185, 193, 194, 196, 208, 216, 217-218, 239, 246-248, 251, 259, 298  
 contractors, 216-217  
 facilities, 213-216, 251  
 lunar orbital rendezvous (LOR), 246-247  
 management, 259  
 study, 212-213, 246  
 program, 39, 65, 153, 185, 187, 208, 209, 211-213, 218-221, 224, 246-248, 285, 298-299, 301

- Mariner II*, 248  
 Marshall Space Flight Center (MSFC), NASA  
 (see also Army Ballistic Missile Agency  
 (ABMA), and Huntsville Facility, NASA),  
 123, 245, 251, 253, 255, 300  
 contract, 123, 148, 155, 215  
 establishment, 120  
 finance, 132, 133-134  
 NASA-industry conferences, 174  
 personnel, 121-122, 139, 141, 243  
 Maryland, 79  
 Massachusetts Institute of Technology (MIT),  
 6  
 Medaris, M/G John B. (USA), 46, 47, 109n  
 Mercury Mark II, 238  
 Mercury, Project, 65, 66, 96, 101, 124, 125, 187,  
 238  
 capsule, 69-70, 76  
 completed, 247, 302  
 engine, 70  
 funding, 87  
 personnel, 83  
 tracking network, 76, 239  
 transfer to NASA, 104  
 Merritt Island, Fla., 215  
 Merritt Island Launch Area, NASA, 252  
 Mexico, Gulf of, 216  
 Michoud, La., 215  
 Michoud Operations, 300  
 Miller, Rep. George P., 238  
 Minitrack, 45, 79  
 Missile Firing Laboratory, USA, 123  
 Missiles, 108  
 ballistic  
 intercontinental (ICBM), 4  
 intermediate range (IRBM), 4, 46  
 Mississippi Test Facility, NASA, 215-216, 300  
 MIT. See Massachusetts Institute of Tech-  
 nology  
 Mitchell, Elliott, 50n  
 Moffett Field, Calif., 21  
 Moon (see also Lunar; Lunar program; and  
 Manned space flight), 171, 193  
 Morris, Delmar M., 120  
 MSC. See Manned Spacecraft Center, NASA  
 MSFC. See Marshall Space Flight Center,  
 NASA  
 Mueller, George E., 232, 292
- NACA. See National Advisory Committee for  
 Aeronautics  
 NACA-Air Force-Navy X-15 rocket research  
 aircraft, 6  
 NAS. See National Academy of Sciences  
 NASA. See National Aeronautics and Space  
 Administration and listings by subject  
 NASA-PERT, 151, 205, 212, 231-233  
 NASC. See National Aeronautics and Space  
 Council  
 National Academy of Sciences (NAS)  
 Rocket and Satellite Research Panel, 7n  
 space, 5, 8, 12, 20, 35  
 Space Science Board, 65, 68
- National Advisory Committee for Aeronautics  
 (NACA), 11, 30, 52, 53, 69, 78, 79, 82, 132,  
 133, 135, 136, 148  
 Ad Hoc Committee on NASA Organization  
 (Abbott Committee), 39-40, 42, 48  
 Ames Aeronautical Laboratory, 21, 29  
 appropriations, 20, 22, 58  
 contract, 23, 32, 61, 62, 128  
 cooperation, 9, 22, 23  
 Dryden Plan, 35-36  
 facilities, 22, 29  
 founded, 3, 20  
 history, 19-23  
 leadership, 28  
 "Main Committee," 24, 28, 32, 33, 35  
 national space program, 39  
 legislation  
 draft, 11-12  
 Space Act, 12-15  
 proposal, 7n  
 redesignation for, 8-10, 19  
 organization  
 committees and subcommittees, 23-28, 33  
 divisions, 30-31  
 headquarters, 29-32  
 personnel, 20, 22, 29, 31, 33, 57, 141-142, 144  
 relationships  
 committee-agency, 32-33  
 headquarters-field, 34-35  
 research, 21, 22, 29, 32, 34-35  
 space-related activities, 6, 9, 34-36, 37-38  
 Special Committee on Space Technology, 35,  
 96  
 "Top Three," 28, 30, 33-34  
 transfers, 37, 38-39, 43  
 Western Coordination Office (WCO), 29, 95  
 X-1, 21  
 X-15, 6, 21, 34
- National Aeronautics and Space Act of 1958,  
 39, 71, 101, 105, 284  
 amendment, 16, 92, 169-171, 173, 189-190,  
 302  
 enactment, 12-13  
 international cooperation, 49n  
 provisions and requirements, 13-15, 43, 98  
 civilian-military coordination, 67, 103  
 contracting, 61, 62  
 funding, 59, 60  
 inventions, 50n, 91, 170  
 patents, 92, 170, 278  
 peaceful uses, 65-66  
 personnel, 56, 104, 140  
 text as amended, A1-A12  
 transfers to NASA, 46, 109, 118
- National Aeronautics and Space Administra-  
 tion (NASA) (see also listings by subject)  
 Administration, Office of, 206, 222, 224, 225,  
 234, 257, 295  
 administrative procedures, 62-66, 81-83, 88-  
 89, 92, 95-96, 130-131, 134-135, 141-144,  
 146-147, 151-152, 154-160, 177-178, 198,  
 205, 212, 231-233  
 Advanced Research and Technology, Office  
 of (OART), 221, 224, 252, 255, 292



- Advanced Research Programs, Office of (OARP), 116, 162, 221, 224
- Aeronautical and Space Research, Office of (OASR), 55, 115-116, 128
- agreements, 44-45, 47, 66-67, 104-105, 108, 110-111, 118, 121-122, 122-123, 172-173, 237, 252, 254, 288, 289
- Applications, Office of (OA), 221, 224, 259, 290, 295
- appropriations, 10, 38, 47, 58, 59, 79-80, 85-88, 136-138, 169, 171, 233-234
- Associate Administrator, Office of, 49, 50, 52, 55, 78, 79, 84, 96, 129, 148-149, 149-150, 178, 197, 199, 203, 205, 229, 255-258, 289
- astronauts, 76, 192, 214, 238
- awards, 15
- Bioscience Advisory Committee, 96<sub>n</sub>, 97, 124-126
- budget, 52, 60-61, 73, 76, 80, 88-91, 106, 114, 130-131, 134-135, 136-139, 176, 185, 190-191, 192-196, 201, 204, 208, 211, 230, 233-234, 238, 242, 245, 283, 284-289
- Budget Policy Committee, 89
- Business Administration, Office of, 52, 83, 127<sub>n</sub>, 140, 159, 167, 201, 202, 204, 206, 207, 222
- conferences
- NASA-industry, 174, 216
  - staff, 138, 152
- Construction, Office of (OC), 258
- contract, 42, 45, 50, 73<sub>n</sub>, 74, 92, 94, 99-102, 123, 146, 147, 154, 161<sub>n</sub>, 162
- Contract (University) Research, Office of, 55
- contracting/procurement, 42, 45, 50, 54, 55, 61-65, 91-93, 128-129, 146-148, 154-160, 174, 236-237, 270-274
- cooperation, 66-69
- AEC, 67, 77, 196, 254-255
  - Air Force, 66, 279-280
  - DOD, 9, 23, 63, 66-67, 73-76, 77, 125, 126, 158, 162, 171, 214-215, 257, 263, 272
  - DOD-Weather Bureau, 77
  - FAA, 68, 280
  - international, 14
  - U.S.-U.S.S.R., 279, 284, 288
  - Weather Bureau, 68, 280
- coordination
- facility, 51, 53-54, 159<sub>n</sub>
  - intra-agency, 165-166, 201-202, 209-210, 226-227
  - NASA-DOD, 13, 14, 16, 67, 102-104, 105, 170, 172-173, 196
  - space flight programs, 276-277
- Defense Affairs, Office of, 257, 295
- establishment, 37, 43-44
- background, 3-10
  - legislation, draft, 10-12
  - Space Act, 12-15, 43
- Executive Salary Committee, 57
- facilities, 111, 122, 123, 126
- construction, 208, 213, 301
  - coordination, 51, 53-54, 159<sub>n</sub>
- finance, 40, 48, 51, 52-53, 59-60, 85-91, 132-136, 167, 229-231, 233-234, 260-264
- Financial Management, Office of, 133, 136
- Financial Management Division, 58<sub>n</sub>
- funds, 45, 58, 59-60, 72, 74-75, 90, 111, 118, 119, 231
- General Counsel Office, 92<sub>n</sub>, 93, 146, 147
- Grants and Research Contracts, Office of (OGRC), 128-129
- Industrial Affairs, Office of (OIA), 258, 295
- industrial relations, 154-160, 174, 301
- International Activities, Office of, 49
- International Programs, Office of, 128
- Inventions and Contributions Board, 15, 49, 50<sub>n</sub>, 65, 78, 91, 295
- launch, 123, 238, 299
- development, launch vehicle, 72-76, 175
  - probe, lunar, 70, 77
  - satellite, 70, 77, 175
  - site selection, 214-215
- Launch Vehicle Programs, Office of (OLVP), 115, 162, 166, 168, 221, 224
- Life Science Programs, Office of (OLSP), 96<sub>n</sub>, 124-127, 201, 221, 224
- management, 51, 52-54, 64-65, 81-83, 95-96, 132-136, 145-146, 148-152, 157-158, 200-201, 203-209, 212, 218-221, 228-233, 273-276, 290-291, 299-301
- Management Analysis, Office of, 161, 202
- Manned Space Flight, Office of (OMSF), 221, 222, 224, 259, 292, 297
- nuclear activities, 124, 192, 196, 254-255
- organization, 39-40, 42, 48-56, 71, 78-81, 149-150, 161-169, 176-178, 199-202, 218-221, 219, 220, 299-302
- reorganization, 110, 115-116, 166, 217-227, 289-298
- patents, 15, 91-92, 93, 170, 174, 278
- personnel, 14, 44-45, 47, 48, 56-58, 83-84, 120-121, 126, 139-146, 167, 222, 234-235, 242-244, 268-269, 297-298, 301
- Personnel Division, 84, 122, 142, 144, 146
- planning, 37-39, 177-178
- long-range, 91, 130-131, 167, 193
  - studies, 212-213
- policy, 82, 105-107, 296
- Policy Planning Board, 296
- powers, 11-12
- Procurement Division, 62, 129, 158-159, 236-237, 257
- Program Analysis and Control, Office of, 151, 204
- Program Management, Office of, 149
- Program Planning and Evaluation, Office of (OPPE), 49, 50, 130-131, 167, 296
- programs, 72, 175-176
- engine development, 68, 69, 74, 99, 115
  - launch vehicle, 70, 72-76, 77, 90, 108-109, 115, 173, 209
  - life sciences, 96-97, 124-127, 209
  - problems, 177-178
  - source, 3, 10, 11, 69, 71
  - space flight development, 38, 40, 48, 54-55, 69, 70, 207, 299
  - space sciences, 48, 49, 50, 55, 209, 245
  - study, 137
  - tracking and data acquisition, 45, 67, 74, 76, 209, 239, 245, 250-251

- National Aeronautics and Space Administration (NASA)—Continued  
 Programs, Office of, 150, 201, 204, 205–206, 207–208, 217, 222, 230, 234, 290, 295  
 Project Review Division, 208  
 Public Affairs, Office of (OPA), 127, 258  
 Public Information, Office of, 222  
 Reliability and Systems Analysis, Office of, 149, 153, 204  
 research, 48, 50, 54, 55, 66, 68, 74, 77, 126, 162, 164, 193, 209, 245, 249–250  
 Research Advisory Committee(s), 78, 152  
 Research Grants and Contracts, Office of (ORGC), 32*n*, 128–129, 222, 224, 237  
 scientists and engineers, 3, 4, 5–6, 56, 235, 244, 264, 265–266  
 security, 15, 174–175  
 small business, 92, 237, 244  
 Space Exploration Program Council (SEPC), 152–153  
 Space Flight Development, Office of (OSFD), 54–55, 78, 95, 114, 115–116, 130  
 Space Flight Programs, Office of (OSFP), 116, 162, 166, 168, 201, 206, 221, 224  
 Space Sciences, Office of (OSS), 221, 222, 224, 290, 295  
 studies, 42, 50–56, 93–96, 154–169, 163, 164, 167, 185–187, 188, 198–202, 235–236, 270–272  
 Technical Information and Educational Programs, Office of (OTIEP), 127, 167, 222, 258  
 technology utilization, 258–259, 299  
 Technology Utilization Division, 259  
 Tracking and Data Acquisition, Office of (OTDA), 224, 295  
 transfers, 38–39, 43, 44–48, 62, 107–115, 118–123, 139, 140–141  
 United Nations Conference, Office for (OUNC), 127–128  
 universities, 49, 65, 93, 156, 164, 209, 248–249, 283, 298–299  
 University Research Program Office, 128  
 X–15, 66, 77, 250
- National Aeronautics and Space Board, proposed, 12
- National Aeronautics and Space Council (NASC), 13–14, 67–68, 98, 99, 102, 103, 130, 169–170, 173, 186, 189–190, 192, 196, 214, 284
- National Bureau of Standards (NBS), 20, 28, 40, 67
- National Science Foundation (NSF), 5, 8, 12, 35, 41, 67, 84*n*, 142
- National Space Vehicle Program, NASA–DOD, 66
- Naval Appropriation Act of 1915, 20*n*
- Naval Research Laboratory (NRL), 59, 80, 84  
 Vanguard, Project, 5–6, 43, 44–45, 47
- Navy. *See* U.S. Navy
- NBS. *See* National Bureau of Standards
- Nevada Test Site, AEC, 254
- Newell, Homer E., 47, 292
- New York, N.Y., 124
- New York Times*, 283, 285, 288
- Nixon, Vice Pres. Richard M., 183
- North American Aviation, Inc., 45, 216–217, 253–254  
 Rocketdyne Division, 70, 77, 95, 99, 100, 101
- Northeastern Operations Office (NEO), NASA, 252, 258
- Nova, 73, 108, 194–195, 213
- NPO. *See* Nuclear Propulsion Office, AEC–NASA
- NRDS. *See* Nuclear Rocket Development Station, NASA
- NRL. *See* Naval Research Laboratory
- NSF. *See* National Science Foundation
- NTS. *See* Nevada Test Site
- Nuclear activities (*see also* Atomic Energy Commission), 124, 192, 196, 254–255
- Nuclear Propulsion Office (NPO), AEC–NASA (*see also* Space Nuclear Propulsion Office (SNPO), AEC–NASA), 124, 254–255
- Nuclear Rocket Development Station (NRDS), NASA (*see also* Atomic Energy Commission), 250, 254–255
- Nunn, Robert G., Jr., 92
- OAo. *See* Orbiting astronomical observatory
- OCDM. *See* Civil and Defense Mobilization, Office of
- OGO. *See* Orbiting geophysical observatory
- Orbiter-Vanguard controversy, 5*n*
- Orbiting astronomical observatory (OAo), 248
- Orbiting geophysical observatory (OGO), 248
- Organization  
 changes, 78–81, 149–150, 176–178, 299–302  
 charts, 328–346  
 planning, 39–40  
 reorganization, 110, 115–116, 166, 217–227, 289–298  
 studies, 209–211, 218–221  
 structure, 42, 48–50, 52, 71, 219, 220  
 studies, 42, 50–56, 93–96, 161–169, 199–202
- Ostrander, M/G Don (USAF), 115, 116, 121*n*, 164, 166, 207
- Pacific Launch Operations Office (PLOO), NASA, 251–252, 292
- Pacific Missile Range (PMR), 123, 124, 176, 252
- Paperclip, Project, 4
- Patents, 15, 91–92, 93, 170, 174, 278
- Patterson, Morehead, 161*n*
- Pearson, Nathan, 161*n*
- Pentagon, 47
- Perkins, James A., 161*n*
- Pershing, 108
- Personnel, 47, 48, 120–121, 126, 222, 297–298, 301  
 ceiling, 138, 139–140  
 CSC inspection, 268–269  
 examination, civil service, 84, 141–144, 266–268  
 excepted positions, 14, 56–58, 84, 130, 140–141, 268  
 Federal Management Intern Program, 269  
 flexibility, 58  
 growth, 56, 83–84, 139, 234–235, 242–244, 299, 347–348

- management, 133, 146, 268-269  
 recruitment, 264-265  
 training, 144-146, 167  
 transfer to NASA, 44-45, 56, 111, 118, 120-122
- PERT. *See* NASA-PERT
- Phillips, Frank, 68
- Pickering, William H., 46
- Piland, Robert O., 68
- Pilotless aircraft, 4
- Pilotless Aircraft Research Station, NACA (*see also* Wallops Station), 21, 48, 81
- Pioneer V*, 153, 175
- Plan, long-range, NASA, 90, 130-131
- Plan, Ten-Year, NASA, 130, 185, 191
- Planning, 37-39, 177-178  
 long-range, 130-131, 167, 193  
 studies, 212-213
- PLOO. *See* Pacific Launch Operations Office, NASA
- PMR. *See* Pacific Missile Range
- Polaris, 4
- Policy Planning Board, 296
- President's Science Advisory Committee (PSAC), 23, 130  
 reconstituted, 6  
 Space Sciences Panel, 8
- Procurement. *See* Contracting/procurement *Progress Report*, 81
- Proxmire, Sen. William J., 285, 289
- PSAC. *See* President's Science Advisory Committee
- Public Health Service, 97
- Public Law 313, 56, 57
- Quarles, Donald A., 10n, 38, 102, 103
- RA. *See* Redstone Arsenal
- Randt, Dr. Clark T., 97, 126, 127
- Ranger spacecraft, 194
- Redstone, 4, 108
- Redstone Arsenal (RA), 46, 110, 113, 121, 122
- Redstone program, 46
- Relay, 249
- Reorganization, 110, 115-116, 166, 217-227, 289-298  
 studies, 209-211, 218-221
- Reorganization Act of 1949, 15
- Research, 48, 50, 54, 55, 66, 68, 74, 77, 126, 162, 164, 193, 209, 245, 249-250
- Retaliata, John, 68
- Ritland, M/G O. J. (USAF), 280
- Rockefeller, Nelson A., 8
- Roey, Jacob M., 92
- Rosen, Milton W., 47, 114
- Rosenthal, Aaron, 121n, 133, 136n
- Rothrock, Addison M., 34n
- Rover, Project, 67, 124, 254
- Russia. *See* U.S.S.R.
- San Francisco, Calif., 21
- Satellites, 45, 74, 76  
 communications, 74, 77, 175, 184, 192, 196, 249  
 distinction, 7  
 foreign, 77  
 launch, 70, 77, 175  
 meteorological, 67, 74, 77, 175, 192, 196, 249, 280  
 reconnaissance, 39  
 scientific, 115, 175, 248
- Saturn (program) (*see also* Army Ballistic Missile Agency (ABMA) and Marshall Space Flight Center (MSFC), NASA), 71, 72, 131, 137, 191, 193, 194, 238  
 Advanced Saturn, 213  
 Saturn V, 217, 247, 253  
 transfer to NASA, 76, 78, 79, 90, 107-110, 114-115, 118
- Schirra, Cdr. Walter M., Jr. (USN), 247
- School of Aviation Medicine (SAM), USAF, 96
- Science Advisory Committee, President's. *See* President's Science Advisory Committee (PSAC)
- Scientists and engineers, 3, 4, 5-6, 56, 235, 244, 264, 265-266
- Scout, 73, 74, 76
- Seamans, Robert C., Jr., 129, 150, 191, 200, 207, 221, 251, 255, 290, 292, 295-296
- Seattle World's Fair, 128
- Senate. *See* U.S. Congress
- SEPC. *See* Space Exploration Program Council, NASA
- Sergeant program, 47
- Shapley, Willis H., 11n, 39, 61
- Shea, Joseph F., 275
- Shepard, Cdr. Alan B., Jr. (USN), 192, 238, 247
- Siepert, Albert F., 43n, 51, 53, 57, 89, 111, 112, 136, 148, 200, 207
- Silverstein, Abe, 37-38, 48, 54, 60n, 70, 73, 80, 95, 114, 115-116, 128, 148, 206, 207, 211, 217-218, 222
- Small business, 92, 237, 244
- Smithsonian Institution, 19, 20  
 Astrophysical Observatory, 67
- Snap, Project, 67
- SNPO. *See* Space Nuclear Propulsion Office, AEC-NASA
- Sohier, Walter D., 270
- Soviet Union. *See* U.S.S.R.
- Space Council. *See* National Aeronautics and Space Council (NASC)
- Space Exploration Program Council (SEPC), NASA, 152-153
- Space Nuclear Propulsion Office (SNPO), AEC-NASA (*see also* Nuclear Propulsion Office (NPO), AEC-NASA), 254-255
- Space Task Group (STG), NASA (*see also* Langley Research Center (LaRC), NASA and Manned Spacecraft Center (MSC), NASA), 69, 80, 83, 124, 166, 213-214, 235, 300
- Sputnik, 15  
 NACA reaction to, 34-36  
*Sputnik I*, 3, 5, 6, 16, 22, 96, 106  
*Sputnik II*, 6  
 U.S. reaction to, 6-8, 183
- SST. *See* Supersonic transport aircraft
- St. Louis, Mo., 70
- Stack, John, 22n

- Standard Oil of Ohio, 41  
 Stans, Maurice H., 10*n*, 88, 184-185  
 State Department of, 68  
 Stauffacher, Charles, 161*n*  
 Stever, H. Guyford, 96  
 Stewart, Dr. Homer J., 130  
 STG. See Space Task Group, NASA  
 Studies  
   contracting/procurement, 42, 50, 54, 154-160, 163, 164, 167, 235-236, 270-272  
   McKinsey Report, 42, 49, 50-56, 63, 79  
   management, 200-201, 203-209, 218-221  
   manned lunar landing, 212-213, 246  
   organization, 42, 50-56, 93-96, 161-169, 199-202  
   planning, 212-213  
   reorganization, 209-211, 218-221  
 Stuhlinger, Dr. Ernst, 255  
 Supersonic transport (SST) aircraft, NASA-FAA, 280  
 Surveyor, 194  
 Symington, Sen. Stuart W., 98, 102, 130  
 Syncom, 249
- Telstar, 249  
 Thomas, Rep. Albert, 88, 139, 214, 287-288  
 Thompson, Shelby, 127*n*  
 Thor, 4, 153  
 Thor-Able, 73, 76  
 Thor-Delta, 73  
 Tiros, Project, 77, 249  
*Tiros I and II*, 175  
 Titan, 4  
 Titan II, 238  
 Townsend, John W., Jr., 47, 80  
 Tracking and data acquisition, 74, 209  
   network, 45, 76, 77, 239, 245, 250  
   optical, 67  
   program, 250-251  
   stations, 250  
 Transfers to NASA  
   Advanced Research Projects Agency (ARPA), 45  
   Army Ballistic Missile Agency (ABMA), 46-47, 107-114, 117-123  
   Cape Canaveral, USA, 123  
   discussions, NASA-DOD, 38-39, 43  
   Jet Propulsion Laboratory (JPL), 46-47, 49, 50  
 Mercury, Project, 104  
   Saturn (program), 76, 78, 79, 90, 107-110, 114-115  
   Vanguard, Project, 44-45  
 Treasury, Department of, 68
- Ulmer, Ralph E., 39*n*, 140*n*, 208  
 UN. See United Nations  
 Union of Soviet Socialist Republics. See U.S.S.R.  
 United Kingdom (U.K.)  
   Advisory Committee for Aeronautics, 19-20  
 United Nations (UN), 284, 288  
   Committee on Peaceful Uses of Outer Space, 69, 127
- United Nations Conference, Office for (OUNC), NASA, 127-128  
 United States (U.S.)  
   space program  
     acceleration, 192-193, 201, 202, 233-234  
     debate, national, 7, 282-283  
     Eisenhower Administration plan, 8-12  
     International Geophysical Year (IGY), 5-6  
     legislation, 10-15  
     military missiles, 4-5, 6  
     nature and scope, 7-8, 16-17, 22, 107  
     reappraisal, 192  
     Wiesner Report, 185-187  
   space race, 183-184, 191-192, 283  
 U.S. Air Force (USAF), 62, 63, 108, 184, 188, 189, 247-248  
 Air Force Ballistic Missile Division (AFBMD), 45  
 Atlantic Missile Range (AMR), 123, 176, 194, 251, 279  
 Atlas, 4, 7*n*, 76  
 contract, 45  
 cooperation, 66, 76, 81*n*, 93, 104, 172, 244, 279-280  
 launch, 66, 70, 77  
 missile activity, 4-5, 7*n*, 45  
 School of Aviation Medicine (SAM), 96  
 Titan, 4  
 Thor, 4  
 transfers to NASA, 45, 59, 67  
 X-15, 6, 66  
 U.S. Army (USA), 108  
   agreement, 104, 108, 118, 121-122, 122-123  
   Army Ordnance Missile Command (AOMC), 46, 47  
   Army Ballistic Missile Agency (ABMA), 45, 46-47, 107-114, 117-123, 133, 139, 140-141  
   Army Rocket and Guided Missile Agency (ARGMA), 46  
   White Sands (N. Mex.) Missile Range (WSMR), 46  
   contract, 47  
   cooperation, 76, 93, 172, 244  
   Corps of Engineers, 173, 214, 215, 244  
   Jet Propulsion Laboratory (JPL), 46-47  
   Jupiter, 4  
   Jupiter C, 7  
   launch, 66, 70  
   missile activity, 5, 45-47, 122  
   Orbiter, Project, 5*n*  
   Redstone, 4, 76  
   transfers, 45, 46-47, 59, 78, 107-115, 117-123, 133, 139, 140-141  
 U.S. Congress, 8, 10, 16, 21, 22, 23, 36, 46, 58, 61, 71, 90, 103, 109, 126, 193, 202, 215, 230, 284  
   authorization and appropriation, 60, 85-88, 134, 136-138, 169, 233-234, 284-289  
   draft legislation, 12  
   General Accounting Office (GAO), 68, 100-101, 102  
   House of Representatives, 14, 90, 102, 170-171, 284

- Appropriations Committee, 86, 88, 139, 234, 287, 288-289  
 Committee on Government Operations, 99n  
 Committee on Science and Astronautics, 99-102, 119, 130, 171, 173, 188, 190n, 191, 234, 237, 238, 253, 273, 285, 286-287, 288, 292  
 Select Committee on Astronautics and Space Exploration, 12, 40  
 Joint Committee on Atomic Energy, 8  
 National Aeronautics and Space Act of 1958 amendment, 16, 92, 169-171, 173, 189-190 enactment, 12-15  
 Senate, 15, 68, 86-87, 90, 102, 119, 170  
   Appropriations Committee, 80, 138, 234  
   Committee on Aeronautical and Space Sciences, 98-99, 119n, 130, 137, 138, 141, 171n, 187-188, 190n, 234, 238, 285, 287, 289, 302  
   Committee on Armed Services, 7  
   Special Committee on Space and Astronautics, 12, 41, 302  
 transfers to NASA, 109, 111, 118-119  
 U.S. IGY Committee (National Academy of Sciences), 5  
 U.S. Information Agency, 184  
 U.S. Navy (USN)  
   agreement, 104  
   missile activity, 4-5  
   Naval Research Laboratory (NRL), 5-6, 43, 44-45, 59, 80, 84  
   Naval Research, Office of, 5, 84  
   Polaris, 4  
   recovery, 76  
   satellites, 184  
   transfers, 43, 44-45, 59  
   Underwater Sound Laboratories, 41  
   Viking/Aerobee-Hi, 5  
   X-15, 6, 66  
 U.S.S.R. (Union of Soviet Socialist Republics) (see also Sputnik), 17, 22, 41, 107, 186, 279  
   intercontinental ballistic missile (ICBM) capability, 3  
   Lunik I, II, and III, 77  
   space race, 183-184, 191-192, 283  
   Sputnik I, 3, 5, 16  
   Sputnik II, 6  
   Vostok I, 191-192  
  
 Van Allen, James A., 7n  
 Van Allen radiation belts, 184  
 Vanguard, Project, 34, 39, 73, 76, 77, 78  
   cost, 23n, 74  
   International Geophysical Year (IGY), 5-6  
   transfer to NASA, 43, 44-45, 47, 79  
 Vanguard III, 77  
 Venus, 248  
 Veterans Administration, 133  
  
 Veterans' Preference Act, 143  
 Victory, John F., 20, 28, 29, 39n  
 von Braun, Wernher, 46, 114, 119, 120, 122, 141  
 Vostok I, 191-192  
  
 Walcott, Charles D., 20n  
 Waller, Fletcher, 161n  
 Wallops Island, Va., 21  
 Wallops Station (NASA) (see also Pilotless Aircraft Research Station, NACA), 50, 75, 81, 104, 250, 292  
 War Department, 20n  
 Washington, D.C., 34, 45, 79, 80, 125, 174  
 WCO. See Western Coordination Office  
 Weather Bureau, 20n, 67, 77  
 Webb, James E., 203, 247, 287-288  
   appointments, 297-298  
   first 33 months, review, 298-302  
   nomination and confirmation of, 187-188, 302  
   organization and management, 227, 281, 296-297, 299, 351-354  
   studies, 199-202, 291-292  
 Welsh, Dr. Edward C., 190  
 Western Coordination Office (WCO), NACA, 29, 95  
 Western Coordination Office (WCO), NASA (see also Western Operations Office (WOO), NASA), 78, 79, 95-96  
 Western Electric Co., 76  
 Western Operations Office (WOO), NASA (see also Western Coordination Office (WCO), NASA), 79, 83, 96, 206, 243, 253, 258  
 White, Gen. Thomas D. (USAF), 189  
 White House, 3, 6, 71, 98, 99, 109, 137  
 White Sands (N. Mex.) Missile Range (WSMR), 46  
 White Sands Proving Grounds (WSPG), N. Mex., 4  
 Wiesner, Jerome, 185, 187  
 Wiesner Report, 185-187, 189, 199n  
 Williams, Walter C., 76  
 Williamsburg, Va., 102  
 WOO. See Western Operations Office, NASA  
 Wood, Clotaire, 34n, 39n, 49n  
 World War I, 20  
 World War II, 4, 21, 41, 61, 215  
 Wright-Patterson AFB, Ohio, 21, 62n  
 WSMR. See White Sands Missile Range  
 Wyatt, DeMarquis D., 208  
  
 X-1 (research aircraft), 21  
 X-15 (rocket research aircraft), 6, 34, 66, 77, 250  
  
 Yale University, 41  
 York, Herbert F., 10n, 38, 131, 172  
 Young, John D., 51n, 94n, 112, 155, 168, 200, 202





NATIONAL AERONAUTICS AND SPACE ADMINISTRATION

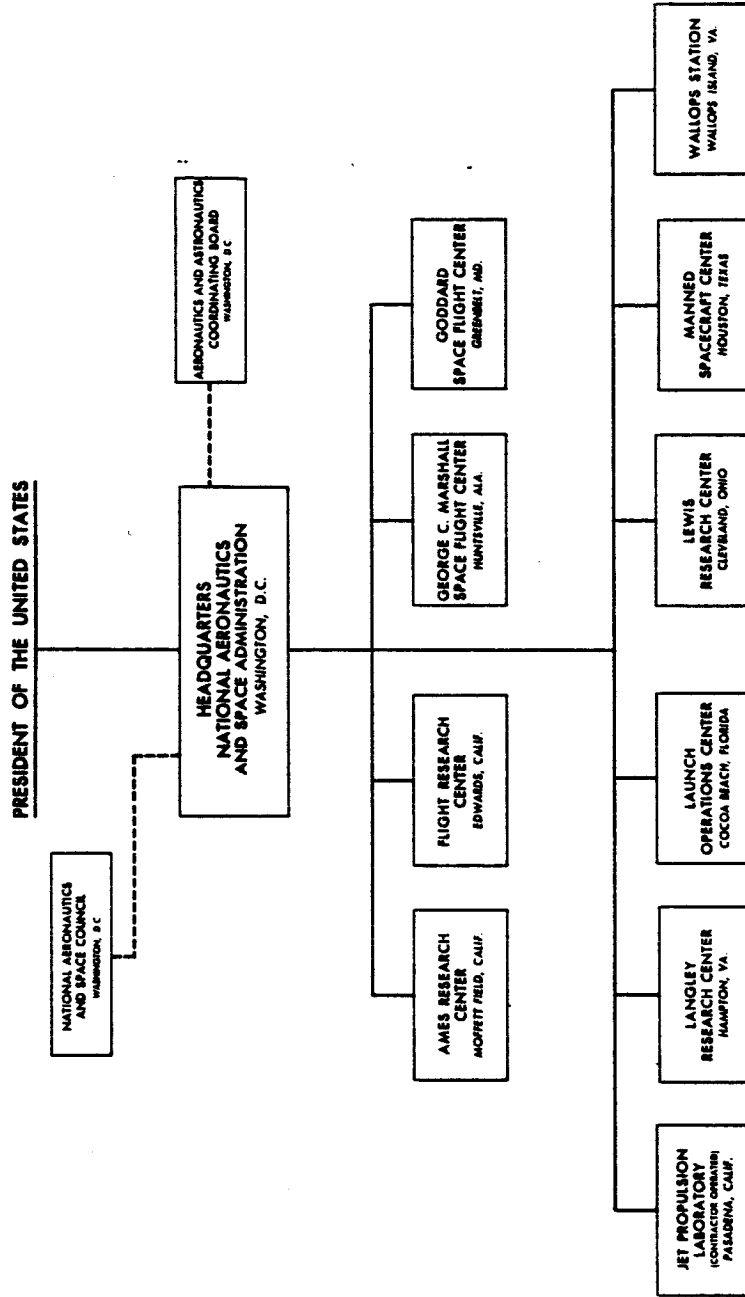

APPROVED: *James E. Webb*  
Administrator, NASA  
 DATE: *February 26, 1963*



APPROVED: *James E. Webb*  
 ADMINISTRATOR  
 EFFECTIVE DATE: November 1, 1962  
 (Supersedes chart dated Apr. 30, 1962)

NATIONAL AERONAUTICS AND SPACE ADMINISTRATION

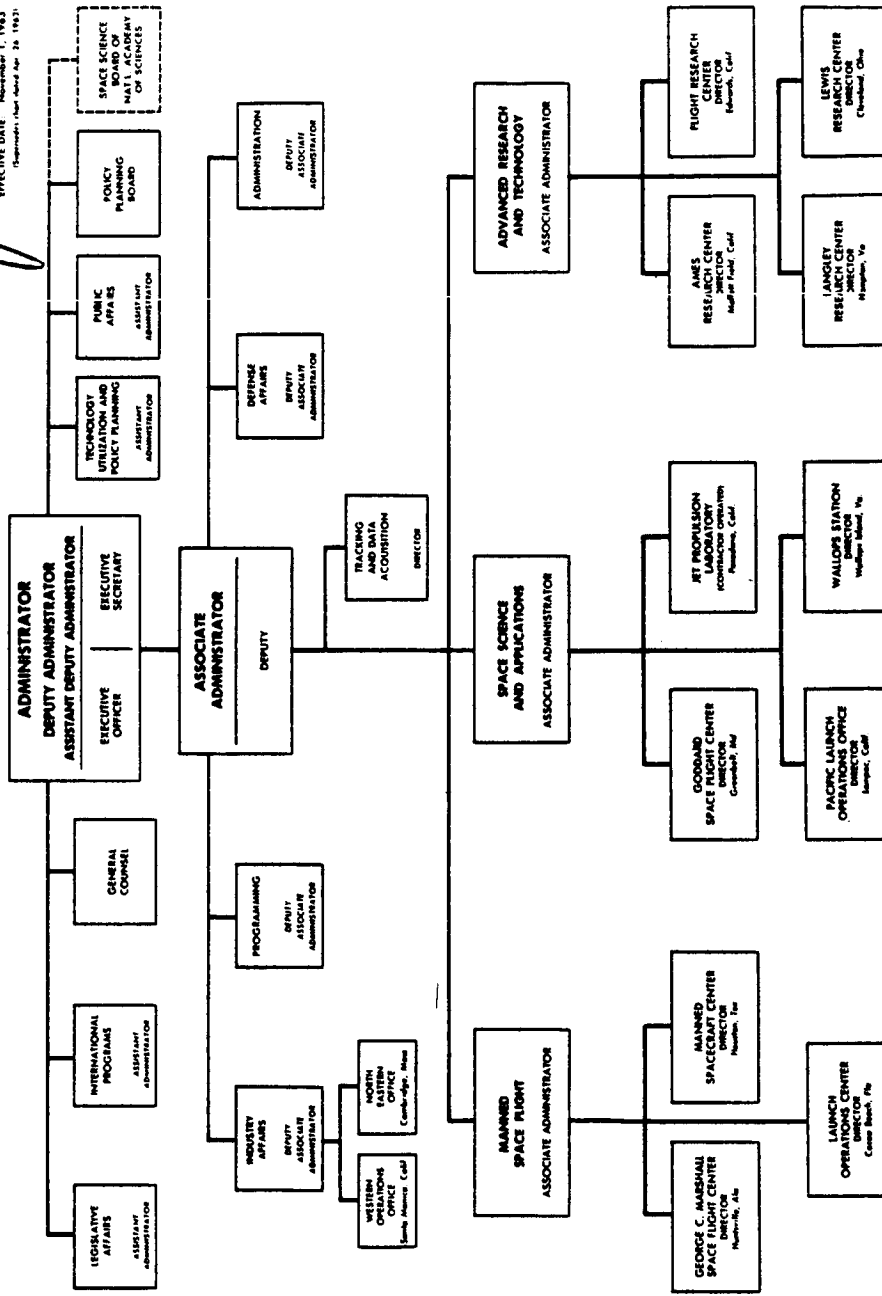

APPENDIX C

GROWTH OF NASA PERSONNEL, 1958-63\*

Installation <sup>1</sup>	1958		1959		1960		1961		1962		1963	
	Sept. 30 <sup>a</sup>	Dec. 31	June 30	Dec. 31	June 30	Dec. 31	June 30	Dec. 31	June 30	Dec. 31	June 30	Dec. 31
	Headquarters.....	180	274	429	456	585	662	744	960	1,485	1,693	2,026
Langley Research Center..	3,368	3,501	3,795	3,456 <sup>b</sup>	3,203 <sup>b</sup>	3,208	3,338	3,460	3,894	4,007	4,220	4,234
Ames Research Center....	1,413	1,427	1,464	1,429	1,421	1,418	1,462	1,529	1,658	1,825	2,116	2,166
Lewis Research Center....	2,713	2,696	2,809	2,749	2,722	2,743	2,773	3,036	3,800	4,118	4,697	4,760
Flight Research Center... Goddard Space Flight Center.....	292	306	340	360	408	416	447	494	538	568	616	618
Western Operations Office..	.....	216 <sup>c</sup>	398	1,117 <sup>d</sup>	1,257	1,881	1,599 <sup>e</sup>	1,858	2,755	2,858	3,487	3,443
Wallops Station.....	.....	.....	.....	.....	37	50	60	84	136	247	308	318
Marshall Space Flight Center.....	.....	.....	.....	.....	229 <sup>f</sup>	297	302	371	421	490	493	502
Manned Spacecraft Center.....	.....	.....	.....	.....	370	5,367 <sup>g</sup>	5,948	6,034	7,182	6,844 <sup>h</sup>	7,332 <sup>h</sup>	7,227
	.....	.....	.....	.....	.....	.....	794 <sup>i</sup>	1,146	1,786	2,392	3,345	3,364

Installation <sup>1</sup>	1958		1959		1960		1961		1962		1963			
	Sept. 30 <sup>2</sup>	Dec. 31	June 30	Dec. 31	June 30	Dec. 31	June 30	Dec. 31	June 30	Dec. 31	June 30	Dec. 31		
Space Nuclear Propulsion Office.....							4	15			31	67	96	102
Kennedy Space Center.....												604*	1,181*	1,269
Pacific Launch Operations Office.....												14	17	19
<b>Total NASA.....</b>	<b>7,966</b>	<b>8,420</b>	<b>9,235</b>	<b>9,567</b>	<b>10,232</b>	<b>16,042</b>	<b>17,471</b>	<b>18,987</b>	<b>23,686</b>	<b>25,667</b>	<b>29,934</b>	<b>30,066</b>		

\*Figures are taken from Monthly Report of Federal Civilian Employment (Standard Form 113).

<sup>1</sup> Installation names are those used as of Dec. 31, 1963. Figures for Michoud Operations and Mississippi Test Operations are part of Marshall; figures for North Eastern Office are part of Headquarters.

<sup>2</sup> Figures for Sept. 30, 1958, are for NACA's last day of business.

<sup>3</sup> Includes 148 persons transferred from NRL/Vanguard on Nov. 30, 1958.

<sup>4</sup> Space Task Group (480 persons) transferred from Langley Research Center to Goddard Space Flight Center in November 1959.

<sup>5</sup> Wallops Station established as an independent installation in January 1960. 225 persons transferred from Langley Research Center.

<sup>6</sup> Includes 4,256 persons transferred from ABMA on July 10, 1960.

<sup>7</sup> Space Task Group established as an independent installation in January 1961. About 660 persons transferred from Goddard Space Flight Center.

<sup>8</sup> Launch Operations Center established as an independent installation. 338 persons transferred from Marshall Space Flight Center in July 1962.

<sup>9</sup> 276 persons transferred to Launch Operations Center from Marshall Space Flight Center during May 1963.

**APPENDIX D**  
**NASA FINANCES, 1958 THROUGH 1963\***

[In millions of dollars]

Fiscal year and quarter	Net disbursements				Obligations			
	S&E	R&D	CoF	Total	S&E	R&D	CoF	Total
<b>1958:</b>								
3d.....	20		5	25	21		8	29
4th.....	22	1	7	30	21	73	6	100
<b>1959:</b>								
1st.....	21	9	6	36	21	50	6	78
2d.....	24	24	7	55	22	52	19	93
3d.....	22	38	10	70	21	61	10	92
4th.....	22	59	9	90	22	121	27	170
<b>1960:</b>								
1st.....	24	73	15	112	23	77	22	121
2d.....	22	85	22	129	24	57	30	111
3d.....	36	77	25	139	39	76	13	128
4th.....	39	128	27	194	42	154	34	229
<b>1961:</b>								
1st.....	42	105	23	169	44	223	20	288
2d.....	42	177	23	242	47	201	31	279
3d.....	47	161	20	228	49	164	43	255
4th.....	47	187	17	251	50	322	70	442
<b>1962:</b>								
1st.....	55	260	22	337	56	379	42	476
2d.....	59	327	57	441	61	440	65	567
3d.....	87	332	39	459	90	412	27	528
4th.....	100	415	41	556	109	587	191	886
<b>1963:</b>								
1st.....	110	528	46	684	104	813	141	1,058
2d.....	119	636	99	854	124	704	216	1,043
3d.....	111	678	50	839	127	729	87	943
4th.....	120	780	104	1,005	116	898	113	1,127
<b>Total.....</b>	<b>1,189</b>	<b>5,080</b>	<b>674</b>	<b>6,945</b>	<b>1,233</b>	<b>6,593</b>	<b>1,221</b>	<b>9,043</b>
<b>Fiscal year:</b>								
1959.....	87	34	25	145	86	183	35	305
1960.....	91	256	54	401	89	315	90	494
1961.....	159	487	98	744	172	653	98	923
1962.....	207	936	114	1,257	216	1,304	220	1,740
1963.....	416	1,912	225	2,552	426	2,516	574	3,516
<b>Calendar year:</b>								
1959.....	89	130	32	251	86	284	62	433
1960.....	121	363	89	574	128	364	99	589
1961.....	176	630	83	890	190	910	164	1,264
1962.....	301	1,334	159	1,793	316	1,818	325	2,457
1963.....	460	2,622	299	3,382	471	3,144	557	4,171

\*Source: Standard Form 133, Report on Budget Status. Slight discrepancies are the result of rounding.

APPENDIX E

TRENDS IN NASA PROCUREMENT BY FISCAL YEAR <sup>1</sup>

	1959 <sup>2</sup>	1960	1961	1962	1963
Total number of procurement actions . . . . .	26, 900	44, 100	93, 500	126, 800	184, 400
Percent with large business . . . . .		29	24	20	29
Percent with small business . . . . .		66	65	66	66
Percent with Government agencies . . . . .		4	10	10	4
Percent with other organizations . . . . .		1	1	1	1
Net value of awards (thousands of dollars) . . . . .	213, 000	337, 000	756, 000	1, 551, 000	3, 231, 000
Percent of total NASA obligations . . . . .	70	68	82	90	92
Percent to large business . . . . .	34	43	48	58	64
Percent to small business . . . . .	7	9	8	8	6
Percent to Government agencies . . . . .	45	32	29	21	20
Percent to JPL . . . . .	11	11	12	10	7
Percent to other organizations . . . . .	3	5	3	3	3
Geographical distribution: <sup>3</sup>					
California . . . . .			39	47	50
Missouri . . . . .			11	8	9
New York . . . . .			12	6	5
Alabama . . . . .			10	9	4
Louisiana . . . . .				2	8
Placement by Procurement Office: <sup>4</sup>					
Marshall Space Flight Center . . . . .			34	39	29
Manned Spacecraft Center . . . . .			11	13	23
Goddard Space Flight Center . . . . .		23	21	14	9
Western Operations Office . . . . .		2	17	17	13
All other . . . . .		75	17	17	26

<sup>1</sup> Data taken from NASA's Annual Procurement Reports.

<sup>2</sup> For 9 months only.

<sup>3</sup> Percentage of direct awards of \$25,000 and over to business.

<sup>4</sup> Percentage of net value of awards.

## APPENDIX F

### ADMINISTRATION AND THE CONQUEST OF SPACE\*

JAMES E. WEBB, *Administrator, National Aeronautics and Space Administration*

Soon after taking office in February, 1961, guided by skill and judgment of NASA's Director of Administration, Mr. Albert Siefert, and Mr. John Young, his Deputy, steps were initiated by Dr. Hugh Dryden, the Deputy Administrator, Dr. Robert Seamans, the Associate Administrator, and myself, to identify the major organizational and management problems NASA's general management should concern itself with over the near term future. This was little more than another step in the continuous process of review and evaluation that had been initiated by Dr. Keith Glennan, NASA's outstandingly capable first Administrator. Our review and evaluation had gotten to the point where we were considering several evolutionary changes in organizational and management concepts when the President recommended the accelerated and expanded space program last Spring. Prior to the President's message, we had begun our study of the steps we would have to take to bring the organization structure, staffing, and management concepts in line with what we anticipated might be a decision to undertake an accelerated and expanded space program. Our study, among other things, included:

1. Setting down a statement of program objectives, major policy assumptions, and management concepts as a basic frame of reference against which NASA's general management might judge various organizational alternatives.
2. We conducted comparative analysis of other experiences, such as the Manhattan Engineering District, Polaris Special Project Office, and Air Force Weapons Systems Management.
3. We developed alternative organizational plans and reviewed these with senior NASA staff and knowledgeable individuals from private life.

After thorough consideration, President Kennedy in May, sent to Congress his recommendation for a program to build the necessary big boosters and step up the program. The Congress completed its authorization of the accelerated and expanded space program in September, 1961. In October, we announced the steps we planned to take to bring NASA's organization and management concepts in line with this new program. We began detailed implementation of these steps around November 1 of last year. We are still in this process. As I am sure you can understand, it takes considerable time and effort to implement effectively even relatively small changes

\*Excerpts from banquet address at the National Conference of the American Society for Public Administration, Detroit, Mich., Apr. 13, 1962.

in large complex enterprises—private or public. I think you will agree that in few cases has so much effective organizational realignment taken place in so short a time.

Our current concepts of organization and management fall logically into five areas:

1. *Headquarters Program Offices* which correspond with each of NASA's four major programs.
2. *Center Directors reporting directly to headquarters general management* on over-all Center matters, and to headquarters program directors on program development and execution.
3. *Single focus for tracking and data acquisition support* in headquarters.
4. *Provision for integrated launch operations services* at the Atlantic and Pacific Missile Ranges to serve all NASA projects.
5. *Improved staff services for general management*; that is, an Office of Programs and an Office of Administration at headquarters.

It may be useful to explain in some detail our thinking underlying several of these basic concepts; those that I believe would be of most interest to members of ASPA. These are (1) the role of the Headquarters Program Offices; (2) reporting relationships of Center Directors; (3) staff services for general management; and (4) the role of functional managers in the area of administration.

1. *Headquarters Program Directors.* Program management in NASA involves the planning and direction of an interrelated series of research and development projects designed to achieve one or more of NASA's major objectives; for example, manned space flight, including a lunar landing and return.

Effective November 1, 1961, the primary responsibility for each of NASA's four major programs—Manned Space Flight, Space Sciences, Applications, and Advanced Research and Technology—was assigned to a headquarters program director. If traditional organization terminology were to be used, the headquarters program directors are responsible for both staff and line functions. A program director has a dual role in which he both advises and operates. He is the principal adviser to the Associate Administrator—"NASA's General Manager"—in regard to his assigned program area. He is also the principal headquarters operating official in regard to management of his assigned program. He directs his assigned program by working directly with Center directors and their project, and their project and systems managers. In addition to handling such matters as budgeting and programming of funds and establishing and issuing technical guidelines, each program director is also responsible for providing continuing leadership in external and interagency relationships related to an assigned program.

2. *Reporting Relationships of Center Directors.* The reorganization of last November provided that the Directors of NASA's research and development centers report directly to the Associate Administrator—"NASA's general manager"—rather than a particular technical program office in headquarters as they had up to that time. This was done in recognition that most of the Centers that had been transferred to NASA were multi-purpose Centers. Although each had a primary orientation (for example, the Jet Propulsion Laboratory in the area of unmanned spacecraft), most had an across-the-board capability that was important to maintain in terms of rapid feedback from one area to another; for example, from applied research in electronics to the design of particular spacecraft instrumentation, such as Ranger.

We explored the feasibility of (a) making NASA's Centers more single purpose, and (b) more or less completely self-sufficient. Both of these approaches appeared unrealistic in terms of the effective and rapid use of the resources that had been made available to NASA. Thus, it was on basic considerations of that nature that we determined to have NASA's Centers report to the Associate Administrator and contribute to the various programs on the basis of their available in-house capabilities. This approach also provides opportunities for the Center Directors to have an increased voice in day-to-day policy making and programing decisions.

3. *Staff Services for General Management.* During the last year, we have taken steps to improve and strengthen the staff services available to general management. This has been done primarily to provide general management with more accurate, complete, and timely information on which to base program policies and decisions, particularly in terms of ensuring that the interrelationships among the four basic programs are continually being properly adjusted.

These staff services are provided by an Office of Programs and an Office of Administration. These offices in reality have multiple bosses. They are responsible for servicing all three members of general management: Administrator, Deputy Administrator, and the Associate Administrator, and the headquarters program directors. This approach helps to minimize the size of headquarters staff services while at the same time obtaining better integration of these services throughout NASA. I must, however, be frank on this point. This approach requires a very unique type of individual. Those that are only at ease and secure when they "serve only one boss" are ill adapted to provide effective performance on staffs organized in such a manner.

4. *Role of Functional Managers in the Area of Administration.* Here is another area where, I believe, we are departing somewhat from traditional or classical concepts of organization. The Directors of divisions, Headquarters Office of Administration—for example, the Director of Personnel—are NASA's functional managers and specialists for their particular areas. As functional managers, they are responsible to see that their assigned administrative activities are performed throughout NASA in a manner to accomplish NASA's objectives. Here we are directly and consciously departing from traditional line and staff concepts of organization. Functional management, as we perceive it, is a means of optimizing administrative specialization, while at the same time retaining the essential ingredients of traditional line management concepts. It is an effort to cope with the persistent problems we have in modern complex organizations of solving the dilemma between hierarchy and specialization.

The headquarters division directors, Office of Administration, as functional managers, are among other things, responsible for observing and evaluating the manner in which work in his assigned area is carried on throughout NASA. Thus, the division directors share with the Center Directors the responsibility for performance of administrative elements within the Center. The administrative elements in the Center do in fact have two bosses. This concept places a premium on competent leadership in the headquarters administrative divisions. There is no escape into the jargon "that I am only a staff man, but they don't take my advice." The functional manager approach places a premium on people who can operate on the basis of competence and confidence in relationship to Center Director and Center administrative elements rather than on traditional authority concepts; i.e., "I have the right to issue directives and you have the obligation to carry them out."



These, then, are some of the basic concepts that underlie the present organization and management of NASA and the civilian space program. In some areas, we believe we are beginning to plow new ground. However, in light of the unprecedented nature of NASA's job, and its distinctive characteristics, we must do more. We must continually, vigorously, and intelligently seek better answers to the organization and management of the large technological enterprise such as NASA.

## CLASSIFIED BIBLIOGRAPHY OF SOURCES CITED IN THIS STUDY

This Bibliography lists the sources cited in footnotes, plus a few key references not known to the author at the time of writing. Additional documents pertaining to NASA's administrative history, collected and collated in the preparation of this study, have been made part of the NASA Historical Archives. Within the categories of this Bibliography, items have been put in chronological or alphabetical order on the basis of their nature.

### I. Books

- DUPREE, A. HUNTER, *Science in the Federal Government: A History of Policies and Activities to 1940*. Cambridge: Harvard Univ., 1957.
- EMME, EUGENE M. (ED.), *History of Rocket Technology*. Detroit: Wayne State University Press, 1964.
- GRAY, GEORGE W., *Frontiers of Flight: The Story of NACA Research*. New York: Alfred A. Knopf, 1948.
- GRIFFITH, ALISON, *The National Aeronautics and Space Act: A Study of the Development of Public Policy*. Washington: Public Affairs Press, 1962.
- HOLMES, JAY, *America on the Moon: The Enterprise of the Sixties*. Philadelphia: J. B. Lippincott Co., 1962.
- MEDARIS, JOHN B., *Countdown for Decision*. New York: Putnam's, 1960.
- VAN DYKE, VERNON, *Pride and Power: The Rationals of the Space Program*. Urbana: University of Illinois Press, 1964.

### II. Articles (Periodicals)

- CORSON, JOHN, "Government and Business: Partners in the Space Age," *Management Review*, September 1959.
- DRYDEN, HUGH L., "Future Exploration and Utilization of Outer Space," *Technology and Culture*, Spring 1961, pp. 112-126.
- DEMBLING, PAUL, "National Coordination for Space Exploration . . .," *The JAG Journal*, February 1959.
- GLENNAN, T. KEITH, "Our National Space Program," address before the Institute of World Affairs, Pasadena, Calif., Dec. 7, 1959.
- GLENNAN, T. KEITH, "Opportunities for International Cooperation in Space Exploration," *U.S. Department of State Bulletin* (Jan. 11, 1960), pp. 58-63.
- OATES, STEPHEN B., "NASA's Manned Spacecraft Center at Houston, Texas," *The Southwestern Historical Quarterly*, January 1964.
- WEBB, JAMES E., "Interview: Why Spend \$20 Billion To Go To the Moon?" *U.S. News and World Report*, July 3, 1961, pp. 58-63.
- WEBB, JAMES E., "NASA and USAF: A Space Age Partnership," *The Airman*, August 1964, pp. 6-11.

### III. Articles and Editorials (Newspapers)

Newport News *Daily Press*, July 27, 1961.

*New York Times*:

Feb. 5, 1958 (p. 1)	Oct. 21, 1959 (p. 1)	May 17, 1961 (p. 18)
Aug. 6, 1958 (p. 10)	Oct. 22, 1959 (p. 1)	May 26, 1961 (p. 12)
Aug. 7, 1958 (p. 24)	July 3, 1960 (p. 2)	Oct. 8, 1961 (p. 35)
Oct. 16, 1958 (p. 14)	Oct. 29, 1960 (p. 10)	Dec. 7, 1961 (p. 21)
Oct. 19, 1958 (p. 16)	Dec. 21, 1960 (p. 1)	Dec. 9, 1961 (p. 7)
Oct. 23, 1958 (p. 1)	Jan. 12, 1961 (p. 14)	Dec. 11, 1961 (p. 68)
Oct. 30, 1958 (p. 14)	Jan. 26, 1961 (p. 10)	July 25, 1962 (p. 12)
Nov. 17, 1958 (p. 1)	Jan. 31, 1961 (p. 18)	June 28, 1963
June 30, 1959 (p. 3)	Mar. 19, 1961 (p. 1)	Aug. 10, 1963
Sept. 24, 1959 (p. 1)	Apr. 22, 1961 (p. 1)	Sept. 28, 1963
Oct. 13, 1959 (p. 1)	May 6, 1961 (p. 14)	Nov. 21, 1963

*New York Times* (Western Edition), Jan. 27, 1963.

*The Wall Street Journal*, Aug. 2, 1963.

*Washington Evening Star*, Jan. 20, 1961.

*Washington Post & Times Herald*, Nov. 8, 1957 (p. A14).

*Washington Post*, Sept. 21, 1963 (p. A10).

### IV. Public Laws

63-271 (Mar. 3, 1915)	86-30 (May 20, 1959)	87-584 (Aug. 14, 1962)
85-325 (Feb. 12, 1958)	86-45 (June 15, 1959)	87-741 (Oct. 3, 1962)
85-568 (July 29, 1958)	86-213 (Sept. 1, 1959)	87-793 (Oct. 11, 1962)
85-617 (Aug. 8, 1958)	86-255 (Sept. 14, 1959)	88-113 (Sept. 6, 1963)
85-657 (Aug. 14, 1958)	86-481 (June 1, 1960)	88-215 (Dec. 19, 1963)
85-766 (Aug. 27, 1958)	87-26 (Apr. 25, 1961)	
85-844 (Aug. 28, 1958)	87-545 (July 25, 1962)	

### V. Congressional Documents and Publications

(Entries are grouped by committee and titles alphabetized. "Washington: GPO" has been omitted)

House:

Select Committee on Astronautics and Space Exploration.

*Astronautics and Space Exploration*. Hearings on H.R. 11881, 85th Cong., 2d sess., 1958.

*Authorizing Construction for the National Aeronautics and Space Administration*. Hearings on H.R. 13619, 85th Cong., 2d sess., 1958.

*Establishment of the National Space Program*. H. Rept. 1770 on H.R. 12575, 85th Cong., 2d sess., 1958.

Committee on Science and Astronautics.

*Authorizing Appropriations to the National Aeronautics and Space Administration*. H. Rept. 591, 88th Cong., 1st sess., 1959.

*Briefing on NASA Reorganization, Project Mercury Summary*. Hearing, 88th Cong., 1st sess., 1963.

*A Chronology of Missile and Astronautic Events*. H. Rept. 67, 87th Cong., 1st sess., 1961.

- Defense Space Interests.* Hearings, 87th Cong., 1st sess., 1961.
- Discussion of U.S. Satellite Tracking System.* Hearings, 87th Cong., 1st sess., 1961.
- Master Planning of NASA Installations.* H. Rept. 167, 89th Cong., 1st sess., 1965.
- 1961 NASA Authorization.* Hearings on H.R. 10246, 86th Cong., 2d sess., 1960.
- 1962 NASA Authorization.* Hearings, 87th Cong., 1st sess., 1961.
- 1964 NASA Authorization.* Hearings on H.R. 5466, 88th Cong., 1st sess., 1963.
- The Production of Documents by the National Aeronautics and Space Administration for the Committee on Science and Astronautics.* Hearings, 86th Cong., 2d sess., 1960.
- Property Rights in Inventions Made under Federal Space Research Contracts.* Hearings, 86th Cong., 1st sess., 1959.
- Proposed Revisions to the Patent Section, National Aeronautics and Space Act of 1958.* Committee Print of Subcommittee Report, 86th Cong., 2d sess., 1960.
- Report on the Activities of the Committee on Science and Astronautics.* H. Rept. 2215, 86th Cong., 2d sess., 1960.
- Small Business Participation in the NASA Research and Development Programs.* Staff Study, 87th Cong., 1st sess., 1961.
- Space Medicine Research.* Hearings, 86th Cong., 2d sess., 1960.
- To Amend the National Aeronautics and Space Act of 1958.* Hearings on H.R. 9675, 86th Cong., 2d sess., 1960.
- Transfer of the Development Operations Division of the Army Ballistic Missile Agency to the National Aeronautics and Space Administration.* Hearing on H.J. Res. 567, 86th Cong., 2d sess., 1960.
- Ways and Means of Effecting Economies in the National Space Program.* Hearings, 87th Cong., 2d sess., 1962.
- Committee on Appropriations.
- Independent Offices Appropriations for 1959, Part 2.* Subcommittee Hearings, 85th Cong., 2d sess., 1958.
- Independent Offices Appropriations for 1964, Part 3.* Subcommittee Hearings, 88th Cong., 1st sess., 1963.
- Committee on Government Operations.
- Organization and Management of Missile Programs.* Subcommittee Hearings, 86th Cong., 1st sess., 1959.
- Systems Development and Management, Part 5.* Hearings, 87th Cong., 2d sess., 1962.
- Senate: Special Committee on Space and Astronautics.
- Compilation of Materials on Space and Astronautics, No. 1.* Committee Print, 85th Cong., 2d sess., 1958.
- Compilation of Materials on Space and Astronautics, No. 2.* Committee Print, 85th Cong., 2d sess., 1958.
- Final Report.* S. Rept. 100 Pursuant to S. Res. 256, 85th Cong., 1st sess., 1959.
- National Aeronautics and Space Act.* Hearings on S. 3609, Parts 1 and 2, 85th Cong., 2d sess., 1958.
- Nominations.* Hearing on the Nomination of T. Keith Glennan . . . and Hugh L. Dryden, Aug. 14, 1958, 85th Cong., 2d sess., 1958.
- Committee on Aeronautical and Space Sciences.
- Amending the NASA Authorization Act for Fiscal Year 1962.* Hearing on S. 2481, 87th Cong., 1st sess., 1961.
- Documents on International Aspects of the Exploration and Use of Outer Space, 1954-1962.* Staff Report issued as S. Doc. 18, 88th Cong., 1st sess., 1963.
- Governmental Organization for Space Activities.* S. Rept. 806, 86th Cong., 1st sess., 1959.

- Investigation of Governmental Organization for Space Activities.* Subcommittee Hearings, 86th Cong., 1st sess., 1959.
- Missile and Space Activities.* Joint Hearings with Armed Services Subcommittee, 86th Cong., 1st sess., 1959.
- NASA Authorization for Fiscal Year 1960.* Hearings on S. 1582, 86th Cong., 1st sess., 1959.
- NASA Authorization for Fiscal Year 1961.* Hearings on H.R. 10809, 86th Cong., 2d sess., 1960.
- NASA Authorization for Fiscal Year 1961.* S. Rept. 1300, 86th Cong., 2d sess., 1960.
- NASA Authorization for Fiscal Year 1962.* S. Rept. 475, 87th Cong., 1st sess., 1961.
- NASA Authorization for Fiscal Year 1964.* Hearings on S. 1245, 88th Cong., 1st sess., 1963.
- NASA Supplemental Authorization for Fiscal Year 1959.* Hearings on S. 1096, 86th Cong., 1st sess., 1959.
- Nomination.* Hearing on Nomination of James Edwin Webb, 87th Cong., 1st sess., 1961.
- Nominations.* Hearing on Nominations of William Burden and John Rettaliata, May 19, 1959, 86th Cong., 1st sess., 1959.
- Space Research in the Life Sciences: An Inventory of Related Programs, Resources, and Facilities.* Committee Print, 86th Cong., 2d sess., 1960.
- Transfer of von Braun Team to NASA.* Subcommittee Hearing on H.J. Res. 567, 86th Cong., 2d sess., 1962.
- Committee on Appropriations.
- Supplemental Appropriation Bill for 1960.* Hearings on H.R. 7978, 86th Cong., 1st sess., 1959.
- Second Supplemental Appropriation Bill for 1962.* Hearings on H.R. 11038, 87th Cong., 2d sess., 1962.
- Committee on Armed Services.
- Inquiry Into Satellite and Missile Programs, Parts I, II, and III.* Preparedness Investigating Subcommittee Hearings, 85th Cong., 1st and 2d sess., 1957, 1958.
- Committee on Government Operations.
- Science Program—86th Congress.* S. Rept. 120, 86th Cong., 1st sess., 1959.

## VI. Entries in the Federal Register

- |                               |                               |
|-------------------------------|-------------------------------|
| 23 F.R. 7579 (Sept. 30, 1958) | 24 F.R. 7638 (Sept. 23, 1959) |
| 23 F.R. 7643 (Oct. 1, 1958)   | 24 F.R. 7639 (Sept. 23, 1959) |
| 23 F.R. 9405 (Dec. 3, 1958)   | 24 F.R. 8788 (Oct. 29, 1959)  |
| 23 F.R. 9646 (Dec. 12, 1958)  | 25 F.R. 403 (Jan. 19, 1960)   |
| 24 F.R. 1644 (Mar. 5, 1959)   | 25 F.R. 2100 (Mar. 12, 1960)  |
| 24 F.R. 1816 (Mar. 12, 1959)  | 25 F.R. 2151 (Mar. 16, 1960)  |
| 24 F.R. 3574 (May 5, 1959)    | 25 F.R. 2197 (Mar. 17, 1960)  |
| 24 F.R. 5178 (June 25, 1959)  | 25 F.R. 10763 (Nov. 11, 1960) |
| 24 F.R. 5183 (June 25, 1959)  | 25 F.R. 10766 (Nov. 11, 1960) |
| 24 F.R. 6086 (July 30, 1959)  | 27 F.R. 10460 (Oct. 26, 1962) |
| 24 F.R. 6615 (Aug. 14, 1959)  | 28 F.R. 10943 (Oct. 12, 1963) |
| 24 F.R. 6907 (Aug. 26, 1959)  |                               |

## VII. NASA Publications and News Releases

## A. SEMIANNUAL REPORTS

First (Oct. 1, 1958 to Mar. 31, 1959)	No. 187, 86th Cong.
Second (Apr. 1, 1959 to Sept. 30, 1959)	No. 361, 86th Cong.
Third (Oct. 1, 1959 to Mar. 31, 1960)	No. 454, 86th Cong.
Fourth (Apr. 1, 1960 to Sept. 30, 1960)	No. 55, 87th Cong.
Fifth (Oct. 1, 1960 to June 30, 1961)	No. 468, 87th Cong.
Sixth (July 1, 1961 to Dec. 31, 1961)	No. 588, 87th Cong.
Seventh (Jan. 1, 1962 to June 30, 1962)	No. 78, 88th Cong.
Eighth (July 1, 1962 to Dec. 31, 1962)	No. 179, 88th Cong.
Ninth (Jan. 1, 1963 to June 30, 1963)	No. 314, 88th Cong.

Also issued as House Document:

## B. PROCUREMENT REPORTS

*NASA Procurement, October 1, 1958, to June 30, 1960.**Annual Procurement Report, Fiscal Year 1961.* (Also Fiscal Year 1962 and Fiscal Year 1963.)*Semiannual Procurement Report, July 1, 1960, through December 31, 1960.* (Also July 1 through December 31 for 1961, 1962, and 1963.)

## C. GENERAL PUBLICATIONS

AKENS, DAVID S., *Historical Origins of the George C. Marshall Space Flight Center.* (MSFC Historical Monograph No. 1) Huntsville, Ala.: NASA, 1960."Chronology of Major NASA Launchings, October 1, 1958, Through December 31, 1962" (App. B of *Astronautical and Aeronautical Events of 1962.* Washington: GPO, 1963.)EMME, EUGENE M., *Aeronautics and Astronautics, 1915-60.* Washington: NASA, 1961.GRIMWOOD, JAMES, *Project Mercury: A Chronology.* Washington: NASA SP-4001, 1963.

LINDEMANN, ROBERT A., and FRANK JARRETT, "Historical Origins of Launch Operations Center to December 1962" (KHM-1).

LINK, MAE MILLS, *Space Medicine in Project Mercury.* Washington: NASA SP-4003, 1965.*Mercury Project Summary.* Washington: NASA SP-45, 1963.NASA Historical Staff, *Historical Sketch of NASA.* Washington: NASA EP-29, 1965.NASA Historical Staff, *Astronautics and Aeronautics, 1963.* Washington: NASA SP-4004, 1964.*NASA-Industry Program Plans Conference, July 28-29, 1960.* (Includes Brackett, Ernest, "NASA's Procurement System," and Sohler, Walter, "Legal Framework of NASA's Procurement Program.")*Proceedings of the Second NASA-Industry Program Plans Conference.* Washington: NASA SP-29, 1963. (Includes O'Brien, Gerald, "NASA Patent Policy and Procedure.")ROSENTHAL, ALFRED, *The Early Years, Goddard Space Flight Center, Historical Origins and Activities Through December 1962.*

"Saturn Chronology to December 31, 1960." May 1961, MHR-1, MSFC Historical Office.

*Selling to NASA.* Washington: GPO, 1962.STILLWELL, WENDELL H., *X-15 Research Results.* Washington: NASA SP-60, 1965.

## D. NEWS RELEASES

"NASA To Take Over NACA September 30," Sept. 26, 1958. (NACA Release.)

"Fact Sheet on the Transfer of Certain Functions From Department of Defense . . .," Oct. 1, 1958.

". . . brief biographies of the top officers . . .," Oct. 5, 1958.

"Glennan Announces First Details of New Space Agency Organization," Oct. 5, 1958.

"NASA Announces Contracting Procedures," Oct. 30, 1958.

"Functions and Responsibilities of Research Advisory Committees of the National Aeronautics and Space Administration," Nov. 21, 1958.

59-121 (Apr. 23, 1959)	61-201 (Sept. 7, 1961)	62-115 (May 11, 1962)
59-123 (Apr. 30, 1959)	61-203 (Sept. 11, 1961)	62-155 (July 3, 1962)
59-125 (May 1, 1959)	61-207 (Sept. 19, 1961)	62-179 (Aug. 7, 1962)
59-153 (May 28, 1959)	61-213 (Sept. 24, 1961)	62-215 (Oct. 12, 1962)
59-167 (June 25, 1959)	61-236 (Oct. 25, 1961)	62-228 (Oct. 26, 1962)
59-206 (Aug. 25, 1959)	61-244 (Nov. 3, 1961)	62-233 (Oct. 30, 1962)
59-270 (Dec. 8, 1959)	61-255 (Nov. 11, 1961)	62-249 (Nov. 21, 1962)
59-285 (Jan. 1, 1960)	61-263 (Nov. 28, 1961)	62-251 (Nov. 27, 1962)
60-231 (July 22, 1960)	61-273 (Dec. 7, 1961)	62-261 (Dec. 12, 1962)
60-260 (Sept. 13, 1960)	61-281 (Dec. 15, 1961)	63- 11 (Jan. 22, 1963)
60-300 (Nov. 17, 1960)	61-284 (Dec. 21, 1961)	63- 44 (Mar. 4, 1963)
60-319 (Dec. 19, 1960)	61-287 (Dec. 31, 1961)	63-225 (Oct. 9, 1963)
61- 65 (Mar. 28, 1961)	62- 37 (Feb. 19, 1962)	63-233 (Oct. 21, 1963)
61-115 (May 25, 1961)	62- 53 (Mar. 7, 1962)	

### VIII. Internal NASA Documents

#### A. NASA GENERAL DIRECTIVES

No. 9, Jan. 29, 1959. Subject: Delegation of Authority—NASA Patent Matters.

No. 10, Feb. 10, 1959. Subject: NASA Advisory Committee.

#### B. MEMORANDA FROM THE ADMINISTRATOR

Oct. 20, 1958. Subject: Establishment and Approval of Excepted Positions and Salaries Under the Authority of Sec. 203(b) of the National Aeronautics and Space Act.

Jan. 30, 1959. Subject: NASA Organization.

Apr. 6, 1959. Subject: Functions and Authority—Office of Research Grants and Contracts.

May 1, 1959. Subject: Functions and Authority—Goddard Space Flight Center (GSFC).

May 25, 1959. Subject: Preliminary Budget Proposals—FY 1961.

May 27, 1959. Subject: Establishment of the Administrator's Progress Report.

#### C. GENERAL MANAGEMENT INSTRUCTIONS, ADMINISTRATIVE PROCEDURES AND REGULATIONS

Introduction, June 1, 1959. Subject: NASA Issuance System.

Introduction, July 22, 1959. Subject: NASA Issuance System.

2-1-6, Jan. 24, 1962. Subject: Functions and Authority—Assistant Administrator for Public Affairs.

2-1-6, Apr. 26, 1963. Subject: Functions and Authority—Assistant Administrator for Technology Utilization and Policy Planning.

2-1-8.8, Jan. 17, 1962. Subject: Function and Authority—Audit Division.

2-1-13, May 30, 1960. Subject: Functions and Authority—Office of Technical Information and Educational Programs.

2-2-9.1, Oct. 27, 1960. Subject: Establishment of NASA Test Support Office, Pacific Missile Range.

2-2-16.1, May 11, 1962. Subject: Establishment and Functions of the National Aeronautics and Space Administration Office—Downey.

2-5-5, Mar. 29, 1963. Subject: Management Advisory Committee for Manned Space Flight.

- 3-3-7.1, May 10, 1963. Subject: Contractual Relationship between the Headquarters Contracting Officer for Contract NASw-410, Center Directors and Procurement Officers at LOC, MSFC, MSC, and the General Electric Co.
- 3-3-7.2, May 10, 1963. Subject: Contractual Relationship Between Headquarters Contracting Officer for Contract NASw-410, the Director and Procurement Officer at MSFC, and the General Electric Co. Concerning the Mississippi Test Facility.
- 3-5-3, June 14, 1960. Subject: Financial Operating System.
- 3-6-1, July 5, 1963. Subject: Automatic Data Processing (ADP) Equipment and Services.
- 3-6-2, Oct. 4, 1963. Subject: NASA Inter-Center Committee on ADP.
- 4-1-1, Jan. 18, 1961. Subject: Planning and Implementation of NASA Projects.
- 4-1-1, Mar. 8, 1963. Subject: Planning and Implementation of NASA Projects.
- 4-1-5, Sept. 1, 1961. Subject: NASA Program Evaluation and Review Technique—PERT System.
- 6-1-1, June 1, 1959. Subject: NASA Issuance Procedures.
- 6-2-1, July 1, 1959. Subject: Administrator's Progress Report.
- 6-2-2, July 1, 1959. Subject: Preparation of Administrator's Progress Report.
- 6-2-3, May 5, 1960. Subject: NASA Program Management System.
- 18-9-101, Oct. 26, 1963. Subject: Property Rights in Inventions Made in the Performance of Work Under NASA Contracts.

## D. CIRCULARS

- No. 55, Mar. 7, 1960. Subject: Detail of Personnel to the Office for the United Nations' Conference.
- No. 57, Mar. 14, 1960. Subject: Establishment of NASA Huntsville Facility.
- No. 93, Aug. 3, 1960. Subject: Interim Operating Plans—Office of the Associate Administrator.
- No. 110, Oct. 21, 1960. Subject: Establishment of Positions of Assistant Administrator for Programs and Assistant Administrator for Resources—Office of Associate Administrator.
- No. 147, July 1, 1961. Subject: Functions and Authority—Headquarters Procurement Branch.
- No. 208, Mar. 7, 1962. Subject: Establishment of the Launch Operations Center at AMR and the Pacific Launch Operations Office at PMR.
- No. 219, May 7, 1962. Subject: Planning and Implementation of NASA Projects—Interim Changes to.
- No. 231, May 29, 1962. Subject: Special Procurement Study.
- No. 233, June 15, 1962. Subject: Informational Material on Assignment of Responsibilities in NASA Headquarters, Attachment A: General Responsibilities and Functions of a NASA Headquarters Program Director; and Attachment B: Functional Management Responsibilities of the Office of Administration.
- No. 242, Sept. 1, 1962. Subject: Use of Incentive Contracts.
- No. 243, Aug. 16, 1962. Subject: Geographic Distribution of NASA Subcontracts.
- No. 277, Mar. 29, 1963. Subject: NASA Management Advisory Committee for Manned Space Flight.
- No. 280, Apr. 16, 1963. Subject: Restrictions on Contracting with the General Electric Co. where Competitive Advantage May Exist.

## E. ANNOUNCEMENTS

- No. 58, Dec. 14, 1959. Subject: Establishment of New Headquarters Staff Component.
- No. 71, Jan. 18, 1960. Subject: Arrival of New Deputy Associate Administrator.
- No. 85, Feb. 2, 1960. Subject: Appointment of Director of Financial Management.
- No. 86, Feb. 2, 1960. Subject: Appointment of Director of Audits.



- No. 134, May 17, 1960. Subject: Reorganization of the Office of Research Grants and Contracts.
- No. 156, June 13, 1960. Subject: NASA Organizational Changes at AMR and PMR.
- No. 165, June 30, 1960. Subject: Establishment of Headquarters Personnel Office.
- No. 173, July 19, 1960. Subject: Appointment of Associate Administrator.
- No. 314, June 5, 1961. Subject: Organizational and Functional Changes in NASA Headquarters.
- No. 384, Oct. 23, 1961. Subject: Activation of the Joint AEC-NASA Space Nuclear Propulsion Office, Cleveland.
- No. 513, June 5, 1962. Subject: Bob P. Helgeson Appointed Chief, Space Nuclear Propulsion Office—Nevada Extension.
- No. 558, July 16, 1962. Subject: Management Intern Program Now Underway.

## F. LETTERS

- Barclay, Gen. J. A., U.S. Army.  
June 9, 1960. To Gen. Don Ostrander, NASA.
- Brooks, Representative Overton.  
May 28, 1959. To T. Keith Glennan.
- Corson, John, McKinsey & Co.  
Dec. 18, 1958. To T. Keith Glennan.
- Dryden, Hugh.  
Apr. 15, 1958. To Roy Johnson, ARPA.
- Eisenhower, President Dwight D.  
Jan. 5, 1959. To T. Keith Glennan.
- Glennan, T. Keith.  
Sept. 29, 1958. To Joseph Campbell, GAO.  
Nov. 10, 1958. To NACA Committee Chairman.  
Dec. 26, 1958. To President Dwight D. Eisenhower.  
Feb. 9, 1959. To James Perkins, Carnegie Institution.  
Apr. 7, 1959. To Senator Stuart Symington.  
May 25, 1959. To Maurice Stans, BOB.  
June 15, 1959. To Representative Overton Brooks.  
Aug. 14, 1959. To Crawford Greenewalt, Du Pont Co.  
Aug. 28, 1959. To Joseph Campbell, GAO.  
Sept. 2, 1959. To John Rettaliata, NASC.  
Sept. 8, 1959. To Gen. John Medaris, U.S. Army.  
Oct. 20, 1959. To President Dwight D. Eisenhower.  
Nov. 16, 1959. To President Dwight D. Eisenhower.  
Nov. 18, 1959. To John Corson, McKinsey & Co.  
Jan. 14, 1960. To Speaker, House of Representatives.  
Feb. 10, 1960. To Crawford Greenewalt, Du Pont Co.  
Mar. 25, 1960. To James Douglas, DOD.  
June 6, 1960. To John Corson, McKinsey & Co.  
July 15, 1960. To Roger Jones, CSC.  
Aug. 5, 1960. To Ralph Besse, Cleveland Electric Co.  
Jan. 12, 1961. To Richard Horner, formerly of NASA.
- Harbridge House, Inc.  
Apr. 25, 1961. To George Vecchiatti.
- Jones, Roger, CSC.  
Aug. 23, 1960. To T. Keith Glennan.
- McKinsey & Co.  
Sept. 26, 1958. To T. Keith Glennan.

Siepert, Albert.

Dec. 12, 1961. To Lt. Gen. W. K. Wilson, ACE.

Webb, James E.

Sept. 21, 1961. To Lt. Gen. W. K. Wilson, ACE.

Feb. 21, 1962. To Frederick Kappel, AT&T.

Apr. 11, 1962. To J. McNeely, AT&T.

**G. MEMORANDA**

Abbott, Ira.

May 23, 1958. To Edward Chamberlin et al. Subject: Organization and Staffing of NASA Headquarters.

Brackett, Ernest.

Mar. 6, 1961. To Albert Siepert. Subject: Suggestion for Centralized Headquarters Procurement Office.

Corson, John, McKinsey & Co.

Sept. 16, 1958. To NASA (Memorandum for Discussion). Subject: Assistance on Organization of the National Aeronautics and Space Administration.

Dec. 8, 1958. To T. Keith Glennan. Subject: Next Steps in Organization of the National Aeronautics and Space Administration.

Nov. 2, 1969. To T. Keith Glennan.

Jan. 26, 1960. To T. Keith Glennan. Subject: A Plan for Appraising NASA's Contracting Policies and Over-all Organization.

Cortright, Edgar.

Aug. 23, 1960. To Newell Sanders. Subject: Some Comments on "An Evaluation of NASA's Contracting Policies, Organization, and Performance" by McKinsey & Co.

Nov. 3, 1960. To Abe Silverstein and Don Ostrander.

Dembling, Paul.

Apr. 26, 1960. To Director of Business Administration. Subject: Contracts for Services.

Gamble, Allen.

June 8, 1959. Memorandum of Record.

July 19, 1960. To Langley Personnel Officer et al. Subject: Aero-Space Technology Examination.

Dec. 11, 1959. To Langley Personnel Officer et al. Subject: Draft of Aero-Space Technologist Examination.

Glennan, T. Keith.

Oct. 10, 1958. To Wesley Hjernevik.

Nov. 19, 1958. Memorandum of Record.

Dec. 24, 1958. To Hugh Dryden.

Apr. 7, 1959. To Abe Silverstein, John Crowley, and Albert Siepert. Subject: Program Reporting.

Apr. 15, 1959. Memorandum to record the results of the conversation between Messrs. McElroy, Dryden, and Glennan, who were joined later at lunch by Dr. Quarles.

May 19, 1959. To Albert Siepert.

July 7, 1959. To Headquarters Staff. Subject: Bioscience Advisory Committee.

Aug. 28, 1959. To Richard Horner.

Sept. 9, 1959. To Richard Horner.

Oct. 7, 1959. To Hugh Dryden et al.

Nov. 16, 1959. To Richard Horner.

Feb. 2, 1960. To Headquarters Directorates. Subject: 1962 Budget Guidelines.

Feb. 24, 1960. To Homer Stewart. Subject: Distribution of "The Ten-Year Plan," a Confidential Document of NASA.

Mar. 7, 1960. To Albert Siepert.

- Mar. 18, 1960. To Members of the Advisory Committee on Organization. Subject: The Evaluation of NASA's Organization: The Problem, Suggested Approaches, and the End Objective.
- Aug. 1, 1960. To Robert Lacklen.
- Sept. 1, 1960. To Albert Siefert.
- Dec. 14, 1960. To Abe Silverstein.
- Glennan, T. Keith, and Gates, Thomas.
- Oct. 21, 1959. Memorandum for the President. Subject: Responsibility and Organization for Certain Space Activities.
- Golovin, Nicholas.
- Apr. 8, 1960. To Program Directors. Subject: NASA Program Presentation to Industry.
- Apr. 13, 1960. To Richard Horner. Subject: Principal Conclusions of the Meeting of April 13, 1960, NASA-Industry Conference.
- Finan, William, John Diebold & Associates, Inc.
- Dec. 31, 1961. To John Young. Subject: Final Report Under Contract No. NASw-272.
- Hahn, Walter.
- Mar. 1, 1962. To Albert Siefert et al. Subject: NASA Representative at North American—Downey.
- Hjornevik, Wesley.
- Apr. 27, 1959. To T. Keith Glennan.
- Horner, Richard.
- Aug. 3, 1959. To Abe Silverstein, Ira Abbott, Albert Siefert. Subject: Program Management.
- Sept. 24, 1959. To Directors of OBS, OASR, OSFD. Subject: Necessity of Timely Decisions.
- Mar. 22, 1960. To Headquarters Directors. Subject: Planning Schedule for the 1960 Long-Range Plan.
- King, Robert.
- Aug. 24, 1960. To Don Ostrander and Abe Silverstein. Subject: Initiation of Review for the Administrator.
- Lacklen, Robert.
- Apr. 4, 1958. To John Victory.
- McKinsey & Co.
- June 3, 1960. To T. Keith Glennan. Subject: Progress Report on Study of Contracting Policies.
- Ostrander, Don.
- July 27, 1960. To T. Keith Glennan.
- Nov. 14, 1960. To Edgar Cortright.
- Rosenthal, Aaron.
- Apr. 25, 1961. To Albert Siefert. Subject: Mechanization of Fiscal and Reporting Operations.
- Aug. 4, 1960. To T. Keith Glennan. Subject: Fiscal Year 1961 Financial Operating Plans.
- Aug. 16, 1960. To Albert Siefert. Subject: Status of Financial Management System.
- Nov. 14, 1960. To Program Directors et al. Subject: Agencywide Coding Structure.
- Apr. 10, 1961. To Stephen Grillo. Subject: Mechanization of Financial Accounting and Reporting.
- Rosenthal, Aaron, and Ostrander, Don.
- Apr. 29, 1960. To T. Keith Glennan.

- Seamans, Robert.  
 July 28, 1961. To Program Directors. Subject: Financial Operating Plans.  
 Aug. 8, 1961. To Program Directors. Subject: Financial Operating Plans.  
 Aug. 23, 1961. To Program Directors. Subject: Call for Financial Operating Plan Obligation Estimates for the Fiscal Year 1962 Construction of Facilities Appropriation.
- Siepert, Albert.  
 May 7, 1959. To T. Keith Glennan.  
 Jan. 13, 1961. To T. Keith Glennan. Subject: Comments on Final Report of Advisory Committee on Organization.  
 Oct. 19, 1962. To Directors of Headquarters Program and Staff Offices and NASA Centers and Installations. Subject: New Examination Announcement for R&D Administration Positions: Part C of the Aero-Space Technology Announcement.
- Sohier, Walter.  
 July 20, 1962. To James E. Webb.  
 Feb. 21, 1963. To James E. Webb. Subject: Conclusion of Special Procurement Study.
- Stewart, Homer.  
 Nov. 12, 1958. To T. Keith Glennan.
- Webb, James E.  
 Apr. 3, 1962. To Robert Seamans. Subject: NASA Procurement Study Group.
- Webster, Grove.  
 Oct. 13, 1960. Subject: Personnel Management Evaluation for NASA.
- Wyatt, DeMarquis.  
 Nov. 18, 1960. To Edgar Cortright.  
 Aug. 24, 1961. To Program Directors. Subject: Content and Structure of Project Development Plans (PDP's) and Preliminary Project Development Plans Submitted to the Associate Administrator for Approval.
- Young, John.  
 July 24, 1961. To James E. Webb. Subject: Additional Item on Organization.
- H. REPORTS AND STUDIES PREPARED FOR NASA  
 "The Evaluation and Selection of Major R&D Sources." Feb. 28, 1963. Prepared by Harbridge House, Inc.  
 "An Evaluation of NASA's Contracting Policies, Organization, and Performance." October 1960. Prepared by McKinsey & Co.  
 "National Aeronautics and Space Administration: Its Organization and Management." October 1960. Prepared by the Advisory Committee on Organization, Lawrence Kimpton, Chairman.  
 "NASA Incentive Contracting Guide." September 1962. Prepared by Harbridge House, Inc.  
 "NASA Management and Control System." Nov. 30, 1960. Prepared by Ramo-Woolbridge Co.  
 "NASA-JPL Relationships and the Role of the Western Coordination Office." March 1959. Prepared by McKinsey & Co.  
 "NASA Procurement Management Seminar." 1962. Prepared by Harbridge House, Inc.  
 "Operational Plan for NASA Advisory Committee." Aug. 7, 1959. Prepared by the RAND Corp.  
*Proposed Studies of the Implications of Peaceful Space Activities for Human Affairs.* Prepared by Brookings Institution. (Published as H. Rept. 242, 87th Cong., Washington: GPO, 1961.)  
 "Providing Supporting Services for the Development Operations Division." Jan. 16, 1960. Prepared by McKinsey & Co.

"Recommendations to the NASA Regarding a National Civil Space Program." Oct. 28, 1958. Prepared by the NACA Special Committee on Space Technology.

"Report of National Aeronautics and Space Administration Bioscience Advisory Committee." Jan. 25, 1960. Prepared by Bioscience Advisory Committee, Seymour Kety, Chairman.

#### I. REPORTS AND ITEMS IN A SERIES

"Annual Training Report for Fiscal Year 1960." Also for Fiscal Year 1961 and Fiscal Year 1962.

"Minutes, Space Exploration Program Council Meeting, February 10-11, 1960." Also Apr. 25-26, 1960.

"NASA Headquarters Personnel Bulletin" (HPB 3-62), Nov. 2, 1962. Also HPB 4-62, Nov. 13, 1962, and HPB 5-62, Nov. 27, 1962.

"Quarterly Manpower Utilization Report to Subcommittee on Manpower Utilization of the Committee on Post Office and Civil Service, House of Representatives, for Quarter ending Mar. 31, 1959." Apr. 27, 1959. Also for quarters ending June 30, Sept. 30 and Dec. 31, 1959, and subsequent quarters in 1960, 1961, and 1962.

"Report of Ad Hoc Committee on NASA Organization." May 21, 1958. Also Revised Report, Ad Hoc Committee on NASA Organization, June 2, 1958; Second Revision of Report of Ad Hoc Committee on NASA Organization, July 25, 1958; and Final Report of the Ad Hoc Committee on NASA Organization, Aug. 12, 1958. Prepared by Ad Hoc Committee on NASA Organization, Ira Abbott, Chairman.

#### J. INDIVIDUAL REPORTS, STUDIES, STAFF PAPERS, ETC.

"Adapting NASA's Organization and Management to Future Challenges." October 1963. Prepared by the Office of Administration.

"AST and Engineering Recruiting Results (July 1, 1961-September 30, 1962)." Prepared by the Personnel Division.

"Brief Discussion of Procurement Organization and Practices of NACA-NASA." August 1958. Prepared by Ralph Cushman.

"Briefing Regarding the Commission's Agency-wide Evaluation of Personnel Management in NASA." Apr. 12, 1963.

"Clarifying and Strengthening the Role of NASA's General Management." Apr. 14, 1961. Prepared by the Management Analysis Division.

"Draft for Discussion Purposes, Subject: Administrator's Report." Apr. 6, 1959.

"Inadequate and Conflicting Management Systems." Sept. 28, 1962. Draft memorandum prepared by the Management Analysis Division.

"Justification of College Education Requirements for Professional Aero-Space Technology Administrative Management and Information Positions in the National Aeronautics and Space Administration." July 1, 1960. Prepared by Allen Gamble.

"Legislation Pertaining to the National Advisory Committee for Aeronautics as of April 1958." Prepared by NACA Office of Legal Adviser.

"Major Problems of Concern in the Organization and Management of the Civilian Space Program." Mar. 31, 1961. Draft memorandum prepared for James Webb by John Young.

"Managing Major New Technologies." Oct. 1, 1960, 39 pp. Prepared by Walter T. Sohler.

"Manpower Utilization Aspects of the Transfer to the NASA of the Former 'Development Operations Division,' ABMA, Army Missile Ordnance [sic] Command." See Annex D to the Quarterly Manpower Utilization Report for the quarter ending Sept. 30, 1960.

"Memorandum on Need for Study to Develop Supportable Position on Rate and Scale in Space Research." June 19, 1959. Prepared by T. Keith Glennan.

"NASA Electronics Research Center, Staff Report." January 1963.

"NASA Executive Development Program." July 15, 1960.

"NASA Guide to Source Evaluation and Selection." Oct. 1, 1963. (A Draft Guide.)

- "NASA Lunar Program and Large Booster Chronology" (Draft). Mar. 15, 1964. HHN-33 prepared by NASA Historical Staff.
- "NASA Staff Conference," Monterey, Calif., Mar. 3-5, 1960. Summary.
- "National Space Vehicle Program." Sept. 30, 1959. Prepared by William Holaday, Chairman, CMLC.
- "Notes of Conversation." Aug. 20, 1958. (Glennan, Quarles, et al.)
- "Notes of Discussion With Rear Admiral Rawson Bennett." Aug. 20, 1958.
- "Organizing to Achieve the Objectives of an Accelerated Civilian Space Program." Aug. 7, 1961. (Draft.)
- "Personnel Data Relating to the Transfer of ABMA DOD to MSFC." (Enclosure, Letter from Ruth Jarrell, MSFC, to Helen Wells, NASA Headquarters, Aug. 21, 1963.)
- "Reappraising NASA's Organizational Structure To Achieve the Objectives of an Accelerated Program." June 12, 1961. Cover memorandum signed by John Young.
- "Recommendations Toward a Sound Procurement Policy for NASA." Nov. 15, 1958.
- "Report to the House Committee on Science and Astronautics" (Requested in hearings before the committee on March 9, 1959). Mar. 17, 1959. Prepared by NASA Personnel Division.
- "Suggested Additional Points for Consideration by NASA Advisory Committee on Organization" (Attachment A). July 15, 1960.
- "Suggested Organizational and Operating Pattern for NASA" (Attachment B). July 15, 1960.
- "Summary Financial Plan for Fiscal Year 1961, NASA." Aug. 19, 1960.
- "A Summary Look at 'The Headquarters Organization Problem.'" Feb. 27, 1961. Prepared by Hjernevik, Siepert, Hodgson, and Young.
- "Summary of Discussion at Conference on National Space Program held October 22, 23, 1959." Nov. 2, 1959.
- "Summary of Meeting with Mr. Finney, April 27, 1960." Apr. 28, 1960. Prepared by Aaron Rosenthal.
- "Summary of Reports to the Congress. . . . January 25, 1963." Prepared by Office of Legislative Affairs.
- "Summary Progress Report No. 5." May 28, 1960. Subject: Development and Installation of New Financial Management System at MSFC. Prepared by Martin Finney for Aaron Rosenthal.
- "Supplement to Examination for Professional Positions in Aero-Space Technology . . ." (Draft). July 1, 1960.
- K. INTERAGENCY AGREEMENTS, UNDERSTANDINGS, ETC.**
- Agreement Between NASA and AEC on Management of Nuclear Rocket Engine Contracts. Feb. 1, 1961.
- Agreement Between the Department of Defense and the National Aeronautics and Space Administration Concerning the Aeronautics and Astronautics Coordinating Board. Sept. 13, 1960.
- Agreement Between the Department of Defense and the National Aeronautics and Space Administration Concerning Principles Governing Reimbursement of Costs. Nov. 12, 1959.
- Agreement Between Department of Defense and National Aeronautics and Space Administration Regarding Transfer of Records, Property, Facilities, and Civilian Personnel of Project Vanguard. Nov. 20, 1958.
- Agreement Between the Department of the Air Force and the National Aeronautics and Space Administration Concerning Air Force Assistance to NASA. . . . Aug. 15, 1959.
- Agreement Between the Department of the Army and NASA on the Objectives and Guidelines of the Implementation of the Presidential Decision To Transfer a Portion of ABMA to NASA. Nov. 16, 1959.

- Army NASA Transfer Plan. Dec. 11, 1959.
- Cooperative Agreement on Jet Propulsion Laboratory Between the National Aeronautics and Space Administration and the Department of the Army. Dec. 3, 1958.
- Inter-agency Agreement on the Program for the Development of Space Nuclear Rocket Propulsion (Project Rover). July 28, 1961.
- Memorandum of Understanding. Nov. 20, 1958. Subject: Program for a Manned Orbital Vehicle. (NASA and ARPA.)
- Memorandum of Understanding. Nov. 14, 1958. Subject: Principles of Participation of NASA in Development and Testing of the Air Force System 464L Hypersonic Boost Glide Vehicle (Dyna-soar I). (NASA, Air Force.)
- NASA-DOD Joint Report on Facilities and Resources Required at Launch Site To Support NASA Manned Lunar Landing Program, Phase I. July 31, 1961. (Debus-Davis Report.)
- The National Space Vehicle Program, prepared by the National Aeronautics and Space Administration in consultation with the Advanced Research Projects Agency of the Department of Defense. Jan. 27, 1959.
- Terms of Reference—Civilian-Military Liaison Committee to the National Aeronautics and Space Administration and the Department of Defense. Oct. 29, 1958.
- L. OTHER
- Notice of Change of Address. Sept. 30, 1958. (NACA Announcement.)
- Interim Procedure for Issuing NASA Management Manual Instructions. Oct. 1, 1958. (NASA General Notice.)

### IX. Speeches

- Dryden, Hugh L. "The National and International Significance of the Lunar Exploration Program." Dec. 29, 1961. Delivered at the AAAS Meeting, Denver, Colo.
- Dryden, Hugh L. "The Utilization of Technical Personnel in the Space Age." May 8, 1961. Delivered at the Engineering Manpower Conference, Denver, Colo.
- Kennedy, President John F. May 25, 1961. State of the Union Message delivered at a joint session of Congress.
- Kennedy, President John F. Sept. 12, 1962. Delivered at Rice University, Houston, Tex.
- Webb, James E. "Administration and the Conquest of Space." Apr. 13, 1962. Delivered at the National Conference of the American Society for Public Administration, Detroit, Mich.

### X. Miscellaneous Items

- A. PRE-APRIL 1958 NACA ITEMS
- "Rules and Regulations for the Conduct of the Work of the National Advisory Committee for Aeronautics With Amendments Approved by the President to May 3, 1949."
- Memorandum of Understanding. Dec. 23, 1954. Subject: Principles for the Conduct by the NACA, Navy and Air Force of a Joint Project for a New High Speed Research Airplane.
- Forty Years of Aeronautical Research.* By Jerome Hunsaker. (Smithsonian Report for 1955. Washington: Smithsonian Institution, 1956. Pp. 241-271.)
- "A National Research Program for Space Technology." Jan. 14, 1958. Prepared by NACA.
- "A Program for Expansion of NACA Research in Space Flight Technology With Estimates of the Staff and Facilities Required." February 10, 1958. Prepared by NACA.
- B. ITEMS RELATED TO SPACE
- "Advisory Committee on Government Organization." Memorandum for the President. Mar. 5, 1958. Subject: Organization for Civil Space Programs.