

***Optimization of ODS-Alloy Properties
for
High Temperature Oxidation Resistant Components***

Bimal Kad

University of California – San Diego

I. G. Wright

Oak Ridge National Laboratory

Gaylord Smith

Special Metals Corporation

22nd Annual Fossil Energy Meeting

July 8th – 10th 2008, Pittsburgh, PA

Why ODS-Alloys?

- Viable alternatives to Ni-base superalloys for engine hot section components
- Superior environmental durability than currently-used metallic materials
- Excellent oxidation, sulphidation resistance over an extended temperature range
- Thermodynamically stable phases in matrix for prolonged creep life
- Focus: ODS-Fe₃Al and ODS-FeCrAl

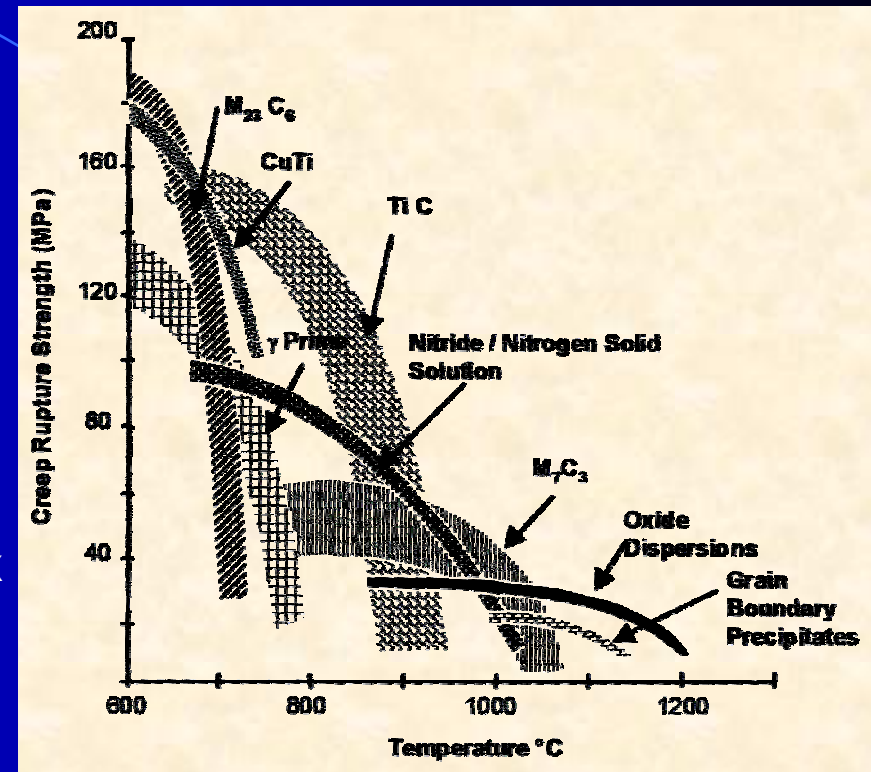

Unresolved Issues

- Microstructure modification for improved matching of the intrinsic material vs. the expected '*in-service*' design stress anisotropies

Devising and validating microstructure preserving joining methodologies

Goal: Oxidation Resistant Components

High Temperature Heat Exchangers–Vision 21, FutureGen Combustor Liners – Energy Efficiency Programs

Target Product:

- 1-3” diameter 10’ft long tubes for heat exchangers
- oxidizing/sulphidizing service environments
- Operating pressure of 1000psi at 1000-1100°C

Material Options:

- Y_2O_3 strengthened Fe_3Al
- Y_2O_3 strengthened Fe-Cr-Al (MA956™)

Barriers:

- Grain shape dependent anisotropic properties
- In-service creep strength anisotropy
- Microstructure preserving non-fusion joining

Scientific approach:

- Hoop Creep enhancement via flow forming
- Enhancement via thermo-mechanical processing
- Component specific joining methodologies

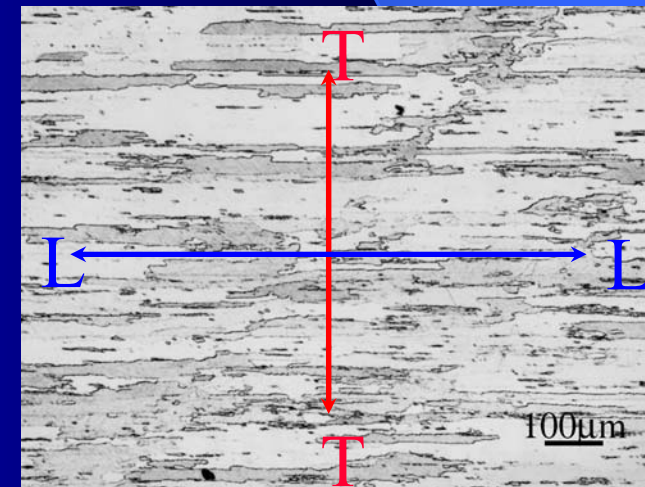
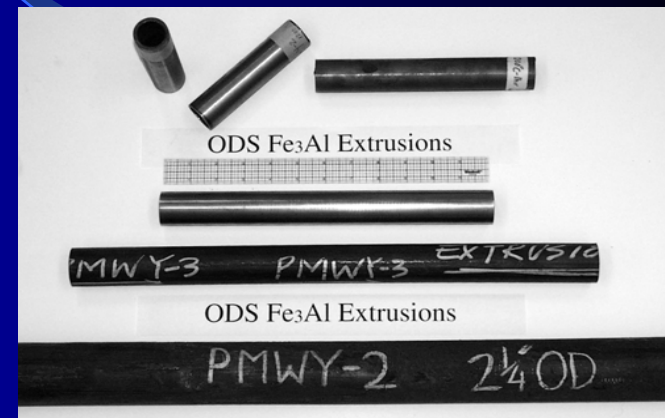

Today's presentation themes

- Improving ODS-FeCrAl alloy hoop creep response
 - *Thermo-mechanical routes to altering the underlying grain shape*
 - *Motivation for cross-rolling and flow-forming*
- Understanding the precise role of flow forming
 - *Whether grain fibering or simply cold-working*
- Exploring Ytria content in ODS FeCrAl alloys
 - *Does chemistry, oxide content play a role?*



Grain realignment in the hoop direction

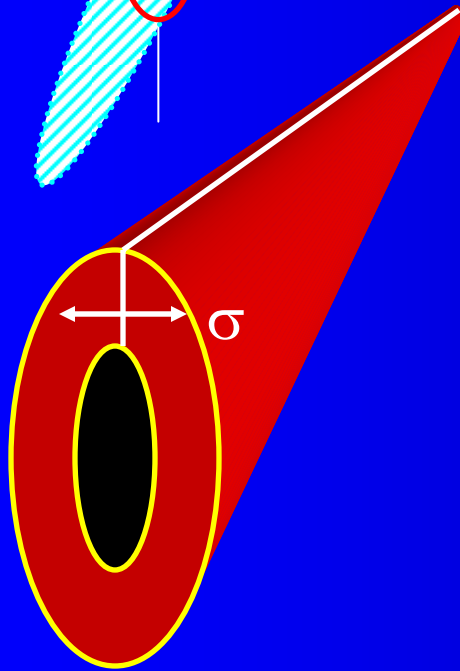
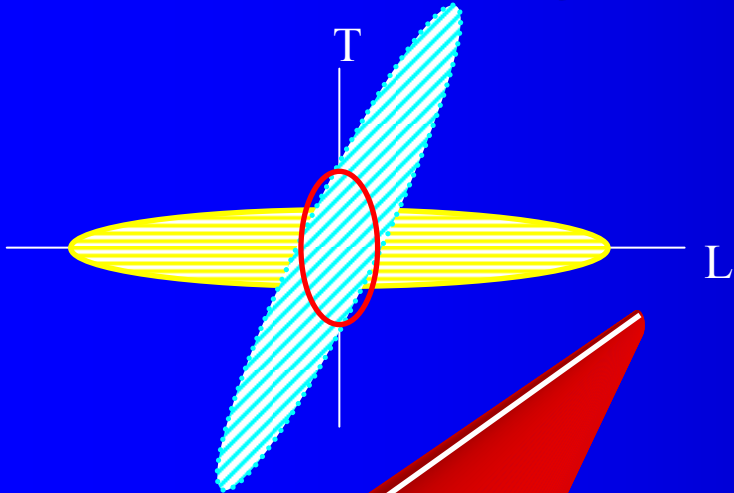

As processed grain boundaries normal to hoop loading axis

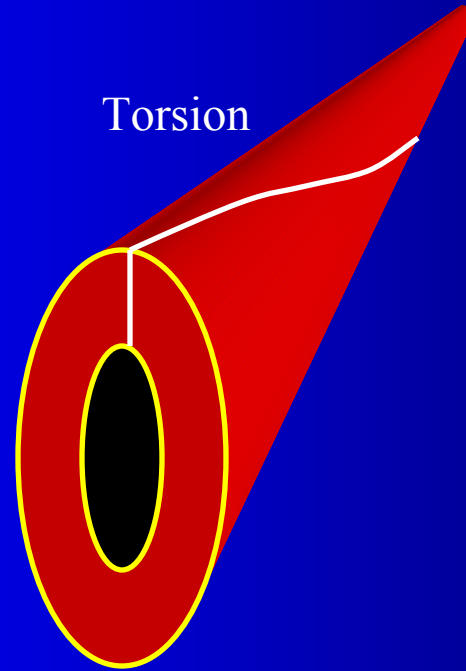

Grain realignment along length of tube



Shear

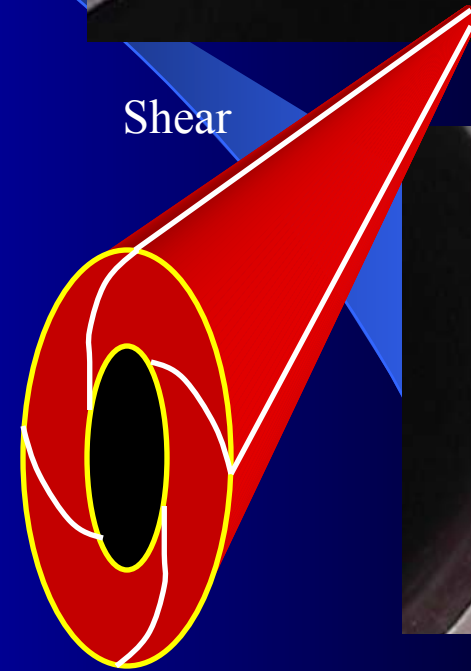

Grain realignment along radius of tube

Cross rolling technique

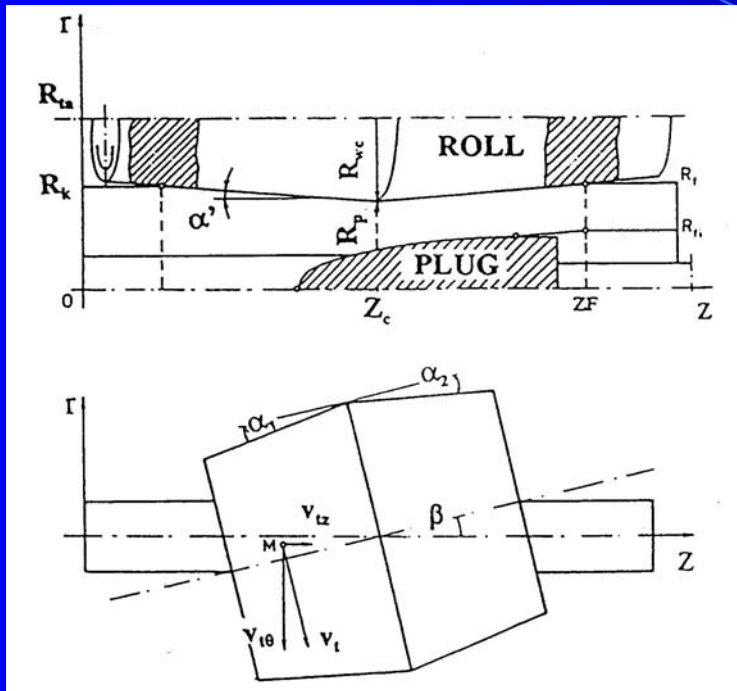

$$V_{tz} = V_t \sin \alpha = \omega R_{\omega z} \sin \beta$$

$$V_{t\theta} = V_t \cos \alpha = \omega R_{\omega z} \cos \beta$$



Grain shapes can be altered via torsion techniques.

Such helical grain modification is anticipated to improve hoop creep response.

Improved Grain Aspect Ratio

Grain Fibering via Cross Rolling

As-processed grain size

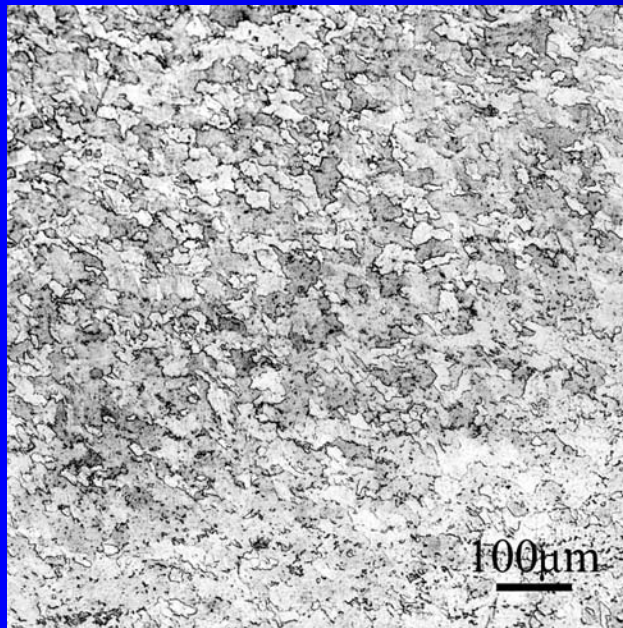

Cross rolled grain size

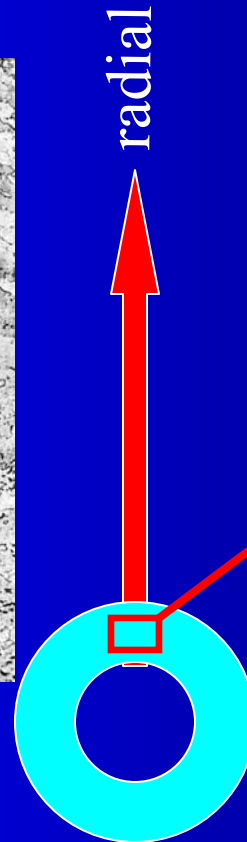
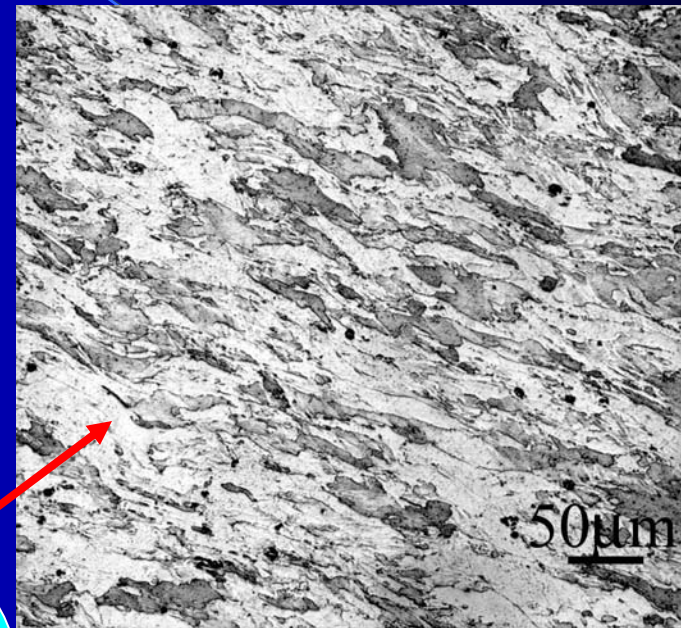

The as-extruded grain shape as viewed in the tube cross-section is roughly equi-axed. On cross-rolling the grain aspect-ratio is significantly enhanced in the hoop direction. However, the small overall processed grain size only provided marginal improvements in Hoop Creep.

Desired Microstructure

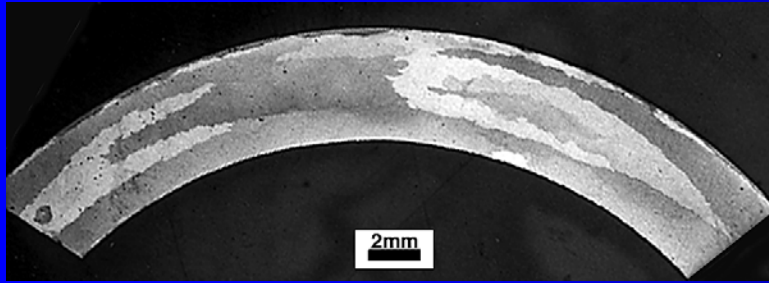

ODM-751, Onion-skin grain structure

In ODS MA956, coarse, secondary recrystallized, grain structure was only possible after extreme cold-working via flow forming.

Flow forming does NOT produce any fibering.

Only contribution is Cold Working

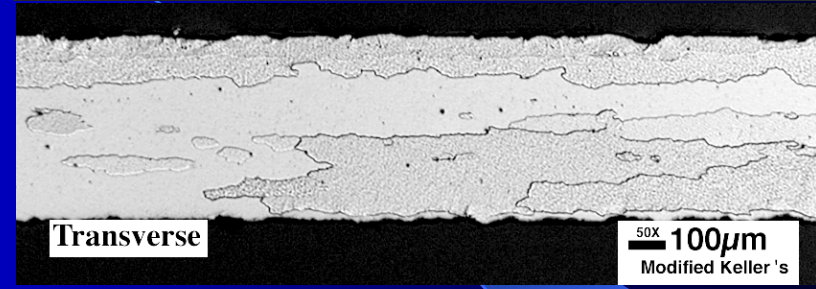
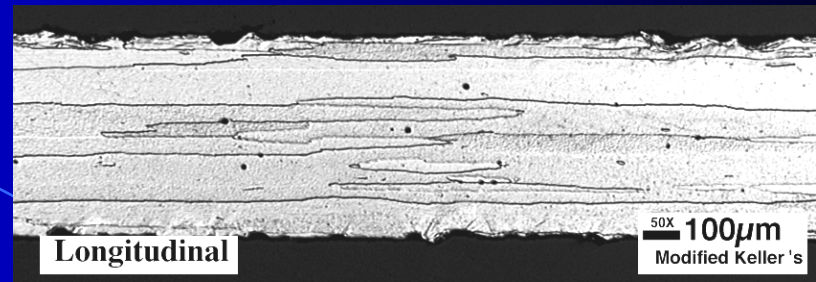

MA956, flow formed grain structure



MA956, starting tube 0.25" thick wall. *flow formed* tube 0.03-0.04"

Experimental Hoop Creep Test Regime

- The baseline Larsen-Miller Parameter for ODS MA956 hoop creep at 900°C, 2Ksi = 46
- Test samples cut in transverse orientation from flattened tubes
- All tests performed at 2Ksi for comparison of creep rates, creep life and failure mode
- *Status Today: increased LMP from 46 to 55*
$$LMP = 0.001 (Temp^{\circ}F + 460) (20 + \text{Log}(\text{life}))$$



Hoop Creep Test Status for ODS Alloys

Data points only for test surviving at least 6 months on the test rig

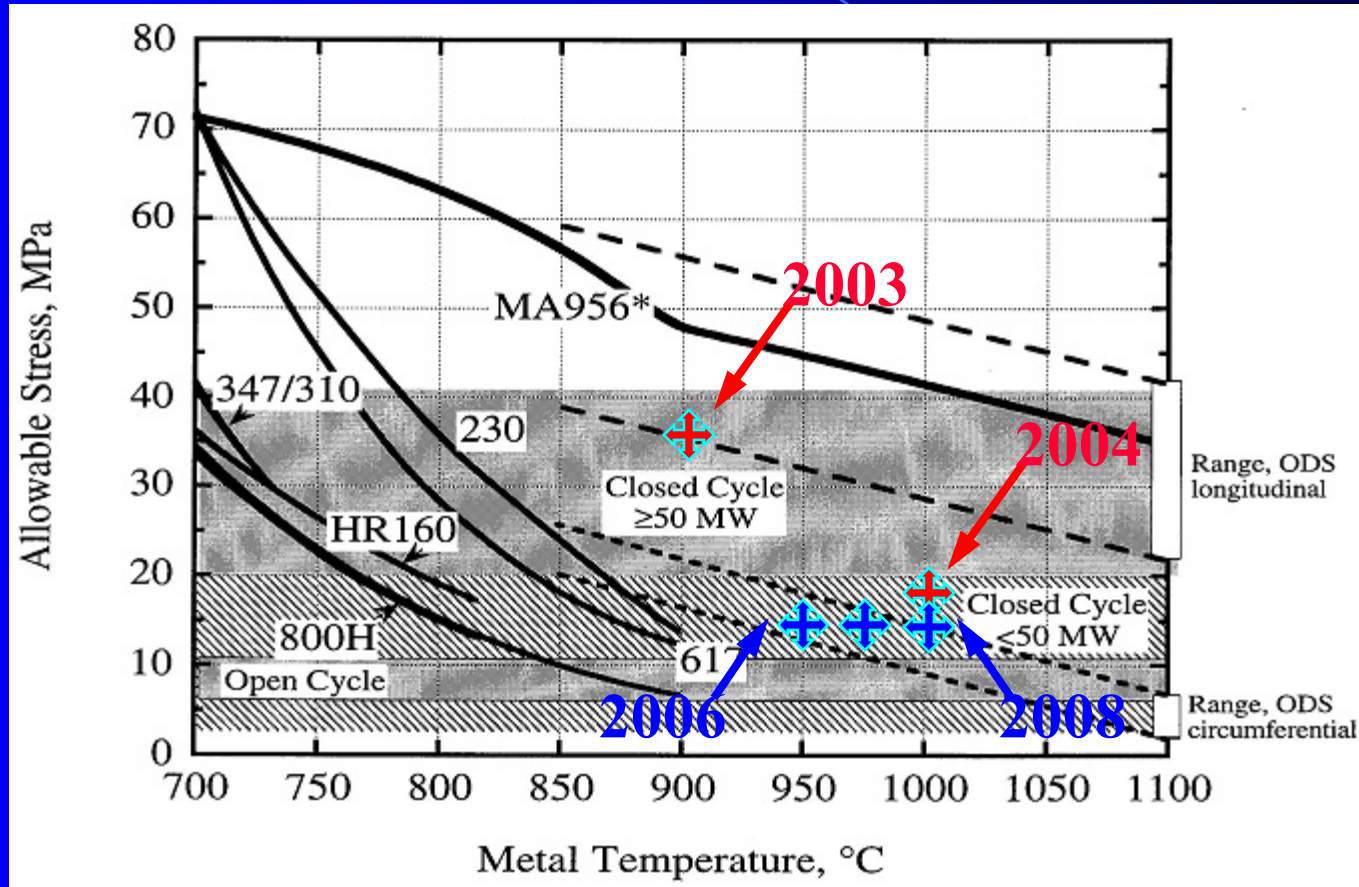

- ✚ Current hoop creep metrics for ODS-Fe₃Al tubes
- ✚ Current hoop creep metrics for *flow formed* MA956 tubes

Hoop Creep: Processed MA956 Tubes

Test	MA956 Alloy Treatment & HT	Temp	Stress	Life, hrs	LM Para	rate/day
1	MA956 Tube As-Is, HT:1375°C-1hr, Air	900°C	2Ksi		46.09	2.00e ⁻²
2	MA956 Tube As-Is, HT:1375°C-1hr, Air	900°C	1Ksi		48.81	2.00e ⁻⁵
3	CR-20%@900C, HT: 1375°C-1hr, Air	900°C	2Ksi		48.87	9.00e ⁻⁵
4	CR-20%@900C, HT: 1375°C-1hr, Air	900°C	2Ksi		48.24	6.00e ⁻⁴
5	CR-20%@900C, HT: 1375°C-1hr, Air	900°C	2Ksi		48.89	1.00e ⁻⁴
6	CR@900C, β=8°, HT:1375°C-1hr, Air	900°C	2Ksi		46.89	5.70e ⁻³
7	FlowForm@RT, HT:1375°C-1hr, Air2	1000°C	2Ksi	452	51.93	7.00e ⁻⁴
8	FlowForm@RT, HT:1375°C-1hr, Air2	950°C	2Ksi	7329	52.55	2.00e ⁻⁵
9	FlowForm@RT, HT:1375°C-1hr, Air2	975°C	2Ksi	13574*	54.23	5.00e ⁻⁶
10	FlowForm@RT, HT:1375°C-1hr, Air2	1000°C	2Ksi	10081*	55.02	7.00e ⁻⁶



Creep characteristic of ODS Alloys

$$\frac{\dot{\epsilon}}{D_L} = A \frac{Gb}{kT} \left(\frac{\sigma}{G} \right)^n \qquad \frac{\dot{\epsilon}}{Dl} = A \frac{Gb}{kT} \left(\frac{\sigma}{G} - \frac{\sigma_b}{G} \right)^n$$

Where A and n are constants , $n = 4$.

The Activation energy and the rate sensitivity are given as

$$Q_c = \left[\frac{\partial \ln \dot{\epsilon}_s}{\partial (-1/kT)} \right]_{\sigma} \qquad m' = \left(\frac{\partial \ln \dot{\epsilon}_s}{\partial \ln \sigma} \right)$$

$$Q_c = \Delta H_L = kT^2 \left[(n-1) \frac{1}{G} \frac{dG}{dT} + \frac{n}{\sigma - \sigma_B} \left(\frac{d\sigma_B}{dT} \right)_{\sigma} \right]$$

$$m' = \frac{n\sigma}{\sigma - \sigma_B} \left[1 - \left(\frac{\partial \sigma_B}{\partial \sigma} \right)_T \right] \qquad \text{when} \left(\frac{\partial \sigma_B}{\partial \sigma} \right) = 0, m' = \frac{n\sigma}{\sigma - \sigma_B}$$

Classical ODS-MA956 Creep Curve

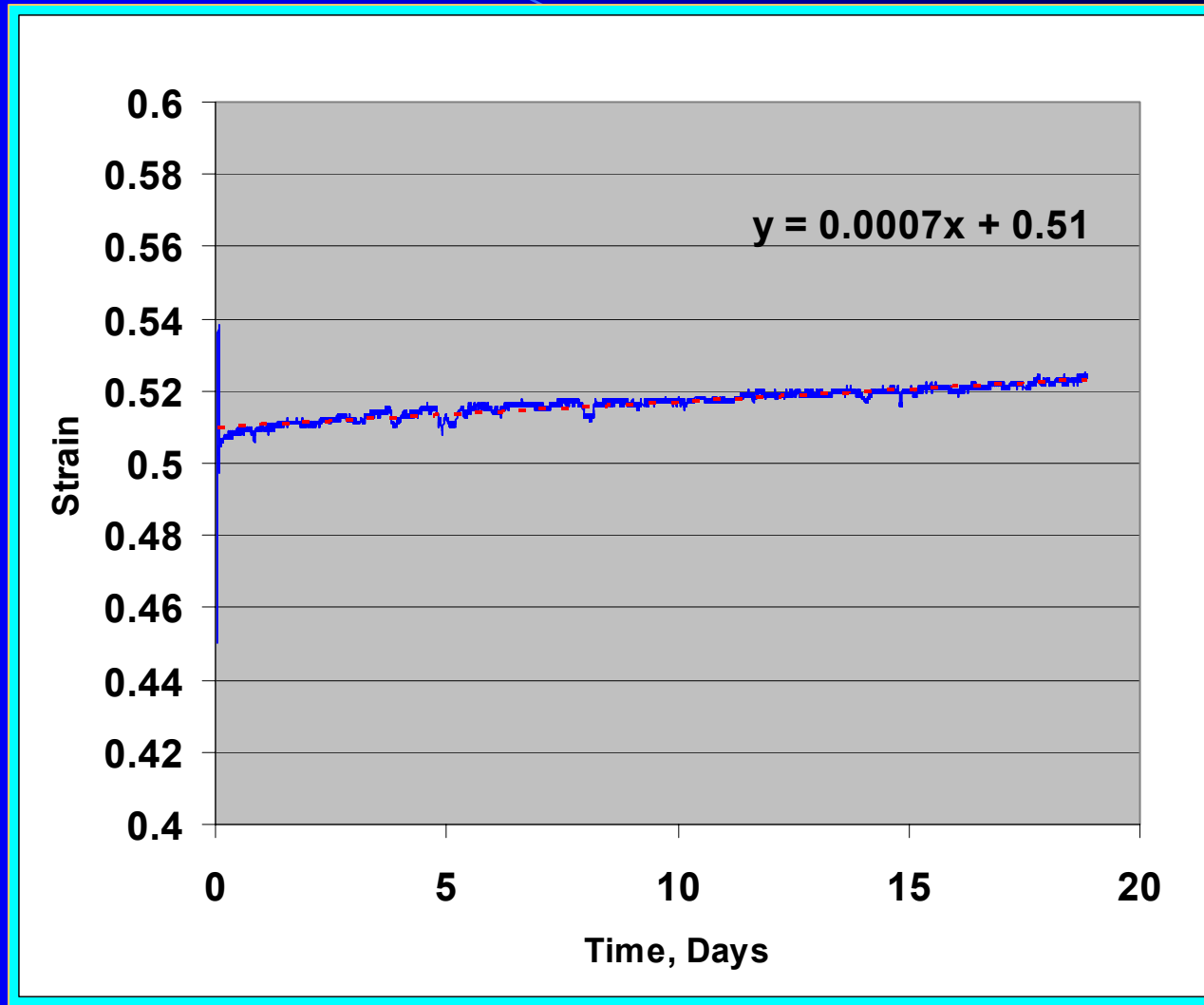

Flow Formed ODS MA956 Hoop Creep

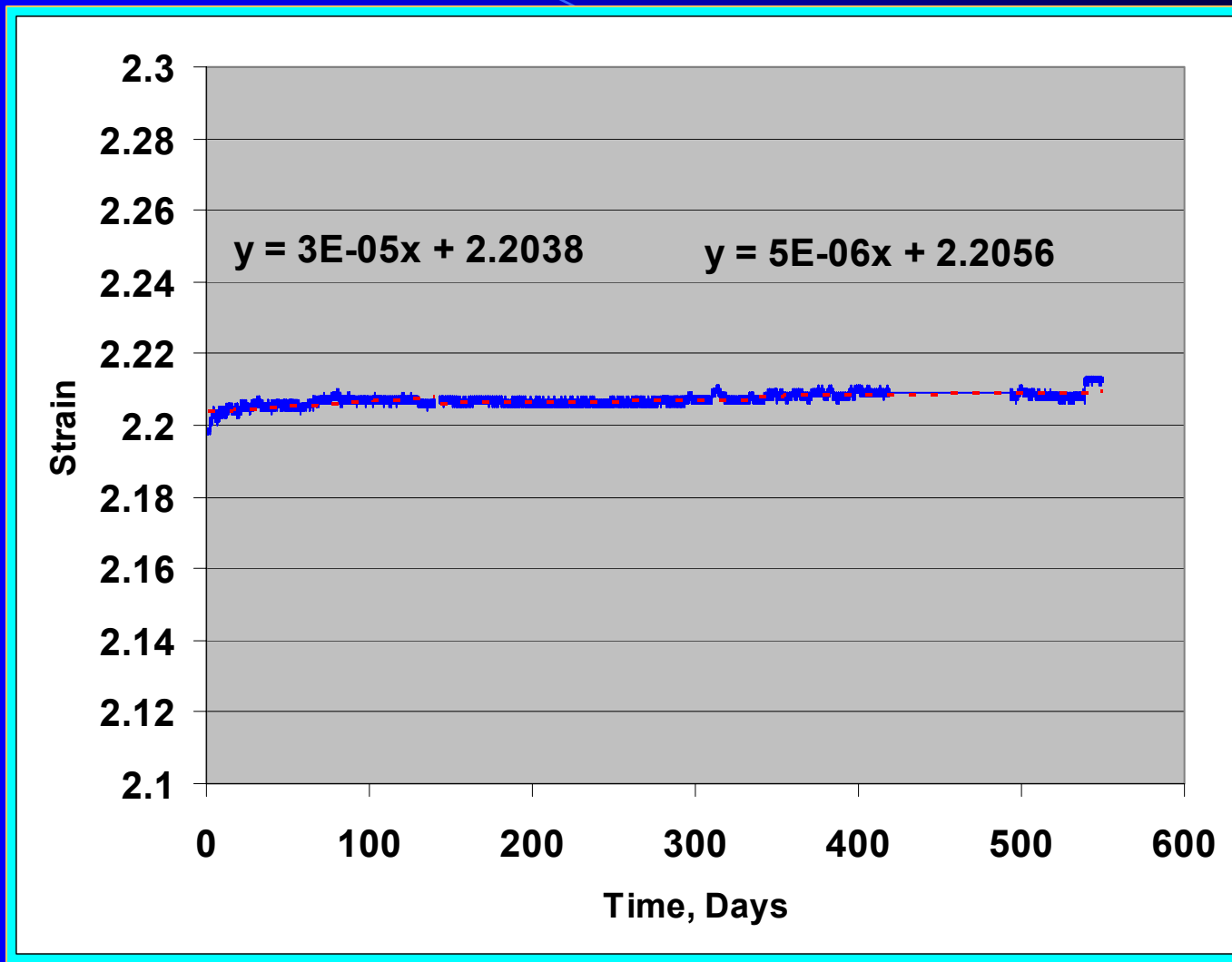

Test Continuing: 1000°C, 2Ksi, in Air

Why do ODS-MA956 need much help?

- Extremely large strains are required.
- Cold work seems to produce better result than hot working & grain fibering
- Better bang from large grain size alone.

explore alternate ODS-MA956 chemistry?

- In parallel universe of ODS-Fe₃Al large grain structure are possible – without any special, or expensive treatments.



Parallel Universe of ODS-Fe₃Al Alloys

Oxide content, impurities affect recrystallization

High impurity powder batch

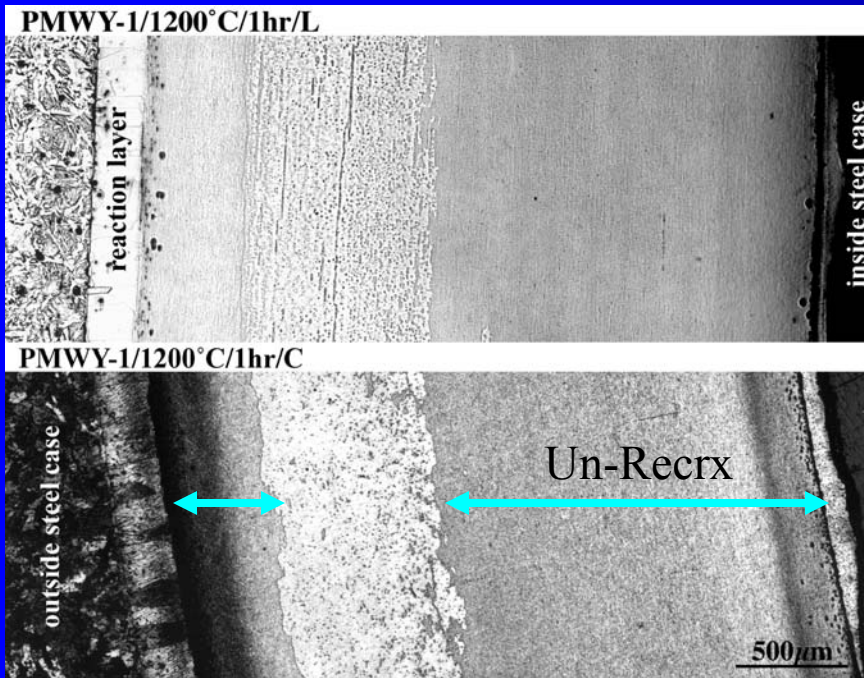

Low impurity powder batch

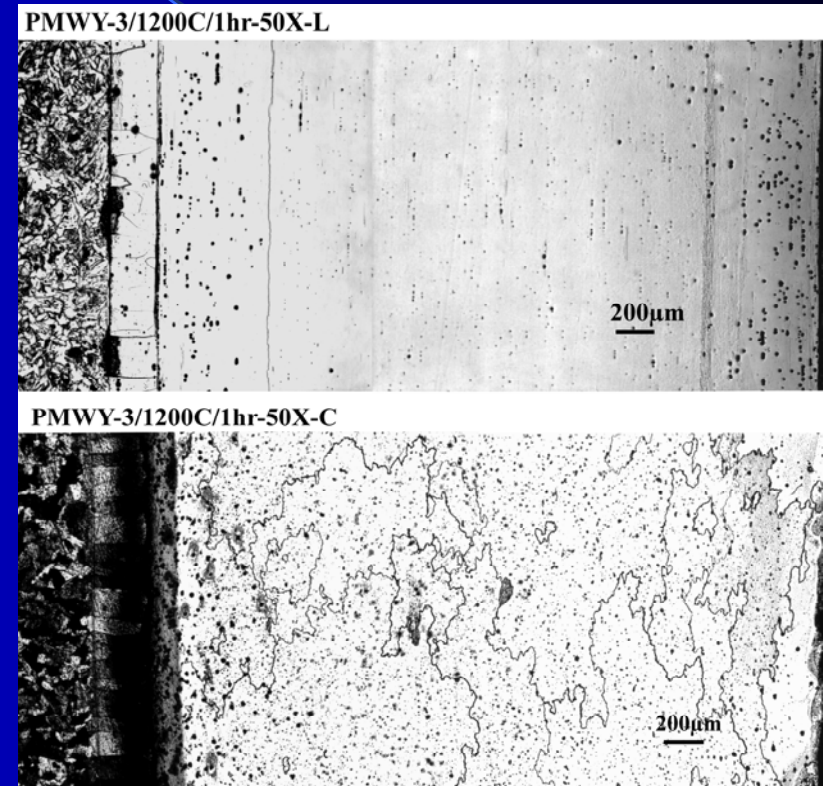

Powder batches with high interstitial impurity are particularly resistant to static recrystallization treatments. Efforts to increase time-temperature combinations have met with only marginal success.

Parallel Universe of ODS-Fe₃Al Alloy

Large Recrystallized grain size POSSIBLE via control of IMPURITY & OXIDE CONTENT.
High oxide content produced small pinned grain similar to that seen in ODS-FeCrAl alloy

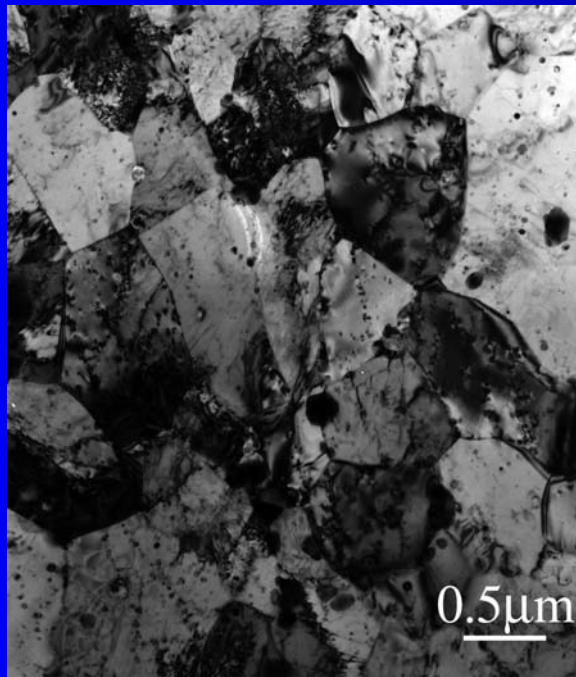
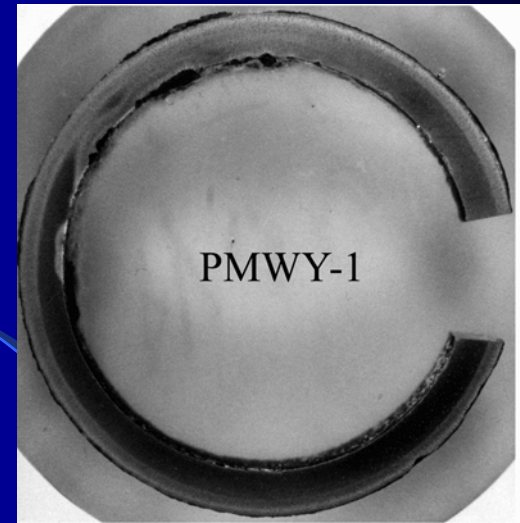

High oxide, impurity content; Small Grains

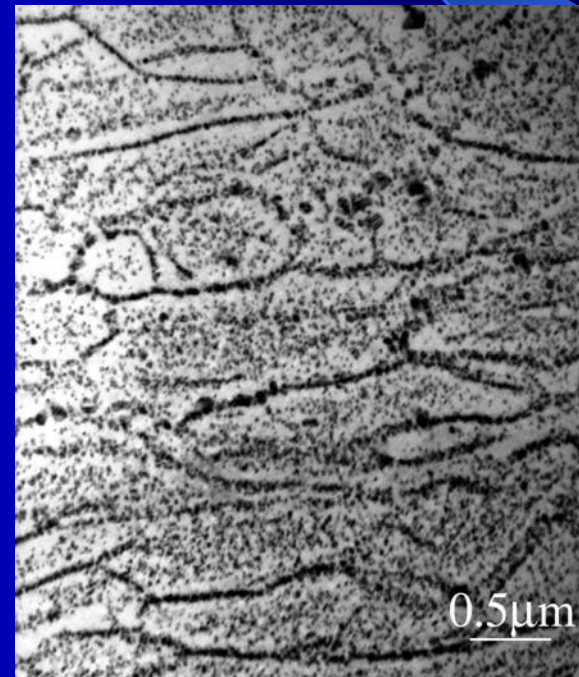

Low oxide, impurity content; Large Grains

Transverse Creep: Failure Microstructures

The dirt on ODS alloys

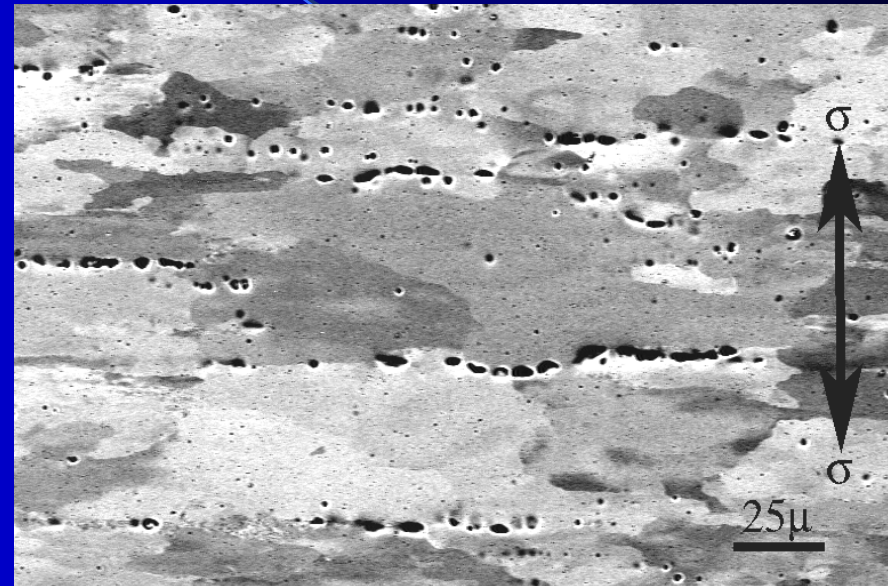
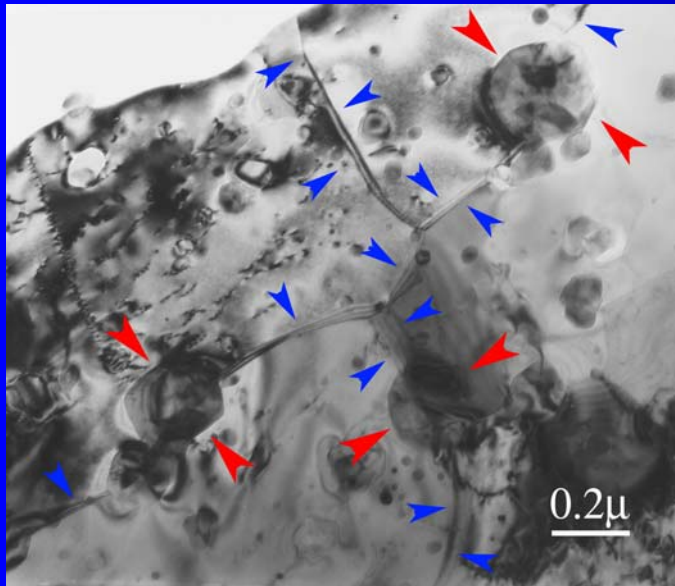

MA-956, transverse creep @ 900°C

Creep void formation is suggested to occur in the vicinity of large impurity oxide particles and/or stringers. Low impurity oxides in ODS-Fe₃Al produce large recrystallized grains which respond better in transverse creep testing.

MA956 has larger vol. frac. of yttria precipitates than ODS-Fe₃Al Alloy

Chemistry of Available Ferritic ODS Alloys

Alloy	Density, gm/cm ³	Fe	Cr	Al	Ti	Si	RE
SMC MA-956		Bal	20.0	4.5	0.5	-	0.5, Y ₂ O ₃
SMC MA-956HT	7.20	Bal	21.6	5.9	0.4	0.07	0.5, Y ₂ O ₃
PM 2000	7.18	Bal	20.0	5.5	0.5	-	0.5, Y ₂ O ₃
ODS-Fe ₃ Al	6.53	Bal	2.2	15.9	0.07	0.1	0.5, Y ₂ O ₃

Ytria addition is made by wt%. In high chromium FeCrAl denser alloy this has the net effect of increasing dispersion vol. frac. (f) by 10-15%. This affects the pinned grain size and may dictate secondary recrystallization.

Zener-Smith eq. for predicting grain size controlled by particle pinning:

$$D_{max} \leq 4r/3f \quad D = \text{grain size}, f = \text{ppt. vol. frac}$$



Summary of Results

- A firm threshold established for ODS-Fe₃Al and MA956 transverse creep tested at 2Ksi at 950-1000°C.
- Grain fibering, flow-forming methods offer significant hoop creep enhancement
- Flow forming contributes to cold-work only
- ODS MA956 resistance to secondary recrystallization may stem from chemistry.

