

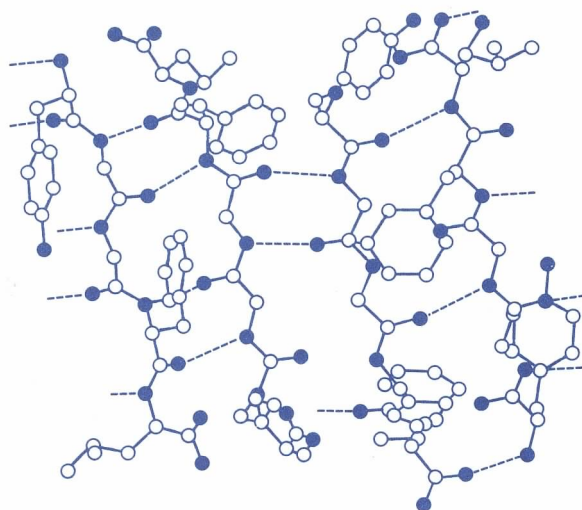
National  
Institute on  
Drug  
Abuse

70

# Research

MONOGRAPH SERIES

## Opioid Peptides: Molecular Pharmacology, Biosynthesis, and Analysis



# Opioid Peptides: Molecular Pharmacology, Biosynthesis, and Analysis

Editors:

Rao S. Rapaka, Ph.D.  
Richard L. Hawks, Ph.D.

Division of Preclinical Research  
National Institute on Drug Abuse

NIDA Research Monograph 70  
1986

DEPARTMENT OF HEALTH AND HUMAN SERVICES  
Public Health Service  
Alcohol, Drug Abuse, and Mental Health Administration

National Institute on Drug Abuse  
5600 Fishers Lane  
Rockville, Maryland 20857

NIDA Research Monographs are prepared by the research divisions of the National Institute on Drug Abuse and published by its Office of Science. The primary objective of the series is to provide critical reviews of research problem areas and techniques, the content of state-of-the-art conferences, and integrative research reviews. Its dual publication emphasis is rapid and targeted dissemination to the scientific and professional community

## Editorial Advisors

MARTIN W. ADLER, Ph.D.

Temple University School of Medicine  
Philadelphia, Pennsylvania

SYDNEY ARCHER, Ph.D.

Rensselaer Polytechnic Institute  
Troy, New York

RICHARD E. BELLEVILLE, Ph.D.

NB Associates Health Sciences  
Rockville, Maryland

KARST J. BESTEMAN

Alcohol and Drug Problems Association  
of North America  
Washington, D.C.

GILBERT J. BOTVIN, Ph.D.

Cornell University Medical College  
New York, New York

JOSEPH V. BRADY, Ph.D.

The Johns Hopkins University School of  
Medicine  
Baltimore, Maryland

THEODORE J. CICERO, Ph.D.

Washington University School of  
Medicine  
St. Louis, Missouri

SIDNEY COHEN, M.D.

Los Angeles, California

MARY L. JACOBSON

National Federation of Parents for  
Drug Free Youth  
Omaha, Nebraska

REESE T. JONES, M.D.

Langley Porter Neuropsychiatric Institute  
San Francisco, California

DENISE KANDEL, Ph.D.

College of Physicians and Surgeons of  
Columbia University  
New York, New York

HERBERT KLEBER, M.D.

Yale University School of Medicine  
New Haven, Connecticut

RICHARD RUSSO

New Jersey State Department of Health  
Trenton, New Jersey

## NIDA Research Monograph Series

CHARLES R. SCHUSTER, Ph.D.

Director, NIDA

JEAN PAUL SMITH, Ph.D.

Acting Associate Director for Science, NIDA  
Acting Editor

# Opioid Peptides: Molecular Pharmacology, Biosynthesis, and Analysis

## ACKNOWLEDGMENT

This monograph is based upon papers and discussion from the technical review on the medicinal chemistry and molecular pharmacology of opioid peptides and the opiates which took place on September 4 - 6, 1984, at Bethesda, Maryland. The meeting was sponsored by the Office of Science and the Division of Preclinical Research, National Institute on Drug Abuse. The papers on molecular pharmacology, biosynthesis, and analysis are presented in this volume. Those on the medicinal chemistry of opioid peptides appear in NIDA Research Monograph 69.

## COPYRIGHT STATUS

The diagram on the cover of this volume is reprinted by permission from Camerman et al. Crystal structure of leucine-enkephalin. Nature 306:447-450. Copyright 1983, Macmillan Journals Limited. The National Institute on Drug Abuse has also obtained permission from the copyright holders to reproduce certain previously published material as noted in the text. Further reproduction of this copyrighted material is permitted only as part of a reprinting of the entire publication or chapter. For any other use, the copyright holder's permission is required. All other material in this volume except quoted passages from copyrighted sources is in the public domain and may be used or reproduced without permission from the Institute or the authors. Citation of the source is appreciated.

Opinions expressed in this volume are those of the authors and do not necessarily reflect the opinions or official policy of the National Institute on Drug Abuse or any other part of the U.S. Department of Health and Human Services.

The U.S. Government does not endorse or favor any specific commercial product or company. Trade, proprietary, or company names appearing in this publication are used only because they are considered essential in the context of the studies reported herein.

DHHS Publication No. (ADM)87-1455  
Alcohol, Drug Abuse, and Mental Health Administration  
Printed 1986 Reprinted 1987

NIDA Research Monographs are Indexed in the Index Medicus. They are selectively included in the coverage of American Statistics Index, Biosciences Information Service, Chemical Abstracts, Current Contents, Psychological Abstracts, and Psychopharmacology Abstracts.

# Foreword

The discovery of opioid peptides in the mid-seventies came at an opportune time, as all the technologies required for identification and synthesis of opioid peptides were readily available. The identification of opioid genes followed shortly, facilitated by recent advances in recombinant technology. This in turn led to the rapid identification of many more opioid peptides. Concurrently, recognition of opioid receptor heterogeneity brought to the fore questions about the role of the multiple receptors in analgesia and abuse liability.

Another area of research which quickly developed following these discoveries was the analysis of opioid peptides in biofluids, a difficult area which presents unique problems due to the low levels present. Most analytical development has been based on radioimmunoassays, which are quite sensitive but which suffer from variable specificities. Development of chemical methods that are both specific and sensitive has been urgently needed, particularly in anticipation of the development of peptides for clinical trials and the need to have adequate pharmacokinetic analyses of such drugs.

This volume is primarily concerned with the molecular pharmacology, biosynthesis, and analysis of the opioid peptides. It is the companion volume to NIDA Research Monograph 69, Opioid Peptides: Medicinal Chemistry.

We stand at an exciting point in this rapidly expanding field. It is hoped that this volume and the preceding one will serve as useful reference sources for researchers and will provide new incentives for drug abuse research in the opioid peptide field.

Marvin Snyder, Ph.D., Director  
Division of Preclinical Research  
National Institute on Drug Abuse



# Contents

Foreword	
Marvin Snyder . . . . .	v
Introduction	
Rao S. Rapaka . . . . .	1
Folding and Enzymatic Processing of Precursors of Biologically Active Peptides and Proteins	
Irwin M. Chaiken; Tatsuhiko Kanmera; and Reginald P. Sequeira . . . . .	3
Biosynthesis of Opioid Peptides	
Olivier Civelli; Jim Douglass; Haim Rosen; Gerard Martens; and Edward Herbert . . . . .	21
Proenkephalin Biosynthesis in the Rat	
Richard D. Howells . . . . .	43
Enzymes in the Metabolism of Opioid Peptides: Isolation, Assay, and Specificity	
Neville Marks; Myron Benuck; and Martin J. Berg . . . . .	66
Isolation and Identification of Opioid Peptides	
Hisayuki Matsuo . . . . .	92
B-Endorphin: Naturally Occurring or Synthetic Agonists and Antagonists	
Choh Hao Li . . . . .	109
Enkephalin Degrading Enzyme Inhibitors: A Physiological Way to New Analgesics and Psychoactive Agents	
Bernard P. Roques and Marie-Claude Fournie-Zaluski . . . . .	128
Progress in the Characterization of the Opioid Receptor Subtypes: Peptides as Probes. Future Directions	
Eric J. Simon . . . . .	155
Regulation of Agonist Binding to Opioid Receptor Types by Sodium and GTP: Relevance to Receptor Function	
Brian M. Cox; Linda L. Werling; and Gary Zarr . . . . .	175
Opioid Receptors for the Dynorphin Peptides	
Iaian F. James . . . . .	192



Computer Analysis of Radioligand Data: Advantages, Problems, and Pitfalls David Rodbard; Rudolph A. Lutz; Ricardo A. Cruciani; Vincenzo Guardabasso; Guido O. Pesce; and Peter J. Munson . . .	209
Recent Developments in Bioassay Using Selective Ligands and Selective <i>In Vitro</i> Preparations Hans W. Kosterlitz; Alistair D. Corbett; Maureen G. C. Gillan; Alexander T. McKnight; Stewart J. Paterson; and Linda E. Robson . . . . .	223
Endorphins and Memory Regulation Ivan Izquierdo; Carlos A. Netto; and Renato D. Dias . . . .	237
Current Status of RIA Methods for the Analysis of Enkephalins and Endorphins R. Wayne Hendren. . . . .	255
The Analysis of Endogenous Opioid Peptides With HPLC, Radioreceptor Assay, Radioimmunoassay, and Mass Spectrometry Dominic M. Desiderio; Hisayoshi Takeshita; Hiroshi Onishi; Genevieve Fridland; Francis S. Tanzer; Claire Wakelyn; and Chhabil Dass. . . . .	304
Reverse Phase HPLC of Peptides: Application to the Opioid Peptides Tatsuhiko Kanmera and Reginald P. Sequeira . . . . .	319
Peptides as Drugs in the Treatment of Opiate Addiction Hemendra N. Bhargava . . . . .	337
Progress in the Potential Use of Enkephalin Analogs Robert C. A. Frederickson. . . . .	367
Opioid Peptides as Drug Products: FDA Regulatory Requirements Charles P. Hoiberg and Rao S. Rapaka . . . . .	385
A Few Thoughts on the Development and Regulation of Neuropeptides John L. Gueriguian and Yuan-Yuan H. Chiu. . . . .	405

# Introduction

Rao S. Rapaka, Ph.D.

In order to bring into focus the rapidly expanding areas of research associated with the opioid peptides, the National Institute on Drug Abuse sponsored a technical review in September 1984 on the medicinal chemistry and molecular pharmacology of opioid peptides and the opiates. As stated in the introduction to NIDA Research Monograph 69, a companion volume to NIDA Research Monograph 70, this is an area of major interest for both the short-term and long-term goals of the Institute because of its potential usefulness in further research and in treatment applications.

This monograph presents contributions both from the symposium speakers and from other invited authors in the various aspects of the molecular pharmacology, biosynthesis, and analysis of opioid peptides. Highlights of these reviews are presented here. Medicinal chemistry aspects are presented in NIDA Research Monograph 69.

Biosynthesis of neuroendocrine and opioid peptides and the processing of precursors is not only dependent on their primary sequence, but on their three-dimensional conformation. This subject is reviewed by Chaiken et al. Civelli and colleagues discuss the biosynthesis of opioid peptides with emphasis on opioid peptide genes, transcriptional and posttranscriptional regulation of opioid peptide gene expression, and translational and posttranslational regulation of opioid peptide production. Dr. Howells discusses the general biosynthetic aspects of opioid peptides and proenkephalin biosynthesis in rats. All these metabolic processes involve a number of specific enzymes. An account of their isolation, assay, and specificity is presented by Marks et al. An account on the synthesis of specific enzyme inhibitors of enkephalinase as new analgesic drugs is given by Drs. Roques and Fournie-Zaluski, an area yet to be more fully explored.

To follow the release of the processed precursors and to establish their structures involves a number of chemical and biochemical techniques. A discussion on isolation and identification of the opioid peptides, along with a table of the known peptides and a

demonstration of these techniques with adrenorphin and neuromedins, is presented by Dr. Matsuo. Similar isolation studies and synthesis of  $\beta$ -endorphin analogs on naturally occurring  $\beta$ -endorphin peptides have resulted in the hypothesis by Dr. Li that segments of the hormone may act as inhibitors to the hormonal action.

An understanding of the types and structures of receptors is critical in understanding mechanisms of action and also in aiding in the design of new analogs. A review of this subject is presented by Dr. Simon and on opioid receptors for dynorphin by Dr. James, while a discussion of regulating factors of agonist binding is presented by Dr. Cox and associates. As analysis of binding data is critical, an account on computer analyses of ligand data is given by Dr. Rodbard and colleagues. In the binding studies, receptor-specific ligands have played a critical role; recent developments in bioassay are described by Dr. Kosterlitz and colleagues. The role of endorphin in memory regulation is discussed by Dr. Izquierdo and colleagues.

Great progress in research on opioid peptides has been made possible by simultaneous advances in the techniques of synthesis, purification, and analysis of peptides. RP-HPLC purification and analysis techniques are discussed by Drs. Kanmera and Sequeira, and analysis of endogenous peptides using advanced techniques by Dr. Desiderio and colleagues. Current status of RIA methods for the analysis of enkephalins and endorphins is reviewed by Dr. Hendren.

The ultimate goal of the medicinal chemist and biologist is to develop therapeutic drugs. Progress in this area with clinical data on FK 330824 (Sandoz) and Ly 127623 (Metkephamid, Lilly) is discussed by Dr. Frederickson. Other potential uses of the peptide drugs, such as in the treatment of opiate addiction, are described by Dr. Bhargava.

As more and more peptides are likely to be clinically evaluated in the near future, it is appropriate to update information on regulatory requirements for new drugs from the FDA perspective. Hence, these requirements are presented in an introductory chapter by Drs. Hoiberg and Rapaka, and in a chapter by Drs. Gueriguian and Chiu which specifically addresses the regulation of neuropeptides.

Based on the presentations and discussions of scientists from various disciplines and nations who participated in the conference and others who submitted papers, an effort has been made in this monograph and its companion volume to bring together a substantial body of information and to summarize its potential applications in future research and treatment.

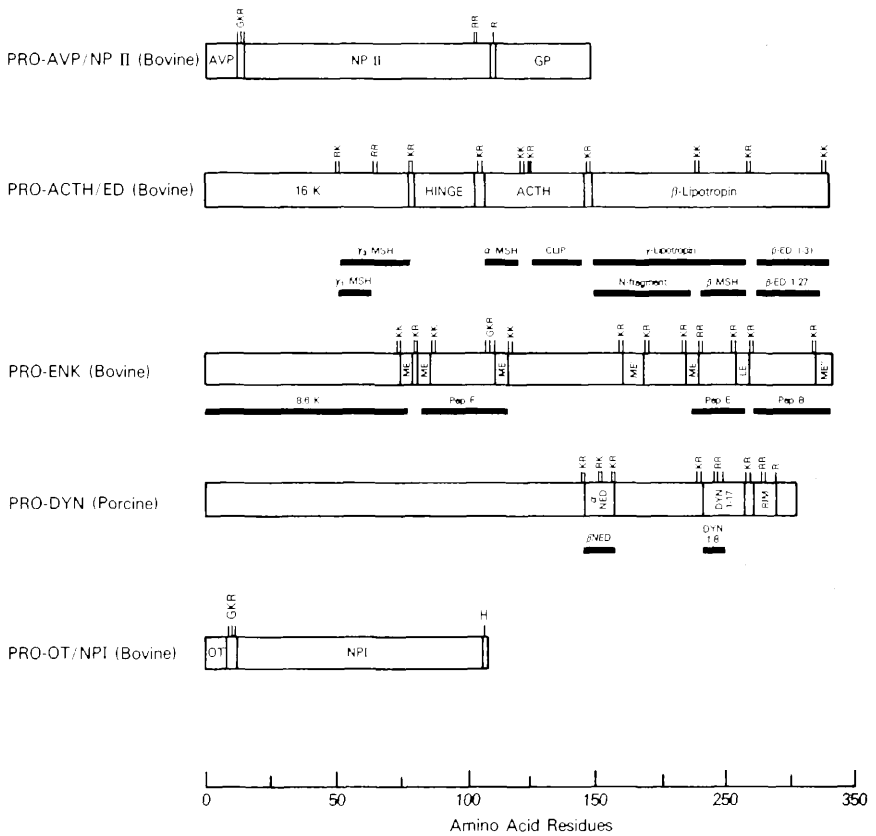
# Folding and Enzymatic Processing of Precursors of Biologically Active Peptides and Proteins

Irwin M. Chaiken, Ph.D.; Tatsuhiko Kanmera, Ph.D.; and Reginald P. Sequeira, Ph.D.

## **INTRODUCTION: NEUROENDOCRINE PRECURSORS AS LINEAR AND THREE DIMENSIONAL MACROMOLECULES**

The molecular events which lead from protein precursors to active peptides are governed both by a cascade of specific converting enzymes for posttranslational processing and by precursor structure which encodes the action of these enzymes. A rapidly expanding list of biologically active polypeptides which are derived from precursors has been identified (Docherty and Steiner 1982; Udenfriend and Kilpatrick 1983; Douglass et al. 1984). And, though the biosynthesized proteins themselves often are difficult to obtain in large amounts due to their transient existence in vivo, amino acid sequences have been defined through genomic or complementary DNA structure determination. Such sequence information has been helpful to identify what peptides may be derived from a particular precursor as well as to define and characterize the types of posttranslational enzymatic conversions, including limited proteolysis and such modifications as acetylation, phosphorylation, sulfation, and glycosylation, which must occur to produce active peptides. Yet, because of nonavailability of precursors per se, the molecular understanding of these proteins remains rudimentary.

The sequences of several neuroendocrine precursors are shown in figure 1, including those for the opioid peptides as well as the neurohypophysial hormones. What marks our current view of all such precursors is that we typically draw them as linearly connected blocks of sequence; each block or sequence domain represents either an ultimately active polypeptide, an activity domain, or a region of no or uncertain function bordering or between activity domains. These precursor structures also reveal the repeated occurrence of cleavage signals, such as dibasic pairs between sequence domains. In spite of this conceptual linearization, proteins do fold and this should be true of precursor proteins as well. While local sequence provides chemically defined sites for



**FIGURE 1**

Schematic representation of the primary structures of pro-AVP/NP II (proressophysin), pro-ACTH/ED (proopiomelanocortin), pro-ENK (proenkephalin), pro-DYN (prodynorphin), and pro-OT/NPI (prooxyphysin) deduced by c-DNA sequencing. The positions are shown of paired and single basic amino acid residues which serve as processing sites for trypsinlike and carboxypeptidase B-like enzymes. Enzymatic amidation sites are indicated by "G"; the residue amino to G is amidated. Domains of sequence which yield active peptides (activity domains) or other peptides accumulated upon precursor processing are labeled as follows: AVP, arginine vasopressin; NP II, AVP-associated neurophysin; GP, glycopeptide; ACTH, adrenocorticotrophic hormone;  $\beta$ -EDO, beta endorphin;  $\beta$ -MSH, beta melanocyte stimulating hormone; ENK, enkephalin; ME, methionine enkephalin; ME', methionine enkephalin-Arg<sup>6</sup>-Gly<sup>7</sup>-Leu<sup>8</sup>; ME'', methionine enkephalin-Arg<sup>6</sup>-Phe<sup>7</sup>; DYN, dynorphin; BNEDO, beta neocendorphin; LE, leucine enkephalin; RIM, rimorphin; OT, oxytocin; and NPI, OT-associated neurophysin. Amino acid residue abbreviations are: G, glycine; K, lysine; R, arginine; and H, histidine. The scale at the bottom denotes the length of the sequence, in residues from the amino terminus.

processing, precursor folding is expected to provide overall guidance and control. Understanding the biosynthetic origin of opioid and other neuroendocrine peptides thus is both a three-dimensional and a linear problem.

The interplay of sequence and conformation is reflected elegantly in classical protein chemistry by such well-studied cases as protease zymogens. Perhaps the best example is the chymotrypsinogen-chymotrypsin system, for which the activation pathway is known and the crystal structures of both precursor and processed forms have been solved (Blow 1971; Kraut 1971). Chymotrypsinogen is activated by limited proteolysis, with the critical step being tryptic cleavage at the Arg 15-Ile 16 bond to liberate the Ile 16  $\alpha$ -amino group which forms an essential component of active site organization (Blow 1971). But neither trypsin nor the chymotrypsin generated during processing act significantly on chymotrypsinogen at a large number of other peptide bonds which are possible as cleavage sites based on sequence alone. Thus, while protease specificity dictates cleavage based on linear sequence, precursor conformation limits the availability of proteolysis sites. In addition, while chymotrypsinogen can refold and form correct disulfide bonds from an unfolded, disulfide disordered state, chymotrypsin cannot. This suggests that the three-dimensional organization of the processed form needed for activity depends on the prior attainment of correct conformation by precursor folding.

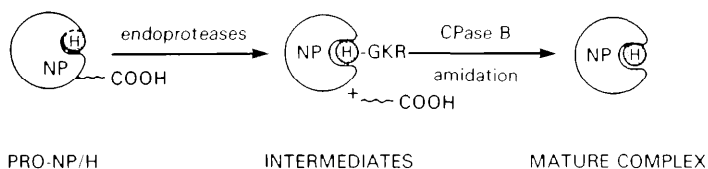
It is evident from the chymotrypsinogen example that folded precursor structure can play at least two major roles in the biosynthesis of active polypeptides: (1) control of posttranslational enzymatic reactions by steric access to scissile bonds and residue side chains; and (2), at least for disulfide-containing polypeptides, preformation of natively like conformation of ultimate end-products. Based on the above, two major and interrelated goals may be addressed in considering neuroendocrine precursor structure. One is to define the primary sequence and to use this as a guide to describe the linear pathway of processing reactions which yield active neuroendocrine peptides. The second is to define the higher order secondary, tertiary, and quaternary structure of precursors and to understand how such conformational features regulate processing reactions and the nature of polypeptides produced.

#### **THE PROCESSING PATHWAY OF NEUROHYPOPHYSIAL HORMONE/NEUROPHYSIN PRECURSOR**

In our own work, we have tried to correlate neuroendocrine precursor processing and precursor structure in the neurohypophysial hormone/neurophysin system. Figure 1 schematically shows the linear sequences of composite precursors identified for oxytocin and vasopressin. These sequences were defined directly by cDNA and genomic DNA cloning (Ivell et al. 1983). The DNA sequencing was a culmination of prior studies by in vivo pulse labeling (Brown-

stein et al. 1980) and *in vitro* translation (Chaiken et al. 1982; Ivell et al. 1983). Each neurohypophysial hormone precursor sequence contains at least two activity domains, one for hormone and a second for the associated binding protein, neurophysin. A tripeptide spacer links the hormone and neurophysin domains, while the C-terminus is either a single His residue in the oxytocin case or an arginyl linker followed by a glycopeptide of unknown functional significance (but known to be an accumulated product of processing) in the vasopressin case. Both pro-forms are translated with a leader (signal peptide) sequence, which is removed *in vivo* by the time translation is complete.

The sequences of neuroendocrine precursor proteins, such as those for neurophysins and hormones, infer the presence of a small corps of enzymes which must act to produce the final set of active peptides (see review by Marks, this volume). The peptide cleavage conversions in the hormone/neurophysin case can be inferred, as shown in figure 2, to include three types of enzymatic reactions: an endoprotease step in the tripeptide linker region and, in the AVP case, an additional endoprotease step at the linker between neurophysin and glycopeptide; carboxypeptidase B (CPase B) trimming of basic residues from the linker vestiges on the C-termini of the hormone and neurophysin domains; and amidation to generate the active, C-terminal amidated form of hormone.



**FIGURE 2**

Schematic diagram depicting the steps in enzymatic processing of neurophysin (NP)/hormone (H) biosynthetic precursor proteins to produce, in each case, a mature neurophysin and either oxytocin or vasopressin. The precursors are visualized to be compact, folded macromolecules in which processing sites are accessible in external surface regions. The enzymatic steps of endoproteolysis are expected to occur in the linkage region between hormone and neurophysin domains and, in the case of the vasopressin precursor, between the neurophysin and carboxyl terminal glycopeptide domains. Exproteolytic trimming by CPase B to produce mature neurophysin and hormone-Gly, and amidation to convert the latter to mature amidated hormone, are viewed as occurring sequentially after endoproteolysis.

Based on these inferences on processing, one tactic that we are using to study the enzymatic reactions is to chemically synthesize local segments of the precursor sequence suspected to contain processing sites or to be processing intermediates in conversion of intact precursor, and then to use these segments as substrates to identify, isolate, and characterize processing enzymes. A family of such synthetic segments related to the oxytocin precursor has been made (Kanmera et al. 1983; Rapaka et al. in press), including orytocinyl-Gly-Lys-Arg (OT-GKR), Oxytocinyl-Gly-Lys (OT-GK), and oxytocinyl-Gly (OT-G). The first of these was obtained by solid phase peptide synthesis, the second by immobilized trypsin cleavage of OT-GKR, and the third by pancreatic CPase B digestion of OT-GKR. All peptides were purified by reverse phase high performance liquid chromatography (HPLC).

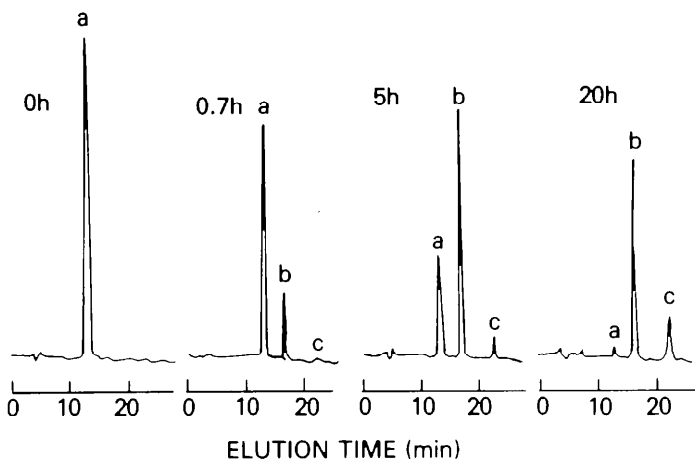
Both OT-GKR and OT-GX have been used to detect and characterize the CPase B of posterior pituitary neurosecretory granules, the enzyme which is expected to act on hormone/neurophysin precursor and intermediates in vivo. When OT-GKR was incubated with whole granule lysate, the sequential release of Arg and Lys was detected (figure 3). The release of Lys from OT-GK occurred with the same pH-dependence as that of Arg from OT-GKR. The rates of release and nature of products detected suggest that no significant amount of "dipeptidase" cleavage occurred to produce OT-G and Lys-Arg in a single step. The sequential CPase B activity had a pH optimum of about 5.5 to 6, a value similar to the internal pH of posterior pituitary neurosecretory granules (Gainer 1981). Of note, the properties found for the CPase B activity at the crude (granule lysate) level of isolation are similar in our own work (Kanmera et al. 1983; Kanmera and Chaiken, in press and in that of Hook and Loh (1984).

Partial purification of the crude CPase B, which is active against the oxytocinyl peptides, was achieved by gel filtration on Sephacryl S-300 (Kanmera et al. 1983). What has made this step particularly useful was that it allowed separation of two carboxypeptidase activities, the later-eluting of which is the CPase B with clear preference for basic residues and relatively little tendency, for example, to cleave Gly from OT-G to give oxytocinoic acid (OT acid). The earlier-eluting CPase has little preference for exoproteolytic removal of Arg from OT-GKR versus Gly from OT-G. The later-eluting specific CPase B has several enzymatic properties similar to those reported for a CPase B that can act on enkephalinyll peptide (Supattapone et al. 1984).

Based on prior conversion studies with model peptides by pituitary amidating enzyme (Bradbury et al. 1982; Eipper et al. 1983), oxytocin in its active C-terminal amidated form is expected to be derived from conversion of the CPase B product OT-G. This enzymatic conversion was detected using <sup>125</sup>I-OT-G (labeled at Tyr 2 using the lactoperoxidase-glucose oxidase method). By reverse phase HPLC, <sup>125</sup>I-OT could be detected as a product of reaction

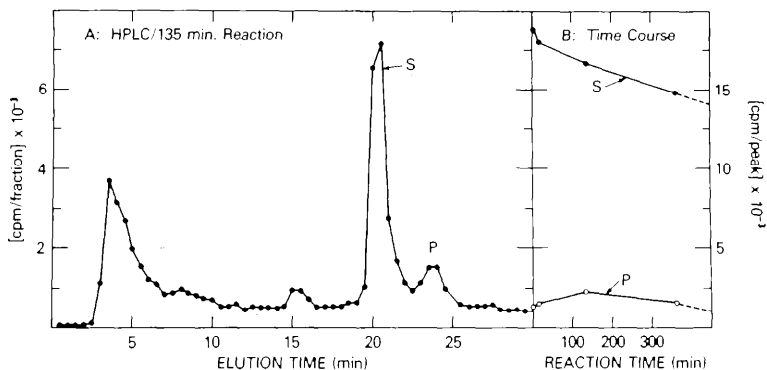
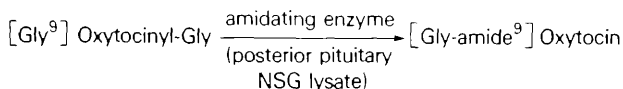


with lysates of granules obtained by differential centrifugation (figure 4). However, with the latter as the source of enzyme, a competing and presumably nonspecific (possibly lysozymal) proteolytic degradation led to loss of product as well as substrate and to the appearance of early-eluting iodinated species, presumably degradation products. The amidating enzyme was found to be substantially enriched over the nonspecific proteolytic activity in granule subfractions obtained by Percoll density gradient ultracentrifugation of posterior pituitary granules. Thus, subfractions migrating as the most dense in the Percoll gradient were relatively more free of degrading activity and led to a more obvious accumulation of product ( $^{125}\text{I}$ -oT) in RP-HPLC and little of the early-eluting degradation peaks evident in figure 4 (Kanmera and Chaiken, in press). The specific granule fractions obtained



**FIGURE 3**

Reverse phase HPLC analysis of conversion of the oxytocinyl precursor fragment GT-GKR by neurosecretory granule lysate. OT-GKR (80 nmles, prepared by solid phase peptide synthesis) was incubated with 10  $\mu\text{l}$  of granule lysate (granules prepared by differential centrifugation) in 200  $\mu\text{l}$  of 0.1 M sodium phosphate buffer, pH 5.5. Aliquots of reaction mixture taken at 0, 0.7, 5, and 20 hours at 37°C were applied to a cyanopropyl silyl RP-HPLC column (Zorbax CN, 0.46 x 25 cm, Dupont) using a Varian LC 5000 system and eluted with a linear gradient, at 0.8 ml/min., from 93% triethylammonium phosphate (TEAP, 67 mM, pH 3)/7% acetonitrile at 0 time to 70% TEAP/30% acetonitrile at 20 min. Peaks, identified by amino acid analysis, are: (a) OT-GKR; (b) OT-GK; and (c) OT-G.



**FIGURE 4**

Reverse phase HPLC analysis of conversion of [<sup>125</sup>I]OT-G (substrate peak, S) to C-terminal amidated [<sup>125</sup>I]OT (product peak, P) by neurosecretory granule lysate (see figure 3 legend). A: Reverse phase HPLC profile of aliquot of reaction at 135 minutes after addition of granule lysate. The reaction mixture consisted of 200  $\mu$ l of lysate in 10 mM HEPES, pH 7.0, and 100  $\mu$ l of a solution of 0.03 mM CuSO<sub>4</sub>, 1 mM sodium ascorbate, 0.3 mg catalase/ml, and 3 x 10<sup>5</sup> cpm [<sup>125</sup>I]OT-G (<.1  $\mu$ g) in 50 mM TES, pH 7.0. Aliquot of 50  $\mu$ l was mixed with 100  $\mu$ l of 50 mM ammonium acetate, pH 5.0, and injected onto an octadecyl silyl column (Zorbax ODS, Dupont, 0.46 x 25 cm) and eluted with a linear gradient of 85% 50 mM ammonium acetate, pH 5.0/15% acetonitrile at 0 time to 60% 50 mM ammonium acetate, pH 5.0/40% acetonitrile at 30 min. S and P were identified by comparison with elution of starting substrate and iodinated authentic oxytocin. Peaks centered at 4 min. (breakthrough volume) and 15 min. increase with time of reaction and are assumed to arise from nonspecific proteolytic degradation of S, P, or both. B: Time course of decrease of S and transient increase followed by decrease of P. Conversion reactions carried out with lysates of selected neurosecretory granules prepared by Percoll density gradient centrifugation (Kanmera and Chaiken. in press; Rapaka et al., in press) show a more obvious and prolonged increase in P with time and a reduced degradation to early-eluting forms.

by density gradient centrifugation provide a partially purified amidation enzyme preparation suitable for further isolation and study.

In terms of observable reactions, the enzymatic conversions expected from the oxytocinyl precursor sequence--CPase B trimming followed by amidation - can occur with the precursor fragments OT-GKR, OT-GK, and OT-G. Yet, several data argue that processing reactions of the hormone/neurophysin precursors must involve overall precursor structure, and the neurophysin domain in particular. First, the initial endoproteolytic conversion of precursor to yield precursor intermediates of the type OT-GKR would be expected to occur with the full-sequence and, therefore, fully-folded precursor as substrate. Data reviewed below show that such a precursor has a well-defined folded conformation. Second, the putative precursor intermediate OT-GKR was found, by analytical affinity chromatography on Sepharose-immobilized neurophysin II, to bind noncovalently to neurophysin (Kanmera et al. 1983; Kanmera and Chaiken, in press). Based on the degree of retardation *in vitro* that for OT and Met-Tyr-Phe amide, OT-GKR binding to neurophysin is concluded to have a  $K_a$  value close to that of OT (a greater value cannot be excluded by the data obtained so far). At the high concentrations of neurophysin and hormone expected to exist in neurosecretory granules, OT-GKR likely remains bound to neurophysin noncovalently after endoproteolytic cleavage. Thus, the actual substrates for CPase B and amidating enzymes are likely to be, not free peptides, but rather those folded into relatively fixed conformations as parts of noncovalent peptide/neurophysin complexes. The conformations of the peptide/protein complexes are likely to mimic those of the precursors themselves. This conclusion makes it important to define the conformation of precursors and of the intermediate complexes that arise from them.

#### **THE FOLDED NATURE OF NEUROENDOCRINE PRECURSORS**

Describing the degree of ordered structure in neuroendocrine precursor proteins depends largely on obtaining sufficient amounts of precursor for conformational characterization, including crystallographic analysis where possible. This need contrasts with the realization that such precursors are only transiently persistent species *in situ* and obtainable in only very small (subfemtomole) amounts by such procedures as *in vitro* translation or *in vivo* pulse-labeling. The gap between availability and need is likely to be reduced, but only partially, by using micromethods for characterization.

In order to obtain workable amounts of hormone/neurophysin precursor, we have used semisynthesis, an approach in which synthetic and natural polypeptide components are reconstituted to rebuild a larger protein (Chaiken 1981). As a first target, we have chosen the oxytocin/neurophysin I precursor, which consists essentially of a dodecapeptide hormone-linker domain (OT-GKR) attached to a

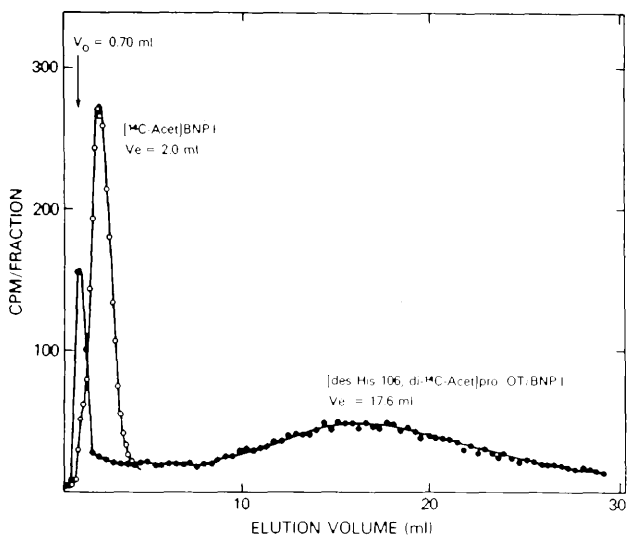
neurophysin I domain (see figure 1). The reaction scheme used for the formation of this precursor (Kanmera and Chaiken 1985) employed coupling of an  $\alpha$ -amino protected synthetic OT-GKR ( $[N^{\alpha 1, \epsilon 11} - diBoc]OT-GKR$ ) as an active ester to a selectively  $\epsilon$ -amino-blocked native protein ([dl-acetimidyl] NPI). In our studies so far, the partially protected species [des His 106, dl-Acet 30,71]pro-OT/NPI has been prepared, with the product purified by reverse phase HPLC. The acetimidyl groups on the two  $\epsilon$ -amino functions of NPI can be removed, but have been retained in studies so far since they are useful for incorporation of radiolabel and do not affect the functional and folding properties examined (see below). The lack of C-terminal His in the semisynthetic precursor is assumed, as a first order approximation, not to lead to a significant aberration in the major conformational properties of precursor protein. The semisynthesis scheme we have developed is general and is being used at present to build vasopressin-containing, precursorlike molecules and, ultimately, a set of mutant precursors.

[des His 106, di- $^{14}C$ - acetimidyl 30,71]Pro-OT/NPI has been used to Investigate the question of whether neurohypophysial hormone precursors fold to form well-defined conformations that act as "blueprints" for the ultimate conformation-dependent interaction properties of the mature hormone/neurophysin noncovalent complexes. One aspect of this study has been to examine both the binding properties of the semisynthetic precursor for hormone binding site ligands and the self-association potential by analytical affinity chromatography (Chaiken 1979; Angal and Chaiken 1982). [des His 106, di-Acet]Pro-OT/NPI was found (Kanmera and Chaiken 1985) not to bind significantly to Met-Tyr-The-Affigel 102. The latter Immobilized tripeptide acts as a mimic of hormone and binds to the hormone binding site of neurophysin (Angal and Chaiken 1982). The tripeptide affinity matrix does bind to [di-Acet 18,59]NPI, with an affinity essentially equal to that of native NPI (Kanmera and Chaiken 1985). The blocking of the hormone binding site of the neurophysin domain of the precursor is concluded to be due to intramolecular hormone domain-neurophysin domain interaction. Interestingly, intramolecular domain-domain interaction such as that considered likely in the precursor is increasingly considered as a common feature of folded protein conformation in general (Wetlaufer 1981; Fontana et al. 1983).

The observation of intramolecular domain-domain interaction in [des His 106, di-Acet]pro-OT/NPI suggests that neurohypophysial hormone precursors also can self-associate with relatively high affinity. This prediction is based on the known self-association of native neurophysin to dimers and the potentiation of the self-association by ligand binding to the neurophysin subunits (Cohen et al. 1979; Angal and Chaiken 1982). Indeed, [des His 106, di-Acet]pro-OT/NPI is retarded on [NPII]Sepharose, with a net elution volume (observed elution volume,  $V$ , minus unretarded elution volume  $V_0$ ) about an order of magnitude greater than that of

[diAcet]NPI (figure 5). The results show that precursor, with an intramolecularly liganded neurophysin domain, associates with unliganded immobilized neurophysin and that the association has a higher affinity ( $1.7 \times 10^5 M^{-1}$ ) than that of [di-Acet]NPI ( $1.3 \times 6 \times 10^5 M^{-1}$ ). Moreover, precursor retardation is increased by addition of close to saturating amounts of hormone (Lys 8-vasopressin) to the elution buffer. This shows that liganding of the immobilized neurophysin potentiates precursor-protein association further. We take the analytical affinity chromatographic data together to argue that hormone/neurophysin precursor self-associates upon storage in secretory granules after biosynthesis and that the self-association is stabilized by intramolecular hormone domain interactions which persist after proteolytic processing.

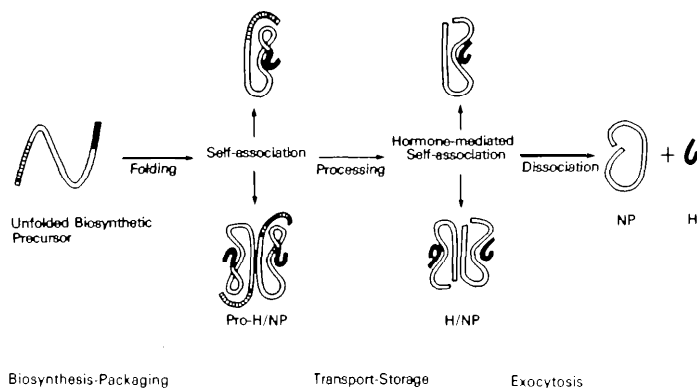
During the events leading from precursors to neurohypophysial hormones, the well-defined folded structures of precursors may



**FIGURE 5**

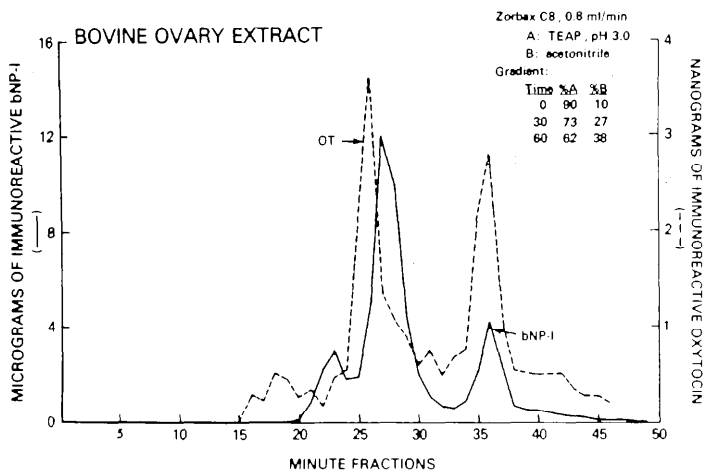
Analytical affinity chromatography assay of protein-association property of semisynthetic oxytocin/neurophysin I precursor and, for comparison, neurophysin I. Zones containing 1500-3000 cpm ( $<10.5 \mu g$ ) of [ $di-^{14}C$ -Acet 18,59]NPI and [ $des$  His 106,  $di-^{14}C$ -Acet 30,71]pro-OT/NPI were eluted on bovine NP<sub>II</sub>-Sepharose (70 nmole BN<sub>PII</sub>/ml of bed volume, 198  $\mu l$  bed volume) with 0.4 M ammonium acetate/0.5% bovine serum albumin, pH 5.7. Fraction size was 4 drops (157  $\mu l$ ) for NPI and 10 drops (391  $\mu l$ ) for semisynthetic precursor. Flow rate was 5 ml/min.; chromatography was at ambient temperature.

well help control the subsequent enzymatic processing reactions leading to active neuroendocrine peptides. This hypothesis is shown schematically in figure 6. One prediction of this scheme is that hormone/neurophysin precursors should be able to fold spontaneously from a disordered state, in a manner expected for intact biosynthetic precursors but not observed for native neurophysin itself (Chaiken et al. 1975). This feature now has been examined with the semisynthetic precursor by testing whether the precursor is stable to disulfide shuffling: nonbiosynthetically intact proteins such as neurophysin are not stable, but biosynthetically intact proteins as a rule are (Givol et al. 1965). We have observed that, in the presence of dithioerythritol, [des His 106, di-Acet]pro-OT/NPI exhibits such disulfide stability but [di-Acet]NPI does not. Neurohypophysial hormone precursors (pro-forms) of the sequence type shown in figure 1 thus are viewed as having sufficient sequence information to code for stabilization of the correct disulfide pairing. It is concluded that the precursors fold spontaneously to a defined native conformation upon completion of translation and before packaging and enzymatic processing.



**FIGURE 6**

*Schematic model depicting relationship of biosynthetic precursor structure to molecular events occurring in neurohypophysial hormone/neurophysin biosynthesis. The filled and open lines denote hormone and neurophysin sequence domains, respectively. The cross-hatched line represents the C-terminal glycopeptide occurring in pro-Arg 8 vasopressin/neurophysin. Folding of the precursor leads to establishment of self-association through the NP domains of the precursors. The NP-NP and H-NP interaction surfaces are retained after enzymatic processing, which leads to formation of noncovalent complex between Hand NP and its dimer in secretory granules until released exocytotically.*

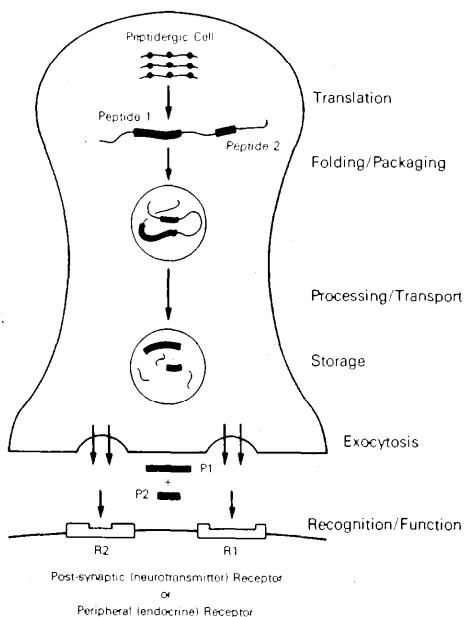


**FIGURE 7**

Analysis of bovine ovary extract by reverse phase HPLC for immunoactive (ir) OT and bovine NPI. Pooled acetic acid extracts of bovine ovaries were fractionated on Sep-Pak<sup>R</sup>; the eluate was dissolved in 0.2 ml triethylammonium phosphate buffer (67 mM TEAP; pH 3.0) and injected onto an octylsilyl column (Zorbax C8, Dupont, 0.46 x 25 cm). One minute fractions were collected, dried in a speed vac, reconstituted in 0.99 ml of radioimmunoassay buffer (50 mM phosphate-150 mM NaCl, pH 7.61 containing 0.5% bovine serum albumin and 0.1% sodium aside, and the pH adjusted to 7.6 with 10  $\mu$ l of 5 M NaOH. Duplicate aliquots of 0.1 ml of the fractions were analyzed by radioimmunoassay for ir-OT and -bNPI. Note the ir-peaks at or close to those of neurohypophysial OT and bNPI. An additional ir-OT peak having a longer retention time is also observed. Upon re-examination using gradients allowing more refined separation in the neurophysin elution regions, it was found that most of the ir-bNPI species (about 80%) have a retention time significantly shorter than that of neurohypophysial bNPI.

While the scheme of figure 6 denotes a single molecular pathway for the biosynthesis of the neurohypophysial hormone/neurophysin system, it is oversimplified in at least one important way. It is becoming more evident that there are sites of occurrence of the hormone/neurophysin system besides the classically defined hypothalamo-neurohypophysial tract. It is likely that some of these other sites represent independent anatomical pathways of *de novo* biosynthesis. We have been examining one such site, namely the ovary. Data obtained by reverse phase HPLC mapping of bovine ovary extracts show the presence of both ir-neurophysin and ir-hormones (Sequeira and Chaiken 1984; Chaiken et al. 1984a). The data for oxytocin and NPI are shown in figure 7. The co-occur-

rence of HP with oxytocin and a growing body of other data argue that the ovary is likely to be a site of independent hormone synthesis (Rodgers et al. 1983; Suann et al. 1984). Indeed, there is a significant peak of ovarian OT which essentially co-eluted with pituitary OT (figure 7). However, the ovarian NPI identified in the ovary, which elutes close to pituitary NPI in figure 7, has been found to be a different molecular form than the pituitary form (R.P. Sequeira and T. Kanmura, unpublished data) when examined both by RP-HPLC using a flattened gradient more suitable for separation of neurophysin isoforms (Chaiken et al. 1984b) and by HPLC peptide mapping (Chaiken and Hough 1980). This analysis suggests that products of processing of the pro-OT/NPI precursor synthesized in the ovary apparently are different than those produced in the hypothalamo-neurohypophysial tract. This view is supported by the observation of a second, prominent ovarian ir-OT



**FIGURE 8**

*Schematic diagram of neuroendocrine peptide/protein pathways. Depicted are the biosynthesis, folding, and granule packaging of precursors containing multiple activity domains; enzymatic processing of precursors to produce mature, active polypeptides; axonal transport and storage of matured granules; exocytotic release of neuroendocrine polypeptides; and ultimate action of active peptides at postsynaptic or peripheral target receptors.*



form with a much greater retention time than that of pituitary OT. This later-eluting form has immunoreactivity and neurophysin-binding properties consistent with it containing the oxytocin sequence, but it is not biologically active in the rat uterus (R.P. Sequelra, R. Medway, and W.H. Sawyer, unpublished data). Such a species was not observed in pituitary extracts. That this form may be an alternatively processed, stable oxytocin precursor intermediate, containing OT with a C-terminal extension of indeterminate length, is an intriguing possibility currently being examined. Taken together, the data indicate that some species of ovarian ir-OT and ir-NPI are not fully identical with the molecular species stored in pituitary. This suggests that, if there is a local synthesis in the ovary by a precursor akin to that identified for pituitary OT, it may well occur by a different processing pathway than that of the hypothalamic-neurohypophysial tract. These results suggest that, if we wish to define how precursors fold and are processed, as in figure 7, the mechanisms we examine may be different at different sites of synthesis.

#### **OPIOID PEPTIDES, NEUROHYPOPHYSIAL HORMONES, AND COMMONALITY IN NEUROENDOCRINE BIOSYNTHETIC PATHWAYS**

Both molecular similarities and co-occurrence mark the emerging view of the relationship of neuroendocrine pathways for classical neurohypophysial hormones and opioid peptides. A common view has evolved of the origin and fate of neuroendocrine peptides by pathways in which precursors are posttranslationally processed enzymatically to produce a set (most often more than one) of biologically active peptides that can function as neurotransmitters, neuromodulators, or endocrine hormones (figure 8). Met- and Leu-enkephalins, dynorphin,  $\beta$ -endorphin, oxytocin, vasopressin, and neurophysins among other neuroendocrine peptides all are produced by such a pathway. Several of the features described in this chapter for precursor structure and processing in the hormone/neurophysin system also are repeated themes for opioid peptides. These include multidomain precursors (figure 1), types of endo- and exo-proteases and nonproteolytic-converting enzymes (e.g., amidating enzymes) to process precursors (Loh et al. 1984), and tissue-specific processing (Watson and Akil 1982; Weber et al. 1982). More than similarity, opioid and hormone/neurophysin pathways apparently are co-localized in some anatomical sites. This has been observed in magnocellular neurons of the hypothalamus for Met-enkephalin and oxytocin (Rossier 1982; Vanderhaeghen et al. 1983) and in neurohypophysial nerve terminals for dynorphin and vasopressin (Whitnall et al. 1983) and for [Met]-enkephalin and oxytocin (Martin and Volgt 1981).

While apparent similarities exist, our understanding of the detailed mechanistic relatedness between opioid and hormone/neurophysin pathways is not well developed. Future studies need to address at least two sets of questions. First, to what extent is conformation a controlling feature? are all precursors conforma-

tionally defined structures (as with the hormone/neurophyzin cases)? is the conversion to intermediates and products marked by transition to less or more conformational order? do most mature neuroendocrine peptides assume more disordered structures (at least when dissociated from other interactive components in storage granules) which make them amenable to productive recognition (in a sense, capture) of a particular conformation by receptors? Second, do pathways for different neuroendocrine peptides have common enzymatic processing machinery? for example, are carboxypeptidases B, dibasic endoproteases, or amidating enzymes similar or even the same for producing different peptides from different precursors or are there instead sequence-specific enzymes for each type of precursor system? Describing the molecular mechanisms controlling the biosynthetic origin for any single neuroendocrine peptide pathway is certainly a far-from-simple task. How closely similar these molecular mechanisms are for a family of neuroendocrine pathways, including those for hormone/neurophyzin and opioid peptides, remains an even more provocative challenge for future investigation.

#### REFERENCES

- Angal, S., and Chaiken, I.M. Interdependence of neurophysin self-association and neuropeptide hormone binding as expressed by quantitative affinity chromatography. Biochemistry 21:1574-1580, 1982.
- Blow, D.M. The structure of chymotrypsin. In: Boyer, P.D., ed. The Enzymes. The Vol. III., 3d ed., New York: Academic Press, 1971. pp. 185-205.
- Bradbury, A.F.; Finnie, M.D.A.; and Smyth, D.G. Mechanism of C-terminal amide formation by pituitary enzymes. Nature 295:686-688, 1982.
- Brownstein, M.J.; Russell, J.T.; and Gainer, H. Synthesis, transport, and release of posterior pituitary hormones. Science 207:373-378, 1980.
- Chaiken, I.M. Quantitative uses of affinity chromatography - a review. Anal Biochem 97:1-10, 1979.
- Chaiken, I.M. Semisynthetic peptides and proteins. CRC Crit Rev Biochem 11:255-301, 1981.
- Chaiken, and Hough, C.J. Mapping and isolation of large peptide fragments from bovine neurophysins and biosynthetic neurophysin-containing species by high-performance liquid chromatography. Anal Biochem 107:11-16, 1980.
- Chaiken, I.M.; Randolph, R.E.; and Taylor, H. Conformational effects associated with the interactions of polypeptide ligands with neurophysins. Ann NY Acad Sci 248:442-450, 1975.
- Chaiken, I.M.; Fischer, E.A.; Giudice, L.C.; and Hough, C.J. In vitro synthesis of hypothalamic neurophysin precursors. In: McKerns, K.W., and Pandic, V., edz. Hormonally Active Brain Peptides: Structure and Function. New York: Plenum, 1982. pp. 327-347.

- Chaiken, I.M.; Kanmera, T.; Sequeira, R.P.; and Swaisgood, H.E. HPLC and studies of neurophysin-neurohypophysial hormone pathways. J Chromatogr 336:63-71, 1984a.
- Chaiken, I.M.; Miller, T.; Sequeira, R.P.; and Kanmera, T. HPLC mapping and structural characterization of neurophysin isoforms. Anal Biochem 143:215-225, 1984b.
- Cohen, P.; Nicolas, P.; and Camier, P. Biochemical aspects of neurosecretion: Neurophysin-neurohypophysial hormone complexes. Curr Top Cell Regul 15:163-318, 1979.
- Docherty, K., and Steiner, D.F. Post-translational proteolysis in polypeptide hormone biosynthesis. Annu Rev Physiol 44:625:638, 1982.
- Douglass, J.; Civelli, O.; and Herbert, E. Polyprotein gene expression: Generation of diversity of neuroendocrine peptides. Annu Rev Biochem 53:665-715, 1984.
- Eipper, B.A.; Mains, R.E.; and Cilembotski, C.C. Identification in pituitary tissue of a peptide  $\alpha$ -amidation activity that acts on glycine-extended peptides and requires molecular oxygen, copper, and ascorbic acid. Proc Natl Acad Sci USA 80:5144-5148, 1983.
- Fontana, A.; Vita, C.; and Chaiken, I.M. Domain characteristics of the carboxyl-terminal fragment 206-316 of thermolysin. Bio-polymers 22:69-78, 1983.
- Gainer, H. The biology of neurosecretory neurons. In: Martin, J.B.; Reichlin, S.; and Bick, K.L., eds. Neurosecretion and Brain Peptides. New York: Raven Press, 1981. pp. 5-20.
- Givol, D.; De Lorenzo, F.; Goldberger, R.F.; and Anfinsen, C.B. Disulphide interchange and the three-dimensional structure of proteins. Proc Natl Acad Sci USA 53:676-684, 1965.
- Hock, V.Y.H., and Loh, Y.P. Carboxypeptidase B-like converting enzyme activity in secretory granules of rat pituitary. Proc Natl Acad Sci USA 81:2776-2780, 1984.
- Ivell, R.; Schmale, H.; and Richter, D. Vazopressin and oxytocin precursors as model prohormones. Neuroendocrinology 37:235-239, 1983.
- Kanmera, T., and Chaiken, I.M. Semisynthesis and the molecular properties of the oxytocin/neurophysin biosynthetic precursor. In: Ragnarsson, U., ed. Peptides - 1984. Stockholm: Almqvist and Wiksell International 1984. pp. 213-216.
- Kanmera, T., and Chaiken, I.M. Pituitary enzyme conversion of putative synthetic oxytocin precursor intermediates. J Biol Chem, in press (1985a).
- Kanmera, T., and Chaiken, I.M. Molecular properties of the oxytocin/neurophysin biosynthetic precursor: Studies using a semisynthetic precursor. J Biol Chem 255:8474-8481, 1985b.
- Kanmera, T.; Feinstein, G.; and Chaiken, I.M. Study of proteolytic processing of neurophysin/neurohypophysial hormone biosynthetic precursors using a synthetic precursor fragment. In: Hruby, V.J., and Rich, D.H., eds. Peptides - Structure and Function. Rockford: Pierce Chemical Company, 1983. pp. 261-264.

- Kraut, J. Chymotrypsinogen: X-ray structure. In: Boyer, P.D., ed. The Enzymes. Vol. III., 3d ed. New York: Academic Press, 1971. pp. 165-169.
- Loh, Y.P.; Brownstein, M.J.; and Gainer, H. Proteolysis in neuro-peptide processing and other neural functions. Annu Rev Neuro-Sci 7:189-222, 1984.
- Martin, M., and Voigt, K.H. Enkephalins co-exist with oxytocin and vasopressin in nerve terminals of rat neurohypophysis. Nature 289:502-504, 1981.
- Rapak, R.S.; Ando, S.; Kanmera, T.; Miller, T.H.; and Chaiken, I.M. Use of synthetic fragments to study enzymatic processing and molecular organization of neuropeptide biosynthetic precursors. In: Deber, C.M., and Hruby, V.J., eds. Proc 9th Amer Pept Symp. Rockford: Pierce Chemical Company, 1985, in press.
- Rodgers, R.J.; O'Shea, J.D.; Findlay, J.K.; Flint, A.P.F.; and Sheldrick, E.L. Large luteal cells are the source of luteal oxytocin in the sheep. Endocrinology 113:2302-2304, 1983.
- Rossier, J. Opioid peptides in the hypothalamo-neurohypophysial system., In: Baertschii, A.J., and Dreifuss, J.J., eds. Neuro-endocrinology of Vasopressin, Corticoliberin and Opiomelanocortin. New York: Academic Press, 1982. pp. 87-93.
- Sequeira, R.P., and Chaiken, I.M. Molecular characterization of oxytocin, AVP and neurophysins in the ovary. Fed Proc 43:913, 1984.
- Supattapone, S.; Fricker, L.D.; and Snyder, S.H. Purification and characterization of a membrane-bound enkephalin-forming carboxypeptidase, "enkephalin-convertase." J Neurochem 42:1017-1023, 1984.
- Swann, R.W.; O'Shaughnessy, P.J.; Birkett, S.D.; Wathes, D.C.; Porter, D.G.; and Pickering, B.T. Biosynthesis of oxytocin in the corpus luteum. FEBS Lett 174:262-266, 1984.
- Udenfriend, S., and Kilpatrick, D.L. Biochemistry of the enkephalins and enkephalin-containing peptides. Arch Biochem Biophys 221:307-323, 1983.
- Vanderhaeghen, J.J.; Lotstra, F.; Liston, D.A.; and Rossier, J. Proenkephalin, [Met]enkephalin, and oxytocin immunoreactivities are co-localized in bovine hypothalamic magnocellular neurons. Proc Natl Acad Sci USA 80:5139-5143, 1983.
- Watson, S.J., and Akil, H. Recent studies on dynorphin and enkephalin precursor fragments in central nervous system. Adv Biochem Psychopharmacol 33:35-42, 1982.
- Weber, E.; Evans, C.J.; Cheng, J.K.; and Barchas, J.D. Brain distributions of  $\alpha$ -neo-endorphin and  $\beta$ -neo-endorphin: Evidence for regional processing differences. Biochem Biophys Res Commun 108:81-88, 1982.
- Wetlaufer, D.B. Folding of protein fragments. Adv Protein Chem 34:61-92, 1981.
- Whitnall, M.H.; Gainer, H.; Cox, B.M.; and Mollineaux, C.J. Dynorphin-A-(1-8) is contained within vasopressin neurosecretory vesicles in rat pituitary. Science 222:1137-1139, 1983.

**AUTHORS**

Irvin M. Chaiken, Ph.D.  
Tatsuhiko Kanmera, Ph.D.  
Reginald P. Sequeira, Ph.D.

Molecular, Cellular, and Nutritional Endocrinology Branch  
National Institute of Arthritis, Diabetes, and Digestive and  
Kidney Diseases,  
National Institutes of Health  
Bethesda, Maryland 20205 USA

# Biosynthesis of Opioid Peptides

Olivier Civelli, Ph.D; Jim Douglass, Ph.D.;  
Haim Rosen, Ph.D.; Gerard Martens, Ph.D.; and  
Edward Herbert, Ph.D.

## INTRODUCTION

In the last decade, a number of peptides have been described which have opioid activity. Although these peptides induce diverse reactions in animals, they share two important physical features: they have an enkephalin sequence at their amino-terminus which confers upon them their biological activity and they have a small size ranging from 5 to 40 amino acids (figure 1). While many researchers have concentrated on the implication of the opioid peptides in behavior, others have concerned themselves with the mode of biosynthesis of the opioid peptides, with the goal of understanding regulation of synthesis in the animal.

In this review, we summarize the results obtained on the biosynthesis of the opioid peptides. By applying recombinant DNA technology, it has been possible to show that all of the opioid peptides are derived from three precursors: proopiomelanocortin (POMC), proenkephalin, and prodynorphin. The complete sequence of these precursors has been determined in different species, as well as the sequences of their corresponding genes. These studies have provided researchers with the DNA probes necessary to analyze the regulation of opioid gene expression under different physiological conditions. Although only a few physiological changes have been analyzed thus far, they reveal a great diversity in regulatory mechanisms and in the opioid gene sequences. Finally, we review the experiments which deal with the generation of the bioactive opioid peptides from the polypeptide precursors. Probably the most intriguing results are those which show that important regulatory steps occur after the translation of the precursors.

## STRUCTURAL RELATIONSHIPS OF OPIOID PEPTIDES

<i>β</i> -endorphin (31 amino acids)	Tyr · Gly · Gly · Phe · Met	Thr · Ser · Glu · Lys · Ser · Gln · Thr · Pro · Leu · Val · Thr · Leu · Phe · Lys · Asn · Ala · Ile · Ile · Lys · Asn · Ala · Tyr · Lys · Lys · Gly · Glu <sup>31</sup>
Peptide E	Tyr · Gly · Gly · Phe · Met	Arg · Arg · Val · Gly · Arg · Pro · Glu · Trp · Trp · Met · Asp · Tyr · Gln · Lys · Arg · Tyr · Gly · Gly · Phe · Leu <sup>25</sup>
Met-enk · arg · phe	Tyr · Gly · Gly · Phe · Met	Arg · Phe <sup>7</sup>
Met-enk · arg · gly · leu	Tyr · Gly · Gly · Phe · Met	Arg · Gly · Leu <sup>8</sup>
Met-enkephalin	Tyr · Gly · Gly · Phe · Met	
Leu-enkephalin	Tyr · Gly · Gly · Phe · Leu	
Dynorphin 1-17	Tyr · Gly · Gly · Phe · Leu	Arg · Arg · Ile · Arg · Pro · Lys · Leu · Lys · Trp · Asp · Asn · Gln <sup>17</sup>
Dynorphin 1-8	Tyr · Gly · Gly · Phe · Leu	Arg · Arg · Ile <sup>8</sup>
<i>α</i> -Neo-endorphin	Tyr · Gly · Gly · Phe · Leu	Arg · Lys · Tyr · Pro · Lys <sup>10</sup>
<i>β</i> -Neo-endorphin	Tyr · Gly · Gly · Phe · Leu	Arg · Lys · Tyr · Pro <sup>9</sup>
Dynorphin B or Rimorphin	Tyr · Gly · Gly · Phe · Leu	Arg · Arg · Gln · Phe · Lys · Val · Val · Thr <sup>13</sup>

22

FIGURE 1

Structure of some opioid peptides

The enkephalin domains are in boxes.

While these discoveries open the way for looking at specific processing factors, they add another level to the diversity in the production of opioid peptides.

### **THE OPIOID POLYPEPTIDE PRECURSORS**

Because of the small size of the opioid peptides (5 to 40 amino acids) (figure 1), it was thought initially that their synthesis might not involve the ribosome-dependent protein synthesizing machinery of the cell. However, numerous neuropeptides and peptide hormones share this size characteristic. The studies carried out on the biosynthesis of adrenocorticotropin (ACTH) finally revealed the key of the enigma. It was shown that ACTH is synthesized in the form of a large polypeptide precursor and that this precursor also contains the sequence of an opioid peptide  $\beta$ -endorphin. This discovery ignited numerous studies on the biosynthesis of other small bioactive peptides, which confirmed that all of these peptides are synthesized in the form of large polypeptides precursors and that in the majority of the cases, these precursors code for more than one bioactive peptide. This gave rise to the concept of polyproteins for polyfunctional precursors (Douglass et al. 1984).

The first opioid precursor protein to be characterized by recombinant DNA methods was POMC, which gives rise to the opioid  $\beta$ -endorphin and a variety of other peptides, including ACTH and  $\alpha$ ,  $\beta$ , and  $\gamma$ -melanocyte stimulating hormones (MSH) (Nakanishi et al. 1979). The second precursor protein to be characterized was proenkephalin, which contains six copies of Met-enkephalin and one copy of Leu-enkephalin (Comb et al. 1982; Gubler et al. 1982; Noda et al. 1982a). In the adrenal medulla, this precursor produces a number of different opioid peptides that include Met- and Leu-enkephalins: peptide E, which contains one copy of Met-enkephalin and one copy of Leu-enkephalin; and peptide F, which contains two copies of Met-enkephalin and Met-enk-Arg-Gly-Leu. The third precursor to be sequenced was prodynorphin, which contains three copies of Leu-enkephalin and gives rise to the opioids dynorphin,  $\beta$ -neo-endorphin, and rimorphin (dynorphin B) (Kakidani et al. 1982) (figure 2). Some remarkable similarities in the structure of the opioid peptide precursors are revealed in figure 2. First, the precursors are almost all the same length and the sequences of the biologically active peptides are confined almost exclusively to the C-terminal half of the precursors. Then, the N-terminal region of each precursor is rich in cysteine residues and the distribution of these residues is similar in each case, indicating that formation of disulfide bridges may be essential for stabilizing the protein in conformations required for correct processing. Finally, almost all of the biologically active domains in each precursor are flanked on both sides by pairs of basic amino acid residues, a feature not specific to precursors of opioid peptides but common to all the polyproteins, which implies that trypsinlike cleavages are involved in the maturation of the active peptides.



## OPIOID PEPTIDE PRECURSORS

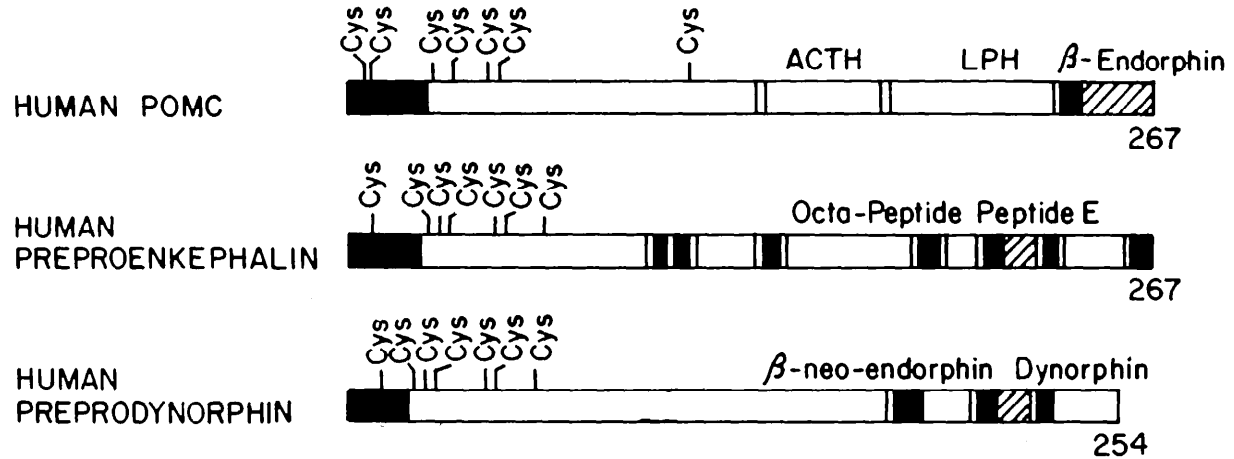


FIGURE 2

Schematic representation of the three opioid polypeptide precursors

The black box at the N-terminus represents the signal sequence. Cys indicates the presence of a cysteine residue in the precursor. Some of the bioactive peptides are indicated. The black boxes in the precursors indicate the presence of an enkephalin sequence. Pairs of basic amino acid residues are indicated by a bar.

The similarities in structure between these different precursors suggest that they arose by similar evolutionary mechanisms. This suggestion is supported by similarities in the structures of the opioid peptide genes.

## **THE OPIOID PEPTIDE GENES**

The three peptide genes share the characteristics common to the majority of the eukaryotic genes; their coding regions (exons) are separated by noncoding intervening sequences (introns). In the opioid genes, however, the introns do not separate functional regions of the polypeptide precursors as is the case for some other polyprotein (Douglass et al. 1984).

### **Opioid Peptide Gene Structure**

The proopiomelanocortin gene structure has been determined for human (Cochet et al. 1982), bovine (Nakanishi et al. 1981), rat (Drouin and Goodman 1980), and mouse (Notake et al. 1983; Uhler et al. 1983). The overall structure of the POMC gene is highly conserve among these different species. The human, rat, and amphibian proenkephalin (Noda et al. 1982b; Comb et al. 1983; Rosen et al. 1984; Martens and Herbert 1984) and human prodynorphin genes (Horikawa et al. 1983) have also been isolated. The general organization of the proenkephalin and prodynorphin genes is remarkably similar to that of the human POMC gene and is schematically diagramed in figure 3. All three genes have large 3'exons which contain the nucleotides coding for all of the biologically active peptides and the majority of the N-terminal portions of the precursors. Note that the 3' untranslated region of the prodynorphin gene is much larger than that of the other two genes. Some 3 kb upstream (5') is a smaller exon which contains sequences coding for the remainder of the amino-terminal portion of the precursor molecule, the initiator methionine, and a few bases of the 5' untranslated region of the mRNA. The remaining sequences coding for the 5' untranslated region of the mRNA are found further upstream on either one (POMC) or two (proenkephalin and prodynorphin) exons. The prodynorphin gene differs from the other two genes in that its 5' untranslated region is large.

The structural similarities between these two genes in the human suggest that they may have arisen via a common evolutionary mechanism. The human POMC and proenkephalin genes are not, however, closely linked in the genome. POMC has been localized to chromosome 2, while the proenkephalin gene is located on chromosome 12. The location of the prodynorphin gene is not known.

The 3' exons of all the opioid genes contain regions of intra-sequence homology. In POMC, three repetitive nucleotide regions are present (approximately 50 nucleotides in length) which code for  $\alpha$ -,  $\beta$ -,  $\gamma$ -MHS. In human proenkephalin, there are seven regions of internal nucleotide sequence homology (approximately

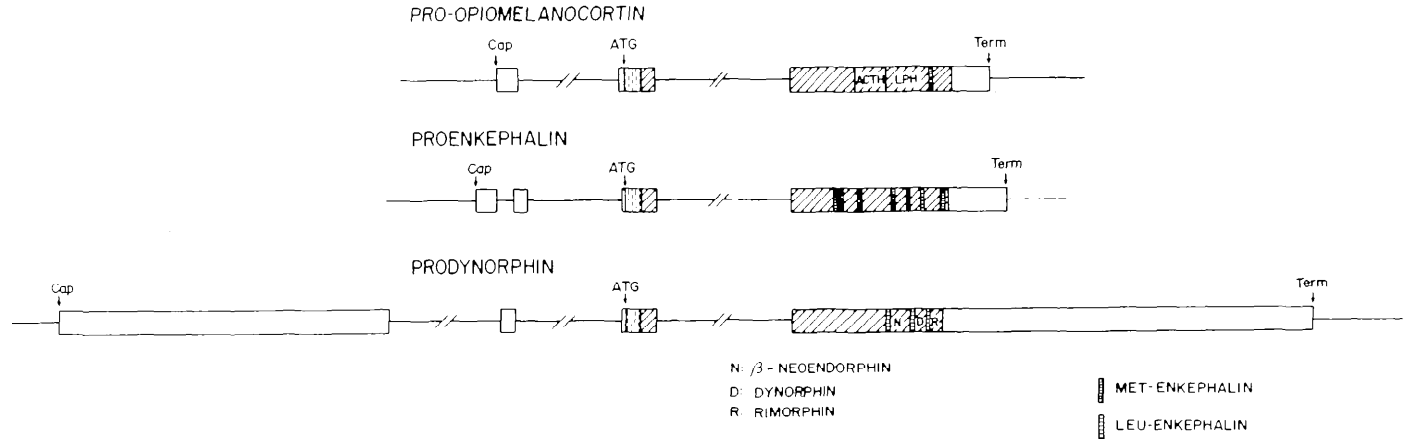


FIGURE 3

Structural comparison of the human POMC, proenkephalin, and prodynorphin genes

Lines indicate introns; boxes indicate exons. ATG Indicates the initiator methionine; TERM Indicates the mRNA 3'-end. CAP shows the start of transcription. Dashed boxes indicate the signal peptide; hatched boxes the extent of the coding region. The different enkephalin sequences are indicated.

25 base pairs in length) which code for the biologically active enkephalin moieties. This observation has led to the suggestion that the POMC and proenkephalin genes have evolved via a series of duplication and rearrangement events of ancestral MSH-like sequences and enkephalinlike sequences, respectively (Noda et al. 1982b).

Southern blotting experiments and the isolation of genomic clones from genomic libraries have implied that only one proenkephalin and POMC gene is present in the human genome. The same holds true for the number of POMC genes in the bovine and rat genome. In contrast, two groups (Notake et al. 1983; Uhler et al. 1983) have reported the presence of two POMC genes in the mouse genome, one of which is a pseudogene. The pseudogene exhibits 92% homology with 533 base pairs of the functional POMC gene, including the coding regions for ACTH and  $\beta$ -LPH. However, the presence of a premature translation termination codon and a mutation in a codon for a dibasic amino acid cleavage site within the protein predicts that  $\beta$ -endorphin would not be present in the translation product, and ACTH would not be cleaved from the precursor by a trypsinlike cleavage enzyme. Thus, the POMC pseudogene in mouse cannot encode a functional precursor protein similar to the POMC precursor. Finally, the mouse POMC pseudogene sequence is flanked on both sides by direct repeats 10 basepairs in length. This observation raises the interesting possibility that the pseudogene may have arisen via the formation of an aberrant transcript of the functional gene, followed by the insertion of its cDNA copy into the mouse genome (Uptake et al. 1983).

### **Comparative Aspects of Proenkephalin Genes in the Human, and Amphibian**

Analysis of protein sequences in different species in order to determine conserved regions constitutes an approach to understanding which sequences may be functionally significant. The proenkephalin amino acid sequences are known in the human, bovine, and rat as well as the toad Xenopus laevis and, therefore, can serve such a comparison. The toad proenkephalin contains five copies of Met-enkephalin and one copy of Met-enkephalin-Arg-Gly-Tyr and one Met-enkephalin-Arg-Phe (Martens and Herbert 1984). Met-enkephalin-Arg-Gly-Leu and Leu-enkephalin, two enkephalin sequences present in human, bovine, and rat proenkephalin, are not found in the Xenopus sequence. Thus, amphibian proenkephalin contains no Leu-enkephalin sequences, suggesting that a switch from a Met-enkephalin to a Leu-enkephalin sequence in the mammalian proenkephalins occurred less than 350 million years ago (time of divergence between the Xenopus line and the main vertebrate line).

The distribution of enkephalin sequences appeared to be very similar among human, bovine, rat, and Xenopus proenkephalin. Some of the spacer regions between the enkephalin sequences have a high degree of amino acid homology, while others have diverged

to a considerable extent. It is interesting to note that the highly conserved regions between enkephalin units 2 and 3, 5 and 6, and 6 and 7 (figure 4) correspond to enkephalin-containing peptides isolated from bovine adrenal medulla (peptides F, E, and B, respectively). The high degree of conservation of these peptides (especially of the highly potent opioid peptide E) might point to an important physiological role for them, both in mammals and lower vertebrates. The enkephalin sequences in both mammalian and amphibian precursors are flanked by pairs of basic amino acids, suggesting that similar processing mechanisms are used in both mammals and amphibians. In mammals, the cysteine residues in three opioid precursor proteins are located in almost identical positions in the N-terminal region. It has been suggested that this region is important for proper folding of the precursor molecule in order to ensure correct processing. The conservation of the cysteine residues in the proenkephalin sequences of the four species reinforces this concept. Thus, the high conservation of proenkephalin sequences in mammals and amphibians suggests that the enkephalins and enkephalin-containing peptides have an important physiological function(s) in a wide range of vertebrates (Martens and Herbert 1984).

#### **TRANSCRIPTIONAL AND POSTTRANSCRIPTIONAL REGULATION OF OPIOID PEPTIDE GENE EXPRESSION**

The tissue levels of opioid peptides can be altered by a variety of synthetic as well as naturally occurring substances. In this section, we will document some examples in which various regulators are altering opioid peptide levels as the result of changes in the level of mRNA that codes for these peptides. The following questions will be addressed: (1) Which tissues are actively transcribing polyprotein genes? (2) What are some of the characteristics of these genes that make them transcriptionally active? (3) How are transcriptionally active opioid genes regulated in vivo?

#### **Detection of mRNA Coding for Various Polyproteins**

An opioid cDNA clone or genomic clone can be used as a hybridization probe for detecting and quantifying the corresponding mRNA. Study of the distribution of POMC mRNA in various rat brain tissues shows that the hypothalamus, amygdala, and cerebral cortex contain POMC transcripts (mRNA) while the cerebellum and midbrain do not (Civelli et al. 1982). In addition, POMC transcripts in the amygdala and cortex appear to be slightly smaller in size than POMC transcripts isolated from the hypothalamus. The distribution of proenkephalin mRNA in these same tissues has been measured (Tang et al. 1983) and proenkephalin transcripts were detected (in order of abundance) in the striatum, hypothalamus, cerebellum, midbrain, hippocampus, and cortex.

These data provide two important pieces of information. First, the distribution of POMC mRNA in the rat brain is different from

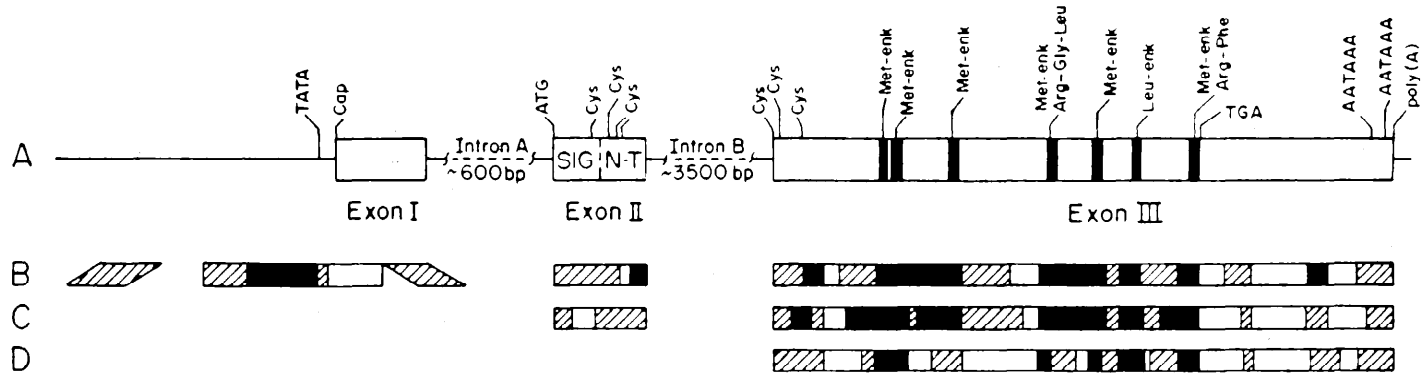


FIGURE 4

Nucleotide sequences comparisons between the rat (A), human (B), bovine (C), and *Xenopus laevis* (D) proenkephal in genes.

The exons are shown by blocks, the introns by lines. The "TATA" sequence, capping site, translational initiator ATG and terminator TGA, and poly (A) addition sites are indicated. The enkephalin sequences are represented in the rat gene by black boxes. Three degrees of homology are used to characterize the nucleotide sequence comparison: open box, shaded box and solid box representing homology of less than 65%, between 65-86%, and more than 85%, respectively.

that of proenkephalin mRNA. For example, the rat cerebellum contains relatively high levels of proenkephalin transcripts but no detectable POMC mRNA. Since opioid peptides are derived from both precursor molecules, proenkephalin-derived peptides may play an important role in this region of the brain while  $\beta$ -endorphin (from POMC) does not. Second, the levels of mRNA can be correlated with the levels of the bioactive peptides derived from POMC or proenkephalin. In most cases, a direct correlation is observed, confirming that the opioid peptides previously detected in these tissues by radioimmunoassay are present as a result of direct synthesis in those tissues, and not transport to those tissues from a secondary site of synthesis. Recently, this has been demonstrated to be also true for POMC mRNA and POMC-derived peptides in the testis (Pintar et al. 1984).

Several groups (Hudson et al. 1981; Gee and Roberts 1982) have used POMC cDNA as a hybridization probe to study the differential expression of the POMC gene in the various lobes of the rat pituitary. Using these probes, approximately 3% to 5% of anterior lobe cells appear to contain POMC transcripts, while greater than 90% of the intermediate lobe cells show cytoplasmic localization of POMC mRNA. By combining immunohistochemical methods with in situ hybridization histochemistry, it has also been shown that the same cells contain both POMC peptides and POMC mRNA (Gee and Roberts 1982). These data suggest that the presence of the POMC peptides in these cells is due to their local synthesis and is not the result of uptake from the plasma.

#### **Characteristics of Transcriptionally Active Opioid Genes**

Gene expression in eukaryotic cells is influenced by a wide variety of factors. Of particular importance are the DNA sequences situated upstream to the transcription start, since they can potentially change the level of transcription. Gene transfer experiments have been applied in order to localize these DNA sequences.

A cloned human POMC gene has been ligated to SV40 DNA, introduced into CDS monkey cells, and transcribed from its own promoter (Mishina et al. 1982). Deletion mutants in the 5' region of the gene were generated to determine the effects of these sequences on transcription of the gene in vivo. If nucleotide +1 is the first base of the primary transcript, deletion of sequences from -20 to -40 (containing the TATA box start of transcription) completely abolished accurate transcription from the POMC promoter. This result suggests that the TATA box region is a distinct promoter element of the human POMC gene.

A unique feature of the human POMC promoter region is that the deletion of sequences from -53 to -59 results in a threefold enhancement of the transcriptional efficiency. This region overlaps with a continuous stretch of G-C pairs present -48 to -56 bp upstream from the cap site. The G-C stretch itself, or

its specific pattern of methylation, may depress transcription of the gene; and its partial removal may therefore increase the transcriptional efficiency of the human POMC gene.

### **Regulation of Expression of Cpioid Peptide Genes**

Many compounds alter the levels of bioactive peptides. Some of these substances change the rate of processing of the precursor molecules. Others regulate the rate of transport or secretion of the bioactive peptides following their release from the precursor molecule.

Regulation of POMC Gene Expression The secretion of POMC-derived peptides is regulated differently in the anterior lobe (AL) and neurointermediate lobe (NIL) of the rat pituitary. In the AL, the secretion of POMC-derived peptides is positively regulated by corticotropin-releasing factor (CRF) and negatively regulated by endogenous glucocorticoids released from the adrenal cortex. Glucocorticoids also inhibit POMC production in AL corticotrophs but have no effect on NIL cells that produce POMC.

In the NIL, dopaminergic neurons from the hypothalamus impinge on POMC-containing cells and inhibit the release of POMC-derived peptides. As expected, the administration of dopamine antagonists, such as haloperidol, stimulates the release of POMC peptides from the NIL and increases the levels of POMC peptides within the NIL. These agents have no effect on the release of POMC peptides from AL corticotrophs (Douglass et al. 1984).

POMC cDNA clones have been used as hybridization probes to accurately determine the effects of adrenalectomy and subsequent dexamethasone (DM) administration on POMC mRNA levels in the rat AL (Birnberg et al. 1983). Eight hours after adrenalectomy the levels of POMC mRNA levels increased markedly, reaching fifteenfold to twentyfold the control level at 18 days postoperation. When DEX was administered to rats 8 days after adrenalectomy, the above events were reversed (Bimberg et al. 1983), and after 5 daily injections of DEX, POMC mRNA had returned to control levels (figure 5). These results confirmed previous experiments which used POMC mRNA translational activity as a measure of POMC mRNA content.

The large changes in POMC mRNA levels in anterior pituitary after adrenalectomy raised the question of whether glucocorticoids regulate POMC gene expression at the level of transcription. To test this possibility, POMC transcription rates were assayed by the nuclear transcription method which measures the number of RNA polymerase molecules transcribing POMC genes in a given time period (1 and 4 hours after adrenalectomy). The results show that the rate of transcription increases by twentyfold in the anterior pituitary within 1 hour of adrenalectomy. The observed increase in transcription rate was completely suppressed by administration of DEX to animals immediately after adrenalectomy.



# POMC

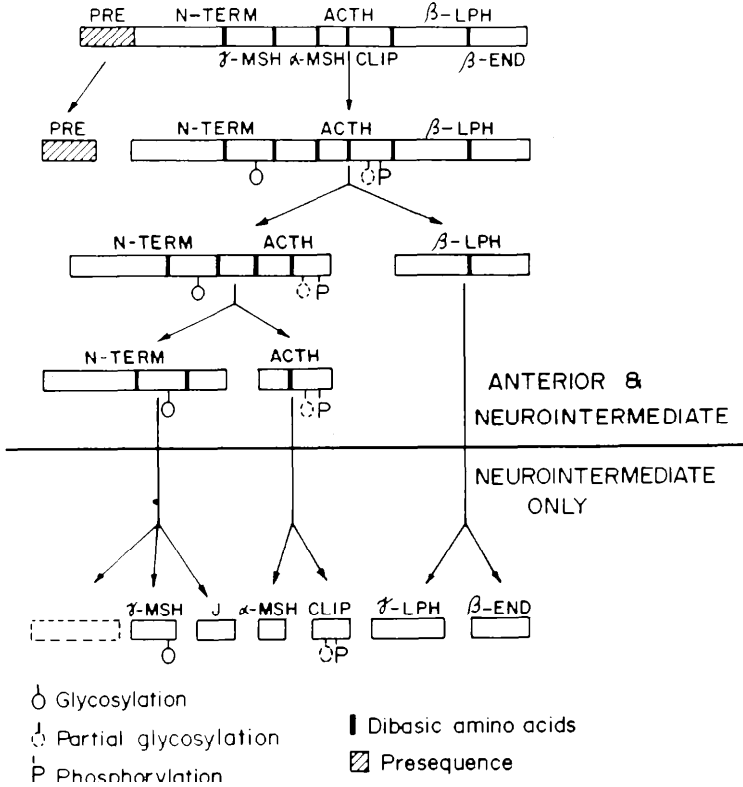


FIGURE 5

Time-specific processing pathways of the POMC precursor

PRE: Presequence; N-TERM: N-terminal peptide; J: joining peptide; CLIP: corticotropinlike intermediate lobe peptide; beta-END: beta-endorphin.

The above effects are specific to POMC gene expression in the AL; POMC mRNA levels and the rate of transcription of the POMC gene in the NIL are not altered by adrenalectomy or DEX administration (Birnberg et al. 1983).

In situ hybridization has been used to determine that the increase in POMC mRNA levels in the AL following adrenalectomy is due to a number of factors, including enlarged cell volume and an increase in the number of POMC-producing cells (Gee and Roberts 1982). This technique clearly allows for a more refined analysis of the factors involved when a heterogeneous tissue is being studied.

Cell-free translation studies and RNA dot blotting (Chen et al. 1983) have been used to study the effects of dopamine agonists and antagonists on POMC mRNA levels in the rat NIL. Administration of the dopamine antagonist haloperidol results in a fourfold to sixfold (time-and-dose-dependent) increase in the level of NIL POMC mRNA. This stimulatory effect is observed as early as six hours after administration. In contrast, ergocryptine, a dopamine agonist, decreases twofold to threefold the level of POMC mRNA in the rat NIL (Chen et al. 1983). The time-dependent changes in POMC mRNA levels and the magnitude of these changes suggest that dopaminergic compounds modulate POMC mRNA levels in the NIL in the same fashion as they regulate POMC peptide secretion. The mechanisms underlying dopaminergic modulation of POMC mRNA levels in the NIL remain to be elucidated.

It is also worthwhile to note that dopaminergic compounds have no effect on POMC mRNA levels in the AL (Chen et al. 1983).

Proenkephalin Gene Regulation. Daily injections in rats for 2 to 3 weeks with haloperidol, a dopamine receptor antagonist, increases twofold the level of Met-enkephalin in the striatum. From these data, it was suggested that the prolonged blockage of dopamine receptors by haloperidol accelerates the synthesis of the enkephalin precursor molecule.

To investigate the possibility that haloperidol was modulating the level of proenkephalin mRNA in the striatum, cell-free translation and immunoprecipitation (Sabol et al. 1983) and Northern blotting techniques (Tang et al. 1983) were employed. Following chronic haloperidol treatment for 3 weeks, the levels of proenkephalin mRNA in the striatum were increased twofold (Sabol et al. 1983) to fourfold (Tang et al. 1983), consistent with the concomitant elevation of striatal Met-enkephalin content. Thus, haloperidol elevates the Met-enkephalin content in the striatum primarily by increasing the proenkephalin in mRNA content in that tissue. This effect was specific to the striatum since haloperidol had no effect on maintaining proenkephalin mRNA levels in the rat hypothalamus, cortex, or hippocampus (Tang et al. 1983).

## **TRANSLATIONAL AND POSTTRANSLATIONAL REGULATION OF OPIOID PEPTIDE PRODUCTION**

Opioid peptides become active only after they are cleaved out of their precursor molecules. In some cases, other modifications such as glycosylation, phosphorylation, amidation, or acetylation must also occur in order to activate these peptides. Amino acid sequences specify the enzymatic processes that lead to activation of the opioid peptides. These processes usually occur in a well-defined order as the proteins and peptides move through compartments in the secretion pathway.

Most of the domains of the opioid peptides in the precursors are flanked by pairs of basic amino acid residues (either Lys-Arg, Lys-Lys, or Arg-Arg), suggesting that trypsinlike enzymes are involved in the cleavage reaction. A carboxypeptidase-like enzyme is thought to remove the C-terminal basic amino acid to produce the bioactive peptide. However, other types of cleavage recognition sites are also used, including a single Arg site in proenkephalin and prodynorphin.

Carboxyterminal amidation has been observed in the formation of  $\alpha$ -MSH from POMC and a Met-enkephalin octapeptide from proenkephalin. The C-terminal amino acid of peptides that undergo amidation is followed by a glycine residue in the precursors which is involved in transfer of the amino group and is cleaved from the peptide during the amidation reaction.

Glycosylation of a protein at asparagine (Asp) residues requires the sequence asparagine-x-threonine or -x-serine. Glycosylation can also occur at serine or threonine (Thr) residues, POMC is known to be glycosylated. Human and bovine proenkephalin also have Asp-x-Thr sequences. However, as not all such sequences are glycosylated in a protein, it is not possible to predict which precursors will contain these oligosaccharides. In order to demonstrate the existence of oligosaccharides, one must isolate the protein and analyze its carbohydrate content or carry out pulse label studies with radioactive sugars.

Other posttranslational modifications have been detected in the processing of POMC, including phosphorylation, acetylation, sulfation, and methylation (Herbert et al. 1984).

### **Tissue-Specific Processing of POMC, Proenkephalin, and Prodynorphin**

Processing of POMC in Anterior and Neurointermediate Lobes of the Rodent Pituitary. Cultures of AL and NIL of rat pituitary provide viable and convenient systems for studying expression of POMC-derived peptides. In addition to the tissue-specific differences in regulation of hormone release described earlier, there are marked differences in the types of peptides derived

from the ACTH- $\beta$ -LPH portion of the precursor in the two lobes of the pituitary. The AL contains predominantly the steroidogenic hormone, ACTH1-39, while the intermediate lobe of the pituitary contains high levels of  $\alpha$ -MSH (ACTH1-13 with an acetylated N-terminus and an amidated C-terminus) and corticotropinlike intermediate lobe peptide (CLIP) (ACTH18-39) as shown in figure 5 (Scott et al. 1974; Roberts et al. 1978; Mains and Eipper 1979; Eipper and Mains 1980). Thus, ACTH]39 is further processed in the neurointermediate lobe to yield  $\alpha$ -MSH and CLIP (Scott et al. 1973). The lobes of the rodent pituitary also differ in the amounts of  $\beta$ -LPH,  $\beta$ -endorphin, and acetylated derivatives of  $\beta$ -endorphin that they contain. While the AL contains mainly  $\beta$ -LPH, the neurointermediate lobe has predominantly  $\beta$ -endorphin and derivatives of  $\beta$ -endorphin (Herbert et al. 1984) (see figure 5). Despite the differences in the ACTH/endorphin peptides in the two lobes of the pituitary, the forms of POMC that they contain are very similar (Roberts et al. 1978).

Pulse-label and pulse-chase studies with rodent pituitary cells show that the initial cleavages and glycosylation steps in the processing of POMC are the same in the two lobes of the pituitary (Roberts et al. 1978; Hinman and Herbert 1980). As shown in figure 5, glycosylation of the N-terminal portion of POMC occurs first in the  $\gamma$ -MSH region of the molecule. About half of the POMC molecules are also glycosylated at Asn residue 29 in the ACTH portion of the molecule. After core glycosylation is complete, cleavage occurs between ACTH and  $\beta$ -LPH, resulting in the formation of glycosylated ACTH intermediates and  $\beta$ -LPH as in AtT-20-D16v cells. Another cleavage then occurs to release glycosylated and unglycosylated forms of ACTH (Roberts et al. 1978; Mains and Eipper 1979; Eipper and Mains 1980; Hinman and Herbert 1980) and an N-terminal fragment. In the rodent anterior pituitary processing essentially ceases at this point; but in the NIL ACTH is processed to  $\alpha$ -MSH and CLIP by cleavage in the middle of the molecule. The N-terminus ACTH is then trimmed back to 13 residues (ACTH1-13) presumably by carboxypeptidases, amidated at the C-terminus and acetylated at the N-terminus (Scott et al. 1973). The  $\beta$ -LPH portion of POMC is cleaved in the NIL to form  $\gamma$ -LPH and  $\beta$ -endorphin.  $\beta$ -Endorphin is then acetylated at its N-terminus and shortened by removal of four C-terminal amino acids. Acetylation of  $\beta$ -endorphin at its N-terminus destroys its analgesic activity. Hence, this modification might be a way of regulating the amount of active endorphin available in the NIL.

Recent evidence suggests that the N-terminal portion of POMC is also cleaved extensively in the pituitary. In the rodent NIL, proteolytic cleavages occur at both pairs of basic amino acids in the N-terminal portion of POMC. These cleavages give rise to  $\gamma$ -MSH, which has been shown to be present in its glycosylated form, and to an acidic peptide called a joining peptide (J) (Seidah et al. 1981). Formation of these peptides is

essentially confined to the NIL since  $\gamma$ -MSH peptides are not detected in the anterior pituitary. Hence, the N-terminal of POMC is more correctly processed in the NIL of the pituitary than in the anterior pituitary (Herbert et al. 1984; Douglass et al. 1984), as already demonstrated for the ACTH and  $\beta$ -LPH domains.

These results show that cleavage occurs at all of the pairs of basic amino acid residues contained in POMC (figure 5).

Almost all of the POMC-derived products shown in figure 5 arise by proteolytic cleavages at Lys-Arg sites. It appears that in mammals this sequence is preferred as a cleavage site over Arg-Arg or Lys-Lys (as in the case of conversion of proinsulin to insulin).

Processing of Proenkephalin and Prodynorpin. Detection of immunoreactive enkephalin peptides in the bovine adrenal medulla provided impetus for using this tissue to study biosynthesis of enkephalins. Since these subjects have been reviewed in depth recently (Udenfriend and Kilpatrick 1983; Lewis and Stem 1983), we will present only a brief summary emphasizing tissue-specific differences in processing of proenkephalin.

A variety of enkephalin-containing peptides (ECPs), in addition to the pentapeptides Met- and Leu-enkephalin, are present in adrenal medulla and brain. Figure 6 shows the biosynthetic relationship of these peptides in the adrenal medulla and brain. The arrangement of the six Met- and one Leu-enkephalin units in preproenkephalin is presented first. Met-enkephalin-Arg-Phe is present at the C-terminal part of the precursor and the octapeptide product, Met-enkephalin-Arg-Gly-Leu, comprises the amino acid sequence 186 to 193 in the precursor. Larger ECPs containing more than one enkephalin sequence are also observed, including peptide E which has a Met-enkephalin at its N-terminus and a Leu-enkephalin at its C-terminus, and peptide F which has a Met-enkephalin sequence at each end. These smaller ECPs are derived from larger peptides. For example, peptide E arises from peptide I by cleavage at a Lys-Arg site and peptide F comes from still larger fragments which have also been characterized (figure 6). It is still not clear which of these peptides are and products of processing and which are intermediates. Bioassays indicate that peptide E, Met-enkephalin-Arg-Phe and Met-enkephalin-Arg-Gly-Leu are very potent opioids. However, peptide F and larger ECPs are not very active in assays of opioid activity. The bioactivity assays suggest that peptide E and the smaller ECPs are the true end products of biosynthesis, whereas the larger fragments are intermediates in processing.

The proenkephalin peptide sequences flanked by Lys-Arg or Lys-Lys sites are cleaved out of the precursor, whereas, the Met-enkephalin sequence in peptide E that has an Arg-Arg on its C-terminus is not released from the precursor.

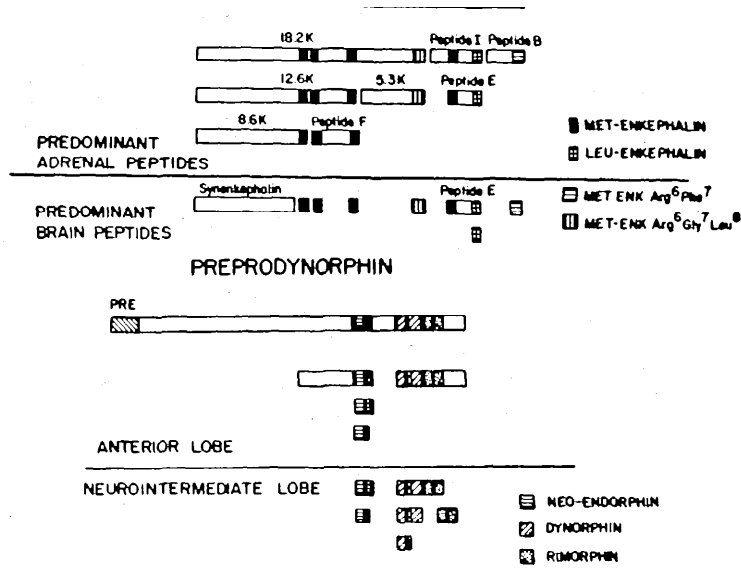


FIGURE 6

Tissue-specific processing pathways of the proenkephalin and prodynorphin precursors

The products of proenkephalin processing are compared between the adrenal medulla and brain. The anterior and the neurointermediate lobe of the pituitary.

An amidated octapeptide, ECP, has recently been isolated from bovine brain and human pheochromocytoma (a tumor of the adrenal medulla). This peptide, which results from cleavage at a single Arg residue in peptide E, is the first amidated opioid peptide that has been isolated. Cleavage at a single Arg residue also occurs in the processing of several other precursors, including proAVP (producing a glycopeptide), prodynorphin, procholecystokinin, and progrowth-hormone-releasing-factor (Douglass et al. 1984).

As in the case of POMC, the processing of proenkephalin is tissue-specific. The major products of processing in the adrenal medulla are the higher molecular weight ECPs, whereas in the brain, one finds mainly the enkephalins and other small ECPs (Udenfriend and Kilpatrick 1983; Weber et al. 1983; Liston et al. 1983). Indeed, it has been shown recently that three of the proenkephalin-derived peptides, synenkephalin, Met-enkephalin-Arg-Phe, and the octapeptide Met-enkephalin-Arg-Gly-Leu, are present in different processing intermediates in the brain as compared to the intermediates in the adrenal medulla (Liston et al. 1983). Although the processing of prodynorphin has been less studied, its proteolytic cleavages appear also to be tissue-specific in the two lobes of the rat pituitary (Seizinger et al. 1984). Dynorphin(1-17) and rimorphin, two of the opioid peptides present in this precursor, exist in these forms in the AL but are only detected as part of 6000 MW polypeptide in the AL. Also, dynorphin(1-8) which is present in the NIL, is undetectable in the AL. The peptides containing neoendorphin sequences also differ in the two lobes of pituitary. While both lobes contain  $\alpha$ - and  $\beta$ -neoendorphin, an 8000 MW polypeptide immunoreactivity against neo-endorphin antibodies is detected in the AL and not in the NIL. These data are summarized in figure 6 and show that, as for the two other opioid polypeptide precursors, the processing pathways of prodynorphin are tissue-specific.

Several mechanisms can be proposed to explain tissue-specific processing of neuroendocrine peptide precursors. One is the existence of a different set of processing enzymes in different tissues. The environment at the sites of processing could also differ in different tissues. Another possibility is a difference in the structures of the precursor molecules in different tissues. In the latter case, a sequence difference in the precursor molecule would dictate how the precursor is processed in each tissue. Different translational modifications of the precursor might also account for tissue differences in processing. Different precursors could arise by selective expression of one or more of a family of genes in each tissue or from a single gene by alternate modes of splicing. Most of the evidence to date suggests that differential processing of POMC occurs at the level of processing enzymes in the pituitary. First, there is only one POMC gene in the mouse (Uhler et al. 1983) and rat (J. Drouin, personal communication, 1984); second, an extensive search for different forms of mRNA that might code

for different POMC forms in the two lobes of the pituitary has been negative (Herbert et al. 1984); and third, posttranslational modifications of POMC appear to be the same in the two lobes of the pituitary.

Thus, different sets of processing enzymes appear to be responsible for tissue-specific expression of neuroendocrine peptides. Posttranslational processing comprises the last steps in the numerous events leading to expression of the opioid genes and appears to be a major mechanism for generating diverse sets of peptides in the opioid peptide system

In conclusion, we have tried at the generation of the opioid peptides as the products of a complex cascade of events. All the steps involved in the expression of a gene are used to generate the greatest diversity of bioactive peptides. The synthesis of the opioid peptides from only three precursors provides a means of coordinating the synthesis of functionally related peptides which could act together to mediate distinct behavioral responses. Future experiments will provide information about the role of opioid peptides in behavior. On the other hand, the transfer of opioid genes from one cell to another will reveal the basic mechanisms directing the genetic expression of the opioid peptides. We will then be in the position of being able to control the production of the opioid peptides and, therefore, to test specifically their actions in the organism

#### REFERENCES

- Birnberg, N.; Lissitzky, J.C.; Hinman, M.; and Herbert, E. Glucocorticoids regulate pro-opiomelanocortin gene expression in vivo at the levels of transcription and secretion. Proc Natl Acad Sci USA 80:6982-6986, 1983.
- Chen, C.L.C.; Dionne, F.T.; and Roberts, J.L. Regulation of the pro-opiomelanocortin mRNA levels in rat pituitary by dopaminergic compound. Proc Natl Acad Sci USA 80:2211-2215, 1983.
- Civelli, O.; Birnberg, N.; and Herbert, E. Detection and quantification of pro-opiomelanocortin mRNA in pituitary and brain tissues from different species. J Biol Chem 257:6783-6787, 1982.
- Cochet, M.; Chang, A.C.Y.; and Cohen, S.N. Characterization of the structural gene and putative 5'-regulatory sequences for human pro-opiomelanocortin. Nature 297:335-339, 1982.
- Comb, M.; Seeburg, P.H.; Adelman, J.; Eiden, L.; and Herbert, E. Primary structure of the human Met- and Leu-enkephalin precursor and its mRNA. Nature 295:663-666, 1982.
- Comb, M.; Rosen, H.; Seeburg, P.; Adelman, J.; and Herbert, E. Primary structure of human preproenkephalin gene. DNA 2:213-229, 1983.
- Douglass, J.; Civelli, O.; and Herbert, E. Polyprotein gene expression: Generation of diversity of neuroendocrine peptides. Annu Rev Biochem 53:665-715, 1984.



- Drouin, J., and Goodman, H.M. Most of the coding region of rat ACTH- $\beta$ -LPH precursor lacks intervening sequences. Nature 288:610-613, 1980.
- Eipper, B.A., and Mains, R.E. Structure and biosynthesis of pro-adrenocorticotropin/endorphin and related peptides. Endocr Rev 1:1-27, 1980.
- Gee, C.E., and Roberts, J.L. In situ hybridization histochemistry: A technique for the study of gene expression in single cell. DNA 2:157-163, 1982.
- Gubler, U.; Seeburg, P.H.; Gage, L.P.; and Udenfriend, S. Molecular cloning establishes proenkephalin as precursor of enkephalin-containing peptides. Nature 295:206-209, 1982.
- Herbert, E.; Civelli, O.; Douglass, J.; Rosen, H.; and Martens, G. Generation of opioid peptides. Biochem Actions of Hormones 2, 1984.
- Hinman, M., and Herbert, E. Processing of the precursor to adrenocorticotrophic hormone and  $\beta$ -lipotropin in monolayer cultures of mouse anterior pituitary. Biochemistry 19:5395-5402, 1980.
- Horikawa, S.; Takai, T.; Toyosato, M.; Takahashi, H.; Noda, M.; Kakidani, H.; Kubo, T.; Hirose, T.; Inayama, S.; Hayashida, H.; Miyata, T.; and Numa, S. Isolation and structural organization of the human preproenkephalin B gene. Nature 306:611-614, 1983.
- Hudson, P.; Penschow, J.; Shine, J.; Ryan, G.; Niall, H.; and Coghlan, J. Hybridization histochemistry: Use of recombinant DNA as a "homing probe" for tissue localization of specific mRNA populations. Endocrinology 108:353-356, 1981.
- Kakidani, H.; Furutani, Y.; Takahashi, H.; Noda, M.; Morimoto, Y.; Hirose, T.; Asai, M.; Inayama, S.; Nakanishi, S.; and Numa, S. Cloning and sequence analysis of cDNA for porcine  $\beta$ -neoendorphin/dynorphin precursors. Nature 298:245-249, 1982.
- Lewis, R.V., and Stern, A.S. Biosyntheses of the enkephalins and enkephalin-containing polypeptides. Annu Rev Pharmacol Toxicol 23:353-372, 1983.
- Liston, D.R.; Vanderhaeghen, J.-J.; and Rossier, J. Presence in brain of synenkephalin a proenkephalin-immunoreactive protein which does not contain enkephalin. Nature 302:62-65, 1983.
- Liston, D.R.; Patey, G.; Rossier, J.; Verbanck, P.; and Vanderhaeghen, J.-J. Processing of proenkephalin is tissue-specific. Science 225:734-736, 1984.
- Mains, R.E., and Eipper, B.A. Synthesis and secretion of corticotropins, melanotropin and endorphin by rat intermediate pituitary cells. J Biol Chem 254:7885-7894, 1979.
- Martens, G., and Herbert, E. Polymorphism and absence of Leu-enkephalin in sequences in proenkephalin genes in Xenopus laevis. Nature 310:251-254, 1984.
- Mishina, M.; Kurosaki, T.; Yamamoto, T.; Notake, M.; Masu, M.; and Numa, S. DNA sequences required for transcription in vivo of the human corticotropin- $\beta$ -lipotropin precursor gene. EMBO J 1:1533-1538, 1982.
- Nakanishi, S.; Inoue, A.; Kita, T.; Nakamura, M.; Chang, A.C.Y.; Cohen, S.N.; and Numa, S. Nucleotide sequence of cloned cDNA for bovine corticotropin- $\beta$ -lipotropin precursor. Nature 278:423-427, 1979.

- Nakanishi, S.; Teranishi, Y.; Watanabe, Y.; Notake, M.; Noda, M.; Kakidani, H.; Jingami, H.; and Numa, S. Isolation and characterization of bovine corticotropin/ $\beta$ -lipotropin precursor gene. Eur J Biochem 115:429-438, 1981.
- Noda, M.; Furutani, Y.; Takahashi, H.; Toyosato, M.; Hirose, T.; Inayama, S.; Nakanishi, S.; and Numa, S. Cloning and sequence analysis of cDNA for bovine adrenal preproenkephalin. Nature 295:202-206, 1982a.
- Noda, M.; Teranishi, Y.; Takahashi, H.; Toyosato, M.; Notake, M.; Nakanishi, S.; and Numa, S. Isolation and structural organization of human preproenkephalin gene. Nature 297:431-434, 1982b.
- Notake, M.; Tobimatsu, T.; Watanabe, Y.; Takahashi, H.; Mishina, M.; and Numa, S. Isolation and characterization of mouse corticotropin- $\beta$ -lipotropin gene and a related pseudogene. FEBS Lett 156:67-71, 1983.
- Pintar, J.E.; Schachter, B.S.; Herman, A.B.; Durgerian, S.; and Krieger, D.T. Characterization and localization of pro-opiomelanocortin messenger RNA in the adult rat testis. Science 225:632-634, 1984.
- Roberts, J.L.; Phillips, M.; Rosa, P.A.; and Herbert, E. Steps involved in the processing of common precursor forms of adrenocorticotropin and endorphin in cultures of mouse pituitary cells. Biochemistry 17:3609-3618, 1978.
- Rosen, H.; Douglass, J.; and Herbert, E. Isolation and characterization of rat preproenkephalin gene. J Biol Chem 259:14309-14313, 1984.
- Sabol, S.L.; Yoshikawa, K.; and Hong, J.S. Regulation of methionine-enkephalin precursor messenger RNA in rat striatum by haloperidol and lithium. Biochem Biophys Res Commun 113:391-399, 1983.
- Scott, A.P.; Ratcliff, J.G.; Rees, L.H.; Bennett, H.P.J.; Lowry, P.J.; and McMartin, C. Pituitary peptides, Nature New Biol 244:65-67, 1973.
- Scott, A.P.; Lowry, P.L.; Ratcliff, J.G.; Rees, L.H.; and Landon, J. Corticotropin-like peptides in the rat pituitary. J Endocrinol 61:355-364, 1974.
- Seidah, N.G.; Rochemont, J.; Hamelin, J.; Benjannet, S.; and Chretien, M. The missing fragment of the pro-sequence of human pro-opiomelanocortin: Sequence and evidence for C-terminal amidation. Biochem Biophys Res Commun 102:710-716, 1981.
- Seizinger, B.R.; Holtt, V.; and Herz, A. Proenkephalin B (Prodynorphin)-derived opioid peptides: Evidence for a differential processing in lobes of the pituitary. Endocrinology 115:662-671, 1984.
- Tang, F.; Costa, E.; and Schwartz, J.P. Increase of proenkephalin mRNA and enkephalin content of rat striatum after daily injection of haloperidol for 2 to 3 weeks. Proc Natl Acad Sci USA 80:3841-3844, 1983.
- Udenfriend, S., and Kilpatrick, D.L. Biochemistry of the enkephalin and enkephalin-containing peptides. Arch Biochem Biophys 221:309-323, 1983.

Uhler, M.; Herbert, E.; D'Eustachio, P.; and Ruddle, F.D. The mouse genome contains two non-allelic pro-opiomelanocortin genes. J Biol Chem 258:9444-9453, 1983.

Weber, E.; Esch, F.S.; Bohlen, P.; Paterson, S.; Corbett, A.D.; McKnight, A.T.; Kosterlitz, H.W.; Barchas, J.D.; and Evans, C.J. Metorphamide: Isolation, structure, and biologic activity of an amidated opioid octapeptide from bovine brain. Proc Natl Acad Sci USA 80:7362-7366, 1983.

#### **AUTHORS**

Olivier Civelli, Ph.D.  
Jim Douglass, Ph.D.  
Edward Herbert, Ph.D.  
Institute for Advanced Biomedical Research  
The Oregon Health Sciences University  
Portland, Oregon 97201

Haim Rosen, Ph.D.  
The Hebrew University Medical School  
Hadassa, Jerusalem, Israel 91010

Gerard Martens, Ph.D.  
Katholieke Universiteit  
The Netherlands

# Proenkephalin Biosynthesis in the Rat

Richard D. Howells, Ph.D.

The discovery of opiate receptors in mammalian brain (Pert and Snyder 1973; Simon et al. 1973; Terenius 1973) naturally stimulated speculation on the purpose of these sites. Surely they did not survive eons of evolution for the chance consumption of opiate alkaloids. Since none of the many substances which had been proposed as neurotransmitters or neuromodulators had an appreciable affinity for opiate receptors, the search began for an endogenous ligand. Shortly thereafter, two substances were isolated from porcine brain which could interact with opiate receptors and mimic the pharmacological activity of morphine in the guinea pig ileum bioassay (Hughes et al. 1975). These substances were pentapeptides with the structures Tyr-Gly-Gly-Phe-Met and Tyr-Gly-Gly-Phe-Leu and were named methionine enkephalin and leucine enkephalin, respectively. It was fortuitously noticed that the sequence of [Met]enkephalin was contained within  $\beta$ -lipotropin ( $\beta$ -LPH), a protein that was first isolated from porcine pituitary glands (Li 1965). At about the same time, several groups isolated and determined the structure of other peptides with opiate activity that were derived from  $\beta$ -LPH which had C-terminal extensions of the [Met]enkephalin sequence. These peptides became known as  $\alpha$ -endorphin,  $\gamma$ -endorphin (Ling et al. 1976), C'-fragment (Bradbury et al. 1976a), and  $\beta$ -endorphin (Cox et al. 1976; Li and Chung 1976; Bradbury et al. 1976b; Graf et al. 1976).  $\beta$ -LPH and adrenocorticotrophic hormone (ACTH) were shown to be derived from a common 31 kilodalton precursor, proopiomelanocortin (Mains et al. 1977; Roberts and Herbert 1977; Rubinstein et al. 1978; Kimura et al. 1979). The entire primary structure of bovine preproopiomelanocortin (prePOMC) was determined using molecular cloning and cDNA sequencing (Nakanishi et al. 1979). PrePOMC contains 265 amino acids with a molecular weight of 29,259. The precursor contains the sequences of ACTH,  $\beta$ -LPH, and another melanocyte stimulating hormone-related peptide,  $\gamma$ -MSH. These peptides are bounded by two basic amino acids (Lys or Arg), which presumably serve as signals for a processing enzyme (Steiner et al. 1980) to selectively release the active peptide. POMC is processed differently in the anterior and intermediate lobes of the pituitary (Mains and Eipper 1980). Although  $\beta$ -endorphin was originally thought to be the precursor of [Met]enkephalin, it became apparent rather quickly that the opioid pentapeptides were

derived from a different precursor (Rossier et al. 1977; Watson et al. 1978; Bloom et al. 1978; Lewis et al. 1978; Nakanishi et al. 1979). It was clear from these studies that the enkephalins and  $\beta$ -endorphin were contained within discrete, separate neuronal systems in the brain. Also, the sequence of [Leu]enkephalin did not occur in prePOMC. Work then began anew for the precursor to the enkephalins.

Bovine striatum was used originally as the starting point for the extraction and purification of enkephalin precursors; however, it became apparent that bovine adrenal medulla would be more suitable for these studies. In 1978, Hökfelt and colleagues (Shultzberg et al. 1978) reported the presence of enkephalin immunofluorescence in adrenal medulla. It was noted that rat adrenal glands contained significantly less enkephalin immunofluorescence compared with guinea pig adrenals. The difference in enkephalin content was found to be even greater between the adrenals of rats and that of dogs and cattle (Viveros et al. 1979; Hexum et al. 1980). The bovine adrenal gland was found to have several advantages over brain tissue as a starting point for the isolation of enkephalin precursors (Lewis et al. 1979). The total amount of enkephalin was greater and, more importantly, the bulk of the enkephalin activity (90%) was found to be contained within higher molecular weight (1-18 kD) peptides which were presumably intermediates in the biosynthetic pathway of the enkephalins. These larger peptides did not crossreact with enkephalin antibodies or bind to opiate receptors unless they were treated with trypsin; subsequent treatment with carboxypeptidase B (CPB) increased the activity even more. Digestion with these enzymes would liberate enkephalin sequences if they were bounded by dibasic amino acids. Another advantage of the bovine adrenal medulla was that the enkephalin-containing (EC) peptides could be greatly enriched by purifying the secretory granules which contained almost all of the opioid activity in the chromaffin cells. Udenfriend's group began the systematic isolation and sequencing of these peptides. A totally unexpected finding which arose from this work was that some of the purified EC peptides contained more than one copy of the enkephalin sequence. The first such peptide that was discovered was named peptide F (Kimura et al. 1980), which has the Try-Gly-Gly-Phe-Met sequence at its N- and C-termini. Peptide I (Kimura et al. 1980) was the first EC peptide shown to contain the [Leu]enkephalin sequence; it also contained [Met]enkephalin. A total of 16 different EC peptides (figure 1) were sequenced (see Udenfriend and Kilpatrick 1983); the largest of these, an 18.2 kD polypeptide, was shown to contain four copies of [Met]enkephalin (Kilpatrick et al. 1982a). Although the putative enkephalin precursor, proenkephalin (Lewis et al. 1980), had not been isolated, there was considerable evidence to support a biosynthetic pathway beginning with proenkephalin which was processed subsequently by specific trypsin- and CPB-like enzymes to yield smaller active opioid peptides. Ultimately, the entire coding regions of bovine and human preproenkephalin were obtained via recombinant DNA technology (Gubler et al. 1982; Noda et al.

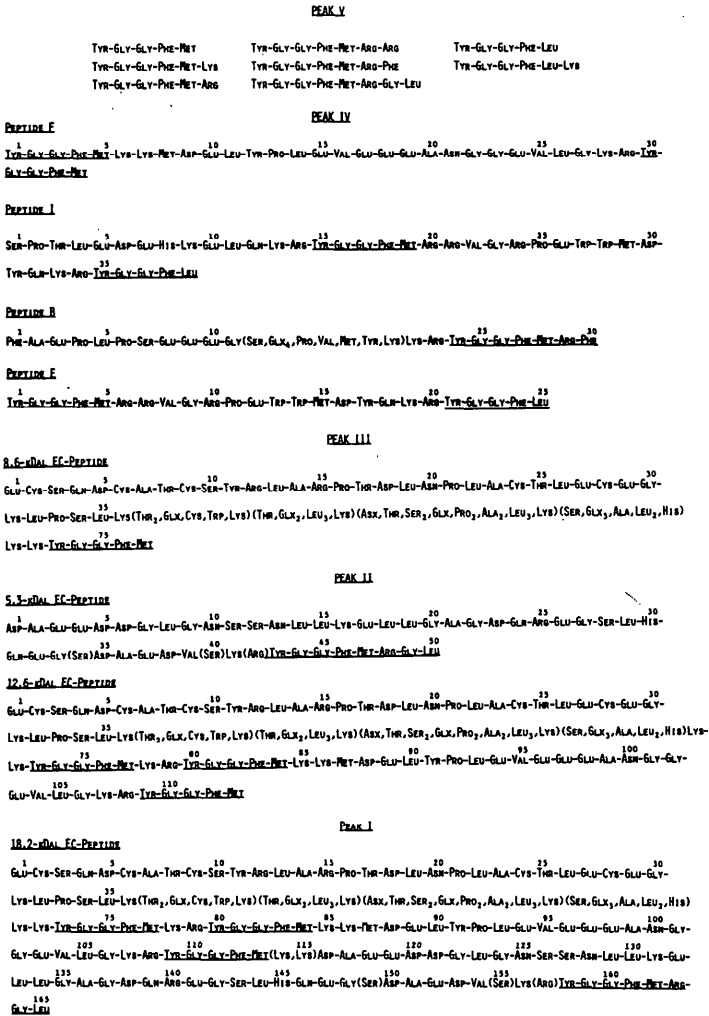


FIGURE 1

Structure of Endogenous EC Peptides Isolated From Bovine Adrenal Medulla.

Adrenal medulla tissue was used to prepare partially purified chromaffin granules. The granules were extracted in acid and chromatographed on Sephadex G-75. The chromatogram was divided arbitrarily into five peaks; some of the EC peptides contained in these peaks were purified using HPLC. Regions for which the amino acid sequence was not determined are in parentheses. The sequences of [Met]enkephalin, [Leu]enkephalin, [Met]enkephalin-Arg-Gly-Leu and [Met]enkephalin-Arg-Phe are underlined.

1982; Comb et al. 1982). Preproenkephalin was shown to have within its primary structure four copies of [Met]enkephalin and one each of [Leu]enkephalin, [Met]enkephalin-Arg-Gly-Leu, and [Met]enkephalin-Arg-Phe. All of these sequences are bound by two basic amino acids, except for the heptapeptide, which is followed by a chain termination codon. It had been predicted earlier that the heptapeptide was at the C-terminus of proenkephalin (Lewis et al. 1980). Both the octapeptide and heptapeptide have been shown to bind to opiate receptors (Kilpatrick et al. 1981a; Stern et al. 1979). In addition, [Met]enkephalin-Arg-Phe was found to be eight times more effective than [Met]enkephalin on a molar basis for eliciting antinociception in mice (Inturrisi et al. 1980).

Elucidation of the primary structures of prePOMC and preproenkephalin did not account for two other peptides which contained [Leu]enkephalin,  $\alpha$ -neo-endorphin (Kangawa et al. 1981) and dynorphin (Goldstein et al. 1981). Evidently there was still another precursor which contained these peptides. Investigations into their origin led to the discovery of a third [Leu]EC peptide (Kilpatrick et al. 1982b), rimorphin (figure 2), and a 32 amino acid peptide which contained dynorphin at its N-terminus and rimorphin at its C-terminus, the two being linked by a Lys-Arg sequence (Fischli et al. 1982). It was shown by Kakidani et al. (1982) that all of these [Leu]EC peptides were derived from a single precursor named proenkephalin B (also known as pro-dynorphin and pronorphin). The cloned cDNA from pig hypothalamus contained one copy each of  $\alpha$ -neo-endorphin, dynorphin, and rimorphin. Like the other opioid peptide precursor proteins, the active peptide sequences have two basic amino acids at the NH<sub>2</sub>- and COOH-termini.

All of the opioid peptides that have been isolated are derived from one of the three precursors: POMC, proenkephalin, or proenkephalin B ([Leu]enkephalin can arise from proenkephalin or proenkephalin B). Several structural similarities exist between the three gene products besides the presence of enkephalin sequences flanked by paired basic residues (figure 3). They are all approximately the same size. All three contain a cysteine-rich amino terminal region that is devoid of typical processing recognition sites and is preceded by a signal peptide sequence. The presence of an even number of cysteine residues in each precursor suggests that disulfide linkages are likely present in the mature proteins. These similarities suggest an evolutionary relationship among the three different precursors.

Having elucidated the biosynthetic origin and details of the pathway whereby [Met]- and [Leu]enkephalin are produced, we began experiments to understand the regulation of proenkephalin biosynthesis. The previously mentioned paper by Schultzberg et al. (1978) was important not only for establishing the presence of opioid peptides in adrenal medulla, but also for discovering the influence of the splanchnic nerve on the enkephalin content of the rat adrenal medulla. The authors observed that the rat adrenal ordinarily contained very little enkepha-

	1	5	10	15	20	25
$\alpha$ -NEO-ENDORPHIN:	TYR-GLY-GLY-PHE-LEU-ARG-LYS-TYR-PRO-LYS					
DYNORPHIN	:	TYR-GLY-GLY-PHE-LEU-ARG-ARG-ILE-ARG-PRO-LYS-LEU-LYS-TRP-ASP-ASN-GLN				
RIMORPHIN	:	TYR-GLY-GLY-PHE-LEU-ARG-ARG-GLN-PHE-LYS-VAL-VAL-THR				
DYNORPHIN-32	:	TYR-GLY-GLY-PHE-LEU-ARG-ARG-ILE-ARG-PRO-LYS-LEU-LYS-TRP-ASP-ASN-GLN-LYS-ARG-TYR-GLY-GLY-PHE-LEU-ARG-				
		30	ARG-GLN-PHE-LYS-VAL-VAL-THR			

**FIGURE 2**

Structures of [Leu]EC Peptides Isolated From Posterior Pituitary Glands.



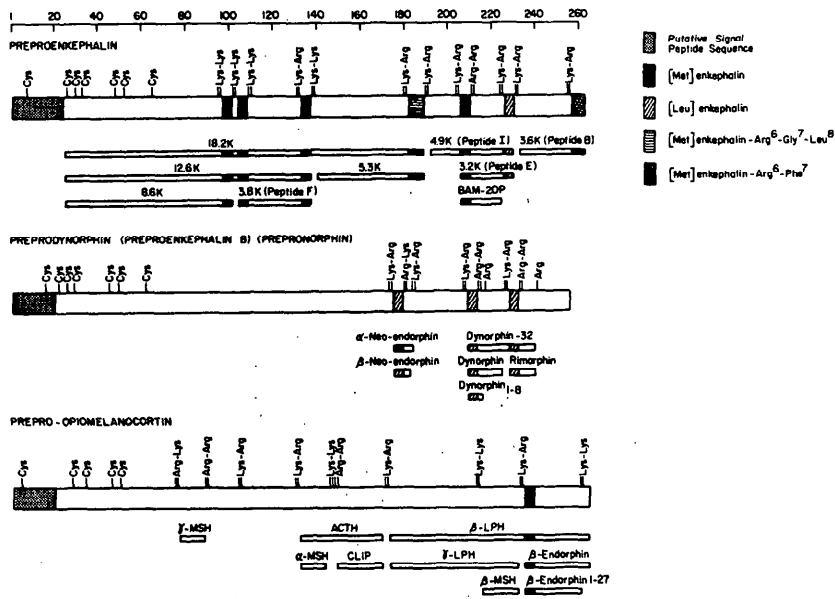


FIGURE 3

Schematic Representation of the Three EC Peptide Gene Products.

The positions of cysteine residues and paired and single basic amino acids serving as processing sites are indicated. Characterized products of processing are also shown.

lin like immunoreactivity; however, when the splanchnic nerve which innervates the gland was severed, there was a marked increase in enkephalin immunoreactivity. Our group followed up this interesting phenomenon on a quantitative basis (Lewis et al. 1981; Fleminger et al. 1984a). After denervation, there was a lag period of 12 hours before EC peptides levels began to rise (figure 4). The levels peaked 72 to 96 hours following surgery, then declined slowly over several weeks. The observed changes in EC peptides following denervation were in marked contrast to those seen with catecholamines. While the EC peptide content of the denervated glands was increasing, the catecholamine content of the same glands was decreasing, reaching levels that were 30% to 40% of the innervated glands after 24 hours. Thus, despite evidence that enkephalins and catecholamines are stored and concomitantly secreted from the same secretory vesicles (Viveros et al. 1979), they appear to be under separate control.

We found that the increase in EC peptides at all time points was due almost entirely to a polypeptide which was 20-30 kD (figure 5). This material is believed to be intact proenkephalin, based on the following criteria (Fleminger et al. 1984b): it migrates with an apparent molecular weight of 25,000, as estimated by gel filtration chromatography; on high performance liquid chromatography, it eluted at much higher propanol concentrations than the largest previously characterized EC peptide which is 18.2 kD; treatment of the polypeptide with Lys-C endoproteinase yielded [Met]enkephalin, [Leu]enkephalin, [Met]enkephalin-Arg<sup>6</sup>-Phe<sup>7</sup>, and [Met]enkephalin-Arg-Gly-Leu (figure 6) in the same ratios that are found in rat proenkephalin as deduced from sequencing rat preproenkephalin cDNA (see below.)

Some processing of the "proenkephalin" was observed with time in the denervated adrenals. As shown in figure 7, a peak of 3-6 kD slowly increased with time. This peak reacted with [Met]enkephalin antisera, but not [Leu]enkephalin antisera, following digestion with trypsin and CPB; and it crossreacted with [Met]enkephalin-Arg-Phe antibodies without digestion. Based on these results, we assume that this peptide is probably peptide B (Stern et al. 1981).

Having characterized the increase in EC peptides following denervation of the rat adrenal gland, we wanted to learn more about the mechanisms underlying the effect. Were the increases due, for instance, to increased transcription of the proenkephalin gene, increased translation of a fixed amount of proenkephalin mRNA, decreased release, or decreased degradation of the EC peptides? We found that after splanchnicectomy, there was a several-fold increase in the steady-state levels of preproenkephalin mRNA (figure 8) which became maximal (>tenfold) after 24 to 48 hours (Kilpatrick et al. 1984). These results indicated that the increased EC peptide levels following denervation were due to pretranslational mechanisms. It is interesting to note that the increase in preproenkephalin mRNA was accompanied by a twofold to fourfold decrease in total poly(A)

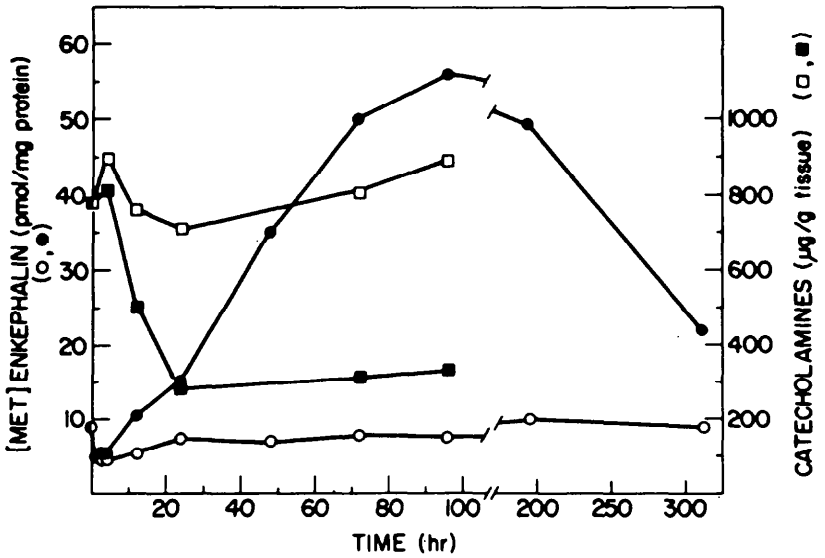


FIGURE 4

Changes in [Met]EC Peptides And Catecholamines in Rat Adrenal Glands After Denervation.

Aliquots of the tissue extracts of innervated (○) and denervated (●) glands (10-200 µl) were lyophilized, redissolved in 100 µl of 0.2 M N-ethylmorpholine acetate buffer (pH 8.0), and treated with trypsin and carboxypeptidase B. [Met]enkephalin released was assayed by a specific radioimmunoassay. Aliquots of tissue extracts in 5% trichloroacetic acid/100 mM HCl (20 µl) of the innervated (○) and denervated (■) gland were assayed for catecholamines.

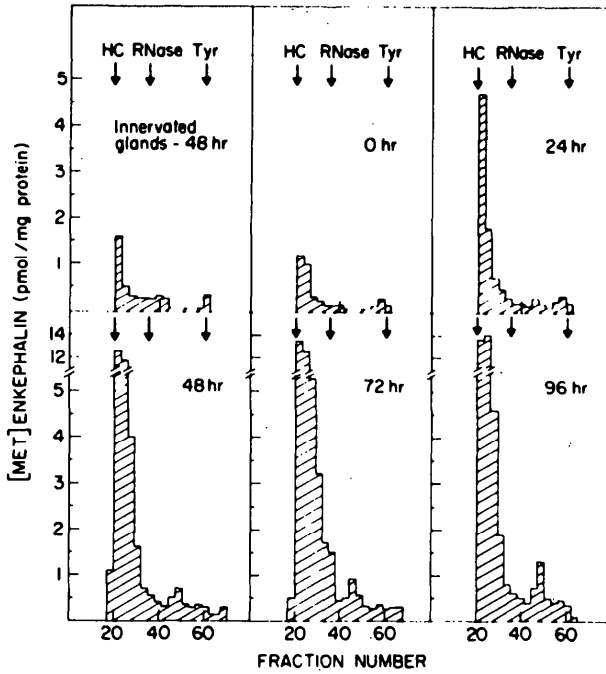


FIGURE 5

Size Distribution of [Met]EC Peptides in Tissue Extracts at Various Time Intervals After Denervation on a Sephadex G-75 Column.

Aliquots (20-200  $\mu$ l) from each fraction were lyophilized, treated with trypsin and carboxypeptidase B, and assayed for [Met]enkephalin, as described in figure 4. All panels, except for the first two, show [Met]EC peptides in denervated rat adrenal glands. The column was calibrated with markers showing the elution position of hemocyanin (HC), RNase, and tyrosine (Tyr), respectively.

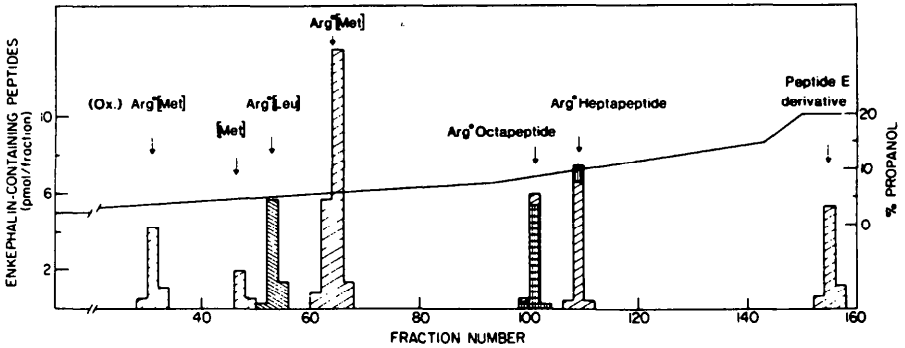


FIGURE 6

Mapping of EC Peptides Derived From Proenkephalin.

An aliquot (1 ml, equivalent to 8 pmol of proenkephalin) of the pooled fractions from RP-8 chromatography was evaporated to dryness and redissolved in 200  $\mu$ l of 0.2 M N-ethylmorpholine acetate buffer, pH 7.4. Lys-C endoproteinase (40  $\mu$ l, 1 mg/ml) was added and the solution was incubated at 37  $^{\circ}$ C for 16 hrs. The solution was then heated to 100  $^{\circ}$ C and, after cooling, purified carboxypeptidase B (40  $\mu$ l, 5  $\mu$ g/ml) was added. The solution was again incubated at 37  $^{\circ}$ C for 4 hrs. 2-Mercaptoethanol was then added (0.5% final concentration) and the solution was heated to 100  $^{\circ}$ C for 30 mins. After cooling,  $^{125}$ I-[Met]enkephalin was added and the solution was applied to an RP-18 column (0.46 x 10 cm) and developed with a gradient of I-propanol. Each fraction (1 ml) was dried down and redissolved in 200  $\mu$ l of 0.2 M N-ethylmorpholine buffer, pH 8.0. [Met]enkephalin (▨) and [Leu]enkephalin (▩) immunoreactivities were assayed after treatment with trypsin and carboxypeptidase B. Octapeptide (▧) and heptapeptide (▦) immunoreactivities were assayed directly without any further enzymatic treatment. "Peptide E Derivative" refers to the peptide Arg<sup>0</sup>-Des(Arg<sup>6</sup>[Leu]enkephalin) peptide E (rat proenkephalin (187-206).

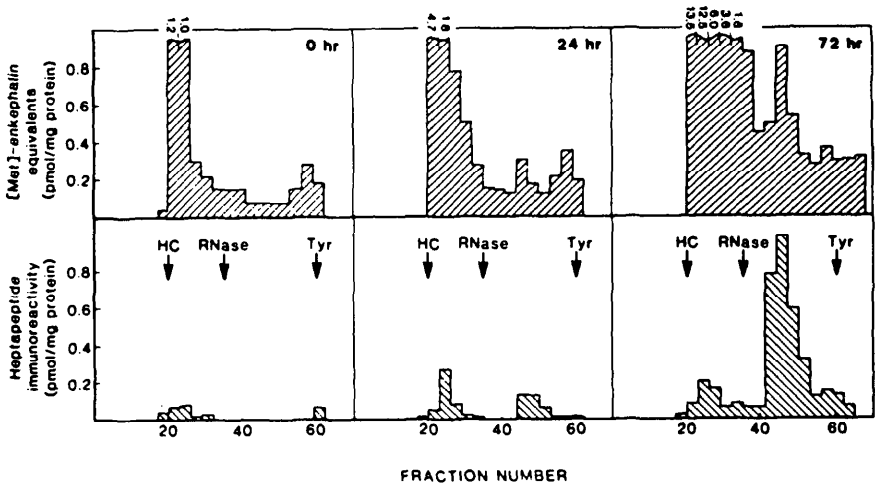
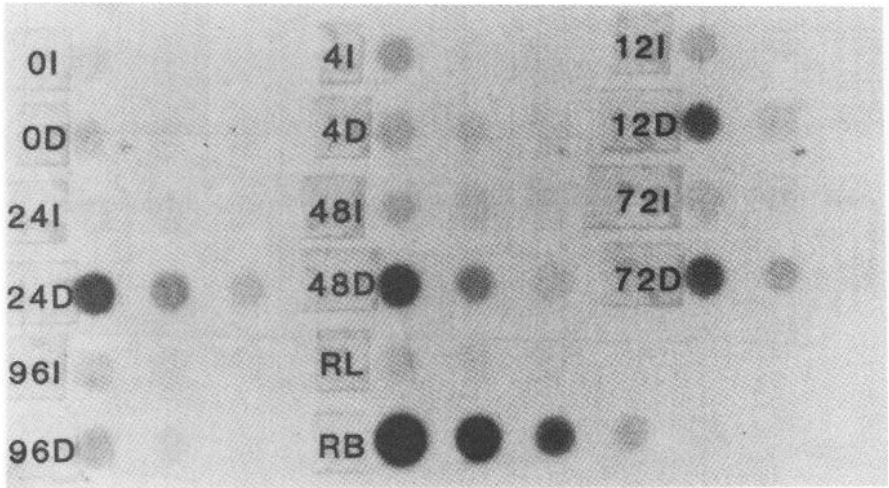


FIGURE 7

Processing of Proenkephalin in Denervated Rat Adrenal Glands.

(Lower) Aliquots (200  $\mu$ l) of the fractions of a Sephadex G-75 column (see figure 5) were lyophilized and assayed with specific antibodies to the heptapeptide [Met]enkephalin-Arg<sup>6</sup>-Phe<sup>7</sup>. (Upper) Enlargement of the corresponding panels in figure 5. Numbers represent the amounts of [Met]enkephalin that are higher than 1 pmol/mg of protein.



**FIGURE 8**

Time Course For The Effect of Unilateral Denervation on Rat Adrenal Preproenkephalin mRNA.

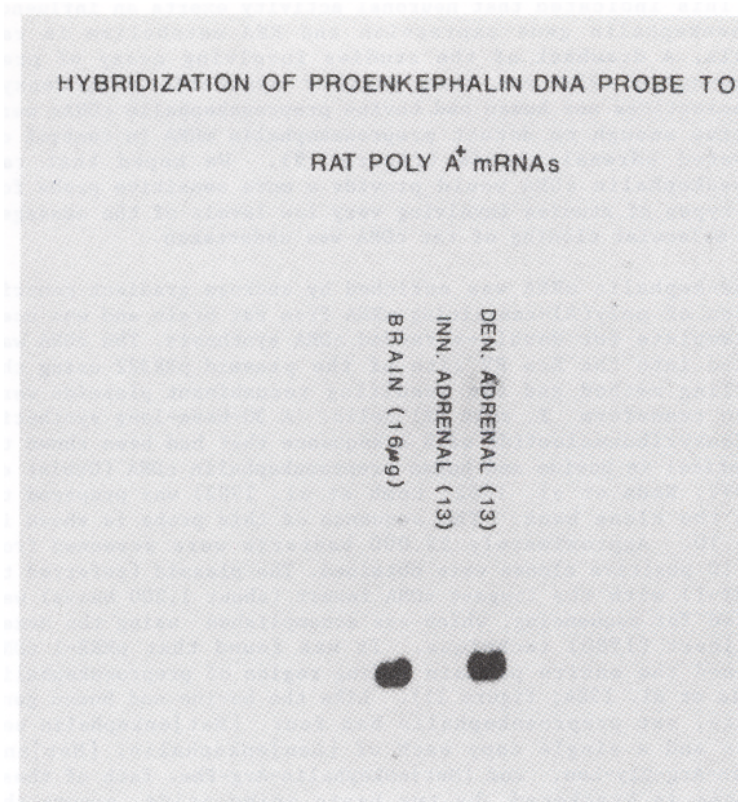
Poly(A) mRNA (12 µg) from innervated (I) and denervated (D) rat adrenal glands, rat liver (RL) and rat brain (RB) were denatured by heating to 60 °C for 15 mins in the presence of 7.4% formaldehyde/0.9 M NaCl/0.09 M Na citrate (denaturing buffer). Threefold serial dilutions of each sample were made up in denaturing buffer and applied in a volume of 0.5 ml to nitrocellulose filters (8.0, 2.7, and 0.9 µg of adrenal samples and 8.0 to 0.1 µg of liver and brain samples, from left to right). Wells were rinsed with 0.5 ml denaturing buffer, and the filter was then baked, prehybridized, and hybridized with nick-translated human proenkephalin cDNA ( $10^7$  cpm) at 42 °C, as outlined in the legend to figure 9. Numbers refer to the hours following denervation after which adrenal glands were removed.

mRNA. This indicated that neuronal activity exerts an influence on proenkephalin gene expression and RNA metabolism in rat adrenals. A drawback of the studies involving assay of preproenkephalin mRNA was that neither synthetic oligodeoxyribonucleotides nor human and bovine preproenkephalin cDNAs were sensitive enough to detect preproenkephalin mRNA in control or innervated adrenal glands (figure 9). We hoped that rat preproenkephalin cDNA would provide a more sensitive probe for these types of studies involving very low levels of the message, so the molecular cloning of rat cDNA was undertaken.

Preproenkephalin mRNA was enriched by sucrose gradient centrifugation of poly(A)-containing mRNA from rat brain and was used as a template for double-stranded cDNA synthesis. The cDNA was inserted into the Eco RV site of the plasmid pBR322 using the GC-tailing method and the resulting recombinant plasmids were used to transform *E. coli* RR1 cells. A 30-base-long synthetic oligodeoxyribonucleotide with a sequence that had been shown to be identical in bovine and human preproenkephalin cDNA (Gubler et al. 1982; Noda et al. 1982; Comb et al. 1982) was prepared to screen the clone bank. The sequence of this probe is shown in figure 10. Approximately 28,000 bacteria were screened from which 10 positive clones were obtained. The plasmid (referred to as pRPE-1) with the longest cDNA insert (about 1,200 bases) was selected for sequencing, which was accomplished using the Maxam and Gilbert (1980) technique. It was found that pRPE-1 cDNA contained the entire protein coding region of preproenkephalin (Howells et al. 1984; figure 11). Like the bovine and human gene products, rat preproenkephalin has four [Met]enkephalin sequences and a single copy each of [Leu]enkephalin, [Met]enkephalin-Arg-Gly-Leu, and [Met]enkephalin-Arg-Phe. Each of these sequences is bracketed by two basic amino acids, except the heptapeptide which is followed by the termination codon UGA. It should be noted that the sequence of the highly active peptide E (Kilpatrick et al. 1981b) is entirely conserved in all three species, even though there are a significant number of single base changes.

The initiation site for translation has been tentatively assigned to the methionine codon at positions 1 to 3, based on the amino acid sequences of bovine and human preproenkephalin (figure 12). Rat preproenkephalin would consist then of 269 amino acids with a molecular weight of 30,936. This compares to 267 residues for human and 263 residues for bovine preproenkephalin. The amino terminus of rat preproenkephalin is most likely the Asp (coded for by GAC) at position 24 of the amino acid sequence by analogy to the bovine and human proteins. In those species, the N-terminal amino acid is Glu, which is coded for by GAA. The signal peptide would then contain 24 largely hydrophobic amino acids and terminate in Ala. This is typical of signal peptides (Steiner et al. 1980). The rat signal peptide contains two cysteine residues at positions 8 and 17, whereas the human and bovine forms contain only a single Cys at position 8. All three species contain six additional Cys residues (excluding those in





**FIGURE 9**

Effect of Splanchnicectomy on Rat Adrenal Preproenkephalin mRNA.

Innervated and denervated adrenal glands (0.3-0.4 gm) were obtained from rats that had been unilaterally denervated for 24 hrs. Poly(A) mRNA was prepared and the entire sample from each group of glands (30 µg from innervated adrenals and 6 µg from denervated adrenals) was subjected to electrophoresis on 1% agarose gels containing 10 mM methylmercury hydroxide. Sixteen µg of rat brain poly(A) mRNA were included as a standard. After transfer onto nitrocellulose, the filters were baked and then prehybridized for 4-12 hrs at 30 °C in 0.7 M NaCl/0.07 M sodium citrate/0.05 M sodium phosphate (pH 7)/0.02% BSA/0.02% Ficoll/0.02% polyvinylpyrrolidone/0.1 mg/ml salmon sperm DNA and 50% formamide. Hybridization with <sup>32</sup>P-labeled synthetic oligodeoxyribonucleotide (2 x 10<sup>7</sup> cpm) was carried out at 30 °C for 12-18 hrs in prehybridization buffer containing 10% dextran sulfate. The filter was washed four times in 0.3 M NaCl/0.03 M sodium citrate/0.1% SDS at room temperature for 10 mins each, followed by four washes at 50 °C in 15 mM NaCl/1.5 mM sodium citrate/0.1% SDS for 30 mins. An autoradiogram was exposed after an overnight incubation at -70 °C.



5'-----GGCAUCCGGCUCUCCAGCUACUCUGCGGCAUCUGAACCAACGGCAGCCCC

```

          30                               60                               90
AUG GCC CAG UUC CUG ACA CUU UDC AUG UGC CUG CUA GCG CUU GCG UCC UCC CUG CUG CUU ACA GUG CAG GCA GAC UGC ADC CAG GAC UGC
Met Ala Gln Phe Leu Arg Leu Cys Ile Trp Leu Leu Ala Leu Gly Ser Cys Leu Leu Ala Thr Val Gln Ala Asp Cys Ser Gln Asp Cys
1
          10
          120                               150                               180
GCU AAA UDC ADC UAC GCG CUG GUA CCG CCC GGC GAC AUC AAC UUC CUG GCA UCC ACA CUC GAA UGU GAA GGC CAG CUG CCU UCU UUC AAA
Ala Lys Cys Ser Tyr Arg Leu Val Arg Pro Gly Asp Ile Asn Phe Leu Ala Cys Thr Leu Glu Cys Glu Gly Gln Leu Pro Ser Phe Lys
40
          40
          210                               240                               270
AUC UGG GAG ACC UGC AAG GAU CUC CUG CAG GUG UCC AAG CCC GAG UUC CCU UGG GAU AAC AUC GAC AUC UAC AAA GAC ACC AGC AAA
Ile Trp Glu Thr Cys Lys Asp Leu Leu Gln Val Ser Lys Pro Glu Phe Pro Trp Asp Asn Ile Asp Met Tyr Lys Asp Ser Ser Lys Gln
70
          70
          300                               330                               360
GAU CAG AGC CAC UUG CUA GCC AAG AAC UAU GGA GCG UUC AUG AAA CCG UAU GGA GCG UUC AUG AAG AAG AUG GAU CAG CUG UAC CCC CUG
Asp Glu Ser His Leu Leu Ala Lys Lys Tyr Gly Gly Phe Met Lys Arg Tyr Gly Gly Phe Met Lys Lys Met Asp Glu Leu Tyr Pro Val
100
          100
          390                               420                               450
GAG CCA GAA GAA GAG GCC AAU GGA GGC GAG AUC CUU GCC AAG AGG UAU GGC GGU UUC AUG AAG AAG GAU GCA GAU GAG GGA GAC ACC UUG
Glu Pro Glu Glu Glu Ala Asn Gly Gly Ile Leu Ala Lys Arg Tyr Gly Gly Phe Met Lys Lys Asp Ala Asp Glu Gly Asp Thr Leu
130
          130
          480                               510                               540
GCC AAC UCC UCC GAC CUG CUG AAA GAG CUA CUG GGA ACA GGA GAC AAC CCG UCC AAA GAU AGC CAC CAA CAG GAA AGC ACC AAC AAU GAU
Ala Asn Ser Ser Asp Leu Leu Lys Glu CUA CUG GGA ACA GGA GAC AAC CCG UCC AAA GAU AGC CAC CAA CAG GAA AGC ACC AAC AAU GAU
160
          160
          570                               600                               630
GAA GAC AGC ADC ADC AAG AGG UAU GGG GGC UUC AUG AGA GGC CUC AAA AGA ACC CCG CAG CUG GAA CAG GAA GCA AAG CAG CUG CAG AAG
Glu Asp Ser Thr Ser Lys Arg Tyr Gly Gly Phe Met Arg Gly Leu Lys Arg Ser Pro Gln Leu Glu Asp Glu Ala Lys Glu Leu Gln Lys
190
          190
          660                               690                               720
CGC UAU GGG GGC UUC AUG AGA AGC GUC GGG CGC CCC GAG U G GGG AUG GAC UAU CAG AAG AGA UAC GGA GGC UUC CUG AAG CCG UUU GCU
Arg Tyr Gly Gly Phe Met Arg Arg Val Gly Arg Pro Glu Trp Trp Met Asp Tyr Gln Lys Arg Tyr Gly Gly Phe Leu Lys Arg Phe Ala
220
          220
          750                               780                               810
GAG UCU CUA CCC UCG GAU GAA GAA GGC GAA AGU UAC UCU AAA GAA GUU CCC GAG AUG GAA AAA AGA UAC GGA GGC UUU AUG CCG UUU UGA
Glu Ser Leu Pro Ser Asp Glu Glu Glu Ser Tyr Ser Lys Glu Val Pro Glu Met Glu Lys Arg Tyr Gly Gly Phe Met Arg Phe
250
          250

```

AGCCCU-----3'

FIGURE 11

Partial Nucleotide Sequence of Rat Preproenkephalin Messenger RNA.

Nucleotides are numbered in the 5' to 3' direction beginning with the first residue of the initiator codon AUG; nucleotides preceding the AUG codon are given negative numbers. The sequence is incomplete at both the 5'- and 3'-termini of the mRNA. The predicted amino acid sequence, is displayed below the mRNA. Amino acids are numbered beginning with the methionine residue coded for by nucleotides 1-3. The sequences of [Met]enkephalin, [Leu]enkephalin, [Met]enkephalin-Arg-Gly-Leu and [Met]enkephalin-Arg-Phe are boxed.

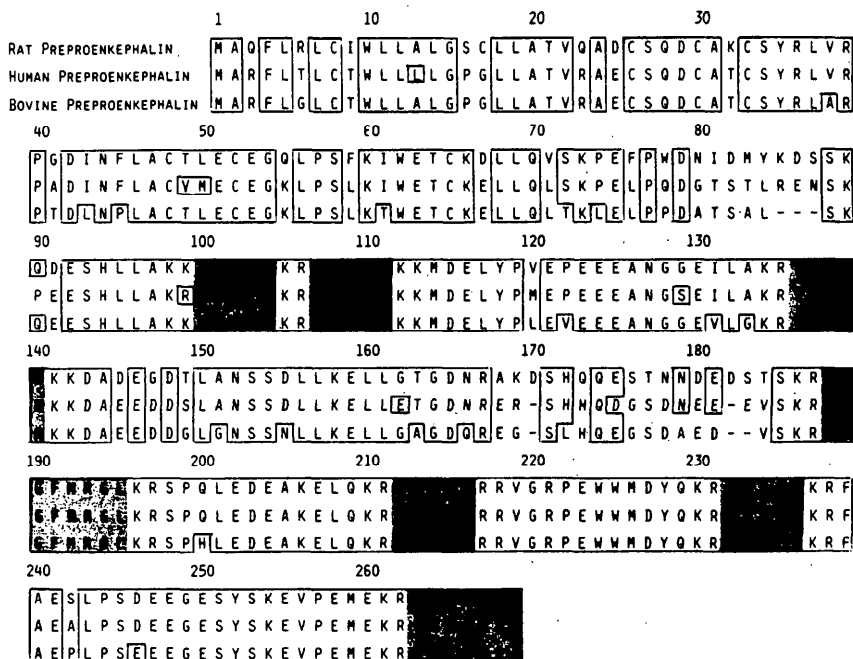
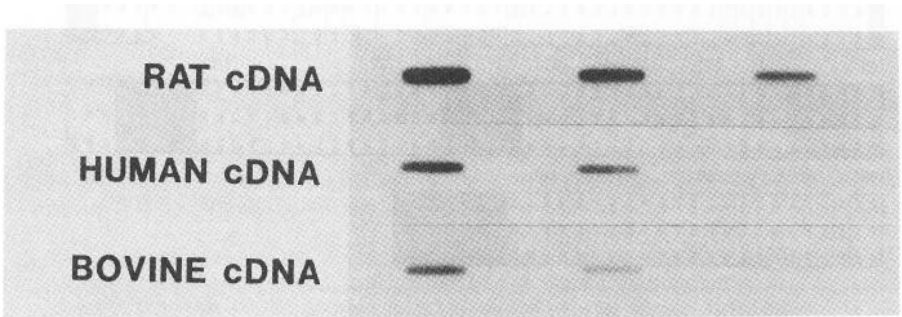


FIGURE 12

Comparative Amino Acid Sequences of Rat, Human, and Bovine Preproenkephalin.

Rat preproenkephalin is displayed on top in each row, human preproenkephalin in the middle, and bovine preproenkephalin on the bottom. The human and bovine proteins are compared with rat preproenkephalin; regions of homology with the rat sequence are boxed. Deletions in the human and bovine sequences are denoted with a line under the corresponding rat amino acid. Numbering is as in figure 11. The sequences of [Met]enkephalin, [Leu]enkephalin, [Met]enkephalin-Arg-Gly-Leu and [Met]enkephalin-Arg-Phe are shaded.



**FIGURE 13**

Comparative Hybridization of Different Preproenkephalin cDNAs to Rat Brain Poly(A) mRNA.

Rat, human and bovine cDNAs (250 ng each) were labeled by nick translation to a specific activity of approximately  $10^8$  cpm/ $\mu$ g. Rat brain poly(A) mRNA was blotted onto nitrocellulose in threefold serial dilutions (left, 6  $\mu$ g; middle, 2  $\mu$ g; right, 0.67  $\mu$ g) in triplicate and each replicate was hybridized with one of the preproenkephalin cDNAs ( $3 \times 10^6$  cpm). Autoradiograms of the washed filters were developed after overnight exposure at  $-70^\circ \text{C}$  and relative band intensities were measured by scanning laser densitometry.

the signal peptide) which are located in the amino-terminal region of proenkephalin; all occur at exactly the same positions (amino acid residues 26, 30, 33, 48, 52, and 65). The amino acid sequence of rat preproenkephalin is 82% homologous to both bovine and human preproenkephalin, allowing for the additional amino acids at positions 170 and 182 in the rat molecule relative to the human and bovine molecules and at positions 85-87 and 183 relative to the bovine form. Rat preproenkephalin cDNA is 80% and 83% homologous to the bovine and human cDNAs, respectively, at the nucleotide level.

As mentioned earlier, it was hoped that rat proenkephalin cDNA would be a more sensitive probe than bovine or human cDNA. A 435 base pair (bp) PvuII fragment of pRPE-1 cDNA, extending from nucleotides 165 to 600, was chosen as the probe, which was compared with a 1000 bp bovine cDNA and a 918 bp human cDNA fragment to hybridize to preproenkephalin mRNA in extracts of rat brain (figure 13). When the band intensities were quantified using scanning laser densitometry, the rat cDNA was shown to be four times more sensitive as a probe for the detection of rat preproenkephalin mRNA than the heterologous cDNAs. Moreover, only rat cDNA was able to detect consistently the message in normal rat adrenal glands. This probe is currently being used to monitor changes in preproenkephalin mRNA following denervation of the rat adrenal gland and to study proenkephalin metabolism in other tissues.

#### REFERENCES

- Bloom, F.E.; Battenberg, E.; Rossier, J.; Ling, N.; and Guillemin, R. Neurons containing beta-endorphin in rat brain exist separately from those containing enkephalin: Immunocytochemical studies. Proc Natl Acad Sci USA 75:1591-1595, 1978.
- Bradbury, A.F.; Smyth, D.G.; and Snell, C.R. Lipotropin: Precursor of two biologically active peptides. Biochem Biophys Res Commun 69:950-956, 1976a.
- Bradbury, A.F.; Smyth, D.G.; Snell, C.R.; Birdsall, N.J.M.; and Hulme, E.C. C fragment of lipotropin has a high affinity for brain opiate receptors. Nature 260:793-795, 1976b.
- Comb, M.; Seeburg, P.H.; Adelman, J.; Eiden, L.; and Herbert, E. Primary structure of the human Met- and Leu-enkephalin precursor and its mRNA. Nature 295:663-666, 1982.
- Cox, B.M.; Goldstein, A.; and Li, C.H., Opioid activity of a peptide  $\beta$ -lipotropin-(61-91), derived from  $\beta$ -lipotropin. Proc Natl Acad Sci USA 73:1821-1823, 1976.
- Fischli, W.; Goldstein, A.; Hunkapillar, M.W.; and Hood, L. Isolation and amino acid sequence analysis of a 4,000-dalton dynorphin from porcine pituitary. Proc Natl Acad Sci USA 79:5435-5437, 1982.
- Fleminger, G.; Lahm, H.W.; and Udenfriend, S. Changes in rat adrenal catecholamines and proenkephalin metabolism after denervation. Proc Natl Acad Sci USA 81:3587-3590, 1984a.

- Fleminger, G.; Howells, R.D.; Kilpatrick, D.L.; and Udenfriend, S. Intact proenkephalin is the major enkephalin-containing peptide produced in rat adrenal glands after denervation. Proc Natl Acad Sci USA 81:7985-7988, 1984b.
- Goldstein, A.; Eschli, W.; Lowney, L.T.; Hunkapillar, M.; and Hood, L. Porcine pituitary dynorphin: Complete amino acid sequence of the biologically active heptadecapeptide. Proc Natl Acad Sci USA 78:7219-7223, 1981.
- Graf, L.; Barat, E.; and Patthy, A. Isolation of a COOH-terminal  $\beta$ -lipotropin (residues 61-91) with morphine-like analgesic activity from porcine pituitary glands. Acta Biochem Biophys Acad Sci Hung 11:121-122, 1976.
- Gubler, U.; Seeburg, P.; Hoffmann, B.J.; Gage, L.P.; and Udenfriend, S. Molecular cloning establishes proenkephalin as a precursor of enkephalin-containing peptides. Nature 295:206-208, 1982.
- Hexum, T.D.; Yang, H.-Y.T.; and Costa, E. Biochemical characterization of enkephalin-like immunoreactive peptides of adrenal glands. Life Sci 27:1211-1216, 1980.
- Howells, R.D.; Kilpatrick, D.L.; Bhatt, R.; Monahan, J.J.; Poonian, M.; and Udenfriend, S. Molecular cloning and sequence determination of rat preproenkephalin cDNA: Sensitive probe for studying transcriptional changes in rat tissues. Proc Natl Acad Sci USA 81:7651-7655, 1984.
- Hughes, J.; Smith, T.W.; Kosterlitz, H.W.; Fothergill, L.A.; Morgan, B.A.; and Morris, H.R. Identification of two related pentapeptides from the brain with potent opiate agonist activity. Nature 258:577-579, 1975.
- Inturrisi, C.; Umans, J.G.; Wolff, D.; Stern, A.S.; Lewis, R.V.; Stein, S.; and Udenfriend, S. Analgesic activity of the naturally occurring heptapeptide [Met]enkephalin-Arg<sup>6</sup>-Phe<sup>7</sup>. Proc Natl Acad Sci USA 77:5512-5514, 1980.
- Kakidani, H.; Furutani, Y.; Takanashi, H.; Noda, M.; Morimoto, Y.; Hirose, T.; Asai, M.; Inayama, S.; Nakanishi, S.; and Numa, S. Cloning and sequence analysis of cDNA for porcine  $\beta$ -neoendorphin/dynorphin precursor. Nature 298:245-249, 1982.
- Kangawa, K.; Minamino, N.; Chino, N.; Sakakibara, A.; and Matsuo, H. The complete amino acid sequence of  $\alpha$ -neo-endorphin. Biochem Biophys Res Commun 99:871-878, 1981.
- Kilpatrick, D.; Jones, B.N.; Kojima, K.; and Udenfriend, S. Identification of the octapeptide [Met]enkephalin-Arg<sup>6</sup>-Gly<sup>7</sup>-Leu<sup>8</sup> in extracts of bovine adrenal medulla. Biochem Biophys Res Commun 103:698-705, 1981a.
- Kilpatrick, D.; Taniguchi, T.; Jones, B.N.; Stern, A.S.; Shively, J.E.; Hüllihan, J.; Kimura, S.; Stein, S.; and Udenfriend, S. A highly potent 3200-dalton adrenal opioid peptide that contains both a [Met]- and [Leu]enkephalin sequence. Proc Natl Acad Sci USA 78:3265-3268, 1981b.
- Kilpatrick, D.; Jones, B.N.; Lewis, R.V.; Stern, A.S.; Kojima, K.; Shively, J.E.; and Udenfriend, S. An 18,200-dalton adrenal protein that contains four [Met]enkephalin sequences. Proc Natl Acad Sci USA 79:3057-3061, 1982a.

- Kilpatrick, D.L.; Wahlstrom, A.; Lahm, H.W.; Blacher, R.; and Udenfriend, S. Rimorphin, a unique, naturally occurring [Leu]enkephalin-containing peptide found in association with dynorphin and  $\alpha$ -neo-endorphin. Proc Natl Acad Sci USA 79:6480-6483, 1982b.
- Kilpatrick, D.L.; Howells, R.D.; Fleminger, G.; and Udenfriend, S. Denervation of rat adrenal glands markedly increases preproenkephalin mRNA. Proc Natl Acad Sci USA 81:7221-7223, 1984.
- Kimura, S.; Lewis, R.V.; Gerber, L.D.; Brink, L.; Rubinstein, M.; Stein, S.; and Udenfriend, S. Purification to homogeneity of camel pituitary pro-opiocortin, the common precursor of opioid peptides and corticotropin. Proc Natl Acad Sci USA 76:1756-1759, 1979.
- Kimura, S.; Lewis, R.V.; Stern, A.S.; Rossier, J.; Stein, S.; and Udenfriend, S. Probable precursors of [Leu]enkephalin and [Met]enkephalin in adrenal medulla: Peptides of 3-5 kilodaltons. Proc Natl Acad Sci USA 77:1681-1685, 1980.
- Lewis, R.V.; Stein, S.; Gerber, L.D.; Rubinstein, M.; and Udenfriend, S. High molecular weight opioid-containing proteins in striatum. Proc Natl Acad Sci USA 75:4021-4023, 1978.
- Lewis, R.V.; Stern, A.S.; Rossier, J.; Stein, S.; and Udenfriend, S. Putative enkephalin precursors in bovine adrenal medulla. Biochem Biophys Res Commun 89:822-829, 1979.
- Lewis, R.V.; Stern, A.S.; Kimura, S.; Rossier, J.; Stein, S.; and Udenfriend, S. An about 50,000-dalton protein in adrenal medulla: A common precursor of [Met]- and [Leu]enkephalin. Science 208:1459-1461, 1980.
- Lewis, R.V.; Stern, A.S.; Kilpatrick, D.; Gerber, L.D.; Rossier, J.; Stein, S.; and Udenfriend, S. Marked increases in large enkephalin-containing polypeptides in the rat adrenal gland following denervation. J Neurosci 1:80-82, 1981.
- Li, C.H. Lipotropin, a new active peptide from pituitary glands. Nature 201:924, 1965.
- Li, C.H., and Chung, D. Isolation and structure of an untripeptide with opiate activity from camel pituitary gland. Proc Natl Acad Sci USA 75:1145-1148, 1976.
- Ling, N.; Burgus, R.; and Guillemin, R. Isolation, primary structure and synthesis of  $\alpha$ -endorphin and  $\gamma$ -endorphin, two peptides of hypothalamic-hypophysial origin with morphinomimetic activities. Proc Natl Acad Sci USA 73:3942-3946, 1976.
- Mains, R.E., and Eipper, B.A. Biosynthetic studies on ACTH,  $\beta$ -endorphin, and  $\alpha$ -melanotropin in the rat. Ann NY Acad Sci 343:94-110, 1980.
- Mains, R.E.; Eipper, B.A.; and Ling, N. Common precursor to corticotropins and endorphins. Proc Natl Acad Sci USA 74:3014-3018, 1977.
- Maxam, A., and Gilbert, W. Sequencing end-labeled DNA with base-specific chemical cleavages. Methods Enzymol 65:499-560, 1980.



- Nakanishi, S.; Inoue, A.; Kita, T.; Nakamura, M.; Chang, A.C.Y.; Cohen, S.N.; and Numa, S. Nucleotide sequence of clonal cDNA for bovine corticotropin- $\beta$ -lipotropin precursor. Nature 278:423-427, 1979.
- Noda, M.; Furutani, Y.; Takahashi, H.; Toyosato, M.; Hirose, T.; Inayama, S.; Nakanishi, S.; and Numa, S. Cloning and sequence analysis of cDNA for bovine adrenal preproenkephalin. Nature 295:202-206, 1982.
- Pert, C.B., and Snyder, S.H. Opiate receptor: Demonstration in nervous tissue. Science 179:1011-1014, 1973.
- Roberts, J.L., and Herbert, E. Characterization of a common precursor to corticotropin and  $\beta$ -lipotropin: Cell-free synthesis of the precursor and identification of corticotropin peptides in the molecule. Proc Natl Acad Sci USA 74:4826-4830, 1977.
- Rossier, J.; Vargo, T.M.; Minick, S.; Ling, N.; Bloom, F.E.; and Guillemin, R. Regional dissociation of  $\beta$ -endorphin and enkephalin contents in rat brain and pituitary. Proc Natl Acad Sci USA 74:5162-5165, 1977.
- Rubinstein, M.; Stein, S.; and Udenfriend, S. Characterization of pro-opioid cortin, a precursor to opioid peptides and corticotropin. Proc Natl Acad Sci USA 75:669-671, 1978.
- Schultzberg, M.; Lundberg, J.M.; Hökfelt, T.; Terenius, L.; Brandt, J.; Elde, R.P.; and Goldstein, M. Enkephalin-like immunoreactivity in gland cells and nerve terminals of the adrenal medulla. Neurosci 3:1169-1186, 1978.
- Simon, E.J.; Hiller, J.M.; and Edelman, I. Stereospecific binding of the potent narcotic analgesic [ $^3$ H]etorphine to rat brain homogenate. Proc Natl Acad Sci USA 70:1947-1949, 1973.
- Steiner, D.F.; Quinn, P.S.; Chan, S.J.; Marsh, J.; and Tager, H.S. Processing mechanisms in the biosynthesis of proteins. Ann NY Acad Sci 343:1-16, 1980.
- Stern, A.S.; Lewis, R.V.; Kimura, S.; Rossier, J.; Gerber, L.D.; Brink, L.; Stein, S.; and Udenfriend, S. Isolation of the opioid heptapeptide Met-enkephalin[Arg<sup>6</sup>Phe<sup>7</sup>] from bovine adrenal medullary granules and striatum. Proc Natl Acad Sci USA 76:6680-6683, 1979.
- Stern, A.S.; Jones, B.N.; Shively, J.E.; Stein, S.; and Udenfriend, S. Two adrenal opioid polypeptides: Proposed intermediates in the processing of proenkephalin. Proc Natl Acad Sci USA 78:1962-1966; 1981.
- Terenius, L. Stereospecific interaction between narcotic analgesics and a synaptic plasma membrane fraction of rat cerebral cortex. Acta Pharmacol Toxicol 32:317-320, 1973.
- Udenfriend, S., and Kilpatrick, D. Biochemistry of the enkephalins and enkephalin-containing peptides. Arch Biochem Biophys 221:309-323, 1983.
- Viveros, O.H.; Diliberto, E.J.; Hazum, E.; and Chang, K.-J. Opiate-like materials in the adrenal medulla: Evidence for storage and secretion with catecholamines. Mol Pharmacol 16:1101-1108, 1979.

Watson, S.J.; Akil, H.; Richard, C.W.; and Barchas, J. Evidence for two separate opiate peptide neuronal systems and the coexistence of  $\beta$ -lipotropin,  $\beta$ -endorphin, and ACTH immunoreactivities in the same hypothalamic neurons. Nature 275:226-228, 1978.

#### **ACKNOWLEDGMENTS**

Dr. G. Fleminger performed the peptide and catecholamine assays and Dr. D. Kilpatrick quantified the changes in preproenkephalin mRNA following denervation. The research reported herein was carried out in the laboratory of Dr. S. Udenfriend.

#### **AUTHOR**

Richard D. Howells, Ph. D.  
Roche Research Center  
Roche Institute of Molecular Biology  
Nutley, New Jersey 07110

# Enzymes in the Metabolism of Opioid Peptides: Isolation, Assay, and Specificity

Neville Marks; Myron Benuck; and Martin J. Berg

This chapter provides an overview of opioid peptide metabolism with emphasis placed on inactivation (as illustrated by some work from this laboratory) rather than conversion. This limitation is necessary since processing covers a wide field, including the genome itself, translation and translocation of the growing peptide chain, sorting and posttranslational modifications within the rough endoplasmic reticulum or Golgi apparatus, and transport and packaging to the extracellular compartments (see figure 1). Since inactivation cannot always be differentiated from activation (biodegradation may result in generation of a new active species as, for example, conversion of a kappa to a delta agonist), I have included a brief section on recent aspects of conversion (or transformation) and its implications to regulation of opioid peptide activity.

Despite rapid progress in the cloning and sequence of preprohormones (see Civelli and Howells, this volume), very little is known about the enzymes associated with processing. Since it is difficult to reconstitute *in vitro* a full processing system (other than through the use of whole cell preparations), the strategy for many investigators has been to use prohormonal intermediates in order to identify processing or inactivating enzymes (see Chaiken, this volume). Some common enkephalins are listed in figure 2, along with enzymes identified as cleaving at one or more sites. In some cases, more than one category of enzyme can cleave the same site; for convenience, enzymes acting at the same site are compared in this chapter in tabular form. Much of the older literature has been reviewed (see Marks 1977; Marks et al. 1982a) and only recent citations are given. Enzymes acting at sites 1, 2, and 3 result in complete loss of opioid properties for all forms shown (figure 2). Action at the other sites can result in inactivation or conversion to smaller active opioid peptides. The existence of multiple pathways for the degradation of a neuro-peptide poses questions on the significance of each enzyme. Several strategies have been used to evaluate the importance of

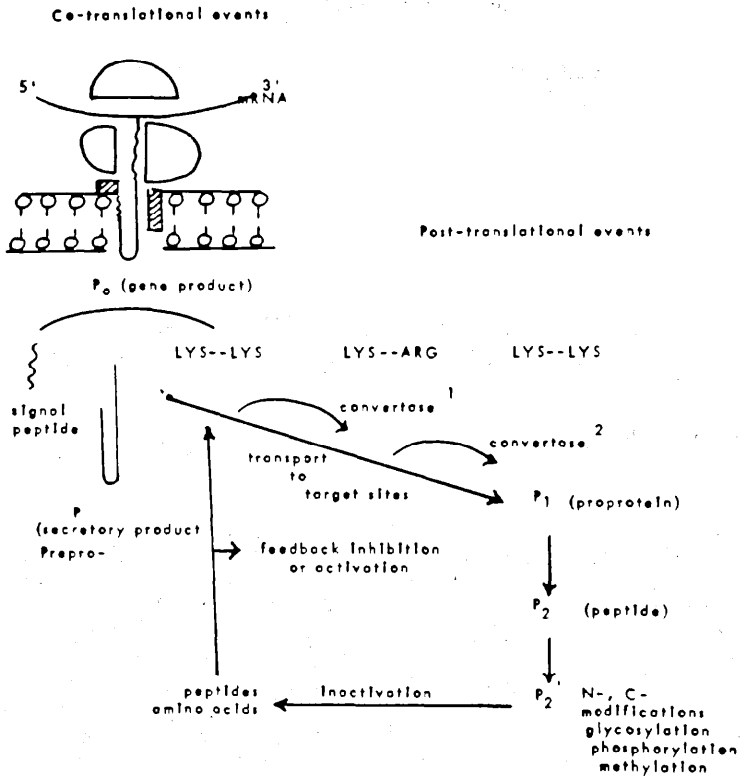


FIGURE 1

Co- and Post-translational events associated with maturation of gene product (P<sub>0</sub>). Convertases can act at sites adjacent to pairs of basic residues as depicted, or at other linkages (renin acts at Leu-Leu). Those acting at pairs of basic residues yielding C-terminal extensions, such as Arg-Lys, require further trimming by carboxypeptidases.

individual enzymes. These include localization with respect to opioid receptors and substrate, and inferences that can be drawn from the biological effects of biostable analogs or specific inhibitors of the enzyme. Among factors that have to be considered in extrapolating from *in vitro* to *in vivo* are: environmental influences (pH, ion, cofactors, inhibitors) and the physiological status of the tissue (addictive states, physical dependency, stress, etc). There is also a question on whether there are specific hormonal degrading peptidases or ones with broad specificity which recognize peptide domains having the correct

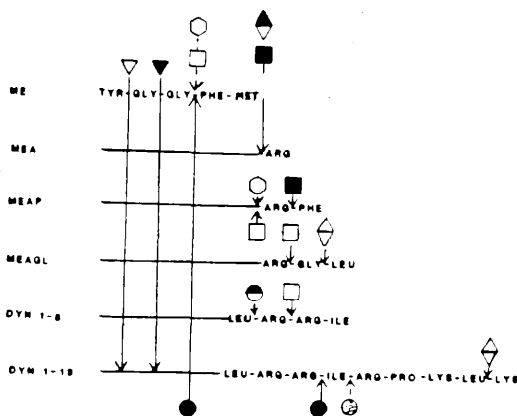


FIGURE 2

Abbreviations: ME, Met-enkephalin; MEA, Met-enkephalin-Arg; MEAP, Met-enkephalin-Arg-Phe; MEAGL, Met-enkephalin-Arg-Gly-Leu.

Dynorphin 1-8 and 1-13 are derived from dynorphin A.

Exopeptidases: ▽, aminopeptidase (amylamidase, LAP); ▽, diaminopeptidase I or III (cathepsin C, DAP-III); □, angiotensin converting enzyme (PD-A, ACE); ■, lysosomal carboxypeptidase A (cathepsin A); ◆, carboxypeptidase B; ◇, neutral carboxypeptidase.

Endopeptidases: ●, metalloendopeptidase (E.C.3.4.24.11); ●, soluble (phosphoramidon insensitive) metalloendopeptidase; ⊖, synaptic endopeptidase; ⬡, cysteine endopeptidase (cathepsin B). For citations, see text.

conformational and structural requirements. The discovery of enkephalins and other neuropeptides has spurred the enzymologist to reinvestigate a number of enzymes in the contact of their physiological roles. In some cases, enzymes have been rediscovered and, in others, there is evidence for presence of new enzymes hitherto unsuspected. The characterization of such enzymes provides a basis for the rational design of potent analogs or specific inhibitors having clinical potential.

## METHODS

This chapter on brain neuropeptidases is illustrated with work from this laboratory. Purification schemes have appeared for aminopeptidase (Marks et al. 1968; Berg and Marks 1984), metalloendopeptidase (Benuck et al. 1981), cysteine proteinase (Suhar and Marks 1979; Suhar et al. 1981), and lysosomal carboxypeptidases (cathepsin A) (Grynbaum and Marks 1976; Marks et al. 1976, 1981).

Measurements with chromogenic or fluorogenic substrates were undertaken as previously described in the publications. For studies with opioid peptides, the products were separated by hydrophobic chromatography; or by high pressure liquid chromatography (HPLC) using isocratic or gradient procedures (Eenuck et al. 1982a, 1982b, 1984). In some instances, peaks separated by HPLC were identified further by amino acid or end-group analysis using dansyl or other procedures as described. The C-terminal residues were examined by use of carboxypeptidase Y followed by prederivatization and HPLC separations. The potency of various enkephalin analogs was evaluated by the hot-plate or tail-flick assays (Jacquet and Marks 1976).

## **SITE ONE CLEAVAGES**

### **Soluble Aminopeptidases**

Several groups have isolated soluble site 1 cleaving enzymes as summarized in tabular form in table 1. The term "soluble" is operational since since groups used hypotonic buffer or even water (see Schnebli et al. 1979; Hersh and McKelvy 1981) and thus may have included loosely bound (membrane) or vesicle forms. Different methods of extraction and, in some cases, assay probably account for the wide divergence in  $M_r$  and other properties, although species differences also may be a factor. Enzyme has been purified 50-to 2,000-fold from man, monkey, rat, mouse, and bovine brain, and consist of two groups: puromycin sensitive (column 1, the majority of enzymes purified) and puromycin insensitive (mouse brain leucine aminopeptidase is the only example available).

Aminopeptidases in table 1 are nonspecific and degrade a variety of polypeptides with N-terminal free groups, such as enkephalins, angiotensins, melanostatin, and adrenocorticotrophic hormone (ACTH). Within the group of puromycin-sensitive enzymes, separate categories exist based on preferential specificity toward basic (-B) or neutral (-N or -M) naphthylamide substrates. There was some evidence in earlier studies for presence in brain of enzymes hydrolyzing Arg- preferentially to Leu- or Ala-2NA (Marks et al. 1968). These enzymes, termed "arylamidases," were shown active toward a large number of peptide substrates (Marks 1977). Hayashi (1978) showed that monkey brain arylamidase purified with the aid of Arg-2NA sequentially degraded enkephalin to release all substituents, and this was confirmed for enzyme purified from rat (Schnebli et al. 1979) and bovine brain (Hersh and McKelvy 1981) with the aid of Tyr-2NA. Traficante et al. (1980) observed the presence of an aminopeptidase in soluble extracts of human striatum having a restricted specificity and purified with the aid of labeled enkephalin. Arylamidases purified from different species are inhibited by metal chelating reagents and can be reactivated with  $Zn^{2+}$ ,  $Co^{2+}$ , or  $Mn^{2+}$ .

TABLE 1

Aminopeptidases Degrading Enkephalin at Sites 1 and 2  
(Tyr-Gly or Gly-Gly)

	Aminopeptidase (E.C.3.4.11)	Leucineamino- peptidase (E.C.3.4.11.1)	Diamino- peptidase III (E.C.3.4.14)
pH optima	6.5-7.5	8.5	8.5-9.0
M <sub>r</sub> (K <sub>d</sub> )	62-192	> 350	80-110
Specificity	Arylamides di, tripeptides Enkephalins Angiotensins MIF Kinins Dynorphins Endorphins	Leu.NH <sub>2</sub> di, tripeptides Enkephalins MIF Proteins	Arg-Arg-2NA Tetrapeptides Enkephalins Angiotensin-II β-endorphin
Inhibitors	Chelators -SH agents Puromycin Bestatin Asbtin	Chelators - Bestatin	Chelators -SH agents  DFP
Comments	Known also as arylamidases. Consists of more than one group in cytosol and membranes. purified 70-2,000 x	Known also as cytosolic amino- peptidase-I, but particulate forms observed in brain. Purified 2,000 x	Properties of a serine protease. Largely cytosolic. purified 50-1,500 x

Data taken from the following sources with species in parentheses. Puromycin sensitive aminopeptidases (column 1): Marks et al. 1968 (rat); Suszkiv and Brecher 1970 (bovine); Hayashi and Oshino 1977 (monkey); Traficante et al. 1980 (human striatum); Schnebli et al. 1979 (rat); Wagner et al. 1981 (rat); Hersh and McKelvy 1981 (bovine); Shimmura et al. 1984 (monkey membranes); Hersh 1981 (rat membranes); Hui et al. 1983 (rat membranes). The second column lists puromycin sensitive leucine aminopeptidase purified from mouse brain by Neidle (1981). The third column lists DAP-III purified from brain or pituitary (McDonald and Schwabe 1977; Lee and Snyder 1982; Marks and Sachs 1983) and unpublished findings.

Hydrolysis of peptides at the N-terminal is related to peptide size and conformation as shown for a series of dynorphin-related peptides (table 2); values for peptide are 50 to 100 times

those with 13 and 17 residues. Rapid inactivation of pentapeptides is in keeping with the notion that they act as putative neurotransmitters. Given the high concentration of aminopeptidases and the low concentrations of peptide in the range of ng per g wet weight, along with a  $K_m$  of about 20  $\mu\text{M}$  plus a high turnover rate, it is understandable that enkephalins have a relatively short half-life in vivo (Jaquet and Marks 1976). Analogs with D-Ala or other residues blocking the action of aminopeptidases have longer duration of action in vitro and sometimes in vivo (see Marks et al. 1982a).

**TABLE 2**

Degradation of Dynorphins by Purified Aminopeptidase

Peptide	Relative activity
YG	1.0
YGG	0.8
YGGF	0.8
YGGFL	14.3
TGGFL-NH <sub>2</sub>	15.2
YGGFLR	6.1
YGGFLRRI	4.4
YGGFLRRIRPKLK	0.3
YGGFLRRIRPKLKWDBQ	0.14

Aminopeptidase activity (cleavage of Tyr<sup>1</sup>-Gly<sup>2</sup> bcmd) was assayed by ultra violet detection of tyrosine by HPLC on a Spherisorb C<sub>18</sub> column with particle size of 5  $\mu$ . Activities expressed relative to Tyr-Gly degradation (4.4 nmol mg<sup>-1</sup> min<sup>-1</sup>). Values are the means of three or four determinations agreeing within 5%. The single letter code used for amino acids was: Y-Tyr, G-Gly, F-Phe, L-Leu, R-Arg, I-Ile, P-Pro, K-Lys, W-Trp, D-Asn, B-Asp, Q-Gln, M-Net, Reprinted from Berg and Marks (1984) by permission of Alan R. Liss, NY. Copyright 1984, Alan R. Liss, Inc.

Another strategy to enhance action of injected enkephalins is to use aminopeptidase inhibitors. Surprisingly, there have been few studies on puromycin with respect to its action on degradative enzymes, albeit it has been subject to studies concerning its role in elongation of the growing polypeptide chain. In an early study, we found that substituting the amino acid moiety (methoxy-Phe) for other residues (Tyr, Leu, beta -alanine, methoxy Tyr-Gly, Tyr methoxy Gly) led to loss of potency (Marks and Lajtha 1970) with even lower activity for the aminonucleotide (see also Hersh 1982). Aminopeptidases are inhibited by bestatin and amastatin (Barclay and Phillipps 1980) : analogs of bestatin (replacing Leu with Lys) were observed by Wagner and Dixon (1981) to be more potent toward rat brain "soluble" enzyme (compare to membrane-bound forms below). Aminopeptidases are inhibited also by various metal chelating reagents or hydroxamates (Blumberg et al. 1981).



## **Formation of des-Tyr Enkephalins**

Sane studies have been directed to the formation of des-Tyr derivatives and their metabolism. Many of these derivatives appear to have nonopioid properties when injected centrally (Burbach et al. 1980; Walker et al. 1982). Action by soluble or membrane-bound aminopeptidases can provide a pathway for their formation. Some aminopeptidase preparations sequentially release all five amino acids of enkephalin while others preferentially release only Tyr. The Gly-Gly is believed to retard the action of aminopeptidases and this may account for the accumulation of Gly-Gly subunits in digests of enkephalin made with brain homogenates (Marks 1977; Stem and Marks 1979).

Des-Tyr enkephalin serves as a substrate for angiotensin converting enzyme, yielding two dipeptides (see Marks et al. 1982a), and for a peptide dipeptidase recently purified from brain to homogeneity by Neidle and Kelly (1984). The latter acts preferentially on tetrapeptides with an aromatic residue in the third position (e.g., des-Tyr enkephalin, ACTH 7-10).

## **Morphiceptin**

The synthetic mu agonist Tyr-Pro-Phe-Pro.NH<sub>2</sub> illustrates the potential for characterizing novel enzymes using biologically active materials. Morphiceptin was not a substrate for purified site 1 enzymes described in the preceding paragraphs, yet was degraded by brain homogenates (Marks et al. 1984). Further studies revealed the presence of an aminopeptidase P-like enzyme active toward X-Pro peptides, such as morphiceptin itself, Tyr-MIF, substance P, and kinin-9 (Neidle et al. 1984). This enzyme demonstrates that proline (Pro) in the second position can affect significantly the specificity of an aminopeptidase. Pro in the first position is recognized by arylamidases, e.g., MIF (Pro-Leu-Gly.NH<sub>2</sub>) (Marks 1977). Another class of enzyme with restricted specificity is aminopeptidase A. Recently, Kelly et al. (1983) described an enzyme purified with Asp-Phe-MeE (aspartame) that cleaved aspartyl peptides or ACTH 5-10 (Glu- ) but was inactive toward enkephalin.

## **Membrane-Bound Aminopeptidases**

Early studies with brain membranes pointed to the presence of a site 1 enzyme in brain membranes having a significantly lower affinity than other enkephalin degrading enzymes (see Schwartz et al. 1981). In our studies, illustrated in figures 3 and 4, Tyr was found to be released in higher amounts than Tyr-Gly-Gly at all substrate concentrations, although at 50 uM the ratio was smaller than at 450 uM. Membranes may contain more than one site 1 cleaving enzyme responsible for the changes seen with alteration in substrate concentration. As in the case of soluble enzyme, there was a relationship between peptide size and rates; rates for the pentapeptide were 27-to 40-fold higher than for dynorphin 1-10 or 1-13 (table 4).

Enzyme cleaving site 1 has been purified from membranes of rat and monkey brain (Hersh 1981; Hui et al. 1983; Shimamura et al. 1984). For the most part, these resemble arylamidases of the "soluble" fractions. Hersh (1981) separated two kinetically different forms, with one more active toward Arg than Ala 2NA; the type that was active against the neutral substrate had the highest affinity for enkephalin ( $K_m$  20  $\mu$ M) and was inhibited by low concentrations of puromycin ( $K_i$   $10^{-6}$ M). The membrane-bound enzyme of Hui et al. (1983) was inhibited by bestatin and anastatin. In a comparison of bestatin analogs, Shimamura et al. (1984) observed highest inhibition by those with Leu or Met and some activity for analogs with dipeptide Leu-Arg, Leu-Asp. The use of bestatin analogs with differently charged amino acids provides potential

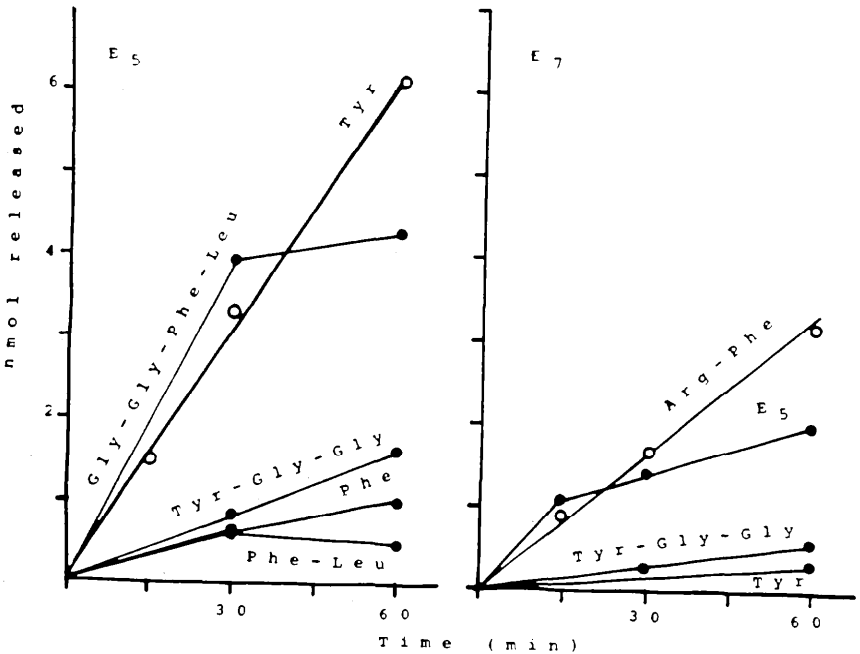
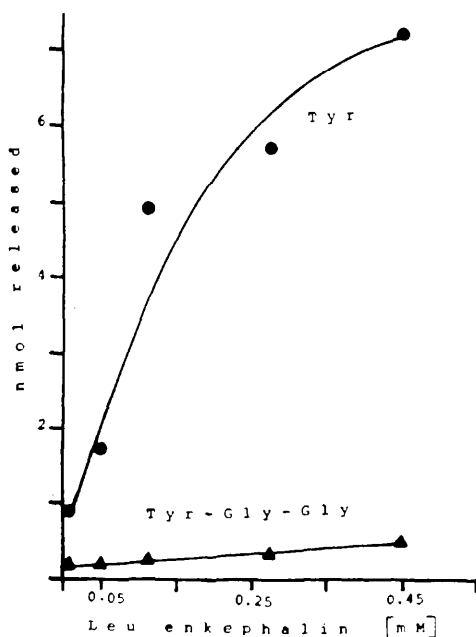


FIGURE 3

Comparison of Leu-enkephalin (E<sub>5</sub>) and Met-enkephalin-Arg<sup>6</sup>-Phe<sup>7</sup> (E<sub>7</sub>) breakdown by time of incubation with rat striatal membranes. Results were plotted as nmol of product recovered from 100  $\mu$ l of incubation mixture containing 45 nmol E<sub>5</sub> 14  $\mu$ g protein as compared to 14.5 nmol E<sub>7</sub> and 0.7  $\mu$ g protein. Note major products for E<sub>5</sub> were Tyr and Gly-Gly-Phe-Leu and for E<sub>7</sub> were Arg-Phe and Met-enkephalin. Benuck et al. 1982b. Copyright 1982, Pergamon Press.



**FIGURE 4**

Effect of  $E_3$  concentration on rate of Tyr vs Tyr-Gly-Gly release incubated in presence of whole brain SPM. Benuck et al. 1982b. Copyright 1982, Pergamon Press.

probes to separate aminopeptidase N and B. Amastatin, a microbial peptide with the structure amino-2-hydroxyl-5-methyl hexanoyl-Val-Val-Asp, is an inhibitor of aminopeptidase A and LAP. Analogs prepared with C-terminal peptides of varying length were shown by Tobe et al. (1982) to be specific inhibitors of aminopeptidase A. In our studies, amastatin was equipotent to bestatin and puromycin for the inhibition of purified brain aminopeptidase from cytosol (Berg and Marks 1984).

#### **SITE 2 CLEAVAGE (GLY-GLY)**

Since the yield of Tyr-Gly from opioids is low, less attention has been paid to the role of diaminopeptidases (IMP-enzymes). Such enzymes are widely distributed in tissues and can be grouped according to their chromogenic substrate, pH, localization, and -SH or  $Cl^-$  requirements (Marks 1968; McDonald and Schwabe 1977). Those implicated in enkephalin metabolism include DAP-1 (cathepsin C, a lysosomal enzyme active at pH 5.5 in presence of -SH and  $Cl^-$ ) and DAP-III (largely cytosolic, pH 9.0 optimum for hydrolysis of Arg-Arg-2NA or cogeners) (Lee and Snyder 1982; Marks and Sachs 1983).

Incubation of purified brain P<sub>2</sub> or SPM membranes at pH 5.5 with enkephalin led to release of Tyr-Gly by a pathway stimulated by -SH and Cl<sup>-</sup>, leading to our conclusion that DAP-I is a potential enkephalin degrading enzyme (Marks and Sachs 1983). This enzyme has been purified from pituitary and other tissues and has been extensively studied; it is regarded as nonspecific and can be used to sequentially degrade peptides such as glucagon. Hazato et al. (1982) isolated a DAP enzyme from monkey particulates and observed release of Tyr-Gly at pH 7.6; they indicated that their DAP enzyme required metals for activity. Lee and Snyder (1982) purified a M<sub>r</sub> 86,000 protein from rat brain cytosol and observed cleavage of enkephalin and angiotensin-II or its related peptides; 15% of the activity was observed at pH 6.5 and 60% at pH 7.4, indicating actions within the physiological range. Enzyme was high in pituitary when soluble extracts were compared but lower in pituitary particulates compared to other brain areas. Enzyme was unaffected by 10<sup>-4</sup>M puromycin and could be differentiated from other aminopeptidases. Specific inhibitors are not available, but W-III was shown to be inhibited by tyrosyl dipeptides among others. In our studies on purified preparations of DAP-II and DAP-III obtained from brain, we showed that the former acted only on tripeptides (as a carboxytripeptidase) and the latter degraded larger opioids except dynorphin 1-13; the action of cytosolic and membrane-bound forms decreased with peptide size (table 3).

**TABLE 3**

Substrate Specificity of Rat Brain DP-III

Substrate	Cytosolic	Membrane bound
Leu-enkephalin	100*	100
Met-enkephalin	184	77
Met-enkephalin-Arg-Phe	43	11
Dynorphin 1-13.	0	0
H-beta endorphin	12	11

100 ul contained 4-12 ug purified enzyme protein incubated with 40 nmol peptide for 75 min and analyzed for Tyr-Gly by HPLC.

\*Represented release of 7-8 nmol of Tyr-Gly. From Marks and Sachs (1983) and unpublished findings.

**SITES 6 AND 7 CLEAVAGES**

The specificity of the enzymes shown in figure 2 indicate that they convert MEA or MEAP to shorter active forms but do not inactivate the pentapeptide (HE). Rat brain P<sub>2</sub> membranes contain carboxypeptidases active at pH 7.6 in the metabolism of MEAGL (cleavage of Gly-Leu) and dynorphin 1-13 (cleavage of Leu-Lys) (Benuck et al. 1984; Leslie and Goldstein 1982) (table 4). Cleavage at the C-terminal of MEAGL to form MEA equaled in rate that of aminopeptidase at site 1; that of the dynorphin 1-13 exceeded rates for sites 1 and 3 cleavages. Previously, Grynbaum

and Marks (1976) found activity toward carboxypeptidase A (Z-Phe-Leu) and B (Z-Ala-Arg) substrates in purified rat brain P<sub>2</sub> fractions and in subfractions. Brain carboxypeptidases active at physiological pH have neither been purified nor have their actions toward neuropeptides been established.

Rat brain homogenates and P<sub>2</sub> subfractions contain a carboxypeptidase-degrading Z-Glu-Tyr and other N-protected tyrosyl dipeptides which are active at pH 5.5 and capable of metabolizing angiotensin-II, myelin basic protein peptides, and MEAP with removal of Phe (rapidly) and Arg (slowly) (Grynbaum and Marks 1976; Marks et al. 1976, 1981, 1982a, 1982b). Enzyme can be purified several hundredfold from detergent extracts of particulates and this allows its properties to be examined. Results indicated that it resembled cathepsin A or lysosomal carboxypeptidase A. Hook et al. (1982) and Hook and Loh (1984) showed that secretory granules of rat pituitary lobes contained a carboxypeptidase B-like enzyme converting iodinated Met-enkephalin-Arg to Met-enkephalin, or ACTH 1-17 (Gly-Lys-Arg) to ACTH 1-15 (Gly). An enzyme with similar Properties (inhibited by metal chelating agents and activated by Co<sup>2+</sup>) was purified from adrenal chromaffin granules and the pituitary lobe that also converted MEA (see table 5) (Fricker and Snyder 1982; Supattopone et al. 1984). This enzyme was assayed with synthetic substrates such as Dns-Phe-Ala-Arg or <sup>3</sup>H-benzoyl on the N-terminal (Stack et al. 1984); activity was highest in pituitary compared to other regions. Carboxypeptidase B-like enzymes,

TABLE 4

Degradation of Dynorphin Fragments and of Met-Enkephalin-Arg-Gly-Leu by Whole Brain SPM

Substrate	Rate (nmol/mg protein/min)			
	Tyr	Tyr-Gly-Gly+	C-terminal dipeptide	C-terminal amino acid
Dynorphin sequence				
1-5 (Leu-enkephalin)	8.2	0.7	0.7 <sup>+</sup> (1.4) <sup>a</sup>	-
1-6	4.0	0.5	1.2 <sup>++</sup>	-
1-8	1.9	0.1	3.5 <sup>++</sup>	-
1-13	0.3	0.1	0	0.7
1-17	0.2	0.1	0	-
Met-enkephalin-Arg-Gly-Leu	6.0	0.6	nd	7

<sup>+</sup> Measured in the presence of MK 421 and bestatin.

<sup>++</sup> Based on formation of dynorphin 1-6 or 1-4.

<sup>a</sup> Based on release of Tyr-Gly-Gly in the absence of inhibitor. nd: not determined.

Sequences are based on the structure of dynorphin 1-17: Tyr-Gly-Gly-Phe-Leu-Arg-Arg-Ile-Arg-Pro-Lys-Leu-Lys-Trp-Asp-Asn-Gln. SPM containing 50-100 ug of protein was incubated with 10 nmol of peptide in 0.1 ml at 37°C in 20 mM Tris buffer, pH 7.6. Products were assayed by HPLC as described in the Methods.

**TABLE 5**

Acidic Carboxypeptidases Mediating Conversion or Transformation

	Carboxypeptidase A E.C. 3.4.12A.1	Carboxypeptidase B
pH	5.5	5.4-5.8
M <sub>r</sub> (K <sub>d</sub> )	100-650 (isoforms)	52
Specificity	Angiotensin-I MEAP MEA Z-Glu-Tyr Z-Phe-Tyr	ACTH 1-17 (Gly-Lys-Arg) MEA (-Lys) DNS-Phe-X-Arg X = Ala, Leu, Gly <sup>3</sup> H-benzoyl-Phe-Ala-Arg
Inhibitors	DFP PCMB	p-chloromercuriophenyl sulfonate chelators (GPSA, GEMSA)
Comments	Membrane bound High concentration in P <sub>2</sub> fraction  Inactive toward pentapeptide enkephalins	Activated by Co <sup>2+</sup> Particulate and soluble form. Secretory granules of bovine pituitary, and adrenal (chromaffin cells)  Inactive toward penta- peptide enkephalins

Data compiled from Grynbaum and Marks (1976) and Marks et al. (1976, 1981, 1982a, 1982b) (carboxypeptidase A); Hook and Loh (1984), Supattopone et al. (1984), and Stack et al. (1984) (carboxypeptidase B). GEMSA, guanidoethylmercaptosuccinic acid; GPSA, guanidopropylsuccinic acid.

active at acid pH having a thiol requirement, have been purified from spleen and shown to have a broad specificity (McDonald and Schwabe 1977). Brain enzymes could be involved in trimming of prohormonal intermediates formed by cleavage at sites adjacent to basic residues (figure 1).

**SITE 3 CLEAVAGE (-Gly-Phe)**

**Angiotensin Converting Enzyme (ACE, PD-A)**

ACE has been the subject of extensive studies largely as a result of its pivotal role in the renin-angiotensin system and its vasoactive properties (Soffer 1981). Studies conducted on brain SPM using enkephalins exclude ACE as a key enzyme for inactivation, but do point to a possible role for conversion of larger

forms (Marks et al. 1982a; Benuck et al. 1982b). Brain enzyme cross-reacts with antibody generated to ACE of peripheral organs, and is widely distributed in the brain as shown by immunohistochemical work or binding by inhibitors in circumventricular organs, substantia nigra, and the striatum (Strittmatter et al. 1984; Chevillard and Saavedra 1982). In subcellular fractions, ACE is particulate bound and found in cellular debris, and in the P<sub>2</sub> fraction and microsomes (Benuck and Marks 1978).

Brain enzyme has been purified from detergent extracts of brain particulates by ion-exchange, and by affinity procedures using ricin-Sepharose (Yokosawa et al. 1983a), immunoaffinity to prepare an immobilized form (Benuck et al. 1981), or the lysyl analog of MK-421 (MK-521) linked via the epsilon grouping to Sepharose (El-Dorry et al. 1982; Benuck and Marks, unpublished findings). Purified enzyme acted on a variety of enkephalins, including ME or LE, MEAP, and dynorphin 1-8, but not on dynorphin 1-13 and 1-17 (see legend-table 6). The K<sub>m</sub> for enkephalins was 50 to 100 μM, yet SPM fractions enriched in ACE from striatum or whole brain at these concentrations did not act rapidly at site 3 (as confirmed by use of specific inhibitors). Activity, however, was observed at higher concentrations of substrate (table 4). The action of membranes at these concentrations correspond with the specificity of the purified enzyme (see relative rates, table 6). Reasons for the discrepancies between the rates for the purified enzyme (active at lower substrate concentration) and SRI are unclear but might be related to altered affinities of membrane-bound forms.

ACE has served as a useful model for the design, on a rational basis, of specific inhibitors (see Cushman and Ondetti 1980; Marks et al. 1982a; Roques, this volume). Modifications of succinyl proline to enhance interactions with the metallo- and other subsites led to the synthesis of captopril, which is active at about K<sub>i</sub> 10 nM range. Presence of a free carboxyl group is not mandatory since affinity purified ACE from brain or lung can recognize the P<sub>4</sub>-P<sub>3</sub> residues of substance P with release of the C-terminal tripeptidyl amide (Yokosawa et al. 1983b; Cascieri et al. 1984). The model proposed for the catalytic center will require modification to accommodate the "endopeptidase"-like function of ACE. This may explain the action of centrally applied ACE inhibitors on increased levels of iR-substance P in rat brain (Hanson and Lovenberg 1982) or following intravenous injection on the enhancement of substance P stimulation of rat salivary gland (Cascieri et al. 1984).

The properties of purified brain ACE as compared to other site 3 enzyme are shown in table 6, which includes activity toward enkephalin substrates. Conversion of angiotensin-I to -II is enhanced by high (100 to 150 mM), and inactivation of kinins by low, anion (Cl<sup>-</sup>) concentrations; anion levels intracellularly have been invoked as one mode of regulation. A very large number of inhibitors have been synthesized and their effects *in vivo* have been summarized recently (see Symposium 1984). In view of the central actions of enkephalin on blood pressure, there is scope also to examine interaction of ACE inhibitors on enkephalinergic systems (see Summy-Long et al. 1981; Marks and Benuck 1983).

## Metalloendopeptidase

Several different lines of evidence showed that the non-ACE pathway acting on site 3 of pentapeptides was a metalloendopeptidase similar in properties to one purified earlier by Kerr and Kenny (1974) from kidney brush border. This enzyme has "thermolysin"-like specificity, although it differs from the bacterial enzyme in several respects. Clues concerning its presence in SPM were provided in studies conducted with SPM and enkephalin; at low substrate concentrations, cleavage occurred at Gly-Phe with release of Tyr-Gly-Gly, and at the C-terminal dipeptide (incubation conditions adjusted to reduce inopeptidase action by addition of bestatin, or use of D-Ala<sup>2</sup> analogs). Initially, this enzyme was termed a dipeptidyl carboxypeptidase or Tyr-Gly-Gly generating enzyme (see Schwartz et al. 1981; Marks et al. 1982a). Almenoff et al. (1981) noted that purified bovine pituitary or brain metalloendopeptidase (assayed with synthetic substrates, see table 6) also cleaved pentapeptide enkephalins at site 3. Fulcher et al. (1982), using purified kidney enzyme or SPM, observed that site 3 cleavage was inhibited by phosphoramidon or Thiorphan. These data established that site 3 enzyme of SPM was a metalloendopeptidase of the thermolysin type and has received the designation E.C.3.4.24.11 (Matsas et al. 1983). This enzyme has been purified from kidney brush border, intestine, pituitary, and brain (Fulcher et al. 1983; Almenoff and Orłowski 1983, 1984) and has been observed in dog pancreatic membranes (Mumford et al. 1980, 1981). It can be purified from detergent extracts by a number of techniques that include ion-exchange and immunoabsorbent chromatography using polyvalent or monovalent antibodies (Fulcher et al. 1983) and affinity chromatography on lentil-lectin columns (Benuck et al. 1982a). Metalloendopeptidases have a  $M_r$  of about 90,000, are glycosylated, and are characterized by phosphoramidon inhibition.

Purified enzymes are nonspecific, degrade insulin B chain or a variety of synthetic substrates, and also degrade a number of neuropeptides at one or more sites. Many of the sites contain hydrophobic residues on the amino side of the vulnerable bond, although there are exceptions. Cleavage at sites adjacent to one or more basic residues, e.g., dynorphin 1-13 (figure 2), imply a role in processing for this widely distributed membrane-bound enzyme.

Aside from phosphoramidon (a microbial sugar-dipeptide), several groups have synthesized new peptide derivatives active as inhibitors and interacting with the metallosubsite of the enzyme. Inhibition by metabolic products of enkephalin provided clues that led to the synthesis of Thiorphan (see Rogues, this volume). Inhibitors provide probes to examine the nature of the active center. Understanding the mechanisms of action of inhibitors is an important goal and applies equally to other materials acting at sites 1 or 3.

In studies on structure-activity for different dynorphins, a relationship was noted between peptide size and rates of breakdown



by membrane (table 4) or purified metalloendopeptidase (see table 7). Highest activity was found for the pentapeptide ( $K_m$ , 20  $\mu$ M) and was significantly lower for peptides with 8-17 residues. In the case of dynorphins 1-13 and 1-17, incubation with purified enzyme led to cleavage at two sites, at Gly-Phe and Arg-Ile; incubation with SPM, however, resulted in formation of dynorphin 1-8 as one of products. The metabolism of dynorphin 1-8 (a peptide with preferential affinity to k-receptors) is complex since it can serve as a substrate for membrane ACE and metalloendopeptidase. In studies on the appearance of products with time, SPM degraded dynorphin 1-8 to release 1-6 and 1-4 by release of C-terminal dipeptides (Benuck et al. 1984).

### **Cysteine Proteinase (cathepsin B)**

Fusion of primary or secondary lysosomes with synthesizing particles within the RER has focused attention on cathepsin B (Bienkowski 1983; Docherty et al. 1984). Purified cathepsin B has exo- and endo-peptidase actions towards polypeptides such as glucagon and insulin. In recent studies, we showed that it displayed a dipeptidyl carboxypeptidase action toward some enkephalins with C-terminal extensions (table 7). In other cases, it acted on peptidyl amides C-terminally with removal of the amino acid amide and may be a factor, therefore, in the metabolism of neuropeptides having  $-\text{CONH}_2$  (Marks et al. 1984). The  $K_m$  for MEAP was 24  $\mu$ M, and for MEAGL was 117  $\mu$ M (C-terminal dipeptide removal); purified brain cathepsin B acted also on pentapeptides, but the  $K_m$  was higher with a value of 470  $\mu$ M. The low turnover of enkephalin ( $k_{\text{cat}}$  0.89  $\text{sec}^{-1}$ ) would tend to exclude a role for cathepsin B in inactivation per se, but the higher values for hepta- or octa-peptides (25-39) point to a role in processing. Removal of C-terminal dipeptides can generate smaller active opioids from precursor forms.

Cathepsin B has been purified from rat brain, utilizing synthetic substrates (BANA); it was shown to be dependent on  $-\text{SH}$  and to be potently inhibited by leupeptin or by an endogenous protein with  $M_r$  12,500 present in brain in high concentration (Suhar and Marks 1979; Kopitar et al. 1983). Intracellular levels of  $-\text{SH}$  or endogenous inhibitor thus could provide a mechanism for regulating peptide processing by cysteine proteinases.

### **GENERAL COMMENTS ON PROCESSING**

Co- or post-translational events are rate limiting, yet little is known about these processes in the brain. The secretory pathway for hormones is compartmentalized within the endoplasmic reticulum (ER) and Golgi complex (Bienkowski 1983). It is established that most secretory proteins are formed with a hydrophobic leader sequence that becomes detached during translocation of the growing peptide chain. Recent studies show the presence of a signal recognition particle on the outer ER surface consisting of a 7s RNA and several proteins, two of which bind to the Alu transcripts of the RNA: the leader sequence can engage with a "docking protein" on the cytoplasmic surface of the ER, forming a pore for translocation of the polypeptide (Walter and Blobel 1983). Very

TABLE 6

Enzymes Cleaving -Gly-Phe (Site -3) of  
Pentapeptide Enkephalins

Peptidyl Dipeptidase (E.C. 3.4.15.1)	Metalloendopeptidase (E.C. 3.4.24.11)	Cysteine Proteinase (E.C. 3.4.22.1)
pH 8.0	7.5-8.0	6.5
$M_r$ ( $K_d$ ) 180	98-100	24-28
<u>Specificity</u> -R <sub>1</sub> -R <sub>2</sub> - where Pro is not R <sub>1</sub>	-R <sub>1</sub> -R <sub>2</sub> - R <sub>2</sub> , hydrophobic	Can act as dipep- tidyl carboxypepti- dase removes C- terminal R-R
Angiotensin-I Substance P Dynorphin 1-8 Hipp-His-Leu	Angiotensin-II Substance P Dynorphin 1-8 Succ-Ala <sub>7</sub> -Phe-N <sup>Me</sup> c Bz-Ala <sub>2</sub> -Phe-4MeONA Bz-Gly-Arg <sub>2</sub> -Leu-2NA	- Substance P MEAP Bz-Arg-2NA Z-Phe-Arg-N-Mec
<u>Inhibitors</u> <u>Chelators</u> Dipeptide analogs Snake venom nonapeptide Captopril MK-421	Chelators Dipeptide analogs  Thiorphan Phosphoramidon	Leupeptin Cystatins Cerebrocystatin
<u>Comments</u> Activated by Cl <sup>-</sup> Membrane bound Synaptic enzyme has low affinity for enkephalin Inhibitors are anti- hypertensive agents	Membrane bound Synaptic enzyme has high affinity for enkephalin Thiorphan i.v.t. has antinociceptive properties	Membrane(lysosomes) Present in P <sub>2</sub> fraction Low affinity for enkephalin Dependent on cysteine Suppressed by endogenous inhibitors Has exo- and endo- peptidase actions

Data derived from Benuck et al. (1982a); Cascieri et al. (1984); Yokosawa et al. (1983a, 1983b) for ACE. Relative rates for ACE degradation of enkephalins were Dyn 1-8 (100) MEAGL, (31) Dyn 1-6 (27), Dyn 1-5 (18), Dyn 1-13 or 1-17 (0). Metalloendopeptidase data derived from Mumford et al. (1980); Orlowski and Wilk (1981); Almenoff and Orlowski (1984); Fulcher et al. (1982, 1983). Relative rates found in our studies for enkephalins were Dyn 1-5 (100), 1-6 (71), 1-8 and larger (14), MEAGL (86). (See table 4 for comparison with SPM). Data for cysteine proteinase compiled from Suhar and Marks (1979); Kopitar et al. (1983); Marks et al., in press).

TABLE 7

Cleavage of Different Enkephalins by Purified Rat  
Brain Cathepsin B

Substrate and Point of Cleavage	Relative Rate
1. Tyr-Gly-Gly-Phe-Met-Arg-Gly-Leu	100
2. Tyr-Gly-Gly-Phe-Met-Arg-Phe.NH <sub>2</sub>	92
3. Tyr-Gly-Gly-Phe-Leu-Arg-Arg-Ile	42
4. Tyr-Gly-Gly-Phe-Met-Arg-Phe	32
5. Tyr-Gly-Gly-Phe-Met-Arg-Arg	2
6. Tyr-Gly-Gly-Phe-Leu-Arg	1
7. Tyr-Gly-Gly-Phe-Leu	0.5
8. Tyr-Gly-Gly-Phe-Met	0.5

Values are expressed relative to substrate 1 (rate was 1.6  $\mu$ mol per mg protein per min). The substrate concentration used was 0.1 mM and the incubation mixture contained 0.047-0.094  $\mu$ g of purified rat brain cathepsin B. Incubations were for 30 min, or in the case of substrates 5-8, for 240 min. Points of cleavage ( $\blacktriangle$ ).

little information is available on the nature and specificity of the signal peptidase other than the fact that some membranes (pancreatic, pituitary, and liver) contain a detergent extractable enzyme which converts some preproproteins (Jackson and Blobel 1980; Mumford et al. 1980). The enzyme cleaves bonds linking the leader sequence to the prohormone and includes Gly-Lys (PTH), Ala-Leu (rat GH), Ala-Phe (rat insulin), and Gly-Tyr (porcine POMC) among others. The rapid action of ER signal peptidase generally prevents isolation of the preproprotein. Most of the data on the presequence can be deduced from cloning the appropriate mRNA (Chretien and Seidah 1985).

Proproteins can be processed differently within a given tissue, dependent on the anatomical regions. One explanation is the sorting or guiding of prohormones along the ER and Golgi complex to secretory or storage vesicles, or fusion with primary or secondary lysosomes (Bienkowski 1983). This might explain the diversity of products obtainable from POMC in pituitary regions or proenkephalins in adrenal and various brain areas (Marks 1977; Seizinger et al. 1984).

A large number of membrane-bound or soluble enzymes are available for processing at sites adjacent to basic residues (trypticlike enzymes) or other bonds (reninlike). The strategy of using secretory vesicles or storage granules as a source of enzyme, combined with RIA for detection of enkephalins, has provided new information. Enzyme can be extracted from adrenal medullary chromaffin granules and has been shown to convert ECP's (enkephalin containing peptides) at pH 8.0 (Lindberg et al. 1982; Mizuno et al. 1982) or at acidic pH (Troy and Musacchio 1982; Evangelista et al. 1982). In brain, Devi and Goldstein (1984) observed conversion at pH 7.6 of Dyn-B-29 to form 1-13 by cleavage of the

Thr-Arg bond. In pituitary, Loh and Gainer (1982) observed an acidic enzyme in processing POMC. Wallace et al. (1984) reported that atrial extracts of *Aplysia* converted dynorphin 1-13 to 1-8 at pH 7.6 by cleavage of the Ile-Arg bond. The latter enzyme may be analogous in specificity to one observed in rat brain SPM converting Dyn 1-13 (Benuck et al. 1984).

Metalloendopeptidase present in membranes and soluble extracts of brain or pituitary also convert a number of neuropeptides by cleaving bonds adjacent to one or more basic residues (Chu and Orłowski 1984; Benuck et al. 1984; see table 8 and figure 2). Neutral endopeptidases from brain membrane or soluble fractions have been purified and shown to convert  $\beta$ -endorphin or smaller fragments to ME (Koida et al. 1979; Orłowski et al. 1980). Knight et al. (1982) also purified an enzyme from rat membranes that converted ECP's (extracted from striatum) to smaller iR-enkephalins. More recently, brain cathepsin B was shown to convert small enkephalins with C-terminal extensions to yield ME or MEA (table 7). There is some data suggesting that kallikreins, a group of serine proteases, play diverse roles in processing. The mRNA of salivary gland after cloning (mouse) contains sequences that are homologous with the mouse genome, implying a wide distribution in tissues of kallikreins (Mason et al. 1983).

A coherent scheme for processing of prohormones cannot be advanced on the basis of available data. A fully integrated scheme must take into account any variables (several were cited in the introduction), not least of which are anatomical factors and the role of posttranslational modifications, such as glycosylations, N-acetylation, methylation, phosphorylation, sulfation, formation of pyroGlu on the N-terminal, and CONH<sub>2</sub> on the C-terminal. Mechanisms exist for addition of such groups, many of which are catalyzed by cellular enzymes; but removal of groups such as N-acetyl or C-terminal amide (rather the removal of the amino acid itself) is an unresolved area. These groupies modify neuropeptide actions--in some cases, activating (a-MSH); in others, inactivating (endorphins). Since tissues contain a number of inactive N-acetylated endorphins and other opioid peptides, we surveyed brain for the presence of enzyme(s), removing specifically the N<sup>a</sup>-acetyl grouping. Such enzyme(s) were absent in brain, although the latter contained an enzyme removing N-acetyl-Met or Ala from di- or tri-peptides, and "acylases" which deacetylated single amino acids (Marks et al. 1983b). N-acetyl endorphins may be inactive forms of opioid peptides or serve as precursors for as yet unidentified peptides with novel properties. The covalent modifications that affect biological activity of neuropeptides may occur in the processing pathway, or extracellularly.

Despite evidence that insulin exists as a pro- and prepro- form and the latter were isolated, there has been very little progress in understanding the manner in which they are processed. Pituitary AtT-20 cells grown in culture can be induced to process and secrete insulin after transfection with the proinsulin gene, demonstrating that they contain the requisite enzymes for processing more than one type of precursor (Moore et al. 1983).

Of interest is the finding of Docherty et al. (1984) that insulin secretory cells contain a cysteine proteinase involved in conversion of proinsulin. These experimental models together with availability of opioid peptide intermediates present opportunities to unravel some of the pathways associated with processing in the central nervous system.

## REFERENCES

- Almenoff, J., and Orlowski, M. Membrane-bound kidney neutral metalloendopeptidase: Interaction with synthetic substrates, natural peptides and inhibitors. Biochemistry 22:590-599, 1983.
- Almenoff, J., and Orlowski, M. Biochemical and Immunological properties of a membrane-bound brain metalloendopeptidase: Comparison with thermolysin-like kidney neutral metalloendopeptidase. J Neurochem 42:151-157, 1984.
- Almenoff, J.; Wilk, S.; and Orlowski, M. Membrane-bound pituitary metalloendopeptidase: Apparent identity to enkephalinase. Biochem Biophys Res Commun 102:206-214, 1981.
- Barclay, R.K., and Phillips, M.A. Inhibition of enkephalin-degrading aminopeptidase activity by certain peptides. Biochem Biophys Res Commun 96:1732-1738, 1980.
- Benuck, M., and Marks, N. Subcellular localization and partial purification of a chloride dependent angiotensin converting enzyme from rat brain. J Neurochem 30:729-734, 1978.
- Benuck, M.; Berg, M.J.; and Marks, N. A distinct peptidyl dipeptidase that degrades enkephalin: Exceptionally high activity in rabbit kidney. Life Sci 28:2643-2650, 1981.
- Benuck, M.; Berg, M.J.; and Marks, N. Rat brain and kidney metalloendopeptidase: Enkephalin heptapeptide conversion to form a cardioactive neuropeptide Phe-Met-Arg-Phe amide. Biochem Biophys Res Commun 107:1123-1129, 1982a.
- Benuck, M.; Berg, M.J.; and Marks, N. Separate metabolic pathways for Leu-enkephalin and Met-enkephalin-Arg<sup>6</sup>-Phe<sup>7</sup> degradation by rat striatal synaptosomal membranes. Neurochem Int 4:389-396, 1982b.
- Benuck, M.; Berg, M.J.; and Marks, N. Membrane-bound enzymes and their role in processing of the dynorphins and of the proenkephalin octapeptide Met-enkephalin-Arg-Gly-Leu. Neurochem Res 8:731-747, 1984.
- Berg, M.J., and Marks, N. Formation of des Tyr dynorphins 5-17 by a purified cytosolic aminopeptidase of rat brain. J Neurosci Res 11:313-321, 1984.
- Bienkowski, RS. Intracellular degradation of newly synthesized secretory proteins. Biochem J 214:1-10, 1983.
- Blumberg, S.; Vogel, Z.; and Altstein, M. Inhibition of enkephalin-degrading enzymes from rat brain and of thermolysin by amino acid hydroxamates. Life Sci 28:301-306, 1981.
- Burbach, J.P.H.; Loeber, J.G.; Verhoef, J.; Wiegant, V.M.; de Kloet E.R.; and de Wied, D. Selective conversion of  $\beta$ -endorphin into peptides related to  $\alpha$  and  $\delta$ -endorphin. Nature 283:96-97, 1980.
- Cascieri, M.A.; Bull, H.G.; Mumford, R.A.; Patchett, A.A.; Thornberry, N.A.; and Liang, T. Carboxyl-terminal tripeptidyl hydrolysis of substance P by purified rabbit lung angiotensin converting enzyme and the potentiation of substance P activity *in vivo* by captopril and MK-422. Mol Pharmacol 25:287-298, 1984.
- Chevillard, C., and Saavedra, J.M. Distribution of angiotensin converting enzyme activity in specific areas of the rat brain stem. J Neurochem 38:281-284, 1982.

- Chretien, M., and Seidah, N.G. Microsequence of polypeptide hormones: Its usefulness to monitor the isolation of novel molecules. Res Methods Neurochem 6:195-209, 1985.
- Chu, T.G., and Orłowski, M. Active site directed N-carboxymethyl peptide inhibitors of a soluble metalloendopeptidase from rat brain. Biochemistry 23:3598-3603 1984.
- Coy, D.H., and Kastin, A.J. Tyrosine modified analogs of methionine-enkephalins and their effects on the mouse vas deferens. Peptides 1:175-177, 1980.
- Cushman, D.W., and Ondetti, M.A. Inhibitors of angiotensin converting enzyme. Prog Med Chem 17:42-104, 1980.
- Devi, L., and Goldstein, A. Dynorphin converting enzyme with unusual specificity from rat brain. Proc Natl Acad Sci USA 81:1892-1896, 1984.
- Docherty, K.; Carroll, R.; and Steiner, D.F. Identification of a 31,500 molecular weight islet cell protease as cathepsin B. Proc Natl Acad Sci USA 80:3245-3249, 1980.
- El-Dorry, H.A.; Bull, H.G.; Kazushi, I.; Thornberry, N.A.; Cordes, E.H.; and Soffer, R.L. Molecular and catalytic properties of rabbit testicular dipeptidyl carboxypeptidase. J Biol Chem 282:14128-14133, 1982.
- Evangelista, R.; Purinima, R.; and Lewis, R.V. "Trypsin-like" enzyme in adrenal chromaffin granules: A proenkephalin processing enzyme. Biochem Biophys Res Commun 106:895-902, 1982.
- Fricker, L.D., and Snyder, H. Enkephalin convertase purification and characterization of a specific enkephalin synthesizing carboxypeptidase localized in adrenal chromaffin granules. Proc Natl Acad Sci USA 79:3886-3890, 1982.
- Fulcher, I.S.; Matsas, R.; Turner, A.J.; and Kenny, A.J. Kidney neutral endopeptidase and the hydrolysis of enkephalins by synaptic membranes show similar sensitivity to inhibitors. Biochem J 203:519-522, 1982.
- F&her, I.S.; Chaplin, M.F.; and Kenny, A.J. Endopeptidase-24-11 purified from pig intestine is differently glycosylate from that in kidney. Biochem J 215:317-323, 1983.
- Grynbaum, A., and Marks, N. Characterization of a rat brain catheptic carboxypeptidase (cathepsin A) inactivating angiotensin-II. J Neurochem 26:313-318, 1976.
- Hachisu, M.; Nakamura, T.; Kawashima, H.; Shitoh, K.; Fukatsu, S.; Koeda, T.; Sekizawa, Y.; Munakata, M.; Kamamura, K.; Umezawa, H. Takeachi, T.; and Aoyagi, T. Relationship between enhancement of morphine analgesia and inhibition of enkephalinase by 2S, 2R 3-amino-2-hydroxy-4-phenylbutanoic acid derivatives. Life Sci 30:1739-1746, 1982.
- Hanson, G.R., and Lovenberg, W. Elevation of substance P-like immunoreactivity in rat CNS by protease inhibitors. J Neurochem 35:1370-1374, 1982.
- Hayashi, M. Monkey brain arylamidase. II. Further characterization and studies on mode of hydrolysis of physiologically active peptide. J Biochem (Tokyo) 84:1363-1372, 1978.
- Hayashi, M., and Oshino, K. Purification and characterization of arylamidase from monkey brain. J Biochem (Tokyo) 81:631-639, 1977.

- Hazato, T.; Inagaki-Shimamura, M.; Katayana, T.; and Yamamdo, T. Separation and characterization of a dipeptidyl aminopeptidase that degrades enkephalins from monkey brain. Biochem Biophys Res Commun 105:470-475, 1982.
- Hersh Solubilization and characterization of two rat brain membrane-bound aminopeptidases active on Met-enkephalin. Biochemistry 20:2345-2350 1981.
- Hersh, L.B. Degradation of enkephalins: The search for an enkephalinase. Mol Cell Biochem 47:35-43, 1982.
- Hersh, L.B., and McKelvy, J.F. An aminopeptidase from bovine brain which catalyzes the hydrolysis of enkephalin. J Neurochem 36:171-178, 1981.
- Hook, V.Y.H., and Loh, Y.P. Carboxypeptidase B-like converting enzyme activity in secretory granules of rat pituitary. Proc Natl Acad Sci USA 81:2776-2780, 1984.
- Hook, V.Y.; Eiden, L.E.; and Brownstein, M.J. A carboxypeptidase processing enzyme for enkephalin precursors. Nature 295:341-342, 1982.
- Hui, K.-S.; Wang, Y.-J.; and Lajtha, A. Purification and characterization of an enkephalin aminopeptidase from rat brain membranes. Biochemistry 22:1063-1067, 1983.
- Jackson, J.C., and Blobel, G. Post-translational processing of full length presecretory proteins with canine pancreatic signal peptidase. Ann NY Acad Sci 143:391-404, 1980.
- Jacquet, Y., and Marks, N. The C-fragment of  $\beta$ -lipotropin, an endogenous neuroleptic or an antipsychotogen. Science 194:632-635, 1976.
- Kelly, J.A.; Neidle, E.L.; and Neidle, A. An aminopeptidase from mouse brain cytosol that cleaves N-terminal acidic amino acid residues. J Neurochem 40(6):1727-1734, 1983.
- Kenny, A.J. Proteinases associated with cell membranes. In: Barratt, A.J., ed. Proteinases in Mammalian Cells and Tissues. Amsterdam: North Holland Publishing Co., 1977. pp. 393-422.
- Kerr, M.A., and Kenny, A.J. The purification and specificity of a neutral endopeptidase from rabbit kidney brush border. Biochem J 137:477-488, 1974.
- Knighit, M.; Plotkin, C.; and Tamminga, C.A. Brain endopeptidase generates enkephalin from striatal precursors. Peptides 3:461-468, 1982.
- Koida, M.; Ano, J.; Takenaga, K.; Yoshimoto, T.; Kimura, T.; and Sakakibara, S. A novel enzyme in rat brain converting  $\beta$ -endorphin into methionine enkephalin: Affinity-chromatography and specificity. J Neurochem 33:1233-1237, 1979.
- Kopitar, N.; Stern, F.; and Marks, N. Cerebrocystatin suppresses degradation of myelin basic protein by purified cysteine proteinase. Biochem Biophys Res Commun 112:1000-1006, 1983.
- Lee, C.-M., and Snyder, S.H. Dipeptidyl-aminopeptidase III of rat brain. J Biol Chem 257:12043-12050, 1982.
- Leslie, F.M., and Goldstein, A. Degradation of dynorphin (1-13) by membrane-bound rat brain enzymes. Neuropeptides 2:185-196, 1982.
- Lindberg, I.; Yang, H.-Y.T.; and Costa, E. An enkephalin-generating enzyme in bovine adrenal medulla. Biochem Biophys Res Commun 106:185-193. 1982.



- Loh, Y.P., and Gainer, H. Characterization of Pro-opiocortin-converting activity in purified secretory granules from rat pituitary neurointermediate lobe. Proc Natl Acad Sci USA 79:108-112, 1982.
- Marks, N. Exopeptidases of the nervous system. Int Rev Neurobiol 11:57-97, 1968.
- Marks, M. Conversion and inactivation of neuropeptides. In: Gainer, H., ed. Peptides in Neurobiology. New York: Plenum Press, 1977. pp. 221-258.
- Marks, N., and Benuck, M. Metalloenzymes and cleavage of the Gly-Phe bond of enkephalins: Comparison of purified enzymes with membranes and effect of MK-421 and thiorphan. In: Ehrenpreis, S. and Sicuteri, F., eds. Degradation of Endogenous Opioids: Its Relevance in Human Pathology and Therapy. New York: Raven Press, 1983. pp.67-81.
- Marks, N., and Tajtha, A. Developmental changes in peptide-bond hydrolases. In: Lajtha, A., ed. Protein Metabolism of the Nervous System. New York: Plenum Press, 1970. pp. 39-75.
- Marks, N., and Sachs, L. Specificity of dipeptidyl peptidase I-III with evidence that I and III act as enkephalinases. J Neurochem 41(supp):S.99, 1983.
- Marks, N.; Datta, R.K.; and Tajtha, A. Partial resolution of brain arylamidase and aminopeptidase. J Biol Chem 243:2882-2889, 1968.
- Marks, N.; Grynbaum, A.; and Benuck, M. On the sequential cleavage of myelin basic protein by cathepsins A and D. J Neurochem 1:93-111, 1976.
- Marks N.; Sachs, L.; and Stem, F. Conversion of Met-enkephalin-Arg<sup>6</sup>-Phe<sup>7</sup> by a purified brain carboxypeptidase (cathepsin A). Peptides, 2:159-164, 1981.
- Marks, N., Bernuck, M.J.; and Sachs, L. Metabolism of enkephalin analogs and surrogates having enhanced pharmacologic activities. Ann NY Acad Sci 398:308-326, 1982a.
- Marks, N.; Sachs, L.; Berg, M.J.; Stem, F.; and Benuck, M. Conversion of Met-enkephalin-Arg-Phe by brain carboxypeptidases and membrane fractions. Adv Biochem Psychopharmacol 33:281-289, 1982b.
- Marks, N.; Lo, E.-S.; Stem, F.; and Danho, W. Observations on N-deacetylation of model amino acids and peptides: Distribution and purification of a specific N-acyl amino acid releasing enzyme in rat brain. J Neurochem 40:201-208, 1983.
- Marks, N.; Berg, M.J.; Kastin, A.J.; and Coy, D.H. Evidence for conversion of N-Tyr-MIF-I into MIF-I by a specific brain carboxypeptidase. Neurochem Int 6:347-353, 1984.
- Marks, N.; Kopitar, M.; Berg, M.J.; and Stem, F. Proenkephalin and enkephalin metabolism by rat brain cathepsin B: Conversion, inactivation and suppression by endogenous inhibitor. In: Khairallah, E., and Bond, J., eds. Proteases and Endogenous Inhibitors. New York: Raven Press, in press.
- Mason, A.J.; Evans, B.A.; Cox, D.R.; Shine, J.; and Richards, R.I. Structure of mouse kallikrein gene family suggests role in specifically processing of biological active peptides. Nature 303:300-307, 1983.

- Matsas, R; Fulcher, I.S.; Kenny, A.J.; and Turner, A.J.  
 Substance P and Leu-enkephalin are hydrolyzed by an enzyme in pig caudate synaptic membranes that is identical with the endopeptidase of kidney microvilli. Proc Natl Acad Sci USA 80:3111-3115, 1983.
- McDonald, J.K., and Schwabe, C. Intracellular exopeptidases. In: Barret, A.J., ed. Proteinases in Mammalian Cells and Tissues. Amsterdam: North Holland Publishing Co., 1977. pp. 311-386.
- Mizuno, K.; Miyata, A; Kangawa, K.; and Matsuo, H. A unique proenkephalin converting enzyme purified from bovine adrenal chromaffin granules. Biochem Biophys Res Commun 108:1235-1242, 1982.
- Moore, H.H.; Walker, M.D.; Lee, F.; and Kelly, RB. Processing of human cDNA in a mouse ACTH-secreting cell: Intracellular storage, proteolytic processing and secretion on stimulation. Cell 35:531-538, 1983.
- Mumford, R.A.; Strauss, A.W.; Powers, J.C.; Pierzchala, P.A.; Norikazu, N.; and Zimmerman, M. A zinc metalloendopeptidase associated with dog pancreatic membranes. J Biol Chem 255:2227-2230, 1980.
- Mumford, R.A.; Pierzchala, P.A.; Strauss, A.W.; and Zimmerman, M. Purification of a membrane-bound metalloendopeptidase from porcine kidney that degrades peptide hormones. Proc Natl Acad Sci USA 78:6623-6627. 1981.
- Neidle, A. Leucine aminopeptidase from mouse brain. Trans Am Soc Neurochem 12:275, 1981.
- Neidle, A and Kelly, J.A. The isolation of a dipeptidyl dipeptidase from mouse cytosol that cleaves adrenocorticotrophic hormone (7-10) and des-tyrosine enkephalins. Arch Biochem Biophys 223:115-126:, 1984.
- Neidle, A.; Yessaian, N.; and Lajtha, A. Degradation of MIF by mouse brain. Neurochem Res 5:1011-1023, 1980.
- Neidle, A.; Berg, M.J.; and Marks, N. The isolation of an X-Pro aminopeptidase from rat brain cytosol. Trans Am Soc Neurochem 15:120, 1984.
- Orlowski, M., and Wilk, S. Purification and specificity of a membrane-bound metalloendopeptidase from bovine pituitaries. Biochemistry 20:4942-4950, 1981.
- Orlowski, M.; Michaud, C.; and Wilk, S. Generation of methionine and leucine-enkephalini from precursor molecules by cation sensitive neutral endopeptidase by bovine pituitary. Biochem Biophys Res Commun 94:1145-1153. 1980.
- Schnebli, H.P. Phillips, M.A.; and Barclay, R.K. Isolation and characterization of an enkephalin degrading aminopeptidase from rat brain. Biochem Biophys Acta 569:89-98, 1979.
- Schwartz, J.-C.; Malfroy B.; and de la Baume, S. Biological inactivation of enkephalins and the role of enkephalin-dipeptidyl-carboxypeptidase ("enkephalinase") as neuropeptidase. Life Sci 29:1715-1740, 1981.
- Seizinger, B.R.; Grimm, C.; Holt, V.; and Herz, A. Evidence for a selective processing of proenkephalin B into different opioid peptide forms in particular regions of rat brain and pituitary. J Neurochem 42:447-457, 1984.
- Shimamura, M.; Hazeto, T.; Hachisu, M.; and Katayama, T. Inhibition of a membrane-bound enkephalin-degrading aminopeptidase by bestatin analogs. J Neurochem 43:888-890, 1984.

- Soffer, R.L. Angiotensin converting enzyme. In: Soffer, R.L., ed. Brochemical Regulation of Blood Pressure. New York: John Wiley, 1981. pp. 123-164.
- Stack, G.; Kicker, L. D.; and Snyder, S.H. A sensitive radio-active assay for enkephalins convertase and other carboxypeptidase B-like enzyme. Life Sci 34:113-121, 1984.
- Stem, F., and Marks, N. Glycyl-glycine hydrolase of rat brain: Distribution and in cleavage of glycine rich oligopeptides. Brain Res Bull 4:49-55, 1979.
- Strittmatter, S.M.; Lo, M.S.; Javitch, J.A.; and Snyder, S.H. Autoradiographic visualization of angiotensin-converting enzyme in rat brain with [<sup>3</sup>H]captopril: Localization to a striatonigral pathway. Proc Natl Acad Sci USA 81:1599-1603, 1984.
- Suhar, A., and Marks, N. Purification and properties of brain cathepsin B. Evidence for cleavage of pituitary lipotropins. Eur J Biochem 101:23-30, 1979.
- Suhar, A.; N.; Turk, V.; and Benuck, M. On the metabolism of opiate peptides by brain proteolytic enzymes. In: Turk, V., and Vitale, E.J., eds. Proteins and Their Inhibitors. New York: Pergamon Press, 1981 pp. 33-41,
- Summy-Long, J.Y.; Keil, L.C.; Dean, K.; Rosella, L.; and Severs, W.B. Endogenous opioid inhibition of the central actions of angiotensin. J Pharmacol Exp Ther 217:619-629, 1981.
- Supattapone, S.; Fricker, L.D.; and Snyder, S.H. Purification and characterization of a membrane-bound enkephalin forming carboxypeptidase "enkephalin convertase". J Neurochem 42:1017-1023, 1984,
- Suszkiv, J.B., and Brecher, A.S. Brain amino acyl arylamidase. Further purification of the soluble bovine enzyme and studies on substrate specificity and possible active site residues. Biochemistry 9:4008-4017, 1970.
- Symposium 1984 Research Forum: Angiotensin-converting enzyme inhibitors. Fed Proc 43(5):1313-1350, 1984.
- Tobe, H.; Morishima, H.; Aoyagi, T.; Umezawa, H.; Ishiki, K.; Nakamura, K.; Yoshioka, T.; Shimauchi, Y.; and Inui, T. Synthesis and structure-activity relationships of anastatin analogues, inhibitors of aminopeptidase A. Agric Biol Chem (Japan) 46(7):1865-1872, 1982.
- Traficante, L.J.; Rotrosen, J.; Siekierski, J.; Tracer, H.; and Gershon, S. Enkephalin inactivation by N-terminal tyrosine cleavage: Purification and partial characterization of a highly specific enzyme from human brain. Life Sci 26:1697-1706, 1980.
- Troy, C.M., and Musacchio, J.M. Processing of enkephalin precursors by chromaffin granule enzymes. Life Sci 31:1717-1720, 1982.
- Wagner, G.W., and Dixon, J.C. Inhibitors of a rat brain enkephalin aminopeptidase. J Neurochem 37:709-713, 1981.
- Wagner, G.W.; Taviani, N.A.; Herrmann, K.M.; and Dixon, J.C. Purification and characterization of an enkephalin aminopeptidase from rat brain. Biochemistry 20:3884-3990, 1981.
- Walker, J.M.; Moises, H.C.; Coy, D.H.; Balrighi, G.; and Akil, H. Non-opiate effects of dynorphin and desTyr dynorphin. Science 218:1136-1138, 1982.

- Wallace, E.F.; Weber, E.; Barchas, J.D.; and Evans, C.J. A putative processing enzyme from aplysia that cleaves dynorphin A at the single arginine residue. Biochem Biophys Res Commun 119:415-422. 1984.
- Walter, P., and Blobel, G. Disassembly and reconstruction of signal recognition particle. Cell 34:525-533, 1983.
- Yokosawa, H.; Ogura, Y.; and Ishii, S.-I. Unification and inhibition by neuropeptides of angiotensin converting enzyme from rat brain. J Neurochem 41:403-410, 1983a.
- Yokosawa, H.; Eudo, S.; Ogura, Y.; and Ishii, S.-I. A new feature of angiotensin converting enzyme in the brain: Hydrolysis of substance P. Biochem Biophys Res Commun 116:735-742, 1983b.

## **AUTHORS**

Neville Marks, Research Scientist  
Myron Bernuck, Research Scientist  
Martin J. Berg, Research Technician  
Center for Neurohistory  
The Nathan S. Kline Institute for Psychiatric Research  
Ward's Island  
New York, New York 10035

# Isolation and Identification of Opioid Peptides

Hisayuki Matsuo, Ph.D.

## INTRODUCTION

It is well known that a variety of peptides participate in a complex network of neural and hormonal communications. In order to clarify the subtle mechanism of peptidergic communication, it is essential that yet unidentified peptides be discovered. Identification of the key peptide leads us to further discoveries of its related peptides or precursor, with the aid of immunochemical methods and recombinant DNA techniques. Radioimmunoassay and immunohistochemical data, as well as pharmacological findings, will provide further information on the newly identified peptide.

Within a few years of the discovery of the two enkephalins in brain (Hughes et al. 1975), an explosive series of related discoveries have revealed the existence of a vast network of enkephalin-containing peptides that are produced in many tissues by the processing of at least three genetically distinct precursors.

Soon after discovery of the Met- and Leu-enkephalins, Met-enkephalin sequence was fortunately found in  $\beta$ -lipotropin (Hughes et al. 1975) and  $\beta$ -endorphin (Bradbury et al. 1976; Li et al. 1976). These facts led to identification of pro-opiomelanocortin (POMC) (Nakanishi et al. 1979) as a common precursor of  $\beta$ -endorphin and adrenocorticotrophic hormone (ACTH). To many it seemed obvious that Met-enkephalin was derived from, POMC via processing through  $\beta$ -lipotropin and  $\beta$ -endorphin. However, POMC does not contain a Leu-enkephalin unit. Furthermore, although the  $\beta$ -endorphin sequence is preceded by a Lys-Arg sequence, a typical processing signal, the Met-enkephalin sequence is not followed by a recognized signal for proteolytic processing. This would indicate that the  $\beta$ -endorphin sequence is not programmed to be a precursor of Met-enkephalin. Moreover, it had been shown that the tissue distribution of the enkephalins did not parallel that of  $\beta$ -endorphin. In order to

answer the question as to the nature of the precursors of Met- and Leu-enkephalins, we carried out a systematic survey for possible precursors of the two enkephalins in hypothalamic tissue and in adrenal medulla.

#### **STRATEGY OF OUR SURVEY FOR THE UNIDENTIFIED PEPTIDES**

As previously mentioned, it is essential for understanding the mechanism of peptidergic communication if unidentified peptides are to be discovered. However, there have been two major obstacles in the search for the novel peptides in the tissues. One arises from the unfavorable proteolytic decomposition of the objective peptide and fragmentation of other higher molecular proteins, which seriously interfere with the separation and lower the yield of the peptide. Therefore, tremendous amounts of the tissue must be collected for the isolation. It is well known that Schally collected 165,000 pig hypothalami to obtain only 200  $\mu\text{g}$  of the purified LH-RH (Matsuo et al. 1971). However, about 20,000 hypothalami are sufficient to obtain 200  $\mu\text{g}$  of LH-RH, according to the actual content of LH-RH determined by radioimmunoassay (RIA). Such a big difference mainly is a result of proteolytic decomposition of LH-RH during the extraction. Therefore, methods should be developed to inactivate the intrinsic protease activity. After numerous trials, we found that boiling of the tissues for 10 minutes before homogenization is most effective for inactivation of proteases to minimize the decomposition of the peptide (Kangawa et al. 1984). Moreover, recent progress in the sequencing techniques makes it possible to determine the complete structure at the sacrifice of the sample of at most 10 nanomoles. Thus, now we are able to carry out the search for the peptides in the brain of small laboratory animals. For instance, we successfully purified two distinct LH-RH-like peptides (Gn-RH I and II), eliciting gonadotropin (Gn)-releasing activity, from only 2,000 chicken hypothalami and sequenced them, as shown in figure 1 (Miyamoto et al. 1983; Miyamoto et al. 1984). In this study, the sensitive assay using cultured pituitary cell system was effectively used for detecting Gn-releasing activity. However, such a specific assay relevant for monitoring the new peptides is not always available. Thus, the second but most serious obstacle is difficulty in discovering the appropriate tools for finding undiscovered species in the tissues. Most of neuropeptides so far identified elicit a variety of biological and pharmacological actions according to the method used. For instance, substance P exhibits a wide spectrum of diverse activities, such as smooth-muscle stimulation, and hypotensive and sialogogic effects. These facts suggest that sensitive assay system for the effects on muscle contraction or blood pressure, even though they are not specific, would be well suited for detecting unknown bioactive peptides. In this context, we have been conducting the systematic survey for the unidentified peptides by utilizing our "nonspecific assay method" for the effects on contractility of smooth-muscle preparations or blood pressure.

chicken Gn-RH I: pGlu-His-Trp-Ser-Tyr-Gly-Leu-Gln-Pro-Gly-NH<sub>2</sub>  
 chicken Gn-RH II: pGlu-His-Trp-Ser-His-Gly-Trp-Tyr-Pro-Gly-NH<sub>2</sub>  
 mammalian LH-RH: pGlu-His-Trp-Ser-Tyr-Gly-Leu-Arg-Pro-Gly-NH<sub>2</sub>

FIGURE 1  
 Amino Acid Sequences of Chicken Gonadotropin-releasing Hormone

<b>Group I: <math>\beta</math>-endorphin-<math>\beta</math>-LPH-proopiomelanocortin series</b>	
$\beta$ -endorphin	Tyr-Gly-Gly-Phe-Met-Thr-Ser-Glu-Lys-Ser-Gln- Thr-Pro-Leu-Val-Thr-Leu-Phe-Lys-Asn-Ala-Ile- Ile-Lys-Asn-Ala-Tyr-Lys-Lys-Gly-Gln
$\alpha$ -endorphin	Tyr-Gly-Gly-Phe-Met-Thr-Ser-Val-Thr
$\gamma$ -endorphin	Tyr-Gly-Gly-Phe-Met-Thr-Ser-Val-Thr-Leu
$\delta$ -endorphin	Tyr-Gly-Gly-Phe-Met-Thr-Ser-Asn-Ala-Tyr
<b>Group II: <math>\alpha</math>-neo-endorphin, dynorphin series</b>	
$\alpha$ -neo-endorphin*	Tyr-Gly-Gly-Phe-Leu-Arg-Lys-Tyr-Pro-Lys
$\beta$ -neo-endorphin*	Tyr-Gly-Gly-Phe-Leu-Arg-Lys-Tyr-Pro
[Arg <sup>4</sup> ]-Leu-enkephalin*	Tyr-Gly-Gly-Phe-Leu-Arg
dynorphin	Tyr-Gly-Gly-Phe-Leu-Arg-Arg-Ile-Arg-Pro-Lys-Leu- Lys-Trp-Asp-Asn-Gln
PH-8P (dynorphin[1-8])*	Tyr-Gly-Gly-Phe-Leu-Arg-Arg-Ile
Leu-enkephalin	Tyr-Gly-Gly-Phe-Leu
rimorphin	Tyr-Gly-Gly-Phe-Leu-Arg-Arg-Gln-Phe-Lys-Val- Val-Thr
<b>Group III: adrenomedullary "big" enkephalin series</b>	
Met-enkephalin	Tyr-Gly-Gly-Phe-Met
Leu-enkephalin	Tyr-Gly-Gly-Phe-Leu
[Arg <sup>4</sup> ]-Met-enkephalin	Tyr-Gly-Gly-Phe-Met-Arg
[Arg <sup>4</sup> , Phe <sup>5</sup> ]-Met-enkephalin	Tyr-Gly-Gly-Phe-Met-Arg-Phe
[Arg <sup>4</sup> , Gly <sup>5</sup> , Leu <sup>6</sup> ]-Met-enkephalin	Tyr-Gly-Gly-Phe-Met-Arg-Gly-Leu
BAM-12P*	Tyr-Gly-Gly-Phe-Met-Arg-Arg-Val-Gly-Arg- Pro-Glu
BAM-20P*	Tyr-Gly-Gly-Phe-Met-Arg-Arg-Val-Gly-Arg- Pro-Glu-Trp-Trp-Met-Asp-Tyr-Gln-Lys- Arg
BAM-22P*	Tyr-Gly-Gly-Phe-Met-Arg-Arg-Val-Gly- Arg-Pro-Glu-Trp-Trp-Met-Asp-Tyr-Gln- Lys-Arg-Tyr-Gly
BAM-25P (peptide E)*	Tyr-Gly-Gly-Phe-Met-Arg-Arg-Val-Gly- Arg-Pro-Glu-Trp-Trp-Met-Asp-Tyr-Gln- Lys-Arg-Tyr-Gly-Gly-Phe-Leu
peptide F	Tyr-Gly-Gly-Phe-Met-Lys-Lys-Met-Asp- Glu-Leu-Tyr-Pro-Leu-Glu-Val-Glu-Glu- Glu-Ala-Asn-Gly-Gly-Glu-Val-Leu-Gly- Lys-Arg-Tyr-Gly-Gly-Phe-Met

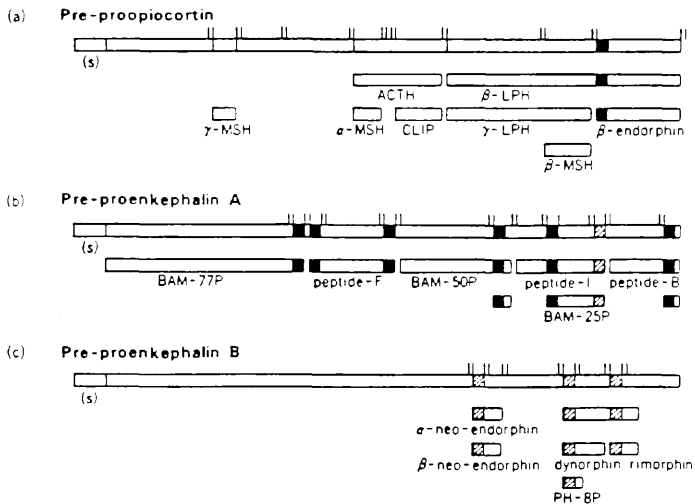
FIGURE 2  
 Sequences of Endogenous Opioid Peptides  
 (\* indicates the peptides identified by our group)

As a matter of fact,  $\alpha$ -neo-endorphin was originally discovered in the fraction exhibiting hypotensive effect of hypothalamic extracts (Kangawa et al. 1979). The result reveals that our assay method, even though not specific, is a useful tool for detecting still undiscovered peptides. Furthermore, our nonspecific assay led us to the identification of neuromedins K (Kangawa et al. 1983), L (Minamino et al. 1984) [kassinin-like], B (Minamino et al. 1984), C (Minamino et al. 1984) [bombesin-like], and N (Minamino et al. 1984) (neurotensin-like) in porcine spinal cord. They were isolated as the peptides eliciting smooth-muscle stimulant activity.

#### **DISCOVERY OF $\alpha$ -NEO-ENDORPHIN AND "BIG" LEU-ENKEPHALINS RELATED TO PROENKEPHALIN B**

From the earlier stage of our survey, we have utilized a very simple in vitro assay to determine the effect on the contractility of various smooth-muscle preparations or on the blood pressure (rat and rabbit), even though they are not so specific. By the aid of such a nonspecific assay,  $\alpha$ -neo-endorphin was originally isolated from the fraction eliciting hypotensive activity of porcine hypothalamic extracts. Even at the time when the peptide was obtained in a pure state, it was not known that the peptide is the first form of the long-sought "big" Leu-enkephalin, having a potent morphinomimetic activity. During the sequencing, we first realized that the peptide has a Leu-enkephalin unit at its N-terminal portion, which is followed by a paired basic signal of Arg-Lys. Then, the peptide was named "neo-endorphin" (Kangawa et al. 1979; Kangawa et al. 1981). A little later on, dynorphin, which retained opioid activity even after cyanogen bromide treatment, was purified as the second form of the "big" Leu-enkephalin by Goldstein and co-workers (Goldstein et al. 1979; Tachibana et al. 1982). The discovery of  $\alpha$ -neo-endorphin and dynorphin initiated a search for the unknown Leu-enkephalin precursor. In the attempted survey for the still unknown "big" enkephalin or proenkephalin, pharmacological assay for opiate activity or radioreceptor assay was usually used. However, such methods are not able to discriminate the objective "big" Leu-enkephalins from the known opioid peptides, but identification of the key peptides led us to further discoveries of its related peptides or precursor. When  $\alpha$ -neo-endorphin and dynorphin were identified, it was not so hard to find their related peptides, indicating a product-precursor relationship. Since  $\alpha$ -neo-endorphin and dynorphin have (Arg<sup>6</sup>)-Leu-enkephalin moiety in common at their N-terminus, which is easily released by trypsinization, we raised the antiserum specific for (Arg<sup>6</sup>)-Leu-enkephalin and established sensitive radioimmunoassay for this tryptic fragment (Kangawa et al. 1980). With the aid of the RIA coupled with trypsinization, two novel "big" Leu-enkephalins named  $\beta$ -neo-endorphin (Minamino et al. 1981) and PH-8P (dynorphin(1-8)) (Minamino et al. 1980) were identified (figure 2). Based on these findings, Numa and co-workers (Kakidani et al. 1982) elucidated the base sequence of cDNA encoding their common precursor, named preproenkephalin B, which also contains the third Leu-enkephalin unit, named Leu-morphin or rimorphin (figure 3).





**FIGURE 3**

Schematic Structures of the Precursors and the Processed Opioid Peptides. Black and hatched boxes represent Met- and Leu-enkephalin units, respectively.

#### Radioimmunoassay for (Arg<sup>6</sup>)-Leu-Enkephalin

The antiserum against (Arg<sup>6</sup>)-Leu-enkephalin was raised in rabbits to synthetic (Arg<sup>6</sup>)-Leu-enkephalin coupled with carbodiimide to bovine serum albumin. The antiserum was usable at a final dilution of 1:0,000 for the radioimmunoassay for (Arg<sup>6</sup>)-Leu-enkephalin, utilizing <sup>125</sup>I-labeled ligand under conditions where 30% to 40% of ligands were bound to the antiserum. As seen from figure 4, (Arg<sup>6</sup>)-Leu-enkephalin is measurable by this method with the sensitivity of less than 1 pg/tube and the measurable range of the inhibition curve is 1 pg to 10<sup>4</sup> pg. The specificity of the antiserum was evaluated by determining its cross-reactivity with several peptides.  $\beta$ -Endorphin does not cross-react with the antiserum at all in the entire region of concentrations tested and Met- and Leu-enkephalins do not cross-react appreciably with the antiserum. This fact verifies that arginyl residue at the carboxyl terminus of the ligand is necessary for the sensitive recognition by the antiserum. Thus, the present radioimmunoassay, if used after trypsinization of sample, makes it possible to detect with good sensitivity the "big" Leu-enkephalins, such as  $\alpha$ -neo-endorphin or dynorphin in the tissues, which easily releases an (Arg<sup>6</sup>)-Leu-enkephalin from the molecule by trypsinization. The antiserum also shows some cross-reactivity with (Arg<sup>6</sup>)-Met-enkephalin containing peptides, although sensitivity is of course not so high as in the case of (Arg<sup>6</sup>)-Leu-enkephalin (Kangawa et al. 1980).

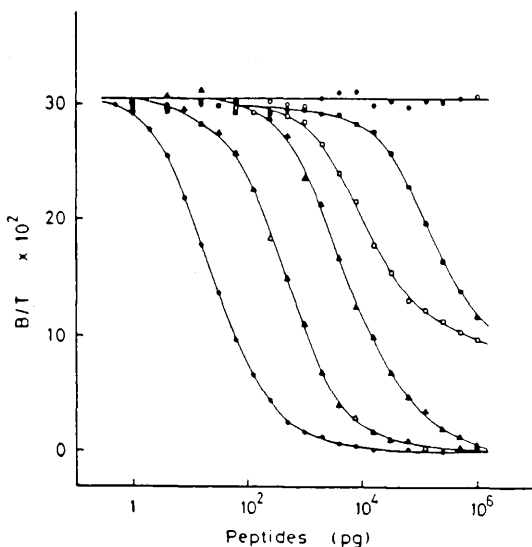


FIGURE 4

Inhibition of binding of  $^{125}\text{I}$ -labeled  $(\text{Arg}^6)$ -Leu-enkephalin to the antiserum raised against  $(\text{Arg}^6)$ -Leu-enkephalin by serial dilution of unlabeled ligands:  $(\text{Arg}^6)$ -Leu-enkephalin ( $\bullet$ ),  $(\text{Arg}^6)$ -Met-enkephalin ( $\triangle$ ),  $(\text{Arg}^6, \text{Lys}^7)$ -Leu-enkephalin ( $\blacktriangle$ ), Leu-enkephalin ( $\square$ ), Met-enkephalin ( $\blacksquare$ ), and  $\beta\text{h}$ -endorphin ( $\circ$ ). Antiserum used at 1:70,000 dilution.

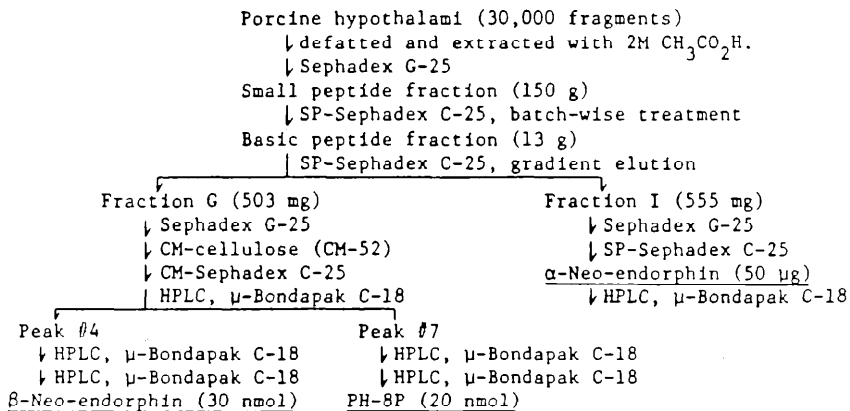


FIGURE 5

Purification Procedures of "Big" Leu-Enkephalins from Porcine Hypothalamus

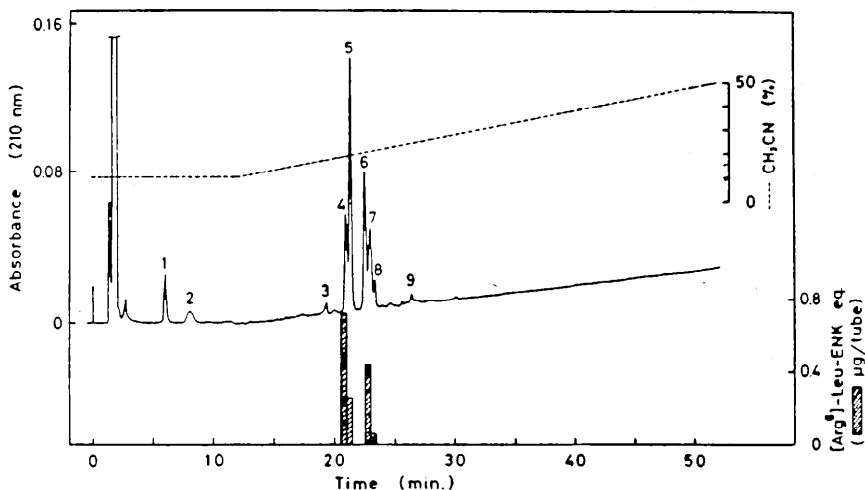


FIGURE 6

Separation of  $\beta$ -Neo-Endorphin(#4) and PH-8P(#7) on Reverse-Phase HPLC by the Aid of RIA for (Arg<sup>6</sup>)-Leu-Enkephalin

Hatched bars represent (Arg<sup>6</sup>)-Leu-enkephalin immunoreactive peaks(#4 and #7). Column:  $\mu$ -Bondapak C-18 (Waters). Solvent system: A linear gradient from (A) to (B). (A) : 0.05M phosphate buffer(pH2.0): CH<sub>3</sub>CN = 90:10; (B) : 0.05M phosphate buffer(pH2.0): CH<sub>3</sub>CN = 50:50

### Purification

On every purification step, pro-Leu-enkephalin containing fractions were monitored by the use of RIA for (Arg<sup>6</sup>)-Leu-enkephalin, coupled with trypsinization. The outline of the purification procedures is summarized in figure 5. A low-molecular-weight and basic peptide fraction, obtained from the acid extracts of porcine hypothalami (30,000 fragments), was chromatographed on SP-Sephadex C-25. In this chromatographic separation, there were two major immunoreactive fractions, designated as fraction G (tubes 115-129) and fraction I (tubes 149-160), when the latter  $\alpha$ -neo-endorphin was purified. Fraction G yielded a single immunoreactive peak after the successive chromatographies, as listed in fig. 5. This immunoreactive material was separated into two immunoreactive peaks (peaks 4 and 7), as shown in figure 6. Peaks 4 and 7 were further purified by repeated HPLC. Finally,  $\beta$ -neo-endorphin (30 nmol) from peak 4 and PH-8P (20 nmol) from peak 7 were purified, respectively, to homogeneity (Minamino et al. 1980, 1981)

### Structural Analyses

All of the structural analyses were carried out in a nanomole scale. Control experiments were made in every case under exactly

the same conditions except that only the sample peptide was omitted.

Sequence analyses were performed mainly by the manual dansyl-Edman procedure. Special caution was exercised to avoid loss of the peptide on the extraction step by aqueous butyl acetate. Results thus obtained are summarized in figure 3. Sequence analyses of  $\alpha$ - and  $\beta$ -neo-endorphin were successfully performed up to the carboxyl ends. C-Terminal Lys of  $\alpha$ -neo-endorphin was also identified by the  $^3\text{H}$ -labeling method. In the case of PH-8P, its sequence analysis, combined with C-terminal analysis by carboxypeptidase A, revealed the complete structure. Furthermore, tryptic peptides of PH-8P and  $\beta$ -neo-endorphin were isolated by HPLC and the amino acid sequence was determined to corroborate their structures elucidated above. Consequently, the complete amino acid sequences of PH-8P and  $\beta$ - and  $\alpha$ -neo-endorphin have been established, as shown in figure 2.

According to the proposed structures, PH-8P,  $\beta$ - and  $\alpha$ -neo-endorphin, and their tryptic peptides were newly synthesized. The structures of  $\alpha$ - and  $\beta$ -neo-endorphin and PH-8P (determined above) were confirmed in the following way. Upon trypsinization, each peptide was found to be cleaved specifically at the linkage (6-7) to yield only two tryptic fragments, which were well separated on HPLC. The chemical structures of the tryptic peptides separated above were confirmed by the chromatographical comparison on HPLC with synthetic peptides. In the case of  $\alpha$ -neo-endorphin, chymotryptic peptides were also compared on HPLC with authentic specimens. Confirmation of the proposed structures of PH-8P,  $\beta$ - and  $\alpha$ -neo-endorphin was provided by comparing natural peptides with synthetic ones on HPLC.

Thus,  $\alpha$ -neo-endorphin was shown to be C-terminally extended peptide of  $\beta$ -neo-endorphin. On the other hand, PH-8P was found to be the N-terminal octapeptide of dynorphin and previously only the partial sequence (1-13) was known (Minamino et al. 1980, 1981).

#### **"BIG" ENKEPHALINS IN BOVINE ADRENOMEDULLARY GLAND**

On the other hand, Udenfriend and his co-workers (Udenfriend et al. 1983) and our group (Mizuno et al. 1980a; Mizuno et al. 1980b; Mizuno et al. 1981) have identified a variety of enkephalin-containing peptides in adrenomedullary gland, all of which are known to be processed from the third precursor named preproenkephalin A. Thus, all the endogenous opioid peptides so far identified are derived from either of three genetically distinct precursors: pre-POMC and preproenkephalin A and B.

Since the antiserum used above shows 5% cross-reactivity with  $[\text{Arg}^6]$ -Met-enkephalin, the radioimmunoassay mentioned above has proven its capability to detect not only  $(\text{Arg}^6)$ -Leu-enkephalin, but also  $(\text{Arg}^6)$ -Met-enkephalin with an appreciable sensitivity.

Using radioimmunoassay coupled with trypsinization, we successfully purified a dodecapeptide (BAM-12P) as a novel "big" Met-enkephalin (Mizuno et al. 1980). Furthermore, two novel "big" Met-enkephalins, a docosapeptide (BAM-22P) and eicosapeptide (BAM-20P), both of which yield immunoreactive (Arg<sup>6</sup>)-Met-enkephalin by the action of trypsin, were also purified (Mizuno et al. 1980a) from the side-fractions that were obtained in the purification of BAM-12P. Sequence analyses have shown that both peptides contain a common BAM-12P sequence at their N-terminals with progressive C-terminal extension. The identification of a series of BAM-22P, -20P, and -12P in the adrenomedullary gland introduces a new family of "big" Met-enkephalins into the opioid field, which may be indicative of the unknown feature of enkephalin biosynthesis. In a similar manner, BAM-18P (Matsuo et al. 1983) --- which corresponds to the N-terminal peptide of BAM-20P and BAM-22P --- and other types of enkephalin-containing peptide have been identified. BAM-30P and BAM-77P were found to have a Met-enkephalin unit at their C-terminal part (Mizuno et al. 1981). On the other hand, Udenfriend and his associates (Udenfriend et al. 1983) identified a new series of enkephalin-containing peptides, such as peptides B, E, F, and I, by the combined treatments of trypsin and carboxypeptidase B, coupled with a radioreceptor assay for the released Met-enkephalin. In particular, peptide E, whose N-terminal part corresponds to BAM-12P, -18P, and -22P, was revealed to contain Met- and Leu-enkephalin units, implying a possibility that Met- and Leu-enkephalin may be derived from a common precursor. Combined results obtained by both groups strongly indicated the presence of the third enkephalin precursor (proenkephalin A), containing six Met-enkephalin units and one Leu-enkephalin unit. These findings afforded the basis for the base sequence analysis of cDNA (Noda et al. 1982) encoding preproenkephalin A.

Thus, all the endogenous enkephalin-containing peptides so far identified are known to be derived from either of three distinct precursors: POMC and preproenkephalin A and B. The recent progress in recombinant DNA analyses provided precise structure of the precursors. Most of the enkephalin units are flanked by paired basic residues composed of Lys and Arg, which are now thought to be typical processing signals. However, our knowledge of the processing event intervening from the precursor to the mature peptides is still very limited (Mizuno et al. 1982). In this context, the discovery of PH-8P in brain raised a quite interesting pattern of processing that occurred before Arg-Pro signal. As clearly seen in the sequence of dynorphin, PH-8P (dynorphin(1-8)) was located at the N-terminal part of dynorphin, and followed by Arg-Pro sequence. Since PH-8P is the predominant opioid in posterior pituitary, it is obvious that PH-8P is processed out of preproenkephalin B precursor by the specific cleavage before Arg-Pro linkage, which so far has not been accepted as the processing site (Mizuno et al. 1984). A similar processing pattern was also observed in the case of preproenkephalin A, as shown in the following section.

## ADRENORPHIN: A C-TERMINALLY AMIDATED OPIOID PEPTIDE

As observed in various peptide hormones, the carboxy terminal amide structure is a unique feature of peptides exhibiting physiological activities. Although a variety of opioid peptides have been identified, such a C-terminally amidated species has never before been discovered in mammals. Adrenorphin isolated from human pheochromocytoma tumor derived from adrenal medulla is the first identification of a peptide with a C-terminal amide structure (Matsuo et al. 1983). The complete amino acid sequence of adrenorphin, as determined by microsequencing, is Tyr-Gly-Gly-Phe-Met-Arg-Arg-Val-NH<sub>2</sub> and corresponds to the sequence of the first eight amino acids of peptide E, which is derived from proenkephalin A. Adrenorphin exhibits a potent opioid activity in guinea pig ileum (GPI) assay. Using an antiserum raised against synthetic adrenorphin, a highly sensitive and specific radioimmunoassay was developed. The peptide has also been identified in normal human and bovine adrenal medulla on reverse-phase HPLC, using the RIA for adrenorphin. The distribution of adrenorphin in rat brain has also been determined (Miyata et al. 1984).

Adrenorphin was purified as follows. A portion corresponding to the lower molecular weight (Mr ca. 2,000) that was separated from acid extracts of tumor tissue by gel filtration on Sephadex G-50 was treated batchwise with CM-cellulose in a buffer of 10 mM ammonium formate (pH 6.6). After washing the resin with the same buffer, the basic peptides adsorbed on the column were eluted with 1M formic acid and the eluates were then pooled. As shown in figure 7, the basic peptide pool obtained above was subjected to reverse-phase HPLC. An aliquot of fractions was trypsinized and then generation of (Arg<sup>6</sup>)-enkephalin was analyzed by RIA utilizing anti-(Arg<sup>6</sup>)-Leu-enkephalin antiserum, having 5% cross-reactivity with (Arg<sup>6</sup>)-Met-enkephalin. As seen in figure 7, five immunoreactive peaks (A to E) were obtained.

Finally, adrenorphin was purified from the portion of peak B by successive reverse-phase HPLC (figure 8). Only a tyrosine residue was identified by dansylation as the amino terminal residue of the peptide thus purified, confirming its homogeneity. On hydrolysis with 6N HCl, adrenorphin afforded the following amino acid composition: Gly 2, Val 1, Met 1, Tyr 1, Phe 1, Arg 2, suggesting its octapeptide structure. The yield of the peptide was 20 nmol from 42.6 g of pheochromocytoma tumor. C-Terminal analysis of adrenorphin by carboxypeptidase method revealed that the C-terminal is blocked. By the stepwise Edman degradation of the native peptide, the complete amino acid sequence thus ascertained is Tyr-Gly-Gly-Phe-Met-Arg-Arg-Val-NH<sub>2</sub>. The presence of C-terminal Val-NH<sub>2</sub> was verified as dansyl-valineamide by thermolytic digestion, followed by dansylation in a manner similar to that described by Tatemoto and Mutt (1978). For structural confirmation, the octapeptide amide, according to the adrenorphin sequence determined above, was synthesized by solid-phase techniques, conducted on a p-methyl-benzhydrylamines resin. Des-amido-adrenorphin (adrenorphin-OH), having a free carboxy terminus, was also synthesized.

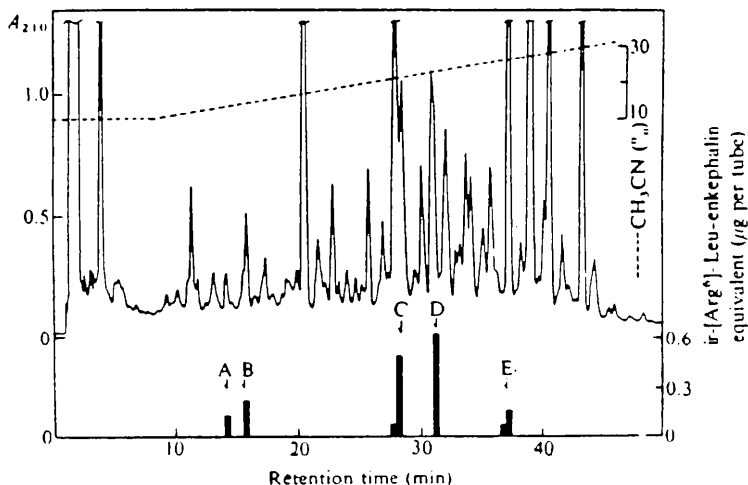
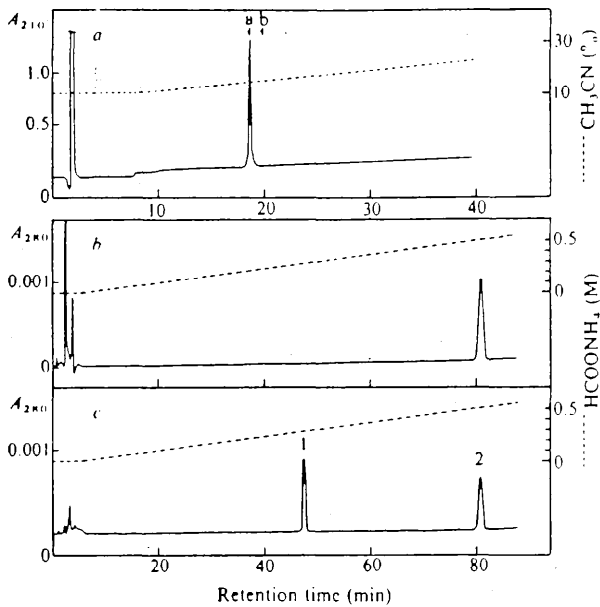


FIGURE 7

Reverse-phase HPLC of the fraction containing the low-molecular-weight and basic peptides obtained from human pheochromocytoma tumor. A: (Arg<sup>6</sup>)-Met-enkephalin, B: BAM-12P, Met-enkephalin-Arg<sup>6</sup>-Gly<sup>7</sup>-Leu<sup>8</sup>, D:Met-Enkephalin-Arg<sup>6</sup>-Phe<sup>7</sup>, E:BAM-18P. Column: TSK LS-410 ODS SIL(Toyosoda). Solvent system: A linear gradient from (A) to (B). (80 min): (A) 0.05M phosphate buffer(pH2.0): CH<sub>3</sub>CN = 90:10 (v/v); (B) 0.05M phosphate buffer(pH2.0): CH<sub>3</sub>CN = 50:50 (v/v)

Natural adrenorphin comigrates with synthetic adrenorphin on cation-exchange HPLC, and it is well separated from synthetic adrenorphin-OH. This confirmed that adrenorphin was isolated in an amide form.

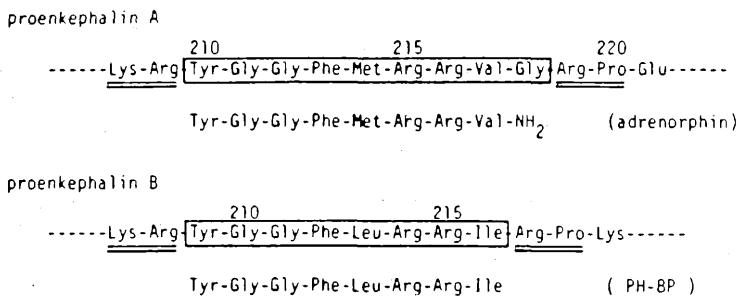
Adrenorphin sequence has a significant feature in its own biosynthesis. The sequence corresponding to adrenorphin was found to be present in human (and bovine) preproenkephalin A at positions 210-217, suggesting that adrenorphin is derived from this precursor. As shown in figure 9, adrenorphin sequence in the precursor is followed by a glycine residue, serving as a nitrogen donor to amidate the preceding valine residue (Bradbury et al. 1982). This conversion is thought to be carried out by a specific amidating enzyme. The glycine residue attached to adrenorphin sequence connects to the sequence of -Arg-Pro-, which so far has not been regarded as a typical processing signal. However, a similar cleavage before Arg-Pro was also observed in the formation of PH-8P from dynorphin molecule in preproenkephalin B, implying that the linkage of Arg-Pro is likely a processing signal. Accordingly, adrenorphin is thought to be programmed to be processed out of the precursor as a C-terminally amidated opioid.



**FIGURE 8**

HPLC of the Purified Adrenorphin Compared With the Synthetic Adrenorphin and Deamido-adrenorphin (adrenorphin-OH)

- a) Final purification of adrenorphin by reverse-phase HPLC (Arrows indicate the elution positions of synthetic adrenorphin (a) and BAM-12P(b))  
 b) Cation-exchange HPLC of natural adrenorphin  
 c) Cation-exchange HPLC of natural adrenorphin (2) compared with synthetic adrenorphin-OH(1)



**FIGURE 9**

Location of Adrenorphin and PH-8P in Their Respective Precursors

Residue numbers are taken from the sequences of human preproenkephalin A and porcine preproenkephalin B. The sequences corresponding to adrenorphin and PH-8P are boxed and the flanking residues are underlined. Natural occurrence of adrenorphin and PH-8P indicates that a sequence of -Arg-Pro- is likely a processing signal.



It should be noted that Weber et al. (1983) also isolated the identical peptide, named metorphamide, in brain. And they recently reported the presence of a peptidase activity cleaving dynorphin A into PH-8P in the atria of *Aplysia californica* (Weber et al. 1982).

#### PURIFICATION AND IDENTIFICATION OF "NEUROMEDINS"

In this section, an outline of our refined purification procedure will be briefly summarized, by which a series of new smooth-muscle stimulant peptides, named neuromedins have recently been purified (Kangawa et al. 1983; Minamino et al. 1983; Minamino et al. 1984a; Kinamino et al. 1984b; Minamino et al. 1984c). As shown in figure 10, peptides of Mr 700 to 5,000 daltons, prepared from acid extract of porcine spinal cords (ca. 20 kg), were absorbed on SP-Sephadex in the presence of 1N AcOH, and then eluted with the same solution (SP-I), 2M pyridine (SP-II), and 2M pyridine-AcOH (pH 5.0) (SP-III), successively. Fractions SP-II and SP-III thus obtained were the starting materials. After repeated gel-filtrations of each fraction, remarkable stimulant activity was observed in the various chromatographic regions. SP-II-D and SP-III-C showed a potent ileum activity, while SP-III-E and SP-III-F elicited a uterus activity. These four bioactive fractions were each subjected to further purification by repeated reverse-phase HPLC or a combination with ion-exchange HPLC. In this manner, neuromedin K and L with prominent ileum activity and neuromedin B and C with a uterus activity were each purified in a homogeneous state. The structures of four neuromedins were each determined by microsequencing in a subnanomole level and confirmed by chromatographic comparison with synthetic specimens that were

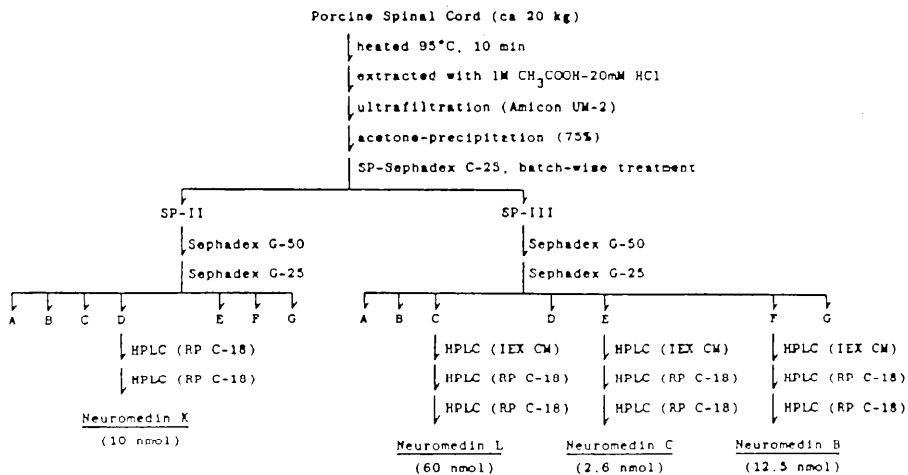


FIGURE 10

Purification Scheme of Neuromedins from Porcine Spinal Cord

prepared by solid-phase techniques. The complete amino acid sequences thus determined are listed in figure 11. Neuromedin K and L have a remarkable sequence homology to the known amphibian tachykinins, which in common have a C-terminal structure represented as Phe-X-Gly-Leu-Met-NH<sub>2</sub>. Such a structural resemblance of the first peptide to kassinin is a basis for naming it as neuromedin K, while the second one is designated as neuromedin L--the next letter in alphabetical sequence. Substance P has hitherto been thought to be the only tachykinin identified in mammals. Now, neuromedin K and L are filed as new members of this family. These two neuromedins, as well as substance P, have been found to share a common spectrum of tachykinin activity, such as a quick stimulant action on smooth-muscle and a prompt hypotensive effect. To date, substance P is well known as a neurotransmitter in the primary sensory neuron of mammalian spinal cords. The resemblance in structure as well as in biological actions of neuromedin K and L to substance P strongly suggests that these new peptides may also function as a neuromediator in the mammalian neural network. Another surprising sequence homology was observed between neuromedin B and C and amphibian bombesin, as shown in figure 11. Furthermore, neuromedin B and C elicit biological activities similar to those of bombesin in the contractile reaction of rat uterus and guinea pig ileum, distinct from those of tachykinins. Since amphibian bombesin elicits a variety of pharmacological effects in mammalian central nervous system, neuromedin B and C are both expected to function in brain as an endogenous bombesin. Incidentally, it should be noted that neuromedin C is identical to a C-terminal decapeptide of gastrin-releasing peptide (GRP(18-27)), which has recently been isolated from canine intestine.

These results revealed that even a nonspecific assay as used in these works provided an effective tool for finding hidden neuropeptides.

#### Tachykinin family

Asp-Met-His-Asp-Phe-Phe-Val-Gly-Leu-Met-NH<sub>2</sub> : Neuromedin K  
 His-Lys-Thr-Asp-Ser-Phe-Val-Gly-Leu-Met-NH<sub>2</sub> : Neuromedin L  
 Arg-Pro-Lys-Pro-Gln-Gln-Phe-Phe-Gly-Leu-Met-NH<sub>2</sub> : Substance P  
 Asp-Val-Pro-Lys-Ser-Asp-Gln-Phe-Val-Gly-Leu-Met-NH<sub>2</sub> : Kassinin

#### Bombesin family

Gly-Asn-Leu-Trp-Ala-Thr-Gly-His-Phe-Met-NH<sub>2</sub> : Neuromedin B  
 Gly-Asn-His-Trp-Ala-Val-Gly-His-Leu-Met-NH<sub>2</sub> : Neuromedin C  
 ---Pro-Arg-Gly-Asn-His-Trp-Ala-Val-Gly-His-Leu-Met-NH<sub>2</sub> : GRP  
 ---Arg-Leu-Gly-Asn-Gln-Trp-Ala-Val-Gly-His-Leu-Met-NH<sub>2</sub> : Bombesin

#### Neurotensin family

Lys-Ile-Pro-Tyr-Ile-Leu : Neuromedin N  
 pGlu-Leu-Tyr-Glu-Asn-Lys-Pro-Arg-Arg-Pro-Tyr-Ile-Leu : Neurotensin

FIGURE 11

Sequences of Neuromedins Identified in Porcine Spinal Cord

## REFERENCES

- Bradbury, A.F.; Smyth, D.G.; Snell, C.R.; Birdsall, N.J.M.; and Hulme, E.C. C-Fragment of lipotropin has a high affinity for brain opiate receptor. Nature 260:423-427, 1976.
- Bradbury, A.F.; Finnie, M.D.A.; and Smyth, D.G. Mechanism of C-terminal amide formation by pituitary enzymes. Nature 298:686-688, 1982.
- Goldstein, A.; Tachibana, S.; Lowry, P.J.; Hunkapiller, M.; and Hood, L. Dynorphin (1-13), an extraordinary potent opioid. Proc Natl Acad Sci USA 68:6666-6670, 1979.
- Hughes, J.; Smith, T.W.; Kosterlitz, H.W.; Fothergill, L.H.; Morgan, B.A.; and Moris, H. Identification of two related pentapeptides from the brain with potent opiate agonist activity. Nature 258:577-579, 1975.
- Kakidani, H.; Furutani, Y.; Takahashi, H.; Noda, M.; Morimoto, Y.; Hirose, T.; Asai, M.; Inayama, S.; Nakanishi, S.; and Numa, S. Cloning and sequence analysis of cDNA for porcine Beta-neo-endorphin/dynorphin precursor. Nature 298:245-249, 1982.
- Kangawa, K., and Matsuo, H. Alpha-Neo-endorphin: A "big" Leu-enkephalin with potent opiate activity from porcine hypothalami. Biochem Biophys Res Commun 86:153-160, 1979.
- Kangawa, K.; Mizuno, K.; Minamino, N.; and Matsuo, H. Radioimmunoassay for detecting pro-Leu-enkephalins in tissue extracts: Purification and identification of [Arg<sup>6</sup>]-Leu-enkephalin in porcine pituitary. Biochem Biophys Res Commun 95:1467-1474, 1980.
- Kangawa, K.; Minamino, N.; Chino, H.; Sakakibara, S.; and Matsuo, H. The complete amino acid sequence of Alpha-neo-endorphin. Biochem Biophys Res Commun 99:871-878, 1981.
- Kangawa, K.; Minamino, N.; Fukuda, A.; and Matsuo, H. Neuromedin K: A novel mammalian tachykinin identified in porcine spinal cord. Biochem Biophys Res Commun 114:533-540, 1983.
- Kangawa, K.; Fukuda, A.; Kubota, I.; Hayashi, Y.; and Matsuo, H. Identification in rat atrial tissue of multiple forms of natriuretic polypeptides of about 3,000 daltons. Biochem Biophys Res Commun 121:585-591, 1984.
- Li, C.H., and Chung, D. Isolation and structure of an untridecapeptide with opiate activity from camel pituitary glands. Proc Natl Acad Sci USA 73:1145-1148, 1976.
- Matsuo, H.; Baba, Y.; Nair, R.M.G.; Arimura, A.; and Schally, A.V. Structure of porcine LH- & FSH-releasing hormone I. The proposed amino acid sequence. Biochem Biophys Res Commun 43:1334-1339, 1971.
- Matsuo, H.; Miyata, A.; and Mizuno, K. Novel C-terminally amidated opioid peptide in human pheochromocytoma tumour. Nature 305:721-723, 1983.
- Minamino, N.; Kangawa, K.; Fukuda, A.; and Matsuo, H. A new opioid octapeptide related to dynorphin from porcine hypothalamus. Biochem Biophys Res Commun 95:1475-1481, 1980.
- Minamino, N.; Kangawa, K.; Chino, H.; Sakakibara, S.; and Matsuo, H. Beta-Neo-endorphin, a new hypothalamic "big" Leu-enkephalin of porcine origin: Its purification and the complete amino acid sequence. Biochem Biophys Res Commun 99:864-870, 1981.
- Minamino, N.; Kangawa, K.; and Matsuo, H. Neuromedin B: A novel bombesin-like peptide identified in porcine spinal cord. Biochem Biophys Res Commun 114:541-548, 1983.
- Minamino, N.; Kangawa, K.; and Matsuo, H. Neuromedin, C: A bombesin-like peptide identified in porcine spinal cord. Biochem Biophys Res Commun 119:14-20, 1984a.

- Minamino, N.; Kangawa, K.; and Matsuo, H. Neuromedin N: A novel neurotensin-like peptide identified in porcine spinal cord. Biochem Biophys Res Commun 122:542-549, 1984b.
- Minamino, N.; Kangawa, K.; Fukuda, A.; and Matsuo, H. Neuromedin L: A novel mammalian tachykinin identified in porcine spinal cord. Neuropeptides 4:157-166, 1984c.
- Minamino, N.; Masuda, H.; Kangawa, K.; Honzawa, M.; Tohyarna, M.; and Matsuo, H. Regional distribution of neuromedin K, L, B and C in rat brain, pituitary and spinal cord. Peptide Chem 1984:295-300, 1985.
- Miyamoto, K.; Hasegawa, Y.; Igarashi, M.; Chino, N.; Sakakibara, S.; Kangawa, K.; and Matsuo, H. Evidence that chicken hypothalamic luteinizing hormone-releasing hormone is [Gin<sup>8</sup>]-LH-RH. Life Sci 32:1341-1347, 1983.
- Miyamoto, K.; Hasegawa, Y.; Nomura, M.; Igarashi, M.; Kangawa, K.; and Matsuo, H. Identification of the second gonadotropin-releasing hormone in chicken hypothalamus: Evidence that gonadotropin secretion is probably controlled by two distinct gonadotropin-releasing hormones in avian species. Proc Natl Acad Sci USA 81:3874-3878, 1984.
- Miyata, A.; Mizuno, K.; Minamino, N.; and Matsuo, H. Regional distribution of adrenorphin in rat brain: Comparative study with PH-8P. Biochem Biophys Res Commun 120:1030-1036, 1984.
- Mizuno, K., and Matsuo, H. A novel protease from yeast with specificity towards paired basic residues. Nature 309:558-560, 1984.
- Mizuno, K.; Minamino, N.; Kangawa, K.; and Matsuo, H. A new endogenous opioid peptide from bovine adrenal medulla: Isolation and amino acid sequence of a dodecapeptide (BAM-12P). Biochem Biophys Res Commun 95:1482-1488, 1980a.
- Mizuno, K.; Minamino, N.; Kangawa, K.; and Matsuo, H. A new family of endogenous "big" Met-enkephalin from bovine adrenal medulla Purification and structure of docosa- (BAM-22P) and eicosapeptide (BAM-20P) with very potent opiate activity. Biochem Biophys Res Commun 97:1283-1290, 1980b.
- Mizuno, K.; Minamino, N.; Kangawa, K.; and Matsuo, H. "Big" enkephalin from bovine adrenomedullary gland. "Advances in endogenous and exogenous opioids," 131-134, 1981.
- Mizuno, K.; Miyata, A.; Kangawa, K.; and Matsuo, H. A unique proenkephalin-converting enzyme purified from bovine adrenal chromaffin granules. Biochem Biophys Res Commun 108:1235-1242, 1982.
- Nakanishi, S.; Inoue, A.; Kita, T.; Nakamura, M.; Chang, A.C.Y.; Cohen, S.N.; and Numa, S. Nucleotide sequence of cloned cDNA for bovine corticotropin-beta-lipotropin precursor. Nature 278:423-427, 1979.
- Noda, M.; Furutani, Y.; Takahashi, M.; Toyosato, M.; Hirose, T.; Inayama, S.; Nakanishi, S.; and Numa, S. Cloning and sequence analysis of cDNA for bovine adrenal preproenkephalin. Nature 295:202-206, 1982.
- Tachibana, S.; Araki, K.; Ohya, S.; and Yoshida, S. Isolation and structure of dynorphin, an opioid peptide, from porcine duodenum. Nature 295:339-340, 1982.
- Tatemoto, K., and Mutt, V. Chemical determination of polypeptide hormones. Proc Natl Acad Sci USA 75:4115-4119, 1978.
- Udenfriend, S., and Kilpatrick, D.L. Biochemistry of the enkephalin and enkephalin-containing peptides. Arch Biochem Biophys 221:309-323, 1983.
- Weber, E.; Evans, C.J.; and Barchas, J.D. Predominant of the amino-terminal octapeptide fragment of dynorphin in rat brain regions. Nature 299:77-78, 1982.

Weber, E.; Esch, F.S.; Bohlen, P.; Paterson, S.; Corbett, A.D.; McKnight, A.T.; Kosterlitz, H.W.; Barchas, J.D.; and Evans, C.J. Metorphamide: Isolation, structure, and biologic activity of an amidated opioid octapeptide from bovine brain. Proc Natl Acad Sci USA 80:7362-7366, 1983.

**AUTHOR**

Hisayuki Matsuo, Ph.D.  
Department of Biochemistry  
Miyazaki Medical College  
Kiyotake, Miyazaki 889-16, Japan

# $\beta$ -Endorphin: Naturally Occurring or Synthetic Agonists and Antagonists

Choh Hao Li, Ph.D.

## INTRODUCTION

$\beta$ -Endorphin ( $\beta$ -EP) is derived from  $\beta$ -lipotropin ( $\beta$ -LPH) which in turn comes from a large precursor molecule proopiomelanocortin (POMC) (Eipper and Mains 1980; Chrétien and Seidah 1984). It has been isolated and sequenced from pituitary glands of various species (Li 1982), except turkey  $\beta$ -EP which was deduced from the structure of  $\beta$ -LPH (Chang et al. 1980). They all consist of 31 amino acids, with the Met-enkephalin sequence at the  $\text{NH}_2$ -terminus. As noted in figure 1, only the human hormone has glutamic acid at the  $\text{COOH}$ -terminus, while  $\beta$ -EP from other species has glutamine. The sequential structure of human  $\beta$ -EP is remarkably similar to that of other species. Other than the position 31, the camel sequence differs only in one position: His-25 (Tyr); and the ostrich sequence differs in seven positions: Ser-6 (Thr), Arg-9 (Lys), Gly-10 (Ser), Arg-11 (Gln), Ala-12 (Thr), Val-23 (Ile), and Ser-25 (Asn). These differences are comparatively minor in terms of base pair in the genetic code. During evolution, the amino acid sequence of  $\beta$ -EP is highly conserved.

## Synthesis of $\beta$ -EP and Analogs

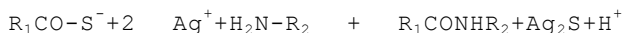
The protocol for solid-phase synthesis of  $\beta$ -EP and its analogs was established in an earlier synthesis of sheep  $\beta$ -LPH-(42-91), which contained the sequences of camel  $\beta$ -EP (Yamashiro and Li 1974). The important features of the protocol included the use of symmetrical anhydrides for this coupling amino acid residues and the use of an appropriate set of side-chain protected groups (see table 1) stable to trifluoroacetic acid (TFA) and easily removable at the end of the synthesis by HF.  $\beta$ -EP and analogs can be prepared in good yield (10% to 30%) and high purity.

		5					10
Human:	H-Tyr-Gly-Gly-Phe-Met-Thr-Ser-Glu-Lys-Ser-						
Horse:			Ser				
Ostrich:			Ser			Arg-Gly-	
Turkey:						His	
		15					20
Human:	Gln-Thr-Pro-Leu-Val-Thr-Leu-Phe-Lys-Asn-						
Horse:							
Ostrich:	Arg-Ala						
Turkey:	Met		Leu				
		25					30
Human:	Ala-Ile-Ile-Lys-Asn-Ala-Tyr-Lys-Lys-Gly-Glu-OH						
Horse:				His			Gln
Ostrich:	Val	Ser					Gln
Turkey:	Val	Ser					Gln
Porcine:	Val			His			Gln
Camel,Bovine,							
Ovine,Whale:				His			Gln
Rat:			Val-His				Gln
Mouse:				His			Gln

FIGURE 1

Amino Acid Sequence of  $\beta$ -EP from Various Species

One of the  $\beta$ -EP analogs was synthesized by a new segment coupling method (Blake 1981; Blake and Li 1981). This involves the use of thiol acids for coupling segments in aqueous solution:



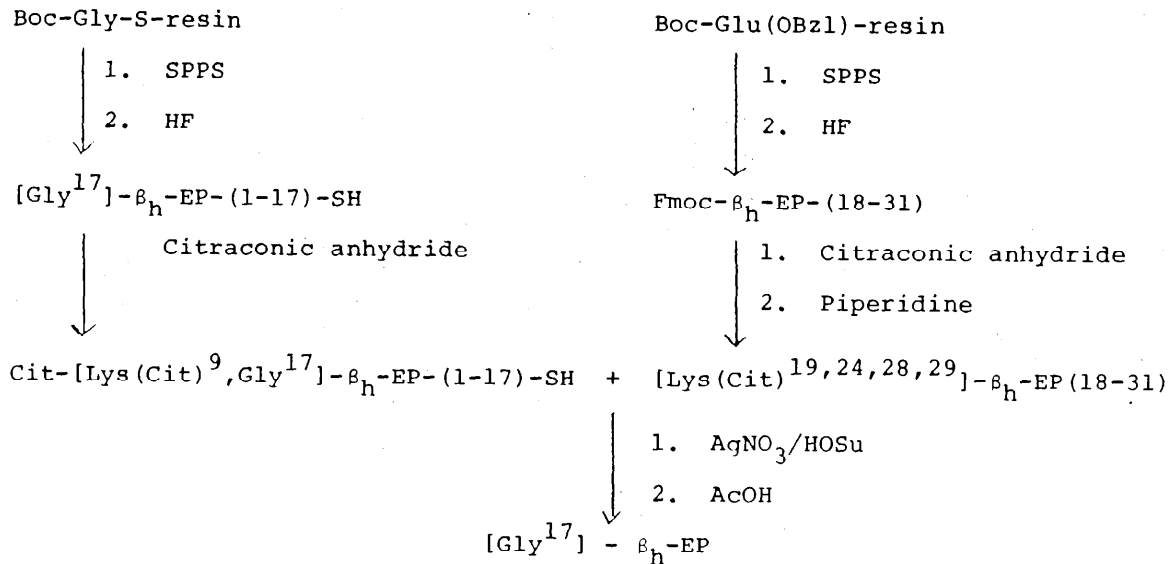
where R1 and R2 are peptide segments which may be synthesized by the solid-phase method. The scheme for the synthesis of [Gly<sup>17</sup>]- $\beta$ h-EP by this new method is shown in figure 2.

TABLE 1

Protecting Groups for Amino Acid Side-Chain Functions in Solid-Phase Peptide Synthesis

Amino Acid	Protecting Group <sup>a</sup>
Asp	Bzl, cyclopentyl
Thr	Bzl
Ser	Bzl
Glu	Bzl, cyclopentyl
Cys	3,4-dimethylbenzyl
Met	none or sulfoxide
Tyr	Z, 2-BrZ, cyclopentyl
His	Z
Lys	2-BrZ, 2-ClZ
Arg	tosyl
Trp	formyl

<sup>a</sup>Z = benzyloxycarbonyl; Bzl = benzyl



**FIGURE 2**

Synthesis  $[\text{Gly}^{17}] - 8\text{h} - \text{EP}$  by Segment Coupling:  
 SPPS, Solid-Phase Peptide Synthesis; Cit, Citraconyl; HOSu, N-Hydroxysuccinimide



The purity of the synthetic product should be examined by both high performance liquid chromatography (HPLC) and partition chromatography on gels (Yamashiro 1980). For peptides synthesized by the solid-phase method, single-deletion peptides are likely to be generated and extremely difficult to separate from the desired product. It has been shown that HPLC is inadequate for effecting these separations (Yamashiro and Li 1981).

### Bioassay

The opiate-receptor binding assay with rat brain membranes was carried out as described by Ferrara et al. (1979) and Nicolas et al. (1982), using [ $^3\text{H}_2$ -Tyr $^2$ ]- $\beta\text{h-EP}$  (Houghten and Li 1978) as the primary ligand and synthetic  $\beta\text{h-EP}$  (Li et al. 1977b) as the standard competing ligand. The analgesic potency was estimated by the mouse tail-flick method (Loh et al. 1976).

### Naturally Occurring Agonists

$\beta$ -EPs isolated from pituitary glands of various species are naturally occurring analogs of the opioid peptide. Human (Li et al. 1977b), camel (Li et al. 1976), equine (Li et al. 1981b), turkey (Yamashiro et al. 1980), and ostrich (Yamashiro et al. 1982a)  $\beta$ -EPs have been synthesized for biological characterization. Table 2 presents potencies of these  $\beta$ -EPs in the binding and analgesic assays (Hammonds et al. 1982). Parallelism of the dose-response curves in both assays indicate that  $\beta$ -EPs from different species bind to the same brain opioid receptors. However, the ratio of binding activity to analgesic potency varies from 164 to 555 relative to  $\beta\text{h-EP}$  as 100 (see table 2). No correlation between these two activities exists. It was suggested that, once bound to the receptor, these naturally occurring agonists do not possess equal ability or efficacy to produce analgesia.

**TABLE 2**

Biological Activities of Human, Camel, Equine, Turkey, and Ostrich  $\beta$ -Endorphin

$\beta$ -EP	Analgesic potency (A)	Opioid-receptor binding activity (B)	B/A X 100 (Potency ratio)
Human	100	100	100
Camel	165	270	164
Equine	153	330	216
Turkey	45	96	213
Ostrich	110	610	555

## Synthetic Agonists

For the last 8 years, over 90  $\beta$ -EP analogs have been synthesized and characterized (Li 1981; Yamashiro and Li 1984). Some analogs are purer agonists than the parent peptide as they exhibit higher biological activities. Five of these analogs are: [Gln<sup>8</sup>]- $\beta_h$ -EP (Li et al. 1981a), [Trp<sup>27</sup>]- $\beta_h$ -EP (Li et al. 1982), [Gln<sup>8,31</sup>]- $\beta_h$ -EP (Yamashiro et al. 1982b), (Arg<sup>8</sup>,Gln<sup>31</sup>)- $\beta_h$ -EP (Yamashiro et al. 1982b), and [Dem<sup>1-7</sup>]- $\beta_c$ -EP (Yamashiro et al. 1983). Their binding activity and analgesic potency are summarized in table 3. Among these analogs, [Trp<sup>27</sup>]- $\beta_h$ -EP exhibits the lowest binding/analgesia ratio, indicating that it is a very efficacious molecule for producing analgesia when it is bound to the receptor. Residue position 27 in  $\beta$ -EPs (see figure 1) is occupied by either His or Tyr. This represents a marked difference in hydrophobicity when this property is measured in a two-phase solvent system (Yamashiro 1980). On the same scale, Trp is the most hydrophobic amino acid. It is of interest that [Trp<sup>27</sup>]- $\beta_h$ -EP is one of the most potent synthetic analogs as an analgesic agent (Li et al. 1982).

**TABLE 3**

Biological Activities of Some Synthetic  
 $\beta$ -EP Agonists

Synthetic peptides	Analgesic potency (A)	Opioid-receptor binding activity (B)	B/A X 100 (Potency ratio)
$\beta_h$ -EP	100	100	100
[Gln <sup>8</sup> ]- $\beta_h$ -EP	220	170	77
[Trp <sup>27</sup> ]- $\beta_h$ -EP	371	68	18
[Gln <sup>8,31</sup> ]- $\beta_h$ -EP	236	200	93
[Arg <sup>8</sup> ,Gln <sup>31</sup> ]- $\beta_h$ -EP	254	150	59
[Dem <sup>1-7</sup> ]- $\beta_h$ -EP*	440	301	68

\*Dem = Dermorphin: H-Tyr-DAla-Phe-Gly-Tyr-Pro-Ser-NH<sub>2</sub>

There are two Glu residues in the  $\beta_h$ -EP structure at positions 8 and 31 (see figure 1). Replacement of Glu<sup>31</sup> by Gly does not alter the analgesic potency (Li et al. 1979) or Tyr (Yamashiro et al. 1982b). However, replacement of Glu<sup>8</sup> by Gln enhances both analgesic potency and opioid-receptor binding activity. This is also true for the replacement of Glu<sup>8</sup> by Arg (Yamashiro et al. 1982b). Since alterations of the Met-enkephalin

sequence in  $\beta$ -EP have led to loss of analgesic potency (Li 1981), it was surprising that the hybrid [Dem<sup>1-7</sup>]- $\beta_c$ -EP is a potent analgesic (Yamashiro et al. 1983). Dermorphin (Dem) is isolated from the frog skin with very potent opiatelike activity (Montecucchi et al. 1981). When Dermorphin, the hybrid, and  $\beta_h$ -EP are assayed for analgesia (see table 4), Dermorphin and [Dem<sup>1-7</sup>]- $\beta_c$ -EP exhibit nearly identical potency. This suggests that the 8-31 segment of the hybrid has no apparent influence on the analgesic actions of the Dermorphin segment and is in contrast to the analgesic potency of  $\beta$ -EP which is dependent on chain length (Li 1981).

**TABLE 4**

Biological Activities of Dermorphin and  
[Dem<sup>1,7</sup>]- $\beta_c$ -Endorphin

Peptide	Analgesic potency (A)	Opioid-receptor binding activity (B)	B/A X 100 (Potency ratio)
$\beta_h$ -EP	100	100	100
$\beta_h$ -EP	164	311	190
Dermorphin	450	30	7
[Dem <sup>1-7</sup> ]- $\beta_c$ -EP	440	301	68

#### Naturally Occurring Antagonist

$\beta$ -EP-(1-27) has been isolated and characterized from pig (Smyth et al. 1978), rat (Zakarian and Smyth 1979), and horse (Ng et al. 1981) pituitary glands. It is also shown to occur in rat (Zakarian and Smyth 1979) and bovine (Ng et al. 1982) brains as well as in human ectopic ACTH-producing lung cancers (Suda et al. 1982). Figure 3 presents the protocol for the isolation of  $\beta$ -EP-(1-27) from horse pituitary (Ng et al. 1981). The final steps involved paper electrophoresis and HPLC. From 300 g of fresh horse glands, 1.2 mg  $\beta_e$ -EP-(1-27) and 3 mg  $\beta_e$ -EP were isolated. As shown in figure 4, only 0.018 mg  $\beta_e$ -EP-(1-27) and 0.026 mg  $\beta_e$ -EP were obtained from 16 kg of bovine brains (Ng et al. 1982).  $\beta_h$ -EP-(1-27) was subsequently synthesized (Zaoral et al. 1981) for biological investigations.

Horse pituitaries, 300 g  
 +  
 Acid-acetone powder, 11 g  
 +  
 NaCl fractionation: Fraction D, 790 mg  
 +  
 CM-cellulose chromatography: Component C, 120 mg  
 +  
 Sephadex G-25: retarded peak, 37 mg  
 +  
 Paper electrophoresis at pH 6.7: fasting band, 1.5 mg  
 +  
 HPLC: 1.2 mg [ $\beta_e$ -EP-(1-27)]  
 ( $\beta_e$ -EP, 3 mg)

**FIGURE 3**

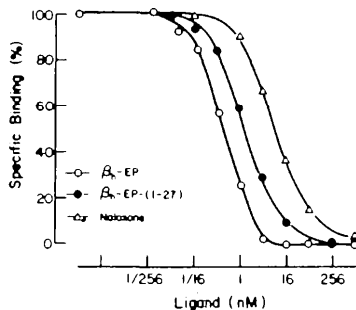
Protocol for the Isolation of  $\beta$ -EP-(1-27)  
from Horse Pituitary

Bovine brains, 16 kg  
 +  
 Acid-acetone powder, 160 g  
 + pH 4.6 soluble fraction  
  
 CM-Cellulose chromatography  
 un-retarded material, 80 g  
 +  
 Sephadex G-100 in pH 4.6, 0.1 M  $\text{NH}_4\text{OAc}$  buffer: 12 g  
 +  
 Sephadex G-50 in 0.1 M HOAc: 0.9 g  
 +  
 Sephadex G-25 in 0.1 M HOAc: 530 mg  
 +  
 CM-Cellulose chromatography: 17 mg  
 +  
 HPLC: peak 3  
 +  
 Paper electrophoresis: 2 bands  
 +  
 Band with  $R_f=0.36$ , 0.018 mg [ $\beta_b$ -EP-(1-27)]  
 ( $\beta_b$ -EP, 0.026 mg)

**FIGURE 4**

Protocol for the Isolation of  $\beta$ -EP-(1-27)  
from Bovine Brain

Figure 5 presents inhibition of [ $^3\text{H-Tyr}^{27}$ ]- $\beta_{\text{h}}$ -EP binding to rat brain membranes by  $\beta_{\text{h}}$ -EP-(1-27) or naloxone. Thus,  $\beta_{\text{h}}$ -EP-(1-27) retained 30% of the  $\beta_{\text{h}}$ -EP potency in displacing tritiated  $\beta_{\text{h}}$ -EP, whereas naloxone was one-tenth as potent. In the mouse tail-flick assay,  $\beta_{\text{h}}$ -EP-(1-27) exhibited less than 2% of the  $\beta_{\text{h}}$ -EP potency in producing analgesia (figure 6). Results are summarized in table 5. The high ratio of opioid-receptor binding activity to analgesic potency (potency ratio) predicts  $\beta_{\text{h}}$ -EP-(1-27) as an antagonist to  $\beta_{\text{h}}$ -EP-induced analgesia. This turns out to be the case (Hammonds et al. 1984).



**FIGURE 5**

Inhibition of [ $^3\text{H-Tyr}^{27}$ ]- $\beta_{\text{h}}$ -EP Binding to Rat Brain Membrane by  $\beta_{\text{h}}$ -EP-(1-27) or Naloxone

**TABLE 5**

Biological Activities of  $\beta_{\text{h}}$ -EP-(1-27) and Naloxone

Preparation	Analgesic potency		Opioid-receptor binding activity		B/A (Potency ratio)
	$\text{AD}_{50}$	Relative potency (A)	$\text{IC}_{50}$	Relative potency (B)	
	pmol/mouse		nM		
$\beta_{\text{h}}$ -EP	27	100	0.33	100	1
$\beta_{\text{h}}$ -EP-(1-27)	1500	1.8	1.10	30	17
Naloxone			12.00	2.8	

As shown in figure 6, intracerebroventricular (i.c.v.) injection of various doses of  $\beta_{\text{h}}$ -EP together with a fixed dose of  $\beta_{\text{h}}$ -EP-(1-27) produced a parallel shift of the dose-response curve (Hammonds et al. 1984).

Similar results were obtained with naloxone. Analyses of the data are clearly evident that the antagonistic effect of  $\beta_h$ -EP-(1-27) is competitive in nature and that the analog is at least 4 times more potent than naloxone in antagonizing analgesia.

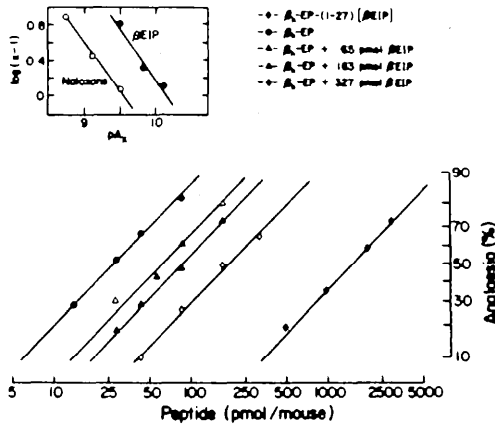


FIGURE 6

Analgesic Effect of  $\beta_h$ -EP and  $\beta_h$ -EP-(1-27)

### Synthetic Antagonists

The first synthetic analog of  $\beta$ -EP shown to be an antagonist is  $\beta_c$ -EP-(6-31). This analog does not contain the Met-enkephalin segment and appears to possess measurable analgesic activity (Li et al. 1978). At high doses,  $\beta_c$ -EP-(6-31) produces analgesia in 4 out of 11 mice, and in some mice, inhibition of the tail-flick response was not blocked by naloxone (Li et al. 1978). In guinea pig ileum assay, it had about 4% opiate activity in comparison with  $\beta_c$ -EP (Li et al. 1977a).

At 40  $\mu$ g but not at 25  $\mu$ g,  $\beta_c$ -EP-(6-31) was analgesic, although the main tail-flick latency was not as high as that with morphine (6  $\mu$ g) or  $\beta_h$ -EP (6  $\mu$ g). When 40  $\mu$ g  $\beta_c$ -EP-(6-31) was injected i.c.v. together with either morphine or  $\beta_h$ -EP, it inhibited morphine-induced analgesia measured 10 minutes later but not 30 minutes later (Lee et al. 1980). However, the analog appeared to inhibit significantly  $\beta_h$ -EP-induced analgesia at all time intervals. When the effect of  $\beta_h$ -EP (6  $\mu$ g) was at its peak in 30 minutes, the analog was capable of antagonizing  $\beta_h$ -EP-induced analgesia in a dose-related manner with some inhibition at a  $\beta_c$ -EP-(6-31)/ $\beta_h$ -EP ratio as low as 2.5 (Lee et al. 1980).

We subsequently discovered three synthetic analogs of  $\beta_h$ -EP with high potency ratio (the ratio of potency in displacing [ $^3\text{H-Tyr}^{27}$ ]- $\beta_h$ -EP to analgesic potency) to be good inhibitors to  $\beta_h$ -EP-induced analgesia (Nicolas et al. 1984). These synthetic analogs with their biological activities are listed in table 6. Lack of correlation between the opioid-receptor binding activity and analgesic potency is evident and the potency ratio is high, indicating that these analogs may act as antagonists.

Dose-response curves for the analgesic effect produced by i.c.v. injection of  $\beta_h$ -EP, [ $\text{Trp}^{27}$ ]- $\beta_h$ -EP, synthetic analogs, and their combinations are shown in figures 7 and 8. The duration of analgesia for the analogs and the parent peptide was identical. Dose-response curves were parallel, suggesting that they produced analgesia by acting through similar opiate receptors. In addition, the time for the peak analgesic effect of  $\beta_h$ -EP and [ $\text{Trp}^{27}$ ]- $\beta_h$ -EP either alone or in the presence of various doses of analogs was the same. There was a marked decrease in the analgesic response to  $\beta_h$ -EP or [ $\text{Trp}^{27}$ ]- $\beta_h$ -EP when small doses of the analogs were co-injected. For each combination of agonist/antagonist investigated, a parallel shift of the dose-response curve of the agonist to the right with increasing doses of antagonist was observed. This parallel shift indicates competitive inhibition as also shown by straight lines in the Schild plots. Figure 9 presents Schild plots for  $\beta_h$ -EP and [ $\text{Trp}^{27}$ ]- $\beta_h$ -EP as agonists with various doses of antagonists. From these data, the apparent antagonist potencies, assuming the potency of  $\beta_h$ -EP-(1-27 to be 1, were estimated as follows: [ $\text{Cys}^{11,26}, \text{Phe}^{27}, \text{Gly}^{31}$ ]- $\beta_h$ -EP 6; [ $\text{Arg}^{9,19,24,28,29}$ ]- $\beta_h$ -EP, 17; and [ $\text{Gln}^8, \text{Gly}^{31}$ ]- $\beta_h$ -EP-Gly-Gly-NH<sub>2</sub>, 48. Thus, [ $\text{Gln}^8, \text{Gly}^{31}$ ]- $\beta_h$ -EP-Gly-Gly-NH<sub>2</sub> is more than 200 times as potent than naloxone in inhibiting  $\beta_h$ -EP-induced analgesia.

### **Concluding Remarks**

Since 1976,  $\beta_h$ -EP has been isolated and identified from pituitary glands of camel, porcine, human, horse, ostrich, turkey, bovine, ovine, whale, rat, and mouse. Camel, human, equine, turkey, and ostrich  $\beta$ -EP were synthesized by improved procedure of the solid-phase method. In the mouse tail-flick assay, analgesic potency was found in the following order: camel > equine > ostrich > human > turkey. The opioid-receptor binding activity order was: ostrich > equine > camel human > turkey. They are naturally occurring agonists.

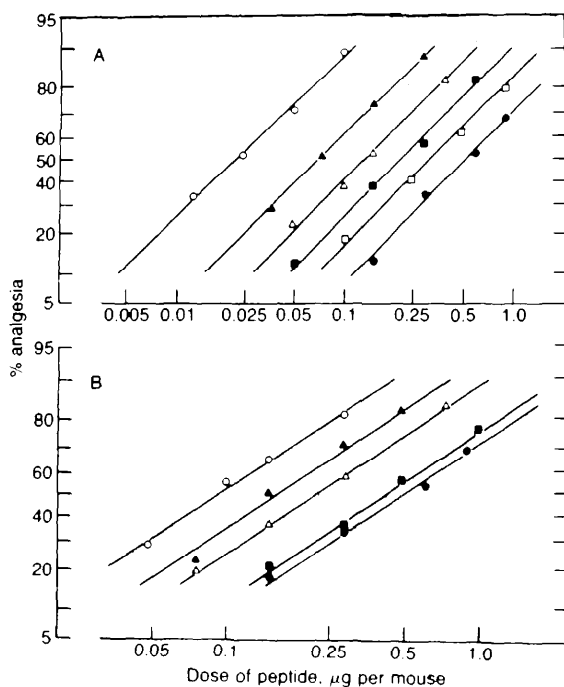
TABLE 6

Analgesic Potency and Binding Affinity of Synthetic  
 $\beta_h$ -EP Analogs with Inhibiting Activity

Synthetic Peptide	Analgesic potency (A)		Receptor-binding activity (B)		B/A (Potency ratio)
	AD <sub>50</sub> <sup>*</sup> pmol/ mouse	Relative potency	IC <sub>50</sub> <sup>*</sup> nM	Relative potency	
$\beta_h$ -EP	27 (18-36)	100	0.33 (0.1-0.4)	100	1
[Gln <sup>8</sup> , Gly <sup>31</sup> ]- $\beta_h$ -EP-Gly-Gly-NH <sub>2</sub>	150 (110-210)	18	0.094 (0.087-0.10)	350	19
[Arg <sup>9,19,24,28,29</sup> ]- $\beta_h$ -EP	190 (130-270)	14	0.180 (0.160-0.19)	180	13
[Cys <sup>11,26</sup> , Phe <sup>27</sup> , Gly <sup>31</sup> ]- $\beta_h$ -EP	470 (400-560)	6	0.18 (0.160-0.19)	180	30

\* 95% Confidence limit in parentheses.





**FIGURE 7**

(A) Log-probit dose-response curves for antinociceptive effect produced by i.c.v. injection of [Trp<sup>27</sup>]-β<sub>h</sub>-EP alone (o-o) and in the presence of 0.01 μg (▲), 0.025 μg (△), 0.04 μg (■), or 0.1 μg (□) of [Gln<sup>8</sup>, Gly<sup>31</sup>]-β<sub>h</sub>-EP-Gly-Gly-NH<sub>2</sub>. (B) As in figure 7(A), but for β<sub>h</sub>-EP alone (○) or in combination with 0.0045 μg (▲), 0.009 μg (△) or 0.02 μg (■) of [Gln<sup>8</sup>, Gly<sup>31</sup>]-β<sub>h</sub>-EP-Gly-Gly-NH<sub>2</sub>. The dose-response curve for analgesia produced by [Gln<sup>8</sup>, Gly<sup>31</sup>]-β<sub>h</sub>-EP-Gly-Gly-NH<sub>2</sub> alone is shown (●) in both cases.

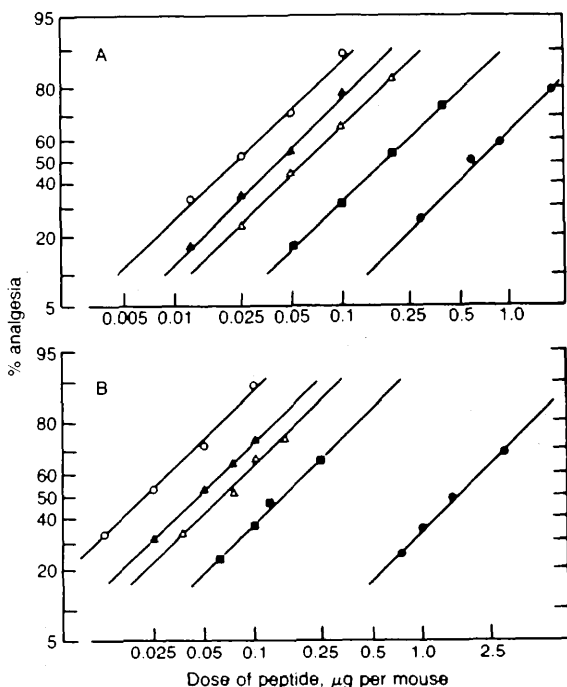


FIGURE 8

(A) As in figure 7A, [Trp<sup>27</sup>]-B<sub>h</sub>-EP alone (○) or in combination with 0.010 μg (▲), 0.025 μg (Δ), or 0.075 μg (■) of [Arg<sup>9,19,24,28,29</sup>]-B<sub>h</sub>-EP. (○), Antinociceptive effect produced by [Arg<sup>9,19,24,28,29</sup>]-B<sub>h</sub>-EP alone. (B) As in figure 7A, [Trp<sup>27</sup>]-B<sub>h</sub>-EP alone (○) or in combination with 0.05 μg (▲), 0.075 μg (Δ), or 0.300 μg (■) of [Cys<sup>11</sup>,Cys<sup>26</sup>,Phe<sup>27</sup>,Gly<sup>31</sup>]-B<sub>h</sub>-EP. (○), Antinociceptive effect elicited by [Cys<sup>11</sup>,Cys<sup>26</sup>,Phe<sup>27</sup>]-Gly<sup>31</sup>]-B<sub>h</sub>-EP.

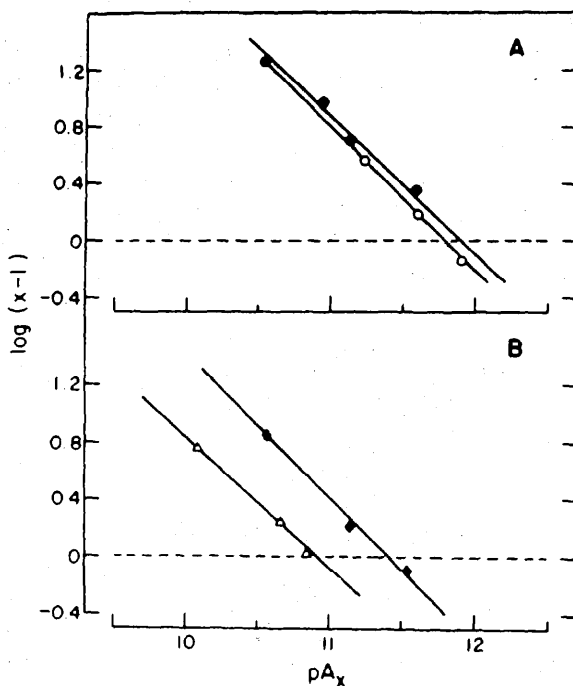


FIGURE 9

(A) Relationship between dose ratio for analgesia with  $[\text{Trp}^{27}]\text{-}\beta_{\text{h}}\text{-EP}$  (●-●) or  $\beta_{\text{h}}\text{-EP}$  (O-o) and corresponding doses of  $[\text{Gln}^8, \text{Gly}^{31}]\text{-}\beta_{\text{h}}\text{-EP-Gly-Gly-NH}_2$ . Abscissa: negative logarithm of the molar dose of antagonist injected per 25  $\mu\text{g}$  of body weight. Ordinate:  $\log(x-1)$ , where  $x$  is the dose ratio. (B) As in figure 8A, but for  $[\text{Trp}^{27}]\text{-}\beta_{\text{h}}\text{-EP}$  and corresponding doses of either  $[\text{Cys}^{11}, \text{Cys}^{26}, \text{Phe}^{27}, \text{Gly}^{31}]\text{-}\beta_{\text{h}}\text{-EP}$  (A-A) or  $[\text{Arg}^{9, 19, 24, 26, 29}]\text{-}\beta_{\text{h}}\text{-EP}$  (◆-◆).

Among more than 90 synthetic analogs of  $\beta$ -EP, at least 5 are potent agonists, namely [GLN<sup>8</sup>- $\beta$ <sub>h</sub>-EP, [Trp<sup>27</sup>]- $\beta$ <sub>h</sub>-EP, [Gln<sup>8-31</sup>]- $\beta$ <sub>h</sub>-EP, [Arg<sup>8</sup>,Gln<sup>8-31</sup>]- $\beta$ <sub>h</sub>-EP, and [Dem<sup>1-7</sup>]- $\beta$ <sub>c</sub>-EP

The naturally occurring antagonist  $\beta$ -EP-(1-27) is at least 4 times more potent than naloxone in antagonizing analgesia. It was named  $\beta$ -EP-inhibiting peptide ( $\beta$ EIP). Three synthetic analogs of  $\beta$ <sub>h</sub>-EP were shown to possess inhibiting activity to  $\beta$ -EP-induced analgesia. One of them, ([Gln<sup>8</sup>,Gly<sup>31</sup>]- $\beta$ <sub>h</sub>-EP-Gly-Gly-NH<sub>2</sub>), was estimated to be more than 200 times more potent than naloxone in the mouse tail-flick assay.

In most naturally occurring  $\beta$ -EP agonists and synthetic analogs, the opiate-receptor binding activity and analgesic potency do not correlate. This may be explained by differences in efficacy of the agonist or analog once it is bound to the receptor. The ratio of binding affinity to analgesic potency (potency ratio) is a measure of the degree of efficacy. Thus, a naturally occurring or synthetic  $\beta$ -EP analog with high potency ratio is expected to be an antagonist to  $\beta$ -EP-induced analgesia.

As pointed out earlier,  $\beta$ -EP-(1-27) with a potency ratio of 17 is shown to be present in the brain and pituitary gland. It acts as an inhibitor to  $\beta$ -EP-induced analgesia and is 4.5 times more potent than naloxone. This is highly significant. Inhibition of a peptide hormone by a naturally occurring segment of the same hormone may be a general phenomenon in biologically active peptides.

## REFERENCES

- Blake, J. Peptide segment coupling in aqueous medium: Silver ion activation of the thiolcarboxyl group. Int J Pept Protein Res 17:273-274, 1981.
- Blake, J., and Li, C.H. New segment-coupling method for peptide synthesis in aqueous solution: Application to synthesis of human [Gly<sup>17</sup>]- $\beta$ -endorphin. Proc Natl Acad Sci USA 78:4055-4058, 1981.
- Chang; W.-C.; Chung, D.; and Li, C.H. Isolation and characterization of  $\beta$ -lipotropin and adrenocorticotropin from-turkey pituitary glands. Protein Res 15:261-270, 1980.
- Chrétien M., and Seidah, N.G. Precursor polyproteins in endocrine and neuroendocrine systems. Int J Pept Protein Res 23:335-341, 1984.
- Eipper, B.A., and Mains, R.E. Structure and biosynthesis of Pro-ACTH/Endorphin and related peptides. Endocrin Rev 1:1-27, 1980.

- Ferrara, P.; Houghten, R.; and Li, C.H.  $\beta$ -Endorphin: Characteristics of binding sites in the rat brain. Biochem Biophys Res Commun 89:786-792, 1979.
- Hammonds, R.G., Jr.; Nm, P.; and Li, C.H.  $\beta$ -Endorphin: Analgesic and receptor binding activity of non-mammalian homologs. Lack of correlation between in vivo and in vitro opiate potency. Int J Pept Proteins 19:556-561, 1982.
- Hammonds, R.G., Jr.; Nicolas, P.; and Li, C.H.  $\beta$ -Endorphin-(1-27) is an antagonist of  $\beta$ -endorphin analgesia. Proc Natl Acad Sci USA 81:1389-1390, 1984.
- Houghten, R.A., and Li, C.H. Preparation and properties of tritiated human  $\beta$ -endorphin with high specific radioactivity. Int J Pept Protein Res 12: 325-326, 1978.
- Lee, N.M.; Friedman, H.J.; Leybin, L.; Cho, T.M.; Loh, H.H.; and Li, C.H. Peptide inhibitor of morphine- and  $\beta$ -endorphin-induced analgesia. Proc Natl Acad Sci USA 77:5525-5526, 1980.
- Li, C.H.  $\beta$ -Endorphin: Synthetic analogs and structure-activity relationships. In: Li, C.H., ed. Hormonal Proteins and Peptides: Vol. X. New York: Academic Press, 1981. pp. 1-34.
- Li, C.H.  $\beta$ -Endorphin. Cell 31:504-505, 1982.
- Li, C.H.; Lemaire, S.; Yamashiro, D.; and Doneen, B.A. The synthesis and opiate activity of  $\beta$ -endorphin. Biochem Biophys Res Commun 71:19-25, 1976.
- Li, C.H.; Rao, A.J.; Doneen, B.A.; and Yamashiro, D.  $\beta$ -Endorphin: Lack of correlation between opiate activity and immunoreactivity by radioimmunoassay. Biochem Biophys Res Commun 75:576-580, 1977a.
- Li, C.H.; Yamashiro, D.; Tseng, L-F.; and Loh, H.H. Synthesis and analgesic activity of human  $\beta$ -endorphin. J Med Chem 20:325-328, 1977b.
- Li, C.H.; Yamashiro, D.; Tseng, L-F.; and Loh, H.H.  $\beta$ -Endorphin: Synthesis and biological activity of shortened peptide chains. Int J Pept Protein Res 11:154-158, 1978.
- Li, C.H.; Yamashiro, D.; Tseng, L-F.; Chang, W.-C.; and Ferrara, P.  $\beta$ -Endorphin: Synthesis of analogs modified at the carboxyl terminus with increased activities. Proc Natl Acad Sci USA 76:3276-3278, 1979.
- Li, C.H.; Yamashiro, D.; Hammonds, R.G., Jr.; Nicolas, P.; and Tseng, L-F.  $\beta$ -Endorphin: Replacement of glutamic acid in position 8 by glutamine increases analgesic potency and opiate receptor-binding activity. Biochem Biophys Res Commun 101:118-123, 1981a.

- Li, C.H.; Ng, T.B.; Yamashiro, D.; Chung, D.; Hammonds, R.G., Jr.; and Tseng, L.-F.  $\beta$ -Endorphin isolation, amino acid sequence and synthesis of the hormone from horse pituitary glands. Int J Pept Protein Res 18: 242-248, 1981b.
- Li, C. H.; Yamashiro, D.; and Nicolas, P.  $\beta$ -Endorphin: Replacement of tyrosine in position 27 by tryptophan increases analgesic potency--preparation and properties of 2-nitrophenylsulfenyl derivative. Proc Natl Acad Sci USA 79:1042-1044, 1982.
- Loh, H.H.; Tseng, L.F.; Wei, E.; and Li, C.H.  $\beta$ -Endorphin is a potent analgesic agent. Proc Natl Acad Sci USA 73:2895-2898, 1976.
- Montecucchi, P.C.; de Castiglione, R.; Piani, S.; Gozzini, L.; and Erspamer, V. Amino acid composition and sequence of dermorphin, a novel opiate-like peptide from the skin of *Phyllomedusa Sauvagei*. Int J Pept Protein Res 17:275-283, 1981.
- Ng, T.B.; Chung, D.; and Li, C.H. Isolation and properties of  $\beta$ -endorphin-(1-27),  $N^{\alpha}$ -acetyl- $\beta$ -endorphin, corticotropin, gamma-lipotropin and neurophysin from equine pituitary glands. Int J Pept Protein Res 18:443-450, 1981.
- Ng, T.B.; Chung, D.; and Li, C.H. Isolation and properties of  $\beta$ -endorphin-(1-27)-like peptide from bovine brains. Int J Pept Protein Res 19:343-347, 1982.
- Nicolas, P.; Hammonds, R.G., Jr.; and Li, C.H.  $\beta$ -Endorphin: Opiate receptor binding activities of six naturally occurring  $\beta$ -endorphin homologs studied by using tritiated human hormone and naloxone as primary ligands--effects of sodium ion. Proc Natl Acad Sci USA 79:2191-2193, 1982.
- Nicolas, P.; Hammonds, R.G., Jr.; and Li, C.H.  $\beta$ -Endorphin-induced analgesia is inhibited by synthetic analogs of  $\beta$ -endorphin. Proc Natl Acad Sci USA 81:3074-3077, 1984.
- Smyth, D.G.; Snell, C.R.; and Massey, D.E. Isolation of the C-fragment and C'-fragment of lipotropin from pig pituitary and C-fragment from brain. Biochem J 175:261-270, 1978.
- Suda, T.; Tozawa, F.; Yamaguchi, H.; Shibasaki, T.; Demura, H.; and Shizume, K. Multiple forms of immunoreactive  $\beta$ -endorphin are present in an ectopic adrenocorticotropin-producing tumor but not in normal pituitary or pituitary adenomas. J Clin Endocrin Metab 54:167-171, 1982.
- Yamashiro, D. Partition and partition chromatography of peptides and proteins. In: Li, C.H., ed. Hormonal Proteins and Peptides. Vol. IX. New York: Academic Press, 1980. pp. 25-107.

- Yamashiro, D., and Li, C.H. Synthesis of a pentekontapeptide with high lipolytic activity corresponding to the carboxyl-terminal fifty amino acids of ovine-lipotropin. Proc Natl Acad Sci USA 71:4945-4949, 1974.
- Yamashiro, D., and Li, C.H. Partition and high-performance liquid chromatography of  $\beta$ -lipotropin and synthetic  $\beta$ -endorphin analogues. J Chromatog 215:255-261, 1981.
- Yamashiro, D., and Li, C.H.  $\beta$ -Endorphin: Structure and activity. In: Meienhofer, J., and Udenfriend, S., eds. The Peptides. Vol. 6. New York: Academic Press, 1984. pp 191-217.
- Yamashiro, D.; Ferrara, P.; and Li, C.H. Synthesis and radioreceptor binding activity of turkey  $\beta$ -endorphin and deacetylated salmon endorphin. Int J Pept Protein Res 16:75-78, 1980.
- Yamashiro, D.; Hammonds, R.G., Jr.; and Li, C.H.  $\beta$ -Endorphin: Synthesis and radioreceptor-binding activity of the ostrich hormone. Int J Pept Protein Res 19:251-253, 1982a.
- Yamashiro, D.; Nicolas, P.; and Li, C.H.  $\beta$ -Endorphin: Synthesis and properties of analogs modified in positions 8 and 31. Int J Pept Protein Res 20:43-46, 1982b.
- Yamashiro, D.; Nicolas, P.; and Li, C.H. Synthesis and properties of dermorphin and an analog of  $\beta$ -endorphin containing the dermorphin sequence. Int J Pept Protein Res 21:219-222, 1983.
- Yamashiro, D.; Li, C.H.; Nicolas, P.; and Hammonds, R.G., Jr.  $\beta$ -Endorphin: Synthesis and properties of double-headed and related analogs. Int J Pept Protein Res 19:348-353, 1982.
- Zakarian, S. and Smyth, D.G. Distribution of active and inactive forms of endorphins in rat pituitary and brain. Proc Natl Acad Sci USA 76:5972-5976, 1979.
- Zaoral, M.; Yamashiro, D.; Hammonds, R.G., Jr.; and Li, C.H.  $\beta$ -Endorphin: Synthesis and radioreceptor binding activity of  $\beta_n$ -endorphin-(1-27) and its analogs. Int J Pept Protein Res 17:292-296, 1981.

#### **ACKNOWLEDGMENTS**

The experimental work, summarized herein, was derived from collaborations with my coworkers whose names appear in the cited publications. This work was supported in part by National Institute on Drug Abuse grant DA-03434 and National Institutes of Health grant GM02907.

**AUTHOR**

Choh Hao Li, Ph.D.  
Laboratory of Molecular Endocrinology  
University of California, San Francisco  
San Francisco, California 94143



# Enkephalin Degrading Enzyme Inhibitors: A Physiological Way to New Analgesics and Psychoactive Agents

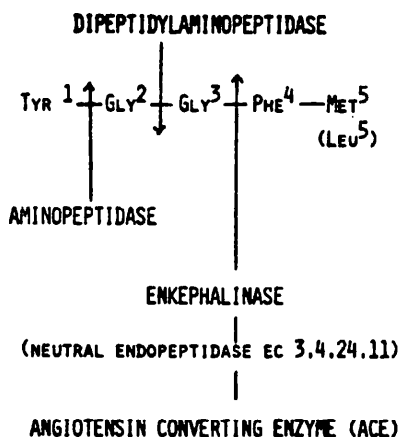
Bernard P. Roques and Marie-Claude Fournie-Zaluski

It is now well accepted that the pain suppression effect of morphine is related to the interaction of this alkaloid with binding sites located in the central nervous system (CNS) and more precisely within structures (e.g., spinal cord, periaqueductal gray matter, and thalamus) known for their involvement in the regulation of nociceptive stimuli. Moreover, the wide distribution of opioid receptors in brain probably accounts for the multiplicity of pharmacological responses (including euphoria) elicited by administration of morphine (Martin et al. 1976). In addition to its strong analgesic potency, it must also be observed that morphine was shown to display anxiolytic and disinhibitory properties. According to these features, psychic dependence and respiratory depression-- which are among the major side effects of narcotics--could be related to overstimulation of brain receptors involved, respectively, in behavioural and bulbar respiratory control (Morin-Surun et al. 1984). Several thousand compounds were synthesized with the aim to discard or at least to minimize these major side effects, but at this time no potent analgesic proved completely devoid of these serious drawbacks. However, the discovery in the CNS of the endogenous morphinelike peptides, enkephalins (Hughes et al. 1975), which interact with multiple opioid receptors (Lord et al. 1977) and are degraded by recently well-defined metabolic pathways, could allow resolution of the challenging problem of addiction. In this chapter, we have summarized the results that we have obtained both in the characterization of enkephalin degrading enzymes and in the rational design of inhibitors of these various peptidases. These compounds, being able to prolong the duration of action of the endogenously released

enkephalins following nociceptive stimuli, behave as completely new analgesics acting through a more physiological mechanism. Owing to the probable role of enkephalins in emotional and behavioural controls, enkephalin degrading enzyme inhibitors could occur also as new psychoactive agents.

#### **ENZYMATIC INACTIVATION OF ENKEPHALINS**

A weak and transient analgesia was obtained only for high doses (= 100 µg per mouse) of intracerebroventricularly administered Met<sup>5</sup>-enkephalin (Tyr-Gly-Cly-Phe-Met) or Leu<sup>5</sup>-enkephalin (Tyr-Gly-Gly-Phe-Leu) (Belluzi et al. 1976). These features suggested that, according to their neurotransmitter role, these peptides were quickly removed from the synaptic cleft. In vitro incubation of enkephalins with brain tissue has shown that several peptidases are able to cleave the endogenous pentapeptides into inactive fragments. So, the Tyr-Gly bond can be hydrolyzed by several membrane-bound aminopeptidases (Hambrook et al. 1976; Vogel and Altstein 1977; Guyon et al. 1979). As discussed further, one of these brain enzymes, resembling aminopeptidase M from rabbit kidney (Kerr and Kenny 1974), could be more specific (Hersch 1981; Shimamura et al. 1983; Fournié-Zaluski et al., in press [1985a]). Furthermore, a dipeptidyl-aminopeptidase activity releasing the Tyr-Gly fragment is also involved in enkephalin degradation (Gorenstein and Snyder 1979). The putative physiological role of this enzyme will be discussed in this paper. Finally, the enkephalins are easily metabolized by cleavage of the Gly<sup>5</sup>-Phe bond under the action of two enzymes present in brain: the angiotensin converting enzyme (ACE) (Erdoş et al. 1978) and a distinct peptidase, originally designated enkephalinase (Malfroy et al. 1978). It is now well established that the brain membrane-bound enkephalinase is identical (Almenoff and Orlowski 1983; Fulcher et al. 1982) to the neutral metalloendopeptidase originally isolated by Kerr and Kenny (1974) from rabbit kidney. The in vitro metabolic pathways of enkephalins are schematized in figure 1. It is of major interest to notice that all the enkephalin inactivating enzymes belong to the group of metallopeptidases offering, therefore, the possibility to design mixed inhibitors.



**FIGURE 1**

In Vitro Inactivation of the Enkephalins  
by Various Enzymes of Brain Tissue

**ENKEPHALINASE, DIPEPTIDYLAMINOPEPTIDASE, AND AMINOPEPTIDASE  
SOURCES AND ASSAYS OF ENZYME ACTIVITY**

Enkephalinase from rat brain and rabbit kidney being identical (Fulcher et al. 1982; Almenoff and Orlovskii 1983), we obtained the purified enzyme from the latter. Membrane-bound dipeptidyl-aminopeptidase activity was purified from rat brain by slight modification (Bouboutou et al. 1984) of the reported method (Gorenstein and Snyder 1979). Two membrane-bound aminopeptidase activities releasing Tyr from enkephalins were separated from a particulate fraction (P<sub>2</sub>) of rat brain using a linear gradient of NaCl. One peptidase was more sensitive to ketorphan and was found to be identical to the aminopeptidase M from rabbit kidney. As this enzyme is very likely to be specifically involved in the synaptic degradation of enkephalins, aminopeptidase M isolated from rabbit kidney was commonly used as the enzyme source (Fournié-Zaluski et al., In press [1985a]).

The enkephalinase activity and its inhibition were determined using either [<sup>3</sup>H] Leu-enkephalin or [<sup>3</sup>H] D-Ala<sup>2</sup>-Leu-enkephalin as substrates (Fournié-Zaluski et al. 1983). The formed [<sup>3</sup>H] Tyr-Gly-Gly metabolite was separated as described (Vogel and Altstein 1977). Moreover, a fluorimetric determination of

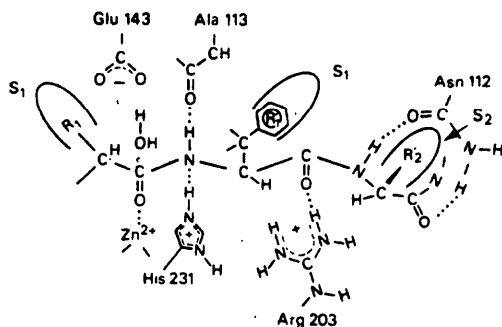


FIGURE 2

Schematic Representation of the Binding of Substrates  
or Inhibitors to Thermolysin

enkephalinase activity was also used (Florentin et al. 1984). The formation of [<sup>3</sup>H] Tyr or [<sup>3</sup>H] Tyr-Cly by aminopeptidase or dipeptidylaminopeptidase, activities, respectively, and the inhibition of these peptidases were evaluated using [<sup>3</sup>H] Leu-enkephalin, as reported by Bouboutou et al. (1984). Determinations of inhibition constants, and kinetic experiments were computed from regression analysis using a Hewlett Packard calculator. The biological relevance of the results obtained with purified enzymes was established by comparison with those evaluated using membrane preparations of rat brain tissue.

#### STRUCTURAL AND FUNCTIONAL CHARACTERISTICS OF METALLOPEPTIDASES

As nicely shown from the crystallographic analysis of two metallopeptidases--the carboxypeptidase A (Lipscomb 1980) and the bacterial endopeptidase thermolysin (Holmes and Matthews 1981; Monzingo and Matthews 1982), all the zinc metalloproteases have similarities in their active sites and in their respective mechanisms of action (Kester and Matthews 1977). As shown in figure 2, the hydrolysis of a peptide bond could involve: 1) the coordination of the oxygen of the fragile bond to the Zn atom; 2) the Glu-143 promoted nucleophilic attack of a water molecule on the carbonyl carbon polarized by the Zn ion; and 3) the protonation of the nitrogen of the peptide bond to be cleaved by His-231. In the final step, the bond between the tetrahedral carbon and nitrogen atoms breaks to yield the two peptide products. Thercent crystallographic study of hydroxamate-thermo-

lysine complexes have suggested that the hydrolysis process could occur through the initial formation of a pentacoordinate complex of the metal without displacement of the water molecule bound to the Zn atom by the oxygen of the fragile bond (Monzingo and Matthews 1982). On the other hand, a careful analysis of several complexes between thermolysin and substrates or inhibitors have shown that the specificity of the metallopeptidase is ensured by: 1) Van der Waals interactions between  $S_1$ ,  $S_1'$ , and  $S_2'$  subsites of the enzyme and the lateral chains of the corresponding  $P_1$ ,  $P_1'$ , and  $P_2'$  moieties of the substrate or the inhibitor; and 2) several well-positioned hydrogen bonds between donor and acceptor groups of the bound molecule and polar residues of the peptidase, such as Asn-112, Arg-203, etc. Owing to the great similarities in the active site of all metallopeptidases (Kester and Matthews 1977), the knowledge of the binding mode of inhibitors to thermolysin at the molecular level allowed us to design potent inhibitors of enkephalin degrading enzymes in a rational way.

#### **CHARACTERIZATION OF ENKEPHALINASE ACTIVE SITES**

Among the various peptidases able to cleave the enkephalins, in vitro, enkephalinase was the first for which a crucial role in the biological inactivation of the opioid peptides has been demonstrated (Roques et al. 1980). This feature is supported by the strong analgesic potency of enkephalin analogs protected from enkephalinase degrading activity (Fournié-Zaluski et al. 1979) and by changes in enzymatic activity following chronic morphine treatment (Roques et al. 1980). Therefore, our first studies were directed toward the synthesis of enkephalinase inhibitors. However, the carboxydipeptidase, ACE, also displays some ability to split the Gly<sup>3</sup>-Phe<sup>4</sup> bond of enkephalins (Erdos et al. 1978), suggesting the presence of similarities in the active sites of enkephalinase and ACE. Therefore, given the involvement of this latter enzyme in blood pressure regulation, it was very important to develop enkephalinase inhibitors exhibiting both a strong potency and a selectivity as high as possible in anticipation of their eventual clinical use.

#### **PRELIMINARY INVESTIGATIONS OF $S_1'$ AND $S_2'$ SUBSITES OF ENKEPHALINASE**

A careful analysis of a large series of dipeptides with the sequences X-Ala and Phe-X (X, corresponding to various amino

acids) has shown that the specificity of enkephalinase is essentially ensured by 1) an  $S_1'$  subsite which interacts preferentially with aromatic or hydrophobic moiety (Fournié-Zaluski et al. 1981; Llorens et al. 1980); 2) a moderate but significant preference of the  $S_2'$  subsite for short side chains; and 3) an enhanced affinity for substrates bearing a free COOH-terminal group (Fournié-Zaluski et al. 1979). Therefore, according to its specificity toward bonds of the amino side of aromatic or hydrophobic amino acids, enkephalinase is able to cleave a large variety of peptides, such as substance P, neurotensin, cholecystokinin, etc. Regarding the differences with ACE, it is of great importance to notice that the  $S_2'$  subsite of enkephalinase displays a large aversion for proline (Fournié-Zaluski et al. 1979, Fournié-Zaluski et al. 1981). To illustrate, compounds bearing a C-terminal proline such as captopril (Cushman et al. 1977) are well recognized by the  $S_2'$  subsite of ACE; whereas, in contrast to enkephalinase, the  $S_1'$  subsite of ACE does not exhibit a significant preference for aromatic or hydrophobic side chains (Cushman et al. 1977). So, as shown in table 1, in contrast to Phe-Pro, the dipeptides Phe-Leu and Phe-Ala behave as relatively good enkephalinase inhibitors but are badly recognized by ACE. Moreover, several interesting binding properties of enkephalinase are reported in table 1. As expected, the replacement of the natural amino acid L-Phe by its stereoisomer D-Phe leads to a large loss of inhibitory potency. A similar effect was obtained by N-methylation of the amide bond of Phe-Ala; whereas, surprisingly, retroinversion of this bond (change from -CONH- to -NHCO-) led only to a tenfold decrease in activity. This result was interpreted by a topological analogy between the crucial components (benzyl and methyl chains,  $NH_3^+$ , and  $COO^-$  groups) in the R,R isomer of retro-Phe-Ala and the natural dipeptide L-Phe-L-Ala (Roques et al. 1983). This was confirmed by the synthesis of the two enantiomers of retro Phe-Gly (table 1).

This very interesting result indicates that, despite the amide bond reversal, the oxygen and hydrogen atoms fill similar spatial positions in both retro and natural amide bonds (Roques et al. 1983). This probably allows the crucially required hydrogen bond formation of the -NHCO- group within the enkephalinase active site.

TABLE 1

**Inhibitory Potency of Natural and Modified Dipeptides on Enkephalinase and Angiotensin Converting Enzymes (ACE) <sup>a</sup>**

<u>COMPOUNDS</u>	IC <sub>50</sub> (μM)	
	<u>ENKASE</u>	<u>ACE</u>
L-Phe-L-Leu	20	700
L-Phe-L-Ala	1	> 1000
D-Phe-L-Ala	100	> 1000
L-Phe-(N-Me)L-Ala	> 100	> 1000
<i>retro</i> -Phe-Ala (R,S + R,R)	10	NT
<i>retro</i> -Phe-Gly (R)	15	NT
<i>retro</i> -Phe-Gly (S)	100	NT
L-Phe-L-Pro	> 100	NT

<sup>a</sup> The IC<sub>50</sub> values (means from five independent experiments with SEM < 10%) were computed using [<sup>3</sup>H]-Leu-Enk (20 nM) as substrate on enkephalinase from mouse striata and ACE from Calbiochem.

**RATIONAL DESIGN OF CARBOXY AND THIOL INHIBITORS OF ENKEPHALINASE**

According to their selectivity and relatively good potency against enkephalinase activity, the dipeptides Phe-Ala and Phe-Leu were selected as starting models. to design highly potent enkephalinase inhibitors by introduction of a Zn-chelating group. As nicely shown by Cushman et al. (1977) in the synthesis of ACE inhibitors, carboxyl and mercapto groups appeared among the most potent metal coordinating agents. For the first time, new carboxyalkyl compounds derived from Phe-Leu were selected as enkephalinase inhibitors (Fournié-Zaluski et al. 1982, Fournié-Zaluski et al. 1983). The general formula of these molecules is: R-CH(CH<sub>2</sub>ϕ)-CONH-CH-[CH<sub>2</sub>CH(CH<sub>3</sub>)<sub>2</sub>COOH with R = COOH, 1; R = CH<sub>2</sub>COOH, 2; R = NH-CH<sub>2</sub>-COOH, 3; and R = NH-CH<sub>2</sub>-CH<sub>2</sub>-COOH, 4. All these compounds behave as competitive inhibitors of enkephalinase, with IC values in the 0.7 to 10 μM range. Similar results were reported for compounds 2 and 3 by Smith and Wilkinson (1982).

The most interesting characteristics of this first series of inhibitors are the following: 1) Whatever the position of the carboxyl group in the chain, the  $IC_{50}$  values on enkephalinase remain in the same range, whereas ACE recognition is strongly modulated by the length of the chain bearing the COOH group. So, in accordance with ACE inhibitors derived from carboxyalkanoyl-L-proline (Cushman et al. 1977), the most potent blockers of this latter enzyme are compounds 2 and 3 with  $IC_{50}$  of 20 and 2  $\mu M$ , respectively.. 2) The enkephalinase specificity of 2 and 3 is tightly decreased as compared to their dipeptide precursors.

According to the demonstrated selectivity of the  $S_1'$  subsite of enkephalinase for aromatic or hydrophobic side chains (Fournié-Zaluski et al. 1981), various carboxyl inhibitors containing these moieties as  $P_1'$  components were synthesized. Highly potent enkephalinase inhibitors ( $IC_{50}$  of 20 nM) were obtained in two series of compounds derived from the dipeptide L-Phe- $\beta$ -Ala. The two series were characterized by introduction on the amino group of Phe to one of the following chelating residues:  $\phi-CH_2-CH(COOH)-$  (Berger and Chipkin, personal communication) or  $\phi-CH_2-CH_2-CH(COOH)-$  (Mumford et al. 1982). Interestingly, as compared to 3, introduction of the additional phenyl ring seems to increase the affinity for enkephalinase. This could indicate the presence in the enzyme of an  $S_1$  subsite interacting favorably with an aromatic moiety. Moreover, the affinity of these compounds for enkephalinase is modulated by the configuration of both the  $\alpha$  carbon of Phe and the carbon bearing the carboxyl group. Thus, the S,S isomer is at least 100 times more potent than the other stereoisomers (R,S; S,R; R,R) (Berger and Chipkin 1984). In contrast, the inhibitory potency of compound 3 remains practically identical whatever the configuration of Phe is. These features can be interpreted by the fact that binding of the carboxyl group to the metal atom represents the most important factor for affinity. Therefore, the binding strength can probably overcome an imperfect fitting of the  $P_1'$  moiety in the  $S_1'$  subsite but is unable to counterbalance an additional adverse interaction occurring at the level of the  $S_1$  subsite. On the other hand, the replacement of  $\beta$ -Ala in the preceding inhibitors by the  $^2HN-C_6H_4-COOH$  group, led also to efficient enkephalinase blockers (Almenoff and Orłowski 1983).



The second series of enkephalinase inhibitors that we have designed bears a thiol group as metal chelating agent (Roques et al. 1980; Fournié-Zaluski et al. 1984b). The general formula is:  $R-CH(CH_2\phi)CONH-CH[CH_2-CH(CH_3)_2]-COOH$ . In contrast to the carboxyl inhibitors, the enkephalinase recognition is crucially dependent on the length of the thiol containing group R. The most potent compound, with  $R = CH_2SH$ , exhibits an  $IC_{50}$  of 4.5 nM on enkephalinase but behaves also as a good ACE inhibitor ( $IC_{50} = 55$  nM). This unfavorable feature, already observed in the case of carboxyl inhibitors, could be related to the binding strength of the coordinating group which minimizes the preferential interaction of the side chains with the specific subsites of enkephalinase or ACE. Therefore, in order to find a selective enkephalinase inhibitor, various amino acids were used as  $P_2'$  components. Increase in the size of the side chain does not change significantly the  $IC_{50}$  on enkephalinase but enhances the affinity for ACE. Consequently, the best  $P_2'$  moiety for selective inhibition was shown to be a glycine residue, and the obtained compound N-[(R,S)-3-mercapto-2-benzylpropanoyl]-glycine ( $K_I = 2$  nM) with a discrimination factor of around 40 was designated thiorphan and used in the first biological studies (Roques et al. 1980). Interestingly, the reduction of the  $P_1'$  benzyl group of thiorphan into a methylene cyclohexyl chain ( $-CH_2-C_6H_{11}$ ) led to a less potent enkephalinase inhibitor ( $IC_{50} = 31$  nM), but this change strongly inhibits the binding to ACE ( $IC_{50} > 10,000$  nM) (Fournié-Zaluski et al. 1984b). Likewise, introduction of an  $HS-CH_2-CO$  group on the N-terminal part of L-Phe-L-Leu led to relatively good enkephalinase inhibitor ( $IC_{50} = 70$  nM) with weaker ACE affinity (Altstein et al. 1983).

#### **COMPLETE DIFFERENTIATION BETWEEN ENKEPHALINASE AND ACE INHIBITION BY RETROTHIORPHAN**

On the other hand, a large decrease in  $IC_{50}$  on enkephalinase but not on ACE was observed by N-methylation of the amide bond of the previous thiol inhibitors (Fournié-Zaluski et al. 1984b). This finding agrees both with the results obtained at the dipeptide level and with the good affinity for ACE of inhibitors bearing an  $N-CH_3$  group or a proline in  $P_2'$  position (Cushman et al. 1977). So, taking into account that the subsite specificity of  $P_1'$  and  $P_2'$  residues cannot ensure a complete differentiation of these two enzymes, the modification of the amide bond was considered as the most promising discriminating factors. This

clearly demonstrated through the synthesis of retrothiorphan, HS-CH<sub>2</sub>CH(CH<sub>2</sub>Φ)NHCO-CH<sub>2</sub>-COOH; since with a K<sub>T</sub> = 6 nM, this compound is almost as potent as thiorphan on enkephalinase but displays a drastic loss of potency on ACE (IC<sub>50</sub> > 10,000 nM) (Roques et al. 1983). Moreover, a stereospecific synthesis of retrothiorphan showed that the R isomer (K<sub>T</sub>=2 nM) is much more potent on enkephalinase than the S isomer (IC<sub>50</sub> - 200 nM). In contrast, the R and S isomers of thiorphan have almost the same potency (Fournié-Zaluski et al., in press [1985a]). Therefore, the topological concept of retro-inverso isomers (Goodman and Chorev 1979) that we have extended for the first time to enzyme inhibitors could be adapted to other enkephalinase inhibitors. Preliminary results support this assumption. Finally, it must be observed that the retro-inversion of an amide bond in peptides or related compounds bestows to these molecules an enhanced resistance to proteolytic enzymatic degradation.

#### **STRUCTURAL CHARACTERISTICS OF THE ACTIVE SITE OF THE NEUTRAL METALLOENDOPEPTIDASE (EC 3.4.24.11) ENKEPHALINASE AND FUNCTIONAL IMPLICATIONS**

The major structural requirements for selective interaction with enkephalinase or ACE were schematized in figure 3. Owing to its endopeptidase activity, enkephalinase might be compared to thermolysin while, in view of its largely preferential exopeptidase action, ACE could be related to carboxypeptidase A. Therefore, starting from the crystallographic analysis of the complex of thermolysin with a thiol (Monzingo and Matthews 1982) or an hydroxamate inhibitor (Holmes and Matthews 1981), some characteristics of the enkephalinase active site and mechanism of action can be derived (Fournié-Zaluski et al. 1984b). All of the Zn metalloenzymes, including ACE and enkephalinase, contain an essential arginine residue in their active site. In thermolysin, and possibly in enkephalinase, the oxygen and the hydrogen atoms of the peptide bonds between the P<sub>1</sub>' and P<sub>2</sub>' moieties of substrates or inhibitors are hydrogen bonded, respectively, to the guanidinium group of the Arg residue and to the oxygen of the amide bond of an Asn amino acid. Obviously, this latter interaction is hindered by N-methylation of the amide bond or by inclusion of the nitrogen atom in a proline ring accounting for: 1) the decreased affinity for enkephalinase of inhibitors with an N-methylated amide group (Fournié-Zaluski et al. 1984b); 2) the severe loss of potency of captopril on enkephalinase

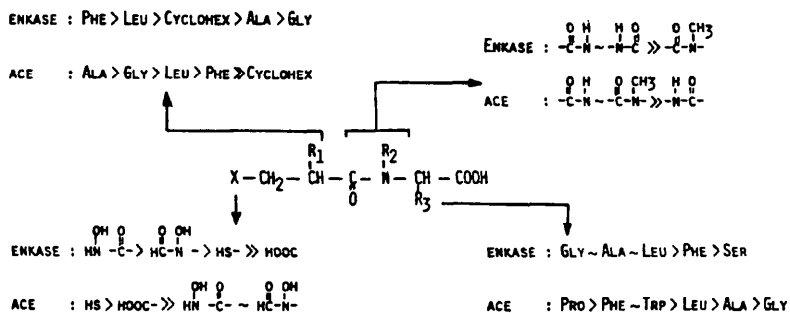


FIGURE 3

Schematic drawing showing the main structural requirements allowing preferential interaction with enkephalinase or ACE at the level of: the metal atom, the S<sub>1</sub>' and S<sub>2</sub>' subsites, the amide bond.

(IC<sub>50</sub> > 10,000 nM) (Roques et al. 1980). On the other hand, the Arg side chain is located on the "side" of the substrate or inhibitor in complexed thermolysin (Holmes and Matthews 1981). Assuming the same kind of disposition for enkephalinase, the somewhat preferential carboxypeptidase activity of this enzyme (Florentin et al. 1984) could be due to a larger degree of freedom of the Arg side chain, allowing the formation of a salt bridge with the free carboxyl group of enkephalins. Such a process accounts for the catalytic activity of carboxypeptidase A and probably of ACE. In this way, it is interesting to note that enkephalin analogs with a CH<sub>2</sub>OH C-terminal group in place of COOH are protected from degradation by enkephalinase. The assumed arginine side-chain flexibility within the active site of enkephalinase probably counteracts the small change in the position of the oxygen and hydrogen atoms at the retroamide bond as compared to the natural amide bond. This should permit the formation of hydrogen bonds between the retroamide group of retrothiorphan and enkephalinase (Roques et al. 1983). The S<sub>1</sub>' hydrophobic pocket of enkephalinase is clearly larger than the corresponding subsite of thermolysin or ACE, since the former does not bind compounds with a Trp as P<sub>1</sub>' component; whereas, a cyclohexyl ring in this position leads to a complete loss of affinity for ACE. Therefore, the assumed mobility of a P<sub>1</sub>' residue in the large hydrophobic pocket of enkephalinase could

explain the less stringent structural requirement for optimal binding to the Zn atom in enkephalinase than in ACE (Fournié-Zaluski et al. 1983). This assumption is supported by the strong affinity of carboxyl inhibitors bearing a very large P<sub>1</sub>' group (p.C<sub>6</sub>H<sub>5</sub>-CH<sub>2</sub>-OC<sub>6</sub>H<sub>4</sub>-CH<sub>2</sub>-) in place of the benzyl residue (Berger and Chipkin 1984).

#### **BIDENTATE PEPTIDES AS HIGHLY POTENT AND MIXED INHIBITORS OF ENKEPHALIN DEGRADING ENZYME**

As noted in the first section, the enkephalins are cleaved in vitro by enkephalinase, a dipeptidylaminopeptidase, and a membrane-bound aminopeptidase. Recently, inhibition of this latter enzymatic activity by bestatin was shown to induce an increase in brain enkephalin content and subsequently a naloxone reversible analgesia following intracerebroventricular (i.c.v.) administration (Carenzi et al. 1981; Chaillet et al. 1983). All the enkephalin degrading enzymes belong to the group of metalloproteases characterized by a wide specificity. It was, therefore, theoretically possible to design a compound able to inhibit the three peptidases, provided that the expected loss of binding affinity due to a relative inability of the lateral chains of the inhibitor to fit adequately the respective subsites of the three different enzymes is counterbalanced by the strength of coordination to the Zn atom.

As shown by Nishino and Powers (1978), bidentate group such as hydroxamic, NH(OH)CO, or N-acyl-N-hydroxyamino, -CO-N(OH)- are able to form strongly stabilized pentacoordinate complexes with the metal atom of various metallopeptidases. So, the thermolysin inhibitor, HN(OH)-CO-CH(CH<sub>2</sub>φ)-Ala-Gly-NH<sub>2</sub>, behaves also as a potent enkephalinase inhibitor (Mumford et al. 1981). Likewise, Blumberg et al. (1981) have shown that amino acid hydroxamates, such as Z-Phe-NHOH and Z-Leu-NHOH, were able to inhibit enkephalinase and aminopeptidase with IC<sub>50</sub> values in the micromolar range. According to these features, we decided to prepare four series of inhibitors bearing bidentate groups on structures related to Phe-Gly or Phe-Ala (Bouboutou et al. 1984; Fournié-Zaluski et al., in press [1985]).

To avoid isomerization of inhibitors belonging to the series of hydroxamic acids, NH(OH)CO-CH<sub>2</sub>-CH(CH<sub>2</sub>φ)CONHCH(R)-COOH, which may occur during the synthesis by classical methods a new

TABLE 2

Inhibitory Potency of Various Hydroxamates and N-hydroxy, N-acyl Peptides on Enkephalinase and ACE Activity <sup>a</sup>

	Chemical Structure	IC <sub>50</sub> (nM)	
		Enkephalinase	ACE
<u>1</u>		10 <sup>±2</sup>	-30,000
<u>2</u>		1500 <sup>±200</sup>	>100,000
<u>3</u>		15 <sup>±1.5</sup>	-100,000
<u>4</u>		3.8 <sup>±1.5</sup>	-25,000
<u>5</u>		4.0 <sup>±1.0</sup>	-20,000
<u>6</u>		800 <sup>±50</sup>	-20,000
<u>7</u>		5,000 <sup>±700</sup>	-30,000

<sup>a</sup> IC<sub>50</sub> values (means ± SEM of five determinations) were determined using [<sup>3</sup>H]D-Ala<sup>2</sup>-Leu-Enk as substrates with pure enkephalinase and ACE.

synthetic procedure was developed (M.C. Fournié-Zaluski et al., patent and unpublished results). The binding of the bidentate inhibitors is schematized (table 2) using the currently accepted active site model (Cushman et al. 1977). As expected, compounds 1, 2, and 3 belonging to three different series of bidentates behave as highly potent enkephalinase inhibitors with IC<sub>50</sub> values in the 4 to 15 nM range (table 2). As for thiol inhibitors (Fournié-Zaluski et al. 1984b), a methylene spacer separates the benzyl P<sub>1</sub>' moiety from the metal ion-chelating group in the most active compounds, 4 and 5. The chromatographic separation of the two diastereoisomers of 5 led to a pure compound [(R)-3-(N-hydroxy)-carboxamido-2-benzylpropanoyl]L-alanine, whose configuration, analogous to that of a natural dipeptide, was established by NMR spectroscopy (Fournié-Zaluski et al., in press[1985b]).

**TABLE 3**

Influence of the Stereochemistry of Compound 5 on the Binding Affinity to the Three Enkephalin Degrading Enzymes

STEREO SELECTIVE INHIBITION OF ENKEPHALIN DEGRADING METALLOENZYMES BY		
	(S) (R)	(S) (S)
	$  \begin{array}{c}  \text{H-O} \quad \text{O} \\    \quad \quad   \\  \text{H-N-C-CH}_2\text{-CH-CO-NH-CH-COOH} \\  \quad \quad \quad   \quad \quad   \\  \quad \quad \quad \text{CH}_2 \quad \text{CH}_3  \end{array}  $	
	*RS* ISOMER = KELATORPHAN IC <sub>50</sub>	*SS* ISOMER IC <sub>50</sub>
ENKEPHALINASE	1.7 ± 0.4 × 10 <sup>-9</sup>	1.8 ± 0.4 × 10 <sup>-9</sup>
DIPEPTIDYLAMINOPEPTIDASE	0.9 ± 0.1 × 10 <sup>-9</sup>	1.0 ± 0.5 × 10 <sup>-7</sup>
AMINOPEPTIDASE	3.8 ± 0.5 × 10 <sup>-7</sup>	2.9 ± 0.5 × 10 <sup>-5</sup>

On the other hand, among the four series of bidentates, compounds 4 and 5 behave as highly potent and competitive inhibitors of the dipeptidylaminopeptidase that releases Tyr-Gly from enkephalins. These derivatives are the first described highly potent inhibitors of this enzyme (Bouboutou et al. 1984).

Very interestingly, compound 5 also interacts with a relatively good affinity (IC<sub>50</sub> = 0.4 μM) to both the aminopeptidase M isolated from rabbit kidney and a membrane-bound aminopeptidase partially purified from rat brain (Waksman et al. 1985 ; Fournié-Zaluski et al., in press [1985a]). The (R) isomer of 5, designated kelatorphan, behaves therefore as the first fully described inhibitor of enkephalin metabolism (Fournié-Zaluski et al. 1984b). Moreover, inhibition of the three enkephalin degrading enzymes is modulated by the stereochemistry of 5 (table 3).

It is interesting to observe that the potency of bestatin to inhibit the release of tyrosine from enkephalins is almost identical (IC<sub>50</sub> = 0.5 μM) on purified aminopeptidase and on the set of various aminopeptidases of mouse brain membrane preparation. In contrast, kelatorphan is about fiftyfold less potent (IC<sub>50</sub> = 20 μM) on brain tissue than on pure enzyme (IC<sub>50</sub> = 0.4 μM), suggesting that this new inhibitor is more selective than bestatin on the biologically relevant enkephalin degrading

aminopeptidase. As shown in the next section, this assumption is supported by the similar analgesic effects produced by kelatorphan or by the association of bestatin and thiorphan, since the efficiency of kelatorphan and thiorphan to inhibit enkephalinase are identical.

#### **IN VITRO AND IN VIVO PROTECTION OF ENKEPBALINS FROM DEGRADING ENZYMES**

As already discussed, in vitro incubation of enkephalins with rat brain tissue leads to rapid destruction of the peptides. This feature occurs also after i.c.v. injection of Met- or Leu-enkephalin. It was, therefore, possible to evaluate the in vivo protecting ability of a given inhibitor by i.c.v. coadministration in mice of increasing concentrations of this compound with a fixed dose of [<sup>3</sup>H] Leu-enkephalin. After 5 minutes, the mice were killed, and the intact [<sup>3</sup>H] Leu-enkephalin was determined. In this assay, kelatorphan at 50 µg is able to protect 80% of Leu-enkephalin and this protecting effect is at least as efficient as that produced by the association of thiorphan (50 µg) and bestatin (50 µg) (Waksman et al. 1985; Waksman et al., in press).

Another way of testing the potency of inhibitors to protect the enkephalins from the various peptidases is to use washed brain slices. In this condition, more closely related to the actual physiological situation, the peptide substrate is cleaved only by membrane-bound enzymes (Patey et al. 1981). As-shown in figure 4, incubation of a mixture of 20 µM of [<sup>3</sup>H] Met-Enk with rat striatal slices leads to the appearance of the tritiated metabolites Tyr, Tyr-Gly, and Tyr-Gly-Gly, with Tyr as the most abundant compound. Addition of different inhibitors induces a decrease in the formed products corresponding to the selectivity of the inhibitor against each peptidase. In this test, kelatorphan alone was found to be more efficient than thiorphan, bestatin, or the two in combination and occurs as the single compound to inhibit the Tyr-Gly formation (figure 4) (Waksman et al., in press).

#### **POTENTIATION OF THE ANALGESIC EFFECT OF ENKEPHALINS EXHIBITING DIFFERENT SENSITIVITY TO ENKEPHALIN DEGRADING ENZYME**

In vivo activity of kelatorphan was compared to that of thiorphan, bestatin, or the two in combination by evaluating the

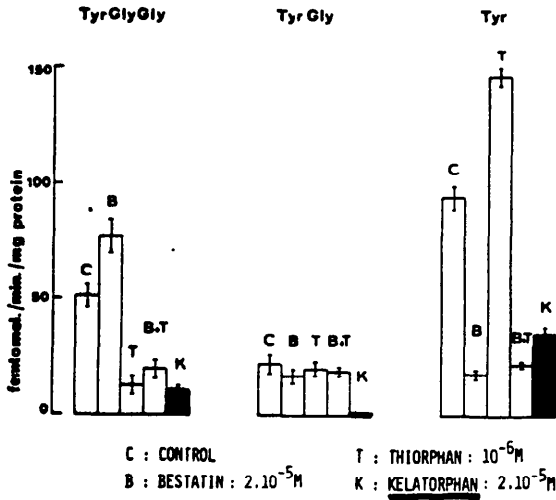


FIGURE 4

Effect of Peptidase Inhibitors on Formation of (Met)Tyr<sup>1</sup>, Enkephalin Metabolites by Rat Striatal Slices.

TABLE 4

Analgesic Effects (Hot-Plate Test) of Peptidase Inhibitors and Potentiation of the Analgesic Effects of Co administered Opioid Peptide

**POTENTIATION OF SUBACTIVE DOSES OF DIFFERENT ENKEPHALIN ANALOGUES BY VARIOUS INHIBITORS ICV ADMINISTERED IN MICE**

**MHP LATENCY TIME (S)**

	SOL. PHYS.	Met <sup>5</sup> ENKE (50 µg)	TYR-GLY-GLY-PHE-PHE- <sup>1</sup> Tyr (10 µg)	TYR-D-ALA-GLY-PHE- <sup>1</sup> Tyr (0.1 µg)
SOL. PHYS.	57 ± 6	54 ± 5	59 ± 5	55 ± 6
BESTATINE (10 µg)	79 ± 8	131 ± 14	240 ± 0	85 ± 10
THIORPHAN (10 µg)	87 ± 10	135 ± 15	105 ± 13	240 ± 0 <sup>a</sup>
BEST+THIOR. (10 µg+10 µg)	129 ± 15	240 ± 0 <sup>a</sup>	240 ± 0 <sup>a</sup>	240 ± 0 <sup>a</sup>
KELATORPHAN (10 µg)	153 ± 19	240 ± 0 <sup>a</sup>	240 ± 0 <sup>a</sup>	240 ± 0 <sup>a</sup>
SENSITIVITY TO				
ENKEPHALINASE		+	-	+
AMINOPEPTIDASE		+	+	-
DIPEPTIDYLAMINOP.		+	+	-

a) CUT-OFF TIME = 240 s.



analgesia produced in mice by these inhibitors in the presence of subanalgesic doses of three enkephalins exhibiting different sensitivity toward enkephalin degrading enzymes (Fournié-Zaluski et al. 1984a) (table 4).

When Met-enkephalin, which is sensitive to the three peptidase was used as analgesic agent, the maximal response was obtained with 10 µg of kelatorphan (cutoff time, 240 seconds), while the same effect required the association of bestatin and thiorphan (10 µg each). Moreover, as judged by its inhibitory potency on the three enkephalin degrading enzymes, the proper antinociceptive effect of kelatorphan administered i.c.v. was found to be twofold higher than that of bestatin or thiorphan (table 4, first column). All inhibitor-induced analgesic responses were prevented by prior administration of naloxone, demonstrating that the observed effects were due to specific stimulation of opioid receptors.

Interestingly, naloxone shows pronociceptive effects in these assays (Jacob et al. 1974; Roques et al. 1980). In contrast, peptidase inhibitors as well as naloxone are inactive on mouse tail-flick and mouse tail-withdrawal tests; likely because the physiological release of enkephalins is not high enough to lessen the high nociceptive stimuli produced by these latter tests. So, in strong nociceptive conditions, peptidase inhibitors cannot significantly reduce painful messages, and naloxone cannot magnify them. Another explanation may be that, in tail-flick and tail-withdrawal tests, opioid peptides less sensitive to enkephalinase, such as dynorphin, should be preferentially involved in pain regulation. In any case, in the presence of subanalgesic doses of exogenous enkephalins, peptidase inhibitors are strongly active on tail-flick and tail-withdrawal tests.

Finally, the protecting activity of the various inhibitors was compared by measuring on the tail flick-test the apparent analgesic efficiency (ED<sub>50</sub>) of Met-enkephalin i.c.v. coadministered with different concentrations of inhibitors. On this test, kelatorphan was about fivefold more active than bestatin in combination with thiorphan and was able to decrease 50,000 times the ED<sub>50</sub> of Met-Enk (Fournié-Zaluski et al. 1984b).

## STUDY OF ENKEPHALIN DEGRADING ENZYMES BY USE OF A TRITIATED INHIBITOR

The final demonstration of the physiological and selective role of the three enkephalin degrading enzymes at the level of enkephalinergic transmission requires acute investigations on: 1) the binding characteristics of these peptidases; 2) a quantitative determination of their subcellular distribution and localization in the CNS; and 3) an evaluation of the possible changes in these parameters under different pharmacological situations (acute and chronic treatment by inhibitors, opiates, neuroleptics, etc.) or after lesions of assumed enkephalinergic neuronal pathways. These studies cannot be done safely without the assistance of a radiolabeled probe. We have therefore synthesized the inhibitor 4 under its tritiated form: [ $^3\text{H}$ ]-[(R,S)-3-(hydroxyamino)carbonyl-2-benzyl-1-oxopropyl]-glycine ([ $^3\text{H}$ ]-HACBO-Gly; 45 Ci/mmmole).

The binding of [ $^3\text{H}$ ]-HACBO-Gly to crude rat brain membranes shows that the inhibitor interacts with two distinct populations of independent sites with KI values close to 0.3 nM ( $B_{\text{max}} = 55$  femtomole/mg protein) and 20 nM ( $B_{\text{max}} = 600$  femtomole/mg protein), respectively (figure 5).

Inhibition of [ $^3\text{H}$ ]-HACBO-Gly binding by different effectors shows that the high-affinity binding site corresponds to enkephalinase and the low-affinity site very likely to dipeptidylaminopeptidase activity (table 5). Indeed the KI values to the high affinity site computed from displacement curves were in close agreement with the KI values obtained from kinetics experiments performed on both pure and rat brain membrane-bound enkephalinase. Finally, the bidentate HACBO-Gly is poorly recognized by aminopeptidase ( $\text{IC}_{50} = 40 \mu\text{M}$ ) and, therefore, the binding of [ $^3\text{H}$ ]-HACBO-Gly to both sites was not inhibited by bestatin ( $10 \mu\text{M}$ ) (Waksman et al. 1984, 1985).

## VISUALIZATION OF ENKEPHALINASE IN RAT BRAIN

The highly favourable binding characteristics of [ $^3\text{H}$ ]-HACBO-Gly allowed us to perform, for the first time, a direct visualization of enkephalinase in rat brain by radioautography (Waksman et al. 1984). As shown on figure 6, the selective binding (completely eliminated in presence of thiorphan  $1 \mu\text{M}$  but unmodified by captopril  $1 \mu\text{M}$ ), is especially dense in discrete cerebral regions, such as globus pallidus, caudate nucleus, putamen, substantia

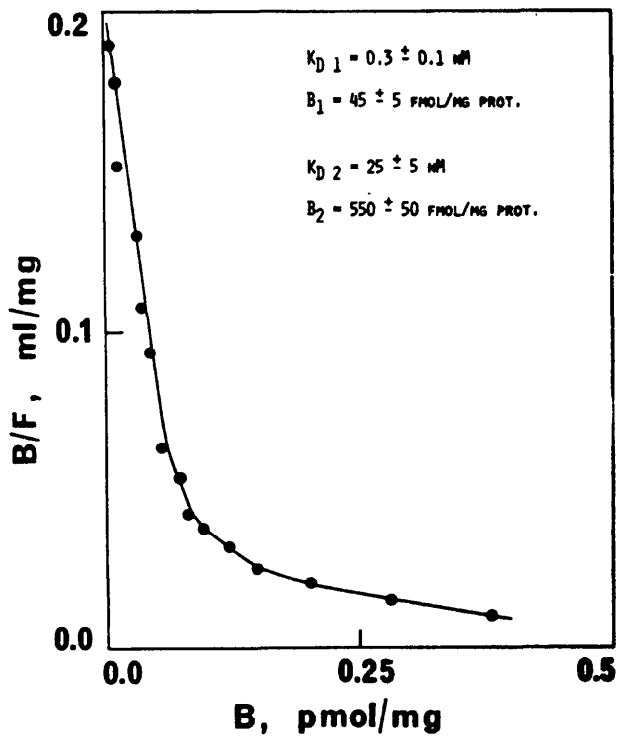


FIGURE 5

Binding Isotherm of [<sup>3</sup>H]ACBO-Gly to Crude Rat Brain Membranes Preparation (P<sub>2</sub>Fraction)

The First linear part of the curve corresponds to the binding with enkephalinase ( $K_D = 0.3 \text{ nM}$ ) and the second part to the binding with a dipeptidylaminpeptidase activity.

**TABLE 5**

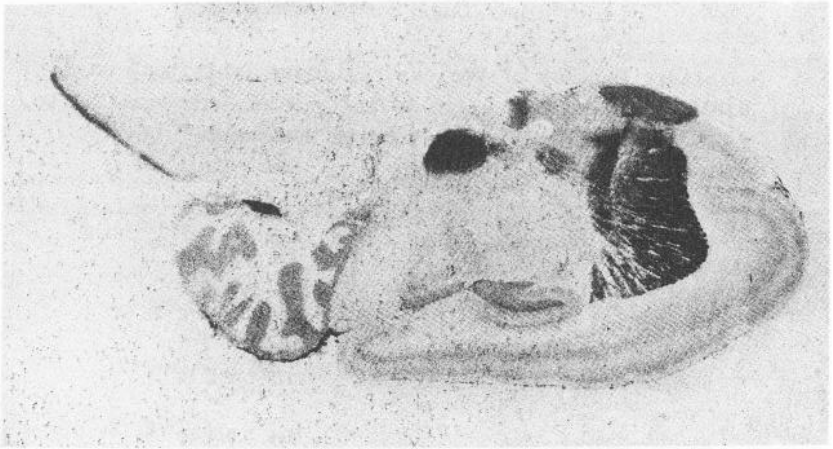
Inhibitory Potency of Various Peptidase Inhibitors on the [<sup>3</sup>H]HACBO-Gly Binding (High Affinity Site Corresponding to Enkephalinase) to Rat Brain Membranes<sup>a</sup>

Compounds	K <sub>i</sub> (M)
Thiorphan	3.0 ± 1.0 10 <sup>-10</sup>
Kelatorphan	5.0 ± 0.5 10 <sup>-10</sup>
Phosphoramidon	3.5 ± 0.5 10 <sup>-10</sup>
HS-CH--CONH-CH <sub>2</sub> -COOH C H 2ϕ	6.6 ± 0.4 10 <sup>-8</sup>
HOOC-CH <sub>2</sub> -CH-CONH-CH-COOH CH <sub>2</sub> ϕ CH <sub>2</sub> CH(CH <sub>3</sub> ) <sub>2</sub>	5.0 ± 1.2 10 <sup>-7</sup>
Captopril	> 10 <sup>-3</sup>
Bestatin	9.0 ± 0.5 10 <sup>-4</sup>

<sup>a</sup> [<sup>3</sup>H]HACBO-Gly (1 nM), K<sub>D</sub> = 0.3 nM. K<sub>i</sub> values were computed from Cheng-Prusoff equation assuming competitive inhibition.

nigra (SN), olfactory bulb, choroid plexus, and spinal cord. The density of grains is weaker in hippocampus cortex and cerebellum. Finally, the aspect of the labeling in the striatum and substantia nigra could indicate the occurrence of enkephalinergic pathways linking the SN to the putamen and this latter structure to the caudate nucleus. These assumptions are now being tested by lesion experiments.

Finally, it must be observed that this preliminary study clearly indicates that-except for striatum and SN, the distribution of enkephalinase does not overlap that of ACE (Strittmatter et al. 1984). Likewise the distribution of in vitro enkephalinase sensitive neuropeptides (cholecystokinin, SP) are not correlated with that of the enzyme. In contrast, there is a relatively strong correlation between the radioautographic distribution of the enzyme labeled with [<sup>3</sup>H]-HACBO-Gly and its assumed substrates, enkephalins. However, the very weak labeling of particular brain areas rich in μ receptors (thalamus, brain stem, etc.), if confirmed, could be of great physiological interest.



**FIGURE 6**

Autoradiographic Distribution of Enkephalinase  
in a Lateral Section of Rat Brain, Labeled with the Tritiated  
Inhibitor [<sup>3</sup>H]HACBO-Gly (3 nM).

The specificity of binding was demonstrated by the complete loss  
of [<sup>3</sup>H]HACBO-Gly labeling in presence of 1  $\mu$ M thiorphan (Waksman  
et al. 1984).

## CONCLUSION

The antinociceptive effects elicited by inhibitors of enkephalin degrading enzymes show clearly the validity of this heuristic approach. These results were confirmed by various groups (Chipkin et al. 1982; Greenberg and O'Keefe 1982; Yaksh and Harty 1982) and several pharmaceutical firms are now working in this field (Roques and Fournié-Zaluski, in preparation).

As expected, preliminary experiments seem to indicate the lack of the major side effects of narcotics (tolerance, dependence and respiratory depression) after chronic treatment by enkephalinase inhibitors (J. Costentin et al., unpublished results). Nevertheless, the possible clinical use of these compounds remains conditioned by the strength of the induced analgesia and by the development of pharmacokinetically acceptable forms.

In any case, inhibitors of enkephalin metabolism behave as useful tools in the investigation of the physiological role of these neuromodulators in different brain areas. It is interesting to note that stereotaxic injection of kelatorphan in rat caudate nucleus induced behavioural responses similar to those produced by DTLET, a selective  $\delta$  agonist for opioid receptors (Zajac et al. 1983). Taking into account that the striatal dopamine release seems to be regulated by  $\delta$ -receptor stimulation (Chesselet et al. 1982), this feature could suggest the occurrence of an enkephalinergic tonus in this structure and, therefore, a putative role for enkephalinase inhibitors at this level. Accordingly, these compounds could behave as new psychoactive agents. The respective roles of the three enkephalin degrading enzymes in the metabolism of the endogenous peptides remain still to be specified. It appears clear, nevertheless, that enkephalinase and an aminopeptidase selectively inhibited by kelatorphan are involved in enkephalin metabolism. The significant increase in Tyr formation following selective inhibition of enkephalinase could suggest, as recently proposed (Carenzi et al. 1983), that the aminopeptidase activity may increase when the content of enkephalins reaches too high a concentration. Such a mechanism should be dependent on both the level and the  $K_m$  of enkephalinase and aminopeptidase, respectively. This model could probably be investigated using tritiated probes such as HACBO-Gly. Obviously, the thiorphan-induced modulation of the formed tyrosine was not observed with kelatorphan, since this compound is able to

inhibit the three peptidases simultaneously. According to this property, an analgesia significantly longer than that induced by thiorphan was observed after administration of kelatorphan (Fournié-Zaluski et al. 1984a). Finally, the visualization of enkephalinase in the brain by radioautography strongly supports a selective role of this enzyme in enkephalin metabolism, but it would be of great interest to compare by this precise method the distribution of enkephalinase and that of the various opioid receptor-subtypes ( $\mu$ ,  $\delta$ ,  $\kappa$ ) in different brain areas. Although the role of the dipeptidylaminopeptidase in enkephalin metabolism at the synaptic level seems to be not very important, the high concentration of this enzyme could suggest its involvement in the regulation of enkephalin levels within the neuron terminals. This hypothesis would be tested by radioautographic visualization of this peptidase using [ $^3\text{H}$ ]-HACBO-Gly.

## REFERENCES

- Almenoff, J., and Orlowski, M. Membrane-bound kidney neutral metalloendopeptidase: interaction with synthetic substrates, natural peptides and inhibitors. Biochemistry 22:590-599, 1983.
- Alstein, M.; Bachar, E.; Vogel, Z.; and Blumberg, S. Protection of enkephalins from enzymatic degradation utilizing selective metal-chelating inhibitors. Eur J Pharmacol 91:353-361, 1983.
- Berger, J., and Chipkin, R.C. Enkephalinase inhibitors. In: Hruby, V., ed. Proceedings of the Peptide Symposium USA Tucson. in press, 1984.
- Belluzi, J.D.; Grant, N.; Garsky, V.; Sarantakis, D.; Wise, C.D.; and Stein, L. Analgesia induced in vivo by central administration of enkephalin in rat. Nature 60:625-627, 1976.
- Blumberg, S.; Vogel, Z.; and Altstein, M. Inhibition of enkephalin-degrading enzymes from rat brain and of thermolysin by amino acid hydroxamates. Life Sci 28:301,306, 1981.
- Bouboutou, R.; Waksman, G.; Devin, J.; Fournié-Zaluski, M.C.; and Roques, B.P. Bidentate peptides: Highly potent new inhibitors of enkephalin degrading enzymes. Life Sci 35:1023-1030, 1984.
- Carenzi, A.; Frigeni, V.; and Della Bella, D. Strong analgesic effect of Leu-enkephalin after inhibition of brain aminopeptidase: A pharmacological study. In: Takagi, H., and Simon, E.F. eds. Advances in Endogenous and Exogenous Opioids. Tokyo: Elsevier Biomedical, 1981. pp. 267-269.
- Carenzi, A.; Frigeni, V.; Reggiani, A.; and Della Bella, D. Effect of inhibition of neuropeptidases on the pain threshold of mice and rats. Neuropharmacology 22:1315-1319, 1983.

- Chaillet, P.; Marçais-Collado, H.; Costentin, J.; Yi, C.C.; de la Baume, S.; and Schwartz, J.C. Inhibition of enkephalin metabolism by and antinociceptive activity of bestatin an aminopeptidase Inhibitor. Eur J Pharmacol 86:329-336, 1983.
- Chesselet, M.F.; Cheramy, A.; Reisine, T.D.; Lubetzki, C.; Glowinski, J.; Fournié-Zaluski, M.C.; and Roques, B.P. Effects of various opiates including specific delta and mu agonists on dopamine release from nigrostriatal dopaminergic neurons in vitro in the rat and in vivo in the cat. Life Sci 31:2291-2294, 1982.
- Chipkin, R.E.; Latranyi, M.B.; Iorio, L.C.; and Barnett, A. Potentiation of [D.Ala<sup>2</sup>] enkephalinamide analgesia in rats by thiorphan. Eur J Pharmacol 83:283-288, 1982.
- Cushman, D.W.; Cheung, H.S.; Sabo, E.F.; and Ondetti, M.A. Design of potent competitive inhibitors of angiotensin-converting enzyme: Carboxyalkanoyl and mercaptoalkanoyl aminoacids. Biochemistry 16:5484-5491, 1977.
- Erdos, E.G.; Johnson, A.R.; and Boyden, N.T. Hydrolysis of enkephalin by cultured human endothelial cells and by purified peptidyl peptidase. Biochem Pharmacol 27:843-848, 1978.
- Florentin, D.; Sassi, A.; and Roques, B.P. A highly sensitive fluorimetric assay for enkephalinase, a neutral metalloendopeptidase that releases Tyr-Cly-Cly from enkephalins. Anal Biochem 141:62-69, 1984.
- Fournié-Zaluski, M.C.; Perdrisot, R.; Gacel, G.; Swerts, J.P.; Roques, B.P.; and Schwartz, J.C. Inhibitory potency of various peptides on enkephalinase activity from mouse striatum. Biochem Biophys Res Commun 91:130-135, 1979.
- Fournié-Zaluski, M.C.; Llorens, C.; Gacel, G.; Malfroy, B.; Swerts, J.P.; Lecomte, J.M.; Schwartz, J.C.; and Roques, B.P. Synthesis and biological properties of highly potent enkephalinase inhibitors. In: Brunfelt K., ed. Proceedings of the XVIth European Peptide Symposium. Copenhagen Scriptor, 1981. pp. 476-481.
- Fournié-Zaluski, M.C.; Soroca-Lucas, E.; Waksman, G.; Llorens, C.; Schwartz, J.C.; and Roques, B.P. Differential recognition of enkephalinase and angiotensin converting enzyme by new carboxyalkyl Inhibitors. Life Sci 31:2947-2954, 1982.
- Fournié-Zaluski, M.C.; Chaillet, P.; Soroca-Lucas, E.; Marçais-Collado, H.; Costentin, J.; and Roques, B.P. New carboxyalkyl inhibitors of brain enkephalinase: Synthesis, biological activity and analgesic properties. J Med Chem 26:60-65, 1983.
- Fournié-Zaluski, M.C.; Chaillet, P.; Bouboutou, R.; Coulaud, A.; Cherot, P.; Waksman, G.; Costentin, J.; and Roques, B.P. Analgesic effects of kelatorphan, a new highly potent inhibitor of multiple enkephalin degrading enzymes. Eur J Pharmacol 102:525-528, 1984a.
- Fournié-Zaluski, M.C.; Lucas, E.; Waksman, G.; and Roques, B.P. Differences in the structural requirements for selective interaction with neutral metalloendopeptidase (enkephalinase) or angiotensin converting enzyme. Molecular Investigation by use of new thiol inhibitors. Eur J Biochem 139:267-274, 1984b.



- Fournié-Zaluski, M.C.; Coulaud, A.; Bouboutou, R.; Chaillet, P.; Devin, J.; Waksman, G.; Costentin, J.; and Roques, B.P. New bidentates as full inhibitors of enkephalin degrading enzymes: Synthesis and analgesic properties. J Med Chem, in press (1985a).
- Fournié-Zaluski, M.C.; Lucas-Soroça, E.; Devin, J.; and Roques, B.P. <sup>1</sup>H NMR configurational correlation for retro-inverso dipeptides: Application to the determination of the absolute configuration of enkephalinase inhibitors. Relationships between stereochemistry and enzyme recognition. J Med Chem, in Press (1985b).
- Fulcher, I.S.; Matsas, R.; Turner, A.J.; and Kenny, A.J. Kidney neutral endopeptidase and the hydrolysis of enkephalin by synaptic membranes show similar sensitivity to inhibitors. Biochem J 203:519-522, 1982.
- Goodman, M., and Chorev, M. On the concept of linear modified retro-peptide structures. Act Chem Res 12:1-7, 1979.
- Gorenstein, C., and Snyder, H.S. Two distinct enkephalinases: Solubilization, partial purification and separation from angiotensin converting enzyme. Life Sci 25:2065-2070, 1979.
- Greenberg, R., and O'Keefe, E.H.; Thiorphan potentiation of stress induced analgesia in the mouse. Life Sci 31:1185-1188, 1982.
- Guyon, A.; Barbet, J.; Roques, B.P.; Swerts, J.P.; Malfroy, B.; and Schwartz, J.C. Disappearance of energy transfer as a tool for fluorimetric study of the degradation of enkephalins by aminopeptidase activity from mouse brain. Biochem Biophys Res Commun 88:919-926, 1979.
- Hambrook, J.M.; Morgan, B.A.; Rance, M.J.; and Smith, C.F. Mode of deactivation of the enkephalins by rat and human plasma and rat brain homogenates. Nature 262:782-783, 1976.
- Hersch, L.B. Solubilisation and characterization of two rat brain membrane-bound aminopeptidases active on Met-enkephalin. Biochemistry 20:2345-2350, 1981.
- Holmes, M.A., and Matthews, B.W. Binding of hydroxamic acid inhibitors to crystalline thermolysin suggests a pentacoordinate zinc intermediate in catalysis. Biochemistry 20:6912-6920, 1981.
- Hughes, J.; Smith, T.W.; Kosterlitz, H.W.; Fothergill, L.A.; Morgan, B.A.; and Morris, H.R. Identification of two related pentapeptides from the brain with potent opiate agonist activity. Nature 258:577-579, 1975.
- Jacob, J.; Tremblay, E.C.; and Colomel, M.C. Facilitation des reactions nociceptives par la naloxone chez la souris et chez le rat. Psychopharmacology 37:217-223, 1974.
- Kerr, M.A., and Kenny, A.J. The purification and specificity of a neutral endopeptidase from rabbit kidney brush border. Biochem J 137:477-488, 1974.
- Kester, W.R., and Matthews, B.W. Crystallographic study of the binding of dipeptide inhibitors to thermolysin: Implications for the mechanism of catalysis. Biochemistry 16:2506-2516, 1977.
- Lipscomb, W.N. Carboxypeptidase A mechanisms. Proc Natl Acad Sci USA 77:3875-3878, 1980.

- Llorens, C.; Cacel, G.; Swerts, J.P.; Perdrisot, R.; Fournié-Zaluski, M.C.; Schwartz, J.C.; and Roques, B.P. Rational design of enkephalins inhibitors: Substrate specificity of enkephalinase studied from inhibitory potency of various dipeptides. Biochem Biophys Res Commun 96:1710-1716, 1980.
- Lord, J.A.H.; Waterfield, A.A.; Hughes, I.; and Kosterlitz, H.W. Endogenous opioid peptides: Multiple agonists and receptors. Nature 267:495-499, 1977.
- Malfroy, B.; Swerts, J.P.; Guyon, A.; Roques, B.P.; and Schwartz, J.C. High affinity enkephalin degrading peptidase in brain is increased after morphine. Nature 276:523-526, 1978.
- Martin, W.H.; Eades, C.G.; Thompson, J.A.; Huppler, R.E.; and Gilbert, P.E. The effects of morphine and nalorphine-like drugs in the nondependent and morphine-dependent chronic spinal dog. J Pharmacol Exp Ther 197:517-525, 1976.
- Monzingo, A.F., and Matthews, B.W. Structure of a mercaptan - thermolysin complex illustrates mode of inhibition of zinc proteases by substrate-analogue mercaptans. Biochemistry 21:3390-3394, 1982.
- Morin-Surun, M.P.; Gacel, G.; Champagnat, J.; Denavit-Saubie, M.; and Roques, B.P. Pharmacological identification of  $\delta$  and  $\mu$  opiate receptors on bulbar respiratory neurons. Eur J Pharmacol 98:241-247, 1984.
- Mumford, R.A.; Pierzchala, P.A.; Strauss, A.W.; and Zimmerman, M. Purification of a membrane-bound q metalloendopeptidase from porcine kidney that degrades peptide hormones. Proc Natl Acad Sci USA 78:6623-6627, 1981.
- Mumford, R.A.; Zimmerman, M.; ten Brocke, J.; Taub, D.; Joshua, M.; Rothrock, J.W.; Hirshfield, J.M.; Springer, J.P.; and Patchett, A.A. Inhibition of porcine kidney enkephalinase by substituted -N-carboxymethyl dipeptides. Biochem Biophys Res Commun 109:1303-1309, 1982.
- Nishino, N., and Powers, J.C. Peptide hydroxamic acids as inhibitors of thermolysin. Biochemistry 17:2846-2850, 1978.
- Patey, G.; de la Baume, S.; Schwartz, J.C.; Gros, C.; Roques, B.P.; Fournié-Zaluski, M.C.; and Soroça-Lucas, E. Selective protection of methionine enkephalin released from brain slices by enkephalinase inhibition. Science 212:1153-1155, 1981.
- Roques, B.P.; Fournié-Zaluski, M.C.; Soroça, E.; Lecomte, J.M.; Malfroy, B.; Llorens, C.; and Schwartz, J.C. The enkephalinase inhibitor thiorphan shows antinociceptive activity in mice. Nature 288:286-288, 1980.
- Roques, B.P.; Lucas-Soroça, E.; Chaillet, P.; Costentin, J.; and Fournié-Zaluski, M.C. Complete differentiation between enkephalinase and angiotensin converting enzyme inhibition by retro-thiorphan. Proc Natl Acad Sci USA 80:3178-3182, 1983.
- Shimamura, M.; Hazato, T.; and Katayama, T. A membrane bound aminopeptidase isolated from monkey brain and its action on enkephalins. Biochem Biophys Acta 756:223-229, 1983.
- Smith, T.W., and Wilkinson, S. The chemistry and pharmacology of opioid peptides. In: Creighton, A.M., and Turner, S., eds. Chemical Regulation of Biological Mechanisms. London: The Royal Society of Chemistry; 1982.. pp. 230-254.

- Straittmatter, S.M. Lo, M.M.S. ; Javitch, J.A. and Snyder, S.H. Autoradiographic visualization of angiotensin-converting enzyme in rat brain with [<sup>3</sup>H] captopril; localization to a striatonigral pathway. Proc Natl Acad Sci USA 81:1599-1603, 1984.
- Vogel, Z., and Altein, The absorption of enkephalin to porous polystyrene beads: A simple assay for enkephalin hydrolysis. FEBS Lett 80:332-336, 1977.
- Waksman, G.; Hamel, E.; Bouboutou, R.; Besselièvre, R.; Fournié-Zaluski, M.C.; and Roques, B.P. Regional distribution of enkephalinase in rat brain by autoradiography. C R Acad Sci III 299:613-616, 1984.
- Waksman, G.; Bouboutou, R.; Chaillet, P.; Devin, J.; Coulaud, A.; Hamel, E.; Besselièvre, R.; Fournié-Zaluski, M.C.; and Roques, B.P. Kelatorphan: A full inhibitor of enkephalin degrading enzymes. Biochemical and pharmacological properties, regional distribution of enkephalinase in rat brain by use of a tritiated derivative. Neuropeptides 5:529-532, 1985.
- Waksman, C.; Bouboutou, R.; Devin, J.; Bourgoïn, S.; Cesselin, F.; Hamon, M.; Fournié-Zaluski, M.C.; and Roques, B.P. In vitro and in vivo effects of kelatorphan on enkephalin metabolism in rodent brain. Eur J Pharmacol, in press.
- Yaksh, T.L., and Harty, G.J. Effects of thiorphan on the antinociceptive actions of intrathecal [D-Ala<sup>2</sup>, Met<sup>5</sup>] enkephalin. Eur J Pharmacol 79:293-300, 1982.
- Zajac, J.M.; Gacel, G.; Dodey, P.; Morgat, J.L.; Chaillet, P.; Costentin, J.; and Roques, B.P. Deltakephalin, Tyr-D-Thr-Gly-Phe-Leu-Thr: A new highly potent and fully specific agonist for opiate  $\delta$ -receptors. Biochem Biophys Res Commun 111:390-397, 1983.

#### **AUTHORS**

Bernard P. Roques  
 Marie-Claude Fournié-Zaluski  
 Departement de Chimie Organique  
 U 266 INSERM et UA 498 CNRS  
 Faculté de Pharmacie  
 4 Avenue de l'observatoire  
 75006 Paris, France.

# Progress in the Characterization of the Opioid Receptor Subtypes: Peptides as Probes. Future Directions

Eric J. Simon, Ph.D.

## INTRODUCTION

It is my task to review the progress that has been made in the characterization of the different types and subtypes of opioid receptors. In the framework of the present conference, I shall try to emphasize those areas of the research in which opioid peptides have been particularly useful. This does not mean that I plan to ignore other aspects which are essential for an overview and understanding of this area.

In 1973, three laboratories (Simon et al. 1973; Terenius 1973; Pert and Snyder 1973) independently reported the existence of stereospecific binding sites for opiates in the central nervous system of animals and man (Hiller et al. 1973). Since that time, a large amount of evidence from numerous laboratories has strongly supported the view that these binding sites represent the recognition portion of functional opioid receptors.

This discovery was instrumental in the subsequent discovery about 2 years later of the existence of opioid peptides which appear to be the endogenous ligands of opioid receptors. Since this entire conference is devoted to these peptides, I shall not review further their discovery and characterization, except to point out that the existence of such endogenous ligands lent further confirmation to the functional importance of opioid binding sites and receptors. It also gave the impetus to the search for multiple types of receptors, since approximately a dozen opioid peptides are now known and each could act via its own receptor or receptors.

## EARLY EVIDENCE FOR MULTIPLICITY OF OPIOID RECEPTORS

In the mid-1960s, Portoghese (1965) postulated the existence of multiple opioid receptors based on the relationship between molecular structure of opiate drugs and their analgesic activity.

The first pharmacological evidence for several classes of receptors was obtained by Martin and coworkers (Martin et al. 1976; Gilbert and Martin 1976) in experiments performed in chronic spinal dogs.

Different opiates were found to exhibit differing pharmacological profiles. Moreover, morphine and the analogues used were unable to substitute for each other in the prevention of withdrawal symptoms in dogs made dependent on one of the drugs. Based on these results, Martin postulated the existence of three kinds of

opioid receptors which he named for the prototypic drugs used in the study: mu for morphine, kappa for ketocyclazocine, and sigma for SKF 10,047 (N-allylnormetazocine). As will be seen from the subsequent discussion, these three types of receptors have withstood the tests of time and of in vitro studies remarkably well.

After the discovery and characterization of the enkephalins, Hans Kosterlitz and his group raised the question whether these peptides act via the same receptors as those through which opiate alkaloids appear to act. To attempt to answer this question, the Kosterlitz group (Lord et al. 1977) utilized the in vitro bioassay systems it had used so effectively for many years. They found that opiate alkaloids were more effective than enkephalins in inhibiting the electrically induced contractions of the myenteric plexus of the guinea pig ileum. Similar experiments performed with the vas deferens of the mouse showed that enkephalins exhibit greater potency than opiates in this system. Furthermore, the inhibition of contraction of the mouse vas deferens by enkephalins proved to be much less sensitive to reversal by naloxone. These results were most readily explained by postulating that different classes of opioid receptors predominate in the two systems. The major receptor present in the guinea pig ileum was called mu because of its resemblance to Martin's mu receptor, while the receptor in the mouse vas deferens was named delta (for deferens).

This group also reported that these two classes of receptors (or rather, binding sites) could also be demonstrated by binding studies. When competition binding experiments were carried out in guinea pig brain membrane preparations, it was observed that enkephalins compete more effectively for binding against labeled enkephalins than against labeled opiate alkaloids (e.g.,  $^3\text{H}$ -naloxone), while opiates compete better against labeled opiates. These results agreed well with those obtained with the bioassay systems and supported the existence of opiate-preferring (mu) and enkephalin-preferring (delta) sites. Since then considerable evidence has accumulated in support of the existence of separate mu and delta sites. The synthesis of stable analogues of the enkephalins--in particular, [Dala<sup>2</sup>-Dleu<sup>3</sup>]enkephalin (DADLE)--has been very important to the experiments that are summarized below.

## **FURTHER EVIDENCE FOR THE EXISTENCE OF MU AND DELTA BINDING SITES**

### **Protection of Opioid Binding Sites by Selective Ligands**

The best way to demonstrate the existence of separate receptors or binding sites is to be able to inhibit or inactivate one site selectively. Early attempts in our laboratory to inactivate mu or delta sites selectively using a variety of chemical agents and enzymes were unsuccessful. Thus, the sulfhydryl group alkylating agent, N-ethylmaleimide (NEM), inactivated opiate (naltrexone) and enkephalin (DADLE) binding to the same extent and with similar kinetics ( $t_{1/2} = 8$  to 10 min). These results suggested that differences between mu and delta sites seem to be quite subtle ones and stimulated us to try selective protection experiments.

We had previously found (Simon and Groth 1975) that opioid receptors could be protected against inactivation by NEM by the presence of low concentrations of a ligand. In my laboratory, Dr. Smith (Smith and Simon 1980) carried out experiments to see whether ligands selective for mu or delta sites gave different degrees of protection against NEM depending on the type of labeled ligand used. He found that the inactivation by NEM of  $^3\text{H}$ -naltrexone binding was prevented more

effectively by morphine than by DADLE (figure 1A), whereas DADLE was dramatically more effective than morphine in protecting binding sites for  $^3\text{H}$ -naltrexone (figure 1B). At the time these experiments were performed, Robson and Kosterlitz (1979) carried out very similar protection studies using phenoxybenzamine to inactivate opioid binding sites irreversibly. The results of the two laboratories were in excellent agreement. These selective protection experiments furnished strong support for the existence of separate mu and delta opioid binding sites.

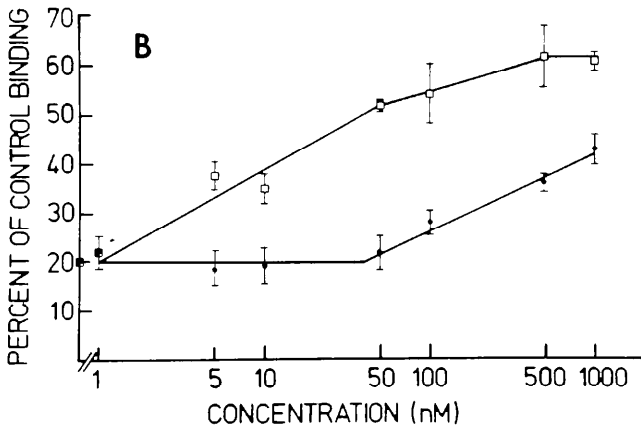
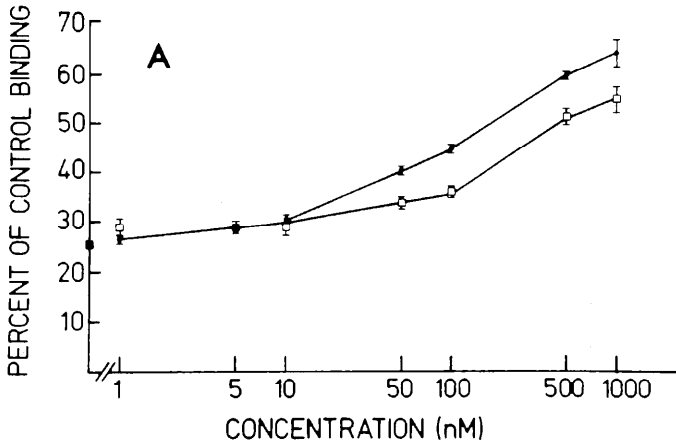
### **Selective Inhibition of Delta Opioid Binding Sites by Aliphatic Alcohols**

More recently, our laboratory has achieved the selective inhibition of delta opioid binding sites (Hiller et al. 1981, 1984). Ethanol (figure 2) inhibited the binding of enkephalins and their analogues (in this case, DADLE) at concentrations at which the binding of  $^3\text{H}$ -naloxone was unaffected and the binding of dihydromorphine was, in fact, slightly but consistently stimulated. Inhibition of  $^3\text{H}$ -DADLE binding was completely reversible and the potency of the alcohols increased exponentially with the length of their carbon chain. A number of experiments were done to determine whether alcohols affect the binding site or the ligand. Space does not permit a detailed discussion of these studies, but the evidence was consistent with an effect on the binding site. To cite one study, Scatchard analysis of  $^3\text{H}$ -DADLE binding in the presence and absence of n-butanol (0.5%) showed that alcohol decreased the affinity of binding rather than the number of binding sites (figure 3). Kinetic studies demonstrated that the inhibition of binding (increase in KD) was the result of an increase in the rate of dissociation of the ligand-receptor complex.  $K_D$ 's calculated from the equilibrium and kinetic experiments were in agreement. These results support the notion that the inhibition is exerted on the binding site. Moreover, they indicate that the effect of the alcohols is not due to competitive inhibition of opioid binding. Competitive inhibition would result in a decrease in the rate of association of ligand and receptor.

The mechanism of the inhibition is not known. However, we have now tested a large number of alcohols of varying chain length--primary, secondary, and tertiary--and have found an excellent correlation between lipid solubility and ability to disorder cell membranes on the one hand, and potency to inhibit binding to delta sites on the other (figure 4). We therefore postulate that alcohols increase membrane fluidity and that delta sites are more sensitive than mu sites to the alteration in their lipid environment.

### **Selective Opioid Peptide Ligands for Mu and Delta Sites**

The delta opioid binding sites have highest affinity for enkephalins and their analogues and may be the receptors for endogenous enkephalins. It is therefore not surprising that a number of highly selective delta ligands recently synthesized are derivatives of enkephalins. What is surprising is the fact that three of the most selective ligands currently known for mu sites are also peptides, two of which are close analogues of enkephalin.



**FIGURE 1**

Protection of Opioid Binding From Inactivation by NEM. Membrane preparations from rat brain were incubated for 10 mins in Tris buffer pH 7.4 with various concentrations of protecting ligand at 37°C followed by incubation for 20 mins with NEM (0.5 mM). The reaction was terminated by addition of 0.5 mM glutathione and the incubation mixture was centrifuged at 20,000 x g for 15 mins followed by two washings by centrifugation at the same speed. For binding, samples were resuspended in the original volume of buffer and incubated for 15 mins at 37°C with 1 nM of either <sup>3</sup>H-naltrexone (A) or <sup>3</sup>H-DAla<sup>2</sup>DLeu<sup>5</sup> enkephalin (B). The protecting ligands used were: Morphine (●) and DAla<sup>2</sup>Met<sup>5</sup>enkephalin (□). The data shown are the mean of 5 experiments (from Smith and Simon 1980).

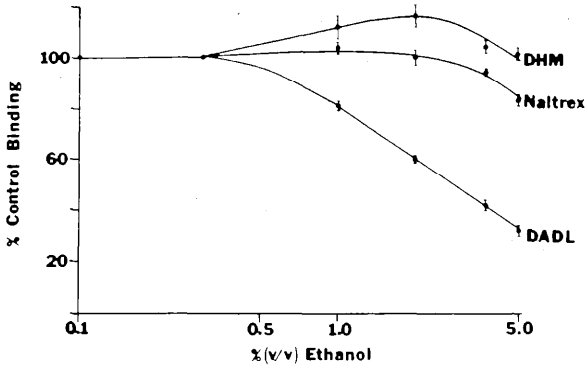


FIGURE 2

Effects of Ethanol on the Binding of  $^3\text{H}$ -labeled Opioids to Opioid Receptors in Rat Brain Membrane Preparations. Duplicate 2-ml samples (0.9 to 1.1 mg of protein per milliliter) in 0.05 M Tris-HCl (pH 7.4) containing 1 mM dipotassium EDTA were incubated with 1nM  $^3\text{H}$ -dihydromorphine (specific activity 73.2 Ci/mmole),  $^3\text{H}$ -naltrexone (8.5 Ci/mmole), and  $^3\text{H}$ -DADLE (31.0 Ci/mmole). To assess specific binding, samples were incubated in the presence or absence of 1  $\mu\text{M}$  unlabeled ligand. Incubations were followed by cooling in an ice water bath for 10 mins before filtration. The values represent the means  $\pm$  standard errors for at least three experiments (from Hiller et al. 1981. Copyright 1981, AAAS).

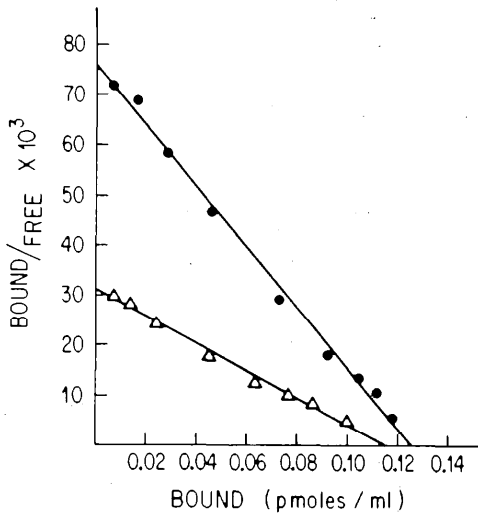


FIGURE 3

Scatchard Analysis of Saturation Curves for the Specific Binding of  $^3\text{H}$ -DADLE in Rat Brain Membrane Preparations in the Presence ( $\Delta$ ) and Absence ( $\bullet$ ) of 0.5% N-butanol. Binding of  $^3\text{H}$ -DADLE (0.5 to 10 nM) was carried out at 25°C for 45 mins. Lines of best fit were determined by regression analysis (from Hiller et al. 1984. Copyright 1984, American Society for Pharmacology and Experimental Therapeutics),



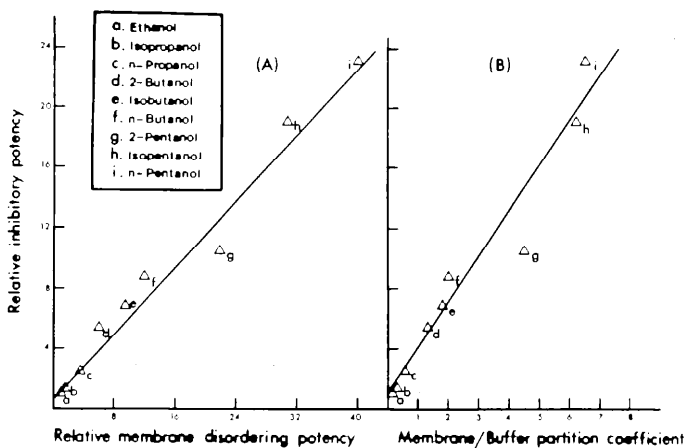


FIGURE 4

Correlation between the relative potency of alcohols to inhibit  $^3\text{H}$ -DADLE specific binding and (A) their relative membrane-disordering potencies and (B) their membrane/buffer partition coefficients. The relative inhibitory potency (ethanol = 1) for each alcohol was determined from their  $\text{IC}_{50}$  values for the inhibition of  $^3\text{H}$ -DADLE binding. Values for relative membrane-disordering potency and membrane/buffer coefficient (moles per kilogram of membrane per mole per liter of water) are from Lyon et al. (1981). Lines of best fit were determined by regression analysis (from Hiller et al. 1984. Copyright 1984, American Society for Pharmacology and Experimental Therapeutics).

Synthetic work in the laboratory of Professor B. P. Roques in Paris (Gacel et al. 1980; Zajac et al. 1983) has resulted in two relatively selective ligands for delta opioid binding sites, D-Tyr-Ser-Gly-Phe-Leu-Thr (DSTLE) and Tyr-DThr-Gly-Phe-Leu-Thr (DTLET). More recently, a number of highly selective delta ligands were synthesized by Mosberg et al. (1983). These are penicillamine analogues of enkephalin, the most selective of which is  $[\text{DPen}^2, \text{DPen}^5]\text{enkephalin}$ .

Shaw et al. (1982) have reported on the synthesis of some relatively selective antagonists for delta receptors which have the disadvantage of possessing low affinity. More recently, the ICI group (Cotton et al. 1984) has developed an even more selective and more potent antagonist which has the structure N,N-diAllyl-Tyr-AIB-AIB-Phe-Leu. Based on the mouse vas deferens assay, this compound is as potent as naloxone against delta receptors, but is inactive against mu receptors.

For mu binding sites, the most selective ligand is the peptide  $[\text{DAla}^2\text{-MePhe}^4\text{-gly-ol}^3]\text{enkephalin}$  (DAGO) synthesized by Handa et al. (1981). An enkephalin analogue synthesized by Roemer et al. (1977),  $[\text{DAla}^2\text{DMePhe}^4\text{Met}(\text{O})^5\text{-ol}]\text{enkephalin}$  (FK-33-824), is also quite mu-selective, though less so than DAGO. It was the first peptide recognized to have a clear preference for mu receptors. Finally, the peptide morphiceptin (Chang et al. 1981b) is a highly selective, but rather weak, mu ligand. It is the amide of the N-terminal tetrapeptide of the heptapeptide casomorphin, isolated from the milk protein casein (Brantl et al. 1979). There is as yet no mu

antagonist derived from a peptide. The best mu antagonists continue to be naloxone and naltrexone, though they are not highly selective.

## EVIDENCE FOR THE EXISTENCE OF KAPPA AND SIGMA SITES

The other two receptors postulated by Martin, the kappa and sigma receptors, have also survived remarkably well. Support for the existence of kappa receptors came from studies in monkeys by Woods and collaborators (1979). These animals reacted very differently to kappa-type opiates, like ethylketocyclazocine (EKC) or bremazocine, compared to the way they reacted to morphine. Moreover, morphine-addicted monkeys in abstinence did not show reduction of withdrawal symptoms when given one of these benzomorphanes.

Further support for the existence of separate kappa and/or sigma sites came from drug discrimination studies. Thus, Shearman and Herz (1981) found that rats trained to recognize bremazocine were able to generalize to EKC, cyclazocine, and SKF 10,047, but were unable to recognize fentanyl or morphine. These results suggest that these benzomorphanes interact with a receptor different from the receptor for the mu ligands fentanyl and morphine, which has properties similar to kappa and/or sigma receptors.

Early attempts to demonstrate separate binding sites for  $^3\text{H}$ -EKC were unsuccessful in several laboratories (Hiller and Simon 1980; Harris and Sethy 1980; Pasternak 1980). This was due to two problems not recognized at that time. The rat brain has the lowest proportion of kappa receptors of any species so far studied. Moreover, it is now known that EKC and other kappa-type benzomorphanes bind almost as well to mu and delta sites as they do to kappa sites. This means that a simple investigation of the distribution and characteristics of the binding of  $^3\text{H}$ -EKC will give results which suggest that EKC binds to mu and delta sites, especially in rat brain where kappa sites represent only 10% to 20% of total opioid binding sites (Maurer 1982).

Kosterlitz and his group (Kosterlitz et al. 1981; Magnan et al. 1982) were able to demonstrate the existence of separate benzomorphan binding sites with the properties expected of kappa sites. They accomplished this by the use of guinea pig brain which is relatively rich in kappa receptors, and by including in the incubation mixture saturating concentrations of the selective mu ligand DAGO and the delta-preferring ligand DADLE. Sites that show a preference for benzomorphanes were also reported in rats by Chang et al. (1981a), who used high levels of morphiceptin to block mu sites and of DADLE to block delta sites. Because the remaining sites bound benzomorphan of both the kappa and sigma type, these researchers preferred to call them "benzomorphan" sites.

Evidence for the existence of sigma sites was the last to be obtained and is still the most controversial. Binding sites for phencyclidine (PCP) were first reported to exist in animal brain by Vincent et al. (1979) and by Zukin and Zukin (1979). In more recent papers, Zukin and Zukin (1981) and Quirion et al. (1981) reported that opiates of the sigma type, such as cyclazocine and SKF 10,047, but not the more classical opiates or the opioid peptides, can displace PCP from its binding site. PCP, in turn, is able to displace the sigma ligands quite specifically. The authors suggested that the PCP binding site may also be the sigma opioid binding site. Support for this intriguing idea came from behavioral experiments by Holtzman (1980). Rats trained to distinguish PCP from saline were able to generalize the drug cue to cyclazocine and SKF 10,047 but not to other opiates. Rats trained to recognize cyclazocine were unable to distinguish this drug from PCP. It has been argued, with considerable

justification, that sigma receptors should not be classified as a subclass of opioid receptors since the sigma-type drugs produce effects most of which are not reversed by naloxone.

Furthermore, there is now evidence from binding (Itzhak et al. 1985) as well as pharmacological (Brady et al. 1982) studies that the stereoselectivity of benzomorphans for sigma sites is opposite to that for more classical opioid sites, i.e., the dextrorotatory isomer exhibits higher affinity.

Dynorphin A exhibits high affinity and good selectivity for kappa receptors and it has been suggested that it may be the endogenous ligand of this receptor type (Chavkin et al. 1982; Yoshimura et al. 1982). Corbett et al. (1982) have obtained evidence that the shorter peptides dynorphin 1-8 and dynorphin 1-9 are also rather selective ligands for kappa binding sites. Other peptides derived from the precursor prodynorphin, such as dynorphin B (rimorphin) and leumorphin, also seem to bind preferentially to kappa sites (Rezvani et al. 1983; Suda et al. 1983).

No peptide ligand for sigma receptors is currently known. However, several laboratories are trying to isolate and characterize putative endogenous ligands for PCP binding sites. Such a putative endogenous substance has been termed "angeldustin" by C. Pert.

At present, the dynorphin peptides are the only relatively selective peptide ligands for kappa receptors. The most selective ligands are two nonpeptide compounds. One is U-50,488H, a compound synthesized and tested by scientists at the Upjohn Company (Von Voigtlander et al. 1983). The other is tifluadom, a benzodiazepine devoid of affinity for benzodiazepine receptors, which was discovered at Sandoz to be a quite selective kappa ligand (Roemer et al. 1982).

## **OTHER OPIOID RECEPTOR SUBCLASSES**

It should be mentioned that, in addition to the four opioid receptor types (or three, if sigma is not considered opioid) discussed so far, a number of others have been proposed. They will be mentioned only briefly since their existence is still very tenuous.

A receptor found in the rat vas deferens by several laboratories (Lemaire et al. 1978; Miranda et al. 1979; Schulz et al. 1979) seems to be rather specific for  $\beta$  endorphin. It has been named the  $\epsilon$  receptor. Oka et al. (1981) have reported the presence in dog and rabbit ileum of a receptor which preferentially binds enkephalins but seems to be different from delta receptors. They have called this the  $\iota$  receptor.

There are also reports of heterogeneity within the major receptor types. Based on extensive studies with the irreversible opiate ligand naloxazone, Wolozin and Pasternak (1981) have suggested the existence of two subtypes of mu receptors,  $\mu_1$  and  $\mu_2$ . Their data suggest that  $\mu_1$  is a site to which mu, delta, and kappa ligands bind with greater affinity than to their "own" type of receptor. The  $\mu_2$  site seems to be identical with the classical mu site. Evidence by Pasternak et al. (1980) indicates that analgesia may be mediated via  $\mu_1$  receptors.

Audigier et al. (1982) have reported evidence for two types of kappa receptors,  $\kappa_{p1}$  and  $\kappa_{p2}$ . Evidence for subtypes of both mu and kappa receptor classes

was also reported by Schulz and Wuster (1981) based on cross-tolerance studies in the mouse vas deferens.

### DISTRIBUTION OF OPIOID RECEPTOR TYPES IN THE CNS

If the postulated types of opioid receptors represent different entities, it should be possible to demonstrate their differential distribution.

By *in vitro* binding and competition experiments, Chang et al. (1979) and our laboratory (Simon et al. 1980) found differences in the distribution of mu and delta binding sites in rat brain. Regions were found that were relatively enriched in delta sites, such as the frontal cortex. However, no brain region has yet been found to contain pure or nearly pure delta sites. On the other hand, the thalamus seems to be highly enriched in mu sites. This is evident from the ratio of binding of mu selective to delta selective ligands (at low concentration, e.g., 0.5 nM) as well as from competition experiments. While in other brain regions, naloxone competed 6- to 10-fold more effectively against H-naloxone than against <sup>3</sup>H-enkephalin, naloxone is equally effective against both ligands in rat thalamus. Similar results have been obtained in bovine brain by Ninkovic et al. (1981) and in our laboratory (Bonnet et al. 1981) in postmortem human brain tissue (table 1).

TABLE 1

Binding Competition Experiments in Human Brain Regions

Brain Region	n	<sup>3</sup> H-naloxone		<sup>3</sup> H-DADLE	
		Naloxone	DADLE	Naloxone	PAPLE
Thalamus	5	2.7 ± 0.3	49 ± 4.9	1.4 ± 0.1	13 ± 2.2
Amygdala	3	2.8 ± 0.2	63 ± 24	14 ± 2.9	3.3 ± 0.7
Frontal cortex	4	2.7 ± 0.3	57 ± 4.9	12 ± 5.4	2.2 ± 0.5
Striatum	5	2.6 ± 0.4	58 ± 15	31 ± 5.2	3.8 ± 0.6

n = no. of experiments. Results are expressed as the mean IC (nM) ± standard error of the mean (from Bonnet et al. 1981. Copyright 1981, Elsevier/North Holland Biomedical Press).

The differential distribution of mu and delta opioid binding sites has also been demonstrated by autoradiography of rat brain slices (Goodman et al. 1980). These data are in good agreement with the results obtained by *in vitro* binding to homogenates of brain regions.

The distribution of kappa sites was studied in guinea pig brain regions by autoradiography (Goodman and Snyder 1982). By binding <sup>3</sup>H-EKC or <sup>3</sup>H-bremazocine to brain slices in the presence of high concentrations of morphine and DADLE to block mu and delta sites, it was possible to visualize residual sites believed to be kappa sites. The highest density of these putative kappa sites was found in layers V and VI of the cerebral cortex and in the pyriform cortex. Low levels were seen in the caudate and the nucleus accumbens, while other brain regions did not have detectable kappa sites.

We have studied the distribution of kappa sites in human brain regions (Itzhak et al. 1982a). These experiments were done by measuring the binding of <sup>3</sup>H-bremazocine (1 nM) in both the presence and the absence of mu and delta blockers (100 nM each of DAGO and DADLE). Most of the regions examined were found to have a high proportion of kappa sites, ranging from a high of 60% in the hypothalamus to a low of about 20% in the thalamus. In most regions, the proportion of kappa sites was about 40% of total bremazocine binding. We have also obtained some evidence that the bremazocine sites may, in fact, be a mixture of kappa and sigma sites. This is based on the effectiveness of the sigma ligand SKF 10,047 in displacing bound bremazocine and, more convincingly, on the ability of the rather selective sigma ligand 3-hydroxyphenacyclidine (Itzhak et al. 1981) to displace a portion of the bound bremazocine from membranes prepared from human brain regions.

### **TISSUES ENRICHED IN A PARTICULAR TYPE OF OPIOID BINDING SITE OR RECEPTOR--AND A METHOD TO ENRICH TISSUES**

In order to study a particular type of binding site or receptor, it would be useful to have tissues that are highly enriched in the receptor in question, or better yet, contain only a single type. Some useful tissues are known and have been briefly mentioned previously. They will be summarized here.

For mu binding sites, there is evidence of very high proportions in rat (Chang et al. 1979), bovine (Ninkovic et al. 1981), and human thalamus (Bonnet et al. 1981), and in rabbit cerebellum (Meunier et al. 1983).

There are some brain regions which are enriched in delta sites, but they all contain large proportions of other receptor types. The only system known to be highly enriched in sites essentially indistinguishable from brain delta sites are the neuroblastoma cells (N4TG1) and neuroblastoma x glioma hybrid cells (NG-108-15) (Chang and Cuatrecasas 1979) in culture. The mouse *vas deferens* has long been known to be enriched in delta receptors but is not very useful for binding studies.

Several tissues have been reported to contain very high proportions of kappa sites. These include human placenta (Valette et al. 1980), toad brain (Simon et al. 1982), and guinea pig cerebellum (Robson et al. 1984). No other binding sites have yet been demonstrated in human placenta. The guinea pig cerebellum could have somewhere between 85% to 100% kappa sites based on the available evidence. Toad brain is likely to contain a significant number of mu sites (20% to 30%) but very few delta sites.

For researchers wishing to study the major types of opioid binding sites in the same tissue, a method of enrichment has been developed (James and Goldstein 1984; Goldstein and James 1984). It is based on the selective protection studies (Smith and Simon 1980) discussed earlier and uses the alkylating opiate,  $\beta$ CNA, developed by Portoghese et al. (1979) as the inactivating agent. By adding a relatively selective ligand for a given type of receptor, this receptor can be selectively protected and significant enrichment of the tissue achieved.

Finally, it should be noted that selective tolerance to a given receptor type can be produced in *in vitro* systems, such as the guinea pig ileum (Schulz et al. 1981b) and the mouse *vas deferens* (Schulz et al. 1980). There is also preliminary evidence for selective tolerance in intact animals (Schulz et al. 1981a). Such a selectively tolerant animal will be useful for studying the remaining "nontolerant" receptors, since the

“tolerant” type or types will be inactive. It is not yet known whether the inactivation of a receptor by tolerance involves a change in binding characteristics.

## **THE MOLECULAR BASIS OF OPIOID RECEPTOR HETEROGENEITY**

All of the evidence lends rather good support to the existence of heterogeneity among opioid receptors. The question arises as to the molecular basis of this observed heterogeneity.

One possibility, which may prove correct for some types or subtypes of receptors, is that they represent interconvertible conformations of the same receptor. This possibility has been suggested by Bowen et al. (1981). This theory is unlikely to be correct for all three types, based on the available evidence. However, in view of the finding that mu and delta sites often occur in the same regions and even on the same neurons (Egan and North 1981), the idea that they may be interconvertible forms of the same binding site is more difficult to rule out, though unlikely in this reviewer’s opinion.

The other possibility is that all or most of the types of receptors are, in fact, separate entities. There are again several possibilities if this assumption proves to be correct.

1. Each may be a distinct polypeptide chain or aggregate of such chains.
2. Two or more types may share polypeptide chains, but differ in one or more of the polypeptide subunits that make up the active receptor molecule.
3. The different types may consist of identical polypeptides, but differ in their state of aggregation.
4. They may be identical proteins, but differ in their posttranslational modifications (e.g., carbohydrate or lipid moieties, phosphorylation, methylation, etc.).
5. Any of the above differences could occur at the level of the binding site or at the level of proteins and enzymes coupled to the binding site, or both.

Detailed answers regarding the exact molecular basis of heterogeneity will have to await purification and attempted separation of the various receptor types. The progress made so far in this area of research will be the subject of the next section.

## **SOLUBILIZATION AND SEPARATION OF TYPES OF OPIOID BINDING SITES**

We reported the solubilization of a prebound etorphine-receptor complex in 1975 (Simon et al. 1975). The solubilization of opioid binding sites which retain their ability to bind opioids in solution was achieved more recently in several laboratories. Bidlack and Abood (1980) reported solubilization of active sites from rat brain using Triton X-100. Simonds et al. (1980) used a newly synthesized detergent call CHAPS to solubilize opioid binding sites from NG 108-15 cultures. This technique was also applicable to rat brain, though yields of soluble receptors tended to be low.

Our laboratory (Ruegg et al. 1980, 1981) reported the solubilization in good yield (40% to 50%) of opioid binding sites from the brain of the toad, Bufo marinus, by the use of digitonin. More recently, we succeeded in adapting this method to

mammalian tissues by adding 0.5 M to 1.0 M NaCl during the extraction process (Howells et al. 1982). Yields of soluble receptor from mammalian brain tend to range between 20% to 40%.

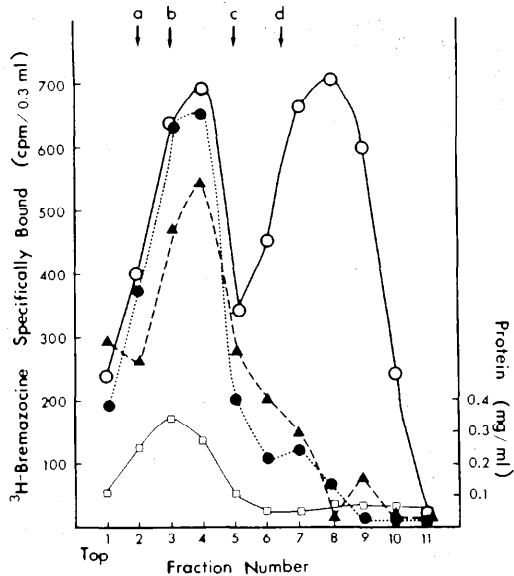
The solubilized receptors bind antagonists well. However, because of the high level of sodium and the inhibitory effect of digitonin (even at 0.05% to 0.1%) on agonist binding (Itzhak et al. 1984b), the soluble receptors bind agonists poorly. It was therefore difficult to determine which types of receptors had been extracted from the cell membranes.

This problem was approached in our laboratory (Itzhak et al. 1982b, 1984a) by sucrose density gradient centrifugation of the extract of guinea pig brain into a gradient devoid of sodium and containing only a low concentration of digitonin (0.02%), which was further diluted before binding assays were done on the fractions.

When  $^3\text{H}$ -bremazocine binding was measured in the fractions, two well-separated peaks were found, as shown in figure 5. When the bremazocine was bound in the presence of DAGO and DADLE (100 nM each), the first peak was essentially unchanged, while the second peak was virtually eliminated. As seen from figure 6, direct binding studies on the gradient fractions demonstrated good binding of both  $^3\text{H}$ -DAGO and  $^3\text{H}$ -DADLE in peak 2. Competition binding studies provided further evidence that peak 1 contained predominantly sites of the kappa type, while peak 2 had the characteristics of a mixture of mu and delta sites. Centrifugation of receptors solubilized from guinea pig cerebellum on the same gradient (figure 5) yielded only the first peak of binding which again, as expected, exhibited the properties of kappa sites. Since this tissue is known to contain mainly kappa sites, this result validates our method of separation and confirms the finding that the first peak obtained from guinea pig brain extracts contains largely kappa sites. These results indicate that kappa sites are separable and seem therefore to be distinct molecular entities. We have not yet succeeded in separating mu and delta sites from each other.

Separation of kappa sites from other receptor types has also been reported (Chow and Zukin 1983) by the use of gel filtration columns on CHAPS extracts of rat brain membranes. The mu sites ( $^3\text{H}$ -di-hydromorphine binding) eluted at a position corresponding to a protein Stokes radius of 70A, while most of the  $^3\text{H}$ -bremazocine binding in the presence of 40 nM normorphine and 100 nM DADLE eluted at a position corresponding to a Stokes radius of 50A. This is in agreement with our results which showed that the mu-delta peak had a higher apparent molecular weight than the kappa peak as determined on a calibrated sucrose gradient.

A word should be added about our recent success in the partial purification of opioid binding sites. Dr. Gioannini in our laboratory (Gioannini et al. 1984) synthesized a novel derivative of naltrexone,  $\beta$ -naltrexyl-6-ethylenediamine (NED). This derivative was found to retain high affinity for opioid binding sites



**FIGURE 5**

Bremazocine Binding to Fractions of Solubilized Guinea Pig Brain and Cerebellar Membranes After Sucrose Gradient Centrifugation. Fractions from brain were assayed for specific  $^3\text{H}$ -bremazocine (3 nM) binding in the absence (o) and presence (●) of DAGO and DADLE (100 nM each). Fractions from cerebellum were assayed under identical conditions, in the absence of DAGO and DADLE (Δ). The protein concentration (□) was assayed for each fraction. Protein markers for the determination of  $S_{20,w}$  were as follows: a) catalase; b) thyroglobulin (monomer); c) ferritin; and d) thyroglobulin (dimer). Each point for  $^3\text{H}$ -bremazocine binding is the mean of at least three assays, which differed from each other by <15% (from Itzhak et al. 1984a).

( $\text{IC}_{50}$  for competition against  $^3\text{H}$ -naltrexone (1 nM) was 15 nM). It was coupled to CH-Sepharose 4B beads which contain a 6-carbon side arm ending in a carboxyl group (see figure 7). The resulting affinity gel retained solubilized opioid binding sites from cow, rat, or toad brain very efficiently. Elution of about 20% of the receptors retained on the column was achieved with micromolar concentrations of naloxone. In our paper, we reported purifications of 300- to 450-fold. However, in recent experiments (Gioannini et al., unpublished results) with opioid binding sites solubilized from cow brain, we found that purification is on the order of 3000- to 5000-fold in a single pass. The crude digitonin extract was iodinated with  $^{125}\text{I}$  and the protein eluted from the NED-agarose column was determined by measuring the total  $^{125}\text{I}$  radioactivity in the eluate. Electrophoresis of the eluate on SDS-polyacrylamide gels indicated the presence of only 7 to 8 protein bands. Work is in progress to determine which bands are derived from opioid binding sites. The improvement in purification was partly the result of improved washing procedures prior to elution, but also became manifest because of the improved sensitivity of protein determination due to the use of radioactivity. It has not yet been possible to determine the ratio of opioid receptor types eluted from the NED-agarose beads because all these studies were done in high concentrations of sodium chloride.



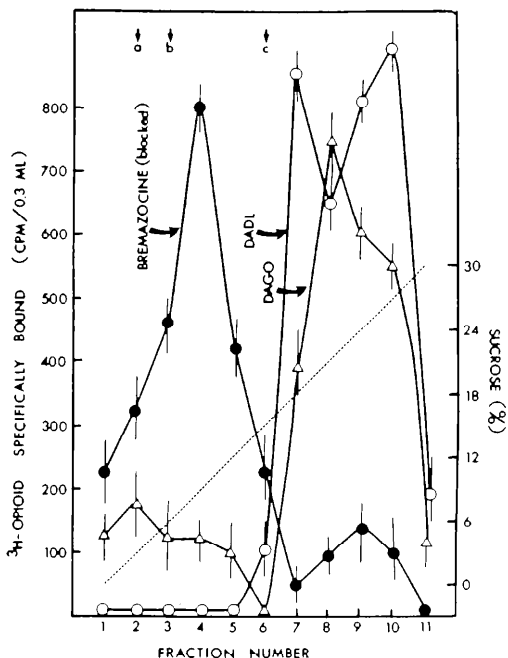
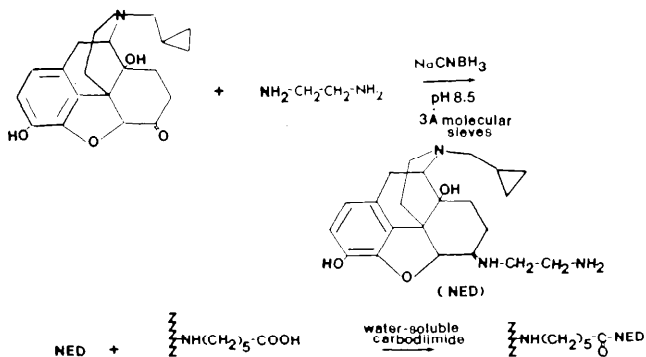


FIGURE 6

Sucrose Density Gradient Centrifugation of Solubilized Opioid Binding Sites from Guinea Pig Brain Membranes. Fractions were assayed for the binding of <sup>3</sup>H-bremazocine (3.5 nM) in the presence of DAGO and DADLE (100 nM each) (●), <sup>3</sup>H-DAGO (7nM) (A), and <sup>3</sup>H-DADLE (7 nM) (o). Protein markers for the estimation of molecular weight are as follows: a) catalase; b) thyroglobulin (monomer); and c) thyroglobulin (dimer). Each point represents the mean ± SEM of at least three determinations (from Itzhak et al. 1983. Copyright 1983, Pergamon Press, Ltd.).

## CONCLUDING COMMENTS

The discovery of multiple opioid receptors is of great theoretical and practical importance. It now becomes important to determine which of the receptors proposed represent separate molecular entities and which peptides serve as endogenous ligands for which type of receptor. As stated in this review, one can make the generalization that peptides derived from proenkephalin generally exhibit highest affinity to delta receptors, while peptides derived from prodynorphin have a preference for kappa receptors. There are no known natural opioid peptides which show preferential binding to mu sites. It is therefore possible that the endogenous ligands for mu receptors have not yet been discovered. Since the enkephalins have an affinity for mu only 10- to 20-fold lower than for delta sites, this reviewer feels that the possibility must be kept in mind that mu and delta represent isoreceptors for the enkephalins. The suggestion has also been made that mu and delta receptors may interact allosterically (Rothman and Westfall 1982a, 1982b). Some credence is lent to this hypothesis by the finding that mu and delta receptors can often be found on the same neurons (Egan and North 1981).



**FIGURE 7**

Scheme for the Preparation of Affinity Beads for the Purification of Solubilized Opioid Binding Sites

From a practical point of view, it is evident that the multiplicity of receptor types could be useful, provided that some of them prove to be functionally distinct. It would then become possible to design drugs with certain desired properties that have no undesirable side effects. This could be done by synthesizing highly specific ligands for the type of opioid receptor that mediates the desired function. Thus, if a type of opioid receptor were found to mediate analgesia but not physical and psychic dependence, a more rational approach to the long-sought nonaddictive potent analgesic becomes possible. It is currently believed that both delta and kappa receptors may be candidates for such a role, but much more work is required to confirm or disprove this interesting idea. Such studies require highly selective ligands as well as highly selective antagonists for each receptor type. We hope that meetings such as this one will stimulate our organic chemist friends to synthesize substances which may provide us with the needed specificity.

The isolation and purification of opioid receptors and the separation of all separable, distinct types is the only way to settle the question of the number of different binding sites or receptors that really exist. This work will also provide us with other, very important information, including the chemical composition, subunit structure, and posttranslational modifications of the molecules that comprise the binding sites. Similar information is needed for coupling factors and for enzymes which are coupled to the binding sites and essential for transducing ligand binding into physiological or pharmacological activity. Once the purified molecules become available, reconstitution experiments will help us to understand the steps between binding and pharmacological response. This is currently happening with the nicotinic cholinergic receptor and one may be optimistic that it will happen in the not too distant future for opioid receptors as well.

## REFERENCES

- Audigier, Y.; Attali, B.; Mazarguil, H.; and Cros, J. Characterization of  $^3\text{H}$ -etorphine binding in guinea pig striatum after blockade of mu and delta sites. *Life Sci* 31:1287-1290, 1982.

- Bidlack, J.M., and Abood, L.G. Solubilization of the opiate receptor. Life Sci 27:331-340, 1980.
- Bonnet, K.A.; Groth, J.; Giannini, T.; Cortes, M.; and Simon, E.J. Opiate receptor heterogeneity in human brain regions. Brain Res 221:431-440, 1981.
- Bowen, W.D.; Gentleman, S.; Herkenham, M.; and Pert, C.B. Interconverting and forms of the opiate receptor in rat striatal patches. Proc Natl Acad Sci USA 78:4818-4822, 1981.
- Brady, K.T.; Balster, R.L.; and May, E.L. Stereoisomers of N-allylnorm-etazocine: Phencyclidine-like behavioral effects in squirrel monkeys and rats. Science 215:178-180, 1982.
- Brantl, V.; Teschemacher, H.; Henschen, A.; and Lottspeich, F. Novel Opioid peptides derived from casein ( $\beta$  casomorphins). I. Isolation from bovine casein peptide. Hoppe Sevlers Z Physiol Chem 360:1211-1216, 1979.
- Chang, K.-J., and Cuatrecasas, P. Multiple opiate receptors: Enkephalins and morphine bind to receptors of different specificity. J Biol Chem 254:2610-2618, 1979.
- Chang, K.-J.; Cooper, B.R.; Hazum, E.; and Cuatrecasas, P. Multiple opiate receptors: Different regional distribution in the brain and differential binding of opiates and opioid peptides. Mol Pharmacol 16:91-104, 1979.
- Chang, K.-J.; Hazum, E.; and Cuatrecasas, P. Novel opiate binding sites selective for benzomorphan drugs. Proc Natl Acad Sci USA 78:4141-4145, 1981a.
- Chang, K.-J.; Killian, A.; Hazum, E.; Cuatrecasas, P.; and Chang, J.-K. Morphiceptin: A potent and specific agonist for morphine ( $\mu$ ) receptors. Science 212:75-77, 1981b.
- Chavkin, C.; James, I.F.; and Goldstein, A. Dynorphin is a specific endogenous ligand of the kappa opioid receptor. Science 215:413-415, 1982.
- Chow, T., and Zukin, R.S. Solubilization and preliminary characterization of mu and kappa opiate receptor subtypes from rat brain. Mol Pharmacol 24:203-212, 1983.
- Corbett, A.D.; Paterson, S.J.; McKnight, A.T.; Magnan, J.; and Kosterlitz, H.W. Dynorphin<sub>1-8</sub> and dynorphin<sub>1-9</sub> are ligands of the K-subtype of opiate receptor. Nature 299:79-81, 1982.
- Cotton, R.; Giles, M.G.; Miller, L.; Shaw, J.S.; and Timms, D. ICI 174864: A highly selective antagonist for the opioid  $\delta$  receptor. Eur J Pharmacol 97:331-332, 1984.
- Egan, T.M., and North, R.A. Both  $\mu$  and  $\delta$  opiate receptors exist on the same neuron. Science 214:923-924, 1981.
- Gacel, G.; Fournie-Zaluskie, M.-C.; and Roques, B.P. DTyr-Ser-Gly-Phe-Leu-Thr, a highly preferential ligand for  $\delta$  opiate receptors. FEBS Lett 118:245-247, 1980.
- Gilbert, P.E., and Martin, W.R. The effects of morphine- and nalorphine-like drugs in the nondependent, morphine-dependent and cyclazocine-dependent chronic spinal dog. J Pharmacol Exp Ther 198:66-82, 1976.
- Giannini, T.L.; Howard, A.; Hiller, J.M.; and Simon, E.J. Affinity chromatography of solubilized opioid binding sites using CH-Sepharose modified with a new naltrexone derivative. Biochem Res Commun 119:624-629, 1984.
- Goldstein, A., and James, I.F. Site-directed alkylation of multiple opioid receptors. II. Pharmacological selectivity. Mol Pharmacol 25:343-348, 1984.
- Goodman, R.R., and Snyder, S.H. Autoradiographic localization of kappa opiate receptors to deep layers of the cerebral cortex may explain unique sedative and analgesic effects. Life Sci 31:1291-1294, 1982.
- Goodman, R.R.; Snyder, S.H.; Kuhar, M.J.; and Young, W.S., III. Differentiation of delta and mu opiate receptor localization by light microscopic autoradiography. Proc Natl Acad Sci USA 77:6239-6242, 1980.

- Handa, B.K.; Lane, A.C.; Lord, J.A.H.; Morgan, B.A.; Rance, M.J.; and Smith, C.F.C. Analogues of LPH<sub>61-64</sub> possessing selective agonist activity at  $\mu$  opiate receptors. Eur J Pharmacol 70:531-540, 1981.
- Harris, D.W., and Sethy, V.H. High affinity binding of <sup>3</sup>H-ethylketocyclazocine to rat brain homogenate. Eur J Pharmacol 66:121-123, 1980.
- Hiller, J.M., and Simon, E.J. Specific, high affinity H-ethylketocyclazocine binding in rat central nervous system: Lack of evidence for  $\kappa$  receptors. J Pharmacol Exp Ther 214:516-519, 1980.
- Hiller, J.M.; Angel, L.M.; and Simon, E.J. Multiple opiate receptors: Alcohol selectively inhibits binding to delta receptors. Science 214:468-469, 1981.
- Hiller, J.M.; Angel, L.M.; and Simon, E.J. Characterization of the selective inhibition of the delta subclass of opioid binding sites by alcohols. Mol Pharmacol 25:249-255, 1984.
- Hiller, J.M.; Pearson, J.; and Simon, E.J. Distribution of stereo-specific binding of the potent narcotic analgesic etorphine in the human brain: Predominance in the limbic system. Res Commun Chem Pathol Pharmacol 6:1052-1062, 1973.
- Holtzman, S.F. Phencyclidine-like discriminative effects of opioids in the rat. Pharmacol Exp Ther 214:614-619, 1980.
- Howells, R.D.; Gioannini, T.L.; Hiller, J.M.; Simon, E.J. Solubilization and characterization of active opiate binding sites from mammalian brain. J Pharmacol Exp Ther 222:629-634, 1982.
- Itzhak, Y.; Kalir, A.; and Sarne, Y. On the opioid nature of PCP and its 3-hydroxy derivative. Eur J Pharmacol 73:229-233, 1981.
- Itzhak, Y.; Bonnet, K.A.; Groth, J.; Hiller, J.M.; and Simon, E.J. Multiple opiate binding sites in human brain regions: Evidence for  $\kappa$  and  $\sigma$  sites. Life Sci 31:1363-1366, 1982.
- Itzhak, Y.; Hiller, J.M.; Gioannini, T.L.; and Simon, E.J. Evidence for the solubilization of multiple opioid binding sites from mammalian brain. Life Sci 33:191-194, 1983.
- Itzhak, Y.; Hiller, J.M.; and Simon, E.J. Solubilization and characterization of  $\mu$ ,  $\delta$  and  $\kappa$  opioid binding sites from guinea pig brain: Physical separation of  $\kappa$  receptors. Proc Natl Acad Sci 81:4217-4221, 1984a.
- Itzhak, Y.; Hiller, J.M.; and Simon, E.J. Molec Pharmacol 27:46-52, 1985.
- Itzhak, Y.; Hiller, J.M.; Giannini, T.L.; and Simon, E.J. Effect of digitonin on the binding of opiate agonists and antagonists to membrane-bound and soluble opioid binding sites. Brain Res 291:309-315, 1984b.
- James, I.F., and Goldstein, A. Site-directed alkylation of multiple opioid receptors. I. Binding selectivity. Mol Pharmacol 25:337-342, 1984.
- Kosterlitz, H.W.; Paterson, S.J.; and Robson, L.E. Characterization of the  $\kappa$ -subtype of the opiate receptor in the guinea pig brain. Br J Pharmacol 73:939-949, 1981.
- Lemaire, S.; Magnan, J.; and Regnoli, D. Rat vas deferens: A specific bioassay for endogenous opioid peptide. Br J Pharmacol 64:327-329, 1978.
- Lord, J.A.H.; Waterfield, A.A.; Hughes, J.; and Kosterlitz, H.W. Endogenous opioid peptides: Multiple agonists and receptors. Nature 267:495-499, 1977.
- Magnan, J.; Paterson, S.J.; Tavani, A.; and Kosterlitz, H.W. The binding spectrum of narcotic analgesic drugs with different agonist and antagonist properties. Naunyn Schmiedebergs Arch Pharmacol 319:197-205, 1982.
- Martin, W.R.; Eades, C.G.; Thompson, J.A.; Huppler, R.E.; and Gilbert, P.E. The effects of morphine- and nalorphine-like drugs in the nondependent and morphine-dependent chronic spinal dog. J Pharmacol Exp Ther 197:517-532, 1976.
- Maurer, R. Multiplicity of opiate receptors in different species. Neurosci Lett 30:303-307, 1982.

- Meunier, J.-C.; Kouakon, Y.; Puget, A.; and Moisan, C. Multiple opiate binding sites in the central nervous system of the rabbit: Large predominance of a mu subtype in the cerebellum and characterization of a kappa subtype in the thalamus. Mol Pharmacol 24:23-29, 1983.
- Miranda, H.; Huidobro, F.; and Huidobro-Toro, J.P. Evidence for morphine and morphine-like alkaloid responses resistant to naloxone blockade in the rat vas deferens. Life Sci 24:1511-1518, 1979.
- Mosberg, H.I.; Hurst, R.; Hruby, V.J.; Gee, K.; Yamamura, H.I.; Galligan, J.J.; and Burks, T.F. Bis-penicillamine enkephalins possess highly improved specificity toward  $\delta$  opioid receptors. Proc Natl Acad Sci USA 80:5871-5874, 1983.
- Ninkovic, M.; Hunt, S.P.; Emson, P.C.; and Iversen, L.L. The distribution of multiple opiate receptors in bovine brain. Brain Res 214:163-167, 1981.
- Oka, T.; Negishi, K.; and Suda, K. Effects of opioid peptides and kappa agonists on *in vitro* isolated preparations. In: Takagi, H., and Simon, E.J., eds. Advances in Endogenous and Exogenous Opioids. Tokyo: Kodansha Ltd., 1981. pp. 21-23.
- Pasternak, G.W. Multiple opiate receptors:  $^3\text{H}$ -ethylketocyclazocine receptor binding and ketocyclazocine analgesia. Proc Natl Acad Sci USA 77:3691-3694, 1980.
- Pasternak, G.W.; Childers, S.R.; and Snyder, S.H. Opiate analgesia: Evidence for mediation by a subpopulation of opiate receptors. Science 208:514-516, 1980.
- Pert, C.B., and Snyder, S.H. Opiate receptor: Demonstration in nervous tissue. Science 179:1011-1014, 1973.
- Portoghese, P.S. A new concept on the mode of interaction of narcotic analgesics with receptors. J Med Chem 8:609-619, 1965.
- Portoghese, P.S.; Larson, D.L.; Jiang, J.B.; Caruso, T.P.; and Takemori, A.E. Synthesis and pharmacologic characterization of an alkylating analogue (chlomaltrexamine) of naltrexone with ultra long-lasting narcotic antagonist properties. J Med Chem 22:168-173, 1979.
- Quirion, R.; Hammer, R.; Herkenham, M.; and Pert, C.B. A phencyclidine/sigma opiate receptor: Its visualization by tritium-sensitive film. Proc Natl Acad Sci USA 78:5881-5885, 1981.
- Rezvani, A.; Holtt, V.; and Way, E.L.  $\kappa$  receptor activities of the three opioid peptide families. Life Sci 33(Supp 1):271-274, 1983.
- Robson L.E and Kosterlitz, H.W. Specific protection of the binding sites of D-Ala<sup>2</sup>-D-Leu<sup>5</sup>-enkephalin ( $\delta$ -receptors) and dihydromorphine ( $\mu$ -receptors). Proc R Soc Lond [Biol] 205:425-432, 1979.
- Robson, L.E.; Forte, R.W.; Maurer, R.; and Kosterlitz, H.W. Opioid binding sites of the  $\kappa$ -type in guinea pig cerebellum. Neuroscience 12:621-627, 1984.
- Roemer, D.; Buescher, H.H.; Hill, R.C.; Pless, J.; Bauer, W.; Cardinaux, F.; Closse, A.; Hauser, D.; and Huguenin, R. A synthetic enkephalin analogue with prolonged parenteral and oral analgesic activity. Nature 268:547-549, 1977.
- Roemer, D.; Buscher, H.H.; Hill, R.C.; Maurer, R.; and Petcher, T.J. An opioid benzodiazepine. Nature 298:759-760, 1982.
- Rothman, R.B., and Westfall, T.C. Morphine allosterically modulates the binding of  $^3\text{H}$ -leucine enkephalin to a particulate fraction of rat brain. Mol Pharmacol 21:538-547, 1982a.
- Rothman, R.B., and Westfall, T.C. Allosteric coupling between morphine and enkephalin receptors *in vitro*. Mol Pharmacol 21:548-557, 1982b.
- Ruegg, U.T.; Cuenod, S.; Hiller, J.M.; Gioannini, T.; Howells, R.D.; and Simon, E.J. Characterization and partial purification of solubilized active opiate receptors from toad brain. Proc Natl Acad Sci USA 78:4635-4638, 1981.
- Ruegg, U.T.; Hiller, J.M.; and Simon, E.J. Solubilization of an active opiate receptor from Bufo marinus. Eur J Pharmacol 64:367-368, 1980.

- Schulz, R., and Wuster, M. Are there subtypes (isoreceptors) of multiple opiate receptors in the mouse vas deferens? Eur J Pharmacol 76:61-66, 1981.
- Schulz, R.; Faase, E.; Wuster, M.; and Hertz, A. Selective receptors for endorphin on the rat vas deferens. Life Sci 24:843-853, 1979.
- Schulz, R.; Wuster, M.; Krenss, H.; and Herz, A. Lack of cross-tolerance on multiple opiate receptors in the mouse vas deferens. Mol Pharmacol 18:395-401, 1980.
- Schulz, R.; Wuster, M.; and Herz, A. Differentiation of opiate receptors in the brain by selective development of tolerance. Pharmacol Biochem Behav 14:75-79, 1981a.
- Schulz, R.; Wuster, M.; Rubini, P.; and Herz, A. Functional opiate receptors in the guinea pig ileum: Their differentiation by means of selective tolerance development. J Pharmacol Exp Ther 291:547-550, 1981b.
- Shaw, J.S.; Miller, L.; Turnbull, M.J.; Gormley, J.J.; and Morley, J.S. Selective antagonists at the opiate delta-receptor. Life Sci 31:1259-1262, 1982.
- Shearman, G.T., and Herz, A. Discriminative stimulus properties of bremazocine in the rat. Neuropharmacology 20:1209-1213, 1981.
- Simon, E.J., and Groth, J. Kinetics of opiate receptor inactivation by sulfhydryl reagents: Evidence for conformational change in presence of sodium ions. Proc Natl Acad Sci USA 72:2404-2407, 1975.
- Simon, E.J.; Hiller, J.M.; and Edelman, I. Stereospecific binding of the potent narcotic analgesic <sup>3</sup>H-etorphine to rat brain homogenate. Proc Natl Acad Sci USA 70:1947-1949, 1973.
- Simon, E.J.; Bonnet, K.A.; Crain, S.M.; Groth, J.; Hiller, J.M.; and Smith, J.R. Recent studies on interaction between opioid peptides and their receptors. In: Costa, E., and Trabucchi, M., eds. Neural Peptides and Neuronal Communication. New York: Raven Press, 1980. pp. 335-346.
- Simon, E.J.; Hiller, J.M.; and Edelman, I. Solubilization of a stereospecific opiate-macromolecular complex from rat brain. Science 190:389-390, 1975.
- Simon, E.J.; Hiller, J.M.; Groth, J.; Itzhak, Y.; Holland, M.J.; and Beck, S.G. The nature of opiate receptors in toad brain. Life Sci 31:1367-1370, 1972.
- Simonds, W.F.; Koski, G.; Streaty, R.A.; Hjelmeland, L.M.; and Klee, W.A. Solubilization of active opiate receptors. Proc Natl Acad Sci USA 77:4623-4627, 1980.
- Smith, J.R., and Simon, E.J. Selective protection of stereospecific enkephalin and opiate binding against inactivation by N-ethylmaleimide. Evidence for two classes of receptors. Proc Natl Acad Sci USA 77:281-284, 1980.
- Suda, M.; Nakao, K.; Yoshimasa, T.; Ikada, Y.; Sakamoto, M.; Yanaihara, C.; Yanaihara, N.; Numa, S.; and Imura, H. Comparison of the action of putative endogenous  $\kappa$ -agonists, leuorphin and rimorphin *in vitro*. Life Sci 33 (Supp 1):275-278, 1983.
- Terenius, L. Stereospecific interaction between narcotic analgesics and a synaptic plasma membrane fraction of rat cerebral cortex. Acta Pharmacol Toxicol Copen 32:317-320, 1973.
- Valette, A.; Reme, J.M.; Pontonnier, G.; and Cros, J. Specific binding for opiate-like drugs in the placenta. Biochem Pharmacol 29:2657-2661, 1980.
- Vincent, J.R.; Kartalovski, B.; Geneste, P.; Kamenko, J.M.; and Ladzunski, K. Interaction of phencyclidine ("angel dust") with a specific receptor in rat brain membranes. Proc Natl Acad Sci USA 76:4678-4682, 1979.
- Von Voigtlander, P.F.; Lahti, R.A.; and Ludens, J.H. U-50, 488: A selective and structurally novel non  $\mu$  (kappa) opioid agonist. J Pharmacol Exp Ther 224:7-12, 1983.

- Wolozin, B.L., and Pasternak, G.W. Classification of multiple morphine and enkephalin binding sites in the central nervous system. Proc Natl Acad Sci USA 78:6181-6185, 1981.
- Woods, J.H.; Smith, C.B.; Medzihradsky, F.; and Swain, H.H. Preclinical testing of new analgesic drugs. In: Beers, R.F., and Basset, E.G., eds. Mechanisms of Pain and Analgesic Compounds. New York Raven Press, 1979. pp. 429-445.
- Yoshimura, K.; Huidobro-Toro, J.P.; Lee, N.M.; Loh, H.H.; and Way, E.L. Kappa opioid properties of dynorphin and its peptide fragment on the guinea pig ileum. J Pharmacol Exp Ther 222:71-79, 1982.
- Zajac, J.-M.; Gacel, G.; Petit, F.; Dodey, P.; Rossignol, P.; and Roques, B. Deltakephalin, Tyr-D-Thr-Gly-Phe-Leu-Thr. A new highly potent and fully specific agonist for opiate  $\delta$  receptors. Biochem Biophys Res Commun 111:390-397, 1983.
- Zukin, R.S., and Zukin, S.R. Demonstration of  $^3\text{H}$ -cyclazocine binding to multiple opiate receptor sites. Mol Pharmacol 20:246-254, 1981.
- Zukin, S.R., and Zukin, R.S. Specific  $^3\text{H}$ -phencyclidine binding in rat central nervous system. Proc Natl Acad Sci USA 76:5372-5376, 1979.

## ACKNOWLEDGMENT

The work in the author's laboratory was supported by grant DA-00017 from the National Institute on Drug Abuse.

## AUTHOR

Eric J. Simon, Ph.D.  
Professor  
Departments of Psychiatry and Pharmacology  
New York University Medical Center  
550 First Avenue  
New York, New York 10016

# Regulation of Agonist Binding to Opioid Receptor Types by Sodium and GTP: Relevance to Receptor Function

Brian M. Cox, Ph.D.; Linda L. Werling, Ph.D.; and Gary Zarr, M.S., ANC

Measurements of radiolabeled opioid ligand binding to membrane preparations from mammalian brain tissue (Lord et al. 1977; Chang and Cuatrecasas 1979; Leslie et al. 1980; James and Goldstein 1984) have confirmed the apparent presence of heterogeneity in opioid binding sites analogous to the opioid receptor heterogeneity postulated on the basis of physiological studies (Martin et al. 1976; Gilbert and Martin 1976) and studies of opioid action in *in vivo* bioassays (Lord et al. 1977). The quantitative analysis of opioid ligand binding to receptor sites is important in the analysis of opiate drug action because it provides a measure of the critical primary interaction between the drug or endogenous opioid and the first in the series of tissue components which mediate the drug or ligand action. This interaction is a primary determinant of subsequent events initiated by receptor activation. A quantitative analysis of this process is therefore essential to an understanding of the events mediating opioid drug or peptide action. It is preferable that the properties of the receptor ligand interaction are measured under conditions which also permit the observation of drug-induced responses. However, studies of radiolabeled opioid binding have generally been conducted under conditions of low temperature and low salt concentration which preclude the demonstration in the same preparation of any biochemical or physiological consequences of opioid receptor activation (Lord et al. 1977; Chang and Cuatrecasas 1979; Leslie et al. 1980; James and Goldstein 1984). Furthermore, agonist binding affinity is significantly affected by variations in incubation temperatures (Pert and Snyder 1974; Simantov et al. 1976) and by the concentration of sodium and other cations (Simon et al. 1973; Pasternak et al. 1975). It is therefore important to establish that the opioid receptor types discriminated under nonphysiological conditions can also be identified by radioligand techniques during incubations conducted at 37° in the presence of physiological cations.

The immediate biochemical consequences of the activation of each opioid receptor type in mammalian brain membranes have not been



ascertained. Studies of oploid effects in neuroblastoma x glioma (NG 108-15) hybrid cells have demonstrated that opioid receptors of the  $\delta$  type provide inhibitory regulation of adenylate cyclase (Sharma et al. 1975; Traber et al. 1975; Blume et al. 1979). In recent years, confirmation of the initial report (Collier and Boy 1974) that opioid regulation of adenylate cyclase also occurs in mammalian brain has appeared (Havemann and Kuschinsky 1978; Walczak et al. 1979; Law et al. 1981; Cooper et al. 1982). At this time, the opioid receptor types regulating adenylate cyclase in brain have not been identified with certainty. It has generally been difficult to quantify oploid inhibition of brain adenylate cyclase because of the small fraction of brain cyclase activity that is sensitive to oploid inhibition.

Electrophysiological studies have suggested that one consequence of  $\mu$ - and  $\delta$ -selective opioid interactions with receptors in the locus coeruleus and substantia gelatinosa of the rat, myenteric plexus of the guinea pig, and dorsal root ganglion neurons of the mouse is an increase in a neuronal potassium conductance, resulting in an outward flow of potassium ions (Williams et al. 1982; Yoshimura and North 1983; Morita and North 1981; Werz and Macdonald 1983). In contrast, the  $k$ -selective oploid, dynorphin, apparently has little effect on potassium conductances, but decreases a voltage-dependent calcium conductance in mouse dorsal root ganglion neurons (Werz and Macdonald 1984). The many types of potassium and calcium channels in mammalian neurons (Nachshen and Blaustein 1980; Brown et al. 1982; Petersen and Maruyama 1984), and their complex regulation by voltage and ion concentrations, have made it difficult to confirm these observations by direct measures of opiate-induced alterations in ion fluxes. Furthermore, it is not presently known if the opioid-induced effects on ion conductances are mediated through inhibition of adenylate cyclase or by alternative linking mechanisms.

A secondary consequence of opioid action in the central and peripheral nervous systems is inhibition of transmitter release. The inhibition of acetylcholine (ACh) release from guinea pig myenteric plexus by opioids has been known for many years (Paton 1957; Cox and Weinstock 1966; Kosterlitz and Watt 1968). Morphine also inhibits the release of adrenergic neurotransmitter at the cat nictitating membrane (Trendelenburg 1957; Cairnie et al. 1961) and in mouse vas deferens (Henderson et al. 1972). Several groups have reported the inhibition of norepinephrine (NE) release from cerebral cortex tissue by opiate drugs (Montel et al. 1974; Arbilla and Langer 1978; Hagan and Hughes 1984), and electrophysiological evidence of an opioid-mediated reduction in excitability of noradrenergic terminal fields in rat cerebral cortex has also been noted (Nakamura et al. 1982). Opioid effects on transmitter release in striatum are less clear. Loh et al. (1976) reported that morphine inhibited dopamine (DA) release from rat striatal slices; this could not be confirmed by Arbilla and Langer (1978). However, it has recently been reported that the

k-selective opioid, dynorphin A, inhibits the potassium-stimulated release of DA from striatal slices, while [Leu<sup>5</sup>]enkephalin and [D-Ala<sup>2</sup>,D-Leu<sup>5</sup>]enkephalin (DADLE) had little effect on release of this amine, but inhibited the release of ACh (Mulder et al. 1984). Using push-pull cannula perfusion of cat caudate nucleus in vivo, morphine has been reported to stimulate DA release (Chesselet et al. 1981). It seems possible that this is an indirect effect resulting from interactions with other neurotransmitters in striatum. An inhibition of DA release by morphine and enkephalin analogs has been reported, however, in rabbit retina (Dubocovich and Weiner 1983).

The mechanisms by which opioid receptor activation is translated into an inhibition of neurotransmitter release are not yet known. The increase in potassium conductance induced by  $\mu$ - and  $\delta$ -selective opioids (Yoshimura and North 1983; Werz and Macdonald 1984) produces a hyperpolarization of the neuronal membrane that may be sufficient to inhibit transmitter release from terminals of that neuron. Likewise, the  $k$  agonist-induced reduction in calcium conductance (Werz and Macdonald 1984) may be of sufficient magnitude to reduce the calcium-dependent release of transmitter. However, the coupling between opioid receptor activation and effects on ion conductances is not understood. A role for CAMP-dependent phosphorylation in the regulation of potassium ion channels has been proposed in *Aplysia* neurons (Kandel and Schwarz 1982). It is conceivable that opioid-induced inhibition of adenylate cyclase results in the reduced phosphorylation of a protein which in its phosphorylated state mediates the closing of a select set of potassium channels. Clearly, much further work is required to elucidate the possible role of adenylate cyclase inhibition in opioid-induced increases in potassium conductance and also in elucidating the possible linkage between  $k$ -type opioid receptors and calcium channels.

The opioid receptor types mediating opioid inhibition of transmitter release in cerebral cortex or other brain structures also have not been identified with certainty. Recent studies by Hagan and Hughes (1984) have demonstrated that the  $\mu$ -selective agonist [D-Ala<sup>2</sup>-MePhe<sup>4</sup>-Gly<sup>5</sup>]enkephalin-ol (DAGO) was more potent than DADLE, an agonist with high activity at both  $\delta$ - and  $\mu$ -type receptors, in inhibiting NE release from rat cerebral cortex. Naloxone  $K_e$  values in the range 1 to 4 nM in antagonizing the effects of both DAGO and DADLE suggest that  $\mu$ -type receptors were probably responsible for this action. However, the concentrations ( $EC_{50}$ ) of DAGO and DADLE needed to produce 50% inhibition of the maximum inhibition of NE release in this tissue were approximately 100 nM and 500 nM, respectively (table 1). These values are roughly two orders of magnitude higher than the estimated affinities of these ligands for  $\mu$ -type opioid binding sites measured in TRIS-HCl buffer at reduced temperature, and tenfold to fiftyfold higher than their receptor affinities measured in the presence of physiological cations. Other studies have confirmed the low potencies of opioids in inhibiting transmitter release

from brain preparations. Thus, concentrations of opioids in the range 100 nM to 10  $\mu$ M have commonly been used to produce measurable inhibition of transmitter release in studies of this type (Montel et al. 1974; Loh et al. 1976; Arbilla and Langer 1978). Only in retina were slightly lower concentrations required for significant inhibition of DA release (Dubocovitch and Weiner 1983) and, even here, effective doses were an order of magnitude higher than estimated  $\mu$  receptor affinity.

The reasons for this discrepancy between estimates of affinity and effective concentrations are not clear. It cannot be accounted for by the probable existence of "spare" opioid receptors (Cox and Chavkin 1982) since the greater the receptor reserve, the more the receptor affinity ( $K_D$ ) should exceed the  $EC_{50}$ . Another possible explanation of the low potencies of opioids in inhibiting transmitter release is degradation by the brain slices during diffusion through the slice to the receptor sites. This is probably a significant factor in the low potencies of [Met<sup>5</sup>]- and [Leu<sup>5</sup>]-enkephalin in tissue slices (Loh et al. 1976). However, it is less likely as an explanation of the discrepancies between  $EC_{50}$  and  $K_D$  for stable opioids such as morphine, DAGO, and DADLE. Estimates of binding affinity of stable opioids determined in brain slice preparations are not very different from binding affinities determined in homogenates (Davis et al. 1975; Rothman et al. 1984). It seems more probable that the estimates of agonist affinity determined in nonphysiological buffers at low temperatures are a poor reflection of the actual affinities of receptors on intact neurons at normal body temperature. It remains to be established that the discrimination of receptor types observed in ligand binding studies under these nonphysiological conditions can still be demonstrated in the presence of physiological cations at 37°. We have therefore set out to determine the characteristics of opioid binding sites in neural membranes under more appropriate conditions.

## COMPOSITION OF INCUBATION MEDIUM

Opioid binding is regulated by both monovalent and divalent cations (Simon et al. 1973; Pasternak et al. 1975). An initial decision must be made as to whether to select conditions comparable to extra- or intra-cellular ionic composition. Since sodium has a major effect on the binding of opioids to some receptor types, and the intracellular sodium concentration is very roughly one-tenth of the extracellular concentration, the selected sodium concentration will have a major effect on the observed opioid binding parameters. As a starting point, we have opted to employ a modified Krebs solution (see legend, figure 1) with cation composition comparable to that of extracellular fluid in experiments in which we sought to confirm the discrimination of  $\mu$ ,  $\delta$ -, and  $k$ -type binding sites. This solution has the relatively high ionic strength characteristic of both intra- and extra-cellular fluid. We assumed that under these conditions the specific inhibitory effect of sodium is maximal. Divalent cations appear to

TABLE 1  
Effects of Opioid Receptor Activation:  
Estimates of Agonist Potency

Effect	Drug	Approximate Effective Conc.*	
Inhibition of striatal adenylyate cyclase:			
Law et al. 1981	morphine DADLE	1 - 10	μM
Cooper et al. 1982	morphine	1 - 10	μM
Membrane hyperpolarization (increased K <sup>+</sup> conductance):			
Williams et al. 1982	morphine DADLE	1 0.3	μM μM
Inhibition of NE release from rat cortex:			
Montel et al. 1974	morphine	0.1 - 1	μM
Arbilla and Langer 1978	morphine	<10	μM
Hagan and Hughes 1984	morphine normorphine DAGO DADLE	1 3 0.1 0.5	μM μM μM μM
Inhibition of DA release from rat striatum:			
Mulder et al. 1984	dynorphin A ketocyclazocine	10 20	nM nM
Inhibition of DA release from rabbit retina:			
Dubocovich and Weiner 1983	morphine DADLE	0.3 60	μM nM

\*In most studies, EC<sub>50</sub> concentrations were not determined. The concentrations noted here are those reported to produce significant effects.

have their greatest effect on opioid binding in the regulation of the interactions of guanine nucleotides with the receptor (Childers and Snyder 1980). Manganese is probably most active in reducing the inhibitory effects of guanosine triphosphate (GTP), but the concentrations at which this effect is observed are higher than those present in normal neurons. Magnesium may exert a similar effect (Charg et al. 1983) and is present in effective concentrations in physiological fluids. It is therefore appropriate that it should be present in the incubation medium.

Physiological fluids are buffered by bicarbonate, phosphate, and proteins if they are present. These are inconvenient buffers for in vitro studies. TRIS-HCl buffers have a long history of use, but many physiological processes, including neurotransmitter release, do not function in this buffer. We have therefore used HEPES buffer, which has good buffering capacity at physiological pH, and appears compatible with many aspects of cell function.

## INCUBATION CONDITIONS

Transmitter release in mammalian neurons does not function efficiently at temperatures much below 30°; most studies of opioid effects on transmitter release have used 37° incubations (Montel et al. 1974; Mulder et al. 1984). We have therefore used this temperature in measurements of opioid binding parameters. These incubation conditions tend to facilitate the degradation of peptides. In determining the characteristics of each type of opioid binding site, we have therefore selected relatively stable labeled and unlabeled ligands. Washed neural membrane preparations from rat whole brain minus cerebellum or from guinea pig cortex have been incubated in modified Krebs solution at 37° with selected radiolabeled ligands. Studies of the rate of ligand association indicated that equilibrium had been reached by 20 minutes of incubation. Bound and free labeled ligands were separated by rapid filtration through glass fiber filters, and radioactivity retained on the filters was measured by liquid scintillation spectrometry. Binding sites with  $\mu$ -type characteristics were identified by [<sup>3</sup>H]DAGO;  $\delta$ -type binding sites by [<sup>3</sup>H]DADLE binding in the presence of 10 nM unlabeled DAGO; and k type binding sites by [<sup>3</sup>H]ethylketocyclazocine ([<sup>3</sup>H]EKC) in the presence of 1  $\mu$ M unlabeled DAGO. The concentrations of displacing ligands required to permit specificity of labeled ligand binding were determined from displacement curves discussed below. Nonspecific binding was determined by inclusion in the incubation mixture of 1  $\mu$ M DAGO, 1  $\mu$ M [D-Ser<sup>2</sup>Leu<sup>5</sup>]enkephalyl-Thr (DSTLE) (David et al. 1982), or 1  $\mu$ M EKC for  $\mu$ -,  $\delta$ - or k-binding sites, respectively.

Binding site properties were characterized by saturation analysis, and by displacement studies using selective unlabeled ligands. Data were analyzed by the nonlinear curve fitting program LIGAND developed by Munson and Rodbard (1980). In control experiments, it was confirmed by thin-layer chromatography of extracts of the incubate that incubation of neural membranes with these labeled

ligands for periods as long as 60 minutes did not result in significant degradation of any of the labeled ligands. Incubations of unlabeled ligands for varying periods of time up to 60 minutes demonstrated that equilibrium was attained by 20 minutes and that no reduction of displacement, which might indicate degradation of displacing ligand, had occurred up to 60 minutes of incubation.

#### OPIOID BINDING SITE CHARACTERISTICS IN MODIFIED KREBS BUFFER AT 37°

The properties of opioid binding sites in modified Krebs solution at 37° are similar to those previously identified in medium depleted of physiological cations. Binding sites labeled with the selective  $\mu$  ligand, [<sup>3</sup>H]DAGO, are relatively insensitive to displacement by the  $\delta$  receptor-selective peptide DSTLE, and by the k-selective agent, U-50488H (James and Goldstein 1984). Thus, as observed by other workers (Gillan and Kosterlitz 1982), DAGO appears to be a very selective ligand for  $\mu$ -type receptors under most experimental conditions. This high selectivity of DAGO makes it very useful in the selective protection of  $\mu$  sites from occupation by less selective ligands used for labeling of other types of sites. Binding sites labeled by [<sup>3</sup>H]DADLE appear to comprise two classes; a fraction of the binding was readily displaced by low concentrations of DAGO, while the remaining binding was more resistant to displacement by this peptide, but could be displaced by low concentrations of DSTLE. U-50488H had little effect on [<sup>3</sup>H]DADLE binding. Binding sites labeled by [<sup>3</sup>H]EKC were also readily discriminated into two classes by the use of DAGO or by U-50488H, which each selectively displaced a fraction of the [<sup>3</sup>H]EKC binding (figure 1). Thus, as previously suggested by others (Gillan and Kosterlitz 1982; James and Goldstein 1984), [<sup>3</sup>H]DAGO binds almost exclusively to  $\mu$ -type  $\delta$  sites. [<sup>3</sup>H]DADLE binds to both  $\mu$  and  $\delta$  sites, with a slight preference for sites; however, its affinity for the two types of opioid binding sites is sufficiently similar in modified Krebs solution at 37° for it not to be possible to resolve these by saturation analysis. Our results suggest that it has no more than a fivefold preference for  $\delta$ -type sites (Werling et al. 1985a). [<sup>3</sup>H]EKC binding was also discriminated into two classes. In our studies; it has preferential affinity for k-type sites, and approximately tenfold lower affinity for  $\mu$ -type sites. Significant occupation of  $\delta$  sites by [<sup>3</sup>H]EKC was not observed. Thus, when compared to previous studies of [<sup>3</sup>H]EKC binding using TRIS-HCl buffer at reduced temperature, where EKC showed relatively poor discrimination between k,  $\mu$ , and  $\delta$  sites (Gillan and Kosterlitz 1982), its selectivity for k sites was increased under our incubation conditions. Of the displacing ligands, DAGO and U-50488H retained the  $\mu$  and k selectivity, respectively, previously reported for these compounds (James and Goldstein 1984), but DSTLE was less selective for  $\delta$  sites under our incubation conditions than in TRIS-HCl buffer at lower temperature (James and Goldstein 1984). Under our incubation conditions, this ligand was not sufficiently selective for  $\delta$  sites relative to  $\mu$  sites to be used in the

selective masking of these sites. Overall, however,  $\mu$ ,  $\delta$ , and  $k$  binding sites were still readily identified under our more physiologic incubation conditions.

## EFFECTS OF SODIUM ON THE BINDING PROPERTIES OF OPIOID RECEPTOR TYPES

The effects of sodium under conditions of constant ionic strength were determined by the stoichiometric replacement of the sodium in modified Krebs solution by potassium. Replacement of sodium by potassium resulted in a small increase in the affinity of ligands binding selectively to all three receptor types. A 2.8-fold increase in the affinity of  $[^3H]DAGO$  at  $\mu$  sites was observed. The affinity of  $[^3H]EKC$  binding affinity at  $k$  sites was increased 2-fold, while the increase in the  $[^3H]DADLE$  binding affinity at  $\delta$  sites was only 1.2-fold. However, there was also a substantial increase in the number of  $\delta$ -type binding sites after sodium replacement, an effect which was not observed at  $\mu$  and  $k$  binding sites (Werling et al. 1985b). Thus, in these experiments,  $\delta$ -type binding sites were substantially more sensitive overall to the specific inhibitory effects of sodium than the  $\mu$  and  $k$  sites. This is in contrast to the results of Pfeiffer and Herz (1982). Using rat brain membranes in TRIS-HCl buffer at reduced temperature, they found that  $\mu$  binding sites were more affected than  $\delta$  or  $k$  sites by the addition of 100 mM sodium to the TRIS buffer. In these studies, however, the effects of increasing ionic strength and increasing sodium concentration are confounded. Our results are consistent with our observation noted above that DSTLE was less selective for  $\delta$  binding sites in the modified Krebs solution than in the TRIS-HCl buffer.

It appears that DSTLE binding to  $\delta$  sites was reduced more than its binding to  $\mu$  sites by the presence of sodium in the incubation medium. The apparent increase in the number of  $\delta$  binding sites when sodium was replaced by potassium (Werling et al. 1985b) deserves comment. This might indicate that sodium can actually inactivate  $\delta$ -type receptors; it seems more probable, however, that the sites apparently lost in the presence of sodium actually had an affinity that was too low to be detected under the conditions of that experiment. There is no evidence indicating that exposure of brain membranes to sodium results in a permanent depletion of  $\delta$  binding sites. The magnitude of the sodium effect observed in these experiments was not large overall, except at some  $\delta$  sites.

The effective concentration of sodium in reducing binding to each type of binding site was determined by measuring the effect of varying the sodium concentration (at constant ionic strength) on the binding of standard concentrations of selective labeled opioid agonists. The effect of reducing the sodium concentration on  $k$  binding was relatively small over the complete concentration range. Binding to  $d$  sites was reduced 50% to 60% at the highest sodium concentration, relative to the binding in the absence of sodium; 50% of the maximum sodium inhibition was observed at sodium concen-

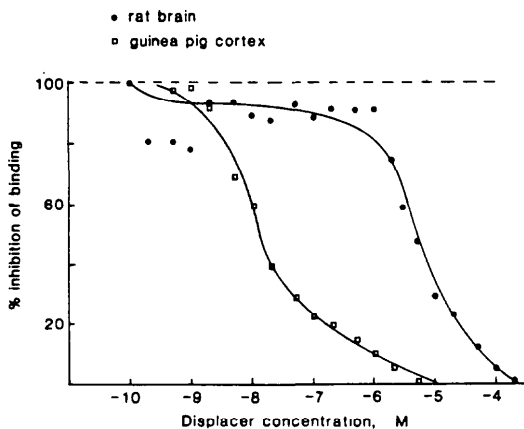


FIGURE 1

DISPLACEMENT OF SPECIFIC EKC BINDING BY U-50,488H

Increasing concentrations of U-50,488H were incubated with brain membranes and [<sup>3</sup>H]EKC, 2nM for 20 min at 37°. The modified Krebs incubation medium contained: NaCl, 118 mM; KCl, 4.8 mM; CaCl<sub>2</sub>, 2.5 mM; MgCl<sub>2</sub>, 1.2 mM; pH was adjusted to 7.4 with HCl. Bound ligand was separated by rapid filtration through glass fiber filters, and radioactivity determined by liquid scintillation spectrometry. Nonspecific binding was estimated by the addition of 1 μM unlabelled EKC. In guinea pig cortex homogenates, U-50,488H showed considerable displacement of [<sup>3</sup>H]EKC binding at 10 nM. In rat brain, the number of k receptors is relatively low, and U-50,488H displaced only about 10% of specifically bound [<sup>3</sup>H]EKC at this concentration. Further displacement was not observed until the U-50,488H concentration exceeded 1 μM.

trations in the range of 10 to 30 mM. Similar results were observed at μ sites. Thus, the effective concentration of sodium (i.e., its EC<sub>50</sub>) was much closer to its estimated intracellular concentration, in the range of 10 to 30 mM (Fozzard and Kipnis 1967), than its extracellular concentration (>120 mM). Preliminary studies with the sodium-selective ion carrier, monensin (Feinstein et al. 1977), in intact NG-108 cells have suggested that monensin can inhibit binding to δ-type receptors by increasing the intracellular concentration of sodium (Puttfarcken et al., unpublished observations). Since sodium is apparently critical to the inhibition of adenylate cyclase by opioids (Blume et al. 1979), it is probable that sodium interacts at a common intracellular site which both facilitates the coupling of the receptor to adenylate cyclase and also regulates agonist binding properties at δ, and probably at μ, sites.

EFFECTS OF GTP ON THE BINDING PROPERTIES OF OPIOID RECEPTOR TYPES

Guanine nucleotides regulate the binding of opioids (Blume 1978; Chang et al. 1983; Rosenbaum and Sadee 1983). We have therefore also evaluated the effects of GTP on opioid binding under our experimental conditions. The effects of GTP in the presence of sodium were more pronounced than the effects of sodium alone in



reducing agonist binding. The specific binding of [<sup>3</sup>H]DAGO was almost completely inhibited by 100 μM GTP, resulting in very low specific binding, with an affinity probably in the micromolar range. Binding affinities as low as this are not accurately determined, partly because of the high nonspecific binding at the labeled ligand concentrations required to characterize these sites, and partly because the ligand dissociation rate from the receptor is high, relative to the time needed to separate bound from free ligand by the filtration technique. However, it is clear that the μ site affinity for DAGO is low in the presence of GTP, and now consistent with the concentrations required for inhibition of adenylate cyclase or transmitter release in rat brain slices. Binding of [<sup>3</sup>H]DADLE at δ sites was also substantially reduced by 100 μM GTP, with a roughly fourfold reduction in K<sub>D</sub>. In contrast, [<sup>3</sup>H]EKC binding at k sites was only slightly reduced. Scatchard analysis suggested that GTP reduced the total binding of EKC at k-type sites by 20% to 25% with little effect on the affinity of the residual sites (figure 2). These results probably indicate that only a fraction of the k sites was coupled to a GTP binding protein under the conditions of our experiments. The ligand affinity of the coupled sites was probably reduced below the measurable range by GTP, thus reducing the apparent number of total sites while leaving the remaining sites unaffected by GTP.

Our results thus suggest that GTP substantially lowers the agonist affinity of opioid binding sites with μ-, δ-, and k-type selectivity, the difference between the k sites and the μ and δ sites presumably being related to the extent of coupling of each receptor type to GTP binding proteins. The significance of GTP regulation of opioid binding is not clear. It might indicate that each type of opioid receptor is coupled to adenylate cyclase through a GTP binding protein, as has been suggested for other receptor-mediated inhibitions of adenylate cyclase (Rodbell 1980; Spiegel and Downs 1981). However, GTP binding proteins might also play a critical role in the coupling of hormone or neurotransmitter receptors to other effector systems (e.g., see Fung et al. 1981).

The apparent variability in sensitivity to GTP (and hence, presumably in extent of coupling to GTP binding proteins) between different opioid receptor types also deserves some comment. Bowen et al. (1981) and Rothman et al. (1984) have characterized binding sites with δ-type characteristics as Type I or Type II on the basis of their sensitivity to GTP. By varying treatment conditions, evidence implying a possible shift between Type I and Type II properties was obtained (Bowen et al. 1981). Thus, some variability in the extent of coupling, particularly of the δ-type binding site, appears possible (Rothman et al. 1984). Our results suggest that a much smaller fraction of k-type sites than μ or δ sites is coupled to GTP binding proteins under our experimental conditions. Low fractional coupling might be an artifact of membrane preparation; however, substantial coupling of μ-type

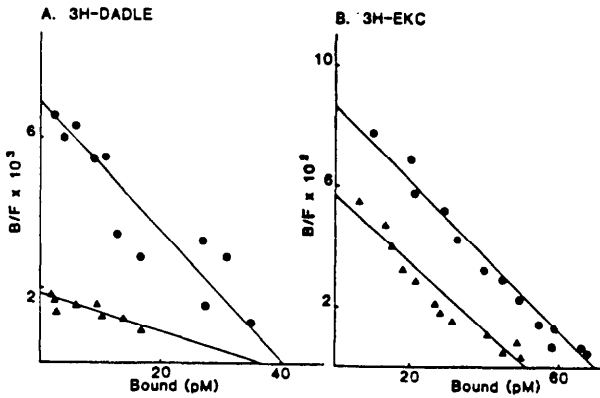


FIGURE 2

INHIBITION OF 3H-DADLE AND 3H-EKC SPECIFIC BINDING BY GTP

*Scatchard analysis of the effect of GTP (100  $\mu$ M) on the specific binding of [<sup>3</sup>H]DADLE to d sites (A), and [<sup>3</sup>H]EKC binding to k sites (B) in guinea pig cortical membranes. ● No GTP added; ▲ GTP was added to give a final concentration of 100  $\mu$ M at the start of the incubation with labelled ligand. To correct for probable GTP hydrolysis, a second addition of an equal amount of GTP was made after 10 min of incubation at 37°. The reaction was terminated after 20 min incubation, as described in Fig. 1.*

sites was observed in the same membrane preparations. Differential GTP sensitivity between different types of opioid binding site might therefore indicate a difference in the mechanisms of coupling. However, GTP sensitivity of opioid agonist binding is also related to the source of the membranes. Roth and Coscia (1984) have recently shown that opioid binding sites in microsomal membranes are not sensitive to GTP regulation, although they continue to show sodium inhibition of agonist binding. The types of opioid binding site present in microsomal membranes has not been ascertained as yet. Since microsomal membranes are probably present in our membrane preparations, our results might be explained if the proportion of k to  $\mu$  plus  $\delta$  sites in microsomal membranes was higher than in the total crude membrane preparation, but there is no evidence to suggest such a distribution of binding site types. Uncoupling of receptors from the catalytic and regulatory components of adenylate cyclase is also a feature of agonist-mediated desensitization (Law et al. 1983). Thus, an alternative interpretation might be that a significant fraction of k sites is desensitized in guinea pig cortex. Further studies are clearly required to evaluate these possibilities.

## SODIUM AND GUANINE NUCLEOTIDES IN THE REGULATION OF OPIOID ACTION

The effect of GTP was to produce an even greater reduction of agonist affinity than sodium alone. The low affinities induced by the combined treatment are much closer to the effective concentrations of morphine, DADLE, and DAGO in inhibiting adenylate cyclase or transmitter release in slices of rat brain cortex or striatum. Thus, it is not improbable that the active conformations of  $\mu$  and  $\delta$  opioid receptors are regulated by intracellular sodium and guanine nucleotides. The studies discussed above employed a high concentration of GTP, comparable to estimates of the intracellular concentration of GTP in neuroblastoma and glioma cells (0.3 to 0.5 mM) (Franklin and Twose 1977; Cass et al. 1977). However, much lower concentrations of GTP have been shown to be sufficient to affect opioid binding (Zukin and Gintzler 1980; Bowen et al. 1981). Thus, while GTP is probably essential for opioid action through  $\delta$  and perhaps  $\mu$  receptors (Blume et al. 1979), it may not act as a variable regulator of opioid binding in the intact cell. However, intracellular compartmentalization of GTP is probable (Cass et al. 1977; Johnson and Mukka 1979), which would make a regulatory role for GTP feasible. The critical effective sodium concentration in regulating binding is close to the intracellular concentration of this ion (Fozzard and Kipnis 1967). Thus, binding affinities at opioid receptors might be influenced by physiologic, pharmacologic, or pathologic changes in the local intracellular sodium concentration.

In several respects, the effects of agonists acting through k-type receptors appear to differ from those mediated through  $\mu$  or  $\delta$  sites. Electrophysiological studies suggest that while  $\mu$  and  $\delta$  agonists hyperpolarize the membranes of sensitive neurons by increasing potassium permeability (Williams et al. 1982), k agonists might act by inhibiting an inward calcium current (Werz and Macdonald 1984). Agonist binding at  $\mu$  and  $\delta$  sites is apparently more sensitive to inhibition by sodium and GTP than binding at k sites, although these agents do have some effect on k binding. These results suggest that k receptors may be linked to their effectors in a different manner than  $\mu$  and  $\delta$  receptors. To date, the ability of k agonists, acting through k receptors, to inhibit adenylate cyclase has not been demonstrated. It is possible that an alternative transduction system may mediate the consequences of k receptor activation.

## REFERENCES

- Arbilla, S., and Langer, S.Z. Morphine and  $\beta$ -endorphin inhibit release of noradrenaline from cerebral cortex but not of dopamine from rat striatum. Nature 271:559-561, 1978.
- Blume, A.J. Interaction of ligands with the opiate receptors of brain membranes: Regulation by ions and nucleotides. Proc Natl Acad Sci USA 75:1713-1717, 1978.

- Blume, A.J.; Lichshtein, D.; and Boone A. Coupling of opiate receptors to adenylate cyclase: Requirement for Na<sup>+</sup> and GTP. Proc Natl Acad Sci USA 76:5626-5630, 1979.
- Bowen W.D.; Gentleman, S.; Herkenham, M.; and Pert, C.B. Interconverting  $\mu$  and  $\delta$  forms of the opiate receptor in rat striatal patches. Proc Natl Acad Sci USA 78:4818-4822, 1981.
- Brown, D.A.; Adams, P.R.; and Constanti, A. Voltage-sensitive K-currents in sympathetic neurons and their modulation by neurotransmitters. J Auton Nerv Syst 6:23-35, 1982.
- Cairnie, A.B.; Kosterlitz, H.W.; and Taylor, D.W. Effect of morphine on some sympathetically innervated effectors. Br J Pharmacol 17:539-551, 1961.
- Cass, C.E.; Lowe, J.K.; Manchak, J.M.; and Henderson, J.F. Biological effects of inhibition of guanine nucleotide synthesis by mycophenolic acid in cultured neuroblastoma cells. Cancer Res 37:3314-3320, 1977.
- Chang, K.J., and Cuatrecasas, P. Multiple opiate receptors - enkephalins and morphine bind to receptors of different specificity. J Biol Chem 254:2610-2618, 1979.
- Chang, K.J. Blanchard, S.G.; and Cuatrecasas, P. Unmasking of magnesium-dependent high-affinity binding sites for [DALa<sup>2</sup>, DLeu<sup>5</sup>] enkephalin after pretreatment of brain membranes with guanine nucleotides. Proc Natl Acad Sci USA 80:940-944, 1983.
- Chesselet, M.F.; Cheramy, A.; Reisine, T.D.; and Glowinski, J. Morphine and  $\delta$  opiate agonists locally stimulate in vivo dopamine release in cat caudate nucleus. Nature 291:320-322, 1981.
- Childers, S.R., and Snyder, S.H. Differential regulation by guanine nucleotides of opiate agonist and antagonist receptor interactions. J Neurochem 34:583-593, 1980.
- Collier, H.O.J., and Roy, A.C. Morphine-like drugs inhibit the stimulation by E prostaglandins of cyclic AMP formation by rat brain homogenate. Nature 248:24-27, 1974.
- Cooper, D.M.F.; Londos, C.; Gill, D.L.; and Rodbell, M. Opiate receptor-mediated inhibition of adenylate cyclase in rat striatal plasma membranes. J Neurochem 38:1164-1167, 1982.
- Cox, B.M., and Chavkin, C. Comparison of dynorphin-selective kappa receptors in mouse vas deferens and guinea pig ileum. Mol Pharmacol 23:36-43, 1982.
- Cox, B.M., and Weinstock, M. The effect of analgesic drugs on the release of acetylcholine from electrically stimulated guinea-pig, ileum. Br J Pharmacol 27:81-92, 1966.
- David, M.; Moisand, C.; Meunier, J.C.; Morgat, J.L.; Gacel, G.; and Roques, B.P. [<sup>3</sup>H]Tyr-D-Ser-Gly-Phe-Leu-Thr: A specific probe for the  $\delta$ -opiate receptor subtype in brain membranes. Eur J Pharmacol 78:385-387, 1982.
- Davis, M.E.; Akera, T.; and Brody, T.M. Saturable binding of morphine to rat brain-stem slices and the effect of chronic morphine treatment. Res Commun Chem Pathol Pharmacol 12:409-418, 1975.
- Dubocovich, M.L. and Weiner, N. Enkephalins modulate [<sup>3</sup>H]dopamine release from rabbit retina in vitro. J Pharmacol Exp Ther 224:634-639, 1983.
- Feinstein, M.B.; Henderson, I.A.; and Sha'afi, R.I. The effects

- of alterations of transmembrane Na<sup>+</sup> and K<sup>+</sup> gradients by ionophores (nigericin, monensin) on serotonin transport in human blood platelets. Biochim Biophys Acta 468:284-295, 1977.
- Fozzard, H.A. and Kipnis, D.M. Regulation of intracellular sodium concentration in rat diaphragm muscle. Science 156:1257-1260, 1967.
- Franklin, T.J., and Twose, P.A. Reduction in  $\beta$ -adrenergic response of cultured glioma cells following depletion of intracellular GTP. Eur J Biochem 77:113-117, 1977.
- Fung, K.K.; Hurley, J.B.; and Stryer, L. Flow of information in the light-triggered cyclic nucleotide cascade of vision. Proc Natl Acad Sci USA 78:152-156, 1981.
- Gilbert, P.E., and Martin, W.R. The effects of morphine- and nalorphinlike drugs in the nondependent, morphine-dependent and cyazocine-dependent chronic spinal dog. J Pharmacol Exp Ther 198:66-82, 1976.
- Gillan, M.G.C., and Kosterlitz, H.W. Spectrum of the  $\mu$ -,  $\delta$  and  $\kappa$ -binding sites in homogenates of rat brain. Br J Pharmacol 77:461-469, 1982.
- Hagan, R.M., and Hughes, I.E. Opioid receptor sub-types involved in the control of transmitter release in cortex of the brain of the rat. Neuropharmacology 23:491-495, 1984.
- Havemann, U., and Kuschinsky, K. Interactions of opiates and prostaglandins-E with regard to cyclic AMP in striatal tissue of rats in vitro. Naunyn Schiedebergs Arch Pharmacol 302:103-106, 1978.
- Henderson, G.; Hughes, J.; and Kosterlitz, H.W. A new example of morphine-sensitive neuro-effector junction: Adrenergic transmission in the mouse vas deferens. Br J Pharmacol 46:764-766, 1972.
- James, I.F., and Goldstein, A. Site directed alkylation of multiple opioid receptors: I binding selectivity. Mol Pharmacol 25:337-342, 1984.
- Johnson, G.S., and Mukka, V.R. Evidence in intact cells for an involvement of GTP in the activation of adenylate cyclase. J Biol Chem 254:95-100, 1979.
- Kandel, E.R., and Schwarz, J.H. Molecular biology of learning: Modulation of transmitter release. Science 218: 433-443, 1982.
- Kosterlitz, H.W., and Watt, A.J. Kinetic parameters of narcotic agonists and antagonists, with particular reference to N-allylnoroxymorphone (naloxone). Br J Pharmacol 33:266-276, 1968.
- Law, P.Y.; Wu, J.; Koehler, J.E.; and Loh, H.H. Demonstration and characterization of opiate inhibition of the striatal adenylate cyclase. J Neurochem 36:1834-1846, 1981.
- Law, P.Y.; Hom, D.S.; and Loh, H.H. Opiate receptor down regulation and desensitization in neuroblastoma x glioma NG 108-15 hybrid cells are two separate cellular adaptation processes. Mol Pharmacol 24:413-424, 1983.
- Leslie, F.M.; Chavkin, C.; and Cox, B.M. Opioid binding properties of brain and peripheral tissues: Evidence for heterogeneity in opioid ligand binding sites. J Pharmacol Exp Ther 214:395-402,

- 1980.
- Loh, H.H.; Brase, D.A.; Sampath-Khanna, S.; Mar, J.B.; and Way, E.L.  $\beta$  Endorphin in vitro inhibition of striatal dopamine release. Nature 284:567-568, 1976.
- Lord, J.A.H.; Waterfield, A.A.; Hughes, J.; and Kosterlitz, H.W. Endogenous opioid peptides: Multiple agonists and receptors. Nature 267:495-499, 1977.
- Martin, W.R.; Eades, C.G.; Thompson, J.A.; Huppler, R.E.; and Gilbert, P.E. The effects of morphine and nalorphine-like drugs in the nondependent and morphine-dependent chronic spinal dog. J Pharmacol Exp Ther 197:517-532, 1976.
- Montel, H.; Starke, K.; and Weber, F. Influence of morphine and naloxone on the release of noradrenaline from rat brain cortex slices. Naunyn Schmiedebergs Arch Pharmacol 283:357-369, 1974.
- Morita, K., and North, R.A. Opiates and enkephalin reduce the excitability of neuronal processes. Neuroscience 6:1943-1951, 1981.
- Mulder, A.H.; Wardeh, G.; Hogenboom, F.; and Frankhuyzen, A.L.  $\kappa$ - and  $\delta$ -opioid receptor agonists differentially inhibit striatal dopamine and acetylcholine release. Nature 308:278-280, 1984.
- Munson, P.J., and Rodbard, D. LIGAND: A versatile computerized approach for characterization of ligand-binding systems. Anal Biochem 107:220-239, 1980.
- Nachshen, D.A., and Blaustein, M.P. Some properties of potassium-stimulated calcium influx in presynaptic nerve endings. J Gen Physiol 76:709-728, 1980.
- Nakamura, S.; Tepper, J.M.; Young, S.J.; Ling, N.; and Groves, P.M. Noradrenergic terminal excitability: Effects of opioids. Neurosci Lett 30: 57-62, 1982.
- Pasternak, G.W.; Snowman, A.M.; and Snyder, S.H. Selective enhancement of [ $^3$ H]opiate agonist binding by divalent cations. Mol Pharmacol 11:735-744, 1975.
- Paton, W.D.M. The action of morphine and related substances on contraction and on acetylcholine output of coaxially stimulated guinea-pig ileum. Br J Pharmacol 12:119-127, 1957.
- Pert, C.B., and Snyder, S.H. Opiate receptor binding of agonists and antagonists affected differentially by sodium. Mol Pharmacol 10:868-879, 1974.
- Petersen, O.H., and Maruyama, Y. Calcium-activated potassium channels and their role in secretion. Nature 307:693-696, 1984.
- Pfeiffer, A., and Herz, A. Different types of opiate agonist interact distinguishably with mu, delta and kappa opiate binding sites. Life Sci 31:1355-1358, 1982.
- Rodbell, M. The role of hormone receptors and GTP-regulatory proteins in membrane transduction. Nature 284:17-22, 1980.
- Rosenbaum, J.S., and Sadee, W. Opiate receptor binding affected by guanine nucleotide. J Biol Chem 258:1419-1422, 1983.
- Roth, B.L., and Coscia, C.J. Microsomal opiate receptors: Characterization of smooth microsomal and synaptic membrane opiate receptors. J Neurochem 42:1677-1684, 1984.
- Rothman, R.B., and Westfall, T.C. Allosteric coupling between morphine and enkephalin receptors in vitro. Mol Pharmacol

- 21:548-557, 1982.
- Rothman, R.B.; Danks, J.A.; and Pert, C.B. Ionic conditions differentially affect  $^3\text{H}$ -DADL binding to type-I and type-II opiate delta receptors in vitro. Neuropeptides 4:261-268, 1984.
- Schumacher, U.K.; Pert, C.B.; Jacobsen, A.E.; Burke, T.R., Jr.; and Rice, K.C. Preparation of rat brain membranes greatly enriched with either type-I-delta or type-II-delta opiate binding sites using site directed alkylating agents: Evidence for a two-site allosteric model. Neuropeptides 4:201-215, 1984.
- Sharma, S.K.; Nirenberg, M.; and Klee, W.A. Morphine receptors as regulators of adenylate cyclase activity. Proc Natl Acad Sci USA 72:590-594, 1975.
- Simantov, R.; Snowman, A.M.; and Snyder, S.H. Temperature and ionic influences on opiate receptor binding. Mol Pharmacol 12:977-986, 1976.
- Simon, E.J.; Hiller, J.M.; and Edelman, I. Stereospecific binding of the potent narcotic analgesic [ $^3\text{H}$ ]etorphine to rat-brain homogenate. Proc Natl Acad Sci USA 70:1947-1949, 1973.
- Spiegel, A.M., and Downs, R.W., Jr. Guanine nucleotides: Key regulators of hormone receptors adenylate cyclase interactions. Endoc Rev 2:275-305, 1981.
- Traber, J.; Fischer, K.; Latzin, S.; and Hamprecht, B. Morphine antagonizes action of prostaglandin in neuroblastoma and neuroblastoma x glioma hybrid cells. Nature 253:120-122, 1975.
- Trendelenberg, U.; The action of morphine on the superior cervical ganglion and on the nictitating membrane of the cat. Br J Pharmacol 12:79-85, 1957.
- Walczak, S.A.; Wilkening, D.; and Makman, M.H. Interaction of morphine, etorphine and enkephalins with dopamine-stimulated adenylate cyclase of monkey amygdala. Brain Res 160:105-116, 1979.
- Werling, L.L.; Brown, S.; and Cox, B.M. The sensitivity of opioid receptor types to regulation by sodium and GTP. Neuropeptides 5: 137-140, 1985a.
- Werling, L.L.; Zarr, G.D.; Brown, S.R.; and Cox, B.M. Opioid binding to rat and guinea pig neural membranes in the presence of physiological cations at 37°C. J Pharmacol Exp Ther 233:722-728, 1985b.
- Werz, M.A., and Macdonald, R.L. Opioid peptides selective for mu- and delta-opiate receptors increase a DRG neuron potassium conductance. Soc Neurosci Abstr 9:1129, 1983.
- Werz, M.A., and Macdonald, R.L. Dynorphin reduces calcium-dependent action potential duration by decreasing voltage-dependent calcium conductance. Neurosci Lett 46:185-190, 1984.
- Williams, J.T.; Egan, T.M.; and Enkephalin opens potassium channels on mammalian central neurones. Nature 294:74-77, 1982.
- Yoshimura, M., and North, R.A. Substantia gelatinosa neurones in vitro hyperpolarized by enkephalin. Nature 305:529-530, 1983.
- Zukin, R.S.; and Gintzler, A.R. Guanyl nucleotide interactions with opiate receptors in guinea pig brain and ileum. Brain Res 186:486-491, 1980.

## ACKNOWLEDGMENTS

Permission from Stephen Brown and Pamela Puttfarcken for the authors to report unpublished results is gratefully acknowledged. The experimental work described here was supported by grant DA03102 from the National Institute on Drug Abuse. The opinions or assertions contained herein are the private ones of the authors and are not to be construed as official or reflecting the view of the Department of Defense or the Uniformed Services University of the Health Sciences. The experiments reported herein were conducted according to the principles set forth in the "Guide for the Care and Use of Laboratory Animals," Institute of Laboratory Animal Resources, National Research Council (DHEW Publication No. [NIH] 78-23, 1978).

## AUTHORS

Brian M. Cox, Ph.D.  
Linda L. Werling, Ph.D.  
Department of Pharmacology  
Uniformed Services University of the Health Sciences  
4301 Jones Bridge Road  
Bethesda, Maryland 20814

Gary Zarr, M.S., ANC  
Department of Anesthesia  
Walter Reed Army Medical Center  
Washington, D.C. 20307



# Opioid Receptors for the Dynorphin Peptides

Iain F. James, Ph.D.

## THE DYNORPHIN/NEOENDORPHIN FAMILY OF PEPTIDES

Since the discovery of the enkephalins in 1975, some 20 other opioid peptides have been isolated, presenting a confusing picture of mammalian opioid systems. The confusion was cleared somewhat by the finding that all the known endogenous mammalian opioids belong to one of three families: the endorphin family (Nakanishi et al. 1979), the enkephalin family (Noda et al. 1982; Gubler et al. 1982), or the dynorphin/neoendorphin family (Kakidani et al. 1982). Each family is coded for by a single gene and is synthesized as a single precursor protein which is processed by specific enzymes to produce the biologically active peptides. This paper deals with the interaction of the dynorphin (dyn) and neoendorphin (neo) peptides with opioid receptors in mammalian nervous tissue. There are several reviews dealing with the isolation, distribution, and possible physiologic effects of dynorphins (Cox 1982; Holtt 1983; Lee and Smith 1984; Goldstein 1984a, 1984b).

Dynorphin was isolated from porcine pituitary and sequenced partially in 1979 (Goldstein et al. 1979). The sequence was completed in 1981 (Goldstein et al. 1981; Tachibana et al. 1982). Around the same time, the fragment dyn-(1-8) was isolated from porcine hypothalamus (Minamino et al. 1980). In 1982, a second dyn was found as part of a larger peptide from porcine pituitary (Fischli et al. 1982) and independently as a separate peptide from bovine pituitary (Kilpatrick et al. 1982). This second dyn was called dyn B (or rimorphin) and the original dyn renamed dyn A. The sequence of the dyn precursor obtained from the sequence of the mRNA (Kakidani et al. 1982) showed that two other peptides,  $\alpha$ -neo and  $\beta$ -neo, were also members of the dyn family. These peptides had already been isolated from porcine hypothalami (Kangawa et al. 1981; Minamino et al. 1980). In addition, the sequence of the precursor revealed a new peptide, an extension of dyn B comprising 29 amino acid residues. This peptide, known as dyn B-29 or leumorphin, has since been detected in mammalian nervous tissue (Nakao et al. 1983).

The structures of the dyn and neo peptides have several features in common and are shown in figure 1. All have the [Leu] enkephalin sequence at the amino terminus and basic residues at positions six and seven. Most have another basic residue in position 10 or 13; the exceptions are dyn A-(1-8) and  $\beta$ -neo. These features are important both for receptor selectivity and affinity.

### THE DYNORPHINS AND THE KAPPA OPIOID RECEPTOR

It is now well established that there are at least three and possibly as many as five different types of opioid receptors. Several reviews summarize the evidence for this and discuss properties of the different receptor types (Miller 1982; Wood 1982; Paterson et al. 1983). Each type of receptor is known by a Greek letter; hence, the  $\mu$  opioid receptor is the classical morphine receptor, enkephalins are somewhat selective for the  $\delta$  receptor, benzomorphans and dynorphins for the  $\kappa$  receptor, and  $\beta$ -endorphin for the  $\epsilon$  receptor (table 1).

**TABLE 1**

Multiple Opioid Receptors--Summary of Different Types

Receptor Type	Ligands	Tissues
$\mu$	morphine, naloxone, sufentanil	brain guinea pig ileum mouse vas deferens
$\delta$	enkephalins, DADLE	brain mouse vas deferens
$\kappa$	benzomorphans, ethylketocyclazocine (EKC), dynorphin	brain guinea pig ileum mouse vas deferens rabbit vas deferens
$\epsilon$	$\beta$ -endorphin	rat vas deferens brain?
$\sigma$	benzomorphans? phencyclidine?	brain

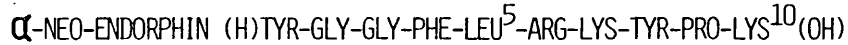
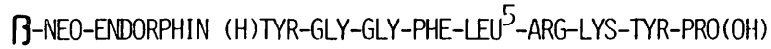
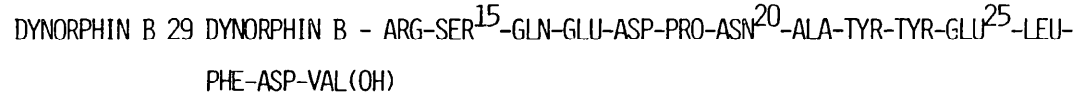
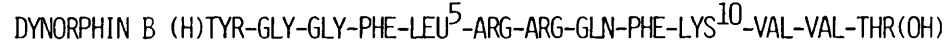
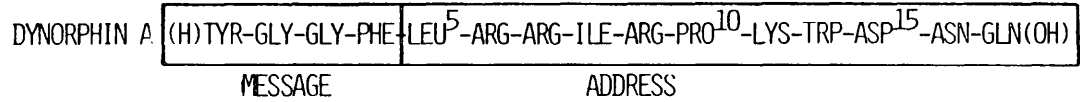


FIGURE 1

STRUCTURES OF DYNORPHIN PEPTIDES

There are three ways to approach receptor selectivity. First, the most simple way is to measure selectivity in a binding assay. Here, selectivity is expressed simply by the ratios of affinities for a given ligand at the different receptor types. Though measurement of binding affinity may present technical problems, as discussed below, the definition of binding selectivity is straightforward. Affinity does not depend on number of receptors and is not likely to change from tissue to tissue, as long as conditions for the binding assay (buffer, temperature, etc.) are kept the same. One can therefore make general statements about binding selectivity of a given ligand.

Second, one can determine which type of receptor is activated by a given agonist in a bioassay after exogenous administration of the agonist. This is pharmacologic selectivity. The bioassays most commonly used in opioid research are the guinea pig ileum longitudinal muscle preparation (GPI) and mouse vas deferens (MVD). In both bioassays, opiates and opioid peptides act through opioid receptors to inhibit the electrically stimulated contractions of the muscle. For pharmacologic selectivity, we are dealing with ratios of potency at different receptor types. Potency is dependent not only on affinity for a given receptor, but also on the intrinsic activity (Ariens et al. 1960) or efficacy (Nickerson 1956) of the agonist and on the number of receptors in the tissue. Hence, a compound can be selective for one receptor type in one tissue and a different type in another tissue. For example, [Leu]enkephalin works through  $\delta$  receptors in MVD and  $\mu$  receptors in GPI (Lord et al. 1977). It is not possible, therefore, to make general statements about pharmacologic selectivity. For further discussion of binding selectivity and pharmacologic selectivity, see James and Goldstein (1984) and Goldstein and James (1984a, 1984b).

Third, there is the question of physiologic selectivity, i.e., which receptor mediates the physiologic effects of endogenously released agonist. Physiologic selectivity will depend on efficacy as well as affinity, but most importantly it will depend on which receptors are available at the synapses where the endogenous agonists are released. Theoretically at least, a ligand may be selective for, say,  $\kappa$  receptors in binding assays and in pharmacologic assays, but physiologically may never encounter a  $\kappa$  receptor and may always be paired with other receptor types. There is as yet very little information on physiologic selectivity of dynorphins, so this discussion will be limited to binding and pharmacologic selectivity.

### **Binding Selectivity**

The technical problems associated with binding assays are of two kinds. First, peptides are often degraded by enzymes present in the receptor preparations. Second, until recently, the so-called prototypical radioligands for the different types of opioid receptor showed rather poor selectivity in binding assays. This is

especially true for [<sup>3</sup>H] (D-Ala<sup>2</sup>, D-Leu<sup>5</sup>)enkephalin (DADLE), which is commonly used to label δ binding sites but interacts almost equally well with μ sites, and for [<sup>3</sup>H]ethylketocyclazocine (EKC) or [<sup>3</sup>H]bremazocine, which are used to label κ sites but cross-react considerably with μ sites (James and Goldstein 1984). We now have highly selective ligands for μ, δ, and κ binding sites, but only the poorly selective radioligands were available for most opioid binding studies until 1984. In the most useful of these studies, degradation of peptides is controlled and attempts are made to improve the selectivity of the radioligands by blocking their binding at secondary sites with unlabeled ligands. This can be done by adding high concentrations of competing ligands that are selective for cross-reacting sites along with the radioligands or by selective alkylation of the cross-reacting sites before addition of radioligand. Both strategies have been used in the study of dyn binding.

Corbett et al. (1982) used competitive blocking ligands along with [<sup>3</sup>H]bremazocine to label κ sites in guinea pig brain. They also measured binding to μ sites with the selective μ ligand [<sup>3</sup>H](D-Ala<sup>2</sup>, MePhe<sup>4</sup>, Gly<sup>5</sup>-ol)enkephalin, but used the nonselective ligand [<sup>3</sup>H]DADLE to label δ sites. In competition binding assays with these radioligands, they estimated a dissociation constant of 0.1 nM for dyn A at κ sites. This was about six fold lower than the dissociation constant of dyn A at μ sites and about twenty fold lower than its dissociation constant at δ sites. Dyn A-(1-8) and α-neo were also slightly selective for κ sites. Quirion and Weiss (1983) used a similar blocking technique and found that in rat and guinea pig brain, dyn A, dyn B, and α-neo had the same affinity for κ sites (5 to 10 nM), but did not differentiate very well between κ, μ, or δ sites. Strangely, their measurements of κ binding were made in a different buffer from measurements of μ and δ binding. For a valid comparison of affinities, measurements should be made under the same conditions.

In neither of these studies was there adequate control for peptide degradation. This is particularly important with dynorphins because some potential degradation products (e.g., [Leu]enkephalin or [Leu]enkephalin-Arg) would still be active opioids but would have different receptor selectivities from the longer dynorphins (see the next section of this chapter). Corbett et al. (1982) ran their experiments at 0°C, and Quirion and Weiss (1983) added bacitracin to their assays, but there were no demonstrations that these precautions inhibited degradation of dynorphins. In our laboratory, we find that dyn A is degraded even at 0° C or in the presence of bacitracin (unpublished results).

Pfeiffer et al. (1981) showed by high performance liquid chromatography and bioassay that dyn A was intact during their binding assays with human brain. They estimated a dissociation constant of 0.08 nM for dyn A at sites with properties very similar

to those expected for  $\kappa$  receptors, but did not measure affinities at other receptor types.

The use of selective alkylation in binding assays was suggested by some early experiments of Robson and Kosterlitz (1979) and Smith and Simon (1980). They showed that enkephalins protected their own binding sites in rat brain from alkylation by phenoxybenzamine or N-ethyl-maleimide more efficiently than they protected binding sites for dihydromorphine (DHM) or naltrexone. We extended these findings using the alkylating agent  $\beta$ -chlornaltrexamine (B-CNA), an analog of the antagonist naltrexone, synthesized by Portoghese et al. (1979). Treatment of membranes from guinea pig brain with  $\beta$ -CNA resulted in loss of binding sites for [ $^3$ H]EKC, [ $^3$ H]DHM and [ $^3$ H]DADLE. The presence of high concentrations of dyn A during the reaction with  $\beta$ -CNA protected [ $^3$ H]EKC sites partially without protecting sites for [ $^3$ H]DHM or [ $^3$ H]DADLE at all (James et al. 1982). This result suggested that dyn A was highly selective for  $\kappa$ : over  $\mu$  and  $\delta$  receptors. Furthermore, we could prepare membrane fractions enriched in  $\kappa$  receptors by treatment with B-CNA in the presence of dyn A, followed by extensive washing to remove the protecting ligand. Similarly, we were able to enrich preparations in  $\mu$  sites by treatment with  $\beta$ -CNA in the presence of sufentanil (a  $\mu$ -selective agonist) and in  $\delta$  sites by treatment in the presence of DADLE. We used these selectively enriched membrane preparations to study the binding selectivity of a number of opiates (James and Goldstein 1984), including the peptide dyn A-(1-13) amide, chosen because of its stability in binding assays (Leslie and Goldstein 1982). We estimated a dissociation constant of 0.02 nM for this peptide at  $\kappa$  sites and found that it had about 30 times higher affinity at  $\kappa$  than at  $\mu$  binding sites and about 80 times higher affinity at  $\kappa$  than at  $\delta$  sites (table 2).

**TABLE 2**

Affinity of Dynorphin and U50,488 at Opioid Receptors in Guinea Pig Brain

	$\mu$	$K_d$ (nM) at	
		<b>d</b>	<b>k</b>
Dynorphin A-(1-13) amide	0.6	1.6	0.02
U 5 0 , 4 8 8	940	2400	0.72

Direct assays of dyn binding have been complicated by high non-specific binding to many different surfaces (Ho et al. 1980). Recently, however, Young et al. (1983) developed a method for measuring binding of [<sup>3</sup>H]dyn A to sites in guinea pig brain. They found that both dyn and the kappa ligand UM 1071 were about 200 times more potent than morphine or DADLE in competition with [<sup>3</sup>H]dyn A, a result consistent with binding of [<sup>3</sup>H]dyn A at  $\kappa$  sites. Specific binding sites for [<sup>3</sup>H]dyn A, measured by autoradiography, were localized in the deep layers of guinea pig cerebral cortex (Lewis et al. 1984), a distribution consistent with that of  $\kappa$  receptors (Goodman and Snyder 1982).

Binding of [<sup>3</sup>H]dyn A-(1-8) to sites in rat and guinea pig brain was measured by Quirion and Pilapil (1984). In general, ligands with some selectivity for  $\kappa$  receptors (including EKC,bremazocine, and dyn A) were more potent in competition with [<sup>3</sup>H]dyn A-(1-8) than ligands selective for  $\mu$  or  $\delta$  receptors. Similarly, [<sup>3</sup>H]  $\alpha$ -neo appears to bind to  $\kappa$  receptors in rat brain membranes, though it also labels other types of binding sites (Houghton et al. 1983).

### Pharmacologic Selectivity

In pharmacologic assays, the maximum effect of an agonist is often reached by interaction at its preferred receptor. It may not be possible to disrupt this interaction and allow measurements of potency at other receptor types. Hence, there have been no reliable quantitative measurements of pharmacologic selectivity (i.e., ratio of potencies at different receptors in the same tissue) for opioid drugs. Instead, most people make qualitative assessments of selectivity, limiting their pharmacologic studies to the question of which receptor type is activated by a given agonist in a given bioassay. There have been two general approaches to this question: measurement of sensitivity to antagonism by selective antagonists, and selective inactivation of receptor types. For studies with dyn, the antagonists naloxone and MR 2266 (figure 2) have been most useful.

The most convenient measure of sensitivity to antagonism is the antagonist  $K_e$ , an estimate of the dissociation constant for the antagonist at the receptor through which the test agonist is having its effect. Values of  $K_e$  are estimated from the shift in agonist potency when antagonist is present in the medium bathing the tissue (Kosterlitz and Watt 1968). Naloxone is somewhat selective for  $\mu$  receptors, with  $K_e$  values around 2 to 3 nM. The naloxone  $K_e$  for  $\kappa$  and  $\delta$  receptors is 20 to 30 nM (Hutchinson et al. 1975; Lord et al. 1977). MR 2266 is reported to be a selective  $\kappa$  antagonist (Oka et al. 1982a).

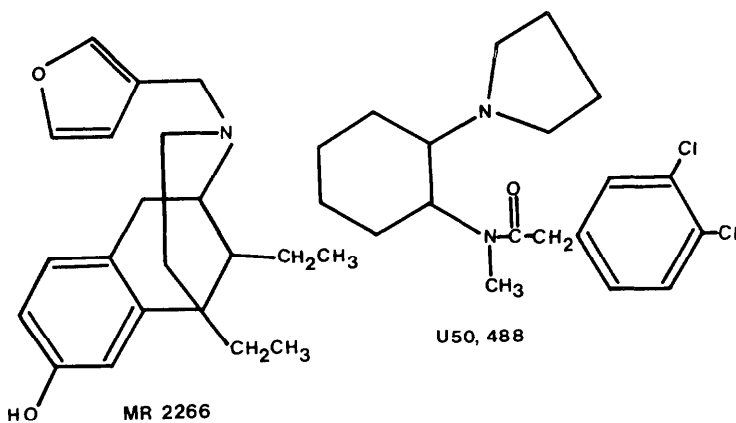


FIGURE 2

Structure of MR 2266 and U50,488

In GPI, the naloxone  $K_e$  when dyn A-(1-13) is used as test agonist is significantly higher than that for typical  $\mu$  agonists (Goldstein et al. 1979; Vaught 1981; Chavkin et al. 1982; Huidobro-Toro et al. 1982) and is the same as that for the  $\kappa$  agonist EKC (Goldstein et al. 1979; Chavkin et al. 1982; Oka et al. 1982a; Huidobro-Toro et al. 1982). Activity of both dyn A and dyn A-(1-13) is reversed more easily by MR 2266 than by naloxone (Oka et al. 1982a; Yoshimura et al. 1982a). Dyn B and  $\alpha$ -neo have the same high naloxone  $K_e$  as dyn A in GPI (Oka et al. 1982b; Suda et al. 1983; James et al. 1984). There is some disagreement about naloxone  $K_e$  values for dyn B-29 and  $\beta$ -neo. Oka et al. (1982b) found that  $\beta$ -neo had the same  $K_e$  as dyn A. Suda et al. (1983) obtained the same result and also found the same  $K_e$  for dyn B-29 and dyn A. In experiments where all the comparisons of potency and  $K_e$  were made relative to dyn A on the same GPI preparation, we found that naloxone  $K_e$  values for dyn A-(1-8), dyn B-29, and  $\beta$ -neo were significantly lower than those for dyn A, but still significantly higher than for normorphine, a  $\mu$  agonist in GPI. These intermediate  $K_e$  values had been seen before by Chavkin and Goldstein (1981a) in their study of structure-function relationships with dyn. Our interpretation is that an agonist with naloxone  $K_e$  intermediate between values typical of  $\kappa$  and  $\mu$  receptors is acting simultaneously at both types of receptor. This is supported by the observation that selective inactivation of  $\mu$  receptors in GPI changes the naloxone  $K_e$  for dyn A-(1-8) from the intermediate value to one much closer to that found for dyn A (James et al. 1984). McKnight et al. (1983) showed that peptides are degraded during bioassays and that degradation can affect estimates of potency. Since addition of peptidase inhibitors to the assay stabilized the peptides but did not change the intermediate  $K_e$  values, these values are not a result of degradation to fragments with different selectivity from the intact peptide.



The evidence from measurements of antagonist  $K_e$  values suggests that, at least in GPI, dyn A, dyn B, and  $\alpha$ -neo are selective for  $\kappa$  receptors. Dyn A-(1-8), dyn B-29, and  $\beta$ -neo act at both  $\kappa$  and  $\mu$  receptors. The structural basis for this loss in selectivity is discussed in the next section.

**TABLE 3**  
Potency and Naloxone  $K_e$  of Dynorphin Peptides in GPI

Peptide	ED <sub>50</sub> (nM)	Naloxone $K_e$ (nM)
Dynorphin A	0.19	31
Dynorphin B	3.3	33
$\alpha$ -neoendorphin	3.5	22
Dynorphin A-(1-8)	58	15
Dynorphin B-29	2.4	15
$\beta$ -neoendorphin	43	14
Normorphine	63	3.8

Selective inactivation of receptors can be achieved either by covalent blocking of a site, as described for binding assays, or by selective induction of tolerance. In both cases, a decrease in potency for the test agonist after selective inactivation of a given type of receptor suggests that the agonist normally works through that receptor type. In experiments similar to those described already for binding assays, Chavkin and Goldstein (1981b) showed that treatment of GPI with  $\beta$ -CNA caused a decrease in potency for dyn A-(1-13), [Leu]enkephalin, and normorphine. Treatment in the presence of dyn A-(1-13) reduced the potency shift for dyn but not for the other two agonists. Dyn also eliminated the reduction in EKC potency normally caused by  $\beta$ -CNA (Chavkin et al. 1982). Conversely, DADLE present during reaction of the tissue with  $\beta$ -CNA reduced the potency shifts for [Leu]enkephalin and normorphine, but not for dyn and only partially for EKC (Chavkin and Goldstein 1981b; Chavkin et al. 1982). Other groups found that inactivation of  $\mu$  receptors either by induction of tolerance (Vaught 1981) or by alkylation with  $\beta$ -funaltrexamine (Huidobro-Toro et al. 1982) did not alter dyn potency. The interpretation of these results was that dyn interacts with  $\kappa$  receptors (hence, the cross-protection of EKC potency) but not  $\mu$  receptors in GPI. Reaction of GPI with  $\beta$ -CNA in the presence of dyn A also leads to protection of dyn B and  $\alpha$ -neo receptors. Similarly, either dyn B or  $\alpha$ -neo will protect receptors for all three peptides (James et al. 1984). Hence, in GPI, dyn A, dyn B, and  $\alpha$ -neo all act through the same population of receptors.

In GPI from animals made tolerant to morphine, fentanyl, or DADLE (all of which would induce tolerance to  $\mu$  receptors in this tissue), the potency of dyn A-(1-13) did not differ from controls. Induction of tolerance to the  $\kappa$  agonists MR 2034, MRZ 2549 or EKC also produced tolerance to dyn A-(1-13). Similar results were obtained in MVD, where tolerance to sufentanil, DADLE, or DADLE and sufentanil together did not produce cross-tolerance to dyn A-(1-13), but tolerance to the  $\kappa$  agonists did (Wuster et al. 1981).

MVD from animals tolerant to dyn A or dyn A-(1-13) show cross-tolerance to EKC and  $\alpha$ -neo. Similarly, tissue tolerant to  $\alpha$ -neo was also tolerant to dyn A and EKC. There was no cross-tolerance between DADLE and dyn A or  $\alpha$ -neo (Schultz et al. 1982). Results from cross-tolerance studies support the measurements of antagonist  $K_e$  and the selective alkylation or protection studies in suggesting that dynorphins act at  $\kappa$  receptors in GPI or MVD.

A third bioassay used in studying  $\kappa$  receptors is the rabbit vas deferens (RVD). This tissue behaves as though only  $\kappa$  and not  $\mu$  or  $\delta$  receptors were active in inhibiting contraction of the muscle (Oka et al. 1981). In RVD, dyn A, dyn A(1-8), dyn B, and  $\alpha$ -neo are all potent agonists, whereas [Leu]enkephalin, [Met]enkephalin,  $\beta$ -endorphin, and DADLE are inactive even at concentrations in the micromolar range (Oka et al. 1982a, McKnight et al. 1983; Corbett et al. 1982; Quirion and Weiss 1983).

In more complex behavioural measurements, there is evidence that dyn distinguishes between receptor types. There was no cross-tolerance between sufentanil and dyn A-(1-13) in induction of catalepsy in rats (Herman and Goldstein 1981). Nor was there cross-tolerance between morphine and dyn B in measurements of analgesia after intrathecal administration of the drugs in rats, but there was cross-tolerance between EKC and dyn B in the same experiments (Han et al. 1984).

Dynorphins, then, are selective for  $\kappa$  opioid receptors in binding assays; in three opioid bioassays--GPI, MVD, and RVD; and possibly also in production of analgesia in spinal cord. It remains to be seen whether endogenously released dynorphins also act at  $\kappa$  receptors.

## **STRUCTURE-ACTIVITY RELATIONSHIPS OF DYNORPHIN PEPTIDES**

Dyn A is an extension of the opioid peptide [Leu]enkephalin, yet it is 700 times more potent than [Leu]enkephalin in the GPI assay and about 3 times more potent in MVD (Goldstein et al. 1979). Dynorphins are selective for  $\kappa$  receptors while [Leu]enkephalin is somewhat selective for  $\delta$  receptors (Lord et al. 1977). What are the structural features of dyn that cause the increased potency and the change in receptor selectivity?

Removal of the C-terminal four residues has no effect on potency or selectivity, since dyn A and dyn A-(1-13) have the same potencies and naloxone  $K_e$  values in GPI (Goldstein et al. 1981). In a series of experiments using peptides obtained by removing one amino acid residue at a time from the carboxyl terminus of dyn A-(1-13), Chavkin and Goldstein (1981a) identified three critically important basic residues, removal of which resulted in loss of potency in GPI; these were lysine-13, lysine-11, and arginine-7. Furthermore, removal of lysine-11 caused a drop in naloxone  $K_e$  from relatively high ( $\kappa$ -like) values to values intermediate between those typical for  $\kappa$  and  $\mu$  receptors. Removal of arginine-7 caused a further drop in naloxone  $K_e$  to relatively low ( $\mu$ -like) values. Hence, lysine-11 and arginine-7 are important not only for the high potency of dyn A, but also for its  $\kappa$  selectivity. The position of these basic residues in relation to the enkephalin part of dyn is also important. Movement of the C-terminal portion of the molecule one residue to the left, as in (Des-Arg<sup>6</sup>)dyn A-(1-13), or one residue to the right, as in (endo-Gly<sup>5a</sup>)dyn A-(1-13), causes about tenfold reduction in potency in GPI (Goldstein et al. 1979). Substitution of arginine-7 or lysine-11 with alanine also causes a tenfold to twentyfold drop in potency (Turcotte et al. 1984).

Other groups (Yoshimura et al. 1982b; Corbett et al. 1982; Sanchez-Blazquez et al. 1984) obtained similar results in their potency measurements on GPI. Yoshimura et al. (1982b) did not detect intermediate  $K_e$  values; their estimates of naloxone  $K_e$  for dyn A-(1-9) and dyn A-(1-7) were the same as for dyn A. They did, however, find some degree of cross-tolerance between morphine and dyn A-(1-7), indicating some interaction of this shorter dyn peptide at  $\mu$  receptors.

The receptor selectivity profiles for other members of the dyn/neo family are consistent with the structure-activity relationships for dyn A fragments. In general, those endogenous peptides with basic residues in position 7 and 10 or 11 (dyn A, dyn B, and  $\alpha$ -neo) are  $\kappa$  selective in GPI, whereas those without the basic residue in position 10 or 11 (dyn A-(1-8) and  $\beta$ -neo) act through both  $\kappa$  and  $\mu$  receptors. Movement of the critical basic residue from position 11 (as in dyn A) to position 10 (as in dyn B and  $\alpha$ -neo) causes a tenfold reduction in potency. Removal of this residue altogether (as in dyn A-(1-8) and  $\beta$ -neo) causes a hundredfold reduction in potency (James et al. 1984).

In the MVD assay, the structure-activity results for shorter dyn fragments are different from those obtained with GPI. For example, there is very little difference in the potencies of dyn A-(1-13) and [Leu]enkephalin (Corbett et al. 1982; Cox and Chavkin 1983; Schultz et al. 1984; Sanchez-Blazquez et al. 1984). When vasa were made tolerant to DADLE, effectively inactivating  $\delta$  receptors, a structure-activity pattern similar to that found in GPI emerged (Cox and Chavkin 1983; Schultz et al. 1984). In untreated MVD, as

dyn is shortened the potency at  $\kappa$  receptors is decreased, but the shorter peptides can act at  $\delta$  receptors, resulting in relatively small net effects. Inactivation of  $\delta$  receptors reveals the typical  $\kappa$  structure-activity pattern. In GPI,  $\delta$  receptors can only be detected by special treatment of the tissue (Gintzler and Hyde 1984). In untreated tissue, the  $\delta$  mediated effects are negligible; hence, the structural requirements for activity at  $\kappa$  receptors are easily seen.

Measurements of naloxone  $K_e$  in MVD also show a slightly different pattern from GPI, with relatively high  $K_e$  (around 30nM) for dyn A, dropping to intermediate (about 13 nM) for dyn A-(1-8), but rising again to 30 nM for [Leu]enkephalin (Schultz et al. 1984). The high  $K_e$  for [Leu]enkephalin reflects interaction at  $\delta$  receptors, which, like  $\kappa$  receptors, have a relatively low affinity for naloxone (Lord et al. 1977). Inactivation of  $\delta$  receptors by induction of tolerance resulted in a pattern of  $K_e$  measurements similar to that found in GPI, with  $K_e$  for [Leu]enkephalin being lower than that for dyn A-(1-8). In MVD, unlike GPI, the intermediate  $K_e$  for dyn A-(1-8) apparently is not caused by cross-reaction at  $\mu$  receptors. Inactivation of  $\mu$  receptors either by selective tolerance or selective alkylation did not change the  $K_e$ . It is possible that in MVD, dyn A-(1-8) acts through a different type of receptor than the classical  $\mu$ ,  $\delta$  or  $\kappa$  types (Schultz et al. 1984).

Changes in the enkephalin part of the molecule also change the activity of dyn. Substitution of tyrosine-1, glycine-2, or phenylalanine-4 with alanine in dyn A-(1-13) causes large decreases in potency in both GPI and MVD (Turcotte et al. 1984). Substitution of glycine-2 with D-alanine causes a decrease in potency in GPI for those dyn fragments that show some selectivity for  $\kappa$  receptors (i.e., are longer than seven residues), but causes an increase for dyn A-(1-6) and [Leu]enkephalin, both of which act through  $\mu$  receptors in GPI (Chavkin and Goldstein 1981a). In MVD, the D-alanine-2 substitution increases potency of dyn A fragments up to 10 residues long (Cox and Chavkin 1983), presumably because of interaction with  $\delta$  receptors.

Nitration of the phenylalanine residue in position 4 of dyn A-(1-13) caused about fourfold decrease in potency in GPI but did not affect potency in MVD. The same modification of [Leu]enkephalin increased the potency 25-fold in GPI and 40-fold in MVD (Schiller et al. 1982). The cyclic analog c(D-Cys<sup>2</sup>,L-Cys<sup>5</sup>)dyn A-(1-13) was about five times more potent than the parent compound in GPI, whereas the same cyclization increased the potency 160-fold for [Leu]enkephalin. These differential effects on potency of dyn and enkephalin suggested to Schiller and his colleagues that the structural requirements for the enkephalin binding domain of the dyn ( $\kappa$ ) receptor are different from the enkephalin receptor (the  $\mu$  receptor in GPI). Schiller (1983) extended these observations and showed by resonance energy transfer fluorescence experiments

using the tryptophan-4 analogs of dyn A-(1-13) and [Leu]enkephalin that the distance between tyrosine-1 and tryptophan-4 was different in these two peptides. He concluded that in aqueous solution the predominant conformation of the N-terminal tetrapeptide in the dyn analog was almost completely extended, whereas there was considerable folding in the same segment of the enkephalin analog. He also suggested that there was no interaction between the N-terminal and C-terminal portions of dyn A, since he could not measure any energy transfer between tyrosine-1 and tryptophan-14 in this peptide. These results are consistent with an earlier study where Maroun and Mattice (1981) found that circular dichroism spectra of dyn A-(1-13) had the characteristics of random coil in aqueous solution.

Adopting Schwyzer's terminology (Schwyzer et al. 1980), dyn A can be divided into two regions (figure 1): a message comprising the N-terminal four residues, which says "occupy an opioid receptor"; and an address comprising residues 5-13, which says "of the  $\kappa$  type". As yet, we know of no specific function for residues 14-17, though they may be involved in control of the processing of prodynorphin (Devi and Goldstein 1984). The way in which the address sequence specifies  $\kappa$  receptors is still an open and fascinating question. Perhaps  $\kappa$  binding sites have negative charges complementary to the positive charges in positions 7, 11, and 13 of dyn A, as suggested by Chavkin and Goldstein (1981a). Alternatively, these residues may act by stabilizing a conformation of the enkephalin portion that is recognized well by  $\kappa$  receptors but not by  $\mu$  or  $\delta$ , as implied by Schiller (1983). Extended structures are not absolutely necessary for high affinity and selectivity for  $\kappa$  receptors. The compound U50,488 (figure 2) synthesized at the Upjohn Company, has high affinity and is highly selective for  $\kappa$  receptors (table 2). The conformation of dyn in its receptor site may well turn out to be very close to the shape of the U50,488 molecule.

## REFERENCES

- Ariens, E.J.; Van Rossum, J.M.; and Koopman, P.C. Receptor reserve and threshold phenomena. 1. Theory and experiments with autonomic drugs tested on isolated organs. Arch Int Pharmacodyn 127:459-478, 1960.
- Chavkin, C., and Goldstein, A. Specific receptor for the opioid peptide dynorphin: Structure-activity relationships. Proc Natl Acad Sci USA 78:6543-6547, 1981a.
- Chavkin, C., and Goldstein, A. Demonstration of a specific dynorphin receptor in guinea pig ileum myenteric plexus. Nature 291:591-593, 1981b.
- Chavkin, C.; James, I.F.; and Goldstein, A. Dynorphin is a specific endogenous ligand of the kappa opioid receptor. Science 215:413-415, 1982.

- Corbett, A.D.; Paterson, S.J.; McKnight, A.T.; Magnan, J.; and Kosterlitz, H.W. Dynorphin and dynorphin are ligands for the kappa-subtype of opiate receptor. Nature 299:78-81, 1982.
- Cox, B.M. Endogenous opioid peptides: A guide to structures and terminology. Life Sci 31:1645-1658, 1982.
- Cox, B.M., and Chavkin, C. Comparison of dynorphin-selective kappa receptors in mouse vas deferens and guinea pig ileum. Mol Pharmacol 23:36-43, 1983.
- Devi, L., and Goldstein, A. Dynorphin converting enzyme with unusual specificity from rat brain. Proc Natl Acad Sci USA 81:1892-1896, 1984.
- Fischli, W.; Goldstein, A.; Hunkapiller, M.W.; and Hood, L.E. Isolation and amino acid sequence analysis of a 4,000-dalton dynorphin from porcine pituitary. Proc Natl Acad Sci USA 79:5435-5437, 1982.
- Gintzler, A.R., and Hyde, D. Multiple opiate receptors in the guinea pig enteric nervous system: Unmasking the copresence of receptor subtypes. Proc Natl Acad Sci USA 81:2252-2254, 1984.
- Goldstein, A. Opioid peptides: Function and significance. In: Hughes, J.; Collier, H.O.J.; Rance, M.J.; and Tyers, M.B., eds. Opioids: Past, Present and Future. London: Taylor & Francis Ltd., 1984a. pp. 127-143.
- Goldstein, A. Biology and chemistry of the dynorphon peptides. In: Meienhofer, J., and Udenfriend, S., eds. The Peptides: Analysis, Synthesis, Biology. Vol. 6. New York: Academic Press, 1984b. pp. 127-143.
- Goldstein, A., and James, I.F. Site-directed alkylation of multiple opioid receptors. II. Pharmacological selectivity. Mol Pharmacol 25:343-348, 1984a.
- Goldstein, A., and James, I.F. Multiple opioid receptors: Criteria for identification and classification. Trends in Pharmacol Sci 5:403-505 1984b.
- Goldstein, A.; Tachibana, S.; Lowney, L.I.; Hunkapiller, M.; and Hood, L. Dynorphin-(1-13), an extraordinarily potent opioid peptide. Proc Natl Acad Sci USA 76:6666-6670, 1979.
- Goldstein, A.; Fischli, W.; Lowney, L.I.; Hunkapiller, M.; and Hood, L. Porcine pituitary dynorphin: Complete amino acid sequence of the biologically active heptadecapeptide. Proc Natl Acad Sci USA 78:7219-7223, 1981.
- Goodman, R.R., and Snyder, S.H. Autoradiographic localization of kappa opiate receptors to deep layers of the cerebral cortex may explain unique sedation and analgesic effects. Life Sci 31:1291-1294, 1982.
- Gubler, U.; Seeburg, P.; Hoffman, B.J.; Gage, L.P.; and Udenfriend, S. Molecular cloning establishes proenkephalin as precursor of enkephalin-containing peptides. Nature 295:206-208, 1982.
- Han, J.S.; Xie, G.X.; and Goldstein, A. Analgesia induced by intrathecal injection of dynorphin B in the rat. Life Sci 34:1573-1579, 1984.
- Herman, B.H., and Goldstein, A. Cataleptic effects of dynorphin (1-13) in rats made tolerant to a mu opiate receptor agonist. Neuropeptides 2:13-22, 1981.
- Ho, W.K.K.; Cox, B.M.; Chavkin, C.; and Goldstein, A. Opioid peptide dynorphin-(1-13): Adsorptive losses and potency estimates. Neuropeptides 1:143-152, 1980.
- Holtt, V. Multiple endogenous opioid peptides. Trends Neurosci 6:24-26, 1983.
- Houghton, R.A.; Bartlett, S.M.; and Ostresh, J.M. Alpha-neo-endorphin: Receptor binding properties of the tritiated ligand. Life Sci 33:1811-1820, 1983.
- Huidobro-Toro, J.P.; Yoshimura, K.; and Way, E.L. Application of an irreversible opiate antagonist (Beta-FNA, Beta-funaltrexamine) to demonstrate dynorphin selectivity for kappa-opioid sites. Life Sci 31:2409-2416, 1982.

- Hutchinson, M.; Kosterlitz, H.W.; Leslie, F.M.; Waterfield, A.A.; and Terenius, L. Assessment in the guinea pig ileum and mouse vas deferens of benzomorphans which have strong antinociceptive activity but do not substitute for morphine in the dependent monkey. Br J Pharmacol 55:541-546, 1975.
- James, I.F., and Goldstein, A. Site-directed alkylation of multiple opioid receptors. I. Binding selectivity. Mol Pharmacol 25:337-342, 1984.
- James, I.F.; Chavkin, C.; and Goldstein, A. Preparation of brain membranes containing a single type of opioid receptor highly selective for dynorphin. Proc Natl Acad Sci USA 79:7570-7574, 1982.
- James, I.F.; Fischli, W.; and Goldstein, A. Opioid receptor selectivity of dynorphin gene products. J Pharmacol Exp Ther 228:88-93, 1984.
- Kakidani, H.; Furutani, Y.; Takahashi, H.; Noda, M.; Morimoto, Y.; Hirose, T.; Asai, M.; Inayama, S.; Nakanishi, S.; and Numa, S. Cloning and sequence analysis of cDNA for porcine beta-neo-endorphin/dynorphin precursor. Nature 298:245-249, 1982.
- Kangawa, K.; Minamino N.; Chino, N.; Sakakibara, S.; and Matsuo, H. The complete amino acid sequence of alpha-neo-endorphin. Biochem Biophys Res Commun 99:871-878, 1981.
- Kilpatrick, D.L.; Wahlstrom, A.; Lahm, H.W.; Blacjer, R.; and Udenfriend, S. Rimorphin, a unique, naturally occurring (Leu)enkephalin-containing peptide found in association with dynorphin and alpha-neo-endorphin. Proc Natl Acad Sci USA 79:6480-6483, 1982.
- Kosterlitz, H.W., and Watt, A.J. Kinetic parameters of narcotic agonists and antagonists, with particular reference to N-allylnoroxymorphone (naloxone). Br J Pharmacol Chemother 33:266-276, 1968.
- Lee, N.M., and Smith, A.P. Possible regulatory function of dynorphin and its clinical implications. Trends Pharmacol Sci 5:108-110, 1984.
- Leslie, F.M., and Goldstein, A. Degradation of dynorphin-(1-13) by membrane bound rat brain enzymes. Neuropeptides 2:185-196, 1982.
- Lewis, M.E.; Young, E.A.; Houghten, R.A.; Akil, H.; and Watson, S.J. Binding of [<sup>3</sup>H] dynorphin A to apparent kappa opioid receptors in deep layers of guinea pig cerebral cortex. Eur J Pharmacol 98:149-150, 1984.
- Lord, J.A.H.; Waterfield, A.A.; Hughes, J.; and Kosterlitz, H.W. Endogenous opioid peptides: Multiple agonists and receptors. Nature 267:495-499, 1977.
- Magnan, J.; Paterson, S.J.; and Kosterlitz, H.W. The interaction of (Met<sup>5</sup>)enkephalin and (Leu<sup>5</sup>)enkephalin sequences, extended at the C-terminus, with the mu-, delta- and kappa-binding sites in the guinea pig brain. Life Sci 31:1359-1361, 1982.
- Maroun, R., and Mattice, W.L. Solution conformations of the pituitary opioid peptide dynorphin-(1-13). Biochem Biophys Res Commun 103:442-446, 1981.
- McKnight, A.T.; Corbett, A.D.; and Kosterlitz, H.W. Increase in potencies of opioid peptides after peptidase inhibition. Eur J Pharmacol 86:393-402, 1983.
- Miller: R.J. Multiple opiate receptors for multiple opioid peptides. Med Biol 60:1-6, 1982.
- Minamino, N.; Kangawa, K.; Fukuda, A.; Matsuo, H.; and Igarashi, M. A new opioid octapeptide related to dynorphin from porcine hypothalamus. Biochem Biophys Res Commun 95:1475-1481, 1980.
- Minamino, N.; Kangawa, K.; Chino, N.; Sakakibara, S.; and Matsuo, H. Beta-neo-endorphin, a new hypothalamic "big" leu-enkephalin of porcine origin: Its purification and the complete amino acid sequence. Biochem Biophys Res Commun 99:864-870, 1981.
- Nakanishi, S.; Inoue, A.; Kita, T.; Nakamura, M.; Chang, A.C.Y.; Cohen, S.N.; and Numa, S. Nucleotide sequence of cloned cDNA for bovine corticotropin-beta-lipotropin precursor. Nature 278:423-427, 1979.

- Nakao, K.; Suda, M.; Sakamoto, M.; Yoshimasa, T.; Morii, N.; Ikeda, Y.; Yanaihara, C.; Yanaihara, N.; Numa, S.; and Imura, H. Leumorphin is a novel endogenous opioid peptide derived from preproenkephalin B. Biochem Biophys Res Commun 117:695-701, 1983.
- Nickerson, M. Receptor occupancy and tissue response. Nature 178:697-698, 1956.
- Noda, M.; Furutani, Y.; Takahashi, H.; Toyosato, M.; Hirose, T.; Inayama, S.; Nakanishi, S.; and Numa, S. Cloning and sequence analysis of cDNA for bovine adrenal preproenkephalin. Nature 295:202-206, 1982.
- Oka, T.; Negishi, K.; Suda, M.; Matsumiya, T.; Iinazu, T.; and Ueki, M. Rabbit vas deferens: A specific bioassay for opioid kappa-receptor agonists. Eur J Pharmacol 73:235-236, 1981.
- Oka, T.; Negishi, K.; Suda, M.; Sawa, A.; Fujino, M.; and Wakimasu, M. Evidence that dynorphin-(1-13) acts as an agonist on opioid kappa-receptors. Eur J Pharmacol 77:137-141, 1982a.
- Oka, T.; Negishi, K.; Kajiwara, M.; Watanabe, Y.; Ishizuka, Y.; and Matsumiya, T. The choice of opiate receptor subtype by neo-endorphins. Eur J Pharmacol 79:301-305, 1982b.
- Paterson, S.J.; Robson, L.E.; and Kosterlitz, H.W. Classification of opioid receptors. Br Med Bull 39:31-36, 1983.
- Pfeiffer, A.; Pasi, A.; Mehraein, P.; and Hertz, A. A subclassification of kappa-sites in human brain by use of dynorphin 1-17. Neuropeptides 2:89-97, 1981.
- Portoghese, P.S.; Larson, D.L.; Jiang, J.B.; Caruso, T.P.; and Takemori, A.E. Synthesis and pharmacologic characterization of an alkylating analogue (chlornaltrexamine) of naltrexone with ultralong-lasting narcotic antagonist properties. J Med Chem 22:168-173, 1979.
- Quirion, R., and Pilapil, C. Opioid receptor binding profile of [<sup>3</sup>H]dynorphin A-(1-8) in rat and guinea pig brain. Eur J Pharmacol 99:361-363, 1984.
- Quirion, R., and Weiss, A.S. Peptide E and other proenkephalin-derived peptides are potent kappa opiate receptor agonists. Peptides 4:445-449, 1983.
- Robson, L.E., and Kosterlitz, H.W. Specific protection of the binding sites of D-Ala<sup>2</sup>-D-Leu<sup>5</sup>-enkephalin (delta-receptors) and dihydromorphine (mu-receptors). Proc R Soc Lond (Biol) 205:425-432, 1979.
- Sanchez-Blazquez, P.; Garzon, J.; and Lee, N.M. (Leu<sup>5</sup>) enkephalin containing peptides derived from a common precursor: Evaluation of opioid activity in *in vitro* bioassays. Eur J Pharmacol 98:389-396, 1984.
- Schiller, P.W. Fluorescence study on the solution conformation of dynorphin in comparison to enkephalin. Int J Pept Protein Res 21:307-312, 1983.
- Schiller, P.W.; Eggimann, B.; and Nguyen, T.M.-D. Comparative structure-function studies with analogs of dynorphin-(1-13) and (Leu<sup>5</sup>) enkephalin. Life Sci 31:1777-1780, 1982.
- Schultz, R.; Wuster, M.; and Hertz, A. Endogenous ligands for kappa-opiate receptors. Peptides 3:973-976, 1982.
- Schultz, R.; Wuster, M.; and Hertz, A. Receptor preference of dynorphin A fragments in the mouse vas deferens determined by different techniques. J Pharmacol Exp Ther 230:200-204, 1984.
- Schwyzler, R.; Karlaganis, G.; and Lang, V. Hormone-receptor interactions: A study of the molecular mechanism of receptor stimulation in isolated fat cells by the partial agonist corticotropin-(5-24)-icosapeptide. In: Ananchenko, S.N., ed. Frontiers of Bioorganic Chemistry and Molecular Biology. New York: Pergamon Press, 1980. pp. 277-283.
- Smith, J. R., and Simon, E.J. Selective protection of stereo-specific enkephalin and opiate binding against inactivation by N-ethylmaleimide: Evidence for two classes of opiate receptors. Proc Natl Acad Sci USA 77:281-284, 1980.



- Suda, M.; Nakao, K.; Yoshimasa, T.; Ikeda, Y.; Sakamoto, M.; Yanaihara, N.; Numa, S.; and Imura, H. A novel opioid peptide, leumorphin, acts as an agonist at the kappa opiate receptor. Life Sci 32:2769-2775, 1983.
- Tachibana, S.; Araki, K.; Ohya, S.; and Yoshida, S. Isolation and structure of dynorphin, an opioid peptide, from porcine duodenum. Nature 295:339-340, 1982.
- Turcotte, A.; Lalonde, J.M.; St-Pierre, S.; and Lemaire, S. Dynorphin-(1-13). I. Structure-function relationships of Ala-containing analogs. Int J Pept Protein Res 23:361-367, 1984.
- Vaught, J.L. A characterization of dynorphin-(1-13) on the guinea pig ileal longitudinal muscle. Eur J Pharmacol 76:453-456, 1981.
- Wood, P.L. Multiple opiate receptors: Support for unique mu-sites, delta-sites, and kappa-sites. Neuropharmacology 21:487-497, 1982.
- Wuster, M.; Schulz, R.; and Herz, A. Opiate activity and receptor selectivity of dynorphin 1-13 and related peptides. Neurosci Lett 20:79-83, 1980.
- Wuster, M.; Rubini, P.; and Schulz, R. The preference of putative pro-enkephalins for different types of opiate receptors. Life Sci 29:1219-1227, 1981.
- Yoshimura, K.; Huidobro-Toro, J.P.; and Way, E.L. Potency of three opiate antagonists to reverse the inhibitory activity of dynorphin, enkephalins and opioid-like alkaloids on the guinea pig ileum. Eur J Pharmacol 84:17-24, 1982a.
- Yoshimura, K.; Huidobro-Toro, J.P.; Lee, N.M.; Loh, H.H.; and Way, E.L. Kappa opiod properties of dynorphin and its peptide fragments on the guinea pig ileum. J Pharmacol Exp Ther 222:71-79, 1982b.
- Young, E.A.; Walker, J.M.; Houghton, R.; and Akil H. (<sup>3</sup>H)Dynorphin A binds selectively to guinea pig brain. Eur J Pharmacol 91:327-328, 1983.

## AUTHOR

Iain F. James, Ph.D  
 Sandoz Institute for Medical Research  
 5 Gower Place  
 London WC1E 6BN England

# Computer Analysis of Radioligand Data: Advantages, Problems, and Pitfalls

David Rodbard, M.D.; Rudolph A. Lutz, Ph.D.; Ricardo A. Cruciani, M.D.; Vincenzo Guardabasso, M.D.; Guido O. Pesce, M.D.; and Peter J. Munson, M.A.

## ABSTRACT

Mathematical modeling combined with nonlinear least-squares curve fitting provides a systematic, objective, reproducible, and consistent method to aid the interpretation of ligand-binding data. It forces the experimentalist to formulate hypotheses in an unambiguous manner and to consider alternative, closely related models as plausible counter-hypotheses. Modeling provides estimates of the "goodness-of-fit" of the theory to the data and estimates of the minimal uncertainty of the parameters. With the availability of many programs for micro- and mini-computers, as well as mainframe computers, these methods are now becoming widely used. Accordingly, we must emphasize a number of potential problems and limitations, based on our experience. Interpretation of results of modeling study should be made, in light of the following points:

- a) no amount of computer analysis will compensate for "bad" or insufficient data, or for poor experimental design;
- b) the interpretation of the computer analysis is subject to the caveat that all underlying assumptions must be satisfied;
- c) one must examine the data graphically in several coordinate systems (e.g., "raw data," as well as standardized residuals);
- d) one must continuously search for possible systematic biases or artifacts;
- e) one must closely examine the reproducibility of results between multiple experiments; and
- f) one must recognize that all of the "test tubes" in an experiment are not necessarily "independent observations" in a statistical sense.

In view of these potential problems and limitations, one should always seek to corroborate results and interpretations of "modeling" studies of ligand binding by independent biochemical, biophysical, or structural evidence. In this context, ligand-binding studies, appropriately analyzed, can play a useful and constructive role.

## INTRODUCTION

Even today, most of the ligand-binding data in the scientific literature is being analyzed by graphical methods. Graphical methods are not to be completely condemned: they have served well in enzymology for more than 70 years (e.g., Segel 1975). However, these methods are notoriously subjective: different users can obtain different "measurements" from the same data. Graphical methods usually deal effectively with simple linear (or linearizable) cases, but not with complex nonlinear ones. With the growing availability of computer programs for nonlinear least-squares curve fitting on relatively inexpensive micro- and mini-computers (Munson and Rodbard 1980; Rodbard 1984; McIntosh 1984; Sacchi-Landriani et al. 1983; Bevington 1969), their use is becoming more widespread in the biochemical and pharmacological community.

Approaches to computerized analysis of binding data have been discussed extensively elsewhere, by ourselves and others (Munson and Rodbard 1980, 1984; Munson 1983a, 1984; Baulieu and Raynaud 1970; Feldman 1972; Fletcher and Spector 1977; Priore and Rosenthal 1976). In brief, the "computerized" approach offers several of the following advantages:

- Ease and speed of data processing;
- Freedom from mathematical errors;
- Precise formulation of models;
- Objective measures of goodness of fit;
- Provision for appropriate weighting of data;
- Objective criteria for distinguishing models;
- Estimation of uncertainty of the parameters of the model;
- Optimal estimation of nonspecific binding;
- Provision for parameter constraints; and
- Ability to pool data,

Computer modeling is not a panacea; careful examination of such results is mandatory. There are many limitations and pitfalls in the methodology, perhaps the chief of which is the tendency of the investigator to believe the results because "the computer said it was so." The prudent investigator should consider the following potential problems: Failure to satisfy the assumptions; insufficient data to define parameters; failure to replicate experiments; poor initial estimates or lack of global convergence of the fitting algorithm; overparameterization; lack of independence of observations; and failure to use an appropriate experimental design. We shall discuss each of these potential advantages and problems in turn.

## ADVANTAGES

The advantages of using computerized modeling techniques for ligand-binding data analysis are many. First is the ease and speed of data processing, potentially allowing the scientist more time for critical interpretation and evaluation of his or her results. Freedom from mathematical or computational errors (provided that the data have been

accurately entered) is assured. Thus, there is no need to use approximations in the calculations. The computer is equally capable of using the exact formulation.

Another advantage is the precise formulation of a model, and the ability to examine other models involving the same number of parameters, as well as models involving one or two more, or one or two less, parameters. Thus, a family rather than a single model may be evaluated, along with many plausible alternative models or counter-hypotheses.

Computerized analysis allows objective measures of goodness-of-fit, e.g., the sum of squares of deviations (SS), the mean square deviation (MS), and the "root mean square error" (RMS error) or standard deviation of a point around the fitted curve (Draper and Smith 1981). Other tests of goodness-of-fit examine the randomness of the deviations of the points around the curve. These include the "runs test" (a nonparametric and robust test which is very sensitive when dealing with a large number of residuals, e.g., more than 20, but less sensitive with a small number of "points"), and the serial correlation of residuals (or equivalently, the mean square successive difference), which is somewhat more sensitive for small numbers of observations (Bennett and Franklin 1954). Of course, graphical display of data remains one of the best, if not the best, method for evaluation of goodness-of-fit. The computer makes it possible to obtain high resolution graphs, free of manual errors, in several coordinate systems, e.g., saturation curves, displacement or competition curves, and Scatchard plots. The utility of these graphs may be improved when one superimposes the 95% confidence limits for an observation (to assist detection of outliers) and the standard error (and/or 95% confidence limits) for the fitted curve(s).

The computer analysis should provide appropriate weighting: an imprecise data point (say  $\pm 100$ ) should not be counted the same as a more precise value ( $\pm 10$  or  $\pm 1$ ). Failure to use weighting, or failure to use proper weighting, can reduce the performance of the "computer analysis" to something far worse than simple graphical analysis, where the experimentalist "knows" which portions of the curve are measured precisely and known reliably, and which portions of the curve are subject to wide variation. Thus, the computer analysis forces the experimentalist to state his assumptions and examine his data regarding its statistical "error structure" (Rodbard 1984; Rodbard et al. 1976).

The computer permits and facilitates use of objective criteria to distinguish among several alternative plausible models. Should the data be described by a model involving one binding site? Two sites? Three sites? By applying the "extra sum of squares principle," one can objectively select among various models of varying degrees of complexity.

The computer analysis provides estimates--usually lower bounds--of the degree of uncertainty in the parameter values. The true uncertainty is often much larger because these error estimates are based on the apparent random variability in the data: they do not protect against systematic errors (e.g., adsorption of ligand to the test tubes at low concentrations).

When dealing with two or more parameters simultaneously, the standard error of the parameters can be misleading. One must examine the Joint confidence limits for two parameters considered simultaneously (Munson and Rodbard 1980, 1984). This is due to the interaction or "covariance" in the errors in the parameters. For example, an overestimate of the affinity (K) is usually accompanied by an underestimate of the binding capacity for that site (R), because  $K \cdot R$ --the binding (measured as B/F) for infinitesimal ligand concentration--is often relatively precisely determined. An overestimate of nonspecific binding is likely to be accompanied by an underestimate of the concentration of low affinity sites, and vice versa.

The computer allows one to estimate nonspecific binding as a fitted parameter (N). Even when nonspecific binding has been measured repeatedly and at several concentrations of labeled ligand, it is still subject to some degree of uncertainty. Subtracting nonspecific binding from the total binding to obtain specific binding, as is commonly practiced, tends to propagate and magnify the error of measurement, sometimes leading to unstable or incorrect results. Considering nonspecific binding as a "fitted" parameter also gives a more accurate (and usually larger) estimate of the confidence limits for an observation, for the fitted curve, and for the estimates of parameters, especially  $B_{max}$ --albeit at the cost of an increase in the apparent degree of complexity.

The computer analysis enables us to interject "constraints," i.e., to test certain assumptions or to use data from previous experiments or from independent studies. For example, one can require that a parameter is fixed or constant, e.g.,  $K_{11} = 1.3E9$ . Or, one can force or constrain two parameters to be equal, i.e. "shared," but both of them will be fit (e.g.,  $R_1 = R_2$ , or  $N_1 = N_2$ ). Or, shared parameters can be set equal to a constant (e.g.,  $C_1 = C_2 = C_3 = 1$ ). Use of constraints can be helpful in simplifying a model to obtain initial or starting estimates of parameters for the iterative curve fitting procedure.

The computer analysis permits one to pool data from several curves using the same labeled ligand; from several curves using different labeled ligands within one experiment (e.g., for a given membrane preparation and set of conditions); and finally, from multiple experiments. Such pooling of data is often necessary: a) to test consistency of results; b) to obtain a sufficient number of observations to permit testing of more complex models (e.g., involving multiple classes of receptors); and c) to obtain more reliable estimates of parameters for such complex models. Of course, if the data are not "homogeneous" --if the qualitative nature of the system (e.g., cell or membrane preparation) has changed between experiments--then the loss of information due to heterogeneity and increased systematic and/or random variability may outweigh the advantages of the larger amount of data.

## LIMITATIONS and PITFALLS

In view of the many advantages, or at least potential advantages, of computerized mathematical modeling and curve fitting enumerated above, it is not surprising that many laboratories are in the process of letting up such facilities. However, computerized curve fitting is not a panacea.

It will not change bad data into good. Several of the potential problems and pitfalls evolve from the inability to simultaneously satisfy all of the following assumptions of the mass action models.

- a) attainment of equilibrium;
- b) accurate measurement of bound and/or free ligand concentration (this implies "perfect separation of bound and free," without perturbing the preexisting equilibrium);
- c) absence of degradation of ligand and/or receptor during the incubation;
- d) absence of cooperative interactions between the receptors, although cooperativity may also be modeled explicitly;
- e) absence of catalytic or enzymatic reactions, and absence of internalization of receptors or other active transport processes requiring energy, and hence departure from an equilibrium situation;
- f) accurate and appropriate measurement of nonspecific binding;
- g) chemical identity of the labeled ligand and the corresponding unlabeled ligand, which requires the absence of an isotope effect, absence of "damage" during labeling with iodine, accurate estimation of specific activity (to within a few percent, not within a factor of two), and homogeneity of labeled ligand (chemically pure, and not a racemic mixture);
- h) absence of extraneous binding proteins (or solubilized receptors) in the medium;
- i) absence of other "special effects", such as ligand induced conformational changes and induced aggregation or disaggregation. interaction of receptor with other membrane components (e.g., guanyl nucleotide binding proteins, phospholipids, and enzymes);
- j) both ligand and receptor are in true solution, i.e., not subject to unstirred layers or diffusion boundary effects, or to increased effective concentrations in the vicinity of a solid phase; and
- k) if the receptor is membrane bound, there are no membrane ligand effects due to partitioning of ligand into the membrane, or due to charge or Van der Waals forces.

The above is only a partial list of the implicit assumptions underlying most "equilibrium binding analysis" studies. These assumptions are involved, whether or not the data analysis is performed manually, graphically, or by computer. Each of these assumptions is vulnerable: in many systems we have strong evidence that these assumptions are not, strictly speaking, correct. One can use computer simulation studies to evaluate the potential qualitative and quantitative problems raised by failure to meet any one of these assumptions (Buergisser et al. 1981a, 1981b; Rodbard and Catt 1972; Ketelslegers et al. 1975; Munson 1983b; Krumins and Rodbard, submitted). Further, if any one of these assumptions is violated, one can potentially utilize a more complex model to fit the data (DeLean and Rodbard 1980; Ketelslegers et al. 1975) and still obtain reliable estimates of parameters. Of course, one must pay a price: usually it becomes necessary to collect substantially more data (e.g., at several "time points") to fit the more complex models which usually involve more parameters (e.g., rate constants, degradation rates, etc.). For instance, if the "tracer" were damaged or heterogeneous, one can

measure its "maximal bindability," which is analogous to the concept of "immunoreactivity of tracer" in the context of radioimmunoassay, by progressively increasing the receptor (membrane, cell) concentration and extrapolating to "infinite" receptor concentration (Krumins and Rodbard, submitted). Such extrapolations of necessity involve increased random variability, and it is difficult to protect oneself from systematic errors as well.

If two or more of the above assumptions have been violated to a significant or substantial degree, then the necessary models usually become so complex that they become impractical. For instance, one could write the equations for a cooperative model involving multiple receptors under nonequilibrium conditions and in the presence of degradation. With modern computing facilities, simulation and curve fitting would still be possible. The problem is that the amount of data required would be prohibitive, and random errors would have to be reduced to vanishing levels so that the system would not become "indeterminate" and the parameters "nonidentifiable" (Carson et al. 1983; DiStefano 1984).

What do we mean when we say that the assumptions must not be violated to a significant or substantial degree? This is a subjective matter, a matter of judgment. This will depend on the system, the conditions, the magnitude of the errors, the number of sites, the number of parameters, and the degree of vulnerability of the "other" assumptions.

One of the paradoxes of the use of a statistical approach to the data is that the better the data (i.e., the more precise the data), the more vulnerable the results are to minor departures from the assumptions. For example, in the presence of 10% random errors, one would not be able to detect the presence of a small (2%) systematic error. However, if by optimizing experimental conditions, reducing pipetting and counting errors, and using a high degree of replication (quadruplicates), one can reduce the random errors to 1%, then a small systematic (2%) error may appear to be "highly statistically significant." In this sense, the "sloppy" experimentalist with widely scattered data, while likely to miss small effects, would be protected from overinterpretation of his/her data: only very large, dramatic effects would be "statistically significant." In contrast, the very cautious and quality control minded experimentalist who reduces his random errors to minimal levels (e.g.,  $\pm 1\%$ ) has a greater chance of detecting real but minor phenomena (e.g., a small amount of an additional class of binding sites). However, this also increases the chance of being misled by some small systematic error introduced by some small but definite failure to meet one of the underlying assumptions (i.e., a small, subtle artifact). It follows that one must not only reduce random errors as much as possible, but also test all of the underlying assumptions, and strive to minimize systematic errors insofar as possible. By providing a measure of random errors, the computer facilitates the refining of "noisy" ligand-binding systems. Having done so, one is now faced with the problem that a statistically significant result is not necessarily "biologically or biochemically significant." The more precise the data, the greater the likelihood of detecting a minor artifact as though it were a signal.

Failure to meet the assumptions is probably responsible for the greatest likelihood of misinterpretation of ligand-binding data, again, whether computerized or not. However, in addition, there are several technical issues which arise in the curve fitting process and can result in biased results or misinterpretation. These are briefly discussed below.

### Insufficient Data to Define Parameters

The more complex the model, with more fitted parameters, the larger the number of data points required. For example, for a single class of binding site, one has a single affinity constant (K) and a single binding capacity (R). In addition, one probably should regard the nonspecific binding (N) as a fitted parameter. In contrast, when dealing with 2 classes of binding sites and 2 ligands, one then has  $2 \times 2 = 4$  K values, 2 R values, and 2 N values, or eight parameters altogether. With 3 ligands and 3 binding sites, one has  $3 \times 3 = 9$  K values, 3 R values, and 3 N values, or 15 parameters. In order to estimate all parameters simultaneously, one needs a large number of independent observations (e.g., one might have a displacement curve for each of the three unlabeled ligands displacing each of the corresponding labeled ligands, or nine curves in all). Such experiments are necessarily large and may be impractical or impossible to perform. For instance, one of the three ligands may not be available in homogeneous form (i.e., a racemic mixture), or in labeled form with sufficiently high specific activity. One can often still obtain a reasonable characterization of the system, even when all possible combinations and permutations of ligands cannot be tested. For example, if one has a "universal ligand," which appears to label all classes of sites with equal or nearly equal affinity, then one can use this single ligand as the "tracer" and displace with the several unlabeled ligands which display specificity or at least partial specificity or selectivity for the various classes of sites. This approach has been used successfully by DeLean and Lefkowitz in the characterization of alpha and beta adrenergic systems (Hancock et al. 1979; Hoffman et al. 1979). Alternatively, one can use perhaps six of the nine possible combinations of ligands in a cross-displacement study to characterize a ligand-binding system (Clayton et al. 1979). The more combinations of ligands one uses, the greater the likelihood of detecting a small, systematic but real departure from the model. An experimental design using multiple ligands displaced by the corresponding unlabeled ligands has been employed by Pfeiffer and Herz (1982) to characterize the mu, delta, and kappa receptors in rat brain. They succeeded in demonstrating kappa sites with binding studies using [3H]-ethylketocyclazocine, at a point in time when other laboratories were having difficulty finding a distinct class of kappa sites. Loew et al. (1983) have utilized a similar experimental design to reexamine the mechanisms of the "sodium effect" on opiate receptors.

The more predictions of the model one tests, the greater one's confidence in the model and the more precise the estimates of parameters. Of course, the larger the experiment, the greater the probability that one will encounter systematic errors or drift: the human or even the apparatus (e.g., pipetting machines) are subject to fatigue; the incubation time may vary; the degree of suction on the filtration machine may vary; the temperature may vary; the membrane particles may sediment to the bottom of a tube or flask; and the dryness of the filters and, hence, the efficiency



of counting may vary. Thus, the task of accumulating sufficient data to characterize a complex system becomes progressively more challenging for a larger model. Often, frozen membrane preparations have different properties than fresh membranes. Hence, one must use fresh membranes, prepared every day. Then, the density of the receptors will inevitably vary from one day to another, even after correcting per gram wet weight of tissue or per milligram of protein. One can correct for this systematic error, between experiments, by introducing a scaling or correction factor for each membrane preparation (designated C) (Munson and Rodbard 1980). These are additional parameters to be estimated. The C factors can usually be estimated very precisely, since all of the tubes in an experiment can be used to help estimate them. Use of the C's is based on the assumption that the relative proportions of binding sites must be constant from one experiment to another. In other words, the "binding isotherm" (or its Scatchard plot representation) should have a constant shape. Furthermore, the usual use of C factors involves the assumption that the specific and nonspecific bindings varies in a proportional manner between membrane preparations. This is not always the case. Suitable modification of the model can be made to allow for separate correction or adjustment factors for the specific and nonspecific binding. Of course, this further increases the number of parameters, and especially the uninteresting or extraneous factors (correction factors) which are not (usually) of biological interest. This results in an "overhead," reducing the efficiency of experimentation.

It is difficult to give guidelines regarding the number of observations necessary to estimate a given number of parameters. This will depend on the precision of the measurements, the concentration range and the placement of each experimental point, the nature of the "nonuniformity of variance" (which is usually present), the precision with which one wishes to estimate selected parameters, the degree of complexity of the model and the degree of interaction (covariance) of the errors in the model, and the purposes for which the results are to be used. As a general rule, one might suggest a ratio of at least five observations per parameter. However, if one can pool information between experiments, and if one is willing to do multiple experiments, then one might be able to use considerably fewer "tubes" within each experiment. The number of observations needed depends on whether one wants to be able to reject a given model, to show that a given parameter is nonzero (but perhaps indeterminate within a factor of 2 or three), or whether one wants to estimate a given parameter (e.g., binding capacity) within 5% or 10%.

### **Failure to Test Consistency of Results in Independent Experiments**

Use of mathematical modeling and curve fitting enables one to obtain an estimate of the standard errors of parameters from a single experiment. These are analogous to the standard errors of the slope and intercept in standard linear regression. Ideally, these standard errors should predict the degree of reproducibility of the parameter(s) in future experiments of the same kind, but this assumes that the future experiments are all statistically homogeneous, i.e., not subject to additional sources of variability. However, a within-experiment standard error, even when it is based on a large number of degrees of freedom, is usually not equivalent to a between-experiment standard error, due to the unavoidable, additional sources of between-experiment variation.

If one detects a significant "component of variance" between experiments, one should not be too alarmed or dismayed: this is a common experience and expected-by any reasonable experimentalist. Often, one finds that the between-experiment error is two or three times larger than the within-experiment error. In one of the experiments, due to a small error in dilution, all of the "points" for one of the competition curves may be shifted to the right. Another curve may be shifted to the left; another curve may be shifted slightly upward or downward. If we have an experimental design involving two labeled ligands and two unlabeled ligands, we may find that one of the labeled ligands has changed--thus affecting, not just a single "point," but systematically biasing results on two of the curves. Likewise, a systematic error in the preparation, dilution, or purity of one of the unlabeled ligands will affect half of the data in the experiment. As generally practiced, computer modeling of the data does not take these systematic errors into account, but treats each observation as an independent data point. Thus, although we may have 200 observations, their errors may be interacting in a complex and unknown fashion. This can alter, possibly severely, the probability levels for tests of goodness-of-fit (e.g., randomness of residuals). Thus, the wise experimentalist must examine and compare the results from several experiments. In a multiple binding site model, receptor class number one (R1) in one experiment might correspond to receptor class number three (R3) in the next experiment. One can use a graphical method, designated the "Kd versus Kd plot," to detect clusters of similar behavior from different experiments (Munson et al. 1984). Other two-dimensional plots for pairs of parameters can be useful. If parameters agree closely, within a few percentage points, then identification of parameters is easy. However, in complex models, it is common to find that some of the parameters are poorly determined--perhaps only within an order of magnitude, if that. Here, one can plot results for  $\log(K)$  versus  $\log(R)$ , or  $\log(K_{11})$  versus  $\log(K_{21})$ . etc. Then, one can estimate the between-experiment standard errors and confidence regions for pairs of parameters considered simultaneously.

### **Failure to Use an Appropriate or Optimal Experimental Design**

Another factor that must be considered is the optimal location and spacing of points. If we know that a relationship is linear, then we can obtain our most precise estimate of the slope by placing our observations as far apart as possible: we would have half the observations as far as possible to the left and half the observations as far as possible to the right. Likewise, when fitting a relationship which is known to be a perfect Michaelis-Menten hyperbola or hyperbolic binding isotherm for a single class of sites, one should attempt to locate about half of the points near the  $K_m$  or  $K_d$ , and the other half of the points well up on the plateau corresponding to saturation or "Bmax" (Endrenyl 1981). Thus, the optimal location of the observations to minimize the errors in one or two parameters can be quite different from the optimal location of observations if one wishes to detect departure of the data from the model, or to optimize the performance of a test to discriminate between two different models. Prior information is required in either event--hence the need for a sequence of experiments to make a series of successive approximations. This goal (to refine and optimize the performance of the test) conflicts with the desirability of keeping the

experimental design constant for a series of experiments in order to evaluate between-experiment reproducibility. In principle, one can use computer simulation and optimization to assist in the selection of experimental design (Carson et al. 1983; DiStefano 1984; Munson and Rodbard 1984), although this has yet to be translated into practical terms for routine application in the context of ligand binding. Next, we consider a series of issues which, although quite technical, can seriously influence the interpretation of the computerized analysis.

### **Initial Estimates of Parameters, and Failure of Convergence**

Complex nonlinear models with multiple parameters will often have a "limited region of convergence." In other words, the program may not find the true optimal weighted least-squares solution unless the initial estimates of parameters are reasonably close to this value. Otherwise, the program may converge to a false "local minimum" or not converge at all. This might lead the experimentalist to conclude that a given model has failed, even though it might have been perfectly satisfactory if only another set of starting estimates had been tested. Given two different sets of starting estimates, the program may converge to different solutions corresponding to models which are qualitatively very different. To avoid (or at least detect) the existence of these problems, one should attempt repeated curve fitting for complex models, using several different sets of starting estimates of parameters. At present, fitting complex models involving more than 9 or 10 parameters is, for practical purposes, beyond the limits of the personal or desktop microcomputers. On minicomputers and mainframe computers, one might potentially automate this process to some extent, e.g., first use a grid-search, then a Nelder-Mead (simplex) algorithm to select initial starting estimates (Magar 1972), and then check to see that several different starting estimates lead to the same solution. Use of constraints (e.g., the parameters must be positive) and reparameterizing (e.g., use of  $\log(K)$ ,  $\log(R)$ , or  $\log(K^*R)$ ) can sometimes lead to better reliability of convergence. However, in general, one cannot guarantee that one has converged to the true optimal solution.

### **Overparameterization**

One should inspect the RMS error; ideally, this should be close to the "residual error" estimated from the standard deviation of replicate measurements. For instance, if the measurement error for replicates were  $\pm 2\%$  and the RMS error of the curve fit were  $\pm 10\%$ , one would have a strong indication of a large and significant degree of lack of fit. On the other hand, if the measurement error were  $\pm 5\%$  and the RMS error were  $\pm 1\%$ , then something is likely to be wrong. On the average, the fitted curve should pass no closer to the points than the statistical uncertainty in the observations. An unusually small RMS may indicate that the model is overparameterized, involving too many parameters. In effect, the model is too flexible and is able to explain minor random variation in the observations. Of course, the measurement error and the RMS error need not agree perfectly--both are subject to random sampling errors, depending on their respective numbers of (effective) degrees of freedom. However, the two measures should be closely comparable (Rodbard 1984; Rodbard et al. 1976).

## Lack of Independence of Observations

In the least squares curve fitting procedure, we assume that each of the data points entered into the computer is independent, i.e., that the errors in the observations are independent and randomly distributed. Even robust and "nonparametric" methods of analysis retain this requirement. What constitutes a (reasonably) independent observation? Ideally, each tube in an experiment would be an independent observation. This would largely (but not entirely) be true if we could use an automated device for all mechanical steps (pipetting, shaking, filtering) and if we were to use randomization. Until the experiment is both fully automated and fully randomized (and hence, presumably, computer controlled in its entirety), the various tubes in a rack will not be fully independent. Even then, neighboring tubes in a rack will have a tendency to give correlated results.

A common, indeed unavoidable question is whether to use each tube as an independent observation or whether to use the means of duplicates (triplicates, etc.) as the experimental unit. This somewhat arbitrary choice can have enormous consequences since it can drastically affect the apparent number of degrees of freedom and, hence, the possible significance of "F tests" based on the "extra sum of squares principle." It may also affect, or bias, the estimates of the RMS error. For example, if we have triplicates at each of 10 dose levels, then we may regard the experiment as providing either 10 or 30 independent observations. If we are fitting 4 parameters, that might make the difference between 6 and 26 degrees of freedom (number of observations minus number of fitted parameters). In general, we recommend the conservative approach, where the dose means is regarded as the independent observation. This should, if anything, bias the results toward selection of a model with fewer parameters, i.e., a lesser degree of complexity.

How many replicates should one use? This becomes a critical question. For a given total number of experimental tubes, the more replicates there are for each dose, the fewer doses can be used; and the fewer the number of degrees of freedom, the less likely one will be able to demonstrate and characterize a complex system. To maximize the number of degrees of freedom, one would use only singletons at each dose. However, to obtain a measure of the residual error, within doses, one needs to run at least duplicates for a fair number of dose levels, and possibly pool this information from various curves in one or more experiments (Rodbard 1984; Rodbard et al. 1976). This information is also necessary to decide whether weighting should be used and, if so, to select an appropriate weighting model (e.g., constant percentage error) and to estimate the coefficients of the weighting model (e.g.,  $\pm 5\%$  error). With duplicates, one can begin to detect poor agreement; but identification of an outlier only becomes possible (usually) when using triplicates or quadruplicates.

## DISCUSSION AND CONCLUSIONS

The art of hypothesis formulation, experimental design, and data analysis is partly, but only partly, amenable to assistance from statistical methods, mathematical modeling, and computerization. These approaches will not and cannot compensate for any fundamental flaws in the data or correct for major violations of underlying assumptions. Statistical analyses protect against random errors but can be completely impotent in the face of certain types of systematic errors. It is desirable that one obtain experience with the use of curve fitting programs from a series of applications of progressive and gradually increasing complexity. Even this provides no guarantee of protection against erroneous interpretation or conclusions. A number of arbitrary assumptions and decisions, and skillful judgment are still required. What then is the role or contribution of the curve fitting procedure? If implemented properly, it does provide optimal utilization of the data as well as a systematic method for formulating and testing hypotheses, analyzing sources of random errors, and detecting inconsistencies. There are several pitfalls, including the possibility that one will select an oversimplified model to minimize mathematical complexity, rather than introduce features which are needed to realistically represent the system (e.g., degradation, aggregation of receptors, etc.). Qualitative, intuitive analysis of a more complex but realistic model may be preferable to a mathematically exact and statistically optimal analysis of an incorrect model. This tradeoff between simplicity and realism is one that perpetually confronts the scientist, with or without computerized modeling. Objective computerized modeling provides a basis for making an informed compromise between these two ideals.

## REFERENCES

- Baulieu, E.E., and Raynaud, J.P. A "proportion graph" method for measuring binding systems. Eur. J. Biochem 13:293-304, 1970.
- Bennett, C.A., and Franklin, N.L. Statistical Analysis in Chemistry and the Chemical Industry. New York: Wiley, 1954. 724 pp.
- Bevington, P.R. Data Reduction and Error Analysis for the Physical Sciences. New York: McGraw Hill, 1969. 36 pp.
- Buergisser, E.; Hancock, A.A.; Lefkowitz, R.J.; and DeLean, A. Anomalous equilibrium binding properties of high-affinity racemic radioligands. Mol Pharmacol 19:205-216, 1981a.
- Buergisser, E.; Lefkowitz, R.J.; and DeLean, A. Alternative explanation for the apparent "two step" binding kinetics of high affinity antagonist radioligands. Mol Pharmacol 19:509-512, 1981b.
- Carson, E.R.; Cobelli, C.; and Finkelstein, L. The Mathematical Modeling of Metabolic and Endocrine Systems: Model Formulation, Identification, and Validation. New York: Wiley, 1983. 394 pp.
- Clayton, R.N.; Shakespeare, R.A.; Duncan, J.A.; and Marshall, J.C. Radioiodinated nondegradable gonadotropin-releasing hormone analogs: new probes for the investigation of pituitary gonadotropin-releasing hormone receptors. Endocrinology 105:1369-1381, 1979.
- DeLean, A., and Rodbard, D. Kinetic analysis of cooperative ligand binding: applications to the insulin receptor. Fed Proc 39(1): 116-120. 1980.

- Distefano, J.J. Some theoretical and practical considerations in modeling and experiment design for quantifying physiological and pharmacokinetic systems. In: Rodbard, D., and Forti, G., eds. Computers in Endocrinology. New York: Raven Press, 1984. pp. 259-276.
- Draper, N.R., and Smith, H. Applied Regression Analysis. New York: Wiley, 1981. 709 pp.
- Endrenyi, L. Kinetic Data Analysis: Design and Analysis of Enzyme and Pharmacokinetic Experiments. New York: Plenum Press, 1981. 427 pp.
- Feldman, H. A. Mathematical theory of complex ligand-binding system at equilibrium: some methods for parameter fitting. Anal Biochem 48:317-338, 1972.
- Fletcher, J.A., and Spector, A.A. Alternative models for the analysis of drug-protein interaction. Mol Pharmacol 13:387-399, 1977
- Hancock, A.A.; DeLean, A.L.; and Lefkowitz, R.J. Quantitative resolution of beta-adrenergic receptor subtypes by selective ligand binding: application of a computerized model fitting technique. Mol Pharmacol 16:1-9, 1979.
- Hoffman, B.B.; DeLean, A.; Wood, C.L.; Schocken, D.D.; and Lefkowitz, R.J. Alpha-adrenergic receptor subtypes: quantitative assessment by ligand binding. Life Sci 24:1739-1746, 1979.
- Ketelslegers, J. M.; Knott, G. D.; and Catt, K. J. Kinetics of gonadotropin binding by receptors of the rat testis: analysis by a non-linear curve fitting method. Biochemistry 14:3075-3083, 1975.
- Krumins, S.A., and Rodbard, D. Comparative studies of the binding of dimeric and monomeric enkephalins to neuroblastoma-glioma NG108-15 cells. J Neurochem, submitted for publication.
- Loew, G.H.; Toll, L.; and Keys, C. Computer-assisted analysis of receptor-binding studies of [3H]-naloxone and [3H]-DADL: a reinterpretation of the Na<sup>+</sup> effect. Life Sci 33(supp. I): 163-166, 1983.
- Magar, M.E. Data Analysis in Biochemistry and Biophysics. New York: Academic Press, 1972. 497 pp.
- McIntosh, R.P. Principles of mathematical modeling in endocrinology. In: Rodbard, D., and Forti, G., eds. Computers in Endocrinology. New York: Raven Press, 1984. pp. 15-36.
- Munson, P.J. Ligand: A computerized analysis of ligand binding data. In: Langene, J.J., and Van Vunakis, H., eds. Methods in Enzymology. Vol 92. New York: Academic Press, 1983a. pp. 543-576.
- Munson, P.J. Experimental artifacts and the analysis of ligand binding data: Results of a Computer Simulation. J Recept Res 3:249-259. 1983b.
- Munson, P.J. Heterogeneous receptors and binding curve analysis in neurobiology. In: Marangos, P.J.; Campbell, I.C.; and Cohen, R.H., eds. Brain Receptor Methodologies. New York: Academic Press, 1984. pp. 33-48.
- Munson, P.J., and Rodbard, D. Ligand: A versatile computerized approach for characterization of ligand-binding systems. Anal Biochem 107:220-239, 1980.
- Munson, P.J., and Rodbard, D. Computerized analysis of ligand binding data: basic principles and recent developments. In: Rodbard, D., and Forti, G., eds. Computers in Endocrinology. New York: Raven Press, 1984. pp. 117-145.

- Munson, P.J.; Cruciani R.A.; Lutz R.A.; and Rodbard, D. New methods for characterization of complex receptor systems involving 3 or more binding sites: Application to brain opiate receptors. J Recept Res. 4:339-355, 1984.
- Pfeiffer, A., and Herz, A. Discrimination of Three Opiate Receptor Binding Sites with the Use of a Computerized Curve-Fitting Technique. Mol Pharmacol 21:266-271, 1982.
- Priore, R.L., and Rosenthal, H.E. A statistical method for the estimation of binding parameters in a complex system. Anal Biochem 70:231-240, 1976.
- Rodbard, D. Lessons from the computerization of radioimmunoassays: an introduction to the basic principles of modeling. In: Rodbard, D., and Forti, G., eds. Computers in Endocrinology. New York: Raven Press, 1984. pp. 75-100.
- Rodbard, D., and Catt, K.J. Mathematical theory of radioligand assays: the kinetics of separation of bound and free. J Steroid Biochem 3:255-273, 1972.
- Rodbard, D.; Lenox, R.H.; Wray, H.L.; and Ramseth, D. Statistical characterization of the random errors in the radioimmunoassay dose response variable. Clin Chem 22:350-358, 1976.
- Sacchi-Landriani, G.; Guardabaaso, V.; and Rocchetti, M. Nlfit: a microcomputer program for non-linear fitting. Comput Programs Biomed 16:35-42, 1983.
- Segel, I.H. Enzyme Kinetics: Behavior and Analysis of Rapid Equilibrium and Steady-State Enzyme Systems. New York: Wiley-Interscience, 1975. 975 pp.

## ACKNOWLEDGMENT

Edward Fulton, Jr., assisted in performing several ligand-binding studies and provided valuable assistance with data analysis.

## AUTHORS

David Rodbard, M.D.  
 Rudolph A. Lutz, Ph.D.  
 Ricardo A. Cruciani, M.D.  
 Vincenzo Guardabasso, M.D.  
 Guido O. Pesce, M.D.  
 Peter J. Munson, M.A.  
 Laboratory of Theoretical and Physical Biology  
 National Institute of Child Health and Human Development  
 National Institutes of Health  
 Bethesda, Maryland 20892

# Recent Developments in Bioassay Using Selective Ligands and Selective In Vitro Preparations

Hans W. Kosterlitz, M.D., Ph.D.; Alistair D. Corbett, Ph.D.;  
Maureen G. C. Gillan, Ph.D.; Alexander T. McKnight, Ph.D.;  
Stewart J. Paterson, B.Sc.; and Linda E. Robson, Ph.D.

## INTRODUCTION

In an analysis of the mode of action of endogenous opioids and of opioid drugs, fundamental problems arise because these ligands bind to more than one site of the complex macromolecule of the receptor. Such an interaction may or may not be followed by a biological response of the effector. If the compound is an agonist, the response may lead either to excitatory or inhibitory activity. On the other hand, an antagonist compound is able to block such excitatory or inhibitory responses. Therefore, it is important to note that binding does not decide by itself whether the ligand acts as an agonist or antagonist or has no pharmacological effect at the receptor.

While responses to opioid peptides or nonpeptides will ultimately have to be tested *in vivo*, the pharmacological effects are often more readily analyzed using excised tissues. Compounds with high selectivity for each of the three opioid binding sites have been used in isolated tissue preparations obtained from five different species (table 1). The receptors in the mouse vas deferens interact with the  $\mu$ -,  $\delta$ -, and  $\kappa$ -ligands, for which the receptors have a high degree of sensitivity. The receptors of the guinea pig ileum interact with  $\mu$ - and  $\kappa$ -ligands, those of the rat vas deferens mainly, but not solely, with  $\mu$ -ligands, those of the hamster selectively with  $\delta$ -ligands, and the receptors of the rabbit vas deferens selectively with  $\kappa$ -ligands. As far as selectivity of the ligands is concerned, [D-Ala<sup>2</sup>,MePhe<sup>4</sup>,Gly-ol<sup>5</sup>]enkephalin is suitable for testing the  $\mu$ -receptor in the rat vas deferens, [D-Pen<sup>2</sup>,D-Pen<sup>5</sup>]enkephalin for testing the  $\delta$ -receptor in the hamster vas deferens, and U-50, 488H for testing the  $\kappa$ -receptor in the rabbit vas deferens. It is important to note that some ligands may be agonists in some tissues and antagonists in others. Ethylketazocine and bremazocine are examples of this behaviour, as they are  $\kappa$ agonists in the guinea pig ileum and the vasa deferentia of the mouse and rabbit. In contrast, in the vas deferens of the rat they are pure  $\mu$ -antagonists (Gillan et al. 1981) and in the vas deferens of the hamster they are pure  $\delta$ -antagonists (McKnight et al. 1984a, in press). These aspects will be more fully discussed in later sections.

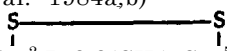


TABLE 1

Distribution of Opioid Receptors in the Mouse Vas Deferens (MVD), Myenteric Plexus of Guinea Pig Ileum (GPI), Rat Vas Deferens (RVD), Hamster Vas Deferens (HVD), and Rabbit Vas Deferens (LVD)<sup>(a)</sup>

	MVD	GPI	RVD	HVD	LVD
	$\mu + \delta + \kappa$	$\mu + \kappa$	( $\mu$ )	$\delta$	$\kappa$
Normorphine	<b>A</b>	<b>A</b>	<b>A</b>	<b>O</b>	<b>O</b>
[D-Ala <sup>2</sup> ,MePhe <sup>4</sup> ,Gly-ol <sup>5</sup> ]Enkephalin	<b>A</b>	<b>A</b>	<b>A</b>	<b>(A)</b>	<b>O</b>
$\beta$ -Endorphin	<b>A</b>	<b>A</b>	<b>A</b>	<b>(A)</b>	<b>O</b>
[Leu]Enkephalin	<b>A</b>	<b>A</b>	<b>A</b>	<b>A</b>	<b>O</b>
[Met]Enkephalin	<b>A</b>	<b>A</b>	<b>A</b>	<b>A</b>	<b>O</b>
(D-Pen <sup>2</sup> ,D-Pen <sup>5</sup> )Enkephalin <sup>(b)</sup>	<b>A</b>	<b>(A)</b>	<b>O</b>	<b>A</b>	<b>O</b>
Dynorphin A	<b>A</b>	<b>A</b>	<b>O</b>	<b>(A)</b>	<b>A</b>
U-50,488H <sup>(c)</sup>	<b>A</b>	<b>A</b>	<b>O</b>	<b>O</b>	<b>A</b>
Ethylketazocine	<b>A</b>	<b>A</b>	<b>ANT</b>	<b>ANT</b>	<b>A</b>
Bremazocine	<b>A</b>	<b>A</b>	<b>ANT</b>	<b>ANT</b>	<b>A</b>

<sup>a</sup>O = no effect, A = agonist, ANT = antagonist. Data are based on published results (McKnight et al. 1983, 1984a, in press; Paterson et al. 1984a,b)

<sup>b</sup>  [D- $\beta$ , $\beta$ (CH<sub>3</sub>)<sub>2</sub>Cys<sup>2</sup>,D- $\beta$ , $\beta$ (CH<sub>3</sub>)<sub>2</sub>Cys<sup>5</sup>]enkephalin (Mosberg et al. 1983)

<sup>c</sup> Trans-3,4-dichloro-N-methyl-N-(2-(pyrrolidinyl)cyclohexyl)-benzeneacetamine (Piercey et al. 1982)

## SELECTIVITY OF OPIOID LIGANDS

The results obtained in this section are summarized in tables 2 to 4. The affinity of a ligand is given as its binding affinity constant,  $(K_i, \text{nM})^{-1}$ , which is the reciprocal of its inhibition constant. In addition, it was found useful to determine the relative binding affinities by the ratio  $[K_i^{-1} \text{ for } \mu, \delta, \text{ or } \kappa / (K_i^{-1} \text{ for } \mu + K_i^{-1} \text{ for } \delta + K_i^{-1} \text{ for } \kappa)]$ . The temperature of the binding assays was 25°C when peptidase resistant compounds were used and 0°C when peptides that are sensitive to enzyme activity were used.

Table 2 gives the results obtained with some of the  $\mu$ -selective ligands. The affinity values are around  $0.5 \text{ nM}^{-1}$  with the exception of [Met]enkephalyl-Arg-Arg-Val-NH<sub>2</sub> which has a very high affinity of  $8.7 \text{ nM}^{-1}$ . The relative affinity of [D-Ala<sup>2</sup>,MePhe<sup>4</sup>,Gly-ol<sup>5</sup>]enkephalin is 0.99 and that of morphine 0.97; thus, these compounds are much more  $\mu$ -selective than any of the other three. The degree of selectivity is important for agonist compounds but even more so for antagonists. For instance, naloxone is widely used as a  $\mu$ -antagonist, but this is only permissible in low concentrations. The fact has to be remembered that in higher concentrations naloxone also antagonizes the action of compounds having  $\delta$  or  $\kappa$  affinities. Unfortunately, it is often not appreciated sufficiently in in vivo situations that naloxone is a  $\mu$ -selective agonist only when used in low concentration. In conclusion, the most suitable  $\mu$ -ligands are [D-Ala<sup>2</sup>,MePhe<sup>4</sup>,Gly-ol<sup>5</sup>]enkephalin, morphine, and also normorphine (which is not included in the table); naloxone is a selective  $\mu$ -antagonist if used with care in low concentrations of up to  $15 \text{ nM}$ .

TABLE 2

Binding Affinities of  $\mu$ -Selective Opioids and Their Relative Binding Affinities for the  $\mu$ -,  $\delta$ -, and  $\kappa$ -Sites in Homogenates of Guinea Pig Brain

		$\mu$ -Affinity (K <sub>i</sub> , nM) <sup>-1</sup>	Relative Affinity		
			$\mu$	$\delta$	$\kappa$
[Met]Enkephalyl-Arg-Arg-Val-NH <sub>2</sub>	0°C	8.7	0.66	0.03	0.31
Naloxone	25°C	0.56	0.85	0.06	0.09
Morphine	25°C	0.56	0.97	0.02	0.01
[D-Ala <sup>2</sup> ,MePhe <sup>4</sup> ,Gly-ol <sup>5</sup> ] Enkephalin	25°C	0.54	0.99	0.01	0
$\beta$ -Endorphin	0°C	0.49	0.53	0.42	0.02

The relative binding affinities at the  $\mu$ -,  $\delta$ -, and  $\kappa$ -sites are: K<sub>i</sub> for  $\mu$ -,  $\delta$ -, or  $\kappa$ / (K<sub>i</sub><sup>-1</sup> for  $\mu$  + K<sub>i</sub><sup>-1</sup> for  $\delta$  + K<sub>i</sub><sup>-1</sup> for  $\kappa$ ).

<sup>a</sup> Paterson et al. 1984a, 1984b; Kosterlitz and Paterson 1985

As far as  $\delta$ -ligands are concerned (table 3), the most selective peptide analogues are [D-Ser<sup>2</sup>,L-Leu<sup>5</sup>]enkephalyl-Thr, [D-Pen<sup>2</sup>,L-Pen<sup>5</sup>]enkephalin, and [D-Pen<sup>2</sup>,D-Pen<sup>5</sup>]enkephalin. They are resistant to peptidase activity and can therefore be used at 25°C in binding assays and at 37°C in the guinea pig ileum and the mouse and rat vasa deferentia. While the latter two analogues are almost fully selective, they are not quite as potent as the first analogue. It is of interest to note that, while the endogenous peptides [Leu]enkephalin and [Met]enkephalin have higher affinities to the  $\delta$ -binding site than the analogues, they are very susceptible to the degrading action of peptidases. The antagonist ICI 174864 is highly selective for the  $\delta$ -binding site and is not affected by peptidases, but it is of low potency.

TABLE 3

Binding Affinities of  $\delta$ -Selective Opioids and Their Relative Binding Affinities for the  $\mu$ -,  $\delta$ -, and  $\kappa$ -Sites in Homogenates of Guinea Pig Brain<sup>(a)</sup>

		$\delta$ -Affinity (K <sub>i</sub> , nM) <sup>-1</sup>	Relative Affinity		
			$\mu$	$\delta$	$\kappa$
[Met]enkephalin	0°C	1.10	0.09	0.91	0
[Leu]enkephalin	0°C	0.85	0.06	0.94	0
[D-Ser <sup>2</sup> ,L-Leu <sup>5</sup> ]enkephalyl-Thr	25°C	0.56	0.04	0.96	0
[D-Pen <sup>2</sup> ,D-Pen <sup>5</sup> ]enkephalin	25°C	0.37	0.004	0.996	0
ICI 174864 <sup>(b)</sup>	25°C	0.005	0.01	0.99	0

The relative binding affinities at the  $\mu$ -,  $\delta$ -, and  $\kappa$ -sites are: K<sub>i</sub> for  $\mu$ ,  $\delta$ , or  $\kappa$ / (K<sub>i</sub><sup>-1</sup> for  $\mu$  + K<sub>i</sub><sup>-1</sup> for  $\delta$  + K<sub>i</sub><sup>-1</sup> for  $\kappa$ ).

<sup>a</sup> Paterson et al. 1984a. 1984b: Kosterlitz and Paterson 1985

<sup>b</sup> N,N-diallyl-Tyr-( $\alpha$ -aminoisobutyric acid)<sub>2</sub>-Phe-Leu-OH (Cotton et al. 1984)

With regard to  $\kappa$ -ligands, there are so far no endogenous peptides or nonpeptide compounds of high potency with a selectivity similar to those found with  $\mu$ - and  $\delta$ -ligands. Fragments of the pro-dynorphin series are very sensitive to degradation by peptidases and therefore have to be assayed at 0°C (table 4). The endogenous peptides dynorphin A and dynorphin B have high affinities ( $K_i^{-1}$ ) of 8.7 and 8.5  $\text{nM}^{-1}$ , respectively, at the  $\kappa$ -binding site; however, when the relative affinities were determined, it was found that dynorphins A and B have values about 0.14 for binding at the  $\mu$ -site. The endogenous fragment dynorphin A (1-8) has a different binding pattern; its affinity at the  $\kappa$ -binding site is only 0.75  $\text{nM}^{-1}$  and it has relative affinities at the  $\mu$ - and  $\delta$ -binding sites of 0.22 and 0.16, respectively. The affinity of  $\alpha$ -neo-endorphin at the  $\kappa$ -binding site is 5.1  $\text{nM}^{-1}$  and its relative affinities at the  $\mu$ - and  $\delta$ -binding sites are

TABLE 4

Binding Affinities of K-Selective Opioids and Their Relative Binding Affinities for the  $\mu$ -  $\delta$ -, and  $\kappa$ -Sites in Homogenates of Guinea Pig Brain

	Temperature	K-Affinity ( $K_i$ , nM) <sup>-1</sup>	Relative Affinity		
			$\mu$	$\delta$	$\kappa$
Dynorphin A	0°C	8.7	0.13	0.04	0.83
Dynorphin B	0°C	8.5	0.14	0.03	0.83
a-Neo-endorphin	0°C	5.1	0.10	0.23	0.67
Dynorphin A (1-9)	0°C	4.76	0.05	0.06	0.89
Dynorphin A (1-8)	0°C	0.75	0.22	0.16	0.62
(-) -Ethylketazocine	25°C	1.92	0.32	0.06	0.62
Mr 2266 <sup>(b)</sup>	25°C	1.45	0.31	0.07	0.62
(-)-Bremazocine	25°C	2.44	0.30	0.25	0.45

The relative binding affinities at the  $\mu$ -,  $\delta$ -, and  $\kappa$ -sites are:  $K_i$  for  $\mu$ ,  $\delta$ , or  $\kappa$  / ( $K_i^{-1}$  for  $\mu$  +  $K_i^{-1}$  for  $\delta$  +  $K_i^{-1}$  for  $\kappa$ ).

<sup>a</sup> Paterson et al. 1984a, 1984b; Kosterlitz and Paterson 1985

<sup>b</sup> (-)- $\alpha$ -5,9-diethyl-2'-hydroxy-2-(3-furylmethyl)-6,7-benzomorphan

0.10 and 0.23, respectively. The nonendogenous peptide dynorphin A (1-9) has an affinity at the  $\kappa$ -binding site of about  $4.8 \text{ nM}^{-1}$ , with relative affinities at the  $\mu$ - and  $\delta$ -sites of only 0.05 and 0.06, respectively. This analogue would be a very suitable  $\kappa$ -ligand if it were not for the fact that it is readily degraded by peptidase.

Two nonpeptide compounds with affinity to the  $\kappa$ -binding-site are ethylketazocine and bremazocine, both of which can be assayed at  $25^\circ\text{C}$  as they are not subject to enzymatic degradation. Their affinities at the  $\kappa$ -binding site are  $1.9$  and  $2.4 \text{ nM}^{-1}$  (table 4). However, their selectivity for an agonist action on the  $\kappa$ -receptor is not high, as their relative affinities for the  $\mu$ -binding site are about 0.31 and the relative affinity of bremazocine for the  $\delta$ -binding site is 0.25. In this context, it is noteworthy that both compounds are  $\mu$ -antagonists in the rat *vas deferens* and  $\delta$ -antagonists in the hamster *vas deferens* (table 1). Their selectivity for binding at the  $\kappa$ -site is improved when their effects on the  $\mu$ - and  $\delta$ -binding sites are prevented by the addition of unlabeled  $\mu$ -ligand [D-Ala<sup>2</sup>,MePhe<sup>4</sup>,Gly-ol<sup>5</sup>]enkephalin and unlabeled  $\delta$ -ligand [D-Ala<sup>2</sup>,D-Leu<sup>5</sup>]enkephalin. Two other nonpeptide compounds which have affinities at the  $\kappa$ -binding sites are tipluadom ( $0.25 \text{ nM}^{-1}$ ) and U-50, 488H ( $0.13 \text{ nM}^{-1}$ ); they are of particular interest because the relative affinities are 0.84 for tipluadom and 0.99 for U-50, 488H (Kosterlitz and Paterson 1965).

There is so far no selective  $\kappa$ -antagonist. The best compound is Mr 2266 which has an affinity of  $1.45 \text{ nM}^{-1}$  at the  $\kappa$ -binding site (table 4). However, its relative affinity is only 0.62 for the  $\kappa$ -binding site and 0.32 for the  $\mu$ -binding site; this low selectivity makes it impossible to identify  $\kappa$ -receptors by the antagonist action of Mr 2266.

In conclusion, there are so far no  $\kappa$ -agonists or  $\kappa$ -antagonists which have reached the high standard of potency and selectivity already achieved for  $\mu$ - and  $\delta$ -receptors. It is of particular importance to search for an antagonist which is potent, and is highly selective and resistant to degradation by enzymes.

#### **BINDING CHARACTERISTICS AND DEGRADATION PROFILE OF [<sup>3</sup>H]-DYNORPHIN A (1-8) AND [<sup>3</sup>H]-DYNORPHIN A (1-9)**

Dynorphin A (1-8) or [Leu<sup>5</sup>]enkephalyl-Arg-Arg-Ile, and dynorphin A (1-9) or [Leu<sup>5</sup>]enkephalyl-Arg-Arg-Ile-Arg, are of particular interest for two reasons. The octapeptide is endogenous (Weber et al. 1982), while the nonendogenous nonapeptide is the more  $\kappa$ -selective and more potent of the two peptides (Corbett et al. 1982).

With regard to the possible mode of action of these two peptides, it is important to note that, in the preparation of the guinea pig myenteric plexus-longitudinal muscle immersed in Krebs solution, the onset of their depressant effect is rapid and, after washing out the peptides, the recovery of the electrically induced twitch is also not much delayed. Thus, an analysis of the factors involved should give an insight into their mode of action (Corbett et al. 1982).

For this reason, it was decided to investigate binding assays of [<sup>3</sup>H]-dynorphin A (1-8) and [<sup>3</sup>H]-dynorphin A (1-9) in homogenates of guinea pig brain and, since both peptides are very sensitive to the peptidases present in the homogenates, to investigate the degradation products and the effects of possible peptidase inhibitors (Robson et al. 1983; Gillan et al. 1985, in press).

The degradation products of [<sup>3</sup>H]-dynorphin A (1-8) or [<sup>3</sup>H]-dynorphin A (1-9) were assessed in the supernatant obtained after centrifugation of the homogenates of guinea pig brain previously incubated at 0°C for 120 minutes or at 25°C for 30 minutes. In the supernatant, 50% to 60% of the tritium appeared as [<sup>3</sup>H]-tyrosine after incubation at 0°C, whether [<sup>3</sup>H]-dynorphin A (1-8) or [<sup>3</sup>H]-dynorphin A (1-9) was used. When bestatin (30 μM) was present during incubation to prevent aminopeptidase activity, 42% of the original [<sup>3</sup>H]-dynorphin A (1-8) was recovered at 0°C and 4% at 25°C. [<sup>3</sup>H]-Dynorphin A (1-9) was even more susceptible to degradation by peptidases since in the presence of bestatin only 20% was recovered after an incubation at 0°C. A mixture of bestatin (30 μM) and captopril (300 μM) was a more effective inhibitor of peptidases. The amount of dynorphin A (1-8) recovered in the supernatant rose to 82% at 0°C and to 37% at 25°C; the amount of recovered dynorphin A (1-9) was 48% at 0°C (Gillan et al. 1985, in press).

In assays for the determination of κ-binding, μ- and δ-bindings were suppressed by the necessary amounts of unlabeled [D-Ala<sup>2</sup>,MePhe<sup>4</sup>, Gly-ol<sup>5</sup>]enkephalin and [D-Ala<sup>2</sup>,D-Leu<sup>5</sup>]enkephalin. The κ-binding of [<sup>3</sup>H]-dynorphin A (1-8) was increased by the addition of bestatin (30 μM) and captopril (300 μM) about 1.4-fold at 0°C and 3.7-fold at 25°C.

Scatchard plots obtained with [<sup>3</sup>H]-dynorphin A (1-8) were found to be linear at 0°C. Protection from degradation by bestatin (30 μM) and captopril (300 μM) lowered the K<sub>D</sub> value, but did not affect the binding capacity of about 3.5 pmol/g brain; the capacity value is similar to that obtained with [<sup>3</sup>H]-dynorphin A (1-9) and [<sup>3</sup>H]-(-)-bremazocine at 0°C. It is also similar to that obtained with different assay conditions (Quirion and Pilapil 1984).

At 25°C, the maximum binding capacity of [<sup>3</sup>H]-dynorphin A (1-8) varied, as did the K<sub>d</sub> values. For this reason, no values are given. As far as [<sup>3</sup>H]-dynorphin A (1-9) is concerned, it was found in an earlier series of experiments (Robson et al. 1983) that the binding capacity was of the order of 4.9 pmol/g brain; this value corresponds to the maximum κ-binding capacity of [<sup>3</sup>H]-(-)-bremazocine after suppression of μ- and δ-bindings (5.4 pmol/g brain).

It would therefore appear that the maximum capacity of κ-binding of [<sup>3</sup>H]-dynorphin A (1-9) and [<sup>3</sup>H]-(-)-bremazocine at 25°C are of the order of 5 pmol/g guinea pig brain and that both of these compounds may be used for investigations in vitro. However, it has to be noted that the sensitivity to peptidases of [<sup>3</sup>H]-dynorphin A (1-9) may cause problems which do not arise with [<sup>3</sup>H]-(-)-bremazocine. On the other hand, [<sup>3</sup>H]-(-)-bremazocine is not κ-selective,

as it binds also to  $\mu$ - and  $\delta$ -sites. Neither of these two compounds is endogenous; in this respect, dynorphin A (1-8) would be advantageous, but in inhibitory assays it is less selective and has a lower affinity to the  $\kappa$ -binding site than dynorphin A (1-9) (table 4).

### THE OPIOID RECEPTORS OF THE HAMSTER VAS DEFERENS ARE OF THE $\delta$ -TYPE

Tissues have recently become available which have only one of the several opioid receptors. The vas deferens of the rabbit contains only  $\kappa$ -receptors (Oka et al. 1981); that of the rat, almost solely  $\mu$ -receptors (Gillan et al. 1981); and that of the hamster, only  $\delta$ -receptors (McKnight et al. 1984a, in press).

This section describes the results obtained with the Golden Syrian hamster. Single vasa deferentia were suspended in 3 ml siliconized organ baths containing Krebs solution kept at 37°C and aerated with 95% oxygen and 5% CO<sub>2</sub>. Contractions were induced by electric field stimulation, by trains consisting of 3 to 4 rectangular biphasic pulses with intervals of approximately 200 msec; the voltage of each pulse was supramaximal (50 to 60 mA) and its duration 1 msec. The rate of trains was 0.1 Hz. The regular contractions caused by electrical stimulation were of about 0.5 to 1 g tension. Omission of Mg from the Krebs solution did not significantly affect the strength of the contraction, in contrast to the finding with the vas deferens of the mouse (Hughes et al. 1975).

The potencies of the opioid peptides were determined with and without addition of the peptidase mixture used in this unit (McKnight et al. 1983), except that the inhibitor thiorphan was raised to 10  $\mu$ M.

The first important observation was that neither the selective  $\mu$ -receptor agonist [D-Ala<sup>2</sup>,MePhe<sup>4</sup>,Gly-ol<sup>5</sup>]enkephalin nor the selective  $\kappa$ -receptor agonist U-50, 488H had any significant activity in the hamster vas deferens. The IC<sub>50</sub> values of these compounds and of normorphine were >10,000. Thus, the hamster vas deferens has no significant amounts of  $\mu$ - and  $\kappa$ -opioid receptors.

In contrast, all the endogenous and exogenous opioid peptides which interact with the  $\delta$ -binding site are active in the hamster vas deferens, either as agonists or antagonists (McKnight et al. 1984a, in press). When peptidase inhibitors had been added to the solution of the test medium, the agonist potencies (IC<sub>50</sub>) of [D-Ala<sup>2</sup>, D-Leu<sup>5</sup>]-enkephalin, [D-Thr<sup>2</sup>,Leu<sup>5</sup>]enkephalyl-Thr, and [D-Ser<sup>2</sup>,Leu<sup>5</sup>]enkephalyl-Thr were all of the order of 21 nM. These peptides are relatively selective as  $\delta$ -ligands; the highly selective [D-Pen<sup>2</sup>,D-Pen<sup>5</sup>]-enkephalin (Mosberg et al. 1983; Corbett et al. 1984) gave an IC<sub>50</sub> value of 82 nM, and a similar value was obtained for [D-Pen<sup>2</sup>,L-Pen<sup>5</sup>]-enkephalin. It should be noted that only the two latter peptide analogues and [D-Ala<sup>2</sup>,D-Leu<sup>5</sup>]enkephalin are resistant to peptidases, whereas the potencies of [D-Thr<sup>2</sup>,Leu<sup>5</sup>]enkephalyl-Thr and [D-Ser<sup>2</sup>,Leu<sup>5</sup>]enkephalyl-Thr are increased Ten-fold when antipeptidases are added to the bath fluid. [Met<sup>3</sup>]Enkephalin and [Leu<sup>5</sup>]enkephalin are the only endogenous opioid peptides which are active in the

hamster vas deferens; they required antipeptidase to measure their activity.

The most selective  $\delta$ -antagonist available at present is ICI 174864 (N,N-diallyl-Tyr- $[\alpha$ -aminoisobutyric acid]<sub>2</sub>-Phe-Leu-OH) (Cotton et al. 1984; Corbett et al. 1984) with a  $K_e$  value of approximately 30 nM; naloxone, which has affinities to the three opioid receptors, interacts in the hamster vas deferens only at the  $\delta$ -site, and is an antagonist with a potency similar to that of ICI 174864. It is of particular interest that the benzomorphans, bremazocine and ethylketazocine, which have affinities not only to the  $\kappa$ -site but also at the  $\mu$ - and  $\delta$ -sites, are antagonists in the hamster vas deferens. Bremazocine is a particularly potent  $\delta$ -antagonist with  $K_e$  values of 6.9 nM against [D-Ala<sub>2</sub>,D-Leu<sub>5</sub>]enkephalin and 15.8 nM against [D-Ser<sup>2</sup>,Leu<sup>5</sup>]enkephalyl-Thr as agonists.

In conclusion, the hamster vas deferens is a selective in vitro preparation for the assay of  $\delta$ -receptor activities of exogenous peptides and exogenous peptide analogues and nonpeptide compounds. It is also very important to realize that the widely used  $\kappa$ -agonists of the benzomorphan group are antagonists at other receptors in the nervous system; for instance, ethylketazocine and bremazocine are antagonists at the  $\mu$ -receptor in the rat vas deferens and antagonists at the  $\delta$ -receptor in the hamster vas deferens (Gillan et al. 1981; McKnight et al. 1984a).

#### **TRANSIENT AND PERSISTENT OPIOID EFFECTS OF $\beta$ -FUNALTREXAMINE IN THE MYENTERIC PLEXUS OF THE GUINEA PIG ILEUM**

$\beta$ -Funaltrexamine ( $\beta$ -FNA), the fumaramate methyl ester of naltrexone, is an acute agonist in the isolated myenteric plexus-longitudinal muscle preparation of the guinea pig, but preincubation with  $\beta$ -FNA causes a decrease in the agonist responses to morphine but not to ethylketazocine. Portoghese and his group found that in acute experiments these effects are transient. However, after prolonged exposure of  $\beta$ -FNA for 30 minutes or more, the depressant effects on the action of morphine are not reversed by repeated changing of the bath fluid, but similar effects on the action of ethylketazocine are reversible (Portoghese et al. 1980; Takemori et al. 1981; Ward et al. 1982). Part of the binding of [<sup>3</sup>H]- $\beta$ -FNA in homogenates of brains of guinea pig end mouse is irreversible (Fries et al. 1980; Ward et al. 1980). Preincubation of rat brain with  $\beta$ -FNA reduced the binding of [<sup>3</sup>H]-naltrexone (Rothman et al. 1983). Finally, evidence has been presented which supports the view that these findings can be explained if  $\beta$ -FNA acts at a site which is not the binding site itself but a secondary regulatory site (Portoghese and Takemori 1983).

The data presented in this section have the purpose of confirming the results obtained by Portoghese and his colleagues and extending them by the use of highly selective opioid ligands. The two approaches (McKnight et al. 1984b; Corbett et al., in press) were binding assays on homogenates of guinea pig brain and bioassays using preparations of the myenteric plexus-longitudinal muscle of the guinea pig and the vas deferens of the rabbit as described by Corbett et al. (1982). The preincubation period was with 100 nM  $\beta$ -FNA for 30



minutes, unless stated otherwise; the tissue was then washed for 60 minutes in order to remove unbound  $\beta$ -FNA. Antagonist potency of naloxone ( $K_e$ ) was determined against [D-Ala<sup>2</sup>,MePhe<sup>4</sup>,Gly-ol<sup>5</sup>]enkephalin in control groups and in preparations pretreated with  $\beta$ -FNA. Binding of tritiated ligand was determined by the method of Leslie and Kosterlitz (1979). Binding was determined with the  $\mu$ -selective [<sup>3</sup>H]-[D-Ala<sup>2</sup>,MePhe<sup>4</sup>,Gly-ol<sup>5</sup>]enkephalin (6 nM) and the  $\kappa$ -selective [<sup>3</sup>H]-(-)-bremazocine (0.5 nM) in the presence of 250 nM each of unlabeled [D-Ala<sup>2</sup>,MePhe<sup>4</sup>,Gly-ol<sup>5</sup>]enkephalin and [D-Ala<sup>2</sup>,D-Leu<sup>5</sup>]enkephalin to suppress  $\mu$ - and  $\delta$ -binding.

In naive preparations of the myenteric plexus, [D-Ala<sup>2</sup>,MePhe<sup>4</sup>,Gly-ol<sup>5</sup>]enkephalin is a potent  $\mu$ -agonist with an  $IC_{50}$  of 4.35 nM, whereas after pretreatment with 100 nM  $\beta$ -FNA for 30 minutes, this value increased to 80 nM; when the concentration of  $\beta$ -FNA was raised to 1000 nM, the  $IC_{50}$  of [D-Ala<sup>2</sup>,MePhe<sup>4</sup>,Gly-ol<sup>5</sup>]enkephalin was not significantly increased to 91 nM. These findings are in agreement with those of Portoghese and his group, obtained with the less  $\mu$ -selective compound morphine. A new important finding is the fact that the antagonist activity of naloxone is not affected by pretreatment of the preparation with 100 nM  $\beta$ -FNA for 30 minutes. The  $K_e$  value was 1.9 nM before and 1.8 nM after pretreatment; if the concentration of  $\beta$ -FNA was increased to 1000 nM, the  $K_e$  value was raised to 4.7 nM. Thus, pretreatment with 100 nM  $\beta$ -FNA for 30 minutes irreversibly raises the agonist value of [D-Ala<sup>2</sup>,MePhe<sup>4</sup>,Gly-ol<sup>5</sup>]enkephalin about 11-fold without affecting the antagonist effect of naloxone (McKnight et al. 1984b; Corbett et al., in press).

It was of interest to correlate these observations with data obtained from binding assays. In homogenates of the myenteric plexus  $\beta$ -FNA inhibited the binding of the selective  $\mu$ -ligand [<sup>3</sup>H]-[D-Ala<sup>2</sup>,MePhe<sup>4</sup>,Gly-ol<sup>5</sup>]enkephalin ( $K_i = 0.8$ ) more potently than the binding of [<sup>3</sup>H]-(-)-bremazocine ( $K_i = 12.1$ ) made selective for  $\kappa$ -binding by the addition of unlabeled  $\mu$ - and  $\delta$ -ligands. Pretreatment with 100 or 1000 nM  $\beta$ -FNA for 30 or 60 minutes at 37°C did not reduce the binding of either the  $\mu$ -ligand (6 nM) or the  $\kappa$ -ligand (0.5 nM) in the myenteric plexus of the guinea pig ileum. However, when the pretreatment with  $\beta$ -FNA was increased to 500 nM for 60 minutes, in homogenates of guinea pig brain,  $\mu$ -binding was reduced by about 20% but  $\kappa$ -binding was unaffected (McKnight et al. 1984b; Corbett et al., in press). This observation was similar to that found with [<sup>3</sup>H]-naloxone binding in rat brain after pretreatment with 1000 nM for 60 minutes (Rothman et al. 1983).

The findings presented in this section support the view first proposed by Portoghese and Takemori (1983) that the irreversible action of  $\beta$ -FNA on the  $\mu$ -receptor is not at the binding site itself, but on a secondary regulatory site which so far has not been identified experimentally. As  $\beta$ -FNA does not affect the response of selective  $\kappa$ -ligands on the action of  $\kappa$ -receptors in the guinea pig ileum, the regulatory effect on the coupling between activation of the binding site and the effector response applies only to the action of  $\mu$ -ligands but not of  $\kappa$ -ligands. For a further analysis of these phenomena, it will be necessary to understand the reasons why there is the absence of an effect of pretreatment by  $\beta$ -FNA (1) on binding

of the selective  $\mu$ -ligand [D-Ala<sup>2</sup>,MePhe<sup>4</sup>,Gly-ol<sup>5</sup>]enkephalin at concentrations which depress the response of the myenteric plexus to electrical stimulation and (2) on the antagonist action of naloxone on  $\mu$ -receptors when, at the same time, the agonist action of the selective  $\mu$ -ligand is reduced by about 90%.

## CONCLUSIONS

1. Agonist and antagonist ligands should have a high degree of selectivity for one type of opioid receptor. This requirement has been achieved with the  $\mu$ -ligand [D-Ala<sup>2</sup>,MePhe<sup>4</sup>,Gly-ol<sup>5</sup>]enkephalin and with the  $\delta$ -ligand [D-Pen<sup>2</sup>,D-Pen<sup>5</sup>]enkephalin or [D-Pen<sup>2</sup>,L-Pen<sup>5</sup>]enkephalin. Furthermore, both ligands are peptidase-resistant. With regard to  $\kappa$ -ligands, the situation is such less satisfactory. Dynorphin A (1-9) is almost sufficiently selective for  $\kappa$ -binding, but is readily degraded by peptidases: it is probably possible to use this fragment of dynorphin A at 0°C. U-50,488H is a highly selective  $\kappa$ -ligand; it is stable but has a low potency. The selectivity of tifluadom is almost as high as that of dynorphin A (1-9), but it has a much lower potency. The benzomorphan analogues --ethylketazocine, bremazocine, and Mr 2034--are agonists at the  $\kappa$ -receptor but antagonists at the  $\mu$ - and  $\delta$ -receptors. Naloxone is usually used as a selective  $\mu$ -antagonist; however, this is only true in concentrations of not more than 15 nM because in higher concentrations it interacts also at  $\delta$ - and  $\kappa$ -receptors. The  $\delta$ -antagonist ICI 174864 is selective but is of rather low potency. Mr 2266 is an antagonist at both the  $\kappa$ -receptor and  $\mu$ -receptor.

2. The tissues which have only one type of opioid receptor are the hamster vas deferens, which has  $\delta$ -receptors, and the rabbit vas deferens, which has  $\kappa$ -receptors. On the other hand, the guinea pig myenteric plexus-longitudinal muscle has  $\mu$ - and  $\kappa$ -receptors, the mouse vas deferens has  $\mu$ -,  $\delta$ -, and  $\kappa$ -receptors and the rat vas deferens has  $\mu$ -receptors and perhaps the putative  $\epsilon$ -receptor.

3. While  $\beta$ -funaltrexamine blocks irreversibly the effect of  $\mu$ -agonists on the response to electrical stimulation of the guinea pig myenteric plexus and the mouse vas deferens, it does not affect the binding of  $\mu$ -,  $\delta$ -, or  $\kappa$ -ligands after pretreatment with up to 1000 nM for 60 minutes. These observations confirm the view proposed by Portoghese and his colleagues that the irreversible action of  $\beta$ -funaltrexamine is not at the binding site itself.

4. Finally, it should be noted that several opioid peptides from which the N-terminal tyrosine has been inactivated or removed may still have nonopioid biological activity. Such observations are increasing and may become of importance, e.g., studies by Schweiger et al. (1982), McCain et al. (1982), Przewlocki et al. (1983), and Puett et al. (1983).

## REFERENCES

- Corbett, A.D.; Paterson, S.J.; McKnight, A.T.; Magnan, J.; and Kosterlitz, H.W. Dynorphin<sub>1,8</sub> and dynorphin<sub>1,9</sub> are ligands for the  $\kappa$ -receptor. Nature 299:79-81, 1982.

- Corbett, A.D.; Gillan, M.G.C.; Kosterlitz, H.W.; McKnight, A.T.; Paterson, S.J.; and Robson, L.E. Selectivities of opioid peptide analogues as agonists and antagonists at the  $\delta$  receptor. Br J Pharmacol 83:271-279, 1984.
- Corbett, A.D.; Kosterlitz, H.W.; McKnight, A.T.; Paterson, S.J.; and Robson, L.E. Pre-incubation of guinea-pig myenteric plexus with  $\beta$ -funaltrexamine. Discrepancy between binding assays and bioassays. Br J Pharmacol, in press.
- Cotton, R.; Giles, M.B.; Miller, L.; Shaw, J.S.; and Timms, T. ICI 174864: A highly selective antagonist for the opioid  $\delta$ -receptor. Eur J Pharmacol 78:385-387, 1984.
- Fries, D.S.; Ward, S.J.; Larson, D.L.; Portoghese, P.S.; and Takemori, A.E. Opioid receptor binding characteristics of the fumaramido methyl ester derivative ( $\beta$ -FNA) of naltrexone. The Pharmacologist 22:305, 1980.
- Gillan, M.G.C.; Kosterlitz, H.W.; and Magnan, J. Unexpected antagonism in the rat vas deferens by benzomorphans which are agonists in other pharmacological tests. Br J Pharmacol 72:13-15, 1981.
- Gillan, M.G.C.; Robson, L.E.; McKnight, A.T.; and Kosterlitz, H.W. [ $^3$ H]-Dynorphin A (1-8): Degradation profile and binding characteristics in brain homogenates. Neuropeptides 5:533-536, 1985.
- Gillan, M.G.C.; Robson, L.E.; McKnight, A.T.; and Kosterlitz, H.W. W-Binding and degradation of [ $^3$ H]-dynorphin A (1-8) and [ $^3$ H]-dynorphin A (1-9) in suspensions of guinea-pig brain membranes. J Neurochem, in press.
- Hughes, J.; Kosterlitz, H.W.; and Leslie, F.M. Effect of morphine on adrenergic transmission in the mouse vas deferens. Assessment of agonist and antagonist narcotic analgesics. Br J Pharmacol 53:371-381, 1975.
- Kosterlitz, H.W., and Paterson, S.J. Types of opioid receptors: Relation to antinociception. Philos Trans R Soc Lond [Biol] 308:291-297, 1985.
- Leslie, F.M., and Kosterlitz, H.W. Comparison of binding of [ $^3$ H]-methionine-enkephalin, [ $^3$ H]-naltrexone and [ $^3$ H]-dihydromorphine in the mouse vas deferens and the myenteric plexus and brain of the guinea-pig. Eur J Pharmacol 56:379-383, 1979.
- McCain, H.W.; Lamster, I.B.; Bozzone, J.M.; and Grbic, J.T.  $\beta$ -Endorphin modulates human immune activity via non-opiate receptor mechanisms. Life Sci 31:1619-1624, 1982.
- McKnight, A.T.; Corbett, A.D.; and Kosterlitz, H.W. Increase in potencies of opioid peptides after peptidase inhibition. Eur J Pharmacol 86:393-402, 1983.
- McKnight, A.T.; Corbett, A.D.; Marcoli, M.; and Kosterlitz, H.W. Hamster vas deferens contains  $\delta$ -opioid receptors. Neuropeptides 5:97-100, 1984a.
- McKnight, A.T.; Paterson, S.J.; Corbett, A.D.; and Kosterlitz, H.W. Acute and persistent effects of  $\beta$ -funaltrexamine on the binding and agonist potencies of opioids in the myenteric plexus of the guinea-pig ileum. Neuropeptides 5:169-172, 1984b.
- McKnight, A.T.; Corbett, A.D.; Marcoli, M.; and Kosterlitz, H.W. The opioid receptors in the hamster vas deferens are of the  $\delta$ -type. Neuropharmacology, in press.

- Mosberg, H.I.; Hurst, R.; Hruby, V.J.; Gee, K.; Yamamura, H.I.; Galligan, J.J.; and Burks, T.F. Bis-penicillamine enkephalins possess highly improved specificity towards  $\delta$  opioid receptors. Proc Natl Acad Sci USA 80:5871-5874, 1983.
- Oka, T.; Negishi, K.; Suda, M.; Matsumiya, T.; Inazu, T.; and Ueki, T. Rabbit vas deferens: A specific bioassay for opioid  $\kappa$ -receptor agonists. Eur J Pharmacol 73:235-236, 1981.
- Paterson, S.J.; Corbett, A.D.; Gillan, M.G.C.; Kosterlitz, H.W.; McKnight, A.T.; and Robson, L.E. Radioligands for probing opioid receptors. J Receptor Res 4:143-154, 1984a.
- Paterson, S.J.; Robson, L.E.; and Kosterlitz, H.W. Opioid receptors. In: Udenfriend, S., and Meienhofer, J., eds. The Peptides. Vol. 6. New York: Academic Press, Inc., 1984b. pp. 147-189.
- Piercey, M.F.; Lahti, R.A.; Schroeder, L.A.; Einspahr, F.J.; and Bahrsuhn, C. U-50488H, a pure kappa receptor agonist with spinal analgesic loci in the mouse. Life Sci 31:1197-1200, 1982.
- Portoghtst, P.S., and Takemori, A.E. Different receptor sites mediate opioid agonism and antagonism. J Med Chem 26:1341-1343, 1983.
- Portoghtst, P.S.; Larson, D.L.; Sayre, L.M. Fries, D.S.; and Takemori, A.E. A novel opioid receptor site directed alkylating agent with irreversible narcotic antagonistic and reversible agonistic activities. J Med Chem 23:233-234, 1980.
- Przewlocki, R.; Shearman, G.T.; and Herz, A. Mixed opioid/nonopioid effects of dynorphin and dynorphin related peptides after their intrathecal injection in rats. Neuropeptides 3:233-240, 1983.
- Puett, D.; Giedrock, D.P.; and Tollefson, S. des-(1-13) Human  $\beta$ -endorphin interacts with calmodulin. Peptides 4:191-194, 1983.
- Quirion, R., and Pilapil, C. Opioid receptor binding profile of [ $^3$ H]-dynorphin A-(1-8) in rat and guinea-pig brain. Eur J Pharmacol 99:361-363, 1984.
- Robson, L.E.; Gillan, M.G.C.; McKnight, A.T.; and Kosterlitz, H.W. [ $^3$ H]-Dynorphin A (1-9): Binding characteristics and degradation profile in brain homogenates. Life Sci 33(Supp I): 283-286, 1983.
- Rothman, R.B.; Bowen, W.D.; Schumacher, U.K.; and Pert, C.B. The effect of  $\beta$ -FNA on opiate receptor binding: Preliminary evidence for two types of  $\mu$ -receptors. Eur J Pharmacol 95:147-148, 1983.
- Schweiger, L.; Bhakdi, S.; and Teschemacher, H. Specific non-opiate binding sites for human  $\beta$ -endorphin on the terminal complex of human complement. Nature 296:572-574, 1982.
- Takemori, A.E.; Larson, D.L.; and Portoghese, P.S. The irreversible narcotic antagonistic and reversible agonistic properties of the fumaramate methyl ester derivative of naltrexone. Eur J Pharmacol 70:445-451, 1981.
- Ward, S.J.; Portoghese, P.S.; and Takemori, A.E. Binding characteristics of the  $\mu$ -antagonist  $\beta$ -FNA, the fumaramate methyl ester of naltrexone. Fed Proc 40:289, 1980.
- Ward, S.J.; Portoghese, P.S.; and Takemori, A.E. Improved assays for the assessment of  $\kappa$ - and  $\mu$ -properties of opioid ligands. Eur J Pharmacol 85:163-170, 1982.
- Weber, E.; Evans, C.J.; and Barchas, J.D. Predominance of the amino-terminal octapeptide fragment of dynorphin in rat brain regions. Nature 299:77-79, 1982.

## **ACKNOWLEDGMENTS**

Supported by grants from the Medical Research Council and the National Institute on Drug Abuse (DA-00662).

## **AUTHORS**

Hans W. Kosterlitz, M.D., Ph.D.  
Alistair D. Corbett, Ph.D.  
Maureen G.C. Gillan, Ph.D.  
Alexander T. McKnight, Ph.D.  
Stewart J. Paterson, B.Sc.  
Linda E. Robson, Ph.D.  
University of Aberdeen  
Unit for Research on Addictive Drugs  
Marischal College  
Aberdeen, AB9 1AS, Scotland

# Endorphins and Memory Regulation

Ivan Izquierdo, M.D., Ph.D.; Carlos A. Netto, M.D.; and Renato D. Dias, M.D.

Memory can only be evaluated by measuring retrieval at various times from a training experience. The mechanisms underlying memory formation are not known. Changes in ionic conductance and neurotransmitter release that may underly changes in neuronal electrical activity might explain some short-lived memory processes in invertebrates, but not memory that lasts for days, months, or years in mammals (Greenough 1984). Hypotheses on the storage of memory molecules were popular years ago but have now fallen into discredit, mainly because the half-life of all known molecules, particularly proteins, is orders of magnitude shorter than the duration of memory in vertebrates (Greenough 1984). Cajal's (1911) postulation that memory may involve structural synaptic changes, including the formation of new synapses, has received some recent support (Greenough 1984); but it cannot explain retrieval in seconds or minutes after training, which is behaviorally indistinguishable from retrieval at longer periods (same stimuli, same responses) and is thus probably mediated by similar sensorimotor coupling systems (although it may be modulated by different systems, as discussed below).

We believe that at this stage the most judicious attitude toward putative memory mechanisms is agnosticism coupled with an intense search for the mechanisms that modulate retrieval at different stages in the training-test process. One reason for this attitude is that it is inefficient to invest worry, time, and money in a task for which we have neither the tools nor a good theoretical framework. We do not really know how to look for memory (we can only measure retrieval), or what to look for (is there an engram? is there a record anywhere in the brain of past experiences? what if all neural activity tends to leave a trace and what we measure as retrieval is only the result of poor inhibition?). The other

reason for the active agnosticism proposed above is that a large and increasing segment of the population --the old-- suffers from memory disturbances. Many of these are accompanied by cell loss or by a reduction in the number of synapses in brain regions involved in memory regulation. These structural losses cannot be helped by any form of replacement therapy. Even if brain grafts some day become clinically feasible, it would be impracticable to implant the brain connections relevant to a face one has forgotten or a music piece one does not remember how to play. There is hope for the alleviation of memory disorders in the search for drugs active upon the diverse modulatory systems that appear to be deranged in patients and/or in animals with age- or disease-related memory disturbances: the cholinergic (Bartus et al. 1982), central catecholaminergic (Winblad et al. 1985), brain opioid (Gambert et al. 1980; Jensen et al. 1980, 1981), and pituitary hormonal systems (Jensen et al. 1981).

This chapter reviews evidence pointing to the involvement of one of the three major opioid systems of the brain, the hypothalamic beta-endorphin system, in memory regulation. As will be seen, this system interacts with the other systems mentioned above.

#### **EFFECTS OF THE POSTTRAINING ADMINISTRATION OF OPIATE ANTAGONISTS AND OF OPIOID PEPTIDES ON RETRIEVAL**

Memory facilitation by the opiate antagonist naloxone was first described by Gallagher and Kapp (1978) and Jensen et al. (1978) in an inhibitory avoidance task, and by Izquierdo (1979) in classical and avoidance conditioning in a shuttle box and in a habituation task. Since then, this has become the most confirmed posttraining pharmacological effect in the memory literature: it has been observed in 29 aversive and nonaversive tasks: in 14 different laboratories: and in 6 different species, including humans (Izquierdo et al. in press, b).

The memory facilitating effect of naloxone has usually been reported using posttraining injections, but it can also be observed using pretraining administrations (Izquierdo 1980a). The effect is shared by other opiate antagonists, whose decreasing order of potency for this effect roughly parallels their decreasing order of affinity for opiate mu receptors: diprenorphine > naltrexone > naloxone > levallorphan > dextrallorphan = 0 (Gallagher

Posttraining memory facilitation by naloxone suggests that endogenous opioids may physiologically modulate memory at that time (Izquierdo 1979). Opiates had been known for some time to depress memory at low, subanalgesic doses and to facilitate retention at high, toxic doses given after training (e.g., 100 mg/kg of morphine, Mondadori and Waser 1979). The effect of these high doses may be due to a strengthening of the aversive motivation rather than to a memory effect: animals learn a given behavior in order to avoid not only the shock, but also the drug that comes after the shock and makes them feel sick (Izquierdo 1982). The i.c.v. administration of 200 ug of Met-enkephalin in rats, which is roughly  $10^3$  times the total brain content of that substance, facilitates the retention of avoidance behavior (Stein and Belluzzi 1978); doses 10,000 to 40,000 times lower have an amnesic effect (Lucion et al. 1982). A major reason to believe that these effects of toxic doses of opiates or opioids do not reflect their physiological role in memory is that, contrarily to all other posttraining facilitatory drugs known (Gold and McGaugh 1975), naloxone does not have an inverted U dose-response curve: it facilitates memory over a very wide dose range (Gallagher 1982).

Subanalgesic doses of opioid peptides given i.p. or i.c.v. shortly after training inhibit retrieval of aversive and nonaversive tasks in rats or mice: shuttle avoidance (Izquierdo et al. 1980a). various forms of inhibitory avoidance (Martinez and Rigter 1980; Izquierdo and Dias 1983a, 1983b, 1983c, 1983d, in press; Introini and Baratti 1984; Irquierdo and Netto 1985a, 1985b), habituation to a tone (Izquierdo et al. 1980a), or to a new environment (Itquierdo and Netto, in press), etc. The effect of beta-endorphin can also be observed upon pretraining administration (Itquierdo 1980a, 1980b), in which case it can be antagonized by posttraining naloxone (Itquierdo 1980b), which shows that it develops after rather than during training. Pretraining beta-endorphin administration disrupts acquisition only at doses 10 or 20 times higher than those which affect retention (Izquierdo 1980b), which stands in contrast to the effects of the enkephalins. The posttraining i.p. or i.c.v. injection of Met- or Leu-enkephalin also disrupts retrieval (Izquierdo 1982; Lucion et al. 1982); but their injection prior to training markedly depresses acquisition at doses even lower than those that affect retention (Dias et al. 1982), which rules them out as physiological modulators. If they were released during training, they would make learning impossible (Dias et al. 1982; Izquierdo 1982).



On a molar basis, beta-endorphin is 6 to 10 times more potent than the enkephalins in producing memory disruption given i.p. (Dias et al. 1982) or i.c.v. (Lucion et al. 1982). This is further suggestion of an involvement of opiate mu receptors in posttraining memory regulation (Izquierdo and Netto 1985a). In the rat (Izquierdo et al., in press, a), but not in the mouse (Introini et al., in press), dynorphin has no effect. The effective dose range for beta-endorphin is 0.1 to 10.0 ug/kg i.p. (Izquierdo et al. 1980b; Martinez and Rigter 1980) or 5.0 to 25.0 ng/rat i.c.v. (Lucion et al. 1982).

Naloxone antagonizes the posttraining amnesic effect of morphine (Izquierdo 1979), levorphanol (Gallagher and Kapp 1978), the enkephalins (Irquierdo 1982), and beta-endorphin (Irquierdo 1982; Irquierdo and Dias 1983a, in press; Irquierdo and Netto 1985b). At least, the antagonism between naloxone and beta-endorphin appears to be competitive (Izquierdo 1982).

The enkephalins morphine, adrenocorticotropin (ACTH), epinephrine (Carrasco et al. 1982b). and possibly vasopressin (Izquierdo and Dias, in press) release beta-endorphin from the rat hypothalamus. This may explain wholly or in part the amnesic effect of morphine or the enkephalins at low doses, or of the hormones at high doses (Gold and Delanoy 1981; Hagan et al. 1982; Izquierdo and Dias 1983a, in press).

#### **BETA-ENDORPHIN IS RELEASED IN THE RAT BRAIN BY ALL FORMS OF TRAINING STUDIED SO FAR**

The biosynthesis of beta-endorphin takes hours (Liotta et al. 1980) and the ratio of beta-endorphin to its precursors is high in the hypothalamus and other brain regions (Rossier et al. 1977). Therefore, if a given treatment is shown to reduce hypothalamic beta-endorphin immunoreactivity in a matter of minutes, the effect may reasonably be attributed to a release of the substance.

All forms of training studied so far cause a quick decrease of rat hypothalamic beta-endorphin immunoreactivity: simple exposure to a training apparatus with no shocks or any other stimulation during 30 seconds (Perry et al. 1983; Izquierdo et al. 1984; Izquierdo and Netto 1985a) or 2 minutes (Izquierdo and Netto, in press), various forms of inhibitory avoidance (Perry et al, 1983; Izquierdo et al. 1984; Izquierdo and Netto 1985a). a single 5-second inescapable footshock (Izquierdo et al. 1984). 50 footshocks over 25 minutes (Izquierdo et al. 1980b, 1981, 1982, 1984), 50 low level tones over 25 minutes (Izquierdo et al. 1984), 50 tone-footshock trials

using tone-footshock pairings over 25 minutes (Izquierdo et al. 1980b, 1981, 1982, 1984), and extinction of the shuttle avoidance task using tones alone (Izquierdo et al. 1984).

The effect is observed only when the animals are exposed to each task for the first time; a repetition of the task (i.e., a test session) is not accompanied by a brain beta-endorphin release (Izquierdo et al. 1982, 1984). The effect obviously does not depend on the duration of the tasks, on the type of learning, on the presence of footshocks, on the intensity or the number of footshocks, or on the degree of stress or arousal presumably involved in each task (Izquierdo et al. 1984). Therefore, it may be considered as a result of "novelty" (Izquierdo et al. 1984; Izquierdo and Netto 1985a). The effect is indeed abolished by prior bilateral transection of the fornix (Izquierdo and Netto 1985a; Netto et al. 1985), but not by other hypothalamic deafferentations. The fornix is the output of the hippocampal system, which has been proposed to be involved in the recognition of novelty (Gray 1982). Whether the release of beta-endorphin caused by training is due just to the recognition of novelty, or to a reaction to it, or to the inhibition of that reaction (i.e., habituation) is not known (Izquierdo and Netto, in press).

Depending on how the brain is dissected, the beta-endorphin depletion caused by training can also be observed in the rest of the brain excluding the hypothalamus (Izquierdo et al. 1980b, 1982). The depletion can be observed as early as 3 minutes (Izquierdo et al. 1984) or 6 minutes (Izquierdo and Netto 1985a; Netto et al. 1985) after training and lasts for over 2 hours; recovery is complete at 6 hours from training (Izquierdo and Netto 1985a).

None of the forms of training listed above, with the exception of repeated footshocks (Rossier et al. 1977; Izquierdo et al. 1981), release pituitary beta-endorphin, as measured either in the gland or in the plasma (Perry et al. 1983). Repeated footshocks release beta-endorphin immunoreactive material together with ACTH into the plasma (Rossier et al. 1977). The role of circulating beta-endorphin is not known.

In contrast to brain beta-endorphin, brain Met-enkephalin is unchanged by habituation or shuttle avoidance in rats (Carrasco et al. 1982c), two tasks whose memory is strongly affected by pre- or posttraining naloxone administration (Izquierdo 1979). This, together with the other reasons given above, rules out the enkephalins from

an involvement in posttraining memory modulation. Reasons for excluding the dynorphin systems (lack of generality across species, lack of pretest effects) are given elsewhere in detail (Introini et al., in press). Therefore, evidence points to the brain (but not to the pituitary) beta-endorphin system as the only major endogenous opioid system involved in memory regulation; and the influence of the opioid receptor blockers on retention may be explained by an interference with the normal operation of this system (Izquierdo 1982; Izquierdo and Netto 1985a).

**RELATION BETWEEN THE AMOUNT OF HYPOTHALAMIC BETA-ENDORPHIN RELEASED BY TRAINING AND EFFECTIVE DOSES OF THIS SUBSTANCE**

All training procedures studied so far reduce brain beta-endorphin immunoreactivity by approximately the same amount, equivalent to 15 to 30 ng of beta-endorphin per brain (Izquierdo et al. 1984; Izquierdo and Netto, in press). This amount is similar to doses of the substance that affect memory when given i.c.v. (5 to 25 ng) (Lucion et al. 1982; de Almeida and Izquierdo 1984), and corresponds to about 20% of the i.p. ED<sub>50</sub> of the drug (Dias et al. 1982). Approximately 20% of a systemic dose of this substance enters the cerebrospinal fluid in rabbits within 1 hour from injection (Houghten et al. 1980). Therefore, it is reasonable to postulate a role for brain beta-endorphin in posttraining memory regulation.

Injected beta-endorphin does penetrate the cerebrospinal fluid in significant amounts, but it is probably quickly inactivated once in contact with brain tissue by the removal of N-terminal tyrosine. At 1 hour from injection of either <sup>125</sup>I-labeled (Izquierdo et al. 1980b) or <sup>3</sup>H-Tyr<sup>1</sup> or <sup>27</sup>-labeled beta-endorphin (Houghten et al. 1980). 20% of the label may be found in the brain; but when the <sup>3</sup>H-Tyr label is used, radioactivity corresponds almost exclusively to free tyrosine, in contrast to cerebrospinal fluid radioactivity, which was 75% intact beta-endorphin (Houghten et al. 1980). However, the report using <sup>3</sup>H-Tyr labeling does not mention whether the label was at position 1 or 27 in the experiment in which free tyrosine radioactivity was found in brain tissue. Clearly, interpretations could be very different depending on where the label was.

Anyway, since beta-endorphin has very powerful effects on behavior when given i.c.v. (Lucion et al. 1982; de Almeida and Izquierdo 1984). it must be acting on receptors somewhere in the brain; and since it enters the cerebrospinal fluid when injected, it is likely that those receptors are near the ventricular walls. The area

close to the walls of the third ventricle is particularly rich in opiate receptors and in beta-endorphin containing fibers originating in the medial basal hypothalamus (Bloom and McGinty 1981). Presumably the peptide acts on periventricular receptors and is destroyed soon afterwards (Izquierdo and Netto 1985a).

#### **POSTTRAINING MEMORY MODULATION BY ENDOGENOUSLY RELEASED OR INJECTED BETA-ENDORPHIN: INTERPRETATIONS**

Agents that alter retention when given at the post-training period are usually assumed to affect consolidation (McGaugh and Herz 1972; Gold and McGaugh 1975; Izquierdo 1979; Izquierdo and Dias 1983a); i.e., the hypothetical process by which recently acquired information is transformed, at a loss, from an initially unstable into a long-lasting stable trace (Izquierdo et al. 1982).

There are, however, alternative explanations for post-training drug effects. One, as was mentioned, is that they may add to the motivational component of the tasks; for example, by generating an aversive state that will reinforce behavior in addition to the customary footshocks used during training. Posttraining effects of opioid peptides obtained with i.p. or i.c.v. doses within the physiological range, or of naloxone, cannot be explained by motivational effects. These substances affect retention of aversive and nonaversive tasks with very different response requirements and very different motivation in the same way: opioids reduce, and naloxone enhances, retrieval measured 1 day or more after training.

These findings also rule out a second possible alternative explanation for posttraining drug effects: that they may establish long-lasting changes in general activity, thus leading to an enhancement of response suppression or of response commission.

There is, however, a third alternative explanation for posttraining drug effects: that they may add to the context of the task by setting up a "state" from which memory may become dependent for retrieval (Zornetzer 1978; Izquierdo 1984). In other words, that they may establish a form of state dependency (Overton 1974) involving the posttraining period and the state at the time of testing (Izquierdo and Dias 1983b, 1983c, in press; Izquierdo 1984). As will be seen below, current evidence supports this interpretation in the case of beta-endorphin.

## BETA-ENDORPHIN INDUCED STATE DEPENDENCY

The first indications that the posttraining deleterious effect of beta-endorphin on retention could be due to the establishment of a neurohumoral "asymmetry" (Overton 1974) between the posttraining period and the test session came from various sources. As mentioned above, the release of brain beta-endorphin is asymmetrical: it occurs after training, but not after test, sessions unless the task is changed (Izquierdo et al. 1984). In 1978, de Wied et al. reported that administration of this substance prior to testing retarded the extinction of a one-way active avoidance task; effective doses were similar to those that impair retention when given after training. This was confirmed by Izquierdo (1980a) using a shuttle avoidance and a habituation task, and by Izquierdo and Dias (1983b, in press) using inhibitory avoidance conditioning. Pretest retrieval enhancement can be obtained using 1.0 or 2.0 ug/kg of beta-endorphin given i.p. or 25 ng/rat given i.c.v. (de Almeida and Izquierdo 1984).

Posttraining naloxone would reduce the asymmetry caused by the injection or the release of beta-endorphin exclusively after training; and pretest beta-endorphin administration would also reduce the asymmetry. Thus, both treatments would be expected to facilitate retrieval, which is exactly what they do. In contrast, posttraining beta-endorphin administration would enhance the asymmetry and would be expected to disrupt retrieval, which is exactly what it does (Izquierdo and Dias, in press).

The state dependency interpretation is further substantiated by recent observations in animals with bilateral section of the fornix. This lesion blocks the hypothalamic release of beta-endorphin caused by training (Netto et al. 1985; Izquierdo and Netto 1985a). In rats with bilateral section of the fornix, both the posttraining effect of naloxone and the pretest effect of beta-endorphin are not seen (Izquierdo and Netto 1985b).

As was mentioned, the hypothalamic release of beta-endorphin caused by training may result from the novelty inherent to each task (Izquierdo et al. 1984). The beta-endorphin depletion caused by a training session lasts about 6 hours (Izquierdo and Netto 1985a). The post-training effects of naloxone or beta-endorphin, or the pretest effects of the latter, on retention do not become manifest before hypothalamic levels have recovered (Izquierdo and Netto 1985a, 1985b; Izquierdo and McGaugh, in press). Therefore, there is a period of several hours after training in which retrieval occurs independently of this substance.

In this respect, it is important to distinguish between immediate retrieval and retrieval measured 1 to 3 hours after training. Immediate retrieval (i.e., retrieval measured 0 hours after training) has been recently studied in this laboratory in detail. It is better than retrieval at later times, and it occurs independently of hormonal or neurohumoral modulation, including beta-endorphin modulation; but it depends on the integrity of the fornix (Izquierdo and Netto 1985b). The role of the fornix in immediate retrieval is unrelated to its role in beta-endorphin release, since the effect of the fornix lesion on immediate retrieval is not mimicked by naloxone or reversed by beta-endorphin administration (Izquierdo and Netto 1985b).

Pre- or posttraining beta-endorphin administration does not affect retrieval measured 1, 2, or 3 hours after training (Izquierdo and Netto 1985a; Izquierdo and McGaugh, in press); its amnesic effect becomes manifest only 6 hours or more after training. In contrast, the modulatory influence of the hormones, ACTH and epinephrine, can be seen as early as 1 or 3 hours after training (Izquierdo and Netto 1985a, 1985b). Apparently, in the first few hours after training when endogenous beta-endorphin stores are low because they have been recently depleted by the training experience, memory is regulated by other systems, including the hormone systems. Recent findings (Izquierdo and McGaugh, in press) suggest that beta-endorphin activates a beta-adrenergic system which maintains retrieval capability high for several hours after training.

Thus, the role of beta-endorphin in memory modulation is limited by the long time of recovery of the system once it has been activated by appropriately novel experiences. It may be a "tag" or a "marker" of particularly significant events that the animals recognize as "novel," so that these events may be properly recalled only when new events of similar importance cause a new release of brain beta-endorphin (Izquierdo and Dias, in press; Izquierdo and Netto 1985a, 1985b). This may be useful to recall coping strategies, for example. Retrieval of the "novel" or "significant" events will occur normally and independently of the beta-endorphin system for a few hours after each experience, so that animals can react appropriately to each circumstance. After a few hours, memory of the events will be side-tracked into a store from which it can be well retrieved only under the influence of beta-endorphin (Izquierdo et al. 1984; Izquierdo and Netto 1985a, 1985b; Izquierdo and Dias, in press; Izquierdo and McGaugh, in press).

This possible role of beta-endorphin in adaptive behavior is different from, and independent of, those of the stress hormones ACTH and epinephrine, which are also released in peculiarly striking events. The release of brain beta-endorphin caused by training is unaffected by treatments that block stress-induced ACTH release (dexamethasone, anterior hypothalamic deafferentation) or epinephrine release (adrenal medullectomy) (Izquierdo and Netto 1985a; Netto et al. 1985). This is so in spite of the fact that ACTH and epinephrine at high doses may cause themselves a release of hypothalamic beta-endorphin (Carrasco et al. 1982b).

#### **MEMORY CONSOLIDATION EFFECTS AND STATE DEPENDENCY**

Posttraining memory modulation by beta-endorphin is best explained by the induction of state dependency; but other endogenous or exogenous agents acting at the post-training period may exert their effects through an influence on consolidation (McGaugh and Herz 1972; Izquierdo and Netto 1985b). Posttraining ACTH, epinephrine, and vasopressin administrations facilitate the late retrieval of inhibitory avoidance tasks acquired with a low-intensity training footshock (Gold and Delaney 1981; Izquierdo and Dias 1983a). Injections of these substances add to the amounts that are released during training (Gold and Delaney 1981); so, there is probably an optimum circulating level of ACTH, epinephrine, and vasopressin for consolidation at the posttraining period (Gold and McGaugh 1975; Gold and Delaney 1981; Izquierdo and Dias 1983a). Training with low-intensity footshock causes a low release of endogenous stress hormones and leaves poor memory which can be boosted with extra amounts of the hormones given by injection. Training with a strong footshock releases a larger amount of the hormones and leaves better memory (Gold and McGaugh 1975; Gold and Delaney 1981).

As was mentioned, posttraining memory facilitation by ACTH and epinephrine can be observed when retrieval is measured at short periods after training, i.e., when brain beta-endorphin stores are still low and before the posttraining effects of naloxone and beta-endorphin can be observed (Izquierdo and Netto 1985b). In addition, posttraining facilitation by ACTH and epinephrine is either unaffected (Izquierdo and Netto 1985b) or enhanced (Izquierdo and Dias 1983a, in press) by naloxone. Therefore, posttraining facilitation by the stress hormones is a different phenomenon from posttraining opioid modulation: and, unlike the latter, it may be explained by an influence on consolidation (Gold and McGaugh 1975; Izquierdo and Dias 1983a, in press).

In contrast, pretest retrieval facilitation by ACTH, epinephrine, and vasopressin seems to depend on brain beta-endorphin release: it is naloxone-reversible and mimicked by beta-endorphin (Izquierdo and Netto 1985b; Izquierdo and Dias, in press). It cannot be detected less than 6 hours after training, which is typical of the beta-endorphin effects (Izquierdo and Netto 1985b). It is possible that the hormones are able to release beta-endorphin from the brain at the time of testing, when there is no task-induced depletion, but not right after training, when the stores are already depleted by training itself (Izquierdo and Netto 1985a, 1985b; Izquierdo and Dias, in press).

#### **RETROGRADE AMNESIA INDUCED BY ELECTROCONVULSIVE SHOCK**

One major side effect of electroconvulsive shock therapy in humans is retrograde amnesia. This side effect is widely used in laboratory animals as an experimental tool. Electroconvulsive shock produces widespread hormonal and neurohumoral changes (Netto and Izquierdo 1985), among which is a depletion of Met-enkephalin (Carrasco et al. 1982c) and beta-endorphin (Dias et al. 1981) from the hypothalamus. The depletion of beta-endorphin is much larger than that produced by training (see above). The amnesic effect of electroconvulsive shock is reversed by naloxone (Carrasco et al. 1982a). This suggests that it may be due to an exaggeration of the state dependency inducing effect of the opioids, to the point where it cannot be readily reversed by a new training-induced beta-endorphin release, and amnesia occurs.

The amnesic effect of electroconvulsive shock is abolished by posterior hypothalamic deafferentation, but not by anterior hypothalamic deafferentation or by section of the fornix (Netto and Izquierdo 1985). This suggests that, if it is an effect mediated by a massive release of hypothalamic opioids, the brain pathways involved are different from those that are activated by training (Izquierdo and Netto 1985a). Training is normally not accompanied by a release of brain Met-enkephalin (Carrasco et al. 1982c).

#### **BETA-ENDORPHIN MEMORY MODULATION AND THE DESIGN OF COGNITIVE ENHANCING DRUGS**

Agents used for the alleviation of human memory disorders are called cognitive enhancing drugs by the industry. Many such drugs have been tried (physostigmine, naloxone, piracetam, codergocrine, vincamine, ACTH fragments, vasopressin, etc.). None has yet been found to be universally effective, which was to be expected in view



of the many systems involved in memory modulation at different times, and the search continues. The potential market is very large: the fast growing aging population of the world.

It is clear that a hyperfunction of the brain beta-endorphin system may result in amnesia; electroconvulsive shock-induced amnesia may be an example. It is not clear, however, that electroconvulsive shock-induced amnesia may be at all a good model for most cases of human memory dysfunction, such as the Korsakoff or Alzheimer syndromes and senile dementia. In these conditions, the dysfunction is not time-locked to any particular external event like electroconvulsive shock, and memory is altered both retro- and pro-actively. Korsakoff patients are disturbed by their inability to form new memories; Alzheimer and senile patients are disturbed mainly by the loss of old but important information (where is the bathroom? how do I get back home? who is this person who talks to me as if he were my son?).

Naloxone has recently been tried with apparent success on several clinical psychometric tests in patients with senile dementia (Reisberg et al. 1983). The drug would certainly be expected to facilitate retrieval of information acquired shortly before or after its administration, because it does so in animals both when given shortly before or after training (Itquierdo 1979, 1980a). However, in animals treated with posttraining naloxone (Izquierdo and Netto 1985b; Izquierdo and Dias, in press) or with a fornix lesion (Izquierdo and Netto 1985a, 1985b), a new release or an injection of beta-endorphin, ACTH, or epinephrine will be unable to facilitate retrieval; so it is difficult to expect a beneficial effect of naloxone either in the long run for most memories or in the short run for some.

Both a reduction in the number of opiate receptor sites (Jensen et al. 1980) and in the hypothalamic content of beta-endorphin (Gambert et al. 1980) have been observed in old rats. Therefore, it is more likely that old age, or diseases that accelerate, enhance, or mimic the memory deficit caused by old age, may be accompanied by a hypofunction rather than by a hyperfunction of brain opioid systems. In view of this, and by virtue of the physiological role of beta-endorphin in memory discussed above, possibly this peptide or its analogs or drugs that may release it (ACTH, vasopressin, epinephrine) may have a higher therapeutic potential. ACTH, epinephrine, and vasopressin have additional effects of their own on consolidation, independent of beta-endorphin (see above).

ACTH and vasopressin have been tried clinically with some degree of success, but their action is too short and the side effects too many to warrant a more widespread application (Jensen et al. 1981).

Knowledge of the factors that maintain high retrieval scores shortly after training, independently of ACTH, epinephrine, or beta-endorphin modulation (Izquierdo and Netto 1985a, 1985b), may also be important in the search for cognitive enhancing drugs. Some of these factors are known: the fornix is necessary for immediate retrieval (Izquierdo and Netto 1985b), and beta-adrenergic systems, presumably central, are apparently important in the next 2 or 3 hours (Izquierdo and McGaugh, in press). Research on these factors is currently in progress in this and other laboratories.

## REFERENCES

- Bartus, R.T.; Dean, R.L.; Beer, B.; and Lippa, A. The cholinergic hypothesis of geriatric memory dysfunction. Science 217:408-417. 1982.
- Bloom, F.E., and McGinty, J.F. Cellular distribution and function of the endorphins. In: Martinez, J.L., Jr.; Jensen, R.A.; Messing, R.B.; Rigter, H.; and McGaugh, J.L., eds. Endogenous Peptides and Learning and Memory Processes. New York: Academic Press, 1981. pp. 199-230.
- Cajal, S.R. Hystologie du Systeme Nerveux de l'Homme et des Vertébrés. Vol. 2. Paris: Maloine, 1911.
- Carrasco, M.A.; Dias, R.D.; and Izquierdo, I. Naloxone reverses retrograde amnesia caused by electroconvulsive shock. Behav Neural Biol 34:352-357, 1982a.
- Carrasco, M.A.; Dias, R.D.; Perry, M.L.; Wofchuk, S.T.; Souza, D.O.; and Izquierdo, I. Effect of morphine, ACTH, epinephrine, Met-, Leu-, and des-Tyr-Met-enkephalin on B-endorphin-like immunoreactivity of rat brain. Psychoneuroendocrinology 7:229-234, 1982b.
- Carrasco, M.A.; Perry, M.L.; Dias, R.D.; Wofchuk S.T.; and Izquierdo, I. Effect of tones, footshocks, shuttle avoidance and electroconvulsive shock on Met-enkephalin immunoreactivity of rat brain. Behav Neural Biol 34:1-4, 1982c.
- de Almeida, M.A.M.R.. and Izquierdo, I. Effect of the intraperitoneal and intracerebroventricular administration of ACTH, epinephrine or B-endorphin on retrieval of an inhibitory avoidance task in rats. Behav Neural Biol 40:119-122, 1984.

- de Wied, D.; Bohus, B.; van Ree, J.M.; and Urban, I. Behavioral and electrophysiological effects of peptides related to lipotropin (B-LPH). J Pharmacol Exp Ther 204:570-580, 1978.
- Dias, R.D.; Perry, M.L.; Carrasco, M.A.; and Itquierdo, I. Effect of electroconvulsive shock on B-endorphin immunoreactivity of rat brain, pituitary gland, and plasma. Behav Neural Biol 32:265-268, 1981.
- Dias, R.D.; Carrasco, M.A.; and Izquierdo, I. Effect of the pretraining administration of B-endorphin, Met-, Leu-, and des-Tyr-Met-enkephalin on acquisition and retention of a shuttle avoidance response in rats. Braz J Med Biol Res 15:55-60, 1982.
- Gallagher, M. Naloxone enhancement of memory processes: Effect of other opiate antagonists. Behav Neural Biol 35:375-382, 1982.
- Gallagher, M., and Kapp, B.S. Opiate administration into the amygdala. Effects on memory processes. Life Sci 23: 1973-1978, 1978.
- Gambert, S.; Garthwaite, T.L.; Pontzer, C.H.; and Hagen, T.C. Age-related changes in central nervous system beta-endorphin and ACTH. Neuroendocrinology 31:252-255, 1980.
- Gold, P.E., and Delaney, R.L. ACTH modulation of memory processes. In: Martinez, J.L., Jr.; Jensen, R.A.; Messing, R.B.; Rigter, H.; and McGaugh, J.L., eds. Endogenous Peptides and Learning and Memory Processes. New York: Academic Press 1981. pp. 79-98.
- Gold, P.E., and McGaugh, J.L. A single-trace, two-process view of memory storage processes. In: Deutsch, D., and Deutsch, J.A., eds. Short-term Memory. New York: Academic Press, 1975. pp. 355-378.
- Gray, J.A. The Neuropsychology of Anxiety: An Enquiry into the Functions of the Septo-Hippocampal System. Oxford: Clarendon, 1982.
- Greenough, W.T. Structural correlates of information storage in the mammalian brain: A review and hypothesis. Trends Neurosci 7:229-233. 1984.
- Hagan, J.J.; Bohus, B.; and de Wied, D. Post-training vasopressin injections may facilitate or delay shuttle-box avoidance extinction. Behav Neural Biol 36: 211-218, 1982.
- Houghten, R.A.; Swann, R.W.; and Li, C.H. B-Endorphin: Stability, clearance behavior, and entry into the central nervous system after injection of the tritiated peptide in rats and rabbits. Proc Natl Acad Sci USA 77:4588-4591. 1980.

- Introini, I.B., and Baratti, C.M. The impairment of retention induced by B-endorphin in mice may be mediated by a reduction of central cholinergic activity. Behav Neural Biol 41:152-163, 1984.
- Introini, I.B.; Izquierdo, I.; Baratti, C.M.; and McGaugh, J.L. Effect of posttraining and pretest dynorphin administration on retention of step-through inhibitory avoidance in mice. Psychopharmacology, in press.
- Izquierdo, I. Effect of naloxone and morphine on various forms of memory in the rat: Possible role of endogenous opiates in memory consolidation. Psychopharmacology 66:199-203, 1979.
- Izquierdo, I. Effect of beta-endorphin and naloxone on acquisition, memory and retrieval of shuttle avoidance and habituation learning in rats. Psychopharmacology 69:111-115, 1980a.
- Izquierdo, I. Effect of a low and a high dose of B-endorphin on acquisition and retention in the rat. Behav Neural Biol 30:460-464, 1980b.
- Izquierdo, I. B-Endorphin and forgetting. Trends Pharmacol Sci 3:455-437, 1982.
- Izquierdo, I. Endogenous state dependency: Memory depends on the relation between the neurohumoral and hormonal states present after training and at the time of testing. In: Lynch, G.; McGaugh, J.L.; and Weinberger, N., eds. Neurobiology of Learning and Memory, New York: Guilford Press, 1984, pp. 333-350.
- Izquierdo, I., and Dias, R.D. Effect of ACTH, epinephrine, B-endorphin, naloxone, and of the combination of naloxone or B-endorphin with ACTH or epinephrine, on memory consolidation. Psychoneuroendocrinology 8:81-87, 1983a.
- Izquierdo, I., and Dias, R.D. Endogenous state-dependency: Memory regulation by post-training and pre-testing administration of ACTH, B-endorphin, adrenaline and tyramine. Braz J Med Biol Res 16:55-64, 1983b.
- Izquierdo, I., and Dias, R.D. Memory as a state-dependent phenomenon: Role of ACTH and epinephrine. Behav Neural Biol 38:144-151, 1983c.
- Izquierdo, I., and Dias, R.D. The influence of adrenergic receptor antagonists on the amnestic and anti-amnestic actions of adrenaline and tyramine. Psychopharmacology 80:181-183 1983d.
- Izquierdo, I., and Dias, R.D. Influence on memory of the posttraining and pre-test injection of ACTH, vasopressin, epinephrine, and B-endorphin, and their interaction with naloxone. Psychoneuroendocrinology, in press.

- Izquierdo, I., and McGaugh, J.L. Delayed onset of amnesia produced by posttraining beta endorphin: Effects of propranolol administered prior to retention testing. Eur J Pharmacol. in press.
- Izquierdo, I., and Netto, C.A. The role of B-endorphin in memory regulation. Ann NY Acad Sci 444:162-177, 1985a.
- Izquierdo, I., and Netto, C.A. Factors that influence retrieval measured 0, 3, or 6 hours after inhibitory avoidance training. Behav Neural Biol 43:260-273, 1985b.
- Izquierdo, I., and Netto, C.A. The brain beta-endorphin system and behavior: The modulation of consecutively and simultaneously processed memories. Behav Neural Biol, in press.
- Izquierdo, I.; Paiva, A.C.M.; and Elisabetsky, E. Post-training intraperitoneal administration of Leu-enkephalin and beta-endorphin causes retrograde amnesia for two different tasks in rats. Behav Neural Biol 28:246-250, 1980a.
- Izquierdo, I.; Souza, D.O.; Carrasco, M.A.; Dias, R.D.; Perry, M.L.; Eisinger, S.; Elisabetsky, E.; and Vendite, D.A. Beta-endorphin causes retrograde amnesia and is released from the rat brain by various forms of training and stimulation. Psychopharmacology 70:173-177, 1980b.
- Izquierdo, I.; Perry, M.L.; Dias, R.D.; Souza, D.O.; Elisabetsky, E.; Carrasco, M.A.; Orsingher, O.A.; and Netto, C.A. Endogenous opioids, memory modulation, and state dependency. In: Martinez, J.L., Jr.; Jensen, R.A.; Messing, R.B.; Rigter, H.; and McGaugh, J.L., eds. Endogenous Peptides and Learning and Memory Processes. New York: Academic Press, 1981. pp. 269-290.
- Izquierdo, I.; Dias, R.D.; Perry, M.L.S.; Souza, D.O.; Elisabetsky, E.; and Carrasco, M.A. A physiological amnesic mechanism mediated by endogenous opioid peptides and its possible role in learning. In: Ajmone-Marsan, C., and Matthies, H., eds. Neuronal Plasticity and Memory Formation. New York: Raven Press, 1982. pp. 89-111.
- Izquierdo, I.; Souza, D.O.; Dias, R.D.; Perry, M.L.S.; Carrasco, M.A.; Volkmer, N.; and Netto, C.A. Effect of various behavioral training and testing procedures on brain B-endorphin-like immunoreactivity and the possible role of B-endorphin in behavioral regulation. Psychoneuroendocrinology 9:381-389, 1984.
- Izquierdo, I.; de Almeida, M.A.M.R.; and Emiliano, V.R. Unlike B-endorphin, dynorphin<sub>1-13</sub> does not cause retrograde amnesia for shuttle avoidance or inhibitory avoidance learning in rats. Psychopharmacology, in press, a.

- Izquierdo, I.; Netto, C.A.; Chaves, M.F.; Quillfeldt, J.; Gianlupi, A.; and Oliveira C.B. Role of beta-endorphin and other mechanisms in the simultaneous and consecutive processing of new and old memories. In: Matthies, H.J., ed. Information Processing in the Brain. Oxford: Pergamon Press, in press, b.
- Jensen, R.A.; Martinez, J.L., Jr.; Messing, R.B.; -Spiehler, V.; Vasquez, B.J.; Soumireu-Mourat, B.; Liang, K.C.; and McGaugh, J.L. Morphine and naloxone alter memory in the rat. Soc Neurosci Abstracts 4:260, 1978.
- Jensen, R.A.; Messing, R.B.; Spiehler, V.R.; Martinez, J.L., Jr.; Vasquez, B.J.; and McGaugh, J.L. Memory, opiate receptors, and aging. Peptides 1 (Supp. 1):197-201, 1980.
- Jensen, R.A.; Messing, R.B.; Martinez, J.L., Jr.; Vasquez, B.J.; Spiehler, V.R.; and McGaugh, J.L. Changes in brain peptide systems and altered learning and memory processes in aged animals. In: Martinez, J.L., Jr.; Jensen, R.A.; Messing, R.B.; Rigter, H.; and McGaugh, J.L., eds. Endogenous Peptides and Learning and Memory Processes. New York: Academic Press, 1981. pp. 463-477.
- Liotta, A.S.; Loudes, C.; McKelvey, J.F.; and Krieger, D.T. Biosynthesis of precursor corticotropin/endorphin-, corticotropin-, d-melanotropin, B-lipotropin-, and B-endorphin-like material by cultured neonatal rat hypothalamic neurons. Proc Natl Acad Sci USA 77:1880-1884, 1980.
- Lucion, A.B.; Rosito, G.; Sapper, D.; Palmi, A.L.; and Izquierdo, I. Intracerebroventricular administration of nanogram amounts of B-endorphin and Met-enkephalin causes retrograde amnesia in rats. Behav Brain Res 4:111-115, 1982.
- Martinez, J.L., Jr., and Rigter, H. Endorphins alter acquisition and consolidation of an inhibitory avoidance response in rats. Neurosci Lett 19:197-201, 1980.
- McGaugh, J.L., and Herz, M.J. Memory Consolidation. San Francisco: Albion, 1972.
- Mondadori, C., and Waser, P.G. Facilitation of memory processes by posttrial morphine: Possible involvement of reinforcement mechanisms? Psychopharmacology 63:297-300, 1979.
- Netto, C.A., and Izquierdo, I. Amnesia as a major side effect of electroconvulsive shock: The possible involvement of hypothalamic opioid systems; Braz J Med Biol Res 17:349-351, 1985.
- Netto, C.A.; Cavalheiro, E.A.; Carrasco, M.A.; Volkmer, N.; Dias, R.D.; and Izquierdo, I. Response of the rat brain B-endorphin system to novelty: Importance of the fornix connection. Behav Neural Biol 43:37-46, 1985.

- Overton, D.A. Experimental methods for the study of state-dependency. Fed Proc 33:1800-1815, 1974.
- Perry, M.L.S.; Dias, Carrasco, M.A.; and Izquierdo, I. Effect of step-down inhibitory avoidance training on B-endorphin like immunoreactivity of rat hypothalamus and plasma. Braz J Med Biol Res 16: 339-343. 1983.
- Reisberg, B.; Ferris, S.H.; Anand, P.; Mir, P.; Geibel, V.; de Leon, M.; and Roberts, E. Effect of naloxone in senile dementia: A double-blind trial. N Engl J Med 308: 721-722, 1983.
- Rossier, J.; French, E.D.; Rivier, C.; Ling, N.; Guillemin, R.; and Bloom, F. Foot-shock induced stress increases B-endorphin levels in blood but not brain. Nature 270:618-620, 1977.
- Stein, L., and Belluzzi, J.D. Brain endorphins and the sense of well-being: A psychobiological hypothesis. In: Costa, E., and Trabucchi, M., eds. The Endorphins. New York: Raven Press, 1978. pp. 299-311.
- Winblad, B.; Hardy, J.; Backman, L.; and Nilsson, L.-G. Memory function and brain biochemistry in normal aging and in senile dementia. Ann NY Acad Sci 444: 255-265, 1985.
- Zornetzer, S.F. Neurotransmitter modulation and memory: A new neuropharmacological phrenology? In: Lipton, M.A.; DiMascio, A.; and Killam, K.F., eds. Psychopharmacology: A Generation of Progress. New York: Raven Press, 1978. pp. 637-649.

#### **ACKNOWLEDGMENTS**

This work was supported by Financiadora de Projetos (FINEP), and Conselho Nacional de Desenvolvimento Científico e Tecnológico (CNPq), Brazil,

#### **AUTHORS**

Ivan Izquierdo, M.D., Ph.D.  
Carlos A. Netto, M.D., M.S.  
Renato D. Dias, M.D.  
Laboratório de Neuroquímica  
Departamento de Bioquímica  
Instituto de Biociências  
Universidade Federal  
do Rio Grande do Sul (UFRGS)  
(centro), 90000 Porto Alegre, RS,  
Brazil

# Current Status of RIA Methods for the Analysis of Enkephalins and Endorphins

R. Wayne Hendren, Ph.D.

## INTRODUCTION

Radioimmunoassay has been widely employed as a key analytical tool in studies of the structure, distribution, and function of opioid peptides. These peptides normally occur in biological tissues and fluids in very low concentrations and in the presence of many other peptides having similar structures, thus making their analysis a challenging task. Although exquisite sensitivity and specificity are hallmarks of radioimmunoassay (RIA), this technique is not always capable of selectively measuring one opioid peptide in the presence of others. As a result, techniques for resolving complex mixtures of opioid peptides by gel filtration and high performance liquid chromatography (HPLC) prior to quantifying by RIA have been developed and widely adopted. In addition, a wide variety of antisera has been developed to selectively recognize structures unique to the families of opioid peptides derived from the three large precursors: proopiomelanocortin (POMC), proenkephalin, and prodynorphin.

The purpose of this chapter is to review specific applications of RIA to the measurement of opioid peptides in biological tissues and fluids. Thorough discussions of the general theory and practice of RIA are available elsewhere (Chard 1978; Jaffe and Behrman 1979; Odell and Daughaday 1971; Orth 1975; Van Vunakis 1980). Practical aspects of measuring endorphins and enkephalins by RIA have been reviewed by Bayon et al. (1983), Hong et al. (1983), and Loeber and Verhoef (1981).

## ANTISERA

Competition between a radiolabeled antigen, or tracer, and unlabeled antigen for a limited number of specific antibody binding sites forms the basis of all radioimmunoassays. The sensitivity of an RIA is determined by the affinity with which the antibody reversibly binds the antigenic epitope, or determinant, and by the specific activity of the tracer. The specificity of an antibody results from the recognition of only a



portion of the antigen, the determinant, by the antibody binding sites. Conventional sources of antisera used for RIA are polyclonal and thus frequently contain multiple populations of antibodies of differing affinity and specificity. In contrast, monoclonal antibodies are comprised of a single population with uniform affinity and selectivity for the antigen.

Numerous antisera have been developed and used for RIA of opioid peptides. Representative, but far from comprehensive, listings of antisera against peptides derived from POMC, proenkephalin, and prodynorphin are provided in tables 1 to 3, respectively.

### Immunogens

Peptides of molecular weight less than 4,000 or 5,000 are generally only weakly immunogenic unless coupled to a larger carrier molecule. For this reason, most of the antisera listed in tables 1 to 3 have been produced by immunizing animals with a conjugate of the opioid peptide hapten with a carrier protein, such as bovine serum albumin or thyroglobulin. Although commercial sources of antisera to opioid peptides are included in these tables, specific information concerning the derivation of these antisera is often unavailable. Water soluble carbodiimides have been the most commonly used reagents for coupling opioid peptides to carrier molecules. Carbodiimides promote amide formation between free amino groups in the hapten and free carboxyl groups in the carrier, and vice versa (Bauminger and Wilchek 1980). Many of the antisera produced against  $\beta$ -endorphin coupled to carriers with carbodiimides recognize the middle or carboxyl portions of the hapten, suggesting that coupling occurs preferentially between the alpha amino terminus of the hapten and carboxyl groups on the carrier (table 1). Conversely, antisera directed against the amino end of  $\beta$ -endorphin resulted when carbodiimide coupling was forced through the hapten carboxyl groups by using polylysine as an intermediate carrier (Gramsch et al. 1983; Meo et al. 1983) or by acetylating the hapten prior to coupling (Weber et al. 1982c). Alternatively, glutaraldehyde has been widely used to couple amino groups on opioid peptides to carrier amino groups, resulting in diimine conjugates. If coupling through hapten residues other than amino or carboxyl groups is desired, bis-diazotized benzidine or similar reagents may be used to react with tyrosyl or histidyl residues (Guillemin et al. 1977). Strategies for influencing antiserum specificity through selection of hapten coupling reagents are discussed further by Rorstad (1983).

Although most of the polyclonal antisera to opioid peptides have been produced against conjugates with large carriers, Bramnert et al. (1982) successfully immunized rabbits with unconjugated  $\beta$ -endorphin. Antisera directed against  $\beta$ -endorphin have also been produced by immunizing with a crude preparation of porcine ACTH<sup>1</sup> which must have contained substantial quantities of  $\beta$ -endorphin or its precursors (Yoshimi et al. 1978).

TABLE 1

Antisera Against Pro-Opiomelanocortin Related Peptides<sup>a</sup>

Immunogen	Sensitivity	Cross-Reactivity (>5%)	Reference
( $\beta$ -endorphin)	3 fmol	$\beta_c$ , $\beta_x$ , $\beta_p$ -endorphins (C-terminus)	Accurate Chemical & Scientific Corp. (UCB Bioproducts) <sup>b</sup>
$\beta_h$ -endorphin/ CDI/IgG	2-3 fmol	$\beta_h$ -LPH	Akil et al. 1979
( $\beta$ -endorphin)	—	$\beta$ -LPH	Amersham Corp. <sup>c</sup>
$\gamma_h$ -LPH (37-58)/ glutaraldehyde/BSA	3.5 fmol	—	Bertagna et al. 1981
partially purified $\beta_h$ -LPH	0.8 fmol	$\beta_h$ -endorphin	Bertagna et al. 1981
$\beta_h$ -endorphin	1.9 fmol	$\alpha$ -endorphin Met-enkephalin, $\beta$ -endorphin (1-27), $\beta$ -endorphin (1-9) (N-terminus)	Brammert et al. 1982
$\beta_h$ -endorphin	—	$\alpha$ -N-acetyl- $\beta_h$ -endorphin, $\beta_h$ -LPH, $\beta$ -endorphin (1-27), $\beta$ -endorphin (6-31) (C-terminus)	Brammert et al. 1982
$\gamma_m$ -LPH + $\beta_m$ -LPH (Crude mixture)	<5 fmol $\gamma_h$ -LPH	$\beta_m$ -LPH	Eipper and Mains 1979
Leu <sup>5</sup> - $\beta$ -endorphin/CDI/ Tg	2 fmol (ID <sub>50</sub> )	(C-terminus, residues 16-31)	Ghazarossian et al. 1980b

TABLE 1 (continued)

Immunogen	Sensitivity	Cross-Reactivity (>5%)	Reference
$\beta_h$ -endorphin/CDI/ polylysine and BSA (mice; monoclonal hybridoma)	<1 pmol (solid phase RIA)	Met-enkephalin Leu-enkephalin BAM-22P Dynorphin (1-13) $\alpha$ -Neo-endorphin (N-terminus)	Gramsch et al. 1983
$\beta_o$ -endorphin/diazotized benzidine/BSA	14 fmol	$\beta_o$ -LPH (C terminus, residues 6-19, 20-27)	Guillemin et al. 1977
$\alpha$ -endorphin/diazotized benzidine/Tg	28 fmol	(C terminus, residues 10-16)	Guillemin et al. 1977
$\beta_h$ -endorphin/CDI/ Tg	7 fmol	$\beta_h$ -LPH	Hollt et al. 1978
( $\beta_h$ -endorphin)	1.5 fmol	Des-Tyr <sup>1</sup> - $\beta$ -endorphin, N-Acetyl- $\beta$ -endorphin	Immuno Nuclear Corp. <sup>d</sup>
$\beta_h$ -LPH	12 fmol $\beta_h$ -endorphin	$\beta_h$ -endorphin	Jeffcoate et al. 1978b
$\gamma$ -endorphin/CDI/ BSA	<5 fmol	(C terminus, residues 8-17)	Jegou et al. 1978
$\beta_h$ -LPH	1 fmol	(N terminus, residues 1-36)	Jeffcoate et al. 1978a
( $\beta$ -endorphin)	<1.4 fmol	$\beta_o$ , $\beta_o$ , $\beta_h$ -endorphins, $\beta_p$ -LPH	Karyon <sup>e</sup>
$\beta$ -LPH	2.4-7.3 fmol	(N terminus)	Krieger et al. 1977

TABLE 1 (continued)

Immunogen	Sensitivity	Cross-Reactivity (>5%)	Reference
$\beta_o$ -LPH/CDI/ ovalbumin	<250 fmol	(N terminus)	La Bella et al. 1977
$\beta_h$ -endorphin/CDI/ $\gamma_h$ globulin (guinea pig)	<30 fmol	(midportion, residues 6-15)	Li et al. 1977
$\beta_o$ -LPH	10 fmol $\beta_o$ -LPH (1-47)	$\beta_h$ -LPH	Lissitsky et al. 1978
$\beta_h$ -endorphin/CDI/ polylysine + Tg (mice; monoclonal hybridoma)	100 fmol	$\beta$ -endorphin Met-enkephalin, Leu-enkephalin, Dynorphin (1-13) (N-terminus)	Meo et al. 1983
$\beta_h$ -endorphin/CDI/ Tg	2-3 fmol	(C-terminus)	Merin et al. 1980
$\beta_h$ -endorphin/CDI/Tg	10-12 fmol	(midportion)	Merin et al. 1980
$\beta_h$ -endorphin/CDI/Tg	<3 fmol	$\beta_h$ -LPH, (C-terminus)	Mueller 1980
( $\beta_h$ -LPH)	10 fmol	$\beta$ -melanotropin	New England Nuclear <sup>f</sup>
( $\beta_h$ -endorphin)	1.4 fmol	(C-terminus)	New England Nuclear <sup>f</sup>
$\beta_h$ -endorphin/diazotized pararosaniline/BSA	<6 fmol	$\beta_h$ -LPH, $\beta_c$ -endorphin (midportion)	NIDA <sup>g</sup>
(N-acetyl- $\beta$ -endorphin)	105 fmol (IC <sub>50</sub> )	N-acetyl- $\beta$ -endorphin (1-27)	Peninsula Laboratories <sup>h</sup>
( $\beta_h$ -endorphin)	75 fmol (IC <sub>50</sub> )	$\beta_h$ -LPH, $\beta_h$ -endorphin, N-acetyl- $\beta_c$ -endorphin	Peninsula Laboratories <sup>h</sup>

TABLE 1 (continued)

Immunogen	Sensitivity	Cross-Reactivity (>5%)	Reference
$\beta$ -LPH/CDI/ ovaalbumin	$\sim 2$ fmol ( $\beta_h$ -LPH (1-47))	(N-terminus)	Pezalla et al. 1978
$\beta$ -endorphin/m-amino- benzylloxymethyl cellulose	<115 fmol	(residues 10-13, 20-27)	Ross et al. 1978
$\alpha$ -endorphin/CDI/Ty	<29 fmol	$\beta$ -endorphin, $\beta$ -LPH (N-terminus)	Ross et al. 1978
( $\beta_h$ -endorphin)	1.7 fmol	--	Seragen <sup>i</sup>
( $\beta_h$ -endorphin)	1.4 fmol	$\beta_h$ -LPH	Seragen <sup>i</sup>
$\beta_h$ -endorphin/diazotized benzidine/BSA	14 fmol	$\beta_h$ -LPH	Shaaban et al. 1982
$\beta_h$ -endorphin/CDI/BSA	4.5 fmol	$\beta$ -endorphin $\beta_c^C$ -LPH	Tejwani et al. 1983
$\beta_h$ -endorphin/CDI/Ty	2.8 fmol	$\beta$ -endorphin $\beta^D$ -endorphin (6-31) $\gamma$ -endorphin	Vuolteenaho et al. 1981
$\beta_h$ -endorphin/CDI/Ty	7.2 fmol	$\beta_h$ -LPH $\beta_c^C$ -endorphin	Wardlaw and Frantz 1979
acetylated- $\beta$ -endorphin (1-9)/ CDI/Ty	$\sim 50$ fmol	(N-terminus)	Weber et al. 1982c
acetylated- $\beta$ -endorphin/ CDI/Ty	$\sim 50$ fmol	(N-terminus)	Weber et al. 1982c
( $\beta_h$ -endorphin)	0.3 fmol	$\beta_h$ -LPH	Wiedemann et al. 1979

TABLE 1 (continued)

Immunogen	Sensitivity	Cross-Reactivity (>5%)	Reference
$\beta_h$ -endorphin/diazotized benzidine/BSA	1.4 fmol	$\beta_h$ -LPH	Wilkes et al. 1980
Crude porcine ACTH	1.4 fmol	$\beta_o$ -LPH (C-terminus)	Yoshimi et al. 1978
$\beta_p$ -endorphin/CDI/ bovine $\gamma$ -globulin	130 fmol	$\beta_p$ -LPH, $\beta_p$ -endorphin (1-27) N-acetyl- $\beta_p$ -endorphin N-acetyl- $\beta_p^p$ -endorphin (1-27)	Zakarian and Smyth 1979

<sup>a</sup>Unless otherwise noted, antisera were produced in rabbits, and <sup>125</sup>I- labeled tracers were used. Sensitivities are those stated in the cited publications. If not stated by the original authors, the sensitivities (90% B/B<sub>0</sub>) have been estimated from the published standard curves. Undefined immunogenic conjugates are enclosed in parentheses. The subscripts c, h, m, o, p, and r abbreviate camel, human, mouse, ovine, porcine, and rat, respectively.

<sup>b</sup>Accurate Chemical and Scientific Corp., Westbury, NY.

<sup>c</sup>Amersham Corp., Arlington Heights, IL.

<sup>d</sup>Immuno Nuclear Corp., Stillwater, MN.

<sup>e</sup>Karyon Technology Inc., Norwood, MA.

<sup>f</sup>New England Nuclear, Boston, MA.

<sup>g</sup>Contact Dr. Richard L. Hawks, Research Technology Branch, Room 10-A-19, National Institute on Drug Abuse, 5600 Fishers Lane, Rockville, MD 20857.

<sup>h</sup>Peninsula Laboratories, Belmont, CA.

<sup>i</sup>Seragen, Inc., Boston, MA.

TABLE 2

Antisera Against Proenkephalin-Related Peptides<sup>a</sup>

Immunogen	Sensitivity	Cross-Reactivity (>5%)	Reference
(Met-enkephalin)	<17 fmol	Leu-enkephalin	Accurate Chemical and Scientific Corp. (UCB Bioproducts)
Met-enkephalin/ glutaraldehyde/BSA	1 pmol ( <sup>3</sup> H)	—	Akil et al. 1978a
Leu-enkephalin/ glutaraldehyde/BSA	1 pmol ( <sup>3</sup> H)	Met-enkephalin	Akil et al. 1978a
midportion nonapeptide fragment of peptide F/ glutaraldehyde/Ty	300 fmol/ml (IC <sub>50</sub> )	—	Alessi et al. 1982
(Leu-enkephalin)	—	Met-enkephalin	Amersham Corp. <sup>c</sup>
(Met-enkephalin)	—	Leu-enkephalin	Amersham Corp. <sup>c</sup>
BAM-22P/ methylated BSA	<6 fmol	(C-terminus)	Baird et al. 1984
BAM-12P/ methylated BSA	<36 fmol	(C-terminus)	Baird et al. 1982
Leu-enkephalin/CDI/ BSA	—	(C-terminus)	Bergstrom et al. 1983
Leu-enkephalin[Arg <sup>6</sup> ]- CDI/BSA	—	(C-terminus)	Bergstrom et al. 1983
Met(O)-enkephalin[Arg <sup>6</sup> ,Phe <sup>7</sup> ]/ glutaraldehyde/Ty	10-100 fmol	Met-enkephalin[Arg <sup>6</sup> ,Phe <sup>7</sup> ] (C-terminus)	Boarder et al. 1982c, 1982d
Met-enkephalin/CDI/Ty	150 fmol	Arg-Tyr-Gly-Gly-Phe-Met (C-terminus)	Boarder et al. 1982d

TABLE 2 (continued)

Immunogen	Sensitivity	Cross-Reactivity (>5%)	Reference
Met-enkephalin/glutaraldehyde/hemocyanin	<10 pmol ( <sup>3</sup> H)	—	Childers et al. 1977
Met(O)-enkephalin/glutaraldehyde/Ty	2-8 fmol	Gly-Gly-Phe-Met(O)	Clement-Jones et al. 1980b
Met-enkephalin[Arg <sup>6</sup> ,Phe <sup>7</sup> ]/glutaraldehyde/BSA	23 fmol	Met(O)-enkephalin[Arg <sup>6</sup> ,Phe <sup>7</sup> ](C-terminus)	Giraud et al. 1983
Met-enkephalin/CDI/ovalbumin	<20 fmol	Leu-enkephalin	Gros et al. 1978
Leu-enkephalin/CDI/ovalbumin	<20 fmol	Met-enkephalin	Gros et al. 1978
Succinyl-Met-enkephalin/CDI/succinyl-hemocyanin + polylysine	50 fmol	Leu-enkephalin	Hong et al. 1978
(Met-enkephalin)	10 fmol	—	Immuno Nuclear Corp. <sup>d</sup>
(Leu-enkephalin)	13 fmol	Met-enkephalin	Immuno Nuclear Corp. <sup>d</sup>
Leu-enkephalin/glutaraldehyde + CDI/hemocyanin (mice; monoclonal hybridoma)	180 fmol	Met-enkephalin	Jones et al. 1983
Leu-enkephalin[Arg <sup>6</sup> ]/CDI/BSA	1.4 fmol	(C-terminus)	Kangawa et al. 1980
(Leu-enkephalin)	<1.8 fmol	Met-enkephalin	Karyon <sup>e</sup>
(Met-enkephalin)	<17 fmol	Leu-enkephalin	Karyon <sup>e</sup>



TABLE 2 (continued)

Immunogen	Sensitivity	Cross-Reactivity (>5%)	Reference
Met-enkephalin/glutaraldehyde or CDI/BSA or hemocyanin	20 fmol	Met(O)-enkephalin (2-5)	King and Millar 1980
Leu-enkephalin/glutaraldehyde or CDI/hemocyanin or BSA	120 fmol	Met-enkephalin	King and Millar 1981
Met-enkephalin/ hemocyanin	20 fmol	--	Lindberg et al. 1983
(Leu-enkephalin)	--	Met-enkephalin	Miles Scientific <sup>f</sup>
Met-enkephalin/glutaraldehyde/ BSA	10 fmol	--	Miller et al. 1978
Leu-enkephalin/glutaraldehyde/ BSA	10 fmol	--	Miller et al. 1978
Met(O)enkephalin/glutaraldehyde/ Tg	<30 fmol	Met-enkephalin Leu-enkephalin	NIDA <sup>g</sup>
(Phe-Met-Arg-Phe-NH <sub>2</sub> )	160 fmol (IC <sub>50</sub> )	Met-enkephalin [Arg <sup>6</sup> ,Phe <sup>7</sup> -NH <sub>2</sub> ]	Peninsula Laboratories <sup>h</sup>
(Met-enkephalin[Arg <sup>6</sup> ,Gly <sup>7</sup> ,Leu <sup>8</sup> ])	185 fmol (IC <sub>50</sub> )	--	Peninsula Laboratories <sup>h</sup>
(peptide F)	47 fmol (IC <sub>50</sub> )	--	Peninsula Laboratories <sup>h</sup>
(BAM-22P)	2.4 μmol (IC <sub>50</sub> )	--	Peninsula Laboratories <sup>h</sup>
(BAM-12P)	6.2 μmol (IC <sub>50</sub> )	--	Peninsula Laboratories <sup>h</sup>
(Leu-enkephalin)	235 fmol (IC <sub>50</sub> )	--	Peninsula Laboratories <sup>h</sup>

TABLE 2 (continued)

Immunogen	Sensitivity	Cross-Reactivity (>5%)	Reference
Leu-enkephalin/ diazotized benzidine/BSA	4 fmol	—	Rossier et al. 1977
Met-enkephalin/ CDI/hemocyanin (guinea pigs and rabbits)	10 pmol ( <sup>3</sup> H)	Leu-enkephalin	Simantov et al. 1977
Leu-enkephalin/ CDI/hemocyanin (guinea pigs and rabbits)	4 pmol ( <sup>3</sup> H)	—	Simantov et al. 1977
Met-enkephalin/ glutaraldehyde/BSA	500 fmol ( <sup>3</sup> H)	—	Sullivan et al. 1977
Met-enkephalin- p-diazophenylacetic acid/ CDI/BSA	1000 fmol ( <sup>3</sup> H)	—	Takahashi et al. 1979
Leu-enkephalin/CDI/BSA	90 fmol ( <sup>3</sup> H)	Met-enkephalin	Weissman and Gershon 1976
Met-enkephalin/Ty	200 fmol ( <sup>3</sup> H)	—	Wesche et al. 1977
Leu-enkephalin/Ty Succinyl-Met-enkephalin/CDI/ succinyl hemocyanin + polylysine	50 fmol ( <sup>3</sup> H) <10 pmol ( <sup>3</sup> H)	— Leu-enkephalin	Wesche et al. 1977 Yang et al. 1977
Leu-enkephalin/hemocyanin	<2 pmol ( <sup>3</sup> H)	Met-enkephalin	Yang et al. 1977
Met-enkephalin/CDI/Ty	1.4 fmol	Leu-enkephalin	Yoshimasa et al. 1982
Leu-enkephalin/CDI/Ty	1.4 fmol	Met-enkephalin	Yoshimasa et al. 1982

**TABLE 2 (continued)**

<sup>a</sup> Unless otherwise noted, antisera were produced in rabbits, and <sup>125</sup>I-labeled tracers were used. Sensitivities are those stated in the cited publications. If not stated by the original authors, the sensitivities (90% B/B<sub>0</sub>) have been estimated from the published standard curves. Undefined immunogenic conjugates are enclosed in parentheses. The subscripts c, h, m, o, p, and r abbreviate camel, human, mouse, ovine, porcine, and rat, respectively.

<sup>b</sup> Accurate Chemical and Scientific Corp., Westbury, NY.

<sup>c</sup> Amersham Corp., Arlington Heights, IL.

<sup>d</sup> Immuno Nuclear Corp., Stillwater, MN.

<sup>e</sup> Karyon Technology Inc., Norwood, MA.

<sup>f</sup> Miles Scientific, Naperville, IL.

<sup>g</sup> Contact Dr. Richard L. Hawks, Research Technology Branch, Room 10-A-19, National Institute on Drug Abuse, 5600 Fishers Lane, Rockville, MD 20857.

<sup>h</sup> Peninsula Laboratories, Belmont, CA.

TABLE 3

Antisera Against Prodynorphin-Related Peptides<sup>a</sup>

Immunogen	Sensitivity	Cross-Reactivity (>5%)	Reference
(Dynorphin)	300 fmol	Neurotensin	Accurate Chemical and Scientific Corp. (UCB Bioproducts)
Dynorphin B/glutaraldehyde/Tg	5 fmol	—	Cone and Goldstein 1982
Dynorphin (1-13)/methylated BSA	10 fmol	—	Day et al. 1982
Dynorphin (1-13)/glutaraldehyde/Tg	17 fmol (IC <sub>50</sub> )	(Midportion, residues 2-12)	Ghazarossian et al. 1980a
(Dynorphin)	—	Neurotensin	Karyon <sup>c</sup>
β-neo-endorphin/CDI/Tg	1.8 fmol	(C-terminus)	Kitamura et al. 1982
α-Neo-endorphin/CDI/BSA	0.4 fmol	(C-terminus, residues 9-10)	Minamino et al. 1981
Dynorphin (1-13)/glutaraldehyde/Tg	3 fmol	(C-terminus, residues 4-13)	Nakao et al. 1981
(Dynorphin B (rimorphin))	350 fmol (IC <sub>50</sub> )	Dynorphin B (1-29)	Peninsula Laboratories <sup>d</sup>
(α-Neo-endorphin)	21 fmol (IC <sub>50</sub> )	—	Peninsula Laboratories <sup>d</sup>
(Dynorphin A (1-8))	20 fmol (IC <sub>50</sub> )	—	Peninsula Laboratories <sup>d</sup>
(Dynorphin A (1-17))	145 fmol (IC <sub>50</sub> )	Dynorphin A (1-13)	Peninsula Laboratories <sup>d</sup>
(Dynorphin A (1-13))	85 fmol (IC <sub>50</sub> )	Dynorphin A (1-17)	Peninsula Laboratories <sup>d</sup>
Dynorphin (1-13)/CDI/BSA	—	α-N-acetyl-dynorphin (1-9)	Weber et al. 1981

**TABLE 3 (continued)**

<sup>a</sup> Unless otherwise noted, antisera were produced in rabbits, and <sup>125</sup>I-labeled tracers were used. Sensitivities are those stated in the cited publications. If not stated by the original authors, the sensitivities (90% B/B<sub>0</sub>) have been estimated from the published standard curves. Undefined immunogenic conjugates are enclosed in parentheses. The subscripts c, h, m, o, p, and r abbreviate camel, human, mouse, ovine, porcine, and rat, respectively.

<sup>b</sup> Accurate Chemical and Scientific Corp., Westbury, NY.

<sup>c</sup> Karyon Technology Inc., Norwood, MA.

<sup>d</sup> Peninsula Laboratories, Belmont, CA.

Occasionally, peptides are inadvertently modified in the course of conjugation to carrier. For example, Weber et al. (1981) immunized rabbits with a conjugate made by linking dynorphin(1-13) to bovine serum albumin (BSA) with a carbodiimide but obtained antisera directed specifically against  $\alpha$ -N-acetyl dynorphin(1-13). In this case, acetate salts present in the dynorphin(1-13) preparation were apparently coupled to the free amino group of the peptide when the carbodiimide was added. Likewise, antisera directed against the sulfoxide of Met-enkephalin are sometimes produced when an immunizing conjugate of Met-enkephalin is inadvertently oxidized (King and Millar 1980, 1981). The vulnerability of Met-enkephalin to oxidation has led other investigators to deliberately prepare antisera to Met(O)-enkephalin and then oxidize all samples prior to assay (Clement-Jones et al. 1980a). In some cases, an antiserum will recognize the oxidized and reduced forms of Met-enkephalin equally well (Liston and Rossier 1984). On the other hand, Boarder et al. (1982c) found that an antiserum against Met(O)-enkephalin[Arg6,Phe7] cross-reacted with the reduced form by only 30%.

### **Immunization Procedures**

Most of the polyclonal antisera for opioid peptides have been produced in rabbits. The immunogen is usually injected intradermally or subcutaneously at multiple sites in the form of an emulsion with Freund's complete adjuvant. Booster immunizations are usually administered as emulsions of immunogen in Freund's incomplete adjuvant at monthly intervals after the primary immunizations. Each laboratory uses slightly different immunization protocols, and there is little comparative evidence for evaluating these variations. Detailed procedures for preparing emulsions of immunogen, protocols for immunization, and procedures for collecting, processing, and storing antisera have been described by Hurn and Chantler (1980).

### **Specificity**

Development of antisera recognizing only a single opioid peptide is made difficult by the fact that common amino acid sequences are shared by peptides derived from the same precursor. The common sequences found among opioid peptides derived from POMC, proenkephalin, and prodynorphin are shown in figures 1 to 3, respectively. Thus,  $\beta$ -endorphin constitutes the 31 residues at the carboxyl terminus of  $\beta$ -LPH<sup>1</sup>, and the  $\alpha$ -endorphin sequence is contained within all of the structures shown in figure 1. Likewise, the Tyr-Gly-Gly-Phe-Met-Lys or Tyr-Gly-Gly-Phe-Met-Arg sequence is common to the peptides derived from proenkephalin (figure 2). Furthermore, the Met-enkephalin structure is common to peptides derived from both POMC and proenkephalin, and the Leu-enkephalin sequence is common to peptides derived from both prodynorphin and proenkephalin. Detailed discussions of opioid peptide structures, biosynthesis, and nomenclatural conventions are available elsewhere (Burbach 1984; Cox 1982; Morley 1983).

	61	62	63	64	65	66	67	68	69	70	71	72	73	74	75	76	77	78	79	80	81	82	83	84	85	86	87	88	89	90	91	
$\beta_n$ -LPH	$\beta_n$ -LPH(1-60)	Tyr	Gly	Gly	Phe	Met	Thr	Ser	Glu	Lys	Ser	Gln	Thr	Pro	Leu	Val	Thr	Leu	Phe	Lys	Asn	Ala	Ile	Ile	Lys	Asn	Ala	Tyr	Lys	Lys	Gly	Glu
$\beta_n$ -Endorphin		Tyr	Gly	Gly	Phe	Met	Thr	Ser	Glu	Lys	Ser	Gln	Thr	Pro	Leu	Val	Thr	Leu	Phe	Lys	Asn	Ala	Ile	Ile	Lys	Asn	Ala	Tyr	Lys	Lys	Gly	Glu
$\beta_n$ -Endorphin (1-27)		Tyr	Gly	Gly	Phe	Met	Thr	Ser	Glu	Lys	Ser	Gln	Thr	Pro	Leu	Val	Thr	Leu	Phe	Lys	Asn	Ala	Ile	Ile	Lys	Asn	Ala	Tyr				
$\gamma$ -Endorphin		Tyr	Gly	Gly	Phe	Met	Thr	Ser	Glu	Lys	Ser	Gln	Thr	Pro	Leu	Val	Thr	Leu														
$\alpha$ -Endorphin		Tyr	Gly	Gly	Phe	Met	Thr	Ser	Glu	Lys	Ser	Gln	Thr	Pro	Leu	Val	Thr															

**FIGURE 1**

Common Amino Acid Sequences Among Peptides Derived from Proopiomelanocortin.

Numbers refer to the sequence of  $\beta$ -lipotropin.

Peptide F		Tyr-Gly-Gly-Phe-Met-Lys-Lys-Met-Asp-Glu-[15residues]-Leu-Gly-Lys-Arg-Tyr-Gly-Gly-Phe-Met
[Met <sup>5</sup> ]-enkephalyl-Lys		Tyr-Gly-Gly-Phe-Met-Lys
Peptide I	[16 residues]	Tyr-Gly-Gly-Phe-Met-Arg-Arg-Val-Gly-Arg-Pro-Glu-Trp-Trp-Met-Asp-Tyr-Gln-Lys-Arg-Tyr-Gly-Gly-Phe-Leu
Peptide E		Tyr-Gly-Gly-Phe-Met-Arg-Arg-Val-Gly-Arg-Pro-Glu-Trp-Trp-Met-Asp-Tyr-Gln-Lys-Arg-Tyr-Gly-Gly-Phe-Leu
[Leu <sup>5</sup> ]-enkephalin		Tyr-Gly-Gly-Phe-Leu
BAM-22P		Tyr-Gly-Gly-Phe-Met-Arg-Arg-Val-Gly-Arg-Pro-Glu-Trp-Trp-Met-Asp-Tyr-Gln-Lys-Arg-Tyr-Gly
BAM-20P		Tyr-Gly-Gly-Phe-Met-Arg-Arg-Val-Gly-Arg-Pro-Glu-Trp-Trp-Met-Asp-Tyr-Gln-Lys-Arg
BAM-12P		Tyr-Gly-Gly-Phe-Met-Arg-Arg-Val-Gly-Arg-Pro-Glu
Metorphinamide		Tyr-Gly-Gly-Phe-Met-Arg-Arg-Val-NH <sub>2</sub>
[Met <sup>5</sup> ]-enkephalyl-Arg-Arg		Tyr-Gly-Gly-Phe-Met-Arg-Arg
[Met <sup>5</sup> ]enkephalyl-Arg		Tyr-Gly-Gly-Phe-Met-Arg
Peptide B	[26 residues]	Tyr-Gly-Gly-Phe-Met-Arg-Phe
[Met <sup>5</sup> ]enkephalyl-Arg-Phe		Tyr-Gly-Gly-Phe-Met-Arg-Phe
[Met <sup>5</sup> ]-enkephalyl-Arg-Gly-Leu		Tyr-Gly-Gly-Phe-Met-Arg-Gly-Leu
[Met <sup>5</sup> ]enkephalin		Tyr-Gly-Gly-Phe-Met

**FIGURE 2**

Common Amino Acid Sequences Among Peptides Derived from Proenkephalin



Dynorphin (1-32)	Tyr-Gly-Gly-Phe-Leu-Arg-Arg-Ile-Arg-Pro-Lys-Leu-Lys-Trp-Asp-Asn-Gln-Lys-Arg-Tyr-Gly-Gly-Phe-Leu-Arg-Arg-Gln-Phe-Lys-Val-Val-Thr	
Leumorphin		Tyr-Gly-Gly-Phe-Leu-Arg-Arg-Gln-Phe-Lys-Val-Val-Thr Arg-[15 Residues]
Dynorphin B		Tyr-Gly-Gly-Phe-Leu-Arg-Arg-Gln-Phe-Lys-Val-Val-Thr
Dynorphin A	Tyr-Gly-Gly-Phe-Leu-Arg-Arg-Ile-Arg-Pro-Lys-Leu-Lys-Trp-Asp-Asn-Gln	
Dynorphin A (1-8)	Tyr-Gly-Gly-Phe-Leu-Arg-Arg-Ile	
$\alpha$ -Neo-endorphin	Tyr-Gly-Gly-Phe-Leu-Arg-Lys-Tyr-Pro-Lys	
$\beta$ -Neo-endorphin	Tyr-Gly-Gly-Phe-Leu-Arg-Lys-Tyr-Pro	
[Leu <sup>5</sup> ]-enkephalin	Tyr-Gly-Gly-Phe-Leu	

### FIGURE 3

Common Amino Acid Sequences Among Peptides Derived from Prodynorphin

Antiserum specificity is evaluated by comparing the concentration of unlabeled hapten required to displace approximately half of the antibody-bound radiolabeled hapten with the concentrations of potential cross-reactants which produce the same displacement. Determinants recognized by conventional antisera to peptides generally contain two to eight amino acid residues. For example, the "Lucia 9/14" antiserum developed by Ghazarossian et al. (1980a) recognized the amino acids in positions 5 to 12 of dynorphin(1-13). This antiserum cross-reacted with dynorphin(1-17) and dynorphin(1-32) but failed to recognize  $\alpha$ -neo-endorphin,  $\beta$ -neo-endorphin, Met-enkephalin, Leu-enkephalin,  $\alpha$ -endorphin, or  $\beta$ -endorphin (Ghazarossian et al. 1980a; Zamir et al. 1983). In contrast, other antisera appear to require virtually the entire sequence of the hapten for effective binding (Chang et al. 1979). Thus, the dynorphin(1-13) antiserum developed by Nakao et al. (1981) failed to cross-react with the hapten fragments containing residues 1 to 5, 4 to 8, or 8 to 13 and cross-reacted with dynorphin(4-13) by only 1%. Similarly, Wilkes et al. (1980) found that a highly specific antiserum against  $\beta$ -endorphin failed to cross-react with fragments containing residues 1 to 16, 1 to 17, or 19 to 31 and concluded that contributions from both the amino and carboxyl termini of  $\beta$ -endorphin were required for antibody recognition. In such cases, it appears that antibodies are developed against a three-dimensional determinant which may contain residues quite separated within the primary sequence. These observations are consistent with evidence that, in the preferred conformation of  $\beta$ -endorphin, the hydrophobic Phe<sup>18</sup> and Tyr<sup>27</sup> residues interact with the Phe<sup>4</sup> and Tyr<sup>1</sup> residues (Taylor et al. 1982).

As expected, many  $\beta$ -endorphin antisera cross-react extensively with  $\beta$ -LPH. For example, Guillemin et al. (1977) developed an antiserum which recognized the carboxyl terminus of  $\beta$ -endorphin and cross-reacted completely with  $\beta$ -LPH and POMC but not at all with Met-enkephalin. A distinctly different specificity profile was reported by Bramnert et al. (1982), who produced a  $\beta$ -endorphin antiserum which cross-reacted strongly with a fragment containing residues 1 to 9, required a free alpha amino group, and cross-reacted with  $\beta$ -LPH by only 1.5%.  $\beta$ -Endorphin generally fails to cross-react strongly with Met-enkephalin antisera, and vice versa. Although moderate cross-reaction with Leu-enkephalin is commonly observed with Met-enkephalin antisera, Miller et al. (1978) reported assays for both Met- and Leu-enkephalin with mutual cross-reactions of only 1%.

Complex patterns of cross-reaction may be observed when heterogeneous antibody populations are present (Bayon et al. 1983). Asymmetric or biphasic curves with full displacement of tracer may result when separate antibody subpopulations recognize different antigenic determinants. Impure tracers, e.g., mixtures of mono- and di-iodinated species, can also lead to asymmetric displacement curves. Incomplete displacement of tracer by fragments of the antigen is observed when a heterogeneous antiserum recognizes homologous antigens. Ross et al. (1978)

concluded that an  $\alpha$ -endorphin antiserum contained a subpopulation requiring a free alpha amino group, because peptides lacking this feature displaced the tracer incompletely.

In some cases, the nonspecificity of an antiserum can be exploited to detect peptides for which a specific RIA may not be available. Mizuno et al. (1980) used an antiserum against Leu-enkephalin[Arg<sup>6</sup>] to measure BAM-12P<sup>1</sup> concentrations in extracts of bovine adrenal medulla, even though the latter peptide cross-reacted by only 5%.

The selectivity of an RIA may be improved by physically separating the analyte from cross-reactants prior to assay. This approach is discussed in detail in the Sample Preparation section. Undesired specificities in a heterogeneous antiserum may also be eliminated by appropriate selection of the tracer. This approach was illustrated by Akil et al. (1983), who used <sup>125</sup>I-N-acetyl- $\beta$ -endorphin as a tracer to eliminate amino-specific determinants in an antiserum against N-acetyl-Tyr-Gly-Gly-Phe. Alternatively, the antibodies may be purified by affinity chromatography, as described by Blake et al. (1982) for a  $\beta$ -endorphin antiserum. Others have achieved selectivity by measuring each sample with two or more antisera having different specificities. For example, Jeffcoate et al. (1978b) measured concentrations of  $\beta$ -endorphin and  $\beta$ -LPH in human plasma and cerebrospinal fluid (CSF) with one antiserum recognizing both peptides equally and with another recognizing only  $\beta$ -LPH; the difference between the two immunoreactivities was taken as the concentration of  $\beta$ -endorphin.

### Monoclonal Antibodies

The problems sometimes associated with the use of heterogeneous antibody populations in RIA may be avoided if monoclonal antibodies of appropriate sensitivity and specificity can be developed. Monoclonal antibodies directed against the amino terminus of  $\beta$ -endorphin have been reported by Gramsch et al. (1983) and Meo et al. (1983). These antibodies failed to bind  $\beta$ -LPH or N-acetyl- $\beta$ -endorphin but cross-reacted nearly completely with Met- and Leu-enkephalin. Jones et al. (1983) described Leu-enkephalin antibodies secreted by two different hybridoma clones, one of which failed to bind Met-enkephalin. The antibodies produced by the second clone cross-reacted completely with Met-enkephalin but not at all with Met(O)-enkephalin. Monoclonal antibodies which fail to distinguish Met- and Leu-enkephalin have also been reported by Cuello et al. (1984). Unfortunately, none of the monoclonal antibodies produced against endorphins or enkephalins have approached the sensitivity obtained with polyclonal antibodies, and their utility for RIA has been somewhat limited.

### Sensitivity

A radiolabeled tracer of the highest possible specific activity is used to maximize sensitivity in RIA. For this reason, most

RIAs for opioid peptides incorporate a tracer labeled with  $^{125}\text{I}$ , which has a maximum specific activity of 2200 Ci/matom. Tritium, with a maximum specific activity of 29 Ci/matom, is sometimes used in enkephalin RIAs, because some enkephalin antisera do not bind the iodinated tracer as well as the  $^3\text{H}$ -labeled hapten.

When  $^{125}\text{I}$  tracers are used, the most sensitive antisera can detect approximately 1 to 5 fmol of POMC-related peptides (table 1). Similar sensitivities have been achieved with a few enkephalin antisera and with several antisera raised against prodynorphin-related peptides (tables 2 and 3). Although RIA sensitivity is primarily determined by the antibody binding affinity and the tracer specific activity, additional improvement can sometimes be achieved under nonequilibrium conditions by delayed addition of tracer.

### RADIOLABELED LIGANDS

Radiolabeled ligands for RIA of opioid peptides are commonly prepared by the chloramine-T catalyzed introduction of  $^{125}\text{I}$ , as first described by Hunter and Greenwood (1962). Applications of this method to a wide variety of peptides and proteins have been reviewed by McConahey and Dixon (1980). Alternatively, some opioid peptides have been radioiodinated by lactoperoxidase catalysis (Morrison 1980). The specific activity of radioiodinated peptides may be determined by precipitation with trichloroacetic acid (Chen et al. 1981) or by thin-layer chromatography (Rosenberg and Teare 1977). The thin-layer chromatographic method is generally applicable, but some small peptides, such as Met-enkephalin, are not quantitatively precipitated by trichloroacetic acid. The talc-resin-trichloroacetic acid test described by Tower et al. (1980) is useful for evaluating individual preparations of radioiodinated peptides that can be precipitated, e.g.,  $\beta$ -endorphin.

Radioiodinated peptides may be isolated from the crude reaction mixture by gel filtration. Although these peptides generally elute prior to radioiodide on gel filtration,  $^{125}\text{I}$ -Met-enkephalin and  $^{125}\text{I}$ -Leu-enkephalin have been observed to elute after radioiodide due to partial adsorptive retardation by Sephadex (Khanna and Sharma 1983). Thin-layer chromatography (Gros et al. 1978) and adsorption to octadecylsilyl-silica (Clement-Jones et al. 1980b) have also been used to isolate  $^{125}\text{I}$ -Met-enkephalin and to separate the mono- and diiodinated forms.

Radioiodinated opioid peptides may also be purified by HPLC, as illustrated for  $^{125}\text{I}$ - $\beta$ -endorphin and  $^{125}\text{I}$ -Met-enkephalin in figures 4 and 5, respectively. Introduction of iodine into  $\beta$ -endorphin or Met-enkephalin sufficiently alters their physicochemical properties so that the iodinated peptides can be resolved from the unlabeled starting material by reversed-phase HPLC. In addition, Met-enkephalin is oxidized to the sulfoxide during

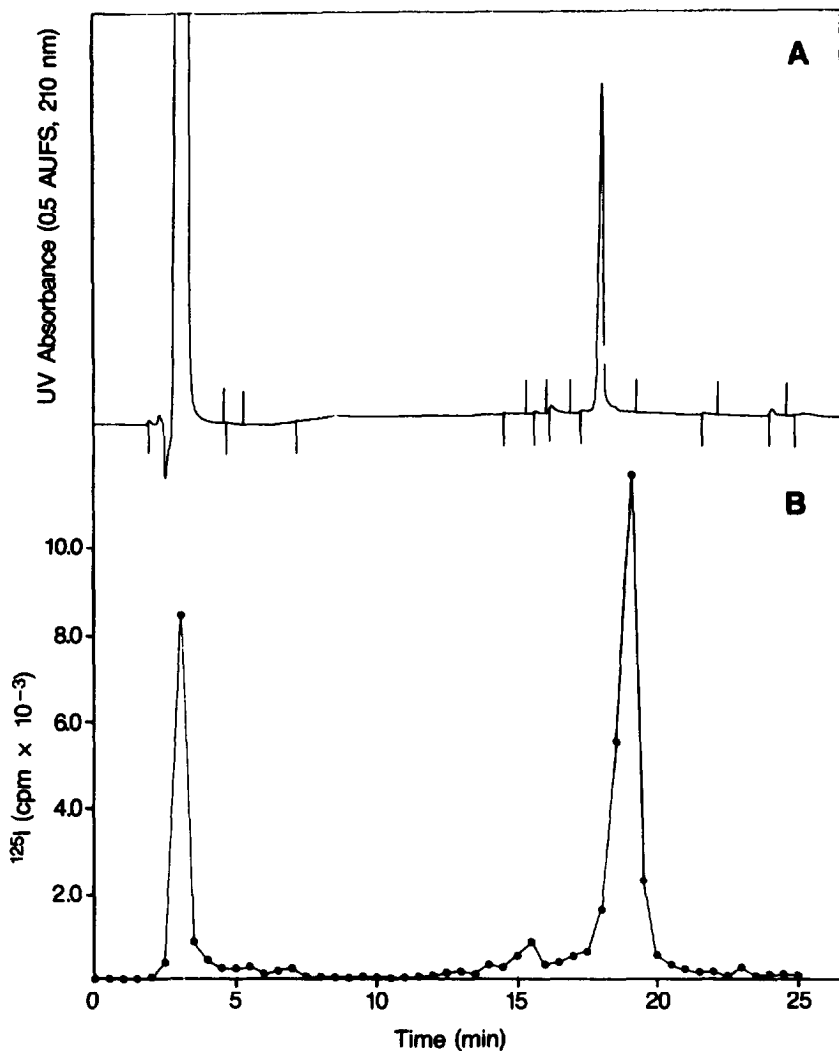


FIGURE 4

Purification of  $^{125}\text{I}$ - $\beta_{\text{h}}$ -Endorphin by Reversed-Phase HPLC

Unlabeled  $\beta_{\text{h}}$ -endorphin (A) and  $^{125}\text{I}$ - $\beta_{\text{h}}$ -endorphin (B) were eluted from a 3.9 mm x 30 cm  $\mu\text{Bondapak C}_{18}$  reversed-phase HPLC column (Waters Associates, Milford, MA) with a 20-minute linear gradient from 10% to 60% acetonitrile in 0.08% trifluoroacetic acid at 1.0 ml/min .

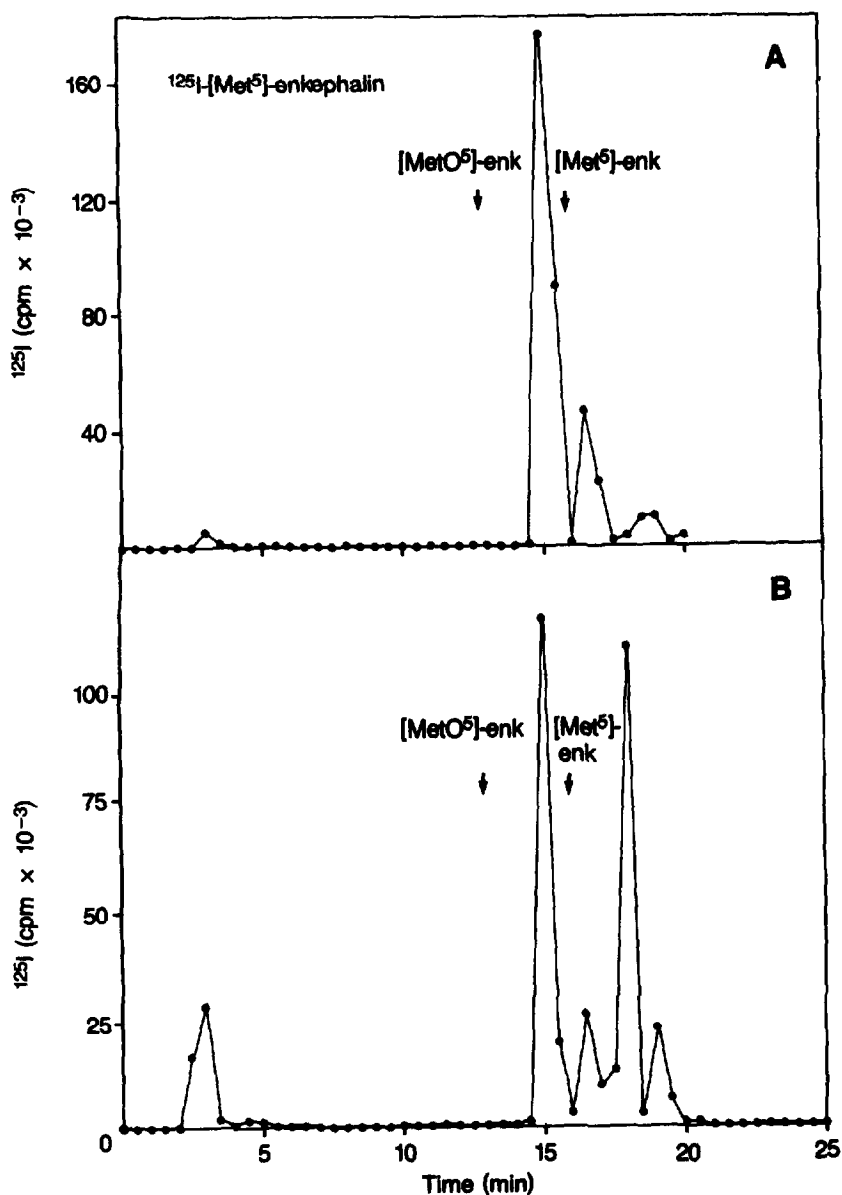


FIGURE 5

Purification of  $^{125}\text{I}$ -Met-Enkephalin by Reversed-Phase HPLC

$^{125}\text{I}$ -Met-enkephalin was chromatographed as described in the legend to figure 4 before (A) and after incubation with 0.75 M dithiothreitol for 16 hr at 37°C (B).

the course of chloramine-T catalyzed radioiodination (figure 5A).  $^{125}\text{I}$ -Met(O)-enkephalin can be partially reduced to  $^{125}\text{I}$ -Met-enkephalin by treatment with 0.75 M dithiothreitol for 16 hours at 37°C (figure 5B).

Tritium-labeled peptides are useful for monitoring recovery from extraction and chromatographic procedures used prior to RIA. The use of radioiodinated peptides for this purpose is not strictly valid, given the changes in physical properties which occur upon iodination. Tritium-labeled enkephalins are commercially available, and  $^3\text{H}$ - $\beta$ -endorphin and  $^3\text{H}$ -dynorphin(1-17) have been prepared by a palladium oxide catalyzed exchange reaction between tritium gas and synthetic diiodinated derivatives (Houghten and Li 1978; Houghten 1982).

## STANDARDS

Quantitative analysis by RIA requires accurate calibration with standard analyte solutions of known purity and concentration. Although most of the naturally occurring opioid peptides are available pure from commercial sources, the purity of primary standards should be checked periodically.

Reversed-phase HPLC is a powerful analytical tool for resolving impurities in opioid peptides. The same technique may also be used preparatively to purify the peptide standard. Opioid peptides are commonly chromatographed on columns containing hydrocarbon chains of 8 to 18 carbons covalently bonded to silica particles. Resolution of peptide mixtures is often achieved by elution with gradients of acetonitrile or propanol in aqueous solutions of ion-pairing reagents, such as acetic acid, trifluoroacetic acid, or heptafluorobutyric acid (Gabriel et al. 1981; Henderson et al. 1981; Hong et al. 1983; Lewis et al. 1979; Loeber and Verhoef 1981; McDermott et al. 1981; Morris et al. 1980). These solvent systems are relatively transparent in the ultraviolet region and are completely volatile, thus facilitating the detection and recovery of peptides in a salt-free form suitable for direct measurement by RIA. Although ultraviolet absorbance detection is most commonly used for HPLC of opioid peptides, Lewis et al. (1979) have also used fluorescence detection following post-column derivatization with fluorescamine.

A peptide's retention time on reversed-phase HPLC may be estimated from its amino acid composition by an empirical method described by Meek (1980). With the exceptions of  $\alpha$ -endorphin and  $\beta$ -endorphin(77-91), the observed relative retention times of the peptides shown in figure 6 are consistent with those predicted from the amino acid compositions.

Preparation of standard solutions from weighed portions of dry peptide is unreliable, because water and salts frequently constitute a significant fraction of the mass. The absolute

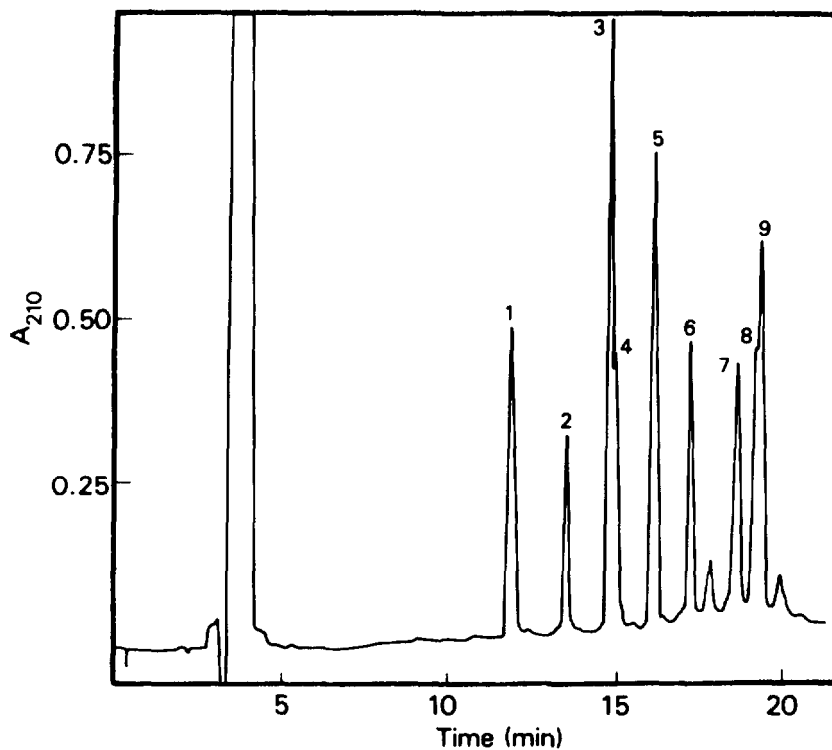


FIGURE 6.

Separation of Opioid Peptides by Reversed-Phase HPLC.

A mixture of Met(O)-enkephalin (1),  $\beta$ -LPH 77-91 (2), Met-enkephalin (3),  $\alpha$ -endorphin (4), Leu-enkephalin (5),  $\gamma$ -endorphin (6),  $\beta_c$ -endorphin (7),  $\beta_h$ -endorphin (8), and [Leu<sup>5</sup>]-B<sub>h</sub>-endorphin (9) was resolved by reversed-phase HPLC as described in the legend to figure 4.



concentration of a standard peptide solution is best determined by quantitative amino acid analysis following acid hydrolysis (Hong et al. 1983). Alternatively, the concentration may be calculated from ultraviolet absorbance measurements, provided the extinction coefficient is accurately known. Peptide standards will generally be most stable when stored dry under an inert gas.

## **SAMPLE PREPARATION**

Extraction and purification steps are often required before RIA can be used to measure opioid peptides in biological tissues and fluids. Opioid peptides are widely distributed in the central nervous system, gut, peripheral circulation, and endocrine tissues. Tissue-, cell-, and species-specific variations in processing of the precursors POMC, proenkephalin, and prodynorphin determine the characteristic and distinct distribution patterns observed for the various opioid peptides (for reviews, see Adler 1980; Bouras et al. 1984; Burbach 1984; Clement-Jones and Besser 1983, 1984; Cox and Baizman 1982; Cuello 1983; Goodman et al. 1983; Gramsch et al. 1982; Liotta and Krieger 1983; Miller et al. 1979; Rossier and Bloom 1982; Simon 1982; Smyth 1983; Terenius 1982; Yang et al. 1980; Zakarian and Smyth 1982). Depending on the tissue or fluid to be analyzed, different sample preparation problems are encountered.

### **Tissue Extraction**

Conditions for extracting opioid peptides from biological tissues are chosen to maximize peptide recovery and to minimize degradation by endogenous proteases. Enkephalins are best extracted from tissue with 0.1 N HCl or 2 N acetic acid (Miller et al. 1979). Ghazarossian et al. (1980a) found that dynorphin could be reliably extracted from porcine pituitaries only when 0.1 N HCl/methanol (50:50) was used at 70°C. In order to avoid losses of sample and tracer, these investigators also diluted the tissue extract and standards for the dynorphin RIA in the same HCl/methanol mixture and included 17% methanol, 0.1% BSA, and 0.1% Triton X-100 in the final assay mixture. Likewise, Guillemin et al. (1977) used an assay buffer containing 0.15 M NaCl, 0.1% gelatin, and 0.01% BSA and diluted the tracer in the same buffer containing 0.1% Triton X-100 to prevent adsorptive losses of <sup>125</sup>I-β-endorphin. Detailed procedures for extracting endorphins and enkephalins from biological tissues have been described by Hong et al. (1983).

When easily oxidized peptides such as Met-enkephalin are to be analyzed, some investigators deliberately convert all of the extracted peptide to the sulfoxide with hydrogen peroxide, thereby avoiding complications of variable recoveries among samples. The sensitivity of methionine to oxidation is illustrated by Huang et al. (1979), who first reported the existence of Met-enkephalin[Arg<sup>6</sup>] based on the isolation of the sulfoxide

form. Using a somewhat analogous approach, Boarder et al. (1983) measured relative concentrations of acetylated and nonacetylated endorphins in tissue extracts by assaying samples before and after treatment with acetic anhydride.

Many opioid peptides are present in biological tissues in concentrations of pmol/g and occasionally nmol/g, levels which are easily measured with RIAs capable of detecting fmol quantities. For example,  $\beta$ -endorphin concentrations of 45 nmol/g and 40 pmol/g were found in human anterior pituitary and hypothalamus) respectively (Gramsch et al. 1980). Similarly, Emson et al. (1984) measured a Met-enkephalin concentration of 905 pmol/g in the globus pallidus region of human brain, and Zhu et al. (1983) reported dynorphin concentrations of 252 and 37.4 pmol/g in rat anterior pituitary and hypothalamus, respectively.

### Chromatographic Separation

Mixtures of opioid peptides obtained from extracts of biological tissues may be further separated and purified prior to RIA by gel filtration chromatography and/or HPLC. Gel filtration chromatography is often used to separate opioid peptides from the larger precursors. Thus,  $\beta$ -endorphin and  $\beta$ -LPH in tissue or plasma extracts are readily separated by chromatography on Sephadex G-50 or Bio-Gel P60 in a solvent such as 0.1 N acetic acid containing 0.1% BSA (Holtt et al. 1979a, 1979b; Nakao et al. 1978; Wardlaw and Frantz 1979). Ion exchange chromatography, for example with SP-Sephadex, may be used in conjunction with gel filtration chromatography to separate N-acetylated peptides from the nonacetylated forms. This technique was used by Suda et al. (1982) to detect  $\beta$ -endorphin(1-31),  $\beta$ -endorphin(1-27), N-acetyl- $\beta$ -endorphin(1-31), and N-acetyl- $\beta$ -endorphin(1-27) in plasma and pituitary tumor tissue from patients with ectopic ACTH-producing tumors. Similar techniques were employed by Vuolteenaho et al. (1983) and Zakarian and Smyth (1979) in studies of acetylated and nonacetylated peptides derived from POMC in rat and human pituitaries. Various combinations of gel filtration media and solvents suitable for chromatography of opioid peptides have been summarized by Zakarian and Smyth (1982).

Caution is required when gel filtration chromatography alone is used to identify an opioid peptide, because some peptides are retarded by adsorptive processes as well as by size exclusion. Thus, Zhu et al. (1983) observed that leumorphin, or dynorphin B-29, was retarded much more than expected by Sephadex G-50.

The resolving power of reversed-phase HPLC for separating mixtures of opioid peptides is illustrated in figure 6. Reversed-phase HPLC has been applied in combination with gel filtration and/or ion exchange chromatography to resolve complex mixtures of opioid peptides in extracts of biological tissues and fluids prior to detection by RIA. For example, Cone et al. (1983)

fractionated extracts of rat brain, spinal cord, and pituitary gland on a column of Sephadex G-50 eluted with 0.1 M acetic acid containing 0.15 M NaCl and 0.1% Triton X-100, then further chromatographed the effluent on a  $\mu$ Bondapak C18 reversed-phase HPLC column in an acetonitrile gradient in 5 mM trifluoroacetic acid, and finally assayed each fraction with 5 different antisera against  $\alpha$ -neo-endorphin,  $\beta$ -neo-endorphin, dynorphin-A(1-8), dynorphin A(1-17), and dynorphin B. Similar techniques have been applied to identify the peptides derived from POMC (Burbach and Wiegant 1984; Margioris et al. 1983; Weber et al. 1982c), proenkephalin (Stern et al. 1982) and prodynorphin (Bergstrom et al. 1983; Minamino et al. 1981; Przewlocki et al. 1983; Seizinger et al. 1984; Suda et al. 1984; Tozawa et al. 1984; Weber et al. 1982a, 1982b) present in extracts of various biological tissues and fluids. Applications of HPLC and RIA to the measurement of endorphins and enkephalins in tissue extracts have been reviewed by Loeber and Verhoef (1981). Nyberg et al. (1983) have extended the combination of separation and detection techniques to include gel filtration chromatography, agarose electrophoresis, HPLC, radioreceptor assay, and RIA in characterizing the opioid peptides in pooled human CSF.

### Plasma and CSF

Most investigators have extracted opioid peptides from plasma prior to RIA in order to eliminate nonspecific interference by plasma proteins. This interference is usually manifested by decreased binding of tracer to antiserum and increased nonspecific binding of tracer. The problems associated with direct RIA for  $\beta$ -endorphin in plasma have been discussed by Lindall et al. (1979). Silicic acid has been commonly used to extract  $\beta$ -endorphin and  $\beta$ -LPH from plasma (Angwin and Barchas 1982; Brammert et al. 1982; Facchinetti and Genazzani 1979; Ghazarossian et al. 1980b; Holtt et al. 1979a; Petrucha et al. 1983). The adsorbed  $\beta$ -endorphin may then be recovered by elution with solvent mixtures such as 1% acetic acid in 40% acetone (Brammert et al. 1982) or 2 N HCl/acetone (20:80) (Facchinetti and Genazzani 1979). Reversed-phase Sep-Pak C18 cartridges (Waters Associates, Milford, MA) have also been used to extract FOMC-related peptides (Cahill et al. 1983) and Met-enkephalin (Clement-Jones et al. 1980b) from plasma. Gay and Lahti (1981) have described procedures for fractionating mixtures of endorphins and enkephalins by adsorption and sequential elution from Sep-Pak C18 cartridges. Likewise, Inturrisi et al. (1982) and Wardlaw and Frantz (1979) extracted  $\beta$ -endorphin and  $\beta$ -LPH from human plasma with talc. Alternatively, immobilized antibodies have been used to extract and separate  $\beta$ -endorphin and  $\beta$ -LPH in plasma samples to be assayed by RIA (Aronin and Krieger 1983; Lindall et al. 1979; Yamaguchi et al. 1980). Enkephalins may be extracted from plasma with a porous copolymer of styrene and ethylvinylbenzene cross-linked with divinylbenzene (Vogel and Altstein 1977) or with XAD-2 resin (Ryder and Eng 1981) and subsequently eluted with 50% to 60% ethanol or methanol. To compensate for variable oxidation

of Met-enkephalin during plasma extraction, Clement-Jones et al. (1980a, 1980b) and Ring and Millar (1980, 1981) routinely oxidized all plasma extracts with  $H_2O_2$  prior to analysis with a Met(O)-enkephalin RIA. Similarly, Boarder et al. (1982c) oxidized extracts containing Met-enkephalin[Arg<sup>6</sup>, Phe<sup>7</sup>] prior to incubation with an antiserum directed against the corresponding sulfoxide.

Several groups have reported direct RIA measurements of  $\beta$ -endorphin in unextracted rat (Akil et al. 1979), horse (Bossut et al. 1983), and human (Akil et al. 1979; Hindmarsh et al. 1983; Wiedemann et al. 1979; Wilkes et al. 1980) plasma. Wilkes et al. (1980) found comparable values for plasma  $\beta$ -endorphin in normal subjects by direct assay and after extraction with silicic acid. Nevertheless, the values reported by Wilkes et al. (1980), 33 +/- 2.6 fmol/ml for men (n=27) and 32 +/- 1.4 fmol/ml for women (n=25), are higher than the values for normal subjects reported by others. Likewise, Hindmarsh et al. (1983) reported concentrations of immunoreactive  $\beta$ -endorphin in normal human subjects of 43 to 55 fmol/ml, based on measurements with a commercially available RIA kit on unextracted plasma. In contrast, Wiedemann et al. (1979) found  $\beta$ -endorphin concentrations of <2.9 fmol/ml in 7 of 14 normal subjects and concentrations of 4.6 to 13 fmol/ml in the remaining 7 subjects, also using unextracted plasma for the measurements.

A wide variety of opioid peptides have been detected in plasma from normal human subjects, e.g.,  $\beta$ -endorphin, several forms of immunoreactive dynorphin, and many opiate active forms, including some which become opiate active only after trypsin treatment (Boarder et al. 1982a, 1982b). Many investigators have reported very low concentrations of  $\beta$ -endorphin in plasma from normal human subjects when samples are extracted prior to assay. For example, Bramnert et al. (1982) reported  $\beta$ -endorphin concentrations of <3 fmol/ml in 26 of 27 normal subjects, and Yamaguchi et al. (1980) found concentrations of <1.5 fmol/ml in 7 of 19 subjects and values of 2.3 +/- 0.2 fmol/ml in the remaining 12. Likewise, Aronin and Krieger (1983) and Cahill et al. (1983) both reported a  $\beta$ -endorphin concentration of 2.3 fmol/ml in normal subjects; Goland et al. (1981) found 1.3 fmol/ml; Nakao et al. (1978, 1979) reported values from <0.9 to 1.7 fmol/ml; and Suda et al. (1978) found normal  $\beta$ -endorphin levels to be <0.48 fmol/ml. Other groups have reported a range of values between 4 and 12 fmol/ml for  $\beta$ -endorphin in normal human plasma (Akil et al. 1979; Atkinson et al. 1983; Bertagna et al. 1981; Facchinetti et al. 1984; Genazzani et al. 1983a; Ghazarossian et al. 1980b; Holtt et al. 1979b; Wardlaw and Frantz 1979). Reported concentrations of  $\beta$ -LPH in normal human plasma have varied between 3.5 and 12.9 fmol/ml (Aronin and Krieger 1983; Facchinetti et al. 1984; Genazzani et al. 1983a; Ghazarossian et al. 1980b; Goland et al. 1981; Holtt et al. 1979b; Nakao et al. 1980a, 1978; Wardlaw and Frantz 1979; Yamaguchi et al. 1980).

Increases in plasma concentrations of  $\beta$ -endorphin and  $\beta$ -LPH are associated with a variety of factors, including insulin-induced hypoglycemia (Nakao et al. 1979; Smith et al. 1981), stress, physical exercise, and labor (Genazzani et al. 1984). Marked elevations in plasma concentrations of  $\beta$ -endorphin and  $\beta$ -LPH have also been observed in cases of adrenal or pituitary disorders, such as Addison's disease, Nelson's syndrome, Cushing's disease, and ectopic ACTH production, which result in pituitary hyperfunction (Bramnert et al. 1982; Bertagna et al. 1981; Holtt et al. 1979b; Krieger et al. 1979, 1980). Diurnal variations in  $\beta$ -endorphin and  $\beta$ -LPH concentrations in normal human subjects have been noted by Facchinetti et al. (1984) and Jeffcoate et al. (1978a); minimum concentrations were observed at 8:00 to 11:00 p.m., and maximum concentrations at 8:00 to 9:00 a.m. Human plasma concentrations of  $\beta$ -endorphin and  $\beta$ -LPH increase during prepuberty and reach adult levels by adolescence, but no sex-related differences in these levels have been detected (Genazzani et al. 1983b).

Normal plasma concentrations of  $\beta$ -endorphin in some other species appear to be substantially higher than in humans. Thus,  $\beta$ -endorphin levels of 75 +/- 15 fmol/ml in rats (Akil et al. 1979) and 72 to 205 fmol/ml in horses (Bossut et al. 1983) have been reported.

Concentrations of 24 to 244 fmol/ml Met-enkephalin (Clement-Jones et al. 1980a, 1980b) and 97 +/- 18 fmol/ml Leu-enkephalin (Ryder and Eng 1981) have been reported in plasma from normal human subjects.

Procedures for extracting Met-enkephalin from CSF with octadecylsilyl-silica followed by elution with 1% formic acid in 80% methanol have been reported by Clement-Jones et al. (1980b). Akil et al. (1978b) also extracted Met-enkephalin from acidified CSF with Biobeads SM-2 and eluted the adsorbed material with methanol.

Concentrations of 5.1 to 144 fmol/ml  $\beta$ -endorphin (Clement-Jones et al. 1980c; Hosobuchi et al. 1979; Nakao et al. 1980a), 9.1 to 122 fmol/ml  $\beta$ -LPH (Clement-Jones et al. 1980c; Jeffcoate et al. 1978b; Nakao et al. 1980a, 1980b), and 14 +/- 0.9 fmol/ml dynorphin(1-17) (Tozawa et al. 1984) have been measured in human CSF. Met-enkephalin levels in human CSF have been variously reported as 9 to 51 fmol/ml (Clement-Jones et al. 1980c) and 3 pmol/ml (Akil et al. 1978b; Sullivan et al. 1977).

Acupuncture has been reported to increase CSF concentrations of Met-enkephalin without affecting the CSF level of  $\beta$ -endorphin or the plasma levels of either  $\beta$ -endorphin or Met-enkephalin (Clement-Jones et al. 1979). Denko et al. (1981) have reported apparent  $\beta$ -endorphin concentrations of 110 to 136 fmol/ml in human urine, but the immunoreactive material was not characterized physically.

## SEPARATION OF BOUND AND FREE LIGAND

Once the binding of radioligand and unlabeled analyte to antibody has reached equilibrium, the antibody-bound fraction of radioligand is measured following physical separation from the unbound fraction. Dextran-coated charcoal has been widely used to adsorb radiolabeled opioid peptides not bound by antibody and thus effect a separation of the bound and free fractions of tracer. Following centrifugation to pellet the charcoal, the supernatant containing the antibody-bound radioligand is decanted into a second tube for counting. Detailed procedures for the preparation and use of charcoal as a separating reagent for RIA have been described by Odell (1980).

Antibodies directed against the nonbinding regions of the primary antibodies, so-called second antibodies, are also commonly used to separate the bound and free fractions of tracer in RIAs for opioid peptides. If the antibody recognizing an opioid peptide determinant is obtained from rabbits, then a goat antirabbit gamma globulin might be used as the second antibody. In this case, the primary antibodies and bound fraction of radioligand will be precipitated from solution by the second antibody, provided that sufficient nonimmune rabbit serum is added as a carrier. After the precipitated antibodies are pelleted by centrifugation, the supernatant containing the fraction of radioligand not bound to antibody is decanted and discarded. When large numbers of samples must be assayed, the second antibody separation technique is more convenient than the charcoal method, because each tube need not be individually decanted into a second tube prior to counting. Although the second antibody technique can be very time-consuming when a second incubation is included (Guillemin et al. 1977), this potential disadvantage can be eliminated by adding the second antibody in a pre-precipitated form with nonimmune rabbit serum. Methods for using the second antibody technique, including the pre-precipitation method, have been reviewed by Midgley and Hepburn (1980).

The antibody-bound fraction of radioligand may also be precipitated by adding polyethylene glycol (Ghazarossian et al. 1980b; Miller et al. 1978; Ross et al. 1978) or ammonium sulfate (Weissman and Gershon 1976) along with carrier serum. The use of these reagents for separating antigen from antigen-antibody complexes has been reviewed by Chard (1980).

## CALCULATIONS

Measurements of radioligand displacement allow the concentration of an opioid peptide in an unknown sample to be determined by RIA through interpolation from a standard displacement curve relating levels of antibody-bound radioligand to increasing quantities of unlabeled analyte. The standard displacement curve may be described by the four-parameter logistic formulation shown in equation 1 (Rodbard and Hutt 1974).

$$Y = [(a - d)/(1 + (X/c)^b)] + d \quad (1)$$

In this equation, Y is the level of radioligand (cpm) bound to antibody in the presence of a quantity X of analyte, a is the level of radioligand bound to antibody in the absence of competing analyte, d is the level of radioligand bound nonspecifically in the absence of antibody, c is the quantity of analyte required to displace 50% of the radioligand bound to antibody in the absence of analyte, and b is a slope factor which is equal to 1 under ideal circumstances. The four parameters in equation 1 may be calculated by the weighted iterative nonlinear regression analysis described by Rodbard and Hutt (1974), using a computer program available through the National Technical Information Service (Rodbard et al. 1975). Alternatively, the standard displacement curve may be linearized by plotting the logit function of %B/B<sub>0</sub> versus the natural logarithm of the analyte quantity (Rodbard et al. 1969). When defined in terms of the parameters used in equation 1, the logit function can be derived in the form shown in equation 2.

$$\text{logit } (B/B_0) = \ln[(B/B_0)/(1 - (B/B_0))] = \ln(X/c)^{-b} \quad (2)$$

Thus, logit (B/B<sub>0</sub>) is a linear function of ln X, where B/B<sub>0</sub> = (Y - c)/(a - d) is the fraction of radioligand remaining bound to antibody in the presence of quantity X of analyte, after correction for nonspecific binding.

## VALIDATION

Measurements of opioid peptide concentrations by RIA must be validated for each sample type or application. Any factor which interferes with the specific binding of radiolabeled ligand to antibody will simulate analyte and lead to falsely elevated estimates of peptide concentration. Such effects may result from adsorption of tracer to sample proteins or to glass or plastic surfaces, from proteolytic degradation of tracer, or from cross-reaction with shared determinants in related or unrelated peptides. The impact of these factors on the validity of RIAs for opioid peptides has been discussed by Bayon et al. (1983), Rorstad (1983), and Vuolteenaho et al. (1981).

### Parallel Displacement Curves

Displacement of antibody-bound radioligand by increasing quantities of an opioid peptide will parallel the displacement produced by a substance having an identical determinant, such as a common sequence of amino acids. Unfortunately, this is not a very sensitive test of immunological equivalence because ligands with tenfold differences in affinity constants may yield essentially parallel displacement curves (Bayon et al. 1983). Thus, displacement of a radioligand by a biological tissue or fluid extract in parallel with an unlabeled opioid peptide is necessary but not sufficient to attribute the extract immunoreactivity to the peptide.

## Dose-Response Linearity

When an extract of a biological tissue or fluid is assayed at different dilutions, the measured peptide concentrations should vary linearly with sample dilution and should extrapolate to a zero intercept at infinite dilution. If low and constant levels of nonspecific interference are encountered, measured concentrations may be corrected by concurrently analyzing appropriate blank or analyte-free extracts (Hong et al. 1983). Akil et al. (1979) measured plasma levels of  $\beta$ -endorphin using standards prepared in pooled hypophysectomized plasma, while Inturrisi et al. (1982) dissolved standards in talc-treated plasma. Unfortunately, an appropriate blank may be difficult to prepare because the technique used to extract the antigen from a pooled sample may also remove some of the interfering substances. When biological fluids contain peptides derived from multiple tissues, simple surgical procedures may not produce analyte-free fluid. For example, Smith et al. (1981) reported that adrenalectomized patients with Cushing's disease have normal plasma levels of Met-enkephalin, suggesting a source other than the adrenal gland for the circulating peptide. Likewise,  $\beta$ -endorphin is still detectable in CSF in cases of hypopituitarism (Jeffcoate et al. 1978b) and following hypophysectomy (Schlachter et al. 1983).

## Tracer Degradation

Apparent immunoreactivity will be detected if the radiolabeled ligand is degraded by proteases in the biological tissue or fluid extract being assayed. The radiolabeled products of tracer degradation will not be bound by antibody and will thus appear to have been displaced by antigen. In some cases, the false immunoreactivity caused by tracer degradation even parallels the displacement curve generated by authentic analyte. For example, Di Augustine et al. (1980) found proteolytic tracer degradation to be responsible for all of the apparent  $\beta$ -endorphin immunoreactivity in rat mast cells. Conversely, Cone and Goldstein (1982) extracted  $^{125}\text{I}$ -dynorphin B from an RIA mixture containing a brain extract and analyzed the recovered tracer by HPLC to demonstrate its stability during the incubation. Protease activity may be destroyed by boiling samples prior to assay or, in some instances, by adding specific inhibitors such as aprotinin (Zyznar 1981).

## Interspecies Comparisons

Although the enkephalin sequences are common to all species studied, the structures of the larger opioid peptides such as  $\beta$ -endorphin display species-dependent variation (Burbach 1984). As shown in figure 7, the structures of human, bovine, ovine, camel, porcine, and rat  $\beta$ -endorphin are identical except for variations at positions 23, 27, and 31. Conflicting reports have been published concerning the structure of rat  $\beta$ -endorphin. Although Rubinstein et al. (1977) found purified rat  $\beta$ -endorphin



	1	2	3	4	5	6	7	8	9	10	11	12	13	14	15	16	17	18	19	20	21	22	23	24	25	26	27	26	29	30	31
Human	Tyr	Gly	Gly	Phe	Met	Thr	Ser	Glu	Lys	Ser	Gln	Thr	Pro	Leu	Val	Thr	Leu	Phe	Lys	Asn	Ala	Ile	Ile	Lys	Asn	Ala	Tyr	Lys	Lys	Gly	Glu
Bovine, ovine, camel	Tyr	Gly	Gly	Phe	Met	Thr	Ser	Glu	Lys	Ser	Gln	Thr	Pro	Leu	Val	Thr	Leu	Phe	Lys	Asn	Ala	Ile	Ile	Lys	Asn	Ala	His	Lys	Lys	Gly	Gln
Porcine	Tyr	Gly	Gly	Phe	Met	Thr	Ser	Glu	Lys	Ser	Gln	Thr	Pro	Leu	Val	Thr	Leu	Phe	Lys	Asn	Ala	Ile	Val	Lys	Asn	Ala	His	Lys	Lys	Gly	Gln
Rat	Tyr	Gly	Gly	Phe	Met	Thr	Ser	Glu	Lys	Ser	Gln	Thr	Pro	Leu	Val	Thr	Leu	Phe	Lys	Asn	Ala	Ile	Ile	Lys	Asn	(Val)	His	Lys	Lys	Gly	Gln

### FIGURE 7

#### Species Variation in $\beta$ -Endorphin Structure

See text for discussion of uncertainty in the rat structure.

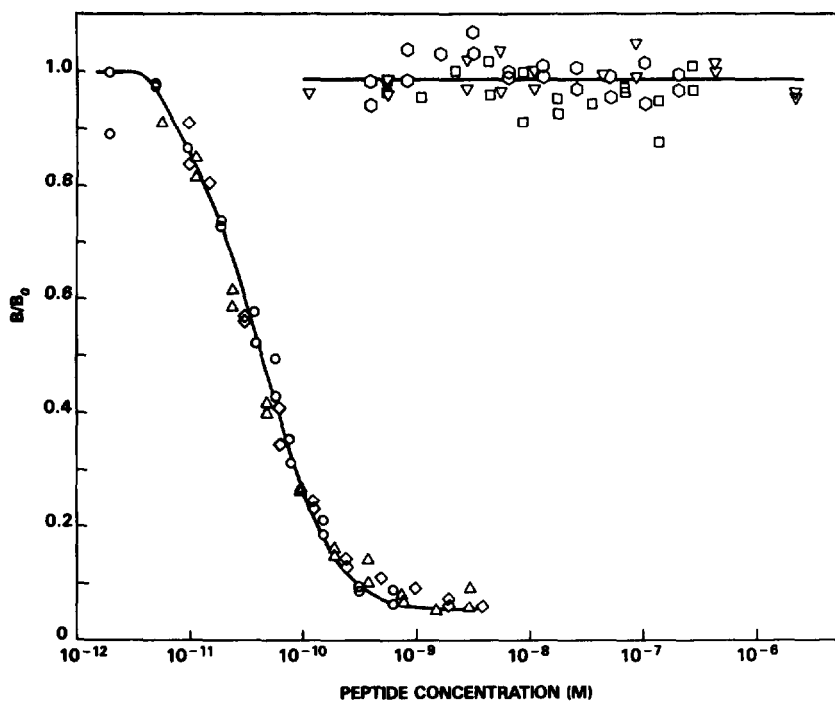


FIGURE 8

Specificity Profile of an Antiserum Directed Against the Carboxyl Terminus of  $\beta_{\text{h}}$ -Endorphin

Displacement of  $^{125}\text{I}$ - $\beta_{\text{h}}$ -endorphin from a  $\beta_{\text{h}}$ -endorphin antiserum (New England Nuclear, Boston, MA) was determined at various concentrations of unlabeled  $\beta_{\text{h}}$ -endorphin (—○—), [Leu5]- $\beta_{\text{h}}$ -endorphin (—△—),  $\gamma$ -endorphin (—◇—),  $\alpha$ -endorphin (—□—), [des-Tyr<sup>1</sup>]- $\beta_{\text{h}}$ -endorphin (—◇—), and Met-enkephalin (—▽—).

to be identical with the ovine and camel forms by tryptic mapping, Drouin and Goodman (1980) concluded from analysis of the sequence of a cloned rat POMC gene that a valine residue occupies position 26 instead of alanine. Caution must be exercised when an antiserum produced against  $\beta_n$ -endorphin is applied to the RIA of samples derived from other species. Thus, an antiserum directed against a determinant in the carboxyl terminus of  $\beta_n$ -endorphin, such as the one illustrated in figure 8, may not recognize the bovine, ovine, camel, porcine, and rat forms equally well.

### Physical Characterization of Analyte

Physical isolation, purification, and characterization of analyte affords the most definitive identification of immunoreactivity in biological tissues or fluids. Techniques such as gel filtration chromatography and HPLC, as described in the Sample Preparation section, may be applied along with electrophoresis, tryptic mapping, or partial sequence analysis to isolate and characterize opioid peptides. Purification and characterization of immunoreactive substances can detect unexpected cross-reactions. For example, when Julliard et. al. (1980) purified the  $\beta$ -endorphin immunoreactivity in extracts of human placenta and analyzed the material by electrophoresis, they found that the immunoreactivity could be attributed to the heavy chain of immunoglobulin G. Other instances of unexpected cross-reactions have been documented, including the cross-reaction of myelin basic protein with  $\beta$ -endorphin (Bayon et al. 1983).

### FOOTNOTES

<sup>1</sup>The following abbreviations are used: 1-ethyl-3-(3-dimethylaminopropyl)carbodiimide (CDI), immunoglobulin G (IgG), lipotropin (LPH), thyroglobulin (Tg), bovine adrenal medulla peptide 12 (BAM-12P), adrenocorticotrophic hormone (ACTH).

### REFERENCES

- Adler, M.W. Minireview. Opioid peptides. Life Sci 26(7): 497-510, 1980.
- Akil, H.; Watson, S.J.; Berger, P.A.; and Barchas, J.D. Endorphins,  $\beta$ -LPH, and ACTH: Biochemical, pharmacological and anatomical studies. Adv Biochem Psychopharmacol 18: 125-139, 1978a.
- Akin, H.; Watson, S.J.; Sullivan, S.; and Barchas, J.D. Enkephalin-like material in normal human CSF: Measurement and levels. Life Sci 23(2):121-126, 1978b.
- Akil, H.; Watson, S. J.; Barchas, J.D.; and Li, C.H.  $\beta$ -Endorphin immunoreactivity in rat and human blood: Radioimmunoassay, comparative levels and physiological alterations. Life Sci 24(18):1659-1666, 1979.
- Akil, H.; Lin, H.L.; Ueda, Y.; Knobloch, M.; Watson, S.J.; and Coy, D. Some of the alpha-NH<sub>2</sub>-acetylated beta-endorphin-like material in rat and monkey pituitary and brain is acetylated alpha- and beta-endorphin. Life Sci 33(Supp. 1): 9-12, 1983.

- Alessi, N.; Taylor, L.; and Akil, H. Peptide F (pro-enkephalin fragment): Radioimmunoassay, and stress-induced changes in adrenal. Life Sci 31(16-17):1875-1878, 1982.
- Angwin, P., and Barchas, J.D. Analysis of peptides in tissue and plasma. Use of silicic acid extraction and reversed-phase columns for rapid purification prior to radioimmunoassay. J Chromatogr 231(1):173-177, 1982.
- Aronin, N., and Krieger, D.T. Plasma immunoreactive beta-endorphin is elevated in uraemia. Clin Endocrinol (Oxf) 18(5): 459-464, 1983.
- Atkinson, J.H.; Kremer, E.F.; Risch, S.C.; Morgan, C.D.; Azad, R.F.; Ehlers, C.L.; and Bloom, F.E. Plasma measures of  $\beta$ -endorphin/beta-lipotropin-like immunoreactivity in chronic pain syndrome and psychiatric subjects. Psychiatry Res 9(4): 319-327, 1983.
- Baird, A.; Ling, N.; Böhlen, P.; Benoit, R.; Klepper, R.; and Guillemin, R. Molecular forms of the putative enkephalin precursor BAM-12P in bovine adrenal, pituitary, and hypothalamus. Proc Natl Acad Sci USA 79(6):2023-2025, 1982.
- Baird, A.; Klepper, R.; and Ling, N. In vitro and in vivo evidence that the C-terminus of preproenkephalin-A circulates as an 8500-dalton molecule. Proc Soc Exp Biol Med 175(3): 304-308, 1984.
- Bauminger, S., and Wilchek, M. The use of carbodiimides in the preparation of immunizing conjugates. Methods Enzymol 70:151-159, 1980.
- Bayon, A.; Shoemaker, W.J.; McGinty, J.F.; and Bloom, F. Immunodetection of endorphins and enkephalins: A search for reliability. Int Rev Neurobiol 24:51-92, 1983.
- Bergstrom, L.; Christensson, I.; Folkesson, R.; Stenstrom, B.; and Terenius, L. An ion exchange chromatography and radioimmunoassay procedure for measuring opioid peptides and substance P. Life Sci 33(16):1613-1619, 1983.
- Bertagna, X.Y.; Stone, W.J.; Nicholson, W.E.; Mount, C.D.; and Orth, D.N. Simultaneous assay of immunoreactive  $\beta$ -lipotropin,  $\gamma$ -lipotropin, and  $\beta$ -endorphin in plasma of normal human subjects, patients with ACTH/lipotropin hypersecretory syndromes, and patients undergoing chronic hemodialysis. J Clin Invest 67:124-133, 1981.
- Blake, J.; Hines, K.K.; and Li, C.H. Synthesis of human beta-endorphinyl-thiolglycine and its use for the preparation of affinity columns of beta-endorphin. Int J Pept Protein Res 20(5):429-433, 1982.
- Boarder, M.R.; Erdelyi, E.; and Barchas, J.D. Forms of opioid peptides circulating in human blood: Investigation with multiple radioimmunoassays and radioreceptor assay. Adv Biochem Psychopharmacol 33:117-122, 1982a.
- Boarder, M.R.; Erdelyi, E.; and Barchas, J.D. Opioid peptides in human plasma: Evidence for multiple forms. J Clin Endocrinol Metab 54(4):715-720, 1982b.
- Boarder, M.R.; Lockfeld, A.J.; and Barchas, J.D. Measurement of methionine-enkephalin [Arg<sup>6</sup>, Phe<sup>7</sup>] in rat brain by specific radioimmunoassay directed at methionine sulphoxide enkephalin [Arg<sup>6</sup>, Phe<sup>7</sup>]. J Neurochem 38(2):299-304, 1982c.

- Boarder, M.R.; Lockfield, A.J.; and Barchas, J.D. Met-enkephalin [Arg<sup>6</sup>, Phe<sup>7</sup>] immunoreactivity in bovine caudate and bovine adrenal medulla. J Neurochem 39(1):149-154, 1982d.
- Boarder, M.R.; Weber, E.; Evans, C.J.; Erdelyi, E.; and Barchas, J. Measurement of total opioid peptides in rat brain and pituitary by radioimmunoassays directed at the alpha-N-acetyl derivative. J Neurochem 46(6):1517-1522, 1983.
- Bossut, D.F.; Leshin, L.S.; and Malven, P.V. Radioimmunological measurement of beta-endorphin in equine plasma. Proc Soc Exp Biol Med 173(3):454-459, 1983.
- Bouras, C.; Taban, C.H.; and Constantinidis, J. Mapping of enkephalins in human brain. An immunohistofluorescence study on brains from patients with senile and presenile dementia. Neuroscience 12(1):179-190, 1984.
- Brammert, M.; Ekman, R.; Larsson, I.; and Thorell, J.I. Characterization and application of a radioimmunoassay for  $\beta$ -endorphin using an antiserum with negligible cross-reactivity against  $\beta$ -lipotropin. Regul Pept 5:65-75, 1982.
- Burbach, J.P.H. Action of proteolytic enzymes on lipotropins and endorphins: Biosynthesis, biotransformations and fate. Pharmacol Ther 24:321-354, 1984.
- Burbach, J.P., and Wiegant, V.M. Isolation and characterization of alpha-endorphin and gamma-endorphin from single human pituitary glands. FEBS Lett 166(2):267-272, 1984.
- Cahill, C.A.; Matthews, J.D.; and Akil, H. Human plasma beta-endorphin-like peptides: A rapid, high recovery extraction technique and validation of radioimmunoassay. J Clin Endocrinol Metab 56(5):992-997, 1983.
- Chang, W.-C.; Yeung, H.-W.; and Li, C.H. Human  $\beta$ -endorphin. Immunoreactivity of synthetic analogs with various chain lengths. Int J Pept Protein Res, 13:278-281, 1979.
- Chard, T. An introduction to radioimmunoassay and related techniques. In: Work, T.S., and Work, E., eds. Laboratory Techniques in Biochemistry and Molecular Biology. Vol. 6. Part II. Amsterdam: North-Holland Publishing Company, 1978. pp. 293-530.
- Chard, T. Ammonium sulfate and polyethylene glycol as reagents to separate antigen from antigen-antibody complexes. Methods Enzymol 70:280-291, 1980.
- Chen, M.; Berman, J.R.; McCarroll, M.C.; and Chen, I.W. Method for rapidly estimating specific radioactivity and radiochemical purity of radioiodinated peptide hormones used in radioimmunoassays. Clin Chem 27(4):632-633, 1981.
- Childers, S.R.; Simantov, R.; Snyder, S.H. Enkephalin: Radioimmunoassay and radioreceptor assay in morphine dependent rats. Eur J Pharmacol 46:289-292, 1977.
- Clement-Jones, V., and Besser, G.M. Clinical perspectives in opioid peptides. Br Med Bull 39(1): 95-100, 1983.
- Clement-Jones, V., and Besser, G.M. Opioid peptides in humans and their clinical significance. In: Udenfriend, S., and Meienhofer, J., eds. The Peptides. Analysis, Synthesis, Biology. Vol. 6. Orlando: Academic Press, Inc., 1984. pp. 323-389.
- Clement-Jones, V.; McLoughlin, L.; Lowry, P.J.; Besser, G.M.; Rees, L.H.; and Wen, H.L. Acupuncture in heroin addicts: Changes in met-enkephalin and  $\beta$ -endorphin in blood and cerebrospinal fluid. Lancet 2:380-383, 1979.

- Clement-Jones, V.; Lowry, P. J.; Rees, L.H.; and Besser, G.M. Met-enkephalin circulates in human plasma. Nature 283:295-297, 1980a.
- Clement-Jones, V.; Lowry, P.J.; Rees, L.H.; and Besser, G.M. Development of a specific extracted radioimmunoassay for methionine enkephalin in human plasma and cerebrospinal fluid. J Endocrinol 86:231-243, 1980b.
- Clement-Jones, V.; McLoughlin, L.; Tomlin, S.; Besser, G.M.; Rees, L.H.; and Wen, H.L. Increased  $\beta$ -endorphin but not Met-enkephalin levels in human cerebrospinal fluid after acupuncture for recurrent pain. Lancet 2:946-948, 1980c.
- Cone, R.I., and Goldstein, A. A specific radioimmunoassay for the opioid peptide dynorphin B in neural tissues. Neuropeptides 3(2):97-106, 1982.
- Cone, R.I.; Weber, E.; Barchas, J.D.; and Goldstein, A. Regional distribution of dynorphin and neo-endorphin peptides in rat brain, spinal cord, and pituitary. J Neurosci 3(11):2146-2152, 1983.
- Cox, B.M. Minireview. Endogenous opioid peptides: A guide to structures and terminology. Life Sci 31(16-17):1645-1658, 1982.
- Cox, B.M., and Baizman, E.R. Physiological functions of endorphins. In: Malick, J.B., and Bell, R.M.S., eds. Endorphins. Chemistry, Physiology, Pharmacology, and Clinical Relevance. New York: Marcel Dekker, Inc., 1982. pp. 113-196.
- Cuello, A.C. Central distribution of opioid peptides. Br Med Bull 39(1):11-16, 1983.
- Cuello, A.C.; Milstein, C.; Couture, R.; Wright, B.; Priestley, J.V.; and Jarvis, J. Characterization and immunocytochemical application of monoclonal antibodies against enkephalins. J Histochem Cytochem 32(9):947-957, 1984.
- Day, R.; Denis, D.; Barabe, J.; St-Pierre, S.; and Lemaire, S. Dynorphin in bovine adrenal medulla. I. Detection in glandular and cellular extracts and secretion from isolated chromaffin cells. Int J Pept Protein Res 19(1):10-17, 1982.
- Denko, C.W.; Gabriel, P.; and Petricevic, M. Urinary excretion of material with  $\beta$ -endorphin immunoreactivity. Clin Chem 27(1):207-208, 1981.
- Di Augustine, R.P.; Lazarus, L.H.; Jahnke, G.; Khan, M.N.; Erisman, M.D.; and Linnoila, R.I. Corticotropin/ $\beta$ -endorphin immunoreactivity in rat mast cells. Peptide or protease? Life Sci 27(25-26):2663-2668, 1980.
- Drouin, J., and Goodman, H.M. Most of the coding region of rat ACTH  $\beta$ -LPH precursor gene lacks intervening sequences. Nature 288:610-613, 1980.
- Eipper, B.A., and Mains, R.E. Characterization of mouse tumor cell  $\beta$ -lipotropin. J Biol Chem 254(20):10190-10199, 1979.
- Emson, P.C.; Corder, R.; Ratter, S.J.; Tomlin, S.; Lowry, P.J.; Rees, L.H.; Arregui, A.; and Rosser, M.N. Regional distribution of pro-opiomelanocortin-derived peptides in the human brain. Neuroendocrinology 38(1):45-50, 1984.

- Facchinetti, F., and Genazzani, A.R. Simultaneous radioimmunoassay for  $\beta$ -lipotropin and  $\beta$ -endorphin in human plasma. In: Albertini, A.; Da Prada, M.; and Peskar, B.A., eds. Radioimmunoassay of Drugs and Hormones in Cardiovascular Medicine. New York: Elsevier/North-Holland Biomedical Press, 1979. pp. 347-354.
- Facchinetti, F.; Grasso, A.; Petraglia, F.; Parrini, D.; Volpe, A.; and Genazzani, A.R. Impaired circadian rhythmicity of beta-lipotrophin, beta-endorphin and ACTH in heroin addicts. Acta Endocrinol (Copenh) 105(2):149-155, 1984.
- Gabriel, T.F.; Michalewsky, J.; and Meienhofer, J. Development of preparative scale high performance liquid chromatography for peptide and protein purification. In: Eberle, A.; Geiger, R.; and Wieland, T., eds. Perspectives in Peptide Chemistry. Basel: S. Karger, 1981. pp. 195-206.
- Gay, D.D., and Lahti, R.<sup>®</sup>A. Rapid separation of enkephalins and endorphins on Sep-Pak reverse phase cartridges. Int J Pept Protein Res 18:107-110, 1981.
- Genazzani, A.R.; Facchinetti, F.; Petraglia, F.; Pintor, C.; Bagnoli, F.; Puggioni, R.; and Corda, R. Correlations between plasma levels of opioid peptides and adrenal androgens in prepuberty and puberty. J Steroid Biochem 19(1):891-895, 1983a.
- Genazzani, A.R.; Facchinetti, F.; Pintor, C.; Puggioni, R.; Parrini, D.; Petraglia, F.; Bagnoli, F.; and Corda, R. Proopiomelanocortin-related peptide plasma levels throughout prepuberty and puberty. J Clin Endocrinol Metab 57(7):56-61, 1983b.
- Genazzani, A.R.; Petraglia, F.; Nappi, G.; Martignoni, E.; De Leo, M.; and Facchinetti, F. Endorphins in peripheral plasma: Origin and influencing factors. In: Müller, E.E., and Genazzani, A.R., eds. Central and Peripheral Endorphins. Basic and Clinical Aspects. New York: Raven Press, 1984. pp. 89-97.
- Ghazarossian, V.E.; Chavkin, C.; and Goldstein, A. A specific radioimmunoassay for the novel opioid peptide dynorphin. Life Sci 27(1):75-86, 1980a.
- Ghazarossian, V.E.; Dent, R.R.; Otsu, K.; Ross, M.; Cox, B.; and Goldstein, A. Development and validation of a sensitive radioimmunoassay for naturally occurring  $\beta$ -endorphin-like peptides in human plasma. Anal Biochem 102:80-89, 1980b.
- Giraud, P.; Castanas, E.; Patey, G.; Oliver, C.; and Rossier, J. Regional distribution of methionine-enkephalin-Arg<sup>6</sup>-Phe<sup>7</sup> in the rat brain: Comparative study with the distribution of other opioid peptides. J Neurochem 41(1):154-160, 1983.
- Goland, R.S.; Wardlaw, S.L.; Stark, R.I.; and Frantz, A.G. Human plasma  $\beta$ -endorphin during pregnancy, labor, and delivery. J Clin Endocrinol Metab 52(1):74-78, 1981.
- Goodman, R.R.; Fricker, L.D.; and Synder, S.H. Enkephalins. In: Krieger, D.T.; Brownstein, M.J.; and Martin, J.B., eds. Brain Peptides. New York: John Wiley and Sons, 1983. pp. 827-849.
- Gramsch, C.; Kleber, G.; Höllt, V.; Pasi, A.; Mehraein, P.; and Herz, A. Pro-opiomelanocortin fragments in human and rat brain:  $\beta$ -Endorphin and  $\alpha$ -MSH are the predominant peptides. Brain Res 192: 109-119, 1980.

- Gramsch, C.; Höllt, V.; Pasi, A.; Mehraein, P.; and Herz, A. Immunoreactive dynorphin in human brain and pituitary. Brain Res 233(1):65-74, 1982.
- Gramsch, C.; Meo, T.; Riethmüller, G.; and Herz, A. Binding characteristics of a monoclonal beta-endorphin antibody recognizing the N-terminus of opioid peptides. J Neurochem 40(5):1220-1226, 1983.
- Gros, C.; Pradelles, P.; Rouget, C.; Bepoldin, O.; Dray, F.; Fournie-Zaluski, M.C.; Roques, B.P.; Pollard, H.; Llorens-Cortes, C.; and Schwartz, J.C. Radioimmunoassay of methionine- and leucine-enkephalins in regions of rat brain and comparison with endorphins estimated by a radioreceptor assay. J Neurochem 31:29-39, 1978.
- Guillemin, R.; Ling, N.; and Vargo, T. Radioimmunoassays for a-endorphin and  $\beta$ -endorphin. Biochem Biophys Res Commun 77(1):361-366, 1977.
- Henderson, L.E.; Sowder, R.; and Oroszlan, S. Protein and peptide purification by reversed-phase high pressure chromatography using volatile solvents. In: Liu, T.-Y.; Schechter, A.N.; Henrikson, R.L.; and Condliffe, P.G., eds. Chemical Synthesis and Sequencing of Peptides and Proteins. New York: Elsevier/North-Holland, 1981. pp. 251-260.
- Hindmarsh, K.W.; Sankaran, K.; and Watson, V.G. Human beta-endorphin level determination. J Pediatr 103(5):833-834, 1983.
- Höllt, V.; Przewlocki, R.; and Herz, A. Radioimmunoassay of  $\beta$ -endorphin. Basal and stimulated levels in extracted rat plasma. Naunyn Schmiedebergs Arch Pharmacol 303:171-174, 1978.
- Höllt, V.; Gramsch, C.; and Herz, A. Immunoassay of  $\beta$ -endorphin. In: Albertini, A.; Da Prada, M.; and Peskar, B.A., eds. Radioimmunoassay of Drugs and Hormones in Cardiovascular Medicine. New York: Elsevier/North-Holland Biomedical Press, 1979a. pp. 293-307.
- Höllt, V.; Müller, O.A.; and Fahlbusch, R.  $\beta$ -Endorphin in human plasma: Basal and pathologically elevated levels. Life Sci 25(1):37-44, 1979b.
- Hong, J.-S.; Yang, H.-Y.T.; Fratta, W.; and Costa, E. Rat striatal methionine-enkephalin content after chronic treatment with cataleptogenic and noncataleptogenic antischizophrenic drugs. J Pharmacol Exp Ther 205(1):141-147, 1978.
- Hong, J.-S.; Yoshikawa, K.; and Hendren, R.W. Measurements of  $\beta$ -endorphin and enkephalins in biological tissues and fluids. Methods Enzymol 103:547-564, 1983.
- Hosobuchi, Y.; Rossier, J.; Bloom, F.E.; and Guillemin, R. Stimulation of human periaqueductal gray for pain relief increases immunoreactive  $\beta$ -endorphin in ventricular fluid. Science 203:279-281, 1979.
- Houghten, R.A. Tritiated porcine dynorphin (1-17): Synthesis and characterization. Life Sci 31(16-17):1805-1808, 1982.
- Houghten, R.A., and Li, C.H. Preparation and properties of tritiated human  $\beta$ -endorphin with high specific radioactivity. Int J Pept Protein Res 12:325-326, 1978.



- Huang, W.-Y.; Chang, R.C.C.; Kastin, A.J.; Coy, D.H.; and Schally, A.V. Isolation and structure of pro-methionine-enkephalin: Potential enkephalin precursor from porcine hypothalamus. Proc Natl Acad Sci USA 76(12):6177-6180, 1979.
- Hunter, W.M., and Greenwood, F.C. Preparation of iodine-131 labelled human growth hormone of high specific activity. Nature 194(4827):495-496, 1962.
- Hurn, B.A.L., and Chantler, S.M. Production of reagent antibodies. Methods Enzymol 70:104-142, 1980.
- Inturrisi, C.E.; Alexopoulos, G.; Lipman, R.; Foley, K.; and Rossier, J. Beta-endorphin immunoreactivity in the plasma of psychiatric patients receiving electroconvulsive treatment. Ann NY Acad Sci 398:413-423, 1982.
- Jaffe, B.M., and Behrman, H.R., eds. Methods of Hormone Radioimmunoassay. 2d ed. New York: Academic Press, 1979. 1024 pp.
- Jeffcoate, W. J.; Rees, L.H.; Lowry, P.J.; and Besser, G.M. A specific radioimmunoassay for human  $\beta$ -lipotropin. J Clin Endocrinol Metab 47(1):160-167, 1978a.
- Jeffcoate, W.J.; Rees, L.H.; McLoughlin, L.; Ratter, S.J.; Hope, J.; Lowry, P.J.; and Besser, G.M.  $\beta$ -Endorphin in human cerebrospinal fluid. Lancet 2:119-121, 1978b.
- Jégou, S.; Tonon, M.-C.; Leboulenger, F.; Delarue, C.; Vaudry, H.; and Ling, N. Radioimmunoassay for  $\gamma$ -endorphin. Biochem Biophys Res Commun 83(1):201-208, 1978.
- Jones, C.A.; Lane, D.P.; and Hughes, J. Monoclonal antibodies to leucine enkephalin. Biochem Biophys Res Commun 113(3):757-764, 1983.
- Julliard, J.H.; Shibasaki, T.; Ling, N.; and Guillemin, R. High-molecular-weight immunoreactive  $\beta$ -endorphin in extracts of human placenta is a fragment of immunoglobulin G. Science 208:183-185, 1980.
- Kangawa, K.; Mizuno, K.; Minamino, N.; and Matsuo, H. Radioimmunoassay for detecting pro-Leu-enkephalins in tissue extracts: Purification and identification of [Arg<sup>6</sup>]-Leu-enkephalin in porcine pituitary. Biochem Biophys Res Commun 95(4):1467-1474, 1980.
- Khanna, N.C., and Sharma, S.K. A simple solid-phase radioimmunoassay for enkephalins with Staphylococcus aureus. Anal Chim Acta 151:487-490, 1983.
- King, J.A. and Millar, R.P. Radioimmunoassay of methionine<sup>5</sup>-enkephalin sulphoxide: Phylogenetic and anatomical distribution. Peptides 1:211-216, 1980.
- King, J.A., and Millar, R.P. Development of radioimmunoassays for enkephalins. In: Millar, R.P., ed. Neuropeptides. Biochemical and Physiological Studies. New York: Churchill Livingstone, 1981. pp. 284-292.
- Kitamura, K.; Minamino, N.; Hayashi, Y.; Kangawa, K.; and Matsuo, H. Regional distribution of beta-neo-endorphin in rat brain and pituitary. Biochem Biophys Res Commun 109(3):966-974, 1982.
- Krieger, D.T.; Liotta, A.; and Li, C.H. Human plasma immunoreactive  $\beta$ -lipotropin: Correlation with basal and stimulated plasma ACTH concentrations. Life Sci 21(12):1771-1778, 1977.

- Krieger, D.T.; Liotta, A.; and Suds, T. Plasma  $\beta$ -lipotropin in the human. In: Usdin, E.; Bunney, W.E., Jr.; and Kline, N.S., eds. Endorphins in Mental Health Research. New York: Oxford University Press, 1979. pp. 561-568.
- Krieger, D.T.; Liotta, A.S.; Suda, T.; and Yamaguchi, H. Plasma ACTH, lipotropin and endorphin in the human. In: Wuttke, W.; Weindl, A.; Voigt, K.H.; and Dries, R.-R., eds. Brain and Pituitary Peptides. Basel: S. Karger, 1980. pp. 35-45.
- La Bella, F.; Queen, G.; Senyshyn, J.; Lis, M.; and Chretien, M. Lipotropin: Localization by radioimmunoassay of endorphin precursor in pituitary and brain. Biochem Biophys Res Commun 75(2):350-357, 1977.
- Lewis, R.V.; Stein, S.; and Udenfriend, S. Separation of opioid peptides utilizing high performance liquid chromatography. Int J Pept Protein Res 13:493-497, 1979.
- Li, C.H.; Rao, A.J.; Doneen, B.A.; and Yamashiro, D.  $\beta$ -Endorphin. Lack of correlation between opiate activity and immunoreactivity by radioimmunoassay. Biochem Biophys Res Commun 75(3):576-580, 1977.
- Lindall, A.W.; Ells, J.; and Roos, B. The radioimmunoassay of several neuropeptides. In: Albertini, A.; Da Prada, M.; and Peskar, B.A., eds. Radioimmunoassay of Drugs and Hormones in Cardiovascular Medicine. New York: Elsevier/North-Holland Biomedical Press, 1979. pp. 319-334.
- Lindberg, I.; Yang, H.-Y.T.; and Costa, E. A high molecular weight form of Met<sup>5</sup>-enkephalin-Arg<sup>6</sup>-Gly<sup>7</sup>-Leu<sup>8</sup> in rat brain and bovine adrenal chromaffin granules. Life Sci 33 (Supp. 1):5-8, 1983.
- Liotta, A.S., and Krieger, D.T. Pro-opiomelanocortin-related and other pituitary hormones in the central nervous system. In: Krieger, D.T.; Brownstein, M.J.; and Martin, J.B., eds. Brain Peptides. New York: John Wiley and Sons, 1983. pp. 613-660.
- Lissitsky, J.-C.; Morin, O.; Dupont, A.; Labrie, F.; Seidah, N.G.; Chrétien, M.; Lis, M.; and Coy, D.H. Content of  $\beta$ -LPH and its fragments (including endorphins) in anterior and intermediate lobes of the bovine pituitary gland. Life Sci 22:1715-1722, 1978.
- Liston, D., and Rossier, J. Distribution and characterization of synenkephalin immunoreactivity in the bovine brain and pituitary. Regul Pept 8(1):79-87, 1984.
- Loeber, J.G., and Verhoef, J. High-pressure liquid chromatography and radioimmunoassay for the specific and quantitative determination of endorphins and related peptides. Methods Enzymol 73:261-274, 1981.
- Margioris, A.N.; Liotta, A.S.; Vaudry, H.; Bardin, C.W.; and Krieger, D.T. Characterization of immunoreactive proopiomelanocortin-related peptides in rat testes. Endocrinology 113(2):663-671, 1983.
- McConahey, P.J.; and Dixon, F.J. Radioiodination of proteins by the use of the chloramine-T method. Methods Enzymol 70:210-213, 1980.
- McDermott, J.R.; Smith, A.I.; Biggins, J.A.; Al-Noaemi, M.C.; and Edwardson, J.A. Characterization and determination of

- neuropeptides by high-performance liquid chromatography and radioimmunoassay. J Chromatogr 222:371-379, 1981.
- Meek, J.L. Prediction of peptide retention times in high-pressure liquid chromatography on the basis of amino acid composition. Proc Natl Acad Sci USA 77(3):1632-1636, 1980.
- Meo, T.; Gramsch, C.; Inan, R.; Höllt, V.; Weber, E.; Herz, A.; and Riethmüller, G. Monoclonal antibody to the message sequence Tyr-Gly-Gly-Phe of opioid peptides exhibits the specificity requirements of mammalian opioid receptors. Proc Natl Acad Sci USA 80(13):4084-4088, 1983.
- Merin, M.; Höllt, V.; Przewlocki, R.; and Herz, A. Low permeation of systemically administered human  $\beta$ -endorphin into rabbit brain measured by radioimmunoassays differentiating human and rabbit  $\beta$ -endorphin. Life Sci 27:281-289, 1980.
- Midgley, A.R., Jr., and Hepburn, M.R. Use of the double-antibody method to separate antibody bound from free ligand in radioimmunoassay. Methods Enzymol 70:266-274, 1980.
- Miller, R.J.; Chang, K.J.; Cooper, B.; and Cuatrecasas, P. Radioimmunoassay and characterization of enkephalins in rat tissues. J Biol Chem 253(2):531-538, 1978.
- Miller, R.J.; Meltzer, H.Y.; and Fang, V.S. Distribution and pharmacology of the enkephalins. In: Usdin, E.; Bunney, W.E., Jr.; and Kline, N.S., eds. Endorphins in Mental Health Research. New York: Oxford University Press, 1979. pp. 3-16.
- Minamino, N.; Kitamura, K.; Hayashi, Y.; Kangawa, K.; and Matsuo, H. Regional distribution of alpha-neo-endorphin in rat brain and pituitary. Biochem Biophys Res Commun 102(1):226-234, 1981.
- Mizuno, K.; Minamino, N.; Kangawa, K.; and Matsuo, H. A new endogenous opioid peptide from bovine adrenal medulla: Isolation and amino acid sequence of a dodecapeptide (BAM-12P). Biochem Biophys Res Commun 95(4):1482-1488, 1980.
- Morley, J.S. Chemistry of opioid peptides. Br Med Bull 39(1):5-10, 1983.
- Morris, H.R.; Etienne, A.T.; Dell, A.; and Albuquerque, R. A rapid and specific method for the high resolution purification and characterization of neuropeptides. J Neurochem 34(3):574-582, 1980.
- Morrison, M. Lactoperoxidase-catalyzed iodination as a tool for investigation of proteins. Methods Enzymol 70:214-220, 1980.
- Mueller, G.P. Attenuated pituitary  $\beta$ -endorphin release in estrogen-treated rats (40936). Proc Soc Exp Biol Med 165:75-81, 1980.
- Nakao, K.; Nakai, Y.; Oki, S.; Horii, K.; and Imura, H. Presence of immunoreactive  $\beta$ -endorphin in normal human plasma. J Clin Invest 62:1395-1398, 1978.
- Nakao, K.; Nakai, Y.; Jingami, H.; Oki, S.; Fukata, J.; and Imura, H. Substantial rise of plasma  $\beta$ -endorphin levels after insulin-induced hypoglycemia in human subjects. J Clin Endocrinol Metab 49(6):838-841, 1979.
- Nakao, K.; Nakai, Y.; Oki, S.; Matsubara, S.; Konishi, T.; Nishitani, H.; and Imura, H. Immunoreactive  $\beta$ -endorphin in human cerebrospinal fluid. J Clin Endocrinol Metab 50(2):230-233, 1980a.

- Nakao, K.; Oki, S.; Tanaka, I.; Horii, K.; Nakai, Y.; Furui, T.; Fukushima, M.; Kuwayama, A.; Kageyama, N.; and Imura, H. Immunoreactive  $\beta$ -endorphin and adrenocorticotropin in human cerebrospinal fluid. J Clin Invest 66:1383-1390, 1980b.
- Nakao, K.; Yoshimasa, T.; Oki, S.; Tanaka, I.; Nakai, Y.; Wakimasu, M.; Fujino, M.; and Imura, H. Presence of dynorphin-like immunoreactivity in rat pituitary gland and hypothalamus. Regul Pept 2(3):201-208, 1981.
- Nyberg, F.; Wahlström, A.; Sjölund, B.; and Terenius, L. Characterization of electrophoretically separable endorphins in human CSF. Brain Res 259(2):267-274, 1983.
- Odell, W.D. Use of charcoal to separate antibody complexes from free ligand in radioimmunoassay. Methods Enzymol 70:274-279, 1980.
- Odell, W.D., and Daughaday, W.H., eds. Principles of Competitive Protein Binding Assays. Philadelphia: J.B. Lippincott Co., 1971. 429 pp.
- Orth, D.N. General considerations for radioimmunoassay of peptide hormones. Methods Enzymol 37:22-38, 1975.
- Petrucha, R.A.; Goebelsmann, U.; Hung, T.T.; Haase, H.R.; and Lobo, R.A. Amniotic fluid beta-endorphin and beta-lipotropin concentrations during the second and third trimesters. Am J Obstet Gynecol 146(6):644-651, 1983.
- Pezalla, P.D.; Clarke, W.C.; Lis, M.; Seidah, N.G.; and Chrétien, M. Immunological characterization of  $\beta$ -lipotropin fragments (endorphin,  $\beta$ -MSH and N-fragment) from fish pituitaries. Gen Comp Endocrinol 34:163-168, 1978.
- Przewlocki, R.; Gramsch, C.; Pasi, A.; and Herz, A. Characterization and localization of immunoreactive dynorphin,  $\alpha$ -neo-endorphin, Met-enkephalin and substance P in human spinal cord. Brain Res 280:95-103, 1983.
- Rodbard, D., and Hunt, D.M. Statistical analysis of radioimmunoassays and immunoradiometric (labelled antibody) assays. A generalized weighted, iterative, least-squares method for logistic curve fitting. In: Radioimmunoassay and Related Procedures in Medicine. Vol. I. New York: Unipub, Inc., 1974. pp. 165-192.
- Rodbard, D.; Bridson, W.; and Rayford, P.L. Rapid calculation of radioimmunoassay results. J Lab Clin Med 74(5):770-781, 1969.
- Rodbard, D.; Faden, V.B.; Hutt, D.M.; and Knisley, S. Radioimmunoassay Data Processing: Listings and Documentation, Third Edition, Volume II: The Logistic Method and Quality Control. Documents. no. PB-246 224 and PB-246 222. Springfield, VA: National Technical Information Service, U.S. Department of Commerce, 1975. 100 pp.
- Rorstad, O.P. Competitive binding assays. In: Krieger, D.T.; Brownstein, M.J.; and Martin, J.B., eds. Brain Peptides. New York: John Wiley and Sons, 1983. pp. 465-483.
- Rosenberg, A., and Teare, F.W. A novel thin-layer chromatographic monitoring system for the radioiodination of protein and polypeptides. Anal Biochem 77:289-292, 1977.
- Ross, M.; Ghazarossian, V.; Cox, B.M.; and Goldstein, A. Radioimmunoassays for  $\beta$ -endorphin: Comparison of properties of two antisera. Life Sci 22(13-15):1123-1130, 1978.

- Rossier, J.P., and Bloom, F.E. Distribution of opioid peptides. In: Malick, J.B., and Bell, R.M.S., eds. Endorphins. Chemistry, Physiology, Pharmacology, and Clinical Relevance. New York: Marcel Decker, Inc., 1982. pp. 89-111.
- Rossier, J.; Vargo, T.M.; Minick, S.; Ling, N.; Bloom, F.E.; and Guillemin, R. Regional distribution of  $\beta$ -endorphin and enkephalin contents in rat brain and pituitary. Proc Natl Acad Sci USA 74(11):5162-5165, 1977.
- Rubinstein, M.; Stein, S.; and Udenfriend, S. Isolation and characterization of the opioid peptides from rat pituitary:  $\beta$ -Endorphin. Proc Natl Acad Sci USA 74(11):4969-4972, 1977.
- Ryder, S.W., and Eng, J. Radioimmunoassay of leucine-enkephalin-like substance in human and canine plasma. J Clin Endocrinol Metab 52(2):367-369, 1981.
- Schlachter, L.B.; Wardlaw, S.L.; Tindall, G.T.; and Frantz, A.G. Persistence of  $\beta$ -endorphin in human cerebrospinal fluid after hypophysectomy. J Clin Endocrinol Metab 57(1):221-224, 1983.
- Seizinger, B.R.; Grimm, C.; Höllt, V.; and Herz, A. Evidence for a selective processing of proenkephalin B into different opioid peptide forms in particular regions of rat brain and pituitary. J Neurochem 42(2):447-457, 1984.
- Shaaban, M.H.; Hung, T.T.; Hoffman, D.I.; Lobo, R.A.; and Goebelsmann, U. Beta-endorphin and beta-lipotropin concentrations in umbilical cord blood. Am J Obstet Gynecol 144(5):560-568, 1982.
- Simantov, R.; Childers, S.R.; and Snyder, S.H. Opioid peptides: Differentiation by radioimmunoassay and radioreceptor assay. Brain Res 135:358-367, 1977.
- Simon, E.J. Opiate receptors and opioid peptides: An overview. Ann NY Acad Sci 398:327-339, 1982.
- Smith, R.; Grossman, A.; Gaillard, R.; Clement-Jones, V.; Ratter, S.; Mallinson, J.; Lowry, P.J.; Besser, G.M.; and Rees, L.H. Studies on circulating Met-enkephalin and  $\beta$ -endorphin: Normal subjects and patients with renal and adrenal disease. Clin Endocrinol (Oxf) 15:291-300, 1981.
- Smyth, D.G.  $\beta$ -Endorphin and related peptides in pituitary, brain, pancreas and antrum. Br Med Bull 39(1):25-30, 1983.
- Stern, A.S.; Wurzbarger, R.J.; Barkey, R.; and Spector, S. Opioid polypeptides in guinea pig pancreas. Proc Natl Acad Sci USA 79(21):6703-6706, 1982.
- Suda, M.; Nakao, K.; Sakamoto, M.; Yoshimasa, T.; Morii, N.; Yanaihara, N.; Numa, S.; and Imura, H. Leumorphin is a novel endogenous opioid peptide in man. Biochem Biophys Res Commun 123(1):148-155, 1984.
- Suda, T.; Liotta, A.S.; and Krieger, D.T.  $\beta$ -Endorphin is not detectable in plasma from normal human subjects. Science 202:221-223, 1978.
- Suda, T.; Tozawa, F.; Yamaguchi, H.; Shibasaki, T.; Demura, H.; and Shizume, K. Multiple forms of immunoreactive beta-endorphin are present in an ectopic adrenocortico-tropin-producing tumor but not in normal pituitary or pituitary adenomas. J Clin Endocrinol Metab 54(1):167-171, 1982.

- Sullivan, S.; Akil, H.; Watson, S.J.; and Barchas, J.D. Antibodies to enkephalins: Coupling of antigens and a specific methionine-enkephalin radioimmunoassay. Commun Psychopharmacol 1:605-610, 1977.
- Takahashi, M.; Kaneto, H.; Ueno, E.; Watanabe, J.; Koida, M.; Ogawa, H.; and Yajima, H. Radioimmunoassay of methionine-enkephalin and interference by brain factor of immunoreactivity and opiate receptor binding activity. Jpn J Pharmacol 29:203-209, 1979.
- Taylor, J.W.; Miller, R.J.; and Kaiser, E.T. Structural characterization of beta-endorphin through the design, synthesis, and study of model peptides. Mol Pharmacol 22(3):657-666, 1982.
- Tejwani, G.A.; Vaswani, K.K.; Barbacci, J.C.; Richard, C.W. III; and Bianchine, J.R. Effect of oral contraceptives on the rat brain and pituitary  $\beta$ -endorphin. Life Sci 33 (Supp. 1):519-522. 1983.
- Terenius, L. Clinical aspects. In: Malick, J.B., and Bell, R.M.S., eds. Endorphins. Chemistry, Physiology, Pharmacology, and Clinical Relevance. New York: Marcel Dekker, Inc., 1982. pp. 229-255.
- Tower, B.B.; Sigel, M.B.; Poland, R.E.; Vanderlaan, W.P.; and Rubin, R.T. The talc-resin-trichloroacetic acid test for screening radioiodinated polypeptide hormones. Methods Enzymol 70:322-334, 1980.
- Tozawa, F.; Suda, T.; Tachibana, S.; Tomori, N.; Demura, H.; and Shizume, K. Presence of immunoreactive hynorphin in human cerebrospinal fluid. Life Sci 35(16):1633-1637, 1984.
- Van Vunakis, H. Radioimmunoassays: An overview. Methods Enzymol 70:201-209, 1980.
- Vogel, Z., and Altstein, M. The adsorption of enkephalin to porous polystyrene beads. A simple assay for enkephalin hydrolysis. FEBS Lett 80(2):332-336, 1977.
- Vuolteenaho, O.; Leppäluoto, J.; Vakkuri, O.; Karppinen, J.; Höyhty, M.; and Ling, N. Development and validation of a radioimmunoassay for beta-endorphin-related peptides. Acta Physiol Scand 112:313-321, 1981.
- Vuolteenaho, O.; Leppäluoto, J.; Höyhty, M.; and Hirvonen, J. Beta-endorphin-like peptides in autopsy pituitaries from adults, neonates and fetuses. Acta Endocrinol (Copenh) 102(1):27-84, 1983.
- Wardlaw, S.L., and Frantz, A.G. Measurement of  $\beta$ -endorphin in human plasma. J Clin Endocrinol Metab 48(1):176-180, 1979.
- Weber, E.; Truscott, R.J.; Evans, C.; Sullivan, S.; Angwin, P.; and Barchas, J.D. Alpha-N-acetyl beta-endorphins in the pituitary: Immunohistochemical localization using antibodies raised against dynorphin (1-13). J Neurochem 36(6):1977-1985, 1981.
- Weber, E.; Evans, C.J.; and Barchas, J.D. Predominance of the amino-terminal octapeptide fragment of dynorphin in rat brain regions. Nature 299(5878):77-79, 1982a.
- Weber, E.; Evans, C.J.; Chang, J.K.; and Barchas, J.D. Brain distributions of alpha-neo-endorphin and beta-neo-endorphin: Evidence for regional processing differences. Biochem Biophys Res Commun 108(1):81-88, 1982b.

- Weber, E.; Evans, C.J.; Chang, J.K. and Barchas, J.D. Antibodies specific for alpha-N-acetyl-beta-endorphins: Radioimmunoassays and detection of acetylated beta-endorphins in pituitary extracts. J Neurochem 38(2):436-437, 1982c.
- Weissman, B.A.; Gershon, H.; and Pert, C.B. Specific antiserum to Leu-enkephalin and its use in a radioimmunoassay. FEBS LETT 70(1):245-248, 1976.
- Wesche, D.; Höllt, V.; and Herz, A. Radioimmunoassay of enkephalins. Regional distribution in rat brain after morphine treatment and hypophysectomy. Naunyn Schmiedebergs Arch Pharmacol 301:79-82, 1977.
- Wiedemann, E.; Saito, T.; Linfoot, J.A.; and Li, C.H. Specific radioimmunoassay of human  $\beta$ -endorphin in unextracted plasma. J Clin Endocrinol Metab 49(3):478-480, 1979.
- Wilkes, M.M.; Stewart, R.D.; Bruni, J.F.; Quigley, M.E.; Yen, S.S.C.; Ling, N.; and Chrétien, M. A specific homologous radioimmunoassay for human  $\beta$ -endorphin: Direct measurement in biological fluids. J Clin Endocrinol Metab 50(2):309-315, 1980.
- Yamaguchi, H.; Liotta, A.S.; and Krieger, D.T. Simultaneous determination of human plasma immunoreactive  $\beta$ -lipotropin,  $\gamma$ -lipotropin, and  $\beta$ -endorphin using immune-affinity chromatography. J Clin Endocrinol Metab 51(5):1002-1008, 1980.
- Yang, H.-Y.T.; Hong, J.S.; and Costa, E. Regional distribution of Leu and Met enkephalin in rat brain. Neuropharmacology 16:303-307, 1977.
- Yang, H.-Y.T.; Hexum, T.; and Costa, E. Minireview. Opioid peptides in adrenal gland. Life Sci 27(13):1119-1125, 1980.
- Yoshimasa, T.; Nakao, K.; Ohtsuki, H.; Li, S.; and Imura, H. Methionine-enkephalin and leucine-enkephalin in human sympathoadrenal system and pheochromocytoma. J Clin Invest 69:643-650, 1982.
- Yoshimi, H.; Matsukura, S.; Sueoka, S.; Fukase, M.; Yokota, M.; Hirata, Y.; and Imura, H. Radioimmunoassay for  $\beta$ -endorphin: Presence of immunoreactive "big-big"  $\beta$ -endorphin ("big"  $\beta$ -lipotropin) in human and rat pituitaries. Life Sci 22:2189-2196, 1978.
- Zakarian, S., and Smyth, D. Distribution of active and inactive forms of endorphins in rat pituitary and brain. Proc Natl Acad Sci USA 76(11):5972-5976, 1979.
- Zakarian, S., and Smyth, D.G. Distribution of  $\beta$ -endorphin-related peptides in rat pituitary and brain. Biochem J 202:561-571, 1982.
- Zamir, N.; Palkovits, M.; and Brownstein, M.J. Distribution of immunoreactive dynorphin in the central nervous system of the rat. Brain Res 280:81-93, 1983.
- Zhu, Y.X.; Höllt, V.; and Loh, H. Immunoreactive peptides related to dynorphin B (= rimorphin) in the rat brain. Peptides 4:871-874, 1983.
- Zyznar, E.S. A rationale for the application of trasylol as a protease inhibitor in radioimmunoassay. Life Sci 28(17):1861-1866, 1981.

## **ACKNOWLEDGMENTS**

Portions of this work were supported by National Institute on Drug Abuse contract numbers 271-79-3627 and 271-81-3801.

## **AUTHOR**

R. Wayne Hendren, Ph.D.  
Chemistry and Life Sciences Unit  
Research Triangle Institute  
P.O. Box 12194  
Research Triangle Park, North Carolina 27709



# The Analysis of Endogenous Opioid Peptides With HPLC, Radioreceptor Assay, Radio-immunoassay, and Mass Spectrometry

Dominic M. Desiderio, Ph.D.; Hisayoshi Takeshita, M.D., Ph.D.; Hiroshi Onishi, M.D., Ph.D.; Genevieve Fridland, B.S.; Francis S. Tanzer, Ph.D., D.D.S.; Claire Wakelyn, B.S.; and Chhabil Dass, Ph.D.

## INTRODUCTION

Since the discovery of the endogenous opioid peptidergic pathways, it has been the goal of many scientists to understand and rationalize the metabolic roles that these peptidergic pathways and their corresponding peptides may play. One focus for this type of research activity that is of great interest is the participation of the peptidergic pathways in pain mechanisms. Because each individual peptidergic pathway is comprised of a larger precursor that is the result of gene expression, several potential intermediate larger precursors, the working peptide itself, and several inactive metabolites, it is crucial to employ state-of-the-art analytical methodologies to efficiently prepare purified chromatographic fractions and to measure the endogenous amounts of these peptides. The molecular specificity of the measurement process must be unambiguous (or nearly so) so that the analyst has confidence that the measurement that is being made reflects with high fidelity the structure of the target compound. This objective of unambiguous molecular specificity is a crucial aspect of this type of research because many conclusions are made from that analytical measurement, many other laboratories around the world will try to reproduce or refute that measurement, and in some cases, some decisions on the clinical course of management of a patient will be involved. For all of these reasons, it is of paramount importance to know the structure of the compound which is being measured.

This chapter describes the use of a unique combination of several state-of-the-art analytical assay methodologies for the study of the role that endogenous opioid peptides play in nociception. That overall objective of this work has five specific aims:

1. Describe accurately the precise molecular events which are involved in nociception processes.

2. Quantify endogenous opioid peptides in biological extracts with a minimum of structural ambiguity in that measurement. While minimum structural ambiguity is generally assumed during the measurement of an endogenous peptide, it is rarely proven (Desiderio 1984). Stated simply, do we know the structure of the peptide which is being measured?

3. Utilize this analytical methodology to monitor four peptidergic pathways, namely, endorphinergic, enkephalinergic, dynorphinergic, and substance P-ergic pathways. (Hughes 1983; Comb et al. 1982; Kirkpatrick et al. 1981; Gubler et al. 1982; Noda et al. 1982; Nawa et al. 1983).

4. Utilize gradient elution, reversed-phase high performance liquid chromatography (RP-HPLC) as a prepurification step for the peptide to be measured (Desiderio et al. 1984a).

5. Following RP-HPLC, utilize a series of eight different detectors to establish the identity of that peptide which is being measured. For radioreceptor assay (RRA), utilize four ligands (etorphine, dihydromorphine, DADL, ethylketoazocine) to focus on four different receptors; for radioimmunoassay (RIA), utilize antibodies that are directed toward leucine enkephalin (LE) and methionine enkephalin (ME); and utilize several mass spectrometric (MS) methods [field desorption (FD), fast atom bombardment (FAB),  $^{18}\text{O}$  peptide internal standards, protonated molecular ions  $-(\text{M}+\text{H})$ , and amino acid sequence-determining ions].

To demonstrate this type of novel measurement procedure, the peptide-rich fraction that is derived from the canine pituitary is analyzed. Gradient RP-HPLC separates a broad range of hydrophobicity which includes a number of endogenous peptides. A standard mixture of synthetic peptides is used to define the retention time for those peptides. Individual fractions are collected and analyzed with RRA. Selected enkephalin fractions are analyzed by RIA and FAB MS.

## MATERIALS AND METHODS

### Synthetic Peptides

Dynorphin 1-7, dynorphin 1-8, dynorphin 1-12, dynorphin 1-13, dynorphin 1-17, dynorphin 8, big dynorphin, substance P, beta-endorphin, alpha-neo-endorphin, beta-neo-endorphin, ME-Lys, and ME-Lys-Arg are purchased from Peninsula Laboratories (Belmont, CA). ME, LE, ME-Arg-Gly-Leu, and ME-Arg-Phe are purchased from Sigma Chemical Company (St. Louis, MO). ME-sulfoxide is synthesized from ME using  $\text{H}_2\text{O}_2$ . ME-sulfoxide elutes on the RP-HPLC before ME.

### Tissue Procurement

Biologic tissue is obtained from two sources, dogs and humans. From the canine model, cerebrospinal fluid (CSF), the four canine teeth,

and several brain tissues (pituitary, hypothalamus, caudate nucleus, thalamus, etc.) are obtained. From the human, CSF and teeth are obtained. Tissue acquisition is rapid (within minutes) to minimize any chemical or enzymatic interconversions. Tissue is stored at -70° under which biochemical extractions are begun.

### Extraction Procedures

The tissue is homogenized (Polytron, setting 3, 15 seconds, 4 times) in acetic acid (3 ml, 1N). Proteins are precipitated with acidified acetone (10 volumes, 80:20 = acetone: 0.1 N HCl). The solution is centrifuged (27,000 x g, 20 minutes) and the supernatant is dried under a stream of nitrogen. The residue is resuspended and injected onto a prewashed Sep-Pak. The peptide-rich fraction is eluted with acetonitrile: trifluoroacetic acid (80:20; 0.5% TFA) (Desiderio and Yamada 1983).

### Reversed-Phase HPLC

Advantage is taken of the recent developments in analytical RP-HPLC separations of peptide mixtures. Previous workers have shown that a buffer: peptide ion-pair possesses a sufficient level of hydrophobicity to participate effectively in RP chromatographic separation mechanisms. These types of RP analytical columns have been used in many laboratories for rapid, efficient, and high recovery separations of mixtures of peptides.

A Varian RP-HPLC instrument, coupled to a microcomputer, and a C-18 analytical column (10 micron pore diameter) are utilized. Acetonitrile organic modifier and a volatile triethylamine formate (TEAF) buffer (pH 3.1) are used. The flow rate is 1.5 ml/min<sup>-1</sup>; separations are done at ambient temperature; and a fraction collector is utilized to collect fractions every minute.

The gradient developed for this work is: 10% acetonitrile at the beginning of the elution; 22% at 48 minutes; 30% at 60 minutes; and 100% at 65 minutes. This gradient efficiently separates most, but not all, of the peptides in a standard synthetic mixture. It is important to realize the fact that it is possible to experimentally increase the chromatographic resolution of any RP-HPLC process. Experimental parameters that can be readily modified include the column temperature, flow rate, buffer, percentage of organic modifier, type of organic modifier, ionic strength, and several other experimental parameters. Much time can be invested in this optimization procedure and excellent RP-HPLC chromatograms can be produced for mixtures of synthetic compounds and even in some cases, for biologic extracts. However, because of the high molecular specificity of one of the detectors that is utilized in this study, namely, mass spectrometry, this additional work to improve chromatographic resolution is not necessary.

While it is understood that RIA and RRA assays demand purified chromatographic fractions before analysis, this goal is extremely difficult (if ever possible) to attain and, indeed, in our laboratory, we have noticed spurious results that result from incomplete chromatographic resolution. However, because of the availability of a mass spectrometer and the presence of molecular ion information and amino acid sequencing-determining information that can be provided by this type of detector, the maximum amount of chromatographic resolution is not required. This resolution versus specificity phenomenon is widespread and is further rationalized by considering the fact that no matter what mixture of synthetic peptides may be the target of the study, the next biologic extract to be separated may provide a new peptide that coelutes with a peptide which has been studied by RIA, RRA, or mass spectrometry.

### **Radioimmunoassay**

Because a majority of laboratories around the world utilize RIA kits for the measurement of biologically important peptides, commercially available (Immunonuclear, Stillwater, MS) RIA kits were used to measure ME and LE in a study comparing our results with those obtained in other laboratories.

### **Radioreceptor Assay**

Again, because several laboratories utilize RRA for the measurement of peptides, and because it is extremely useful to have a "screen" for a gradient HPLC which can be used to detect peptides that bind to an opiate receptor, a novel type of RRA was developed.

The canine animal model is utilized to provide the limbic system synaptosomes for RRA (Desiderio et al., submitted). The canine model is utilized because it is used for our tooth pulp studies (Tanzer et al. 1981) and because, in an evolutionary sense, the dog is closer to the human than the other types of laboratory animals that are commonly utilized. The limbic system is considered to include the cingulate and parahippocampal gyri, the hippocampus, the septum, the amygdaloid body, and the hypothalamus (Heimer 1983). The limbic system contains a high concentration of opioid receptors (Atweh and Kuhar 1983). Presumably, these opiate/opioid receptors are located on the synaptosome surfaces and, therefore, a synaptosomal-enriched, fraction is produced from the canine limbic system. The four ligands, etorphine, dihydromorphine, DADL, and ethylketazocine, are utilized for RRA because of their relative specificities for the four receptors, sigma, mu, delta, and kappa, respectively. While these four radiolabeled synthetic ligands are used for competitive displacement studies, it is known that each ligand does not have a specific and exclusive interaction with only one of the four receptors, but rather some overlap occurs amongst the different ligand specificities for the receptors.

## Mass Spectrometry

A Finnigan MAT 731 (Bremen, FRG) double-focusing forward geometry (E,B = electric sector before magnetic sector) MS that is outfitted with a combination EI-FI-FD-FAB ion source is utilized. Fast atoms are produced by an Ion Tech (Teddington, UK) gun, and fast atoms that have translational energies up to 8 kilovolts are utilized. A fast atom bombardment probe tip that is beveled at an appropriate angle of incidence (60°) is used: a methanolic solution of the peptide or an HPLC-purified fraction is placed onto the FAB tip; and the methanol is evaporated. Glycerol (0.3 ml) is utilized as the liquid matrix for FAB as a means to provide a continuously replenished surface of molecules and to prevent sample burning (Martin et al. 1982). Collision activated dissociations (CAD) occur in a 134 microliter volume which is located immediately after the MS ion source acceleration plates. Either unimolecular dissociations will occur, or the collisionally activated ions will decompose, in the first field-free region of the mass spectrometer. The products of those dissociations are collected and analyzed by combining the electric and magnetic fields in a linked-field scan, keeping the B/E ratio constant. A B/E linked-field scan collects all of the product ions that derive from a selected precursor ion, as opposed to another type of linked-field scan,  $B^2/E$ , that will collect all of the precursor ions that lead to a selected product ion.

While any type of compound may be used for an internal standard for the measurement of peptides, an internal standard that has the same chemical structure as the target compound is the most desirable type of internal standard. Toward this end, the direct chemical incorporation of a stable isotope into the peptide produces a compound which possesses very similar, if not identical, physical and chemical properties. For example, a stable isotope-incorporated peptide internal standard will virtually coelute from a RP-HPLC column with the target peptide, and the mass spectrometric behavior (ionization, evaporation, fragmentation, etc.) will also be similar. The experimental benefit to using a stable isotope-incorporated peptide internal standard for the measurement of endogenous peptides is that the mass spectra, while being similar in general features, will contain unique ions that will also shift the appropriate number of masses to reflect the number of stable isotopes which have been incorporated.

Peptide internal standards are synthesized in our laboratory by incorporating  $^{18}\text{O}$  atoms specifically and only into the carboxy terminus of the peptides. The source of the stable isotope ( $^{18}\text{O}$ ) that is used in this study is preferentially enriched  $\text{H}_2^{18}\text{O}$ . (Desiderio and Kai 1983).

An Apple II microcomputer is interfaced to the source and detector regions of the mass spectrometer and is used to effectively

acquire the analog data from the mass spectrometer and to digitize the data (Desiderio et al. 1984b). The use of a microcomputer for the acquisition and reduction of the mass spectrometric data extends the number of measurements which can be made, effectively reduces operator fatigue and errors, and, because of the increased amount of data that can be acquired, also enhances the signal-to-noise ratio.

## RESULTS AND DISCUSSION

### Recovery Studies

In the past, we have shown that approximately 26% of the radioactively labeled LE, when added early in the extraction scheme, is collected following HPLC. The early addition of radioactively labeled LE provides sufficient time for the exogenously added peptide to equilibrate with the endogenous enkephalin. This permits time for the exogenous peptide to penetrate into subcellular structures, and for the equilibration of peptide:peptide or peptide:protein, or other types of interactions to occur.

### Reversed-Phase HPLC Chromatograms

Figure 1 contains the RP-HPLC chromatogram of the peptide-rich fraction that is extracted from a canine pituitary. A gradient of the concentration of the organic modifier (acetonitrile) is utilized in order to cover a wide elution range of peptides, from amino acids and dipeptides, through the pentapeptides, up to, perhaps, precursors. Several detectors have been used for this RP-HPLC separation.

One of the detectors that is used is the RRA which uses etorphine as the displaced ligand. This ligand is chosen because it is displaced from several types of receptors and thus serves as an efficient detector having a broader range of specificity. This RP-HPLC chromatogram demonstrates the screening aspect of using an etorphine-based RRA. RRA may also be used to semiquantitate endogenous peptides (Desiderio et al., submitted). It must be strictly remembered, however, that etorphine is displaced from the receptor and that no peptide structure can be assigned to any of the observed RP-HPLC peaks.

A second detector is a UV detector. The UV absorption profile at 200 nm is superimposed on the chromatogram. Along the top of this chromatogram, indicated in figure 1 by the arrows, are those retention times where the synthetic peptides elute. Coelution of a peak at that arrow does not substantiate the structure of a peptide. That type of structural information can only be provided by appropriate amino acid sequence-determination data.

A third detector used in this study is MS, and this type of analytical data is shown below.

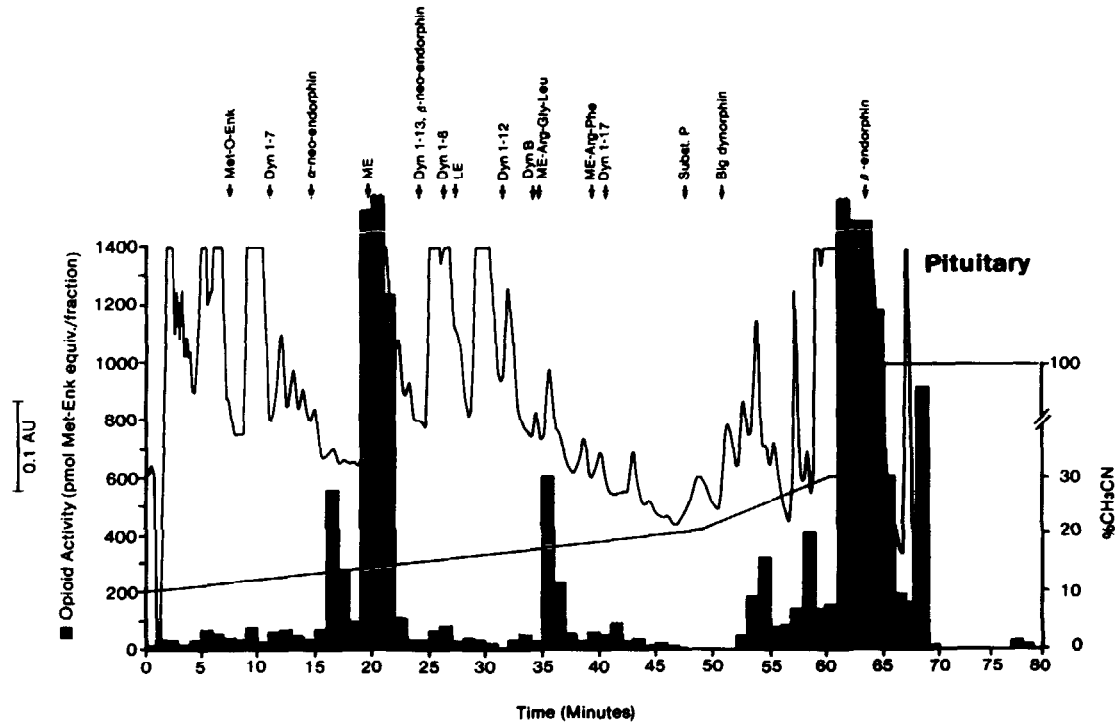


FIGURE 1

RR-HPLC chromatogram utilizing a detector that is based on a synaptosomal receptor and displacement of the ligand tritiated etorphine. UV absorption, gradient, and elution times of synthetic peptides are shown.

## Radioimmunoassay

Table 1 contains the analytical measurement of enkephalins that are obtained by utilizing commercial RIA antibodies. Peptides have been measured in a variety of tissues and fluids (Tanzer et al. 1984).

The data in table 1 are divided into two groups, controls and treated. The controls are those patients whose teeth are removed with no preliminary orthodontic treatment (Walker et al., submitted). It can be seen that the RIA data range in value from 1.3 to 1,138 ng of enkephalin  $g^{-1}$  wet weight of tooth pulp tissue. On the other hand, the treated population is comprised of those patients who, before their four canine teeth were extracted, had the two upper (and two lower) teeth connected together, and a force applied between those two teeth. The amount of endogenous enkephalin is significantly reduced when stress is applied to human teeth.

## Radioreceptor Assay

Table 1 also contains analytical measurements that utilize the canine limbic system synaptosomal RRA preparation and etorphine as the displaced ligand. Again, the data in table 1 indicate that, for the controls, the measured amounts range from 47 to 6,726 ng of enkephalin  $g^{-1}$  wet weight of tissue, and that the treated data are reduced.

It is interesting to note that the two sets of data parallel each other, but that the RRA assay data are numerically higher than RIA data.

The difference in RIA and RRA data is a reflection of several experimental factors. The RIA antibody is raised by a host animal's immune system against an immunogenic peptide: carrier protein complex, and not necessarily against the pentapeptide. The RRA preparation contains several types of receptors. Each radioligand has its own specific affinity toward its preferred receptor and a reduced affinity toward the other receptors. The binding constants of each ligand-receptor pair are also different. For these reasons, among other experimental reasons, it is relatively difficult to directly compare RRA results, either to other RRA-ligand receptor pairs or to radioimmunoassay. At best, general trends can be observed in the data.

These two sets of data indicate that stress effectively mobilizes the enkephalinergic peptidergic pathway (and perhaps also others) either in an overall fashion (amongst the individual family members of the peptide pathways), or that one target peptide that is being measured in this study (ME and LE) is preferentially metabolized.



TABLE 1

Opioid Concentrations Measured as Ng Enkephalin Equivalents  $g^{-1}$  Wet Weight Tissue in a Radioreceptor Assay, which is Based on the Displacement of  $^3H$ -Dihydromorphine, and in a Radioimmunoassay

<u>PATIENT</u>	<u>TOOTH NO.</u>	<u>WET WEIGHT</u>	<u>RIA</u>	<u>RRA</u>
<b><u>A. CONTROLS</u></b>				
DD	5	.1181	68	**
	12	.0576	4.9	521
	21	---	---	---
	28	.1181	5	47
JG	1	.0394	15.9	6 726
	16*	.0252	500	3 155
	17	.0543	7.2	5 608
	32	.0649	16.6	1 495
JW	--*	.0123	1 138	6 098
	--	.0273	7.1	421
	--	.0478	1.3	1 339
CB (a)	5	.0710	176	292
	12*	.0843	148	1 751
	21	.0496	51	107
	28	.0556	155	79
CB (b)	5	.0710	38	1 215
	12*	.0843	14	867
	21	.0496	5	968
	28	.0556	12	809
<b><u>B. TREATED</u></b>				
TH (a)	5*	.0448	19	91
	12	.0456	4	52
	21	.0396	n. d.	67
	28	.0402	15	74
TH (b)	5*	.0448	n. d.	81
	12	.0456	4	86
	21	.0396	n. d.	83
	28	.0402	40	114
SG (a)	5*	.0486	12	n. d.
	12	.0489	33	22
	21	.1107	17	29
	28	.0925	1	n. d.
SG (b)	5*	.0486	4	66
	12	.0489	16	21
	21	.1107	6	25
	28	.0925	1	n. d.
SS (a)	5*	.1303	32	68
	12	.1056	2	28
	21	.0773	5	29
	28	.0732	22	80
SS (b)	5*	.1303	2	39
	12	.1056	2	19
	21	.0773	3	28
	28	.0732	n. d.	23

(a) HPLC fraction collected at synthetic ME (YGGFM) retention time.

(b) HPLC fraction collected at synthetic LE (YGGFL) retention time.

\* first tooth extracted

\*\* sample used for MS corroboration

n. d. = not detected

Patients TH, SG, and SS were fitted with springs.

## Mass Spectrometry--Molecular Ion Determination

The other analytical methods that were employed above (HPLC, RIA, and RRA) for peptide measurement cannot convey any primary structural information in the analytical measurement. Only when a firm structural parameter (mass of the entire molecule or a subfragment of the structure) is measured can we confidently state that the peptide we think we are measuring is actually the one that is being measured. While mass spectrometry has been utilized for many years to quantify a great number of other types of compounds, peptides have been rigorously avoided for MS measurements because of their low volatility.

However, with the recent development of FAB MS, these experimental problems have been overcome. Indeed, recent work demonstrates that MS may even be the method of choice for measuring endogenous peptides, or at least, it can now be used to calibrate the other available analytical methods. FAB MS is ideally suited for peptide studies because a protonated molecular ion may be formed for the entire structure of the compound or, as described below, specialized MS techniques can produce amino acid sequence-determining ions.

As indicated above in the RP-HPLC example, FAB MS is utilized to determine the molecular ion of several of the RRA-responding peaks that are shown in figure 1. In the area surrounding fraction 17, a protonated molecular ion is found that corresponds to a molecular ion of 1,259. It is known that alpha-neoendorphin, which elutes in this area, has a molecular weight of 1,229. While the structure of this particular compound is not yet known, by utilizing MS peptide standards it is estimated that the peak at 1,259 mass units corresponds to 3 to 4 micrograms of peptide material. This peptide will be further characterized by utilizing a linked-field (B/E) scan to elucidate the amino acid sequence-determining information that derives only from the molecular ion.

In a second area of the chromatogram in figure 1 (fractions 21 and 22), a protonated molecular ion corresponding to ME is observed at 574, and its intensity correlates semiquantitatively to approximately 600 ng of material. A more intense peak is also observed at 453, and a less intense peak at 485. The latter two ions are presumed to be protonated molecular ions. The peak at 453 is also found in several of the HPLC fractions, and it may be due to chromatographic background material.

This set of three molecular ions (544, 485, and 453) in a region of a chromatogram, which may erroneously be thought to correspond to only an HPLC-pure ME peak, is an effective example that clearly demonstrates the need for the judicious use of a combination of detection systems in peptide research. One cannot depend upon

only one detection system to measure a peptide because of the limited molecular specificity which is inherent in most detection systems, even if extensive HPLC purification is done and appropriate calibration curves are drawn. It is interesting to note that the RRA analysis of this selected peak (fractions 21 and 22) in a large number of human tooth pulp extracts does yield highly variable results, This may be due to the variable proportions of these peptides, whose molecular ions are noted above, and also due to the peptide interactions with the RRA but not necessarily with the RIA antibody.

Mass spectrometric analysis of a third (fractions 36 and 37) region of the RP-HPLC chromatogram in figure 1 indicates the presence of a protonated molecular ion at mass 900, a mass which corresponds to the molecular weight of the proenkephalin molecule, Tyr-Gly-Gly-Phe-Met-Arg-Phe. No amino acid sequence-determining information has been determined yet for this peak. The amount of material in this fraction approximates 50 ng. FAB MS does not indicate the presence of dynorphin-1-17, a peptide which elutes before proenkephalin under these RP-HPLC conditions and which has a molecular weight of 1,571 mass units. However, a very small (but real) peak is observed instead at 1,755 mass units.

#### **FAB-CAD-B/E, B'/E'-SIM-Microcomputer Measurements**

FAB MS very effectively produces the protonated molecular ion  $(M+H)^+$  of a peptide. Collision activated dissociations (CAD) may cause the fragmentation of that protonated molecular ion into its constituent amino acid sequence-determining ion fragments. On the other hand, spontaneous unimolecular decompositions may occur. Linked-field scanning (B/E) can be used to select a unique amino acid sequence-determining ion that can form the basis of the analytical measurement. A B/E scan collects all of the product ions that arise from a selected precursor ion.  $^{10}O$ -incorporated peptide internal standards can be used to shift appropriate monitored masses by several mass units and also to provide an excellent internal standard, because a stable isotope-incorporated peptide possesses equivalent physicochemical properties during homogenization, equilibration, Sep-Pak, RP-HPLC, and MS processes. A microcomputer effectively extends the number of analytical measurements beyond that number which can be made manually.

The data in table 2 indicate that there is sufficient level of detection sensitivity in the MS method to measure endogenous amounts of LE and ME in the extracts from the anterior and posterior pituitary, the caudate nucleus, and tooth pulp. A previous method that used field desorption mass spectrometry (FD-MS) has been used to measure enkephalins in the hypothalamus and CSF. At the current level of sensitivity with this MS instrumentation, approximately 20 ng of enkephalin  $g^{-1}$  wet weight of tissue can be measured.

TABLE 2

Mass Spectrometric Measurement of Enkephalins  
in Canine Tissue Extracts ( $\text{ng g}^{-1}$ ) and CSF ( $\text{ng ml}^{-1}$ )

SOURCE	ENKEPHALIN	AMOUNT	METHOD*
Hypothalamus	LE	170	1
Cerebrospinal fluid	LE	44	1
Pituitary			
Anterior	LE	70	2
	ME	2,950	2
Posterior	LE	2	2
	ME	3,760	2
Caudate nucleus	LE	1,500	2
Tooth pulp**	LE	30	2
	ME	179	2
Tooth pulp			
Control	LE	20	2
	ME	487	2
Electrostimulated	LE	45	2
	ME	390	2

From Desiderio 1984.

\*Method 1: FDMS-SIM-Microcomputer;

2: FAB-CAD-B/E-B'/E'-SIM-Microcomputer

\*\*Unstimulated pooled tissue from five dogs

As indicated below, some recent instrumental developments indicate that the subnanogram level of sensitivity will soon be attained.

The data in table 2 demonstrate the ability of mass spectrometry to quantify the endogenous amount of a peptide in a biologic extract. These types of analytical measurement data represent, for the first time, the kinds of analytical measurement that can now be made for peptides by utilizing novel MS processes and that can greatly extend the molecular specificity of the measurement itself.

This extension of the molecular specificity of peptide measurements by MS methods can be readily rationalized by considering the following experimental parameters: a peptide-rich fraction is extracted from a Sep-Pak; RP-HPLC will provide a "purified" peptide fraction (however, note the limitations to this statement concerning purity in the previous section); FAB MS will produce a protonated molecular ion of a peptide (or peptides) in

an HPLC fraction; a B/E linked-field scan will select the amino acid sequence-determining information from a selected unique protonated molecular ion; and, an  $^{18}\text{O}$ -incorporated peptide internal standard will provide the best internal standard for quantification of the peptide. This combination of unique instrumental developments, as stated above, greatly extends the confidence that we are quantifying the peptide that we think we are.

## CONCLUSIONS

The data described in this manuscript demonstrate a novel, multifaceted approach to the analytical measurement of endogenous opioid peptides in biological extracts. This type of a multifaceted approach is obligatory for today's research problems into opioid neuropeptides because of the inherent complexity of the biologic extracts, because of the numerous peptides which can coelute irrespective of the gradient that is developed for HPLC, and because of the great importance that is attached to obtaining an accurate understanding of endogenous opioid peptidergic pathways.

Each analytical approach that is utilized in this and other studies possesses a different molecular specificity which, according to increasing molecular specificity, may be ranked in the following order: HPLC, bioassay (BA), RRA, RIA, FAB MS, and the combination FAB-CAD-B/E-SIM- $\mu$ COM. Each analytical method has its own unique mode of interaction with an opioid peptide. For example, HPLC can measure several secondary structural characteristics of a molecule, including electroactivity, fluorescence, ultraviolet absorption, and refractive index, or it can be used online with a mass spectrometer (LC-MS) (Desiderio and Fridland 1984). A bioassay using the response of biological tissues, such as the vas deferens or guinea pig ileum, measures the biologic effect that results from the interaction of a peptide with its biologic receptor on those tissues. RRA monitors the interaction of several different types of opioid receptors ( $\mu$ ,  $\delta$ ,  $\sigma$ , and  $\kappa$ ) with a variety of synthetic ligands. RIA may be relatively specific, but it must be remembered that generally a small peptide such as an enkephalin must be chemically conjugated to a larger protein carrier molecule and that this peptide: carrier protein antigenic complex is the molecule(s) that is injected into an animal, where the host animal's immune system raises an antibody to that complex. The antibody may or may not be entirely specific toward the structure of the entire original small peptide target molecule. By analyzing these measurement methods in such a critical, structural manner, it can be seen that they cannot determine the structure of the entire target molecule. FAB MS can produce a protonated molecular ion of a peptide to substantiate the presence of that peptide in an HPLC fraction-(but it must be remembered that a specific amino acid sequence is not necessarily specified), or an amino acid sequence-determining ion may be selected and analyzed by linked-field scan processes. By using an  $^{18}\text{O}$  peptide internal standard, quantification may be performed in the latter measurement mode. It must be remembered

that, even with MS producing a protonated molecular ion, several amino acid sequences may produce exactly the same nominal and accurate mass. For example, for a pentapeptide, 51 or 120 different amino acid sequences are possible.

Finally, several future directions are clear from this type of work. On one hand, we are aiming toward analyzing the larger peptide precursors by enzymatically excising appropriate target peptides, utilizing a combination of trypsin and carboxypeptidase. Furthermore, the intact larger peptide precursors will be analyzed by utilizing HPLC protein columns, where those columns have pore sizes that range up to 300 angstroms. Lastly, newer mass spectrometry instrumentation will be used in these studies. For example, a VG 7070E-HF mass spectrometer has been installed in our laboratory. This newer MS instrumentation is capable of analyzing peptides that have molecular weights which range up to 15,000 mass units--a mass range that will encompass the larger peptide precursors. Both positive and negative ions may also be studied in our continuing effort to develop several different molecular specificities and/or sensitivities. We will target our measurement sensitivities toward the subnanogram amount for quantification of endogenous peptides.

## REFERENCES

- Atweh, S.F., and Kuhar, M.J. Distribution and physiological significance of opioid receptors in the brain. Br Med Bull 39:47-52, 1983.
- Comb, M.; Seeburg, P.H.; Adelman, J.; Eiden, L.; and Herbert, E. Primary structure of the human met- and leu-enkephalin precursor and its RNA. Nature 295:663-666, 1982.
- Desiderio, D.M. Analysis Neuropeptides by Liquid Chromatography and Mass Spectrometry. Amsterdam: Elsevier Science Publishers, 1984, 235 pp.
- Desiderio, D.M.; Kai, M.; Tanzer, F.S.; Trimble, J.; and Wakelyn, C. Measurement of enkephalin peptides in canine brain regions, teeth, and CSF with HPLC and mass spectrometry. J Chromatogr 342: 245-260, 1984a.
- Desiderio, D.M.; Laughter, J.; Katakuse, I.; Kai, M.; and Trimble, J. A microcomputer data acquisition system for mass spectrometry. Comp Enhanc Spectros, 2:21-31, 1984b.
- Desiderio, D.M., and Fridland, G. A review of combined liquid chromatography and mass spectrometry. J Lig Chromatogr 7(S-2): 317-351, 1984.
- Desiderio, D.M., and Yamada, S. Field desorption mass spectrometric measurement of picomole amounts of leucine enkephalin in canine spinal cord tissue. Biomed Mass Spectrum 10:358-362, 1983.
- Desiderio, D.M., and Kai, M. Preparation of stable isotope-incorporated peptide internal standards for field desorption mass spectrometry quantification of peptides in biologic tissue. Biomed Mass Spectrum 10:471-479, 1983.

- Desiderio, D.M.; Onishi, H.; Takeshita, H.; Tanzer, F.S.; Wakelyn, C.; Walker, J.A., Jr.; and Fridland, G. Measurement of opioid peptides in human tooth pulp with a limbic synaptosomal radioreceptor assay. J Chromatogr - Biomed Appl, submitted.
- Gubler, U.; Seeburg, P.; Hoffman, B.J.; Gage, L.P.; and Udenfriend, S. Molecular cloning establishes proenkephalin as precursor of enkephalin-containing peptides. Nature 295:206-208, 1982.
- Heimer, L. The Human Brain and Spinal Cord. New York: Springer-Verlag, 1983.
- Hughes, J. Biogenesis, release, and inactivation of enkephalins and dynorphins. Br Med Bull 39:17-24, 1983.
- Kirkpatrick, D.L.; Taniguchi, T.; Jones, B.N.; Stern, A.S.; Shively, J.E.; Hulliha, J.; Kimura, S.; Stein, S.; and Udenfriend, S. A highly potent 3200-dalton adrenal opioid peptide that contains both a [Met]- and [Leu]-enkephalin sequence. Proc Natl Acad Sci USA 78:3265-3268, 1981.
- Martin, S.A.; Costello, C.E.; and Biemann, K. Optimization of experimental procedures for FAB MS. Anal Chem 54:2362-2368, 1982.
- Nawa, H.; Hirose, T.; Takeshima, H.; Inayama, S.; and Nakanishi, S. Nucleotide sequences of clones cDNAs for two types of bovine brain substance P precursor. Nature 306:32-36, 1983.
- Noda, M.; Furutani, Y.; Takahashi, H.; Toyosato, M.; Hirose, T.; Inayama, S.; Nakanishi, S.; and Numa, S. Cloning and sequence analysis of DNA for bovine adrenal preproenkephalin. Nature 295:202-205, 1982.
- Tanzer, F.S.; Desiderio, D.M.; and Yamada, S. HPLC isolation and FD-MS quantification of picomole amounts of methionine-enkephalin in canine tooth pulp. In: Rich, D.H., and Gross, E., eds. Peptides: Synthesis-Structure-Function. Rockford, IL: Pierce Chemical Co., 1981. pp. 761-764.
- Walker, J.A. Jr.; Tanzer, F.S.; Harris, E.F.; Wakelyn, C.; and Desiderio, D.M. Stress decreases endogenous methionine enkephalin in human teeth. Am J Orthod, submitted.

#### ACKNOWLEDGMENT

Support from the National Institutes of Health (GM-26666 and GM-28611) is acknowledged.

#### AUTHORS

Dominic M. Desiderio, Ph.D. Department of Neurology Director, Stout Neuroscience Laboratory	Francis S. Tanzer, Ph.D., D.D.S. College of Dentistry
--	--

Hisayoshi Takeshita, M.D., Ph.D. Hiroshi Onishi, M.D., Ph.D. Genevieve Fridland, B.S.	Claire Wakelyn, B.S. Chhabil Dass, Ph.D.
---	---

The Charles B. Stout Neuroscience Mass Spectrometry Laboratory  
The University of Tennessee Center for the Health Sciences  
959 Court Avenue, Memphis, Tennessee 38163

# Reverse Phase HPLC of Peptides: Application to the Opioid Peptides

Tatsuhiko Kanmera, Ph.D., and Reginald P. Sequeira, Ph.D.

High performance liquid chromatography (HPLC) is probably the most versatile method for the rapid and effective separation of peptides and proteins by using reverse phase, gel permeation, and ion exchange columns (Hearn 1980; Dizdaroglu 1984). The factor contributing most to the increased use of HPLC for analysis of peptides in biological specimens is the development of reverse phase (RP) columns. These columns containing a nonpolar support are used with an organic solvent in aqueous buffer as the mobile phase. The control of separation selectivity via manipulation of the mobile phase composition provides a powerful means of achieving rapid analytical separation. The tremendous progress made during the past decade in the area of peptides in general and especially in the opioid peptide research could partly be attributed to availability of the RP-HPLC technique. It has provided a means for the separation and the isolation of a variety of opioid peptides derived from their precursors. While a number of studies have shown the separation conditions for different opioid peptides, the elution conditions required to obtain an optimum resolution have to be defined for a particular set of opioid peptides. The objective of this chapter is to provide some general principles of the RP-HPLC method of peptide separation and its application to the opioid peptides.

## **PRINCIPLE**

Reverse phase liquid chromatography predominantly depends upon the hydrophobic interaction between a nonpolar stationary phase on a silica support and hydrophobic groups of the solute molecules, and the concomitant expulsion of hydrophobic groups to the polar mobile phase. The solutes are eluted by increasing the concentration of the organic solvent in the mobile phase (decreasing the polarity of the mobile phase). The hydrophobicity of a peptide depends upon its amino acid composition and, hence, peptides containing hydrophobic amino acids, such as Trp, Phe, Leu, Ile, Tyr, Val, etc., are retained strongly on the



column and elute later. Indeed, the relationship between the retention time and the amino acid composition of a peptide could be statistically analyzed. The retention times have been successfully predicted for relatively small peptides (Sasagawa et al. 1982; Meek and Rossetti 1981). Despite the predominant hydrophobic interaction, other interactions (such as ionic interactions) also occur between the stationary phase and solutes. Such interaction properties vary among each set of columns and elution conditions. Therefore, it is important to optimize the separation condition for a particular peptide mixture.

## COLUMN

A variety of reverse phase columns are commercially available, e.g.,  $\mu$ Bondapak (Waters), LiChrosorb (E. Merck), Ultrasphere (Altex), MicroPak (Varian), Partisil (Whatman), Zorbax (DuPont), Nucleosil (Macherey-Nagel), Vydac (Vydac), Supelcosil (Supelco), TSK (Toyo Soda), etc. There are several types of reverse phase columns having different pore sizes, bonded phases, and column dimensions. The elution patterns of peptides sometimes are affected significantly by these factors. It would be helpful to know their effects on elution of peptides. Most commercially available packing materials have alkyl chains ranging from c-3 to c-18. It has been observed by many workers that the retention times of a peptide on c-8 and c-18 (or ODS) columns, which are most commonly used for peptide separation, are virtually similar (Wilson et al. 1981). A bonded phase with a shorter alkyl chain retains peptides less strongly, and hence, the peptides tend to elute earlier. However, we have observed most peptides are retained even on C-3 or cyanopropyl columns strongly enough to yield reasonable resolution. For larger peptides and proteins, alkyl chain length is less important. It has been shown that alkyl chain length does not affect the retention times of proteins (Lewis and DeWald 1982). Recent, a number of reverse phase columns with large pore sizes (>300Å) have become commercially available. These columns are designed particularly for the separation of large peptides and proteins to yield better resolution and recoveries. While relatively small folded proteins could be separated effectively on a small pore size column (Chaiken et al. 1984), the use of large pore size columns may help to achieve better separation of unfolded large peptides (>30 residues) such as protein fragments (Pearson et al. 1981). As shown in figure 1, the wide pore columns also could effectively separate small peptides. However, since they have less surface area, the column capacity might be less than that for small pore size columns. Reverse phase columns of 15 to 25 cm length are commonly used. These columns separate up to 1 mg of peptides without significant loss of resolution.

Resolution and peak shapes of peptides are not greatly affected by the size of columns when a gradient elution is employed. As shown in figure 1, 2 cm columns separated enkephalins and dynorphin peptides as effectively as the 25 cm column with the same packing material (figure 2, panel B). However, the column

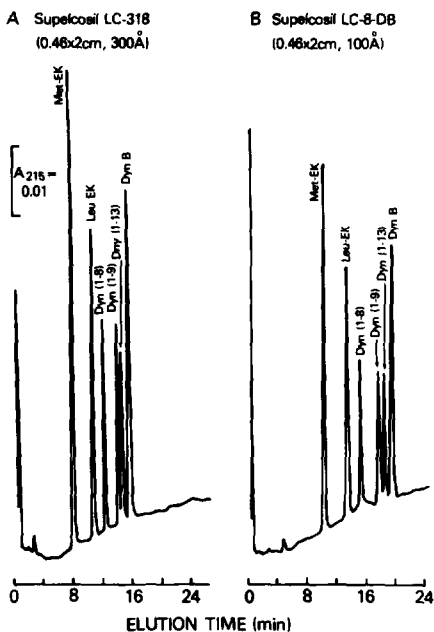


FIGURE 1

Separation of Dynorphin Related Peptides on Short Reverse Phase Columns with Different Pore Sizes.

Samples containing  $\approx 1$   $\mu$ g each of dynorphin peptides are eluted on short reverse phase columns. (2 cm) with a linear gradient of 0.1% TFA (a) - 0.1% TFA/CH<sub>3</sub>CN (b) [10-20% (b) in 10 min and then 20-30% (b) in 20 min]. Flow rate, 0.8 ml/min. Ambient temperature. Structures of the dynorphin peptides are listed in the legend for figure 2.

size directly affects its capacity. Although the shorter columns are not useful for a large-scale preparation, they are relatively inexpensive. We are routinely using 2 cm guard columns with the same packing material as used for analytical columns to analyze peptide samples. It might also be suggested to use such small columns for routine purification of radioactive peptides used for a radioimmunoassay. Sincethetypes of silica, coating, and packing process vary with manufacturers, the resulting elution patterns and resolution could be different among various columns (Pearson et al. 1981; figure 2, panels A and B). Endcapping, which often appears in manufacturers' specifications, is a process to inactivate free silanol groups. The silanol groups cause one of the most unfavorable ionic interactions with basic groups of peptides. Resides, the endcapping greatly extends the column lifespan.

## MOBILE PHASE

### Aqueous Buffer

The selection of a mobile phase is one of the most important factors for the effective separation of peptides. Optimization of the elution condition might be achieved by appropriate selection of a buffer (or acid) and an organic solvent, and sometimes by the addition of ion pairing reagents. The use of

aqueous acid or buffer is essential to obtain effective resolution and peak shapes. The most commonly used aqueous buffers for RP-HPLC of peptides are phosphate (or phosphoric acid), trifluoroacetic acid (TFA), formate, and acetate.

Phosphate. The phosphate buffer is superior in its transparency to other buffer systems, being transparent in the UV range up to 200 nm. Peptide elution with a phosphate buffer system containing a transparent organic solvent is usually monitored at 210 to 220 nm. While the phosphate buffers can be used in a wide range of pH, highly acidic pH (2.0 to 3.0) would be appropriate for peptide separation. Higher column efficiency for peptides was observed at the acidic pH than at pH 3 to 7 (Rivier 1978; Hearn et al. 1979). In general, the phosphate buffer appears to yield a little better resolution of peptides than acetate or formate (Hearn 1980; figure 2). Anionic ion pair reagents, such as hexane sulfonate or SDS, are sometimes added to the buffer. These reagents with negative charges form ion pairs with protonated basic groups, such as  $\alpha$ -amino,  $\epsilon$ -amino, and arginine guanidyl groups; consequently the retention times of peptides increase (Hancock et al. 1978). Addition of anionic ion pairing reagents is particularly useful for separation of polar peptides which otherwise are not retained on the reverse phase column. Cationic ion pair reagents, such as alkylamines, can also be added to alter elution profiles (Hancock et al. 1979). In particular, the high recoveries and resolution of peptides and proteins were obtained with triethylammonium phosphate (Rivier 1978). This may be due to the effect of triethylammonium ion to block the interaction between the silanol on silica and the peptides. A drawback of the phosphate buffers is that since they are not volatile, a desalting process is required to obtain salt-free peptides. The phosphate buffers coupled with UV detection at 210 to 220 nm would be particularly useful for the sensitive analysis of a peptide mixture.

TFA. TFA may be the most popular solvent for the purification of acids because of its complete volatility. It has the advantage of low absorbance compared with acetic acid and formic acid, which permits the highly sensitive detection at 210 to 220 nm. The concentrations between 0.05 to 0.1 % are commonly used. Its high dissolving power has made it more popular than dilute phosphoric acid for the separation of peptides. In order to eliminate the change of the baseline absorbance in a gradient elution, equivalent amounts of TFA should be added to the organic solvent. Similarly, more hydrophobic perfluorinated acids, such as pentafluoropropanoic acid and heptafluorobutyric acid, can be used for peptide separations. Since the perfluorinated acids form ion pairs with basic groups of peptides, the retention time increase with the hydrophobicity of the counter ions. Increase in the retention time is most apparent with basic peptides (Bennett et al. 1980). A better recovery of  $\beta$ -endorphin with 0.1% TFA than with dilute formic acid was observed (Dunlap et al. 1978). However, we have observed that the ionic strength of 0.1% TFA is not high enough to block unfavorable nonspecific interactions between very basic peptides and silica supports.

Formate and acetate. Although these solvent systems have the disadvantage of higher absorbance at wavelengths below 220 nm, peptides can be detected at 210 to 220 nm at a lower absorbance full scale unit. As with the TFA system, it would be recommended to add the acid to the organic solvent to minimize the baseline absorbance change upon gradient elution. Because of the volatility, these buffers are frequently used in the form of ammonium or pyridinium, for isolation and analysis of peptides in conjunction with radioimmunoassay of peptides. Probably ammonium acetate is the most commonly used buffer for the separation of endogenous opioid peptides. Pyridine acetate is sometimes used with fluorescence detection of postcolumn derivatized peptides. Although 10 mM ammonium acetate is commonly used, concentrations more than 50 mM might be required for some peptides to avoid nonspecific electrostatic interactions.

### **Organic Solvent**

Methanol, acetonitrile, and propanol are frequently used as the organic modifier for the reverse phase HPLC of peptides. The relative elution power of these solvents is in the following order: propan-1-ol  $\geq$  propan-2-ol  $>$  acetonitrile  $\gg$  methanol (Wilson et al. 1981). Among these solvents, acetonitrile is most transparent, permitting detection up to 200 nm, and has very low viscosity. Gradient elutions, therefore, can be monitored without significant change of the baseline absorbance. In both methanol and acetonitrile systems, peptide elutions are usually monitored at 210 to 220 nm. Propanol has a disadvantage of high viscosity which causes high back pressure and slower mass transfer of large peptides and proteins. Such problems may be solved by increasing the temperature of the propanol system. Due to its high elution power, propanol is better suited for elution of very hydrophobic peptides and proteins.

### **DETECTION**

#### **UV Detection**

Most HPLC systems are equipped with a UV detector. Since peptide bonds strongly absorb UV light at wavelengths below 220 nm, all peptides can be detected at the wavelength unless UV absorbing mobile phase is used. When pure transparent buffer systems such as dilute TFA and phosphate are used, 10 to 100 ng of peptides can be detected at 210 to 220 nm. Since many organic compounds also absorb UV light strongly at the same wavelength, it is not possible to discriminate peptide peaks from those of other organic compounds. In order to obtain a flat baseline at higher sensitivity, it is important to use pure mobile phases. Peptides containing Tyr or Trp residues can be detected at 280 nm. By comparing the elution profile at 280 nm with that at 210 to 220 nm, it can be judged whether the peptide contains these aromatic residues. The detection limits at 280 nm would be subnanomoles.

The advanced computerized detectors currently available provide UV spectra of eluate which would give structural information of the eluted components, including the types of aromatic residues.

### **Fluorescence Detection**

For peptides containing Tyr or Trp residues, elutions can be monitored online with a fluorescence detector; fortunately, all enkephalin containing peptides have Tyr residues. The detection limit for peptides is 6 to 10 pmol (Schlabach and Wehr 1982). If the HPLC system is equipped with a postcolumn derivatization system and a fluorescence detector, eluted peptides are monitored after modification with fluorescamine (Stein 1981) or o-phthalaldehyde (Schlabach and Wehr 1982). Fluorescamine reacts with  $\alpha$ - and  $\epsilon$ -amino groups; therefore, the peptides must contain at least one free amino group to react. Since fluorescamine reacts only with primary amino groups, this method has the advantage of less interference by nonpeptide substances than that for ultraviolet detection. In contrast, the application of o-phthalaldehyde is limited to Lys-containing peptides, since it reacts only with  $\epsilon$ -amino groups of lysine residues. The detection limit of these methods is 10 pmol of amino groups. The disadvantage of these methods is that the eluted peptides are destroyed by the derivatization. For preparative purpose, the eluent has to be split so that only an aliquot is taken for fluorescence detection. Details of the instrumentation have been described by Bohlen et al. (1975).

### **Other Detection Methods**

Electrochemical detection of enkephalin-related peptides has been reported (Mousa and Couri 1983). Subnanogram amounts of  $\beta$ -endorphin was detected by this method. The electrochemical detection, however, is applicable to the peptides with oxidizable residues (DiBussolo 1984). Mass spectrometry technique was used to quantitate endogenous Leu-enkephalin in the HPLC fraction of a tissue extract (Desiderio and Yamada 1982). The application of this method to other peptides with higher molecular weight is yet to be developed. Radioimmunoassay (RIA) is the most sensitive detection method. Despite its cumbersome experimental procedure, it has been widely used in biological studies because of its unique selectivity and extremely high sensitivity. This method will be discussed below. The receptor binding assay of enkephalin has been used for the detection of enkephalin-containing peptides after the digestion of the HPLC fractionated peptides with trypsin and carboxypeptidase B (Stein and Udenfriend 1984).

### **RP-HPLC AND RADIOIMMUNOASSAY OF OPIOID PEPTIDES**

By using a combination of HPLC to effect physicochemical separation and RIA for measurement, it is often possible to achieve a specificity and sensitivity unsurpassed by any other analytical techniques. Since a variety of structurally related

peptides are derived in different sites, RIA of the whole extract does not necessarily provide sufficient information regarding their molecular forms and identity. Specific determination of a particular opioid peptide in a biological sample requires its chromatographic separation from related peptides and other interfering substances. This can generally be achieved by HPLC which, although too insensitive on its own for this purpose for determining the amounts of opioid peptides in most biological specimens, can be linked to an RIA which acts as an exquisite detection system for both the peptide under investigation and its other immunoreactive forms (precursor/metabolite). These can be quantitated accurately provided a suitable standard is employed in the assay. Otherwise, it is reported as "equivalent immunoreactivity."

The RIA of HPLC fractions of various opioid peptides has been reviewed earlier (Loeber and Verhoef 1981; Hong et al. 1983) and also in this monograph. In general, volatile buffers such as ammonium acetate or pyridine acetate and TFA are preferred in those situations where RIA detection is employed. Conversely, if nonvolatile buffers are to be used, adjustment of the sample pH and salt concentration to those of the standard is necessary. In view of extremely high sensitivity of RIA, special care has to be exercised to prevent contamination. The recovery of injected peptides is sometimes fairly low due to nonspecific interactions between the packing material and peptides. Thus, the possibility of immunoreactive material eluting from the column has to be considered, especially after eluting the standard peptides on the column for calibration. The injector loop and syringes also have to be cleaned properly. It is strongly recommended to wash the column extensively and run a blank to ensure no background immunoreactive material is eluting from the columns.

#### **OTHER CHROMATOGRAPHIC CONDITIONS**

Since peptides elute at a specific concentration of the organic solvent in a gradient, sample volume, when dissolved in a weaker solvent does not affect the elution profile significantly. If the sample volume is more than the capacity of the injection loop, it is possible to inject repeatedly before starting a gradient elution. Such multiple injection should not be made for isocratic elutions. Column temperature is usually not a very important parameter for separation of peptides. Most peptide elutions are carried out at 20 to 45 °C. Increasing the temperature is expected to facilitate the mass transfer of solute and resolution (DiBussolo 1984). However, a poor resolution has also been observed at an elevated column temperature (Rivier 1978). Operations at an elevated temperature may improve the resolution when a viscous organic solvent, such as propanol, is used.

The flow rates of 0.5 to 2 ml/min have been employed for the RP-HPLC of peptides. However, flow rates of 0.5 to 1 ml/min have been observed to yield better resolution for large peptides and proteins because of their relatively slower diffusion (Jones et

al. 1980). Use of a guard column is strongly recommended since column damage often occurs at the top of column due to coating and breaking of the packing material and gradual accumulation of insoluble material from samples. Such damage not only ruins the resolution, but also yields irregular peak shapes. By placing a guard column between the injector and the analytical column, the column lifespan greatly increases. This is especially important when complex mixtures, such as crude tissue extracts, are injected onto the column.

#### **APPLICATION TO OPIOID PEPTIDES**

The structures of proenkephalin, prodynorphin, and proopiomelanocortin containing Met- or Leu-enkephalin sequences have been demonstrated by recombinant DNA techniques. The post-translational processing mechanisms of the precursors and the distribution of each form of the enkephalin-containing peptides appear to vary among biological tissues (Akil et al. 1984). Defining the molecular forms of the opioid peptides in a given tissue would provide an important clue to the function of the peptides. The development of the RP-HPLC techniques has made a great contribution to the studies in this area. The RP-HPLC is also an important technique for the studies of the processing mechanisms and metabolism of the opioid peptides.

A number of studies on the separation of synthetic and natural opioid peptides have been reported (e.g., Hong et al. 1983; Loeber and Verhoef 1981; Lewis et al. 1979). In table 1, conditions for the RP-HPLC separation of opioid peptides are listed. Most of these elution conditions are used for the isolation of the peptides or for the identification of the peptides in the tissue extracts. Although  $\mu$ Bondapak C-18 and Ultrasphere ODS have been used frequently for opioid peptides, they are not necessarily the best columns currently available since the quality of the columns is being improved rapidly. The separation of biologically active peptides, including opioid peptides, on commercially available columns were compared using dilute TFA as the mobile phase (Tan 1983). As listed in table 1, most frequently used aqueous buffers are ammonium acetate (or formate) and TFA. Acetonitrile ( $\text{CH}_3\text{CN}$ ) and methanol are the common organic solvents. Effects of aqueous buffer on the separation of dynorphin peptides are shown in figure 1. When 0.1% TFA-acetonitrile was used as the mobile phase, only Met- and Leu-enkephalins eluted from the LiChrosorb column. Although the dynorphin peptides with at least two arginine residues could be eluted at higher concentrations of acetonitrile, trailing was noticed. Similarly, a poor resolution pattern was observed with 10 mM ammonium acetate, pH 4.1, which had been sometimes employed for the separation of opioid peptides. Similar profiles were observed for the Zorbax ODS and MicroPak columns. On the contrary, Supelcosil LC-8-DB, which is claimed to be deactivated for basic compounds, yielded a reasonable elution profile. Ultrapore ODS also gave a good resolution for the peptides. The elution profiles for the LiChrosorb and other columns were

**FIGURE 2**  
(following page)

Effects of Mobile Phase on RP-HPLC  
Separation of Dynorphin Peptides

Six dynorphin peptides were eluted on Supelcosil LC-8-DB (0.46 x 25 cm) and Lichrosorb RP-8 (0.46 x 25 cm) with the following linear gradients:

Panels A and B, 0.1% TFA (a)-0.1% TFA/CH<sub>3</sub> CN (b), 25%-30% b in 20 min and then 30%-60% b in 10 min, 0.1 AFU at 215 nm, ~1 μg each peptide;

Panels C and D, 50 mM triethylammonium phosphate (TEAP, pH 3.0) (a) - CH<sub>3</sub>CN (b), 15%-30% b in 30 min, 0.1 AFU at 215 nm, ~1 μg each peptide; and

Panels E and F, 50 mM ammonium acetate (ACONH<sub>4</sub>, pH 5.0) (a) - CH<sub>3</sub>CN (b), ~2 μg each peptide, 0.2 AFU at 220 nm. Flow rate, 0.8 ml/min. Room temperature.

Amino acid sequences of the peptides are:

Met-EK, Tyr-Gly-Gly-Phe-Met; Leu-EK, Tyr-Gly-Gly-Phe-Leu;  
Dyn (1-8), Tyr-Gly-Gly-Phe-Leu-Arg-Arg-Ile;  
Dyn (1-9), Tyr-Gly-Gly-Phe-Leu-Arg-Arg-Ile-Arg;  
Dyn (1-13), Tyr-Gly-Gly-Phe-Leu-Arg-Arg-Ile-Arg-Pro-Lys-Leu-Lys; and  
Dyn B, Tyr-Gly-Gly-Phe-Leu-Arg-Arg-Gln-Phe-Lys-Val-Val-Thr.



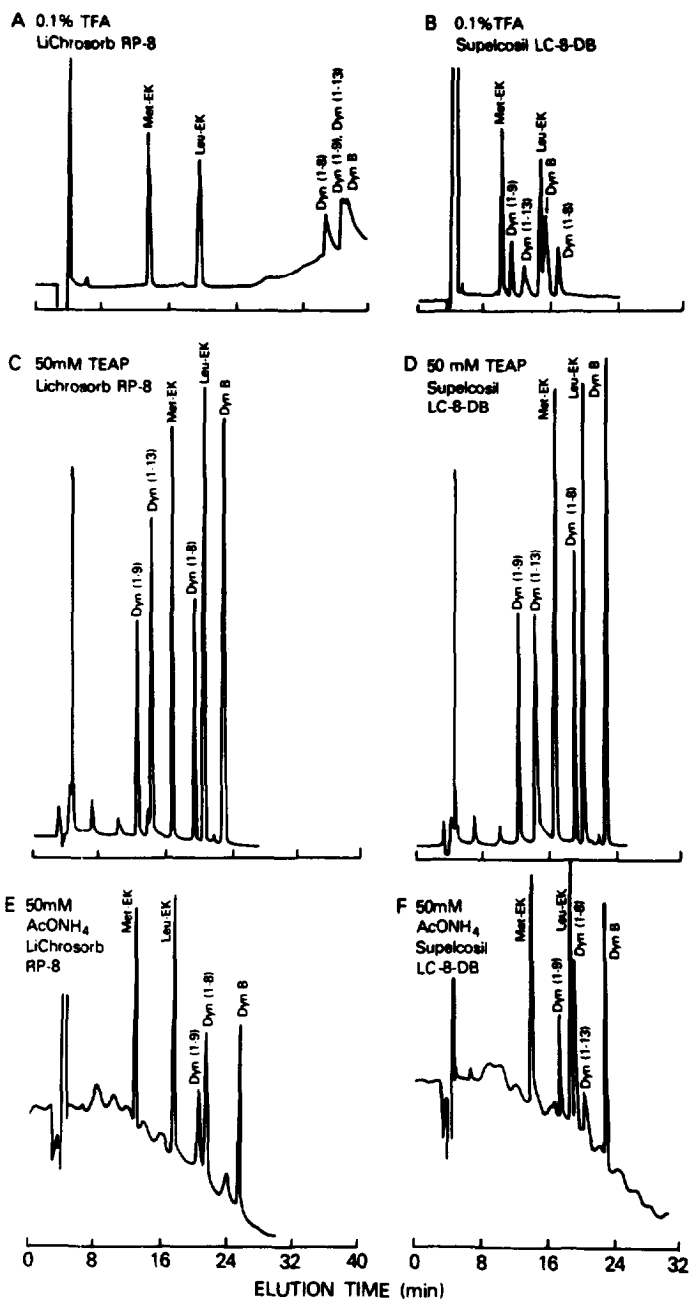


FIGURE 2

TABLE 1

Separation of Various Opioid Peptides by RP-HPLC:  
Comparison of the Column, Solvent System, and Detection Method Employed<sup>(a)</sup>

<u>Peptide</u>	<u>Column</u>	<u>Mobile Phase</u>	<u>Elution Condition</u>	<u>Detection</u>	<u>Reference</u>
		(A) Aqueous Buffer (B) Organic Solvent			
<u>Proopiomelanocortin related peptides</u>					
$\alpha$ -, $\beta$ - & $\gamma$ -End and fragments	$\mu$ -Bondapak C18 (3.9 x 300 mm)	(A) 10 mM AcONH <sub>4</sub> (pH 4.15) (B) 0.15 % AcOH/MeOH	30-75 % B	210 nm	Loeber & Verhoef 1981
[Met]-, [Met(O)]- & [Leu]-EK, $\beta$ -LPH- (77-91), $\alpha$ -, $\beta$ h,c- & $\gamma$ -End	$\mu$ -Bondapak C18 (3.9 x 300mm)	(A) 0.08 % TFA (B) CH <sub>3</sub> CN	10-60 % CH <sub>3</sub> CN 1 ml/min room temp.	210 nm	Hong et al. 1983
[Met]- & [Leu]- EK, $\alpha$ -, $\beta$ -End, [Met5]- & [Leu5]- $\beta$ h-End	LiChrosorb RP-18 (4.6 x 250 mm)	(A) 0.5 M pyridine formate (pH 4.0) (B) n-propanol	0-20 % B 40 ml/hr	fluorescence	Lewis et al. 1979
$\alpha$ -N-acetyl- $\beta$ -End (1-26)	$\mu$ -Bondapak C18	(A) 0.1 % TFA (B) CH <sub>3</sub> CN	30-40 % CH <sub>3</sub> CN 1.5 ml/min	210 nm RIA	Bennett et al. 1983

(table 1 continued next page)

TABLE 1 (continued)

<u>Peptide</u>	<u>Column</u>	<u>Mobile Phase</u>	<u>Elution Condition</u>	<u>Detection</u>	<u>Reference</u>
des-[Tyr <sup>1</sup> ]-γ-End and fragments	μ-Bondapak C <sub>18</sub>	(A) 10 mM AcONH <sub>4</sub> (pH 4.15) (B) 0.15 % AcOH/MeOH	25-60 % B 2 ml/min	210 nm RIA	Burbach 1983
α-, β-, & γ-End and fragments	Ultrasphere-ODS (4 x 250 mm)	(A) 0.1 M NaH <sub>2</sub> PO <sub>4</sub> (B) CH <sub>3</sub> CN	16-35 % B 2.0 ml/min, 40 °C	210 nm	Davis et al. 1983
β-End, N-acetyl- β-End, β-End-(1- 27), N-acetyl-β- End-(1-27)	μ-Bondapak C <sub>18</sub> (3.9 x 300 mm)	(A) 0.13 % heptafluoro- butyric acid (B) CH <sub>3</sub> CN	35-40 % CH <sub>3</sub> CN	RIA <sup>(b)</sup>	Dennis et al. 1983
<u>Proenkephalin A related peptides</u>					
[Met]-, [Leu]- & [Met(O)]-EK, [Leu]-EK-Arg, Arg-[Met]-EK, [Met]-EK-Arg-Phe	BioSil ODS-10	(A) 0.1 % TFA (B) MeOH	34 % MeOH (35 min) 34-60 % MeOH (10 min) 60 % MeOH (10 min) 1 ml/min	RIA <sup>(b)</sup>	Lindberg et al. 1982
[Met]- & [Leu]- EK, [Met]-EK-Arg- Gly-Leu, [Met]- EK-Arg-Phe	Ultrasphere-ODS (4.6 x 150 mm)	(A) 10 mM AcONH <sub>4</sub> (pH 4.2) (B) MeOH	40 % MeOH 1 ml/min	RIA <sup>(b)</sup>	Ikeda et al. 1982

(table 1 continued next page)

TABLE 1. (continued)

Peptide	Column	Mobile Phase	Elution Condition	Detection	Reference
Peptide E	Ultrasphere-ODS	(A) 0.5 M formic acid -0.4 M pyridine (B) 1-propanol	linear gradient 20 ml/hr	Receptor binding, fluorescence	Kilpatrick et al. 1981
[Met]-EK-Arg, BAM-12P, [Met]- EK-Arg-Gly-Leu, [Met]-EK-Arg- Phe, BAM-24	TSK LS-410 ODS-SIL (4 x 250 mm)	(A) 50 mM KH <sub>2</sub> PO <sub>4</sub> (pH 2.0) (B) CH <sub>3</sub> CN	10 - 50 % B 2 ml/min	210 nm RIA <sup>(b)</sup>	Matsuo et al. 1983
331 Adrenorphin ([Met]-EK-Arg- Arg-Val-NH <sub>2</sub> )	TSK LS-410 ODS-SIL (4 x 250 mm)	(A) 12.1 mM HCOONH <sub>4</sub> 20 mM HCOONH <sub>4</sub> (B) CH <sub>3</sub> CN	salt gradient and 10 - 50 % CH <sub>3</sub> CN	210 nm	Matsuo et al. 1983
<u>Prodynorphin (proenkephalin B) related peptides</u>					
$\alpha$ - & $\beta$ -neo-End des-[Tyr <sup>1</sup> ]- $\beta$ - neo-End, Dyn A- (1-8), Dyn A	TSK LS-410 ODS-SIL (4 x 250 mm)	(A) 50 mM KH <sub>2</sub> PO <sub>4</sub> (B) CH <sub>3</sub> CN	10 - 50 % CH <sub>3</sub> CN 2 ml/min	RIA <sup>(b)</sup>	Kitamura et al. 1982
Dyn B, Dyn A- (1-7)	$\mu$ -Bondapak C <sub>18</sub>	(A) 1 M AcOH (B) CH <sub>3</sub> CN	5 - 40 % CH <sub>3</sub> CN 2 ml/min	RIA <sup>(b)</sup>	Seizinger et al. 1984
Dyn A-(1-32), Dyn A-(1-24)	$\mu$ -Bondapak C <sub>18</sub> (3.9 x 300 mm)	(A) 5 mM TFA (B) CH <sub>3</sub> CN	20 - 50 % CH <sub>3</sub> CN 1.5 ml/min	228 nm	Fischli et al. 1982

(table 1 continued next page)

TABLE 1 (continued)

<u>Peptide</u>	<u>Column</u>	<u>Mobile Phase</u>	<u>Elution Condition</u>	<u>Detection</u>	<u>Reference</u>
Dyn A, Dyn B	$\mu$ -Bondapak C18 (3.9 x 300 mm)	(A) 5 mM TFA (B) CH <sub>3</sub> CN	22 - 32 % CH <sub>3</sub> CN 1 ml/min	RIA <sup>(b)</sup>	Cone et al. 1983
Dyn A-32 Dyn B-29	$\mu$ -Bondapak C18 (3.9 x 300mm)	(A) 5 mM TFA (B) CH <sub>3</sub> CN	22 - 55 % CH <sub>3</sub> CN 1.5 ml/min	RIA <sup>(b)</sup>	Cone et al. 1983
[Met]- & [Leu]- EK, [Met]- & [Leu]-EK-Lys, [Leu]-EK-Arg, Dyn A, $\alpha$ - & $\beta$ -neo End, [Met]-EK-Arg- Phe, [Met]-EK-Arg- Gly-Leu	Ultrasphere (250 mm)	(A) 0.25 M triethyl- ammonium formate (B) CH <sub>3</sub> CN	stepwise (0 - 50 %) 1 ml/min	280 nm	Giraud et al. 1983
$\alpha$ - & $\beta$ -neo-End Dyn A-(1-8), Dyn A, [Leu]-EK, Dyn B	Nucleosil 17C18	(A) 5 mM TFA (B) CH <sub>3</sub> CN	15 - 30 % CH <sub>3</sub> CN 1 ml/min	RIA <sup>(b)</sup>	Nakao et al. 1983
Dyn A-(1-10), (1-11), (1-12), (1-13) & (1-17)	Nucleosil C18 (4.6 x 250 mm)	(A) 0.065 % TFA (B) CH <sub>3</sub> CN	20 - 40 % CH <sub>3</sub> CN	228 nm RIA	Suda et al. 1983

<sup>a</sup>Abbreviations: EK, enkephalin; End, endorphin; Dyn, dynorphin; LPH, lipotropin; BAM, bovine adrenal medulla peptide.

<sup>b</sup>The elution positions for the listed peptides are indicated by arrows.

greatly improved when the concentration of TFA (for example, 0.15% TFA) or ammonium acetate was increased. Use of TFA at the high concentration is not recommended because the concomitant decrease of pH may ruin the column. Much better resolution was observed with 50 mM ammonium acetate, pH 5.0 (figure 2, panels E and F). These data suggest that the poor resolution of the dynorphin peptides is due to the nonspecific interactions of the basic peptides with the silica support and such interactions are suppressed by increasing the acid or salt concentration. The best resolution and peak shapes were observed for the elution with a triethylammonium phosphate buffer (TEAP). In the system, the elution profiles of the dynorphin peptides on the Supelcosil and LiChrosorb columns are very similar. This may suggest that most of the ionic interactions are blocked by triethylammonium phosphate. In general, amines are considered to block interactions between silanols and peptides (Hancock and Harding 1984). In the separation of the dynorphins, both columns gave reasonable separation when 50 mM triethylammonium phosphate was employed. Despite the fact that phosphate is an excellent buffer, it is not frequently used for the studies of opioid peptides probably due to its nonvolatility. Although only two columns are compared here, the data revealed the possible differences in interaction properties among various columns and that the problems might be solved by optimizing the elution conditions.

#### REFERENCES

- Akil, H.; Watson, S.J.; Young, E.; Lewis, M.E.; Khachaturian, H.; and Walker, J.M. Endogenous opioids: Biology and function. Ann Rev Neurosci 7:223-225, 1984.
- Browne, C.A.; and Solomon, S. The use of perfluorinated carboxylic acids in the reversed-phase HPLC of peptides. J Lig Chromatogr 3:1353-1365, 1980.
- Bennett, H.P.J.; Browne, C.A.; and Solomon, S.  $\alpha$ -N-Acetyl $\beta$ -endorphin 1-26 from the neurointermediary lobe of the rat pituitary: Isolation, purification, and characterization by high-performance liquid chromatography. Anal Biochem 128:121-129, 1983.
- Bohlen, P.; Stein, S.; Stone, S.; and Udenfriend, S. Automatic monitoring of primary amines in preparative column effluents with fluorescamine. Anal Biochem 67:438-443, 1975.
- Burbach, J.P.H. Local biotransformation of des-Tyr<sup>1</sup>- $\gamma$ -endorphin in brain. Studies by a push-pull technique and HPLC analysis. Neurosci Lett 38:281-285, 1983.
- Chaiken, I.M.; Miller, T.; Sequeira, R.P.; and Kanmura, T. HPLC mapping and structural characterization of neurophysin isoforms. Anal Biochem 143:215-225, 1984.
- Cone, R.I.; Weber, E.; Barchas, J.D.; and Goldstein, A. Regional distribution of dynorphin and neo-endorphin peptides in rat brain, spinal cord, and pituitary. J Neurosci 3:2146-2152, 1983.
- Davis, T.P.; Culling, A.J.; Schoemaker, H.; and Galligan, J.J.  $\beta$ -Endorphin and its metabolites stimulate motility of the dog small intestine. J Pharmacol Exp Ther 227:499-507, 1983.

- Dennis, M.; Lazure, C.; Seidah, N.G.; and Chretien, M. Characterization of  $\beta$ -endorphin immunoreactive peptides in rat pituitary and brain by coupled gel and reversed-phase high-performance liquid chromatography. J Chromatogr 266:163-172, 1983.
- Desiderio, D.M., and Yamada, S. Measurement of endogenous leucine enkephalin in canine thalamus by high performance liquid chromatography and field desorption mass spectrometry. J Chromatogr 239:87-95, 1982.
- DiBussolo, J.M. A practical introduction to reversed-phase liquid chromatography of proteins and peptides. Liq Chromatogr 1984:20-37.
- Dizdaroglu, M. Separation of peptides by high performance ion-exchange chromatography. In: Hancock, W.S., ed. Handbook of HPLC for the Separation of Amino Acids, Peptides and Proteins. Vol. II. Boca Raton, Florida: CRC Press, 1984. pp. 23-43.
- Dunlap, C.E., III; Gentleman, S.; and Lowney, L.I. Use of trifluoroacetic acid in the separation of opiates and opioid peptides by reversed-phase high-performance liquid chromatography. J Chromatogr 160:191-198, 1978.
- Fischli, W.; Goldstein, A.; Hunkapiller, M.W.; and Hood, L.E. Isolation and amino acid sequence analysis of a 4000-dalton dynorphin from porcine pituitary. Proc Natl Acad Sci USA 79:5435-5437, 1982.
- Giraud, P.; Castanas, E.; Patey, G.; Oliver, C.; and Rossier, J. Regional distribution of methionine-enkephalin-Arg<sup>6</sup>-Phe<sup>7</sup> in the rat brain: Comparative study with the distribution of other opioid peptides. J Endocrinol 98:19-34, 1983.
- Hancock, W.S. and Harding, D.R.K. Review of separation condition for peptides. In: Hancock, W.S., ed. Handbook of HPLC for the separation amino acids, peptides and proteins. Vol. II. Boca Raton, Florida: CRC Press, 1984. pp. 23-43.
- Hancock, W.S.; Bishop, C.A.; Meyer, L.J.; Harding, D.R.K.; and Hearn, M.T.W. Rapid analysis of peptides by HPLC with hydrophobic ion pairing of amino groups. J Chromatogr 153:391-398, 1978.
- Hancock, W.S.; Bishop, C.A.; Battersby, J.E.; Harding, D.R.K.; and Hearn, M.T.W. The use of cationic reagent for the analysis of peptides by HPLC. J Chromatogr 168:377-384, 1979.
- Hearn, M.T.W. The use of reversed phase high performance liquid chromatography for the structural mapping of polypeptides and proteins. J Liq Chromatogr 3:1255-1276, 1980.
- Hearn, M.T.W.; Grego, B.; and Hancock, W.S. High-performance liquid chromatography of amino acids, peptides and proteins. XX. Investigation of the effects of pH and ion pair formation on the retention of peptides on chemically-bonded hydrocarbonaceous stationary phases. J Chromatogr 185:429-444, 1979.
- Hong, J.S.; Yoshikawa, K.; and Hendren, R.W. Measurement of  $\beta$ -endorphin and enkephalins in biological tissues and fluids. Methods Enzymol 103:547-564, 1983.
- Ikeda, Y.; Nakao, K.; Yoshimasa, T.; Yanaihara, N.; Numa, S.; and Imura, H. Existence of Met-enkephalin-Arg<sup>6</sup>-Gly<sup>7</sup>-Leu<sup>8</sup> with Met-enkephalin, Leu-enkephalin and Met-enkephalin-Arg<sup>6</sup>-Phe<sup>7</sup> in the brain of guinea pig, rat and golden hamster. Biochem Biophys Res Commun 107:656-662, 1982.

- Jones, B.N.; Lewis, R.W.; Paabo, S.; Kojima, K.; Kimura, S.; and Stein, S. Effects of flow rate and eluant composition on the high performance liquid chromatography of proteins. J Liq Chromatogr 3:1373-1383, 1980.
- Kilpatrick, D.L.; Taniguchi, T.; Jones, B.N.; Stern, A.S.; Shively, J.E.; Hulihan, J.; Kimura, S.; Stein, S.; and Udenfriend, S. A highly potent 3200-dalton adrenal opioid peptide that contains both a [Met]- and [Leu]-enkephalin sequence. Proc Natl Acad Sci USA 78:3265-3268, 1981.
- Kitamura, K.; Minamino, N.; Hayashi, Y.; Kangawa, K.; and Matsuo, H. Regional distribution of  $\alpha$ -neo-endorphin in rat brain and pituitary. Biochem Biophys Res Commun 109:966-974, 1982.
- Lewis, R.V., and DeWald, D. Reverse-phase HPLC of proteins: Effects of various bonded phases. J Liq Chromatogr 5:1367-1374, 1982.
- Lewis, R.V.; Stein, S.; and Udenfriend, S. Separation of opioid peptides utilizing high performance liquid chromatography. Int J Pept Protein Res 13:493-497, 1979.
- Lindberg, I.; Yang, H.-Y.T.; and Costa, E. An enkephalin-generating enzyme in bovine adrenal medulla. Biochem Biophys Res Commun 106:186-193, 1982.
- Loeber, J.G., and Verhoef, J. High-performance liquid chromatography and radioimmunoassay for the specific and quantitative determination of endorphins and related peptides. Methods Enzymol 73: 261-275, 1981.
- Matsuo, H.; Miyata, A.; and Mizuno, K. Novel C-terminally amidated opioid peptide in human pheochromocytoma tumor. Nature 305: 721-723, 1983.
- Meek, J.L., and Rossetti, Z.L. Factors affecting retention and resolution of peptides in high-performance liquid chromatography. J Chromatogr. 211:15-28, 1981.
- Mousa, S., and Couri, D. Analysis of enkephalins,  $\beta$ -endorphins and small peptides in their sequences by highly sensitive high performance liquid chromatography with electrochemical detection: Implications in opioid peptide metabolism. J Chromatogr 267:191-198, 1983.
- Nakao, K.; Yoshimasa, T.; Suda, M.; Sakamoto, M.; Ikeda, Y.; Hayashi, K.; and Imura, S. Rimorphin (dynorphin B) exists together with  $\beta$ -neo-endorphin and dynorphin (dynorphin A) in human hypothalamus. Biochem Biophys Res Commun 113:30-34, 1983.
- Pearson, J.D.; Mahoney, W.C.; Hermodson, M.A.; and Regnier, R.E.; Reversed-phase supports for the resolution of large denatured protein fragments. J Chromatogr 207:325-332, 1981.
- Rivier, J.E. Use of trialkylammonium phosphate (TAAP) buffers in reverse phase HPLC for high resolution and high recovery of peptides and proteins. J Liq Chromatogr 1:343-366, 1978.
- Sasagawa, I.; Okuyama, T.; and Teller, D.C. Prediction of peptide retention times in reverse-phase high-performance liquid chromatography during linear gradient elution. J Chromatogr 240:329-340, 1982.
- Schlabach, T.D., and Wehr, T.C. Fluorescent techniques for the selective detection of chromatographically separated peptides.



- Anal Biochem 127:222-223, 1982.
- Seizinger, B.R.; Grimm, C.; Holtt, V.; and Herz, A. Evidence for a selective processing of proenkephalin B into different opioid peptide forms in particular regions of rat brain and pituitary. J Neurochem 42:447-457, 1984.
- Stein, S. Ultramicroanalysis of peptides and proteins by high performance liquid chromatography and fluorescence detection. In: Gross, E., and Meienhofer, J., eds. The Peptides. Vol. IV. New York: Academic Press, 1981. pp. 185-216.
- Stein, S., and Udenfriend, S. A picomole protein and peptide chemistry: Some applications to the opioid peptides. Anal Biochem 136:7-23, 1984.
- Suda, T.; Tozawa, F.; Tachibana, S.; Demura, H.; Shizume, K.; Sasaki, A.; A.; Mouri, T.; and Miura, Y. Multiple forms of immunoreactive dynorphin in human pituitary and pheochromocytoma. Life Sci 32:865-870, 1983.
- Tan, L. Simple, efficient ternary solvent system for the separation of luteinizing hormone-releasing hormone and enkephalins by reversed-phase high-performance liquid chromatography. J Chromatogr 266:67-74, 1983.
- Wilson, K.J.; Honegger, A.; Stotzel, R.P.; and Hughes, G.H. The behavior of peptides on reverse-phase support during high-pressure liquid chromatography. Biochem J 199:31-41, 1981.

#### **AUTHORS**

Tatsuhiko Kanmera, Ph.D.  
Laboratory of Biochemistry, Department of Chemistry  
Faculty of Science  
Kyushu University 33  
Fukuoka 812, Japan

Reginald P. Sequeira, Ph.D.  
Department of Pharmacology  
Kasturba Medical College  
P.O. Manipal 576119  
Karnataka, India

# Peptides as Drugs in the Treatment of Opiate Addiction

Hemendra N. Bhargava, Ph.D.

To date, morphine and its derivatives are still the most widely used drugs for the relief of pain of moderate to severe intensity, such as the pain of terminal cancer, the traumatic pain, or the postoperative pain. However, these drugs suffer from the disadvantage that on repeated administration tolerance develops to many of their pharmacological actions, particularly to the analgesic effect. This then leads to the use of increasing amounts of the drug to provide the same degree of pain relief. The diminished effect of opiates is attributed to pharmacodynamic tolerance, although in some cases dispositional tolerance (hepatic microsomal enzyme induction) may be a contributing factor (Masten et al, 1974; Liu et al. 1978). In addition, prolonged use of narcotic drug leads to the development of physical dependence as evidenced by the appearance of a constellation of distressing withdrawal symptoms and by their immediate suppression following readministration of the drug. Furthermore, chronic use of this class of drugs leads to the development of emotional dependence. The tolerance, physical and emotional dependence, and the drug-seeking behavior are termed the drug addiction process.

In spite of great advances made in understanding the mechanisms by which tolerance to and physical dependence on opiates are produced, these processes are still poorly understood (Way 1980). Obviously, the treatment modalities are not available. Much of the research has concentrated on the role of brain neurotransmitter systems in the development of opiate-induced tolerance-dependence processes. Pharmacological alteration in the activity of brain chemical substances indicate that cyclic 3',5'-adenosine monophosphate (cAMP) (Ho et al. 1973a), gamma aminobutyric acid (GABA) (Ho et al. 1973b), and 5-hydroxytryptamine (5-HT) (Shen et al. 1970) may be involved in the genesis of tolerance and physical dependence phenomena. Administration of cAMP, GABA, and agents known to increase 5-HT activity enhance the development of tolerance to and physical dependence on opiates. However, evidence against the role of central 5-HT also exists in the literature (Algeri and Costa 1971; Marshall and Grahame-Smith 1971; Bhargava and Matwyshyn 1977; Bhargava 1979). The development of some

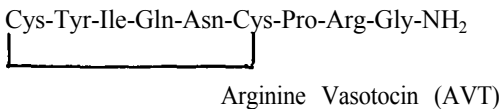
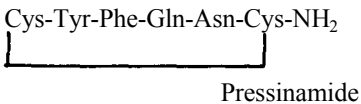
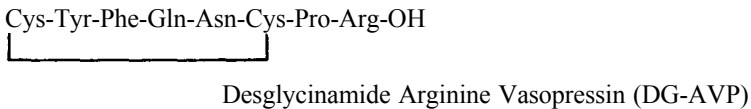
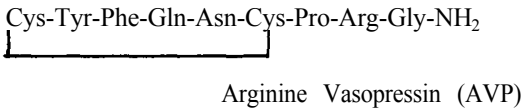
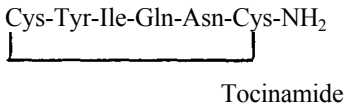
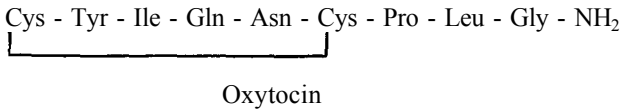
of the symptoms of narcotic withdrawal syndrome appears to be associated with a hypoactivity of cholinergic systems (Bhargava et al. 1974; Bhargava and Way 1975, 1976) and hyperactivity of dopaminergic systems (Iwamoto et al. 1973) in the brain. Cholinergic agonists and dopaminergic antagonists inhibit the symptoms of opiate abstinence syndrome, indicating a cholinergic-dopaminergic imbalance in the production of abstinence symptoms.

Acute and chronic treatment with narcotic drugs affects the activity of the pituitary hormones (George 1971). Narcotic analgesics, particularly morphine, influence pituitary function by their action on the central nervous system (CNS). The hypothalamus acts as the final common pathway for the integration of all neuronal activity that affects the anterior pituitary activity. It is also the principal central anatomical site through which narcotic analgesics exert their effects on the pituitary. In general, acute administration of narcotic drugs stimulates the pituitary (increases the release of pituitary hormones) except for pituitary gonadotropin secretion, whereas, in nearly all cases, chronic administration of these drugs depresses pituitary function (George 1971). Although the mechanism(s) by which narcotics influence hypothalamic pituitary function are not clear, two possibilities exist. The hypothalamus contains neurosecretory cells which secrete releasing or release inhibiting factors (peptide hormones) for the control of pituitary activity. It is plausible that narcotic analgesics exert their effect on the pituitary through direct actions on the neurosecretory cells by interfering with the synthesis and/or release of these peptide hormones. The second possibility involves the presence and role of cholinergic and monoaminergic pathways in the CNS (Shute and Lewis 1967) and the transmitters that are released at their terminals. The hypothalamus contains varying concentrations of acetylcholine (ACh), norepinephrine (NE), dopamine (DA), and 5-HT. If one assumes that the neurosecretory cells, which contain the releasing and release inhibiting factors, are in a postsynaptic position, then any change in the synthesis, release, or degradation of transmitter substance in the presynaptic neurons innervating these cells could influence the synthesis and/or release of the cell contents. Changes in turnover rates and concentrations of the neurotransmitter substances in the brain have been associated with alterations in the anterior pituitary functions (Corrodi et al. 1968; de Schaepdryver et al. 1969).

The hormones of the mammalian posterior pituitary, vasopressin and oxytocin (figure 1), elicit both endocrine (Knobil and Sawyer 1975) and extra-endocrine effects (Delanoy et al. 1979; Legros et al, 1978; van Ree et al. 1978). The extra-endocrine activities include centrally mediated effects on learning and memory, which have been interpreted as modification of consolidation or retrieval of information (de Wied 1973; Walter et al. 1975, 1978a). In addition, the neurohypophyseal hormones can induce specific behavioral patterns in rodents (Kruse et al. 1977).

It is known that certain pituitary hormones can influence the behavior of animals when injected peripherally. For instance, vasopressin and its analogs facilitate retention of conditioned avoidance behavior in hypophysectomized (Lande et al. 1971) and intact (King and de Wied 1974)

rats and increase resistance to extinction of active and passive avoidance behavior (de Wied 1971; Ader and de Wied 1972). These observations suggest that vasopressin and its analogs are involved in learning and memory processes. Since development of tolerance to opiates is thought by some (Smith et al. 1966; Cohen et al. 1965) to be a learning process, Krivoy et al. (1974)<sup>9</sup> reported that a naturally occurring vasopressin analog, desglycinamide<sup>9</sup>-lysine vasopressin (Lande et al. 1972), which has essentially a behavioral profile similar to vasopressin but which is endocrinologically rather inert (de Wied et al. 1972), facilitated the development of tolerance to the analgesic effect of morphine in mice only if morphine was administered before the peptide. The dose of the peptide used was 50 µg/mouse subcutaneously (s.c.). The tolerance was induced by multiple injections of morphine and the analgesia was measured by the hot-plate test. Desglycinamide<sup>9</sup>-lysine vasopressin did not affect the analgesic response to an acute injection of morphine.



**FIGURE 1:** Structures of Posterior Pituitary Hormones and Their Analogs

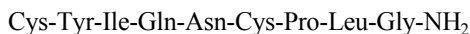
Consistent with this finding, it was demonstrated that Brattleboro rats with hereditary diabetes insipidus which lack the ability to synthesize vasopressin exhibited resistance to develop tolerance to the analgesic action of narcotics (de Wied and Gispen 1976). These authors suggested that vasopressin plays an important role in the development of tolerance to the actions of narcotic analgesics and that its mechanism of action is dissociated from its endocrine effect and resembles that of its known influence on memory consolidation. In addition to vasopressin and its analogs, it was found that oxytocin also facilitates the development of tolerance to and physical dependence on morphine in the rat (van Ree and de Wied 1976). Studies by Schmidt et al. (1978), however, indicate that oxytocin and vasopressin antagonized neither the analgesia induced by morphine nor the development of tolerance to the analgesic effect of morphine in mice and rats.

While the hormones from the pituitary are well characterized, oxytocin has also been shown to serve as a precursor for a peptide, Pro-Leu-Gly-NH<sub>2</sub> (melanotropin-release inhibiting factor or MIF), with divergent biological activities. This COOH-terminal tripeptide of oxytocin, which can be released enzymatically from the hormone by a membrane-bound hypothalamic enzyme (Celis and Taleisnik 1971; Walter et al. 1973), was originally proposed to be the natural factor that inhibits the release of melanocyte-stimulating hormone (MSH) from the pituitary (Celis et al. 1971). MIF was isolated from bovine hypothalamic tissue and was shown to inhibit MSH release, both in vitro and in vivo (Celis et al. 1971; Nair et al. 1971). As yet, the role MIF as the MSH-release inhibiting hormone as well as its formation from oxytocin is not universally accepted, and its efficacy in humans has not been demonstrated (Kastin et al. 1979). However, this peptide has attracted a great deal of attention for its action on the CNS. In animals, MIF potentiates the behavioral effects of small amounts of L-dopa and reverses both the tremor induced by oxotremorine and the sedation caused by deserpidine (Kastin et al. 1975). These behavioral responses to MIF could be demonstrated in hypophysectomized rodents (Kastin et al. 1975), indicating a direct action in the CNS. MIF has also been shown, at least in some Parkinsonian patients, to ameliorate the symptoms of rigidity and tremor (Barbeau 1979).

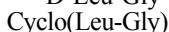
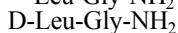
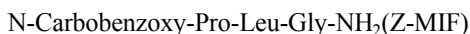
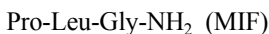
#### Effects of COOH-Terminal Fragments of Neurohypophyseal Hormones on the Central Nervous System

Although oxytocin was not active, the COOH-terminal tripeptide of oxytocin, MIF, and peptides related structurally to MIF (figure 2), such as N-carbobenzyloxy-MIF (Z-MIF), Leu-Gly-NH<sub>2</sub>, D-Leu-Gly-NH<sub>2</sub>, cyclo(Leu-Gly), all attenuated puromycin-induced amnesia. This is also true of Pro-Lys-Gly-NH<sub>2</sub>, the COOH-terminal peptide of lysine vasopressin (figure 3).

The effect of vasopressin on memory-related processes has a longer duration of action (de Wied 1973) in spite of its short biological half-life (Lauson 1974). It is, therefore, possible that either the hormone can trigger an event that results in long-term changes or it is converted into an active metabolite with long biological half-life.

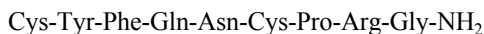


Oxytocin

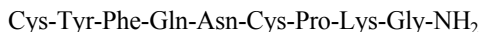
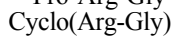
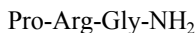


**FIGURE 2:** Structures of Oxytocin, MIF, and Analogs of MIF

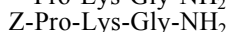
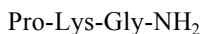
Arginine and lysine vasopressin, as well as cyclo(Leu-Gly) (CLG), were effective when given up to 24 hours before training (Flexner et al. 1978). Interestingly, Z-MIF was active even if given 5 days before training (Flexner et al. 1978). It appears, therefore, that not only the neurohypophyseal hormones but also their COOH-terminal peptides had long duration of action.



Arginine Vasopressin



Lysine Vasopressin



**FIGURE 3:** Structures of Arginine and Lysine Vasopressin and Their COOH-Terminal Fragments

The effect of C-terminal peptides of neurohypophyseal hormones on the development of tolerance to and physical dependence on opiates has been studied. Studies by van Ree and de Wied (1976) indicated that not only are oxytocin and 8-arginine vasotocin more potent than 8-arginine vasopressin, but that their C-terminal tripeptide, MIF, and its analog, CLG, were as effective as oxytocin in facilitating the development of tolerance and physical dependence in the rat. MIF and CLG were administered s.c. in doses of 1  $\mu\text{g}$  per rat. Tolerance and physical dependence were measured by analgesia and changes in body weight and temperature, respectively.

Z-Pro-Arg-Gly-NH <sub>2</sub>		
Arg-Gly-NH <sub>2</sub>		Cyclo(Arg-Gly)
Z-Pro-Leu-Gly-NH <sub>2</sub>		Cyclo(Leu-Gly)
Z-Pro-Lys-Gly-NH <sub>2</sub>		Cyclo(Lys-Gly)

**FIGURE 4:** Structures of COOH-Terminal Peptides of Arginine Vasopressin, Lysine Vasopressin, Oxytocin, and Their Cyclic Analogs

Since de Wied and coworkers had observed facilitation in the development of tolerance to and dependence on morphine (van Ree and de Wied 1976) and on beta-endorphin (van Ree et al. 1976), it was decided to examine some analogs of MIF which could perhaps inhibit the genesis of narcotic tolerance and dependence. Replacement of an L-residue in a peptide hormone or in an agonistic analog by D-isomer has been reported to result in certain instances in a competitive inhibitor or a partial agonist. These findings might be explained by steric misplacement of an active element from its preferred orientation in the "active site," such that intrinsic activity is decreased or even lost with the retention of receptor affinity (Walter 1977). Based on this assumption, the effect of Z-Pro-D-Leu on the development of tolerance to and physical dependence on morphine was determined in the mouse (Walter et al. 1978b). Various strains of mice were made tolerant to and dependent on morphine by s.c. implantation of morphine pellets for 3 days. Control animals were implanted with placebo pellets. Tolerance to the analgesic effects of morphine was determined by measuring the jump threshold to an increasing electric current; tolerance to the hypothermic effects was determined by measuring body temperature after intraventricular (i.v.t.) injection of morphine. The degree of physical dependence development was quantitated after either abrupt or naloxone-precipitated withdrawal symptoms such as changes in body weight, body temperature, and stereotyped jumping behavior. When Z-Pro-D-Leu was injected once a day during the exposure to morphine, the tolerance to the analgesic and hyperthermic effects of morphine did not develop. Similarly, the withdrawal-induced hypothermic response in morphine-dependent mice was blocked by Z-Pro-D-Leu. These studies have been confirmed by Kovacs et al. (1981).

Further studies revealed that the stereochemistry of Z-Pro-D-Leu was not important since all four stereoisomers-Pro-Leu, D-Pro-Leu, Pro-D-Leu, and D-Pro-D-Leu-were active (Walter et al. 1979). In addition, it was found that even MB<sup>2</sup>, CLG, and a number of analogs of MIF (figure 5) were active in inhibiting the development of tolerance to and physical dependence on morphine in mice (Walter et al. 1979; Bhargava et al. 1980). Structure-activity relationship studies with MIF in inhibiting naloxone-precipitated withdrawal revealed that MIF was very effective when injected daily at a dose of 50 µg per mouse. The addition of a N-benzyloxycarbonyl(Z) group apparently did not alter the activity, but the addition of Z-Gly or substitution of pyro-Glu (pGlu) for the NH<sub>2</sub>-terminal proline produced analogs with reduced activity. Replacement of the proline residue by 3,4,-dehydroproline ( $\Delta^3$ -Pro), deletion of the proline

moiety, dimethylation of the primary carboxamide group, or replacement of the glycinamide moiety by glycine resulted in inactive analogs of MIF (figure 5). The substitution of Gln, Met, or Tyr for Leu in Z-Pro-Leu gave potent analogs, but the substitution of either Ser or Phe produced peptides with reduced activity. The peptides discussed above can be considered to be analogs of MIF. In addition to the above peptides, some cyclic peptides like cyclo(Leu-Gly) and cyclo(Phe-Pro) exhibited activity.

Since the initial studies with MIF and its derivatives on the development of tolerance to and physical dependence on morphine in the mouse provided encouraging results, these studies were further expanded. Chronic administration of opiates to mice results in the development of tolerance to the analgesic and hypothermic effect (Bhargava 1981a), to locomotor depressant and stimulant activities (Goldstein and Sheehan 1969; Eidelberg and Erspamer 1975; Matwyshyn and Bhargava 1980), and to the inhibitory effect on gastrointestinal transit (Pillai and Bhargava 1984a). In the rat, chronic treatment with opiates results in the development of tolerance to their analgesic, hypothermic, hyperthermic, cataleptic, locomotor activity (Bhargava, 1980c, 1980d, 1981b 1981c, 1981d; Bhargava and Kim 1982), and antidiuretic activity (Huidobro 1978; Pillai and Bhargava 1984b). The following section describes studies conducted in this laboratory on the effects of MIF and its analogs on the development of tolerance to and physical dependence on morphine in the mouse and on morphine,  $\beta$ -endorphin, and buprenorphine in the rat. The mechanism of action of those peptides is also examined. The effect of another peptide, (thyrotropin releasing hormone or TRH) pGlu-His-Pro-NH<sub>2</sub>, on morphine tolerance, dependence, and withdrawal syndrome is described. In addition, the effects of MSH and protein synthesis inhibitor, dactinomycin, on opiate-induced tolerance and dependence in rodents is described.

#### Active Analogs

Pro-Leu-Gly-NH<sub>2</sub> (MIF)  
 Z-Pro-Leu-Gly-NH<sub>2</sub> (Z-MIF)  
 Z-Gly-Pro-Leu-Gly-COOH  
 Glu-Leu-Gly-NH<sub>2</sub>  
 Pro-Leu  
 Z-Pro-Leu  
 Z-D-Pro-D-Leu  
 Z-Pro-D-Leu  
 Z-D-Pro-Leu  
 Z-Pro-Gln  
 Z-Pro-Ser  
 Z-Pro-Met  
 Z-Pro-D-Phe  
 Z-Pro-Tyr  
 Cyclo(Leu-Gly)  
 Cyclo(Pro-Phe)

#### Inactive Analogs

$\Delta^3$ -Pro-Leu-Gly-NH<sub>2</sub>  
 Z-Pro-Leu-Gly-N(CH<sub>3</sub>)<sub>2</sub>  
 Z-Pro-Leu-Gly-COOH  
 Z-Leu-Gly-NH<sub>2</sub>  
 Z-Pro-Leu-NH<sub>2</sub>  
 Z-Pro-Gly  
 Z-Pro-Ala  
 Z-Pro-D-Ala DCHA\*  
 Z-Pro-Ile  
 Z-Pro-Val  
 Z-Pro-Glu  
 Z-Pro-Phe  
 Z-Ala-Pro  
 Cyclo(Leu-Ala)  
 Cyclo(Pro-D-Leu)

\*Dicyclohexylamine

**FIGURE 5:** Structures of Active and Inactive Analogs of Pro-Leu-Gly-NH<sub>2</sub> (MIF) in Blocking Naloxone-Precipitated Withdrawal in Mice



## **MATERIALS AND METHOD**

### **Animals**

Male Swiss Webster mice weighing 25 to 30 g (Scientific Small Animals Inc., Arlington Heights, IL) and male Sprague-Dawley rats weighing 200 to 250 g (King Animal Co., Oregon, WI) were acclimated for at least 4 days prior to being used in a room with controlled temperature ( $23 \pm 1^\circ\text{C}$ ), humidity ( $65 \pm 2\%$ ), and light (L 600 to 1800 h). The animals had free access to food and tap water.

### **Chemicals**

Cyclo(Leu-Gly) was synthesized according to the method of Fischer (1906). MIF and related peptides were dissolved in distilled deionized water and injected s.c. in a volume such that each mouse or the rat received 1 ml/kg of the drug solution. Morphine sulfate was dissolved in physiological saline and injected intraperitoneally (i.p.) in 1 ml/kg volume. Human  $\beta$ -endorphin was dissolved in physiological saline and injected in volume of 10  $\mu\text{l}$  via the indwelling cannulae implanted stereotaxically in the lateral ventricle of the rat. Buprenorphine was dissolved in distilled deionized water and injected s.c.

## **STUDIES WITH MORPHINE IN MICE**

### **Induction and Assessment of Tolerance to Morphine**

Each mouse was rendered tolerant to morphine by s.c. implantation of a morphine pellet containing 75 mg of morphine base (Way et al. 1969; Bhargava 1978a). The effects of MIF and its theoretically derived analog CLG on tolerance to the analgesic, locomotor stimulant, and depressant actions of morphine were investigated in mice. Mice were divided into three groups and were injected with peptide-vehicle (water), MIF, and CLG (2 mg/kg each), respectively. Two hours later, mice from each of the three groups were further divided into two subgroups. One subgroup was implanted with placebo pellets (one each) and the other subgroup was implanted with morphine pellets. The injections of water and the peptide were repeated twice, 24 hours apart, in their respective groups. The pellets were removed 70 hours after their implantation. Six hours after pellet removal, tolerance to morphine was assessed as described below.

### **Assessment of Tolerance to the Analgesic Effect of Morphine**

The degree of tolerance to the analgesic effect of morphine was determined by measuring the analgesic response to a challenge dose of morphine using the tail-flick procedure. The placebo and morphine pellet implanted mice were challenged with 4 mg/kg and 10 mg/kg of morphine, respectively. The tail-flick latencies to thermal stimulation were determined prior to ( $T_0$ ) and at "t" minutes ( $T_t$ ) after morphine injection. The basal latencies were found to be  $1.3 \pm 0.2$  sec. A "cut off" time of 10 seconds was used to avoid damage to the tail. The percent analgesia was calculated by using the formula:  $(T_t - T_0) / (10 - T_0) \times 100$ . Percent analgesic response was calculated for each mouse and results were expressed as mean percent analgesic response  $\pm$  S.E.M. Nine mice were used for each treatment group. The differences in the means were analyzed by the Student's t-test.

## Assessment of Tolerance to the Locomotor Effects of Morphine

Preliminary studies indicated that a 10 mg/kg dose of morphine depressed locomotor activity, whereas an 80 mg/kg dose increased the activity of the mice. These results are consistent with the studies of Eidelberg and Erspamer (1975). In subsequent studies, these two doses of morphine were used to measure tolerance to the locomotor activity effects. Mice *were* treated with water or the peptide and implanted with placebo or morphine pellets as described above. Six hours later, the locomotor response was measured by means of circular activity cages as described by Bhargava (1978b). Each cage measured 35 cm in diameter and 20 cm in height and was equipped with six light sources and six photo cells placed just above the floor level. The lights were placed orthogonally to each other so that the light beams crossed in the center of the cage. Activity was measured by the number of times the light beam was broken within a specified period of time. The activity counts were recorded automatically on a digital electronic counter.

Each mouse was placed in the activity cage for a 5-minute acclimation period that was followed by activity recording for 30 minutes. These constituted the control or basal counts. The mouse was taken out of the cage and, after a rest period of 35 minutes, injected with an appropriate dose of morphine. It was then placed in the activity cage and, after a 5-minute acclimation, the activity was again recorded for 30 minutes. The activity of the morphine-treated group was expressed as percent of control or basal activity. The results were expressed as mean percent activity  $\pm$  S.E.M.

## STUDIES WITH MORPHINE IN THE RAT

The effects of MIF and several of its analogs on the development of tolerance to its analgesic, hypothermic, hyperthermic, locomotor depressant, and cataleptic effects of morphine were investigated in the rat. The rats were made tolerant to and physically dependent on morphine by implantation of four morphine pellets during a 3-day period (Bhargava 1977a, 1978c). Rats were injected with peptide-vehicle (water) or an appropriate peptide. This was followed 2 hours later by implantation of placebo or morphine pellets. The vehicle and the peptide injections were repeated two more times 24 hours apart. The pellets were removed 70 hours after their first implantation. The pellet implantation and removal were done under light ether anesthesia. The development of tolerance to the analgesic, locomotor depressant, and hyperthermic effects of morphine was determined at 6 hours after pellet removal, and tolerance to hyperthermic and cataleptic effects was determined at 24 hours after pellet removal. These time intervals were used as a matter of convenience to allow the handling of a large number of rats. The daily doses of peptides used were as follows: MIF (2 mg/kg, 7  $\mu$ moles/kg), CLG (2 mg/kg, 11  $\mu$ moles/kg), Pro-ILeu-Gly-NH<sub>2</sub> (3.2 mg/kg, 10  $\mu$ moles/kg), and Leu-Gly-NH<sub>2</sub> (2.2 mg/kg, 10  $\mu$ moles/kg)

### **Assessment of Tolerance to the Analgesic Effect of Morphine**

The effect of single and multiple administration of MIF and CLG and of various doses (dose-response) of the peptides on the development of tolerance to the analgesic effect of morphine was determined. In single administration studies, the peptides were given 2 hours before the first pellet implantation, whereas; in multiple injection studies, the peptides were given daily for 3 days. Tolerance to the analgesic effect of morphine was measured as described above for mice,

### **Assessment of Tolerance to the Locomotor Depressant Action of Morphine**

The locomotor activity was measured as described above for mice. Preliminary studies indicated that morphine at an 8 mg/kg dose produced an 80% decrease in motor activity and this dose was used in subsequent tolerance studies.

### **Assessment of Tolerance to Hypothermic and Hyperthermic Effects of Morphine**

Preliminary studies indicated that morphine at 50 mg/kg produced hypothermia and at 8 mg/kg produced hyperthermia. The rats were treated with vehicle or peptides and implanted with placebo or morphine pellets as described above. The effects of 8 mg/kg and 50 mg/kg of morphine on rectal temperature of rats from all treatment groups were determined at 6 and 24 hours, respectively, after pellet removal. The rectal temperature of each rat was measured prior to and 30 minutes after morphine injection using a telethermometer (Yellow Springs Instruments Co., Yellow Springs, OH) model no. 73 and probe type 423. The difference in the rectal temperature of each rat before and at 30 minutes after morphine administration was calculated for each treatment group. The data were expressed as mean change in temperature  $\pm$  S.E.M.

### **Assessment of Tolerance to the Cataleptic Effect of Morphine**

Twenty-four hours after pellet removal, morphin-induced catalepsy was measured by using a bar test (Costall and Naylor 1974). Each rat was injected with morphine (50 mg/kg) and 30 minutes later the intensity of the cataleptic effect was determined. The forepaws of the rat were gently placed across a bar which was held 10 cm above floor level by two iron stands. If the rat did not step off the bar within 60 seconds, it was removed from the bar and was considered to have a 100% catalepsy. If the rat stayed on the bar for less than 60 seconds, then the percent catalepsy was calculated using 60 seconds as 100% response. The catalepsy was expressed as mean response  $\pm$  S.E.M.

## **STUDIES WITH HUMAN $\beta$ -ENDORPHIN IN THE RAT**

The effects of MIF and CLG on the development of tolerance to the analgesic, cataleptic, and hypothermic effects of  $\beta$ -endorphin were investigated in the rat. Tolerance to  $\beta$ -endorphin was induced by i.v.t.

injections of 15  $\mu\text{g}$  of  $\beta$ -endorphin given every 8 hours for 3 days (Bhargava 1981d). Control rats were injected with i.v.t. saline. To study the effect of peptides, rats were injected with vehicle, MIF, or CLG (2 mg/kg). They were then divided into two subgroups, one of which was injected with saline i.v.t. and the other with  $\beta$ -endorphin (15  $\mu\text{g}$ ). The injections of vehicle, MIF, and CLG were repeated two more times 24 hours apart. To follow the course of development of tolerance to  $\beta$ -endorphin, the analgesia, body temperature, and catalepsy were measured 1 hour after  $\beta$ -endorphin injection in rats given various number of injections. At the time of the eighth injection, rats from all six groups were injected with  $\beta$ -endorphin; and 1 hour later, analgesia, body temperature, and catalepsy were measured as described above.

## **STUDIES WITH BUPRENORPHINE IN THE RAT**

The effects of MIF and CLG on the development of tolerance to the analgesic and the hyperthermic effects of buprenorphine, a mixed opiate agonist-antagonist analgesic, were determined. Tolerance to buprenorphine was developed by twice daily injections of 0.5 mg/kg s.c. for 4 days (Bhargava 1982). The peptides were given in daily doses of 2 mg/kg. The degree of tolerance developed to buprenorphine was tested on day 5.

## **STUDIES ON THE MECHANISM OF ACTION OF PEPTIDES INHIBITING OPIATE-INDUCED TOLERANCE**

### **Determination of Brain and Plasma Concentration of Morphine**

To ascertain whether treatment with MIF or its analogs altered the distribution of morphine, the brain and plasma were analyzed for morphine. The rats were treated with vehicle or peptide and implanted with placebo or morphine pellets as described above. Twenty-four hours after the pellet removal, rats from all treatment groups were injected with morphine (50 mg/kg) and were sacrificed 1 hour later. Brain and plasma samples were collected and stored at  $-20^{\circ}\text{C}$  until analyzed for morphine by the fluorometric procedure (Kupferberg et al. 1964; Bhargava 1977b).

### **Assessment of Dopaminergic Receptor Function in Rats Treated Chronically with Morphine or $\beta$ -Endorphin**

Dopamine (DA) receptor function was assessed by both behavioral and biochemical methods. Behaviorally, DA receptor sensitivity was assessed by measuring the locomotor activity and body temperature responses to apomorphine, a DA agonist (Ernst 1967). Biochemically, the receptors labeled with  $^3\text{H}$ -spiroperidol were characterized in morphine naive and morphine-dependent rats (Bhargava 1983a). Rats were made tolerant-dependent by s.c. implantation of four morphine pellets during a 3-day period and were treated with peptides as described above. Twenty-four hours after the removal of the pellets, the binding of  $^3\text{H}$ -spiroperidol to striatal membranes was determined. In order to study a direct action of the peptides on dopamine receptors, their effects on the binding of  $^3\text{H}$ -

spiroperidol and  $^3\text{H}$ -apomorphine to striatal and hypothalamic membranes of rats were determined (Bhargava 1983b).

## RESULTS

### **The Effects of MIF and CLG on Development of Tolerance to Morphine in Mice**

Administration of MIF or CLG prior to and during chronic morphinization inhibited the development of tolerance to the analgesic effect of morphine. A dose (4 mg/kg) of morphine produced 22.5% analgesia 30 minutes after its administration to mice implanted with placebo pellets and pretreated with water. The analgesic response to morphine in mice implanted with placebo pellets was not altered by MIF or CLG. Tolerance to the analgesic effect of morphine developed as a result of pellet implantation, and it was inhibited by both MIF and CLG treatment as evidenced by a greater degree of analgesia in peptide-treated, morphine tolerant mice.

Depending upon the dose employed, morphine produced either locomotor depressant or locomotor stimulant effects in mice. The locomotor activity rates of mice following 10, 20, and 80 mg/kg were  $57.5 \pm 14.8\%$ ,  $97.6 \pm 8.2\%$ , and  $209.0 \pm 9.0\%$ , respectively, of their own control values. Thus, a low dose of morphine decreased motor activity and a high dose stimulated it.

Tolerance developed to both the locomotor stimulant and depressant effects of morphine. A dose of morphine (80 mg/kg) which stimulated motor activity (213% of controls) failed to increase it in morphine tolerant mice ( $115 \pm 26\%$ ). Treatment with MIF or CLG did not modify the development of tolerance to the stimulant action of morphine.

Administration of MIF or CLG inhibited the development of tolerance to the locomotor depressant effect of morphine. Morphine (10 mg/kg) decreased the activity of mice implanted with placebo pellets to 27.5% of their own control, and this was not modified by MIF or CLG pretreatment. In morphine tolerant mice, the same dose of morphine (10 mg/kg) reduced the motor activity to 86.8% of controls, indicating the development of tolerance. Mice pretreated with MIF or CLG showed 23.5% and 32.2% activity, respectively, of their control values. These values were virtually identical to those obtained for mice from the placebo pellet implanted group.

### **Effects of MIF and Its Analogs on Tolerance to Morphine in the Rat**

Administration of MIF and CLG inhibited the development of tolerance to the analgesic effect of morphine in the rat. Multiple injections of MIF had no effect on morphine-induced (2 mg/kg) analgesia in rats implanted with placebo pellets. Tolerance developed as a result of pellet implantation. A dose of 8 mg/kg of morphine produced 36.5% analgesia in morphine tolerant rats pretreated with water (vehicle). In contrast, morphine tolerant rats treated with 2 and 4 mg/kg of MIF daily exhibited respectively 74.0% and 64.9% analgesia. Dose-response relationship

studies established that the minimum daily dose of MIF necessary to show significant inhibition in the development of tolerance to morphine was 0.5 mg/kg.

Administration of CLG (2 and 4 mg/kg) also inhibited the development of tolerance to morphine. In chronic saline-injected rats implanted with placebo pellets, morphine at a dose of 1 mg/kg produced significant analgesia at 30, 60, and 90 minutes after its administration, which did not differ [ $F(2,5) = 0.78$ ;  $p = 0.49$ ] from that observed in CLG-treated rats. In morphine pellet implanted rats, morphine (5 mg/kg) produced an 18% analgesic response, whereas rats injected with CLG exhibited an 86% analgesic response at 30 minutes after morphine injection. Dose-response relationship studies indicated that the minimum daily dose of CLG to show a significant inhibitory effect was 0.5 mg/kg. The effects of single injections of MIF and CLG on development of tolerance to the analgesic effect of morphine in the rat revealed that the minimum doses of CLG and MIF were 4 and 8 mg/kg, respectively.

Administration of not only MIP but also its analogs-CLG, Pro-ILeu-Gly-NH<sub>2</sub> and Leu-Gly-NH<sub>2</sub>-inhibited the development of tolerance to locomotor depressant, hyperthermic, hypothermic, and cataleptic effects of morphine in the rat. Dose-response relationship studies indicated that in the rat, morphine at 2, 4, and 8 mg/kg decreased the locomotor activity by 35.6%, 60.8%, and 80.5%. Multiple injections of MIF or CLG to placebo pellet implanted rats did not alter morphine-induced depression of locomotor activity. An 8 mg/kg dose of morphine, which produced a 78.5% decrease in activity in placebo pellet implanted rats, produced only a 29.3% decrease in morphine pellet implanted rats. However, in rats pretreated with MIF or CLG and implanted with morphine pellets, the decrease in motor activity was similar to that in placebo pellet implanted rats. Similar effects were produced by Leu-Gly-NH<sub>2</sub> and Pro-ILeu-Gly-NH<sub>2</sub>.

Administration of morphine to rats produced either hyperthermia (8 mg/kg) or hypothermia (50 mg/kg). As a result of pellet implantation, tolerance developed to both the hyperthermic and hypothermic effects of morphine. In placebo pellet implanted rats, injection of morphine (8 mg/kg) increased the body temperature by 0.9°C, whereas, in morphine pellet implanted rats, only a 0.2°C rise was noted. All four daily administered peptides blocked the development of tolerance to the hyperthermic effect of morphine. A similar inhibitory effect on the development of tolerance to the hypothermic effect of morphine was produced by all four peptides.

Administration of morphine at a 50 mg/kg dose also produced catalepsy which lasted for 50 to 60 seconds. The peak cataleptic response was noted at 30 minutes after morphine injection. A 78.5% catalepsy (as defined in the Materials and Method section) was observed in rats implanted with placebo pellets. In contrast, in rats implanted with morphine pellets, only a 26.5% cataleptic response was noted. Treatment with MIF and its analogs did not modify morphine-induced catalepsy in morphine naive rats, but inhibited the development of tolerance to morphine-induced catalepsy.

## Effects of MIF and Its Analogs on Brain Uptake of Morphine in Placebo and Morphine Pellet Implanted Rats

Chronic administration of MIF or its analogs to rats implanted with placebo or morphine pellets did not alter the uptake of morphine in the brain. Sixty minutes after an injection of morphine (59 mg/kg), the brain and plasma concentrations of morphine were approximately 400 ng/g and 1000 ng/ml, respectively, regardless of prior pretreatment.

## Effects of MIF and CLG on the Development of Tolerance to $\beta$ -Endorphin in the Rat

Chronic administration of  $\beta$ -endorphin to the rat resulted in the development of tolerance to its analgesic, cataleptic, and hypothermic effects. Daily injections of MIF or CLG inhibited the development of tolerance to the above pharmacological effects. At the time of the seventh injection, the analgesic response to  $\beta$ -endorphin (15  $\mu$ g) was only 4% in comparison to 16.3% following the first injection. Administration of MIF or CLG (2 mg/kg/day) blocked the development of tolerance to the analgesic effect of  $\beta$ -endorphin as evidenced by a 24.3% and 24.5% analgesic response to  $\beta$ -endorphin. At the time of eighth injection of  $\beta$ -endorphin, complete tolerance to its analgesic effect was observed, since only 1.8% analgesia was seen. The analgesic response to  $\beta$ -endorphin in MIF or CLG treated rats given  $\beta$ -endorphin chronically was indistinguishable from the chronic saline injected rats.

Chronic administration of  $\beta$ -endorphin (15  $\mu$ g) to rats also resulted in the development of tolerance to its cataleptic effect and it was blocked by MIF or CLG treatment. At the time of the first and seventh injections, the cataleptic response to  $\beta$ -endorphin was 61.2% and 28.1%, respectively. However, in MIF or CLG pretreated rats, the catalepsy was maintained at 67.5% and 61.0%, respectively. At the time of the eighth injection, all the treatment groups had a catalepsy score of 50% except those injected chronically with  $\beta$ -endorphin and having a 24% response.

Acute administration of  $\beta$ -endorphin produced a hypothermic effect. The body temperature decreased from 37.3 to 36.7°C ( $p < 0.05$ ). Tolerance to the hyperthermic effect of  $\beta$ -endorphin developed very rapidly. Even the second injection of  $\beta$ -endorphin did not alter body temperature of the rats. On repeated injections, instead of hypothermia, a hyperthermic effect was observed (37.2 to 39.1°C). The hyperthermic response was attenuated by treatment with MIF and CLG.

## Effects of MIF and CLG on the Development of Tolerance to Buprenorphine in the Rat

Administration of buprenorphine to rats produced dose-dependent analgesia and hyperthermia. Chronic treatment with buprenorphine resulted in the development of tolerance to its analgesic and hyperthermic effects. Concurrent administration of MIF or CLG inhibited the development of tolerance to both the pharmacological effects of buprenorphine (Bhargava 1982).

## Effects of MIF and CLG on Dopamine Receptor Sensitivity in Rats Treated Chronically with Morphine or $\beta$ -Endorphin

Chronic administration of morphine by morphine pellet implantation or of  $\beta$ -endorphin by repeated i.v.t. injections resulted in the development of supersensitivity of brain dopaminergic (DA) receptors, and the latter were blocked by MIF or CLG treatment. The development of DA receptor supersensitivity was evidenced by an enhanced hypothermic or locomotor activity response to apomorphine. Administration of apomorphine (2 mg/kg i.p.) to rats implanted with placebo pellets and given peptide-vehicle (water) decreased the body temperature from 38.0 to 36.9°C, whereas in rats implanted with morphine pellets the body temperature decreased to 36.2°C. In rats implanted with morphine pellets, and given MIF or CLG injections, the decrease in body temperature after apomorphine injections was similar to that observed in placebo pellet implanted rats (Bhargava 1981b). In addition, administration of apomorphine produced a greater increase in locomotor activity in morphine pellet implanted rats when compared with placebo pellet implanted rats. The enhanced response to apomorphine was blocked by CLG (2 and 4 mg/kg). The effects of two doses of CLG did not differ. Similarly, enhanced locomotor activity response was seen in chronic  $\beta$ -endorphin treated rats and it was blocked by MIF or CLG treatment (Bhargava 1981f).

The biochemical studies revealed that chronic administration of morphine was associated with enhanced activity of striatal dopaminergic systems. This was evidenced by a decrease in the  $K_d$  value of  $^3\text{H}$ -spiroperidol binding in morphine tolerant-dependent rats compared with placebo pellet implanted rats. However, the  $B_{\max}$  values in the two groups did not differ (Bhargava 1983a). Concurrent administration of MIF or CLG antagonized the decrease in  $K_d$  value of  $^3\text{H}$ -spiroperidol induced by chronic morphine treatment.

Direct interaction studies revealed that neither MIF nor CLG affected the binding of  $^3\text{H}$ -spiroperidol in the striatum, but they did enhance the binding of  $^3\text{H}$ -apomorphine to striatal and hypothalamic membranes. The enhancement in binding was not due to changes in  $B_{\max}$  values, but due to a decrease in the  $K_d$  value (Bhargava 1983b).

## DISCUSSION

The present studies indicate that the hypothalamically derived peptide factor MIF and several of its analogs can inhibit the development of tolerance to various pharmacological effects of morphine,  $\beta$ -endorphin, and buprenorphine in rodents.

In mice, some of the morphine-induced responses include analgesia, hypothermia, locomotor depression, and locomotor stimulation. Tolerance developed to all these effects on chronic administration of morphine. The development of tolerance to the analgesic and locomotor depressant effect was blocked by MIF and CLG, but the tolerance to the locomotor stimulant effect was not modified by these peptides. In our earlier study (Walter et al. 1978), it was demonstrated that the development of



tolerance to the analgesic and hypothermic effect of morphine was inhibited by carbobenzyloxy-Pro-D-Leu (Z-Pro-D-Leu), an analog of MIF.

In rats, the most prominent effects of morphine are analgesia, hyperthermia, hypothermia, catalepsy, and locomotor depression, and tolerance developed to all these effects on chronic administration. The development of tolerance to the above mentioned pharmacological effects of morphine was blocked not only by MIF, but also by several of its analogs. Thus, Pro-ILeu-Gly-NH<sub>2</sub>, Leu-Gly-NH<sub>2</sub>, and CLG were all active. This indicates that substitution of ILeu- in place of Leu- does not alter the activity of MIF. The plasma half-life of MIF was found to be 9 minutes (Redding et al. 1973), and yet in these studies, MIF was active when given in single administration or multiple administration 24 hours apart. This indicates that MIF may be producing its actions by conversion to an active metabolite with, perhaps, a long biological half-life. The studies on metabolism of MIF revealed that it is primarily metabolized by the cleavage of the Pro-Leu-bond with the formation of proline and Leu Gly-NH<sub>2</sub> (Redding et al. 1973). The present studies demonstrate that Leu-Gly-NH<sub>2</sub>, which is the major metabolite of MIF, is also an effective inhibitor of the development of tolerance to opiates.

The present studies also indicate that repeated intraventricular administration of  $\beta$ -endorphin to rats results in the development of tolerance to its pharmacological effects. These results are in agreement with previous studies (Tseng et al. 1977; van Loon et al. 1978). Administration of MIF or CLG also inhibited the development of tolerance to  $\beta$ -endorphin. These studies thus provide additional evidence for the similarities between the exogenous and endogenous opiates.

The development of tolerance to the analgesic and hyperthermic effects of buprenorphine was also antagonized by MIF and CLG. All these studies show the similar effects of MIF and its analog CLG in inhibiting the development to tolerance of some actions of the endogenous and exogenous opiates, particularly to their analgesic activity.

The development of physical dependence to morphine was also inhibited by MIF and CLG as evidenced by antagonism of withdrawal-induced hypothermic response (Walter et al. 1979). However, other signs of withdrawal like body weight loss and stereotyped jumping response were unaffected by the two peptides (Bhargava et al. 1980).

The mechanism(s) by which MIF and its analogs inhibit the development of tolerance to the pharmacological effects of exogenous and endogenous opiates remains to be delineated. It is possible that these peptides may be acting as endogenous opiate antagonists. Opiate antagonists like naloxone have been shown to inhibit the development of dependence on morphine (Bhargava 1978a). These peptides, however, do not affect morphine-induced analgesia or displace the <sup>3</sup>H-ligands for  $\mu$ ,  $\delta$ , or  $\kappa$  opiate receptors (Bhargava et al. 1983a), suggesting thereby that these peptides do not interact at opiate receptors. The development of tolerance to morphine is associated with enhanced sensitivity of brain DA receptors (Lal 1925; Ritzmann et al. 1979; Bhargava 1980c, 1981b). Similarly, chronic administration of  $\beta$ -endorphin results in increases in

striatal homovanillic acid concentration suggesting an increase in DA turnover (van Loon et al. 1978). Preliminary work in this laboratory indicates that chronic administration of  $\beta$ -endorphin to rats is associated with enhanced sensitivity to apomorphine (Bhargava 1981f). Christie and Overstreet (1979), using tritiated spiroperidol as ligand, observed that morphine tolerant rats exhibited supersensitivity of DA receptors. However, rats withdrawn from morphine exhibited subsensitivity of DA receptors. Our studies indicate that morphine- or  $\beta$ -endorphin-induced supersensitivity of brain DA receptors is blocked by MIF and CLG (Ritzmann et al. 1979; Bhargava 1980c, 1981b, 1981f). Studies in our laboratory indicate that in morphine tolerance-dependent rats, the binding of  $^3\text{H}$ -spiroperidol to striatal DA receptors is enhanced because of increased affinity. The number of binding sites do not appear to change. These changes are inhibited by both MIF and CLG (Bhargava 1983a). This suggests the existence of an interaction between MIF and brain dopaminergic systems. In fact, MIF has been shown to potentiate the behavioral effects of L-dopa (Barbeau 1973; Plotnikoff et al. 1971; Plotnikoff and Kastin 1974a) and of apomorphine (Kostrzewa et al. 1978). Our results also indicate that MIF and CLG enhance the binding of  $^3\text{H}$ -apomorphine to striatal and hypothalamic DA receptors by enhancing the affinity of the ligand to its receptors (Bhargava 1983b). Evidence for the existence of binding sites for MIF in the brain has been provided recently (Chiu et al. 1980). The binding of MIF to brain tissue was shown to be inhibited by CLG, indicating that CLG may be interacting with the MIF receptors or similar receptor sites. These studies thus indicate that MIF and its analogs may be enhancing dopaminergic neurotransmission in the brain.

### **Peptides Other than MIF and Its Analogs which Inhibit the Development of Tolerance to and Dependence on Opiates and the Withdrawal Symptoms**

The following section, describes the effects of peptides other than MIF and its analogs on the addiction to opiates. They include  $\alpha$ -melanocyte stimulating hormone ( $\alpha$ -MSH), actinomycin D (dactinomycin), and thyrotropin releasing hormone (TRH).

$\alpha$ -Melanocyte-stimulating hormone. For the past several years, our hypothesis has been that if there are mechanisms present in the body to induce tolerance and dependence to endogenous and exogenous opiates, then there must also be present systems or substances which could prevent or retard the development of the addictive states. Studies indicate that an adrenocorticotrophic hormone (ACH)-secreting mouse pituitary tumor cells synthesize a large glycoprotein molecule (Pro-ACTH/endorphin) which serves as a precursor for smaller molecular forms of ATCH and also for  $\beta$ -lipotropin (Mains et al. 1977; Eipper and Mains 1978). ACTH is cleaved further to  $\alpha$ -MSH and corticotropinlike intermediate lobe peptide (CLIP) in cell suspensions of intermediate lobe of the rat.  $\beta$ -Lipotropin and ACTH and their fragments  $\beta$ -endorphin,  $\gamma$ -lipotropin,  $\alpha$ -MSH, CLIP, and  $\alpha$ -MSH are released at the same time by the pituitary.

The effects of some of these fragments on tolerance to and dependence on morphine was determined (Szekely et al. 1979). The tolerance was

induced in the rat by twice daily injections of morphine in increasing doses of 4.35 to 14.5 mg/kg s.c. during a 4-day period. Tolerance developed to the analgesic effect of morphine as measured by the tail-flick test. Administration of 0.1 mg/kg s.c. of  $\alpha$ -MSH immediately prior to each morphine injection inhibited the development of tolerance to the analgesic effect of morphine. The development of dependence on morphine was studied in the mouse.  $\alpha$ -MSH treatment was shown to inhibit naloxone-precipitated loss in body weight, but the naloxone-precipitated withdrawal jumping was not modified by  $\alpha$ -MSH. On the other hand, administration of CLIP 1 mg/kg s.c. had no effect on morphine-induced tolerance and dependence development (Szekely et al. 1979).

Actinomycin D. It is envisioned that the development of tolerance to morphine may be related to an increase in the synthesis of receptor proteins in the CNS. Cohen et al. (1965) showed that actinomycin D administered to mice did not produce analgesia or affect morphine induced analgesia. However, when given i.p. (0.03 to 8.0  $\mu$ g per mouse), it produced a dose-dependent inhibition in the development of tolerance to morphine. Similar effect was demonstrated in the rat. It was concluded that the inhibition of tolerance may be related to the suppression of the synthesis of new RNA and consequently of proteins or peptides which decrease the effects of morphine. Because widespread metabolic disturbances were noted after prolonged treatment with inhibitors of protein synthesis (Young et al. 1963), Cox et al. (1968) studied the effect of actinomycin D on the development of tolerance to morphine in the rat, induced by continuous intravenous infusion of morphine for 4 hours. Infusion of actinomycin D at a rate of 10  $\mu$ g/kg/hr blocked the development of tolerance to the analgesic effect of not only morphine but also of diamorphine, etorphine, and pethidine, and confirmed the finding of Cohen et al. (1965). The interpretation of the inhibitory effect of actinomycin D on opiate tolerance was confounded by the fact that Loh et al. (1971) showed that actinomycin D increased the uptake of morphine in the brain, perhaps by modifying the blood-brain barrier.

Thyrotropin releasing hormone and analogs. In addition to MIF, studies in our laboratory have explored the effect of other hypothalamic peptides, particularly the TRH. TRH is a tripeptide (pGlu-His-Pro-NH<sub>2</sub>) which releases thyrotropin and prolactin from the anterior pituitary (Bowers et al. 1971). It is distributed ubiquitously in the CNS and is concentrated in the nerve terminals (Brownstein et al. 1974; Hokfelt et al. 1975). Besides its endocrine activity, TRH has been shown to have direct effects on the CNS since they can be observed in hypophysectomized rodents. TRH enhances the stimulant action of L-dopa in pargyline-pretreated hypophysectomized and thyroidectomized rodents (Plotnikoff et al. 1974), and antagonizes the CNS depressant drugs like barbiturates and alcohol (Plotnikoff et al. 1974), tetrahydrocannabinol (Bhargava 1980b; Bhargava and Matwyshyn 1980), ketamine (Bhargava 1981g), and morphine (Bhargava et al. 1982).

The mechanisms by which TRH produces its effect on the CNS or modifies effects of other drugs have not yet been elucidated. It is possible that it may serve as a neurotransmitter or a neuromodulator since it is

concentrated in the nerve terminals. A TRH uptake process sharing properties of a high-affinity transport system, like saturation kinetics, high-affinity kinetic constants, and temperature and sodium dependency, has been shown to exist in the rat cerebellar slices (Pacheco et al. 1981). The specific receptors for TRH have been characterized in the brain by radioligand binding studies using  $^3\text{H}$ -TRH (Burt and Snyder 1975; Burt and Taylor 1980) and by using  $^3\text{H}$ -( $^3\text{-MeHis}^2$ ) TRH (Simasko and Horita 1982).

The half-life of TRH in plasma has been found to be 4 minutes (Redding and Schally 1972), yet its pharmacological activities indicate that it has a much longer duration of action. It is thus possible that TRH produces its action via an active metabolite or by modifying other neurotransmitter systems. Studies show that TRH undergoes metabolic changes by two pathways. The first involves a specific TRH amidase which hydrolyzes the terminal amide of the molecule to produce pyroglutamylhistidyl proline (TRH acid). The second pathway involves a nonspecific pyroglutamyl peptidase which cleaves pGlu-His-bond to yield His-Pro-NH<sub>2</sub>. The latter is rather unstable and readily cyclizes to form histidyl-proline diketopiperazine, which is also referred to as cyclo(His-Pro) (Prasad et al. 1977). TRH acid does not appear to be pharmacologically active (Prange et al. 1975; Prasad et al. 1977), whereas cyclo(His-Pro) has been found to be active and may be responsible for some of the CNS actions of TRH (Bhargava 1980a, 1981a; Bhargava and Matwyshyn 1980; Prasad et al. 1977; Yanagisawa et al. 1979). However, it is not a prerequisite for TRH-like agents to form a cyclic analog to exhibit its pharmacological effects, since SAR studies indicate that TRH analogs which could not form the diketopiperazine structure were able to antagonize the effects of morphine just like the TRH did (Bhargava et al. 1982). Further support against a role of cyclo(His-Pro) in mediating TRH effects stems from the studies showing the absence of the binding sites for  $^3\text{H}$ -cyclo(His-Pro) in the brain (Koch et al. 1982) and that cyclo(His-Pro) does not displace  $^3\text{H}$ -TRH from its binding sites in the brain (Burt and Taylor 1980).

TRH is a weakly basic tripeptide. Its structural requirements to elicit TRH-like endocrine activity are rather rigid. The TSH releasing activity increases only by methylation in the 3-position of histidine ring. Structural modifications have yielded compounds which are only resistant to degradation by the enzyme (Brewster et al. 1980; Brewster and Rance 1980; Miyamoto et al. 1981; Porter et al. 1977; Bhargava et al. 1982), but they are not more active than TRH at its binding sites in the brain (Simasko and Horita 1982).

The studies involving the effect of TRH on opiate addiction in our laboratory were prompted by the previous reports on the interactions of TRH with endogenous and exogenous opiates, mostly involving single administration of an opiate. Many of these findings have recently been reviewed (Bhargava et al. 1983b), and the reader may wish to refer to this article. In summary, TRH by itself is devoid of analgesic activity and does not modify analgesia induced by morphine or  $\beta$ -endorphin (Martin et al. 1977; Holaday et al. 1978; Bhargava 1981d). Similarly, the stereospecific binding of  $^3\text{H}$ -dihydromorphine (Martin et al. 1977; Holaday et al. 1978) or of  $^3\text{H}$ -naloxone (Tache et al. 1977) to brain homogenates is not affected by TRH. TRH antagonizes the catalepsy induced by  $\beta$ -endorphin in the rat (Holaday et al. 1978), respiratory depression induced

by morphine in the rat (Horita et al. 1976), depressant and hypothermia effects of morphine in the mouse (Bhargava et al. 1982) and of  $\beta$ -endorphin in the rat (Cache et al. 1977; Holaday et al. 1978).

The following section describes the experiments carried out in this laboratory with TRH and its analogs on the development of tolerance to and dependence on morphine and also on the morphine abstinence syndrome.

The effect of TRH on the development of tolerance to the analgesic, hypothermic, constipating, and urinary retention activities of morphine were investigated in rodents. Tolerance to morphine was induced in mice by pellet implantation procedure as described previously. TRH administered subcutaneously in a dose of 4 mg/kg twice a day for 3 days inhibited the development of tolerance to the analgesic effect of morphine as evidenced by increased analgesic response to a challenge dose of morphine in TRH treated morphine tolerant mice as compared to vehicle treated morphine tolerant mice. The inhibition of tolerance to the analgesic effect of morphine was produced without altering the disposition of morphine in brain and plasma, indicating that TRH may be interacting directly in the CNS with processes responsible for the genesis of tolerance phenomenon (Bhargava 1961a). Chronic administration of morphine resulted in the development of tolerance to its hypothermic effect. However, this tolerance was not modified by TRH treatment (Bhargava 1981a). A single injection of morphine was found to inhibit gastrointestinal transit in the mouse in a dose-dependent fashion. Chronic administration of morphine resulted in the development of tolerance to the inhibitory effect on gastrointestinal transit which was not affected by daily injections of TRH (Pillai and Bhargava 1984a).

Administration of morphine also caused a dose-dependent decrease in urinary output in the rat, Tolerance developed to this effect and it was not affected by chronic treatment with TRH given in a dose of 10 mg/kg twice a day for 3 days (Pillai and Bhargava 1984b).

Thus, TRH blocks tolerance to the analgesic effect of opiates selectively and does not modify the tolerance to constipating, hypothermic, and urinary retention activities of opiates. These findings suggest that different mechanisms may be involved in the development of tolerance to various pharmacological effects of morphine. Furthermore, selective blockade by TRH of the tolerance to the analgesic effect of morphine may represent a clinically beneficial effect.

Chronic administration of TRH inhibits the development of physical dependence on morphine in mice (Bhargava 1980a). The physical dependence on morphine was induced by pellet implantation as described for tolerance studies. The degree of physical dependence development was assessed by monitoring the intensity of withdrawal symptoms such as body weight loss, hypothermia during abrupt and antagonist-induced abstinence, and the stereotyped jumping response after administration of an antagonist like naloxone (Bhargava 1977a; Way et al. 1969). The greater the intensity of these signs, the greater is the degree of

dependence. A single injection of TRH (4, 8, or 16 mg/kg s.c.) given prior to morphine pellet implantation did not affect the development of dependence on morphine. However, the same doses given prior to and during the course of development of dependence inhibited the development of withdrawal-induced hypothermia. The intensity of naloxone-induced withdrawal jumping syndrome measured 18 to 18 hours after the last injection of TRH was unaffected. Similarly, the withdrawal-induced body weight loss was unaffected by TRH treatment. The inability of TRH to modify body weight loss may be related to its suppressive effect on food intake (Morley and Levine 1980) and increased gastrointestinal activity (Morley et al. 1979). Studies in our laboratory, however, indicate that in the mouse, TRH administered centrally causes inhibition of the gastrointestinal transit and this effect is mediated via stereospecific opiate receptors (Bhargava and Pillai 1984, 1985).

The effects of TRH on the withdrawal symptoms observed after termination of morphine treatment were also investigated in the mouse. Mice were made physically dependent on morphine as described before. Morphine pellets were removed 72 hours after their implantation and at various times thereafter the intensity of withdrawal symptoms was assessed in vehicle and TRH injected animals. Intracerebral administration of TRH (1-25 µg per mouse) prevented the hypothermic response observed during abrupt and naloxone-precipitated withdrawal. TRH also inhibited the naloxone-induced withdrawal jumping response in a dose-related manner (Bhargava 1980a). These studies were consistent with the findings of Morley et al. (1980) who showed that naloxone induced withdrawal in morphine-dependent rats is associated with lowering of serum TRH concentration,

The abstinence syndrome in morphine-dependent mice was inhibited not only by TRH, but also by its postulated metabolite cyclo(His-Pro) (Bhargava 1981e). Intracerebral administration of cyclo(His-Pro) (1 or 5 µg per mouse) inhibited both the naloxone-induced stereotyped jumping response as well as the withdrawal-induced hypothermia. In addition, the analogs of TRH, namely L-N-(2-oxopiperidin-6-yl-carbonyl)-L-histidyl-L-thiazolidine-4-carboxamide (MK-771) and  $\gamma$ -butyrolactone-4-carboxyl-histidylprolineamide (DN-1417) also inhibited the intensity of morphine abstinence syndrome (Matwyshyn and Bhargava 1984). Studies are ongoing in these laboratories to delineate the mechanisms by which TRH and its analogs modify the development of tolerance to and physical dependence on opiates.

In summary, peptides derived from the mammalian systems and their analogs may find their applications in the management of withdrawal syndrome of opiates, to antagonize certain side effects of opiates and as prophyactics in the development of addiction to opiates.

## REFERENCES

- Ader, R., and de Wied, D. Effects of lysine vasopressin on passive avoidance learning. Psychon Sci 29:46-48, 1972.
- Algeri, S., and Costa, Physical dependence on morphine fails to increase serotonin turnover rate in rat brain, Biochem Pharmacol 20:877-884, 1971.
- Barbeau, A. Potentiation of levodopa effect by intravenous l-prolyl-l-leucyl-glycinamide in man. Lancet 2:683-684, 1975.
- Barbeau, A. Role of peptides in the pathogenesis and treatment of Parkinson's disease, In: Cdlu, R.; Barbeau, A.; Ducharme, J.R.; and Rochefort, J.G., eds. Central Nervous System Effects of Hypothalamic Hormones and Other Peptides. New York: Raven Press, 1979. pp. 403-414.
- Bhargava, H.N. Rapid induction and quantitation of morphine dependence in the rat by pellet implantation. Psychopharmacology 52:55-62, 1977a.
- Bhargava, H.N. Improved recovery of morphine from biological tissues using siliconized glassware. J Pharm Sci 66:1044-1045, 1977b.
- Bhargava, H.N. The effect of naltrexone on the development of physical dependence on morphine. Eur J Pharmacol 50:193-202, 1978a.
- Bhargava, H.N. Effect of methionine-enkephalin and morphine on spontaneous locomotor activity: Antagonism by naloxone. Pharmacol Biochem Behav 9:167-171, 1978b.
- Bhargava, B.N. Quantitation of morphine tolerance induced by pellet implantation in the rat. J Pharm Pharmacol 30:133-135, 1978c.
- Bhargava, H.N. The synthesis rate and turnover time of 5-hydroxytryptamine in brains of rats treated chronically with morphine. Br J Pharmacol 65:311-317, 1979.
- Bhargava, H.N. The effects of thyrotropin releasing hormone on the central nervous system responses to chronic morphine administration. Psychopharmacology 68:185-189, 1980a.
- Bhargava, H.N. The effects of thyrotropin releasing hormone and histidyl-proline diketopiperazine on delta-9-tetrahydrocannabinol induced hypothermia. Life Sci 26:845-850, 1980b.
- Bhargava, H.N. Cyclo (leucylglycine) inhibits the development of morphine-induced analgesic tolerance and dopamine receptor supersensitivity in rats. Life Sci 27:117-123, 1980c.
- Bhargava, H.N. Inability of cyclo (leucylglycine) to facilitate the development of tolerance to a physical dependence on morphine in the rat. Life Sci 27:1075-1081, 1980d.
- Bhargava, H.N. Dissociation of tolerance to the analgesic and hypothermic effects of morphine by using thyrotropin releasing hormone. Life Sci 29:1015-1020, 1981a.
- Bhargava, H.N. The effects of melanotropin release inhibiting factor and cyclo (Leu-Gly) on the tolerance to morphine-induced antinociception in the rat: A dose response study. Br J Pharmacol 72: 707-714, 1981b.
- Bhargava, H.N. The effect of peptides on tolerance to the cataleptic and hypothermic effects of morphine in the rat. Neuropharmacology 20:385-390, 1981c.

- Bhargava, H.N. Inhibition of tolerance to the pharmacological effects of human  $\beta$ -endorphin in the rat by prolyl-leucyl-glycinamide and cyclo (leucylglycine). Exp Ther 218:404-408, 1981d.
- Bhargava, H.N. Inhibition abstinence syndrome in opiate dependent mice by cyclo (His-Pro). Life Sci 28:1261-1267, 1981e.
- Bhargava, H.N. Enhanced response to apomorphine in rats treated with multiple injections of human  $\beta$ -endorphin and its blockade by Pro-Leu-Gly-NH<sub>2</sub> and cyclo (Leu-Gly). Life Sci 29:1945-1949, 1981f.
- Bhargava, H.N. Antagonism of ketamine-induced anesthesia and hypothermia by TRH and cyclo (His-Pro). Neuropharmacology 20: 699-702, 1981g.
- Bhargava, H.N. Effect of peptides on the development of tolerance to buprenorphine, a mixed opiate agonist-antagonist analgesic. Eur J Pharmacol 79:117-123, 1982.
- Bhargava, H.N. Binding of (<sup>3</sup>H)spiroperidol to striatal membranes of rats treated chronically with morphine. Influence of Pro-Leu-Gly-NH<sub>2</sub> and cyclo(Leu-Gly). Neuropharmacology 22:1357-1361, 1983a.
- Bhargava, H.N. The effect of melanotropin release inhibiting factor, its metabolites and analogs on (<sup>3</sup>H)spiroperidol and (<sup>3</sup>H)apomorphine binding sites. Gen Pharmacol 14:609-614, 1983b.
- Bhargava, H.N. and Kim, H.S. Structure activity relationship studies with hypothalamic peptide hormones. I. Effect of melanotropin release inhibiting factor and analogs on tolerance to morphine in the rat. J Pharmacol Exp Ther 220:394-398, 1982.
- Bhargava, H.N., and Matwyshyn, G.A. Brain serotonin turnover and morphine tolerance-dependence induced by multiple injections in the rat. Eur J Pharmacol 44:25-33, 1977.
- Bhargava, H.N., and Matwyshyn, G.A. Influence of thyrotropin releasing hormone and histidyl proline diketopeperazine on spontaneous locomotor activity and analgesia induced by delta-9-tetrahydrocannabinol in the mouse. Eur J Pharmacol 68:147-154, 1980.
- Bhargava, H.N.; and Pillai, N.P. Studies on the mechanism of action of thyrotropin releasing hormone (TRH) on the gastrointestinal transit (GIT) in the mouse. The Pharmacologist 26:140, 1984.
- Bhargava, H.N., and Pillai, N.P. Stereospecific opiate receptors in the actions of thyrotropin releasing hormone and morphine on the gastrointestinal transit. Life Sci 36:83-88, 1985.
- Bhargava, H.N., and Way, E.L. Brain acetylcholine and choline following acute and chronic morphinization and during withdrawal. J Pharmacol Exp Ther 194:65-73, 1975.
- Bhargava, H.N., and Way, E.L. Morphine tolerance and physical dependence: Influence of cholinergic agonists and antagonists. Eur J Pharmacol 36:79-88, 1976.
- Bhargava, H.N.; Chan, S.L.; and Way, E.L. Influence of hemicholinium-3 on morphine tolerance and physical dependence and on brain acetylcholine. Eur J Pharmacol 29:253-261, 1974.
- Bhargava, H.N.; Walter, R.; and Ritzmann, R.F. Development of narcotic tolerance and physical dependence effects of Pro-Leu-Gly-NH<sub>2</sub> and cyclo(Leu-Gly) Pharmacol Biochem Behav 12:73-77, 1980.
- Bhargava, H.N.; Matwyshyn, G.A.; Currie, B.L., and Goebel, R.J. Structure activity relationship studies with hypothalamic peptide hormones. II. Effects of thyrotropin releasing hormone analogs on morphine-induced responses in mice. Life Sci 32:711-718, 1982.



- Bhargava, H.N.; Pandey, R.N.; and Matwyshyn, G.A. Effects of prolyl-leucylglycinamide and cyclo(leucyl-glycine) on morphine induced antinociception and brain  $\mu$ ,  $\delta$  and  $\kappa$  opiate receptors. Life Sci 32: 2095-2101, 1983a.
- Bhargava, H.N.; Yousif, D.J.; and Matwyshyn, G.A. Interactions of thyrotropin releasing hormone, its metabolites and analogs with endogenous and exogenous opiates. Gen Pharmacol 14:565-570, 1983b.
- Bowers, C.Y.; Friesen, H.G.; Hwang, P.; Guyda, H.J.; and Folkers, K. Prolactin and thyrotropin release in man by synthetic pyroglutamyl-histidyl-prolineamide. Biochem Biophys Res Commun 45:1033-1041, 1971.
- Brewster, D., and Rance, M.J. An analogue of thyrotropin releasing hormone with improved biological stability both in vitro and in vivo. Biochem Pharmacol 29:2619-2623, 1980.
- Brewster, D.; Dettmar, P.W.; Lynn, A.G.; Metcalf, G.; Morgan, B.A.; and Rance, M.J. Modification of the proline residue of TRH enhances biological activity and inhibits degradation. Eur J Pharmacol 66:65-71, 1980.
- Brownstein, M.J.; Palkovits, M.; Saavedra, J.M.; Bassiri, R.M.; and Utiger, R.D. Thyrotropin releasing hormone in specific nuclei of rat brain Science 185:267-269, 1974.
- Burt, D.R. Snyder S.H. Thyrotropin releasing hormone (TRH): Apparent receptor binding in rat brain membranes. Brain Res 93: 309-328, 1975.
- Burt, D.R., and Taylor R.L. Binding sites for thyrotropin-releasing hormone in sheep nucleus accumbens resemble pituitary receptors. Endocrinology 106:14116-1426, 1980.
- Celis, M.E., and Taleisnik, S. Formation of a melanocyte-stimulating hormone-release inhibiting factor by hypothalamic extracts from rats. Int J Neurosci 1:223-230, 1971.
- Celis, M.E.; Taleisnik, S.; and Walter, R. Regulation of formation and proposed structure of the factor inhibiting the release of melanocyte-stimulating hormone. Proc Natl Acad Sci USA 68:1428-1433, 1971.
- Chiu, S.; Wong, Y.W.; and Mishra, R.K. Direct evidence for L-prolyl-L-leucyl-glycinamide (PLG) receptor in mammalian brain. Fed Proc 39: 625, 1980.
- Christie, M.J.; and Overstreet, D.H. Sensitivity of morphine-tolerant rats to muscarinic and dopaminergic agonists: Relation to tolerance or withdrawal. Psychopharmacology 65:27-34, 1979.
- Cohen, M.; Keats, A.S.; Krivoy, W.; and Ungar, G. Effect of actinomycin D on morphine tolerance. Proc Soc Exp Biol Med 119: 381-384, 1965.
- Corrodi, H.; Fuxe, K.; and Hokfelt, T. The effects of immobilization stress on the activity of central monoamine neurons. Life Sci 7: 107-112, 1968.
- Costall, B., and Naylor, R.J. On catalepsy and catatonia and the predictability of the catalepsy test for neuroleptic activity. Psychopharmacologia (Berl) 34:233-241, 1974.
- Cox, B.M.; Ginsburg, M.; and Osman, O.H. Acute tolerance to narcotic analgesic drugs in the rat. Br J Pharmacol 33:245-256, 1968.
- Delanoy, R. L.; Dunn, A.J.; and Walter, R. Neurohypophyseal hormones and behavior: Effects of intracerebroventricularly injected hormone analogs in mice. Life Sci 24:651-658, 1979.

- de Schaepdryver, A.; Preziosi, P., and Scapagnini U. Brain monoamines and adrenocortical activation, Br J Pharmacol 35:460-467, 1969.
- de Wied, D. Long term effect of vasopressin on the maintenance of a conditioned avoidance response in rats. Nature 232:58-60, 1971.
- de Wied, D. Long-term effects of vasopressin the maintenance of a conditioned avoidance response in rats. Nature 232:137-143, 1973.
- de Wied, D., and Gispen, W.H. Impaired development of tolerance to morphine analgesia in rats with hereditary diabetes insipidus. Psychopharmacologia (Berl) 46:27-29, 1976.
- de Wied, D.; Greven, H.M.; Lande, S.; and Witter, A. Dissociation of the behavior and endocrine effects of lysine vasopressin by tryptic digestion. Br J Pharmacol 45:118-122, 1972.
- Eidelberg, E., and Erspamer, R. Dopaminergic mechanisms of opiate actions in brain. J Pharmacol Exp Ther 192:50-57, 1975.
- Eipper, B.A., and Mains, R.E. Analysis of the common precursor to corticotropin and endorphin. J Biol Chem 253:5732-5744, 1978.
- Ernst, A.M. Mode of action of apomorphine and dexamphetamine on gnawing compulsion in rats. Psychopharmacologia (Berl) 10:316-323, 1967.
- Fischer, E., Synthese von Polypeptiden XV. Chem Ber 29:2893-2931, 1906.
- Flexner, J.B.; Flexner, L.B.; Walter, R.; and Hoffman, P.L. ADH and related peptides: Effect of pre or post-training treatment on puromycin amnesia. Pharmacol Biochem Behav 8:93-95, 1978.
- George, R. Hypothalamus anterior pituitary gland. In: Clouet, D., ed. Narcotic Drugs Biochemical Pharmacology. New York: Plenum Press 1971. pp. 283-299.
- Goldstein, A., and Sheehan, P. Tolerance to opioid narcotics. I. Tolerance to the "running fit" caused by levorphanol in the mouse. J Pharmacol Exp Ther 169:175-184, 1969.
- Ho, I.K.; Loh, H.H. Way, E.L. Effects of cyclic AMP on morphine tolerance and physical dependence. J Pharmacol Exp Ther 165:347-357, 1973a.
- Ho, I.K.; Loh, H.H.; and Way, E.L. Influence of GABA on morphine analgesia, tolerance and physical dependence. Proc West Pharmacol Soc 16:4-7, 1973b.
- Hokfelt, T.; Fuxe, K.; Johansson, O.; Jeffcoate, S.L.; and White, N. Distribution of TRH in the central nervous system as revealed by immunohistochemistry. Eur J Pharmacol 34:389-392, 1975.
- Holaday, J.W.; Tseng, L.E Loh, H.H.: and Li, C.H. Thyrotropin releasing hormone antagonizes  $\beta$ -endorphin hypothermia and catalepsy. Life Sci 22:1537-1544, 1978.
- Horita, A.; Carino, M.A.; and Chestnut, R.M. Influence of thyrotropin releasing hormone on drug induced narcosis and hypothermia in rabbits. Psychopharmacology 49:57-62, 1976.
- Huidobro, F. Antidiuretic effect of morphine in the rat: Tolerance and physical dependence. Br J Pharmacol 64:167-171, 1978.
- Iwamoto, E.T.; Ho, I.K., and Way, E.L. Elevation of brain dopamine during naloxone-precipitated withdrawal in morphine-dependent mice and rats. J Pharmacol Exp Ther 187:558-567, 1973.
- Kastin, A.J.; Plotnikoff, N.P.; Sandman, C.A.; Spirtes, M.A.; Kostrzewa, R.M.; Paul, S.M.; Stratton, L.O.; Miller, L.H.; Labrie, F.; Schally, A.V.; and Goldman, H. The effects of MSH and MIF on the

- brain. In: Stumpf, W.E., and Grant, L.D., eds. Anatomical Neuroendocrinology. Basel: Karger, 1975. pp 290-297.
- Kastin, A.J.; Barbeau, A.; Plotnikoff, N.P.; Schally, A.V.; and Ehrensing, R.H. MIF 1: Actions in man. In: Martini, L., and Besser, G.M., eds. Clinical Neuroendocrinology. New York: Academic Press, 1979. pp 393-400.
- King, A.R., and de Wied, D. Localized behavioral effects of vasopressin on maintenance of an active avoidance response in rats. J Physiol Psychol 86:1008-1018, 1974.
- Knobil, E., and Sawyer, W.H., eds. The Pituitary Gland and Its Neuroendocrine Control Part I. Handbook of Physiology. Section 7, Volume 4. Baltimore: Waverly Press, 1975.
- Koch, Y.; Battani, F.; and Peterkofsky A. (<sup>3</sup>H)Cyclo(histidyl-proline) in rat tissues: Distribution, clearance and binding. Biochem Biophys Res Commun 104:823-829, 1982
- Kostrzewa, R.M.; Kastin, A.J.; and Sobrian, S.K. Potentiation of apomorphine action in rats by 1-prolyl-1-leucyl-glycinamide. Pharmacol Biochem Behav 9:375-378, 1978.
- Kovacs, G.L.; Szontagh, L.; Balaspiri, L.; Hodi, K.; Bohus, P.; and Telegdy, G. On the mode of action of an oxytocin derivative (Z-Pro-D-Leu) on morphine dependence in mice. Neuropharmacology 20: 647-651, 1981.
- Krivoy, W.A.; Zimmerman, E.; and Lande, S. Facilitation of development of resistance to morphine analgesia by desglycinamide<sup>9</sup>-lysine vasopressin. Proc Natl Acad Sci USA 71:1852-1856, 1974.
- Kruse, H.; Van Wimersma, G.; Ti, B.; and de Wied, D. Barrel rotation induced by vasopressin and related peptides in rats. Pharmacol Biochem Behav 7:311-313, 1977.
- Kupferberg, H.J.; Burkhalter, A.; and Way, E.L. A sensitive fluorometric assay of morphine in plasma and brain. J Pharmacol Exp Ther 145:247-251, 1964.
- Lal, H. Narcotic dependence, narcotic action and dopamine receptors. Life Sci 17:483-496, 1975.
- Lande, S.; Writter, A.; and deWied, D. Pituitary peptides, an octapeptide that stimulates conditioned avoidance acquisition in hypophysectomized rats. J Biol Chem 246:2058-2062, 1971.
- Lande, S.; Flexner, J.B.; and Flexner, L.B. Effect of corticotropin and desglycinamide<sup>9</sup> lysine vasopressin on suppression of memory by puromycin. Proc Natl Acad Sci USA 69:558-560, 1972.
- Lauson, H.D. Metabolism of neurohypophyseal hormones. In: Knobil, E., and Sawyer, W.H., eds. Handbook of Physiology Section 7 Volume 4. Baltimore: Waverly Press, 1974. pp. 287-293.
- Legros, J.; Gilot, P.; Seron, X.; Claessens, J.; Adam, A.; Moeglen, J.M.; Audibert, A.; and Berchier, P. Influence of vasopressin on learning memory. Lancet 1:41-42, 1978.
- Liu, S.J.; Evans, D.B.; and Wang, R.I.H. Correlation of urinary excretion of methadone metabolites with methadone metabolism and analgesia in the rat. J Pharmacol Exp Ther 204:67-76, 1978.
- Loh, B.M.; Ginsburg, M.; and Osman, O.H. Acute tolerance to narcotic analgesic drugs in the rat. Br J Pharmacol 33:245-256, 1968.
- Loh, H.H.; Shen, F.H.; and Way, E.L. Effect of dactinomycin on the acute toxicity and brain uptake of morphine. J Pharmacol Exp Ther 177:326-331, 1971.

- Mains, R.E.; Eipper, B.A.; and Ling, N. Common precursor to corticotropins and endorphins. Proc Natl Acad Sci USA 74:3014-3018, 1977.
- Marshall, I., and Grahame-Smith, D.G. Evidence against a role of brain 5-hydroxytryptamine in the development and physical dependence upon morphine in mice. J Pharmacol Exp Ther 179:634-641, 1971.
- Martin, B.R.; Dewey, W.L.; Chau-Pham, and Prange, A.J., Jr. Interactions of thyrotropin releasing hormone and morphine sulfate in rodents. Life Sci 20:715-722, 1977.
- Masten, L.W.; Peterson, G.R.; Burkhalter, A.; and Way, E.L. Effect of oral administration of methadone on hepatic microsomal mixed function oxidase activity in mice. Life Sci Part I: 1635-1840, 1974.
- Matwyshyn, G.A., and Bhargava, H.N. The effects of MIF and cyclo(Leu-Gly) on the development of tolerance to the locomotor activity of morphine in mice. The Pharmacologist 23:303, 1980.
- Matwyshyn, G.A., and Bhargava, H.N. Effect of thyrotropin releasing hormone (TRH) and its analogs on morphine abstinence syndrome in the mouse. Fed Proc 43:557, 1984.
- Miyamoto, M.; Fukuda, N.; Narumi, S.; Nagai, Y.; Saji, Y.; and Nagawa, Y. Gamma-butyrolactone-gamma-carbonyl-histidyl-prolineamide citrate (DN-1417): A novel TRH analog with potent effects on the central nervous system. Life Sci 28:861-869, 1981.
- Morely, J.E.; and Levine, A.S. Thyrotropin releasing hormone (TRH) suppresses stress induced eating. Life Sci 27:269-274, 1980.
- Morely, J.E.; Steinbach, J.H.; Feldman, E.J. and Solomon, T.E. The effects of thyrotropin releasing hormone (TRH) on the gastrointestinal tract. Life Sci 24:1059-1066, 1979.
- Morely, J.E.; Yammada, T.; Walsh, J.H.; Lamers, C.B.; Wong, H.; Shulkes, A.; Damassa, D.A.; Gordon, J.; Carlson, H.E.; and Hershman, J.M. Morphine addiction and withdrawal alters brain peptide concentrations. Life Sci 26:2239-2244, 1980.
- Nair, R.M.G.; Kastin, A.J.; and Schally, A.V. Isolation and structure of hypothalamic MSH release-inhibiting hormone. Biochem Biophys Res Commun 43:1376-1381, 1971.
- Pacheo, M.F.; Woodward, D.J.; McKelvy, J.F.; and Griffin, W.S.T. TRH in rat cerebellum: II. Uptake by cerebellar slices. Peptides 2:283-288, 1981.
- Pillai, N.P., and Bhargava, H.N. Effect of thyrotropin releasing hormone on the development of tolerance to the inhibitory effect of morphine on the gastrointestinal transit in mice. Paper presented at the International Narcotic Research Conference, University of Cambridge, England, 1984a p. 6.
- Pillai, N.P., and Bhargava, H.N. The effect of thyrotropin releasing hormone on the changes in urinary output induced by acute and chronic treatment with morphine. The Pharmacologist 26:140, 1984b.
- Plotnikoff, N.P., and Kastin, A.J. Pharmacological studies with a tripeptide, prolyl-leucyl-glycinamide. Arch Int Pharmacodyn Ther 211:211-224, 1974a.
- Plotnikoff, N.P., and Kastin, A.J. Oxotremorine antagonism by prolyl-leucyl-glycinamide administered by different routes and several anticholinergics. Pharmacol Biochem Behav 2:417-419, 1974b.

- Plotnikoff, N.P.; Kastin, A.J.; Anderson, M.S.; and Schally, A.V. DOPA potentiation by MIF. Life Sci 10:1279-1283, 1971.
- Plotnikoff, N.P.; Prange, A.J.; Breese, G.R.; Anderson, M.S.; and Wilson, I.C. The effects of TRH on DOPA responses in normal hypophysectomized and thyroidectomized animals. In: Prange, A.J., eds. The Thyroid Axis, Drugs and Behavior. New York: Raven Press, 1974. pp. 103-113.
- Porter, C.C.; Lotti, V.J.; and DeFelice, M.J. The effect of TRH and a related tripeptide, L-N-(2-oxopiperidin-6-yl-carbonyl)-L-histidyl-L-thioxaline-4-carboxamide (MK-711, OHT), on the depressant action of barbiturates and alcohol in mice and rats. Life Sci 21:811-820, 1977.
- Prange, A.J., Jr.; Breese, G.R.; Jahnke, G.D.; Martin, B.R.; Cooper, B.R.; Cott, J.M.; Wilson, I.C.; Alltop, L.B.; Lipton, M.A.; Bisette G.; Nemeroff, C.B.; and Loosen, P.T. Modification of pentobarbital effects by natural and synthetic polypeptides: Dissociation of brain and pituitary effects. Life Sci 16:1907-1914, 1975.
- Prasad, C.; Matsui, T.; and Peterkofsky, A. Antagonism of ethanol narcosis by histidylproline diketopiperazine. Nature 268:142-144, 1977.
- Redding, T.W., and Schally, A.V. On the half-life of thyrotropin releasing hormone in rats. Neuroendocrinology 9:250-256, 1972.
- Redding, T.W.; Kastin, A.J.; Nair, R.M.G. and Schally, A.V. Distribution, half life, and excretion of <sup>14</sup>C- and <sup>3</sup>H-labeled L-prolyl-L-leucyl-glycinamide in the rat. Neuroendocrinology 11:92-100, 1973.
- Ritzmann, R.F.; Walter, R.; Bhargava, H.N.; and Flexner, L.B. Blockage of narcotic induced dopamine receptor supersensitivity by cyclo (Leu-Gly). Proc Natl Acad Sci USA 76:5997-5998, 1979.
- Schmidt, W.K.; Holaday, J.W.; Loh, H.H.; and Way, E.L. Failure of vasopressin and oxytocin to antagonize acute morphine antinoiception or facilitate narcotic tolerance development. Life Sci 23:151-158, 1978.
- Shen, F.H.; Loh, H.H.; and Way, E.L. Brain serotonin turnover in morphine tolerant and dependent mice. J Pharmacol Exp Ther 175: 427-434, 1970.
- Shute, C.C.D., and Lewis, P.R. The ascending cholinergic reticular system: Neocortical, olfactory and subcortical projections. Brain 90: 497-519, 1967.
- Simasko, S.M., and Horita, A. Characterization and distribution of <sup>3</sup>H-(3-MeHis<sup>2</sup>)thyrotropin releasing hormone receptors in rat brain. Life Sci 30:1793-1799, 1982.
- Smith, A.A.; Karmin, M.; and Gavitt, J. Blocking effect of puromycin, ethanol and chloroform on the development of tolerance to an opiate. Biochem Pharmacol 15:1877-1879, 1966.
- Szekely, J.I.; Miglecz, E.; Dunai-Kovacs, Z.; Tarnawa, I.; Ronai, A.Z.; Graf, L.; and Bajusz, S. Attenuation of morphine tolerance and dependence by  $\alpha$ -melanocyte stimulating hormone ( $\alpha$  MSH). Life Sci 24:1931-1938, 1979.
- Tache, Y.; Lis, M.; and Collu, R. Effects of thyrotropin-releasing hormone on behavioral and hormonal changes induced by  $\beta$ -endorphin. Life Sci 21:841-846, 1977.
- Tseng, L.F.; Loh, H.H.; and Li, C.H. Human  $\beta$ -endorphin: Development of tolerance and behavioral activity in rats. Biochem Biophys Res Commun 74:390-396, 1977.

- van Loon, G.R.; De Souza, E.; and Kim, C. Alterations in brain dopamine and serotonin metabolism during the development of tolerance to human  $\beta$ -endorphin in rats. Can J Physiol Pharmacol 56:1067-1071, 1978.
- van Ree, J.M., and de Wied, D. Prolyl-leucyl-glycinamide (PLG) facilitates morphine dependence. Life Sci 19:1331-1340, 1976.
- van Ree, J.M.; de Wied, D.; Bradbury, A.F.; Hulme, E.C.; Smyth, D.G.; and Snell, C.R. Induction of tolerance to the analgesic action of lipotropin C-fragment. Nature 264:792-794, 1976.
- van Ree, J.M.; Bohus, B.; Versteeg, D.H.G.; and de Wied, D. Neurohypophyseal principles and memory processes. Biochem Pharmacol 27:1793-1800, 1978.
- Walter, R. Identification of sites in oxytocin involved in uterine receptor recognition and activation. Fed Proc 36:1872-1878, 1977.
- Walter, R.; Griffiths, E.D.; and Hooper, K.C. Production of MSH release inhibiting hormone by a particulate preparation of hypothalami: Mechanism of oxytocin in activation. Brain Res 60: 449-457, 1973.
- Walter R.; Hoffman, P.L.; Flexner, J.B.; and Flexner, L.B.; Neurohypophyseal hormones, analogs and fragments; their effect on puromycin-induced amnesia. Proc Natl Acad Sci USA 72:4180-4184, 1975
- Walter, R.; van Ree, J.M.; and de Wied, D. Modification of conditional behavior of rats by neurohypophyseal hormones and analogues. Proc Natl Acad Sci USA 75:2493-2496, 1978a.
- Walter, R.; Ritzmann, R.F.; Bhargava, H.N.; Rainbow, T.C.; Flexner, L.B.; and Krivoy, W.A. Inhibition by Z-Pro-D-Leu-of development of tolerance to and physical dependence on morphine in mice. Proc Natl Acad Sci USA 75:4573-4576, 1978b.
- Walter, R.; Ritzmann, R.F.; Bhargava, H.N.; and Flexner, L.B. Prolyl-leucyl-glycineamide, cyclo (leucylglycine) and derivatives block development of physical dependence on morphine in mice. Proc Natl Acad Sci USA 76:518-520, 1979.
- Way, E.L., ed. Endogenous and Exogenous Opiate Agonists and Antagonists. New York: Pergamon Press, 1980.
- Way, E.L.; Loh, H.H.; and Shen, F.H. Simultaneous quantitative assessment of morphine tolerance and physical dependence. J Pharmacol Exp Ther 167:1-8, 1969.
- Yanagisawa, T.; Prasad, C.; Williams, J.; and Peterkofsky, A. Antagonism of ethanol-induced decrease in rat brain cGMP concentration by histidyl-proline diketopiperazine, a thyrotropin releasing hormone metabolite. Biochem Biophys Res Commun 86: 1146-1153, 1979.
- Young, C.W.; Robinson, P.F.; and Socktor, B. Inhibition of the synthesis of protein in intact animals by acetoxycycloheximide and a metabolic derangement concomitant with this blockade. Biochem Pharmacol 12:855-856, 1963.

## ACKNOWLEDGMENT

The studies described here were supported in part by USPHS grant DA-02598 from the National Institute on Drug Abuse.

## **AUTHOR**

Hemendra N. Bhargava, Ph.D.  
Professor of Pharmacology  
Department of Pharmacodynamics  
College of Pharmacy  
University of Illinois at Chicago  
Health Sciences Center  
Chicago, Illinois 60612

# Progress in the Potential Use of Enkephalin Analogs

Robert C.A. Frederickson, Ph.D.

With the discovery of the first endogenous opioid peptides a decade ago came the speculation that the elusive analgesic without abuse potential was finally within reach. This speculation was tempered by the more pessimistic predictions that these materials are probably artifacts of some sort; that, even if they are real, they may have nothing to do with analgesia; and, finally, that, even if they are real and have analgesic properties, their exploitation will merely result in the redesign of morphine. Ten years of research and development now give us a little more basis for reasoned evaluation of the various speculations. The natural pentapeptide enkephalins were quickly realized to have no therapeutic utility since they are almost immediately degraded upon injection into the whole animal. Thus, a number of industrial concerns embarked upon analog synthesis programs to develop an enkephalin-related structure that would resist enzymatic attack and allow the study of their pharmacology in the whole animal. Various endorphins and analogs have been evaluated for a number of uses besides analgesia, and these various studies will be reviewed briefly. The work of the past 10 years has already demonstrated that the endogenous opioids are indeed real and that at least some of them are involved in one way or another in pain/analgesia mechanisms. Whether they might provide the long-sought nonaddicting analgesic remains to be demonstrated. Of the various analogs synthesized, one in particular, metkephamid, remains under clinical evaluation and will be discussed in some detail. The future of this area of research will rely on the development of receptor-specific structures and the improvement of bioavailability. The methodology and progress in these efforts will be critically reviewed.

## **STRATEGIES FOR THE THERAPEUTIC EXPLOITATION OF ENDOGENOUS OPIOIDS**

With the recognition and acceptance of the existence of the endogenous opioids, several possible ways (table 1) to manipulate these systems for experimental and possible therapeutic purposes were considered. The small enkephalin pentapeptides promised little potential in the unmodified state since they are almost



TABLE 1

## Strategies for Exploiting the Therapeutic Possibilities of the Endogenous Opioid Systems

1. Development of B-endorphin and analogs.
  2. Development of releasers of endogenous opioids.
  3. Development of inhibitors of specific inactivating enzymes.
  4. Development of enkephalin analogs.
- 

immediately degraded upon systemic administration. Since B-endorphin is less susceptible to enzymatic degradation than the smaller enkephalins, a number of studies were undertaken to evaluate the effect of direct administration of this substance on pain and various mental disorders (Oyama et al. 1980; Kline et al. 1977; Berger et al. 1980; Marx 1981). B-endorphin produces potent, long-lasting analgesia when injected directly into spinal fluid (Oyama et al. 1980); and careful, controlled studies in schizophrenic patients have indicated statistically, although not clinically, significant beneficial effects (Berger et al. 1980). B-endorphin has limited access to the brain, however, and the cost for sufficient quantities of this large peptide is still prohibitive. The potential clinical utility of this substance seems limited at this time.

Other approaches include development of agents which will release the endogenous substances or protect them from degradation by the various inactivating enzymes. The latter approach is particularly interesting and has received much attention. Extensive efforts have delineated the enzymes which inactivate the enkephalins (see Marks, this volume; Roques, this volume). The neutral metalloendopeptidase, enkephalinase A, appears to be important in synaptic inactivation of enkephalins, and a selective inhibitor of this enzyme, thiorphan, has been synthesized (Roques et al. 1980). This agent has been demonstrated to potentiate the analgesic activity of various enkephalin analogs and may produce analgesia by itself under certain conditions (Roques et al. 1980; Frederickson 1984). Thiorphan does not appear likely to have clinical utility since its bioavailability by systemic routes of administration appears limited and the analgesic activity it exerts when given alone is not remarkable. This relative lack of direct analgesic activity may be due to a very low basal activity of the enkephalinergic systems. If clinical pain were to activate these systems, however, such a compound might have clinical utility not predicted by standard analgesic model systems. Efforts are in progress in a number of laboratories to produce successors to thiorphan which may have clinical utility. Much of these efforts are being directed at improved bioavailability and a broader spectrum of inhibition of the various enkephalin-degrading enzymes (see Roques, this volume). Although an intact and active endogenous opioid system would be necessary to achieve utility with the enzyme inhibitors, this will not be a requirement for a direct-acting opioid receptor ligand. The rationale and efforts at developing better enkephalin analogs are-discussed in the next two sections.

## RATIONALE AND MECHANISM FOR ENKEPHALIN ANALOGS

The multiple opioid receptor concept provides a strong theoretical rationale for the development of receptor-selective analgesic structures. This in turn offers promise for reduction of physical dependence or abuse potential, respiratory depression, and psychotomimetic or other unwanted side effects. Since the natural opioids are too labile to have therapeutic utility, the research challenge is to develop analogs with desirable receptor selectivity and which are able to achieve effective concentrations at the appropriate receptors in the brain after systemic administration. Since high activity resides in the enkephalinlike pentapeptide and tetrapeptide sequences, the preparation of analogs of these or even smaller fragments is more feasible and cost-efficient than analogs of the larger endorphins. Many hundreds of such analogs have been synthesized, and considerable structure activity data are discussed in this volume and elsewhere (Frederickson 1977; Morley 1980). The basic mechanistic model upon which the enkephalin analog and enzyme inhibitor approaches are based is illustrated in figure 1.

Two analogs of Met-enkephalin are of particular interest because they have progressed to the clinic. These are FK 33-824 and metkephamid (LY127623), which are shown in figure 2. The work with these two enkephalin analogs has confirmed the important concept that appropriate modification of the natural enkephalin structure can produce systemically active analgesic agents. The present status of these two new compounds is discussed in the next section.

## STATUS OF ENKEPHALIN ANALOGS IN PRECLINICAL AND CLINICAL TRIALS

### FK 33-824

Preclinical. This compound showed high activity at opioid receptors in vitro and demonstrated preference for the  $\mu$ -receptor compared with the  $\delta$ -receptor (Kosterlitz et al. 1980). It was 100 to 1,000 times more potent than morphine as an analgesic when given by the intraventricular route and was active also after systemic administration (Römer et al. 1977). Naloxone precipitated a marked withdrawal syndrome in monkeys self-administering this compound (Römer et al. 1977).

Clinical. Von Graffenried et al. (1978) examined FK 33-824 in normal male volunteers. After 0.1 to 1.2 mg administered intramuscularly, all subjects in this study experienced a "feeling of heaviness in all the muscles of the body, often combined with a feeling of oppression in the chest or tightness in the throat which induced a certain amount of anxiety." Other symptoms noted were a marked increase in bowel sounds, redness of *face*, injection of the conjunctiva, chemosis, whole body flush, rhinitis vasomotorica, and a flare reaction after intradermal injection. Plasma prolactin and growth hormone were increased. Expected morphine-like effects, such as changes in emotional behavior or mental alertness, formication, and nausea, were not observed; and the unexpected signs were not blocked by opioid, histamine, serotonin, or cholinergic antagonists. The lack of blockade with nalorphine, a mixed agonist-antagonist,

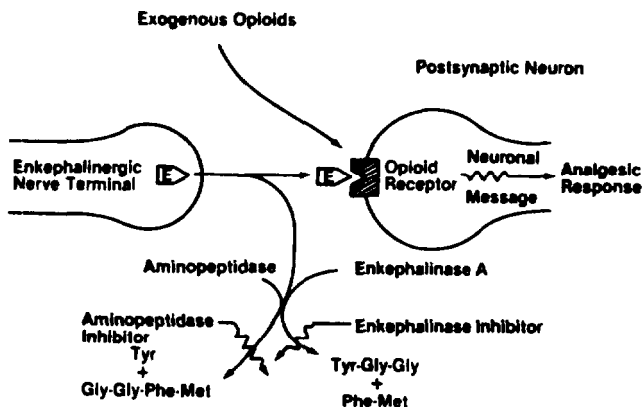


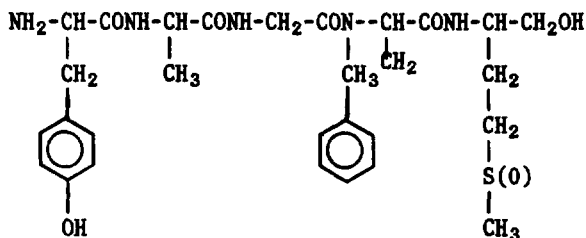
FIGURE 1

Neuronal model for mechanisms for producing analgesia by compounds interacting with enkephalineric systems. The natural enkephalins are not analgesics, but rather neurotransmitters sending brief neuronal messages. The message is brief because the enkephalins are rapidly inactivated by the enzymes as shown. Beta-endorphin, reaching these receptors as a circulating neurohormone, on the other hand, might be able to provide a message sustained enough to be perceived as analgesia since it is less susceptible than shorter enkephalins to these degradative enzymes. One approach to developing analgesics based on the enkephalins is to modify the structure to provide protection from these enzymes, so that when they are applied exogenously they produce analgesia as discussed above for beta-endorphin. Another approach would be to develop inhibitors of the degradative enzymes so that the activity of the natural enkephalins would be prolonged sufficiently to provide an analgesic effect.

suggested to the authors that the effects were not mediated by opioid receptors, but a subsequent report (Stubbs et al. 1978) claimed that the hormonal effects and other side effects could be blocked by the pure opioid antagonist naloxone.

FK 33-824, administered intramuscularly (i.m.), was reported to have analgesic activity against experimental pain in man (Stacher et al. 1979). A single i.m. dose of 1 mg produced a significant increase in tolerance to electrically evoked pain, but caused no change in threshold to pain. FW 34-569, an (N-Me)Tyr<sup>1</sup> analog of FK 33-824, administered i.m. at 0.5 and 1.0 mg, stimulated growth hormone and prolactin release and inhibited the release of cortisol and LH in human volunteers, but neither dose influenced pain threshold to a hot-plate analgesimeter (Lindenburg et al. 1981). There have been no reports of the evaluation of FK 33-824 in pathological pain after systemic administration, but it did have an analgesic effect after epidural administration (0.02 to 0.5 mg) in subjects with postoperative pain. The effect, however, was rated as

FK 33-824 (Sandoz)



LY127623 (Metkephamid, Lilly)

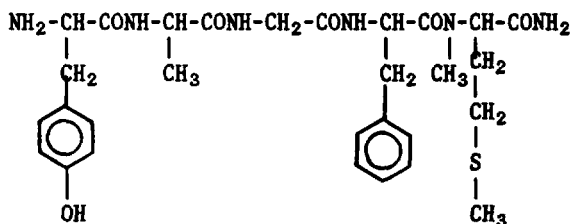


FIGURE 2

Structures of the two Met<sup>5</sup>-enkephalin analogs, FK33-824 and LY127623, which have been evaluated in clinical studies as potential analgesics.

unpredictable and dose-independent, and the investigators saw no advantages over epidural morphine (Andersen et al. 1982). This compound is apparently no longer being pursued clinically as an analgesic candidate.

### Metkephamid

Preclinical. Metkephamid is an analog of Met-enkephalin with several simple modifications, as shown in figure 2. Like FK 33-824, it competes with labeled opioid ligands for binding in brain homogenate and produces potent naloxone-reversible depression of the electrically induced twitch of both mouse vas deferens (MVD) and guinea pig ileum (GPI), with IC<sub>50</sub> values in the nanomolar range (Frederickson et al. 1981, 1982). In the MVD preparation, pA<sub>2</sub> values for naloxone versus metkephamid, normorphine, and Met-enkephalin were determined to be 7.60, 0.32, and 7.54, respectively. These data suggested that metkephamid and Met-enkephalin share preference for a similar receptor, presumably the δ-receptor. This differs from normorphine, which prefers the μ-receptor. This was corroborated by the GPI:MVD ratios which were about 4.1 for metkephamid and 0.25 for morphine, indicating a

sixteenfold greater  $\delta$ -selectivity for metkephamid compared to morphine. This contrasted with the ratios for competing with ( $^3\text{H}$ )N<sub>x</sub> versus ( $^3\text{H}$ )DADL binding in brain homogenates, which were 0.6 and 0.1, respectively, for metkephamid and morphine (Frederickson et al. 1981, 1982). These latter data indicated that, although metkephamid had a sixfold greater preference for the  $\delta$ -receptor than did morphine in the binding studies, it still had a slightly higher affinity for the  $\mu$ -receptor than for the  $\delta$ -receptor. Metkephamid has little or no affinity for the K-receptor.

The difference between the  $\mu$ : $\delta$  binding ratios and the ratios in the isolated muscle preparations suggests that either metkephamid has considerably greater efficacy at the  $\delta$ -receptor than at the  $\mu$ -receptor or that the  $\delta$ -receptors in MVD differ from the  $\delta$ -receptors in brain. Support for the latter suggestion has been recently reported (Brantl et al. 1982). Indeed, both factors most likely contribute to the lack of complete correlation in general between brain binding activity and activity on the isolated muscle preparations.

TABLE 2

In vivo - in vitro correlation: Metkephamid is about 70 times more potent than morphine as an analgesic after administration into the lateral ventricle. This correlates best with the relative activity of these compounds on the MVD which reflects mainly activity at the delta receptor.

	IC <sub>50</sub> Values (nM)		Ratio MOR/MET
	Morphine	Metkephamid	
1. <u>Pleasures of <math>\mu</math>-Receptor Activity</u>			
$^3\text{H}$ -Naloxone binding guinea pig ileum	6.5 100	2.5 21	2.6 4.8
2. <u>Measures of <math>\delta</math>-Receptor Activity</u>			
$^3\text{H}$ -DADL binding mouse vas deferens	75 390	4.4 5.4	17.0 72.2
3. <u>Analgesia (mouse hot plate)</u>	ED <sub>50</sub> Values (Nanograms/mouse, ICV)		
	103	1.5	68.7

Metkephamid demonstrated distinct antinociceptive activity when it was administered by systemic routes of administration (Frederickson et al. 1981, 1982), being anywhere from one-third to 10 times as

potent as morphine, depending on the test system and the route of administration. When given by the intraventricular route, metkephamid was almost a hundredfold more potent than morphine. The relative analgesic potencies of metkephamid and morphine by this route correlated much better with their relative potencies on the MVD preparation than on the GPI preparation (table 2). This suggested that metkephamid produced its greater analgesic activity by action on the  $\delta$ -receptor and, indeed, data to be discussed later confirm a correlation between analgesic activity and activity at the  $\delta$ -receptor. An attractive possibility is that such  $\delta$ -mediated analgesia may be associated with less physical dependence or abuse potential than is the more conventional  $\mu$ -mediated analgesia. tletkephamid produced little stimulation of locomotor activity or naloxone-precipitated withdrawal jumping in mice compared with morphine. Chronic treatment of rats with wtkephamid, furthermore, produced only slightly more physical dependence than did saline, unlike other drugs similarly tested such as morphine, meperidine, and pentazocine (Frederickson et al. 1981, 1982). Metkephamid was also reported to have a lesser depressant effect than morphine on respiration in a rodent model.

The ability of metkephamid to cross the placental barrier was assessed by measuring the maternal and fetal serum levels in rats and sheep (table 3) at various times after i.m. injection of metkephamid (Frederickson et al. 1982). In the rat, the fetal:maternal ratio of metkephamid in blood at 1 hour after injection was about 1:60 compared with 1:1.8 for meperidine. In sheep, the fetal:maternal ratio for metkephamid was less than 1:200 compared with 1:1 or 2 reported for meperidine. This indicates a remarkable advantage of metkephamid over meperidine for use in obstetric analgesia.

TABLE 3

Maternal and Fetal Serum Levels ( $\mu\text{g/ml}$ ) of Hetkephamid and Heperidine at Various Times after Administration\* to Sheep (Intramuscular) and Rats (Subcutaneous)

Species	Time (min)	Metkephamid		Meperidine	
		Maternal	Fetal	Maternal	Fetal
Sheep	0	0.0	0.0		
	10	9.46 $\pm$ 3.01	0.0		
	20	9.43 $\pm$ 2.6	0.0		
	45	8.54 $\pm$ 2.6	0.0		
Rat	60	7.17 $\pm$ 0.28	0.12 $\pm$ 0.04		
Rat	45			3.73 $\pm$ 0.89	2.02 $\pm$ 0.23

\*The dose of metkephamid administered to the sheep was 5 mg/kg. The rats received 50 mg/Kg of metkephamid or meperidine (table modified from Frederickson et al. 1982).

The preclinical profile of metkephamid described above demonstrated that metkephamid was different enough from standard analgesics and promised enough therapeutic advantage to warrant entering clinical trial.

Clinical. In initial safety studies, metkephamid was administered to normal male volunteers in single i.m. doses ranging from 0.5 to 150 mg (Frederickson et al. 1980). No clinically relevant effects were seen by routine clinical chemistry, electrolytes, urinalysis, hemograms, EKG, blood pressure, or heart rate. At doses greater than 12.5 mg, subjects reported a mild retro-orbital burning that progressed to nasal congestion and dry mouth. A heavy sensation in the extremities, emotional detachment, and conjunctival injection were also reported, but no flushing or changes in bowel sounds were noted and a flare formation did not occur after intradermal administration. Serum prolactin was increased, but no change in serum growth hormone was observed after 75 mg.

Clinical tests in postoperative pain have demonstrated metkephamid to be efficacious as an analgesic in man (Calimlim et al. 1982; Bloomfield et al. 1983). In one controlled double-blind clinical trial by Calimlim et al., setkephamid at a single parenteral dose of 70 mg was compared with meperidine at 100 mg and placebo in 30 patients with severe postoperative pain. All measures indicated that the analgesic activity of metkephamid 70 mg was significantly greater than placebo and not less than that of meperidine 100 mg. The duration of activity was about 4 hours, and up to the 4-hour point, metkephamid 70 mg appeared more efficacious than did meperidine 100 mg (figure 3). The frequency of remedication with metkephamid was also less than with meperidine or placebo. In a second controlled double-blind study (Bloomfield 1983), metkephamid at 70 mg and 140 mg i.m. was compared with meperidine at 100 mg and placebo in 60 postpartum women with severe pain after episiotomy. Using subjective reports as indices of response, patients rated pain intensity, pain relief, and side effects at periodic intervals for 6 hours. Metkephamid at the 140-mg dose was rated most effective, followed in order by meperidine (100 mg), metkephamid (70 mg), and placebo. Only metkephamid at 140 mg and meperidine at 100 mg showed statistically significant superiority over placebo. Both treatments took effect within ½ hour, peaked at 1 to 2 hours; and, with 140 mg metkephamid, maximum analgesia was sustained for 6 hours, i.e., 2 hours longer than with meperidine.

There was a higher incidence of minor side effects with metkephamid than with the other treatments in these studies, but these effects were relatively transient and were not distressing to the patients. The side effects peculiar to metkephamid were a sensation of heavy limbs, dry mouth, eye redness, and nasal stuffiness. The spectrum of these side effects suggested that the pharmacological properties of metkephamid are different from those of standard narcotic analgesics. It has been suggested that this might be due to greater utilization of the  $\delta$ -receptor than is the case with standard analgesics (Bloomfield et al. 1983). Metkephamid has high affinity for both the  $\mu$ - and  $\delta$ -receptors, but little or no affinity for the

$\kappa$ -receptor. This unique receptor preference of metkephamid may also contribute to its apparently lesser potential for physical dependence and respiratory depression. It is not yet clear whether more selective  $\delta$ -activity or some combination of  $\mu$ - and  $\delta$ -activity

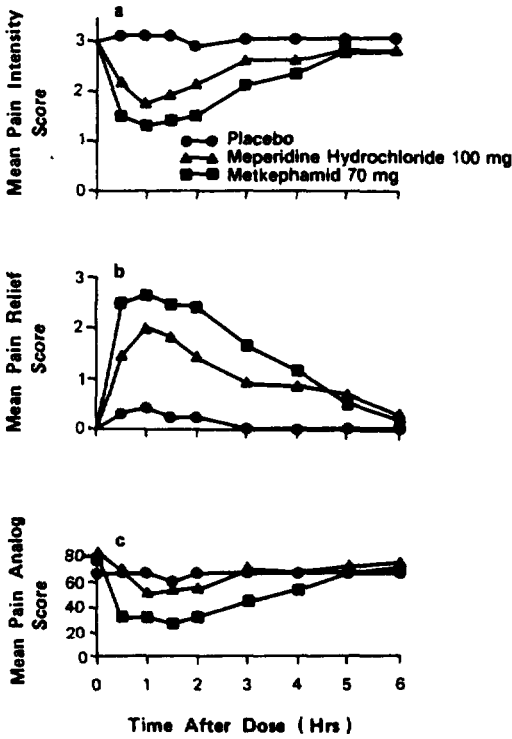


FIGURE 3

Time-effect curves of the analgesic activity of metkephamid (70 mg, i.m.) compared with placebo and meperidine (100 mg, i.m.). Pain was assessed subjectively at each interview by: (a) a reported pain score on an ordinal scale of 0 (no pain) to 4 ("terrible" pain); (b) a reported score for pain relief compared with pre-medication pain level on an ordinal scale of 0 (no relief) to 4 (complete relief); and (c) an analog scale of pain consisting of a 20-cm line marked 0 ("no pain") at one end and 100 ("worst pain I have ever felt") at the other end. From these observations, the mean pain intensity scores, mean pain relief scores, and mean pain analog scores were calculated for each observation time and plotted as shown. The placebo generally had no effect on pain. Metkephamid and meperidine began to reduce pain by ½ hr, with peak analgesic effect usually at 1 hr; the analgesic effect was considerably diminished by 4 hrs. Up to the 4-hr point, metkephamid (70 mg) appeared more effective than meperidine (100 mg).

Modified from Calimlim et al. Copyright 1982, Lancet.



is most desirable for the best analgesia versus adverse effect profile. Finally, if the transfer across the placenta seen in rats and sheep proves to be the case in humans as well, metkephamid could be an important advance for obstetric analgesia. This latter question is under investigation.

## FUTURE GOALS AND DIRECTIONS

An evaluation of future prospects first requires consideration of some dogma which seem far too widely accepted. These include the beliefs that 1) opioid analgesia is  $\mu$ -receptor, and not  $\delta$ -receptor, mediated; 2) that endogenous opioids and analogs produce physical dependence and, therefore, offer no advantage as potential new analgesics; and 3) that endorphins do not cross the blood-brain barrier (B-B-B). Certainly, if these or even some of these beliefs are true, then the future looks bleak for the possibility that enkephalin analogs will provide any therapeutic advances. In this section, these dogma will be critically examined and the major goals and prospects for future development of this area will be explored.

### $\mu$ -Receptors Versus $\delta$ -Receptors in Analgesia

Several lines of evidence support the existence of separate  $\mu$ - and  $\delta$ -receptors (Goodman et al. 1980; see also chapters by Simon, Portoghese, and Kosterlitz, this volume). The prevalent opinion has been, however, that the  $\mu$ -receptor rather than the  $\delta$ -receptor mediates analgesia. Roques and colleagues (Gacel et al. 1981; Chaillet et al. 1984) have reported that the analgesic activity of a series of enkephalin analogs correlated better with activity on the GPI than on the MVD. They concluded, therefore, that analgesia correlates with  $\mu$ -activity and not with  $\delta$ -activity.

A number of other investigators, on the other hand, have reported strong evidence for the existence of  $\delta$ -mediated analgesia. We, for example, have observed that the analgesic  $ED_{50}$ 's in the mouse hot-plate test after intraventricular administration of a series of opioids of widely differing  $\mu$ - versus  $\delta$ -activities correlated very well with  $IC_{50}$  values on the MVD and  $K$  values for inhibition of  $^3H$ -DADL binding (both preferentially  $\delta^1$  measures), but less well with measures of  $\mu$ -activity (GPI and  $^3H$ -naloxone binding). A portion of this data is shown in table 4. A number of confounding factors may contribute to the differences between these results and those discussed above. For example,  $\delta$ -preferring analogs are not generally modified at the C-terminal, while  $\mu$ -preferring analogs are, and generally in ways which provide enzymatic stability and better bioavailability. Even as simple a modification as amidation of the C-terminal acid increases both  $\mu$ -preference and bioavailability to brain receptors. Thus,  $\mu$ -preferring analogs may appear more potent for reasons not related to their  $\mu$ -preference. This is not adequately compensated by utilization of the intraventricular route of administration because the brain possesses C-terminal inactivating enzymes.

TABLE 4

Correlation between the activity on isolated tissues and analgesic activity for several opioids with widely differing  $\delta$ - versus  $\mu$ -receptor activity. The analgesic activity appears to correlate best with  $\delta$ -receptor activation as represented by  $IC_{50}$  on MVD.

Compound	$IC_{50}$ (nM)			Preference	Analgesic $ED_{50}$ (ng/mouse, ICV)
	MVD	GPI	$\frac{GPI}{MVD}$		
Tyr-D-Ser-Gly-Phe-Leu-Thr-OH	0.63	65	105	d	1.2
Tyr-D-Ala-Gly-Phe-(Me)Met-NH <sub>2</sub>	5.6	21	3.9	d	2.2
Morphine	390	100	0.26	$\mu$	82.7
(Me)Tyr-D-Ala-Gly-(Et)Phe- CH <sub>2</sub> -N(Me) <sub>2</sub>	507	13	0.03	$\mu$	144.5

There are other experimental means besides *in vivo/in vitro* structure activity correlation studies for evaluating the roles of different receptor types in pharmacologically induced behavioral changes. These include cross-tolerance studies and studies with selective antagonists.

Cross-tolerance between metkephamid and morphine was assessed in the mouse writhing test for analgesia (Hynes and Frederickson 1982). The mice were treated chronically with either saline or morphine on a 5-day schedule with four doses per day. Sixteen to twenty hours after the last injection of morphine, dose-response curves were generated to morphine and metkephamid. The dose-response curve for morphine was shifted to the right in the morphine-treated animals, resulting in a 3.5-fold increase in the  $ED_{50}$  value for morphine. A similar shift to the right in the dose-response curve was not observed for metkephamid in the morphine-tolerant mice (figure 4). Only at the higher end of the dose-response curve was there some reduction in the analgesic activity of metkephamid in the morphine-tolerant mice. These results were interpreted to indicate that a  $\delta$ -receptor-mediated mechanism contributes to the analgesia produced by metkephamid, although a  $\mu$ -mechanism appears to become more prominent at the higher doses. Yaksh and colleagues (1984) have reported similar findings of a relative lack of tolerance to metkephamid in morphine-tolerant animals, using both the shock titration model with the monkey and the hot-plate model with the rat.

Further support for the concept that metkephamid produces analgesia by action on  $\delta$ -receptors was provided by studies with naloxazone (Hynes and Frederickson 1982). It was possible to determine a dose of this irreversible antagonist which, when given 20 hours earlier, would selectively antagonize morphine-induced analgesia without affecting analgesia produced by metkephamid (figure 5). The above studies suggest that metkephamid is producing analgesia by some mechanism or receptor type not utilized by morphine under the conditions of the experiments described.

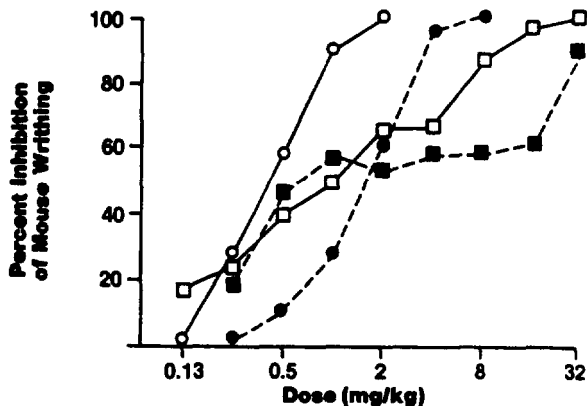


FIGURE 4

Inhibition of writhing by morphine (circles) and metkephamid (squares) in morphine-tolerant mice (filled symbols) and saline-treated mice (open symbols). The morphine dose-response curve is shifted to the right in the chronic morphine-treated mice, but the metkephamid curve is not (modified from Hynes and Frederickson 1982).

This different mechanism is presumed to be  $\delta$ -mediated because metkephamid does not recognize the K-receptor adequately for this to provide an explanation.

There are other lines of evidence for  $\delta$ -mediated analgesia, particularly at the spinal level. Hylden and Wilcox (1983) reported evidence that antinociceptive activity induced in mice by intrathecal opioids was mediated by both  $\mu$ - and  $\delta$ -receptors, but not by K-receptors. Tung and Yaksh (1982) reported identical findings for opioid-mediated analgesia in the rat spinal cord. Tseng (1982) utilized cross-tolerance studies to differentiate morphine and D-Ala<sup>2</sup>, D-Leu<sup>5</sup>-enkephalin and provided evidence for both  $\mu$ - and  $\delta$ -receptors mediating analgesia in the spinal cord.

As a final note here, it should be recognized that demonstrating that the analgesic activity seen in a given species in a given test system under a given set of conditions, which appears to be mediated by a particular set of receptors, does not imply that a different receptor type cannot contribute in a different species in a different test system and/or under a different set of test conditions.

### Physical Dependence

A general conclusion from the above discussion would be that analgesia can be induced by actions on both  $\mu$ - and  $\delta$ -receptors. A more pertinent question now concerns whether there is any difference in the activity profile of the two receptors such that,

for example,  $\delta$ -mediated analgesia is associated with less physical dependence or abuse potential than is  $\mu$ -mediated analgesia. Certainly, the data presented for metkephamid imply lesser dependence potential for a given degree of analgesic activity consequent upon activation of  $\delta$ -receptors compared to  $\mu$ -receptors. A number of investigators, however, have reported the development of physical dependence consequent upon prolonged exposure to enkephalin analogs and implied a close correlation between analgesia and physical dependence (Pert et al. 1976; Wei and Loh 1976; Römer et al. 1977; Miglecz et al. 1979; Wei 1981). None of these studies focused carefully on potential differences depending on receptor selectivity, however; they merely demonstrated that opioid peptides, like opioid alkaloids, can produce physical dependence. Since none of the peptides tested was devoid of  $\mu$ -activity, and since the protocol for such studies is to expose the organism to increasing levels of a drug until dependence is produced, none of these studies answers whether  $\delta$ -receptor activation may be associated with similar or less physical dependence than is  $\mu$ -receptor activation. Careful studies comparing in a quantitative dose-related fashion the analgesic versus physical dependence-producing properties after intra-ventricular administration of highly  $\mu$ - and  $\delta$ -selective enkephalin analogs, taking into account their relative bioavailabilities and enzymatic susceptibilities, will be required to answer the important question here.

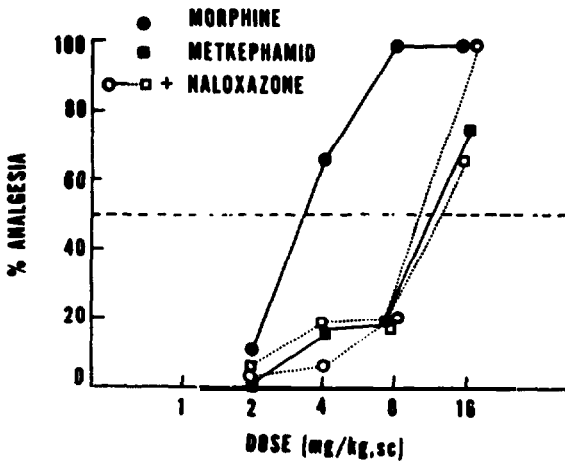


FIGURE 5

Analgesic dose-response curves for morphine (circles) and metkephamid (squares) in the mouse hot-plate test. The filled symbols represent data generated in mice pretreated 20 hrs. earlier with saline, subcutaneous (s.c.). The open symbols refer to data generated in mice pretreated 20 hrs. earlier with naloxazone, 50 mg/kg, s.c. The morphine dose-response curve was shifted to the right after naloxazone pretreatment, but the metkephamid curve was not.

## Therapeutic Potential Other Than Analgesia

The dramatic proliferation of investigations inspired by the discovery of opioid receptors and their endogenous ligands has revealed a multitude of other possible physiological functions and, thus, potential therapeutic utilities for the opioids besides analgesia. There is, for example, evidence for opioid modulation, which would suggest potential opioid utility, in neuroendocrine disorders (Meites et al. 1979), sexual disorders (Meyerson and Terenius 1977), food intake and obesity (McKay et al. 1981), cardiovascular disorders (Holaday and Faden 1978; Lang et al. 1982), convulsive disorders (Frenk et al. 1978; Frenk 1983), and mental disorders (Verebey 1982; Shah and Donald 1982; DeWied 1980). For detailed discussions of the evidences for an opioid excess or an opioid deficiency in the etiology of schizophrenia, see Watson et al. (1979) and Berger et al. (1980, 1981). The specific receptor types involved in each of the proposed roles for opioids are not yet fully established, but efforts are increasing to elucidate such questions. Presently, there is evidence that  $\sigma$ - and/or K-receptors are involved in psychotomimetic activity, K-receptors in appetite suppressant activity, and  $\delta$ -receptors in hypotensive and anticonvulsant activities. More definite assignment of receptor type to function will be served by development of ligands with more selective agonist and antagonist activity for each subset of opioid receptor. If such agents can be delivered to the brain by systemic administration, their evaluation in animal models of disease states and in the clinic, when justified, may provide some significant therapeutic advances.

## Peptide Drug Delivery

It is well recognized that there is a significant B-B-B to peptides, and this definitely includes the opioid peptides. The B-B-B to peptides has been the subject of two recent reviews (Pardridge 1983; Meisenberg and Simmons 1983). The B-B-B consists of tight junctions between adjacent endothelial cells, and most peptides diffuse very slowly through this barrier. While there are transport systems for amino acids and dipeptides, there does not appear to be any such system for the enkephalins. Brain capillaries have a high aminopeptidase activity and rapidly degrade enkephalins. Modification of the P-position of enkephalins, such as by replacement of Gly<sup>2</sup> by D-Ala<sup>2</sup>, does improve penetration, however; and there are brain structures with diminished barriers, such as the circumventricular organs and the choroid plexus. Thus, enkephalin analogs can penetrate the B-B-B sufficiently after systemic administration to have behavioral effects. This is exemplified, for example, by metkephamid which is very potent indeed after intravenous administration.

Thus, while B-B-B passage of peptides is limited, this is not the limiting factor in the potential therapeutic use of enkephalin analogs. The major limitation to realization of the therapeutic potential of peptides including enkephalin analogs is the lack of sufficient oral bioavailability. These peptides suffer dramatic degradation in the gut, and the small proportion of a dose delivered to the gut which reaches the circulation suffers

further substantial degradation in first pass through the liver. Due to the variability of oral absorption, a parameter of major importance for peptide delivery is the oral to intravenous delivery ratio. Increasing the absolute potency of a peptide or its penetration of the B-B-B will increase its apparent oral potency, but may decrease its safety as a drug by increasing the chance of an overdose after oral delivery. The major focus should be on increasing peptide survival through the gut and liver or on finding ways to bypass the gut and liver. The ways of attacking this problem include chemical modification to improve lipid solubility and enzymatic stability (which have the possible drawback of also improving B-B-B penetration) and/or exploring new pharmaceutical preparations and alternate routes of noninvasive administration, such as sublingual, transdermal, and intranasal.

## CONCLUSIONS

A new opioid receptor recognized subsequent to the discovery of the endogenous opioids is the  $\delta$ -receptor. There is reason to believe that activation of this receptor, like activation of the  $\mu$ -receptor, will produce analgesia. The possibility that  $\delta$ -mediated analgesia is associated with less physical dependence and abuse potential than is  $\mu$ -mediated analgesia requires verification and is worth pursuing. There are a number of potential therapeutic utilities for the opioids besides analgesia. The realization of this potential will require the development of more selective agonists and antagonists at each of the receptors and the improvement of the oral bioavailability of these peptides. Nonpeptide opioids might achieve this end, but the greatest receptor selectivity achieved to date has been with peptide analogs. And, it must not be forgotten that the world has had thousands of years of experience with nonpeptide opioids without achieving the elusive goal.

## REFERENCES

- Anderson, H.B.; Jorgensen, B.C.; and Engquist, A. Epidural Met-enkephalin (FK33-824). A dose-effect study. Acta Anaesthesiol Scand 26:69-71, 1982.
- Berger, P.A.; Watson, S.J.; Akil, H.; Elliott, G.R.; Rubin, R.T.; Pfefferbaum, A.; Davis, K.A.; Barchas, J.D.; and Li, C.H.  $\beta$ -Endorphin and schizophrenia. Arch Gen Psychiatry 37:635-640, 1980.
- Berger, P.A.; Watson, S.J.; Akil, H.; and Barchas, J.D. The effects of naloxone in chronic schizophrenia. Am J Psychiatry 138:913-918, 1981.
- Bloomfield, S.S.; Barden, T.P.; and Mitchell, J. Metkephamid and meperidine analgesia after post-episiotomy. Clin Pharmacol Ther 34:240-247, 1983.
- Brantl, V.; Pfeiffer, A.; Herz, A.; Henschen, A.; and Lottspeich, F. Antinociceptive potencies of  $\beta$ -casomorphin analogs as compared to their affinities towards  $\mu$  and  $\delta$  opiate receptor sites in brain and periphery. Peptides 3:793-797, 1982.

- Calimlim, J.F.; Wandell, W.M.; Sriwatanakul, K.; Lasagna, L.; and Cox, C. Analgesic efficacy of parenteral metkephamid acetate in treatment of post-operative pain. Lancet 1:1374-1375, 1982.
- Chaillet, P.; Couland, A.; Zajac, J.M.; Fournie-Zaluski, H.C.; Costentia, J.; and Roques, B.P. The  $\mu$  rather than the  $\delta$  subtype of opioid receptors appears to be involved in enkephalin-induced analgesia. Eur J Pharmacol 101:83-90, 1984.
- DeWied, D. Neuropeptides and psychopathology. Endeavor 4: 154-159, 1980.
- Frederickson, R.C.A. Enkephalin pentapeptides - a review of current evidence for a physiological role in vertebrate neurotransmission. Life Sci 21:23-42, 1977.
- Frederickson, R.C.A. Endogenous opioids and related derivatives. In: Kuhar, M., and Pasternak, G., eds. Analgesics: Neurochemical, Behavioral and Clinical Perspectives. New York: Raven Press, 1984. pp. 9-68.
- Frederickson, R.C.A.; Smithwick, E.L.; and Henry, D.P. Opioid peptides as brain neurotransmitters with therapeutic potential: Basic and clinical studies. In: Ajmone-Marsan, C., and Traczyk, W.Z., eds. Neuropeptides and Neural Transmission. New York: Raven Press, 1980. pp. 227-235.
- Frederickson, R.C.A.; Smithwick, E.L.; Shuman, R.; and Bemis, K.G. Metkephamid, a systemically active analog of methionine-enkephalin with potent opioid  $\delta$ -receptor activity. Science 211:603-604, 1981.
- Frederickson, R.C.A.; Parli, C.J.; DeVane, G.W.; and Hynes, M.D. Preclinical pharmacology of metkephamid (LY127623), a Met-enkephalin analogue. In: Harris, L.S., ed. National Institute on Drug Abuse Research Monograph 43. Problems of Drug Dependence, 1982: Proceedings of the 44th Annual Scientific Meeting, The Committee on Problems of Drug Dependence, Inc. DHHS Pub. No. (ADM) 83-1264. Washington, D.C.: Supt. of Docs., U.S. Govt. Print. Off., 1982. pp. 150-156.
- Frenk, H. Pro- and anticonvulsant actions of morphine and the endogenous opioids: Involvement and interactions of multiple opiate and non-opiate systems. Brain Res Reviews 6: 197-210, 1983.
- Frenk, H.; Urca, G.; and Liebeskind, J.C. Epileptic properties of leucine and methionine-enkephalin: Comparison with morphine and reversibility by naloxone. Brain Res 147:327-337, 1978.
- Gacel, G.; Fournie-Zaluski, M.C.; Fellion, E.; and Roques, B.P. Evidence of the preferential involvement of  $\mu$  receptors in analgesia using enkephalins highly selective for peripheral  $\mu$  or  $\delta$  receptors. J Med Chem 24:1119-1124, 1981.
- Goodman, R.R.; Snyder, S.H.; Kuhar, M.J.; and Young, W.S., III. Differentiation of delta-opiate and mu-opiate receptor localizations by light microscopic autoradiography. Proc Natl Acad Sci USA 77:6239-6243, 1980.
- Holaday, J.W., and Faden, A.I. Naloxone reversal of endotoxin hypotension suggests role of endorphins in shock. Nature 275:450-451, 1978.
- Hylden, J.L.K., and Wilcox, G.L. Intrathecal opioids block a spinal action of substance P in mice: Functional importance of both  $\mu$ - and  $\delta$ -receptors. Eur J Pharmacol 86:95-98, 1983.
- Hynes, M.D., and Frederickson, R.C.A. Cross-tolerance studies distinguish morphine- and metkephamid-induced analgesia. Life Sci 31:1201-1204, 1982.

- Kline, N.S.; Li, C.H.; and Lehmann, H.E.  $\beta$ -Endorphin-induced changes in schizophrenic and depressed patients. Arch Gen Psychiatry 34:1111-1113, 1977.
- Kosterlitz, H.W.; Lord, J.A.H.; Paterson, S.J.; and Waterfield, A.A. Effects of changes in the structure of enkephalins and of narcotic analgesic drugs on their interactions with  $\mu$ - and  $\delta$ -receptors. Br J Pharmacol 68:333-342, 1980.
- Lang, R.E.; Bruckner, U.B.; Kempf, B.; Rascher, W.; Sturm, V.; Unger, T.H.; Speck, G.; and Ganten, D. Opioid peptides and blood pressure regulation. Clin Exp Hypertens TR(#[A]#4)(1-2):249-269, 1982.
- Lindenbarg, T.; Larsen, V.; Kehlet, H.; and Jacobsen, E. Respiratory, analgesic and endocrine responses to an enkephalin analogue in normal man. Acta Anaesthesiol Scand 25: 254-257, 1981.
- Marx, J.L. Brain opiates in mental illness. Science 214:1013-1015 1981.
- McKay, L.D.; Kenney, N.J.; Edens, N.K.; Williams, R.H.; and Woods, S.C. Intracerebro-ventricular beta-endorphin increases food intake in rats. Life Sci 29:1429-1434, 1981.
- Meisenberg, G., and Simmons, W.H. Peptides and the blood-brain-barrier. Life Sci 32:2611-2623, 1983.
- Meites, J.; Bruni, J.F.; Van Vugt, D.A.; and Smith, A.F. Relation of endogenous opioid peptides and morphine to neuroendocrine functions. Life Sci 24:1325-1336, 1979.
- Meyerson, B.J., and Terenius, L.  $\beta$ -Endorphin and male sexual behavior. Eur J Pharmacol 42:191-192, 1977.
- Miglecz, E.; Szekely, J.I.; and Dumai-Kovacs, Z. Comparison of tolerance development and dependence capacities of morphine,  $\beta$ -endorphin and (D-Met<sup>2</sup>, Pro<sup>3</sup>)-enkephalinamide. Psychopharmacology 62:29-34, 1979.
- Morley, J.S. Structure-activity relationships of enkephalin-like peptides. Annu Rev Pharmacol Toxicol 20:81-110, 1980.
- Oyama, T.; Jin, T.; Yamaya, R.; Ling, N.; and Giullemia, R. Profound analgesic effects of  $\beta$ -endorphin in man. Lancet 1:122-125, 1980.
- Pardridge, W.M. Neuropeptides and the blood-brain-barrier. Annu Rev Physiol 45:73-82, 1983.
- Pert C.B.; Pert, A.; Chang, J.K.; and Fong, B.T.W. (D-Ala<sup>2</sup>)-Met-enkephalinamide: A potent long-lasting synthetic pentapeptide analgesic. Science 194:330-332, 1976.
- Römer, D.; Buscher, H.H.; Hill, R.C.; Pless, J.; Bauer, W.; Cardinaux, F.; Closse, A.; Hauser, D.; and Huguenin, R. A synthetic enkephalin analogue with prolonged parenteral and oral analgesic activity. Nature 268:547-549, 1977.
- Roques, B.P.; Fournie-Zaluski, M.C.; Soroça, E.; Lecomte, J.H.; Malfroy, B.; Llorens, C.; and Schwartz, J.C. The enkephalinase inhibitor thiorphan shows antinociceptive activity in mice. Nature 288:286-288, 1980.
- Shah, N.S., and Donald, A.G., eds. Endorphins and Opiate Antagonists in Psychiatric Research: Clinical Implications. New York: Plenum, 1982.
- Stacher, G.; Bauer, P.; Steinringer, H.; Schreiber, E.; and Schmierer, G. Effects of the synthetic enkephalin analogue FK 33-824 on pain threshold and pain tolerance in man. Pain 7:159-172, 1979.



- Stubbs, W.A.; Jones, A.; Edwards, C.A.W.; Delitala, D.; Jeffcoate, W.J.; and Ratter, S.J. Hormonal and metabolic responses to an enkephalin analogue in normal man. Lancet 2:1225-1227, 1978.
- Tseng, L.F. Tolerance and cross-tolerance to morphine after chronic spinal DADL infusion. Life Sci 31:987-992, 1982.
- Tung, A.S., and Yaksh, T.L. In vivo evidence for multiple opiate receptors mediating analgesia in the rat spinal cord. Brain Res 247: 75-83, 1982.
- Verebey, K., ed. Opioids in Mental Illness: Theories, Clinical Observations and Treatment Possibilities. New York: The New York Academy of Sciences, 1982.
- Von Graffenried, B.; del Pozo, E.; Roubicek, J.; Krebs, E.; Poldinger, W.; Burmeister, P.; and Kerp, L. Effects of the synthetic enkephalin analogue FK33-824 in man. Nature 272:729-730, 1978.
- Watson, S.J.; Akil, H.; and Berger, P.A. Some observations on the opiate peptides and schizophrenia. Arch Gen Psychiatry 36:220-223, 1979.
- Wei, E.T. Enkephalin analogs and physical dependence. J PET 216:12-18, 1981.
- Wei, E.T., and Loh, H. Physical dependence on opiate-like peptides. Science 193:1262-1263, 1976.
- Yaksh, T.L.; Howe, J.R.; and Harty, G.J. The pharmacology of spinal pain modulatory systems. In: Benedetti, J., ed. Recent Advances in the Management of Pain. New York: Raven Press, 1984, 7:57-70.

R.C.A. Frederickson, Ph.D.

Director, Central Nervous System  
Research  
Health Care Division  
Monsanto Company  
Life Sciences Research Center  
700 Chesterfield Village Parkway  
St. Louis, Missouri 63198

# Opioid Peptides as Drug Products: FDA Regulatory Requirements

Charles P. Hoiberg, Ph.D., and Rao S. Rapaka, Ph.D.

Recent progress in opioid peptides research has resulted in the development of potentially beneficial drugs. The beneficial effects of these peptides have yet to be demonstrated in humans with clinical trials. Following successful clinical trials, these drugs may be approved by the Food and Drug Administration (FDA) based on the demonstrated therapeutic effectiveness and safety. Since it is expected that many opioid peptide drugs will undergo human clinical trials in the near future, it appears to be the appropriate time to acquaint researchers with the regulatory process involved in drug approval, particularly since the regulations concerning the submission of drug applications have been recently revised. This chapter will address the regulatory requirements in general with particular emphasis on the manufacturing and control requirements. For specific regulatory information concerning neuropeptides, the chapter by Gueriguian and Chlu should be consulted.

## FDA LEGISLATIVE HISTORY

The passage of the Import Drugs Act in 1848 marked the beginning of Federal regulatory legislation. This statute was passed when quinine used by American troops in Mexico to treat malaria was found to be adulterated. In 1906, the original Food and Drug Act was passed, mandating drug standards for strength, quality, and purity. The use of toxic preservatives and dyes in foods and "cure-all" claims for worthless and dangerous patent medicines led to the enactment of this law. In 1938, the Federal Food, Drug and Cosmetic (FD&C) Act was enacted after over 100 deaths resulted from a marketed elixir of sulfanilamide which contained diethylene glycol. This legislation required predistribution clearance for safety of new drugs prior to interstate shipment. Following the thalidomide tragedy in Europe in 1962, the Kefauver-Harris amendments were passed. These amendments required that the effectiveness of a drug product, as well as its safety, be demonstrated prior to approval and that the FDA be notified when a drug is to be tested in humans.

## INVESTIGATIONAL NEW DRUG APPLICATIONS

Under the current FD&C Act, a manufacturer of a new molecular entity must have on file with the FDA an approved application (e.g., a new drug application [NDA]) prior to interstate distribution. However, in order to give a researcher the opportunity to investigate the safety and efficacy of a compound which has potential therapeutic activity, an exemption to the FD&C Act may first be granted. This is accomplished by filing with the FDA a "Notice of Claimed Investigational Exemption for a New Drug," commonly referred to as an "Investigational New Drug (IND) Application". During the IND phase, human clinical trials and additional animal testing are to be performed under carefully controlled conditions. The objectives of the FDA reviews at the IND stage are to assure (1) that safety standards and the rights of the test subjects are observed, and (2) that the quality of scientific evaluation is adequate to permit a proper assessment of the effectiveness and safety of the drug.

On June 9, 1983, the FDA published (Federal Register, Vol. 48, No. 112, p. 26720) a proposal to revise the current regulations governing the review of investigational drugs. These regulations would apply to new drugs, antibiotic drugs, and biological drugs, including biological products that will be used in vitro for diagnostic purposes. Under the present and the proposed regulations, the following information should be included in an IND application:

1. A complete list of all components present in the drug substance and drug product, using the best available descriptive names.
2. The quantitative composition of the investigational drug product, including inactive components.
3. The name(s) and address of the manufacturer(s) of the drug substance and the drug product.
4. A description of the methods of preparation of the drug substance and the drug product. Detailed information should be provided regarding the extraction, isolation, synthesis, and/or purification procedures.
5. Information regarding the analytical methods and release specifications used to assure the identity, strength, quality, and purity of the drug. In the initial phases of an IND study, greater emphasis is generally placed by the FDA on the identification and control of the raw materials and the new drug substance than on the final dosage form.

6. Test results of all preclinical investigations, such as animal toxicology/pharmacology data, as well as a summary of previous human experience, if any, with the investigational drug (e.g., published material). Additional animal studies may be performed concurrently with the proposed clinical trials. The data submitted should adequately demonstrate that the described drug product is reasonably safe to warrant investigation in human subjects.
7. A detailed clinical protocol which describes the rationale and objectives of the proposed multiphased investigation. As described in the pending IND Rewrite, the progressive three phases of an IND study proposed by a pharmaceutical company or research center would be as follows:
  - a. Phase 1 is to include the initial introduction of an investigational new drug into humans. These studies should be closely monitored and be conducted in patients or normal volunteer subjects. This phase should be designed to determine the metabolism and pharmacologic actions of the drug in humans, the side effects associated with increasing doses, and, if possible, early evidence of effectiveness. During this phase, sufficient information about the pharmacokinetics and pharmacological effects of the drug should be obtained to permit the design of well-controlled, scientifically valid, Phase 2 studies.

Phase 1 should also include studies of drug metabolism, structure-activity relationships, and mechanism of action in humans, as well as studies in which investigational drugs are used, as research tools to explore biological phenomena or disease processes.

The total number of subjects and patients included in Phase 1 studies will vary with the drug, but is generally in the range of 20 to 80.

- b. Phase 2 is to include the controlled clinical studies conducted to evaluate the effectiveness of the drug for particular indications in patients with the disease or condition under study and to determine the common short-term side effects and risks associated with the drug. These studies are

typically well controlled, closely monitored, and conducted in a relatively small number of patients, usually involving no more than several hundred subjects.

- c. Phase 3 studies are expanded controlled and uncontrolled trials. They are performed after preliminary evidence of effectiveness of the drug has been established, and they are intended to gather the additional information about effectiveness and safety that is needed to evaluate the overall benefit-risk relationship of the drug and to provide an adequate basis for physician labelling. Phase 3 studies usually include from several hundred to several thousand subjects.

Much simpler protocols are permitted by the agency for "sponsor-investigator INDs" (e.g., an individual researcher associated with an academic institution) or for "treatment INDs" (e.g., a request by a practicing physician to administer an unapproved drug primarily for treatment purposes within the investigational context).

8. Information regarding the scientific training and experience of each investigator.
9. Copies of all informational material, including all labels and labeling which will be utilized by each investigator. The immediate package of an investigational new drug must bear a label with the statement "Caution: New Drug - Limited by Federal (or United States) law to investigational use." The immediate container label should also indicate the non-proprietary or established name; the dosage form (e.g., capsule, injection, etc.); the strength of the drug per dosage unit (e.g., mg/ml); the route of administration; the name and address of the investigator; and the lot number.
10. A statement that each investigator will obtain prior permission (informed consent) from each human subject who is involved in the study. The patient should be provided with all pertinent information, such as the nature of the study, the potential hazards, and the possible beneficial effects.
11. A statement that the FDA and all investigators will be notified immediately if any adverse effects arise during the animal or human testing, or if the study is discontinued. The sponsor is also to submit, at intervals of 1 year after the date of submission of the IND, annual reports which describe the progress of the investigation.

After submitting an IND, the sponsor must wait 30 days after the date of the FDA receipt of the application before the clinical studies may be initiated. This 30-day delay is utilized by the agency to determine whether the investigational drug and the protocol are reasonably safe to justify investigation with human subjects. In general, this safety evaluation is performed by a review team consisting of a medical officer, a chemist, and a pharmacologist, and for certain drug products, a microbiologist. If the IND is not placed on "clinical hold" or if the 30-day delay is waived by the agency, the human testing may proceed. However, if the FDA notifies the sponsor that the proposed study is subject to a clinical hold, the clinical testing may not be initiated until the cited deficiencies are corrected to the agency's satisfaction. Examples of deficiencies cited for the imposition of a clinical hold are as follows:

1. Unreasonable and significant risk of illness or injury to the human subject.
2. Insufficient information provided so that a proper assessment of the risk of the study could not be determined. such as inadequate animal testing data, lack of assurance that an injectable drug is sterile and pyrogen-free, etc.
3. The clinical investigator is not adequately qualified to perform the investigation.
4. A misleading or erroneous investigation brochure.

Under the proposed IND regulations, the director of a review division will also have clear authority to impose a clinical hold at Phases 2 and 3 of the clinical trials. In addition, the FDA may communicate in writing or orally with the sponsor at any time during the course of the investigation concerning other deficiencies or recommendations. Such comments or advice, however, are considered to be solely advisory. To aid the sponsor in meeting the FDA requirements, the agency has published and makes available to all investigators various guidelines and instructional brochures. The agency also encourages sponsors to contact the review division prior to and during the clinical trials for guidance.

Once the sponsor feels that the results of the animal and human testing have adequately demonstrated the safety and effectiveness of the investigational drug, a new drug application may be filed to permit the marketing of the drug product.

#### **NEW DRUG APPLICATIONS**

On February 22, 1985, the FDA published (Federal Register, Vol. 50, No. 36, p. 7542) a comprehensive revision of the Code of

Federal Regulations pertaining to the procedures and requirements for the submission, review, and approval of new drugs and antibiotics for human use. The final rule, commonly referred to as the "NDA Rewrite," went into effect on May 23, 1985, except for the postmarketing reporting requirements for adverse drug experience; these were delayed until August 22, 1985. The agency, however, will accept applications that are in the format prescribed under the previous regulations up to February 24, 1986.

To reduce duplication, an applicant may by reference incorporate information that has previously been submitted to the agency in drug master files (DMFs), INDs, and other new drug applications. The identity of the reference file should be fully described, such as the file name, the reference number, the submission date, and the volume number. If the reference document was submitted by a party other than the applicant, a Letter of Authorization from such party must be filed.

To facilitate the drug approval process, the applicant is required to submit two copies of an application: an archival copy and a review copy.

#### Archival Copy

The archival copy of an NDA is to be a complete application. It is retained as the sole file copy after the approval. Prior to approval, it serves as a reference source for information not contained in the technical sections of the segmented review copy, which will be discussed later.

The archival copy includes the following: (1) an application form; (2) an index; (3) a summary; (4) five technical sections (six for anti-infectives); (5) drug samples and labeling; and (6) case report forms and tabulations. These sections are described below:

1. Application Form: This form serves as a cover sheet and contains basic identifying information regarding the applicant and the proposed drug product. Examples of the type of information to be provided are: the name and address of the applicant; the application date; the name of the drug product; a checklist identifying the enclosures filed; and a commitment to comply with all applicable laws and regulations.
2. Index: A comprehensive index is to be provided in the archival copy; it should indicate the volume number and the page numbers where the summary, the technical sections, and other supporting information can be located.

3. Summary: The archival copy should contain an overall summary of the entire application. In addition, each of the segmented copies of the review copy is to contain this overall summary, so that each of the FDA review disciplines will have a general understanding of the data and information submitted in the complete application. The summary should also contain an annotated copy of the proposed labeling, a discussion of the benefits and risks of the drug product, a brief description of any marketing history of the drug outside the United States, and a synopsis of each technical section.

The summary should be approximately 50 to 200 pages long, depending on the nature of the drug and on the degree of information available; it should be written in the same detail and meet the editorial standards required for publication in refereed scientific and medical journals. When feasible, the data presented in the summary should be in tabular and graphic forms.

Since the FDA intends to use the overall summary to prepare the Summary Basis for Approval document, updated summaries should be filed with major re-submissions. The agency is currently preparing guidelines for the format and content of the overall summary.

The following information should be included in the summary of the chemistry, manufacturing, and controls technical section.

- a. Drug Substance
  - (1) Description (names, physical properties, chemical properties, and stability);
  - (2) Manufacturers (names and addresses);
  - (3) Methods of manufacture (synthesis and purification);
  - (4) Process controls at each stage of manufacturing and packaging; and
  - (5) Specifications and analytical methods.
- b. Drug Product
  - (1) Composition and dosage form (capsule, tablet, aerosol, etc.);
  - (2) Manufacturers (names and addresses);



- (3) Methods of manufacture (manufacturing process for the finished dosage form);
  - (4) Specifications and analytical methods;
  - (5) Container/closure systems;
  - (6) Stability (data summary, expiration dating period, and recommended storage conditions); and
  - (7) Test formulations (composition and lot numbers of the drug products used in the clinical trials, toxicology studies, etc.).
4. Technical Sections: The five technical sections (six with anti-infectives) of the application are each to contain all the specific information needed by the review disciplines to make a knowledgeable and thorough review of the proposed drug product.

The required technical sections for a new drug application are as follows:

- (a) Chemistry, Manufacturing, and Controls Section;
- (b) Nonclinical Pharmacology and Toxicology Section;
- (c) Human Pharmacokinetics and Bioavailability Section;
- (d) Microbiology Section (anti-infective drugs only);
- (e) Clinical Data Section; and
- (f) Statistical Section.

The content and format of the Chemistry, Manufacturing, and Controls Section will be expanded in the discussion of the review copy.

5. Samples and Labeling: When requested, the applicant will be required to provide representative samples of the drug substance, the drug product, and the reference standards directly to the FDA laboratories so that the regulatory suitability of the proposed analytical methods may be determined. The review chemist may also request samples of the finished market package in order to perform a visual examination of the drug product, the container/closure system, and the placement of the immediate container label.

The methods validation package should consist of copies of the appropriate pages contained in the chemistry technical section, so that additional review will not

be required. The agency has prepared and is distributing detailed guidelines describing the preparation of the requisite method validation packages and the submission of the drug samples.

This section of the application is also to include copies of the proposed labels and all other labeling for the drug product. Should the labeling not contain an established name for the active component present in the finished dosage form, the name proposed to the United States Adopted Name Council should be stated.

6. Case Report Forms and Tabulations: The last section of the archival copy is to contain the case report tabulations for each adequate and well-controlled study, as well as the case report forms for each patient who died during a clinical study or who did not complete the study due to adverse events. Additional case report forms may be requested by the agency should it be felt that ancillary data are necessary to conduct a proper review of the application.

Applicants are encouraged to meet with the agency prior to submitting an application to discuss the extent of the information that must be provided in this section.

#### Review Copy

The second copy of an application to be filed with the agency is the review copy. This submission is to consist of 5 or 6 detailed technical sections, each containing an overall summary and an application form. These separately bound sections are to contain the technical and scientific information required for approval by each of the following review disciplines: clinical; pharmacology; chemistry; statistics; biopharmaceutics; and microbiology (anti-infective drugs only). The filing of this segmented review copy permits the various scientific reviewers of the agency to evaluate the applications concurrently, thereby expediting the approval process. Guidelines have been prepared by the agency setting forth the extent and nature of the information that should be provided in each of the technical sections.

Since the chemistry section of the review copy for all NDAs may be submitted 90 to 120 days prior to the submission of the archival copy, this section should include, although not required, all requisite material needed to facilitate review, such as: an index; copies of all labeling; appropriate references (INDs, DMFs, etc.); Letters of Authorization; and the overall summary which should include information regarding the composition and method of manufacture of each investigational formulation.

The chemistry technical section should fully describe the composition, the synthesis, the manufacture, the stability, the specifications, and the control procedures for the drug substance, the drug product, and the components used in preparing the drug product. The following requirements should be addressed using the same or similar format to expedite review:

1. Drug Substance (active ingredient)

a. Description Including Physical Properties, Chemical Properties, and Stability:

1. Names: A listing of the names used for the drug substance should be provided including, where appropriate, the established name, the proprietary name, and the chemical name, the code designations.
2. Formulas: The chemical structural formula, the molecular formula, and the molecular weight should be indicated, if known.
3. Physical and Chemical Properties: The pertinent physicochemical characteristics should be described, including appearance, solubility properties, pH and pKa values, melting and boiling points, isomeric and polymorphic forms, and chemical stability (e.g., potential degradation products).
4. Proof of Structure: A full technical description and interpretation of the data obtained and the reference standards employed in the structure elucidation of the drug substance should be provided.
5. Stability: A complete description and interpretation of the studies performed and of the data collected should be submitted, including validation data demonstrating the suitability of the analytical methods utilized (e.g., stability indicating capability). The stability samples should be evaluated in containers that approximate the containers in which the drug substance is to be stored and shipped.

- b. Manufacturers: The name and address of each manufacturer that will perform any part of the synthesis, extraction, isolation, and/or purification of the drug substance should be stated and its responsibilities designated.

- c. Methods of Manufacture: A full description should be provided of the acceptance tests and specifications for the raw materials, as well as of the methods and components used in the synthesis, preparation, and purification of the drug substances; the description should be in detail equivalent to that used in scientific journals. Any alternative methods or variations in the synthesis should be noted, with an explanation of the circumstances under which they would be used and of the effect they would have on the purity and stability of the drug product. If the drug substance is prepared by fermentation or by extraction from natural sources (plant or animal), a full description of each step of the process should be provided.
  - d. Process Controls: A full description of the control procedures performed at each stage of the manufacturing, processing, and packaging of the drug substance should be provided, including the specification and test procedures for pivotal and key/critical intermediates.
  - e. Specifications and Analytical Methods: A full description of the acceptance specifications and the analytical methods used to assure the identity, strength, quality, and purity of the drug substance should be provided. Actual and potential impurities, such as by-products, degradation products, isomeric and polymorphic components, heavy metal contaminants, and residual solvents should be indicated.
2. Drug Product (finished dosage form)
- a. Components: A list of all components used in the manufacture of the drug product, regardless of whether they undergo chemical change or are removed during manufacture, should be included. Each component should be identified by its established name, if any, or by its complete chemical name, using structural formulas when necessary for specific identification. If any proprietary preparation or other mixtures are used as components, their identity should be fully described, including a complete statement of composition and of any other information that will properly identify the material. Proposed alternatives for any listed component should be fully justified.

- b. Composition: A statement of the quantitative composition of the drug product should be provided, specifying the name and amount of each active and inactive ingredient contained in a stated quantity of the drug product. A batch formula should be included which is representative of the one to be employed in the manufacture of the finished dosage form. Any calculated excess for an ingredient over the label declaration should be designated as such and the percent excess shown.
- c. Specifications and Analytical Methods for Components: A full description of the acceptance specifications and the test methods used to assure the identity, strength, quality, and purity of each inactive ingredient should be submitted. Alternate release methods should be demonstrated to be equivalent to, or better than, the proposed regulatory method.
- d. Manufacturers: The name and address of each manufacturer that performs the manufacturing, processing, packaging, labeling, or control operations of the drug product should be listed and its responsibilities described.
- e. Methods of Manufacture, Packaging Procedures, and In-Process Controls: A detailed description of the manufacturing and packaging procedures should be included which specifies the facilities, the materials flow plan, the equipment used, and the various sampling points. In this regard, the submission of a schematic diagram of the production process may be helpful. A description of the in-process controls, including analytical tests and appropriate data to support the specifications, should be included.
- f. Specifications and Analytical Methods For Drug Product: A full description should be provided of the sampling plans, the release specifications, and the analytical methods which will be implemented to assure the identity, strength, quality, purity, and bioavailability of the drug product. The accuracy, sensitivity, specificity, and reproducibility of the proposed test methods should be established and documented. All alternate release tests should be demonstrated to be equivalent to, or better than, the proposed regulatory method.
- g. Container-Closure Systems: Full information should be submitted regarding the physical,

chemical, and biological characteristics of the container-closure or other component parts of the drug product package to assure its suitability for the intended use; the test methods employed should be specified and the manufacturing process described. A description of the entire packaging operation and relevant in-process controls should also be Included.

h. Stability: A complete and detailed description of, and data derived from, studies of the stability of the drug product should be submitted, including information showing the suitability of the sampling plans, the analytical methods employed, and the stability protocol. Any additional stability studies under way or contemplated should be indicated. Stability data should be submitted for the finished dosage form in the container-closure systems in which it is to be marketed. If the drug product is to be reconstituted at the time of dispensing, stability data should also be included for the solution prepared as directed. The expiration dating period should be clearly specified.

### 3. Environmental Impact Analysis Report:

An environmental impact analysis report should be filed in accordance with 21 CFR 25. The environmental impact of the manufacturing process and of the ultimate use of the drug product should be described as set forth in the Federal Register published April 26, 1985.

Information regarding administrative policies and procedures for the drug approval process, such as time frames, action letters, and supplements to an approved application can be obtained from the FDA consumer safety officers and/or the Federal Register notice published on February 22, 1985.

An abbreviated organization chart is provided in figure 1 to identify the various units involved in the drug approval process.

### BIOAVAILABILITY/PHARMACOKINETIC AND BIOEQUIVALENCE STUDIES

For a long time, it was believed that if the dosage form contained the stated amount of an active ingredient, the patient is assured of full availability of the medication for the stated therapeutic purpose; it was also assumed that dosage forms containing equal amounts of the active ingredient are equipotent. (Bioavailability indicates the rate and relative amount of drug that reaches the circulation. Two drug products are termed bioequivalent if both of them are approximately equal in their bioavailable dose and rate of supply.) Soon it was realized that dosage forms containing the same amount of active ingredient need not necessarily be bioavailable to the same

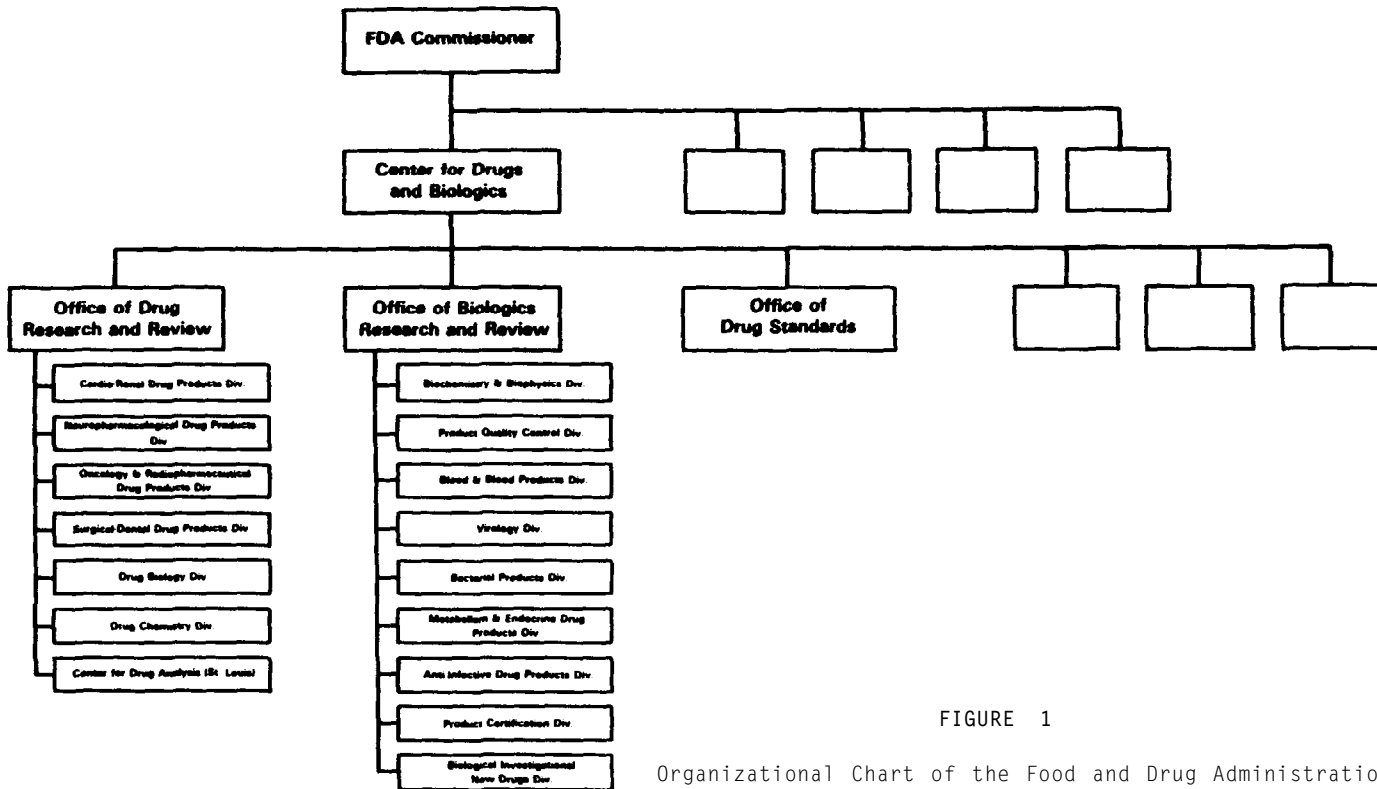


FIGURE 1

Organizational Chart of the Food and Drug Administration

extent, as the bioavailability is influenced by several factors, such as particle size of the drug, polymorphic forms of the drug, presence of different excipients, differences in formulation, the physiologic state of the individual utilizing medication, etc.

An organization chart of the Office of Drug Standards is presented in figure 2. Realizing the importance of bioavailability/bioequivalence of drug products, on January 7, 1977, the FDA published a final order entitled "Bioavailability and Bioequivalence Requirements." These were published in the Federal Register (Vol. 42[5], pp. 1624-1653). These requirements took effect in July 1977 and were published as two separate regulations to deal more effectively with the issues of drug bioequivalence of multisource generic drugs and the issues of drug-to-drug bioavailability involving new drug entities. In this regard, pharmacokinetics (involving the study of kinetics of absorption, distribution, metabolism, and excretion of drugs and their pharmacologic response) should be fully utilized in the early developmental stage of the drug product to ensure an adequate delivery of the drug to the site of action; examination of bioavailability at a later stage may require reformulation due to poor absorption as well as potential by giving rise to questions of the validity of the results of "pivotal" clinical studies used to support the submission.

The following sections should be included for all INDs and NDAs submitted to the Agency requiring a bioavailability review: background, chemistry, metabolism, pharmacology, statistics, and pharmacokinetics. Draft guidelines are available from the FDA and these guidelines are appropriate to identify pivotal studies as well as additional studies that should be considered with the IND/NDA phase of drug development. Some of these are:

1. Bioavailability Study(ies)

Proposed marketed dosage form(s) compared to a reference(s), e.g., comparison of a solid dosage form to a reference solution and/or to a different route of administration.

2. Dose Proportionality Study(ies)

- a. A dose proportionality study over the dosing range proposed in the labeling, used in Phase 2 and 3 clinical trials; or
- b. A dose proportionality study to the highest tolerated single dose.

3. Bioequivalence Study(ies)

- a. An in vivo comparison of dosage form(s) used in



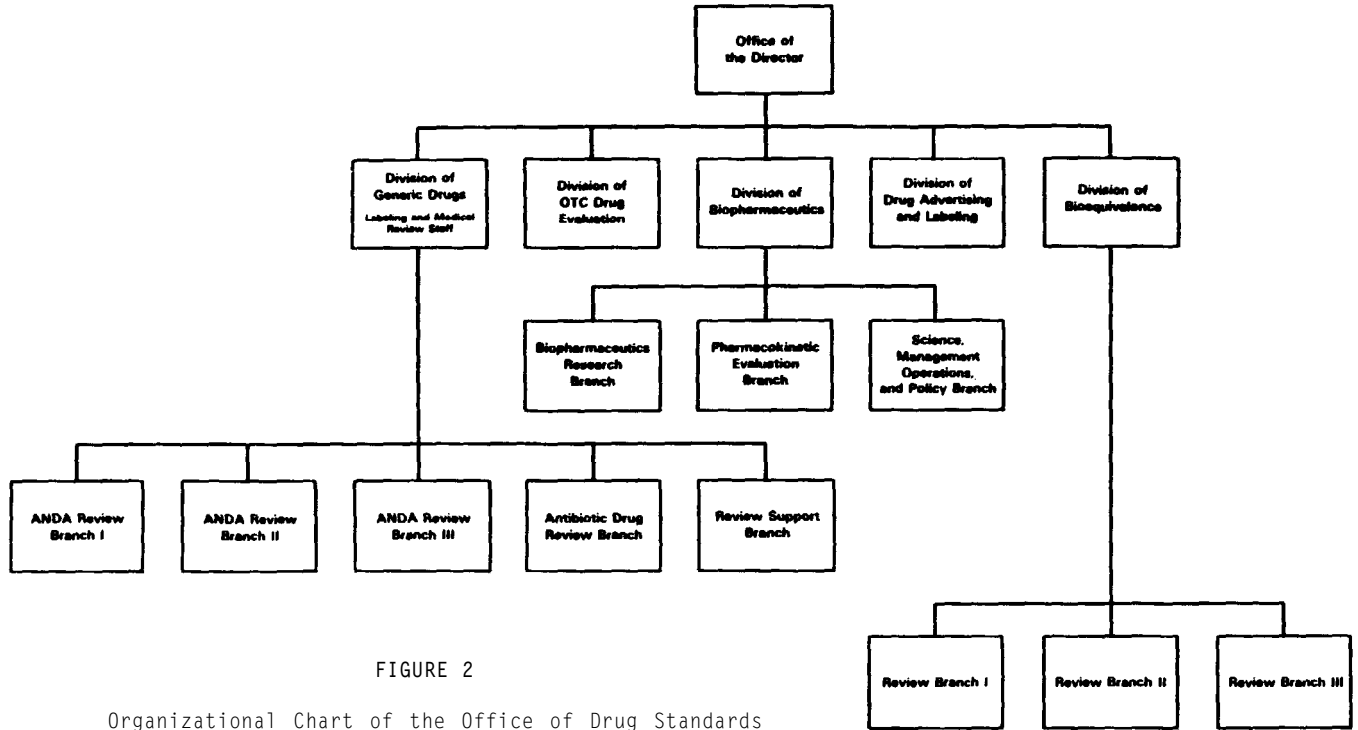


FIGURE 2

Organizational Chart of the Office of Drug Standards

pivotal clinical study(ies) to the proposed marketed dosage form(s).

b. An in vivo comparison of the proposed marketed dosage form(s), e.g., multiple strengths if the drug/excipient ratio varies.

#### 4. Dissolution of Solid Oral Dosage Forms

a. Dissolution profiles of all solid dosage forms used in pivotal clinical studies.

b. Dissolution profiles of all solid dosage strengths and forms proposed for marketing.

c. Evaluation of a) and b) above with respect to similarity and/or deviations from the proposed marketed product.

#### 5. Multiple Dose Studies

To demonstrate that steady-state plasma and/or other biologic fluid concentration can be predicted from single dose.

#### 6. Define Michaelis-Henten Kinetics

To more fully describe the effects of Michaelis-Menten Kinetics on the body at steady-state if single dose studies indicate the possibility of nonlinear kinetics.

#### 7. Specific Patient Populations and Diseased States

Drugs which are targeted for a particular patient population, whether a disease state or an age group, e.g., pediatrics, should be evaluated within that group. For instance, the effect of renal disease, i.e., reduced G.F.R., should always be performed for drugs extensively cleared by the kidney. Although it can be anticipated that failure of the main organ to metabolize a drug will alter the clearance and half-life, the compensatory pathways of elimination cannot necessarily be predicted. Therefore, drugs extensively cleared or bound by any organ should be studied in patients with disease of the organ in order to quantitatively define the effects of various levels of disease. The most important organs in drug elimination and binding are the kidney, liver, and plasma (proteins). Disease or alteration of function in the kidney in particular is not only disease dependent but also age dependent. Drugs extensively eliminated by the kidney should always be studied for effects of renal disease and age. The degree of liver disease is more difficult to define for

drugs extensively metabolized by the liver; if identifiable subpopulations of patients exist with the indicated use and liver disease, they should be studied. Similarly, for drugs extensively protein bound, studies of the effect of derangements in the plasma proteins should be conducted if there is a likelihood of significant plasma protein changes in some patients for whom the drug is indicated.

#### 8. Effect of Food

Drugs labeled to be administered with food should be so investigated to support labeling. Because of the potential for alteration in drug absorption when administered with food, the effect of food on bioavailability, especially those critical drugs, i.e., drugs with a narrow therapeutic ratio or drugs requiring close patient titration, should be investigated and labeled appropriately.

#### 9. Combination Drug Products-Compatibility with Respect to Pharmacokinetics

#### 10. Drug-Drug Interaction

Drugs indicated to be coadministered with specific drugs should be investigated for evidence of interaction.

In addition, for good submission, an overall report should be prepared containing all the pertinent information with appropriate references to the individual study reports. The abbreviated Summary and Recommended Format for the Biopharmaceutics Report is expected to contain the following information:

1. A summary of the mode of action and therapeutic index, where applicable and if known, of the drug and a listing of other chemically or pharmacologically related active substances.
2. A summary of the absorption, distribution, metabolism, and elimination of the drug, including references of supportive studies.
3. A summary of the drug protein binding, pKa, pharmacokinetic data such as  $K_a$ ,  $K_{el}$ ,  $T_{1/2}$ , relative area under the curve and/or absolute bioavailability, dose proportionality, and therapeutic dose range where appropriate.
4. A summary of the pivotal bioavailability studies which establish the bioavailability/pharmacokinetics and metabolism of the drug, including data on the proposed

dosage form, and basic study design with appropriate statistical summary.

5. In the case of products containing new chemical entities, an evaluation of potential bioavailability/bioequivalence problems of the dosage form and/or the drug based on medical, physiochemical, and pharmacokinetic criteria or on information to permit waiver of evidence of bioavailability where appropriate.
6. A summary of the pivotal studies which support bioavailability and/or pharmacokinetic statements in the labeling, with an explanation of the basic study design, reference drug (product) selection, and statistical analysis.
7. A listing of all human bioavailability/pharmacokinetic studies pertaining to the drug which were performed by the firm or its agent, with appropriate referencing.
8. Summary documentation of the analytical methodologies used in pivotal bioavailability/pharmacokinetic studies for the drug and/or metabolite(s), at the concentration of the drug (metabolite(s)) in physiological fluid documenting the specificity, linearity, sensitivity, limit of detection, and reproducibility.
9. A full statement of the composition of the drug product.
10. Summary of the content uniformity data. Where applicable, the solubility profile of the drug as a function of pH should also be provided.
11. In vitro dissolution data on all proposed dosage forms, including instrumentation, media, agitation, temperature, sampling times, sink conditions, and infinity value\* (if less than percent in 1 hour).  
\*Defined as same reading at 150 rpm (paddle/basket) at three successive 10-minute intervals.

## CONCLUSION

The ultimate goal of a medicinal chemist is to have his or her discovery successfully utilized in the treatment and/or management of a disease state. The path to success, however, is often long and tortuous. Although many years of research may have been invested in the isolation, identification, and/or synthesis of a pharmacologically active compound, the drug product cannot be routinely used in the practice of medicine until extensive animal and human testing is completed. The results of this testing, plus information regarding manufacturing and control procedures, must be evaluated by the Food and Drug Administration prior to the marketing of a drug product.

The time interval between the discovery of a potentially therapeutic compound and its general use in the medical community may involve many scientific and regulatory hurdles. However, this delay is usually offset by the assurance that the prescribed drug products are safe and effective.

#### AUTHORS

Charles P. Hoiberg\*, Ph.D.  
Food and Drug Administration  
Rockville, Maryland 20857

Rao S. Rapaka\*\*, Ph.D.  
National Institute on Drug Abuse  
Rockville, Maryland 20857

\*Please note that the interpretation of the agency's policies represents the opinion of the author, not necessarily those of FDA.

\*\*Please note that the views expressed are those of the author, and not necessarily those of NIDA.

# A Few Thoughts on the Development and Regulation of Neuropeptides

John L. Gueriguian, Ph.D., and Yuan-Yuan H. Chiu, Ph.D.

## INTRODUCTION

In the past decade, scientific and technical progress has facilitated the rapid identification and study of many new neuropeptides. Immunocytochemistry, radioimmunoassays, automated solid-phase synthesis, high resolution purification procedures, and, most importantly, genetic engineering and *in-situ* hybridization techniques have been extremely contributory to this field as they have in others. Neuropeptides may be neurotransmitters, neuromodulators, or neurohormones and thus possess a wide range of activities and effects. These new substances, and their synthetic analogs, hold considerable promise toward the development of many potent drugs. Of course, the traditional aspects of drug development and regulation apply here as they would in any other area. And yet, this extremely original field also requires novel considerations and approaches dictated by its particular merits.

## THE ORIGINAL CAST

### Hypothalamic neurohormones

Many neurohormonal analogs are currently being studied in humans, some of them very actively. Luteinizing-hormone releasing hormone (LHRH) and its analogs are clinically investigated as stimulators and inhibitors of the male and female pituitary-gonadal axis. An LHRH analog has already been approved by the Food and Drug Administration (FDA) for the palliative treatment of hormone-responsive prostatic cancer. The potential of growth-hormone releasing factor (GRF) and its analogs to beneficially affect general growth parameters is also explored at present. Sufficient practical knowledge and experience have already been developed in these and other areas -- thyrotropin releasing hormone (TRH), corticotropin releasing factor (CRF), etc. -- to benefit adjacent and related fields.

### Opioid peptides and hormonal activities

Longer length peptides of various opioid families, e.g., dynorphin, beta-neoendorphin, and beta-endorphin, have been detected in the brain

and the pituitary (Goldstein and Ghazarossian 1980; Goldstein et al. 1981); and usually carry hormonal modulation functions, as opposed to the neurotransmitter function of other opioid peptides. These peptides act through a tonic inhibitory effect on corticotropin and gonadotropins via the inhibition of CRF and LHRH, respectively. In addition, opioid peptides modulate the release of adrenocorticotrophic hormone (ACTH) during stress and stimulate the release of prolactin, growth hormone, and thyroid-stimulating hormone (TSH).

### **Other neuropeptides**

Substance P was the first neuropeptide discovered more than 50 years ago (von Euler and Gaddum 1931), but it was not until 40 years later that its chemical structure was determined (Chang et al. 1971). Several other molecules have been discovered and characterized since. These peptides are neurotransmitters or neuromodulators, and have effects on the brain development, thermoregulation, cardiovascular and sleep regulation, feeling (pain, analgesia, euphoria), or behavior (memory, learning, feeding).

## **SECOND GENERATION PRODUCTS**

### **Development of analogs**

The automation of solid-phase peptide synthesis and the availability of the sophisticated contemporary purification and analytical tools have provided us with an excellent opportunity to seriously study the therapeutic applications of neuropeptide analogs. The development of agonistic and antagonistic analogs is of both scientific and economic significance.

### **Medical advantages**

Since neuropeptides are usually multifunctional, analogs may be designed to increase the therapeutic index of the drug class intended for use in a specific indication. Analogues may be more resistant to metabolic degradation and thus become more available at the site of action. They may be designed to pass the blood-brain barrier more effectively than the natural ones. Finally, one may develop dosage forms which are more acceptable to the patient than the conventional parenterals (e.g., nasal sprays, transdermal patches, or depot microspheres). A number of analogs of vasopressin, somatostatin, LHRH, and GRF have already undergone relatively extensive clinical investigations.

### **Economic advantages**

In most circumstances, natural products are not patentable, and economic considerations dictate that nonpatentable drugs are usually unable to make it in the marketplace. Analogues, on the other hand, can and, in point of fact, should be patented, and are therefore able to sometimes yield sizeable returns on research and development investments. Also, analogues may contain fewer amino acid residues and are usually more potent than the natural product, even though careful

studies are needed to define the minimal sequence consistent with reasonable pharmacodynamic activity (Baskin et al. 1984). Such built-in advantages will increase the probability of the eventual marketing of a given product.

### Special requirements

Analogs also deserve special attention and handling, particularly from the point of view of unsuspected toxicities. Antagonistic LHRH analogs, for example, possess structures drifting farther and farther away from the original molecule while exhibiting lowered relative potencies. Thus, experts were not surprised when some highly hydrophobic arginine-containing antagonists were shown to produce untoward effects in certain animal species.

## SOME BASIC FACTS AND THEIR PRACTICAL CONSEQUENCES

### Chemistry

The approximately 50 neuropeptides discovered so far have many common characteristics. They generally are small peptides and very few of them contain more than 50 amino acid residues. The smaller neuropeptides, e.g., TRH and enkephalins, contain only three and five amino acid residues, respectively. Even the relatively larger ones, such as CRF and GRF, contain only 41 and 43 amino acid residues, respectively. All this is, of course, good news for the organic chemists. But the implications for the physiopharmacologist are more uncertain. Indeed, most neuropeptides have quite flexible tertiary and, in some cases, even secondary structures. The fact that many of these peptides are usually linear and contain none or only one disulfide bond further compounds this characteristic. Thus, the conformation of these peptides may be greatly influenced by their environment. In other words, the structure adopted in the aqueous solution may be quite different from that found in the nonaqueous phase. Structure-activity relationship studies are already inherently complex; and, given the relative greater flexibility of neuropeptides (as opposed to steroids, for example), their experimental behavior becomes even more difficult to understand and to interpret. Any hypothesis as to the efficacy and safety of a given analog has to be carefully tested during animal and, later, human studies. During such studies, we may find that a desired pharmacodynamic effect is accidentally lost in a first analog, while a second one causes some totally unexpected side effects, even though it retains the expected therapeutic activity.

Structural studies will nevertheless be pursued and may, at times, provide helpful hints and ideas. The crystal structure of Leu-enkephelin (Tyr-Gly-Gly-Phe-Leu) recently published by Camerman et al. (1983), serves as an excellent example. These authors found that the side chains of the four independent Leu-enkephalin molecules in the same crystal lattice assume different orientations. In addition, the fully extended polypeptide backbones of two molecules have a slightly more puckered conformation than that of the remaining two. Moreover, the two glycine residues (Gly<sup>2</sup> and Gly<sup>3</sup>) in two of the four Leu-enkephalin molecules adopt a conformation closer to that of D-amino acid than to L-amino



acid. In fact, an analog with a D-Ala substitution for Gly<sup>2</sup> was found to be biologically active, whereas an analog with a D-Phe substitution for Leu<sup>5</sup> was inactive. This may help explain why D-amino acid analogs of many other peptides are not only biologically active, but sometimes more potent.

### Biochemical data

We know that neuropeptides can be present at several sites in the central nervous system, with distinctly different functions at each site; also, several peptides may be present at a given site. Through DNA cloning, many of these neuropeptides were found to be synthesized in the form of precursors, which are biologically inactive large polypeptides. The precursors usually contain several small biologically active peptides, which are flanked at both ends by pairs of basic amino acids, lysine and arginine, and liberated by the action of trypsinlike proteolytic enzyme, followed by carboxypeptidase B-mediated cleavage. The liberation of the small peptides is tissue specific, i.e., different sets of peptides with distinct physiological functions may be formed from the same precursor, depending on the local tissue abilities and needs. The processing of proopiomelanocortin (Nakanishi et al. 1979, 1960) illustrates well some of these complications. In the anterior pituitary lobe, proopiomelanocortin is processed to produce ACTH and beta-lipotropin (LPH), and some of the beta-LPH is further split into beta-endorphin and gamma-LPH. In the intermediate lobe, ACTH and beta-LPH are no longer present, because ACTH is further cleaved to form alpha-melanostimulating hormone (MSH) and corticotropin like intermediate lobe peptide, and beta-LPH into gamma-LPH and beta-endorphin completely. The processing of the initial precursor in the hypothalamus and other sites of the brain may be different from the particular ones described above. The processing of the precursor can also occur at the RNA level. For instance, the RNA transcribed from the calcitonin gene is processed into an mRNA in the brain different from that in thyroid cells (Rosenfeld et al. 1983). It then leads the synthesis of two different precursor polypeptides which yield calcitonin in the thyroid and the so-called calcitonin gene-related peptide whose function in neural tissues is at present unknown.

A precursor may contain several copies of the same peptide, and one peptide may also be present in two different precursors. The precursor preproenkephalin (Comb et al. 1982; Gubler et al. 1982; Noda et al. 1982a, 1982b), for example, contains four copies of Met-enkephelin molecule, one copy of Leu-enkephalin, and other peptides. On the other hand, Leu-enkephalin was also found to be present in a second precursor, beta-neoendorphin/dynorphin (Kakidani et al. 1982). Moreover, many peptides encoded in a gene family can act in close coordination to cause behavioral and physiological changes. The study on the sea slug *Aplysia* showed (Scheller et al. 1983, 1984) that multiple peptides coded by genes in a five-membered gene family together orchestrate the complex behavior repertoire of egg-laying (Kandel 1979).

Since many neuropeptides act at the membranes where receptors reside, the conformation of the peptides while binding to receptor molecules may be quite different from that found in the simple aqueous phase. Kaiser and Kezdy (1984) have suggested that an amphiphilic structural

site of the neuropeptide may be present to accommodate the amphophilic environment of the membrane lipid bilayer. By examining the amino acid sequence of GRF, they found that the first 29 amino acid segment could form an amphophilic alpha-helix, which may explain why the shortest biologically active GRF agonist is, precisely, the fragment spanning residues 1-29.

Again, the above considerations indicate the complexity of the processes that we are proposing to deal with. They underline the potential for progress while also emphasizing the need for imaginative yet careful investigation.

## CHEMISTRY AND MANUFACTURING CONTROLS

The general FDA requirements in chemistry and manufacturing controls for drug substances (pure peptides) and drug products (formulated dosage forms) for human trials emphasize the structural identity, the chemical purity and stability, and the biological potency of the active moiety, and also the lot-to-lot consistency of both the active principle and its contaminants. With the currently available technologies, the chemical purity of a small peptide prepared on a small scale can reach 99% or greater without major or unsurmountable difficulties. The important issue is whether this purity level can be achieved in the scaled-up production lots. If not, the materials to be used in preclinical and clinical studies should preferably be prepared at a purity level which can best be achieved at the production scale. Chemical structure should be firmly determined by suitable chemical and physical methods; thus, the amino acid sequence, the disulfide linkage, if any, and the substitution with D-amino acid residue and other functional groups in the peptide molecule must be established. The biological potency of an agonist should be compared to its natural product by a suitable bioassay, whereas the biological potency of an antagonist may be measured by using a suitable inhibitory bioassay and a proper reference standard. When the biological potency of a lot is found to fall within the established acceptable range, dosing can be prescribed in terms of the weight of the peptide calculated as the free base (excluding the content of moisture and salt, e.g., acetate). The stability data should be collected to support the intended shelf life of the lots used in clinical trials and the to-be-marketed production lots. The identity, toxicity, and biological activity of the major contaminants present in the drug substance and of the major degradation products present in the dosage form after storage should be documented.

## ANIMAL STUDIES

### Potency determinations

The biological potency of a given compound should be established against a reference standard and expressed in terms of its specific activity. Experts should determine, if they have not already done so, the appropriate chemical reference standards for each class of activity. The rat, obviously a perennially popular animal for research studies, is acceptable to define potency; but its use for other preclinical studies of LHRH analogs, for example, has been discouraged because its endocrine physiology radically differs from that of the human,

## Clinical studies using peptidic drugs

Peptidic drugs pose some interesting problems of their own that have to be satisfactorily resolved before clinical trials are allowed to proceed. For example, their manufacturing methodologies might create special regulatory situations, some of which have already been substantially addressed (Gueriguian et al. 1981). Their widespread use requires precise efforts of definition and standardization (Gueriguian et al. 1982). Many natural peptides and their analogs are also somewhat different from ordinary drugs in that they are usually highly potent substances with relatively few side effects. Certainly, this is generally true for LHRH analogs (Gueriguian et al. 1984). Under these circumstances, one is compelled to handle them somewhat differently from ordinary drugs.

## General regulatory requirements for peptidic drugs

Phase 1 studies using natural peptides and their analogs may commence after the drug has been well defined chemically, and after preliminary end well-conducted animal studies have not raised any significant safety issue. The required animal studies are usually performed using two species, one of them preferably a nonrodent, from 2 weeks to 3 months, depending on the situation. The FDA pharmacologists in charge would, of course, make specific recommendations based on the merits of each case. Before phase II and III studies are permitted, additional requirements must be met: (1) tightened physicochemical specifications consistent with a prolonged and enlarged use of the drug; and, (2) if warranted by pertinent observations during phase I studies, additional animal studies to further support the safety of the drug. Pivotal studies must be double-blinded and well-controlled against either a placebo-treated group or an established medical therapy, as the situation requires. Efficacy of treatment has to be clinically defined, and so-called biochemical efficacies alone, e.g., the fall in blood testosterone to castrate levels, are not sufficient by themselves. The efficacy of a drug will depend on the demonstration of objective and subjective proof of reversal, or at least stabilization, of a well-defined disease process. Prior to any therapy, the diagnosis must have been confirmed and, if at all possible, objectively recorded.

## Specific requirements

If uncommon or unusual administration routes are chosen, e.g., the intranasal, that administration form should be tested for bioequivalency with a parenteral form. Regardless of the form of administration, adequate tests must be performed to detect any peptidic antigenicity. If and when immunogenicity is detected, additional clinical and laboratory scrutiny is warranted (particularly of liver, kidney, and bone marrow functions) to exclude any evidence that neutralizing antibodies are present, or that an immune-related disorder is developing. In certain cases, one may have to use a number of sophisticated methods, e.g., measurements of complementemia and detection of specific antibodies in urinary casts. Children may be treated, but under stricter guidelines, and only after the tested drug has previously been safely used in adults.

## Pharmacological studies

The pharmacokinetic parameters of analogs should be determined, preferably in a primate species, and, if at all possible, through direct measurement of drug blood levels. General pharmacological and toxicological requirements may be initially satisfied by animal studies in two species (one of which may be a rodent), at two reasonable multiples of the intended maximal human dose, and for 2 to 4 weeks. If proof of intended efficacy is already on hand, and the toxicological studies have not suspected or documented adverse effects, open label clinical studies may begin in the form of a single dose study. Such preliminary studies in humans allow the retention of promising products for further studies while the less promising moieties are readily and quickly rejected.

## SOME USEFUL CONCEPTS IN DRUG DEVELOPMENT AND REGULATION

### Shuttling

After relatively limited animal studies, initial human trials were permitted to gauge the clinical usefulness of certain LHRH agonistic analogs (Gueriguian et al. 1984). Under the circumstances, unpromising or ineffective drugs would have been quickly detected and discarded. At this point, the FDA mandated additional animal studies to more firmly establish the general safety of the more promising compounds. Additional ad hoc animal studies would certainly be required in the future if clinical toxicity were suspected. We refer to these back-and-forth maneuvers between animal and human studies as "shuttling," an extremely useful technique that has helped us to safely and rapidly develop LHRH analogs for at least certain clinical indications. Shuttling may be useful in the development of therapeutic neuropeptides as well.

### Developmental algorithm

During the continuing development of these same LHRH analogs, we found it extremely important to create and to try to adhere to a rational algorithm for drug development. LHRH itself was first used as a diagnostic tool. This was fortunate in that it allowed any number of safe studies, using an endogenous compound at slightly supraphysiological doses, to determine the effects of a natural peptide permitted to wander, so to speak, outside its physiological compartments. After considerable scrutiny, the FDA and industry eventually agreed that LHRH analogs should next be administered to patients with hormone-responsive metastatic prostatic cancer. Various reasons militated in favor of this choice: (1) this indication was based on a sound scientific rationale; (2) it had a high estimated probability of therapeutic success; (3) its benefit versus risk ratio appeared to be as high as attainable at the time; (4) it would allow the safe use of relatively higher doses of the compounds for relatively longer periods of time; and, finally, (5) such studies would allow for the careful collection of considerable toxicological data in the human. From that point on, and after a suitable lag period, the analogs were tried in the treatment of other pathological conditions, the moment their benefit versus risk ratios

were found to be acceptable. The above considerations may usefully guide the clinical studies of any novel class of drugs, particularly the related group of neuropeptides, even though it is well understood that each case has to be judged on its own merits.

### Lead population samples

LHRH analogs have so far been shown to be generally safe and effective in the treatment of true precocious puberty. Initially, however, many hypothetical safety questions loomed very large, e.g., the potential immunogenicity of peptide analogs and the eventual pathological consequences of such antigenicity. To this day, the reversibility of long-term inhibition of the pituitary-gonadal axis can only be proven by actual experimentation. To meet these challenges, academic investigators and regulators from the FDA defined and applied the concept of a "lead population sample," i.e., a small group of patients enrolled in a clinical study that fully meets general criteria of safety and effectiveness, during which a very careful and precise monitoring is in force, so that one may be able to eventually detect hypothetical side effects, if and when they occur. As time passes by and safety is better established, other patients may be enrolled in the study. If the hypothesized event, or any other untoward event, is picked up in the lead sample, protective measures may be immediately taken to insulate the larger but lagging populations from such undesirable events. In certain cases, successive and increasingly bigger samples may be introduced one after another in an ever expanding clinical study, thus allowing for continually improving detection abilities of, at first, high, and, later, lower frequency events. This general approach allows us to resolutely move ahead while minimizing in the extreme unavoidable iatrogenic risks.

## PRINCIPLES GOVERNING THE CLINICAL STUDIES OF NEW DRUGS

### General rules

The FDA should approve a new drug only after at least two well-controlled clinical trials have shown it to be safe and effective in the treatment of a defined clinical condition. All human studies in the United States and abroad using drugs manufactured in the United States must be performed under the scrutiny of the FDA. Clinical studies are permitted after adequate chemical definition of the drug and suitable animal studies, and these studies generally pass through four distinct phases.

Phase I studies are almost always conducted with normal volunteers and are meant to define the general safety of the drug and its significant pharmacological properties. The clinical effectiveness of the drug for a given condition is tested during phase II studies, albeit with relatively small groups of patients. Phase III enlarges such studies into large-scale, well-controlled clinical trials, at the end of which a new drug may be approved if it is found to be, as mandated by law, safe and affective. Phase IV, or post approval, studies are sometimes needed to answer some secondary, yet still important, questions or to resolve some long-term safety considerations.

## REFERENCES

- Baskin, D.S.; Hosobuchi, Y.; Loh, H.H.; and Lee, N.M. Dynorphin (1-13) improves survival in cats with focal cerebral ischaemia. Nature 312:551-552, 1984.
- Camerman, A.; Mastroiolo, D.; Karle, I.; Karle, J.; and Camerman, N. Crystal structure of leucine-enkephalin. Nature 306:447-450, 1983.
- Chang, M.M.; Leeman, S.E.; and Niall, H.D. Amino-acid sequence of substance P. Nature New Biol 232:86-87, 1971.
- Comb, M.; Seeburg, P.H.; Adelman, J.; Eiden, L.; and Herbert, E. Primary structure of the human Met- and Leu-enkephalin precursor and its mRNA. Nature 295:663-666, 1982.
- Goldstein, A., and Ghazarossian, V.E. Immunoreactive dynorphin in pituitary and brain. Proc Natl Acad Sci USA 77:6207-6211, 1980.
- Goldstein, A.; Fischli, W.; Lowney, L.I.; Hunkapiller, M.; and Hood, L. Porcine pituitary dynorphin: Complete amino-acid sequence of the biologically active heptadecapeptide. Proc Natl Acad Sci USA 78:7219-7223, 1981.
- Gubler, U.; Seeburg, P.; Hoffman, B.J.; Gage, L.P.; and Udenfriend, S. Molecular cloning establishes proenkephalin as precursor of enkephalin-containing peptides. Nature 295:206-208, 1982.
- Guerriguian, J.L.; Miller, H.; Schaffenburg, C.A.; Gregoire, A.T.; and Sobel, S., eds. Insulins, Growth Hormone and Recombinant DNA Technology. New York: Raven Press, 1981.
- Guerriguian, J.L.; Bransome, E.D., Jr.; and Outschoorn, A.S., eds. Hormone Drugs. Rockville, Maryland: U.S. Pharmacopeia, 1982.
- Guerriguian, J.L.; Schaffenburg, C.A.; and Chiu, Y.-Y.H. Trends in drug development with special reference to the testing of LHRH analogues. In: Labrie, F.; Belain, A.; and DuPont, A., eds. LHRH and Its Analogues. Amsterdam: Excerpta Medica, 1984. pp. 507-516.
- Kaiser, E.T., and Kezdy, F.J. Amphiphilic secondary structure: Design of peptide hormones. Science 223:249-255, 1984.
- Kakidani, H.; Furutani, Y.; Takahashi, H.; Noda, M.; Morimoto, Y.; Hirose, T.; Asai, M.; Inayama, S.; Nakanishi, S.; and Numa, S. Cloning and sequence analysis of cDNA for porcine beta-neo-endorphin/dynorphin precursor. Nature 298:245-249, 1982.
- Kandel, E.R. Behavior Biology of Aplysia. New York: Freeman, 1979.
- Nakanishi, S.; Inoue, A.; Kika, T.; Nakamura, M.; Chang, A.C.Y.; Cohen, S.N.; and Numa, S. Nucleotide sequence of cloned cDNA for bovine corticotropin-beta-lipotropin precursor. Nature 278:423-427, 1979.
- Nakanishi, S.; Teranishi, Y.; Noda, M.; Notake, M.; Watanabe, Y.; Kakidani, H.; Jingami, H.; and Numa, S. The protein-coating sequence of the bovine ACTH-beta-LPH precursor gene is split near the single peptide region. Nature 287:752-755, 1980.
- Noda, M.; Furutani, Y.; Takahashi, H.; Toyosato, M.; Hirose, T.; Inayama, S.; Nakanishi, S.; and Numa, S. Cloning and sequence analysis of cDNA for bovine adrenal preproenkephalin. Nature 295:202-206, 1982a.
- Noda, M.; Teranishi, Y.; Takahashi, H.; Toyosato, M.; Notake, M.; Nakanishi, S.; and Numa, S. Isolation and structural organization of the human preproenkephalin. Nature 297:431-434, 1982b.
- Rosenfeld, M.G.; Mermod, J.-J.; Amara, S.G.; Swanson, L.W.; Sawchenko, P.E.; Rivier, J.; Vale, W.W.; and Evans, R.M. Production of a novel neuropeptide encoded by the calcitonin gene via tissue-specific RNA processing. Nature 304:129-139, 1983.

- Scheller, R.H.; Jackson, J.F.; McAllister, L.B.; Rothman, B.S.; Mayeri, E.; and Axel, R. A single gene encodes multiple neuropeptides mediating a stereotyped behavior. Cell 32:7-22, 1983.
- Scheller, R.H.; Kaldany, R.-R.; Kreiner, T.; Mahon, A.C.; Nambu, J.R.; Schaefer, M.; and Taussig, R. Neuropeptides: Mediators of behavior in aplysia. Science 225:1300-1308, 1984.
- von Euler, U.S., and Gaddum, J.H. An unidentified depressor substance in certain tissue extracts. J Physiol (Lond) 72:74-87, 1931.

## **AUTHORS**

John L. Gueriguian, Ph.D.

Yuan-Yuan H. Chiu, Ph.D.

Division of Metabolism and Endocrine Drug Products

Center for Drugs and Biologics

Food and Drug Administration

5600 Fishers Lane, Room 14B-04

Rockville, Maryland 20857



DHHS Publication No. (ADM)87-1455  
Alcohol, Drug Abuse, and Mental Health Administration  
Printed 1986 Reprinted 1987