

Junior Solar Sprint

An Introduction to Building a Model Solar Car

Student Guide for the Junior Solar Sprint Competition

*Produced by:
Krisztina Holly and Akhil Madhani*

Introduction

Welcome to Junior Solar Sprint! By competing in Junior Solar Sprint, you will learn how to make your own model solar car that will run entirely from the power of the sun.

Design

You will experience first-hand the process of design. When you design your car, you will start with some ideas in your head and turn them into real-life models that work. Design is different than normal problem-solving, because:

- you don't know what the problems are (you discover and solve problems as you go along -- everyone's challenges will be different)
- there is never one right answer

Designers have to deal with tradeoffs. For example, when a car designer uses a larger engine for greater performance, this usually sacrifices fuel efficiency. In a sports car, performance and speed are very important. But in a city car, fuel efficiency is more important. So it is up to the designer to decide which are the most important goals. Even though there is no one right answer, some answers may be better than others for a particular application. Obviously, in Junior Solar Sprint, the faster cars will win.

How to Get Started

You will receive short handouts on a variety of subjects from how to build the wheels to how the solar cells work. These handouts will cover the following topics:

- **chassis:** how to build the frame of the car
- **wheels and bearings:** how to make wheels that turn
- **power source:** how the solar panel and motor work
- **transmission:** how to transfer power from the motor to the wheels
- **body shell:** how the shell affects car performance

In general, when you design, it is good to keep the different parts in mind, but don't worry about the details of each component until you are ready for them. Each handout will be composed of 4 parts:

- purpose
- ideas
- concept
- suggested materials

The concept section will raise issues that will help you decide how to make the right decisions and build the winning car.

Experiment as much as possible early on and don't worry about making mistakes. It is always the case with design that you don't know what the problems are until you encounter them. So get your hands dirty and get started! Good luck and have fun.

Chassis

Purpose

The car's chassis is its frame. It holds all of its main parts together.

Ideas

Some possible ideas for a solar car chassis are below. Try different ideas! Try different materials!

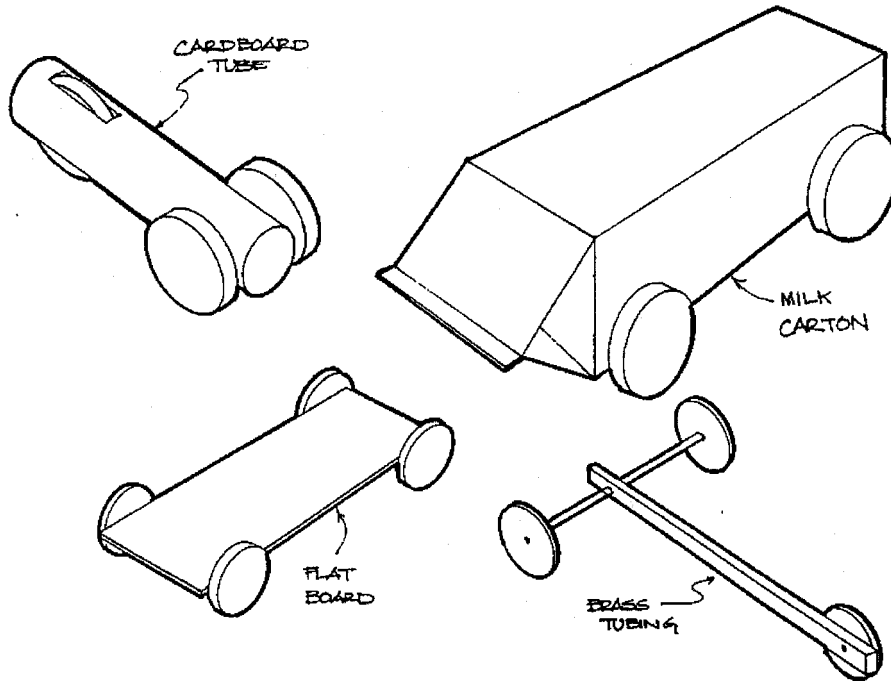

Concepts: Weight and Stiffness

One thing you will discover when you build your solar car is that designing and building involves tradeoffs. There is no ideal design. This is true with the chassis of your car.

One obvious consideration is that you don't want your car too heavy. It is easier for your motor to push a light car than a big, heavy one. In solar cars, efficiency is very important, and you don't want to waste energy.

But something you must also keep in mind is that a light car can be pushed easily by the wind too. Even if the wind does not blow the car over, it may make it harder to go in a straight line. (This depends not only on the weight, but on where the weight aerodynamics in a later section.)



Materials

In most cases it is more difficult to make the car light enough (you can always add a little ballast anyway) so in this section we will emphasize lightweight materials and construction. The first step to a lightweight chassis is choosing the right materials. Balsa wood, for example, is a commonly chosen material because it is lightweight. But more importantly, is fairly stiff for its weight.

What is the difference between strong and stiff? Strong means it will not break easily. Stiff means it will not bend easily.

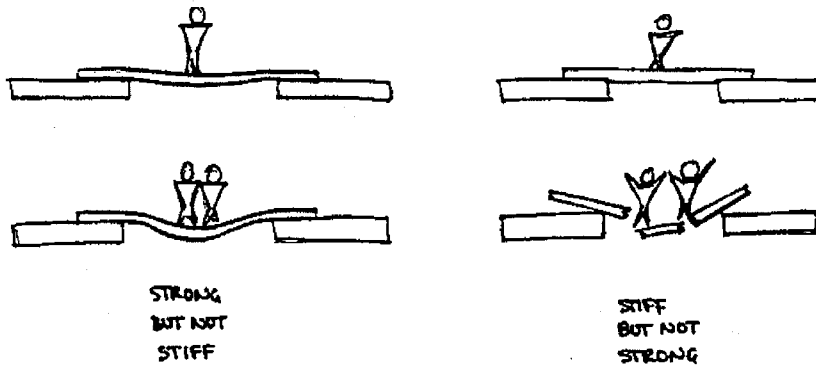

For the solar car, stiffness is very important. Stiff, light materials include Styrofoam, foam core, balsa wood, corrugated cardboard, and some plastics.

Shape

Some heavier materials are also appropriate if they are constructed correctly. Let's try an experiment. Place two books side by side and out 6 inches apart. Now place a piece of paper across the two books. What happens?

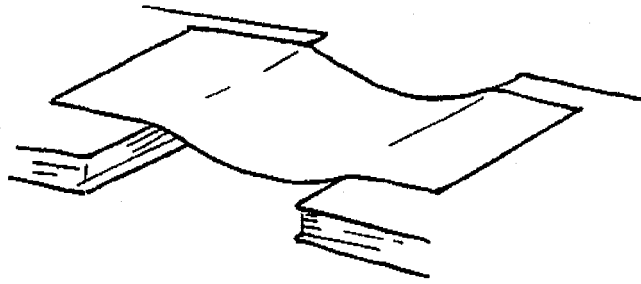

The paper is not stiff, so it bends in the middle. Now, fold the same piece of paper in thirds, like a “u” (see drawing) and put it back across the books. Now what happens?

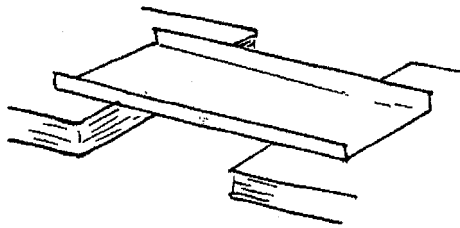

The paper is not any heavier, but it is much stiffer now because of its shape. Try other shapes and see how stiff they are:

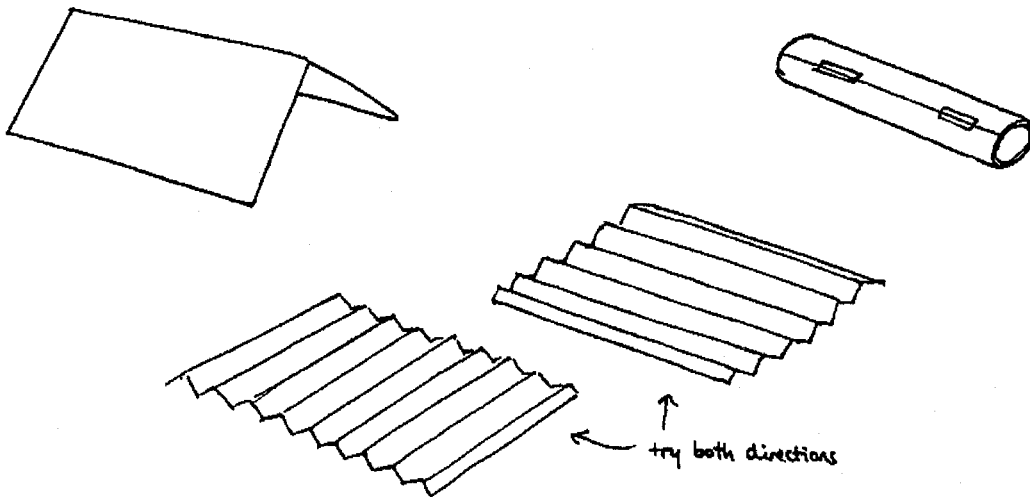

And in this way engineers can stiffen flexible material -- or use less of a heavier material -- with just a change of shape! Look at a cardboard box. Why is the inside “corrugated”?

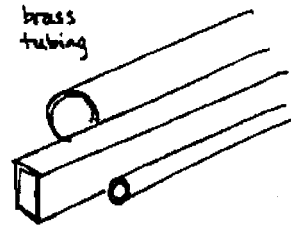
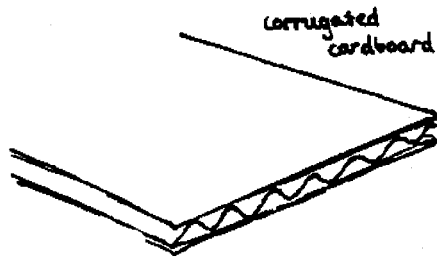

Other materials are made stiffer or stronger by sandwiching them between other materials.

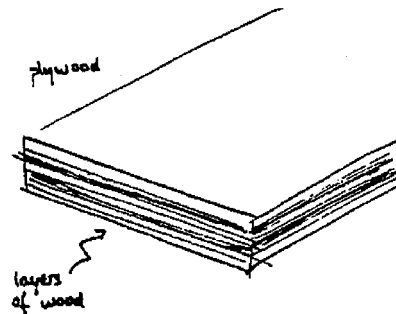
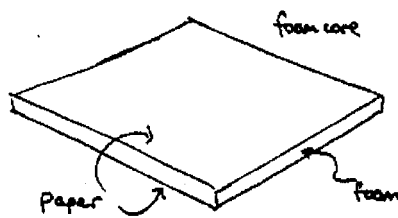

Orientation

As you saw with the folded pieces of paper, orientation is also very important in determining stiffness. Take an ordinary wood or plastic ruler. Try to bend it both directions.

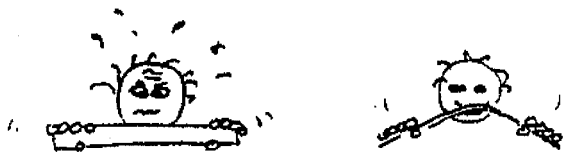

It is easier to bend it the thin way, of course.

Imagine you wish to stiffen your chassis by adding ribs. You glue two strips of materials to the bottom of the chassis like this:

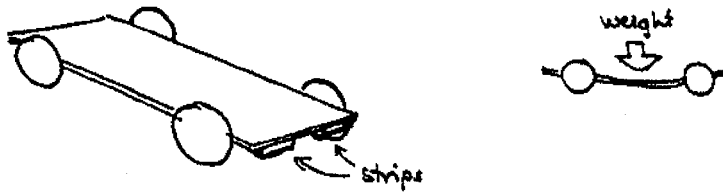

Unfortunately, that didn't seem to do the trick -- the chassis still sags. Your partner insists that adding more strips of material will help, but you know that this is not necessary. You have a better idea! What is your idea?

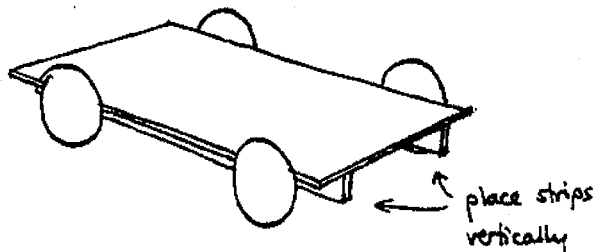

Well, if you turn the strips sideways (remember which way the ruler was stiffer), your chassis will be much stiffer ... without adding material!

So, as you can see, if you are smart about your material selection -- and you remember the importance of shape and orientation of the materials -- you will have much more control over the weight of your solar car.

Materials

Any material that is light and stiff would be appropriate. Some hollow and tube like pieces are very stiff for their weight. Arts and crafts stores and hobby stores are good sources. Some stores have scrap materials like cardboard. Or, look around your house for scraps. Some materials we found that are useful are:

- stiff insulating foam (large hardware store or home improvement center)
- foam core (like the back of your solar panel -- try arts and crafts stores)
- balsa wood (a&c or hobby stores)
- brass tubing (a&c or hobby)
- cardboard tube (scrap from a&c store)
- shoe box
- soda bottle
- rigid plastic
- corrugated cardboard (scrap from boxes)

Wheels and Bearings

Purpose

Wheels support the chassis and allow the car to roll forward. Bearings support the wheel while allowing them to rotate.

Ideas

Wheels can be large, small, narrow, wide...here are some ideas to start you thinking:

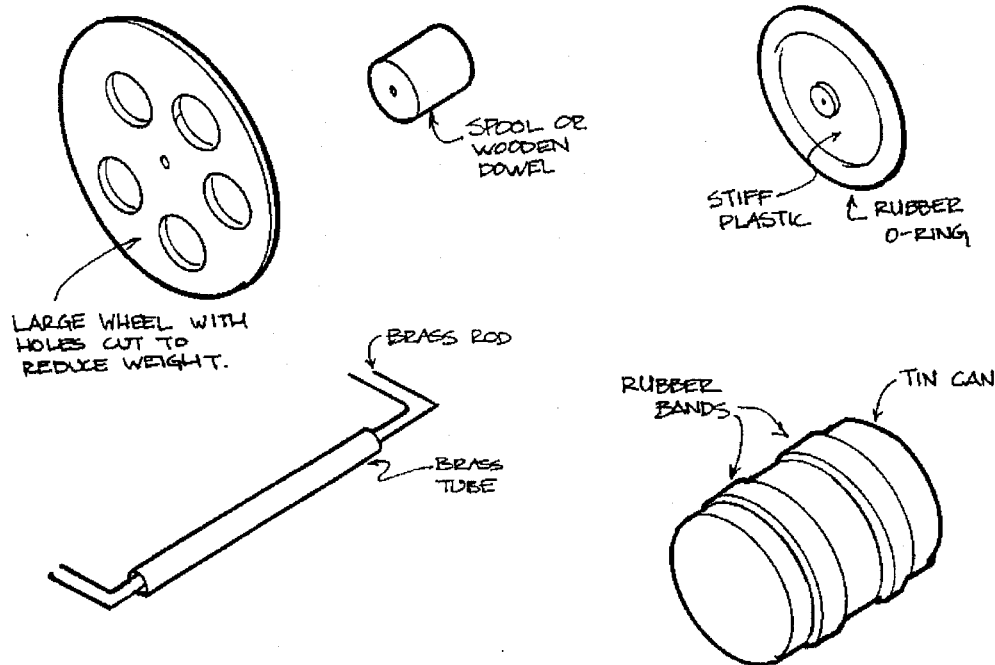

Concept: Friction

Friction keeps things from sliding against each other. When you build your cars, there are some parts that you want to slide easily, and there are other parts you don't want to slide at all.

Tire Traction

When you have two things that must roll against each other, like a wheel rolling along the road, friction keeps them from slipping. This type of friction is also called "traction," and is important to remember when building your wheels.

Why do mountain bikes have big, fat knobby tires? If you have to bike up a muddy hill covered with leaves, your tires will slip if they don't have enough traction. And the big knobs of rubber can grip onto the dirt and rocks and keep the tires from slipping on the ground.



MOUNTAIN BIKE

(Another reason for the thick tires, too, is because they are more rugged and can take the abuse from the trail!)

Now, the question is, why don't racing bicycles have fat, knobby tires if these wheels have good traction? Once again, there is a tradeoff in designing a wheel.

Mountain bike tires have two main disadvantages. The first disadvantage is the thick, knobby rubber which gives them such great traction also makes them inefficient. Every time a rubber "knob" is compressed and bent by the road, energy is lost. Where does this energy go? If you have ever felt an automobile tire after it has been on the road, you probably noticed that it was hot. The energy it took to compress the rubber and air in the tire was lost as heat.

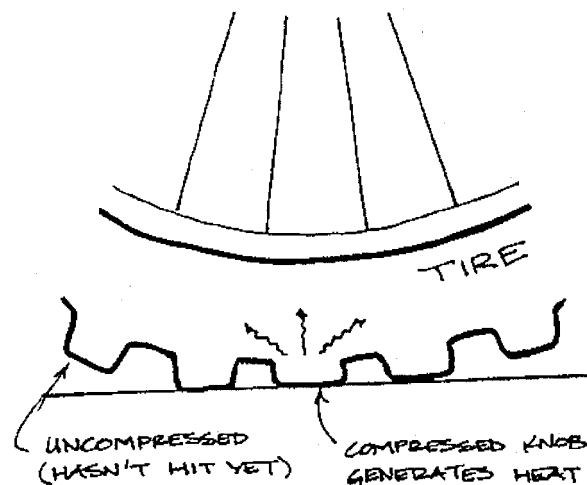

The other main disadvantage of mountain bike tires is their weight. Weight in tires is actually more difficult to move than weight in the chassis. Weight in the chassis has to be moved forward, but the weight in the wheels has to be moved forward and around in a

circle. The heavier the wheel, the more energy it takes to get the wheel turning. Surprisingly, the bigger the wheel diameter (even if it is the same weight), the more energy it takes to get the wheel turning.

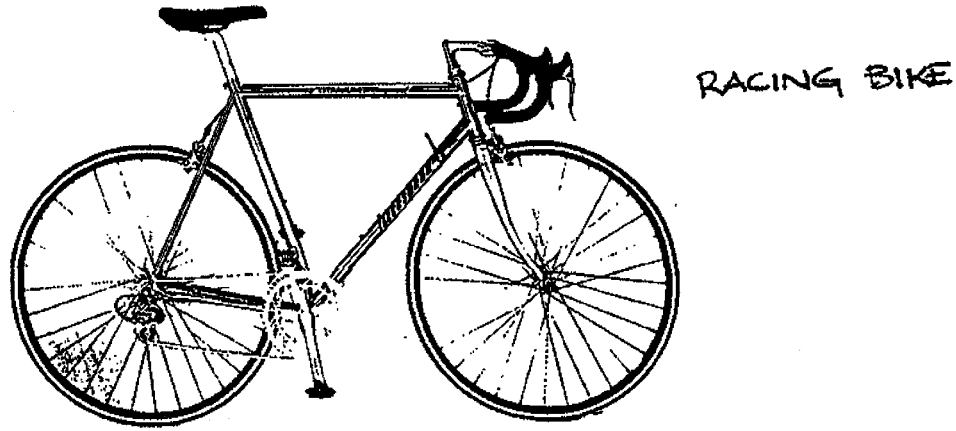

So, racing bicycles do not have mountain bike tires, because traction is not as important. But what is important is efficiency, so that the bicyclist does not need to expend a lot of energy. The bicycle designers have made a conscious decision to use different tires designed for efficiency and not traction.

Weight Distribution and Traction

Imagine your rear-wheel-drive solar car has trouble -- its back wheels are slipping. Your partner suggests adding some rubber bands around the wheels to increase traction, and you agree.

The rear wheel still slips some. Your other partner wants to add some weight to the car, like this:

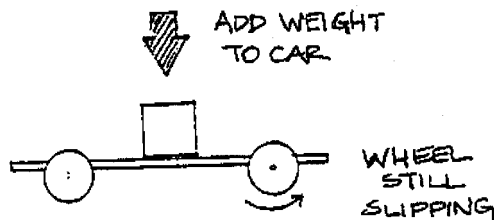

But it doesn't work. You tell him you have a better idea. You move the existing weight, and now it works! Why?

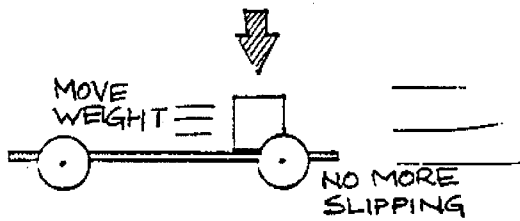

Remember that all of the force is transmitted through the driven wheels, so the moved weight increased the traction where it was needed. Weight distribution is very important, since you can increase traction just by moving existing weight from one part of the car to the other.

Have you ever heard that front wheel drive cars are better in snow and ice than rear wheel drive vehicles? Front wheel drive cars aren't heavier. But the engine is very heavy and is located above the front wheel. This helps traction in front wheel drive cars because the weight is right above the driven wheels.

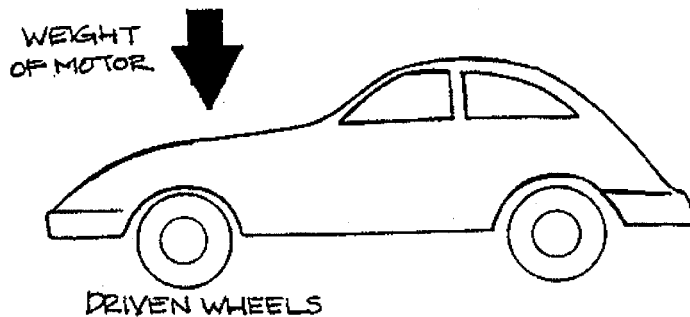

So, in summary, traction is important for transmitting the forces from the wheels to the road. If any of your wheels are spinning rather than rolling, you probably need more traction. Traction can be increased by adding a non-slip material around the wheels (like a tire) or by moving weight over the driven wheels. But, remember, it is also important to have efficient wheels, which are usually thin and lightweight.

Bearings

When you have two things rubbing against each other and you want them to move freely, friction slows things down and wastes energy. For example, try sliding a coin and an eraser across the table. The reason the coin slides much more easily is there is less friction between the coin and the table than there is between the eraser and the table.

One case where friction is very undesirable is in the wheel axle. The axle must be supported and attached to the chassis, but still must be able to turn. Components which all the relative motion of two parts are called bearings. Some ideas bearings are sketched on the next page:

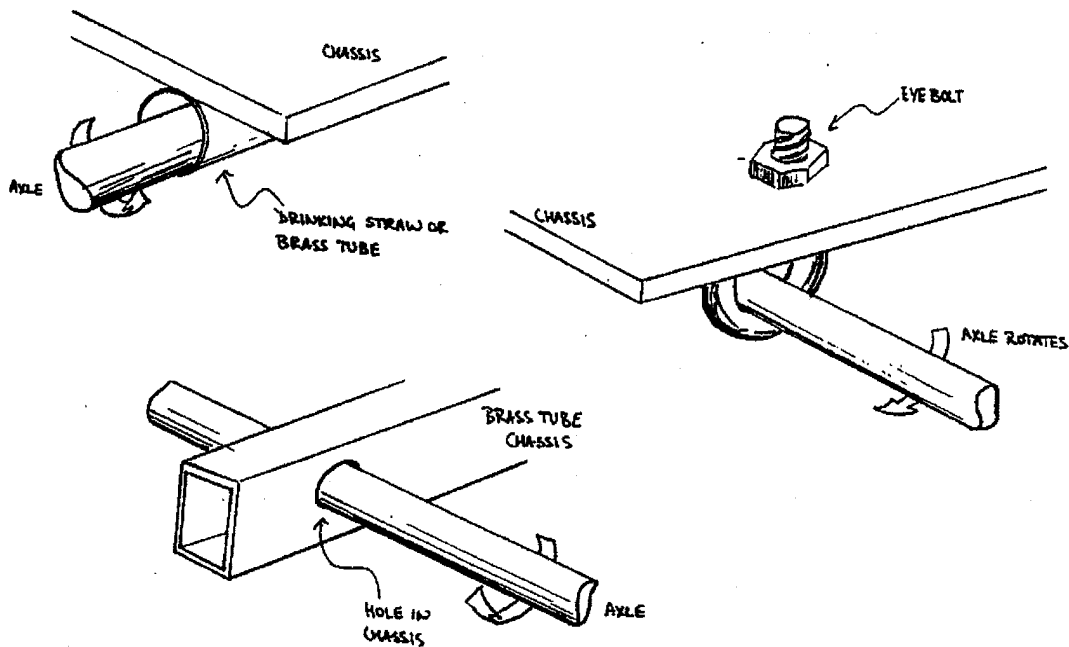

Look at a bicycle or a Roller Blade. Hold it above the ground and spin one of the wheels. Between each wheel and its center axle is a type of bearing called a “ball bearing.” The bearing holds the wheel on the axle, but reduces the friction between them, so the wheel can spin for a long time without slowing down.

Lubrication

Lubrication helps parts slide against each other, so it is used in bearings to reduce friction.

Let’s try a small experiment. Rub your hands together very lightly and quickly. Your hands should feel warm. Where is the heat coming from? There is friction between your hands, and some of the energy you expend rubbing is turned into heat. If you put a lot of hand lotion or cream between your hands and rub, your hands slide more easily and should not get as warm. That is because the lotion acts as a lubricant.

Different lubricants work better with different materials. In the case of machines, one generally uses oil or grease to help the parts slide together easily. On a water slide, the water acts as a lubricant. If you bake cookies, a little oil or butter on the cookie sheet keeps the cookies from sticking.

Some appropriate lubricants for the solar car bearings may be light oil, light grease, or graphite powder (crushed pencil lead). Try various lubricants and see which ones work best in your car.

Wheel Alignment

Another problem that wastes energy is poor wheel alignment. When the wheels on your vehicle are not lined up properly, some of the wheels must slide sideways. One way this might happen is sketched below.

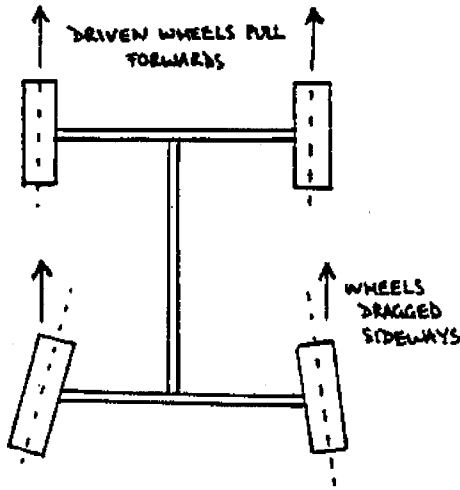

When the driven wheels try to pull the car one way, but the rest of the car wants to roll the other way, the traction in the wheels (normally a good thing) wastes quite a bit of energy.

Also, make sure that the axle goes through the center of the wheel. One suggestion is to use a compass, rather than tracing a circle, if you cut a circle out of a material. The compass will show you where the center of the circle is.

Taking time to align the wheels carefully the first time will make a huge difference in how well your car runs.

Materials

For wheels: Look around for anything round, or things which can be cut into circular shapes...look at home, arts and crafts stores, and hardware stores. Hobby stores sell model wheels, but they are more expensive and are not designed for building a solar car. They may be much too heavy. Some materials we found were:

thin plywood
foam core
Styrofoam
toy/model wheels
tape spool
brass tube
wood dowels

balsa wood
stiff plastic sheet
cardboard tubes
tin can
thread spool
plastic pipe

For traction: Things that are rough or rubber-like usually add traction. A few things we found were:

- rubber o-rings (hardware store)
- rubber bands
- rubber sheet
- cloth tape
- silicone or other caulking (hardware store)

For axle: The axle must be stiff, narrow and round. Some ideas:

- nails
- brass rod
- brass tubing
- coat-hanger wire

For bearing: Some ideas of things that would support the axle:

- Screw eyes/eyebolts (hardware store)
- brass tubing
- hard material (wood, aluminum, etc.) with a hole drilled into it
- brackets with screw holes pre-drilled
- holes drilled directly into the chassis

Power Source: The Solar Panel and Electric Motor

Purpose

The purpose of the solar panel is to capture energy from the sun and to turn this energy into electrical energy. The electric motor then uses this electrical energy to power the wheel of the solar car.

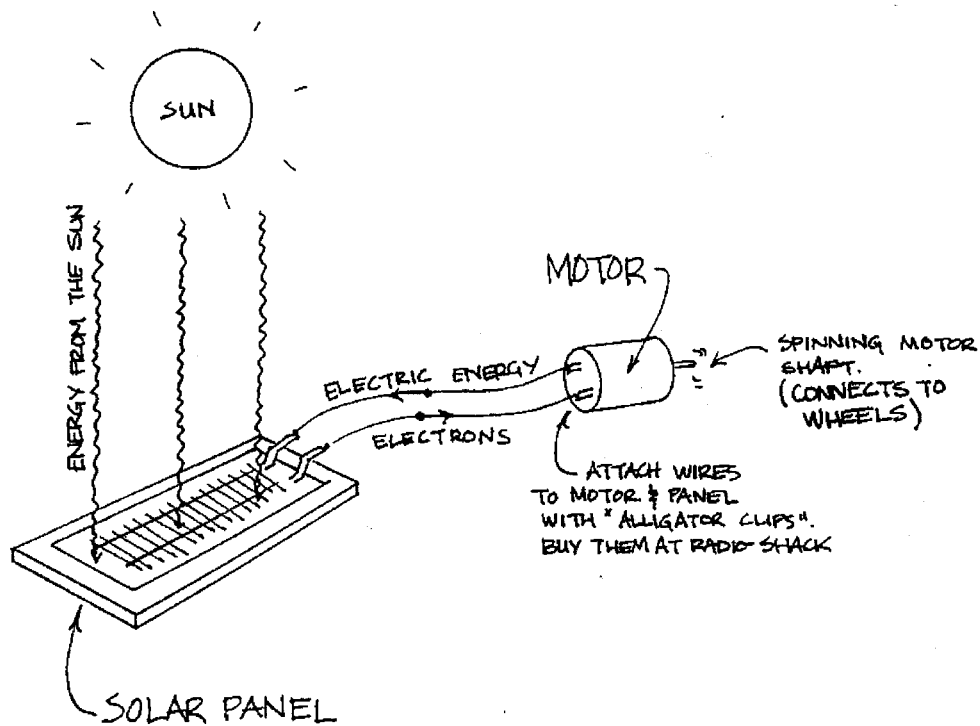

Concept: Solar Power

How the Solar Panel Works

When you look at the picture above, you might ask, “How does the solar panel turn the sun’s energy into electric energy?”

The solar panel is made of a sandwich of two materials called *semiconductors*. Each material is made of millions of atoms. As you might already know, atoms have a positively charged *nucleus*, and negatively charged *electrons*, which spin around the nucleus. When these two materials are put together in a sandwich, an interesting thing happens: electrons become pulled from the bottom half of the sandwich to the top half. But there’s a problem. The electrons are all attached to atoms, and the atoms won’t let go very easily. This is where the sun’s energy helps out. If we shine sunlight on these materials, the sunlight has enough energy to knock the electrons off of the atoms. The electrons will then be free to be pulled to the top of the sandwich.

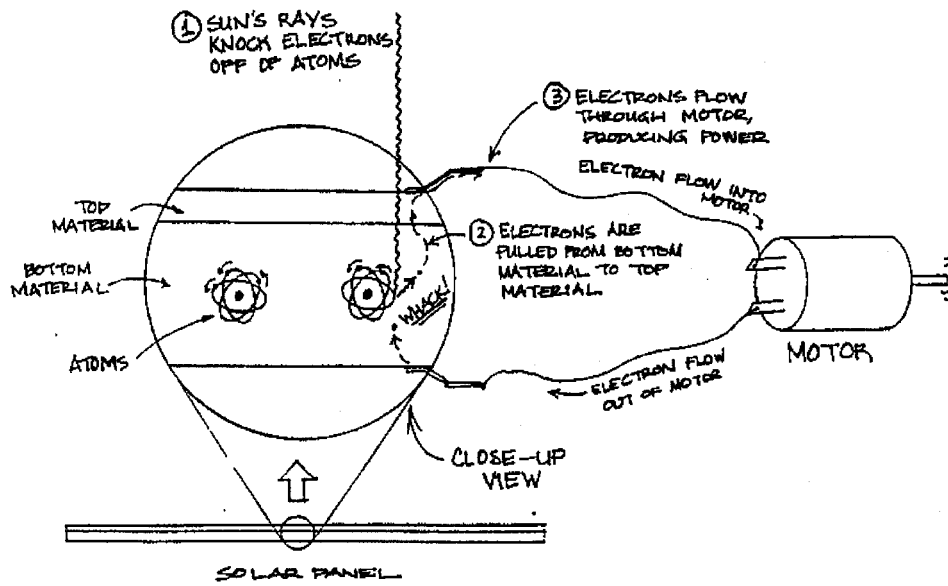

Now if we connect wires to a motor, electrons will flow through the wire into the motor (making it spin) and back through another wire to the solar panel where they can fill the “holes” left in the atoms who lost their electrons.

Power

How does such a solar panel create power? To understand power more clearly, let’s look at a mechanical example to illustrate the main ideas. For example, imagine a water wheel, like the one on the next page:

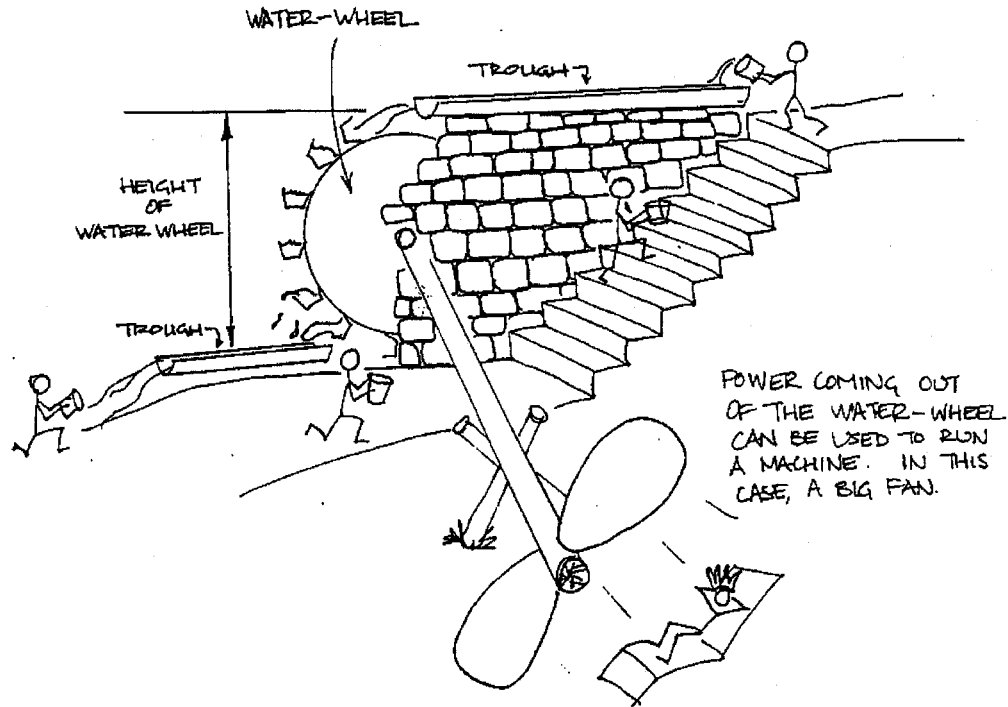

This doesn't look very much like a solar panel and motor, but we'll see that in many ways they're actually quite alike. In this example, people have to climb stairs to carry buckets of water up a hill, and then pour the water into a trough. The water flows down over a water-wheel, which has buckets attached to it that catch the water. The weight of the water in the buckets is what makes the wheel spin. Now, we can use the power of the spinning wheel to run a machine, like the big fan in the picture.

For the water-wheel, the *power* coming out depends on two things:

- 1) How *high* the water falls, and
- 2) How *much* water (how many buckets) is poured over the wheel.

In fact, the power you get is:

$$\text{Power} = \text{Height} \times \text{Amount of water}$$

The larger the height of the wheel, the more power we get, and the more buckets of water we pour over the wheel, the more power we get.

Now let's think about the solar panel and the motor. Imagine that the electrons are buckets of water, the wires are like the troughs, and the electric motor is the water wheel. In the solar panel, the sun's energy is used to carry the electrons up an electric "hill" inside

the solar panel, then they are poured down through the motor. So, if we drew the picture again for the solar panel, it would look like this:

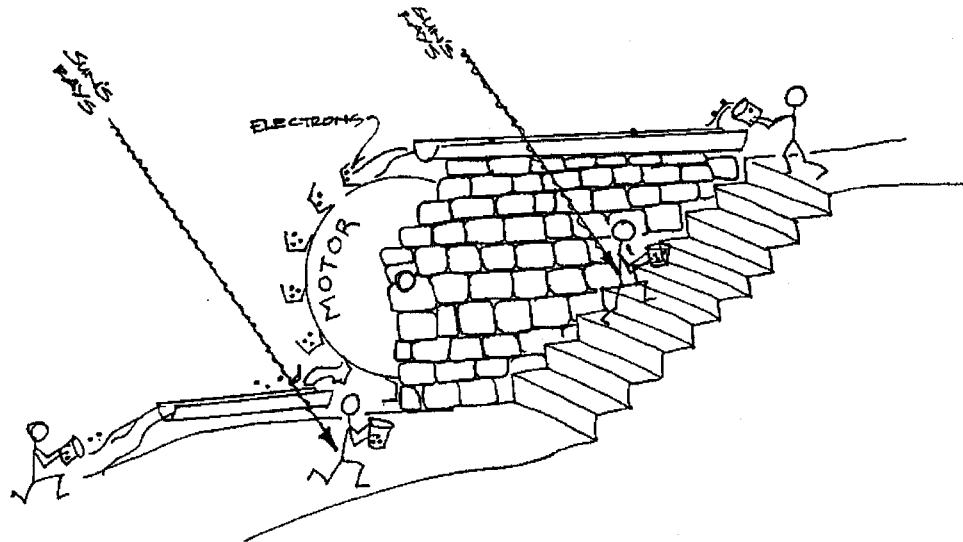

In the solar panel, a very similar equation for power is true as for the water wheel. But instead of height, we have what is called *voltage*, and instead of buckets of water, we have *electric current* (or the number of electrons flowing through the motor).

The *power* coming out of the solar panel is the product of the voltage and the number of electrons flowing (the current):

$$\text{Power} = \text{Voltage} \times \text{Current}$$

Maximizing Power

How can we build the solar car so it gives us the most power from the solar panel? One way is to try to get the solar panel to produce more current. To produce current, more electrons need to be forced to move inside the panel. If more sunlight hits the solar panel, more electrons are knocked away from atoms in the solar panel and more current is then produced!

How can we do this? One way is to tilt the solar panel towards the sun. The more of the sun's rays hit the panel, the more current will flow and the more power will be produced. Think of the following two cars:

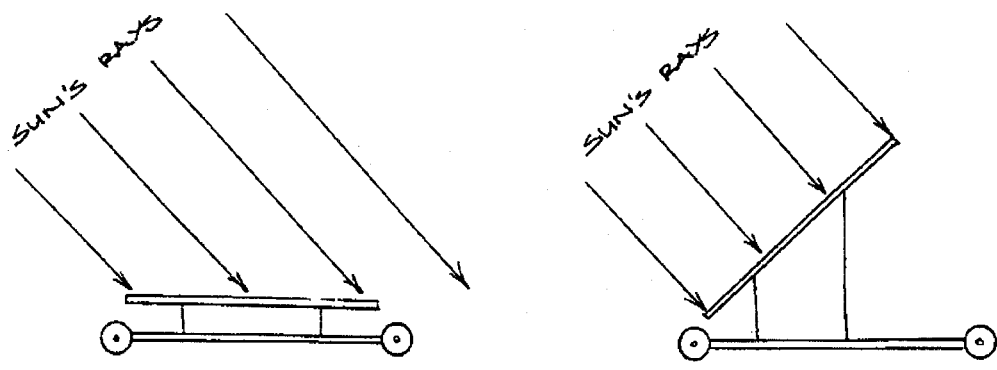

Which one would have more power? In this case, car B would, because it has more sunlight hitting it than A does:

Of course, the best way to tell if this will affect your car is to try it with the solar panel mounted at different angles -- experiments are the best way to find out.

Another idea that you might want to experiment with is using a reflector to capture more sunlight with the solar panel.

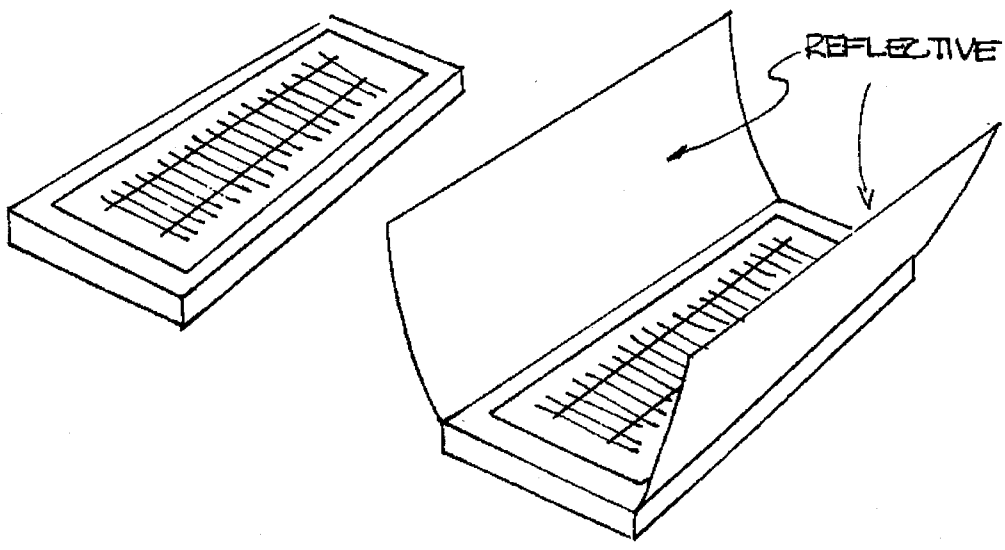

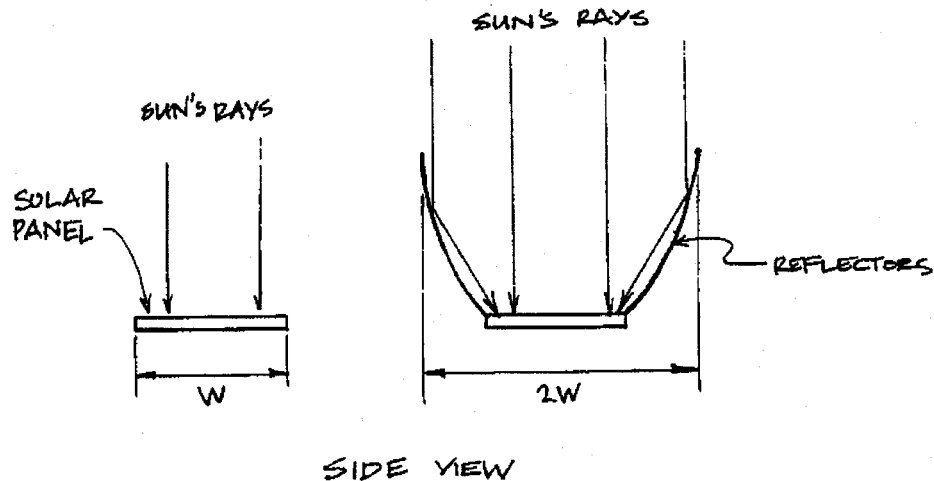

On the right, a reflector that is twice as wide as the solar panel could be made to direct twice as much sunlight to it. This would double the current coming out of the solar panel and double its power!

The disadvantage is that the car would be heavier with a reflector, and a heavier car will be harder to move. Also the reflectors might add air drag or get caught in side winds causing the car to top over. But, as usual, the only real way to find out is to build one and see!

Transmission

Purpose

A car's transmission transfers the power from the motor to the wheels. While doing so, it may make the wheels spin at a different speed than the motor.

Ideas

There are different ways to transfer power from the motor to the wheels. Some popular techniques are direct drive, friction drive, belt drive, chain drive, and gears.

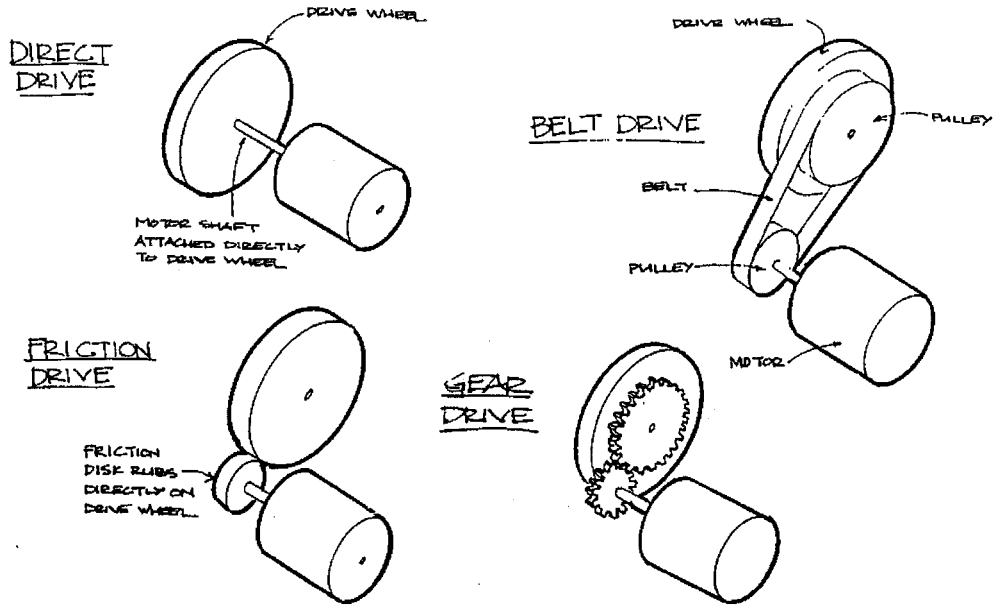

Some transmissions are easier to build than others, and not all are appropriate for a solar car.

Concept: Speed vs. Force

The most simple type of transmission is direct drive, which means the motor is connected directly to the axle of the driven wheel. Direct drives are not common in vehicles; one of the few vehicles that uses direct drive is a unicycle. Every time your feet make one revolution, the front wheel makes one revolution.

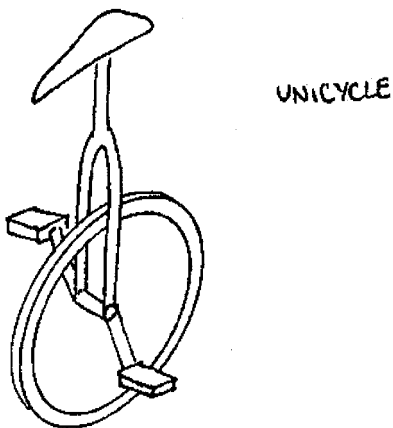

Speed

Imagine two of your neighbors have a unicycle race. Bruce's unicycle has a regular wheel, and Karen's has a very large wheel. If they both pedal the same rate, which one of them will win?

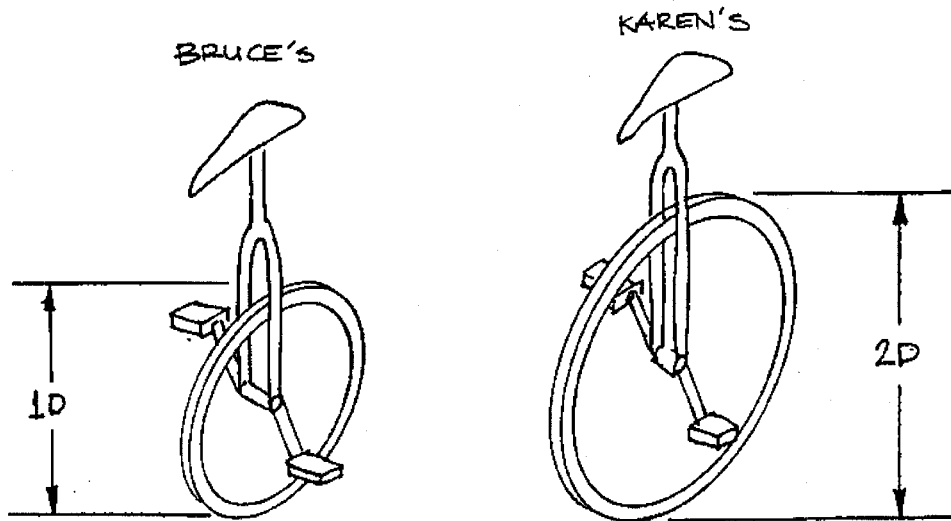

In both cases, each revolution of the pedal means one revolution of the wheel. BUT, one revolution of Karen's wheel will roll twice as far as Bruce's. So Karen would win if they pedaled at the same rate. If Bruce wanted to win, he would have to pedal twice as fast as Karen.

Have you ever seen pictures of very old bicycles that have huge front wheels? These bicycles allowed the rider to go faster without pedaling like a maniac!

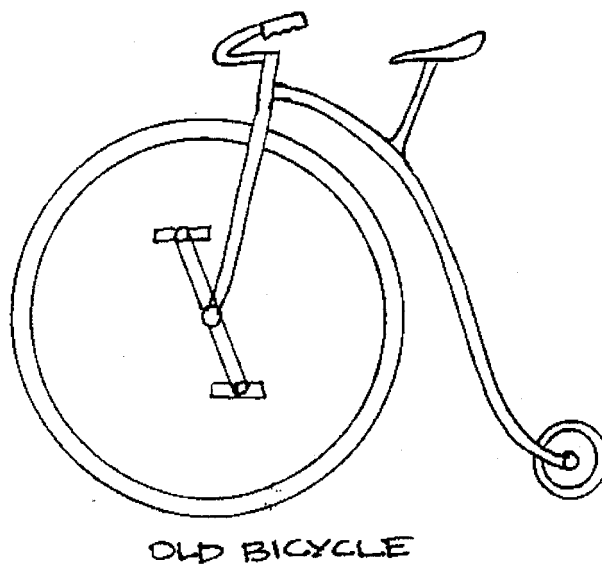

As mentioned before, most vehicles are not direct drive, so let's look at another type of vehicle: a 3-speed bicycle. A bicycle uses a chain drive. It allows you to move the pedals, and the chain transfers the energy from the pedals to the rear wheel.

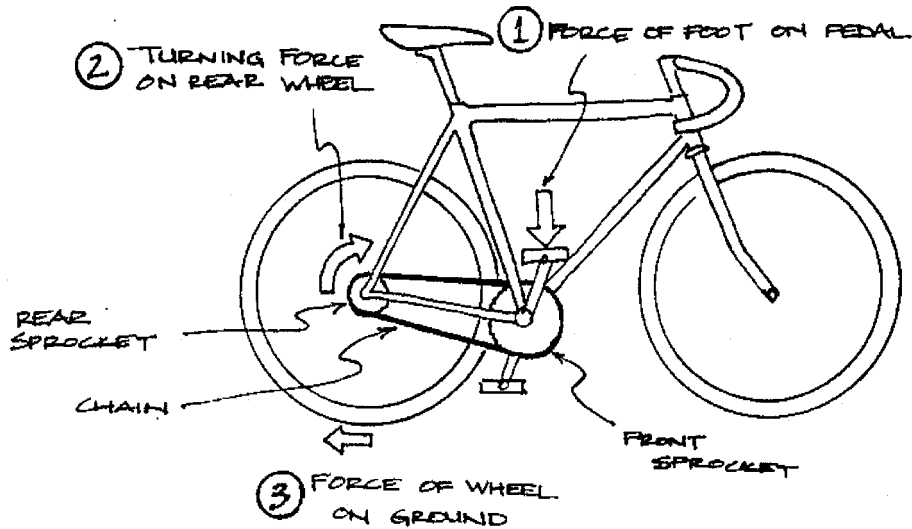

The chain glides over different sized sprockets, depending on the speed of the rider. Which sprocket combination will make the rider go the fastest, given the same pedaling rate, or cadence? (Hint: how many times will the back sprocket (and therefore the back wheel) turn with each rotation of the front sprocket?)

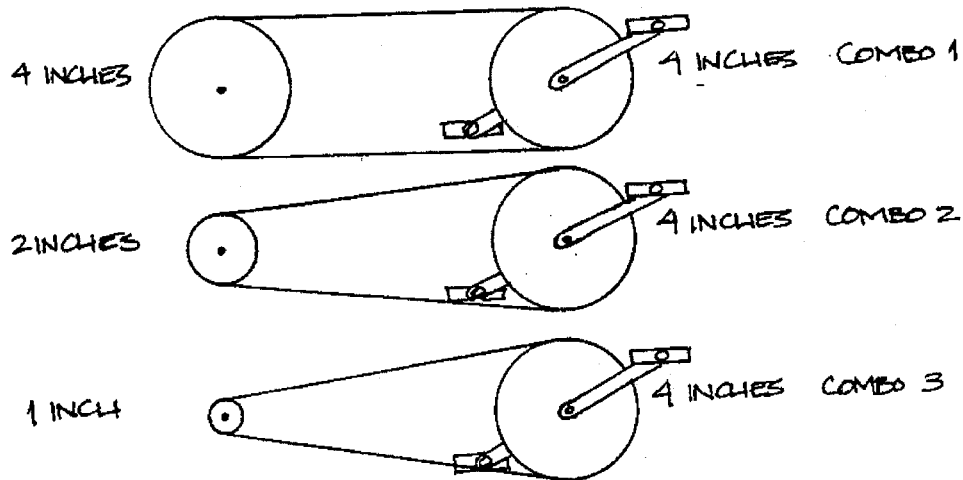

Each rotation of the front sprocket will make the back wheel rotate once in combo 1, twice in combo 2, and four times in combo 3. So, combination 3 will go the fastest. (these sprocket combinations can also be called *gear ratios*, because the new speed is calculated as the ratio of the driven (front) sprocket over the back sprocket.)

So how does this affect the way a biker would use the bicycle? Well, when she starts out, she starts in first gear (combo 1). As she pedals faster, the bike starts going faster. After a while, her legs are moving very fast, so she switched to second gear (combo 2). Now her legs only go half as fast as a second ago, but the bike is still going fast. She can increase her cadence again and make the bike go even faster. Once her cadence is very high again, she can shift up to third gear (combo 3).

If she was going 5 miles per hour in first gear, how fast is she going in third gear with the same pedaling rate?

Well, the jump from first to second gear doubles the speed, and the step from second to third gear doubles it again. So, she is going four times as fast as in first gear. She is now going 20 miles per hour, but her legs are going the same rate as at the very beginning.

The term “3-speed” bike is not entirely correct, because a biker can go more than just three different speeds. As we saw in the previous example, our biker was able to continuously speed up from 5 mph to 20 mph. But the name comes from the fact that given one cadence, the three gear ratios will give you three different speeds. Of course, your legs can pedal at many different rates, but ”3-speed” bike sounds better than “3-gear ratio” bike.

Force

You may ask, then, why isn't it the best to go for the highest speed possible? Well, you can't get something for nothing! So what are you giving up when you gain speed? Let's investigate...

Imagine two bikers approaching a very steep hill. Jeff and Dave are both in third gear, because they are going very fast. Dave downshifts into second. But Jeff decides to stay in third gear, because he knows that third gear is for going fast, and he wants to go up this hill very fast.

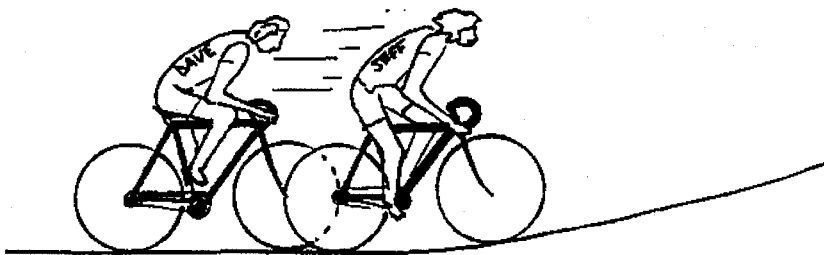

Dave is going half the speed now, because he just downshifted. Jeff smirks as he blows by Dave. But Jeff hits the hill, and he suddenly realizes that his legs can't go very fast anymore -- it becomes very hard to pedal! He gets slower and slower, and finally stops pedaling because it's too hard. Dave passes, slowly but surely, and makes it to the top of the hill. Jeff now owes him a new pair of bicycling gloves!

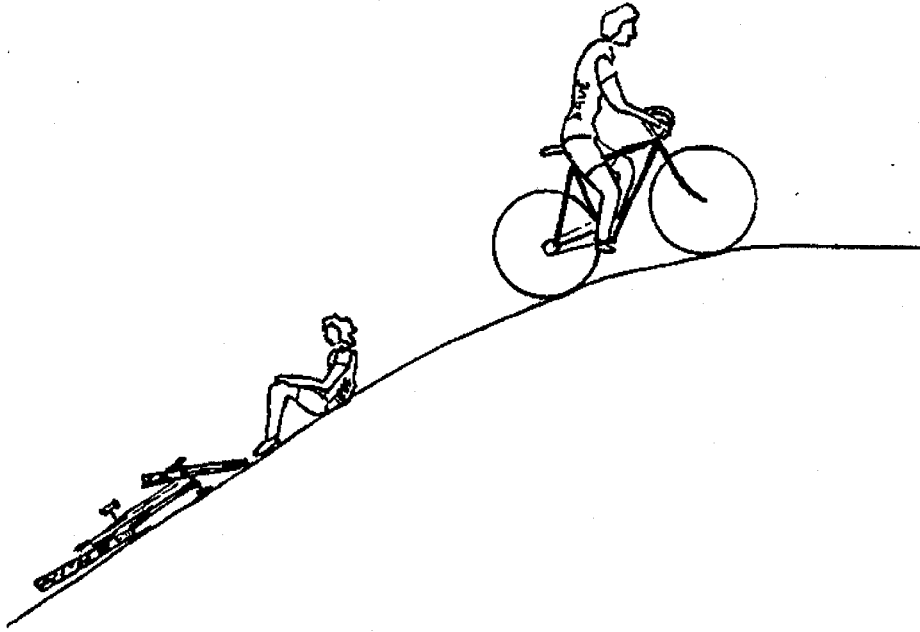

What happened? If only Jeff could've kept pedaling at the same rate, he would've beat Dave by a mile! Let's look at each pedal stroke. Each time Dave and Jeff pedal once, Dave's back wheel goes around once (let's say it travels 10 feet), but Jeff's back wheel goes around twice (20 feet).

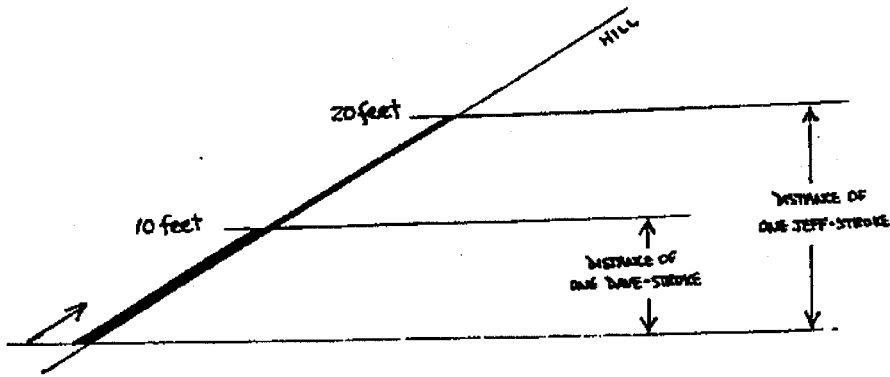

Dave realizes that he only has to expend half the energy per pedal revolution than Jeff does, because Jeff goes twice as far each time. That is why Jeff started getting very tired, because his pedals were difficult to push. In other words, his pedals required more force than Dave's did.

So does Dave expend less energy going up the same hill?

Dave expends half the energy per pedal revolution, but this is only because he goes half the distance per pedal revolution. Dave has to pedal twice as many times to get up the hill. So, the energy expended both Dave and Jeff going up the entire hill is the SAME in either case.

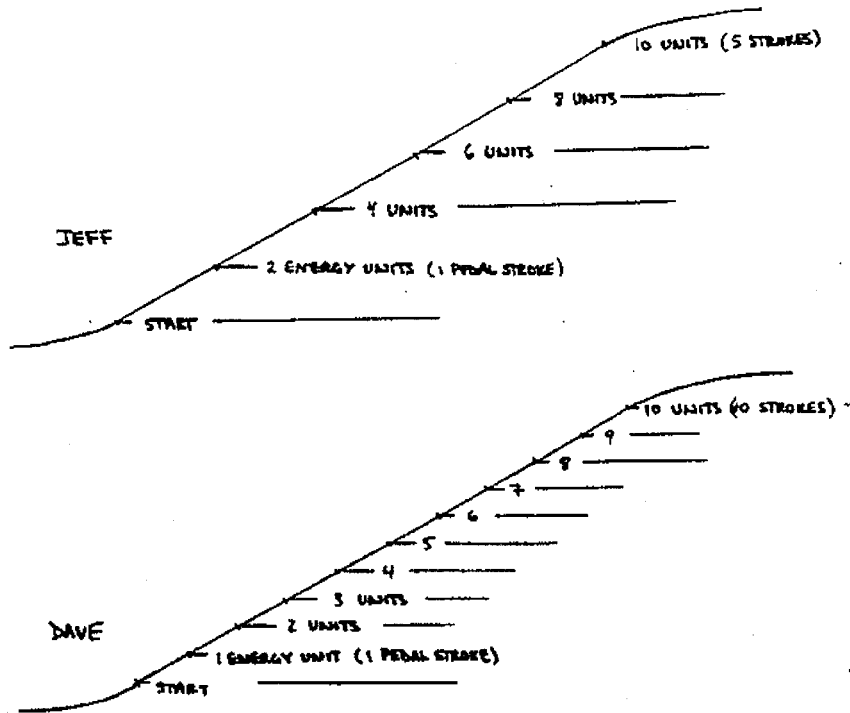

So, the bottom line is, when we gain a speed advantage, we are losing the force advantage. The pedals are more difficult to turn. You can gain either speed or force advantage, but not at the same time.

Selecting the Proper Gear Ratio

So, how can you choose the best gear ratio? Experimentation is probably the easiest way to find out.

The idea is that your motor, like your legs when you ride a bike, like to go a certain speed. They also have a limit as to how much force they can exert. First you must find the speed at which the motor gives the most power (this is usually half the speed the motor will rotate if there is no load, or force, exerted on the motor shaft). Try to keep the motor turning at approximately that speed as you experiment with different gear ratios.

It helps if you build your car in such a way that you can change the gear ratios easily as you experiment. Remember, the ideal gear ratio may change some if you change different characteristics of your car (size, weight, etc.). Just remember, if your car is not going very

fast it can either be that the wheel speed is too slow, or (like Jeff riding uphill) the force required to turn the wheel is too high. Try a different gear ratio!

Materials

The materials you choose vary greatly depending on the type of transmission you build. If you decide to build a belt drive, try stiff, rubbery materials for the belt - such as a slice of inner tube or an o-ring. Make sure your pulleys are pulled away from each other so that the belt is tight. One suggestion: one way to change the gear ratio on a pulley drive is to add or remove masking tape around the pulley, which changes its diameter.

If you use a friction drive, make sure you have enough traction on the *friction disk*, or it will slip (see the materials section for wheels and bearings). Also, make sure the friction gears are pressed against each other snugly to ensure traction.

In all cases, you will need wheel like parts to put on the motor shaft and the wheel, and you can get ideas from reading the suggestions for wheel materials.

Body/Shell

Purpose

The body or shell of a real car has several purposes. It protects the passengers from wind and rain, it provides added safety in case of a crash, and it improves how the car looks. But it also changes how the car performs because a well designed shell can reduce the force of air on the car as it moves.

Ideas

Some ideas for shells are given below:

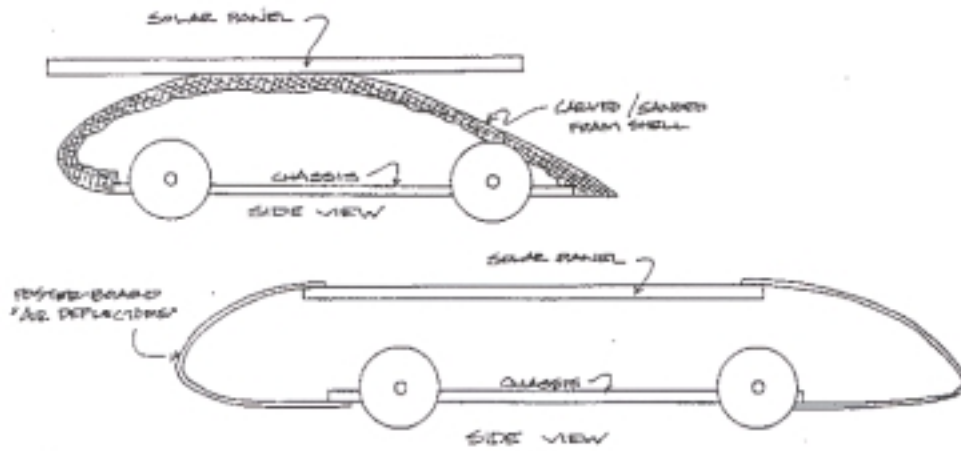
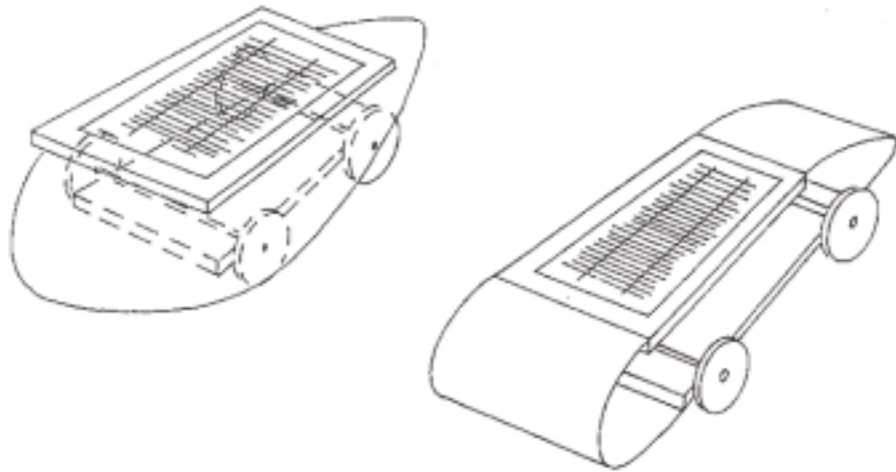

Concept: Aerodynamics

To see how much force air can have, you can try some simple experiments. While driving in a car, try (carefully!) holding your hand flat, and sticking it out of the window. Feel how much force the air has on your hand. What happens to the force when you tilt your hand?

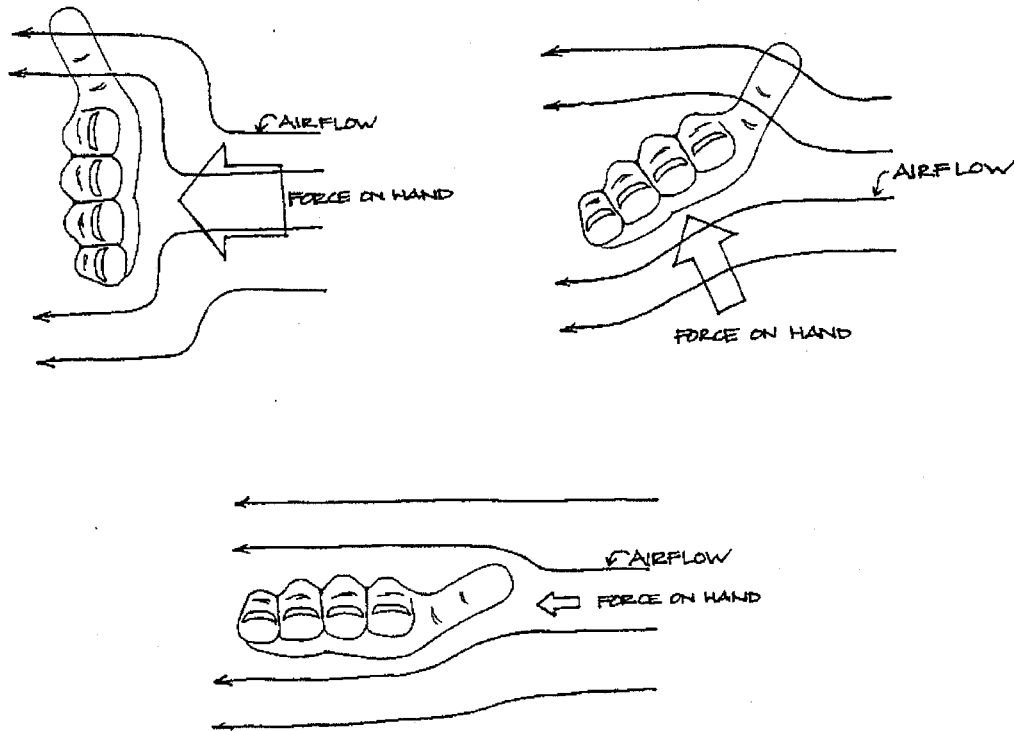

Or while riding a bike down hill, compare how fast you can go while sitting upright, or leaning forward. If you crouch down, the air can go over you instead of hitting you in the chest, so you should be able to go faster. In either words, the force of the air on your body when you crouch down is less, so you are more *aerodynamic*.

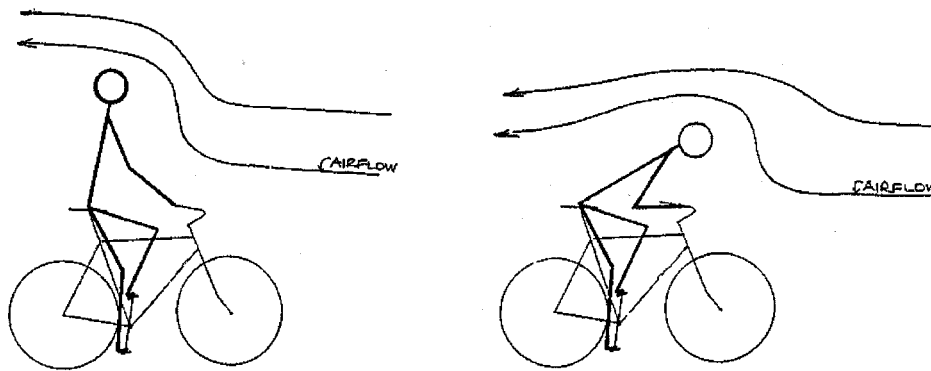

Look at things that move through the air, and notice how they are shaped:

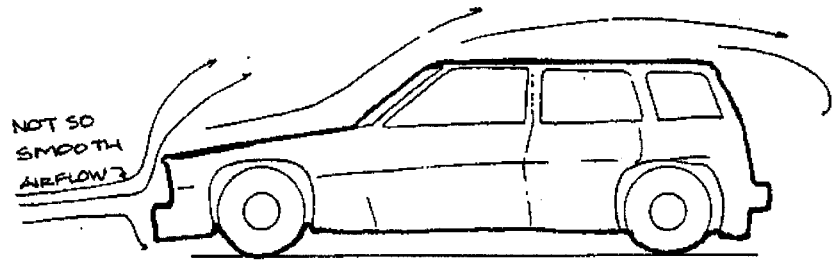
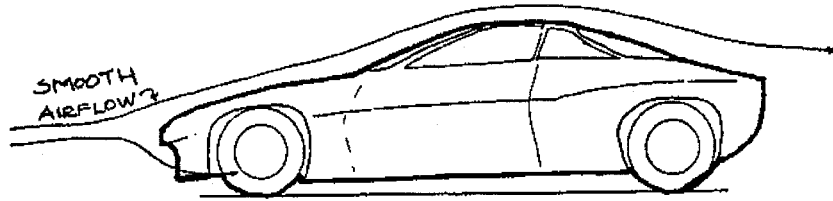

Fast cars are shaped so that, when moving quickly, they can cut more easily through the air. As another example, you may have seen tractor-trailer trucks with big air deflectors on them. The reason for this deflector is to make the truck more aerodynamic, so the truck's engine doesn't have to work as hard and the truck driver saves money on gas.

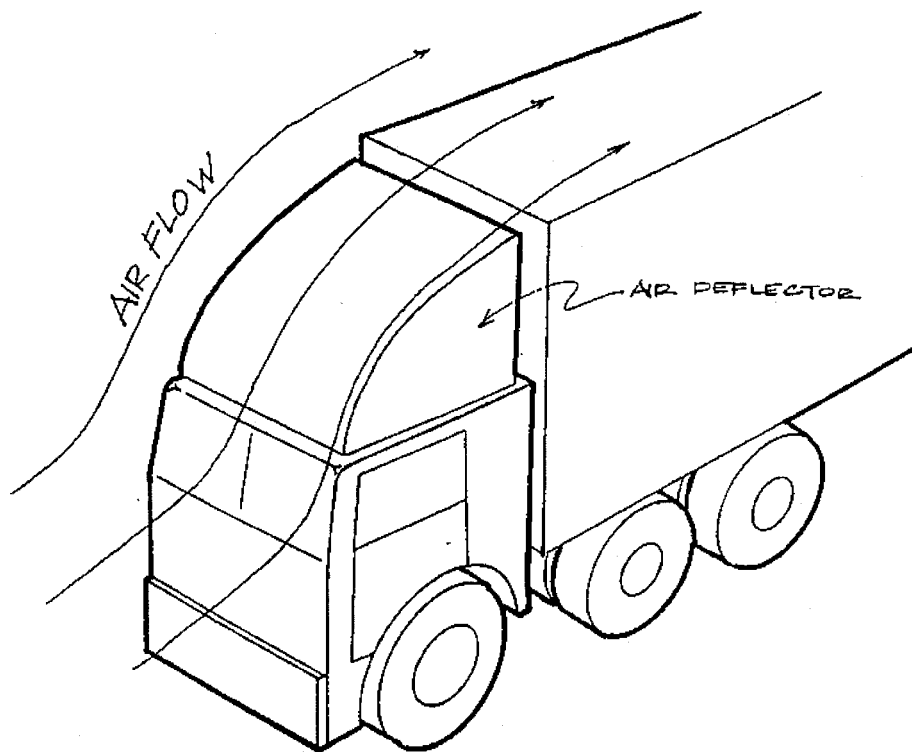

In some situations, the force of air helps you instead of hurting you. For example, what if you want to *slow down* very fast? How about using a parachute? Now the force of the air is helping you.

Materials

So how do you reduce the force of air on your solar car? One way might be to add a body or shell to it that deflects the air around the car. Some possible materials you might use are:

- poster board
- cardboard
- foam core
- stiff insulation foam (e.g. "Foamula" - can be bought at lumber stores)
- mylar or plastic sheet

Insulation foam can be carved to shape, made smooth with sandpaper, and even painted to look nice. (Warning: some paints, like spray paint, will "melt" foam, so always try your paint on a piece of scrap foam that you don't need before using it on the real thing.)