

# Photobiological Studies with Dioxetanes in Isolated DNA, Bacteria, and Mammalian Cells

by Waldemar Adam,\* Axel Beinhauer,\* Thomas Mosandl,\* Chantu Saha-Möller,\* Franklin Vargas,\* Bernd Epe,† Elvira Müller,† Dietmar Schiffmann,† and Dieter Wild†

1,2-Dioxetanes, efficient chemical sources of triplet excited carbonyl compounds, were observed to be genotoxic in isolated DNA, bacteria, and cultured mammalian cells. In superhelical DNA of bacteriophage PM2, various alkyl- and hydroxyalkyl-substituted dioxetanes (1) induced predominantly endonuclease-sensitive base modifications and only few single strand breaks. With a specific endonuclease a small fraction of the base modifications was identified as pyrimidine dimers. The psoralen dioxetane (2a) or PsD bound photochemically to calf thymus DNA at the  $\alpha$ -pyrone ring of psoralen (fluorescence measurements). Photobinding was also observed when calf thymus DNA was incubated with psoralen and 3-hydroxymethyl-3,4,4-trimethyl-1,2-dioxetane. In Syrian hamster embryo fibroblasts and HL-60 cells, dioxetanes induced DNA single strand breaks. The alkyl- and hydroxyalkyl-substituted dioxetanes 1 and 2 were efficiently inactivated by cysteine, glutathione, ascorbic acid, tocopherol, NADH and FADH<sub>2</sub>. While dioxetanes 1 and 2 were not mutagenic in *Salmonella typhimurium* strain TA100, benzofuran dioxetanes 3 exhibited substantial effects. Further data imply that presumably a mutagenic intermediate with a lifetime of a few minutes is produced from the benzofuran dioxetane.

## Introduction

It has been well established that electronically excited compounds, especially triplet ketones that are generated by optical excitation, cause DNA damage (1-3). The possible pathways of DNA damage by triplet ketones are summarized in Figure 1. These properties of triplet ketones suggest that 1,2-dioxetanes, which are efficient chemical sources (4) of triplet excited carbonyl compounds [Eq. (1)] (Table 1), should also induce DNA damage via the pathways outlined in Figure 1. Indeed, two years after the synthesis of the first dioxetane (5,6) in 1969, Lamola (7) showed that thermal decomposition of 3,3,4-trimethyl-1,2-dioxetane (TrMD) in the presence of calf thymus DNA led to thymine dimers. No further reports have appeared in the meantime concerning the genotoxicity of 1,2-dioxetanes, except recent results by Lown et al. (8) and by us (9-12). The photobiological activity of enzymatically generated triplet excited spe-

cies (11,13,14), postulated to be formed via dioxetane intermediates (13,15), should also be mentioned.

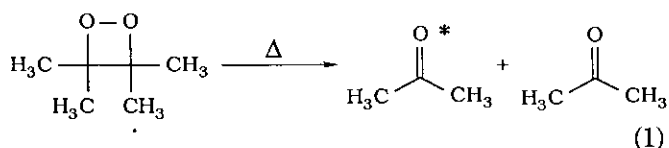

The involvement of excited states and radicals in tumor promotion (16,17) and in spontaneous mutation (18) has been proposed. To substantiate this proposal and to make a contribution to the mechanistic understanding of carcinogenesis and mutagenesis at the molecular level, we have been investigating intensively during the last 5 years the genotoxicity of dioxetanes, substances that possess the unique property of efficiently and selectively generating triplet excited carbonyl compounds on thermal decomposition. Here we summarize our recent results on the DNA damage caused by 1,2-dioxetanes in cell-free DNA (PM2 and calf thymus), mammalian cells (SHE, HL-60), and bacteria (*Salmonella typhimurium*).

## Preparation of the 1,2-Dioxetanes and Photophysical Data

Three different types of dioxetanes 1-3 (Fig. 2) have been employed for the genotoxicity investigations de-

\*Institute of Organic Chemistry, University of Würzburg, D-8700 Würzburg, Federal Republic of Germany.

†Institute of Toxicology, University of Würzburg, D-8700 Würzburg, Federal Republic of Germany.

Address reprint requests to W. Adam, Institute of Organic Chemistry, University of Würzburg, D-8700 Würzburg, Federal Republic of Germany.

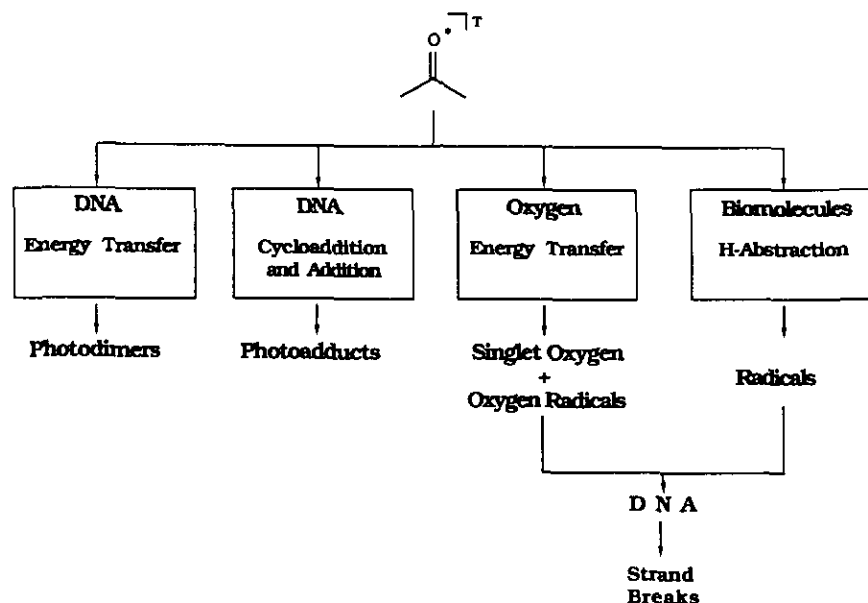

FIGURE 1. The possible pathways of DNA damage by triplet ketones.

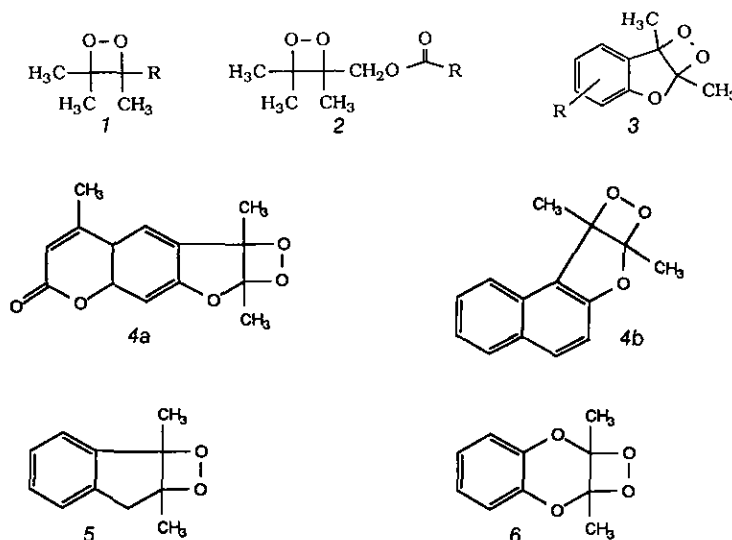
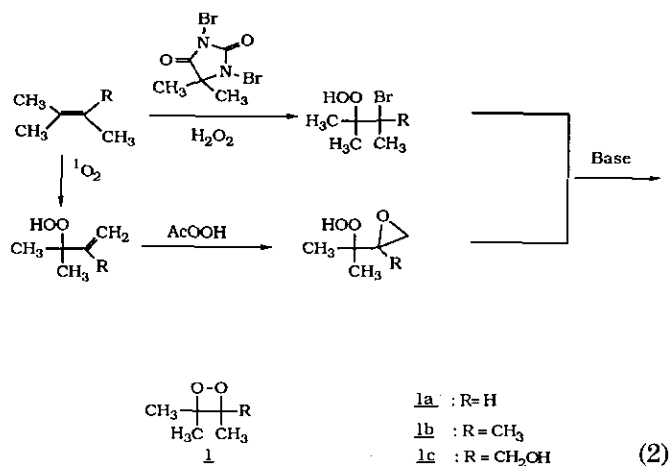
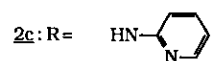
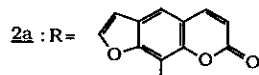
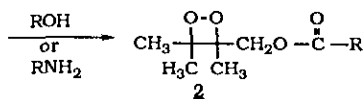
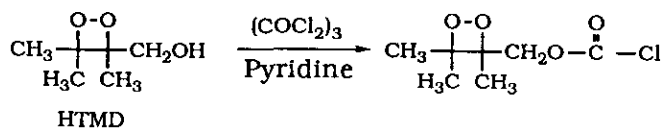

FIGURE 2. Structures of dioxetanes 1, 2, and 3.

scribed here. The alkyl- and hydroxyalkyl-substituted dioxetanes 1 were prepared according to published procedures summarized in Equation (2) (5,6,19,20). Dioxetanes 2, which possess an intercalating substituent (furocoumarin) or electron-rich group (aminopyridine), were prepared by transforming 3-hydroxymethyl-3,4,4-trimethyl-1,2-dioxetane (HTMD) (1c) into its chlorocarbonyl derivative by means of triphosgene (a commercially available substitute for gaseous phosgene) and subsequent reaction with the corresponding alcohol or amine [Eq. (3)]. The details of this synthetic method and the chemical properties of dioxetanes have been published elsewhere (21,22). The benzofuran dioxetanes 3 and structural analogues were synthesized by photooxygenation of the benzofurans [Eq. (4)] as published for 2,3-dimethylbenzofuran dioxetane 3a (DBFD) (23).





(3)

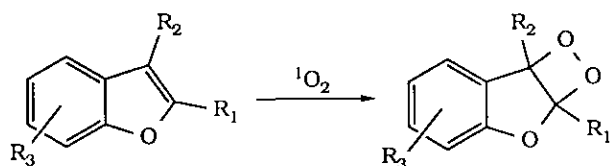

(4)

The activation parameters and excitation yield of selected dioxetanes were determined according to the reported photometric procedures (4). From the rate data and the triplet excitation efficiency the triplet excitation flux ( $E_p^T$ ) was calculated, which is defined according to Equation 5, and represents the number of triplet excited states per unit time per unit volume. The results are presented in Table 1.

$$E_p^T = k \cdot C \cdot \Phi^T \cdot N_L \quad (5)$$

where  $k$  = rate constant;  $C$  = concentration of dioxetane;  $\Phi^T$  = triplet excitation yield;  $N_L$  = Avogadro number.

## Genotoxicity in Cell-free DNA

### Calf Thymus DNA

After incubation of calf thymus DNA (2 hr, 50°C) with TrMD (290 mM), thymine dimers were formed and detected by HPLC (24). This result confirmed the earlier report of Lamola (7) that thermal decomposition of TrMD in calf thymus DNA promoted thymine photo-dimerization.

Treatment of calf thymus DNA with psoralen (performed in collaboration with F. Dall'Acqua and D. Veldali, University of Padova, Italy), an excellent DNA intercalator, in the presence of 10 equivalents of HTMD at 50°C led to the psoralen monoadduct of DNA at the  $\alpha$ -pyrone ring [Eq. (6)], as confirmed by fluorescence measurements (25).

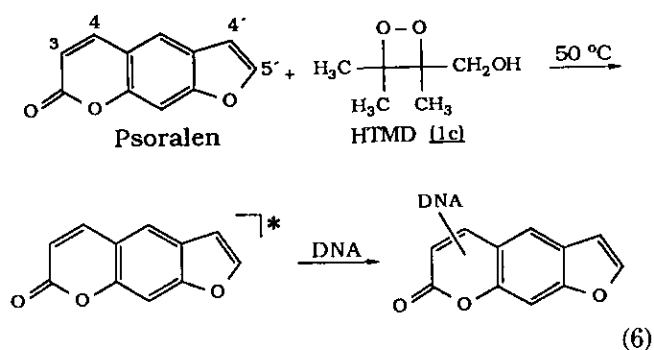

Similar observations (Fig. 3a) were made with psoralen dioxetane (PsD) (2a) and calf thymus DNA [Eq. (7)]. In this case photobinding was more effective, as evidenced by the higher fluorescence intensity resulting from the fact that the excitation source (dioxetane) and the photoactive chromophore (psoralen) are part of the same molecule. When the cleavage product of PsD is irradiated at 365 nm, efficient photobinding was also observed (Fig. 3b); however, now the binding apparently involved the furan-ring (4',5'-position). This finding is in agreement with earlier observations (25) indicating that direct and ketone-sensitized irradiation produce different regioisomeric photoadducts. For example, the triplet state formed in the latter case gave rise to cycloaddition at the  $\alpha$ -pyrone ring. The triplet state formed by dioxetane-cleavage, therefore, reacted in an analogous way.

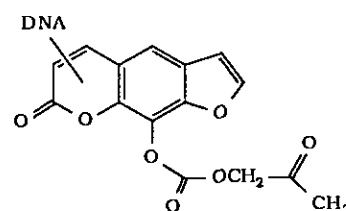
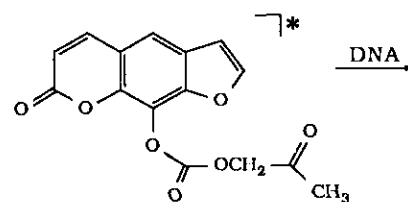
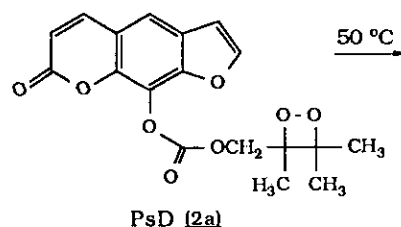

(7)

Table 1. Activation and excitation parameters of 1,2-dioxetanes.

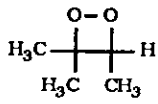
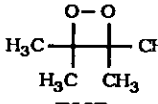
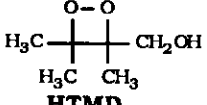
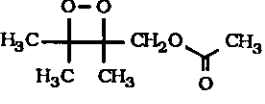
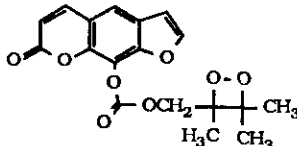
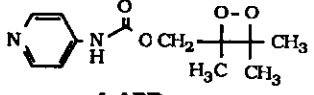
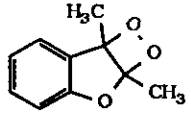
Dioxetane in toluene <sup>a</sup>	$\Delta G^\ddagger$ , 37° C, kcal/mole	$t_{1/2}$ , 37° C, hr	$\Phi^T$ , % <sup>b</sup>	$E_p^T \cdot 10^{-17}$ , E/mole/sec/L <sup>c</sup>
 TrMD	23.8 ± 0.4 (24.7 ± 1.0) <sup>d</sup>	10.7 ± 0.6 (6.5 ± 0.3)	25 ± 5 (5 ± 1)	27 ± 5 (9 ± 2)
 TMD	25.6 ± 0.6	45.2 ± 2.3	35 ± 4 (4 ± 1)	9 ± 2 (4 ± 1)
 HTMD	25.1 ± 0.5 (25.0 ± 4.0)	22.4 ± 1.2 (38.7 ± 11.1)	14 ± 3 (5 ± 1)	8 ± 2 (2 ± 1)
 AcTMD	25.5 ± 0.5 (26.1 ± 1.3)	24.6 ± 0.8 (58.9 ± 3.0)	50 ± 20 (10 ± 1)	23 ± 8 (2 ± 1)
 PsD	25.3 ± 0.4	36.5 ± 1.3	4 ± 1	2 ± 1
 4-APD	26.3 ± 0.4	32.0 ± 1.3	33 ± 8	9 ± 2
 DBFD	24.2 ± 0.3	3.9 ± 0.1	3 ± 1	7 ± 1

<sup>a</sup> TrMD, 3,3,4-trimethyl-1,2-dioxetane; TMD, 3,3,4,4-tetramethyl-1,2-dioxetane; HTMD, 3-hydroxymethyl-3,4,4-trimethyl-1,2-dioxetane; AcTMD, acetoxy-3,3,4,4-tetramethyl-1,2-dioxetane; PsD, psoralen dioxetane; 4-APD, 3-(N-[4-pyridino]carbamoyl)methyl-3,4,4-trimethyl-1,2-dioxetane; DBFD, 2,3-dimethylbenzofuran dioxetane.

<sup>b</sup> Calculated from Stern-Volmer kinetics using 9,10-dibromoanthracene in toluene and sodium 9,10-dibromoanthracenesulfonate in water.

<sup>c</sup> Calculated for 1 M solution at 37°C.

<sup>d</sup> Values in parentheses were measured in water.

Preliminary experiments with tritium-labeled trimethyl-angelicin (<sup>3</sup>H-TMA), calf thymus DNA, and 3,3,4,4-tetramethyl-1,2-dioxetane (TMD) have shown that about one

photoadduct per 30,000 nucleotides was generated (performed in collaboration with F. Dall'Acqua and D. Vedrali, University of Padova, Italy), as shown in Equation (8).

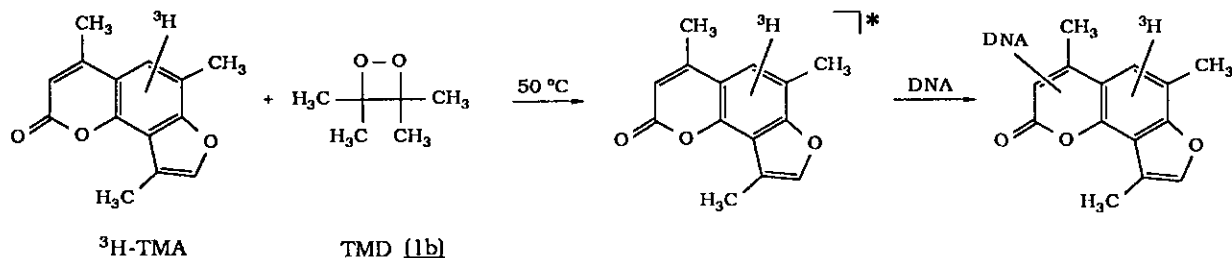

(8)

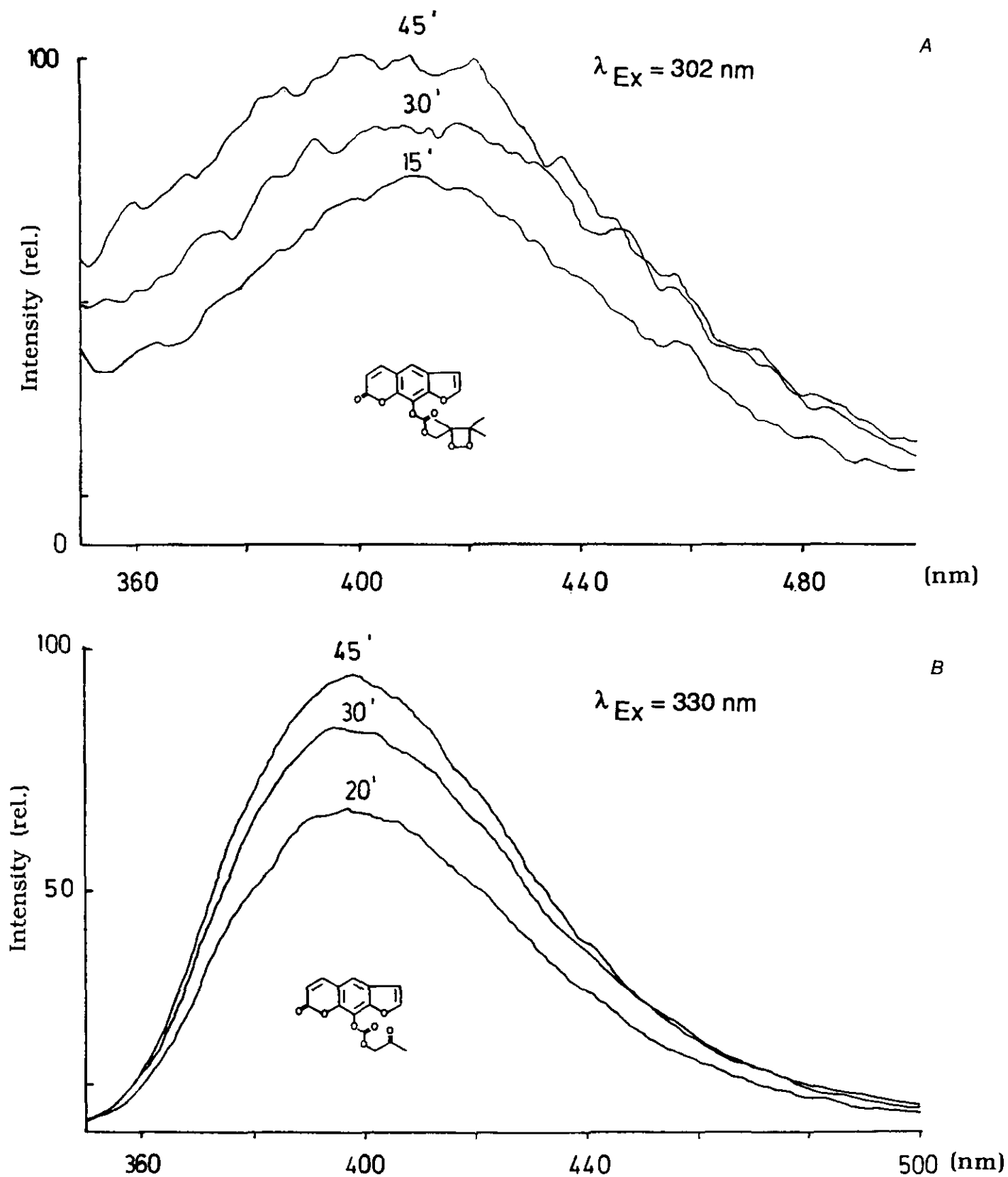

FIGURE 3. (A) Fluorescence spectrum (excitation wavelength 302 nm) of the DNA photobinding product obtained from the reaction between calf thymus DNA and psoralen dioxetane at 50°C after 15, 30, and 45 min. (B) Fluorescence spectrum (excitation wavelength 330 nm) of the DNA photobinding product obtained after irradiation of psoralen dioxetane decomposition product in the presence of DNA.

Table 2. Dioxetane-induced DNA lesions.<sup>a</sup>

Dioxetane <sup>b</sup>	Endonuclease-sensitive lesions/ 10 <sup>6</sup> bp/mM			Single strand breaks/ 10 <sup>6</sup> bp/mM
	MI <sup>c</sup>	AP sites <sup>d</sup>	Pyrimidine dimers <sup>e</sup>	
TrMD	20 ± 0.6	1.8 ± 0.1	5 ± 0.5	0.4 ± 0.2
TMD	6.5 ± 0.3	0.35 ± 0.04	0.1 ± 0.01	0.1 ± 0.01
HTMD	52 ± 5	5 ± 0.5	1 ± 1.4	0.4 ± 0.2
AcTMD	72 ± 5	4 ± 0.1	0	0.9 ± 0.4

<sup>a</sup> Dioxetane, 1 hr at 37°C, phosphate buffer, pH 7.4.

<sup>b</sup> For chemical structures and names see Table 1.

<sup>c</sup> Lesions detected by endonucleases from *Micrococcus luteus*, MI, crude cell extract (12).

<sup>d</sup> Lesions detected by exonuclease III from *E. coli* (26).

<sup>e</sup> Detected by the dimer-specific enzyme from MI corrected for AP sites (27).

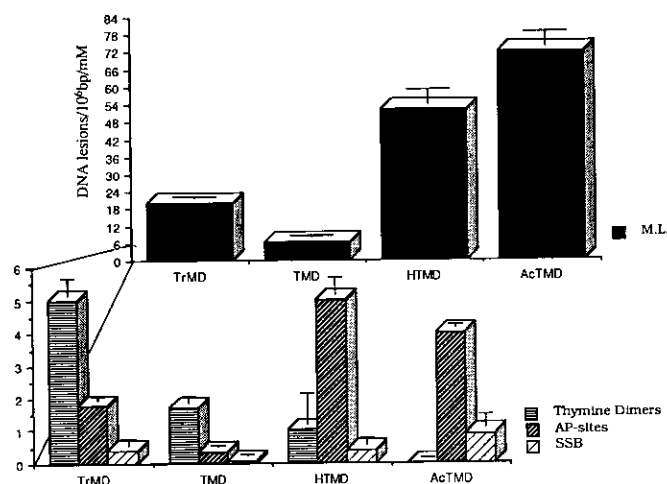

FIGURE 4. The upper diagram shows the total endonuclease sensitive sites, detected using *M. luteus* endonucleases (crude cell extract, M.L.). The lower diagram gives the thymine dimers and AP sites, which were detected using specific endonucleases and single strand breaks (SSB).

Table 3. DNA single-strand breaks in SHE and HL-60 cells.<sup>a</sup>

Dioxetane <sup>b</sup>	Single-strand breaks/10 <sup>7</sup> bp	
	SHE cells <sup>b</sup>	HL-60 cells <sup>c</sup>
TrMD	0.8 ± 0.2	1.2 ± 0.3
HTMD	0.2 ± 0.1	0.3 ± 0.1
4-APD	1.9 ± 0.3	2.8 ± 0.4
PsD	0.2 ± 0.3	2.8 ± 0.4

<sup>a</sup> Cells were incubated for 30 min at 37°C with 50 μM dioxetane.

<sup>b</sup> TrMD, 3,3,4-trimethyl-1,2-dioxetane; HTMD, 3-hydroxymethyl-3,4,4-trimethyl-1,2-dioxetane; 4-APD, 3-(N-[4-pyridino]carbonyl)methyl-3,4,4-trimethyl-1,2-dioxetane; PsD, psoralen dioxetane.

<sup>c</sup> Determined by alkaline elution technique, calibrated with γ-rays (1 Gy = 1.6 × 10<sup>-7</sup> single-strand breaks/bp) (28).

## Superhelical DNA from Bacteriophage PM2

Dioxetanes also efficiently induced DNA damage in superhelical DNA from bacteriophage PM2. They caused predominantly endonuclease-sensitive base modifications, detected by a crude enzyme preparation from *Micrococcus luteus*, but only few single strand

Table 4. Induction of micronuclei in SHE cells.<sup>a</sup>

Dioxetane <sup>b</sup>	Micronuclei <sup>c</sup>
HTMD	100 ± 5
4-APD	240 ± 40
2-APD	190 ± 75
DBFD	2680 ± 390

<sup>a</sup> SHE cells were incubated with the dioxetanes for 30 min at 37°C.

<sup>b</sup> HTMD, 3-hydroxymethyl-3,4,4-trimethyl-1,2-dioxetane; 4-APD, 3-(N-[4-pyridino]carbonyl)methyl-3,4,4-trimethyl-12-dioxetane; 2-APD, 3-(N-[2-pyridino]carbonyl)methyl-3,4,4-trimethyl-1,2-dioxetane; DBFD, 2,3-dimethylbenzofuran dioxetane.

<sup>c</sup> Micronuclei/2000 cells/mM dioxetane.

breaks and AP sites. The latter were detected using exonuclease III (26) from *E. coli*. Only a relatively small fraction of the base modifications consisted of pyrimidine dimers, as established by employing the dimer-specific endonuclease from *M. luteus* (27) and correcting for AP sites (Table 2 and Fig. 4). In Figure 5 the relative numbers of single strand breaks and of modified sites detected in PM2 DNA by three different crude repair-endonuclease preparations are shown for various damaging agents. Comparison of these damage profiles revealed that the DNA damage caused by dioxetanes did not correspond to that caused by optically excited carbonyl compounds (acetone/UV-330) nor by UV (260 nm) radiation. Rather, it appeared to be similar to the damage caused by Rose Bengal and light, which has previously been attributed to singlet oxygen (12).

## Genotoxicity in Mammalian Cells

In Syrian hamster embryo (SHE) fibroblasts and in human leukemia cells (HL-60), dioxetanes exhibited genotoxic activity. Single strand breaks were detected in both types of cells by the alkaline elution technique (28); the results are shown in Table 3. No *M. luteus* endonuclease-sensitive sites could be detected in HTMD-damaged DNA (10). This implies that the damage is not of the type induced by UV, and it still needs to be established whether or not the damage is of photochemical origin. However, dioxetane decomposition products and also related cyclic peroxides, which do not lead to excited triplet states on thermal decomposition

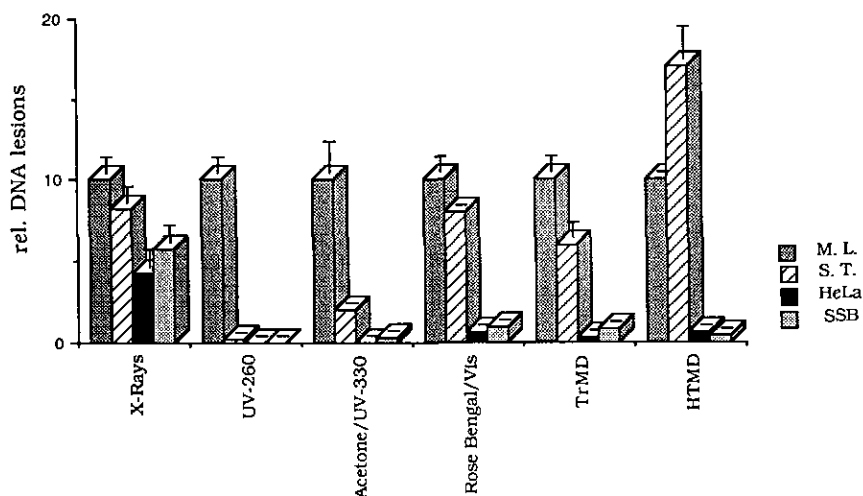

FIGURE 5. Damage profiles produced by different agents in cell-free PM2 DNA. The first three columns of each group indicate relative numbers of sites sensitive to endonucleases from *M. luteus* (normalized to 10 units), *S. typhimurium*, and HeLa, respectively. The fourth column in each group represents single strand breaks.

Table 5. Mutagenicity of benzofuran dioxetanes and their structural analogues in *Salmonella typhimurium* strain TA100.

**3**

Dioxetane	R <sub>1</sub>	R <sub>2</sub>	R <sub>3</sub>	Revertants/μmole <sup>a</sup>
3a	CH <sub>3</sub>	CH <sub>3</sub>	H	117,000
3b	CH <sub>3</sub>	CH <sub>3</sub>	6-COCH <sub>3</sub>	370,000
3c	CH <sub>3</sub>	CH <sub>3</sub>	6-COPh	73,000
3d	CH <sub>3</sub>	CH <sub>3</sub>	6-COCH <sub>3</sub>	~ 2,000
3e	CH <sub>3</sub>	CH <sub>3</sub>	5-OOCCH <sub>3</sub>	10,000
3f	CH <sub>3</sub>	CH <sub>3</sub> O	H	~ 2,000
3g	H	CH <sub>3</sub>	H	1,290
3i	CH <sub>2</sub> OCH <sub>3</sub>	CH <sub>3</sub>	H	1,270
3j	CH <sub>2</sub> OCOCH <sub>3</sub>	CH <sub>3</sub>	H	5,220
4a				115,000
4b				ND <sup>b</sup>
5				ND
6				ND

<sup>a</sup> Calculated by linear regression analysis from the linear portion of the dose-response curve.

<sup>b</sup> ND, not detectable; see Figure 2 for structures.

(β-peroxy lactones, 1,2-dioxolanes, endoperoxides, etc.), proved inactive in these tests (10).

Dioxetanes generated micronuclei in SHE cells, indicating genotoxicity at the chromosomal level. The number of micronuclei produced was determined as described (29), and the results are presented in Table 4. Furthermore, HTMD and 3-(*N*-[4-pyridino] carbamoyl)methyl-3,4,4-trimethyl-1,2-dioxetane (4-APD) promoted dose-dependent morphological transformation of SHE cells (10). Both dioxetanes failed to induce unscheduled DNA synthesis (UDS) in SHE cells or in HeLa cells (10).

## Genotoxicity in Bacteria

HTMD and 4-APD caused dose-dependent SOS function *sfiA* in *E. coli* (11). In view of the unspecific nature of this genotoxic activity, the mechanism of the SOS induction by dioxetanes remains unclear.

*Salmonella typhimurium* mutation assays with dioxetanes were performed using the preincubation technique (30). None of the dioxetanes of type 1 and 2 listed in Table 1 showed significant mutagenicity in strain TA100 (sensitive to alkylating agents and UV<sup>260</sup> radiation) or in strain TA2638 (sensitive to peroxides and

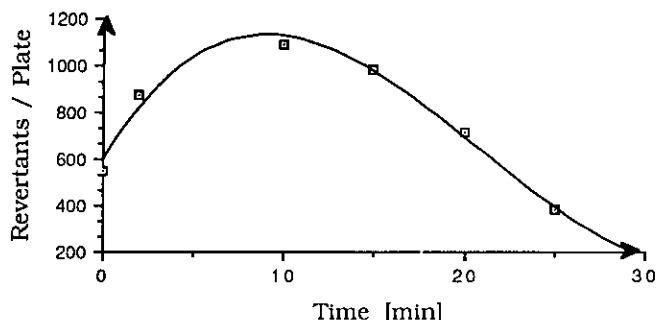

FIGURE 6. Mutagenicity versus time profiles of benzofuran dioxetane 3a; dioxetane solutions in phosphate buffer were incubated at 30°C for the indicated times prior to the addition of the bacteria.

oxygen radicals). These dioxetanes are efficiently inactivated by cellular components, as shown by chemical model studies with glutathione, cysteine, ascorbic acid, NADH, FADH<sub>2</sub>, and tocopherol (31,32), which might explain their lack of mutagenic activity.

In contrast, numerous benzofuran dioxetanes 3 were highly mutagenic in the strain TA100. This genotoxic activity was strongly dependent on the chemical structure, as displayed in Table 5. Furthermore, the DNA lesions induced by DBFD (3a) in the bacteria could not be photoreactivated (data not shown). This finding suggests that the dioxetane-induced DNA damage differs from that induced by UV radiation. Moreover, the mutagenic activity of an aqueous buffer solution of DBFD increased with time; the mutagenic activity was maximal when the solution was incubated at 37°C for 10 min prior to the addition of the bacteria (Fig. 6). This observation suggested that an intermediate with a lifetime of a few minutes was first produced from the benzofuran dioxetane 3a in the aqueous solution and subsequently interacted with the DNA and was responsible for the mutagenicity.

In an attempt to identify the chemical structure of the mutagenic intermediate, the transformations of 3a in water were studied (Fig. 7). The products 6–9 were isolated and subjected to the Ames test using strain TA100; all were nonmutagenic. The spiro-epoxide 4, which was postulated as the precursor of the products 5 and 6, has still not been isolated. Whether this unusual epoxide is responsible for the high mutagenicity of dioxetane 3a is at this time still unanswered. However, preliminary results indicate that the authentic epoxide 10 is the most likely mutagenic intermediate.

## Conclusions and Perspectives

The various types of tests mentioned here have convincingly shown that dioxetanes are genotoxic. Dioxetane-induced DNA damage in cell-free systems (superhelical DNA) consists in part of pyrimidine dimers; this clearly confirms the expected photochemical DNA damage. However, the major DNA lesions are other endonuclease-sensitive base modifications that have not yet been characterized. An intercalating dioxetane, the psoralen dioxetane, photobinds to calf thymus DNA when treated at 50°C.

The DNA damage caused by dioxetanes in mammalian cells consists mainly of single strand breaks. Reactive oxygen species are likely to be responsible for this kind of damage, but the mechanistic details remain to be explored.

Despite the finding of DNA damage in cell-free DNA and mammalian cells, mutations are not detected in *Salmonella typhimurium* with most dioxetanes. The benzofuran dioxetanes 3 are an interesting exception in that they are potent mutagens in *Salmonella typhimurium* strain TA100. The mutagenic DNA lesions induced by these dioxetanes are apparently not of photochemical

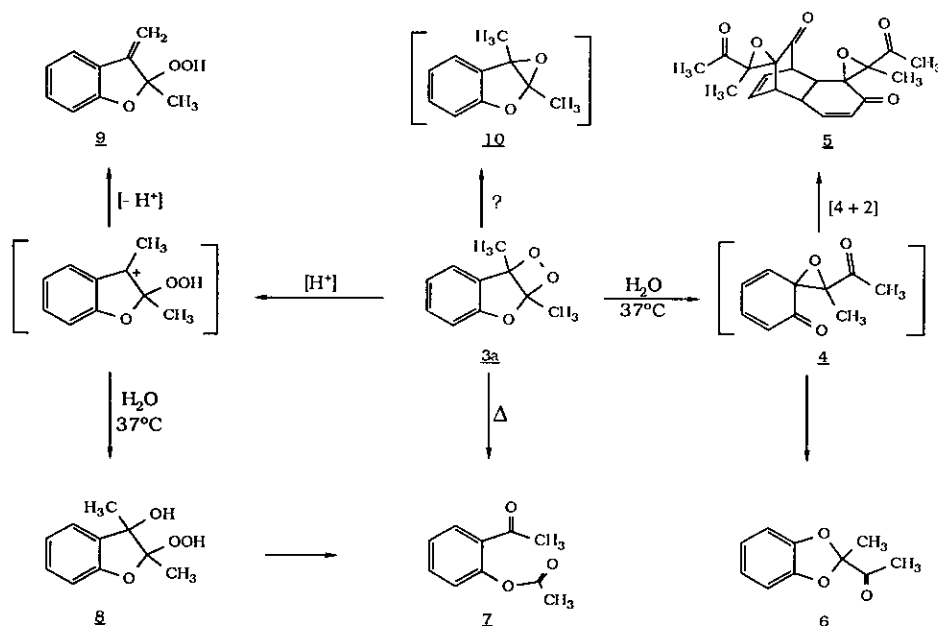

FIGURE 7. Transformations of benzofuran dioxetane 3a in water.



origin; rather, a reactive intermediate with a lifetime of a few minutes, possibly an alkylating agent, appears to be the ultimate mutagen.

In recent years much attention has been devoted to the involvement of excited states in biological processes, especially DNA damage. Dioxetanes are convenient chemical sources, specific for triplet excited states, and offer interesting opportunities for photobiological studies in the dark. We suspect that in its oxygen-dependent metabolism, the cell is capable of producing triplet excited states *in situ* via such dioxetanes, inducing DNA damage. Future efforts to establish the photogenotoxic activity of these unusual substances in cellular systems will be intensified.

We thank the Deutsche Forschungsgemeinschaft, Sonderforschungsbereich 172, Molekulare Mechanismen kanzerogener Primärveränderungen and the Wilhem-Sander-Stiftung for generous financial support. F. Vargas thanks the DAAD for a doctoral fellowship.

#### REFERENCES

- Mennigmann, H. -D., and Wacker, A. Photoreactivation of *Escherichia coli* BS-3 after inactivation by 313 nm radiation in the presence of acetone. *Photochem. Photobiol.* 11: 2911-2916 (1970).
- Rahn, R. O. Sensitized photoinduction of pyrimidine dimers in DNA. In: *DNA Repair: A Laboratory Manual of Research Procedures*, Vol. 2 (E. C. Friedberg and P. C. Hanawalt, Eds.), Marcel Dekker, New York, 1983, pp. 75-85.
- Umlas, M. E., Franklin, W. A., Chan, G. L., and Haseltine, W. A. Ultraviolet light irradiation of defined-sequence DNA and conditions of chemical photosensitization. *Photochem. Photobiol.* 42: 265-273 (1985).
- Adam, W. Thermal generation of electronic excitation with hyperenergetic molecules. *Pure Appl. Chem.* 52: 2591-2608 (1980).
- Kopecky, K. R., and Mumford, C. Luminescence in the thermal decomposition of 3,3,4-trimethyl-1,2-dioxetane. *Can. J. Chem.* 47: 709-711 (1969).
- Kopecky, K. R., Filby, C., Mumford, C., Lockwood, P. A., Ding, J. -Y. Preparation and thermolysis of some 1,2-dioxetanes. *Can. J. Chem.* 53: 1103-1122 (1975).
- Lamola, A. A. Production of pyrimidine dimers in DNA in the dark. *Biochem. Biophys. Res. Commun.* 43: 898-899 (1971).
- Lown, J. W., Koganty, R. R., Kopecky, K. R. Trimethyl-1,2-dioxetane induced lesions in DNA: photoinduced pyrimidine dimers detected by T4 UV-endonuclease, local denaturation and interstrand crosslinking. *Photobiochem. Photobiophys.* 12: 295-304 (1986).
- Adam, W., Beinhauer, A., Epe, B., Fuchs, R., Griesbeck, A., Hauer, H., Muetzel, P., Nassi, L., Schiffmann, D., and Wild, D. Genotoxic effects of 1,2-dioxetanes. In: *Primary Changes and Control Factors in Carcinogenesis* (T. Friedberg and F. Oesch, Eds.), Deutscher Fachschriften Verlag, Wiesbaden, FRG, 1986, pp. 64-67.
- Nassi, L., Epe, B., Schiffmann, D., Adam, W., Beinhauer, A., and Griesbeck, A. Induction of morphological transformation and micronuclei in Syrian hamster embryo fibroblasts by 1,2-dioxetanes. Correlation with single strand breaks in HL-60 cells. *Carcinogenesis* 8: 947-953 (1987).
- Nassi, L., Schiffmann, D., Fayre, A., Adam, W., and Fuchs, R. Induction of the SOS function *sfiA* in *E. coli* by systems which generate triplet ketones. *Mutat. Res.* 198: 53-60 (1988).
- Epe, B., Muetzel, P., and Adam, W. DNA damage by oxygen radicals and excited state species: comparative study using enzymatic probes *in vitro*. *Chem.-Biol. Interact.* 67: 149-165 (1988).
- Cilento, G., and Adam, W. Photochemistry and photobiology without light. *Photochem. Photobiol.* 48: 361-368 (1988).
- Menck, C. R. M., Cabral-Neto, J. B., Faljoni-Alaxio, A., and Alcantara-Gomes, R. Damages induced in  $\lambda$  phage DNA by enzyme generated triplet acetone. *Mutat. Res.* 165: 9-14 (1986).
- Cilento, G. Generation of electronically excited triplet species in biochemical systems. *Pure Appl. Chem.* 56: 1179-1190 (1984).
- Troll, W., and Wiesner, R. The role of oxygen radicals as a possible mechanism of tumor promotion. In: *Annual Review of Pharmacology and Toxicology*, Vol. 25 (R. George, R. Okun, and A. K. Cho, Eds.), Annual Reviews Inc., Palo Alto, CA, 1985, p. 509.
- Cerutti, P. A. Prooxidant state and tumor promotion. *Science* 227: 375-381 (1985).
- Ames, B. N. Dietary carcinogens and anticarcinogens. *Science* 221: 1256-1264 (1983).
- Adam, W., and Baader, W. J. Effects of methylation on the thermal stability and chemiluminescence properties of 1,2-dioxetanes. *J. Am. Chem. Soc.* 107: 410-416 (1985).
- Leclercq, D., Bats, J. -P., Picard, P., and Moulines, P. A new promising route of functionalized 1,2-dioxetanes. *Synthesis* 778-779 (1982).
- Adam, W., Beinhauer, A., Fischer, R., and Hauer, H. A psoralen-substituted dioxetane as DNA intercalator for photogenotoxic studies. *Angew. Chem. Int. Ed. Engl.* 26: 796-797 (1987).
- Adam, W., Bhushan, V., Dirnberger, T., and Fuchs, R. Functionalized 1,2-dioxetanes as potential chemotherapeutic agents: the synthesis of dioxetane-substituted carbamates. *Synthesis* 86: 330-332 (1986).
- Basselier, J. -J., Cherton, J. -C., and Caille, J. Photooxydation of polycyclic furans. *CR Acad. Sci. Ser. C* 273: 514-517 (1971).
- Mützel, P. Genotoxic activity of 1,2-dioxetanes in cell-free and cellular systems. Ph.D. dissertation, University of Würzburg, Würzburg, FRG, 1988.
- Cimino, G. D., Gamper, A. B., Isaacs, S. T., and Hearst, J. E. Psoralen as photoactive probes of nucleic acid structure and function: organic chemistry, photochemistry and biochemistry. *Ann. Rev. Biochem.* 54: 1151-1193 (1985).
- Rogers, S. G., and Weiss, B. Exonuclease III of *Escherichia coli* K-12, an AP endonuclease. In: *Methods in Enzymology*, Vol. 65 (L. Grossman and K. Mordave, Eds.), Academic Press, New York, 1980, pp. 201-211.
- Razzudin, S. Purification and properties of pyrimidine dimer specific endonucleases from *Micrococcus luteus*. In: *Methods in Enzymology*, Vol. 65 (L. Grossman and K. Mordave, Eds.), Academic Press, New York, 1980, pp. 185-191.
- Kohn, K. W., Erickson, L. C., Ermig, R. A. G., and Friedman, C. A. Fractionation of DNA from mammalian cells by alkaline elution. *Biochemistry* 15: 4629-4637 (1976).
- Schmuck, G., Lieb, G., Wild, D., Schiffmann, D., and Henschler, D. Characterization of an *in situ* micronucleus assay with Syrian hamster embryo fibroblasts. *Mutat. Res.* 203: 397-404 (1988).
- Maron, D. M., and Ames, B. N. Revised methods for the *Salmonella* mutagenicity test. *Mutat. Res.* 113: 173-215 (1983).
- Adam, W., Epe, B., Schiffmann, D., Vargas, F., and Wild, D. Facile reduction of 1,2-dioxetanes by thiols as potential protective measure against photochemical damage of cellular DNA. *Angew. Chem. Int. Ed. Engl.* 27: 429-431 (1988).
- Adam, W., Epe, B., Schiffmann, D., Vargas, F., and Wild, D. Single-electron-transfer in the reduction of 1,2-dioxetanes by biologically active substrates. *Free Rad. Res. Commun.* 5: 253-288 (1989).