

Derivatives and Risk Management in the Petroleum, Natural Gas, and Electricity Industries

October 2002

Energy Information Administration
U.S. Department of Energy
Washington, DC 20585

This report was prepared by the Energy Information Administration, the independent statistical and analytical agency within the U.S. Department of Energy. The information contained herein should be attributed to the Energy Information Administration and should not be construed as advocating or reflecting any policy position of the Department of Energy or any other organization. Service Reports are prepared by the Energy Information Administration upon special request and are based on assumptions specified by the requester.

Contacts

This report was prepared by the staff of the Energy Information Administration and Gregory Kuserk of the Commodity Futures Trading Commission. General questions regarding the report may be directed to the project leader, Douglas R. Hale. Specific questions should be directed to the following analysts:

**Summary, Chapters 1, 3,
and 5 (Prices and Electricity)**

Douglas R. Hale
(202/287-1723, Douglas.R.Hale@eia.doe.gov).

Chapter 2

Thomas Lee
(202.586.0829, Thomas.Lee@eia.doe.gov)

John Zyren
(202.586.6405, John.Zyren@eia.doe.gov)

Chapter 4

James Joosten
(202.287.1918, James.Joosten@eia.doe.gov)

Chapter 6

Gregory Kuserk
(202.418.5286, gkuserk@cftc.gov)

Chapters 5 (Accounting) and 7

Jon Rasmussen
(202.586.1449, Jon.Rasmussen@eia.doe.gov)

Chapter 8

James Hewlett
(202.586.9536, James.Hewlett@eia.doe.gov)

Other contributors to the report include Preston McDowney, Lawrence Stroud, and Cathy Smith.

The Energy Information Administration would like to acknowledge the indispensable help of the Commodity Futures Trading Commission in the research and writing of this report. EIA's special expertise is in energy, not financial markets. The Commission assigned one of its senior economists, Gregory Kuserk, to this project. He not only wrote sections of the report and provided data, he also provided the invaluable professional judgment and perspective that can only be gained from long experience. The EIA staff appreciated his exceptional productivity, flexibility, and good humor. Without the support of the CFTC, EIA would not have been able to write this report.

The authors would like to acknowledge the contribution of three independent expert reviewers. Dr. Hendrik Bessembinder, University of Utah, Department of Finance, and Dr. Alexander J. Triantis, University of Maryland, Department of Finance, contributed to framing the research plan and reviewed two early versions of the report. Dr. Bessembinder also contributed two of the report's examples of the benefits of hedging and swaps. Dr. Bala Dharan, Rice University, Graduate School of Management, carefully reviewed all the accounting material in the report. Dr. Dharan also contributed to the analyses of questionable uses of derivatives that appear in Chapters 5 and 7. In addition, Tracy Terry, National Commission on Energy Policy, and Russell Tucker, Edison Electric Institute, provided exceptionally helpful reviews of drafts of Chapter 4.

Preface

Section 205(a)(2) of the Department of Energy Organization Act (Public Law 95-91) requires that the Administrator of the Energy Information Administration (EIA) carry out a comprehensive program that will collect, evaluate, assemble, analyze, and disseminate data and information relevant to energy resources, reserves, production, demand, technology, and related economic and statistical information. Federal law prohibits EIA from advocating policy.

In February 2002 the Secretary of Energy directed the Energy Information Administration (EIA) to prepare a report on the nature and use of derivative contracts in the petroleum, natural gas, and electricity industries.¹ Derivatives are contracts (“financial instruments”) that are used to manage risk, especially price risk. In accord with the Secretary’s direction, this report specifically includes:

- A description of energy risk management tools
- A description of exchanges and mechanisms for trading energy contracts

- Exploration of the varied uses of energy risk management tools
- Discussion of the impediments to the development of energy risk management tools
- Analysis of energy price volatility relative to other commodities
- Review of the current regulatory structure for energy derivatives markets
- A survey of the literature on energy derivatives and trading.

Derivatives transfer risk, especially price risk, to those who are able and willing to bear it; but, how they transfer risk is complicated and frequently misinterpreted. This report provides energy policymakers with information for their assessment of the merits of derivatives for managing risk in energy industries. It also indicates how policy decisions that affect energy markets can limit or enhance the usefulness of derivatives as tools for risk management.

¹Memo from Secretary of Energy Spencer Abraham to Acting EIA Administrator Mary J. Hutzler (February 8, 2002).

Contents

	Page
Summary	ix
1. Introduction	1
Purpose of the Report	1
Findings	1
Organization of the Report	2
2. Derivatives and Risk in Energy Markets	3
Introduction	3
Risk Management Without Derivatives	3
Managing Risk With Derivative Contracts	4
Energy Price Risk	9
Price Risk and Returns to Investment in a New Combined-Cycle Generator	11
3. Managing Risk With Derivatives in the Petroleum and Natural Gas Industries	15
Introduction	15
Oil and Natural Gas Markets	15
Price Risk and Derivatives in Petroleum and Natural Gas Markets	20
Markets for Oil and Gas Derivatives: Organized Exchanges, Trading Firms, and Bulletin Boards	23
Use of Derivatives by Firms in the Petroleum and Natural Gas Industries	26
4. Derivatives in the Electricity Industry	29
Introduction	29
Structural and Regulatory Constraints on Electricity Markets	29
Risk Management Instruments in the Electricity Industry	31
The Unique Nature of Electricity as a Commodity	33
Price Volatility	34
Spot Market Complexity	35
Poor Price Transparency	36
FERC's Standard Market Design	37
Regulatory Challenges Ahead for Electricity Derivatives	38
5. Prospects for Derivatives in Energy Industries	39
Introduction	39
Transparency of Financial Information	39
Financial Reporting and Abuse of Derivatives: Some Recent Examples	40
Transparency of Market Information	42
Electricity Spot Markets	43
Conclusion	43
6. Derivative Markets and Their Regulation	45
Introduction	45
Development of Derivative Markets	45
Trading Environments	46
Regulation of Exchange-Traded Derivatives	48
Regulation of OTC Derivatives	49

Contents (Continued)

Page

7. Accounting for Derivatives 53
Introduction. 53
Why and How, Simply 53
Financial Accounting Standards Board Statement 133 54
Conclusion. 59

8. Public Interest and Private Risk Management 61
Introduction. 61
Investment, Cost of Capital, and the Value of the Firm 61
Effects of Derivatives on the Volatility of Market Prices 64
Market Power 65
Derivatives and Financial Failure. 66
Conclusions. 68

Appendixes

A. Memorandum from the Secretary of Energy 71
B. Details of Present Net Value Calculation 75
C. Reported Natural Gas Prices 79
Glossary. 81

Tables

Page

S1. Spot Market Price Volatility for Selected Commodities	x
S2. Example of an Oil Futures Contract	xi
S3. Petroleum and Natural Gas Price Risks and Risk Management Strategies.	xiv
1. Major U.S. and Foreign Futures Exchanges	6
2. Example of an Oil Futures Contract	7
3. Spot Market Price Volatility for Selected Commodities	12
4. Expected Annual Net Cash Flows and Net Present Value (NPV) of Investment in a New Generator	13
5. Summary of Simulation Results.	14
6. Average Transmission Charges from Henry Hub and Their Standard Deviations	20
7. Petroleum and Natural Gas Price Risks and Risk Management Strategies.	20
8. Summary Statistics for Exchange-Traded Petroleum and Natural Gas Futures Contracts.	24
9. Summary Statistics for Exchange-Traded Petroleum and Natural Gas Options Contracts	24
10. NYMEX Light Sweet Crude Oil Contract Specifications	25
11. Moody's Bond Ratings for the Top 20 Natural Gas Marketers, 2000-2002	26
12. Use of Derivatives by Large Energy Marketing Firms, 2002	28
13. Trading Activity in Global Over-the-Counter Markets, 1998 and 2001	45
14. CEA and CFTC Exemptions and Exclusions for OTC Derivative Transactions	51
15. Balance Sheet and Income Statement Impacts of Cash Flow and Fair Value Hedges	58
16. Results of Various Studies on the Effects of Derivatives on Commodity Prices.	64
B1. Basic Assumptions for the NPV Calculation	75
B2. Estimation of Annual Net Cash Flows for a New Combined-Cycle Generator	76
B3. Expected Price Range with Risk Tolerance (Triangular Distribution)	77
B4. Summary of Statistical Results from the NPV Simulation	77
C1. Differences Between NGI and Platts Reported Natural Gas Prices	80

Figures

S1. Illustration of Crude Oil Swap Contract Between an Oil Producer and a Refiner.	xiii
S2. Crude Oil Acquisition Cost With and Without a Swap Contract.	xiii
1. Illustration of a Crude Oil Swap Contract Between an Oil Producer and a Refiner	8
2. Crude Oil Acquisition Cost With and Without a Swap Contract	8
3. Spot Market Prices for Selected Commodities, January 1999-September 2001.	9
4. Spot Market Prices for Selected Energy Commodities, January 1999-May 2002	10
5. Wholesale Electricity Prices in Selected Regions, March 1999-March 2002.	11
6. Net Present Value (NPV) Simulation Results.	14
7. Crude Oil Processing Stages, 2000	17
8. Natural Gas Processing Stages, 2000	18
9. Major Pricing Points (Hubs) for Natural Gas	19
10. Illustration of a Natural Gas Swap Contract Between a Gas Producer and a Local Distribution Company (LDC)	21
11. U.S. Electricity Interconnections.	30
12. SO ₂ Allowance Trading Activity, 1994-2001.	32
13. Delivery of 100 Megawatts of Electricity on Interconnected Systems	34
14. Electricity Supply Cost Curve.	34
15. Market Shares of Futures Contracts Traded on U.S. Exchanges by Commodity Type, 1991 and 2001.	46
B1. NPV Simulation with Hedging for Input and Output Price Volatilities	77
C1. Differences Between NGI and Platts Low Prices.	79
C2. Differences Between NGI and Platts High Prices	79

Summary

Introduction

Derivatives are financial instruments (contracts) that do not represent ownership rights in any asset but, rather, derive their value from the value of some other underlying commodity or other asset. When used prudently, derivatives are efficient and effective tools for isolating financial risk and “hedging” to reduce exposure to risk.

Although derivatives have been used in American agriculture since the mid-1800s and are a mainstay of international currency and interest rate markets, their use in domestic energy industries has come about only in the past 20 years with energy price deregulation. Under regulation, domestic petroleum, natural gas, and electricity prices were set by regulators and infrequently changed. Unfortunately, stable prices were paid for with shortages in some areas and surpluses elsewhere, and by complex cross-subsidies from areas where prices would have been lower to areas where prices would have been higher, with accompanying efficiency costs. Free markets revealed that energy prices are among the most volatile of all commodities. Widely varying prices encouraged consumers to find ways to protect their budgets; producers looked for ways to stabilize cash flow.

Derivative contracts transfer risk, especially price risk, to those who are able and willing to bear it. How they transfer risk is complicated and frequently misinterpreted. Derivatives have also been associated with some spectacular financial failures and with dubious financial reporting.

The Energy Information Administration prepared this report at the direction of the Secretary of Energy to provide energy policymakers with information for their assessment of the state of markets for energy derivatives. It also indicates how policy decisions that affect the underlying energy markets, in particular natural gas and electricity transmission and spot markets, limit or enhance the usefulness of derivatives as tools for risk management.

Energy Derivatives and Risk Management

This report examines the role of derivatives in managing some of the risks in the production and consumption of petroleum, natural gas, and electricity. Price risk management is relatively new to these industries because for much of their history they have been regulated. Electricity has not been a thoroughly competitive industry since the early 1900s. Natural gas and oil pipelines and

residential natural gas prices are still regulated. Operating under government protection, these industries had little need for risk management before the wave of deregulation that began in the 1980s—about the same time that modern risk management tools came into use.

There are five general types of risk that are faced by all businesses: *market risk* (unexpected changes in interest rates, exchange rates, stock prices, or commodity prices), *credit/default risk*; *operational risk* (equipment failure, fraud); *liquidity risk* (inability to buy or sell commodities at quoted prices); and *political risk* (new regulations, expropriation). Businesses operating in the petroleum, natural gas, and electricity industries are particularly susceptible to market risk—or more specifically, *price risk*—as a consequence of the extreme volatility of energy commodity prices. Electricity prices, in particular, are substantially more volatile than other commodity prices (Table S1).

Price volatility is caused by shifts in the supply and demand for a commodity. Natural gas and wholesale electricity prices are particularly volatile, for several reasons. Demand shifts quickly in response to weather conditions, and “surge production” is limited and expensive. In addition, electricity and natural gas often cannot be moved to areas where there are unexpected increases in demand, and cheap local storage is limited, especially for electricity. Public policy efforts to reduce price volatility have focused on increasing both reserve production capacity and transmission and transportation capability. There has also been recent emphasis on making real-time prices more visible to users so that they will reduce their usage when supplies are tight and costs are high, limiting the size and duration of price spikes.

To the extent that prices vary because of rapid changes in supply and demand, often associated with severe weather or international political events, energy price volatility is evidence that markets are working to allocate scarce supplies to their highest value uses; **however**, rapidly changing prices threaten household budgets and financial plans. In addition, price variation makes investments in energy conservation and production risky. Investors, whether individuals considering fuel-efficient hybrid cars or corporations assessing new energy production opportunities, have difficulty judging whether current prices indicate long-term values or transient events. Bad timing can spell ruin, and even good investments can generate large temporary cash losses that must be funded.

To a large extent, energy company managers and investors can make accurate estimates of the likely success of exploration ventures, the likelihood of refinery failures, or the performance of electricity generators. Diversification, long-term contracts, inventory maintenance, and insurance are effective tools for managing those risks. Such traditional approaches do not work well, however, for managing price risk.

When energy prices fall, so do the equity values of producing companies, ready cash becomes scarce, and it is more likely that contract obligations for energy sales or purchases may not be honored. When prices soar, governments tend to step in to protect consumers. Thus, commodity price risk plays a dominant role in the energy industries, and the use of derivatives has become a common means of helping energy firms, investors, and customers manage the risks that arise from the high volatility of energy prices.

Derivatives allow investors to transfer risk to others who could profit from taking the risk. The person transferring risk achieves price certainty but loses the opportunity for making additional profits when prices

move opposite his fears. Likewise, the person taking on the risk will lose if the counterparty's fears are realized. Except for transactions costs, the winner's gains are equal to the loser's losses. Like insurance, derivatives protect against some adverse events. The cost of the insurance is either forgone profit or cash losses. Because of their flexibility in dealing with price risk, derivatives have become an increasingly popular way to isolate cash earnings from price fluctuations.

The most commonly used derivative contracts are forward contracts, futures contracts, options, and swaps. A forward contract is an agreement between two parties to buy (sell) a specified quality and quantity of a good at an agreed date in the future at a fixed price or at a price determined by formula at the time of delivery to the location specified in the contract. For example, a natural gas producer may agree to deliver a billion cubic feet of gas to a petrochemical plant at Henry Hub, Louisiana, during the first week of July 2005 at a price of \$3.20 per thousand cubic feet. Forward contracts between independent generators and large industrial customers are used extensively in the electricity industry.

Table S1. Spot Market Price Volatility for Selected Commodities

Commodity	Average Annual Volatility (Percent)	Market	Period
Electricity			
California-Oregon Border	309.9	Spot-Peak	1996-2001
Cinergy	435.7	Spot-Peak	1996-2001
Palo Verde	304.5	Spot-Peak	1996-2001
PJM	389.1	Spot-Peak	1996-2001
Natural Gas and Petroleum			
Light Sweet Crude Oil, LLS	38.3	Spot	1989-2001
Motor Gasoline, NYH	39.1	Spot	1989-2001
Heating Oil, NYH	38.5	Spot	1989-2001
Natural Gas	78.0	Spot	1992-2001
Financial			
Federal Funds Rate	85.7	Spot	1989-2001
Stock Index, S&P 500	15.1	Spot	1989-2001
Treasury Bonds, 30 Year	12.6	Spot	1989-2001
Metals			
Copper, LME Grade A	32.3	Spot	January 1989-August 2001
Gold Bar, Handy & Harman, NY	12.0	Spot	1989-2001
Silver Bar, Handy & Harman, NY	20.2	Spot	January 1989-August 2001
Platinum, Producers	22.6	Spot	January 1989-August 2001
Agriculture			
Coffee, BH OM Arabic	37.3	Spot	January 1989-August 2001
Sugar, World Spot	99.0	Spot	January 1989-August 2001
Corn, N. Illinois River	37.7	Spot	1994-2001
Soybeans, N. Illinois River	23.8	Spot	1994-2001
Cotton, East TX & OK	76.2	Spot	January 1989-August 2001
FCOJ, Florida Citrus Mutual	20.3	Spot	September 1998-December 2001
Meat			
Cattle, Amarillo	13.3	Spot	January 1989-August 2001
Pork Bellies	71.8	Spot	January 1989-August 1999

Sources: Data from Commodity Futures Trading Commission. Calculations by Energy Information Administration staff.

Forward contracts have problems that can be serious at times. First, buyers and sellers (counterparties) have to find each other and settle on a price. Finding suitable counterparties can be difficult. Discovering the market price for a delivery at a specific place far into the future is also daunting. For example, after the collapse of the California power market in the summer of 2000, the California Independent System Operator (ISO) had to discover the price for electricity delivered in the future through lengthy, expensive negotiation, because there was no market price for future electricity deliveries. Second, when the agreed-upon price is far different from the market price, one of the parties may default (“non-perform”). As companies that signed contracts with California for future deliveries of electricity at more than \$100 a megawatt found when current prices dropped into the range of \$20 to \$40 a megawatt, enforcing a “too favorable” contract is expensive and often futile. Third, one or the other party’s circumstances might change. The only way for a party to back out of a forward contract is to renegotiate it and face penalties.

Futures contracts solve these problems but introduce some of their own. Like a forward contract, a futures contract obligates each party to buy or sell a specific amount of a commodity at a specified price. Unlike a forward contract, buyers and sellers of futures contracts deal with an exchange, not with each other. For example, a producer wanting to sell crude oil in December 2002 can sell a futures contract for 1,000 barrels of West Texas Intermediate (WTI) to the New York Mercantile Exchange (NYMEX), and a refinery can buy a December 2002 oil future from the exchange. The December futures price is the one that causes offers to sell to equal bids to buy—i.e., the demand for futures equals the supply. The December futures price is public, as is the volume of trade. If the buyer of a December futures finds later that he does not need the oil, he can get out of the contract by selling a December oil future at the prevailing price. Since he has both bought and sold a December oil future, he has met his obligations to the exchange by netting them out.

Table S2 illustrates how futures contracts can be used both to fix a price in advance and to guarantee performance. Suppose in January a refiner can make a sure profit by acquiring 10,000 barrels of WTI crude oil in December at the current December futures price of \$28 per barrel. One way he could guarantee the December price would be to “buy” 10 WTI December contracts. The refiner pays nothing for the futures contracts but has to make a good-faith deposit (“initial margin”) with his broker. NYMEX currently requires an initial margin of \$2,200 per contract. During the year the December futures price will change in response to new information about the demand and supply of crude oil.

In the example, the December price remains constant until May, when it falls to \$26 per barrel. At that point the exchange pays those who sold December futures contracts and collects from those who bought them. The money comes from the margin accounts of the refiner and other buyers. The broker then issues a “margin call,” requiring the refiner to restore his margin account by adding \$20,000 to it.

This “marking to market” is done every day and may be done several times during a single day. Brokers close out parties unable to pay (make their margin calls) by selling their clients’ futures contracts. Usually, the initial margin is enough to cover a defaulting party’s losses. If not, the broker covers the loss. If the broker cannot, the exchange does. Following settlement after the first change in the December futures price, the process is started anew, but with the current price of the December future used as the basis for calculating gains and losses.

In September, the December futures price increases to \$29 per barrel, the refiner’s contract is marked to market, and he receives \$30,000 from the exchange. In October, the price increases again to \$35 per barrel, and the refiner receives an additional \$60,000. By the end of November, the WTI spot price and the December futures price are necessarily the same, for the reasons given below. The refiner can either demand delivery and buy the oil at the spot price or “sell” his contract. In either event his initial

Table S2. Example of an Oil Futures Contract

Date	Prices per Barrel		Contract Activity	Cash In (Out)
	WTI Spot	December Future		
January	\$26	\$28	Refiner “buys” 10 contracts for 1,000 barrels each and pays the initial margin.	(\$22,000)
May	\$20	\$26	Mark to market: (26 - 28) x 10,000	(\$20,000)
September	\$20	\$29	Mark to market: (29 - 26) x 10,000	\$30,000
October	\$27	\$35	Mark to market: (35 - 29) x 10,000	\$60,000
November (end)	\$35	\$35	Refiner either: (a) buys oil, or (b) “sells” the contracts. Initial margin is refunded.	(\$350,000) \$22,000

Source: Energy Information Administration.

margin is refunded, sometimes with interest. If he buys oil he pays \$35 per barrel or \$350,000, but his trading profit is \$70,000 ($\$30,000 + \$60,000 - \$20,000$). Effectively, he ends up paying \$28 per barrel [$(\$350,000 - \$70,000) / 10,000$], which is precisely the January price for December futures. If he “sells” his contract he keeps the trading profit of \$70,000.

Several features of futures are worth emphasizing. First, a party who elects to hold the contract until maturity is guaranteed the price he paid when he initially bought the contract. The buyer of the futures contract can always demand delivery; the seller can always insist on delivering. As a result, at maturity the December futures price for WTI and the spot market price will be the same. If the WTI price were lower, people would sell futures contracts and deliver oil for a guaranteed profit. If the WTI price were higher, people would buy futures and demand delivery, again for a guaranteed profit. Only when the December futures price and the December spot price are the same is the opportunity for a sure profit eliminated.

Second, a party can sell oil futures even though he has no access to oil. Likewise a party can buy oil even though he has no use for it. Speculators routinely buy and sell futures contracts in anticipation of price changes. Instead of delivering or accepting oil, they close out their positions before the contracts mature. Speculators perform the useful function of taking on the price risk that producers and refiners do not wish to bear.

Third, futures allow a party to make a commitment to buy or sell large amounts of oil (or other commodities) for a very small initial commitment, the initial margin. An investment of \$22,000 is enough to commit a party to buy (sell) \$280,000 of oil when the futures price is \$28 per barrel. Consequently, traders can make large profits or suffer huge losses from small changes in the futures price. This *leverage* has been the source of spectacular failures in the past.

Futures contracts are not by themselves useful for all those who want to manage price risk. Futures contracts are available for only a few commodities and a few delivery locations. Nor are they available for deliveries a decade or more into the future. There is a robust business conducted outside exchanges, in the over-the-counter (OTC) market, in selling contracts to supplement futures contracts and better meet the needs of individual companies.

An option is a contract that gives the buyer of the contract the right to buy (a call option) or sell (a put option) at a specified price (the “strike price”) over a specified period of time. American options allow the buyer to exercise his right either to buy or sell at any time until the option expires. European options can be exercised only at maturity. Whether the option is sold on an exchange

or on the OTC market, the buyer pays for it up front. For example, the option to buy a thousand cubic feet of natural gas at a price of \$3.60 in December 2002 may cost \$0.73. If the price in December exceeds \$3.60, the buyer can exercise his option and buy the gas for \$3.60. More commonly, the option writer pays the buyer the difference between the market price and the strike price. If the natural gas price is less than \$3.60, the buyer lets the option expire and loses \$0.73. Options are used successfully to put floors and ceilings on prices; however, they tend to be expensive.

Swaps (also called contracts for differences) are the most recent innovation in finance. Swaps were created in part to give price certainty at a cost that is lower than the cost of options. A swap contract is an agreement between two parties to exchange a series of cash flows generated by underlying assets. No physical commodity is actually transferred between the buyer and seller. The contracts are entered into between the two counterparties, or principals, outside any centralized trading facility or exchange and are therefore characterized as OTC derivatives.

Because swaps do not involve the actual transfer of any assets or principal amounts, a base must be established in order to determine the amounts that will periodically be swapped. This principal base is known as the “notional amount” of the contract. For example, one person might want to “swap” the variable earnings on a million dollar stock portfolio for the fixed interest earned on a treasury bond of the same market value. The notional amount of this swap is \$1 million. Swapping avoids the expense of selling the portfolio and buying the bond. It also permits the investor to retain any capital gains that his portfolio might realize.

Figure S1 illustrates an example of a standard crude oil swap. In the example, a refiner and an oil producer agree to enter into a 10-year crude oil swap with a monthly exchange of payments. The refiner (Party A) agrees to pay the producer (Party B) a fixed price of \$25 per barrel, and the producer agrees to pay the refiner the settlement price of a futures contract for NYMEX light, sweet crude oil on the final day of trading for the contract. The notional amount of the contract is 10,000 barrels. Under this contract the payments are netted, so that the party owing the larger payment for the month makes a net payment to the party owing the lesser amount. If the NYMEX settlement price on the final day of trading is \$23 per barrel, Party A will make a payment of \$2 per barrel times 10,000, or \$20,000, to Party B. If the NYMEX price is \$28 per barrel, Party B will make a payment of \$30,000 to Party A. The 10-year swap effectively creates a package of 120 cash-settled forward contracts, one maturing each month for 10 years.

So long as both parties in the example are able to buy and sell crude oil at the variable NYMEX settlement

price, the swap guarantees a fixed price of \$25 per barrel, because the producer and the refiner can combine their financial swap with physical sales and purchases in the spot market in quantities that match the nominal contract size. All that remains after the purchases and sales shown in the inner loop cancel each other out are the fixed payment of money to the producer and the refiner's purchase of crude oil. The producer never actually delivers crude oil to the refiner, nor does the refiner directly buy crude oil from the producer. All their physical purchases and sales are in the spot market, at the NYMEX price. Figure S2 shows the acquisition costs with and without a swap contract.

Many of the benefits associated with swap contracts are similar to those associated with futures or options contracts.¹ That is, they allow users to manage price exposure risk without having to take possession of the commodity. They differ from exchange-traded futures and options in that, because they are individually negotiated instruments, users can customize them to suit their risk management activities to a greater degree than is easily accomplished with more standardized futures contracts or exchange-traded options.² So, for instance, in the example above the floating price reference for crude oil might be switched from the NYMEX contract, which calls for delivery at Cushing, Oklahoma, to an Alaskan North Slope oil price for delivery at Long Beach, California. Such a swap contract might be more useful for a refiner located in the Los Angeles area.

Although swaps can be highly customized, the counterparties are exposed to higher credit risk because the

Figure S1. Illustration of Crude Oil Swap Contract Between an Oil Producer and a Refiner

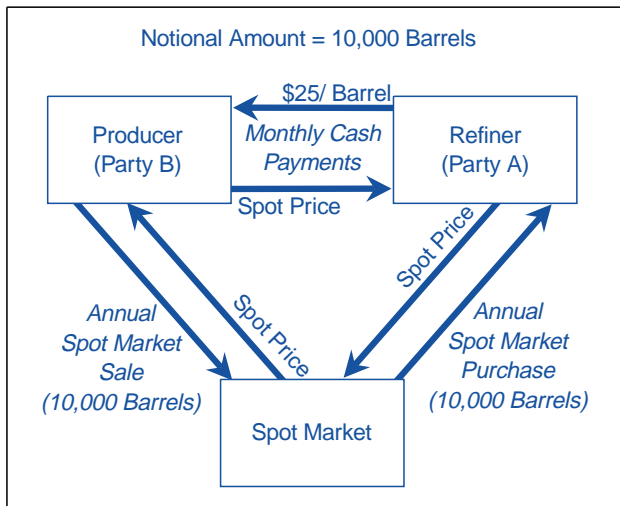

Source: Energy Information Administration.

¹A portfolio of a put and a call option can replicate a forward or a swap. See M. Hampton, "Energy Options," in *Managing Energy Price Risk*, 2nd Edition (London, UK: Risk Books, 1999), p. 39.

²Swaps and other OTC derivatives differ from futures in another functional respect that is related in part to their lack of standardization. Because their pricing terms are not widely disseminated, swaps and most other OTC derivatives generally do not serve a price discovery function. To the extent, however, that swap market participants tend to settle on standardized contract terms and that prices for transactions on those swaps are reported, it is potentially the case that particular swaps could serve this function. An important example is the inter-bank market in foreign currencies, from which quotes on certain forward rates are readily accessible from sizable commercial banks.

contracts generally are not guaranteed by a clearinghouse as are exchange-traded derivatives. In addition, customized swaps generally are less liquid instruments, usually requiring parties to renegotiate terms before prematurely terminating or offsetting a contract.

Oil and Natural Gas Markets: A Growing Role for Derivatives

Diversification and insurance are the major tools for managing exploration risk and protecting firms from property loss and liability. Firms manage volume risk—not having adequate supplies—by maintaining inventories or acquiring productive assets. Derivatives are particularly appropriate for managing the price risk that arises as a result of highly volatile prices in the petroleum and natural gas industries. The typical price risks faced by market participants and the standard derivative contracts used to manage those risks are shown in Table S3.

The growth in trading of petroleum and natural gas contracts has been tremendous. For example, the monthly volume of energy-related futures contracts on the NYMEX has grown from approximately 170,000 contracts per month in January 1982 to 7 million contracts per month in January 2000. Today, energy products are the second most heavily traded category of futures contracts on organized exchanges, after financial products. In addition to exchange-traded contracts, many energy companies enter into OTC forward contracts or swaps to manage price risk.

Figure S2. Crude Oil Acquisition Cost With and Without a Swap Contract

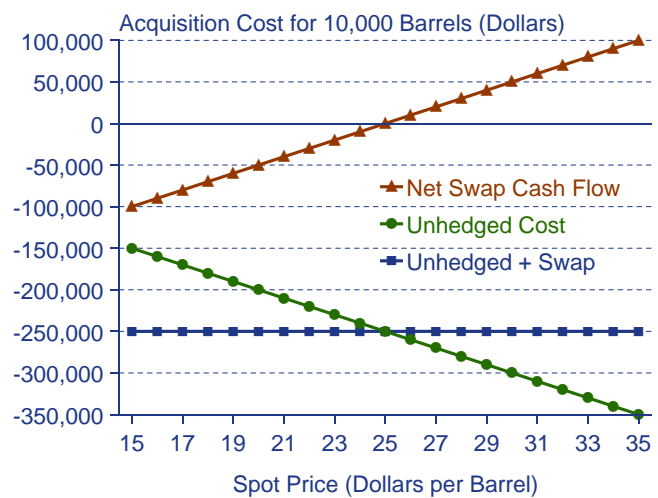

Source: Energy Information Administration

The Internet is responsible for the latest innovation in energy trading. In November 1999, EnronOnline was launched to facilitate physical and financial trading. EnronOnline was a principal-based exchange in which all trades were done with Enron as the counterparty. As a consequence, Enron's perceived creditworthiness was crucial to its ability to operate EnronOnline.

After the launch of EnronOnline, several other online exchanges quickly followed, including Intercontinental-Exchange (ICE), which was backed by major producers and financial services companies, and TradeSpark, which was backed by major electric utilities, traders, and gas pipeline companies. Both ICE and TradeSpark provide electronic trading platforms offering registered users anonymity for posting prices and executing trades. Unlike EnronOnline, they do not take trading positions. ICE offers swaps on crude oils other than Brent and West Texas Intermediate and on refined products in numerous locations, to complement the futures contracts trading of NYMEX and the International Petroleum Exchange (IPE). The bulletin boards also are doing a brisk business in physical trades, despite the fact that several have ceased operations in recent months.

Because natural gas pipelines (and electric power lines) have essentially no competitors, frustrated customers cannot buy supplies "off system." In addition, it is difficult to achieve competitive transmission pricing in networks. Changes in transmission charges (measured as the difference in prices between locations), therefore, do

not necessarily reflect changes in marginal cost, nor do they reliably induce investment in congestion-relieving capacity. Over a given year, the variation in transmission charges to locations physically connected to Henry Hub can vary between one-half and twice the average charge itself. To the extent that the variation in transmission charges is solely the result of recurrent bottlenecks, new capacity could make transmission charges more predictable by relieving congestion. Until that happens, the uncertainty about transmission charges will make large trades hard to execute and limit the usefulness of derivatives for local markets.

All available evidence indicates that the oil industry has successfully used derivatives to manage risk. Natural gas derivatives based on the Henry Hub price are well established. For local gas markets where there is a predictable difference between the local price and the Henry Hub price, customers can use Henry Hub contracts with premiums or discounts to manage local price risk. Unfortunately, price differences are not predictable for many local gas markets, because natural gas (and electricity) markets are not integrated to the same extent as petroleum markets.

Derivative traders are competing vigorously for business, evidence that risk is being transferred to those who profit from bearing it at competitive rates. However, continuing problems with the reporting of natural gas price data and with pipeline transmission costs may be denying the benefits of derivatives to many potential users.

Table S3. Petroleum and Natural Gas Price Risks and Risk Management Strategies

Participants	Price Risks	Risk Management Strategies and Derivative Instruments Employed
Oil Producers	Low crude oil price	Sell crude oil future, buy put option
Petroleum Refiners	High crude oil price	Buy crude oil future or call option
	Low product price	Sell product future or swap contract, buy put option
	Thin profit margin	Buy crack spread ^a
Storage Operators	High purchase price or low sale price	Buy or sell futures
Large Consumers		
Local Distribution Companies (Natural Gas)	Unstable prices, wholesale prices higher than retail	Buy future or call option, buy basis contract ^b
Power Plants (Natural Gas)	Thin profit margin	Buy spark spread ^c
Airlines and Shippers	High fuel price	Buy swap contract

^aEssentially, buy crude oil future and simultaneously sell product future.

^bA basis contract fixes the transportation cost between Henry Hub and a local market.

^cBuy natural gas future and sell electricity future.

Source: Energy Information Administration.

Electricity Markets: Limited Success for Derivatives So Far

The electricity generation industry is the latest to be deregulated, and participants have discovered that they are subject to wholesale price swings even greater than in the oil and gas markets. Before deregulation, electric utilities were guaranteed the ability to recover reasonable costs incurred in providing service to their customers. As a result, they had no need to hedge against unforeseen price risks. Consumers paid for stable prices in the form of higher average prices due to excess capacity, inappropriate technology, and inefficient operations.

As in the petroleum and natural gas industries, the opening of electricity generation markets to competition has exposed firms to greater price uncertainty, and market participants have tried to turn to derivative contracts to deal with the price risk. Unlike the oil and gas markets, derivatives in electricity markets have not met with a great deal of success. NYMEX began offering electricity derivatives in March 1996, and the Chicago Board of Trade and the Minneapolis Grain Exchange have also offered electricity derivatives. NYMEX had the most success, at one point listing six different futures contracts. Trading in electricity futures and options

contracts peaked in the fall of 1998; however, by the fall of 2000 most activity had ceased. Today no electricity contracts are listed on the regulated exchanges.

Although futures and exchange-listed options failed in electricity markets, the trading of other derivative contracts continues. Commonly used electricity derivatives traded in OTC markets include forward contracts, swaps, and options. Aggregate data on the overall size of the OTC market in electricity-related derivatives do not exist; however, anecdotal evidence from the trade press and market participants indicates significant interest in their use and trading. Other, tangential derivatives for managing risk are being used in the industry, including emissions trading, weather derivatives, and outage derivatives.

Many of the current problems with electricity derivatives result from problems in the underlying physical market for electricity. Until the market for the underlying commodity is working well, it is difficult for a robust derivatives market to develop. Competitive electricity markets require competitive, robust transmission markets. A physical grid that has sufficient capacity to move large amounts of cheap power to force down prices in areas where they are high fosters competition; however, creating competitive transmission markets has proven particularly difficult. Competitive transmission charges are the marginal cost of moving power. Except in a few locations, transmission charges are currently set arbitrarily with no regard to the system's marginal cost. Many States actively discourage transmission of their cheap power to higher cost areas in neighboring States. Similarly, high-cost suppliers have not been anxious for lower cost supplies to be imported into "their" territory. The result is a balkanized marketplace, where trade does not discipline electricity prices.

In addition to structural obstacles and regulatory uncertainties, deregulation of electricity generation and the development of truly competitive spot markets are hindered by the nature of electricity as a commodity, the extreme volatility of wholesale prices, the balkanization of the existing spot markets, and a lack of price transparency.

Unlike many commodities, electricity is expensive to store. As a result, it is consumed the instant it is produced, and any excess is dissipated. Standard risk management textbooks provide numerous formulas for valuation of derivative contracts on storable assets, but none that apply to non-storable commodities. As a

consequence, risk managers have difficulty valuing the risk associated with electricity derivatives.

The extreme volatility of wholesale electricity prices is due to the rapid increase in marginal generation cost for near capacity operations, combined with the lack of customer demand response to wholesale price changes. With very few exceptions, the retail price customers see does not vary with the wholesale price (marginal cost) of electricity. When demand and marginal generation costs are high, retail prices do not increase. Likewise, when demand and generation costs are low, retail prices do not decrease. Consequently, customers consume too much when supplies are stressed and too little when supplies are ample. Compared to a competitive market, electricity wholesale prices increase too much in periods of tight supplies and fall too much in surplus. Moreover, because retail price increases do not limit demand, regulated suppliers have to maintain expensive excess capacity to meet infrequent demand peaks.

The complexity of electricity markets and their limited price transparency have created an environment that allows market participants to guess the behavior of others and "game the system." The task of valuing (pricing) derivatives is further complicated to the extent that gaming affects prices. The California ISO rules explicitly prohibit such behavior.

Whether gaming in the California market reflected efforts to make money within the rules or efforts to affect prices outside the rules is currently an open question.³ Analysts also continue to debate whether gaming affected California electricity prices.⁴ Markets for derivatives would be adversely affected only if the market and futures prices of electricity changed unexpectedly because of gaming.

The Federal Energy Regulatory Commission (FERC) has taken two recent steps to encourage competitive wholesale electricity markets. On January 6, 2000, FERC published Order 2000 requiring "... all transmission owning entities in the Nation, including non-public utility entities, to place their transmission facilities under the control of appropriate regional transmission institutions [RTOs] in a timely manner."⁵ The purpose of this order was to encourage trade and competition by ensuring open, equal access to transmission within large areas. On July 31, 2002, FERC issued a notice of Proposed Rulemaking (NOPR) to establish a Standard Market Design that would apply to "all public utilities that own, control or operate transmission facilities" ⁶ This

³Federal Energy Regulatory Commission, letter to Sam Behrends, IV, Esq. (May 6, 2002), concerning "Fact-Finding Investigation of Potential Manipulation of Electric and Natural Gas Prices, FERC Docket No. PA02-2-000."

⁴Although most commentators accept that gaming increased prices in California, some analysts argue that the effects, if any, were small. See J. Taylor and P. VanDoren, *Did Enron Pillage California?*, Briefing Paper No. 72 (Washington, DC: The Cato Institute, August 22, 2002).

⁵Federal Energy Regulatory Commission, *Regional Transmission Organizations*, Order No. 2000, 65 Fed. Reg. 809 (January 6, 2000).

⁶Federal Energy Regulatory Commission, *Remedying Undue Discrimination through Open Access Transmission Service and Standard Electricity Market Design*, Notice of Proposed Rulemaking, 18 CFR Part 35, Docket No. RM01-212-000 (Washington, DC, July 31, 2002), p. 9.

NOPR would ensure that all areas have similar market rules, particularly in regard to spot electricity markets and transmission pricing.

If these initiatives are successful, they will go a long way toward making wholesale electricity markets more competitive. However, neither the Order nor the NOPR requires that retail customers be exposed to changing wholesale prices. Until then, either wholesale electricity prices will remain volatile or the industry will have to maintain significant excess capacity.

Accounting for Derivatives

There are a number of accounting issues related to derivatives that have existed and been debated for some time:

- How should a derivative be accounted for when its value at inception may be very small or zero but may vary greatly over a potentially long lifetime?
- If the derivative is being used to hedge a physical asset or commitment to buy or sell a physical asset, how should such hedged positions be accounted for?
- Once an accounting method has been agreed to, what is the appropriate methodology to use in valuing the derivative, particularly when long maturities are involved?

After 6 years of deliberation, the Financial Accounting Standards Board (FASB) issued Statement 133, *Accounting for Derivative Instruments and Hedging Activities*, in June 1998. Statement 133 was subsequently amended by Statement 137 in June 1999 and Statement 138 in June 2000. In developing these statements, the FASB identified four problem areas under previous accounting conventions:

- The effects of derivatives were not transparent in basic financial statements.
- Accounting guidance for derivative instruments and hedging activities was incomplete.
- Accounting guidance for derivative instruments and hedging activities was inconsistent.
- Accounting guidance for derivatives and hedging was difficult to apply.

The statement issued by FASB addresses each of these shortcomings. First, the visibility, comparability, and understandability of the risks associated with derivatives are increased by the requirement that all derivatives be reported as assets or liabilities and measured at fair value. Second, inconsistency, incompleteness, and the difficulty of applying previous accounting guidance and practice were reduced by the provision of guidance for all derivatives and hedging activities. Third, the statement accommodates a range of hedge accounting

practices by permitting hedge accounting for most derivative instruments, including cash flow hedges of expected transactions. Further, the statement eliminates the requirement that an entity demonstrate risk reduction on an entity-wide basis to qualify for hedge accounting. These changes have the effect of reducing uncertainty about accounting requirements and may therefore encourage wider use of derivatives to manage risk.

Although Statement 133 is comprehensive and rigorous, it is also new. Its limits undoubtedly will be tested as publicly traded companies reporting to their shareholders gain familiarity with its complexity. At least one aspect of accounting practice—estimation of the fair value of derivatives—could prove problematical. Statement 133 holds that market prices should be used to measure fair value (mark-to-market valuation); however, when there are no market values for either the derivative or the underlying commodity (such as electricity that is to be supplied 5 years in the future), the guidance from the statement is more general than concrete. Market values are to be estimated, usually by means of models. Hence, the term “mark-to-model” is often used to describe these valuations.

Because Statement 133 does not restrain the firm’s choice of assumptions and models for making estimates of market values, different companies could report a wide range of values for the same derivative. The variance surrounding such estimates could be so large as to seriously impair their credibility. Indeed, “mark-to-model” has taken on a pejorative connotation. Valuation techniques might well be the subject of future opinions and standards issued by the accounting authorities.

Economic Impacts

There are a number of questions about the actual economic impacts of derivatives: Do they make the underlying energy commodity markets more volatile? Do they lower the cost of capital or encourage investment? Do they simply transfer private risk to the public?

The effects of derivatives on the volatility of underlying commodity prices have been one of the most intensively studied subjects in finance. One recent study reviewed more than 150 published analyses on the subject.⁷ With a very few exceptions, the available research suggests that the use of derivatives has either reduced or had no effect on price volatility.

Derivatives are often used to hedge (insure) against adverse or ruinous financial outcomes. Firms incur costs when they are in financial duress or bankruptcy. To the extent that companies avoid such costs by hedging, the use of derivatives could increase the profitability of a

⁷S. Mayhew, “The Impact of Derivatives on Cash Markets: What Have We Learned?” Working paper, Department of Banking and Finance, Terry College of Business, University of Georgia (Athens, GA, February 2000).

given investment and make it more attractive. Consistent with that interpretation, several recent studies have found that firms more likely to face financial duress are also more likely to use derivatives to hedge. Smaller and medium-sized firms in the oil and gas industry that cannot limit price risk by integrating their operations and diversifying are particularly likely to benefit from the use of derivatives.

A 2001 study by Allayannis and Weston found that hedging activity increases the value of the firm. Specifically, they used a sample of firms that faced currency risk directly because of foreign sales or indirectly because of import competition. They found that firms with sales in foreign countries that hedged with currency derivatives had a 4.87-percent higher firm value (hedging premium) than similar firms that did not use derivatives.⁸ Firms that did not have foreign sales but faced currency risk indirectly had a smaller, but statistically insignificant, hedging premium. The study also found evidence that after firms began hedging, their market value increased, and that after firms quit hedging, their value fell. Thus, there is evidence that hedging increases the value of the firm and, by implication, increases investment.

Although derivatives meet legitimate needs, they have also been implicated in tremendous losses. For example, Orange County, California, lost \$1.7 billion in 1993; Metallgesellschaft lost about \$1.3 billion in 1993 in energy trading; and in 1998 the Federal Reserve Bank of New York organized a rescue of Long Term Capital Management in order to avoid disrupting international capital markets. And in 2001 Enron became at that time the largest bankruptcy in American history. Enron was a large user and promoter of derivative contracts. Although Enron's failure was not caused by derivatives, its demise raised significant concerns about counterparty (credit) risk and financial reporting in many energy companies.

A reasonable question, then, is whether the benefits conferred by derivatives are sufficient to compensate for their occasional, but probably inevitable, misuse. Derivatives, properly used, are generally found to be beneficial. They can allow a firm to invest in worthwhile projects that it otherwise would forgo. In addition, they rarely if ever increase volatility in spot markets. Nor

have they been shown historically in oil markets to be a major tool for market manipulation. As recent history makes clear, however, derivatives have been associated with spectacular financial failures and, possibly, fraud.

Prospects for Energy Derivatives

Derivatives have proven to be useful in the petroleum and natural gas industries, and they still are being used in the electricity industry despite the setbacks discussed above. They probably would be used more extensively if financial and market data were more transparent. Managers may limit derivative use because their presence in company accounts is troubling to some classes of investors. In addition, the lack of timely, reliable spot price and quantity data in most markets makes it difficult and expensive for traders to provide derivatives to manage local risks.

More fundamentally, the effectiveness of derivatives is dependent upon the nature of the underlying commodity market. Commodity markets with large numbers of informed buyers and sellers, each with multiple means of moving the commodity to where it is needed, support derivative markets. Derivatives for managing local price risks can then be based on the overall market price with relatively small, predictable adjustments for moving the commodity to local users. Federal energy policy has a significant impact on competitors' access to transportation (transmission), on the volatility of transmission charges, and therefore on derivative markets.

Price risk managers in natural gas markets have to contend with frequent, unexpected, and large changes in the difference between prices in physically connected markets. The effect of highly variable price spreads—the transmission charge—between areas is to subdivide the national market into multiple small pricing hubs. New pipeline construction and capacity additions should eventually promote more competition in the markets they serve by relieving the congestion that may account for some of the variation in price spreads. Until then, market fragmentation will make it hard and relatively expensive to protect against local price variation.

The prospects for the growth of an active electricity derivatives market are tied to the course of industry restructuring. Until the electricity spot markets work well, the prospects for electricity derivatives are limited.

⁸About 36 percent of the firms in this sample that had foreign sales did not hedge. Note that this study did not address the issue of why they failed to hedge if doing so would increase firm value. See G. Allayannis and J. Weston, "The Use of Foreign Currency Derivatives and Firm Market Value," *Review of Financial Studies*, Vol. 14 (2001), pp. 243-276.

1. Introduction

Purpose of the Report

Derivatives are financial instruments (contracts) that do not represent ownership rights in any asset but, rather, derive their value from the value of some other underlying commodity or other asset. When used prudently, derivatives are efficient and effective tools for isolating financial risk and “hedging” to reduce exposure to risk.

Although derivatives have been used in American agriculture since the mid-1800s and are a mainstay of international currency and interest rate markets, their use in domestic energy industries has come about only in the past 20 years with energy price deregulation. Under regulation, domestic petroleum, natural gas, and electricity prices were set by regulators and infrequently changed. Deregulation revealed that energy prices are among the most volatile of all commodities. Widely varying prices encouraged consumers to find ways to protect their budgets; producers looked for ways to stabilize cash flow.

Derivative contracts transfer risk, especially price risk, to those who are able and willing to bear it. How they transfer risk is complicated and frequently misinterpreted. Derivatives have also been associated with some spectacular financial failures and with dubious financial reporting.

The Energy Information Administration prepared this report at the direction of the Secretary of Energy to provide energy policymakers with information for their assessment of the merits of derivatives for managing risk in energy industries.¹ In accord with the Secretary’s direction, this report specifically includes:

- A description of energy risk management tools
- A description of exchanges and mechanisms for trading energy contracts
- Exploration of the varied uses of energy risk management tools
- Discussion of the impediments to the development of energy risk management tools
- Analysis of energy price volatility relative to other commodities
- Review of the current regulatory structure for energy derivatives markets

- A survey of the literature on energy derivatives and trading.

It also indicates how policy decisions that affect energy markets can limit or enhance the usefulness of derivatives as tools for risk management.

Findings

The past 25 years have seen a revolution in academic understanding and practical management of risk in economic affairs. Businesses and consumers are increasingly isolating particular risks and using derivative contracts to transfer risk to others who profit by bearing it. Normally, both parties to a derivative contract are better off as a result. For example, a local distribution company that sells natural gas to end users may be concerned in the spring that the wholesale price of natural gas in the following winter will be too high to allow for a reasonable profit on retail sales to customers. The company may therefore “hedge” against the possibility of high winter prices by entering into a forward or futures contract for wholesale gas purchases at a guaranteed fixed price. The seller of the contract would profit if the distribution company’s fears were not realized. Both parties would be better off, because each would accept only those risks that it was willing and able to bear.

Nothing is new in using derivative contracts to manage particular risks. What is new is that global competition, flexible exchange rates, price deregulation, and the growth of spot (cash) markets have exposed more market participants to large financial risks. Simultaneously, advances in information technology and computation have allowed traders to assign a value (price) to risk by using formulas developed by academics starting in the 1960s.² Starting from the late 1960s, the business of isolating, packaging, and selling specific risks has become a multi-trillion dollar industry.

Price risk management is relatively new to the domestic petroleum, natural gas, and electricity industries. Electricity has not been a thoroughly competitive industry since the early 1900s. Natural gas and oil pipelines and residential natural gas prices (in most areas) still are regulated. Operating under government protection, these industries had little need for risk management before

¹Memo from Secretary of Energy Spencer Abraham to Acting EIA Administrator Mary J. Hutzler (February 8, 2002). See Appendix A.

²See the Nobel Prize address by Myron S. Scholes, delivered in Stockholm, Sweden, on December 9, 1997, reprinted in *American Economic Review*, Vol. 88, No. 3 (June 1998), pp. 350-370.

the wave of deregulation that began in the 1980s—about the same time that modern risk management tools came into practice.

Derivatives, properly used, are generally found to be beneficial. They can allow a firm to invest in worthwhile projects that it otherwise would forgo. In addition, they neither increase volatility in spot markets nor have been shown historically in oil markets to be a major tool for market manipulation.

Energy policy affects derivatives mainly through its impacts on the underlying commodity and transportation (transmission) markets. Commodity markets with large numbers of informed buyers and sellers, each with multiple means of moving the commodity to where it is needed, support competitive prices. Derivatives for managing local price risks can then be based on the overall market price with relatively small, predictable adjustments for moving the commodity to local users. Federal energy policy has a significant impact on competitors' access to transportation (transmission), on the volatility of transmission charges, and therefore on derivative markets.

Price risk managers in natural gas markets, for example, have to contend with frequent, unexpected, and large changes in the difference between prices in physically connected markets. The effect of highly variable price spreads—the transmission charge—between areas is to subdivide the national market into multiple small pricing hubs. New pipeline construction and capacity additions should eventually promote more competition in the markets they serve by relieving the congestion that may account for some of the variation in price spreads. Until then, market fragmentation will make it hard and relatively expensive to protect against local price variation.

The prospects for the growth of an active electricity derivatives market are tied to the course of industry restructuring. Until the electricity spot markets work well, the prospects for electricity derivatives are limited. FERC is undertaking massive efforts to promote competitive pricing and better integration of electricity markets across political boundaries. In 1999 FERC issued order 2000 requiring wholesale market participants to join regional transmission organizations (RTOs) to establish regional transmission management. Progress in establishing RTOs has been slow. In July 2002 FERC followed up with a Notice of Proposed Rulemaking to establish a Standard Market Design (SMD) that would apply within and across RTOs.³ Within each RTO the

business and operating rules would be the same for all market participants, and all the RTOs would be encouraged to adopt a standard market design, so that the basic rules and regulations of the regional markets would be similar from one RTO to another. Essentially the idea is to encourage a common market for electricity to replace the balkanized industry that exists today. If these efforts succeed, the result should be larger, more competitive regional markets and more cost-reducing trades across areas.

Although derivatives meet legitimate needs, they have also been implicated in tremendous losses. For example, Orange County, California, lost \$1.7 billion in 1993; Metallgesellschaft lost about \$1.3 billion in 1993 in energy trading; and in 1998 the Federal Reserve Bank of New York organized a rescue of Long Term Capital Management in order to avoid disrupting international capital markets. And in 2001 Enron became at that time the largest bankruptcy in American history. Enron was a large user and promoter of derivative contracts. Although Enron's failure was not caused by derivatives, its demise raised significant concerns about counterparty (credit) risk and financial reporting in many energy companies.

Organization of the Report

This report is presented in two parts. Chapters 2 through 5 focus on general tools for risk management and their use in the oil and gas and electricity industries. Chapter 2 introduces the basic kinds of derivatives and describes their use in managing the price risks endemic to the energy industry. Chapters 3 and 4 are case studies of derivatives in the oil and natural gas industries and the electricity industry, respectively. Chapter 5 examines the potential for further development of these energy derivatives markets.

The second part of the report, Chapters 6 through 8, examines the more general role of derivatives in the economy. Chapter 6 documents the enormous growth of derivative markets worldwide, discusses the markets where they are priced, and describes how derivatives are regulated in the United States. Chapter 7 provides a primer on accounting for derivatives, highlighting Statement 133 of the Financial Accounting Standards Board (FASB), "Accounting for Derivative Instruments and Hedging Activities." Chapter 8 summarizes the published literature (primarily academic) on the overall economic impacts of derivatives.

³See Federal Energy Regulatory Commission, "Commission Proposes New Foundation for Bulk Power Markets with Clear, Standardized Rules and Vigilant Oversight," News Release (July 31, 2002), Docket No. RM01-12-000 and Attachments (Questions and Answers), web site www.ferc.fed.us.

2. Derivatives and Risk in Energy Markets

Introduction

The general types of risk faced by all businesses can be grouped into five broad categories: *market risk* (unexpected changes in interest rates, exchange rates, stock prices, or commodity prices); *credit/default risk*; *operational risk* (equipment failure, fraud); *liquidity risk* (inability to pay bills, inability to buy or sell commodities at quoted prices); and *political risk* (new regulations, expropriation). In addition, the financial future of a business enterprise can be dramatically altered by unpredictable events—such as depression, war, or technological breakthroughs—whose probability of occurrence cannot be reasonably quantified from historical data.⁴

Businesses operating in the petroleum, natural gas, and electricity industries are particularly susceptible to market risk—or more specifically, *price risk*—as a consequence of the extreme volatility of energy commodity prices. To a large extent, energy company managers and investors can make accurate estimates of the likely success of exploration ventures, the likelihood of refinery failures, or the performance of electricity generators. Diversification, long-term contracts, inventory maintenance, and insurance are effective tools for managing those risks. Such traditional approaches do not work well, however, for managing price risk.

With the onset of domestic market deregulation in the 1980s, stable, administered prices for petroleum products and natural gas gave way to widely fluctuating spot market prices. Similarly, in the late 1990s, deregulation of wholesale electricity markets revealed that electricity prices, when free to respond to supply and demand, can vary by factors of more than 100 over periods of days or even hours. Spot prices for natural gas and electricity can also vary widely by location. International crude oil prices have long been volatile.

When energy prices fall, so do the equity values of producing companies; as a result, ready cash becomes scarce, and it is more likely that contract obligations for energy sales or purchases may not be honored. When prices soar, governments tend to step in to protect consumers. Thus, commodity price risk plays a dominant

role in the energy industries, and the use of derivatives has become a common means of helping energy firms, investors, and customers manage the risks that arise from the high volatility of energy prices.

Derivatives are particularly useful for managing price risk. Their use in the energy arena is not surprising, in that they have been used successfully to manage agriculture price risk for more than a century. Deregulation of domestic energy industries has shown price risk to be greater for energy than for other commodities; in a sense, energy derivatives are a natural outgrowth of market deregulation. Derivatives allow investors to transfer risk to others who could profit from taking the risk, and they have become an increasingly popular way for investors to isolate cash earnings from fluctuations in prices.

Energy price risk has economic consequences of general interest because it can decisively affect whether desirable investments in energy projects are actually made. Investments in large power plants run from \$200 million to over \$1 billion, and the plants take 2 to 7 years to construct. Following general discussions of risk management without and with the use of derivatives, descriptions of various kinds of derivative contracts, and a brief analysis of energy price volatility, this chapter presents an illustration of the potential impact of price volatility on the economics of investment in a natural-gas-fired combined-cycle electricity generator. Combined-cycle generators are of particular interest because the Energy Information Administration (EIA) and other forecasters expect them to be the dominant choice for investments in new generating capacity over the next decade.⁵ The example shows that an economically efficient investment, one that is in society's interest to undertake, could generate large cash losses that must be managed.

Risk Management Without Derivatives

When investors, managers, and/or a firm's owners are averse to risk, there is an incentive to take actions to

⁴F.H. Knight, *Risk, Uncertainty and Profit* (New York, NY: Century Press, 1964; originally published in 1921).

⁵Combined-cycle generating facilities are less capital-intensive than other technologies, such as coal, nuclear, or renewable electricity plants, but have higher fuel costs. In a recent EIA study, the share of natural-gas-fired generation in the Nation's electricity supply is projected to grow from 16 percent in 2000 to 32 percent in 2020. As a result, by 2004, natural gas is expected to overtake nuclear power as the Nation's second-largest source of electricity. See Energy Information Administration, *Annual Energy Outlook 2002*, DOE/EIA-0383(2002) (Washington, DC, December 2001).

reduce it. Diversification—investing in a variety of unrelated businesses, often in different locations—can be an effective way of reducing a firm’s dependence on the performance of a particular industry or project. In theory it is possible to “diversify away” all the risks of a particular project;⁶ in practice, however, diversification is expensive and often fails because of the complexity of managing diverse businesses.⁷ More fundamentally, the success of most projects is strongly tied to the state of the general economy, so that the fortunes of various businesses and projects are not independent but move together. In the real world, therefore, diversification is often not a viable response to risk.

Another method of managing the risk created by fluctuating prices is to use long-term fixed-price contracts: the owner of a firm that invests in a natural gas combined-cycle plant could simply sign a long-term contract with a gas supplier. For example, in January 2002 it would have been possible to lock in gas prices of \$2.59 per thousand British thermal units (Btu), \$2.92 for 2003, and so on. However, such a hedging strategy still would leave some risk. If the spot market price for natural gas in 2003 turned out to be only \$2.70 as opposed to \$2.92, power from the firm’s plant might not be competitive, because other plant owners could purchase natural gas at \$2.70 and undercut the price of power from the plant with a higher fuel cost of \$2.92. Conversely, if natural gas prices in 2003 rose to \$4.00, the seller might choose to default on the plant’s gas supply contract.

Insurance contracts can also be used to manage risk. For example, there is some probability that the natural gas plant in the previous example might malfunction and be taken out of service. The owner of the plant could purchase an insurance contract that would provide compensation for lost revenue (and perhaps for repair costs) in the event of an unplanned outage. The insurance would essentially shift the risks from the owner of the plant to the “counterparty” of the contract (in this case, the insurance provider). The counterparty would accept the risk if it had greater ability to pool risks and/or were less averse to risk than was the owner of the plant.

The plant owner could also reduce the risk of adverse movements in future natural gas prices by purchasing the fuel in the current period and storing it as inventory. If prices fell, the firm could buy the fuel on the open market; if they increased, it could draw down the inventory. This could be an expensive way to manage risk, because storage costs could be considerable.

Managing Risk With Derivative Contracts

Derivatives are contracts, financial instruments, which derive their value from that of an underlying asset. Unlike a stock or securitized asset, a derivative contract does not represent an ownership right in the underlying asset. For example, a call option on IBM stock gives the option holder the right to buy a specified quantity of IBM stock at a given price (the “strike price”). The option does not represent an ownership interest in IBM (the underlying asset). The right to purchase the stock at a given price, however, is of value. If, for instance, the option is to buy a share of IBM stock at \$40, that option will be worth at least \$60 when the stock is selling for \$100. The option holder can exercise the option, pay \$40 to acquire the stock, and then immediately sell the stock at \$100 for a \$60 profit.

The asset that underlies a derivative can be a physical commodity (e.g., crude oil or wheat), foreign or domestic currencies, treasury bonds, company stock, indices representing the value of groups of securities or commodities, a service, or even an intangible commodity such as a weather-related index (e.g., rainfall, heating degree days, or cooling degree days). What is critical is that the value of the underlying commodity or asset be unambiguous; otherwise, the value of the derivative becomes ill-defined.

The following sections describe various derivative instruments and how they can be used to isolate and transfer risk. Most of the discussion is in terms of price risk, but derivatives have also been developed with other non-price risks, such as weather or credit. When used prudently, derivatives are efficient and effective tools for reducing certain risks through hedging.

Forward Contracts

Forward contracts are a simple extension of cash or cash-and-carry transactions. Whereas in a standard cash transaction the transfer of ownership and possession of the commodity occur in the present, delivery under a forward contract is delayed to the future. For example, farmers often enter into forward contracts to guarantee the sale of crops they are planting. Forward contracts are sometimes used to secure loans for the farming operation. In energy markets, an oil refiner may enter into forward contracts to secure crude oil for future operations, thereby avoiding both volatility in spot oil prices and the need to store oil for extended periods.

⁶To get a riskless portfolio would require that the average correlation across all asset pairs be zero—a stronger condition than having a particular asset uncorrelated with the rest of the portfolio.

⁷P.G. Berger and E. Ofek, “Diversification’s Effect on Firm Value,” *Journal of Financial Economics*, Vol. 37 (1995), pp. 39-65.

Forward contracts are as varied as the parties using them, but they all tend to deal with the same aspects of a forward sale. All forward contracts specify the type, quality, and quantity of commodity to be delivered as well as when and where delivery will take place. In addition, forward contracts set a price or pricing formula. The simplest forward contract sets a fixed (firm) price. More elaborate price-setting mechanisms include floors, ceilings, and inflation escalators. By setting such a price, the buyer and seller are able to reduce or eliminate uncertainty with respect to the sale price of the commodity in the future. Knowing such prices with certainty may allow forward contract users to better plan their commercial activity. Finally, the contract may contain miscellaneous terms or conditions, such as establishing the responsibilities of the parties under circumstances where one party fails to perform in an acceptable manner (lack of delivery, late delivery, poor quality, etc.). Overall, forward contracts are designed to be flexible so as to match the commercial merchandising needs of the parties entering into them.

A direct result of the forward pricing and delivery features of forward contracts are default and credit risks. In the case of long-term forward contracts, the exposure to default and credit risks may be substantial. Parties to forward contracts must be concerned about the other party's performance, particularly when the value of the contract moves in one's favor. For example, if an oil refiner has contracted to purchase oil at \$19 per barrel, its level of concern that the other party will perform by delivering oil rises progressively as the price of oil rises above \$19 per barrel and the incentive for the counterparty to "walk away" from the contract increases. To deal with the risk of default, parties scrutinize the creditworthiness of counterparties and deal only with parties that maintain good credit ratings. They may also limit how much they will buy from or sell to a particular trader based on his credit rating. In some circumstances parties may also ask counterparties to post collateral or good faith deposits to assure performance. Ultimately, how parties deal with default and credit risk in a forward contract is up to them.

Futures Contracts

Futures trading in the United States evolved from the trading of forward contracts in the mid-1800s at the Chicago Board of Trade (CBOT). By the 1850s, the practice of forward contracting had become established as farmers and grain merchants in the Midwest sought to reduce

their exposure to changes in the price of grain they were producing or storing.⁸ After the CBOT standardized forward contracts, speculators began to purchase and sell the contracts in an effort to profit from the change in the value of the contracts. Actual delivery of the commodity became of secondary importance.⁹ Eventually this practice became institutionalized on the CBOT, and the modern futures contract was born. Today futures contracts are traded on a number of exchanges in the United States and abroad (Table 1).

Forward contracts have problems that can be serious at times. First, buyers and sellers (counterparties) have to find each other and settle on a price. Finding suitable counterparties can be difficult. Discovering the market price for a delivery at a specific place far into the future is also daunting. For example, after the collapse of the California power market in the summer of 2000, the California Independent System Operator (ISO) had to discover the price for electricity delivered in the future through lengthy, expensive negotiation, because there was no market price for future electricity deliveries. Second, when the agreed-upon price is far different from the market price, one of the parties may default ("non-perform"). As companies that signed contracts with California for future deliveries of electricity at more than \$100 a megawatt found when current prices dropped into the range of \$20 to \$40 a megawatt, enforcing a "too favorable" contract is expensive and often futile. Third, one or the other party's circumstances might change. The only way for a party to back out of a forward contract is to renegotiate it and face penalties.

Futures contracts solve these problems but introduce some of their own. Like a forward contract, a futures contract obligates each party to buy or sell a specific amount of a commodity at a specified price. Unlike a forward contract, buyers and sellers of futures contracts deal with an exchange, not with each other. For example, a producer wanting to sell crude oil in December 2002 can sell a futures contract for 1,000 barrels of West Texas Intermediate (WTI) to the New York Mercantile Exchange (NYMEX), and a refinery can buy a December 2002 oil future from the exchange. The December futures price is the one that causes offers to sell to equal bids to buy—i.e., the demand for futures equals the supply. The December futures price is public, as is the volume of trade. If the buyer of a December futures finds later that he does not need the oil, he can get out of the contract by selling a December oil future at the prevailing price. Since he has both bought and sold a December oil future,

⁸For a detailed discussion of the early development of futures trading, see T.A. Hieronymus, *Economics of Futures Trading for Commercial and Personal Profit* (New York, NY: Commodity Research Bureau, Inc., 1971), pp. 73-76.

⁹A forward contract takes on a value when the price expected to exist at the time of delivery deviates from the price specified in the forward contract. For example, if a forward contract specifies a price of \$19 per barrel for crude oil and the price expected to exist at the time of delivery rises to \$20 per barrel, the value of the contract from the perspective of the party taking delivery is \$1 per barrel, in that the party could take delivery of the oil and immediately sell it at a profit of \$1 per barrel. Conversely, the value of the contract to the party making delivery is -\$1 per barrel.

he has met his obligations to the exchange by netting them out.

Table 2 illustrates how futures contracts can be used both to fix a price in advance and to guarantee performance. Suppose in January a refiner can make a sure profit by acquiring 10,000 barrels of WTI crude oil in December at the current December futures price of \$28 per barrel. One way he could guarantee the December price would be to “buy” 10 WTI December contracts. The refiner pays nothing for the futures contracts but has to make a good-faith deposit (“initial margin”) with his broker. NYMEX currently requires an initial margin of \$2,200 per contract. During the year the December futures price will change in response to new information about the demand and supply of crude oil.

In the example, the December price remains constant until May, when it falls to \$26 per barrel. At that point the exchange pays those who sold December futures contracts and collects from those who bought them. The money comes from the margin accounts of the refiner and other buyers. The broker then issues a “margin call,” requiring the refiner to restore his margin account by adding \$20,000 to it.

This “marking to market” is done every day and may be done several times during a single day. Brokers close out parties unable to pay (make their margin calls) by selling their clients’ futures contracts. Usually, the initial margin is enough to cover a defaulting party’s losses. If not, the broker covers the loss. If the broker cannot, the exchange does. Following settlement after the first change in the December futures price, the process is started anew, but with the current price of the December future used as the basis for calculating gains and losses.

In September, the December futures price increases to \$29 per barrel, the refiner’s contract is marked to market, and he receives \$30,000 from the exchange. In October, the price increases again to \$35 per barrel, and the refiner receives an additional \$60,000. By the end of November, the WTI spot price and the December futures price are necessarily the same, for the reasons given below. The refiner can either demand delivery and buy the oil at the spot price or “sell” his contract. In either event his initial margin is refunded, sometimes with interest. If he buys oil he pays \$35 per barrel or \$350,000, but his trading profit is \$70,000 (\$30,000 + \$60,000 - \$20,000). Effectively, he ends up paying \$28 per barrel [(\$350,000 - \$70,000)/

Table 1. Major U.S. and Foreign Futures Exchanges

Exchange	Country	Primary Commodities
Chicago Board of Trade (CBOT)	USA	Grains, US Treasury notes and bonds, other interest rates, stock indexes
Chicago Mercantile Exchange (CME)	USA	Livestock, dairy products, stock indexes, Eurodollars and other interest rates, currencies
Kansas City Board of Trade (KCBT)	USA	Wheat and stock indexes
Minneapolis Grain Exchange (MGE)	USA	Spring wheat
New York Board of Trade (NYBOT)	USA	Sugar, coffee, cocoa, cotton, currencies
New York Mercantile Exchange (NYMEX)	USA	Metals, crude oil, heating oil, natural gas, gasoline
Philadelphia Board of Trade (PBOT)	USA	Currencies
Bolsa de Mercadorias & Futuros (BMF)	Brazil	Gold, stock indexes, interest rates, exchange rates, anhydrous fuel alcohol, coffee, corn, cotton, cattle, soybeans, sugar
EUREX	Germany/Switzerland	Interest rates, bonds, stock indexes
Hong Kong Futures Exchange (HKFE)	Hong Kong	Stock indexes, interest rates, currencies
International Petroleum Exchange (IPE)	England	Crude oil, gas oil, natural gas, electricity
London International Financial Futures Exchange (LIFFE)	England	Interest rates, stock indexes, bonds, coffee, sugar, cocoa, grain
London Metals Exchange (LME)	England	Copper, aluminum, lead, zinc, nickel, tin, silver
Marche Terme International de France (MATIF)	France	Bonds, notes, interest rates, rapeseed, wheat, corn, sunflower seeds, stock indexes
MEEF Renta Fija	Spain	Bonds, interest rates, stock indexes
Singapore Futures Exchange	Singapore	Interest rates, stock indexes, crude oil
Sydney Futures Exchange	Australia	Interest rates, stocks, stock indexes, currencies, electricity, wool, grains
Tokyo Grain Exchange (TGE)	Japan	Corn, soybeans, red beans, coffee, sugar
Tokyo International Financial Futures Exchange (TIFFE)	Japan	Interest rates, currencies

Source: Commodity Futures Trading Commission.

Table 2. Example of an Oil Futures Contract

Date	Prices per Barrel		Contract Activity	Cash In (Out)
	WTI Spot	December Future		
January	\$26	\$28	Refiner "buys" 10 contracts for 1,000 barrels each and pays the initial margin.	(\$22,000)
May	\$20	\$26	Mark to market: (26 - 28) x 10,000	(\$20,000)
September	\$20	\$29	Mark to market: (29 - 26) x 10,000	\$30,000
October	\$27	\$35	Mark to market: (35 - 29) x 10,000	\$60,000
November (end)	\$35	\$35	Refiner either: (a) buys oil, or (b) "sells" the contracts. Initial margin is refunded.	(\$350,000) \$22,000

Source: Energy Information Administration.

10,000], which is precisely the January price for December futures. If he "sells" his contract he keeps the trading profit of \$70,000.

Several features of futures are worth emphasizing. First, a party who elects to hold the contract until maturity is guaranteed the price he paid when he initially bought the contract. The buyer of the futures contract can always demand delivery; the seller can always insist on delivering. As a result, at maturity the December futures price for WTI and the spot market price will be the same. If the WTI price were lower, people would sell futures contracts and deliver oil for a guaranteed profit. If the WTI price were higher, people would buy futures and demand delivery, again for a guaranteed profit. Only when the December futures price and the December spot price are the same is the opportunity for a sure profit eliminated.

Second, a party can sell oil futures even though he has no access to oil. Likewise a party can buy oil even though he has no use for it. Speculators routinely buy and sell futures contracts in anticipation of price changes. Instead of delivering or accepting oil, they close out their positions before the contracts mature. Speculators perform the useful function of taking on the price risk that producers and refiners do not wish to bear.

Third, futures allow a party to make a commitment to buy or sell large amounts of oil (or other commodities) for a very small initial commitment, the initial margin. An investment of \$22,000 is enough to commit a party to buy (sell) \$280,000 of oil when the futures price is \$28 per barrel. Consequently, traders can make large profits or suffer huge losses from small changes in the futures price. This *leverage* has been the source of spectacular failures in the past.

Futures contracts are not by themselves useful for all those who want to manage price risk. Futures contracts are available for only a few commodities and a few delivery locations. Nor are they available for deliveries a decade or more into the future. There is a robust

business conducted outside exchanges, in the over-the-counter (OTC) market, in selling contracts to supplement futures contracts and better meet the needs of individual companies.

Options

An option is a contract that gives the buyer of the contract the right to buy (a call option) or sell (a put option) at a specified price (the "strike price") over a specified period of time. American options allow the buyer to exercise his right either to buy or sell at any time until the option expires. European options can be exercised only at maturity. Whether the option is sold on an exchange or on the OTC market, the buyer pays for it up front. For example, the option to buy a thousand cubic feet of natural gas at a price of \$3.40 in December 2002 may cost \$0.14. If the price in December exceeds \$3.40, the buyer can exercise his option and buy the gas for \$3.40. More commonly, the option writer pays the buyer the difference between the market price and the strike price. If the natural gas price is less than \$3.40, the buyer lets the option expire and loses \$0.14. Options are used successfully to put floors and ceilings on prices; however, they tend to be expensive.

Swaps

Swaps (also called contracts for differences) are the most recent innovation in finance. Swaps were created in part to give price certainty at a cost that is lower than the cost of options. A swap contract is an agreement between two parties to exchange a series of cash flows generated by underlying assets. No physical commodity is actually transferred between the buyer and seller. The contracts are entered into between the two counterparties, or principals, outside any centralized trading facility or exchange and are therefore characterized as OTC derivatives.

Because swaps do not involve the actual transfer of any assets or principal amounts, a base must be established in order to determine the amounts that will periodically

be swapped. This principal base is known as the “notional amount” of the contract. For example, one person might want to “swap” the variable earnings on a million dollar stock portfolio for the fixed interest earned on a treasury bond of the same market value. The notional amount of this swap is \$1 million. Swapping avoids the expense of selling the portfolio and buying the bond. It also permits the investor to retain any capital gains that his portfolio might realize.

Figure 1 illustrates an example of a standard crude oil swap. In the example, a refiner and an oil producer agree to enter into a 10-year crude oil swap with a monthly exchange of payments. The refiner (Party A) agrees to pay the producer (Party B) a fixed price of \$25 per barrel, and the producer agrees to pay the refiner the settlement price of a futures contract for NYMEX light, sweet crude oil on the final day of trading for the contract. The notional amount of the contract is 10,000 barrels. Under this contract the payments are netted, so that the party owing the larger payment for the month makes a net payment to the party owing the lesser amount. If the NYMEX settlement price on the final day of trading is \$23 per barrel, Party A will make a payment of \$2 per barrel times 10,000, or \$20,000, to Party B. If the NYMEX price is \$28 per barrel, Party B will make a payment of \$30,000 to Party A. The 10-year swap effectively creates a package of 120 cash-settled forward contracts, one maturing each month for 10 years.

Figure 1. Illustration of a Crude Oil Swap Contract Between an Oil Producer and a Refiner

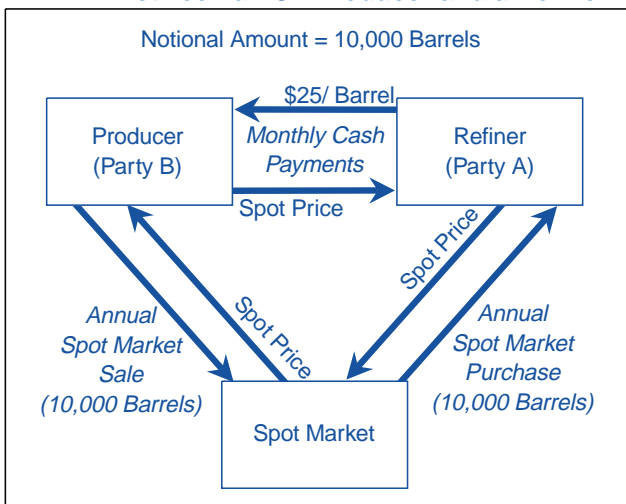

Source: Energy Information Administration.

So long as both parties in the example are able to buy and sell crude oil at the variable NYMEX settlement price, the swap guarantees a fixed price of \$25 per barrel, because the producer and the refiner can combine their financial swap with physical sales and purchases in the spot market in quantities that match the nominal contract size. All that remains after the purchases and sales shown in the inner loop cancel each other out are the fixed payment of money to the producer and the refiner’s purchase of crude oil. The producer never actually delivers crude oil to the refiner, nor does the refiner directly buy crude oil from the producer. All their physical purchases and sales are in the spot market, at the NYMEX price. Figure 2 shows the acquisition costs with and without a swap contract.

Many of the benefits associated with swap contracts are similar to those associated with futures or options contracts.¹⁰ That is, they allow users to manage price exposure risk without having to take possession of the commodity. They differ from exchange-traded futures and options in that, because they are individually negotiated instruments, users can customize them to suit their risk management activities to a greater degree than is easily accomplished with more standardized futures contracts or exchange-traded options.¹¹ So, for instance, in the example above the floating price reference for crude oil might be switched from the NYMEX contract, which calls for delivery at Cushing, Oklahoma, to an

Figure 2. Crude Oil Acquisition Cost With and Without a Swap Contract

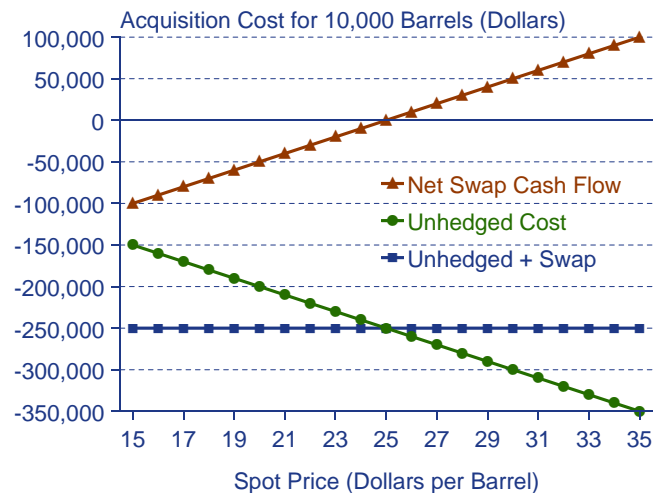

Source: Energy Information Administration

¹⁰A portfolio of a put and a call option can replicate a forward or a swap. See M. Hampton, “Energy Options,” in *Managing Energy Price Risk*, 2nd Edition (London, UK: Risk Books, 1999), p. 39.

¹¹Swaps and other OTC derivatives differ from futures in another functional respect that is related in part to their lack of standardization. Because their pricing terms are not widely disseminated, swaps and most other OTC derivatives generally do not serve a price discovery function. To the extent, however, that swap market participants tend to settle on standardized contract terms and that prices for transactions on those swaps are reported, it is potentially the case that particular swaps could serve this function. An important example is the inter-bank market in foreign currencies, from which quotes on certain forward rates are readily accessible from sizable commercial banks.

Alaskan North Slope oil price for delivery at Long Beach, California. Such a swap contract might be more useful for a refiner located in the Los Angeles area.

Although swaps can be highly customized, the counterparties are exposed to higher credit risk because the contracts generally are not guaranteed by a clearinghouse as are exchange-traded derivatives.¹² In addition, customized swaps generally are less liquid instruments, usually requiring parties to renegotiate terms before prematurely terminating or offsetting a contract.

Energy Price Risk

Energy prices vary more than the prices of other commodities and are also sensitive to location. Price variation increases the difficulty of cash and credit management and of assessing the worth of prospective investments. Historical price data clearly illustrate the relatively high volatility of energy prices.

Figure 3 compares the spot prices for sugar, gold, and crude oil and an index of stock prices (S&P 500) from January 1989 to December 2001. The price of sugar can be seen to be fairly constant at around 10 cents per pound, except for a spike in late 2000 and early 2001. Gold prices, which ranged between roughly \$350 and \$420 per ounce from 1989 through 1995, have generally fallen since mid-1996. The S&P 500 index has generally risen in fits and starts to a peak in the early part of 2000, followed by a steep decline.

In contrast to the patterns apparent in other spot prices, energy commodity prices show no discernible trends. For example, Figure 4 shows spot market prices for crude oil (West Texas Intermediate at Cushing, Oklahoma), heating oil (New York Harbor), unleaded gasoline (New York Harbor), and natural gas (Henry Hub, Louisiana). The price of crude oil appears to fluctuate randomly around an average of about \$20 per barrel, and heating oil and gasoline prices tend to move with

Figure 3. Spot Market Prices for Selected Commodities, January 1999-September 2001

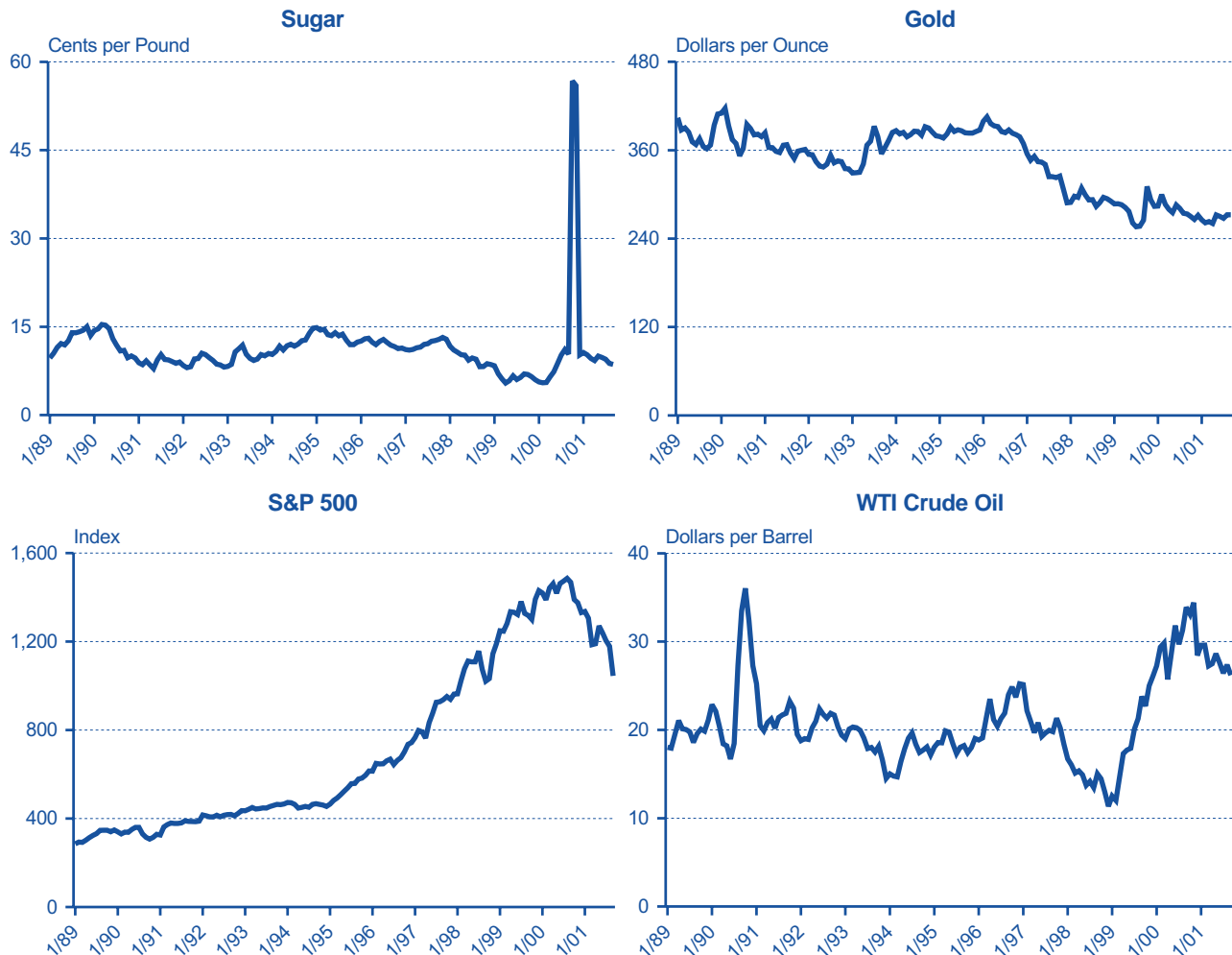

Source: Commodity Futures Trading Commission. Data are available from the authors on request.

¹²EnergyClear (www.energyclear.com) is one, relatively new clearinghouse for OTC contracts. Like an exchange, this clearinghouse is the buyer and seller of all contracts, offers netting, and has margin requirements.

the oil price. The spot market price of natural gas peaks periodically with no obvious warning.

Wholesale electricity prices since 1999 (Figure 5) in the Midwest (ECAR) and Pennsylvania-Maryland-New Jersey (PJM) regions, at the California-Oregon border (COB), and at Palo Verde, a major hub for importing electricity into California, have shown a number of very large “spikes” during the summer months. In addition, wholesale electricity prices on the West Coast were extremely volatile in the winter and spring of 2001.

Natural gas and electricity are particularly subject to wide price swings as demand responds to changing weather. Inventories are of limited help in damping price spikes, because natural gas users typically do not maintain large inventories on site, and the options for storing electricity are few and expensive (pumped hydro, reservoirs, idle capacity, etc.). Shipping low-cost supplies to areas where prices are high can be very difficult in these industries because of limited capability on the physical networks connecting customers to suppliers. Limited storage capacity and the lack of cheaper

alternative supplies from other areas can cause prices to soar in areas where demand increases suddenly.

Daily price volatility is the standard deviation of the percentage change in the commodity’s price. The standard deviation is a measure of how concentrated daily percentage price changes are around the average percentage price change. For a normal distribution, approximately 67 percent of all the percentage price changes will be within one standard derivation of the average percentage change. Volatility is usually expressed on an annual basis, where a year is understood to be the number of trading days, usually 252, in a calendar year. Annual volatility is calculated by multiplying daily volatility times 15.87, which is the square root of 252.

Price volatility is caused by shifts in the supply and demand for a commodity. Natural gas and wholesale electricity prices are particularly volatile for several reasons. Demand increases quickly in response to weather, and “surge” production is limited and expensive. In addition, neither can be moved to where it is needed quickly, and local storage is limited, especially in the

Figure 4. Spot Market Prices for Selected Energy Commodities, January 1999-May 2002

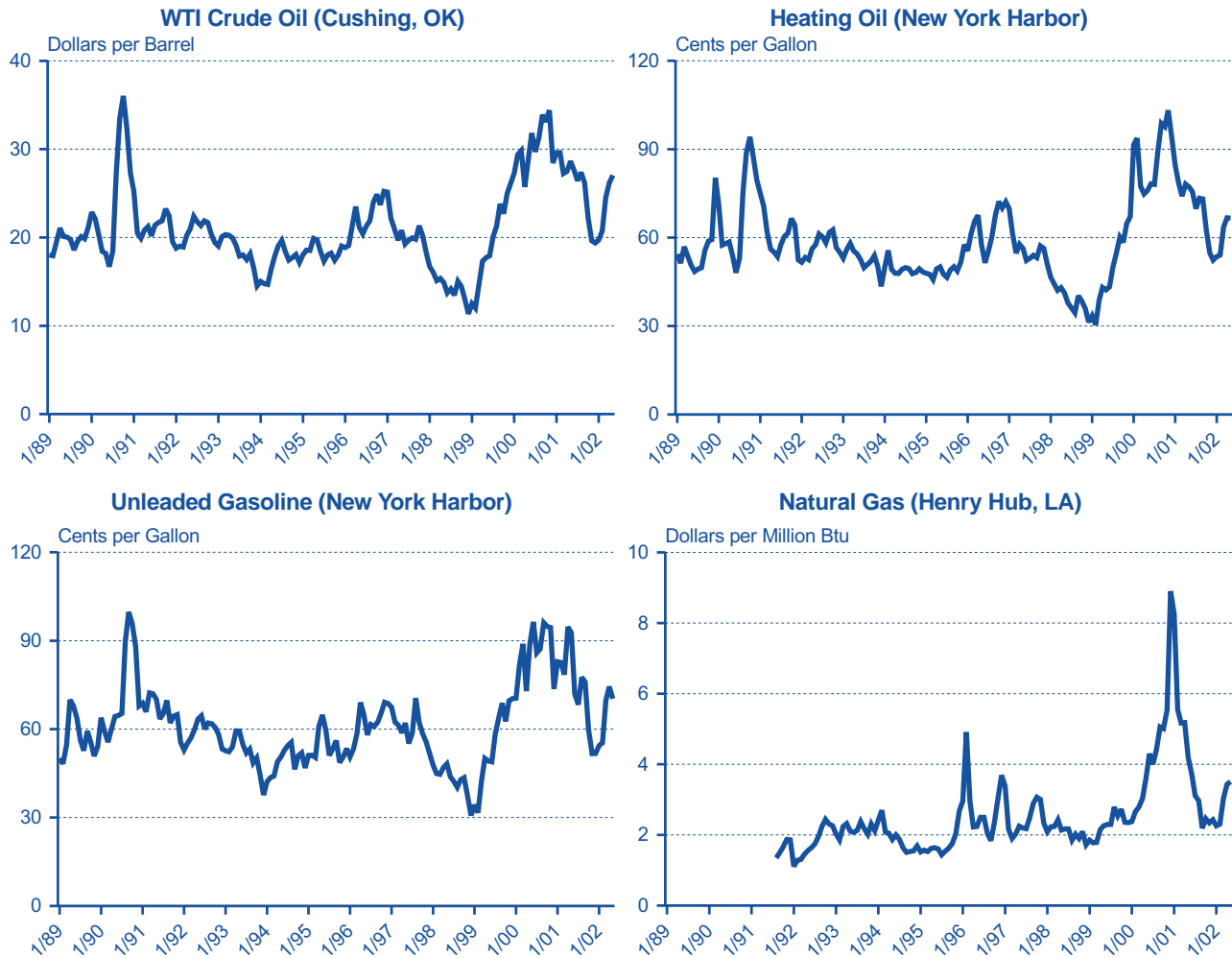

Source: Commodity Futures Trading Commission. Data are available from the authors on request.

case of electricity. Public policy efforts to reduce volatility have focused on increasing reserve production capability and increasing transmission and transportation capability. Recently there has been an emphasis on making prices more visible to users so that they will conserve when supplies are tight, thus limiting price spikes.

The average of the annual historical price volatility for a number of commodities from 1992 to 2001 is shown in Table 3. The financial group has the lowest overall volatility, and the electricity group has by far the highest. Generally, energy commodities have distinctly higher volatility than other types of commodities. The following example illustrates the impact of price volatility on the profitability of investments in electricity generation capacity.

Price Risk and Returns to Investment in a New Combined-Cycle Generator

EIA forecasts indicate that meeting U.S. demand for electricity over the next decade will require about 198 gigawatts of new generating capacity. About 7 gigawatts of the required new capacity is projected to come from coal-fired plants, 170 gigawatts from natural-gas-fired combined-cycle and combustion turbine plants, and the remainder from other technologies.¹³ Investment in the new projects will depend on how investors assess future natural gas and electricity prices and the consequences of price variation for cash earnings and project returns.

Figure 5. Wholesale Electricity Prices in Selected Regions, March 1999-March 2002

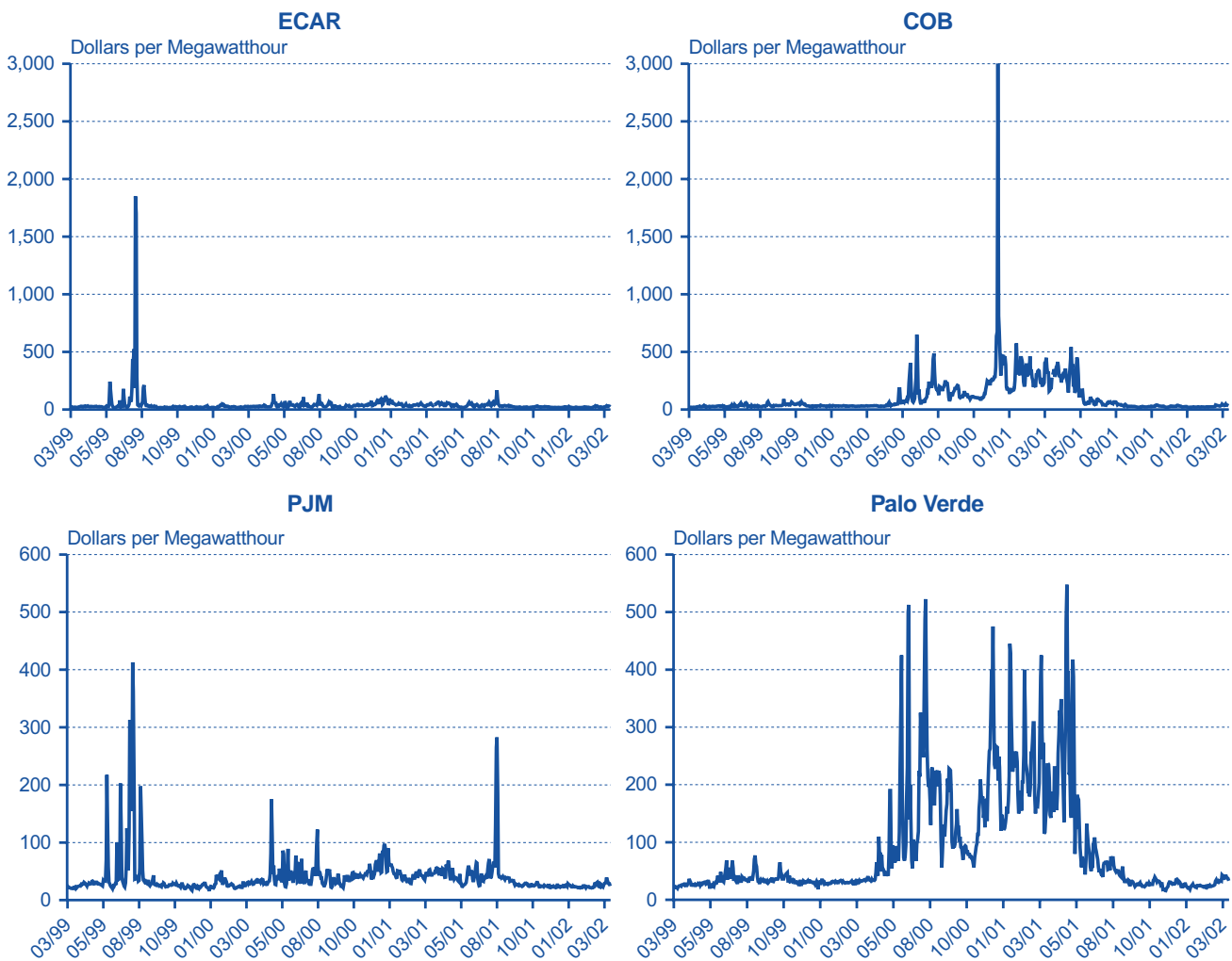

Source: Commodity Futures Trading Commission. Data are available from the authors on request.

¹³The other technologies include nuclear capacity expansions, fuel cells, renewable technologies, and cogenerators. Together they are expected to account for the remaining 21 gigawatts of additional new capacity. Energy Information Administration, *Annual Energy Outlook 2002*, DOE/EIA-0383(2002) (Washington, DC, December 2001), Table A9.

The case of a typical gas-fired combined-cycle plant shows what is at stake. Investors compare the cost of a new plant with the cash it is expected to generate over the life of its operation. The conventional way of making the comparison is called net present value (NPV) analysis. The stream of cash payments to investors is called the net cash flow. Each year's net cash return is adjusted for the time value of money (the implicit interest on delayed receipt) and for risk—i.e., discounted at the firm's cost of capital. The discounted net cash flows are added up, and the resulting sum is called the present value of net cash flows. If the present value of future net

cash flows exceeds the initial investment, then the project is economical and should be undertaken.¹⁴ Such projects are said to have a positive net present value and projects with a negative net present value should not be undertaken.¹⁵

Table 4 shows the cash flows that a new generator would be expected to produce under a recent EIA forecast of natural gas and electricity prices.¹⁶ Details of this and other calculations in this example are included in Appendix B. Over its 20-year life, the project has a positive NPV of \$2,118,017.¹⁷ Thus, the power plant should

Table 3. Spot Market Price Volatility for Selected Commodities

Commodity	Average Annual Volatility (Percent)	Market	Period
Electricity			
California-Oregon Border	309.9	Spot-Peak	1996-2001
Cinergy	435.7	Spot-Peak	1996-2001
Palo Verde	304.5	Spot-Peak	1996-2001
PJM	389.1	Spot-Peak	1996-2001
Natural Gas and Petroleum			
Light Sweet Crude Oil, LLS	38.3	Spot	1989-2001
Motor Gasoline, NYH	39.1	Spot	1989-2001
Heating Oil, NYH	38.5	Spot	1989-2001
Natural Gas	78.0	Spot	1992-2001
Financial			
Federal Funds Rate	85.7	Spot	1989-2001
Stock Index, S&P 500	15.1	Spot	1989-2001
Treasury Bonds, 30 Year	12.6	Spot	1989-2001
Metals			
Copper, LME Grade A	32.3	Spot	January 1989-August 2001
Gold Bar, Handy & Harman, NY	12.0	Spot	1989-2001
Silver Bar, Handy & Harman, NY	20.2	Spot	January 1989-August 2001
Platinum, Producers	22.6	Spot	January 1989-August 2001
Agriculture			
Coffee, BH OM Arabic	37.3	Spot	January 1989-August 2001
Sugar, World Spot	99.0	Spot	January 1989-August 2001
Corn, N. Illinois River	37.7	Spot	1994-2001
Soybeans, N. Illinois River	23.8	Spot	1994-2001
Cotton, East TX & OK	76.2	Spot	January 1989-August 2001
FCOJ, Florida Citrus Mutual	20.3	Spot	September 1998-December 2001
Meat			
Cattle, Amarillo	13.3	Spot	January 1989-August 2001
Pork Bellies	71.8	Spot	January 1989-August 1999

Sources: Energy Information Administration and Commodity Futures Trading Commission. Data are available from the authors on request.

¹⁴This assumes a “now or never” choice—that is, an irreversible investment decision. In reality, investors can sometimes postpone investing until they have more information. This is called the real options approach (the option to defer is one form of real option). Perhaps more important is the option to turn the plant on and off on individual dates and hours—i.e., to convert gas to power only when the relative prices are right. The static NPV approach assumes that the plant will run even when gas prices are too high to allow for a profit on the electricity that is generated.

¹⁵A somewhat different approach is to compute the internal rate of return—i.e., a discount rate that would set the NPV of the project to zero. This return is compared with the cost of capital, and if the internal rate of return is greater than the cost of capital, the project should be undertaken. A similar analysis was carried out using this approach.

¹⁶Energy Information Administration, *Annual Energy Outlook 2002*, DOE/EIA-0383(2002) (Washington, DC, December 2001), Tables A3 and A8.

¹⁷The calculation assumes that the firm's cost of capital (discount rate) is constant over time and is not affected by the amount of funds invested in the project. This assumption avoids the problems imposed by capital rationing and varying money and capital market rates.

be built because it would be profitable, generating an additional \$2 million for the investment after satisfying obligations to debt holders (interest payment at 10.5 percent) and equity holders (equity cost of dividends and/or capital gains of 17.5 percent). Moreover, after the initial investment it generates positive net cash flows in every year.

When input and output prices are uncertain, the NPV is no longer a single number but a distribution. Under wholesale price deregulation, investors in generators face not only fuel price risk but also electricity price risk. As shown in Figure 5 above, electricity prices have been very volatile in California and PJM for the past few years. From a generator's point of view, increased electricity price is not a concern; however, lower price can affect the viability of the new investment. Simulating

future outcomes by assuming historical volatilities is one way to calculate the probability distribution of a project's NPV.¹⁸ Among other things, the distribution of NPV shows the probability that an investment will turn out to be profitable after the fact.

Figure 6 shows the impact on the NPV of the investment when electricity and natural gas prices are varied by plus and minus 77 percent and 47 percent, as a standard deviation, from their expected prices, respectively.¹⁹ In this simulation, there is an 83-percent probability that the project's NPV would be at least zero, with mean of \$110 million, and a 17-percent probability that it would be unprofitable.²⁰ A summary of the simulation results is shown in Table 5. Despite the significant probability of failure, it makes economic sense for society to invest in the generator, because the project has a single positive

Table 4. Expected Annual Net Cash Flows and Net Present Value (NPV) of Investment in a New Generator

Year	After-Tax Net Cash Flows		Electricity Price (Cents per Kilowatthour)		Fuel Cost (Dollars per Million Btu)	
	Outflow	Inflow	Mean	Standard Deviation	Mean	Standard Deviation
2001	\$236,000,000	—	—	—	—	—
2002	—	\$36,397,248	4.215	3.246	2.590	1.218
2003	—	\$34,065,271	3.983	3.067	2.921	1.373
2004	—	\$31,645,037	3.974	3.060	3.123	1.468
2005	—	\$29,628,339	3.902	3.004	3.194	1.501
2006	—	\$27,823,397	3.816	2.938	3.225	1.516
2007	—	\$26,633,754	3.769	2.902	3.258	1.531
2008	—	\$25,720,350	3.737	2.878	3.313	1.557
2009	—	\$33,451,675	3.719	2.864	3.343	1.571
2010	—	\$26,061,919	3.741	2.881	3.381	1.589
2011	—	\$25,939,059	3.758	2.894	3.460	1.626
2012	—	\$25,134,117	3.732	2.874	3.524	1.656
2013	—	\$38,647,637	3.746	2.884	3.572	1.679
2014	—	\$25,094,989	3.735	2.876	3.610	1.697
2015	—	\$41,493,066	3.740	2.880	3.654	1.718
2016	—	\$25,627,301	3.760	2.895	3.685	1.732
2017	—	\$23,837,762	3.797	2.924	3.729	1.752
2018	—	\$22,297,428	3.847	2.962	3.777	1.775
2019	—	\$22,945,190	3.877	2.985	3.818	1.795
2020	—	\$23,656,442	3.916	3.015	3.871	1.819
2021	—	\$24,295,166	3.916	3.015	3.871	1.819

NPV at 11.03 percent weighted average cost of capital = \$2,118,017 Rate of return on investment = 11.18 percent

Sources: **Expected Mean Prices:** Energy Information Administration, *Annual Energy Outlook 2002*, DOE/EIA-0383(2002) (Washington, DC, December 2001), Tables A3 and A8. **Standard Deviations:** Calculation based on historical data from Platts.

¹⁸The use of simulation analysis in capital budgeting was first reported by David Hertz. See D.B. Hertz, "Risk Analysis in Capital Investment," *Harvard Business Review* (January-February 1964), pp. 95-106; and "Investment Policies That Pay Off," *Harvard Business Review* (January-February 1968), pp. 96-108. The simulation is a tool for considering all possible combinations and, therefore, enables analysts to inspect the entire distribution of project outcomes.

¹⁹Based on published NYMEX historical spot data in ECAR, PJM, COB, and Palo Verde from March 1999 to March 2002, the average mean and standard deviation of electricity prices are 6.66 and 5.11 cents per kilowatthour. For the same time periods, the average and standard deviation of the Henry Hub Gulf Coast natural gas spot price are 3.522 and 1.648 dollars per million Btu. As a result, the standard deviations used here for the price of electricity and natural gas are 77 percent (5.11/6.66) and 47 percent (1.648/3.522) of the expected mean prices for the corresponding years for the project's life.

²⁰This simulation was performed using a risk-free rate as a discount rate rather than the weighted average cost of capital. See Appendix B for detailed calculations.

NPV of \$2,118,017.²¹ The problem is that individual investors, not society as a whole, bear the risk if the investment goes wrong.

To the extent that prices vary because of rapid changes in supply and demand, energy price volatility is evidence that markets are working to allocate scarce

supplies to their best uses. As shown by the example, however, price variation also has the effect of making energy investment risky. Investors have difficulty judging whether current prices indicate long-term values or transient events. Bad timing can spell ruin. In addition, even good investments can generate large temporary cash losses that must be funded.

Figure 6. Net Present Value (NPV) Simulation Results

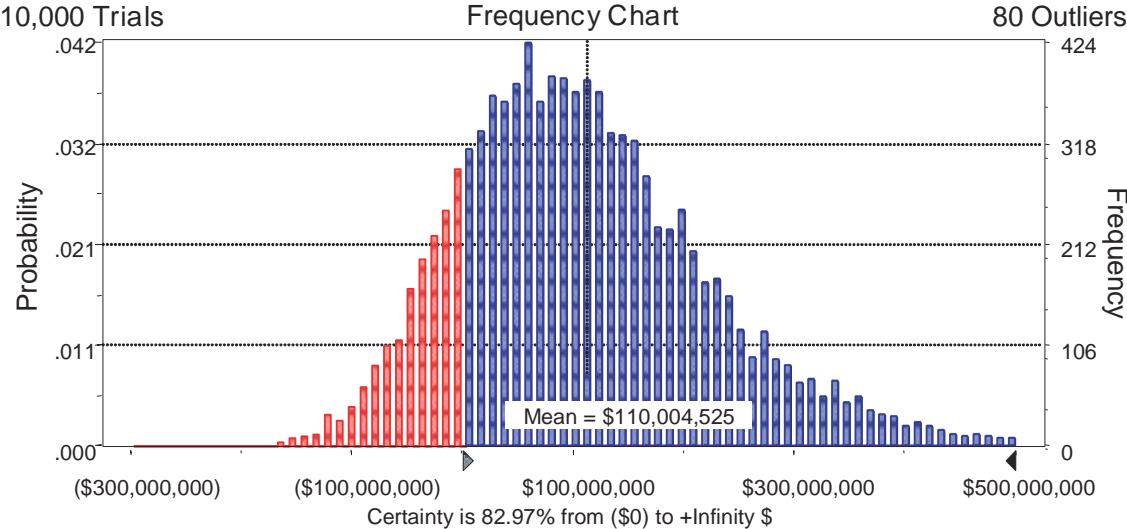

Source: Energy Information Administration.

Table 5. Summary of Simulation Results

Statistic	Net Present Value (NPV)
Mean	\$110,004,525
Median	\$95,713,767
Standard Deviation	\$120,382,899
Maximum	\$1,187,415,173
Minimum	-\$213,218,338
Probability of NPV > 0	82.97%
Coefficient of Variation	1.09

Sources: **Expected Mean Prices:** Calculated from Energy Information Administration, *Annual Energy Outlook 2002*, DOE/EIA-0383 (2002) (Washington, DC, December 2001), Tables A3 and A8. **Standard Deviations:** Calculation based on historical data from Platts.

²¹Economically speaking, an investment decision should be based on NPV criteria, because the NPV methodology implies risk and opportunity cost of an investment. On the other hand, a whole distribution of NPVs obtained by simulation will help guide an investor to know the danger and the actions that might be taken to guard the investment.

3. Managing Risk With Derivatives in the Petroleum and Natural Gas Industries

Introduction

For more than 20 years, businesses in the petroleum and natural gas industry have used derivatives to reduce their exposure to volatile prices, limit their need for cash cushions, and finance investment. In recent times, however, derivatives and energy trading generally have been implicated in Enron's bankruptcy, manipulation of the California electricity market, and major downgrades of energy company credit ratings and growth prospects. This makes reasonable people wonder whether derivatives create more risk than they manage.

The preceding chapter described the concept of business risk in general and the importance of managing price risk for energy businesses in particular. This chapter looks at the current state of U.S. spot markets for oil and natural gas and shows that derivatives of various kinds have proven useful in managing price risk, especially for small and medium-sized firms operating in only one or a few market segments.

There is vigorous competition among suppliers of risk management tools for energy firms, and the market for derivative contracts is large. But there are problems. Enron's case illustrates that certain derivatives, especially pre-paid swaps, have been used to disguise what appear to be loans from stockholders. The Securities and Exchange Commission (SEC) and the Congress are vigorously investigating these abuses for the purpose of ending them.

Oil and Natural Gas Markets

Domestic oil and petroleum prices were deregulated in the 1980s, and natural gas prices were partially deregulated. Before price deregulation, the market for domestic oil and gas derivatives was limited. Under price regulation, the U.S. Department of Energy (DOE), the Federal Energy Regulatory Commission (FERC), and the State public utility commissions (PUCs) directly or indirectly controlled the prices of domestic crude oil, petroleum products, wellhead natural gas, pipeline transmission,

and retail gas service.²² Government was also deeply involved in deciding the merits of pipeline investment and siting. The immediate effect of price controls was to stabilize price. Unfortunately, price certainty was paid for with shortages in some areas and surplus elsewhere and by complex cross-subsidies from areas where prices would have been lower to areas where prices would have been higher, with accompanying efficiency costs.²³

Currently, the prices of crude oil, natural gas, and all petroleum products are free from Federal regulation. The FERC continues to impose price ceilings on pipeline services and has approval authority for new pipeline construction. Most States continue to regulate prices for small users of natural gas (residences and commercial enterprises), but large users—particularly, power plants, which accounted for about 21 percent of the Nation's natural gas consumption in 2001, and petrochemical plants—are generally free to make their best deals.

Spot markets have long been an important part of international trade in crude oil and petroleum products. For example, oil tankers routinely are diverted en route to take advantage of price differences that arise during transit. In the United States, price deregulation has encouraged the rapid growth of domestic spot markets. According to the New York Mercantile Exchange (NYMEX), "In 1982 a spot market for natural gas hardly existed; by the late 1980s, it accounted for 80% of the entire gas market."²⁴ Although spot transactions had fallen to between 35 and 40 percent of the overall market by 1992, most of the remainder was bought and sold under long-term contracts at prices that usually were tied to those in the spot markets. A similar process had unfolded earlier in domestic crude oil and petroleum product markets.

Spot markets fundamentally change how businesses perceive their opportunities. The opportunity costs of idle assets become apparent, because spot markets make current price visible. Firms can clearly see how small differences in the timing of their acquisition, production, and storage decisions affect their profits. Firms also have the option of using a liquid spot market as if it were an

²²The FERC's authority was limited to natural gas that entered interstate commerce.

²³See J. Kalts, *The Economics and Politics of Oil Price Regulation* (Cambridge, MA: MIT Press, 1981); and P.W. MacAvoy and R.S. Pindyck, *Price Controls and the Natural Gas Shortage* (American Enterprise Institute, 1975, and University of Arizona Press, 1977).

²⁴NYMEX, *Risk Management with Natural Gas Futures and Options* (June 4, 2001), p. 3.

actual supplier, warehouse, or customer. Customers can easily compare the price of a supplier's offer with the spot market price. In addition, spot markets are critical for the valuation of cash-settled derivative contracts.²⁵

The advent of energy spot markets has also introduced some new risks. For example, sometimes commodities cannot be sold in the spot market or, if they can, only at prices substantially different from the last reported market price.²⁶ Sometimes spot market prices appear to be manipulated.²⁷ If the reported spot prices are not accurate, or if the market is subject to manipulation or turmoil, traders may be unable to design, much less trade, derivatives. The best defense against these problems is large, liquid spot markets with many buyers and sellers.

Crude Oil and Petroleum Products

Much of the nearly 79 million barrels per day of crude oil produced worldwide in 2000 was sold into international markets. World oil traders use several locations and types of crude oil as pricing benchmarks. The price of West Texas Intermediate (WTI), a light, sweet (low-sulfur) crude oil sold at Cushing, Oklahoma, is used as a principal pricing benchmark for spot trading in the United States. Brent crude, a light, sweet North Sea oil, serves as an international pricing benchmark.²⁸ Brent is shipped from Sullom Voe in the Shetland Islands, United Kingdom, and is traded actively on a free-on-board (FOB) basis. There are many other types of crude oil, and their pricing is frequently expressed as a differential to Brent or WTI, depending on quality differences and location. Crude oil and petroleum product prices vary with world economic growth, weather and seasonal patterns, and regional refining and transportation capability. Crude oil prices have also been sensitive to international political events and to the production policies of the Organization of Petroleum Exporting Countries (OPEC).

Tankers move most crude oil from producing areas to major markets in the United States, Northwest Europe, and Japan for refining. The three major trading areas for

refined products are New York Harbor, Northwest Europe (Antwerp, Amsterdam, and Rotterdam), and Singapore. There are also dozens of other trading areas for refined products, including Japan and the U.S. Gulf Coast, West Coast, and Midwest. The physical trading of refined products tends to be regional, with surpluses also being traded internationally.

Although more than 50 percent of the petroleum consumed in the United States originates from foreign sources, domestic crude oil production is still a major extractive industry. Turning the crude oil into useful products involves huge capital investments at many stages of processing (Figure 7), and the risks facing firms at each stage of processing differ. Historically one way firms have attempted to limit price risk is to integrate their operations from crude oil through final product delivery; however, that strategy is available only to a few very large companies. The rest must turn to other means of managing risk.

There are dozens of domestic spot markets for petroleum products, but in general they tend to be closely linked, because traders quickly take advantage of price differences that do not reflect the marginal cost of transportation. If pipelines are not available to move product, barges and trucks usually are. Consequently, *location arbitrage* generally causes crude oil and petroleum product prices to move together across all the spot markets.²⁹

Natural Gas

World trade in natural gas is divided among major regional markets dominated by pipeline infrastructures that provide the means of transporting the gas from producers to consumers and a single worldwide market for liquefied natural gas (LNG). The United States is the largest pipeline gas market. In 2000, the United States produced 19.3 trillion cubic feet of natural gas and consumed 23 trillion cubic feet. The supply gap was covered by 3.2 trillion cubic feet of imports from Canada and 0.5 trillion cubic feet of LNG from the world market. The European countries produced 10.5 trillion cubic feet and

²⁵Weather derivatives do not require a spot market for settlement, but they do require objective measurement of the relevant outcomes, such as heating degree days or rainfall totals. "Asian options" average spot prices over a period of time to ensure that the settlements reflect representative market conditions.

²⁶See, for example, reports of the rapid escalation of heating oil prices in Energy Information Administration, *The Northeast Heating Fuel Market: Assessment and Options*, SR/OIAF/2000-03 (Washington, DC, May 2000). Also, reports of physical shortage cited there appear in the testimony of Peter D'Arco, SJ Fuel, Before the House Committee on Commerce, Subcommittee on Energy and Power, U.S. House of Representatives (March 9, 2000). A typical reference to natural gas being unavailable following storms appears in Energy Information Administration, *Natural Gas 1992: Issues and Trends*, DOE/EIA-0560(92) (Washington, DC, March 1993), p. 96: "On Tuesday August 25, the Henry Hub, where deliveries through the futures market are made, was closed."

²⁷See, for example, a series of articles by staff writer Martin Rosenberg in the *Kansas City Star* during January 1998. The analysis in those articles was challenged in "Kansas Regulator Disputes Report Alleging Spot Market Manipulation," *Inside F.E.R.C.'s Gas Market Report* (April 3, 1998), p. 7. See also S. Borenstein, "The Trouble With Electricity Markets: Understanding California's Restructuring Disaster," *Journal of Economic Perspectives*, Vol. 16, No. 1 (Winter 2002), pp. 191-211.

²⁸The Brent field is declining, and there have been concerns about the potential for market squeezes. On July 10, 2002, Platts redefined the Brent benchmark to include prices of Forties and Oseberg crude oils.

²⁹Arbitrage is not perfect. Several East Coast gasoline markets have a history of price differences that cannot be explained by transportation costs. See for example, K. Bredemeier, "Bargain Hunters Hit the Road," *Washington Post* (October 27, 2001), p. E1.

consumed 16.2 trillion cubic feet, with the supply gap covered by Russian imports and small amounts of imported LNG. Russia was the world's largest producer of natural gas in 2000 at 20.3 trillion cubic feet, followed by the United States and Canada. Major exporters of LNG are Indonesia, Malaysia, Australia, Qatar, Oman, Nigeria, and Trinidad. Japan is the largest importer of LNG.

Natural gas production, like oil production, is an extractive industry (Figure 8). Unlike crude oil, however, natural gas requires relatively little processing to be useful. Natural gas is essentially the same everywhere it is sold: there are not dozens of natural gas products. In addition, domestic natural gas reserves are the main source of

supply, and transportation is essentially limited to pipelines.

Because natural gas supplies are primarily domestic and international shipments other than with Canada and Mexico are expensive, market and political forces in the United States, Canada, and Mexico mainly determine domestic natural gas prices. Short-term changes in weather—especially extreme weather—can have major effects on natural gas prices. Inventory changes, pipeline capacity curtailments or additions, and equipment outage can also have significant impacts on regional prices.

Natural gas, like electricity, is a network industry in the sense that all suppliers and users are linked by the

Figure 7. Crude Oil Processing Stages, 2000

(Million Barrels per Day)

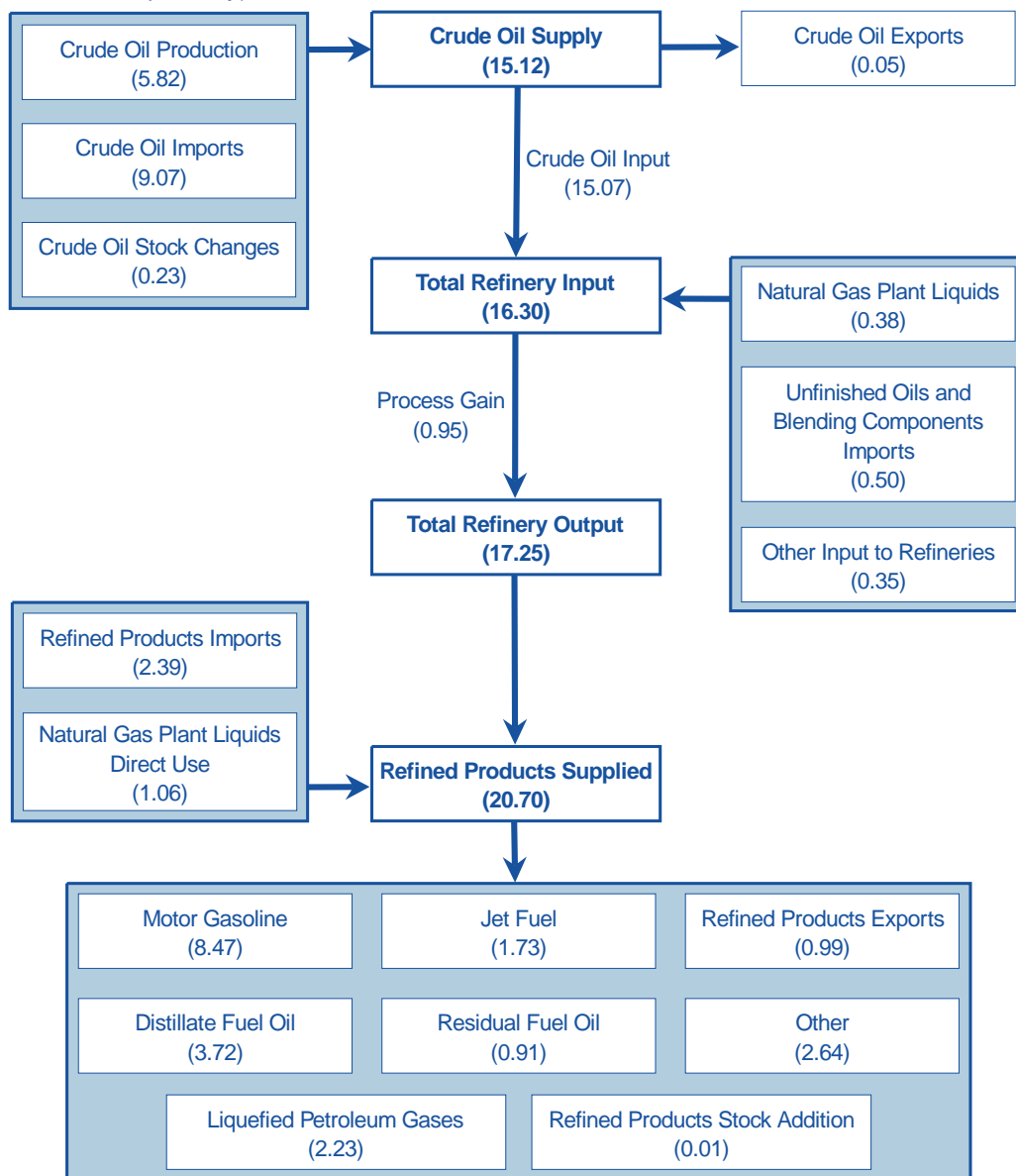

Source: Energy Information Administration, Petroleum and Energy Profile 1999, DOE/EIA-0545(99) (Washington, DC, July 1999), p. 46, updated to 2000 by EIA staff.

physical distribution system for the commodity. Pipelines have no effective competition for moving gas within the United States. Figure 9 shows the general locations served by major pipelines and several of the spot markets (pricing points) that have emerged at major transshipment points (hubs).

Location arbitrage does not work as well for natural gas and electricity as it does for crude oil. Because gas pipelines and power lines have essentially no competitors, frustrated customers cannot buy supplies “off system.” In addition, it is difficult to achieve competitive transmission pricing.³⁰ Consequently, transmission charges are set in noncompetitive markets, with the result that arbitrary price differences between and across markets, not based on marginal costs, can persist in more or less independent, local markets.

Table 6 shows the average daily transmission charges (price differences) for moving natural gas from Henry Hub to 12 local spot markets for the period April 1, 2001, through March 31, 2002. The average price difference ranges from \$0.02 below to \$0.15 above the Henry Hub spot price.³¹ In a competitive market, the transmission charges at different locations would represent the marginal cost of transporting natural gas to each location. If the markets are closely related, the differences in their prices should be stable except for infrequent occasions when capacity is in short supply. This is not the case for natural gas. The standard deviation of the transmission charges listed in Table 6 range from 50 percent to more than 220 percent of the charge itself. That is, the variation in the transmission charge ranges from one-half to twice the average charge itself.

Figure 8. Natural Gas Processing Stages, 2000
(Trillion Cubic Feet)

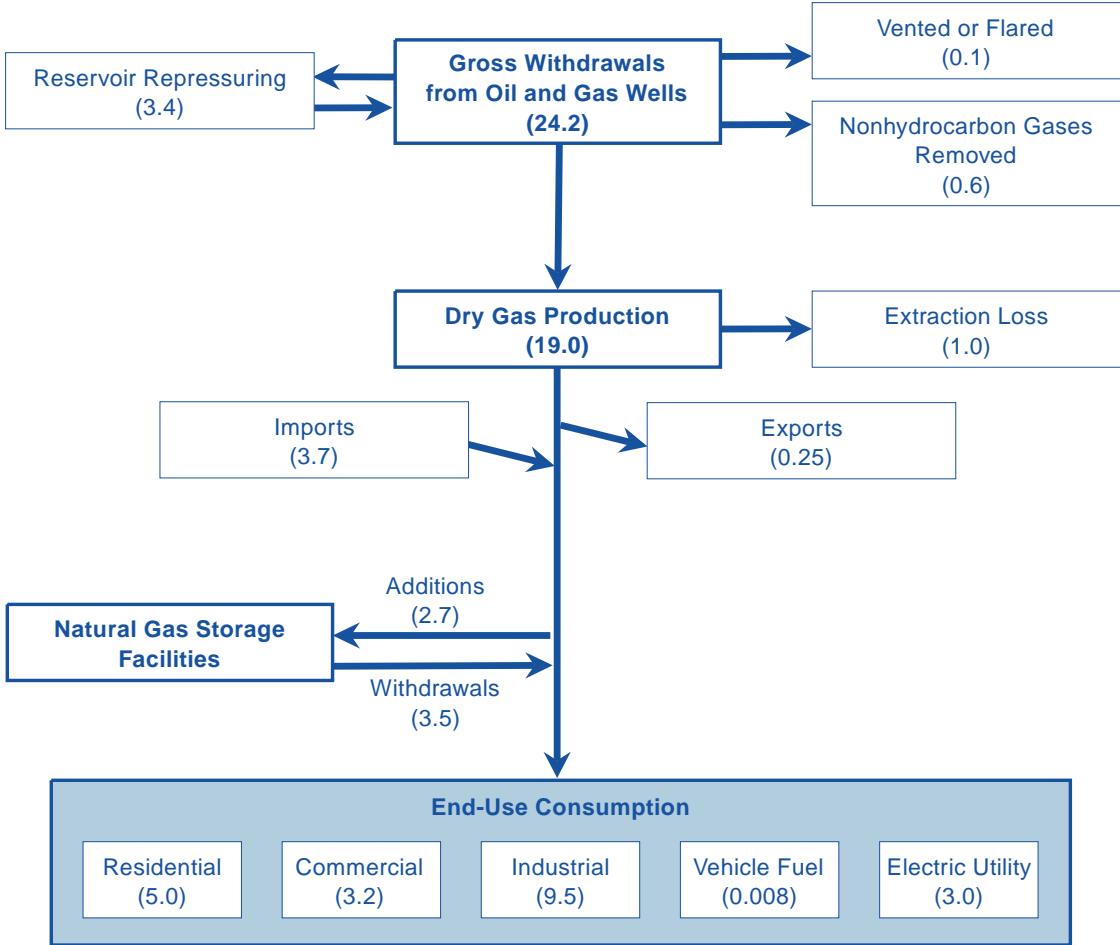

Source: Energy Information Administration, *Natural Gas Annual 2000*, DOE/EIA-0131(00), (Washington, DC, November 2001).

³⁰Competitive pricing of pipeline transportation and electricity transmission could, arguably, be ruinous, because their average costs are greater than their marginal cost unless system utilization is at or near capacity. Most economists argue for tariffs with at least two parts: an access fee to cover capital charges and a transportation charge that reflects marginal operating costs. The heated debates show little sign of ending soon.

³¹A negative transmission charge means that the price is lower at the “receiving” location than at Henry Hub. The negative charge should be interpreted as the charge for moving gas from the cheaper location to Henry Hub.

Natural Gas Spot Markets: How Accurate Are Reported Prices?

Because spot market prices generally are used to settle contracts, it is crucial that the reported prices accurately reflect market prices. For example, in the case of the New York Stock Exchange, all security sales and prices are recorded and promptly reported, and on most exchanges dealers are required to buy and sell at their posted bids and offers. In the case of natural gas, bids, offers, and prices are collected from traders by reporting firms. Bloomberg Energy Service, for example, reports only bids and offers. But unlike exchange dealers, traders are not required to honor them. Consequently, bids and offers may not be accurate indicators of the actual range of sales prices on natural gas spot markets.

The reporting firms base their price estimates on informal polls of traders. Their responses to a FERC inquiry confirm that traders are under no obligation to report and their reports are not verified except by comparison with other reports. None of the reporting firms

publishes the sample sizes or trade volumes associated with their reported prices. Similarly, there is no estimate of total trading volume through the day. Each reporter also has different conventions for defining precisely what is meant by “price.”^a Consequently it is not surprising that the reporters differ as to what the price is at any particular time and place. Indeed, as detailed in Appendix C, the differences in reported prices can be large.

The firms do not assert that the numbers are accurate. The following are typical disclaimers: “. . . [NGI] . . . makes no warranty as to the accuracy of these numbers . . .”;^b and “Platts cannot . . . insure against or be held responsible for inaccuracies . . .”^c Accordingly, NYMEX makes provision for traders to protest reported prices that they dispute. Designing risk-sharing instruments when the reported prices are themselves of uncertain quality and the trading volumes are not known is a challenge.

^aFederal Energy Regulatory Commission, *Investigation of Potential Manipulation of Electric and Natural Gas Prices*, Docket No. PA-02-2-000 (Washington, DC, August 2002), pp. 32-57.

^bNGI Daily Gas Price Index (February 4, 2002), p. 9.

^cPlatts, *Gas Daily* (February 4, 2002), p. 2.

Figure 9. Major Pricing Points (Hubs) for Natural Gas

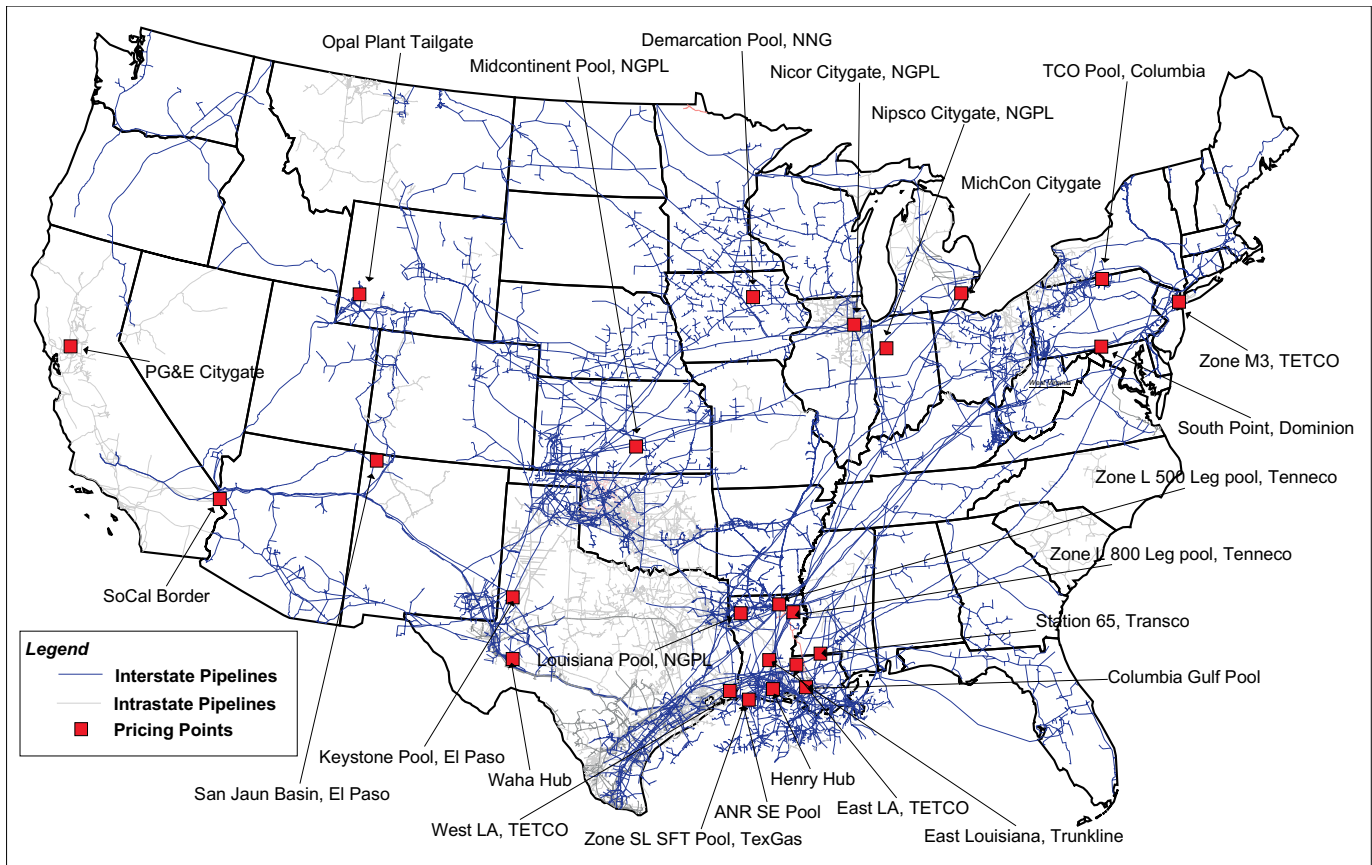

Source: Energy Information Administration, EIAGIS-NG Geographic Information System.

Table 6. Average Transmission Charges from Henry Hub and Their Standard Deviations

Location	Average Transmission Charge (Dollars per Thousand Cubic Feet)	Standard Deviation	Standard Deviation / Average Transmission Charge
American Natural Resources Pipeline Co. – SE Transmission Pool . . .	0.06	0.03201	0.51
Columbia Gulf Transmission Co. – Onshore Pool	0.03	0.02787	0.87
El Paso – Keystone Pool	0.15	0.11119	0.75
Natural Gas Pipeline Co. of America – Louisiana Pool	0.05	0.03136	0.59
Tennessee Gas Pipeline Co. – Zone L, 500 Leg Pool	0.07	0.04366	0.67
Tennessee Gas Pipeline Co. – Zone L, 800 Leg Pool	0.09	0.04617	0.54
Texas Eastern – East LA	0.05	0.04053	0.84
Texas Eastern – West LA	0.07	0.04134	0.61
Texas Gas Transmission Corp. – Zone SL \$FT Pool	0.02	0.02429	1.03
Transcontinental Gas Pipeline Corp. – Station 65	-0.02	0.05230	-2.22
Trunkline Gas Company – East Louisiana Pool	0.09	0.05269	0.57
Waha Hub – West Texas	0.10	0.09210	0.90

Source: Energy Information Administration, computed from data on the IntercontinentalExchange web site, www.intcx.com.

These results suggest that there is not a single domestic natural gas market; instead there is a collection of loosely connected, relatively small spot markets. New pipeline construction and capacity additions should eventually promote more competition in the markets they serve, by relieving the congestion that may account for some of the variation in transmission charges. Until then, market fragmentation will make large trades hard to execute and limit the number of buyers and sellers. It may also encourage attempts to manipulate market prices.

Price Risk and Derivatives in Petroleum and Natural Gas Markets

Diversification and insurance are the major tools for managing exploration risk and protecting firms from property loss and liability. Firms manage volume risk—not having adequate supplies—by maintaining inventories or acquiring productive assets.³² Derivatives are particularly appropriate for managing the price risk that arises as a result of highly volatile prices in the petroleum and natural gas industries.

The typical price risks faced by market participants and the standard derivative contracts used to manage those risks are shown in Table 7. Price risk in the petroleum and natural gas industries is naturally associated with each participant’s stage of production. Some companies integrate their operations from exploration through final sales to eliminate the price risks that arise at the intermediate stages of processing. For example, for an integrated producer, an increase in the cost of crude oil purchased at its refinery will be offset by revenue gains from its sales of crude oil. Other, smaller companies usually do not have integrated operations. Independent

Table 7. Petroleum and Natural Gas Price Risks and Risk Management Strategies

Participants	Price Risks	Risk Management Strategies and Derivative Instruments Employed
Oil Producers	Low crude oil price	Sell crude oil future or buy put option
Petroleum Refiners	High crude oil price	Buy crude oil future or call option
	Low product price	Sell product future or swap contract, buy put option
	Thin profit margin	Buy crack spread
Storage Operators	High purchase price or low sale price	Buy or sell calendar spread
Large Consumers		
Local Distribution Companies (Natural Gas)	Unstable prices, wholesale prices higher than retail	Buy future or call option, buy basis contract
Power Plants (Natural Gas)	Thin profit margin	Buy spark spread
Airlines and Shippers	High fuel price	Buy swap contract

Source: Energy Information Administration.

producers want protection from low crude oil prices, and they sell to refiners who want protection from high prices. Refiners want protection from low product prices, and they sell to storage facilities and customers who are concerned about high prices. At each stage, suppliers and purchasers can split the risk in order to allay their concerns. They typically supplement exchange-traded futures and options with over-the-counter (OTC) products to manage their price risks.

Risk managers in the petroleum and natural gas industries commonly use derivatives to achieve certainty about the prices they pay or receive. Depending on their

³²In an ideal competitive market, traders would be able to buy as much as they wanted at the market price. In actual markets, large trades sometimes cannot be accomplished quickly at any price. Volume risk recognizes that reality.

circumstance, they may be concerned with the price paid *per se*, with price spreads (differences between prices), with ceilings and floors, and/or with price changes over time. In addition, volumetric production payment contracts—a variant of a standard swap—may be used to reduce uncertainty about cash flows and credit. Some of the instruments particular to the oil and gas industries are described below.

The principal difficulty in using exchange-traded products is they often do not exactly correspond to what the trader is attempting to hedge or to speculate in. For examples, price movements in premium gasoline are not identical to those in unleaded gasoline. Similarly, the price of natural gas at Henry Hub is not identical to that at Chicago. The distinction between what exchange products can hedge and what the user wants to hedge is the source of *basis risk*. Basis risk is the risk that the price difference between the exchange contract and the commodity being hedged will widen (or narrow) unexpectedly. To a large extent, the OTC market exists to bridge the gap between exchange-traded products and the needs of individual traders, so that the two markets in effect have a symbiotic relationship.³³

Basis Contracts

As described in Chapter 2, price certainty in a unified market can be bought with forward sales, futures contracts, or swaps (contracts for differences). When one or both parties face a spot market price that differs from the price in reference market, however, other derivative contract instruments may be needed to manage the resulting basis risk. For example, a local distribution company (LDC) in Tennessee could enter into a swap contract with a natural gas producer, using the Henry Hub price as the reference price; however, the LDC would lose price certainty if the local spot market price differed from the Henry Hub price (Figure 10). In this example, when the Henry Hub price is higher than the Tennessee price by more than it was at the initiation of the swap contract, the LDC gains, because its payment from the producer will exceed the amount it pays to buy gas in its local market. Effectively, the LDC will pay less per thousand cubic feet than the fixed amount the LDC pays the producer. Conversely, if the Tennessee price is lower, the producer's payment will not cover the LDC's gas bill in its local market.

A variety of *basis contracts* are available in OTC markets to hedge locational, product, and even temporal differences between exchange-traded standard contracts and the particular circumstances of contract users. The simplest is a *basis swap*. In the example above, the OTC trader would pay the LDC the difference between the

Tennessee price and the Henry Hub price (for the nominal amount of gas) in exchange for a fixed payment. The variety of contractual provisions is unlimited. For example, the flexible payment could be defined as a daily or monthly average (weighted or unweighted) price difference; it could be capped; or it could require the LDC to share the costs when the contract's ceiling price is exceeded. What this OTC contract does is to close the gap between the Henry Hub price and the price on the LDC's local spot market, allowing the LDC to achieve price certainty.

The traders supplying basis contracts can survive only if the basis difference they pay—averaged over time and adjusted for both financing charges and the time value of money—is less than the fixed payment from the LDC. Competition among OTC traders can only reduce the premium for supplying basis protection. Reducing the underlying causes of volatile price differences would require more pipeline capacity, more storage capacity, cost-based transmission pricing, and other physical and economic changes to the delivery system itself.

Crack Spread Contracts

In the petroleum industry, refinery managers are more concerned about the difference between their input and output prices than about the level of prices. Refiners' profits are tied directly to the spread, or difference, between the price of crude oil and the prices of refined products. Because refiners can reliably predict their costs other than crude oil, the spread is their major uncertainty.³⁴ One way in which a refiner could ensure a

Figure 10. Illustration of a Natural Gas Swap Contract Between a Gas Producer and a Local Distribution Company (LDC)

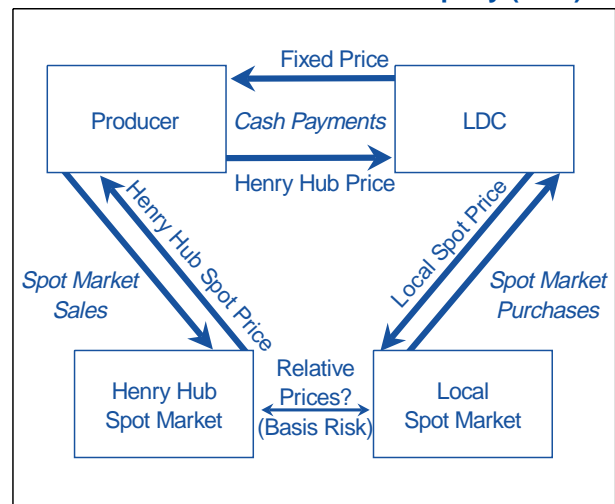

Source: Energy Information Administration.

³³See W. Falloon and D. Turner, "The Evolution of a Market," in *Managing Energy Price Risk*, 2nd Edition (London, UK: Risk Books, 1999), p. 8: "... one of the main reasons the OTC market exists is the desire on the part of end-users to isolate themselves from this basis risk."

³⁴Operational risks, such as explosions, are covered with insurance.

given spread would be to buy crude oil futures and sell product futures. Another would be to buy crude oil call options and sell product put options. Both of those strategies are complex, however, and they require the hedger to tie up funds in margin accounts.

To ease this burden, NYMEX in 1994 launched the *crack spread contract*. NYMEX treats crack spread purchases or sales of multiple futures as a single trade for the purposes of establishing margin requirements. The crack spread contract helps refiners to lock in a crude oil price and heating oil and unleaded gasoline prices simultaneously in order to establish a fixed refining margin. One type of crack spread contract bundles the purchase of three crude oil futures (30,000 barrels) with the sale a month later of two unleaded gasoline futures (20,000 barrels) and one heating oil future (10,000 barrels). The 3-2-1 ratio approximates the real-world ratio of refinery output—2 barrels of unleaded gasoline and 1 barrel of heating oil from 3 barrels of crude oil. Buyers and sellers concern themselves only with the margin requirements for the crack spread contract. They do not deal with individual margins for the underlying trades.

An average 3-2-1 ratio based on sweet crude is not appropriate for all refiners, however, and the OTC market provides contracts that better reflect the situation of individual refineries. Some refineries specialize in heavy crude oils, while others specialize in gasoline. One thing OTC traders can attempt is to aggregate individual refineries so that the trader's portfolio is close to the exchange ratios. Traders can also devise swaps that are based on the differences between their clients' situations and the exchange standards.

Crack Spread Options

Some industry participants may be comfortable with price variation so long as prices do not get too high or too low. An LDC that cannot readily pass along natural gas price increases to its residential customers may want to ensure that wholesale prices do not exceed what regulators allow it to charge. Holders of heating oil inventories may want to protect against price declines, but without giving up the opportunity to profit from price increases. As described in Chapter 2 a call option, which allows the holder to buy the commodity at a fixed strike price, sets a price ceiling. A put option, which allows the holder to sell at a fixed price, sets a floor.

NYMEX *crack spread options* are unusual because they protect against the growth or shrinkage in the *difference* between prices. A refiner, fearing that a currently

profitable spread will disappear, can buy a crack spread put option. A large user of refined products, fearing that the spread will grow while the price of crude oil is stable, can buy a crack spread call option to compensate for potentially large increases in petroleum product prices when refinery margins grow.

Refiners who use crack spread options pay in advance for the price protection they desire. Options can be expensive when the terms are more favorable to the buyer, and the longer their lifespan, the more they cost. An alternative strategy is for a refiner to simultaneously buy a put and sell a call, so that the cost of the put is offset by the premium earned on the call. In essence, such a *collar* pays for the desired downside protection by selling off the opportunity for a windfall when the crack spread increases.

Calendar Spread Options

Storage facilities play an important role in the crude oil and refining supply chain. Facilities near producing fields allow the producers to store crude oil temporarily until it is transported to market. Facilities at or near refining sites allow refiners to store crude oil and refined products. Heating oil dealers build inventories during the summer and fall for winter delivery. Natural gas storage facilities allow producers to inject excess supply during "shoulder months" for withdrawal during peak demand months and provide producers with the convenience of a shortened injection and withdrawal cycle (a day or a few days), giving the producers and traders the ability to capitalize on the differential between forward prices and spot prices.

For most non-energy commodities, the cost of storage is one of the key determinants of the differential between current and future prices. Although storage plays a smaller role in price determination in some energy markets (most notably, for electricity), it can be important for heating oil and natural gas.³⁵ For example, natural gas prices in the winter months could be established by the prices in the preceding shoulder months plus storage expenses and an uncertainty premium to account for the possibility of a colder than normal winter. If the price differential between winter months and shoulder months substantially exceeds storage expenses, traders can buy and store gas and sell gas futures. Such arbitrage tends to narrow the price differential.

The owners of storage facilities can use excess capacity both to manage the price risk that often exists between months and to make additional income. Assuming the

³⁵Models of heating oil and natural gas markets stress the importance of convenience yield, seasonality, random economic disruptions, and similar factors not included in the simple storage model. See for example, A. Kaushik, V. Ng, and C. Pirrong, "Arbitrage-Free Valuation of Energy Derivatives," in *Managing Energy Price Risk*, 2nd Edition (London, UK: Risk Books, 1999), pp. 259-289; and M. Baker, S. Mayfield, and J. Parsons, "Alternative Models of Uncertain Commodity Prices for Use with Modern Asset Pricing Methods," *Energy Journal*, Vol. 19, No. 1 (1998), pp. 115-147.

market is in *contango*—i.e., when near-term prices (for “prompt months” are lower than prices for the months further in the future—owners of underground natural gas storage facilities with excess capacity that can be used to store natural gas for less than the difference between the prices can purchase futures contracts for the prompt months and sell futures contracts for the further future months. The storage facility can then take delivery of the natural gas on the nearby contract and deliver it against the distant contract, earning an arbitrage profit equal to the difference between the sale and purchase of the futures contracts less the facility’s cost of storage.

Such arbitrage can also be accomplished by using a *calendar spread call option*. NYMEX offers calendar spread options on crude oil, heating oil, and unleaded gasoline. Buying a call on the calendar spread options contract will represent a long position (purchase) in the prompt months of the futures contract and a short position (sale) in the further months of the contract. Thus, the storage facility can buy a call on a calendar spread that will allow it to lock in a storage profit or to arbitrage a spread that is larger than its cost of storage.

If the market is in *backwardation*—i.e., when the prices for prompt months are higher than the prices for further months—storage facilities with excess capacity cannot arbitrage the calendar spread. In this case, storage facilities can sell put options on calendar spreads to earn income from the option premium. The buyer of a calendar spread put option, when the option is exercised, will receive a short position (sale) in the prompt months of the futures contract and a long position (purchase) in the further months of the contract. Thus, if the storage facility that sold (wrote) the put option is forced to accept delivery because the buyer has exercised the option, it will receive a long position in the prompt futures and a short position in the further futures. If the facility has excess storage capacity, however, it can take delivery on the prompt contract and then deliver on the later dated contract. If the put option is not exercised, the facility can keep the option premium without any further obligation. In summary, storage facilities can use futures contracts and calendar spread options to optimize utilization by arbitraging the difference in the prices specified for different months of a futures contract.

Volumetric Production Payment Contracts

A *volumetric production payment contract* (VPP) is both a prepaid swap and a synthetic loan. Unlike a normal swap, where the differences between the fixed and variable payments are periodically settled in cash, the buyer (usually a producer) is paid the present value of the fixed payments in advance. In exchange, the seller

receives an agreed-upon amount of natural gas or other product over time. These deals typically last for 3 to 5 years. VPPs have been purchased by natural gas producers in the past, and in some cases they appear to have been used in project finance.³⁶ In function, VPPs are identical to loans paid off with product.

The obvious problem with VPPs is that the seller, usually an energy trader, invests a large amount in advance, risking both buyer default and adverse price movements. In addition, VPPs can be used in place of loans to hide debt. What Enron and others often did was to find users of the product who were willing to pay up front in exchange for a price guarantee, use part of those payments to make the advance payment on the VPP, and then hedge their price risks by securing guarantees in the event of default.³⁷

Markets for Oil and Gas Derivatives: Organized Exchanges, Trading Firms, and Bulletin Boards

All the contract types discussed above are bought and sold in markets, both public and private. Exchanges, energy traders, and electronic bulletin boards compete vigorously for business in energy derivatives, and investment banks and insurance companies have also participated. Society relies on competition within and across these markets to ensure that risk is transferred at least cost. The exchanges and OTC traders have designed derivatives that respond to the concerns of market participants while recognizing the limits of location arbitrage, the importance of input-output price spreads to profits, and the role of price controls in retail natural gas markets.

Successful petroleum futures contracts first appeared in 1978, when NYMEX introduced futures contracts on both No. 2 heating oil and No. 6 fuel oil. The No. 6 contract failed because utilities, the largest purchasers of No. 6 fuel oil, were able to pass the risk of escalating prices on to their customers by means of fuel adjustment clauses; therefore, they did not need the futures market to minimize price risk. The No. 2 contract has been successful, however, because heating oil is bought and sold by a large number of market participants. The heating oil market is also active year-round: inventories are built up in the off season and worked off in the winter to meet seasonal demands.

Trading volume in a successful contract can climb dramatically. For example, the annual trading volumes of the No. 2 heating oil contract grew from 25,910 in 1978 to

³⁶ *Managing Energy Price Risk*, 2nd Edition (London, UK: Risk Books, 1999), pp. 159 and 11.

³⁷ C. Johnson and P. Behr, “Loans Hidden, Enron Probers Say,” *Washington Post* (July 22, 2002), p. A9.

more than 932,000 in 1980, to 5.7 million in 1989,³⁸ and to a record 9.6 million in 2000.

NYMEX has become the dominant market for energy futures and options trading, with 73,701,461 futures contracts and 15,445,318 options contracts traded in 2001 (Tables 8 and 9). The largest contract by volume is the light sweet crude oil futures contract, which began trading in 1983 and had over 37 million contracts traded in 2001. Other heavily traded futures contracts include heating oil, natural gas (introduced in 1990), and unleaded gasoline (introduced in 1984). The propane futures contract (introduced in 1987) is much less heavily traded but remains an active market.

As discussed in Chapter 2, all exchange contracts are standardized. Standardization focuses all bidding on price, thereby maximizing market liquidity and minimizing transaction costs. Table 10 shows the specifications for the light sweet crude oil contract as an example. The details defining standard contracts determine their usefulness to traders.

Because futures contracts specify delivery at a particular location, traders desiring delivery or price protection at other locations must contend with “basis differential.”

In the case of natural gas, the basis differential is the cost of transporting the gas from Henry Hub to the location in question. There are no exchange-traded products to deal with this basis risk. Consequently producers in this and analogous circumstances looked to the OTC market, especially energy traders, for hedging instruments.

Although energy trading firms have played an important role in helping energy businesses manage basis and other risks, they have fallen from prominence in the last year. Table 11 lists the top oil and natural gas traders as of the third quarter of 2001 and reports their credit status as of mid-2002. The outlook for these firms is uncertain. Moody’s Investor Services, for one, is not sanguine:

Moody’s believes that energy trading, as presently configured, may lack investment grade characteristics unless it is ancillary to a more stable core business that generates strong sustainable cash flow. The typical business model marries a Baa-caliber energy producer and distributor with a volatile, confidence-sensitive trading operation. A negative credit event, either in the core business or in the trading segment—resulting in even a modest rating downgrade—can trigger a significant call on cash. Moreover, the lack of regulatory oversight and the opaque accounting are not conducive to

Table 8. Summary Statistics for Exchange-Traded Petroleum and Natural Gas Futures Contracts

Exchange	Commodity	Point of Delivery	Contract Size	Futures	Date Begun	2001 Annual Volume (Contracts)	2002 Estimated Volume on April 17, 2002 (Contracts)
NYMEX	Heating Oil	New York Harbor	42,000 Gallons	18 Months	11/14/1978	9,264,472	31,831
NYMEX	Natural Gas	Henry Hub, LA	10,000 Million Btu	72 Months	04/03/1990	16,468,355	105,522
NYMEX	Light Sweet Crude Oil	Cushing, TX	1,000 Barrels	30 Months + 5 Long	03/30/1983	37,530,568	240,823
NYMEX	Unleaded Gasoline	New York Harbor	42,000 Gallons	12 Months	12/03/1984	10,427,500	43,854
NYMEX	Propane	Mont Belvieu, TX	42,000 Gallons	15 Months	08/21/1987	10,566	6
KCBOT	Western Natural Gas	Permian Hub, West Texas	10,000 Million Btu	18 Months	08/01/1995	0	0

Source: New York Mercantile Exchange (NYMEX) and Kansas City Board of Trade (KCBOT).

Table 9. Summary Statistics for Exchange-Traded Petroleum and Natural Gas Options Contracts

Exchange	Commodity	Options	Date Begun	2001 Annual Volume (Contracts)	2002 Estimated Volume on April 17, 2002 (Contracts)
NYMEX	Heating Oil	18 Months	06/26/1987	704,972	2,034
NYMEX	Natural Gas	12 Months + 20 Long	10/02/1992	5,974,240	39,660
NYMEX	Light Sweet Crude Oil	12 Months + 3 Long	11/14/1986	7,726,076	65,688
NYMEX	Unleaded Gasoline	12 Months	03/13/1989	1,040,030	5,674
KCBOT	Western Natural Gas	18 Months	08/01/1995	0	0

Source: New York Mercantile Exchange (NYMEX) and Kansas City Board of Trade (KCBOT).

³⁸C. Dale, “Economics of Energy Futures Markets,” in Energy Information Administration, *Petroleum Marketing Monthly*, DOE/EIA-0380(91/09) (Washington, DC, September 1991), p. 6.

*maintaining counterparty confidence We believe that a fundamental restructuring will need to occur in the near term for this sector to regain investor confidence.*³⁹

How this sector will evolve is unknowable. Investment banks might return to a prominent role in energy markets. As William Falloon and David Turner have noted, “Energy companies . . . argue that banks have a permanent disadvantage arising from their lack of knowledge of inventories and other aspects of the physical market. Even so, those banks still in the market seem to be thriving.”⁴⁰ Insurance companies also have the financial reserves to withstand inevitable market setbacks and may become more interested in applying their expertise to energy markets. Moody’s suggests that either industry consolidation into a few well-capitalized companies, the development of a clearing system, or the creation of derivative product companies that are near bankruptcy-proof would restore this group of competitors.

The Internet is responsible for the latest innovation in energy trading. In November 1999, EnronOnline was launched to facilitate physical and financial trading. EnronOnline was a principal-based exchange in which all trades were done with Enron as the counterparty. As a consequence, Enron’s perceived creditworthiness was crucial to its ability to operate EnronOnline.

After the launch of EnronOnline, several other online exchanges quickly followed, including Intercontinental-Exchange (ICE), which was backed by major producers and financial services companies, and TradeSpark, which was backed by major electric utilities, traders, and gas pipeline companies. Both ICE and TradeSpark provide electronic trading platforms offering registered users anonymity for posting prices and executing trades. Unlike EnronOnline, they do not take trading positions. ICE offers swaps on crude oils other than Brent and WTI and on refined products in numerous locations, to complement the futures contracts trading of

Table 10. NYMEX Light Sweet Crude Oil Contract Specifications

Trading Unit	1,000 U.S. Barrels (42,000 gallons).
Trading Hours	Open outcry trading conducted between 10 am till 2:30 pm. NYMEX ACCESS@ on Mon-Thu begins at 3:15 pm and concludes 9 am the following day. Sunday ACCESS begins at 7 pm (all times are New York).
Trading Months	30 consecutive months plus long-dated futures initially listed 36, 48, 60, 72, and 84 months prior to delivery. Additionally, calendar strips can be executed (during open outcry trading hours) at an average differential to the previous day’s settlement prices for periods of 2 to 30 consecutive months in a single transaction.
Price Quotation	Dollars and cents per barrel.
Minimum Price Fluctuation	\$0.01 per barrel (i.e., \$10 per contract).
Maximum Daily Price Fluctuation	Initially \$3.00 per barrel for all but the first two months, rising to \$6.00 per barrel if the previous settlement price of any back month is at the \$3.00 limit. If \$7.50 per barrel movement in either of the two front months, then the limit for all months becomes \$7.50 per barrel in the direction of the price movement.
Last Trading Day	Trading stops at close of business on the 3rd business day prior to the 25th calendar day of the month preceding the delivery month. If 25th is a non-business, then trading stops on 3rd business day prior to last business day preceding the 25th.
Delivery	FOB seller’s facility, Cushing, OK, at any pipeline or storage facility with access to pipeline, by in-tank transfer, in-line transfer, book-out, inter-facility transfer.
Delivery Period	Deliveries are rateable over the course of the month and must be initiated on or after the first calendar day and completed by the last calendar day of the delivery month.
Alternative Delivery Procedure	Available to buyers and sellers matched by the Exchange after termination of spot month contract. If buyer and seller agree to the contract specifications, they may proceed and must notify the Exchange.
Exchange of Futures for Physicals (EFP)	Commercial buyer or seller may exchange a futures position for a physical position by notifying the Exchange. EFPs may be used to initiate or liquidate a futures position.
Deliverable Grades	Specific domestic crudes with 0.42% sulfur or less, and not less than 37 degree API gravity nor more than 42 degree API gravity; including WTI, Low Sweet Mix, NM Sweet, North TX Sweet, OK Sweet, South TX Sweet. Specific foreign crudes not less than 34 degree API nor more than 42 degree API; including Brent, Forties, and Osenberg Blend for which the seller will receive a 30 cent per barrel discount; Bonny Light and Cusiana (a 15 cent premium); and Qua Iboe (a 5 cent premium).
Inspection	Will be conducted according to pipeline practices. Buyer or seller may appoint an inspector and the requesting party will cover the cost and notify the other party.
Position Limits	20,000 contracts for all months combined, but not to exceed 1,000 in the last 3 days of trading in the spot month or 10,000 in any one month.
Margin Requirements	Margins are required for open futures positions.

Source: New York Mercantile Exchange (NYMEX), web site www.nymex.com.

³⁹P. Stumpp, J. Diaz, D. Gates, S. Solomon, and M. Hilderman, Moody’s Investors Service, *Moody’s View on Energy Merchants: Long on Debt—Short on Cash Flow: Restructuring Expected*, Special Comment (May 2002).

⁴⁰W. Falloon and D. Turner, “The Evolution of a Market,” in *Managing Energy Price Risk*, 2nd Edition (London, UK: Risk Books, 1999), p. 2.

NYMEX and the International Petroleum Exchange (IPE). The bulletin boards also are doing a brisk business in physical trades, despite the fact that several have ceased operations in recent months.

Use of Derivatives by Firms in the Petroleum and Natural Gas Industries

There is little quantitative information available on the extent to which derivative contracts are used by individual firms and utilities. Some academics have conducted large, voluntary surveys on the use of derivatives, but their results are far from definitive because of a lack of statistical sampling, among other problems. New information about the use of derivatives is just now appearing on firms' SEC 10K filings, but those filings do not provide much in the way of details. The following sections summarize the data that are available from academic research on the benefits that oil and gas producers and natural gas pipelines gain from using derivatives and the newly available data from the SEC Form 10K.

Academic Research

G. David Haushalter has examined the risk management activities of 100 oil and gas producers in 1992, 1993,

and 1994.⁴¹ He attempted to relate the extent of different firms' hedging activity to their capital structure (debt/equity ratio, interest coverage, etc.), tax status, compensation policies, ownership structure, and operating characteristics. He found the following:

- The presence of hedging activity increased from 43 percent of the firms in the sample in 1992 to 57 percent in 1994. About one-quarter of the firms surveyed hedged more than 28 percent of their production. Hedgers as a group hedged about 24 percent of their total production.
- Companies with more assets were more likely to hedge.
- Hedgers with larger proportions of debt in their capital structure hedged a greater fraction of their production.
- Hedging was more likely for firms whose local spot market prices closely followed the Henry Hub (natural gas) or Cushing (sweet crude) spot prices used in NYMEX futures. In other words, the lower the basis risk, the more likely a firm was to hedge.
- There was no clear relationship between managers' compensation and hedging.

Haushalter interpreted his findings as being "... consistent with the notion that hedging enables companies to

Table 11. Moody's Bond Ratings for the Top 20 Natural Gas Marketers, 2000-2002

Company	2002		2001		2000	
	Date	Rating	Date	Rating	Date	Rating
1 Enron	NR	NR	03 DEC 2001	Ca	23 MAR 2000	Baa1
2 Reliant Energy	NR	NR	27 APR 2001	Baa2	20 MAR 2000	Baa1
3 American Energy Power	19 APR 2002	Review For Downgrade	24 APR 2001	Baa1	15 JUN 2000	Baa2
4 Duke Energy	NR	NR	21 SEP 2001	A2	NR	NR
5 Mirant	NR	NR	19 DEC 2001	Ba1	16 OCT 2000	Baa2
6 BP Energy (tied)	NR	NR	NR	NR	NR	NR
6 Aquila (tied)	20 MAY 2002	Review For Downgrade	NR	NR	13 DEC 2000	Baa3
8 Dynegy	25 APR 2002	Review For Downgrade	14 DEC 2001	Baa3	26 OCT 2000	Baa2
9 Sempra	22 APR 2002	Review For Downgrade	25 JUN 2001	A2	17 FEB 2000	A2
10 Coral	27 MAR 2002	A1	NR	NR	14 AUG 2000	A1
11 El Paso	29 MAY 2002	Baa2	12 DEC 2001	Baa2	31 JAN 2000	Baa2
12 Conoco (tied)	NR	NR	16 JUL 2001	Baa1	21 FEB 2001	A3
12 Entergy-Koch (tied)	NR	NR	19 JUL 2001	A3	NR	NR
14 Texaco	NR	NR	10 OCT 2001	A2	NR	NR
15 Dominion Resources	NR	NR	24 OCT 2001	Baa1	24 AUG 2000	Baa1
16 Williams	7 JUN 2002	Baa3	19 DEC 2001	Baa2	NR	NR
17 Exxon Mobil (tied)	NR	NR	NR	NR	NR	NR
17 Anadarko (tied)	30 JAN 2002	Baa1	24 JUL 2001	Baa1	17 JUL 2000	Baa1
19 Oneok (tied)	NR	NR	03 DEC 2001	Review For Downgrade	14 FEB 2000	A2
19 TXU (tied)	NR	NR	30 MAR 2001	Aaa	13 MAR 2000	Baa3

Rating Definitions: Aaa, Issuers rated Aaa offer exceptional security; Aa, Issuers rated Aa offer excellent financial security; A, Issuers rated A offer good financial security; Baa, Issuers rated Baa offer adequate financial security; Ba, Issuers rated Ba offer questionable financial security; B, Issuers rated B offer poor financial security; Caa, Issuers rated Caa offer very poor financial security; Ca, Issuers rated Ca offer extremely poor financial security; C, Issuers rated C are the lowest-rated class of entity; NR, No Rating.

Note: Moody's applies numerical modifiers 1, 2, and 3 in each generic rating category from Aa to Caa. The modifier 1 indicates that the issuer is in the higher end of its letter rating category; the modifier 2 indicates a mid-range ranking; the modifier 3 indicates that the issuer is in the lower end of the letter ranking category.

Source: Web site www.moody.com (June 26, 2002).

⁴¹G.D. Haushalter, "Financing Policy, Basis Risk, and Corporate Hedging: Evidence from Oil and Gas Producers," *Journal of Finance*, Vol. 55, No. 1 (February 2000); and "Why Hedge? Some Evidence from Oil and Gas Producers," *Journal of Applied Corporate Finance*, Vol. 13, No. 4 (Winter 2001).

reduce their dependence on the capital markets to finance investment projects. It also supports the idea that managers hedge to reduce the likelihood that the company will encounter financial distress. Under either of these interpretations, theory suggests that corporate hedging could increase shareholder value.”⁴²

Géczy, Minton, and Schrand have studied how natural gas pipelines used a variety of risk management tools—including cash reserves, storage, diversification, and derivatives (when available)—from 1978 through 1995.⁴³ They selected all major natural gas companies that were (or had) major interstate natural gas pipelines. At the beginning of deregulation (1979), natural gas sales made up 60 percent of the total sales for the companies surveyed. By 1995, gas sales made up about 8 percent of the companies’ total sales, reflecting the new role of pipelines as common carriers rather than merchants of natural gas.

A major risk for pipelines is that they will not be able to deliver enough gas to meet demand. One way in which they address volume risk is by storing large quantities of gas near their markets. Another risk is fluctuating demand for transport: when demand is low, transport prices usually are low; when demand is strong, both natural gas prices and transportation rates usually are high. Consequently, even though pipelines no longer marketed significant volumes of gas by the early 1990s, their revenues were directly correlated with the price of natural gas.

The research strategy used by Géczy et al. was first to describe any changes in how firms use cash, storage, diversification, and derivatives over the period. Next they measured the sensitivity of each firm’s stock price to natural gas prices. Then they examined the differences between firms with high and low sensitivity to natural gas prices. Their findings about trends in risk management practices include the following:

- There was no clear trend in cash holdings or storage policy over the time period.
- Pipelines did not use derivatives in the early years of deregulation, but by 1993 about 83 percent of the selected firms used derivatives.

⁴²G.D. Haushalter, “Why Hedge? Some Evidence from Oil and Gas Producers,” *Journal of Applied Corporate Finance*, Vol. 13, No. 4 (Winter 2001), p. 92.

⁴³C. Géczy, B.A. Minton, and C. Schrand, “Choices Among Alternative Risk Management Strategies: Evidence from the Natural Gas Industry,” working paper (University of Pennsylvania, Wharton School of Economics, 2002).

⁴⁴“Fair value” is not the same as “notional value.” Fair value is an estimate of a contract’s worth under current conditions. Notional value is the size of the position. Fair value at contract initiation is zero. If prices do not change much during the contract’s life, fair value can remain near zero even if notional value is large.

⁴⁵Although \$20 billion appears to be large, it is small in relation to firms in other industries. For example, Fannie Mae, a large corporation that provides a secondary market for mortgages, has derivative holdings valued at just under \$500 billion, and the derivative holdings of Morgan Stanley, a large investment bank, are about \$60 billion.

They also found that hedging was effective:

- Cash holdings, storage, and line-of-business diversification all lowered the sensitivity of stock returns to natural gas price.
- Users of commodity derivatives had smaller and less variable stock price sensitivities than did non-users.
- Storage was used to hedge volume risk. Derivatives were used to manage price risk.

Like Haushalter, Géczy et al. found that derivative users had lower bond ratings and dividend yields than did non-hedgers.

SEC 10K Filings

Because there are no academic studies of how LDCs and storage facilities use derivatives, the newly available 10K data were examined for this study to see whether and how such firms use derivatives. As is noted in Chapter 7, firms are now required to report in their 10K filings to the SEC the “fair value” of their derivative holdings on their balance sheets and the change in the fair value on their income statements.

The fair values of the derivative holdings of the 27 largest natural gas and electricity marketers are shown in Table 12.⁴⁴ Note that these derivative holdings are reported as both assets and liabilities. In publicly traded companies’ quarterly and annual reports, a positive change in the value of a derivative is classified as an asset on the balance sheet, and a negative change is classified as a liability (see Chapter 7 for a discussion of accounting for derivatives). If a firm judges that the fair value of its derivative holdings is “not material,” their value is not reported as a separate line item on the balance sheet. Across the 27 companies, the values of financial derivative assets and liabilities are roughly the same size.

Perhaps the most striking result shown in Table 12 is the wide variation in the value of the firms’ derivative holdings. Information from their financial reports indicates that all the firms did indeed use derivatives to hedge; however, the value of their holdings varied from an amount so small that it was “not material” to about \$20 billion.⁴⁵

The financial reports of large oil and natural gas producers and petroleum refiners were also examined. All but one of the firms indicated that they did use derivatives to hedge. In virtually all cases, however, the fair value of their holdings was not reported as a separate line item, implying that their holdings were “not material.” It would therefore appear that marketers use derivatives more than producers and refiners do. Interestingly, in a number of cases, several petroleum firms indicated that

they were vertically integrated and had limited need to hedge.

The U.S. General Accounting Office is in the process of surveying derivative use by a few hundred natural gas distribution companies. Although the results of that survey will not be available until September 2002, preliminary reports indicate that some LDCs are using derivatives to manage price risk.

Table 12. Use of Derivatives by Large Energy Marketing Firms, 2002
(Million Dollars)

Company	Derivative Assets	Derivative Liabilities	Total Assets	Derivative Assets as a Fraction of Total Assets
Reliant	2,058	1,840	5,989	0.344
American Electric Power	10,942	10,494	53,350	0.205
Duke Energy	5,443	3,731	19,478	0.279
Mirant	4,703	2,033	22,754	0.207
BP Energy	NR	NR	105,050	NR
Aquala	1,261	1,503	11,948	0.106
Dynegy	6,336	10,739	19,659	0.322
Sempra	2,575	1,793	15,156	0.170
El Paso	692	214	19,066	0.036
Conoco	221	NR	27,904	0.008
Entergy	2,089	1,982	25,910	0.081
Texaco	NR	NR	18,327	NR
Dominion Resources	1,856	1,408	34,369	0.054
Williams	10,724	8,462	38,906	0.276
ExxonMobil	NR	NR	26,461	NR
Anadarko	105	207	16,771	0.006
Oneok	1,063	873	7,441	0.143
Texus Utilities	2,447	2,049	42,275	0.058
Aquila	1,261	1,503	11,948	0.106
PG&E	807	711	19,554	0.041
Exelon	NR	NR	26,461	NR
Allegheny	NR	NR	NR	NR
Constellation Energy	2,218	1,800	14,078	0.158
Calpirie	1,328	1,448	21,309	0.062
CMS Marketing	885	733	17,102	0.052
Edison Mission	68	193	10,730	0.006
First Energy	NR	NR	37,351	NR

NR = Not reported as a line item on the company's balance sheet.

Source: Securities and Exchange Commission Form 10K filings, web site www.sec.com (June 26, 2002).

4. Derivatives in the Electricity Industry

Introduction

For several years, market analysts predicted rapid growth in the use of electricity derivatives. The U.S. Power Marketing Association, for example, argued in 1998 that the electricity industry would eventually support more than a trillion dollars in futures contract trading.⁴⁶ In fact, electricity derivative markets grew rapidly into the first part of 2000; however, in the last quarter of 2000, the market for exchange-traded electricity futures and options virtually collapsed. By February 2002, the New York Mercantile Exchange (NYMEX) decided to delist all of its futures contracts due to lack of trading.⁴⁷ The Chicago Board of Trade (CBOT) and the Minneapolis Grain Exchange (MGE) also suspended trading in electricity futures.

Enron's collapse eliminated a major innovator and trader of electricity derivatives. It also highlighted the problems of credit risk and default risk. In recent months, market participants have become increasingly cautious and have begun using methods to reduce credit risk and default risk by forming alliances, by increasing reliance on more traditional utility suppliers and consumers with known physical assets, and by reducing the scope of their derivative products (e.g., moving toward shorter term forward contracts).

The exit of electricity traders such as Aquila and Dynegy from the over-the-counter (OTC) market suggests that it is contracting, but overall data on the size and nature of the OTC market for electricity derivative contracts do not exist. What has actually happened to the electricity derivatives market over the past few years may never be known.

The discussion in this chapter suggests that the failure of exchange-traded electricity derivatives and the apparent contraction of the OTC market seem to have resulted from problems in the underlying market for electricity itself. Until the market for the underlying commodity is working well, it is hard for a robust derivatives market to develop.

Barriers to the development of the electricity derivatives market are numerous:

- The physical supply system is still encumbered by a 50-year-old legacy of vertical integration.
- Electricity markets are subject to Federal and State regulations that are still evolving.
- As a commodity, electricity has many unique aspects, including instantaneous delivery, non-storability, an interactive delivery system, and extreme price volatility.
- The complexity of electricity spot markets is not conducive to common futures transactions.
- There are also substantial problems with price transparency, modeling of derivative instruments, effective arbitrage, credit risk, and default risk.

The Federal Energy Regulatory Commission (FERC) has recently taken two steps, discussed below, to encourage competition in wholesale electricity markets. If these initiatives are successful, they will go a long way toward making wholesale electricity markets more competitive.

Structural and Regulatory Constraints on Electricity Markets

Market Structure

Many of the current constraints on developing competitive electric power markets and supporting derivatives markets for managing risk stem directly from the historic evolution of the domestic power industry. The U.S. electricity market began in the 1880s as a collection of several hundred unregulated electricity suppliers. Following the stock market collapse of 1929, many of the supplier companies went into bankruptcy, prompting calls for reform.⁴⁸ Congress responded by enacting two key legislative acts: The Public Utilities Holding Company Act of 1935 (PUHCA) and the Federal Power Act (PUHCA, Title II). The regulatory structure created by

⁴⁶S. Spiewak, "Power Marketing: Price Creation in Electricity Markets," *PMA OnLine Magazine* (March 1998), p. 8, web site www.retailenergy.com/spiewak/sstoc.htm.

⁴⁷NYMEX Notice number 02-57, "Notice of Delisting of NYMEX Electricity Contracts," (February 14, 2002).

⁴⁸J. Wengler, *Managing Energy Risk: A Non-Technical Guide to Markets and Trading* (Tulsa, OK: PennWell Publishing, 2001).

those laws defined the States' role as regulating local markets and the Federal role as one of regulating interstate wholesale markets and corporate structures.⁴⁹

Until recently the States exercised their retail market authority by giving integrated utilities exclusive franchises to serve customers within prescribed geographic areas. The integrated utilities owned the generators, lines, and distribution facilities needed to supply their customers. State public utility commissions (PUCs) regulated the retail price or "tariff" for electricity, typically using a prudence standard to determine which costs were acceptable to pass on to consumers and what would be a "fair rate of return" on investments.

In general, the prudence standard allowed utilities to build enough capacity to serve local demand. This regulatory approach led to the development of a physical electric supply industry that was optimized for serving local markets on a monopoly basis but offered little financial incentive for connecting the tariff-based electric companies. Currently, there is very little surplus capacity for moving power within regions (wheeling),⁵⁰ and the Eastern, Western, and ERCOT (Texas) markets for electricity remain virtually disconnected (Figure 11).

Regulation

Electricity regulation has some similarities to natural gas regulation. The wholesale prices for electricity and interstate transmission services are regulated at the Federal level. Retail prices and intrastate transmission are regulated by dozens of State PUCs. This multi-tier arrangement gives rise to electricity market rules that vary by locality. Retail deregulation legislation is also evolving at different rates in different regions and States.

The Federal Energy Regulatory Commission (FERC) regulates wholesale markets and interstate transmission.⁵¹ In 1996, the FERC took a major step in deregulating the wholesale electricity markets by ordering utilities to "unbundle" their generation, transmission, and distribution functions and provide nondiscriminatory access to the national electricity grid.⁵² A new price discovery mechanism for transmission tariffs, the Open Access Same-time Information System (OASIS), was also created by FERC order.⁵³ These measures were

intended to open the door for a robust wholesale electricity market in the United States.

Some States have also been actively promoting competition in retail markets. By the end of 1999, 24 States and the District of Columbia had enacted legislation to promote competition among retail electricity suppliers. Although deregulation activity initially proceeded rapidly, its progress has slowed in recent years, and the electricity industry is several years behind the natural gas industry in developing fully competitive markets.⁵⁴

The physical design of electricity generation, transmission, and distribution systems has not kept pace with deregulation.⁵⁵ Consequently, many power plants still operate in a "must-run" mode, and the transmission system remains severely constrained by thermal limitations and congestion.⁵⁶ In short, for the foreseeable future, the various electricity markets may remain loosely connected with limited opportunities to move power from cheaper to higher cost areas.

Several States responded promptly to the FERC's initiative to deregulate wholesale electricity markets. California and Pennsylvania essentially led the market reform. In mid-2000 and 2001, however, California's electricity market virtually collapsed, causing a major utility to file for bankruptcy and another to accrue huge financial losses. The fallout from the California debacle served to

Figure 11. U.S. Electricity Interconnections

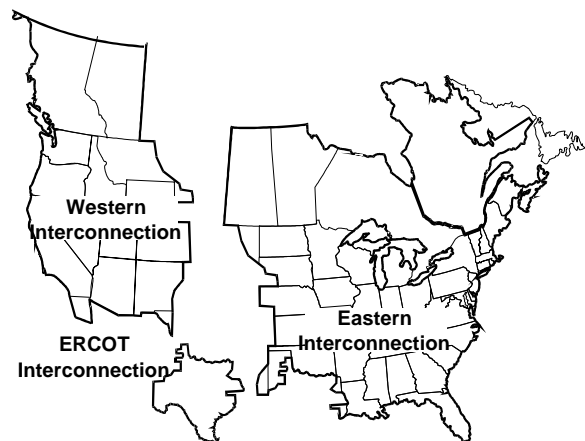

Source: Energy Information Administration.

⁴⁹See Energy Information Administration, *The Changing Structure of the Electric Power Industry: An Update*, DOE/EIA-0562(96) (Washington, DC, December 1996).

⁵⁰Wheeling occurs when a transmission-owning utility allows another utility or independent power producer to move (or wheel) power over its transmission lines.

⁵¹ERCOT is not under FERC jurisdiction, because its operations are largely isolated from those in other States.

⁵²FERC Order 888, Final Rule, 18 CFR Part 35 and 385 (April 24, 1996).

⁵³FERC Order 889, Final Rule, 18 CFR Part 37 (April 24, 1996).

⁵⁴FERC Order 888 in 1996, requiring open access to electrical transmission services, roughly parallels FERC Order 436 in 1985, which required natural gas pipelines to provide open access to gas transportation services.

⁵⁵P. Fusaro, *Energy Derivatives: Trading Emerging Markets* (New York, NY: Energy Publishing Enterprises, 2000).

⁵⁶A "must run" power plant is one that must operate at all times during peak load conditions in order to satisfy the demand and reliability requirements of the grid for its particular location (i.e., there is no surplus capacity that could replace it).

remind everyone of the relevance of sovereign risk for electricity markets. In March and October 2001, for example, the FERC ordered California power wholesalers to refund tens of millions of dollars in overcharges.^{57,58}

FERC is undertaking massive efforts to promote better integration of electricity markets across political boundaries. In 1999 FERC issued order 2000 requiring wholesale market participants to join regional transmission organizations (RTOs) to establish regional transmission management. Progress in establishing RTOs has been slow. In July 2002 FERC followed up with a Notice of Proposed Rulemaking to establish a Standard Market Design (SMD) that would apply within and across RTOs.⁵⁹ Within each RTO the business and operating rules would be the same for all market participants, and all the RTOs would be encouraged to adopt a standard market design, so that the basic rules and regulations of the regional markets would be similar from one RTO to another. If these efforts succeed, the result should be larger, more competitive regional markets and more cost-reducing trades across areas. Essentially the idea is to encourage a common market for electricity to replace the balkanized industry that exists today.

Risk Management Instruments in the Electricity Industry

As discussed below the FERC's RTO and SMD initiatives go a long way toward strengthening competition in U.S. electricity markets. Even with the development of robust competitive markets, however, the use of derivatives to manage electricity price risk will remain difficult, because the simple pricing models used to value derivatives in other energy industries do not work well in the electricity sector. These considerations suggest that innovative derivatives that are based on something other than the underlying energy spot price—such as weather derivatives, marketable emissions permits, and specialty insurance contracts—will be important for the foreseeable future. Forward contracts using increasingly standardized terms are also likely to supplant futures contracts for the foreseeable future.

Commonly Used Electricity Derivatives

Commonly used electricity derivatives traded in OTC markets include forward price contracts, swaps, options, and spark spreads. Several designs for electricity futures also appeared briefly on the NYMEX, CBOT, and MGE exchanges before being withdrawn.

Forward Price Contracts. The primary derivative used in electricity price risk management is the forward price contract. Similar to forward fuel contracts in design (see description in Chapter 2), electricity forwards typically consist of a custom-tailored supply contract between a buyer and seller, whereby the buyer is obligated to take power and the seller is obligated to supply a fixed amount of power at a predetermined price on a specified future date. Payment in full is due at the time of, or following, delivery. This differs from a futures contract, where contracts are marked to market daily, resulting in partial payment over the life of the contract.

Futures Contracts. Electricity futures contracts differ from forward contracts in that a highly standardized fixed price contract is established for the delivery or receipt of a certain quantity of power at some time in the future—usually, during peak hours for a period of a month. Also, futures contracts are traded exclusively on regulated exchanges. For example, the Mid-Columbia future offered by NYMEX specified a delivery of 432 megawatthours of firm electricity, delivered to the Palo Verde hub at a rate of 1 megawatt per hour, for 16 on-peak hours per day during the delivery month. To meet the long-term hedging needs of the customer (load-serving entity), power marketers typically combined several months of futures contracts into a “strip” of deliveries.

Electricity Price Swaps. Electricity swap contracts typically are established for a specified quantity of power that is referenced to the variable spot price at either the generator's or consumer's location. Basis swaps are also commonly used to lock in a fixed price at a location other than the delivery point of the futures contract. That is, the holder of an electricity basis swap has agreed to either pay or receive the difference between the specified contract price and the locational spot price at the time of the transaction.

Options Contracts. Many electricity customers prefer to have a delivery contract with flexible consumption terms. They prefer to pay the same rate per kilowatthour no matter how many kilowatthours they use. An electricity supplier who is holding a futures contract covering the delivery of a fixed number of kilowatthours is therefore at risk that the consumer could use more or less electricity than his futures contract covers. To cover the risk, a supplier often buys an electricity option (i.e., the right but not obligation to purchase additional power at a fixed price). *Spark spreads* (similar to *crack spreads* in the petroleum industry) are cross-commodity options designed to minimize differences between the

⁵⁷See web site <http://democrats.assembly.ca.gov/energy/pubs/EnergyUpdate23.pdf>.

⁵⁸*San Francisco Business Times* (October 8, 2001).

⁵⁹See Federal Energy Regulatory Commission, “Commission Proposes New Foundation for Bulk Power Markets with Clear, Standardized Rules and Vigilant Oversight,” News Release (July 31, 2002), Docket No. RM01-12-000 and Attachments (Questions and Answers), web site www.ferc.fed.us.

price of electricity sold by generators and the price of the fuels used to generate it.

Other Risk Management Tools

Although derivatives that focus on price risk *per se* have had mixed success in the electricity industry, three interesting tangential derivatives for managing risk in the industry are also being used: emissions trading, weather derivatives, and insurance contracts.

Emissions Trading. A critical input to electricity prices at fossil-fueled stations can arise from the requirement to meet various State and Federal air pollution standards. The Clean Air Act Amendments of 1990 established national ceilings on emissions of sulfur dioxide (SO₂) and nitrogen oxides (NO_x) and set up a system of allotting marketable permits to power generators for each ton of emissions. At times, often depending on weather conditions, SO₂ and NO_x standards can require an electricity generator to reduce operations or pay more than normal for SO₂ and NO_x allowances. To hedge against potential losses, power plant owners can purchase or trade in SO₂ and NO_x allowances in order to manage their permit price risk and continue operations at more normal levels.

SO₂ trading has flourished in recent years. Trading volumes have increased from 9 million tons to more than 25 million tons over the past 8 years, with a notional annual value of transactions exceeding \$4 billion in 2001 (Figure 12). Records compiled by the U.S. Environmental Protection Agency indicate that the notional value of private NO_x allowance transfers in 2001 exceeded \$300

million, and a fivefold expansion of the NO_x program is expected during 2003 and 2004, when new Federal regulations expand NO_x allowance trading from the current 9 to 21 eastern States. In the SO₂ and NO_x markets, complex financial structures have been created to address the risk management needs of participants.⁶⁰

Weather Hedges. Weather is a strong determinant of electricity prices and transmission availability. Weather risk is defined as the uncertainty in cash flow and earnings caused by weather volatility. For example, colder than normal summers reduce electric power sales for residential and commercial space cooling, leading to idle capacity—which raises the average cost of power production—and reducing demand for natural gas and coal. Similarly, lower than normal precipitation upstream of hydropower facilities can reduce power production and revenues.

To manage weather risk, some independent power producers have weather adjustments built into their fuel supply contracts. Other large energy companies and power marketers are now using “weather hedges” in the form of custom OTC contracts that settle on weather statistics. Weather derivatives include cooling and heating degree-day swaps and options.⁶¹

Insurance. Most participants in electricity markets use derivatives to manage the price risks associated with reasonably probable events, such as normal market fluctuations. There are also a number of less probable events that can affect their ability to supply electricity or take delivery and that pose large financial risks. In June 1998, for example, an investor-owned utility in Ohio

Figure 12. SO₂ Allowance Trading Activity, 1994-2001

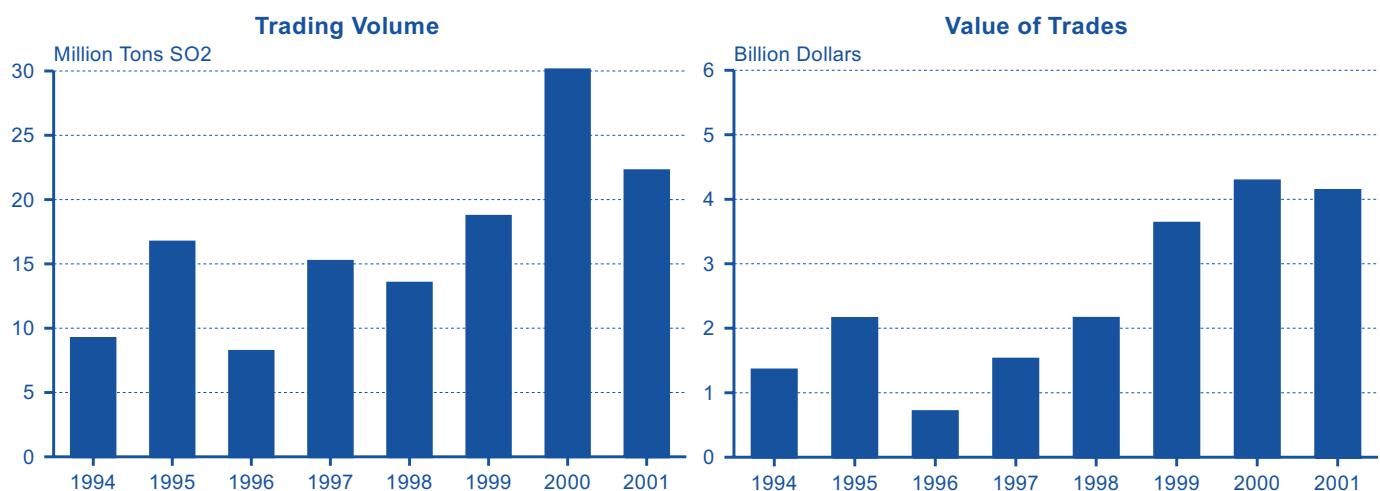

Source: U.S. Environmental Protection Agency, web sites www.epa.gov/airmarkets/trading/so2market/cumchart.html and www.epa.gov/airmarkets/trading/so2market/pricetbl.html. Values estimated by multiplying annual volume by average annual price.

⁶⁰P. Zaborowsky, “The Evolution of the Environmental Markets,” *Energy + Power Risk Management* (April 23, 2002).

⁶¹For further information on weather derivatives and risk, see web sites www.retailenergy.com/articles/weather.htm and <http://ourworld.compuserve.com/homepages/JWeinstein/weatherd.htm>.

experienced forced outages at its fossil fuel plant and at a nuclear power station. The utility's loss of supply occurred concurrently with a surge in electricity market prices, and it reportedly lost \$50 million.

To cover the risk from such low-probability events, multiple-trigger derivatives and specialty insurance contracts are used to complement normal derivative products. For example, in a forced-outage derivative transaction, there are two triggers: (1) the utility must experience a forced outage, and (2) the spot price must exceed an agreed-upon strike price per megawatt-hour. If the two events occur together, the derivative contract will pay an amount specified in the contract. Insurance policies also offer possibilities of custom design and minimal counterparty credit risk.

Many of the current problems with electricity derivatives result from problems in the underlying market for electricity itself. Until competition in the market for the underlying commodity is working well, it is hard for a robust derivatives market to develop. In addition to the structural obstacles and regulatory uncertainties described above, deregulation of electricity markets and the development of truly competitive spot markets are hindered by the nature of electricity as a commodity, the extreme volatility of prices, the complexity of the existing spot markets, and a lack of price transparency.

The impediments to competitive markets dramatically complicate the forecasting of electricity prices and limit opportunities for arbitrage to resolve market imbalances. The added complexity also creates opportunities for price manipulation through market gaming and market power strategies.

The Unique Nature of Electricity as a Commodity

Storage and Real-Time Balance

The two most significant characteristics of electricity are that it cannot be easily stored and it flows at the speed of light. As a result, electricity must be produced at virtually the same instant that it is consumed, and electricity transactions must be balanced in real time on an instantaneous spot market. Electricity's real-time market contrasts sharply with the markets for other energy commodities, such as natural gas, oil, and coal, in which the underlying commodity can be stocked and dispensed over time to deal with peaks and troughs in supply and demand. Real-time balancing requirements also complicate the market settlement process. Some electricity market transactions occur before the system constraints are fully known or the price is calculated. In extreme cases, the settlement price may be readjusted up to several months later.

Electricity is typically "stored" in the form of spare generating capacity and fuel inventories at power stations. For existing plants, the "storage costs" are usually less than or equivalent to the costs of storing other energy fuels; however, the addition of new storage capacity (i.e., power stations) can be very capital intensive. The high cost of new capacity also means that there are disincentives to building spare power capacity. Instead, existing plants must be available to respond to the strong local, weather-related, and seasonal patterns of electricity demand. Over the course of a year or even a day, electricity demand cycles through peaks and valleys corresponding to changes in heating or air conditioning loads. Two distinct diurnal electricity markets also exist, corresponding to the on-peak and off-peak load periods. Each of these markets has its own volatility characteristics and associated price risks.

System Interactivity

The laws of nature, rather than the law of contracts, govern the power flows from electricity suppliers to consumers. By nature, electricity flows over the path of least resistance and will travel down whatever paths are made available to it. Because the suppliers and consumers of electricity are interconnected on the transmission grid, the voltage and current at any point are determined by the behavior of the system as a whole (i.e., impedance) rather than by the actions of any two individual market players. Consequently, the delivery of 100 megawatts of electricity differs dramatically from a simple fuel oil delivery in which 100 barrels of oil are physically piped or trucked between the oil supplier's depot and the consumer's facility.

The following example illustrates the system interactivity. Figure 13 shows interconnections among six hypothetical electric service systems. Supplier A makes a simple contract with B to deliver 100 megawatts of electricity. Once the contract is set, A turns on a generator to supply power, and B turns on electric equipment to create a new 100-megawatt load on the system. Because the loads on the power grid are interactive, the 100 megawatts of electrons will not flow directly from A to B. Instead, the new 100-megawatt supply and load cause a system-wide imbalance in impedance, and the electricity flows readjust across all the interconnected service areas. The contractual path for 100 megawatts of electricity from A to B does not match the actual physical movement of the commodity itself. This unique feature of electricity dramatically complicates transmission pricing by requiring a price settlement process that involves all market participants.

In this example, the power contract between A and B actually uses the physical systems and services of entities C, D, E, and F, which are not parties to the commodity contract. Thus, the virtual marketplace allows B to

make transactions and manage price risk in a manner that would not be possible in other energy sectors. Suppose, for example, that party B wants to buy energy and party A prices energy significantly lower than either C or F. In Figure 13, party A cannot realistically transport the energy to B due to transmission congestion or other constraints. In other energy sectors, the inability to deliver the commodity would preclude party A from bidding at its low price. Either A would have to contract delivery services through the neighboring transmission systems, or B would be forced to buy energy at a higher price directly from C or F.

In the current virtual electricity market, party B can proceed to buy low-cost power from A despite the inability of A to make a direct physical delivery of the commodity. Because of system interactivity, the actual flows of the commodity must be determined in real-time. Thus, the basis risk and total price for delivered electricity remain unpredictable in both futures and forward derivative contracts until after the physical power transaction has occurred.

Price Volatility

As noted above, the high cost of idle capacity discourages deregulated electricity suppliers from acquiring surplus capacity that would rarely operate. When demand in an area exceeds the capacity of its low-cost suppliers, it is often difficult to import cheap power from other areas because of limited transmission capability. Demand then must be met by running cheaper generators to their limits and by dispatching more expensive generators. This gives rise to extreme price volatility, as described in Chapter 2.

An efficient electricity system, with no transmission constraints, dispatches generators in order of their

operating cost: the cheapest ones, generally baseline hydroelectric and nuclear generators, are generally dispatched first, followed by increasingly costly forms of generation, such as natural-gas-fired and oil-fired units. Over most system operating conditions, the supply costs are fairly flat; however, as the supply system gets closer to its capacity limit, the supply costs escalate rapidly. These conditions of supply produce a characteristic “hockey stick” shape in the supply cost curve (Figure 14).

Price volatility is exacerbated by the unresponsiveness (inelasticity) of consumer demand for electricity to high prices. Most consumers pay electricity prices that are still regulated. Because they are based on average generating costs, regulated prices do not vary significantly even when the real-time (marginal) cost of supplying electricity changes. As a result, there are few incentives in the U.S. electricity market to reduce demand.

Recognizing this problem, some European electricity markets already have adopted real-time pricing schemes. In France, for example, the electric utility transmits a special signal at various times of the day to indicate a change in the electricity price. Consumers can purchase sensor switches that detect the price change signal and regulate the operation of appliances such as hot water heaters and air conditioners. If they are successful in reducing demand at times of high supply cost and increasing it when cost is low, these measures should reduce price volatility.

In the United States, one simple approach to reducing price volatility could involve making electricity prices more visible to large users.⁶² Although large power users make up less than 1 percent of all electricity consumers, their share of power consumption is about 30 percent of total demand.

Figure 13. Delivery of 100 Megawatts of Electricity on Interconnected Systems

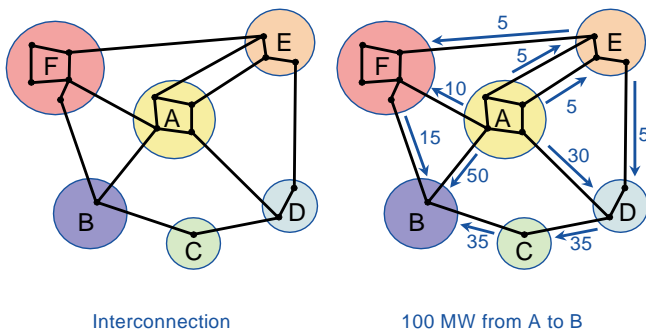

Source: Energy Information Administration.

Figure 14. Electricity Supply Cost Curve

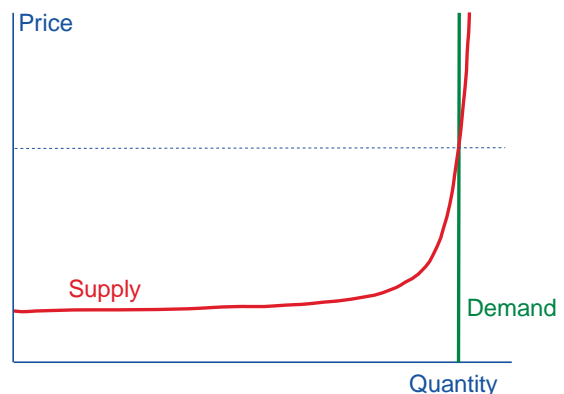

Source: Energy Information Administration.

⁶²See, for example, *Staff Report to the Federal Energy Regulatory Commission on the Cause of Wholesale Electricity Pricing Abnormalities in the Midwest During June 1998* (Washington, DC, September 22, 1998).

As it stands, the price volatility that characterizes electricity markets in the United States is unmatched in any other domestic energy market. On rare occasions, daily volatility can reach extremes of 1,000 percent or more. In 1998, for example, electricity prices in the Midwest spiked from an average of \$25 per megawatt-hour to more than \$7,500 per megawatt-hour for a short time in a single day in response to hot weather and forced outages.⁶³ Although volatility generally creates a high-risk market environment that is attractive to speculators, such extraordinary price spikes are difficult to manage. Given the extreme volatility of electricity prices, the cost of derivatives can be prohibitive.

Spot Market Complexity

Multiple Market Hubs

Historically, the Nation's power grid has been divided into numerous control areas where wholesale power is physically exchanged within regions of the North American Electric Reliability Council (NERC). Trading hubs are aggregations of representative electrical bus bars grouped by region, creating price signals and controls.

Theoretically, there are more than 166 potential hubs in the United States where electricity could be exchanged;⁶⁴ however, more than 85 percent of power trading historically has been conducted at only a dozen trading points. The Cinergy, Entergy, and TVA hubs have been the core of the market east of the Rockies, with ERCOT, PJM, ComED, NY-ISO, and New England constituting most of the remaining marketplace. In the West, most bilateral trading has been conducted at COB, Palo Verde, and Mid Columbia. Before the rollback of deregulation in the State, the California Power Exchange dominated the next-day market.

As a result of system interactivity, limited transmission capability between areas, and local congestion, there is only a weak relationship between pricing at the major hubs and pricing at nearby locations. In addition, it is not clear that the level of competition among traders is sufficient to ensure that arbitrage opportunities will be taken at minimum cost to ultimate buyers and sellers. Electronic trading, which appears to have great potential for encouraging beneficial trading, is still in its infancy, and the top 10 to 20 gas and power marketers were responsible for the vast majority of activity in 2001.

Time-Differentiated Markets

The successful deregulation of natural gas markets influenced many initial policies on electricity deregulation; however, a single spot market design for electricity has proved to be elusive. Instead, differing regulatory views have led to the creation of several inconsistent market designs. For the majority of hubs, an independent system operator (ISO) and three-tiered market have failed to develop; rather, a combination of traditional tariff-based utility pricing, wholesale price matching, bilateral purchases, and sales contracts is used to commit, schedule, and dispatch power.

In contrast, in New England, New York, the Pennsylvania-New Jersey-Maryland (PJM) Interconnection, and California, a three-tiered trading structure consisting of a "day-ahead" market, an "hour-ahead" market, and a "real-time" market was designed in order to ensure that market performance would match the grid's reliability requirements. The PJM Interconnection provides an illustration of how the day-ahead, hour-ahead, and real-time markets are coordinated.

The Day-Ahead Market. In the PJM region, market players submit their bids for generation and load to the day-ahead market. The bids and offers are binding in the sense that parties must perform, and accepted proposals are settled at the day-ahead prices. Any prearranged bilateral transactions may also be submitted. The bidding process continues until about 5AM on the day before dispatch, at which point a complex software program determines the "day-ahead" market-clearing prices. The software analyzes economics, overall system reliability, and each potential constraint in the transmission system. It then determines the optimal generation, the load schedules, and the market-clearing prices for each hour of the following day.⁶⁵

The Hour-Ahead Market. On the actual day of delivery, a "balancing market evaluation" (BME) is performed about 90 minutes before each hour to take into account last-minute deviations from expected levels of electricity supply and demand. The BME considers any necessary additional bids and proposed transactions for that same hour. A modified schedule is then posted 30 minutes before the beginning of the hour.

The Real-Time Market. At the start of the hour for actual delivery, power is dispatched in a real-time market using a program called "security-constrained

⁶³See Energy Information Administration, "Electric Utilities Pay Lowest Price for Petroleum Since 1976," web site www.eia.doe.gov/neic/press/press126.html (May 4, 1999); and R. Michaels and J. Ellig, "Electricity: Price Spikes by Design?" *Regulation*, Vol. 22, No. 2 (August 6, 1999).

⁶⁴R. Braziel, "Trading Hubs: Where Power Is Traded and Why," *PMA Online Magazine* (December 1998).

⁶⁵See web site www.eei.org/future/reliability/hirst_0104.pdf.

dispatch.” It matches the generation forecast and actual data from the power system to the actual load demand during the hour. The results of dispatch are also used to compute real-time, location-based marginal prices for about 2,000 bus bars or nodes within the PJM service area.

Ancillary Services Markets

Most large hubs also have a market for the ancillary services that are required to ensure the smooth functioning and reliability of the electric power system.^{66,67} Bids for ancillary services are placed in advance of the real-time market. Settlements are generally *ex post*. The ancillary services include energy imbalance services, spinning or non-spinning reserve capacity, supplemental reserve capacity, reactive power supply and voltage control services, and voltage regulation and frequency response services.

Transmission Services Markets

As described above, system interactivity creates a fundamental problem for electricity pricing, in that each party’s decision to buy or sell electricity potentially affects other parties in economically important ways. In a sense, everyone on the grid is a partner in each electricity purchase or sale. The interaction creates the need for a market in transmission services.

Two different market designs are used for transmission services. The first approach assumes that it is more trouble than it is worth to charge each system user for the cost it imposes on the system. In this case, external costs are apportioned to users according to local rules and FERC-approved transmission tariffs. If congestion cannot be fully managed using re-dispatch, the transmission operators use a priority system to decide who remains on line. Transmission costs are “socialized” (shared out to everyone) in this approach.

The second approach (used by PJM) associates transmission charges with the costs each user imposes on the system. The transmission system controller calculates a “shadow price” of transmission on every congested line and then charges users according to their marginal contributions to congestion. When a line becomes overloaded, system controllers increase the implicit price of using the line until market participants voluntarily reduce the line loadings. A priority system for allocating transmission is not employed.

The advantage of the first approach is that the transmission pricing mechanism is simple. The chief disadvantage is that a priority system is used to decide who is dropped, and it does not account for the value of the trade. As a result, low-value trades can be allowed while high-value trades are curtailed. Who is dropped, when, and under what circumstances is not always clear. The advantages of the PJM approach are that all transmission users can see the economic impacts of their choices on all other users, and line capability is allocated to those who value it most. The chief disadvantage of the PJM approach is that the transmission price calculation is complex, *ex post*, and can lead to significant price variations, depending on the level of system congestion. To reduce the price risk to users, PJM also markets financial transmission rights (FTR) contracts, which allow users to lock in a transmission cost more than a day in advance.⁶⁸ The FTR is a financial derivative that compensates its owner for any transmission congestion charges that may be imposed during periods of constraint.

Most of the U.S. market currently “socializes” transmission costs. In that environment, arbitrage may not bring price convergence, because price-reducing trades cannot always be made. Efficient pricing of transmission services will remain a serious challenge to the development of competitive electricity markets.

Poor Price Transparency

Price information is a critical part of market mechanisms. Price information allows transactions between distant parties and gives market participants opportunities to anticipate future prices and to act on those anticipations by hedging. In ISO-controlled areas, the price for electrical energy itself is settled in the day-ahead, hour-ahead, and real-time markets. Although the reported prices are subject to revision and some prices (especially for ancillary services) are known only after the fact, the reported prices reflect the actual prices at which electricity is bought and sold. Most non-ISO markets, however, are not nearly as transparent.

Only about 10 of the largest hubs have large, liquid spot markets with readily transparent electricity price data, and only the IntercontinentalExchange web site shows megawatts traded. More than 100 hubs do not supply current market price data. Prices in one locality may

⁶⁶A. Weisman, “FERC 101: The Essential Primer on the Fundamentals of FERC,” *Energy Business Watch* (February 11, 2002).

⁶⁷For the sake of brevity, a full discussion on ancillary services, reactive power, and black-start capability has been omitted. See, for example, A. Siddiqui et al. “Spot Pricing of Electricity and Ancillary Services in a Competitive California Market” in *IEEE Proceedings of the 34th Annual Hawaii International Conference on System Sciences* (2001).

⁶⁸W. Hogan, “Getting the Prices Right in PJM: April 1998 Through March 1999, The First Anniversary of Full Locational Pricing,” web site www.ksghome.harvard.edu/~whogan.cbg/pjm0399.pdf (April 2, 1999).

depend on prices in other areas, adding to the overall complexity of price information in the marketplace. Certain transmission prices and ancillary charges are often not reported publicly and may not be known even to market participants until well after the market settles. Thus, although the price of the energy component may be published, the remaining components of total electricity price are not transparent. In addition, the majority of electricity derivatives are now exchanged in private OTC transactions that shield price information from other participants. These broad problems in price transparency make it difficult, if not impossible, to develop accurate models for pricing derivatives.

FERC’s Standard Market Design

The FERC has recently taken two steps to encourage competitive wholesale electricity markets. On January 6, 2000, it published Order 2000, requiring “. . . all transmission owning entities in the Nation, including non-public utility entities, to place their transmission facilities under the control of appropriate regional transmission institutions [RTOs] in a timely manner.”⁶⁹ The purpose of Order 2000 is to encourage trade and competition by ensuring open, equal access to the transmission grid within large areas.

On July 31, 2002, the FERC issued a Notice of Proposed Rulemaking (NOPR) to “. . . establish a single non-discriminatory open access transmission tariff with a single transmission service . . . that is applicable to all users of the interstate transmission grid: wholesale and unbundled retail transmission customers, and bundled retail customers.” The Standard Market Design (SMD) established under the proposal would apply to “. . . all public utilities that own, control or operate transmission facilities”⁷⁰

Under the proposal, an Independent Transmission Provider would operate all affected transmission facilities. The Independent Transmission Provider would:

- Operate day-ahead and real-time markets for real power and ancillary services.
- Establish a two-part transmission charge: a fixed access charge paid by customers taking power off the grid and a congestion fee based on the differences in locational prices.
- Offer congestion revenue rights, which could be bought to “lock in” a fixed price for transmission.
- Establish market monitors to detect and mitigate market power.

Taken together the RTO Order and the SMD proposal address many of the fundamental problems with the electricity commodity markets discussed above, as summarized briefly in the table below.

Problem	RTO Order	SMD Proposal
Balkanized markets	A few regional markets	—
Lack of price, capacity, and other market data	Reported by RTO	Required
Varying business rules	General rules	Detailed rules
Binding day-ahead market	—	Required
Spot market	—	Required
Appropriate congestion charge?	—	Yes
Market power	—	Monitor

All these requirements flow directly from FERC’s experience. Market monitoring, for example, came out of the California experience. It appears that California generators were holding back power from the California Power Exchange in 2000 in order to force heavier use of real-time markets and the California ISO reliability markets, resulting in higher prices. A new gaming strategy appeared in June 2000, suggesting that big utilities were deliberately under-scheduling demand requirements to force market-clearing prices down.⁷¹

FERC modeled its day-ahead and spot markets after PJM’s markets, which seem to work well for at least two reasons. First, all day-ahead deals are binding: buyers and sellers settle at the termination of bidding. Generators that cannot perform in real time (because of outages, for example) have to pay for the power they do not deliver at spot market rates. Second, PJM manages congestion with locational prices. Had locational pricing been in place in California, Enron’s various strategies for profiting from anomalies in prices would have failed.

In the “inc-ing load” strategy, a company artificially increases load on a schedule it submits to the ISO with a corresponding amount of generation. The company then dispatches the generation it has scheduled, which is in excess of its actual load, and the ISO is forced to pay the company for the excess generation. Under the SMD, the generator and the customer would have been paid the previous day at prices that equated overall supplies with demand. There would have been no systematic benefit from overscheduling generation and under-scheduling load.

Similarly, Enron’s “Death Star” and “Load Shift” strategies worked only when congestion was not properly priced. “Death Star” involved the scheduling of energy counterflows but with no energy actually put onto or

⁶⁹Federal Energy Regulatory Commission, Regional Transmission Organizations, Order No. 2000, 65 Fed. Reg. 809 (January 6, 2000).
⁷⁰Federal Energy Regulatory Commission, *Remedying Undue Discrimination through Open Access Transmission Service and Standard Electricity Market Design*, Notice of Proposed Rulemaking, 18 CFR Part 35, Docket No. RM01-212-000 (Washington, DC, July 31, 2002), p. 9.
⁷¹San Diego Gas & Electric Company, letter to the California ISO (June 23, 2000).

taken off the grid. This strategy allowed the company to receive congestion payments from the ISO without actually moving any energy or relieving any congestion.⁷² The “Load Shift” strategy involved submission of artificial schedules in order to receive inter-zonal congestion payments. The appearance of congestion was created by deliberately overscheduling load in one zone and underscheduling load in another, connected zone, then shifting load from the “congested” zone to the “less congested” zone in order to earn payments for reducing congestion.

Neither Order 2000 nor the SMD NOPR requires that retail customers be exposed to changing wholesale prices. As discussed earlier, the extreme volatility of wholesale electricity prices is due to the rapid increase in marginal generation cost when generators operate near capacity, combined with the lack of customer demand response to wholesale price changes. Until customers, especially large ones, are exposed to real-time wholesale price variation, either wholesale electricity prices will remain volatile or the industry will have to maintain significant excess capacity. Nevertheless, the FERC initiatives, if successful, will go a long way toward creating well-functioning commodity markets. Once that is a reality, the prospects for electricity derivatives will be greatly improved.

Regulatory Challenges Ahead for Electricity Derivatives

The use (and misuse) of electricity derivatives raises at least three key regulatory concerns: What are the financial risks to ratepayers? How can market power and gaming be controlled? What is the proper role for demand-side management programs in the new market?

Financial Risk to Ratepayers. The financial risks resulting from the use of derivatives are illustrated by the

number of companies that have suffered significant losses in derivative markets.⁷³ Large losses can be the result of well-intentioned hedging activities or of wanton speculation. In either case, regulators must be concerned with the impact that such losses could have on ratepayers who, absent protections, might be placed at financial risk for large losses.

Market Power. The preceding text has illustrated the complexity and non-homogeneity of the electricity markets. Amid this dynamic environment, opportunities abound for market power and gaming strategies to develop. Controlling this potential threat to competitive markets will require substantial regulatory review, as well as physical changes in the marketplace itself. In many areas of the country, only a small number of suppliers are capable of delivering power to consumers on a particular bus bar, and each of the suppliers can easily anticipate the bids of the others. In such “thin” markets, the price of electricity can be driven by market power rather than by the marginal costs of production. The need for overall market transparency will be critical to traders and to the market monitors established by the FERC’s Standard Market Design.

Conservation and Demand. One of the key tools available to regulators for reducing the volatility of electricity prices is demand-side management programs. Electricity prices are most volatile during the on-peak hours of the day and substantially more stable (and lower) during the off-peak periods. This fact, coupled with the hockey stick shaped supply cost curve (Figure 14, above) suggests that substantial reductions in volatility could be achieved through the use of market mechanisms and demand-side management programs to shift consumption to off-peak hours. State and Federal authorities have been examining a variety of possible methods for shifting consumer demand for electricity; however, one of the most direct methods—real-time pricing for large electricity consumers—remains largely untapped.

⁷² *Electricity Utility Week* (May 20, 2002), p. 2, and *Public Power Weekly* (May 13, 2002), p. 1.

⁷³ See, for example, Connecticut’s investigation of the State trash authority’s loss of \$200 million in a failed deal with Enron: “Officials See Parallels Between Enron’s Bank Deals and a Power Pact in Connecticut,” *New York Times* (August 8, 2002), p. A21.

5. Prospects for Derivatives in Energy Industries

Introduction

Derivatives have proven to be useful in the petroleum and natural gas industries, and they still are being used in the electricity industry despite the setbacks discussed in Chapter 4. They probably would be used more extensively if financial and market data were more transparent. Managers may limit derivative use because their presence in company accounts is troubling to some classes of investors. In addition, the lack of timely, reliable spot price and quantity data in most markets makes it difficult and expensive for traders to provide derivatives to manage local risks. The prospects for the growth of an active electricity derivatives market are tied to the course of industry restructuring. Until the electricity spot markets work well, the prospects for electricity derivatives are limited.

Transparency of Financial Information

The crucial question to be asked about the new Statement 133 from the Financial Accounting Standards Board (FASB) for reporting derivatives is whether the guidelines for corporate financial reporting of derivatives are sufficient for investors to understand the risks companies are taking.⁷⁴ Two aspects of accounting practice will be particularly important in determining the answer to that question: estimation of the fair value of derivatives and the scope of accounting for them.

Fair Value Estimation

The issue of transparent commodity prices and determining the value of derivative contracts will also have implications with respect to how they are reported on a firm's financial statements. Most important, derivatives are to be recognized in financial statements at fair value. The guidance from Statement 133 on measurement of fair value states that, "Quoted market prices in active markets are the best evidence of fair value and should be used as the basis for the measurement, if available." The Statement recommends that when market prices are unavailable—as, for example, in an over-the-counter (OTC) forward contract—fair value should be estimated

"... based on the best information available in the circumstances." The Statement allows for the use of valuation techniques, stating that, "Those techniques should incorporate assumptions that market participants would use in their estimates of values, future revenues, and future expenses, including assumptions about interest rates, default, prepayment, and volatility."⁷⁵

Market prices are readily available for futures contracts traded on exchanges and for traded options; however, futures markets account for a minority of energy derivatives activity in the United States. OTC forward contracts and other OTC energy derivatives not only are the major form of energy derivatives but also have been the most rapidly growing. In the case of electricity derivatives, OTC forward contracts are the most commonly used, particularly after the cessation of trading in electricity futures contracts on the New York Mercantile Exchange (NYMEX). Fair value measurement is clearly a concern as the United States moves toward greater deregulation of electricity and a corresponding increase in the use of OTC derivatives in the electricity sector.

In the absence of market price information, guidance provided by Statement 133 appears to be quite general. The documentation required for hedge accounting could contain enough description of fair value estimation to allow a reasonable assessment by investors of the prudence of the methods used; however, rigorous documentation is not required for non-hedge derivative accounting. Perhaps materiality criteria might induce disclosure of valuation methods for non-hedge holdings of derivatives. For example, if changes in fair value totaled more than 5 percent of net income, companies might be required to provide detailed disclosure of their valuation techniques. Valuation techniques may be the subject of future opinions and standards issued by the accounting authorities.

Scope of Derivatives Accounting

Statement 133 has broadened the scope of what is included as a derivative. According to an expert accountant in risk management, "If you are buying or selling energy in the wholesale commodity market, whether you hedge or not, assume this is a derivative unless proven otherwise."⁷⁶ Most contracts for future purchase

⁷⁴Chapter 7 of this report provides a review of Statement 133.

⁷⁵Financial Accounting Standards Board, Statement 133, "Accounting for Derivative Instruments and Hedging Activities," pp. 272-273.

⁷⁶David Johnson, quoted in "Protecting Your Earnings: Managing the FASB 133 Challenge," supplement to *Hart's Oil and Gas Investor* (February 2001), p. 2.

or delivery of energy commodities will be considered derivatives unless they qualify for the “normal purchase or sale exception.” If a contract is an energy derivative, then mark-to-market valuation of the contract will be used, and the change in fair value will be reported quarterly.

Some contracts for future purchase or delivery of energy commodities can have long periods of performance. Contracts for natural gas or power stretching over 10 years are not rare in the United States. Some liquefied natural gas (LNG) projects that involve heavy investment in natural gas production and processing for transport to distant destinations are based on long-term contracts that can have terms lasting up to 20 years. If the future deliveries in the contract can be settled on a net basis even though delivery is expected by the contracting parties, then the contract could be treated as a derivative if the normal purchases and sales exception is not elected through documentation. Long-term contracts for energy commodities not documented as normal sales and purchases could be reportable as derivatives and carried on company balance sheets at fair value under Statement 133. Further, at inception, the contract’s estimated fair value would be recognized in current earnings, on an amortized basis.

This treatment of long-term energy commodity contracts could be problematical. First, there may be time spans of several years between inception of a long-term contract and expected delivery of an energy commodity. Recognition on the balance sheet of the fair value of such a contract at its inception does not convey the uncertainty that accompanies the long lead times to first delivery. Second, such contracts are sparsely traded, if traded at all, and typically do not have market values. Fair value will have to be estimated by market valuation techniques. Given the long lead times and lengthy periods of performance of long-term energy contracts, the variance surrounding such estimates is likely to be so large as to seriously impair their credibility.

Another effect of the wider scope of derivatives and consequent increased application of mark-to-market pricing will be greater volatility in reported earnings and stockholders’ equity. It appears possible that improved reporting of derivatives (which are often used to reduce earnings volatility) through Statement 133 might increase the apparent volatility of earnings. Greater volatility in earnings and shareholders’ equity can complicate investors’ efforts to review and assess companies’ financial disclosures. The same problems might also complicate ratemaking and regulatory review for pipelines and electric power. The Federal Energy Regulatory Commission (FERC) has recently proposed incorporation of significant parts of Statement 133 into a number of reports filed with the Commission.

Financial Reporting and Abuse of Derivatives: Some Recent Examples

The story of derivatives in the energy industry and the accounting for them is incomplete without an examination of the ways in which Enron and other companies have used derivatives for purposes other than risk management, such as managing reported earnings, and for other financial engineering goals, such as hiding debt. Such accounting and financial engineering objectives may have been responsible for at least some of the explosive growth in the derivatives markets in the late 1990s. Some examples of how Enron and other energy traders have used energy derivatives to manage earnings and hide debt are provided below.

Managing Earnings Using Derivatives Valuation

As energy companies expanded their role from being just producers and distributors to become energy traders as well, they found increased opportunities to use derivatives for earnings management. The main reason for this development is the accounting requirement of mark-to-market accounting for derivatives. As discussed in Chapter 7, the accounting rules require all financial contracts, even those energy derivatives that are not actively traded in the futures markets, be marked up or down to their estimated market values on the balance sheet. For complex, non-traded derivatives, companies must develop theoretical valuation models describing the derivatives’ value over time, make appropriate assumptions about model variables (such as price curves and demand), and compute the value.

For long-term derivatives, mark-to-market gains typically are non-cash; the actual cash flows may not be realized for several years. Consequently, a company may report large accounting earnings while at the same time consuming large amounts of cash flow. Investors can get some feel for this phenomenon by examining the difference between “earnings” and “cash flow from operations” (CFO) reported in companies’ cash flow statements. Consider, for example, the following data for net income and CFO for Enron for the year 2000, compiled from its quarterly filings with the Securities and Exchange Commission (SEC).

Item	Stated Value (Million Dollars)				
	Q1	Q2	Q3	Q4	Annual
Net Income	338	289	292	60	979
Cumulative Net Income	338	627	919	979	
Cash Flow from Operations	-457	-90	647	4,679	4,779
Cumulative Cash Flow	-457	-547	100	4,779	

As shown, Enron reported large and positive net income in each of the quarters during 2000, but its cumulative

CFO was negative or negligible for most of the period. Transactions completed in the fourth quarter (often in December) made the cash flow positive for the year on a cumulative basis. The same pattern was also apparent for the company's net income in 1997, 1998, and 1999. Cash flow "red flags" such as these often suggest, although they do not provide conclusive proof, that an energy company might be managing its reported earnings by using mark-to-market gains from derivatives.

The mark-to-market valuation data provided to analysts by another large energy trader, The Williams Companies, show the extent of flexibility available to management in reporting mark-to-market gains. Williams reported that, as of the end of 2001, the gross unrealized cash future flows from its derivative contracts were \$7.82 billion.⁷⁷ It then used its subjective *risk assessment* of the contracts to determine the appropriate discount rates to use over the terms of the contracts and applied the discount rates to determine the net present value (NPV) of future cash flows as \$3.03 billion. Next, it made additional *credit adjustment* provisions to account for the specific and known riskiness of its counterparties and reduced the NPV to \$2.12 billion. Finally, it made a *valuation adjustment* to the contracts for additional unspecified risks, and further reduced the recognized value of the contracts to \$1.37 billion, which was the amount reported in its financial statements.

Although Williams clearly was conservative in assessing the value of its derivative holdings, the data point to the enormous flexibility inherent in the valuation process in taking a \$7.82 billion gross cash flow down to the reported \$1.37 billion value. Critics have said that Enron's traders used these and other so-called *prudence reserves* that were not recognized in the company's accounting systems to subjectively set aside the value of gains and losses on contracts from one period for potential use in a later period.

This example makes clear that the potential for earnings management using derivatives is higher when the derivative contracts are long-term in nature. In addition, the potential for earnings management increases when derivatives are entered into for trading or speculative purposes rather than for pure economic hedging, which would require a corresponding valuation assessment and valuation management for the hedged item as well.

Hiding Debt Using Derivatives

Consider the example of a hypothetical energy company with a prepaid forward contract to deliver natural gas to an entity one year from now. The company receives \$1 million in cash up front and takes on a liability to deliver the gas. Also assume that, simultaneously, the

company enters into a cash-settlement forward contract with another entity, in which it agrees to buy the same amount of gas as specified in the first contract one year from now and pay cash on delivery for \$1.06 million. Both contracts are derivatives, and they may well be legitimate financial transactions with goals such as risk management. But what if the counterparty for each of the two contracts is effectively the same? For example, both might be wholly owned entities of the same company. Canceling out the gas delivery and gas purchase, we are left with what looks like a \$1 million loan transaction with an interest rate of about 6 percent. Published media articles show that Enron and several other energy companies may have abused long-term derivatives in this way to raise billions of dollars of loans and hide them from shareholders and other creditors.

It is important to note that the loan raised in the above example is not a case of an "off balance sheet" item. In fact, the loan is fully disclosed on the balance sheet. However, it is not reported in a visible way as a loan. Instead, it is hidden on the balance sheet by being submerged into another liability line, called "price risk management activities" (PRM). Because energy traders typically would have very large PRM assets and liabilities arising from their legitimate trading portfolios, it would be impossible for an investor to know whether the PRM also includes loans.

The magnitude of the PRM item on energy traders' balance sheets is usually large, making it difficult for an investor or regulator to know whether any loans have been hidden in it. For example, the following table shows the amount of PRM asset and liability on the 2001 balance sheets of Enron and Dynegy.

Item	Stated Value (Million Dollars)	
	Enron (Sept. 30, 2001)	Dynegy (Dec. 31, 2001)
Assets from Price Risk Management Activities	14,661	6,347
Total Assets	52,996	24,874
PRM Assets as Percent of Total Assets	28%	26%
Liabilities from Price Risk Management Activities	13,501	5,635
Total Liabilities	41,720	17,396
PRM Liabilities as Percent of Total Liabilities	32%	32%

As an example of the use of PRM to hide debt, it has been widely quoted in the media and in litigation that Enron raised \$350 million through a 6-month bank loan from J.P. Morgan Chase (Chase) by structuring it as a series of derivative transactions between Enron, Chase, and an entity owned by Chase known as Mahonia.⁷⁸ To make

⁷⁷The Williams Companies, presentation to analysts on December 19, 2001.

⁷⁸"Enron's Many Strands: The Transactions," *New York Times* (February 27, 2002), p. C1.

the loan look like several independent and presumably arms-length derivative deals, Enron and Chase entered into a series of variable-price commodity delivery contracts, which transferred a certain payment amount from Enron to Mahonia, then from Mahonia to Chase, and finally from Chase back to Enron. In other words, the variable payment obligations were merely canceled out, leaving only the fixed payment of \$350 million from Chase to Enron, and a fixed payment of \$356 million from Enron to Chase after 6 months. In another reported transaction, Dynegy raised \$300 million through a loan from Citigroup, using a similarly structured financing deal called Project Alpha.⁷⁹

Since the Enron debacle, the SEC, the FERC, and debt-service agencies such as Moody's have required energy traders to disclose information about transactions similar to Project Alpha. As a result, it is likely that the potential for abuse of derivatives to hide loans will be considerably reduced in the future.

Transparency of Market Information

The applications of derivatives to risk management are limited by the availability of spot market data—specifically, timely, public, and accurate information on prices and quantities. In addition, to judge the creditworthiness of counterparties and the risks managers are taking, their financial statements should be transparent.

Accurate, timely price and quantity data from spot markets are critical for the design and pricing of derivatives that can be used to manage rather than amplify price risk. As mentioned in Chapter 2, settling futures, swaps and option contracts requires an unambiguous price for the underlying commodity. The formulas used to value (price) derivatives themselves are based on an idealized description of the underlying physical markets. From time to time, the differences between the theoretical and actual commodity markets are significant. For example, commodities sometimes cannot be sold or can only be sold at prices substantially different from the last reported market price.⁸⁰ Sometimes market prices are manipulated.⁸¹

Of more practical concern, in order to value energy price derivatives, analysts must evaluate long time series of historical and current energy prices.⁸² In the best of circumstances, forecasting future energy prices is difficult. Without long series of reliable data, forecasting and estimation amount to a leap of faith. And modeling prices with inadequate data and estimation of value can itself introduce as much risk as does the market.

As shown in Chapters 3 and 4, the price and quantity data available for natural gas and electricity markets are of decidedly mixed quality. Published prices from different sources are not always the same. Volume data specific to individual spot markets generally are not available. That would not be a problem for an idealized competitive market where all the participants are small relative to the overall size of the market. In real markets, traders need market volume statistics both to assess the depth of a market and to judge whether their trades might affect market prices.⁸³

In the natural gas industry there are a number of firms that more or less informally poll natural gas traders to arrive at various prices. Depending on the source, the published prices may reflect binding bids, offers, actual trades, or starting points for negotiation. Whatever they are, they do not represent the results of a verifiable process.⁸⁴ The reporting of energy prices and trade volumes is erratic, informal, and often far after the fact. Prices are reported by interested parties, and in general no one knows the actual prices and volumes traded.

Electricity prices published by the Independent System Operators (California, PJM, New York, and New England) do accurately report binding, market-clearing day-ahead and real-time prices for electricity and some supporting services. Outside those areas, reporting is idiosyncratic. Even the FERC and the Department of Energy have been forced to resort to secondary sources for high-frequency, market-specific data on electricity prices.⁸⁵

The question of whether domestic energy (commodity) markets are sufficiently transparent, liquid, and competitive to support most beneficial uses of derivative

⁷⁹“Number Crunching: Enron Rival Used Complex Accounting To Burnish Its Profile,” *Wall Street Journal* (April 3, 2002), p. A1.

⁸⁰Even relatively small traders found that they could not buy and sell at the posted prices on the New York Stock Exchange during the October 19, 1997, meltdown. See, for example, J. Hull, *Options, Futures and Other Derivatives*, 4th Edition (New York, NY: Prentice Hall, 2000).

⁸¹Federal Energy Regulatory Commission (FERC) Staff Report, *Fact-Finding Investigation of Potential Manipulation of Electric and Natural Gas Prices*, Docket No. PA02-2-000 (Washington, DC, August 2002), and FERC, “Commission Takes Enforcement Action Against Six Companies,” News Release (Washington, DC, August 13, 2002).

⁸²See, for example, E. Deman, *The Principles and Practice of Verifying Derivatives Prices* (New York, NY: Goldman, Sachs & Company, April 2001).

⁸³Derivative pricing models assume that the underlying commodity can be bought or sold at the market price. That is to say, the pricing models contemplate relatively small trades.

⁸⁴See FERC's investigation of methods used by various spot market data reporters, Docket number PA-02-2000, *Investigation of Potential Manipulation of Electric and Natural Gas Prices*, August 2002.

⁸⁵See, for example, “Staff Report to the Federal Energy Regulatory Commission on the Causes of Wholesale Electric Pricing Abnormalities in the Midwest During June 1998” (September 22, 1998), pp. 5-3 and 5-4.

instruments is unsettled. The inconclusive evidence that is available suggests that location dependence tends to make energy markets smaller, less liquid, and more subject to manipulation than they otherwise would be.⁸⁶ The extent to which the use of derivatives is limited by these problems is not known; however, the necessity for valuing derivative contracts on the basis of market data suggests that they constitute a significant barrier. Timely, accurate market data could only encourage the wider use of derivatives to manage local energy price risks.

Electricity Spot Markets

Until electricity spot markets are working well and providing electricity reliably at competitive prices (near marginal cost), prospects for growth in the market for price-based derivatives are limited. Weather derivatives, outage insurance contracts, and similar risk management instruments are likely to fill the breach partially until such time as electricity markets stabilize.

Recent academic and business literature reflects a growing consensus on what will have to happen in order for electricity markets to become better behaved.⁸⁷ Three fundamental elements of that consensus are:

- Some portion of demand must be exposed to real-time prices.
- Transmission must be open, and its cost must be based on congestion charges and any physical marginal costs.
- Rules must be standardized over large areas.

As mentioned in Chapter 4, one cause of extremely high electricity prices is that consumers do not see the actual cost of their use. As a consequence, they continue consuming while the supply system is under stress. Academic economists and many engineers now argue that exposing as little as 10 percent of demand—generally, industry and large commercial users—would decisively reduce price spikes. Price-responsive demand would also be a countervailing force to the exercise of market power.

The U.S. electricity grid was not built to support competition, and transmission service has not been priced to reflect the actual costs of using the system. There is

general agreement that substantial investments will be required to increase the capability of the grid to support competition.⁸⁸

What is currently lacking is a market indication of which investments are worth the cost. Generally, in the present situation, transmission charges are set without regard to current congestion and do not reflect actual wear and tear on the grid. When lines are congested, users are cut back according to their priority, and the priorities do not reflect the relative values of canceled and permitted transactions. Economists argue for charges that vary to reflect the real-time congestion that individual generation and consumption decisions impose on the grid.

If transmission charges reflected actual costs, the usage data could be a reliable indicator of the value of particular transmission lines to users. Heavy usage in the presence of high transmission charges would indicate demand for more capability. Given that information, planners would have a market-based reason for investing in particular grid expansions. At present, however, the rules for market participants depend almost entirely on their location. This balkanization of market rules is a source of complexity that increases the cost of participating in the markets. The FERC's Regional Transmission Organization (RTO) and Standard Market Design (SMD) initiatives, if successful, are likely to reduce both complexity and costs significantly.⁸⁹ They do not however directly address the need for price responsive demand.

Even with the development of a generally competitive market, using derivatives to manage electricity price risk will remain difficult. The simple pricing models used to value derivatives in other energy industries do not work in electricity. Barring transmission that is unlimited and free, some participants will be able to manipulate prices in some markets some of the time. These considerations suggest that innovative derivatives, based on something other than spot prices, will be important for the foreseeable future.

Conclusion

The development of energy derivative markets is strongly influenced by the transparency of financial and

⁸⁶Energy markets are inherently local: natural gas in western Pennsylvania cannot readily be transformed at a known, stable price into natural gas in Philadelphia. For example, correlations between changes in natural gas prices in separated markets are on the order of 0.3, reflecting the high variability of transportation (transmission) costs.

⁸⁷For current examples, see S. Hunt, *Making Competition Work in Electricity* (New York, NY: John Wiley & Sons, 2002); T. Brennan, K.L. Palmer, and S.A. Martinez, *Alternating Currents* (Washington, DC, Resources for the Future, 2002); and S. Borenstein, "The Trouble with Electricity Markets: Understanding California's Restructuring Disaster," *Journal of Economic Perspectives*, Vol. 16, No. 1 (Winter 2002), pp. 191-211.

⁸⁸See U.S. Department of Energy, Office of the Secretary of Energy, *National Transmission Grid Study* (Washington, DC, May 2002).

⁸⁹See Federal Energy Regulatory Commission, *Regional Transmission Organizations*, Order No. 2000, 65 Fed. Reg. 809 (January 6, 2000); and *Notice of Proposed Rulemaking: Remedying Undue Discrimination through Open Access Transmission Service and Standard Electricity Market Design*, Docket No. RM01-12-000 (July 31, 2002).

spot market data. The development of the electricity derivative market is especially dependent on the success of restructuring. None of these problems can be solved solely by private initiative. Whether and how

associations (both trade and consumer) and governments will address these issues is an open question that is unlikely to be answered soon.

6. Derivative Markets and Their Regulation

Introduction

Risk is inherent in human affairs. Some risks can be managed by pooling individuals into a larger group, as with automobile insurance. Others can be addressed by diversification, as with mutual funds. Still others can be mitigated with stockpiles: in ancient Egypt, granaries were built to store grain to cover periods of drought; and in the United States, a Strategic Petroleum Reserve has been built to counter the risk of supply disruptions. As described in the first section of this report, derivatives have become increasingly important over the past two decades as a means of transferring the financial risks associated with price volatility in commodity markets and, in particular, energy markets.

This chapter recounts the rapid growth of derivative markets following the deregulation of exchange rates, freeing of interest rates, and decontrol of energy prices and describes in some detail how they are traded. The regulatory structure applicable to derivative contracts in the United States is described briefly, including the role of the Commodity Future Trading Commission (CFTC), the Securities and Exchange Commission (SEC), and the Federal Reserve Board (FED) in the regulation of

exchanges, over-the-counter (OTC) markets, and banks that are active in derivative markets. Exemptions of energy commodities and electronic exchanges from CFTC regulation are also discussed.

Development of Derivative Markets

Although derivatives have been used in agricultural markets since the mid-1800s, much of the growth in their use over the past several decades has been in financial markets as a direct response to increased volatility in credit and foreign exchange markets. After the decision was made to allow exchange rates to “float,” they became very volatile. The futures exchanges and OTC markets responded by creating derivative products that could be used to mitigate financial risks related to this volatility. Today the most heavily traded contracts on futures exchanges are on such products as U.S. Treasury Bonds, the S&P 500 stock index, and Eurodollars. Likewise, the most heavily traded products in the OTC markets are contracts based on interest rates and foreign currencies.

Table 13 shows the notional amounts and market values of global outstanding OTC derivative contracts at the

Table 13. Trading Activity in Global Over-the-Counter Markets, 1998 and 2001
(Billion U.S. Dollars)

Risk Category and Instrument	Notional Amounts		Gross Market Value	
	June 1998	December 2001	June 1998	December 2001
Total Notional Value	72,144	111,115	2,579	3,788
Foreign Exchange Contracts	18,719	16,748	799	779
Outright Forwards and Forex Swaps	12,149	10,336	476	374
Currency Swaps	1,947	3,942	208	335
Options	4,623	2,470	115	70
Interest Rate Contracts	42,368	77,513	1,159	2,210
Forward Rate Agreements	5,147	7,737	33	19
Interest Rate Swaps	29,363	58,897	1,018	1,969
Options	7,858	10,879	108	222
Equity-Linked Contracts	1,274	1,881	190	205
Forwards and Swaps	154	320	20	58
Options	1,120	1,561	170	147
Commodity Contracts	452	598	38	75
Gold	193	231	10	20
Other Commodities	259	367	28	55
Forwards and Swaps	153	217	—	—
Options	106	150	—	—
Other	9,331	14,375	393	519

Source: Bank for International Settlements.

end of June 1998 and December 2001.⁹⁰ The global market for OTC derivatives amounted to \$111 trillion in December 2001 up from \$72 trillion in June 1998. The increase represents an average yearly rise of 11.4 percent. Interest rate derivatives accounted for the greatest activity, with \$78 trillion in notional amounts outstanding as of December 2001, followed by foreign exchange markets, with \$17 trillion outstanding. OTC derivatives on physical commodities represented the least active category of contracts, with an outstanding notional value of \$0.6 trillion as of December 2001. Although that amount is small overall in comparison with interest rate and foreign exchange products, the yearly average growth rate of 8 percent since 1998 is comparable.

While trading in OTC derivatives has grown rapidly over the past decade, exchange-based trading in futures contracts, particularly in financial and energy commodities, has also progressed (Figure 15). From 1991 to 2001, the total volume of trading in futures contracts increased by 139 percent, or 9.1 percent per year on average. The share of energy-related products (petroleum, natural gas, coal, electricity, etc.) was 13 percent in 1991 and 12 percent in 2001. The contract volumes for energy-related products over the 10-year time period grew by a total of 115 percent, or 8 percent per year. As the energy industry moves toward a more competitive environment, increasing price volatility of energy commodities can be expected to induce further growth in the demand for energy futures and option contracts.

Trading Environments

Derivative contracts are traded or entered into in several trading environments. Derivatives traded on an exchange are called exchange-traded derivatives. The primary purpose of exchanges is to aggregate a large number of participants in order to build liquidity in a contract. Contracts entered into through private negotiation are typically called off-exchange or OTC derivatives. The primary motive of participants in the OTC markets is to create instruments whose risk-return characteristics closely match the needs of individual customers. In addition, there exist a number of trading systems, such as voice brokering and electronic bulletin boards, that attempt to combine the strengths of the exchange and off-exchange markets, gathering together large numbers of participants but also offering at least some level of customization through individual negotiations. Contracts traded in each market share similar risk-shifting attributes, but the means by which the contracts are negotiated and the information, liquidity, and counterparty risks can be much different. The common threads that tend to run across all markets are the market participants and their functions (see box above).

⁹⁰OTC derivatives, which are not traded on organized exchanges, represent only part of the derivative market.

Derivative Market Participants

Hedgers: Enter into derivative contracts to offset similar risks that they hold in an underlying physical market. In so doing, they transfer risk to other market participants, such as speculators or other hedgers. Hedging is the primary social rationale for trading in derivatives.

Speculators: Take unhedged risk positions in order to exploit informational inefficiencies and mispriced instruments or to take advantage of their risk capacity. Speculators are individual traders and companies willing to take on risk in the pursuit of profits.

Arbitrageurs: Take opposite positions in mispriced instruments in order to earn an essentially riskless return. The arbitrage process ensures that prices between related markets stay consistent with one another.

Figure 15. Market Shares of Futures Contracts Traded on U.S. Exchanges by Commodity Type, 1991 and 2001

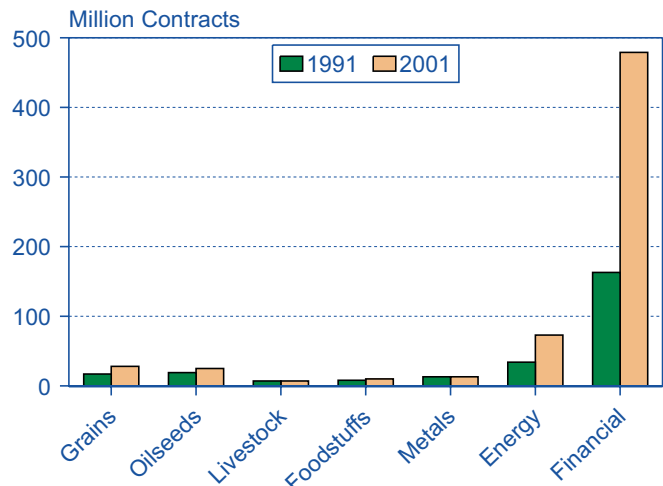

Source: Commodity Futures Trading Commission.

Each market participant performs a specific role. Speculators play the critical role of taking on the risks that hedgers wish to avoid: without speculators there is no derivatives market. The price of risk is determined by the interaction between how much hedgers are willing to pay to reduce risk and how much speculators require to bear it. Arbitrageurs ensure that the prices of individual risk-bearing instruments are consistent across the various derivative contracts. A well-functioning derivative market requires all three kinds of traders.

Exchange Markets

One of the main features of contracts offered by exchanges is standardization. Standardization ensures

that any one contract is indistinguishable from any other in terms of what, how much, when, and where a commodity is to be delivered. All contracts for a particular commodity and a particular date are the same. Standardization is an important feature in that it allows a trader who, for example, has sold a contract to deliver natural gas at Henry Hub in November to get out of the market easily by buying a contract to deliver natural gas at Henry Hub in November. His net position is zero; he has offset his sell with a buy. If he sells gas for more than he bought it, he profits. Otherwise he loses money.

In addition to offering standard contracts, exchanges offer two other features: a trading platform and a clearing system. The trading platform is the mechanism by which buyers and sellers are brought together and orders are matched. For much of the history of futures and options trading, exchanges have relied on an open outcry system on a designated trading floor or pit at an exchange. During the past decade, however, there has been a move to establish electronic markets for trading in futures and options contracts. Many European and other overseas exchanges have shifted exclusively to electronic trading, although U.S. exchanges still rely primarily on open outcry conducted on the floor of an exchange.

The primary difference between open outcry and electronic trading is the method by which trades are matched. In open outcry, matching relies on the ability of traders in a pit to locate other traders in the pit who have an opposite trading interest. As the name implies, traders cry out their bids and offers in the hope of finding a counterparty. In electronic trading, a computer algorithm takes the place of traders in monitoring bids and offers and finding traders on the other side of the market. Usually the computer screen will list the bids and offers being quoted by traders. Traders may then submit orders in an attempt to “hit” the quotes. When an order that matches a bid or offer enters the computer, the computer algorithm will automatically match the orders, send the match to the clearinghouse for clearing and update the bids and offers displayed on the screen.

Clearing is the procedure by which the clearinghouse becomes the buyer to each seller and the seller to each buyer of every futures and options contract traded on the exchange. The clearinghouse typically is an adjunct to, or division of, a commodity exchange. The mechanics of clearing a trade are straightforward. Once a trade has occurred on the exchange floor or electronic trading system, the information from the trades is sent to the clearinghouse for confirmation. The clearinghouse checks that the information provided by the two parties matches exactly. If it does, the clearinghouse takes the

opposite side of each counterparty that entered into the trade on the exchange.

The main purpose of a clearinghouse is to take the other side of each contract, allowing contracts to be fungible and making it easy for parties to enter into and exit contracts. Because the clearinghouse ultimately ends up on the other side of every contract, a counterparty does not need to be concerned with whom he trades against on the floor of the exchange or whether that person exits his position before the contract expires. If contracts were not cleared, counterparties would need to go back to the original counterparty to negotiate an early termination of the contract or to seek permission to substitute a different counterparty to take on the obligations of the contract. The clearing process eliminates those concerns, allowing exchange customers to enter and exit the market freely.

In the process of making contracts fungible, clearinghouses assure the financial integrity of the contracts. That is, the clearinghouse establishes a guarantee of performance on the contracts. This is typically accomplished through five levels of control that come into play before transactions are ever entered into, while contracts are being held and after problems may arise:

- The first level, control of the credit risk faced by the clearinghouse, is accomplished by admitting only creditworthy counterparties to membership in the clearinghouse.⁹¹ Most clearinghouses do this by establishing minimum financial requirements and standards that its members must meet on an ongoing basis.
- As a second level of control, clearinghouses may impose position limits on members or its members’ customers to limit the potential losses to which a member may be exposed.
- The third level of control is to establish a “margin system” to cover the risk of positions that have been entered into. A margin is essentially a performance bond designed to cover potential short-term losses on futures and options positions.
- The fourth means of protecting contracts is to establish default procedures in the event that a clearing member does default. While these procedures may differ from one clearinghouse to another, they typically involve an attempt to isolate the house accounts of the offending clearing member while transferring the accounts of its non-defaulting customers to other clearing members.
- The fifth level of protection is to establish supplemental resources to cover situations in which a

⁹¹While customers of the exchange are exposed to the credit risk of the clearinghouse, the clearinghouse is exposed to the individual credit risks of the futures commission merchants (FCMs) that are members of the clearinghouse and, ultimately, to the customers of those FCMs.

margin is insufficient to cover losses. This may take the form of outside guarantees, insurance, excess reserve funds, or collateral pools.

Over-the-Counter Markets

Over-the-counter is not a well-defined term. In fact, it is commonly used simply to describe trading activity that does not take place on an exchange, whether that exchange is a futures, options, or stock exchange. For example, in a 1997 report of the U.S. General Accounting Office, OTC derivatives were described as contracts that “are entered into between counterparties, also called principals, outside centralized trading facilities such as futures exchanges.”⁹² The report noted that, in OTC markets, counterparties typically negotiate contract terms such as the price, maturity, and size of the contract in order to customize the contract to meet their economic needs. Moreover, because OTC contracts are entered into on a principal-to-principal basis, each counterparty is exposed to the credit risk of the opposite party.

Although OTC transactions predate the trading of futures contracts, the interest in modern OTC derivatives trading had its beginning in the 1980s, when parties interested in entering into derivative contracts began to explore alternatives to the exchange. Exchange-traded contracts offer high liquidity and low credit risk, but typically they are standardized and inflexible, meaning that users often face large basis risk when using the contracts to hedge.⁹³ By being able to negotiate contract terms, users can reduce basis risk by assuring that the terms of derivative contracts more closely match the characteristics of their physical market positions; however, the advantage of customization generally comes at the expense of liquidity and credit assurances.

Technically, OTC derivatives may be entered into between any two counterparties. In practice, however, the market has come to be structured as a dealer market. In such a market, the end users of derivatives tend to seek out companies (i.e., derivative dealers) that create customized contracts to fit their needs. The dealers then offset the risk of the contracts by entering into exchange-traded futures and option contracts or other OTC derivative contracts that have an opposite risk profile.

The dealer market tends to be dominated by large investment banks and some commercial banks,

although as the market has matured, specialized companies have moved into niches where they may have an informational or operational advantage over the banks. This has been particularly true in the energy and power markets where firms such as American Energy Power, Reliant Energy, Duke Energy, and the large petroleum companies have become significant players in the markets. As a result, the commodity derivative dealer affiliates of the large investment banks have become less dominant, although they continue to be important players. For example, the recently established IntercontinentalExchange, which primarily offers OTC energy contracts, is a joint venture of BP Amoco, Deutsche Bank AG, The Goldman Sachs Group, Inc., Morgan Stanley Dean Witter, Royal Dutch/Shell Group, SG Investment Banking, and the Totalfina Group.

Because OTC derivatives and exchange-traded futures serve similar economic functions, they can be used as substitutes for each other and thus may compete in the marketplace. They are not perfect substitutes, however, because of potential differences in their contract terms, transaction costs, regulations, and other factors. OTC derivatives and exchange-traded futures can also complement each other. For example, swaps dealers use exchange-traded futures to hedge the residual risk from unmatched positions in their swaps portfolios. Similarly, food processors, grain elevators, and other commercial firms use exchange-traded futures to hedge their forward positions.

Regulation of Exchange-Traded Derivatives

The regulation of derivative trading in the United States depends on a variety of circumstances, including whether trading is conducted on an exchange and whether the trader is a bank, an insurance company, or another regulated entity. Regulation of the futures and options markets is accomplished jointly through self-regulation by the exchanges and oversight by the Federal Government through the Commodity Futures Trading Commission (CFTC). In the legislation establishing the CFTC, Congress recognized that futures markets serve a national interest.⁹⁴ Congress sought to assure orderly futures markets, operating fairly, with prices free of distortion.

⁹²U.S. General Accounting Office, *The Commodity Exchange Act: Legal and Regulatory Issues Remain*, GAO/GGD-97-50 (Washington, DC, April 1997).

⁹³Basis risk describes the lack of correlation that may exist between the price of a derivative contract and the price of the commodity that is being hedged. To the extent that these prices move independently, the hedger faces a risk that the change in the value of the physical position may not be entirely offset by the change in the value of the derivative position. Thus, the hedge may not be a perfect one.

⁹⁴Section 3 of the Commodity Exchange Act, 7 U.S.C. Section 5.

The CFTC oversees the enforcement of exchange rules and conducts its own surveillance of trading in futures and related cash markets as part of its mission to prevent market abuse and to enhance market operations. The Commission oversees the regulations and rules of the futures exchanges and requires exchanges to enforce them. The CFTC also relies on its economists and trading experts to monitor contracts and trading in the public interest, to assure that markets provide a means for managing and assuming price risks, discovering prices, or disseminating pricing information through trading in liquid, fair, and financially secure trading facilities. Finally, the CFTC offers a reparations procedure for customers of CFTC registrants to file grievances.

In addition to regulation by the Federal Government, futures trading is overseen by the National Futures Association (NFA), a “registered futures association” under the Commodity Exchange Act (CEA) that has been authorized by the Commission to register all categories of persons and firms dealing with customers. Before registering a new person or firm, the NFA conducts a thorough background check of the applicant to determine whether they should be precluded from conducting commodity business.

While the CFTC is responsible for the oversight of the U.S. futures and options exchanges, the exchanges themselves have broad self-regulatory responsibilities. Commodity exchanges complement Federal regulation with rules and regulations of their own for the conduct of their markets—rules covering clearance of trades, trade orders and records, position limits, price limits, disciplinary actions, floor trading practices, and standards of business conduct. A new or amended exchange rule must be reported to the CFTC, which may also direct an exchange to change its rules and practices. The CFTC regularly audits the compliance program of each exchange.

Regulation of OTC Derivatives

The overall OTC derivatives “marketplace” encompasses a wide variety of types of transactions and customized products, which generally lack the unifying characteristics of conventional markets. The OTC market exists primarily to meet the needs of customers who are interested in particular commodities—at particular locations and times—that are not available on exchanges. The variety of OTC contracts reflects the variety of individual situations, and unlike the market for exchange contracts the OTC market tends to change quickly.

The OTC marketplace includes, among other types of products, transactions in securities such as OTC options on individual equities and stock indexes; transactions in hybrids such as oil-indexed notes; swaps; and transactions in certain specialized “forward” markets such as the interbank market in foreign currency and the Brent oil market. In addition, the Commodity Futures Modernization Act of 2000 (P.L. 106-554, 114 Stat. 2763) established a number of exemptions and exclusions for qualifying OTC transactions.⁹⁵ These exclusions and exemptions apply to a variety of transactions and contracts involving various counterparties, commodities, and trading arrangements.

Multiple types and levels of regulation, depending on the product and on how transactions are settled, complicate the regulatory landscape for OTC derivatives. Further complexity results from the significant use of OTC derivatives by entities also subject to one or more regulatory regimes, either as intermediaries (e.g., commercial banks and investment banks) or as end users (e.g., pension funds and investment companies). In addition, because OTC derivative transactions grew out of the unbundling of price differentials from commercial transactions, many derivative transactions are conducted directly between unregulated counterparties or corporate end users. Such end-user activity may be in the nature of commercial transactions and, as such, qualitatively different from intermediation, which could involve extensions or guarantees of credit or custodianship of assets or could concentrate risk. The level of regulatory interest in commercial transactions is clearly different from that which would be applied to intermediated transactions.

In addition to transactions in the OTC markets that fall outside CFTC or SEC jurisdiction, there are certain transactions that may fall within these agencies’ jurisdiction but are regulated differently from exchanged-traded products. The exchange regulatory model is a basic component of both the CFTC and SEC regulatory systems; however, neither is confined to transactions occurring on centralized exchange markets. Both the CFTC and SEC regulatory frameworks currently contemplate less comprehensive regulation of certain essentially private transactions with accredited parties than for exchange trading or public securities offerings. These categories of reduced regulatory requirements are directly relevant to the OTC derivatives market.

Under the CEA, centralized trading of futures contracts and commodity options on CFTC-approved exchanges is the exclusive form of permissible trading, absent a specific exemption or exclusion. In late 1992, however, Congress granted this authority in the Futures Trading

⁹⁵See Commodity Exchange Act, Sections 2d—Excluded Derivative Transactions; 2e—Excluded Electronic Trading Facilities; 2f—Exclusion for Qualifying Hybrid Instruments; 2g—Excluded Swap Transactions; and 2h—Legal Certainty for Certain Transactions in Exempt Commodities (7 U.S.C. 2d, 2e, 2f, 2g and 2h).

Practices Act of 1992 (FTPA).⁹⁶ Using this authority, the CFTC acted in 1993 to grant several exemptions for OTC derivative contracts. The first exemptions were granted for swaps and other OTC derivative contracts and for hybrid instruments.⁹⁷ They were soon followed by a CFTC order exempting certain energy contracts from regulation under the CEA, including the antifraud provision of the CEA.⁹⁸ The purpose of the order was to improve the legal certainty of energy contracts and reduce the risk that physical markets would be disrupted. While the swaps and hybrid instrument exemptions applied to all commodities, the order for energy contracts extended only to contracts for the purchase and sale of crude oil, natural gas, natural gas liquids, or other energy products derived from crude oil, natural gas, natural gas liquids, and used primarily as an energy source. Moreover, the order applied only to energy contracts entered into between principals.

While the FTPA and the exemptions granted under it by the CFTC allowed the OTC markets in derivatives to continue to develop, it did not specifically address whether or not any particular type of transaction, such as a swap agreement, is a futures or an option. As a result of this omission and the continuing evolution of the OTC markets, concerns about legal uncertainty persisted. Thus, in 1998 Congress indicated that the President's Working Group on Financial Markets (Working Group)⁹⁹ should work to develop policy with respect to OTC derivative instruments,¹⁰⁰ and the Chairmen of the Senate and House Agricultural Committees requested that the Working Group conduct a study of OTC derivatives markets and provide legislative recommendations to Congress.¹⁰¹ In general, the Working Group recommended that OTC derivatives traded between sophisticated counterparties should be excluded from the CEA. Similarly, the group recommended that electronic trading systems for derivatives on financial commodities should also be excluded from CFTC regulation.

On December 21, 2000, Congress passed the Commodity Futures Modernization Act of 2000 (CFMA),¹⁰² incorporating many of the recommendations contained in the Working Group report. With respect to the energy and power markets, the relevant exclusions and exemptions contained in the CFMA are the exclusion for hybrid instruments, the exclusion for swap transactions, the exemption for transactions in exempt commodities, and the exemption for commercial markets. Each of these exemptions and exclusions can be relied on by issuers of the contracts, depending on the nature of the counterparties and the means by which the contracts are entered into. Table 14 summarizes the various exemptions and exclusions available to energy- and power-related contracts.

For OTC derivatives exempt or excluded from CFTC regulation, the application of a regulatory scheme typically is based on the party that is offering or entering into the contract being a registered entity. The contract or transaction itself, however, is typically not regulated.¹⁰³ Similarly, the SEC has the authority only to regulate the activities of broker-dealers.¹⁰⁴ These firms are required to register with the SEC and comply with its requirements for regulatory reporting, minimum capital, and examination; however, U.S. securities laws do not apply to a broker-dealer's entire organizational structure, which may also include a holding company and other affiliates. Thus, because the SEC's jurisdiction extends only to securities, and because it does not regulate affiliates of broker-dealers whose activities do not involve securities, the SEC has only limited authority. In essence, the jurisdiction of the SEC extends only to the activity of broker-dealers that engage in both securities and derivatives activities.

Unlike the authority of the CFTC and SEC to oversee activities related to futures and securities, respectively, Federal banking regulators oversee all bank activities,

⁹⁶Section 4(c) of the Commodity Exchange Act, 7 U.S.C. § 6(c), added by the Futures Trading Practices Act of 1992, grants the Commission broad authority to exempt any agreement, contract, or transaction (or class thereof) from any of the requirements of the Act except Section 2(a)(1)(B), 7 U.S.C. § 2a, based upon, among other things, a determination that such exemption would be consistent with the public interest.

⁹⁷"Exemption for Certain Swap Agreements," 58 FR 5587 (January 22, 1993), and "Regulation of Hybrid Instruments," 58 FR 5580 (January 22, 1993).

⁹⁸"Exemption for Certain Contracts Involving Energy Products," 58 FR 21286 (April 20, 1993) It should be noted that the CFTC Commissioner, Sheila Bair, dissented from the majority, voting against the order on the basis of its failure to retain the general antifraud provisions of the CEA. See 58 FR at 21295 (April 20, 1993).

⁹⁹The Working Group is comprised of the Secretary of the Treasury, the Chairman of the Board of Governors of the Federal Reserve System, the Chairman of the Securities and Exchange Commission, and the Chairman of the Commodity Futures Trading Commission.

¹⁰⁰H.R. Rep. No. 825, 105th Congress, 2nd Session, 991-992 (1998).

¹⁰¹Letter from the Honorable Richard G. Lugar, Chairman, Senate Committee on Agriculture, Nutrition, and Forestry, and the Honorable Robert Smith, Chairman, House Committee on Agriculture, to the Honorable Robert Rubin, Secretary of the Treasury (September 30, 1998).

¹⁰²P.L. 106-554, 114 Stat. 2763.

¹⁰³The exception is a hybrid instrument, which would be regulated as a security or a bank product.

¹⁰⁴Broker-dealers are firms that buy and sell securities for their own accounts and as agents for their customers.

including derivatives activities. A primary purpose of Federal banking regulation is to ensure the safety and soundness of individual banks and the U.S. financial system. Bank regulators, therefore, are authorized to regulate affiliates of banks or bank holding companies, regardless of the activities in which they are engaged. Bank regulators rely on three primary means to oversee bank activities: reviewing required reports; requiring adherence to minimum capital standards; and conducting periodic examinations to verify compliance with reporting, capital, and other regulatory requirements. The banking regulators, however, do not regulate the specific transactions or maintain oversight of OTC derivatives as a class of instruments.

Finally, derivatives may also fall under the jurisdiction of a State insurance regulator. Like banking regulators, State insurance regulators generally regulate the overall activities of their regulatees, including the types of transactions or trading activities in which they may engage.

Thus, a State regulator may indirectly regulate derivative trading activity by allowing or not allowing insurance companies to engage in such activity.

In summary, OTC derivatives may fall into one of four general regulatory jurisdictions—CFTC, SEC, a banking regulator, or an insurance regulator—or none at all. For transactions falling within the purview of the CEA, the transactions themselves as well as those offering the contracts fall under the regulatory scheme of the CFTC. If a contract is either exempt from or excluded from the CEA but is either a security product or offered or entered into by an SEC, banking registrant, or insurance company, the contract would be regulated under the regulatory authority of the SEC or the relevant banking or insurance regulator. If the contract does not fall within the regulatory authority of the SEC or banking or insurance regulator, it would be subject only to general commercial laws.

Table 14. CEA and CFTC Exemptions and Exclusions for OTC Derivative Transactions

Exemption or Exclusion	Type of Exemption or Exclusion	Commodity	Trader	Conditions	Retained Rules
Forward Contract Exclusion: 1a(19) of CEA	Statutory exclusion	All	No restriction	Any sale of any cash commodity for deferred shipment or delivery	None
Exclusion for Hybrid Instruments: 2(f) of CEA	Statutory exclusion	All	No restriction	Hybrid instruments that are predominantly securities as defined in the exclusion	None
Exclusion for Swap Transactions: 2(g) or CEA	Statutory exclusion	All non-agricultural	Eligible contract participants ^a	Transactions subject to individual negotiation and not executed on a trading facility	None
Transactions in Exempt Commodities: 2(h)(1)	Statutory exemption	Exempt commodities ^b	Eligible contract participants	Transactions not executed on a trading facility ^c	Anti-fraud and anti-manipulation
Exempt Commercial Markets: 2(h)(3)	Statutory exemption	Exempt commodities	Eligible commercial entities	Transactions executed on an electronic trading facility ^d	Anti-fraud and anti-manipulation; Rules related to transaction information dissemination as prescribed by the Commission if found to be a price discovery market
Trade Option Exemption: CFTC Part 32.4(a)	Regulatory exemption	All non-enumerated agricultural commodities ^e	Commercial entities ^f	One party must be a commercial entity using the option for purposes related to its business	Anti-fraud
Hybrid Instrument Exemption: CFTC Part 34	Regulatory exemption	All	No restriction	Hybrid must be predominantly a security or banking product as measured by CFTC prescribed predominance test	None (Securities or bank products must be subject to regulation by the SEC or a banking regulator)
Swap Exemption: CFTC Part 35	Regulatory exemption	All	Eligible swap participants ^g	Not part of a fungible class of agreements that are standardized; creditworthiness is a material consideration; not traded on a multilateral transaction execution facility	Anti-fraud and anti-manipulation
Energy Order: 58 FR 21286 (April 20, 1993)	Regulatory exemption	Crude oil, natural gas, natural gas liquids and their derivative products	Commercial participants in the energy markets	Transactions between principals and subject to individual negotiation; no unilateral right of offset	None

^aDefined in §1a(12) of the CEA.

^bDefined in §1a(14) of the CEA.

^cDefined in §1a(33) of the CEA.

^dDefined in §1a(10) of the CEA.

^eThe “enumerated commodities” are listed in §1a(4) of the CEA and generally include the major domestically produced field crops and livestock.

^fPart 32.4 of the CFTC’s regulations limits users of trade options to producers, processors, or commercial users of, or merchants handling a commodity, or byproducts of such commodity.

^gDefined in §35.1(b)(2) of the CFTC’s regulations.

7. Accounting for Derivatives

Introduction

The preceding chapter showed that the rapid growth in derivatives, especially in the over-the-counter market, has complicated the regulation of derivative trading. This chapter discusses an equally complex question, which because of the increased use of derivatives is also a very important one: namely, how should a company account to its shareholders for the derivatives it holds? Many derivatives are costless, apart from fees, at their inception. Hence, to carry a derivative at original cost might mean no recognition at all. However, the value of a derivative generally changes over the duration of its life because of market developments. To the non-accountant, the challenge of accounting for derivatives has the quality of a riddle: how should one tell the world about a promise that might cost virtually nothing at inception, can fluctuate wildly in value over its life, and may yield the holder no net gain at all at the end (which, in the case of a hedge, is the desired outcome)?

Why and How, Simply

If a company liquidated its derivative holdings through immediate settlement, the value realized by the company would likely be something other than zero. That is, at a point in time, the company holding a derivative is essentially holding an asset (positive settlement value) or liability (negative impact on earnings and cash flow upon settlement). Accordingly, shareholders and investors in general should be able to know the asset and liability values of the derivatives that a company is holding at a point in time. In the case of a publicly traded U.S. company, or any other company that files quarterly financial statements with the U.S. Securities and Exchange Commission (SEC), the value of the company's holdings or derivatives would be disclosed on a quarterly basis. The two examples that follow illustrate mark-to-market accounting for derivatives: the adjustment of a position to its current market value.

Example: Accounting for a Simple Speculative Position

For example, suppose in August a company expects the price of natural gas to fall below \$4.50 per million Btu by the end of the year. Acting on this expectation, the company enters into a futures contract to sell 100,000 million Btu of natural gas (10 contracts) in December for \$4.50 per million Btu. The transaction is speculative in that the company is assumed not to produce or hold the gas for sale. Suppose next that,

contrary to the company's expectations, the price of natural gas rises in September, resulting in, say, a value for December natural gas futures of \$5.00 per million Btu. At the end of September, the company has a potential liability equal to the \$0.50 rise in price times the 100,000 million Btu in the December sales contract, or \$50,000. The value of the company, as measured by shareholders' equity (i.e., assets minus liabilities), is also reduced by \$50,000 potentially.

It is in the shareholders' interest to know that the value of the company has fallen. The drop in market value of the company's derivative holdings should be reported as a liability of \$50,000 in the company's third-quarter financial statements. Shareholders' equity is \$50,000 lower at the end of September as a result of the movements in the December futures prices. The company's earnings for the third quarter should be reduced by \$50,000, because retained earnings and shareholders' equity form the link between the company's income statement and balance sheet.

Suppose, then, that in December the company's expectations are vindicated, and the spot price of natural gas falls to \$4.00 per million Btu. The company can settle the contract or, alternatively, purchase 100,000 million Btu for \$4.00 per million Btu and sell the 100,000 million Btu to the contract's counterparty for \$4.50 per million Btu. Either way, the company realizes a profit of \$50,000 on its derivatives trade. As a result of closing the contract, the company increases its cash holdings by \$50,000 and, at the same time, erases the \$50,000 liability that was reported in the third quarter, when the market value of the derivative fell by \$50,000. The effect on shareholders' equity in the fourth quarter is a positive \$100,000 (cash increases by \$50,000 in the fourth quarter at the same time that \$50,000 in liabilities carried from the third quarter is eliminated). Thus, the effect on fourth-quarter earnings equals the effect on shareholders' equity, which is a positive \$100,000. For the entire year, the impact on earnings is \$50,000: the positive \$100,000 recognized in the fourth quarter plus the negative \$50,000 recognized in the third quarter.

Example: Accounting for a Simple Hedging Position

Suppose the situation is identical to that described above, except that the company has an inventory of 100,000 million Btu of natural gas that it plans to sell in December. The company's cost of the inventory is, for this example, \$450,000. The company includes this

amount as inventory on its balance sheet. The company wants to protect the value of its inventory until its sale in December. In this case the company uses the futures contract (sale of 100,000 million Btu in December for \$4.50 per million Btu) to protect the value of its inventory. As before, the contract sales price for December is \$4.50, the December natural gas futures price rises to \$5.00 in September, and the December spot price turns out to be \$4.00. Additionally, suppose the spot price of natural gas rises to \$4.95 in September. Shouldn't the accounting for derivatives differentiate between speculation and hedging?

Following the mark-to-market valuation method in the first example, at the end of September, the value of the derivative declines by \$50,000, increasing the company's liabilities by that amount. However, with the spot price of natural gas at \$4.95 in September, the inventory has increased in value by \$45,000 (\$4.95 times 100,000 in liquidation value of the inventory minus \$450,000 in initial cost of the inventory carried on the balance sheet). If both the derivative position and inventory are marked to market, the effect on shareholders' equity is the gain in value on the inventory (\$45,000) less the increase in liabilities (\$50,000) or a negative \$5,000. A negative \$5,000 would also be the effect on earnings in the third quarter. The impacts on reported earnings and the balance sheet should include the change in value of the hedged item as well as the change in value of the derivative used to hedge the value of the item.

In December, when the inventory is actually sold, the company can settle its contract and sell its natural gas inventory of 100,000 million Btu, realizing \$450,000 in cash. Recalling that the inventory was marked to market at \$495,000 at the end of September, the net effect on the company's assets in its fourth-quarter financial report is a negative \$45,000 (i.e., an increase in cash of \$450,000 less the elimination of \$495,000 in inventory). On the liabilities side, the \$50,000 from the third quarter is eliminated when the December contract is settled. The net effect on shareholders' equity in the fourth quarter is a positive \$5,000: a negative \$45,000 in asset value change plus a \$50,000 reduction in liabilities. A positive \$5,000 is also the effect on fourth-quarter earnings. For the year, the total effect on earnings is zero: a negative \$5,000 from the third quarter plus a positive \$5,000 from the fourth quarter. The intended effect of the hedge was just to maintain inventory value from August until sale in December, which it did. Thus, a zero total effect on earnings appears reasonable.

Several observations emerge from these two examples of accounting for energy commodity derivatives:

- Derivatives can become potential liabilities or assets when their value changes. Accordingly, shareholders should be informed of the impact of the changes

on the value of their equity in the company. Companies need to report their derivative holdings in their quarterly reports to shareholders. Further, shareholders should be informed on an interim basis (quarterly for most energy-related companies) as well as when the derivative is settled.

- Market prices are the measure of derivative value. Current market values should be the measure used to track changes in derivative holdings. That is, mark-to-market valuation should be employed. The situations in which current market values are not readily available are discussed in Chapter 5.
- Changes in the value of the derivative can be reflected as an asset or liability as appropriate. The changes in the value of the derivative will also have a direct effect on shareholders' equity (i.e., assets minus liabilities). Since a company's balance sheet and income statement are linked directly through retained earnings and shareholders' equity, the change in the value of derivatives should be included in earnings.
- If a company uses a derivative to hedge the value of an asset, liability, or firm commitment (a firm commitment is an agreement that specifies all significant terms, including a fixed price, the quantity to be exchanged, and the timing of the transaction), then reporting changes in the value of the hedged item as well as in the value of the derivative is appropriate. When changes in the value of the derivative exactly offset changes in the value of the hedged item, there should be no impact on earnings. When the derivative is not effective in exactly offsetting changes in the value of the hedged item, then the ineffective amount should be included in earnings.

Financial Accounting Standards Board Statement 133

The Financial Accounting Standards Board (FASB) has developed standards for reporting of derivatives and hedging transactions. According to the FASB:

Since 1973, the Financial Accounting Standards Board (FASB) has been the designated organization in the private sector for establishing standards of financial accounting and reporting. Those standards govern the preparation of financial reports. They are officially recognized as authoritative by the Securities and Exchange Commission (Financial Reporting Release No. 1, Section 101) and the American Institute of Certified Public Accountants (Rule 203, Rules of Professional Conduct, as amended May 1973 and May 1979). Such standards are essential to the efficient functioning of the economy because investors, creditors, auditors and others rely on credible, transparent and comparable financial information.

The Securities and Exchange Commission (SEC) has statutory authority to establish financial accounting and reporting standards for publicly held companies under the Securities Exchange Act of 1934. Throughout its history, however, the Commission's policy has been to rely on the private sector for this function to the extent that the private sector demonstrates ability to fulfill the responsibility in the public interest.¹⁰⁵

After more than 6 years of deliberations, the FASB issued Statement 133, *Accounting for Derivative Instruments and Hedging Activities*, in June 1998. Amended by Statement 137 (June 1999) and Statement 138 (June 2000), Statement 133 became effective for fiscal years that began after June 15, 2000, but adoption by a company as early as the third quarter of 1998 was allowed. The impetus for Statement 133 is rooted in at least three developments: the growth in uses of derivatives (see Figure 15 in Chapter 6), the growth in the variety and complexity of derivatives (discussed in Chapter 6), and problems with previous accounting and reporting practices. The FASB identified four problem areas in previous practices:¹⁰⁶

- The effects of derivatives were not transparent in basic financial statements.
- Accounting guidance for derivative instruments and hedging activities was incomplete.
- Accounting guidance for derivative instruments and hedging activities was inconsistent.
- Accounting guidance for derivatives and hedging was difficult to apply.

According to the FASB, Statement 133 mitigates these four problems:

It increases the visibility, comparability, and understandability of the risks associated with derivatives by requiring that all derivatives be reported as assets or liabilities and measured at fair value. It reduces the inconsistency, incompleteness, and difficulty of applying previous accounting guidance and practice by providing comprehensive guidance for all derivatives and hedging activities. The comprehensive guidance in this

Statement also eliminates some accounting practices, such as "synthetic instrument accounting" that had evolved beyond the authoritative literature.

In addition to mitigating the previous problems, this Statement accommodates a range of hedge accounting practices by (a) permitting hedge accounting for most derivative instruments, (b) permitting hedge accounting for cash flow hedges of expected transactions for specified risks, and (c) eliminating the requirements in Statement 80 that an entity demonstrate risk reduction on an entity-wide basis to qualify for hedge accounting. The combination of accommodating a range of hedge accounting practices and removing the uncertainty about the accounting requirements for certain strategies should facilitate, and may actually increase, entities' use of derivatives to manage risks.¹⁰⁷

Statement 133, including the full text of implementation issues, runs to 795 pages and has been characterized by one of the "Big Five" accounting firms as ". . . arguably the most complex accounting standard ever issued by the FASB."¹⁰⁸ Much of the material concerns derivatives related to interest rates, foreign exchange, and other purely financial issues and will not be reviewed here. The remainder of this section provides a general overview of how Statement 133 applies to accounting for energy derivatives.¹⁰⁹ It is not intended as a guide to implementing Statement 133. The main questions are: What is a derivative? What are hedges and how can they be identified? How should hedges be reported in company financial statements?

Derivatives According to Statement 133

In Statement 133, the key elements of the definition of a derivative are:¹¹⁰

- A derivative's cash flow or fair value must fluctuate and vary based on the changes in one or more underlying variables.
- The contract must be based on one or more notional amounts or payment provisions or both, even though title to that amount never changes hands.

¹⁰⁵See web site <http://raw.rutgers.edu/raw/fasb/facts/index.html>.

¹⁰⁶Federal Accounting Standards Board, *Accounting for Derivative Instruments and Hedging Activities* (Norwalk, CT, June 1998), pp. 144-145. The following statements issued by the FASB prior to Statement 133 related to reporting of derivatives: SFAS No. 15—Accounting by Debtors and Creditors for Troubled Debt Restructuring; SFAS No. 80—Accounting for Futures Contracts; SFAS No. 114—Accounting by Creditors for Impairment of a Loan (an amendment of FASB Statement Nos. 5 and 15); SFAS No. 115—Accounting for Certain Investments in Debt and Equity Securities; SFAS No. 119—Disclosures about Derivative Financial Instruments and Fair Value of Financial Instruments (an amendment of FASB Statements 105 and 107); SFAS No. 125—Accounting for Transfers and Servicing of Financial Assets and Extinguishments of Liabilities; and SFAS No. 127—Deferral of the Effective Date of Certain Provisions of FASB Statement No. 125 (an amendment of FASB Statement No. 125).

¹⁰⁷Federal Accounting Standards Board, *Accounting for Derivative Instruments and Hedging Activities* (Norwalk, CT, June 1998), pp. 144-145.

¹⁰⁸R. Sullivan, C.P. Jones, and L. Le Guyader, "FAS 133: New Rules for Derivatives," web site www.pwcglobal.com/extweb/newcolth.nsf/DocID/B8953173DFDE5BB88525694A004BE549 (February 2002).

¹⁰⁹The discussion draws heavily on Ernst & Young, *Financial Reporting Developments: Accounting for Derivative Instruments and Hedging Activities*, web site [www.ey.com/global/vault.nsf/US/Library9/\\$file/BB0877.pdf](http://www.ey.com/global/vault.nsf/US/Library9/$file/BB0877.pdf) (July 2000).

¹¹⁰Ernst & Young, *Financial Reporting Developments: Accounting for Derivative Instruments and Hedging Activities* (July 2000), p. 3.

The underlying and notional amounts determine the amount of settlement, whether or not a settlement is required.

- The contract requires no initial net investment, or an insignificant initial net investment relative to the value of the underlying item (as would be the case for a purchased option, for example).
- The contract can readily be settled by a net cash payment, or with an asset that is readily convertible to cash.
- All derivatives are carried on the balance sheet at fair market value.

The FASB defined a derivative by the properties of a derivative rather than by enumerating what contracts and instruments qualify as derivatives. However, the FASB did specify certain contracts that should not be accounted for as derivatives even though they would otherwise qualify as derivatives under Statement 133. The list is lengthy, and nearly all items on it are of a purely financial type (e.g., traditional life insurance). The one exception that is clearly relevant for energy commodities is the normal purchase and sale of commodities for which net settlement is not intended, delivery is probable, and the commodity is expected to be used or sold in the normal course of business (the “normal purchase or sales exception”). The forward purchase of natural gas by a petrochemical plant for use as a feedstock in the following month is an example of a normal purchase exception.

Hedges According to Statement 133

To understand the importance of appropriately defining hedges, recall the difference between the speculator and hedger in the examples in the first section of this chapter. In particular, the hedger, using a derivative to protect the value of an asset (100,000 million Btu of natural gas in storage in the example), reported not only changes in the value of the derivative (the futures contract to sell 100,000 million Btu at \$4.50 per million Btu in December in the example) in earnings but also changes in the value of the hedged item. The rationale for including both amounts in earnings is that in a hedge, the company intended for the derivative to offset changes in the value of the hedged item.

Now turn to the case of the speculator. Suppose in the example that the spot price of natural gas in December was \$5.00 per million Btu instead of \$4.00. With a December spot price of \$5.00, the speculator would have to pay \$50,000 in cash instead of receiving \$50,000 to settle the December futures contract. The settlement would decrease the company’s reported earnings by \$50,000. To the extent that the speculating company owns other

assets (liabilities) that gained (declined) in value with a \$5.00 spot price in December, the company might be tempted to include those gains in its reported earnings as if the company were a hedger, thereby reducing the negative impact on reported earnings. In this example, there would be no such temptation if the spot price of natural gas were \$4.00 in December. It is clear, however, that improper use of hedge accounting can cover up adverse impacts on earnings stemming from speculative uses of derivatives.

In Statement 133, the FASB addresses hedging in terms that are rigorous and comprehensive. Many of the issues addressed by the FASB are not directly relevant to energy commodity derivatives and are not reviewed here. The main overall issues are definition of hedges, accounting for hedges, and criteria for hedging. The last issue is perhaps the most straightforward.

Criteria for Hedging

The criteria for hedging require the company, at the inception of the hedge, to identify and document:

- The hedging relationship (e.g., changes in the value of the inventory of natural gas should be protected by a futures contract to sell natural gas in December)
- The derivative (e.g., futures contract for December delivery of 100,000 million Btu of natural gas at \$4.50 per million Btu)
- The hedged item (e.g., 100,000 million Btu of natural gas in storage)
- The nature of the risk being hedged (e.g., declines in the December spot price of natural gas)
- How the effectiveness of the hedging instrument (derivative) will be assessed on an ongoing basis (e.g., the amount, or relative amount, by which the changes in the value of the December future sales contract offset changes in the market value of the natural gas in storage).

These requirements mean that hedged items cannot be identified after a derivative contract has been made. Thus, in the example, the speculator could not offset his losses by identifying a hedged item *ad hoc*. Also, shareholders will know what the company’s hedge strategy is and what items are being hedged. Conoco’s disclosure about its derivatives and hedging provides a good example of documentation.¹¹¹

Definition of Hedges

In Statement 133, the FASB allows special accounting treatment for *fair value hedges*, *cash flow hedges*, and *foreign currency hedges*, the first two of which are directly relevant to energy commodity derivatives. In a fair value

¹¹¹Conoco Inc., “IR-Gram: Conoco’s Hedging Program,” www.conoco.com/investor/investor-irgram_1001.asp (October 9, 2001).

hedge, a specified derivative is used to protect the existing value of assets, liabilities, or firm commitments. The criteria for a hedge, a summary of which appears above, must be satisfied in order for the transaction to qualify for hedge accounting. Fair value for energy commodity hedges should be measured by market value; that is, mark-to-market valuation should be used.

The previous example, where a futures sales contract was used to protect the value of a company's inventory of natural gas, is an example of a fair value hedge. The company entered into a futures contract to deliver 100,000 million Btu of natural gas in December for \$4.50 in order to protect its inventory against a price drop when the company sells the natural gas in December. The company is hedging changes in the inventory's fair value, not changes in anticipated cash flow from its planned sale. Hence, fair value hedge accounting is appropriate.

A cash flow hedge uses a derivative to hedge the anticipated future cash flow of a transaction that is expected to occur but whose value is uncertain. This contrasts with a firm commitment, where price, quantity, and delivery date have been fixed. Hedging the value of a firm commitment is a fair value hedge.

An example of a cash flow hedge is a petrochemical company that, in August, fully intends to purchase 100,000 million Btu of natural gas in December and wants to protect its cash flow from an unforeseen rise in the purchase price of natural gas. In order to hedge its exposure to rising natural gas prices, the company can, in August, enter into a contract to purchase 100,000 million Btu at the December futures price of, say, \$4.50 per million Btu. By this action, hedging is used to lock in the amount of cash flow to be paid for natural gas in December.

Cash flow hedges must meet the following additional criteria to qualify for hedge accounting:

- The expected transaction must be explicitly identified and formally documented.
- Occurrence of the expected transaction must be probable.
- The expected transaction must be with a third party (i.e., external to the company).

Accounting for Hedges

Hedge Effectiveness

The concept of hedge effectiveness is important in two ways in accounting for hedges. First, for all types of hedges, a derivative is expected to be *highly effective* in offsetting changes in fair value stemming from the risk being hedged. In Statement 133, the FASB was vague as

to how much ineffectiveness will be tolerated before a derivative no longer qualifies for hedge accounting. The statement does make reference to prior guidance in which 80 percent is considered effective (i.e., the derivative offsets at least 80 percent of the change in fair value attributable to the risk being hedged). Nevertheless, Statement 133 requires a company to specify how it will measure effectiveness over the life of a derivative.

Second, hedge ineffectiveness will generally be included in earnings in the quarter in which it occurs. Ineffectiveness is the amount by which the change in value of the derivative does not exactly offset changes in the value of the hedged item. In the earlier example, in which the value of natural gas inventory was being hedged in August, the derivative was a contract for delivery of 100,000 million Btu of natural gas in December for \$4.50 per million Btu and the hedged item was the company's inventory of 100,000 million Btu of natural gas with an initial value of \$450,000. In September, the spot price rose to \$4.95 per million Btu and the December futures price rose to \$5.00. In the third quarter, the derivative declined in value by \$50,000 and the inventory increased in value by \$45,000. In this example, the hedge ineffectiveness was negative \$5,000, which would be recognized in earnings.

Fair Value Hedges

For hedges qualifying as fair value hedges under Statement 133: (a) the gain or loss on the derivative will be recognized currently in earnings, and (b) the change in fair value of the hedged item attributable to the hedged risk will be recognized in earnings as well as adjusting the balance sheet value of the hedged item. The earlier example of a hedge illustrates these concepts. In the example, a company hedges its August inventory of 100,000 million Btu of natural gas at \$4.50 per million Btu. The hedging instrument (derivative) is the December sales contract, the hedged item is the company's natural gas inventory, and a decline in natural gas prices is the risk being hedged.

Cash Flow Hedges

A cash flow hedge differs from a fair value hedge in a way that makes the accounting more complex. In a fair value hedge, the hedged item is an asset, liability, or fixed commitment. Assets and liabilities are carried on the balance sheet, and changes in the fair value of a fixed commitment are carried on the balance sheet during the duration of the hedge. With a cash flow hedge, it is the cash flow from an expected future transaction that is being hedged, and so there is no balance sheet entry for the hedged item. This reporting practice reflects the fact that, while an expected transaction is an asset or liability from an economic perspective, it is not recognized as such on balance sheets.

Without further refinement of the accounting guidelines, only changes in the value of the derivative would be recognized in current earnings in a cash flow hedge (Table 15). If this were in fact the case, there would be no benefit to hedge accounting for cash flow hedges. The accounting would be the same as the accounting for non-hedge (speculative) holdings of derivatives. Yet the company hedging the cash flow of an expected transaction is not seeking to profit from price movements but rather to stabilize future cash flows.

Statement 133 does provide for cash flow hedges to be reported differently from speculative uses of derivatives. In a cash flow hedge, the change in the fair value of the hedging instrument (i.e., derivative), to the extent that the hedge is effective, is reported in “other comprehensive income.” Other comprehensive income consists of those financial items that are included in shareholders’ equity but not included in net income. That is, until the expected transaction takes place, the effective part of the hedge is not recognized in current earnings. When the expected transaction does take place, the effective part of the hedge is recognized in the income statement, and the earlier recognized amounts are removed from other comprehensive income.

Consider the earlier example of the petrochemical company locking in the price of its December purchase of natural gas that it plans to use as a feedstock. The company documents that it will be using a futures contract to stabilize cash flow associated with this purchase, and so it is a cash flow hedge. In August, the company enters into a futures contract for the purchase of 100,000 million Btu of natural gas in December at \$4.50 per million Btu. If the December contract price rises to \$5.00 per million Btu by the end of September, the value of the contract will increase by \$50,000, and that amount will be included as an asset in the company’s third-quarter report to shareholders. The effect on reported third-quarter earnings will be zero, however. In the cash flow hedge, the hedging instrument is fully effective, and the expected transaction will occur in December, which is in

the fourth quarter; however, the \$50,000 gain in the value of the derivative will be included in other comprehensive income in the third quarter.

If the hedge of the future cash flow transaction is not fully effective, then the accounting treatment of changes in the value of the derivative is somewhat more involved. A perfectly effective hedge is one in which changes in the value of the derivative exactly offset changes in the value of the hedged item or expected cash flow of the future transactions in reporting periods between the inception of the hedge and the hedged instrument. The part of the change in the value of the derivative that is not effective in offsetting undesired changes in expected cash flow is recognized in the income statement. For example, the expected transaction might be a natural gas delivery in St. Louis, but the hedge is for natural gas delivered at Henry Hub, Louisiana. In this case, the delivery location of the item being hedged is different from the delivery point of the hedging instrument. To the extent that changes in the price of natural gas in St. Louis differ from changes in the value of the Henry Hub-based hedge, there will be hedge ineffectiveness.

The requirement to reassess and report hedge ineffectiveness of cash flow hedges frequently can increase the volatility of reported earnings and add to the burden of reporting; however, Statement 133 does provide relief for commodity forward contracts, including energy commodities. When certain criteria are met, the hedge can be considered to be perfectly effective, thereby simplifying the accounting. Namely, an entity may assume that a hedge of an expected purchase of a commodity with a forward contract will be highly effective and that there will be no ineffectiveness if: (1) the forward contract is for purchase of the same quantity of the same commodity at the same time and location as the hedged expected purchase; (2) the fair value of the forward contract at inception is zero; (3) either the change in the discount or premium on the forward contract is excluded from assessment of effectiveness and included directly

Table 15. Balance Sheet and Income Statement Impacts of Cash Flow and Fair Value Hedges

Type of Derivative	Balance Sheet Impact	Income Statement Impact
Fair Value Hedge	Derivative (asset or liability) is reported at fair value. Hedged item is also reported at fair value.	Changes in fair value are reported as income/loss in income statement. Offsetting changes in fair value of hedged item are also reported as income/loss in income statement.
Cash Flow Hedge	Derivative (asset or liability) is reported at fair value. Changes in fair value of derivative are reported as components of Other Comprehensive Income (balance sheet).	No immediate income statement impact. Changes in fair value of derivative are reclassified into income statement (from Other Comprehensive Income in the balance sheet) when the expected (hedged) transaction affects the net income.
Speculative Transaction	Derivative (asset or liability) is reported at fair value.	Changes in fair value are reported as income/loss in income statement. (There will be no offsetting changes in the fair value of the hedged item.)

Source: FASB Statement 133.

in earnings or the change in expected cash flows on the expected transaction is based on the forward price for the commodity.

In this case, a company assumes that changes in the fair value of the derivatives exactly offset changes in the hedged item. In a cash flow hedge, other comprehensive income changes by exactly as much as the derivative and there is no impact on earnings. In a fair value hedge, the hedged item changes by exactly the same amount as the changes in the fair value of the derivative. In both types of hedges, the derivative is carried at fair value in the balance sheet.

Conclusion

Market developments can change the value of a company's holdings of derivatives prior to their stated settlement date. Should liquidation be required, a company could be liable for outlays to settle its derivative position. On the other hand, a company, and its shareholders, could benefit from an increase in their value. Shareholders should be aware of these developments, and companies should report changes in the value of their derivative holdings on a periodic basis. Changes in

the value of derivatives should be reflected both on the balance sheet and in earnings. Mark-to-market should be the basis for valuing derivatives. When a derivative is used to hedge the value of an asset, liability, or fixed commitment, the effects of price changes on the derivative and the hedged item should be reported.

Standards for publicly traded companies' reporting of the value of derivatives (Statement 133) were recently issued by the Financial Accounting Standards Board (FASB) for fiscal years beginning after June 15, 2000. This standard is possibly the most complex and extensive standard ever issued by FASB. Statement 133 provides rigorous guidance on accounting for hedges and provides for somewhat different treatment of hedges of balance sheet items versus hedges of the cash flow of a future transaction for which there is no corresponding balance sheet item. Mark-to-market valuation of derivatives should be used wherever possible according to the standard. The standard is somewhat general in guidance when this is not possible, and valuation could be a component of the standard that is likely to be revisited. Other areas of possible controversy are the scope of the definition of derivatives, which appears to be broad in Statement 133, and interactions with other reporting standards.

8. Public Interest and Private Risk Management

Introduction

Other chapters of this report have shown how derivatives are used to manage risk and described the difficulties in measuring their effects on a company's financial position. The huge size of international derivative markets is evidence that private parties are better off when they use derivatives; but Enron's failure and the earlier financial crises discussed below raise the possibility that derivatives may shift private risk to society as a whole, leaving open the question of their overall economic impact. This chapter discusses four issues that are central to a balanced assessment of the role of derivatives in the economy:

- Would economically sensible investments be forgone in the absence of derivatives? Alternatively, do derivatives increase a firm's market value? If derivatives do increase worthwhile investment, then there is a clear public interest in their use.
- Do derivatives affect prices and volatility in the underlying commodity and security markets? If they tend to decrease volatility, then the functioning of markets would improve, and society would be better off.
- Can firms with market power use derivatives to manipulate underlying spot markets? If derivatives can be used to distort markets, then there might be a case for regulatory intervention.
- Does the widespread use of derivatives increase the likelihood of financial crisis? Is the public subsidizing private risk-taking through deposit insurance and liquidity backing from the Federal Reserve System? If derivatives do increase the likelihood of a "public bailout," how large are the likely costs?

Investment, Cost of Capital, and the Value of the Firm

This section discusses how the use of derivatives could affect the level and type of investment in energy-related businesses. As described below, hedging does have the

potential to increase the value of the firm and the level of investment in it; however, the reasons are subtle.

A tenet of finance is that a firm will undertake an investment if the discounted present value of net revenues (revenues less operating costs) is greater than its capital costs.¹¹² Hedging can be a low-cost way of insuring against unexpectedly low prices or high costs. Because hedging reduces the variability of revenues and costs, it might seem that derivative use would "reduce risk" and increase investment. Similarly, because the value of a firm is the expected present value of the net revenues (discounted cash flows, revenue inflows less cash outflows) of a company's investment portfolio, hedging might seem to increase the value of the firm.

The general question of whether financial actions, including hedging, can affect the value of the firm (or the level of investment) was first analyzed within the context of debt versus equity financing by Modigliani and Miller (M&M) in 1958. In this context, because debt financing is less expensive than equity financing, one might think that the use of debt would increase the firm's value. M&M argued to the contrary, that in a perfect world with no taxes, no bankruptcy costs, etc., the financial decision as to how to fund a firm's investment (i.e., fund it using debt or equity financing) would not increase the value of the firm. That is, according to M&M, in a perfect world any financial activity would not affect the value of the firm or the level of investment.

M&M's arguments are complex and are only summarized here.¹¹³ Suppose that the management of the firm attempted to increase the firm's value by using debt financing. M&M show that the firm's stockholders can borrow (lend) funds to buy (sell) the firm's stock, such that the overall value of the firm is unaffected by the use of debt financing.¹¹⁴ In effect, they show that the owners of the firm would substitute their own debt for the firm's debt (using "homemade leverage"). Thus, "as long as investors can borrow and lend on their own account on the same terms as firms can, they can offset changes in corporate leverage with changes in personal leverage."¹¹⁵ This would leave the value of the firm unaffected by the use of leverage.

¹¹²See Chapter 2 for more discussion.

¹¹³More detailed discussions about M&M arguments can be found in A.C. Shapiro, *Modern Corporate Finance* (New York, NY: Macmillan, 1990).

¹¹⁴The value of the firm is the sum of the market value of the firm's debt and equity. M&M show that the process of buying or selling stocks and bonds will produce changes in the market price of the debt and equity, such that the sum is unaffected by the use of debt.

¹¹⁵A.C. Shapiro, *Modern Corporate Finance* (New York, NY: Macmillan, 1990).

Stated somewhat differently, M&M's arguments are a straightforward application of the "law of the conservation of value," a law of finance which states that the value of the firm is basically the present value of the expected future stream of income from all its investments. In a perfect world, this value does not depend upon whether the assets are owned by the stockholders or by the holders of the firm's debt.

In the real world of taxes, capital rationing, transaction costs, imperfect information, and large bankruptcy costs, however, financing matters. In subsequent work, M&M showed that, in a more realistic world, the value of the firm could be increased by using debt. For example, the Internal Revenue Service allows firms to deduct interest (return to debt) as a cost for tax purposes, whereas dividends (the returns to equity) are taxed at the corporate level. Because of this differential treatment of taxes, the after-tax cost of capital would depend upon the use of debt. If a firm can reduce its tax liabilities by using debt financing, the use of debt will increase cash flows and increase investment.¹¹⁶

Baron (1976) used a "perfect world" argument similar to that of the original M&M model to conclude that any financing strategy, including the use of derivatives to hedge risk, will not affect the value of the firm and, therefore, will not affect the overall economics of the investment project.¹¹⁷ In other words, given these assumptions, the investment and financing decisions are completely separable.

Over the past 20 years there have been a series of studies examining how certain "market imperfections" affect the incentives to hedge, the value of the firm, and the level of investment. Most importantly, Froot et al. (1993) argued that hedging "helps ensure that a corporation has sufficient funds available to take advantage of investment opportunities."¹¹⁸ Here the market imperfection is one that would cause external funding to be more costly than internal funding. Thus, without hedging, low cash flow forces a company either to bypass profitable investment opportunities because they could not be funded internally or to increase the cost of the

investment because it must use more expensive external funds. The latter would decrease the overall economics of the project; however, hedging will reduce the probability of facing shortages in cash flows caused by decreases in output prices or increases in costs. Thus, hedging would decrease the probability that a firm would bypass economic investments.

Two studies published in the late 1980s argued that hedging reduces expected bankruptcy costs by reducing variability in cash flows. There are three types of bankruptcy costs. The first are the direct costs. In bankruptcy cases, lenders generally recover about 30 to 50 percent of the amount borrowed. When bankruptcy occurs the lawyers have first claim to the firm's assets.¹¹⁹ After that, bondholders have first (senior) claims on the firm's assets. Whatever remains after their claims are satisfied is distributed to shareholders. The other costs include "the loss of tax shields and the losses of valuable growth options."¹²⁰

There are also costs incurred when there is a real chance that a firm might go bankrupt. For example, a firm that could go bankrupt may lose customers to other firms. In the case of Enron, this in fact occurred. Additionally, as noted by Shapiro, when a firm faces financial duress, there are incentives to exit lines of business "under conditions when they would otherwise continue to operate," and/or to reduce the quality of goods and services.¹²¹ Thus, by reducing the probability of default, hedging would reduce the expected costs associated with near, or actual, bankruptcy.

Bessembinder has made a somewhat similar argument. Analysts have noted that the issuance of senior claimants (debt) creates incentives to "underinvest." Because the benefits from increased investment are shared with senior claimants, equity holders bypass some economic projects. Bessembinder has shown that hedging, which again lowers the variability of a project's returns, reduces the incentive to underinvest because it "shifts individual future states from default to non default" and "this increases the number of future states in which equity holders are the residual claimants."¹²² Thus,

¹¹⁶This argument should be familiar to those deciding whether to buy or rent a house. Clearly, everything else being equal, there is an incentive to a buy a house, because the interest on the mortgage is tax deductible.

¹¹⁷D.P. Baron, "Flexible Exchange Rates, Forward Markets, and the Level of Trade," *American Economic Review*, Vol. 66 (June 1976), pp. 1253-1266.

¹¹⁸D.G. Haushalter, "Financing Policy, Basis Risk, and Corporate Hedging: Evidence from Oil and Gas Producers," *Journal of Finance*, Vol. 55, No. 1 (February 2000), p. 110; and "Why Hedge? Some Evidence from Oil and Gas Producers," *Journal of Applied Corporate Finance*, Vol. 13, No. 4 (Winter 2001). See also K. Froot, D. Scharfsten, and J. Stein, "Risk management: Coordinating Corporate Investment and Financing Policies," *Journal of Finance*, Vol. 48 (1993), pp. 1629-1658.

¹¹⁹See J. Hull, *Options, Futures and Other Derivatives* (Upper Saddle River, NY: Prentice Hall, 1999), p. 628. Lawyers' fees can be substantial. According to the *Washington Post*, Enron's bankruptcy lawyers had billed more than \$20 million through April 8, 2002, with no end in sight. A month earlier the bill was reported to be \$8 million. *Washington Post* (April 8, 2002), p. E1.

¹²⁰G.D. Haushalter, "Financing Policy, Basis Risk, and Corporate Hedging: Evidence from Oil and Gas Producers," *Journal of Finance*, Vol. 55, No. 1 (February 2000), p. 110.

¹²¹A.C. Shapiro, *Modern Corporate Finance* (New York, NY: Macmillan, 1990).

¹²²H. Bessembinder, "Forward Contracts and Firm Value: Investment Incentive and Contracting Effects," *Journal of Financial and Quantitative Analysis*, Vol. 26, No. 6, p. 520.

hedging would effectively increase investment and the value of the firm.

There are also some incentives to hedge that are related to the progressive nature of the corporate tax structure. First, given the existence of progressive corporate tax rates, increases in the variability of the firm's income will increase the present value of its future tax liabilities, because the increased variability in income will increase the probability that the firm will fall into higher tax brackets. The same increase in variability will also increase the probability of losses and a corresponding reduction in tax liabilities, but there are no subsidies paid to companies by governments in that event. Thus, hedging, which reduces variability in income, will cause a reduction in expected taxes and thereby increase expected cash flows, after-tax profitability of investment, and the level of investment and value of the firm.

The preceding discussion suggests that firm managers could use hedging to increase firm value and the level of investment. Managers may choose not to use derivatives or to use derivatives for speculation instead of hedging, depending in part on how they are compensated.¹²³ Whether the use of derivatives induced by actual incentives will increase the firm's value is unclear.

Stulz (1984) and Smith and Stulz (1985) have argued that the method of compensating managers can affect the incentive for them to hedge against variations in the firm's income. Managers' compensation often includes bonuses that are tied to accounting measures of earnings. If managers avoid risk, everything else being equal, they will prefer less variability in their income. One way of reducing this variability is to reduce the variability in the firm's earnings by hedging. If a risk-averse manager has a significant share of his personal wealth in company stock he will be inclined to hedge.¹²⁴

Often managers do not hold a large proportion of their wealth in stock but are eligible for stock options. Options have become a popular way of tying a manager's income to the performance of the firm. If the strike price of the option is much higher than the current price of the stock, there is an incentive for the manager to take some risks by not hedging the firm's cash flows.¹²⁵ That is,

management might be inclined to "roll the dice" in hope of huge gains from which they will profit, forgoing surer options with less upside potential. In fact, as discussed below, there is some empirical evidence for a negative correlation between hedging and the use of stock options in managers' compensation packages. That is, increases in the use of stock options in a manager's compensation package may lead to less hedging of the firm's income.

What the Data Show

Researchers are just beginning to test whether the arguments described above are consistent with real-world data. Empirical research has lagged because firms were not required to report their derivative positions until 1990. To date, the limited empirical evidence is consistent with the notion that factors such as taxes and distress costs influence firms' use of derivatives.

For example, a 1993 study by Nance, Smith, and Smithson found that firms which hedged faced more progressive tax structures and had higher expenditures on research and development.¹²⁶ Additionally, a 2000 study by Haushalter of hedging activity in the oil and gas industry found evidence that firms with higher amounts of financial leverage hedged more. This result is consistent with the notion that reducing distress costs is an incentive to hedge. He also found that companies with production facilities closer to Henry Hub hedged more than those located farther from Henry Hub, because they had less basis risk. Haushalter also found that large firms hedged more than smaller ones, perhaps reflecting the fact that larger firms are better able to specialize.¹²⁷

As noted above, some of the reasons managers might hedge (or not) have more to do with their own compensation than with increasing stockholder wealth. Tufano (1996) found that as the number of stock options increases, the amount of hedging decreases, and as the value of the stock held by managers and directors increases, hedging increases.¹²⁸

Most importantly, a 2001 study by Allayannis and Weston found that hedging activity increases the value

¹²³This is an example of the so called "principal-agent" effect. In such cases, the agent behaves in a manner that will maximize his/her own income as opposed to the income of the principal. There is a long literature on this subject and how incentives should be structured so that the incomes of both the agent and the principal are maximized. See, for example, B. Holmstrom, "Moral Hazard and Observability," *Bell Journal of Economics*, Vol. 10, No.1 (Spring 1979), pp. 74-91.

¹²⁴R. Stulz, "Optimal Hedging Policies," *Journal of Financial and Quantitative Analysis*, Vol. 19 (June 1984), pp. 127-140; and C. Smith and R. Stulz, "The Determinants of Firms' Hedging Policies," *Journal of Financial and Quantitative Analysis*, Vol. 20 (December 1985), pp. 391-405.

¹²⁵The strike price must be sufficiently high so that the effects of risk aversion are offset.

¹²⁶In this study, the researchers derived an effective tax rate schedule that included the ability to carry tax losses forward, investment tax credits, and effective taxes on nominal pre-tax earnings. See D. Nance, C. Smith, and C. Smithson, "On the Determinants of Corporate Hedging," *Journal of Finance*, Vol. 48 (1993), pp. 267-284.

¹²⁷G.D. Haushalter, "Financing Policy, Basis Risk, and Corporate Hedging: Evidence from Oil and Gas Producers," *Journal of Finance*, Vol. 55, No. 1 (February 2000), p. 110.

¹²⁸P. Tufano, "Who Manages Risk: An Empirical Analysis of Risk Management Practices in the Gold Mining Industry," *Journal of Finance*, Vol. 51 (1996), pp. 1097-1137.

of the firm. Specifically, they used a sample of firms that faced currency risk directly because of foreign sales or indirectly because of import competition. They found that firms with sales in foreign countries that hedged with currency derivatives had a 4.87-percent higher firm value (hedging premium) than similar firms that did not use derivatives.¹²⁹ Firms that did not have foreign sales but faced currency risk indirectly had a smaller, but statistically insignificant, hedging premium. The study also found evidence that after firms began hedging, their market value increased, and that after firms quit hedging, their value fell. Thus, there is evidence that hedging increases the value of the firm and, by implication, increases investment.

Effects of Derivatives on the Volatility of Market Prices

The theoretical work described above assumes that the use of derivatives will not affect the overall volatility of the market. If this assertion is not correct, hedging could reduce social welfare even if it increased firm value. The general issue of the effects of speculation goes as far back as Adam Smith in 1776 and John Stuart Mill in 1871.¹³⁰ Both argued that speculators profit by buying when prices are low and selling when they are high. Successful speculation would be expected, therefore, to lower price volatility. Milton Friedman made similar arguments for almost 60 years, beginning in the 1940s.¹³¹

Kaldor (1939) argued that sophisticated speculators would exacerbate price changes by selling to less informed agents at prices above the competitive price. In a more formal model, Baumol (1957) argued that speculators amplified price changes by buying after prices have increased, causing additional price increases.¹³²

Because derivatives are highly leveraged investments, they enhance both the incentive and means for speculation. Thus, if speculation is destabilizing, the introduction of derivatives will increase volatility. Additionally, derivatives can increase the speed at which new information about the fundamentals of a product is reflected in prices. Thus, in markets with derivatives, prices

should respond more quickly to new information, which would increase volatility in the commodity market. In this case, however, the greater volatility would be associated with more accurate prices and improved allocation of resources.¹³³

Academic researchers have intensively studied the actual relationship between derivatives and market volatility. A recent literature review included more than 150 published studies in this area.¹³⁴ The results of studies dealing with commodities are shown in Table 16. (Because the focus of this report is on energy, the volatility studies dealing with financial assets are not discussed here.)

Almost all the studies found that the use of derivatives either reduced or had no effect on market volatility. Two of the studies examined the relationship between the use of derivatives and crude oil prices. It appears that there have been no studies of the effect of derivatives on the volatility of electricity and natural gas markets.

Two basic methodologies were used in the research summarized in Table 16. One method compared the

Table 16. Results of Various Studies on the Effects of Derivatives on Commodity Prices

Author	Commodity	Effect on Volatility
Emergy (1896)	Cotton, wheat	Lower, lower
Hooker (1901)	Wheat	Lower
Working (1960)	Onions	Lower
Gray (1963)	Onions	Lower
Powers (1970)	Pork bellies, cattle	Lower
Tomek (1971)	Wheat	Lower
Johnson (1973)	Onions	No effect
Taylor and Leuthold (1974)	Cattle	Lower
Brorsen, Oellermann, and Farris (1989)	Cattle	Higher
Weaver and Banerjee (1990)	Cattle	No effect
Antoniou and Foster (1992)	Crude oil	No effect
Netz (1995)	Wheat	Lower
Kocagil (1997)	Four metals	No effect
Fleming and Osydiek (1999)	Brent crude oil	Higher

Source: Energy Information Administration.

¹²⁹About 36 percent of the firms in this sample that had foreign sales did not hedge. Note that this study did not address the issue of why they failed to hedge if doing so would increase firm value. See G. Allayannis and J. Weston, "The Use of Foreign Currency Derivatives and Firm Market Value," *Review of Financial Studies*, Vol. 14 (2001), pp. 243-276.

¹³⁰Adam Smith, *The Wealth of Nations* (1776); and John Stuart Mill, *Principles of Political Economy*, 7th edition (1871).

¹³¹M. Friedman, "The Case for Flexible Exchange Rates," in *Essays in Positive Economics* (Chicago, IL: Chicago Press, 1953).

¹³²See W. J. Baumol, "Speculation, Profitability, and Stability," *Review of Economics and Statistics*, Vol. 39 (1957), pp. 263-271. Additionally, Milton Friedman noted that this type of speculation would result in losses if the good was then sold at the higher price. The exact opposite would be true when prices are falling. See C. Kindleberger, *Manias, Panics, and Crashes*, 4th edition (New York, NY: John Wiley & Sons), p. 24, 1989.

¹³³See, for example, A. Antoniou and A. Foster, "The Effects of Futures Trading on Spot Price Volatility: Evidence for Brent Crude Oil using Garch," *Journal of Business Finance and Accounting*, Vol. 19 (June 1992), pp. 473-484.

¹³⁴S. Mayhew, "The Impact of Derivatives on Cash Markets: What Have We Learned?" Working paper, Department of Banking and Finance, Terry College of Business, University of Georgia (Athens, GA, February 2000).

volatility of the underlying cash market before and after derivative trading began. This approach is useful in isolating the short-term effects, but the comparisons do not isolate other factors that may have caused the observed changes. The other method correlated increases (decreases) in the level of derivative trading with volatility.

Other studies have used different measures of volatility. The earlier studies simply looked at high-low ranges or used simple standard deviations before and after derivatives were introduced into a given market. The later studies introduced methodological refinements, the most important of which were adjusting for seasonal factors and allowing for the fact that volatility might not be constant in the pre- and post-event samples. Given the different approaches, the consistency of the results is remarkable.

Two studies examining the effects of derivative trading on the crude oil market produced some slightly different results. The more recent of the two, by Fleming and Ostdiek, found some evidence that volatility increased in the 3-week period after the introduction of NYMEX crude oil futures, but the introduction of crude oil options and derivatives for other energy commodities had no effect on crude oil price volatility.¹³⁵ The earlier of the two studies, by Antoniou and Foster, did not find any evidence that the introduction of futures contracts on Brent crude oil in 1988 increased the volatility of Brent crude oil prices.¹³⁶

There are a number of differences in the two studies that might explain why they obtained different results. First, Brent crude oil futures studied by Antoniou and Foster are traded on the International Petroleum Exchange in the United Kingdom, whereas the crude oil futures studied by Fleming and Ostdiek are traded on the NYMEX in the United States. There are differences in the structure of the two markets that perhaps could explain the differences in the results of the two studies. Second, removing the seasonal and other factors from the measure of volatility is difficult, and differences in the methods of computing volatility in the two studies might also explain the differences in the results.

Lastly, as can be seen from Table 16, the bulk of the studies dealt with agricultural commodities, and only two of them focused on one energy commodity—crude oil. Oil

and natural gas have some important similarities: both can be stored, and both are traded in large liquid spot markets. Thus, it is plausible that future studies will also find that derivatives have not affected the volatility of natural gas prices. For the reasons discussed in Chapter 4, however, it would be premature to extrapolate these results to electricity markets.

Market Power

The analysis so far suggests that there are benefits from using derivatives. There are also costs. Issues dealing with the risks from the use of derivatives and possible third-party failures are discussed in the next section. The question discussed here is whether a firm with market power in the cash market can use derivatives to distort commodity prices. For example, there is evidence of market power in the deregulated electricity markets,¹³⁷ suggesting that such a firm's use of derivatives could increase market volatility.

Economic theory suggests that a firm with market power can influence price by altering supply.¹³⁸ The analytical question is whether the existence of derivative markets gives the firm another way to manipulate supply. There have been a number of theoretical papers in this area. Unfortunately, there is but one empirical paper, which deals with the electricity market in New Zealand.

One way of manipulating the spot (cash) market is by “cornering and squeezing” it. Under this strategy, a firm will buy large amounts of future contracts and then demand delivery of the good as the contracts become due. By “cornering” the futures market, the firm has artificially increased demand for the good. At the same time, the firm, which has market power in the cash market, would restrict supply to “squeeze” the market. The combination of the two can cause substantial increases in price. In other words, the dominant firm can amplify the price effects of withholding supply by becoming a large trader and simultaneously increasing demand.

The best real-world example of such a strategy is the infamous manipulation of the silver market by the Hunt family (and others) who at one time held about \$14 billion worth of silver. In January 1979, before the market manipulation, silver was selling for about \$6 an ounce.

¹³⁵J. Fleming and B. Ostdiek, “The Impact of Energy Derivatives on the Crude Oil Market,” *Energy Economics*, Vol. 21 (1999), pp. 135-167.

¹³⁶A. Antoniou and A. Foster, “The Effects of Futures Trading on Spot Price Volatility: Evidence for Brent Crude Oil using Garch,” *Journal of Business Finance and Accounting*, Vol. 19 (June 1992), pp. 473-484.

¹³⁷Note that there is also the question of whether a firm with no market power in the cash market can manipulate the derivatives market. This question is addressed in S. Mayhew, “The Impact of Derivatives on Cash Markets: What Have We Learned?” Working paper, Department of Banking and Finance, Terry College of Business, University of Georgia (Athens, GA, February 2000).

¹³⁸Typically, such a firm could increase price by reducing supply. In electricity markets, under certain circumstances, the same outcome can be achieved by increasing supply. See J.B. Cardell, C. Cullen-Hitt, and W.W. Hogan, “Market Power and Strategic Interaction in Electricity Networks,” *Resource and Energy Economics* (January 1997).

Then in 1979, the Hunts began to buy silver futures and demand delivery (i.e., they cornered the market). At the same time, they bought large quantities of silver and held the physical silver off the market (i.e., the market was squeezed). As a result, in January 1980 silver prices reached about \$48 an ounce. Then, the regulators and the exchanges instituted “liquidation-only trading.” That is, traders were only allowed to close existing contracts; they could not establish any new positions. This forced traders (the Hunts and others) to exit the market as existing contracts became due, so that the manipulators could not continue to accrue large numbers of contracts and were gradually forced to withdraw from the market. The day after the rule was passed, silver prices fell by \$12 per ounce, and by March 27, 1980, they fell to about \$10 per ounce.

Market corners and squeezes are illegal, but hard to prove. In fact, the Hunts, their co-conspirators, and their brokers were sued, and a \$200 million judgement was awarded. The brokers and Lamar Hunt paid about \$34 million and \$17 million, respectively. The remaining amounts were never collected, because the other parties declared bankruptcy.

There are two other ways in which a dominant firm can use futures to increase prices. First, the key factor in the corner and squeeze strategy is the supply response of the dominant producer. Consider a world where there is one dominant firm that can set the market price and a number of smaller firms that simply react to the price. A number of theoretical studies have argued that under certain circumstances it would be rational for the dominant firm to lower futures prices, because the smaller firms’ response to the lower prices would be to reduce output.¹³⁹ As a result of this strategy, the market share of the dominant firm would increase. In traditional market power analysis, there is a pricing strategy called “predatory pricing,” where the dominant firm lowers prices below marginal costs to force smaller firms out of the market. Again, it can be shown that under certain circumstances a dominant firm can achieve a similar outcome by using derivatives.

The dominant firm could also attempt to introduce some instability into the futures markets, thereby increasing risk and thus costs for the other firms, which would reduce their output and benefit the dominant firm. It should be noted that most analysts view this type of manipulation as more theoretical than practical, because in most cases the costs of introducing instability would exceed the benefits.¹⁴⁰

It must be stressed that all of these strategies to use derivative markets to increase market power in the cash market are rational only under special circumstances. The research suggests that there is no general case to be made against futures trading when there is imperfect competition in the product market.

In a recent analysis, Wolak examined how one type of derivative (a contract for differences, also called a swap) could affect the spot price of electricity. A contract for differences could have the effect of fixing the price of electricity at a given level, creating an incentive to bid very low prices to ensure that the power is dispatched. When everyone does this, prices will fall. In the early days of the restructured electricity market in New Zealand, prices were indeed very low. Wolak noted that the government required generators to enter into a large number of futures contracts when the New Zealand market was restructured. He had some evidence that the low prices were partly the result of those contracts. He concluded that if one is concerned about market power, “then effective price regulation can be imposed by forcing a large enough quantity of hedge contracts on newly privatized generators.”¹⁴¹

Derivatives and Financial Failure

Derivative contracts generally require little money “up front” but can impose huge cash obligations on their writers and buyers. The trouble begins when unforeseen market changes require one party to the contract to post large amounts of cash quickly to cover collateral obligations. This section discusses some infamous cases in which the use of derivatives has been involved with large-scale financial failures. Enron’s collapse is not examined; analysis of its collapse will occupy scholars for decades.

Apart from the human tragedies, private failures are of public interest because they could lead to the failure of other firms to the point of a “public bailout.” Such a bailout could have important public policy implications. First, as was the case with the Savings and Loan debacle in the late 1980s, a bailout could have major budgetary implications. Second, if decisionmakers perceive that there is a real possibility of a bailout, there may be an incentive to undertake investments that are too risky. (In economics, this problem is called “moral hazard.”) At least according to some, one example of this would be deposit insurance that induced the owners of some savings and loan institutions to make very risky real estate

¹³⁹See D.M.G. Newbery, “The Manipulation of Futures Markets by a Dominant Producer,” in R.W. Anderson, ed., *The Industrial Organization of Futures Markets* (Lexington, MA: Lexington Books, 1984), p. 44.

¹⁴⁰*Ibid.*, pp. 55.

¹⁴¹F. Wolak, “An Empirical Analysis of the Impact of Hedge Contracts on Bidding Behavior in a Competitive Electricity Market.” Unpublished manuscript, Department of Economics, Stanford University (Palo Alto, CA, January 2000), p. 45.

loans. After outlining the reasons for four of the largest derivatives-related failures, this section briefly discusses the protections in place to limit public liability for private failures.

An example of a failure resulting from the use of derivatives to speculate is the bankruptcy of Orange County, California. In the early 1990s, the manager of the Orange County Investment Pool successfully invested the funds in long term bonds. When interest rates fell, bond prices increased, and as a result the fund's yield was greater than the market rate of return. Then, in 1993, believing that interest rates would continue to fall, the manager undertook a more aggressive investment strategy, buying "inverse floaters" whose returns were inversely related to the London Interbank Offer Rate (LIBOR). He also made extensive use of "reverse repos"—an investment strategy that amounts to buying Treasury bonds on margin. In both cases, profits were potentially very large if interest rates continued to fall. Unfortunately, just the opposite happened. In February 1994, the Federal Reserve Board started to increase interest rates, and by late 1994 they had been increased six times. In addition, the LIBOR rate rose from 3.6 percent to 6.8 percent. As a result, the fund lost about \$1.7 billion, leading to the County's bankruptcy.

The bankruptcy of Barings, PLC, in early 1995 also illustrates the problems that can occur when derivatives are used for speculation and when the trading activity is not properly controlled. In early 1995, a trader working for Barings Future Singapore (BFS) wrote both put and call options on Japan's Nikkei 225 stock index with the same strike price. This strategy, called a "straddle," was not authorized. A straddle will be profitable if the price of the underlying asset (in this case the Nikkei 225) remains close to the option strike price. If, however, prices either increase or decrease relative to the option strike price, very large losses will result. Unfortunately for Barings, the Nikkei 225 did fall substantially. As a result, Barings lost about \$1.5 billion and was placed in "administration" by the High Court in the United Kingdom. Indeed, this failure shows what can happen when appropriate risk control systems are not in place.

Hedging can require substantial amounts of ready cash (liquidity). In practice hedging will only reduce (but will not eliminate) risk. For example, MG Corporation (MGRM), the U.S. oil trading arm of Metallgesellschaft (MG), sold forward supply contracts that committed it to supply about 160 million gallons of motor gasoline and heating oil over a 10-year period at a fixed price. This obviously exposed MGRM to substantial losses if

spot prices were greater than the agreed-upon fixed selling price, and MGRM decided to hedge the risk with oil futures (and swaps).

The problem was that the futures contracts were very short term (a few months) in nature, while the supply contracts were longer term. Thus, every few months MGRM had to replace the futures contracts, and this presented some problems. First, MGRM had to do a lot of trading and was therefore dependent upon the liquidity of the NYMEX market. Additionally, the oil products it was contracted to deliver were in different locations from the products traded on the futures exchanges, exposing the company to some basis risk. Lastly and most importantly, the rollover strategy is not without costs unless the price of oil for immediate delivery ("nearby oil") is equal to the price of futures contracts ("deferred month oil").

Based on historical price patterns, on average, nearby prices were greater than deferred month prices, and thus MGRM could expect its rollover strategy to generate some profits. However, because oil prices fell in the first year, the nearby prices were less than the deferred prices, and the rollovers of the futures contracts generated substantial cash losses, causing some funding problems. As a result, in late 1993 the company closed out all the positions and took a loss of about \$1.3 billion. (That decision turned out to be an unfortunate one. Over the next year futures prices returned to their historical patterns, and the rollover strategy could have produced some gains.)

Even after the decision was made to terminate MGRM's hedging program, experts disagreed about the appropriateness of that decision.¹⁴² Nevertheless, one lesson here is that hedging strategies can be complex and are not without costs and risks. Indeed, management should anticipate risks and liquidity requirements before entering into such strategies. Additionally, when spot market oil prices fell in 1993, the value of MGRM's forward contracts increased. Under German accounting rules at the time, MG was not permitted to include the unrealized gains in its forward contracts as income, but it was required to deduct the unrealized losses on its futures contracts. As a result, its losses were overstated. At least according to Steinherr, this could have affected the MG board's decision.¹⁴³ Additionally, one study argued that the increase in the value of the forward contracts was less than 50 percent of the losses from rolling the futures contracts over. Thus, the hedge was far from perfect. There was no agreement among the experts about whether there was any better hedging strategy.¹⁴⁴

¹⁴²See, for example, A. Steinherr, *Derivatives: The Wild Beast of Finance* (New York, NY: John Wiley & Sons, 1998); and M. Miller, *Merton Miller on Derivatives* (New York, NY: John Wiley & Sons, 1997).

¹⁴³A. Steinherr, *Derivatives: The Wild Beast of Finance* (New York, NY: John Wiley & Sons, 1998), p. 95.

¹⁴⁴*Ibid.*, p. 95.

The failures just discussed were largely the result of “managerial” factors. The collapse of Long Term Capital Management (LTCM) was due to the fact that “history did not repeat itself.” LTCM was a very risky hedge fund that invested heavily in derivatives. (A hedge fund is a limited partnership, managing the investment of wealthy people. Minimum investments are over \$300,000, and each partnership has fewer than 99 investors.) The hedging strategies used in this fund were based on a very detailed mathematical model, and many of the relationships were based largely on historical experience.

One key for LTCM was the spread between developed and developing countries’ government bond prices. In particular, their investment strategy was based on a historical relationship which suggested that if this spread became unusually wide it would subsequently narrow to normal levels. However, in mid-1998, after the Russian government devalued the ruble and declared a moratorium on future debt repayments, the spread increased rather than narrowed. As a result, the fund’s capital fell from \$4.8 billion to about \$600 million. The Federal Reserve Bank of New York organized a consortium of banks and investment houses to rescue the fund. LTCM survived but had to turn over 90 percent of the fund’s equity to its rescuers.

As this history demonstrates, derivative use is not without costs, which in some cases can be ruinous. In principle, a major failure could start a series of failures of otherwise solvent firms and disrupt other financial and physical markets. Indeed, fear of contagion was the rationale for the Fed’s intervention in the rescue of LTCM. It must be noted, however, that for a number of reasons large failures are in fact uncommon.

Bad experience has given managers ample reason to understand the risks associated with their hedging operations and to discipline traders. Even so, a well-conceived, well-executed hedging strategy has a small chance of material losses. The small risk of failure is inherent and cannot be eliminated. Recognizing this, rating companies and trade organizations have taken steps to identify firms subject to losses they cannot withstand and to contain the inevitable failures.

Moody’s Investors Services, for example, is currently reexamining the creditworthiness of all energy trading

firms.¹⁴⁵ Moody’s is essentially assessing the ability of firms to raise enough cash to cover claims quickly in the event that unlikely but plausible market conditions move against them. Their focus is on “. . . sustainable cash flow generation, debt levels, and the quality and diversity of assets . . .” and on “. . . disclosure in financial reporting”^{146,147} The Edison Electric Institute has initiated a master netting agreement for use by companies trading electricity-related derivatives and is heading the industry’s effort to adopt credit standards and to guarantee performance. This effort is in the spirit of Moody’s suggestion that energy trading would benefit from “. . . a clearing system that would provide liquidity, transparency and a more efficient transfer of credit risk”¹⁴⁸

In addition, the banking authorities—the U.S. Federal Reserve Board, the Comptroller of the Currency, and the Federal Deposit Insurance Corporation—have imposed financial safeguards on the few investment banks that remain active in energy trading. The banking system also provides investment banks with subsidies in the form of liquidity (access to the Fed’s discount window) in the event of crisis and with deposit insurance. Recent research indicates that these subsidies are small and probably are offset by regulatory costs, and that they are, in any case, effective in preventing liquidity crises.¹⁴⁹

Over-the-counter energy traders, such as Mirant, Duke Capital, Williams, and Reliant, face far less government oversight than do investment bankers conducting similar business, and the private initiatives mentioned above may prove ineffective. On the other hand, Enron’s case showed that the collapse of the largest U.S. energy trader was not enough to threaten domestic financial markets.

Conclusions

This chapter has examined four issues related to the societal benefits and costs that result from using derivatives. Existing theoretical and empirical work suggests that the use of derivatives does in fact increase the level of investment and increase a firm’s market value. The bulk of the empirical studies find that the use of derivatives has either reduced or had no effect on the volatility of commodity prices; however, one of the two

¹⁴⁵ Moody’s Investors Services, *Moody’s View on Energy Merchants: Long on Debt-Short on Cash Flow Restructuring Expected* (May 2002).

¹⁴⁶ *Ibid.*, p. 3.

¹⁴⁷ Moody’s has identified several red flags that they are using in this difficult assessment: high leverage and meager cash flow; loan agreements with extensive use of credit triggers calling for more collateral in the event of a ratings downgrade or adverse market movements; lack of financial reporting transparency, especially by business segment; large proportions of income from long-lived contracts that are marked to model; synthetic leases; hybrid securities; and project finance devices that may add obligations to the company.

¹⁴⁸ *Ibid.*, p. 1.

¹⁴⁹ See, for example, G. Whalen, *The Competitive Implications of Safety Net-Related Subsidies*, Office of the Comptroller of the Currency, Economics Working Paper 97-9 (May 1997); and A. Lehnert and W. Passmore, *The Banking Industry and the Safety Net Subsidy*, Staff Working Paper, Federal Reserve System Board of Governors (1999).

studies examining the effects of futures trading on crude oil markets found that in the short term the introduction of futures increased the volatility of crude oil prices. As just noted, this result is the “exception rather than the rule.” There have been no published academic studies examining whether derivative use increases the volatility of natural gas or electricity prices. Additionally, theoretical analyses on whether firms with market power can use derivatives to manipulate spots markets are inclusive.

The use of derivatives can be very risky, and there have been some cases in which their misuse has proved to be ruinous; however, the public as a whole was not affected by those failures. Moreover, the Federal Reserve, by its implicit commitment to provide liquidity and avert financial crisis, is providing a small subsidy to those banks that use derivatives, because banks are heavily involved with derivative use. The subsidy probably is overwhelmed by the costs of bank regulation and is in any case unavoidable and appears to be worth the cost.

Appendix A
Memorandum from the Secretary of Energy



The Secretary of Energy
Washington, DC 20585

February 8, 2002

MEMORANDUM FOR MARY HUTZLER
ACTING ADMINISTRATOR
ENERGY INFORMATION ADMINISTRATION

FROM: SPENCER ABRAHAM

SUBJECT: Energy Derivatives Review

Recently there has been significant policy focus on volatile energy markets and particularly on the role of energy derivatives in these markets. To assist policy makers and the public in better understanding these markets, I am requesting the Energy Information Administration to prepare a review to be completed no later than September 1, 2002, to include the following components:

1. A description of energy risk management tools;
2. A description of exchanges and mechanisms for trading energy contracts;
3. Exploration of the varied uses of energy risk management tools;
4. Discussion of any impediments to the development of energy risk management tools;
5. Analysis of energy price volatility relative to other commodities;
6. Review of current regulatory structure for energy derivatives markets;
and
7. A survey of literature on energy derivatives and trading.

I look forward to the opportunity to study the results of this review in light of the significant recent growth in energy derivatives markets.



Printed on recycled paper

Appendix B

Details of Present Net Value Calculation

Economics of New Combined-Cycle Generator

This appendix describes in more detail the calculations of net present value (NPV) reported in Chapter 2. The combined-cycle (CC) generator example is particularly relevant because the technology is less capital intensive than other technologies, such as coal, nuclear, and renewable electricity plants. In addition, Energy Information Administration projections show natural-gas-fired generation increasing from 16 percent of total U.S. electricity generation in 2000 to 32 percent of the total in 2020, overtaking nuclear power as the Nation's second-largest source of electricity by 2004.¹⁵⁰ Moreover, a growing number of refineries, petrochemical plants, and other industrial facilities that use natural gas to generate electricity for their own needs are becoming cogenerators, selling excess electricity to local utilities and power marketers. Those firms rely on stable natural gas supplies and prices; volatile gas prices can have considerable impact on their earnings, as noted in Chapter 2.

Capital Budgeting for a Power Generator

In the example shown in Chapter 2, an independent power producer faces a capital budgeting project (e.g., building a gas-fired plant) and uses NPV methodology to evaluate the project. The simple rule often given for choosing investment projects is the NPV rule: choose only projects with positive NPVs. The NPV methodology implicitly assumes that the incremental cash flows from a project will be reinvested to earn the firm's risk-adjusted required rate of return throughout the life of the project. The NPV of a project reveals the amount

by which its productive value (present value of net cash flows) exceeds or is less than its cost. Naturally, investors choose only those projects whose productive values exceed or at least equal their costs. If the NPV of a project is positive ($NPV > 0$), the amount of the NPV is the amount by which the project will increase the value of the firm making the investment.

The assumptions underlying the capital investment example shown in Chapter 2, Table 4, are summarized in Table B1.¹⁵¹ Table B2 shows the detailed annual cash flow calculations based on the assumptions and the price projections shown in Chapter 2, Table 4. Because the plant has a positive NPV of \$2,118,017, it is profitable and should be built.

NPV Distributions with Simulation

In fact, the future output and input prices for the project are uncertain, and it may become unprofitable if the actual input and output prices vary much from their expected means. Therefore, a Monte Carlo simulation was used to estimate the distribution of the project's NPV when both electricity and natural gas prices are varied.¹⁵² For the simulation analysis, lognormal distributions were defined for both electricity and natural gas prices, and the prices were varied by plus and minus 77 percent and 47 percent, respectively, as a standard deviation, from the expected prices.¹⁵³ The price variations were based on daily historical data on NYMEX spot prices from March 1999 through March 2002. A historical positive correlation of 0.88 between the average electricity spot price and Henry Hub natural gas spot price

Table B1. Basic Assumptions for the NPV Calculation

Variable	Assumed Value	Variable	Assumed Value
Heat Rate	6,800 Btu per kilowatthour	Corporate Tax Rate	36.00%
Capital Cost	\$590 per kilowatt	Debt Capital Fraction	60.00%
Capacity Factor	65%	Equity Capital Fraction	40.00%
O&M Fixed Costs	\$14.46 per kilowatt per year	Cost of Debt	10.50%
O&M Variable Costs	\$0.00052 per kilowatthour	Cost of Equity	17.50%
Generator Capability	400 megawatts	Weighted Average Cost of Capital . .	11.03%

Source: Energy Information Administration.

¹⁵⁰Energy Information Administration, *Annual Energy Outlook 2002*, DOE/EIA-0383(2002) (Washington, DC, December 2001).

¹⁵¹Energy Information Administration, *Assumptions to the Annual Energy Outlook 2002 (AEO2002)*, DOE/EIA-0554(2002) (Washington, DC, December 2001).

¹⁵²The use of simulation analysis in capital budgeting was first reported by David B. Hertz. See D.B. Hertz, "Risk Analysis in Capital Investment," *Harvard Business Review* (January-February 1964), pp. 95-106, and "Investment Policies That Pay Off," *Harvard Business Review* (January-February 1968), pp. 96-108.

¹⁵³The lognormal distribution rather than a normal distribution is a legitimate assumption for price data, in that prices cannot be less than zero in reality.

was specified for each year of the project's life.¹⁵⁴ The NPV distribution generated by the simulation is shown Figure 6, and the statistical results and summary are shown Table 5, in Chapter 2.¹⁵⁵ The simulation results indicate that there is about a 17-percent chance that the investment will be unprofitable (i.e., that it will have a negative NPV).

Because the investor faces some probability of loss as a result of price fluctuations, he may have an incentive to mitigate the risk by hedging with such tools as long-term contracts, futures, options, and swaps. It was assumed for the analysis that the power producer's maximum risk tolerance for the price volatilities was plus or minus one standard deviation from their means, or 77

percent and 47 percent of the mean price for electricity and natural gas, respectively. This assumption led to triangular distributions for both prices (Table B3).

When it was assumed that the price volatility would be hedged, the probability of positive NPV increased from 83 percent to 99 percent with a coefficient of variation (CV) of 0.42. Without hedging the price volatility, the CV was 1.09. The distribution is shown in Figure B1. The summary of statistical results and a statistical comparison of the simulations are shown in Table B4. As shown, a hedged project has less probability of negative NPV, smaller standard deviation of NPV, and a smaller risk measurement (CV).

Table B2. Estimation of Annual Net Cash Flows for a New Combined-Cycle Generator

Estimate	2001	2002	2003	2004	2005	2021
Initial Investment	-\$236,000,000	—	—	—	—	—
Annual Unit Sales (Megawatthours)	—	2,277,600	2,277,600	2,277,600	2,277,600	2,277,600
Sale Price (Dollars per Megawatthour) . .	—	\$43.29	\$42.01	\$43.04	\$43.40	\$66.72
Revenue	—	\$98,593,747	\$95,687,611	\$98,034,736	\$98,855,121	\$151,965,867
O&M Costs (Dollars per Megawatthour)	—					
Fixed	—	5,940,168	6,100,553	6,265,267	6,434,430	9,854,558
Variable	—	1,216,330	1,249,170	1,282,898	1,317,536	2,017,854
Fuel (Natural Gas) Costs	—	41,204,050	47,722,153	52,391,326	55,030,625	102,132,258
Depreciation	—	11,800,000	22,420,000	20,178,000	18,172,000	0
Earnings Before Taxes (EBT)	—	\$38,433,200	\$18,195,736	\$17,917,245	\$17,900,530	\$37,961,196
Taxes	—	13,835,952	6,550,465	6,450,208	6,444,191	13,666,031
Net Operating Income	—	\$24,597,248	\$11,645,271	\$11,467,037	\$11,456,339	\$24,295,166
Noncash Expenses (Depreciation)	—	11,800,000	22,420,000	20,178,000	18,172,000	0
Net Cash Flow from Operations	-\$236,000,000	\$36,397,248	\$34,065,271	\$31,645,037	\$29,628,339	\$24,295,166

Notes: Assumptions based on Energy Information Administration, *Assumptions to the Annual Energy Outlook 2002 (AEO2002)*, DOE/EIA-0554(2002) (Washington, DC, December 2001). Depreciation schedule over the 20-year life of the fixed asset is as follows: 5%, 9.5%, 8.55%, 7.7%, 6.93%, 6.23%, 5.9%, 5.9%, 5.9%, 5.9%, 5.9%, 5.9%, 5.9%, 5.9%, 5.9%, 5.9%, and 2.95% for year 1 through year 16, respectively.

Source: Energy Information Administration.

¹⁵⁴The positive correlation coefficient, 0.88, was generated by the daily NYMEX spot price relationship between Henry Hub natural gas prices and an average of ECAR, PJM, COB, and Palo Verde electricity prices from March 1999 through March 2002.

¹⁵⁵The simulation was run for 10,000 trials using Crystal Ball[®] computer software. The risk-free rate of 5.62 percent (average monthly 10-year Treasury constant maturity from January 1997 through May 2002) was used for the discount rate rather than the weighted average cost of capital (WACC) to get NPVs and avoid double-counting risk. For details, see R.H. Keeley and R. Westerfield, "A Problem in Probability Distribution Techniques for Capital Budgeting," *Journal of Finance* (June 1972), pp. 703-709.

Table B3. Expected Price Range with Risk Tolerance (Triangular Distribution)

Year	Electricity Price (Cents per Kilowatthour)			Natural Gas Price (Dollars per Thousand Btu)		
	Mean	Lower Limit	Upper Limit	Mean	Lower Limit	Upper Limit
2002	4.215	0.969	7.461	2.590	1.373	3.808
2003	3.983	0.916	7.050	2.921	1.548	4.294
2004	3.974	0.914	7.033	3.123	1.655	4.591
2005	3.902	0.897	6.906	3.194	1.693	4.695
2006	3.816	0.878	6.754	3.225	1.709	4.740
2007	3.769	0.867	6.671	3.258	1.727	4.789
2008	3.737	0.860	6.615	3.313	1.756	4.870
2009	3.719	0.855	6.583	3.343	1.772	4.914
2010	3.741	0.860	6.621	3.381	1.792	4.969
2011	3.758	0.864	6.652	3.460	1.834	5.086
2012	3.732	0.858	6.606	3.524	1.868	5.180
2013	3.746	0.862	6.630	3.572	1.893	5.251
2014	3.735	0.859	6.611	3.610	1.913	5.307
2015	3.740	0.860	6.620	3.654	1.937	5.372
2016	3.760	0.865	6.655	3.685	1.953	5.417
2017	3.797	0.873	6.721	3.729	1.976	5.481
2018	3.847	0.885	6.809	3.777	2.002	5.552
2019	3.877	0.892	6.862	3.818	2.024	5.613
2020	3.916	0.901	6.932	3.871	2.051	5.690
2021	3.916	0.901	6.932	3.871	2.051	5.690

Source: Energy Information Administration.

Figure B1. NPV Simulation with Hedging for Input and Output Price Volatilities

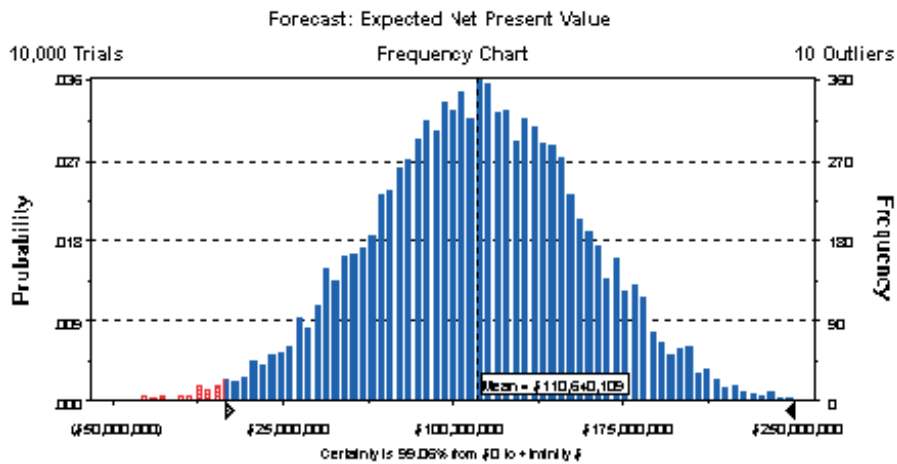

Source: Energy Information Administration.

Table B4. Summary of Statistical Results from the NPV Simulation

Statistics	Net Present Value	
	Without Hedging	With Hedging
Trials	10,000	10,000
Mean	\$110,004,525	\$110,640,109
Median	\$95,173,767	\$111,069,433
Standard Deviations	\$120,382,899	\$46,299,875
Maximum	\$1,187,415,173	\$287,794,307
Minimum	-\$213,218,338	-\$49,672,944
Probability of NPV > 0	82.97%	99.06%
Coefficient of Variation	1.09	0.42

Source: Energy Information Administration, output from Crystal Ball[®] software used with an Excel spreadsheet program.

Appendix C

Reported Natural Gas Prices

This appendix documents differences in natural gas prices reported by Intelligence Press, Inc., in its *NGI's Daily Gas Price Index*¹⁵⁶ and by Platts in its *Gas Daily*¹⁵⁷ for the same arbitrary date (February 4, 2002) and the same locations. NGI publishes daily high, low, and average prices for 86 locations, and Platts publishes daily absolute high and low prices, common high and low prices, and a midpoint natural gas price for 114 locations. Neither NGI nor Platts publishes data on volumes of natural gas traded. There are other sources, but these two are sufficient to describe the general nature of the price data available to the markets.

Table C1 on the following page shows low and high prices reported by NGI and Platts and the differences between the estimated lows and the estimated highs.¹⁵⁸ Low-level statistical tests do not show the differences to be significant, but graphs appear to present a different story. Figure C1 shows that the differences between the

NGI and Platts low values are positively skewed. That is, NGI's reported low prices tend to be higher than those published by Platts. In fact, of the 59 data points shown, 31 are greater than zero, 22 are zero (no difference), and only 6 are less than zero. Figure C2 shows the differences between the high values. In this case, the high prices reported by NGI tend to be lower than those reported by Platts: only 8 values are greater than zero, 29 are zero (no difference), and 22 are less than zero. Another observation from these graphs is the different range held by the two series. The minimum for the difference in the lows is -\$0.03 and the maximum is \$0.11, yielding a range of \$0.14. Conversely, with the high difference series, the minimum is -\$0.16 and the maximum is \$0.23, giving a range of \$0.39. Although these graphs appear to show that there are differences between the two data series, further analysis would be necessary to demonstrate that the differences are systematic and persistent.

Figure C1. Differences Between NGI and Platts Low Prices

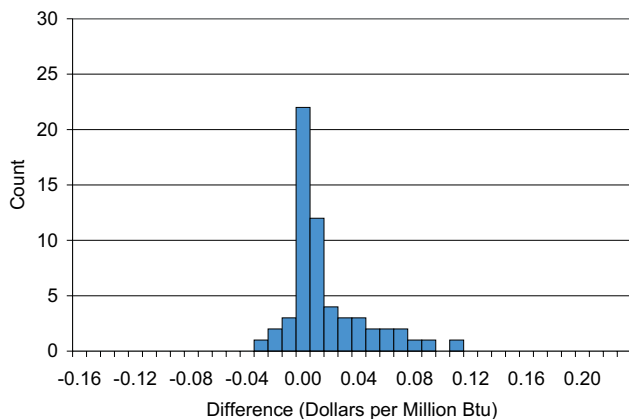

Source: Energy Information Administration, based on data from Intelligence Press, *NGI's Daily Gas Price Index*, and Platts, *Gas Daily*.

Figure C2. Differences Between NGI and Platts High Prices

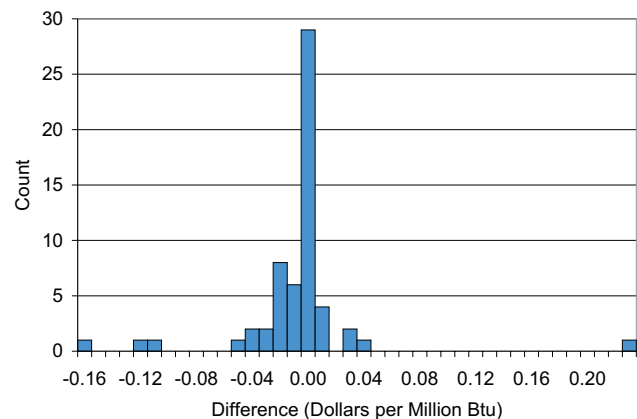

Source: Energy Information Administration, based on data from Intelligence Press, *NGI's Daily Gas Price Index*, and Platts, *Gas Daily*.

¹⁵⁶See web site <http://www.platts.com/>.

¹⁵⁷See web site <http://intelligencepress.com/>.

¹⁵⁸NGI publishes an average and Platts publishes a midpoint of the "most common prices." These are not obviously comparable.

Table C1. Differences Between NGI and Platts Reported Natural Gas Prices

Region	Location	NGI		Platts		Low Difference	High Difference
		Low	High	Low	High		
South Texas	Aqua Dulce	\$2.00	\$2.09	\$1.95	\$2.12	\$0.05	-\$0.03
	Florida Gas Zone	\$2.17	\$2.25	\$2.10	\$2.25	\$0.07	\$0.00
	NGPL S. TX	\$2.08	\$2.13	\$2.04	\$2.13	\$0.04	\$0.00
	Tennessee	\$2.07	\$2.14	\$2.04	\$2.14	\$0.03	\$0.00
	Texas Eastern	\$2.04	\$2.13	\$2.03	\$2.12	\$0.01	\$0.01
	Transco St. 30	\$2.10	\$2.19	\$2.10	\$2.20	\$0.00	-\$0.01
	Trunkline	\$2.08	\$2.14	\$2.08	\$2.14	\$0.00	\$0.00
East Texas	Carthage	\$2.08	\$2.14	\$2.08	\$2.15	\$0.00	-\$0.01
	Houston Ship Channel	\$2.14	\$2.22	\$2.12	\$2.22	\$0.02	\$0.00
	Katy	\$2.10	\$2.16	\$2.07	\$2.16	\$0.03	\$0.00
	NGPL TexOK (West)	\$2.09	\$2.14	\$2.12	\$2.14	-\$0.03	\$0.00
	Texas East.	\$2.09	\$2.14	\$2.09	\$2.15	\$0.00	-\$0.01
	Texas Gas Zone 1	\$2.15	\$2.19	\$2.14	\$2.19	\$0.01	\$0.00
	Transco St. 45	\$2.07	\$2.18	\$2.08	\$2.23	-\$0.01	-\$0.05
	Trunkline North	\$2.10	\$2.15	\$2.10	\$2.15	\$0.00	\$0.00
West Texas	NGPL Permian	\$1.97	\$2.03	\$1.89	\$2.00	\$0.08	\$0.03
	Transwestern	\$2.04	\$2.09	\$2.05	\$2.08	-\$0.01	\$0.01
Midwest	Alliance	\$2.17	\$2.21	\$2.17	\$2.23	\$0.00	-\$0.02
	ANR ML7 (entire zone)	\$2.25	\$2.30	\$2.18	\$2.34	\$0.07	-\$0.04
	Dawn	\$2.25	\$2.30	\$2.23	\$2.31	\$0.02	-\$0.01
	Michigan Consolidated	\$2.20	\$2.27	\$2.20	\$2.29	\$0.00	-\$0.02
Mid-continent	NGPL Amarillo Mainline	\$2.04	\$2.19	\$2.04	\$2.19	\$0.00	\$0.00
	NGPL Iowa-Illinois	\$2.11	\$2.16	\$2.11	\$2.17	\$0.00	-\$0.01
	NGPL Mid-continent	\$2.02	\$2.11	\$2.02	\$2.11	\$0.00	\$0.00
	Northern Natural Demarc	\$2.12	\$2.22	\$2.11	\$2.21	\$0.01	\$0.01
	Northern Natural Mid 10-13	\$2.05	\$2.14	\$2.05	\$2.11	\$0.00	\$0.03
	Northern Natural Ventura	\$2.13	\$2.20	\$2.11	\$2.20	\$0.02	\$0.00
	OGT	\$2.04	\$2.11	\$2.06	\$2.13	-\$0.02	-\$0.02
	Reliant West (NorAm)	\$2.04	\$2.12	\$2.04	\$2.13	\$0.00	-\$0.01
	Williams	\$2.05	\$2.13	\$2.05	\$2.12	\$0.00	\$0.01
Louisiana	Gulf South (Koch)	\$2.03	\$2.04	\$1.94	\$2.20	\$0.09	-\$0.16
	Henry Hub	\$2.14	\$2.24	\$2.14	\$2.24	\$0.00	\$0.00
	NGPL LA	\$2.09	\$2.16	\$2.09	\$2.16	\$0.00	\$0.00
	Tennessee Line 500	\$2.06	\$2.20	\$2.06	\$2.20	\$0.00	\$0.00
	Tennessee Line 800	\$2.09	\$2.18	\$2.08	\$2.18	\$0.01	\$0.00
	Texas Eastern E. LA	\$2.12	\$2.20	\$2.11	\$2.22	\$0.01	-\$0.02
	Texas Eastern W. LA	\$2.09	\$2.17	\$2.09	\$2.20	\$0.00	-\$0.03
	Texas Gas Zone SL	\$2.13	\$2.21	\$2.13	\$2.21	\$0.00	\$0.00
	Transco St. 65	\$2.17	\$2.27	\$2.17	\$2.27	\$0.00	\$0.00
	Trunkline E. LA	\$2.11	\$2.18	\$2.09	\$2.18	\$0.02	\$0.00
Trunkline W. LA	\$2.10	\$2.18	\$2.12	\$2.20	-\$0.02	-\$0.02	
Alabama/Mississippi	Texas Eastern Kosciusko	\$2.19	\$2.26	\$2.18	\$2.26	\$0.01	\$0.00
	Transco St. 85	\$2.24	\$2.31	\$2.20	\$2.31	\$0.04	\$0.00
Rocky Mountains	CIG	\$1.83	\$1.95	\$1.80	\$1.95	\$0.03	\$0.00
	Cheyenne Hub	\$1.89	\$1.96	\$1.83	\$1.98	\$0.06	-\$0.02
	El Paso non-Bondad	\$2.02	\$2.09	\$2.02	\$2.11	\$0.00	-\$0.02
	Kern River/Opal	\$1.84	\$1.98	\$1.80	\$2.00	\$0.04	-\$0.02
	Northwest S. of Green River	\$1.84	\$1.85	\$1.85	\$1.97	-\$0.01	-\$0.12
	Northwest Sumas	\$1.97	\$2.03	\$1.97	\$2.14	\$0.00	-\$0.11
	Questar	\$1.87	\$1.94	\$1.81	\$1.94	\$0.06	\$0.00
	Stanfield	\$2.02	\$2.12	\$1.97	\$2.12	\$0.05	\$0.00
Northeast	Algonquin (citygate)	\$2.52	\$2.72	\$2.51	\$2.72	\$0.01	\$0.00
	Algonquin (into)	\$2.43	\$2.55	\$2.42	\$2.55	\$0.01	\$0.00
	Columbia Gas	\$2.25	\$2.44	\$2.14	\$2.21	\$0.11	\$0.23
	Iroquois Zone 2	\$2.48	\$2.61	\$2.47	\$2.61	\$0.01	\$0.00
	Niagara	\$2.34	\$2.40	\$2.33	\$2.44	\$0.01	-\$0.04
	Tennessee Zone 6	\$2.47	\$2.63	\$2.46	\$2.59	\$0.01	\$0.04
	Transco Zone 6 NY	\$2.48	\$2.75	\$2.48	\$2.75	\$0.00	\$0.00
	Transco Zone 6 non -NY	\$2.43	\$2.60	\$2.42	\$2.60	\$0.01	\$0.00

Source: Energy Information Administration, based on data from Intelligence Press, *NGI's Daily Gas Price Index*, and Platts, *Gas Daily* (Monday, February 4, 2002).

Glossary

Abandon: The act of an option holder in electing not to exercise or offset an option.

Approved Delivery Facility: Any bank, stockyard, mill, storehouse, plant, elevator, or other depository that is authorized by an exchange for the delivery of commodities tendered on futures contracts.

Arbitrage: Simultaneous purchase of cash commodities or futures in one market against the sale of cash commodities or future in the same or a different market to profit from a discrepancy in prices. Also includes some aspects of hedging. See *Spread, Switch*.

Asian Option: An option whose payoff depends on the average price of the underlying asset during some portion of the life of the option.

At-the-Money: When an option's exercise price is the same as the current trading price of the underlying commodity, the option is at-the-money.

Backwardation: Market situation in which futures prices are progressively lower in the distant delivery months. For instance, if the gold quotation for the February is \$160.00 per ounce and that for June is \$155.00 per ounce, the backwardation for four months against January is \$5.00 per ounce. (Backwardation is the opposite of *contango*.) See *Inverted Market*.

Basis: The difference between the spot or cash price of a commodity and the price of the nearest futures contract for the same or a related commodity. Basis is usually computed in relation to the futures contract next to expire and may reflect different time periods, product forms, qualities, or locations.

Basis Risk: The risk associated with an unexpected widening or narrowing of basis between the time a hedge position is established and the time it is lifted.

Bear: One who expects a decline in prices. The opposite of a *bull*. A news item is considered bearish if it is expected to result in lower prices.

Bear Market: A market in which prices are declining.

Bear Spread: The simultaneous purchase and sale of two futures contracts in the same or related commodities with the intention of profiting from a decline in prices but at the same time limiting the potential loss if this expectation does not materialize. In agricultural products, this is accomplished by selling a nearby delivery and buying a deferred delivery.

Bid: An offer to buy a specific quantity of a commodity at a stated price.

Broker: A person paid a fee or commission for executing buy or sell orders for a customer. In commodity futures trading, the term may refer to: (1) Floor Broker—a person who actually executes orders on the trading floor of an exchange. (2) Account Executive, Associated Person, registered Commodity Representative or Customer's Man—the person who deals with customers in the offices of futures commission merchants. (3) The futures Commission Merchant.

Bucketing: Directly or indirectly taking the opposite side of a customer's order into a broker's own account or into an account in which a broker has an interest, without open and competitive execution of the order on an exchange.

Bucket Shop: A brokerage enterprise which "books" (i.e., takes the opposite side of) a customer's order without actually having it executed on an exchange.

Bull: One who expects a rise in prices. The opposite of *bear*. A news item is considered bullish if it portends higher prices.

Bull Market: A market in which prices are rising.

Buyer: A market participant who takes a long futures position or buys an option. An option buyer is also called a *taker, holder, or owner*.

Buying Hedge (or Long Hedge): Hedging transaction in which futures contracts are brought to protect against possible increases in the cost of commodities. See *Hedging*.

Call: (1) A period at the opening and the close of some futures markets in which the price for each futures contract is established by auction. (2) *Buyer's Call*, also called *Call Sale*, generally applies to cotton. A purchase of a specified quantity or grade of a commodity at a fixed number of points above or below a specified delivery month futures price with the buyer allowed a period of time to fix the price either by purchasing a future for the account of the seller or telling the seller when he wishes to fix the price. (3) *Seller's Call*, also called *Call Purchase*, is the same as the buyer's call except that the obligation is to purchase the commodity or to enter into a long futures position. (4) The requirement that a financial instrument be returned to the issuer prior to maturity, with principal and accrued interest paid off upon return.

Called: Another term for “exercised” when the option is a call. The writer of a call must deliver the indicated underlying commodity when the option is exercised or called.

Call Option: A contract that entitles the buyer/taker to buy a fixed quantity of commodity at a stipulated basis or striking price at any time up to the expiration of the option. The buyer pays a premium to the seller.

Cash Commodity: The physical or actual commodity as distinguished from the futures contract. Sometimes called *Spot Commodity* or *Actuals*.

Cash Forward Sale: See *Forward Contracting*.

Cash Market: The market for the cash commodity (as contrasted to a futures contract), taking the form of: (1) an organized, self-regulated central market (e.g., a commodity exchange); (2) a decentralized over-the-counter market; or (3) a local organization, such as a grain elevator or meat processor, which provides a market for a small region.

Cash Price: The price in the marketplace for actual cash or spot commodities to be delivered via customary market channels.

Cash Settlement: A method of settling certain futures or option contracts whereby the seller (or short) pays the buyer (or long) the cash value of the commodity traded according to a procedure specified in the contract.

Circuit Breakers: A system of trading halts and price limits on equities and derivative markets designed to provide a cooling-off period during large, intraday market movements. The first known use of the term circuit breaker in this context was in the Report of the Presidential Task Force on Market Mechanisms (January 1988), which recommended that circuit breakers be adopted following the market break of October 1987.

Clearing: The procedures through which the clearinghouse or association becomes the buyer to each seller of a futures contract, and the seller to each buyer, and assumes responsibility for protecting buyers and sellers from financial loss by assuring performance on each contract.

Clearinghouse: An adjunct to, or division of, a commodity exchange through which transactions executed on the floor of the exchange are settled. Also charged with assuring the proper conduct of the exchange’s delivery procedures and the adequate financing of the trading.

Clearing Member: A member of the Clearinghouse or Association. All trades of a non-clearing member must be registered and eventually settled through a clearing member.

Close: The period at the end of the trading session, officially designated by the exchange, during which all transactions are considered made “at the close.” See also *Call*.

Closing-Out: Liquidating an existing long or short futures or option position with an equal and opposite transaction. Also known as *Offset*.

Closing Price (or Range): The price (or price range) recorded during trading that takes place in the final moments of day’s activity that is officially designated as the *close*.

Commodity Futures Trading Commission (CFTC): The Federal regulatory agency established by the CFTC Act of 1974 to administer the Commodity Exchange Act.

Congestion: (1) A market situation in which shorts attempting to cover their positions are unable to find an adequate supply of contacts provided by longs willing to liquidate or by new sellers willing to enter the market, except at sharply higher prices. (2) In technical analysis, a period of time characterized by repetitious and limited price fluctuations.

Contango: Market situation in which prices in succeeding delivery months are progressively higher than in the nearest delivery month; the opposite of *backwardation*.

Convergence: The tendency for prices of physicals and futures to approach one another, usually during the delivery month. Also called a *narrowing of the basis*.

Corner: (1) Securing such relative control of a commodity or security that its price can be manipulated. (2) In the extreme situation, obtaining contracts requiring the delivery of more commodities or securities than are available for delivery.

Cover: (1) Purchasing futures to offset a short position. Same as *Short Covering*. See *Offset*, *Liquidation*. (2) To have in hand the physical commodity when a short futures or leverage sale is made, or to acquire the commodity that might be deliverable on a short sale.

Covered Option: A short call or put option position that is covered by the sale or purchase of the underlying futures contract or physical commodity. For example, in the case of options on futures contracts, a covered call is a short call position combined with a long futures position. A covered put is a short put position combined with a short future position.

Crack: In energy futures, the simultaneous purchase of crude oil futures and the sale of petroleum product futures to establish a refining margin. See *Gross Processing Margin*.

Cross-Hedge: Hedging a cash market position in a futures contract for a different but price-related commodity.

Default: Failure to perform on a futures contract as required by exchange rules, such as failure to meet a margin call, or to make or take delivery.

Delivery: The tender and receipt of the actual commodity, the cash value of the commodity, or of a delivery instrument covering the commodity (e.g., warehouse receipts or shipping certificates), used to settle a futures contract. See *Notice of Delivery*.

Delivery Price: The price fixed by the clearinghouse at which deliveries on futures are invoiced—generally the price at which the futures contract is settled when deliveries are made.

Deposit: The initial outlay required by a broker of a client to open a futures position, returnable upon liquidation of that position.

Derivative: A financial instrument, traded on or off an exchange, the price of which is directly dependent upon (i.e., “derived from”) the value of one or more underlying securities, equity indexes, debt instruments, commodities, other derivative instrument, or any agreed upon pricing index or arrangement (e.g., the movement over time of the Consumer Price Index or freight rates). Derivatives involve the trading of rights or obligations based on the underlying product but do not directly transfer property. They are used to hedge risk or to exchange a floating rate of return for a fixed rate of return.

Distant or Deferred Delivery: Usually, one of the more distant months in which futures trading is taking place.

Efficient Market: A market in which new information is immediately available to all investors and potential investors. A market in which all information is instantaneously assimilated and therefore has no distortions.

EFP: Exchange for Physical.

Exchange Rate: The price of one currency stated in terms of another currency.

Exercise: To elect to buy or sell, taking advantage of the right (but not the obligation) conferred by an option contract.

Exercise (Strike) Price: The price specified in the option contract at which the buyer of a call can purchase the commodity during the life of the option, and the price specified in the option contract at which the buyer of a put can sell the commodity during the life of the option.

Exotic Options: Any of a wide variety of options with non-standard payout structures, including Asian options and Lookback options. Exotic options are mostly traded in the over-the-counter market.

Expiration Date: The date on which an option contract automatically expires; the last day an option can be exercised.

Fictitious Trading: Wash trading, bucketing, cross trading, or other schemes which give the appearance of trading when, actually, no *bona fide* competitive trade has occurred.

Financial Instrument: As used by the CFTC, this term generally refers to any futures or option contract that is based on an agricultural commodity or a natural resource. It includes currencies, securities, mortgages, commercial paper, and indexes of various kinds.

Forced Liquidation: The situation in which a customer’s account is liquidated (open positions are offset) by the brokerage firm holding the account, usually after notification that the account is undercapitalized (margin calls).

Force Majeure: A clause in a supply contract which permits either party not to fulfill the contractual commitments due to events beyond their control. These events may range from strikes to exports delays in producing countries.

Foreign Exchange: Foreign currency. On the foreign exchange market, foreign currency is bought and sold for immediate or future delivery.

Forward: In the future.

Forward Contracting: A cash transaction common in many industries, including commodity merchandising, in which a commercial buyer and seller agree upon delivery of a specified quality and quantity of goods at a specified future date. A price may be agreed upon in advance, or there may be agreement that the price will be determined at the time of delivery.

Forward Market: Refers to informal (non-exchange) trading of commodities to be delivered at a future date. Contracts for forward delivery are “personalized” (i.e., delivery time and amount are as determined between seller and customer).

Fungibility: The characteristic of interchangeability. Futures contracts for the same commodity and delivery month are fungible due to their standardized specifications for quality, quantity, delivery dates, and delivery locations.

Futures Commission Merchant (FCM): Individuals, associations, partnerships, corporations, and trusts that solicit or accept orders for the purchase or sale of any commodity for future delivery on or subject to the rules of any contract market and that accept payment from or extend credit to those whose orders are accepted.

Futures Contract: An agreement to purchase or sell a commodity for delivery in the future: (1) at a price that is determined at initiation of the contract; (2) which obligates each party to the contract to fulfill the contract at the specified price; (3) which is used to assume or shift price risk; and (4) which may be satisfied by delivery or offset.

Futures Price: (1) Commonly held to mean the price of a commodity for future delivery that is traded on a futures exchange. (2) The price of any futures contract.

Grantor: The maker, writer, or issuer of an option contract who, in return for the premium paid for the option, stands ready to purchase the underlying commodity (or futures contract) in the case of a put option or to sell the underlying commodity (or futures contract) in the case of a call option.

Haircut: (1) In determining whether assets meet capital requirements, a percentage reduction in the stated value of assets. (2) In computing the worth of assets deposited as collateral or margin, a reduction from market value.

Hedge Ratio: Ratio of the value of futures contracts purchased or sold to the value of the cash commodity being hedged, a computation necessary to minimize basis risk.

Hedging: Taking a position in a futures market opposite to a position held in the cash market to minimize the risk of financial loss from an adverse price change; a purchase or sale of futures as a temporary substitute for a cash transaction that will occur later.

Initial Margin: Customers' funds put up as security for a guarantee of contract fulfillment at the time a futures market position is established.

In-the-Money: A term used to describe an option contract that has a positive value if exercised. A call at \$400 on gold trading at \$10 is in-the-money 10 dollars.

Intrinsic Value: A measure of the value of an option or a warrant if immediately exercised. The amount by which the current price for the underlying commodity or futures contract is above the strike price of a call option or below the strike price of a put option for the commodity or futures contract.

Introducing Broker (IB): Any person (other than a person registered as an "associated person" of a futures commission merchant) who is engaged in soliciting or in accepting orders for the purchase or sale of any

commodity for future delivery on an exchange and who does not accept any money, securities, or property to margin, guarantee, or secure any trades or contracts that result therefrom.

Inverted Market: A futures market in which the nearer months are selling at prices higher than the more distant months; a market displaying "inverse carrying charges," characteristic of markets with supply shortages. See *Backwardation*.

Invisible Supply: Uncounted stocks of a commodity in the hands of wholesalers, manufacturers, and producers that cannot be identified accurately; stocks outside commercial channels but theoretically available to the market.

Licensed Warehouse: A warehouse approved by an exchange from which a commodity may be delivered on a futures contract.

Limit (Up or Down): The maximum price advance or decline from the previous day's settlement price permitted during one trading session, as fixed by the rules of an exchange. See *Daily Price Limits*.

Limit Order: An order in which the customer specifies a price limit or other condition, such as time of an order; as contrasted with a market order, which implies that the order should be filled as soon as possible.

Liquidation: The closing out of a long position. The term is sometimes used to denote closing out a short position, but this is more often referred to as covering.

Liquid Market: A market in which selling and buying can be accomplished with minimal price change.

Long: (1) One who has bought a futures contract to establish a market position. (2) A market position which obligates the holder to take delivery. (3) One who owns an inventory of commodities. See also *Short*.

Long Hedge: Purchase of futures against the fixed-price forward sale of a cash commodity.

Margin: The amount of money or collateral deposited by a customer with his broker, by a broker with a clearing member, or by a clearing member with the clearinghouse, for the purpose of insuring the broker or clearinghouse against loss on open futures contracts. The margin is not partial payment on a purchase. (1) Initial margin is the total amount of margin per contract required by the broker when a futures position is opened. (2) Maintenance margin is a sum which must be maintained on deposit at all times. If the equity in a customer's account drops to, or under, the required level because of adverse price movement, the broker must issue a margin call to restore the customer's equity.

Margin Call: (1) A request from a brokerage firm to a customer to bring margin deposits up to initial levels. (2) A request by the clearinghouse to a clearing member to make a deposit of original margin, or a daily or intra-day variation payment, because of adverse price movement, based on positions carried by the clearing member.

Mark to Market: Daily cash flow system used by U.S. futures exchanges to maintain minimum level of margin equity for a given futures or option contract position by calculating the gain or loss in each contract position resulting from changes in the futures or option contracts at the end of each trading day.

Maturity: Period within which a futures contract can be settled by delivery of the actual commodity.

Naked Option: The sale of a call or put option without holding an offsetting position in the underlying commodity.

Nearby Delivery Month: The month of the futures contract closest to maturity.

Nominal Price (or Nominal Quotation): Computed price quotation on futures for a period in which no actual trading took place, usually an average of bid and asked prices.

Notional Amount: The amount (in an interest rate swap, forward rate agreement, or other derivative instrument) or each of the amounts (in a currency swap) to which interest rates are applied (whether or not expressed as a rate or stated on a coupon basis) in order to calculate periodic payment obligations. Also called the *notional principal amount*, the *reference amount*, and the *currency amount*.

Offer: An indication of willingness to sell at a given price; opposite of *bid*.

Offset: Liquidating a purchase of futures contracts through the sale of an equal number of contracts of the same delivery month, or liquidating a short sale of futures through the purchase of an equal number contracts of the same delivery month.

Open Interest: The total number of futures contracts long or short in a delivery month or market that has been entered into and not yet liquidated by an offsetting transaction or fulfilled by delivery. Also called *Open Contracts* or *Open Commitments*.

Option: (1) A commodity option is a unilateral contract that gives the buyer the right to buy or sell a specified quantity of a commodity at a specific price within a specified period of time, regardless of the market price of that commodity. See also *Put*, *Call*. (2) A term sometimes erroneously applied to a futures contract. It may refer to a specific delivery month, such as the "July Option."

Out-of-the-Money: A term used to describe an option that has no intrinsic value. For example, a call at \$400 on gold trading at \$390 is out-of-the-money 10 dollars.

Out Trade: A trade that cannot be cleared by a clearinghouse because the trade data submitted by the two clearing members involved in the trade differ in some respect (e.g., price and/or quantity). In such cases, the two members or brokers involved must reconcile the discrepancy, if possible, and resubmit the trade for clearing. If an agreement cannot be reached by the two clearing members or brokers involved, the dispute is settled by an appropriate exchange committee.

Paper Profit or Loss: The profit or loss that would be realized if open contracts were liquidated as of a certain time or a certain price.

Pit: A specially constructed arena on the trading floor of some exchanges where trading in a futures contract is conducted. On other exchanges the term "ring" designates the trading area for a commodity.

Point: A measure of price change equal to 1/100 of one cent in most futures in decimal units. For grains, such as wheat or corn, a point is one cent. For Treasury bonds, a point is one percent of par. See *Tick*.

Pork Bellies: One of the major cuts of the hog carcass that, when cured, becomes bacon.

Position: An interest in the market, either long or short, in the form of one or more open contracts. Also, *in position* refers to a commodity located where it can readily be moved to another point or delivered on a futures contract. Commodities not so situated are *out of position*. Soybeans in Mississippi are out of position for delivery in Chicago but in position for export shipment from the Gulf.

Position Limit: the maximum position, either net long or short, in one commodity future (or option) or in all futures (or options) of one commodity combined which may be held or controlled by one person as prescribed by an exchange and/or by the CFTC.

Position Trader: A commodity trader who either buys or sells contracts and hold them for an extended period of time, as distinguished from the day trader, who will normally initiate and offset a futures position within a single trading session.

Price Discovery: The process of determining the price level for a commodity based on supply and demand factors.

Price Manipulation: Any planned operation, transactions, or practice calculated to cause or maintain an artificial price.

Primary Market: (1) For producers, their major purchaser of commodities. (2) In commercial marketing channels, an important center at which spot commodities are concentrated for shipment to terminal markets. (3) To processors, the market that is the major supplier of their commodity needs.

Puts: Option contracts which give the holder the right but not the obligation to sell a specified quantity of a particular commodity or other interest at a given price (the *strike price*) prior to or on a future date. Also called *put options*, they will have a higher (lower) value when the current market value of the underlying article is lower (higher) than the strike price.

Put Option: An option to sell a specified amount of a commodity at an agreed price and time at any time until the expiration of the option. A put option is purchased to protect against a fall in price. The buyer pays a premium to the seller/grantor of this option. The buyer has the right to sell the commodity or enter into a short position in the futures market if the option is exercised. See also *Call Option*.

Pyramiding: The use of profits on existing positions as margin to increase the size of the position, normally in successively smaller increments.

Range: The difference between the high and low price of a commodity during a given period.

Ratio Hedge: the number of options compared to the number of futures contracts bought or sold in order to establish a hedge that is risk neutral.

Ratio Spread: This strategy, which applies to both puts and calls, involves buying or selling options at one strike price in greater numbers than those bought or sold at another strike price.

Replicating Portfolio: A portfolio of assets for which changes in value match those of a target asset. For example, a portfolio replicating a standard option can be constructed with certain amounts of the asset underlying the option and bonds. Sometimes referred to as a *Synthetic Asset*.

Reporting Level: Sizes of positions set by the exchange and/or the CFTC at or above which commodity traders or brokers who carry these accounts must make daily reports about the size of the position by commodity, by delivery month, and whether the position is controlled by a commercial or noncommercial trader.

Risk/Reward Ratio: The relationship between the probability of loss and profit. The ratio is often used as a basis for trade selection or comparison.

Short: (1) The selling side of an open futures contract. (2) A trader whose net position in the futures market shows

an excess of open sales over open purchases. See also *Long*.

Short Selling: Selling a futures contract with the idea of delivering on it or offsetting it at a later date.

Short the Basis: The purchase of futures as a hedge against a commitment to sell in the cash or spot markets.

Special Purpose Entity (SPE): A subsidiary established by a company for a particular project or activity. The company establishing the SPE may treat the SPE as if it were an independent, outside entity for accounting purposes if two conditions are met: (1) an owner independent of the company must make a substantive equity investment of at least 3 percent of the SPE's assets, and that 3 percent must remain at risk throughout the transaction; and (2) the independent owner must exercise control of the SPE. In those circumstances, the company may record gains and losses on transactions with the SPE, and the assets and liabilities of the SPE are not included in the company's balance sheet, even though the company and the SPE are closely related.

Speculative Bubble: A rapid, but usually short-lived, run-up in prices caused by excessive buying unrelated to any of the basic, underlying factors affecting the supply or demand for the commodity. Speculative bubbles usually are associated with a "bandwagon" effect in which speculators rush to buy the commodity (in the case of futures, "to take positions") before the price trend ends, and an even greater rush to sell the commodity (unwind positions) when prices reverse.

Speculator: In commodity futures, an individual who does not hedge, but who trades with the objective of achieving profits through the successful anticipation of price movements.

Spot: Market of immediate delivery of the product and immediate payment. Also refers to a maturing delivery month of a futures contract.

Spot Commodity: (1) The actual commodity as distinguished from a futures contract. (2) Sometimes used to refer to cash commodities available for immediate delivery. See also *Actuals*, *Cash Commodity*.

Spot Cash Price: The price at which a physical commodity for immediate delivery is selling at a given time and place.

Squeeze: A market situation in which the lack of supplies tends to force shorts to cover their positions by offset at higher prices.

Striking Price (Exercise or Contract Price): The price, specified in an option contract, at which the underlying futures contract or commodity will move from seller to buyer.

Swap: In general, the exchange of one asset or liability for a similar asset or liability for the purpose of lengthening or shortening maturities, or raising or lowering coupon rates, to maximize revenue or minimize financing costs. In securities, this may entail selling one issue and buying another in foreign currency, or it may entail buying a currency on the spot market and simultaneously selling it forward. Swaps may also involve exchanging income flows; for example, exchanging the fixed rate coupon stream of a bond for a variable rate payment stream, or vice versa, while not swapping the principal component of the bond.

Swaption: An option to enter into swap—i.e., the right, but not the obligation, to enter into a specified type of swap at a specified future date.

Tick: Refers to a minimum change in price up or down. See *Point*.

Time Spread: The selling of a nearby option and buying of a more deferred option with the same strike price.

Time Value: That portion of an option's premium that exceeds the intrinsic value. The time value of an option reflects the probability that the option will move into-the-money. Therefore, the longer the time remaining until expiration of the option, the greater its time value. Also called *Extrinsic Value*.

Trade Option: A commodity option transaction in which the taker is reasonably believed by the writer to be engaged in business involving use of that commodity or related commodity.

Trader: (1) A merchant involved in cash commodities. (2) A professional speculator who trades for his own account.

Transaction: The entry or liquidation of a trade.

Underlying Commodity: The commodity or futures contract on which a commodity option is based, and which must be accepted or delivered if the option is exercised. Also, the cash commodity underlying a futures contract.

Wash Sale: Transactions that give the appearance of purchases and sales but which are initiated without the intent to make a *bona fide* transaction and which generally do not result in any actual change in ownership. Such sales are prohibited by the Commodity Exchange Act.

Wash Trading: Entering into, or purporting to enter into, transactions to give the appearance that purchases and sales have been made, without resulting in a change in the trader's market position.

Writer: The issuer, grantor, or maker of an option contract.

Yield Curve: A graphic representation of market yield for a fixed income security plotted against the maturity of the security.

